

# WILLIAMS®

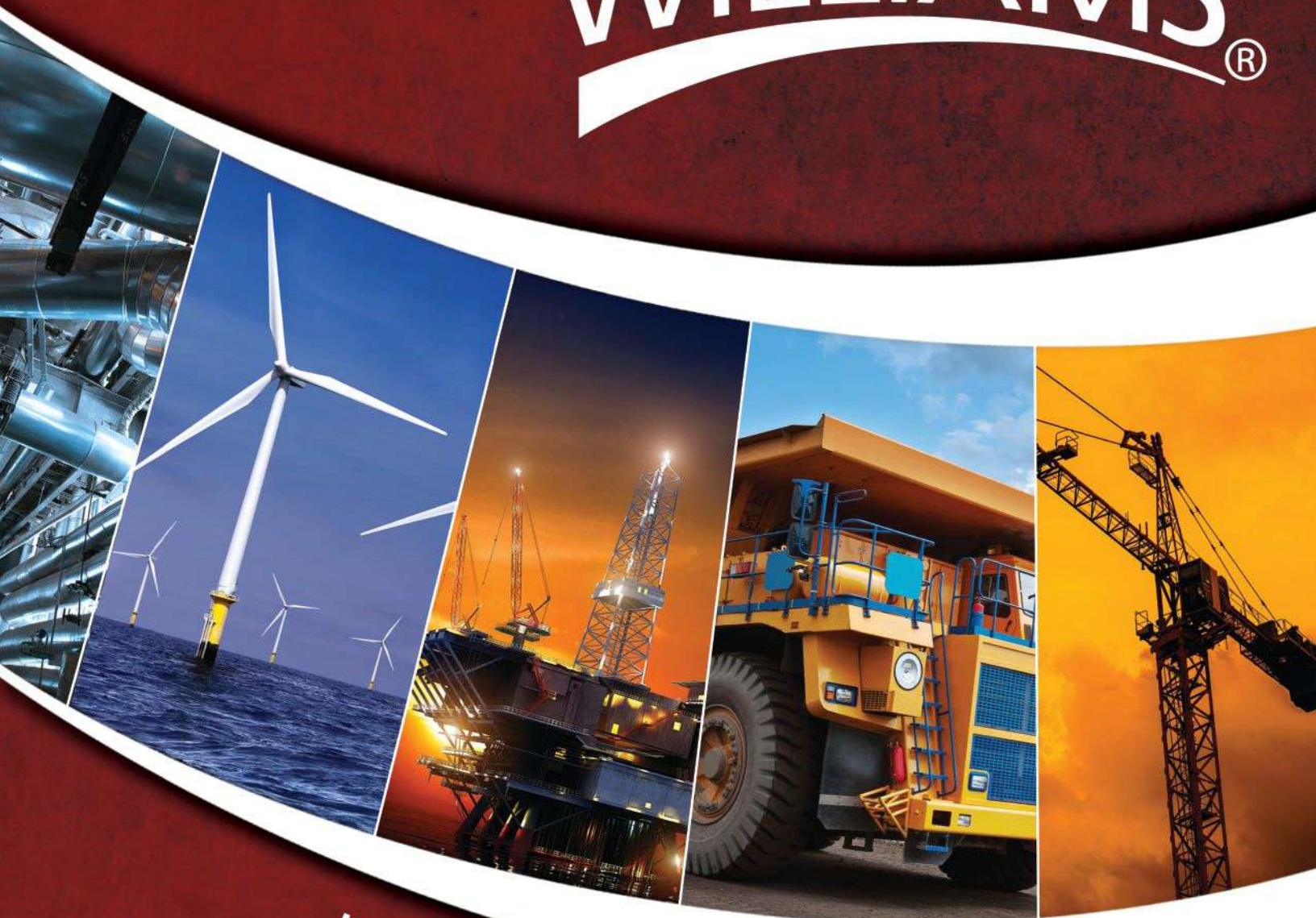

## INDUSTRIAL TOOLS

WILLIAMS®

A SNAP-ON BRAND

# WILLIAMS®

Williams' Super Drop-For Wrench

**YOU SHOULD KNOW THIS**  
about  
**WILLIAMS TOOLS**



ut 1000 size  
Ask for out

- Here are the steps through which every Williams tool must pass before it reaches the customer.
- 1. Market Research:**—to determine demand and scope of market.
  - 2. Product Research and Design:**—To develop the finest possible product.
  - 3. Preparation of Dies and Tooling:**—To effect manufacturing economies.
  - 4. Pilot Run:**—To prove manufacturing process and provide test units.
  - 5. Product Test:**—To provide accurate results in field and laboratory.
  - 6. Refinement:**—To incorporate all improvements developed through test.
  - 7. Production:**—Under continuous material and process controls.
  - 8. Guarantee:**—Against defective workmanship and materials is the final position of Williams built-in quality.



**AUTOMOTIVE AND WILLIAMS AIR**

**WILLIAMS' "SUPERSOCKET" WRENCHES**  
Selected Alloy Steel  
HEAVY DUTY PATTERN—3/4" SQUARE DRIVE  
HANDLES and PARTS

**"SUPERSOCKET" SOLENS  
HEAVY DUTY PATT**

**SET No. H-1-G  
# Pieces—4 Set  
Description**

Set No.	Description
H-1-1	1/2" 12 Pt. Socket
H-1-2	3/4" 12 Pt. Socket
H-1-3	1" 12 Pt. Socket
H-1-4	1 1/4" 12 Pt. Socket
H-1-5	1 1/2" 12 Pt. Socket
H-1-6	1 3/4" 12 Pt. Socket
H-1-7	2" 12 Pt. Socket
H-1-8	2 1/4" 12 Pt. Socket
H-1-9	2 1/2" 12 Pt. Socket
H-1-10	2 3/4" 12 Pt. Socket
H-1-11	3" 12 Pt. Socket
H-1-12	3 1/4" 12 Pt. Socket
H-1-13	3 1/2" 12 Pt. Socket
H-1-14	3 3/4" 12 Pt. Socket
H-1-15	4" 12 Pt. Socket
H-1-16	4 1/4" 12 Pt. Socket
H-1-17	4 1/2" 12 Pt. Socket
H-1-18	4 3/4" 12 Pt. Socket
H-1-19	5" 12 Pt. Socket
H-1-20	5 1/4" 12 Pt. Socket
H-1-21	5 1/2" 12 Pt. Socket
H-1-22	5 3/4" 12 Pt. Socket
H-1-23	6" 12 Pt. Socket
H-1-24	6 1/4" 12 Pt. Socket
H-1-25	6 1/2" 12 Pt. Socket
H-1-26	6 3/4" 12 Pt. Socket
H-1-27	7" 12 Pt. Socket
H-1-28	7 1/4" 12 Pt. Socket
H-1-29	7 1/2" 12 Pt. Socket
H-1-30	7 3/4" 12 Pt. Socket
H-1-31	8" 12 Pt. Socket
H-1-32	8 1/4" 12 Pt. Socket
H-1-33	8 1/2" 12 Pt. Socket
H-1-34	8 3/4" 12 Pt. Socket
H-1-35	9" 12 Pt. Socket
H-1-36	9 1/4" 12 Pt. Socket
H-1-37	9 1/2" 12 Pt. Socket
H-1-38	9 3/4" 12 Pt. Socket
H-1-39	10" 12 Pt. Socket
H-1-40	10 1/4" 12 Pt. Socket
H-1-41	10 1/2" 12 Pt. Socket
H-1-42	10 3/4" 12 Pt. Socket
H-1-43	11" 12 Pt. Socket
H-1-44	11 1/4" 12 Pt. Socket
H-1-45	11 1/2" 12 Pt. Socket
H-1-46	11 3/4" 12 Pt. Socket
H-1-47	12" 12 Pt. Socket
H-1-48	12 1/4" 12 Pt. Socket
H-1-49	12 1/2" 12 Pt. Socket
H-1-50	12 3/4" 12 Pt. Socket
H-1-51	13" 12 Pt. Socket
H-1-52	13 1/4" 12 Pt. Socket
H-1-53	13 1/2" 12 Pt. Socket
H-1-54	13 3/4" 12 Pt. Socket
H-1-55	14" 12 Pt. Socket
H-1-56	14 1/4" 12 Pt. Socket
H-1-57	14 1/2" 12 Pt. Socket
H-1-58	14 3/4" 12 Pt. Socket
H-1-59	15" 12 Pt. Socket
H-1-60	15 1/4" 12 Pt. Socket
H-1-61	15 1/2" 12 Pt. Socket
H-1-62	15 3/4" 12 Pt. Socket
H-1-63	16" 12 Pt. Socket
H-1-64	16 1/4" 12 Pt. Socket
H-1-65	16 1/2" 12 Pt. Socket
H-1-66	16 3/4" 12 Pt. Socket
H-1-67	17" 12 Pt. Socket
H-1-68	17 1/4" 12 Pt. Socket
H-1-69	17 1/2" 12 Pt. Socket
H-1-70	17 3/4" 12 Pt. Socket
H-1-71	18" 12 Pt. Socket
H-1-72	18 1/4" 12 Pt. Socket
H-1-73	18 1/2" 12 Pt. Socket
H-1-74	18 3/4" 12 Pt. Socket
H-1-75	19" 12 Pt. Socket
H-1-76	19 1/4" 12 Pt. Socket
H-1-77	19 1/2" 12 Pt. Socket
H-1-78	19 3/4" 12 Pt. Socket
H-1-79	20" 12 Pt. Socket
H-1-80	20 1/4" 12 Pt. Socket
H-1-81	20 1/2" 12 Pt. Socket
H-1-82	20 3/4" 12 Pt. Socket
H-1-83	21" 12 Pt. Socket
H-1-84	21 1/4" 12 Pt. Socket
H-1-85	21 1/2" 12 Pt. Socket
H-1-86	21 3/4" 12 Pt. Socket
H-1-87	22" 12 Pt. Socket
H-1-88	22 1/4" 12 Pt. Socket
H-1-89	22 1/2" 12 Pt. Socket
H-1-90	22 3/4" 12 Pt. Socket
H-1-91	23" 12 Pt. Socket
H-1-92	23 1/4" 12 Pt. Socket
H-1-93	23 1/2" 12 Pt. Socket
H-1-94	23 3/4" 12 Pt. Socket
H-1-95	24" 12 Pt. Socket
H-1-96	24 1/4" 12 Pt. Socket
H-1-97	24 1/2" 12 Pt. Socket
H-1-98	24 3/4" 12 Pt. Socket
H-1-99	25" 12 Pt. Socket
H-1-100	25 1/4" 12 Pt. Socket
H-1-101	25 1/2" 12 Pt. Socket
H-1-102	25 3/4" 12 Pt. Socket
H-1-103	26" 12 Pt. Socket
H-1-104	26 1/4" 12 Pt. Socket
H-1-105	26 1/2" 12 Pt. Socket
H-1-106	26 3/4" 12 Pt. Socket
H-1-107	27" 12 Pt. Socket
H-1-108	27 1/4" 12 Pt. Socket
H-1-109	27 1/2" 12 Pt. Socket
H-1-110	27 3/4" 12 Pt. Socket
H-1-111	28" 12 Pt. Socket
H-1-112	28 1/4" 12 Pt. Socket
H-1-113	28 1/2" 12 Pt. Socket
H-1-114	28 3/4" 12 Pt. Socket
H-1-115	29" 12 Pt. Socket
H-1-116	29 1/4" 12 Pt. Socket
H-1-117	29 1/2" 12 Pt. Socket
H-1-118	29 3/4" 12 Pt. Socket
H-1-119	30" 12 Pt. Socket
H-1-120	30 1/4" 12 Pt. Socket
H-1-121	30 1/2" 12 Pt. Socket
H-1-122	30 3/4" 12 Pt. Socket
H-1-123	31" 12 Pt. Socket
H-1-124	31 1/4" 12 Pt. Socket
H-1-125	31 1/2" 12 Pt. Socket
H-1-126	31 3/4" 12 Pt. Socket
H-1-127	32" 12 Pt. Socket
H-1-128	32 1/4" 12 Pt. Socket
H-1-129	32 1/2" 12 Pt. Socket
H-1-130	32 3/4" 12 Pt. Socket
H-1-131	33" 12 Pt. Socket
H-1-132	33 1/4" 12 Pt. Socket
H-1-133	33 1/2" 12 Pt. Socket
H-1-134	33 3/4" 12 Pt. Socket
H-1-135	34" 12 Pt. Socket
H-1-136	34 1/4" 12 Pt. Socket
H-1-137	34 1/2" 12 Pt. Socket
H-1-138	34 3/4" 12 Pt. Socket
H-1-139	35" 12 Pt. Socket
H-1-140	35 1/4" 12 Pt. Socket
H-1-141	35 1/2" 12 Pt. Socket
H-1-142	35 3/4" 12 Pt. Socket
H-1-143	36" 12 Pt. Socket
H-1-144	36 1/4" 12 Pt. Socket
H-1-145	36 1/2" 12 Pt. Socket
H-1-146	36 3/4" 12 Pt. Socket
H-1-147	37" 12 Pt. Socket
H-1-148	37 1/4" 12 Pt. Socket
H-1-149	37 1/2" 12 Pt. Socket
H-1-150	37 3/4" 12 Pt. Socket
H-1-151	38" 12 Pt. Socket
H-1-152	38 1/4" 12 Pt. Socket
H-1-153	38 1/2" 12 Pt. Socket
H-1-154	38 3/4" 12 Pt. Socket
H-1-155	39" 12 Pt. Socket
H-1-156	39 1/4" 12 Pt. Socket
H-1-157	39 1/2" 12 Pt. Socket
H-1-158	39 3/4" 12 Pt. Socket
H-1-159	40" 12 Pt. Socket
H-1-160	40 1/4" 12 Pt. Socket
H-1-161	40 1/2" 12 Pt. Socket
H-1-162	40 3/4" 12 Pt. Socket
H-1-163	41" 12 Pt. Socket
H-1-164	41 1/4" 12 Pt. Socket
H-1-165	41 1/2" 12 Pt. Socket
H-1-166	41 3/4" 12 Pt. Socket
H-1-167	42" 12 Pt. Socket
H-1-168	42 1/4" 12 Pt. Socket
H-1-169	42 1/2" 12 Pt. Socket
H-1-170	42 3/4" 12 Pt. Socket
H-1-171	43" 12 Pt. Socket
H-1-172	43 1/4" 12 Pt. Socket
H-1-173	43 1/2" 12 Pt. Socket
H-1-174	43 3/4" 12 Pt. Socket
H-1-175	44" 12 Pt. Socket
H-1-176	44 1/4" 12 Pt. Socket
H-1-177	44 1/2" 12 Pt. Socket
H-1-178	44 3/4" 12 Pt. Socket
H-1-179	45" 12 Pt. Socket
H-1-180	45 1/4" 12 Pt. Socket
H-1-181	45 1/2" 12 Pt. Socket
H-1-182	45 3/4" 12 Pt. Socket
H-1-183	46" 12 Pt. Socket
H-1-184	46 1/4" 12 Pt. Socket
H-1-185	46 1/2" 12 Pt. Socket
H-1-186	46 3/4" 12 Pt. Socket
H-1-187	47" 12 Pt. Socket
H-1-188	47 1/4" 12 Pt. Socket
H-1-189	47 1/2" 12 Pt. Socket
H-1-190	47 3/4" 12 Pt. Socket
H-1-191	48" 12 Pt. Socket
H-1-192	48 1/4" 12 Pt. Socket
H-1-193	48 1/2" 12 Pt. Socket
H-1-194	48 3/4" 12 Pt. Socket
H-1-195	49" 12 Pt. Socket
H-1-196	49 1/4" 12 Pt. Socket
H-1-197	49 1/2" 12 Pt. Socket
H-1-198	49 3/4" 12 Pt. Socket
H-1-199	50" 12 Pt. Socket

**SOCKETS**  
Williams Heavy Duty Sockets are designed for heavier service where more strength is required than on the every-day job. Will make auto completely where handle can be swung only 90°.

Made from Selected Alloy Steel heat-treated, and chrome-plated.

Regular 12 Pt.      Extra Deep 12 Pt.      Extra Deep 6 Pt.

## TOOLS YOU CAN COUNT ON, DAY IN, DAY OUT

In 1882, James Harvey Williams opened a small forge shop in Flushing, New York, and pioneered the concept of standardized industrial tools. For over 130 years, **WILLIAMS** Hand tools have been the standard of quality, dependability and value. **WILLIAMS** prides itself on being the best and most innovative tools to the industrial market. In keeping with this vision, the line of **WILLIAMS** Industrial hand tools offers quality, comfort, durability and value.



# QUICK REFERENCE

---



**MASTER SETS**

**TOOL STORAGE**

**WRENCHES**

**SOCKETS & DRIVE TOOLS**

**SCREWDRIVERS**

**PLIERS, CLAMPS & PIPE TOOLS**

**HAMMERS, PUNCHES, CHISELS & PRYBARS**

**TOOLS FOR THE TRADES**



6  
**WILLIAMS**<sup>®</sup>



## **WILLIAMS HAND TOOLS: OUR HERITAGE, YOUR FUTURE**

Whatever the job, whatever the industry, whatever the challenge, **WILLIAMS** tools gets the job done. This tradition dates back more than a century and among the very first manufacturers in the world to offer mass produced tools. **WILLIAMS** is the company that introduced drop-forged tools, the 15 degree wrench and heavy duty slugging wrenches in the 1880's amongst many other innovations, and is still a proud brand in the 21st century, continuing to offer innovative products for those critical industries whose demands are greater than ever.



# MASTER SETS

**TACKLE INCREASINGLY COMPLEX MAINTENANCE TASKS  
WITH OUR MASTER TOOL SETS**

• A FULL COMPLEMENT OF WRENCHES • SELECTION OF KEY HAND TOOLS • TOOL STORAGE INCLUDED

**WHATEVER THE INDUSTRY, OUR MASTER TOOL SETS WILL  
HELP YOU KEEP YOUR EQUIPMENT AND ASSETS WORKING.  
GET YOUR WORK DONE FASTER, EASIER AND SAFER.**



DEPENDENT ON YOUR APPLICATION, SETS IN VARIOUS FORMATS AND SIZES AVAILABLE TO MEET YOUR SPECIFIC NEEDS  
COMPLETE MONSTER SET WITH TOOL BOXES - WSMSC-595TB  
MONSTER TOOL SET ONLY - WSMSC-595

**WE CONTINUE TO INNOVATE TO DELIVER SAFETY  
AND PRODUCTIVITY TO OUR CUSTOMERS**

# MASTER SETS

## MASTER SETS CHART

Master Sets with Tools Only Product Code	WSC-1390	WSC-1390MM	WSC-1390SAE	WSC-960	WSC-960MM	WSC-960SAE	WSC-680	WSC-680MM
Description	Mammoth Tool Set Only	Mammoth Tool Set with Metric Wrenches and sockets Only	Mammoth tool Set with Fractional Wrenches and Sockets Only	Mega tool set Only	Mega Tool Set with Metric Wrenches and Sockets Only	Mega Tool Set with Fractional Wrenches and Socket Sets	Maxxum Tool Set Only	Maxxum Tool Set with Metric Wrenches and Sockets Only
# of Pieces	1384	811	991	956	557	804	677	410
Master Sets with Tool Box Product Code	WSC-1390TB			WSC-960TB			WSC-680TB	
Tool Boxes for Master Sets	W40TC4			W55TC10			W55TC10	
	W40RC7			W55RC11			W55RC11	
	W55TC10			50721			50721	
	W55RC11			50855				
	50721							
	50855							
SAE/METRIC	Both	Metric	SAE	Both	Metric	SAE	Both	Metric
Chisels & Punches	27	27	27	27	27	27	27	27
Clamps	2	2	2	2	2	2	2	2
Electric Crimping Pliers	5	5	5	3	3	3	3	3
Electrical Specialty Tools								
Extractors								
Feeler Gauge								
Files	12	12	12	12	12	12	11	11
Gear Pullers	41	41	41	25	25	25		
Hacksaw								
Hammers	16	16	16	16	16	16	15	15
Hand Sockets	417	198	219	281	85	196	192	57
Hex keys	85	85	85	59	69	69	51	51
Holesaw Sets	17	17	17					
Impact Drive Tools	24	24	24	9	9	9	12	12
Impact Sockets	187	78	109	135	36	99	87	29
Knives	2	2	2	3	3	3	2	2
Miscellaneous Tools	23	23	23	24	24	24	23	23
Nutdrivers								
Pick up Tool/Mirror								
Pipe Specialty Tools								
Pipe Wrenches								
Pliers	63	63	63	67	67	67	45	45
Pliers- Electrical								
Pliers - Insulated								
Pry Bars	6	6	6	4	4	4	6	6
Ratchets, Drive Tools, and Accessories	58	58	58	58	58	58	46	46
Saws and Saw Blades	36	36	36	26	26	26	13	13
Scrapers	7	7	7	6	6	6	2	2
Screwdrivers	36	36	36	38	38	38	29	29
Screwdrivers - Insulated								
Snips	5	5	5	3	3	3	3	3
Tape Measure								
T- Handles								
Tools@Height eters, Lanyards & Specialities								
Torque Wrenches	3	3	3	2	2	2	2	2
Utility Tools								
Wrenches	312	117	195	156	53	103	106	39



Master set cabinetry and contents are subject to change and may not be exactly as illustrated and listed.

# MASTER SETS

## MASTER SETS CHART

	WSC-680SAE	WSC-595	WSC-352	WSC-317	WSC-277	WMSC-344	WSC-281	WSC-238	WSC-231	WSC-173
	Maxxum Tool set wih Fractional Wrenches and Sockets Only	Monster Tool Set	Master Maintenance Service Set	Intermediate Technician's Tool Set	Advanced Maintenance Service Set Tools Only	Petroleum Oilfield Service Set	Oilfield Tool Set	General Maintenance Set	Maintenance Tools Only	Intermediate Maintenance Service Tools Only
	538	595	350	306	275	274	263	236	218	171
		WSC-595TB	WSC-352TB	WSC-317TB	WSC-277TB	WMSC-344TB	WSC-281TB	WSC-238TB	WSC-231TB	WSC-173TB
		W55TC10	W40TC4	W40RC7	W40TC4	W40RC7	W40TC4	W26RC7	50871	W26TC4
		W55RC11	W40RC7	W40TC4	W40RC7	W40TC4	W40RC7		50901	W26RC7
	SAE	Both	SAE	Both	SAE	Both	Both	Both	SAE	SAE
	27	19	19	9	17	8	15	16	9	12
	2		2				2		2	
	3									
				9						
				1						
	11		6	4	6				6	6
		2							1	
	15	10	7	4	3	2	4	2	1	1
	126	290	116	133	100	179	94	97	89	66
	51	44		22			22	17		
	12		4		2					
	51		38		16					
	2	1								
	23	30	3		8		10			6
		19					7		7	
							3			
						1				
	45	14	15	11	12	15	14	10	6	5
	6	2				3	2			
	46	20	28	28	24	15	22	18	27	16
	13		8		8					1
	2		1			1	1		2	
	29	21	18	8	18	8	8	21	21	15
	3	3	4				2		3	
		1		1						
	2			2			2			
						8				
	67	119	81	74	61	32	55	55	44	43

# MASTER SETS

## MASTER SETS CHART

Master Sets with Tools Only Product Code	WSC-172	WSC-167	WMSC-142	WSC-137	WSC-130	WSC-102	MSOS-102	WSC-95
Description	Heavy Maintenance Service Tools Only	Electrical Maintenance Service Set Tools Only	Petroleum Oilfield Service Set	Industrial Plumbing & Pipefitting Tool Set	Maintenance Tools Only	Basic Machine Repair Set Tools Only	Oilfield Service Set	Basic Electric Repair Set
# of Pieces	170	166	141	136	129	101	101	94
Master Sets with Tool Box Product Code	WSC-172TB	WSC-167TB	WMSC-142TB	WSC-137TB	WSC-130TB	WSC-102TB	MSOS-102TB	WSC-95TB
Tool Boxes for Master Sets	W40RC7	W40RC7	W40RC7	W40RC7	50721	W26RC7	W26RC7	50721
SAE/METRIC	SAE	SAE	Both	SAE	SAE	SAE	Both	SAE
Chisels & Punches	17			12	1	7	8	
Clamps	2			1				
Electric Crimping Pliers								
Electrical Specialty Tools		2						
Extractors								
Feeler Gauge	1					1		
Files								
Gear Pullers								
Hacksaw								
Hammers	6	3		3	2	4	1	1
Hand Sockets	55	28	65		41	38	34	22
Hex keys					13		13	
Holesaw Sets								
Impact Drive Tools								
Impact Sockets								
Knives								
Miscellaneous Tools		9		12				
Nutdrivers								
Pick up Tool/Mirror			2					
Pipe Specialty Tools				19				
Pipe Wrenches				4				
Pliers	8	8	10	8	10	6	5	5
Pliers- Electrical		12						4
Pliers - Insulated		5						4
Pry Bars								
Ratchets, Drive Tools, and Accessories	17	7	11		21	5	9	7
Saws and Saw Blades		32		32				
Scrapers								
Screwdrivers	10	14	12	9	21	5	8	13
Screwdrivers - Insulated		11						10
Snips								
Tape Measure								
T- Handles			10					
Tools@Height ethods, Lanyards & Specialities								
Torque Wrenches								
Utility Tools							4	
Wrenches	54	35	31	36	20	35	19	28



Master set cabinetry and contents are subject to change and may not be exactly as illustrated and listed.





# MASTER SETS

## MAMMOTH TOOL SET



WSC-1390TB



**WARNING**

Master set cabinetry and contents are subject to change and may not be exactly as illustrated and listed.

# MASTER SETS

## MAMMOTH TOOL SET



Professional industrial cabinets W40RC7-W40TC4 are also included in WSC-1390TB



### 1,390 PIECE MAMMOTH TOOL SET

The largest tool set in the industry. Contains the following tools:

Product Category	Number of Pieces
Chisel and Punches	27
Clamps	2
Electrical Crimping Pliers	5
Files	12
Gear Pullers	41
Hammers	16
Hand Sockets	417
Hex Keys	85
Holesaw Set	17
Impact Drive Tools	24
Impact Sockets	187
Knives	2
Miscellaneous Tools	23
Pliers	63
Pry Bars	6
Ratchets, Drive Tools, and Accessories	58
Saws and Saw Blades	36
Scrapers	7
Screwdrivers	36
Snips	5
Tool Boxes	6
Torque Wrenches	3
Wrenches	312

**Note: Complete set contents are listed in Appendix A Set Configurations Available**

Product Code	Description
WSC-1390TB	Complete Mammoth Tool Set with Tool Boxes (1390 Pieces Total)
WSC-1390	Mammoth Tool Set Only (1384 Pieces)
WSC-1390SAE	Mammoth Tool Set with Fractional Wrenches and Sockets Only Tools Only - 991 Pieces (Not Pictured)
WSC-1390MM	Mammoth Tool Set with Metric Wrenches and Sockets Only Tools Only - 811 Pieces (Not Pictured)

#### Tool Boxes Included

W40TC4	40" Wide x 20" Deep 4-Drawer Top Chest
W40RC7	40" Wide x 20" Deep 7-Drawer Roll Cabinet
W55TC10	55" Wide x 20" Deep 10-Drawer Top Chest
W55RC11	55" Wide x 20" Deep 11-Drawer Roll Cabinet
50721	3-Drawer Service Cart with Lid
50855	37" 1 Shelf Heavy Duty Tall Side Cabinet

#### Features

- It's better to have it and not need it than need it and not have it - and with this tool set, you're almost certain to have what you need. This set contains the tools to handle almost any job your shop is likely to see, in both fractional and metric sizes. It includes a comprehensive assortment of sockets, ratchets, and accessories in 1/4", 3/8", 1/2", and 3/4" drive, for both hand and impact use. A full complement of wrenches in a number of styles helps you tackle increasingly complex maintenance tasks. A comprehensive assortment of screwdrivers, pliers, hammers, punches and chisels, is there when you need them, and specialty items such as gear pullers, saws, scrapers, and other tools for industrial maintenance mechanics and tradesmen round out this truly Mammoth tool set.
- You'll want to keep your tools safe and secure, and our industry-leading Mammoth Tool Set includes the storage cabinets necessary to do that. Two top-chest / roll-cabinet combinations are included, as well as a side cabinet and rolling three-drawer tool cart. A total of 35 drawers and over 75,000 cubic inches of storage capacity will help you organize your tools effectively. And the mobile tool cart helps bring your tools to the job, where you need them.
- Whatever the industry, this set will help you keep your equipment and assets working, helping you compete more effectively. Get your work done faster, easier, and safer with the Mammoth Tool Set from Williams. All other tool sets are simply ordinary.

# MASTER SETS

## MEGA TOOL SET



WSC-960TB



Master set cabinetry and contents are subject to change and may not be exactly as illustrated and listed.

# MASTER SETS

## MEGA TOOL SET



### 960 PIECE MEGA TOOL SET

**A comprehensive assortment. Contains the following tools:**

Product Category	Number of Pieces
Chisel and Punches	27
Clamps	2
Electrical Crimping Pliers	3
Files	12
Gear Pullers	25
Hammers	16
Hand Sockets	281
Hex Keys	59
Impact Sockets	135
Impact Drive Tools	9
Knives	3
Miscellaneous Tools	24
Pliers	67
Pry Bars	4
Ratchets, Drive Tools, and Accessories	58
Saws and Saw Blades	26
Scrapers	6
Screwdrivers	38
Snips	3
Tool Boxes	4
Torque Wrenches	2
Wrenches	156

**Note: Complete set contents are listed in Appendix A**

#### Set Configurations Available

Product Code	Description
WSC-960TB	Complete Mega Tool Set with Tool Boxes (960 Pieces Total)
WSC-960	Mega Tool Set Only (956 Pieces)
WSC-960SAE	Mega Tool Set with Fractional Wrenches and Sockets Only Tools Only - 804 Pieces (Not Pictured)
WSC-960MM	Mega Tool Set with Metric Wrenches and Sockets Only Tools Only - 557 Pieces (Not Pictured)

#### Tool Boxes Included

W55TC10	55" Wide x 20" Deep 10-Drawer Top Chest
W55RC11	55" Wide x 20" Deep 11-Drawer Roll Cabinet
50721	3-Drawer Service Cart with Lid
50855	37" 1 Shelf Heavy Duty Tall Side Cabinet

#### Features

- The Mega Set contains a comprehensive assortment of tools, in both fractional and metric sizes. Includes an extensive assortment of sockets, ratchets, and accessories in 1/4", 3/8", 1/2", and 3/4" drive, for both hand and impact use. A full complement of wrenches in a number of styles helps you tackle increasingly complex maintenance tasks. Over 150 screwdrivers, pliers, hammers, punches and chisels, are included, and specialty items such as gear pullers, saws, scrapers, and other tools for industrial maintenance mechanics and tradesmen round out the Mega Set from Williams.
- Mega Set includes the tool storage cabinets necessary to organize your tools. A top-chest / roll-cabinet combination is included, as well as a side cabinet and rolling three-drawer tool cart. A total of 26 drawers and over 45,000 cubic inches of storage capacity will help you store your tools effectively. The mobile tool cart helps bring your tools to the job, where you need them.
- Get your work done faster, easier, and safer with the Mega Tool Set from Williams. All other tool sets are simply ordinary.

# MASTER SETS

## MAXXUM TOOL SET



WSC-680TB



**WARNING**

Master set cabinetry and contents are subject to change and may not be exactly as illustrated and listed.

# MASTER SETS

## MAXXUM TOOL SET



### 680 PIECE MAXXUM TOOL SET

#### Contains the following tools:

Product Category	Number of Pieces
Chisel and Punches	27
Clamps	2
Electrical Crimping Pliers	3
Files	11
Hammers	15
Hand Sockets	192
Hex Keys	51
Impact Sockets	87
Impact Drive Tools	12
Knives	2
Miscellaneous Tools	23
Pliers	45
Pry Bars	6
Ratchets, Drive Tools, and Accessories	46
Saws and Saw Blades	13
Scrapers	2
Screwdrivers	29
Snips	3
Tool Boxes	3
Torque Wrenches	2
Wrenches	106

#### Note: Complete set contents are listed in Appendix A Set Configurations Available

Product Code	Description
WSC-680TB	Complete Maxxum Tool Set with Tool Boxes (680 Pieces Total)
WSC-680	Maxxum Tool Set Only (677 Pieces)
WSC-680SAE	Maxxum Tool Set with Fractional Wrenches and Sockets Only Tools Only - 538 Pieces (Not Pictured)
WSC-680MM	Maxxum Tool Set with Metric Wrenches and Sockets Only Tools Only - 410 Pieces (Not Pictured)

#### Tool Boxes Included

W55TC10	55" Wide x 20" Deep 10-Drawer Top Chest
W55RC11	55" Wide x 20" Deep 11-Drawer Roll Cabinet
50721	3-Drawer Service Cart with Lid

#### Features

- The Maxxum Set contains a full complement of tools, in both fractional and metric sizes. It includes an assortment of sockets, ratchets, and accessories in 1/4", 3/8", and 1/2" drive, for both hand and impact use. Hand wrenches in a number of styles helps you tackle increasingly complex maintenance tasks. Over 100 screwdrivers, pliers, hammers, punches and chisels, are included, and specialty items such as saws, scrapers, and other tools for industrial maintenance mechanics and tradesmen round out the Maxxum Set from Williams.
- Maxxum includes the tool storage cabinets necessary to organize your tools. A top-chest / roll-cabinet combination is included, as well as a rolling three-drawer tool cart. A total of 26 drawers and over 35,000 cubic inches of storage capacity will help you store your tools effectively. The mobile tool cart helps bring your tools to the job, where you need them.
- Get your work done faster, easier, and safer with the Maxxum Tool Set from Williams. All other tool sets are simply ordinary.

# MASTER SETS

## MONSTER TOOL SET



W55TC10

W55RC11

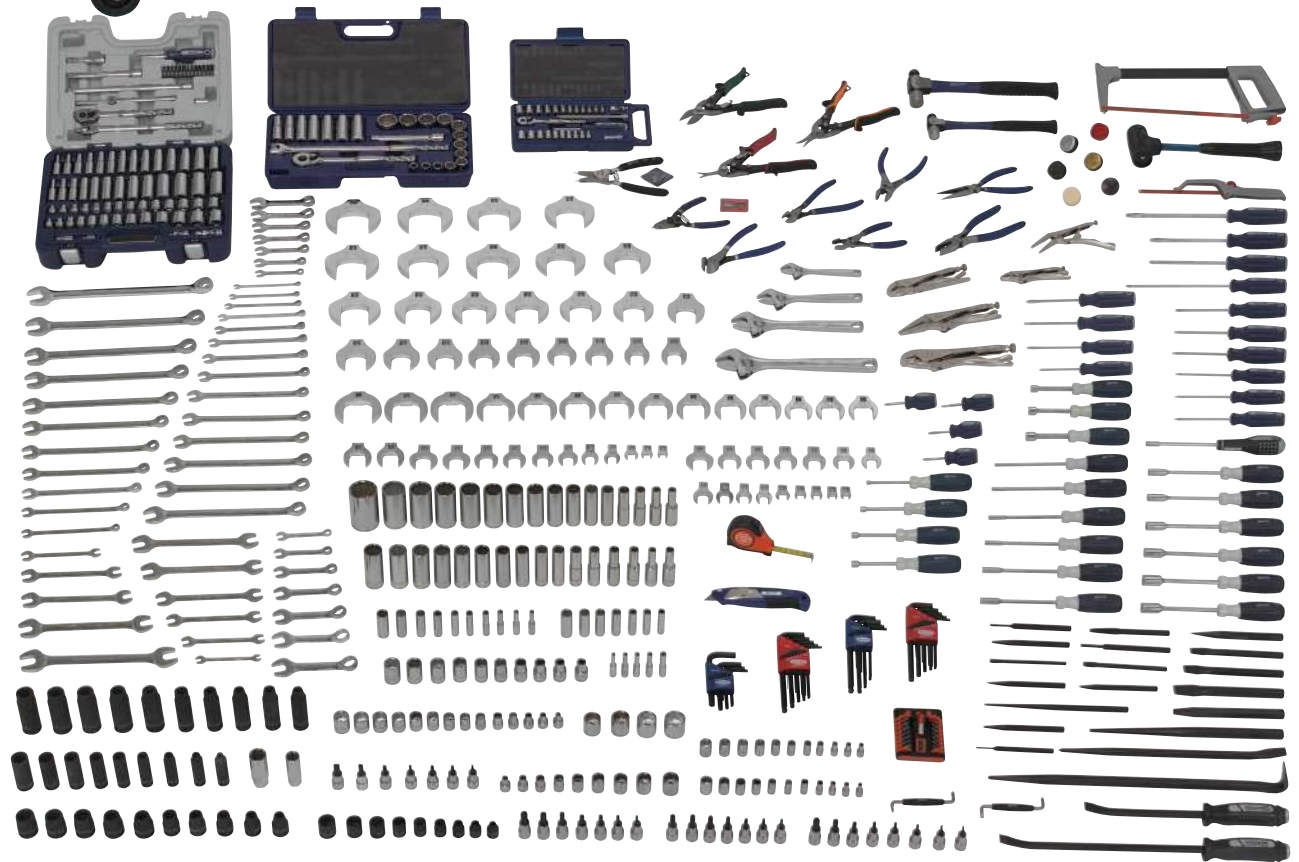

WSC-595TB



Master set cabinetry and contents are subject to change and may not be exactly as illustrated and listed.



# MASTER SETS

## MONSTER TOOL SET



### 595 PIECE MONSTER TOOL SET

#### Contains the following tools:

Product Category	Number of Pieces
Crowfoot Wrenches	65
Hacksaw Frame	2
Hammer	10
Hex Key	44
knives	1
Miscellaneous Tools	30
Nut drive	19
Pliers	14
Pry Bars	2
Punch & Chisels	19
Screwdriver	21
Snips	3
Sockets, Ratchets, Drive Tools and Accessories	310
Tape Measure	1
Wrenches	54

#### Note: Complete set contents are listed in Appendix A Set Configurations Available

Product Code	Description
WSMSC-595TB	Complete Master Tool Set with Tool Boxes (597 Piece Total)
WSMSC-595	Master Tool Set Only (595 Pieces)

#### Tool Boxes Included

W55TC10	55" Wide x 20" Deep 10 Drawer Top Chest
W55RC11	55" Wide x 20" Deep 11 Drawer Tool Cabinet

#### Features

- The Monster Set contains a full complement of tools, in both fractional and metric sizes. It includes an assortment of sockets, ratchets, and accessories in 1/4", 3/8", and 1/2" drive.
- Hand wrenches in a number of styles helps you tackle increasingly complex maintenance tasks. Also included are screwdrivers, pliers, hammers, punches and chisels, are included, and specialty items such as hacksaws, tape measure, and other tools for industrial maintenance mechanics and tradesmen round out this Master set from Williams.
- Includes the tool storage cabinets necessary to organize your tools. A top-chest /roll-cabinet combination is included.
- Get your work done faster, easier, and safer with this Master Tool Set from
- Williams. All other tool sets are simply ordinary.

# MASTER SETS

## MAINTENANCE SERVICE SET

W40TC4



### 352 PIECE MASTER MAINTENANCE SERVICE SET

Contains the following tools:

Product Category	Number of Pieces
Chisel and Punches	19
Clamps	2
Files	6
Hammers	7
Hand Sockets	116
Impact Drive Tools	4
Impact Sockets	38
Miscellaneous Tools	3
Pliers	15
Ratchets, Drive Tools, and Accessories	28
Saws and Saw Blades	8
Scrapers	1
Screwdrivers	18
Snips	4
Tool Boxes	2
Wrenches	81

**Note: Complete set contents are listed in Appendix A**  
**Set Configurations Available**

Product Code	Description
WSC-352TB	352 Piece Master Maintenance Service Set with Tool Boxes
WSC-352	Tool Set Only (350 Pieces)

#### Tool Boxes Included

W40TC4	40" Wide x 20" Deep 4-Drawer Top Chest
W40RC7	40" Wide x 20" Deep 7-Drawer Roll Cabinet



W40RC7

#### Features

- This set provides the tools necessary for most general service and repair applications. Included are a wide variety of fractional wrenches, hand and impact sockets, and popular 1/4", 3/8" and 1/2" drive ratchets and accessories. An assortment of professional industrial tools such as pliers, screwdrivers, hammers, punches, chisels, and other tools round out the offering.

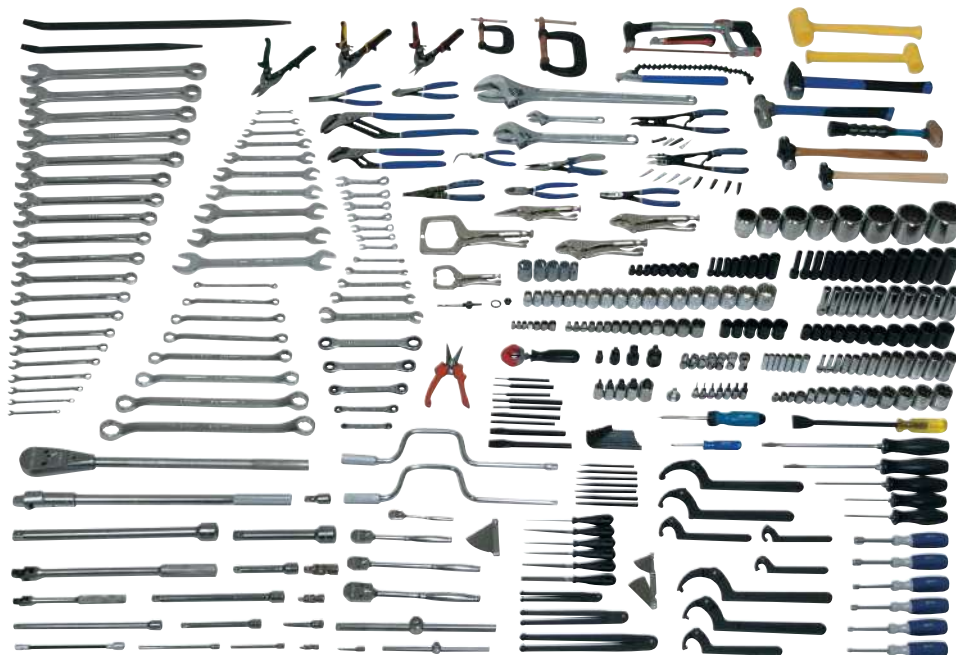

WSC-352



Master set cabinetry and contents are subject to change and may not be exactly as illustrated and listed.

# MASTER SETS

## INTERMEDIATE TECHNICIAN'S TOOL SET



W40TC4

W40RC7



### 308 PIECE INTERMEDIATE TECHNICIAN'S TOOL SET

Contains the following tools:

Product Category	Number of Pieces
Chisel and Punches	9
Extractor	9
Feeler Gauge	1
Files	4
Hammers	4
Hex Keys	22
Pliers	11
Ratchets, Drive Tools, and Accessories	28
Screwdrivers	8
Hand Sockets	133
Tape Measure	1
Torque Wrenches	2
Wrenches	74

**Note: Complete set contents are listed in appendix A**

#### Set Configurations Available

Product Code	Description
WSC-317TB	308 Piece Tool Set with Tool Boxes
WSC-317	Tool Set Only (306 Pieces)

#### Tool Boxes Included

W40RC7	40" 4 Drawer Professional Top Chest
W40TC4	40" 7 Drawer Professional Roll Cabinet

#### Features

- This set provides the tools necessary for many general service and repair applications. Included are a variety of fractional wrenches, hand and impact sockets, and 1/4", 3/8" and 1/2" drive ratchets and accessories. An assortment of professional industrial tools such as pliers, screwdrivers, hammers, punches, chisels, and other tools round out the offering.



WSC-317

# MASTER SETS

## ADVANCED MAINTENCE SERVICE SET



W40TC4

### 277 PIECE ADVANCED MAINTENANCE SERVICE SET

Contains the following tools:

Product Category	Number of Pieces
Chisel and Punches	17
Files	6
Hammers	3
Hand Sockets	100
Impact Drive Tools	2
Impact Sockets	16
Miscellaneous Tools	8
Pliers	12
Ratchets, Drive Tools, and Accessories	24
Saws and Saw Blades	8
Screwdrivers	18
Tool Boxes	2
Wrenches	61

Note: Complete set contents are listed in Appendix A

#### Set Configurations Available

Product Code	Description
WSC-277TB	277 Piece Advanced Maintenance Service Set with Tool Boxes
WSC-277	Tool Set Only (275 Pieces)

#### Tool Boxes Included

W40TC4	40" Wide x 20" Deep 4-Drawer Top Chest
W40RC7	40" Wide x 20" Deep 7-Drawer Roll Cabinet

#### Features

- This set provides the tools necessary for many general service and repair applications. Included are a variety of fractional wrenches, hand and impact sockets, and 1/4", 3/8" and 1/2" drive ratchets and accessories. An assortment of professional industrial tools such as pliers, screwdrivers, hammers, punches, chisels, and other tools round out the offering.



W40RC7

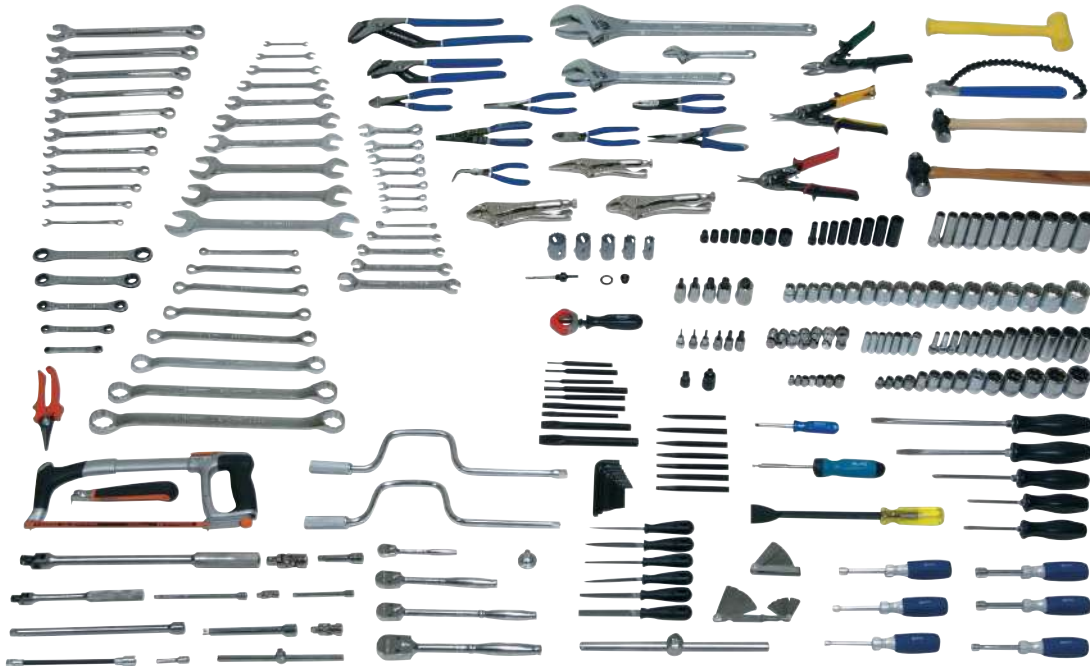

WSC-277



Master set cabinetry and contents are subject to change and may not be exactly as illustrated and listed.

# MASTER SETS

## OIL FIELD SERVICE SET



### 274 PIECE PETROLEUM OIL FIELD SERVICE SET

Contains the following tools:

Product Category	Number of Pieces
Chisels & Punch	8
Haer	2
Pipe Wrenches	1
Pliers	15
Prybar	3
Ratchets, Drive Tools & Accessories	15
Scraper	1
Screwdrivers	8
Sockets	103
Utility Tools	8
Wrenches	32

**Note: Complete set contents are listed in Appendix A  
Set Configurations Available**

Product Code	Description
WMSC-344TB	274 Piece Petroleum Oilfield Service Set
WMSC-344	Tool Set Only (272 Pieces)

#### Tool Boxes Included

W40RC7	40" 4 Drawer Professional Top Chest
W40TC4	40" 7 Drawer Professional Roll Cabinet

#### Features

- The set provides the tools necessary for Petroleum Oil field general service and repair applications. Included are a wide variety of chisels, punches, haers, pliers, adjustable wrenches, pipe wrenches, 3/8" and 1/2" drive sockets, ratchets and accessories. Also includes is professional utility tools and scrapers.

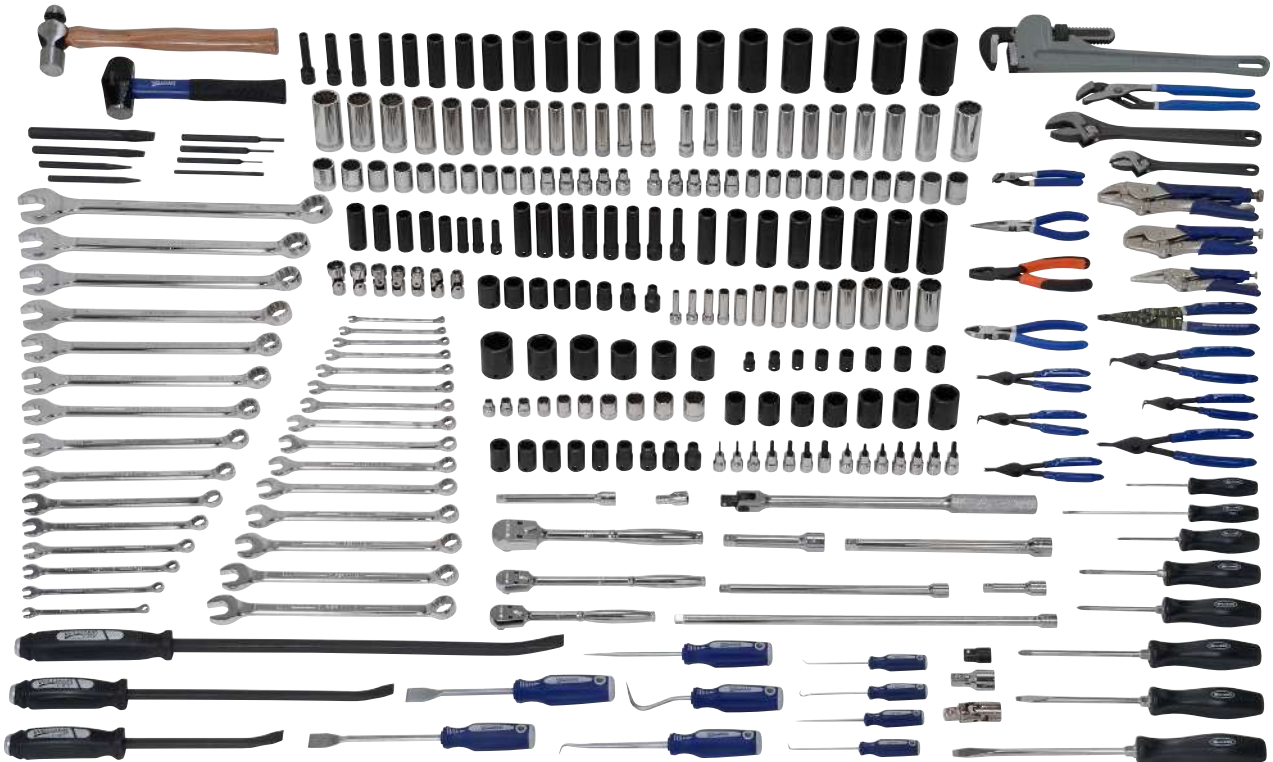

# MASTER SETS

## OIL FIELD TOOL SET



### 265 PIECE OIL FIELD TOOL SET

Contains the following tools:

Product Category	Number of Pieces
C-Clamp	2
Chain Wrench	1
Hammer	4
Hex Key	22
Miscellaneous	9
Nut Drivers	7
Pipe Wrench	2
Pliers	14
Pry Bar	2
Puller	1
Punch & Chisels	15
Ratchets, Drive Tools and Accessories	22
Scraper	1
Screwdrivers	8
Snips	2
Sockets	94
Torque Wrench	2
Wrenches	55

**Note: Complete set contents are listed in Appendix A  
Set Configurations Available**

Product Code	Description
WSC-281TB	Complete Oilfield Tool Set with Tool Boxes (265 Piece Total)
WSC-281	Oilfield Tool set only (263 Pieces)

#### Tool Boxes Included

W40TC4	40" Wide x 20" Deep 4 Drawer Top Chest
W40RC7	40" Wide x 20" Deep 7 Drawer Tool Cabinet

#### Features

- The set provides the tools necessary for Oilfield general service and repair applications. Included are a wide variety of pliers, box wrenches, combination wrenches, flare wrenches, 1/4", 3/8" and 1/2" drive sockets, ratchets and accessories. Also includes is c-clamps, chain wrench and other tools.

W40TC4



W40RC7



WSC-281



Master set cabinetry and contents are subject to change and may not be exactly as illustrated and listed.

# MASTER SETS

## GENERAL MAINTENANCE SET



### 238 PIECE GENERAL MAINTENANCE SET

Contains the following tools:

Product Category	Number of Pieces
Hammer	2
Hex Key	17
Pliers	10
Punch & Chisels	16
Ratchet, Drive Tools and Accessories	18
Screwdriver	21
Sockets	97
Wrenches	55

**Note: Complete set contents are listed in Appendix A**  
**Set Configurations Available**

Product Code	Description
WSC-238TB	Complete General Maintenance with Tool Boxes (238 Piece Total)
WSC-238	General Maintenance Tool set only (236 Pieces)

#### Tool Boxes Included

W26TC4	26" Wide x 20" Deep 4 Drawer Top Chest
W26RC7	26" Wide x 20" Deep 7 Drawer Tool Cabinet

#### Features

- The set provides the tools necessary for many general service and repair applications. Included are a wide variety of pliers, box wrenches, hex keys, flare wrenches, 1/4", 3/8" and 1/2" drive sockets, ratchets and accessories. Also includes is punch, chisels, hammers and other tools.

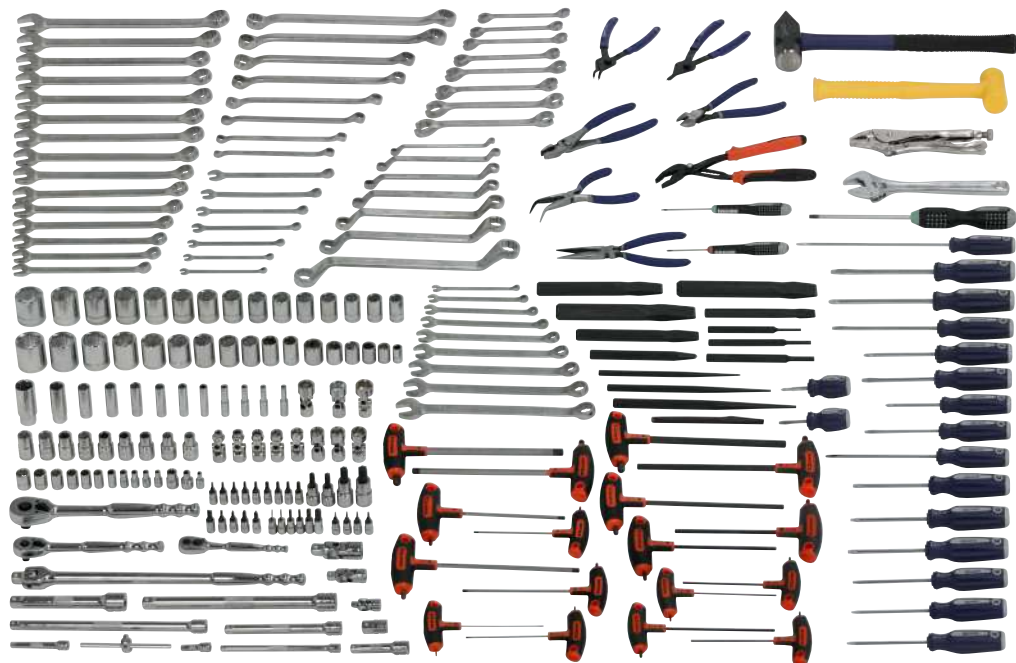

WSC-281

# MASTER SETS

## MAINTENANCE TOOL SET



### 220 PIECE MAINTENANCE TOOL SET

Contains the following tools:

Product Category	Number of Pieces
C-Clamps	2
Chisels & Punches	9
Hammers	1
Files	6
Hacksaws	1
Nutdrivers	7
Pliers	6
Ratchet, Drive Tools & Accessories	27
Scrapers	2
Screwdrivers & Bits	21
Snips	3
Sockets	91
Wrenches	44

**Note: Complete set contents are listed in appendix A Set Configurations Available**

Product Code	Description
WSC-231TB	220 Piece Maintenance Tool Set
WSC-231	Tool Set Only (218 Pieces)

#### Tool Boxes Included

50871	27" 10 Drawer Heavy Duty Roller Bearing Top Chest
50901	27" 8 Drawer Heavy Duty Roller Bearing Roll Cabinet

#### Features

- This set provides the tools necessary for most general service and repair applications. Included are a wide variety of adjustable wrenches, locking pliers, screwdrivers, hammers and 1/4" 3/8" and 1/2" drive ratchets and accessories. An assortment of professional industrial tools such as punches, chisels and pliers are also included.



WSC-231



Master set cabinetry and contents are subject to change and may not be exactly as illustrated and listed.



# MASTER SETS

## INTERMEDIATE MAINTENANCE SET



### 173 PIECE INTERMEDIATE MAINTENANCE SET

Contains the following tools:

Product Category	Number of Pieces
Chisel and Punches	12
Files	6
Hammers	1
Hand Sockets	66
Miscellaneous Tools	6
Pliers	5
Ratchets, Drive Tools, and Accessories	16
Saws and Saw Blades	1
Screwdrivers	15
Tool Boxes	2
Wrenches	43

**Note: Complete set contents are listed in Appendix A Set Configurations Available**

Product Code	Description
WSC-173TB	173 Piece Intermediate Maintenance Service Set with Tool Boxes
WSC-173	Tool Set Only (171 Pieces)

#### Tool Boxes Included

W26TC4	26" Wide x 20" Deep 4-Drawer Top Chest
W26RC7	26" Wide x 20" Deep 7-Drawer Roll Cabinet

#### Features

- This set provides the tools necessary for many general service and repair applications. Included are a variety of fractional wrenches, hand sockets, and 1/4", 3/8" and 1/2" drive ratchets and accessories. An assortment of professional industrial tools such as punches, chisels, and pliers is also included.



WSC-173

# MASTER SETS

## HEAVY MAINTENANCE SERVICE SET



### 171 PIECE HEAVY MAINTENANCE SERVICE SET

Contains the following tools:

Product Category	Number of Pieces
Chisel and Punches	17
Clamps	2
Feeler Gauge Set	1
Hammers	6
Hand Sockets	55
Pliers	8
Ratchets, Drive Tools, and Accessories	17
Screwdrivers	10
Tool Box	1
Wrenches	54

**Note: Complete set contents are listed in Appendix A Set Configurations Available**

Product Code	Description
WSC-172TB	171 Piece Heavy Maintenance Service Set with Tool Box
WSC-172	Tool Set Only (170 Pieces)

#### Tool Box Included

W40RC7	40" Wide x 20" Deep 7-Drawer Roll Cabinet
--------	---



#### Features

- Designed for the shop that performs maintenance on heavy equipment, this set emphasizes larger tools, including combination wrenches up to 2" and sockets up to 1-3/4". Ratchets, drive tools, and fractional sockets in 3/8", 1/2", and 3/4" drive are included, as well as a complement of screwdrivers, pliers, chisels, punches, hammers, and other common tools. If you need a basic assortment of beefy tools, this is the set for you.



WSC-172



Master set cabinetry and contents are subject to change and may not be exactly as illustrated and listed.

# MASTER SETS

## ELECTRICAL MAINTENANCE SERVICE SET



### 167 PIECE ELECTRICAL MAINTENANCE SERVICE SET

Contains the following tools:

Product Category	Number of Pieces
Electrical Specialty Tools	2
Hammers	3
Hand Sockets	28
Miscellaneous Tools	9
Pliers	8
Pliers - Electrical	12
Pliers - Insulated	5
Ratchets, Drive Tools, and Accessories	7
Saws and Saw Blades	32
Screwdrivers	14
Screwdrivers - Insulated	11
Tool Box	1
Wrenches	35

**Note: Complete set contents are listed in Appendix A**

#### Set Configurations Available

Product Code	Description
WSC-167TB	167 Piece Electrical Maintenance Service Set with Tool Box
WSC-167	Tool Set Only (166 Pieces)

#### Tool Box Included

W40RC7	40" Wide x 20" Deep 7-Drawer Roll Cabinet
--------	---

#### Features

- Designed to satisfy electrical maintenance tool requirements, this set has both the standard hand tools and special tools needed to accomplish a wide variety of electrical maintenance and installation. Start with 1/4" and 3/8" drive sockets and accessories, hammers, and hand wrenches, and add the special items needed for electrical work:
- Insulated and non-insulated pliers and screwdrivers.
- A electrician's holesaw set and a 10-pack of assorted recip blades.
- A comprehensive assortment of electrical strippers / crimpers / cutters.
- Drywall, hacksaw, and toolbox saws.
- And a full-size roll cabinet to organize, store, and move your tool set. Unique in the industry, this set will help you get those critical electrical maintenance tasks done quickly, efficiently, professionally, and safely.



W40RC7



WSC-167

# MASTER SETS

## SPECIALTY TOOL SETS



### 142 PIECE PETROLEUM OIL FIELD SERVICE SET

Contains the following tools:

Product Category	Number of Pieces	Product Category	Number of Pieces
Pick up Tool/Mirror	2	Screwdrivers	12
Pliers	10	Sockets	68
Ratchet, Drive Tools & Accessories	11	T-Handles	10
		Wrenches	31

**Note: Complete set contents are listed in Appendix A**  
**Set Configurations Available**

Product Code	Description
WMSC-142TB	142 Piece Petroleum Oilfield Service Set
WMSC-142	Tool Set Only (141 Pieces)

#### Tool Boxes Included

W40RC7	40" Wide x 20" Deep 7 Drawer Roll Cabinet
--------	---

#### Features

- The set provides the tools necessary for Petroleum Oilfield general service and repair applications. Included are a wide variety of pliers, adjustable wrenches, combination wrenches, ratcheting combination wrenches, 1/4" and 3/8" drive sockets, ratchets and accessories. Also included is professional pick up tools and mirror.



### 137 PIECE INDUSTRIAL PLUMBING & PIPEFITTING TOOL SET

Contains the following tools:

Product Category	Number of Pieces
Chisel and Punches	12
Clamps	1
Hammers	3
Miscellaneous Tools	12
Pipe Specialty Tools	19
Pliers	8
Screwdrivers	9
Tool Box	1
Wrenches	36
Pipe Wrenches	4
Saws and Blades	32

**Note: Complete set contents are listed in Appendix A**  
**Set Configurations Available**

Product Code	Description
WSC-137TB	137 Piece Industrial Plumbing and Pipefitting Tool Set with Tool Box
WSC-137	Tool Set Only (136 Pieces)

#### Tool Box Included

W40RC7	40" Wide x 20" Deep 7-Drawer Roll Cabinet
--------	---

#### Features

- This set is geared specifically for industrial plumbers and pipefitters. It includes an assortment of basic hand tools such as wrenches, pliers, hammers, and screwdrivers. What really makes this set special is the assortment of everyday and specialized plumbing and pipefitting tools included:
- 4 pipe wrenches from 12" through 42" length handle pipe sizes through 5" OD.
- A pair of Williams' famous FJ-20 flange jacks.
- 3 sets of our unique, professional pipe nipple removal/inserting tools covering 1/8" NPT through 1-1/4" NPT pipe sizes.
- Tube cutters and flaring tools.
- Ratcheting valve and flare nut wrenches.
- A toolbox saw, drywall saw, and hacksaw and blades.
- 2 utility knives and a pack of blades.
- A plumber's holesaw set and a 10-pack of assorted recip blades.
- And a full-size roll cabinet to organize, store, and move your tool set. Unique in the industry, this set will help you get those critical pipefitting and plumbing tasks done quickly, efficiently, professionally, and safely.



W40RC7



WMSC-142



W40RC7



WSC-137



Master set cabinetry and contents are subject to change and may not be exactly as illustrated and listed.

# MASTER SETS

## SPECIALTY TOOL SETS



### 130 PIECE MAINTENANCE TOOL SET

**Contains the following tools:**

Product Category	Number of Pieces
Chisels & Punches	1
Hammers	2
Hex Key Set	13
Pliers	10
Ratchet, Drive Tools & Accessories	21
Screwdrivers & Bits	21
Sockets	40
Wrenches	20

**Note: Complete set contents are listed in appendix A  
Set Configurations Available**

Product Code	Description
WSC-130TB	130 Piece Maintenance Tool Set
WSC-130	Tool Set Only (129 Pieces)

#### Tool Boxes Included

50721	3 Drawer Service Cart with Lid
-------	--------------------------------

#### Features

- This set provides the tools necessary for most general service and repair applications. Included are a wide variety of adjustable wrenches, locking pliers, screwdrivers, hammers and 1/4" 3/8" and 1/2" drive ratchets and accessories. An assortment of professional industrial tools such as punches, chisels and pliers are also included.



50721



WSC-130

# MASTER SETS

## SPECIALTY TOOL SETS



### 102 PIECE OILFIELD SERVICE SET

Contains the following tools:

Product Category	Number of Pieces
Chisels & Punch	8
Haer	1
Hex Keys	13
Pliers	5
Ratchets, Drive Tools & Accessories	9
Screwdrivers	8
Sockets	35
Utility Tools	4
Wrenches	19

**Note: Complete set contents are listed in Appendix A Set Configurations Available**

Product Code	Description
MSOS-102TB	102 Piece Oilfield Service Set
MSOS-102	Tool Set Only (101 Pieces)

#### Tool Boxes Included

W26RC7	26" Wide x 20" Deep 7 Drawer Roll Cabinet
--------	---

#### Features

- The set provides the tools necessary for Oilfield general service and repair applications. Included are a wide variety of chisels, punches, haers, pliers, wrenches 3/8" and 1/2" drive sockets, ratchets and accessories. Also includes is professional utility tools.



W26RC7



MSOS-102TB



### 102 PIECE BASIC MACHINE REPAIR SET

Contains the following tools:

Product Category	Number of Pieces
Chisel and Punches	7
Feeler Gauge Set	1
Hammers	4
Hand Sockets	38
Pliers	6
Ratchets, Drive Tools, and Accessories	5
Screwdrivers	5
Tool Box	1
Wrenches	35

**Note: Complete set contents are listed in Appendix A Set Configurations Available**

Product Code	Description
WSC-102TB	102 Piece Basic Machine Repair Set with Tool Box
WSC-102	Tool Set Only (101 Pieces)

#### Tool Box Included

W26RC7	26" Wide x 20" Deep 7-Drawer Roll Cabinet
--------	---

#### Features

- Designed for the shop that requires a basic tool set for machine repair, this set includes the popular sizes in 1/4" and 1/2" drive sockets, an assortment of wrenches, and the most commonly used pliers, screwdrivers, and hammers.



W26RC7



WSC-102



Master set cabinetry and contents are subject to change and may not be exactly as illustrated and listed.

# MASTER SETS

## GENERAL SERVICE SETS



50721



WSC-95



W26RC7



WSC-88



### 95 PIECE BASIC ELECTRICAL REPAIR SET

Contains the following tools:

Product Category	Number of Pieces
Hammers	1
Hand Sockets	22
Pliers	5
Pliers - Electrical	4
Pliers - Insulated	4
Ratchets, Drive Tools, and Accessories	7
Screwdrivers	13
Screwdrivers - Insulated	10
Tool Box	1
Wrenches	28

**Note: Complete set contents are listed in appendix A**  
**Set Configurations Available**

Product Code	Description
WSC-95TB	95 Piece Electrical Repair Set with Tool Box
WSC-95	Tool Set Only (94 Pieces)

#### Tool Box Included

50721	3-Drawer Service Cart with Lid
-------	--------------------------------

#### Features

- Designed to satisfy electrical maintenance tool requirements, this set has both the standard hand tools and special tools needed to accomplish a wide variety of electrical maintenance and installation. Start with 1/4" and 3/8" drive sockets and accessories.
- Insulated and non-insulated pliers and screwdrivers.
- A electrician's holesaw set and a 10-pack of assorted recip blades.
- A comprehensive assortment of electrical strippers / crimpers / cutters.
- Drywall, hacksaw, and toolbox saws.
- And a 3-drawer roll cart helps organize, store, and move your tool set. Unique in the industry, this set will help you get those critical electrical maintenance tasks done quickly, efficiently, professionally, and safely.



### 88 PIECE GENERAL INDUSTRIAL REPAIR SET

Contains the following tools:

Product Category	Number of Pieces
Clamp	1
Feeler Gauge Set	1
Hand Sockets	28
Pliers	4
Ratchets, Drive Tools, and Accessories	7
Screwdrivers	8
Tool Box	1
Wrenches	32

**Note: Complete set contents are listed in appendix A**  
**Set Configurations Available**

Product Code	Description
WSC-88TB	88 Piece General Industrial Repair Set with Tool Box
WSC-88	Tool Set Only (87 Pieces)

#### Tool Box Included

W26RC7	26" Wide x 20" Deep 7-Drawer Roll Cabinet
--------	---

#### Features

- Designed for the shop that requires a basic industrial tool set, this set includes the popular sizes in 3/8" and 1/2" drive sockets, an assortment of wrenches, and the most commonly used pliers and screwdrivers.

# MASTER SETS

## GENERAL SERVICE SETS



### 80 PIECE GENERAL SERVICE SET

Contains the following tools:

Product Category	Number of Pieces
Chisel and Punches	8
Feeler Gauge Set	1
Hammer	1
Hand Sockets	24
Pliers	6
Ratchets, Drive Tools, and Accessories	16
Screwdrivers	6
Tool Box	1
Wrenches	17

**Note: Complete set contents are listed in appendix A**  
**Set Configurations Available**

Product Code	Description
WSC-80TB	80 Piece General Service Set with Tool Box
WSC-80	Tool Set Only (79 Pieces)

#### Tool Box Included

50721	3-Drawer Service Cart with Lid
-------	--------------------------------

#### Features

- Designed for the shop that requires a general service set. This set includes 3/8" and 1/2" drive sockets, assortments of pliers and screwdrivers



50721



WSC-80



### 41 PIECE BASIC SERVICE SET

Contains the following tools:

Product Category	Number of Pieces
Chisel and Punches	3
Hammer	1
Hand Sockets	14
Pliers	3
Ratchets, Drive Tools, and Accessories	5
Screwdrivers	3
Tool Box	1
Wrenches	11

**Note: Complete set contents are listed in appendix A**  
**Set Configurations Available**

Product Code	Description
WSC-41TB	41 Piece Basic Service Set with Tool Box
WSC-41	Tool Set Only (40 Pieces)

#### Tool Box Included

50721	3-Drawer Service Cart with Lid
-------	--------------------------------

#### Features

- Designed for the shop that requires a basic industrial tool set, this set includes the popular sizes in 3/8" drive sockets, an assortment of wrenches, and commonly used pliers and screwdrivers.



50721



WSC-41



Master set cabinetry and contents are subject to change and may not be exactly as illustrated and listed.



# MASTER SETS

## METRIC SERVICE SETS



### 225 PIECE METRIC MAINTENANCE SERVICE SET

Contains the following tools:

Product Category	Number of Pieces
Chisel and Punches	18
Hammers	6
Hand Sockets	120
Pliers	10
Ratchets, Drive Tools, and Accessories	8
Screwdrivers	15
Tool Box	1
Torque Wrench	1
Wrenches	46

**Note: Complete set contents are listed in Appendix A**  
**Set Configurations Available**

Product Code	Description
MSC-225TB	225 Piece Heavy Maintenance Service Set with Tool Box
MSC-225	Tool Set Only (224 Pieces)

#### Tool Box Included

W40RC7	40" Wide x 20" Deep 7-Drawer Roll Cabinet
--------	---

#### Features

- Designed for the shop that requires metric tools for maintenance. 1/4", 3/8", and 1/2" drive tools are included, as well as a full assortment of wrenches, pliers, screwdrivers, and other commonly used hand tools.



W40RC7



MSC-225

# MASTER SETS

## METRIC SERVICE SETS



### 118 PIECE METRIC HEAVY EQUIPMENT SERVICE SET

Contains the following tools:

Product Category	Number of Pieces
Chisel, Punches, and Prybars	7
Hammers	3
Hand Sockets	42
Pliers	4
Ratchets, Drive Tools, and Accessories	12
Screwdrivers	10
Tool Box	1
Wrenches	39

**Note: Complete set contents are listed in Appendix A**

#### Set Configurations Available

Product Code	Description
MSC-118TB	118 Piece Metric Heavy Equipment Service Set with Tool Box
MSC-118	Tool Set Only (117 Pieces)

#### Tool Box Included

W40RC7	40" Wide x 20" Deep 7-Drawer Roll Cabinet
--------	---

#### Features

- Designed for the shop that requires metric tools for maintenance of heavy equipment. 3/8", 1/2", and 3/4" drive tools are included, as well as a basic assortment of wrenches, pliers, screwdrivers, and other commonly used hand tools.



W40RC7



MSC-118



Master set cabinetry and contents are subject to change and may not be exactly as illustrated and listed.

# TOOL STORAGE

**OUR TOOL STORAGE COMES IN MULTIPLE CONFIGURATIONS AND LEVELS TO MEET YOUR NEEDS:**

• PROFESSIONAL • HEAVY INDUSTRIAL • COMMERCIAL • SUPER VALUE

**KEY FEATURES:**

• DOUBLE WALL CONSTRUCTION • DRAWER LINERS • HIGH GLOSS POWDER-COAT PAINT • BALL BEARING DRAWER SLIDES



55" PROFESSIONAL SERIES  
TOOL CABINET





HEAVY INDUSTRIAL 54" ROLL CABINET  
WITH HARDWOOD TOP











**WE CONTINUE TO INNOVATE TO DELIVER SAFETY AND PRODUCTIVITY TO OUR CUSTOMERS**



# TOOL STORAGE

Series		Professional				Heavy-Industrial	
Nominal Size (Inches)		 55	 55 Bulk Storage	 40	 26	 73	 54
Product Codes	Chest	W55TC10		W40TC4	W26TC4		
	Roll Cabinet	W55RC11	W55RC5BS	W40RC7	W26TRC7	50990	50885
	Locker						
	Side Cabinet						
Capacity (cu. in.)	Top Chest	21,283		9,746	6,180		
	Roll Cabinet	25,000	25,000	15,253	9,374	29,477	25,304
	Locker						
	Side Cabinet						
Top Chest Dimensions	Overall Width, Inches	55		40	26		53
	Depth, Inches	24		19	19		24
	Height, Inches	28		19	19		27
Roll Cabinet Dimensions	Overall Width, Inches	55	55	40	26	80	53
	Depth, Inches	24	24	19	19	24	24
	Height, Inches	39	39	37	37	43	43
Number of Drawers	Top Chest	10		4	4		
	Roll Cabinet	11	5	7	7	21	12
Colours Available	Red	•	•	•	•	•	•
	Black	•		•	•	•	•
	Blue	•		•	•	•	•
	Orange						
	Yellow	•					
Hardwood Top	Roll Cabinet						•
Heavy Duty Casters	Rigid					50938	50938
	Swivel					50939	50939
Medium Duty Casters	Rigid						
	Swivel						
Replacement Locks and Keys	Top Chest	50974 - Key Only					
	Roll Cabinet	50975 - Lock Only				50969	50962









# AT-A-GLANCE

Heavy-Industrial Cont.			Commercial							
										
42	35	27	75	54	54	42	42	27	27	
50860	50881	50880		50861		50865	50778	50872	50873	
50890	50887	50888	50992	50891	50866	50895	50748	50902	50903	
	50855	50855			50855	50855, 50851		50855	50855	
13,798	9,041	7,217		20,988		9,205	15,675	5,980	6,571	
21,051	14,230	9,177	38,598	41,328	20,484	14,623	20,321	10,354	10,354	
						8,200, 3,921				
41	35	26		53		42	41	27	27	
24	18	18		18		18	23	18	18	
22	22	42		22		19	20	18	19	
41	35	27	75	56	53	44	41	29	29	
24	18	18	24	41	18	18	24	18	18	
42	42	42	44	18	42	43	43	36	36	
4	5	5		9		6	8	4	5	
5	4	6	17	13		14	10	5	7	
•	•	•	•	•	•	•	•	•	•	
•	•	•	•	•	•	•	•	•	•	
•	•	•	•	•	•	•	•	•	•	
50936	50936	50936				50834	50834	50834	50834	
50937	50937	50937				50935	50935	50935	50935	
50976	50976	50976		50962		50962	50962	50962	50962	
50964	50964	50964	50969	50965	50962	50963	50962	50972	50972	

# TOOL STORAGE



## TOOL STORAGE AT-A-GLANCE CONTINUED

Series		Super Value							
Nominal Size (Inches)									
Nominal Size (Inches)		75	56	42	42	42 (One-Piece)	27	27	26
Product Codes	Chest		50740	50741	50744	50730	50742	50743	TB-6024RA
	Roll Cabinet	50764	50765	50766	50769		50767	50768	
	Keyless Entry								
	Cart/Metal Peg Board								
	Locker		50790	50791, 50792					
	Side Cabinet			50855	50855		50855	50855	
Cage									
Capacity (cu. in.)	Top Chest		12,763	6,387	6,387		3,050	4,806	3,073
	Roll Cabinet	26,505	21,866	8,606	8,606	8,503	5,193	8,223	
	Locker		35,640						
	Side Cabinet								
Top Chest Dimensions	Overall Width, Inches	75	55	40	42	41	26	26	26
	Depth, Inches	24	24	16	18	18	12	17	12
	Height, Inches	39	10	10	18	61	14	18	14
Roll Cabinet Dimensions	Overall Width, Inches		56	41	43		27	27	
	Depth, Inches		24	18	18		18	18	
	Height, Inches		39	39	38		31	35	
Number of Drawers	Top Chest		6	10	4		4	6	6
	Roll Cabinet	15	10	11	5	20	5	7	
Colours Available	Red	•	•	•	•		•	•	•
	Black	•	•	•	•		•	•	
	Blue	•	•	•	•		•	•	
	Orange		•	•					
	Yellow								
Hardwood Top	Roll Cabinet	•	•	•					
Heavy Duty Casters	Rigid								
	Swivel								
Medium Duty Casters	Rigid	50932	50932	50932	50932	50932	50932	50932	50932
	Swivel	50933	50933	50933	50933	50933	50933	50933	50933
Replacement Locks and Keys	Top Chest		50962	50968	50962	50730	50960	50960	50961
	Roll Cabinet	50969	50962	50963	50972		50963	50963	



# TOOL STORAGE

## PROFESSIONAL SERIES



### 55" PROFESSIONAL SERIES TOOL CABINETS

#### Designed for industrial use

Product Code	Description
W55TC10	55" Wide x 24" Deep 10-Drawer Tool Chest
W55RC11	55" Wide x 24" Deep 11-Drawer Roll Cabinet

Colour Options: Standard colour is red. To order in an optional colour, simply add the appropriate colour code to the end of the product code. Example: To order #W55TC10 in Blue, specify product code W55TC10BL.

#### W55TC10 Top Chest Overall Dimensions

Capacity (cu.in.)	Width (Inches)	Depth (Inches)	Height (Inches)
21283	55	24	28.5

#### Top Chest Drawer Sizes

Number	Width (inches)	Depth (inches)	Height (inches)
2	14 <sup>5</sup> / <sub>8</sub>	21 <sup>5</sup> / <sub>8</sub>	1 <sup>3</sup> / <sub>4</sub>
3	14 <sup>5</sup> / <sub>8</sub>	21 <sup>5</sup> / <sub>8</sub>	4
2	30 <sup>1</sup> / <sub>2</sub>	21 <sup>5</sup> / <sub>8</sub>	1 <sup>3</sup> / <sub>4</sub>
3	30 <sup>1</sup> / <sub>2</sub>	21 <sup>5</sup> / <sub>8</sub>	4

#### W55RC11 Roll Cabinet Overall Dimensions

Capacity (cu.in.)	Width (Inches)	Depth (Inches)	Height (Inches)
25000	55	24	39

#### Roll Cabinet Drawer Sizes

Number	Width (inches)	Depth (inches)	Height (inches)
1	14 <sup>5</sup> / <sub>8</sub>	21 <sup>7</sup> / <sub>8</sub>	1 <sup>3</sup> / <sub>4</sub>
2	14 <sup>5</sup> / <sub>8</sub>	21 <sup>7</sup> / <sub>8</sub>	4
1	14 <sup>5</sup> / <sub>8</sub>	21 <sup>7</sup> / <sub>8</sub>	10 <sup>9</sup> / <sub>16</sub>
3	30 <sup>9</sup> / <sub>16</sub>	21 <sup>7</sup> / <sub>8</sub>	1 <sup>3</sup> / <sub>4</sub>
2	30 <sup>9</sup> / <sub>16</sub>	21 <sup>7</sup> / <sub>8</sub>	4
1	30 <sup>9</sup> / <sub>16</sub>	21 <sup>7</sup> / <sub>8</sub>	6 <sup>3</sup> / <sub>16</sub>
1	49 <sup>1</sup> / <sub>4</sub>	21 <sup>7</sup> / <sub>8</sub>	3 <sup>3</sup> / <sub>16</sub>

#### Features

- Made of High-Quality Class I steel to enhance strength and finish.
- Double wall construction provides strength.
- Reinforcement corner gussets add strength and reduce racking.
- 2" mounting centers provide flexibility in arranging drawers to individual needs
- Drawers equipped with positive latching drawer retention to prevent unwanted drawer opening.
- All drawers equipped with 75 pound full extension ball bearing slides with quick disconnect.
- All 4" and deeper drawers provide for adding additional slides to double drawer capacity.
- Rolled hem on all drawers provide superior strength, rigidity and safety.
- Casters absorb vibrations transmitted to frame while moving on uneven surfaces.
- Casters equipped with pedal brake and ball bearings for easy operation.
- High luster paint protects against scratches, peeling, blistering and corrosion.
- Paint pretreatment process both sprays and immerses boxes for added corrosion protection.
- Drawer liners included at no extra charge.
- Gas struts in lid of chest make lid easy to open and close.
- Two point locking design adds extra security on all chests.

#### Colour Options

	Red: Standard
	Black: B
	Blue: BL
	Yellow: Y

W55TC10



W55RC11





# TOOL STORAGE

## PROFESSIONAL SERIES



### 55" PROFESSIONAL SERIES ROLL CABINET

Designed for industrial use

Product Code	Description
W55RC5BS	55" Wide x 24" Deep 5-Drawer Roll Cabinet with Bulk Storage

#### W55RC5BS Roll Cabinet Overall Dimensions

Capacity (cu.in.)	Width (Inches)	Depth (Inches)	Height (Inches)
25,000	55	24	39

#### Roll Cabinet Drawer Sizes

Number	Width (inches)	Depth (inches)	Height (inches)
4	30 <sup>9</sup> / <sub>16</sub>	21 <sup>7</sup> / <sub>8</sub>	5
1	30 <sup>9</sup> / <sub>16</sub>	21 <sup>7</sup> / <sub>8</sub>	7
Bulk	23	21 <sup>7</sup> / <sub>8</sub>	33

#### Features

- Wide Drawer to hold long tools such as pry bars and extensions.
- Bulk section with adjustable shelf perfect for storing large, bulky tools
- Made of High-Quality Class I steel to enhance strength and finish.
- Double wall construction provides strength.
- Reinforcement corner gussets add strength and reduce racking.
- 2" mounting centers provide flexibility in arranging drawers to individual needs
- Drawers equipped with positive latching drawer retention to prevent unwanted drawer opening.
- All drawers equipped with 75 pound full extension ball bearing slides with quick disconnect.
- All 4" and deeper drawers provide for adding additional slides to double drawer capacity.
- Rolled hem on all drawers provide superior strength, rigidity and safety.
- Casters absorb vibrations transmitted to frame while moving on uneven surfaces.
- Casters equipped with pedal brake and ball bearings for easy operation.
- High luster paint protects against scratches, peeling, blistering and corrosion.
- Paint pretreatment process both sprays and ierses boxes for added corrosion protected.
- Drawer liners included at no extra charge.
- Gas struts in lid of chest make lid easy to open and close.
- Two point locking design adds extra security on all chests.



W55RCBS

# TOOL STORAGE

## PROFESSIONAL SERIES



### 40" PROFESSIONAL SERIES TOOL CABINETS

#### Designed for industrial use

Product Code	Description
W40TC4	40" Wide x 20" Deep 4-Drawer Top Chest
W40RC7	40" Wide x 20" Deep 7-Drawer Roll Cabinet

Colour Options: Standard colour is red. To order in an optional colour, simply add the appropriate colour code to the end of the product code. Example: To order #W40TC4 in Blue, specify product code W40TC4BL

#### W40TC4 Top Chest Overall Dimensions

Capacity (cu. in.)	Width (inches)	Depth (inches)	Height (inches)
9746	40 1/2	19 13/16	19 7/16

#### Top Chest Drawer Sizes

Number	Width	Depth	Height
Top Compartment	39 29/32	18 23/32	4 23/32
2	34 11/16	17 17/32	1 13/32
2	34 11/16	17 17/32	3 19/32

#### W40RC7 Roll Cabinet Overall Dimensions

Capacity (cu. in.)	Width (inches)	Depth (inches)	Height (inches)
15253	40	19 13/16	37 7/8

#### Roll Cabinet Drawer Sizes

Number	Width	Depth	Height
2	34 11/16	17 17/32	1 13/32
4	34 11/16	17 17/32	3 19/32
1	34 11/16	17 17/32	7 21/32

#### Features

- Made of High-Quality Class I steel to enhance strength and finish.
- Double wall construction provides strength.
- Reinforcement corner gussets add strength and reduce racking.
- 2" mounting centers provide flexibility in arranging drawers to individual needs.
- Drawers equipped with positive latching drawer retention to prevent unwanted drawer opening.
- All drawers equipped with 75 pound full extension ball bearing slides with quick disconnect.
- All 4" and deeper drawers provide for adding additional slides to double drawer capacity.
- Rolled hem on all drawers provide superior strength, rigidity and safety.
- Casters absorb vibrations transmitted to frame while moving on uneven surfaces.
- Casters equipped with pedal brake and ball bearings for easy operation.
- High luster paint protects against scratches, peeling, blistering and corrosion.
- Paint pretreatment process both sprays and immerses boxes for added corrosion protected.
- Drawer liners included at no extra charge.
- Gas struts in lid of chest make lid easy to open and close.
- Two point locking design adds extra security on all chests
- W40X50RV Side Handles

#### Colour Options

	Red: Standard
	Black: B
	Blue: BL



# TOOL STORAGE

## PROFESSIONAL SERIES



### Colour Options

<span style="color: red;">■</span>	Red: Standard
<span style="color: black;">■</span>	Black: B
<span style="color: blue;">■</span>	Blue: BL



## 26" PROFESSIONAL SERIES TOOL CABINET

### Designed for industrial use

Product Code	Description
W26TC4	26" Wide x 20" Deep 4-Drawer Top Chest
W26RC7	26" Wide x 20" Deep 7-Drawer Roll Cabinet

Colour Options: Standard colour is red. To order in an optional colour, simply add the appropriate colour code to the end of the product code. Example: To order #W26TC4 in Blue, specify product code W26TC4BL

### W26TC4 Top Chest Overall Dimensions

Capacity (cu. in.)	Width (inches)	Depth (inches)	Height (inches)
6180	26 <sup>23</sup> / <sub>32</sub>	19 <sup>13</sup> / <sub>16</sub>	19 <sup>13</sup> / <sub>32</sub>

### Top Chest Drawer Sizes

Number	Width (inches)	Depth (inches)	Height (inches)
Top Compartment	26 <sup>19</sup> / <sub>32</sub>	18 <sup>23</sup> / <sub>32</sub>	4 <sup>23</sup> / <sub>32</sub>
2	21 <sup>3</sup> / <sub>8</sub>	17 <sup>11</sup> / <sub>32</sub>	1 <sup>13</sup> / <sub>32</sub>
2	21 <sup>3</sup> / <sub>8</sub>	17 <sup>17</sup> / <sub>32</sub>	3 <sup>19</sup> / <sub>32</sub>

### W26RC7 Roll Cabinet Overall Dimensions

Capacity (cu. in.)	Width (inches)	Depth (inches)	Height (inches)
9374	26	19 <sup>13</sup> / <sub>16</sub>	37 <sup>7</sup> / <sub>8</sub>

### Roll Cabinet Drawer Sizes

Number	Width (inches)	Depth (inches)	Height (inches)
2	21 <sup>3</sup> / <sub>8</sub>	17 <sup>11</sup> / <sub>32</sub>	1 <sup>15</sup> / <sub>32</sub>
4	21 <sup>3</sup> / <sub>8</sub>	17 <sup>11</sup> / <sub>32</sub>	3 <sup>19</sup> / <sub>32</sub>
1	21 <sup>3</sup> / <sub>8</sub>	17 <sup>11</sup> / <sub>32</sub>	7 <sup>21</sup> / <sub>32</sub>

### Features

- Made of High-Quality Class I steel to enhance strength and finish.
- Double wall construction provides strength.
- Reinforcement corner gussets add strength and reduce racking.
- 2" mounting centers provide flexibility in arranging drawers to individual needs.
- Drawers equipped with positive latching drawer retention to prevent unwanted drawer opening.
- All drawers equipped with 75 pound full extension ball bearing slides with quick disconnect.
- All 4" and deeper drawers provide for adding additional slides to double drawer capacity.
- Rolled hem on all drawers provide superior strength, rigidity and safety.
- Casters absorb vibrations transmitted to frame while moving on uneven surfaces.
- Casters equipped with pedal brake and ball bearings for easy operation.
- High luster paint protects against scratches, peeling, blistering and corrosion.
- Paint pretreatment process both sprays and immerses boxes for added corrosion protection.
- Drawer liners included at no extra charge.
- Two point locking design adds extra security on all chests.

# TOOL STORAGE

## HEAVY-INDUSTRIAL



### HEAVY-INDUSTRIAL 73" ROLL CABINET

Heavy-Industrial roll cabinet designed for the toughest work environments

Product Code	Description
50990	73" Wide 21 Drawer Roll Cabinet

Colour Options: Standard colour is red. To order in an optional colour, simply add the appropriate colour code to the end of the product code. Example: To order #50990 in Blue, specify product code 50990BL

#### 50990 Roll Cabinet Overall Dimensions

Capacity (cu. in.)	Width (inches)	Depth (inches)	Height (inches)
29,477	80 <sup>7</sup> / <sub>32</sub>	24 <sup>9</sup> / <sub>16</sub>	43 <sup>1</sup> / <sub>16</sub>

#### Roll Cabinet Drawer Sizes

Number	Width (inches)	Depth (inches)	Height (inches)
Left side:			
1	50	22	4 <sup>1</sup> / <sub>4</sub>
1	23	22	2
2	23	22	3 <sup>1</sup> / <sub>8</sub>
2	23	22	4 <sup>1</sup> / <sub>4</sub>
1	23	22	6 <sup>7</sup> / <sub>16</sub>
Center:			
1	23	22	2
2	23	22	3 <sup>1</sup> / <sub>8</sub>
1	23	22	4 <sup>1</sup> / <sub>4</sub>
1	23	22	10 <sup>13</sup> / <sub>16</sub>
Right side:			
4	16 <sup>9</sup> / <sub>16</sub>	22	2
2	16 <sup>9</sup> / <sub>16</sub>	22	3 <sup>1</sup> / <sub>8</sub>
3	16 <sup>9</sup> / <sub>16</sub>	22	4 <sup>1</sup> / <sub>4</sub>

#### Features

- High gloss powder coat paint is scratch & chemical resistant
- Stainless steel work surface
- Heavy gauge metal for a lifetime of use
- Double wall construction for greater strength and durability
- Heavy duty 5" x 2" casters on cabinets
- Aluminum corner trim
- Handles on both side of cabinet
- Two pairs of 120 pounds rated ball bearing slides on all drawers over 3" deep.
- Anti-skid drawer liners included
- Overall width with handles is 80 <sup>1</sup>/<sub>4</sub>"

#### Colour Options

	Red: Standard
	Black: B
	Blue: BL



50990



50990B





50990BL





# TOOL STORAGE

## HEAVY-INDUSTRIAL

### Colour Options

	Red: Standard
	Black: B
	Blue: BL

### Colour Options with Hardwood Top

	Red with Hardwood Top: W
	Black with Hardwood Top: BW
	Blue with Hardwood Top: BLW

Colour Options with Hardwood Top: To order in an optional colour with a hardwood top simply add the appropriate colour and hardwood top code to the end of the product code. Example: To order #50885 in Blue with a Hardwood top, specify product code 50885BLW



## HEAVY-INDUSTRIAL 54" ROLL CABINET WITH OPTIONAL HARDWOOD TOP

Heavy-Industrial roll cabinet designed for the toughest work environments

Product Code	Description
50885	54" Wide x 24 1/2" Deep 12 Drawer Roll Cabinet
50111	Hardwood Top Only

Colour Options: Standard colour is red. To order in an optional colour, simply add the appropriate colour code to the end of the product code. Example: To order #50885 in Blue, specify product code 50885BL

### 50885 Roll Cabinet Overall Dimensions

Capacity (cu. in.)	Width (inches)	Depth (inches)	Height (inches)
25,304	53 1/2	24 1/2	43

### Roll Cabinet Drawer Sizes

Number	Width (inches)	Depth (inches)	Height (inches)
1	50	22	4 1/4
2	23	22	2
4	23	22	3
3	23	22	4 1/4
1	23	22	6 7/16
1	23	22	10 1/2

### Features

- Frame is reinforced using 14 gauge plates on the front of cabinet
- Rigidity of frame is significantly increased with full height & width triple channel wall
- Three layers of metal guard the corners with interlock corner design
- Two pairs of 120 lb. rated ball bearing drawer slides on all drawers except 2" drawers
- 6" x 2" precision ball bearing casters made of high tech thermoplastic rubber.
- Casters absorb vibrations transmitted to frame while moving on uneven surface
- Casters equipped with pedal brake and ball bearings for easy operation
- All drawers equipped with safe-lock system & made of 18 gauge heavy duty steel
- Extruded aluminum drawer handle trim
- Red high gloss powder coat paint is scratch resistant
- Drawer liners included at no extra charge
- Gas struts in lid of chest make lid easy to open and close

# TOOL STORAGE

## HEAVY-INDUSTRIAL



### HEAVY-INDUSTRIAL SERIES 42" TOOL CABINETS

Heavy-Industrial-grade tool cabinets with ball bearing drawer slides for rugged service in the toughest work environments

Product Code	Description
50860	42" Wide x 24" Deep 4-Drawer Top Chest
50890	42" Wide x 24" Deep 5-Drawer Roll Cabinet

Colour Options: Standard colour is red. To order in an optional colour, simply add the appropriate colour code to the end of the product code. Example: To order #50860 in Blue, specify product code 50860BL

#### 50860 Top Chest Overall Dimensions

Capacity (cu. in.)	Width (inches)	Depth (inches)	Height (inches)
13798	41 1/2	24 1/2	22 3/4

#### Top Chest Drawer Sizes

Number	Width (inches)	Depth (inches)	Height (inches)
2	38	22	2
1	38	22	4 1/4
1	38	22	6 7/16

#### 50890 Roll Cabinet Overall Dimensions

Capacity (cu. in.)	Width (inches)	Depth (inches)	Height (inches)
21051	41 1/2	24 1/2	42 1/8

#### Roll Cabinet Drawer Sizes

Number	Width (inches)	Depth (inches)	Height (inches)
3	38	22	4 1/4
1	38	22	6 7/16
1	38	22	8 1/2

#### Features

- Frame is reinforced using 14 gauge plates on the front of cabinet.
- Rigidity of frame is significantly increased with full height & width triple channel wall.
- Three layers of metal guard the corners with interlock corner design.
- TWO pairs of 120 lb. rated ball bearing drawer slides on all drawers except 2" drawers.
- 6"x2" precision ball bearing casters made of high tech thermoplastic rubber.
- Casters absorb vibrations transmitted to frame while moving on uneven surfaces.
- Casters equipped with pedal brake and ball bearings for easy operation.
- All drawers equipped with safe-lock system & made of 18 gauge heavy duty steel.
- Extruded aluminum drawer handle trim.
- Red high gloss powder coat paint is scratch resistant.
- Drawer liners included at no extra charge.
- Gas struts in lid of chest make lid easy to open and close.

#### Colour Options

	Red: Standard
	Black: B
	Blue: BL



# TOOL STORAGE

## HEAVY-INDUSTRIAL



### HEAVY-INDUSTRIAL SERIES 35" TOOL CABINETS

Heavy-Industrial roll cabinet designed for the toughest work environments

Product Code	Description
50881	35" Wide x 18" Deep 5 Drawer Top Chest
50887	35" Wide x 18" Deep 6 Drawer Roll Cabinet

Colour Options: Standard colour is red. To order in an optional colour, simply add the appropriate colour code to the end of the product code. Example: To order #50881 in Blue, specify product code 50881BL

#### 50881 Top Chest Overall Dimensions

Capacity (cu. in.)	Width (inches)	Depth (inches)	Height (inches)
9,041	35	18 ¾	22 ¾

#### Top Chest Drawer Sizes

Number	Width (inches)	Depth (inches)	Height (inches)
2	31	16	2
2	31	16	3
1	31	16	4 ¼

#### 50887 Roll Cabinet Overall Dimensions

Capacity (cu. in.)	Width (inches)	Depth (inches)	Height (inches)
14,230	35	18 ¾	42

#### Roll Cabinet Drawer Sizes

Number	Width (inches)	Depth (inches)	Height (inches)
1	31	16	2
2	31	16	3
1	31	16	4 ¼
1	31	16	6 7/16
1	31	16	8 ½



#### Colour Options

<span style="color: red;">■</span>	Red: Standard
<span style="color: black;">■</span>	Black: B
<span style="color: blue;">■</span>	Blue: BL

### HEAVY-INDUSTRIAL SERIES 27" TOOL CABINETS

Heavy-Industrial roll cabinet designed for the toughest work environments

Product Code	Description
50880	27" Wide x 18" Deep 5 Drawer Top Chest
50888	27" Wide x 18" Deep 6 Drawer Roll Cabinet

Colour Options: Standard colour is red. To order in an optional colour, simply add the appropriate colour code to the end of the product code. Example: To order #50880 in Blue, specify product code 50880BL

#### 50880 Top Chest Overall Dimensions

Capacity (cu. in.)	Width (inches)	Depth (inches)	Height (inches)
7,217	26 ½	18 ¾	22 ¾

#### Top Chest Drawer Sizes

Number	Width (inches)	Depth (inches)	Height (inches)
2	23	16	2
2	23	16	3
1	23	16	4 ¼

#### 50888 Roll Cabinet Overall Dimensions

Capacity (cu. in.)	Width (inches)	Depth (inches)	Height (inches)
9,177	27	18 ¾	42

#### Roll Cabinet Drawer Sizes

Number	Width (inches)	Depth (inches)	Height (inches)
1	23	16	2
2	23	16	3
1	23	16	4 ¼
1	23	16	6 7/16
1	23	16	8 ½

#### Features

- Frame is reinforced using 14 gauge plates on the front of cabinet
- Rigidity of frame is significantly increased with full height & width triple channel wall
- Three layers of metal guard the corners with interlock corner design
- TWO pairs of 120 lb. rated ball bearing drawer slides on all drawers except 2" drawers
- 6"x2" precision ball bearing casters made of high tech thermoplastic rubber .
- Casters absorb vibrations transmitted to frame while moving on uneven surfaces
- Casters equipped with pedal brake and ball bearings for easy operation
- All drawers equipped with safe-lock system & made of 18 gauge heavy duty steel
- Extruded aluminum drawer handle trim
- Red high gloss powder coat paint is scratch resistant
- Drawer liners included at no extra charge
- Gas struts in lid of chest make lid easy to open and close



#### Colour Options

<span style="color: red;">■</span>	Red: Standard
<span style="color: black;">■</span>	Black: B
<span style="color: blue;">■</span>	Blue: BL

# TOOL STORAGE

## COMMERCIAL SERIES



### 75" COMMERCIAL SERIES TOOL CABINET

Designed for use in commercial applications.  
Equipped with ball bearing slides

Product Code	Description
50992	75" Wide x 24-1/2" Deep 17-Drawer Tool Chest

Colour Options: Standard colour is red. To order in an optional colour, simply add the appropriate colour code to the end of the product code.  
Example: To order #50992 in Blue, specify product code 50992BL

#### 50992 Roll Cabinet Overall Dimensions

Capacity (cu. in.)	Width (inches)	Depth (inches)	Height (inches)
38598	75 1/4	24 1/2	44 1/8

#### Top Chest Drawer Sizes

Number	Width (inches)	Depth (inches)	Height (inches)
<b>Long Drawer</b>			
1	51 5/8	22	1 5/8
1	51 5/8	22	3 3/4
<b>Left Bank</b>			
1	32 5/8	22	1 5/8
3	32 5/8	22	3 7/8
1	32 5/8	22	8 1/8
<b>Center Bank</b>			
1	15 3/4	22	1 5/8
2	15 3/4	22	3 7/8
1	15 3/4	22	12 5/8
<b>Right Bank</b>			
1	15 3/4	22	1 5/8
1	15 3/4	22	3 7/8
1	15 3/4	22	1 5/8
2	15 3/4	22	3 7/8
1	15 3/4	22	12 5/8

#### Features

- Heavy duty double wall construction, built to last
- Ball bearing slides on all drawers
- Double ball bearing slide on all 4" and 6" drawers
- Full extension slides for easy reach inside
- Reinforced bottom channels
- Full length extruded aluminum drawer pulls
- Integrated latch security systems on all drawer
- Aluminum protective corners
- Aluminum recessed side handle on top chest
- Heavy duty gas struts on top lid for smooth and easy opening
- Oversized elliptical chromed side handle for comfort and easy maneuvering
- 4 heavy duty casters with double layer ball bearing and chromed hub caps
- High security locks
- High quality anti skid drawer liners in all drawers and top lid area
- Easy access to top compartment area

#### Colour Options

	Red: Standard
	Black: B
	Blue: BL





# TOOL STORAGE

## COMMERCIAL SERIES



### Colour Options

<span style="color: red;">■</span>	Red: Standard
<span style="color: black;">■</span>	Black: B
<span style="color: blue;">■</span>	Blue: BL



50861

50891



50866

## 54" COMMERCIAL SERIES TOOL CABINET

Designed for use in commercial applications.  
Equipped with ball bearing slides

Product Code	Description
50861	54" Wide x 18" Deep 9-Drawer Top Chest
50891	54" Wide x 18" Deep 13-Drawer Roll Cabinet
50866	54" Wide x 18" Deep 12-Drawer Roll Cabinet

Colour Options: Standard colour is red. To order in an optional colour, simply add the appropriate colour code to the end of the product code. Example: To order #50861 in Blue, specify product code 50861BL

### 50861 Top Chest Overall Dimensions

Capacity (cu. in.)	Width (inches)	Depth (inches)	Height (inches)
20988	53 <sup>3</sup> / <sub>8</sub>	18 <sup>5</sup> / <sub>32</sub>	22 <sup>1</sup> / <sub>4</sub>

### Top Chest Drawer Sizes

Number	Width (inches)	Depth (inches)	Height (inches)
1	50 <sup>1</sup> / <sub>2</sub>	17 <sup>11</sup> / <sub>16</sub>	3 <sup>3</sup> / <sub>32</sub>
3	22 <sup>29</sup> / <sub>32</sub>	16 <sup>11</sup> / <sub>32</sub>	1 <sup>3</sup> / <sub>8</sub>
2	22 <sup>29</sup> / <sub>32</sub>	16 <sup>11</sup> / <sub>32</sub>	3 <sup>1</sup> / <sub>16</sub>
2	22 <sup>29</sup> / <sub>32</sub>	16 <sup>11</sup> / <sub>32</sub>	3 <sup>1</sup> / <sub>2</sub>
1	22 <sup>29</sup> / <sub>32</sub>	16 <sup>11</sup> / <sub>32</sub>	3 <sup>3</sup> / <sub>16</sub>
1	22 <sup>29</sup> / <sub>32</sub>	16 <sup>11</sup> / <sub>32</sub>	5 <sup>3</sup> / <sub>4</sub>

### 50891 Roll Cabinet Overall Dimensions

Capacity (cu. in.)	Width (inches)	Depth (inches)	Height (inches)
41328	53 <sup>17</sup> / <sub>32</sub>	18 <sup>3</sup> / <sub>4</sub>	42 <sup>3</sup> / <sub>8</sub>

### Roll Cabinet Drawer Sizes

Number	Width (inches)	Depth (inches)	Height (inches)
1	22 <sup>29</sup> / <sub>32</sub>	16 <sup>11</sup> / <sub>32</sub>	1 <sup>3</sup> / <sub>8</sub>
4	22 <sup>29</sup> / <sub>32</sub>	16 <sup>11</sup> / <sub>32</sub>	3 <sup>9</sup> / <sub>16</sub>
1	22 <sup>29</sup> / <sub>32</sub>	16 <sup>11</sup> / <sub>32</sub>	7 <sup>15</sup> / <sub>16</sub>
1	22 <sup>29</sup> / <sub>32</sub>	16 <sup>11</sup> / <sub>32</sub>	1 <sup>3</sup> / <sub>8</sub>
2	22 <sup>29</sup> / <sub>32</sub>	16 <sup>11</sup> / <sub>32</sub>	2 <sup>15</sup> / <sub>32</sub>
3	22 <sup>29</sup> / <sub>32</sub>	16 <sup>11</sup> / <sub>32</sub>	3 <sup>9</sup> / <sub>16</sub>
1	22 <sup>29</sup> / <sub>32</sub>	16 <sup>11</sup> / <sub>32</sub>	5 <sup>3</sup> / <sub>4</sub>

### 50866 Roll Cabinet Overall Dimensions

Capacity (cu. in.)	Width (inches)	Depth (inches)	Height (inches)
20484	53 <sup>5</sup> / <sub>8</sub>	18 <sup>3</sup> / <sub>4</sub>	42 <sup>1</sup> / <sub>2</sub>

### Roll Cabinet Drawer Sizes

Number	Width (inches)	Depth (inches)	Height (inches)
<b>Long Drawer</b>			
1	49 <sup>3</sup> / <sub>8</sub>	16 <sup>1</sup> / <sub>4</sub>	1 <sup>5</sup> / <sub>8</sub>
1	49 <sup>3</sup> / <sub>8</sub>	16 <sup>1</sup> / <sub>4</sub>	3 <sup>7</sup> / <sub>8</sub>
<b>Left Bank</b>			
2	23	16 <sup>1</sup> / <sub>4</sub>	2 <sup>3</sup> / <sub>4</sub>
2	23	16 <sup>1</sup> / <sub>4</sub>	3 <sup>7</sup> / <sub>8</sub>
1	23	16 <sup>1</sup> / <sub>4</sub>	8 <sup>1</sup> / <sub>4</sub>
<b>Right Bank</b>			
2	23	16 <sup>1</sup> / <sub>4</sub>	2 <sup>3</sup> / <sub>4</sub>
2	23	16 <sup>1</sup> / <sub>4</sub>	3 <sup>7</sup> / <sub>8</sub>
1	23	16 <sup>1</sup> / <sub>4</sub>	8 <sup>1</sup> / <sub>4</sub>

### Features

- Heavy duty double wall construction, built to last
- Ball bearing slides on all drawers
- Double ball bearing slide on all 4" and 6" drawers
- Full extension slides for easy reach inside
- Reinforced bottom channels
- Full length extruded aluminum drawer pulls
- Integrated latch security systems on all drawer
- Aluminum protective corners
- Aluminum recessed side handle on top chest
- Heavy duty gas struts on top lid for smooth and easy opening
- Oversized elliptical chromed side handle for comfort and easy maneuvering
- 4 heavy duty casters with double layer ball bearing and chromed hub caps
- High security locks
- High quality anti skid drawer liners in all drawers and top lid area
- Easy access to top compartment area

# TOOL STORAGE

## COMMERCIAL SERIES



### 42" COMMERCIAL SERIES TOOL CABINETS

Designed for use in commercial applications.  
Equipped with ball bearing slides

Product Code	Description
50778	42" Wide x 23" Deep 8-Drawer Top Chest
50748	42" Wide x 24" Deep 13-Drawer Roll Cabinet

Colour Options: Standard colour is red. To order in an optional colour, simply add the appropriate colour code to the end of the product code.  
Example: To order #50778 in Blue, specify product code 50778BL

#### 50778 Top Chest Overall Dimensions

Capacity (cu. in.)	Width (inches)	Depth (inches)	Height (inches)
15675	41 1/2	23 3/8	20

#### Top Chest Drawer Sizes

Number	Width (inches)	Depth (inches)	Height (inches)	Number	Width (inches)	Depth (inches)	Height (inches)
1 Shelf	38 1/2	23 3/8	3 1/4	1	11	22	1 3/8
1	23	22	1 1/8	2	11	22	2 3/8
2	23	22	2 3/8	1	11	22	3 7/8
1	23	22	3 7/8				

#### 50748 Roll Cabinet Overall Dimensions

Capacity (cu. in.)	Width (inches)	Depth (inches)	Height (inches)
20321	41 1/2	24 1/2	43 3/8

#### Roll Cabinet Drawer Sizes

Number	Width (inches)	Depth (inches)	Height (inches)	Number	Width (inches)	Depth (inches)	Height (inches)
1	37 3/8	22	1 3/8	1	23	22	6 1/8
1	37 3/8	22	3 7/8	1	11	22	1 1/8
1	23	22	1 3/8	2	11	22	2 3/8
2	23	22	2 3/8	1	11	22	3 7/8
2	23	22	3 7/8	1	11	22	10 3/8

#### Colour Options

	Red: Standard
	Black: B
	Blue: BL



### 42" COMMERCIAL SERIES TOOL CABINETS

Designed for use in commercial applications.  
Equipped with ball bearing slides

Product Code	Description
50865	42" Wide x 18" Deep 6-Drawer Top Chest
50895	42" Wide x 18" Deep 14-Drawer Roll Cabinet

Colour Options: Standard colour is red. To order in an optional colour, simply add the appropriate colour code to the end of the product code.  
Example: To order #50778 in Blue, specify product code 50865BL

#### 50865 Top Chest Overall Dimensions

Capacity (cu. in.)	Width (inches)	Depth (inches)	Height (inches)
9205	42	18 3/32	19 15/16

#### Top Chest Drawer Sizes

Number	Width (inches)	Depth (inches)	Height (inches)	Number	Width (inches)	Depth (inches)	Height (inches)
1	37 5/16	16 11/32	1 3/8	1	22 29/32	16 11/32	3 1/2
1	37 5/16	16 11/32	3 1/2	1	10 29/32	16 11/32	1 3/8
1	22 29/32	16 11/32	1 3/8	1	10 29/32	16 11/32	3 1/2

#### 50895 Roll Cabinet Overall Dimensions

Capacity (cu. in.)	Width (inches)	Depth (inches)	Height (inches)
14623	44	18 27/32	43 1/4

#### Roll Cabinet Drawer Sizes

Number	Width (inches)	Depth (inches)	Height (inches)	Number	Width (inches)	Depth (inches)	Height (inches)
1	37 5/16	16 11/32	1 3/8	1	22 29/32	16 11/32	5 3/4
1	37 5/16	16 11/32	3 1/2	1	10 29/32	16 11/32	1 3/8
1	22 29/32	16 11/32	1 3/8	2	10 29/32	16 11/32	2 15/32
2	22 29/32	16 11/32	2 15/32	2	10 29/32	16 11/32	3 1/2
2	22 29/32	16 11/32	3 1/2	1	10 29/32	16 11/32	5 3/4

#### Colour Options

	Red: Standard
	Black: B
	Blue: BL



#### Features

- Frame is reinforced using 14 gauge plates on the front of cabinet
- Rigidity of frame is significantly increased with full height & width triple channel wall
- Three layers of metal guard the corners with interlock corner design
- TWO pairs of 120 lb. rated ball bearing drawer slides on all drawers except 2" drawers
- 6"x2" precision ball bearing casters made of high tech thermoplastic rubber.
- Casters absorb vibrations transmitted to frame while moving on uneven surfaces
- Casters equipped with pedal brake and ball bearings for easy operation
- All drawers equipped with safe-lock system & made of 18 gauge heavy duty steel
- Extruded aluminum drawer handle trim
- Red high gloss powder coat paint is scratch resistant
- Drawer liners included at no extra charge
- Gas struts in lid of chest make lid easy to open and close



# TOOL STORAGE

## COMMERCIAL SERIES



### 27" COMMERCIAL SERIES TOOL CABINETS

**Designed for use in commercial applications. Equipped with ball bearing slides**

Product Code	Description
50872	27" Wide x 18" Deep 4-Drawer Top Chest
50902	27" Wide x 18" Deep 5-Drawer Roll Cabinet

Colour Options: Standard colour is red. To order in an optional colour, simply add the appropriate colour code to the end of the product code. Example: To order #50872 in Blue, specify product code 50872BL

#### Colour Options

<span style="display:inline-block; width:15px; height:10px; background-color:red; border:1px solid black;"></span> Red: Standard
<span style="display:inline-block; width:15px; height:10px; background-color:black; border:1px solid black;"></span> Black: B
<span style="display:inline-block; width:15px; height:10px; background-color:blue; border:1px solid black;"></span> Blue: BL



#### 50872 Top Chest Overall Dimensions

Capacity (cu. in.)	Width (inches)	Depth (inches)	Height (inches)
5980	27	18	18 7/8

#### Top Chest Drawer Sizes

Number	Width (inches)	Depth (inches)	Height (inches)
2	22 29/32	16 11/32	1 3/8
1	22 29/32	16 11/32	2 15/32
1	22 29/32	16 11/32	3 9/16

#### 50902 Roll Cabinet Overall Dimensions

Capacity (cu. in.)	Width (inches)	Depth (inches)	Height (inches)
10354	29 25/32	18	36 5/8

#### Roll Cabinet Drawer Sizes

Number	Width (inches)	Depth (inches)	Height (inches)
1	22 29/32	16 11/32	1 3/8
3	22 29/32	16 11/32	3 9/16
1	22 29/32	16 11/32	7 15/16

#### Features

- Heavy duty double wall construction, built to last
- Ball bearing slides on all drawers
- Double ball bearing slide on all 4" and 6" drawers
- Full extension slides for easy reach inside
- Reinforced bottom channels
- Full length extruded aluminum drawer pulls
- Integrated latch security systems on all drawer
- Aluminum protective corners
- Aluminum recessed side handle on top chest
- Heavy duty gas struts on top lid for smooth and easy opening
- Oversized elliptical chromed side handle for comfort and easy maneuvering
- 4 heavy duty casters with double layer ball bearing and chromed hub caps
- High security locks
- High quality anti skid drawer liners in all drawers and top lid area
- Easy access to top compartment area
- Casters 6" Height

# TOOL STORAGE

## COMMERCIAL SERIES



### 27" COMMERCIAL SERIES TOOL CABINETS

Designed for use in commercial applications.  
Equipped with ball bearing slides

Product Code	Description
50873	27" Wide x 18" Deep 5-Drawer Top Chest
50903	27" Wide x 18" Deep 7-Drawer Roll Cabinet

Colour Options: Standard colour is red. To order in an optional colour, simply add the appropriate colour code to the end of the product code. Example: To order #50873 in Blue, specify product code 50873BL

#### 50873 Top Chest Overall Dimensions

Capacity (cu. in.)	Width (inches)	Depth (inches)	Height (inches)
6571	27	18	19 15/16

#### Top Chest Drawer Sizes

Number	Width (inches)	Depth (inches)	Height (inches)
4	22 29/32	16 11/32	1 3/8
1	22 29/32	16 11/32	3 9/16

#### 50903 Roll Cabinet Overall Dimensions

Capacity (cu. in.)	Width (inches)	Depth (inches)	Height (inches)
10,354	29 25/32	18	36 5/8

#### Roll Cabinet Drawer Sizes

Number	Width (inches)	Depth (inches)	Height (inches)
1	22 29/32	16 11/32	1 3/8
2	22 29/32	16 11/32	2 15/32
3	22 29/32	16 11/32	3 9/16
1	22 29/32	16 11/32	7 15/16

#### Features

- Frame is reinforced using 14 gauge plates on the front of cabinet
- Rigidity of frame is significantly increased with full height & width triple channel wall
- Three layers of metal guard the corners with interlock corner design
- TWO pairs of 120 lb. rated ball bearing drawer slides on all drawers except 2" drawers
- 6"x2" precision ball bearing casters made of high tech thermoplastic rubber .
- Casters absorb vibrations transmitted to frame while moving on uneven surfaces
- Casters equipped with pedal brake and ball bearings for easy operation
- All drawers equipped with safe-lock system & made of 18 gauge heavy duty steel
- Extruded aluminum drawer handle trim
- Red high gloss powder coat paint is scratch resistant
- Drawer liners included at no extra charge
- Gas struts in lid of chest make lid easy to open and close

#### Colour Options

	Red: Standard
	Black: B
	Blue: BL

50873





50903



# TOOL STORAGE

## SUPER VALUE SERIES

### Colour Options

	Red: Standard
	Black: B
	Blue: BL

### Colour Options with Hardwood Top

	Red with Hardwood Top: W
	Black with Hardwood Top: BW
	Blue with Hardwood Top: BLW



### SUPER VALUE SERIES 75" ROLL CABINET WITH OPTIONAL HARDWOOD TOP

Designed for use in commercial applications. Equipped with ball bearing slides

Product Code	Description
50764	75" Wide 15 Drawer Roll Cabinet
50103	Hardwood Top Only

Colour Options: Standard colour is red. To order in an optional colour, simply add the appropriate colour code to the end of the product code. Example: To order #50764 in Blue, specify product code 50764BL

Colour Options with Hardwood Top: To order in an optional colour with a hardwood top simply add the appropriate colour and hardwood top code to the end of the product code. Example: To order #50764 in Blue with a Hardwood top, specify product code 50764BLW

### 50764 Roll Cabinet Overall Dimensions

Capacity (cu. in.)	Width (inches)	Depth (inches)	Height (inches)
26,505	75 ¼	24 ½	39 ⅜

### Roll Cabinet Drawer Sizes

Number	Width (inches)	Depth (inches)	Height (inches)
1	52 ¾	22	4 ⅜
2	33 ½	22	3 ⅜
1	33 ½	22	4 ⅜
1	33 ½	22	8
2	16 ⅝	22	3 ⅜
1	16 ⅝	22	4 ⅜
1	16 ⅝	22	8
4	16 ⅝	22	2
1	16 ⅝	22	4 ⅜
1	16 ⅝	22	12

### Features

- Ball bearings slides on all drawers
- Double slides on all 8" drawers (on 53" side only)
- High gloss powder coat scratch resistant paint
- Six 6"x2" casters with load rating of 900 lbs. each
- Four swivel and two rigid casters
- Heavy duty 14 gauge caster channel
- Chrome plated handles on both sides of cabinet
- Full width aluminum drawer pulls
- 3/8" Rubber top mat working surface
- Pre-cut anti-skid drawer liners



50764



50764W

# TOOL STORAGE

## SUPER VALUE SERIES



### SUPER VALUE SERIES 56" TOOL CABINETS WITH OPTIONAL HARDWOOD TOP

Super Value units equipped with ball bearing slides designed for professional use at a value price.

Product Code	Description
50740	56" Wide x 24" Deep 6 Drawer Top Chest
50765	56" Wide x 24" Deep 10 Drawer Roll Cabinet

Colour Options: Standard colour is red. To order in an optional colour, simply add the appropriate colour code to the end of the product code.  
Example: To order #50740 in Blue, specify product code 50740BL

Colour Options with Hardwood Top: To order in an optional colour with a hardwood top simply add the appropriate colour and hardwood top code to the end of the product code.  
Example: To order #50764 in Blue with a Hardwood top, specify product code 50764BLW

#### 50740 Top Chest Overall Dimensions

Capacity (cu. in.)	Width (inches)	Depth (inches)	Height (inches)
12,763	55 1/2	24	10 1/10

#### Top Chest Drawer Sizes

Number	Width (inches)	Depth (inches)	Height (inches)
2	33 3/8	22	1 1/2
2	33 3/8	22	3 1/2
1	16 1/2	22	3 1/2
1	16 1/2	22	8

#### 50765 Roll Cabinet Overall Dimensions

Capacity (cu. in.)	Width (inches)	Depth (inches)	Height (inches)
53,562	56 1/2	24	39 1/2

#### Roll Cabinet Drawer Sizes

Number	Width (inches)	Depth (inches)	Height (inches)
1	51 7/8	22	4 3/16
2	33 3/8	22	3 3/2
3	33 3/8	22	4 3/16
3	16 1/2	22	2
1	16 1/2	22	12

#### Features

- Ball bearing slides on all drawers
- Double wall steel construction
- High gloss power coat scratch resistant paint
- Extruded aluminum drawer handle trim
- Comes with pre-cut drawer liners
- Gas struts in the lid for ease in opening and closing the lid



### SUPER VALUE SERIES ONE PIECE UNIT

Super Value units equipped with ball bearing slides designed for professional use at a value price.

Product Code	Description
50730	42" Wide x 18 3/4" Deep 20 Drawer One Piece Unit

#### 50730 One Piece Unit Overall Dimensions

Capacity (cu. in.)	Width (inches)	Depth (inches)	Height (inches)
8,503	41 1/2	18 3/4	61 3/16

#### Top Chest Drawer Sizes

Number	Width (inches)	Depth (inches)	Height (inches)
1	38	16	4 3/16
5	23	16	2
3	23	16	3 3/2
2	23	16	4 3/16
5	11	16	2
3	11	16	3 3/2
1	11	16	8 3/8

#### Features

- The Unit includes 20 drawers with a pull out work surface
- 9-1/2" canopy in top for holding large tools & other materials
- Canopy has electrical knockouts so cordless tool charger's can be kept secure
- Gas struts help to easily open the lid
- Ball bearing slides
- 5" x 2" Heavy duty casters
- Includes pre-cut drawer liners
- Red only

#### Colour Options

	Red: Standard
	Black: B
	Blue: BL
	Orange: O

#### Colour Options with Hardwood Top

	Red with Hardwood Top: W
	Black with Hardwood Top: BW
	Blue with Hardwood Top: BLW
	Orange with Hardwood Top: OW



# TOOL STORAGE

## SUPER VALUE SERIES



### SUPER VALUE SERIES 42" TOOL CABINETS WITH OPTIONAL HARDWOOD TOP

Super Value units equipped with ball bearing slides designed for professional use at a value price.

Product Code	Description
50741	42" Wide x 18" Deep 10 Drawer Top Chest
50766	35" Wide x 18" Deep 11 Drawer Roll Cabinet

Colour Options: Standard colour is red. To order in an optional colour, simply add the appropriate colour code to the end of the product code. Example: To order #50741 in Blue, specify product code 50741BL

Colour Options with Hardwood Top: To order in an optional colour with a hardwood top simply add the appropriate colour and hardwood top code to the end of the product code. Example: To order #50766 in Blue with a Hardwood top, specify product code 50766BLW

#### 50741 Top Chest Overall Dimensions

Capacity (cu. in.)	Width (inches)	Depth (inches)	Height (inches)
6,387	42	18	10 1/4

#### Top Chest Drawer Sizes

Number	Width (inches)	Depth (inches)	Height (inches)
3	23	16	2
2	23	16	3
3	11	16	2
2	11	16	3

#### 50766 Roll Cabinet Overall Dimensions

Capacity (cu. in.)	Width (inches)	Depth (inches)	Height (inches)
8,606	42	24 1/2	38 3/8

#### Roll Cabinet Drawer Sizes

Number	Width	Depth	Height
1	38	16 1/4	4 3/16
1	23	16 1/4	2
4	23	16 1/4	3 1/8
1	23	16 1/4	4 3/16
2	11	16 1/4	3 1/8
1	11	16 1/4	4 3/16
1	11	16 1/4	8 1/8

#### Colour Options

<span style="display:inline-block; width:15px; height:10px; background-color:red; border:1px solid black;"></span> Red: Standard
<span style="display:inline-block; width:15px; height:10px; background-color:black; border:1px solid black;"></span> Black: B
<span style="display:inline-block; width:15px; height:10px; background-color:blue; border:1px solid black;"></span> Blue: BL
<span style="display:inline-block; width:15px; height:10px; background-color:orange; border:1px solid black;"></span> Orange: O

#### Colour Options with Hardwood Top

<span style="display:inline-block; width:15px; height:10px; background-color:red; border:1px solid black;"></span> Red with Hardwood Top: W
<span style="display:inline-block; width:15px; height:10px; background-color:black; border:1px solid black;"></span> Black with Hardwood Top: BW
<span style="display:inline-block; width:15px; height:10px; background-color:blue; border:1px solid black;"></span> Blue with Hardwood Top: BLW
<span style="display:inline-block; width:15px; height:10px; background-color:orange; border:1px solid black;"></span> Orange with Hardwood Top: OW



### SUPER VALUE SERIES 42" TOOL CABINETS

Super Value units equipped with ball bearing slides designed for professional use at a value price.

Product Code	Description
50744	42" Wide x 18" Deep 4-Drawer Top Chest
50769	44" Wide x 18" Deep 5-Drawer Roll Cabinet

Colour Options: Standard colour is red. To order in an optional colour, simply add the appropriate colour code to the end of the product code. Example: To order #50744 in Blue, specify product code 50744BL

#### 50744 Top Chest Overall Dimensions

Capacity (cu. in.)	Width (inches)	Depth (inches)	Height (inches)
13608	42	18 5/32	18 7/16

#### Top Chest Drawer Sizes

Number	Width (inches)	Depth (inches)	Height (inches)
2	38	16	2
2	38	16	6

#### 50769 Roll Cabinet Overall Dimensions

Capacity (cu. in.)	Width (inches)	Depth (inches)	Height (inches)
29412	42	18 7/8	38 3/8

#### Roll Cabinet Drawer Sizes

Number	Width	Depth	Height
3	38	4 3/16	16
2	38	6 3/8	16

#### Colour Options

<span style="display:inline-block; width:15px; height:10px; background-color:red; border:1px solid black;"></span> Red: Standard
<span style="display:inline-block; width:15px; height:10px; background-color:black; border:1px solid black;"></span> Black: B
<span style="display:inline-block; width:15px; height:10px; background-color:blue; border:1px solid black;"></span> Blue: BL



#### Features

- Ball bearing slides on all drawers
- Double wall steel construction
- High gloss power coat scratch resistant paint
- Extruded aluminum drawer handle trim.
- Comes with pre-cut drawer liners
- Gas struts in the lid of the 42" wide chest for ease in opening and closing the lid

# TOOL STORAGE

## SUPER VALUE SERIES



### SUPER VALUE SERIES 27" TOOL CABINETS

Super Value units equipped with ball bearing slides designed for professional use at a value price.

Product Code	Description
50742	27" Wide x 12" Deep 4 Drawer Top Chest
50767	27" Wide x 18" Deep 5 Drawer Roll Cabinet

Colour Options: Standard colour is red. To order in an optional colour, simply add the appropriate colour code to the end of the product code. Example: To order #50742 in Blue, specify product code 50742BL.

#### 50742 Top Chest Overall Dimensions

Capacity (cu. in.)	Width (inches)	Depth (inches)	Height (inches)
3050	26	12	14 1/2

#### Top Chest Drawer Sizes

Number	Width (inches)	Depth (inches)	Height (inches)
3	23	10 1/2	2
1	23	10 1/2	2 1/2

#### 50767 Roll Cabinet Overall Dimensions

Capacity (cu. in.)	Width (inches)	Depth (inches)	Height (inches)
5,193	27	18 3/4	31 1/2

#### Roll Cabinet Drawer Sizes

Number	Width	Depth	Height
1	23	16	2
4	23	16	4 1/4

#### Features

- Ball bearing slides on all drawers
- Double wall steel construction
- High gloss power coat scratch resistant paint
- Extruded aluminum drawer handle trim.
- Comes with pre-cut drawer liners
- Gas struts in the lid of the 42" wide chest for ease in opening and closing the lid

#### Colour Options

	Red: Standard
	Black: B
	Blue: BL



### SUPER VALUE SERIES 27" TOOL CABINETS

Super Value units equipped with ball bearing slides designed for professional use at a value price.

Product Code	Description
50743	27" Wide x 18" Deep 6 Drawer Top Chest
50768	27" Wide x 18" Deep 7 Drawer Roll Cabinet

Colour Options: Standard colour is red. To order in an optional colour, simply add the appropriate colour code to the end of the product code. Example: To order #50743 in Blue, specify product code 50743BL.

#### 50743 Top Chest Overall Dimensions

Capacity (cu. in.)	Width (inches)	Depth (inches)	Height (inches)
4806	26	17 7/8	18 15/16

#### 50743 Top Chest Drawer Sizes

Number	Width (inches)	Depth (inches)	Height (inches)
6	23	16	2

#### 50768 Roll Cabinet Overall Dimensions

Capacity (cu. in.)	Width (inches)	Depth (inches)	Height (inches)
8,223	27	18 3/4	35 1/2

#### Roll Cabinet Drawer Sizes

Number	Width (inches)	Depth (inches)	Height (inches)
4	23	16	2
2	23	16	4 1/4
1	23	16	6 7/16

#### Features

- Ball bearing slides on all drawers
- Double wall steel construction
- High gloss power coat scratch resistant paint
- Extruded aluminum drawer handle trim.
- Comes with pre-cut drawer liners
- Gas struts in the lid of the 42" wide chest for ease in opening and closing the lid

#### Colour Options

	Red: Standard
	Black: B
	Blue: BL





# TOOL STORAGE

## SERVICE CARTS



50726



### HEAVY DUTY SERVICE CARTS

#### Heavy Duty Industrial Cart

Product Code	Description
50726	4 Drawer Heavy Duty Industrial Cart

#### Service Carts Overall Dimensions

Product Code	Width (Inches)	Depth (Inches)	Height (Inches)
50726	30	20 1/2	40 1/2

#### Drawer Sizes

Number	Width (inches)	Depth (inches)	Height (inches)
2	11	19 1/8	3
1	25	16 1/4	3
1	25	16 1/4	6 5/8

#### Features

- Heavy duty steel construction
- High gloss power coat scratch resistant paint
- Quality swivel casters on all units
- Drawer units have 45 mm "secure latch" ball bearing slides



50721



50723



### SERVICE CARTS

Easy and convenient access to tools when and where you need them.

Product Code	Description
50721	2 Drawer with Lockable Lid & Tray, Black
50722	2 Shelves, Red
50723	2 Shelves with Locking Drawer, Red
50724	4 Drawers with Lid, Rack and Shelf, Red

#### Service Cart Overall Dimensions

Product Code	Width (inches)	Depth (inches)	Height (inches)
50721	45 1/2 with a lid	16 1/2	36
50722	30	17	36 7/32
50723	30	17	36 7/32
50724	41	17	36 7/32

#### Features

- High gloss powder coat paint is scratch & chemical resistant
- Storage drawers for frequently used tools
- Heavy duty undercarriage to help support bottom tray load
- 18 gauge heavy duty steel
- 4" x 1" swivel casters



50722



50724

# TOOL STORAGE

## JOB SITE BOXES



### JOB SITE BOXES

Designed for the toughest outdoor work environments

Product Code	50950	50951	50952	50953
Overall (Inches)				
Width	32	42	48	48
Depth	19	20	24	30
Height	17 1/2	23 1/2	27 1/2	33 1/2
Inside of body (Inches)				
Width	17 7/8	41 7/8	47 7/8	47 7/8
Depth	18 7/8	19 7/8	23 7/8	29 7/8
Height	11 1/8	17	21 1/8	27 1/8
Inside of top Lid (Inches)				
Width	31 7/8	41 7/8	47 7/8	47 7/8
Depth	18 7/8	19 7/8	23 7/8	29 7/8
Height	2 5/8	2 5/8	2 5/8	2 5/8

#### Features

- Casters weight capacity is 3500 lbs
- Tough industrial powder coating finish
- Heavy 16 gauge steel construction with 12 gauge feet
- Recessed and concealed locking area protects padlock for ultimate security against drills and bolt cutter
- Fully welded seams provide maximum strength
- Recessed side handles for easy transportation
- Reinforced overlapping lid provides protection from weather and forced entry
- Heavy duty industrial lid stays prevents accidental closure
- Tread plate design for rugged durability



50950



### JOB SITE BOXES

Designed for the toughest outdoor work environments

Product Code	Width (inches)	Depth (inches)	Height (inches)
50954	48	24	28 3/8
50949	6" x 2" Swivel Caster Set		

#### Features

- Tough industrial powder coating finish
- Super heavy gauge steel construction
- Recessed locking area protects contents.
- Fully welded seams provide maximum strength
- Reinforced overlapping lid provides protection from weather and forced entry
- Heavy duty industrial lid stays open prevents accidental closure
- 4 way entry skid for easy handling.
- 16 gauge steel construction with 12 gauge feet.



50954



# TOOL STORAGE

## ROAD BOX WORK BENCH



50946B



50946RED



50923



50920



### HEAVY-DUTY ROAD BOXES - 26" AND 34"

Designed with extra heavy-duty features for mobile use in the factory or on the road in service trucks.

Product Code	Description
50947B	34" 5-Drawer Heavy Duty Road Box / Top Chest - Black
50946B	26" 5-Drawer Heavy Duty Road Box / Top Chest - Black
50946RED	26" 5-Drawer Heavy Duty Road Box / Top Chest - Red

#### 50947B Road Box Overall Dimensions

Capacity (cu. in.)	Width (inches)	Depth (inches)	Height (inches)
8882	34	17 7/8	23

#### 50947B Road Box Drawer Sizes

Number	Width (inches)	Depth (inches)	Height (inches)
3	31	16	2
2	31	16	4 1/2

#### 50946B and 50946RED Road Box Overall Dimensions

Capacity (cu. in.)	Width (inches)	Depth (inches)	Height (inches)
6749	26	17 7/8	22

#### 50946B and 50946RED Road Box Drawer Sizes

Number	Width (inches)	Depth (inches)	Height (inches)
2	23	16	4 1/4
3	23	16	2

#### Features

- Drop front panel has neoprene water & dust resistant seal.
- Shielded hinges for long life in harsh environments.
- Cushion feet pads attached to bottom for protection.
- Extra heavy duty metal with 75 lb load rating per drawer.
- Secure key internal locking system.
- 50946RED includes a padlock eye with slotted hasp provides security



### WORK BENCH

#### Heavy duty steel construction

Product Code	Width (inches)	Depth (inches)	Height (inches)
50921	71 3/4	25 3/4	34 13/16
50920	71 3/4	26 11/16	58 7/8
50922	57 1/4	25 3/4	34 7/8
50923	45 1/4	25 3/4	34 7/8
50924	36	25 3/4	34 7/8

#### Features

- 50920 includes pegboard
- Heavy duty steel construction
- High gloss powder coat scratch resistant paint
- Back and side roll-off panel prevents tools and hardware from rolling off the bench

# TOOL STORAGE

## HAND CARRY



### SUPER VALUE SERIES 26" CHEST

Product Code	Description
TB-6024RA	26" 6-Drawer Top Chest with Drop Front

#### TB-6024RA Top Chest, Overall Dimensions

Capacity (cu. in.)	Width (inches)	Depth (inches)	Height (inches)
3.073	26	12	14 ½

#### Top Chests, Drawer Sizes

Number	Width (inches)	Depth (inches)	Height (inches)
3	23	10 ½	2
3	7	10 ½	2

#### Features

- Heavy bottom support rails.
- High gloss powder coat paint is scratch & chemical resistant.
- Heavy gauge metal for a lifetime of use.
- Double wall construction for greater strength.
- Standard compound friction slides.
- TB-6024A pictured with optional tote tray.
- TTR-6024RA tote tray



TB-6024RA  
Pictured with optional tote tray TTR-6024RA



### 26" FLAT TOP TOOLBOX

Product Code	Width (Inches)	Depth (Inches)	Height (Inches)	Cubic Inch Capacity
TB-6124A	26	8 ¾	9	1980

- Ruggedly constructed hand tool box.
- Extra long tools up to 25" fit neatly inside.
- Three compartment tray with socket divider to keep small tools better organized and close at hand.
- Double drawbolts keep the lid tightly closed.
- Padlock eye with slotted hasp provides security.



TB-6124A



### 21" FLAT TOP TOOLBOX

Product Code	Width (Inches)	Depth (Inches)	Height (Inches)	Cubic Inch Capacity
TB-6121	21 ¼	8 ¾	12	1613

- Ruggedly constructed hand tool box
- Three compartment tray with socket divider to keep small tools better organized and close at hand.
- Double drawbolts keep the lid lightly closed.
- Padlock eye with slotted hasp provides security



TB-6121



# TOOL STORAGE

## HAND CARRY



TB-6123

**WILLIAMS**

### 21" FLAT TOP TOOLBOX

Product Code	Width (Inches)	Depth (Inches)	Height (Inches)	Cubic Inch Capacity
TB-6123	21	8 ¾	12	1606

- Ideal for general use
- Steel tote tray keeps smaller items handy
- Combination drawbolt and padlock eye provide security



TB-6218A

**WILLIAMS**

### 21" FOUR TRAY CANTILEVER TOOLBOX

Product Code	Width (Inches)	Depth (Inches)	Height (Inches)	Cubic Inch Capacity
TB-6218A	21 ¼	8 ¾	12	1971

- Four trays cantilever outward when box is open providing access to the exceptionally deep box.
- Two of the trays feature movable dividers and another has a protective cover to prevent small tools or parts from spilling into the box.
- Formed feet in the box bottom add to strength and keep the box away from wet, dirty surfaces.



TB-6220A

**WILLIAMS**

### 20" HIP ROOF TOOLBOX

Product Code	Width (Inches)	Depth (Inches)	Height (Inches)	Cubic Inch Capacity
TB-6220A	20	7	8	959

- Hip roof design for fitting bulky tools.
- Ideal for tradesman who carries bulky drills or ¾ inch drive sets.
- Extra large tote tray with deeper space between handle and tray bottom.
- Combination drawbolt and padlock eye provide security.

# TOOL STORAGE

## HAND CARRY / TOOL CABINETS



### 19" FLAT TOP TOOLBOX

Product Code	Width (Inches)	Depth (Inches)	Height (Inches)	Cubic Inch Capacity
TB-6119A	19	6	6 ½	741

- Ideal for general use.
- Steel tote tray keeps smaller items handy.
- Combination drawbolt and padlock eye provide security.



TB-6119A



### 16" FLAT TOP TOOLBOX WITH TRAY

Product Code	Width (Inches)	Depth (Inches)	Height (Inches)	Cubic Inch Capacity
TB-6116	16	6	6 ½	574

- Ruggedly constructed hand tool box
- Three compartment tray with socket divider to keep small tools better organized and close at hand.
- Double drawbolts keep the lid lightly closed.
- Padlock eye with slotted hasp provides security



TB-6116



### 42" COMMERCIAL SERIES TOOL CABINETS

#### 50855 Side Cabinet Overall Dimensions

Capacity (cu. in.)	Width (inches)	Depth (inches)	Height (inches)
8200	15	18 ¾	37 ½

#### 50851 Side Cabinet Overall Dimensions

Capacity (cu. in.)	Width (inches)	Depth (inches)	Height (inches)
3,921	15	18 ¾	30 ½

#### Features

- High gloss powder coat paint is scratch & chemical resistant.
- Heavy gauge metal for a lifetime of use.
- Adjustable shelf for versatile tool storage options.
- Can be used on all Williams Commercial Series roll cabinets.
- 50851 - 7-Drawer side cabinet - red only
- 50855 - Side cabinet with 1 shelf



50851



50855



# TOOL STORAGE

## HARDWOOD WORK SURFACE



50885W

WILLIAMS®

### HARDWOOD WORK SURFACE

Product Code	Width (Inches)	Depth (Inches)	Height (Inches)	Fits Roll Cabinet	Roll Cabinet Description
50111	53 3/4	24	1 1/2	50885	Heavy Duty 54"
50103	74 3/4	24	3/4	50764	Super Value 75"
50102	55	24	3/4	50765	Super Value 56"
50101	40	18	3/4	50766	Super Value 42"

#### Features

- Laminated maple, hardwood work surface 1-1/2" for the Heavy Duty Series
- Hardwood surface 3/4" used on the Super Value Series



50764W



50766W

# TOOL STORAGE

## TOTES/RAILS AND CLIPS



### TOOL TOTE BAGS

Product Code	Length (Inches)	Width (Inches)	Height (Inches)
JHW TOTE BAGA	14	11	10

#### Features

- Constructed from heavy Cordura® for maximum durability.
- Ideal for storing and toting tools, parts, and supplies.
- Heavy duty zippers for extra long life.



JHW TOTE BAGA



### METAL SOCKET SET TOOLBOXES

#### Rugged storage for Williams' premium socket sets

Product Code	Width (Inches)	Depth (Inches)	Height (Inches)	Gauge
TB-101	10	7	1 1/2	22
TB-102	13	9	1 3/4	22
TB-103	18	8	2	22
TB-104	25	9	2	20
TB-12	30 1/4	11 1/2	4 3/4	18
TB-35	14 1/2	5 1/2	1 3/4	22
TB-49	24 7/8	8 1/8	3 7/8	18

#### Features

- Ruggedly constructed for long life.
- Ideal for storing socket sets, other tools, and small parts.
- Made from cold-rolled steel.



TB-103



### METAL SOCKET RAILS AND CLIPS

Product Code	Description	Material	Length (Inches)
R-9	Socket Rail	Metal	9
R-13R	Socket Rail	Metal	13
R-17	Socket Rail	Metal	17

Product Code	Description	Material	Drive Size (Inches)
RC-25	Socket Clip	Metal	1/4
RC-37	Socket Clip	Metal	3/8
RC-50	Socket Clip	Metal	1/2
RC-75	Socket Clip	Metal	3/4

\* Socket clips sold individually

\* All rails hold any size clips



R-9





# TOOL STORAGE

## RAILS AND CLIPS POUCHES



RC-37-15P

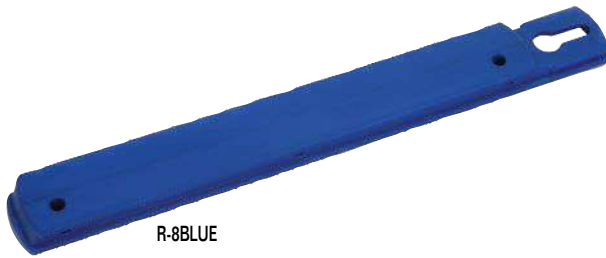

R-8BLUE



R-4A



50001A



50003A



### PLASTIC SOCKET RAILS AND CLIPS

Product Code	Description	Material	Length (Inches)
R-8BLUE	Socket Rail - Blue	Plastic	8
R-8RED	Socket Rail - Red	Plastic	8
R-13BLUE	Socket Rail - Blue	Plastic	13
R-13RED	Socket Rail - Red	Plastic	13
R-18BLUE	Socket Rail - Blue	Plastic	18
R-18RED	Socket Rail - Red	Plastic	18

Product Code	Description	Package Quantity	Drive Size (Inches)
RC-25-15P	Socket Clip	15 Pack	1/4
RC-37-15P	Socket Clip	15 Pack	3/8
RC-50-15P	Socket Clip	15 Pack	1/2

\* Socket clips sold individually

\* All rails hold any size clips



### ROLL POUCHES

#### Customize Your Own Tool Sets

Product Code	Number of Pockets	Width (Inches)	Height (Inches)
R-1A	5	6	7 1/2
R-2A	5	8	12
R-3A	5	11 1/2	15 1/2
R-4A	5	12 1/2	18 1/2
R-5A	5	16	25
R-8A	15	17 1/4	10 1/2
R-10A	10	19 3/4	17 1/4
R-11A	10	26 1/2	25
R-13A	10	34 1/2	32
R-14A	14	20 1/4	9 3/4
R-15A	8	15 1/4	16 3/4
R-20A	14	14 1/2	8
R-23A	8	23 1/4	26
R-24A	4	8 3/4	11
R-27A	17	23 1/4	17 3/4
R-28A	26	19 1/2	27
R-29A	8	11	12 3/4
R-30A	9	14 5/8	13
R-30XA	9	14 3/4	8 1/2
R-31A	6	13 1/4	16
R-36A	9	9 1/4	10 1/2
R-37A	15	37	26 1/2
R-38A	7	13	16 3/4
R-41A	11	24	20
R-42A	7	12 3/4	16
R-43A	7	13	16 1/2
R-47A	7	12 3/4	14 1/2
R-48A	3	15 1/4	9 1/4
R-49A	12	25 3/8	29

#### Features

- Heavy construction for long life.
- Ideal for storing a variety of tools such as wrenches, extensions, and ratchets.



### VINYL POUCHES

#### Customize Your Own Tool Sets

Product Code	Width (Inches)	Height (Inches)
50001A	4 1/2	12 1/2
50003A	6	15
50005A	7 1/2	19
50007A	9 1/2	19
097411A	6	3/8
099965A	9 1/2	1/8

#### Features

- Extra heavy construction with snap fastening
- Clear plastic front panels allows full visibility to tools
- Metal grommets allow pouch to be hung on pegboard

# TOOL STORAGE

## ACCESSORIES



### REPLACEMENT CASTERS

#### Heavy Duty Casters

Product Code	Type	Size	Series	Tool Storage Part #	Max Load
50938	Rigid	6 x 2	Heavy Industrial, 54", & 73"	50885, 50990	900
50939	Swivel	6 x 2		50885, 50990	900
50936	Rigid	6 x 2	Heavy Industrial, 27", 36", 41"	50887, 50888, 50890	600
50937	Swivel	6 x 2		50887, 50888, 50890	600
50934	Rigid	5 x 2	Heavy Industrial & Commercial 27" & 42"	50891, 50895, 50897, 50901, 50902, 50903	412
50935	Swivel	5 x 2		50891, 50895, 50897, 50901, 50902, 50903	412

#### Medium Duty Casters

Product Code	Type	Size	Series	Tool Storage Part #	Max Load
50932	Rigid	5 x 2	Super Value & Utility	50730, 50731, 50765, 50766, 50767, 50768, 50831, 50837	400
50933	Swivel	5 x 2		50730, 50731, 50765, 50766, 50767, 50768, 50831, 50837	400
50930	Rigid	5 x 1 1/4	Utility	50833, 50835	150
50931	Swivel	5 x 1 1/4		50833, 50835	150

#### Features

- Caster - 6" in height



### REPLACEMENT LOCK AND KEYS

Product Code	Tool Storage Product Code
50960	50742, 50743
50961	TB-6024RA, 50792, 50855
50962	50740, 50744, 50748, 50765, 50778, 50861, 50865, 50866, 50872, 50873, 50885, 50969
50963	50766, 50767, 50768, 50831, 50833, 50837, 50851, 50895, 50897, 50901
50964	50885, 50887, 50888, 50890
50965	50891
50966	50805, 50807, 50867, 50871
50967	50790, 50791, 50883, 50884, 50946
50968	50741, 50801
50969	50990, 50992
50970	50850
50971	50830
50972	50769, 50898, 50903, 50902, 50764
50963	50868
50976	50860, 50881, 50880
50974	Key Only - Professional Series
50975	Lock Only - Professional Series



# WRENCHES

## VARIETY IN STYLES AND SIZES TO ADDRESS MOST APPLICATIONS

- SUPERCOMBO® WRENCHES
- UNIQUE TUBULAR HANDLE WRENCHES
- ADJUSTABLE WRENCHES
- RATCHETING COMBINATION WRENCHES

## UNIQUE DESIGN FEATURES FOR EXTRA STRENGTH, EASY ACCESS AND COMFORT

- SPECIALLY DESIGNED GROOVES IN THE SUPERCOMBO® OPEN ENDS DIRECT FORCE AWAY FROM CORNERS
  - SUPERTORQUE® BOX OPENING DESIGN ALLOWS HIGHER TORQUE WITHOUT ROUNDING OR DEFORMING FASTENER CORNERS
- ROUND EDGE PROFILES PROVIDE A MORE COMFORTABLE GRIP TO APPLY MORE FORCE
- SATIN CHROME TEXTURED FINISH PROVIDES GREAT FEEL AND EXTRA GRIPPING POWER



COMBINATION RATCHETING  
WRENCHES



SINGLE HEAD RATCHETING  
BOX WRENCH



**WE CONTINUE TO INNOVATE TO DELIVER SAFETY  
AND PRODUCTIVITY TO OUR CUSTOMERS**

## Wrenches



### Supercombo® Wrenches

- **Open End:** SUPERCOMBO® open end has specially designed grooves that contact fasteners on the flats and direct force away from corners, eliminating corner rounding. A 45° chamfer on the jaw tips allow for easy fastener insertion.
- **Handle:** Round edge profiles eliminate sharp edges, providing a more comfortable grip to apply more force. Large stamp size in the handle allows for quick and easy identification.
- **Box End:** SUPERTORQUE® lobular box design prevents rounding of the nuts and bolt heads by providing “no contact” clearance of the corners while applying all of the wrenching force (torque) on the flat surfaces behind the corner points. Box end chamfer is designed for quick, positive placement on the fastener.

### Unique Tubular Handle Wrenches

- Wrenches may be used without the handle to quickly run down nuts. The handle can then be slipped on for final tightening or to reach otherwise inaccessible nuts.
- A “stop” on the wrench shaft helps to align locking button with handle hole.
- Offset box design provides turning clearance for hands above work surface.
- Continuous arc design distributes stress over the entire wrench opening radius for greater strength.
- Available in 3 styles — offset box, straight box and open end.
- Interchangeable handle lengths — 13", 24" and 36".
- Large size ranges from 3/4" to 3 1/8" (depending upon style).



**WARNING**



## Adjustable Wrenches

- Snap-on Industrial Brands offers the largest variety of adjustable wrenches in the industry: ergonomically designed, Big Mouth, combination adjustable pipe wrench, construction; chrome and black finish, comfort grip and standard handles.
- All models thru 18" feature measurement scale on head that conveniently shows fastener size.

## Ratcheting Combination Wrenches

- High-polished chrome finish cleans easily.
- Ratchet lever is easily accessible for quick direction changes.
- SUPERTORQUE® corners on box ends provide extra turning power.
- Available in Standard, Flex-Head and Stubby styles to suit every need.
- Fine tooth design with dual-pawl mechanism for extra strength.
- Flex-Head models feature 90 degree pivot in either direction.
- Stubby models feature extra short handles for access in tight areas.

# WRENCHES COMBINATION



## SUPERCOMBO® COMBINATION WRENCHES

High Polish Chrome and Satin Chrome Finish, 12 Point, SAE

Product Code	Size (Inches)	A	B	C	D	E
		Overall Length (Inches)	Open End Width (Inches)	Open End Thickness (Inches)	Box End Diameter (Inches)	Box End Thickness (Inches)
1208SC +	1/4	4 1/4	9/16	1/8	13/32	3/16
1210SC +	5/16	5 3/4	1 1/16	5/32	1/2	7/32
1211SC +	11/32	6 1/4	3/4	3/16	9/16	1/4
1212SC ++	3/8	6 1/2	19/16	19/16	9/16	1/4
1214SC ++	7/16	7 1/4	19/16	7/32	11/16	9/32
1216SC ++	1/2	8	1 1/16	1/4	3/4	11/32
1218SC ++	9/16	8 3/4	1 1/4	1/4	7/8	3/8
1220SC ++	5/8	9 1/2	1 3/8	9/32	15/16	13/32
1222SC ++	11/16	10 1/4	1 1/2	5/16	1 1/32	7/16
1224SC ++	3/4	11	1 5/8	5/16	1 1/8	1/2
1226SC ++	13/16	11 3/4	1 3/4	3/8	1 7/32	17/32
1228SC ++	7/8	12 1/2	1 7/8	13/32	1 5/16	9/16
1230SC ++	15/16	13 1/4	2	7/16	1 3/8	19/32
1232SC ++	1	14	2 1/8	15/32	1 15/32	5/8
1234SC ++	1 1/16	14 3/4	2 1/4	1/2	1 9/16	21/32
1236SC ++	1 1/8	15 1/2	2 13/32	17/32	1 21/32	11/16
1238SC ++	1 3/16	16 1/4	2 17/32	17/32	1 23/32	3/4
1240SC ++	1 1/4	17	2 21/32	9/16	1 13/16	3/4
1242 **	1 5/16	17 3/4	2 13/16	19/32	1 29/32	3/4
1244 **	1 3/8	18 1/2	2 15/16	5/8	2	3/4
1246 **	1 7/16	19 1/4	3 1/16	5/8	2 3/32	7/8
1248 **	1 1/2	20 1/32	3 3/16	11/16	2 3/16	7/8
1178A **	1 9/16	20 29/32	3 3/16	21/32	2 1/4	7/8
1180 **	1 5/8	21 1/2	3 5/16	11/16	2 11/32	7/8
1182 **	1 11/16	22 9/32	3 7/16	23/32	2 7/16	7/8
1184 **	1 3/4	22 7/8	3 9/16	23/32	2 17/32	1 1/32
1186 **	1 13/16	23 15/32	3 11/16	3/4	2 5/8	1 1/32
1188 **	1 7/8	24 1/32	3 13/16	23/32	2 23/32	1 1/32
1190 **	2	25 1/4	4 1/16	21/32	2 7/8	1 1/32
1191 **	2 1/16	25 13/16	4 3/16	21/32	2 31/32	1 5/32
1192 **	2 1/8	26 3/8	4 5/16	7/8	3 1/16	1 5/32
1193 **	2 3/16	26 31/32	4 7/16	29/32	3 5/32	1 5/32
1194 **	2 1/4	27 9/16	4 9/16	15/16	3 7/32	1 5/32
1195 **	2 3/8	28 3/4	4 13/16	31/32	3 13/32	1 9/32
1197 **	2 1/2	29 29/32	5 1/16	1 1/32	3 19/32	1 9/32
1198 *	2 5/8	32	6 5/8	1 7/32	4 7/8	1 5/8
1198A *	2 3/4	32	6 5/8	1 7/32	4 7/8	1 5/8
1198B *	2 7/8	32	6 5/8	1 7/32	4 7/8	1 5/8
1198C *	2 15/16	32	6 5/8	1 7/32	4 7/8	1 5/8
1199 *	3	32	6 5/8	1 7/32	4 7/8	1 5/8
1199A *	3 1/8	32	6 5/8	1 7/32	4 7/8	1 5/8
1199B *	3 3/8	31 3/8	6 5/8	1 7/32	4 7/8	1 5/8
1199C *	3 1/2	31 29/32	6 5/8	1 7/32	4 7/8	1 5/8

+ High Polish Chrome Finish with SUPERTORQUE® Box End.

++ High Polish Chrome Finish with SUPERCOMBO® Open End and SUPERTORQUE® Box End.

\*\* Satin Chrome Finish with SUPERTORQUE® Box End and Standard Open End.

\* Satin Chrome Finish with Standard Open and Box Ends.

Fed. Spec.: ANSI B107.6; SAE AS 954

### Features

- SUPERCOMBO® open end has specially designed grooves that direct wrench force away from fastener corners.
- SUPERTORQUE® box opening design allows application of higher torque without rounding or deforming hex fastener points. No contact is made at the corners. Instead, wrenching forces are placed on the flat surfaces behind the points.
- Meets or exceeds aerospace specification AS 954 for 12 point fasteners (as defined by AS 870) to provide accurate torque/tension relationship for precision application.
- May be used on all common hex (6 point) fasteners with considerable advantage over conventional box end wrenches to increase both hand tool flexibility and economy.
- Box and open end openings are identical.



Grooves in the SUPERCOMBO® open ends direct wrench force away from fastener corners.



1216SC

SUPERTORQUE® box opening design allows higher torque without rounding or deforming fastener corners by placing wrenching forces on the flat surfaces rather than the points.



1248

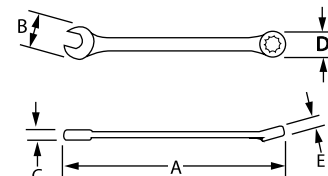

# WRENCHES COMBINATION



WS-1170SCA



WS-1171SCA



WS-1175



WS-1174TA



WS-1172SCA



WS-1190SCA

**WILLIAMS**



## SUPERCOMBO® WRENCH SETS

High Polish Chrome and Satin Chrome Finish, 12 Point, SAE  
Set Contents:

Product Code	Size (Inches)	WS-1170SCA	WS-1171SCA	WS-1172SCA	WS-1190SCA	WS-1174TA	WS-1175	WS-1176*	WS-1191SC*
		7-Piece Set in Pouch	11-Piece Set in Pouch	15-Piece Set in Pouch	26-Piece Set	10-Piece Set	6-Piece Set	16-Piece Set	32-Piece Set
1208SC	1/4				X				X
1210SC	5/16			X	X				X
1212SC	3/8	X	X	X	X				X
1214SC	7/16	X	X	X	X				X
1216SC	1/2	X	X	X	X				X
1218SC	9/16	X	X	X	X				X
1220SC	5/8	X	X	X	X				X
1222SC	11/16	X	X	X	X				X
1224SC	3/4	X	X	X	X				X
1226SC	13/16		X	X	X				X
1228SC	7/8		X	X	X				X
1230SC	15/16		X	X	X				X
1232SC	1		X	X	X				X
1234SC	1 1/16			X	X				X
1236SC	1 1/8			X	X				X
1240SC	1 1/4			X	X				X
1242	1 5/16				X	X		X	X
1244	1 3/8				X	X		X	X
1246	1 7/16				X	X		X	X
1248	1 1/2				X	X		X	X
1180	1 5/8				X	X		X	X
1182	1 11/16				X	X		X	X
1184	1 3/4				X	X		X	X
1186	1 13/16				X	X		X	X
1188	1 7/8				X	X		X	X
1190	2				X	X		X	X
1191	2 1/16						X	X	X
1192	2 1/8						X	X	X
1193	2 3/16						X	X	X
1194	2 1/4						X	X	X
1195	2 3/8						X	X	X
1197	2 1/2						X	X	X

\*NOT PICTURED

# WRENCHES COMBINATION



## SUPERCOMBO® COMBINATION WRENCHES

Black Industrial Finish, 12 Point, SAE

Product Code	Size (Inches)	A Overall Length (Inches)	B Open End Width (Inches)	C Open End Thickness (Inches)	D Box End Diameter (Inches)	E Box End Thickness (Inches)
1210BSC +	5/16	5 3/4	1 1/16	5/32	1/2	7/32
1212BSC ++	3/8	6 1/2	1 3/16	3/16	9/16	1/4
1214BSC ++	7/16	7 1/4	1 5/16	7/32	1 1/16	9/32
1216BSC ++	1/2	8	1 1/16	1/4	3/4	11/32
1218BSC ++	9/16	8 3/4	1 1/4	1/4	7/8	3/8
1220BSC ++	5/8	9 1/2	1 3/8	9/32	15/16	13/32
1222BSC ++	11/16	10 1/4	1 1/2	5/16	1 1/32	7/16
1224BSC ++	3/4	11	1 5/8	5/16	1 1/8	1/2
1226BSC ++	13/16	11 3/4	1 3/4	3/8	1 7/32	17/32
1228BSC ++	7/8	12 1/2	1 7/8	13/32	1 9/16	9/16
1230BSC ++	15/16	13 1/4	2	7/16	1 3/8	19/32
1232BSC ++	1	14	2 1/8	15/32	1 19/32	5/8
1234BSC ++	1 1/16	14 3/4	2 1/4	1/2	1 9/16	21/32
1236BSC ++	1 1/8	15 1/2	2 13/32	17/32	1 21/32	11/16
1240BSC ++	1 1/4	17	2 21/32	9/16	1 19/16	3/4
1242B **	1 5/16	17 3/4	2 13/16	19/32	1 29/32	3/4
1244B **	1 3/8	18 1/2	2 15/16	5/8	2	3/4
1246B **	1 7/16	19 1/4	3 1/16	5/8	2 3/32	7/8
1248B **	1 1/2	20 1/32	3 3/16	11/16	2 3/16	7/8
1178AB **	1 9/16	20 25/32	3 3/16	21/32	2 1/4	7/8
1180B **	1 5/8	21 1/2	3 5/16	11/16	2 11/32	7/8
1182B **	1 11/16	22 3/32	3 1/16	23/32	2 7/16	7/8
1184B **	1 3/4	22 7/8	3 9/16	23/32	2 17/32	1 1/32
1186B **	1 13/16	23 15/32	3 11/16	3/4	2 5/8	1 1/32
1188B **	1 7/8	24 1/32	3 13/16	25/32	2 23/32	1 1/32
1190B **	2	25 1/4	4 1/16	27/32	2 7/8	1 1/32
1191B **	2 1/16	25 13/16	4 3/16	27/32	2 31/32	1 5/32
1192B **	2 1/8	26 3/8	4 5/16	7/8	3 1/16	1 5/32
1193B **	2 3/16	26 31/32	4 7/16	29/32	3 5/32	1 5/32
1194B **	2 1/4	27 9/16	4 9/16	15/16	3 3/32	1 5/32
1195B **	2 3/8	28 3/4	4 13/16	31/32	3 19/32	1 9/32
1197B **	2 1/2	29 29/32	5 1/16	1 1/32	3 19/32	1 9/32
1198BL *	2 5/8	32	6 3/8	1 7/32	4 7/8	1 5/8
1198ABL *	2 3/4	32	6 5/8	1 7/32	4 7/8	1 5/8
1198BBL *	2 7/8	32	6 3/4	1 7/32	4 7/8	1 5/8
1198CBL *	2 15/16	32	6 5/8	1 7/32	4 7/8	1 5/8
1199BL *	3	32	6 5/8	1 7/32	4 7/8	1 5/8
1199ABL *	3 1/8	32	6 3/4	1 7/32	4 7/8	1 5/8
1199BBL *	3 3/8	31 29/32	6 3/4	1 7/32	4 7/8	1 5/8
1199CBL *	3 1/2	31 29/32	6 5/8	1 7/32	4 7/8	1 5/8

+ Black Industrial Finish with SUPERTORQUE® Box End

++ Black Industrial Finish with SUPERCOMBO® Open End and SUPERTORQUE® Box End

\*\* Black Industrial Finish with SUPERTORQUE® Box End and standard open end

\* Satin Chrome Finish with Standard Open and Box Ends

Fed. Spec.: ANSI B107.6; SAE AS 954

### Features

- SUPERCOMBO® open end has specially designed grooves that direct wrench force away from fastener corners.
- SUPERTORQUE® box opening design allows application of higher torque without rounding or deforming hex fastener points. No contact is made at the corners. Instead, wrenching forces are placed on the flat surfaces behind the points.
- Meets or exceeds aerospace specification AS 954 for 12 point fasteners (as defined by AS 870) to provide accurate torque/tension relationship for precision application.
- May be used on all common hex (6 point) fasteners with considerable advantage over conventional box end wrenches to increase both hand tool flexibility and economy.
- Box and open end openings are identical.



Grooves in the SUPERCOMBO® open ends direct wrench force away from fastener corners.



1216BSC



SUPERTORQUE® box opening design allows higher torque without rounding or deforming fastener corners by placing wrenching forces on the flat surfaces rather than the points.

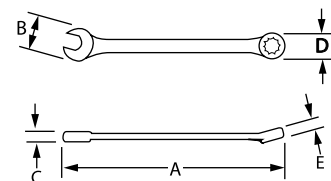



# WRENCHES COMBINATION

WILLIAMS®



## SUPERCOMBO® WRENCH SETS

Black Industrial Finish, 12 Point, SAE  
Set Contents

Product Code	Size (Inches)	WS-1170BSC	WS-1171BSC	WS-1172BSC	WS-1190BSC	WS-1174BTA
		7-Piece Set in Pouch	11-Piece Set in Pouch	15-Piece Set in Pouch	26-Piece Set	11-Piece Set
1210BSC	5/16			X	X	
1212BSC	3/8	X	X	X	X	
1214BSC	7/16	X	X	X	X	
1216BSC	1/2	X	X	X	X	
1218BSC	9/16	X	X	X	X	
1220BSC	5/8	X	X	X	X	
1222BSC	11/16	X	X	X	X	
1224BSC	3/4	X	X	X	X	
1226BSC	13/16		X	X	X	
1228BSC	7/8		X	X	X	
1230BSC	15/16		X	X	X	
1232BSC	1		X	X	X	
1234BSC	1 1/16			X	X	
1236BSC	1 1/8			X	X	
1240BSC	1 1/4			X	X	
1242B	1 5/16				X	X
1244B	1 3/8				X	X
1246B	1 7/16				X	X
1248B	1 1/2				X	X
1178AB	1 9/16				X	X
1180B	1 5/8				X	X
1182B	1 11/16				X	X
1184B	1 3/4				X	X
1186B	1 13/16				X	X
1188B	1 7/8				X	X
1190B	2				X	X



WS-1170BSC



WS-1171BSC



WS-1172BSC



WS-1174BTA



WS-1190BSC

# WRENCHES COMBINATION



## SUPERCOMBO® COMBINATION WRENCHES

High Polish Chrome Finish, 12 Point, Metric

Product Code	Size (MM)	A Overall Length (Inches)	B Open End Width (Inches)	C Open End Thickness (Inches)	D Box End Diameter (Inches)	E Box End Thickness (Inches)
1206MSC +	6	4 <sup>27</sup> / <sub>32</sub>	<sup>9</sup> / <sub>16</sub>	<sup>1</sup> / <sub>8</sub>	<sup>13</sup> / <sub>32</sub>	<sup>3</sup> / <sub>16</sub>
1207MSC ++	7	5 <sup>5</sup> / <sub>16</sub>	<sup>5</sup> / <sub>8</sub>	<sup>9</sup> / <sub>32</sub>	<sup>15</sup> / <sub>32</sub>	<sup>7</sup> / <sub>32</sub>
1208MSC ++	8	5 <sup>25</sup> / <sub>32</sub>	<sup>23</sup> / <sub>32</sub>	<sup>5</sup> / <sub>32</sub>	<sup>1</sup> / <sub>2</sub>	<sup>7</sup> / <sub>32</sub>
1209MSC ++	9	6 <sup>9</sup> / <sub>32</sub>	<sup>13</sup> / <sub>16</sub>	<sup>9</sup> / <sub>16</sub>	<sup>9</sup> / <sub>16</sub>	<sup>1</sup> / <sub>4</sub>
1210MSC ++	10	6 <sup>3</sup> / <sub>4</sub>	<sup>7</sup> / <sub>8</sub>	<sup>9</sup> / <sub>16</sub>	<sup>5</sup> / <sub>8</sub>	<sup>9</sup> / <sub>32</sub>
1211MSC ++	11	7 <sup>1</sup> / <sub>4</sub>	<sup>3</sup> / <sub>2</sub>	<sup>7</sup> / <sub>32</sub>	<sup>11</sup> / <sub>16</sub>	<sup>5</sup> / <sub>16</sub>
1212MSC ++	12	7 <sup>11</sup> / <sub>16</sub>	1 <sup>1</sup> / <sub>32</sub>	<sup>7</sup> / <sub>32</sub>	<sup>3</sup> / <sub>4</sub>	<sup>5</sup> / <sub>16</sub>
1213MSC ++	13	8 <sup>1</sup> / <sub>32</sub>	1 <sup>1</sup> / <sub>8</sub>	<sup>1</sup> / <sub>4</sub>	<sup>25</sup> / <sub>32</sub>	<sup>11</sup> / <sub>32</sub>
1214MSC ++	14	8 <sup>5</sup> / <sub>8</sub>	1 <sup>7</sup> / <sub>32</sub>	<sup>1</sup> / <sub>4</sub>	<sup>27</sup> / <sub>32</sub>	<sup>3</sup> / <sub>8</sub>
1215MSC ++	15	9 <sup>3</sup> / <sub>32</sub>	1 <sup>9</sup> / <sub>32</sub>	<sup>9</sup> / <sub>32</sub>	<sup>29</sup> / <sub>32</sub>	<sup>13</sup> / <sub>32</sub>
1216MSC ++	16	9 <sup>1</sup> / <sub>2</sub>	1 <sup>3</sup> / <sub>8</sub>	<sup>9</sup> / <sub>32</sub>	<sup>15</sup> / <sub>16</sub>	<sup>13</sup> / <sub>32</sub>
1217MSC ++	17	10 <sup>1</sup> / <sub>16</sub>	1 <sup>15</sup> / <sub>32</sub>	<sup>9</sup> / <sub>16</sub>	1	<sup>7</sup> / <sub>16</sub>
1218MSC ++	18	10 <sup>17</sup> / <sub>32</sub>	1 <sup>17</sup> / <sub>32</sub>	<sup>9</sup> / <sub>16</sub>	1 <sup>1</sup> / <sub>16</sub>	<sup>15</sup> / <sub>32</sub>
1219MSC ++	19	11 <sup>1</sup> / <sub>32</sub>	1 <sup>5</sup> / <sub>8</sub>	<sup>11</sup> / <sub>32</sub>	1 <sup>1</sup> / <sub>8</sub>	<sup>1</sup> / <sub>2</sub>
1220MSC ++	20	11 <sup>1</sup> / <sub>2</sub>	1 <sup>23</sup> / <sub>32</sub>	<sup>3</sup> / <sub>8</sub>	1 <sup>3</sup> / <sub>16</sub>	<sup>1</sup> / <sub>2</sub>
1221MSC ++	21	11 <sup>25</sup> / <sub>32</sub>	1 <sup>3</sup> / <sub>4</sub>	<sup>3</sup> / <sub>8</sub>	1 <sup>7</sup> / <sub>32</sub>	<sup>17</sup> / <sub>32</sub>
1222MSC ++	22	12 <sup>1</sup> / <sub>2</sub>	1 <sup>29</sup> / <sub>32</sub>	<sup>13</sup> / <sub>32</sub>	1 <sup>5</sup> / <sub>16</sub>	<sup>9</sup> / <sub>16</sub>
1223MSC ++	23	12 <sup>7</sup> / <sub>8</sub>	1 <sup>31</sup> / <sub>32</sub>	<sup>7</sup> / <sub>16</sub>	1 <sup>11</sup> / <sub>32</sub>	<sup>9</sup> / <sub>16</sub>
1224MSC ++	24	13 <sup>3</sup> / <sub>32</sub>	2	<sup>7</sup> / <sub>16</sub>	1 <sup>3</sup> / <sub>8</sub>	<sup>19</sup> / <sub>32</sub>
1225MSC ++	25	14 <sup>1</sup> / <sub>32</sub>	2 <sup>5</sup> / <sub>32</sub>	<sup>15</sup> / <sub>32</sub>	1 <sup>15</sup> / <sub>32</sub>	<sup>5</sup> / <sub>8</sub>
1226MSC +	26	14 <sup>9</sup> / <sub>16</sub>	2 <sup>3</sup> / <sub>16</sub>	<sup>1</sup> / <sub>2</sub>	1 <sup>1</sup> / <sub>2</sub>	<sup>21</sup> / <sub>32</sub>
1227MSC +	27	14 <sup>29</sup> / <sub>32</sub>	2 <sup>9</sup> / <sub>32</sub>	<sup>1</sup> / <sub>2</sub>	1 <sup>9</sup> / <sub>16</sub>	<sup>11</sup> / <sub>16</sub>
1229MSC +	29	15 <sup>17</sup> / <sub>32</sub>	2 <sup>13</sup> / <sub>32</sub>	<sup>17</sup> / <sub>32</sub>	1 <sup>29</sup> / <sub>32</sub>	<sup>23</sup> / <sub>32</sub>
1230MSC +	30	16 <sup>3</sup> / <sub>32</sub>	2 <sup>17</sup> / <sub>32</sub>	<sup>17</sup> / <sub>32</sub>	1 <sup>3</sup> / <sub>4</sub>	<sup>3</sup> / <sub>4</sub>
1232MSC +	32	17 <sup>1</sup> / <sub>32</sub>	2 <sup>11</sup> / <sub>16</sub>	<sup>9</sup> / <sub>16</sub>	1 <sup>13</sup> / <sub>16</sub>	<sup>3</sup> / <sub>4</sub>
1234MSC +	34	17 <sup>29</sup> / <sub>32</sub>	2 <sup>13</sup> / <sub>16</sub>	<sup>19</sup> / <sub>32</sub>	1 <sup>29</sup> / <sub>32</sub>	<sup>3</sup> / <sub>4</sub>
1236MSC +	36	19 <sup>3</sup> / <sub>32</sub>	3 <sup>1</sup> / <sub>16</sub>	<sup>21</sup> / <sub>32</sub>	2 <sup>3</sup> / <sub>32</sub>	<sup>7</sup> / <sub>8</sub>

+ High Polish Chrome Finish with SUPERTORQUE® Box End

++ High Polish Chrome Finish with SUPERCOMBO® Open End and SUPERTORQUE® Box End

Fed. Spec.: ANSI B107.6; SAE AS 954

### Features

- SUPERCOMBO® open end has specially designed grooves that direct wrench force away from fastener corners.
- SUPERTORQUE® box opening design allows application of higher torque without rounding or deforming hex fastener points. No contact is made at the corners. Instead, wrenching forces are placed on the flat surfaces behind the points.
- Meets or exceeds aerospace specification AS 954 for 12 point fasteners (as defined by AS 870) to provide accurate torque/tension relationship for precision application.
- May be used on all common hex (6 point) fasteners with considerable advantage over conventional box end wrenches to increase both hand tool flexibility and economy.
- Box and open end openings are identical.

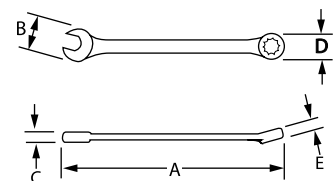
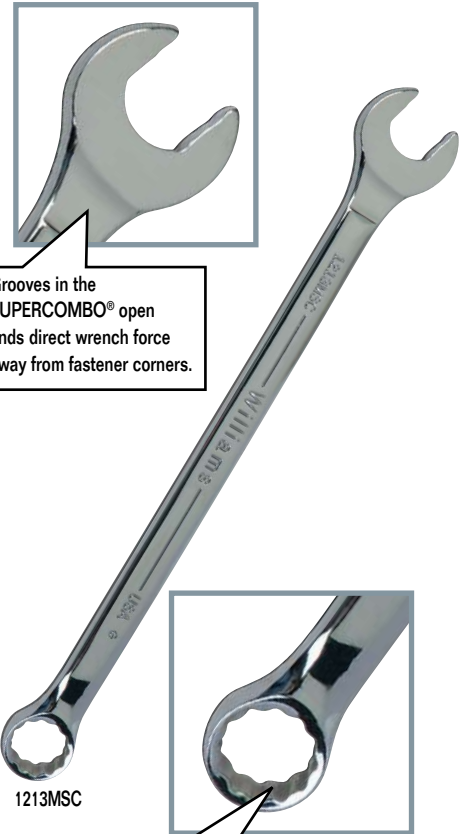

**WARNING**

# WRENCHES COMBINATION



## SUPERCOMBO® WRENCH SETS

High Polish Chrome Finish, 12 Point, Metric  
Set Contents:

Product Code	Size (MM)	MWS-1B	MWS-5A	MWS-10A	MWS-15A	MWS-18A	MWS-6A	MWS-27TA*
		8-Piece Set in Pouch	10-Piece Set in Pouch	10-Piece Set in Pouch	15-Piece Set in Pouch	18-Piece Set in Pouch	10-Piece Set in Pouch	27-Piece Set
1206MSC	6	X						X
1207MSC	7	X	X		X	X		X
1208MSC	8	X	X		X	X		X
1209MSC	9	X	X		X	X		X
1210MSC	10	X	X	X	X	X		X
1211MSC	11	X	X	X	X	X		X
1212MSC	12	X	X	X	X	X		X
1213MSC	13	X	X	X	X	X		X
1214MSC	14		X	X	X	X		X
1215MSC	15		X	X	X	X		X
1216MSC	16			X	X	X		X
1217MSC	17		X	X	X	X		X
1218MSC	18			X	X	X	X	X
1219MSC	19			X	X	X	X	X
1220MSC	20				X	X		X
1221MSC	21				X	X	X	X
1222MSC	22					X	X	X
1223MSC	23					X		X
1224MSC	24					X	X	X
1225MSC	25							X
1226MSC	26							X
1227MSC	27						X	X
1229MSC	29							X
1230MSC	30						X	X
1232MSC	32						X	X
1234MSC	34						X	X
1236MSC	36						X	X



MWS-1B



MWS-5A



MWS-10A



MWS-15A

\*NOT PICTURED



MWS-18A



MWS-6A

# WRENCHES COMBINATION



## SUPERCOMBO® COMBINATION WRENCHES

High Visibility Red Finish, 12 Point, SAE

Product Code	Size (Inches)	A	B	C	D	E
		Overall Length (Inches)	Open End Width (Inches)	Open End Thickness (Inches)	Box End Diameter (Inches)	Box End Thickness (Inches)
1212RSC ++	3/8	6 1/2	13/16	3/16	9/16	1/4
1214RSC ++	7/16	7 1/4	15/16	7/32	11/16	9/32
1216RSC ++	1/2	8	1 1/16	1/4	3/4	11/32
1218RSC ++	9/16	8 3/4	1 1/4	1/4	7/8	3/8
1220RSC ++	5/8	9 1/2	1 3/8	9/32	15/16	13/32
1222RSC ++	11/16	10 1/4	1 1/2	5/16	1 1/32	7/16
1224RSC ++	3/4	11	1 5/8	5/16	1 1/8	1/2
1226RSC ++	13/16	11 3/4	1 3/4	3/8	1 7/32	17/32
1228RSC ++	7/8	12 1/2	1 7/8	13/32	1 5/16	9/16
1230RSC ++	15/16	13 1/4	2	7/16	1 3/8	19/32
1232RSC ++	1	14	2 1/8	15/32	1 15/32	5/8
1234RSC ++	1 1/16	14 3/4	2 1/4	1/2	1 9/16	21/32
1236RSC ++	1 1/8	15 1/2	2 13/32	17/32	1 21/32	11/16
1240RSC ++	1 1/4	17	2 21/32	9/16	1 13/16	3/4

++ Hi-Vis Red Finish with SUPERCOMBO® Open End and SUPERTORQUE® Box End

Fed. Spec.: ANSI B107.6

### WS-1170RSC 7 Piece Hi-Vis Red Combination Wrench Set, 12 Point, SAE, in Pouch

Contents Include:

Product Code	Size (Inches)	Product Code	Size (Inches)	Product Code	Size (Inches)
1212RSC	3/8	1218RSC	9/16	1224RSC	3/4
1214RSC	7/16	1220RSC	5/8	Pouch	
1216RSC	1/2	1222RSC	11/16		

### WS-1171RSC 11 Piece Hi-Vis Red Combination Wrench Set, 12 Point, SAE, in Pouch

Contents Include:

Product Code	Size (Inches)	Product Code	Size (Inches)	Product Code	Size (Inches)
1212RSC	3/8	1220RSC	5/8	1228RSC	7/8
1214RSC	7/16	1222RSC	11/16	1230RSC	15/16
1216RSC	1/2	1224RSC	3/4	1232RSC	1
1218RSC	9/16	1226RSC	13/16	Pouch	

### WS-1172RSC 14 Piece Hi-Vis Red Combination Wrench Set, 12 Point, SAE, in Pouch

Contents Include:

Product Code	Size (Inches)	Product Code	Size (Inches)	Product Code	Size (Inches)
1212RSC	3/8	1222RSC	11/16	1232RSC	1
1214RSC	7/16	1224RSC	3/4	1234RSC	1 1/16
1216RSC	1/2	1226RSC	13/16	1236RSC	1 1/8
1218RSC	9/16	1228RSC	7/8	1240RSC	1 1/4
1220RSC	5/8	1230RSC	15/16	Pouch	

### Features

- SUPERCOMBO® open end has specially designed grooves that direct wrench force away from fastener corners.
- SUPERTORQUE® box opening design allows application of higher torque without rounding or deforming hex fastener points. No contact is made at the corners. Instead, wrenching forces are placed on the flat surfaces behind the points.
- Meets or exceeds aerospace specification AS 954 for 12 point fasteners (as defined by AS 870) to provide accurate torque/tension relationship for precision application.
- May be used on all common hex (6 point) fasteners with considerable advantage over conventional box end wrenches to increase both hand tool flexibility and economy.
- Box and open end openings are identical.

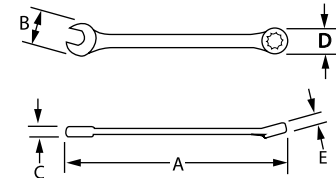
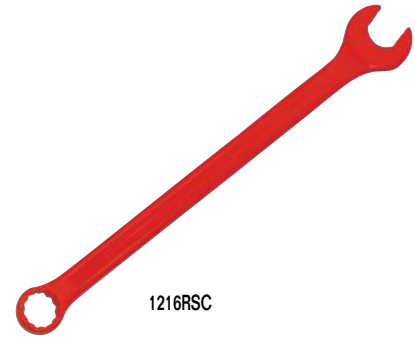

WS-1170RSC



WS-1171RSC



WS-1172RSC



# WRENCHES COMBINATION



## SUPERCOMBO® COMBINATION WRENCHES

High Visibility Yellow Finish, 12 Point, SAE

Product Code	Size (Inches)	A	B	C	D	E
		Overall Length (Inches)	Open End Width (Inches)	Open End Thickness (Inches)	Box End Diameter (Inches)	Box End Thickness (Inches)
1212YSC ++	3/8	6 1/2	13/16	3/16	9/16	1/4
1214YSC ++	7/16	7 1/4	15/16	7/32	11/16	9/32
1216YSC ++	1/2	8	1 1/16	1/4	3/4	11/32
1218YSC ++	9/16	8 3/4	1 1/4	1/4	7/8	3/8
1220YSC ++	5/8	9 1/2	1 3/8	9/32	15/16	13/32
1222YSC ++	11/16	10 1/4	1 1/2	5/16	1 1/32	7/16
1224YSC ++	3/4	11	1 5/8	5/16	1 1/8	1/2
1226YSC ++	13/16	11 3/4	1 3/4	3/8	1 7/32	17/32
1228YSC ++	7/8	12 1/2	1 7/8	13/32	1 9/16	9/16
1230YSC ++	15/16	13 1/4	2	7/16	1 3/8	19/32
1232YSC ++	1	14	2 1/8	15/32	1 15/32	5/8
1234YSC ++	1 1/16	14 3/4	2 1/4	1/2	1 9/16	21/32
1236YSC ++	1 1/8	15 1/2	2 13/32	17/32	1 21/32	11/16
1240YSC ++	1 1/4	17	2 21/32	9/16	1 13/16	3/4

++ Hi-Vis Yellow Finish with SUPERCOMBO® Open End and SUPERTORQUE® Box End  
Fed. Spec.: ANSI B107.6

### WS-1170YSC 7 Piece Hi-Vis Yellow Combination Wrench Set, 12 Point, SAE, in Pouch

Contents Include:

Product Code	Size (Inches)	Product Code	Size (Inches)	Product Code	Size (Inches)
1212YSC	3/8	1218YSC	9/16	1224YSC	3/4
1214YSC	7/16	1220YSC	5/8	Pouch	
1216YSC	1/2	1222YSC	11/16		

### WS-1171YSC 11 Piece Hi-Vis Yellow Combination Wrench Set, 12 Point, SAE, in Pouch

Contents Include:

Product Code	Size (Inches)	Product Code	Size (Inches)	Product Code	Size (Inches)
1212YSC	3/8	1220YSC	5/8	1228YSC	7/8
1214YSC	7/16	1222YSC	11/16	1230YSC	15/16
1216YSC	1/2	1224YSC	3/4	1232YSC	1
1218YSC	9/16	1226YSC	13/16	Pouch	

### WS-1172YSC 14 Piece Hi-Vis Yellow Combination Wrench Set, 12 Point, SAE, in Pouch

Contents Include:

Product Code	Size (Inches)	Product Code	Size (Inches)	Product Code	Size (Inches)
1212YSC	3/8	1222YSC	11/16	1232YSC	1
1214YSC	7/16	1224YSC	3/4	1234YSC	1 1/16
1216YSC	1/2	1226YSC	13/16	1236YSC	1 1/8
1218YSC	9/16	1228YSC	7/8	1240YSC	1 1/4
1220YSC	5/8	1230YSC	15/16	Pouch	

### Features

- SUPERCOMBO® open end has specially designed grooves that direct wrench force away from fastener corners.
- SUPERTORQUE® box opening design allows application of higher torque without rounding or deforming hex fastener points. No contact is made at the corners. Instead, wrenching forces are placed on the flat surfaces behind the points.
- Meets or exceeds aerospace specification AS 954 for 12 point fasteners (as defined by AS 870) to provide accurate torque/tension relationship for precision application.
- May be used on all common hex (6 point) fasteners with considerable advantage over conventional box end wrenches to increase both hand tool flexibility and economy.
- Box and open end openings are identical.



1216YSC



WS-1170YSC



WS-1171YSC

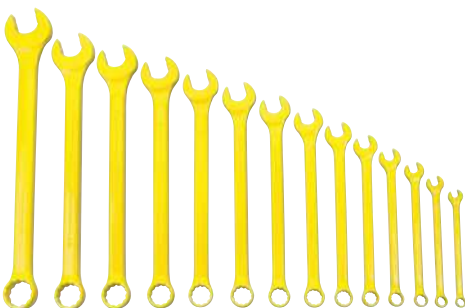

WS-1172YSC

# WRENCHES COMBINATION



## COMBINATION WRENCHES

High Polish Chrome Finish, 12 Point, SAE

Product Code	Size (Inches)	A Overall Length (Inches)	B Open End Width (Inches)	C Open End Thickness (Inches)	D Box End Diameter (Inches)	E Box End Thickness (Inches)
11208	1/4	5 1/8	9/16	5/32	7/16	7/32
11210	5/16	5 3/4	23/32	3/16	17/32	9/32
11212	3/8	6 1/2	13/16	3/16	5/8	5/16
11214	7/16	7 1/4	31/32	7/32	11/16	5/16
11216	1/2	8 1/8	1 3/32	1/4	25/32	3/8
11218	9/16	8 3/4	1 7/32	1/4	7/8	3/8
11220	5/8	9 1/2	1 3/8	9/32	31/32	7/16
11222	11/16	10 1/4	1 1/2	11/32	1 1/16	15/32
11224	3/4	11	1 5/8	3/8	1 3/32	1/2
11226	13/16	12	1 25/32	13/32	1 5/16	9/16
11228	7/8	12 3/8	1 7/8	3/8	1 11/32	9/16
11230	15/16	13 1/4	2 1/32	13/32	1 13/32	5/8
11232	1	14	2 3/32	7/16	1 1/2	11/16
11234	1 1/16	14 5/8	2 5/32	15/32	1 19/32	11/16
11236	1 1/8	16 1/4	2 9/16	1/2	1 21/32	3/4
11240	1 1/4	17	2 17/32	9/16	1 3/4	3/4



Fed. Spec.: ANSI B107.6; SAE AS 954

### 11003 9 Piece Combination Wrench Set, 12 Point, SAE, in Pouch

Contents Include:

Product Code	Size (Inches)	Product Code	Size (Inches)	Product Code	Size (Inches)
11208	1/4	11214	7/16	11220	5/8
11210	5/16	11216	1/2	11222	11/16
11212	3/8	11218	9/16	11224	3/4



### 11007 11 Piece Combination Wrench Set, 12 Point, SAE, in Pouch

Contents Include:

Product Code	Size (Inches)	Product Code	Size (Inches)	Product Code	Size (Inches)
11212	3/8	11220	5/8	11228	7/8
11214	7/16	11222	11/16	11230	15/16
11216	1/2	11224	3/4	11232	1
11218	9/16	11226	13/16		

### 11008 14 Piece Combination Wrench Set, 12 Point, SAE, in Pouch

Contents Include:

Product Code	Size (Inches)	Product Code	Size (Inches)	Product Code	Size (Inches)
11208	1/4	11220	5/8	11232	1
11210	5/16	11222	11/16	11234	1 1/16
11212	3/8	11224	3/4		
11214	7/16	11226	13/16		
11216	1/2	11228	7/8		
11218	9/16	11230	15/16		



### 11009 16 Piece Combination Wrench Set, 12 Point, SAE, in Pouch

Contents Include:

Product Code	Size (Inches)	Product Code	Size (Inches)	Product Code	Size (Inches)
11208	1/4	11220	5/8	11232	1
11210	5/16	11222	11/16	11234	1 1/16
11212	3/8	11224	3/4	11236	1 1/8
11214	7/16	11226	13/16	11240	1 1/4
11216	1/2	11228	7/8		
11218	9/16	11230	15/16		



### Features

- High polish chrome textured finish provides great feel and extra gripping power.
- 12 point box end provides easy socket engagement and maximum versatility.
- Recessed corners in box end provide extra turning power.
- Sets are packed in a pouch.

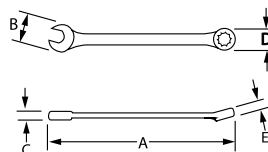

# WRENCHES COMBINATION



11610



11011



11013



11015



11017

WILLIAMS®



## COMBINATION WRENCHES

High Polish Chrome Finish, 12 Point, Metric

Product Code	Size (MM)	A	B	C	D	E
		Overall Length (Inches)	Open End Width (Inches)	Open End Thickness (Inches)	Box End Diameter (Inches)	Box End Thickness (Inches)
11606	6	5 1/8	9/16	5/32	7/16	7/32
11607	7	5 3/8	21/32	5/32	1/2	1/4
11608	8	5 3/4	23/32	3/16	17/32	9/32
11609	9	6 1/2	13/16	7/32	19/32	5/16
11610	10	6 3/4	7/8	7/32	5/8	5/16
11611	11	7 1/4	31/32	7/32	11/16	5/16
11612	12	7 3/4	1	7/32	3/4	11/32
11613	13	8 1/8	1 3/32	1/4	25/32	3/8
11614	14	8 3/4	1 7/32	1/4	7/8	3/8
11615	15	9 1/8	1 9/32	9/32	29/32	13/32
11616	16	9 1/2	1 11/32	9/32	31/32	7/16
11617	17	10 1/4	1 15/32	11/32	1 1/32	15/32
11618	18	10 1/2	1 9/16	11/32	1 3/32	1/2
11619	19	11	1 21/32	11/32	1 1/8	1/2
11620	20	11 3/8	1 11/16	3/8	1 27/32	9/16
11621	21	12	1 25/32	13/32	1 5/16	9/16
11622	22	12 1/2	1 7/8	3/8	1 9/32	9/16
11623	23	12 1/2	1 27/32	3/8	1 11/32	9/16
11624	24	13 1/4	2 1/32	13/32	1 13/32	5/8
11625	25	14	2 5/32	7/16	1 1/2	11/16
11626	26	14	2 3/32	7/16	1 1/2	11/16
11627	27	14 5/8	2 3/32	13/32	1 19/32	11/16
11629	29	16 1/4	2 5/16	1/2	1 21/32	3/4
11630	30	16 1/4	2 9/16	1/2	1 25/32	3/4
11632	32	17	2 17/32	9/16	1 3/4	3/4

Fed. Spec.: ANSI B107.6; SAE AS 954

### 11011 9 Piece Combination Wrench Set, 12 Point, Metric, in Pouch

Contents Include:

Product Code	Size (MM)	Product Code	Size (MM)	Product Code	Size (MM)
11606	6	11609	9	11612	12
11607	7	11610	10	11613	13
11608	8	11611	11	11614	14

### 11013 14 Piece Combination Wrench Set, 12 Point, Metric, in Pouch

Contents Include:

Product Code	Size (MM)	Product Code	Size (MM)	Product Code	Size (MM)
11606	6	11611	11	11616	16
11607	7	11612	12	11617	17
11608	8	11613	13	11618	18
11609	9	11614	14	11619	19
11610	10	11615	15		

### 11015 19 Piece Combination Wrench Set, 12 Point, Metric, in Pouch

Contents Include:

Product Code	Size (MM)	Product Code	Size (MM)	Product Code	Size (MM)
11606	6	11613	13	11620	20
11607	7	11614	14	11621	21
11608	8	11615	15	11622	22
11609	9	11616	16	11623	23
11610	10	11617	17	11624	24
11611	11	11618	18		
11612	12	11619	19		

### 11017 25 Piece Combination Wrench Set, 12 Point, Metric, in Pouch

Contents Include:

Product Code	Size (MM)	Product Code	Size (MM)	Product Code	Size (MM)
11606	6	11615	15	11623	23
11607	7	11616	16	11624	24
11608	8	11617	17	11625	25
11609	9	11618	18	11626	26
11610	10	11619	19	11627	27
11611	11	11620	20	11629	29
11612	12	11621	21	11630	30
11613	13	11622	22	11632	32
11614	14				

### Features

- High polish chrome textured finish provides great feel and extra gripping power.
- 12 point box end provides easy socket engagement and maximum versatility.
- Recessed corners in box end provide extra turning power.
- Sets are packed in pouch.

# WRENCHES COMBINATION



## COMBINATION WRENCHES

Satin Chrome Finish, 12 Point, SAE

Product Code	Size (Inches)	A Overall Length (Inches)	B Open End Width (Inches)	C Open End Thickness (Inches)	D Box End Diameter (Inches)	E Box End Thickness (Inches)
11108	1/4	5 1/8	9/16	5/32	7/16	7/32
11110	5/16	5 3/4	23/32	3/16	17/32	9/32
11112	3/8	6 1/2	13/16	3/16	5/8	5/16
11114	7/16	7 1/4	31/32	7/32	11/16	5/16
11116	1/2	8 1/8	1 1/32	1/4	25/32	3/8
11118	9/16	8 3/4	1 7/32	1/4	7/8	3/8
11120	5/8	9 1/2	1 3/8	9/32	31/32	7/16
11122	11/16	10 1/4	1 1/2	11/32	1 1/16	15/32
11124	3/4	11	1 5/8	3/8	1 3/32	1/2
11126	13/16	12	1 25/32	13/32	1 1/2	9/16
11128	7/8	12 3/8	1 7/8	3/8	1 11/32	9/16
11130	15/16	13 1/4	2 1/32	13/32	1 13/32	5/8
11132	1	14	2 3/32	7/16	1 1/2	11/16
11134	1 1/16	14 5/8	2 5/16	15/32	1 19/32	11/16
11136	1 1/8	16 1/4	2 9/16	1/2	1 21/32	3/4
11140	1 1/4	17	2 17/32	9/16	1 3/4	3/4
11142	1 5/16	18 1/2	2 3/4	1/2	2	11/16
11144	1 3/8	18 1/2	2 3/4	1/2	2	11/16
11146	1 7/16	20	3	1/2	2 3/16	3/4
11148	1 1/2	20	3	1/2	2 3/16	3/4
11150	1 9/16	21 5/8	3 1/4	1/2	2 3/8	3/4
11152	1 5/8	21 5/8	3 1/4	1/2	2 3/8	3/4
11154	1 11/16	21 5/8	3 1/4	1/2	2 3/8	3/4
11156	1 3/4	24	3 3/4	11/16	2 1/2	3/4
11158	1 13/16	24	3 3/4	11/16	2 1/2	3/4
11160	1 7/8	25 1/2	3 3/4	3/4	2 7/8	7/8
11164	2	25 1/2	3 3/4	3/4	2 7/8	7/8

Fed. Spec.: ANSI B107.6; SAE AS 954

### Combination Wrenches Set Contents Include:

Product Code	Size (Inches)	11002 9 Piece Set in Pouch	11004 11 Piece Set in Pouch	11005 14 Piece Set in Pouch	11006 16 Piece Set in Pouch	11019* 11 Piece Set
11108	1/4	X		X	X	
11110	5/16	X		X	X	
11112	3/8	X	X	X	X	
11114	7/16	X	X	X	X	
11116	1/2	X	X	X	X	
11118	9/16	X	X	X	X	
11120	5/8	X	X	X	X	
11122	11/16	X	X	X	X	
11124	3/4	X	X	X	X	
11126	13/16	X	X	X	X	
11128	7/8		X	X	X	
11130	15/16		X	X	X	
11132	1		X	X	X	
11134	1 1/16			X	X	
11136	1 1/8				X	
11140	1 1/4				X	
11142	1 5/16					X
11144	1 3/8					X
11146	1 7/16					X
11148	1 1/2					X
11150	1 9/16					X
11152	1 5/8					X
11154	1 11/16					X
11156	1 3/4					X
11158	1 13/16					X
11160	1 7/8					X
11164	2					X

\*NOT PICTURED

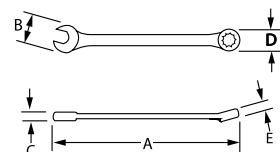
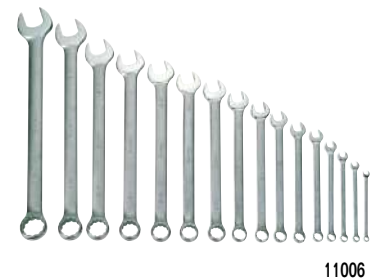
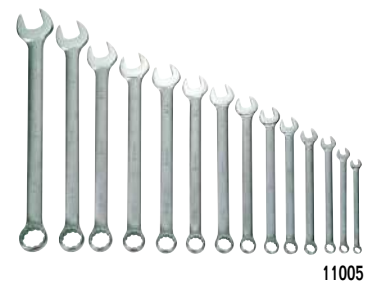

**WARNING**



# WRENCHES COMBINATION



## COMBINATION WRENCHES

Satin Chrome Finish, 12 Point, Metric



11510

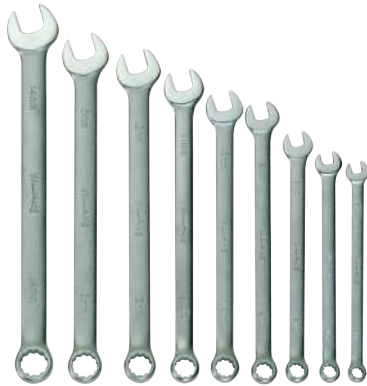

11010



11012

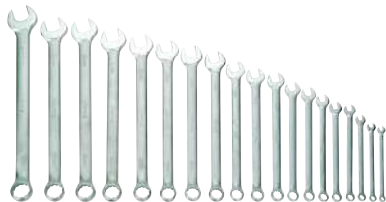

11014



11016

Product Code	Size (MM)	A Overall Length (Inches)	B Open End Width (Inches)	C Open End Thickness (Inches)	D Box End Diameter (Inches)	E Box End Thickness (Inches)
11506	6	5 1/8	9/16	5/32	7/16	7/32
11507	7	5 3/8	21/32	5/32	1/2	1/4
11508	8	5 3/4	23/32	3/16	17/32	9/32
11509	9	6 1/2	13/16	7/32	19/32	5/16
11510	10	6 3/4	7/8	7/32	5/8	5/16
11511	11	7 1/4	31/32	7/32	11/16	5/16
11512	12	7 3/4	1	7/32	3/4	11/32
11513	13	8 1/8	1 3/32	1/4	25/32	3/8
11514	14	8 3/4	1 7/32	1/4	7/8	3/8
11515	15	9 1/8	1 9/32	9/32	29/32	13/32
11516	16	9 1/2	1 11/32	9/32	31/32	7/16
11517	17	10 1/4	1 15/32	11/32	1 1/32	15/32
11518	18	10 1/2	1 9/16	11/32	1 3/32	1/2
11519	19	11	1 21/32	11/32	1 1/8	1/2
11520	20	11 3/8	1 11/16	3/8	1 27/32	9/16
11521	21	12	1 29/32	19/32	1 5/16	9/16
11522	22	12 1/2	1 7/8	3/8	1 9/32	9/16
11523	23	12 1/2	1 27/32	3/8	1 11/32	9/16
11524	24	13 1/4	2 1/32	19/32	1 13/32	5/8
11525	25	14	2 5/32	7/16	1 1/2	11/16
11526	26	14	2 9/32	7/16	1 1/2	11/16
11527	27	14 5/8	2 5/32	15/32	1 19/32	11/16
11529	29	16 1/4	2 3/16	1/2	1 21/32	3/4
11530	30	16 1/4	2 7/16	1/2	1 21/32	3/4
11532	32	17	2 11/32	9/16	1 3/4	3/4
11533	33	18 1/2	2 3/4	1/2	2	11/16
11534	34	18 1/2	2 3/4	1/2	2	11/16
11535	35	18 1/2	2 3/4	1/2	2	11/16
11536	36	20	3	1/2	2 3/16	3/4
11538	38	20	3	1/2	2 3/16	3/4
11540	40	21 5/8	3 1/4	1/2	2 3/8	3/4
11541	41	21 5/8	3 1/4	1/2	2 3/8	3/4
11542	42	21 5/8	3 1/4	1/2	2 3/8	3/4
11543	43	21 5/8	3 1/4	1/2	2 3/8	3/4
11545	45	24	3 3/8	11/16	2 1/2	3/4
11546	46	24	3 3/8	11/16	2 1/2	3/4
11548	48	25 1/2	3 3/4	3/4	2 7/8	7/8
11550	50	25 1/2	3 3/4	3/4	2 7/8	7/8

Fed. Spec.: ANSI B107.6; SAE AS 954

### Combination Wrenches Set

#### Contents Include:

Product Code	Size (MM)	11010 9 Piece Set in Pouch	11012 14 Piece Set in Pouch	11014 19 Piece Set In Pouch	11016 25 Piece Set In Pouch	11018* 13 Piece Set
11506	6	X	X	X	X	
11507	7	X	X	X	X	
11508	8	X	X	X	X	
11509	9	X	X	X	X	
11510	10	X	X	X	X	
11511	11	X	X	X	X	
11512	12	X	X	X	X	
11513	13	X	X	X	X	
11514	14	X	X	X	X	
11515	15		X	X	X	
11516	16		X	X	X	
11517	17		X	X	X	
11518	18		X	X	X	
11519	19		X	X	X	
11520	20			X	X	
11521	21			X	X	
11522	22			X	X	
11523	23			X	X	
11524	24			X	X	
11525	25				X	
11526	26				X	
11527	27				X	
11529	29				X	
11530	30				X	
11532	32				X	
11533	33					X
11534	34					X
11535	35					X
11536	36					X
11538	38					X
11540	40					X
11541	41					X
11542	42					X
11543	43					X
11545	45					X
11546	46					X
11548	48					X
11550	50					X

\*NOT PICTURED

# WRENCHES

## OFFSET COMBINATION



### OFFSET COMBINATION WRENCHES

High Polish Chrome Finish, 12 Point Offset Box End, SAE

Product Code	Size (Inches)	A	B	C	D	E
		Overall Length (Inches)	Open End Width (Inches)	Open End Thickness (Inches)	Box End Diameter (Inches)	Box End Thickness (Inches)
11950	1/4	3 3/4	9/16	5/32	13/32	5/32
11951	9/16	4 1/2	1 1/16	3/16	1/2	7/32
11970	1 1/32	5	25/32	3/16	17/32	1/4
11952	3/8	5	25/32	3/16	9/16	1/4
11953	7/16	5 3/4	15/16	3/16	5/8	1/4
11954	1/2	6 3/4	1 1/8	7/32	23/32	5/16
11955	9/16	7 1/4	1 7/32	1/4	13/16	3/8
11956	5/8	8 1/8	1 3/8	1/4	29/32	3/8
11957	1 1/16	8 3/4	1 7/16	9/32	3 1/32	13/32
11958	3/4	9 5/8	1 5/8	9/16	1 1/16	15/32
11959	13/16	10 1/2	1 2 1/32	5/16	1 5/32	15/32
11960	7/8	10 1/2	1 7/8	1 1/32	1 9/32	1/2
11961	15/16	11 3/4	2 1/32	1 1/32	1 11/32	9/16
11962	1	13	2 5/32	1 1/32	1 7/16	19/32
11963	1 1/16	13	2 9/32	3/8	1 17/32	5/8
11964	1 1/8	14 1/2	2 13/32	3/8	1 19/32	1 1/16
11965	1 1/4	15 1/4	2 2 1/32	7/16	1 25/32	23/32
11966	1 5/16	16 1/4	2 13/16	15/32	1 7/8	25/32
11967	1 3/8	16 3/8	2 13/16	15/32	1 7/8	25/32
11968	1 7/16	17	3 1/16	9/16	2 1/8	7/8
11969	1 1/2	17	3 1/16	17/32	2 3/32	27/32



11954

### 11990 9 Piece Offset Combination Wrench Set, 12 Point, SAE, in Pouch

Contents Include:

Product Code	Size (Inches)	Product Code	Size (Inches)	Product Code	Size (Inches)
11952	3/8	11955	9/16	11958	3/4
11953	7/16	11956	5/8	11959	13/16
11954	1/2	11957	1 1/16	11960	7/8

#### Features

- Unique 15° offset box end provides extra knuckle clearance.
- High-polished chrome finish cleans easily.
- 12 point box end provides maximum versatility.
- Recessed corners in box end provide extra turning power.
- Includes pouch



11990

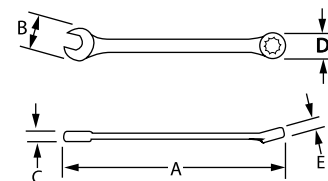

# WRENCHES

## STUBBY COMBINATION



11316



11030



11714



11032



### STUBBY COMBINATION WRENCHES

High Polish Chrome Finish, 12 Point, SAE

Product Code	Size (Inches)	A	B	C	D	E
		Overall Length (Inches)	Open End Width (Inches)	Open End Thickness (Inches)	Box End Diameter (Inches)	Box End Thickness (Inches)
11310	5/16	3 <sup>9</sup> / <sub>16</sub>	1 <sup>1</sup> / <sub>16</sub>	5/32	1/2	7/16
11312	3/8	3 <sup>3</sup> / <sub>4</sub>	1 <sup>3</sup> / <sub>16</sub>	3/16	1 <sup>9</sup> / <sub>32</sub>	1/2
11314	7/16	3 <sup>15</sup> / <sub>16</sub>	1 <sup>5</sup> / <sub>16</sub>	7/32	2 <sup>1</sup> / <sub>32</sub>	9/16
11316	1/2	4 <sup>1</sup> / <sub>4</sub>	1 <sup>1</sup> / <sub>16</sub>	1/4	3/4	1 <sup>1</sup> / <sub>16</sub>
11318	9/16	4 <sup>1</sup> / <sub>2</sub>	1 <sup>3</sup> / <sub>16</sub>	9/32	2 <sup>7</sup> / <sub>32</sub>	3/4
11320	5/8	4 <sup>3</sup> / <sub>4</sub>	1 <sup>5</sup> / <sub>16</sub>	9/32	1 <sup>5</sup> / <sub>16</sub>	13/16
11322	1 <sup>1</sup> / <sub>16</sub>	5	1 <sup>7</sup> / <sub>16</sub>	5/16	1 <sup>1</sup> / <sub>32</sub>	7/8
11324	3/4	5 <sup>7</sup> / <sub>16</sub>	1 <sup>9</sup> / <sub>16</sub>	1 <sup>1</sup> / <sub>32</sub>	1 <sup>1</sup> / <sub>8</sub>	1 <sup>5</sup> / <sub>16</sub>

Fed. Spec.: ANSI B107.6

### 11030 7 Piece Stubby Combination Wrench Set, 12 Point, SAE, in Pouch

Contents Include:

Product Code	Size (Inches)	Product Code	Size (Inches)	Product Code	Size (Inches)
11312	3/8	11318	9/16	11324	3/4
11314	7/16	11320	5/8		
11316	1/2	11322	1 <sup>1</sup> / <sub>16</sub>		

#### Features

- Extra short handle for access where clearance is limited.
- High-polished chrome finish cleans easily.
- 12 point box end provides maximum versatility.
- Recessed corners in box end provide extra turning power.



### STUBBY COMBINATION WRENCHES

High Polish Chrome Finish, 12 Point, Metric

Product Code	Size (MM)	A	B	C	D	E
		Overall Length (Inches)	Open End Width (Inches)	Open End Thickness (Inches)	Box End Diameter (Inches)	Box End Thickness (Inches)
11708	8	3 <sup>1</sup> / <sub>2</sub>	1 <sup>1</sup> / <sub>16</sub>	5/32	1/2	7/16
11710	10	3 <sup>3</sup> / <sub>4</sub>	1 <sup>3</sup> / <sub>16</sub>	7/32	1 <sup>9</sup> / <sub>32</sub>	1/2
11711	11	3 <sup>15</sup> / <sub>16</sub>	1 <sup>5</sup> / <sub>16</sub>	7/32	2 <sup>1</sup> / <sub>32</sub>	9/16
11712	12	4 <sup>1</sup> / <sub>16</sub>	1	1/4	2 <sup>1</sup> / <sub>32</sub>	5/8
11713	13	4 <sup>1</sup> / <sub>4</sub>	1 <sup>1</sup> / <sub>16</sub>	1/4	2 <sup>5</sup> / <sub>32</sub>	1 <sup>1</sup> / <sub>16</sub>
11714	14	4 <sup>1</sup> / <sub>2</sub>	1 <sup>1</sup> / <sub>8</sub>	9/32	2 <sup>7</sup> / <sub>32</sub>	1 <sup>1</sup> / <sub>16</sub>
11715	15	4 <sup>5</sup> / <sub>8</sub>	1 <sup>1</sup> / <sub>4</sub>	9/32	2 <sup>9</sup> / <sub>32</sub>	3/4
11716	16	4 <sup>3</sup> / <sub>4</sub>	1 <sup>5</sup> / <sub>16</sub>	5/16	1 <sup>5</sup> / <sub>16</sub>	13/16
11717	17	5	1 <sup>3</sup> / <sub>8</sub>	5/16	1	7/8
11718	18	5 <sup>5</sup> / <sub>16</sub>	1 <sup>7</sup> / <sub>16</sub>	5/16	1 <sup>1</sup> / <sub>32</sub>	7/8
11719	19	5 <sup>7</sup> / <sub>16</sub>	1 <sup>9</sup> / <sub>16</sub>	5/16	1 <sup>1</sup> / <sub>8</sub>	1 <sup>5</sup> / <sub>16</sub>

Fed. Spec.: ANSI B107.9M

### 11032 7 Piece Stubby Combination Wrench Set, 12 Point, Metric, in Pouch

Contents Include:

Product Code	Size (MM)	Product Code	Size (MM)	Product Code	Size (MM)
11710	10	11714	14	11718	18
11712	12	11715	15		
11713	13	11717	17		

#### Features

- Extra short handle for access where clearance is limited.
- High-polished chrome finish cleans easily.
- 12 point box end provides maximum versatility.
- Recessed corners in box end provide extra turning power.

# WRENCHES

## FLEX-HEAD



### FLEX-HEAD COMBINATION WRENCHES

High Polish Chrome Finish,  
12 Point Flex-Head Semi-Deep Socket End, SAE

Product Code	Size (Inches)	A Overall Length (Inches)	B Open End Width (Inches)	C Open End Thickness (Inches)	D Socket Diameter (Inches)	E Hex Depth (Inches)
11900	3/8	7	15/16	7/32	9/16	1/2
11901	7/16	7	15/16	7/32	5/8	17/32
11902	1/2	8	1 15/16	1/4	25/32	19/32
11903	9/16	8 3/4	1 9/32	1/4	13/16	21/32
11904	5/8	9 3/4	1 15/32	9/32	14/16	3/4
11905	11/16	9 3/4	1 15/32	9/32	15/16	3/4
11906	3/4	10 3/4	1 19/32	1/4	1	25/32

11940 7 Piece Flex-Head Combination Wrench Set, 12 Point, SAE,  
in Pouch

Contents Include:

Product Code	Size (Inches)	Product Code	Size (Inches)	Product Code	Size (Inches)
11900	3/8	11903	9/16	11906	3/4
11901	7/16	11904	5/8		
11902	1/2	11905	11/16		

#### Features

- Unique semi-deep socket end provides extra bolt clearance.
- High-polished chrome finish cleans easily.
- 12 point socket end provides maximum versatility.
- Recessed corners in socket end provide extra turning power.
- Includes pouch



11900



11940



### DOUBLE FLEX-HEAD WRENCHES

High Polish Chrome Finish, 12 Point Flex-Head Semi-Deep  
Socket End, SAE

Product Code	Size (Inches)	A Overall Length (Inches)	B Socket Diameter (Inches)	C Hex Depth (Inches)	D Socket Diameter (Inches)	E Hex Depth (Inches)
12601	3/8 x 7/16	7 13/16	9/16	15/32	5/8	17/32
12603	1/2 x 9/16	9 3/4	23/32	5/8	13/16	21/32
12605	5/8 x 11/16	10	27/32	23/32	15/16	3/4
12607	3/4 x 7/8	12	1	3/4	1 5/32	29/32

12691 4 Piece Double Flex-Head Wrench Set, 12 Point, SAE, in Pouch

Contents Include:

Product Code	Size (Inches)	Product Code	Size (Inches)
12601	3/8 x 7/16	12605	5/8 x 11/16
12603	1/2 x 9/16	12607	3/4 x 7/8

#### Features

- Unique semi-deep socket end provides extra bolt clearance.
- High-polished chrome finish cleans easily.
- 12 point socket end provides maximum versatility.
- Recessed corners in socket end provide extra turning power.



12607



12691



# WRENCHES

## RATCHETING COMBINATION



1216RCF



WS-1168RCF



1213MRCF



MWS-12RCF



### FLEX-HEAD REVERSIBLE RATCHETING COMBINATION WRENCHES

High Polish Chrome Finish, 12 Point, SAE

Product Code	Size (Inches)	A	B	C	D	E
		Overall Length (Inches)	Open End Width (Inches)	Open End Thickness (Inches)	Box End Diameter (Inches)	Box End Thickness (Inches)
1210RCF	5/16	5 1/2	23/32	5/32	23/32	1/4
1212RCF	3/8	6 5/16	29/32	7/32	7/8	5/16
1214RCF	7/16	6 11/16	31/32	7/32	29/32	11/32
1216RCF	1/2	7 1/4	1 1/32	1/4	1	13/32
1218RCF	9/16	7 19/32	1 3/16	1/4	1 3/32	13/32
1220RCF	5/8	8 13/32	1 3/8	9/32	1 1/4	7/16
1222RCF	11/16	9	1 19/32	9/32	1 9/32	1/2
1224RCF	3/4	10	1 9/16	11/32	1 15/32	1/2

### WS-1168RCF 8 Piece Reversible Flex-Head Ratcheting Combination Wrench Set, SAE, in Plastic Tray

Contents Include:

Product Code	Size (Inches)	Product Code	Size (Inches)	Product Code	Size (Inches)
1210RCF	5/16	1216RCF	1/2	1222RCF	11/16
1212RCF	3/8	1218RCF	9/16	1224RCF	3/4
1214RCF	7/16	1220RCF	5/8		

#### Features

- Flex-Head pivots 90° in either direction for access in tight areas.
- Fine tooth design with dual-pawl mechanism for extra strength.
- High-polished chrome finish cleans easily.
- Ratchet lever is easily accessible for quick direction changes.
- Recessed corners in ends provide extra turning power.



### FLEX-HEAD REVERSIBLE RATCHETING COMBINATION WRENCHES

High Polish Chrome Finish, 12 Point, Metric

Product Code	Size (MM)	A	B	C	D	E
		Overall Length (Inches)	Open End Width (Inches)	Open End Thickness (Inches)	Box End Diameter (Inches)	Box End Thickness (Inches)
1208MRCF	8	5 9/16	23/32	5/32	23/32	9/32
1209MRCF	9	6	13/16	5/32	25/32	5/16
1210MRCF	10	6 7/16	29/32	7/32	27/32	5/16
1211MRCF	11	6 3/4	31/32	7/32	29/32	11/32
1212MRCF	12	7	1 1/32	7/32	31/32	3/8
1213MRCF	13	7 11/16	1 1/16	1/4	1	13/32
1214MRCF	14	7 19/32	1 3/16	1/4	1 3/32	13/32
1215MRCF	15	8	1 1/4	9/32	1 5/32	7/16
1216MRCF	16	8 9/16	1 3/8	9/32	1 7/32	7/16
1217MRCF	17	9	1 15/32	9/32	1 9/32	1/2
1218MRCF	18	9 1/2	1 9/16	5/16	1 3/8	1/2
1219MRCF	19	10	1 9/16	11/32	1 15/32	17/32

### MWS-12RCF 12 Piece Reversible Flex-Head Ratcheting Combination Wrench Set, Metric, in Plastic Tray

Contents Include:

Product Code	Size (MM)	Product Code	Size (MM)	Product Code	Size (MM)
1208MRCF	8	1212MRCF	12	1216MRCF	16
1209MRCF	9	1213MRCF	13	1217MRCF	17
1210MRCF	10	1214MRCF	14	1218MRCF	18
1211MRCF	11	1215MRCF	15	1219MRCF	19

#### Features

- Flex-Head pivots 90° in either direction for access in tight areas.
- Fine tooth design with dual-pawl mechanism for extra strength.
- High-polished chrome finish cleans easily.
- Ratchet lever is easily accessible for quick direction changes.
- Recessed corners in ends provide extra turning power.

# WRENCHES

## RATCHETING COMBINATION



### REVERSIBLE RATCHETING COMBINATION WRENCHES

High Polish Chrome Finish, 12 Point, SAE

Product Code	Size (Inches)	A Overall Length (Inches)	B Open End Width (Inches)	C Open End Thickness (Inches)	D Box End Diameter (Inches)	E Box End Thickness (Inches)
1208RC	1/4	4 1/2	2 1/32	5/32	2 1/32	9/32
1210RC	3/16	5 1/4	2 3/32	5/32	2 3/32	9/32
1212RC	3/8	6 1/4	7/8	3/16	7/8	5/16
1214RC	7/16	6 3/8	1 5/16	7/32	2 9/32	1 1/32
1216RC	1/2	7	1 1/32	1/4	1	1 3/32
1218RC	9/16	7 3/8	1 3/16	1/4	1 3/32	1 3/32
1220RC	5/8	8 7/32	1 11/32	9/32	1 7/32	7/16
1222RC	1 1/16	9	1 7/16	9/32	1 11/16	1/2
1224RC	3/4	9 3/4	1 17/32	1 1/32	1 15/32	17/32
1226RC	13/16	10 1/2	1 23/32	3/8	1 9/16	17/32
1228RC	7/8	11 13/32	1 7/8	1 1/32	1 21/32	1 9/32
1230RC	15/16	12	1 31/32	1 5/32	1 27/32	5/8
1232RC	1	13	2 3/32	1 5/32	1 7/8	5/8



1226RC

### WS-1168RC 8 Piece Reversible Ratcheting Combination Wrench Set, SAE, in Plastic Tray

Contents Include:

Product Code	Size (Inches)	Product Code	Size (Inches)	Product Code	Size (Inches)
1210RC	5/16	1216RC	1/2	1222RC	1 1/16
1212RC	3/8	1218RC	9/16	1224RC	3/4
1214RC	7/16	1220RC	5/8		



WS-1168RC

### WS-1164RC 4 Piece Reversible Ratcheting Combination Wrench Set, SAE, in Plastic Tray

Contents Include:

Product Code	Size (Inches)	Product Code	Size (Inches)
1226RC	13/16	1230RC	15/16
1228RC	7/8	1232RC	1



WS-1164RC

### Features

- High-polished chrome finish cleans easily.
- Ratchet lever is easily accessible for quick direction changes.
- Recessed corners in ends provide extra turning power.

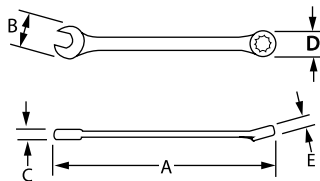

# WRENCHES

## RATCHETING COMBINATION



### REVERSIBLE RATCHETING COMBINATION WRENCHES

High Polish Chrome Finish, 12 Point, Metric

Product Code	Size (MM)	A	B	C	D	E
		Overall Length (Inches)	Open End Width (Inches)	Open End Thickness (Inches)	Box End Diameter (Inches)	Box End Thickness (Inches)
1206MRC	6	4 1/2	21/32	5/32	21/32	1/4
1208MRC	8	5 1/4	23/32	3/16	23/32	9/32
1209MRC	9	5 7/8	13/16	5/32	25/32	5/16
1210MRC	10	6 1/4	7/8	7/32	7/8	11/32
1211MRC	11	6 5/8	15/16	7/32	29/32	11/32
1212MRC	12	6 13/16	1	7/32	31/32	3/8
1213MRC	13	7	1 1/32	1/4	1	13/32
1214MRC	14	7 3/8	1 3/16	1/4	1 3/32	13/32
1215MRC	15	7 3/4	1 1/4	9/32	1 5/32	7/16
1216MRC	16	8 3/16	1 11/32	9/32	1 7/32	7/16
1217MRC	17	9	1 7/16	9/32	1 9/32	1/2
1218MRC	18	9 3/8	1 17/32	5/16	1 3/8	15/32
1219MRC	19	9 3/4	1 17/32	11/32	1 7/16	17/32
1221MRC	21	10 3/4	1 23/32	3/8	1 9/16	9/16
1222MRC	22	11 1/4	1 27/32	3/8	1 21/32	19/32
1224MRC	24	12	1 31/32	15/32	1 27/32	5/8
1225MRC	25	12 3/32	2 3/32	15/32	1 7/8	5/8



1219MRC

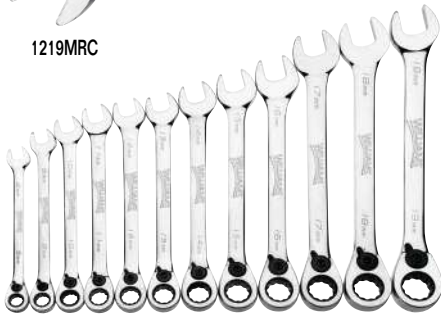

MWS-12RC



MWS-4RC

### MWS-12RC 12 Piece Reversible Ratcheting Combination Wrench Set, Metric, in Plastic Tray

Contents Include:

Product Code	Size (MM)	Product Code	Size (MM)	Product Code	Size (MM)
1208MRC	8	1212MRC	12	1216MRC	16
1209MRC	9	1213MRC	13	1217MRC	17
1210MRC	10	1214MRC	14	1218MRC	18
1211MRC	11	1215MRC	15	1219MRC	19

### MWS-4RC 4 Piece Reversible Ratcheting Combination Wrench Set, Metric, in Pouch

Contents Include:

Product Code	Size (MM)	Product Code	Size (MM)
1221MRC	21	1224MRC	24
1222MRC	22	1225MRC	25

### Features

- High-polished chrome finish cleans easily.
- Ratchet lever is easily accessible for quick direction changes.
- Recessed corners in ends provide extra turning power.



### 4 PIECE RATCHETING ADAPTOR SET

Product Code	Description
WS-4RWA	4 Piece Ratcheting Adaptor Set

Contents Include:

Description	Description
1/4" Drive male Adaptor	3/8" Drive Male Adaptor
1/4" Hex Shank Coupler	1/2" Drive Male Adaptor

### Features

- Converts a ratcheting wrench into a ratchet.
- To be used with Ratcheting Combination Wrenches
- Allows the use of hex bits, 1/4", 3/8", 1/2" Drive Sockets
- Adaptor locks into the wrench by twisting the top cap.
- Push-button socket release



WS-4RWA

# WRENCHES

## RATCHETING COMBINATION



### COMBINATION RATCHETING WRENCHES

High Polish Chrome Finish, 12 Point, SAE

Product Code	Size (Inches)	A Overall Length (Inches)	B Open End Width (Inches)	C Open End Thickness (Inches)	D Box End Diameter (Inches)	E Box End Thickness (Inches)
1208NRC	1/4"	5 1/2	3/4	1/4	3/4	1/4
1210NRC	5/16"	5 1/2	3/4	1/4	3/4	1/4
1212NRC	3/8"	6 1/2	3/4	1/4	3/4	1/4
1214NRC	7/16"	6 1/2	1	1/4	3/4	1/4
1216NRC	1/2"	7	1	1/4	1	1/4
1218NRC	9/16"	7 1/2	1 1/4	1/2	1	1/4
1220NRC	5/8"	8 1/2	1 5/16	1/2	1 1/4	3/8
1222NRC	11/16"	9	1 1/2	1/2	1 5/16	3/8
1224NRC	3/4"	10	1 1/2	5/8	1 5/16	3/8
1226NRC	13/16"	11 1/4	1 3/4	5/8	1 5/8	1/2
1228NRC	7/8"	11 1/4	1 3/4	5/8	1 5/8	1/2
1230NRC	15/16"	13	2	5/8	1 3/4	1/2
1232NRC	1"	13	2	5/8	1 3/4	1/2
1234NRC	1 1/16"	14	2 1/8	1/2	2	1/2
1236NRC	1 1/8"	16 3/4	2 1/2	1/2	2 5/16	5/8
1238NRC	1 1/4"	16 3/4	2 1/2	1/2	2 5/16	5/8

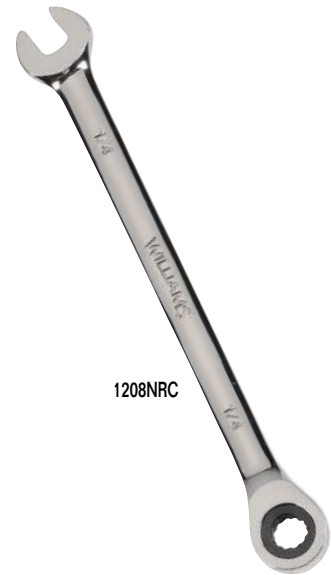

1208NRC

#### Features

- 72-tooth gear requires only 5° of ratcheting arc to engage next gear
- High polish satin-chrome finish cleans easily & protects against corrosion
- Thin profile is perfect for tight clearances where accessibility is critical
- 12-point ratcheting box end allows for superior fastener engagement

#### WS-1120NRC 9 Piece Combination Wrench, in Pouch

##### Contents Include:

Product Code	Size (Inches)	Product Code	Size (Inches)
1208NRC	1/4"	1218NRC	9/16"
1210NRC	5/16"	1220NRC	5/8"
1212NRC	3/8"	1222NRC	11/16"
1214NRC	7/16"	1224NRC	3/4"
1216NRC	1/2"		



WS-1120NRC

#### WS-1121NRC 11 Piece Combination Wrench, in Pouch

##### Contents Include:

Product Code	Size (Inches)	Product Code	Size (Inches)	Product Code	Size (Inches)
1212NRC	3/8"	1220NRC	5/8"	1228NRC	7/8"
1214NRC	7/16"	1222NRC	11/16"	1230NRC	15/16"
1216NRC	1/2"	1224NRC	3/4"	1232NRC	1"
1218NRC	9/16"	1226NRC	13/16"		



WS-1121NRC

#### WS-1122NRC 16 Piece Combination Wrench, in Pouch

##### Contents Include:

Product Code	Size (Inches)	Product Code	Size (Inches)	Product Code	Size (Inches)
1208NRC	1/4"	1220NRC	5/8"	1232NRC	1"
1210NRC	5/16"	1222NRC	11/16"	1234NRC	1 1/16"
1212NRC	3/8"	1224NRC	3/4"	1236NRC	1 1/8"
1214NRC	7/16"	1226NRC	13/16"	1238NRC	1 1/4"
1216NRC	1/2"	1228NRC	7/8"		
1218NRC	9/16"	1230NRC	15/16"		



WS-1122NRC





# WRENCHES

## RATCHETING COMBINATION

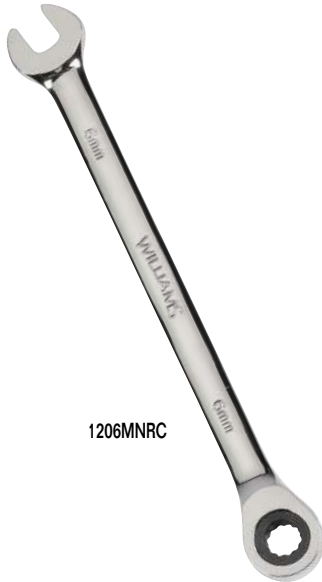

1206MNRC



### COMBINATION RATCHETING WRENCHES

High Polish Chrome Finish, 12 Point, MM

Product Code	Size (Inches)	A Overall Length (Inches)	B Open End Width (Inches)	C Open End Thickness (Inches)	D Box End Diameter (Inches)	E Box End Thickness (Inches)
1206MNRC	6	5 3/8	3/4	1/4	1/4	1/4
1207MNRC	7	5 3/8	3/4	1/4	1/4	1/4
1208MNRC	8	5 3/8	3/4	1/4	1/4	1/4
1209MNRC	9	5 3/8	3/4	1/4	1/4	1/4
1210MNRC	10	6 1/2	7/8	1/4	7/8	1/4
1211MNRC	11	6 5/8	1	1/4	7/8	3/8
1212MNRC	12	6 7/8	1	1/4	1	3/8
1213MNRC	13	7 1/8	1	1/4	1	3/8
1214MNRC	14	7 5/8	1 1/4	3/8	1	3/8
1215MNRC	15	7 7/8	1 1/8	3/8	1	3/8
1216MNRC	16	8 1/2	1 1/8	3/8	1 1/4	3/8
1217MNRC	17	9 1/8	1 1/2	3/8	1 1/4	3/8
1218MNRC	18	9 3/8	1 1/2	3/8	1 1/4	1/2
1219MNRC	19	9 7/8	1 5/8	3/8	1 1/4	1/2
1220MNRC	20	11	1 7/8	3/8	1 5/8	1/2
1221MNRC	21	11	1 7/8	3/8	1 5/8	1/2
1222MNRC	22	11	1 7/8	3/8	1 5/8	1/2
1223MNRC	23	11	1 7/8	3/8	1 5/8	1/2
1224MNRC	24	12 3/4	2	3/8	1 7/8	1/2
1225MNRC	25	12 3/4	2	3/8	1 7/8	1/2
1226MNRC	26	12 3/4	2	3/8	1 7/8	1/2
1227MNRC	27	14 1/8	2 1/8	1/2	2	1/2
1228MNRC	28	14 1/8	2 1/8	1/2	2	1/2
1230MNRC	30	16 3/4	2 1/2	1/2	2 3/8	5/8
1232MNRC	32	16 3/4	2 1/2	1/2	2 3/8	5/8



MWS-1123NRC

#### Features

- 72-tooth gear requires only 5° of ratcheting arc to engage next gear
- High polish satin-chrome finish cleans easily & protects against corrosion
- Thin profile is perfect for tight clearances where accessibility is critical
- 12-point ratcheting box end allows for superior fastener engagement

#### MWS-1123NRC 9 Piece Combination Wrench, in Pouch

Contents Include:

Product Code	Size (MM)	Product Code	Size (MM)	Product Code	Size (MM)
1206MNRC	6	1209MNRC	9	1212MNRC	12
1207MNRC	7	1210MNRC	10	1213MNRC	13
1208MNRC	8	1211MNRC	11	1214MNRC	14



MWS-1124NRC

#### MWS-1124NRC 14 Piece Combination Wrench, in Pouch

Contents Include:

Product Code	Size (MM)	Product Code	Size (MM)	Product Code	Size (MM)	Product Code	Size (MM)
1206MNRC	6	1210MNRC	10	1214MNRC	14	1218MNRC	18
1207MNRC	7	1211MNRC	11	1215MNRC	15	1219MNRC	19
1208MNRC	8	1212MNRC	12	1216MNRC	16		
1209MNRC	9	1213MNRC	13	1217MNRC	17		



MWS-1125NRC

#### MWS-1125NRC 19 Piece Combination Wrench, in Pouch

Contents Include:

Product Code	Size (MM)	Product Code	Size (MM)	Product Code	Size (MM)	Product Code	Size (MM)
1206MNRC	6	1211MNRC	11	1216MNRC	16	1221MNRC	21
1207MNRC	7	1212MNRC	12	1217MNRC	17	1222MNRC	22
1208MNRC	8	1213MNRC	13	1218MNRC	18	1223MNRC	23
1209MNRC	9	1214MNRC	14	1219MNRC	19	1224MNRC	24
1210MNRC	10	1215MNRC	15	1220MNRC	20		



MWS-1126NRC

#### MWS-1126NRC 25 Piece Combination Wrench, in Pouch

Contents Include:

Product Code	Size (MM)	Product Code	Size (MM)	Product Code	Size (MM)	Product Code	Size (MM)	Product Code	Size (MM)
1206MNRC	6	1211MNRC	11	1216MNRC	16	1221MNRC	21	1226MNRC	26
1207MNRC	7	1212MNRC	12	1217MNRC	17	1222MNRC	22	1227MNRC	27
1208MNRC	8	1213MNRC	13	1218MNRC	18	1223MNRC	23	1228MNRC	28
1209MNRC	9	1214MNRC	14	1219MNRC	19	1224MNRC	24	1230MNRC	30
1210MNRC	10	1215MNRC	15	1220MNRC	20	1225MNRC	25	1232MNRC	32

# WRENCHES

## RATCHETING COMBINATION



### STUBBY REVERSIBLE RATCHETING COMBINATION WRENCHES

High Polish Chrome Finish, 12 Point, SAE

Product Code	Size (Inches)	A	B	C	D	E
		Overall Length (Inches)	Open End Width (Inches)	Open End Thickness (Inches)	Box End Diameter (Inches)	Box End Thickness (Inches)
1210RCS	5/16	3 1/2	23/32	5/32	23/32	9/32
1212RCS	3/8	3 29/32	7/8	9/16	7/8	11/32
1214RCS	7/16	4	31/32	7/32	7/8	11/32
1216RCS	1/2	4 1/2	1 1/16	1/4	1	13/32
1218RCS	9/16	4 11/16	1 3/16	1/4	1 3/32	13/32
1220RCS	5/8	5	1 11/32	9/32	1 7/32	15/32
1222RCS	11/16	5 1/4	1 1/2	9/32	1 5/16	1/2
1224RCS	3/4	5 1/2	1 19/32	11/32	1 15/32	17/32

### WS-1168RCS 8 Piece Reversible Stubby Ratcheting Combination Wrench Set, SAE, in Plastic Tray

Contents Include:

Product Code	Size (Inches)	Product Code	Size (Inches)	Product Code	Size (Inches)
1210RCS	5/16	1216RCS	1/2	1222RCS	11/16
1212RCS	3/8	1218RCS	9/16	1224RCS	3/4
1214RCS	7/16	1220RCS	5/8		

#### Features

- Fine tooth design with dual-pawl mechanism for extra strength.
- High-polished chrome finish cleans easily.
- Ratchet lever is easily accessible for quick direction changes.
- Recessed corners in ends provide extra turning power.



1216RCS



WS-1168RCS

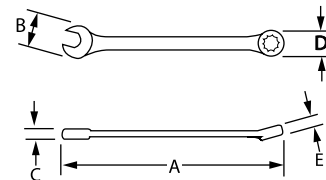

### STUBBY REVERSIBLE RATCHETING COMBINATION WRENCHES

High Polish Chrome Finish, 12 Point, Metric

Product Code	Size (MM)	A	B	C	D	E
		Overall Length (Inches)	Open End Width (Inches)	Open End Thickness (Inches)	Box End Diameter (Inches)	Box End Thickness (Inches)
1208MRCS	8	3 1/2	23/32	5/32	23/32	9/32
1209MRCS	9	3 3/4	13/16	9/32	3/4	9/16
1210MRCS	10	3 27/32	7/8	9/16	7/8	11/32
1211MRCS	11	4 1/8	31/32	7/32	29/32	11/32
1212MRCS	12	4 1/4	1	7/32	15/16	3/8
1213MRCS	13	4 1/2	1	1/4	1	13/32
1214MRCS	14	4 11/16	1 5/32	1/4	1 3/32	13/32
1215MRCS	15	4 29/32	1 1/4	9/32	1 5/32	7/16
1216MRCS	16	5	1 3/8	9/32	1 1/4	15/32
1217MRCS	17	5 5/32	1 7/16	9/32	1 9/32	1/2
1218MRCS	18	5 1/4	1 1/2	9/16	1 3/8	1/2
1219MRCS	19	5 1/2	1 9/16	11/32	1 15/32	17/32

### MWS-12RCS 12 Piece Reversible Stubby Ratcheting Combination Wrench Set, Metric, in Plastic Tray

Contents Include:

Product Code	Size (MM)	Product Code	Size (MM)	Product Code	Size (MM)
1208MRCS	8	1212MRCS	12	1216MRCS	16
1209MRCS	9	1213MRCS	13	1217MRCS	17
1210MRCS	10	1214MRCS	14	1218MRCS	18
1211MRCS	11	1215MRCS	15	1219MRCS	19

#### Features

- Fine tooth design with dual-pawl mechanism for extra strength.
- High-polished chrome finish cleans easily.
- Ratchet lever is easily accessible for quick direction changes.
- Recessed corners in ends provide extra turning power.



1213MRCS



MWS-12RCS



# WRENCHES

## DOUBLE OPEN END



1037



WS-1705A



WS-1710A



### DOUBLE HEAD OPEN END WRENCHES

Chrome Satin Finish, SAE

Product Code	Size (Inches)	A	B	C	D	E
		Overall Length (Inches)	Open End Width (Inches)	Open End Thickness (Inches)	Open End Width (Inches)	Open End Thickness (Inches)
1020	1/4 x 5/16	4 1/16	9/16	5/32	11/16	3/16
1721	3/16 x 3/8	4 11/16	1 1/16	5/32	13/16	3/16
1723	3/8 x 7/16	5 5/16	1 3/16	3/16	15/16	7/32
1725	7/16 x 1/2	5 31/32	3/32	7/32	1 1/16	1/4
1725B	1/2 x 9/16	6 19/32	1 1/16	1/4	1 3/16	9/32
1727	9/16 x 5/8	7 9/32	1 3/16	9/32	1 5/16	9/32
1027B	5/8 x 11/16	7 31/32	1 5/16	5/16	1 7/16	5/16
1729	5/8 x 3/4	8 9/32	1 5/16	9/32	1 9/16	11/32
1729B	11/16 x 3/4	8 21/32	1 7/16	5/16	1 9/16	11/32
1731	3/4 x 13/16	9 11/32	1 9/16	11/32	1 11/16	3/8
1731A	3/4 x 7/8	9 11/16	1 19/32	11/32	1 27/32	3/8
1731B	13/16 x 7/8	10 1/32	1 11/16	3/8	1 13/16	9/32
1033A	7/8 x 15/16	10 3/4	1 13/16	3/8	1 15/16	13/32
1033C	15/16 x 1	11 1/2	1 15/16	13/32	2 1/32	13/32
1037	1 1/16 x 1 1/4	12 19/16	2 3/16	7/16	2 17/32	1/2
1037B	1 1/8 x 1 3/16	13 29/32	2 5/16	15/32	2 7/16	15/32
1038	1 1/4 x 1 5/16	15 9/32	2 9/16	1/2	2 11/16	17/32
1038A	1 3/8 x 1 7/16	16 7/8	2 13/16	17/32	2 15/16	17/32
1039B	1 1/2 x 1 5/8	18 29/32	3 1/16	9/16	3 5/16	19/32

Fed. Spec. ANSI B107.6

#### WS-1705A 5 Piece Double Head Open End Wrench Set, SAE, in Pouch

Contents Include:

Product Code	Size (Inches)	Product Code	Size (Inches)	Product Code	Size (Inches)
1723	3/8 x 7/16	1727	9/16 x 5/8	1731B	13/16 x 7/8
1725B	1/2 x 9/16	1729B	11/16 x 3/4		

#### WS-1710A 10 Piece Double Head Open End Wrench Set, SAE, in Pouch

Contents Include:

Product Code	Size (Inches)	Product Code	Size (Inches)	Product Code	Size (Inches)
1020	1/4 x 5/16	1727	9/16 x 5/8	1037	1 1/16 x 1 1/4
1723	3/8 x 7/16	1729B	11/16 x 3/4	1037B	1 1/8 x 1 3/16
1725	7/16 x 1/2	1731B	13/16 x 7/8		
1725B	1/2 x 9/16	1033C	15/16 x 1		

#### Features

- Two openings in each wrench with 45° chamfer on wrench ends allow easy placement of wrench on the fastener.
- Continuous arc design minimizes spreading and is stronger than "V" design.
- Satin chrome finish provides good grip and cleans easily.

# WRENCHES

## DOUBLE OPEN END



### 15°-60° DOUBLE OPEN END ANGLE-HEAD WRENCHES

Chrome Satin Finish, SAE

Product Code	Size (Inches)	A Head Diameter	B Head Thickness	C Overall Length (Inches)
3712	3/8	25/32	7/32	4 3/4
3714	7/16	7/8	7/32	5
3716	1/2	1	7/32	5 1/2
3718	9/16	1 1/8	1/4	6
3720	5/8	1 3/16	9/32	6 1/4
3722	11/16	1 5/16	9/32	7
3724	3/4	1 7/16	9/32	7 1/4
3726	13/16	1 19/32	9/32	7 1/2
3728	7/8	1 21/32	9/32	8 1/4
3730	15/16	1 25/32	9/16	9 1/16
3732	1	1 15/16	5/16	9 3/4
3734	1 1/16	2 1/16	9/16	10
3736	1 1/8	2 1/4	5/16	11
3740	1 1/4	2 3/8	11/32	11 1/2
3744	1 3/8	2 11/16	13/32	12 1/2
3746	1 7/16	2 11/16	13/32	12 1/2
3748	1 1/2	2 11/16	13/32	12 1/2
3752	1 5/8	3 13/64	15/32	15 3/4
3754	1 11/16	3 11/32	1/2	16 1/2
3756	1 3/4	3 7/16	17/32	17
3758	1 13/16	3 9/16	17/32	17 3/4
3760	1 7/8	3 11/16	9/16	18 1/2
3764	2	3 15/16	19/32	19 1/4

Fed. Spec. ANSI B107.39 Type 2 Class 3

### 3780 5 Piece Double Open End Wrench Set, SAE, in Pouch

Contents Include:

Product Code	Size (Inches)	Product Code	Size (Inches)
3712	3/8	3718	9/16
3714	7/16	3720	5/8
3716	1/2		

### 3782 10 Piece Double Open End Wrench Set, SAE, in Pouch

Contents Include:

Product Code	Size (Inches)	Product Code	Size (Inches)
3712	3/8	3722	11/16
3714	7/16	3724	3/4
3716	1/2	3726	13/16
3718	9/16	3728	7/8
3720	5/8	3732	1

### Features

- Wrench heads are offset at 15° and 60° to the handle
- Both ends are the same size to permit the wrench to be used in four different positions
- 45° chamfer on wrench ends allow easy placement of wrench on the fastener
- Continuous arc design minimizes spreading and is stronger than "V" design
- Thin head is perfect for tight clearances
- Satin chrome finish provides good grip and cleans easily

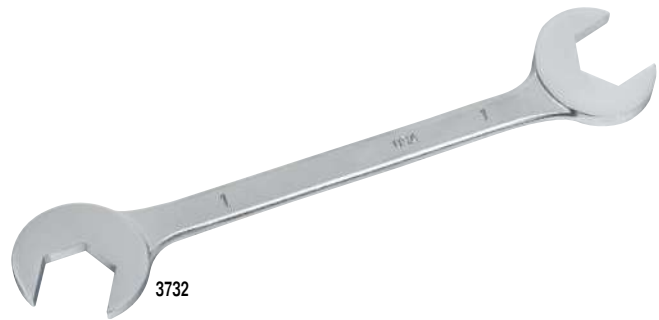

3780

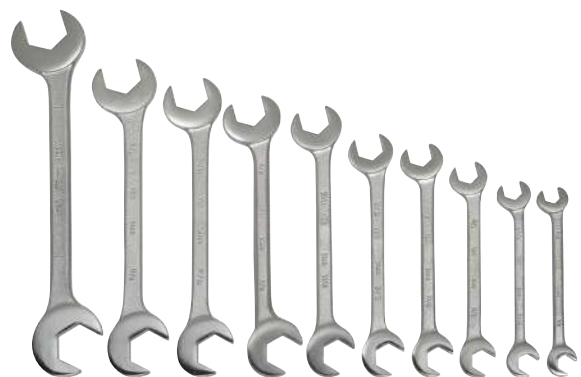

3782



# WRENCHES

## DOUBLE OPEN END



EWM-1618



MWS-26



MWS-31



OES-1011



WS-1605

WILLIAMS®



### DOUBLE HEAD OPEN END WRENCHES

Chrome Satin Finish, Metric

Product Code	Size (MM)	A	B	C	D	E
		Overall Length (Inches)	Open End Width (Inches)	Open End Thickness (Inches)	Open End Width (Inches)	Open End Thickness (Inches)
EWM-0607	6 x 7	3 13/16	17/32	5/32	19/32	5/32
EWM-0708	7 x 8	4 9/16	19/32	5/32	11/16	3/16
EWM-0910	9 x 10	5	3/4	3/16	27/32	7/32
EWM-1011	10 x 11	5 9/8	27/32	7/32	15/16	7/32
EWM-1213	12 x 13	6 3/16	1	1/4	1 3/32	1/4
EWM-1415	14 x 15	7 1/32	1 1/32	9/32	1 1/4	9/32
EWM-1618	16 x 18	8 3/32	1 5/16	5/16	1 15/32	11/32
EWM-1719	17 x 19	8 17/32	1 13/32	5/16	1 9/16	11/32
EWM-2124	21 x 24	10 17/32	1 23/32	3/8	1 15/16	13/32
EWM-2224	22 x 24	10 3/4	1 19/16	3/8	1 15/16	13/32
EWM-2427	24 x 27	11 29/32	1 15/16	13/32	2 3/16	7/16
EWM-2730	27 x 30	13 5/16	2 3/16	7/16	2 7/16	15/32
EWM-3032	30 x 32	14 1/2	2 7/16	15/32	2 9/16	1/2

Fed. Spec. ANSI B107.9M

#### MWS-26 6 Piece Double Head Open End Wrench Set, Metric, in Pouch

Contents Include:

Product Code	Size (MM)	Product Code	Size (MM)	Product Code	Size (MM)
EWM-0708	7 x 8	EWM-1213	12 x 13	EWM-1618	16 x 18
EWM-1011	10 x 11	EWM-1415	14 x 15	EWM-1719	17 x 19

#### MWS-31 10 Piece Double Head Open End Wrench Set, Metric, in Pouch

Contents Include:

Product Code	Size (MM)	Product Code	Size (MM)	Product Code	Size (MM)
EWM-0607	6 x 7	EWM-1415	14 x 15	EWM-2427	24 x 27
EWM-0708	7 x 8	EWM-1618	16 x 18	EWM-2730	27 x 30
EWM-1011	10 x 11	EWM-1719	17 x 19		
EWM-1213	12 x 13	EWM-2124	21 x 24		

#### Features

- Two openings in each wrench with 45° chamfer on wrench ends allow easy placement of wrench on the fastener.
- Continuous arc design minimizes spreading and is stronger than "V" design.
- Satin chrome finish provides good grip and cleans easily.

WILLIAMS®



### SHORT DOUBLE HEAD OPEN END WRENCHES

Chrome Satin Finish, SAE

Product Code	Size (Inches)	A	B	C	D	E
		Overall Length (Inches)	Open End Width (Inches)	Open End Thickness (Inches)	Open End Width (Inches)	Open End Thickness (Inches)
OES-0607	3/16 x 7/32	2 27/32	13/32	1/8	15/32	1/8
OES-0809	1/4 x 9/32	3 5/32	1/2	1/8	9/16	1/8
OES-1011	5/16 x 11/32	3 7/16	5/8	5/32	11/16	1/8
OES-1214	3/8 x 7/16	3 3/4	3/4	5/32	29/32	1/8
OES-1618	1/2 x 9/16	4 11/32	1	3/16	1 1/8	3/16

Fed. Spec. ANSI B107.6

#### WS-1605 5 Piece Short Double Head Open End Wrench Set, SAE, in Pouch

Contents Include:

Product Code	Size (Inches)	Product Code	Size (Inches)	Product Code	Size (Inches)
OES-0607	3/16 x 7/32	OES-1011	5/16 x 11/32	OES-1618	1/2 x 9/16
OES-0809	1/4 x 9/32	OES-1214	3/8 x 7/16		

#### Features

- Two openings in each wrench with 45° chamfer on wrench ends allow easy placement of wrench on the fastener.
- Continuous arc design minimizes spreading and is stronger than "V" design.
- Satin chrome finish provides good grip and cleans easily.

# WRENCHES

## DOUBLE OPEN END



### MINIATURE 15° x 80° DOUBLE HEAD OPEN END WRENCHES

Satin Chrome Finish, SAE

Product Code	Size (Inches)	Overall Length (Inches)	Open End Width (Inches)	Open End Thickness (Inches)	Open End Width (Inches)	Open End Thickness (Inches)
1112A	3/16	3	1/2	7/64	1/2	7/64
1113A	13/64	3	1/2	7/64	1/2	7/64
1114A	7/32	3	1/2	7/64	1/2	7/64
1115A	15/64	3	1/2	7/64	1/2	7/64
1116A	1/4	3	1/2	7/64	1/2	7/64
1118A	9/32	3 1/2	5/8	9/64	5/8	9/64
1120A	5/16	3 1/2	5/8	9/64	5/8	9/64
1122A	11/32	3 3/4	3/4	9/64	3/4	9/64
1124A	3/8	3 3/4	3/4	9/64	3/4	9/64
1128A	7/16	4 7/16	7/16	11/64	7/16	11/64
1132A	1/2	4 7/16	7/16	11/64	7/16	11/64
1136A	9/16	5 3/4	1 5/32	13/64	1 5/32	13/64
1140A	5/8	5 3/4	1 5/32	13/64	1 5/32	13/64

#### Features

- Wrench heads are offset at 15° and 80° to the handle
- Both ends are the same size to permit the wrench to be used in four different positions
- 45° chamfer on wrench ends allow easy placement of wrench on the fastener
- Continuous arc design minimizes spreading and is stronger than "V" design
- Thin head is perfect for tight clearances
- Satin finish provides corrosion resistance and slip resistant grip.
- Excellent for fast turning of fasteners in limited clearance areas.
- Each wrench has the same size opening at both ends.

#### WS-1108SP 8 Piece Mini Double Open End Wrench & Plier Set, SAE, in Pouch

##### Contents Include:

Product Code	Size (Inches)	Product Code	Size (Inches)	Product Code	Size (Inches)
1114A	7/32	1118A	9/32	1124A	3/8
1115A	15/64	1120A	5/16	1128A	7/16
1116A	1/4	1122A	11/32		

#### WS-1113CA 10 Piece Mini Double Open End Wrench & Plier Set, SAE, in Pouch

##### Contents Include:

Product Code	Size (Inches)	Product Code	Size (Inches)	Product Code	Size (Inches)
1112A	3/16	1116A	1/4	1124A	3/8
1113A	13/64	1118A	9/32	PL-1519C	5" SUPERJOINT® Utility Pliers
1114A	7/32	1120A	5/16		
1115A	15/64	1122A	11/32		

#### WS-1142PCA 14 Piece Mini Double Open End Wrench & Plier Set, SAE, in Pouch

##### Contents Include:

Product Code	Size (Inches)	Product Code	Size (Inches)	Product Code	Size (Inches)
1112A	3/16	1118A	9/32	1132A	1/2
1113A	13/64	1120A	5/16	1136A	9/16
1114A	7/32	1122A	11/32	1140A	5/8
1115A	15/64	1124A	3/8	PL-1519C	5" SUPERJOINT® Utility Pliers
1116A	1/4	1128A	7/16		



1128A



WS-1108SP



WS-1113CA



WS-1142PCA



# WRENCHES

## DOUBLE OPEN END



### MINIATURE 15° x 80° DOUBLE HEAD OPEN END WRENCHES

Satin Chrome Finish, MM

Product Code	Size (MM)	Overall Length (Inches)	Open End Width (Inches)	Open End Thickness (Inches)	Open End Width (Inches)	Open End Thickness (Inches)
1104MM	4	3	1/2	7/64	1/2	7/64
1105MM	5	3	1/2	7/64	1/2	7/64
1105.5MM	5.5	3	1/2	7/64	1/2	7/64
1106MM	6	3	1/2	7/64	1/2	7/64
1107MM	7	3 1/2	5/8	9/64	5/8	9/64
1108MM	8	3 1/2	5/8	9/64	5/8	9/64
1109MM	9	3 3/4	3/4	9/64	3/4	9/64
1110MM	10	4 7/16	7/16	1 1/64	7/16	1 1/64
1111MM	11	4 7/16	7/16	1 1/64	7/16	1 1/64
1112MM	12	4 7/16	7/16	1 1/64	7/16	1 1/64
1113MM	13	4 7/16	7/16	1 1/64	7/16	1 1/64
1114MM	14	5 3/4	1 5/32	13/64	1 5/32	13/64
1115MM	15	5 3/4	1 5/32	13/64	1 5/32	13/64
1116MM	16	5 3/4	1 5/32	13/64	1 5/32	13/64



MWS-1110

#### Features

- Wrench heads are offset at 15° and 80° to the handle
- Both ends are the same size to permit the wrench to be used in four different positions
- 45° chamfer on wrench ends allow easy placement of wrench on the fastener
- Continuous arc design minimizes spreading and is stronger than "V" design
- Thin head is perfect for tight clearances
- Satin finish provides corrosion resistance and slip resistant grip.

#### MWS-1110 10 Piece Mini Double Open End Wrench & Plier Set, SAE, in Pouch

##### Contents Include:

Product Code	Size (MM)	Product Code	Size (MM)	Product Code	Size (MM)
1104MM	4	1107MM	7	1111MM	11
1105MM	5	1108MM	8	PL-1519C	5" SUPERJOINT Utility Pliers
1105.5MM	5.5	1109MM	9		
1106MM	6	1110MM	10		

#### MWS-1115 15 Piece Mini Double Open End Wrench & Plier Set, SAE, in Pouch

##### Contents Include:

Product Code	Size (MM)	Product Code	Size (MM)	Product Code	Size (MM)
1104MM	4	1108MM	8	1113MM	13
1105MM	5	1109MM	9	1114MM	14
1105.5MM	5.5	1110MM	10	1115MM	15
1106MM	6	1111MM	11	1116MM	16
1107MM	7	1112MM	12	PL-1519C	5" SUPERJOINT Utility Pliers



MWS-1115

# WRENCHES

## SERVICE

WILLIAMS®

### 30° SERVICE WRENCHES, SAE



#### Satin Chrome Finish, SAE

Product Code	Size (Inches)	Overall Length (Inches)	Head Diameter	Head Thickness
3524	3/4	6 1/4	1 11/16	1/4
3526	13/16	6 1/4	1 11/16	1/4
3528	7/8	6 1/4	1 11/16	1/4
3530	15/16	6 7/8	1 7/8	1/4
3532	1	6 7/8	1 7/8	1/4
3534	1 1/16	6 7/8	1 7/8	1/4
3536	1 1/8	7	2 1/16	1/4
3538	1 3/16	7	2 1/16	1/4
3540	1 1/4	7	2 1/16	1/4
3542	1 5/16	7 5/8	2 1/2	9/32
3544	1 3/8	7 5/8	2 1/2	9/32
3546	1 1/16	7 5/8	2 1/2	9/32
3548	1 1/2	7 5/8	2 1/2	9/32
3550	1 9/16	7 5/8	2 5/8	9/32
3552	1 5/8	7 5/8	2 5/8	9/32
3554	1 11/16	7 5/8	2 5/8	9/32
3556	1 3/4	8 1/2	3 1/8	5/16
3558	1 13/16	8 1/2	3 1/8	5/16
3560	1 7/8	8 1/2	3 1/8	5/16
3562	1 15/16	8 1/2	3 1/8	5/16
3564	2	8 1/2	3 1/2	5/16
3568	2 1/8	8 1/2	3 1/2	5/16
3572	2 1/4	8 1/2	3 1/2	5/16
3576	2 3/8	9 1/2	3 1/2	5/16

Fed. Spec: GGG-W-636E Type 17 Class 3

#### WS-3510 10 Piece Service Wrench Set, SAE in Pouch

##### Contents Include:

Product Code	Size (MM)	Product Code	Size (MM)	Product Code	Size (MM)
3524	3/4	3532	1	3538	1 5/16
3526	13/16	3534	1 1/16	3540	1 1/4
3528	7/8	3536	1 1/8	3544	1 3/8
3530	15/16				



3542



WS-3510

### 30° SERVICE WRENCHES, METRIC



#### Satin Chrome Finish, Metric

Product Code	Size (Inches)	Overall Length (Inches)	Head Diameter	Head Thickness
3519M	19	6 1/4	1 11/16	1/4
3521M	21	6 1/4	1 11/16	1/4
3522M	22	6 1/4	1 11/16	1/4
3524M	24	6 7/8	1 7/8	1/4
3527M	27	6 7/8	1 7/8	1/4
3530M	30	7	2 1/16	1/4
3532M	32	7	2 1/16	1/4
3536M	36	7 5/8	2 1/2	9/32
3537M	37	7 5/8	2 1/2	9/32
3538M	38	7 5/8	2 1/2	9/32
3540M	40	7 5/8	2 5/8	9/32
3541M	41	7 5/8	2 5/8	9/32
3542M	42	7 5/8	2 5/8	9/32
3544M	44	7 5/8	2 5/8	9/32
3546M	46	8 1/2	3 1/8	5/16
3548M	48	8 1/2	3 1/8	5/16
3550M	50	8 1/2	3 1/8	5/16
3552M	52	8 1/2	3 1/2	5/16
3555M	55	8 1/2	3 1/2	5/16
3560M	60	9 1/2	3 1/2	5/16
3565M	65	9 1/2	3 1/2	5/16

Fed. Spec: GGG-W-636E Type 17 Class 3

#### MWS-3510 10 Piece Service Wrench Set, MM in Pouch

##### Contents Include:

Product Code	Size (MM)	Product Code	Size (MM)	Product Code	Size (MM)
3519M	19	3527M	27	3536M	36
3521M	21	3530M	30	3538M	38
3522M	22	3532M	32	3540M	40
3524M	24				

#### Features

- Ultra thin pattern for use on jam nuts and access to confined areas
- 30° offset head
- Satin chrome finish



3537M



MWS-3510



**WARNING**



# WRENCHES

## DOUBLE BOX END



### DOUBLE HEAD 10° OFFSET BOX END WRENCHES

Chrome Satin Finish, 12 Point, SAE

Product Code	Size (Inches)	A Overall Length (Inches)	B Box End Diameter (Inches)	C Box End Thickness (Inches)	D Box End Diameter (Inches)	E Box End Thickness (Inches)
7723	3/8 x 7/16	7 5/8	19/32	5/16	21/32	11/32
7725B	1/2 x 9/16	8 11/16	3/4	3/8	27/32	3/8
7727A	5/8 x 11/16	10 9/32	29/32	7/16	1	15/32
7029B	1 1/16 x 3/4	10 15/16	1	15/32	1 3/32	1/2
7731A	3/4 x 7/8	12 1/32	1 3/32	1/2	1 1/4	9/16
7731B	13/16 x 7/8	12 13/32	1 3/16	17/32	1 1/4	9/16
7033C	15/16 x 1	14 1/8	1 11/32	19/32	1 7/16	5/8
7038	1 1/8 x 1 3/16	16 3/32	1 19/32	11/16	1 11/16	11/16
7039B	1 1/4 x 1 5/16	17 5/8	1 25/32	23/32	1 27/32	3/4

Fed. Spec. ANSI B107.6

### WS-7707 7 Piece Double Head 10° Offset Box End Wrench Set, SAE, in Pouch

#### Contents Include:

Product Code	Size (Inches)	Product Code	Size (Inches)	Product Code	Size (Inches)
7723	3/8 x 7/16	7029B	1 1/16 x 3/4	7033C	15/16 x 1
7725B	1/2 x 9/16	7731A	3/4 x 7/8		
7727A	5/8 x 11/16	7731B	13/16 x 7/8		



#### Features

- SUPERTORQUE® box opening design allows application of higher torque without rounding or deforming hex fastener points. No contact is made at the corners. Instead, wrenching forces are placed on the flat surfaces behind the points.
- 10° offset box end allows clearance in tight areas.
- Sizes are clearly marked on handle ends.

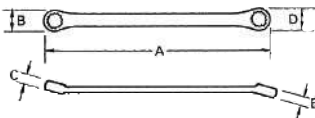

WS-7707

# WRENCHES

## DOUBLE BOX END



### DOUBLE HEAD 10° OFFSET BOX END WRENCHES

Chrome Satin Finish, 12 Point, Metric

Product Code	Size (MM)	A	B	C	D	E
		Overall Length (Inches)	Box End Diameter (Inches)	Box End Thickness (Inches)	Box End Diameter (Inches)	Box End Thickness (Inches)
BWM-0810	8 x 10	7 5/16	1/2	9/32	19/32	5/16
BWM-1011	10 x 11	7 31/32	19/32	9/16	21/32	11/32
BWM-1012	10 x 12	8 3/16	19/32	9/16	23/32	11/32
BWM-1113	11 x 13	8 5/8	21/32	11/32	25/32	3/8
BWM-1213	12 x 13	8 27/32	25/32	11/32	25/32	3/8
BWM-1214	12 x 14	9 1/16	23/32	11/32	13/16	13/32
BWM-1315	13 x 15	9 1/2	25/32	3/8	7/8	13/32
BWM-1415	14 x 15	9 3/4	13/16	13/32	7/8	13/32
BWM-1417	14 x 17	9 25/32	13/16	13/32	31/32	15/32
BWM-1618	16 x 18	10 27/32	15/16	7/16	1 1/32	15/32
BWM-1719	17 x 19	11 9/32	31/32	15/32	1 3/32	1/2
BWM-1821	18 x 21	11 15/16	1 3/32	15/32	1 3/16	17/32
BWM-1922	19 x 22	12 3/8	1 3/32	1/2	1 1/4	9/16
BWM-2124	21 x 24	13 1/4	1 3/16	17/32	1 11/32	19/32
BWM-2224	22 x 24	13 19/32	1 1/4	9/16	1 11/32	19/32
BWM-2427	24 x 27	14 19/32	1 11/32	19/32	1 17/32	21/32
BWM-2730	27 x 30	15 29/32	1 17/32	21/32	1 11/16	11/16
BWM-3032	30 x 32	17 1/32	1 11/16	11/16	1 25/32	23/32

Fed. Spec. ANSI B107.9M

### MWS-BWM10 10 Piece Double Head 10° Offset Box End Wrench Set, Metric, in Pouch

#### Contents Include:

Product Code	Size (MM)	Product Code	Size (MM)	Product Code	Size (MM)
BWM-0810	8 x 10	BWM-1618	16 x 18	BWM-2730	27 x 30
BWM-1113	11 x 13	BWM-1719	17 x 19	BWM-3032	30 x 32
BWM-1214	12 x 14	BWM-1922	19 x 22		
BWM-1415	14 x 15	BWM-2124	21 x 24		

### MWS-BWM12 12 Piece Double Head 10° Offset Box End Wrench Set, Metric, in Pouch

#### Contents Include:

Product Code	Size (MM)	Product Code	Size (MM)	Product Code	Size (MM)
BWM-1011	10 x 11	BWM-1417	14 x 17	BWM-1922	19 x 22
BWM-1214	12 x 14	BWM-1618	16 x 18	BWM-2224	22 x 24
BWM-1315	13 x 15	BWM-1719	17 x 19	BWM-2730	27 x 30
BWM-1415	14 x 15	BWM-1821	18 x 21	BWM-3032	30 x 32

#### Features

- SUPERTORQUE® box opening design allows application of higher torque without rounding or deforming hex fastener points. No contact is made at the corners. Instead, wrenching forces are placed on the flat surfaces behind the points.
- 10° offset box end allows clearance in tight areas.
- Sizes are clearly marked on handle ends.

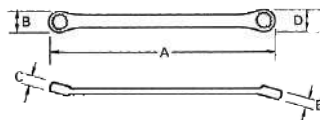

BWM-1012



MWS-BWM10



MWS-BWM12



# WRENCHES

## OFFSET BOX END/ RATCHETING BOX END



### DOUBLE HEAD 60° OFFSET BOX END WRENCHES

Chrome Satin Finish, 12 Point, SAE



8725B



WS-8707

Product Code	Size (Inches)	A	B	C	D	E
		Overall Length (Inches)	Box End Diameter (Inches)	Box End Thickness (Inches)	Box End Diameter (Inches)	Box End Thickness (Inches)
8720	1/4 x 5/16	6 7/16	13/32	1/4	15/32	9/32
8723	3/8 x 7/16	7 5/8	9/16	5/16	21/32	5/16
8725	7/16 x 1/2	8 3/16	21/32	11/32	3/4	11/32
8725B	1/2 x 9/16	8 25/32	3/4	3/8	27/32	3/8
8727	9/16 x 5/8	9 3/8	27/32	13/32	29/32	13/32
8727A	5/8 x 11/16	9 31/32	29/32	7/16	1	7/16
8729	5/8 x 3/4	10 1/4	15/16	7/16	1 3/32	7/16
8729A	11/16 x 13/16	10 27/32	1	15/32	1 3/16	15/32
8731A	3/4 x 7/8	11 7/16	1 3/32	17/32	1 9/32	17/32
8033A	7/8 x 15/16	13	1 9/32	9/16	1 3/8	9/16
8033C	15/16 x 1	13 31/32	1 3/8	19/32	1 7/16	19/32

Fed. Spec. ANSI B107.6

### WS-8707 7 Piece Double Head 60° Offset Box End Wrench Set, SAE, in Pouch

#### Contents Include:

Product Code	Size (Inches)	Product Code	Size (Inches)	Product Code	Size (Inches)
8720	1/4 x 5/16	8729	5/8 x 3/4	8033C	15/16 x 1
8723	3/8 x 7/16	8729A	11/16 x 13/16		
8725B	1/2 x 9/16	8731A	3/4 x 7/8		

#### Features

- SUPERTORQUE® box opening design allows application of higher torque without rounding or deforming hex fastener points. No contact is made at the corners. Instead, wrenching forces are placed on the flat surfaces behind the points.
- 60° offset box end allows extra knuckle and bolt clearance in tight areas.
- Sizes are clearly marked on handle ends.



### SINGLE HEAD RATCHETING BOX WRENCHES

High Polish Chrome Finish, 12 Point, SAE



RB-52

Product Code	Size (Inches)	A	Product Code	Size (Inches)	A
		Overall Length (Inches)			Overall Length (Inches)
RB-42	1 3/16	15 1/2	RB-54	1 11/16	19
RB-44	1 3/8	15 1/2	RB-56	1 3/4	19
RB-46	1 7/16	15 1/2	RB-58	1 13/16	19
RB-48	1 1/2	15 1/2	RB-60	1 7/8	19
RB-50	1 9/16	15 1/2	RB-64	2	19
RB-52	1 5/8	15 1/2	RB-68	2 1/8	19

#### Features

- Combines the quick ratcheting action with opening sizes large enough to handle most industrial applications.
- Requires less effort than a conventional combination wrench.
- All wrenches contain 12-point Torque Grip® wheels.
- Ideal for long "bolt-through" applications.
- Turn wrench over to change direction.

# WRENCHES

## RATCHETING BOX END



### SINGLE HEAD RATCHETING BOX WRENCHES

High Polish Chrome Finish, 12 Point, Metric

Product Code	Size (MM)	A Overall Length (Inches)	Product Code	Size (MM)	A Overall Length (Inches)
RBM-22	22	12	RBM-27	27	12
RBM-23	23	12	RBM-29	29	12
RBM-24	24	12	RBM-30	30	12
RBM-25	25	12	RBM-32	32	15½
RBM-26	26	12	RBM-36	36	15½

#### Features

- Combines the quick ratcheting action with opening sizes large enough to handle most industrial applications.
- Requires less effort than a conventional combination wrench.
- All wrenches contain 12-point Torque Grip® wheels.
- Ideal for long "bolt-through" applications.
- Turn wrench over to change direction.



RBM-52



### DOUBLE HEAD RATCHETING BOX WRENCHES

High Polish Chrome Finish, 6 & 12 Point, SAE

Product Code	Number of Points	Size (Inches)	A Overall Length (Inches)	B Box End Diameter (Inches)	C Box End Thickness (Inches)	D Box End Diameter (Inches)	E Box End Thickness (Inches)
RB-810	6	¼ x ⅝	4 ¼	19/32	⅜	11/16	⅜
RB-1214	6	⅜ x 7/16	5 ½	29/32	⅜	7/8	⅜
RB-1618	6	½ x 9/16	6 ¾	1	½	1 ⅝	½
RB-1820	12	⅝ x ⅝	8 ½	1 5/16	½	1 7/16	½
RB-2022	12	⅝ x 11/16	8 ½	1 5/16	½	1 7/16	½
RB-2024	12	⅝ x ¾	8 ½	1 5/16	½	1 7/16	½
RB-2428	12	¾ x 7/8	9 ¼	1 13/32	½	1 9/16	½
RB-3036	12	15/16 x 1 ½	15 ½	1 21/32	9/16	2 9/32	9/16
RB-3440	12	1 ½ x 1 ¼	15 ½	1 29/32	9/16	2 9/32	9/16

### WS-12 5 Piece Ratcheting Box Wrench Set, 6 & 12 Point, SAE, in Pouch

#### Contents Include:

Product Code	Size (Inches)	Product Code	Size (Inches)	Product Code	Size (Inches)
RB-810	¼ x ⅝	RB-1618	½ x 9/16	RB-2428	¾ x 7/8
RB-1214	⅜ x 7/16	RB-2022	⅝ x 11/16		

#### Features

- Allows fast removal of fasteners with a ratcheting action at each end.
- Ideal for long "bolt-through" applications.
- Flat handle allows access to tight clearance areas.
- Turn wrench over to change direction.

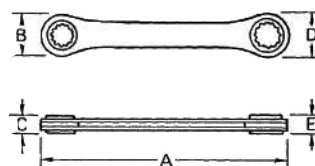

RB-1618



WS-12



# WRENCHES

## RATCHETING BOX END



WILLIAMS®



### DOUBLE HEAD RATCHETING BOX WRENCHES

High Polish Chrome Finish, 6 & 12 Point, Metric

Product Code	Number of Points	Size (MM)	A	B	C	D	E
			Overall Length (Inches)	Box End Diameter (Inches)	Box End Thickness (Inches)	Box End Diameter (Inches)	Box End Thickness (Inches)
RBM-0708	6	7 x 8	4 1/2	1 1/16	3/8	1 1/32	3/8
RBM-0910	6	9 x 10	5 1/2	7/8	3/8	7/8	3/8
RBM-1112	6	11 x 12	6 7/8	1 3/16	1/2	1 1/8	1/2
RBM-1314	6	13 x 14	6 7/8	1 3/16	1/2	1 1/8	1/2
RBM-1517	12	15 x 17	8 1/8	1 7/16	1/2	1 7/16	1/2
RBM-1618	12	16 x 18	8 1/8	1 7/16	1/2	1 7/16	1/2
RBM-1921	12	19 x 21	9 1/4	1 9/16	1/2	1 9/16	1/2

### MWS-30 5 Piece Ratcheting Box Wrench Set, 6 & 12 Point, Metric, in Pouch

Contents Include:

Product Code	Size (MM)	Product Code	Size (MM)	Product Code	Size (MM)
RBM-0708	7 x 8	RBM-1112	11 x 12	RBM-1517	15 x 17
RBM-0910	9 x 10	RBM-1314	13 x 14		

### Features

- Allows fast removal of fasteners with a ratcheting action at each end.
- Ideal for long "bolt-through" applications.
- Flat handle allows access to tight clearance areas.
- Turn wrench over to change direction.



WILLIAMS®



### DOUBLE HEAD 25° REVERSIBLE OFFSET RATCHETING BOX WRENCHES

High Polish Chrome Finish, 12 Point, SAE

Product Code	Size (Inches)	A	B	C	D	E
		Overall Length (Inches)	Box End Diameter (Inches)	Box End Thickness (Inches)	Box End Diameter (Inches)	Box End Thickness (Inches)
RBO-810	1/4 x 5/16	4 1/4	19/32	3/8	2 1/32	3/8
RBO-1214	3/8 x 7/16	5 7/16	25/32	3/8	7/8	3/8
RBO-1618	1/2 x 9/16	6 3/4	1	1/2	1 5/32	1/2
RBO-2022	5/8 x 1 1/16	8	1 5/16	1/2	1 7/16	1/2
RBO-2024	5/8 x 3/4	8	1 5/16	1/2	1 7/16	1/2
RBO-2226	1 1/16 x 13/16	9 1/8	1 13/32	1/2	1 9/16	1/2
RBO-2428	3/4 x 7/8	9 1/8	1 13/32	1/2	1 9/16	1/2
RBO-2630	13/16 x 15/16	9 1/8	1 13/32	1/2	1 9/16	1/2

### WS-5 5 Piece Reversible Offset Ratcheting Box Wrench Set, 12 Point, SAE, in Pouch

Contents Include:

Product Code	Size (Inches)	Product Code	Size (Inches)	Product Code	Size (Inches)
RBO-810	1/4 x 5/16	RBO-1618	1/2 x 9/16	RBO-2428	3/4 x 7/8
RBO-1214	3/8 x 7/16	RBO-2022	5/8 x 1 1/16		

### Features

- 25° offset handle clears obstructions that flat handle wrenches cannot.
- Allows fast removal of fasteners with a ratcheting action at each end.
- Ideal for long "bolt-through" applications.

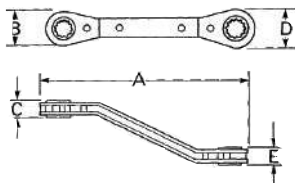

# WRENCHES

## FLARE NUT



### RATCHETING FLARE NUT WRENCHES

Black Industrial Finish, 12 Point, SAE

Product Code	Size (Inches)	Overall Length (Inches)	Head Diameter (Inches)	Head Thickness (Inches)
RFW-12	3/8	5 3/8	1	5/16
RFW-14	7/16	5 3/8	1	5/16
RFW-16	1/2	5 3/8	1	5/16
RFW-18	9/16	7 1/4	1 1/32	3/8
RFW-20	5/8	7 1/4	1 1/32	3/8
RFW-22	11/16	7 1/4	1 1/32	3/8
RFW-24	3/4	7 1/4	1 1/32	3/8
RFW-26	13/16	9 5/16	1 5/8	1/2
RFW-28	7/8	9 5/16	1 5/8	1/2
RFW-30	15/16	9 5/16	1 5/8	1/2
RFW-32	1	9 5/16	1 5/8	1/2



RFW-24

#### Features

- Designed for use on 6 and 12 point tube fittings, fasteners, valves and compression fittings.
- Unique design requires only 30° rotation for ratcheting action.
- High carbon steel jaws snap open, then close around fastener with 6 point contact.
- Prevents distortion of thin-walled fitting.
- Allow easy access to tight locations.



### DOUBLE HEAD FLARE NUT WRENCHES

Chrome Satin Finish, 6 Point, SAE

Product Code	Size (Inches)	A Overall Length (Inches)	B Open End Dia (Inches)	C Open End Thickness (Inches)	D Open End Dia (Inches)	E Open End Thickness (Inches)
XFN-0810	1/4 x 5/16	4 27/32	19/32	1/4	5/8	9/32
XFN-1214	3/8 x 7/16	5 13/16	25/32	5/16	27/32	11/32
XFN-1618	1/2 x 9/16	6 13/16	15/16	3/8	1	13/32
XFN-2022	5/8 x 11/16	7 3/4	1 3/32	7/16	3/16	15/32
XFN-2432	3/4 x 1	9 1/2	1 1/4	1/2	19/32	5/8
XFN-2836	7/8 x 1 1/8	10.5	1 7/16	9/16	1 3/4	11/16



XFN-1618

Fed. Spec.: ANSI B107.6

### WS-14 5 Piece Double Head Flare Nut Wrench Set, 6 Point, SAE, in Pouch

#### Contents Include:

Product Code	Size (Inches)	Product Code	Size (Inches)	Product Code	Size (Inches)
XFN-1214	3/8 x 7/16	XFN-2022	5/8 x 11/16	XFN-2836	7/8 x 1 1/8
XFN-1618	1/2 x 9/16	XFN-2432	3/4 x 1		



WS-14

#### Features

- Will not mar fittings on pipes and tubing.
- Satin chrome textured finish provides great feel and extra gripping power.
- Recessed corners in ends provide extra turning power.



# WRENCHES

## FLARE NUT

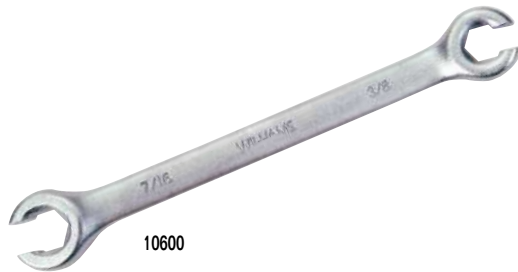

### DOUBLE HEAD FLARE NUT WRENCHES

Chrome Satin Finish, 6 Point, SAE

Product Code	Size (Inches)	A Overall Length (Inches)	B Open End Dia (Inches)	C Open End Thickness (Inches)	D Open End Dia (Inches)	E Open End Thickness (Inches)
10600	3/8 x 7/16	6	27/32	11/32	15/16	11/32
10602	1/2 x 9/16	6 3/4	15/16	13/32	1	13/32
10604	5/8 x 11/16	7 3/4	1 3/32	7/16	1 3/16	15/32
10606	3/4 x 7/8	8 5/8	1 9/32	0.5	1 13/32	17/32

Fed. Spec.: ANSI B107.6

#### 11690 4 Piece Double Head Flare Nut Wrench Set, 6 Point, SAE, in Pouch

Contents Include:

Product Code	Size (Inches)	Product Code	Size (Inches)
10600	3/8 x 7/16	10604	5/8 x 11/16
10602	1/2 x 9/16	10606	3/4 x 7/8

#### 11691 3 Piece Double Head Flare Nut Wrench Set, 6 Point, SAE, in Pouch

Contents Include:

Product Code	Size (Inches)	Product Code	Size (Inches)
10600	3/8 x 7/16	10604	5/8 x 11/16
10602	1/2 x 9/16		

#### Features

- Will not mar fittings on pipes and tubing.
- Satin chrome textured finish provides great feel and extra gripping power.
- Recessed corners in ends provide extra turning power.



### DOUBLE HEAD FLARE NUT WRENCHES

Chrome Satin Finish, 6 Point, Metric

Product Code	Size (MM)	A Overall Length (Inches)	B Open End Dia (Inches)	C Open End Thickness (Inches)	D Open End Dia (Inches)	E Open End Thickness (Inches)
10650	9 x 11	5 11/16	13/16	11/32	15/16	5/16
10652	10 x 12	6 1/8	7/8	3/8	29/32	5/16
10654	13 x 14	6 7/8	1	3/8	1 3/32	3/8
10656	15 x 17	7 7/8	1 1/16	7/16	1 7/32	1/2
10658	19 x 21	8 7/8	1 9/32	1/2	1 13/32	17/32

Fed. Spec.: ANSI B107.9M

#### 11692 5 Piece Double Head Flare Nut Wrench Set, 6 Point, Metric, in Pouch

Contents Include:

Product Code	Size (MM)	Product Code	Size (MM)	Product Code	Size (MM)
10650	9 x 11	10654	13 x 14	10658	19 x 21
10652	10 x 12	10656	15 x 17		

#### Features

- Will not damage fittings on pipes and tubing.
- Satin chrome textured finish provides great feel and extra gripping power.
- Recessed corners in ends provide extra turning power.

# WRENCHES

## ADJUSTABLE

WILLIAMS®



### ADJUSTABLE WRENCH

#### Chrome Finish

Product Code	Length (Inches)	Maximum Jaw Opening (Inches)	Head Thickness (Inches)
AP-4A	4	1/2	11/32
AP-6A	6	3/4	7/16
AP-8A	8	1	1/2
AP-10A	10	1 1/64	39/64
AP-12A	12	1 5/16	23/32
AP-15A	15	1 11/16	51/64
AP-18A	18	2 1/16	57/64
AP-24A	24	2 7/16	1 9/64

#### Features

- Chrome plated finish allows for easy cleaning after each use.
- Serrated knurl is designed for quick and smooth adjustments.
- I-Beam designed handle provides strength and durability.
- Inch (SAE) scale is laser-etched on head face for easy determination of bolt head width.



AP-10A

WILLIAMS®



### ADJUSTABLE WRENCH

#### Black Finish

Product Code	Length (Inches)	Maximum Jaw Opening (Inches)	Head Thickness (Inches)
AB-4A	4	1/2	11/32
AB-6A	6	3/4	7/16
AB-8A	8	1	1/2
AB-10A	10	1 1/64	39/64
AB-12A	12	1 5/16	23/32
AB-15A	15	1 11/16	51/64
AB-18A	18	2 1/16	57/64
AB-24A	24	2 7/16	1 9/64

#### Features

- Drop forged, heat treated industrial finish with satin finish handles for firm safe grip.
- Inch (SAE) scale is laser-etched on head face for easy determination of bolt head width.



AB-10A



**WARNING**



# WRENCHES

## ADJUSTABLE



APC-10A

WILLIAMS®



### ADJUSTABLE WRENCH

#### Comfort Grip

Product Code	Length (Inches)	Maximum Jaw Opening (Inches)	Head Thickness (Inches)
APC-6A	6	3/4	7/8
APC-8A	8	1	1/2
APC-10A	10	1 11/64	39/64
APC-12A	12	1 5/8	23/32

#### Features

- Comfort thermoplastic grips cushion the handle surface and stay comfortable even in extreme temperatures.
- Chrome plated finish allows for easy cleaning.
- Serrated knurl is designed for quick and smooth adjustments.
- I-Beam designed handle provides strength and durability.
- Inch (SAE) scale is laser-etched on head face for easy determination of bolt head width.



13404



13610



13342



13642

WILLIAMS®

### ADJUSTABLE WRENCHES

#### Heavy Duty Industrial Grade Adjustable Wrenches

Product Code	Overall Length (Inches)	Maximum Jaw Opening Not less Than (Inches)	Head Thickness (Inches)
<b>Chrome Finish:</b>			
13404A	4	11/16	3/8
13406A	6	15/16	7/16
13408A	8	1 1/8	9/16
13410A	10	1 5/16	11/16
13412A	12	1 1/2	13/16
13415A	15	2	1
13418A	18	2 3/8	1 3/16
13424A	24	2 3/4	1 7/16
<b>Black Phosphate Finish:</b>			
13604A	4	11/16	3/8
13606A	6	15/16	7/16
13608A	8	1 1/8	9/16
13610A	10	1 5/16	11/16
13612A	12	1 1/2	13/16
13615A	15	2	1
13618A	18	2 3/8	1 3/16
13624A	24	2 3/4	1 7/16

Fed. Spec.: ANSI B107.8M

#### 13342A 4 Piece Chrome Adjustable Wrench Set, in Pouch

##### Contents Include:

Product Code	Size (Inches)	Product Code	Size (Inches)
13406A	6	13410A	10
13408A	8	13412A	12

#### 13642A 4 Piece Black Adjustable Wrench Set, in Pouch

##### Contents Include:

Product Code	Size (Inches)	Product Code	Size (Inches)
13606A	6	13610A	10
13608A	8	13612A	12

#### Features

- Measurement scale on head conveniently shows fastener size.
- Wrench heads are fully polished for easy clean-up.
- Exceed ANSI specifications for strength.
- Precision hardened and anti-corrosion treated.

# WRENCHES

## ADJUSTABLE/CONSTRUCTION/STRUCTURAL



### RATCHETING ADJUSTABLE WRENCHES

#### Comfort Grip

Product Code	Overall Length (Inches)	Maximum Jaw Opening (Inches)	Head Thickness (Inches)
13106	6	1 <sup>3</sup> / <sub>16</sub>	7 <sup>1</sup> / <sub>16</sub>
13108	8	1 <sup>9</sup> / <sub>16</sub>	9 <sup>1</sup> / <sub>16</sub>
13110	10	1 3 <sup>1</sup> / <sub>16</sub>	1 <sup>1</sup> / <sub>16</sub>

#### 13343 3 Piece Set Ratcheting Adjustable Wrench Set, in Pouch

##### Contents Include:

Product Code	Size (Inches)	Product Code	Size (Inches)
13106	6	13110	10
13108	8		

#### Features

- Easy to use in limited space



13110



### ADJUSTABLE CONSTRUCTION WRENCH

#### Heavy-Duty With Polished Head and Measurement Scales

Product Code	Length (Inches)	Maximum Jaw Opening (Inches)	Head Thickness (Inches)
13625A	15	1 1/2	2 <sup>3</sup> / <sub>32</sub>

#### Features

- Tapered spud handle locates and aligns bolts and rivets.
- Hole in handle permits tethering wrench for safety.
- Measurement scale on head conveniently shows fastener size.
- Economical black phosphate finish resists rust.



13625A



### SINGLE HEAD OPEN END OFFSET STRUCTURAL WRENCHES

#### Industrial Black Finish, SAE

Product Code	Size (Inches)	A	B	C	D
		Overall Length (Inches)	Open End Width (Inches)	Open End Thickness (Inches)	Handle Offset (Inches)
1904A	3/4	11 9/16	1 19/32	15/32	7/8
1905	7/8	14 5/16	2	9/16	1
1906	1 1/16	14 3/16	1 31/32	19/32	1
1906B	1	14 1/4	2	19/32	1
1907	1 1/16	16 13/16	2 5/32	5/8	1 1/8
1907A	1 1/8	16 13/16	2 1/4	5/8	1 1/8
1908	1 1/4	17 11/16	2 23/32	11/16	1 1/4
1908A	1 5/16	18 3/4	2 13/16	23/32	1 1/4
1909	1 7/16	19 3/4	3 3/32	25/32	1 1/4
1909A	1 1/2	19 7/8	3 5/32	25/32	1 1/2
1910	1 5/8	21 1/16	3 7/32	7/8	1 1/2
1911	1 13/16	23	3 3/4	1 3/4	1 5/8
1911A	1 7/8	22 13/16	3 25/32	31/32	1 5/8
1912	2	23 3/4	4 7/32	31/32	1 5/8

#### Features

- Long offset handle is designed for clearance of obstructions while providing greater leverage.
- Tapered spud handle locates and aligns bolt and rivet holes.

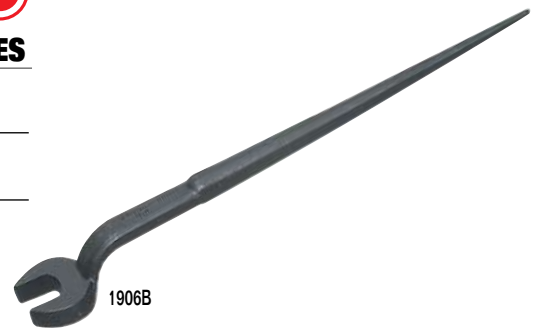

1906B

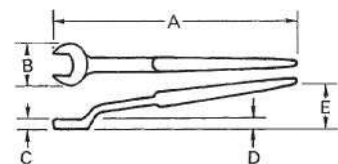

# WRENCHES

## STRUCTURAL BOX

WILLIAMS®



### SINGLE HEAD OPEN END CONSTRUCTION WRENCHES

Industrial Black Finish, SAE

Product Code	Size (Inches)	A	B	C
		Overall Length (Inches)	Open End Width (Inches)	Open End Thickness (Inches)
204A	3/4	12	1 23/32	15/32
205	7/8	14 1/4	2 1/16	19/32
206	15/16	14 3/4	2 1/8	19/32
206B	1	13 1/8	2 3/32	1/2
207	1 1/16	16 9/16	2 7/16	21/32
207A	1 1/8	17	2 9/16	11/16
Q-208	1 1/4	18 15/16	2 23/32	23/32
208A	1 5/16	19	2 27/32	3/4
209	1 7/16	21 1/8	3 3/8	27/32
209A	1 1/2	18 3/4	2 3/4	13/16
Q-210	1 5/8	22 11/16	3 21/32	7/8
211	1 13/16	25	4 1/2	1 1/32
211A	1 7/8	25 1/8	4 9/16	1 1/8

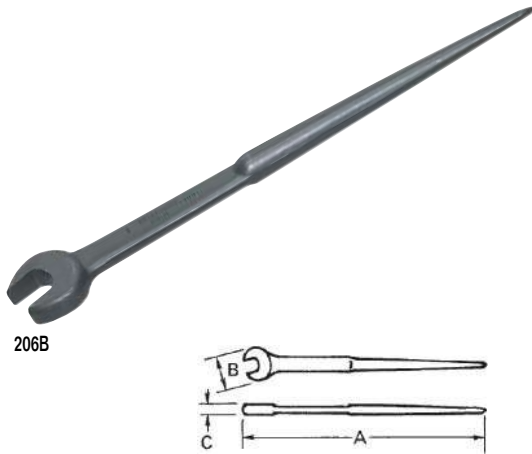

#### Features

- 15° open end provides two gripping angles when wrench is turned over.
- Tapered spud handle locates and aligns bolt and rivet holes.

WILLIAMS®



### OFFSET STRUCTURAL BOX WRENCHES

Industrial Black Finish, SAE

Product Code	Size (Inches)	A	B	C
		Overall Length (Inches)	Head Diameter (Inches)	Offset at End
8905A	13/16	12	1 15/32	1 25/32
8905	7/8	12	1 15/32	1 25/32
8906	15/16	12	1 5/8	1 61/64
8906B	1	12	1 5/8	1 61/64
8907	1 1/16	15	1 53/64	2 9/64
8907A	1 1/8	15	1 53/64	2 9/64
8908	1 1/4	17	2 5/64	2 21/64
8908A	1 5/16	17	2 5/64	2 21/64
8909	1 7/16	21	2 3/8	2 3/4
8909A	1 1/2	21	2 3/8	2 3/4
8910	1 5/8	22	2 5/8	2 7/8
8910A	1 11/16	22	2 5/8	2 7/8
8911	1 13/16	23	2 29/32	3
8911A	1 7/8	23	2 29/32	3
8912	2	24 1/2	3 5/32	3 5/32
8913	2 3/16	26	3 15/32	3 1/2
8914	2 3/8	28	3 23/32	3 11/16
8915	2 9/16	30	3 29/32	3 13/16
8916	2 3/4	30	4 5/32	3 29/32

Fed. Spec: GGG-W-636E Type 9 Class 2

#### Features

- Offset from handle to permit clearance of obstructions
- Handles are tapered for insertion into bolt holes
- Industrial Black Finish



# WRENCHES

## TUBULAR



### TUBULAR WRENCH HANDLES

#### Industrial Black Finish

Product Code	Length (Inches)	Inside Handle Diameter (Inches)
13TH	13½	7/8
24TH	24	7/8
36TH	36	1½

#### Features

- For use with all Williams Tubular Handle Wrenches.
- A detent on the wrench shaft helps to align locking button with handle hole.
- Tubular wrenches may be used without the handle to quickly run down nuts.



13TH



### OPEN END TUBULAR HANDLE WRENCHES

#### Industrial Black Finish, SAE / Metric

Product Code	Size (Inches)	Size (MM)	B		C		Assembled Length From Bolt Center (Inches) 13TH	Assembled Length From Bolt Center (Inches) 24TH	Fits Handle No.
			Outside Head Diameter (Inches)	Head Depth (Inches)	Outside Head Diameter (Inches)	Head Depth (Inches)			
1228TOE	7/8	-	1 15/16	1/2	19 3/8	29 7/8			13TH - 24TH
1230TOE	15/16	-	1 15/16	1/2	19 3/8	29 7/8			13TH - 24TH
1232TOE	1	-	2 5/16	9/16	20 5/32	30 21/32			13TH - 24TH
1234TOE	1 1/16	-	2 5/16	9/16	20 5/32	30 21/32			13TH - 24TH
1236TOE	1 1/8	-	2 5/16	9/16	20 5/32	30 21/32			13TH - 24TH
1240TOE	1 1/4	32	2 11/16	5/8	21 5/32	31 21/32			13TH - 24TH
1242TOE	1 5/16	33	2 11/16	5/8	21 5/32	31 21/32			13TH - 24TH
1244TOE	1 3/8	35	2 11/16	5/8	22	32 1/2			13TH - 24TH
1246TOE	1 7/16	36	3 1/8	11/16	22 1/16	32 9/16			13TH - 24TH
1248TOE	1 1/2	38	3 1/8	11/16	22 1/16	33 9/16			13TH - 24TH

#### Features

- Unique, versatile design allows wrench to be used with or without optional handles.
- Tubular wrenches may be used without the handle to quickly run down nuts.
- The handle can then be attached to provide maximum turning power for final tightening or to reach otherwise inaccessible fasteners.
- A detent on the wrench shaft helps to align locking button with handle hole.
- Open end wrench head provides access in tight areas.
- Sizes of both SAE and corresponding metric fasteners are shown.



1228TOE

CDI WSC-400CA and WSC-600CA Split Beam Torque Wrenches accept the Williams Heavy Duty Tubular Wrenches that fit the 24TH handle. The length of the wrench head matches the effective length of the ratchet head and extender that come with the torque wrench, creating the same effective length. Removing the ratchet head and extender from the torque wrench and inserting the desired Heavy Duty Tubular wrench of choice (fitting 24TH handle) creates an expanded use interchangeable head system. The complete assortment of CDI Split Beam Torque Wrenches is found on page 98.

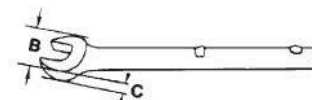

B = Outside Dia.  
C = Head Depth



# WRENCHES

## TUBULAR



1234TOB

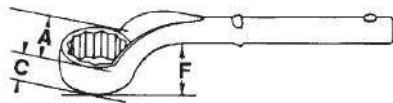

A = Outside Dia.  
C = Head Depth  
F = Height of Offset

WILLIAMS®



### OFFSET BOX END TUBULAR HANDLE WRENCHES

Industrial Black Finish, 12 Point, SAE / Metric

Product Code	Size (Inches)	Size (MM)	A		C		F		Assembled Length From Bolt Center (Inches) 13TH	Assembled Length From Bolt Center (Inches) 24TH/36TH	Fits Handle No.
			Outside Head Diameter (Inches)	Head Depth (Inches)	Head Depth (Inches)	Height of Offset (Inches)	Assembled Length From Bolt Center (Inches) 13TH				
1234TOB	1 1/16	-	1 21/32	5/8	1 1/16	9 3/32	30 3/32	13TH - 24TH			
1236TOB	1 1/8	-	1 7/8	23/32	1 1/16	9 7/32	30 7/32	13TH - 24TH			
1240TOB	1 1/4	32	1 29/32	23/32	1 1/16	9 7/32	30 7/32	13TH - 24TH			
1242TOB	1 5/16	33	2	27/32	1 1/8	11 1/2	32 1/2	13TH - 24TH			
1244TOB	1 3/8	35	2 1/16	7/8	1 1/16	11 19/32	32 19/32	13TH - 24TH			
1246TOB	1 7/16	36	2 5/32	7/8	1 1/4	11 19/32	32 19/32	13TH - 24TH			
1248TOB	1 1/2	38	2 1/4	15/16	1 5/16	11 19/32	32 19/32	13TH - 24TH			
1250TOB	1 9/16	40	2 5/16	15/16	1 9/16	11 19/32	32 19/32	13TH - 24TH			
1252TOB	1 5/8	41	2 3/8	31/32	1 3/8	11 23/32	32 23/32	13TH - 24TH			
1254TOB	1 11/16	43	2 19/32	1 1/16	1 7/16		43 3/32	36TH			
1256TOB	1 3/4	44	2 5/8	1 1/16	1 1/2		43 3/32	36TH			
1258TOB	1 13/16	46	2 23/32	1 1/8	1 9/16		43 13/32	36TH			
1260TOB	1 7/8	47	2 3/4	1 1/8	1 5/8		43 13/32	36TH			
1264TOB	2	51	2 31/32	1 1/4	1 3/4		43 1/2	36TH			
1266TOB	2 1/16	52	2 31/32	1 1/4	1 3/4		43 1/2	36TH			
1270TOB	2 3/16	55	3 3/16	1 5/16	1 7/8		43 19/32	36TH			
1272TOB	2 1/4	57	3 1/4	1 5/16	1 7/8		43 19/32	36TH			
1276TOB	2 3/8	60	3 13/32	1 13/32	2		43 11/16	36TH			
1282TOB	2 9/16	65	3 21/32	1 1/2	2 1/4		43 13/16	36TH			
1284TOB	2 5/8	67	3 11/16	1 1/2	2 1/4		44 7/32	36TH			
1288TOB	2 3/4	70	3 15/16	1 19/32	2 1/2		44	36TH			
1294TOB	2 15/16	75	4 5/32	1 11/16	2 5/8		44 5/32	36TH			
12100TOB	3 1/8	79	4 3/8	1 11/16	2 3/4		44 19/32	36TH			

#### Features

- Unique, versatile design allows wrench to be used with or without optional handles.
- Tubular Wrenches may be used without the handle to quickly run down nuts.
- The handle can then be attached to provide maximum turning power for final tightening or to reach otherwise inaccessible fasteners.
- A detent on the wrench shaft helps to align locking button with handle hole.
- Offset box wrench head provides turning clearance.
- Sizes of both SAE and corresponding metric fasteners are shown.



1224TSB

WILLIAMS®



### STRAIGHT BOX END TUBULAR HANDLE WRENCHES

Industrial Black Finish, 12 Point, SAE / Metric

Product Code	Size (Inches)	Size (MM)	A		C		Assembled Length From Bolt Center (Inches) 13TH	Assembled Length From Bolt Center (Inches) 24TH/36TH	Fits Handle No.
			Outside Head Diameter (Inches)	Head Depth (Inches)	Head Depth (Inches)	Height of Offset (Inches)			
1224TSB	3/4	-	1 1/4	17/32	19 1/32	29 17/32	13TH - 24TH		
1226TSB	13/16	-	1 1/4	17/32	19 1/32	29 17/32	13TH - 24TH		
1228TSB	7/8	-	1 13/32	19/32	19 1/32	29 17/32	13TH - 24TH		
1230TSB	15/16	-	1 13/32	19/32	19 1/32	29 17/32	13TH - 24TH		
1232TSB	1	-	1 9/16	21/32	19 3/32	29 19/32	13TH - 24TH		
1234TSB	1 1/16	-	1 9/16	21/32	19 3/32	29 19/32	13TH - 24TH		
1236TSB	1 1/8	-	1 5/16	11/16	19 3/32	29 19/32	13TH - 24TH		
1240TSB	1 1/4	32	1 29/32	27/32	21 13/32	31 29/32	13TH - 24TH		
1242TSB	1 5/16	33	1 29/32	27/32	21 13/32	31 29/32	13TH - 24TH		
1246TSB	1 7/16	36	2 5/32	7/8	21 13/32	31 29/32	13TH - 24TH		
1248TSB	1 1/2	38	2 3/32	7/8	21 13/32	31 29/32	13TH - 24TH		
1252TSB	1 5/8	41	2 5/16	15/16	22 7/32	32 23/32	13TH - 24TH		
12100TSB	3 1/8	79	4 3/32	1 3/4		42 5/32	36TH		

#### Features

- Unique, versatile design allows wrench to be used with or without optional handles.
- Tubular wrenches may be used without the handle to quickly run down nuts.
- The handle can then be attached to provide maximum turning power for final tightening or to reach otherwise inaccessible fasteners.
- A detent on the wrench shaft helps to align locking button with handle hole.
- Straight box wrench head provides access when clearance is limited.
- Sizes of both SAE and corresponding metric fasteners are shown.

# WRENCHES

## STRIKING



### STRAIGHT PATTERN BOX END STRIKING WRENCHES

Industrial Black Finish, 12 Point, SAE / Metric

Product Code	Size (Inches)	Size (MM)	A	B	C
			Overall Length (Inches)	Box End Diameter (Inches)	Box End Thickness (Inches)
SFH-1808BW	1 3/16	30	7 9/16	2 3/32	7/8
SFH-1808W	1 1/4	32	7 9/16	2 3/32	7/8
SFH-1808AW	1 5/16	33	7 9/16	2 3/32	7/8
SFH-1808CW	1 3/8	35	7 21/32	2 9/32	31/32
SFH-1809W	1 7/16	-	7 21/32	2 9/32	31/32
SFH-1809BW	-	36	7 21/32	2 9/32	31/32
SFH-1809AW	1 1/2	38	7 21/32	2 9/32	31/32
SFH-1810W	1 5/8	41	7 27/32	2 21/32	1 5/32
SFH-1810AW	1 11/16	43	7 13/16	2 21/32	1 5/32
SFH-1810BW	1 3/4	44	7 15/16	2 13/16	1 1/4
SFH-1811W	1 13/16	46	7 15/16	2 13/16	1 1/4
SFH-1811AW	1 7/8	-	7 15/16	2 13/16	1 1/4
SFH-1812BW	-	50	11 19/32	3 3/16	1 13/32
SFH-1812W	2	51	11 19/32	3 3/16	1 13/32
SFH-1812AW	2 1/16	52	11 19/32	3 3/16	1 13/32
SFH-1813W	2 3/16	55	11 3/4	2 9/16	1 17/32
SFH-1813AW	2 1/4	57	11 3/4	2 9/16	1 17/32
SFH-1814W	2 3/8	60	11 7/8	3 3/4	1 11/16
SFH-1814AW	2 7/16	62	11 7/8	3 3/4	1 11/16
SFH-1814BW	2 1/2	64	11 7/8	3 3/4	1 11/16
SFH-1815W	2 9/16	65	13	4	1 13/16
SFH-1815AW	2 5/8	67	13	4	1 13/16
SFH-1816W	2 3/4	70	14 9/32	4 9/32	1 15/16
SFH-1816AW	2 13/16	71	14 9/32	4 9/32	1 15/16
SFH-1816BW	2 15/16	75	14 17/32	4 17/32	2 1/16
SFH-1817AW	3	76	14 13/32	4 17/32	2 1/16
SFH-1817W	3 1/8	80	17 19/32	4 29/32	2 9/32
SFH-1818AW	3 3/8	85	17 19/32	4 29/32	2 9/32
SFH-1818W	3 1/2	89	17 13/16	5 5/16	2 15/32
SFH-1819BWA	3 3/4	95	17 29/32	5 17/32	2 21/32
SFH-1819WA	3 7/8	98	17 29/32	5 17/32	2 21/32
SFH-1819CWA	4 1/8	105	18 3/32	6 1/32	2 15/16
SFH-1819AWA	4 1/4	108	18 3/32	6 1/32	2 15/16
SFH-1820BWA	4 1/2	114	20 1/32	6 25/32	3 3/16
SFH-1820WA	4 5/8	117	20 1/32	6 25/32	3 3/16



SFH-1812W

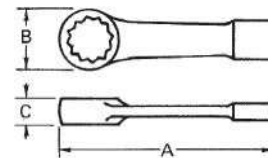

#### Features

- Striking face wrenches are designed to be struck by a hammer on the anvil area in order to loosen frozen fasteners or to set and tighten fasteners.
- Anvils are proportional to opening sizes. Special heat treating provides maximum durability for long life.
- Straight handle design resists springing while allowing the fastener to turn more easily.
- Williams' expanded line of offset striking face wrenches, up to 4-5/8", provides the most extensive line on the market.
- Specifically engineered to hold up under the most rigorous industrial use.



# WRENCHES

## STRIKING



### OFFSET PATTERN BOX END STRIKING WRENCHES

Industrial Black Finish, 12 Point, SAE / Metric

Product Code	Size (Inches)	Size (MM)	A	B	C
			Overall Length (Inches)	Box End Diameter (Inches)	Box End Thickness (Inches)
8807W	1 1/16	27	9 3/32	1 21/32	23/32
8807AW	1 1/8	-	10 31/32	1 15/16	3/4
8808BW	1 3/16	30	10 31/32	1 15/16	3/4
8808W	1 1/4	32	10 31/32	1 15/16	3/4
8808AW	1 5/16	33	10 31/32	1 15/16	3/4
8808CW	1 3/8	35	11 1/2	2 7/32	29/32
8809W	1 7/16	-	11 1/2	2 7/32	29/32
8809BW	-	36	11 1/2	2 5/32	29/32
8809AW	1 1/2	38	12	2 7/16	1
8810W	1 5/8	41	12	2 7/16	1
8810AW	1 11/16	43	12 9/16	2 11/16	1 1/8
8811BW	1 3/4	44	12 9/16	2 11/16	1 1/8
8811W	1 13/16	46	12 9/16	2 11/16	1 1/8
8811AW	1 7/8	-	13	2 7/8	1 1/4
8812AW	1 15/16	49	13	2 7/8	1 1/4
8812BW	-	50	13	2 7/8	1 1/4
8812W	2	51	13	2 7/8	1 1/4
8813BW	2 1/8	54	13 9/16	3 1/4	1 13/32
8813W	2 3/16	55	13 9/16	3 1/4	1 13/32
8813AW	2 1/4	57	13 9/16	3 1/4	1 13/32
8814AW	2 5/16	59	13 9/16	3 1/4	1 13/32
8814W	2 3/8	60	14 1/8	3 11/16	1 1/2
8815BW	2 1/2	64	14 1/8	3 11/16	1 1/2
8815W	2 9/16	65	14 1/8	3 11/16	1 1/2
8815AW	2 5/8	67	15	3 15/16	1 5/8
8816W	2 3/4	70	15	2 15/16	1 5/8
8816CW	2 7/8	73	16	4 7/16	1 3/4
8816BW	2 15/16	75	16	4 7/16	1 3/4
8817AW	3	76	16	4 7/16	1 3/4
8817W	3 1/8	80	16	4 7/16	1 3/4
8818AW	3 3/8	85	18 9/32	6	2
8818W	3 1/2	89	18 9/32	6	2
8819BW	3 3/4	95	18 9/32	6	2
8819W	3 7/8	98	18 9/32	6	2
8819CW	4 1/8	105	18 9/32	6	2
8819AW	4 1/4	108	18 9/32	6	2



8811BW

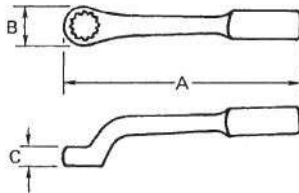

#### Features

- Striking face wrenches are designed to be struck by a hammer on the anvil area in order to loosen frozen fasteners or to set and tighten fasteners.
- Anvils are proportional to opening sizes. Special heat treating provides maximum durability for long life.
- Offset handle is close to head to provide clearance in confined areas.
- Williams' expanded line of offset striking face wrenches, up to 4-1/4", provides the most extensive line on the market.
- Specifically engineered to hold up under the most rigorous industrial use.



### FRAC PUMP WRENCH

A safer, more durable tool

Product Code	Stud Size
8817AFPW	Frac Pump Wrench

#### Features

- Specially designed for the oil and gas industry to work on fluid ends of well servicing pumps from all major manufacturers with 3" valve cover retainer nuts
- Offset design with 3" integrated hex driver
- A larger striking surface ensures fewer errant blows
- Offset reduces damage to manifold
- Robust metallurgy ensures a safer tool that is less likely to break



8817AFPW

# WRENCHES

## RETAINERS/HAMMER



### SLUGGING WRENCH RETAINERS

Product Code	Stud Size	Length	C	D
SWR-24	3/8	1 29/32	1 15/16	1 3/4
SWR-28	7/8	2	2 3/16	1 29/32
SWR-32	1	2 1/8	2 1/2	2 1/32
SWR-36	1 1/8	2 1/4	2 1/2	2 5/32
SWR-40	1 1/4	2 3/8	2 7/8	2 9/32
SWR-44	1 3/8	2 15/32	3 1/8	2 3/8
SWR-48	1 1/2	2 5/8	3 1/8	2 1/2
SWR-52	1 5/8	2 3/4	3 3/8	2 21/32
SWR-56	1 3/4	2 7/8	3 7/8	2 3/4
SWR-60	1 7/8	3	4 1/2	2 7/8

#### SWR-SET 10 Piece Slugging Wrench Retainers Set

##### Contents Include:

Product Code	Stud Size	Product Code	Stud Size
SWR-24	3/8	SWR-44	1 3/8
SWR-28	7/8	SWR-48	1 1/2
SWR-32	1	SWR-52	1 5/8
SWR-36	1 1/8	SWR-56	1 3/4
SWR-40	1 1/4	SWR-60	1 7/8

##### Features

- Slugging Wrench Retainers thread onto the end of the stud over the slugging wrench to ensure the wrench stays affixed to the fastener
- A spring loaded plate allows for easy adjustment of the wrench without having to unscrew the retainer.
- Increased productivity and safer operation by eliminating the need for a second worker to hold and slugging wrench in place
- Available in 10 sizes, marked with stud sizes (not hex sizes)
- Configured to work with offset and straight handle slugging wrenches

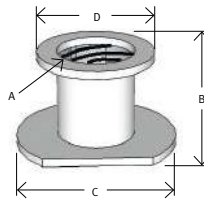

SWR-52

SWR-24



SWR-SET



### HAMMER WRENCHES

#### 6 Point

Product Code	Wrench Opening (Nut Size)	Head Dia.	Head Thickness	Overall Length
HW-6034	1 1/16	1 25/32	5/8	9 7/8
HW-6040	1 1/4	2	23/32	10 1/4
HW-6046	1 7/16	2 17/64	7/8	10 9/16
HW-6052	1 5/8	2 31/64	61/64	11
HW-6058	1 13/16	2 21/32	63/64	11 5/16
HW-6064	2	3 1/32	1 7/32	11 11/16
HW-6070	2 3/16	3 9/32	1 1/4	12
HW-6076	2 3/8	3 13/32	1 7/16	12 3/8
HW-6082	2 5/16	3 3/4	1 17/32	12 11/16
HW-6088	2 3/4	4 11/64	1 17/32	13 1/16
HW-6094	2 15/16	4 23/64	1 17/32	13 7/16
HW-6100	3 1/8	4 31/64	1 5/8	13 13/16
HW-6112	3 1/2	4 31/32	1 23/32	14 1/8
HW-6124	3 7/8	5 35/64	1 23/32	14 1/2

##### Features

- Designed for use in the petrochemical industries where clearance, particularly on flanges, and cored fasteners are often a problem:
- 6 Point Hex is offset 15 degree, and short handle length allows for use in tight spaces
- Straight Handle transfers maximum torque when struck
- Assortment fits Stud Sizes up to 2-1/2"



HW-6034





# WRENCHES

## SPANNER



WS-476



WS-474



WS-483

WILLIAMS®



### ADJUSTABLE PIN SPANNER WRENCHES

Industrial Black Finish, SAE

Product Code	Span Diameter (Inches)	Pin Diameter (Inches)	Pin Length (Inches)	Overall Length (Inches)
O-471	3/4 to 2	1/8	1/8	5 3/8
O-471A	3/4 to 2	3/16	5/32	5 3/8
O-472	1 1/4 to 3	3/16	3/16	6 7/8
O-472A	1 1/4 to 3	1/4	7/32	6 7/8
O-474	2 to 4 3/4	1/4	1/4	9 1/2
O-474A	4 1/2 to 6 1/4	3/8	1/4	9 7/8

#### WS-476 6-Piece Adjustable Pin Spanner Wrench Set, in Pouch

Contents Include:

Product Code	Overall Length (Inches)	Product Code	Overall Length (Inches)
O-471	5 3/8	O-472A	6 7/8
O-471A	5 3/8	O-474	9 1/2
O-472	6 7/8	O-474A	9 7/8

#### Features

- Ideal for adjusting collars, lock nut rings, and bearings.
- Specifically engineered to hold up under the most rigorous industrial use.

WILLIAMS®



### ADJUSTABLE HOOK SPANNER WRENCHES

Industrial Black Finish, SAE

Product Code	Span Diameter (Inches)	Hook Depth (Inches)	Hook Thickness (Inches)	Overall Length (Inches)
471	3/4 to 2	1/8	1 1/32	5 3/8
472	1 1/4 to 3	5/32	13/32	7 1/4
474	2 to 4 3/4	3/16	15/32	11 1/2
474A	4 1/2 to 6 1/4	1/4	15/32	17 1/2
474B	6 1/8 to 8 3/4	5/16	15/32	18 1/2

#### WS-474 4-Piece Adjustable Hook Spanner Wrench Set, in Pouch

Product Code	Overall Length (Inches)	Product Code	Overall Length (Inches)
471	5 3/8	474	11 1/2
472	7 1/4	474A	17 1/2

#### Features

- Ideal for adjusting collars, lock nut rings, and bearings.
- Specifically engineered to hold up under the most rigorous industrial use.

WILLIAMS®



### ADJUSTABLE FACE SPANNER WRENCHES

Industrial Black Finish, SAE

Product Code	Span Diameter (Inches)	Pin Diameter (Inches)	Pin Length (Inches)	Overall Length (Inches)
482	2	3/16	1/4	6 1/4
483	3	1/4	1/4	8 1/8
484	4	5/16	1/2	10 3/8

#### WS-483 3-Piece Adjustable Face Spanner Wrench Set, in Pouch

Contents Include:

Product Code	Overall Length (Inches)	Product Code	Overall Length (Inches)
482	6 1/4	484	10 3/8
483	8 1/8		

#### Features

- Ideal for adjusting collars, lock nut rings, and bearings.
- Specifically engineered to hold up under the most rigorous industrial use.

# WRENCHES

## HEX KEY



### T-HANDLE HEX DRIVERS

#### Cushion Grip Handle

Product Code	Size (Inches)	Product Code	Size (MM)
HKT-3/32	3/32	HKT-2MM	2
HKT-7/64	7/64	HKT-2.5MM	2.5
HKT-1/8	1/8	HKT-3MM	3
HKT-9/64	9/64	HKT-4MM	4
HKT-5/32	5/32	HKT-5MM	5
HKT-3/16	3/16	HKT-6MM	6
HKT-7/32	7/32	HKT-8MM	8
HKT-1/4	1/4	HKT-10MM	10
HKT-5/16	5/16		
HKT-3/8	3/8		

#### Features

- Cushion grip provides extra comfort
- One-Piece handle construction for extra strength
- 6 Inch shaft length

### WSHKT-10 10 Piece T-Handle Hex Driver Set, SAE in Pouch

#### Contents Include:

Product Code	Size	Product Code	Size	Product Code	Size
HKT-3/32	3/32	HKT-5/32	5/32	HKT-1/4	1/4
HKT-7/64	7/64	HKT-3/16	3/16	HKT-5/16	5/16
HKT-1/8	1/8	HKT-7/32	7/32	HKT-3/8	3/8
HKT-9/64	9/64				

### MWSHKT-8 8 Piece T-Handle Hex Driver Set, MM in Pouch

#### Contents Include:

Product Code	Size	Product Code	Size
HKT-2MM	2	HKT-5MM	5
HKT-2.5MM	2.5	HKT-6MM	6
HKT-3MM	3	HKT-8MM	8
HKT-4MM	4	HKT-10MM	10

#### Features

- Set comes in pouch for tool box or can be hung.

### Universal Hex Key Stand

Product Code	Size
HKTSTAND	Width 7 1/2 x Depth 5 1/2 x Height 6

#### Features

- Universal T-handle stand, fits inch/metric sets
- Number of slots: 22
- Fits up to 3/8" hex
- For Inch, Metric and Torx hex keys
- Can be attached to wall, bench or each other
- T-handle hex drivers are sold separately and are not included with stand
- 6" overall length



HKT-1/4



HKT-6MM



WSHKT-10



MWSHKT-8



HKTSTAND



# WRENCHES

## HEX KEY



WS-45



WS-46



MWS-47



10213

10507



### FOLDING HEX KEY SETS

#### SAE and Metric

Product Code	WS-45		WS-46		MWS-47	
Number of Pieces	8		9		7	
	Hex Size (Inches)	Key Length (Inches)	Hex Size (Inches)	Key Length (Inches)	Includes Hex Size (MM)	Key Length (Inches)
	.050	1 <sup>1</sup> / <sub>4</sub>	<sup>5</sup> / <sub>64</sub>	1 <sup>1</sup> / <sub>2</sub>	1.5	1 <sup>3</sup> / <sub>8</sub>
	<sup>1</sup> / <sub>16</sub>	1 <sup>3</sup> / <sub>8</sub>	<sup>3</sup> / <sub>32</sub>	1 <sup>9</sup> / <sub>16</sub>	2	1 <sup>1</sup> / <sub>2</sub>
	<sup>5</sup> / <sub>64</sub>	1 <sup>7</sup> / <sub>16</sub>	<sup>7</sup> / <sub>64</sub>	1 <sup>11</sup> / <sub>16</sub>	2.5	1 <sup>5</sup> / <sub>8</sub>
	<sup>3</sup> / <sub>32</sub>	1 <sup>9</sup> / <sub>16</sub>	<sup>1</sup> / <sub>8</sub>	1 <sup>15</sup> / <sub>16</sub>	3	1 <sup>3</sup> / <sub>4</sub>
	<sup>7</sup> / <sub>64</sub>	1 <sup>5</sup> / <sub>8</sub>	<sup>9</sup> / <sub>64</sub>	2	4	2
	<sup>1</sup> / <sub>8</sub>	1 <sup>11</sup> / <sub>16</sub>	<sup>3</sup> / <sub>32</sub>	2 <sup>1</sup> / <sub>4</sub>	5	2 <sup>1</sup> / <sub>4</sub>
	<sup>9</sup> / <sub>64</sub>	1 <sup>13</sup> / <sub>16</sub>	<sup>3</sup> / <sub>16</sub>	2 <sup>1</sup> / <sub>2</sub>	6	2 <sup>1</sup> / <sub>2</sub>
	<sup>5</sup> / <sub>32</sub>	2	<sup>7</sup> / <sub>32</sub>	2 <sup>5</sup> / <sub>8</sub>		
			<sup>1</sup> / <sub>4</sub>	2 <sup>7</sup> / <sub>8</sub>		

#### Features

- Steel case is chrome plated to resist corrosion.
- Keys are black oxide finish.
- Convenient item for pocket or tool box.



### BALL END AND STANDARD HEX KEY SETS

#### SAE and Metric, in Handy Compact Plastic Holder

Product Code	Number of Pieces	Type	Key Style	Key Length	Size Range
10107	7	SAE	Standard	Short	<sup>5</sup> / <sub>64</sub> - <sup>1</sup> / <sub>4</sub> "
10111	11	SAE	Standard	Short	.050 - <sup>1</sup> / <sub>4</sub> "
10113	13	SAE	Standard	Short	.050 - <sup>3</sup> / <sub>8</sub> "
10213	13	SAE	Standard	Long	.050 - <sup>3</sup> / <sub>8</sub> "
10507	7	Metric	Standard	Short	1.5 - 6.0 mm
10509	9	Metric	Standard	Short	1.5 - 10.0 mm
13213	13	SAE	Ball Hex	Long	.050 - <sup>3</sup> / <sub>8</sub> "
13609	9	Metric	Ball Hex	Long	1.5 - 10.0 mm

#### Features

- Plastic holders organize hex keys securely in place.
- Keys are black oxide finish.
- Holders are colour coded, red for fractional and blue for metric.
- Ball hex key ends are designed with ball on long arm to provide 360° of rotation at up to a 30° angle.

# WRENCHES

## HEX KEY



### HEX KEY SETS IN POUCH

#### SAE and Metric

Product Code	WS-44		MWS-27	
Number of Pieces	13		11	
	Hex Size (Inches)	Key Length (Inches)	Hex Size (MM)	Key Length (Inches)
	.050	1 11/16	2	2
	1/16	1 13/16	2 1/2	2 5/16
	5/64	1 31/32	3	2 7/32
	3/32	2 1/8	4	2 13/16
	7/64	2 1/4	5	3 5/16
	1/8	2 3/8	6	3 23/32
	9/64	2 9/16	8	4 1/16
	5/32	2 19/32	10	4 5/8
	3/16	3	12	5 7/32
	7/32	3 3/16	14	5 15/16
	1/4	3 1/2	17	6 7/8
	5/16	4		
	3/8	4 17/32		

#### Features

- Pouch keeps hex keys organized.
- Keys are black oxide finish.

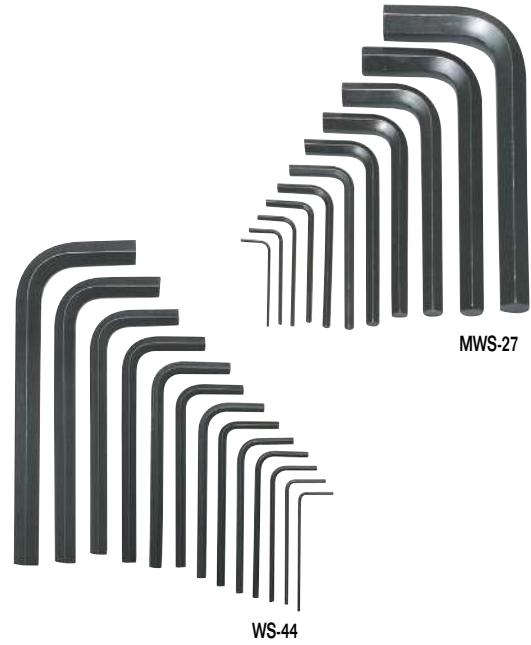

### L-TYPE HEX KEYS

#### Industrial Black Finish, SAE

Product Code	Size (Inches)	Length (Inches)	Width (Inches)	Pkg. Qty.
HK-050	.050	1 23/32	1/2	25
HK-1/16	1/16	1 7/8	1/2	25
HK-5/64	5/64	1 31/32	5/8	25
HK-3/32	3/32	1 13/16	9/16	25
HK-7/64	7/64	2 1/4	23/32	25
HK-1/8	1/8	2 13/32	3/4	25
HK-9/64	9/64	2 3/8	25/32	25
HK-5/32	5/32	2 21/32	27/32	25
HK-3/16	3/16	2 31/32	1	25
HK-7/32	7/32	3 5/16	1	25
HK-1/4	1/4	3 5/8	1 1/8	25
HK-3/8	3/8	4 23/32	1 13/32	5

#### Features

- Keys are black oxide finish.



### L-TYPE HEX KEYS

#### Industrial Black Finish, Metric

Product Code	Size (MM)	Length (Inches)	Width (Inches)	Pkg. Qty.
HK-2mm	2	2	5/8	25
HK-2.5mm	2 1/2	2 1/4	23/32	25
HK-3mm	3	2 9/16	13/16	25
HK-4mm	4	2 13/16	31/32	25
HK-5mm	5	3 13/32	1 1/8	25
HK-6mm	6	3 3/4	1 1/8	10
HK-8mm	8	4 5/16	1 1/8	5
HK-10mm	10	4 3/4	1 1/2	5
HK-12mm	12	5 1/4	1 5/8	5
HK-14mm	14	6	1 1/2	5
HK-17mm	17	6 3/4	2 1/2	1

#### Features

- Keys are black oxide finish.



# SOCKETS & DRIVE TOOLS

## LARGE ASSORTMENT

- CHROME SOCKETS • IMPACT UNIVERSALS • IMPACT SOCKETS
- TURBOSOCKET SALVAGE SOCKETS • RATCHETS

## UNIQUE DESIGN

- SUPERTORQUE LOBULAR OPENING ALLOWS SOCKET TO CONTACT THE FASTENER'S FLATS WITHOUT ROUNDING OR DEFORMING NUTS AND BOLTS
- TURBOSOCKET SALVAGE SOCKETS ARE SPECIFICALLY DESIGNED TO REMOVE DAMAGED OR ROUNDED NUTS AND BOLTS

## MANUFACTURED FOR HEAVY DUTY APPLICATIONS

- EXTRUDED OR HOT BROACHED FROM ALLOY STEEL, PRECISION MACHINED OR FULLY TREATED



15 PIECE 3/8" DRIVE SOCKET & DRIVE TOOL SET



63 PIECE 3/8" DRIVE SOCKET, SCREWDRIVER, & WRENCH SET



27 PIECE 3/8" DRIVE SOCKET & DRIVE TOOL SET

**WE CONTINUE TO INNOVATE TO DELIVER SAFETY AND PRODUCTIVITY TO OUR CUSTOMERS**

# SOCKETS & DRIVE TOOLS

## MULTI DRIVE SOCKET & DRIVE TOOL SETS



### 38 PIECE 1/4" DRIVE SOCKET AND DRIVE TOOL SET

**6 & 8 Point SAE, Packed in Exclusive Keep-Safe-Foam System with Metal Box**

Product Code	Description
WSM-38HFTB	38 Piece Tool Set with TB-103 Metal Tool Box
WSM-38HF	38 Piece Tool Set Only - Packed in Keep Safe Foam System

**Contents Include:**

Drive Tools:		Drive Tools:	
Product Code	Description	Product Code	Description
M-52EHA	5 1/2" Enclosed Head Ratchet	M-106A	Spinner Handle
M-42A	Flex Handle	M-140A	Universal Joint
M-102	2" Extension	M-20A	Sliding T-Handle
M-104	4" Extension	MFE-6	6" Flexible Extension
M-115	6" Extension		

**Shallow 6-Point Sockets**

Product Code	Size (Inches)
M-605	5/32
M-606	3/16
M-607	7/32
M-608	1/4
M-609	9/32
M-610	5/16
M-611	11/32
M-612	3/8
M-614	7/16
M-616	1/2
M-618	9/16

**Deep 6-Point Sockets**

Product Code	Size (Inches)
MD-606	3/16
MD-607	7/32
MD-608	1/4
MD-609	9/32
MD-610	5/16
MD-611	11/32
MD-612	3/8
MD-614	7/16
MD-616	1/2
MD-618	9/16

**Screwdriver Bit Sockets**

Product Code	Description
MA-7A-1P	#1 Phillips® Tip
MA-7A-2P	#2 Phillips® Tip
MA-5A-1S	3/16" Slotted Tip
MA-7A-2S	7/32" Slotted Tip
MA-8A-3S	9/32" Slotted Tip

**Shallow 8-Point Sockets**

Product Code	Size (Inches)
M-808	1/4
M-810	5/16
M-812	3/8

**Features**

- Keep-Safe-Foam system keeps tools organized and helps prevent loss.
- All tools are professional quality, made of high-grade chrome vanadium steel.
- Sockets feature SUPERTORQUE® lobular openings for greater turning power without deforming the fastener.
- Metal tool box made for years of rugged use.



WSM-38HFTB



### 26 PIECE 1/4" DRIVE SOCKET AND DRIVE TOOL SET

**6 Point SAE, Packed in Exclusive Keep-Safe-Foam System with Metal Box**

Product Code	Description
WSM-26HFTB	26 Piece Tool Set with TB-102 Metal Tool Box
WSM-26HF	26 Piece Tool Set Only - Packed in Keep Safe Foam System

**Contents Include:**

Drive Tools:		Drive Tools:	
Product Code	Description	Product Code	Description
M-52EHA	5 1/2" Enclosed Head Ratchet	M-106A	Spinner Handle
M-102	2" Extension	M-140A	Universal Joint
M-115	6" Extension		

**Shallow 6-Point Sockets**

Product Code	Size (Inches)
M-605	5/32
M-606	3/16
M-607	7/32
M-608	1/4
M-609	9/32
M-610	5/16
M-611	11/32
M-612	3/8
M-614	7/16
M-616	1/2
M-618	9/16

**Deep 6-Point Sockets**

Product Code	Size (Inches)
MD-606	3/16
MD-607	7/32
MD-608	1/4
MD-609	9/32
MD-610	5/16
MD-611	11/32
MD-612	3/8
MD-614	7/16
MD-616	1/2
MD-618	9/16

**Features**

- Keep-Safe-Foam system keeps tools organized and helps prevent loss.
- All tools are professional quality, made of high-grade chrome vanadium steel.
- Sockets feature SUPERTORQUE® lobular openings for greater turning power without deforming the fastener.
- Metal tool box made for years of rugged use.



WSM-26HFTB



# SOCKETS & DRIVE TOOLS

## 1/4" DRIVE



### 22 PIECE 1/4" DRIVE SOCKET AND DRIVE TOOL SET

**6 & 12 Point SAE, Packed in Exclusive Keep-Safe-Foam System with Metal Box**

Product Code	Description
WSM-22FTB	22 Piece Tool Set with TB-102 Metal Tool Box
WSM-22F	22 Piece Tool Set Only - Packed in Keep Safe Foam System



WSM-22FTB

#### Contents Include:

Drive Tools:		Deep 6-Point Sockets	
Product Code	Description	Product Code	Size (Inches)
M-52EHA	5 1/2" Enclosed Head Ratchet	MD-605	5/32
M-102	2" Extension	MD-606	3/16
M-106A	Spinner Handle	MD-608	1/4
M-140A	Universal Joint		

Shallow 6-Point Sockets		Deep 12-Point Sockets	
Product Code	Size (Inches)	Product Code	Size (Inches)
M-605	5/32	MD-1210	5/16
M-606	3/16	MD-1211	11/32
M-608	1/4	MD-1212	3/8
		MD-1214	7/16
		MD-1216	1/2
		MD-1218	9/16

Shallow 12-Point Sockets	
Product Code	Size (Inches)
M-1210	5/16
M-1211	11/32
M-1212	3/8
M-1214	7/16
M-1216	1/2
M-1218	9/16

#### Features

- Keep-Safe-Foam system keeps tools organized and helps prevent loss.
- All tools are professional quality, made of high-grade chrome vanadium steel.
- Sockets feature SUPERTORQUE® lobular openings for greater turning power without deforming the fastener.
- Metal tool box made for years of rugged use.



### 19 PIECE 1/4" DRIVE SOCKET AND DRIVE TOOL SET

**6 & 8 Point SAE, Packed in Exclusive Keep-Safe-Foam System with Metal Box**

Product Code	Description
WSM-19HFTB	19 Piece Tool Set with TB-101 Metal Tool Box
WSM-19HF	19 Piece Tool Set Only - Packed in Keep Safe Foam System



WSM-19HFTB

#### Contents Include:

Drive Tools:		Shallow 6-Point Sockets	
Product Code	Description	Product Code	Size (Inches)
M-52EHA	5 1/2" Enclosed Head Ratchet	M-606	3/16
M-102	2" Extension	M-607	7/32
M-115	6" Extension	M-608	1/4
M-106A	Spinner Handle	M-609	9/32
M-140A	Universal Joint	M-610	5/16
M-42A	Flex Handle	M-611	11/32
		M-612	3/8
		M-614	7/16
		M-616	1/2
		M-618	9/16

Shallow 8-Point Sockets	
Product Code	Size (Inches)
M-808	1/4
M-810	3/16
M-812	3/8

#### Features

- Keep-Safe-Foam system keeps tools organized and helps prevent loss.
- All tools are professional quality, made of high-grade chrome vanadium steel.
- Sockets feature SUPERTORQUE® lobular openings for greater turning power without deforming the fastener.
- Metal tool box made for years of rugged use.

# SOCKETS & DRIVE TOOLS

## 1/4" DRIVE



### 15 PIECE 1/4" DRIVE SOCKET AND DRIVE TOOL SET

**6 Point SAE, Packed in Exclusive Keep-Safe-Foam System with Metal Box**

Product Code	Description
WSM-15HFTB	15 Piece Tool Set with TB-101 Metal Tool Box
WSM-15HF	15 Piece Tool Set Only - Packed in Keep Safe Foam System

**Contents Include:**

Drive Tools:		Product Code	Description
Product Code	Description		
M-52EHA	5 1/2" Enclosed Head Ratchet	M-106A	Spinner Handle
M-102	2" Extension	M-140A	Universal Joint
M-115	6" Extension		

Shallow 6-Point Sockets		Shallow 6-Point Sockets	
Product Code	Size (Inches)	Product Code	Size (Inches)
M-606	3/16	M-611	11/32
M-607	7/32	M-612	3/8
M-608	1/4	M-614	7/16
M-609	9/32	M-616	1/2
M-610	5/16	M-618	9/16

**Features**

- Keep-Safe-Foam system keeps tools organized and helps prevent loss.
- All tools are professional quality, made of high-grade chrome vanadium steel.
- Sockets feature SUPERTORQUE® lobular openings for greater turning power without deforming the fastener.
- Metal tool box made for years of rugged use.



WSM-15HFTB



### 13 PIECE 1/4" DRIVE SOCKET AND DRIVE TOOL SET

**6 & 12 Point SAE, Packed in Exclusive Keep-Safe-Foam System with Metal Box**

Product Code	Description
WSM-13FTB	13 Piece Tool Set with TB-101 Metal Tool Box
WSM-13F	13 Piece Tool Set Only - Packed in Keep Safe Foam System

**Contents Include:**

Drive Tools:		Shallow 12-Point Sockets	
Product Code	Description	Product Code	Size (Inches)
M-52EHA	5 1/2" Enclosed Head Ratchet	M-1208	1/4
M-102	2" Extension	M-1210	5/16
M-106A	Spinner Handle	M-1211	11/32
M-140A	Universal Joint	M-1212	3/8
		M-1214	7/16
		M-1216	1/2
		M-1218	9/16

Shallow 6-Point Sockets	
Product Code	Size (Inches)
M-605	5/32
M-606	3/16

**Features**

- Keep-Safe-Foam system keeps tools organized and helps prevent loss.
- All tools are professional quality, made of high-grade chrome vanadium steel.
- Sockets feature SUPERTORQUE® lobular openings for greater turning power without deforming the fastener.
- Metal tool box made for years of rugged use.



WSM-13FTB





# SOCKETS & DRIVE TOOLS

## 1/4" DRIVE



### 30 PIECE 1/4" DRIVE SOCKET AND DRIVE TOOL SET

**6 Point Metric, Packed in Exclusive Keep-Safe-Foam System with Metal Box**

Product Code	Description
MSM-30HFTB	30 Piece Metric Tool Set with TB-103 Metal Tool Box
MSM-30HF	30 Piece Tool Set Only - Packed in Keep Safe Foam System

**Contents Include:**

**Drive Tools:**

Product Code	Description	Product Code	Description
M-52EHA	5 1/2" Enclosed Head Ratchet	M-106A	Spinner Handle
M-102	2" Extension	M-140A	Universal Joint
M-115	6" Extension	M-42A	Flex Handle

**Shallow 6-Point Sockets**

Product Code	Size (MM)
MM-604	4
MM-605	5
MM-605.5	5 1/2
MM-606	6
MM-607	7
MM-608	8
MM-609	9
MM-610	10
MM-611	11
MM-612	12
MM-613	13
MM-614	14

**Deep 6-Point Sockets**

Product Code	Size (MM)
MMD-604	4
MMD-605	5
MMD-605.5	5 1/2
MMD-606	6
MMD-607	7
MMD-608	8
MMD-609	9
MMD-610	10
MMD-611	11
MMD-612	12
MMD-613	13
MMD-614	14



MSM-30HFTB

**Features**

- Keep-Safe-Foam system keeps tools organized and helps prevent loss.
- All tools are professional quality, made of high-grade chrome vanadium steel.
- Sockets feature SUPERTORQUE® lobular openings for greater turning power without deforming the fastener.
- Metal tool box made for years of rugged use.



### 17 PIECE 1/4" DRIVE SOCKET AND DRIVE TOOL SET

**6 Point Metric, Packed in Exclusive Keep-Safe-Foam System with Metal Box**

Product Code	Description
MSM-17HFTB	17 Piece Metric Tool Set with TB-101 Metal Tool Box
MSM-17HF	17 Piece Tool Set Only - Packed in Keep Safe Foam System

**Contents Include:**

**Drive Tools:**

Product Code	Description	Product Code	Description
M-52EHA	5-1/2" Enclosed Head Ratchet	M-106A	Spinner Handle
M-102	2" Extension	M-140A	Universal Joint
M-115	6" Extension		

**Shallow 6-Point Sockets**

Product Code	Size (MM)
MM-604	4
MM-605	5
MM-605.5	5.5
MM-606	6
MM-607	7
MM-608	8

Product Code	Size (MM)
MM-609	9
MM-610	10
MM-611	11
MM-612	12
MM-613	13
MM-614	14



MSM-17HFTB

**Features**

- Keep-Safe-Foam system keeps tools organized and helps prevent loss.
- All tools are professional quality, made of high-grade chrome vanadium steel.
- Sockets feature SUPERTORQUE® lobular openings for greater turning power without deforming the fastener.
- Metal tool box made for years of rugged use.

# SOCKETS & DRIVE TOOLS

## 1/4", 3/8" & 1/2" DRIVE TOOL SET



### 146 PIECE 1/4", 3/8", 1/2" DRIVE SOCKET SET

#### 6 & 12 Point Rugged-Case-System Tool Set, SAE and Metric

Product Code	Description
50614	146 Piece 1/4", 3/8", 1/2" Drive Socket Set

#### Contents Include:

##### 1/4" Drive Tools:

Product Code	Description
33001	Ratchet
33003	3" Extension
33006	Handle
30007	Universal Joint
30009	Adaptor 1/4" F x 3/8" M

##### 1/4" Drive Deep 6 Point Sockets, MM

Product Code	Size (MM)
30704	4
30705	5
30706	6
30707	7
30708	8
30709	9
30710	10
30711	11
30712	12
30713	13

##### 1/4" Drive Deep 6 Point Sockets, SAE

Product Code	Size (Inches)
30306	3/16
30307	7/32
30308	1/4
30309	9/32
30310	5/16
30311	11/32
30312	3/8
30314	7/16
30316	1/2

##### 1/4" Drive Shallow 6 Point Sockets, MM

Product Code	Size (MM)
30504	4
30505	5
30599	5.5
30506	6
30507	7
30508	8
30509	9
30510	10
30511	11
30512	12
30513	13
30514	14

##### 1/4" Drive Shallow 6 Point Sockets, SAE

Product Code	Size (Inches)
30105	5/32
30106	3/16
30107	7/32
30108	1/4
30109	9/32
30110	5/16
30111	11/32
30112	3/8
30114	7/16
30116	1/2
30118	9/16

##### 1/4" Drive Hex Bit Sockets, SAE

Product Code	Size (Inches)
35000	1/8
35001	5/32
35002	3/16
35003	7/32
35004	1/4
35005	5/16

##### 1/4" Drive Hex Bit Sockets, SAE

Product Code	Size (MM)
35070	3
35071	4
35072	5
35073	6
35074	7
35075	8

##### 1/4" Drive Screwdriver Bit Sockets

Product Code	Description
35040	5/32" Slotted Tip
35041	7/32" Slotted Tip
35042	9/32" Slotted Tip
35050	#0 Phillips Tip
35051	#1 Phillips Tip
35052	#2 Phillips Tip

##### 1/4" Drive Torx Bit Sockets

Product Code	Size
35080	T10
35081	T15
35082	T20
35083	T25
35084	T27
35085	T30

##### 3/8" Drive Tools

Product Code	Description
31001	Ratchet
31002	3" Extension
31003	6" Extension

##### 3/8" Drive Deep 12 Point Sockets, MM

Product Code	Size (MM)
31806	6
31807	7
31808	8
31809	9
31810	10
31811	11
31812	12
31813	13
31814	14
31815	15
31816	16
31817	17
31818	18
31819	19

##### 3/8" Drive Deep 12 Point Sockets, SAE

Product Code	Size (Inches)
31408	1/4
31410	5/16
31412	3/8
31414	7/16
31416	1/2
31418	9/16
31420	5/8
31422	11/16
31424	3/4
31426	13/16
31428	7/8
31430	15/16
31432	1

##### 3/8" Drive Shallow 6 Point Sockets, MM

Product Code	Size (MM)
31506	6
31507	7
31508	8
31509	9
31510	10
31511	11
31512	12
31513	13
31514	14
31515	15
31516	16
31517	17
31518	18
31519	19

##### 3/8" Drive Shallow 6 Point Sockets, SAE

Product Code	Size (Inches)
31108	1/4
31110	5/16
31112	3/8
31114	7/16
31116	1/2
31118	9/16
31120	5/8
31122	11/16
31124	3/4
31126	13/16
31128	7/8
31130	15/16
31132	1

##### 3/8" Drive Spark Plug Socket

Product Code	Size (Inches)
31301	5/8
31303	13/16

##### 1/2" Drive Tools

Product Code	Description
32001	Ratchet
32003	6" Extension
32004	10" Extension
32006	Universal Joint
32008	Adaptor - 1/2" F x 3/8" M

##### 1/2" Drive Shallow 12 Point Sockets, SAE

Product Code	Size (Inches)
32412	3/8
32414	7/16
32416	1/2
32418	9/16
32420	5/8
32422	11/16
32424	3/4
32426	13/16
32428	7/8
32430	15/16
32432	1



50614

#### Features

- All tools are professional quality, made of high-grade chrome vanadium steel.
- Sockets feature SUPERTORQUE® lobular openings for greater turning power without deforming the fastener.
- Packed in rugged high-density polyethylene (HDPE) cases that are strong and durable yet light in weight.
- Case is shock proof at both high and low temperatures, equipped with heavy-duty metal latches and hinges.
- Two-component handles are easy to grip and comfortable to carry.



# SOCKETS & DRIVE TOOLS

## 1/4", 3/8" & 1/2" DRIVE TOOL SET



### 138 PIECE 1/4", 3/8", 1/2" DRIVE SOCKET SET

#### 6 Point Rugged-Case-System Tool Set, SAE and Metric

Product Code	Description
50612	138 Piece 1/4", 3/8", 1/2" Drive Socket Set

#### Contents Include:

1/4" Drive Tools:		3/8" Drive Tools		1/2" Drive Tools	
Product Code	Description	Product Code	Description	Product Code	Description
33001	Ratchet	31001	Ratchet	32001	Ratchet
33002	4" Extension	31002	3" Extension	32002	6" Extension
33003	8" Extension	31003	6" Extension	32004	10" Extension
33006	18" Sliding T-handle	31006	Universal Joint	32006	Universal Joint
30007	Universal Joint	31008	Adaptor	32008	Adaptor
30013	Hex Bit Holder	31013	Hex Bit Holder		
24880	13 Piece Insert Bit Set				

1/4" Drive Deep 6 Point Sockets, MM		3/8" Drive Deep 6 Point Sockets, MM		1/2" Drive Shallow 6 Point Sockets, MM	
Product Code	Size (MM)	Product Code	Size (MM)	Product Code	Size (MM)
30704	4	31710	10	32510	10
30705	5	31711	11	32511	11
30706	6	31712	12	32512	12
30707	7	31713	13	32513	13
30708	8	31714	14	32514	14
30709	9	31715	15	32515	15
30710	10	31716	16	32516	16
30711	11	31717	17	32517	17
30712	12	31718	18	32518	18
30713	13	31719	19	32519	19
				32521	21
				32522	22
				32524	24
				32527	27
				32530	30
				32532	32

1/4" Drive Deep 6 Point Sockets, SAE		3/8" Drive Deep 6 Point Sockets, SAE		1/2" Drive Shallow 6 Point Sockets, SAE	
Product Code	Size (Inches)	Product Code	Size (Inches)	Product Code	Size (Inches)
30305	5/32	31312	3/8	32112	3/8
30306	3/16	31314	7/16	32114	7/16
30307	7/32	31316	1/2	32116	1/2
30308	1/4	31318	9/16	32118	9/16
30309	9/32	31320	5/8	32120	5/8
30310	5/16	31322	11/16	32122	11/16
30311	11/32	31324	3/4	32124	3/4
30312	3/8	31326	13/16	32126	13/16
30314	7/16	31328	7/8	32128	7/8
30316	1/2			32130	15/16

1/4" Drive Shallow 6 Point Sockets, MM		3/8" Drive Shallow 6 Point Sockets, MM		3/8" Drive Shallow 6 Point Sockets, SAE	
Product Code	Size (MM)	Product Code	Size (MM)	Product Code	Size (Inches)
30504	4	31510	10	31112	3/8
30505	5	31511	11	31114	7/16
30509	5.5	31512	12	31116	1/2
30506	6	31513	13	31118	9/16
30507	7	31514	14	31120	5/8
30508	8	31515	15	31122	11/16
30509	9	31516	16	31124	3/4
30510	10	31517	17		
30511	11	31518	18		
30512	12	31519	19		
30513	13				

1/4" Drive Shallow 6 Point Sockets, SAE	
Product Code	Size (Inches)
30105	5/32
30106	3/16
30107	7/32
30108	1/4
30109	9/32
30110	5/16
30111	11/32
30112	3/8
30114	7/16
30116	1/2



50612

#### Features

- All tools are professional quality, made of high-grade chrome vanadium steel.
- Sockets feature SUPERTORQUE® lobular openings for greater turning power without deforming the fastener.
- Packed in rugged high-density polyethylene (HDPE) cases that are strong and durable yet light in weight.
- Case is shock proof at both high and low temperatures, equipped with heavy-duty metal latches and hinges.
- Two-component handles are easy to grip and comfortable to carry.

# SOCKETS & DRIVE TOOLS

## 1/4", 3/8" & 1/2" DRIVE TOOL SET



### 95 PIECE 1/4" & 3/8" DRIVE MASTER SOCKET & TOOL SET

#### 6 & 12 Point Rugged-Case-System Tool Set, SAE

Product Code	Description
50611	95 Piece Master Socket, Wrench, and Screwdriver Set

#### Contents Include:

1/4" Drive Tools:		1/4" Drive Hex Bit Sockets	
Product Code	Description	Product Code	Size (MM)
30001	36 Tooth Quick-Release Ratchet	35070	3
30002	1 1/2" Extension	35071	4
30003	3" Extension	35072	5
30005	Flex Handle	35073	6
30006	Spinner Handle	35074	7
30007	Universal Joint	35075	8
30009	1/4" F x 3/8" M Adapter		

1/4" Drive Shallow 6-Point Sockets		1/4" Drive Screwdriver Bit Sockets	
Product Code	Size (Inches)	Product Code	Description
30106	3/16	35040	5/32" Slotted Tip
30107	7/32	35041	7/32" Slotted Tip
30108	1/4	35042	9/32" Slotted Tip
30109	9/32	35050	#0 Phillips® Tip
30110	5/16	35051	#1 Phillips® Tip
30111	11/32	35052	#2 Phillips® Tip
30112	3/8		
30114	7/16		
30116	1/2		
30118	9/16		

1/4" Drive Deep 6-Point Sockets		1/4" Drive Torx® Bit Sockets	
Product Code	Size (Inches)	Product Code	Size
30306	3/16	35080	T10
30307	7/32	35081	T15
30308	1/4	35082	T20
30309	9/32	35083	T25
30310	5/16	35084	T27
30311	11/32	35085	T30
30312	3/8		
30314	7/16		
30316	1/2		
30318	9/16		

1/4" Drive Hex Bit Sockets		3/8" Drive Shallow 6-Point Sockets	
Product Code	Size (Inches)	Product Code	Size (Inches)
35000	1/8	31112	3/8
35001	5/32	31114	7/16
35002	3/16	31116	1/2
35003	7/32	31118	9/16
35004	1/4	31120	5/8
35005	5/16	31122	11/16
		31124	3/4
		31126	13/16
		31128	7/8
		31130	15/16
		31132	1

3/8" Drive Tools:		3/8" Drive Deep 12-Point Sockets	
Product Code	Description	Product Code	Size (Inches)
31001	38 Tooth Quick-Release Ratchet	31412	3/8
31002	3" Extension	31414	7/16
31003	6" Extension	31416	1/2
31004	10" Extension	31418	9/16
31005	10" Flex Handle	31420	5/8
31006	Universal Joint	31422	11/16
31007	Sliding T-Handle	31424	3/4
31008	3/8" F x 1/4" M Adapter	31426	13/16
31009	3/8" F x 1/2" M Adapter	31428	7/8
		31430	15/16
		31432	1

12 Point Combination Wrenches	
Product Code	Size (Inches)
11108	1/4
11110	5/16
11112	3/8
11114	7/16
11116	1/2
11118	6/16
11120	5/8
11122	11/16
11124	3/4

Comfort Grip Screwdrivers	
Product Code	Description
24205	3/16" x 4" Slotted
24219	1/4" x 4" Slotted
24249	#1 x 3" Phillips®
24253	#2 x 4" Phillips®



50611

#### Features

- All tools are professional quality, made of high-grade chrome vanadium steel.
- Sockets feature SUPERTORQUE® lobular openings for greater turning power without deforming the fastener.
- Packed in rugged high-density polyethylene (HDPE) cases that are strong and durable yet light in weight.
- Case is shock proof at both high and low temperatures, equipped with heavy-duty metal latches and hinges.
- Two-component handles are easy to grip and comfortable to carry.



# SOCKETS & DRIVE TOOLS

## 1/4" & 3/8" DRIVE TOOL SET



### 89 PIECE 1/4" & 3/8" DRIVE MASTER SOCKET AND TOOL SET

#### 6 & 12 Point Rugged-Case-System Tool Set, Metric

Product Code	Description
50622	89 Piece Master Socket, Wrench and Screwdriver Set

#### Contents Include:

##### 1/4" Drive Tools:

Product Code	Description
30001	36 Tooth Quick-Release Ratchet
30002	1 1/2" Extension
30003	3" Extension
30005	Flex Handle
30006	Spinner Handle
30007	Universal Joint
30009	1/4" F x 3/8" M Adapter

##### 1/4" Drive Shallow 6-Point Sockets

Product Code	Size (MM)
30504	4
30505	5
30599	5 1/2
30506	6
30507	7
30508	8
30509	9
30510	10
30511	11
30512	12
30513	13
30514	14

##### 1/4" Drive Hex Bit Sockets

Product Code	Size (Inches)
35000	1/8
35001	5/32
35002	3/16
35003	7/32
35004	1/4
35005	5/16

##### 1/4" Drive Hex Bit Sockets

Product Code	Size (MM)
35070	3
35071	4
35072	5
35073	6
35074	7
35075	8

##### 1/4" Drive Screwdriver Bit Sockets

Product Code	Description
35040	5/32" Slotted Tip
35041	7/32" Slotted Tip
35042	9/32" Slotted Tip
35050	#0 Phillips® Tip
35051	#1 Phillips® Tip
35052	#2 Phillips® Tip

##### 1/4" Drive Torx® Bit Sockets

Product Code	Size
35080	T10
35081	T15
35082	T20
35083	T25
35084	T27
35085	T30

##### 3/8" Drive Tools:

Product Code	Description
31001	38 Tooth Quick-Release Ratchet
31002	3" Extension
31003	6" Extension
31004	10" Extension
31005	10" Flex Handle
31006	Universal Joint
31007	Sliding T-Handle
31008	3/8" F x 1/4" M Adapter
31009	3/8" F x 1/2" M Adapter

##### 3/8" Drive Shallow 6-Point Sockets

Product Code	Size (MM)
31508	8
31509	9
31510	10
31511	11
31512	12
31513	13
31514	14
31515	15
31516	16
31517	17
31518	18
31519	19

##### 3/8" Drive Deep 12-Point Sockets

Product Code	Size (MM)
31808	8
31809	9
31810	10
31811	11
31812	12
31813	13
31814	14
31815	15
31816	16
31817	17
31818	18
31819	19

##### Comfort Grip Screwdrivers

Product Code	Description
24205	3/16" x 4" Slotted
24219	1/4" x 4" Slotted
24249	#1 x 3" Phillips®
24253	#2 x 4" Phillips®

##### 12 Point Combination Wrenches

Product Code	Size (MM)
11506	6
11508	8
11510	10
11512	12
11513	13
11514	14
11515	15
11517	17
11519	19



50622

#### Features

- All tools are professional quality, made of high-grade chrome vanadium steel.
- Sockets feature SUPERTORQUE® lobular openings for greater turning power without deforming the fastener.
- Packed in rugged high-density polyethylene (HDPE) cases that are strong and durable yet light in weight.
- Case is shock proof at both high and low temperatures, equipped with heavy-duty metal latches and hinges.
- Two-component handles are easy to grip and comfortable to carry.

# SOCKETS & DRIVE TOOLS

## 1/4" & 3/8" DRIVE TOOL SET



### 67 PIECE 1/4" DRIVE SOCKET SET

#### 6 Point Rugged-Case-System Tool Set, SAE and Metric

Product Code	Description
50602	67 Piece 1/4" Drive Socket Set

#### Contents Include:

1/4" Drive Tools		1/4" Drive Shallow 6 Point Sockets, MM		1/4" Drive Hex Bit Sockets, MM	
Product Code	Description	Product Code	Size (MM)	Product Code	Size (MM)
30001	Ratchet	30504	4	35070	3
30005	Flex handle	30505	5	35071	4
30002	4" Extension	30599	5.5	35072	5
30003	8" Extension	30506	6	35073	6
30006	18" Sliding T-handle	30507	7	35074	7
30007	Universal Joint	30508	8	35075	8
30010	Spinner Disc	30509	9		
		30510	10	<b>1/4" Drive Slotted Bit Sockets, SAE</b>	
		30511	11	Product Code	Size (Inches)
		30512	12	35040	5/32
		30513	13	35041	7/32
		30514	14	35042	9/32
				<b>1/4" Drive Phillips Bit Sockets, SAE</b>	
				Product Code	Size (Inches)
				35050	# 0
				35051	# 1
				35052	# 2



50602



### 47 PIECE 1/4" DRIVE 47 PIECE DELUXE SOCKET SET

#### 6 Point Rugged-Case-System Tool Set, SAE and Metric

Product Code	Description
50601	47 Piece Deluxe 6-Point 1/4" Drive Socket Set

#### Contents Include:

Drive Tools:		Shallow 6-Point Sockets		Hex Bit Sockets	
Product Code	Description	Product Code	Size (MM)	Product Code	Size (MM)
30001	36 Tooth Quick-Release Ratchet	30504	4	35070	3
30002	1 1/2" Extension	30505	5	35071	4
30003	3" Extension	30599	5 1/2	35072	5
30005	Flex Handle	30506	6	35073	6
30006	Spinner Handle	30507	7	35074	7
30007	Universal Joint	30508	8	35075	8
30010	Ratchet Spinner	30509	9		
		30510	10	<b>Screwdriver Bit Sockets</b>	
		30511	11	Product Code	Description
		30512	12	35040	5/32" Slotted Tip
		30513	13	35041	7/32" Slotted Tip
		30514	14	35042	9/32" Slotted Tip
				35050	#0 Phillips® Tip
				35051	#1 Phillips® Tip
				35052	#2 Phillips® Tip



50601

#### Features

- All tools are professional quality, made of high-grade chrome vanadium steel
- Sockets feature SUPERTORQUE® lobular openings for greater turning power without deforming the fastener.
- Packed in rugged high-density polyethylene (HDPE) cases that are strong and durable yet light in weight.
- Case is shock proof at both high and low temperatures, equipped with heavy-duty metal latches and hinges.
- Two-component handles are easy to grip and comfortable to carry.



# SOCKETS & DRIVE TOOLS

## 1/4" & 3/8" DRIVE TOOL SET

WILLIAMS®



### 36 PIECE 1/4" DRIVE SOCKET

#### 6 Point Rugged-Case-System Tool Set, Metric

Product Code	Description
50604	36 Piece Socket Set

#### Contents Include:

1/4" Drive Tools		1/4" Drive Slotted Socket	
Product Code	Description	Product Code	Size (MM)
30011	Ratchet	35043	4
30002	4" Extension	35044	5.5
30004	6" Extension	35045	7
30007	Universal Joint		
30008	Sliding T-Handle		
1/4" Drive Shallow 6 Point Sockets, MM		1/4" Drive Hex Bit Socket	
Product Code	Size (MM)	Product Code	Size (MM)
30504	4	35070	3
30505	5	35071	4
30598	5.5	35072	5
30506	6	35073	6
30507	7	35075	8
30508	8		
30509	9	1/4" Drive Torx Bit Socket	
30510	10	Product Code	Description
30511	11	35079	T8
30512	12	35080	T10
30513	13	35081	T15
		35082	T20
		35083	T25
		35084	T27
		35085	T30
1/4" Drive Phillips Socket			
Product Code	Description		
35051	# 1		
35052	# 2		
35053	# 3		



50604

WILLIAMS®



### 32 PIECE 1/4" & 3/8" DRIVE BIT SOCKET SET

#### 6 Point Compact Case Tool Set, SAE & MM

Product Code	Description
50681	32 Piece 1/4" & 3/8" Drive Bit Socket Set

#### Contents Include:

1/4" Drive Torx Bit Socket		3/8" Drive Slotted Socket	
Product Code	Description	Product Code	Size (SAE)
35080	T10	35140	1/4
35081	T15	35141	5/16
35082	T20	35142	3/8
35083	T25	35143	7/16
35084	T27		
3/8" Drive Torx Bit Socket		3/8" Drive Phillips Socket	
Product Code	Description	Product Code	Description
35185	T40	35150	#1
35186	T45	35151	#2
35187	T47	35152	#3
35188	T50		
3/8" Drive Hex Bit Socket		3/8" Drive Hex Bit Socket	
Product Code	Size (MM)	Product Code	Size (SAE)
35170	4	35100	1/8
35171	5	35101	9/64
35172	6	35102	5/32
35173	7	35103	3/16
35174	8	35104	7/32
35175	9	35105	1/4
35176	10	35106	5/16
		35107	3/8



50681

#### Features

- All tools are professional quality, made of high-grade chrome vanadium steel
- Sockets feature SUPERTORQUE® lobular openings for greater turning power without deforming the fastener
- Packed in rugged compact high-density polyethylene (HDPE) cases that are strong and durable yet light in weight

# SOCKETS & DRIVE TOOLS

## 1/4" DRIVE



### 27 PIECE 1/4" DRIVE SOCKET AND DRIVE TOOL SET

#### 6 Point Compact Case Tool Set, SAE and Metric

Product Code	Description
50661	27 Piece 1/4" Drive Socket and Drive Tool Set

#### Contents Include:

1/4" Drive Tools:		1/4" Drive Shallow 6 Point Sockets:	1/4" Drive Shallow 6 Point Sockets:
Product Code	Description	Product Code	Size (Inches)
30001	5 1/4" Pear Head Ratchet	30106	3/16
30002	1 1/2" Extension	30107	7/32
30004	6" Extension	30108	1/4
30006	Spinner Handle	30109	9/32
30007	Universal Joint	30110	5/16
		30111	11/32
		30112	3/8
		30114	7/16
		30116	1/2
		30118	9/16

Product Code	Size (mm)
30504	4
30505	5
30599	5.5
30506	6
30507	7
30508	8
30509	9
30510	10
30511	11
30512	12
30513	13
30514	14



50661

#### Features

- All tools are professional quality, made of high-grade chrome vanadium steel
- Sockets feature SUPERTORQUE® lobular openings for greater turning power without deforming the fastener
- Packed in rugged compact high-density polyethylene (HDPE) cases that are strong and durable yet light in weight



### 21 PIECE 1/4" DRIVE SOCKET AND DRIVE TOOL SET

#### 6 Point Compact Case Tool Set, SAE

Product Code	Description
50662	21 Piece 1/4" Drive Socket and Drive Tool Set

#### Contents Include:

1/4" Drive Tools:		1/4" Drive Shallow 6 Point Sockets:	1/4" Drive Deep 6 Point Sockets:
Product Code	Description	Product Code	Size (SAE)
30001	5 1/4" Pear Head Ratchet	30106	3/16
30003	1 1/2" Extension	30107	7/32
30004	3" Extension	30108	1/4
30006	Spinner Handle	30109	9/32
30007	6" Extension	30110	5/16
		30111	11/32
		30112	3/8
		30114	7/16
		30116	1/2

Product Code	Size (SAE)
30308	1/4
30309	9/32
30310	5/16
30311	11/32
30312	3/8
30314	7/16
30316	1/2



50662

#### Features

- All tools are professional quality, made of high-grade chrome vanadium steel
- Sockets feature SUPERTORQUE® lobular openings for greater turning power without deforming the fastener
- Packed in rugged compact high-density polyethylene (HDPE) cases that are strong and durable yet light in weight



### 27 PIECE 1/4" DRIVE SOCKET AND DRIVE TOOL SET

#### 12 Point Compact Case Tool Set, SAE & MM

Product Code	Description
50672	27 Piece 1/4" Drive Socket and Drive Tool Set

#### Contents Include:

1/4" Drive Tools:		1/4" Drive Shallow 12 Point Sockets:	1/4" Drive Shallow 12 Point Sockets:
Product Code	Description	Product Code	Size (mm)
30001	5-1/4" Pear Head Ratchet	30206	3/16
30002	1-1/2" Extension	30207	7/32
30004	6" Extension	30208	1/4
30006	Spinner Handle	30209	9/32
30007	Universal Joint	30210	5/16
		30211	11/32
		30212	3/8
		30214	7/16
		30216	1/2
		30218	9/16

Product Code	Size (mm)
30604	4
30605	5
30699	5.5
30606	6
30607	7
30608	8
30609	9
30610	10
30611	11
30612	12
30613	13
30614	14



50672

#### Features

- All tools are professional quality, made of high-grade chrome vanadium steel
- Sockets feature SUPERTORQUE® lobular openings for greater turning power without deforming the fastener
- Packed in rugged compact high-density polyethylene (HDPE) cases that are strong and durable yet light in weight



**WARNING**



# SOCKETS & DRIVE TOOLS

## 1/4" DRIVE



MB-52EHA



M-52EHFA



M-52EHA



M-52A



M-42A



M-106A

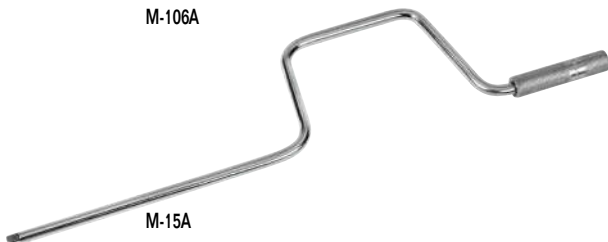

M-15A



### 1/4" DRIVE ENCLOSED HEAD RATCHETS

#### Sealed Narrow Head Design, Chrome and Black Industrial Finish

Product Code	Description	Length (Inches)	Number of Teeth
M-52EHA	Chrome Finish Enclosed Head Ratchet	5 1/4	36
M-52EHFA	Chrome Finish Flex Head Ratchet	7	36
MB-52EHA	Black Industrial Finish Enclosed Head Ratchet	5 1/4	36
M-52EHRKA	Repair Kit for Enclosed Head Ratchets		

Fed. Spec: ANSI B107.10M

#### Features

- Enclosed head is sealed to prevent dust, dirt, and liquids from entering head, preserving internal lubrication.
- Forged one-piece ratchet provide strength and safety for industrial applications.
- 36 tooth gear with 10 degree of engagement allows engagement in tight working areas.
- Nickel/Chrome plating provides increase protection from rust and corrosion.
- Chrome finish models feature mirror-like exterior that can be easily cleaned after each use.
- Single Pawl ratchet design:
  - Designed for tighter tolerances between pawl and gear which reduces metal fatigue and slippage under load.
  - Does not require as many working parts, reducing possible breakage and parts to repair.
- Easy access reverse lever allows user to change working direction quickly and easily with only one hand.



### 1/4" DRIVE ROUND HEAD RATCHET

#### High-Polished Chrome Finish

Product Code	Description	Length (Inches)	Number of Teeth
M-52A	Chrome Finish Round Head Ratchet	5	72
M-52ARK	Repair Kit for Round Head Ratchet		

Fed. Spec: ANSI B107.10M

#### Features

- Double pawl design with 72 teeth action provides a 5° ratcheting angle.
- Shift lever reverses action instantly.
- Knurled handle provides a non-slip grip.
- Chrome plating provides increased protection from rust and corrosion.



### 1/4" DRIVE HANDLES

#### High-Polished Chrome Finish

Product Code	Description	Length (Inches)
M-106A	Spinner Handle	6
M-15A	Speeder Handle	15 1/2
M-42A	Flex Handle Breaker Bar	5 3/4
M-42RK	Repair Kit for Flex Handle	

Fed. Spec: ANSI B107.10M

#### Features

- Chrome plating provides increased protection from rust and corrosion.
- Drive handles provide extra leverage with greater strength than ratchets.
- Spinner handle features 1/4" drive female handle end.

# SOCKETS & DRIVE TOOLS

## 1/4" DRIVE



### 1/4" DRIVE EXTENSIONS

#### High-Polished Chrome Finish

Product Code	Description	Length (Inches)
M-102	Extension	2
M-104	Extension	4
M-115	Extension	6
M-110	Extension	10
M-124	Extension	24
MFE-6	Flexible Extension	6
M-140A	Universal Joint	1 7/16

Fed. Spec: ANSI B107.10M

#### Features

- Chrome plating provides increased protection from rust and corrosion.
- Flexible extension is designed for low torque applications in limited access areas.
- Ball and spring socket retention.



### 1/4" DRIVE ADAPTORS

#### High-Polished Chrome and Black Industrial Finish

Product Code	Length (Inches)	Male End (Inches)	Female End (Inches)
Chrome Finish			
MB-130	1	3/8	1/4
Black Finish			
MB-130B	1	3/8	1/4
MB-131BA	1 1/8	1/4	3/8

Fed. Spec: ANSI B107.10M

#### Features

- Ball and spring socket retention.



### 1/4" DRIVE RATCHETS AND HANDLES

#### High-Polished Chrome Finish

Product Code	Description	Length (Inches)	Repair Kit
30001	36 Tooth Quick-Release Ratchet	5 1/4	30001RK
30011	Ultra-Fine 60-Tooth Ratchet	5 1/4	30011RK
30005	Flex Handle	6	
30008	Sliding T-Handle	4 1/2	
30006	Spinner Handle	6 3/8	
30012	Square Drive Ratchet Wrench	5	

Fed. Spec: ANSI B107.10M

#### Features

- Ball and spring socket retention.
- Williams 1/4" Drive Ratchets Feature:
  - \* Ultra-fine 60 tooth model offers 6° tooth action in a narrow pear head.
  - \* Unique Finger-Fit handles to provide a comfortable, non-slip grip and extra turning power.
  - \* Choice of 36-tooth quick-release or 60-tooth ultra-fine gear.
  - \* Narrow pear-shaped heads for access into confined work areas.
  - \* High-polished chrome finish for easy cleaning.
- Spinner handle features bi-mold comfort-grip handle.
- 30012 - Drives 1/4" Drive Sockets & 1/4" Hex Bits



# SOCKETS & DRIVE TOOLS

## 1/4" DRIVE



### 1/4" DRIVE EXTENSIONS AND ACCESSORIES

#### High-Polished Chrome Finish

Product Code	Description	Length (Inches)
30002	Extension	1 1/2
30003	Extension	3
30004	Extension	6
30007	Universal Joint Extension	1 3/8
30009	Adaptor, 1/4" F x 3/8" M	1
30010	Spinner Disk	
30013	Holder for 1/4" Hex Screwdriver Bits	3/4
30023	Locking Extension	4
30024	Locking Extension	6
30025	Locking Extension	10
30026	Locking Extension	12
30027	Locking Extension	18
30028	Locking Extension	24

Fed. Spec: ANSI B107.10M

#### Features

- Chrome plating provides increased protection from rust and corrosion.
- Ball and spring socket retention.



### 6 PIECE 1/4" DRIVE RATCHET AND DRIVE TOOL SET

#### Furnished in a Pouch

Product Code	Description
30920	6 Piece 1/4" Drive Ratchet and Accessory Set

#### Contents Include:

Product Code	Description	Product Code	Description
30001	36 Tooth Quick-Release Ratchet	30005	Flex Handle
30002	1 1/2" Extension	30006	Spinner Handle
30004	6" Extension	30007	Universal Joint

#### Features

- All tools are professional quality, made of high-grade chrome vanadium steel.



### 1/4" DRIVE SHALLOW 12 POINT SOCKETS, SAE

#### High-Polished Chrome Finish

Product Code	Size (Inches)	A OAL (Inches)	B Drive End Diameter (Inches)	C Working End Diameter (Inches)	D Broach Depth (Inches)	E Bolt Clearance Depth (Inches)	Bolt Clearance Diameter (Inches)	F Nose Length (Inches)
M-1208	1/4	7/8	15/32	3/8	7/32	17/32	7/32	7/16
M-1210	3/16	7/8	15/32	15/32	9/32	17/32	7/32	-
M-1211	11/32	7/8	1/2	1/2	9/32	17/32	11/32	-
M-1212	3/8	7/8	17/32	17/32	9/32	17/32	3/8	-
M-1214	7/16	7/8	19/32	19/32	3/8	17/32	7/16	-
M-1216	1/2	7/8	11/16	11/16	3/8	17/32	1/2	-
M-1218	9/16	29/32	3/4	3/4	3/8	17/32	7/32	-

Fed. Spec: ANSI B107.1

### WSM-7RC 7 Piece 1/4" Drive Shallow 12-Point Socket Set on Clip Rail

#### Contents Include:

Product Code	Size (Inches)	Product Code	Size (Inches)	Product Code	Size (Inches)	Product Code	Size (Inches)
M-1208	1/4	M-1211	11/32	M-1214	7/16	M-1218	9/16
M-1210	3/16	M-1212	3/8	M-1216	1/2		

#### Features

- SUPERTORQUE® lobular openings for greater turning power without deforming the fastener.
- Designed for quick engagement on both 6 and 12 point fasteners.



M-1208 M-1212



WSM-7RC

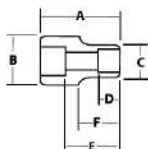

# SOCKETS & DRIVE TOOLS

## 1/4" DRIVE



### 1/4" DRIVE SHALLOW SOCKETS, 6 POINT, SAE

High-Polished Chrome Finish

Product Code	Size (Inches)	A	B	C	D	E	F
		OAL (Inches)	Drive End Diameter (Inches)	Working End Diameter (Inches)	Broach Depth (Inches)	Bolt Clearance Depth (Inches)	Bolt Clearance Diameter (Inches)
M-604	1/8	7/8	15/32	7/32	1/8	17/32	7/16
M-605	9/32	7/8	15/32	7/32	1/8	17/32	7/16
M-606	3/16	7/8	15/32	7/32	1/8	17/32	7/16
M-607	7/32	7/8	15/32	7/32	1/8	17/32	7/16
M-608	1/4	7/8	15/32	7/32	1/8	17/32	7/16
M-609	9/32	7/8	15/32	7/32	1/8	17/32	7/16
M-610	5/16	7/8	15/32	7/32	1/8	17/32	7/16
M-611	11/32	7/8	1/2	1/2	11/32	17/32	-
M-612	3/8	7/8	9/16	9/16	19/32	17/32	-
M-614	7/16	7/8	5/8	5/8	19/32	17/32	-
M-616	1/2	7/8	11/16	11/16	15/32	17/32	-
M-618	9/16	29/32	3/4	3/4	1/2	17/32	-
M-620	5/8	31/32	27/32	27/32	9/16	5/8	-

Fed. Spec: ANSI B107.1



WSM-11 HRC

### WSM-11HRC 11 Piece 1/4" Drive Shallow 6 Point Socket Set on Clip Rail

Contents Include:

Product Code	Size (Inches)	Product Code	Size (Inches)	Product Code	Size (Inches)	Product Code	Size (Inches)
M-605	9/32	M-608	1/4	M-611	11/32	M-616	1/2
M-606	3/16	M-609	9/32	M-612	3/8	M-618	9/16
M-607	7/32	M-610	5/16	M-614	7/16		

#### Features

- SUPERTORQUE® lobular openings for greater turning power without deforming the fastener.
- Designed for maximum engagement on 6 point fasteners.

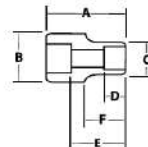

### 1/4" DRIVE SHALLOW SOCKETS, 12 POINT, SAE

High-Polished Chrome Finish

Product Code	Size (Inches)	A	B	C	D	E	F
		OAL (Inches)	Drive End Diameter (Inches)	Working End Diameter (Inches)	Broach Depth (Inches)	Bolt Clearance Depth (Inches)	Bolt Clearance Diameter (Inches)
30206	3/16	1	19/32	9/16	9/32	19/32	1/2
30207	7/32	1	15/32	11/32	5/16	19/32	1/2
30208	1/4	1	19/32	3/8	9/16	19/32	1/2
30209	9/32	1	15/32	7/16	9/16	19/32	1/2
30210	5/16	1	19/32	15/32	5/16	19/32	-
30211	11/32	1	1/2	1/2	9/16	19/32	-
30212	3/8	1	9/16	9/16	11/32	19/32	-
30214	7/16	1	3/8	3/8	7/16	19/32	-
30216	1/2	1	11/16	11/16	7/16	19/32	-
30218	9/16	1	3/4	3/4	7/16	19/32	-

Fed. Spec: ANSI B107.1



30923

### 30923 10 Piece 1/4" Drive Shallow 12 Point Socket Set on Clip Rail

Contents Include:

Product Code	Size (Inches)	Product Code	Size (Inches)	Product Code	Size (Inches)	Product Code	Size (Inches)
30206	3/16	30209	9/32	30212	3/8	30218	9/16
30207	7/32	30210	5/16	30214	7/16		
30208	1/4	30211	11/32	30216	1/2		

#### Features

- SUPERTORQUE® lobular openings for greater turning power without deforming the fastener.
- Designed for maximum engagement on both 6 and 12 point fasteners.



# SOCKETS & DRIVE TOOLS

## 1/4" DRIVE

WILLIAMS®



### 1/4" DRIVE SHALLOW SOCKETS, 6 POINT, SAE

High-Polished Chrome Finish



Product Code	Size (Inches)	A (Inches)	B		D (Inches)	E		F (Inches)
			OAL (Inches)	Drive End Diameter (Inches)		Working End Diameter (Inches)	Broach Depth (Inches)	
30105	9/32	1	15/32	5/16	9/32	19/32	3/16	1/2
30106	3/16	1	19/32	5/16	9/32	19/32	3/16	1/2
30107	7/32	1	15/32	11/32	5/16	19/32	7/32	1/2
30108	1/4	1	19/32	3/8	5/16	19/32	7/32	1/2
30109	9/32	1	19/32	7/16	5/16	19/32	1/4	1/2
30110	5/16	1	15/32	15/32	5/16	19/32	1/4	-
30111	11/32	1	1/2	1/2	5/16	19/32	11/32	-
30112	3/8	1	9/16	9/16	11/32	19/32	3/8	-
30114	7/16	1	5/8	5/8	7/16	19/32	7/16	-
30116	1/2	1	11/16	11/16	7/16	19/32	1/2	-
30118	9/16	1	3/4	3/4	7/16	19/32	17/32	-

Fed. Spec: ANSI B107.1

### 30922 10 Piece 1/4" Drive Shallow 6 Point Socket Set on Clip Rail

Contents Include:



Product Code	Size (Inches)	Product Code	Size (Inches)	Product Code	Size (Inches)	Product Code	Size (Inches)
30106	3/16	30109	9/32	30112	3/8	30118	9/16
30107	7/32	30110	3/16	30114	7/16		
30108	1/4	30111	11/32	30116	1/2		

#### Features

- SUPERTORQUE® lobular openings for greater turning power without deforming the fastener.
- Designed for maximum engagement on 6 point fasteners.

WILLIAMS®



### 1/4" DRIVE SHALLOW SOCKETS, 8 POINT, SAE

High-Polished Chrome Finish



M-810

Product Code	Size (Inches)	A (Inches)	B		D (Inches)	E		F (Inches)
			OAL (Inches)	Drive End Diameter (Inches)		Working End Diameter (Inches)	Broach Depth (Inches)	
M-808	1/4	7/8	15/32	7/16	1/4	17/32	1/4	7/16
M-810	5/16	7/8	9/16	9/16	9/32	17/32	1/4	-
M-812	3/8	7/8	21/32	21/32	5/16	17/32	3/8	-

#### Features

- SUPERTORQUE® lobular openings for greater turning power without deforming the fastener.
- Designed for quick engagement on both 4 and 8 point fasteners.

# SOCKETS & DRIVE TOOLS

## 1/4" DRIVE



### 1/4" DRIVE DEEP SOCKETS, 12 POINT, SAE

High-Polished Chrome Finish

Product Code	Size (Inches)	A		B		C		D		E		F
		OAL (Inches)	Drive End Diameter (Inches)	Working End Diameter (Inches)	Broach Depth (Inches)	Bolt Clearance Depth (Inches)	Bolt Clearance Diameter (Inches)	Nose Length (Inches)				
MD-1210	5/16	2	15/32	7/16	9/32	1 1/16	9/32	1 1/16	9/32	1 1/16	1 1/16	
MD-1211	11/32	2	1/2	1/2	9/32	1 21/32	11/32	1 21/32	11/32	1 21/32	-	
MD-1212	3/8	2	17/32	17/32	9/32	1 21/32	3/8	1 21/32	3/8	1 21/32	-	
MD-1214	7/16	2	19/32	19/32	3/8	1 21/32	13/32	1 21/32	13/32	1 21/32	-	
MD-1216	1/2	2	11/16	11/16	3/8	1 21/32	15/32	1 21/32	15/32	1 21/32	-	
MD-1218	9/16	2	3/4	3/4	3/8	1 21/32	17/32	1 21/32	17/32	1 21/32	-	

Fed. Spec: ANSI B107.1



MD-1216 MD-1210

### WSMD-6RC 6 Piece 1/4" Drive Deep 12 Point Socket Set on Clip Rail

Contents Include:

Product Code	Size (Inches)	Product Code	Size (Inches)	Product Code	Size (Inches)
MD-1210	5/16	MD-1212	3/8	MD-1216	1/2
MD-1211	11/32	MD-1214	7/16	MD-1218	9/16

#### Features

- SUPERTORQUE® lobular openings for greater turning power without deforming the fastener.
- Designed for quick engagement on both 6 and 12 point fasteners.



WSMD-6RC



### 1/4" DRIVE DEEP SOCKETS, 6 POINT, SAE

High-Polished Chrome Finish

Product Code	Size (Inches)	A		B		C		D		E		F
		OAL (Inches)	Drive End Diameter (Inches)	Working End Diameter (Inches)	Broach Depth (Inches)	Bolt Clearance Depth (Inches)	Bolt Clearance Diameter (Inches)	Nose Length (Inches)				
MD-605	5/32	2	15/32	9/32	5/32	5/32	5/32	5/32	5/32	1 9/16	-	
MD-606	3/16	2	15/32	5/16	3/16	3/16	3/16	3/16	3/16	1 9/16	-	
MD-607	7/32	2	15/32	11/32	7/32	7/32	7/32	7/32	7/32	1 9/16	-	
MD-608	1/4	2	15/32	3/8	7/32	7/32	7/32	7/32	7/32	1 9/16	-	
MD-609	9/32	2	15/32	13/32	1/4	9/32	9/32	9/32	9/32	1 9/16	-	
MD-610	5/16	2	15/32	7/16	9/32	9/32	9/32	9/32	9/32	1 9/16	-	
MD-611	11/32	2	1/2	1/2	9/32	11/32	11/32	11/32	11/32	-	-	
MD-612	3/8	2	17/32	17/32	9/32	3/8	3/8	3/8	3/8	-	-	
MD-614	7/16	2	19/32	19/32	3/8	13/32	13/32	13/32	13/32	-	-	
MD-616	1/2	2	11/16	11/16	3/8	15/32	15/32	15/32	15/32	-	-	
MD-618	9/16	2	3/4	3/4	3/8	17/32	17/32	17/32	17/32	-	-	

Fed. Spec: ANSI B107.1



MD-605 MD-618

### WSMD-10HRC 10 Piece 1/4" Drive Deep 6 Point Socket Set on Clip Rail

Contents Include:

Product Code	Size (Inches)	Product Code	Size (Inches)	Product Code	Size (Inches)	Product Code	Size (Inches)
MD-606	3/16	MD-609	9/32	MD-612	3/8	MD-618	9/16
MD-607	7/32	MD-610	5/16	MD-614	7/16		
MD-608	1/4	MD-611	11/32	MD-616	1/2		

#### Features

- SUPERTORQUE® lobular openings for greater turning power without deforming the fastener.
- Designed for maximum engagement on 6 point fasteners.



WSMD-10HRC



# SOCKETS & DRIVE TOOLS

## 1/4" DRIVE



### 1/4" DRIVE DEEP SOCKETS, 12 POINT, SAE

#### High-Polished Chrome Finish



30410 30406

Product Code	A		B	C	D	E		F
	Size (Inches)	OAL (Inches)	Drive End Diameter (Inches)	Working End Diameter (Inches)	Broach Depth (Inches)	Bolt Clearance Depth (Inches)	Bolt Clearance Diameter (Inches)	Nose Length (Inches)
30406	3/16	1 31/32	15/32	5/16	5/16	1 5/16	1/8	1 1/32
30407	7/32	1 31/32	15/32	11/32	3/8	1 5/16	3/16	15/16
30408	1/4	1 31/32	15/32	7/16	13/16	1 11/32	7/32	1 1/32
30409	9/32	1 31/32	15/32	7/16	23/32	1 11/32	1/4	31/32
30410	5/16	1 31/32	15/32	15/32	13/16	1 5/16	9/32	-
30411	11/32	1 31/32	1/2	1/2	23/32	1 5/16	9/32	-
30412	3/8	1 31/32	9/16	9/16	7/8	1 11/32	5/16	-
30414	7/16	1 31/32	5/8	5/8	7/8	1 1/2	13/32	-
30416	1/2	1 31/32	11/16	11/16	27/32	1 17/32	7/16	-
30418	9/16	1 31/32	3/4	3/4	29/32	1 9/16	17/32	-

Fed. Spec: ANSI B107.1

### 30937 10 Piece 1/4" Drive Deep 12 Point Socket Set on Clip Rail

#### Contents Include:



30937

Product Code	Size (Inches)	Product Code	Size (Inches)	Product Code	Size (Inches)	Product Code	Size (Inches)
30406	3/16	30409	9/32	30412	3/8	30418	9/16
30407	7/32	30410	5/16	30414	7/16		
30408	1/4	30411	11/32	30416	1/2		

#### Features

- SUPERTORQUE® lobular openings for greater turning power without deforming the fastener.
- Designed for maximum engagement on 12 point fasteners.



### 1/4" DRIVE DEEP SOCKETS, 6 POINT, SAE

#### High-Polished Chrome Finish



30310 30306

Product Code	A		B	C	D	E		F
	Size (Inches)	OAL (Inches)	Drive End Diameter (Inches)	Working End Diameter (Inches)	Broach Depth (Inches)	Bolt Clearance Depth (Inches)	Bolt Clearance Diameter (Inches)	Nose Length (Inches)
30305	5/32	1 31/32	15/32	5/16	5/16	1 5/16	1/8	1 1/32
30306	3/16	1 31/32	15/32	5/16	5/16	1 5/16	1/8	1 1/32
30307	7/32	1 31/32	15/32	11/32	3/8	1 5/16	3/16	15/16
30308	1/4	1 31/32	15/32	7/16	13/16	1 11/32	7/32	1 1/32
30309	9/32	1 31/32	15/32	7/16	23/32	1 11/32	1/4	31/32
30310	5/16	1 31/32	15/32	15/32	13/16	1 5/16	9/32	-
30311	11/32	1 31/32	1/2	1/2	23/32	1 5/16	9/32	-
30312	3/8	1 31/32	9/16	9/16	7/8	1 11/32	5/16	-
30314	7/16	1 31/32	5/8	5/8	7/8	1 1/2	13/32	-
30316	1/2	1 31/32	11/16	11/16	27/32	1 17/32	7/16	-
30318	9/16	1 31/32	3/4	3/4	29/32	1 9/16	17/32	-

Fed. Spec: ANSI B107.1

### 30924 10 Piece 1/4" Drive Deep 6 Point Socket Set on Clip Rail

#### Contents Include:



30924

Product Code	Size (Inches)	Product Code	Size (Inches)	Product Code	Size (Inches)	Product Code	Size (Inches)
30306	3/16	30309	9/32	30312	3/8	30318	9/16
30307	7/32	30310	5/16	30314	7/16		
30308	1/4	30311	11/32	30316	1/2		

#### Features

- SUPERTORQUE® lobular openings for greater turning power without deforming the fastener.
- Designed for maximum engagement on 6 point fasteners.

# SOCKETS & DRIVE TOOLS

## 1/4" DRIVE



### 1/4" DRIVE SHALLOW SOCKETS, 6 POINT, METRIC

High-Polished Chrome Finish

Product Code	Size (MM)	A		B		C		D		E		F	
		OAL (Inches)	Drive End Diameter (Inches)	Working End Diameter (Inches)	Broach Depth (Inches)	Bolt Clearance Depth (Inches)	Bolt Clearance Diameter (Inches)	Nose Length (Inches)					
MM-604	4	7/8	15/32	9/32	3/16	17/32	5/32	7/16					
MM-605	5	7/8	15/32	5/16	3/16	17/32	5/32	7/16					
MM-605.5	5.5	7/8	15/32	11/32	3/16	17/32	7/32	7/16					
MM-606	6	7/8	15/32	3/8	7/32	17/32	7/32	7/16					
MM-607	7	7/8	15/32	13/32	1/4	17/32	1/4	7/16					
MM-608	8	7/8	15/32	15/32	9/32	17/32	1/4	7/16					
MM-609	9	7/8	1/2	1/2	1/2	17/32	5/16	-					
MM-610	10	7/8	9/16	9/16	1/2	17/32	3/8	-					
MM-611	11	7/8	19/32	19/32	1/2	17/32	13/32	-					
MM-612	12	7/8	21/32	21/32	1/2	17/32	7/16	-					
MM-613	13	7/8	23/32	23/32	15/32	17/32	15/32	-					
MM-614	14	29/32	3/4	3/4	1/2	17/32	17/32	-					

Fed. Spec: ANSI B107.5



MM-608 MM-604

### MSM-12HRC 12 Piece 1/4" Drive Shallow 6 Point Socket Set on Clip Rail

Contents Include:

Product Code	Size (MM)	Product Code	Size (MM)	Product Code	Size (MM)	Product Code	Size (MM)
MM-604	4	MM-606	6	MM-609	9	MM-612	12
MM-605	5	MM-607	7	MM-610	10	MM-613	13
MM-605.5	5 1/2	MM-608	8	MM-611	11	MM-614	14



MSM-12HRC

#### Features

- SUPERTORQUE® lobular openings for greater turning power without deforming the fastener.
- Designed for maximum engagement on 6 point fasteners.

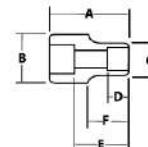

### 1/4" DRIVE SHALLOW SOCKETS, 12 POINT, METRIC

High-Polished Chrome Finish

Product Code	Size (MM)	A		B		C		D		E		F	
		OAL (Inches)	Drive End Diameter (Inches)	Working End Diameter (Inches)	Broach Depth (Inches)	Bolt Clearance Depth (Inches)	Bolt Clearance Diameter (Inches)	Nose Length (Inches)					
30604	4	1	15/32	1/4	1/4	19/32	1/2						
30605	5	1	15/32	5/16	5/16	19/32	1/2						
30699	5.5	1	15/32	11/32	15/32	19/32	1/2						
30606	6	1	15/32	11/32	5/16	19/32	1/2						
30607	7	1	15/32	7/16	5/16	19/32	1/2						
30608	8	1	15/32	15/32	3/8	1/2	-						
30609	9	1	17/32	17/32	3/8	21/32	-						
30610	10	1	19/32	19/32	1/2	7/8	-						
30611	11	1	5/8	5/8	17/32	7/8	-						
30612	12	1	11/16	11/16	1/2	7/8	-						
30613	13	1	23/32	23/32	1/2	7/8	-						
30614	14	1	3/4	3/4	1/2	7/8	-						

Fed. Spec: ANSI B107.5



30608 30604

### 30925 12 Piece 1/4" Drive Shallow 12 Point Socket Set on Clip Rail

Contents Include:

Product Code	Size (MM)	Product Code	Size (MM)	Product Code	Size (MM)	Product Code	Size (MM)
30604	4	30606	6	30609	9	30612	12
30605	5	30607	7	30610	10	30613	13
30699	5.5	30608	8	30611	11	30614	14



30925

#### Features

- SUPERTORQUE® lobular openings for greater turning power without deforming the fastener.
- Designed for maximum engagement on 12 point fasteners.





# SOCKETS & DRIVE TOOLS

## 1/4" DRIVE



### 1/4" DRIVE SHALLOW SOCKETS, 6 POINT, METRIC

High-Polished Chrome Finish



Product Code	Size (MM)	A OAL (Inches)	B Drive End Diameter (Inches)	C Working End Diameter (Inches)	D Broach Depth (Inches)	E		F Nose Length (Inches)
						Bolt Clearance Diameter (Inches)	Bolt Clearance Depth (Inches)	
30504	4	1	15/32	1/4	1/4	19/32		1/2
30598	4.5	1	15/32	1/4	1/4	19/32		1/2
30505	5	1	15/32	5/16	9/16	19/32		1/2
30599	5.5	1	15/32	11/32	15/32	19/32		1/2
30506	6	1	15/32	11/32	5/16	19/32		1/2
30507	7	1	15/32	7/16	9/16	15/32		1/2
30508	8	1	15/32	15/32	3/8	1/2		-
30509	9	1	17/32	17/32	3/8	21/32		-
30510	10	1	19/32	19/32	1/2	7/8		-
30511	11	1	5/8	5/8	17/32	7/8		-
30512	12	1	11/16	11/16	1/2	7/8		-
30513	13	1	23/32	23/32	1/2	7/8		-
30514	14	1	3/4	3/4	1/2	7/8		-

Fed. Spec: ANSI B107.5

### 30926 12 Piece 1/4" Drive Shallow 6 Point Socket Set on Clip Rail

Contents Include:

Product Code	Size (MM)	Product Code	Size (MM)	Product Code	Size (MM)	Product Code	Size (MM)
30504	4	30506	6	30509	9	30512	12
30505	5	30507	7	30510	10	30513	13
30599	5.5	30508	8	30511	11	30514	14

#### Features

- SUPERTORQUE® lobular openings for greater turning power without deforming the fastener.
- Designed for maximum engagement on 6 point fasteners.



### 1/4" DRIVE DEEP SOCKETS, 6 POINT, METRIC

High-Polished Chrome Finish



Product Code	Size (MM)	A OAL (Inches)	B Drive End Diameter (Inches)	C Working End Diameter (Inches)	D Broach Depth (Inches)	E		F Nose Length (Inches)
						Bolt Clearance Diameter (Inches)	Bolt Clearance Depth (Inches)	
MMD-604	4	2	15/32	9/32	3/16	1 21/32	7/8	1 9/16
MMD-605	5	2	15/32	5/16	3/16	1 21/32	5/32	1 9/16
MMD-605.5	5.5	2	15/32	5/16	7/32	1 21/32	7/32	1 9/16
MMD-606	6	2	15/32	3/8	7/32	1 21/32	7/32	1 9/16
MMD-607	7	2	15/32	13/32	1/4	1 21/32	1/4	1 9/16
MMD-608	8	2	15/32	15/32	9/32	1 21/32	1/4	1 9/16
MMD-609	9	2	1/2	1/2	9/32	1 21/32	5/16	-
MMD-610	10	2	9/16	9/16	9/32	1 21/32	3/8	-
MMD-611	11	2	19/32	19/32	3/8	1 21/32	13/32	-
MMD-612	12	2	21/32	21/32	3/8	1 21/32	7/16	-
MMD-613	13	2	23/32	23/32	3/8	1 21/32	15/32	-
MMD-614	14	2	3/4	3/4	7/16	1 21/32	17/32	-

Fed. Spec: ANSI B107.5

### MSMD-12HRC 12 Piece 1/4" Drive Deep 6 Point Socket Set on Clip Rail

Contents Include:

Product Code	Size (MM)	Product Code	Size (MM)	Product Code	Size (MM)	Product Code	Size (MM)
MMD-604	4	MMD-606	6	MMD-609	9	MMD-612	12
MMD-605	5	MMD-607	7	MMD-610	10	MMD-613	13
MMD-605.5	5.5	MMD-608	8	MMD-611	11	MMD-614	14

#### Features

- SUPERTORQUE® lobular openings for greater turning power without deforming the fastener.
- Designed for maximum engagement on 6 point fasteners.

# SOCKETS & DRIVE TOOLS

## 1/4" DRIVE



### 1/4" DRIVE DEEP SOCKETS, 12 POINT, METRIC

High-Polished Chrome Finish

Product Code	A		B		C		D		E		F
	Size (MM)	OAL (Inches)	Drive End Diameter (Inches)	Working End Diameter (Inches)	Broach Depth (Inches)	Bolt Clearance Depth (Inches)	Bolt Clearance Diameter (Inches)	Bolt Clearance Nose Length (Inches)			
30804	4	2	15/32	9/32	3/16	1 2/32	1/8	15/16			
30805	5	2	15/32	5/16	3/16	1 2/32	5/32	15/16			
30855	5.5	2	15/32	5/16	7/32	1 2/32	7/32	15/16			
30806	6	2	15/32	3/8	7/32	1 2/32	7/32	15/16			
30807	7	2	15/32	13/32	1/4	1 2/32	1/4	15/16			
30808	8	2	15/32	15/32	9/32	1 2/32	1/4	15/16			
30809	9	2	1/2	1/2	9/32	1 2/32	5/16	-			
30810	10	2	9/16	9/16	9/32	1 2/32	3/8	-			
30811	11	2	19/32	19/32	3/8	1 2/32	13/32	-			
30812	12	2	21/32	21/32	3/8	1 2/32	7/16	-			
30813	13	2	23/32	23/32	3/8	1 2/32	15/32	-			
30814	14	2	3/4	3/4	7/16	1 2/32	17/32	-			

Fed. Spec: ANSI B107.5



30808 30814

### 30941 12 Piece 1/4" Drive Deep 12 Point Socket Set on Clip Rail

Contents Include:

Product Code	Size (MM)	Product Code	Size (MM)	Product Code	Size (MM)	Product Code	Size (MM)
30804	4	30806	6	30809	9	30812	12
30805	5	30807	7	30810	10	30813	13
30855	5.5	30808	8	30811	11	30814	14



30941

#### Features

- SUPERTORQUE® lobular openings for greater turning power without deforming the fastener.
- Designed for maximum engagement on both 6 and 12 point fasteners.



### 1/4" DRIVE DEEP SOCKETS, 6 POINT, METRIC

High-Polished Chrome Finish

Product Code	A		B		C		D		E		F
	Size (MM)	OAL (Inches)	Drive End Diameter (Inches)	Working End Diameter (Inches)	Broach Depth (Inches)	Bolt Clearance Depth (Inches)	Bolt Clearance Diameter (Inches)	Bolt Clearance Nose Length (Inches)			
30704	4	2	15/32	9/32	3/16	1 2/32	1/8	5/16			
30705	5	2	15/32	5/16	3/16	1 2/32	5/32	5/16			
30755	5.5	2	15/32	5/16	7/32	1 2/32	7/32	5/16			
30706	6	2	15/32	3/8	7/32	1 2/32	7/32	5/16			
30707	7	2	15/32	13/32	1/4	1 2/32	1/4	5/16			
30708	8	2	15/32	15/32	9/32	1 2/32	1/4	5/16			
30709	9	2	1/2	1/2	9/32	1 2/32	5/16	-			
30710	10	2	9/16	9/16	9/32	1 2/32	3/8	-			
30711	11	2	19/32	19/32	3/8	1 2/32	13/32	-			
30712	12	2	21/32	21/32	3/8	1 2/32	7/16	-			
30713	13	2	23/32	23/32	3/8	1 2/32	15/32	-			
30714	14	2	3/4	3/4	7/16	1 2/32	17/32	-			

Fed. Spec: ANSI B107.5



30708 30714



30939

### 30939 12 Piece 1/4" Drive Deep 6 Point Socket Set on Clip Rail

Contents Include:

Product Code	Size (MM)	Product Code	Size (MM)	Product Code	Size (MM)	Product Code	Size (MM)
30704	4	30706	6	30709	9	30712	12
30705	5	30707	7	30710	10	30713	13
30755	5.5	30708	8	30711	11	30714	14

#### Features

- SUPERTORQUE® lobular openings for greater turning power without deforming the fastener.
- Designed for maximum engagement on 6 point fasteners.



# SOCKETS & DRIVE TOOLS

## 1/4" DRIVE



### 1/4" DRIVE STANDARD LENGTH HEX BIT SOCKETS, SAE

High-Polished Chrome Finish



MA-4A



WSM-11TRC

Product Code	Size (Inches)	Socket Length (Inches)	Socket Outside Diameter (Inches)	Overall Length (Inches)	Replacement Bit Product Code
MA-050A	.050	7/8	15/32	1 1/2	BITH05001
MA-2A	1/16	7/8	15/32	1 1/2	BITH0201
MA-2 1/2A	5/64	7/8	15/32	1 1/2	BITH2.501
MA-3A	3/32	7/8	15/32	1 1/2	BITH0301
MA-3 1/2A	7/64	7/8	15/32	1 1/2	BITH3.501
MA-4A	1/8	7/8	15/32	1 1/2	BITH0401
MA-4 1/2A	9/64	7/8	15/32	1 1/2	BITH4.501
MA-5A	5/32	7/8	15/32	1 1/2	BITH0501
MA-6A	3/16	7/8	15/32	1 1/2	BITH0601
MA-7A	7/32	7/8	15/32	1 1/2	BITH0701
MA-8A	1/4	7/8	15/32	1 1/2	BITH0801
MA-10A	5/16	7/8	15/32	1 1/2	BITH1001

### WSM-11TRC 11 Piece Hex Bit Socket Set on Clip Rail

Contents Include:

Product Code	Size (Inches)	Product Code	Size (Inches)	Product Code	Size (Inches)
MA-2A	1/16	MA-4A	1/8	MA-7A	7/32
MA-2 1/2A	5/64	MA-4 1/2A	9/64	MA-8A	1/4
MA-3A	3/32	MA-5A	5/32	MA-10A	5/16
MA-3 1/2A	7/64	MA-6A	3/16		

### Features

- High-polished chrome finish socket cleans easily.
- Two piece design allows bits to be replaced easily.



### 1/4" DRIVE STANDARD LENGTH HEX BIT SOCKETS, SAE

High-Polished Chrome Finish



35000



30902

Product Code	Size (Inches)	Socket Length (Inches)	Socket Outside Diameter (Inches)	Overall Length (Inches)	Bit Length (Inches)
35000	1/8	19/16	15/32	1 13/32	5/8
35001	5/32	19/16	15/32	1 13/32	5/8
35002	3/16	19/16	15/32	1 13/32	5/8
35003	7/32	19/16	15/32	1 13/32	5/8
35004	1/4	19/16	15/32	1 13/32	5/8
35005	5/16	19/16	15/32	1 13/32	5/8

### 30902 6 Piece Hex Bit Socket Set on Clip Rail

Contents Include:

Product Code	Size (Inches)	Product Code	Size (Inches)	Product Code	Size (Inches)
35000	1/8	35002	3/16	35004	1/4
35001	5/32	35003	7/32	35005	5/16

### Features

- High-polished chrome finish socket cleans easily.

# SOCKETS & DRIVE TOOLS

## 1/4" DRIVE

WILLIAMS



### 1/4" DRIVE STANDARD LENGTH HEX BIT SOCKETS, METRIC

High-Polished Chrome Finish

Product Code	Size (MM)	Socket Length (Inches)	Socket Outside Diameter (Inches)	Overall Length (Inches)	Bit Length (Inches)
35070	3	13/16	15/32	1 13/32	5/8
35071	4	13/16	15/32	1 13/32	5/8
35072	5	13/16	15/32	1 13/32	5/8
35073	6	13/16	15/32	1 13/32	5/8
35074	7	13/16	15/32	1 13/32	5/8
35075	8	13/16	15/32	1 13/32	5/8

#### 30904 6 Piece Hex Bit Socket Set on Clip Rail

Contents Include:

Product Code	Size (MM)	Product Code	Size (MM)	Product Code	Size (MM)
35070	3	35072	5	35074	7
35071	4	35073	6	35075	8

#### Features

- High-polished chrome finish socket cleans easily.



35070



30904

WILLIAMS



### 1/4" DRIVE BALL TIP HEX BIT SOCKETS, SAE

High-Polished Chrome Finish

Product Code	Size (Inches)	Socket Length (Inches)	Socket Outside Diameter (Inches)	Overall Length (Inches)	Replacement Bit Product Code (Inches)
MA-3HBA	3/32	7/8	15/32	1 1/2	BITHB03-01
MA-4HBA	1/8	7/8	15/32	1 1/2	BITHB04-01
MA-4 1/2 HBA	9/64	7/8	15/32	1 1/2	BITHB4.5-01
MA-5HBA	5/32	7/8	15/32	1 1/2	BITHB05-01
MA-6HBA	3/16	7/8	15/32	1 1/2	BITHB06-01
MA-7HBA	7/32	7/8	15/32	1 1/2	BITHB07-01
MA-8HBA	1/4	7/8	15/32	1 1/2	BITHB08-01

#### WSM-7HBA 7 Piece Ball Tip Hex Bit Socket Set on Clip Rail

Contents Include:

Product Code	Size (Inches)	Product Code	Size (Inches)	Product Code	Size (Inches)
MA-3HBA	3/32	MA-5HBA	5/32	MA-8HBA	1/4
MA-4HBA	1/8	MA-6HBA	3/16		
MA-4 1/2 HBA	9/64	MA-7HBA	7/32		

#### Features

- High-polished chrome finish socket cleans easily.
- Two piece design allows bits to be replaced easily.



MA-3HBA



WSM-7HBA



**WARNING**

# SOCKETS & DRIVE TOOLS

## 1/4" DRIVE



WILLIAMS®



### 1/4" DRIVE LONG HEX BIT SOCKETS, SAE

#### High-Polished Chrome Finish

Product Code	Size (Inches)	Socket Length (Inches)	Socket Outside Diameter (Inches)	Overall Length (Inches)	Replacement Bit Product Code
MA-3LA	3/32	7/8	15/32	3	BITH03-02
MA-3½LA	7/64	7/8	15/32	3	BITH3.5-02
MA-4LA	1/8	7/8	15/32	3	BITH04-02
MA-4½LA	9/64	7/8	15/32	3	BITH4.5-02
MA-5LA	5/32	7/8	15/32	3	BITH05-02
MA-6LA	3/16	7/8	15/32	3	BITH06-02
MA-7LA	7/32	7/8	15/32	3	BITH07-02
MA-8LA	1/4	7/8	15/32	3	BITH08-02
MA-10LA	5/16	7/8	15/32	3	BITH10-02

#### WSMS-9LRC 9 Piece Long Hex Bit Socket Set on Clip Rail

##### Contents Include:

Product Code	Size (Inches)	Product Code	Size (Inches)	Product Code	Size (Inches)
MA-3LA	3/32	MA-4½LA	9/64	MA-7LA	7/32
MA-3½LA	7/64	MA-5LA	5/32	MA-8LA	1/4
MA-4LA	1/8	MA-6LA	3/16	MA-10LA	5/16

##### Features

- High-polished chrome finish socket cleans easily.
- Two piece design allows bits to be replaced easily.



WILLIAMS®



### 1/4" DRIVE MID LENGTH HEX BIT SOCKETS, SAE

#### High-Polished Chrome Finish

Product Code	Size (Inches)	Socket Length (Inches)	Socket Outside Diameter (Inches)	Overall Length (Inches)	Bit Length (Inches)
35020	1/8	25/32	15/32	1 13/16	1
35021	5/32	25/32	15/32	1 13/16	1
35022	3/16	25/32	15/32	1 13/16	1
35023	7/32	25/32	15/32	1 13/16	1
35024	1/4	25/32	15/32	1 13/16	1
35025	5/16	25/32	15/32	1 13/16	1

#### 30943 6 Piece Hex Bit Socket Set on Clip Rail

##### Contents Include:

Product Code	Size (Inches)	Product Code	Size (Inches)	Product Code	Size (Inches)
35020	1/8	35022	3/16	35024	1/4
35021	5/32	35023	7/32	35025	5/16

##### Features

- High-polished chrome finish socket cleans easily.



WILLIAMS®



### 1/4" DRIVE MID LENGTH HEX BIT SOCKETS, METRIC

#### High-Polished Chrome Finish

Product Code	Size (MM)	Socket Length (Inches)	Socket Outside Diameter (Inches)	Overall Length (Inches)	Bit Length (Inches)
35063	3	25/32	15/32	1 13/16	1
35064	4	25/32	15/32	1 13/16	1
35065	5	25/32	15/32	1 13/16	1
35066	6	25/32	15/32	1 13/16	1
35067	7	25/32	15/32	1 13/16	1
35068	8	25/32	15/32	1 13/16	1

#### 30945 6 Piece Hex Bit Socket Set on Clip Rail

##### Contents Include:

Product Code	Size (MM)	Product Code	Size (MM)	Product Code	Size (MM)
35063	3	35065	5	35067	7
35064	4	35066	6	35068	8

##### Features

- High-polished chrome finish socket cleans easily.

# SOCKETS & DRIVE TOOLS

## 1/4" DRIVE



### 1/4" DRIVE STUBBY HEX BIT SOCKETS, SAE

#### High-Polished Chrome Finish

Product Code	Size (Inches)	Socket Length (Inches)	Socket Outside Diameter (Inches)	Overall Length (Inches)	Replacement Bit Product Code
MA-4SA	1/8	7/8	1 1/32	1 1/16	TMAXS4E2
MA-4.5SA	9/64	7/8	1 1/32	1 1/16	TMAXS4.5E2
MA-5SA	5/32	7/8	1 1/32	1 1/16	TMAXS5E2
MA-6SA	3/16	7/8	1 1/32	1 1/16	TMAXS6E2



MA-4SA

### WSM-4TRC 4 Piece Stubby Hex Bit Socket Set on Clip Rail

#### Contents Include:

Product Code	Size (Inches)	Product Code	Size (Inches)
MA-4SA	1/8	MA-5SA	5/32
MA-4.5SA	9/64	MA-6SA	3/16

#### Features

- High-polished chrome finish socket cleans easily.
- Two piece design allows bits to be replaced easily.
- Extra-short bits provide access in confined areas.



WSM-4TRC



### 1/4" DRIVE TORX® BIT SOCKETS

#### High-Polished Chrome Finish

Product Code	Torx® Size	Socket Length (Inches)	Socket Outside Diameter (Inches)	Overall Length (Inches)	Bit Length (Inches)
35079	T8	1 1/16	1/2	1 13/32	5/8
35080	T10	1 1/16	1/2	1 13/32	5/8
35081	T15	1 1/16	1/2	1 13/32	5/8
35082	T20	1 1/16	1/2	1 13/32	5/8
35083	T25	1 1/16	1/2	1 13/32	5/8
35084	T27	1 1/16	1/2	1 13/32	5/8
35085	T30	1 1/16	1/2	1 13/32	5/8



35080

### 30908 6 Piece Torx® Bit Socket Set on Clip Rail

#### Contents Include:

Product Code	Torx® Size	Product Code	Torx® Size	Product Code	Torx® Size
35080	T10	35082	T20	35084	T27
35081	T15	35083	T25	35085	T30

#### Features

- High-polished chrome finish socket cleans easily.



30908



### 1/4" DRIVE SCREWDRIVER BIT SOCKETS

#### High-Polished Chrome Finish, Phillips® and Slotted

Product Code	Tip Size (Inches)	Socket Length (Inches)	Socket Outside Diameter (Inches)	Overall Length (Inches)	Bit Length (Inches)
<b>Slotted Bits:</b>					
35040	5/32	1 1/16	1 1/32	1 13/32	5/8
35041	7/32	1 1/16	1 1/32	1 13/32	5/8
35042	9/32	1 1/16	1 1/32	1 13/32	5/8
<b>Phillips® Bits:</b>					
35050	#0	1 1/16	1 1/32	1 13/32	5/8
35051	#1	1 1/16	1 1/32	1 13/32	5/8
35052	#2	1 1/16	1 1/32	1 13/32	5/8
35053	#3	1 1/16	1 1/32	1 13/32	5/8

### 30906 6 Piece Screwdriver Bit Socket Set on Clip Rail

#### Contents Include:

Product Code	Tip Size (Inches)	Product Code	Tip Size (Inches)	Product Code	Tip Size
35040	5/32	35042	9/32	35051	#1
35041	7/32	35050	#0	35052	#2

#### Features

- High-polished chrome finish socket cleans easily.



30906



# SOCKETS & DRIVE TOOLS

## 3/8" DRIVE



### 56 PIECE 3/8" DRIVE SOCKET AND DRIVE TOOL SET

#### 8 & 12 Point SAE, with Metal Box

Product Code	Description
WSB-56FTB	56 Piece Tool Set with TB-104 Metal Tool Box (Keep-Safe-Foam is not included)
WSB-56F	56 Piece Tool Set Only Packed in Keep-Safe-Foam System

#### Contents Include:

##### Drive Tools:

Product Code	Description
B-52EHA	8" Enclosed Head Ratchet
B-108	3" Extension
B-110	6" Extension
B-115	11" Extension

##### Drive Tools:

Product Code	Description
B-40A	8 9/16" Flex Handle
B-140A	Universal Joint
B-20A	Sliding T-Handle

##### Shallow 12-Point Sockets

Product Code	Size (Inches)
B-1208	1/4
B-1210	5/16
B-1212	3/8
B-1214	7/16
B-1216	1/2
B-1218	9/16
B-1220	5/8
B-1222	11/16
B-1224	3/4
B-1226	13/16
B-1228	7/8
B-1230	15/16
B-1232	1

##### Deep 12-Point Sockets

Product Code	Size (Inches)
BD-1212	3/8
BD-1214	7/16
BD-1216	1/2
BD-1218	9/16
BD-1220	5/8
BD-1222	11/16
BD-1224	3/4
BD-1226	13/16
BD-1228	7/8
BD-1230	15/16
BD-1232	1

##### Shallow 8-Point Sockets

Product Code	Size (Inches)
BD-808	1/4
BD-810	5/16
BD-812	3/8
BD-814	7/16
BD-816	1/2

##### Shallow 12-Point Universal Sockets

Product Code	Size (Inches)
BU-1212	3/8
BU-1214	7/16
BU-1216	1/2
BU-1218	9/16
BU-1220	5/8
BU-1222	11/16
BU-1224	3/4

##### Standard Hex Bit Sockets

Product Code	Size (Inches)
BA-4A	1/8
BA-5A	5/32
BA-6A	3/16
BA-7A	7/32
BA-8A	1/4
BA-10A	5/16
BA-12A	3/8

##### Screwdriver Bit Sockets

Product Code	Size
BA-7A-2S	7/32" x .040"
BA-10A-3S	9/32" x .045"
BA-10A-4S	5/16" x .055"
BA-7A-2P	#2
BA-10A-3P	#3
BA-12A-4P	#4

#### Features

- All tools are professional quality, made of high-grade chrome vanadium steel.
- Sockets feature SUPERTORQUE® lobular openings for greater turning power without deforming the fastener.
- Metal tool box made for years of rugged use.



WSB-56FTB

# SOCKETS & DRIVE TOOLS

## 3/8" DRIVE



### 32 PIECE 3/8" DRIVE SOCKET AND DRIVE TOOL SET

8 & 12 Point SAE, Packed in Exclusive Keep-Safe-Foam System with Metal Box

Product Code	Description
WSB-32FTB	32 Piece Tool Set with TB-104 Metal Tool Box
WSB-32F	32 Piece Tool Set Only - Packed in Keep Safe Foam System

#### Contents Include:

Drive Tools:		Drive Tools:	
Product Code	Description	Product Code	Description
B-52EHA	8" Enclosed Head Ratchet	B-115	11" Extension
B-108	3" Extension	B-40A	8 9/16" Flex Handle
B-110	6" Extension	B-140A	Universal Joint

Shallow 12-Point Sockets		Deep 12-Point Sockets	
Product Code	Size (Inches)	Product Code	Size (Inches)
B-1212	3/8	BD-1212	3/8
B-1214	7/16	BD-1214	7/16
B-1216	1/2	BD-1216	1/2
B-1218	9/16	BD-1218	9/16
B-1220	5/8	BD-1220	5/8
B-1222	11/16	BD-1222	11/16
B-1224	3/4	BD-1224	3/4
B-1226	13/16	BD-1226	13/16
B-1228	7/8	BD-1228	7/8

Shallow 8-Point Sockets		Shallow 12-Point Universal Sockets	
Product Code	Size (Inches)	Product Code	Size (Inches)
BD-808	1/4	BU-1212	3/8
BD-810	5/16	BU-1214	7/16
BD-812	3/8	BU-1216	1/2
		BU-1218	9/16
		BU-1220	5/8

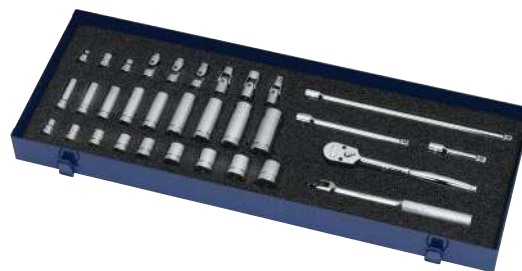

#### Features

- Keep-Safe-Foam system keeps tools organized and helps prevent loss
- All tools are professional quality, made of high-grade chrome vanadium steel
- Sockets feature SUPERTORQUE® lobular openings for greater turning power without deforming the fastener
- Metal tool box made for years of rugged use.



WSB-32FTB





# SOCKETS & DRIVE TOOLS

## 3/8" DRIVE



### 27 PIECE 3/8" DRIVE SOCKET AND DRIVE TOOL SET

**12 Point SAE, Packed in Exclusive Keep-Safe-Foam System with Metal Box**

Product Code	Description
WSB-27FTB	27 Piece Tool Set with TB-104 Metal Tool Box
WSB-27F	27 Piece Tool Set Only - Packed in Keep Safe Foam System

**Contents Include:**

Drive Tools:		Drive Tools:	
Product Code	Description	Product Code	Description
B-52EHA	8" Enclosed Head Ratchet	B-40A	8 9/16" Flex Handle
B-108	3" Extension	B-140A	Universal Joint
B-110	6" Extension		

**Shallow 12-Point Sockets**

Product Code	Size (Inches)
B-1208	1/4
B-1210	5/16
B-1212	3/8
B-1214	7/16
B-1216	1/2
B-1218	9/16
B-1220	5/8
B-1222	11/16
B-1224	3/4
B-1226	13/16
B-1228	7/8
B-1230	15/16
B-1232	1

**Deep 12-Point Sockets**

Product Code	Size (Inches)
BD-1212	3/8
BD-1214	7/16
BD-1216	1/2
BD-1218	9/16
BD-1220	5/8
BD-1222	11/16
BD-1224	3/4
BD-1226	13/16
BD-1228	7/8



WSB-27FTB

**Features**

- Keep-Safe-Foam system keeps tools organized and helps prevent loss.
- All tools are professional quality, made of high-grade chrome vanadium steel.
- Sockets feature SUPERTORQUE® lobular openings for greater turning power without deforming the fastener.
- Metal tool box made for years of rugged use.



### 23 PIECE 3/8" DRIVE SOCKET AND DRIVE TOOL SET

**6 Point SAE, Packed in Exclusive Keep-Safe-Foam System with Metal Box**

Product Code	Description
WSB-23HFTB	23 Piece Tool Set with TB-102 Metal Tool Box
WSB-23HF	23 Piece Tool Set Only - Packed in Keep Safe Foam System

**Contents Include:**

Drive Tools:		Drive Tools:	
Product Code	Description	Product Code	Description
B-52EHA	8" Enclosed Head Ratchet	B-40A	8 9/16" Flex Handle
B-108	3" Extension	B-140A	Universal Joint
B-110	6" Extension		

**Shallow 6-Point Sockets**

Product Code	Size (Inches)
B-612	3/8
B-614	7/16
B-616	1/2
B-618	9/16
B-620	5/8
B-622	11/16
B-624	3/4
B-626	13/16
B-628	7/8

**Deep 6-Point Sockets**

Product Code	Size (Inches)
BD-612	3/8
BD-614	7/16
BD-616	1/2
BD-618	9/16
BD-620	5/8
BD-622	11/16
BD-624	3/4
BD-626	13/16
BD-628	7/8



WSB-23HFTB

**Features**

- Keep-Safe-Foam system keeps tools organized and helps prevent loss.
- All tools are professional quality, made of high-grade chrome vanadium steel.
- Sockets feature SUPERTORQUE® lobular openings for greater turning power without deforming the fastener.
- Metal tool box made for years of rugged use.

# SOCKETS & DRIVE TOOLS

## 3/8" DRIVE



### 23 PIECE 3/8" DRIVE SOCKET AND DRIVE TOOL SET

12 Point SAE, Packed in Exclusive Keep-Safe-Foam System with Metal Box

Product Code	Description
WSB-23FTB	23 Piece Tool Set with TB-102 Metal Tool Box
WSB-23F	23 Piece Tool Set Only - Packed in Keep Safe Foam System

#### Contents Include:

Drive Tools:		Drive Tools:	
Product Code	Description	Product Code	Description
B-52EHA	8" Enclosed Head Ratchet	B-40A	8 9/16" Flex Handle
B-108	3" Extension	B-140A	Universal Joint
B-110	6" Extension		

#### Shallow 12-Point Sockets

Product Code	Size (Inches)	Product Code	Size (Inches)
B-1212	3/8	BD-1212	3/8
B-1214	7/16	BD-1214	7/16
B-1216	1/2	BD-1216	1/2
B-1218	9/16	BD-1218	9/16
B-1220	5/8	BD-1220	5/8
B-1222	11/16	BD-1222	11/16
B-1224	3/4	BD-1224	3/4
B-1226	13/16	BD-1226	13/16
B-1228	7/8	BD-1228	7/8

#### Deep 12-Point Sockets

#### Features

- Keep-Safe-Foam system keeps tools organized and helps prevent loss.
- All tools are professional quality, made of high-grade chrome vanadium steel.
- Sockets feature SUPERTORQUE® lobular openings for greater turning power without deforming the fastener.
- Metal tool box made for years of rugged use.



WSB-23FTB



### 15 PIECE 3/8" DRIVE SOCKET AND DRIVE TOOL SET

12 Point SAE, Packed in Exclusive Keep-Safe-Foam System with Metal Box

Product Code	Description
WSB-15FTB	15 Piece Tool Set with TB-102 Metal Tool Box
WSB-15F	15 Piece Tool Set Only - Packed in Keep Safe Foam System

#### Contents Include:

Drive Tools:		Shallow 12-Point Sockets	
Product Code	Description	Product Code	Size (Inches)
B-52EHA	8" Enclosed Head Ratchet	B-1212	3/8
B-108	3" Extension	B-1214	7/16
B-110	6" Extension	B-1216	1/2
B-115	11" Extension	B-1218	9/16
B-40A	8 9/16" Flex Handle	B-1220	5/8
B-140A	Universal Joint	B-1222	11/16
		B-1224	3/4
		B-1226	13/16
		B-1228	7/8

#### Features

- Keep-Safe-Foam system keeps tools organized and helps prevent loss.
- All tools are professional quality, made of high-grade chrome vanadium steel.
- Sockets feature SUPERTORQUE® lobular openings for greater turning power without deforming the fastener.
- Metal tool box made for years of rugged use.



WSB-15FTB



# SOCKETS & DRIVE TOOLS

## 3/8" DRIVE



### 12 PIECE 3/8" DRIVE SOCKET AND DRIVE TOOL SET

**6 Point SAE, Packed in Exclusive Keep-Safe-Foam System with Metal Box**

Product Code	Description
WSB-12HFTB	12 Piece Tool Set with TB-101 Metal Tool Box
WSB-12HF	12 Piece Tool Set Only - Packed in Keep Safe Foam System

**Contents Include:**

Drive Tools:		Shallow 12-Point Sockets	
Product Code	Description	Product Code	Size (Inches)
B-52EHA	8" Enclosed Head Ratchet	B-612	3/8
B-108	3" Extension	B-614	7/16
B-110	6" Extension	B-616	1/2
		B-618	9/16
		B-620	5/8
		B-622	11/16
		B-624	3/4
		B-626	13/16
		B-628	7/8

**Features**

- Keep-Safe-Foam system keeps tools organized and helps prevent loss.
- All tools are professional quality, made of high-grade chrome vanadium steel.
- Sockets feature SUPERTORQUE® lobular openings for greater turning power without deforming the fastener.
- Metal tool box made for years of rugged use.



WSB-12HFTB



### 29 PIECE 3/8" DRIVE SOCKET AND DRIVE TOOL SET

**6 & 12 Point SAE & Metric, Packed in Exclusive Keep-Safe-Foam System with Metal Box**

Product Code	Description
WSMB-29FTB	29 Piece Tool Set with TB-103 Metal Tool Box
WSMB-29F	29 Piece Tool Set Only - Packed in Keep Safe Foam System

**Contents Include:**

Drive Tools:		Drive Tools:	
Product Code	Description	Product Code	Description
B-52EHA	8" Enclosed Head Ratchet	B-110	6" Extension
B-108	3" Extension	B-140A	Universal Joint

Shallow 6-Point Sockets, SAE		Shallow 6-Point Sockets, mm	
Product Code	Size (Inches)	Product Code	Metric Size (mm)
B-608	1/4	BM-606	6
B-610	5/16	BM-607	7
B-612	3/8	BM-608	8
B-614	7/16	BM-609	9
B-616	1/2	BM-610	10
B-618	9/16	BM-611	11
		BM-612	12
		BM-613	13
		BM-614	14

Shallow 12-point Sockets, SAE	
Product Code	Size (Inches)
B-1220	5/8
B-1222	11/16
B-1224	3/4
B-1226	13/16
B-1228	7/8

**Features**

- Keep-Safe-Foam system keeps tools organized and helps prevent loss.
- All tools are professional quality, made of high-grade chrome vanadium steel.
- Sockets feature SUPERTORQUE® lobular openings for greater turning power without deforming the fastener.
- Metal tool box made for years of rugged use.



WSMB-29FTB

# SOCKETS & DRIVE TOOLS

## 3/8" DRIVE



### 39 PIECE 3/8" DRIVE SOCKET AND DRIVE TOOL SET

6 & 12 Point Metric, Packed in Exclusive Keep-Safe-Foam System with Metal Box

Product Code	Description
MSB-39FTB	39 Piece Tool Set with TB-104 Metal Tool Box
MSB-39F	39 Piece Tool Set Only - Packed in Keep Safe Foam System

#### Contents Include:

Drive Tools:		Drive Tools:	
Product Code	Description	Product Code	Description
B-52EHA	8" Enclosed Head Ratchet	B-20A	Sliding T-Handle Ratchet Spinner
B-108	3" Extension	B-70	Ratchet Spinner
B-110	6" Extension		
B-115	11" Extension		
BFE-8	8" Flexible Extension		
B-40A	8 9/16" Flex Handle		
B-140A	Universal Joint		

Deep 6-Point Sockets		Shallow 12-Point Sockets	
Product Code	Size (MM)	Product Code	Size (MM)
BMD-608	8	BM-1206	6
BMD-609	9	BM-1207	7
BMD-610	10	BM-1208	8
BMD-611	11	BM-1209	9
BMD-612	12	BM-1210	10
BMD-613	13	BM-1211	11
BMD-614	14	BM-1212	12
BMD-615	15	BM-1213	13
BMD-616	16	BM-1214	14
BMD-617	17	BM-1215	15
BMD-618	18	BM-1216	16
BMD-619	19	BM-1217	17
		BM-1218	18
		BM-1219	19
		BM-1220	20
		BM-1221	21
		BM-1222	22
		BM-1224	24

#### Features

- Keep-Safe-Foam system keeps tools organized and helps prevent loss.
- All tools are professional quality, made of high-grade chrome vanadium steel.
- Sockets feature SUPERTORQUE® lobular openings for greater turning power without deforming the fastener.
- Metal tool box made for years of rugged use.

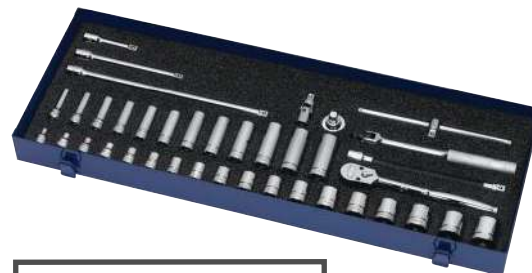

MSB-39FTB



# SOCKETS & DRIVE TOOLS

## 3/8" DRIVE



### 29 PIECE 3/8" DRIVE SOCKET AND DRIVE TOOL SET

**6 Point Metric, Packed in Exclusive Keep-Safe-Foam System with Metal Box**

Product Code	Description
MSB-29HFTB	29 Piece Tool Set with TB-103 Metal Tool Box
MSB-29HF	29 Piece Tool Set Only - Packed in Keep Safe Foam System

**Contents Include:**

Drive Tools:		Drive Tools:	
Product Code	Description	Product Code	Description
B-52EHA	8" Enclosed Head Ratchet	B-40A	8 9/16" Flex Handle
B-108	3" Extension	B-140A	Universal Joint
B-110	6" Extension		

Shallow 6-Point Sockets		Deep 6-Point Sockets	
Product Code	Size (MM)	Product Code	Size (MM)
BM-608	8	BMD-608	8
BM-609	9	BMD-609	9
BM-610	10	BMD-610	10
BM-611	11	BMD-611	11
BM-612	12	BMD-612	12
BM-613	13	BMD-613	13
BM-614	14	BMD-614	14
BM-615	15	BMD-615	15
BM-616	16	BMD-616	16
BM-617	17	BMD-617	17
BM-618	18	BMD-618	18
BM-619	19	BMD-619	19

**Features**

- Keep-Safe-Foam system keeps tools organized and helps prevent loss.
- All tools are professional quality, made of high-grade chrome vanadium steel.
- Sockets feature SUPERTORQUE® lobular openings for greater turning power without deforming the fastener.
- Metal tool box made for years of rugged use.



MSB-29HFTB



### 29 PIECE 3/8" DRIVE SOCKET AND DRIVE TOOL SET

**6 & 12 Point Metric, Packed in Exclusive Keep-Safe-Foam System with Metal Box**

Product Code	Description
MSB-29FTB	29 Piece Tool Set with TB-103 Metal Tool Box
MSB-29F	29 Piece Tool Set Only - Packed in Keep Safe Foam System

**Contents Include:**

Drive Tools:		Drive Tools:	
Product Code	Description	Product Code	Description
B-52EHA	8" Enclosed Head Ratchet	B-40A	8 9/16" Flex Handle
B-108	3" Extension	B-140A	Universal Joint
B-110	6" Extension		

Shallow 12-Point Sockets		Deep 6-Point Sockets	
Product Code	Size (MM)	Product Code	Size (MM)
BM-1208	8	BMD-608	8
BM-1209	9	BMD-609	9
BM-1210	10	BMD-610	10
BM-1211	11	BMD-611	11
BM-1212	12	BMD-612	12
BM-1213	13	BMD-613	13
BM-1214	14	BMD-614	14
BM-1215	15	BMD-615	15
BM-1216	16	BMD-616	16
BM-1217	17	BMD-617	17
BM-1218	18	BMD-618	18
BM-1219	19	BMD-619	19

**Features**

- Keep-Safe-Foam system keeps tools organized and helps prevent loss.
- All tools are professional quality, made of high-grade chrome vanadium steel.
- Sockets feature SUPERTORQUE® lobular openings for greater turning power without deforming the fastener.
- Metal tool box made for years of rugged use.



MSB-29FTB

# SOCKETS & DRIVE TOOLS

## 3/8" DRIVE



### 18 PIECE 3/8" DRIVE SOCKET AND DRIVE TOOL SET

**6 Point Metric, Packed in Exclusive Keep-Safe-Foam System with Metal Box**

Product Code	Description
MSB-18HFTB	18 Piece Tool Set with TB-102 Metal Tool Box
MSB-18HF	18 Piece Tool Set Only - Packed in Keep Safe Foam System

**Contents Include:**

Drive Tools:		Drive Tools:	
Product Code	Description	Product Code	Description
B-52EHA	8" Enclosed Head Ratchet	B-110	6" Extension
B-108	3" Extension	B-140A	Universal Joint

Shallow 6-Point Sockets		Shallow 6-Point Sockets	
Product Code	Size (MM)	Product Code	Size (MM)
BM-606	6	BM-613	13
BM-607	7	BM-614	14
BM-608	8	BM-615	15
BM-609	9	BM-616	16
BM-610	10	BM-617	17
BM-611	11	BM-618	18
BM-612	12	BM-619	19

**Features**

- Keep-Safe-Foam system keeps tools organized and helps prevent loss.
- All tools are professional quality, made of high-grade chrome vanadium steel.
- Sockets feature SUPERTORQUE® lobular openings for greater turning power without deforming the fastener.
- Metal tool box made for years of rugged use.



MSB-18HFTB



### 17 PIECE 3/8" DRIVE SOCKET AND DRIVE TOOL SET

**12 Point Metric, Packed in Exclusive Keep-Safe-Foam System with Metal Box**

Product Code	Description
MSB-17FTB	17 Piece Tool Set with TB-102 Metal Tool Box
MSB-17F	17 Piece Tool Set Only - Packed in Keep Safe Foam System

**Contents Include:**

Drive Tools:		Drive Tools:	
Product Code	Description	Product Code	Description
B-52EHA	8" Enclosed Head Ratchet	B-40A	8 1/16" Flex Handle
B-108	3" Extension	B-140A	Universal Joint
B-110	6" Extension		

Shallow 12-Point Sockets		Shallow 12-Point Sockets	
Product Code	Size (MM)	Product Code	Size (MM)
BM-1208	8	BM-1214	14
BM-1209	9	BM-1215	15
BM-1210	10	BM-1216	16
BM-1211	11	BM-1217	17
BM-1212	12	BM-1218	18
BM-1213	13	BM-1219	19

**Features**

- Keep-Safe-Foam system keeps tools organized and helps prevent loss.
- All tools are professional quality, made of high-grade chrome vanadium steel.
- Sockets feature SUPERTORQUE® lobular openings for greater turning power without deforming the fastener.
- Metal tool box made for years of rugged use.



MSB-17FTB





# SOCKETS & DRIVE TOOLS

## 1/4", 3/8" & 1/2" DRIVE TOOL SET



### 146 PIECE 1/4", 3/8", 1/2" DRIVE SOCKET SET

#### 6 & 12 Point Rugged-Case-System Tool Set, SAE and Metric

Product Code	Description
50614	146 Piece 1/4", 3/8", 1/2" Drive Socket Set

#### Contents Include:

##### 1/4" Drive Tools:

Product Code	Description
33001	Ratchet
33003	3" Extension
33006	18" Sliding T-handle
30007	Universal Joint
30009	Adaptor 1/4" F x 3/8" M

##### 1/4" Drive Deep 6 Point Sockets, MM

Product Code	Size (MM)
30704	4
30705	5
30706	6
30707	7
30708	8
30709	9
30710	10
30711	11
30712	12
30713	13

##### 1/4" Drive Deep 6 Point Sockets, SAE

Product Code	Size (Inches)
30306	3/16
30307	7/32
30308	1/4
30309	9/32
30310	5/16
30311	11/32
30312	3/8
30314	7/16
30316	1/2

##### 1/4" Drive Shallow 6 Point Sockets, MM

Product Code	Size (MM)
30504	4
30505	5
30599	5.5
30506	6
30507	7
30508	8
30509	9
30510	10
30511	11
30512	12
30513	13
30514	14

##### 1/4" Drive Shallow 6 Point Sockets, SAE

Product Code	Size (Inches)
30105	5/32
30106	3/16
30107	7/32
30108	1/4
30109	9/32
30110	5/16
30111	11/32
30112	3/8
30114	7/16
30116	1/2
30118	9/16

##### 1/4" Drive Hex Bit Sockets, SAE

Product Code	Size (Inches)
35000	1/8
35001	5/32
35002	3/16
35003	7/32
35004	1/4
35005	5/16

##### 1/4" Drive Hex Bit Sockets, SAE

Product Code	Size (MM)
35070	3
35071	4
35072	5
35073	6
35074	7
35075	8

##### 1/4" Drive Screwdriver Bit Sockets

Product Code	Description
35040	5/32" Slotted Tip
35041	7/32" Slotted Tip
35042	9/32" Slotted Tip
35050	#0 Phillips Tip
35051	#1 Phillips Tip
35052	#2 Phillips Tip

##### 1/4" Drive Torx Bit Sockets

Product Code	Size
35080	T10
35081	T15
35082	T20
35083	T25
35084	T27
35085	T30

##### 3/8" Drive Tools

Product Code	Description
31001	Ratchet
31002	3" Extension
31003	6" Extension

##### 3/8" Drive Deep 12 Point Sockets, MM

Product Code	Size (MM)
31806	6
31807	7
31808	8
31809	9
31810	10
31811	11
31812	12
31813	13
31814	14
31815	15
31816	16
31817	17
31818	18
31819	19

##### 3/8" Drive Deep 6 Point Sockets, SAE

Product Code	Size (Inches)
31408	1/4
31410	5/16
31412	3/8
31414	7/16
31416	1/2
31418	9/16
31420	5/8
31422	11/16
31424	3/4
31426	13/16
31428	7/8
31430	15/16
31432	1

##### 3/8" Drive Shallow 6 Point Sockets, MM

Product Code	Size (MM)
31506	6
31507	7
31508	8
31509	9
31510	10
31511	11
31512	12
31513	13
31514	14
31515	15
31516	16
31517	17
31518	18
31519	19

##### 3/8" Drive Shallow 6 Point Sockets, SAE

Product Code	Size (Inches)
31108	1/4
31110	5/16
31112	3/8
31114	7/16
31116	1/2
31118	9/16
31120	5/8
31122	11/16
31124	3/4
31126	13/16
31128	7/8
31130	15/16
31132	1

##### 3/8" Drive Spark Plug Socket

Product Code	Size (Inches)
31301	3/8
31303	15/16

##### 1/2" Drive Tools

Product Code	Description
32001	Ratchet
32003	6" Extension
32004	10" Extension
32006	Universal Joint
32008	Adaptor - 1/2" F x 3/8" M

##### 1/2" Drive Shallow 12 Point Sockets, SAE

Product Code	Size (Inches)
32412	3/8
32414	7/16
32416	1/2
32418	9/16
32420	5/8
32422	11/16
32424	3/4
32426	13/16
32428	7/8
32430	15/16
32432	1



50614

#### Features

- All tools are professional quality, made of high-grade chrome vanadium steel.
- Sockets feature SUPERTORQUE® lobular openings for greater turning power without deforming the fastener.
- Packed in rugged high-density polyethylene (HDPE) cases that are strong and durable yet light in weight.
- Case is shock proof at both high and low temperatures, equipped with heavy-duty metal latches and hinges.
- Two-component handles are easy to grip and comfortable to carry.





# SOCKETS & DRIVE TOOLS

## 1/4", 3/8" & 1/2" DRIVE TOOL SET



### 138 PIECE 1/4", 3/8", 1/2" DRIVE SOCKET SET

#### 6 Point Rugged-Case-System Tool Set, SAE and Metric

Product Code	Description
50612	138 Piece 1/4", 3/8", 1/2" Drive Socket Set

#### Contents Include:

1/4" Drive Tools:	
Product Code	Description
33001	Ratchet
33002	4" Extension
33003	8" Extension
33006	18" Sliding T-handle
30007	Universal Joint
30013	Hex Bit Holder
24880	13 Piece Insert Bit Set

1/4" Drive Deep 6 Point Sockets, MM	
Product Code	Size (MM)
30704	4
30705	5
30706	6
30707	7
30708	8
30709	9
30710	10
30711	11
30712	12
30713	13

1/4" Drive Deep 6 Point Sockets, SAE	
Product Code	Size (Inches)
30305	5/32
30306	3/16
30307	7/32
30308	1/4
30309	9/32
30310	5/16
30311	11/32
30312	3/8
30314	7/16
30316	1/2

1/4" Drive Shallow 6 Point Sockets, MM	
Product Code	Size (MM)
30504	4
30505	5
30599	5.5
30506	6
30507	7
30508	8
30509	9
30510	10
30511	11
30512	12
30513	13

1/4" Drive Shallow 6 Point Sockets, SAE	
Product Code	Size (Inches)
30105	5/32
30106	3/16
30107	7/32
30108	1/4
30109	9/32
30110	5/16
30111	11/32
30112	3/8
30114	7/16
30116	1/2

3/8" Drive Tools	
Product Code	Description
31001	Ratchet
31002	3" Extension
31003	6" Extension
31006	Universal Joint
31008	Adaptor
31013	Hex Bit Holder

3/8" Drive Deep 6 Point Sockets, MM	
Product Code	Size (MM)
31710	10
31711	11
31712	12
31713	13
31714	14
31715	15
31716	16
31717	17
31718	18
31719	19

3/8" Drive Deep 6 Point Sockets, SAE	
Product Code	Size (Inches)
31312	3/8
31314	7/16
31316	1/2
31318	9/16
31320	5/8
31322	11/16
31324	3/4
31326	13/16
31328	7/8

3/8" Drive Shallow 6 Point Sockets, MM	
Product Code	Size (MM)
31510	10
31511	11
31512	12
31513	13
31514	14
31515	15
31516	16
31517	17
31518	18
31519	19

3/8" Drive Shallow 6 Point Sockets, SAE	
Product Code	Size (Inches)
31112	3/8
31114	7/16
31116	1/2
31118	9/16
31120	5/8
31122	11/16
31124	3/4

1/2" Drive Tools	
Product Code	Description
32001	Ratchet
32002	6" Extension
32004	10" Extension
32006	Universal Joint
32008	Adaptor

1/2" Drive Shallow 6 Point Sockets, MM	
Product Code	Size (MM)
32510	10
32511	11
32512	12
32513	13
32514	14
32515	15
32516	16
32517	17
32518	18
32519	19
32521	21
32522	22
32524	24
32527	27
32530	30
32532	32

1/2" Drive Shallow 6 Point Sockets, SAE	
Product Code	Size (Inches)
32112	3/8
32114	7/16
32116	1/2
32118	9/16
32120	5/8
32122	11/16
32124	3/4
32126	13/16
32128	7/8
32130	15/16
32132	1
32134	1 1/16
32136	1 1/8
32138	1 3/16
32140	1 1/4



50612

#### Features

- All tools are professional quality, made of high-grade chrome vanadium steel.
- Sockets feature SUPERTORQUE® lobular openings for greater turning power without deforming the fastener.
- Packed in rugged high-density polyethylene (HDPE) cases that are strong and durable yet light in weight.
- Case is shock proof at both high and low temperatures, equipped with heavy-duty metal latches and hinges.
- Two-component handles are easy to grip and comfortable to carry.

# SOCKETS & DRIVE TOOLS

## 1/4" & 3/8" DRIVE TOOL SET



### 95 PIECE 1/4" & 3/8" DRIVE MASTER SOCKET & TOOL SET

#### 6 & 12 Point Rugged-Case-System Tool Set, SAE

Product Code	Description
50611	95 Piece Master Socket, Wrench, and Screwdriver Set

#### Contents Include:

1/4" Drive Tools:		1/4" Drive Hex Bit Sockets	
Product Code	Description	Product Code	Size (MM)
30001	36 Tooth Quick-Release Ratchet	35070	3
30002	1 1/2" Extension	35071	4
30003	3" Extension	35072	5
30005	Flex Handle	35073	6
30006	Spinner Handle	35074	7
30007	Universal Joint	35075	8
30009	1/4" F x 3/8" M Adapter		

1/4" Drive Shallow 6-Point Sockets		1/4" Drive Screwdriver Bit Sockets	
Product Code	Size (Inches)	Product Code	Description
30106	3/16	35040	5/32" Slotted Tip
30107	7/32	35041	7/32" Slotted Tip
30108	1/4	35042	9/32" Slotted Tip
30109	9/32	35050	#0 Phillips® Tip
30110	5/16	35051	#1 Phillips® Tip
30111	11/32	35052	#2 Phillips® Tip
30112	3/8		
30114	7/16		
30116	1/2		
30118	9/16		

1/4" Drive Deep 6-Point Sockets		1/4" Drive Torx® Bit Sockets	
Product Code	Size (Inches)	Product Code	Size
30306	3/16	35080	T10
30307	7/32	35081	T15
30308	1/4	35082	T20
30309	9/32	35083	T25
30310	5/16	35084	T27
30311	11/32	35085	T30
30312	3/8		
30314	7/16		
30316	1/2		
30318	9/16		

1/4" Drive Hex Bit Sockets		3/8" Drive Shallow 6-Point Sockets	
Product Code	Size (Inches)	Product Code	Size (Inches)
35000	1/8	31112	3/8
35001	5/32	31114	7/16
35002	3/16	31116	1/2
35003	7/32	31118	9/16
35004	1/4	31120	5/8
35005	5/16	31122	11/16
		31124	3/4
		31126	13/16
		31128	7/8
		31130	15/16
		31132	1

3/8" Drive Tools:		3/8" Drive Deep 12-Point Sockets	
Product Code	Description	Product Code	Size (Inches)
31001	38 Tooth Quick-Release Ratchet	31412	3/8
31002	3" Extension	31414	7/16
31003	6" Extension	31416	1/2
31004	10" Extension	31418	9/16
31005	10" Flex Handle	31420	5/8
31006	Universal Joint	31422	11/16
31007	Sliding T-Handle	31424	3/4
31008	3/8" F x 1/4" M Adapter	31426	13/16
31009	3/8" F x 1/2" M Adapter	31428	7/8
		31430	15/16
		31432	1

12 Point Combination Wrenches	
Product Code	Size (Inches)
11108	1/4
11110	5/16
11112	3/8
11114	7/16
11116	1/2
11118	6/16
11120	5/8
11122	11/16
11124	3/4

Comfort Grip Screwdrivers	
Product Code	Description
24205	3/16" x 4" Slotted
24219	1/4" x 4" Slotted
24249	#1 x 3" Phillips®
24253	#2 x 4" Phillips®



50611

#### Features

- All tools are professional quality, made of high-grade chrome vanadium steel.
- Sockets feature SUPERTORQUE® lobular openings for greater turning power without deforming the fastener.
- Packed in rugged high-density polyethylene (HDPE) cases that are strong and durable yet light in weight.
- Case is shock proof at both high and low temperatures, equipped with heavy-duty metal latches and hinges.
- Two-component handles are easy to grip and comfortable to carry.



# SOCKETS & DRIVE TOOLS

## 1/4" & 3/8" DRIVE TOOL SET



50622

### Features

- All tools are professional quality, made of high-grade chrome vanadium steel.
- Sockets feature SUPERTORQUE® lobular openings for greater turning power without deforming the fastener.
- Packed in rugged high-density polyethylene (HDPE) cases that are strong and durable yet light in weight.
- Case is shock proof at both high and low temperatures, equipped with heavy-duty metal latches and hinges.
- Two-component handles are easy to grip and comfortable to carry.

### 89 PIECE 1/4" & 3/8" DRIVE MASTER SOCKET AND TOOL SET

#### 6 & 12 Point Rugged-Case-System Tool Set, Metric

Product Code	Description
50622	89 Piece Master Socket, Wrench and Screwdriver Set

#### Contents Include:

1/4" Drive Tools:		3/8" Drive Tools:	
Product Code	Description	Product Code	Description
30001	36 Tooth Quick-Release Ratchet	31001	38 Tooth Quick-Release Ratchet
30002	1 1/2" Extension	31002	3" Extension
30003	3" Extension	31003	6" Extension
30005	Flex Handle	31004	10" Extension
30006	Spinner Handle	31005	10" Flex Handle
30007	Universal Joint	31006	Universal Joint
30009	1/4" F x 3/8" M Adapter	31007	Sliding T-Handle
		31008	3/8" F x 1/4" M Adapter
		31009	3/8" F x 1/2" M Adapter

#### 1/4" Drive Shallow 6-Point Sockets

Product Code	Size (MM)
30504	4
30505	5
30599	5 1/2
30506	6
30507	7
30508	8
30509	9
30510	10
30511	11
30512	12
30513	13
30514	14

#### 1/4" Drive Hex Bit Sockets

Product Code	Size (Inches)
35000	1/8
35001	5/32
35002	3/16
35003	7/32
35004	1/4
35005	5/16

#### 1/4" Drive Hex Bit Sockets

Product Code	Size (MM)
35070	3
35071	4
35072	5
35073	6
35074	7
35075	8

#### 1/4" Drive Screwdriver Bit Sockets

Product Code	Description
35040	5/32" Slotted Tip
35041	7/32" Slotted Tip
35042	9/32" Slotted Tip
35050	#0 Phillips® Tip
35051	#1 Phillips® Tip
35052	#2 Phillips® Tip

#### 1/4" Drive Torx® Bit Sockets

Product Code	Size
35080	T10
35081	T15
35082	T20
35083	T25
35084	T27
35085	T30

#### 3/8" Drive Shallow 6-Point Sockets

Product Code	Size (MM)
31508	8
31509	9
31510	10
31511	11
31512	12
31513	13
31514	14
31515	15
31516	16
31517	17
31518	18
31519	19

#### 3/8" Drive Deep 12-Point Sockets

Product Code	Size (MM)
31808	8
31809	9
31810	10
31811	11
31812	12
31813	13
31814	14
31815	15
31816	16
31817	17
31818	18
31819	19

#### Comfort Grip Screwdrivers

Product Code	Description
24205	3/16" x 4" Slotted
24219	1/4" x 4" Slotted
24249	#1 x 3" Phillips®
24253	#2 x 4" Phillips®

#### 12 Point Combination Wrenches

Product Code	Size (MM)
11506	6
11508	8
11510	10
11512	12
11513	13
11514	14
11515	15
11517	17
11519	19

# SOCKETS & DRIVE TOOLS

## 3/8" DRIVE



### 79 PIECE 3/8" DRIVE DELUXE TOOL SET

#### 6 & 12 Point Rugged-Case-System Tool Set, SAE and Metric, with 1/4" Hex Screwdriver Bits

Product Code	Description
50607	79 Piece 3/8" Drive Deluxe Tool Set

#### Contents Include:

##### 1/4" Drive Tools:

Product Code	Description
30006	Spinner Handle
30007	Universal Joint
30013	1/4" Hex Bit Holder

##### 3/8" Drive Tools:

Product Code	Description
31001	38 Tooth Quick-Release Ratchet
31002	3" Extension
31003	6" Extension
31004	10" Extension
31005	10" Flex Handle
31006	Universal Joint
31007	Sliding T-Handle
31008	3/8" F x 1/4" M Adapter
31009	3/8" F x 1/2" M Adapter

##### 3/8" Drive Shallow 6-Point Sockets, Metric

Product Code	Size (MM)
31506	6
31507	7
31508	8
31509	9
31510	10
31511	11
31512	12
31513	13
31514	14
31515	15
31516	16
31517	17
31518	18
31519	19

##### 3/8" Drive Shallow 6-Point Sockets, SAE

Product Code	Size (Inches)
31108	1/4
31110	5/16
31112	3/8
31114	7/16
31116	1/2
31118	9/16
31120	5/8
31122	11/16
31124	3/4
31126	13/16
31128	7/8
31130	15/16
31132	1

##### 3/8" Drive Deep 12-Point Sockets, Metric

Product Code	Size (MM)
31806	6
31807	7
31808	8
31809	9
31810	10
31811	11
31812	12
31813	13
31814	14
31815	15
31816	16
31817	17
31818	18
31819	19

##### 3/8" Drive, SAE Deep 12-Point Sockets

Product Code	Size (Inches)
31408	1/4
31410	5/16
31412	3/8
31414	7/16
31416	1/2
31418	9/16
31420	5/8
31422	11/16
31424	3/4
31426	13/16
31428	7/8
31430	15/16
31432	1

##### 1/4" Hex Screwdriver Bits

Product Code	Description / Size
24803	5/32" Slotted Tip
24805	3/16" Slotted Tip
24807	1/4" Slotted Tip
24809	#0 Phillips® Tip
24811	#1 Phillips® Tip
24813	#2 Phillips® Tip
24815	#3 Phillips® Tip
24819	#1 Square Tip
24821	#2 Square Tip
24911	1/8" Hex Tip
24915	5/32" Hex Tip
24919	7/32" Hex Tip
24921	1/4" Hex Tip



50607

#### Features

- All tools are professional quality, made of high-grade chrome vanadium steel.
- Sockets feature SUPERTORQUE® lobular openings for greater turning power without deforming the fastener.
- Packed in rugged high-density polyethylene (HDPE) cases that are strong and durable yet light in weight.
- Case is shock proof at both high and low temperatures, equipped with heavy-duty metal latches and hinges.
- Two-component handles are easy to grip and comfortable to carry.



# SOCKETS & DRIVE TOOLS

## 3/8" DRIVE

WILLIAMS®



### 63 PIECE 3/8" DRIVE SOCKET, SCREWDRIVER, & WRENCH SET

#### 6 & 12 Point Rugged-Case-System Tool Set, SAE and Metric

Product Code	Description
50605	63 Piece 3/8" Drive Socket, Screwdriver, and Wrench Set

#### Contents Include:

##### 1/4" Drive Tools:

Product Code	Description
30006	Spinner Handle
30007	Universal Joint
30013	1/4" Hex Bit Holder

##### 3/8" Drive Tools:

Product Code	Description
31001	38 Tooth Quick-Release Ratchet
31002	3" Extension
31003	6" Extension
31004	10" Extension
31005	10" Flex Handle
31006	Universal Joint
31007	Sliding T-Handle
31008	3/8" F x 1/4" M Adapter
31009	3/8" F x 1/2" M Adapter

##### 12 Point Combination Wrenches

Product Code	Size (Inches)
11108	1/4
11110	5/16
11112	3/8
11114	7/16
11116	1/2
11118	9/16
11120	5/8

##### Comfort Grip Screwdrivers

Product Code	Description
24205	3/16" x 4" Slotted
24219	1/4" x 4" Slotted
24249	#1 x 3" Phillips®
24253	#2 x 4" Phillips®

##### 1/4" Hex Screwdriver Bits

Product Code	Description / Size
24803	5/32" Slotted Tip
24805	3/16" Slotted Tip
24807	1/4" Slotted Tip
24809	#0 Phillips® Tip
24811	#1 Phillips® Tip
24813	#2 Phillips® Tip
24815	#3 Phillips® Tip

##### 3/8" Drive Shallow 6-Point Sockets, SAE

Product Code	Size (Inches)
31108	1/4
31110	5/16
31112	3/8
31114	7/16
31116	1/2
31118	9/16
31120	5/8
31122	11/16
31124	3/4
31126	13/16
31128	7/8
31130	15/16
31132	1

##### 3/8" Drive Shallow 6-Point Sockets, Metric

Product Code	Size (MM)
31506	6
31507	7
31508	8
31509	9
31510	10
31511	11
31512	12
31513	13
31514	14
31515	15
31516	16
31517	17
31518	18
31519	19

##### 1/4" Hex Screwdriver Bits

Product Code	Description / Size
24819	#1 Square Tip
24821	#2 Square Tip
24911	1/8" Hex Tip
24915	5/32" Hex Tip
24919	1/32" Hex Tip
24921	1/4" Hex Tip



50605

#### Features

- All tools are professional quality, made of high-grade chrome vanadium steel.
- Sockets feature SUPERTORQUE® lobular openings for greater turning power without deforming the fastener.
- Packed in rugged high-density polyethylene (HDPE) cases that are strong and durable yet light in weight.
- Case is shock proof at both high and low temperatures, equipped with heavy-duty metal latches and hinges.
- Two-component handles are easy to grip and comfortable to carry.

# SOCKETS & DRIVE TOOLS

## 3/8" DRIVE



### 58 PIECE 3/8" DRIVE SOCKET, SCREWDRIVER, & PLIERS SET

#### 6 Point Rugged-Case-System Tool Set, SAE and Metric

Product Code	Description
50615	58 Piece 3/8" Drive Socket, Screwdriver and Pliers Set

#### Contents Include:

##### 1/4" Drive Tools:

Product Code	Description
30006	Spinner Handle
30007	Universal Joint
30013	1/4" Hex Bit Holder

##### 3/8" Drive Tools:

Product Code	Description
31001	38 Tooth Quick-Release Ratchet
31002	3" Extension
31003	6" Extension
31004	10" Extension
31005	10" Flex Handle
31006	Universal Joint
31007	Sliding T-Handle
31008	3/8" F x 1/4" M Adapter
31009	3/8" F x 1/2" M Adapter
31013	1/4" Hex Bit Holder

##### Adjustable Wrench

Product Code	Size (Inches)
13408	8"

##### Pliers

Product Code	Description
23102	8" Slip Joint Pliers
23105	9 3/4" Groove Joint Pliers
23407	7" Diagonal Cutting Pliers
23410	6 1/4" Long Nose Pliers W / Cutter

##### 1/4" Hex Screwdriver Bits

Product Code	Description / Size
24803	5/32" Slotted Tip
24805	3/16" Slotted Tip
24807	1/4" Slotted Tip
24809	#0 Phillips® Tip
24811	#1 Phillips® Tip
24813	#2 Phillips® Tip
24815	#3 Phillips® Tip

##### 3/8" Drive Shallow 6-Point Sockets, SAE

Product Code	Size (Inches)
31108	1/4
31110	5/16
31112	3/8
31114	7/16
31116	1/2
31118	9/16
31120	5/8
31122	11/16
31124	3/4
31126	13/16
31128	7/8
31130	15/16
31132	1

##### 3/8" Drive Shallow 6-Point Sockets, Metric

Product Code	Size (MM)
31506	6
31507	7
31508	8
31509	9
31510	10
31511	11
31512	12
31513	13
31514	14
31515	15
31516	16
31517	17
31518	18
31519	19

##### 1/4" Hex Screwdriver Bits

Product Code	Description / Size
24819	#1 Square Tip
24821	#2 Square Tip
24911	1/8" Hex Tip
24915	5/32" Hex Tip
24919	7/32" Hex Tip
24921	1/4" Hex Tip



50615

#### Features

- All tools are professional quality, made of high-grade chrome vanadium steel.
- Sockets feature SUPERTORQUE® lobular openings for greater turning power without deforming the fastener.
- Packed in rugged high-density polyethylene (HDPE) cases that are strong and durable yet light in weight.
- Case is shock proof at both high and low temperatures, equipped with heavy-duty metal latches and hinges.
- Two-component handles are easy to grip and comfortable to carry.



# SOCKETS & DRIVE TOOLS

## 3/8" DRIVE



### 35 PIECE 3/8" DRIVE BASIC TOOL SET

#### 6 Point Rugged-Case-System Tool Set, Metric, with 1/4" Hex Screwdriver Bits

Product Code	Description
50613	35 Piece Basic Tool Set, Metric

#### Contents Include:

1/4" Drive Tools:		3/8" Drive Shallow 6-Point Sockets	
Product Code	Description	Product Code	Size (MM)
30006	Spinner Handle	31506	6
30007	Universal Joint	31507	7
30013	1/4" Hex Bit Holder	31508	8
		31509	9
		31510	10
		31511	11
		31512	12
		31513	13
		31514	14
		31515	15
		31516	16
		31517	17
		31518	18
		31519	19

1/4" Hex Screwdriver Bits		1/4" Hex Screwdriver Bits	
Product Code	Description / Size	Product Code	Description / Size
24803	5/32" Slotted Tip	24819	#1 Square Tip
24805	3/16" Slotted Tip	24821	#2 Square Tip
24807	1/4" Slotted Tip	24911	1/8" Hex Tip
24809	#0 Phillips® Tip	24915	5/32" Hex Tip
24811	#1 Phillips® Tip	24919	7/32" Hex Tip
24813	#2 Phillips® Tip	24921	1/4" Hex Tip
24815	#3 Phillips® Tip		

#### Features

- All tools are professional quality, made of high-grade chrome vanadium steel.
- Sockets feature SUPERTORQUE® lobular openings for greater turning power without deforming the fastener.
- Packed in rugged high-density polyethylene (HDPE) cases that are strong and durable yet light in weight.
- Case is shock proof at both high and low temperatures, equipped with heavy-duty metal latches and hinges.
- Two-component handles are easy to grip and comfortable to carry.



50613

# SOCKETS & DRIVE TOOLS

## 3/8" DRIVE



### 34 PIECE 3/8" DRIVE BASIC TOOL SET

#### 6 Point Rugged-Case-System Tool Set, SAE, with 1/4" Hex Screwdriver Bits

Product Code	Description
50603	34 Piece Basic Tool Set, SAE

#### Contents Include:

1/4" Drive Tools:		3/8" Drive Shallow 6-Point Sockets	
Product Code	Description	Product Code	Size (Inches)
30006	Spinner Handle	31108	1/4
30007	Universal Joint	31110	5/16
30013	1/4" Hex Bit Holder	31112	3/8
		31114	7/16
		31116	1/2
		31118	9/16
		31120	5/8
		31122	11/16
		31124	3/4
		31126	13/16
		31128	7/8
		31130	15/16
		31132	1

1/4" Hex Screwdriver Bits		1/4" Hex Screwdriver Bits	
Product Code	Description / Size	Product Code	Description / Size
24803	5/32" Slotted Tip	24819	#1 Square Tip
24805	3/16" Slotted Tip	24821	#2 Square Tip
24807	1/4" Slotted Tip	24911	1/8" Hex Tip
24809	#0 Phillips® Tip	24915	5/32" Hex Tip
24811	#1 Phillips® Tip	24919	7/32" Hex Tip
24813	#2 Phillips® Tip	24921	1/4" Hex Tip
24815	#3 Phillips® Tip		



50603

#### Features

- All tools are professional quality, made of high-grade chrome vanadium steel.
- Sockets feature SUPERTORQUE® lobular openings for greater turning power without deforming the fastener.
- Packed in rugged high-density polyethylene (HDPE) cases that are strong and durable yet light in weight.
- Case is shock proof at both high and low temperatures, equipped with heavy-duty metal latches and hinges.
- Two-component handles are easy to grip and comfortable to carry.



### 22 PIECE 3/8" DRIVE BOLT THRU SOCKET SET

#### 6 Point Compact Case Tool Set, SAE & MM

Product Code	Description
50671	22 Piece 3/8" Drive Bolt Thru Socket Set

#### Contents Include:

3/8" Drive Tools:		3/8" Drive Shallow 6-Point Sockets	
Product Code	Description	Product Code	Size (mm)
31018	Locking Flexible Ratchet	31708BT	8
31019	3" Extension	31709BT	9
31020	Adaptor	31710BT	10
		31711BT	11
		31712BT	12
		31713BT	13
		31714BT	14
		31715BT	15
		31716BT	16
		31717BT	17
		31718BT	18
		31719BT	19

3/8" Drive Shallow 6 Point Sockets:	
Product Code	Size (Inches)
31612BT	3/8
31614BT	7/16
31616BT	1/2
31618BT	9/16
31620BT	5/8
31622BT	11/16
31624BT	3/4



50671

#### Features

- All tools are professional quality, made of high-grade chrome vanadium steel
- Sockets feature SUPERTORQUE® lobular openings for greater turning power without deforming the fastener
- Packed in rugged compact high-density polyethylene (HDPE) cases that are strong and durable yet light in weight
- Ratchet with 7 locking positions and flex head design.





# SOCKETS & DRIVE TOOLS

## 3/8" DRIVE



50664



### 18 PIECE 3/8" DRIVE SOCKET AND DRIVE TOOL SET

#### 6 & 12 Point Compact Case Tool Set, SAE

Product Code	Description
50664	18 Piece 3/8" Drive Socket and Drive Tool Set

#### Contents Include:

3/8" Drive Tools:		3/8" Drive Deep 12 Point Sockets:	
Product Code	Description	Product Code	Size (Inches)
31001	7 3/4" Pear Head Ratchet	31412	3/8
31002	3" Extension	31414	7/16
31003	6" Extension	31416	1/2
		31418	9/16
		31420	5/8
		31422	11/16
		31424	3/4
3/8" Drive Shallow 6 Point Sockets:		3/8" Drive Spark Plug Socket:	
Product Code	Size (Inches)	Product Code	Size (Inches)
31112	3/8	31301	5/8
31114	7/16		
31116	1/2		
31118	9/16		
31120	5/8		
31122	11/16		
31124	3/4		

#### Features

- All tools are professional quality, made of high-grade chrome vanadium steel
- Sockets feature SUPERTORQUE<sup>®</sup> lobular openings for greater turning power without deforming the fastener
- Packed in rugged compact high-density polyethylene (HDPE) cases that are strong and durable yet light in weight



50666



### 47 PIECE 3/8" DRIVE SOCKET AND DRIVE TOOL SET

#### 6 & 12 Point Compact Case Tool Set, SAE & Metric

Product Code	Description
50666	47 Piece 3/8" Drive Socket and Drive Tool Set

#### Contents Include:

3/8" Drive Tools:		3/8" Drive Deep 12 Point Sockets:	
Product Code	Description	Product Code	Size (SAE)
31001	5 1/4" Pear Head Ratchet	31410	5/16
31002	3" Extension	31412	3/8
31003	1 1/2" Extension	31414	7/16
31006	Universal Joint	31416	1/2
		31418	9/16
		31420	5/8
		31422	11/16
		31424	3/4
3/8" Drive Shallow 6 Point Sockets:		3/8" Drive Deep 12 Point Sockets:	
Product Code	Size (Inches)	Product Code	Size (Metric)
31110	5/16	31807	7
31112	3/8	31808	8
31114	7/16	31809	9
31116	1/2	31810	10
31118	9/16	31811	11
31120	5/8	31812	12
31122	11/16	31813	13
31124	3/4	31814	14
3/8" Drive Shallow 6 Point Sockets:		31815	15
Product Code	Size (Metric)	31816	16
31506	6	31817	17
31507	7	31818	18
31508	8	31819	19
31509	9		
31510	10		
31511	11		
31512	12		
31513	13		
31514	14		
31515	15		
31516	16		
31517	17		
31518	18		
31519	19		

#### Features

- All tools are professional quality, made of high-grade chrome vanadium steel
- Sockets feature SUPERTORQUE<sup>®</sup> lobular openings for greater turning power without deforming the fastener
- Packed in rugged compact high-density polyethylene (HDPE) cases that are strong and durable yet light in weight

# SOCKETS & DRIVE TOOLS

## 3/8" DRIVE



### 15 PIECE 3/8" DRIVE SOCKET AND DRIVE TOOL SET

#### 12 Point Compact Case Tool Set, SAE

Product Code	Description
50673	15 Piece 3/8" Drive Socket and Drive Tool Set

#### Contents Include:

3/8" Drive Tools:		3/8" Drive Shallow 12 Point Sockets:					
Product Code	Description	Product Code	Size (Inches)	Product Code	Size (Inches)	Product Code	Size (Inches)
31001	7 3/4" Pear Head Ratchet	31208	1/4	31216	1/2	31224	3/4
31002	3" Extension	31210	5/16	31218	9/16	31226	13/16
31003	6" Extension	31212	3/8	31220	5/8	31228	7/8
31006	Universal Joint	31214	7/16	31222	11/16		

#### Features

- All tools are professional quality, made of high-grade chrome vanadium steel
- Sockets feature SUPERTORQUE® lobular openings for greater turning power without deforming the fastener
- Packed in rugged compact high-density polyethylene (HDPE) cases that are strong and durable yet light in weight



50673



### 15 PIECE 3/8" DRIVE SOCKET AND DRIVE TOOL SET

#### 6 Point Compact Case Tool Set, SAE

Product Code	Description
50663	15 Piece 3/8" Drive Socket and Drive Tool Set

#### Contents Include:

3/8" Drive Tools:		3/8" Drive Shallow 12 Point Sockets:					
Product Code	Description	Product Code	Size (Inches)	Product Code	Size (Inches)	Product Code	Size (Inches)
31001	7 3/4" Pear Head Ratchet	31108	1/4	31116	1/2	31124	3/4
31002	3" Extension	31110	5/16	31118	9/16	31126	13/16
31003	6" Extension	31112	3/8	31120	5/8	31128	7/8
31006	Universal Joint	31114	7/16	31122	11/16		

#### Features

- All tools are professional quality, made of high-grade chrome vanadium steel
- Sockets feature SUPERTORQUE® lobular openings for greater turning power without deforming the fastener
- Packed in rugged compact high-density polyethylene (HDPE) cases that are strong and durable yet light in weight



50663



### 15 PIECE 3/8" DRIVE SOCKET AND DRIVE TOOL SET

#### 6 Point Compact Case Tool Set, Metric

Product Code	Description
50665	16 Piece 3/8" Drive Socket and Drive Tool Set

#### Contents Include:

3/8" Drive Tools:		3/8" Drive Shallow 12 Point Sockets:					
Product Code	Description	Product Code	Size (mm)	Product Code	Size (mm)	Product Code	Size (mm)
31001	7 3/4" Pear Head Ratchet	31508	8	31512	12	31516	16
31002	3" Extension	31509	9	31513	13	31517	17
31003	6" Extension	31510	10	31514	14	31518	18
31006	Universal Joint	31511	11	31515	15	31519	19

#### Features

- All tools are professional quality, made of high-grade chrome vanadium steel
- Sockets feature SUPERTORQUE® lobular openings for greater turning power without deforming the fastener
- Packed in rugged compact high-density polyethylene (HDPE) cases that are strong and durable yet light in weight



50665



# SOCKETS & DRIVE TOOLS

## 3/8" DRIVE



### 3/8" DRIVE ENCLOSED HEAD RATCHETS

Williams® Sealed Narrow Head Design,  
Chrome and Black Industrial Finish

Product Code	Description	Length (Inches)	Number of Teeth
B-52EHA	Chrome Finish Enclosed Head Ratchet	8	36
B-52EHLA	Chrome Finish Enclosed Head Ratchet, Long	10 1/4	36
B-52EHFA	Chrome Finish Flex Head Ratchet	9 11/16	36
BB-52EHA	Black Industrial Finish Enclosed Head Ratchet	8	36
B-52EHRKA	Repair Kit "EHA, EHLA, EHFA" Model Enclosed Head Ratchets		

Fed. Spec: ANSI B107.10M

#### Features

- Enclosed head is sealed to prevent dust, dirt, and liquids from entering head, preserving internal lubrication.
- Forged one-piece ratchet provide strength and safety for industrial applications.
- Smooth comfort-grip handle permits all-day use without gloves.
- 36 tooth gear with 10 degree of engagement allows engagement in tight working areas.
- Nickel/Chrome plating provides increase protection from rust and corrosion.
- Chrome finish models feature mirror-like exterior that can be easily cleaned after each use.
- Single Pawl ratchet design:
  - 1) Designed for tighter tolerances between pawl and gear which reduces metal fatigue and slippage under load.
  - 2) Does not require as many working parts, reducing possible breakage and parts to repair.
- Easy access reverse lever allows user to change working direction quickly and easily with only one hand.



B-52EHA



B-52EHLA



B-52EHF



BB-52EHA



### 3/8" DRIVE ROUND HEAD RATCHETS

Knurled Handle, Chrome and Black Industrial Finish

Product Code	Description	Length (Inches)	Number of Teeth
B-52A	Chrome Finish Round Head Ratchet	7 5/8	72
B-53A	Chrome Finish Round Head Ratchet, Long	10 1/2	72
BB-52A	Black Industrial Finish Round Head Ratchet	7 5/8	72
B-52ARK	Repair Kit for Round Head Ratchets		

Fed. Spec: ANSI B107.10M

#### Features

- Double pawl design with 72 teeth action provides a 5° ratcheting angle.
- Shift lever reverses action instantly.
- Knurled handle provides a non-slip grip.
- Chrome finish models provides increased protection from rust and corrosion.



B-52A



BB52A



B-53A

# SOCKETS & DRIVE TOOLS

## 3/8" DRIVE



### 3/8" DRIVE HANDLES

#### Knurled Handle, High-Polished Chrome Finish

Product Code	Description	Length (Inches)
B-40A	Flex Handle	8 <sup>9</sup> / <sub>16</sub>
B-20A	Sliding T-Handle	7 <sup>15</sup> / <sub>16</sub>
B-15	Speeder Handle	18

Fed. Spec: ANSI B107.10M

#### Features

- Chrome plating provides increased protection from rust and corrosion.
- Drive handles provide extra leverage with greater strength than ratchets.
- Speeder handle is ideal for fast turn down of fasteners.



B-20A



B-15

B-40A



### 3/8" DRIVE EXTENSIONS AND ACCESSORIES

#### High-Polished Chrome Finish

Product Code	Description	Length (Inches)
B-101	Extension	1 1/2
B-108	Extension	3
B-110	Extension	6
B-115	Extension	11
B-118	Extension	18
BFE-8	Flexible Extension	8
B-140A	Universal Joint	2
B-70	Ratchet Spinner Disk	1 1/4

Fed. Spec: ANSI B107.10M

#### WSB-5XT 5 Piece Extension Set in Pouch - 049605

#### Contents Include:

Product Code	Size (Inches)	Product Code	Size (Inches)
B-101	1 1/2	B-115	11
B-108	3	B-118	18
B-110	6		

#### Features

- Chrome plating provides increased protection from rust and corrosion.
- Flexible extension is designed for low torque applications in limited access areas.
- Ball and spring socket retention.
- Spinner disk is ideal for fast turn down of fasteners.



B-101

B-140A

B-70



B-108



B-110



B-115



BFE-8



WSB-5XT



### 3/8" DRIVE ADAPTORS

#### High-Polished Chrome and Black Industrial Finish

Product Code	Length (Inches)	Male End (Inches)	Female End (Inches)
--------------	-----------------	-------------------	---------------------

#### Chrome Finish

BS-130	1 <sup>5</sup> / <sub>16</sub>	1/2	3/8
--------	--------------------------------	-----	-----

#### Black Industrial Finish

BS-130B	1 <sup>5</sup> / <sub>16</sub>	1/2	3/8
BS-131BF	1 <sup>5</sup> / <sub>16</sub>	3/8	1/2

Fed. Spec: ANSI B107.10M

#### Features

- Ball and spring socket retention.



BS-131BF



BS-130B



BS-130



# SOCKETS & DRIVE TOOLS

## 3/8" DRIVE



### 3/8" DRIVE RATCHETS AND HANDLES

#### High-Polished Chrome Finish

Product Code	Description	Length (Inches)	Repair Kit
31001	38 Tooth Quick-Release Ratchet	7 3/4	31001RK
31011	Ultra-Fine 60-Tooth Ratchet	7 3/4	31011RK
31005	Flex Handle	10	
11920	Flex Handle, Comb. 3/8" x 1/2" Drive	10	
31007	Sliding T-Handle	7 3/4	
31016	3/8" Drive Spinner Handle	9	

Fed. Spec: ANSI B107.10M

#### Features

- Ball and spring socket retention.
- Williams 3/8" Drive Ratchets Feature:
  - Ultra-fine 60 tooth model offers 6° tooth action in a narrow pear head.
  - Unique Finger-Fit handles to provide a comfortable, non-slip grip and extra turning power.
  - Choice of 38-tooth quick-release or 60-tooth ultra-fine gear.
  - Narrow pear-shaped heads for access into confined work areas.
  - High-polished chrome finish for easy cleaning.
- Spinner handle features bi-mold comfort-grip handle.
- Unique combination 3/8" x 1/2" drive flex handle offers convenience of both drive sizes on one handle.



### 3/8" DRIVE EXTENSIONS AND ACCESSORIES

#### High-Polished Chrome Finish

Product Code	Description	Length (Inches)
31002	Extension	3
31003	Extension	6
31004	Extension	10
31006	Universal Joint	2
31008	Adaptor, 3/8" F x 1/4" M	1
31009	Adaptor, 3/8" F x 1/2" M	1 1/4
31013	Holder for 1/4" Hex Screwdriver Bits	3/4
31023	Locking Extension	3
31024	Locking Extension	6
31025	Locking Extension	10
31026	Locking Extension	12
31027	Locking Extension	18
31028	Locking Extension	24

Fed. Spec: ANSI B107.10M

#### Features

- Chrome plating provides increased protection from rust and corrosion.
- Ball and spring socket retention.



### 6 PIECE 3/8" DRIVE RATCHET AND DRIVE TOOL SET

#### Furnished in a Pouch

Product Code	Description
31920	6 Piece 3/8" Drive Ratchet and Accessory Set

#### Contents Include:

Product Code	Description	Product Code	Description
31001	38 Tooth Quick-Release Ratchet	31005	10" Flex Handle Breaker Bar
31002	3" Extension	31006	Universal Joint
31004	10" Extension	31007	7 3/4" Sliding T-Handle

#### Features

- All tools are professional quality, made of high-grade chrome vanadium steel.

# SOCKETS & DRIVE TOOLS

## 3/8" DRIVE



### 3/8" DRIVE SHALLOW 12 POINT SOCKETS, SAE

High-Polished Chrome Finish

Product Code	Size (Inches)	A		B		C		D		E		F	
		OAL (Inches)	Drive End Diameter (Inches)	Working End Diameter (Inches)	Broach Depth (Inches)	Bolt Clearance Depth (Inches)	Bolt Clearance Diameter (Inches)	Nose Length (Inches)					
B-1208	1/4	1 1/32	1 1/16	1 3/32	7/32	9/16	7/32	17/32					
B-1210	5/16	1 1/32	1 1/16	7/16	1/4	9/16	17/64	17/32					
B-1211	11/32	1 1/32	1 1/16	1/2	9/32	9/16	21/64	17/32					
B-1212	3/8	1 1/32	1 1/16	9/16	9/32	9/16	11/32	17/32					
B-1214	7/16	1 1/32	1 1/16	5/8	5/16	9/16	11/32	17/32					
B-1216	1/2	1 1/32	23/32	23/32	11/32	3/8	3/8	-					
B-1217	17/32	1 1/32	25/32	25/32	13/32	3/4	1/2	-					
B-1218	9/16	1 3/32	25/32	25/32	9/16	19/32	17/32	-					
B-1219	19/32	1 3/32	25/32	25/32	9/16	9/16	9/16	-					
B-1220	5/8	1 1/8	27/32	27/32	19/32	5/8	19/32	-					
B-1222	11/16	1 5/32	15/16	15/16	5/8	5/8	11/16	-					
B-1224	3/4	1 3/16	1	1	11/16	11/16	23/32	-					
B-1226	13/16	1 1/4	1 1/16	1 1/16	11/16	11/16	25/32	-					
B-1228	7/8	1 9/32	1 5/32	1 5/32	25/32	25/32	7/8	-					
B-1230	15/16	1 3/8	1 1/4	1 1/4	13/16	27/32	29/32	-					
B-1232	1	1 13/32	1 5/16	1 5/16	27/32	7/8	1	-					

Fed. Spec: ANSI B107.1



B-1212 B-1208

### WSB-10RC 10 Piece 3/8" Drive Shallow 12-Point Socket Set on Clip Rail

Contents Include:

Product Code	Size (Inches)	Product Code	Size (Inches)	Product Code	Size (Inches)
B-1210	5/16	B-1218	9/16	B-1226	13/16
B-1212	3/8	B-1220	5/8	B-1228	7/8
B-1214	7/16	B-1222	11/16		
B-1216	1/2	B-1224	3/4		

### WSB-13RC 13 Piece 3/8" Drive Shallow 12-Point Socket Set on Clip Rail

Contents Include:

Product Code	Size (Inches)	Product Code	Size (Inches)	Product Code	Size (Inches)
B-1208	1/4	B-1218	9/16	B-1228	7/8
B-1210	5/16	B-1220	5/8	B-1230	15/16
B-1212	3/8	B-1222	11/16	B-1232	1
B-1214	7/16	B-1224	3/4		
B-1216	1/2	B-1226	13/16		

### Features

- SUPERTORQUE® lobular openings for greater turning power without deforming the fastener.
- Designed for quick engagement on both 6 and 12 point fasteners.

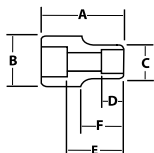

WSB-10RC



WSB-13RC



# SOCKETS & DRIVE TOOLS

## 3/8" DRIVE



### 3/8" DRIVE SHALLOW SOCKETS, 6 POINT, SAE

High-Polished Chrome Finish



B-616

B-608

Product Code	Size (Inches)	Dimensions					
		A (Inches)	B (Inches)	C (Inches)	D (Inches)	E (Inches)	F (Inches)
B-608	1/4	1 1/32	11/16	13/32	7/32	9/16	1/2
B-610	5/16	1 1/32	11/16	7/16	1/4	9/16	1/2
B-611	11/32	1 1/32	11/16	1/2	9/32	9/16	1/2
B-612	3/8	1 1/32	11/16	9/16	9/32	9/16	1/2
B-614	7/16	1 1/32	11/16	5/8	5/16	9/16	1/2
B-616	1/2	1 1/32	23/32	23/32	11/32	9/16	-
B-618	9/16	1 3/32	29/32	29/32	9/16	19/32	-
B-620	5/8	1 1/8	27/32	27/32	19/32	5/8	-
B-622	11/16	1 5/32	15/16	15/16	5/8	5/8	-
B-624	3/4	1 3/16	1	1	21/32	11/16	-
B-626	13/16	1 1/4	1 1/16	1 1/16	11/16	23/32	-
B-628	7/8	1 9/32	1 5/32	1 5/32	3/4	25/32	-
B-630	15/16	1 3/8	1 1/4	1 1/4	13/16	27/32	-
B-632	1	1 13/32	1 5/16	1 5/16	27/32	7/8	-

Fed. Spec: ANSI B107.1

### WSB-10HRC 10 Piece 3/8" Drive Shallow 6 Point Socket Set on Clip Rail

Contents Include:

Product Code	Size (Inches)	Product Code	Size (Inches)	Product Code	Size (Inches)
B-610	5/16	B-618	9/16	B-626	13/16
B-612	3/8	B-620	5/8	B-628	7/8
B-614	7/16	B-622	11/16		
B-616	1/2	B-624	3/4		

### WSB-13HRC 13 Piece 3/8" Drive Shallow 6 Point Socket Set on Clip Rail

Contents Include:

Product Code	Size (Inches)	Product Code	Size (Inches)	Product Code	Size (Inches)
B-608	1/4	B-618	9/16	B-628	7/8
B-610	5/16	B-620	5/8	B-630	15/16
B-612	3/8	B-622	11/16	B-632	1
B-614	7/16	B-624	3/4		
B-616	1/2	B-626	13/16		

### Features

- SUPERTORQUE® lobular openings for greater turning power without deforming the fastener.
- Designed for maximum engagement on 6 point fasteners.



WSB-10HRC



WSB-13HRC

# SOCKETS & DRIVE TOOLS

## 3/8" DRIVE



### 3/8" DRIVE SHALLOW SOCKETS, 12 POINT, SAE

High-Polished Chrome Finish

Product Code	Size (Inches)	A		B		C		D		E		F
		OAL (Inches)	Drive End Diameter (Inches)	Working End Diameter (Inches)	Broach Depth (Inches)	Bolt Clearance Depth (Inches)	Bolt Clearance Diameter (Inches)	Nose Length (Inches)				
31208	1/4	1	1 1/16	7/16	1 1/32	9/16	7/32	17/32				
31210	5/16	1	1 1/16	15/32	3/8	17/32	1/4	17/32				
31212	3/8	1	1 1/16	9/16	3/8	1/2	9/32	17/32				
31214	7/16	1	1 1/16	5/8	1 1/32	17/32	13/32	17/32				
31216	1/2	1	3/4	3/4	13/32	19/32	7/16	-				
31218	9/16	1 1/16	25/32	25/32	17/32	5/8	17/32	-				
31220	5/8	1 1/16	7/8	7/8	19/32	11/16	19/32	-				
31222	1 1/16	1 1/16	15/16	15/16	1/2	1 1/16	21/32	-				
31224	3/4	1 1/8	1	1	9/16	23/32	23/32	-				
31226	13/16	1 1/8	1 1/8	1 1/8	9/16	23/32	25/32	-				
31228	7/8	1 7/32	1 3/16	1 3/16	2 1/32	13/16	27/32	-				
31230	15/16	1 7/32	1 1/4	1 1/4	2 1/32	13/16	27/32	-				
31232	1	1 7/32	1 5/16	1 5/16	1 1/16	13/16	31/32	-				

Fed. Spec: ANSI B107.1

#### 31923 9 Piece 3/8" Drive Shallow 12 Point Socket Set on Clip Rail

Product Code	Size (Inches)	Product Code	Size (Inches)	Product Code	Size (Inches)
31208	1/4	31214	7/16	31220	5/8
31210	5/16	31216	1/2	31222	1 1/16
31212	3/8	31218	9/16	31224	3/4

#### 31925 13 Piece 3/8" Drive Shallow 12 Point Socket Set on Clip Rail

Product Code	Size (Inches)	Product Code	Size (Inches)	Product Code	Size (Inches)
31208	1/4	31218	9/16	31228	7/8
31210	5/16	31220	5/8	31230	15/16
31212	3/8	31222	1 1/16	31232	1
31214	7/16	31224	3/4		
31216	1/2	31226	13/16		



#### Features

- SUPERTORQUE® lobular openings for greater turning power without deforming the fastener.
- Designed for maximum engagement on 12 point fasteners.



### 3/8" DRIVE SHALLOW SOCKETS, 6 POINT, SAE

High-Polished Chrome Finish

Product Code	Size (Inches)	A		B		C		D		E		F
		OAL (Inches)	Drive End Diameter (Inches)	Working End Diameter (Inches)	Broach Depth (Inches)	Bolt Clearance Depth (Inches)	Bolt Clearance Diameter (Inches)	Nose Length (Inches)				
31108	1/4	1	1 1/16	7/16	1 1/32	9/16	7/32	17/32				
31110	5/16	1	1 1/16	15/32	3/8	17/32	1/4	17/32				
31112	3/8	1	1 1/16	9/16	3/8	1/2	9/32	17/32				
31114	7/16	1	1 1/16	5/8	1 1/32	17/32	13/32	17/32				
31116	1/2	1	3/4	3/4	13/32	19/32	7/16	-				
31118	9/16	1 1/16	25/32	25/32	17/32	5/8	17/32	-				
31120	5/8	1 1/16	7/8	7/8	19/32	11/16	19/32	-				
31122	1 1/16	1 1/16	15/16	15/16	1/2	1 1/16	21/32	-				
31124	3/4	1 1/8	1	1	9/16	23/32	23/32	-				
31126	13/16	1 1/8	1 1/8	1 1/8	9/16	23/32	25/32	-				
31128	7/8	1 7/32	1 3/16	1 3/16	2 1/32	13/16	27/32	-				
31130	15/16	1 7/32	1 1/4	1 1/4	2 1/32	13/16	27/32	-				
31132	1	1 7/32	1 5/16	1 5/16	1 1/16	13/16	31/32	-				

Fed. Spec: ANSI B107.1

#### 31922 9 Piece 3/8" Drive Shallow 6 Point Socket Set on Clip Rail

Product Code	Size (Inches)	Product Code	Size (Inches)	Product Code	Size (Inches)
31108	1/4	31114	7/16	31120	5/8
31110	5/16	31116	1/2	31122	1 1/16
31112	3/8	31118	9/16	31124	3/4

#### 31924 13 Piece 3/8" Drive Shallow 6 Point Socket Set on Clip Rail

Product Code	Size (Inches)	Product Code	Size (Inches)	Product Code	Size (Inches)
31108	1/4	31118	9/16	31128	7/8
31110	5/16	31120	5/8	31130	15/16
31112	3/8	31122	1 1/16	31132	1
31114	7/16	31124	3/4		
31116	1/2	31126	13/16		

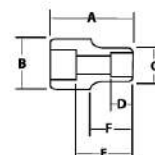

#### Features

- SUPERTORQUE® lobular openings for greater turning power without deforming the fastener.
- Designed for maximum engagement on 6 point fasteners.





# SOCKETS & DRIVE TOOLS

## 3/8" DRIVE



### 3/8" DRIVE SHALLOW SOCKETS, 4 & 8 POINT, SAE

High-Polished Chrome Finish



BD-814



WSBD-7RC

Product Code	Size (Inches)	A		B		C		D		E		F
		OAL (Inches)	Drive End Diameter (Inches)	Working End Diameter (Inches)	Broach Depth (Inches)	Bolt Clearance Depth (Inches)	Bolt Clearance Diameter (Inches)	Nose Length (Inches)				
BD-808	1/4	29/32	21/32	15/32	7/32	13/32	5/32	7/16				
B-409 **	9/32	1 1/32	11/16	9/16	5/16	17/32	3/16	1/2				
BD-810	5/16	29/32	21/32	9/16	1/4	13/32	1/4	7/16				
BD-812	3/8	15/16	11/16	41/64	9/32	7/16	9/16	15/32				
BD-814	7/16	1	23/32	23/32	9/32	1/2	5/16	-				
BD-816	1/2	1	29/32	29/32	5/16	1/2	13/32	-				
BD-818	9/16	1 1/8	1	1	13/32	5/8	17/32	-				
BD-820	5/8	1 1/8	1 1/16	1 1/16	7/16	5/8	19/32	-				

\*\* 4 Point Socket  
Fed. Spec: ANSI B107.1

### WSBD-7RC 7 Piece 8 Point Socket Set on Clip Rail

Contents Include:

Product Code	Size (Inches)	Product Code	Size (Inches)	Product Code	Size (Inches)
BD-808	1/4	BD-814	7/16	BD-820	5/8
BD-810	5/16	BD-816	1/2		
BD-812	3/8	BD-818	9/16		

Features

- SUPERTORQUE® lobular openings for greater turning power without deforming the fastener.
- 8 point sockets are designed for quick engagement on 4 point fasteners.



### 3/8" DRIVE 5 POINT PENTA-SOCKET

Black Industrial Finish



BB-526

Product Code	Size (Inches)	A		B		C		D		E		F
		OAL (Inches)	Drive End Diameter (Inches)	Working End Diameter (Inches)	Broach Depth (Inches)	Bolt Clearance Depth (Inches)	Bolt Clearance Diameter (Inches)	Nose Length (Inches)				
BB-526	51/64	1 1/16	1 1/8	1 1/8	7/16	1/2	23/32	-				

Features

- 5 point Penta-Socket services 5 point nuts found on tamper-resistant Buffalo covers used by gas, electric, and some water companies to protect shutoff gates.



### 3/8" DRIVE UNIVERSAL SOCKETS, 12 POINT, SAE

High-Polished Chrome Finish



BU-1220, BU-1212

Product Code	Size (Inches)	A		B		C		D		E		F
		OAL (Inches)	Drive End Diameter (Inches)	Open End Diameter (Inches)	Broach Depth (Inches)	Bolt Clearance Depth (Inches)	Bolt Clearance Diameter (Inches)	Nose Length (Inches)				
BU-1212	3/8	1 25/32	3/4	1/2	1/4	1/2	5/16	15/64				
BU-1214	7/16	1 25/32	3/4	5/8	1/4	1/2	11/32	15/64				
BU-1216	1/2	1 25/32	3/4	11/16	5/16	9/16	11/32	9/32				
BU-1218	9/16	1 25/32	3/4	3/4	11/32	5/8	11/32	17/32				
BU-1220	5/8	1 25/32	3/4	7/8	13/32	11/16	11/32	17/32				
BU-1222	11/16	2	3/4	15/16	7/16	23/32	11/32	17/32				
BU-1224	3/4	2 1/8	3/4	1	17/32	13/16	11/32	5/8				

Fed. Spec: ANSI B107.1

### WSB-7U 7 Piece 12 Point Universal Socket Set on Clip Rail

Contents Include:

Product Code	Size (Inches)	Product Code	Size (Inches)	Product Code	Size (Inches)
BU-1212	3/8	BU-1218	9/16	BU-1224	3/4
BU-1214	7/16	BU-1220	5/8		
BU-1216	1/2	BU-1222	11/16		

Features

- Ideal for work in confined areas where fastener is inaccessible to standard sockets.



WSB-7U

# SOCKETS & DRIVE TOOLS

## 3/8" DRIVE



### 3/8" DRIVE UNIVERSAL SOCKETS, 6 POINT, SAE

High-Polished Chrome Finish

Product Code	Size (Inches)	A OAL (Inches)	B Drive End Diameter (Inches)	C Open End Diameter (Inches)	D Broach Depth (Inches)	E Bolt Clearance Depth (Inches)	Bolt Clearance Diameter (Inches)	F Nose Length (Inches)
31142	3/8	1 53/64	3/4	9/16	3/8	35/64	21/64	5/16
31144	7/16	1 53/64	3/4	5/8	3/8	35/64	21/64	5/16
31146	1/2	1 57/64	3/4	45/64	13/32	37/64	21/64	13/32
31148	9/16	1 57/64	3/4	25/32	7/16	43/64	21/64	33/64
31150	5/8	2	3/4	55/64	7/16	49/64	21/64	33/64
31152	11/16	2 3/64	3/4	19/16	31/64	3/4	21/64	17/32
31154	3/4	2 3/64	3/4	1 1/64	1/2	51/64	21/64	17/32

Fed. Spec: ANSI B107.1

### 31938 7 Piece 6 Point Universal socket Set on Clip Rail

Contents Include:

Product Code	Size (Inches)	Product Code	Size (Inches)	Product Code	Size (Inches)
31142	3/8	31148	9/16	31154	3/4
31144	7/16	31150	5/8		
31146	1/2	31152	11/16		

#### Features

- Ideal for work in confined areas where fastener is inaccessible to standard sockets



31154 31142



31938



### 3/8" DRIVE UNIVERSAL SOCKETS, 6 POINT, MM

High-Polished Chrome Finish

Product Code	Size (mm)	A OAL (Inches)	B Drive End Diameter (Inches)	C Open End Diameter (Inches)	D Broach Depth (Inches)	E Bolt Clearance Depth (Inches)	Bolt Clearance Diameter (Inches)	F Nose Length (Inches)
31528	8	1 27/32	3/4	15/32	23/64	35/64	15/64	21/64
31530	10	1 53/64	3/4	9/16	23/64	35/64	21/64	21/64
31531	11	1 55/64	3/4	5/8	23/64	35/64	21/64	21/64
31532	12	1 57/64	3/4	43/64	23/64	37/64	21/64	21/64
31533	13	1 59/64	3/4	45/64	23/64	39/64	21/64	23/64
31534	14	1 15/16	3/4	49/64	25/64	39/64	21/64	1/2
31535	15	1 57/64	3/4	53/64	25/64	39/64	21/64	1/2
31536	16	2	3/4	55/64	7/16	45/64	21/64	1/2
31537	17	2	3/4	15/16	7/16	45/64	21/64	1/2
31538	18	2 1/64	3/4	15/16	15/32	3/4	21/64	1/2
31539	19	2 3/64	3/4	1	1/2	49/64	21/64	1/2

Fed. Spec: ANSI B107.1

### 31939 11 Piece 6 Point Universal Socket Set on Clip Rail

Contents Include:

Product Code	Size (mm)	Product Code	Size (mm)	Product Code	Size (mm)
31528	8	31533	13	31537	17
31530	10	31534	14	31538	18
31531	11	31535	15	31539	19
31532	12	31536	16		

#### Features

- Ideal for work in confined areas where fastener is inaccessible to standard sockets



31539 31528



31939



# SOCKETS & DRIVE TOOLS

## 3/8" DRIVE



### 3/8" DRIVE CROWFOOT WRENCH, FLARE NUT, 12 POINT

Satin Chrome Finish, SAE

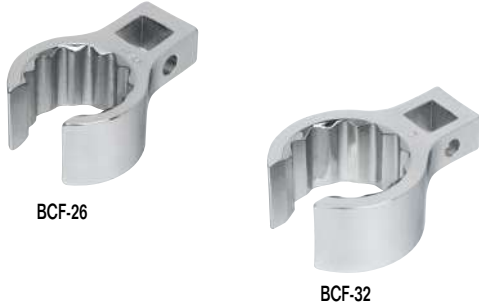

BCF-26

BCF-32

Product Code	Size (Inches)	A Diameter of Head	B Thickness of Head	C Width of Slot	D Length of Centers
BCF20	5/8	1 5/16	1 1/16	1 5/32	4 7/64
BCF22	1 1/16	1 1/32	1 1/16	1 7/32	2 5/32
BCF24	3/4	1 1/8	2 3/32	9/16	5 3/64
BCF26	1 3/16	1 13/64	2 3/32	5/8	7/8
BCF28	7/8	1 19/64	3/4	1 1/16	1 5/16
BCF30	1 5/16	1 3/8	3/4	2 3/32	1 5/16
BCF32	1	1 29/64	2 5/32	3/4	1 1/64
BCF34	1 1/16	1 17/32	2 5/32	2 5/32	1 3/64

Fed. Spec: ASME B107.21 Type 1 Class 1

### WSBCF-8 8 Piece 12 Point Crowfoot Wrench on Clip Rail

Contents Include:



WSBCF-8

Product Code	Size (Inches)	Product Code	Size (Inches)	Product Code	Size (Inches)	Product Code	Size (Inches)
BCF20	5/8	BCF24	3/4	BCF28	7/8	BCF32	1
BCF22	1 1/16	BCF26	1 3/16	BCF30	1 5/16	BCF34	1 1/16
BCF24	3/4						



### 3/8" DRIVE CROWFOOT WRENCH, OPEN END, SAE

High-Polished Chrome Finish

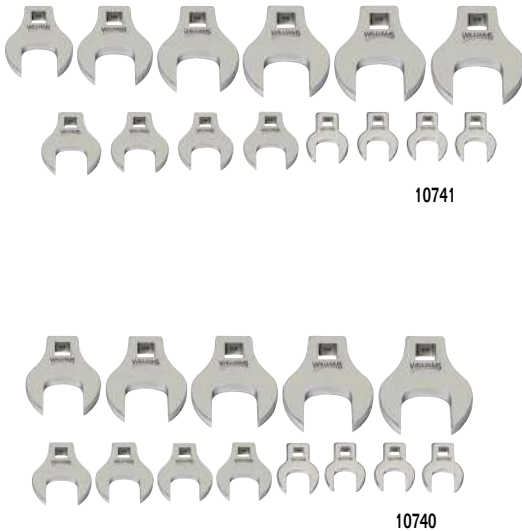

10741

10740

Product Code	Size (Inches)	A Overall Length (Inches)	B Diameter of Head (Inches)	C Thickness of Head (Inches)	D Thickness of Drive End (Inches)	Length of Centers (Inches)
10700	3/8	1 1/4	3/4	1/4	1/2	5/8
10701	7/16	1 3/8	3/4	1/4	1/2	3/4
10702	1/2	1 1/2	1	1/4	1/2	3/4
10703	9/16	1 3/4	1 1/8	1/4	1/2	1
10704	5/8	1 3/4	1 1/4	1/4	1/2	1
10705	1 1/16	2	1 1/2	1/4	1/2	1 1/8
10706	3/4	2	1 1/2	1/4	1/2	1 1/8
10707	13/16	2 1/8	1 5/8	1/4	1/2	1 1/4
10708	7/8	2 1/4	1 3/8	1/4	1/2	1 1/4
10709	1 5/16	2 1/4	2	3/8	1/2	1 1/4
10710	1	2 1/4	2	3/8	1/2	1 1/4
10711	1 1/16	2	1 3/4	3/8	5/8	1 1/8
10712	1 1/8	2	2	3/8	5/8	1 1/8
10713	1 3/16	1 1/8	2	3/8	5/8	1 1/4
10714	1 1/4	1 1/8	2	3/8	5/8	1 1/4
10715	1 5/16	1 1/8	2 1/8	3/8	5/8	1 1/4
10716	1 3/8	2 1/4	2 1/4	3/8	5/8	1 1/4
10717	1 7/16	2 1/4	2 3/8	3/8	5/8	1 3/8
10718	1 1/2	2 1/2	2 1/2	3/8	5/8	1 3/8
10719	1 9/16	2 1/2	2 1/2	3/8	5/8	1 1/2
10720	1 5/8	2 1/2	2 1/2	3/8	5/8	1 1/2
10721	1 1 1/16	2 1/2	2 3/8	3/8	5/8	1 1/2
10722	1 3/4	2 1/2	2 3/4	3/8	5/8	1 1/2
10723	1 13/16	2 1/2	2 3/4	3/8	5/8	1 1/2
10724	1 7/8	2 3/4	3 1/8	3/8	5/8	1 5/8
10725	1 15/16	2 3/4	3 1/8	3/8	5/8	1 5/8
10726	2	3	3 3/8	1/2	5/8	1 3/4

Fed. Spec: ANSI B107.1

### 10740 13 Piece 3/8" Drive Crowfoot Wrenches on Clip Rails

Contents Include:

Product Code	Size (Inches)	Product Code	Size (Inches)	Product Code	Size (Inches)
10700	3/8	10704	5/8	10708	7/8
10701	7/16	10705	1 1/16	10709	1 5/16
10702	1/2	10706	3/4	10710	1
10703	9/16	10707	1 3/16	10711	1 1/16
				10712	1 1/8

### 10741 14 Piece 3/8" Drive Crowfoot Wrenches on Clip Rails

Contents Include:

Product Code	Size (Inches)	Product Code	Size (Inches)	Product Code	Size (Inches)
10713	1 3/16	10718	1 1/2	10723	1 13/16
10714	1 1/4	10719	1 9/16	10724	1 7/8
10715	1 5/16	10720	1 3/8	10725	1 15/16
10716	1 3/8	10721	1 1 1/16	10726	2
10717	1 3/16	10722	1 3/4		

### Features

- Designed for quick engagement on both 6 and 12 point fasteners.

# SOCKETS & DRIVE TOOLS

## 3/8" DRIVE

WILLIAMS®



### 3/8" DRIVE CROWFOOT WRENCH, OPEN END, MM

Product Code	Size (MM)	A Overall Length (Inches)	B Diameter of Head (Inches)	C Thickness of Head (Inches)	D Thickness of Drive End (Inches)	E Length of Centers (Inches)
10759	9	1 1/4	3/4	1/4	1/2	5/8
10760	10	1 1/4	3/4	1/4	1/2	5/8
10761	11	1 3/8	7/8	1/4	1/2	3/4
10762	12	1 3/8	7/8	1/4	1/2	3/4
10763	13	1 1/2	1	1/4	1/2	3/4
10764	14	1 3/4	1 1/8	1/4	1/2	1
10765	15	1 3/4	1 1/8	1/4	1/2	1
10766	16	1 3/4	1 1/4	1/4	1/2	1
10767	17	2	1 1/2	1/4	1/2	1 1/8
10768	18	2	1 1/2	1/4	1/2	1 1/8
10769	19	2	1 1/2	1/4	1/2	1 1/8
10770	20	2 1/8	1 5/8	1/4	1/2	1 1/4
10771	21	2 1/8	1 5/8	1/4	1/2	1 1/4
10772	22	2 1/4	1 5/8	1/4	1/2	1 1/4
10773	23	2 1/4	1 5/8	1/4	1/2	1 1/4
10774	24	2 1/8	2	1/4	1/2	1 1/4



10790

#### 10790 8 Piece 3/8" Drive Crowfoot Wrenches on Clip Rails Contents Include:

Product Code	Size (mm)	Product Code	Size (mm)	Product Code	Size (mm)
10759	9	10762	12	10765	15
10760	10	10763	13	10766	16
10761	11	10764	14		



10791

#### 10791 8 Piece 3/8" Drive Crowfoot Wrenches on Clip Rails Contents Include:

Product Code	Size (mm)	Product Code	Size (mm)	Product Code	Size (mm)
10767	17	10770	20	10773	23
10768	18	10771	21	10774	24
10769	19	10772	22		

#### Features

- Designed for quick engagement on both 6 and 12 point fasteners.

WILLIAMS®



### 3/8" DRIVE BOLT THRU SOCKETS, 6 POINT, SAE

Product Code	Size (Inches)	Overall Length (Inches)	External Hex Inches
31612BT	3/8	1 7/16	3/4
31614BT	7/16	1 7/16	3/4
31616BT	1/2	1 7/16	3/4
31618BT	9/16	1 7/16	3/4
31620BT	5/8	1 7/16	3/4
31622BT	11/16	1 7/16	3/4
31624BT	3/4	1 7/16	3/4



31612BT

#### Features

- SUPERTORQUE® lobular openings for greater turning power without deforming the fastener.
- Designed for quick engagement on both 6 point fasteners.



# SOCKETS & DRIVE TOOLS

## 3/8" DRIVE



31708BT

### 3/8" DRIVE BOLT THRU SOCKETS, 6 POINT, MM

Product Code	Size (mm)	Overall Length (Inches)	External Hex Inches
31708BT	8	1 7/16	3/4
31709BT	9	1 7/16	3/4
31710BT	10	1 7/16	3/4
31711BT	11	1 7/16	3/4
31712BT	12	1 7/16	3/4
31713BT	13	1 7/16	3/4
31714BT	14	1 7/16	3/4
31715BT	15	1 7/16	3/4
31716BT	16	1 7/16	3/4
31717BT	17	1 7/16	3/4
31718BT	18	1 7/16	3/4
31719BT	19	1 7/16	3/4

#### Features

- Designed for quick engagement on 6 point fasteners.



BD-1216 BD-1208

### 3/8" DRIVE DEEP SOCKETS, 12 POINT, SAE

#### High-Polished Chrome Finish

Product Code	Size (Inches)	OAL (Inches)	A B C D E F					
			Drive End Diameter (Inches)	Working End Diameter (Inches)	Broach Depth (Inches)	Bolt Clearance Depth (Inches)	Bolt Clearance Diameter (Inches)	Nose Length (Inches)
BD-1208	1/4	2 1/8	11/16	13/32	7/32	1 11/16	7/32	1 5/8
BD-1210	5/16	2 1/8	11/16	15/32	1/4	1 11/16	9/16	1 5/8
BD-1212	3/8	2 1/8	11/16	9/16	9/32	1 11/16	3/8	1 5/8
BD-1214	7/16	2 1/8	11/16	5/8	9/32	1 11/16	7/16	1 5/8
BD-1216	1/2	2 1/8	23/32	23/32	11/32	1 11/32	15/32	-
BD-1218	9/16	2 3/8	27/32	27/32	9/16	1 9/16	17/32	-
BD-1220	5/8	2 3/8	27/32	27/32	19/32	1 9/16	17/32	-
BD-1222	11/16	2 5/8	15/16	15/16	5/8	1 11/16	21/32	-
BD-1224	3/4	2 5/8	1	1	21/32	1 11/16	23/32	-
BD-1226	13/16	2 3/4	1 1/16	1 1/16	11/16	2 1/32	25/32	-
BD-1228	7/8	2 3/4	1 5/32	1 5/32	3/4	2 1/32	27/32	-
BD-1230	15/16	2 3/4	1 1/4	1 1/4	13/16	2 1/32	27/32	-
BD-1232	1	2 3/4	1 5/16	1 5/16	27/32	2	31/32	-

Fed. Spec: ANSI B107.1

### WSBD-9RC 9 Piece 3/8" Drive Deep 12 Point Socket Set on Clip Rail

#### Contents Include:

Product Code	Size (Inches)	Product Code	Size (Inches)	Product Code	Size (Inches)
BD-1212	3/8	BD-1218	9/16	BD-1224	3/4
BD-1214	7/16	BD-1220	5/8	BD-1226	13/16
BD-1216	1/2	BD-1222	11/16	BD-1228	7/8

### WSBD-13RC 13 Piece 3/8" Drive Deep 12 Point Socket Set on Clip Rail

#### Contents Include:

Product Code	Size (Inches)	Product Code	Size (Inches)	Product Code	Size (Inches)
BD-1208	1/4	BD-1218	9/16	BD-1228	7/8
BD-1210	5/16	BD-1220	5/8	BD-1230	15/16
BD-1212	3/8	BD-1222	11/16	BD-1232	1
BD-1214	7/16	BD-1224	3/4		
BD-1216	1/2	BD-1226	13/16		



WSBD-9RC



WSBD-13RC

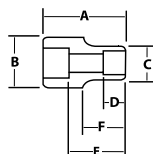

#### Features

- SUPERTORQUE® lobular openings for greater turning power without deforming the fastener.
- Designed for quick engagement on both 6 and 12 point fasteners.

# SOCKETS & DRIVE TOOLS

## 3/8" DRIVE



### 3/8" DRIVE DEEP SOCKETS, 12 POINT, SAE

High-Polished Chrome Finish

Product Code	Size (Inches)	A OAL (Inches)	B Drive End Diameter (Inches)	C Working End Diameter (Inches)	D Broach Depth (Inches)	E Bolt Clearance Depth (Inches)	Bolt Clearance Diameter (Inches)	F Nose Length (Inches)
31408	1/4	2 1/2	11/16	7/16	11/32	1 11/16	7/32	1 1/16
31410	5/16	2 1/2	11/16	15/32	3/8	1 11/16	5/16	1 1/16
31412	3/8	2 1/2	11/16	9/16	3/8	1 11/16	3/8	1 1/16
31414	7/16	2 1/2	11/16	5/8	11/32	1 11/16	7/16	1 1/16
31416	1/2	2 1/2	3/4	3/4	13/32	1 11/32	15/32	-
31418	9/16	2 1/2	25/32	25/32	17/32	1 9/16	17/32	-
31420	5/8	2 1/2	7/8	7/8	19/32	1 9/16	19/32	-
31422	11/16	2 1/2	15/16	15/16	1/2	1 11/16	21/32	-
31424	3/4	2 1/2	1	1	9/16	1 11/16	23/32	-
31426	13/16	2 1/2	1 1/8	1 1/8	9/16	2 1/32	25/32	-
31428	7/8	2 1/2	1 3/16	1 3/16	21/32	2 1/32	27/32	-
31430	15/16	2 1/2	1 1/4	1 1/4	21/32	2 1/32	27/32	-
31432	1	2 1/2	1 5/16	1 5/16	11/16	2	31/32	-

Fed. Spec: ANSI B107.1

#### 31926 9 Piece 3/8" Drive Deep 12 Point Socket Set on Clip Rail

Contents Include:

Product Code	Size (Inches)	Product Code	Size (Inches)	Product Code	Size (Inches)
31408	1/4	31414	7/16	31420	5/8
31410	5/16	31416	1/2	31422	11/16
31412	3/8	31418	9/16	31424	3/4

#### 31928 13 Piece 3/8" Drive Deep 12 Point Socket Set on Clip Rail

Contents Include:

Product Code	Size (Inches)	Product Code	Size (Inches)	Product Code	Size (Inches)
31408	1/4	31418	9/16	31428	7/8
31410	5/16	31420	5/8	31430	15/16
31412	3/8	31422	11/16	31432	1
31414	7/16	31424	3/4		
31416	1/2	31426	13/16		

#### Features

- SUPERTORQUE® lobular openings for greater turning power without deforming the fastener.
- Designed for quick engagement on both 6 and 12 point fasteners.



31416 31408



31926



31928



### 3/8" DRIVE DEEP SOCKETS, 6 POINT, SAE

High-Polished Chrome Finish

Product Code	Size (Inches)	A OAL (Inches)	B Drive End Diameter (Inches)	C Working End Diameter (Inches)	D Broach Depth (Inches)	E Bolt Clearance Depth (Inches)	Bolt Clearance Diameter (Inches)	F Nose Length (Inches)
BD-608	1/4	2 1/8	11/16	13/32	1/4	1 11/16	7/32	1 5/8
BD-610	5/16	2 1/8	11/16	7/16	9/32	1 11/16	5/16	1 5/8
BD-611	11/32	2 1/8	11/16	1/2	1/4	1 11/16	11/32	1 5/8
BD-612	3/8	2 1/8	11/16	9/16	5/16	1 11/16	3/8	1 5/8
BD-614	7/16	2 1/8	11/16	19/32	3/8	1 11/16	7/16	1 5/8
BD-616	1/2	2 1/8	23/32	23/32	7/16	1 11/16	19/32	-
BD-618	9/16	2 3/8	25/32	25/32	7/16	1 9/16	17/32	-
BD-620	5/8	2 3/8	27/32	27/32	1/2	1 9/16	19/32	-
BD-622	11/16	2 5/8	15/16	15/16	11/32	1 3/4	21/32	-
BD-624	3/4	2 5/8	1	1	5/8	1 3/4	23/32	-
BD-626	13/16	2 3/4	1 1/16	1 1/16	11/16	1 27/32	25/32	-
BD-628	7/8	2 3/4	1 5/32	1 9/32	23/32	1 27/32	27/32	-
BD-630	15/16	2 3/4	1 1/4	1 1/4	25/32	2 1/32	27/32	-
BD-632	1	2 3/4	1 5/16	1 5/16	13/16	2 1/2	31/32	-

Fed. Spec: ANSI B107.1

#### WSBD-13HRC 13 Piece 3/8" Drive Deep 6 Point Socket Set on Clip Rail

Contents Include:

Product Code	Size (Inches)	Product Code	Size (Inches)	Product Code	Size (Inches)
BD-608	1/4	BD-618	9/16	BD-628	7/8
BD-610	5/16	BD-620	5/8	BD-630	15/16
BD-612	3/8	BD-622	11/16	BD-632	1
BD-614	7/16	BD-624	3/4		
BD-616	1/2	BD-626	13/16		

#### Features

- SUPERTORQUE® lobular openings for greater turning power without deforming the fastener.
- Designed for maximum engagement on 6 point fasteners.



BD-616 BD-608



WSBD-13HRC



# SOCKETS & DRIVE TOOLS

## 3/8" DRIVE



31316 31308



31940



31941



31303



31301



### 3/8" DRIVE DEEP SOCKETS, 6 POINT, SAE

High-Polished Chrome Finish

Product Code	Size (Inches)	A OAL (Inches)	B Drive End Diameter (Inches)	C Working End Diameter (Inches)	D Broach Depth (Inches)	E Bolt Clearance Depth (Inches)	Bolt Clearance Diameter (Inches)	F Nose Length (Inches)
31308	1/4	2 1/2	11/16	7/16	11/32	1 11/16	7/32	1 1/16
31310	5/16	2 1/2	11/16	13/32	3/8	1 11/16	5/16	1 1/16
31312	3/8	2 1/2	11/16	9/16	3/8	1 11/16	3/8	1 1/16
31314	7/16	2 1/2	11/16	5/8	11/32	1 11/16	7/16	1 1/16
31316	1/2	2 1/2	3/4	3/4	13/32	1 11/32	15/32	-
31318	9/16	2 1/2	25/32	25/32	17/32	1 9/16	17/32	-
31320	5/8	2 1/2	7/8	7/8	19/32	1 9/16	19/32	-
31322	11/16	2 1/2	15/16	15/16	1/2	1 11/16	21/32	-
31324	3/4	2 1/2	1	1	9/16	1 11/16	23/32	-
31326	13/16	2 1/2	1 1/8	1 1/8	9/16	2 1/32	25/32	-
31328	7/8	2 1/2	1 3/16	1 3/16	21/32	2 1/32	27/32	-
31330	15/16	2 1/2	1 1/4	1 1/4	21/32	2 1/32	27/32	-
31332	1	2 1/2	1 5/16	1 5/16	11/16	2	31/32	-

Fed. Spec: ANSI B107.1

### 31940 9 Piece 3/8" Drive Deep 6 Point Socket Set on Clip Rail

Contents Include:

Product Code	Size (Inches)	Product Code	Size (Inches)	Product Code	Size (Inches)
31308	1/4	31314	7/16	31320	5/8
31310	5/16	31316	1/2	31322	11/16
31312	3/8	31318	9/16	31324	3/4

### 31941 13 Piece 3/8" Drive Deep 6 Point Socket Set on Clip Rail

Contents Include:

Product Code	Size (Inches)	Product Code	Size (Inches)	Product Code	Size (Inches)
31308	1/4	31318	9/16	31328	7/8
31310	5/16	31320	5/8	31330	15/16
31312	3/8	31322	11/16	31332	1
31314	7/16	31324	3/4		
31316	1/2	31326	13/16		

#### Features

- SUPERTORQUE® lobular openings for greater turning power without deforming the fastener.
- Designed for quick engagement on 6 point fasteners.



### 3/8" DRIVE SPARK PLUG SOCKETS, 6 POINT, SAE

High-Polished Chrome Finish

Product Code	Size (Inches)	A OAL (Inches)	B Drive End Diameter (Inches)	C Working End Diameter (Inches)	D Broach Depth (Inches)	E Bolt Clearance Depth (Inches)	Bolt Clearance Diameter (Inches)	F Nose Length (Inches)
31301	5/8	2 27/32	11/16	27/32	15/32	29/32	11/16	NA
31303	13/16	2 23/32	13/16	1 1/16	15/32	1 1/32	7/8	NA

Fed. Spec: ANSI B107.1

#### Features

- Rubber insert holds spark plug and prevents damage to insulator.

# SOCKETS & DRIVE TOOLS

## 3/8" DRIVE



### 3/8" DRIVE SHALLOW SOCKETS, 12 POINT, METRIC

#### High-Polished Chrome Finish

Product Code	Size (MM)	A (Inches)	B (Inches)	C (Inches)	D (Inches)	E (Inches)	F (Inches)	Nose Length (Inches)
BM-1206	6	1 1/32	1 1/16	1 3/32	7/32	9/16	7/32	17/32
BM-1207	7	1 1/32	1 1/16	1 9/32	7/32	9/16	7/32	17/32
BM-1208	8	1 1/32	1 1/16	1 5/32	1/4	9/16	9/32	17/32
BM-1209	9	1 1/32	1 1/16	1/2	9/32	9/16	1 1/32	17/32
BM-1210	10	1 1/32	1 1/16	9/16	9/32	9/16	1 1/32	17/32
BM-1211	11	1 1/32	1 1/16	5/8	9/32	9/16	1 1/32	17/32
BM-1212	12	1 1/32	1 1/16	2 1/32	1 1/32	9/16	1 1/32	17/32
BM-1213	13	1 1/32	2 9/32	2 9/32	1 1/32	9/16	3/8	-
BM-1214	14	1 1/32	2 5/32	2 5/32	7/16	17/32	17/32	-
BM-1215	15	1 1/32	1 9/16	1 9/16	1 9/32	1 9/32	9/16	-
BM-1216	16	1 1/8	2 7/32	2 7/32	1 9/32	5/8	1 9/32	-
BM-1217	17	1 5/32	2 9/32	2 9/32	5/8	5/8	5/8	-
BM-1218	18	1 9/32	3 1/32	3 1/32	5/8	2 1/32	1 1/16	-
BM-1219	19	1 9/16	1	1	2 1/32	1 1/16	2 3/32	-
BM-1220	20	1 7/32	1 1/32	1 1/32	1 1/16	2 3/32	3/4	-
BM-1221	21	1 1/4	1 1/8	1 1/8	2 3/32	2 3/32	3/16	-
BM-1222	22	1 9/32	1 5/32	1 5/32	3/4	3/4	3/16	-
BM-1223	23	1 3/16	1 3/16	1 3/16	3/4	2 9/32	7/8	-
BM-1224	24	1 3/8	1 1/4	1 1/4	1 3/16	2 7/32	7/8	-
BM-1226	26	1 7/16	1 1 1/32	1 1 1/32	2 7/32	7/8	1 5/16	-

Fed. Spec: ANSI B107.5



BM-1212 BM-1206

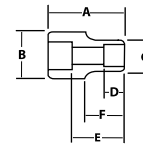

#### MSB-12RC 12 Piece 3/8" Drive Shallow 12 Point Socket Set on Clip Rail

##### Contents Include:

Product Code	Size (MM)	Product Code	Size (MM)	Product Code	Size (MM)
BM-1208	8	BM-1212	12	BM-1216	16
BM-1209	9	BM-1213	13	BM-1217	17
BM-1210	10	BM-1214	14	BM-1218	18
BM-1211	11	BM-1215	15	BM-1219	19

#### MSB-17RC 17 Piece 3/8" Drive Shallow 12 Point Socket Set on Clip Rail

##### Contents Include:

Product Code	Size (MM)	Product Code	Size (MM)	Product Code	Size (MM)	Product Code	Size (MM)
BM-1206	6	BM-1211	11	BM-1216	16	BM-1221	21
BM-1207	7	BM-1212	12	BM-1217	17	BM-1222	22
BM-1208	8	BM-1213	13	BM-1218	18		
BM-1209	9	BM-1214	14	BM-1219	19		
BM-1210	10	BM-1215	15	BM-1220	20		



MSB-12RC

#### MSB-20RC 20 Piece 3/8" Drive Shallow 12 Point Socket Set on Clip Rail

##### Contents Include:

Product Code	Size (MM)	Product Code	Size (MM)	Product Code	Size (MM)	Product Code	Size (MM)
BM-1206	6	BM-1211	11	BM-1216	16	BM-1221	21
BM-1207	7	BM-1212	12	BM-1217	17	BM-1222	22
BM-1208	8	BM-1213	13	BM-1218	18	BM-1223	23
BM-1209	9	BM-1214	14	BM-1219	19	BM-1224	24
BM-1210	10	BM-1215	15	BM-1220	20	BM-1226	26



MSB-17RC

#### Features

- SUPERTORQUE® lobular openings for greater turning power without deforming the fastener.
- Designed for quick engagement on both 6 and 12 point fasteners.



MSB-20RC





# SOCKETS & DRIVE TOOLS

## 3/8" DRIVE



### 3/8" DRIVE SHALLOW SOCKETS, 6 POINT, METRIC

High-Polished Chrome Finish



Product Code	Size (MM)	A		B		C		D		E		F	
		OAL (Inches)	Drive End Diameter (Inches)	Working End Diameter (Inches)	Broach Depth (Inches)	Bolt Clearance Depth (Inches)	Bolt Clearance Diameter (Inches)	Nose Length (Inches)					
BM-605½	5 ½	1 ½/32	1 ¼/16	13/32	7/32	9/16	3/16	17/32					
BM-606	6	1 ½/32	1 ¼/16	13/32	7/32	9/16	7/32	17/32					
BM-607	7	1 ½/32	1 ¼/16	13/32	7/32	9/16	7/32	17/32					
BM-608	8	1 ½/32	1 ¼/16	15/32	¼	9/16	9/32	17/32					
BM-609	9	1 ½/32	1 ¼/16	½	9/32	9/16	1 ½/32	17/32					
BM-610	10	1 ½/32	1 ¼/16	9/16	9/32	9/16	1 ½/32	17/32					
BM-611	11	1 ½/32	1 ¼/16	5/8	9/32	9/16	1 ½/32	17/32					
BM-612	12	1 ½/32	1 ¼/16	21/32	11/32	9/16	1 ½/32	17/32					
BM-613	13	1 ½/32	23/32	23/32	11/32	9/16	3/8	-					
BM-614	14	1 ½/32	25/32	25/32	7/16	17/32	17/32	-					
BM-615	15	1 3/32	13/16	13/16	19/32	19/32	9/16	-					
BM-616	16	1 ½/8	27/32	27/32	19/32	5/8	19/32	-					
BM-617	17	1 5/32	29/32	29/32	5/8	5/8	5/8	-					
BM-618	18	1 5/32	31/32	31/32	5/8	21/32	11/16	-					
BM-619	19	1 3/16	1	1	21/32	11/16	23/32	-					
BM-620	20	1 7/32	1 1/32	1 1/32	11/16	23/32	3/4	-					
BM-621	21	1 ¼	1 ½/8	1 ½/8	23/32	23/32	3/16	-					
BM-622	22	1 9/32	1 7/32	1 7/32	¾	¾	3/16	-					
BM-623	23	1 5/16	1 3/16	1 3/16	¾	25/32	7/8	-					
BM-624	24	1 3/8	1 ¼	1 ¼	19/16	27/32	7/8	-					

Fed. Spec: ANSI B107.5

### MSB-12HRC 12 Piece 3/8" Drive Shallow 6 Point Socket Set on Clip Rail

Contents Include:

Product Code	Size (MM)	Product Code	Size (MM)	Product Code	Size (MM)
BM-608	8	BM-612	12	BM-616	16
BM-609	9	BM-613	13	BM-617	17
BM-610	10	BM-614	14	BM-618	18
BM-611	11	BM-615	15	BM-619	19

### MSB-20HRC 20 Piece 3/8" Drive Shallow 6 Point Socket Set on Clip Rail

Contents Include:

Product Code	Size (MM)	Product Code	Size (MM)	Product Code	Size (MM)	Product Code	Size (MM)
BM-605½	5 ½	BM-610	10	BM-615	15	BM-620	20
BM-606	6	BM-611	11	BM-616	16	BM-621	21
BM-607	7	BM-612	12	BM-617	17	BM-622	22
BM-608	8	BM-613	13	BM-618	18	BM-623	23
BM-609	9	BM-614	14	BM-619	19	BM-624	24

### Features

- SUPERTORQUE® lobular openings for greater turning power without deforming the fastener.
- Designed for maximum engagement on 6 point fasteners.

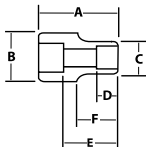

MSB-12HRC



MSB-20HRC

# SOCKETS & DRIVE TOOLS

## 3/8" DRIVE



### 3/8" DRIVE SHALLOW SOCKETS, 12 POINT, METRIC

High-Polished Chrome Finish

Product Code	Size (MM)	A (Inches)	B Drive End Diameter (Inches)	C Working End Diameter (Inches)	D Broach Depth (Inches)	E Bolt Clearance Depth (Inches)	Bolt Clearance Diameter (Inches)	F Nose Length (Inches)
31606	6	1	11/16	3/8	11/32	17/32	7/32	9/16
31607	7	1	11/16	7/16	3/16	17/32	7/32	9/16
31608	8	1	11/16	15/32	1/2	17/32	1/4	9/16
31609	9	1	11/16	17/32	3/8	17/32	9/32	9/16
31610	10	1	11/16	9/16	11/32	15/32	3/8	9/16
31611	11	1	11/16	5/8	11/32	1/2	13/32	9/16
31612	12	1	11/16	11/16	3/8	9/16	7/16	-
31613	13	1	3/4	3/4	3/8	9/16	1/2	-
31614	14	1 1/16	25/32	25/32	17/32	17/32	-	-
31615	15	1 1/16	13/16	13/16	17/32	17/32	-	-
31616	16	1 1/16	7/8	7/8	17/32	17/32	-	-
31617	17	1 1/16	15/16	15/16	17/32	17/32	-	-
31618	18	1 1/16	31/32	31/32	17/32	17/32	-	-
31619	19	1 5/32	1	1	5/8	5/8	-	-

Fed. Spec: ANSI B107.5



31612

31606

#### 31942 8 Piece 3/8" Drive Shallow 12 Point Socket Set on Clip Rail

Contents Include:

Product Code	Size (MM)	Product Code	Size (MM)	Product Code	Size (MM)
31610	10	31613	13	31616	16
31611	11	31614	14	31617	17
31612	12	31615	15		

#### 31943 14 Piece 3/8" Drive Shallow 12 Point Socket Set on Clip Rail

Contents Include:

Product Code	Size (MM)	Product Code	Size (MM)	Product Code	Size (MM)
31606	6	31611	11	31616	16
31607	7	31612	12	31617	17
31608	8	31613	13	31618	18
31609	9	31614	14	31619	19
31610	10	31615	15		

#### Features

- SUPERTORQUE® lobular openings for greater turning power without deforming the fastener.
- Designed for maximum engagement on 12 point fasteners.



31942



31943



# SOCKETS & DRIVE TOOLS

## 3/8" DRIVE



### 3/8" DRIVE SHALLOW SOCKETS, 6 POINT, METRIC

High-Polished Chrome Finish

Product Code	Size (MM)	A		B		C		D		E		F
		OAL (Inches)	Drive End Diameter (Inches)	Working End Diameter (Inches)	Broach Depth (Inches)	Bolt Clearance Depth (Inches)	Bolt Clearance Diameter (Inches)	Nose Length (Inches)				
31506	6	1	11/16	3/8	11/32	17/32	7/32	9/16				
31507	7	1	11/16	7/16	5/16	17/32	7/32	9/16				
31508	8	1	11/16	15/32	11/32	1/2	1/4	9/16				
31509	9	1	11/16	17/32	3/8	17/32	9/32	9/16				
31510	10	1	11/16	9/16	11/32	15/32	3/8	9/16				
31511	11	1	11/16	5/8	11/32	1/2	13/32	9/16				
31512	12	1	11/16	11/16	3/8	9/16	7/16	-				
31513	13	1	3/4	3/4	3/8	9/16	1/2	-				
31514	14	1 1/16	25/32	25/32	17/32	17/32	-	-				
31515	15	1 1/16	13/16	13/16	17/32	17/32	-	-				
31516	16	1 1/16	7/8	7/8	17/32	17/32	-	-				
31517	17	1 1/16	15/16	15/16	17/32	17/32	-	-				
31518	18	1 1/16	31/32	31/32	17/32	17/32	-	-				
31519	19	1 5/32	1	1	5/8	5/8	-	-				

Fed. Spec: ANSI B107.5



### 31930 8 Piece 3/8" Drive Shallow 6 Point Socket Set on Clip Rail

Contents Include:

Product Code	Size (MM)	Product Code	Size (MM)	Product Code	Size (MM)
31510	10	31513	13	31516	16
31511	11	31514	14	31517	17
31512	12	31515	15		

### 31932 14 Piece 3/8" Drive Shallow 6 Point Socket Set on Clip Rail

Contents Include:

Product Code	Size (MM)	Product Code	Size (MM)	Product Code	Size (MM)
31506	6	31511	11	31516	16
31507	7	31512	12	31517	17
31508	8	31513	13	31518	18
31509	9	31514	14	31519	19
31510	10	31515	15		

### Features

- SUPERTORQUE® lobular openings for greater turning power without deforming the fastener.
- Designed for maximum engagement on 6 point fasteners.



31930



31932

# SOCKETS & DRIVE TOOLS

## 3/8" DRIVE



### 3/8" DRIVE DEEP SOCKETS, 6 POINT, METRIC

High-Polished Chrome Finish

Product Code	Size (MM)	A	B	C	D	E	Bolt Clearance Diameter (Inches)	Nose Length (Inches)
		OAL (Inches)	Drive End Diameter (Inches)	Working End Diameter (Inches)	Broach Depth (Inches)	Bolt Clearance Depth (Inches)		
BMD-606	6	2 1/8	11/16	13/32	7/32	1 11/16	7/32	1 5/8
BMD-607	7	2 1/8	11/16	13/32	9/32	1 11/16	1/4	1 5/8
BMD-608	8	2 1/8	11/16	15/32	9/32	1 11/16	5/16	1 5/8
BMD-609	9	2 1/8	11/16	1/2	9/32	1 11/16	11/32	1 5/8
BMD-610	10	2 1/8	11/16	9/16	5/16	1 11/16	3/8	1 5/8
BMD-611	11	2 1/8	11/16	5/8	3/8	1 11/16	7/16	1 5/8
BMD-612	12	2 1/8	11/16	21/32	13/32	1 11/16	19/32	1 5/8
BMD-613	13	2 1/8	23/32	23/32	13/32	1 5/8	17/32	-
BMD-614	14	2 3/8	25/32	25/32	13/32	1 9/16	17/32	-
BMD-615	15	2 3/8	13/16	13/16	13/32	1 9/16	17/32	-
BMD-616	16	2 3/8	27/32	27/32	13/32	1 9/16	19/32	-
BMD-617	17	2 21/32	29/32	29/32	1/2	1 13/16	9/8	-
BMD-618	18	2 21/32	31/32	31/32	1/2	1 13/16	21/32	-
BMD-619	19	2 21/32	1	1	5/8	1 15/16	23/32	-
BMD-620	20	2 21/32	1 1/32	1 1/32	5/8	1 15/16	29/32	-
BMD-622	22	2 7/8	1 5/32	1 5/32	5/8	2 5/32	7/8	-
BMD-623	23	2 7/8	1 3/16	1 1/16	1/2	2 5/32	27/32	-
BMD-624	24	2 7/8	1 1/4	1 1/4	9/16	2 5/32	19/16	-
BMD-625	25	2 7/8	1 9/32	1 9/32	9/16	2 1/8	31/32	-

Fed. Spec: ANSI B107.5



BMD-612 BMD-606

### MSBD-12HRC 12 Piece 3/8" Drive Deep 6 Point Socket Set on Clip Rail

Contents Include:

Product Code	Size (MM)	Product Code	Size (MM)	Product Code	Size (MM)
BMD-608	8	BMD-612	12	BMD-616	16
BMD-609	9	BMD-613	13	BMD-617	17
BMD-610	10	BMD-614	14	BMD-618	18
BMD-611	11	BMD-615	15	BMD-619	19

### MSBD-19HRC 19 Piece 3/8" Drive Deep 6 Point Socket Set on Clip Rail

Contents Include:

Product Code	Size (MM)	Product Code	Size (MM)	Product Code	Size (MM)	Product Code	Size (MM)
BMD-606	6	BMD-611	11	BMD-616	16	BMD-622	22
BMD-607	7	BMD-612	12	BMD-617	17	BMD-623	23
BMD-608	8	BMD-613	13	BMD-618	18	BMD-624	24
BMD-609	9	BMD-614	14	BMD-619	19	BMD-625	25
BMD-610	10	BMD-615	15	BMD-620	20		

### Features

- SUPERTORQUE® lobular openings for greater turning power without deforming the fastener.
- Designed for maximum engagement on 6 point fasteners.



MSBD-12HRC



MSBD-19HRC



# SOCKETS & DRIVE TOOLS

## 3/8" DRIVE



### 3/8" DRIVE DEEP SOCKETS, 12 POINT, METRIC

High-Polished Chrome Finish



31812 31806

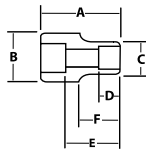

Product Code	Size (MM)	A OAL (Inches)	B Drive End Diameter (Inches)	C Working End Diameter (Inches)	D Broach Depth (Inches)	E Bolt Clearance Depth (Inches)	Bolt Clearance Diameter (Inches)	F Nose Length (Inches)
31806	6	2 1/2	11/16	3/8	5/8	1 9/16	7/32	1 7/32
31807	7	2 1/2	11/16	7/16	5/8	1 9/16	1/4	1 7/32
31808	8	2 1/2	11/16	7/16	5/8	1 9/16	9/32	1 7/32
31809	9	2 1/2	11/16	17/32	5/8	1 9/16	5/16	1 7/32
31810	10	2 1/2	11/16	9/16	1	1 11/16	3/8	1 7/32
31811	11	2 1/2	11/16	5/8	1	1 25/32	13/32	1 7/32
31812	12	2 1/2	11/16	11/16	1	1 25/32	7/16	-
31813	13	2 1/2	23/32	23/32	1	1 31/32	1/2	-
31814	14	2 1/2	3/4	3/4	1	2	17/32	-
31815	15	2 1/2	13/16	13/16	1	1 15/16	9/16	-
31816	16	2 1/2	7/8	7/8	1	1 29/32	19/32	-
31817	17	2 1/2	15/16	15/16	1	2	21/32	-
31818	18	2 1/2	31/32	31/32	1 1/16	1 29/32	11/16	-
31819	19	2 1/2	1	1	1 3/32	1 31/32	23/32	-

Fed. Spec: ANSI B107.5

### 31934 8 Piece 3/8" Drive Deep 12 Point Socket Set on Clip Rail

Contents Include:

Product Code	Size (MM)	Product Code	Size (MM)	Product Code	Size (MM)
31810	10	31813	13	31816	16
31811	11	31814	14	31817	17
31812	12	31815	15		

### 31936 14 Piece 3/8" Drive Deep 12 Point Socket Set on Clip Rail

Contents Include:

Product Code	Size (MM)	Product Code	Size (MM)	Product Code	Size (MM)
31806	6	31811	11	31816	16
31807	7	31812	12	31817	17
31808	8	31813	13	31818	18
31809	9	31814	14	31819	19
31810	10	31815	15		

### Features

- SUPERTORQUE® lobular openings for greater turning power without deforming the fastener.
- Designed for quick engagement on both 6 and 12 point fasteners.



31934



31936

# SOCKETS & DRIVE TOOLS

## 3/8" DRIVE



### 3/8" DRIVE DEEP SOCKETS, 6 POINT, METRIC

High-Polished Chrome Finish

Product Code	Size (MM)	A OAL (Inches)	B Drive End Diameter (Inches)	C Working End Diameter (Inches)	D Broach Depth (Inches)	E Bolt Clearance Depth (Inches)	Bolt Clearance Diameter (Inches)	F Nose Length (Inches)
31706	6	2 1/2	11/16	3/8	5/8	1 9/16	7/32	1 7/32
31707	7	2 1/2	11/16	7/16	5/8	1 9/16	1/4	1 7/32
31708	8	2 1/2	11/16	7/16	5/8	1 9/16	9/32	1 7/32
31709	9	2 1/2	11/16	17/32	5/8	1 9/16	5/16	1 7/32
31710	10	2 1/2	11/16	9/16	1	1 11/16	3/8	1 7/32
31711	11	2 1/2	11/16	5/8	1	1 25/32	13/32	1 7/32
31712	12	2 1/2	11/16	11/16	1	1 29/32	7/16	-
31713	13	2 1/2	23/32	23/32	1	1 31/32	1/2	-
31714	14	2 1/2	3/4	3/4	1	2	17/32	-
31715	15	2 1/2	13/16	13/16	1	1 15/16	9/16	-
31716	16	2 1/2	7/8	7/8	1	1 29/32	19/32	-
31717	17	2 1/2	15/16	15/16	1	2	21/32	-
31718	18	2 1/2	31/32	31/32	1 1/16	1 29/32	11/16	-
31719	19	2 1/2	1	1	1 3/32	1 31/32	23/32	-

Fed. Spec: ANSI B107.5



31712 31706

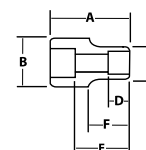

### 31944 8 Piece 3/8" Drive Deep 6 Point Socket Set on Clip Rail

Contents Include:

Product Code	Size (MM)	Product Code	Size (MM)	Product Code	Size (MM)
31710	10	31713	13	31716	16
31711	11	31714	14	31717	17
31712	12	31715	15		

### 31945 14 Piece 3/8" Drive Deep 6 Point Socket Set on Clip Rail

Contents Include:

Product Code	Size (MM)	Product Code	Size (MM)	Product Code	Size (MM)
31706	6	31711	11	31716	16
31707	7	31712	12	31717	17
31708	8	31713	13	31718	18
31709	9	31714	14	31719	19
31710	10	31715	15		

### Features

- SUPERTORQUE® lobular openings for greater turning power without deforming the fastener.
- Designed for quick engagement on 6 point fasteners.



31944



31945



# SOCKETS & DRIVE TOOLS

## 3/8" DRIVE



### 3/8" DRIVE TURBOSOCKET® SALVAGE/DAMAGED FASTENER SOCKETS

Black Industrial Finish, Metric and SAE



TS38375



TSCS3813

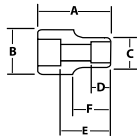

Product Code	Size (Inches)	A		B		C		D		E		F
		OAL (Inches)	Drive End Diameter (Inches)	Working End Diameter (Inches)	Broach Depth (Inches)	Bolt Clearance Depth (Inches)	Bolt Clearance Diameter (Inches)	Nose Length (Inches)				
TS38375	3/8	1 1/4	11/16	19/32	13/32	3/4	3/8	11/16				
TS38437	7/16	1 1/4	11/16	21/32	1/2	3/4	7/16	11/16				
TS38500	1/2	1 1/4	3/4	3/4	1/2	3/4	1/2	-				
TS38562	9/16	1 1/4	13/16	13/16	1/2	23/32	9/16	-				
TS38625	5/8	1 1/4	29/32	29/32	1/2	19/32	5/8	-				
TS38687	11/16	1 13/32	31/32	31/32	21/32	29/32	23/32	-				
TS38750	3/4	1 13/32	1 1/16	1 1/16	21/32	29/32	3/4	-				

Product Code	Size (MM)	A		B		C		D		E		F
		OAL (Inches)	Drive End Diameter (Inches)	Working End Diameter (Inches)	Broach Depth (Inches)	Bolt Clearance Depth (Inches)	Bolt Clearance Diameter (Inches)	Nose Length (Inches)				
TS38394	10	1 1/4	11/16	5/8	13/32	3/4	13/32	11/16				
TS38472	12	1 1/4	23/32	23/32	1/2	3/4	15/32	-				
TS38512	13	1 1/4	3/4	3/4	1/2	3/4	17/32	-				
TS38551	14	1 1/4	13/16	13/16	1/2	23/32	9/16	-				
TS38591	15	1 1/4	21/32	21/32	1/2	19/32	19/32	-				
TS38669	17	1 13/32	31/32	31/32	21/32	29/32	23/32	-				

### TSFS3807 7 Piece TURBOSOCKET® Salvage Socket Set on Clip Rail, SAE

Contents Include:

Product Code	Size (Inches)	Product Code	Size (Inches)	Product Code	Size (Inches)
TS38375	3/8	TS38562	9/16	TS38750	3/4
TS38437	7/16	TS38625	5/8		
TS38500	1/2	TS38687	11/16		

### TSCS3813 13 Piece TURBOSOCKET® Salvage Socket Set on Clip Rail, SAE and Metric

Contents Include:

Product Code	Size (Inches)	Product Code	Size (MM)
TS38375	3/8	TS38394	10
TS38437	7/16	TS38472	12
TS38500	1/2	TS38512	13
TS38562	9/16	TS38551	14
TS38625	5/8	TS38591	15
TS38687	11/16	TS38669	17
TS38750	3/4		

### TSMS3809 9 Piece TURBOSOCKET® Salvage Socket Set on Clip Rail, Metric

Contents Include:

Product Code	Size (MM)	Product Code	Size (MM)	Product Code	Size (MM)
TS38394	10	TS38512	13	TS38625	16 (5/8")
TS38437	11 (7/16")	TS38551	14	TS38669	17
TS38472	12	TS38591	15	TS38750	19 (3/4")

### Features

- Quickly and easily remove damaged or rounded nuts and bolts.
- Place socket on fastener and turn with ratchet, breaker bar or T-handle.
- Grip on fastener tightens as more torque is applied.
- No hammering is required to install socket over fastener.
- Use on all types of standard nuts and bolts as well as studs, pipe nipples, and corroded auto and marine fasteners.
- May be used for "best fit" on metric and fractional fasteners.
- May be used with air or electric impact wrench for extra speed and turning power.



TSMS3809



TSFS3807

# SOCKETS & DRIVE TOOLS

## 3/8" DRIVE



### 3/8" DRIVE STANDARD LENGTH HEX BIT SOCKETS, SAE

#### High-Polished Chrome Finish

Product Code	Size (Inches)	Socket Length (Inches)	Socket Outside Diameter (Inches)	Overall Length (Inches)	Replacement Bit Product Code
BA-3A	3/32	1 1/16	1 1/16	1 27/32	BITH03T-01
BA-4A	1/8	1 1/16	1 1/16	1 7/8	BITH04-03
BA-5A	5/32	1 1/16	1 1/16	1 7/8	BITH05-03
BA-6A	3/16	1 1/16	1 1/16	1 7/8	BITH06-03
BA-7A	7/32	1 1/16	1 1/16	1 7/8	BITH07-03
BA-8A	1/4	1 1/16	1 1/16	1 7/8	BITH08-03
BA-10A	5/16	1 1/16	1 1/16	1 7/8	BITH10-03
BA-12A	3/8	1 1/16	29/32	1 7/8	BITH12-01



BA-7A



WSB-7A

#### WSB-7A 7 Piece Hex Bit Socket Set on Clip Rail

##### Contents Include:

Product Code	Size (Inches)	Product Code	Size (Inches)
BA-4A	1/8	BA-8A	1/4
BA-5A	5/32	BA-10A	5/16
BA-6A	3/16	BA-12A	3/8
BA-7A	7/32		

#### WSBS-10RC 10 Piece Hex Bit Socket Set on Clip Rail, 3/8" and 1/2" Drive

##### Contents Include:

3/8" Drive		3/8" Drive		1/2" Drive	
Product Code	Size (Inches)	Product Code	Size (Inches)	Product Code	Size (Inches)
BA-4A	1/8	BA-8A	1/4	SA-16A	1/2
BA-5A	5/32	BA-10A	5/16	SA-18A	9/16
BA-6A	3/16	BA-12A	3/8	SA-20A	5/8
BA-7A	7/32				



WSBS-10RC

##### Features

- High-polished chrome finish socket cleans easily.
- Two piece design allows bits to be replaced easily.



### 3/8" DRIVE STANDARD LENGTH HEX BIT SOCKETS, SAE

#### High-Polished Chrome Finish

Product Code	Size (Inches)	Socket Length (Inches)	Socket Outside Diameter (Inches)	Overall Length (Inches)	Bit Length (Inches)
35100	1/8	1 3/16	3/4	1 27/32	2 1/32
35101	9/64	1 3/16	3/4	1 27/32	2 1/32
35102	5/32	1 3/16	3/4	1 27/32	2 1/32
35103	3/16	1 3/16	3/4	1 27/32	2 1/32
35104	7/32	1 3/16	3/4	1 27/32	2 1/32
35105	1/4	1 3/16	3/4	1 27/32	2 1/32
35106	5/16	1 3/16	3/4	1 31/32	1 3/16
35107	3/8	1 3/16	3/4	1 31/32	1 3/16



35100



31902

#### 31902 8 Piece Hex Bit Socket Set on Clip Rail

##### Contents Include:

Product Code	Size (Inches)	Product Code	Size (Inches)	Product Code	Size (Inches)
35100	1/8	35103	3/16	35106	5/16
35101	9/64	35104	7/32	35107	3/8
35102	5/32	35105	1/4		

##### Features

- High-polished chrome finish socket cleans easily.





# SOCKETS & DRIVE TOOLS

## 3/8" DRIVE



WILLIAMS®



### 3/8" DRIVE STANDARD LENGTH HEX BIT SOCKETS, METRIC

#### High-Polished Chrome Finish

Product Code	Size (MM)	Socket Length (Inches)	Socket Outside Diameter (Inches)	Overall Length (Inches)	Bit Length (Inches)
35170	4	1 3/16	3/4	1 27/32	2 1/32
35171	5	1 3/16	3/4	1 27/32	2 1/32
35172	6	1 3/16	3/4	1 27/32	2 1/32
35173	7	1 3/16	3/4	1 27/32	2 1/32
35174	8	1 3/16	3/4	1 31/32	13/16
35175	9	1 3/16	3/4	1 31/32	13/16
35176	10	1 3/16	3/4	1 31/32	13/16

#### 31904 7 Piece Hex Bit Socket Set on Clip Rail

#### Contents Include:

Product Code	Size (MM)	Product Code	Size (MM)	Product Code	Size (MM)
35170	4	35173	7	35176	10
35171	5	35174	8		
35172	6	35175	9		

#### Features

- High-polished chrome finish socket cleans easily.



WILLIAMS®



### 3/8" DRIVE BALL TIP HEX BIT SOCKETS, SAE

#### High-Polished Chrome Finish

Product Code	Size (Inches)	Socket Length (Inches)	Socket Outside Diameter (Inches)	Overall Length (Inches)	Replacement Bit Product Code
BA-3HBA	3/32	1 1/16	1 1/16	1 27/32	BITHB03T-01
BA-4HBA	1/8	1 1/16	1 1/16	1 7/8	BITHB04-02
BA-5HBA	5/32	1 1/16	1 1/16	1 7/8	BITHB05-02
BA-6HBA	3/16	1 1/16	1 1/16	1 7/8	BITHB06-02
BA-7HBA	7/32	1 1/16	1 1/16	1 7/8	BITHB07-02
BA-8HBA	1/4	1 1/16	1 1/16	1 7/8	BITHB08-02
BA-10HBA	5/16	1 1/16	1 1/16	1 7/8	BITHB10-01
BA-12HBA	3/8	1 1/16	2 7/32	1 7/8	BITHB12-01

#### WSBB-7RC 7 Piece Ball Tip Hex Bit Socket Set on Clip Rail

#### Contents Include:

Product Code	Size (Inches)	Product Code	Size (Inches)	Product Code	Size (Inches)
BA-4HBA	1/8	BA-7HBA	7/32	BA-12HBA	3/8
BA-5HBA	5/32	BA-8HBA	1/4		
BA-6HBA	3/16	BA-10HBA	5/16		

#### Features

- High-polished chrome finish socket cleans easily.
- Two piece design allows bits to be replaced easily.



WILLIAMS®



### 3/8" DRIVE BALL TIP HEX BIT SOCKETS, SAE

#### High-Polished Chrome Finish

Product Code	Size (Inches)	Socket Length (Inches)	Socket Outside Diameter (Inches)	Overall Length (Inches)	Bit Length (Inches)
35120	1/8	1 3/16	3/4	1 27/32	1 1/16
35121	9/64	1 3/16	3/4	1 27/32	1 1/16
35122	5/32	1 3/16	3/4	1 27/32	1 1/16
35123	3/16	1 3/16	3/4	1 27/32	1 1/16
35124	7/32	1 3/16	3/4	1 27/32	1 1/16
35125	1/4	1 3/16	3/4	1 27/32	1 1/16
35126	5/16	1 3/16	3/4	1 31/32	13/16
35127	3/8	1 3/16	3/4	1 31/32	13/16

#### 31906 8 Piece Ball Tip Hex Bit Socket Set on Clip Rail

#### Contents Include:

Product Code	Size (Inches)	Product Code	Size (Inches)	Product Code	Size (Inches)
35120	1/8	35123	3/16	35126	5/16
35121	9/64	35124	7/32	35127	3/8
35122	5/32	35125	1/4		

#### Features

- High-polished chrome finish socket cleans easily.

# SOCKETS & DRIVE TOOLS

## 3/8" DRIVE



### 3/8" DRIVE LONG HEX BIT SOCKETS, SAE

#### High-Polished Chrome Finish

Product Code	Size (Inches)	Socket Length (Inches)	Socket Outside Diameter (Inches)	Overall Length (Inches)	Replacement Bit Product Code
BA-3LA	3/32	1 1/16	1 1/16	6	BITH03T-02
BA-4LA	1/8	1 1/16	1 1/16	6	BITH04-04
BA-5LA	5/32	1 1/16	1 1/16	6	BITH05-04
BA-6LA	3/16	1 1/16	1 1/16	6	BITH06-04
BA-7LA	7/32	1 1/16	1 1/16	6	BITH07-04
BA-8LA	1/4	1 1/16	1 1/16	6	BITH08-04
BA-10LA	5/16	1 1/16	1 1/16	6	BITH10-04
BA-12LA	3/8	1 1/16	2 3/32	6	BITH12-02

#### WSBS-7LRC 7 Piece Long Hex Bit Socket Set on Clip Rail

##### Contents Include:

Product Code	Size (Inches)	Product Code	Size (Inches)	Product Code	Size (Inches)
BA-4LA	1/8	BA-7LA	7/32	BA-12LA	3/8
BA-5LA	5/32	BA-8LA	1/4		
BA-6LA	3/16	BA-10LA	5/16		

##### Features

- High-polished chrome finish socket cleans easily.
- Two piece design allows bits to be replaced easily.



BA-7LA



WSBS-7LRC



### 3/8" DRIVE LONG LENGTH HEX BIT SOCKETS, SAE

#### High-Polished Chrome Finish

Product Code	Size (Inches)	Socket Length (Inches)	Socket Outside Diameter (Inches)	Overall Length (Inches)
35110	1/8	1 3/16	3/4	6
35111	9/64	1 3/16	3/4	6
35112	5/32	1 3/16	3/4	6
35113	3/16	1 3/16	3/4	6
35114	7/32	1 3/16	3/4	6
35115	1/4	1 3/16	3/4	6
35116	5/16	1 3/16	3/4	6
35117	3/8	1 3/16	3/4	6

#### 31949 8 Piece Hex Bit Socket Set on Clip Rail

##### Contents Include:

Product Code	Size (Inches)	Product Code	Size (Inches)	Product Code	Size (Inches)
35110	1/8	35113	3/16	35116	5/16
35111	9/64	35114	7/32	35117	3/8
35112	5/32	35115	1/4		

##### Features

- High-polished chrome finish socket cleans easily.



35110



31949



### 3/8" DRIVE LONG LENGTH HEX BIT SOCKETS, METRIC

#### High-Polished Chrome Finish

Product Code	Size (MM)	Socket Length (Inches)	Socket Outside Diameter (Inches)	Overall Length (Inches)
35164	4	1 3/16	3/4	6
35165	5	1 3/16	3/4	6
35166	6	1 3/16	3/4	6
35167	7	1 3/16	3/4	6
35168	8	1 3/16	3/4	6
35169	9	1 3/16	3/4	6
35163	10	1 3/16	3/4	6

#### 31951 7 Piece Hex Bit Socket Set on Clip Rail

##### Contents Include:

Product Code	Size (MM)	Product Code	Size (MM)	Product Code	Size (MM)
35164	4	35167	7	35163	10
35165	5	35168	8		
35166	6	35169	9		

##### Features

- High-polished chrome finish socket cleans easily.



35164



31951



# SOCKETS & DRIVE TOOLS

## 3/8" DRIVE



### 3/8" DRIVE LONG BALL TIP HEX BIT SOCKETS, SAE

#### High-Polished Chrome Finish

Product Code	Size (Inches)	Socket Length (Inches)	Socket Outside Diameter (Inches)	Overall Length (Inches)
35130	1/8	1 3/16	3/4	5
35131	9/64	1 3/16	3/4	5
35132	5/32	1 3/16	3/4	5
35133	3/16	1 3/16	3/4	5
35134	7/32	1 3/16	3/4	5
35135	1/4	1 3/16	3/4	5
35136	5/16	1 3/16	3/4	5
35137	3/8	1 3/16	3/4	5

#### 31947 8 Piece Ball Tip Hex Bit Socket Set on Clip Rail

##### Contents Include:

Product Code	Size (Inches)	Product Code	Size (Inches)	Product Code	Size (Inches)
35130	1/8	35133	3/16	35136	5/16
35131	9/64	35134	7/32	35137	3/8
35132	5/32	35135	1/4		

##### Features

- High-polished chrome finish socket cleans easily.



### 3/8" DRIVE TORX® BIT SOCKETS

#### High-Polished Chrome Finish

Product Code	Torx® Size	Socket Length (Inches)	Socket Outside Diameter (Inches)	Overall Length (Inches)	Bit Length (Inches)
35182	T25	1 3/16	3/4	1 27/32	1 1/16
35183	T27	1 3/16	3/4	1 27/32	1 1/16
35184	T30	1 3/16	3/4	1 27/32	1 1/16
35185	T40	1 3/16	3/4	1 31/32	1 3/16
35186	T45	1 3/16	3/4	1 31/32	1 3/16
35187	T47	1 3/16	3/4	2	1 3/16
35188	T50	1 3/16	3/4	2	1 3/16

#### 31910 7 Piece Torx® Bit Socket Set on Clip Rail

##### Contents Include:

Product Code	Torx® Size	Product Code	Torx® Size	Product Code	Torx® Size
35182	T25	35185	T40	35188	T50
35183	T27	35186	T45		
35184	T30	35187	T47		

##### Features

- High-polished chrome finish socket cleans easily.



### 3/8" DRIVE TAMPER-RESISTANT TORX® BIT SOCKETS

#### High-Polished Chrome Finish

Product Code	Torx® Size	Socket Length (Inches)	Socket Outside Diameter (Inches)	Overall Length (Inches)	Bit Length (Inches)
35192	T25	1 3/16	3/4	1 27/32	2 1/32
35193	T27	1 3/16	3/4	1 27/32	2 1/32
35194	T30	1 3/16	3/4	1 27/32	2 1/32
35195	T40	1 3/16	3/4	1 31/32	1 3/16
35196	T45	1 3/16	3/4	1 31/32	1 3/16
35197	T47	1 3/16	3/4	1 31/32	1 3/16
35198	T50	1 3/16	3/4	1 31/32	1 3/16

#### 31912 7 Piece Tamper-Resistant Torx® Bit Socket Set on Clip Rail

##### Contents Include:

Product Code	Torx® Size	Product Code	Torx® Size	Product Code	Torx® Size
35192	T25	35195	T40	35198	T50
35193	T27	35196	T45		
35194	T30	35197	T47		

##### Features

- High-polished chrome finish socket cleans easily.



# SOCKETS & DRIVE TOOLS

## 3/8" DRIVE



### 3/8" DRIVE SCREWDRIVER BIT SOCKETS

#### High-Polished Chrome Finish, Phillips® and Slotted

Product Code	Size (Inches)	Socket Length (Inches)	Socket Outside Diameter (Inches)	Overall Length (Inches)	Replacement Bit Product Code
<b>Slotted Bits:</b>					
BA-5A-1S	3/16 x .032	1 1/16	1 1/16	1 13/16	BITHS01
BA-7A-2S	7/32 x .039	1 1/16	1 1/16	1 13/16	BITHS02
BA-10A-3S	9/32 x .047	1 1/16	1 1/16	1 7/8	BITHS04
BA-10A-4S	5/16 x .061	1 1/16	1 1/16	1 7/8	BITHS05
<b>Phillips® Bits:</b>					
BA-7A-1P	1	1 1/16	1 1/16	1 7/8	BITPH01-02
BA-7A-2P	2	1 1/16	1 1/16	1 7/8	BITPH02-02
BA-10A-3P	3	1 1/16	1 1/16	1 7/8	BITPH03-02
BA-12A-4P	4	1 1/16	23/32	1 7/8	BITPH04-01



BA-7A-2S



BA-7A-2P

#### WSBSP-8RC 8 Piece Screwdriver Bit Socket Set on Clip Rail

##### Contents Include:

Product Code	Tip Size	Product Code	Tip Size	Product Code	Tip Size	Product Code	Tip Size
BA-5A-1S	3/16 x .032	BA-10A-3S	9/32 x .047	BA-7A-1P	1	BA-10A-3P	3
BA-7A-2S	7/32 x .039	BA-10A-4S	5/16 x .061	BA-7A-2P	2	BA-12A-4P	4

##### Features

- High-polished chrome finish socket cleans easily.
- Two piece design allows bits to be replaced easily.



WSBSP-8RC



### 3/8" DRIVE SCREWDRIVER BIT SOCKETS

#### High-Polished Chrome Finish, Phillips® and Slotted

Product Code	Tip Size (Inches)	Socket Length (Inches)	Socket Outside Diameter (Inches)	Overall Length (Inches)	Bit Length (Inches)
<b>Slotted Bits:</b>					
35140	1/4 x 1/32	1 3/16	3/4	1 7/8	1 1/16
35141	5/16 x 3/64	1 3/16	3/4	1 7/8	1 1/16
35142	3/8 x 1/16	1 3/16	3/4	1	1 3/16
35143	3/8 x 1/32	1 3/16	3/4	1	1 3/16
<b>Phillips® Bits:</b>					
35150	#1	1 3/16	3/4	1 27/32	2 1/32
35151	#2	1 3/16	3/4	1 27/32	1 1/16
35152	#3	1 3/16	3/4	1 27/32	1 1/16



35143



35150

#### 31908 7 Piece Screwdriver Bit Socket Set on Clip Rail

##### Contents Include:

Product Code	Tip Size	Product Code	Tip Size	Product Code	Tip Size	Product Code	Tip Size
35140	3/16	35142	3/16	35150	#1	35152	#3
35141	1/4	35143	3/8	35151	#2		

##### Features

- High-polished chrome finish socket cleans easily.



31908



### 3/8" DRIVE FLEXTENSIONS

Product Code	Drive Size	OAL (Inches)	Tension Y or N	6 or 12 Point	Nose End Diameter (Inches)	Socket Diameter (Inches)	Socket Length (Inches)	Clearance Depth (Inches)	Hex Opening
ISFXM416	3/8	5 1/2	N	6	7/8	7/8	1 1/16	7/16	16 mm
ISFXM616	3/8	7 1/2	N	6	7/8	7/8	1 1/16	7/16	16 mm
ISFXTM416	3/8	5 1/2	Y	6	7/8	7/8	1 1/16	7/16	16 mm
ISFXTM613	3/8	7 1/2	Y	6	3/4	7/8	1 1/16	3/4	13 mm
ISFXTM616	3/8	7 1/2	Y	6	7/8	7/8	1 1/16	7/16	16 mm

##### Features

- Flexextensions are available in Non-Tension and Tension "T" spring loaded styles.
- Flexextensions are available in various lengths and sizes for production and maintenance applications.
- Flexextensions are designed for use on hand and power (Impulse or Direct drive) "Not for Impact Use"
- Snap-on Industrial Brands will quote any length and socket size you need. Contact your representative for details.



# SOCKETS & DRIVE TOOLS

## 3/8" DRIVE



2-4A



2-140B



2-106A



2-103A



2-02B



2-33B



36004



36001



36003



36002



BHMD-30



### 3/8" DRIVE IMPACT EXTENSIONS AND ACCESS

#### Black Industrial Finish

Product Code	Description	Length (Inches)	Socket Retention
2-103A	Impact Extension	3	Spring Plunger
2-106A	Impact Extension	6	Spring Plunger
2-140B	Impact Universal Joint	2 1/4	Spring Plunger
2-4A	1/2" M x 3/8" F Adapter	1 1/4	Spring Plunger

Fed. Spec: ANSI B107.2

#### Features

- Specially heat treated for impact use to provide long life, safety, and durability.
- Spring plunger provides secure socket retention for safety and convenience.
- Suitable for use with pneumatic and electric impact wrenches.



### 3/8" DRIVE HEX TO SQUARE SHANK IMPACT EXTENSIONS

#### Black Industrial Finish

Product Code	Hex Shank Size (Inches)	Square Drive Size (Inches)	Length (Inches)
2-02B	1/4	3/8	2
2-33B	7/16	3/8	2 3/4

#### Features

- Specially heat treated for impact use to provide long life, safety, and durability.
- Spring plunger provides secure socket retention for safety and convenience.
- Suitable for use with pneumatic and electric impact wrenches.
- 2-33B - Recommended working torque of 80 ft.lb.



### 3/8" DRIVE IMPACT EXTENSIONS AND ACCESSORIES

#### Black Industrial Finish

Product Code	Description	Length (Inches)	Socket Retention
36002	Impact Extension	3	Ball
36003	Impact Extension	6	Ball
36001	Impact Universal Joint	2 1/8	Ball
36004	1/2" M x 3/8" F Adapter	1 5/16	Ball

Fed. Spec: ANSI B107.2

#### Features

- Specially heat treated for impact use to provide long life, safety, and durability.
- Ball socket retention for fast socket changes.
- Suitable for use with pneumatic and electric impact wrenches.
- Drive end features pin retention hole and groove.



### 3/8" DRIVE HAND IMPACT DRIVER

#### Black Industrial Finish

Product Code	Length (Inches)	Shank Diameter (Inches)
BHMD-30	5	1 1/4

#### Features

- Specially heat treated for impact use to provide long life, safety, and durability.
- Ball socket retention for fast socket changes.
- Ideal for loosening screws that cannot be loosened with an ordinary screwdriver.
- Impact driver is struck with a hammer to provide turning power.
- Hammer blow forces bit into screw head to reduce stripping.
- Hand impact driver can be used with all 3/8" drive sockets, such as 6-point and hex-bit sockets.

# SOCKETS & DRIVE TOOLS

## 3/8" DRIVE



### 3/8" DRIVE SHALLOW IMPACT SOCKETS, 6 POINT, SAE

Black Industrial Finish

Product Code	Size (Inches)	A		B		C		D		E		F
		OAL (Inches)	Drive End Diameter (Inches)	Working End Diameter (Inches)	Broach Depth (Inches)	Bolt Clearance Depth (Inches)	Bolt Clearance Diameter (Inches)	Nose Length (Inches)				
2-608	1/4	1 1/32	1 1/16	1/2	7/32	9/16	7/32	17/32				
2-610	5/16	1 1/32	1 1/16	1/2	1/4	9/16	9/32	17/32				
2-612	3/8	1 1/32	1 1/16	5/8	9/32	9/16	1 1/32	17/32				
2-614	7/16	1 1/16	1 1/16	2 1/32	9/32	19/32	1 1/32	-				
2-616	1/2	1 1/16	3/4	3/4	9/16	19/32	3/8	-				
2-618	9/16	1 3/32	13/16	13/16	9/16	19/32	17/32	-				
2-620	5/8	1 1/8	29/32	29/32	19/32	5/8	5/8	-				
2-622	11/16	1 9/32	3 1/32	3 1/32	19/32	5/8	2 1/32	-				
2-624	3/4	1 7/16	1 1/16	1 1/16	2 1/32	1 1/16	23/32	-				
2-626	13/16	1 1/4	1 1/8	1 1/8	1 1/16	23/32	25/32	-				
2-628	7/8	1 5/32	1 3/16	1 3/16	3/4	3/4	27/32	-				
2-630	15/16	1 7/16	1 9/32	1 9/32	29/32	13/16	29/32	-				
2-632	1	1 9/16	1 1 1/32	1 1 1/32	29/32	25/32	3 1/32	-				

Fed. Spec: ANSI B107.2

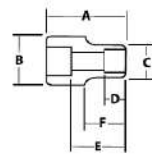

2-618

2-608

#### WS-2-8 8 Piece 3/8" Drive Shallow 6 Point Impact Socket Set on Clip Rail

Contents Include:

Product Code	Size (Inches)	Product Code	Size (Inches)
2-610	5/16	2-618	9/16
2-612	3/8	2-620	5/8
2-614	7/16	2-622	1 1/16
2-616	1/2	2-624	3/4



WS-2-8

#### WS-2-13 13 Piece 3/8" Drive Shallow 6 Point Impact Socket Set on Clip Rail

Contents Include:

Product Code	Size (Inches)	Product Code	Size (Inches)	Product Code	Size (Inches)
2-608	1/4	2-618	9/16	2-628	7/8
2-610	5/16	2-620	5/8	2-630	15/16
2-612	3/8	2-622	1 1/16	2-632	1
2-614	7/16	2-624	3/4		
2-616	1/2	2-626	13/16		



WS-2-13

#### Features

- SUPERTORQUE® lobular openings for greater turning power without deforming the fastener.
- Designed for maximum engagement on 6 point fasteners.
- Suitable for use with pneumatic and electric impact wrenches.
- Specially heat treated for impact use to provide long life, safety, and durability.



### 3/8" DRIVE UNIVERSAL IMPACT SOCKETS, 6 POINT, SAE

Black Industrial Finish

Product Code	Size (Inches)	A		B		C		D		E		F
		OAL (Inches)	Drive End Diameter (Inches)	Working End Diameter (Inches)	Broach Depth (Inches)	Bolt Clearance Depth (Inches)	Bolt Clearance Diameter (Inches)	Nose Length (Inches)				
36212	3/8	2 1/4	1	19/16	9/16	9/16	5/16	15 1/16				
36214	7/16	2 1/4	1	1 1/16	9/16	9/16	9/16	15 1/16				
36216	1/2	2 1/8	1	1 3/16	9/16	9/16	7/16	1 1/16				
36218	9/16	2 1/8	1	1 3/16	9/16	9/16	8/16	1 1/16				
36220	5/8	2 3/8	1	1 9/16	9/16	9/16	9/16	1 1/16				
36222	1 1/16	2 5/8	1	1	9/16	1 1/16	19/16	1 3/16				
36224	3/4	2 5/8	1	1 3/16	9/16	1 1/16	1 1/16	1 3/16				

Fed. Spec: ANSI B107.2

#### 36912 7 Piece 3/8" Drive Universal 6 Point Impact Socket Set on Clip Rail

Contents Include:

Product Code	Size (Inches)	Product Code	Size (Inches)
36212	3/8	36220	5/8
36214	7/16	36222	1 1/16
36216	1/2	36224	3/4
36218	9/16		



36224



36912

#### Features

- SUPERTORQUE® lobular openings for greater turning power without deforming the fastener
- Designed for maximum engagement on 6 point fasteners
- Suitable for use with pneumatic and electric impact wrenches
- Specially heat treated for impact use to provide long life, safety, and durability
- Drive end features pin retention hole and groove



# SOCKETS & DRIVE TOOLS

## 3/8" DRIVE



### 3/8" DRIVE SHALLOW IMPACT SOCKETS, 6 POINT, SAE

#### Black Industrial Finish

Product Code	Size (Inches)	A B C D E F						
		OAL (Inches)	Drive End Diameter (Inches)	Working End Diameter (Inches)	Broach Depth (Inches)	Bolt Clearance Depth (Inches)	Bolt Clearance Diameter (Inches)	Nose Length (Inches)
36108	1/4	1 5/32	3/4	7/16	5/16	21/32	7/32	7/16
36110	5/16	1	3/4	1/2	3/8	17/32	1/4	7/16
36112	3/8	1	3/4	19/32	11/32	17/32	9/32	7/16
36114	7/16	1 3/32	3/4	11/16	3/8	5/8	13/32	7/16
36116	1/2	1 5/32	25/32	25/32	3/8	5/8	7/16	-
36118	9/16	1 1/16	13/16	13/16	9/16	23/32	17/32	-
36120	5/8	1 1/16	15/16	15/16	9/16	23/32	5/8	-
36122	11/16	1 1/16	15/16	15/16	9/16	3/4	21/32	-
36124	3/4	1 1/8	1 1/32	1 1/32	19/32	13/16	23/32	-
36126	13/16	1 9/64	1 1/8	1 1/8	35/64	35/64	3/4	n/a
36128	7/8	1 7/32	1 3/16	1 3/16	5/8	5/8	53/64	n/a
36130	15/16	1 7/32	1 19/64	1 19/64	5/8	5/8	29/32	n/a
36132	1	1 7/32	1 11/32	1 11/32	5/8	5/8	15/16	n/a

Fed. Spec: ANSI B107.2

#### 36902 9 Piece 3/8" Drive Shallow 6 Point Impact Socket Set on Clip Rail

##### Contents Include:

Product Code	Size (Inches)	Product Code	Size (Inches)	Product Code	Size (Inches)
36108	1/4	36114	7/16	36120	5/8
36110	5/16	36116	1/2	36122	11/16
36112	3/8	36118	9/16	36124	3/4

#### 36903 13 piece 3/8" Drive Shallow 6 Point Impact Socket Set on Clip Rail

##### Contents Include:

Product Code	Size (Inches)	Product Code	Size (Inches)	Product Code	Size (Inches)	Product Code	Size (Inches)
36108	1/4	36114	7/16	36120	5/8	36126	13/16
36110	5/16	36116	1/2	36122	11/16	36128	7/8
36112	3/8	36118	9/16	36124	3/4	36130	15/16
						36132	1



#### Features

- SUPERTORQUE® lobular openings for greater turning power without deforming the fastener.
- Designed for maximum engagement on 6 point fasteners.
- Suitable for use with pneumatic and electric impact wrenches.
- Specially heat treated for impact use to provide long life, safety, and durability.
- Drive end features pin retention hole and groove.



### 3/8" DRIVE SHALLOW IMPACT SOCKETS, 12 POINT, SAE

#### Black Industrial Finish

Product Code	Size (Inches)	A B C D E F						
		OAL (Inches)	Drive End Diameter (Inches)	Working End Diameter (Inches)	Broach Depth (Inches)	Bolt Clearance Depth (Inches)	Bolt Clearance Diameter (Inches)	Nose Length (Inches)
35310	5/16	1 1/8	3/4	1/2	3/8	/	1/4	1/2
35312	3/8	1 1/8	3/4	1/2	3/8	/	3/8	1/2
35314	7/16	1 1/8	3/4	5/8	3/8	/	3/8	1/2
35316	1/2	1 1/8	3/4	3/4	3/8	/	3/8	/
35318	9/16	1 1/8	3/4	3/4	3/8	/	1/2	/
35320	5/8	1 1/8	1	19/16	1/2	/	1/2	/
35322	11/16	1 1/8	1	15/16	1/2	/	1/2	/
35324	3/4	1 1/8	1	1	1/2	/	5/8	/
35326	13/16	1 1/8	1 1/8	1	1/2	/	3/4	/
35328	7/8	1 1/8	1 1/8	1 1/8	1/2	/	3/4	/
35330	15/16	1 1/8	1 1/4	1 1/4	1/2	/	3/4	/
35332	1	1 1/8	1 3/8	1 3/8	1/2	/	1	/

#### 36921 12 piece 3/8" Drive Shallow 12 Point Impact Socket Set on Clip Rail

##### Contents Include:

Product Code	Size (Inches)	Product Code	Size (Inches)	Product Code	Size (Inches)
35310	5/16	35318	9/16	35326	13/16
35312	3/8	35320	5/8	35328	7/8
35314	7/16	35322	11/16	35330	15/16
35316	1/2	35324	3/4	35332	1



#### Features

- SUPERTORQUE® lobular openings for greater turning power without deforming the fastener.
- Designed for maximum engagement on 6 or 12 point fasteners.
- Suitable for use with pneumatic and electric impact wrenches.
- Specially heat treated for impact use to provide long life, safety, and durability.
- Drive end features pin retention hole and groove.

# SOCKETS & DRIVE TOOLS

## 3/8" DRIVE



### 3/8" DRIVE DEEP IMPACT SOCKETS, 6 POINT, SAE

#### Black Industrial Finish

Product Code	Size (Inches)	A OAL (Inches)	B Drive End Diameter (Inches)	C Working End Diameter (Inches)	D Broach Depth (Inches)	E Bolt Clearance Depth (Inches)	Bolt Clearance Diameter (Inches)	Nose Length (Inches)
12-610	5/16	2 1/8	11/16	1/2	1/4	1 21/32	9/32	1 5/8
12-612	3/8	2 1/8	11/16	5/8	9/32	1 3/8	11/32	1 5/8
12-614	7/16	2 1/8	11/16	21/32	11/32	1 5/8	11/32	1 5/8
12-616	1/2	2 1/8	3/4	3/4	3/8	1 15/32	7/16	-
12-618	9/16	2 3/8	13/16	13/16	7/16	1 1/2	17/32	-
12-620	5/8	2 3/8	29/32	29/32	15/32	1 11/16	3/4	-
12-622	11/16	2 5/8	31/32	31/32	1/2	1 19/32	21/32	-
12-624	3/4	2 5/8	1 1/16	1 1/16	9/16	1 19/32	23/32	-
12-626	13/16	2 3/4	1 1/8	1 1/8	9/16	1 23/32	25/32	-
12-628	7/8	2 3/4	1 9/16	1 9/16	19/32	1 7/8	27/32	-
12-630	15/16	2 3/4	1 9/16	1 9/16	19/32	1 15/16	29/32	-
12-632	1	2 3/4	1 11/32	1 11/32	5/8	2	1	-

Fed. Spec: ANSI B107.2

#### WS-12-8 8 Piece 3/8" Drive Deep 6 Point Impact Socket Set on Clip Rail

##### Contents Include:

Product Code	Size (Inches)	Product Code	Size (Inches)	Product Code	Size (Inches)	Product Code	Size (Inches)
12-610	5/16	12-614	7/16	12-618	9/16	12-622	11/16
12-612	3/8	12-616	1/2	12-620	5/8	12-624	3/4

#### WS-12-12 12 Piece 3/8" Drive Deep 6 Point Impact Socket Set on Clip Rail

##### Contents Include:

Product Code	Size (Inches)	Product Code	Size (Inches)	Product Code	Size (Inches)	Product Code	Size (Inches)
12-610	5/16	12-616	1/2	12-622	11/16	12-628	7/8
12-612	3/8	12-618	9/16	12-624	3/4	12-630	15/16
12-614	7/16	12-620	5/8	12-626	13/16	12-632	1



12-616 12-610



WS-12-8



WS-12-12

#### Features

- SUPERTORQUE® lobular openings for greater turning power without deforming the fastener.
- Designed for maximum engagement on 6 point fasteners.
- Suitable for use with pneumatic and electric impact wrenches.
- Specially heat treated for impact use to provide long life, safety, and durability.



### 3/8" DRIVE DEEP IMPACT SOCKETS, 6 POINT, SAE

#### Black Industrial Finish

Product Code	Size (Inches)	A OAL (Inches)	B Drive End Diameter (Inches)	C Working End Diameter (Inches)	D Broach Depth (Inches)	E Bolt Clearance Depth (Inches)	Bolt Clearance Diameter (Inches)	Nose Length (Inches)
36308	1/4	2 1/2	3/4	7/16	9/16	1 9/16	7/32	7/16
36310	5/16	2 1/2	3/4	1/2	21/32	1 23/32	9/32	7/16
36312	3/8	2 1/2	3/4	19/32	1 1/16	1 15/16	5/16	7/16
36314	7/16	2 1/2	3/4	21/32	1	1 29/32	13/32	7/16
36316	1/2	2 1/2	29/32	29/32	1 1/16	1 31/32	7/16	-
36318	9/16	2 1/2	13/16	13/16	1 1/16	1 31/32	17/32	-
36320	5/8	2 1/2	29/32	29/32	1 1/16	1 31/32	19/32	-
36322	11/16	2 1/2	15/16	15/16	1	1 31/32	21/32	-
36324	3/4	2 1/2	1 1/32	1 1/32	1 1/32	2	29/32	-
36326	13/16	2 1/2	1 1/8	1 1/8	1	1 13/16	3/4	-
36328	7/8	2 1/2	1 3/16	1 3/16	1	1 13/16	53/64	-
36330	15/16	2 1/2	1 13/64	1 13/64	1	1 13/16	29/32	-
36332	1	2 1/2	1 11/32	1 11/32	1	1 13/16	15/16	-

Fed. Spec: ANSI B107.2

#### 36904 9 Piece 3/8" Drive Deep 6 Point Impact Socket Set on Clip Rail

##### Contents Include:

Product Code	Size (Inches)	Product Code	Size (Inches)	Product Code	Size (Inches)
36308	1/4	36314	7/16	36320	5/8
36310	5/16	36316	1/2	36322	11/16
36312	3/8	36318	9/16	36324	3/4

#### 36905 13 Piece 3/8" Drive Deep 6 Point Impact Socket Set on Clip Rail

##### Contents Include:

Product Code	Size (Inches)	Product Code	Size (Inches)	Product Code	Size (Inches)
36308	1/4	36318	9/16	36326	13/16
36310	5/16	36320	5/8	36328	7/8
36312	3/8	36322	11/16	36330	15/16
36314	7/16	36322	3/4	36332	1
36316	1/2				



36316 36308



36905

#### Features

- SUPERTORQUE® lobular openings for greater turning power without deforming the fastener.
- Designed for maximum engagement on 6 point fasteners.
- Suitable for use with pneumatic and electric impact wrenches.
- Specially heat treated for impact use to provide long life, safety, and durability.
- Drive end features pin retention hole and groove.





# SOCKETS & DRIVE TOOLS

## 3/8" DRIVE



36416 36410



36922



### 3/8" DRIVE DEEP IMPACT SOCKETS, 12 POINT, SAE

Black Industrial Finish

Product Code	Size (Inches)	A	B	C	D	E	Bolt Clearance Diameter (Inches)	Nose Length (Inches)
		OAL (Inches)	Drive End Diameter (Inches)	Working End Diameter (Inches)	Broach Depth (Inches)	Bolt Clearance Depth (Inches)		
36410	5/16	2 1/2	3/4	1/2	1/2	/	3/8	1 1/4
36412	3/8	2 1/2	3/4	1/2	3/4	/	1/2	1 1/4
36414	7/16	2 1/2	3/4	5/8	3/4	/	1/2	1 1/4
36416	1/2	2 1/2	3/4	3/4	1	/	1/2	/
36418	9/16	2 1/2	3/4	3/4	1	/	1/2	/
36420	5/8	2 1/2	1	1	1	/	1/2	/
36422	11/16	2 1/2	1	1	1	/	1/2	/
36424	3/4	2 1/2	1	1	1	/	3/4	/
36426	13/16	2 1/2	1	1	1	/	3/4	/
36428	7/8	2 1/2	1 1/8	1 1/8	1	/	3/4	/
36430	15/16	2 1/2	1 1/4	1 1/4	1	/	5/8	/
36432	1	2 1/2	1 3/8	1 3/8	1	/	1	/

### 36922 12 piece 3/8" Drive Shallow 12 Point Impact Socket Set on Clip Rail

Contents Include:

Product Code	Size (Inches)	Product Code	Size (Inches)	Product Code	Size (Inches)
36410	5/16	36418	9/16	36426	13/16
36412	3/8	36420	5/8	36428	7/8
36414	7/16	36422	11/16	36430	15/16
36416	1/2	36424	3/4	36432	1

#### Features

- SUPERTORQUE® lobular openings for greater turning power without deforming the fastener.
- Designed for maximum engagement on 6 or 12 point fasteners.
- Suitable for use with pneumatic and electric impact wrenches.
- Specially heat treated for impact use to provide long life, safety, and durability.
- Drive end features pin retention hole and groove.



### 3/8" DRIVE SHALLOW IMPACT SOCKETS, 6 POINT, METRIC

Black Industrial Finish

Product Code	Size (MM)	A	B	C	D	E	Bolt Clearance Diameter (Inches)	Nose Length (Inches)
		OAL (Inches)	Drive End Diameter (Inches)	Working End Diameter (Inches)	Broach Depth (Inches)	Bolt Clearance Depth (Inches)		
2M-607	7	1 1/32	11/16	7/16	7/32	9/16	1/4	17/32
2M-608	8	1 1/32	11/16	1/2	1/4	9/16	9/32	17/32
2M-609	9	1 1/32	11/16	9/16	9/32	9/16	11/32	17/32
2M-610	10	1 1/32	11/16	5/8	9/32	9/16	11/32	17/32
2M-611	11	1 1/32	11/16	21/32	9/32	19/32	11/32	9/16
2M-612	12	1 1/16	23/32	23/32	9/32	9/16	11/32	-
2M-613	13	1 1/16	25/32	25/32	9/32	19/32	3/8	-
2M-614	14	1 3/32	13/16	13/16	9/16	19/32	1/2	-
2M-615	15	1 3/32	27/32	27/32	9/16	19/32	9/16	-
2M-616	16	1 1/8	29/32	29/32	19/32	5/8	19/32	-
2M-617	17	1 3/32	31/32	31/32	19/32	5/8	5/8	-
2M-618	18	1 3/32	1	1	5/8	21/32	11/16	-
2M-619	19	1 3/16	1 1/16	1 1/16	21/32	11/16	23/32	-



2M-614 2M-607



MS-2-13H

### MS-2-13H 13 Piece 3/8" Drive Shallow 6 Point Impact Socket Set on Clip Rail

Contents Include:

Product Code	Size (MM)	Product Code	Size (MM)	Product Code	Size (MM)
2M-607	7	2M-612	12	2M-617	17
2M-608	8	2M-613	13	2M-618	18
2M-609	9	2M-614	14	2M-619	19
2M-610	10	2M-615	15		
2M-611	11	2M-616	16		

#### Features

- SUPERTORQUE® lobular openings for greater turning power without deforming the fastener.
- Designed for maximum engagement on 6 point fasteners.
- Suitable for use with pneumatic and electric impact wrenches.
- Specially heat treated for impact use to provide long life, safety, and durability.

# SOCKETS & DRIVE TOOLS

## 3/8" DRIVE



### 3/8" DRIVE SHALLOW IMPACT SOCKETS, 6 POINT, METRIC

Black Industrial Finish

Product Code	Size (MM)	A OAL (Inches)	B Drive End Diameter (Inches)	C Working End Diameter (Inches)	D Broach Depth (Inches)	E Bolt Clearance Depth (Inches)	Bolt Clearance Diameter (Inches)	F Nose Length (Inches)
36507	7	1	3/4	7/16	9/32	17/32	1/4	7/16
36508	8	1	3/4	1/2	5/16	17/32	9/32	7/16
36509	9	1	3/4	1/2	5/16	17/32	11/32	7/16
36510	10	1	3/4	5/8	11/32	17/32	11/32	7/16
36511	11	1	3/4	11/16	11/32	17/32	11/32	7/16
36512	12	1	3/4	23/32	3/8	21/32	11/32	7/16
36513	13	1	7/8	13/16	5/16	1/2	3/8	7/16
36514	14	1 1/16	7/8	13/16	17/32	21/32	1/2	7/16
36515	15	1 1/16	7/8	7/8	9/16	11/16	9/16	-
36516	16	1 1/16	15/16	15/16	9/16	11/16	19/32	-
36517	17	1 1/16	15/16	15/16	9/16	23/32	5/8	-
36518	18	1 1/16	1 1/16	1 1/16	19/32	23/32	11/16	-
36519	19	1 5/32	1 1/16	1 1/16	9/16	3/4	23/32	-



36515 36507

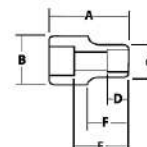

### 36906 10 Piece 3/8" Drive Shallow 6 Point Impact Socket Set on Clip Rail

Contents Include:

Product Code	Size (MM)	Product Code	Size (MM)	Product Code	Size (MM)
36510	10	36514	14	36518	18
36511	11	36515	15	36519	19
36512	12	36516	16		
36513	13	36517	17		



36906

#### Features

- SUPERTORQUE® lobular openings for greater turning power without deforming the fastener.
- Designed for maximum engagement on 6 point fasteners.
- Suitable for use with pneumatic and electric impact wrenches.
- Specially heat treated for impact use to provide long life, safety, and durability.
- Drive end features pin retention hole and groove.



### 3/8" DRIVE SHALLOW IMPACT SOCKETS, 12 POINT, MM

Black Industrial Finish

Product Code	Size (MM)	A Overall Length (Inches)	B Drive End Diameter (Inches)	C Working End Diameter (Inches)	D Broach Depth (Inches)	E Bolt Clearance Depth (Inches)	Bolt Clearance Diameter (Inches)	F Nose Length (Inches)
36607	7	1 1/8	3/4	1/2	3/8	/	3/8	1/2
36608	8	1 1/8	3/4	1/2	3/8	/	1/2	1/2
36609	9	1 1/8	3/4	1/2	3/8	/	1/2	1/2
36610	10	1 1/8	3/4	1/2	3/8	/	1/2	1/2
36611	11	1 1/8	3/4	1/2	1/2	/	1/2	1/2
36612	12	1 1/8	3/4	3/4	1/2	/	1/2	/
36613	13	1 1/8	3/4	3/4	1/2	/	1/2	/
36614	14	1 1/8	3/4	3/4	1/2	/	1/2	/
36615	15	1 1/8	7/8	7/8	1/2	/	1/2	/
36616	16	1 1/8	7/8	1	1/2	/	1/2	/
36617	17	1 1/8	7/8	1	1/2	/	5/8	/
36618	18	1 1/8	1	1	1/2	/	5/8	/
36619	19	1 1/8	1	1	1/2	/	5/8	/



36612 36607

### 36923 13 Piece 3/8" Drive Shallow 12 point Impact Socket Set on Clip and Rail

Contents Include:

Product Code	Size (MM)	Product Code	Size (MM)	Product Code	Size (MM)
36607	7	36612	12	36617	17
36608	8	36613	13	36618	18
36609	9	36614	14	36619	19
36610	10	36615	15		
36611	11	36616	16		



36923

#### Features

- SUPERTORQUE® lobular openings for greater turning power without deforming the fastener.
- Designed for maximum engagement on 6 or 12 point fasteners.
- Suitable for use with pneumatic and electric impact wrenches.
- Specially heat treated for impact use to provide long life, safety, and durability.
- Drive end features pin retention hole and groove.



# SOCKETS & DRIVE TOOLS

## 3/8" DRIVE



36819



36910



### 3/8" DRIVE UNIVERSAL IMPACT SOCKETS, 6 POINT, METRIC

Black Industrial Finish

Product Code	Size (MM)	A OAL (Inches)	B Drive End Diameter (Inches)	C Working End Diameter (Inches)	D Broach Depth (Inches)	E Bolt Clearance Depth (Inches)	F Bolt Clearance Diameter (Inches)	Nose Length (Inches)
36810	10	2 1/4	7/8	5/8	3/8	1/2	3/16	15/16
36811	11	2 1/4	7/8	11/16	1/2	1/2	3/8	15/16
36812	12	2 1/4	7/8	11/16	1/2	1/2	3/8	15/16
36813	13	3/8	7/8	13/16	1/2	9/16	3/8	1 1/16
36814	14	3/8	7/8	13/16	1/2	9/16	1/2	1 1/16
36815	15	3/8	7/8	7/8	1/2	9/16	9/16	1 1/16
36816	16	3/8	7/8	7/8	1/2	9/16	9/16	1 1/16
36817	17	3/8	7/8	1	1/2	1 1/16	5/8	1 1/4
36818	18	2 5/8	7/8	1 1/16	1/2	1 1/16	1 1/16	1 1/4
36819	19	2 5/8	7/8	1/8	1/2	1 1/16	1 1/16	1 1/4

### 36910 10 Piece 3/8" Drive Universal 6 Point Impact Socket Set on Clip Rail

Contents Include:

Product Code	Size (MM)	Product Code	Size (MM)	Product Code	Size (MM)
36810	10	36814	14	36818	18
36811	11	36815	15	36819	19
36812	12	36816	16		
36813	13	36817	17		

#### Features

- SUPERTORQUE® lobular openings for greater turning power without deforming the fastener
- Designed for maximum engagement on 6 point fasteners
- Suitable for use with pneumatic and electric impact wrenches
- Specially heat treated for impact use to provide long life, safety, and durability
- Drive end features pin retention hole and groove



### 3/8" DRIVE ONE PIECE IMPACT HEX BIT STUBBY DRIVERS, SAE

Black Industrial Finish

Product Code	Size (Inches)	OAL (Inches)	Product Code	Size (Inches)	OAL (Inches)
35620	1/8	1 1/8	35628	1/4	1 1/8
35622	5/32	1 1/8	35630	3/16	1 1/8
35624	3/16	1 1/8	35632	3/8	1 1/8
35626	7/32	1 1/8			

Fed. Spec: ANSI B107.2

### 36914 7 Piece 3/8" Drive One Piece Impact Hex Bit Stubby Drivers, SAE

Contents Include:

Product Code	Size (Inches)	Product Code	Size (Inches)	Product Code	Size (Inches)
35620	1/8	35626	7/32	35632	3/8
35622	5/32	35628	1/4		
35624	3/16	35630	3/16		



35622



35630



36914



35605



35608



36918



### 3/8" DRIVE ONE PIECE IMPACT HEX BIT STUBBY DRIVERS, MM

Black Industrial Finish

Product Code	Size (Inches)	OAL (Inches)	Product Code	Size (Inches)	OAL (Inches)
35604	4	1 1/8	35608	8	1 1/8
35605	5	1 1/8	35610	10	1 1/8
35606	6	1 1/8			

Fed. Spec: ANSI B107.2

### 36918 5 Piece 3/8" Drive One Piece Impact Hex Bit Stubby Drivers, MM

Contents Include:

Product Code	Size (MM)	Product Code	Size (MM)	Product Code	Size (MM)
35604	4	35606	6	35610	10
35605	5	35608	8		

# SOCKETS & DRIVE TOOLS

## 3/8" DRIVE



### 3/8" DRIVE DEEP IMPACT SOCKETS, 6 POINT, METRIC

Black Industrial Finish

Product Code	Size (MM)	A OAL (Inches)	B Drive End Diameter (Inches)	C Working End Diameter (Inches)	D Broach Depth (Inches)	E Bolt Clearance Depth (Inches)	Bolt Clearance Diameter (Inches)	F Nose Length (Inches)
12M-607	7	2 1/8	1 1/16	7/16	9/32	1 11/16	1/4	1 5/8
12M-608	8	2 1/8	1 1/16	1/2	1/4	1 11/16	9/32	1 5/8
12M-609	9	2 1/8	1 1/16	9/16	9/32	1 11/16	1 1/32	1 5/8
12M-610	10	2 1/8	1 1/16	5/8	9/32	1 11/16	1 1/32	1 5/8
12M-611	11	2 1/8	1 1/16	21/32	21/64	1 11/16	1 1/32	1 5/8
12M-612	12	2 1/8	23/32	23/32	3/8	1 23/32	7/16	-
12M-613	13	2 1/8	25/32	25/32	7/16	1 3/8	15/32	-
12M-614	14	2 3/8	13/16	13/16	13/32	1 9/16	1/2	-
12M-615	15	2 3/8	27/32	27/32	13/32	1 9/16	9/16	-
12M-616	16	2 3/8	29/32	29/32	13/32	1 9/16	19/32	-
12M-617	17	2 5/8	31/32	31/32	7/16	1 3/4	5/8	-
12M-618	18	2 5/8	1	1	7/16	1 3/4	1 1/16	-
12M-619	19	2 5/8	1 1/16	1 1/16	9/16	1 3/4	29/32	-
12M-620	20	2 5/8	1 1/8	1 1/8	15/32	1 3/4	3/4	-
12M-621	21	2 5/8	1 5/32	1 5/32	1/2	1 3/4	25/32	-
12M-622	22	2 7/8	1 9/16	1 9/16	1/2	1 31/32	27/32	-
12M-623	23	2 7/8	1 1/4	1 1/4	17/32	1 31/32	7/8	-
12M-624	24	2 7/8	1 5/16	1 5/16	19/32	1 31/32	29/32	-



12M-614

12M-607

### MS-12-13H 13 Piece 3/8" Drive Deep 6 Point Impact Socket Set on Clip Rail

Contents Include:

Product Code	Size (MM)	Product Code	Size (MM)	Product Code	Size (MM)
12M-607	7	12M-612	12	12M-617	17
12M-608	8	12M-613	13	12M-618	18
12M-609	9	12M-614	14	12M-619	19
12M-610	10	12M-615	15		
12M-611	11	12M-616	16		

### MS-12-18H 18 Piece 3/8" Drive Deep 6 Point Impact Socket Set on Clip Rail

Contents Include:

Product Code	Size (MM)	Product Code	Size (MM)	Product Code	Size (MM)
12M-607	7	12M-613	13	12M-619	19
12M-608	8	12M-614	14	12M-620	20
12M-609	9	12M-615	15	12M-621	21
12M-610	10	12M-616	16	12M-622	22
12M-611	11	12M-617	17	12M-623	23
12M-612	12	12M-618	18	12M-624	24

### Features

- SUPERTORQUE® lobular openings for greater turning power without deforming the fastener.
- Designed for maximum engagement on 6 point fasteners.
- Suitable for use with pneumatic and electric impact wrenches.
- Specially heat treated for impact use to provide long life, safety, and durability.



MS-12-13H



MS-12-18H



# SOCKETS & DRIVE TOOLS

## 3/8" DRIVE



### 3/8" DRIVE DEEP IMPACT SOCKETS, 6 POINT, METRIC

Black Industrial Finish



36714 36707

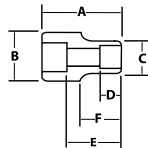

Product Code	Size (MM)	A		B		C		D		E		F	
		OAL (Inches)	Drive End Diameter (Inches)	Working End Diameter (Inches)	Broach Depth (Inches)	Bolt Clearance Depth (Inches)	Bolt Clearance Diameter (Inches)	Nose Length (Inches)					
36707	7	2 1/2	3/4	7/16	15/32	1 23/32	7/16	7/16					
36708	8	2 1/2	3/4	1/2	9/16	1 23/32	7/16	7/16					
36709	9	2 1/2	3/4	1/2	19/32	1 23/32	5/16	7/16					
36710	10	2 1/2	3/4	3/8	1	1 23/32	3/8	7/16					
36711	11	2 1/2	3/4	21/32	1 1/16	1 23/32	19/32	7/16					
36712	12	2 1/2	3/4	23/32	1	1 23/32	7/16	7/16					
36713	13	2 1/2	7/8	29/32	1 3/16	2	1/2	7/16					
36714	14	2 1/2	7/8	19/16	1 1/2	2	19/32	-					
36715	15	2 1/2	7/8	7/8	1 1/16	2	9/16	-					
36716	16	2 1/2	15/16	19/16	1 1/2	2	19/32	-					
36717	17	2 1/2	15/16	15/16	1 1/2	2	19/32	-					
36718	18	2 1/2	1	1	1	2	19/16	-					
36719	19	2 1/2	1 1/16	1 1/16	1	2	23/32	-					

### 36908 10 Piece 3/8" Drive Deep 6 Point Impact Socket Set on Clip Rail

Contents Include:

Product Code	Size (MM)	Product Code	Size (MM)	Product Code	Size (MM)
36710	10	36714	14	36718	18
36711	11	36715	15	36719	19
36712	12	36716	16		
36713	13	36717	17		

#### Features

- SUPERTORQUE® lobular openings for greater turning power without deforming the fastener.
- Designed for maximum engagement on 6 point fasteners.
- Suitable for use with pneumatic and electric impact wrenches.
- Specially heat treated for impact use to provide long life, safety, and durability.
- Drive end features pin retention hole and groove.



### 3/8" DRIVE DEEP IMPACT SOCKETS, 12 POINT, MM

Black Industrial Finish



35412 35407

Product Code	Size (mm)	A		B		C		D		E		F	
		Overall Length (Inches)	Drive End Diameter (Inches)	Working End Diameter (Inches)	Broach Depth (Inches)	Bolt Clearance Depth (Inches)	Bolt Clearance Diameter (Inches)	Nose Length (Inches)					
35407	7	2 1/2	3/4	1/2	1/2	/	1/4	1 1/4					
35408	8	2 1/2	3/4	1/2	1/2	/	1/4	1 1/4					
35409	9	2 1/2	3/4	1/2	1/2	/	1/4	1 1/4					
35410	10	2 1/2	3/4	1/2	3/4	/	3/8	1 1/4					
35411	11	2 1/2	3/4	1/2	3/4	/	3/8	1 1/4					
35412	12	2 1/2	3/4	3/4	3/4	/	3/8	/					
35413	13	2 1/2	3/4	3/4	7/8	/	1/2	/					
35414	14	2 1/2	3/4	3/4	7/8	/	1/2	/					
35415	15	2 1/2	7/8	7/8	1	/	1/2	/					
35416	16	2 1/2	7/8	7/8	1	/	1/2	/					
35417	17	2 1/2	7/8	7/8	1	/	1/2	/					
35418	18	2 1/2	7/8	7/8	1	/	3/8	/					
35419	19	2 1/2	1	1	1	/	3/8	/					

### 36924 13 Piece 3/8" Drive Deep 12 point Impact Socket Set on Clip and Rail

Contents Include:

Product Code	Size (MM)	Product Code	Size (MM)	Product Code	Size (MM)
35407	7	35411	11	35415	15
35408	8	35412	12	35416	16
35409	9	35413	13	35417	17
35410	10	35414	14	35418	18
				35419	19

#### Features

- SUPERTORQUE® lobular openings for greater turning power without deforming the fastener.
- Designed for maximum engagement on 6 or 12 point fasteners.
- Suitable for use with pneumatic and electric impact wrenches.
- Specially heat treated for impact use to provide long life, safety, and durability.
- Drive end features pin retention hole and groove.



36924

# SOCKETS & DRIVE TOOLS

## 1/2" DRIVE



### 57 PIECE 1/2" DRIVE SOCKET AND DRIVE TOOL SET

#### 8 & 12 Point SAE, with Metal Box

Product Code	Description
WSS-57TB	57 Piece Tool Set with TB-6124A Metal Tool Box
WSS-57F	57 Piece Tool Set Only

#### Contents Include:

Drive Tools:		Drive Tools:	
Product Code	Description	Product Code	Description
S-15A	18" Speeder Handle	S-70	Ratchet Spinner Disk
S-20A	12" Sliding T-Handle	S-102P	2" Extension
S-40AA	10 13/16" Flex Handle	S-110P	5" Extension
S-41AA	15 1/2" Flex Handle	S-115P	10" Extension
S-52EHA	10 3/8" Enclosed Head Ratchet	S-140A	Universal Joint
S-52EHLA	15" Enclosed Head Ratchet		

#### Shallow 12-Point Sockets

Product Code	Size (Inches)
ST-1212	3/8
ST-1214	7/16
ST-1216	1/2
ST-1218	9/16
ST-1220	5/8
ST-1222	11/16
ST-1224	3/4
ST-1226	13/16
ST-1228	7/8
ST-1230	15/16
ST-1232	1
ST-1234	1 1/16
ST-1236	1 1/8
ST-1238	1 3/16
ST-1240	1 1/4
ST-1242	1 9/16
ST-1244	1 3/8
ST-1246	1 7/16
ST-1248	1 1/2

#### Standard Hex Bit Sockets

Product Code	Size (Inches)
SA-8A	1/4
SA-10A	5/16
SA-12A	3/8
SA-16A	1/2
SA-18A	9/16
SA-20A	5/8

#### Deep 12-Point Sockets

Product Code	Size (Inches)
SD-1216	1/2
SD-1218	9/16
SD-1220	5/8
SD-1222	11/16
SD-1224	3/4
SD-1226	13/16
SD-1228	7/8
SD-1230	15/16
SD-1232	1
SD-1234	1 1/16
SD-1236	1 1/8

#### Shallow 8-Point Sockets

Product Code	Size (Inches)
ST-812	3/8
ST-814	7/16
ST-816	1/2
ST-818	9/16
ST-820	5/8
ST-822	11/16
ST-824	3/4
ST-826	13/16
ST-828	7/8
ST-832	1



WSS-57TB



TB-6124A

#### Features

- All tools are professional quality, made of high-grade chrome vanadium steel.
- Sockets feature SUPERTORQUE® lobular openings for greater turning power without deforming the fastener.
- Metal tool box made for years of rugged use.



# SOCKETS & DRIVE TOOLS

## 1/2" DRIVE



### 38 PIECE 1/2" DRIVE SOCKET AND DRIVE TOOL SET

#### 12 Point SAE, with Metal Box

Product Code	Description
WSS-38FTB	38 Piece Tool Set with TB-104 Metal Tool Box
WSS-38F	38 Piece Tool Set Only - Packed in Keep Safe Foam System

#### Contents Include:

Drive Tools:		Drive Tools:	
Product Code	Description	Product Code	Description
S-15A	18" Speeder Handle	S-140A	Universal Joint
S-41AA	15 1/2" Flex Handle	S-102P	2" Extension
S-52EHA	10 3/8" Enclosed Head Ratchet	S-110P	5" Extension
S-70	Ratchet Spinner Disk	S-115P	10" Extension

#### Shallow 12-Point Sockets

Product Code	Size (Inches)
ST-1212	3/8
ST-1214	7/16
ST-1216	1/2
ST-1218	9/16
ST-1220	5/8
ST-1222	11/16
ST-1224	3/4
ST-1226	13/16
ST-1228	7/8
ST-1230	15/16
ST-1232	1
ST-1234	1 1/16
ST-1236	1 1/8
ST-1238	1 3/16
ST-1240	1 1/4
ST-1242	1 5/16

#### Shallow 12-Point Sockets

Product Code	Size (Inches)
ST-1244	1 3/8
ST-1246	1 7/16
ST-1248	1 1/2

#### Deep 12-Point Sockets

Product Code	Size (Inches)
SD-1216	1/2
SD-1218	9/16
SD-1220	5/8
SD-1222	11/16
SD-1224	3/4
SD-1226	13/16
SD-1228	7/8
SD-1230	15/16
SD-1232	1
SD-1234	1 1/16
SD-1236	1 1/8

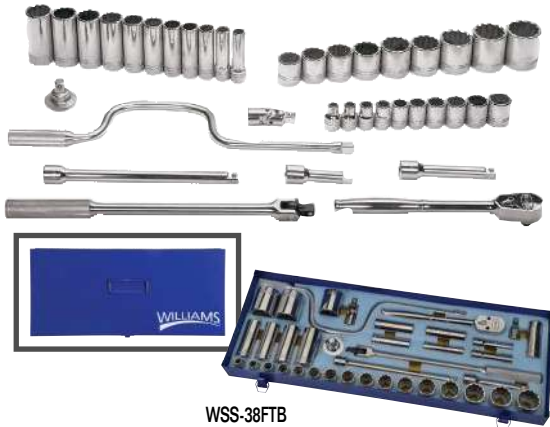

WSS-38FTB

#### Features

- All tools are professional quality, made of high-grade chrome vanadium steel.
- Sockets feature SUPERTORQUE® lobular openings for greater turning power without deforming the fastener.
- Metal tool box made for years of rugged use.



### 30 PIECE 1/2" DRIVE SOCKET AND DRIVE TOOL SET

#### 12 Point SAE, with Metal Box

Product Code	Description
WSS-30FTB	30 Piece Tool Set with TB-104 Metal Tool Box
WSS-30F	30 Piece Tool Set Only - Packed in Keep Safe Foam System

#### Contents Include:

Drive Tools:		Drive Tools:	
Product Code	Description	Product Code	Description
S-41AA	15 1/2" Flex Handle	S-110P	5" Extension
S-52EHA	10 3/8" Enclosed Head Ratchet	S-115P	10" Extension
S-140A	Universal Joint		

#### Shallow 12-Point Sockets

Product Code	Size (Inches)
ST-1212	3/8
ST-1214	7/16
ST-1216	1/2
ST-1218	9/16
ST-1220	5/8
ST-1222	11/16
ST-1224	3/4
ST-1226	13/16
ST-1228	7/8
ST-1230	15/16
ST-1232	1
ST-1234	1 1/16
ST-1236	1 1/8
ST-1240	1 1/4

#### Deep 12-Point Sockets

Product Code	Size (Inches)
SD-1216	1/2
SD-1218	9/16
SD-1220	5/8
SD-1222	11/16
SD-1224	3/4
SD-1226	13/16
SD-1228	7/8
SD-1230	15/16
SD-1232	1
SD-1234	1 1/16
SD-1236	1 1/8



WSS-30FTB

#### Features

- Keep-Safe-Foam system keeps tools organized and helps prevent loss
- All tools are professional quality, made of high-grade chrome vanadium steel
- Sockets feature SUPERTORQUE® lobular openings for greater turning power without deforming the fastener
- Metal tool box made for years of rugged use.

# SOCKETS & DRIVE TOOLS

## 1/2" DRIVE



### 22 PIECE 1/2" DRIVE SOCKET AND DRIVE TOOL SET

**12 Point SAE, Packed in Exclusive Keep-Safe-Foam System with Metal Box**

Product Code	Description
WSS-22FTB	22 Piece Tool Set with TB-104 Metal Tool Box
WSS-22F	22 Piece Tool Set Only - Packed in Keep Safe Foam System

**Contents Include:**

Drive Tools:		Drive Tools:	
Product Code	Description	Product Code	Description
S-15A	18" Speeder Handle	S-102P	2" Extension
S-41AA	15 1/2" Flex Handle	S-110P	5" Extension
S-52EHA	10 3/8" Enclosed Head Ratchet	S-115P	10" Extension
S-140A	Universal Joint		

**Shallow 12-Point Sockets**

Product Code	Size (Inches)	Product Code	Size (Inches)
ST-1212	3/8	ST-1228	7/8
ST-1214	7/16	ST-1230	15/16
ST-1216	1/2	ST-1232	1
ST-1218	9/16	ST-1234	1 1/16
ST-1220	5/8	ST-1236	1 1/8
ST-1222	11/16	ST-1238	1 3/16
ST-1224	3/4	ST-1240	1 1/4
ST-1226	13/16		

**Features**

- Keep-Safe-Foam system keeps tools organized and helps prevent loss.
- All tools are professional quality, made of high-grade chrome vanadium steel.
- Sockets feature SUPERTORQUE® lobular openings for greater turning power without deforming the fastener.
- Metal tool box made for years of rugged use.



### 19 PIECE 1/2" DRIVE SOCKET AND DRIVE TOOL SET

**12 Point SAE, Packed in Exclusive Keep-Safe-Foam System with Metal Box**

Product Code	Description
WSS-19FTB	19 Piece Tool Set with TB-103 Metal Tool Box
WSS-19F	19 Piece Tool Set Only - Packed in Keep Safe Foam System

**Contents Include:**

Drive Tools:		Drive Tools:	
Product Code	Description	Product Code	Description
S-41AA	15 1/2" Flex Handle	S-110P	5" Extension
S-52EHA	10 3/8" Enclosed Head Ratchet	S-140A	Universal Joint

**Shallow 12-Point Sockets**

Product Code	Size (Inches)	Product Code	Size (Inches)
ST-1212	3/8	ST-1228	7/8
ST-1214	7/16	ST-1230	15/16
ST-1216	1/2	ST-1232	1
ST-1218	9/16	ST-1234	1 1/16
ST-1220	5/8	ST-1236	1 1/8
ST-1222	11/16	ST-1238	1 3/16
ST-1224	3/4	ST-1240	1 1/4
ST-1226	13/16		

**Features**

- Keep-Safe-Foam system keeps tools organized and helps prevent loss.
- All tools are professional quality, made of high-grade chrome vanadium steel.
- Sockets feature SUPERTORQUE® lobular openings for greater turning power without deforming the fastener.
- Metal tool box made for years of rugged use.





# SOCKETS & DRIVE TOOLS

## 1/2" DRIVE



WSS-18HFTB



### 18 PIECE 1/2" DRIVE SOCKET AND DRIVE TOOL SET

**6 Point SAE, Packed in Exclusive Keep-Safe-Foam System with Metal Box**

Product Code	Description
WSS-18HFTB	18 Piece Tool Set with TB-103 Metal Tool Box
WSS-18HF	18 Piece Tool Set Only - Packed in Keep Safe Foam System

#### Contents Include:

Drive Tools:		Drive Tools:	
Product Code	Description	Product Code	Description
S-41AA	15 1/2" Flex Handle	S-110P	5" Extension
S-52EHA	10 3/8" Enclosed Head Ratchet	S-140A	Universal Joint

Shallow 6-Point Sockets		Shallow 6-Point Sockets	
Product Code	Size (Inches)	Product Code	Size (Inches)
ST-612	3/8	ST-626	13/16
ST-614	7/16	ST-628	7/8
ST-616	1/2	ST-630	15/16
ST-618	9/16	ST-632	1
ST-620	5/8	ST-634	1 1/16
ST-622	11/16	ST-636	1 1/8
ST-624	3/4	ST-640	1 1/4

#### Features

- Keep-Safe-Foam system keeps tools organized and helps prevent loss.
- All tools are professional quality, made of high-grade chrome vanadium steel.
- Sockets feature SUPERTORQUE® lobular openings for greater turning power without deforming the fastener.
- Metal tool box made for years of rugged use.



WSS-15FTB



### 15 PIECE 1/2" DRIVE SOCKET AND DRIVE TOOL SET

**12 Point SAE, Packed in Exclusive Keep-Safe-Foam System with Metal Box**

Product Code	Description
WSS-15FTB	15 Piece Tool Set with TB-103 Metal Tool Box
WSS-15F	15 Piece Tool Set Only - Packed in Keep Safe Foam System

#### Contents Include:

Drive Tools:		Shallow 12-Point Sockets	
Product Code	Description	Product Code	Size (Inches)
S-41AA	15 1/2" Flex Handle	ST-1214	7/16
S-52EHA	10 3/8" Enclosed Head Ratchet	ST-1216	1/2
S-110P	5" Extension	ST-1218	9/16
S-115P	10" Extension	ST-1220	5/8
S-140A	Universal Joint	ST-1222	11/16
		ST-1224	3/4
		ST-1226	13/16
		ST-1228	7/8
		ST-1230	15/16
		ST-1232	1

#### Features

- Keep-Safe-Foam system keeps tools organized and helps prevent loss.
- All tools are professional quality, made of high-grade chrome vanadium steel.
- Sockets feature SUPERTORQUE® lobular openings for greater turning power without deforming the fastener.
- Metal tool box made for years of rugged use.

# SOCKETS & DRIVE TOOLS

## 1/2" DRIVE

WILLIAMS



### 47 PIECE 1/2" DRIVE SOCKET AND DRIVE TOOL SET

#### 12 Point Metric, with Metal Box

Product Code	Description
MSS-47TB	47 Piece Tool Set with TB-6124A Metal Tool Box (Keep Safe Foam Not Included)
MSS-47F	47 Piece Tool Set Only - Packed in Keep Safe Foam System

#### Contents Include:

Drive Tools:		Shallow 12-Point Sockets	
Product Code	Description	Product Code	Size (MM)
S-15A	18" Speeder Handle	STM-1210	10
S-20A	12" Sliding T-Handle	STM-1211	11
S-40AA	10 19/16" Flex Handle	STM-1212	12
S-41AA	15 1/2" Flex Handle	STM-1213	13
S-52EHA	10 3/8" Enclosed Head Ratchet	STM-1214	14
S-60D	Stud Remover	STM-1215	15
S-70	Ratchet Spinner Disk	STM-1216	16
S-102P	2" Extension	STM-1217	17
S-110P	5" Extension	STM-1218	18
S-115P	10" Extension	STM-1219	19
S-140A	Universal Joint	STM-1220	20
		STM-1221	21
		STM-1222	22
		STM-1223	23
		STM-1224	24
		STM-1225	25
		STM-1226	26
		STM-1227	27
		STM-1228	28
		STM-1229	29
		STM-1230	30
		STM-1232	32
		STM-1234	34
		STM-1236	36

Deep 12-Point Sockets	
Product Code	Size (MM)
SMD-1213	13
SMD-1214	14
SMD-1215	15
SMD-1216	16
SMD-1217	17
SMD-1218	18
SMD-1219	19
SMD-1221	21
SMD-1222	22
SMD-1224	24
SMD-1227	27
SMD-1230	30



MSS-47TB

#### Features

- All tools are professional quality, made of high-grade chrome vanadium steel
- Sockets feature SUPERTORQUE® lobular openings for greater turning power without deforming the fastener.
- Metal tool box made for years of rugged use.

WILLIAMS



### 33 PIECE 1/2" DRIVE SOCKET AND DRIVE TOOL SET

#### 12 Point Metric, with Metal Box

Product Code	Description
MSS-33FTB	33 Piece Tool Set with TB-104 Metal Tool Box
MSS-33F	33 Piece Tool Set Only - Packed in Keep Safe Foam System

#### Contents Include:

Drive Tools:		Shallow 12-Point Sockets	
Product Code	Description	Product Code	Size (MM)
S-41AA	15 1/2" Flex Handle	STM-1210	10
S-52EHA	10 3/8" Enclosed Head Ratchet	STM-1211	11
S-102P	2" Extension	STM-1212	12
S-110P	5" Extension	STM-1213	13
S-115P	10" Extension	STM-1214	14
S-140A	Universal Joint	STM-1215	15
		STM-1216	16
		STM-1217	17
		STM-1218	18
		STM-1219	19
		STM-1220	20
		STM-1221	21
		STM-1222	22
		STM-1223	23
		STM-1224	24

Deep 12-Point Sockets	
Product Code	Size (MM)
SMD-1213	13
SMD-1214	14
SMD-1215	15
SMD-1216	16
SMD-1217	17
SMD-1218	18
SMD-1219	19
SMD-1221	21
SMD-1222	22
SMD-1224	24
SMD-1227	27
SMD-1230	30



MSS-33FTB

#### Features

- All tools are professional quality, made of high-grade chrome vanadium steel.
- Sockets feature SUPERTORQUE® lobular openings for greater turning power without deforming the fastener.
- Metal tool box made for years of rugged use.



**WARNING**

# SOCKETS & DRIVE TOOLS

## 1/2" DRIVE



### 29 PIECE 1/2" DRIVE SOCKET AND DRIVE TOOL SET

**12 Point Metric, Packed in Exclusive Keep-Safe-Foam System with Metal Box**

Product Code	Description
MSS-29FTB	29 Piece Tool Set with TB-104 Metal Tool Box
MSS-29F	29 Piece Tool Set Only - Packed in Keep Safe Foam System

**Contents Include:**

Drive Tools:		Drive Tools:	
Product Code	Description	Product Code	Description
S-41AA	15 1/2" Flex Handle	S-110P	5" Extension
S-52EHA	10 3/8" Enclosed Head Ratchet	S-115P	10" Extension
S-102P	2" Extension	S-140A	Universal Joint

Shallow 12-Point Sockets		Shallow 12-Point Sockets	
Product Code	Size (MM)	Product Code	Size (MM)
STM-1210	10	STM-1222	22
STM-1211	11	STM-1223	23
STM-1212	12	STM-1224	24
STM-1213	13	STM-1225	25
STM-1214	14	STM-1226	26
STM-1215	15	STM-1227	27
STM-1216	16	STM-1228	28
STM-1217	17	STM-1229	29
STM-1218	18	STM-1230	30
STM-1219	19	STM-1232	32
STM-1220	20	STM-1234	34
STM-1221	21		

**Features**

- Keep-Safe-Foam system keeps tools organized and helps prevent loss.
- All tools are professional quality, made of high-grade chrome vanadium steel.
- Sockets feature SUPERTORQUE® lobular openings for greater turning power without deforming the fastener
- Metal tool box made for years of rugged use.



### 22 PIECE 1/2" DRIVE SOCKET AND DRIVE TOOL SET

**12 Point Metric, Packed in Exclusive Keep-Safe-Foam System with Metal Box**

Product Code	Description
MSS-22FTB	22 Piece Tool Set with TB-104 Metal Tool Box
MSS-22F	22 Piece Tool Set Only - Packed in Keep Safe Foam System

**Contents Include:**

Drive Tools:		Drive Tools:	
Product Code	Description	Product Code	Description
S-41AA	15 1/2" Flex Handle	S-115P	10" Extension
S-52EHA	10 3/8" Enclosed Head Ratchet	S-140A	Universal Joint
S-110P	5" Extension		

Shallow 6-Point Sockets		Shallow 12-Point Sockets	
Product Code	Size (MM)	Product Code	Size (MM)
STM-1210	10	STM-1219	19
STM-1211	11	STM-1220	20
STM-1212	12	STM-1221	21
STM-1213	13	STM-1222	22
STM-1214	14	STM-1223	23
STM-1215	15	STM-1224	24
STM-1216	16	STM-1225	25
STM-1217	17	STM-1226	26
STM-1218	18		

**Features**

- Keep-Safe-Foam system keeps tools organized and helps prevent loss.
- All tools are professional quality, made of high-grade chrome vanadium steel.
- Sockets feature SUPERTORQUE® lobular openings for greater turning power without deforming the fastener.
- Metal tool box made for years of rugged use.



# SOCKETS & DRIVE TOOLS

## MULTI DRIVE SOCKET & DRIVE TOOL SETS



### 146 PIECE 1/4", 3/8", 1/2" DRIVE SOCKET SET

#### 6 & 12 Point Rugged-Case-System Tool Set, SAE and Metric

Product Code	Description
50614	146 Piece 1/4", 3/8", 1/2" Drive Socket Set

#### Contents Include:

##### 1/4" Drive Tools:

Product Code	Description
33001	Ratchet
33003	3" Extension
33006	Handle
30007	Universal Joint
30009	Adaptor 1/4" F x 3/8" M

##### 1/4" Drive Deep 6 Point Sockets, MM

Product Code	Size (MM)
30704	4
30705	5
30706	6
30707	7
30708	8
30709	9
30710	10
30711	11
30712	12
30713	13

##### 1/4" Drive Deep 6 Point Sockets, SAE

Product Code	Size (Inches)
30306	3/16
30307	7/32
30308	1/4
30309	9/32
30310	5/16
30311	11/32
30312	3/8
30314	7/16
30316	1/2

##### 1/4" Drive Shallow 6 Point Sockets, MM

Product Code	Size (MM)
30504	4
30505	5
30599	5.5
30506	6
30507	7
30508	8
30509	9
30510	10
30511	11
30512	12
30513	13
30514	14

##### 1/4" Drive Shallow 6 Point Sockets, SAE

Product Code	Size (Inches)
30105	5/32
30106	3/16
30107	7/32
30108	1/4
30109	9/32
30110	5/16
30111	11/32
30112	3/8
30114	7/16
30116	1/2
30118	9/16

##### 1/4" Drive Hex Bit Sockets, SAE

Product Code	Size (Inches)
35000	1/8
35001	5/32
35002	3/16
35003	7/32
35004	1/4
35005	5/16

##### 1/4" Drive Hex Bit Sockets, SAE

Product Code	Size (MM)
35070	3
35071	4
35072	5
35073	6
35074	7
35075	8

##### 1/4" Drive Screwdriver Bit Sockets

Product Code	Description
35040	5/32" Slotted Tip
35041	7/32" Slotted Tip
35042	9/32" Slotted Tip
35050	#0 Phillips Tip
35051	#1 Phillips Tip
35052	#2 Phillips Tip

##### 1/4" Drive Torx Bit Sockets

Product Code	Size
35080	T10
35081	T15
35082	T20
35083	T25
35084	T27
35085	T30

##### 3/8" Drive Tools

Product Code	Description
31001	Ratchet
31002	3" Extension
31003	6" Extension

##### 3/8" Drive Deep 12 Point Sockets, MM

Product Code	Size (MM)
31806	6
31807	7
31808	8
31809	9
31810	10
31811	11
31812	12
31813	13
31814	14
31815	15
31816	16
31817	17
31818	18
31819	19

##### 3/8" Drive Deep 12 Point Sockets, SAE

Product Code	Size (Inches)
31408	1/4
31410	5/16
31412	3/8
31414	7/16
31416	1/2
31418	9/16
31420	5/8
31422	11/16
31424	3/4
31426	13/16
31428	7/8
31430	15/16
31432	1

##### 3/8" Drive Shallow 6 Point Sockets, MM

Product Code	Size (MM)
31506	6
31507	7
31508	8
31509	9
31510	10
31511	11
31512	12
31513	13
31514	14
31515	15
31516	16
31517	17
31518	18
31519	19

##### 3/8" Drive Shallow 6 Point Sockets, SAE

Product Code	Size (Inches)
31108	1/4
31110	5/16
31112	3/8
31114	7/16
31116	1/2
31118	9/16
31120	5/8
31122	11/16
31124	3/4
31126	13/16
31128	7/8
31130	15/16
31132	1

##### 3/8" Drive Spark Plug Socket

Product Code	Size (Inches)
31301	3/8
31303	13/16

##### 1/2" Drive Tools

Product Code	Description
32001	Ratchet
32003	6" Extension
32004	10" Extension
32006	Universal Joint
32008	Adaptor - 1/2" F x 3/8" M

##### 1/2" Drive Shallow 12 Point Sockets, SAE

Product Code	Size (Inches)
32412	3/8
32414	7/16
32416	1/2
32418	9/16
32420	5/8
32422	11/16
32424	3/4
32426	13/16
32428	7/8
32430	15/16
32432	1



50614

#### Features

- All tools are professional quality, made of high-grade chrome vanadium steel.
- Sockets feature SUPERTORQUE® lobular openings for greater turning power without deforming the fastener.
- Packed in rugged high-density polyethylene (HDPE) cases that are strong and durable yet light in weight.
- Case is shock proof at both high and low temperatures, equipped with heavy-duty metal latches and hinges.
- Two-component handles are easy to grip and comfortable to carry.



# SOCKETS & DRIVE TOOLS

## 1/4", 3/8" & 1/2" DRIVE TOOL SET



### 138 PIECE 1/4", 3/8", 1/2" DRIVE SOCKET SET

#### 6 Point Rugged-Case-System Tool Set, SAE and Metric

Product Code	Description
50612	138 Piece 1/4", 3/8", 1/2" Drive Socket Set

#### Contents Include:

1/4" Drive Tools:		3/8" Drive Tools		1/2" Drive Tools	
Product Code	Description	Product Code	Description	Product Code	Description
33001	Ratchet	31001	Ratchet	32001	Ratchet
33002	4" Extension	31002	3" Extension	32002	6" Extension
33003	8" Extension	31003	6" Extension	32004	10" Extension
33006	18" Sliding T-handle	31006	Universal Joint	32006	Universal Joint
30007	Universal Joint	31008	Adaptor	32008	Adaptor
30013	Hex Bit Holder	31013	Hex Bit Holder		
24880	13 Piece Insert Bit Set				

1/4" Drive Deep 6 Point Sockets, MM		3/8" Drive Deep 6 Point Sockets, MM		1/2" Drive Shallow 6 Point Sockets, MM	
Product Code	Size (MM)	Product Code	Size (MM)	Product Code	Size (MM)
30704	4	31710	10	32510	10
30705	5	31711	11	32511	11
30706	6	31712	12	32512	12
30707	7	31713	13	32513	13
30708	8	31714	14	32514	14
30709	9	31715	15	32515	15
30710	10	31716	16	32516	16
30711	11	31717	17	32517	17
30712	12	31718	18	32518	18
30713	13	31719	19	32519	19
				32521	21
				32522	22
				32524	24
				32527	27
				32530	30
				32532	32

1/4" Drive Deep 6 Point Sockets, SAE		3/8" Drive Deep 6 Point Sockets, SAE		1/2" Drive Shallow 6 Point Sockets, SAE	
Product Code	Size (Inches)	Product Code	Size (Inches)	Product Code	Size (Inches)
30305	5/32	31312	3/8	32112	3/8
30306	3/16	31314	7/16	32114	7/16
30307	7/32	31316	1/2	32116	1/2
30308	1/4	31318	9/16	32118	9/16
30309	9/32	31320	5/8	32120	5/8
30310	5/16	31322	11/16	32122	11/16
30311	11/32	31324	3/4	32124	3/4
30312	3/8	31326	13/16	32126	13/16
30314	7/16	31328	7/8	32128	7/8
30316	1/2			32130	15/16

1/4" Drive Shallow 6 Point Sockets, MM		3/8" Drive Shallow 6 Point Sockets, MM		1/2" Drive Shallow 6 Point Sockets, SAE	
Product Code	Size (MM)	Product Code	Size (MM)	Product Code	Size (Inches)
30504	4	31510	10	31112	3/8
30505	5	31511	11	31114	7/16
30509	5.5	31512	12	31116	1/2
30506	6	31513	13	31118	9/16
30507	7	31514	14	31120	5/8
30508	8	31515	15	31122	11/16
30509	9	31516	16	31124	3/4
30510	10	31517	17		
30511	11	31518	18		
30512	12	31519	19		
30513	13				

1/4" Drive Shallow 6 Point Sockets, SAE	
Product Code	Size (Inches)
30105	5/32
30106	3/16
30107	7/32
30108	1/4
30109	9/32
30110	5/16
30111	11/32
30112	3/8
30114	7/16
30116	1/2



50612

#### Features

- All tools are professional quality, made of high-grade chrome vanadium steel.
- Sockets feature SUPERTORQUE® lobular openings for greater turning power without deforming the fastener.
- Packed in rugged high-density polyethylene (HDPE) cases that are strong and durable yet light in weight.
- Case is shock proof at both high and low temperatures, equipped with heavy-duty metal latches and hinges.
- Two-component handles are easy to grip and comfortable to carry.

# SOCKETS & DRIVE TOOLS

## 1/2" DRIVE TOOL SET



### 61 PIECE 1/2" DRIVE SOCKET & TOOL SET

#### 6 Point Rugged-Case-System Tool Set, SAE and Metric

Product Code	Description
50617	61 Piece Socket, Wrench, and Screwdriver Set

#### Contents Include:

1/2" Drive Tools		1/2" Drive Shallow 6 Point Sockets, MM	
Product Code	Description	Product Code	Size (MM)
32001	Ratchet	32510	10
32002	3" Extension	32511	11
32003	6" Extension	32512	12
32004	10" Extension	32513	13
32005	15-1/2" Flex Handle	32514	14
32006	Universal Joint	32515	15
32008	Adaptor	32516	16
32009	Adaptor 1/2 F x 3/4 M	32517	17
		32518	18
		32519	19
		32521	21
		32522	22
		32524	24
		32527	27
		32530	30
		32532	32

1/2" Drive Shallow 6 Point Sockets, SAE		12 Point Combination Wrenches, MM	
Product Code	Size (Inches)	Product Code	Size (MM)
32112	3/8	11506	6
32114	7/16	11508	8
32116	1/2	11510	10
32118	9/16	11512	12
32120	5/8	11513	13
32122	1 1/16	11514	14
32124	3/4	11515	15
32126	13/16	11517	17
32128	7/8	11519	19
32130	1 5/16		
32132	1		
32134	1 1/16		
32136	1 1/8		
32138	1 3/16		
32140	1 1/4		

12 Point Combination Wrenches, SAE		Comfort Grip Screwdrivers	
Product Code	Size (Inches)	Product Code	Description
11108	1/4	24205	3/16" x 4" Slotted
11110	5/16	24219	1/4" x 4" Slotted
11112	3/8	24249	# 1 x 3" Phillips
11114	7/16	24253	# 2 x 4" Phillips
11116	1/2		
11118	9/16		
11120	5/8		
11122	1 1/16		
11124	3/4		



50617

#### Features

- All tools are professional quality, made of high-grade chrome vanadium steel.
- Sockets feature SUPERTORQUE® lobular openings for greater turning power without deforming the fastener.
- Packed in rugged high-density polyethylene (HDPE) cases that are strong and durable yet light in weight.
- Case is shock proof at both high and low temperatures, equipped with heavy-duty metal latches and hinges.
- Two-component handles are easy to grip and comfortable to carry.



**WARNING**

# SOCKETS & DRIVE TOOLS

## 1/2" DRIVE TOOL SET



50609

WILLIAMS®



### 23 PIECE 1/2" DRIVE BASIC TOOL SET

#### 12 Point Rugged-Case-System Tool Set, SAE

Product Code	Description
50609	23 Piece Basic Tool Set, SAE
50626	Replacement Case Only for Set 50609

#### Contents Include:

1/2" Drive Tools:		1/2" Drive Shallow 12-Point Sockets	
Product Code	Description	Product Code	Size (Inches)
32001	9 7/8" Quick-Release Ratchet	32212	3/8
32002	3" Extension	32214	7/16
32003	6" Extension	32216	1/2
32004	10" Extension	32218	9/16
32005	15" Flex Handle Breaker Bar	32220	5/8
32006	Universal Joint	32222	11/16
32008	1/2" F X 3/8" M Adapter	32224	3/4
32009	1/2" F X 3/4" M Adapter	32226	13/16
		32228	7/8
		32230	15/16
		32232	1
		32234	1 1/16
		32236	1 1/8
		32238	1 3/16
		32240	1 1/4

#### Features

- All tools are professional quality, made of high-grade chrome vanadium steel.
- Sockets feature SUPERTORQUE® lobular openings for greater turning power without deforming the fastener.
- Packed in rugged high-density polyethylene (HDPE) cases that are strong and durable yet light in weight.
- Case is shock proof at both high and low temperatures, equipped with heavy-duty metal latches and hinges.
- Two-component handles are easy to grip and comfortable to carry.



50619

WILLIAMS®



### 25 PIECE 1/2" DRIVE BASIC TOOL SET

#### 12 Point Rugged-Case-System Tool Set, Metric

Product Code	Description
50619	25 Piece Basic Tool Set, Metric
50637	Replacement Case Only for Set 50619

#### Contents Include:

1/2" Drive Tools:		1/2" Drive Shallow 12-Point Sockets	
Product Code	Description	Product Code	Size (MM)
32001	9 7/8" Quick-Release Ratchet	32610	10
32002	3" Extension	32611	11
32003	6" Extension	32612	12
32004	10" Extension	32613	13
32005	15" Flex Handle Breaker Bar	32614	14
32006	Universal Joint	32615	15
32008	1/2" F X 3/8" M Adapter	32616	16
32009	1/2" F X 3/4" M Adapter	32617	17
		32618	18
		32619	19
		32620	20
		32621	21
		32622	22
		32624	24
		32627	27
		32630	30
		32632	32

#### Features

- All tools are professional quality, made of high-grade chrome vanadium steel.
- Sockets feature SUPERTORQUE® lobular openings for greater turning power without deforming the fastener.
- Packed in rugged high-density polyethylene (HDPE) cases that are strong and durable yet light in weight.
- Case is shock proof at both high and low temperatures, equipped with heavy-duty metal latches and hinges.
- Two-component handles are easy to grip and comfortable to carry.

# SOCKETS & DRIVE TOOLS

## 1/2" DRIVE



### 23 PIECE 1/2" DRIVE SOCKET AND DRIVE TOOL SET

#### 12 Point Compact Case Tool Set, SAE

Product Code	Description
50668	23 Piece 1/2" Drive Socket and Drive Tool Set

#### Contents Include:

1/2" Drive Tools:		1/2" Drive Deep 12 Point Sockets			
Product Code	Description	Product Code	Size (Inches)	Product Code	Size (Inches)
32001	9 7/8" Pear Head Ratchet	32416	1/2	32424	3/4
32005	15 1/2" Flex Handle	32418	9/16	32426	13/16
32003	6" Extension	32420	5/8	32428	7/8
		32422	1 1/16		

1/2" Drive Shallow 12 Point Sockets:					
Product Code	Size (Inches)	Product Code	Size (Inches)	Product Code	Size (Inches)
32114	7/16	32224	3/4	32234	1 1/16
32216	1/2	32226	13/16	32236	1 1/8
32218	9/16	32228	7/8	32240	1 1/4
32220	5/8	32230	15/16		
32222	1 1/16	32232	1		

#### Features

- All tools are professional quality, made of high-grade chrome vanadium steel
- Sockets feature SUPERTORQUE® lobular openings for greater turning power without deforming the fastener
- Packed in rugged compact high-density polyethylene (HDPE) cases that are strong and durable yet light in weight



50668



### 12 PIECE 1/2" DRIVE SOCKET AND DRIVE TOOL SET

#### 12 Point Compact Case Tool Set, SAE

Product Code	Description
50667	12 Piece 1/2" Drive Socket and Drive Tool Set

#### Contents Include:

1/2" Drive Tools:		Description
Product Code		
32001		9 7/8" Pear Head Ratchet
32003		6" Extension

1/2" Drive Shallow 12 Point Sockets:					
Product Code	Size (Inches)	Product Code	Size (Inches)	Product Code	Size (Inches)
32216	1/2	32224	3/4	32232	1
32218	9/16	32226	13/16	32236	1 1/8
32220	5/8	32228	7/8		
32222	1 1/16	32230	15/16		

#### Features

- All tools are professional quality, made of high-grade chrome vanadium steel
- Sockets feature SUPERTORQUE® lobular openings for greater turning power without deforming the fastener
- Packed in rugged compact high-density polyethylene (HDPE) cases that are strong and durable yet light in weight



50667



### 12 PIECE 1/2" DRIVE SOCKET AND DRIVE TOOL SET

#### 12 Point Compact Case Tool Set, MM

Product Code	Description
50669	12 Piece 1/2" Drive Socket and Drive Tool Set

#### Contents Include:

1/2" Drive Tools:		Description
Product Code		
32001		9 7/8" Pear Head Ratchet
32003		6" Extension

1/2" Drive Shallow 12 Point Sockets:					
Product Code	Size (MM)	Product Code	Size (MM)	Product Code	Size (MM)
32612	12	32616	16	32622	22
32613	13	32617	17	32624	24
32614	14	32618	18		
32615	15	32619	19		

#### Features

- All tools are professional quality, made of high-grade chrome vanadium steel
- Sockets feature SUPERTORQUE® lobular openings for greater turning power without deforming the fastener
- Packed in rugged compact high-density polyethylene (HDPE) cases that are strong and durable yet light in weight



50669





# SOCKETS & DRIVE TOOLS

## 1/2" DRIVE



SB-52EHA



S-52EHLA



SB-52EHLA



S-52EHFA



S-52EHA



S-53A



BS-52A



S-52A



### 1/2" DRIVE ENCLOSED HEAD RATCHETS

**Williams® Sealed Narrow Head Design,  
Chrome and Black Industrial Finish**

Product Code	Description	Length (Inches)	Number of Teeth
S-52EHA	Chrome Finish Enclosed Head Ratchet	10 1/4	36
S-52EHLA	Chrome Finish Enclosed Head Ratchet, Long	15	36
SB-52EHLA	Black Industrial Finish Enclosed Head Ratchet, Long	15	36
S-52EHFA	Chrome Finish Flex Head Ratchet	14 1/4	36
SB-52EHA	Black Industrial Finish Enclosed Head Ratchet	10 1/4	36
S-52EHRKA	Repair Kit "EHA" Model Enclosed Head Ratchets		

Fed. Spec: ANSI B107.10M

#### Features

- Enclosed head is sealed to prevent dust, dirt, and liquids from entering head, preserving internal lubrication.
- Forged one-piece ratchet provide strength and safety for industrial applications.
- Smooth comfort-grip handle permits all-day use without gloves.
- 36 tooth gear with 10 degree of engagement allows engagement in tight working areas.
- Nickel/Chrome plating provides increase protection from rust and corrosion.
- Chrome finish models feature mirror-like exterior that can be easily cleaned after each use.
- Single Pawl ratchet design:
  - 1) Designed for tighter tolerances between pawl and gear which reduces metal fatigue and slippage under load.
  - 2) Does not require as many working parts, reducing possible breakage and parts to repair.
- Easy access reverse lever allows user to change working direction quickly and easily with only one hand.



### 1/2" DRIVE ROUND HEAD RATCHETS

**Knurled Handle, Chrome and Black Industrial Finish**

Product Code	Description	Length (Inches)	Number of Teeth
S-52A	Chrome Finish Round Head Ratchet	11 5/16	72
S-53A	Chrome Finish Round Head Ratchet, Long	15	72
BS-52A	Black Industrial Finish Round Head Ratchet	11 5/16	72
S-52ARK	Repair Kit		

Fed. Spec: ANSI B107.10M

#### Features

- Double pawl design with 72 teeth action provides a 5° ratcheting angle.
- Shift lever reverses action instantly.
- Knurled handle provides a non-slip grip.
- Chrome finish models provides increased protection from rust and corrosion.

# SOCKETS & DRIVE TOOLS

## 1/2" DRIVE



### 1/2" DRIVE ROUND HEAD LINEMAN'S RATCHET

#### Knurled Handle, Chrome Finish

Product Code	Description	Length (Inches)	Number of Teeth
S-52LAB	Round Head Lineman's Ratchet	11 5/16	72
S-52LARK	Repair Kit		

Fed. Spec: ANSI B107.10M

#### Features

- Same features as other Williams' round head ratchets.
- Extra-large shift lever allows easy reversal even when wearing gloves.



S-52LAB



### 1/2" DRIVE NARROW HEAD CONSTRUCTION RATCHET

#### Knurled Handle, Black Industrial Finish

Product Code	Description	Length (Inches)	Number of Teeth
BS-71CBA	Narrow Head Construction Ratchet	15 13/16	32
BS-71ARKA	Repair Kit		

Fed. Spec: ANSI B107.10M

#### Features

- 36 tooth gear with 10 degree of engagement allows engagement in tight working areas.
- Extra-large shift lever reverses action instantly and easily, even when wearing gloves.
- Tapered spud handle easily lines up bolt holes.



BS-71CBA



### 1/2" DRIVE SCAFFOLDING RATCHET

Product Code	Description	Product Code	Description
BS-62	Scaffolding Ratchet with out pry bar	BS-63BTIP	Hammer Tip
BS-63B	Scaffolding Ratchet with pry bar	BS-63BBAR	Pry Bar
BS-63BRK	Repair Kit		

#### Features

- 1/2" Drive with pinned 7/8" 6-point socket, 2-1/4" length
- 36 tooth gear with 10 degree of engagement allows engagement in tight working areas
- Bronze hammer head reduces rebound
- Pry bar handle provide alignment option
- Socket feature SUPERTORQUE lobular opening for greater turning power without deforming the fastener
- Easy access reversing lever allows user to change working direction quickly and easily with only one hand
- Tethering device attached to handle



BS-62



BS-63B



# SOCKETS & DRIVE TOOLS

## 1/2" DRIVE



S-40AA



SB-40AA



BS-41AA



S-20A



S-10A



S-15A



S-41AA



### 1/2" DRIVE HANDLES

#### Knurled Handle, Chrome and Black Industrial Finish

Product Code	Description	Length (Inches)
S-40AA	Chrome Flex Handle	10 13/16
SB-40AA	Black Industrial Finish Flex Handle	10 13/16
S-41AA	Chrome Flex Handle	15 1/2
BS-41AA	Black Industrial Finish Flex Handle	15 1/2
S-20A	Sliding T-Handle	12
S-10A	Speeder Handle	13 5/8
S-15A	Speeder Handle	18 1/16
S-41RK	Flex Handle Repair Kit	

Fed. Spec: ANSI B107.10M

#### Features

- Chrome plating provides increased protection from rust and corrosion.
- Drive handles provide extra leverage with greater strength than ratchets.
- Speeder handle is ideal for fast turn down of fasteners.



S-70



S-140A



WSS-3XT



S-110P



### 1/2" DRIVE EXTENSIONS AND ACCESSORIES

#### High-Polished Chrome Finish

Product Code	Description	Length (Inches)
S-102P	Extension	2
S-110P	Extension	5
S-115P	Extension	10
S-121P	Extension	20
S-140A	Universal Joint	2 11/16
S-70	Ratchet Spinner Disk	1 9/16

Fed. Spec: ANSI B107.10M

#### WSS-3XT 3 Piece Extension Set in Pouch

#### Contents Include:

Product Code	Size (Inches)
S-102P	2
S-110P	5
S-115P	10

#### Features

- Chrome plating provides increased protection from rust and corrosion.
- Ball and spring socket retention.
- Spinner disk is ideal for fast turn down of fasteners.

# SOCKETS & DRIVE TOOLS

## 1/2" DRIVE



### 1/2" DRIVE ADAPTORS AND EXTENSION ADAPTERS

#### High-Polished Chrome and Black Oxide Finish

Product Code	Length (Inches)	Male End (Inches)	Female End (Inches)
<b>Chrome Finish Adapter</b>			
SH-130	1 15/16	3/4	1/2
<b>Black Industrial Finish Adapters</b>			
SH-130B	1 15/16	3/4	1/2
SH-131BA	2 5/16	1/2	3/4
<b>Black Industrial Finish Extension Adapters</b>			
BS-05B	5	3/8	1/2
BS-12B	12	3/8	1/2

Fed. Spec: ANSI B107.10M

#### Features

- Ball and spring socket retention.
- Extension adapters offer convenience of extension and adapter in one tool.



BS-05B

BS-12B



SH-130



SH-131BA



SH-130B



### 1/2" DRIVE STUD REMOVER

#### Satin Chrome Finish

Product Code	Description	Length (Inches)	Capacity (Inches)
S-60D	Stud Remover	2 7/16	1/4 to 3/4

Fed. Spec: ANSI B107.10M

#### Features

- Knurled wheel grips studs during removal.
- Drive shank extends through both sides of housing for even bearing surface.
- Capacity is 1/4" to 3/4" stud diameter.



S-60D



### 1/2" DRIVE RATCHETS AND HANDLES

#### High-Polished Chrome Finish

Product Code	Description	Length (Inches)	Repair Kit
32001	40 Tooth Quick-Release Ratchet	9 7/8	32001RK
32011	Ultra-Fine 60-Tooth Ratchet	9 7/8	32011RK
32005	Flex Handle	15	
11920	Flex Handle, Comb. 3/8" x 1/2" Drive	10	
32007	Sliding T-Handle	15	

Fed. Spec: ANSI B107.10M

#### Features

- Ball and spring socket retention.
- Williams 1/2" Drive Ratchets Feature:
- Ultra-fine 60 tooth model offers 6° tooth action in a narrow pear head
- Unique Finger-Fit handles to provide a comfortable, non-slip grip and extra turning power.
- Choice of 38-tooth quick-release or 60-tooth ultra-fine gear.
- Narrow pear-shaped heads for access into confined work areas.
- High-polished chrome finish for easy cleaning.
- Unique combination 3/8" x 1/2" drive flex handle offers convenience of both drive sizes on one handle.



32001



# SOCKETS & DRIVE TOOLS

## 1/2" DRIVE



### 1/2" DRIVE EXTENSIONS AND ACCESSORIES

#### High-Polished Chrome Finish

Product Code	Description	Length (Inches)
32002	Extension	3
32003	Extension	6
32004	Extension	10
32006	Universal Joint	2 1/16
32008	Adaptor, 1/2" F x 3/8" M	1 7/16
32009	Adaptor, 1/2" F x 3/4" M	1 3/4
32023	Locking Extension	3
32024	Locking Extension	6
32025	Locking Extension	10
32026	Locking Extension	12
32027	Locking Extension	18
32028	Locking Extension	24

Fed. Spec: ANSI B107.10M

#### Features

- Chrome plating provides increased protection from rust and corrosion.
- Ball and spring socket retention.



### 6 PIECE 1/2" DRIVE RATCHET AND DRIVE TOOL SET

#### Furnished in Pouch

Product Code	Description
32920	6 Piece 1/2" Drive Ratchet and Accessory Set

#### Contents Include:

Product Code	Description	Product Code	Description
32001	9 7/8" Quick-Release Ratchet	32005	15" Flex Handle Breaker Bar
32002	3" Extension	32006	Universal Joint
32004	10" Extension	32007	15" Sliding T-Handle

#### Features

- All tools are professional quality, made of high-grade chrome vanadium steel.



# SOCKETS & DRIVE TOOLS

## 1/2" DRIVE



### 1/2" DRIVE SHALLOW 12 POINT SOCKETS, SAE

#### High-Polished Chrome Finish

Product Code	Size (Inches)	A	B	C	D	E	F	
		OAL (Inches)	Drive End Diameter (Inches)	Working End Diameter (Inches)	Broach Depth (Inches)	Bolt Clearance Depth (Inches)	Bolt Clearance Diameter (Inches)	Nose Length (Inches)
ST-1212	3/8	1 1/2	29/32	19/32	5/16	7/8	11/32	23/32
ST-1214	7/16	1 1/2	29/32	21/32	3/8	7/8	13/32	23/32
ST-1216	1/2	1 1/2	29/32	3/4	3/8	7/8	15/32	23/32
ST-1218	9/16	1 1/2	29/32	13/16	3/8	7/8	15/32	23/32
ST-1219	19/32	1 1/2	29/32	7/8	3/8	7/8	15/32	23/32
ST-1220	5/8	1 1/2	29/32	29/32	9/16	7/8	15/32	-
ST-1221	21/32	1 1/2	31/32	31/32	19/32	7/8	15/32	-
ST-1222	11/16	1 1/2	31/32	31/32	19/16	27/32	5/8	-
ST-1224	3/4	1 1/2	1 1/32	1 1/32	13/16	27/32	23/32	-
ST-1225	29/32	1 1/2	1 1/16	1 1/16	19/16	27/32	3/4	-
ST-1226	13/16	1 1/2	1 1/8	1 1/8	19/16	27/32	25/32	-
ST-1228	7/8	1 1/2	1 3/16	1 3/16	19/16	13/16	7/8	-
ST-1230	19/16	1 17/32	1 9/32	1 9/32	19/16	27/32	29/32	-
ST-1231	31/32	1 9/16	1 5/16	1 5/16	27/32	7/8	15/16	-
ST-1232	1	1 9/16	1 11/32	1 11/32	27/32	7/8	31/32	-
ST-1234	1 1/16	1 11/16	1 7/16	1 7/16	31/32	1	1 1/16	-
ST-1236	1 1/8	1 3/4	1 1/2	1 1/2	1 1/32	1 1/16	1 1/8	-
ST-1238	1 3/16	1 3/4	1 5/8	1 5/8	1	1 1/32	1 3/32	-
ST-1240	1 1/4	1 7/8	1 11/16	1 11/16	1 1/8	1 5/32	1 1/4	-
ST-1242	1 3/8	1 7/8	1 3/4	1 3/4	1 1/32	1 3/32	1 3/32	-
ST-1244	1 3/8	2 1/16	1 13/16	1 13/16	1	1 9/16	1 11/32	-
ST-1246	1 7/16	2 1/4	1 15/16	1 15/16	1 1/32	1 1/2	1 1/8	-
ST-1248	1 1/2	2 1/4	2	2	1 1/16	1 1/2	1 1/8	-

Fed. Spec: ANSI B107.1



ST-1220 ST-1212

#### WSS-15RC 15 Piece 1/2" Drive Shallow 12-Point Socket Set on Clip Rail

##### Contents Include:

Product Code	Size (Inches)	Product Code	Size (Inches)	Product Code	Size (Inches)
ST-1212	3/8	ST-1222	11/16	ST-1232	1
ST-1214	7/16	ST-1224	3/4	ST-1234	1 1/16
ST-1216	1/2	ST-1226	13/16	ST-1236	1 1/8
ST-1218	9/16	ST-1228	7/8	ST-1238	1 3/16
ST-1220	5/8	ST-1230	15/16	ST-1240	1 1/4



WSS-15RC

#### WSS-23RC 23 Piece 1/2" Drive Shallow 12-Point Socket Set on Clip Rail

##### Contents Include:

Product Code	Size (Inches)	Product Code	Size (Inches)	Product Code	Size (Inches)	Product Code	Size (Inches)
ST-1212	3/8	ST-1221	21/32	ST-1230	15/16	ST-1240	1 1/4
ST-1214	7/16	ST-1222	11/16	ST-1231	31/32	ST-1242	1 3/16
ST-1216	1/2	ST-1224	3/4	ST-1232	1	ST-1244	1 3/8
ST-1218	9/16	ST-1225	25/32	ST-1234	1 1/16	ST-1246	1 7/16
ST-1219	19/32	ST-1226	13/16	ST-1236	1 1/8	ST-1248	1 1/2
ST-1220	5/8	ST-1228	7/8	ST-1238	1 3/16		

#### Features

- SUPERTORQUE® lobular openings for greater turning power without deforming the fastener.
- Designed for quick engagement on both 6 and 12 point fasteners.



WSS-23RC



# SOCKETS & DRIVE TOOLS

## 1/2" DRIVE

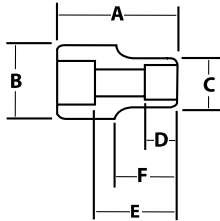

### 1/2" DRIVE SHALLOW 12 POINT SOCKETS, SAE

High-Polished Chrome Finish

Product Code	Size (Inches)	A OAL (Inches)	B Drive End Diameter (Inches)	C Working End Diameter (Inches)	D Broach Depth (Inches)	E Bolt Clearance Depth (Inches)	F Bolt Clearance Diameter (Inches)	Nose Length (Inches)
32212	3/8	1 1/2	7/8	5/8	1/2	25/32	5/16	23/32
32214	7/16	1 1/2	7/8	11/16	1/2	21/32	13/32	11/16
32216	1/2	1 1/2	7/8	3/4	17/32	21/32	15/32	23/32
32218	9/16	1 1/2	7/8	13/16	17/32	21/32	17/32	11/16
32220	5/8	1 1/2	29/32	29/32	17/32	21/32	9/16	-
32222	11/16	1 1/2	31/32	31/32	9/16	27/32	21/32	-
32224	3/4	1 1/2	1	1	3/4	29/32	23/32	-
32226	13/16	1 1/2	1 1/8	1 1/8	25/32	31/32	25/32	-
32228	7/8	1 5/8	1 3/16	1 3/16	7/8	1 1/32	7/8	-
32230	15/16	1 5/8	1 1/4	1 1/4	7/8	1 5/32	29/32	-
32232	1	1 5/8	1 5/16	1 5/16	7/8	1 3/16	31/32	-
32234	1 1/16	1 3/4	1 7/16	1 7/16	31/32	1 9/32	1 1/16	-
32236	1 1/8	1 3/4	1 1/2	1 1/2	31/32	1 5/16	1 5/32	-
32238	1 3/16	1 3/4	1 9/16	1 9/16	31/32	1 5/16	1 1/4	-
32240	1 1/4	1 3/4	1 11/16	1 21/32	31/32	1 5/16	1 1/4	-
32242	1 5/16	1 47/64	1 1/2	1 47/64	59/64	59/64	1 3/16	-
32244	1 3/8	1 47/64	1 37/64	1 53/64	59/64	59/64	1 17/64	-
32246	1 7/16	1 31/32	1 21/32	1 57/64	1 1/16	1 1/16	1 11/32	-
32248	1 1/2	1 31/32	1 11/16	1 31/32	1 1/8	1 1/2	1 1/8	-

Fed. Spec: ANSI B107.1

### 32922 9 Piece 1/2" Drive Shallow 12-Point Socket Set on Clip Rail

Contents Include:

Product Code	Size (Inches)	Product Code	Size (Inches)	Product Code	Size (Inches)
32216	1/2	32222	11/16	32228	7/8
32218	9/16	32224	3/4	32230	15/16
32220	5/8	32226	13/16	32232	1



### 32924 16 piece 1/2" Drive Shallow 12 Point Socket Set on Clip Rails

Contents Include:

Product Code	Size (Inches)	Product Code	Size (Inches)	Product Code	Size (Inches)	Product Code	Size (Inches)
32212	3/8	32220	5/8	32228	7/8	32236	1 1/8
32214	7/16	32222	11/16	32230	15/16	32238	1 3/16
32216	1/2	32224	3/4	32232	1	32240	1 1/4
32218	9/16	32226	13/16	32234	1 1/16	32248	1 1/2



### 32925 19 piece 1/2" Drive Shallow 12 Point Socket Set on Clip Rails

Contents Include:

Product Code	Size (Inches)	Product Code	Size (Inches)	Product Code	Size (Inches)	Product Code	Size (Inches)
32212	3/8	32222	11/16	32232	1	32242	1 5/16
32214	7/16	32224	3/4	32234	1 1/16	32244	1 3/8
32216	1/2	32226	13/16	32236	1 1/8	32246	1 7/16
32218	9/16	32228	7/8	32238	1 3/16	32248	1 1/2
32220	5/8	32230	15/16	32240	1 1/4		

### Features

- SUPERTORQUE® lobular openings for greater turning power without deforming the fastener.
- Designed for quick engagement on both 6 and 12 point fasteners.



32925

# SOCKETS & DRIVE TOOLS

## 1/2" DRIVE



### 1/2" DRIVE SHALLOW SOCKETS, 6 POINT, SAE

High-Polished Chrome Finish

Product Code	Size (Inches)	A		B		C		D		E		F
		OAL (Inches)	Drive End Diameter (Inches)	Working End Diameter (Inches)	Broach Depth (Inches)	Bolt Clearance Depth (Inches)	Bolt Clearance Diameter (Inches)	Nose Length (Inches)				
ST-612	3/8	1 1/2	29/32	19/32	5/16	7/8	11/32	23/32				
ST-614	7/16	1 1/2	29/32	21/32	3/8	7/8	13/32	23/32				
ST-616	1/2	1 1/2	29/32	3/4	3/8	7/8	15/32	23/32				
ST-618	9/16	1 1/2	29/32	13/16	3/8	7/8	15/32	23/32				
ST-619	19/32	1 1/2	29/32	7/8	3/8	7/8	15/32	23/32				
ST-620	5/8	1 1/2	29/32	29/32	9/16	7/8	15/32	-				
ST-622	11/16	1 1/2	31/32	31/32	19/16	27/32	5/8	-				
ST-624	3/4	1 1/2	1 1/32	1 1/32	19/16	27/32	23/32	-				
ST-625	25/32	1 1/2	1 1/16	1 1/16	13/16	27/32	3/4	-				
ST-626	19/16	1 1/2	1 1/8	1 1/8	19/16	27/32	25/32	-				
ST-628	7/8	1 1/2	1 3/16	1 3/16	13/16	13/16	7/8	-				
ST-630	19/16	1 17/32	1 9/32	1 9/32	19/16	27/32	29/32	-				
ST-632	1	1 9/16	1 11/32	1 11/32	27/32	7/8	31/32	-				
ST-634	1 1/16	1 11/16	1 7/16	1 7/16	31/32	1	1 1/16	-				
ST-636	1 1/8	1 3/4	1 1/2	1 1/2	1 1/32	1 1/16	1 1/8	-				
ST-640	1 1/4	1 7/8	1 11/16	1 11/16	1 1/8	1 1/32	1 1/4	-				

Fed. Spec: ANSI B107.1



ST-620

ST-612

### WSS-14HRC 14 Piece 1/2" Drive Shallow 6 Point Socket Set on Clip Rail

#### Contents Include:

Product Code	Size (Inches)	Product Code	Size (Inches)	Product Code	Size (Inches)
ST-612	3/8	ST-622	1 1/16	ST-632	1
ST-614	7/16	ST-624	3/4	ST-634	1 1/16
ST-616	1/2	ST-626	19/16	ST-636	1 1/8
ST-618	9/16	ST-628	7/8	ST-640	1 1/4
ST-620	5/8	ST-630	19/16		

#### Features

- SUPERTORQUE® lobular openings for greater turning power without deforming the fastener.
- Designed for maximum engagement on 6 point fasteners.



WSS-14HRC





# SOCKETS & DRIVE TOOLS

## 1/2" DRIVE



### 1/2" DRIVE SHALLOW 6 POINT SOCKETS, SAE

High-Polished Chrome Finish

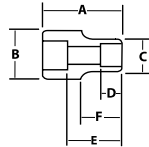

Product Code	Size (Inches)	A OAL (Inches)	B Drive End Diameter (Inches)	C Working End Diameter (Inches)	D Broach Depth (Inches)	E Bolt Clearance Depth (Inches)	F Bolt Clearance Diameter (Inches)	Nose Length (Inches)
32112	3/8	1 1/2	7/8	5/8	1/2	25/32	5/16	23/32
32114	7/16	1 1/2	7/8	11/16	1/2	21/32	13/32	11/16
32116	1/2	1 1/2	7/8	3/4	17/32	21/32	15/32	23/32
32118	9/16	1 1/2	7/8	13/16	17/32	21/32	17/32	11/16
32120	5/8	1 1/2	29/32	29/32	17/32	21/32	9/16	-
32122	11/16	1 1/2	31/32	31/32	9/16	27/32	21/32	-
32124	3/4	1 1/2	1	1	3/4	29/32	23/32	-
32126	13/16	1 1/2	1 1/8	1 1/8	25/32	31/32	25/32	-
32128	7/8	1 5/8	1 3/16	1 3/16	7/8	1 1/32	7/8	-
32130	15/16	1 5/8	1 1/4	1 1/4	7/8	1 5/32	29/32	-
32132	1	1 5/8	1 5/16	1 5/16	7/8	1 3/16	31/32	-
32134	1 1/16	1 3/4	1 7/16	1 7/16	31/32	1 9/32	1 1/16	-
32136	1 1/8	1 3/4	1 1/2	1 1/2	31/32	1 5/16	1 5/32	-
32138	1 3/16	1 3/4	1 9/16	1 9/16	31/32	1 5/16	1 1/4	-
32140	1 1/4	1 3/4	1 11/16	1 21/32	31/32	1 5/16	1 1/4	-
32142	1 5/16	1 47/64	1 1/2	1 47/64	59/64	59/64	1 3/16	-
32144	1 3/8	1 47/64	1 37/64	1 59/64	59/64	59/64	1 17/64	-
32146	1 7/16	1 31/32	1 21/32	1 57/64	1 1/16	1 1/16	1 11/32	-
32148	1 1/2	1 31/32	1 11/16	1 31/32	1 1/8	1 1/2	1 1/8	-

Fed. Spec: ANSI B107.1

### 32934 9 Piece 1/2" Drive Shallow 6-Point Socket Set on Clip Rail

Contents Include:



32934

Product Code	Size (Inches)	Product Code	Size (Inches)	Product Code	Size (Inches)
32116	1/2	32122	11/16	32128	7/8
32118	9/16	32124	3/4	32130	15/16
32120	5/8	32126	19/16	32132	1

### 32937 16 Piece 1/2" Drive Shallow 6-Point Socket Set on Clip Rail

Contents Include:



32937

Product Code	Size (Inches)	Product Code	Size (Inches)	Product Code	Size (Inches)	Product Code	Size (Inches)
32112	3/8	32120	5/8	32128	7/8	32136	1 1/8
32114	7/16	32122	11/16	32130	15/16	32138	1 3/16
32116	1/2	32124	3/4	32132	1	32140	1 1/4
32118	9/16	32126	13/16	32134	1 1/16	32148	1 1/2

### 32938 19 piece 1/2" Drive Shallow 6 Point Socket Set on Clip Rails

Contents Include:



32938

Product Code	Size (Inches)	Product Code	Size (Inches)	Product Code	Size (Inches)	Product Code	Size (Inches)
32112	3/8	32122	11/16	32132	1	32142	1 5/16
32114	7/16	32124	3/4	32134	1 1/16	32144	1 3/8
32116	1/2	32126	13/16	32136	1 1/8	32146	1 7/16
32118	9/16	32128	7/8	32138	1 3/16	32148	1 1/2
32120	5/8	32130	15/16	33140	1 1/4		

### Features

- SUPERTORQUE® lobular openings for greater turning power without deforming the fastener.
- Designed for quick engagement on 6 point fasteners.

# SOCKETS & DRIVE TOOLS

## 1/2" DRIVE



### 1/2" DRIVE CROWFOOT WRENCH, OPEN END, SAE

High Polished Chrome Finish

Product Code	Size (Inches)	Overall Length (Inches)	Diameter of Head (Inches)	Thickness of Head (Inches)	Thickness of Drive End (Inches)	Length of Centers (Inches)
10810	1 5/16	2 5/8	1 7/8	5/16	1/2	1 5/8
10811	1	2 3/8	2	5/16	1/2	1 5/8
10812	1 1/16	2 3/4	2	5/16	1/2	1 3/4
10813	1 1/8	2 3/4	2 7/32	5/16	1/2	1 3/4
10814	1 3/16	3	2 3/16	3/8	1/2	1 7/8
10815	1 1/4	3	2	3/8	1/2	1 7/8
10816	1 5/16	3	2.56	3/8	1/2	2
10817	1 3/8	3	2.68	3/8	1/2	2
10818	1 7/16	3 7/32	3	3/8	1/2	2
10819	1 1/2	3 7/32	3	3/8	1/2	2
10820	1 9/16	3 3/8	3	1/2	1/2	2
10821	1 5/8	3 3/8	3 1/4	1/2	1/2	2
10822	1 11/16	3 1/2	3 5/16	1/2	1/2	2 7/32
10823	1 3/4	3 1/2	3 1/2	1/2	1/2	2 7/32
10824	1 13/16	3 1/2	3 1/2	1/2	1/2	2 7/32
10825	1 7/8	3 1/2	3 1/2	1/2	1/2	2 7/32
10826	1 15/16	3 1/2	3 1/2	1/2	1/2	2 7/32
10827	2	3 3/4	4	1/2	1/2	2 1/4
10828	2 1/16	3 3/4	4	1/2	1/2	2 1/4
10829	2 1/8	4	4	1/2	1/2	2 1/2
10830	2 3/16	4	4	1/2	1/2	2 1/2
10831	2 1/4	4	4 7/32	1/2	1/2	2 1/2
10832	2 5/16	4	4 7/32	1/2	1/2	2 1/2
10833	2 3/8	4 1/4	4 1/4	1/2	1/2	2 1/2
10834	2 7/16	4 1/4	4 3/8	1/2	1/2	2 1/2
10835	2 1/2	4 1/4	4 3/8	1/2	1/2	2 1/2



10840



10841

#### 10840 12 Piece 1/2" Drive Crowfoot Wrenches on Clip Rails Contents Include:

Product Code	Size (Inches)	Product Code	Size (Inches)	Product Code	Size (Inches)
10810	1 5/16	10814	1 3/16	10818	1 7/16
10811	1	10815	1 1/4	10819	1 1/2
10812	1 1/16	10816	1 5/16	10820	1 9/16
10813	1 1/8	10817	1 3/8	10821	1 5/8

#### 10841 14 Piece 1/2" Drive Crowfoot Wrenches on Clip Railst Contents Include:

Product Code	Size (Inches)	Product Code	Size (Inches)	Product Code	Size (Inches)	Product Code	Size (Inches)
10822	1 11/16	10825	1 7/8	10830	2 3/16	10833	2 3/8
10823	1 3/4	10827	2	10831	2 1/4	10834	2 7/16
10824	1 13/16	10828	2 1/16	10832	2 5/16	10835	2 1/2
10826	1 15/16	10829	2 1/8				



### 1/2" DRIVE CROWFOOT WRENCH, FLARE NUT, 12 POINT

Satin Chrome Finish, SAE

Product Code	Size (Inches)	A Diameter of Head	B Thickness of Head	C Width of Slot	D Length of Centers
SCF36	1 1/8	1 5/8	7/8	27/32	1 9/32
SCF38	1 3/16	1 11/16	7/8	27/32	1 1/16
SCF40	1 1/4	1 29/32	7/8	19/16	1 19/64
SCF42	1 5/16	1 27/32	7/8	31/32	1 17/64
SCF44	1 3/8	1 19/16	13/16	1 1/16	1 9/16
SCF46	1 7/16	2	15/16	1 1/16	1 11/32
SCF48	1 1/2	2 1/16	15/16	1 1/8	1 3/8
SCF50	1 9/16	2 5/32	15/16	1 5/32	1 27/64
SCF52	1 5/8	2 7/32	15/16	1 7/32	1 29/64
SCF54	1 11/16	2 5/16	1	1 5/16	1 33/64
SCF56	1 3/4	2 3/8	1	1 3/16	1 35/64
SCF58	1 13/16	2 19/32	1	1 11/32	1 19/32
SCF60	1 7/8	2 9/16	1 1/16	1 3/8	1 41/64
SCF62	1 15/16	2 1/2	1 1/16	1 7/16	1 43/64
SCF64	2	2 29/32	1 1/16	1 9/16	1 23/32

Fed. Spec: ASME B107.21 Type 1 Class 1



SCF36

SCF60



WSSCF-7



WSSCF-15

#### WSSCF-7 7 Piece 12 Point Crowfoot Wrench on Clip Rail Contents Include:

Product Code	Size (Inches)	Product Code	Size (Inches)	Product Code	Size (Inches)
SCF36	1 1/8	SCF42	1 5/16	SCF46	1 7/16
SCF38	1 3/16	SCF44	1 3/8	SCF48	1 1/2
SCF40	1 1/4				

#### WSSCF-15 15 Piece 12 Point Crowfoot Wrench on Clip Rail Contents Include:

Product Code	Size (Inches)	Product Code	Size (Inches)	Product Code	Size (Inches)	Product Code	Size (Inches)
SCF36	1 1/8	SCF44	1 3/8	SCF52	1 5/8	SCF60	1 7/8
SCF38	1 3/16	SCF46	1 7/16	SCF54	1 11/16	SCF62	1 15/16
SCF40	1 1/4	SCF48	1 1/2	SCF56	1 3/4	SCF64	2
SCF42	1 5/16	SCF50	1 9/16	SCF58	1 13/16		



**WARNING**

# SOCKETS & DRIVE TOOLS

## 1/2" DRIVE

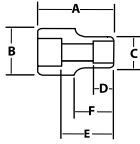

ST-812



WSS-814RC

### Features

- SUPERTORQUE® lobular openings for greater turning power without deforming the fastener.
- 8 point sockets are designed for quick engagement on 4 point fasteners.



SD-1224

SD-1216



WSSD-11RC

### Features

- SUPERTORQUE® lobular openings for greater turning power without deforming the fastener.
- Designed for quick engagement on both 6 and 12 point fasteners.



## 1/2" DRIVE SHALLOW SOCKETS, 8 POINT, SAE

### High-Polished Chrome Finish

Product Code	Size (Inches)	A OAL (Inches)	B Drive End Diameter (Inches)	C Working End Diameter (Inches)	D Broach Depth (Inches)	E Bolt Clearance Depth (Inches)	Bolt Clearance Diameter (Inches)	F Nose Length (Inches)
ST-812	3/8	1 1/2	7/8	23/32	5/16	27/32	5/16	7/8
ST-814	7/16	1 1/2	7/8	13/16	3/8	27/32	5/16	7/8
ST-816	1/2	1 1/2	29/32	29/32	13/32	27/32	11/32	-
ST-818	9/16	1 1/2	31/32	31/32	7/16	27/32	7/16	-
ST-820	5/8	1 1/2	1 1/16	1 1/16	1/2	27/32	7/16	-
ST-822	11/16	1 1/2	1 3/16	1 3/16	1/2	27/32	17/32	-
ST-824	3/4	1 1/2	1 9/32	1 9/32	9/16	13/16	23/32	-
ST-826	13/16	1 5/8	1 7/16	1 7/16	9/16	31/32	27/32	-
ST-828	7/8	1 3/4	1 1/2	1 1/2	5/8	1 1/16	15/16	-
ST-830	15/16	1 13/16	1 5/8	1 5/8	11/16	1 1/8	1 1/32	-
ST-832	1	1 15/16	1 11/16	1 11/16	11/16	1 1/4	1 1/32	-
ST-834	1 1/16	1 15/16	1 3/4	1 3/4	1 3/4	23/32	1 1/8	-
ST-836	1 1/8	2	1 13/16	1 13/16	3/4	1 3/16	13/16	-
ST-840	1 1/4	2	2	2	25/32	1 3/16	1	-

Fed. Spec: ANSI B107.1

### WSS-814RC 14 Piece 8 Point Socket Set on Clip Rail

#### Contents Include:

Product Code	Size (Inches)	Product Code	Size (Inches)	Product Code	Size (Inches)	Product Code	Size (Inches)
ST-812	3/8	ST-820	5/8	ST-828	7/8	ST-834	1 1/16
ST-814	7/16	ST-822	11/16	ST-830	15/16	ST-836	1 1/8
ST-816	1/2	ST-824	3/4	ST-832	1	ST-840	1 1/4
ST-818	9/16	ST-826	13/16				



## 1/2" DRIVE DEEP SOCKETS, 12 POINT, SAE

### High-Polished Chrome Finish

Product Code	Size (Inches)	A OAL (Inches)	B Drive End Diameter (Inches)	C Working End Diameter (Inches)	D Broach Depth (Inches)	E Bolt Clearance Depth (Inches)	Bolt Clearance Diameter (Inches)	F Nose Length (Inches)
SD-1216	1/2	3 1/4	29/32	3/4	13/32	2 19/32	15/32	2 15/32
SD-1218	9/16	3 1/4	29/32	13/16	7/16	2 19/32	15/32	2 19/32
SD-1220	5/8	3 1/4	29/32	29/32	19/32	2 7/16	19/32	-
SD-1222	11/16	3 1/4	31/32	31/32	17/32	2 11/32	21/32	-
SD-1224	3/4	3 1/4	1 1/16	1 1/16	19/32	2 5/16	23/32	-
SD-1225	25/32	3 1/4	1 1/16	1 1/16	21/32	2 9/32	25/32	-
SD-1226	13/16	3 1/4	1 1/8	1 1/8	21/32	2 9/32	25/32	-
SD-1228	7/8	3 1/4	1 3/16	1 3/16	23/32	2 9/32	27/32	-
SD-1230	15/16	3 1/4	1 9/32	1 9/32	3/4	2 9/32	29/32	-
SD-1232	1	3 1/4	1 11/32	1 11/32	3/4	2 1/4	1	-
SD-1234	1 1/16	3 1/4	1 7/16	1 7/16	3/4	2 1/4	1 1/16	-
SD-1236	1 1/8	3 1/4	1 1/2	1 1/2	25/32	2 1/4	1 3/32	-

Fed. Spec: ANSI B107.1

### WSSD-11RC 11 Piece 1/2" Drive Deep 12 Point Socket Set on Clip Rail

#### Contents Include:

Product Code	Size (Inches)	Product Code	Size (Inches)	Product Code	Size (Inches)
SD-1216	1/2	SD-1224	3/4	SD-1232	1
SD-1218	9/16	SD-1226	13/16	SD-1234	1 1/16
SD-1220	5/8	SD-1228	7/8	SD-1236	1 1/8
SD-1222	11/16	SD-1230	15/16		

# SOCKETS & DRIVE TOOLS

## 1/2" DRIVE



### 1/2" DRIVE DEEP SOCKETS, 12 POINT, SAE

High-Polished Chrome Finish

Product Code	Size (Inches)	A OAL (Inches)	B Drive End Diameter (Inches)	C Working End Diameter (Inches)	D Broach Depth (Inches)	E Bolt Clearance Depth (Inches)	F Bolt Clearance Diameter (Inches)	Nose Length (Inches)
32412	3/8	3	7/8	5/8	1	2 7/32	11/32	1 15/32
32414	7/16	3 1/32	7/8	11/16	1 1/8	2 9/32	13/32	1 15/32
32416	1/2	3 1/32	7/8	3/4	31/32	2 7/32	7/16	1 15/32
32418	9/16	3 1/32	7/8	13/16	1 3/32	2 7/32	1/2	1 15/32
32420	5/8	3 1/32	29/32	29/32	1 3/16	2 3/16	9/16	-
32422	11/16	3 1/32	15/16	15/16	1 3/8	2 3/16	21/32	-
32424	3/4	3 1/32	1 1/16	1 1/16	1 1/4	2 11/32	23/32	-
32426	13/16	3 1/32	1 1/8	1 1/8	1 15/32	2 3/16	3/4	-
32428	7/8	3 1/32	1 3/16	1 3/16	1 13/32	2 1/4	27/32	-
32430	15/16	3 1/32	1 1/4	1 1/4	1 13/32	2 5/32	29/32	-
32432	1	3 1/32	1 11/32	1 11/32	1 13/32	2 5/32	15/16	-
32434	1 1/16	3 1/32	1 13/32	1 13/32	1 3/8	2 11/32	1 1/32	-
32436	1 1/8	3 1/32	1 1/2	1 1/2	1 7/16	2 3/8	1 1/16	-
32438	1 3/16	3 1/32	1 9/16	1 9/16	1 7/16	2 3/16	1 1/16	-
32440	1 1/4	3 1/32	1 21/32	1 21/32	1 7/16	2 3/16	1 1/16	-
32442	1 5/16	3 1/32	1 47/64	1 47/64	1 3/8	2 11/64	1 3/16	-
32444	1 3/8	3 1/32	1 53/64	1 53/64	1 3/8	2 11/64	1 17/64	-
32446	1 7/16	3 1/32	1 57/64	1 57/64	1 3/8	2 11/64	1 11/32	-
32448	1 1/2	3 1/32	1 15/16	1 31/32	1 7/16	2 3/16	1 1/16	-

Fed. Spec: ANSI B107.1

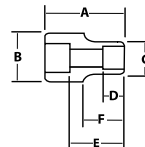

32420 32412

### 32926 9 Piece 1/2" Drive Deep 12 Point Socket Set on Clip Rail

Contents Include:

Product Code	Size (Inches)	Product Code	Size (Inches)	Product Code	Size (Inches)
32416	1/2	32422	11/16	32428	7/8
32418	9/16	32424	3/4	32430	15/16
32420	5/8	32426	13/16	32432	1



32926

### 32928 16 Piece 1/2" Drive Deep 12 Point Socket Set on Clip Rail

Contents Include:

Product Code	Size (Inches)	Product Code	Size (Inches)	Product Code	Size (Inches)	Product Code	Size (Inches)
32412	3/8	32420	5/8	32428	7/8	32436	1 1/8
32414	7/16	32422	11/16	32430	15/16	32438	1 3/16
32416	1/2	32424	3/4	32432	1	32440	1 1/4
32418	9/16	32426	13/16	32434	1 1/16	32448	1 1/2



32928

### 32929 19 piece 1/2" Drive Deep 12 Point Socket Set on Clip Rails

Contents Include:

Product Code	Size (Inches)	Product Code	Size (Inches)	Product Code	Size (Inches)	Product Code	Size (Inches)
32412	3/8	32422	11/16	32432	1	32442	1 3/16
32414	7/16	32424	3/4	32434	1 1/16	32444	1 3/8
32416	1/2	32426	13/16	32436	1 1/8	32446	1 7/16
32418	9/16	32428	7/8	32438	1 3/16	32448	1 1/2
32420	5/8	32430	15/16	32440	1 1/4		



32929

### Features

- SUPERTORQUE® lobular openings for greater turning power without deforming the fastener.
- Designed for quick engagement on both 6 and 12 point fasteners.



# SOCKETS & DRIVE TOOLS

## 1/2" DRIVE



### 1/2" DRIVE DEEP SOCKETS, 6 POINT, SAE

#### High-Polished Chrome Finish



SD-624 SD-616

Product Code	Size (Inches)	A B C D E F						
		OAL (Inches)	Drive End Diameter (Inches)	Working End Diameter (Inches)	Broach Depth (Inches)	Bolt Clearance Depth (Inches)	Bolt Clearance Diameter (Inches)	Nose Length (Inches)
SD-616	1/2	3 1/4	29/32	3/4	13/32	2 19/32	15/32	2 15/32
SD-618	9/16	3 1/4	29/32	13/16	7/16	2 19/32	15/32	2 15/32
SD-620	5/8	3 1/4	29/32	29/32	15/32	2 7/16	19/32	-
SD-622	11/16	3 1/4	31/32	31/32	17/32	2 11/32	21/32	-
SD-624	3/4	3 1/4	1 1/16	1 1/16	19/32	2 5/16	23/32	-
SD-626	13/16	3 1/4	1 1/8	1 1/8	21/32	2 9/32	25/32	-
SD-628	7/8	3 1/4	1 3/16	1 3/16	23/32	2 9/32	27/32	-
SD-630	15/16	3 1/4	1 9/32	1 9/32	3/4	2 9/32	29/32	-
SD-632	1	3 1/4	1 11/32	1 11/32	3/4	2 1/4	1	-
SD-634	1 1/16	3 1/4	1 7/16	1 7/16	25/32	2 1/4	1 1/32	-
SD-636	1 1/8	3 1/4	1 1/2	1 1/2	25/32	2 1/4	1 3/32	-

Fed. Spec: ANSI B107.1

#### WSSD-11HRC 11 Piece 1/2" Drive Deep 6 Point Socket Set on Clip Rail

##### Contents Include:

Product Code	Size (Inches)	Product Code	Size (Inches)	Product Code	Size (Inches)
SD-616	1/2	SD-624	3/4	SD-632	1
SD-618	9/16	SD-626	13/16	SD-634	1 1/16
SD-620	5/8	SD-628	7/8	SD-636	1 1/8
SD-622	11/16	SD-630	15/16		

##### Features

- SUPERTORQUE® lobular openings for greater turning power without deforming the fastener.
- Designed for maximum engagement on 6 point fasteners.



WSSD-11HRC

# SOCKETS & DRIVE TOOLS

## 1/2" DRIVE



### 1/2" DRIVE DEEP SOCKETS, 6 POINT, SAE

High-Polished Chrome Finish

Product Code	Size (Inches)	A		B		C		D		E		F	
		OAL (Inches)	Drive End Diameter (Inches)	Working End Diameter (Inches)	Broach Depth (Inches)	Bolt Clearance Depth (Inches)	Bolt Clearance Diameter (Inches)	Nose Length (Inches)					
32312	3/8	3	7/8	5/8	1	2 7/32	1 1/32	1 15/32					
32314	7/16	3 1/32	7/8	11/16	1 1/8	2 9/32	1 5/32	1 15/32					
32316	1/2	3 1/32	7/8	3/4	1 1/8	2 7/32	7/16	1 15/32					
32318	9/16	3 1/32	7/8	13/16	1 3/32	2 7/32	1/2	1 15/32					
32320	5/8	3 1/32	29/32	29/32	1 3/16	2 3/16	9/16	-					
32322	11/16	3 1/32	15/16	15/16	1 3/8	2 3/16	21/32	-					
32324	3/4	3 1/32	1 1/16	1 1/16	1 1/4	2 11/32	23/32	-					
32326	13/16	3 1/32	1 1/8	1 1/8	1 5/8	2 3/16	3/4	-					
32328	7/8	3 1/32	1 3/16	1 3/16	1 13/32	2 1/4	21/32	-					
32330	15/16	3 1/32	1 1/4	1 1/4	1 13/32	2 5/32	29/32	-					
32332	1	3 1/32	1 11/32	1 11/32	1 13/32	2 5/32	15/16	-					
32334	1 1/16	3 1/32	1 13/32	1 13/32	1 3/8	2 11/32	1 1/32	-					
32336	1 1/8	3 1/32	1 1/2	1 1/2	1 7/16	2 3/8	1 1/16	-					
32338	1 3/16	3 1/32	1 9/16	1 9/16	1 7/16	2 3/16	1 1/16	-					
32340	1 1/4	3 1/32	1 21/32	1 21/32	1 7/16	2 3/16	1 1/16	-					
32342	1 5/16	3 1/32	1 47/64	1 47/64	1 3/8	2 11/64	1 3/16	-					
32344	1 3/8	3 1/32	1 53/64	1 53/64	1 3/8	2 11/64	1 17/64	-					
32346	1 7/16	3 1/32	1 57/64	1 57/64	1 3/8	2 11/64	1 11/32	-					
32348	1 1/2	3 1/32	1 15/16	1 15/16	1 7/16	2 3/16	1 1/16	-					

Fed. Spec: ANSI B107.1

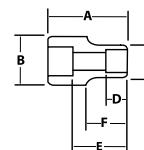

32320 32312



32936

#### 32936 9 Piece 1/2" Drive Deep 6 Point Socket Set on Clip Rail

Contents Include:

Product Code	Size (Inches)	Product Code	Size (Inches)	Product Code	Size (Inches)
32316	1/2	32322	11/16	32328	7/8
32318	9/16	32324	3/4	32330	15/16
32320	5/8	32326	13/16	32332	1

#### 32939 16 Piece 1/2" Drive Deep 6 Point Socket Set on Clip Rail

Contents Include:

Product Code	Size (Inches)	Product Code	Size (Inches)	Product Code	Size (Inches)	Product Code	Size (Inches)
32312	3/8	32320	5/8	32328	7/8	32336	1 1/8
32314	7/16	32322	11/16	32330	15/16	32338	1 3/16
32316	1/2	32324	3/4	32332	1	32340	1 1/4
32318	9/16	32326	13/16	32334	1 1/16	32348	1 1/2



32939

#### 32940 19 piece 1/2" Drive Deep 6 Point Socket Set on Clip Rails

Contents Include:

Product Code	Size (Inches)	Product Code	Size (Inches)	Product Code	Size (Inches)	Product Code	Size (Inches)
32312	3/8	32322	11/16	32332	1	32342	1 5/16
32314	7/16	32322	3/4	32334	1 1/16	32344	1 3/8
32316	1/2	32326	13/16	32336	1 1/8	32346	1 7/16
32318	9/16	32328	7/8	32338	1 3/16	32348	1 1/2
32320	5/8	32330	15/16	32340	1 1/4		



32940

#### Features

- SUPERTORQUE® lobular openings for greater turning power without deforming the fastener.
- Designed for quick engagement on 6 point fasteners.



# SOCKETS & DRIVE TOOLS

## 1/2" DRIVE



### 1/2" DRIVE SHALLOW SOCKETS, 12 POINT, METRIC

High-Polished Chrome Finish

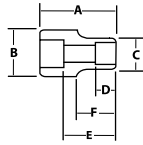

Product Code	Size (MM)	A OAL (Inches)	B Drive End Diameter (Inches)	C Working End Diameter (Inches)	D Broach Depth (Inches)	E Bolt Clearance Depth (Inches)	F Bolt Clearance Diameter (Inches)	Nose Length (Inches)
STM-1210	10	1 1/2	29/32	19/32	5/16	7/8	11/32	23/32
STM-1211	11	1 1/2	29/32	11/16	9/16	7/8	13/32	23/32
STM-1212	12	1 1/2	29/32	23/32	13/32	7/8	7/16	23/32
STM-1213	13	1 1/2	29/32	25/32	3/8	7/8	19/32	23/32
STM-1214	14	1 1/2	29/32	27/32	3/8	7/8	15/32	23/32
STM-1215	15	1 1/2	29/32	7/8	3/8	7/8	15/32	-
STM-1216	16	1 1/2	29/32	29/32	9/16	7/8	19/32	-
STM-1217	17	1 1/2	31/32	31/32	9/16	7/8	19/32	-
STM-1218	18	1 1/2	1	1	13/16	27/32	15/32	-
STM-1219	19	1 1/2	1 1/32	1 1/32	13/16	27/32	23/32	-
STM-1220	20	1 1/2	1 1/16	1 1/16	13/16	27/32	23/32	-
STM-1221	21	1 1/2	1 1/8	1 1/8	13/16	27/32	3/4	-
STM-1222	22	1 1/2	1 3/16	1 3/16	13/16	27/32	29/32	-
STM-1223	23	1 1/2	1 1/4	1 1/4	25/32	13/16	27/32	-
STM-1224	24	1 17/32	1 9/32	1 9/32	13/16	27/32	7/8	-
STM-1225	25	1 9/16	1 9/16	1 5/16	13/16	7/8	19/16	-
STM-1226	26	1 5/8	1 3/8	1 3/8	29/32	15/16	31/32	-
STM-1227	27	1 23/32	1 7/16	1 7/16	31/32	1	1	-
STM-1228	28	1 3/4	1 1/2	1 1/2	1	1 1/16	1 1/32	-
STM-1229	29	1 3/4	1 9/16	1 9/16	1 1/32	1 1/16	1 1/16	-
STM-1230	30	1 3/4	1 5/8	1 5/8	1 1/32	1 1/32	1 3/32	-
STM-1232	32	1 7/8	1 11/16	1 11/16	1 1/8	1 5/32	1 3/16	-
STM-1234	34	2 1/16	1 3/4	1 3/4	7/8	1 7/16	1	-
STM-1236	36	2 1/16	1 15/16	1 15/16	7/8	1 7/16	1 13/32	-

Fed. Spec: ANSI B107.5

### MSS-15RC 15 Piece 1/2" Drive Shallow 12 Point Socket Set on Clip Rail

Contents Include:

Product Code	Size (MM)	Product Code	Size (MM)	Product Code	Size (MM)	Product Code	Size (MM)
STM-1210	10	STM-1214	14	STM-1218	18	STM-1222	22
STM-1211	11	STM-1215	15	STM-1219	19	STM-1223	23
STM-1212	12	STM-1216	16	STM-1220	20	STM-1224	24
STM-1213	13	STM-1217	17	STM-1221	21		



MSS-15RC

### MSS-24RC 24 Piece 1/2" Drive Shallow 12 Point Socket Set on Clip Rail

Contents Include:

Product Code	Size (MM)	Product Code	Size (MM)	Product Code	Size (MM)	Product Code	Size (MM)
STM-1210	10	STM-1216	16	STM-1222	22	STM-1228	28
STM-1211	11	STM-1217	17	STM-1223	23	STM-1229	29
STM-1212	12	STM-1218	18	STM-1224	24	STM-1230	30
STM-1213	13	STM-1219	19	STM-1225	25	STM-1232	32
STM-1214	14	STM-1220	20	STM-1226	26	STM-1234	34
STM-1215	15	STM-1221	21	STM-1227	27	STM-1236	36

### Features

- SUPERTORQUE® lobular openings for greater turning power without deforming the fastener.
- Designed for quick engagement on both 6 and 12 point fasteners.



MSS-24RC

# SOCKETS & DRIVE TOOLS

## 1/2" DRIVE



### 1/2" DRIVE SHALLOW SOCKETS, 12 POINT, METRIC

High-Polished Chrome Finish

Product Code	Size (MM)	A		B		C		D		E		F	
		OAL (Inches)	Drive End Diameter (Inches)	Working End Diameter (Inches)	Broach Depth (Inches)	Bolt Clearance Depth (Inches)	Bolt Clearance Diameter (Inches)	Nose Length (Inches)					
32609	9	1 1/2	7/8	9/16	9/16	11/16	5/16	23/32					
32610	10	1 1/2	7/8	5/8	1/2	27/32	3/8	23/32					
32611	11	1 1/2	7/8	21/32	1/2	7/8	13/32	23/32					
32612	12	1 1/2	7/8	23/32	1/2	7/8	7/16	23/32					
32613	13	1 1/2	7/8	3/4	9/16	27/32	15/32	23/32					
32614	14	1 1/2	7/8	13/16	9/16	13/16	17/32	23/32					
32615	15	1 1/2	7/8	7/8	17/32	13/16	9/16	-					
32616	16	1 1/2	29/32	29/32	17/32	27/32	19/32	-					
32617	17	1 1/2	15/16	15/16	17/32	27/32	21/32	-					
32618	18	1 1/2	1	1	3/4	13/16	11/16	-					
32619	19	1 1/2	1 1/16	1 1/16	3/4	7/8	45/64	-					
32620	20	1 1/2	1 3/32	1 3/32	25/32	15/16	47/64	-					
32621	21	1 1/2	1 1/8	1 1/8	25/32	15/16	49/64	-					
32622	22	1 5/8	1 3/16	1 3/16	7/8	1 1/32	25/32	-					
32623	23	1 5/8	1 7/32	1 7/32	7/8	1 1/32	13/16	-					
32624	24	1 5/8	1 1/4	1 1/4	7/8	1 3/32	53/64	-					
32625	25	1 5/8	1 5/16	1 5/16	7/8	1 3/32	55/64	-					
32626	26	1 3/4	1 9/16	1 9/16	15/16	1 9/16	57/64	-					
32627	27	1 3/4	1 7/16	1 7/16	15/16	1 3/16	29/32	-					
32628	28	1 3/4	1 7/16	1 7/16	31/32	1 9/32	15/16	-					
32629	29	1 3/4	1 1/2	1 1/2	31/32	1 9/32	31/32	-					
32630	30	1 3/4	1 9/16	1 9/16	31/32	1 11/32	63/64	-					
32632	32	1 3/4	1 5/8	1 5/8	31/32	1 11/32	1 1/64	-					
32634	34	1 31/32	1 11/16	1 31/32	1 1/8	1 1/2	1 1/32	-					
32636	36	1 31/32	1 11/16	1 31/32	1 1/8	1 1/2	1 1/32	-					



32615 32609

Fed. Spec: ANSI B107.5

### 32930 10 Piece 1/2" Drive Shallow 12 Point Socket Set on Clip Rail

Contents Include:

Product Code	Size (MM)	Product Code	Size (MM)	Product Code	Size (MM)
32610	10	32614	14	32618	18
32611	11	32615	15	32619	19
32612	12	32616	16		
32613	13	32617	17		



32930

### 32932 16 Piece 1/2" Drive Shallow 12 Point Socket Set on Clip Rail

Contents Include:

Product Code	Size (MM)	Product Code	Size (MM)	Product Code	Size (MM)	Product Code	Size (MM)
32609	9	32613	13	32617	17	32621	21
32610	10	32614	14	32618	18	32622	22
32611	11	32615	15	32619	19	32623	23
32612	12	32616	16	32620	20	32624	24

#### Features

- SUPERTORQUE® lobular openings for greater turning power without deforming the fastener.
- Designed for quick engagement on both 6 and 12 point fasteners.



32932





# SOCKETS & DRIVE TOOLS

## 1/2" DRIVE



### 1/2" DRIVE SHALLOW SOCKETS, 6 POINT, METRIC

High-Polished Chrome Finish



Product Code	Size (MM)	A B C D E F						
		OAL (Inches)	Drive End Diameter (Inches)	Working End Diameter (Inches)	Broach Depth (Inches)	Bolt Clearance Depth (Inches)	Bolt Clearance Diameter (Inches)	Nose Length (Inches)
32509	9	1 1/2	7/8	9/16	9/16	11/16	5/16	23/32
32510	10	1 1/2	7/8	5/8	1/2	27/32	3/8	23/32
32511	11	1 1/2	7/8	21/32	1/2	7/8	13/32	23/32
32512	12	1 1/2	7/8	23/32	1/2	7/8	7/16	23/32
32513	13	1 1/2	7/8	3/4	9/16	27/32	15/32	23/32
32514	14	1 1/2	7/8	13/16	9/16	17/32	17/32	23/32
32515	15	1 1/2	7/8	7/8	17/32	13/16	9/16	-
32516	16	1 1/2	29/32	29/32	17/32	27/32	19/32	-
32517	17	1 1/2	15/16	15/16	17/32	27/32	21/32	-
32518	18	1 1/2	1	1	3/4	13/16	11/16	-
32519	19	1 1/2	1 1/16	1 1/16	3/4	7/8	45/64	-
32520	20	1 1/2	1 3/32	1 3/32	25/32	15/16	47/64	-
32521	21	1 1/2	1 1/8	1 1/8	25/32	15/16	49/64	-
32522	22	1 5/8	1 3/16	1 3/16	7/8	1 1/32	25/32	-
32523	23	1 5/8	1 7/32	1 7/32	7/8	1 1/32	13/16	-
32524	24	1 5/8	1 1/4	1 1/4	7/8	1 3/32	53/64	-
32525	25	1 5/8	1 5/16	1 5/16	7/8	1 3/32	55/64	-
32526	26	1 3/4	1 5/16	1 5/16	15/16	1 3/16	57/64	-
32527	27	1 3/4	1 7/16	1 7/16	15/16	1 3/16	29/32	-
32528	28	1 3/4	1 7/16	1 7/16	31/32	1 9/32	15/16	-
32529	29	1 3/4	1 1/2	1 1/2	31/32	1 9/32	31/32	-
32530	30	1 3/4	1 9/16	1 9/16	31/32	1 11/32	63/64	-
32532	32	1 31/32	1 11/16	1 31/32	1 1/8	1 1/2	1 1/32	-
32534	34	1 47/64	1 1/2	1 49/64	31/32	1 11/32	1 1/64	-
32536	36	2 1/16	1 15/16	1 15/16	7/8	1 7/16	1 13/32	-

Fed. Spec: ANSI B107.5

### 32943 16 Piece 1/2" Drive Shallow 6 Point Socket Set on Clip Rail

Contents Include:



Product Code	Size (MM)	Product Code	Size (MM)	Product Code	Size (MM)	Product Code	Size (MM)
32509	9	32513	13	32517	17	32521	21
32510	10	32514	14	32518	18	32522	22
32511	11	32515	15	32519	19	32523	23
32512	12	32516	16	32520	20	32524	24

### 32941 24 piece 1/2" Drive Shallow 6 Point Socket Set on Clip Rails

Contents Include:



Product Code	Size (MM)	Product Code	Size (MM)	Product Code	Size (MM)	Product Code	Size (MM)
32509	9	32515	15	32521	21	32527	27
32510	10	32516	16	32522	22	32528	28
32511	11	32517	17	32523	23	32529	29
32512	12	32518	18	32524	24	32530	30
32513	13	32519	19	32525	25	32532	32
32514	14	32520	20	32526	26	32536	36

Features

- SUPERTORQUE® lobular openings for greater turning power without deforming the fastener.
- Designed for quick engagement on both 6 point fasteners.

32941

# SOCKETS & DRIVE TOOLS

## 1/2" DRIVE



### 1/2" DRIVE DEEP SOCKETS, 12 POINT, METRIC

High-Polished Chrome Finish

Product Code	Size (MM)	A	B	C	D	E	Bolt Clearance Diameter (Inches)	Nose Length (Inches)
		OAL (Inches)	Drive End Diameter (Inches)	Working End Diameter (Inches)	Broach Depth (Inches)	Bolt Clearance Depth (Inches)		
SMD-1213	13	3 1/4	29/32	25/32	13/32	2 15/32	15/32	2 19/32
SMD-1214	14	3 1/4	29/32	27/32	19/32	2 15/32	19/32	2 19/32
SMD-1215	15	3 1/4	29/32	7/8	19/32	2 15/32	19/32	-
SMD-1216	16	3 1/4	29/32	29/32	15/32	2 7/16	17/32	-
SMD-1217	17	3 1/4	31/32	31/32	1/2	2 11/32	9/8	-
SMD-1218	18	3 1/4	1	1	17/32	2 11/32	21/32	-
SMD-1219	19	3 1/4	1 1/32	1 1/32	9/16	2 5/16	11/16	-
SMD-1221	21	3 1/4	1 1/8	1 1/8	21/32	2 5/16	3/4	-
SMD-1222	22	3 1/4	1 3/16	1 3/16	23/32	2 9/32	13/16	-
SMD-1224	24	3 1/4	1 9/32	1 9/32	3/4	2 9/32	7/8	-
SMD-1227	27	3 1/4	1 7/16	1 7/16	3/4	2 1/4	1	-
SMD-1230	30	3 1/4	1 5/8	1 5/8	19/16	2 1/4	1 3/32	-

Fed. Spec: ANSI B107.5

### MSSD-12RC 12 Piece 1/2" Drive Deep 12 Point Socket Set on Clip Rail

Contents Include:

Product Code	Size (MM)	Product Code	Size (MM)	Product Code	Size (MM)
SMD-1213	13	SMD-1217	17	SMD-1222	22
SMD-1214	14	SMD-1218	18	SMD-1224	24
SMD-1215	15	SMD-1219	19	SMD-1227	27
SMD-1216	16	SMD-1221	21	SMD-1230	30

### Features

- SUPERTORQUE® lobular openings for greater turning power without deforming the fastener.
- Designed for quick engagement on both 6 and 12 point fasteners.

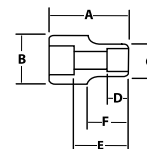

SMD-1218



MSSD-12RC



# SOCKETS & DRIVE TOOLS

## 1/2" DRIVE



### 1/2" DRIVE DEEP SOCKETS, 12 POINT, METRIC

#### High-Polished Chrome Finish

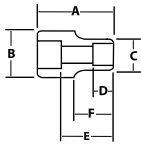

32817 32810

Product Code	Size (MM)	A (Inches)	B Drive End Diameter (Inches)	C Working End Diameter (Inches)	D Broach Depth (Inches)	E Bolt Clearance Depth (Inches)	F Bolt Clearance Diameter (Inches)	Nose Length (Inches)
32809	9	3 1/4	29/32	19/32	5/16	2 15/32	11/32	2 19/32
32810	10	3 1/4	29/32	19/32	5/16	2 15/32	11/32	2 19/32
32811	11	3 1/4	29/32	1 1/16	5/16	2 15/32	13/32	2 19/32
32812	12	3 1/4	29/32	23/32	13/32	2 15/32	7/16	2 19/32
32813	13	3 1/4	29/32	25/32	3/8	2 15/32	15/32	2 19/32
32814	14	3 1/4	29/32	27/32	3/8	2 15/32	15/32	2 19/32
32815	15	3 1/4	29/32	7/8	3/8	2 1 1/2	15/32	-
32816	16	3 1/4	29/32	29/32	9/16	2 1 1/2	15/32	-
32817	17	3 1/4	31/32	31/32	9/16	2 1 1/2	15/32	-
32818	18	3 1/4	1	1	13/16	2 1 1/2	15/32	-
32819	19	3 1/4	1 1/32	1 1/32	13/16	2 5/16	23/32	-
32820	20	3 1/4	1 1/16	1 1/16	13/16	2 5/16	23/32	-
32821	21	3 1/4	1 1/8	1 1/8	13/16	2 5/16	3/4	-
32822	22	3 1/4	1 3/16	1 3/16	13/16	2 5/16	25/32	-
32823	23	3 1/4	1 1/4	1 1/4	25/32	2 5/16	27/32	-
32824	24	3 1/4	1 9/32	1 9/32	13/16	2 5/16	7/8	-
32825	25	3 1/4	1 5/16	1 5/16	13/16	2 1/4	15/16	-
32826	26	3 1/4	1 3/8	1 3/8	29/32	2 1/4	31/32	-
32827	27	3 1/4	1 7/16	1 7/16	31/32	2 1/4	1	-
32828	28	3 1/4	1 1/2	1 1/2	1	2 1/4	1 1/32	-
32829	29	3 1/4	1 9/16	1 9/16	1 1/32	2 1/4	1 1/16	-
32830	30	3 1/4	1 5/8	1 5/8	1 1/32	2 1/4	1 3/32	-
32832	32	3 1/4	1 11/16	1 11/16	1 1/8	2 1/4	1 3/16	-
32834	34	3 1/4	1 3/4	1 3/4	7/8	2 1/4	1	-
32836	36	3 1/4	1 15/16	1 15/16	7/8	2 1/4	1 13/32	-

Fed. Spec: ANSI B107.5

#### 32951 16 Piece 1/2" Drive Deep 12 Point Socket Set on Clip Rail

##### Contents Include:



32951

Product Code	Size (MM)	Product Code	Size (MM)	Product Code	Size (MM)	Product Code	Size (MM)
32809	9	32813	13	32817	17	32821	21
32810	10	32814	14	32818	18	32822	22
32811	11	32815	15	32819	19	32823	23
32812	12	32816	16	32820	20	32824	24

#### 32949 24 Piece 1/2" Drive Deep 12 Point Socket Set on Clip Rail

##### Contents Include:



32949

Product Code	Size (MM)	Product Code	Size (MM)	Product Code	Size (MM)	Product Code	Size (MM)
32809	9	32815	15	32821	21	32827	27
32810	10	32816	16	32822	22	32828	28
32811	11	32817	17	32823	23	32829	29
32812	12	32818	18	32824	24	32830	30
32813	13	32819	19	32825	25	32832	32
32814	14	32820	20	32826	26	32836	36

#### Features

- SUPERTORQUE® lobular openings for greater turning power without deforming the fastener.
- Designed for quick engagement on both 6 and 12 point fasteners.

# SOCKETS & DRIVE TOOLS

## 1/2" DRIVE



### 1/2" DRIVE DEEP SOCKETS, 6 POINT, METRIC

High-Polished Chrome Finish

Product Code	Size (MM)	A		B		C		D		E		F	
		OAL (Inches)	Drive End Diameter (Inches)	Working End Diameter (Inches)	Broach Depth (Inches)	Bolt Clearance Depth (Inches)	Bolt Clearance Diameter (Inches)	Nose Length (Inches)					
32709	9	3 1/4	29/32	19/32	5/16	2 15/32	11/32	2 19/32					
32710	10	3 1/4	29/32	19/32	5/16	2 15/32	11/32	2 19/32					
32711	11	3 1/4	29/32	11/16	5/16	2 7/32	19/32	2 19/32					
32712	12	3 1/4	29/32	23/32	13/32	2 15/32	7/16	2 19/32					
32713	13	3 1/4	29/32	25/32	3/8	2 15/32	19/32	2 19/32					
32714	14	3 1/4	29/32	27/32	3/8	2 15/32	19/32	2 19/32					
32715	15	3 1/4	29/32	7/8	3/8	2 11/32	19/32	-					
32716	16	3 1/4	29/32	29/32	9/16	2 11/32	19/32	-					
32717	17	3 1/4	31/32	31/32	9/16	2 11/32	15/32	-					
32718	18	3 1/4	1	1	13/16	2 11/32	19/32	-					
32719	19	3 1/4	1 1/32	1 1/32	13/16	2 5/16	23/32	-					
32720	20	3 1/4	1 1/16	1 1/16	13/16	2 5/16	23/32	-					
32721	21	3 1/4	1 1/8	1 1/8	13/16	2 5/16	3/4	-					
32722	22	3 1/4	1 3/16	1 3/16	13/16	2 5/16	25/32	-					
32723	23	3 1/4	1 1/4	1 1/4	25/32	2 5/16	27/32	-					
32724	24	3 1/4	1 9/32	1 9/32	13/16	2 5/16	7/8	-					
32725	25	3 1/4	1 5/16	1 5/16	13/16	2 1/4	15/16	-					
32726	26	3 1/4	1 3/8	1 3/8	29/32	2 1/4	31/32	-					
32727	27	3 1/4	1 7/16	1 7/16	31/32	2 1/4	1	-					
32728	28	3 1/4	1 1/2	1 1/2	1	2 1/4	1 1/32	-					
32729	29	3 1/4	1 9/16	1 9/16	1 1/32	2 1/4	1 1/16	-					
32730	30	3 1/4	1 5/8	1 5/8	1 1/32	2 1/4	1 3/32	-					
32732	32	3 1/4	1 11/16	1 11/16	1 1/8	2 1/4	1 3/16	-					
32734	34	3 1/4	1 3/4	1 3/4	7/8	2 1/4	1	-					
32736	36	3 1/4	1 15/16	1 15/16	7/8	2 1/4	1 1/32	-					

Fed. Spec: ANSI B107.5

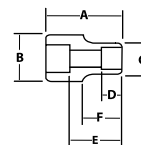

### 32947 16 Piece 1/2" Drive Deep 6 Point Socket Set on Clip Rail

Contents Include:

Product Code	Size (MM)	Product Code	Size (MM)	Product Code	Size (MM)	Product Code	Size (MM)
32709	9	32713	13	32717	17	32721	21
32710	10	32714	14	32718	18	32722	22
32711	11	32715	15	32719	19	32723	23
32712	12	32716	16	32720	20	32724	24



### 32945 24 Piece 1/2" Drive Deep 6 Point Socket Set on Clip Rail

Contents Include:

Product Code	Size (MM)	Product Code	Size (MM)	Product Code	Size (MM)	Product Code	Size (MM)
32709	9	32715	15	32721	21	32727	27
32710	10	32716	16	32722	22	32728	28
32711	11	32717	17	32723	23	32729	29
32712	12	32718	18	32724	24	32730	30
32713	13	32719	19	32725	25	32732	32
32714	14	32720	20	32726	26	32736	36



### Features

- SUPERTORQUE® lobular openings for greater turning power without deforming the fastener.
- Designed for quick engagement on both 6 and 12 point fasteners.



# SOCKETS & DRIVE TOOLS

## 1/2" DRIVE



### 1/2" DRIVE TURBOSOCKET® SALVAGE/DAMAGED FASTENER SOCKETS

Black Industrial Finish, Metric and SAE

Product Code	Size (Inches)	A		B		C		D		E		F
		OAL (Inches)	Drive End Diameter (Inches)	Working End Diameter (Inches)	Broach Depth (Inches)	Bolt Clearance Depth (Inches)	Bolt Clearance Diameter (Inches)	Nose Length (Inches)				
TS50750	3/4	1 21/32	1 1/16	1 1/16	23/32	1	3/4	-				
TS50812	13/16	1 21/32	1 1/8	1 1/8	23/32	1	13/16	-				
TS50875	7/8	1 21/32	1 3/16	1 3/16	23/32	1	7/8	-				
TS50937	15/16	1 21/32	1 5/16	1 5/16	23/32	1	15/16	-				
TS50100	1	1 21/32	1 11/32	1 11/32	23/32	1	1	-				

Product Code	Size (MM)	A		B		C		D		E		F
		OAL (Inches)	Drive End Diameter (Inches)	Working End Diameter (Inches)	Broach Depth (Inches)	Bolt Clearance Depth (Inches)	Bolt Clearance Diameter (Inches)	Nose Length (Inches)				
TS51551	14	1 21/32	29/32	21/32	1/2	1	9/16	29/32				
TS51591	15	1 21/32	29/32	29/32	1/2	1	19/32	-				
TS51625	16	1 21/32	31/32	31/32	1/2	23/32	5/8	-				
TS51669	17	1 21/32	1	1	21/32	23/32	11/16	-				
TS51709	18	1 21/32	1 1/32	1 1/32	21/32	23/32	23/32	-				
TS51750	19	1 21/32	1 1/16	1 1/16	23/32	1	3/4	-				
TS51827	21	1 21/32	1 3/16	1 3/16	21/32	1	27/32	-				



TS50750



TS51551



TSFS5005



TSM5107

#### TSFS5005 5 Piece TURBOSOCKET® Salvage Socket Set on Clip Rail, SAE Contents Include:

Product Code	Size (Inches)	Product Code	Size (Inches)
TS50750	3/4	TS50937	15/16
TS50812	13/16	TS50100	1
TS50875	7/8		

#### TSM5107 7 Piece TURBOSOCKET® Salvage Socket Set on Clip Rail, Metric Contents Include:

Product Code	Size (MM)	Product Code	Size (MM)
TS51551	14	TS51709	18
TS51591	15	TS51750	19 (3/4")
TS51625	16 (5/8")	TS51827	21
TS51669	17		

#### Features

- Quickly and easily remove damaged or rounded nuts and bolts.
- Place socket on fastener and turn with ratchet, breaker bar or T-handle.
- Grip on fastener tightens as more torque is applied.
- No hammering is required to install socket over fastener.
- Use on all types of standard nuts and bolts as well as studs, pipe nipples, and corroded auto and marine fasteners.
- May be used for "best fit" on metric and fractional fasteners.
- May be used with air or electric impact wrench for extra speed and turning power.



### 1/2" DRIVE STANDARD LENGTH HEX BIT SOCKETS, SAE

#### High-Polished Chrome Finish

Product Code	Size (Inches)	Socket Length (Inches)	Socket Outside Diameter (Inches)	Overall Length (Inches)	Replacement Bit Product Code
SA-8A	1/4	1 1/2	29/32	2 1/4	BITH08-05
SA-10A	5/16	1 1/2	29/32	2 1/4	BITH10-05
SA-12A	3/8	1 1/2	29/32	2 1/4	BITH12-03
SA-16A	1/2	1 1/2	31/32	2 1/4	BITH16-01
SA-18A	9/16	1 9/16	1 1/16	2 1/4	BITH18-01
SA-20A	5/8	1 25/32	1 1/4	2 1/4	BITH20-01



SA-16A



WSSS-6RC

#### WSSS-6RC 6 Piece Hex Bit Socket Set on Clip Rail Contents Include:

Product Code	Size (Inches)	Product Code	Size (Inches)
SA-8A	1/4	SA-16A	1/2
SA-10A	5/16	SA-18A	9/16
SA-12A	3/8	SA-20A	5/8

#### Features

- High-polished chrome finish socket cleans easily.
- Two piece design allows bits to be replaced easily.

# SOCKETS & DRIVE TOOLS

## 1/2" DRIVE



### 1/2" DRIVE STANDARD LENGTH HEX BIT SOCKETS, SAE

#### High-Polished Chrome Finish

Product Code	Size (Inches)	Socket Length (Inches)	Socket Outside Diameter (Inches)	Overall Length (Inches)	Bit Length (Inches)
35208	1/4	1 7/16	29/32	2 13/32	27/32
35210	5/16	1 7/16	29/32	2 13/32	27/32
35212	3/8	1 7/16	29/32	2 13/32	27/32
35214	7/16	1 7/16	29/32	2 13/32	27/32
35202	1/2	1 19/32	7/8	2 13/32	27/32
35203	9/16	1 19/32	1	2 13/32	27/32
35204	5/8	1 19/32	1 1/16	2 13/32	27/32
35206	3/4	1 19/32	1 3/16	2 13/32	27/32



35202



32902

#### 32902 4 Piece Hex Bit Socket Set on Clip Rail

##### Contents Include:

Product Code	Size (Inches)	Product Code	Size (Inches)
35202	1/2	35204	5/8
35203	9/16	35206	3/4

#### 32903 8 Piece Hex Bit Socket Set on Clip Rail

##### Contents Include:

Product Code	Size (Inches)	Product Code	Size (Inches)	Product Code	Size (Inches)
35208	1/4	35214	7/16	35204	5/8
35210	5/16	35202	1/2	35206	3/4
35212	3/8	35203	9/16		



32903

#### Features

- High-polished chrome finish socket cleans easily.



### 1/2" DRIVE STANDARD LENGTH HEX BIT SOCKETS, METRIC

#### High-Polished Chrome Finish

Product Code	Size (MM)	Socket Length (Inches)	Socket Outside Diameter (Inches)	Overall Length (Inches)	Bit Length (Inches)
35274	8	1 19/32	29/32	2 13/32	27/32
35275	10	1 19/32	29/32	2 7/16	27/32
35276	12	1 19/32	29/32	2 7/16	27/32
35277	14	1 19/32	1	2 7/16	27/32
35278	17	1 19/32	1 3/32	2 7/16	27/32
35279	19	1 19/32	1 3/16	2 7/16	27/32



35274



32904

#### 32904 6 Piece Hex Bit Socket Set on Clip Rail

##### Contents Include:

Product Code	Size (MM)	Product Code	Size (MM)
35274	8	35277	14
35275	10	35278	17
35276	12	35279	19

#### Features

- High-polished chrome finish socket cleans easily.



# SOCKETS & DRIVE TOOLS

## 1/2" DRIVE



### 1/2" DRIVE LONG HEX BIT SOCKETS, SAE

#### High-Polished Chrome Finish

Product Code	Size (Inches)	Socket Length (Inches)	Socket Outside Diameter (Inches)	Overall Length (Inches)	Replacement Bit Product Code
SA-8LA	1/4	1 1/2	29/32	4 1/2	BITH08-06
SA-10LA	5/16	1 1/2	29/32	4 1/2	BITH10-06
SA-12LA	3/8	1 1/2	29/32	4 1/2	BITH12-04
SA-16LA	1/2	1 1/2	31/32	4 1/2	BITH16-02
SA-18LA	9/16	1 9/16	1 1/16	4 1/2	BITH18-02
SA-20LA	5/8	1 25/32	1 1/4	4 1/2	BITH20-02



SA-16LA



WSSS-6LRC

#### WSSS-6LRC 6 Piece Long Hex Bit Socket Set on Clip Rail

##### Contents Include:

Product Code	Size (Inches)	Product Code	Size (Inches)
SA-8LA	1/4	SA-16LA	1/2
SA-10LA	5/16	SA-18LA	9/16
SA-12LA	3/8	SA-20LA	5/8

##### Features

- High-polished chrome finish socket cleans easily.
- Two piece design allows bits to be replaced easily.



### 1/2" DRIVE LONG LENGTH HEX BIT SOCKETS, SAE

#### High-Polished Chrome Finish

Product Code	Size (Inches)	Socket Length (Inches)	Socket Outside Diameter (Inches)	Overall Length (Inches)
35238	1/4	1 1/2	29/32	5 1/2
35240	5/16	1 1/2	29/32	5 1/2
35242	3/8	1 1/2	29/32	5 1/2
35244	7/16	1 1/2	29/32	5 1/2
35232	1/2	1 1/2	7/8	5 1/2
35233	9/16	1 9/16	1	5 1/2
35234	5/8	1 25/32	1 1/16	5 1/2
35236	3/4	1 25/32	1 3/16	5 1/2



35232



32957

#### 32957 4 Piece Hex Bit Socket Set on Clip Rail

##### Contents Include:

Product Code	Size (Inches)	Product Code	Size (Inches)
35232	1/2	35234	5/8
35233	9/16	35236	3/4

#### 32955 8 Piece Hex Bit Socket Set on Clip Rail

##### Contents Include:

Product Code	Size (Inches)	Product Code	Size (Inches)	Product Code	Size (Inches)
35238	1/4	35244	7/16	35234	5/8
35240	5/16	35232	1/2	35236	3/4
35242	3/8	35233	9/16		

##### Features

- High-polished chrome finish socket cleans easily.



32955

# SOCKETS & DRIVE TOOLS

## 1/2" DRIVE



### 1/2" DRIVE LONG LENGTH HEX BIT SOCKETS, METRIC

#### High-Polished Chrome Finish

Product Code	Size (MM)	Socket Length (Inches)	Socket Outside Diameter (Inches)	Overall Length (Inches)
35294	8	1 1/2	29/32	5 1/2
35295	10	1 1/2	29/32	5 1/2
35296	12	1 1/2	29/32	5 1/2
35297	14	1 1/2	1	5 1/2
35298	17	1 1/2	1 3/32	5 1/2
35299	19	1 1/2	1 3/16	5 1/2

#### 32953 6 Piece Hex Bit Socket Set on Clip Rail

##### Contents Include:

Product Code	Size (MM)	Product Code	Size (MM)
35294	8	35297	14
35295	10	35298	17
35296	12	35299	19

##### Features

- High-polished chrome finish socket cleans easily.



35294



32953



### 1/2" DRIVE TORX® BIT SOCKETS

#### High-Polished Chrome Finish

Product Code	Torx® Size	Socket Length (Inches)	Socket Outside Diameter (Inches)	Overall Length (Inches)	Bit Length (Inches)
35283	T40	1 19/32	29/32	2 7/16	7/8
35284	T45	1 19/32	29/32	2 7/16	7/8
35285	T50	1 19/32	29/32	2 7/16	7/8
35286	T55	1 19/32	29/32	2 7/16	7/8
35287	T60	1 19/32	29/32	2 7/16	7/8

#### 32908 5 Piece Torx® Bit Socket Set on Clip Rail

##### Contents Include:

Product Code	Torx® Size	Product Code	Torx® Size
35283	T40	35286	T55
35284	T45	35287	T60
35285	T50		

##### Features

- High-polished chrome finish socket cleans easily.



35283



32908



### 1/2" DRIVE SCREWDRIVER BIT SOCKETS

#### High-Polished Chrome Finish, Phillips® and Slotted

Product Code	Size (Inches) / Point Size	Socket Length (Inches)	Socket Outside Diameter (Inches)	Overall Length (Inches)	Replacement Bit Product Code
<b>Slotted Bits:</b>					
SA-10A-3S	23/64 x .061	1 1/2	29/32	2 9/32	BITHS03
SA-12A-4S	27/64 x .075	1 1/2	29/32	2 1/4	BITHS04
<b>Phillips® Bits:</b>					
SA-10A-3P	#3	1 1/2	29/32	2 1/4	BITPH03-02
SA-12A-4P	#4	1 1/2	29/32	2 1/4	BITPH04-01

#### WSSSP-4RC 4 Piece Screwdriver Bit Socket Set on Clip Rail

##### Contents Include:

Product Code	Tip Size	Product Code	Tip Size
SA-10A-3S	23/64 x.061	SA-10A-3P	3
SA-12A-4S	27/64 x.075	SA-12A-4P	4

##### Features

- High-polished chrome finish socket cleans easily.
- Two piece design allows bits to be replaced easily.



SA-10A-3P



SA-10A-3S



WSSP-4RC





# SOCKETS & DRIVE TOOLS

## 1/2" DRIVE



**WILLIAMS**



### 1/2" DRIVE PHILLIPS® SCREWDRIVER BIT SOCKETS

High-Polished Chrome Finish

Product Code	Tip Size	Socket Length (Inches)	Socket Outside Diameter (Inches)	Overall Length (Inches)	Bit Length (Inches)
<b>Phillips® Bits:</b>					
35251	#2	1 19/32	29/32	2 7/16	7/8
35252	#3	1 19/32	29/32	2 7/16	7/8
35253	#4	1 19/32	29/32	2 7/16	7/8

### 32906 3 Piece Phillips® Screwdriver Bit Socket Set on Clip Rail

Contents Include:

Product Code	Tip Size
35251	#2
35252	#3
35253	#4

**Features**

- High-polished chrome finish socket cleans easily.



**WILLIAMS**

### 1/2" DRIVE DRAG LINK SOCKETS

High-Polished Chrome Finish

Product Code	Overall Length (Inches)	Tip Thickness (Inches)	Tip Width (Inches)
SB-30	1 5/8	5/32	15/16
SB-40	1 11/16	5/32	1 13/16

Fed. Spec: ANSI B107.1

**Features**

- Ideal for drag links on trucks and heavy equipment, as well as large screws.



**WILLIAMS**

### 1/2" DRIVE 5 POINT PENTA-SOCKET

Black Industrial Finish

Product Code	Size (Inches)	A		B	C	D	E		F
		OAL (Inches)	Drive End Diameter (Inches)	Working End Diameter (Inches)	Broach Depth (Inches)	Bolt Clearance Depth (Inches)	Bolt Clearance Diameter (Inches)	Nose Length (Inches)	
SB-526	5/64	1 1/4	1 1/8	1 1/8	7/16	1/2	23/32	-	

**Features**

- 5 point Penta-Socket services 5 point nuts found on tamper-resistant Buffalo covers used by gas, electric, and some water companies to protect shutoff gates.

# SOCKETS & DRIVE TOOLS

## 1/2" DRIVE



### 1/2" DRIVE FLEXTENSIONS

Product Code	Drive Size	OAL (Inches)	Tension Y or N	6 or 12 Point	Nose End Diameter (Inches)	Socket Diameter (Inches)	Socket Length (Inches)	Clearance Depth (Inches)	Hex Opening
ISDX624LD	1/2	7 1/2	N	12	1	1	7/8	5/16	3/4
ISSH314	1/2	4 1/2	N	6	3/4	29/32	1 1/16	9/16	7/16
ISSHTB618	1/2	7 1/2	Y	6	19/16	29/32	1 1/16	7/16	9/16
ISSHTB618SS	1/2	7 1/2	Y	6	3/4	7/8	1 1/16	7/16	9/16
ISSHTL618SS	1/2	7 1/2	Y	6	3/4	7/8	1 1/16	7/16	9/16
ISSU24	1/2	2 1/2	N	6	1	1 1/8	1 1/4	1/2	3/4
ISSUM16	1/2	2 1/2	N	6		29/32	1 1/16	7/16	16 mm
ISSUM18	1/2	2 1/2	N	6	19/16	1	1 1/16	7/16	18 mm
ISSX618	1/2	7 1/2	N	6	19/16	29/32	1 1/16	7/16	9/16
ISSX624	1/2	7 1/2	N	6	1	1 1/8	1 1/4	1/2	3/4
ISSX624MOD	1/2	7 1/2	N	6	1	1 1/8	7/8	5/16	3/4
ISSXM616	1/2	7 1/2	N	6	29/32	29/32	1 1/16	7/16	16 mm
ISSXM618	1/2	7 1/2	N	6	19/16	1	1 1/16	7/16	18 mm
ISSXT1218	1/2	13 1/2	Y	6	19/16	29/32	1 1/16	7/16	9/16
ISSXT324	1/2	4 1/2	Y	6	1	1 1/8	1 1/4	1/2	3/4
ISSXT418	1/2	5 1/2	Y	6	19/16	29/32	1 1/16	7/16	9/16
ISSXT618	1/2	7 1/2	Y	6	19/16	29/32	1 1/16	7/16	9/16
ISSXT624	1/2	7 1/2	Y	6	1	1 1/8	1 1/4	1/2	3/4
ISSXTB618	1/2	7 1/2	Y	6	19/16	29/32	1 1/16	7/16	9/16
ISSXTB918	1/2	10 1/2	Y	6	19/16	29/32	1 1/16	7/16	9/16
ISSXTD612A	1/2	7 1/2	Y	12	5/8	3/4	13/16	5/16	3/8
ISSXTM1013	1/2	11 1/2	Y	6	3/4	29/32	1 1/16	9/16	13 mm
ISSXTM1016	1/2	11 1/2	Y	6	29/32	29/32	1 1/16	9/16	16 mm
ISSXTM1018	1/2	11 1/2	Y	6	19/16	1	1 1/16	7/16	18 mm
ISSXTM1216	1/2	13 1/2	Y	6	29/32	29/32	1 1/16	7/16	16 mm
ISSXTM612	1/2	7 1/2	Y	6	29/32	29/32	1 1/16	7/16	15 mm
ISSXTM613	1/2	7 1/2	Y	6	3/4	29/32	1 1/16	5/16	13 mm
ISSXTM615	1/2	7 1/2	Y	6	29/32	29/32	1 1/16	7/16	15 mm
ISSXTM616	1/2	7 1/2	Y	6	27/32	29/32	1 1/16	7/16	16 mm
ISSXTM618	1/2	7 1/2	Y	6	19/16	1	1 1/16	7/16	18 mm
ISSXTM915	1/2	10 1/2	Y	6	29/32	29/32	1 1/16	7/16	15 mm
ISSXTM916	1/2	10 1/2	Y	6	29/32	29/32	1 1/16	7/16	16 mm
ISSXTM918	1/2	10 1/2	Y	6	19/16	1	1 1/16	7/16	18 mm
ISSXTMD610	1/2	7 1/2	Y	12	5/8	7/8	1 1/2	13/16	10 mm
SPSXL618	1/2	7	N	6	19/16	29/32	1 1/16	7/16	9/16
SPSXM618	1/2	5 1/2	N	12	19/16	1	1 1/16	7/16	18 mm
SPSXM616	1/2	7 1/2	N	12	29/32	29/32	1 1/16	7/16	16 mm
SPSXM618	1/2	7 1/2	N	12	19/16	1	1 1/16	7/16	18 mm



ISDX624LD



ISSXT618



ISSXM616

#### Features

- Flexextensions are available in Non-Tension and Tension "T" spring loaded styles.
- Flexextensions are available in various lengths and sizes for production and maintenance applications.
- Flexextensions are designed for use on hand and power (Impulse or Direct drive) "Not for Impact Use"
- Snap-on Industrial Brands will quote any length and socket size you need. Contact your representative for details.



### 3/8" DRIVE FLEXTENSIONS

Product Code	Drive Size	OAL (Inches)	Tension Y or N	6 or 12 Point	Nose End Diameter (Inches)	Socket Diameter (Inches)	Socket Length (Inches)	Clearance Depth (Inches)	Hex Opening
ISFXM416	3/8	5 1/2	N	6	7/8	7/8	1 1/16	7/16	16 mm
ISFXM616	3/8	7 1/2	N	6	7/8	7/8	1 1/16	7/16	16 mm
ISFXTM416	3/8	5 1/2	Y	6	7/8	7/8	1 1/16	7/16	16 mm
ISFXTM613	3/8	7 1/2	Y	6	3/4	7/8	1 1/16	3/4	13 mm
ISFXTM616	3/8	7 1/2	Y	6	7/8	7/8	1 1/16	7/16	16 mm

#### Features

- Flexextensions are available in Non-Tension and Tension "T" spring loaded styles.
- Flexextensions are available in various lengths and sizes for production and maintenance applications.
- Flexextensions are designed for use on hand and power (Impulse or Direct drive) "Not for Impact Use"
- Snap-on Industrial Brands will quote any length and socket size you need. Contact your representative for details.



# SOCKETS & DRIVE TOOLS

## 1/2" DRIVE



4-102



4-105A



4-110A



4-140B



4-2F



4-6



4-35B



37002



37003



37004



37001



37005



### 1/2" DRIVE IMPACT EXTENSIONS AND ACCESSORIES

#### Black Industrial Finish

Product Code	Description	Length (Inches)	Socket Retention
4-102	Impact Extension	3 1/2	Lock Ring
4-105A	Impact Extension	5	Spring Plunger
4-110A	Impact Extension	10	Spring Plunger
4-140B	Impact Universal Joint	2 1/2	Spring Plunger
4-2F	3/8" M x 1/2" F Adapter	2 1/4	Spring Plunger
4-6	3/4" M x 1/2" F Adapter	1 1/4	Through Hole

Fed. Spec: ANSI B107.2

#### Features

- Specially heat treated for impact use to provide long life, safety, and durability.
- Spring plunger provides secure socket retention for safety and convenience.
- Suitable for use with pneumatic and electric impact wrenches.



### 1/2" DRIVE HEX TO SQUARE SHANK IMPACT EXTENSIONS

#### Black Industrial Finish

Product Code	Hex Shank Size (Inches)	Square Drive Size (Inches)	Length (Inches)
4-33B	7/16	1/2	2 3/4
4-35B	7/16	1/2	5
4-53B	5/8	1/2	2 3/4

#### Features

- Specially heat treated for impact use to provide long life, safety, and durability.
- Spring plunger provides secure socket retention for safety and convenience.
- Suitable for use with pneumatic and electric impact wrenches.



### 1/2" DRIVE IMPACT EXTENSIONS AND ACCESSORIES

#### Black Industrial Finish

Product Code	Description	Length (Inches)	Socket Retention
37002	Impact Extension	3	Ball
37003	Impact Extension	6	Ball
37004	Impact Extension	10	Ball
37001	Impact Universal Joint	2 9/16	Ball
37005	1/2" F x 3/8" M Adapter	1 7/8	Ball

Fed. Spec: ANSI B107.2

#### Features

- Specially heat treated for impact use to provide long life, safety, and durability.
- Ball socket retention for fast socket changes.
- Suitable for use with pneumatic and electric impact wrenches.
- Drive end features pin retention hole and groove.

# SOCKETS & DRIVE TOOLS

## 1/2" DRIVE



### 1/2" DRIVE SHALLOW IMPACT SOCKETS, 6 POINT, SAE

Black Industrial Finish

Product Code	Size (Inches)	OAL (Inches)	Drive End Diameter (Inches)	Working End Diameter (Inches)	Broach Depth (Inches)	Bolt		Nose Length (Inches)
						Clearance Depth (Inches)	Clearance Diameter (Inches)	
4-612	3/8	1 1/2	29/32	19/32	1/4	7/8	11/32	11/16
4-614	7/16	1 1/2	29/32	23/32	5/16	7/8	13/32	11/16
4-616	1/2	1 1/2	29/32	13/16	13/32	7/8	15/32	11/16
4-618	9/16	1 1/2	29/32	7/8	13/32	7/8	15/32	11/16
4-620	5/8	1 1/2	31/32	31/32	15/32	7/8	1/2	-
4-622	11/16	1 1/2	1 1/16	1 1/16	13/16	27/32	5/8	-
4-624	3/4	1 1/2	1 1/8	1 1/8	13/16	27/32	11/16	-
4-626	13/16	1 1/2	1 1/4	1 1/4	13/16	13/16	25/32	-
4-628	7/8	1 1/2	1 5/16	1 5/16	13/16	13/16	7/8	-
4-630	15/16	1 3/4	1 3/8	1 3/8	1 1/32	1 1/16	15/16	-
4-632	1	1 3/4	1 1/16	1 1/16	1 1/32	1 1/16	1	-
4-634	1 1/16	2	1 9/16	1 9/16	1 1/4	1 9/32	1 1/32	-
4-636	1 1/8	2	1 5/8	1 5/8	1 1/4	1 9/32	1 1/8	-
4-638	1 3/16	2	1 11/16	1 11/16	1 1/4	1 9/32	1 5/32	-
4-640	1 1/4	2	1 3/4	1 3/4	13/16	1 9/32	1 7/32	-
4-642	1 5/16	2	1 1/2	1 7/8	7/8	1 3/8	1 1/16	-
4-644	1 3/8	2	1 1/2	1 15/16	7/8	1 3/8	1 1/16	-
4-646	1 7/16	2	1 1/2	2	29/32	1 3/8	1 1/16	-
4-648	1 1/2	2	1 9/16	2 1/8	29/32	1 3/8	1 1/16	-

Fed. Spec: ANSI B107.2

#### WS-4-7RC 7 Piece 1/2" Drive Shallow 6 Point Impact Socket Set on Clip Rail

Contents Include:

Product Code	Size (Inches)	Product Code	Size (Inches)
4-614	7/16	4-622	11/16
4-616	1/2	4-624	3/4
4-618	9/16	4-626	13/16
4-620	5/8		



WS-4-7RC

#### WS-4-11RC 11 Piece 1/2" Drive Shallow 6 Point Impact Socket Set on Clip Rail

Contents Include:

Product Code	Size (Inches)	Product Code	Size (Inches)	Product Code	Size (Inches)
4-616	1/2	4-624	3/4	4-632	1
4-618	9/16	4-626	13/16	4-634	1 1/16
4-620	5/8	4-628	7/8	4-636	1 1/8
4-622	11/16	4-630	15/16		



WS-4-11RC

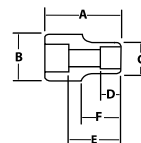

#### WS-4-14 14 Piece 1/2" Drive Shallow 6 Point Impact Socket Set on Clip Rail

Contents Include:

Product Code	Size (Inches)	Product Code	Size (Inches)	Product Code	Size (Inches)
4-612	3/8	4-622	11/16	4-632	1
4-614	7/16	4-624	3/4	4-634	1 1/16
4-616	1/2	4-626	13/16	4-636	1 1/8
4-618	9/16	4-628	7/8	4-640	1 1/4
4-620	5/8	4-630	15/16		



WS-4-14

#### WS-4-19RC 19 Piece 1/2" Drive Shallow 6 Point Impact Socket Set on Clip Rail

Contents Include:

Product Code	Size (Inches)	Product Code	Size (Inches)	Product Code	Size (Inches)	Product Code	Size (Inches)
4-612	3/8	4-622	11/16	4-632	1	4-642	1 5/16
4-614	7/16	4-624	3/4	4-634	1 1/16	4-644	1 3/8
4-616	1/2	4-626	13/16	4-636	1 1/8	4-646	1 7/16
4-618	9/16	4-628	7/8	4-638	1 3/16	4-648	1 1/2
4-620	5/8	4-630	15/16	4-640	1 1/4		



WS-4-19RC

#### Features

- SUPERTORQUE® lobular openings for greater turning power without deforming the fastener.
- Designed for maximum engagement on 6 point fasteners.
- Suitable for use with pneumatic and electric impact wrenches.
- Specially heat treated for impact use to provide long life, safety, and durability.



# SOCKETS & DRIVE TOOLS

## 1/2" DRIVE



### 1/2" DRIVE SHALLOW IMPACT SOCKETS, 6 POINT, SAE

#### Black Industrial Finish

Product Code	Size (Inches)	A		B		C		D		E		F
		OAL (Inches)	Drive End Diameter (Inches)	Working End Diameter (Inches)	Broach Depth (Inches)	Bolt Clearance Depth (Inches)	Bolt Clearance Diameter (Inches)	Nose Length (Inches)				
37112	3/8	1 1/2	15/16	5/8	9/16	7/8	5/16	3/4				
37114	7/16	1 1/2	15/16	23/32	9/16	13/16	13/32	3/4				
37116	1/2	1 1/2	15/16	13/16	9/16	21/32	15/32	3/4				
37118	9/16	1 1/2	15/16	7/8	9/16	27/32	17/32	3/4				
37120	5/8	1 1/2	1	31/32	1/2	29/32	9/16	3/4				
37122	11/16	1 1/2	1 1/8	1 1/32	17/32	29/32	21/32	3/4				
37124	3/4	1 1/2	1 1/8	1 1/8	3/4	29/32	-	-				
37126	13/16	1 1/2	1 3/16	1 3/16	3/4	29/32	-	-				
37128	7/8	1 1/2	1 1/4	1 1/4	3/4	15/16	-	-				
37130	15/16	1 3/4	1 3/8	1 3/8	1	17/32	-	-				
37132	1	1 3/4	1 1/2	1 1/2	1	17/32	-	-				
37134	1 1/16	1 3/4	1 17/32	1 17/32	1	17/32	-	-				
37136	1 1/8	1 3/4	1 5/8	1 5/8	1	1 3/16	-	-				
37138	1 3/16	1 3/4	1 5/8	1 5/8	1	1 3/16	-	-				
37140	1 1/4	1 3/4	1 3/4	1 3/4	1	1 3/16	-	-				
37142	1 5/16	1 3/4	1 7/8	1 7/8	31/32	31/32	1 7/32	-				
37144	1 3/8	2	1 57/64	1 57/64	1 1/16	1 1/16	1 19/64	-				
37146	1 7/16	2	1 31/32	1 31/32	1 1/16	1 1/16	1 11/32	-				
37148	1 1/2	2	2 1/8	2 1/8	1 1/16	1 1/16	1 3/8	-				

Fed. Spec: ANSI B107.2



37112, 37124



37902



37904

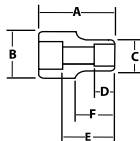

#### 37902 9 Piece 1/2" Drive Shallow 6 Point Impact Socket Set on Clip Rail Contents Include:

Product Code	Size (Inches)	Product Code	Size (Inches)	Product Code	Size (Inches)
37116	1/2	37122	11/16	37128	7/8
37118	9/16	37124	3/4	37130	15/16
37120	5/8	37126	13/16	37132	1

#### 37904 14 Piece 1/2" Drive Shallow 6 Point Impact Socket Set on Clip Rail Contents Include:

Product Code	Size (Inches)	Product Code	Size (Inches)	Product Code	Size (Inches)
37112	3/8	37122	11/16	37132	1
37114	7/16	37124	3/4	37134	1 1/16
37116	1/2	37126	13/16	37136	1 1/8
37118	9/16	37128	7/8	37140	1 1/4
37120	5/8	37130	15/16		

#### 37905 19 piece 1/2" Drive Impact Shallow 6 Point Socket Set on Clip Rails Contents Include:

Product Code	Size (Inches)	Product Code	Size (Inches)	Product Code	Size (Inches)	Product Code	Size (Inches)
37112	3/8	37122	11/16	37132	1	37142	1 5/16
37114	7/16	37124	3/4	37134	1 1/16	37144	1 3/8
37116	1/2	37126	13/16	37136	1 1/8	37146	1 7/16
37118	9/16	37128	7/8	37138	1 3/16	37148	1 1/2
37120	5/8	37130	15/16	37140	1 1/4		

#### Features

- SUPERTORQUE® lobular openings for greater turning power without deforming the fastener.
- Designed for maximum engagement on 6 point fasteners.
- Suitable for use with pneumatic and electric impact wrenches.
- Specially heat treated for impact use to provide long life, safety, and durability.
- Drive end features pin retention hole and groove.



37905

# SOCKETS & DRIVE TOOLS

## 1/2" DRIVE



### 1/2" DRIVE SHALLOW IMPACT SOCKETS, 12 POINT, SAE

#### Black Industrial Finish

Product Code	Size (Inches)	A OAL (Inches)	B Drive End Diameter (Inches)	C Working End Diameter (Inches)	D Broach Depth (Inches)	E Bolt Clearance Depth (Inches)	Bolt Clearance Diameter (Inches)	F Nose Length (Inches)
35512	3/8	1 1/2	7/8	5/8	3/8	/	1/4	5/8
35514	7/16	1 1/2	7/8	3/4	3/8	/	1/4	5/8
35516	1/2	1 1/2	7/8	3/4	3/8	/	1/4	5/8
35518	9/16	1 1/2	1	7/8	3/8	/	1/2	5/8
35520	5/8	1 1/2	1	1	1/2	/	1/2	/
35522	11/16	1 1/2	1	1	1/2	/	1/2	/
35524	3/4	1 1/2	1	1	1/2	/	5/8	/
35526	13/16	1 1/2	1 1/8	1 1/8	1/2	/	3/4	/
35528	7/8	1 1/2	1 1/4	1 1/4	1/2	/	3/4	/
35530	15/16	1 1/2	1 1/4	1 1/4	1/2	/	7/8	/
35532	1	1 1/2	1 1/4	1 1/2	1/2	/	7/8	/
35534	1 1/16	1 9/16	1 1/2	1 1/2	5/8	/	1	/
35536	1 1/8	1 9/16	1 1/2	1 1/2	3/4	/	1	9/16
35538	1 3/16	1 9/16	1 1/2	1 5/8	3/4	/	1	9/16
35540	1 1/4	1 9/16	1 1/2	1 3/4	3/4	/	1 1/8	9/16
35542	1 5/16	1 5/8	1 1/2	1 3/4	7/8	/	1 1/8	9/16
35544	1 3/8	1 5/8	1 1/2	1 7/8	7/8	/	1 1/4	9/16
35546	1 7/16	1 5/8	1 1/2	2	7/8	/	1 1/4	9/16
35548	1 1/2	1 5/8	1 1/2	2	1	/	1 3/8	9/16



35512

#### 37923 11 piece 1/2" Drive Impact Shallow 12 Point Socket Set on Clip Rails

Product Code	Size (Inches)	Product Code	Size (Inches)	Product Code	Size (Inches)
35512	3/8	35520	5/8	35528	7/8
35514	7/16	35522	11/16	35530	15/16
35516	1/2	35524	3/4	35532	1
35518	9/16	35526	13/16		



37923

#### Features

- SUPERTORQUE® lobular openings for greater turning power without deforming the fastener
- Designed for maximum engagement on 6 and 12 point fasteners
- Suitable for use with pneumatic and electric impact wrenches
- Specially heat treated for impact use to provide long life, safety, and durability
- Drive end features pin retention hole and groove



### 1/2" DRIVE UNIVERSAL IMPACT SOCKETS, 6 POINT, SAE

#### Black Industrial Finish

Product Code	Size (Inches)	A OAL (Inches)	B Drive End Diameter (Inches)	C Working End Diameter (Inches)	D Broach Depth (Inches)	E Bolt Clearance Depth (Inches)	Bolt Clearance Diameter (Inches)	F Nose Length (Inches)
37216	1/2	2 3/4	1	3/4	3/8	9/16	7/16	1
37218	9/16	2 3/4	1	3/4	3/8	9/16	7/16	1
37220	5/8	2 3/4	1	3/4	3/8	9/16	9/16	1
37222	11/16	2 3/4	1 1/4	1	1/2	1 1/16	1 1/16	1 1/4
37224	3/4	2 3/4	1 1/4	1	1/2	1 1/16	1 1/16	1 1/4
37226	13/16	3	1 1/4	1 1/4	5/8	1 3/16	1 3/16	1 1/2
37228	7/8	3	1 1/4	1 1/4	5/8	1 3/16	1 3/16	1 1/2

Fed. Spec: ANSI B107.2

#### 37918 7 Piece 1/2" Drive Universal 6 Point Impact Socket Set on Clip Rail

Product Code	Size (Inches)	Product Code	Size (Inches)	Product Code	Size (Inches)
37216	1/2	37222	11/16	37228	7/8
37218	9/16	37224	3/4		
37220	5/8	37226	13/16		



37224

#### Features

- SUPERTORQUE® lobular openings for greater turning power without deforming the fastener
- Designed for maximum engagement on 6 point fasteners
- Suitable for use with pneumatic and electric impact wrenches
- Specially heat treated for impact use to provide long life, safety, and durability
- Drive end features pin retention hole and groove



37918



# SOCKETS & DRIVE TOOLS

## 1/2" DRIVE



### 1/2" DRIVE DEEP IMPACT SOCKETS, 6 POINT, SAE

Black Industrial Finish



14-612 14-624

Product Code	Size (Inches)	A OAL (Inches)	B Drive End Diameter (Inches)	C Working End Diameter (Inches)	D Broach Depth (Inches)	E Bolt Clearance Depth (Inches)	Bolt Clearance Diameter (Inches)	F Nose Length (Inches)
14-612	3/8	3 1/4	29/32	19/32	5/16	2 5/8	11/32	2 15/32
14-614	7/16	3 1/4	29/32	23/32	11/32	2 5/8	13/32	2 15/32
14-616	1/2	3 1/4	29/32	13/16	13/32	2 5/8	15/32	2 15/32
14-618	9/16	3 1/4	29/32	7/8	13/32	2 5/8	15/32	2 15/32
14-620	5/8	3 1/4	31/32	31/32	15/32	2 7/16	5/8	-
14-622	11/16	3 1/4	1 1/16	1 1/16	1/2	2	5/8	-
14-624	3/4	3 1/4	1 1/8	1 1/8	9/16	2	11/16	-
14-626	13/16	3 1/4	1 1/4	1 1/4	5/8	2	29/32	-
14-628	7/8	3 1/2	1 5/16	1 5/16	9/16	2 1/4	7/8	-
14-630	15/16	3 1/2	1 3/8	1 3/8	3/4	2 1/4	15/16	-
14-632	1	3 1/2	1 7/16	1 7/16	3/4	2 1/4	1	-
14-634	1 1/16	3 1/2	1 9/16	1 9/16	25/32	2 1/4	1 1/32	-
14-636	1 1/8	3 1/2	1 5/8	1 5/8	13/16	2 1/4	1 1/8	-
14-638	1 3/16	3 1/2	1 11/16	1 11/16	13/16	2 1/4	1 3/16	-
14-640	1 1/4	3 1/2	1 3/4	1 3/4	1	2 21/32	1 1/4	-
14-642	1 3/16	3 1/2	1 1/2	1 7/8	15/16	2 7/8	1 1/16	-
14-644	1 3/8	3 1/2	1 1/2	2	29/32	2 7/8	1 1/16	-
14-646	1 7/16	3 1/2	1 1/2	2	29/32	2 7/8	1 1/16	-
14-648	1 1/2	3 1/2	1 9/16	2 1/8	29/32	2 7/8	1 1/16	-

Fed. Spec: ANSI B107.2

### WS-14-11 11 Piece 1/2" Drive Deep 6 Point Impact Socket Set on Clip Rail

Contents Include:

Product Code	Size (Inches)	Product Code	Size (Inches)	Product Code	Size (Inches)
14-612	3/8	14-620	5/8	14-628	7/8
14-614	7/16	14-622	11/16	14-630	15/16
14-616	1/2	14-624	3/4	14-632	1
14-618	9/16	14-626	13/16		



WS-14-11

### WS-14-14RC 14 Piece 1/2" Drive Deep 6 Point Impact Socket Set on Clip Rail

Contents Include:

Product Code	Size (Inches)	Product Code	Size (Inches)	Product Code	Size (Inches)
14-612	3/8	14-622	11/16	14-632	1
14-614	7/16	14-624	3/4	14-634	1 1/16
14-616	1/2	14-626	13/16	14-636	1 1/8
14-618	9/16	14-628	7/8	14-640	1 1/4
14-620	5/8	14-630	15/16		



WS-14-14RC

### WS-14-19RC 19 Piece 1/2" Drive Deep 6 Point Impact Socket Set on Clip Rail

Contents Include:

Product Code	Size (Inches)	Product Code	Size (Inches)	Product Code	Size (Inches)	Product Code	Size (Inches)
14-612	3/8	14-622	11/16	14-632	1	14-642	1 3/16
14-614	7/16	14-624	3/4	14-634	1 1/16	14-644	1 3/8
14-616	1/2	14-626	13/16	14-636	1 1/8	14-646	1 7/16
14-618	9/16	14-628	7/8	14-638	1 3/16	14-648	1 1/2
14-620	5/8	14-630	15/16	14-640	1 1/4		



WS-14-19RC

### Features

- SUPERTORQUE® lobular openings for greater turning power without deforming the fastener.
- Designed for maximum engagement on 6 point fasteners.
- Suitable for use with pneumatic and electric impact wrenches.
- Specially heat treated for impact use to provide long life, safety, and durability.

# SOCKETS & DRIVE TOOLS

## 1/2" DRIVE



### 1/2" DRIVE DEEP IMPACT SOCKETS, 6 POINT, SAE

Black Industrial Finish

Product Code	Size (Inches)	A		B		C		D		E		F
		OAL (Inches)	Drive End Diameter (Inches)	Working End Diameter (Inches)	Broach Depth (Inches)	Bolt Clearance Depth (Inches)	Bolt Clearance Diameter (Inches)	Nose Length (Inches)				
37312	3/8	3 1/4	15/16	5/8	1 3/32	2 1/4	11/32	3/4				
37314	7/16	3 1/4	15/16	11/16	1	2 3/8	19/32	3/4				
37316	1/2	3 1/4	15/16	25/32	1 3/32	2 3/8	7/16	3/4				
37318	9/16	3 1/4	15/16	7/8	1 5/32	2 11/32	1/2	3/4				
37320	5/8	3 1/4	1	31/32	1 5/16	2 7/16	9/16	3/4				
37322	11/16	3 1/4	1 1/8	1	1 3/8	2 17/32	21/32	3/4				
37324	3/4	3 1/4	1 1/8	1 1/8	1 5/16	2 9/16	23/32	-				
37326	13/16	3 1/4	1 3/16	1 3/16	1 1/2	2 11/32	3/4	-				
37328	7/8	3 1/2	1 1/4	1 1/4	1 15/32	2 21/32	21/32	-				
37330	15/16	3 1/2	1 3/8	1 3/8	1 13/32	2 19/32	29/32	-				
37332	1	3 1/2	1 1/2	1 1/2	1 15/32	2 5/8	15/16	-				
37334	1 1/16	3 1/2	1 17/32	1 17/32	1 29/32	2 17/32	1 1/32	-				
37336	1 1/8	3 1/2	1 5/8	1 5/8	1 7/16	2 7/16	1 1/16	-				
37338	1 3/16	3 1/2	1 21/32	1 21/32	1 13/32	2 27/32	1 1/16	-				
37340	1 1/4	3 1/2	1 3/4	1 3/4	1 7/16	2 3/4	1 1/16	-				
37342	1 5/16	3 1/2	1 7/8	1 7/8	1 3/8	2 43/64	1 7/32	-				
37344	1 3/8	3 1/2	1 57/64	1 57/64	1 3/8	2 49/64	1 19/64	-				
37346	1 1/2	3 1/2	1 31/32	1 31/32	1 3/8	2 49/64	1 11/32	-				
37348	1 1/2	3 1/2	2 1/8	2 1/8	1 3/8	2 43/64	1 3/8	-				

Fed. Spec: ANSI B107.2

#### 37906 9 Piece 1/2" Drive Deep 6 Point Impact Socket Set on Clip Rail

Contents Include:

Product Code	Size (Inches)	Product Code	Size (Inches)	Product Code	Size (Inches)
37316	1/2	37322	11/16	37328	7/8
37318	9/16	37324	3/4	37330	15/16
37320	5/8	37326	13/16	37332	1



37324 37312



37906

#### 37908 15 Piece 1/2" Drive Deep 6 Point Impact Socket Set on Clip Rail

Contents Include:

Product Code	Size (Inches)	Product Code	Size (Inches)	Product Code	Size (Inches)	Product Code	Size (Inches)
37312	3/8	37320	5/8	37328	7/8	37336	1 1/8
37314	7/16	37322	11/16	37330	15/16	37338	1 3/16
37316	1/2	37324	3/4	37332	1	37340	1 1/4
37318	9/16	37326	13/16	37334	1 1/16		



37908

#### 37909 19 piece 1/2" Drive Impact Deep 6 Point Socket Set on Clip Rails

Contents Include:

Product Code	Size (Inches)	Product Code	Size (Inches)	Product Code	Size (Inches)	Product Code	Size (Inches)
37312	3/8	37322	11/16	37332	1	37342	1 5/16
37314	7/16	37322	11/16	37334	1 1/16	37344	1 3/8
37316	1/2	37326	13/16	37336	1 1/8	37346	1 7/16
37318	9/16	37328	7/8	37338	1 3/16	37348	1 1/2
37320	5/8	37330	15/16	37340	1 1/4		

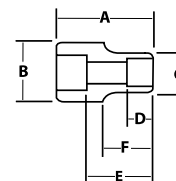

#### Features

- SUPERTORQUE® lobular openings for greater turning power without deforming the fastener.
- Designed for maximum engagement on 6 point fasteners.
- Suitable for use with pneumatic and electric impact wrenches.
- Specially heat treated for impact use to provide long life, safety, and durability.
- Drive end features pin retention hole and groove.



37909





# SOCKETS & DRIVE TOOLS

## 1/2" DRIVE



### 1/2" DRIVE DEEP IMPACT SOCKETS, 12 POINT, SAE

Black Industrial Finish



37424

37412

Product Code	Size (Inches)	OAL (Inches)	Drive End Diameter (Inches)	Working End Diameter (Inches)	Broach Depth (Inches)	Bolt Clearance Depth (Inches)	Bolt Clearance Diameter (Inches)	Nose Length (Inches)
37412	3/8	3 1/4	7/8	7/8	9/16	/	3/8	2
37414	7/16	3 1/4	7/8	3/4	9/16	/	7/8	2
37416	1/2	3 1/4	7/8	13/16	9/16	/	3/2	2
37418	9/16	3 1/4	15/16	7/8	3/8	/	1/2	2
37420	5/8	3 1/4	1	1	5/8	/	1/2	/
37422	11/16	3 1/4	1	1	3/4	/	9/16	/
37424	3/4	3 1/4	1	1	3/4	/	5/8	/
37426	13/16	3 1/4	1 1/8	1 1/8	1	/	3/4	/
37428	7/8	3 1/4	1 1/4	1 1/4	1	/	3/4	/
37430	15/16	3 1/4	1 1/4	1 1/4	1	/	7/8	/
37432	1	3 1/4	1 1/2	1 1/2	1	/	7/8	/
37434	1 1/16	3 1/4	1 1/2	1 1/2	1	/	1	/
37436	1 1/8	3 1/4	1 1/2	1 1/2	1	/	1	9/16
37438	1 3/16	3 1/4	1 1/2	1 3/8	1	/	1	9/16
37440	1 1/4	3 1/4	1 1/2	1 3/4	1	/	1 1/8	9/16
37442	1 5/16	3 1/2	1 1/2	1 13/16	1 3/8	/	1 1/8	9/16
37444	1 3/8	3 1/2	1 1/2	1 7/8	1 3/8	/	1 1/4	9/16
37446	1 1/2	3 1/2	1 1/2	2	1 3/8	/	1 1/4	9/16
37448	1 1/2	3 1/2	1 1/2	2	1 3/8	/	1 3/8	9/16



37924

### 37924 11 Piece 1/2" Drive Impact Deep 12 Point Socket Set on Clip Rail

Contents Include:

Product Code	Size (Inches)	Product Code	Size (Inches)	Product Code	Size (Inches)
37412	3/8	37418	9/16	37426	13/16
37414	7/16	37420	5/8	37428	7/8
37416	1/2	37422	11/16	37430	15/16
		37424	3/4	37432	1

#### Features

- SUPERTORQUE® lobular openings for greater turning power without deforming the fastener
- Designed for maximum engagement on 6 and 12 point fasteners
- Suitable for use with pneumatic and electric impact wrenches
- Specially heat treated for impact use to provide long life, safety, and durability
- Drive end features pin retention hole and groove



37819



### 1/2" DRIVE UNIVERSAL IMPACT SOCKETS, 6 POINT, METRIC

Black Industrial Finish

Product Code	Size (MM)	OAL (Inches)	Drive End Diameter (Inches)	Working End Diameter (Inches)	Broach Depth (Inches)	Bolt Clearance Depth (Inches)	Bolt Clearance Diameter (Inches)	Nose Length (Inches)
37813	13	2 3/4	1	3/4	3/8	1/2	1/2	1
37814	14	2 3/4	1	3/4	3/8	1/2	1/2	1
37815	15	2 3/4	1	1	3/8	1/2	1/2	1
37816	16	2 3/4	1	1	3/8	1/2	1/2	1
37817	17	2 3/4	1 1/4	1	1/2	3/4	3/4	1 1/4
37818	18	2 3/4	1 1/4	1	1/2	3/4	3/4	1 1/4
37819	19	2 3/4	1 1/4	1	1/2	3/4	3/4	1 1/4
37820	20	3	1 1/4	1 1/4	5/8	3/4	3/4	1 1/2
37821	21	3	1 1/4	1 1/4	5/8	3/4	3/4	1 1/2
37822	22	3	1 1/4	1 1/4	5/8	3/4	3/4	1 1/2
37823	23	3	1 1/4	1 1/4	5/8	3/4	3/4	1 1/2

### 37916 11 Piece 1/2" Drive Universal 6 Point Impact Socket Set on Clip Rail

Contents Include:

Product Code	Size (MM)	Product Code	Size (MM)	Product Code	Size (MM)
37813	13	37817	17	37821	21
37814	14	37818	18	37822	22
37815	15	37819	19	37823	23
37816	16	37820	20		

#### Features

- SUPERTORQUE® lobular openings for greater turning power without deforming the fastener
- Designed for maximum engagement on 6 point fasteners
- Suitable for use with pneumatic and electric impact wrenches
- Specially heat treated for impact use to provide long life, safety, and durability
- Drive end features pin retention hole and groove



37916

# SOCKETS & DRIVE TOOLS

## 1/2" DRIVE



### 1/2" DRIVE SHALLOW IMPACT SOCKETS, 6 POINT, METRIC

Black Industrial Finish

Product Code	Size (MM)	A		B		C		D		E		F
		OAL (Inches)	Drive End Diameter (Inches)	Working End Diameter (Inches)	Broach Depth (Inches)	Bolt Clearance Depth (Inches)	Bolt Clearance Diameter (Inches)	Nose Length (Inches)				
4M-610	10	1 1/2	29/32	19/32	1/4	7/8	1 1/2	23/32				
4M-611	11	1 1/2	29/32	23/32	9/16	7/8	1 3/2	23/32				
4M-612	12	1 1/2	29/32	25/32	3/8	7/8	7/16	23/32				
4M-613	13	1 1/2	29/32	27/32	13/32	7/8	15/32	23/32				
4M-614	14	1 1/2	29/32	7/8	7/16	7/8	15/32	23/32				
4M-615	15	1 1/2	19/16	15/16	7/16	7/8	15/32	-				
4M-616	16	1 1/2	31/32	31/32	15/32	7/8	15/32	-				
4M-617	17	1 1/2	1	1	1/2	7/8	15/32	-				
4M-618	18	1 1/2	1 1/16	1 1/16	27/32	27/32	21/32	-				
4M-619	19	1 1/2	1 1/8	1 1/8	19/16	27/32	11/16	-				
4M-620	20	1 1/2	1 3/16	1 3/16	13/16	27/32	23/32	-				
4M-621	21	1 1/2	1 1/4	1 1/4	13/16	27/32	3/4	-				
4M-622	22	1 1/2	1 9/16	1 9/16	13/16	27/32	13/16	-				
4M-623	23	1 3/4	1 5/32	1 5/32	1 1/32	1 3/32	27/32	-				
4M-624	24	1 3/4	1 3/8	1 3/8	1 1/16	1 3/32	7/8	-				
4M-625	25	1 3/4	1 7/16	1 7/16	1 1/16	1 3/32	29/32	-				
4M-626	26	1 3/4	1 1/2	1 1/2	1 1/4	1 9/32	31/32	-				
4M-627	27	1 3/4	1 9/16	1 9/16	1 1/4	1 9/32	1	-				
4M-629	29	1 3/4	1 21/32	1 21/32	1 1/4	1 9/32	1 1/16	-				
4M-630	30	1 3/4	1 11/16	1 11/16	1 1/4	1 9/32	1 3/32	-				
4M-632	32	2	1 13/16	1 13/16	7/8	1 9/32	1 1/8	-				
4M-634	34	2 1/16	1 11/16	1 7/8	29/32	1 7/16	1 11/32	-				
4M-636	36	2 1/4	1 13/16	2	29/32	1 5/8	1 7/16	-				



4M-621

4M-610

#### MS-4-10HRC 10 Piece 1/2" Drive Shallow 6 Point Impact Socket Set on Clip Rail

Contents Include:

Product Code	Size (MM)	Product Code	Size (MM)	Product Code	Size (MM)
4M-610	10	4M-614	14	4M-618	18
4M-611	11	4M-615	15	4M-619	19
4M-612	12	4M-616	16		
4M-613	13	4M-617	17		



MS-4-10HRC

#### MS-4-12HRC 12 Piece 1/2" Drive Shallow 6 Point Impact Socket Set on Clip Rail

Contents Include:

Product Code	Size (MM)	Product Code	Size (MM)	Product Code	Size (MM)
4M-613	13	4M-617	17	4M-622	22
4M-614	14	4M-618	18	4M-624	24
4M-615	15	4M-619	19	4M-627	27
4M-616	16	4M-621	21	4M-630	30



MS-4-12HRC

#### MS-4-16RC 16 Piece 1/2" Drive Shallow 6 Point Impact Socket Set on Clip Rail

Contents Include:

Product Code	Size (MM)	Product Code	Size (MM)	Product Code	Size (MM)	Product Code	Size (MM)
4M-610	10	4M-614	14	4M-618	18	4M-622	22
4M-611	11	4M-615	15	4M-619	19	4M-623	23
4M-612	12	4M-616	16	4M-620	20	4M-624	24
4M-613	13	4M-617	17	4M-621	21	4M-627	27



MS-4-16RC

#### MS-4-23RC 23 Piece 1/2" Drive Shallow 6 Point Impact Socket Set on Clip Rail

Contents Include:

Product Code	Size (MM)	Product Code	Size (MM)	Product Code	Size (MM)	Product Code	Size (MM)
4M-610	10	4M-616	16	4M-622	22	4M-629	29
4M-611	11	4M-617	17	4M-623	23	4M-630	30
4M-612	12	4M-618	18	4M-624	24	4M-632	32
4M-613	13	4M-619	19	4M-625	25	4M-634	34
4M-614	14	4M-620	20	4M-626	26	4M-636	36
4M-615	15	4M-621	21	4M-627	27		



MS-4-23RC

#### Features

- SUPERTORQUE® lobular openings for greater turning power without deforming the fastener.
- Designed for maximum engagement on 6 point fasteners.
- Suitable for use with pneumatic and electric impact wrenches.
- Specially heat treated for impact use to provide long life, safety, and durability.



# SOCKETS & DRIVE TOOLS

## 1/2" DRIVE



### 1/2" DRIVE SHALLOW IMPACT SOCKETS, 6 POINT, METRIC

Black Industrial Finish



37521

37510

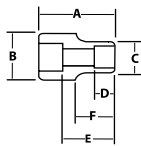

Product Code	Size (MM)	A	B	C	D	E	F
		OAL (Inches)	Drive End Diameter (Inches)	Working End Diameter (Inches)	Broach Depth (Inches)	Bolt Clearance Depth (Inches)	Bolt Clearance Diameter (Inches)
37510	10	1 1/2	1	5/8	9/16	7/8	23/32
37511	11	1 1/2	1	11/16	9/16	7/8	23/32
37512	12	1 1/2	1	3/4	9/16	7/8	23/32
37513	13	1 1/2	1	13/16	17/32	7/8	23/32
37514	14	1 1/2	1	7/8	17/32	7/8	23/32
37515	15	1 1/2	1 3/16	15/16	17/32	29/32	3/4
37516	16	1 1/2	1 3/16	1	17/32	7/8	3/4
37517	17	1 1/2	1 3/16	1 1/32	17/32	7/8	3/4
37518	18	1 1/2	1 3/16	1 3/32	19/16	7/8	3/4
37519	19	1 1/2	1 3/16	1 1/8	3/4	29/32	3/4
37520	20	1 1/2	1 3/16	1 3/16	49/64	49/64	-
37521	21	1 1/2	1 3/16	1 3/16	29/32	15/16	-
37522	22	1 1/2	1 1/4	1 1/4	29/32	1 1/16	-
37523	23	1 3/4	1 19/64	1 19/64	27/32	27/32	-
37524	24	1 3/4	1 3/8	1 3/8	1	1 3/16	-
37525	25	1 3/4	1 15/32	1 15/32	31/32	31/32	-
37526	26	1 3/4	1 1/2	1 1/2	31/32	31/32	-
37527	27	1 3/4	1 17/32	1 17/32	1	1 7/32	-
37529	29	1 3/4	1 39/64	1 39/64	31/32	31/32	-
37530	30	1 3/4	1 21/32	1 21/32	31/32	31/32	-
37532	32	1 3/4	1 47/64	1 47/64	31/32	31/32	-
37534	34	1 3/4	1 7/8	1 7/8	31/32	31/32	-
37536	36	1 31/32	1 31/32	1 31/32	1 1/16	1 1/16	-



37910

#### 37910 10 Piece 1/2" Drive Shallow 6 Point Impact Socket Set on Clip Rail

Contents Include:

Product Code	Size (MM)	Product Code	Size (MM)	Product Code	Size (MM)
37510	10	37514	14	37518	18
37511	11	37515	15	37519	19
37512	12	37516	16		
37513	13	37517	17		



37912

#### 37912 14 Piece 1/2" Drive Shallow 6 Point Impact Socket Set on Clip Rail

Contents Include:

Product Code	Size (MM)	Product Code	Size (MM)	Product Code	Size (MM)
37510	10	37514	14	37518	18
37511	11	37515	15	37519	19
37512	12	37516	16	37521	21
37513	13	37517	17	37522	22



37915

#### 37915 23 piece 1/2" Drive Impact Shallow 6 Point, MM Socket Set on Clip Rails

Contents Include:

Product Code	Size (MM)	Product Code	Size (MM)	Product Code	Size (MM)	Product Code	Size (MM)
37510	10	37515	15	37521	21	37527	27
37511	11	37516	16	37522	22	37529	29
37512	12	37517	17	37523	23	37530	30
37513	13	37518	18	37524	24	37532	32
37514	14	37519	19	37525	25	37534	34
		37520	20	37526	26	37536	36

#### Features

- SUPERTORQUE® lobular openings for greater turning power without deforming the fastener.
- Designed for maximum engagement on 6 point fasteners.
- Suitable for use with pneumatic and electric impact wrenches.
- Specially heat treated for impact use to provide long life, safety, and durability.
- Drive end features pin retention hole and groove.

# SOCKETS & DRIVE TOOLS

## 1/2" DRIVE



### 1/2" DRIVE SHALLOW IMPACT SOCKETS, 12 POINT,MM

#### Black Industrial Finish

Product Code	Size (MM)	A OAL (Inches)	B Drive End Diameter (Inches)	C Working End Diameter (Inches)	D Broach Depth (Inches)	E Bolt Clearance Depth (Inches)	Bolt Clearance Diameter (Inches)	F Nose Length (Inches)
37610	10	1 1/2	7/8	5/8	3/8	/	3/8	5/8
37611	11	1 1/2	7/8	3/4	3/8	/	3/8	5/8
37612	12	1 1/2	7/8	3/4	3/8	/	3/8	5/8
37613	13	1 1/2	15/16	13/16	3/8	/	3/8	5/8
37614	14	1 1/2	15/16	7/8	3/8	/	1/2	5/8
37615	15	1 1/2	1	7/8	1/2	/	1/2	5/8
37616	16	1 1/2	1	1	1/2	/	1/2	/
37617	17	1 1/2	1	1	1/2	/	9/16	/
37618	18	1 1/2	1	1	1/2	/	5/8	/
37619	19	1 1/2	1 1/8	1 1/8	1/2	/	5/8	/
37620	20	1 1/2	1 1/8	1 1/8	1/2	/	3/4	/
37621	21	1 1/2	1 1/4	1 1/4	9/16	/	3/4	/
37622	22	1 1/2	1 1/4	1 1/4	9/16	/	13/16	/
37623	23	1 5/8	1 1/4	1 1/4	5/8	/	13/16	/
37624	24	1 5/8	1 1/2	1 3/8	5/8	/	7/8	/
37625	25	1 5/8	1 1/2	1 3/8	5/8	/	7/8	/
37626	26	1 5/8	1 1/2	1 1/2	5/8	/	15/16	/
37627	27	1 13/16	1 1/2	1 1/2	3/4	/	15/16	9/16
37628	28	1 13/16	1 1/2	1 1/2	3/4	/	1	9/16
37629	29	1 13/16	1 1/2	1 5/8	3/4	/	1	9/16
37630	30	1 13/16	1 1/2	1 5/8	3/4	/	1	9/16
37632	32	1 13/16	1 1/2	1 3/4	13/16	/	1 1/8	9/16
37633	33	1 13/16	1 1/2	1 13/16	7/8	/	1 1/8	9/16
37634	34	1 13/16	1 1/2	1 13/16	7/8	/	1 1/4	9/16
37635	35	2	1 1/2	2	7/8	/	1 1/4	9/16
37636	36	2	1 1/2	2	7/8	/	1 1/4	9/16



37624

37610

#### 37925 10 piece 1/2" Drive Impact Shallow 12 Point, MM Socket Set on Clip Rails Contents Include:

Product Code	Size (MM)	Product Code	Size (MM)	Product Code	Size (MM)
37610	10	37613	13	37616	16
37611	11	37614	14	37617	17
37612	12	37615	15	37618	18
				37619	19

#### Features

- SUPERTORQUE® lobular openings for greater turning power without deforming the fastener.
- Designed for maximum engagement on 6 and 12 point fasteners.
- Suitable for use with pneumatic and electric impact wrenches.
- Specially heat treated for impact use to provide long life, safety, and durability.



37925



# SOCKETS & DRIVE TOOLS

## 1/2" DRIVE



### 1/2" DRIVE DEEP IMPACT SOCKETS, 6 POINT, METRIC

**Black Industrial Finish**



Product Code	Size (MM)	A		B		C		D		E		F	
		OAL (Inches)	Drive End Diameter (Inches)	Working End Diameter (Inches)	Broach Depth (Inches)	Bolt Clearance Depth (Inches)	Bolt Clearance Diameter (Inches)	Nose Length (Inches)					
14M-610	10	3 1/4	29/32	19/32	9/32	2 9/16	11/32	2 15/32					
14M-611	11	3 1/4	29/32	23/32	21/64	2 9/16	13/32	2 15/32					
14M-612	12	3 1/4	29/32	49/64	23/64	2 9/16	7/16	2 15/32					
14M-613	13	3 1/4	29/32	53/64	25/64	2 9/16	15/32	2 15/32					
14M-614	14	3 1/4	29/32	7/8	13/32	2 9/16	15/32	2 15/32					
14M-615	15	3 1/4	15/16	15/16	13/32	2 7/64	33/64	-					
14M-616	16	3 1/4	31/32	31/32	29/64	1 31/32	11/32	-					
14M-617	17	3 1/4	1	1	27/64	1 31/32	39/64	-					
14M-618	18	3 1/4	1 1/16	1 1/16	1/2	1 31/32	21/32	-					
14M-619	19	3 1/4	1 1/4	1 1/4	35/64	1 61/64	11/16	-					
14M-620	20	3 1/4	1 3/16	1 3/16	35/64	1 61/64	23/32	-					
14M-621	21	3 1/4	1 1/4	1 1/4	35/64	1 61/64	3/4	-					
14M-622	22	3 1/2	1 5/16	1 5/16	35/64	2 7/64	51/64	-					
14M-623	23	3 1/2	1 11/32	1 11/32	5/8	2 7/64	53/64	-					
14M-624	24	3 1/2	1 3/8	1 3/8	5/8	2 7/64	7/8	-					
14M-625	25	3 1/2	1 7/16	1 7/16	5/8	2 7/64	29/32	-					
14M-626	26	3 1/2	1 31/64	1 31/64	5/8	2 7/64	15/16	-					
14M-627	27	3 1/2	1 9/16	1 9/16	25/32	2 7/64	31/32	-					
14M-629	29	3 1/2	1 5/8	1 5/8	13/16	2 7/64	1 1/16	-					
14M-630	30	3 1/2	1 11/16	1 11/16	53/64	2 21/32	1 3/32	-					
14M-632	32	3 1/2	1 13/16	1 13/16	7/8	2 21/32	1 1/4	-					
14M-634	34	3 1/2	1 3/4	1 15/16	57/64	2 55/64	1 21/64	-					
14M-635	35	3 1/2	1 3/4	2	57/64	2 55/64	1 23/64	-					
14M-636	36	3 1/2	1 3/4	2	57/64	2 13/16	1 1/8	-					

### MS-14-10HRC 10 Piece 1/2" Drive Deep 6 Point Impact Socket Set on Clip Rail

**Contents Include:**

Product Code	Size (MM)	Product Code	Size (MM)	Product Code	Size (MM)
14M-610	10	14M-614	14	14M-618	18
14M-611	11	14M-615	15	14M-619	19
14M-612	12	14M-616	16		
14M-613	13	14M-617	17		



MS-14-10HRC

### MS-14-16RC 16 Piece 1/2" Drive Deep 6 Point Impact Socket Set on Clip Rail

**Contents Include:**

Product Code	Size (MM)	Product Code	Size (MM)	Product Code	Size (MM)	Product Code	Size (MM)
14M-610	10	14M-614	14	14M-618	18	14M-622	22
14M-611	11	14M-615	15	14M-619	19	14M-623	23
14M-612	12	14M-616	16	14M-620	20	14M-624	24
14M-613	13	14M-617	17	14M-621	21	14M-627	27



MS-14-16RC

### MS-14-24RC 24 Piece 1/2" Drive Deep 6 Point Impact Socket Set on Clip Rail

**Contents Include:**

Product Code	Size (MM)	Product Code	Size (MM)	Product Code	Size (MM)	Product Code	Size (MM)
14M-610	10	14M-616	16	14M-622	22	14M-629	29
14M-611	11	14M-617	17	14M-623	23	14M-630	30
14M-612	12	14M-618	18	14M-624	24	14M-632	32
14M-613	13	14M-619	19	14M-625	25	14M-634	34
14M-614	14	14M-620	20	14M-626	26	14M-635	35
14M-615	15	14M-621	21	14M-627	27	14M-636	36



MS-14-24RC

### Features

- SUPERTORQUE® lobular openings for greater turning power without deforming the fastener.
- Designed for maximum engagement on 6 point fasteners.
- Suitable for use with pneumatic and electric impact wrenches.
- Specially heat treated for impact use to provide long life, safety, and durability.

# SOCKETS & DRIVE TOOLS

## 1/2" DRIVE



### 1/2" DRIVE DEEP IMPACT SOCKETS, 6 POINT, METRIC

#### Black Industrial Finish

Product Code	Size (MM)	A OAL (Inches)	B Drive End Diameter (Inches)	C Working End Diameter (Inches)	D Broach Depth (Inches)	E Bolt Clearance Depth (Inches)	Bolt Clearance Diameter (Inches)	F Nose Length (Inches)
37710	10	3 1/4	29/32	19/32	9/32	2 9/16	11/32	2 15/32
37711	11	3 1/4	29/32	23/32	21/64	2 9/16	13/32	2 15/32
37712	12	3 1/4	29/32	49/64	23/64	2 9/16	7/16	2 15/32
37713	13	3 1/4	29/32	53/64	25/64	2 9/16	15/32	2 15/32
37714	14	3 1/4	29/32	7/8	13/32	2 9/16	15/32	2 15/32
37715	15	3 1/4	15/16	15/16	13/32	2 7/64	33/64	-
37716	16	3 1/4	31/32	31/32	29/64	1 31/32	17/32	-
37717	17	3 1/4	1	1	27/64	1 31/32	39/64	-
37718	18	3 1/4	1 1/16	1 1/16	1/2	1 31/32	21/32	-
37719	19	3 1/4	1 1/4	1 1/4	35/64	1 61/64	11/16	-
37720	20	3 1/4	1 3/16	1 3/16	1 3/64	2 23/64	3/4	-
37721	21	3 1/4	1 1/4	1 1/4	35/64	1 61/64	3/4	-
37722	22	3 1/2	1 5/16	1 5/16	35/64	2 7/64	51/64	-
37723	23	3 1/2	1 19/64	1 19/64	1 3/8	2 9/19	55/64	-
37724	24	3 1/2	1 3/8	1 3/8	5/8	2 7/64	7/8	-
37725	25	3 1/2	1 15/32	1 15/32	1 3/8	2 9/19	15/16	-
37726	26	3 1/2	1 1/2	1 1/2	1 3/64	2 9/19	63/64	-
37727	27	3 1/2	1 9/16	1 9/16	25/32	2 7/64	31/32	-
37729	29	3 1/2	1 39/64	1 39/64	1 3/64	2 19/32	1 1/16	-
37730	30	3 1/2	1 21/32	1 21/32	1 3/8	2 19/32	1 1/16	-
37732	32	3 1/2	1 47/64	1 47/64	1 3/8	2 19/32	1 3/16	-
37734	34	3 1/2	1 7/8	1 7/8	1 3/64	2 19/32	1 19/64	-
37736	36	3 1/2	1 31/32	1 31/32	1 3/64	2 19/32	1 3/64	-



#### 37913 10 Piece 1/2" Drive Deep 6 Point Impact Socket Set on Clip Rail

Contents Include:

Product Code	Size (MM)	Product Code	Size (MM)	Product Code	Size (MM)
37710	10	37714	14	37718	18
37711	11	37715	15	37719	19
37712	12	37716	16		
37713	13	37717	17		



#### 37914 14 Piece 1/2" Drive Deep 6 Point Impact Socket Set on Clip Rail

Contents Include:

Product Code	Size (MM)	Product Code	Size (MM)	Product Code	Size (MM)	Product Code	Size (MM)
37710	10	37714	14	37718	18	37724	24
37711	11	37715	15	37719	19	37727	27
37712	12	37716	16	37721	21		
37713	13	37717	17	37722	22		



#### 37917 23 piece 1/2" Drive Impact Deep 6 Point, MM Socket Set on Clip Rails

Contents Include:

Product Code	Size (MM)	Product Code	Size (MM)	Product Code	Size (MM)	Product Code	Size (MM)
37710	10	37716	16	37723	23	37730	30
37711	11	37717	17	37724	24	37732	32
37712	12	37718	18	37725	25	37734	34
37713	13	37719	19	37726	26	37736	36
37714	14	37720	20	37727	27		
37715	15	37721	21	37729	29		

#### Features

- SUPERTORQUE® lobular openings for greater turning power without deforming the fastener.
- Designed for maximum engagement on 6 point fasteners.
- Suitable for use with pneumatic and electric impact wrenches.
- Specially heat treated for impact use to provide long life, safety, and durability.



# SOCKETS & DRIVE TOOLS

## 1/2" DRIVE



### 1/2" DRIVE DEEP IMPACT SOCKETS, 12 POINT, MM

Black Industrial Finish



Product Code	Size (MM)	A	B	C	D	E	F	
		Overall Length (Inches)	Drive End Diameter (Inches)	Working End Diameter (Inches)	Broach Depth (Inches)	Bolt Clearance Depth (Inches)	Bolt Clearance Diameter (Inches)	Nose Length (Inches)
35910	10	3 1/4	7/8	5/8	5/8	/	3/8	2
35911	11	3 1/4	7/8	5/8	5/8	/	3/8	2
35912	12	3 1/4	7/8	3/4	5/8	/	3/8	2
35913	13	3 1/4	15/16	3/4	5/8	/	1/2	2
35914	14	3 1/4	15/16	3/4	3/4	/	1/2	2
35915	15	3 1/4	1	15/16	3/4	/	1/2	2
35916	16	3 1/4	1	15/16	3/4	/	1/2	/
35917	17	3 1/4	1	1	3/4	/	1/2	/
35918	18	3 1/4	1	1	3/4	/	5/8	/
35919	19	3 1/4	1 3/16	1 1/8	3/4	/	5/8	/
35920	20	3 1/4	1 3/16	1 1/8	1	/	3/4	/
35921	21	3 1/4	1 1/4	1 1/4	1	/	3/4	/
35922	22	3 1/4	1 1/4	1 1/4	1	/	3/4	/
35923	23	3 1/4	1 1/4	1 1/4	1	/	7/8	/
35924	24	3 1/4	1 1/2	1 1/2	1	/	7/8	/
35925	25	3 1/4	1 1/2	1 1/2	1	/	7/8	/
35926	26	3 1/4	1 1/2	1 1/2	1	/	15/16	/
35927	27	3 1/4	1 1/2	1 1/2	1	/	15/16	5/8
35928	28	3 1/4	1 1/2	1 1/2	1	/	1	5/8
35929	29	3 1/4	1 1/2	1 5/8	1	/	1	5/8
35930	30	3 1/4	1 1/2	1 5/8	1	/	1	5/8
35932	32	3 1/4	1 1/2	1 3/4	1	/	1 1/8	5/8
35933	33	3 1/2	1 1/2	1 7/8	1 1/2	/	1 1/8	5/8
35934	34	3 1/2	1 1/2	1 7/8	1 1/2	/	1 1/4	5/8
35935	35	3 1/2	1 1/2	2	1 1/2	/	1 1/4	5/8
35936	36	3 1/2	1 1/2	2	1 1/2	/	1 1/4	5/8

### 37926 10 piece 1/2" Drive Impact Shallow 12 Point Socket Set on Clip Rails

Contents Include:

Product Code	Size (MM)	Product Code	Size (MM)	Product Code	Size (MM)
35910	10	35913	13	35916	16
35911	11	35914	14	35917	17
35912	12	35915	15	35918	18
				35919	19

#### Features

- SUPERTORQUE® lobular openings for greater turning power without deforming the fastener.
- Designed for maximum engagement on 6 and 12 point fasteners.
- Suitable for use with pneumatic and electric impact wrenches.
- Specially heat treated for impact use to provide long life, safety, and durability.



37926

# SOCKETS & DRIVE TOOLS

## 1/2" DRIVE



### 1/2" DRIVE ONE PIECE IMPACT HEX BIT DRIVERS, SAE

#### Black Industrial Finish

Product Code	Size (Inches)	OAL (Inches)	Product Code	Size (Inches)	OAL (Inches)
35730	1/4	1 1/2	35738	1/2	1 1/2
35732	5/16	1 1/2	35740	9/16	1 1/2
35734	3/8	1 1/2	35742	5/8	1 1/2
35736	7/16	1 1/2			

Fed. Spec: ANSI B107.2

### 37920 7 Piece 1/2" Drive One Piece Impact Hex Bit Drivers, SAE

#### Contents Include:

Product Code	Size (Inches)	Product Code	Size (Inches)	Product Code	Size (Inches)
35730	1/4	35736	7/16	35742	5/8
35732	5/16	35738	1/2		
35734	3/8	35740	9/16		



35732



37920



### 1/2" DRIVE ONE PIECE IMPACT HEX BIT DRIVERS, MM

#### Black Industrial Finish

Product Code	Size (Inches)	OAL (Inches)	Product Code	Size (Inches)	OAL (Inches)
35706	6	1 1/2	35712	12	1 1/2
35708	8	1 1/2	35714	14	1 1/2
35710	10	1 1/2	35717	17	

Fed. Spec: ANSI B107.2

### 37922 6 Piece 1/2" Drive One Piece Impact Hex Bit Drivers, MM

#### Contents Include:

Product Code	Size (MM)	Product Code	Size (MM)	Product Code	Size (MM)
35706	6	35710	10	35714	14
35708	8	35712	12	35717	17



35708



37922



### 43 PIECE 3/4" DRIVE SOCKET AND DRIVE TOOL SET

#### 12 Point SAE, with Metal Box

Product Code	Description
WSH-43TB	43 Piece Tool Set with TB-12 Metal Tool Box
WSH-43	43 Piece Tool Set Only

#### Contents Include:

Drive Tools:		Shallow 12-Point Sockets			
Product Code	Description	Product Code	Size (Inches)	Product Code	Size (Inches)
H-20A	19" Sliding T-Handle	H-1224	3/4	H-1250	1 9/16
H-41AA	22" Flex Handle	H-1226	13/16	H-1252	1 5/8
H-51B	20" Ratchet	H-1228	7/8	H-1254	1 11/16
H-104	3" Extension	H-1230	15/16	H-1256	1 3/4
H-110	8" Extension	H-1232	1	H-1258	1 13/16
H-115	16" Extension	H-1234	1 1/16	H-1260	1 7/8
H-140A	Universal Joint	H-1236	1 1/8	H-1264	2
		H-1238	1 3/16	H-1266	2 1/16
		H-1240	1 1/4	H-1268	2 1/8
		H-1242	1 5/16	H-1270	2 3/16
		H-1244	1 3/8	H-1272	2 1/4
		H-1246	1 7/16	H-1276	2 3/8
		H-1248	1 1/2		

Deep 12-Point Sockets	
Product Code	Size (Inches)
HD-628	7/8
HD-630	15/16
HD-632	1
HD-634	1 1/16
HD-636	1 1/8
HD-640	1 1/4
HD-642	1 5/16
HD-644	1 3/8
HD-646	1 7/16
HD-648	1 1/2
HD-652	1 5/8

#### Features

- All tools are professional quality, made of high-grade chrome vanadium steel.
- Sockets feature SUPERTORQUE® lobular openings for greater turning power without deforming the fastener.
- Metal tool box made for years of rugged use.



WSH-43TB





# SOCKETS & DRIVE TOOLS

## 3/4" DRIVE

WILLIAMS®



### 46 PIECE 3/4" DRIVE SOCKET AND DRIVE TOOL SET

#### 12 Point MM, with Metal Box

Product Code	Description
33910	46 Piece Tool Set with TB-12 Metal Tool Box
33911	46 Piece Tool Set Only

#### Contents Include:

Drive Tools:		3/4" Drive Shallow 12 Point Sockets	
Product Code	Description	Product Code	Size (MM)
33001	Ratchet	33619	19
33005	Flex handle	33620	20
33002	4" Extension	33621	21
33003	8" Extension	33622	22
33004	16" Extension	33623	23
33006	18" Sliding T-handle	33624	24
33007	Universal Joint	33625	25
		33626	26
		33627	27
3/4" Drive Deep 12 Point Sockets		3/4" Drive Deep 12 Point Sockets	
Product Code	Size (MM)	Product Code	Size (MM)
33719	19	33628	28
33722	22	33629	29
33723	23	33630	30
33724	24	33632	32
33727	27	33635	35
33730	30	33636	36
33732	32	33638	38
33735	35	33641	41
33736	36	33642	42
33738	38	33646	46
33741	41	33650	50
33746	46	33654	54
33750	50	33655	55
33755	55	33658	58
33760	60	33660	60

#### Features

- All tools are professional quality, made of high-grade chrome vanadium steel.
- Sockets feature SUPERTORQUE® lobular openings for greater turning power without deforming the fastener.
- Metal tool box made for years of rugged use.



33910

# SOCKETS & DRIVE TOOLS

## 3/4" DRIVE



### 30 PIECE 3/4" DRIVE SOCKET AND DRIVE TOOL SET

#### 12 Point, MM with Metal Box

Product Code	Description
33912	30 Piece Tool Set with TB-6124A Metal Tool Box
33913	30 Piece Tool Set Only

#### Contents Include:

3/4" Drive Tools:		3/4" Drive Shallow 12 Point Sockets	
Product Code	Description	Product Code	Size (MM)
33001	Ratchet	33627	27
33005	Flex handle	33628	28
33002	4" Extension	33629	29
33003	8" Extension	33630	30
33004	16" Extension	33632	32
33006	18" Sliding T-handle	33635	35
33007	Universal Joint	33636	36
		33638	38
		33641	41
		33642	42
		33646	46
		33650	50
		33654	54
		33655	55
		33658	58
		33660	60

#### Features

- All tools are professional quality, made of high-grade chrome vanadium steel.
- Sockets feature SUPERTORQUE® lobular openings for greater turning power without deforming the fastener.
- Metal tool box made for years of rugged use.



33912



# SOCKETS & DRIVE TOOLS

## 3/4" DRIVE



WSH-29TB

WILLIAMS®



### 29 PIECE 3/4" DRIVE SOCKET AND DRIVE TOOL SET

#### 12 Point SAE, with Metal Box

Product Code	Description
WSH-29TB	29 Piece Tool Set with TB-6124A Metal Tool Box
WSH-29	29 Piece Tool Set Only

#### Contents Include:

Drive Tools:		Shallow 12-Point Sockets	
Product Code	Description	Product Code	Size (Inches)
H-20A	19" Sliding T-Handle	H-1242	1 9/16
H-41AA	22" Flex Handle	H-1244	1 3/8
H-51B	20" Ratchet	H-1246	1 7/16
H-104	3" Extension	H-1248	1 1/2
H-110	8" Extension	H-1250	1 9/16
H-115	16" Extension	H-1252	1 5/8
H-140A	Universal Joint	H-1254	1 11/16
		H-1256	1 3/4
		H-1258	1 13/16
		H-1260	1 7/8
		H-1264	2
		H-1268	2 1/8
		H-1270	2 9/16
		H-1272	2 1/4
		H-1276	2 3/8
Shallow 12-Point Sockets			
Product Code	Size (Inches)		
H-1228	7/8		
H-1230	15/16		
H-1232	1		
H-1234	1 1/16		
H-1236	1 1/8		
H-1238	1 3/8		
H-1240	1 1/4		

#### Features

- All tools are professional quality, made of high-grade chrome vanadium steel.
- Sockets feature SUPERTORQUE® lobular openings for greater turning power without deforming the fastener.
- Metal tool box made for years of rugged use.



WSH-22TB

WILLIAMS®



### 22 PIECE 3/4" DRIVE SOCKET AND DRIVE TOOL SET

#### 12 Point SAE, with Metal Box

Product Code	Description
WSH-22TB	22 Piece Tool Set with TB-49 Metal Tool Box
WSH-22	22 Piece Tool Set Only

#### Contents Include:

Drive Tools:		Shallow 12-Point Sockets	
Product Code	Description	Product Code	Size (Inches)
H-41AA	22" Flex Handle	H-1236	1 1/8
H-51B	20" Ratchet	H-1240	1 1/4
H-104	3" Extension	H-1242	1 9/16
H-110	8" Extension	H-1244	1 3/8
H-115	16" Extension	H-1246	1 7/16
H-140A	Universal Joint	H-1248	1 1/2
		H-1252	1 5/8
		H-1254	1 11/16
		H-1256	1 3/4
		H-1258	1 13/16
		H-1260	1 7/8
		H-1264	2
Shallow 12-Point Sockets			
Product Code	Size (Inches)		
H-1228	7/8		
H-1230	15/16		
H-1232	1		
H-1234	1 1/16		

#### Features

- All tools are professional quality, made of high-grade chrome vanadium steel.
- Sockets feature SUPERTORQUE® lobular openings for greater turning power without deforming the fastener.
- Metal tool box made for years of rugged use.

# SOCKETS & DRIVE TOOLS

## 3/4" DRIVE

WILLIAMS®



### 23 PIECE 3/4" DRIVE SOCKET AND DRIVE TOOL SET

#### 12 Point, MM with Metal Box

Product Code	Description
33914	23 Piece Tool Set with TB-49 Metal Tool Box
33915	23 Piece Tool Set Only

#### Contents Include:

##### 3/4" Drive Tools:

Product Code	Description
33001	Ratchet
33005	Flex handle
33003	8" Extension
33004	16" Extension

##### 3/4" Drive Shallow 12 Point Sockets

Product Code	Size (MM)
33619	19
33620	20
33621	21
33622	22
33623	23
33624	24
33625	25
33626	26
33627	27
33628	28
33629	29
33630	30
33632	32
33635	35
33636	36
33638	38
33641	41
33642	42
33646	46

#### Features

- All tools are professional quality, made of high-grade chrome vanadium steel.
- Sockets feature SUPERTORQUE® lobular openings for greater turning power without deforming the fastener.
- Metal tool box made for years of rugged use.



33914

Image shown is not actual set, for reference only.



**WARNING**

# SOCKETS & DRIVE TOOLS

## 3/4" DRIVE



### 13 PIECE 3/4" DRIVE SOCKET AND DRIVE TOOL SET

#### 12 Point SAE, with Metal Box

Product Code	Description
WSH-13TB	13 Piece Tool Set with TB-49 Metal Tool Box
WSH-13	13 Piece Tool Set Only

#### Contents Include:

Drive Tools:		Shallow 12-Point Sockets	
Product Code	Description	Product Code	Size (Inches)
H-51B	20" Ratchet	H-1234	1 1/16
H-110	8" Extension	H-1236	1 1/8
		H-1240	1 1/4
		H-1242	1 5/16
		H-1244	1 3/8
		H-1246	1 7/16
		H-1248	1 1/2
		H-1252	1 5/8

#### Features

- All tools are professional quality, made of high-grade chrome vanadium steel.
- Sockets feature SUPERTORQUE® lobular openings for greater turning power without deforming the fastener.
- Metal tool box made for years of rugged use.



WSH-13TB



### 20 PIECE 3/4" DRIVE SOCKET AND DRIVE TOOL SET

#### 12 Point Metric, with Metal Box

Product Code	Description
MSH-20TB	20 Piece Tool Set with TB-49 Metal Tool Box
MSH-20	20 Piece Tool Set Only

#### Contents Include:

Drive Tools:		Shallow 12-Point Sockets	
Product Code	Description	Product Code	Size (MM)
H-41AA	22" Flex Handle	HM-1230	30
H-51B	20" Ratchet	HM-1232	32
H-110	8" Extension	HM-1235	35
H-115	16" Extension	HM-1236	36
H-140A	Universal Joint	HM-1238	38
		HM-1241	41
		HM-1246	46
		HM-1250	50
		HM-1254	54
		HM-1255	55
		HM-1260	60

#### Features

- All tools are professional quality, made of high-grade chrome vanadium steel.
- Sockets feature SUPERTORQUE® lobular openings for greater turning power without deforming the fastener.
- Metal tool box made for years of rugged use.



MSH-20TB

# SOCKETS & DRIVE TOOLS

## 3/4" DRIVE



### 20 PIECE 3/4" DRIVE SOCKET-LOK® TOOL SET

#### 12 Point SAE, with Metal Box

Product Code	Description
33901	20 Piece Tool Set with 50081 Metal Tool Box
50081	Metal Box

#### Contents Include:

3/4" Drive Tools:		3/4" Drive Shallow 12-Point Sockets	
Product Code	Description	Product Code	Size (Inches)
33001	20" Socket-Lok® Ratchet	33238	1 3/16
33006	18" Sliding T-Handle	33240	1 1/4
33002	4" Extension	33242	1 5/16
33003	8" Extension	33244	1 3/8
		33246	1 7/16
		33248	1 1/2
3/4" Drive Shallow 12-Point Sockets		3/4" Drive Shallow 12-Point Sockets	
Product Code	Size (Inches)	Product Code	Size (Inches)
33228	7/8	33252	1 5/8
33230	15/16	33256	1 3/4
33232	1	33258	1 13/16
33234	1 1/16	33260	1 7/8
33236	1 1/8	33264	2

#### Features

- Unique Socket-Lok® Safety Retention System features a spring-loaded locking button for maximum socket retention and quick disassembly when used with our Williams® locking-button square drive tools and sockets. May also be used with all standard 3/4" drive tools.
- Chamfered ends provide easy engagement of the drive tool and fastener.
- All tools are professional quality, made of high-grade chrome vanadium steel.
- Sockets feature SUPERTORQUE® lobular openings for greater turning power without deforming the fastener.
- Metal tool box made for years of rugged use.



**Socket-Lok® button positively locks the socket and drive tool together, providing positive retention and quick disassembly.**



**WARNING**

# SOCKETS & DRIVE TOOLS

## 3/4" DRIVE



33903



33905

WILLIAMS®



### 20 PIECE 3/4" SOCKET SET

#### 12 Point Rugged-Case-System Tool Set, SAE

Product Code	Description
33903	20 Piece 3/4" Socket Set

#### Contents Include:

3/4" Drive Tools:		3/4" Drive Shallow 12 Point Sockets	
Product Code	Description	Product Code	Size (Inches)
33003	8" Extension	33236	1 1/8
33004	16" Extension	33240	1 1/4
33012	32 Tooth Ratchet Head	33242	1 5/16
33013	Universal Extendable Handle	33244	1 3/8
33014	Sliding T-Handle	33246	1 7/16
		33248	1 1/2
		33252	1 5/8
		33256	1 3/4
33228	7/8	33258	1 13/16
33230	1 1/16	33260	1 7/8
33232	1	33264	2
33234	1 1/16		

#### Features

- Extended Handle extends from 23-1/2" to 36"
- Sockets feature SUPERTORQUE® lobular openings for greater turning power without deforming the fastener
- Packed in rugged high-density polyethylene (HDPE) cases that are strong and durable yet light in weight
- Case is shock proof at both high and low temperatures, equipped with heavy-duty metal latches and hinges
- Two-component handles are easy to grip and comfortable to carry

WILLIAMS®



### 25 PIECE 3/4" SOCKET SET

#### 12 Point with Metal Box, SAE

Product Code	Description
33905	25 Piece 3/4" Socket Set

#### Contents Include:

3/4" Drive Tools:		3/4" Drive Shallow 12 Point Sockets	
Product Code	Description	Product Code	Size (Inches)
33001	2 Piece Ratchet	33240	1 1/4
33002	4" Extension	33242	1 5/16
33003	8" Extension	33244	1 3/8
33004	16" Extension	33246	1 7/16
		33248	1 1/2
		33250	1 9/16
		33252	1 3/4
33228	7/8	33256	1 3/4
33230	1 1/16	33258	1 13/16
33232	1	33260	1 7/8
33234	1 1/16	33264	2
33236	1 1/8	33268	2 1/8
33238	1 3/16	33272	2 1/4

#### Features

- All tools are professional quality, made of high-grade chrome vanadium steel
- Sockets feature SUPERTORQUE® lobular openings for greater turning power without deforming the fastener
- Packed in rugged high-density polyethylene (HDPE) cases that are strong and durable yet light in weight
- Case is shock proof at both high and low temperatures, equipped with heavy-duty metal latches and hinges
- Two-component handles are easy to grip and comfortable to carry

# SOCKETS & DRIVE TOOLS

## 3/4" DRIVE



### 3/4" DRIVE INTEGRATED HANDLE RATCHETS

#### Chrome and Black Industrial Finish

Product Code	Description	Length (Inches)	Number of Teeth
H-51B	Chrome Ratchet	20 1/8	24
HB-51B	Black Finish Ratchet	20 1/8	24
H-52EHRK	Repair Kit for H-51B and HB-51B		

Fed. Spec: ANSI B107.10M

#### Features

- Forged one-piece ratchet provide strength and safety for industrial applications.
- Smooth comfort-grip handle permits all-day use without gloves.
- 24 tooth gear with 15 degree of engagement allows engagement in tight working areas.
- Chrome finish with mirror-like exterior can be easily cleaned after each use.
- Single Pawl ratchet design:
  - 1) Designed for tighter tolerances between pawl and gear which reduces metal fatigue and slippage under load.
  - 2) Does not require as many working parts, reducing possible breakage and parts to repair.
- Easy access reverse lever allows user to change working direction quickly and easily with only one hand.
- Ball and Spring socket retention.



H-51B



HB-51B



### 3/4" DRIVE REMOVABLE-HANDLE RATCHETS

#### Knurled Handle, Chrome Finish

Product Code	Description	Length (Inches)	Number of Teeth
--------------	-------------	-----------------	-----------------

#### Complete Ratchet

H-51AB1	Ratchet with 19 1/4" Handle	24 11/16	32
---------	-----------------------------	----------	----

#### Components

H-51AB	Ratchet Head Only	6	32
H-A1	Handle Only	19 1/4	
H-52EHRKA	Repair Kit for H-51AB1 and H-51AB		

Note: Head Bore and Handle End Diameter: 13/16"

Fed. Spec: ANSI B107.10M

#### Features

- 32 teeth action provides an 11° ratcheting angle.
- Shift lever reverses action instantly.
- Ball and spring provide firm socket retention.
- Removable handle makes the tool more versatile, and storage easier.
- Knurled handle provides a non-slip grip.
- Chrome finish models provides increased protection from rust and corrosion.
- Our most rugged, high torque capacity ratchet.



H-51AB1



H-51AB



H-A1



### 3/4" DRIVE HANDLES

#### Chrome and Black Industrial Finish

Product Code	Description	Length (Inches)	Finish
H-41AA	Flex Handle Breaker Bar, Knurled Grip	22 1/8	Chrome
H-20A	Sliding T-Handle	19 1/4	Chrome
HB-20A	Sliding T-Handle	19 1/4	Black Industrial

Fed. Spec: ANSI B107.10M

#### Features

- Chrome plating provides increased protection from rust and corrosion.
- Drive handles provide extra leverage with greater strength than ratchets.
- Square drive slides on T-Handles for versatility.
- Flex handle flex drive swivels 110° in either direction.



H-41AA



H-20A



HB-20A





# SOCKETS & DRIVE TOOLS

## 3/4" DRIVE



H-104



H-104B



H-110



H-115



H-110B



H-115B



HNX-130



HNX-131



HNX-130B



HNX-131B



H-140A



HB-140A



### 3/4" DRIVE EXTENSIONS

#### Chrome and Black Industrial Finish

Product Code	Length (Inches)
--------------	-----------------

#### Chrome Finish

H-104	3
H-110	8
H-115	16

#### Black Industrial Finish

H-104B	3
H-110B	8
H-115B	16

Fed. Spec: ANSI B107.10M

#### Features

- Chrome plating provides increased protection from rust and corrosion.
- Ball and spring socket retention.



### 3/4" DRIVE ADAPTERS

#### Chrome and Black Industrial Finish

Product Code	Length (Inches)	Male End (Inches)	Female End (Inches)	Female End Detent
--------------	-----------------	-------------------	---------------------	-------------------

#### Chrome Finish

HNX-130	3	1	3/4	Detent on Each Wall
HNX-131	3 1/16	3/4	1	Drilled Hole

#### Black Industrial Finish

HNX-130B	3	1	3/4	Detent on Each Wall
HNX-131B	3 1/16	3/4	1	Drilled Hole

Fed. Spec: ANSI B107.10M

#### Features

- Chrome plating provides increased protection from rust and corrosion.
- Ball and spring socket retention.



### 3/4" DRIVE UNIVERSAL JOINTS

#### Chrome and Black Industrial Finish

Product Code	Description	Length (Inches)
--------------	-------------	-----------------

#### Chrome Finish

H-140A	Universal Joint	4 1/16
--------	-----------------	--------

#### Black Industrial Finish

HB-140A	Universal Joint	4 1/16
---------	-----------------	--------

#### Features

- Chrome plating provides increased protection from rust and corrosion.
- Ball and spring socket retention.

# SOCKETS & DRIVE TOOLS

## 3/4" DRIVE



### 3/4" DRIVE EXTENDABLE RATCHET AND T-HEAD

#### High-Polished Chrome Finish

Product Code	Description	Length (Inches)	Repair Kit
33012	32 Tooth Ratchet Head	6	33001RK
33013	Universal Extendable Handle	23 1/2" to 36"	
33014	Sliding T-Head		

Fed. Spec: ANSI B107.10M

#### Features

- Williams 3/4" Drive Ratchet and Drive Tools Feature:
  - Unique Socket-Lok® Safety Retention System features a spring-loaded locking button for maximum socket retention and quick disassembly when used with our Williams® locking-button square drive tools and sockets. May also be used with all standard 3/4" drive tools.
  - Two-piece ratchet design for maximum versatility.
  - Knurled handle to provide a firm, non-slip grip and extra turning power.
  - Narrow pear-shaped head for access into confined work areas.
  - High-polished chrome finish for easy cleaning.
- Chamfered ends provide easy engagement of the drive tool and fastener.
- Extended Handle extends from 23-1/2" to 36"



### 3/4" DRIVE RATCHETS AND HANDLES

#### High-Polished Chrome Finish

Product Code	Description	Length (Inches)	Repair Kit
33001	Socket-Lok Ratchet - 32 Teeth	20	33001RK
33015	Ratchet head only for 33016	6	
33016	Handle only for 33015	16	
30005	Flex Handle	19	
33006	Sliding T-Handle	19	

Fed. Spec: ANSI B107.10M

#### Features

- Williams 3/4" Drive Ratchet and Drive Tools Feature:
  - Unique Socket-Lok® Safety Retention System features a spring-loaded locking button for maximum socket retention and quick disassembly when used with our Williams® locking-button square drive tools and sockets. May also be used with all standard 3/4" drive tools.
  - Two-piece ratchet design for maximum versatility.
  - Knurled handle to provide a firm, non-slip grip and extra turning power.
  - Narrow pear-shaped head for access into confined work areas.
  - High-polished chrome finish for easy cleaning.
- Chamfered ends provide easy engagement of the drive tool and fastener.



33001



33005



33006

**Socket-Lok® button positively locks the socket and drive tool together, providing positive retention and quick disassembly.**



### 3/4" DRIVE EXTENSIONS AND ACCESSORIES

#### High-Polished Chrome Finish

Product Code	Description	Length (Inches)
33002	Extension	4
33003	Extension	8
33004	Extension	16
33007	Universal Joint	4 3/16
33008	3/4" F x 1/2" M Adapter	2 1/8
33009	3/4" F x 1" M Adapter	2 7/16
33011	1" F x 3/4" M Adapter	2 3/8

Fed. Spec: ANSI B107.10M

#### Features

- Williams 3/4" Drive Ratchet and Drive Tools Feature:
  - Unique Socket-Lok® Safety Retention System features a spring-loaded locking button for maximum socket retention and quick disassembly when used with our Williams® locking-button square drive tools and sockets. May also be used with all standard 3/4" drive tools.
  - High-polished chrome finish for easy cleaning.
- Chamfered ends provide easy engagement of the drive tool and fastener.



33002



33003



33004



33007



33008



33009



33011



# SOCKETS & DRIVE TOOLS

## 3/4" DRIVE



### 3/4" DRIVE SHALLOW 12 POINT SOCKETS, SAE

High-Polished Chrome Finish

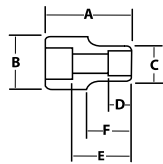

Product Code	Size (Inches)	Dimensions (Inches)						
		A	B	C	D	E	F	
H-1224	3/4	2	1 7/16	1 1/8	17/32	1 1/4	1 1/16	13/16
H-1226	19/16	2	1 7/16	1 7/32	9/16	1 1/4	1 1/16	13/16
H-1228	7/8	2	1 7/16	1 5/16	19/32	1 1/4	1 1/16	13/16
H-1230	15/16	2	1 7/16	1 3/8	21/32	1 1/4	1 1/16	13/16
H-1231	31/32	2	1 7/16	1 13/32	11/16	1 1/4	1 1/16	13/16
H-1232	1	2 1/16	1 7/16	1 15/32	11/16	1 5/16	1 1/16	25/32
H-1234	1 1/16	2 1/8	1 1/2	1 9/16	3/4	1 5/8	1 1/2	7/8
H-1236	1 1/8	2 3/8	1 1/2	1 5/8	19/16	1 7/8	1 1/8	29/32
H-1238	1 3/16	2 1/4	1 1/2	1 11/16	27/32	1 9/8	1 5/8	31/32
H-1240	1 1/4	2 1/4	1 1/2	1 3/4	27/32	1 11/8	1 9/8	15/16
H-1242	1 5/16	2 5/8	1 5/8	1 7/8	27/32	1 13/8	1 11/8	1
H-1244	1 3/8	2 7/8	1 3/4	1 15/16	7/8	1 3/8	1 7/8	1
H-1246	1 7/16	2 3/4	1 3/4	2	19/16	1 7/8	1 1/4	1
H-1248	1 1/2	2 1/2	1 5/8	2 1/8	1	1 9/8	1 1/4	1 1/8
H-1250	1 9/16	2 3/8	1 3/4	2 3/16	1 3/8	1 11/8	1 3/8	1 1/4
H-1252	1 5/8	2 3/8	1 3/4	2 1/4	1 3/8	1 11/8	1 3/8	1 1/4
H-1254	1 11/16	2 3/4	1 25/32	2 3/8	1 3/8	1 13/8	1 3/8	1 3/8
H-1256	1 3/4	2 3/4	1 3/4	2 7/16	1 3/8	1 13/8	1 3/8	1 3/8
H-1258	1 13/16	2 7/8	1 3/4	2 1/2	1 1/4	1 31/8	1 5/8	1 7/8
H-1260	1 7/8	3	1 3/4	2 9/16	1 3/8	2 1/8	1 5/8	1 9/16
H-1264	2	3 1/8	1 3/4	2 3/4	1 5/8	2 3/8	1 5/8	1 11/16
H-1266	2 1/16	3 1/8	1 3/4	2 3/4	1 3/8	2 3/8	1 5/8	1 11/16
H-1268	2 1/8	3 1/4	1 3/4	2 19/16	1 7/8	2 3/8	1 5/8	1 13/16
H-1270	2 3/16	3 1/4	1 3/4	2 19/16	1 1/2	2 5/8	1 5/8	1 13/16
H-1272	2 1/4	3 3/8	1 3/4	3 1/8	1 1/2	2 7/8	1 1/4	1 7/8
H-1274	2 5/16	3 1/2	1 3/4	3 1/4	1 5/8	2 9/8	1 1/4	2
H-1276	2 3/8	3 5/8	1 3/4	3 1/4	1 3/4	2 11/8	1 1/4	2 1/8

Fed. Spec: ANSI B107.1

#### WSH-16TB 16 Piece 3/4" Drive Shallow 12-Point Socket Set with TB-49 Tool Box

#### WSH-16RC 16 Piece 3/4" Drive Shallow 12-Point Socket Set on Clip Rails

Contents Include:

Product Code	Size (Inches)	Product Code	Size (Inches)	Product Code	Size (Inches)	Product Code	Size (Inches)
H-1228	7/8	H-1236	1 1/8	H-1246	1 7/16	H-1256	1 3/4
H-1230	15/16	H-1240	1 1/4	H-1248	1 1/2	H-1258	1 13/16
H-1232	1	H-1242	1 5/16	H-1252	1 5/8	H-1260	1 7/8
H-1234	1 1/16	H-1244	1 3/8	H-1254	1 11/16	H-1264	2



WSH-16TB

#### WSH-26RC 26 Piece 3/4" Drive Shallow 12-Point Socket Set on Clip Rails

Contents Include:

Product Code	Size (Inches)	Product Code	Size (Inches)	Product Code	Size (Inches)	Product Code	Size (Inches)
H-1224	3/4	H-1238	1 3/16	H-1252	1 5/8	H-1268	2 1/8
H-1226	19/16	H-1240	1 1/4	H-1254	1 11/16	H-1270	2 3/16
H-1228	7/8	H-1242	1 5/16	H-1256	1 3/4	H-1272	2 1/4
H-1230	15/16	H-1244	1 3/8	H-1258	1 13/16	H-1274	2 5/16
H-1232	1	H-1246	1 7/16	H-1260	1 7/8	H-1276	2 3/8
H-1234	1 1/16	H-1248	1 1/2	H-1264	2		
H-1236	1 1/8	H-1250	1 9/16	H-1266	2 1/16		



WSH-26RC

#### Features

- SUPERTORQUE® lobular openings for greater turning power without deforming the fastener.
- Designed for quick engagement on both 6 and 12 point fasteners.

# SOCKETS & DRIVE TOOLS

## 3/4" DRIVE



### 3/4" DRIVE SHALLOW 12 POINT SOCKETS, SAE

High-Polished Chrome Finish

Product Code	Size (Inches)	A	B	C	F
		OAL (Inches)	Drive End Diameter (Inches)	Working End Diameter (Inches)	Nose Length (Inches)
33228	7/8	1 15/16	1 7/16	1 1/4	35/64
33230	15/16	2	1 7/16	1 3/8	3/8
33232	1	2 1/16	1 7/16	1 7/16	5/8
33234	1 1/16	2 1/16	1 7/16	1 1/2	7/8
33236	1 1/8	2 1/16	1 1/2	1 9/16	7/8
33238	1 3/16	2 1/8	1 1/2	1 11/16	15/16
33240	1 1/4	2 3/16	1 1/2	1 3/4	15/16
33242	1 5/16	2 3/16	1 1/2	1 13/16	1
33244	1 3/8	2 1/4	1 5/8	1 7/8	1
33246	1 7/16	2 1/4	1 5/8	1 31/32	1 1/64
33248	1 1/2	2 3/8	1 3/4	2 1/16	1 7/64
33250	1 9/16	2 7/16	1 3/4	2 1/8	1 3/16
33252	1 5/8	2 1/2	1 3/4	2 3/16	1 3/16
33256	1 3/4	2 9/16	1 13/16	2 5/16	1 1/4
33258	1 13/16	2 11/16	1 13/16	2 3/8	1 1/4
33260	1 7/8	2 3/4	1 7/8	2 1/2	1 11/32
33264	2	2 13/16	1 7/8	2 11/16	1 13/32

Fed. Spec: ANSI B107.1

#### 33920 11 Piece 3/4" Drive Shallow 12-Point Socket Set on Clip Rails

Contents Include:

Product Code	Size (Inches)	Product Code	Size (Inches)	Product Code	Size (Inches)
33228	7/8	33236	1 1/8	33244	1 3/8
33230	15/16	33238	1 3/16	33246	1 7/16
33232	1	33240	1 1/4	33248	1 1/2
33234	1 1/16	33242	1 5/16		



#### 33922 16 Piece 3/4" Drive Shallow 12-Point Socket Set on Clip Rails

Contents Include:

Product Code	Size (Inches)	Product Code	Size (Inches)	Product Code	Size (Inches)
33228	7/8	33242	1 5/16	33260	1 7/8
33230	15/16	33244	1 3/8	33264	2
33232	1	33246	1 7/16		
33234	1 1/16	33248	1 1/2		
33236	1 1/8	33252	1 5/8		
33238	1 3/16	33256	1 3/4		
33240	1 1/4	33258	1 13/16		



#### Features

- Williams 3/4" Drive Hand Sockets and Drive Tools Feature:
  - Unique Socket-Lok® Safety Retention System features a spring-loaded locking button for maximum socket retention and quick disassembly when used with our Williams® locking-button square drive tools and sockets. May also be used with all standard 3/4" drive tools.
  - Sockets feature a deep chamfer on the drive end to speed insertion onto the drive tool.
  - Chamfered ends provide easy engagement of the drive tool and fastener.
  - SUPERTORQUE® recessed corners in socket end provide extra turning power.
  - High-polished chrome finish tools clean easily and resist rust.
- Designed for quick engagement on both 6 and 12 point fasteners.

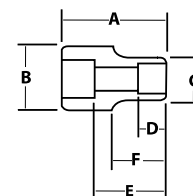

**WARNING**

# SOCKETS & DRIVE TOOLS

## 3/4" DRIVE



### 3/4" DRIVE SHALLOW SOCKETS, 12 POINT, METRIC

#### High-Polished Chrome Finish



HM1232

Product Code	Size (MM)	A		B		C		D		E		F	
		OAL (Inches)	Drive End Diameter (Inches)	Working End Diameter (Inches)	Broach Depth (Inches)	Bolt Clearance Depth (Inches)	Bolt Clearance Diameter (Inches)	Nose Length (Inches)					
HM-1219	19	2	7/16	1 1/8	9/16	1 1/32	11/16	13/16					
HM-1222	22	2	7/16	1 1/4	5/8	1 1/32	11/16	13/16					
HM-1223	23	2	1 7/16	1 11/32	5/8	1 1/32	3/4	9/16					
HM-1224	24	2	7/16	1 3/8	21/32	1 1/32	11/16	13/16					
HM-1225	25	2	1 7/16	1 7/16	2 3/32	1 1/32	3/4	2					
HM-1226	26	2	1 1/2	1 1/2	2 3/32	1 1/32	1 1/32	2					
HM-1227	27	2	1 1/2	1 9/16	3/4	1 1/32	1 1/16	11/16					
HM-1228	28	2	1 1/2	1 21/32	25/32	1 1/32	1 1/32	1 7/32					
HM-1230	30	2 7/32	1 1/2	1 5/8	13/16	1 7/32	1 3/16	27/32					
HM-1232	32	2 1/4	1 1/2	1 3/4	7/8	1 9/16	1 9/16	7/8					
HM-1235	35	2 5/16	1 5/8	1 15/16	29/32	1 13/32	1 7/16	7/8					
HM-1236	36	2 5/16	1 5/8	1 15/16	29/32	1 13/32	1 1/4	7/8					
HM-1238	38	2 1/2	1 5/8	2 1/16	1	1 19/32	1 9/16	1 1/16					
HM-1241	41	2 5/8	1 3/4	2 3/16	1 1/16	1 23/32	1 13/32	1 3/16					
HM-1242	42	2 1/2	1 3/4	2 9/32	1 1/16	1 1/2	1 5/8	1 21/32					
HM-1246	46	3 1/8	1 3/4	2 7/16	1 3/16	1 31/32	1 13/32	1 11/16					
HM-1250	50	3	1 3/4	2 5/8	1 5/16	2 3/32	1 13/32	1 13/32					
HM-1254	54	3 1/4	1 3/4	2 7/8	1 15/32	2 1/8	1 13/32	1 21/32					
HM-1255	55	3 1/4	1 3/4	2 29/32	1 15/32	2 11/32	1 13/32	1 21/32					
HM-1260	60	3 3/8	1 3/4	3 1/4	1 3/4	2 29/32	1 3/4	2 1/8					

Fed. Spec. ANSI B107.5

#### MSH-15RC 15 Piece 3/4" Drive Shallow 12 Point Socket Set on Clip Rail

##### Contents Include:

Product Code	Size (MM)	Product Code	Size (MM)	Product Code	Size (MM)	Product Code	Size (MM)
HM-1219	19	HM-1230	30	HM-1238	38	HM-1254	54
HM-1222	22	HM-1232	32	HM-1241	41	HM-1255	55
HM-1224	24	HM-1235	35	HM-1246	46	HM-1260	60
HM-1227	27	HM-1236	36	HM-1250	50		

##### Features

- SUPERTORQUE® lobular openings for greater turning power without deforming the fastener.
- Designed for quick engagement on both 6 and 12 point fasteners.



MSH-15RC

# SOCKETS & DRIVE TOOLS

## 3/4" DRIVE



### 3/4" DRIVE SHALLOW SOCKET, 12 POINT, MM

High Polished Chrome Finish

Product Code	Size (MM)	A Overall Length (Inches)	B Drive End Diameter (Inches)	C Working End Diameter (Inches)	D Broach Depth (Inches)	E Bolt Clearance Depth (Inches)	Bolt Clearance Diameter (Inches)
33619	19	1 31/32	1 19/64	1 5/32	35/64	35/64	45/64
33620	20	1 31/32	1 19/64	1 3/16	35/64	35/64	45/64
33621	21	1 31/32	1 19/64	1 15/64	35/64	35/64	45/64
33622	22	1 31/32	1 27/64	1 17/64	35/64	35/64	45/64
33623	23	1 31/32	1 27/64	1 5/16	35/64	35/64	45/64
33624	24	2 1/64	1 27/64	1 11/32	21/32	21/32	29/32
33625	25	2 1/32	1 3/8	1 27/64	21/32	21/32	29/32
33626	26	2 1/32	1 27/64	1 29/64	21/32	21/32	29/32
33627	27	2 1/32	1 27/64	1 1/2	55/64	55/64	15/16
33628	28	2 1/32	1 27/64	1 9/16	55/64	55/64	15/16
33629	29	2 1/32	1 27/64	1 19/32	55/64	55/64	15/16
33630	30	2 1/8	1 27/64	1 21/32	15/16	15/16	1 1/16
33632	32	2 13/64	1 27/64	1 47/64	1 1/64	1 1/64	1 9/64
33635	35	2 13/64	1 1/2	1 57/64	1 1/64	1 1/64	1 17/64
33636	36	2 9/32	1 1/2	1 31/32	1 7/64	1 7/64	1 19/64
33638	38	2 23/64	1 1/2	2 1/32	1 7/64	1 7/64	1 3/8
33641	41	2 33/64	1 37/64	2 13/64	1 3/16	1 3/16	1 1/2
33642	42	2 33/64	1 37/64	2 1/4	1 3/16	1 3/16	1 1/2
33646	46	2 19/32	1 21/32	2 7/16	1 17/64	1 17/64	1 21/32
33650	50	2 3/4	1 21/32	2 43/64	1 11/32	1 11/32	1 21/32
33654	54	2 29/32	1 49/64	2 7/16	1 27/64	1 27/64	1 21/32
33655	55	2 63/64	1 49/64	2 29/32	1 1/2	1 1/2	1 11/16
33658	58	3 5/64	1 49/64	3 5/64	1 37/64	1 37/64	1 11/16
33660	60	3 5/64	1 49/64	3 5/32	1 21/32	1 21/32	1 49/64



33619

### 33931 17 piece 3/4" Drive Shallow 12 Point Socket Set in Clip and Rails

Contents Include:

Product Code	Size (MM)	Product Code	Size (MM)	Product Code	Size (MM)	Product Code	Size (MM)
33622	22	33627	27	33635	35	33646	46
33623	23	33628	28	33636	36	33650	50
33624	24	33629	29	33638	38		
33625	25	33630	30	33641	41		
33626	26	33632	32	33642	42		



33931

### 33930 24 piece 3/4" Drive Shallow 12 Point Socket Set Clip and Rails

Contents Include:

Product Code	Size (Inches)	Product Code	Size (Inches)	Product Code	Size (Inches)	Product Code	Size (Inches)
33619	19	33625	25	33632	32	33646	46
33620	20	33626	26	33635	35	33650	50
33621	21	33627	27	33636	36	33654	54
33622	22	33628	28	33638	38	33655	55
33623	23	33629	29	33641	41	33658	58
33624	24	33630	30	33642	42	33660	60

### Features

- Williams 3/4" Drive Hand Sockets and Drive Tools Feature:
  - Unique Socket-Lok® Safety Retention System features a spring-loaded locking button for maximum socket retention and quick disassembly when used with our Williams® locking-button square drive tools and sockets. May also be used with all standard 3/4" drive tools.
  - Sockets feature a deep chamfer on the drive end to speed insertion onto the drive tool.
  - Chamfered ends provide easy engagement of the drive tool and fastener.
  - SUPERTORQUE® recessed corners in socket end provide extra turning power.
  - High-polished chrome finish tools clean easily and resist rust.
- Designed for quick engagement on both 6 and 12 point fasteners.



# SOCKETS & DRIVE TOOLS

## 3/4" DRIVE



### 3/4" DRIVE DEEP SOCKETS, 6 POINT, SAE

#### High-Polished Chrome Finish



HD-628 HD-640



WSHD-11RC

Product Code	Size (Inches)	OAL (Inches)	A		B		C		D		E		F	
			Drive End Diameter (Inches)	Working End Diameter (Inches)	Broach Depth (Inches)	Bolt Clearance Depth (Inches)	Bolt Clearance Diameter (Inches)	Nose Length (Inches)						
HD-628	7/8	3 1/2	1 7/16	1 5/16	5/8	2 1/2	1 1/16	2 5/16						
HD-630	15/16	3 1/2	1 7/16	1 3/8	21/32	2 1/2	1 1/16	2 5/16						
HD-632	1	3 1/2	1 1/2	1 7/16	23/32	2 1/2	1 1/16	2 5/16						
HD-634	1 1/16	3 1/2	1 1/2	1 9/16	3/4	2 1/2	3/4	2 7/32						
HD-636	1 1/8	3 1/2	1 1/2	1 5/8	13/16	2 1/2	25/32	2 7/32						
HD-640	1 1/4	3 1/2	1 1/2	1 3/4	1	2 1/2	7/8	2 3/16						
HD-642	1 5/16	3 1/2	1 5/8	1 7/8	1	2 1/2	15/16	2 3/16						
HD-644	1 3/8	3 1/2	1 5/8	1 15/16	1	2 9/16	1 3/8	2 3/16						
HD-646	1 7/16	3 1/2	1 5/8	2	1	2 9/16	1 7/16	2 1/8						
HD-648	1 1/2	3 1/2	1 5/8	2 1/16	1 1/4	2 9/16	1 1/2	2 1/8						
HD-652	1 5/8	3 1/2	1 3/4	2 1/4	1 3/8	2 9/16	1 5/8	2 1/8						

Fed. Spec. ANSI B107.1

#### WSHD-11HRC 11 Piece 3/4" Drive Deep 6 Point Socket Set on Clip Rail

##### Contents Include:

Product Code	Size (Inches)	Product Code	Size (Inches)	Product Code	Size (Inches)
HD-628	7/8	HD-636	1 1/8	HD-646	1 7/16
HD-630	15/16	HD-640	1 1/4	HD-648	1 1/2
HD-632	1	HD-642	1 5/16	HD-652	1 5/8
HD-634	1 1/16	HD-644	1 3/8		

##### Features

- SUPERTORQUE® lobular openings for greater turning power without deforming the fastener.
- Designed for maximum engagement on 6 point fasteners.



### 3/4" DRIVE DEEP SOCKET, 6 POINT, MM

#### High-Polished Chrome Finish



33719



33932

Product Code	Size (MM)	A		B		C		D		E	
		Overall Length (Inches)	Drive End Diameter (Inches)	Working End Diameter (Inches)	Broach Depth (Inches)	Bolt Clearance Depth (Inches)	Bolt Clearance Diameter (Inches)				
33719	19	3 35/64	1 19/64	1 5/32	1 1/64	1 3/16	45/64				
33722	22	3 35/64	1 27/64	1 17/64	1 1/64	1 3/16	45/64				
33723	23	3 35/64	1 27/64	1 5/16	1 1/64	1 3/16	45/64				
33724	24	3 35/64	1 27/64	1 11/32	1 1/64	1 3/16	45/64				
33727	27	3 35/64	1 27/64	1 1/2	1 1/64	1 3/16	15/16				
33730	30	3 35/64	1 27/64	1 21/32	1 1/64	1 3/16	1 1/16				
33732	32	3 35/64	1 27/64	1 47/64	1 1/64	1 3/16	1 9/64				
33735	35	3 35/64	1 1/2	1 57/64	1 3/16	1 7/64	1 17/64				
33736	36	3 35/64	1 1/2	1 31/32	1 3/16	1 7/64	1 19/64				
33738	38	3 35/64	1 1/2	2 1/32	1 1/32	15/16	1 3/8				
33741	41	3 35/64	1 37/64	2 13/64	1 11/32	15/16	1 1/2				
33746	46	3 35/64	1 21/32	2 7/16	1 11/32	15/16	1 21/32				
33750	50	3 35/64	1 21/32	2 43/64	1 27/64	15/16	1 21/32				
33755	55	3 19/16	1 49/64	2 29/32	1 1/2	29/32	1 11/16				
33760	60	3 81/64	1 49/64	3 5/32	1 37/64	5/8	1 49/64				

#### 33932 15 piece 3/4" Drive Deep 6 Point Socket Set in Clip and Rails

##### Contents Include:

Product Code	Size (MM)	Product Code	Size (MM)	Product Code	Size (MM)	Product Code	Size (MM)
33719	19	33727	27	33736	36	33750	50
33722	22	33730	30	33738	38	33755	55
33723	23	33732	32	33741	41	33760	60
33724	24	33735	35	33746	46		

##### Features

- SUPERTORQUE® lobular openings for greater turning power without deforming the fastener.
- Designed for maximum engagement on 6 point fasteners.

# SOCKETS & DRIVE TOOLS

## 3/4" DRIVE



### 3/4" DRIVE IMPACT EXTENSIONS AND ACCESSORIES

#### Black Industrial Finish

Product Code	Description	Length (Inches)	Use RET RING®	Use O-Ring / Pin	Socket Retention
6-107	Impact Extension	7	6-1XS	6-1A / 6-2C	Through Hole and Pin
6-110	Impact Extension	9 3/4	6-1XS	6-1A / 6-2C	Through Hole and Pin
6-113	Impact Extension	12 3/4	6-1XS	6-1A / 6-2C	Through Hole and Pin
6-140B	Impact Universal Joint	3 1/2	6-1XS	6-1A / 6-2C	Through Hole and Pin
6-7	1"M x 3/4"F Adapter	2 3/4	6-1XS	6-1A / 6-2C	Through Hole and Pin
6-4A	1/2"M x 3/4"F Adapter	2 1/2	6-1XS	6-1A / 6-2C	Spring Plunger

Fed. Spec: ANSI B107.2

#### Features

- Specially heat treated for impact use to provide long life, safety, and durability.
- Pin and o-ring or RET RING® (sold separately) secure tools onto impact wrench for safety and convenience.
- Suitable for use with pneumatic and electric impact wrenches.
- Drive end features pin retention hole and groove.



6-107

6-110

6-113



6-140B

6-7

6-4A



### 3/4" DRIVE IMPACT EXTENSIONS AND ACCESSORIES

#### Black Industrial Finish

Product Code	Description	Length (Inches)	Use RET RING®	Use O-Ring / Pin	Socket Retention
38002	Impact Extension	7	6-1XS	6-1A / 6-2C	Through Hole and Pin
38003	Impact Extension	10	6-1XS	6-1A / 6-2C	Through Hole and Pin
38004	Impact Extension	13	6-1XS	6-1A / 6-2C	Through Hole and Pin
38001	Impact Universal Joint	4 5/16	6-1XS	6-1A / 6-2C	Through Hole and Pin
38005	1/2"M x 3/4"F Adapter	2 3/16	6-1XS	6-1A / 6-2C	Ball and Spring
38006	1"M x 3/4"F Adapter	2 7/16	6-1XS	6-1A / 6-2C	Through Hole and Pin

Fed. Spec: ANSI B107.2

#### Features

- Specially heat treated for impact use to provide long life, safety, and durability.
- Pin and o-ring or RET RING® (sold separately) secure tools onto impact wrench for safety and convenience.
- Suitable for use with pneumatic and electric impact wrenches.
- Drive end features pin retention hole and groove.



38002

38003

38004



38001

38005

38006





# SOCKETS & DRIVE TOOLS

## 3/4" DRIVE



6-1A



6-2B



### 3/4" DRIVE IMPACT RETAINING PINS AND RINGS

#### Black Industrial Finish

Product Code	Description	Diameter	Length	Application
6-1A	Impact Retaining O-Ring	1 1/4"	NA	Fits All Williams 3/4" Drive Sockets and Accessories
6-2B	Impact Retaining Pin	3/16"	1 1/4"	Fits Williams Impact Sockets with "B" Dimension to 1 3/4"
6-2C	Impact Retaining Pin	3/16"	1 1/2"	Fits Williams Impact Sockets with "B" Dimension 1 3/4" and Greater

#### Features

- Specially heat treated for impact use to provide long life, safety, and durability.
- Suitable for use with pneumatic and electric impact wrenches.
- For 3/4" drive impact tools with pin retention hole and groove.



### 3/4" DRIVE RET RING® ONE-PIECE IMPACT RETAINING RINGS WITH CRUSH GAUGE

#### Black Industrial Finish

Product Code	Inside Dia. (In.)
6-0XS	1 1/4"
6-1XS	1 7/16"
6-2XS	1 5/8"
6-3XS	1 3/4"
6-4XS	2"
6-5XS	2 1/8"
6-6XS	2 1/4"

#### Features

- Fits all Williams 3/4" Drive Sockets and Accessories
- Crush Gauge on the resin pin indicates when a socket is excessively worn and should be replaced.
- Securely retains sockets and accessories to square drive of impact wrench
- For 3/4" drive impact tools with pin retention hole and groove
- Made of oil resistant material
- RET RING® is a trademark of FTL Enterprises, Inc.



6-2XS



### 3/4" DRIVE BUDD® WHEEL IMPACT SOCKET, 6 POINT, SAE

#### Black Industrial Finish

Product Code	Size (Inches)	A (Inches)	B (Inches)	C (Inches)	D (Inches)	E (Inches)	Working End Diameter (Inches)	Broach Depth (Inches)	Bolt Clearance Depth (Inches)	Bolt Clearance Diameter (Inches)	Uses RET RING® Number	Use O-Ring / Pin

Fed. Spec: ANSI B107.2

#### Features

- SUPERTORQUE® lobular openings for greater turning power without deforming the fastener.
- 13/16" square opening threads stud into wheel.
- 1-1/2" hex opening engages and tightens the wheel lug nut.
- Suitable for use with pneumatic and electric impact wrenches.
- Specially heat treated for impact use to provide long life, safety, and durability.

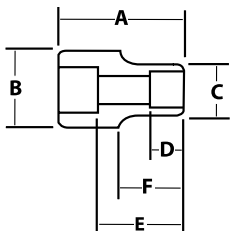

16-648BW

# SOCKETS & DRIVE TOOLS

## 3/4" DRIVE



### 3/4" DRIVE SHALLOW IMPACT SOCKETS, 6 POINT, SAE

#### Black Industrial Finish

Product Code	Size (Inches)	A		B		C		D		E		F		Uses RET RING® Number	Use O-Ring / Pin
		OAL (Inches)	Drive End Diameter (Inches)	Working End Diameter (Inches)	Broach Depth (Inches)	Bolt Clearance Depth (Inches)	Bolt Clearance Diameter (Inches)	Nose Length (Inches)							
6-618A	9/16	2	1 5/8	1	1 7/32	1 1/32	1/2	1	6-1XS	6-1A / 6-2B					
6-620A	5/8	2	1 5/8	1 3/32	1 7/32	1 1/32	1/2	1	6-1XS	6-1A / 6-2B					
6-622A	11/16	2	1 5/8	1 3/32	1 7/32	1 1/32	1/2	1	6-1XS	6-1A / 6-2B					
6-624A	3/4	2	1 5/8	1 1/4	1 7/32	1 1/32	1 1/16	1	6-1XS	6-1A / 6-2B					
6-626A	13/16	2	1 5/8	1 3/8	1 7/32	1 1/32	1 1/16	1	6-1XS	6-1A / 6-2B					
6-628A	7/8	2	1 5/8	1 1/2	1 7/32	1 1/32	1 1/16	1	6-1XS	6-1A / 6-2B					
6-630A	15/16	2	1 5/8	1 5/8	1 7/32	1 1/32	1 1/16	1	6-1XS	6-1A / 6-2B					
6-632A	1	2	1 5/8	1 5/8	1 7/32	1 1/32	1 1/16	1	6-1XS	6-1A / 6-2B					
6-634A	1 1/16	2	1 5/8	1 11/16	3/4	1 7/32	1 1/16	1 3/16	6-1XS	6-1A / 6-2B					
6-636	1 1/8	2 1/8	1 5/8	1 3/4	3/4	1 7/32	1 1/8	1 7/16	6-1XS	6-1A / 6-2B					
6-638	1 3/16	2 1/8	1 5/8	1 7/8	3/4	1 7/32	1 3/16	1 7/16	6-1XS	6-1A / 6-2B					
6-640	1 1/4	2 1/8	1 3/4	2	19/16	1 7/32	1 1/4	1 7/16	6-1XS	6-1A / 6-2C					
6-642	1 5/16	2 1/8	1 3/4	2 1/32	7/8	1 7/32	1 5/16	1 7/16	6-1XS	6-1A / 6-2C					
6-644	1 3/8	2 1/4	1 3/4	2 1/8	7/8	1 7/32	1 3/8	1 9/16	6-1XS	6-1A / 6-2C					
6-646	1 7/16	2 1/4	1 3/4	2 3/16	7/8	1 7/32	1 7/16	1 9/16	6-1XS	6-1A / 6-2C					
6-648	1 1/2	2 1/4	1 3/4	2 1/4	15/16	1 7/32	1 1/2	1 9/16	6-1XS	6-1A / 6-2C					
6-650	1 9/16	2 3/8	1 3/4	2 11/32	15/16	1 7/32	1 9/16	1 11/16	6-1XS	6-1A / 6-2C					
6-652	1 5/8	2 3/8	1 3/4	2 13/32	1	1 7/32	1 5/8	1 11/16	6-1XS	6-1A / 6-2C					
6-654	1 11/16	2 9/16	1 3/4	2 15/32	1 1/32	1 7/32	1 7/16	1 7/8	6-1XS	6-1A / 6-2C					
6-656	1 3/4	2 9/16	1 3/4	2 17/32	1 1/32	1 7/32	1 3/4	1 7/8	6-1XS	6-1A / 6-2C					
6-658	1 13/16	2 5/8	1 3/4	2 19/32	1 1/8	1 7/32	1 13/16	1 15/16	6-1XS	6-1A / 6-2C					
6-660	1 7/8	2 3/4	1 3/4	2 5/8	1 1/8	1 7/32	1 7/16	2 1/16	6-1XS	6-1A / 6-2C					
6-662	1 15/16	2 3/4	1 3/4	2 3/4	1 1/8	1 7/32	1 7/16	2 1/16	6-1XS	6-1A / 6-2C					
6-664	2	2 7/8	1 3/4	2 13/16	1 1/8	1 7/32	1 7/16	2 3/16	6-1XS	6-1A / 6-2C					
6-666	2 1/16	2 7/8	1 3/4	2 7/8	1 3/16	1 7/32	1 7/16	2 3/16	6-1XS	6-1A / 6-2C					
6-670	2 3/16	3 3/16	1 3/4	3 1/16	1 5/16	2 1/16	2 3/16	2 1/2	6-1XS	6-1A / 6-2C					
6-672	2 1/4	3 3/16	1 3/4	3 1/8	1 5/8	2 5/32	1 27/32	2 1/2	6-1XS	6-1A / 6-2C					
6-676	2 3/8	3 1/2	1 3/4	3 1/4	1 7/16	2 7/16	1 27/32	2 13/16	6-1XS	6-1A / 6-2C					

Fed. Spec: ANSI B107.2

#### WS-6-10HA 10 Piece 3/4" Drive Shallow 6 Point Impact Socket Set on Clip Rail

##### Contents Include:

Product Code	Size (Inches)	Product Code	Size (Inches)	Product Code	Size (Inches)
6-654	1 1/16	6-660	1 7/8	6-666	2 1/16
6-656	1 3/4	6-662	1 15/16	6-670	2 3/16
6-658	1 13/16	6-664	2	6-672	2 1/4
				6-676	2 3/8

#### WS-6-14HA 14 Piece 3/4" Drive Shallow 6 Point Impact Socket Set on Clip Rail

##### Contents Include:

Product Code	Size (Inches)	Product Code	Size (Inches)	Product Code	Size (Inches)	Product Code	Size (Inches)
6-624A	3/4	6-632A	1	6-640	1 1/4	6-648	1 1/2
6-626A	13/16	6-634A	1 1/16	6-642	1 5/16	6-652	1 5/8
6-628A	7/8	6-636	1 1/8	6-644	1 3/8		
6-630A	15/16	6-638	1 3/16	6-646	1 7/16		

#### WS-6-18TB 18 Piece 3/4" Drive Shallow 6 Point Impact Socket Set packed in Tool Box

##### Contents Include:

Product Code	Size (Inches)	Product Code	Size (Inches)	Product Code	Size (Inches)
6-628A	7/8	6-640	1 1/4	6-656	1 3/4
6-630A	15/16	6-642	1 5/16	6-658	1 13/16
6-632A	1"	6-644	1 3/8	6-660	1 7/8
6-634A	1 1/16	6-646	1 7/16	6-664	2"
6-636	1 1/8	6-648	1 1/2	6-107	7" EXT
6-638	1 3/16	6-652	1 5/8	6-140B	U-JOINT
				TB-6119A	TOOL BOX

#### Features

- SUPERTORQUE® lobular openings for greater turning power without deforming the fastener.
- Designed for maximum engagement on 6 point fasteners.
- Suitable for use with pneumatic and electric impact wrenches.
- Specially heat treated for impact use to provide long life, safety, and durability.



6-620A



WS-6-14HA



WS-6-18TB



# SOCKETS & DRIVE TOOLS

## 3/4" DRIVE



### 3/4" DRIVE SHALLOW IMPACT SOCKETS, 6 POINT, SAE

#### Black Industrial Finish

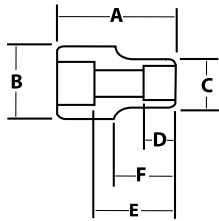

Product Code	Size (Inches)	OAL (Inches)	Drive End Diameter (Inches)	Working End Diameter (Inches)	Nose Length (Inches)	Uses RET RING® Number	Use O-Ring / Pin
38118	9/16	2	1 5/8	1	1	6-1XS	6-1A / 6-2B
38120	5/8	2	1 5/8	1 3/32	1	6-1XS	6-1A / 6-2B
38122	11/16	2	1 5/8	1 5/32	1	6-1XS	6-1A / 6-2B
38124	3/4	2	1 5/8	1 1/4	1	6-1XS	6-1A / 6-2B
38126	13/16	2	1 5/8	1 5/8	1	6-1XS	6-1A / 6-2B
38128	7/8	2	1 11/16	1 7/16	2 3/16	6-1XS	6-1A / 6-2B
38130	15/16	2	1 11/16	1 1/2	2 3/16	6-1XS	6-1A / 6-2B
38132	1	2 1/16	1 11/16	1 9/16	3/8	6-1XS	6-1A / 6-2B
38134	1 1/16	2 1/16	1 11/16	1 11/16	29/32	6-1XS	6-1A / 6-2B
38136	1 1/8	2 1/16	1 3/4	1 3/4	25/32	6-1XS	6-1A / 6-2C
38138	1 3/16	2 1/16	1 3/4	1 13/16	29/32	6-1XS	6-1A / 6-2C
38140	1 1/4	2 1/4	1 3/4	1 7/8	19/16	6-1XS	6-1A / 6-2C
38142	1 3/16	2 1/4	1 3/4	1 15/16	19/16	6-1XS	6-1A / 6-2C
38144	1 3/8	2 1/4	1 3/4	2 1/16	19/16	6-1XS	6-1A / 6-2C
38146	1 7/16	2 1/4	1 3/4	2 7/64	19/16	6-1XS	6-1A / 6-2C
38148	1 1/2	2 1/4	1 3/4	2 13/64	7/8	6-1XS	6-1A / 6-2C
38150	1 9/16	2 1/4	1 3/4	2 7/32	7/8	6-1XS	6-1A / 6-2C
38152	1 5/8	2 1/4	1 3/4	2 15/64	7/8	6-1XS	6-1A / 6-2C
38154	1 11/16	2 7/16	1 3/4	2 15/32	1	6-1XS	6-1A / 6-2C
38156	1 3/4	2 7/16	1 3/4	2 1/2	1	6-1XS	6-1A / 6-2C
38158	1 13/16	2 7/16	1 3/4	2 19/32	1	6-1XS	6-1A / 6-2C
38160	1 7/8	2 11/16	1 3/4	2 11/16	1 3/16	6-1XS	6-1A / 6-2C
38162	1 15/16	2 11/16	1 3/4	2 3/4	1 3/16	6-1XS	6-1A / 6-2C
38164	2	2 11/16	1 3/4	2 13/16	1 3/16	6-1XS	6-1A / 6-2C

Fed. Spec: ANSI B107.2

### 38920 9 Piece 3/4" Drive Shallow 6 Point Impact Socket Set on Clip Rail

#### Contents Include:

Product Code	Size (Inches)	Product Code	Size (Inches)	Product Code	Size (Inches)
38132	1	38138	1 3/16	38144	1 3/8
38134	1 1/16	38140	1 1/4	38146	1 7/16
38136	1 1/8	38142	1 5/16	38148	1 1/2



38920

### 38901 16 Piece 3/4" Drive Shallow 6 Point Impact Socket Set with 50083 Metal Box

#### Contents Include:

Product Code	Size (Inches)	Product Code	Size (Inches)	Product Code	Size (Inches)
38128	7/8	38140	1 1/4	38156	1 3/4
38130	15/16	38142	1 5/16	38158	1 13/16
38132	1	38144	1 3/8	38160	1 7/8
38134	1 1/16	38146	1 7/16	38164	2
38136	1 1/8	38148	1 1/2		
38138	1 3/16	38152	1 5/8		

#### Features

- SUPERTORQUE® lobular openings for greater turning power without deforming the fastener.
- Designed for maximum engagement on 6 point fasteners.
- Suitable for use with pneumatic and electric impact wrenches.
- Specially heat treated for impact use to provide long life, safety, and durability.
- Drive end features pin retention hole and groove.



38901

# SOCKETS & DRIVE TOOLS

## 3/4" DRIVE



### 3/4" DRIVE SHALLOW IMPACT SOCKETS, 12 POINT, SAE

Black Industrial Finish

Product Code	Size (Inches)	A	B	C	D	E	F
		Overall Length (Inches)	Drive End Diameter (Inches)	Working End Diameter (Inches)	Broach Depth (Inches)	Bolt Clearance Depth (Inches)	Bolt Clearance Diameter (Inches)
38420	5/8	2	1 1/2	1 1/8	5/8	/	7/8
38422	11/16	2	1 1/2	1 1/8	5/8	/	7/8
38424	3/4	2	1 1/2	1 1/8	5/8	/	7/8
38426	13/16	2 1/16	1 1/2	1 1/4	3/4	/	15/16
38428	7/8	2 1/16	1 1/2	1 5/16	3/4	/	15/16
38430	15/16	2 1/16	1 1/2	1 7/16	3/4	/	15/16
38432	1	2 1/16	1 1/2	1 1/2	3/4	/	/
38434	1 1/16	2 1/16	1 1/2	1 1/2	3/4	/	/
38436	1 1/8	2 1/16	1 3/4	1 5/8	3/4	/	/
38438	1 3/16	2 1/16	1 3/4	1 3/4	3/4	/	/
38440	1 1/4	2 1/16	1 3/4	1 13/16	3/4	/	15/16
38442	1 5/16	2 1/4	1 3/4	1 13/16	7/8	/	15/16
38444	1 3/8	2 1/4	1 3/4	2	7/8	/	15/16
38446	1 7/16	2 1/4	1 3/4	2	7/8	/	15/16
38448	1 1/2	2 1/4	1 3/4	2 1/16	15/16	/	15/16
38450	1 9/16	2 7/16	1 3/4	2 1/4	15/16	/	1
38452	1 5/8	2 7/16	1 3/4	2 1/4	15/16	/	1
38454	1 11/16	2 7/16	1 3/4	2 1/2	1 1/16	/	1
38456	1 3/4	2 7/16	1 3/4	2 1/2	1 1/16	/	1
38458	1 13/16	2 5/8	1 3/4	2 5/8	1 1/16	/	1
38460	1 7/8	2 5/8	1 3/4	2 5/8	1 1/16	/	1
38462	1 15/16	2 3/4	1 3/4	2 3/4	1 5/16	/	1
38464	2	2 13/16	2 1/8	2 3/4	1 5/16	/	1
38466	2 1/16	2 13/16	2 1/8	3	1 5/16	/	1
38468	2 1/8	2 13/16	2 1/8	3	1 5/16	/	1
38476	2 3/8	3	2 1/8	3 5/16	1 1/2	/	1 1/16

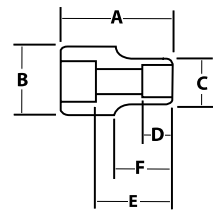

### 38925 9 piece 1/2" Drive Impact Shallow 12 Point, SAE Socket Set on Clip Rails

Contents Include:

Product Code	Size (Inches)	Product Code	Size (Inches)	Product Code	Size (Inches)
38420	5/8	38426	13/16	38432	1
38422	11/16	38428	7/8	38434	1 1/16
38424	3/4	38430	15/16	38436	1 1/8



38925

### 38926 17 piece 1/2" Drive Impact Shallow 12 Point, SAE Socket Set on Clip Rails

Contents Include:

Product Code	Size (Inches)	Product Code	Size (Inches)	Product Code	Size (Inches)	Product Code	Size (Inches)
38438	1 3/16	38446	1 7/16	38454	1 11/16	38462	1 15/16
38440	1 1/4	38448	1 1/2	38456	1 3/4	38464	2
38442	1 5/16	38450	1 9/16	38458	1 13/16	38466	2 1/16
38444	1 3/8	38452	1 5/8	38460	1 7/8	38468	2 1/8
						38476	2 3/8

#### Features

- SUPERTORQUE® lobular openings for greater turning power without deforming the fastener.
- Designed for maximum engagement on 6 or 12 point fasteners.
- Suitable for use with pneumatic and electric impact wrenches.
- Specially heat treated for impact use to provide long life, safety, and durability.



# SOCKETS & DRIVE TOOLS

## 3/4" DRIVE



### 3/4" DRIVE DEEP IMPACT SOCKETS, 6 POINT, SAE

#### Black Industrial Finish



16-624

16-632

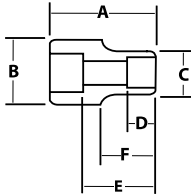

Product Code	Size (Inches)	A		B		C		D		E		F		Uses RET RING® Number	Use O-Ring / Pin
		OAL (Inches)	Drive End Diameter (Inches)	Working End Diameter (Inches)	Broach Depth (Inches)	Bolt Clearance Depth (Inches)	Bolt Clearance Diameter (Inches)	Nose Length (Inches)							
16-624	3/4	3	1 5/8	1 1/4	9/16	2 1/32	9/16	3/4	6-1XS	6-1A / 6-2B					
16-626	13/16	3	1 5/8	1 7/16	5/8	2 1/32	9/16	3/4	6-1XS	6-1A / 6-2B					
16-628	7/8	3	1 5/8	1 7/16	5/8	2 1/32	5/8	3/4	6-1XS	6-1A / 6-2B					
16-630	15/16	3	1 5/8	1 5/8	5/8	2 1/32	5/8	-	6-1XS	6-1A / 6-2B					
16-632	1	3	1 5/8	1 5/8	11/16	2 1/32	21/32	-	6-1XS	6-1A / 6-2B					
16-634	1 1/16	3	1 5/8	1 11/16	11/16	2 1/32	3/4	2 5/16	6-1XS	6-1A / 6-2B					
16-636	1 1/8	3	1 5/8	1 3/4	3/4	2 1/32	13/16	2 9/16	6-1XS	6-1A / 6-2B					
16-638	1 3/16	3 3/16	1 3/4	1 15/16	3/4	2 7/32	1 3/16	2 1/2	6-1XS	6-1A / 6-2C					
16-640	1 1/4	3 1/4	1 3/4	1 15/16	7/8	2 9/32	1 1/4	2 9/16	6-1XS	6-1A / 6-2C					
16-642	1 5/16	3 1/4	1 3/4	2	7/8	2 9/32	1 9/32	2 9/16	6-1XS	6-1A / 6-2C					
16-644	1 3/8	3 1/4	1 3/4	2 1/8	7/8	2 9/32	1 3/8	2 9/16	6-1XS	6-1A / 6-2C					
16-646	1 7/16	3 1/2	1 3/4	2 1/8	7/8	2 17/32	1 13/32	2 13/16	6-1XS	6-1A / 6-2C					
16-648	1 1/2	3 1/2	1 3/4	2 1/4	15/16	2 17/32	1 1/2	2 13/16	6-1XS	6-1A / 6-2C					
16-650	1 9/16	3 1/2	1 3/4	2 5/16	15/16	2 17/32	1 9/16	2 13/16	6-1XS	6-1A / 6-2C					
16-652	1 5/8	3 1/2	1 3/4	2 7/16	15/16	2 17/32	1 5/8	2 13/16	6-1XS	6-1A / 6-2C					
16-654	1 11/16	3 1/2	1 3/4	2 1/2	1	2 17/32	1 11/16	2 13/16	6-1XS	6-1A / 6-2C					
16-656	1 3/4	3 1/2	1 3/4	2 1/2	1	2 17/32	1 3/4	2 13/16	6-1XS	6-1A / 6-2C					
16-658	1 13/16	3 3/4	1 3/4	2 5/8	1 1/16	2 3/4	1 13/16	2 25/32	6-1XS	6-1A / 6-2C					
16-660	1 7/8	3 3/4	1 3/4	2 11/16	1 1/8	2 3/4	1 7/8	2 25/32	6-1XS	6-1A / 6-2C					
16-664	2	3 3/4	1 3/4	2 3/16	1 1/8	2 3/4	2	2 25/32	6-1XS	6-1A / 6-2C					

Fed. Spec: ANSI B107.2

#### WS-16-7H 7 Piece 3/4" Drive Impact Deep 6 Point Socket Set on Clip Rail

##### Contents Include:

Product Code	Size (Inches)	Product Code	Size (Inches)
16-650	1 9/16	16-658	1 13/16
16-652	1 5/8	16-660	1 7/8
16-654	1 11/16	16-664	2
16-656	1 3/4		

#### WS-16-8H 8 Piece 3/4" Drive Deep 6 Point Impact Socket Set on Clip Rail

##### Contents Include:

Product Code	Size (Inches)	Product Code	Size (Inches)
16-628	7/8	16-636	1 1/8
16-630	15/16	16-640	1 1/4
16-632	1	16-642	1 5/16
16-634	1 1/16	16-648	1 1/2

#### Features

- SUPERTORQUE® lobular openings for greater turning power without deforming the fastener.
- Designed for maximum engagement on 6 point fasteners.
- Suitable for use with pneumatic and electric impact wrenches.
- Specially heat treated for impact use to provide long life, safety, and durability.



WS-16-8H

# SOCKETS & DRIVE TOOLS

## 3/4" DRIVE



### 3/4" DRIVE ONE PIECE IMPACT HEX BIT DRIVER, SAE

Black Industrial Finish

Product Code	Hex Size (Inches)	A	B	F	Uses RET RING® Number	Use O-Ring / Pin
		OAL	Drive End Diameter	Nose Length		
38216	1/2	3 1/2	1 3/4	3/4	6-1XS	6-1A / 6-2C
38218	9/16	3 1/2	1 3/4	3/4	6-1XS	6-1A / 6-2C
38220	5/8	3 1/2	1 3/4	3/4	6-1XS	6-1A / 6-2C
38224	3/4	3 1/2	1 3/4	3/4	6-1XS	6-1A / 6-2C
38226	13/16	3 1/2	1 3/4	3/4	6-1XS	6-1A / 6-2C
38228	7/8	3 1/2	1 3/4	3/4	6-1XS	6-1A / 6-2C
38232	1	3 1/2	1 3/4	3/4	6-1XS	6-1A / 6-2C
38236	1 1/8	3 1/2	1 3/4	3/4	6-1XS	6-1A / 6-2C
38240	1 1/4	3 1/2	1 3/4	3/4	6-1XS	6-1A / 6-2C



38240

38216

### 38932 5 Piece 3/4" Drive Hex-Driver Impact Socket Set on Clip Rail

Contents Include:

Product Code	Size (Inches)	Product Code	Size (Inches)
38220	5/8	38228	7/8
38224	3/4	38232	1
38226	13/16		



38932

### 38903 9 Piece 3/4" Drive Hex-Driver Impact Socket Set with 50085 Metal Box

Contents Include:

Product Code	Size (Inches)	Product Code	Size (Inches)
38216	1/2	38228	7/8
38218	9/16	38232	1
38220	5/8	38236	1 1/8
38224	3/4	38240	1 1/4
38226	13/16		

### Features

- One-piece design maximizes strength and reduces breakage.
- Chamfered ends provide easy engagement of the drive tool and fastener.
- Suitable for use with pneumatic and electric impact wrenches.
- Specially heat treated for impact use to provide long life, safety, and durability.
- Drive end features pin retention hole and groove.



38903



**WARNING**

# SOCKETS & DRIVE TOOLS

## 3/4" DRIVE



### 3/4" DRIVE SHALLOW IMPACT SOCKETS, 6 POINT, METRIC

#### Black Industrial Finish

Product Code	Size (MM)	A	B	C	D	E	F		Uses RET RING® Number	Use O-Ring / Pin
		OAL (Inches)	Drive End Diameter (Inches)	Working End Diameter (Inches)	Broach Depth (Inches)	Bolt Clearance Depth (Inches)	Bolt Clearance Diameter (Inches)	Nose Length (Inches)		
6M-617A	17	2	1 5/8	1 5/32	17/32	1 1/32	1/2	1	6-1XS	6-1A / 6-2B
6M-619A	19	2	1 5/8	1 1/4	17/32	1 1/32	11/16	1	6-1XS	6-1A / 6-2B
6M-620A	20	2	1 5/8	1 3/8	35/64	1 1/32	11/16	1	6-1XS	6-1A / 6-2B
6M-622A	22	2	1 5/8	1 1/2	19/32	1 1/32	11/16	1	6-1XS	6-1A / 6-2B
6M-624A	24	2	1 5/8	1 35/64	11/32	1 1/32	11/16	1	6-1XS	6-1A / 6-2B
6M-627A	27	2	1 5/8	1 11/16	3/4	1 1/32	1 1/16	1 5/16	6-1XS	6-1A / 6-2B
6M-630	30	2 3/32	1 5/8	1 27/32	47/64	1 1/8	47/64	1 13/32	6-1XS	6-1A / 6-2B
6M-631	31	2 1/8	1 5/8	1 15/16	3/4	1 3/16	1 1/32	1 7/16	6-1XS	6-1A / 6-2B
6M-632	32	2 1/8	1 3/4	2	13/16	1 3/16	1 1/4	1 7/16	6-1XS	6-1A / 6-2C
6M-634	34	2 1/8	1 3/4	2	7/8	1 3/16	1 21/64	1 7/16	6-1XS	6-1A / 6-2C
6M-635	35	2 1/4	1 3/4	2 1/8	7/8	1 5/16	1 3/8	1 9/16	6-1XS	6-1A / 6-2C
6M-636	36	2 1/4	1 3/4	2 1/8	7/8	1 5/16	1 13/32	1 9/16	6-1XS	6-1A / 6-2C
6M-638	38	2 1/4	1 3/4	2 1/4	15/16	1 5/16	1 1/2	1 9/16	6-1XS	6-1A / 6-2C
6M-641	41	2 5/8	1 3/4	2 13/32	1 1/8	1 11/16	1 39/64	1 15/16	6-1XS	6-1A / 6-2C
6M-646	46	2 5/8	1 3/4	2 19/32	1 1/8	1 21/32	1 13/16	1 15/16	6-1XS	6-1A / 6-2C



6M-617A



MS-6-8H

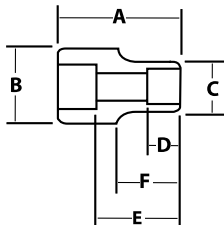

### MS-6-8H 8 Piece 3/4" Drive Shallow 6 Point Impact Socket Set on Clip Rail

#### Contents Include:

Product Code	Size (MM)	Product Code	Size (MM)	Product Code	Size (MM)
6M-619A	19	6M-627A	27	6M-636	36
6M-622A	22	6M-630	30	6M-641	41
6M-624A	24	6M-632	32		

#### Features

- SUPERTORQUE® lobular openings for greater turning power without deforming the fastener.
- Designed for maximum engagement on 6 point fasteners.
- Suitable for use with pneumatic and electric impact wrenches.
- Specially heat treated for impact use to provide long life, safety, and durability.
- Drive end features pin retention hole and groove.



### 3/4" DRIVE ONE PIECE IMPACT HEX BIT DRIVERS, MM

#### Black Industrial Finish

Product Code	Hex Size (MM)	Overall Length (Inches)	Drive End Diameter (Inches)	Nose Length	Uses RET Ring	
					Number	use O-Ring/Pin
35810	10	3 1/2	1 3/4	3/4	6-1XS	6-1A/6-2C
35812	12	3 1/2	1 3/4	3/4	6-1XS	6-1A/6-2C
35814	14	3 1/2	1 3/4	3/4	6-1XS	6-1A/6-2C
35817	17	3 1/2	1 3/4	3/4	6-1XS	6-1A/6-2C
35819	19	3 1/2	1 3/4	3/4	6-1XS	6-1A/6-2C
35821	21	3 1/2	1 3/4	3/4	6-1XS	6-1A/6-2C
35824	24	3 1/2	1 3/4	3/4	6-1XS	6-1A/6-2C
35827	27	3 1/2	1 3/4	3/4	6-1XS	6-1A/6-2C
35830	30	3 1/2	1 3/4	3/4	6-1XS	6-1A/6-2C
35832	32	3 1/2	1 3/4	3/4	6-1XS	6-1A/6-2C

Fed. Spec: ANSI B107.2

### 38936 10 Piece 3/4" Drive One Piece Impact Hex Bit Drivers, MM

#### Contents Include:

Product Code	Size (Inches)	Product Code	Size (Inches)	Product Code	Size (Inches)
35810	10	35819	19	35830	30
35812	12	35821	21	35832	32
35814	14	35824	24		
35817	17	35827	27		



35812

35830



38936

# SOCKETS & DRIVE TOOLS

## 1" DRIVE



### 27 PIECE 1" DRIVE SOCKET AND DRIVE TOOL SET

#### 12 Point SAE, with Metal Box

Product Code	Description
WSX-28TB	27 Piece Tool Set with TB-12 Metal Tool Box
WSX-28	27 Piece Tool Set Only

#### Contents Include:

Drive Tools:		Shallow 12-Point Sockets	
Product Code	Description	Product Code	Size (Inches)
X-20	20" Sliding T-Handle/Head	X-1252	1 5/8
X-41C	34 3/16" Flex Handle	X-1258	1 13/16
X-51B	20" Ratchet	X-1260	1 7/8
X-110	8" Extension	X-1264	2
X-115	16" Extension	X-1268	2 1/8
		X-1270	2 3/16
		X-1272	2 1/4
		X-1276	2 3/8
		X-1280	2 1/2
		X-1282	2 9/16
		X-1284	2 5/8
		X-1288	2 3/4
		X-1294	2 15/16
		X-1296	3
		X-12100	3 1/8

#### Features

- All tools are professional quality, made of high-grade chrome vanadium steel.
- Sockets feature SUPERTORQUE® lobular openings for greater turning power without deforming the fastener.
- Metal tool box made for years of rugged use.



WSX-28TB



### 19 PIECE 1" DRIVE SOCKET AND DRIVE TOOL SET

#### 12 Point SAE, with Metal Box

Product Code	Description
WSX-21TB	19 Piece Tool Set with TB-12 Metal Tool Box
WSX-21	19 Piece Tool Set Only

#### Contents Include:

Drive Tools:		Shallow 12-Point Sockets	
Product Code	Description	Product Code	Size (Inches)
X-20	20" Sliding T-Handle / Head	X-1260	1 7/8
X-41C	34 3/16" Flex Handle	X-1264	2
X-51B	20" Ratchet	X-1270	2 3/16
X-110	8" Extension	X-1272	2 1/4
X-115	16" Extension	X-1276	2 3/8
		X-1280	2 1/2
		X-1282	2 9/16
		X-1284	2 5/8
		X-1288	2 3/4
		X-1294	2 15/16
		X-1296	3

#### Features

- All tools are professional quality, made of high-grade chrome vanadium steel.
- Sockets feature SUPERTORQUE® lobular openings for greater turning power without deforming the fastener.
- Metal tool box made for years of rugged use.



WSX-21TB





# SOCKETS & DRIVE TOOLS

## 1" DRIVE



### 19 PIECE 1" DRIVE SOCKET AND DRIVE TOOL SET

#### 12 Point SAE, with Metal Box

Product Code	Description
WSX-20TB	19 Piece Tool Set with TB-12 Metal Tool Box
WSX-20	19 Piece Tool Set Only

#### Contents Include:

Drive Tools:		Shallow 12-Point Sockets	
Product Code	Description	Product Code	Size (Inches)
X-20	20" Sliding T-Handle/Head	X-1242	1 5/16
X-41C	34 3/16" Flex Handle	X-1244	1 3/8
X-51B	20" Ratchet	X-1246	1 7/16
X-110	8" Extension	X-1248	1 1/2
X-115	16" Extension	X-1252	1 5/8
		X-1258	1 13/16
		X-1260	1 7/8
		X-1264	2
X-1234	1 1/16	X-1270	2 3/16
X-1236	1 1/8	X-1272	2 1/4
X-1240	1 1/4	X-1276	2 3/8

#### Features

- All tools are professional quality, made of high-grade chrome vanadium steel.
- Sockets feature SUPERTORQUE® lobular openings for greater turning power without deforming the fastener.
- Metal tool box made for years of rugged use.



WSX-20TB



### 1" DRIVE RATCHETS

#### Integrated Handle, Chrome Finish

Product Code	Description	Length (Inches)	Number of Teeth
X-51B	Chrome Ratchet	20 1/8	24
X-52EHRK	Repair Kit for X-51B		

Fed. Spec: ANSI B107.10M

#### Features

- Forged one-piece ratchet provide strength and safety for industrial applications.
- Smooth comfort-grip handle permits all-day use without gloves.
- 24 tooth gear with 15 degree of engagement allows engagement in tight working areas.
- Chrome finish with mirror-like exterior can be easily cleaned after each use.
- Single Pawl ratchet design:
  - 1) Designed for tighter tolerances between pawl and gear which reduces metal fatigue and slippage under load.
  - 2) Does not require as many working parts, reducing possible breakage and parts to repair.
- Easy access reverse lever allows user to change working direction quickly and easily with only one hand.
- Spring and plunger socket retention.



X-51B

# SOCKETS & DRIVE TOOLS

## 1" DRIVE



### 1" DRIVE REMOVABLE-HANDLE RATCHETS

#### Knurled Handle, Chrome Finish

Product Code	Description	Length (Inches)	Number of Teeth
--------------	-------------	-----------------	-----------------

#### Complete Ratchet

X-52A1	Ratchet with 36" Handle	41	24
--------	-------------------------	----	----

#### Components

X-52	Ratchet Head Only	7 <sup>13</sup> / <sub>16</sub>	24
X-52H36	Handle Only	36	24
X-52EHRK	Repair Kit		

Note: Head Bore and Handle End Diameter: 1-7/64"

Fed. Spec: ANSI B107.10M

#### Features

- 24 teeth action provides an 15° ratcheting angle.
- Shift lever reverses action instantly.
- Dual socket retention, with both ball and plunger on male drive for versatility.
- Removable handle makes the tool more versatile, and storage easier.
- Knurled handle provides a non-slip grip.
- Chrome finish models provides increased protection from rust and corrosion.
- Our most rugged, high torque capacity ratchet.



X-52



X-52A1



X-52H36



### 1" DRIVE HANDLES

#### Chrome and Black Industrial Finish

Product Code	Description	Length (Inches)	Finish
X-41C	Flex Handle Breaker Bar, Knurled Grip	34 <sup>3</sup> / <sub>16</sub>	Chrome
X-41CB	Flex Handle Breaker Bar, Knurled Grip	34 <sup>3</sup> / <sub>16</sub>	Black Industrial
X-20	Sliding T-Handle	20	Chrome

#### Sliding T-Handle Components

X-20B	Handle	20	Chrome
X-20C	Sliding Head	1 <sup>15</sup> / <sub>16</sub>	Chrome

Fed. Spec: ANSI B107.10M

#### Features

- Chrome plating provides increased protection from rust and corrosion.
- Drive handles provide extra leverage with greater strength than ratchets.
- Square drive slides on T-Handles for versatility.
- Flex handle flex drive swivels 110° in either direction.
- Spring and plunger socket retention.



X-41C



X-41CB



X-20



### 1" DRIVE EXTENSIONS

#### Chrome Finish

Product Code	Length (Inches)
X-110	8
X-115	16

Fed. Spec: ANSI B107.10M

#### Features

- Chrome plating provides increased protection from rust and corrosion.
- Ball and spring socket retention.
- Hole in wall of drive end accommodates plunger for firm tool retention.



X-110



X-115



# SOCKETS & DRIVE TOOLS

## 1" DRIVE



### 1" DRIVE SHALLOW 12 POINT SOCKETS, SAE

#### High-Polished Chrome Finish



Product Code	Size (Inches)	Dimensions (Inches)						
		A	B	C	D	E	F	
		OAL	Drive End Diameter	Working End Diameter	Broach Depth	Bolt Clearance Depth	Bolt Clearance Diameter	Nose Length
X-1234	1 1/16	2 1/4	2	1 5/8	3/4	1 1/16	13/16	7/8
X-1236	1 1/8	2 1/4	2	1 3/4	3/4	1 1/16	13/16	7/8
X-1240	1 1/4	2 3/8	2	1 7/8	3/4	1 1/8	13/16	7/8
X-1242	1 9/16	2 1/2	2	2 1/16	13/16	1 1/32	15/16	1 9/16
X-1244	1 3/8	2 1/2	2	2 1/8	7/8	1 1/32	1 13/32	1 9/16
X-1246	1 7/16	2 3/4	2	2 3/16	1	1 15/32	1 1/2	1 11/16
X-1248	1 1/2	2 3/4	2	2 1/4	1	1 19/32	1 9/16	1 13/16
X-1252	1 5/8	2 7/8	2	2 3/8	1 1/8	1 3/4	1 11/16	1 15/16
X-1254	1 11/16	2 7/8	2	2 3/8	1 3/16	1 9/16	1 3/4	1 15/16
X-1256	1 3/4	3	2	2 9/16	1 1/4	1 27/32	1 13/16	2 1/16
X-1258	1 13/16	3 1/8	2 1/8	2 5/8	1 1/4	1 31/32	1 7/16	2 3/16
X-1260	1 7/8	3 1/4	2 1/8	2 3/4	1 1/16	2 3/32	1 7/16	2 5/16
X-1264	2	3 3/8	2 1/8	2 15/16	1 1/2	2 1/4	1 7/16	2 7/16
X-1268	2 1/8	3 1/2	2 1/4	3 1/8	1 1/2	2 11/32	1 7/16	2 9/16
X-1270	2 9/16	3 5/8	2 1/4	3 1/8	1 17/32	2 15/32	2 1/4	2 11/16
X-1272	2 1/4	3 3/4	2 1/4	3 1/4	1 5/8	2 5/8	2 11/32	2 23/32
X-1276	2 3/8	3 7/8	2 1/4	3 3/8	1 5/8	2 3/4	2 3/8	2 13/16
X-1280	2 1/2	4 1/8	2 1/4	3 1/2	1 3/4	2 31/32	2 1/2	3 1/16
X-1282	2 9/16	4 1/8	2 1/4	3 9/16	1 13/16	2 31/32	2 9/16	3 3/16
X-1284	2 5/8	4 1/4	2 1/4	3 5/8	1 7/8	3 3/32	2 5/8	3 1/8
X-1288	2 3/4	4 1/2	2 1/4	3 3/4	2	3 3/8	2 3/4	3 9/16
X-1294	2 15/16	4 27/32	2 1/4	4	2 1/8	3 23/32	2 15/16	3 25/32
X-1296	3	4 7/8	2 1/4	4 1/8	2 1/8	3 3/4	3	3 27/32
X-12100	3 1/8	4 31/32	2 1/4	4 1/4	2 1/8	3 27/32	3 1/8	3 29/32

Fed. Spec: ANSI B107.1

#### WSX-17 17 Piece 1" Drive Shallow 12-Point Socket Set

#### Contents Include:

Product Code	Size (Inches)	Product Code	Size (Inches)	Product Code	Size (Inches)
X-1234	1 1/16	X-1248	1 1/2	X-1264	2
X-1236	1 1/8	X-1252	1 5/8	X-1268	2 1/8
X-1240	1 1/4	X-1254	1 11/16	X-1270	2 3/16
X-1242	1 9/16	X-1256	1 3/4	X-1272	2 1/4
X-1244	1 3/8	X-1258	1 13/16	X-1276	2 3/8
X-1246	1 7/16	X-1260	1 7/8		

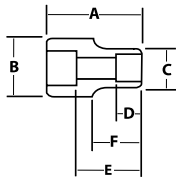

#### Features

- SUPERTORQUE® lobular openings for greater turning power without deforming the fastener.
- Designed for quick engagement on both 6 and 12 point fasteners.



### 1" DRIVE IMPACT EXTENSIONS AND ACCESSORIES

#### Black Industrial Finish



Product Code	Description	Length (Inches)	Use RET RING®	Use O-Ring / Pin	Socket Retention
7-107	Impact Extension	7 1/4	7-2XS	7-1B / 7-2D	Through Hole and Pin
7-113	Impact Extension	13	7-2XS	7-1B / 7-2D	Through Hole and Pin
7-140B	Impact Universal Joint	4 1/2	7-3XS	7-1B / 7-2D	Through Hole and Pin
7-6	3/4"M x 1"F Adapter	3	7-2XS	7-1B / 7-2D	Through Hole and Pin
7-8	1 1/2"M x 1"F Adapter	3 3/8	7-2XS	7-1B / 7-2D	Through Hole and Pin

Fed. Spec: ANSI B107.2

#### Features

- Specially heat treated for impact use to provide long life, safety, and durability.
- Pin and o-ring or RET RING® (sold separately) secure tools onto impact wrench for safety and convenience.
- Universal joint provides 55° range of motion.
- Suitable for use with pneumatic and electric impact wrenches.
- Drive end features pin retention hole and groove.

# SOCKETS & DRIVE TOOLS

## 1" DRIVE



### 1" DRIVE IMPACT EXTENSIONS AND ACCESSORIES

#### Black Industrial Finish

Product Code	Description	Length (Inches)	Use RET RING®	Use O-Ring / Pin	Socket Retention
39003	Impact Extension	7	7-2XS	7-1B / 7-2D	Through Hole and Pin
39004	Impact Extension	13	7-2XS	7-1B / 7-2D	Through Hole and Pin
39002	Impact Universal Joint	4 1/2	7-3XS	7-1B / 7-2D	Through Hole and Pin
39005	3/4" M X 1" F Adapter	3	7-2XS	7-1B / 7-2D	Through Hole and Pin
39006	1-1/2" M X 1" F Adapter	3 3/8	7-2XS	7-1B / 7-2D	Through Hole and Pin

Fed. Spec: ANSI B107.2

#### Features

- Specially heat treated for impact use to provide long life, safety, and durability
- Pin and o-ring or RET RING® (sold separately) secure tools onto impact wrench for safety and convenience
- Universal joint provides 55° range of motion
- Suitable for use with pneumatic and electric impact wrenches
- Drive end features pin retention hole and groove



### 1" DRIVE IMPACT RETAINING PINS AND RINGS

#### Black Industrial Finish

Product Code	Description	Diameter	Length	Application
7-1B	Impact Retaining O-Ring	2	NA	Fits Williams Impact Tools with "B" Dimension to 2 3/8"
7-2D	Impact Retaining Pin	3/16	1 3/4	Fits Williams Impact Tools with "B" Dimension to 2 3/8"
7-1C	Impact Retaining O-Ring	3 1/4	NA	Fits Williams Impact Tools with "B" Dimension of 3 1/4"
7-2F	Impact Retaining Pin	3/16	2 7/8	Fits Williams Impact Tools with "B" Dimension of 3 1/4"

#### Features

- Specially heat treated for impact use to provide long life, safety, and durability.
- Suitable for use with pneumatic and electric impact wrenches.
- For 1" Drive impact tools with pin retention hole and groove.



### 1" DRIVE RET RING® ONE-PIECE IMPACT RETAINING RINGS WITH CRUSH GAUGE

Product Code	Groove Diameter (Inches)	Application
7-1XS	1 3/4	Fits Competitive Impact Sockets
7-2XS	2	Fits Williams 1" Drive Tools with "B" Dimension of 2 1/8" and 2 1/4"
7-3XS	2 1/8	Fits Williams 1" Drive Tools with "B" Dimension of 2 3/8"
7-4XS	2 1/4	Fits Competitive Impact Sockets
7-5XS	2 1/2	Fits Competitive Impact Sockets
7-6XS	2 5/8	Fits Competitive Impact Sockets

#### Features

- Fits all Williams 1" Drive Sockets and Accessories
- Crush Gauge on the resin pin indicates when a socket is excessively worn and should be replaced.
- Securely retains sockets and accessories to square drive of impact wrench
- For 1" drive impact tools with pin retention hole and groove
- Made of oil resistant material
- RET RING® is a trademark of FTL Enterprises, Inc.

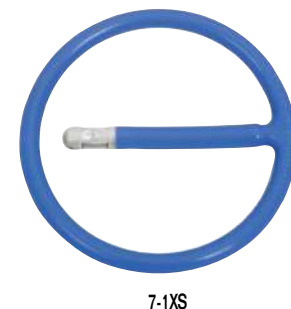

# SOCKETS & DRIVE TOOLS

## 1" DRIVE



### 1" DRIVE SHALLOW IMPACT SOCKETS, 6 POINT, SAE

#### Black Industrial Finish

Product Code	Size (Inches)	A OAL (Inches)	B Drive End Diameter (Inches)	C Working End Diameter (Inches)	D Broach Depth (Inches)	E Bolt Clearance Depth (Inches)	Bolt Clearance Diameter (Inches)	F Nose Length (Inches)	Uses RET RING® Number	Use O-Ring / Pin
39624	3/4	2 1/8	2 1/8	1 7/16	1 1/16	1 5/16	3/4	7/8	7-2XS	7-1B / 7-2D
39626	13/16	2 1/8	2 1/8	1 7/16	1 1/16	1 5/16	3/4	7/8	7-2XS	7-1B / 7-2D
39628	7/8	2 1/8	2 1/8	1 1/2	1 1/16	1 5/16	3/4	7/8	7-2XS	7-1B / 7-2D
39630	15/16	2 1/8	2 1/8	1 13/32	5/8	1 5/16	3/4	7/8	7-2XS	7-1B / 7-2D
39632	1	2 1/4	2 1/8	1 11/16	1 1/16	1 1/16	3/4	7/8	7-2XS	7-1B / 7-2D
39634	1 1/16	2 1/4	2 1/8	1 3/4	1 1/16	1 1/16	3/4	7/8	7-2XS	7-1B / 7-2D
39636	1 1/8	2 1/4	2 1/8	1 7/8	1 1/16	1 1/16	13/16	7/8	7-2XS	7-1B / 7-2D
39638	1 3/16	2 1/4	2 1/8	1 7/8	1 1/16	1 1/16	13/16	7/8	7-2XS	7-1B / 7-2D
39640	1 1/4	2 3/8	2 1/8	2	3/4	1 3/16	15/16	7/8	7-2XS	7-1B / 7-2D
39642	1 3/16	2 1/2	2 1/8	2 1/16	7/8	1 3/16	1	1	7-2XS	7-1B / 7-2D
39644	1 3/8	2 1/2	2 1/8	2 1/8	7/8	1 3/16	1 3/8	-	7-2XS	7-1B / 7-2D
39646	1 7/16	2 1/2	2 1/4	2 1/4	29/32	1 5/16	1 7/16	-	7-2XS	7-1B / 7-2D
39648	1 1/2	2 3/8	2 1/4	2 11/32	15/16	1 15/32	1 1/2	1 5/8	7-2XS	7-1B / 7-2D
39650	1 5/16	2 3/8	2 1/4	2 3/8	15/16	1 7/16	1 5/16	1 5/8	7-2XS	7-1B / 7-2D
39652	1 5/8	2 3/4	2 1/4	2 3/8	1 1/16	1 5/8	1 13/32	1 3/4	7-2XS	7-1B / 7-2D
39654	1 11/16	2 3/4	2 3/8	2 19/32	1 1/16	1 5/8	1 7/32	1 3/4	7-3XS	7-1B / 7-2D
39656	1 3/4	2 3/4	2 3/8	2 5/8	1 5/32	1 23/32	1 7/16	1 7/8	7-3XS	7-1B / 7-2D
39658	1 13/16	2 15/16	2 3/8	2 3/4	1 3/16	1 23/32	1 13/16	1 15/16	7-3XS	7-1B / 7-2D
39660	1 7/8	2 15/16	2 3/8	2 3/4	1 3/16	1 23/32	1 7/16	1 15/16	7-3XS	7-1B / 7-2D
39662	1 15/16	2 5/16	2 3/8	2 3/4	1 3/16	1 23/32	1 3/8	1 15/16	7-3XS	7-1B / 7-2D
39664	2	3 1/8	2 3/8	3	1 9/32	1 31/32	1 13/32	2 1/8	7-3XS	7-1B / 7-2D
39666	2 1/16	3 1/8	2 3/8	3	1 9/32	1 31/32	1 1/2	2 1/8	7-3XS	7-1B / 7-2D
39668	2 1/8	3 1/4	2 3/8	3 1/8	1 9/32	1 31/32	1 5/8	2 1/4	7-3XS	7-1B / 7-2D
39670	2 3/16	3 5/16	2 3/8	3 1/4	1 7/16	2 3/32	1 5/8	2 3/16	7-3XS	7-1B / 7-2D
39672	2 1/4	3 5/16	2 3/8	3 1/4	1 7/16	2 3/32	1 5/8	2 3/16	7-3XS	7-1B / 7-2D
39674	2 5/16	3 1/2	2 3/8	3 3/8	1 1/2	2 5/32	1 3/4	2 1/2	7-3XS	7-1B / 7-2D
39676	2 3/8	3 1/2	2 3/8	3 1/2	1 1/2	2 11/32	1 3/4	2 1/2	7-3XS	7-1B / 7-2D
39678	2 7/16	3 1/2	2 3/8	3 1/2	1 1/2	2 11/32	1 3/4	2 1/2	7-3XS	7-1B / 7-2D
39680	2 1/2	3 3/8	2 3/8	3 1/2	1 5/8	2 15/32	2 1/2	2 5/8	7-3XS	7-1B / 7-2D
39682	2 5/16	3 3/8	2 3/8	3 3/8	1 5/8	2 15/32	2 3/16	2 5/8	7-3XS	7-1B / 7-2D
39684	2 5/8	3 3/8	2 3/8	3 3/4	1 5/8	2 5/16	1 7/8	2 5/8	7-3XS	7-1B / 7-2D
39686	2 11/16	3 3/8	2 3/8	3 3/4	1 13/16	2 15/32	2	2 7/8	7-3XS	7-1B / 7-2D
39688	2 3/4	3 3/8	2 3/8	3 3/4	1 13/16	2 15/32	2 3/4	2 7/8	7-3XS	7-1B / 7-2D
39690	2 13/16	4	2 3/8	4	1 13/16	2 11/16	2	3	7-3XS	7-1B / 7-2D
39692	2 7/8	4	2 3/8	4	1 13/16	2 11/16	2	3	7-3XS	7-1B / 7-2D
39694	2 15/16	4 3/16	2 3/8	4 1/8	2 1/2	2 11/16	2 15/16	3 1/8	7-3XS	7-1B / 7-2D
39696	3	4 3/8	2 3/8	4 1/4	2 1/16	3 5/16	2 3/8	3 3/8	7-3XS	7-1B / 7-2D

Fed. Spec: ANSI B107.2

#### Features

- SUPERTORQUE® lobular openings for greater turning power without deforming the fastener.
- Designed for maximum engagement on 6 point fasteners.
- Suitable for use with pneumatic and electric impact wrenches.
- Specially heat treated for impact use to provide long life, safety, and durability.



39654



17-648BW



### 1" DRIVE BUDD® WHEEL IMPACT SOCKET, 6 POINT, SAE

#### Black Industrial Finish

Product Code	Size (Inches)	A OAL (Inches)	B Drive End Diameter (Inches)	C Working End Diameter (Inches)	D Broach Depth (Inches)	E Bolt Clearance Depth (Inches)	Bolt Clearance Diameter (Inches)
17-648BW	13/16 Square / 1 1/2 Hex	4	1 3/4	2 1/4	1 7/16	2 1/4	1 1/4

Fed. Spec: ANSI B107.2

#### Features

- SUPERTORQUE® lobular openings for greater turning power without deforming the fastener.
- 13/16" square opening threads stud into wheel.
- 1-1/2" hex opening engages and tightens the wheel lug nut.
- Suitable for use with pneumatic and electric impact wrenches.
- Specially heat treated for impact use to provide long life, safety, and durability.

# SOCKETS & DRIVE TOOLS

## 1" DRIVE



### 1" DRIVE SHALLOW IMPACT SOCKETS, 6 POINT, SAE

#### Black Industrial Finish

Product Code	A		B	C	D	E	F		Uses RET RING® Number	Use O-Ring / Pin
	Size (Inches)	OAL (Inches)	Drive End Diameter (Inches)	Working End Diameter (Inches)	Broach Depth (Inches)	Bolt Clearance Depth (Inches)	Bolt Clearance Diameter (Inches)	Nose Length (Inches)		
7-624	3/4	2 1/8	2 1/8	1 7/16	1 1/16	1 5/16	3/4	7/8	7-2XS	7-1B / 7-2D
7-626	13/16	2 1/8	2 1/8	1 7/16	1 1/16	1 5/16	3/4	7/8	7-2XS	7-1B / 7-2D
7-628	7/8	2 1/8	2 1/8	1 1/2	1 1/16	1 5/16	3/4	7/8	7-2XS	7-1B / 7-2D
7-630	15/16	2 1/8	2 1/8	1 19/32	5/8	1 5/16	3/4	7/8	7-2XS	7-1B / 7-2D
7-632	1	2 1/4	2 1/8	1 11/16	1 1/16	1 1/16	3/4	7/8	7-2XS	7-1B / 7-2D
7-634	1 1/16	2 1/4	2 1/8	1 3/4	1 1/16	1 1/16	3/4	7/8	7-2XS	7-1B / 7-2D
7-636	1 1/8	2 1/4	2 1/8	1 7/8	1 1/16	1 1/16	13/16	7/8	7-2XS	7-1B / 7-2D
7-638	1 3/16	2 1/4	2 1/8	1 7/8	1 1/16	1 1/16	13/16	7/8	7-2XS	7-1B / 7-2D
7-640	1 1/4	2 3/8	2 1/8	2	3/4	1 3/16	1 5/16	7/8	7-2XS	7-1B / 7-2D
7-642	1 5/16	2 1/2	2 1/8	2 1/16	7/8	1 5/16	1	1	7-2XS	7-1B / 7-2D
7-644	1 3/8	2 1/2	2 1/8	2 1/8	7/8	1 5/16	1 3/8	-	7-2XS	7-1B / 7-2D
7-646	1 7/16	2 1/2	2 1/4	2 1/4	29/32	1 5/16	1 7/16	-	7-2XS	7-1B / 7-2D
7-648	1 1/2	2 5/8	2 1/4	2 11/32	19/16	1 19/32	1 1/2	1 5/8	7-2XS	7-1B / 7-2D
7-650	1 9/16	2 5/8	2 1/4	2 3/8	15/16	1 7/16	1 9/16	1 5/8	7-2XS	7-1B / 7-2D
7-652	1 5/8	2 3/4	2 1/4	2 3/8	1 1/16	1 5/8	1 19/32	1 3/4	7-2XS	7-1B / 7-2D
7-654	1 11/16	2 3/4	2 3/8	2 19/32	1 1/16	1 5/8	1 7/32	1 3/4	7-3XS	7-1B / 7-2D
7-656	1 3/4	2 7/8	2 3/8	2 5/8	1 5/32	1 23/32	1 7/16	1 7/8	7-3XS	7-1B / 7-2D
7-658	1 13/16	2 15/16	2 3/8	2 3/4	1 3/16	1 23/32	1 13/16	1 15/16	7-3XS	7-1B / 7-2D
7-660	1 7/8	2 15/16	2 3/8	2 3/4	1 3/16	1 23/32	1 7/16	1 15/16	7-3XS	7-1B / 7-2D
7-662	1 15/16	2 15/16	2 3/8	2 3/4	1 3/16	1 23/32	1 3/8	1 15/16	7-3XS	7-1B / 7-2D
7-664	2	3 1/8	2 3/8	3	1 9/32	1 31/32	1 13/32	2 1/8	7-3XS	7-1B / 7-2D
7-666	2 1/16	3 1/8	2 3/8	3	1 9/32	1 31/32	1 1/2	2 1/8	7-3XS	7-1B / 7-2D
7-668	2 1/8	3 1/4	2 3/8	3 1/8	1 9/32	1 31/32	1 5/8	2 1/4	7-3XS	7-1B / 7-2D
7-670	2 3/16	3 5/16	2 3/8	3 1/4	1 7/16	2 5/32	1 5/8	2 5/16	7-3XS	7-1B / 7-2D
7-672	2 1/4	3 5/16	2 3/8	3 1/4	1 7/16	2 5/32	1 5/8	2 9/16	7-3XS	7-1B / 7-2D
7-674	2 5/16	3 1/2	2 3/8	3 3/8	1 1/2	2 5/32	1 3/4	2 1/2	7-3XS	7-1B / 7-2D
7-676	2 3/8	3 1/2	2 3/8	3 1/2	1 1/2	2 11/32	1 3/4	2 1/2	7-3XS	7-1B / 7-2D
7-678	2 7/16	3 1/2	2 3/8	3 1/2	1 1/2	2 11/32	1 3/4	2 1/2	7-3XS	7-1B / 7-2D
7-680	2 1/2	3 5/8	2 3/8	3 1/2	1 5/8	2 15/32	2 1/2	2 5/8	7-3XS	7-1B / 7-2D
7-682	2 9/16	3 5/8	2 3/8	3 5/8	1 5/8	2 15/32	2 9/16	2 5/8	7-3XS	7-1B / 7-2D
7-684	2 5/8	3 5/8	2 3/8	3 3/4	1 5/8	2 5/16	1 7/8	2 5/8	7-3XS	7-1B / 7-2D
7-686	2 11/16	3 7/8	2 3/8	3 3/4	1 13/16	2 15/32	2	2 7/8	7-3XS	7-1B / 7-2D
7-688	2 3/4	3 7/8	2 3/8	3 3/4	1 13/16	2 21/32	2 3/4	2 7/8	7-3XS	7-1B / 7-2D
7-690	2 13/16	4	2 3/8	4	1 13/16	2 11/16	2	3	7-3XS	7-1B / 7-2D
7-692	2 7/8	4	2 3/8	4	1 13/16	2 11/16	2	3	7-3XS	7-1B / 7-2D
7-694	2 15/16	4 3/16	2 3/8	4 1/8	2 1/32	2 11/16	2 15/16	3 1/8	7-3XS	7-1B / 7-2D
7-696	3	4 3/8	2 3/8	4 1/4	2 1/16	3 5/16	2 3/8	3 3/8	7-3XS	7-1B / 7-2D
7-6100	3 1/8	4 3/8	2 3/8	4 1/4	2 1/16	3 5/16	2 3/8	3 3/8	7-3XS	7-1B / 7-2D
7-6104	3 1/4	4 3/8	2 3/8	4 1/2	2 1/16	3 1/32	2 3/8	3 3/8	7-3XS	7-1B / 7-2D
7-6108	3 3/8	4 23/32	2 3/8	4 5/8	2 1/4	3 5/16	2 1/2	2 39/64	7-3XS	7-1B / 7-2D
7-6112	3 1/2	4 3/4	2 3/8	4 3/4	2 1/4	3 11/32	2 1/2	2 5/8	7-3XS	7-1B / 7-2D
7-6116	3 5/8	4 3/4	2 3/8	5	2 5/16	3 11/32	2 5/8	2 19/32	7-3XS	7-1B / 7-2D
7-6118	3 11/16	4 3/4	2 3/8	5 5/16	2 7/16	3 13/32	2 3/4	2 15/16	7-3XS	7-1B / 7-2D
7-6120	3 3/4	5 1/16	2 3/8	5 1/8	2 3/8	3 21/64	2 5/8	3 3/32	7-3XS	7-1B / 7-2D
7-6122	3 13/16	5 3/16	2 3/8	5 3/8	2 17/32	3 9/16	2 5/8	3 23/64	7-3XS	7-1B / 7-2D
7-6124	3 7/8	5 1/4	2 3/8	5 1/4	2 9/16	3 25/32	2 3/4	3 1/8	7-3XS	7-1B / 7-2D
7-6126	3 15/16	5 5/16	2 3/8	5 11/32	2 9/16	3 25/32	3	3 3/16	7-3XS	7-1B / 7-2D
7-6128	4	5 3/8	2 3/8	5 1/2	2 9/16	3 25/32	2 7/8	3 15/64	7-3XS	7-1B / 7-2D
7-6130	4 1/16	5 3/8	2 3/8	5 1/2	2 19/32	2 19/32	3	3 29/64	7-3XS	7-1B / 7-2D
7-6132	4 1/8	5 3/8	2 3/8	5 9/16	2 9/16	3 25/32	2 7/8	3 7/32	7-3XS	7-1B / 7-2D
7-6134	4 3/16	5 1/2	2 3/8	6	2 33/64	3 55/64	3	3 41/64	7-3XS	7-1B / 7-2D
7-6136	4 1/4	5 1/2	2 3/8	5 3/4	2 5/8	3 29/32	3 1/8	3 3/16	7-3XS	7-1B / 7-2D
7-6138	4 5/16	5 1/2	2 3/8	5 13/16	2 21/32	3 25/32	3 3/8	3 5/16	7-3XS	7-1B / 7-2D
7-6140	4 3/8	5 5/8	2 3/8	5 27/32	2 5/8	3 29/32	3 1/8	3 39/64	7-3XS	7-1B / 7-2D
7-6142	4 7/16	5 5/8	2 3/8	6	2 43/64	3 29/32	2 5/8	3 19/32	7-3XS	7-1B / 7-2D
7-6144	4 1/2	5 5/8	2 3/8	6	2 5/8	3 25/32	3 1/8	3 13/32	7-3XS	7-1B / 7-2D
7-6146	4 9/16	5 5/8	3 1/4	6 1/2	2 3/4	3 1/2	3 3/8	3 17/32	8-1XS	7-1C - 7-2F
7-6148	4 5/8	5 3/4	3 1/4	6 13/32	3 1/16	3 25/32	3 1/8	3 25/32	8-1XS	7-1C - 7-2F
7-6152	4 3/4	5 3/4	3 1/4	6 5/8	2 57/64	3 29/32	3 1/2	3 23/32	8-1XS	7-1C - 7-2F
7-6156	4 7/8	6	3 1/4	7	3	3 29/32	3 1/2	3 31/32	8-1XS	7-1C - 7-2F
7-6160	5	6 1/4	3 1/4	7	3	4 3/16	3 1/2	4 7/32	8-1XS	7-1C - 7-2F
7-6172	5 3/8	6 1/2	3 1/4	7 1/2	3 9/16	4 5/16	4 43/64	4 1/4	8-1XS	7-1C - 7-2F
7-6184	5 3/4	6 1/2	3 1/4	8 1/4	3 9/16	4 17/32	4	4 9/32	8-1XS	7-1C - 7-2F

Fed. Spec: ANSI B107.2



7-654

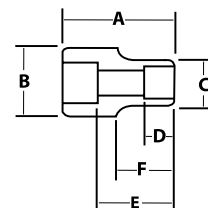

#### Features

- SUPERTORQUE® lobular openings for greater turning power without deforming the fastener.
- Designed for maximum engagement on 6 point fasteners.
- Suitable for use with pneumatic and electric impact wrenches.
- Specially heat treated for impact use to provide long life, safety, and durability.



**WARNING**

# SOCKETS & DRIVE TOOLS

## 1" DRIVE



### 1" DRIVE SHALLOW IMPACT SOCKETS, 6 POINT, SAE

#### WS-7-19TB 19 Piece 1" Drive Shallow 6 Point Impact Socket Set in Tool Box

##### Contents Include:

Product Code	Size (Inches)	Product Code	Size (Inches)	Product Code	Size (Inches)
7-648	1 1/2	7-676	2 3/8	7-6100	3 1/8
7-652	1 5/8	7-680	2 1/2	7-6104	3 1/4
7-656	1 3/4	7-682	2 9/16	7-6112	3 1/2
7-660	1 7/8	7-684	2 5/8	7-107	7 3/8" EXT
7-664	2	7-688	2 3/4	7-140B	U-JOINT
7-668	2 1/8	7-692	2 7/8	TB-6124A	TOOL BOX
7-672	2 1/4	7-696	3		



WS-7-19TB

##### Features

- SUPERTORQUE® lobular openings for greater turning power without deforming the fastener.
- Designed for maximum engagement on 6 point fasteners.
- Suitable for use with pneumatic and electric impact wrenches.
- Specially heat treated for impact use to provide long life, safety, and durability.



### 1" DRIVE SHALLOW IMPACT SOCKETS, 12 POINT, SAE

#### Black Industrial Finish

Product Code	Size (Inches)	A Overall Length (Inches)	B Drive End Diameter (Inches)	C Working End Diameter (Inches)	D Broach Depth (Inches)	E Bolt Clearance Depth (Inches)	F Bolt Clearance Diameter (Inches)	Nose Length (Inches)
39720	5/8	2 1/4	2	1 3/16	7/16	/	/	1
39724	3/4	2 1/4	2	1 1/2	7/16	/	/	1
39726	13/16	2 1/4	2	1 1/2	7/16	/	/	1
39728	7/8	2 1/4	2	1 1/2	1/2	/	/	1
39730	15/16	2 1/4	2	1 1/2	1/2	/	/	1
39732	1	2 1/4	2	1 5/8	1/2	/	/	1
39734	1 1/16	2 1/4	2	1 3/4	1/2	/	/	1
39736	1 1/8	2 1/4	2	1 3/4	5/8	/	/	1
39738	1 3/16	2 7/16	2	1 7/8	5/8	/	/	1 1/8
39740	1 1/4	2 7/16	2	2	5/8	/	/	/
39742	1 5/16	2 7/16	2 1/16	2 1/8	3/4	/	/	1 3/16
39744	1 3/8	2 7/16	2 1/16	2 1/8	3/4	/	/	1 3/16
39746	1 7/16	2 7/16	2 1/16	2 1/4	3/4	/	/	1 3/16
39748	1 1/2	2 7/16	2 1/16	2 1/4	7/8	/	/	1 3/16
39750	1 9/16	2 7/16	2 1/16	2 1/4	7/8	/	/	1 3/16
39752	1 5/8	2 7/16	2 1/16	2 7/16	7/8	/	/	1 3/16
39754	1 11/16	2 1/2	2 1/16	2 1/2	1	/	/	1 3/16
39756	1 3/4	2 1/2	2 1/4	2 1/2	1	/	/	1 3/16
39758	1 13/16	2 1/2	2 1/4	2 5/8	1	/	/	1 3/16
39760	1 7/8	2 1/2	2 1/4	2 3/4	1 1/16	/	/	1 3/16
39762	1 15/16	2 5/8	2 1/4	2 3/4	1 1/16	/	/	1 3/16
39764	2	2 3/4	2 1/4	2 5/16	1 1/16	/	/	1 3/16
39766	2 1/16	2 3/4	2 1/4	2 5/16	1 3/16	/	/	1 3/16
39768	2 1/8	2 3/4	2 1/4	3 1/16	1 3/16	/	/	1 3/16
39770	2 3/16	2 3/4	2 3/16	3 3/16	1 3/16	/	/	1 3/16
39772	2 1/4	2 15/16	2 7/16	3 1/4	1 1/4	/	/	1 3/16
39776	2 3/8	3 1/16	2 7/16	3 1/2	1 3/8	/	/	1 3/16
39780	2 1/2	3 3/16	2 7/16	3 1/2	1 3/8	/	/	1 3/16
39782	2 9/16	3 3/16	2 7/16	3 5/8	1 3/8	/	/	1 3/16
39788	2 3/4	3 3/8	2 7/16	3 7/8	1 1/2	/	/	1 1/4
39794	2 15/16	3 3/4	3 3/8	4 1/8	1 5/8	/	/	1 1/2
39796	3	3 3/4	3 3/8	4 1/8	1 5/8	/	/	1 1/2



39720

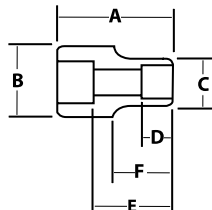

##### Features

- SUPERTORQUE® lobular openings for greater turning power without deforming the fastener.
- Designed for maximum engagement on 6 and 12 point fasteners.
- Suitable for use with pneumatic and electric impact wrenches.
- Specially heat treated for impact use to provide long life, safety, and durability.

# SOCKETS & DRIVE TOOLS

## 1" DRIVE



### 1" DRIVE DEEP IMPACT SOCKETS, 6 POINT, SAE

#### Black Industrial Finish

Product Code	Size (Inches)	A OAL (Inches)	B Drive End Diameter (Inches)	C Working End Diameter (Inches)	D Broach Depth (Inches)	E Bolt Clearance Depth (Inches)	F Bolt Clearance Diameter (Inches)	Nose Length (Inches)	Uses RET RING® Number	Use O-Ring / Pin
17-632	1	3	2 1/8	1 19/32	3/4	1 13/16	1 1/16	7/8	7-2XS	7-1B / 7-2D
17-634	1 1/16	3 3/4	2 1/8	1 3/4	1 23/32	2 19/32	3/4	7/8	7-2XS	7-1B / 7-2D
17-636	1 1/8	3 3/4	2 1/8	1 13/16	1 25/32	2 19/32	7/8	7/8	7-2XS	7-1B / 7-2D
17-638	1 3/16	3	2 1/8	1 13/16	3/4	1 3/16	13/16	7/8	7-2XS	7-1B / 7-2D
17-640	1 1/4	3 3/4	2 1/8	1 31/32	1 15/16	2 19/32	7/8	1	7-2XS	7-1B / 7-2D
17-642	1 5/16	4	2 1/8	2 1/16	2 1/32	2 27/32	1	1	7-2XS	7-1B / 7-2D
17-644	1 3/8	4	2 1/8	2 1/16	2 1/16	2 27/32	1	1	7-2XS	7-1B / 7-2D
17-646	1 7/16	4	2 1/8	2 1/4	2 3/16	2 27/32	1	2 1/4	7-2XS	7-1B / 7-2D
17-648	1 1/2	4	2 1/4	2 3/8	2 1/4	2 27/32	1 1/8	2 1/2	7-2XS	7-1B / 7-2D
17-650	1 5/16	3 1/2	2 1/4	2 3/8	1	2 11/32	1 17/32	2 1/2	7-2XS	7-1B / 7-2D
17-652	1 3/8	4 1/4	2 1/4	2 7/16	2 13/32	3 3/32	1 1/8	2 3/8	7-2XS	7-1B / 7-2D
17-654	1 11/16	4 1/4	2 1/4	2 17/32	2 1/2	3 3/32	1 1/4	2 3/8	7-3XS	7-1B / 7-2D
17-656	1 3/4	4 1/4	2 1/4	2 19/32	2 9/16	3 1/32	1 1/4	2 3/8	7-3XS	7-1B / 7-2D
17-658	1 13/16	4 1/2	2 1/4	2 11/16	2 21/32	3 9/32	1 1/4	2 3/8	7-3XS	7-1B / 7-2D
17-660	1 7/8	4 1/2	2 1/4	2 3/4	2 3/4	3 1/4	1 3/8	2 3/8	7-3XS	7-1B / 7-2D
17-662	1 15/16	4 1/2	2 1/4	2 27/32	2 13/16	3 1/4	1 3/8	3 1/8	7-3XS	7-1B / 7-2D
17-664	2	4 1/2	2 1/4	2 29/32	2 7/8	3 7/32	1 3/8	3 1/8	7-3XS	7-1B / 7-2D
17-666	2 1/16	4 3/4	2 1/4	3	2 31/32	3 15/32	1 1/2	3 1/8	7-3XS	7-1B / 7-2D
17-668	2 1/8	4 3/8	2 3/8	3 1/4	1 5/16	3 3/16	1 5/8	3 3/8	7-3XS	7-1B / 7-2D
17-670	2 3/16	4 3/4	2 13/32	3 5/32	3 1/8	3 7/16	1 1/2	3 3/8	7-3XS	7-1B / 7-2D
17-672	2 1/4	4 3/4	2 13/32	3 7/32	3 3/16	3 13/32	1 5/8	3 3/8	7-3XS	7-1B / 7-2D
17-674	2 3/16	5	2 13/32	3 5/16	3 9/32	3 21/32	1 5/8	3 1/2	7-3XS	7-1B / 7-2D
17-676	2 3/8	5	2 13/32	3 3/8	3 3/8	3 5/8	1 3/4	3 1/2	7-3XS	7-1B / 7-2D
17-678	2 7/16	4 1/2	2 3/8	3 1/2	1 1/2	3 7/32	1 3/4	3 1/2	7-3XS	7-1B / 7-2D
17-680	2 1/2	4 1/2	2 3/8	3 1/2	1 3/8	3	2 1/2	3 1/2	7-3XS	7-1B / 7-2D
17-682	2 9/16	4 7/8	2 3/8	3 3/8	1 5/8	3 1/2	2	3 3/8	7-3XS	7-1B / 7-2D
17-684	2 5/8	4 11/16	2 3/8	3 3/4	1 5/8	3 11/32	2	3 11/16	7-3XS	7-1B / 7-2D
17-686	2 11/16	4 11/16	2 3/8	3 3/4	1 13/16	2 1/2	2	3 11/16	7-3XS	7-1B / 7-2D
17-688	2 3/4	5 1/8	2 3/8	3 3/4	1 3/4	3 5/8	2	4 1/8	7-3XS	7-1B / 7-2D
17-690	2 13/16	5 3/8	2 3/8	4	1 13/16	2 27/32	2	4 1/8	7-3XS	7-1B / 7-2D
17-692	2 7/8	4 7/8	2 3/8	4	1 13/16	3 9/16	2	3 7/8	7-3XS	7-1B / 7-2D
17-694	2 15/16	4 7/8	2 3/8	4 1/8	2 1/32	2 11/16	2	3 7/8	7-3XS	7-1B / 7-2D
17-696	3	5 1/8	2 3/8	4 1/4	2 1/32	3 7/8	2 3/8	4 7/8	7-3XS	7-1B / 7-2D
17-6100	3 1/8	5 1/8	2 3/8	4 3/8	2 1/32	3 1/32	2 3/8	4 7/8	7-3XS	7-1B / 7-2D
17-6104	3 1/4	5 3/8	2 3/8	4 1/2	2 1/32	3 1/32	2 3/8	4 3/8	7-3XS	7-1B / 7-2D
17-6108	3 3/8	5 1/2	2 3/8	4 3/8	2 1/4	3 5/16	2 1/2	4 1/2	7-3XS	7-1B / 7-2D
17-6112	3 1/2	5 1/2	2 3/8	4 3/4	2 1/4	4 3/32	2 1/2	4 1/2	7-3XS	7-1B / 7-2D
17-6116	3 3/8	5 1/2	2 3/8	5	2 5/16	4 3/32	2 3/8	4 1/2	7-3XS	7-1B / 7-2D
17-6118	3 11/16	5 17/32	2 3/8	5 5/16	2 7/16	3 7/8	2 3/4	4 17/32	7-3XS	7-1B / 7-2D
17-6120	3 3/4	5 9/16	2 3/8	5 1/4	2 1/4	3 19/32	2 13/16	4 9/16	7-3XS	7-1B / 7-2D
17-6122	3 13/16	5 31/32	2 3/8	5 3/8	2 17/32	4 11/32	2 3/8	4 31/32	7-3XS	7-1B / 7-2D
17-6124	3 7/8	5 9/16	2 3/8	5 1/4	2 9/16	3 5/8	3	4 9/16	7-3XS	7-1B / 7-2D
17-6126	3 15/16	6 1/16	2 3/8	5 1/2	2 13/32	4 13/32	3	5 1/16	7-3XS	7-1B / 7-2D
17-6128	4	6 1/8	2 3/8	5 1/2	2 17/32	4 3/32	2 7/8	5 1/8	7-3XS	7-1B / 7-2D
17-6130	4 1/16	6 1/8	2 3/8	5 1/2	2 15/32	4 1/2	3	5 5/32	7-3XS	7-1B / 7-2D
17-6132	4 3/8	6 1/8	2 3/8	5 17/32	2 17/32	4 3/32	2 7/8	5 1/8	7-3XS	7-1B / 7-2D
17-6134	4 3/16	6 7/32	2 3/8	6	2 1/2	4 9/16	3	5 7/32	7-3XS	7-1B / 7-2D
17-6136	4 1/4	6 3/32	2 3/8	5 3/4	2 5/8	4 9/16	3 1/8	5 9/32	7-3XS	7-1B / 7-2D
17-6138	4 3/16	6 11/32	2 3/8	5 13/16	2 21/32	4 7/8	3 3/8	5 11/32	7-3XS	7-1B / 7-2D
17-6140	4 3/8	6 13/32	2 3/8	5 27/32	2 5/8	4 9/16	3 1/8	5 13/32	7-3XS	7-1B / 7-2D
17-6142	4 7/16	6 13/32	2 3/8	6	2 21/32	4 9/16	2 5/8	5 13/32	7-3XS	7-1B / 7-2D
17-6144	4 1/2	7	2 3/8	6	2 3/4	5	3 1/8	6	7-3XS	7-1B / 7-2D
17-6146	4 9/16	7 1/8	3 1/4	6 1/2	2 3/4	4 19/32	3 3/8	6 1/8	8-1XS	7-1C - 7-2F
17-6148	4 3/8	7 1/8	3 1/4	6 13/16	2 13/16	4 3/32	3 1/2	6 1/8	8-1XS	7-1C - 7-2F
17-6152	4 3/4	6 3/4	3 1/4	6 3/8	2 29/32	4 29/32	3 1/2	5 3/4	8-1XS	7-1C - 7-2F
17-6156	4 7/8	7 1/4	3 1/4	7	3	5 5/32	3 1/2	6 1/4	8-1XS	7-1C - 7-2F
17-6160	5	7 3/4	3 1/4	7	3	5 21/32	3 1/2	6 3/4	8-1XS	7-1C - 7-2F
17-6172	5 3/8	8	3 1/4	7 1/2	3 3/16	5 25/32	3 21/32	7	8-1XS	7-1C - 7-2F
17-6184	5 3/4	8	3 1/4	8 1/4	3 9/16	6 1/32	4	7	8-1XS	7-1C - 7-2F

Fed. Spec: ANSI B107.2



17-660

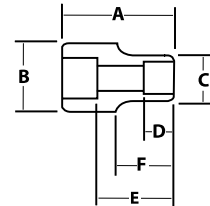

#### Features

- SUPERTORQUE® lobular openings for greater turning power without deforming the fastener.
- Designed for maximum engagement on 6 point fasteners.
- Suitable for use with pneumatic and electric impact wrenches.
- Specially heat treated for impact use to provide long life, safety, and durability.





# SOCKETS & DRIVE TOOLS

## 1" / 1-1/2" DRIVE



### 1" DRIVE SHALLOW IMPACT SOCKETS, 6 POINT, METRIC

Black Industrial Finish

Product Code	Size (MM)	A OAL (Inches)	B Drive End Diameter (Inches)	C Working End Diameter (Inches)	D Broach Depth (Inches)	E Bolt Clearance Depth (Inches)	F Bolt Clearance Diameter (Inches)	Nose Length (Inches)	Uses RET RING® Number	Use O-Ring / Pin
7M-627	27	2 1/4	2 1/8	1 3/4	1 1/16	1 1/16	3/4	7/8	7-2XS	7-1B / 7-2D
7M-630	30	2 1/4	2 1/8	1 7/8	1 1/16	1 1/16	13/16	7/8	7-2XS	7-1B / 7-2D
7M-632	32	2 3/8	2 1/8	2	3/4	1 3/16	15/16	7/8	7-2XS	7-1B / 7-2D
7M-635	35	2 1/2	2 1/8	2 1/8	7/8	1 5/16	1 3/8	-	7-2XS	7-1B / 7-2D
7M-638	38	2 3/8	2 1/4	2 11/32	15/16	1 15/32	1 1/2	1 5/8	7-2XS	7-1B / 7-2D
7M-641	41	2 3/4	2 1/4	2 3/8	1 1/16	1 5/8	1 19/32	1 3/4	7-2XS	7-1B / 7-2D
7M-646	46	2 15/16	2 3/8	2 3/4	1 3/16	1 23/32	1 13/16	1 15/16	7-3XS	7-1B / 7-2D
7M-650	50	3	2 3/8	2 3/4	1 1/4	1 27/32	1 61/64	2	7-3XS	7-1B / 7-2D
7M-660	60	3 1/2	2 3/8	3 1/2	1 1/2	2 11/32	2 1/4	2 1/2	7-3XS	7-1B / 7-2D
7M-665	65	3 5/8	2 3/8	3 5/8	1 5/8	2 1/8	2 1/4	2 5/8	7-3XS	7-1B / 7-2D
7M-670	70	3 7/8	2 3/8	3 3/4	1 13/16	2 21/32	2 3/4	2 7/8	7-3XS	7-1B / 7-2D
7M-675	75	4 3/16	2 3/8	4 1/8	2 1/32	2 11/16	2 15/16	3 1/8	7-3XS	7-1B / 7-2D



7M-650

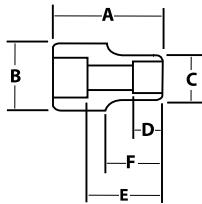

#### Features

- SUPERTORQUE® lobular openings for greater turning power without deforming the fastener.
- Designed for maximum engagement on 6 point fasteners.
- Suitable for use with pneumatic and electric impact wrenches.
- Specially heat treated for impact use to provide long life, safety, and durability.
- Drive end features pin retention hole and groove.
- Dual marked with corresponding SAE size.



### 1-1/2" DRIVE IMPACT EXTENSIONS AND ACCESSORIES

Black Industrial Finish

Product Code	Description	Length (Inches)	Use RET RING®	Use O-Ring / Pin	Socket Retention
8-108	Impact Extension	8	8-1XS	7-1C / 8-2E	Through Hole and Pin
8-115	Impact Extension	15	8-1XS	7-1C / 8-2E	Through Hole and Pin
8-140B	Impact Universal Joint	6 1/16	8-1XS	7-1C / 8-2E	Through Hole and Pin
8-7	1" M x 1 1/2" F Adapter	4 1/4	8-1XS	7-1C / 8-2E	Through Hole and Pin
8-8	1 1/2" M x 2 1/2" F Adapter	6 3/8	8-4XS	9-1D / 9-2G	Through Hole and Pin

Fed. Spec: ANSI B107.2

#### Features

- Specially heat treated for impact use to provide long life, safety, and durability.
- Pin and o-ring or RET RING® (sold separately) secure tools onto impact wrench for safety and convenience.
- Universal joint provides 55° range of motion.
- Suitable for use with pneumatic and electric impact wrenches.
- Drive end features pin retention hole and groove.



8-108



8-140B



8-8



8-7



### 1-1/2" SLIDING T-HANDLE

Black Industrial Finish

Product Code	Length (Inches)	Shaft Diameter (Inches)	Socket Retention
8-20	36	2 1/2	Plunger and Spring

#### Features

- Drive end slides on bar for additional flexibility.
- Ideal for turning 1-1/2" drive sockets when impact wrench is not available.



8-20

# SOCKETS & DRIVE TOOLS

## 1-1/2" DRIVE



### 1-1/2" DRIVE IMPACT RETAINING PINS AND RINGS

#### Black Industrial Finish

Product Code	Description	Diameter (Inches)	Length (Inches)	Application
7-1C	Impact Retaining O-Ring	3 1/4	NA	Fits All Williams 1 1/2" Drive Sockets and Accessories
8-2E	Impact Retaining Pin	1/4	2 7/8	Fits All Williams 1 1/2" Drive Sockets and Accessories
9-1D	Impact Retaining O-Ring	4 1/8	NA	
9-2G	Impact Retaining Pin	5/16	2 7/8	

#### Features

- Specially heat treated for impact use to provide long life, safety, and durability.
- Suitable for use with pneumatic and electric impact wrenches.
- For 1-1/2" Drive impact tools with pin retention hole and groove.



7-1C



8-2E



### 1-1/2" DRIVE RET RING® ONE-PIECE IMPACT RETAINING RINGS WITH CRUSH GAUGE

#### Black Industrial Finish

Product Code	Diameter (Inches)	Application
8-1XS	2 7/8	Fits Williams 1 1/2" Drive Tools with "B" Dimension of 3 1/4"
8-2XS	3 3/8	Fits Competitive Impact Sockets
8-3XS	3 7/8	Fits Competitive Impact Sockets
8-4XS	4 3/8	Fits Competitive Impact Sockets

#### Features

- Fits all Williams 1-1/2" Drive Sockets and Accessories
- Crush Gauge on the resin pin indicates when a socket is excessively worn and should be replaced.
- Securely retains sockets and accessories to square drive of impact wrench
- For 1-1/2" drive impact tools with pin retention hole and groove
- Made of oil resistant material
- RET RING® is a trademark of FTL Enterprises, inc.



8-1XS



# SOCKETS & DRIVE TOOLS

## 1-1/2" DRIVE



### 1-1/2" DRIVE SHALLOW IMPACT SOCKETS, 6 POINT, SAE

Black Industrial Finish



8-696

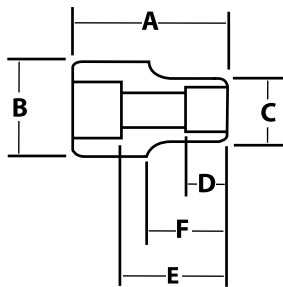

Product Code	Size (Inches)	A		B		C		D		E		F		Uses RET RING® Number	Use O-Ring / Pin
		OAL (Inches)	Drive End Diameter (Inches)	Working End Diameter (Inches)	Broach Depth (Inches)	Bolt Clearance Depth (Inches)	Bolt Clearance Diameter (Inches)	Nose Length (Inches)							
8-646	1 7/16	3 1/32	3 1/4	2 7/8	57/64	1 25/64	1 7/16	1 7/32	8-1XS	7-1C / 8-2E					
8-648	1 1/2	3 3/32	3 1/4	2 7/8	29/32	1 7/16	1 31/64	1 17/64	8-1XS	7-1C / 8-2E					
8-652	1 5/8	3 7/16	3 1/4	2 29/32	1 1/32	1 9/16	1 5/8	1 21/64	8-1XS	7-1C / 8-2E					
8-654	1 11/16	3 1/4	3 1/4	2 31/32	1 1/16	1 9/16	1 1/16	1 39/64	8-1XS	7-1C / 8-2E					
8-656	1 3/4	3 3/32	3 1/4	3 1/32	1 1/32	1 21/32	1 21/32	1 9/16	8-1XS	7-1C / 8-2E					
8-658	1 13/16	3 21/64	3 1/4	3 3/32	1 5/32	1 11/64	1 13/16	1 5/8	8-1XS	7-1C / 8-2E					
8-660	1 7/8	3 3/8	3 1/4	3 3/32	1 7/32	1 3/4	1 7/8	1 23/32	8-1XS	7-1C / 8-2E					
8-664	2	3 7/16	3 1/4	3 1/2	1 9/32	1 13/16	2	1 51/64	8-1XS	7-1C / 8-2E					
8-666	2 1/16	3 1/2	3 1/4	3 1/2	1 13/32	1 55/64	2 1/16	1 55/64	8-1XS	7-1C / 8-2E					
8-668	2 1/8	3 7/16	3 1/4	3 1/2	1 27/64	1 59/64	2 1/8	1 59/64	8-1XS	7-1C / 8-2E					
8-670	2 3/16	3 21/32	3 1/4	3 1/2	1 7/16	2	2 3/16	2 1/64	8-1XS	7-1C / 8-2E					
8-672	2 1/4	3 3/4	3 1/4	3 9/16	1 17/32	2 1/8	2 1/4	2 1/8	8-1XS	7-1C / 8-2E					
8-676	2 3/8	3 7/8	3 1/4	3 25/32	1 9/16	2 1/4	2 3/8	2 17/64	8-1XS	7-1C / 8-2E					
8-678	2 7/16	3 15/16	3 1/4	3 25/32	1 9/16	2 19/64	2 7/16	2 5/16	8-1XS	7-1C / 8-2E					
8-680	2 1/2	4	3 1/4	3 7/8	1 19/32	2 3/8	2 31/64	2 1/64	8-1XS	7-1C / 8-2E					
8-682	2 5/16	4 1/32	3 1/4	3 29/32	1 5/8	2 13/32	2 9/16	2 3/64	8-1XS	7-1C / 8-2E					
8-684	2 3/8	4 3/32	3 1/4	4	1 11/16	2 15/32	2 3/8	2 7/64	8-1XS	7-1C / 8-2E					
8-688	2 3/4	4 7/32	3 1/4	4 5/32	1 13/16	2 7/16	2 3/4	2 15/64	8-1XS	7-1C / 8-2E					
8-692	2 7/8	4 5/16	3 1/4	4 5/16	1 7/8	2 11/16	2 5/8	2 9/32	8-1XS	7-1C / 8-2E					
8-694	2 15/16	4 3/8	3 1/4	4 3/8	1 29/32	2 3/4	2 5/8	2 23/64	8-1XS	7-1C / 8-2E					
8-696	3	4 7/16	3 1/4	4 7/16	1 5/16	2 27/32	2 5/8	2 13/32	8-1XS	7-1C / 8-2E					
8-698	3 1/16	4 1/2	3 1/4	4 9/16	1 31/32	2 7/8	2 5/8	2 15/32	8-1XS	7-1C / 8-2E					
8-6100	3 1/8	4 9/16	3 1/4	4 5/8	2	3	2 5/8	2 1/2	8-1XS	7-1C / 8-2E					
8-6104	3 1/4	4 21/32	3 1/4	4 25/32	2 1/8	3	2 5/8	2 19/32	8-1XS	7-1C / 8-2E					
8-6108	3 3/8	4 3/4	3 1/4	4 15/16	2 7/32	3 1/8	2 5/8	2 43/64	8-1XS	7-1C / 8-2E					
8-6110	3 7/16	4 27/32	3 1/4	5	2 9/32	3 7/32	2 5/8	2 3/4	8-1XS	7-1C / 8-2E					
8-6112	3 1/2	4 29/32	3 1/4	5 1/16	2 5/16	3 1/4	2 5/8	2 13/16	8-1XS	7-1C / 8-2E					
8-6116	3 5/8	5 1/8	3 1/4	5 1/4	2 13/32	3 7/16	2 5/8	3	8-1XS	7-1C / 8-2E					
8-6120	3 3/4	5 1/8	3 1/4	5 3/8	2 15/32	3 1/2	2 5/8	3 1/32	8-1XS	7-1C / 8-2E					
8-6122	3 13/16	5 5/16	3 1/4	5 3/8	2 17/32	3 7/8	2 5/8	3 3/32	8-1XS	7-1C / 8-2E					
8-6124	3 7/8	5 1/4	3 1/4	5 17/32	2 9/16	3 5/8	2 5/8	3 5/32	8-1XS	7-1C / 8-2E					
8-6128	4	5 13/32	3 1/4	5 21/32	2 5/8	3 25/32	2 5/8	3 3/32	8-1XS	7-1C / 8-2E					
8-6132	4 1/8	5 9/16	3 1/4	5 13/16	2 3/4	3 59/64	2 5/8	3 7/16	8-1XS	7-1C / 8-2E					
8-6136	4 1/4	5 11/16	3 1/4	5 31/32	2 13/16	4 1/16	2 5/8	3 9/16	8-1XS	7-1C / 8-2E					
8-6138	4 5/16	5 29/32	3 1/4	6 1/32	2 7/8	4 3/32	2 5/8	3 21/32	8-1XS	7-1C / 8-2E					
8-6140	4 3/8	5 27/32	3 1/4	6 3/32	2 29/32	4 7/32	2 5/8	3 21/32	8-1XS	7-1C / 8-2E					
8-6144	4 1/2	6	3 1/4	6 1/4	3 1/32	4 3/8	2 5/8	3 15/16	8-1XS	7-1C / 8-2E					
8-6148	4 5/8	6 1/16	3 1/4	6 13/16	3 1/16	4 7/16	3 1/2	4 3/32	8-1XS	7-1C / 8-2E					
8-6152	4 3/4	6 1/8	3 1/4	6 9/16	3 1/8	4 1/2	2 5/8	4	8-1XS	7-1C / 8-2E					
8-6156	4 7/8	6 3/4	3 1/4	7	3 1/8	5 7/64	3 1/2	4 19/32	8-1XS	7-1C / 8-2E					
8-6160	5	6 3/4	3 1/4	7 1/8	3 1/16	5 7/64	3 1/2	4 9/16	8-1XS	7-1C / 8-2E					
8-6172	5 3/8	7	3 1/4	7 5/16	3 1/4	5 1/8	4	4 29/32	8-1XS	7-1C / 8-2E					
8-6184	5 3/4	7	3 1/4	7 5/8	3 1/2	5 1/8	3 3/4	4 7/8	8-1XS	7-1C / 8-2E					
8-6196	6 1/8	7 1/4	5	8 1/2	3 11/16	5 3/8	4 1/2	5 1/16	8-4XS	9-1D / 8-2E					
8-6208	6 1/2	7 1/2	5	9 1/4	3 1/2	5 5/8	5	5 9/64	8-4XS	9-1D / 8-2E					
8-6220	6 7/8	7 7/8	5	9 1/4	3 7/8	6	4 3/4	5 33/64	8-4XS	9-1D / 8-2E					
8-6232	7 1/4	8 1/8	5	10	4 1/2	6 1/4	5 1/2	5 49/64	8-4XS	9-1D / 8-2E					
8-6244	7 5/8	8 1/4	5	10 3/4	4 13/16	6 3/8	6 1/2	5 57/64	8-4XS	9-1D / 8-2E					
8-6256	8	8 3/8	5	11	5 1/16	6 1/2	7	6 1/64	8-4XS	9-1D / 8-2E					

Fed. Spec. ANSI B107.2

#### Features

- SUPERTORQUE® lobular openings for greater turning power without deforming the fastener.
- Designed for maximum engagement on 6 point fasteners.
- Suitable for use with pneumatic and electric impact wrenches.
- Specially heat treated for impact use to provide long life, safety, and durability.

# SOCKETS & DRIVE TOOLS

## 1-1/2" DRIVE



### 1-1/2" DRIVE SHALLOW IMPACT SOCKETS, 12 POINT, SAE

#### Black Industrial Finish

Product Code	Size (Inches)	A		B		C		D		E		F	
		Overall Length (Inches)	Drive End Diameter (Inches)	Working End Diameter (Inches)	Broach Depth (Inches)	Bolt Clearance Diameter (Inches)	Bolt Clearance Depth (Inches)	Bolt Clearance Diameter (Inches)	Nose Length (Inches)				
41144	1 3/8	3 1/8	3 3/8	2 1/2	1	/	1 3/16	1 3/8					
41146	1 7/16	3 1/8	3 3/8	2 1/2	1	/	1 1/4	1 3/8					
41148	1 1/2	3 1/8	3 3/8	2 5/8	1	/	1 1/4	1 3/8					
41150	1 9/16	3 1/8	3 3/8	2 5/8	1	/	1 3/8	1 3/8					
41152	1 5/8	3 1/8	3 3/8	2 3/4	1	/	1 3/8	1 3/8					
41154	1 11/16	3 1/4	3 3/8	2 3/4	1 1/16	/	1 1/2	1 1/2					
41156	1 3/4	3 1/4	3 3/8	2 15/16	1 1/16	/	1 1/2	1 1/2					
41158	1 13/16	3 1/4	3 3/8	2 15/16	1 1/16	/	1 5/8	1 1/2					
41160	1 7/8	3 7/16	3 3/8	3 1/8	1 3/16	/	1 5/8	1 5/8					
41162	1 15/16	3 7/16	3 3/8	3 1/8	1 3/16	/	1 3/4	1 5/8					
41164	2	3 7/16	3 3/8	3 1/4	1 3/16	/	1 3/4	1 5/8					
41166	2 1/16	3 7/16	3 3/8	3 1/4	1 3/16	/	1 5/8	1 5/8					
41168	2 1/8	3 1/2	3 3/8	3 3/8	1 1/2	/	1 7/8	/					
41170	2 3/16	3 1/2	3 3/8	3 3/8	1 1/2	/	1 7/8	/					
41172	2 1/4	3 1/2	3 3/8	3 3/8	1 1/2	/	2 1/16	1 3/4					
41174	2 5/16	3 1/2	3 3/8	3 5/8	1 1/2	/	2 1/16	1 3/4					
41176	2 3/8	3 1/2	3 3/8	3 5/8	1 1/2	/	2 1/16	1 3/4					
41178	2 7/16	3 3/4	3 3/8	3 7/8	1 5/8	/	3/4	1 3/4					
41180	2 1/2	3 3/4	3 3/8	3 7/8	1 5/8	/	3/4	1 3/4					
41182	2 9/16	3 3/4	3 3/8	3 7/8	1 5/8	/	3/4	1 3/4					
41184	2 5/8	3 3/4	3 3/8	4 3/16	1 5/8	/	2 7/16	1 3/4					
41186	2 11/16	3 3/4	3 3/8	4 3/16	1 5/8	/	2 7/16	1 3/4					
41188	2 3/4	3 3/4	3 3/8	4 3/16	1 5/8	/	2 1/2	1 3/4					
41190	2 13/16	4 1/16	3 3/8	4 1/4	1 3/4	/	2 1/2	1 3/4					
41192	2 7/8	4 1/16	3 3/8	4 1/4	1 3/4	/	2 5/8	1 3/4					
41194	2 15/16	4 1/16	3 3/8	4 1/4	1 3/4	/	2 5/8	1 3/4					
41196	3	4 1/4	3 3/8	4 5/8	2	/	2 3/4	1 3/4					
41200	3 1/8	4 1/4	3 3/8	4 5/8	2	/	2 3/4	1 3/4					
41204	3 1/4	4 1/4	3 3/8	4 15/16	2	/	3	1 3/4					
41208	3 3/8	4 1/4	3 3/8	4 15/16	2	/	3	1 3/4					
41212	3 1/2	4 5/8	3 3/8	5	2 3/16	/	3 1/4	1 3/4					
41220	3 3/4	4 5/8	3 3/4	5 1/4	2 3/16	/	3 1/2	2					
41224	3 7/8	4 15/16	3 3/4	5 7/16	2 1/4	/	3 5/8	2					
41226	3 15/16	4 15/16	3 3/4	5 7/16	2 1/4	/	3 5/8	2					
41228	4	4 15/16	3 3/4	5 7/16	2 1/4	/	3 3/4	2					



41144

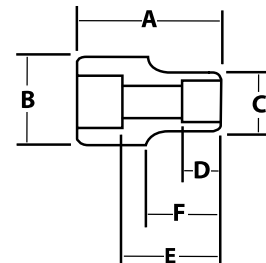

#### Features

- SUPERTORQUE® lobular openings for greater turning power without deforming the fastener.
- Designed for maximum engagement on 6 and 12 point fasteners.
- Suitable for use with pneumatic and electric impact wrenches.
- Specially heat treated for impact use to provide long life, safety, and durability.



# SCREWDRIVERS

## RATCHETING AND T-HANDLE

- ERGONOMICALLY DESIGNED, HIGH IMPACT, PLASTIC HANDLE FOR GREATER USER COMFORT AND CONTROL
- HEAVY DUTY RATCHETING MECHANISM FOR DEPENDABLE, CONSISTENT OPERATION

## SQUARE SHANK

- CHROME BLADES PREVENT CORROSION AND CAN BE EASILY CLEANED AFTER WORK APPLICATION
- SQUARE SHANK ALLOWS THE EASY USE OF A WRENCH FOR ADDITIONAL TURNING TORQUE

## ERGONOMIC

- ERGONOMICALLY DESIGNED HANDLE WITH THUMB STOP PROVIDES COMFORT AND MAXIMUM GRIP EVEN WITH OILY HANDS
- HANDLE LENGTH DESIGNED TO OPTIMIZE CORRECT HAND POSITION FOR QUICK TURNING AND PRECISION CONTROL



WILLIAMS 6 PIECE TORX® SCREWDRIVER SET



WILLIAMS 72-BIT SET



WILLIAMS T-HANDLE RATCHETING SCREWDRIVER

**WE CONTINUE TO INNOVATE TO DELIVER SAFETY AND PRODUCTIVITY TO OUR CUSTOMERS**

# SCREWDRIVERS

## SETS



### 8 PIECE PREMIUM MIXED SCREWDRIVER SET

#### Comfort-Grip Handle With Round Blade

Product Code	Description
100P-8MD	8 Piece Premium Screwdriver Set Phillips® / Slotted Tips

#### Contents Include:

Product Code	Overall Length (Inches)	Blade Length (Inches)	Tip Width / Point Size
SDR-24	7 <sup>7</sup> / <sub>8</sub>	4	1/4
SDR-26	10 <sup>11</sup> / <sub>16</sub>	6	5/16
SDR-28	12 <sup>3</sup> / <sub>4</sub>	8	3/8
SDP-1-3	6 <sup>1</sup> / <sub>4</sub>	3	#1
SDP-2-4	7 <sup>15</sup> / <sub>16</sub>	4	#2
SDP-3-6	10 <sup>1</sup> / <sub>2</sub>	6	#3
SDE-43	6 <sup>11</sup> / <sub>16</sub>	3	3/16" Electrician's Tip
SDE-46	9 <sup>11</sup> / <sub>16</sub>	6	3/16" Electrician's Tip

#### Features

- Contains 3 slotted, 3 Phillips®, and 2 Electrician's screwdrivers.
- Comfort-grip handle with thumb stop allow for added turning power without discomfort or slippage.
- Chrome blades prevent corrosion and can be easily cleaned.
- Blades are made from special alloy steel for extra strength.
- Vapor-blasted tips grip fasteners and prevent chipping, extending tool life.
- Hex bolsters on shafts allow a wrench to be used for extra turning power.



100P-8MD



# SCREWDRIVERS

## SETS



100P-5MD



### 5 PIECE PREMIUM MIXED SCREWDRIVER SET

#### Comfort-Grip Handle With Round Blade

Product Code	Description
100P-5MD	5 Piece Premium Screwdriver Set Phillips® / Slotted Tips

#### Contents Include:

Product Code	Overall Length (Inches)	Blade Length (Inches)	Tip Width / Point Size
SDR-22	6 1/8	3	3/16
SDR-24	7 7/8	4	1/4
SDR-26	10 11/16	6	5/16
SDP-1-3	6 1/4	3	#1 Phillips
SDP-2-4	7 15/16	4	#2 Phillips

#### Features

- Contains 3 slotted and 2 Phillips® screwdrivers.
- Comfort-grip handle with thumb stop allow for added turning power without discomfort or slippage.
- Chrome blades prevent corrosion and can be easily cleaned.
- Blades are made from special alloy steel for extra strength.
- Vapor-blasted tips grip fasteners and prevent chipping, extending tool life.
- Hex bolsters on shafts allow a wrench to be used for extra turning power.



100P-6SD



### 6 PIECE PREMIUM SLOTTED SCREWDRIVER SET

#### Comfort-Grip Handle

Product Code	Description
100P-6SD	6 Piece Premium Slotted Screwdriver Set

#### Contents Include:

Product Code	Overall Length (Inches)	Blade Length (Inches)	Tip Width
SDR-22	6 1/8	3	3/16
SDR-24	7 7/8	4	1/4
SDR-26	10 11/16	6	5/16
SDR-28	12 11/16	8	3/8
SDR-30	14 3/4	10	7/16
SDS-33	17 13/16	12	3/8

#### Features

- Comfort-grip handle with thumb stop allow for added turning power without discomfort or slippage.
- Chrome blades prevent corrosion and can be easily cleaned.
- Blades are made from special alloy steel for extra strength.
- Vapor-blasted tips grip fasteners and prevent chipping, extending tool life.
- Hex bolsters on shafts allow a wrench to be used for extra turning power.

# SCREWDRIVERS

## SETS



### 6 PIECE PREMIUM PHILLIPS® SCREWDRIVER SET

#### Comfort-Grip Handle With Round Blade

Product Code	Description
100P-6PD	6 Piece Premium Phillips® Screwdriver Set

#### Contents Include:

Product Code	Overall Length (Inches)	Blade Length (Inches)	Point Size
SDP-1-3	6 1/4	3	#1
SDP-2-4	7 15/16	4	#2
SDP-2-8*	12	8	#2
SDP-3-6	10 1/2	6	#3
SDP-4-6	10 3/4	6	#4
SDP-2-ST*	3 1/2	1 1/2	#2

\* Does not have Bolster

#### Features

- Comfort-grip handle with thumb stop allow for added turning power without discomfort or slippage.
- Chrome blades prevent corrosion and can be easily cleaned.
- Blades are made from special alloy steel for extra strength.
- Vapor-blasted tips grip fasteners and prevent chipping, extending tool life.
- Hex bolsters on shafts allow a wrench to be used for extra turning power.



100P-6PD



### 12 PIECE COMBINATION SCREWDRIVER SET

#### Bi-Mold Comfort Grip Handles

Product Code	Description
24008	12 Piece Combination Screwdriver Set

#### Contents Include:

Product Code	Overall Length (Inches)	Blade Length (Inches)	Tip Width / Point Size / TORX® Size
24203	3 7/8	1 1/2	3/16
24205	7 3/4	4	3/16
24217	3 7/8	1 1/2	1/4
24219	8 1/4	4	1/4
24229	10 3/16	6	1/4
24237	10 9/16	6	5/16
24249	5 11/16	3	#1
24251	3 7/8	1 1/2	#2
24253	8 1/4	4	#2
24259	10 9/16	6	#3
24265	7 3/4	4	T15
24269	8 1/4	4	T25

#### Features

- Contains 6 slotted, 4 Phillips® and 2 TORX® screwdrivers.
- Bi-Mold handles provide comfortable grip, reducing hand fatigue.
- Set packed in pouch.
- Handle end shows size and style for easy identification.
- Chrome blades prevent corrosion and can be easily cleaned.



24008





# SCREWDRIVERS

## SETS



### 8 PIECE COMBINATION SCREWDRIVER SET

#### Bi-Mold Comfort Grip Handles

Product Code	Description
24006	8 Piece Combination Screwdriver Set

#### Contents Include:

Product Code	Overall Length (Inches)	Blade Length (Inches)	Tip Width / Point Size
24205	7 <sup>3</sup> / <sub>4</sub>	4	<sup>3</sup> / <sub>16</sub>
24217	3 <sup>7</sup> / <sub>8</sub>	1 <sup>1</sup> / <sub>2</sub>	<sup>1</sup> / <sub>4</sub>
24219	8 <sup>1</sup> / <sub>4</sub>	4	<sup>1</sup> / <sub>4</sub>
24237	10 <sup>9</sup> / <sub>16</sub>	6	<sup>5</sup> / <sub>16</sub>
24241	12 <sup>9</sup> / <sub>16</sub>	8	<sup>3</sup> / <sub>8</sub>
24249	5 <sup>11</sup> / <sub>16</sub>	3	#1
24251	3 <sup>7</sup> / <sub>8</sub>	1 <sup>1</sup> / <sub>2</sub>	#2
24253	8 <sup>1</sup> / <sub>4</sub>	4	#2

#### Features

- Contains 5 slotted and 3 Phillips® screwdrivers.
- Bi-Mold handles provide comfortable grip, reducing hand fatigue.
- Set packed in pouch.
- Handle end shows size and style for easy identification.
- Chrome blades prevent corrosion and can be easily cleaned.



24006



### 6 PIECE SLOTTED TIP SCREWDRIVER SET

#### Bi-Mold Comfort Grip Handles

Product Code	Description
24004	6 Piece Slotted Tip Screwdriver Set

#### Contents Include:

Product Code	Overall Length (Inches)	Blade Length (Inches)	Tip Width (Inches)
24203	3 <sup>7</sup> / <sub>8</sub>	1 <sup>1</sup> / <sub>2</sub>	<sup>3</sup> / <sub>16</sub>
24205	7 <sup>3</sup> / <sub>4</sub>	4	<sup>3</sup> / <sub>16</sub>
24217	3 <sup>7</sup> / <sub>8</sub>	1 <sup>1</sup> / <sub>2</sub>	<sup>1</sup> / <sub>4</sub>
24219	8 <sup>1</sup> / <sub>4</sub>	4	<sup>1</sup> / <sub>4</sub>
24237	10 <sup>9</sup> / <sub>16</sub>	6	<sup>5</sup> / <sub>16</sub>
24241	12 <sup>9</sup> / <sub>16</sub>	8	<sup>3</sup> / <sub>8</sub>

#### Features

- Bi-Mold handles provide comfortable grip, reducing hand fatigue.
- Set packed in pouch.
- Handle end shows size and style for easy identification.
- Chrome blades prevent corrosion and can be easily cleaned.



24004

# SCREWDRIVERS

## SETS



### 4 PIECE CABINET TIP SCREWDRIVER SET

#### Bi-Mold Comfort Grip Handles

Product Code	Description
24002	4 Piece Cabinet Tip Screwdriver Set

#### Contents Include:

Product Code	Overall Length (Inches)	Blade Length (Inches)	Tip Width (Inches)
24201	6 11/16	4	1/8
24207	6 13/16	3	3/16
24211	9 3/4	6	3/16
24213	13 11/16	10	3/16

#### Features

- Bi-Mold handles provide comfortable grip, reducing hand fatigue.
- Set packed in pouch.
- Handle end shows size and style for easy identification.
- Chrome blades prevent corrosion and can be easily cleaned.

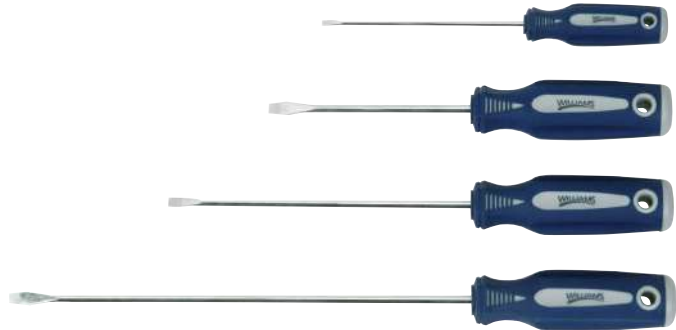

24002



### 6 PIECE PHILLIPS® SCREWDRIVERS SET

#### Bi-Mold Comfort Grip Handles

Product Code	Description
24012	6 Piece Phillips Screwdrivers Set

#### Contents Include:

Product Code	Overall Length (Inches)	Blade Length (Inches)	Tip Width (Inches)
24247	3 7/8	1 1/2	1
24249	5 11/16	3	1
24251	3 7/8	1 1/2	2
24253	8 1/4	4	2
24257	12 1/8	8	2
24259	10 9/16	6	3

#### Features

- Bi-mold handles provide comfortable grip, reducing hand fatigue
- Handle end shows size and style for easy identification



24012



### 6 PIECE TORX® SCREWDRIVER SET

#### Bi-Mold Comfort Grip Handles

Product Code	Description
24010	6 Piece Torx® Screwdriver Set

#### Contents Include:

Product Code	Overall Length (Inches)	Blade Length (Inches)	TORX® Size
24263	7 1/4	4	T10
24265	7 1/4	4	T15
24267	7 3/4	4	T20
24269	8 1/4	4	T25
24271	8 1/4	4	T27
24273	8 1/4	4	T30

#### Features

- Bi-Mold handles provide comfortable grip, reducing hand fatigue.
- Set packed in pouch.
- Handle end shows size and style for easy identification.
- Chrome blades prevent corrosion and can be easily cleaned.



24010



# SCREWDRIVERS

## RATCHETING / BIT HOLDERS



WRS-1



### MAGNETIC RATCHETING SCREWDRIVER

#### Comfort Grip Handle

Product Code	Overall Length (Inches)	Blade Length (Inches)
WRS-1	9	4

#### Features

- Includes 5 bits: 2 slotted, #1 Phillips®, #2 Phillips®, and T-15 Torx®.
- Ergonomically designed handle for greater user comfort and control.
- Hi-impact plastic handle for durability and flexibility in all types of work applications.
- Heavy-duty 3-way On-Off-Locked ratcheting mechanism allows consistent and smooth operation.
- Powerful magnetic shank securely holds bit in place before, during and after the job application.
- Stainless steel shank eliminates problems of chrome chipping or rust.
- Easy bit storage in handle.
- Accepts all standard 1/4" hex shank bits.



WRST8

WRST1

WRST4



### T-HANDLE RATCHETING SCREWDRIVER

#### Comfort Grip T-Handles

Product Code	Overall Length (Inches)	Blade Length (Inches)
WRST1	3 7/8	2
WRST4	5 13/16	3 7/8
WRST8	9 13/16	7 7/8

#### Features

- Includes #2 Phillips® bit.
- Ergonomically designed T-Handle fits the palm and provides extra leverage.
- Hi-impact plastic handle for durability and flexibility in all types of work applications.
- Heavy-duty 3-way On-Off-Locked ratcheting mechanism allows consistent and smooth operation.
- Stainless steel shank eliminates problems of chrome chipping or rust.
- Accept all standard 1/4" hex shank bits.

# SCREWDRIVERS

## SLOTTED / ELECTRICIAN'S

WILLIAMS®



### SLOTTED SCREWDRIVERS

#### Premium Comfort Grip Handles and Blades

Product Code	Overall Length (Inches)	Blade Length (Inches)	Tip Width (Inches)
SDS-62	3 1/2	1 3/4	1/4
SDR-22	6 1/8	3	3/16
SDR-24	7 7/8	4	1/4
SDR-26	10 11/16	6	5/16
SDR-28	12 11/16	8	3/8
SDR-30	14 3/4	10	7/16
SDS-33	17 13/16	12	3/8

#### Features

- Comfort-grip handle with thumb stop allow for added turning power without discomfort or slippage.
- Hi-polish chrome blades prevent corrosion and can be easily cleaned.
- Vapor-blasted tips grip fasteners and prevent chipping, extending tool life.
- Blades are made from special alloy steel for extra strength.
- \*SDS-33 features 3/8" heavy-duty square shank



SDR-24

WILLIAMS®



### ELECTRICIAN'S SCREWDRIVERS W/THIN BLADE

#### Premium Comfort Grip Handles and Blades

Product Code	Overall Length (Inches)	Blade Length (Inches)	Tip Width (Inches)
SDE-4	7 15/16	4	1/4
SDE-8	11 15/16	12	1/4
SDE-43	6 11/16	3	3/16
SDE-46	9 11/16	6	3/16
SDE-50	13 3/4	10	3/16
SDE-53	6 13/64	3	1/8

#### Features

- Comfort-grip handle with thumb stop allow for added turning power without discomfort or slippage.
- Hi-polish chrome blades prevent corrosion and can be easily cleaned.
- Vapor-blasted tips grip fasteners and prevent chipping, extending tool life.
- Blades are made from special alloy steel for extra strength.



SDE-46



**WARNING**

# SCREWDRIVERS

## SLOTTED



WILLIAMS®



### SLOTTED SCREWDRIVERS

#### Bi-Mold Comfort Grip Handles

Product Code	Overall Length (Inches)	Blade Length (Inches)	Tip Width (Inches)
24203	3 <sup>7</sup> / <sub>8</sub>	1 <sup>1</sup> / <sub>2</sub>	<sup>3</sup> / <sub>16</sub>
24205	7 <sup>3</sup> / <sub>4</sub>	4	<sup>3</sup> / <sub>16</sub>
24209	9 <sup>3</sup> / <sub>4</sub>	6	<sup>3</sup> / <sub>16</sub>
24215	12 <sup>11</sup> / <sub>16</sub>	9	<sup>3</sup> / <sub>16</sub>
24217	3 <sup>7</sup> / <sub>8</sub>	1 <sup>1</sup> / <sub>2</sub>	<sup>1</sup> / <sub>4</sub>
24219	8 <sup>1</sup> / <sub>4</sub>	4	<sup>1</sup> / <sub>4</sub>
24229	10 <sup>3</sup> / <sub>16</sub>	6	<sup>1</sup> / <sub>4</sub>
24237	10 <sup>9</sup> / <sub>16</sub>	6	<sup>5</sup> / <sub>16</sub>
24239	12 <sup>9</sup> / <sub>16</sub>	8	<sup>5</sup> / <sub>16</sub>
24241	12 <sup>9</sup> / <sub>16</sub>	8	<sup>3</sup> / <sub>8</sub>
24243	16 <sup>1</sup> / <sub>2</sub>	12	<sup>3</sup> / <sub>8</sub>

#### Features

- Bi-mold handles provide comfortable grip, reducing hand fatigue.
- Handle end shows size and style for easy identification.



WILLIAMS®



### SLOTTED SCREWDRIVERS W/CABINET TIP

#### Bi-Mold Comfort Grip Handles

Product Code	Overall Length (Inches)	Blade Length (Inches)	Tip Width (Inches)
24201	6 <sup>11</sup> / <sub>16</sub>	4	<sup>1</sup> / <sub>8</sub>
24207	6 <sup>13</sup> / <sub>16</sub>	3	<sup>3</sup> / <sub>16</sub>
24211	9 <sup>3</sup> / <sub>4</sub>	6	<sup>3</sup> / <sub>16</sub>
24213	13 <sup>11</sup> / <sub>16</sub>	10	<sup>3</sup> / <sub>16</sub>

#### Features

- Bi-mold handles provide comfortable grip, reducing hand fatigue.
- Cabinet tip allows access to recessed screws.
- Handle end shows size and style for easy identification.

# SCREWDRIVERS

## PHILLIPS



### PHILLIPS® SCREWDRIVERS W/ROUND BLADES

#### Premium Comfort Grip Handles and Blades

Product Code	Overall Length (Inches)	Blade Length (Inches)	Point Size
SDP-1-3	6 1/4	3	1
SDP-2-ST*	3 3/8	1 1/2	2
SDP-2-4	7 15/16	4	2
SDP-2-8*	12	8	2
SDP-3-6	10 1/2	6	3
SDP-4-6	10 3/4	6	4

\* Does not have Bolster

#### Features

- Comfort-grip handle with thumb stop allow for added turning power without discomfort or slippage.
- Hi-polish chrome blades prevent corrosion and can be easily cleaned.
- Vapor-blasted tips grip fasteners and prevent chipping, extending tool life.
- Blades are made from special alloy steel for extra strength.



SDP-2-4



### PHILLIPS® SCREWDRIVERS

#### Bi-Mold Comfort Grip Handles

Product Code	Overall Length (Inches)	Blade Length (Inches)	Point Size
24247	3 7/8	1 1/2	1
24249	5 11/16	3	1
24251	3 7/8	1 1/2	2
24253	8 1/4	4	2
24255	10 3/16	6	2
24257	12 1/8	8	2
24259	10 9/16	6	3

#### Features

- Bi-mold handles provide comfortable grip, reducing hand fatigue.
- Handle end shows size and style for easy identification.



24251

24253



# SCREWDRIVERS

## TORX / OFFSET

WILLIAMS®



### TORX® SCREWDRIVERS

#### Bi-Mold Comfort Grip Handles

Product Code	Overall Length (Inches)	Blade Length (Inches)	TORX® Size
24263	7 3/4	4	T10
24265	7 3/4	4	T15
24267	7 3/4	4	T20
24269	8 1/4	4	T25
24271	8 1/4	4	T27
24273	8 1/4	4	T30

#### Features

- Bi-mold handles provide comfortable grip, reducing hand fatigue.
- Handle end shows size and style for easy identification.



24269

WILLIAMS®

### OFFSET SCREWDRIVERS

#### Cushion Grip Handle

Product Code	Overall Length (Inches)	Tip/Width
24101	4	Slotted 3/16 x PH1
24102	4	Slotted 1/4 x PH2
24103	6	Slotted 5/16 x PH3
24104	4	Phillips® # 1 x # 2
24105	8	Phillips® # 3 x # 4

#### Features

- Blades are made from special alloy steel for extra strength
- One piece tool steel construction
- Tips are 90 degree angled



24101

# SCREWDRIVERS

## NUTDRIVERS



### NUTDRIVERS, SAE

#### Cushion Grip Handle

Product Code	Overall Length (Inches)	Blade Length (Inches)	Size (Inches)
24401	7	3	3/16
24403	7	3	1/4
24405	7	3	5/16
24407	7	3	11/32
24409	7	3	3/8
24411	7	3	7/16
24413	7	3	1/2

#### 24050 7 Piece Nutdriver Set in Carrying Caddy Contents Include:

Product Code	Size (Inches)	Product Code	Size (Inches)
24401	3/16	24409	3/8
24403	1/4	24411	7/16
24405	5/16	24413	1/2
24407	11/32		

#### Features

- Hollow shaft accommodates long bolts or studs.
- Precision machined socket end.
- Cushion grip handle for comfort.
- Size imprinted on color coded ends for easy identification.



24050



### LONG SHAFT NUTDRIVERS, SAE

#### Cushion Grip Handle

Product Code	Overall Length (Inches)	Blade Length (Inches)	Size (Inches)
24415	9	5	3/16
24416	9	5	1/4
24417	9	5	5/16
24418	9	5	11/32
24419	9	5	3/8
24420	9	5	7/16
24421	9	5	1/2
24422	9	5	9/16
24423	9	5	5/8

#### 24051 9 Piece Nutdriver Set in Plastic Tray Contents Include:

Product Code	Size (Inches)	Product Code	Size (Inches)
24415	3/16	24420	7/16
24416	1/4	24421	1/2
24417	5/16	24422	9/16
24418	11/32	24423	5/8
24419	3/8		

#### Features

- Solid shaft accommodates long bolts or studs
- Precision machined socket end
- Cushion grip handle for comfort
- Size imprinted on color coded ends for easy identification



24051





# SCREWDRIVERS

## NUTDRIVERS



### LONG SHAFT NUTDRIVERS, MM

#### Cushion Grip Handle

Product Code	Overall Length (Inches)	Blade Length (Inches)	Size (mm)
24451	9	5	4
24452	9	5	5
24453	9	5	5.5
24454	9	5	6
24455	9	5	7
24456	9	5	8
24457	9	5	9
24458	9	5	10
24459	9	5	11
24460	9	5	12
24461	9	5	13
24462	9	5	14

#### 24061 12 Piece Nutdriver Set in Plastic Tray

##### Contents Include:

Product Code	Size (mm)	Product Code	Size (mm)
24451	4	24457	9
24452	5	24458	10
24453	5.5	24459	11
24454	6	24460	12
24455	7	24461	13
24456	8	24462	14

##### Features

- Solid shaft accommodates long bolts or studs
- Precision machined socket end
- Cushion grip handle for comfort
- Size imprinted on color coded ends for easy identification

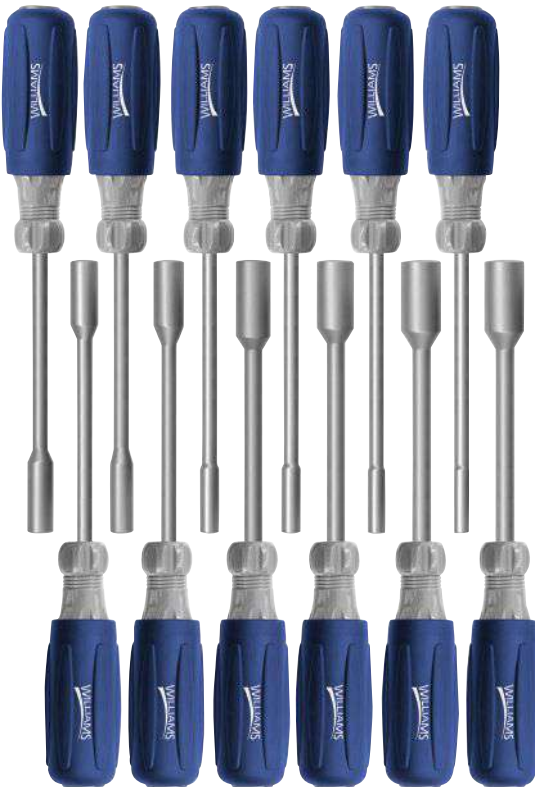

24061

# SCREWDRIVERS

## BIT SET



### 72 PIECE BIT SET

Product Code	Description
24900	72 Piece Bit Set

#### Contents Include:

##### Hex

Product Code	Size	Length
24914	1/4	1"
24912	3/16	1"
24915	5/16	1"
24911	5/32	1"
24913	7/32	1"

##### Phillips

Product Code	Size	Length
24918	1	1"
24931	2	1"
24901	3	1"
24927	1	2"
24916	2	2"
24928	3	2"

##### Pozidriv

Product Code	Size	Length
24932	2	1"
24902	3	1"
24917	2	2"
24929	3	2"

##### Square

Product Code	Size	Length
24907	2	1"
24908	3	1"
24930	2	2"

##### Slotted Tip

Product Code	Size	Length
24903	6-8	1"
24904	8-10	1"
24905	10-12	1"
24906	12-14	1"
24936	8-10	2"
24937	10-12	2"
24938	12-14	2"

##### Torx

Product Code	Size	Length
24919	7	1"
24920	8	1"
24921	10	1"
24922	15	1"
24923	20	1"
24924	25	1"
24925	27	1"
24909	30	1"
24926	30	1"
24910	40	1"
24933	15	2"
24934	20	2"
24935	25	2"

##### Nut Driver

Product Code	Size	Length
24941	1/4	1"
24944	11/32	1"
24940	3/16	1"
24945	3/8	1"
24943	5/16	1"
24939	5/32	1"
24946	7/16	1"
24942	9/32	1"

##### Hex Magnetic Holder

Product Code	Description
24947	Hex Magnetic Holder



24900

#### Features

- S2 material for higher torque, optimum durability and performance.
- All parts are engineered and produced according to ANSI standard.
- The set also includes a magnetic bit holder allowing for quick change of driving bits.
- Folding case design is compact and robust with pivoting dual bit holders that allow for easy and quick access to the accessories
- Industrial case is made from a highly durable, plastic material



# PLIERS, CLAMPS & PIPE TOOLS

## PLIERS

### WIDE ASSORTMENT:

- LONG NOSE PLIERS WITH SIDE CUTTER
- HEAVY DUTY DIAGONAL CUTTER • LINEMAN'S PLIERS

### COMFORT:

- BI-MOLD HANDLES PROVIDE COMFORTABLE GRIP, REDUCING HAND FATIGUE
- HIGH-LEVERAGE JOINT PLACEMENT INCREASES LEVERAGE TO REDUCE THE CUTTING FORCE NEEDED

### PERFORMANCE:

- SAW-TOOTHED SERRATIONS PROVIDE A SOLID GRIP ON APPLICATION MATERIAL
- CUTTING EDGES STAY SHARP LONGER

## CLAMPS

- I-BEAM DESIGN FOR GREATER STRENGTH AND LIGHTER WEIGHT
- DROP FORGED AND HEAT TREATED FRAMES FOR GREATER SAFETY AND STRENGTH
- COPPER PLATED SCREWS RESIST ADHERENCE OF WELDING SPLATTER

## PIPE TOOLS

- ALUMINUM AND CAST IRON PIPE WRENCHES AVAILABLE IN SIZES UP TO 48"
- UNIVERSAL PIPE WRENCHES AVAILABLE IN LENGTHS UP TO 42"
- TUBING CUTTERS AND FLARING TOOLS ROUND OUT THE PRODUCT LINE



WILLIAMS UTILITY  
SUPERJOINT PLIERS

WILLIAMS HEAVY DUTY FRONT  
END WIRE STRIPPERS

WILLIAMS LINEMAN'S  
PLIERS

**WE CONTINUE TO INNOVATE TO DELIVER SAFETY  
AND PRODUCTIVITY TO OUR CUSTOMERS**

# PLIERS, CLAMPS & PIPE TOOLS

## SETS



### 4 PIECE COMBINATION PLIERS SET

#### Double-Dipped Plastic Handles

Product Code	Description
23054	4 Piece Combination Pliers Set

#### Contents Include:

Product Code	Description
23106	11 3/4" groove joint pliers
23403	8" linesman pliers
23407	7" heavy-duty diagonal cutting pliers
23411	8" long nose pliers

#### Features

- Double-dipped plastic handle grips are comfortable yet durable.
- Jaws are polished with rust-protective coating.
- Packaged in a bag.



23054



### 4 PIECE COMBINATION PLIERS SET

#### Double-Dipped Plastic Handles

Product Code	Description
23052	4 Piece Combination Pliers Set

#### Contents Include:

Product Code	Description
23102	8" slip joint pliers
23105	9 3/4" groove joint pliers
23407	7" heavy-duty diagonal cutting pliers
23411	8" long nose pliers

#### Features

- Double-dipped plastic handle grips are comfortable yet durable.
- Jaws are polished with rust-protective coating.
- Packaged in a bag.



23052



# PLIERS, CLAMPS & PIPE TOOLS

## SLIP JOINT/COMBINATION



PL-1524C



### UTILITY SUPERJOINT PLIERS

#### Double-Dipped Plastic Handles

Features	Overall Length (Inches)	Maximum Opening (Inches)	Tip Width (Inches)
PL-1519C	5	1/2	3/16
PL-1520C	10	1 1/2	5/16
PL-1523C	12	2 5/8	1/2
PL-1524C	16	4	1/2

#### Features

- Multiple parallel jaw positions are locked in to proper groove for superior non-slip performance.
- Serrated jaws for maximum gripping power.
- Polished heads resist rust and corrosion, extending the tool life.



23104



### GROOVE JOINT PLIERS

#### Double-Dipped Plastic Handles

Product Code	Overall Length (Inches)	Maximum Jaw Opening (Inches)
23104	7	3/4
23105	9 3/4	1 7/8
23106	11 3/4	2 1/4
23107	16	4 3/4

#### Features

- Double-dipped plastic handle grips are comfortable yet durable.
- Jaws are phosphate finish for rust protection.
- Parallel jaw grip in all positions to maximum opening.



PL-8C



### COMBINATION SLIP-JOINT PLIERS

#### Double-Dipped Plastic Handles

Product Code	Overall Length (Inches)	Jaw Length (Inches)	Tip Width (Inches)
PL-6C	6	1 5/32	3/8
PL-8C	8	1 13/32	3/8
PL-10C	10	1 13/32	1/2

#### Features

- Multiple parallel jaw positions are locked in to proper groove for superior non-slip performance.
- Serrated jaws for maximum gripping power.
- Polished heads resist rust and corrosion, extending the tool life.
- Shear type wire cutter extends tool use.



23101



### COMBINATION SLIP-JOINT PLIERS

#### Double-Dipped Plastic Handles

Product Code	Overall Length (Inches)
23101	6 1/4
23102	8
23103	9 3/4

#### Features

- Double-dipped plastic handle grips are comfortable yet durable.
- Jaws are polished with rust-protective coating.
- 2 position joint allows wide range of grip.
- Shear type wire cutter extends tool use.

# PLIERS, CLAMPS & PIPE TOOLS

## LINESMAN'S



### INDUSTRIAL GRADE LINESMAN'S PLIERS

#### Double-Dipped Plastic Handles

Product Code	Description	Overall Length (Inches)	Jaw Length (Inches)
PL-204C	Electrician's	7	1/2
PL-205C	Electrician's	8 1/2	17/32
PL-209X	New England	9 1/2	3/4

#### Features

- Designed for wiring, electrical equipment installation and maintenance for utility linemen.
- Polished faces look good and resist corrosion.
- Induction hardened cutting edges stay sharp longer.
- Diamond serrated jaws provide solid grip on wire.
- Double-dipped plastic handle grips are comfortable yet durable.



PL-204C



PL-209X



### INDUSTRIAL GRADE LINESMAN'S PLIERS

#### Supplied Without Grips

Product Code	Description	Overall Length (Inches)	Jaw Length (Inches)
PL-208	Linesman's	8 1/2	17/32
PL-209	New England	9 1/2	3/4

#### Features

- Designed for wiring, electrical equipment installation and maintenance for utility linemen.
- Polished heads resist rust and corrosion, extending the tool life.
- Induction hardened cutting edges stay sharp longer.
- Diamond serrated jaws provide solid grip on wire.
- Supplied without grips - handles are bare steel.



PL-208



PL-209



# PLIERS, CLAMPS & PIPE TOOLS

LINESMAN'S

WILLIAMS®

## HEAVY-DUTY PIANO WIRE CUTTING LINESMAN'S PLIERS

### Double-Dipped Plastic and Bi-Mold Comfort Grip Handles

Product Code	Overall Length (Inches)	Handle Style	Maximum Cutting Capacity (Inches)
23603	9	Double-Dipped	$\frac{3}{32}$ Piano Wire

#### Features

- Specially heat-treated for cutting piano wire and other hard wire.
- High leverage jaws for increase cutting power.
- Cross-cut teeth for extra gripping power.
- Induction hardened and precisely ground cutting edges stay sharp longer.



23603

WILLIAMS®

## STANDARD LINESMAN'S PLIERS

### Double-Dipped Plastic Handles

Product Code	Overall Length (Inches)	Jaw Length (Inches)
23402	7	$\frac{1}{2}$
23403	8	$\frac{17}{32}$

#### Features

- High leverage jaws for increase cutting power.
- Cross-cut teeth for extra gripping power.
- Induction hardened and precisely ground cutting edges stay sharp longer.



23402

# PLIERS, CLAMPS & PIPE TOOLS

## DIAGONAL CUTTING



### HIGH LEVERAGE DIAGONAL CUTTING PLIERS

#### Double-Dipped Plastic Handles

Product Code	Description	Overall Length (Inches)	Cutting Blade Length (Inches)
PL-57C	High Leverage Head	7 1/4	15/16
PL-411C	Extra Long Handle, Offset Head	11	1

#### Features

- Handles are designed to cut wire with ease.
- Polished heads resist rust and corrosion, extending the tool life.
- Induction hardened cutting edges.



PL-57C

PL-411C



### INDUSTRIAL GRADE DIAGONAL CUTTING PLIERS

#### Double-Dipped Plastic Handles

Product Code	Overall Length (Inches)	Cutting Blade Length (Inches)
PL-44C	4	17/32
PL-45C	5	11/16
PL-46C	6	3/4
PL-47C	7	11/16

#### Features

- Handles are designed to cut wire with ease.
- Polished heads resist rust and corrosion, extending the tool life.
- Induction hardened cutting edges.
- Regular flush cutters are used for cutting hard wire.



PL-46C



### FLUSH CUT DIAGONAL CUTTING PLIERS WITH SPRING

#### Double-Dipped Plastic Handles

Product Code	Overall Length (Inches)	Cutting Blade Length (Inches)
PLM-1CS	4 1/4	17/32
PL-40CS	5	11/16

#### Features

- Handles are designed to cut wire with ease
- Polished heads resist rust and corrosion, extending the tool life
- Induction hardened cutting edges
- Flush cutters are used for close cutting of medium wire



PL-40CS





# PLIERS, CLAMPS & PIPE TOOLS

## CUTTING



PL-48C



### PLASTIC CUTTING DIAGONAL PLIERS

#### Double-Dipped Plastic Handles

Product Code	Overall Length (Inches)	Cutting Blade Length (Inches)
PL-48C	6 <sup>3</sup> / <sub>8</sub>	<sup>7</sup> / <sub>8</sub>
PL-49C	7 <sup>1</sup> / <sub>2</sub>	1 <sup>1</sup> / <sub>8</sub>

#### Features

- Polished heads resist rust and corrosion, extending the tool life.
- Induction hardened cutting edges.



23407



### HEAVY-DUTY DIAGONAL CUTTING PLIERS

#### Double-Dipped Plastic Handles

Product Code	Overall Length (Inches)
23406	6 <sup>1</sup> / <sub>4</sub>
23407	7

#### Features

- Jaws are polished with rust-protective coating.
- Wider, high leverage jaws for increased cutting power.
- Double-dipped plastic handle grips are comfortable yet durable.
- Induction hardened and precisely ground cutting edges stay sharp longer.



23404



### STANDARD DIAGONAL CUTTING PLIERS

#### Double-Dipped Plastic Handles

Product Code	Overall Length (Inches)
23404	5 <sup>1</sup> / <sub>2</sub>
23405	6 <sup>1</sup> / <sub>4</sub>

#### Features

- Jaws are polished with rust-protective coating.
- Double-dipped plastic handle grips are comfortable yet durable.
- Induction hardened and precisely ground cutting edges stay sharp longer.



PL-167



### END CUTTING NIPPERS

#### Double-Dipped Plastic Handles

Product Code	Overall Length (Inches)	Cutting Blade Length (Inches)
PLM-2C	4 <sup>1</sup> / <sub>2</sub>	<sup>15</sup> / <sub>32</sub>
PL-167	7 <sup>1</sup> / <sub>2</sub>	<sup>13</sup> / <sub>16</sub>

#### Features

- Ideal for cutting wire or nails that are close to the work.
- Polished heads resist rust and corrosion, extending the tool life.
- The wide throat clearance, width of blades and angles of the cutting edges along with the handle leverage provide for easy, clean cutting or nipping.

# PLIERS, CLAMPS & PIPE TOOLS

## CUTTING



### EXTRA LONG REACH CHAIN NOSE PLIERS

#### Double-Dipped Plastic Handles

Product Code	Description	Overall Length (Inches)	Jaw Length (Inches)
PL-211C	Straight Jaw	11	2 <sup>13</sup> / <sub>16</sub>
PL-211BC	45° Bent Nose	11	2 <sup>9</sup> / <sub>16</sub>

#### Features

- Polished heads resist rust and corrosion, extending the tool life.
- Extra long handles provide access into confined areas and greater holding power at the tip.
- Bent nose model provides access to obstructed areas.



### HIGH LEVERAGE CHAIN NOSE PLIERS

#### Double-Dipped Plastic Handles

Product Code	Overall Length (Inches)	Jaw Length (Inches)	Width at Tip (Inches)
PL-98C	8	1 <sup>7</sup> / <sub>32</sub>	<sup>3</sup> / <sub>32</sub>

#### Features

- Polished heads resist rust and corrosion, extending the tool life.
- Longer handles for more convenient use and greater jaw gripping power.



# PLIERS, CLAMPS & PIPE TOOLS

## LONG NOSE



### CHAIN NOSE PLIERS

#### Double-Dipped Plastic Handles

Product Code	Description	Overall Length (Inches)	Jaw Length (Inches)
PL-95C	Short Nose w/cutter	5 1/2	1 5/32
PL-75C	Long Nose	6 3/4	2 5/16
PL-76C	Long Nose w/cutter	6 1/2	1 5/16
PL-77C	Extra Long Nose w/cutter	7 1/2	1 29/32

#### Features

- Polished heads resist rust and corrosion, extending the tool life.
- Diamond serrated jaws with industrial hardened cutting edges.

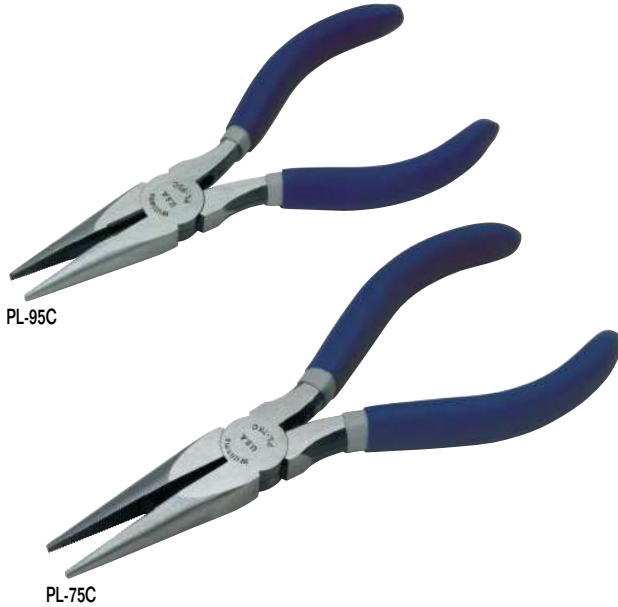

PL-95C

PL-75C



### THIN BENT CHAIN NOSE PLIERS

#### Double-Dipped Plastic Handles

Product Code	Description	Overall Length (Inches)	Jaw Length (Inches)
PL-126C	73° Bent Thin Nose	6 1/4	1 1/4

#### Features

- Polished heads resist rust and corrosion, extending the tool life.
- Serrated jaws for extra gripping power.
- 73° bent nose model featured thin jaws angled to reach around obstacles and hard-to-reach spaces.



PL-126C

# PLIERS, CLAMPS & PIPE TOOLS

## LONG NOSE



### NEEDLE NOSE PLIERS

#### Double-Dipped Plastic Handles

Product Code	Description	Overall Length (Inches)	Jaw Length (Inches)
PL-114CS	Short Nose	4 1/2	1
PL-116C	Long Nose	7	2 3/16

#### Features

- Polished heads resist rust and corrosion, extending the tool life.
- Serrated jaws provide extra gripping power.
- The PL-114CS short nose model is supplied with a spring and is designed for close, fine electrical and mechanical work.
- The PL-116C long nose model provides excellent gripping ability for use in tight, narrow places.



PL-114CS



PL-116C



### LONG NOSE PLIERS WITH SIDE CUTTER

#### Double-Dipped Plastic Handles

Product Code	Description	Overall Length (Inches)
23409	Bent Nose	6 1/4
23411	Straight Nose	8

#### Features

- Jaws are polished with rust-protective coating.
- Double-dipped plastic handle grips are comfortable yet durable.
- Induction hardened and precisely ground cutting edges stay sharp longer.



23409



23411



# PLIERS, CLAMPS & PIPE TOOLS

## LONG NOSE



PL-146C



PL-149C



### DUCK BILL PLIERS

#### Double-Dipped Plastic Handles

Product Code	Description	Overall Length (Inches)	Jaw Length (Inches)
PL-146C	Standard Jaw	6 1/2	2 1/16
PL-149C	High Leverage	8	1 1/4

#### Features

- Jaws are polished with rust-protective coating.
- Flat wide nose provides a better grip than the regular needle nose models.

# PLIERS, CLAMPS & PIPE TOOLS

## ELECTRICAL



### ELECTRICAL MINI PLIERS

#### Double-Dipped Plastic Handles

Product Code	Description	Overall Length (Inches)	Capacity (AWG)
23541	Mini Cutter	5 1/2	8
23542	Mini Stripper	5 1/2	8-18 Solid/10-22 Stranded
23543	Mini Crimper	5 1/2	10-22

#### 23080 3 Piece Electrical Mini Pliers Set in Pouch

##### Contents Include:

Product Code	Description	Product Code	Description
23541	Mini Cutter	23543	Mini Crimper
23542	Mini Stripper		

##### Features

- Double-dipped handles with air cushion pockets provide comfortable grip, reducing hand fatigue.
- Cutter is hardened and precision-ground for cutting stranded and solid copper and aluminum wire.
- Stripper features up-front precision-ground stripping stations for exacting results in tight spaces.
- Crimper features front-end crimp pockets guaranteed to be free from burrs and sharp edges.



23541



23542



23543



### HEAVY DUTY FRONT END WIRE STRIPPERS

#### Double-Dipped Plastic Handles

Product Code	Overall Length (Inches)	Capacity (AWG-solid wire)	Capacity (stranded wire)
23506	6 1/4	10-20	12-20
23518	6 1/4	14-24	16-26
23521	6 1/4	22-30	24-32

##### Features

- Double-dipped handles with air cushion pockets provide comfortable grip, reducing hand fatigue.
- Spring-loaded handles speed work and reduce hand effort.
- Serrated gripping jaws in nose for use as pliers.
- 2-piece hardened steel pivot for long life service.
- Lock protects cutting edges in storage.



23506



### SUPER-DUTY FRONT END WIRE STRIPPERS WITH BOLT CUTTERS

#### Double-Dipped Plastic Handles with Curved Wire Cutter

Product Code	Overall Length (Inches)	Capacity (AWG-solid wire)	Capacity (stranded wire)
23533	7 1/4	10-18	12-20
23535	7 1/4	20-30	22-32

##### Features

- Double-dipped handles with air cushion pockets provide comfortable grip, reducing hand fatigue.
- Longer, curved handles provide extra leverage and greater comfort.
- Serrated gripping jaws in nose for use as pliers.
- Built-in bolt cutters cleanly cut 6-32 and 8-32 screws.



23533



# PLIERS, CLAMPS & PIPE TOOLS

## ELECTRICAL



23503

23524



23512

23515



23530



### MULTI-PURPOSE COMBINATION WIRE TOOLS

#### Double-Dipped Plastic Handles with Curved Wire Cutter

Product Code	Description	Overall Length (Inches)	Nose Style
23503	Front-end Stripper	8 1/4	Serrated Pliers
23524	Front-end Crimper	8 3/4	Anvil Cutter

#### Features

- Crimp and strip wire sizes 10-22 AWG.
- Double-dipped handles with air cushion pockets provide comfortable grip, reducing hand fatigue.
- 23503 cuts 6 bolt sizes: 4-40 / 5-40 / 6-32 / 8-32 / 10-32 / 10-24.
- 23524 cuts 5 bolt sizes: 4-40 / 6-32 / 8-32 / 10-32 / 10-24.



### ROMEX® STRIPPERS AND CUTTERS

#### Double-Dipped Plastic Handles with Staggered Type Strippers

Product Code	Description	Overall Length (Inches)	Stripper Sizes (AWG)
23512	Dual Romex®	7 3/4	12-2 / 14-2 NM-B
23515	10-2 Heavy Duty	7 3/4	10-2 NM-B

#### Features

- Staggered cutting design produces cleaner cuts with less effort.
- Double-dipped handles with air cushion pockets provide comfortable grip, reducing hand fatigue.
- Built-in bolt cutters cleanly cut 6-32 and 8-32 screws.
- Serrated gripping jaws in nose for use as pliers.



### COAX CABLE MULTI TOOL

#### Double-Dipped Plastic Handles

Product Code	Description	Overall Length (Inches)	Stripper Sizes (AWG)
23530	Coax Cable Tool	8 1/2	RG6 / RG59

#### Features

- Cut, strip, and crimp popular RG6 and RG59 coax cable sizes with one tool.
- Curved cutting blade cuts cleanly with less effort.
- Instructions provided on the tool for easy operation.

# PLIERS, CLAMPS & PIPE TOOLS

## ELECTRICAL WIRE TWISTER/CABLE CUTTER



### 4-IN-1 DATACOM WIRE CUTTER

#### Double-Dipped Plastic Handles

Product Code	Description	Overall Length (Inches)	Cutter Type
23527	4-in-1 Multi Purpose Datacom Wire Cutter	7 3/4	Anvil / Curved / Shear

#### Features

- Cuts solid and stranded copper electrical wire/cable and multi-conductor communications wire.
- Built-in bolt cutters cleanly cut 6-32 and 8-32 screws.
- Wire looping holes in jaws for speedy component assembly.
- Anvil cutter at nose allow nipping wire in close quarters, while 5/8" capacity curved cutter maintain cable shape.
- Steel wire-shear easily cuts steel reinforced coax.



23527



### WIRE TWISTER / CUTTER

#### Produces Right Hand (clockwise) Twists

Product Code	Overall Length (Inches)	Jaw Length (Inches)	Cutting Blade Length (Inches)
WTC-11	8.5	1 1/16	1/4

#### Features

- Diamond-shaped, flat top jaw serrations hold wire firmly and resist knicking material being worked on.
- Diagonal nose configurations & "mini" frame allows access in tight quarters.
- Automatic return feature retracts automatically, speeding up operation use and reducing operator fatigue.
- Heat-treated cutting edge holds its edge for cutting tough (up to .041) stainless steel and safety wire.
- One hand operation allows for operator closing and locking with minimum of handle force.
- High carbon alloy steel forging are used for maximum durability and long life.



WTC-11





# PLIERS, CLAMPS & PIPE TOOLS

## LOCKING



### LOCKING PLIERS AND SET

#### Bi-Mold Comfort Grip Handles

Product Code	Overall Length (Inches)	Style
23201	5	Curved Jaw with Cutter
23202	7	Curved Jaw with Cutter
23203	10	Curved Jaw with Cutter
23210	7	Straight Jaw
23211	10	Straight Jaw
23220	6	Long Nose with cutter
23221	9	Long Nose with cutter

#### Locking Pliers Sets

Product Code	Description
23070	3 Piece Locking Pliers Set with Bi-Mold Comfort Grip Handles

#### Contents Include:

Product Code	Description
23201	5" Curved Jaw Locking Pliers with Cutter
23202	7" Curved Jaw Locking Pliers with Cutter
23203	10" Curved Jaw Locking Pliers with Cutter

Product Code	Description
23071	3 Piece Locking Pliers Set with Bi-Mold Comfort Grip Handles

#### Contents Include:

Product Code	Description
23203	10" Curved Jaw Locking Pliers with Cutter
23210	7" Straight Jaw Locking Pliers
23220	6" Long Nose Locking Pliers with Cutter

#### Features

- Bi-mold handles provide comfortable grip, reducing hand fatigue.
- Convenient one-hand release lever.
- Heavy-duty jaw surfaces provide extra gripping power.
- Packed in a pouch.



23201



23210



23220



23070



23071

# PLIERS, CLAMPS & PIPE TOOLS

## LOCKING



### LOCKING PLIERS

#### Curved Jaw with Wire Cutter Locking Pliers

Product Code	Overall Length (Inches)
23301	5
23302	7
23303	10

#### Straight Jaw Locking Pliers

Product Code	Overall Length (Inches)
23304	7
23305	10

#### Long Nose with Wire Cutter Locking Pliers

Product Code	Overall Length (Inches)
23309	6
23310	9

#### Locking C-Clamps

Product Code	Overall Length (Inches)	Throat Depth	Capacity (Lbs.)
23320	6	1¼"	450
23321	11	2¼"	900

#### Locking C-Clamps wth Swivel Pad

Product Code	Overall Length (Inches)	Throat Depth	Capacity (Lbs.)
23222	6	1½/16"	450
23223	9	2¾/16"	900
23224	11	2¼"	900
23225	14	4½"	700

#### Features

- Convenient one-hand release lever
- Heavy-duty jaw surfaces provide extra gripping power



### LOCKING PLIERS SETS

#### 23072 3 Piece Locking Pliers Set

##### Contents Include:

Product Code	Description
23301	5" Curved Jaw Locking Pliers with Cutter
23302	7" Curved Jaw Locking Pliers with Cutter
23303	10" Curved Jaw Locking Pliers with Cutter

#### 23074 4 Piece Locking Pliers Set

##### Contents Include:

Product Code	Description
23301	5" Curved Jaw Locking Pliers with Cutter
23303	10" Curved Jaw Locking Pliers with Cutter
23309	6" Long Nose with Wire Cutter
23310	9" Long Nose with Wire Cutter

#### 23076 5 Piece Locking Pliers Set

##### Contents Include:

Product Code	Description
23301	5" Curved Jaw Locking Pliers with Cutter
23302	7" Curved Jaw Locking Pliers with Cutter
23305	10" Straight Jaw
23310	9" Long Nose with Wire Cutter
23320	6" Locking C-Clamp

#### Features

- Convenient one-hand release lever
- Heavy-duty jaw surfaces provide extra gripping power



23303



23305



23309



23320



23222



23072



23074

23076



# PLIERS, CLAMPS & PIPE TOOLS

## SNAP RING



PL-1622



PL-1620



PL-1621



### SNAP RING PLIERS

#### Double-Dipped Plastic Handles

Product Code	Tip Size	Tip Angle (Degree)
PL-1620	0.038	0°
PL-1621	0.038	45°
PL-1622	0.038	90°
PL-1623	0.047	0°
PL-1624	0.047	45°
PL-1625	0.047	90°
PL-1626	0.070	0°
PL-1627	0.070	45°
PL-1628	0.070	90°
PL-1629	0.000	0°
PL-1630	0.090	45°
PL-1631	0.090	90°

#### Combination Internal/External Snap Ring Pliers Set Pliers set in a plastic carrying case

##### Contents Include:

Product Code	Description
PL-1612	12 Piece Combination Internal/External Snap Ring Pliers Set

Set includes 1 each Snap Ring Plier listed above

#### Combination Internal/External Snap Ring Pliers Set Pliers set in a plastic carrying case

##### Contents Include:

Product Code	Description
PL-1606	6 Piece Combination Internal/External Snap Ring Pliers Set

Set includes 1 each Snap Ring Pliers, PL-1620, PL-1622, PL-1623, PL-1625, PL-1626, PL-1628

#### Features

- Cushioned grip handles
- Pliers are convertible for use on internal and external snap rings
- Knurled center screw with spring for easy changing and secure hold



PL-1612



PL-1606

# PLIERS, CLAMPS & PIPE TOOLS

## RETAINING RING



### RETAINING RING PLIERS AND SET

#### Double-Dipped Plastic Handles

Product Code	Description	Minimum Opening (Ctr. To Ctr.)	Maximum Opening (Ctr. To Ctr.)	Tips Included (Each Plier Includes 2 of Each)
PL-1600C-1	Internal pliers with tips	3/32	25/32	0.035" 90°
PL-1600C-2	External pliers with tips	3/32	1 1/32	0.045" 45° 0.045" Straight 0.060" Straight

#### Snap Ring Pliers Set

Product Code	Description
PL-1600C	Snap Ring Pliers Set

#### Contents Includes:

Product Code	Description
PL-1600C-1	PL-1600C-1 Internal Pliers
PL-1600C-2	PL-1600C-2 External Pliers

#### Replacement Tip Set Contents Includes:

Product Code	Description
PL-1600C-3	16 Piece Replacement tip set

#### Features

- Internal snap rings designed for use in housings, boxes, etc with bore diameters .375 to 1.750 inches.
- External snap rings designed for use in shafts, studs, etc with shaft diameters .250 to 1.438 inches.
- PL-1600C-1 and PL-1600C-2 each supplied with 8 tips (2 each: 90° x .035 and 45° x .045 angle tips and .045 and .060 straight tips).
- Made of high quality carbon steel with black-oxide finish to resist rust and other corrosions.
- Tips heat treated for a secure grip.
- Pliers provided with cushion grip handles.
- Set consists of one internal and one external snap ring pliers and 16 tips in a pouch.
- Tip set includes 4 each of interchangeable tips: 90° x .035 and 45° x .045 angle tips and .045 and .060 straight tips.



PL-1600C-1



PL-1600C-2



### CONVERTIBLE RETAINING RING PLIERS AND SET

#### Double-Dipped Plastic Handles

Product Code	Capacity (Max. Ring Dia.)	Tips Included (Includes 2 of Each)
23801	2"	0.038" Straight Tips (Yellow) 0.038" 90° Tips (Yellow) 0.047" Straight Tips (Green) 0.047" 90° Tips (Green)
23803	1"	0.070" Straight Tips (Copper) 0.024" Straight Tips (Red) 0.038" Straight Tips (Yellow) 0.038" 90° Tips (Yellow) 0.047" Straight Tips (Green) 0.047" 90° Tips (Green)

#### Retaining Ring Pliers Set

Product Code	Description
23092	Retaining Ring Pliers Set

#### Contents Includes:

Product Code	Description
23801	2" Capacity Retaining Ring Pliers
23803	1" Capacity Retaining Ring Pliers

#### Replacement Tip Kits Contents Includes:

Product Code	Description
23802	Replacement Tip Kit Only for 23801
23804	Replacement Tip Kit Only for 23803

#### Features

- Easily convert for use on internal and external rings by moving convenient adjusting levers.
- Each pliers includes five pairs of colour-coded tips for maximum versatility.
- Hex-shaped locking guides firmly hold tips in place.
- Double-dipped handles with air cushion pockets provide comfortable grip, reducing hand fatigue.
- Spring-loaded handles speed work.



23801



23803



# PLIERS, CLAMPS & PIPE TOOLS

## RETAINING RING



PL-529



### HEAVY DUTY RETAINING RING PLIERS & TIPS

#### Double-Dipped Plastic Handles

Product Code	Description	Minimum Opening (Ctr. To Ctr.)	Maximum Opening (Ctr. To Ctr.)
PL-527	Internal snap ring pliers	5/16	1 13/32
PL-528	External snap ring pliers	1 1/32	1 17/32

#### Tips for Heavy Duty Retaining Ring Pliers

Product Code	Description (Includes 2 each)
PL-529A	0.108" Straight Tips
PL-529B	0.108" 15° Tips
PL-529C	0.108 45° Tips
PL-529D	0.108 90° Tips
PL-530A	0.120 Straight Tips
PL-530B	0.120 15° Tips
PL-530C	0.120 45° Tips
PL-530D	0.120 90° Tips

#### Heavy Duty Retaining Ring Pliers Set PL-529

Product Code	Contents Include:
PL-527	Internal snap ring pliers
PL-528	External snap ring pliers

Set includes 2 each of heavy duty tips listed above

#### Features

- Internal snap rings designed for use in housings, boxes, etc.
- External snap rings designed for use in shafts, studs, etc.
- Pliers supplied with spring ratchet lock assembly which allows the ring to be compressed or expanded with gradual adjustments which lock at the desired size without continued pressure on the handles.
- Made of high quality carbon steel with black-oxide finish to resist rust and other corrosions.
- Tips heat treated for a secure grip.
- Tips not provided with pliers when pliers are ordered individually.

# PLIERS, CLAMPS & PIPE TOOLS

## RETAINING RING



### FIXED TIP RETAINING RING PLIERS

#### Double-Dipped Plastic Handles

Product Code	Overall Length (Inches)	Jaw Length (Inches)	Tip Diameter (Inches)	Minimum Jaw Opening (Inches)	Maximum Jaw Opening
<b>Internal</b>					
PL-531	5 1/2	7/8	0.038	3/32	2 3/8
PL-532	6 1/2	1	0.070	3/32	2 31/32
<b>External</b>					
PL-533	6 1/2	7/8	0.038	3/32	1 1/32
PL-534	7	2 1/16	0.070	3/32	1 1/4

#### Features

- Internal - used for installing and removing internal retaining rings in a bore without damage to the ring.
- External - used for installing and removing external retaining rings on a shaft without damage to the ring.
- Manufactured from high carbon, heat treated steel.
- Designed for accurate fit and long wear by precision forming and induction hardening.
- Finished with black oxide coating.



PL-531



PL-532



PL-534



PL-533



### LOCKING RING PLIERS

#### Black Jaws

Product Code	Overall Length (Inches)	Jaw Length (Inches)	Width at Tip (Inches)
PL-1515	8	1 3/8	5/16

#### Features

- For spreading horseshoe lock washers and steel lock rings used on gear and bearing shafts.



PL-1515



# PLIERS, CLAMPS & PIPE TOOLS

## C-CLAMPS



CC-406C



### DROP FORGED C-CLAMPS

#### Deep Throat Design, Copper Plated Screw

Product Code	Capacity (Inches)	Throat Depth (Inches)	Screw Diameter (Inches)	Min Test Load (lbs)
CC-402C	2	2 11/32	1/2	3500
CC-403C	3	2 3/4	1/2	3500
CC-404C	4	3 3/16	3/4	6500
CC-406C	6	4 1/8	3/4	6900
CC-408C	8	5 3/16	3/4	6900
CC-410C	10	6	3/4	8000
CC-412C	12	6 1/2	7/8	9500

#### Features

- Copper plated screw resists weld splatter.
- Drop-forged and heat treated for maximum strength and greater rigidity.
- I-Beam design for extra strength.
- Highly resistant to "springing".



CC-406S



### DROP FORGED C-CLAMPS

#### Deep Throat Design, Standard Screw

Product Code	Capacity (Inches)	Throat Depth (Inches)	Screw Diameter (Inches)	Min Test Load (lbs)
CC-402S	2	2 11/32	1/2	3500
CC-403S	3	2 3/4	1/2	3500
CC-404S	4	3 3/16	3/4	6500
CC-406S	6	4 1/8	3/4	6900
CC-408S	8	5 3/16	3/4	6900
CC-410S	10	6	3/4	8000
CC-412S	12	6 1/2	7/8	9500

#### Features

- Black threaded screw with T-handle.
- Drop-forged and heat treated for maximum strength and greater rigidity.
- I-Beam design for extra strength.
- Highly resistant to "springing".

# PLIERS, CLAMPS & PIPE TOOLS

## C-CLAMPS



### DROP FORGED C-CLAMPS

#### Deep Throat Design, Copper Plated Screw

Product Code	Capacity (Inches)	Throat Depth (Inches)	Screw Diameter (Inches)	Working Load (lbs)	Max. Hand Load (lbs)	Frame Proof Load (lbs)
20002	2	2-1/4	9/16	2000	2600	3500
20003	3	2-7/16	9/16	2400	2880	3500
20004	4	3-1/4	11/16	2800	4480	6500
20006	6	4-1/16	3/4	3400	4700	6900
20008	8	5	3/4	4000	4930	6900
20010	10	6	7/8	5000	5500	8000
20012	12	6-1/2	7/8	6000	7000	9500



#### C-Clamp Set

Product Code	Contents Include:
20042	4 Piece C-Clamp Set. Includes sizes 2", 4", 6", and 8"

#### Features

- Copper plated screw resists weld splatter
- Drop-forged and heat treated for maximum strength and greater rigidity
- I-Beam design for extra strength
- Powder coated frame resists rust
- "Safety Yellow" colour makes clamps easy to locate in dark work areas



### HEAVY SERVICE C-CLAMPS

#### Deep Throat Design, Standard Screw

Product Code	Maximum Capacity (Inches)	Minimum Capacity (Inches)	Throat Depth From Center (Inches)	Exterior Body Width (Inches)	Screw Diameter (Inches)	Screw Length Under Head (Inches)	Min Test Load (Lbs.)
CC-1AAW	1 3/8	0	1 1/8	2 23/32	13/32	2 7/16	5,600
CC-1 1/2AAW	1 7/8	0	1 21/32	3 19/32	5/8	3 1/4	8,750
CC-2AAW	2 11/32	0	1 7/8	4 1/4	23/32	4 1/8	12,500
CC-3AAW	3 7/16	1/8	2 13/32	5 3/4	27/32	4 7/8	16,250
CC-3LAAW **	3 7/16	0	2 1/2	5 3/4	27/32	5 3/4	16,250
CC-4AAW	4 21/32	17/32	2 7/8	6 1/4	27/32	6	20,000
CC-4LAAW **	4 21/32	0	2 7/8	6 1/4	27/32	7 1/4	20,000
CC-5AAW	5 5/8	1/2	3 1/8	7	27/32	7 1/4	23,800
CC-5LAAW **	5 5/8	0	3 1/8	7	27/32	8 7/8	23,800
CC-6AAW	6 1/2	1 5/32	3 1/2	7 1/2	1 3/32	8	27,500
CC-6LAAW **	6 1/2	0	3 1/2	7 1/2	1 3/32	10	27,500
CC-8AAW	8 1/2	4	3 11/16	8 1/2	1 3/32	7 1/8	31,250
CC-8LAAW **	8 1/2	0	3 11/16	8 1/2	1 3/32	11 5/8	31,250
CC-10AAW	10 3/8	5 3/8	4 3/8	8 1/2	1 3/32	7 3/4	35,000
CC-10LAAW **	10 3/8	0	4 5/16	8 1/2	1 3/32	14 3/8	35,000
CC-12AAW	12 3/8	7 1/4	4 7/16	9 1/2	1 3/32	8 1/4	40,000
CC-12LAAW **	12 3/8	0	4 1/4	9 1/2	1 3/32	16 7/16	40,000

\*\* Where zero capacity is desired, the clamps with long screws should be ordered. These are indicated with an "L" in the product code.

#### Features

- Especially designed for heavy duty service, frames are drop-forged and heat-treated for maximum strength and reduced springing
- Screws are made of special grade steel and are heat-treated for added strength not found in typical case-hardened screws
- To tighten, the square headed screw must be turned with a wrench
- Ideal for the most demanding applications such as construction and heavy industry
- Square head screw allows tightening with wrench for extra heavy duty clamping requirements
- Greater anvil surface for gripping larger work pieces and for greater stability





# PLIERS, CLAMPS & PIPE TOOLS

## PIPE WRENCHES



13500

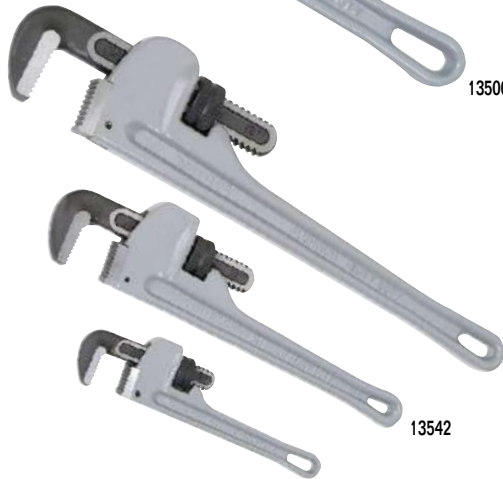

13542



13544



### PIPE WRENCHES

#### Aluminum, Heavy Duty

Product Code	Overall Capacity (Inches)	Maximum Jaw Opening (Inches)	Spare Parts		
			Hook Jaw	Heel Jaw & Pin	Knurl Nut
13500	8	1 5/16	13551	13567	13571
13502	10	1 5/8	13552	13562	13572
13504	12	2 1/8	13553	13563	13573
13506	14	2 9/16	13554	13564	13574
13508	18	3 1/8	13555	13565	13575
13510	24	3 3/4	13556	13566	13576
13512	36	5	13557	13568	13577
13514	48	6	13558	13569	13578

#### Pipe Wrench Set

Product Code	Contents Include:
13542	3 Piece Aluminum Pipe Wrench Set. Includes 8", 12", and 18" wrenches

#### Features

- Aluminum pipe wrenches are approximately 40% lighter than cast iron.
- Heavy duty construction for strength and durability.
- Scale on wrench indicates pipe diameter.



### PIPE WRENCHES

#### Cast Iron, Heavy-Duty

Product Code	Overall Capacity (Inches)	Maximum Jaw Opening (Inches)	Spare Parts		
			Hook Jaw	Heel Jaw & Pin	Knurl Nut
13516	6	7/8	13550	13560	13570
13518	8	1 3/16	13511	13567	13571
13520	10	1 5/8	13552	13562	13572
13522	12	2 1/8	13553	13563	13573
13524	14	2 9/16	13554	13564	13574
13526	18	3 1/8	13555	13565	13575
13528	24	3 3/4	13556	13566	13576
13530	36	5	13557	13568	13577
13532	48	6	13558	13569	13578

#### Pipe Wrench Set

Product Code	Contents Include:
13544	3 Piece Cast Iron Pipe Wrench Set. Includes 8", 12", and 18" wrenches

#### Features

- Heavy duty construction for strength and durability
- Scale on wrench indicates pipe diameter

# PLIERS, CLAMPS & PIPE TOOLS

## FLANGE JACKS/ STRAP



### FLANGE-JACKS

#### Tremendous Pressure With Minimum Effort

Product Code	Flange Diameter Capacity			
	* 125 Pound Cast Iron	* 150 Pound Cast Iron	* 250 Pound Cast Iron	* 300 Pound Cast Iron
FJ-20	2 to 20	2 to 20	1 to 12	3/4 to 12
FJ-30	16 to 48	18 to 24	12 to 30	12 to 24

#### Features

- Ideal for working on pipe lines and other applications involving flanges.
- Makes gasket removal fast and easy.
- Flanges are separated smoothly and evenly without damage to flange faces.
- Flange jacks are sold only in pairs.
- Eliminates danger from flying wedges and sparks caused by hammer blows.
- Ideal for hard to reach locations.



FJ-20

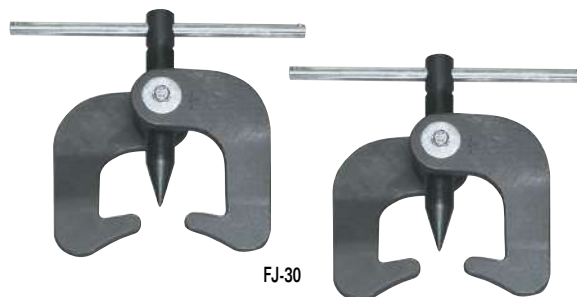

FJ-30



### STRAP WRENCH

#### Aluminum Handle

Product Code	Handle Length (Inches)	Maximum Diameter (Inches)	Strap Size (Inches)
40221	12	8	1 1/8 x 30

#### Features

- Use on irregularly shaped objects where other wrenches won't work.
- Useful for turning handwheels and other knurled handles.
- Reduces risk of damage on plastic pipe and tubing.
- Strap is made out of cotton.

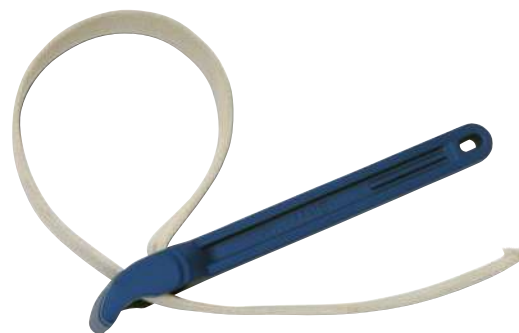

40221



# PLIERS, CLAMPS & PIPE TOOLS

## PIPE TOOLS



CT13



CT-13-1



CT-13-4



CW-4



40223



### CHAIN PIPE TONGS

#### The Original Williams Chain Pipe Tong

Product Code	Pipe Minimum Diameter (Inches)	Pipe Maximum Diameter (Inches)	Tong Length (Inches)	Chain Length (Inches)
CT-12	1/4	2 1/2	27	18 1/2
CT-13	3/4	4	38 1/8	25
CT-13-1/2	1	6	46 1/4	33
CT-14	1 1/2	8	50 1/2	40 3/4
CT-15	2	12	67	56

#### Features

- Chain swings from the center and can be used on either side of the jaws, reducing tooth wear.
- Flat link chains are heat-treated for greater strength and reliability.
- Fully adjustable to fit any shape pipe.

#### Replacement Parts for Pipe Tongs

Product Code	Replacement Jaw Sets		Replacement Chain Assembly	
	Product Code	Product Code	Length (Inches)	Loading Capacity
CT-12	CT-12-4	CT-12-1	18 1/2	13,800
CT-13	CT-13-4	CT-13-1	25	17,600
CT-13 1/2	CT-13-1/2-4	CT-13-1/2-1	33	20,000
CT-14	CT-14-4	CT-14-1	40 3/4	22,000
CT-15	CT-15-4	CT-15-1	56	31,000

#### Features

- Chain is heat-treated after assembly which results in a 40 % increase in strength as well as an extended chain life and improved performance.
- Jaws are drop forged from carbon steel and heat treated to provide the strength and reliability expected from Williams pipe tools.



### PIPE CHAIN WRENCH

#### Heat Treated

Product Code	Pipe Diameter Minimum - Maximum (Pipe Size)	Handle Length (Inches)	Chain Length (Inches)
CW-4	3/8 - 4	11	15

#### Features

- Forged handle is fully heat-treated.
- Ideal for use in close quarters and where space is at a premium.
- Successive "bites" can be taken without removal of wrench from the work piece.
- Fully adjustable to fit any shape pipe.



### PIPE CHAIN WRENCH

#### Heat Treated

Product Code	Pipe Diameter Capacity	Handle Length (Inches)	Chain Length (Inches)
40222	4	12	16
40223	5	15	19
40224	6	24	23

#### Features

- Forged strong I Beam handle.
- Designed for working in confined areas when regular pipe wrenches will not fit, excellent for pipe fittings.
- Portable and lightweight can be used for overhead and underground work.

# PLIERS, CLAMPS & PIPE TOOLS

## TUBING CUTTER



### 5/8" CAPACITY MINI-TUBING CUTTER

For Hard or Soft Copper Tubing, Brass, Stainless Steel, etc.

Product Code	Description	Cutting Capacity (Inches)	Overall Length (Inches)
43603	Mini-Tubing Cutter	1/8 to 5/8	1 3/4
43613	Replacement Cutter Wheel for 43603 (Pack of 5)		

#### Features

- Designed for use in tight access areas.
- Enclosed feed screw assures smooth operation by minimizing contamination.
- Corrosion resistant stainless steel rollers produce easier, smoother cuts.



43603



### 1 - 1/8" CAPACITY TUBING CUTTER

For Hard or Soft Copper Tubing, Brass, Stainless Steel, etc.

Product Code	Description	Cutting Capacity (Inches)	Overall Length (Inches)
43605	1 1/8" Tubing Cutter	1/8 to 1 1/8	5
43611	General Purpose Replacement Cutter Wheel (Pack of 10)		
43615	Optional Cutter Wheel for Stainless Steel (Pack of 5)		

#### Features

- Enclosed hardened steel thrust-bearing mechanism assures smooth cuts and reliable operation.
- Rugged aluminum alloy body looks good and handles well.
- Foldaway hardened steel reamer removes inside burrs cleanly.
- Includes (2) general-purpose cutter wheels.



43605



### 2-5/8" CAPACITY TUBING CUTTER

For Hard or Soft Copper Tubing, Brass, Stainless Steel, etc.

Product Code	Description	Cutting Capacity (Inches)	Overall Length (Inches)
43607	2 5/8" Tubing Cutter	3/8 to 2 5/8	7 3/4 (Closed)
43617	General Purpose Replacement Cutter Wheel for 43607 (Pack of 5)		
43616	Optional PVC Cutter Wheel for 43607 - Cuts Schedule 40 PVC up to 2" Diameter (Pack of 5)		

#### Features

- Ratchet feed mechanism speeds up cutting operations while extra-wide rollers stabilize the tubing.
- Light-weight aluminum body.
- Spare cutting wheel included under cap.
- Cuts Schedule 40 PVC pipe up to 2" diameter with optional 43616 cutter wheel.



43607



# PLIERS, CLAMPS & PIPE TOOLS

## FLARING TOOL



43631



### 45° SINGLE FLARING TOOL

#### For Soft Tubing

Product Code	Description	O.D. Capacity (Inches)
43631	45° Single Flaring Tool	$\frac{3}{16}$ , $\frac{1}{4}$ , $\frac{5}{16}$ , $\frac{3}{8}$ , $\frac{7}{16}$ , $\frac{1}{2}$ , & $\frac{5}{8}$

#### Features

- For soft copper, aluminum, and brass tubing.
- Forged steel yoke and hardened flaring bar for durability.
- Positive clamping action prevents tube slippage.
- Self-centering yoke with swivel-type, hardened steel, chrome-plated flaring cone forms better flares with less effort.
- Chrome plated to resist rust and corrosion.



43633



### 45° DOUBLE FLARING TOOL

#### For Soft Tubing

Product Code	Description	O.D. Capacity (Inches)
43633	45° Double Flaring Tool	$\frac{3}{16}$ , $\frac{1}{4}$ , $\frac{5}{16}$ , $\frac{3}{8}$ , & $\frac{1}{2}$

#### Features

- Recommended for Bundy and other annealed soft steel tubing (wall thickness to .035").
- Also makes single or double flares in soft copper and aluminum tubing.
- Small, lightweight, and easy to handle.
- Forged steel yoke and hardened flaring bar for durability.
- Swivel-type, hardened steel, chrome-plated flaring cone forms better flares with less effort.
- Chrome plated to resist rust and corrosion.



43621



### TRIPLE-HEAD TUBING BENDER

#### For Soft Tubing

Product Code	Description	O.D. Capacity (Inches)
43621	Triple-Head Tube Bender	$\frac{3}{16}$ , $\frac{1}{4}$ , $\frac{5}{16}$ , & $\frac{3}{8}$

#### Features

- For copper, aluminum, and thin-wall steel tubing.
- Calibrated markings for making accurate left, right, and offset bends.
- 90° start requires less effort, making bending fast and easy.

# PLIERS, CLAMPS & PIPE TOOLS

## NIPPLE KITS/HOSE CUTTER



### TIGHT-GRIP PIPE NIPPLE REMOVER & INSTALLER KITS

#### Remove and Install Pipe Nipples Without Thread Damage

Product Code	Description
87025	Pipe Nipple Remover / Installer Kit for 1/8", 1/4", and 3/8" NPT Pipe Nipples

#### Kit Includes:

87035	Stud Remover / Installer Housing
87036	Collet, 1/8" NPT
87037	Collet, 1/4" NPT
87038	Collet, 3/8" NPT

Product Code	Description
87026	Pipe Nipple Remover / Installer Kit for 1/2" and 3/4" NPT Pipe Nipples

#### Kit Includes:

87039	Stud Remover / Installer Housing
87040	Collet, 1/2" NPT
87041	Collet, 3/4" NPT

Product Code	Description
87027	Pipe Nipple Remover / Installer Kit for 1" and 1 1/4" NPT Pipe Nipples

#### Kit Includes:

87042	Stud Remover / Installer Housing
87043	Collet, 1" NPT
87044	Collet, 1 1/4" NPT

#### Features

- Remove pipe nipples and other lengths of pipe without damaging pipe threads.
- Collet is placed in housing and threaded over pipe. Draw bolt is then used to clamp tool onto nipple for secure removal or installation.
- Nipples and other lengths of pipe may be reused.
- Essential when working with decorative brass, bronze, and stainless piping.
- Ideal for working in confined areas where a pipe wrench will not fit.



The Tight-Grip Nipple Tool in use. One wrench holds the housing in place while the other wrench turns the top nut, clamping the collet and housing assembly onto the nipple. The housing, collet, and nipple then turn as one.



### PLASTIC AND RUBBER HOSE CUTTER

#### Compact and Light

Product Code	Description	Replacement Cutting Wheel
43618	Plastic and rubber hose cutter	43619

#### Features

- Cuts plastic tubing and non-metal reinforced hose.
- Cuts sizes 1/16" to 1/2" and 1mm to 13mm O.D.
- Spring loaded for safety.
- Weighs only one ounce.



43618



# HAMMERS, PUNCHES CHISELS & PRYBARS

## HAMMERS

- LARGE VARIETY INCLUDING DEADBLOW, BALL PEIN AND SLEDGE HAMMERS
- HEAVY DUTY CONSTRUCTION FOR STRENGTH AND DURABILITY USING SPECIALLY SELECTED STEEL AND MANUFACTURING PROCESSES

## PUNCHES, CHISELS AND PRYBARS

- HEAVY DUTY INDUSTRIAL GRADE CONSTRUCTION FOR VARIOUS APPLICATIONS
  - COMFORT GRIP HOLDER FOR SAFE USE
- PRYBARS DESIGNED FOR POWERFUL LEVERAGE UP TO 24' IN LENGTH



DEADBLOW SLEDGE  
HAMMER



LIGHTWEIGHT HANDLE  
PRY BAR



WILLIAMS COMFORT GRIP  
PRYBAR SET

**WE CONTINUE TO INNOVATE TO DELIVER SAFETY  
AND PRODUCTIVITY TO OUR CUSTOMERS**

# HAMMERS, PUNCHES, CHISELS & PRYBARS

## DEADBLOW/POWER DRIVE/BALL PEIN



### DEADBLOW HAMMERS

#### Ergonomically Designed Handles

Product Code	Weight (ozs.)	Overall Length (Inches)	Head Length (Inches)	Face Diameter (Inches)
JHW-16	16	12	3 1/4	1 5/16
JHW-24	24	12 3/4	3 3/4	1 3/4
JHW-32	32	13 1/2	4 1/4	2
JHW-48	48	15	4 3/4	2 1/4
JHW-56	56	15 3/4	5 7/16	2 3/4

#### Features

- Hard urethane construction resists cut damage to hammer head
- Head provides a non-marring contact surface that will not damage equipment
- Deadblow feature minimizes hammer bounce back, reducing fatigue and improving productivity.



JHW-24



### EXTREME POWER DRIVE HAMMERS

#### Fiberglass Handles with Cushion Grip and Shot-Filled Heads

Product Code	Weight (ozs.)	Head Length (Inches)	Overall Length (Inches)	Face Diameter (Inches)
HPDX-1	16	12 1/2	17	1 1/2
HPDX-2	32	13 3/4	18 3/4	2
HPDX-3	48	14 1/2	20	2 1/4
HPDX-4	64	15 1/2	21 3/4	2 5/8

#### Features

- Urethane face greatly improves durability
- Durable design for a long lasting hammer.



HPDX-2



### POWER DRIVE HAMMERS

#### Fiberglass Handles with Cushion Grip and Shot-Filled Heads

Product Code	Weight (ozs.)	Handle Length (Inches)	Overall Length (Inches)	Face Diameter (Inches)
HPD-1	16	9 5/8	12 1/2	1 1/2
HPD-2	32	10 3/4	13 7/8	2
HPD-3	48	10 3/4	14 1/8	2 1/4
HPD-4	64	10 3/8	15 1/4	2 5/8

#### Features

- Shot-loaded head delivers more striking force per blow and reduces vibration as well as rebound.
- Cushion grip handle provides greater comfort and safety.
- Durable design for a long lasting hammer.



HPD-2



### BALL PEIN HAMMERS

#### Fiberglass Handles with Cushion Grip

Product Code	Weight (ozs.)	Handle Length (Inches)	Overall Length (Inches)	Face Diameter (Inches)
20542	8	9 1/2	10 3/4	7/8
20543	12	10 1/4	11 3/4	7/8
20544	16	11 1/4	13	1 1/8
20545	24	13	15	1 1/4
20546	32	12 3/4	15	1 1/4

#### Features

- Ideal for driving punches, chisels and other metal work.
- Fiberglass handle has a cushion grip for greater comfort and safety.
- Hammer heads are drop-forged from specially selected steel and carefully heat treated for dependable strength, hardness and uniformity.



20543





# HAMMERS, PUNCHES, CHISELS & PRYBARS

## BALL PEIN/DRILLING CROSS PEIN/CLAW



### BALL PEIN HAMMERS

#### Wood Handle

Product code	Head Weight (ozs.)	Handle Length (Inches)	Overall length (Inches)	Face Diameter (Inches)
HBP-5-0A	4	9 3/8	10 7/16	3/4
HBP-3-0A	8	10 1/2	11 3/4	1
HBP-2-0A	12	11 1/8	12 1/2	1 1/8
HBP-0A	16	12 1/8	13 3/8	1 1/4
HBP-2A	24	13 1/4	15 5/8	1 1/2
HBP-4A	32	13 1/4	15 5/16	1 1/2
HBP-6A	40	13 5/16	15 5/16	1 5/8
HBP-8A	48	13 1/2	15 3/8	1 7/8

#### Features

- Ideal for driving punches, chisels and other metal work.
- Wooden handles, which are made from white hickory and clear lacquered, are permanently wedged in to the heads.
- Hammer heads are drop-forged from specially selected steel and carefully heat treated for dependable strength, hardness, and uniformity.
- Polished Face, Bevel & Pein



HBP-4A



20678



20651



20401



### DRILLING HAMMER

#### Fiberglass Handles with Cushion Grip

Product Code	Weight (ozs.)	Handle Length (Inches)	Overall Length (Inches)
20678	32	8 1/2	10 1/4

#### Features

- Handles are durable and comfortable.
- Heavy duty construction for strength and durability.



### CROSS PEIN HAMMER

#### Fiberglass Handles with Cushion Grip

Product Code	Weight (ozs.)	Handle Length (Inches)	Overall Length (Inches)
20651	48	13	15 3/4

#### Features

- Handles are durable and comfortable.
- Heavy duty construction for strength and durability.



### CLAW HAMMERS

#### Fiberglass Handles with Cushion Grip

Product Code	Style	Weight (ozs.)	Handle Length (Inches)	Overall Length (Inches)
20402	Ripping Claw	16	10 3/4	13
20401	Curved Claw	20	10 3/4	13

#### Features

- Handles are durable and comfortable.
- Heavy duty construction for strength and durability.

# HAMMERS, PUNCHES, CHISELS & PRYBARS

BRASS/SOFT FACE



## BRASS HAMMERS

### Fiberglass Handles with Cushion Grip

Product code	Weight (ozs.)	Handle Length (Inches)	Overall length (Inches)	Face Diameter (Inches)
HSB-1.5A	1-½	10	12	1
HSB-2.6A	2-½	10	12	1-¼
HSB-3.8A	3-¾	10	12	1-½

### Features

- Ideal for applications which require non-sparking conditions.
- The flat surface brass head absorbs impact blows, reduces rebound and helps eliminate marred work surfaces.
- Non-slip cushion grip provides greater comfort and safety.



HSB-3.8AA



## 8 PIECE SOFT-FACE HAMMER BODY AND TIP SET

### Fiberglass Handles with Cushion Grip

Product Code	Description
HSF-8SET	8 Piece Soft Face Hammer Body and Tip Set

### Contents Include:

Product Code	Weight Class	Head Length (Inches)	Handle Length (Inches)	Overall Length (Inches)	Head Diameter (Inches)
HSF-151A	16 oz.	1 ½	12 ½	14	1 ½

Product Code	Hardness	Tip Diameter (Inches)	Colour
HSF-15S	Soft	1 ½	Brown
HSF-15M	Medium	1 ½	Red
HSF-15N	Medium Hard	1 ½	Cream
HSF-15H	Hard	1 ½	Black
HSF-15SS	Steel	1 ½	Steel
HSF-15B	Brass	1 ½	Brass

Plastic Storage Case

### Features

- Handles are durable and comfortable
- Heavy duty construction for strength and durability
- Six interchangeable heads meet a number of various applications, including non-marring and non-sparking applications with selected head surfaces



HSF-8SET



# HAMMERS, PUNCHES, CHISELS & PRYBARS

SOFT FACE



## SOFT-FACE AND SHOT FILLED SOFT-FACE HAMMER BODY

Fiberglass Handles with Cushion Grip



HSF-151A

Product Code	Weight Class (ozs.)	Head Length (Inches)	Handle Length (Inches)	Overall Length (Inches)	Head Diameter (Inches)
HSF-202A **	40	4 1/8	10 3/4	13 1/2	2
HSF-100A	5	2	10 3/16	11 1/8	1
HSF-105A	8	2	10 3/16	11 1/8	1
HSF-150A	12	2 1/2	10 1 1/16	12 5/16	1 1/2
HSF-151A	16	1 1/2	12 1/2	14	1 1/2
HSF-155A	20	2 3/8	10 7/8	12 7/16	1 1/2
HSF-200A	20	2 1/2	11 5/8	13 1/2	2
HSF-205A	32	2 1/2	11 9/16	13 1/2	2
HSF-250A	32	3 1/4	12 1/2	14 3/4	2 1/2
HSF-255A	64	3 1/4	12 5/16	14 3/4	2 1/2
HSF-300A	56	3 3/4	12 7/8	14 3/4	3
HSF-305A	96	3 3/4	11 3/4	14 3/4	3

### Features

- \*\*Shot filled head reduces rebound for safety and transmits more force to the work
- Handles are durable and comfortable
- Heavy duty construction for strength and durability
- Use with Soft-Face hammer tips below. Match head diameter with tip diameter for proper fit.
- Tips are not included with hammer body
- 5/16 - 18 thread size



## SOFT-FACE HAMMER TIPS

### Heavy Duty

Product Code	Hardness	Tip Diameter (Inches)	Colour
Brown: Working with soft composites, plastics and soft alloy metals. Replaces vinyl hammer.			
HSF-10S	Soft	1	Brown
HSF-15S	Soft	1 1/2	Brown
HSF-20S	Soft	2	Brown
HSF-25S	Soft	2 1/2	Brown
HSF-30S	Soft	3	Brown
Red: Working with soft composites, plastics and soft alloy metals. Replaces rawhide hammer.			
HSF-10M	Medium	1	Red
HSF-15M	Medium	1 1/2	Red
HSF-20M	Medium	2	Red
HSF-25M	Medium	2 1/2	Red
HSF-30M	Medium	3	Red
Cream: Working with soft composites, plastics and soft alloy metals. Replaces soft-metal hammer			
HSF-10N	Medium Hard	1	Cream
HSF-15N	Medium Hard	1 1/2	Cream
HSF-20N	Medium Hard	2	Cream
HSF-25N	Medium Hard	2 1/2	Cream
HSF-30N	Medium Hard	3	Cream
Black: Working with hard surface composites and other hard metals.			
HSF-10H	Hard	1	Black
HSF-15H	Hard	1 1/2	Black
HSF-20H	Hard	2	Black
HSF-25H	Hard	2 1/2	Black
HSF-30H	Hard	3	Black
Yellow: Working with hard surface composites and other hard metals, hardness is close to steel.			
HSF-10XH	Extra Hard	1	Yellow
HSF-15XH	Extra Hard	1 1/2	Yellow
HSF-20XH	Extra Hard	2	Yellow
HSF-25XH	Extra Hard	2 1/2	Yellow
HSF-30XH	Extra Hard	3	Yellow
Green: Working with soft composites, plastic and soft alloy metals. Replaces brass hammer			
HSF-10T	Tough	1	Green
HSF-15T	Tough	1 1/2	Green
HSF-20T	Tough	2	Green
HSF-25T	Tough	2 1/2	Green
HSF-30T	Tough	3	Green

### Features

- Heavy duty construction for strength and durability



HSF-20S

HSF-20M

HSF-20T

# HAMMERS, PUNCHES, CHISELS & PRYBARS

## SLEDGE



### SLEDGE HAMMERS

#### Wood Handle

Product Code	Weight (lbs.)	Handle Length (Inches)	Overall length (Inches)	Face Diameter (Inches)
SH-2A	2	15	15	1 ½
SH-4A	4	15	15	2
SH-6A	6	36	36	2 ½
SH-8A	8	36	36	2 ½
SH-10A	10	36	36	2 ½
SH-12A	12	36	36	2 ¾
SH-16A	16	36	36	2 ¾

#### Replacement Handle Service Kit

Product code	Description	Weight (ozs.)	Length (Inches)
SHHW-14A	Handle	14	15
SHHW-32A	Handle	24	36

#### Features

- High carbon steel, heat treated and tempered head, with hickory handle



SH-8A



### SLEDGE HAMMERS

#### Fiberglass Handle

Product Code	Weight Class (lbs.)	Handle Length (Inches)	Overall length (Inches)	Face Diameter (Inches)
SHF-4SA **	4	14	14	1 ¼
SHF-8SA **	8	32	32	2
SHF-12SA **	12	32	32	2 ¼
SHF-2A	2	14	14	1 ¼
SHF-3A	3	14	14	1 ½
SHF-4A	4	14	14	1 ¾
SHF-6A	6	32	32	1 ¾
SHF-8A	8	32	32	2
SHF-10A	10	16	16	2 ½
SHF-10LA	10	32	32	2 ½
SHF-12A	12	32	32	2 ¼
SHF-16A	16	24	24	2 ¾
SHF-16LA	16	32	32	2 ¾
SHF-20A	20	36	36	2 ¾

#### Replacement Handle Service Kit

Product Code	Description	Weight (lbs)	Length (Inches)	Product Code	Description	Weight (lbs)	Length (Inches)
SHHF-14A	Fiberglass	2 to 4	14	SHHF-32A	Fiberglass	6 to 16	32
SHHF-16A	Fiberglass	6 to 8	16	SHHF-36	Fiberglass	20	36

#### Features

- \*\* Soft steel safety head is similar in hardness to brass
- \*\* Ideal replacement for Brass Head where non-sparking is not required
- Double faced head is hardened and tempered forged for maximum strength and durability.
- All kits include replacement handle, pre-measured bonding mix, mix container and instructions



SHF-4A



SHF-10LA



### DEAD BLOW SLEDGE HAMMERS WITH REPLACEMENT TIPS

Product Code	Weight (lbs)	Handle Length (Inches)	Overall length (Inches)	Face Diameter (Inches)
SHSFDB-8	8	29	32	2

#### Includes Two 4" Black Tips

#### 4" Replacement Tip

Product code	Hardness	Colour	Product code	Hardness	Colour
SHSFDB-40S	Soft	Brown	SHSFDB-40N	Med/Hard	Cream
SHSFDB-40M	Medium	Red	SHSFDB-40H	Hard	Black
SHSFDB-40T	Tough	Green	SHSFDB-40XH	Extra hard	Yellow

#### Features

- Shot loaded dead blow heads deliver the impact of a steel hammer with little or no rebound
- Oversized head and striking face minimizes miss hits, applying force with greater impact and repeatability
- Strong yet light weight handles provide 90% of the total hammer weight at the head
- 4" Non-marring removable tips can be replaced when worn



SHSFDB-8



SHSFDB-40H



SHSFDB-40M



SHSFDB-40N



SHSFDB-40S



SHSFDB-40T



SHSFDB-40XH



# HAMMERS, PUNCHES, CHISELS & PRYBARS

## SETS



### 27 PIECE PUNCH & CHISEL SET

#### Packed in a Pouch

Product Code	Description
PC-27	27 Piece Punch & Chisel Set

#### Contents Include:

Product Code	Description	Point Diameter (Inches)	Product Code	Description	Blade Width (Inches)
P-3	Pin Punch	3/32	C-8	Cold Chisel	1/4
P-4	Pin Punch	1/8	C-10	Cold Chisel	5/16
P-5	Pin Punch	5/32	C-12	Cold Chisel	3/8
P-6	Pin Punch	3/16	C-16	Cold Chisel	1/2
P-8	Pin Punch	1/4	C-20	Cold Chisel	5/8
P-10	Pin Punch	5/16	C-24	Cold Chisel	3/4
P-13	Solid Punch	3/32	C-28	Cold Chisel	7/8
P-14	Solid Punch	1/8	C-32	Cold Chisel	1
P-15	Solid Punch	5/32	C-36	Cold Chisel	1 1/8
P-16	Solid Punch	3/16			
P-17	Solid Punch	1/4	28449	Punch and Chisel Holder 7/8" Capacity	
P-25	Long Taper Punch	5/32			
P-26	Long Taper Punch	3/16			
P-28	Long Taper Punch	1/4			
P-30	Prick Punch	-			
P-40	Center Punch	-			
P-42	Center Punch	-			

#### Features

- Heavy duty construction for strength and durability.
- Includes punch and chisel holder for safety.



PC-27



### 17 PIECE PUNCH & CHISEL SET

#### Packed in a Pouch

Product Code	Description
PC-17	17 Piece Punch & Chisel Set

#### Contents Include:

Product Code	Description	Point Diameter (Inches)	Product Code	Description	Blade Width (Inches)
P-4	Pin Punch	1/8	C-10	Cold Chisel	5/16
P-6	Pin Punch	3/16	C-12	Cold Chisel	3/8
P-8	Pin Punch	1/4	C-16	Cold Chisel	1/2
P-14	Solid Punch	1/8	C-20	Cold Chisel	5/8
P-15	Solid Punch	5/32	C-24	Cold Chisel	3/4
P-16	Solid Punch	3/16	C-42	Cape Chisel	1/4
P-25	Long Taper Punch	5/32	C-62	Diamond Point Chisel	3/8
P-28	Long Taper Punch	1/4			
P-32	Prick Punch	-			
P-40	Center Punch	-			

#### Features

- Heavy duty construction for strength and durability.



PC-17

# HAMMERS, PUNCHES, CHISELS & PRYBARS

## SETS



### 8 PIECE PUNCH & CHISEL SET

#### Packed in a Pouch

Product Code	Description
PC-8	8 Piece Punch & Chisel Set

#### Contents Include:

Product Code	Description	Point Diameter (Inches)	Product Code	Description	Blade Width (Inches)
P-4	Pin Punch	1/8	C-10	Cold Chisel	5/16
P-6	Pin Punch	3/16	C-16	Cold Chisel	1/2
P-8	Pin Punch	1/4	C-24	Cold Chisel	3/4
P-15	Solid Punch	5/32			
P-40	Center Punch	-			

#### Features

- Heavy duty construction for strength and durability.



PC-8



### 8 PIECE CHISEL SET

#### Packed in a Pouch

Product Code	Description
CS-8	8 Piece Chisel Set

#### Contents Include:

Product Code	Description	Blade Width (Inches)	Product Code	Description	Blade Width (Inches)
C-40	Cape Chisel	3/16	C-60	Diamond Point Chisel	1/4
C-42	Cape Chisel	1/4	C-62	Diamond Point Chisel	3/8
C-44	Cape Chisel	5/16	C-72	Round Nose Chisel	1/4
C-46	Cape Chisel	3/8	C-74	Round Nose Chisel	3/8

#### Features

- Heavy duty construction for strength and durability.



CS-8



### 9 PIECE COLD CHISEL SET

#### Packed in a Pouch

Product Code	Description
CS-9	9 Piece Cold Chisel Set

#### Contents Include:

Product Code	Description	Blade Width (Inches)	Product Code	Description	Blade Width (Inches)
C-8	Cold Chisel	1/4	C-24	Cold Chisel	3/4
C-10	Cold Chisel	5/16	C-28	Cold Chisel	7/8
C-12	Cold Chisel	3/8	C-32	Cold Chisel	1
C-16	Cold Chisel	1/2	C-36	Cold Chisel	1 1/8
C-20	Cold Chisel	5/8			

#### Features

- Heavy duty construction for strength and durability.



CS-9



# HAMMERS, PUNCHES, CHISELS & PRYBARS

## SETS/PUNCHES



PS-17



### 17 PIECE PUNCH SET

Packed in a Pouch

Product Code	Description
PS-17	17 Piece Punch Set

Contents Include:

Product Code	Description	Tip Diameter (Inches)	Product Code	Description	Tip Diameter (Inches)
P-3	Pin Punch	$\frac{3}{32}$	P-16	Solid Punch	$\frac{3}{16}$
P-4	Pin Punch	$\frac{1}{8}$	P-17	Solid Punch	$\frac{1}{4}$
P-5	Pin Punch	$\frac{3}{32}$	P-25	Long Taper Punch	$\frac{5}{32}$
P-6	Pin Punch	$\frac{3}{16}$	P-26	Long Taper Punch	$\frac{3}{16}$
P-8	Pin Punch	$\frac{1}{4}$	P-28	Long Taper Punch	$\frac{1}{4}$
P-10	Pin Punch	$\frac{5}{16}$	P-30	Prick Punch	-
P-13	Solid Punch	$\frac{3}{32}$	P-40	Center Punch	-
P-14	Solid Punch	$\frac{1}{8}$	P-42	Center Punch	-
P-15	Solid Punch	$\frac{5}{32}$			

Features

- Heavy duty construction for strength and durability.



PS-4



### 4 PIECE CENTER PUNCH SET

Packed in a Pouch

Product Code	Description
PS-4	4 Piece Center Punch Set

Contents Include:

Product Code	Description	Stock Diameter (Inches)	Product Code	Description	Stock Diameter (Inches)
P-38	Center Punch	$\frac{1}{4}$	P-40	Center Punch	$\frac{3}{8}$
P-39	Center Punch	$\frac{5}{16}$	P-42	Center Punch	$\frac{1}{2}$

Features

- Heavy duty construction for strength and durability.



PS-12



### 12 PIECE PILOT PUNCH SET

Packed in a Pouch

Product Code	Description
PS-12	12 Piece Pilot Punch Set

Contents Include:

Product Code	Point Diameter	Product Code	Point Diameter
P-51	$\frac{1}{16}$	P-57	$\frac{7}{32}$
P-52	$\frac{5}{64}$	P-58	$\frac{1}{4}$
P-53	$\frac{3}{32}$	P-59	$\frac{5}{16}$
P-54	$\frac{1}{8}$	P-60	$\frac{3}{8}$
P-55	$\frac{5}{32}$	P-61	$\frac{7}{16}$
P-56	$\frac{3}{16}$	P-62	$\frac{1}{2}$

Features

- Designed to apply equal pressure to the end of a pin driving it straight through the hole.
- The ball on the center of the point end assures proper contact with the pin eliminating damage to the pin or hole wall.

# HAMMERS, PUNCHES, CHISELS & PRYBARS

## PILOT/BRASS DRIFT PUNCH AND CHISEL HOLDER/CHISELS



### 8 PIECE PILOT PUNCH SET

#### Packed in a Pouch

Product Code	Description
PS-8	8 Piece Pilot Punch Set

#### Contents Include:

Product Code	Point Diameter	Product Code	Point Diameter
P-51	1/16	P-55	5/32
P-52	5/64	P-56	3/16
P-53	3/32	P-57	7/32
P-54	1/8	P-58	1/4

#### Features

- Designed to apply equal pressure to the end of a pin driving it straight through the hole.
- The ball on the center of the point end assures proper contact with the pin eliminating damage to the pin or hole wall.



PS-8



### 3 PIECE BRASS DRIFT PUNCH SET

#### Packed in a Pouch

Product Code	Description
PS-3	3 Piece Brass Drift Punch Set

#### Contents Include:

Product Code	Point Diameter
P-63	3/8
P-64	1/2
P-65	3/4

#### Features

- For aligning unhardened steel or aluminum



PS-3



### PUNCH AND CHISEL HOLDER

#### Comfort Grip Handle

Product Code	Description
28449	7/8

#### Features

- Holds chisel and punch securely
- Protect user from hand injury



28449



### COLD CHISELS

#### Heavy Duty Industrial Grade

Product Code	Stock Size	Blade Width (Inches)	Length (Inches)
C-8	1/4	1/4	5
C-10	1/4	5/16	5
C-12	5/16	3/8	5 1/2
C-15	3/8	7/16	6
C-16	7/16	1/2	6
C-20	1/2	5/8	6 1/2
C-24	5/8	3/4	7
C-28	3/4	7/8	7 1/2
C-32	7/8	1	8
C-36	7/8	1 1/8	8

#### Features

- The most commonly used chisels in the chisel line.
- For cutting, shaping and removing metal softer than the cutting edge of the chisel.

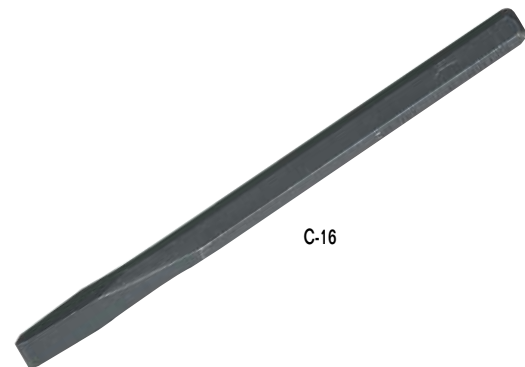

C-16





# HAMMERS, PUNCHES, CHISELS & PRYBARS

## CHISELS

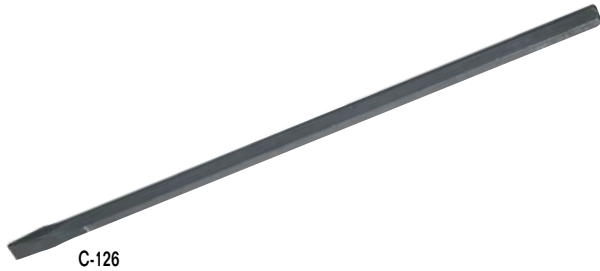

C-126



C-422



C-44

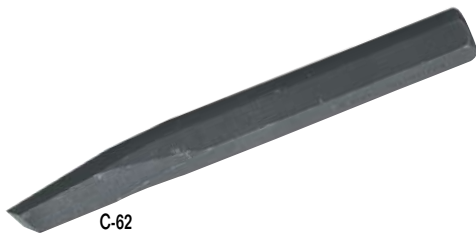

C-62



C-74



### EXTRA-LONG COLD CHISELS

#### Heavy Duty Industrial Grade

Product Code	Stock Size	Blade Width (Inches)	Length (Inches)
C-120	1/2	5/8	12
C-124	5/8	3/4	12
C-125	5/8	3/4	14
C-126	5/8	3/4	18
C-132	3/4	1	12
C-133	3/4	1	18

#### Features

- Designed for cutting, shaping and removing metal softer than the cutting edge of the chisel.



### RIVET-BUSTER CHISEL

#### Heavy Duty Industrial Grade

Product Code	Stock Size	Blade Width (Inches)	Length (Inches)
C-422	5/8	3/4	12

#### Features

- Designed for shearing bolt heads and rivets.



### CAPE CHISELS

#### Heavy Duty Industrial Grade

Product Code	Stock Size	Blade Width (Inches)	Length (Inches)
C-40	3/8	3/16	5 5/8
C-42	3/8	1/4	5 5/8
C-44	1/2	5/16	6 1/4
C-46	5/8	3/8	7

#### Features

- Designed for cutting or grooving keyholes or slots.



### DIAMOND POINT CHISELS

#### Heavy Duty Industrial Grade

Product Code	Stock Size	Square Cut (Inches)	Length (Inches)
C-60	3/8	1/4	5 3/4
C-62	5/8	3/8	7

#### Features

- Designed for making a V-groove in metal and to clean out inside corners.



### ROUND NOSE CHISELS

#### Heavy Duty Industrial Grade

Product Code	Stock Size	Blade Width (Inches)	Length (Inches)
C-72	3/8	1/4	5 3/4
C-73	1/2	5/16	6 1/4
C-74	5/8	3/8	7
C-75	3/4	1/2	8

#### Features

- Designed for cutting or grooving keyholes or slots.

# HAMMERS, PUNCHES, CHISELS & PRYBARS

## PILOT/PIN/SOLID



### PILOT PUNCHES

#### Heavy Duty Industrial Grade

Product Code	Stock Size	Point Diameter	Length (Inches)
P-51	1/4	1/16	2 3/4
P-52	1/4	3/64	3 1/4
P-53	1/4	3/32	3 1/2
P-54	1/4	1/8	4
P-55	1/4	3/32	4 1/2
P-56	3/8	3/16	4 1/2
P-57	3/8	7/32	5
P-58	7/16	1/4	5 1/2
P-59	7/16	5/16	6
P-60	1/2	3/8	6
P-61	3/8	7/16	6
P-62	5/8	1/2	6



P-57

#### Features

- Designed to apply equal pressure to the end of a pin driving it straight through the hole.
- The ball on the center of the point end assures proper contact with the pin eliminating damage to the pin or hole wall.



### PIN PUNCHES

#### Heavy Duty Industrial Grade

Product Code	Stock Size	Point Diameter	Length (Inches)
P-3	3/16	3/32	4 1/2
P-4	5/16	1/8	4 3/4
P-5	5/16	3/32	5
P-6	3/8	3/16	5 1/4
P-8	3/8	1/4	5 3/4
P-10	7/16	5/16	6



P-6

#### Features

- For driving out and removing already loosened pins and keys after initial movement by a solid or starter punch.



### SOLID PUNCHES

#### Heavy Duty Industrial Grade

Product Code	Stock Size	Point Diameter	Length (Inches)
P-12	3/8	1/16	5
P-13	3/8	3/32	5
P-14	3/8	1/8	5
P-15	3/8	5/32	5
P-16	3/8	3/16	5
P-18	3/8	7/32	5
P-17	3/8	1/4	5



P-16

#### Features

- For loosening frozen or tight pins and keys or knocking out rivets.
- Also called starter punches because they are ideal for loosening frozen pins.



# HAMMERS, PUNCHES, CHISELS & PRYBARS

LONG TAPER/CENTER/  
PRICK/ BRASS DRIFT



P-28



P-40



P-30



P-64



## LONG TAPER PUNCHES

### Heavy Duty Industrial Grade

Product Code	Stock Size	Point Diameter	Length (Inches)
P-24	5/16	1/8	8
P-25	3/8	5/32	9
P-26	1/2	3/16	10
P-28	5/8	1/4	12
P-28A	3/4	1/4	15
P-29	5/8	5/16	16
P-27	3/4	3/8	15

### Features

- Designed for aligning the holes in metal pieces through which rivets, bolts, or screws will be inserted.
- Not intended for driving pins as punch may become stuck in work.
- Also called line-up aligning or drift punches.



## CENTER PUNCHES

### Heavy Duty Industrial Grade

Product Code	Stock Size	Blade Width (Inches)
P-38	1/4	4
P-39	3/16	4 1/2
P-40	3/8	5
P-42	1/2	6

### Features

- Pierces or marks work by indentation for starting pilot drills in metal or other materials.



## PRICK PUNCHES

### Heavy Duty Industrial Grade

Product Code	Stock Size	Length (Inches)
P-30	3/8	5
P-32	1/2	6

### Features

- For scribing lines into metal before cutting or riveting, and for punching starting holes for short metal screws.
- Point is more tapered than center punch.



## BRASS DRIFT PUNCHES

### Packed in a Pouch

Product Code	Body Size	Overall Length (Inches)
P-63	3/8	6
P-64	1/2	7
P-65	3/4	8

### Features

- For aligning unhardened steel or aluminum

# HAMMERS, PUNCHES, CHISELS & PRYBARS

## PRY BARS



### 4 PIECE PINCH & ROLL BAR SET

#### Heavy Duty Industrial Grade

Product Code	Description
PBS-7	4 Piece Pinch & Roll Bar Set

#### Contents Include:

Product Code	Description	Stock Diameter (Inches)
C-80A	Pinch Bar	3/4
C-82A	Pinch Bar	3/4
C-715	Roll Bar	1/2
C-718	Roll Bar	5/8

#### Features

- Heavy duty construction for strength and durability.

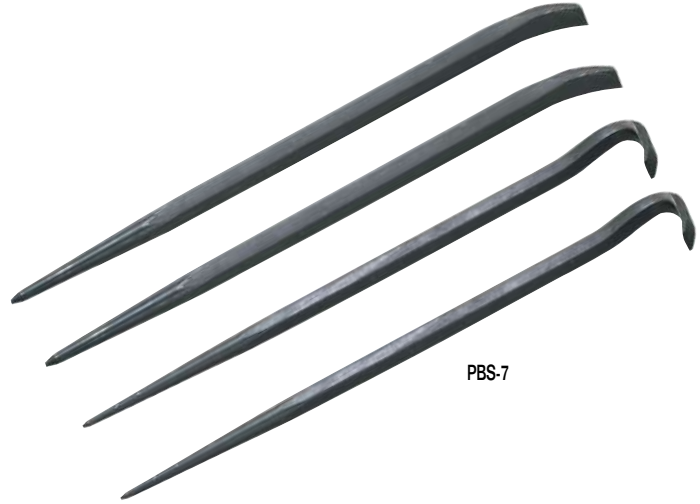

PBS-7



### PRY BARS - SCREWDRIVER TYPE

#### Contents Include:

Product Code	Size	Overall Length (Inches)	Product Code	Size	Overall Length (Inches)
C-807	3/8	12	C-836	5/8	36
C-812	3/8	17	C-842	5/8	42
C-818	1/2	25	C-844	7/8	44
C-824	1/2	31	C-858	3/4	58

Product Code	Description
C-803	3 Piece Pry Bar Set

#### Contents Include:

Product Code	Overall Length (Inches)
C-807	12
C-812	17
C-818	25

#### Features

- Blade is heat-treated the entire length.
- Handle is ergonomically designed to provide a more comfortable and secure grip
- Curved blade style gives extra leverage
- Capped end allows for striking without damage to handle



C-824

C-803



# HAMMERS, PUNCHES, CHISELS & PRYBARS

## PRYBARS/NAIL PULLER



### LIGHTWEIGHT HANDLE PRY BARS

#### Single Curved Tip

Product Code	Overall Length (Inches)	Product Code	Overall Length (Inches)
C-90	30	C-92	41 1/2
C-91	35 1/2	C-93	48 1/2

#### Double End

Product code	Overall length (Inches)	Product code	Overall length (Inches)
C-100	33	C-102	44
C-101	38	C-103	50

#### Features

- Designed with drop forged hardened steel point & wedge ends
- Rust resistant black finish
- Pry bar is chemically bonded to the fiberglass handle.
- Half the weight of steel pry bars
- Handle resists heat & cold less flex than a steel bar
- Non-Conductive fiberglass provides insulation from electrical shock
- Used by:
  - Contractors & mechanics for construction & auto repair
  - Municipalities for safe prying, lifting & digging
  - Fire & Police - Forcible entry

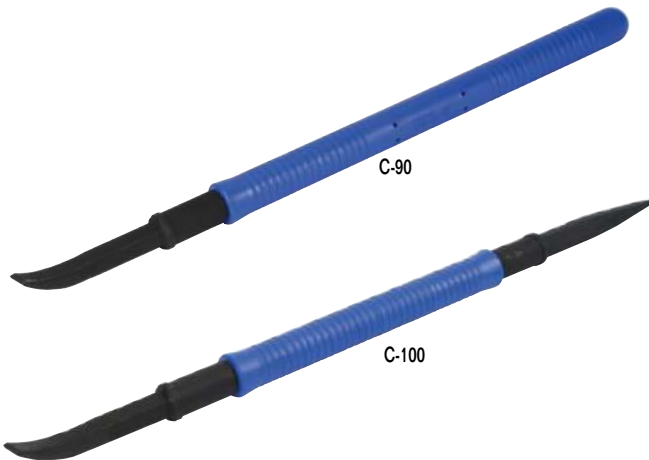

C-90

C-100



### LADYFOOT PRY BARS

Product Code	Stock Size	Overall Length (Inches)
C-612	1/2	12
C-616	5/8	16
C-621	3/4	21

#### Features

- Curved end ensures better leverage in small areas.
- Other end for aligning work.



C-612

# HAMMERS, PUNCHES, CHISELS & PRYBARS

## PRY BARS



### PINCH BARS

#### Heavy Duty Industrial Grade

Product Code	Overall Length (Inches)	Stock Size	Width of Flat (Inches)
C-80	14	1/2	5/8
C-82	16	5/8	3/4
C-82A	18	3/4	7/8
C-83	20	3/4	7/8
C-80A	24	3/4	7/8
C-84	30	7/8	1
C-85	38	3/4	7/8
C-86	42	7/8	1

#### Features

- Used for aligning, prying and positioning.

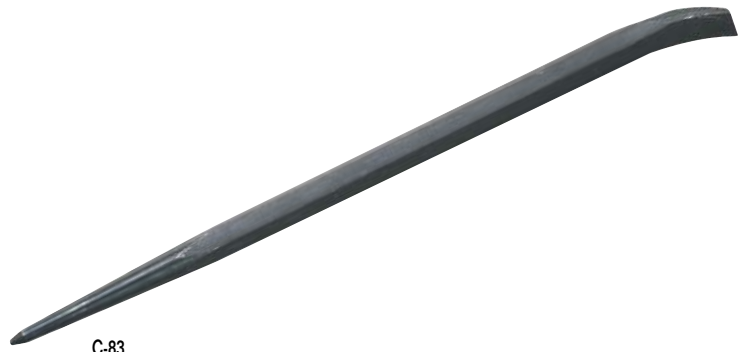

C-83



### ROLL BARS

#### Heavy Duty Industrial Grade

Product Code	Overall Length (Inches)	Stock Size
C-709	9	3/8
C-715	16	1/2
C-718	18	5/8

#### Features

- Aligning and pry bar with long tapered body and 90° rolling head.



C-715



### 2 PIECE COMFORT GRIP PRYBAR SET

#### Bi-Mold Comfort Grip Handles

Product Code	Description
21661	2 Piece Comfort Grip Prybar Set

#### Contents Include:

Size	Overall Length (Inches)
Small	8
Large	18

#### Features

- Bi-mold handles provide comfortable grip, reducing hand fatigue.
- Thumb stop on handle provides control during use.
- Fulcrum end provides extra prying power.



21661



# TOOLS FOR THE TRADES



HEAVY-DUTY DROP-SHOULDER CREEPER



STRAIGHT PATTERN TIN SNIPS



6 PIECE SCREW EXTRACTOR SET



DISPOSABLE FILM CUTTER

**WE CONTINUE TO INNOVATE TO DELIVER SAFETY AND PRODUCTIVITY TO OUR CUSTOMERS**

# TOOLS FOR THE TRADES

## SCRAPERS/TIN SNIPS



### GASKET SCRAPER

#### Plastic Handle

Product Code	Blade Length (Inch)	Overall Length	Blade Width
GSC-12	8 <sup>7</sup> / <sub>8</sub>	13	1 <sup>1</sup> / <sub>2</sub>

#### Features

- Designed for removing gaskets and carbon.
- Comfortable four-sided yellow plastic handle.
- Blade coated to resist corrosion.



GSC-12



### GASKET SCRAPER

#### Bi-Mold Comfort Grip Handle

Product Code	Blade Length (Inch)	Overall Length	Blade Width
40000	6	9 <sup>3</sup> / <sub>4</sub>	<sup>7</sup> / <sub>8</sub>

#### Features

- Bi-mold handle provides comfortable grip, reducing hand fatigue.
- Ideal for gasket removal and cleaning rust and corrosion.



40000



### STRAIGHT PATTERN TIN SNIPS

#### Double-Dipped Plastic Handles

Product Code	Overall Length (Inches)	Cutting Length (Inches)	Cutting Capacity (Cold-Rolled/Stainless)
28301	7	1 <sup>9</sup> / <sub>16</sub>	24 ga. CR / 32 ga. SS
28305	10	2	22 ga. CR / 28 ga. SS
28307	12	2 <sup>3</sup> / <sub>4</sub>	20 ga. CR / 24 ga. SS
28309	14	3	18 ga. CR / 22 ga. SS

#### 28351 2 Piece Straight Pattern Tin Snips Set in Pouch

#### Contents Include:

Product Code	Description	Product Code	Description
28301	7" Tin Snips	28307	12" Tin Snips

#### Features

- Forged steel blades.
- Double-dipped handles provide comfortable grip, reducing hand fatigue.
- Cut straight lines and wide curves.
- Meet ANSI and DIN standards.



28307





# TOOLS FOR THE TRADES

## AVIATION SNIPS



### AVIATION SNIPS

#### Bi-Mold Comfort Grip Handles

Product Code	Cutting Direction	Overall Length (Inches)	Cut Length (Inches)	Cutting Capacity (cold-rolled/stainless)
28201	Left	9 3/4	1 3/8	18 ga.CR / 22 ga.SS
28203	Right	9 3/4	1 3/8	18 ga.CR / 22 ga.SS
28205	Straight	9 13/16	1 1/2	18 ga.CR / 22 ga.SS

#### 28251 3 Piece Aviation Snips Set in Pouch

##### Contents Include:

Product Code	Description	Product Code	Description
28201	Left-cut snips	28205	Straight-cut snips
28203	Right-cut snips		

##### Features

- Color-coded handles help quickly identify the cutting direction.
- Bi-mold handles provide comfortable grip, reduces hand fatigue.
- Meet ANSI and DIN standards.



### OFFSET AVIATION SNIPS

#### Bi-Mold Comfort Grip Handles

Product Code	Cutting Direction	Overall Length (Inches)	Cut Length (Inches)	Cutting Capacity (Cold-Rolled/Stainless)
28231	Left and Straight	9 1/4	1 3/16	18 ga.CR / 22 ga.SS
28233	Right and Straight	9 1/4	1 3/16	18 ga.CR / 22 ga.SS

#### 28253 2 Piece Offset Aviation Snips Set in Pouch

##### Contents Include:

Product Code	Description	Product Code	Description
28231	Left and Straight Cut	28233	Right and Straight Cut

##### Features

- Color-coded handles help quickly identify the cutting direction.
- Bi-mold handles provide comfortable grip, reduces hand fatigue.
- Meet ANSI and DIN standards.
- Offset blades keeps user's hands above the work for safety and flow material away from blades for speed.



### SPECIALTY AVIATION SNIPS

#### Bi-Mold Comfort Grip Handles

Product Code	Style	Overall Length (Inches)	Cut Length (Inches)	Cutting Capacity (Cold-Rolled/Stainless)
28211	Bulldog - Notch	9	1	16 ga.CR / 18 ga.SS
28221	Long Cut - Straight	11 3/8	3	20 ga.CR / 26 ga.SS

#### 28255 2 Piece Specialty Aviation Snips Set in Pouch

28255 2 Piece Specialty Snips Set. Includes one each Bulldog and Long Cut snips above.

##### Contents Include:

Product Code	Description	Product Code	Description
28211	Bulldog - Notch	28221	Long Cut - Straight

##### Features

- Bulldog snips notches and cuts rolled edges, seams, and thick sheet metal up to 16 gauge cold-rolled steel.
- Color-coded handles help quickly identify the cutting direction.
- Bi-mold handles provide comfortable grip, reduces hand fatigue.
- Meet ANSI and DIN standards.



# TOOLS FOR THE TRADES

## UTILITY TOOLS/ CREEPERS



### UTILITY TOOLS AND SETS

#### Bi-Mold Comfort Grip Handles

Product Code	Description	Contents Include
40201	4 Piece Mini Pick & Hook Set	Straight pick 45° bent tip pick 90° bent tip pick Full semi-circular hook
40251	4 Piece Utility Tool Set	Gasket scraper Scratch awl Cotter pin puller Hose removal tool
40150	Magnetic pick-up tool with telescoping shaft	N/A

#### Features

- Bi-mold handles provide comfortable grip, reducing hand fatigue.
- Use for scribing, alignment, o-ring removal, and parts cleaning.
- Small size makes them ideal for hard to reach work surfaces.
- Telescopic pick-up tool features powerful magnetic tip.
- Magnetic pick-up tool extended length is 18¼", pick-up weight is 1¼ pounds
- 40201 Overall length: 6 inches, handle length: 2¾"



40201



40251



40150



### CREEPERS

#### Heavy Duty - Low Profile

Product Code	Description
42301	Heavy-Duty Drop-Shoulder Creeper
42302	Mechanic's Seat Creeper
42304A	Adjustable-Height Swivel Seat-Creeper

#### Features - Heavy-Duty Drop-Shoulder Creeper

- Low-profile design rests only 2" from the ground.
- Drop-rail design allows greater shoulder and arm clearance.
- 16 gauge, ¾" square-stock steel frame.
- 1" padding on bed and 2" padding on headrest.
- Six 2-½" diameter hooded casters shield user's clothing from dirt and grease.

#### Features - Mechanic's Seat Creeper

- Seat is topped with comfortable 1-½" thick foam padding.
- 1" square-stock steel frame.
- Four 2-½" diameter hooded casters shield user's clothing from dirt and grease.
- Heavy-duty 3-section plastic pan stores tools and small parts.

#### Features - Adjustable-Height Swivel Seat-Creeper

- Height adjusts from 17" to 22".
- Seat swivels a full 360°.
- Four 2-½" diameter hooded casters shield user's clothing from dirt and grease.
- Steel tube frame supports cylinder for ultimate strength.
- Bottom pan serves as storage for tools and small parts.



# TOOLS FOR THE TRADES

## EXTRACTORS / FEELER GAUGES



EXS-30



EX-26A



EXS-10



### FLUTED SCREW EXTRACTORS

#### Straight, Tapered Flutes

Product Code	Drill Size (Inches)	For Use on Bolt Sizes (Inches)
EX-21A	1/8	1/4 to 5/16
EX-21B	3/16	3/8
EX-22A	7/32	7/16
EX-24A	5/16	1/2 to 9/16
EX-25B	3/8	5/8
EX-25A	19/32	3/4
EX-26A	9/16	7/8
EX-28	21/32	1 to 1 1/8
EX-29	19/16	1 1/4 to 1 3/8
EX-30	1 1/16	1 1/2

#### EXS-30 Contents Include:

Product Code	Product Code	Product Code
EX-21A	EX-22A	EX-25B
EX-21B	EX-24A	EX-25A

#### EXS-10 10 Piece Screw Extractor Set

##### Contents Include:

Product Code	Product Code	Product Code	Product Code	Product Code
EX-21A	EX-22A	EX-25B	EX-26A	EX-29
EX-21B	EX-24A	EX-25A	EX-28	EX-30

#### Features

- Designed for quick, easy removal of left or right-handed broken screws, bolts, studs or other threaded forms.
- Drill bit sizes to be used are stamped on each extractor.
- A hole is first drilled in the broken stem and the right size Williams extractor is then inserted.



### FEELER GAUGE SET

#### Heavy Duty Machine Shop Tools

Product Code	Description	Thickness	Number of Blades
GS-1	Master Feeler Gauge Set	.0015 - 1/32	25

#### Features

- 25 blades 3-5/16" x 1/2" in the following thicknesses: .0015, .002, .003, .004, .005, .006, .007, .008, .009, .010, .011, .012, .013, .014, .015, .016, .018, .020, .022, .024, .025, .028, .030, .032, and .035.

- Both decimal and equivalent metric size etched in each blade.
- Gauges supplied in holder with knurled lock-nut which allows the user to select the required blade size and lock it into position.

Product Code	Description	Thickness	Number of Blades
GS-2	Standard Feeler Gauge Set	.002 - .015	10

#### Features

- 10 blades 3" x 1/2" in the following thicknesses: .002, .003, .004, .005, .006, .007, .008, .010, .012, .015.

- Both decimal and equivalent metric size etched in each blade.
- Gauges supplied in holder with knurled lock-nut which allows the user to select the required blade size and lock it into position.

Product Code	Description	Thickness	Number of Blades
GS-3	Combination Feeler Gauge Set	.002 - .025	22

#### Features

- Contains total of 22 blades.
- 10 blades 3" x 1/2" in the following thicknesses: .002, .003, .004, .005, .006, .007, .008, .010, .013, .015.

- 12 blades 1-3/4" x 1/4" in the following thicknesses: .011, .012, .013, .014, .015, .016, .017, .018, .019, .020, .022, .025.

- Overall length 5".
- Both decimal and equivalent metric size etched in each blade.
- Gauges supplied in holder with knurled lock-nut which allows the user to select the required blade size and lock it into position.

Product Code	Description	Thickness	Number of Blades
GS-4	Piston Feeler Gauge Set	.002 - .015	8

#### Features

- 8 blades 9" x 1/2" in the following thicknesses: .002, .003, .004, .005, .006, .008, .010, .015.

- Both decimal and equivalent metric size etched in each blade.
- Gauges supplied in holder with knurled lock-nut which allows the user to select the required blade size and lock it into position.

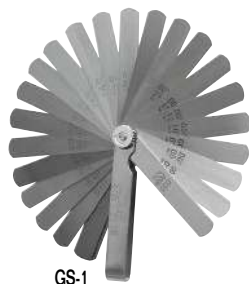

GS-1



GS-2



GS-3



GS-4

# TOOLS FOR THE TRADES

## UTILITY KNIVES



### FOLDING UTILITY KNIFE

Uses Heavy-Duty .025" Thick 2-Notch Blades

Product Code	Description
40058	Folding Utility Knife

#### Features

- Blade safely locks in place when open.
- Quick-change thumb stud release allows for easy blade replacement.
- Stainless steel clip secures knife on belt or in pocket.
- Includes (1) .025" blade.



40058



### AUTOLOAD QUICK-BLADE UTILITY KNIFE

Includes Heavy-Duty .025" Thick 2-Notch Blades

Product Code	Description
40052	Autoload Quick-Blade Utility Knife

#### Features

- Blade is easily removed or reversed from the front with push-button ease.
- New blade is automatically loaded from 5-blade magazine.
- Spring-loaded cover makes reloading quick and tool-free.
- Includes (5) .025" blades.



40052



### UTILITY KNIFE BLADES

Feature Heavy-Duty .025" Thick 2-Notch Blades

Product Code	Description
40072	Quickblade Dispenser Includes (100) .025" 2-Notch Blades
40076	.025" Hook Blades (100)
40078	5-Pack Carded 2-Notch Blades

#### Features

- Quickblade dispensers allow fast and safe blade handling, with convenient storage for used blades.



40072



# TOOLS FOR THE TRADES

## UTILITY KNIVES

**WILLIAMS**

### SAFETY UTILITY KNIVES & BLADES

Product Code	Description
40080	Ambidextrous Safety Cutter with Holster and Lanyard
40086	5-Pack Replacement Safety Point Blades for 40080
40088	3-Pack Film Cutter Unit for 40080

#### Features

- Guarded spring-back blade
- Variable blade depth control for top cuts and tray cuts
- Integrated film and shrink cutter
- Safety point blade standard
- 1 step blade change
- Integrated tape splitter

Applications: cuts corrugated, cartons, taped boxes, tape, strapping, packing film and shrink film.

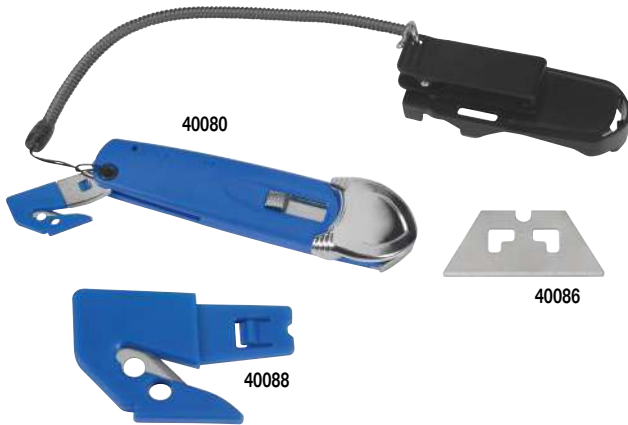

**WILLIAMS**

### DISPOSABLE SAFETY CUTTER

Product Code	Description
40082	Lightweight, ergonomic, ambidextrous disposable safety cutter

#### Features

- Retracting safety hooded guard prevents cuts
- NSF certified for food areas
- Safety point blade included standard
- Integrated tape splitter
- Stainless steel blade for hygiene
- 3-button mechanism for top and side cuts

Applications: multi purpose cutting, food processing areas, cuts corrugate, cartons, taped boxes, film and shrink



**WILLIAMS**

### DISPOSABLE FILM CUTTER

Product Code	Description
40084	Durable plastic construction and a long-lasting super sharp blade

#### Features

- Suitable for use in food areas
- Integrated tape splitter
- Stainless steel blade for hygiene

Applications: cuts tape, strapping, shrink wrap and film



Discover other pry bars on our website.