

Caldwell[®]
Shooting Supplies

Frankford Arsenal[®]
Reloading Tools

LOCKDOWN[®]

Tipton[®]
Gun Cleaning Supplies

Wheeler[®]
Engineering
Fine Gunsmithing Supplies

BOG-POD
TRIPODS • BIPODS • MONOPODS • ACCESSORIES

Hooyman[®]
PREMIUM TREE SAWS



2018 SHOOTING ACCESSORIES

PG. 16 PRECISION TURRET SHOOTING REST

#821400



PG. 24 STABLE TABLE® LITE

#1084745



PG. 34 UNIVERSAL BRASS CATCHER S.A.

#110038



PG. 38 ACCUMAX PREMIUM BIPOD WITH M-LOK®/KEYMOD ADAPTERS

#1081953
#1082223



PG. 38 ACCUMAX PREMIUM PIC RAIL BIPOD

#1081952
#1082222



PG. 39 XLA BIPOD® WITH M-LOK®/KEYMOD ADAPTERS

#1081950
#1081951



PG. 42 TAC OPS BELLY BAND HOLSTER

#1082698



PG. 82 HANDGUN VAULTS

#1082265
#1082264
#1082263



PG. 86 LED VAULT TAPE LIGHT

#1077070



PG. 88 6-GUN HANDGUN MUZZLE RACK

#1081878



**BRASS CLEANING PACK
(24-PACK)**

#110040



PRIMER POCKET SWAGER

#110007



**INTELLIDROPPER POWDER
MEASURE**

#1082250



CASE PREP CENTER

#1077094



STUCK CASE REMOVER

#1078192



**PLASTIC HINGE-TOP
AMMO BOXES**



**COMPACT PISTOL
CLEANING KIT**

#1082252



**FIELD HANDGUN
CLEANING KIT**

#1080202



FIELD RIFLE CLEANING KIT

#1080201



**AR CARBON
MULTI-SCRAPER**

#1078195



COMPACT AR MULTI-TOOL

#1078948



**AR LR/10 VARIANT
RECEIVER LAPPING TOOL**

#1081035



**COMPACT AR
CLEANING KIT**

#102251



**AR GAS BLOCK TAPER
PIN REMOVAL TOOL**

#1079898



**STAR CHAMBER PADS
(20-PACK)**

#1078197



**55-PIECE
SCREWDRIVER SET**

#1081958



**MICRO MULTI-DRIVER
TOOL PEN**

#1082257



MULTI-DRIVER TOOL PEN

#1082256



**30-PIECE
P-HANDLE DRIVER SET**

#1081957



45-PIECE KEY SET

#1081959



**SCOPE RING ALIGNMENT
& LAPPING KIT, 34MM**

#1081035



MASTER GUNSMITHING BENCHTOP MAGNIFIER

#110182



**MASTER GUNSMITHING
HANDHELD MAGNIFIER**

#110183



Caldwell[®]
Shooting Supplies





LEAD SLEDS

SHOOTING RESTS

SHOOTING TABLES

SHOOTING ACCESSORIES

27 AR ACCESSORIES

BIPODS

TAC OPS

HUNTING RESTS

HEARING PROTECTION

TARGETS

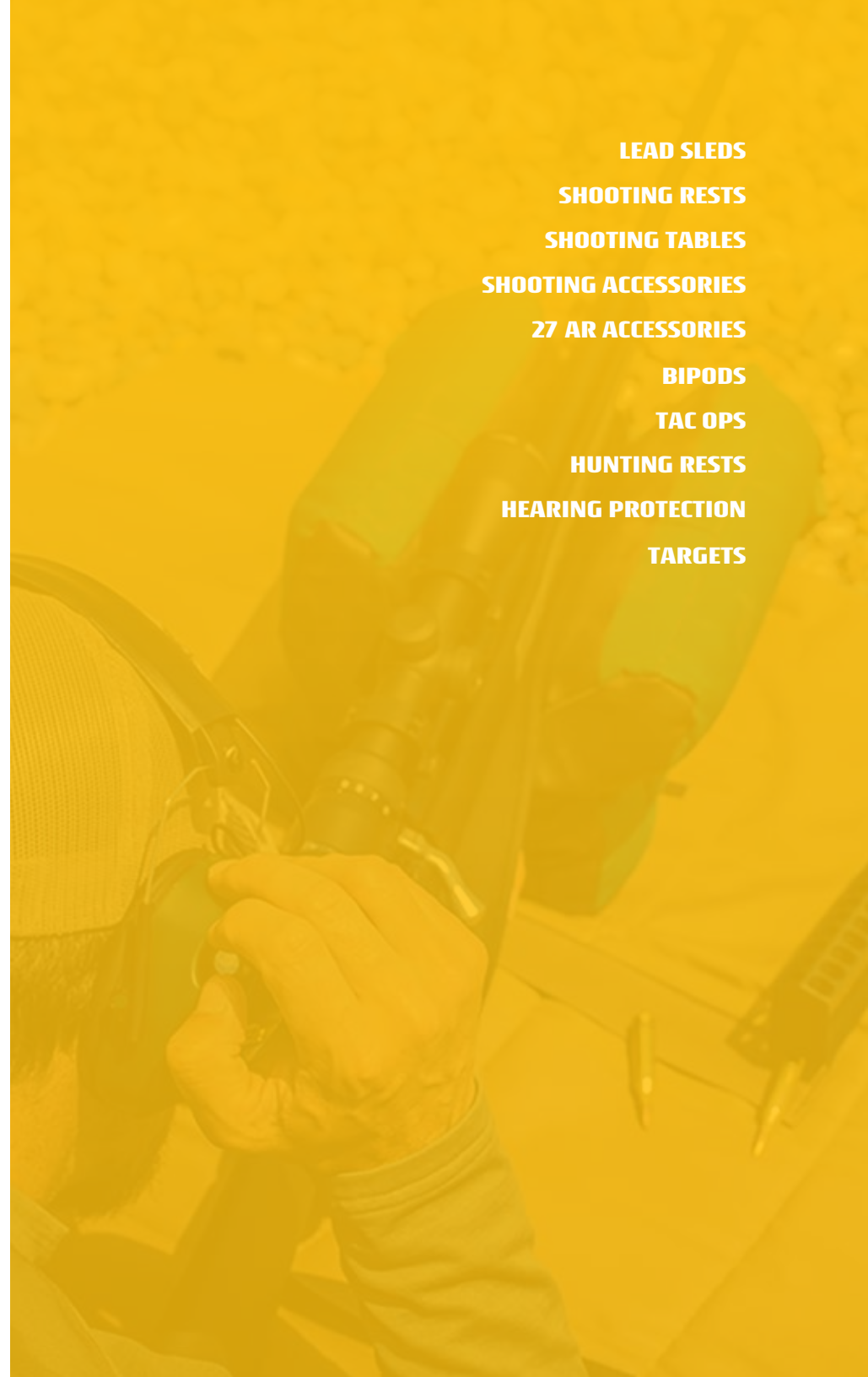

LEAD SLED® 3 #820310

Clam Size: 25.8"W x 11.3"H x 3.9"D Case Pack: 2

- Reduces felt recoil by up to 95%*
- Ideal for magnum rifles and slugs
- Tray accomodates (2) Standard Bags filled with 25lbs of lead shot
(Pictured: Large Bag filled with 20lbs of sand)
- Non-marring skeletonized front rest and rear pad
- Non-slip rubber feet

PATENTED



*Actual felt recoil may vary due to key factors such as bullet weight, velocity, shooting surface, firearm stock and recoil pad design



Weight: approx. 15lbs
Dimensions: 27"L x 12"W



Up to 4" of elevation adjustment



Rear rest has non-marring, recoil reducing pad



Weight tray fits 25lb barbell weights

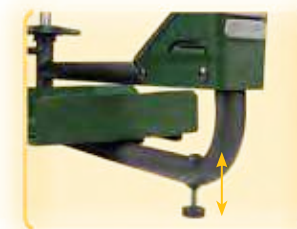

Rear elevation micro adjustment

▲ LEAD SLED® DFT™ 2 #336677

Clam Size: 30"W x 12.75"H x 5"D Case Pack: 1

- Reduces felt recoil by up to 95%*
- Dual Frame Technology (DFT) design disperses maximum amount of recoil energy
- Tray accomodates (2) Standard Bags filled with 25lbs of lead shot
- Front cradle slides to fit rifles and shotguns of virtually any size
- Up to 18" of horizontal adjustment
- Non-marring skeletonized front rest and rear pad
- Rear-height fingertip adjustment

PATENTED

LEAD SLED® DFT™ 2 DUAL FRAME TECHNOLOGY



**UP TO 18"
HORIZONTAL
ADJUSTMENT**

Weight: approx. 24lbs
Dimensions: 30"L x 12"W



**Actual felt recoil may vary due to key factors such as bullet weight, velocity, shooting surface, firearm stock and recoil pad design*



Up to 2.5" of elevation adjustment & easy windage adjustment



Advanced non-marring recoil reducing rear pad



Rubber elastic retention strap secures gun in front rest



Dual Frame Technology accommodates AR mags

▲ LEAD SLED® SOLO™ #101777

Box Size: 24"W x 8.5"H x 6.5"D **Case Pack:** 2

- Heavy-duty steel construction
- Accommodates all rifles, including detachable magazine rifles and lever action guns
- Greatly reduces recoil on all calibers
- Tray accommodates (1) Standard Bag filled with 25lbs of lead shot
- Rubber elastic retention strap secures gun in front rest
- Non-slip rubber feet

PATENTED



Front cradle with vertical adjustment



One knob elevation adjustment



Perfect for detachable magazine rifles

LEAD SLED SOLO RECOIL REDUCING TECHNOLOGY



▲ LEAD SLED® WEIGHT BAGS

Standard Bag (Single) #428334

Standard Bag (4 Bags) #533117

Large Bag (Single) #777800

Clam Size: 5.5"W x 9.25"H x 2"D **Case Pack:** 4

Standard dimensions: 5.5"W x 10"H x 3"D

Large dimensions: 10"W x 16"H x 2.5"D

- Made for Lead Sled® 3, Solo™, or DFT™ 2
- Small bag designed to hold 25lbs of lead shot
- Large bag holds 20lbs of sand
- Durable nylon webbed-handles



▲ LEAD SLED® FCX™ #820444

Box Size: 24.5"W x 8.75"H x 14.25"D **Case Pack:** 1



- Combines Lead Sled® recoil reduction feature with Fire Control® accuracy performance
- Up to 4.5" of coarse elevation adjustment (approx. 5ft of adjustment on target at 100yds)
- Up to 5.5" horizontal adjustment
- Cast aluminum weight tray accommodates approx. 75lbs of lead shot
- Custom-fit weight bag (*included, unfilled*) holds approx. 50lbs of lead shot
- Machined steel gear rack for coarse elevation adjustment and adjustable rear foot elevation

PATENTED



Fire Control alignment system



Fine and coarse elevation adjustment



Contoured rear support protects gun stock



*Weight: approx. 22lbs
Dimensions: 35"L x 13"W*

FIRE CONTROL

Fire Control® is an advanced alignment system that allows the shooter continual, one-hand adjustment of downrange crosshair alignment via a multi-directional control arm.

BOTH RESTS INCLUDE: Medium Varmint Front Bag (pictured) and a 3-lobe bag for wider forends



High quality filled front bag with integral forend stop



Up to 4" of vertical adjustment with locking knob



Control arm provides approx. 60" MOA at 100yds



(3) independent leveling feet with spike bottoms

▲ FIRE CONTROL® FRONT REST #746884

Box Size: 16"W x 13"H x 9"D Case Pack: 1

- Cast iron base for rock-solid stability

PATENTED



Weight: approx. 18lbs
Base dimensions: 15"L x 11.5"W

▲ FIRE CONTROL® FULL LENGTH REST #100259

Box Size: 16"W x 13"H x 9"D Case Pack: 1

- Dual steel tubes connect front and rear bases
- Overmolded, non-marring rear pad

PATENTED

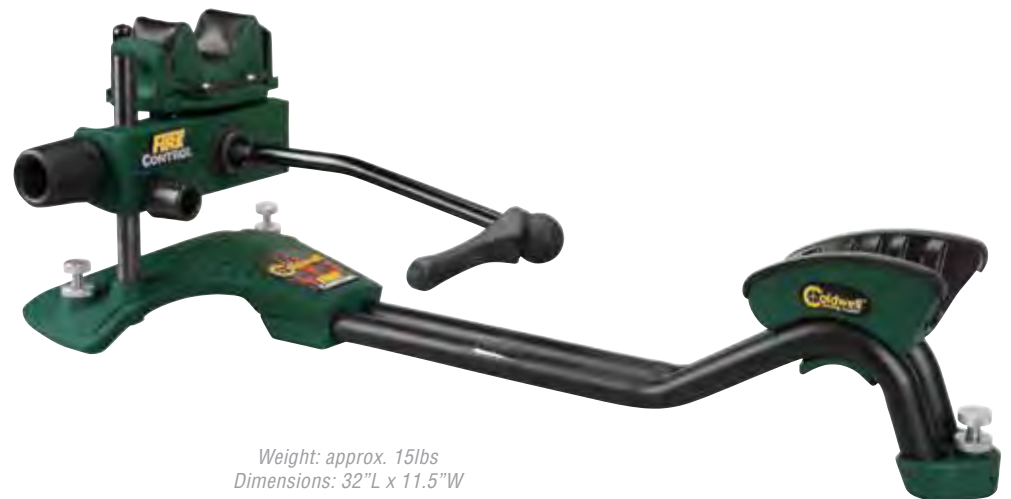

Weight: approx. 15lbs
Dimensions: 32"L x 11.5"W

ZEROMAX™ SHOOTING REST #546889**Box Size:** 23.8"W x 6.5"H x 5"D **Case Pack:** 4

- Durable steel tube frame fabrication
- Front and rear elevation adjustment
- Forend cradle designed to hold all Caldwell® Deluxe Universal Front Rest Bags
- Rock-solid shooting base for rifles and shotguns

INCLUDES

- Filled Medium Varmint Front Bag



Weight: approx. 4lbs
Dimensions: 23"L x 12"W

**7 REST SHOOTING REST #1071001****Box Size:** 8.5"W x 25.5"H x 2"D **Case Pack:** 4

- Ambidextrous
- Independently adjustable feet for vertical adjustment
- Front and rear cradle vertical adjustments
- Over-molded supports for extra stability
- Works great with AR-15s, rolling blocks and lever-action rifles
- Folds compact for transport and storage

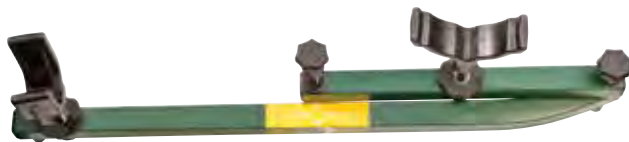

Folded for transport



**PIVOTS LEFT &
RIGHT FOR ALL
SHOOTERS**

Independently adjustable feet

Weight: approx. 3lbs
Dimensions: 24"L x 12"W

▲ NEW PRECISION TURRET SHOOTING REST #821400

Box Size: 8"W x 17"H x 8"D Case Pack: 2

- Designed for use with AR-10/AR-15 platforms
- Forend clamp keeps rifle secure and centered
- Swivel and tilt features for maximum adjustability
- Removable, micro-adjustable pistol grip attachment
- Pistol grip rest vertical adjustment approx. 1"
- Ball bearing panning system
- Metal construction

Patent Pending



AERIAL VIEW

58° panning arc using a gun with extended magazine



▲ STINGER™ SHOOTING REST #110033

Box Size: 16.5"W x 6.75"H x 10"D Case Pack: 1

- Innovative new spring loaded elevation system
- Extremely fine elevation adjustments with fingertip control
- Up to 3" in front rest vertical adjustment
- Overmolded, non-marring front and rear cradles
- Rigid steel tube frame construction



Rear fine elevation adjustment



Up to 3" front vertical adjustment



Accommodates extended magazines and lever actions



Weight: approx. 11lbs
Base dimensions: 29"L x 13"W

MATRIX™ #101600

Box Size: 16.5"W x 6.5"H x 19.5"D Case Pack: 3

- Up to 4.5" length adjustment
- One-handed elevation adjustment knob
- Up to 3" vertical adjustment
- Overmolded, non-marring front and rear cradles

PATENTED



The Matrix™ has multiple rigid supports molded into the frame



23"L x 19"W

MATRIX™

SHOOTING REST™



Remove storage area lid for detachable magazine rifles



Remove the rear rest to accommodate handguns

PISTOLERO™ #562771

Box Size: 16"W x 8.4"H x 5.4"D Case Pack: 4

- Up to 5" length adjustment
- Up to 3" of vertical adjustment
- Overmolded, non-marring front cradle and hand rest

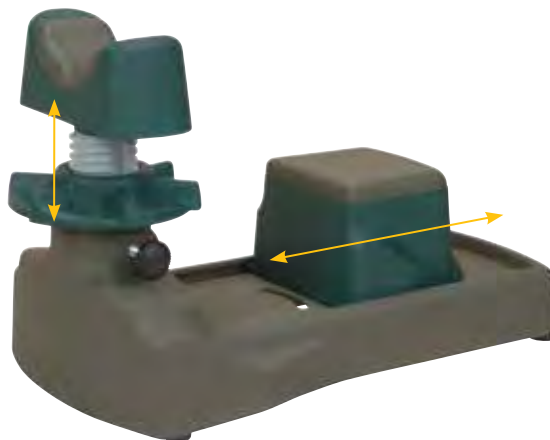

Pistolero™



The Pistolero™ accommodates handguns like the 1911 as easily as the big Smith & Wesson® 500

▲ STEADY REST NXT® #548664

Box Size: 12.2"W x 10.5"H x 5.4"D **Case Pack:** 4

- Overmolded, non-marring front and rear cradle
- Cushioned neoprene base for handgun rest

PATENTED



Separated front rest serves as handgun rest

Removable middle section accommodates all rifle and shotgun lengths

STEADY REST NXT®

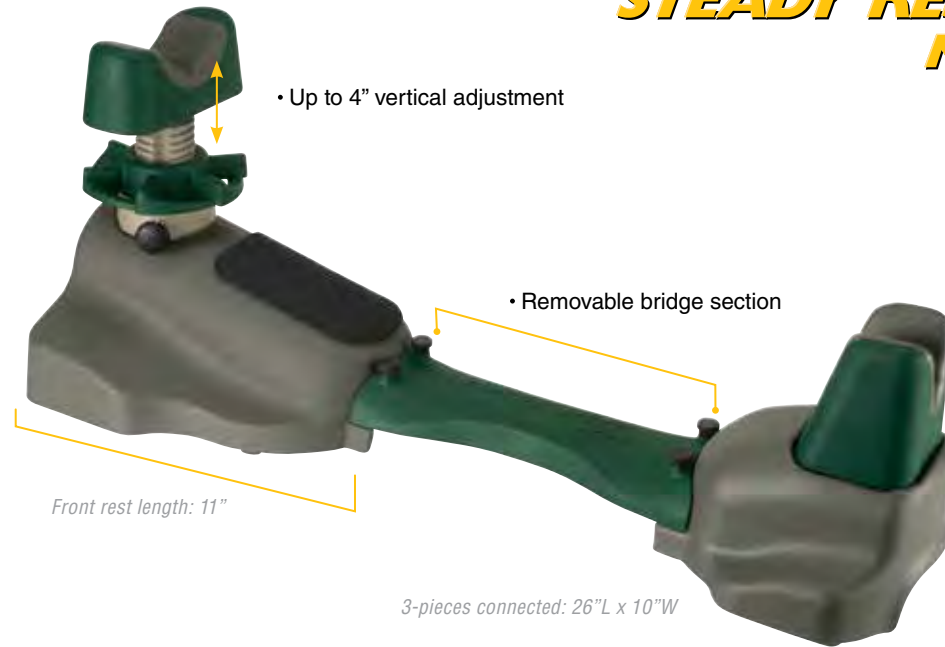

▲ HANDY REST NXT® #574662

Box Size: 14.3"W x 12.5"H x 4.8"D **Case Pack:** 4

- Up to 3" vertical adjustment (approx. 6ft elevation at 100yds)
- Front sling stud clearance groove
- Constructed of durable, lightweight material
- 3 non-slip foot pads for stability

INCLUDES

- Removable handgun support attachment to convert rifle rest into a handgun rest



HANDY REST NXT®



Removable handgun support allows for use with pistols & revolvers

▲ THE ROCK™ SHOOTING REST #383774

Box Size: 13"W x 4"H x 14"D Case Pack: 4

**▲ THE ROCK™ COMBO #383640
(The Rock™ Shooting Rest + Filled Rear Bag)**

Box Size: 15.25"W x 12"H x 4.25"D Case Pack: 4

REST AND COMBO INCLUDE: Filled Medium Varmint Front Bag

- Steel ram provides smooth and quick elevation adjustments
- Forend cradle designed to hold all Caldwell® Deluxe Universal Front Rest Bags
- Wide 3-point iron base for extra stability
- Filled rear bag made of durable water-resistant fabric (*comes with The Rock™ Combo only*)



4.5"–7.25" vertical adjustment



Forend stop ensures consistent stock placement



Independently adjustable feet for precision accuracy



Filled Rear Bag
(pg. 23)



• Forend cradle is adjustable to conform to shooting bag

Weight: approx. 8.5lbs
Base dimensions: 13"Diameter

▲ THE ROCK JR.™ #323225

Box Size: 10"W x 4.25"H x 9.75"D Case Pack: 4

- Sleeker, more economical design than The Rock™
- Durable 3-point base
- 3/4" diameter steel elevation post
- Interchangeable rubber feet or metal spiked feet
- Forend cradle designed to hold all Caldwell® Deluxe Universal Front Rest Bags

INCLUDES

- Filled Medium Varmint Front Bag included



• Up to 8" of vertical adjustment

Weight: approx. 5.5lbs
Base dimensions: 10"Diameter

THE ROCK BR™ #440907**Box Size:** 16.5"W x 6.75"H x 10"D **Case Pack:** 1

- Up to 11.5" vertical adjustment
- Adjustable front cradle for perfect fit on any size bag or gun forend
- Forend cradle designed to hold all Caldwell® Deluxe Universal Front Rest Bags
- 3 independently adjustable metal-spiked feet
- Machined die-cast metal construction

INCLUDES

- Unfilled and filled (*pictured*) 3-lobe bag
- Filled Medium Varmint Front Bag included



*Adjustable forend stop
for precise positioning*



*Medium Varmint Front Bag shown,
for use with narrow forends.*

**BR FOOT PADS (3-PACK) #845221****Box Size:** 16.5"W x 6.75"H x 10"D **Case Pack:** 1

- Rubber-coated metal washers built to hold The Rock BR™ spiked feet
- Provides non-slip base
- Non-marring on tabletop surface

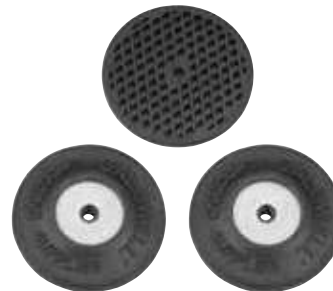

▲ TACK DRIVER® SHOOTING REST (FILLED) #569230

Box Size: 11.4"W x 8.85"H x 7.5"D Case Pack: 1

▲ TACK DRIVER® SHOOTING REST (UNFILLED) #191743

Box Size: 6.8"W x 14.8"H x 1.5"D Case Pack: 6

- Self-tightening surface grips rifle and reduces felt recoil
- Non-marring, non-slip durable polyester
- Supports virtually any rifle or shotgun
- Convenient carry handle



▲ HUNTER'S BLIND BAG #247261

Box Size: 5.75"W x 9.5"H x 1.75"D Case Pack: 6

- Ideal for deer/turkey stands, fence posts, tree limbs or truck bed sides
- Lightweight, durable polyester will not sag over time
- Dark green color blends well with natural surroundings
- Narrow contour of rest matches most sporter weight stocks
- Tie down laces secure the bag to uneven locations



▲ DELUXE UNIVERSAL FRONT BAGS & BENCH SHOOTING BAGS

- A. Narrow Sporter Front Bag** #108325 Case Pack: 4
- B. Medium Varmint Front Bag** #263234 Case Pack: 4
- C. Wide Benchrest Front Bag** #576578 Case Pack: 4
- D. Elbow Bag** #774317 Case Pack: 6
- E. Universal Bag** #116375 Case Pack: 6

A-C Box Sizes: 4"W x 8.25"H x 2.25"D

ALL FRONT AND BENCH BAGS COME FILLED!

- All Deluxe Universal Front Bags & Bench Shooting Bags come filled
- Constructed from no-stretch or sag polyester and high-quality leather
- Hook & loop tabs on Front Bags allow quick installation and removal from the cradle
- Elbow Bag is perfect to rest on when shooting from a bench
- Universal Bag can be used as an elbow bag or rear stock elevation rest



A.



B.



C.



7"L x 7"W x 1.75"H

D.



5"L x 8"W x 2.25"H

E.

▲ DEADSHOT® SHOOTING BAGS

- A. Front Shooting Bag (Filled)** #516620
Box Size: 8"W x 10"H x 6.5"D **Case Pack:** 4
- B. Rear Shooting Bag (Filled)** #640721
Box Size: 5"W x 5"H x 5.5"D **Case Pack:** 4
- Front/Rear Combo (Filled)** #939333
Box Size: 10.3"W x 10.5"H x 6.8" **Case Pack:** 4
- Front/Rear Combo (Unfilled)** #248885
Box Size: 5.5"W x 9.3"H x 2"D **Case Pack:** 4

- Place them on virtually any shooting surface
- Made of durable, water-resistant polyester
- Front Shooting Bag is the industry's largest (approx. 8lbs)
- Quick-connect feature makes bag transport easy



Easy transport with the Quick-Connect System.



Durable water-resistant 600 Denier polyester



5"W x 5"H x 4.5"D



10"W x 8.5"H x 6"D

▲ REAR SHOOTING BAGS

- A. Standard Rear Bag (Filled)** #598458
Box Size: 7.5"W x 5"H x 5.5"D **Case Pack:** 4
- Standard Rear Bag (Unfilled)** #226645
Box Size: 3.875"W x 8.25"H x 2.5"D **Case Pack:** 4
- B. Medium-High Rear Bag (Filled)** #800888
Box Size: 7.5"W x 5"H x 5.5"D **Case Pack:** 4
- C. Magnum Extended Height (Filled)** #445389
Box Size: 7.5"W x 9"H x 5.5"D **Case Pack:** 4

- Constructed from no-stretch or sag polyester and high-quality leather
- Standard Rear: for use with the 4" Center Post on the Rock™ and other similar rests
- Medium-High Rear: for use with the Fire Control® Front Rest and other similar rests
- Magnum Extended Rear Bag: for use with extended height shooting rests
- Unfilled bags should be filled with dry silica sand or other inert fillers



A. Approx. weight 2.5lbs



B. Approx. weight 4.25lbs



C. Approx. weight 7.37lbs

NEW STABLE TABLE® LITE #1084745

Box Size: 40"W x 7.75"H x 38"D Case Pack: 1

- Lightweight, weighs less than 30lbs
- Fully collapsible, easy transportation and storage
- Molded carry handles in tabletop
- Ambidextrous seat pivots around rear table leg
- All-weather tabletop and seat
- Supports up to 250 lbs
- Rotating table, coupled with table depth adjustment, for maximum shooting comfort

Patent Pending



Leg height: 32"



**WEIGHS LESS
THAN 30LBS!**

Legs and seat collapse into a compact footprint for easy transport



36"

7.5"

STABLE TABLE® DELUXE SHOOTING BENCH #252552**Box Size:** 34.7"W x 23.4"H x 7"D **Case Pack:** 1

- Stable design with fewer folding joints than other shooting benches
- Pivoting central shaft, seat and tabletop
- Weather-resistant tabletop surface 34" x 23"
- Quick-release pin adjusts padded seat from 16"– 22" in height
- Welded steel construction
- Quick-release pin breaks down into (7) pieces for easy storage
- Supports up to 275lbs

INCLUDES

- (2) cleaning forks (for forends and buttstocks)



Cleaning forks

**STABLE TABLE®****STABLE TABLE® CARRY BAG #777810****Display Size:** 13"W x 17.5"H x 3.5"D **Case Pack:** 1

- Made for the Caldwell® Stable Table®
- Full wraparound shoulder straps
- Heavy-duty construction with double layer fabric and padded lower portion
- Inner bag for the table hub included



▲ BR PIVOT[®] PREMIUM SHOOTING BENCH #300015

Box Size: 47"W x 8"H x 31"D Case Pack: 1

- Ambidextrous
- Stable design with fewer folding joints than other shooting benches
- Pivoting lightweight aluminum central shaft
- Hardwood maple top pivots 360° independently
- Weatherproof tabletop surface 45" x 26"
- Oversized plush seat with quick-release adjusts from 16"– 27" in height
- Quick-release pin breaks down into (4) pieces for easy storage
- Welded steel construction
- Supports up to 250lbs

Caldwell[®] CUSTOM PRODUCT*



MOUNTS FOR
LEFT-HANDERS!

BR PIVOT[®]
SHOOTING BENCH



Ultimate Versatility
The tabletop rotates both
independently and unified
with the seat



Up to 5" vertical adjustment
on each table leg

▲ CROSSWIND™ PROFESSIONAL WIND METER #112500**Clam Size:** 7.5"W x 8"H x 1.5"D **Case Pack:** 4

- Measures wind speed in mph, ft/min, km/h, m/s or knots
- Measures max wind gust, average wind speed and current wind speed
- Measures/calculates temperature, station pressure, barometric pressure, altitude, density altitude and wind chill
- Anemometer head rotates 90° to calculate the applied crosswind
- Features a data hold function
- Water-resistant
- LCD backlight
- Auto OFF

INCLUDES

- Carry holster
- (1) CR2032 battery

90°
ROTATING
HEAD**▲ WIND WIZARD II™ #102579****Clam Size:** 7.5"W x 8"H x 1.5"D **Case Pack:** 4

- Measures wind speed in mph, ft/min, km/h, m/s or knots
- Temperature display in Celsius and Fahrenheit
- Non-slip protective rubber sleeve
- Wind chill display
- LCD backlight
- Auto OFF

INCLUDES

- Carry holster
- (1) CR2032 battery

**WIND WIZARD II™**



↓ **DOWNLOAD THE FREE APP!**

See the velocity of each shot on screen and record other data identifying the load and environmental conditions. The app automatically calculates average velocity, standard deviation, minimum velocity spread and maximum velocity spread for the shot string.

Ballistic Precision CHRONOGRAPH

The Ballistic Precision Chronograph (B.P.C.) provides accurate velocity measurements across a wide range of shooting conditions. The Chrono can deliver shot string velocity data through the 15ft audio jack cable (*included*) to an iPhone®, iPad®, iPod Touch®, Android® 2.1 or newer smart phones and Kindle® Fire Tablets.

▲ **BALLISTIC PRECISION CHRONOGRAPH** #720001

Box Size: 9.75"W x 21.5"H x 4.75"D **Case Pack:** 4

- Each unit factory calibrated within +/- 0.25% accuracy
- Ideal for firearms, archery, airgun and paintball
- Measures Meters per Second (MPS) or Feet per Second (FPS)
- Measures from 5 to 9,999 FPS
- Wide sun screens for increased readability in full sun
- Operates on a 9 Volt battery (*not included*)



• Large LCD display

SMART PHONE NOT INCLUDED

▲ **B.P.C. LIGHT KIT** #110142

Box Size: 9.75"W x 21.5"H x 4.75"D **Case Pack:** 4

- Ensures reliable readings in poor light conditions
- 120 VAC or 4-AA batteries powered (*not included*)
- Easy installs in place of sunshade
- 16 high-output LEDs in each light strip



▲ **B.P.C. PREMIUM KIT** #721122

Box Size: 9.75"W x 21.5"H x 4.75"D **Case Pack:** 2

PREMIUM KIT INCLUDES

- Ballistic Precision Chronograph
- B.P.C. Light Kit
- Tripod (15"–42" height adjustment)
- ¼-20 dovetail mounting plate
- Y-splitter
- Rechargeable battery pack
- 15ft power cord
- Custom Kit-carry case



! BALLISTIC PRECISION CHRONOGRAPH G2 #720002**Box Size:** 21.75"W x 9.75"H x 6.5"D **Case Pack:** 2

- 18" sensor spacing for maximum accuracy
- Each unit factory calibrated to within +/- 0.25% accuracy
- Ideal for firearms, archery, airgun and paintball
- Powered by Li-ion rechargeable battery
- 3-hour runtime with lights; 12-hour runtime without lights
- Measures Meters per Second (MPS) or Feet per Second (FPS)
- Text or email velocity, log data, notes, weather conditions
- Measures from 5 to 9,999 FPS
- Bluetooth® compatible 

INCLUDES

- Tripod (up to 42" height adjustment)
- Rechargeable Li-ion battery
- 120/220v compatible charger
- Custom carry case for entire system



**GREAT FOR
INDOORS &
OUTDOORS**

CHRONOGRAPH G2



Built-in lights for indoor/low-light use

! OPTIC ARMOR SCOPE COVERS

Large | #110036

XL | #110037

Clam Size: 5"W x 7.5"H x 1.65"D **Case Pack:** 6

- Large fits most scopes up to 3-12x, 42mm objective
- XL fits most scopes up to 6-24x, 50mm objective
- Built in scope lens cloth and storage pocket



**STRETCHABLE,
THICK NEOPRENE
MATERIAL**

! BRASS RETRIEVER #125789

Box Size: 22"W x 8"H x 5.8"D **Case Pack:** 4

- Works on virtually any ground surface (i.e. grass, gravel, concrete)
- Telescoping handle expands from 28"–57" tall



! FAST CASE GUN COVER #110039

Display Size: 7"W x 10"H x 3.5"D **Case Pack:** 6

- Durable fabric withstands abrasion and tough use
- Water resistant PVC-lined fabric
- Fits rifles or shotguns from 40"–54" in length
- Folds up compact for storage



! HP NEO SLING #156218

Display Size: 5.75"W x 17.25"H x 1"D **Case Pack:** 6

- Ergonomic neoprene construction
- Stretchable
- 20"–42" adjustable length
- 2.25" strap to distribute weight of the firearm



**METAL SLING
SWIVELS INCLUDED
WITH ALL SLINGS**



! MAX GRIP SLINGS

Black | #156219

Flat Dark Earth | #156214

Display Size: 5.75"W x 17.25"H x 1"D **Case Pack:** 6

- Ergonomic overmolded design
- Max Grip ensures secure and comfortable gun carry
- Includes quick-detach metal sling swivels
- 20"–41" adjustable length
- 2.75" strap to distribute weight of the firearm





▲ MAG SHIELD #300010

Clam Size: 8.9"W x 11.6"H x 1.5"D **Case Pack:** 6

Weight: 4oz

- Soft leather front and back provides ample friction to keep gun locked into the shield and the shield locked into the shoulder
- Ambidextrous
- 1/2" thick energy-absorbing pad
- Approx. 20 cubic inches of coverage



▲ MAG SHIELD PLUS #310010

Clam Size: 8.9"W x 11.6"H x 1.5"D **Case Pack:** 6

Weight: 6oz

- Soft leather front and back provides ample friction to keep gun locked into the shield and the shield locked into the shoulder
- Ambidextrous
- 1/2" thick heart shaped energy-absorbing pad
- Approx. 32 cubic inches of coverage



▲ SUPER MAG SHIELD PLUS #330110

Clam Size: 8.9"W x 11.6"H x 1.5"D **Case Pack:** 6

Weight: 10oz

- Soft leather front and back provides ample friction to keep gun locked into the shield and the shield locked into the shoulder
- Highest protection level of any PAST Shield
- Ambidextrous
- 1" thick heart shaped energy-absorbing pad
- Approx. 40 cubic inches of coverage



▲ FIELD SHIELD #350010

Clam Size: 8.9"W x 11.6"H x 1.5"D **Case Pack:** 6

Weight: 4oz

- Soft leather front and back provides ample friction to keep gun locked into the shield and the shield locked into the shoulder
- Perfect choice for shotgun use or use in the field
- Ambidextrous
- 1/4" thick energy-absorbing pad
- Approx. 37 cubic inches of coverage



▲ HIDDEN COMFORT RECOIL SHIELD #360000

Clam Size: 8.9"W x 11.6"H x 1.5"D **Case Pack:** 6

Weight: 2oz

- Comfortable cotton-blend cover easily attaches to bra strap without removing the blouse or shirt
- Secures with hook & loop closure system
- Ambidextrous
- 1/4" thick energy-absorbing pad
- Approx. 30 cubic inches of coverage



⚠ MAG CHARGER® AR-15 #397488

Clam Size: 11.25"W x 12.5"H x 4.75"D **Case Pack:** 4

- Accepts (50) rnds of .223, 5.56, .204 or 300 AAC Blackout loaded ammo
- Transfers ammo directly from AR-15 Mag Charger® Ammo Box
- Loads (5) rnds per "stroke" with auto advance
- Compatible with all AR platform mags
- Durable polycarbonate construction

PATENTED



COMPATIBLE WITH:

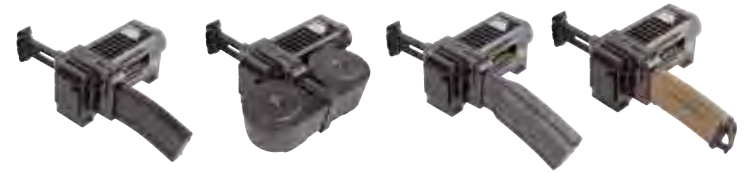

BETA, 60rnd, 30rnd, 20rnd, 10rnd, 50rnd ammo box



300 AAC Blackout, .204 Ruger®, .223/5.56 NATO

⚠ MAG CHARGER® AK #397599

Clam Size: 13.5"W x 15.5"H x 4.375"D **Case Pack:** 4

- Accepts (50) rnds of 7.62 x 39
- Transfers ammo directly from AK Mag Charger® Ammo Box
- Loads (5) rnds per "stroke"
- Durable polycarbonate construction
- Compatible with all AK platform mags

PATENTED



COMPATIBLE WITH:



AK Drum



7.62 x 39

⚠ MAG CHARGER® TAC 30 #397493

Clam Size: 12"W x 11.6"H x 4.85"D **Case Pack:** 4

- Accepts (30) rnds of .223/5.56 NATO, or .204 Ruger®
- Accepts up to (3) 10-round stripper clips
- Transfers ammo directly from a 20 round box, a stripper clip or using the included Stripper Rail
- Loads (10) rnds per "stroke"
- Durable polycarbonate construction
- Compatible with all AR platform mags

PATENTED



COMPATIBLE WITH:



BETA, 60rnd, 30rnd, 20rnd, 10rnd, Stripper Clip, 20rnd ammo box



.223/5.56 NATO, .204 Ruger®



⚠ MAG CHARGER® UNIVERSAL PISTOL LOADER #110002

Clam Size: 7"W x 9"H x 2"D Case Pack: 4

- Universal magazine design compatible with both single-stack and double-stack magazines
- Accepts 9mm, 10mm, .357 Sig, .40 S&W and .45 cal
- Durable polycarbonate construction

COMPATIBLE WITH:

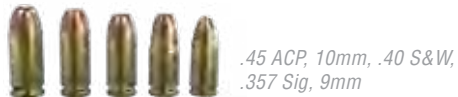

Double stack extended, large single stack, large double stack, small double stack, small single stack and compact

Adjustable side shims align magazines of any width



EASY TO USE!

Drop one round into the charger and squeeze the hand grip to load it into the magazine

Ergonomic die-cast aluminum handle for easy use and "no flex" operation

**2X
FASTER**
HALF AS MUCH FORCE
THAN LOADING BY HAND

⚠ AK MAG CHARGER® AMMO BOX—7.62X39 (5-PACK) #397480

Box Size: 7.5"W x 12.75"H x 3.75"D Case Pack: 6

⚠ AR-15 MAG CHARGER® AMMO BOX—.223/.204 (5-PACK) #397623

Box Size: 6.772"W x 12.52"H x 3.268 Case Pack: 6

- **AK Mag Charger®** holds (50) rnds of 7.62 x 39 per box
- **AR-15 Mag Charger®** holds (50) rnds of .223, 5.56 x 45, .204 and 300 AAC Blackout per box
- Lid is removable and nests with the bottom cavity

AMMO BOXES
COME IN
5-PACKS



NEW UNIVERSAL BRASS CATCHER S.A. #110038

Box Size: 6.7"W x 8"H x 3.9"D **Case Pack:** 4

- Swing-open design allows for convenient chamber access
- Universal double hook & loop attachment for use on bolt-action and semi-automatic rifles
- Internal cage design maintains bag shape
- Heat-resistant mesh bag
- Zippered bottom for easy brass removal
- 100rnd capacity (.223 cal)

Patent Pending



BRASS TRAP #122560

Box Size: 6.75"W x 19.75"H x 2"D **Case Pack:** 4

- Use on benchtop or mount to any tripod with a 1/4-20 male threaded stud (tripod not included)
- Bottom of mesh bag unzips for easy empty
- Heat-resistant mesh
- Collapses into storage bag (*included*)



Brass Trap collapses small enough to fit in most range bags



A. PIC RAIL BRASS CATCHER #530143

Clam Size: 7"W x 9.85"H x 3.5"D Case Pack: 4

B. PIC RAIL SPARE MOUNT #123904

Clam Size: 3.3"W x 5.25"H x 1"D Case Pack: 2

- Mounts to any Picatinny rail hand guard with aluminum clamp
- Also compatible with most AR-10/LR-308 models
- Bottom of mesh bag unzips for easy empty
- Internal wire frame maintains bag shape
- Heat-resistant mesh bag
- 100rnd capacity (.223 cal)



B.

**A. AR-15 BRASS CATCHER #122231**

Clam Size: 6"W x 10.125"H x 1.875"D Case Pack: 4

- Adjustable hook & loop closure attaches to most any AR-15
- Adjustable wire frame forms to most forends
- Bottom of mesh bag unzips for easy empty
- Internal wire frame maintains bag shape
- Heat-resistant mesh bag
- 30rnd capacity (.223 cal)



AR MODULAR DUAL POINT SLING KIT #156216

Clam Size: 5.5"W x 15.5"H x 4.375"D Case Pack: 6

- Use as a single-point sling or detach second spring-loaded carabiner and set up as a standard dual-point sling
- AR Receiver End Plate included
 - Ambidextrous
 - Solid steel plate
 - Made in the U.S.A.

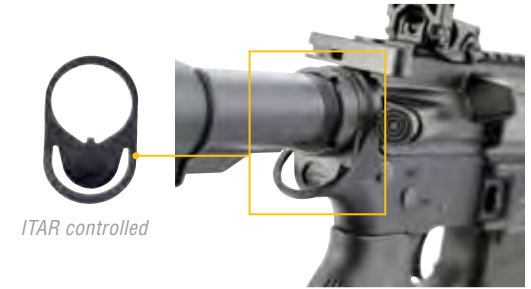
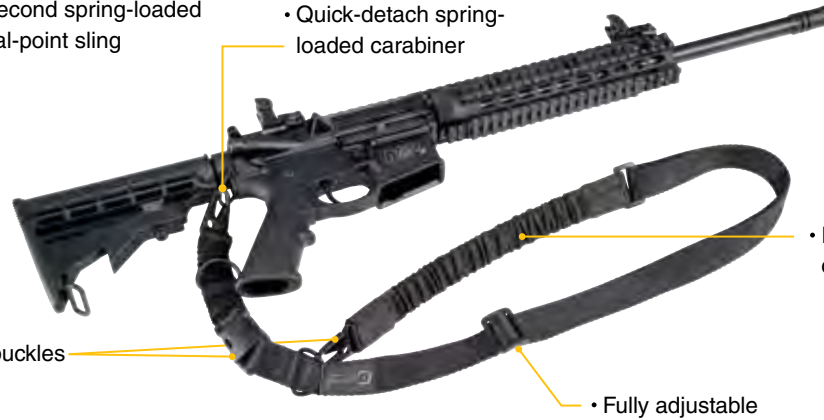

• Flexible high-density bungee cord with nylon shell

SINGLE POINT TACTICAL SLING KITS

● Black | #156215

● Flat Dark Earth | #390662

Clam Size: 4.75"W x 13.75"H x 3"D Case Pack: 4

- AR Receiver End Plate included
 - Ambidextrous
 - Solid steel plate
 - Made in the U.S.A.

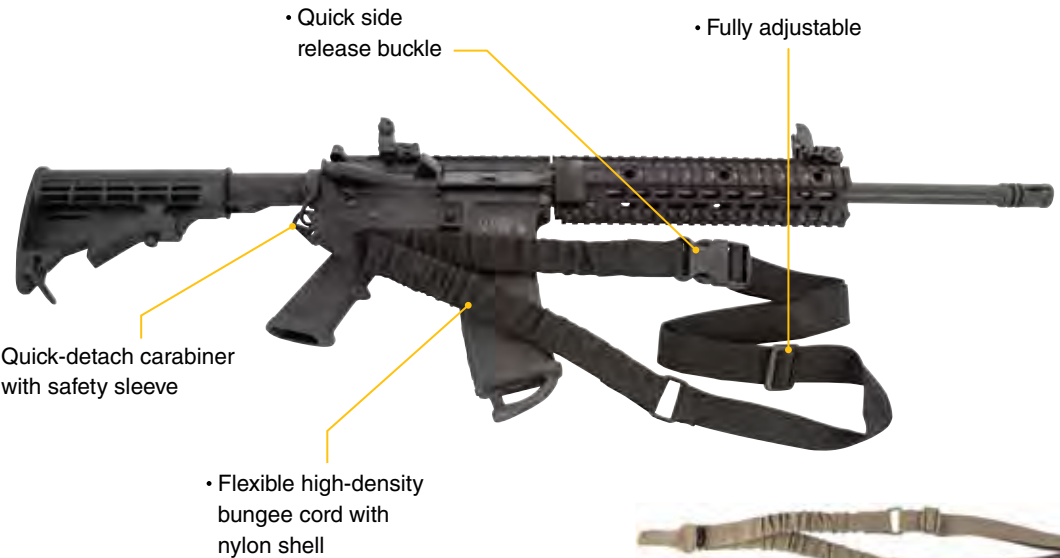

AR Receiver End Plate ONLY | #390501

Clam Size: 3.5"W x 5.5"H x 1.5"D Case Pack: 6

- Ambidextrous
- Solid steel plate
- Made in the U.S.A.



ITAR controlled



Available in Flat Dark Earth

▲ ACCUMAX® AR-15 BARREL COOLER #390247

Clam Size: 5.7"W x 12.5"H x 4"D Case Pack: 4

- Fits any Mil-spec AR-15 by locking into the mag well
- High pressure fan with dual motor bearings for extended life
- Powered by 12v Li-ion rechargeable battery (20v wall charger included)
- 3-4hr run time per charge



AccuMax
AR BARREL COOLER
▲ AR-15 MAG COUPLER (2-PACK) #390504

Clam Size: 5.7"W x 12.5"H x 4"D Case Pack: 4

- Easily couples 2 Mil-spec style 10-round AR-15 magazines with no additional weight
- Holds magazines end-to-end to maintain shape of 30-round mag

INCLUDES

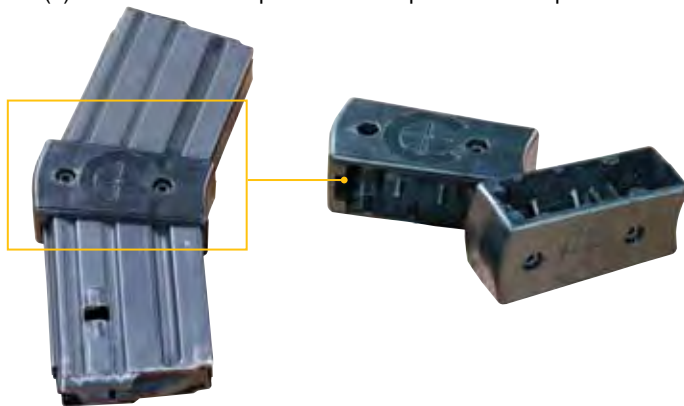
- (2) couplers to couple a total of 4 magazines
- (2) dust covers to keep dust out and protect bullet tips

**▲ AR DEADSHOT® TACTICAL BAG SET #934693**

Box Size: 13.25"W x 9"H x 5.25"D Case Pack: 4

- Stable shooting platform for all AR-15 and AR LR/10 Variant style rifles and tactical bolt-action rifles
- Plenty of clearance for 30-round magazines
- Heavy-duty ballistic nylon fabric
- Pre-filled

Rear bag accommodates fixed & adjustable stocks

▲ NEW ACCUMAX™ PREMIUM BIPOD
COMPATIBLE WITH M-LOK® / KEYMOD

6"–9" | #1081953

Clam Size: 3"W x 8"H x 2"D **Case Pack:** 6

9"–13" | #1082223

Clam Size: 3"W x 10.75"H x 2"D **Case Pack:** 6

- M-LOK® and KeyMod adapter for easy and secure lock-up
- Quick-deployment carbon fiber legs with vertical twist-lock technology
- Leg angle adjustment up to 180° with stainless steel push-button leg lock
- Soft rubber feet for enhanced stability



▲ NEW ACCUMAX™ PREMIUM PIC RAIL BIPOD

6"–9" | #1081952

Clam Size: 2.75"W x 7.25"H x 2"D **Case Pack:** 6

9"–13" | #1082222

Clam Size: 2.75"W x 10.25"H x 2"D **Case Pack:** 6

- Picatinny rail attachment for easy and secure lock-up
- Quick-deployment carbon fiber legs with vertical twist-lock technology
- Leg angle adjustment up to 180° with stainless steel push-button leg lock
- Soft rubber feet for enhanced stability



NEW XLA BIPOD®
COMPATIBLE WITH M-LOK® / KEYMOD



6"–9" | #1081950

Clam Size: 3.25"W x 8.75"H x 2.3"D **Case Pack:** 6

9"–13" | #1081951

Clam Size: 3.25"W x 10.75"H x 2.3"D **Case Pack:** 6

- Lowest profile bipod mount available
- M-LOK® and KeyMod adapter for use on polymer hand guards
- Lightweight and sturdy aluminum construction
- Quick-deployment legs extend to shooting position with the touch of a button
- Legs are notched for easy indexing to a specific height
- Twist-lock technology for locking legs between notches
- Soft rubber feet provide enhanced stability



Bipod weight (without gun):

6"–9" model, 8oz

9"–13" model, 9oz

KeyMod adapter

M-LOK® adapter



PIC RAIL XLA BIPOD® — FIXED

6"–9" | #110140

9"–13" | #110141

Clam Size: 5.25W" x 9.2"H x 1.8"D **Case Pack:** 6

- Lightweight aluminum design
- Adjustable leg height for the perfect positioning
- Soft rubber feet for enhanced stability
- Collapsible for transport



XLA BIPOD[®]

6"–9" (Black)	Fixed	#379852	9oz
6"–9" (Black)	Pivot	#247142	12oz
9"–13" (Black)	Fixed	#403215	11oz
9"–13" (Black)	Pivot	#571429	13oz
9"–13" (Camo)	Pivot	#445033	13oz
13"–23" (Black)	Fixed	#591336	14oz
13"–23" (Black)	Pivot	#701417	16oz
13.5"–27" (Black)	Pivot	#635705	19oz
13.5"–27" (Camo)	Pivot	#445088	19oz
6"–13" Clam Size: 5.8"W x 11.8"H x 2.4"D	Case Pack: 6		
13"–27" Clam Size: 5.8"W x 18.3"H x 2.4"D	Case Pack: 6		

LIGHTWEIGHT ALUMINUM DESIGN



- Legs instantly spring out with the touch of a button
- Legs collapse forward for transport
- Non-slip rubber feet for enhanced stability
- Padded base protects firearm forend

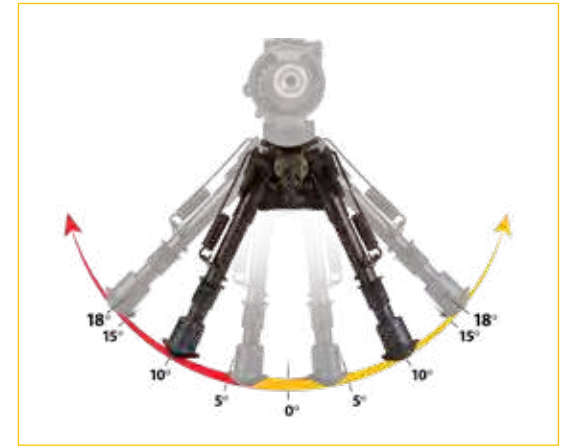

Pivot models allow up to 18° directional cant left or right

SHOOTING BIPOD

Prone Model, 8.75"–12" #457855	10.5oz
Clam Size: 4.75"W x 15"H x 2.3"D	Case Pack: 4
Sitting Model, 14"–30" #335235	15oz
Clam Size: 6"W x 22.2"H x 2.3"D	Case Pack: 4

UP TO 20° PAN LEFT OR RIGHT



- Easily attachable and detachable from the front swivel stud
- Lightweight aluminum design for quiet, weatherproof performance
- Built-in swivel pan feature left or right 20° combined with an 18° bi-directional cant
- Stud for sling attachment

⚠ AR BIPODS

- **Prone Model, 7.5”–10” (Black)** | #531123
- **Prone Model, 7.5”–10” (Desert Tan)** | #534455
Clam Size: 4.75”W x 13.75”H x 3”D Case Pack: 4
- **Sitting Model, 14.5”–30.5” (Black)** | #532255
Clam Size: 4.75”W x 22”H x 3”D Case Pack: 4

- Quickly attaches/detaches to any pic rail
- Lightweight and durable anodized aluminum construction
- Non-slip rubber feet for enhanced stability



⚠ PIC RAIL ADAPTER PLATE #156716

Clam Size: 3.75”W x 7.4”H x 1.25”D Case Pack: 6

- Simultaneously utilizes shoulder sling and a pic rail mounted accessory
- Adjustable tension and vertical angle



⚠ BIPOD ADAPTER FOR PICATINNY RAIL #535423

Clam Size: 3.75”W x 7.25”H x 1.5”D Case Pack: 6

- Attach any traditional bipod or sling to a Picatinny rail
- Lightweight, durable machined aluminum construction
- (2) integrated fasteners for secure attachment



⚠ BIPOD PIVOT LOCK #535881

Clam Size: 3.25”W x 5.5”H x 1”D Case Pack: 6

- Works on all Caldwell® XLA® Bipod Pivot models
- Spring loaded “pull out” for easy handle positioning
- Second adapter for SAE #10-32 threaded external spring bipods



“C” identifies the Caldwell adapter from the SAE adapter

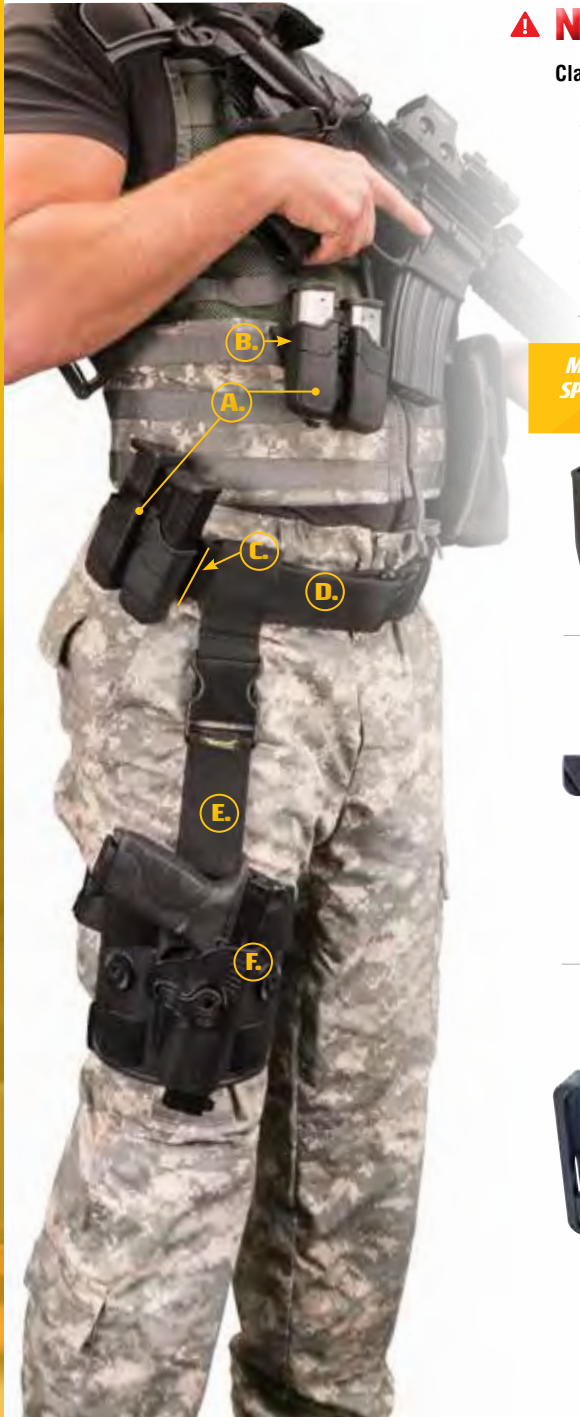

NEW TAC OPS BELLY BAND HOLSTER #1082698

Clam Size: 5.5"W x 6.5"H x 2.25"D Case Pack: 6

- High quality, moisture-wicking material for maximum breathability
- Wide elastic pockets
- Slide protection tabs keep firearms away from the skin
- Holds firearms, flashlights, lasers or cell phones



FITS UP TO 40"
DIAMETER

WASHABLE!

7.85"



MODEL
SPECIFIC
FIT!

A. Magazine Holster

- (2) friction fit magazine holsters
- Wide contoured paddle style clip
- Bottom paddle clip retention posts
- Holster can be removed and added to the M.O.L.L.E. or Belt Clip attachments



D. Duty Belts

- 2" wide synthetic material
- Hook & loop for full adjustability
- 2 sliding keepers on each end of belt keep folded hook & loop end secure
- Full-width dual side lock buckle



B. M.O.L.L.E. Attachment

- Clip attaches to standard M.O.L.L.E. strapping at (3) points, securing holster
- Attach holster or magazine rig to the M.O.L.L.E. clip



E. Drop Leg Rig

- Quick-detach dual side-release buckle removes rig without removing belt
- (2) elastic adjustable thigh straps with dual side release buckle clips
- (3) separate rotating attachment points for holsters, magazine pouches, etc.
- Rigid polymer platform stays secure to leg



MODEL
SPECIFIC
FIT!

C. Belt Clip Attachment

- An internal adjusting bar has 2 Allen screws to secure width
- Rotating attachment point for affixing holsters or magazine holsters
- The Duty Belt Clip can accommodate belts up to 3/8" thick
- Adjustable, fits belt widths from 1.25"-2.5"



F. Molded Retention Holster

- Model specific poly for secure fit
- Bottom paddle clip retention posts
- Index finger holster lock
- Non-slip rubber pad on back of paddle
- Included Allen wrench for quick adjustment
- Holster can be removed and added to the M.O.L.L.E. or Belt Clip attachments





! G. Universal Holster

- Semi-rigid nylon construction keeps holster shape even when empty
- Extra magazine pouch with hook & loop closure
- Wide hook & loop strap secures holster to a belt or M.O.L.L.E. strap
- Accepts medium framed semi-autos and revolvers
- Adjustable retention strap



! H. Covert IWB Holster

- Smooth inside lining for quick and easy draw
- Robust yet flexible hanging clip accommodates belts up to 2" wide
- Hanging clip is sewn into holster
- Foam layer protects handgun from sweat and moisture
- Ultra thin 3-layer soft PU laminate hugs handgun and provides comfortable wear

Semi-auto & Revolver holsters are shaped differently

A. MAGAZINE HOLSTERS

All Magazine Holsters are ambidextrous

- Glock® #110071
- Taurus® 24/7 #110072
- Taurus® PT800 (B92) #110073
- 1911 #110074

All Caldwell® TAC OPS are a Case Pack of 6

B. M.O.L.L.E. Attachment #110086

C. Belt Clip #110087

All Caldwell® TAC OPS are a Case Pack of 6

D. DUTY BELTS

All Duty Belts are ambidextrous

- Small (28"-36" waist) #110088
- Medium (34"-42" waist) #110089
- Large (40"-48" waist) #110090
- XL (48"-56" waist) #110091

All Caldwell® TAC OPS are a Case Pack of 6

E. Tac Ops Drop Leg Rig #110085

All Caldwell® TAC OPS are a Case Pack of 6

F. MOLDED RETENTION HOLSTERS

All Molded Retention Holsters are right-handed

- Glock® 19 (fits 19, 23, 32) #110053
- Glock® 17 (fits 22, 31) #110054
- Glock® 26 (fits 27, 33) #110055
- Glock® 34 #110056
- Glock® 42 #110057
- S&W® M&P® Shield #110058
- S&W® M&P® 9mm #110059
- S&W® M&P® Compact #110060
- S&W® Bodyguard® 380 #110061
- S&W® J Frame Revolver #110062
- Taurus® 24/7 #110063
- Taurus® PT800 #110064
- Beretta 92 #110065
- M1911 #110066
- 1911 3" #110067
- Sig Sauer® P22G #110068
- Ruger® LC9® #110069
- Ruger LCP® #110069

All Caldwell® TAC OPS are a Case Pack of 6

G. UNIVERSAL HOLSTER

Universal Holster is right-handed

- Medium Frame Semi-autos #110075

All Caldwell® TAC OPS are a Case Pack of 6

H. COVERT IWB HOLSTERS

All Covert IWB Holsters are right-handed

- 2" Revolvers #110076
- 3.25"-3.75" Semi-autos #110077
- Sub-compact Semi-autos #110078
- 3.75"-4.5" Semi-autos #110079
- 2"-3" Revolvers #110080
- 4" Revolvers #110081
- 3"-4" Semi-autos #110082
- .22-.25cal Semi-autos #110083
- 4.5"-5" Semi-autos #110084

All Caldwell® TAC OPS are a Case Pack of 6



▲ DEADSHOT® FIELDPOD® #488000

Box Size: 24.25"W x 7"H x 6.25"D **Case Pack:** 4

- Supports shotguns, rifles and crossbows
- Portable, collapses quickly for transportation
- Overmolded, non-marring front and rear supports
- Lightweight, durable aluminum construction
- Vertical adjustment from 20"–42"



**WEIGHS LESS
THAN 6 LBS!**



DeadShot
FieldPod

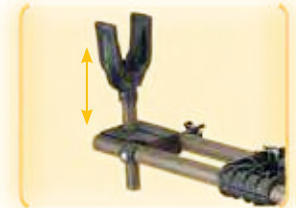

Independent height adjustable front & rear supports



Dual tube frame is fully compatible with detachable magazine rifles



Extends fully to 42"



Folds compact for easy transport, detachable carry strap included

⚠ DEADSHOT® FIELDPOD® MAX #488029

Box Size: 28.5"W x 7"H x 6.25"D **Case Pack:** 4

- Supports shotguns, rifles and crossbows
- Vertical adjustment from 20"–48"
- Independent leg adjustment
- Bubble-level for upper frame
- Ultra-stable, dual-frame aluminum construction



PERFECT FOR CHAIR SHOOTERS



Screw out spike feet

Weight: approx. 5lbs



Cast aluminum hub design with built in bubble-level



Dual tube frame compatible with detachable magazine rifles



Quickly folds compact for easy transport

⚠ DEADSHOT® FIELDPOD® MAGNUM #488111

Box Size: 39"W x 7.75"H x 7"D **Case Pack:** 2

- Supports shotguns, rifles and crossbows
- Vertical adjustment from 20"–60"
- Independent leg adjustment
- Bubble-level for upper frame
- Ultra-stable, dual-frame aluminum construction



360° ROTATION



Spiked all terrain feet gives purchase on any surface

Collapses down to 30" long
Weight: approx. 13lbs

⚠ DEADSHOT® CHAIRPOD™ #795234

Box Size: 24.5"W x 16.5"H x 8"D **Case Pack:** 2

- Supports shotguns, rifles and crossbows
- Swing-arm system and 360° chair allows for maximum range of movement
- Up to 41" vertical adjustment
- Overmolded, non-marring front and rear supports
- Great for hunting from ground blinds, field edges or shooting at the range
- Durable steel-frame construction
- Supports up to 300 lbs

• Integrated shoulder straps for easy carry



Weight: approx. 22lbs

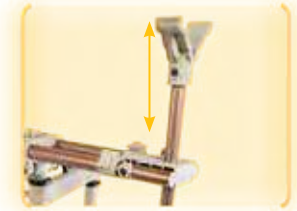

Independent height adjustable front & rear supports



180° panning with 360° rotation



Dual tube frame compatible with detachable magazine rifles



Wide-format polymer feet

DEADSHOT® TREEPOD™ #484148

Box Size: 23.75"W x 12.5"H x 6.5"D **Case Pack:** 2

- Fully supports shotguns, rifles and crossbows
- Keeps gun in the ready position while freeing up hands
- Anodized aluminum and powder-coated steel construction
- Overmolded, non-marring rear and front rests
- Safety gun retention strap included
- Upper frame and swing-arm easily detach for compact transport



Ample vertical tilt for the toughest shots



180° horizontal panning ability

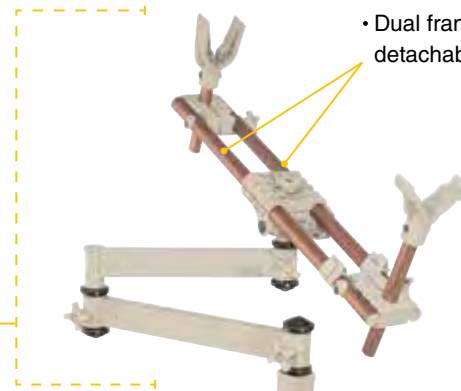

• Dual frame compatible with detachable magazine rifles

• Tension knob for center height adjustment

• Universal mounting plate

Weights approx. 15lbs



DEADSHOT® TREEPOD™ ADD-A-BASE #785468

Box Size: 21"W x 9"H x 6.5"D **Case Pack:** 4

- Mount to almost any tree stand
- Constructed of powder coated steel
- Use multiple bases on different stands

INCLUDES

- (1) base mount
- (1) upper post
- (1) base plate
- (5) bolts
- (5) wing nuts



Height: approx. 31"-47" (with Upper)
Base Plate Size: 6" x 8.5"
Weight: approx. 8.1lbs

ADD-A-BASE TO ALMOST ANY STAND





E-MAX[®] Low Profile

E-MAX[®] LOW PROFILE #487557

Clam Size: 9"W x 10"H x 4"D Case Pack: 6



- Dual microphones
- LED 'ON' indicator
- Padded, adjustable headband
- Cushioned foam ear cups
- Uses 2 AAA batteries (*not included*)



E-MAX[®] Low Profile PINK

E-MAX[®] LOW PROFILE #487111

Clam Size: 9"W x 10"H x 4"D Case Pack: 6



- Dual microphones
- LED 'ON' indicator
- Padded, adjustable headband
- Cushioned foam ear cups
- Uses 2 AAA batteries (*not included*)



E-MAX[®] Low Profile BREAK-UP COUNTRY MOSSY OAK

E-MAX[®] LOW PROFILE #487200

Clam Size: 9"W x 10"H x 4"D Case Pack: 6



- Dual microphones
- LED 'ON' indicator
- Padded, adjustable headband
- Cushioned foam ear cups
- Uses 2 AAA batteries (*not included*)



E-MAX

E-MAX® #497700

Clam Size: 9"W x 10"H x 4"D Case Pack: 6



- Dual microphones
- LED 'ON' indicator
- Padded, adjustable headband
- Cushioned foam ear cups
- Uses 2 AAA batteries (not included)



E-MAX BTH
BEHIND-THE-HEAD

E-MAX® BTH #487605

Clam Size: 9.25"W x 11"H x 5.5"D Case Pack: 6



- Dual microphones
- LED 'ON' indicator
- Padded, adjustable headband
- Cushioned foam ear cups
- Uses 2 AAA batteries (not included)



Caldwell
Shooting Supplies

PASSIVE RANGE MUFFS #489204

Clam Size: 9.25"W x 11"H x 5.5"D Case Pack: 6



- Padded, adjustable headband
- Foam filled for extra protection
- Cushion foam ear cups
- Folds compact
- Ultra lightweight



Caldwell
Shooting Supplies

**LOW PROFILE
PASSIVE RANGE MUFFS** #489024

Clam Size: 6"W x 7"H x 4"D Case Pack: 6



- Padded, adjustable headband
- Foam filled for extra protection
- Cushion foam ear cups
- Folds compact
- Ultra lightweight

COMBO PACKAGE #487309

Case Pack: 6

INCLUDES

- E-Max® Low Profile Electronic Hearing Protection
- Caldwell® Pro Range Shooting Glasses
- Meets ANSI Z87.1 standards
- Adjustable nose piece and temples
- Blocks 99.9% of harmful UV rays
- Impact resistant



PRO RANGE SHOOTING GLASSES #320040

Box Size: 3.75"W x 9.25"H x 3"D Case Pack: 12

- Adjustable nose piece and temples
- Blocks 99.9% of harmful UV rays
- Impact resistant lenses
- Meets ANSI Z87.1 standards



CERTIFIED PERFORMANCE
ANSI Z87.1 STANDARD

RANGE PLUGS (10-PACK) #568231

Clam Size: 2.5"W x 4.25"H x 2.5"D Case Pack: 12



- Tapered design makes the plugs easy to insert
- Polyurethane foam makes plugs comfortable to wear
- Clips to shirts or hats



▲ ULTIMATE SHOOTING GLOVES**Small/Medium** | #1071004**Large/XL** | #1071005**Clam Size:** 5"W x 12"H x 1"D **Case Pack:** 6

- Padded palms reduces felt recoil
- Lightweight, durable material
- Elastic backing and fingers provides a custom grip for extreme dexterity
- Leather reinforcement patch protects against "slide bite"
- Touch-sensitive finger tips allow full use of smart phones

**▲ CLAY LAUNCHERS****Single Thrower** | #505501**Clam Size:** 6.5"W x 19.5"H x 1"D **Case Pack:** 6**Double Thrower** | #505502**Clam Size:** 10.5"W x 31"H x 2"D **Case Pack:** 6

- Portable and affordable hand held clay target launcher
- Works with all standard size clay targets (108-110mm)
- Launches right or left handed



Doubles thrower features 2 single throwers mounted to an adapter handle



↓ DOWNLOAD THE FREE APP!

View your shots, record video, take video stills and even record/save notes without leaving the bench. The app even has a group calculation feature that tells you the grouping size!



! LR TARGET CAMERA SYSTEM #156726

Box Size: 30"W x 9"H x 8.5"D **Case Pack:** 1

- Streams live 720p HD video up to 1 mile away
- Built-in WiFi
- System is water resistant
- Breaks down into a compact storage case for easy transport
- Integrated rechargeable Li-ion batteries for up to 10hrs of use per charge
- Features an external power jack for more permanent installation
- Compatible with Android®, iPhone®, Windows®, Kindle® and most other tablets
- Padded carry case included



Height adjustment up to 7'



TRANSMITS UP TO 1 MILE AWAY!



! 220V TARGET CAMERA SYSTEM #110269



Box Size: 30"W x 9"H x 8.5"D **Case Pack:** 1

- Streams live 720p HD video up to 600 yds away
- CE/ROHS certified
- Built-in WiFi
- System is water resistant
- Integrated rechargeable Li-ion batteries for up to 10hrs of use per charge
- Features an external power jack for more permanent installation
- Compatible with Android®, iPhone®, Windows®, Kindle® and most other tablets
- Padded carry case included



Height adjustment up to 7'



720p HD camera is infinitely positionable with the articulated camera clamp



⚠️ RESETTING METAL TARGETS

Handgun Target | #1071002

Clam Size: 12"W x 26.8"H x 1.8"D **Case Pack:** 4

.22 Rimfire Target | #902365

Clam Size: 16.8"W x 22.5"H x 1.8"D **Case Pack:** 4

Airgun Target | #820585

Clam Size: 11.5"W x 15"H x 1"D **Case Pack:** 4

- Made for up to 45 ACP, 44 Special
- 1/2" thick steel rod frames
- 3/8" thick steel metal shooting plates

Handgun Target

Target size: 3.5"



.22 Rimfire Target

Target size: 2.5"



Airgun Target

Target size: 1.5"



**AUDIBLE
& VISUAL
FEEDBACK**



Orange Shooting Spots included with all metal targets!

⚠️ PLINK 'N SWING ACTION TARGETS

Centerfire Handgun Double Spin | #133565

Box Size: 26.8"W x 12"H x 1.8"D **Case Pack:** 4

.22 Rimfire Triple Spin | #147072

Box Size: 22.5"W x 16.8"H x 1.8"D **Case Pack:** 4

- Made for up to 45 ACP, 44 Special
- 1/2" thick steel rod frames
- 3/8" thick steel metal shooting plates

**AUDIBLE
& VISUAL
FEEDBACK**





- Provides unsurpassed target durability, capable of withstanding nearly all centerfire rifle & handgun cartridges*
- Mill-certified hardness of 550 Brinell (HBW) for AR-550 and 500 Brinell for AR-500 targets
- Specialized through-hardening achieved from proprietary quenching & tempering processes
- Finely tuned & tightly controlled chemical composition produce highly reliable toughness & resistance to pitting, cracking or bending
- Designed to withstand impacts of all high power rifles and handguns
- Magnum Rifle Gong™ Systems are collapsible for easy transport

**Not recommended at 100yds ONLY: .204 Ruger, .22-.205 cal or .416 Remington Mag*

MAGNUM RIFLE GONG™

⚠ MAGNUM RIFLE GONG® #223375

Box Size: 36"W x 4"H x 12"D Case Pack: 2

⚠ (GONG ONLY) #178951

Box Size: 36"W x 4"H x 12"D Case Pack: 2

- Gong hangs 18" above the ground
- Overall size 38"W x 33"H
- Gong is 3/8" thick



MAGNUM RIFLE GONG® DUAL SPINNER

⚠ MAGNUM RIFLE GONG® DUAL SPINNER #309713

Box Size: 36"W x 4"H x 12"D Case Pack: 2

- Hardened steel rotating shaft
- (1) 4" plate and one 6" plate
- Frame made from steel tubing
- Overall size 38"W x 33"H



MAGNUM RIFLE GONG XL

⚠ MAGNUM RIFLE GONG® XL #178953

Box Size: 36"W x 4"H x 12"D Case Pack: 2

- Overall size 38"W x 33"H
- Gong is 3/8" thick



1.125" THICK MILD
STEEL SHOT WITH
.308 FMJ AT 100YDS

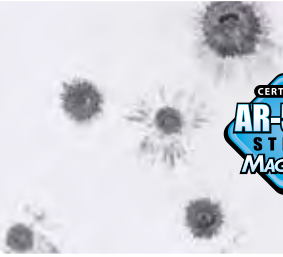

CALIBER	100 yards	200 yards	300 yards
	Velocity / Energy	Velocity / Energy	Velocity / Energy
.204 Ruger	3482 fps / 860 ft-lb	2983 fps / 631 ft-lb	2537 fps / 456 ft-lb
.223 Rem	2871 fps / 1005 ft-lb	2531 fps / 781 ft-lb	2215 fps / 598 ft-lb
.22-250	3341 fps / 1237 ft-lb	2919 fps / 945 ft-lb	2535 fps / 712 ft-lb
.300 Win Mag	2950 fps / 2894 ft-lb	2634 fps / 2308 ft-lb	2340 fps / 1812 ft-lb
.338 Win Mag	2634 fps / 3461 ft-lb	2473 fps / 3053 ft-lb	2319 fps / 2683 ft-lb
.416 Rem Mag	2188 fps / 4227 ft-lb	1987 fps / 3500 ft-lb	1797 fps / 2865 ft-lb

NOT RECOMMENDED

AR-500 SWINGER TARGET #758995

Box Size: 20"W x 4.5"H x 4.5"D Case Pack: 2

- 3/8" through-hardened AR-500 Steel rated up to .308 Winchester at 150 yards
- Extremely durable cast urethane frame connectors provide a rigid frame yet allow bullets to pass right through
- Solid steel legs and crossbar provide a rigid frame
- Legs replaceable by 1/2" re-bar, if damaged
- Highly portable for ease of use

INCLUDES

- (4) steel ground stakes



Cut length by replacing steel legs with 1/2" re-bar



Cast urethane frame connectors

18" tall

5"x 5" Diameter TARGET

MAGNUM TARGET CARRY BAG #894050

Box Size: 18.5"W x 20"H x 1.75"D Case Pack: 2

- Made for Magnum Rifle Gong®, Magnum Rifle Gong Dual Spinner®, and Magnum Rifle Gong XL®
- Heavy-duty fabric construction
- Shoulder strap for easy carry



37"W x 13"H x 25"D

▲ ULTRA PORTABLE TARGET STAND KIT #110005

Box Size: 12"W x 18"H x 2"D **Case Pack:** 6

- Ultra-portable design
- Extra large backer can hold 12" x 18" targets
- Great for sighting in or patterning
- Collapses for easy transport

INCLUDES

- Rod stand
- (8) silhouette targets
- Backer
- (8) high-contrast targets
- Clamps



▲ ULTIMATE TARGET STAND #707055

Box Size: 10.5"W x 24"H x 2"D **Case Pack:** 4

▲ REPLACEMENT BACKER (2-PACK) #707100

Case Pack: 6

- Modular frame design collapses for transport
- All-weather backer resistant to moisture and rotting
- Frame arms constructed of durable steel rod
- Frame stand made of robust thick plastic
- Removable center stabilizing rod



Built-in storage compartment



Use 2 Ultimate Target Stands to hold a 2" x 4" for target shelf



Metal spike feet secure into ground



Backer board easily holds (2) 16"x16" targets (targets sold separately)

▲ HIGH CONTRAST PAPER TARGETS

16" Blue 9 Diamond Target (10-pack).....#966893

16" Blue Target (10-pack).....#198604

16" Black & Orange Target (10-pack).....#195781

Pack Size: 16"W x 16"H x .25"D **Case Pack:** 10

- Large 16" x 16" sheets
- High visibility color to see at long ranges
- Diamond shaped targets for easy crosshair alignment
- 1" grid for simple scope adjustments
- Recycled paper construction

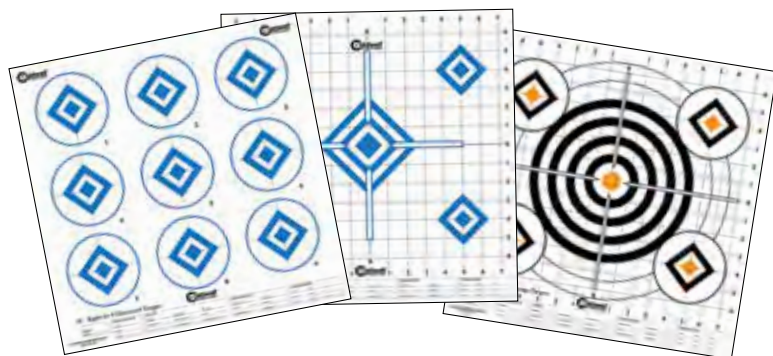

▲ "THE NATURAL SERIES" WHITETAIL DEER TARGET #234412

Box Size: 16"W x 36"H x .5"D **Case Pack:** 6

- Target features a sturdy 48" x 36" cardboard backer
- Includes two adhesive-backed replacement vital targets

**PERFECT FOR
BEGINNING
SHOOTERS**



▲ DURAMAX™ SELF-HEALING TARGETS

5" Square | #897597

5" Ball | #897602

Box Size: 5"W x 10"H x 5"D **Case Pack:** 6

- Made of ballistic polymer for maximum durability
- Targets are self-healing for repeated use
- Rated for pistols or rifles from .22 LR all the way up to 50 BMG
- Reactive targets bounce, roll, spin or flip when hit



DURAMAX
SELF HEALING TARGETS



- Adhesive-backed, sticks to any surface
- Inside black target flakes off neon yellow
- Outside black target and direct bullseye hit flakes off white



▲ ORANGE PEEL® BULLSEYE SHOOTING TARGETS

2" Bullseye Target, 10 sheets	#686444	Case Pack: 10
3" Bullseye Target, 15 sheets	#391984	Case Pack: 10
4" Bullseye Target, 5 sheets	#405515	Case Pack: 10
4" Bullseye Target, 10 sheets	#410864	Case Pack: 10
4" Bullseye Target, 25 sheets	#425824	Case Pack: 5
5.5" Bullseye Target, 10 sheets	#550010	Case Pack: 10
5.5" Bullseye Target, 50 sheets	#555050	Case Pack: 5
8" Bullseye Target, 5 sheets	#805645	Case Pack: 10
8" Bullseye Target, 10 sheets	#810894	Case Pack: 10
8" Bullseye Target, 25 sheets	#825915	Case Pack: 5
8" Bullseye Target, 100 sheets	#810099	Case Pack: 10
12" PINK Bullseye Target, 5 sheets	#317536	Case Pack: 5
12" Bullseye Target, 5 sheets	#120556	Case Pack: 5
12" Bullseye Target, 10 sheets	#121066	Case Pack: 5
12" Bullseye Target, 50 sheets	#125094	Case Pack: 5
12" Bullseye Target, 100 sheets	#121005	Case Pack: 10
16" Bullseye Target, 5 sheets	#172505	Case Pack: 5
16" Bullseye Target, 10 sheets	#172510	Case Pack: 5



PATENTED



Orange Shooting Spots included with all metal targets!

▲ ORANGE PEEL® SIGHT-IN SHOOTING TARGETS

8" Sight-In Target, 5 sheets	#522357	Case Pack: 5
12" Sight-In Target, 5 sheets	#244561	Case Pack: 5
12" Sight-In Target, 100 sheets	#861579	Case Pack: 2
16" Sight-In Target, 5 sheets	#495253	Case Pack: 5
16" Sight-In Target, 12 sheets	#492603	Case Pack: 5



PATENTED

▲ ORANGE PEEL® OVAL SHOOTING TARGETS

- 12" x 18" Sight-In Target, 5 sheets #488789 Case Pack: 10
- 12" x 18" Sight-In Target, 100 sheets #488789 Case Pack: 1

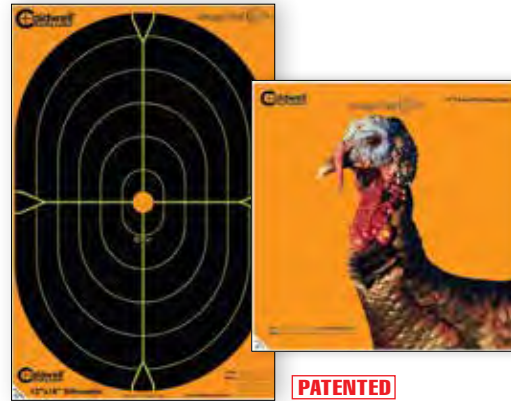

Orange Shooting Spots included with all metal targets!

▲ ORANGE PEEL® ANIMAL SHOOTING TARGETS

- 12" Turkey Target, 5 sheets #586485 Case Pack: 5

▲ SHOOTING SPOTS AND SQUARES

- 1" Shooting Spots, 12 sheets/216ct #754883 Case Pack: 10
- 1.5" Shooting Spots, 12 sheets/96ct #652710 Case Pack: 10
- 2" + 1" Shooting Spots, 12 sheets/108ct #754110 Case Pack: 10
- 3" Shooting Spots, 12 sheets/24ct #271050 Case Pack: 10
- 1" Shooting Squares, 12 sheets/216ct #711236 Case Pack: 10



▲ SILHOUETTE FLAKE OFF TARGETS

- DualZone Flake Off Target (8-pack) | #308214
- CENTER MASS Flake Off Target (8-pack) | #412803
- Size: 12"W x 18"H x .25"D Case Pack: 10
- DualZone Flake Off Target (25-pack) | #280341
- CENTER MASS Flake Off Target (25-pack) | #128034
- Size: 12"W x 18"H x 1"D Case Pack: 5

- Ideal for defensive shooting skill development
- 12" x 18" heavy card stock paper
- 2:1 size ratio (target at 5 yards represents 6' tall target at 10 yards)



Frankford
Arsenal
Reloading Tools

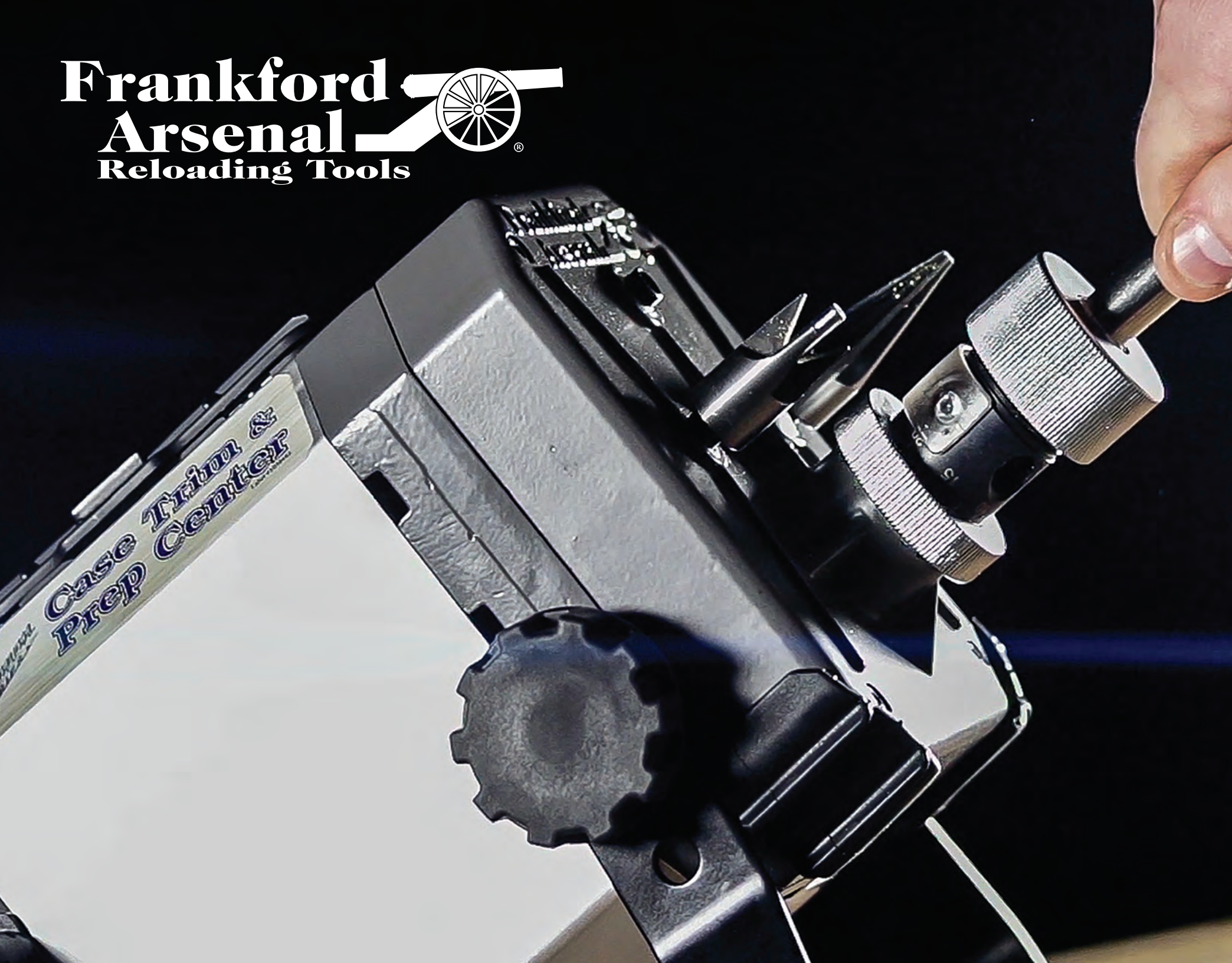



BRASS CLEANING
CASE PREP
RELOADING
STORAGE

Platinum
SERIES

⚠ ROTARY TUMBLER #909544

Package Size: 15"W x 15.75"H x 10.75"D Case Pack: 1

⚠ 230v ROTARY TUMBLER #909567



Package Size: 15"W x 15.75"H x 10.75"D Case Pack: 2

⚠ SPARE TUMBLER DRUM #909789

Package Size: 14.75"W x 9.25"H x 9.25"D Case Pack: 1

- Maintenance-free geared drivetrain
- Large 7 liter capacity (tumbles up to 1000 cases of .223 brass)
- Dual-layer drum with noise dampening rubber lining

INCLUDES

- Clear cleaning caps
- 5lbs of magnetic stainless steel media
- Frankford Arsenal® brass cleaning concentrated solution sample



CLEANS UP TO 1,000 CASES OF BRASS AT ONCE

Weight: approx. 15lbs
Dimensions: 27"L x 12"W



NEW BRASS CLEANING PACKS (24-PACK) #110040

Bag Size: 8"W x 3.5"H x 7.5"D Case Pack: 4

- Quick and effective NEW crystallized, water-soluble formula
- Works with all rotary tumblers
- Resealable bag for easy and secure storage
- Made in the U.S.A.

**1 PACK CLEANS
UP TO 500 PIECES
OF BRASS**



BRASS CLEANING SOLUTION #878787

Box Size: 3"Diameter x 10"H Case Pack: 4

PARTS CLEANING SOLUTION #898989

Box Size: 3"Diameter x 10"H Case Pack: 4

- Removes carbon buildup, tarnish and oxidation on brass and gun parts
- Good for multiple uses



3oz

⚠️ STAINLESS STEEL MEDIA PINS #909191

Box Size: 4.75"W x 1.75"H x 2.25"D Case Pack: 4

- 304 Stainless Steel
- 1mm x 7mm pin size
- Magnetic for convenient handling
- Lifetime use



⚠️ MEDIA TRANSFER MAGNET #909271

Box Size: 4.75"W x 9"H x 4.5"D Case Pack: 4

- Easy-grip handle
- 304 stainless steel
- Collects 1mm x 7mm pins



⚠ CASE TUMBLER #855020

Box Size: 10.5"W x 7"H x 10.5"D Case Pack: 1

⚠ 220v CASE TUMBLER #515667

Box Size: 10.5"W x 7"H x 10.5"D Case Pack: 1

- Holds up to 600 9mm cases or 350 .223 cases
- Use with Corn Cob or Walnut Hull media (pg. 65)



⚠ CASE TUMBLER KIT #645880

Box Size: 12.6"W x 11.8"H x 12.6"D Case Pack: 1

⚠ 220v CASE TUMBLER KIT #645880

Box Size: 12.6"W x 11.8"H x 12.6"D Case Pack: 1

INCLUDES

- Quick-N-EZ™ Case Tumbler (or 220v)
- Quick-N-EZ™ Rotary Media Separator
- 4oz brass polish
- 3lbs of cleaning media
- Plastic bucket



⚠ STANDARD MEDIA SEPARATOR #121925

Box Size: 10.5"W x 10.3"H x 6.8"D Case Pack: 4

- Perforated bottom separates media from brass
- Fits in 5gal bucket



⚠️ ROTARY SIFTER #683551

Box Size: 11.25"W x 5.25"H x 11.125"D Case Pack: 1

INCLUDES

- (2) splash fins
- (2) bucket supports



⚠️ ROTARY SIFTER KIT + 3.5 GAL BUCKET #507565

Case Pack: 1

INCLUDES

- Quick-N-EZ™ Rotary Sifter
- (2) splash fins
- Bucket lid



CLEANING AND POLISHING SUPPLIES

CORN COB MEDIA:

- 4.5 lbs in Plastic Tub** #287178 Case Pack: 6
- 7 lbs in Box** #108729 Case Pack: 1
- 15 lbs in Box** #446063 Case Pack: 1
- 15 lbs in 3.5 gal Bucket** #687756 Case Pack: 1

TREATED CORN COB MEDIA:

- 4.5 lbs in Plastic Tub** #194524 Case Pack: 6

WALNUT HULL MEDIA:

- 5 lbs in Plastic Tub** #881538 Case Pack: 6
- 18 lbs in Box** #496169 Case Pack: 1
- 18 lbs in 3.5 gal Bucket** #636314 Case Pack: 1

TREATED WALNUT HULL MEDIA:

- 5 lbs in Plastic Tub** #881538 Case Pack: 6
- 18 lbs in Box** #496169 Case Pack: 1
- 18 lbs in 3.5 gal Bucket** #636314 Case Pack: 1

BRASS POLISH:

- 4 oz Bottle** #845677 Case Pack: 6
- 8 oz Bottle** #887335 Case Pack: 6
- 32 oz Bottle** #321901 Case Pack: 6



BRASS DRYER #909213

Box Size: 13.6"W x 13.6"H x 9.85"D Case Pack: 4

- Vented trays provide the best airflow for minimal dry time
- 500watt heating unit; temperature control ranges 90°–160°F
- Dry up to 1,000 pieces of .223 brass in less than 1 hour
- (5) removable trays
- Separate and dry multiple calibers at once



220V BRASS DRYER #110123



Box Size: 13.6"W x 13.6"H x 9.85"D Case Pack: 4

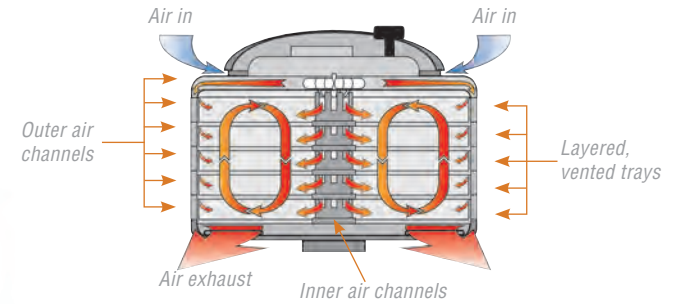

FORCED AIR CONVECTION DRYING SYSTEM

The Frankford Arsenal® Platinum Series Brass Dryer is specifically designed with vented trays, inner and outer layered air flow channels and a large 500watt Heating System to reduce drying time and maximize efficiency. Forced air convection ensures that the brass gets the maximum amount of airflow available. Air is heated to 160°F then blown through the channels and circulated throughout the trays before being exhausted out the bottom of the dryer.

WET/DRY MEDIA SEPARATOR #507567

Box Size: 13.5"W x 13"H x 8.8"D Case Pack: 2

- Ideal for both wet and dry cleaning processes
- (2) sifting handles for ambidextrous use
- Spillproof tub with durable rubber latch
- Mesh strainer for rinsing pins



NEW PRIMER POCKET SWAGER #110007



Box Size: 5.5"W x 9"H x 5.5"D Case Pack: 2

- Ergonomic upright design with adjustable-position handle
- Quick-change swage pin for large or small primer pocket use
- Benchtop mounting system
- Adjustable brass positioning to ensure a centered swaging pin
- Die-cast aluminum construction
- Auto-eject case pin holder for easy loading and unloading

Patent Pending

INCLUDES

- (1) large case holder
- (1) small case holder



Easy-to-use swing out access to insert and remove brass

Mounting wings for permanently mounting to a bench or C clamping to a bench for temporary mounting



NEW INTELLIDROPPER™ POWDER MEASURER #1082250

Box Size: 17.5"W x 10"H x 7"D Case Pack: 2

The Powder Intellidropper features individual powder calibration button for the fastest, most accurate powder measurements.

- Large back-lit LCD display with easy-to-see controls
- Stores load data in free downloadable app
- Auto and manual trickle capability
- Holds up to 7000gr (1lb) of powder
- +/- 0.1 grain accuracy
- Bluetooth capability

FREE APP TO DOWNLOAD

APP FEATURES

- Preloaded bullet and powder databases
- Preloaded cartridge list
- Preloaded powder list (Hodgdon, Alliant, etc.)
- Preloaded caliber with bullet type, weight, ballistic coefficient, sectional density and length options
- Input case, times loaded, primer, length of barrel, and more!



NEW CASE PREP CENTER #1077094

Box Size: 6.7"W x 5"H x 6.5"D Case Pack: 2

Platinum
SERIES

- (4) powered tool stations
- Hardened High Speed Steel (HSS) tools stay sharp for thousands of rounds
- 8-32 threaded output shafts accept a wide variety of aftermarket case prep tools
- 200 RPM output shafts prep brass quickly and efficiently
- Durable aluminum design

INCLUDES

- Inside chamfer tool
- Outside deburring tool
- Small primer pocket scraper
- Large primer pocket scraper



Case Prep Center can be used horizontal or standing

NEW STUCK CASE REMOVER #1078192

Clam Size: 3.6"W x 9"H x 1.25"D Case Pack: 4

Platinum
SERIES

- Provides optimal leverage with use of reloading press
- Case removal with no extra tools required
- No need to remove or adjust the sizing die

Patent Pending



⚠ CASE TRIM AND PREP CENTER #903156

Box Size: 8.5"W x 11"H x 2.5"D Case Pack: 2

Platinum
SERIES

- Adjustable collet system works with all shouldered cases from .17 Remington® to .460 Weatherby®
- (3) accessory output shafts with 8-32 threads
- Ultra-hard HSS cutters stay sharp for thousands of rounds to make trimming quick and easy
- Built-in storage box

INCLUDES

- VLD inside chamfering tool
- Outside deburr tool
- Large primer pocket cleaning tool
- Small primer pocket cleaning tool
- 3 sizes of body collets
- 6 sizes of case shoulder bushings



**INNOVATIVE
ADJUSTABLE
COLLET SYSTEM**

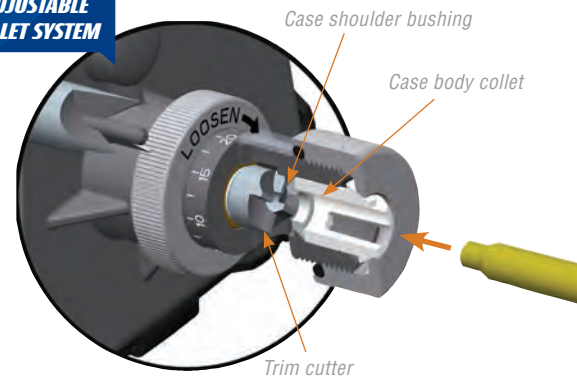

PATENTED

⚠ CASE PREP ESSENTIALS KIT #909214

Box Size: 4.25"W x 4"H x 2.25"D Case Pack: 4

Platinum
SERIES

INCLUDES

- Inside chamfer tool
- Outside deburring tool
- Large and small primer pocket crimp cutter tools
- Large and small pocket uniformer (cleaner)
- Handy storage case
- (2) rubber coated handles



⚠ CASE PREP EXPANSION KIT #909215

Box Size: 4.3"W x 5.2"H x 0.6"D Case Pack: 4

- Hardened High Speed Steel (HSS) large and small primer pocket uniformer/cleaner
- Large and small primer pocket crimp remover
- Standard 8-32 threads fit Frankford® Case Prep Center, Case Trim & Prep Center and most other prep tools



⚠ HAND DEPRIMER #909283

Clam Size: 10.8"W x 13"H x 3.5"D Case Pack: 4

Platinum
SERIES

PATENTED



- Auto-ejecting case holder for easy removal of deprimed cases
- Easily removable spent primer catch tube
- Works on pistol and rifle brass
- Full-length ergonomic hand grip to deprime military crimped primers

⚠ PERFECT SEAT HAND PRIMER #110006

Box Size: 8.5"W x 11"H x 2.5"D Case Pack: 4

Platinum
SERIES

PATENTED



- Hard stop prevents crushing primers
- Primer tray holds 100+ primers
- Thumb release easily switches from large to small primers
- Adjust seating depth by the 0.001" increments

INCLUDES

- Includes (12) shell holders, works on over 265 calibers
- Molded storage case



⚠ DS-750 DIGITAL SCALE #205205

Clam Size: 4.75"W x 9.75"H x 1.75"D Case Pack: 4

- Capacity: 750 grain (50g)
- Accuracy: ± 0.1 grain (0.01g)
- LCD display with blue backlight
- Measures in: grains, grams, carats and ounces
- Tare function and counting function
- Auto shutoff after 60 seconds

INCLUDES

- Calibration weight
- Powder pan
- Clear, protective cover
- Soft carry case
- (2) AAA batteries



PRECISION POWDER SCALE #909672

Box Size: 10.75"W x 9"H x 3.25"D | Case Pack: 4

- Measurements: grains, grams, carats and ounces
- Auto shutoff after 180 seconds
- Stability indicator
- Capacity: 1,500 grain (100g)
- Accuracy: ± 0.1 grain (0.01g)
- Tare function
- Protective cover

INCLUDES

- (2) calibration weights for a 3-point calibration
- Powder pan
- Clear, protective cover
- Storage case
- (4) AAA batteries
- 110v power supply/ 220v adapter



Two calibration weights

Durable metal powder pan

Podium indentations easily index arrow shafts



POWDER MEASURE #909292

Box Size: 7.4"W x 8.25"H x 4.75"D Case Pack: 2

- Universal meter with precise reference marks
- Works with ball, flake, cylinder and extruded powder
- 7/8-14 threads for mounting to a press

INCLUDES

- Stainless steel benchtop mount
- Stainless steel side mount

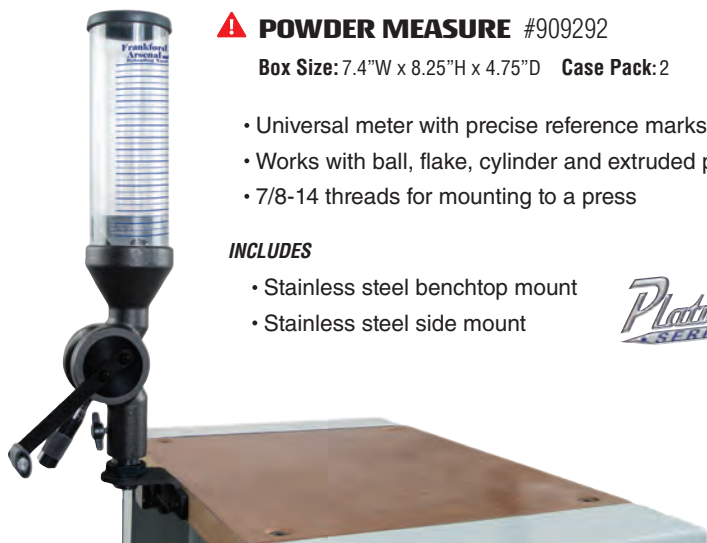

POWDER TRICKLER #903535

Box Size: 6.25"W x 8"H x 3"D Case Pack: 6

- Large powder capacity (8.2cc)
- Heavy-machined steel to prevent tipping
- Synthetic dust cover doubles as non-skid base



2.5"



RELOADING STAND #489621

Box Size: 26.5"W x 26.5"H x 4.5"D Case Pack: 1

- Tabletop width adjustable from 13"—39"
- Tabletop height adjustable from 28.5"—45"
- Frame made of 1.5 tube steel



VIBRA-PRIME™ #855712

Box Size: 26.5"W x 26.5"H x 4.5"D Case Pack: 1



- Works with large and small primers
- Circular auto-indexing ridges for quick primer insertion
- Runs on 2 AA batteries (not included)

INCLUDES

- Vibra-Prime™
- (1) primer tray
- (1) small primer tube
- (1) large primer tube
- (2) universal tube adapters



CLEANCAS T LEAD FLUXING COMPOUND #441888

Box Size: 26.5"W x 26.5"H x 4.5"D Case Pack: 1

CASE LUBE #460478

Box Size: 8oz | Case Pack: 12



DROP OUT #763758

Box Size: 2.25"W x 6.75"H x 2.25"D Case Pack: 12

The modern way to "smoke" bullet molds. Applied to the cavities of a cold, clean bullet mold, Frankford Arsenal® Drop Out literally allows the just-cast bullets to "drop-out" with no tapping or pounding.



⚠ CALIPERS

A. Electronic Calipers | #672060

B. Stainless Steel Dial Calipers | #516503

Box Size: 8"W x 12.25"H x .75"D **Case Pack:** 6

BOTH CALIPERS INCLUDE

- Protective storage case

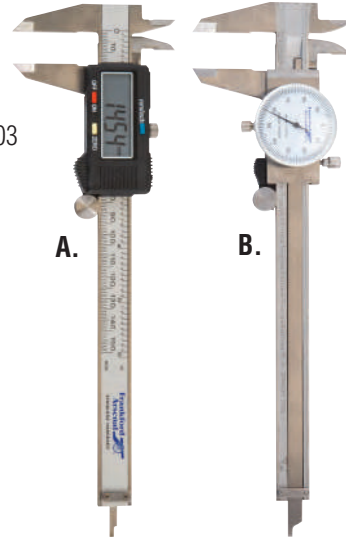

⚠ IMPACT BULLET PULLER #836017

Box Size: 6"W x 14"H x 2"D | **Case Pack:** 6

REPLACEMENT ALUMINUM COLLET SET (3-PACK) #737910

Box Size: 6"W x 14"H x 2"D | **Case Pack:** 2

- Impact style bullet puller
- Works with most calibers from .22 Hornet to 45–70 cal, rimmed or rimless

IMPACT BULLET PULLER INCLUDES

- (3) different sized aluminum collets



⚠ CARTRIDGE OVERALL LENGTH GAUGE #965887

Box Size: 4"W x 7.8"H x 8"D **Case Pack:** 6

This simple kit consists of two clamps that easily attach to any cleaning rod, 1/4" in diameter, or less!

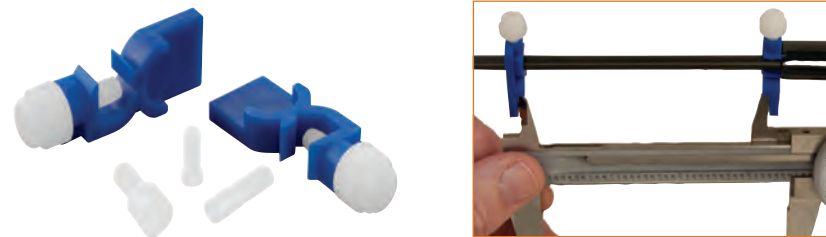

⚠ POWDER FUNNEL KIT #832516

Box Size: 5.7"W x 5.12"H x 4.9"D **Case Pack:** 2

INCLUDES

- (16) quick-change nozzles for (.17–.45 caliber)
- Large funnel
- Extension tube



⚠ CASE NECK LUBRICATOR

Case Neck Lubricator #132530

Box Size: 3.5"W x 3.5"H x 3.5"D **Case Pack:** 1

Fine Powdered Mica (.01oz packet) #595942

Box Size: 2"W x 0.125"H x 3.5"D **Case Pack:** 1

Fine Powdered Mica (4oz jar) 757780

Box Size: 3.5"W x 3.5"H x 3.5"D **Case Pack:** 1





**WITHSTANDS
THE WEIGHT
OF A TRUCK**

AMMO VAULT®

RMD-20 | #912600

RLG-20 | #912610

Box Size: 6.25"W X 6"H x 2"D | **Case Pack:** 4

- Holds (20) rnds of ammunition
- Integrated locking system secures lid in place
- Highly durable material with overmolded soft-touch top and bottom
- Impact-resistant material
- Foam insert holds cartridges securely, prevents rattling/protects bullet tips



Adjustable height accommodates several different cartridges

RELOADER'S LABEL (100-PACK) #202364

Box Size: 3.75"W X 5.75"H x 1"D | **Case Pack:** 6



Labels: 2" wide x 2.5" tall

**PERFECT FIT
RELOADING TRAYS** ⚠️

- Tray #1 #335196
 - Tray #2 #695795
 - Tray #2s #292930
 - Tray #3 #824257
 - Tray #4 #163246
 - Tray #4s #859739
 - Tray #5 #844786
 - Tray #5s #153092
 - Tray #6 #716498
 - Tray #7 #663641
 - Tray #8 #290487
 - Tray #9 #250083
- Case Pack: 6

RIFLE		Tray #								
17 Remington	2		7mm-08	5	7.62x39	4	416 Remington Mag	7	38 S&W	4s
22 Hornet	2		7x57 Mauser	5	7.62x54R Russian	8	416 Weatherby Mag	8	357 Sig	4s
218 Bee	4s		284 Winchester	6	32-20 WCF	4s	44-40WCF	6	38 Super	4s
221 Remington	2		280 Remington	5	32-40 WCF	6	444 Marlin	6	38 Special	4
222 Remington	2		7mm Remington Mag	7	32 Winchester Spl	6	45-70 Government	8	357 Magnum	4
223 Remington	2		7mm Weatherby Mag	7	8x57 Mauser	5	450 Marlin	7	38-40 WCF	6
22-250 Remington	5		7mm WSM	7	8mm Remington Mag	7	45 Sharps	8	40 S&W	4s
220 Swift	5		7mm Remington Ultra Mag	7	33 WCF	8	458 Winchester Mag	7	10mm Auto	4s
6mm PPC	4		30 M1 Carbine	2	338 Winchester Mag	7	460 Weatherby Mag	8	41 Magnum	6
243 Winchester	5		30 Remington	4	338 Ultra Mag	7	470 Nitro	9	44 Special/Magnum	6
6mm/244 Remington	5		30-30 Winchester	6	348 Winchester	8	50-70 Government	9	44-40 WCF	6
25-20 WCF	4s		300 Savage	5	35 Remington	5	500 Nitro	9	445 Super Mag	6
257 Roberts	5		30-40 Krag	7	35 Whelen	5	PISTOL			
250 Savage	5		308 Winchester	5	375 Winchester	6	Tray #		45 ACP	5s
25-06 Remington	5		30-06 Springfield	5	375 H&H Mag	7	25 ACP	1	45 Colt	6
6.5x55mm Swedish Mauser	5		300 WSM	7	378 Weatherby Mag	8	32 ACP	2s	454 Casull	6
264 Winchester Mag	7		300 H&H	7	38-55 WCF	6	32 S&W/S&W Long	2s	45 Auto Rim	6
270 Winchester	5		300 Winchester Mag	7	38-56 WCF	8	32 Colt	2s	45 Winchester Mag	5
270 WSM	7		300 Ultra Mag	7	40-65 WCF	8	32 H&R Mag	2s	480 Ruger	7
7mm BR	5		300 Weatherby Mag	7	40-82 WCF	8	380 Auto	2s	475 Linebaugh	8
			303 British	7	405 Winchester	7	9x19mm Luger	3	50 AE	7
							9x18 Makarov	3		

Each tray holds 50 rounds with the exception of Tray 9, which hold 45 rounds

⚠️ UNIVERSAL RELOADING TRAY #393939

Box Size: 5.5" w x 1.1" H x 11.2" D Case Pack: 6

The Universal Reloading Tray can be used with a wide variety of rifle cartridges from .17 caliber up to .458 caliber. It also works well for handgun cartridges from 9mm to 500 S&W with a 50 round capacity, it conveniently holds brass during different stages of the reloading process.

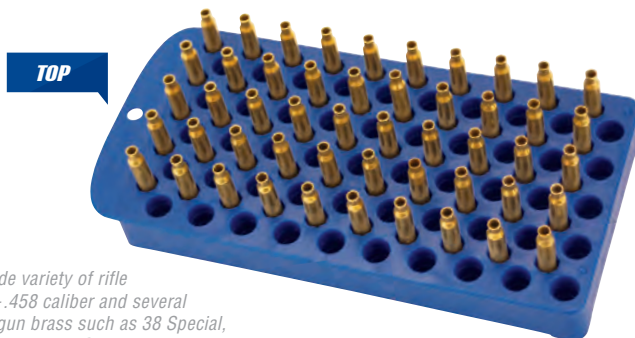

TOP

Top side accepts a wide variety of rifle cartridges from .17—.458 caliber and several various sizes of handgun brass such as 38 Special, 357 Magnum, 40 S&W and 500 S&W



BOTTOM

Bottom side accepts both 9mm and 45 ACP handgun brass

NEW PLASTIC HINGE-TOP AMMO BOXES

100-round Boxes

- Box #1001 #1083797
- Box #1003 #1083794
- Box #1005 #1083799
- Box #1007 #1083800
- Box #1008 #1083798
- Box #1009 #1083801

50-round Boxes

- Box #501 #1083783
- Box #503 #1083784
- Box #504 #1083785
- Box #505 #1083786
- Box #506 #1083787
- Box #507 #1083789

- Box #508 #1083792
- Box #509 #1083788
- Box #510 #1083790
- Box #511 #1083791
- Box #512 #1083793
- Box #514 #1083795
- Box #515 #1083796



Case Pack: 1

	10rnd Box	50rnd Box
RIFLE		
17 Remington	1005	505
22 Hornet		504
22 Remington Jet		504
218 Bee		504
221 Remington		504
22 BR		512
22 PPC		512
222 Remington	1005	505
223 Remington	1005	505
222 Remington Mag	1005	505
22-250 Remington	1009	509
220 Swift	1009	509
243 Winchester	1009	509
6mm BR		512
6mm Remington	1009	509
240 Weatherby Mag		510
25-20 WCF	1003	503
257 Roberts	1009	509
250 Savage	1009	509
25-06 Remington		510
6.5mm Swedish Mauser		510
6.5mm Remington Mag		511
6.8mm SPC		512
270 Winchester		510

270 Weatherby Mag		511
270 WSM		515
7x57 Mauser		510
7mm BR	1009	512
7mm SAUM		515
7mm WSM		515
7mm-08	1009	509
280 Remington		510
7mm Remington Mag		511
77 Remington Ultra Mag		511
Short Ultra Mag		511
30 M1 Carbine		504
30 Remington	1009	509
30-30 Winchester	1009	509
300 Savage	1009	509
30-40 Krag		510
308 Winchester	1009	509
30-06 Springfield		510
300 H&H Mag		511
300 Winchester Mag		511
300 Ultra Mag		511
Short Ultra Mag		511
300 SAVM		515
300 WSM		515

300 Weatherby Mag		511
303 British		510
7.6X39mm	1009	512
32-20 WCF	1003	503
32 Winchester Spl		509
8x57 Mauser		510
8mm Remington Mag		511
338 Winchester Mag		511
338 Lapua Mag		511
340 Weatherby Mag		511
338 Rem Ultra Mag		511
35 Remington Mag	1009	509
35 Whelen		510
375 H&H Mag		511
375 Rem Ultra Mag		511
378 Weatherby Mag		511
38-40 WCF		507
38-56 WCF		514
38-70 WCF		514
40-65 WCF		514
40-65 Ballard		514
404 Jeffery		511
405 Winchester		510
416 Taylor		511

416 Rigby		511
444 Marlin	1009	509
45-70 Govt.	1009	514
45-90 WCF		511
45-100 Sharps		511
458 Winchester Mag		511
50-70 Govt.		514
50 110 WCF		514
PISTOL		
25 ACP	1001	501
32 ACP	1001	501
32 S&W/32 S&W Long	1003	503
32 H&R Magnum	1003	503
380 Auto	1001	501
9x19mm Luger	1001	501
9x19 Makarov	1001	501
38 S&W	1003	503
38 Special	1003	503
38 Super	1003	503
357 Magnum	1003	503
357 Maximum		505
357 Auto Mag		507
10mm Auto	1008	508
40 S&W	1008	508

41 Long Colt	1007	507
41 Magnum	1007	507
44 S&W Russian	1007	507
44 Colt	1007	507
44 Special	1007	507
44-40 WCF	1007	507
44 Magnum	1007	507
445 Super Mag	1009	509
44 Auto Mag	1007	507
45 S&W Schotfield	1007	507
45 ACP	1008	508
45 Auto Rim	1008	508
45 Colt	1007	507
45 Winchester Magnum	1007	507
454 Casull	1007	507
460 S&W		514
480 Ruger		506
475 Linebaugh		506
50 AE		506
500 Linebaugh		506
SHOTGUN		
.410 Gauge 2.5" Shells		509
.410 Gauge 3" Shells		510
28 Gauge		514

PLASTIC FLIP-TOP AMMO BOXES

100-round Boxes

Box #1001 (Blue) #688397 (Gray) #713196

Box #1003 (Blue) #930447 (Gray) #185116

Box #1005 (Blue) #554106 (Gray) #631312

Box #1007 (Blue) #912544 (Gray) #107025

Box #1008 (Blue) #419448 (Gray) #515120

Box #1009 (Blue) #562778 (Gray) #651533

50-round Boxes

Box #501 (Blue) #114596 (Gray) #340663

Box #503 (Blue) #642557 (Gray) #354668

Box #504 (Blue) #698582 (Gray) #441440

Box #505 (Blue) #690047 (Gray) #264395

Box #506 (Blue) #369645 (Gray) #414965

Box #507 (Blue) #349962 (Gray) #398657

Box #508 (Blue) #718498 (Gray) #860416

Box #509 (Blue) #160880 (Gray) #122804

Box #510 (Blue) #513329 (Gray) #450302

Box #511 (Blue) #162882 (Gray) #803479

Box #512 (Blue) #791979 (Gray) #801326

Box #514 (Blue) #563412 (Gray) #118960

Box #515 (Blue) #296112 (Gray) #312874

20-round Boxes

Box #205 (Blue) #205111 (Gray) #205222

Box #209 (Blue) #533573 (Gray) #351167

Box #210 (Blue) #184625 (Gray) #1071003

Box #211 (Blue) #877991 (Gray) #227289

Case Pack: 6



	100rnd Box	50rnd Box	20rnd Box	Ammo Vault®
RIFLE				
17 Remington	1005	505	205	
22 Hornet		504		
22 Remington Jet		504		
218 Bee		504		
221 Remington		504		
22 BR		512		
22 PPC		512		
222 Remington	1005	505	205	RMD
223 Remington	1005	505	205	RMD
222 Remington Mag	1005	505	205	RMD
22-250 Remington	1009	509	209	RMD
220 Swift	1009	509	209	RMD
243 Winchester	1009	509	209	RMD
6mm BR		512		
6mm Remington	1009	509	209	RMD
240 Weatherby Mag		210	210	RMD
25-20 WCF	1003	503		
257 Roberts	1009	509	209	RMD
250 Savage	1009	509	209	RMD
25-06 Remington		510	210	RMD
6.5mm Swedish Mauser		510	210	RMD
6.5mm Remington Mag		511	211	RLG
6.8mm SPC		512		
270 Winchester		510	210	RMD
270 Weatherby Mag		511	211	RLG
270 WSM		515		RLG
7x57 Mauser		510	210	RMD
7mm BR	1009	512	209	RMD
7mm SAUM		515		
7mm WSM		515		RLG
7mm-08	1009	509	209	RMD
280 Remington		510	210	RMD
7mm Remington Mag		511	211	RLG
77 Remington Ultra Mag		511	211	RLG
Short Ultra Mag		511	211	RLG
30 M1 Carbine		504		
30 Remington	1009	509	209	RMD
30-30 Winchester	1009	509	209	RMD
300 Savage	1009	509	209	RMD
30-40 Krag		510	210	RLG
308 Winchester	1009	509	209	RMD
30-06 Springfield		510	210	RMD
300 H&H Mag		511	211	RLG
300 Winchester Mag		511	211	RLG
300 Ultra Mag		511	211	RLG
Short Ultra Mag		511	211	RLG
300 SAVM	515			
300 WSM		515	211	RLG
300 Weatherby Mag		511	211	RLG
303 British		510	210	RMD
7.6X39mm	1009	512	209	RMD
32-20 WCF	1003	503		
32 Winchester Spl		509	209	RMD
8x57 Mauser		510	210	RMD
8mm Remington Mag		511	211	RLG
338 Winchester Mag		511	211	RLG
338 Lapua Mag		511	211	RLG
340 Weatherby Mag		511	211	RLG
338 Rem Ultra Mag		511	211	RLG
35 Remington Mag	1009	509	209	RMD
35 Whelen		510	210	RMD
375 H&H Mag		511	211	RLG
375 Rem Ultra Mag		511	211	RLG
378 Weatherby Mag		511	211	RLG
38-40 WCF		507		
38-56 WCF		514		RLG
38-70 WCF		514		RLG
40-65 WCF		514		RLG
40-65 Ballard		514		
404 Jeffery		511	211	RLG
405 Winchester		510	210	RLG
416 Taylor		511	211	RLG
416 Rigby		511	211	RLG
444 Marlin	1009	509	209	RLG
45-70 Govt.	1009	514	209	RLG
45-90 WCF		511	211	RLG
45-100 Sharps		511	211	RLG
458 Winchester Mag		511	211	RLG
50-70 Govt.		514		RLG
50 110 WCF		514		RLG

PISTOL

25 ACP	1001	501	
32 ACP	1001	501	
32 S&W/32 S&W Long	1003	503	
32 H&R Magnum	1003	503	
380 Auto	1001	501	
9x19mm Luger	1001	501	
9x19 Makarov	1001	501	
38 S&W	1003	503	
38 Special	1003	503	
38 Super	1003	503	
357 Magnum	1003	503	
357 Maximum		505	205
357 Auto Mag		507	
10mm Auto	1008	508	
40 S&W	1008	508	
41 Long Colt	1007	507	
41 Magnum	1007	507	
44 S&W Russian	1007	507	
44 Colt	1007	507	
44 Special	1007	507	
44-40 WCF	1007	507	
44 Magnum	1007	507	
445 Super Mag	1009	509	209
44 Auto Mag	1007	507	
45 S&W Scholfield	1007	507	
45 ACP	1008	508	
45 Auto Rim	1008	508	
45 Colt	1007	507	
45 Winchester Magnum	1007	507	
454 Casull	1007	507	
460 S&W		514	
480 Ruger		506	
475 Linebaugh		506	
50 AE		506	
500 Linebaugh		506	
SHOTGUN			
.410 Gauge 2.5" Shells		509	
.410 Gauge 3" Shells		510	
28 Gauge		514	

LOCKDOWN[®]





SECURITY
HUMIDITY CONTROL
LIGHTING



⚠ GUN CONCEALMENT MAGNET #222501

Clam Size: 5.75"W x 7.5"H x 1.25"D **Case Pack:** 5

- Mounts securely vertically or horizontally, at an angle or upside down
- Magnet works on most handguns with metal slide or barrel
- Holds shotguns or rifles with additional magnet

INCLUDES

- (2) wood screws
- (2) drywall screws with anchors

**USE TWO TO
SUSPEND RIFLES
OR SHOTGUNS**



1.5"W x 4.625"H x 0.5"D



⚠ UNDER DESK WALL MOUNT #110125

Clam Size: 9.25"W x 13.5"H x .25"D **Case Pack:** 6

- Ambidextrous
- Made of nylon with reinforced backing for rigidity
- 4.25" wide elastic holster holds handguns from compact semi-automatics to full frame revolvers

INCLUDES

- (4) mounting screws



⚠ NIGHT GUARDIAN™ LOW PROFILE HOLSTER #110126

Clam Size: 9.25"W x 13.5"H x .25"D **Case Pack:** 6

- Ambidextrous
- Heavy-duty nylon with reinforced backing for rigidity
- Tuckable section can be folded at different depths for holster height adjustment
- 4.25" wide elastic holster holds handguns from compact semi-autos to full frame revolvers
- (2) accessory/magazine elastic holsters along side



8.75"W x 15"L x .125"D
(unloaded)



⚠ NIGHT GUARDIAN™ HOLSTER

Handgun Holster | #222502

Clam Size: 6.5"W x 16.75"H x 4.25"D **Case Pack:** 5

Long Gun Holster (Set of 2) | #222503

Clam Size: 6.5"W x 18.5"H x 4.5"D **Case Pack:** 5

- Ambidextrous
- Universal holster for any size pistol or revolver
- Universal pouches for single or double stack magazines and most flashlights
- Conceals firearm from view under comforter
- Vinyl-coated steel frame keeps holster in place while drawing the firearm



**SET OF 2
SUSPENDS RIFLES
OR SHOTGUNS**



Product is NOT intended to prevent or protect from unauthorized use

⚠ AR MAG WELL LOCK #222818

Clam Size: 6.25"W x 10"H x 3.5"D **Case Pack:** 6

- Secures and disables firing any AR-15 platform
- Durable glass-reinforced nylon construction
- Non-marring surfaces

INCLUDES

- (2) keys



⚠ AR MAG WELL LOCK WITH WALL MOUNT #222819

Box Size: 10.5"W x 6.5"H x 5"D **Case Pack:** 4

INCLUDES

- AR Mag Well Lock contents
- Wall mount
- (2) barrel mount eye bolts



▲ NEW HANDGUN VAULTS

Ultra Compact #1082265

Box Size: 6.7"W x 5.1"H x 2.2"D **Case Pack:** 6

Compact..... #1082264

Box Size: 5.9"W x 8.7"H x 2.2"D **Case Pack:** 6

Large #1082263

Box Size: 6.7"W x 10.2"H x 2.2"D **Case Pack:** 6

- 19-gauge walls with additional 16-gauge side and bottom reinforcement plate
- Meets TSA airline requirements
- Approved by the California Department of Justice
- Key-lock securement

INCLUDES

- (2) keys



*Inside dimensions:
6.5"W x 5.1"H x 1.6"D*



*Inside dimensions:
5.625"W x 8.25"H x 1.75"D*



*Inside dimensions:
6.5"W x 10"H x 1.75"D*

*Large vault comes with
coated-steel cable lock*

▲ 15" CABLE TRIGGER LOCK #110149

Box Size: 1.5"W x 3.5"H x 10.5"D **Case Pack:** 6

- 15" reinforced cable
- 30mm keyed lock
- Approved by the California Department of Justice

INCLUDES

- (2) keys



⚠ MECHANICAL LOCK VAULT #222905**Box Size:** 13.5"W x 8.5"H x 3.5"D **Case Pack:**4

- 1,000+ lock combinations
- 5-button mechanical lock, EMP Proof
- 16-gauge steel construction
- LED light inside vault
- Holds barrel lengths up to 6"

SUPER MAX*Internal dimensions: 12"W x 7.75"H***⚠ KEYED LOCK VAULT #222820****Box Size:** 13.5"W x 8.5"H x 3.5"D **Case Pack:**4

- Keyed vault with dual locking bolts
- 16-gauge steel construction
- LED light inside vault
- Holds barrel lengths up to 6"

INCLUDES

- (2) keys

SUPER MAX*Internal dimensions: 12"W x 7.75"H***⚠ SUPER MAX™ READY VAULT #222933****Box Size:** 13.5"W x 8.5"H x 3.5"D **Case Pack:**4

- 1,000+ lock combinations
- 5-button mechanical lock, EMP proof
- Mountable from top, left or right sides
- LED light inside vault
- Holds barrel lengths up to 6"

INCLUDES

- Mounting hardware

SUPER MAX

Humidity control is an essential factor in storing and protecting firearms. Maintaining consistent humidity and temperature around firearms is very important. High humidity levels and temperature fluctuation can lead to condensation and corrosion; extremely low humidity levels can potentially pull too much moisture from wood stocks causing cracks. 50% relative humidity and 70°F is considered ideal storage conditions for firearms.

⚠ SILICA GEL CAN (750g) #222178

Clam Size: 4.25"W x 5.75"H x 4.25"D **Case Pack:** 4



⚠ SILICA GEL BAG (450g) #222179

Clam Size: 8"W x 5.5"H x 1.5"D **Case Pack:** 8

⚠ SILICA GEL CAN (40g) #222555

Clam Size: 4.25"W x 7.25"H x 1.25"D **Case Pack:** 6

- Absorbs moisture from the air
- Easily recharged* in oven
- 750g Can provides protection for up to 57 cubic feet
- 450g Bag provides protection for up to 33 cubic feet
- 40g Can ideal for small handgun vaults or gun cases

**100%
RECHARGEABLE**

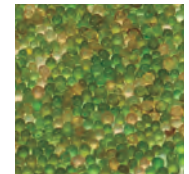

Needs Recharging

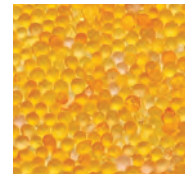

Fully Recharged

**The 750g Silica Can and 450g Silica Bag last for approximately 3 to 6 months, in normal conditions, before recharging is required*

⚠ HYGROMETER #222111

Clam Size: 4.25"W x 7.25"H x 1.25"D **Case Pack:** 4

- Mounts easily with included fastener or hook and loop pad
- Large, easy-to-read numbers

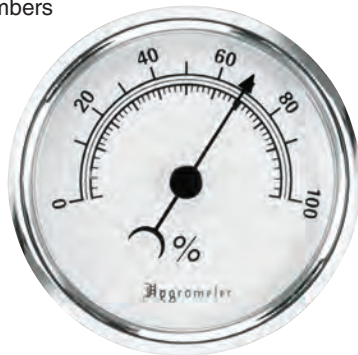

⚠ WIRELESS HYGROMETER #222532

Clam Size: 4.25"W x 7.25"H x 1.25"D **Case Pack:** 4

- Check humidity without opening gun vault
- Displays humidity levels from 20%–90%
- Kickout stand or magnetic back rests base on top of safe or securely on vault door
- Battery operated (2 AA not included)

GOLDEN ROD Moisture Control



2 3/4" diameter

⚠ DEHUMIDIFIER RODS

12" Dehumidifier Rod | #1071006

220v 12" Dehumidifier Rod | #222666

Clam Size: 5.25"W x 18.25"H x 1.25"D **Case Pack:** 4



18" Dehumidifier Rod | #222010

220v 18" Dehumidifier Rod | #222667

Clam Size: 5.25"W x 24.25"H x 1"D **Case Pack:** 4



12"/8 Watt dries up to 100 cu. ft.

18"/12 Watt dries up to 200 cu. ft.



- Stabilizes air-temperature
- Easy-install plug attachment for 110/120v AC
- Perfect for gun safes, storage cabinets, closets and boat compartments
- Mounting brackets included



⚠ GOLDEN ROD™ DEHUMIDIFIER RODS

12" Dehumidifier Rod | #725721

Clam Size: 5.25"W x 18"H x 1.25"D **Case Pack:** 4

18" Dehumidifier Rod | #725731

Clam Size: 5.25"W x 18"H x 1.25"D **Case Pack:** 4

24" Dehumidifier Rod | #725741

36" Dehumidifier Rod | #725751

Clam Size: 4.5"W x 39"H x 1"D **Case Pack:** 4



- Easy-install quick plug attachment
- Mounting brackets included
- 110/120v AC
- Lifetime Warranty



12"/12 watt dries up to 100 cu. ft.

18"/18 watt dries up to 200 cu. ft.

24"/25 watt dries up to 300 cu. ft.

36"/38 watt dries up to 500 cu. ft.



⚠ GUN SAVER™ DEHUMIDIFIER RODS

12" Dehumidifier Rod | #725761

Clam Size: 5.25"W x 18"H x 1.25"D **Case Pack:** 4

18" Dehumidifier Rod | #727771

Clam Size: 5.25"W x 24"H x 1.25"D **Case Pack:** 4

- Easy-install quick plug attachment
- Mounting brackets included
- Protects firearm investment
- 110/120v AC



12"/12 Watt dries up to 100 cu. ft.

18"/18 Watt dries up to 200 cu. ft.





A. NEW LED VAULT TAPE LIGHT #1077070

Box Size: 5.7"W x 7.7"H x 1.6"D Case Pack: 4

- Motion sensor activation with adjustable time delay
- Mounts to any surface (carpet, steel, wood, etc.)
- 3 meters of ultra-bright white LEDs
- 1 meter of power cord
- Cut-to-length capability
- 3M adhesive backer
- 1,200 lumen output

INCLUDES

- 110v AC plug and 2m extension cord
- Mounting tabs with screws

MOUNTS TO ANY SURFACE



VAULT LIGHTING KIT #222020

Clam Size: 8.25"W x 8.75"H x 3.5"D Case Pack: 4

INCLUDES

- 12' white LED rope
- 6' power cord with easy-install cord
- In-line ON/OFF switch
- Mounting hardware



VAULT ACCESSORY ESSENTIALS KIT #222714

Box Size: 13.2"W x 2.2"H x 5.7"D Case Pack: 4

INCLUDES

- 12" Dehumidifier Rod
- Handgun Hanger
- Hygrometer
- Automatic Cordless Vault Light





⚠ A. CORDLESS 75-LED VAULT LIGHT #222008

Box Size: 4.25"W x 11"H x 1"D Case Pack: 5

- 95 lumen output
- Strong magnet or screw attachment
- 5-hour continuous runtime
- Battery operated (3 AAA batteries not included)
- Mounts easily with attached magnet or included screws

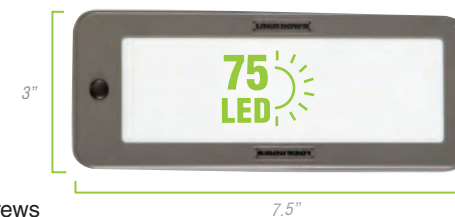

⚠ B. CORDLESS 25-LED VAULT LIGHT (2-PACK) #222009

Box Size: 4.25"W x 11"H x 1"D Case Pack: 5

- Auto ON/OFF sensor
- 70 lumen output
- Battery operated (3 AAA batteries not included)
- 6-hour continuous runtime; 8,700-hour stand by per light
- Mounts easily with attached magnet or included screws



⚠ C. AUTOMATIC CORDLESS VAULT LIGHT #222809

Box Size: 4.75"W x 6.75"H x 1.75"D Case Pack: 4

- Auto ON/OFF
- Manual ON/OFF switch option
- Dimmer
- Battery operated (3 AAA batteries not included)



⚠ CORDLESS VAULT LIGHT #222777

Box Size: 5"W x 13"H x 1.5"D Case Pack: 4

- Ultra bright LEDs
- 90° rotating light head
- Battery operated (3 AAA batteries not included)
- Mounts easily with included hardware



A. NEW 6-HANDGUN MUZZLE RACK #1081878

Clam Size: 4.6"W x 11.6"H x 0.6"D **Case Pack:** 6

- 6-handgun capacity with upright access
- Fits .22--.50 caliber handguns
- Large overmolded wire construction helps protect against firearm damage
- Stable design allows for secure use on vault shelves and shooting benches

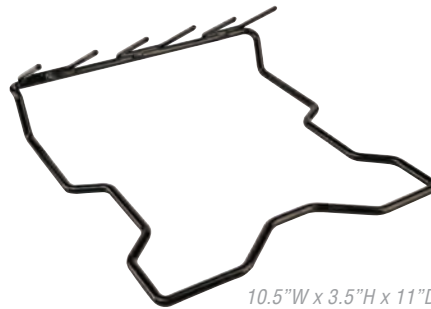

10.5"W x 3.5"H x 11"D

HANDGUN RACKS

Single Handgun Rack (3-pack) | #222314

Hanger Size: 3.3"W x 3.7"H x 9.8"D **Case Pack:** 6

B. 4-Gun Handgun Rack | #222200

Hanger Size: 9.5"W x 5.25"H x 6.5"D **Case Pack:** 6

6-Gun Handgun Rack | #222210

Hanger Size: 14.25"W x 5.25"H x 6.5"D **Case Pack:** 6

- Holds most pistols and/or revolvers
- Non-marring finish
- Perfect for holding handguns while not in use at the range or storage in safe



C. VAULT DRAWER #222155

Clam Size: 17"W x 16"H x 3.75"D **Case Pack:** 4

- Retaining bar keeps drawer secure
- Provides 11.5"W x 12"H x 2"D extra storage



D. AR MAGAZINE RACK #222972

Box Size: 4.25"W x 16"H x 5.5"D **Case Pack:** 4

- Free-standing or mountable (mounting hardware included)
- Non-marring vinyl coating
- Compatible with all in-line mags from 10-rounds up to 30-rounds
- Holds up to 10 AR-15 magazines



UNIVERSAL VAULT DOOR ORGANIZERS

E. Regular Vault Door Organizer | #222316

Clam Size: 8"W x 17"H x 1.5"D **Case Pack:** 5

Flat dimensions: 20"W x 12"H x 0.75"D

F. Large Vault Door Organizer | #222315

Clam Size: 8"W x 17"H x 1.5"D **Case Pack:** 5

Flat dimensions: 14"W x 12"H x 0.75"D



INCLUDES

- Rigid back panel
- Durable mesh pockets
- Lower pockets feature zippers
- Hook screws
- Wallboard hooks
- Door clips

G. HANDGUN/AR UPPER HANGER #222817

Clam Size: 8.25"W x 6"H x .75"D **Case Pack:** 5

Flat dimensions: 8"W x 30.5"H x 0.75"D

- Holds up to (2) spare AR Upper receivers, T/C® Encore® barrels or shotgun barrels
- Holds up to 6 handguns of any size
- (3) mesh pistol hangers per side
- Pockets are heavy-duty mesh with elastic bands

DOUBLE SIDED

INCLUDES

- Hook screws
- Wallboard hooks
- Door clips



⚠️ HANGING ORGANIZERS

A. Large Hanging Organizer | #222168

Clam Size: 8.5"W x 14.5"H x 2"D Case Pack: 5

B. Small Hanging Organizer | #222170

Clam Size: 8.25"W x 6"H x .75"D Case Pack: 5

C. Handgun Hanger | #222172

Clam Size: 7.25"W x 7"H x 1.25"D Case Pack: 5

- All built with durable mesh pockets
- Elastic bands (and zippers on Large Organizer) keep items secure
- Reinforced back panels
- Handgun Hanger fits most compact, medium- and large-frame handguns
- All Hanging Organizers mount using the Universal Attachment System



19.75"W x 12"H x .75"D



8.25"W x 6"H x .75"D



8.25"W x 5"H x .75"D

UNIVERSAL ATTACHMENT SYSTEM



The Universal Attachment System comes with vampire clip style inserts for use with carpeted interior vaults as well as high-strength magnet inserts for bare metal interiors.

⚠️ D. MAGNETIC BARREL REST #222177

Clam Size: 11.5"W x 7"H x 3.75"D Case Pack: 4

- Holds (3) guns when leaned against vault or steel surface
- Overmolded rubber contact points to protect firearm finish
- Rubber-backed magnets



10.25"W x 3"H x 3"D



⚠️ E. EXTERNAL 10" HANGER #222454

Clam Size: 10.75"W x 9.75"H x 1.5"D Case Pack: 4

- Holds up to 30lbs
- High-strength, vinyl-coated magnets to protect vault finish
- Powder-coated steel construction for maximum durability





Tipton[®]

Gun Cleaning Supplies





GUN VISES

CLEANING TOOLS/KITS

JAGS & BRUSHES

CLEANING SUPPLIES

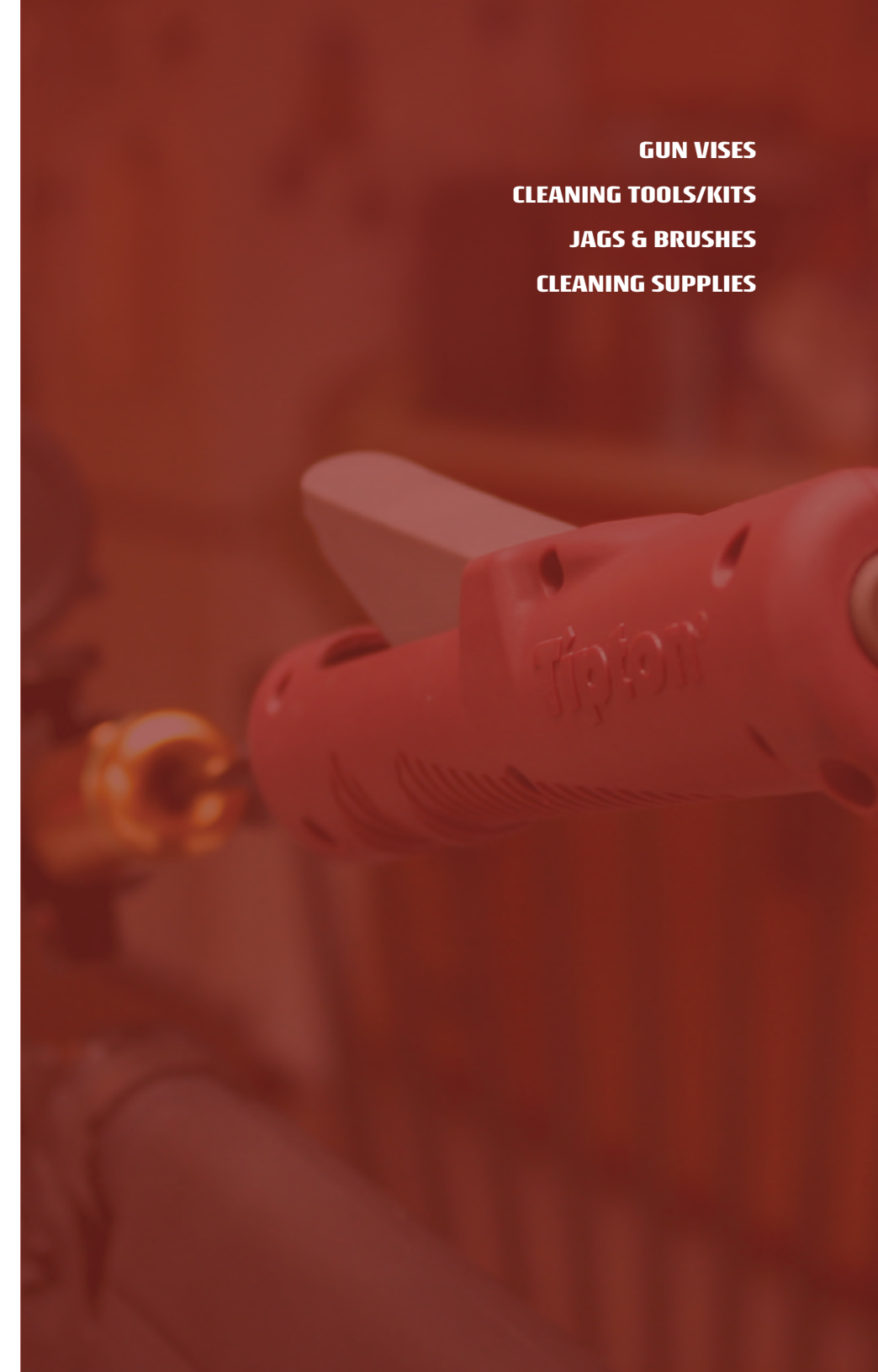

▲ ULTRA GUN VISE #110011

Box Size: 33"W x 12.25"H x 5.5"D **Case Pack:** 4

- Non-marring, glass-filled nylon vise/clamp construction
- Durable steel tube frame structure
- Ball and socket articulating clamp pads allow for the pads to adapt to any firearm's surface
- Front and rear clamps both height and length adjustable
- (4) independently-adjustable, non-slip feet
- Mountable directly to benchtop (*hardware not included*)
- Removable accessory/tool trays

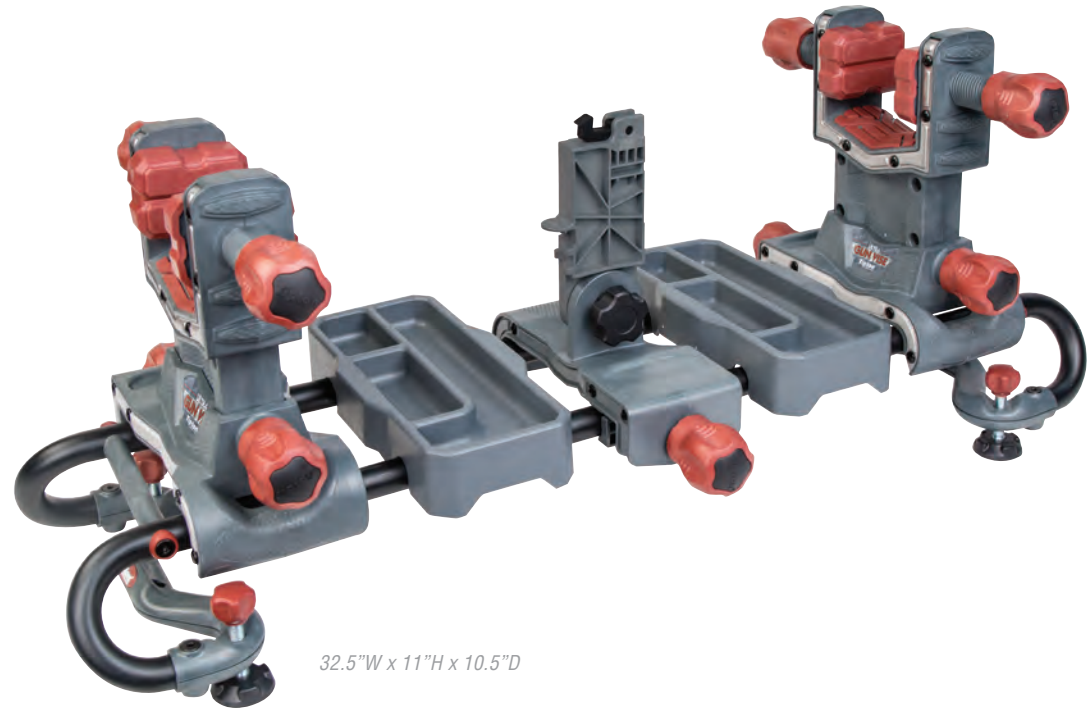

32.5"W x 11"H x 10.5"D

**INTERCHANGEABLE
MODULAR DESIGN**





▲ BEST GUN VISE #181181

Box Size: 33"W x 12.25"H x 5.5"D **Case Pack:** 4

- Non-marring surfaces
- Durable polymer construction
- Mountable directly to benchtop (hardware not included)
- Front and rear base slide on center aluminum rail for optimum length adjustments
- Accommodates multiple different firearms and projects
- Adjustable rear off-set clamping mechanism
- (4) non-slip rubber feet

PATENTED

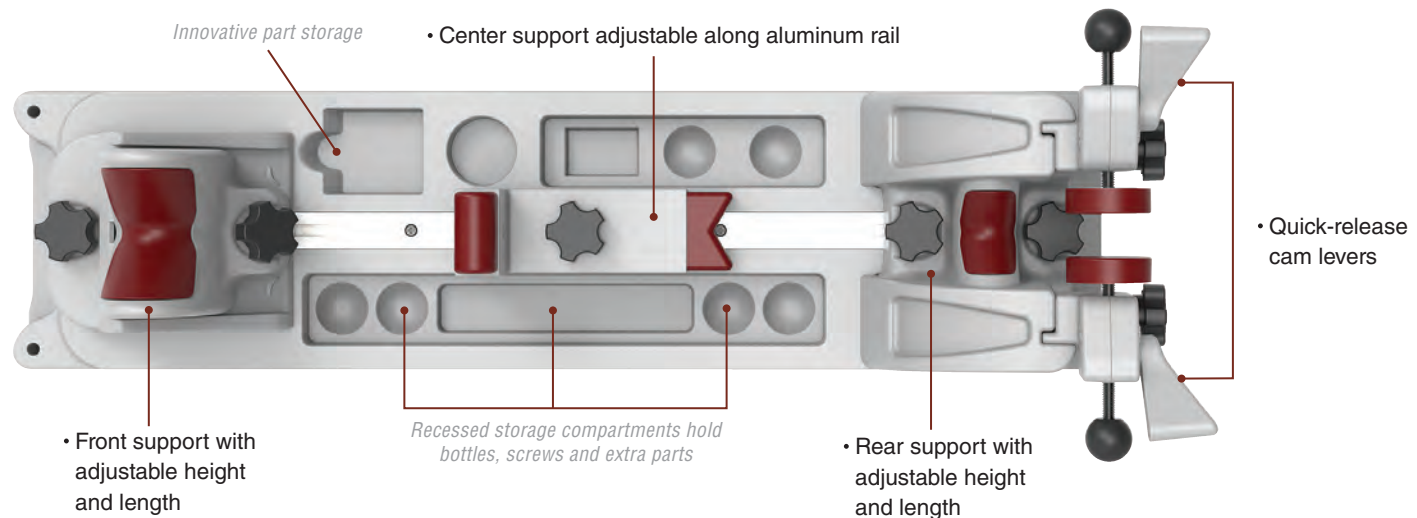

Exposes the breech on any break-open shotgun for easy cleaning or inspection



Versatile clamp and support system accommodates pistols and revolvers



Levels and holds conventional rifles for maintenance and cleaning



Holds AR style rifles open to gain access to bore, receiver and fire control components

⚠ GUN VISE #782731

Box Size: 34"W x 11"H x 9"D **Case Pack:** 3

- Non-marring surfaces
- Durable polymer construction
- Accommodates multiple different firearms and projects
- (4) non-slip rubber feet
- (8) recessed storage compartments



• Quick-release cam for easy operation

• Center support

• Front end supports any style forend, right side up or upside down

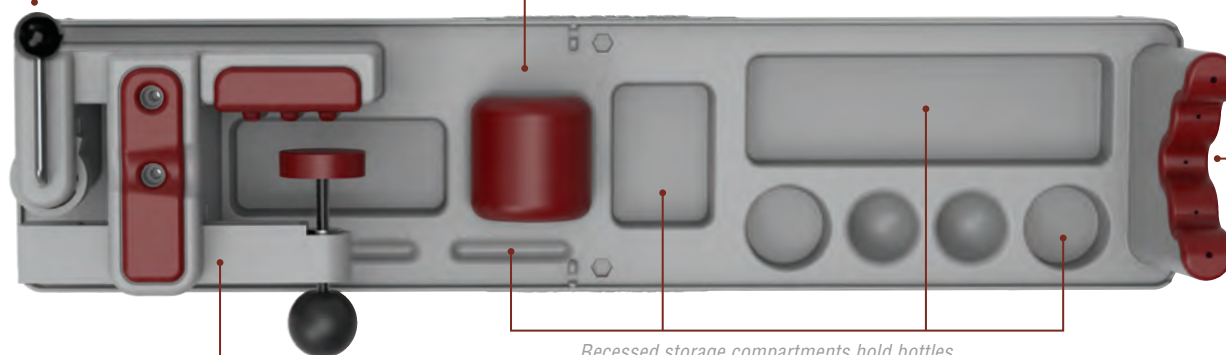

• Adjustable pivot arm to fit any size stock

Recessed storage compartments hold bottles, screws, extra parts, jags and brushes



Clamp sdown shotguns



Clean bolt actions



Secures AR style rifles

⚠ GUN BUTLER #100333

Box Size: 34"W x 11"H x 9"D **Case Pack:** 3

- (2) removable, non-marring forks to securely hold firearm
- Durable polymer construction
- Convenient recessed storage compartments
- Center carry-handle



⚠ TRANSPORTER RANGE VISE #782805

Box Size: 23"W x 9"H x 3.5"D **Case Pack:** 2

- Holds up to (4) long rifles
- Clamps on tabletops up to 3-5/8" in thickness
- (2) removable, non-marring forks
- Disassembles and self-stores in (3) interior pockets
- Buckles close for secure transport



Usable bag: 20"W x 9"H x 9"D
Overall dimensions: 23"W x 11.5"H x 9"D

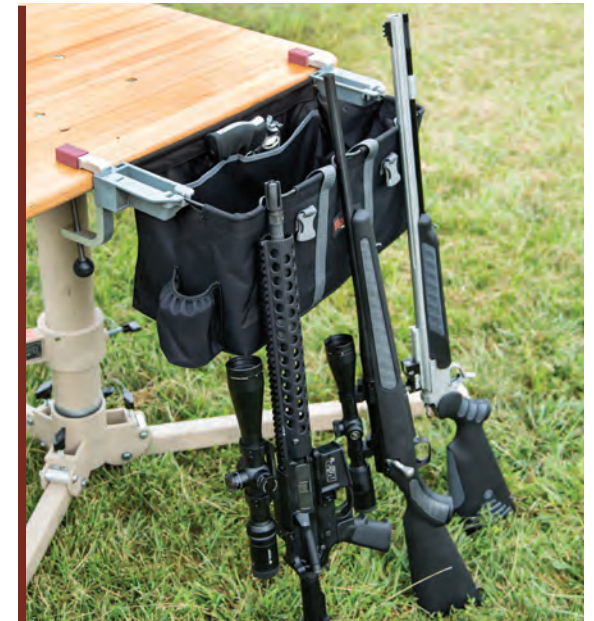

▲ 1911 MAG WELL VISE BLOCK #558080

Box Size: 7.5"W x 7"H x 1"D **Case Pack:** 4

- Non-marring surfaces
- Built-in barrel bushing wrench
- Removable mag well arm
- Solvent-resistant polymer construction
- Mountable directly to benchtop or Tipton® Best Gun Vise

PATENTED



Built-in barrel bushing wrench makes removal easy



▲ COMPACT RANGE VISE #282282

Box Size: 13.5"W x 10.5"H x 7.5"D **Case Pack:** 6

- Durable, solvent-resistant nylon and polymer construction
- Collapses for easy storage or transport in a range bag
- (6) non-slip rubber feet
- Non-marring contact surfaces
- Collapses to 2.75" tall



5.5"W x 17.75"H (extended) x 7.5"D



⚠ DELUXE CARBON FIBER CLEANING ROD™ (1-PIECE)

Hang Tube Size: 1.5" Diameter Case Pack: 1

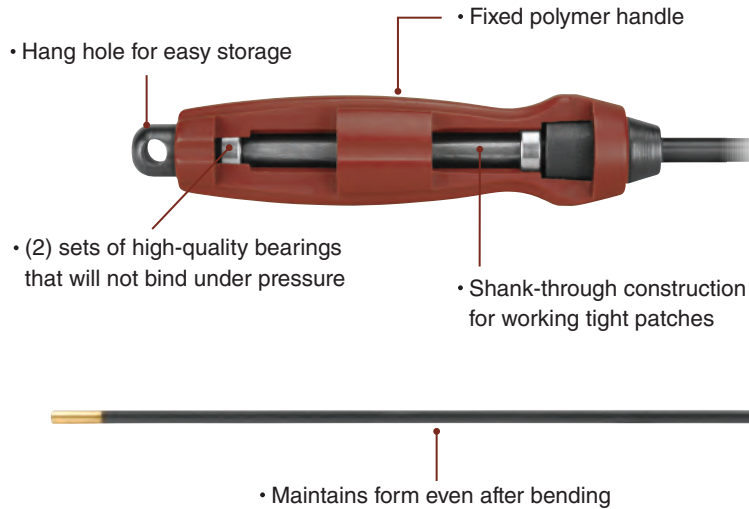

CALIBER ▼	LENGTH					
	12"	26"	36"	40"	44"	50"
.17		#146468R	#107486R			
.20				#175401R		
.22-.26	#658675R	#216411R	#430886R	#182978R	#783485R	
.27-.45	#303569R	#376252R	#720747R	#413662R	#509320R	#751235R
.40+			#654574R			
SHOTGUN			#713415R			

DELUXE CARBON FIBER RODS USED BY THE U.S. MILITARY

• Carbon fiber shaft will not embed particles that could damage the rifle bore



⚠ PREMIUM STAINLESS STEEL 3-PIECE CLEANING ROD #429954

Hang Tube Size: 1.5" Diameter x 17.5" H Case Pack: 5

- Works on calibers .22 (.205" diameter/ standard 8-32 threads) and up
- Rod constructed of extremely high-yield strength stainless steel
- Ergonomic handle has a shank-through construction with (2) bearing sets
- Convenient 3-piece design disassembles to 16" length



⚠ ROD RACK #100335

Display Size: 6"W x 18"H x 2.5"D Case Pack: 4

- Accommodates (6) rods of various sizes
- (2) hanging hooks on either end for additional accessories

INCLUDES

- Mounting holes and screws



MAX FORCE™ CLEANING RODS

.17–.20 Caliber | #658540

.22 Caliber | #658539

Clam Size: 6.25"W x 50.125"H x 1.75"D **Case Pack:** 4

- Handle slides freely, lockable at any point along rod
- 40" usable rod length
- Carbon fiber shaft will not embed particles that could damage the rifle bore
- Highly-durable; no bending or breaking
- Solvent-resistant polymer handle
- .17–.20 caliber has 5-40 threads
- .22 caliber has 8-32 threads

Thumb lever engages clamp on rod

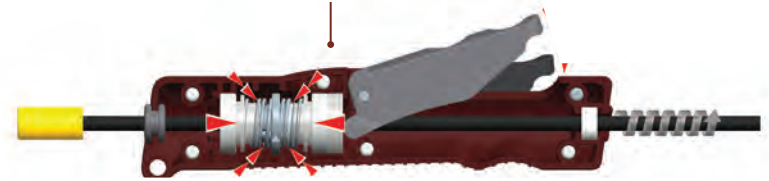

PATENTED

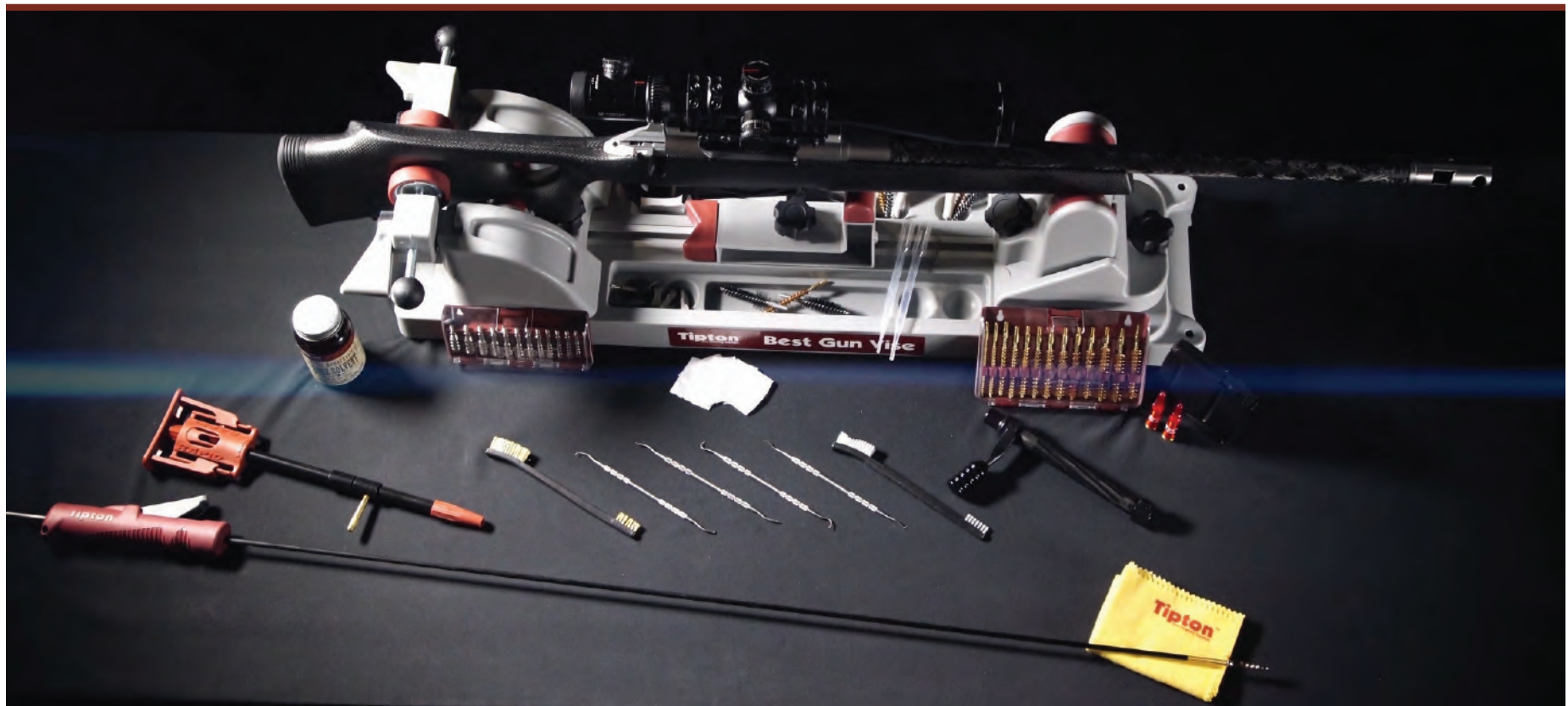

▲ ULTRA CLEANING KIT #554400

Display Size: 16.85"W x 10.5"H x 3.25"D Case Pack: 2

INCLUDES

- 3-piece Premium Stainless Steel Rod
- RAPID™ Deluxe Bore Guide kit
- 13-piece Ultra Jag™ Set with case
- 13-piece Best Bore Brush™ Set with case
- (2) general purpose brushes
 - (1) nylon
 - (1) bronze
- AR-15 bolt carrier and action brushes
- (4) polymer cleaning picks
- Carry case with molded-foam inserts



▲ RAPID™ DELUXE BORE GUIDE KIT #777999

Clam Size: 7"W x 17.25"H x 3"D Case Pack: 4

- Ensures proper rod alignment for easier cleaning
- Bore guides protect chamber and bore from damage
- Anodized aluminum tube for durability
- Fits most bolt-action rifles and AR-15s



INCLUDES

- (3) bore guide tips
- (3) brass muzzle guides
- (2) pipettes
- 10/22 muzzle guide
- Bore guide solvent port
- Bolt-action collar
- AR-15 collar
- Standard length tube
- Extra long tube
- Plastic molded storage case

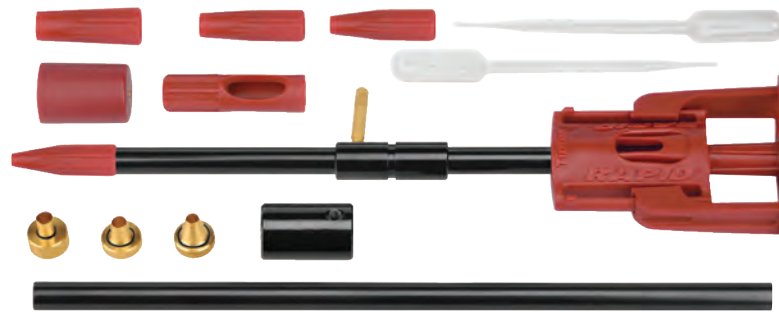

▲ UNIVERSAL BORE GUIDE KIT #777888

Clam Size: 7"W x 17.25"H x 3"D Case Pack: 4



- Anodized aluminum tube for durability
- Fits most bolt-action rifles and AR-15s

INCLUDES

- (3) bore guide tips
- Bore guide solvent port
- Bolt-action collar
- AR-15 collar
- Standard length tube



▲ NEW COMPACT PISTOL CLEANING KIT #1082252

Clam Size: 4"W x 6.5"H x 2"D Case Pack: 6

- For use on pistol calibers ranging from .22-.45
- Collapsible cleaning rod with rotating T-handle
- Stainless steel cleaning rod

INCLUDES

- Cleaning pick
- (10) cotton cleaning patches
- Nylon cleaning brush
- Bronze pistol brushes
 - .22 cal
 - 9mm/.357/.38 cal
 - .40/10mm cal
 - .45 cal
- Nylon jags
 - .22 cal
 - 9mm/.357/.38 cal
 - .40/10mm cal
 - .45 cal
- (2) nylon slotted tips

• Rotating stainless steel T-handle cleaning rod

• Nylon cleaning brush

• Nylon jags

• Bronze Bore Brushes

• Semi-rigid carrying case

• Removable cleaning kit tray for easy use



Case is 1.75" thick

▲ NEW FIELD HANDGUN CLEANING KIT #1080202

Clam Size: 4"W x 6.875"H x 1"D Case Pack: 10

- For cleaning rifle calibers ranging from .380—.45

INCLUDES

- (2) cotton swabs for cleaning barrels, chambers and cylinders
- Nylon brush with pick for stubborn fouling
- Lint-free cloth for wiping down firearms
- Pre-saturated oil wipe for metal protection
- Disposable gloves
- Resealable package for easy and secure storage and transportation



▲ NEW FIELD RIFLE CLEANING KIT #1080201

Clam Size: 4"W x 6.875"H x 1"D Case Pack: 10

- For cleaning rifle calibers ranging from .22—.338

INCLUDES

- Coated steel cable with felt plugs for bore cleaning
- Nylon brush with pick for stubborn fouling
- Lint-free cloth for wiping down firearms
- Pre-saturated oil wipe for metal protection
- Lens cleaning wipe for scopes
- Grease packet for lubrication of high-wear areas
- Disposable gloves
- Resealable package for easy and secure storage and transportation



⚠️ ULTRA JAG™

Clam Size: 2"W x 7"H x .75"D Case Pack: 5

CALIBER

.17.....#175543
 .20.....#589546
 .22.....#225659
 .243/6mm.....#234865
 .25/6.5mm.....#255684
 .270/7mm.....#277555
 .30/.32.....#303033
 .338/8mm.....#338338

.35/9mm.....#348359
 .375.....#375375
 .40/416.....#404169
 .44.....#444444
 .45.....#454545

• Pointed tip for easy patch penetration

• Slotted grooves hold solvent for maximum cleaning

• Slotted grooves secure patches on jag

• Standard size threads

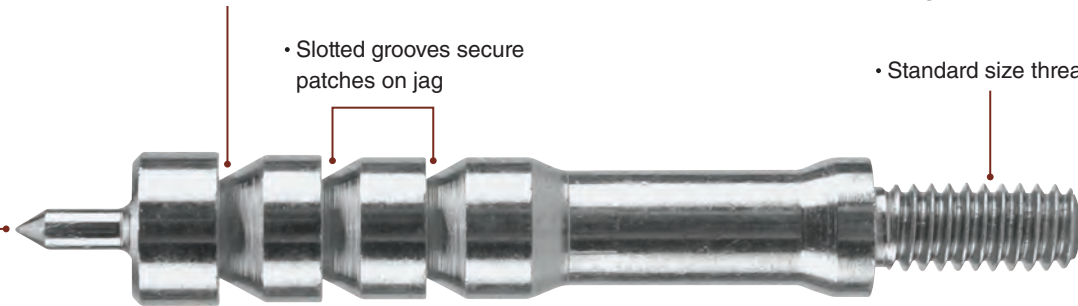

PATENTED

**ULTRA JAG™ TECHNOLOGY
 SOLVENT-PROOF COATING**



The Ultra Jag™ shows no sign of copper bluing, even after soaking in bore solvent overnight.

⚠️ BEST BORE BRUSHES

Clam Size: 2"W x 7"H x 1.75"D Case Pack: 5

- All components are non-marring, made from high-quality bronze
- 20% more bristles than standard brushes

CALIBER	3-PACK	10-PACK
.17.....	#212009	
.20.....	#669638	
.22.....	#140337	#882927
.243 / 6mm.....	#758284	
.25 / 6.5mm.....	#657930	
.270 / 7mm.....	#622858	
.30 / .32.....	#868556	#634045

CALIBER	3-PACK
.338 / 8mm.....	#427343
.35 / 9mm.....	#606367
.375.....	#127759
.40 / .416.....	#317183
.44.....	#629958
.45.....	#211233
.50 BMG.....	#561865

**20% MORE
 BRISTLES THAN
 STANDARD BRUSHES**



• Wire-through coupler for maximum strength

▲ ULTRA JAG™ SET #500012

Clam Size: 6.5"W x 5.5"H x 1"D Case Pack: 6

PATENTED



13-PIECE SET

CALIBERS INCLUDED

- | | | |
|-------------|------------|-------|
| • .17 | • .270/7mm | • .40 |
| • .20 | • .30 | • .44 |
| • .22 | • .338/8mm | • .45 |
| • .243/6mm | • .5/9mm | |
| • .25/6.5mm | • .375 | |

▲ BEST BORE BRUSH SET #402173

Clam Size: 7.5"W x 7"H x 1"D Case Pack: 6



13-PIECE SET

CALIBERS INCLUDED

- | | | |
|-------------|------------|-------|
| • .17 | • .270/7mm | • .40 |
| • .20 | • .30 | • .44 |
| • .22 | • .338/8mm | • .45 |
| • .243/6mm | • .5/9mm | |
| • .25/6.5mm | • .375 | |

▲ ULTRA JAG™ BEST BORE BRUSH SET #402173

Clam Size: 7.5"W x 8.5"H x 2"D Case Pack: 6

PATENTED

26-PIECE SET

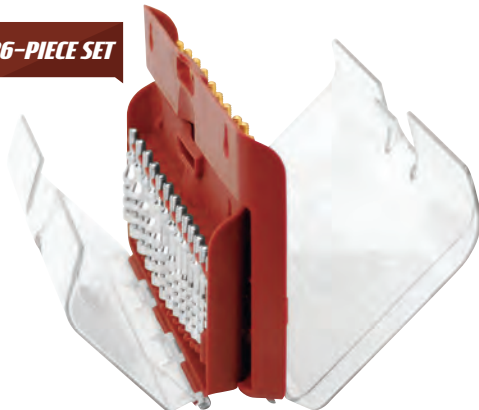

CALIBERS INCLUDED

- | | | |
|-------------|------------|-------|
| • .17 | • .270/7mm | • .40 |
| • .20 | • .30 | • .44 |
| • .22 | • .338/8mm | • .45 |
| • .243/6mm | • .5/9mm | |
| • .25/6.5mm | • .375 | |

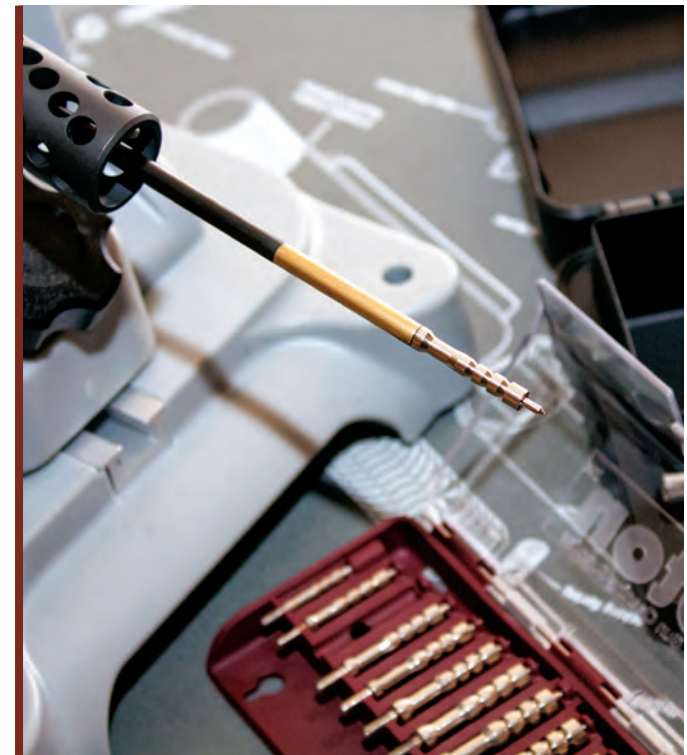

▲ BRASS JAG SET #749245

Clam Size: 7.5"W x 7"H x 1"D Case Pack: 6



- Durable, hinged-box
- Jags made of solid brass

INCLUDES

- .17
- .20
- .22
- .243/6mm
- .25/6.5mm
- .270/7mm
- .30
- .338/8mm
- .5/9mm
- .375
- .40
- .44
- .45

▲ INDIVIDUAL SOLID BRASS JAGS

Clam Sizes: 2"W x 7"H x 1.75"D Case Pack: 5



CALIBER	
.17	#154070
.20	#589555
.22	#356987
.243/6mm	#696435
.25 /6.5mm	#584696
.270/7mm	#768059
.30/.32	#193225
.338/8mm	#485467
.35/9mm	#434832
.375	#272744
.40/.416	#412599
.44	#301110
.45	#239013
.50	#505050

▲ BRONZE BORE BRUSHES

Clam Sizes: 2"W x 7"H x 1.75"D Case Pack: 5



RIFLE	PISTOL	3-PACK
.17	.22	#770767
.20	.25	#507040
.22	.32	#892661
.243/6mm	.38/9mm Auto	#631419
.25/6.5mm	.41/10mm Auto	#223504
.270/7mm	.44	#670133
.30/.32	.45	#737502
.338/8mm	.475/.480	#141054
.35/9	SHOTGUN	
.375	10 gauge	#662575
.40/.416	12 gauge	#612735
.44	16 gauge	#383231
.45	20 gauge	#215223
	28 gauge	#849144
	.410 bore	#286637
	10-PACK	
.22		#466875
.30/.32		#113901

▲ NYLON BRUSHES

Clam Size: 2"W x 7"H x 1.25"D
Case Pack: 5



RIFLE	
.17	#698306
.20	#244596
.22	#749051
.243/6mm	#176663
.25/6.5mm	#559632
.270/7mm	#887541
.30/.32	#125012
.338/8mm	#437445
.35/9	#105458
.375	#468709
.40/.416	#592325
.44	#303351
.45	#244597
	10-PACK
.22	#690246
.30/.32	#479365

▲ BORE BRUSH SETS

Clam Size: 7.5"W x 7"H x 1"D
Case Pack: 5



- Bronze brushes made from premium phosphor bronze
- Nylon brushes untainted by most modern solvents, including copper solvent

13-PIECE SET

Bronze Rifle Set	#168557
Nylon Rifle Set	#615333

8-PIECE SET

Bronze Handgun Set	#854102
Bronze Shotgun Set	#671861

RIFLE SET	PISTOL SET	SHOTGUN SET
• .17	• .22	• .410 ga
• .20	• .243/6mm	• 28 ga
• .22	• .25/6.5mm	• 20 ga
• .243/6mm	• .270/7mm	• 16 ga
• .25/6.5mm	• .30	• 12 ga
• .270/7mm	• .338/8mm	• 10 ga
• .30	• .5/9mm	
• .338/8mm	• .375	
• .5/9mm	• .40	
• .375	• .44	
• .40	• .45	
• .44	• .47/.48	
• .45		

▲ SOLID BRASS SLOTTED TIPS

Clam Size: 2"W x 7"H x 1.75"D
Case Pack: 5



- Longer lasting than synthetic plastic tips

Set of 4#554428
(.22-.29, .30-.35, .35-.44 and .45 calibers)

CALIBER

.22-.29	#428953
.30-.35	#211422
.36-.44	#777753
.45+	#400385
Universal Shotgun	#339005

▲ GUN CLEANING PICKS

Polymer | #549864
Stainless Steel | #324770
Clam Size: 4.5"W x 11.5"H x 5"D
Case Pack: 6

- Cleaning picks come in a set of 4



*Stainless Steel
Cleaning Picks*



▲ DOUBLE ENDED CLEANING BRUSHES #654866

Clam Size: 4.85"W x 11"H x .75"D Case Pack: 6

INCLUDES

- (2) nylon brushes
- (1) bronze brush



ACTION/CHAMBER CLEANING TOOL SET #368628

Clam Size: 5.75"W x 16.5"H x 1"D Case Pack: 12

REPLACEMENT SWABS (100-PACK) #115373

Clam Size: 5"W x 5"H x 5"D

INCLUDES

- Bolt raceway cleaning tool
- Chamber cleaning tool
- Nylon cleaning brush
- Small bore chamber mop
- Large bore chamber mop
- (10) bolt raceway swabs



▲ BORE MOPS

Clam Size: 2"W x 7"H x 1.75"D

CALIBER	3-PACK	
.17.....	#312659	Case Pack: 1
.22-.25.....	#653568	Case Pack: 1
6.5mm-.338.....	#386626	Case Pack: 5
8mm-.375.....	#181031	Case Pack: 5
.40-.45.....	#676648	Case Pack: 5
10-12 gauge.....	#657972	Case Pack: 5
16-20 gauge.....	#681324	Case Pack: 5
.410 gauge.....	#242967	Case Pack: 5



▲ CLEANING PATCHES

Case Pack: 5

CALIBER	100-PACK	
.17-.22.....	#476217	
.22-.270.....	#359811	
.27-.35.....	#444068	
.35-.50/20 gauge.....	#192431	
	250-PACK	
.45-.58 Black Powder.....	#784909	
	500-PACK	
.35-.50/20 gauge.....	#364206	
10, 12, 16 gauge.....	#470796	
	1,000-PACK	
.17-.22.....	#652376	
.22-.270.....	#618061	
.27-.35.....	#279375	



⚠ MAGAZINE CLEANING BRUSH #557575

Clam Size: 3.75"W x 13.75"H x 1.5"D **Case Pack:** 4

- Works on most single and double-stack magazines (including AR mags, 1911 mags and most double-stack pistol mags)
- Solvent resistant nylon bristles



⚠ CLEAN AND OIL BRUSH #375777

Display Size: 3.75"W x 13.75"H x 1.5"D **Case Pack:** 4

- Fine 1-3/4" bristles
- Wood handle



⚠ SHOOTER SWABS

50-count | #757554

Clam Size: 9.6"W x 5.9"H x 2"D **Case Pack:** 6

100-count | #350379

Clam Size: 9.5"W x 8.1"H x 2.4"D **Case Pack:** 6

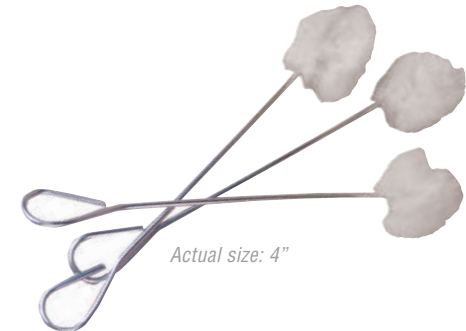

Actual size: 4"

⚠ FLIP-TOP BOTTLES (3-PACK) #197624

Clam Size: 4.85"W x 11"H x .75"D **Case Pack:** 6

INCLUDES

- 4oz polyethylene bottles
- (1) flip-top
- (1) standard



8" PIPETTES (12-PACK) #146527

Display Size: 6"W x 10.25"H x .6"D **Case Pack:** 6

- All-plastic, disposable



SILICONE CLOTH #502260

Clam Size: 5"W x 8.5"H x .52"D **Case Pack:** 6

- Silicone will not dry out or evaporate

Actual size: 14" x 15"



▲ POWER CLEAN™ ELECTRIC GUN-CLEANING BRUSH #110127

Box Size: 2"W x 7"H x 1.75"D Case Pack: 5

- Soft touch rubberized handle and power switch
- Pulse or continuous modes
- Scrubs at 3,600 oscillations per minute
- Oil- and solvent-resistant power handle and brush heads
- Uses standard 8-32 threads to easily change to other caliber brushes
- Battery powered (4 AA batteries not included)

INCLUDES

- (3) interchangeable brush heads:
 - Plastic
 - Stainless steel
 - Bronze bore brush (.22 caliber)



▲ TRULY REMARKABLE BORE SOLVENT #746275

Box Size: 2.25"Diameter x 4"H Case Pack: 6



- Removes carbon copper build-up
- **Rated #1** out of 7 competitor bore solvents in the Blue Patch Test





▲ SNAP CAPS

Clam Size: 3.75"W x 5.5"H x 1.25"D
Case Pack: 6



SHOTGUN 2-PACK
12 gauge.....#280986
16 gauge.....#878078
20 gauge.....#191808
.410 Bore.....#358983

REVOLVER 6-PACK
38 Spec./357 Mag.....#321398
44 Mag.....#347873
45 Colt.....#612637

RIFLE 10-PACK
22 Rimfire Long Rifle..... #831787
25-PACK
22 Rimfire Long Rifle..... #486758
2-PACK
23 Remington..... #415091
243 Winchester..... #270693
270 Winchester..... #709600
308 Winchester..... #134402
.30-06 Springfield..... #391320
7.62x39mm Russian..... #787336

PISTOL 5-PACK
32 ACP.....#647663
380 ACP.....#337377
9mm Luger.....#303958
40 S&W.....#745435
45 ACP.....#146331



▲ MAINTENANCE MATS

**ALL MATS ARE
HAND WASHABLE**



Glock Model 11"x 17"..... #110008
M&P® Model 11"x 17"..... #110009
1911 Model 11"x 17"..... #558680
 Clam Size: 13.25"W x 6.25"H x 1.75"D **Case Pack: 6**



Maintenance Mat 16"x 54" #380861
 Clam Size: 19"W x 5.2"H x 3 **Case Pack: 6**
Maintenance Mat 12"x 24" #602557
 Clam Size: 15"W x 4"H x 2.4" **Case Pack: 6**

Wheeler[®]
Engineering
Fine Gunsmithing Supplies

Wheeler[®]
Engineering 
DELTA SERIES





DELTA SERIES® AR TOOLS

SCREWDRIVER SETS

SCOPE ALIGNMENT

GUNSMITHING TOOLS



NEW AR CARBON MULTI-SCRAPER #1078195

Clam Size: 4"W x 8.2"H x 0.75"D Case Pack: 4

- Cleans (11) surfaces of the Bolt Carrier Group
- Fits inside AR pistol grips

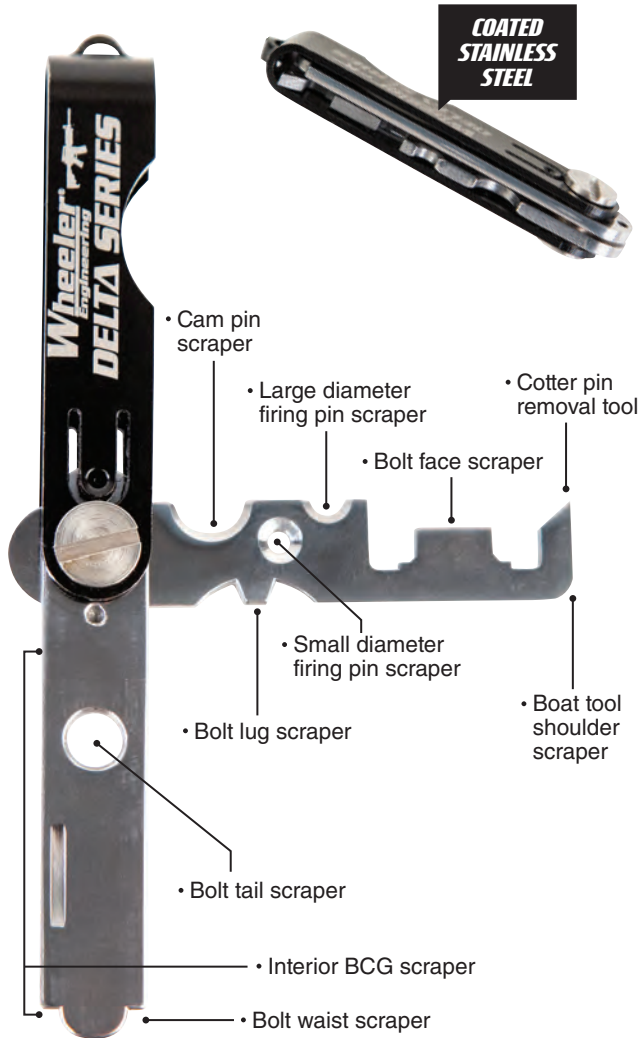

NEW COMPACT AR MULTI-TOOL #1078948

Clam Size: 5"W x 7"H x 2"D Case Pack: 4

- Fits compact into nylon belt sheath
- Multi-tool design to perform many different functions in the field
- Satin finish, stainless steel construction

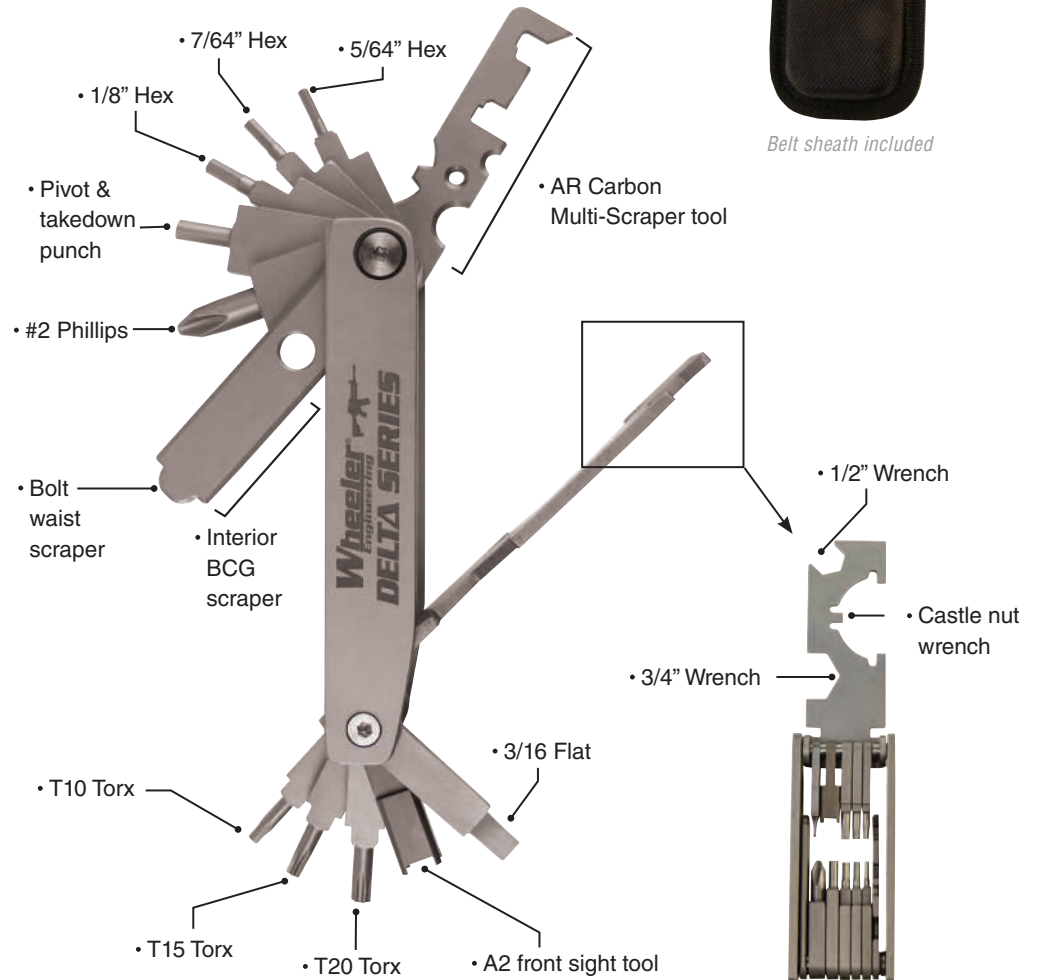

⚠ AR ARMORER'S VISE #156224

Box Size: 21.25"W x 7.75"H x 6"D **Case Pack:** 2

Build, maintain and reconfigure AR's with the Wheeler® Delta Series® AR Armorer's Vise. This product includes the base rear vise block and front support, providing an ideal foundation for all AR tasks. The vise works great for assembled guns in closed or break-open state and ideal for holding a lower-receiver for assembly and maintenance.

- Non-slip rubber feet can be removed for permanent benchtop mounting
- Forend Support can accommodate diameters up to 2.3"
- Base is constructed of rigid steel with depressions to contain spare parts or tools
- Front and rear supports rotate to multiple positions and are reversible for maximum customization

PATENTED



⚠ MAG WELL VISE BLOCK

AR-15 | #156211

AR LR/10 Variant | #146200

Clam Size: 8"W x 13"H x 2.5"D **Case Pack:** 4

- Mountable to benchtop with included fasteners
- Locks into place using magazine lock-on receiver
- Built-in hammer stop prevents damage to lower receiver
- Solvent-resistant polymer provides durability and is non-marring to surfaces
- Mag Well arm is removable for clamping in a vise

PATENTED

AR LR/10 Variant has a larger mag well insert to accommodate a larger platform and is compatible with SR25 type lowers: DPMS® LR308, KAC® SR25, LWRCI REPR®, LaRue OBR®, Bushmaster® .308 ORC®, LMT® .308 MWS, Remington® R-25, POR® P-308, JP Enterprises® LRP-07, Les Baer® .308, Colt® LE901-16S and The Armalite® AR-10A.

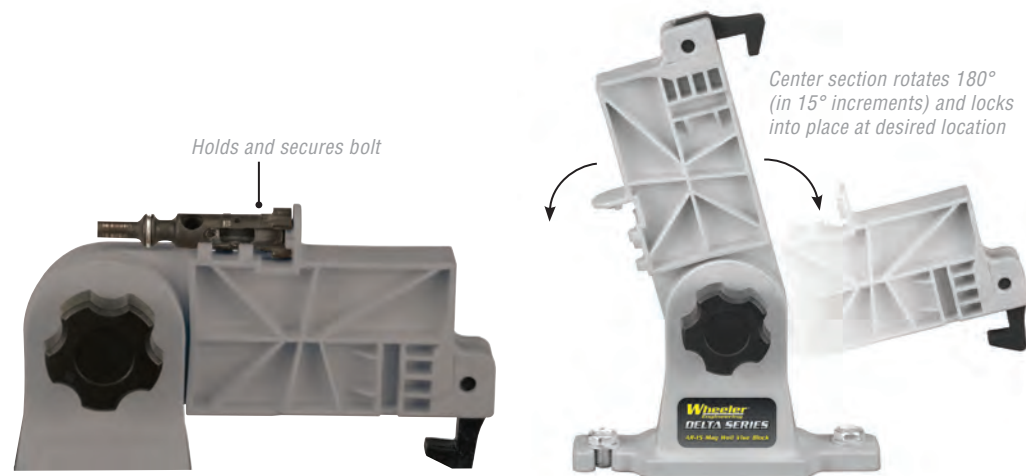

▲ AR ARMORER'S ULTRA KIT #156559

Box Size: 22"W x 10.25"H x 6.75"D **Case Pack:** 2

INCLUDES

- AR-15 AR Armorer's Vise
- AR-15 Combo Tool
- Torque wrench
- AR-15 Bench Block
- AR-15 Roll Pin Install Tool Kit
- Upper Vise Block with gas tube alignment tool
- AR-15 Maintenance Mat
- Pivot & Roll Pin Install Tool
- AR Front Sight Tool
- Delta Ring Tool
- Strap wrench
- AR-15 Bore Guide
- Adjustable Receiver Link
- .22 cal bore brush
- Bolt carrier brush
- Chamber brush
- Mag/upper receiver brush
- Nylon brush handle
- Double-ended general cleaning brush
- Cleaning pick set
- Custom carry case

PATENTED



▲ AR-15 MAINTENANCE MAT #156824

Clam Size: 5.5"W x 22.75"H x 3.5"D **Case Pack:** 4

The Wheeler® Delta Series® AR-15 Maintenance Mat provides a padded neoprene surface that helps absorb oils and solvents and keeps track of small gun parts. The mat has a durable non-slip rubber backing and rolls up easily to fit in a range box. AR-15 Maintenance Mat is hand washable.

47"W x 20"H





▲ AR ARMORER'S PROFESSIONAL KIT #156555

Box Size: 22"W x 10.25"H x 6.75"D Case Pack: 2

INCLUDES

- AR-15 AR Armorer's Vise
- AR-15 Combo Tool
- Torque wrench
- Upper Vise Block with gas tube alignment tool
- AR-15 Maintenance Mat
- Pivot & Roll Pin Install Tool
- AR Front Sight Tool
- Delta Ring Tool
- Strap wrench
- AR-15 Bore Guide
- Adjustable Receiver Link
- .22 cal bore brush
- Bolt carrier brush

PATENTED



- Chamber brush
- Mag/upper receiver brush
- Nylon brush handle
- Double-ended general cleaning brush
- Cleaning pick set
- Custom carry case

▲ AR ARMORER'S ESSENTIALS KIT #156111

Clam Size: 21"W x 7.25"H x 3.5"D Case Pack: 2

INCLUDES

- AR-15 Combo Tool
- Torque wrench
- Upper Vise Block with gas tube alignment tool
- Pivot & Roll Pin Install Tool
- AR-15 Maintenance Mat
- AR-15 Mag Well Vise Block
- AR-15 Adjustable Receiver Link
- Custom carry case

PATENTED



⚠ A. AR COMBO TOOL ONLY #156999

Clam Size: 5"W x 7"H x 2"D Case Pack: 4

⚠ B. AR COMBO TOOL WITH TORQUE WRENCH #156700

Clam Size: 7.5"W x 21"H x 2.5"D Case Pack: 4

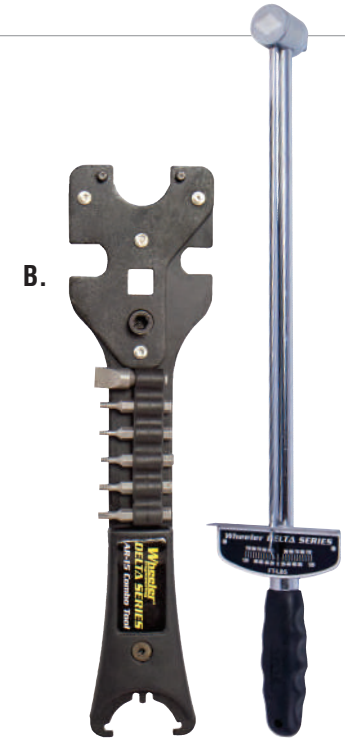
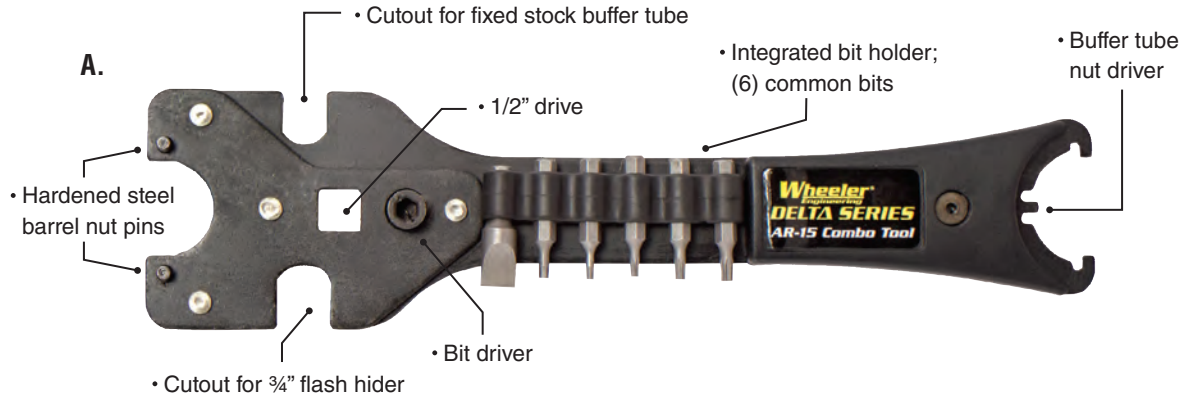

BORE GUIDES

AR-15#156213

AR LR/10 Variant#156777

300 AAC Blackout#777209

Clam Size: 4"W x 15"H x 1.5"D Case Pack: 4

These Wheeler® Delta Series® Bore Guides fit securely in any AR-15 or AR LR/10 variant upper and can be retained in place by closing the dust cover on the upper—engaging a groove in the guide. The AR-15 Bore Guide works well with .223 and .204, while the AR LR/10 Variant works well on .308. The AR-15 300 AAC Blackout Bore Guide works on any 30 caliber, 6.5 or 6.8 AR-15. The AR-15 Bore Guide inner tube diameter is .250"

- Precision CNC machined aluminum
- Durable anodized finish

- Solvent port for adding chemicals after patch has been inserted

- Dust cover locking engagement groove

- Chemical resistant retention O-rings

- Nozzle extends inside the chamber to prevent solvent from leaking

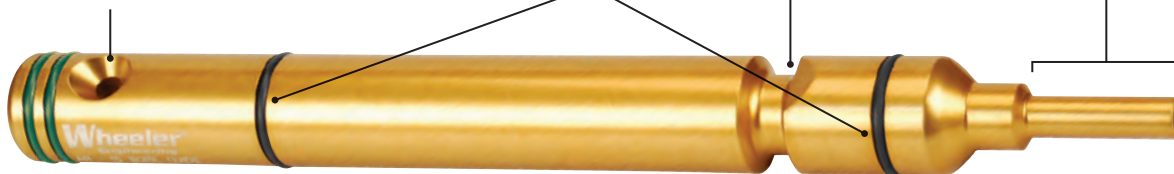

⚠ AR TRIGGER GUARD INSTALL TOOL #710907

Clam Size: 5"W x 6.7"H x 1"D Case Pack: 4

- Install or change trigger guards quickly and easily
- Includes install pin and an uninstall pin
- Pins conveniently store in the frame
- Made of durable aluminum with a Mil-spec anodized surface finish
- No lower damage from hammering the roll pin into the receiver\



AR BOLT CATCH INSTALL PUNCH KIT #710906

Clam Size: 3.25"W x 9.4"H x 0.5"D Case Pack: 4

- Flat on one side for proper alignment
- Rubber overmolded to prevent damage to firearm
- Includes (2) steel punches
 - (1) with counter-bored tips to start roll pins
 - (1) with indexing tips to finish roll pins
- No lower damaging from hammering the roll pin into the receiver
- Made of durable aluminum with a Mil-spec anodized finish



⚠ AR-15 ROLL PIN INSTALL TOOL KIT #952636

Clam Size: 3.6"W x 9"H x 1.75"D Case Pack: 4



INCLUDES

- AR Bolt Catch Install Punch Kit
- AR Trigger Guard Install Tool
- (3) starter steel punches (1/16", 5/16", 3/32")
- (3) driver steel punches (1/16", 5/16", 3/32")
- Two-sided hammer
- Blow-molded storage case



⚠ AR ARMORER'S BENCH BLOCK #156945

Clam Size: 6.25"W x 9"H x 1.25"D **Case Pack:** 4

- Durable, non-marring urethane material to protect gun finish
- Designed to assist in all aspects of an AR-15 build
- Ideal for changing or adjusting triggers



Holds lower secure for roll pin assembly

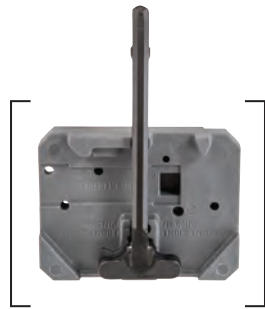

Hassle-free charging handle catches



Secures upper while installing forward assist roll pin



Perfect for gas block pins

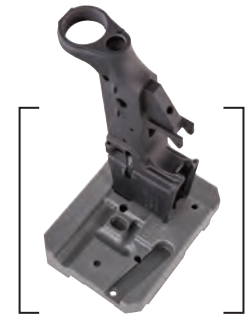

Great for rear-facing pins and springs

⚠ AR FRONT SIGHT TOOL #156437

Clam Size: 5.25"W x 4"H x 1.5"D **Case Pack:** 4

- Compatible with any 1/4" hex driver
- Key ring handle
- Black zinc-plated steel



⚠ AR HANDGUARD TOOL #567839

Clam Size: 4"W x 15"H x 1.5"D **Case Pack:** 4



- Durable, nylon-reinforced 24" x 3/4" rubber strap
- Non-marring
- Rubberized no-slip grips
- Ergonomic handle
- Easily adjustable

⚠ AR DELTA RING TOOL #209943

Clam Size: 4.75"W x 16.5"H x 1.5"D **Case Pack:** 4

- Easily remove mil-spec AR-15 and M16 handguards
- Durable 100% vinyl-coating protects gun's finish
- Custom wire fits securely around Delta Ring
- Steel bracket welded for durability, even with stuck or broken Delta Rings



AR UPPER VISE BLOCK #156444

Clam Size: 7"W x 15"H x 2"D **Case Pack:** 4

- Fits left- and right-hand Mil-spec A2 upper, with carrier handles*
- Fits flat top receivers
- Made of high-pressure, solvent-resistant polymer material



**Other AR-15 variants may be adapted with special attention to potentially non-conforming surfaces or features. Does NOT work with left-handed uppers that have a dust cover that flips upward.*

AR UPPER/PIC RAIL VISE BLOCK #156888

Clam Size: 7"W x 14.5"H x 1.75"D **Case Pack:** 4

- Multi-function design holds AR-15 and most AR LR/10 uppers
- Easily secure any pic rail receiver
- Durable extruded and machined aluminum construction

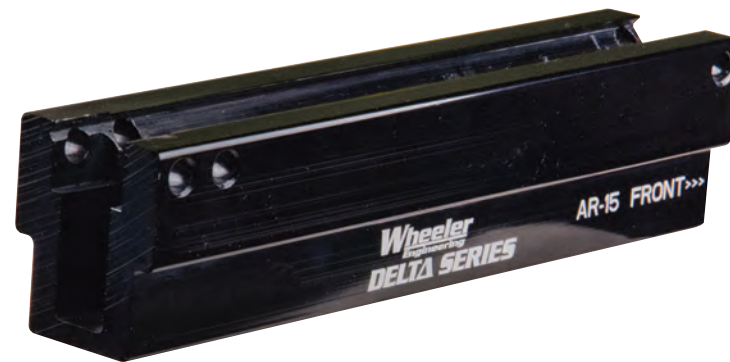

AR PIVOT & ROLL PIN INSTALL TOOL #156243

Clam Size: 5.25"W x 4"H x 1.5"D **Case Pack:** 4

- For the AR-15, M4, or M-16
- Fast and effortless pivot spring and detent work
- Roll Pin Punch and starter for all lower receiver roll pins
- Handy key ring for storage
- Black electro-coated steel



AR-15 COMPLETE BRUSH SET #156715

Clam Size: 5.5"W x 13.75"H x 1.5"D **Case Pack:** 4

INCLUDES

- Magazine/Upper Receiver Brush with Magazine Take Down Tool
- Bolt Carrier Brush with 8-32 threads
- Chamber Brush with 8-32 threads
- .22 Cal Bore Brush with 8-32 threads



NEW AR LR/10 VARIANT RECEIVER LAPPING TOOL #1082227

Clam Size: 4.5"W x 11.5"H x 1.25"D Case Pack: 4

AR-15 RECEIVER LAPPING TOOL #156757

Clam Size: 4.5"W x 11.5"H x 1.25"D Case Pack: 4

- Compatible with battery-powered or electric drill
- Steel construction with a black oxide finish

INCLUDES

- Flex driver shaft
- 220 Grit lapping compound
- Steel lapping bar

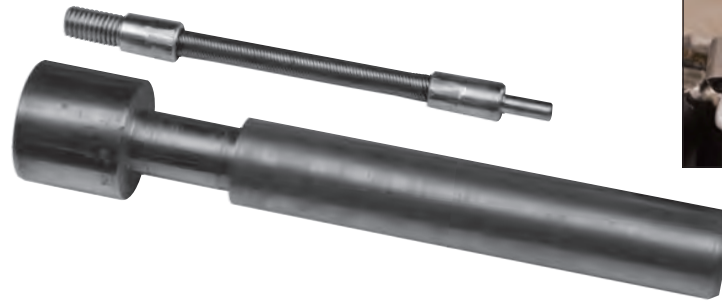

Lapping a receiver ensures a perfectly square and true surface for the barrel to mate against, enhancing accuracy. Also, honing the surface can produce optimal positioning of barrel nut so ideal torque can be achieved along with proper gas tube hole alignment.

GOOD LAP



BAD LAP



NEW COMPACT AR CLEANING KIT #1082251

Box Size: 3.25"W x 7.5"H x 1.75"D Case Pack: 6

- For use on .22 or .30 caliber rifles
- Semi-rigid carry case fits into an AR magazine pouch
- Collapsible cleaning rod with rotating T-handle
- Stainless steel cleaning rod

INCLUDES

- AR chamber brush
- Multi-function bolt scraper tool
- Cleaning pick
- Nylon cleaning brush
- Collapsible 36" stainless steel cleaning rod with rotating T-handle
- (3) Star Chamber Cleaning Pads
- Patches for .22 or .30 cal
- Nylon brushes for .22 or .30 cal
- Jags for .22 or .30 cal



NEW AR GAS BLOCK TAPER PIN REMOVAL TOOL #1079898

Clam Size: 5.75"W x 8.3"H x 2.25"D Case Pack: 4

- Works on A2 front sights
- Works on Smith & Wesson® single-taper pin gas blocks
- Works on dual taper pins
- Durable tool steel

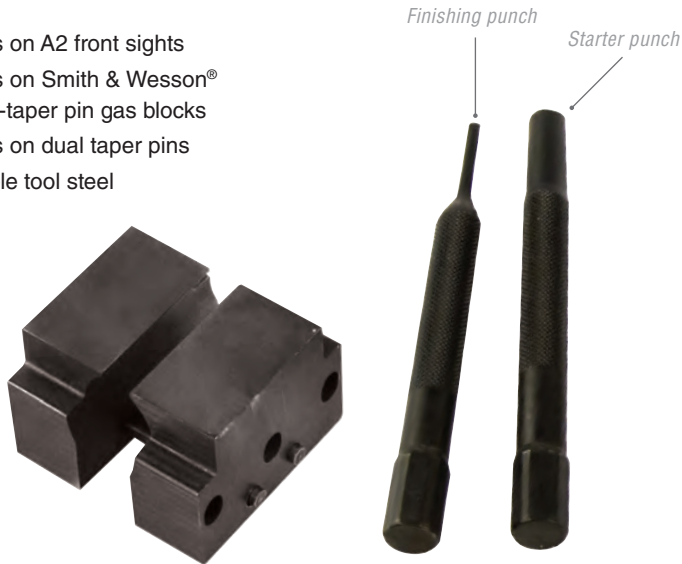

NEW STAR CHAMBER CLEANING PADS (20-PACK) #1078197

Clam Size: 2.8"W x 7.3"H x 0.8"D Case Pack: 4

- Compressed wool cleaning pads specifically die-cut to fit into an AR-15 Star Chamber
- Includes an 8-32 threaded end to secure pad to cleaning rod

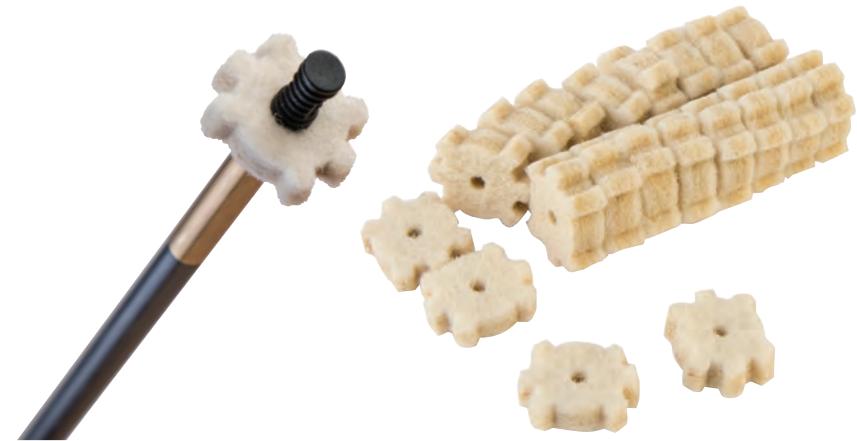

PIC RAIL RISERS

1"#156504

0.7"#156505

0.5"#156506

Clam Size: 3.5"W x 9.875"H x 1.75"D

Case Pack: 4



- Lightweight and durable CNC machined aluminum construction
- Each riser is 5.75" in length and incorporates (3) T15 fasteners for maximum mounting strength
- Allow perfect height alignment for optics and accessories
- (2) sets of fasteners included

AR-15 ADJUSTABLE RECEIVER LINK #156000

Clam Size: 4"W x 8.5"H x 1"D Case Pack: 4

INCLUDES

- (1) upper link
- (2) threaded lower links
 - Short (open position of 1.2"–1.5")
 - Long (open position of 1.4"–1.8")





OUR HOLLOW-GROUND PERFECT-FIT BITS

Standard shape bits cam out of a screw's slot and can gouge or mar the screw head. Hollow-Ground bits gently curve at the tip spreading force equally along the sides of the screw slot damage free.

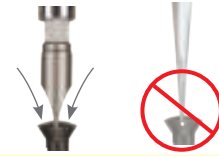

NEW 55-PIECE HEX/TORX SET #1081958

Box Size: 5.6"W x 7.8"H x 2.3"D Case Pack: 4



INCLUDES

- (50) Hollow-Ground flat bits
- 1/4" Driver Handle
- 4mm Driver Handle

SAE Hex

.028" 9/64"
 .035" 5/32"
 .05" 3/16"
 1/16" 7/32"
 5/64" 1/4"
 3/32" 5/16"
 7/64" 3/8"
 1/8"

Metric Hex

.7mm 4.5mm
 .9mm 5mm
 1.3mm 5.5mm
 1.5mm 6mm
 2mm 7mm
 2.5mm 8mm
 3mm 10mm
 4mm

Torx

T1 TT10
 T2 TT15
 T3 TT20
 T4 TT25
 TT5 TT30
 TT6 TT35
 TT7 TT40
 TT8 TT45
 TT9 TT50

Phillips

#1
 #2
 Flat
 #14
 #32

NEW MICRO MULTI-DRIVER TOOL PEN #1082257

Clam Size: 3.6"W x 7.9"H x 1.6"D Case Pack: 4

- Aluminum construction handle
- Pen holds (5) bits internally

BITS INCLUDED

- H0.9, H1.3, H1.5, H2 (Hex Metric)
- SL1.5, SL2, SL2.5, SL3 (Slotted)
- PH00, PH0, PH1 (Phillips)
- T5, T6, T7 (Torx)
- TR8, TR9, TR10 (Torx Security)



NEW MULTI-DRIVER TOOL PEN #1082256

Clam Size: 3.6"W x 7.9"H x 1.6"D Case Pack: 4

- Aluminum constructed handle
- Pen holds (6) bits internally

BITS INCLUDED

- H5/64, H3/32, H1/8, H5/32 (Hex and SAE)
- SL3, SL4, SL4.5 (Slotted)
- PH1, PH2 (Phillips)
- T10, T15, T20, T25 (Torx)



DELUXE 89-PIECE SET #562194

Box Size: 8.3"W x 12.3"H x 3.1"D Case Pack: 10



PATENTED

INCLUDES

- (54) Hollow-Ground flat bits
- (15) Specialty bits***
- Durable S2 tool steel
- (2) No-slip overmolded handles
- 2¼" shaft extension
- Hex-to-square drive adapter
- Convenient hinged storage case

BASIC 72-PIECE SET #776737

Box Size: 8.3"W x 12.3"H x 3.1"D Case Pack: 10



PATENTED

INCLUDES

- (54) Hollow-Ground flat bits
- Durable S2 tool steel
- (2) No-slip overmolded handles
- Convenient hinged storage case

43-PIECE SET #954621

Box Size: 9.25"W x 8.5"H x 3"D Case Pack: 4



PATENTED

INCLUDES

- (21) Hollow-Ground flat bits
- Durable S2 tool steel
- Durable no-slip overmolded handle
- Magnetic bit retention in driver
- Convenient hinged storage case

***See 17-Piece Upgrade Screwdriver Set on pg. 127 for complete list

SPACE SAVER GUNSMITHING SET #664507

Box Size: 5.25"W x 11.5"H x 1"D Case Pack: 4

INCLUDES

- (26) Bits
- Standard, Phillips, hex, and torx bits
- (1) 2" long #2 Phillips bit, ideal for recoil pad installation
- (1) Hex-to-square conversion bit
- (1) Comfortable, overmolded plastic, magnetic handle



21-PIECE EXPANSION SET #954671

Clam Size: 2.75"W x 9"H x 2"D Case Pack: 4



- Durable S2 tool steel
- Plastic storage tray that fits 72 or 89-piece sets
- ½" x ¼" socket driver
- 2.5mm, 3mm, 3.5mm, 4mm, 4.5mm, 5mm, 5.5mm, 6mm, 7mm, and 8mm Hex Bits
- T6, T7, T8, T9, T10, T15, T20, T27, T30 Torx Bit

17-PIECE UPGRADE SET #748555

Clam Size: 2.75"W x 9"H x 2"D Case Pack: 1



INCLUDES

- (15) Specialty bits
- Shaft extension
- Square-to-hex adapter

PRECISION MICRO SET #564018

Clam Size: 5.25"W x 11.5"H x 1"D Case Pack: 4



- 58-piece set
- Chrome plated steel bits
- Extendable Handle from 3-¾"—5-½"
- 5 ¾" flexible extension shaft
- Precision-formed bits for fastener engagement
- Individual bit markings
- Organized carry/storage case

PROFESSIONAL OPTICS FASTENER KIT #142434

Clam Size: 10"W x 8.5"H x 1.5"D Case Pack: 4

- Corrosion-resistant black zinc finish

INCLUDES

- Grade 8 high-strength quenched and tempered alloy steel fasteners
- Ring Windage 10-32 x 7.5mm slotted head fasteners
- 6-48 and 8-40 taps
- Convenient storage case

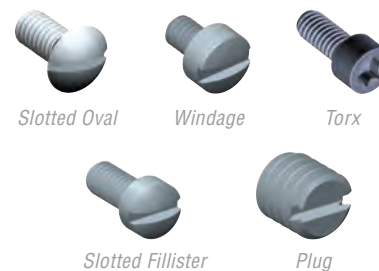

NEW 30-PIECE P-HANDLE DRIVER SET (SAE/METRIC HEX & TORX) #1081957

Box Size: 15"W x 8.8"H x 6.7" Case Pack: 4

SAE Hex
 3/32"
 7/64"
 ball, 1/8"
 ball, 9/64"
 ball, 5/32"
 ball, 3/16"
 ball, 7/32"
 ball, 1/4"
 ball, 5/16"
 ball, 3/8"

Metric Hex
 1.5mm
 ball, 2mm
 ball, 2.5mm
 ball, 3mm
 ball, 4mm
 ball, 5mm
 ball, 6mm
 ball, 7mm
 ball, 8mm
 ball, 10mm

Torx
 T7
 T8
 T9
 T10
 T15
 T20
 T25
 T27
 T30
 T40



Molded stand can sit on bench top or has mounting holes on back for hanging

NEW 45-PIECE KEY SET (SAE/METRIC HEX & TORX) #1081959

Hanging Size: 6"W x 11.5"H x 2"D Case Pack: 4

SAE Hex
 .028" 9/64"
 .035" 5/32"
 .05" 3/16"
 1/16" 7/32"
 5/64" 1/4"
 3/32" 5/16"
 7/64" 3/8"
 1/8"

Metric Hex
 .7mm 4.5mm
 .9mm 5mm
 1.3mm 5.5mm
 1.5mm 6mm
 2mm 7mm
 2.5mm 8mm
 3mm 10mm
 4mm

Torx
 T1 T9
 T2 T10
 T3 T15
 T4 T20
 T5 T25
 T6 T30
 T7 T35
 T8



! PROFESSIONAL LASER BORE SIGHTER

Red Laser | #580022

Green Laser | #589922

Clam Size: 6"W x 11"H x 2"D **Case Pack:** 4

- Machined aluminum body with soft rubber overmolding
- Hand-tuned during manufacturing
- Laser module permanently secured for reliable performance

INCLUDES

- Plastic storage case
- Lithium 123A battery
- Reflective sighting grid

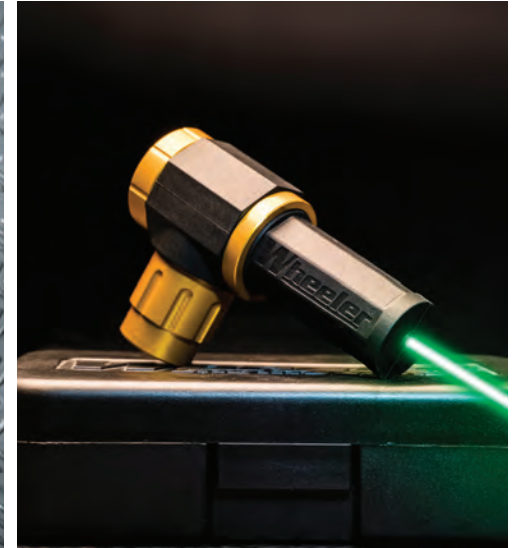

! ULTRA SCOPE MOUNTING KIT #541010

Box Size: 11.25"W x 9.25"H x 3.35"D **Case Pack:** 2

Professional Reticle Leveling System ensures scope is level and crosshairs are perfectly perpendicular.

PATENTED

INCLUDES

- F.A.T. Wrench®
- (9) bits
- (1) socket
- Bit holder
- Thread lockers
- Lens pen to keep scope clean
- Heavy-duty storage case with foam-molded inserts



Level rifle and scope



Mount scope to rifle



Coarse-sight scope with precision and accuracy



⚠ PRO RETICLE LEVELING SYSTEM #119050**Box Size:** 11.25"W x 9.25"H x 3.35"D **Case Pack:** 2

- Precision machined aluminum with anodized finish
- Barrel clamp level has non-marring pads
- Adjustable barrel clamp level fits around even the largest diameter barrels, including shotguns
- Each level has an integrated bubble level for precise measurement
- Reference level has magnetic bottom for stability

INCLUDES

- (2) calibrated machined aluminum level housings
- Foam-molded storage case

**⚠ ARMORER'S HANDGUN SIGHT TOOL #710905****Clam Size:** 8.5"W x 5"H x 5.25"D **Case Pack:** 4

- Fully captures and supports slide
- Sight prong is reversible to accommodate glocks
- Works on all semi-auto pistols
- Large 4-post drive knob to easily push the sight

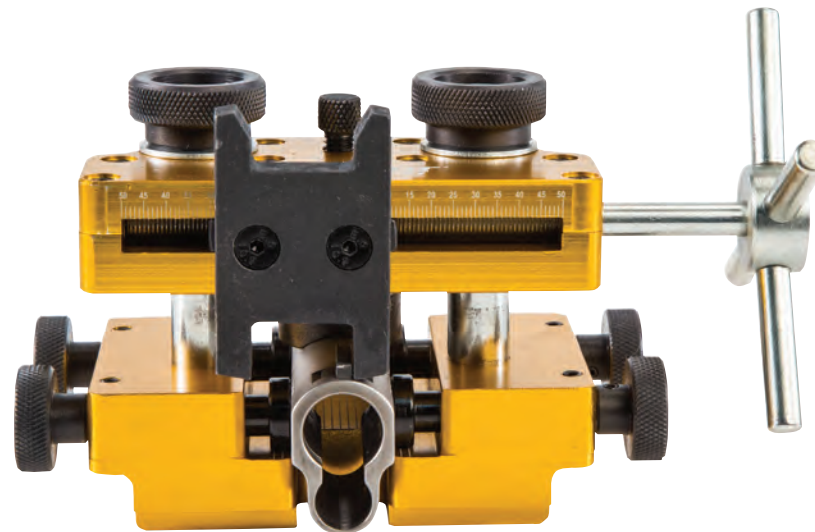

▲ LEVEL-LEVEL-LEVEL #113088

Clam Size: 4"W x 7.5"H x 0.5"D Case Pack: 4

PATENTED



▲ ANTI-CANT INDICATORS

A. 1"#755712

B. 30mm#766112

C. Pic Rail...#580033

Clam Size: 5.4"W x 7"H x 1"D Case Pack: 4

Keeping the scope perfectly aligned is critical to long-range accuracy. Canting your scope, even just a couple of degrees, can cause error in point of impact. With modern "Drop-Compensating" scopes, an Anti-Cant Indicator is a necessity.

- Indicates precise, repeatable level gun position
- Easy-to-view from shooting position
- Attaches to scope, folds in when not in use
- Universal pic rail attachment
- Precision machined aluminum with anodized finish

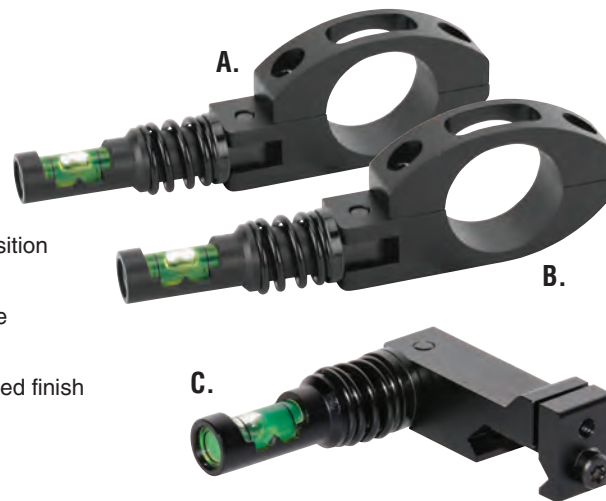

NEW SCOPE RING ALIGNMENT & LAPPING KIT, 34MM #1081035

Clam Size: 4.6"W x 11.5"H x 2.6"D Case Pack: 4

INCLUDES

- Alignment bars
- Lapping bar
- Lapping bar handle
- 220 Grit lapping compound



SCOPE MOUNTING KITS

Professional Scope Mounting Kit 1"#540127 **PATENTED**

Professional Scope Mounting Kit Combo#545454 **PATENTED**

(1" and 30mm alignment and lapping bars) Case Pack: 4

Storage Case#1017566 **PATENTED**

Case Pack: 10

INCLUDES

- F.A.T. Wrench®
- (10) bits
- 1/2" socket
- Level-Level-Level
- Flex driver
- Lapping bar(s)
- Alignment bar
- Lapping bar handle
- Lapping compound
- Thread locker
- Storage case



SCOPE RING ALIGNMENT AND LAPPING KITS

1" Rings#204061 **PATENTED**

30mm Rings#633266 **PATENTED**

Combo Kit.....#305172 **PATENTED**

Lapping Compound Kit.....#342303 **PATENTED**

(1 each: 220, 320 and 600 grit compound)

1" Scope Ring Alignment Bar#781366 **PATENTED**

Case Pack: 1

INCLUDES

- Lapping bar(s)
- Alignment bar
- Lapping bar handle
- 220 Grit lapping bar compound

⚠ F.A.T. WRENCH® #553556

Clam Size: 7.75"W x 9.75"H x 3"D **Case Pack:** 4

- Bits are made from S2 tool steel and hardened to 56-58 Rockwell "C"
- Torque adjustment range from 10 inch/pounds to 65 inch/pounds
- Accuracy plus/minus 2 inch/pounds up to 40 inch/pounds; 40 - 65 is +/- 5%



⚠ DIGITAL F.A.T. WRENCH® #710909

Clam Size: 7.75"W x 9.75"H x 3"D **Case Pack:** 4

- Bits are made from S2 Tool steel and hardened to 56-56 Rockwell "C"
- Ergonomic overmolded design
- 15–100 in/lb. range and measure in lb-in, kg-cm, N-m
- +/- 2% accuracy
- Audible and visual indicator
- Full set of bits included
- Low battery indicator



⚠ PROFESSIONAL DIGITAL TRIGGER GAUGE #710904

Box Size: 6"W x 8.75"H x 1.75"D **Case Pack:** 5

- 0–12lbs range
- +/- .2% accuracy
- Load sensor directly contacts the trigger
- Feature max, min, average and live functions
- Audible indicator tone
- Low battery indicator
- Arm folds inside housing to protect the load sensor when not in use
- Includes bladed trigger adapter to allow use with triggers that have internal safety blades such as: Glock®, Ruger®, Savage® and other manufacturers
- Foam lined storage case

**MEASURES IN
POUNDS & KILOGRAMS**



⚠ TRIGGER PULL SCALE #309888

Clam Size: 4.5"W x 14.75"H x 1.25"D **Case Pack:** 4

- Measures in 2oz increments
- Accurate to +/- 2oz
- Easy-to-read sliding indicator
- Range from 8oz—8lbs



NEW MASTER GUNSMITHING BENCHTOP MAGNIFIER #110182

Box Size: 9.2"W x 30.75"H x 3.8"D Case Pack: 4

- 3 diopter/1.75x magnification
- Integral 40 LED lights
- 400 lumen output
- Adjustable, flex-head gooseneck design
- Tabletop design with metal c-clamp securement
- AC-powdered with 88" power cord

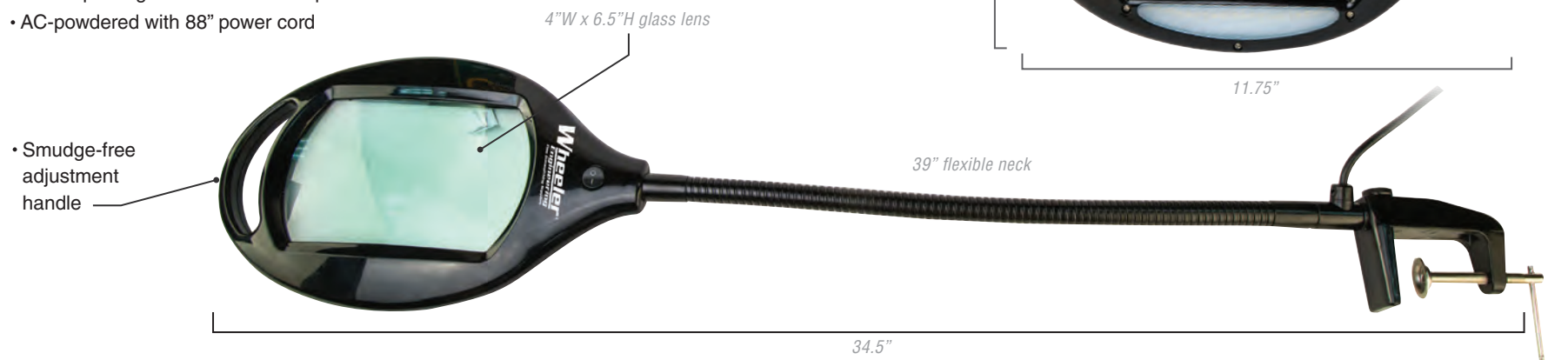

• Smudge-free adjustment handle

4"W x 6.5"H glass lens

39" flexible neck

400 LUMEN OUTPUT

7.25"

11.75"

34.5"

NEW MASTER GUNSMITHING HANDHELD MAGNIFIER #110183

Box Size: 2.8"W x 9"H x 2.3"D Case Pack: 4

- 10x magnifier
- Integral LED light
- Graduated scale
- Sits flat on tabletop or bench
- Carry case included



10x MAGNIFICATION

7.125"

⚠ ROLL PIN STARTER SET #710910

Clam Size: 8"W x 10.75"H x 1"D Case Pack: 4



⚠ ROLL PIN PUNCH SET #204513

Clam Size: 8"W x 10.75"H x 1"D Case Pack: 4



- Machined from hardened steel
- Designed to provide proper alignment of the roll pin and to prevent damage to firearm
- Identified slots in roll-up nylon pouch
- 5/16", 1/4", 7/32", 3/16", 5/32", 1/8", 3/32", 5/64", 1/16"

⚠ HAMMER PUNCH SET #951900

Clam Size: 5.25"W x 11"H x 1.75"D Case Pack: 5

INCLUDES

- Polymer/brass combination hammer
- (8) precision brass punches
- (4) steel punches
- (2) plastic punches
- Handy molded case



⚠ BRASS PUNCH SET #780194

Clam Size: 8.75"W x 5.6"H x 5"D Case Pack: 1



- Made of solid machined metal
- Reduces the chance of marring
- (8) precision crafted pin punches
- Handy roll-up pouch

⚠ NYLON/BRASS HAMMER #711016

Clam Size: 2.6"W x 9.5"H x 1"D Case Pack: 1

- Nylon face is non-marring
- Brass face can be used for driving pins and punches
- 11" length



Weights 8oz

▲ MASTER ROLL PIN PUNCH SET #110128

Clam Size: 5.75"W x 9"H x 2"D Case Pack: 4



INCLUDES

- 5/16"
- 1/4"
- 7/32"
- 3/16"
- 5/32"
- 1/8"
- 3/32"
- 5/64"
- 1/16"

- Machined and hardened steel
- Starter pins designed with a counter-bored tip to properly align and prevent damage
- Roll pins designed with a ball profile tip to properly align and prevent damage
- Knurled pin handles for secure handling
- Non-marring nylon hammer head

▲ MASTER INTERCHANGEABLE HAMMER SET #110268

Clam Size: 3.5"W x 11.5"H x 2.5"D Case Pack: 4

INCLUDES

- (2) machined metal hammer bodies
- (4) hammer faces with each hammer body: metal, brass, nylon, rubber
- Durable blow-molded case



▲ UNIVERSAL 1911/PISTOL BENCH BLOCK #672215

Clam Size: 5"W x 9.25"H x 1.5"D Case Pack: 4

- Made of non-marring urethane
- Main spring removal recess
- Barrel link removal V channel
- Rear sight drift channel/ front sight stalking channel
- Hammer and sear pin removal holes
- Ejector port dressing channel
- Rail dressing round bottom channel
- Perfect for M1911 Pistols and 10/22s



Dimensions: 1¼"H x 4"Diameter

▲ UNIVERSAL BARREL CLAMP #672286

Clam Size: 5"W x 9.25"H x 1.5"D Case Pack: 4

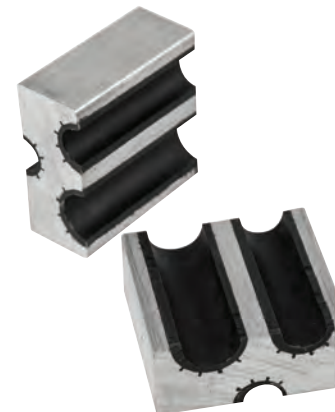

- Precision extruded from aircraft-grade aluminum
- Bonded with non-marring urethane
- (3) barrel openings: .85", .66", .53"



Action Wrench #1 | #808771

(Mausers with flat-bottomed receivers) **Case Pack:** 1

Action Wrench #2 | #414521

(Remington® 700) **Case Pack:** 1

Savage® Barrel Nut Wrench | #123038

Case Pack: 1

Barrel Vise with 3 Oak Bushing | #465185

Case Pack: 1

Replacement Oak Bushings (3-pack) | #844879

(Remington® 700) **Case Pack:** 1

Lead Barrel Vise Shims (4-pack) | #239444

Case Pack: 1

- 15" x 1" diameter steel handle
- Double-ended Savage® Barrel Nut Wrench fits early and late model nuts on the 110 and 10 series rifles
- (2) ½" square drive holes for swing bar or torque wrench
- Barrel Vise includes (2) pre-drilled oak blocks (1" and ¾") and solid block for custom drilling



PROFESSIONAL FILE SET #710908

Box Size: 17"W x 4"H x 2.75"D **Case Pack:** 4



INCLUDES

- 8" half round file
- 8" flat file
- 6" square file
- 6" triangle file
- 6" round file
- 4-in-1 Rasp
- File cleaning brush
- Extra-fine diamond plate
- Stick of file chalk
- Flat coarse grit
- Round coarse grit
- Triangle coarse grit
- Flat medium grit
- Round medium grit
- Triangle medium grit
- Flat fine grit
- Round fine grit
- Triangle fine grit

CERAMA-COAT™ CUSTOM GUN ARMOR

Black Cerama-Coat™ #468993

Flat Dark Earth Cerama-Coat™ #492304

Olive Drab Cerama-Coat™ #567312

Clam Size: 4.75"W x 8.5"H x 3"D **Case Pack:** 4

- Highly resistant to scratching, chipping and gun solvents
- Weatherproof, matte finish
- Bonds to ferrous metals, alloys, stainless steel and other synthetics that can be heated to 200° F



Black



Flat Dark Earth



Olive Drab

⚠ ADVANCED STOCK REFINISH KIT #139021

Box Size: 5.5"W x 9"H x 2"D Case Pack: 4



INCLUDES

- Heavy duty finish remover
- Industrial grade sand paper
- Stock sealer
- Wood filler
- Walnut ftain
- Classic oil finish
- Pumice & rottenstone
- Synthetic steel wool
- Instructional DVD

⚠ BEDROCK™ GLASS BEDDING KIT #190274

Box Size: 4.5"W x 9"H x 2"D Case Pack: 4



- 4oz Bedrock™ (2oz resin, 2oz hardener)
- Brown & Black dye for wood or synthetic gunstocks
- Release gent (plus 2 applicators)
- 2fl oz micro balloons
- Modeling clay
- Surgical Tubing
- (3) Mixing cups
- (3) Mixing/applicator sticks
- Illustrated instruction booklet

⚠ MAGNIFYING VISOR #639552

Box Size: 7.2"W x 2.7"H x 8"D Case Pack: 1

- 1.8x and 2.3x magnification levels
- Accessory loupe for really close inspection
- Adjustable, padded head strap



⚠ RECOIL PAD INSTALLATION FIXTURE #184528

Box Size: 5.5"W x 2.3"H x 2.4"D Case Pack: 1

- Transfers toe-line angle and comb line from the stock to new recoil pad
- Serves as a stable work-holding fixture for off-the-stock sanding of the pad
- Designed for use with any table-mounted belt or disc sander



BOG-POD®

TRIPODS • BIPODS • MONOPODS • ACCESSORIES





RLD SERIES

SB SERIES

CLD SERIES

HD/TAC SERIES

MONOPODS

ACCESSORIES

switcheroo
SHOOTING SYSTEM

The Switcheroo® Shooting System allows you to switch out your shooting rest with a spotting scope, camera, binoculars, or one of our advanced shooting systems!



⚠ RLD-2 BIPOD #735532

Clam Size: 7"W x 38.5"H x 2.5"D Case Pack: 4

⚠ RLD-3 TRIPOD #735533

Clam Size: 7"W x 38.5"H x 2.5"D Case Pack: 4

- Bipod weight: 24oz / Tripod weight: 33oz
- Durable aluminum finish
- Use in sitting, kneeling or standing positions
- Includes weather-resistant carry bag



switcheroo
SHOOTING SYSTEM



Universal Shooting Rest



Ground Spikes



Twist-Lock Legs



Fine Adjustments

ADJUSTABLE
22" – 68"





⚠️ SB-2 BIPOD #735544

Clam Size: 6.25"W x 38.5"H x 2.5"D Case Pack: 4

PATENTED

**ADJUSTABLE
21" — 40"**

⚠️ SB-2C BIPOD #735563

Clam Size: 6.25"W x 38.5"H x 2.5"D Case Pack: 4

PATENTED



- SB Series Bipods weigh 19oz
- SB-2C comes with rubber retention strap



switcheroo
SHOOTING SYSTEM



Universal Shooting Rest



Ground Spikes



Twist-Lock Legs



⚠ CLD-2 BIPOD #735536

Clam Size: 7"W x 38.5"H x 2.5"D Case Pack: 4

⚠ CLD-3 TRIPOD #735535

Clam Size: 7"W x 38.5"H x 2.5"D Case Pack: 4

- Bipod weight: 32oz / Tripod weight: 40oz
- Durable, matte finish aluminum legs
- Includes weather-resistant carry bag

switcheroo
SHOOTING SYSTEM



**ADJUSTABLE
22" — 68"**



Universal Shooting Rest



Fine Adjustments



All-Terrain Foot System



Rapid Adjust Lever Lock





Universal Shooting Rest

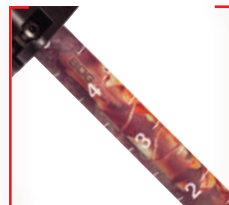

Fine Adjustments



All-Terrain Foot System



Rapid Adjust Lever Lock

⚠ CLD-3S TRIPOD #735542

Clam Size: 7"W x 38.5"H x 2.5"D **Case Pack:** 4

- Tripod weighs 32oz
- Durable, matte finish aluminum legs
- Includes weather-resistant carry bag

switcheroo
SHOOTING SYSTEM



**ADJUSTABLE
6" – 42"**



⚠️ HD-3 TRIPOD #735557

Clam Size: 7.5"W x 39"H x 3.5"D Case Pack: 4



- Tripod weight: 56oz
- Durable, matte finish aluminum legs
- Leg tubes 5mm thicker than the standard Bog-Pod®

ADJUSTABLE
22" – 68"



Universal Shooting Rest



All-Terrain Foot System



Fine Adjustments



Rapid Adjust Lever Lock
(noise-reducing rubber guards)

switcheroo
SHOOTING SYSTEM

⚠️ TAC-3 TRIPOD #735540

Clam Size: 7.5"W x 39"H x 3.5"D Case Pack: 4



- Tripod weight: 40oz
- Non-glare VEL-COAT™ finish aluminum legs

ADJUSTABLE
22" – 68"





⚠️ Q-STIK MONOPOD #735543

Clam Size: 7"W x 38.5"H x 3.5"D **Case Pack:** 4



Universal Shooting Rest



All-Terrain Foot System



Fine Adjustments



Rapid Adjust Lever Lock
(noise-reducing rubber guards)

- Monopod height: 29.5"—68"
- Weight: approximately 15oz
- 3-section, high-strength, lightweight aluminum leg with matte black finish
- Hiker's grip provides comfortable hand support

switcheroo
SHOOTING SYSTEM

INCLUDES

- Weather-resistant carry bag
- Allen wrench
- USR
- Binocular rest
- Camera adapter
- Compass top
- Removable snow disc



⚠️ **USR—UNIVERSAL SHOOTING REST** #735538

Clam Size: 9.5"W x 10"H x 1.5"D **Case Pack:** 4

The Universal Shooting Rest (USR) is designed to be a lightweight (4oz) alternate shooting rest for any Bog-Pod® shooting stick. The USR will provide the very same 360° head rotation as the original XSR.

switcheroo
SHOOTING SYSTEM



⚠️ **XSR—XTREME SHOOTING REST** #735539

Clam Size: 8"W x 22"H x 3"D **Case Pack:** 4

- Weight: approx. 18oz
- Lightweight aluminum
- (2) USRs that adjust laterally to accommodate most rifles and shotguns
- Perfectly balances firearm over tripod
- (2) hook & loop safety straps to secure firearm
- Approximately 15.5"L x 2"W

switcheroo
SHOOTING SYSTEM



⚠️ **SSC—SUPER STEADY COMBO** #735550

Clam Size: 11"W x 38.5"H x 3.25"D **Case Pack:** 2

- Combines RLD-3, XSR and USR
- Cushioned grips
- Independently adjustable legs with inch markers
- Lightweight, durable aluminum construction
- Holds most any stock
- Non-marring, non-slip rubber inserts

**WORKS WITH
RIFLES AND
CROSSBOWS**

switcheroo
SHOOTING SYSTEM



⚠️ **RAPID SHOOTING REST** #110113

Clam Size: 7.25"W x 19.25"H x 2.5"D **Case Pack:** 4

- Rest elevation 7"—11"
- Diecast aluminum construction
- Collapses to 12.8" for transport
- Non-marring, non-slip feet
- Weight 21.6oz

switcheroo
SHOOTING SYSTEM



⚠ DEAD SILENT SHOOTING STICKS

Sitting Model | #735560

Clam Size: 4.25"W x 21.25"H x 2"D **Case Pack:** 4

Standing Model | #735565

Clam Size: 5.25"W x 20.25"H x 2.5"D **Case Pack:** 4

- Durable 9/16" diameter aluminum tubing
- Elastic strap keeps collapsed sticks bound and quiet for transport



- Sitting model:
 - 39" usable height
 - Weight approx. 11oz
- Standing model:
 - 72" usable height
 - Weight approx. 16oz



All-Terrain Foot System



Leg retention clip shortens usable length

⚠ SCA-STANDARD CAMERA ADAPTER #735549

Clam Size: 7"W x 14.5"H x 3"D **Case Pack:** 4

- Omni-directional ball for multi-direction rotation and tilt
- Top lever release lock to prevent accidental lever release
- Accessory plate has 1/4"-20 and 3/8"-16 thread bushings to fit most mounts
- Weight: approx. 14oz

**SMOOTH
360°
ROTATION**

switcheroo
SHOOTING SYSTEM



⚠ PCA-PROFESSIONAL CAMERA ADAPTER #735546

Clam Size: 8"W x 16.5"H x 3.5"D **Case Pack:** 4

- Pistol-grip style ball head allows for one-handed operation
- Omni-directional ball for multi-direction rotation and tilt
- Accessory plate has 1/4"-20 and 3/8"-16 thread bushings
- Weight: approx. 21oz

switcheroo
SHOOTING SYSTEM



⚠️ BSB-SUPER STEADY SADDLEBAG #735559

Clam Size: 7"W x 14"H x 3"D Case Pack: 4

- Made of high density nylon
- (2) velcro-secured side pockets to hold weight/filling
- Removable, aluminum base plate which can be directly secured to various surfaces with screws or zip ties
- Non-slip rubber bottom
- Weighs approximately 16oz (with mounted USR)

switcheroo
SHOOTING SYSTEM

INCLUDES

- USR
- BSB outer nylon bag
- ADAPT-A-POD
- Heavy duty plastic bags for use with your choice of filling
- Aluminum mounting plate



⚠️ WIDE BODY UNIVERSAL SHOOTING REST #735555

Clam Size: 6"W x 10"H x 4.25"D Case Pack: 4

The Wide Body Universal Shooting Rest is both deeper and wider than the Universal Shooting Rest and is designed to give the added stability needed to take that longer shot. The WUSR provides 360° head rotation and weighs 7.9oz.

switcheroo
SHOOTING SYSTEM



⚠️ SSA-SPOTTING SCOPE ADAPTER #735561

Clam Size: 10"W x 12.5"H x 3.5"D Case Pack: 4

- 2-piece design allows USR to clamp on base, or mount the 2-way head any BOG-POD® tripod
- Accessory plate is 1 5/8" x 2" in size fits most common camera mounts
- 3/16-24 and 1/4-20 thread bushings

10"W x 12.5"H x 3.5"D

switcheroo
SHOOTING SYSTEM



⚠ ADAPT-A-POD #735554

Clam Size: 4.5"W x 6.5"H x 2.5"D Case Pack: 4

The ADAPT-A-POD allows use on BOG-POD® accessories with any standard monopod, bipod or tripod.



⚠ ADAPT-2 (2-PACK) #735537

Clam Size: 4.5"W x 10.5"H x 1.5"D Case Pack: 8

- ADAPT-2 quick release plate is 1 5/8" x 2" in size and comes with standard 1/4"-20 camera screw and a 3/8"-16 adapter screw



⚠ BBR-BOG-POD® BINOCULAR REST #735547

Clam Size: 10"W x 8.5"H x 4"D Case Pack: 4

- High-strength, lightweight ABS plastic
- Non-slip rubber-covered platform
- Includes a 3/8"-16 thread and 1/4"-20 size bushing
- Approximately 3 1/4" deep x 6" wide x 3/4" tall
- Weighs only 7oz

PATENTED

FITS MOST 7x-20x BINOCULARS

switcheroo
SHOOTING SYSTEM



⚠ SSM-SLING SWIVEL MOUNT #735562

Clam Size: 5"W x 5.75"H x 1.25"D Case Pack: 4

The SSM mounts directly to rifle sling swivel stud. One end of the SSM can be mounted to any Switcheroo® compatible BOG-POD®. The other end is a sling swivel stud, allowing mounting to a sling while SSM is attached.

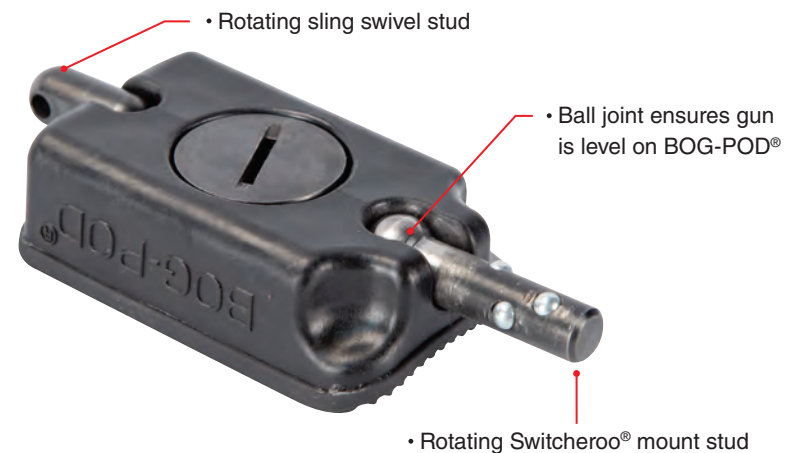

Hooymann®

PREMIUM TREE SAWS





EXTENDABLE TREE SAWS

POWER SAWS

HAND SAWS

NON-TYPICAL WILDLIFE SOLUTIONS™

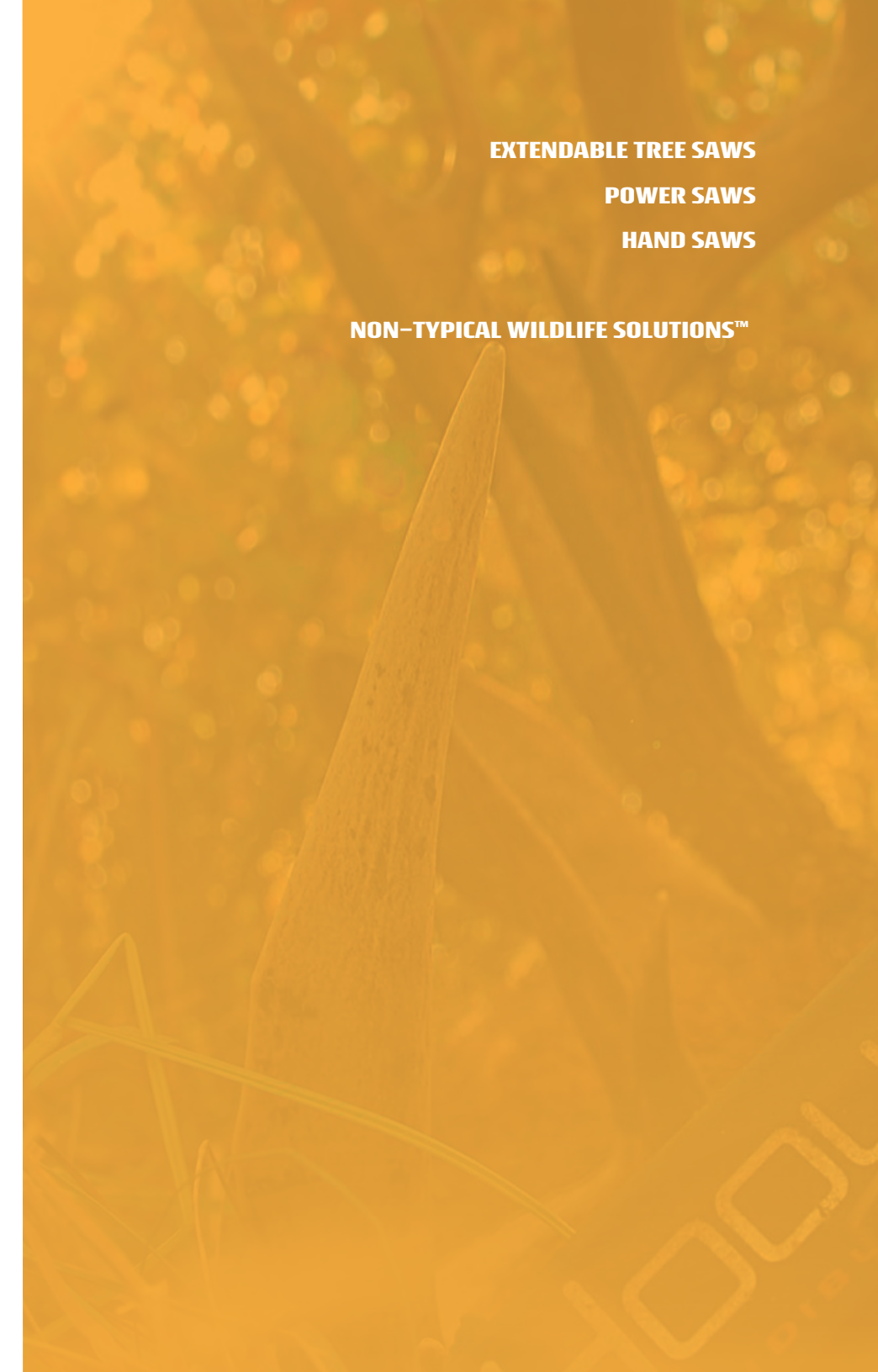

⚠ EXTENDABLE TREE SAWS

5-foot Extendable Tree Saw#655226

Box Size: 5"W x 14.75"H x 3"D Case Pack: 6

10-foot Extendable Tree Saw#655227

Box Size: 5"W x 26.75"H x 3"D Case Pack: 6

16-foot Extendable Tree Saw#655232

Box Size: 5"W x 47.5"H x 3"D Case Pack: 6

⚠ EXTENDABLE TREE SAW ACCESSORIES

5-foot Replacement Case | #655228

5-foot/10-foot Replacement Blade | #655230

Clam Size: 11.25"W x 12"H x 3.35"D Case Pack: 6

- Secure extended saw or detach for hand saw use
- Lockback blades
- I-beam aluminum construction
- MegaBite™ XP 4-edge tooth design
- High-carbon SK5 steel blade



**7" SK5
STEEL BLADE**

Extends to 5'
Collapses to 12"



Folding saw slides and locks into the extension arm with an in-line channel groove for secure connection

**7" SK5
STEEL BLADE**

Extends to 10'
Collapses to 28"



**12" SK5
STEEL BLADE**

Extends to 16'
Collapses to 48"



⚠ EXTENDABLE TREE SAW LOPPER ATTACHMENT #655233

Clam Size: 8.1"W x 22"H x 4.5"D Case Pack: 6

- Fits all Hooyman® extendable tree saws
- High-carbon SK5 steel blade
- 2.25" curved bypass cutting blade
- Cuts branches up to 1.5" in diameter
- Includes carrying case

PATENTED

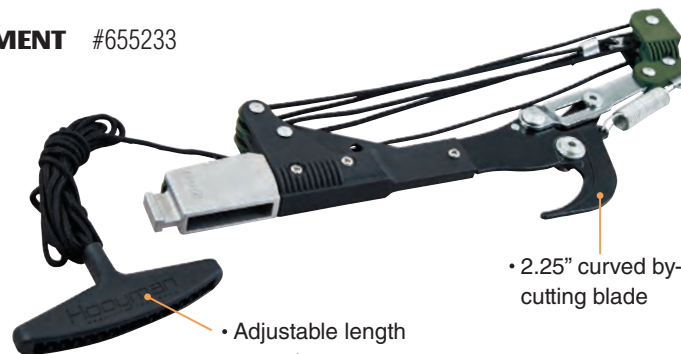

• 2.25" curved by-pass cutting blade

• Adjustable length actuation rope



▲ CORDLESS 40v LITHIUM POLE SAW #655236

Clam Size: 11.25"W x 44.5"H x 5.25"D Case Pack: 1

- Extended length of 10ft
- 3-piece detachable section collapses to 48" for easy transport or storage
- Up to 70min of runtime on included 40v Lithium-Ion battery
- Weighs less than 10lbs
- Auto-oiler with clear view window
- Battery charge-level indicator

Weight: 9.7lbs

INCLUDES

- 40v Lithium-Ion battery (↔)
- Battery Charger (charge time approx. 60min)
- Hooyman® carry case



40v LITHIUM POLE SAW ACCESSORIES

- Spare 40v Lithium-Ion Battery#655237 ▲
 - Replacement Chain Bar#655238 ▲
 - Replacement Chain#655239 ▲
 - 3.5-foot Pole Extension.....#110051 ▲
- Case Packs for All Accessories: 4



**HEAVY-DUTY
8" CHAIN SAW**



Auto-oiler view window



**40% LONGER
LIFE THAN
CONVENTIONAL
BATTERIES**



⚠ MEGABITE™ HANDSAWS

A. MegaBite™ 8" Blade | #110050

B. MegaBite™ 6" Blade | #110049

Clam Size: 7.8"W x 16.2"H x 1.3"D Case Pack: 6

- 2-position lockback blade
- MegaBite™ XP 4-edge tooth design
- High-carbon SK5 steel blade
- Ergonomic rubber overmolded handle

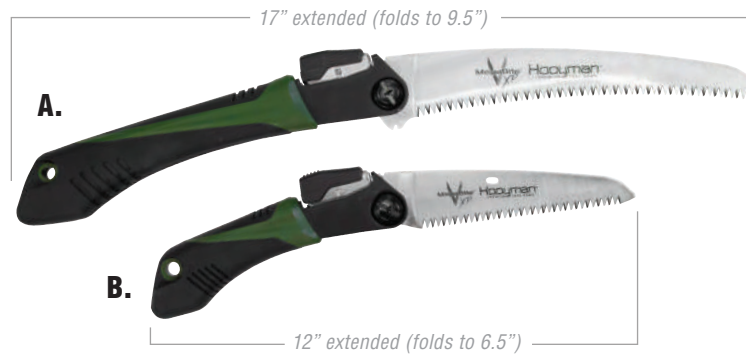

⚠ MEGABITE™ HUNTER'S COMBO #110143

Clam Size: 7.5"W x 11.3"H x 1.2"D Case Pack: 6

INCLUDES

- 8" MegaBite™ Blade XP 4-edge tooth design (#110050)
- 8" MegaBite™ Bone Blade XP 4-edge tooth design
- Ergonomic rubber overmolded handle
- Nylon carry case



⚠ RATCHET PRUNER #110144

Clam Size: 7.5"W x 11.3"H x 1.2"D Case Pack: 6

- MegaBite™ XP 4-edge tooth design
- Premium SK5 high-carbon steel blade
- Black teflon blade coating
- Aluminum frame
- Quick-detach folding saw in handle



⚠ HIGH LIMB CHAIN SAW WITH ROPE #110052

Clam Size: 11"W x 17.4"H x 3"D Case Pack: 4

- High-strength, heat-treated steel
- Dual-sided teeth cut through 6" diameter logs
- Reaches limbs up to 28' high
- Chain length: 49.5"

INCLUDES

- Easy-fill throw bag (unfilled)



The Hot Zone™ Deer Exclusion System (DES) is a complete kit that manages browse pressure on food plots to ensure maximum plot success. Over-browsing can cause limited plot production or even complete plot failure. Protect your time, money and labor investment and maintain control over when deer can access a particular food source.

▲ HOTZONE™ DEER EXCLUSION SYSTEM #717100

Box Size: 49"W x 9"H x 12.5"D **Case Pack:** 1

- Protects up to 3/4 acre (220 yd perimeter)
- Quick and easy setup and takedown
- Integrated solar charging system allows for use in remote areas
- Dual-perimeter electric fencing

Weight: 9.7lbs

INCLUDES:

- (1) HotZone™ Energizer Unit
- (1) solar panel
- (8) 7/8" posts
- (32) 1/2" posts
- (65) post pins
- (3) wire tensioners
- (1) ground rod
- (1) voltage tester
- 460 yds of wire
- 230 yds of tape
- Set-up instructions



12v deep cycle battery not included

▲ HOTZONE™ ENERGIZER UNIT #717133

Case Pack: 2



▲ HOTZONE™ DES EXPANSION KIT #717122

Box Size: 49"W x 14.6"H **Case Pack:** 1

- Protects up to an additional 200yd perimeter

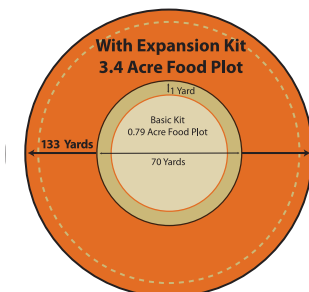
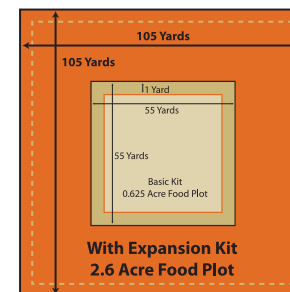
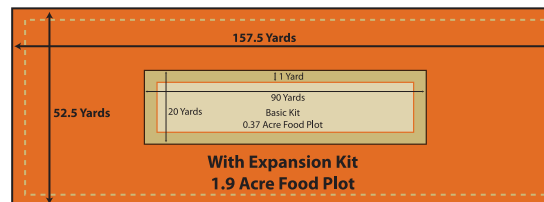

Battenfeld[®]
Technologies, Inc.



SCHRADE® **OLD TIMER**® **BUBBA BLADE**® **IMPERIAL**® *Uncle Henry*®



Battenfeld® **CUTLERY & TOOLS**
Technologies, Inc.

2018 CATALOG

Battenfeld Cutlery & Tools is an industry leading manufacturer of knives, tools and accessories. We produce innovative, top quality products under Schrade®, Old Timer®, Uncle Henry®, Imperial®, Bubba Blade®, Smith & Wesson® Accessories and M&P® Accessories.

Battenfeld Cutlery & Tools is a proud member of the Smith & Wesson® family. Battenfeld is a subsidiary of American Outdoor Brands® Corporation®.



TABLE OF CONTENTS

2018 NEW PRODUCTS

Schrade®
Old Timer®
Uncle Henry®

BUBBA BLADE®

NEW PRODUCTS

Folders
Fillet Knives
Outdoor Knives
Skinners
Tools

SCHRADE®

Assisted Opening
Folding Knives
Fixed Blades
Machetes, Axes and Spears
Tough Tools
Tactical Pens
Training Knives

UNCLE HENRY®

Traditional Staglon Folders
Select Series Lockbacks
Staglon Fixed Blades
Staglon Fillets

OLD TIMER®

Saw Cut Traditional Folders
Saw Cut Fixed Blades
Bone Handle Traditional Folders
Yellow Handle Traditional Folders
Desert Iron Wood Folders and Fixed Blades
Wood Handle Fixed Blades and Lockbacks
Copperhead Series
Old Timer® Tools

IMPERIAL®

Traditional Folders
Folding Knives and Combo Packs

ACCESSORIES

Sharpeners and Sheaths
Ferro Rods and Replacement Items
Promotional Items
Displays

RAY ULTRA-GLIDE® FOLDING KNIFE



9Cr18MoV Titanium Coated High Carbon S.S. Blade
Rubberized Aluminum Handle

- + Finger Flipper
- + Liner Lock
- + Pocket Clip
- + Lanyard Hole

Blade Length
3.54" (9 cm)
Overall Length
8" (20.5 cm)
Weight
4.2 oz.

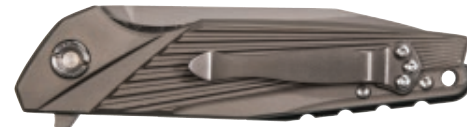

- 1084279 CLIP POINT BLADE RUBBERIZED HANDLE** ▲
UPC - 661120413400
- 1084280 CLIP POINT BLADE RUBBERIZED HANDLE CLAM PACK** ▲
UPC - 661120413417

ULTRA-GLIDE® FOLDING KNIFE



9Cr18MoV Titanium Coated High Carbon S.S. Blade
Ti-Nitride Steel Handle

- + Carbon Fiber Slab on One Side
- + Finger Flipper
- + Frame Lock
- + Pocket Clip
- + Lanyard Hole

Blade Length
2.76" (7 cm)
Overall Length
6.5" (16.5 cm)
Weight
2.3 oz.



- 1084281 DROP POINT BLADE CARBON FIBER HANDLE** ▲
UPC - 661120413424
- 1084282 DROP POINT BLADE CARBON FIBER HANDLE CLAM PACK** ▲
UPC - 661120413431

CAGE ULTRA-GLIDE® FOLDING KNIFE



9Cr18MoV Titanium Coated High Carbon S.S. Blade
Ti-Nitride Steel Machined w/G10 Inlay Handle

- + Thumb Hole
- + Finger Flipper
- + Frame Lock
- + Pocket Clip

Blade Length
2.76" (7 cm)
Overall Length
6.5" (16.5 cm)
Weight
2.3 oz.



- 1084283 CLIP POINT BLADE CAGE HANDLE** ▲
UPC - 661120413448
- 1084284 CLIP POINT BLADE CAGE HANDLE CLAM PACK** ▲
UPC - 661120413455

ULTRA-GLIDE® FOLDING KNIFE



9Cr18MoV Titanium Coated High Carbon S.S. Blade
Ti-Nitride Steel w/Carbon Fiber Inlay Handle

- + Thumbstud
- + Liner Lock
- + Pocket Clip
- + Lanyard Hole

Blade Length
2.95" (7.5 cm)
Overall Length
6.5" (16.5 cm)
Weight
2.4 oz.



- 1084291 DROP POINT BLADE CARBON FIBER HANDLE** ▲
UPC - 661120413523
- 1084292 DROP POINT BLADE CARBON FIBER HANDLE CLAM PACK** ▲
UPC - 661120413530

FOLDING KNIFE

**9Cr18MoV Bead Blast Satin High Carbon S.S. Blade
ABS & Kraton w/Anodized Aluminum Insert Handle**

- + Dual Thumbstuds
- + Liner Lock
- + Pocket Clip
- + Lanyard Hole

Blade Length
3.15" (8 cm)
Overall Length
7.28" (18.5 cm)
Weight
3.3 oz.



1084293 TANTO POINT BLADE RUBBERIZED HANDLE ▲

UPC - 661120413547

1084294 TANTO POINT BLADE RUBBERIZED HANDLE CLAM PACK ▲

UPC - 661120413554



FOLDING KNIFE

**9Cr18MoV Bead Blast Satin High Carbon S.S. Blade
Anodized Aluminum w/Rubber Inlay Handle**

- + Dual Thumbstuds
- + Liner Lock
- + Pocket Clip
- + Lanyard Hole

Blade Length
3.35" (8.5 cm)
Overall Length
7.68" (19.5 cm)
Weight
4.0 oz.



1084289 CLIP POINT BLADE GREY/BLACK HANDLE ▲

UPC - 661120413509

1084290 CLIP POINT BLADE GREY/BLACK HANDLE CLAM PACK ▲

UPC - 661120413516



1084299 OUTDOOR KIT

Steel w/Wrapped Textured Silicone Handles

+ Interchangeable Tool System

+ INCLUDES:

- Saw Blade
- Pick
- Axe
- Shovel

+ Saw, Pick, Axe & Shovel Handles
Expand from 9" – 27"

+ Steel Handles Wrapped
in Textured Silicon

+ Polyester Case

+ Safety Lock Icon

Weight

3 lb, 8.3 oz.

UPC

661120413608



ASSISTED OPENING



**7Cr17MoV High Carbon Stainless Steel Blade
Ironwood Handle**

- + Dual thumbstuds
- + Satin Blade Finish
- + Nickel Silver Caps
- + Lanyard Hole
- + Pocket Clip



6.85"



4"

Blade Length
2.9" (7.6 cm)
Overall Length
6.85" (17.4 cm)
Weight
4.4 oz.

1084273 CLIP POINT BLADE IRONWOOD HANDLE ▲

UPC - 661120413240

1084274 CLIP POINT BLADE IRONWOOD HANDLE CLAM PACK ▲

UPC - 661120413257

ASSISTED OPENING



**7Cr17MoV High Carbon Stainless Steel Blade
Ironwood Handle**

- + Dual thumbstuds
- + Satin Blade Finish
- + Nickel Silver Inlay
- + Lanyard Hole
- + Pocket Clip



7.32"



4.13"

Blade Length
2.9" (7.5 cm)
Overall Length
7.32" (18.6 cm)
Weight
4.3 oz.

1084275 DROP POINT BLADE IRONWOOD HANDLE ▲

UPC - 661120413264

1084276 DROP POINT BLADE IRONWOOD HANDLE CLAM PACK ▲

UPC - 661120413370

ASSISTED OPENING



**7Cr17MoV High Carbon Stainless Steel Blade
Sawcut Ironwood Handle**

- + Dual thumbstuds
- + Satin Blade Finish
- + Nickel Silver Bolster
- + Sawcut Handle
- + Lanyard Hole
- + Pocket Clip



6.89"



3.94"

Blade Length
2.9" (7.5 cm)
Overall Length
6.89" (17.5 cm)
Weight
3.8 oz.

1084277 DROP POINT BLADE SAWCUT HANDLE ▲

UPC - 661120413387

1084278 DROP POINT BLADE SAWCUT HANDLE CLAM PACK ▲

UPC - 661120413394



1085926 STAG HORN SKINNER COMBO ▲

D2 Steel Satin Finish Blade Stag Horn Handle

- + Full Tang
- + Brass Pins
- + Lanyard Hole
- + Leather Sheath
- UPC
- 661120414452

PH2N MINI PRO HUNTER®

- + Nickel Silver Guard
- + Leather Lanyard

Blade Length
2.8" (7.1 cm)
Overall Length
6.8" (17.2 cm)
Weight
3.6 oz.



301UH DETAIL SKINNER

Blade Length
3.1" (7.9 cm)
Overall Length
6.5" (16.5 cm)
Weight
2.5 oz.



1085922 STAG HORN GUT HOOK SKINNER ▲

D2 Steel Satin Finish Blade Stag Horn Handles

- + Full Tang
- + Gut Hook
- + Brass Pins
- + Lanyard Hole
- + Leather Sheath

Blade Length
3.5" (8.89 cm)
Overall Length
7.5" (19.05 cm)
Weight
4.6 oz.
UPC
661120414414



1085923 6.25" STAG HORN FIXED BLADE ▲

D2 Steel Satin Finish Blade Stag Horn Handle

- + Full Tang
- + Brass Pins
- + Lanyard Hole
- + Leather Sheath

Blade Length
2.75" (6.99 cm)
Overall Length
6.25" (15.875 cm)
Weight
3.6 oz.
UPC
661120414421



1085924 7" STAG HORN FIXED BLADE ▲

D2 Steel Satin Finish Blade Stag Horn Handle

- + Full Tang
- + Brass Pins
- + Leather Sheath

Blade Length
3" (7.62 cm)
Overall Length
7" (17.78 cm)
Weight
5.7 oz.
UPC
661120414438



1085925 8" STAG HORN FIXED BLADE ▲

D2 Steel Satin Finish Blade Stag Horn Handle

- + Full Tang
- + Brass Pins
- + Leather Sheath

Blade Length
4" (10.16 cm)
Overall Length
8" (20.32 cm)
Weight
6.2 oz.
UPC
661120414445



**NO RUST
NO SLIP**

**THE
KNIFE**

WITH THE

**BEST
GRIP**

BUBBA BLADE
ONE-KICK-ASS KNIFE

What makes BUBBA BLADE® better than all the rest?

PATENTED large textured "No-Slip Grip" handle is made from a thermoplastic polymer and then wrapped with a special synthetic rubber that stays sticky when wet or bloody.

Trigger grip gives you added control and security through the largest game.

Robust safety guards for protection from the blade and spines of the fish.

Titanium bonded non-stick surface coating helps prevent rusting and pitting.

Ultra smooth Non-stick coating allows meat to slide off the blade surface effortlessly.

The High Carbon S.S. blade has a Rockwell hardness rating of 56-58.

The blade is factory sharpened by hand to a razor's edge.

Full Tang construction from a single piece of steel provides strength, stability and balances the knife.

Contrasted color thumb and finger pads ensure absolute control of the knife.

BUBBA BLADE®...One Kick-Ass Knife

ULTIMATE FILLET GLOVE



Patented SuperFabric® Palm and Back

- + Slash, Cut & Puncture Resistant
- + No-Slip-Grip Technology
- + 2 Layers 1mm neoprene SuperFabric® Over Thumb and Forefinger
- + Penta Texturing Throughout
- + 6mm Neoprene Cuff with Adjustable Wrist Gusset
- + 1mm SuperFabric® Palm
- + 1mm Neoprene + DWR Finger Forchettes
- + Sold in singles not pairs

Only Available in Clam Pack



1085974 RIGHT HAND, SMALL/MEDIUM CLAM PACK

UPC - 661120414292

1085975 RIGHT HAND, LARGE/XL CLAM PACK

UPC - 661120414308

1085976 LEFT HAND, SMALL/MEDIUM CLAM PACK

UPC - 661120414315

1085977 LEFT HAND, LARGE/XL CLAM PACK

UPC - 661120414322



SuperFabric® technology takes a fabric and overlays it with tiny plates "guard plates" in a specific arrangement. The gaps between guard plates allow complete flexibility. The geometry, thickness, and size of the guard plates, as well as the fabric, are designed to deliver a range of performance features such as abrasion resistance, stain resistance, quick drying, weight reduction and more.

The key to this remarkable material is the fact that locally, the guard plates are hard. Globally, the plates allow full motion which gives SuperFabric® a feel similar to traditional fabrics. This SuperFabric® material has a tight array of guard plates integrated into strong fabric to provide the most performance such as abrasion resistance, slash resistance and more.



1085876

6" WIFFIE TAPERED FLEX FILLET KNIFE



8Cr13MoV Ti-Nitride Coated High Carbon S.S. Blade

Patented BUBBA BLADE® Textured Handle

- + Full Tang
- + Lanyard Hole
- + Synthetic Sheath

Blade Length
6" (15.24 cm)

Overall Length
11" (27.94 cm)

UPC
661120414261



1085875

8" WIFFIE TAPERED FLEX FILLET KNIFE



8Cr13MoV Ti-Nitride Coated High Carbon S.S. Blade

Patented BUBBA BLADE® Textured Handle

- + Full Tang
- + Lanyard Hole
- + Synthetic Sheath

Blade Length
8" (20.32 cm)

Overall Length
14.5" (36.81 cm)

UPC
661120414254



1085872 7.5" SPLIT RING PLIERS



8Cr13MoV Ti-Nitride Bonded High Carbon S.S. Jaws
Patented BUBBA BLADE® Textured/Aluminum Handle

- + Ring Splitter Tip
- + Carbide Cutters
- + Crimper Tool
- + Spring Loaded
- + Coiled Lanyard
- + Synthetic Sheath

Jaw Length
3" (7.62 cm)
Overall Length
7.5" (30.48 cm)
UPC
661120412656



7.5"



1085874 8.5" FISHING PLIERS



8Cr13MoV Ti-Nitride Bonded High Carbon S.S. Jaws
Patented BUBBA BLADE® Textured/Aluminum Handle

- + Carbide Cutters
- + Crimper Tool
- + Spring Loaded
- + Coiled Lanyard
- + Synthetic Sheath

Jaw Length
4" (10.16 cm)
Overall Length
8.5" (21.59 cm)
UPC
661120413271

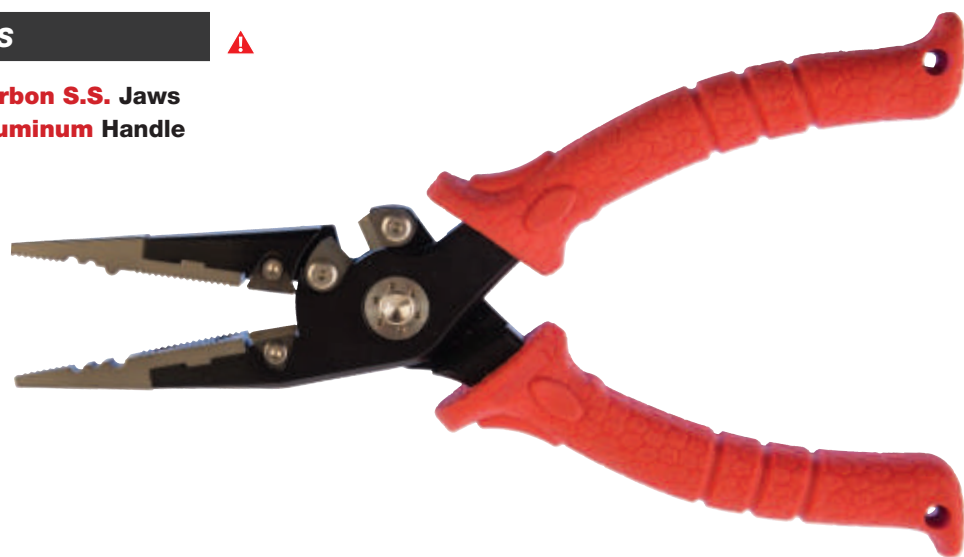

8.5"



1085969 6.5" PISTOL GRIP PLIERS



8Cr13MoV Ti-Nitride Bonded High Carbon S.S. Jaws
Patented BUBBA BLADE® Textured/Aluminum Handle

- + Split Ring Tip
- + Carbide Cutters
- + Line Cutter
- + Crimper Tool
- + Spring Loaded
- + Coiled Lanyard
- + Synthetic Sheath

Jaw Length
5.5" (13.97 cm)
Overall Length
10" (25.4 cm)
UPC
661120414377

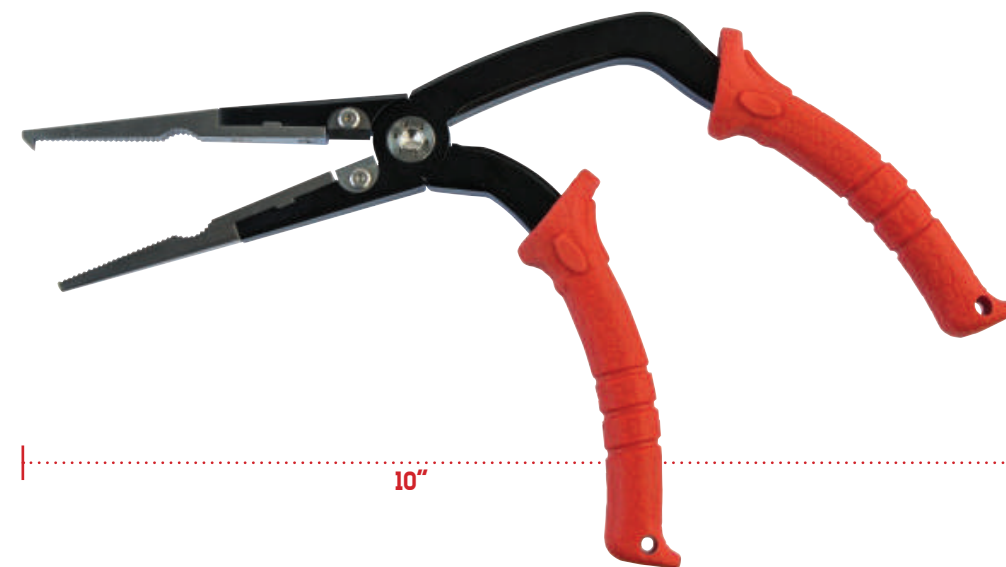

10"

SYNTHETIC SHEATH INCLUDED

1085970 8.5" PISTOL GRIP PLIERS



8Cr13MoV Ti-Nitride Bonded High Carbon S.S. Jaws
Patented BUBBA BLADE® Textured/Aluminum Handle

- + Carbide Cutters
- + Line Cutter
- + Crimper Tool
- + Spring Loaded
- + Coiled Lanyard
- + Synthetic Sheath

Jaw Length
7.5" (13.97 cm)
Overall Length
12" (25.4 cm)
UPC
661120414384



12"

SYNTHETIC SHEATH INCLUDED

BB-CL-FK SCULPIN POCKET KNIFE



8Cr13MoV High Carbon S.S. Blade

G-10 Textured/S.S. Handle

- + Finger Flipper
- + Liner Lock
- + Pocket Clip
- + Lanyard Hole
- + Thin Profile

Blade Length
4" (10.16 cm)
Overall Length
8.46" (21.5 cm)
Weight
5.3 oz.
UPC
653341606402



8.46"



4.65"

BBI-7F 7" TAPERED FLEX FILLET KNIFE



8Cr13MoV Ti-Nitride Coated High Carbon S.S. Blade

Patented BUBBA BLADE® Textured Handle

- + Full Tang
- + Lanyard Hole
- + Synthetic Sheath

Blade Length
7" (17.78 cm)
Overall Length
13" (33.02 cm)
Weight
5.7 oz.
UPC
794504877731



13"



BBI-SFK 5" LUCKY LEW FOLDING KNIFE



8Cr13MoV Ti-Nitride Coated High Carbon S.S. Blade

Patented BUBBA BLADE™ Textured Handle

- + Lockback
- + Lanyard Hole
- + Synthetic Sheath

Blade Length
5" (10.16 cm)
Overall Length
11" (21.5 cm)
Weight
7.1 oz.
UPC
019962430947



11"



6.25"



BBI-STK-MO 6" TURKINATOR FILLET KNIFE



8Cr13MoV Ti-Nitride Coated High Carbon S.S. Blade

Patented BUBBA BLADE® Textured Handle

- + Full Tang
- + Lanyard Hole
- + Mossy Oak® Obsession® on Handle and Sheath
- + Synthetic Sheath

Blade Length
6" (15.24 cm)
Overall Length
11" (27.94 cm)
Weight
5.7 oz.
UPC
019962430145



11"



BBI-9F 9" FLEX FILLET KNIFE



8Cr13MoV Ti-Nitride Coated High Carbon S.S. Blade
Patented BUBBA BLADE® Textured Handle

- + Full Tang
- + Lanyard Hole
- + Synthetic Sheath

Blade Length
9" (22.86 cm)
Overall Length
15" (38.1 cm)
Weight
6.6 oz.
UPC
794504877830



15"



BBI-9TF 9" TAPERED FLEX FILLET KNIFE



8Cr13MoV Ti-Nitride Coated High Carbon S.S. Blade
Patented BUBBA BLADE® Textured Handle

- + Full Tang
- + Lanyard Hole
- + Synthetic Sheath

Blade Length
9" (22.86 cm)
Overall Length
15" (38.1 cm)
Weight
5.9 oz.
UPC
696859308444



15"



BBI-9S 9" STIFF FILLET KNIFE



8Cr13MoV Ti-Nitride Coated High Carbon S.S. Blade
Patented BUBBA BLADE® Textured Handle

- + Full Tang
- + Lanyard Hole
- + Synthetic Sheath

Blade Length
9" (22.86 cm)
Overall Length
15" (38.1 cm)
Weight
7.6 oz.
UPC
696859308291



15"



BBI-12F 12" FLEX FILLET KNIFE



8Cr13MoV Ti-Nitride Coated High Carbon S.S. Blade
Patented BUBBA BLADE® Textured Handle

- + Full Tang
- + Lanyard Hole
- + Synthetic Sheath

Blade Length
12" (30.48 cm)
Overall Length
18" (45.72 cm)
Weight
7 oz.
UPC
696859308437



18"



BBI-SH-BP 4" SHORTY FIXED BLADE



8Cr13MoV Ti-Nitride Coated High Carbon S.S. Blade
Patented BUBBA BLADE® Textured Handle

- + Full Tang
- + Fully Serrated Blade
- + Lanyard Hole
- + Synthetic Sheath

Blade Length
4" (10.16 cm)
 Overall Length
9" (22.86 cm)
 Weight
4.7 oz.
 UPC
019962035012

This knife was designed for people with hand disabilities such as arthritis, gout, and weakened grip. The blade is 4 inches long and features a small serrated edge for easing knife work.



BBI-SR-BP 9" SERRATED FLEX FILLET KNIFE



8Cr13MoV Ti-Nitride Coated High Carbon S.S. Blade
Patented BUBBA BLADE® Textured Handle

- + Full Tang
- + Fully Serrated Blade
- + Lanyard Hole
- + Synthetic Sheath

Blade Length
9" (22.86 cm)
 Overall Length
15" (38.1 cm)
 Weight
6 oz.
 UPC
748252976444

FLEX SCALE



BBI-8CK 8" CHEF KNIFE



8Cr13MoV Ti-Nitride Coated High Carbon S.S. Blade
Patented BUBBA BLADE® Textured Handle

- + Full Tang
- + Lanyard Hole
- + Synthetic Sheath

Blade Length
8" (20.32 cm)
 Overall Length
13.5" (34.29 cm)
 Weight
7.4 oz.
 UPC
748252976246



BBI-8CK-MO 8" CHEF KNIFE



8Cr13MoV Ti-Nitride Coated High Carbon S.S. Blade
Patented BUBBA BLADE® Textured Handle

- + Full Tang
- + Mossy Oak® Break-Up Country® on Handle and Sheath
- + Lanyard Hole
- + Synthetic Sheath

Blade Length
8" (20.32 cm)
 Overall Length
13.5" (34.29 cm)
 Weight
7.4 oz.
 UPC
653341607409



BBI-6B-BX 6" BAYOU FIXED BLADE KNIFE



8Cr13MoV High Carbon S.S. Blade
Patented BUBBA BLADE® Textured Handle

- + Full Tang
- + Lanyard Hole
- + Synthetic Sheath

Blade Length
6" (15.24 cm)
Overall Length
12" (30.48 cm)
Weight
8.9 oz.
UPC
748252649034



BBI-SC 6" SCOUT OUTDOOR KNIFE



8Cr13MoV Ti-Nitride Coated High Carbon S.S. Blade
Patented BUBBA BLADE® Textured Handle

- + Full Tang
- + Lanyard Hole
- + Synthetic Sheath

Blade Length
6" (15.94 cm)
Overall Length
11" (27.94 cm)
Weight
7.6 oz.
UPC
019962035517



BBI-7P 7" PENETRATOR FIXED BLADE



8Cr13MoV Black Coated High Carbon S.S. Blade
Patented BUBBA BLADE® Textured Handle

- + Full Tang
- + 5mm Thick Blade
- + Blood Groove
- + Lanyard Hole
- + Synthetic Sheath

Blade Length
7" (17.78 cm)
Overall Length
13" (33.02 cm)
Weight
11 oz.
UPC
794504877632



BBI-SC-MO 6" SCOUT OUTDOOR KNIFE



8Cr13MoV Ti-Nitride Coated High Carbon S.S. Blade
Patented BUBBA BLADE® Textured Handle

- + Full Tang
- + Mossy Oak® Break-Up Country® on Handle and Sheath
- + Lanyard Hole
- + Synthetic Sheath

Blade Length
6" (15.94 cm)
Overall Length
11" (27.94 cm)
Weight
7.6 oz.
UPC
019962430244



BBI-WD 7" FIXED BLADE KNIFE



8Cr13MoV High Carbon S.S. Blade
Patented BUBBA BLADE® Textured Handle

- + Full Tang
- + Lanyard Hole
- + Synthetic Sheath

Blade Length
7" (17.78 cm)
Overall Length
13" (33.02 cm)
Weight
9 oz.
UPC
696859308482



13"



BBI-CH-BX 6" CHUBBY FIXED BLADE KNIFE



8Cr13MoV High Carbon S.S. Blade
Patented BUBBA BLADE® Textured Handle

- + Full Tang
- + Lanyard Hole
- + Synthetic Sheath

Blade Length
6" (15.24 cm)
Overall Length
12" (30.48 cm)
Weight
9.1 oz.
UPC
748252649133



12"



BBI-GH 4" GUT HOOK FIXED BLADE



8Cr13MoV High Carbon S.S. Blade
Patented BUBBA BLADE® Textured Handle

- + Full Tang
- + Lanyard Hole
- + Synthetic Sheath

Blade Length
4" (10.16 cm)
Overall Length
9" (22.86 cm)
Weight
6.7 oz.
UPC
019962430046



9"



BBI-GH-MO 4" GUT HOOK FIXED BLADE



8Cr13MoV High Carbon S.S. Blade
Patented BUBBA BLADE® Textured Handle

- + Full Tang
- + Mossy Oak® Break-Up Country® on Handle and Sheath
- + Lanyard Hole
- + Synthetic Sheath

Blade Length
4" (10.16 cm)
Overall Length
9" (22.86 cm)
Weight
6.7 oz.
UPC
019962430343



9"



BBI-RH 4" RHINO FIXED BLADE



8Cr13MoV High Carbon S.S. Blade
Patented BUBBA BLADE® Textured Handle

- + Full Tang
- + Lanyard Hole
- + Synthetic Sheath

Blade Length
4" (10.16 cm)
 Overall Length
9" (22.86 cm)
 Weight
6.5 oz.
 UPC
748252976345



9"



BBI-RH-MO 4" RHINO FIXED BLADE



8Cr13MoV High Carbon S.S. Blade
Patented BUBBA BLADE® Textured Handle

- + Full Tang
- + Mossy Oak® Break-Up Country® on Handle and Sheath
- + Lanyard Hole
- + Synthetic Sheath

Blade Length
4" (10.16 cm)
 Overall Length
9" (22.86 cm)
 Weight
6.5 oz.
 UPC
019962430442



9"



BBI-ST-BP 10" SHARPENING STEEL



8Cr13MoV High Carbon S.S. Blade
Patented BUBBA BLADE® Textured Handle

- + Full Tang
- + Lanyard Hole
- + Synthetic Sheath

Steel Length
10" (25.4 cm)
 Overall Length
16" (40.64 cm)
 Weight
12 oz.
 UPC
019962035418



16"

BBI-FP 7.5" FISHING PLIERS



8Cr13MoV Ti-Nitride Bonded High Carbon S.S. Jaws
Patented BUBBA BLADE® Textured/Aluminum Handle

- + Tungsten Cutters
- + 3 Sets of Crimpers for Split Shot/Leader Sleeves
- + Lanyard Hole
- + Coiled Lanyard
- + Synthetic Sheath

Jaw Length
2" (5.08 cm)
 Overall Length
7.5" (30.48 cm)
 Weight
5.8 oz.
 UPC
019962430848



7.5"



SCHRADE®

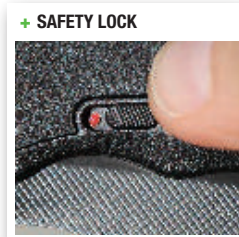
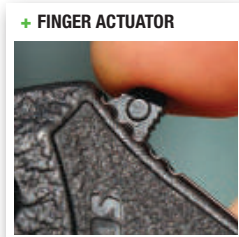
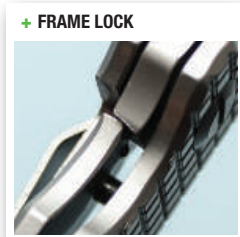
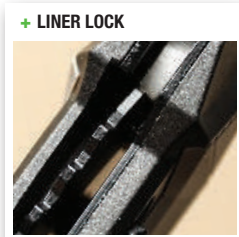
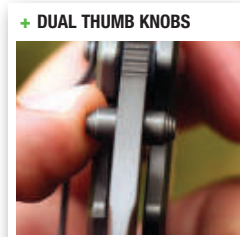

BLAZE THE NEW TRAIL

THE LEGACY OF SCHRADE® KNIVES AND TOOLS IS BUILT ON FINE CRAFTSMANSHIP, QUALITY AND DEPENDABILITY. OUR EXPANSIVE SCHRADE® LINE CONSISTS OF ASSISTED OPENING, FOLDING AND FIXED BLADE KNIVES INCLUDING MACHETES, AXES AND SPEARS. ALSO AVAILABLE, OUR SCHRADE® TOUGH TOOLS, TACTICAL PENS AND THE SCHRADE® PROFESSIONALS SERIES OF PRODUCTS ALL PRODUCED FROM PREMIUM MATERIALS AND BUILT FOR A LIFETIME.

SHIZNIT™ SERIES

SHIZNIT™ ASSISTED OPENING

Blade Length
3.4" (8.7 cm)
Overall Length
7.7" (19.6 cm)
Weight
3.8 oz.



7.7"



4.46"

SCHA13B KUKRI POINT BLACK BLADE BLACK HANDLE ▲
UPC - 044356226103

AUS-8 High Carbon S.S. Blade Aluminum Handle

- + Dual Thumb Knobs
- + Liner Lock
- + Safety Lock
- + Finger Actuator
- + Pocket Clip

24/7® SERIES

24/7® SERIES ASSISTED OPENING

Blade Length
3.2" (8.1 cm)
Overall Length
7.5" (19.1 cm)
Weight
4.9 oz.



7.5"



Serrated Blade Option



4.4"

SCHA8B CLIP POINT BLACK BLADE BLACK/GREY HANDLE ▲
UPC - 044356222877
SCHA8BS CLIP POINT SERRATED BLACK BLADE BLACK/GREY HANDLE ▲
UPC - 044356222884

AUS-8 Steel Blade Aluminum w/TPR Inserts Handle

- + Dual Thumb Knobs
- + Liner Lock
- + Safety Lock
- + Finger Actuator
- + Pocket Clip

SHIZZLE® SERIES

SHIZZLE® ASSISTED OPENING

Blade Length
3.4" (8.7 cm)
Overall Length
7.7" (19.4 cm)
Weight
4.4 oz.



7.7"

SCHA11B DROP POINT BLACK BLADE BLACK HANDLE ▲

UPC - 044356224697

SCHA11BS DROP POINT SERRATED BLACK BLADE BLACK HANDLE ▲

UPC - 044356224703



Serrated Blade Option



4.26"



SHIZZLE® ASSISTED OPENING

Blade Length
3.4" (8.7 cm)
Overall Length
7.7" (19.4 cm)
Weight
4.4 oz.



7.7"

SCHA11C DROP POINT BLACK BLADE SILVER HANDLE ▲

UPC - 044356225267

SCHA11CS DROP POINT SERRATED BLACK BLADE SILVER HANDLE ▲

UPC - 044356225274



Serrated Blade Option



Silver Handle

4.26"



SCHA7 SERIES

SCHA7 SERIES ASSISTED OPENING

Blade Length
3.3" (8.4 cm)
Overall Length
7.6" (19.3 cm)
Weight
4.8 oz.



7.6"

SCHA7GR CLIP POINT BLACK BLADE NEON GREEN HANDLE ▲

UPC - 044356221085



NEON Green Handle

4.3"

SCHA7 SERIES ASSISTED OPENING

Blade Length
3.3" (8.4 cm)
Overall Length
7.6" (19.3 cm)
Weight
4.8 oz.



7.6"

SCHA7B CLIP POINT BLACK BLADE BLACK HANDLE ▲

UPC - 044356220637



Black Handle

4.3"

SCHA4BCP ASSISTED OPENING

Blade Length
3.3" (8.3 cm)
Overall Length
7.7" (19.5 cm)
Weight
5.1 oz.
UPC
044356216852



7.7"

Black Handle

4034 Stainless Steel Blade Aluminum Handle

- + Dual Thumb Knobs
- + Finger Actuator
- + Liner Lock
- + Pocket Clip
- + Safety Lock



4.4"

SCHRADE®

LAND SHARK® SERIES

// SCHRADE® // ASSISTED OPENING //

AUS-8 Steel Blade Aluminum Handle

- + Thumb Plate
- + Liner Lock
- + Safety Lock
- + Finger Actuator
- + Pocket Clip

colorshift®



MINI LAND SHARK® ASSISTED OPENING

Blade Length
2.2" (5.5 cm)
Overall Length
5.1" (13.1 cm)
Weight
1.6 oz.



Serrated Blade Option Colorshift® Handle

5.1"



Straight Blade Option



3"

SCHA9MC CLIP POINT BLACK BLADE COLORSHIFT® HANDLE ▲

UPC - 044356225243

SCHA9MCS CLIP POINT SERRATED BLACK BLADE COLORSHIFT® HANDLE ▲

UPC - 044356225250

MINI LAND SHARK® ASSISTED OPENING

Blade Length
2.2" (5.5 cm)
Overall Length
5.1" (13.1 cm)
Weight
1.6 oz.



5.1"



Serrated Blade Option



Grey Handle

3"

SCHA9M CLIP POINT GREY BLADE GREY HANDLE ▲

UPC - 044356224512

SCHA9MS CLIP POINT SERRATED GREY BLADE GREY HANDLE ▲

UPC - 044356224529

LAND SHARK® SERIES

LAND SHARK® ASSISTED OPENING

Blade Length
3" (7.6 cm)
Overall Length
7" (17.7 cm)
Weight
2.8 oz.



7"

SCHA9 CLIP POINT GREY BLADE GREY HANDLE ▲

UPC - 044356223294

SCHA9S CLIP POINT SERRATED GREY BLADE GREY HANDLE ▲

UPC - 044356223300



Serrated Blade Option



Grey Handle

4"

AUS-8 Steel Blade Aluminum Handle

- + Dual Thumb Knobs
- + Liner Lock
- + Safety Lock
- + Finger Actuator
- + Pocket Clip

SCHA5B ASSISTED OPENING

Blade Length
3.3" (8.4 cm)
Overall Length
7.6" (19.3 cm)
Weight
4.9 oz.
UPC
044356219068



7.6"



Black Handle

4.5"

BONEYARD® SERIES

AUS-8 High Carbon Stainless Steel Blade
Aluminum Handle

- + M.A.G.I.C. Assisted Opening
- + Dual Thumb Knobs
- + Liner Lock
- + Pocket Clip



SCHA14B SCHRADE® BONEYARD® REAPER



Blade Length
3.3" (8.4 cm)
Overall Length
7.7" (19.5 cm)
Weight
5.1 oz.
UPC
044356228633



SCHA15BS SCHRADE® BONEYARD® SPIDER



Blade Length
3.3" (8.4 cm)
Overall Length
7.7" (19.5 cm)
Weight
5.5 oz.
UPC
044356228640

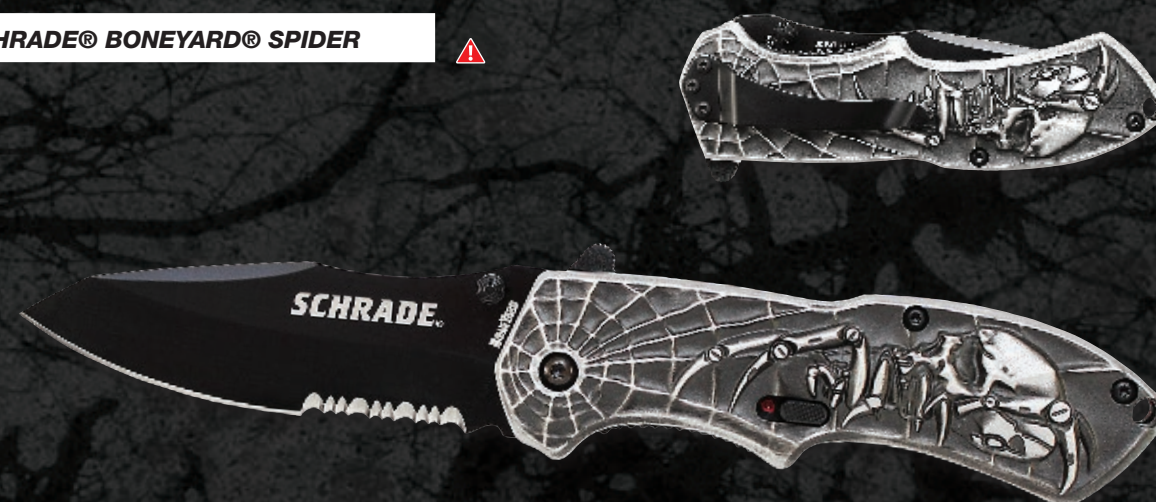

SCHA16B SCHRADE® BONEYARD® LAZY BONES



Blade Length
3.2" (8.0 cm)
Overall Length
7.5" (19.1 cm)
Weight
5.1 oz.
UPC
044356228657



BONEYARD®

ASSISTED OPENING

Blade Length
2.9" (7.3 cm)
Overall Length
7.3" (18.5 cm)
Weight
4.9 oz.



4034 Stainless Steel Blade Aluminum Handle

- + Thumb Plates
- + Liner Lock
- + Safety Lock
- + Finger Actuator
- + Pocket Clip



7.3"

ASSISTED
OPENING

- SCHA3BCP TANTO POINT BLACK BLADE BLACK HANDLE CLAM PACK ▲
- UPC - 044356216753
- SCHA3BS TANTO POINT SERRATED BLACK BLADE BLACK HANDLE ▲
- UPC - 044356216074
- SCHA3BCP TANTO POINT SERRATED BLACK BLADE BLACK HANDLE CLAM PACK ▲
- UPC - 044356216876



Serrated Blade Option



4.4"



colorshift

SCHA3CBS ASSISTED OPENING ▲

Blade Length
2.9" (7.3 cm)
Overall Length
7.3" (18.5 cm)
Weight
4.9 oz.
UPC
044356216777



7.3"

ASSISTED
OPENING



Colorshift® Handle

4.4"

DUAL ASSIST OPENING

AUS-8 Steel Blade Aluminum Handle

- + Mode Selector Switch
- + Dual Thumb Knobs
- + Liner Lock
- + Finger Actuator
- + Pocket Clip

DUAL ASSIST: MANUAL OR ASSISTED OPENING MODE POSSIBLE



SCHA12 DUAL ASSIST OPENING ▲

Blade Length
3.4" (8.7 cm)
Overall Length
8.1" (20.6 cm)
Weight
5.3 oz.
UPC
044356226363



Mode Selector Switch

8.1"

ASSISTED
OPENING



Dual sided clip placement



4.67"

DUAL ASSIST OPENING

Blade Length
3.4" (8.7 cm)
Overall Length
8.1" (20.6 cm)
Weight
5.3 oz.



8.1"

ASSISTED
OPENING

- SCHA12B DROP POINT BLACK BLADE BLACK HANDLE ▲
- UPC - 044356225793
- SCHA12BCP DROP POINT BLACK BLADE BLACK HANDLE CLAM PACK ▲
- UPC - 044356227346
- SCHA12BS DROP POINT SERRATED BLACK BLADE BLACK HANDLE ▲
- UPC - 044356225809



Serrated Blade Option



Dual sided clip placement



4.67"

VIPER

VIPER® SCHOTF3 SERIES

4034 Stainless Steel Blade Aluminum Handle

- + Blade Release
- + Blade Slider
- + Safety Lock
- + Pocket Clip
- + Glass Breaker

VIPER® OTF ASSISTED OPENING

Blade Length
3.5" (8.8 cm)
Overall Length
8.8" (22.4 cm)
Weight
4.9 oz.

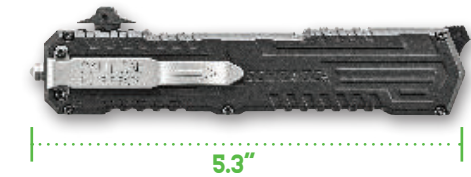

Out-The-Front Assisted Opening

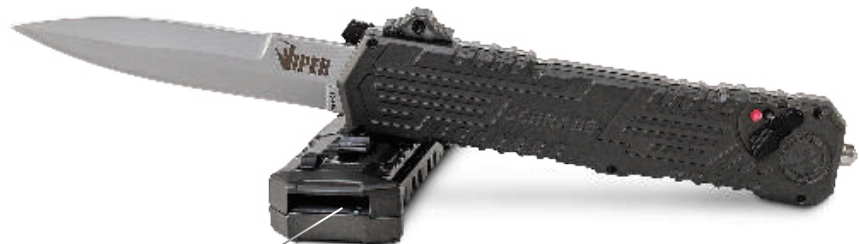

VIPER

VIPER® SCHOTF8 SERIES

AUS-8 Steel Blade Aluminum Handle

- + Blade Release
- + Blade Slider
- + Safety Lock
- + Pocket Clip
- + Finger Actuator
- + Glass Breaker

VIPER® OTF ASSISTED OPENING

Blade Length
3.4" (8.5 cm)
Overall Length
8.5" (21.6 cm)
Weight
4.4 oz.

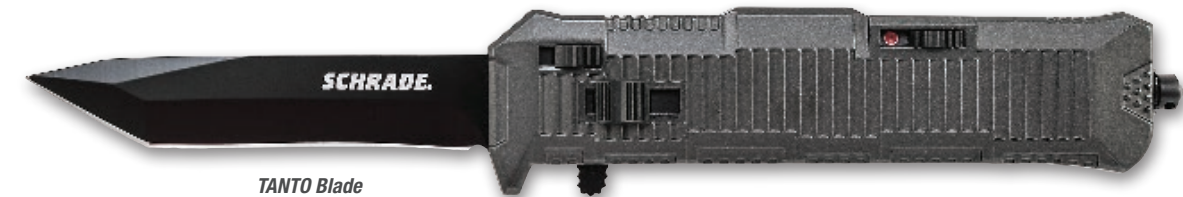

- SCHOTF8TB TANTO POINT BLACK BLADE BLACK HANDLE ▲
UPC - 044356222624
- SCHOTF8TBS TANTO POINT SERRATED BLACK BLADE BLACK HANDLE ▲
UPC - 044356222631
- SCHOTF8B STILETTO POINT BLACK BLADE BLACK HANDLE ▲
UPC - 044356222600 No Ship CA, NY, MA
- SCHOTF8BS STILETTO POINT DOUBLE SERRATED BLACK BLADE BLACK HANDLE ▲
UPC - 044356222617 No Ship CA, NY, MA



VIPER® OTF ASSISTED OPENING

Blade Length
3.6" (9.1 cm)
Overall Length
9.1" (23.1 cm)
Weight
6.2 oz.



- SCHOTF6 STILETTO POINT BLADE BLACK HANDLE ▲
UPC - 044356219839 No Ship CA, NY, MA
- SCHOTF7BS CLIP POINT SERRATED BLACK BLADE BLACK HANDLE ▲
UPC - 044356219846



VIPER



VIPER® SIDE ASSISTED OPENING

4034 Stainless Steel Blade Aluminum Handle

- + Blade Release
- + Punch Hole
- + Safety Lock
- + Pocket Clip

Blade Length
2.5" (6.3 cm)
Overall Length
6.2" (15.6 cm)
Weight
2.6 oz.



SCHSA3BCP DROP POINT BLADE BLACK HANDLE CLAM PACK ⚠️
UPC - 044356216883



SCHA911 SERIES

AUS-8 Steel Blade Aluminum Handle

- + Dual Thumb Knobs
- + Liner Lock
- + Safety Lock
- + Strap Cutter
- + Spring Loaded Glass Punch
- + Finger Actuator
- + Pocket Clip

SCHA911 SERIES PROFESSIONALS ASSISTED OPENING

Blade Length
3.8" (9.6 cm)
Overall Length
8.6" (21.8 cm)
Weight
7.9 oz.



SCHA911B SERRATED EXTRICATION GUT HOOK BLADE BLACK HANDLE ⚠️
UPC - 044356220507

SCHA911 SERIES PROFESSIONALS ASSISTED OPENING

Blade Length
3.8" (9.6 cm)
Overall Length
8.6" (21.8 cm)
Weight
7.9 oz.



SCHA911R SERRATED EXTRICATION GUT HOOK BLADE RED/BLACK HANDLE ⚠️
UPC - 044356220514



STRAP CUTTER

SCH911 SERIES

4034 Stainless Steel Blade
Nylon Fiber Handle

- + Dual Thumb Knobs
- + Safety Lock/Liner Lock
- + Strap Cutter
- + Glass Breaker
- + Oxygen Tank Wrench
- + Finger Actuator
- + Pocket Clip

SCH911

SCHRADE® ASSISTED OPENING



Blade Length
3.4" (8.6 cm)
Overall Length
8.4" (21.3 cm)
Weight
5.6 oz.
UPC
044356202930



SCH911DBS

SCHRADE® ASSISTED OPENING



Blade Length
3.5" (9.0 cm)
Overall Length
8.3" (21.0 cm)
Weight
5.6 oz.
UPC
044356205023



SCHRADE®
FOLDING KNIVES



SCHRADE®

BALISONG MANILLA FOLDER®



**MADE IN
USA**

SCMF SCHRADE® BALISONG MANILLA FOLDER® No Ship CA, NY, MA

D2 High Carbon Blade Stainless Steel Handle

+ Stainless Steel Handle

Blade Length
4" (10.2 cm)
Overall Length
9" (22.8 cm)
Weight
7.9 oz.
UPC
044356229135

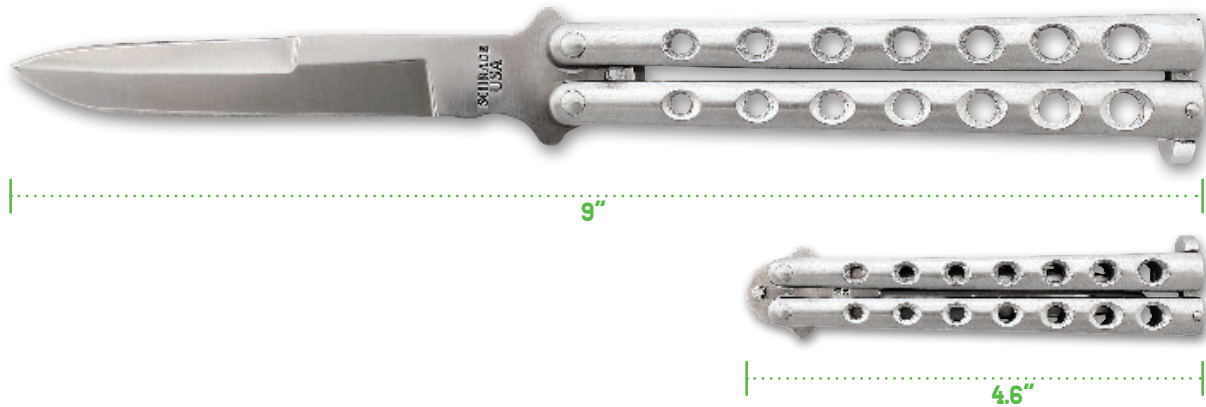

SC60DT FOLDING KNIFE

Blade Length
3.3" (8.3 cm)
Overall Length
7.8" (19.9 cm)
Weight
3.7 oz.
UPC
044356225892

4116 Steel Blade Aluminum Handle

+ Push Button Lock + Safety Lock
+ Glass Breaker + Reversible Pocket Clip

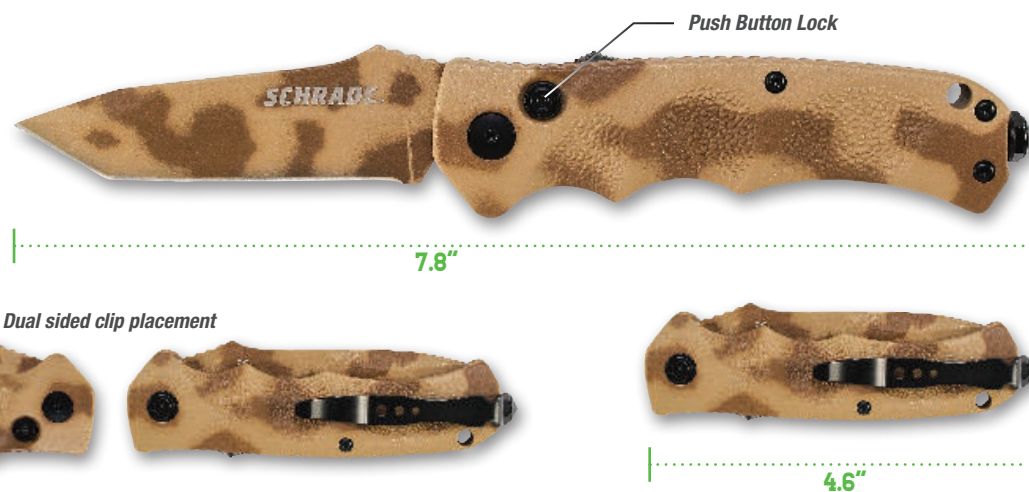

SC60MB FOLDING KNIFE

Blade Length
2.4" (6.1 cm)
Overall Length
6.1" (15.5 cm)
Weight
2.3 oz.
UPC
044356219372

4116 Steel Blade Aluminum Handle

+ Push Button Lock + Safety Lock
+ Glass Breaker + Reversible Pocket Clip



FOLDING KNIFE

Blade Length
3.3" (8.3 cm)
Overall Length
7.8" (19.9 cm)
Weight
3.7 oz.

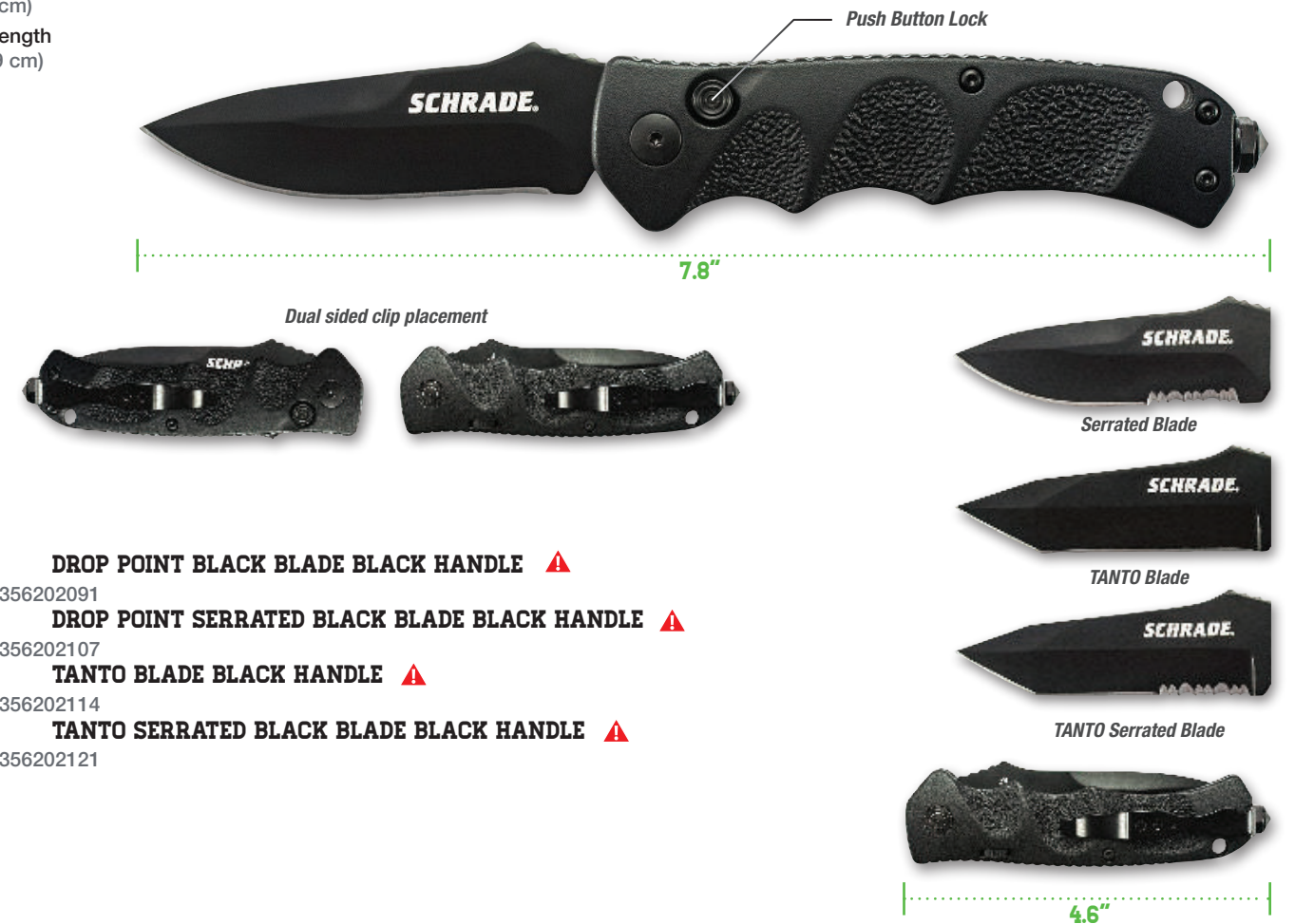

FOLDING KNIFE

AUS-8 High Carbon S.S. Blade Aluminum Handle

- + Push Button Lock + Safety Lock
- + Glass Breaker + Reversible Pocket Clip

Blade Length
3.2" (8.0 cm)
Overall Length
7.8" (19.9 cm)
Weight
3.5 oz.



Dual sided clip placement



SC90B CLIP POINT BLACK BLADE BLACK HANDLE ▲

UPC - 044356226080

SC90BS CLIP POINT SERRATED BLACK BLADE BLACK HANDLE ▲

UPC - 044356226097



SCH401 FOLDING KNIFE ▲

Ceramic Blade Carbon Fiber Handle

- + Dual Thumb Knobs
- + Liner Lock
- + Pocket Clip

Blade Length
2.7" (6.8 cm)
Overall Length
6.5" (16.5 cm)
Weight
1.6 oz.
UPC - 044356219105



SCH401ALBK FOLDING KNIFE ▲

8Cr13MoV High Carbon Stainless Steel Blade Aluminum Handle

- + Dual Thumb Knobs
- + Liner Lock
- + Pocket Clip

Blade Length
2.7" (6.8 cm)
Overall Length
6.5" (16.5 cm)
Weight
2.1 oz.
UPC - 044356223355



SCH403 FOLDING KNIFE ▲

9Cr18MoV High Carbon S.S. Blade Carbon Fiber Handle

- + Dual Thumb Knobs
- + Liner Lock
- + Pocket Clip

Blade Length
3.3" (8.4 cm)
Overall Length
7.7" (19.6 cm)
Weight
3.9 oz.
UPC - 044356222181



SCH402L FOLDING KNIFE

Ceramic Blade Carbon Fiber Handle

- + Dual Thumb Knobs
- + Liner Lock
- + Pocket Clip

Blade Length
3.4" (8.6 cm)
Overall Length
7.7" (19.5 cm)
Weight
2.3 oz.
UPC
044356219136



SCH405 FOLDING KNIFE

Ceramic Blade Carbon Fiber Handle

- + Liner Lock
- + Pocket Clip

Blade Length
2.4" (6.1 cm)
Overall Length
5.6" (14.2 cm)
Weight
1.2 oz.
UPC
044356222518



SCH407 FOLDING KNIFE

Ceramic Blade Textured ABS & TPR Handle

- + Dual Thumb Knobs
- + Liner Lock
- + Pocket Clip

Blade Length
2.9" (7.4 cm)
Overall Length
6.8" (17.1 cm)
Weight
1.9 oz.
UPC
044356222860



FOLDING KNIFE

8Cr13MoV High Carbon S.S. Blade Textured G-10 Handle

- + Dual Thumb Knobs
- + Liner Lock
- + Pocket Clip

Blade Length
2.5" (6.3 cm)
Overall Length
6" (15.2 cm)
Weight
2.1 oz.



SCH107 DROP POINT BLADE BLACK HANDLE

UPC - 044356218870

SCH107CP DROP POINT BLADE BLACK HANDLE CLAM PACK

UPC - 044356218986

FOLDING KNIFE

8Cr13MoV High Carbon S.S. Blade Aluminum Handle

- + Dual Thumb Knobs
- + Liner Lock
- + Pocket Clip

Blade Length
2.5" (6.3 cm)
Overall Length
6" (15.2 cm)
Weight
1.8 oz.



SCH107ALBK DROP POINT BLACK BLADE BLACK HANDLE

UPC - 044356223317

FOLDING KNIFE

Blade Length
2.5" (6.3 cm)
Overall Length
6" (15.2 cm)
Weight
1.8 oz.



SCH107ALOR DROP POINT BLACK BLADE ORANGE HANDLE

UPC - 044356223324

SCH2210R FOLDING KNIFE

Blade Length
3.5" (8.8 cm)
Overall Length
8.4" (21.3 cm)
Weight
4.9 oz.
UPC
044356223577

9Cr18MoV High Carbon S.S. Blade Aluminum Handle

- + Thumb Knob
- + Liner Lock
- + Pocket Clip



8.4"



Orange handle

4.75"

SCH221BKCP FOLDING KNIFE

Blade Length
3.5" (8.8 cm)
Overall Length
8.4" (21.3 cm)
Weight
4.9 oz.
UPC
044356223713



8.4"



4.75"

SCH106ALCCP FOLDING KNIFE

8Cr13MoV High Carbon S.S. Blade Aluminum Handle

- + Dual Thumb Knobs
- + Liner Lock
- + Pocket Clip

Blade Length
2.9" (7.3 cm)
Overall Length
6.7" (17.0 cm)
Weight
2.3 oz.
UPC
044356224086

colorshift
A new color at every angle!



6.7"



3.8"

FOLDING KNIFE

8Cr13MoV Titanium Coated High Carbon S.S. Blade Aluminum Handle

- + Thumb Knob
- + Liner Lock
- + Pocket Clip

Blade Length
2.8" (7.0 cm)
Overall Length
6.6" (16.8 cm)
Weight
2.9 oz.



6.6"

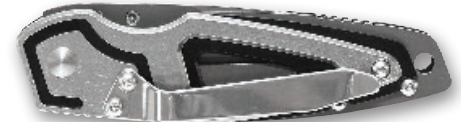

3.85"

SCH224 DROP POINT BLADE ALUMINUM HANDLE

UPC - 044356227209

SCH224CP DROP POINT BLADE ALUMINUM HANDLE CLAM PACK

UPC - 044356227643





POCKET PROTECTOR®

POCKET PROTECTOR®

Blade Length
2.6" (6.5 cm)
Overall Length
5.8" (14.7 cm)
Weight
1.4 oz.



8Cr13MoV High Carbon S.S. Blade
Aluminum & Stainless Steel Handle

- + Dual Thumb Knobs
- + Carabiner Clip
- + Frame Lock
- + Money/Pocket Clip



5.8"



CORRESPONDING COLORED CLIP FOR EACH HANDLE



3.25"

- SCH222BK DROP POINT BLADE BLACK HANDLE ▲
- UPC - 044356225519
- SCH222BKCP DROP POINT BLADE BLACK HANDLE CLAM PACK ▲
- UPC - 044356226394
- SCH222P DROP POINT BLADE PINK HANDLE ▲
- UPC - 044356225540
- SCH222PCP DROP POINT BLADE PINK HANDLE CLAM PACK ▲
- UPC - 044356226417

DOUBLE LOCKBACK

8Cr13MoV High Carbon S.S. Blade
Rubber Coated Aluminum Handle

- + Thumb Holes
- + Double Lockback
- + Pocket Clip



SCH004DLB SCHRADE® DOUBLE LOCKBACK ▲

Blade Length
2.3" (5.8 cm)
Overall Length
7.4" (18.7 cm)
Weight
2.1 oz.
UPC
044356229029



7.4"



3"

SCH005DLB SCHRADE® DOUBLE LOCKBACK ▲

Blade Length
2.9" (7.3 cm)
Overall Length
9.5" (24.0 cm)
Weight
3.3 oz.
UPC
044356229036



9.5"



4"

SCH206 FOLDING KNIFE



8Cr13MoV High Carbon Stainless Steel Blade Aluminum Handle

- + Dual Thumb Knobs
- + Liner Lock
- + Pocket Clip

Blade Length
3" (7.6 cm)
Overall Length
7.5" (19.1 cm)
Weight
4.6 oz.
UPC
044356220460



SCH207 FOLDING KNIFE



8Cr13MoV High Carbon Stainless Steel Blade Aluminum Handle

- + Dual Thumb Knobs
- + Liner Lock
- + Pocket Clip

Blade Length
3.3" (8.4 cm)
Overall Length
7.8" (19.8 cm)
Weight
4.6 oz.
UPC
044356220477



CUSTOMIZABLE GRAPHIC INSERTS TAILORED FOR YOUR SPECIFIC NEEDS

SCH208 FOLDING KNIFE



8Cr13MoV High Carbon Stainless Steel Blade Aluminum Handle

- + Dual Thumb Knobs
- + Liner Lock
- + Pocket Clip

Blade Length
3.1" (7.9 cm)
Overall Length
7.6" (19.3 cm)
Weight
4.6 oz.
UPC
044356220484

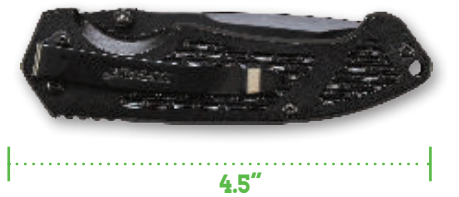

SEE PAGE 172 FOR MORE INFORMATION

FOLDING KNIFE

Blade Length
3.4" (8.5 cm)
Overall Length
7.9" (19.9 cm)
Weight
3.7 oz.

8Cr13MoV High Carbon S.S. Blade ABS & TPR Handle

- + Dual Thumb Knobs
- + Index Flipper
- + Liner Lock
- + Pocket Clip



7.9"

SCH002 DROP POINT BLADE BLACK HANDLE ▲
 UPC - 044356225663
SCH002CP DROP POINT BLADE BLACK HANDLE CLAM PACK ▲
 UPC - 044356228534



4.55"

SCH001 FOLDING KNIFE

8Cr13MoV High Carbon S.S. Blade ABS & TPR Handle

- + Dual Thumb Knobs
- + Liner Lock
- + Index Flipper
- + Pocket Clip

Blade Length
3.3" (8.3 cm)
Overall Length
7.9" (20.1 cm)
Weight
4.4 oz.
UPC
044356221450



7.9"



4.6"

FOLDING KNIFE

8Cr13MoV High Carbon S.S. Blade PP & GF Handle

- + Dual Thumb Knobs
- + Liner Lock
- + Index Flipper
- + Pocket Clip

Blade Length
3.5" (8.9 cm)
Overall Length
8.2" (20.9 cm)
Weight
4.1 oz.



8.2"

SCH003 DROP POINT BLADE BLACK HANDLE ▲
 UPC - 044356228701
SCH003CP DROP POINT BLADE BLACK HANDLE CLAM PACK ▲
 UPC - 044356229531



4.75"

SURE-LOCK® SERIES

AUS-8 High Carbon S.S. Blade Aluminum Handle

- + Dual Thumb Knobs
- + SURE-LOCK® Certified Tested to Resist 325 Pounds of Force (LBF)
- + Pocket Clip

SURE-LOCK® FOLDING KNIFE

Blade Length
3.6" (9.3 cm)
Overall Length
8.5" (21.6 cm)
Weight
6.4 oz.



SURE-LOCK® Mechanism
Rated to 325 Pounds

Red/Black Handle

8.5"



4.94"

SCH503RB DROP POINT BLACK BLADE RED/BLACK HANDLE ▲
 UPC - 044356225823
SCH503RBCP DROP POINT BLACK BLADE RED/BLACK HANDLE CLAM PACK ▲
 UPC - 044356227360
SCH503B DROP POINT BLACK BLADE GREY/BLACK HANDLE ▲
 UPC - 044356225816
SCH503BCP DROP POINT BLACK BLADE GREY/BLACK HANDLE CLAM PACK ▲
 UPC - 044356227353



Grey/Black Handle



SURE-LOCK® FOLDING KNIFE

AUS-8 High Carbon S.S. Blade Aluminum & TPR Handle

Blade Length
3.5" (8.8 cm)
Overall Length
8.4" (21.4 cm)
Weight
7.0 oz.



SURE-LOCK® Mechanism
Rated to 325 Pounds

8.4"

SCH510 CLIP POINT BLACK BLADE BLACK HANDLE ▲
 UPC - 044356229937
SCH510CP CLIP POINT BLACK SERRATED BLADE BLACK HANDLE CLAM PACK ▲
 UPC - 044356229944
SCH510S CLIP POINT BLACK SERRATED BLADE BLACK HANDLE ▲
 UPC - 044356229951



Serrated Blade Option

4.9"

FOLDING KNIFE

Blade Length
3.6" (9.1 cm)
Overall Length
8.1" (20.5 cm)
Weight
4.6 oz.

9Cr18MoV High Carbon S.S. Blade Aluminum Handle

- + Dual Thumb Knobs
- + Index Flipper/Finger Guard
- + Liner Lock
- + Pocket Clip

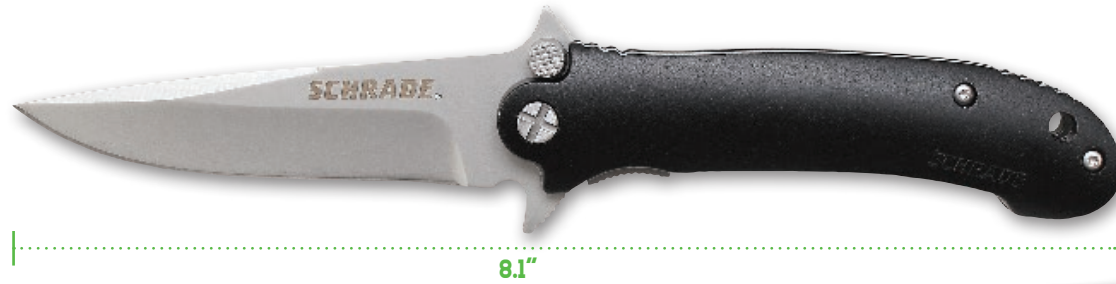

SCH223 CLIP POINT BLADE BLACK HANDLE ▲

UPC - 044356225649

SCH223S CLIP POINT SERRATED BLADE BLACK HANDLE ▲

UPC - 044356225656



Serrated Blade Option



SCH109 FOLDING KNIFE

9Cr18MoV High Carbon Stainless Steel Blade Textured G-10 Handle

- + Dual Thumb Knobs
- + Liner Lock
- + Index Flipper
- + Pocket Clip

Blade Length
3.5" (8.9 cm)
Overall Length
8.2" (20.8 cm)
Weight
5.3 oz.



UPC
044356222211



FOLDING KNIFE

9Cr18MoV High Carbon Stainless Steel Blade Rainbow Titanium Coated Aluminum Handle

- + Dual Thumb Knobs
- + Liner Lock
- + Index Flipper
- + Pocket Clip

Blade Length
3.4" (8.6 cm)
Overall Length
7.9" (20.1 cm)
Weight
5.1 oz.



SCH509R DROP POINT BLADE RAINBOW HANDLE ▲

UPC - 044356229098

SCH509RCP DROP POINT BLADE RAINBOW HANDLE CLAM PACK ▲

UPC - 044356229104



FOLDING KNIFE

Blade Length
3.2" (8.1 cm)
Overall Length
7.8" (19.8 cm)
Weight
5.1 oz.

9Cr18MoV Stonewashed High Carbon S.S. Blade G-10 w/Aluminum Handle

- + Dual Thumb Knobs
- + Index Flipper
- + Liner Lock
- + Pocket Clip
- + Glass Breaker



SCH501 DROP POINT BLADE MOTTLED/BLACK HANDLE ▲

UPC - 044356220996

SCH501S DROP POINT SERRATED BLADE MOTTLED/BLACK HANDLE ▲

UPC - 044356219631

SCH501SCP DROP POINT SERRATED BLADE MOTTLED/BLACK HANDLE CLAM PACK ▲

UPC - 044356219648



Serrated Blade Option



SCH218 FOLDING KNIFE

9Cr18MoV Stonewashed High Carbon S.S. Blade Stonewashed Aluminum Handle

- + Dual Thumb Knobs
- + Liner Lock
- + Index Flipper
- + Pocket Clip

Blade Length
2.9" (7.3 cm)
Overall Length
6.6" (16.9 cm)
Weight
3.0 oz.



UPC
044356223171

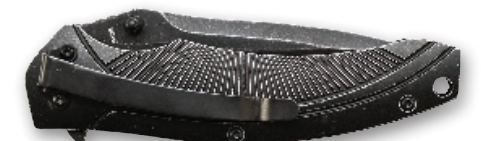

SCHRADE®

ULTRA GLIDE™ SERIES

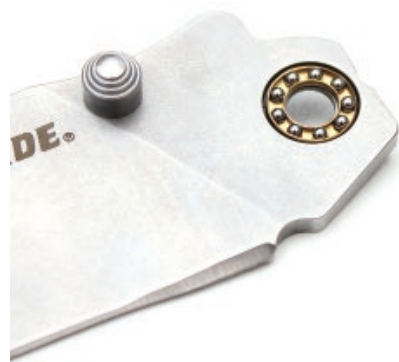

BALL BEARING PIVOT PIN TECH ALLOWS FOR ULTRA SMOOTH OPENING



ULTRA GLIDE™ FOLDING KNIFE

9Cr18MoV High Carbon Stainless Steel Blade Stainless Steel w/G-10 Handle

- + Dual Thumb Knobs
- + Liner Lock
- + Pocket Clip

Blade Length
3.5" (8.9 cm)
Overall Length
8.2" (20.8 cm)
Weight
5.3 oz.



8.2"



4.75"

SCH305 DROP POINT BLADE ALUMINUM/BLACK HANDLE

UPC - 044356228992

SCH305CP DROP POINT BLADE ALUMINUM/BLACK HANDLE CLAM PACK

UPC - 044356229111

ULTRA GLIDE™ FOLDING KNIFE

9Cr18MoV High Carbon Stainless Steel Blade Aluminum Handle

- + Dual Thumb Knobs
- + Liner Lock
- + Pocket Clip

Blade Length
3.5" (8.8 cm)
Overall Length
8.1" (20.7 cm)
Weight
5.2 oz.



8.1"



4.74"

SCH306 CLIP POINT BLADE ALUMINUM HANDLE

UPC - 044356229074

SCH306CP CLIP POINT BLADE ALUMINUM HANDLE CLAM PACK

UPC - 044356229128



SCHRADE®

EXCEPTIONAL EDGE RETENTION // CORROSION RESISTANT
HIGHEST STRENGTH-TO-WEIGHT RATIO OF ANY METAL

SCH602TI TITANIUM FOLDING KNIFE

Blade Length
3.5" (8.9 cm)
Overall Length
7.9" (19.9 cm)
Weight
4.8 oz.
UPC
044356223959

D2 Titanium Coated High Carbon S.S. Blade Titanium Handle

- + Dual Thumb Knobs
- + Frame Lock
- + Pocket Clip
(Additional Clip for
Tip-Up Carry)



7.9"



Tip-Down Carry



Tip-Up Carry



4.65"

SCH603TI TITANIUM FOLDING KNIFE

Blade Length
3.5" (8.9 cm)
Overall Length
7.9" (19.9 cm)
Weight
4.8 oz.
UPC
044356223966



7.9"



Tip-Down Carry



Tip-Up Carry



4.65"

SCHRADE®

SCH301

FOLDING KNIFE



9Cr18MoV Titanium Coated High Carbon S.S. Blade Titanium Coated Stainless Steel Handle

- + Dual Thumb Knobs
- + Frame Lock
- + Index Flipper
- + Pocket Clip

Blade Length
3.7" (9.3 cm)

Overall Length
8.6" (21.8 cm)

Weight
10.6 oz.

UPC
044356217361



8.6"



4.9"

SCH303M

FOLDING KNIFE



9Cr18MoV Titanium Coated High Carbon S.S. Blade Titanium Coated S.S. Handle

- + Dual Thumb Knobs
- + Pocket Clip
- + Frame Lock

Blade Length
2.6" (6.6 cm)

Overall Length
6.0" (15.2 cm)

Weight
2.5 oz.

UPC
044356219693



6"



3.4"

SCH304

FOLDING KNIFE



Blade Length
3.7" (9.3 cm)

Overall Length
8.5" (21.6 cm)

Weight
9.7 oz.

UPC
044356217422



8.5"



4.8"

SCHRADE®

FIXED BLADES



EXTREME SURVIVAL™

FIXED EXTREME SURVIVAL™

Blade Length
7.5" (19.0 cm)
Overall Length
12.7" (32.3 cm)
Weight
1 lb. 1.8 oz.



SAE-1070 High Carbon Steel Blade & Handle

- + Waterproof Hollow Handle
- + Interchangeable Magnetic Tipped Tool
- + Ballistic Sheath

SCHF1 DROP POINT GREY SERRATED BLADE GREY HANDLE ⚠

UPC - 044356202329

SCHF2 BOWIE POINT GREY SERRATED BLADE GREY HANDLE ⚠

UPC - 044356202336



Bowie Blade



Removable Bit Set



Ballistic Sheath

Removable Magnetic Bit Set

- + 1 - Bit Holder
- + 1 - T-Bar
- + 3 - Star Drive Screw Bits (ST10, ST15, ST20)
- + 1 - Hex Key Bit, 5/64"
- + 3 - Slotted Screw Bits (1/4", 3/16", 3/23")
- + 3 - Phillips Screw Bits (PH0, PH1, PH2)



SCHF2SM EXTREME SURVIVAL™ ⚠

Blade Length
5.6" (14.2 cm)
Overall Length
10.3" (26.1 cm)
Weight
12.5 oz.
UPC
044356207669



Removable Magnetic Bit Set

- + 1 - Bit Holder
- + 1 - Star Drive Screw Bit (ST10)
- + 1 - Hex Key Bit, ST10
- + 3 - Slotted Screw Bits (1/8", 5/32", 3/32")
- + 1 - Phillips Screw Bits (PH0)



Removable Bit Set



Ballistic Sheath

EXTREME SURVIVAL™

SCHF21 EXTREME SURVIVAL™ ⚠

SAE-1070 High Carbon Steel Blade & Handle

- + Glass Breaker
- + Waterproof Hollow Handle
- + Glass Filled Nylon Boot/Belt Sheath

Blade Length
4.5" (11.4 cm)
Overall Length
9.0" (22.8 cm)
Weight
5.1 oz.
UPC
044356219518
No Ship CA, NY, MA

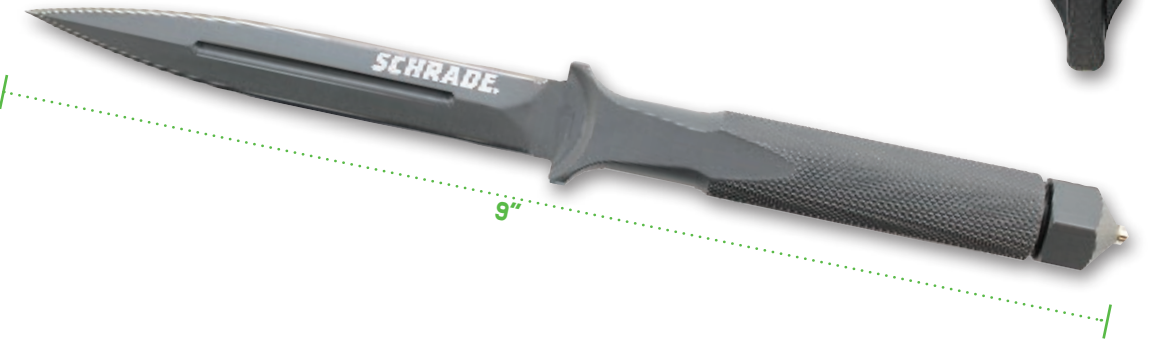

WATERPROOF HOLLOW HANDLE Accessories Not Included



SCHF63B FIXED BLADE ⚠

AUS-8 Steel Blade TPE Handle

- + Full Tang
- + M.O.L.L.E. Compatible Glass-Filled Nylon Sheath

Blade Length
3.5" (8.8 cm)
Overall Length
8.1" (20.7 cm)
Weight
3.6 oz.
UPC
044356228527



45" Paracord Lanyard

8.1"



SCHF3N EXTREME SURVIVAL™

Blade Length
6.4" (16.2 cm)
Overall Length
12" (30.4 cm)
Weight
1 lb. 6 oz.
UPC
044356207393

8Cr13MoV High Carbon S.S. Blade Micarta Handle
+ Full Tang
+ Ballistic Sheath



SCHRADE®

PREMIUM LEATHER SHEATHS ALSO AVAILABLE

LS56 (For SCHRADE® SCHF56) ⚠	LS56L (For SCHRADE® SCHF56L) ⚠
Overall Length 8.2" (20.8 cm)	Overall Length 9.2" (23.3 cm)
Weight 3.1 oz.	Weight 3.2 oz.
UPC 044356228558	UPC 044356228565

+ LS56

+ LS56L



SCHF56M FIXED BLADE

1095 High Carbon Steel Blade Micarta Handle

+ Full Tang
+ Thermoplastic Belt Sheath
Blade Length
3.4" (8.7 cm)
Overall Length
8.2" (20.9 cm)
Weight
8.4 oz.
UPC
044356228602



8.2"

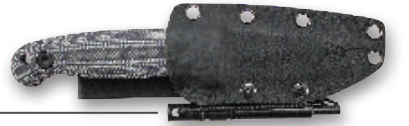

Built-In Ferro Rod Holder
w/Ferro Rod

SCHF56LM FIXED BLADE

1095 High Carbon Steel Blade Micarta Handle

+ Full Tang
+ Thermoplastic Belt Sheath
Blade Length
4.4" (11.1 cm)
Overall Length
9.2" (23.3 cm)
Weight
9.3 oz.
UPC
044356228619



9.2"



Built-In Ferro Rod Holder
w/Ferro Rod

SCHF56 FIXED BLADE

1095 High Carbon Steel Blade TPE Handle

+ Full Tang
+ Polyester Belt Sheath
Blade Length
3.5" (8.8 cm)
Overall Length
8.2" (20.9 cm)
Weight
7.8 oz.
UPC
044356227278



8.2"



Built-In Ferro Rod Holder
w/Ferro Rod

SCHF56L FIXED BLADE

1095 High Carbon Steel Blade TPE Handle

+ Full Tang
+ Polyester Belt Sheath
Blade Length
4.4" (11.1 cm)
Overall Length
9.1" (23.2 cm)
Weight
8.4 oz.
UPC
044356227674



9.1"



Built-In Ferro Rod Holder
w/Ferro Rod

FIXED BLADE

8Cr13MoV High Carbon S.S. Blade Micarta Handle

- + Full Tang
- + Ballistic Belt Sheath

Blade Length
4.1" (10.5 cm)
Overall Length
8.7" (22.1 cm)
Weight
6.9 oz.

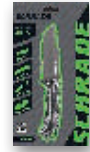

SCHF61 DROP POINT GREY BLADE MICARTA HANDLE ⚠

UPC - 044356227704

SCHF61CP DROP POINT GREY BLADE MICARTA HANDLE CLAM PACK ⚠

UPC - 044356227971

SCHF36M FRONTIER® ⚠

8Cr13MoV Powder Coated High Carbon S.S. Blade Micarta Handle

- + Full Tang
- + Polyester Belt Sheath

Blade Length
5" (12.8 cm)
Overall Length
10.4" (26.4 cm)
Weight
13.4 oz.
UPC
044356222914



Ferro Rod & Sharpening Stone Included

SCHF37M FRONTIER® ⚠

8Cr13MoV Powder Coated High Carbon S.S. Blade Micarta Handle

- + Full Tang
- + Polyester Belt Sheath

Blade Length
7" (17.8 cm)
Overall Length
12.4" (31.4 cm)
Weight
15.9 oz.
UPC
044356222921



Ferro Rod & Sharpening Stone Included

FRONTIER®

Blade Length
5" (12.8 cm)
Overall Length
10.4" (26.4 cm)
Weight
12.3 oz.



Ferro Rod & Sharpening Stone Included

SCHF36 DROP POINT BLACK BLADE BLACK HANDLE ⚠

UPC - 044356222556

SCHF36CP DROP POINT BLACK BLADE BLACK HANDLE CLAM PACK ⚠

UPC - 044356225557

SCHF37 FRONTIER® ⚠

Blade Length
7" (17.8 cm)
Overall Length
12.4" (31.4 cm)
Weight
14.5 oz.
UPC
044356222563



Ferro Rod & Sharpening Stone Included

SCHF38 FRONTIER® ⚠

Blade Length
5.8" (14.7 cm)
Overall Length
11.2" (28.3 cm)
Weight
13.4 oz.
UPC
044356222570



Ferro Rod & Sharpening Stone Included

Powder Coated 1095 High Carbon S.S. Blade TPE Handle

- + Full Tang
- + Polyester Belt Sheath

SCHFS1M FRONTIER®



- + Full Tang
- + Polyester Belt Sheath

1095 High Carbon Stainless Steel Blade Micarta Handle

Blade Length
5.1" (12.8 cm)
Overall Length
10.9" (27.6 cm)
Weight
14.6 oz.
UPC
044356225748



10.9"

Ferro Rod & Sharpening Stone Included



SCHF52M FRONTIER®



1095 High Carbon Stainless Steel Blade Micarta Handle

Blade Length
7.0" (17.9 cm)
Overall Length
13.0" (33.0 cm)
Weight
1 lb. 1.4 oz.
UPC
044356225755



13"

Ferro Rod & Sharpening Stone Included



SCHF51 FRONTIER®



1095 High Carbon Steel Blade TPE Handle

Blade Length
5.1" (12.8 cm)
Overall Length
10.9" (27.6 cm)
Weight
13.5 oz.
UPC
044356225182



10.9"

Ferro Rod & Sharpening Stone Included



SCHF52 FRONTIER®



1095 High Carbon Steel Blade TPE Handle

Blade Length
7.0" (17.9 cm)
Overall Length
13.0" (33.0 cm)
Weight
1.0 lb.
UPC
044356225199



13"

Ferro Rod & Sharpening Stone Included



1095 High Carbon Blade Grivory Handle

- + Full Tang
- + Leather Sheath

SCHF55 FRONTIER®



Blade Length
3.6" (9.0 cm)
Overall Length
7.6" (19.4 cm)
Weight
6 oz.
UPC
044356226424



7.6"



SCHF42 FRONTIER®



Blade Length
5.1" (13.0 cm)
Overall Length
10" (25.3 cm)
Weight
9.5 oz.
UPC
044356223973



10"



SCHF42D FRONTIER®



Blade Length
5.1" (13.0 cm)
Overall Length
10" (25.3 cm)
Weight
9.5 oz.
UPC
044356225786



10"



EXTREME SURVIVAL™

**8Cr13MoV High Carbon S.S. Blade
TPE Handle**

- + Full Tang
- + Polyester Belt Sheath

Blade Length
5.4" (13.7 cm)
Overall Length
10.8" (27.4 cm)
Weight
13.6 oz.

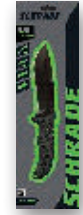

SCHF26 KUKRI POINT BLACK BLADE BLACK HANDLE ▲

UPC - 044356220002

SCHF26CP KUKRI POINT BLACK BLADE BLACK HANDLE CLAM PACK ▲

UPC - 044356219990

EXTREME SURVIVAL™

**1095 High Carbon Stainless Steel Blade
TPE Handle**

- + Full Tang
- + Ballistic Sheath

Blade Length
6.4" (16.3 cm)
Overall Length
12.1" (30.7 cm)
Weight
15.7 oz.



SCHF9 KUKRI POINT GREY BLADE BLACK HANDLE ▲

UPC - 044356207201

SCHF9CP KUKRI POINT GREY BLADE BLACK HANDLE CLAM PACK ▲

UPC - 044356216913

SCHF57

FIXED BLADE



65Mn High Carbon Steel Blade G-10 Handle

- + Full Tang
- + Thermoplastic Belt Sheath
Compatible w/FR4 Removable Ferro Rod Attachment

Blade Length
2.6" (6.7 cm)
Overall Length
6.3" (15.9 cm)
Weight
4 oz.
UPC
044356227285



SCHF59

FIXED BLADE



65Mn High Carbon Steel Blade G-10 Handle

- + Full Tang
- + Thermoplastic Belt Sheath
w/Removable Ferro Rod Attachment

Blade Length
3.8" (9.7 cm)
Overall Length
8.4" (21.3 cm)
Weight
6.2 oz.
UPC
044356227308



Removable Ferro Rod Attachment w/Ferro Rod



FERRO ROD ATTACHMENT ▲

FR4 (Sold Separately) UPC 044356227780

SCHF30 **FIXED BLADE**



8Cr13MoV High Carbon Stainless Steel Blade TPE Handle

- + Full Tang
- + Thermoplastic Sheath

Blade Length
4.9" (12.5 cm)
Overall Length
9.7" (24.6 cm)
Weight
6.3 oz.
UPC
044356222501



SCHRADE WATER RAT® SERIES

WR3 **SCHRADE WATER RAT®**

**7Cr17MoV High Carbon Stainless Steel Blade ▲
Phosphorescence TPR Handle**

- + Full Tang
- + Lanyard Hole
- + Line Cutter
- + PP Vest/Belt/Leg Sheath w/Open Drain Hole

Blade Length
4.7" (11.9 cm)
Overall Length
9.4" (23.8 cm)
Weight
4.4 oz.
UPC
044356220583
No Ship CA, NY, MA

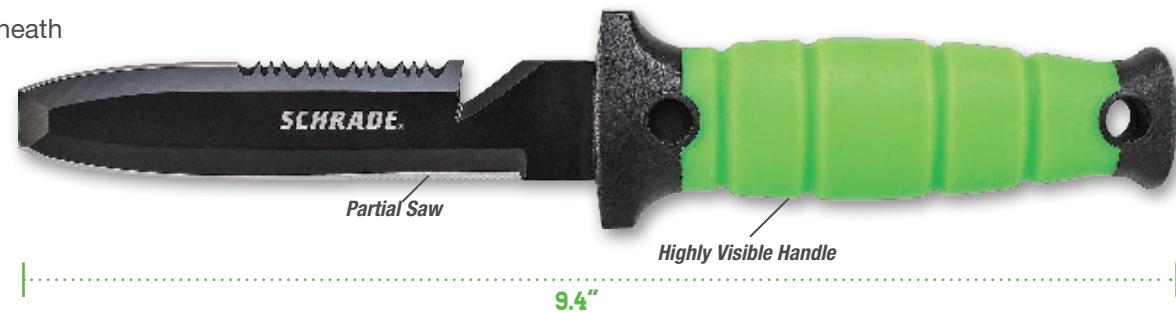

Vest Attachments Included



FIXED BLADE

Blade Length
4.5" (11.4 cm)
Overall Length
9.7" (24.7 cm)
Weight
7.6 oz.

8Cr13MoV High Carbon S.S. Blade TPE Handle

- + Full Tang
- + Thermoplastic Sheath



SCHF31 DROP POINT GREY BLADE BLACK HANDLE ▲
UPC - 044356224376
SCHF31S DROP POINT SERRATED GREY BLADE BLACK HANDLE ▲
UPC - 044356224949

FIXED BLADE

7Cr17MoV High Carbon Stainless Steel Blade TPR Handle

- + Full Tang
- + Polyester Belt Sheath

Blade Length
2.9" (7.4 cm)
Overall Length
6.4" (16.3 cm)
Weight
3.2 oz.
UPC
044356229913



SCHF66 DROP POINT GREY BLADE BLACK HANDLE ▲
UPC - 044356229913
SCHF66CP DROP POINT GREY BLADE BLACK HANDLE CLAM PACK ▲
UPC - 044356229920

**8Cr13MoV Titanium Coated High Carbon S.S. Blade
TPE Handle**

- + Full Tang
- + Thermoplastic Belt Sheath

SCHF28 LITTLE RICKY®

Blade Length
7.9" (20.2 cm)
Overall Length
14.1" (35.7 cm)
Weight
1 lb. 4.8 oz.
UPC
044356222235



14.1"



SCHF45 LEROY®

Blade Length
10.4" (26.3 cm)
Overall Length
16.5" (41.9 cm)
Weight
1 lb. 7.6 oz.
UPC
044356224796



16.5"



JETHRO™

SCHF48 JETHRO®

Blade Length
11.9" (30.2 cm)
Overall Length
18" (45.8 cm)
Weight
1 lb. 9.9 oz.
UPC
044356225205



18"



SCHRADE® GUIDE-MASTER®

8Cr13MoV Steel Blade TPE Handle

- + Full Tang Knife & Slingshot
RST (Replacement Slingshot Tube) UPC 044356226042
- + Built-In 120 & 600 Grit Sharpening Stones
- + Removable Ferro Rod
FR3 (Replacement Ferro Rod) UPC 044356226059
- + Six - 12mm Ball Bearing Shots
- + Twin Locking Key Feature
- + ABS Sheath w/Storage Compartment



SPRING LOADED AMMO MAGAZINE



REMOVABLE FERRO ROD



10.5"

SCHF39 GUIDE-MASTER®

Blade Length 5.2" (13.3 cm) Weight 8.8 oz.
Overall Length 10.5" (26.6 cm) UPC 044356222761

SCHF39CP Clam Pack
UPC 044356226028



**8Cr13MoV Titanium Coated High Carbon S.S. Blade
TPE Handle**

- + Full Tang
- + Pry Tool Locking Pin/Lanyard
- + Multiple Carry Option Nylon Filled Glass Fiber Sheath



3Cr13 Titanium Coated S.S. Pry Tool

- + 4.5" (11.4 cm) Overall Length
- + Flat Head Screwdriver
- + Strap Cutter
- + Bottle Opener
- + 1/4" Hex Wrench
- + Wrench Driver



11.5"

SCHF27 FIXED BLADE

Blade Length	6.6" (16.7 cm)	Weight	9.9 oz.
Overall Length	11.5" (29.2 cm)	UPC	044356221160

SCHF46 NECK KNIFE

Blade Length
2.4" (6.2 cm)
Overall Length
6" (15.2 cm)
Weight
1.9 oz.
UPC
044356225212



9Cr18MoV High Carbon S.S. Blade

- + Full Tang Neck Knife
- + Nylon Fiber Neck Sheath
- + 550 Paracord Wrapped Handle



6"

SCHF47TA NECK KNIFE

9Cr18MoV High Carbon S.S. Blade

- + Full Tang Neck Knife
- + 550 Paracord Wrapped Handle
- + Nylon Fiber Neck Sheath

Blade Length
2.7" (6.7 cm)
Overall Length
6" (15.2 cm)
Weight
2.3 oz.
UPC
044356224833



6"

SCHF16 NECK KNIFE

9Cr18MoV High Carbon Stainless Steel Blade G-10 Handle

- + Full Tang Neck Knife
- + Lanyard Hole
- + Thermoplastic Sheath

Blade Length
3.1" (7.8 cm)
Overall Length
7" (17.7 cm)
Weight
4.6 oz.
UPC
044356217460



7"

SCHF5N EXTREME SURVIVAL® NECK KNIFE

Blade Length
3.1" (7.8 cm)
Overall Length
6.6" (16.7 cm)
Weight
1.8 oz.
UPC
044356209267



- 7Cr17MoV High Carbon S.S. Blade**
- + Full Tang Neck Knife
 - + Bottle Opener
 - + Lanyard Hole
 - + Neck Sheath w/Pocket Clip

SCHF5SM MINI NECK KNIFE

7Cr17MoV High Carbon S.S. Blade

- + Full Tang Neck Knife
- + Lanyard Hole
- + Bottle Opener
- + Neck Sheath w/Breakaway Chain

Blade Length
2.1" (5.2 cm)
Overall Length
4.3" (11.0 cm)
Weight
0.7 oz.
UPC
044356224505

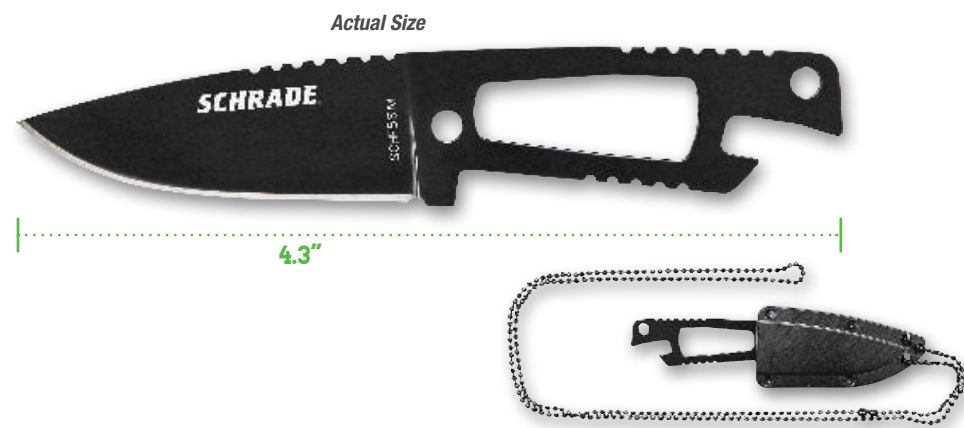

SCH110 FOLDING KARAMBIT

9Cr18MoV High Carbon S.S. Blade G-10 Handle

- + Dual Thumb Knobs
- + Liner Lock
- + Pocket Clip (Additional Clip for Tip-Up Carry)

Blade Length
3.2" (8.0 cm)
Overall Length
7.8" (19.7 cm)
Weight
6.3 oz.
UPC
044356222259



Training Version Available Page 108



SCH406N NECK KNIFE

8Cr13MoV High Carbon S.S. Blade

- + Full Tang Neck Knife
- + 550 Paracord Wrapped Handle
- + Nylon Fiber Neck Sheath

Blade Length
2.3" (5.8 cm)
Overall Length
5.2" (13.2 cm)
Weight
1.9 oz.
UPC
044356224000



SCH112 SHASTA MC'NASTY®

8Cr13MoV High Carbon S.S. Blade TPE Handle

- + Full Tang
- + Dual Edged Blade
- + Thermoplastic Sheath

Blade Length
5.2" (13.2 cm)
Overall Length
8.4" (21.3 cm)
Weight
8.2 oz.
UPC
044356226448
No Ship CA, NY, MA



Designed by Joshua Waggoner

SCH111 KARAMBIT NECK KNIFE

9Cr18MoV High Carbon Stainless Steel Blade

- + Full Tang Neck Knife
- + Thermoplastic Sheath

Blade Length
3.0" (7.5 cm)
Overall Length
6.3" (16.1 cm)
Weight
2.3 oz.
UPC
044356226431

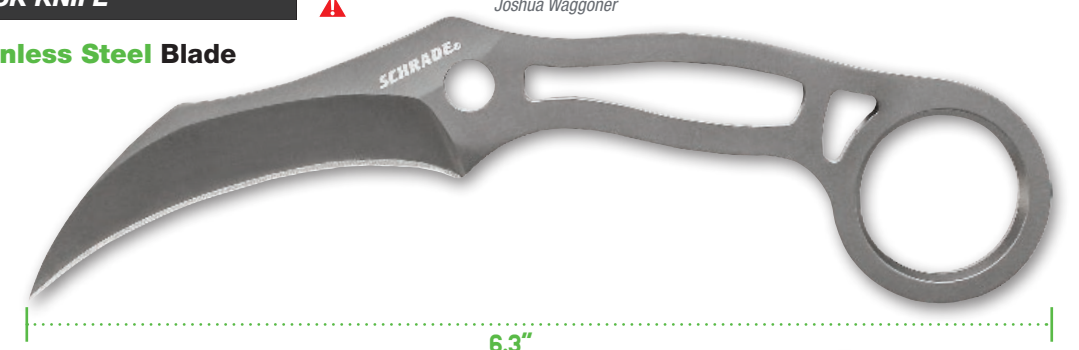

Designed by Joshua Waggoner



SCHF54 PUSH DAGGER ▲

8Cr13MoV High Carbon S.S. Blade
TPE Handle

- + Full Tang
- + Multi-Carry Option Nylon Fiber Sheath

Blade Length
3.2" (8.2 cm)
Overall Length
6.5" (16.4 cm)
Weight
2.7 oz.
UPC
044356226387
No Ship CA, NY, MA



Training Version Available Page 107



Multi-Carry Option Nylon Fiber Sheath

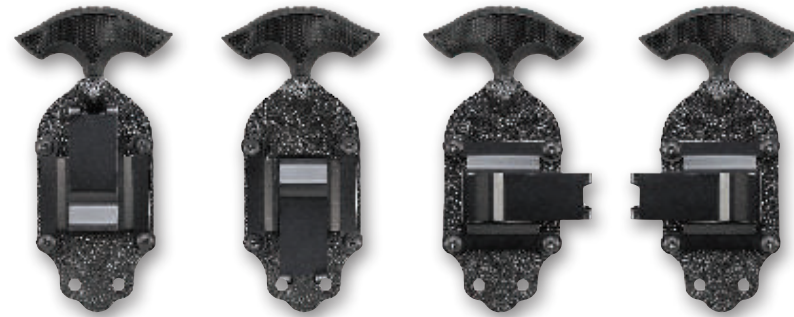

SCHF50 KEYCHAIN DAGGER ▲

9Cr18MoV High Carbon S.S. Blade
TPE Handle

- + Fully Serrated/Fine Edge Spear Point Blade
- + T-Handle w/Palm Jimping
- + ABS Neck Sheath w/Carabiner Clip

Blade Length
1.3" (3.2 cm)
Overall Length
2.8" (7.0 cm)
Weight
0.5 oz.
UPC
044356225137
No Ship CA, NY, MA



Actual Size

SCHCC1 CREDIT CARD KNIFE ▲

8Cr13MoV High Carbon S.S. Blade

- + Full Tang
- + Thermoplastic Belt Sheath/ Money Clip

Blade Length
1.9" (4.8 cm)
Overall Length
3.6" (9.1 cm)
Weight
1.0 oz.
UPC
044356226240

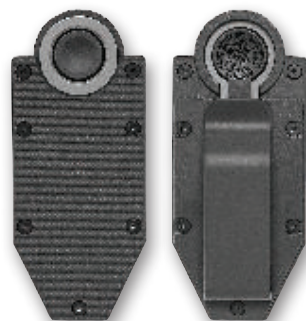

Actual Size



SCHCC1CP Clam Pack
UPC 044356230520



SCHF19 SMALL BOOT KNIFE ▲

Blade Length
3.6" (9.1 cm)
Overall Length
7" (17.7 cm)
Weight
2.1 oz.
UPC
044356219464
No Ship CA, NY, MA



SCHF19L LARGE BOOT KNIFE ▲

Blade Length
4.8" (12.2 cm)
Overall Length
9" (22.9 cm)
Weight
4.1 oz.
UPC
044356219457
No Ship CA, NY, MA

Training Version Available Page 107



SCHF44LS NEEDLE® BOOT KNIFE ▲

Blade Length
7.6" (19.4 cm)
Overall Length
12.7" (32.2 cm)
Weight
5.1 oz.
UPC
044356224840
No Ship CA, NY, MA





SCHF13SM MINI NECK KNIFE



8Cr13MoV Stonewashed High Carbon S.S. Blade
G-10 Handle

- + Full Tang
- + Lanyard Hole
- + Kydex® Neck Sheath w/Breakaway Chain

Blade Length
2.1" (5.2 cm)
Overall Length
4.7" (12.0 cm)
Weight
1.4 oz.
UPC
044356224420

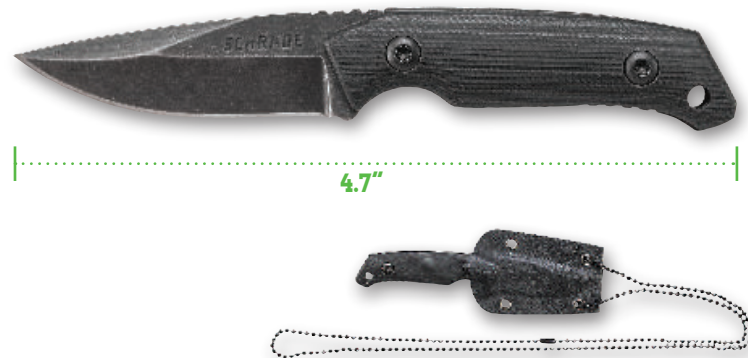

SCHF13 FIXED BLADE



8Cr13MoV Stonewashed High Carbon S.S. Blade
G-10 Handle

- + Full Tang
- + Lanyard Hole
- + Multi-Carry Option Kydex® Belt Sheath

Blade Length
3.7" (9.4 cm)
Overall Length
8.5" (21.6 cm)
Weight
7.4 oz.
UPC
044356217217



FIXED BLADE

Blade Length
3.4" (8.6 cm)
Overall Length
7.9" (20.0 cm)
Weight
5.6 oz.



SCHF14 DROP POINT STONEWASHED BLADE BLACK HANDLE



UPC - 044356217224

SCHF14CP DROP POINT STONEWASHED BLADE BLACK HANDLE CLAM PACK



UPC - 044356217866



SCHF15 FIXED BLADE



Blade Length
3.4" (8.6 cm)
Overall Length
7.9" (20.0 cm)
Weight
6.0 oz.
UPC
044356217231



SCHF20 FIXED BLADE

8Cr13MoV Stonewashed High Carbon S.S. Blade
G-10 Handle

- + Full Tang
- + Multi-Carry
- Option Kydex® Belt Sheath

Blade Length
4.4" (11.2 cm)
Overall Length
8.5" (21.6 cm)
Weight
5.5 oz.
UPC
044356219495
No Ship CA, NY, MA



8.5"



SCHF24 FIXED BLADE

8Cr13MoV Stonewashed High Carbon S.S. Blade
G-10 Handle

- + Full Tang
- + Multi-Carry
- Option Kydex® Belt Sheath

Blade Length
3.4" (8.6 cm)
Overall Length
8" (20.3 cm)
Weight
6.5 oz.
UPC
044356220231



8"



SCHRADE®

SCTK3CP THROWING KNIVES

2Cr13MoV Stonewashed High Carbon S.S.

- + 3 - Full Tang Throwing Knives
- + 3 - Paper Targets Included
- + Polyester Sheath

Overall Length
10" (25.5 cm)
Individual Weight
4.2 oz.
UPC
044356224710
No Ship CA, NY, MA

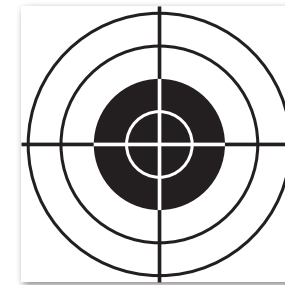

THROWING KNIVES

Only available in clam pack

SCTK6CP THROWING KNIVES

2Cr13MoV Stonewashed High Carbon S.S.

- + 6 - Full Tang Throwing Knives
- + 3 - Paper Targets Included
- + Polyester Sheath

Overall Length
8" (20.3 cm)
Individual Weight
2.6 oz.
UPC
044356224727
No Ship CA, NY, MA

*Sheath Separates for Two Individual,
3 Piece Carry Sets*

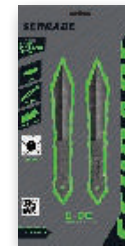



SCHRADE[®]
MACHETES
AXES
SPEARS

BOLO FIXED BLADE



TiCN 3Cr13 Titanium Coated Stainless Steel Blade Safe-T-Grip® Handle

- + Lanyard Hole
- + Polyester Sheath w/Removable Storage Pouch
Shoulder Strap/Leg Straps/Belt Loop

Blade Length
14" (35.5 cm)
 Overall Length
20.2" (51.2 cm)
 Weight
1 lb. 10.8 oz.



20.2"



Ferro Rod & Sharpening Stone Included

SCHBOLO BOLO BLADE BLACK HANDLE

UPC - 044356216814

SCHBOLOCP BOLO BLADE BLACK HANDLE CLAM PACK

UPC - 044356217880

SCHMBSCP PRISCILLA BRUSH SWORD



3Cr13 Powder Coated Stainless Steel Blade TPE Handle

- + Full Tang
- + Thermoplastic Sheath w/Shoulder Strap

Blade Length
16.1" (40.8 cm)
 Overall Length
22.6" (57.5 cm)
 Weight
19.8 oz.
 UPC
044356229609

Only available in clam pack



Designed by Joshua Waggoner

22.6"

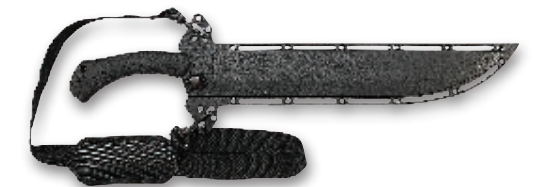

SCHPRICP PARANG MACHETE



3Cr13 Stainless Steel Blade TPE Handle

- + Full Tang
- + Polyester Sheath w/Removable Shoulder Strap/
Leg Strap/Belt Loop

Blade Length
13.7" (34.8 cm)
 Overall Length
19.6" (49.8 cm)
 Weight
21.3 oz.
 UPC
044356228732

Only available in clam pack



19.6"



KUKRI MACHETE

3Cr13 Powder Coated Stainless Steel Blade
Safe-T-Grip® Handle

- + Ferro Rod
- + Sharpening Stone
- + Lanyard Hole
- + Polyester Sheath w/Removable Storage Pouch
- Shoulder Strap/Leg Straps/Belt Loop



SCHKMISMCP KUKRI MACHETE

Blade Length
9.9" (25.1 cm)
Overall Length
15.1" (38.3 cm)
Weight
12.3 oz.
UPC
044356220606

Only available in clam pack



15.1"



Ferro Rod & Sharpening Stone Included



KUKRI MACHETE

Blade Length
13.3" (33.8 cm)
Overall Length
19.7" (50.0 cm)
Weight
1 lb. 6.6 oz.



19.7"



Ferro Rod & Sharpening Stone Included



SCHKMI **KUKRI BLACK BLADE BLACK HANDLE**

UPC - 044356220545

SCHKMICP **KUKRI BLACK BLADE BLACK HANDLE CLAM PACK**

UPC - 044356220590

SCHGKI GURKHA KUKRI

3Cr13MoV Stainless Steel Blade TPE Handle

- + Lanyard Hole
- + Polyester Sheath w/Removable Shoulder Strap/ Leg Strap/Belt Loop

Blade Length
12.8" (32.5 cm)
Overall Length
18.3" (46.5 cm)
Weight
15.9 oz.
UPC
044356225229



18.3"



SCMACH1CP MACHETE

3Cr13 Stainless Steel Blade TPR Handle

- + Full Tang
- + Lanyard Hole
- + Polyester Belt Sheath

Blade Length
12" (30.5 cm)
Overall Length
18.3" (46.4 cm)
Weight
13.2 oz.
UPC
044356224987

Only available in clam pack



18.3"



SCMACH2CP MACHETE

3Cr13 Stainless Steel Blade TPR Handle

- + Full Tang
- + Lanyard Hole
- + Polyester Belt Sheath

Blade Length
14.9" (37.7 cm)
Overall Length
20.9" (53.1 cm)
Weight
15.3 oz.
UPC
044356224994

Only available in clam pack

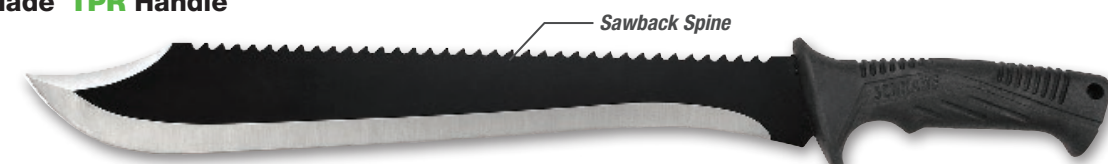

20.9"



SCHF43 JESSICA X FIXED BLADE

1070 High Carbon Steel Blade TPE Handle

- + Versatile Handle Design for Multiple Grip Positions
- + Polyester Sheath w/Removable Shoulder Strap/ Leg Strap/Belt Loop
- + Lanyard Hole

Blade Length
9" (22.9 cm)
Overall Length
17.5" (44.5 cm)
Weight
1 lb. 12.0 oz.
UPC
044356224208

17.5"



GRIP 1 FINER USE



GRIP 2 GENERAL USE



GRIP 3 HEAVY CHOPPING



SCHF64CP FROE FIXED BLADE



1070 High Carbon Steel Blade TPE Handle

- + Full Tang
- + Polyester Belt Sheath w/Leg Strap

Blade Length
8.5" (21.6 cm)

Overall Length
14.7" (37.4 cm)

Weight
15.6 oz.

UPC
044356229043

Only available in clam pack

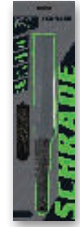

14.7"



SCHPB1BK PRY BAR

Overall Length 7.5" (19.1 cm) UPC 044356222433
Weight 4.1 oz.



- + Powder Coated SK5 High Carbon Stainless Steel
- + Bending Strength: 394 lbf (179 kgf)



550 Paracord
Wrapped Handle

SCHPB1OD PRY BAR

Overall Length 7.5" (19.1 cm) UPC 044356222440
Weight 4.1 oz.



- + Powder Coated SK5 High Carbon Stainless Steel
- + Bending Strength: 394 lbf (179 kgf)



550 Paracord
Wrapped Handle

SCHRADE®
RELY ON YOU

ITS USER'S MANUAL IS
HARDWIRED INTO YOUR DNA.

THE SCHRADE® SURVIVAL HATCHET

A tool of countless primitive applications, re-engineered to survive the collapse of modern civilization if need be. With a titanium-coated blade and virtually indestructible handle, complete with a ferro rod fire starter in the shaft, you're equipped to RELY ON YOU.



SCAXE9CP AXE/SAW

Blade Length
3.3" (8.3 cm)
Overall Length
18" (45.9 cm)
Weight
2 lb. 1.3 oz.
UPC
044356224246
Only available in clam pack

**3Cr13 Titanium Coated S.S. Blade
Glass Fiber Filled PA & TPR Handle**

- + 12.5" Fully Extending Saw Blade
- + Polyester Belt Sheath (Stores in Handle)

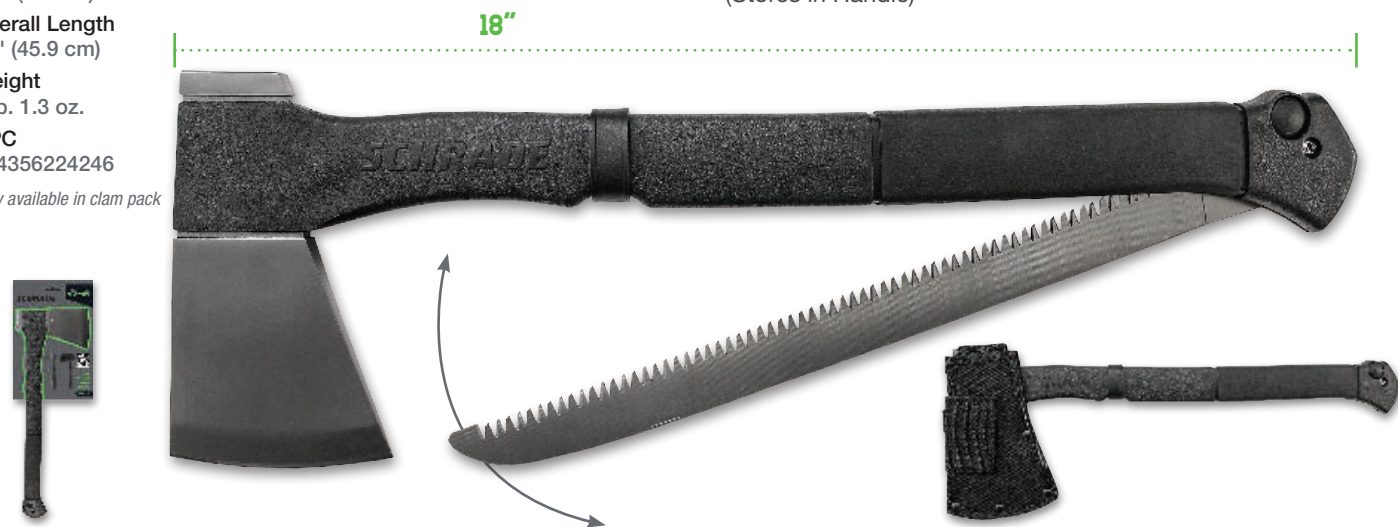

LARGE SURVIVAL AXE

Blade Length
4.2" (10.6 cm)
Overall Length
15.7" (39.9 cm)
Weight
1 lb. 15.0 oz.

**3Cr13 Titanium Coated Stainless Steel Blade
Glass Fiber Filled PA & TPR Rubber Material &
Cold Resistance Flexibilizer Handle**

- + Dual Grit Round Disc Sharpening Stone
- + Ferro Rod (Stores In Shaft)
- + Polyester Belt Sheath



SCAXE2L LARGE AXE BLACK HANDLE ▲

UPC - 044356220941

SCAXE2LCP LARGE AXE BLACK HANDLE CLAM PACK ▲

UPC - 044356220958

TITANIUM-COATED BLADE.
BOMB-PROOF HANDLE. BECAUSE THERE IS

NO SUCH THING AS OVERKILL.

SCHRADE®

SCAXE2 SERIES

Blade Length
3.8" (9.6 cm)
Overall Length
11.8" (30.0 cm)
Weight
1 lb. 6.4 oz.

**3Cr13 Titanium Coated Stainless Steel Blade
Glass Fiber Filled PA & TPR Rubber Material
& Cold Resistance Flexibilizer Handle**

- + Ferro Rod (Stores in Shaft)
- + Thermoplastic Belt Sheath



SCAXE2 SMALL AXE BLACK HANDLE ▲

UPC - 044356216821

SCAXE2CP SMALL AXE BLACK HANDLE CLAM PACK ▲

UPC - 044356217873



HATCHET

Blade Length 3.6" (9.0 cm) Weight 1 lb. 5.9 oz.
Overall Length 11.1" (28.1 cm)



11.1"



3Cr13 Stainless Steel Blade
TPR Handle
+ Full Tang
+ Hammer Pommel
+ Thermoplastic Belt Sheath

SCAXE10 HATCHET BLACK HANDLE ▲
UPC - 044356225502
SCAXE10CP HATCHET BLACK HANDLE CLAM PACK ▲
UPC - 044356227315

SCAXE5 TACTICAL HATCHET

Blade Length 3.1" (7.9 cm) Weight 1 lb. 9.0 oz.
Overall Length 12.8" (32.5 cm) UPC 044356220422

12.8"



SK5 High Carbon Steel Blade
Nylon Fiber Handle
+ Nail Pull/Pry Bar
+ Spike Pommel
+ Nylon Belt Sheath w/Belt Loop



SCHCOM6CP HATCHET/MINI MACHETE COMBO

3Cr13 Stainless Steel Blade TPR Handle
+ Full Tang
+ Individual Belt Sheaths

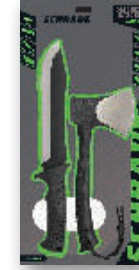

11.1"



Hatchet

Blade Length 3.6" (9.0 cm)
Overall Length 11.1" (28.1 cm)
Weight 1 lb. 5.9 oz.

Machete

Blade Length 8.5" (21.5 cm)
Overall Length 14.6" (37.0 cm)
Weight 12.0 oz.

UPC 044356229968

Only available in clam pack

14.6"



IT DIGS. IT CUTS. IT FORTIFIES YOUR
**POSITION ON THE
 FOOD CHAIN.**

**RELY
 ON YOU**

SCHRADE®
 THE SCHRADE® TELESCOPING FOLDING SHOVEL.
 Unfolds and extends to reveal massive utility. With sharpened edges for
 ultimate efficiency, plus a sheath to carry it in.

SCHSH1 TELESCOPING SHOVEL

1055 Carbon Steel Shovel
PP Handle

- + "T" Handle For Better Leverage
- + 19" Telescoping Handle
- + Sharpened Edges
- + Polyester Sheath

Blade Length
 7.4" (18.9 cm)
 Overall Length
 16.6" (42.1 cm)
 Weight
 1 lb. 15.7 oz.
 UPC
 044356223768

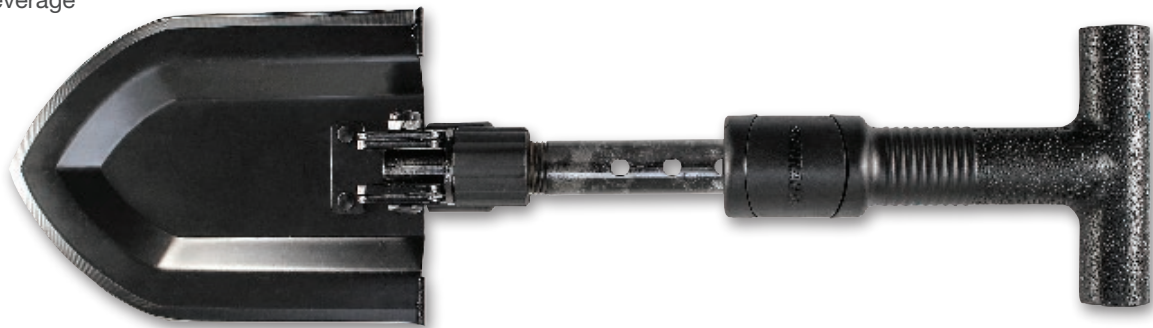

16.6"



Folds for
 Easy Storage

PHANTOM® SPEARS

SCHSP1/SCHSP2/SCHSP3 Features

- 3Cr13 Stainless Steel Blade**
- Nylon Filled Glass Fiber**
- w/Enhance Flexibilizer Shaft**



SPEAR EXTENSION HANDLE



SCHSP-EXT1

- + Screws into Butt Cap
- + 550 Paracord Wrapped
 Textured Grip

Overall Length
 15.7" (39.8 cm)
 Weight
 10.9 oz.
 UPC
 044356225281



SCHSP1 LONG SPEAR

- + Double Edged Blade
 w/Blood Groove
- + 550 Paracord Wrapped
 Textured Grips
- + Large Ferro Rod/Survival Kit
 (Stores in Shaft)
 - + Two Needles
 - + Two Fishing Hooks
 - + Two Split Shots
 - + Fishing Line
- + Nylon Fiber Sheath

Blade Length
 7.2" (18.3 cm)
 Overall Length
 44.5" (113.0 cm)
 Weight
 2 lb. 9.1 oz.
 UPC
 044356222648
 No Ship CA, NY, MA



KEYCHAIN MULTI-TOOL

9 Functions

- + Keychain Lanyard
- + Pliers
- + Wire Stripper
- + Bottle Opener
- + Scissors
- + Screwdriver
- + Phillips Head
- + Tweezers
- + **Drop Point Knife**

Closed Length
2.6" (6.5 cm)
Overall Length
4.2" (10.5 cm)
Weight
2.1 oz.



ST12 MULTI-TOOL GREEN HANDLE

UPC - 044356229975

ST12CP MULTI-TOOL GREEN HANDLE CLAM PACK

UPC - 044356229982

KEYCHAIN MULTI-TOOL

9 Functions

- + Keychain Lanyard
- + Pliers
- + Wire Stripper
- + Bottle Opener
- + Scissors
- + Screwdriver
- + Phillips Head
- + Tweezers
- + **File**

Closed Length
2.6" (6.5 cm)
Overall Length
4.2" (10.5 cm)
Weight
2.1 oz.
UPC
044356229999

Only available in clam pack



Notice: Before traveling with this product, be sure to check the rules and regulations applicable to your mode of transportation for any restrictions regarding this product.

TOUGH MULTI-TOOL

15 Functions

- + Needle Nose Pliers
- + Regular Pliers
- + Wire Cutter
- + Fine Edge Blade
- + Small Phillips Head
- + Can Opener
- + Ruler
- + Fine Grit File
- + Hexagon Wrench - 3 Sizes
- + Large Screwdriver
- + Small Screwdriver
- + Bottle Opener
- + Nail Puller
- + Saw
- + Spring Loaded
- + Molded Polyester Belt Sheath



TOUGH MULTI-TOOL

9 Functions

- + Needle Nose Pliers
- + Regular Pliers
- + Wire Cutter
- + Fine Edge Blade
- + Small Phillips Head
- + Small Flat Head
- + Fine Grit File
- + Bottle Opener
- + Heavy Duty Scissors
- + Pocket Clip
- + Molded Polyester Belt Sheath

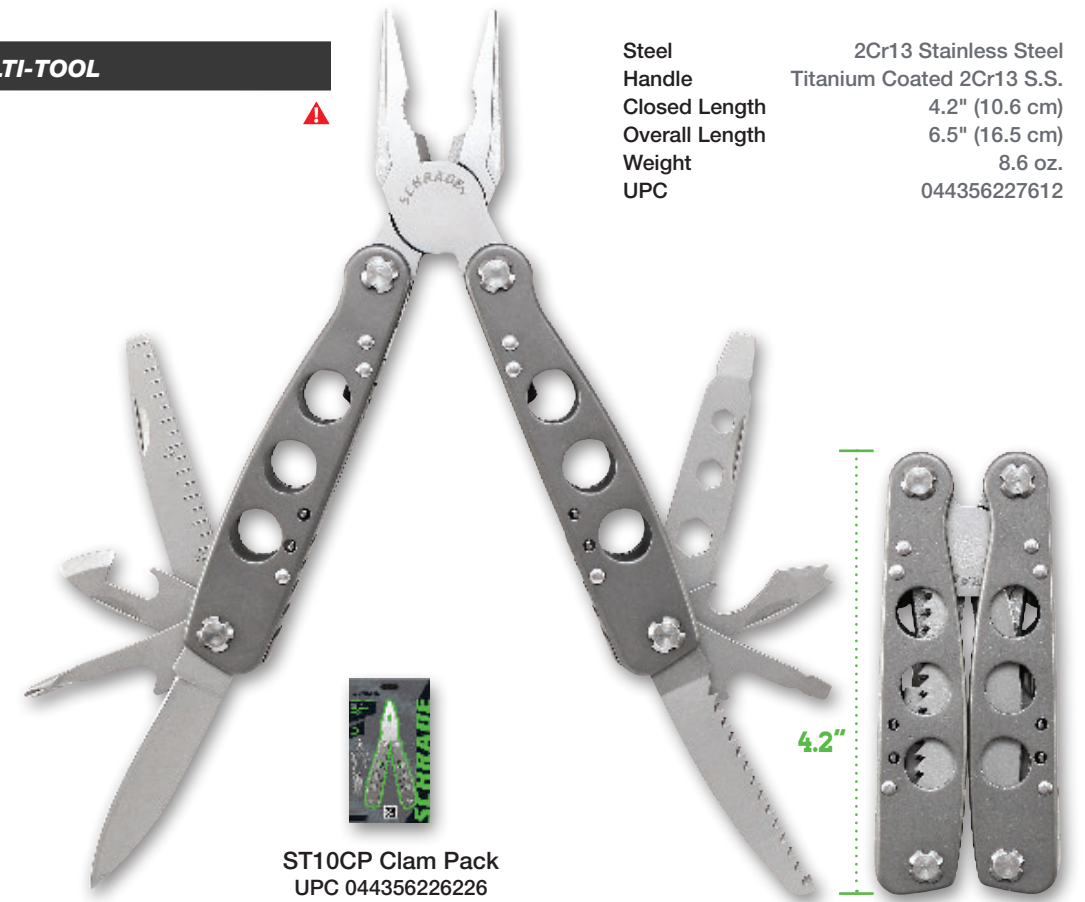

Steel Handle	2Cr13 Stainless Steel
Closed Length	Titanium Coated 2Cr13 S.S.
Overall Length	4.2" (10.6 cm)
Weight	6.5" (16.5 cm)
UPC	8.6 oz.
	044356227612

ST10CP Clam Pack
UPC 044356226226

ST11CP Clam Pack
UPC 044356226479

Steel	2Cr13 Stainless Steel
Closed Length	4.1" (10.4 cm)
Overall Length	6.2" (15.8 cm)
Weight	6.3 oz.
UPC	044356227605



ST1N TOUGH MULTI-TOOL

21 Functions

- + Needle Nose Pliers
- + Regular Pliers
- + Vise
- + Wire Cutter
- + Cap Lifter
- + Can Opener
- + Locking Phillips Screwdriver
- + Scribe
- + Awl
- + Leather Bore
- + Locking Dual Edge Knife Blade
- + Metal File
- + Wood File
- + Measuring Gauge
- + Hook Disgorger
- + Locking Heavy Duty Saw Blade
- + Scraping Blade
- + Wire Strippers
- + Locking Large Flat Screwdriver
- + Fine Flat Head Screwdriver
- + Lanyard Attachment
- + Polyester Belt Sheath



ST1NCP Clam Pack
UPC 044356013048

Steel
Closed Length 4.8" (12.2 cm)
Overall Length 7" (17.8 cm)
Weight 8.1 oz.
UPC 044356013031

ST1NB TOUGH MULTI-TOOL

20 Functions

- + Needle Nose Pliers
- + Regular Pliers
- + Vise
- + Wire Cutter
- + Cap Lifter
- + Can Opener
- + Locking Phillips Screwdriver
- + Scribe
- + Awl
- + Leather Bore
- + Locking Dual Edge Knife Blade
- + Metal File
- + Wood File
- + Heavy Duty Scissors
- + Locking Heavy Duty Saw Blade
- + Scraping Blade
- + Wire Strippers
- + Locking Large Flat Screwdriver
- + Fine Flat Head Screwdriver
- + Lanyard Attachment
- + Polyester Belt Sheath

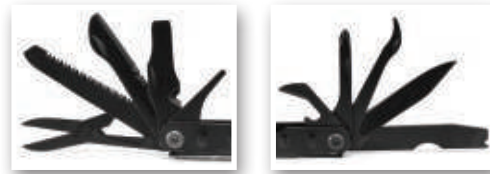

ST1NBCP Clam Pack
UPC 044356205702

Steel
Closed Length 4.8" (12.2 cm)
Overall Length 7" (17.8 cm)
Weight 8.1 oz.
UPC 044356203227

TACTICAL PUSH BUTTON PEN

SCPEN9BK TACTICAL PUSH BUTTON PEN

CNC Machined 6061 T6 Aluminum

- + Pocket Clip
- + Easyflow Schmidt P900M Parker Style Black Ball Point Cartridge

Overall Length
5" (12.8 cm)

Weight
1.6 oz.

UPC
044356222693



5"



BLACK

TACTICAL PEN

TACTICAL PEN

CNC Machined 6061 T6 Aluminum

- + Pocket Clip
- + Schmidt P900 Parker Style Black Ball Point Cartridge

Overall Length
5.7" (14.5 cm)

Weight
1.4 oz.

Pen Refill
UPC 044356206679



5.7"



BLACK



GREY

SCPENBK BLACK PEN ▲
UPC - 044356208550
SCPENG GREY PEN ▲
UPC - 044356206655

TACTICAL SURVIVAL PEN

CNC Machined 6061 T6 Aluminum

- + Whistle Cap (110 dB)
- + Striker Plate
- + Ferro Rod
- + Pocket Clip
- + Black Starminen Fine Point D1 Pen Cartridge
- + Pen Refill 2

FR2 (Replacement Ferro Rod)
UPC 044356221443

Pen Refill 2
UPC 044356217590

SCPEN4BK TACTICAL SURVIVAL PEN

Overall Length
5.9" (15.0 cm)
Weight
1.7 oz.
UPC
044356216128



5.9"



BALL POINT PEN



DEFENSIVE END POINT



EMERGENCY WHISTLE CAP



FERRO ROD



STRIKER PLATE



SCHRADE® TRAINING KNIVES

USING AN UNSHARPENED TRAINING KNIFE ALLOWS FOR THE USER TO PRACTICE FUNDAMENTAL MOVEMENTS, DRILLS AND VARIOUS TECHNIQUES WITHOUT THE RISK OF CUTTING THEMSELVES OR OTHERS.



SCHF54-TR TRAINING PUSH DAGGER

8Cr13MoV High Carbon S.S. Blade
TPE Handle

- + Full Tang
- + Multi-Carry Option Nylon Fiber Sheath

Blade Length
3.2" (8.2 cm)
Overall Length
6.5" (16.4 cm)
Weight
2.7 oz.
UPC
044356228671



UNSHARPENED SAFETY BLADE



SCHF19L-TR TRAINING BOOT KNIFE

7Cr17MoV High Carbon S.S. Blade
TPE Handle

- + Lanyard Hole
- + Leather Sheath with Boot/Belt Clip

Blade Length
4.7" (11.8 cm)
Overall Length
9.8" (24.9 cm)
Weight
4.2 oz.
UPC
044356228688



9.8"

UNSHARPENED SAFETY BLADE



SCHRADE®

SCH110-TR

TRAINING KARAMBIT



9Cr18MoV High Carbon Stainless Steel Blade G-10 Handle

- + Dual Thumb Knobs
- + Liner Lock
- + Pocket Clip
(Additional Clip for Tip-Up Carry)

Blade Length

3.2" (8.0 cm)

Overall Length

7.8" (19.7 cm)

Weight

6.3 oz.

UPC

044356228664



Tip-Down Carry



Tip-Up Carry



UNSHARPENED SAFETY BLADE



7.8"

SCHF23-TR

TRAINING FIXED BLADE



8Cr13MoV Stonewashed High Carbon S.S. Blade G-10 Handle

- + Full Tang
- + Multi-Carry Option
Kydex® Belt Sheath

Blade Length

3.4" (8.6 cm)

Overall Length

8" (20.3 cm)

Weight

6.5 oz.

UPC

044356228695



UNSHARPENED SAFETY BLADE



8"

Uncle Henry®

= EVERLASTINGLY SHARP =



+ BRASS PINS



+ HEAT TREATED
BACK SPRINGS



+ TRADITIONAL
STAGLON® HANDLES



+ NICKEL SILVER BOLSTERS



+ BRASS BOLSTERS



GRIP A LEGEND™

WHEN SEARCHING FOR A LEGENDARY KNIFE, LOOK NO FURTHER THAN WHAT THE EXPERIENCED TRADESMEN CARRIES IN HIS POCKET. LEGENDARY UNCLE HENRY® MODELS SUCH AS OUR HANDSOMELY CRAFTED TRADITIONAL STAGLON® FOLDERS, FIXED BLADES AND SELECT SERIES LOCKBACKS GIVE YOU TRADITIONAL STYLE WITH RUGGED DEPENDABILITY.

22UH DELUXE WOOD CARVING KIT

65Mn High Carbon Blades Wood Handle

- + 6SBL Blade Pack of 6 Small Detail Blades
 - + 20E x 15/16" Radius Ground on Outside Curve
 - + 21EX Straight Blade
 - + 11 Straight Blade Ground on Slanted Edge
 - + 10 1" Radius Ground on Inside Curve
 - + 8 2" Radius Ground on Inside Curve
 - + 22 2" Radius Ground on Inside Curve
- + 1 - LD2 1/2" x .05" Heavy Duty Blade
- + 1 - LN3 1/2" x .05" Carving Blade
- + 1 - LS1 1/2" x .05" Carving Blade
- + 1 - LBG #7 Sweep Gouge 5/16" Cut

Handle Length
4.6" (11.7 cm)
Weight
12.8 oz.
UPC
044356228510



Three Way Brass Jaw Chucking System

- + 7Cr17MoV High Carbon S.S.
- + Drop Point Blade
- + Can Opener
- + Screwdriver & Cap Lifter
- + Awl
- + Shackle
- + Nickel Silver Bolsters



3.6"

23UH SCOUT KNIFE

Blade Length 2.4" (6.2 cm) Weight 3.5 oz.
Overall Length 6.1" (15.5 cm) UPC 044356228497

- + 7Cr17MoV High Carbon S.S.
- + Sheepsfoot Blade (2)
- + Pen Blade
- + Coping Blade
- + Nickel Silver Bolsters



3.5"

4UH MASTER

Blade Length 2.3" (5.8 cm) Weight 2.6 oz.
Overall Length 5.8" (14.7 cm) UPC 044356000437

- + 7Cr17MoV High Carbon S.S.
- + Clip Point Blade
- + Fish Scaling Blade
- + Nickel Silver Bolsters



4.25"

1UH FISH KNIFE

Blade Length 3.3" (8.4 cm) Weight 2.9 oz.
Overall Length 7.6" (19.4 cm) UPC 044356228848

- + 7Cr17MoV High Carbon S.S.
- + Spear Point Blade
- + Coping Blade
- + Pen Blade
- + Nickel Silver Bolsters



4"

9UH CIGAR WHITTILER

Blade Length 2.8" (7.1 cm) Weight 2.3 oz.
Overall Length 6.7" (17.0 cm) UPC 044356000611

- + 7Cr17MoV High Carbon S.S.
- + Clip Point Blade
- + Sheepsfoot Blade
- + Pen Blade
- + Nickel Silver Bolsters



2.8"

807UH JUNIOR

Blade Length 2" (5.1 cm) Weight 1.1 oz.
Overall Length 4.8" (12.2 cm) UPC 044356003162

- + 7Cr17MoV High Carbon S.S.
- + Clip Point Blade
- + Sheepsfoot Blade
- + Spey Blade
- + Nickel Silver Bolsters



3.9"

885UH SENIOR RANCHER®

Blade Length 3" (7.6 cm) UPC 044356003049
Overall Length 6.9" (17.5 cm) 885UHCP CLAM PACK
Weight 2.8 oz. UPC 044356003322

- + 7Cr17MoV High Carbon S.S.
- + Clip Point Blade
- + Sheepsfoot Blade
- + Spey Blade
- + Nickel Silver Bolsters



3.5"

897UH PREMIUM STOCK

Blade Length 2.8" (7.1 cm) UPC 044356003056
Overall Length 6.2" (15.7 cm) 897UHCP CLAM PACK
Weight 2.1 oz. UPC 044356014168

- + 7Cr17MoV High Carbon S.S.
- + Clip Point Blade
- + Sheepsfoot Blade
- + Pen Blade
- + Nickel Silver Bolsters



3.3"

834UH THE RANCHER®

Blade Length 2.5" (6.4 cm) Weight 1.8 oz.
Overall Length 5.8" (14.7 cm) UPC 044356003193

- + 7Cr17MoV High Carbon S.S.
- + Clip Point Blade
- + Pen Blade
- + Shackle
- + Nickel Silver Bolsters



2.8"

804UH JOURNEYMAN

Blade Length 2" (5.1 cm) Weight 1.1 oz.
Overall Length 4.8" (12.2 cm) UPC 044356003506

- + 7Cr17MoV High Carbon S.S.
- + Clip Point Blade
- + Sheepsfoot Blade
- + Spey Blade
- + Stainless Steel Bolsters



3.5"

897UHP PREMIUM STOCK

Blade Length 2.8" (7.1 cm) Weight 2.3 oz.
Overall Length 6.2" (15.7 cm) UPC 044356212830

- + 7Cr17MoV High Carbon S.S.
- + Clip Point Blade
- + Gut Hook
- + Lockblade
- + Nickel Silver Bolsters



877UH MUSKRAT GUTHOOK

Blade Length 3" (7.6 cm) Weight 2.8 oz.
Overall Length 7" (17.8 cm) UPC 044356208574

- + 7Cr17MoV High Carbon S.S.
- + Pen Blade
- + Scissors
- + Nickel Silver Bolsters



707UH GAMBLER

Blade Length 1.7" (4.3 cm) Weight 1.2 oz.
Overall Length 4.5" (11.4 cm) UPC 044356003230

- + 7Cr17MoV High Carbon S.S.
- + Clip Point Blade
- + Lockblade
- + Nickel Silver Bolsters



197UH CAT PAW

Blade Length 2.8" (7.1 cm) Weight 1.9 oz.
Overall Length 6.3" (16.0 cm) UPC 044356226127

- + 7Cr17MoV High Carbon S.S.
- + Drop Point Blade
- + Pen Blade
- + Nickel Silver Bolsters
- + Leather Sheath



11UH LARGE CANOE

Blade Length 2.5" (6.4 cm) Weight 2.5 oz.
Overall Length 6.1" (15.5 cm) UPC 044356209168

- + 7Cr17MoV High Carbon S.S.
- + Drop Point Blade
- + Clip Point Blade
- + Nickel Silver Bolsters
- + Leather Sheath



227UH FOLDING BOWIE

Blade Length 4" (10.2 cm) Weight 6.7 oz.
Overall Length 9.3" (23.6 cm) UPC 044356201704

- + 7Cr17MoV High Carbon S.S.
- + Clip Point Blade
- + Spey Blade
- + Nickel Silver Bolsters



285UH PRO TRAPPER

Blade Length 3.2" (8.1 cm) Weight 2.8 oz.
Overall Length 7" (17.8 cm) UPC 044356003025
285UHCP CLAM PACK UPC 044356203128

- + 7Cr17MoV High Carbon S.S.
- + Clip Point Blade
- + Shackle
- + Nickel Silver Bolsters

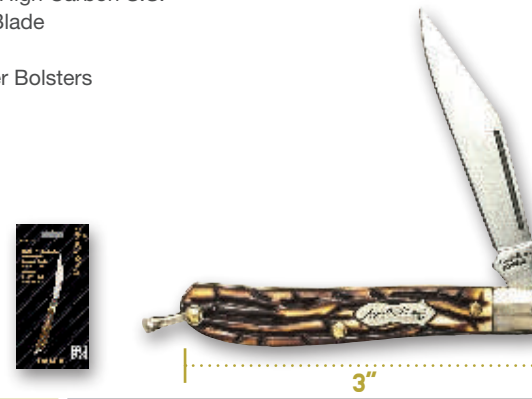

12UH ROADIE

Blade Length 2.2" (5.6 cm) Weight 0.9 oz.
Overall Length 5.1" (13.0 cm) UPC 044356003247
12UHCP CLAM PACK UPC 044356003308

- + 7Cr17MoV High Carbon S.S.
- + Drop Point Blade
- + Lockback
- + Nickel Silver Bolsters

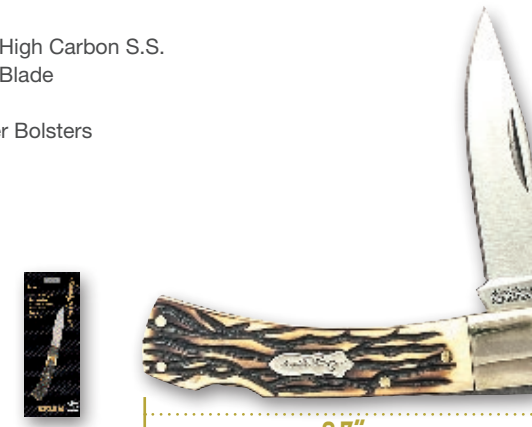

5UH BRUIN

Blade Length 2.8" (7.1 cm) Weight 2.6 oz.
Overall Length 6.5" (16.5 cm) UPC 044356021364
5UHCP CLAM PACK UPC 044356021357

- + 7Cr17MoV High Carbon S.S.
- + Hawkbill Blade
- + Nickel Silver Bolsters



16UH HAWKBILL PRUNER

Blade Length 3" (7.6 cm) Weight 3.4 oz.
Overall Length 7" (17.8 cm) UPC 044356210256

- + 7Cr17MoV High Carbon S.S.
- + Clip Point Blade
- + Lanyard Hole
- + Nickel Silver Bolsters
- + Leather Sheath



124UH TRADESMAN®

Blade Length 3.1" (7.9 cm) Weight 2.5 oz.
Overall Length 7.1" (18.0 cm) UPC 044356209403

- + 7Cr17MoV High Carbon S.S.
- + Drop Point Blade
- + Lockblade
- + Nickel Silver Bolsters



55UH SPECIAL EDITION BRUIN

Blade Length 2.8" (7.0 cm) Weight 3.0 oz.
Overall Length 6.5" (16.5 cm) UPC 044356209397

- + 7Cr17MoV High Carbon S.S.
- + Clip Point Blade
- + Shackle
- + Lockback
- + Nickel Silver Bolsters



LB2 SMOKEY

Blade Length 1.5" (3.8 cm) Weight 1.1 oz.
Overall Length 3.8" (9.7 cm) UPC 044356014090

LBI CUB ▲

**7Cr17MoV High Carbon S.S. Blade
Wood Handle**

- + Clip Point Blade
- + Shackle
- + Lockback
- + Nickel Silver Bolsters

Blade Length
1.5" (3.8 cm)
Overall Length
3.8" (9.7 cm)
Weight
1.1 oz.
UPC
044356014007



BROWN BEAR

**7Cr17MoV High Carbon S.S. Blade
Wood Handle**

- + Clip Point Blade
- + Lockback
- + Nickel Silver Bolsters

Blade Length
2.2" (5.6 cm)
Overall Length
5.1" (13.0 cm)
Weight
1.6 oz.



LB3 BROWN BEAR ▲
UPC - 044356014014
LB3CP BROWN BEAR CLAM PACK ▲
UPC - 044356014182

SMOKEY

**7Cr17MoV High Carbon S.S. Blade
Wood Handle**

- + Clip Point Blade
- + Lockback
- + Nickel Silver Bolsters
- + Leather Sheath

Blade Length
2.8" (7.1 cm)
Overall Length
6.5" (16.5 cm)
Weight
3.1 oz.



LB5 SMOKEY ▲
UPC - 044356014021
LB5CP SMOKEY CLAM PACK ▲
UPC - 044356014199



Uncle Henry®

== EVERLASTINGLY SHARP ==

BEAR PAW

7Cr17MoV High Carbon S.S. Blade Wood Handle

- + Clip Point Blade
- + Lockback
- + Brass Bolsters
- + Leather Sheath

Blade Length
3.7" (9.4 cm)
Overall Length
8.7" (22.1 cm)
Weight
7.6 oz.

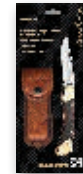

LB7 BEAR PAW ▲
UPC - 044356014038
LB7CP BEAR PAW CLAM PACK ▲
UPC - 044356014151

PAPA BEAR

7Cr17MoV High Carbon S.S. Blade Staglon® Handle

- + Clip Point Blade
- + Lockback
- + Brass Bolsters
- + Leather Sheath

Blade Length
3.7" (9.4 cm)
Overall Length
8.7" (22.1 cm)
Weight
6.9 oz.



LB8 PAPA BEAR ▲
UPC - 044356224901
LB8CP PAPA BEAR CLAM PACK ▲
UPC - 044356227377

ELK HUNTER® DROP POINT

7Cr17MoV High Carbon Stainless Steel Blade Staglon® Handle

- + Full Tang
- + Brass Guard & Pommel
- + Leather Belt Sheath

Blade Length
3.8" (9.7 cm)
Overall Length
8.4" (21.4 cm)
Weight
6.3 oz.



182UH ELK HUNTER® DROP POINT ▲

UPC - 044356222778

182UHCP ELK HUNTER® DROP POINT CLAM PACK ▲

UPC - 044356224345

ELK HUNTER® SKINNER

7Cr17MoV High Carbon Stainless Steel Blade Staglon® Handle

- + Full Tang
- + Brass Guard
- + Leather Belt Sheath

Blade Length
4.6" (11.7 cm)
Overall Length
9.1" (23.1 cm)
Weight
7.8 oz.



183UH ELK HUNTER® SKINNER ▲

UPC - 044356222785

183UHCP ELK HUNTER® SKINNER CLAM PACK ▲

UPC - 044356224352

GOLDEN SPIKE

7Cr17MoV High Carbon Stainless Steel Blade Staglon® Handle

- + Full Tang
- + Nickel Silver Bolsters
- + Sharpening Stone
- + Leather Sheath

Blade Length
5.0" (12.7 cm)
Overall Length
9.4" (23.9 cm)
Weight
6.3 oz.



153UH GOLDEN SPIKE ▲

UPC - 044356003063

153UHCP GOLDEN SPIKE CLAM PACK ▲

UPC - 044356990592

UNCLE HENRY® GUT HOOK

7Cr17MoV High Carbon Stainless Steel Blade Staglon® Handle

- + Full Tang
- + Brass Guard
- + Leather Belt Sheath

Blade Length
4.3" (10.8 cm)
Overall Length
9.1" (23.0 cm)
Weight
7.8 oz.



185UH UNCLE HENRY® GUT HOOK ▲

UPC - 044356229647

185UHCP UNCLE HENRY® GUT HOOK CLAM PACK ▲

UPC - 044356229654

186UH UNCLE HENRY® GUT HOOK ▲

7Cr17MoV High Carbon Stainless Steel Blade Staglon® Handle

- + Full Tang
- + Brass Guard
- + Leather Belt Sheath

Blade Length
4.0" (10.1 cm)
Overall Length
8.4" (21.3 cm)
Weight
6.9 oz.
UPC
044356229661



PRO HUNTER®

7Cr17MoV High Carbon S.S. Blade Staglon® Handle

- + Brass Bolsters
- + Sharpening Stone
- + Leather Sheath

Blade Length
5.5" (14.0 cm)
Overall Length
9.8" (24.9 cm)
Weight
12.0 oz.

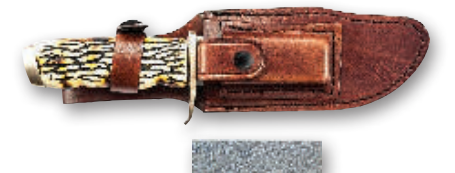

171UH PRO HUNTER® ▲

UPC - 044356033206

171UHCP PRO HUNTER® CLAM PACK ▲

UPC - 044356227735

DETAIL SKINNER

7Cr17MoV High Carbon Stainless Steel Blade Staglon® Handle

- + Full Tang
- + Leather Belt Sheath

Blade Length
3.1" (7.9 cm)
Overall Length
6.5" (16.5 cm)
Weight
2.5 oz.



301UH **DETAIL SKINNER** ▲

UPC - 044356225731

301UHCP **DETAIL SKINNER CLAM PACK** ▲

UPC - 044356227629

WOLVERINE

7Cr17MoV High Carbon Stainless Steel Blade Staglon® Handle

- + Full Tang
- + Nickel Silver Bolster
- + Leather Sheath

Blade Length
3.4" (8.6 cm)
Overall Length
7.4" (18.8 cm)
Weight
3.9 oz.



162UH **WOLVERINE** ▲

UPC - 044356211239

162UHCP **WOLVERINE CLAM PACK** ▲

UPC - 044356213967



MINI PRO HUNTER®

7Cr17MoV High Carbon Stainless Steel Blade Staglon® Handle

- + Full Tang
- + Nickel Silver Guard
- + Leather Belt Sheath

Blade Length
2.8" (7.1 cm)
Overall Length
6.8" (17.2 cm)
Weight
3.6 oz.



PH2N **MINI PRO HUNTER** ▲

UPC - 044356226288

PH2NCP **MINI PRO HUNTER CLAM PACK** ▲

UPC - 044356226646

PRO HUNTER®

7Cr17MoV High Carbon Stainless Steel Blade Staglon® Handle

- + Full Tang
- + Nickel Silver Guard
- + Leather Belt Sheath

Blade Length
3.6" (9.1 cm)
Overall Length
8.1" (20.6 cm)
Weight
6.9 oz.



PHIN **PRO HUNTER** ▲

UPC - 044356225724

PHINCP **PRO HUNTER CLAM PACK** ▲

UPC - 044356226639

BOWIE KNIFE

7Cr17MoV High Carbon S.S. Blade Staglon® Handle

- + Full Tang
- + Nickel Silver Bolster
- + Polyester Sheath

Blade Length
10" (25.4 cm)
Overall Length
15.4" (39.0 cm)
Weight
1 lb. 0.2 oz.



15.4"

181UH UNCLE HENRY® BOWIE KNIFE ▲

UPC - 044356222099

181UHCP UNCLE HENRY® BOWIE KNIFE CLAM PACK ▲

UPC - 044356222105

184UH BOWIE KNIFE ▲

7Cr17MoV High Carbon S.S. Blade Staglon® Handle

- + Full Tang
- + Brass Guard & Pommel
- + Polyester Belt Sheath

Blade Length
9.7" (24.5 cm)
Overall Length
15.1" (38.5 cm)
Weight
1 lb. 5.2 oz.
UPC
044356224888



15.1"

184STUH BOWIE KNIFE ▲

7Cr17MoV High Carbon S.S. Blade Stag Handle

- + Full Tang
- + Brass Guard & Pommel
- + Leather Belt Sheath

Blade Length
9.7" (24.5 cm)
Overall Length
15.1" (38.5 cm)
Weight
1 lb. 3.7 oz.
UPC
044356224895



15.1"

UHCM2CP OUTDOORSMAN COMBO PACK ▲

7Cr17MoV High Carbon Stainless Steel Blade

Staglon® Handle

- + Full Tang
- + Nickel Silver Guard & Pommel
- + Leather Belt Sheath

301UH Detail Skinner

Blade Length
3.1" (7.9 cm)
Overall Length
6.5" (16.5 cm)
Weight
2.5 oz.

182UH Drop Point

Blade Length
3.8" (9.7 cm)
Overall Length
8.4" (21.4 cm)
Weight
6.3 oz.

UPC

044356224482

Only available in clam pack



+ 301UH

6.5"

+ 182UH

8.4"

Dual Knife
Leather Belt Sheath

UHCM3CP BOWIE KNIFE COMBO PACK ▲

7Cr17MoV High Carbon Stainless Steel Blade

Staglon® Handle

- + Full Tang
- + Nickel Silver Guard & Pommel
- + Leather Belt Sheath

191UH Bowie

Blade Length
5.1" (13.1 cm)
Overall Length
8.9" (22.5 cm)
Weight
6.1 oz.

191LUH Bowie

Blade Length
8.3" (21.0 cm)
Overall Length
13" (32.9 cm)
Weight
1 lb. 0.9 oz.

UPC

044356224789

Only available in clam pack

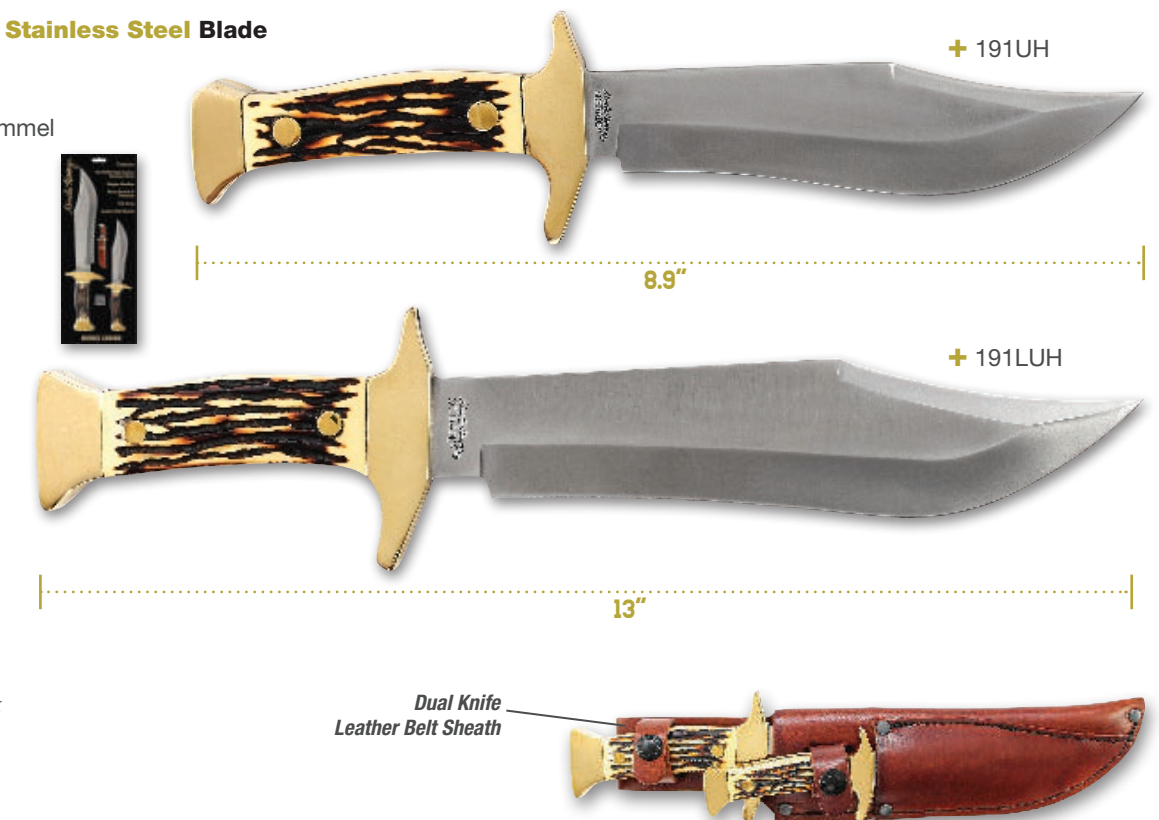

+ 191UH

8.9"

+ 191LUH

13"

Dual Knife
Leather Belt Sheath

LARGE FILLET

7Cr17MoV High Carbon S.S. Blade Staglon® Handle

- + Nickel Silver Bolster
- + Leather Sheath

Blade Length
7.5" (19.1 cm)
Overall Length
12" (30.5 cm)
Weight
2.9 oz.



167UH **LARGE FILLET** ▲

UPC - 044356003094

167UHCP **LARGE FILLET CLAM PACK** ▲

UPC - 044356215978



SMALL FILLET

7Cr17MoV High Carbon S.S. Blade Staglon® Handle

- + Nickel Silver Bolster
- + Leather Sheath

Blade Length
5.3" (13.4 cm)
Overall Length
10.1" (25.6 cm)
Weight
4.1 oz.



168UH **SMALL FILLET** ▲

UPC - 044356208604

168UHCP **SMALL FILLET CLAM PACK** ▲

UPC - 044356213974



169UH

FILLET FOLDER

3Cr14MoV/MH Steel Blade Staglon® Handle

- + Lockback
- + Polyester Sheath

Blade Length
5.5" (14.0 cm)
Overall Length
12" (30.5 cm)
Weight
6.0 oz.
UPC
044356216975



OLD TIMER®

== EVERLASTINGLY SHARP ==



+ BRASS PINS

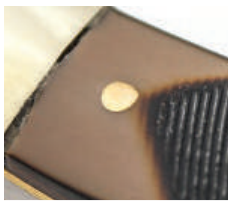

+ HEAT TREATED
BACK SPRINGS



+ SAW CUT HANDLES



+ NICKEL SILVER BOLSTERS



+ BRASS BOLSTERS



BUILT FOR GENERATIONS

THE TRADITION OF PASSING AN OLD TIMER® KNIFE DOWN FROM ONE GENERATION TO THE NEXT HAS PROVEN OLD TIMER® AS A RELIABLE AND TRUSTED BRAND RECOGNIZED THE WORLD OVER. OLD TIMER® KNIVES SUCH AS OUR TRADITIONAL FOLDERS, FIXED BLADES AND THE COPPERHEAD SERIES ARE DESIGNED TO SERVE YOUR EVERY DAY NEEDS, YET BUILT FOR GENERATIONS.

- + 7Cr17MoV High Carbon S.S.
- + Drop Point Blade
- + Can Opener
- + Screwdriver & Cap Lifter
- + Awl
- + Shackle
- + Nickel Silver Bolsters



230T SCOUT KNIFE

Blade Length	2.4" (6.2 cm)	Weight	3.5 oz.
Overall Length	6.1" (15.5 cm)	UPC	044356228480

- + 7Cr17MoV High Carbon S.S.
- + Clip Point Blade
- + Sheepsfoot Blade
- + Pen Blade
- + Wharncliffe Blade
- + Nickel Silver Bolsters



440T WORKMATE

Blade Length	2.2" (5.6 cm)	Weight	1.8 oz.
Overall Length	5.4" (13.7 cm)	UPC	044356205719

- + 7Cr17MoV High Carbon S.S.
- + Clip Point Blade
- + Sheepsfoot Blade
- + Pen Blade
- + Nickel Silver Bolsters

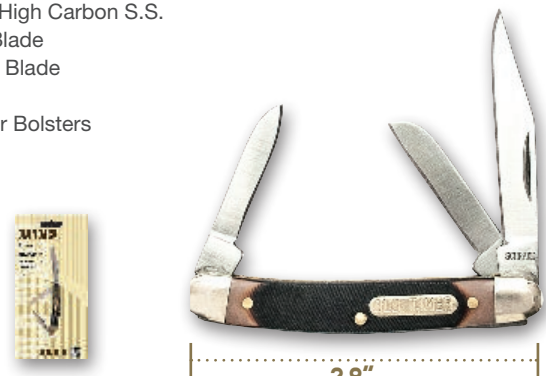

1080T JUNIOR

Blade Length	2" (5.1 cm)	UPC	044356001052
Overall Length	4.7" (11.9 cm)	1080TCP CLAM PACK	
Weight	1.2 oz.	UPC	044356001373

- + 65Mn High Carbon Steel
- + Detail Blade
- + Straight Gouge
- + Hook Blade
- + V-Scorp
- + Gouge Scorp
- + Chisel
- + Nickel Silver Bolsters



240T WOODWORKING KNIFE

Blade Length	1.5" (3.8 cm)	UPC	044356228473
Overall Length	6" (15.3 cm)	240TCP CLAM PACK	
Weight	3.9 oz.	UPC	044356230001

- + 7Cr17MoV High Carbon S.S.
- + Sheepsfoot Blade (2)
- + Pen Blade
- + Coping Blade
- + Nickel Silver Bolsters



40T BIG MAN

Blade Length	2.3" (5.8 cm)	Weight	2.6 oz.
Overall Length	5.8" (14.7 cm)	UPC	044356000420

- + 7Cr17MoV High Carbon S.S.
- + Clip Point Blade
- + Sheepsfoot Blade
- + Pen Blade
- + Nickel Silver Bolsters



340T MIDDLEMAN

Blade Length	2.4" (6.1 cm)	UPC	044356001120
Overall Length	5.7" (14.5 cm)	340TCP CLAM PACK	
Weight	1.8 oz.	UPC	044356001366

- + 7Cr17MoV High Carbon S.S.
- + Spear Point Blade
- + Coping Blade
- + Pen Blade
- + Nickel Silver Bolsters



90T CIGAR WHITTILER

Blade Length	3" (7.6 cm)	Weight	2.3 oz.
Overall Length	6.9" (17.5 cm)	UPC	044356000604

- + 7Cr17MoV High Carbon S.S.
- + Clip Point Blade
- + Sheepsfoot Blade
- + Leather Punch
- + Nickel Silver Bolsters



360T SADDLEMAN

Blade Length	2.4" (6.1 cm)	Weight	1.9 oz.
Overall Length	5.7" (14.5 cm)	UPC	044356209311

- + 7Cr17MoV High Carbon S.S.
- + Clip Point Blade
- + Sheepsfoot Blade
- + Spey Blade
- + Nickel Silver Bolsters



610T SLIM PREMIUM STOCK

Blade Length	3" (7.6 cm)	Weight	2.5 oz.
Overall Length	7.0" (17.8 cm)	UPC	044356208352

- + 7Cr17MoV High Carbon S.S.
- + Clip Point Blade
- + Pen Blade
- + Scissors
- + Nickel Silver Bolsters



1060T GRANDDAD'S

Blade Length	2" (5.1 cm)	Weight	1.2 oz.
Overall Length	4.8" (12.2 cm)	UPC	044356208345

- + 7Cr17MoV High Carbon S.S.
- + Clip Point Blade
- + Sheepsfoot Blade
- + Spey Blade
- + Nickel Silver Bolsters



980T RAMROD

Blade Length	2.7" (6.9 cm)	Weight	1.9 oz.
Overall Length	6.3" (16.0 cm)	UPC	044356209304

- + 7Cr17MoV High Carbon S.S.
- + Clip Point Blade
- + Sheepsfoot Blade
- + Spey Blade
- + Nickel Silver Bolsters
- + Nylon Sheath



80T SENIOR

Blade Length	3" (7.6 cm)	UPC	044356001113
Overall Length	6.9" (17.5 cm)	80TCP CLAM PACK	
Weight	2.8 oz.	UPC	044356001380

- + 7Cr17MoV High Carbon S.S.
- + Clip Point Blade
- + Serrated Sheepsfoot Blade
- + Spey Blade
- + Nickel Silver Bolsters

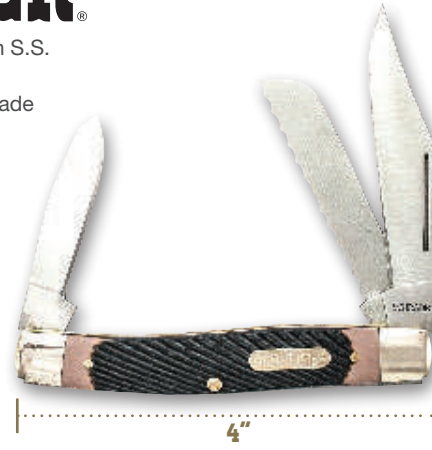

890T / **BLAZER** 

Blade Length	3" (7.6 cm)	Weight	3.0 oz.
Overall Length	7" (17.8 cm)	UPC	044356208369

- + 7Cr17MoV High Carbon S.S.
- + Clip Point Blade
- + Sheepsfoot Blade
- + Spey Blade
- + Nickel Silver Bolsters



8580T / **LUMBERJACK** 

Blade Length	2.8" (7.1 cm)	Weight	4.8 oz.
Overall Length	7.4" (18.8 cm)	UPC	044356205139

- + 7Cr17MoV Stainless Steel
- + Clip Point Blade
- + Pen Blade
- + Nickel Silver Bolsters



2800T / **BARLOW** 

Blade Length	2.3" (5.8 cm)	Weight	2.6 oz.
Overall Length	5.7" (14.5 cm)	UPC	044356205061

- + 7Cr17MoV Stainless Steel
- + Clip Point Blade
- + Pen Blade
- + Nickel Silver Bolsters



720T / **DOG LEG JACK** 

Blade Length	2.3" (5.8 cm)	Weight	1.4 oz.
Overall Length	5.2" (13.2 cm)	UPC	044356001236

- + 7Cr17MoV Stainless Steel
- + Clip Point Blade
- + Pen Blade
- + Nickel Silver Bolsters



330T / **MIDDLEMAN JACK** 

Blade Length	2.4" (6.1 cm)	UPC	044356001083
Overall Length	5.7" (14.5 cm)	330TCP CLAM PACK	
Weight	1.7 oz.	UPC	044356001397

- + 7Cr17MoV Stainless Steel
- + Clip Point Blade
- + Sheepsfoot Blade
- + Nickel Silver Bolsters



930T / **WRANGLER** 

Blade Length	2.7" (6.9 cm)	Weight	1.9 oz.
Overall Length	6.3" (16.0 cm)	UPC	044356208376



- + 7Cr17MoV High Carbon S.S.
- + Clip Point Blade
- + Drop Point Blade
- + Nickel Silver Bolsters



1040T / **MINUTEMAN** 

Blade Length	2" (5.1 cm)	UPC	044356001793
Overall Length	4.7" (11.9 cm)	1040TCP CLAM PACK	
Weight	1.0 oz.	UPC	044356001663

- + 7Cr17MoV High Carbon S.S.
- + Clip Point Blade (2)
- + Nickel Silver Bolsters



770T / **MUSKRAT** 

Blade Length	3" (7.6 cm)	UPC	044356001106
Overall Length	6.9" (17.5 cm)	770TCP CLAM PACK	
Weight	2.8 oz.	UPC	044356001441

- + 7Cr17MoV High Carbon S.S.
- + Drop Point Blade
- + Pen Blade
- + Nickel Silver Bolsters



10110T / **SMALL CANOE** 

Blade Length	2.2" (5.6 cm)	Weight	1.8 oz.
Overall Length	5.2" (13.2 cm)	UPC	044356209151

- + 7Cr17MoV High Carbon S.S.
- + Drop Point Blade
- + Pen Blade
- + Nickel Silver Bolsters



110T / **LARGE CANOE** 

Blade Length	2.5" (6.4 cm)	Weight	2.5 oz.
Overall Length	6.1" (15.5 cm)	UPC	044356209144

- + 7Cr17MoV High Carbon S.S.
- + Clip Point Blade
- + Hoof Pick
- + Nickel Silver Bolsters



S-0THP / **HOOF PICK**

Blade Length	3.1" (7.9 cm)	Weight	3.0 oz.
Overall Length	7" (17.8 cm)	UPC	044356001007

- + 7Cr17MoV High Carbon S.S.
- + Clip Point Blade
- + Spey Blade
- + Nickel Silver Bolsters



940T / **GUNSTOCK TRAPPER**

Blade Length	3" (7.6 cm)	UPC	044356001038
Overall Length	6.9" (17.5 cm)	940TCP CLAM PACK	
Weight	2.8 oz.	UPC	044356002202

- + 7Cr17MoV High Carbon S.S.
- + Clip Point Blade
- + Gut Hook
- + Saw
- + Nickel Silver Bolsters



690T / **PREMIUM TRAPPER**

Blade Length	3.3" (8.4 cm)	UPC	044356208079
Overall Length	7.4" (18.8 cm)	690TCP CLAM PACK	
Weight	4.8 oz.	UPC	044356209854

- + 7Cr17MoV High Carbon S.S.
- + Clip Point Blade
- + Saw
- + Lockblade
- + Nickel Silver Bolsters
- + Leather Sheath



970T / **BUZZSAW TRAPPER**

Blade Length	3.7" (9.4 cm)	Weight	4.0 oz.
Overall Length	7.8" (19.8 cm)	UPC	044356002776

- + 7Cr17MoV High Carbon S.S.
- + Clip Point Blade
- + Spey Blade
- + Nickel Silver Bolsters



950T / **LARGE TRAPPER**

Blade Length	3.3" (8.4 cm)	Weight	3.7 oz.
Overall Length	7.4" (18.8 cm)	UPC	044356211284

- + 7Cr17MoV High Carbon S.S.
- + Clip Point Blade w/Thumb Knob
- + Lockblade
- + Pocket Clip
- + Nickel Silver Bolsters



2940T / **LINER LOCK TRAPPER**

Blade Length	3.1" (7.9 cm)	Weight	3.4 oz.
Overall Length	7.2" (18.3 cm)	UPC	044356220378

- + 7Cr17MoV High Carbon S.S.
- + Clip Point Blade
- + Saw
- + Nickel Silver Bolsters
- + Leather Sheath



2250T / **SON OF A GUN**

Blade Length	4" (10.1 cm)	Weight	5.6 oz.
Overall Length	9.2" (23.3 cm)	UPC	044356209373

- + 7Cr17MoV High Carbon S.S.
- + Clip Point Blade
- + Hatchet
- + Saw
- + Nickel Silver Bolsters
- + Nylon Sheath



2200T / **FOLDING HUNTER**

Blade Length	4" (10.2 cm)	Weight	8.8 oz.
Overall Length	9.2" (23.4 cm)	UPC	044356204712

- + 7Cr17MoV High Carbon S.S.
- + Clip Point Blade
- + Spey Blade
- + Nickel Silver Bolsters



2960T / **TRAPPER**

Blade Length	3.2" (8.1 cm)	Weight	3.9 oz.
Overall Length	7.3" (18.5 cm)	UPC	044356216104

- + 7Cr17MoV High Carbon S.S.
- + Clip Point Blade
- + Pen Blade
- + Field Pick
- + Tweezers
- + Nickel Silver Bolsters



960T / **BEARHEAD TRAPPER**

Blade Length	3.3" (8.4 cm)	Weight	3.7 oz.
Overall Length	7.4" (18.8 cm)	UPC	044356001861

- + 7Cr17MoV High Carbon S.S.
- + Clip Point Blade
- + Sheepsfoot Blade
- + Nickel Silver Bolsters
- + Leather Sheath



250T / **FOLDING HUNTER**

Blade Length	4" (10.2 cm)	Weight	6.7 oz.
Overall Length	9.3" (23.6 cm)	UPC	044356001274

- + 7Cr17MoV High Carbon S.S.
- + Clip Point Blade
- + Nickel Silver Bolsters
- + Leather Sheath



1250T / **MUSTANG**

Blade Length	4" (10.2 cm)	Weight	4.8 oz.
Overall Length	9.3" (23.6 cm)	UPC	044356002134

- + 7Cr17MoV High Carbon S.S.
- + Clip Point Blade
- + Lanyard Hole
- + Nickel Silver Bolsters



1230T	PIONEER		
Blade Length	3.1" (7.9 cm)	Weight	2.5 oz.
Overall Length	7.1" (18.0 cm)	UPC	044356209380

- + 7Cr17MoV High Carbon S.S.
- + Clip Point Blade w/Thumb Knob
- + Lockblade
- + Pocket Clip
- + Nickel Silver Bolsters



2230T	PIONEER		
Blade Length	3.1" (7.9 cm)	Weight	3.4 oz.
Overall Length	7.2" (18.3 cm)	UPC	044356220385

- + 7Cr17MoV High Carbon S.S.
- + Drop Point Blade
- + Lockback
- + Nickel Silver Bolsters



50T	BRUIN		
Blade Length	2.8" (7.1 cm)	Weight	2.3 oz.
Overall Length	6.5" (16.5 cm)	UPC	044356001243

- + 7Cr17MoV High Carbon S.S.
- + Drop Point Blade
- + Lockback
- + Nickel Silver Bolsters



30T	BEARHEAD		
Blade Length	2.2" (5.6 cm)	UPC	044356001229
Overall Length	5.1" (13.0 cm)	30TCP CLAM PACK	
Weight	1.5 oz.	UPC	044356205788

- + 7Cr17MoV High Carbon S.S.
- + Drop Point Blade
- + Lockback
- + Nickel Silver Bolsters
- + Leather Sheath



510T	BIG TIMER		
Blade Length	3.4" (8.6 cm)	Weight	6.5 oz.
Overall Length	8.2" (20.8 cm)	UPC	044356208567

- + 7Cr17MoV High Carbon S.S.
- + Clip Point Blade
- + Lockback
- + Nickel Silver Bolsters
- + Leather Sheath



70T	CAVE BEAR		
Blade Length	3.9" (9.9 cm)	Weight	6.8 oz.
Overall Length	8.7" (22.1 cm)	UPC	044356001342

- + 7Cr17MoV High Carbon S.S.
- + Drop Point Blade
- + Lockback
- + Shackle
- + Nickel Silver Bolsters



10T	SMALL LOCKBACK		
Blade Length	1.6" (4.0 cm)	Weight	0.9 oz.
Overall Length	3.8" (9.7 cm)	UPC	044356205252

- + 7Cr17MoV High Carbon S.S.
- + Clip Point Blade
- + Nickel Silver Bolsters



120T	PAL		
Blade Length	2.2" (5.6 cm)	UPC	044356001786
Overall Length	5.1" (13.0 cm)	120TCP CLAM PACK	
Weight	1.1 oz.	UPC	044356001656

- + 7Cr17MoV High Carbon S.S.
- + Clip Point Blade
- + Lockback
- + Brass Bolsters



60T	GOLDEN BEAR		
Blade Length	3.9" (9.9 cm)	Weight	5.9 oz.
Overall Length	8.7" (22.1 cm)	UPC	044356001939

- + 7Cr17MoV High Carbon S.S.
- + Gut hook
- + Lockback
- + Nickel Silver Bolsters
- + Nylon Sheath



1570T	GOLDEN CLAW		
Blade Length	3.5" (8.9 cm)	Weight	5.6 oz.
Overall Length	8.5" (21.6 cm)	UPC	044356208383

- + 7Cr17MoV High Carbon S.S.
- + Clip Point Blade
- + Lockblade
- + Nickel Silver Bolsters



180T	MIGHTY MITE		
Blade Length	2" (5.1 cm)	UPC	044356001045
Overall Length	4.7" (11.9 cm)	180TCP CLAM PACK	
Weight	1.0 oz.	UPC	044356001403

- + 7Cr17MoV High Carbon S.S.
- + Clip Point Blade
- + Lockblade
- + Nickel Silver Bolsters



1940T	GUNSTOCK TRAPPER		
Blade Length	3.1" (7.9 cm)	UPC	044356001069
Overall Length	7" (17.8 cm)	1940TCP CLAM PACK	
Weight	2.4 oz.	UPC	044356207812



- + 7Cr17MoV High Carbon S.S.
- + Sheepfoot Blade
- + Nickel Silver Bolsters



140T HUNTER

7Cr17MoV High Carbon Stainless Steel Blade

- + Full Tang
- + OT Saw Cut Handle
- + Leather Sheath
- + Nickel Silver Bolster

Blade Length
3.7" (9.4 cm)
Overall Length
8.4" (21.3 cm)
Weight
7.6 oz.
UPC
044356209328



190T LAND SHARK®

Blade Length 2.6" (6.6 cm) Weight 2.6 oz.
Overall Length 6.3" (16.0 cm) UPC 044356990974

- + 7Cr17MoV High Carbon S.S.
- + Hawkbill Blade w/Thumb Knob
- + Lockblade
- + Pocket Clip
- + Nickel Silver Bolsters



2160T HAWKBILL PRUNER

Blade Length 3" (7.6 cm) Weight 4.1 oz.
Overall Length 7" (17.8 cm) UPC 044356221900

- + 7Cr17MoV High Carbon S.S.
- + Clip Point Blade
- + Marlin Spike
- + Leverlock
- + Nickel Silver Bolsters

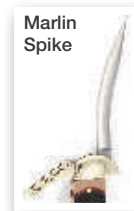

7350T MARINER

Blade Length 2.8" (7.1 cm) Weight 4.4 oz.
Overall Length 6.9" (17.5 cm) UPC 044356217583

- + 7Cr17MoV High Carbon S.S.
- + Hawkbill Blade
- + Nickel Silver Bolsters



160T HAWKBILL PRUNER

Blade Length 3" (7.6 cm) Weight 3.4 oz.
Overall Length 7" (17.8 cm) UPC 044356210249

- + 7Cr17MoV High Carbon S.S.
- + Hawkbill Blade
- + Nickel Silver Bolsters



1590T ELECTRICIAN'S KNIFE

Blade Length 2.7" (6.9 cm) Weight 3.3 oz.
Overall Length 6.4" (16.1 cm) UPC 044356900232

1560T LIL' FINGER

7Cr17MoV High Carbon Stainless Steel Blade

- + Full Tang
- + OT Saw Cut Handle
- + Leather Sheath
- + Nickel Silver Bolster

Blade Length
2.5" (6.3 cm)
Overall Length
6.6" (16.7 cm)
Weight
3.9 oz.
UPC
044356206693



1620T BOOT KNIFE

7Cr17MoV High Carbon Stainless Steel Blade

- + Full Tang
- + OT Saw Cut Handle
- + Leather Sheath
- + Nickel Silver Bolster

Blade Length
3.8" (9.6 cm)
Overall Length
7.8" (19.8 cm)
Weight
3.9 oz.
UPC
044356204705

No Ship CA, NY, MA



1520TBC PRO HUNTER® SHARPFINGER® ▲

7Cr17MoV High Carbon Stainless Steel Blade

- + Full Tang
- + Pro Hunter® Camo Handle
- + Leather Sheath

Blade Length
3.3" (8.4 cm)
Overall Length
7.1" (18.0 cm)
Weight
3.1 oz.
UPC
044356001021



SHARPFINGER®

7Cr17MoV High Carbon Stainless Steel Blade

- + Full Tang
- + OT Saw Cut Handle
- + Leather Sheath

Blade Length
3.3" (8.4 cm)
Overall Length
7.1" (18.0 cm)
Weight
3.1 oz.

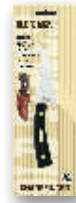

1520T SHARPFINGER® ▲

UPC - 044356001168

1520TCP SHARPFINGER® CLAM PACK ▲

UPC - 044356001427

LARGE SHARPFINGER®

7Cr17MoV High Carbon Stainless Steel Blade

- + Full Tang
- + OT Saw Cut Handle
- + Leather Sheath

Blade Length
4" (10.1 cm)
Overall Length
8.6" (21.8 cm)
Weight
6.0 oz.



1520TL LARGE SHARPFINGER® ▲

UPC - 044356226264

1520TLCP LARGE SHARPFINGER® CLAM PACK ▲

UPC - 044356226271



DEERSLAYER

7Cr17MoV High Carbon Stainless Steel Blade

- + Full Tang
- + Leather Sheath
- + OT Saw Cut Handle

Blade Length
5.6" (14.2 cm)
Overall Length
10.5" (26.7 cm)
Weight
7.7 oz.



150T DEERSLAYER ▲

UPC - 044356001175

150TCP DEERSLAYER CLAM PACK ▲

UPC - 044356000307



GUT HOOK SKINNER

Blade Length
3.5" (8.9 cm)
Overall Length
7.3" (18.5 cm)
Weight
3.3 oz.



1580T GUT HOOK SKINNER ▲

UPC - 044356001250

1580TCP GUT HOOK SKINNER CLAM PACK ▲

UPC - 044356001519



1600T MOUNTAIN LION ▲

- + Nickel Silver Bolster

Blade Length
5" (12.7 cm)
Overall Length
9.3" (23.6 cm)
Weight
6.9 oz.
UPC
044356001281



WOODSMAN

- + Nickel Silver Bolster

Blade Length
5" (12.7 cm)
Overall Length
9.3" (23.6 cm)
Weight
8.3 oz.



1650T WOODSMAN ▲

UPC - 044356000314

1650TCP WOODSMAN CLAM PACK ▲

UPC - 044356000321

- + Mirror Polished 9Cr18MoV High Carbon Stainless Steel
- + Clip Point Blade
- + Sheepsfoot Blade
- + Pen Blade
- + Saw Cut Bone Handle
- + Nickel Silver Bolsters



GENUINE BONE | 3.24"

340TB MIDDLEMAN

Blade Length	2.4" (6.1 cm)	UPC	044356222297
Overall Length	5.6" (14.3 cm)	340TBPCP CLAM PACK	
Weight	1.8 oz.	UPC	044356223997

- + Mirror Polished 9Cr18MoV High Carbon Stainless Steel
- + Clip Point Blade
- + Spey Blade
- + Saw Cut Bone Handle
- + Nickel Silver Bolsters



GENUINE BONE | 3.8"

940TB GUNSTOCK TRAPPER

Blade Length	3" (7.7 cm)	UPC	044356222273
Overall Length	6.8" (17.4 cm)	940TBPCP CLAM PACK	
Weight	2.8 oz.	UPC	044356223980

- + Mirror Polished 9Cr18MoV High Carbon Stainless Steel
- + Clip Point Blade
- + Sheepsfoot Blade
- + Spey Blade
- + Saw Cut Bone Handle
- + Nickel Silver Bolsters



GENUINE BONE | 3.92"

80TB SENIOR

Blade Length	3" (7.5 cm)	UPC	044356222853
Overall Length	6.9" (17.5 cm)	80TBPCP CLAM PACK	
Weight	3.0 oz.	UPC	044356222952

- + Mirror Polished 9Cr18MoV High Carbon Stainless Steel
- + Clip Point Blade
- + Sheepsfoot Blade
- + Spey Blade
- + Saw Cut Bone Handle
- + Nickel Silver Bolsters



GENUINE BONE | 4.58"

8580TB LUMBERJACK STOCKMAN

Blade Length	3.4" (8.7 cm)	UPC	044356222280
Overall Length	7.9" (20.2 cm)	8580TBPCP CLAM PACK	
Weight	4.6 oz.	UPC	044356222969

- + Mirror Polished 9Cr18MoV High Carbon Stainless Steel
- + Clip Point Blade
- + Spey Blade
- + Saw Cut Bone Handle
- + Nickel Silver Bolsters



GENUINE BONE | 4.18"

950TB LARGE TRAPPER

Blade Length	3.1" (8.0 cm)	UPC	044356222303
Overall Length	7.3" (18.6 cm)	950TBPCP CLAM PACK	
Weight	3.5 oz.	UPC	044356222976

- + Mirror Polished 9Cr18MoV High Carbon Stainless Steel
- + Clip Point Blade
- + Pen Blade
- + Saw Cut Bone Handle
- + Nickel Silver Bolsters

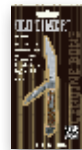

GENUINE BONE | 2.83"

720TB DOG LEG JACK

Blade Length	2.3" (5.7 cm)	UPC	044356222945
Overall Length	5.1" (13.0 cm)	720TBPCP CLAM PACK	
Weight	1.6 oz.	UPC	044356222983

- + 7Cr17MoV High Carbon S.S.
- + Clip Point Blade
- + Pen Blade
- + Old Timer Yellow Handle
- + Nickel Silver Bolsters



330TY MIDDLEMAN JACK

Blade Length	2.4" (6.1 cm)	UPC	044356000543
Overall Length	5.7" (14.5 cm)	330TYPCP CLAM PACK	
Weight	1.7 oz.	UPC	044356210829

- + 7Cr17MoV High Carbon S.S.
- + Clip Point Blade
- + Sheepsfoot Blade
- + Pen Blade
- + Wharncliffe Blade
- + Old Timer Yellow Handle
- + Nickel Silver Bolsters



440TY WORKMATE

Blade Length	2.2" (5.6 cm)	UPC	044356214711
Overall Length	5.4" (13.7 cm)	440TYPCP CLAM PACK	
Weight	1.8 oz.	UPC	044356214582

- + 7Cr17MoV High Carbon S.S.
- + Clip Point Blade (2)
- + Old Timer Yellow Handle
- + Nickel Silver Bolsters



770TY MUSKRAT

Blade Length	3" (7.6 cm)	Weight	2.6 oz.
Overall Length	6.9" (17.5 cm)	UPC	044356203500

- + 7Cr17MoV High Carbon S.S.
- + Clip Point Blade
- + Sheepsfoot Blade
- + Pen Blade
- + Old Timer Yellow Handle
- + Nickel Silver Bolsters



340TY MIDDLEMAN

Blade Length	2.4" (6.1 cm)	UPC	044356000550
Overall Length	5.7" (14.5 cm)	340TYPCP CLAM PACK	
Weight	1.5 oz.	UPC	044356203890

- + 7Cr17MoV High Carbon S.S.
- + Clip Point Blade
- + Sheepsfoot Blade
- + Spey Blade
- + Old Timer Yellow Handle
- + Nickel Silver Bolsters



80TY SENIOR

Blade Length	3" (7.6 cm)	UPC	044356001328
Overall Length	6.9" (17.5 cm)	80TYPCP CLAM PACK	
Weight	2.8 oz.	UPC	044356202862

- + 7Cr17MoV High Carbon S.S.
- + Clip Point Blade
- + Spey Blade
- + Old Timer Yellow Handle
- + Nickel Silver Bolsters



940TY GUNSTOCK TRAPPER

Blade Length	3" (7.6 cm)	UPC	044356000536
Overall Length	6.9" (17.5 cm)	940TYPCP CLAM PACK	
Weight	2.5 oz.	UPC	044356210850

- + 7Cr17MoV High Carbon S.S.
- + Clip Point Blade
- + Pen Blade
- + Desert Iron Wood Handle
- + Nickel Silver Bolsters



330TW MIDDLEMAN JACK ⚠️

Blade Length 2.4" (6.1 cm) Weight 1.7 oz.
Overall Length 5.7" (14.5 cm) UPC 044356203487

- + 7Cr17MoV High Carbon S.S.
- + Clip Point Blade
- + Sheepsfoot Blade
- + Pen Blade
- + Desert Iron Wood Handle
- + Nickel Silver Bolsters

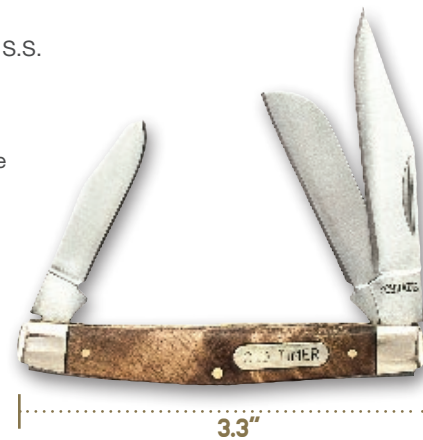

340TW MIDDLEMAN ⚠️

Blade Length 2.4" (6.1 cm) Weight 1.8 oz.
Overall Length 5.7" (14.5 cm) UPC 044356000192

- + 7Cr17MoV High Carbon S.S.
- + Clip Point Blade (2)
- + Desert Iron Wood Handle
- + Nickel Silver Bolsters



770TW MUSKRAT ⚠️

Blade Length 3" (7.6 cm) Weight 2.6 oz.
Overall Length 6.9" (17.5 cm) UPC 044356000215

- + 7Cr17MoV High Carbon S.S.
- + Clip Point Blade
- + Sheepsfoot Blade
- + Pen Blade
- + Desert Iron Wood Handle
- + Nickel Silver Bolsters



1080TW JUNIOR ⚠️

Blade Length 2" (5.1 cm) Weight 1.2 oz.
Overall Length 4.7" (11.9 cm) UPC 044356000239

- + 7Cr17MoV High Carbon S.S.
- + Clip Point Blade
- + Sheepsfoot Blade
- + Spey Blade
- + Desert Iron Wood Handle
- + Nickel Silver Bolsters



80TW SENIOR ⚠️

Blade Length 3" (7.6 cm) Weight 2.6 oz.
Overall Length 6.9" (17.5 cm) UPC 044356000208

- + 7Cr17MoV High Carbon S.S.
- + Clip Point Blade
- + Spey Blade
- + Desert Iron Wood Handle
- + Nickel Silver Bolsters

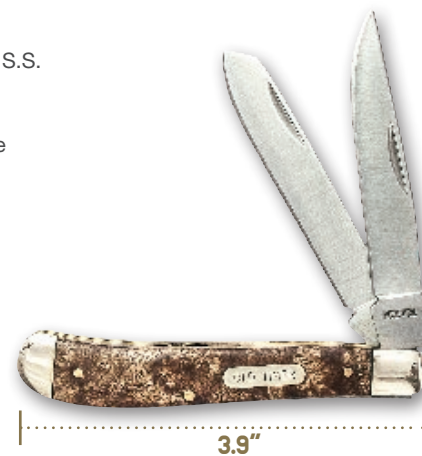

940TW GUNSTOCK TRAPPER ⚠️

Blade Length 3" (7.6 cm) Weight 2.5 oz.
Overall Length 6.9" (17.5 cm) UPC 044356000222

GOLDEN BEAR®

**7Cr17MoV High Carbon Stainless Steel Blade
Desert Iron Wood Handle**

- + Brass Guard
- + Lockback
- + Leather Sheath

Blade Length 3.9" (9.9 cm)
Overall Length 8.7" (22.1 cm)
Weight 5.9 oz.



8.7"

60TW GOLDEN BEAR® ⚠️

UPC - 044356000246

60TWC GOLDEN BEAR® CLAM PACK ⚠️

UPC - 044356200301



PH2W MINI PRO HUNTER® ⚠️

**7Cr17MoV High Carbon Stainless Steel Blade
Desert Iron Wood Handle**

- + Full Tang
- + Nickel Silver Guard
- + Leather Sheath

Blade Length 2.8" (7.1 cm)
Overall Length 6.9" (17.5 cm)
Weight 3.5 oz.



6.9"

UPC 044356001557



PHW PRO HUNTER® ⚠️

**7Cr17MoV High Carbon Stainless Steel Blade
Desert Iron Wood Handle**

- + Full Tang
- + Nickel Silver Guard
- + Leather Sheath

Blade Length 3.6" (9.1 cm)
Overall Length 8" (20.3 cm)
Weight 6.2 oz.



8"

UPC 044356000659



MOUNTAIN BEAVER JR.

9Cr18MoV High Carbon Stainless Steel Blade Rosewood/Ebony Handle

- + Lockback
- + Leather Sheath
- + Nickel Silver Bolster

Blade Length
2.5" (6.4 cm)
Overall Length
6.1" (15.5 cm)
Weight
2.8 oz.



280T MOUNTAIN BEAVER JR. ▲

UPC - 044356218887

280TCP MOUNTAIN BEAVER JR. CLAM PACK ▲

UPC - 044356219778

MOUNTAIN BEAVER SR.

9Cr18MoV High Carbon Stainless Steel Blade Rosewood/Ebony Handle

- + Lockback
- + Leather Sheath
- + Nickel Silver Bolster

Blade Length
3.2" (8.1 cm)
Overall Length
7.7" (19.6 cm)
Weight
5.1 oz.



290T MOUNTAIN BEAVER SR. ▲

UPC - 044356218894

290TCP MOUNTAIN BEAVER SR. CLAM PACK ▲

UPC - 044356219785

CAPYBARA®

8Cr13MoV High Carbon Stainless Steel Blade Rosewood/Ebony Handle

- + Brass Guard
- + Full Tang
- + Leather Sheath

Blade Length
4.0" (10.2 cm)
Overall Length
8.5" (21.5 cm)
Weight
6.3 oz.

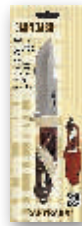

300T CAPYBARA® ▲

UPC - 044356224918

300TCP CAPYBARA® CLAM PACK ▲

UPC - 044356225717

OLD TIMER®

== EVERLASTINGLY SHARP ==

LOCKBACK FOLDING KNIFE

7Cr17MoV High Carbon Stainless Steel Blade Wood Handle

- + Dual Thumb Knobs
- + Lockback
- + Pocket Clip
- + Nickel Silver Bolster

Blade Length
2.9" (7.3 cm)
Overall Length
6.5" (16.5 cm)
Weight
3.2 oz.



310T LOCKBACK FOLDING KNIFE ▲

UPC - 044356229852

310TCP LOCKBACK FOLDING KNIFE CLAM PACK ▲

UPC - 044356229869

LOCKBACK FOLDING KNIFE

7Cr17MoV High Carbon Stainless Steel Blade Wood Handle

- + Dual Thumb Knobs
- + Lockback
- + Pocket Clip
- + Nickel Silver Bolster

Blade Length
3.4" (8.6 cm)
Overall Length
7.7" (19.4 cm)
Weight
5.0 oz.



320T LOCKBACK FOLDING KNIFE ▲

UPC - 044356229876

320TCP LOCKBACK FOLDING KNIFE CLAM PACK ▲

UPC - 044356229883



COPPERHEAD

21560TOKCP **FIXED CAPING KNIFE** 

7Cr17MoV Ti-Nitride Coated High Carbon S.S. Blade
Oak Handle

- + Full Tang
- + Polyester Belt Sheath

Blade Length
2.3" (5.8 cm)
 Overall Length
6.8" (17.4 cm)
 Weight
2.5 oz.
 UPC
044356227964



6.8"



Only available in clam pack

21560TRWCP **FIXED CAPING KNIFE** 

7Cr17MoV Black Coated High Carbon S.S. Blade
Rosewood Handle

- + Full Tang
- + Polyester Belt Sheath

Blade Length
2.3" (5.8 cm)
 Overall Length
6.8" (17.4 cm)
 Weight
2.5 oz.
 UPC
044356227902



6.8"



Only available in clam pack

21560TWNCP **FIXED CAPING KNIFE** 

7Cr17MoV Mirror Polished High Carbon S.S. Blade
Walnut Handle

- + Full Tang
- + Polyester Belt Sheath

Blade Length
2.3" (5.8 cm)
 Overall Length
6.8" (17.4 cm)
 Weight
2.4 oz.
 UPC
044356227933



6.8"



Only available in clam pack

21410TOKCP FIXED DROP POINT



7Cr17MoV Ti-Nitride Coated High Carbon S.S. Blade
Oak Handle

- + Full Tang
- + Polyester Belt Sheath

Blade Length
3.7" (9.4 cm)
Overall Length
8.1" (20.5 cm)
Weight
6.1 oz.
UPC
044356227940

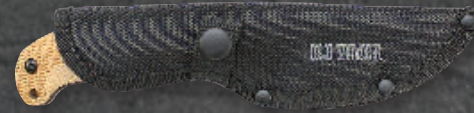

8.1"



Only available in clam pack

21410TRWCP FIXED DROP POINT

7Cr17MoV Black Coated High Carbon S.S. Blade
Rosewood Handle

- + Full Tang
- + Polyester Belt Sheath

Blade Length
3.7" (9.4 cm)
Overall Length
8.1" (20.5 cm)
Weight
6.2 oz.
UPC
044356227889



8.1"



Only available in clam pack

21410TWNCP FIXED DROP POINT

7Cr17MoV Mirror Polished High Carbon S.S. Blade
Walnut Handle

- + Full Tang
- + Polyester Belt Sheath

Blade Length
3.7" (9.4 cm)
Overall Length
8.1" (20.5 cm)
Weight
6.1 oz.
UPC
044356227919



8.1"



Only available in clam pack

21430TOKCP FIXED GUT HOOK



7Cr17MoV Ti-Nitride Coated High Carbon S.S. Blade
Oak Handle

- + Full Tang
- + Polyester Belt Sheath

Blade Length
3.7" (9.4 cm)
Overall Length
8.1" (20.5 cm)
Weight
6.2 oz.
UPC
044356227957

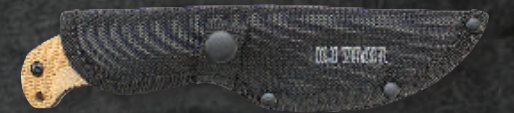

8.1"



Only available in clam pack

21430TRWCP FIXED GUT HOOK

7Cr17MoV Black Coated High Carbon S.S. Blade
Rosewood Handle

- + Full Tang
- + Polyester Belt Sheath

Blade Length
3.7" (9.4 cm)
Overall Length
8.1" (20.5 cm)
Weight
6.3 oz.
UPC
044356227896



8.1"



Only available in clam pack

21430TWNCP FIXED GUT HOOK

7Cr17MoV Mirror Polished High Carbon S.S. Blade
Walnut Handle

- + Full Tang
- + Polyester Belt Sheath

Blade Length
3.7" (9.4 cm)
Overall Length
8.1" (20.5 cm)
Weight
6.1 oz.
UPC
044356227926



8.1"



Only available in clam pack

SWING GUT SAFE-T-LOCK®
7Cr17MoV Ti-Nitride Coated High Carbon S.S. Blade
Rubber Overmold Handle

- + Drop Point Blade w/Folding Guard to Create Gut Hook Blade
- + Thumb Knob
- + Lockback Folding Knife
- + Molded Polyester Belt Sheath

 Blade Length
3.4" (8.6 cm)
Overall Length
7.7" (19.6 cm)
Weight
4.2 oz.



7.7"

21450T SWING GUT SAFE-T-LOCK® ⚠️

UPC - 044356223089

21450TCP SWING GUT SAFE-T-LOCK® CLAM PACK ⚠️

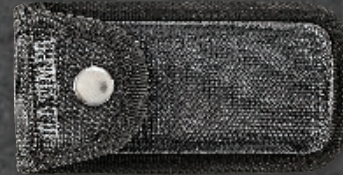
UPC - 044356223096

+ SWING OUT GUT HOOK

FOLDING DROP POINT

- + Dual Thumb Knobs
- + Liner Lock
- + Molded Polyester Belt Sheath

 Blade Length
3.4" (8.6 cm)
Overall Length
7.8" (19.8 cm)
Weight
4.6 oz.

7.8"

21470T FOLDING DROP POINT ⚠️

UPC - 044356223508

21470TCP FOLDING DROP POINT CLAM PACK ⚠️

UPC - 044356223515

FOLDING GUT HOOK

- + Dual Thumb Knobs
- + Liner Lock
- + Molded Polyester Belt Sheath

 Blade Length
3.4" (8.6 cm)
Overall Length
7.8" (19.8 cm)
Weight
4.6 oz.

7.8"

21480T FOLDING GUT HOOK ⚠️

UPC - 044356223522

21480TCP FOLDING GUT HOOK CLAM PACK ⚠️

UPC - 044356223539

FIXED CAPING KNIFE
7Cr17MoV Ti-Nitride Coated High Carbon S.S. Blade
Rubber Overmold Handle

- + Full Tang
- + Polyester Belt Sheath

 Blade Length
2.3" (5.8 cm)
Overall Length
6.8" (17.4 cm)
Weight
3.0 oz.

6.8"

21560T FIXED CAPING KNIFE ⚠️

UPC - 044356226202

21560TCP FIXED CAPING KNIFE CLAM PACK ⚠️

UPC - 044356226660

FIXED DROP POINT

- + Full Tang
- + Polyester Belt Sheath

 Blade Length
3.7" (9.4 cm)
Overall Length
8.1" (20.5 cm)
Weight
6.5 oz.

8.1"

21410T FIXED DROP POINT ⚠️

UPC - 044356223003

21410TCP FIXED DROP POINT CLAM PACK ⚠️

UPC - 044356223010

FIXED GUT HOOK

- + Full Tang
- + Polyester Belt Sheath

 Blade Length
3.7" (9.4 cm)
Overall Length
8.1" (20.5 cm)
Weight
6.5 oz.

8.1"

21430T FIXED DROP POINT ⚠️

UPC - 044356223027

21430TCP FIXED DROP POINT CLAM PACK ⚠️

UPC - 044356223034



FOLDING SAW

3Cr13MoV High Carbon S.S. Blade
Rubber Handle

- + Liner Lock
- + Polyester Belt Sheath

Blade Length
6.6" (16.7 cm)
Overall Length
14.9" (37.9 cm)
Weight
13.2 oz.



21500T FOLDING SAW ⚠

UPC - 044356226257

21500TCP FOLDING SAW CLAM PACK ⚠

UPC - 044356226653

WOOD & BONE SAW

3Cr13MoV High Carbon S.S. Blade
TPE Handle

- + Folding T Handle
- + Polyester Sheath

Blade Length
9.1" (23.0 cm)
Overall Length
12.2" (31.1 cm)
Weight
7.1 oz.

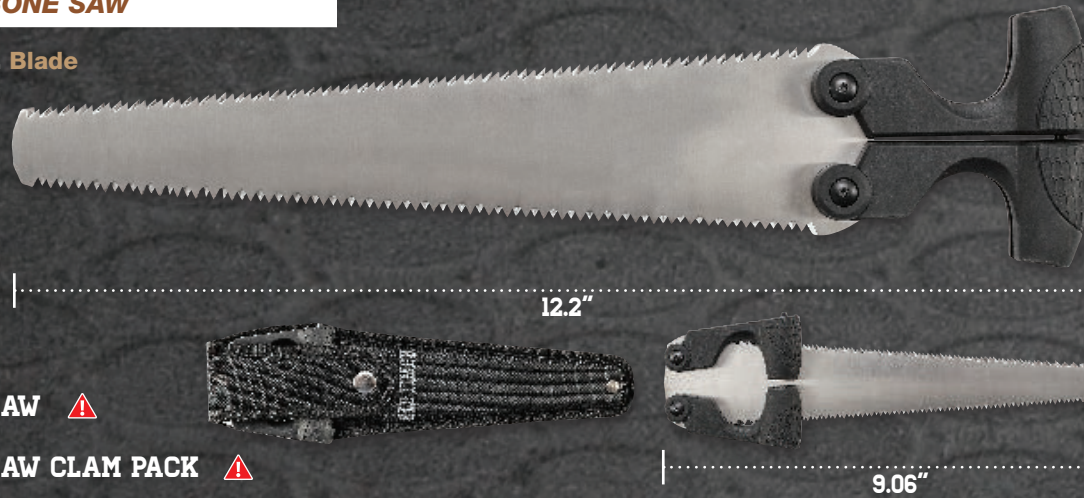

21400T WOOD & BONE SAW ⚠

UPC - 044356223126

21400TCP WOOD & BONE SAW CLAM PACK ⚠

UPC - 044356223133

DOUBLE RATTLER SAFE-T-LOCK®

7Cr17MoV Ti-Nitride Coated High Carbon S.S. Blade
Rubber Overmold Handle

- + Drop Point Blade & Saw Blade
- + Double Lockback
- + Molded Polyester Belt Sheath

Blade Length
3.5" (8.8 cm)
Overall Length
8.1" (20.6 cm)
Weight
8.1 oz.



21440T DOUBLE RATTLER SAFE-T-LOCK® ⚠

UPC - 044356223065

21440TCP DOUBLE RATTLER SAFE-T-LOCK® CLAM PACK ⚠

UPC - 044356223072

3I500TCP T-HANDLE SAW ⚠

3Cr13MoV S.S. Blade
OT Saw Cut Handle

- + OT Saw Cut Handle
- + Synthetic Sheath

Blade Length
6.1" (15.4 cm)
Overall Length
8.2" (20.9 cm)
Weight
2.6 oz.



UPC
044356228596

Only available in clam pack

6020TCP TAKE-A-PART 8" SHEARS ⚠

2Cr13MoV Stainless Steel Blades
Soft Rubber & Hard Nylon Handles

- + Nylon Belt Sheath

Blade Length
4" (10.2 cm)
Overall Length
8.2" (20.9 cm)
Weight
3.4 oz.



UPC
044356228015

Only available in clam pack



IMPERIAL® IMPERIAL®

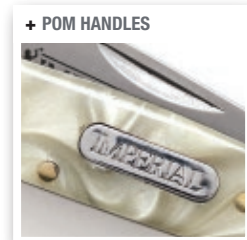
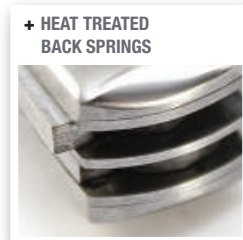
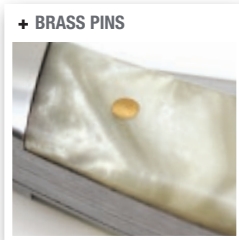

THE EDGE YOU NEED

FORGED WITH AN EYE FOR QUALITY AND STYLE, OUR IMPERIAL LINE OF KNIVES REFLECT THE SKILLFUL LABOR OF KNIFE MAKERS STRETCHING BACK GENERATIONS. DESIGNED TO GIVE EVERY CRAFTSMAN AND TRADESMAN THE EDGE HE NEEDS, IMPERIAL BLADES SUCH AS OUR RAZOR SHARP FRUIT SAMPLER KNIVES AND TRADITIONAL-PATTERNED FOLDING POCKET KNIVES ENSURE THAT ANY CUTTING TASK BECOMES QUICK WORK.



IMPCOM1CP
IMP41 & IMP43
COMBO ▲
UPC
044356229388



IMPCOM3CP
IMP42 & IMP45
COMBO ▲
UPC
044356229401



IMPCOM4CP
IMP40, IMP44 &
IMP45 COMBO ▲
UPC
044356229418

- + 3Cr13MoV High Carbon S.S.
- + Clip Point Blade
- + Shackle

- + 3Cr13MoV High Carbon S.S.
- + Clip Point Blade

- + 3Cr13MoV High Carbon S.S.
- + Clip Point Blade
- + Pen Blade



2.25"

IMP40 / **LOCKBACK** ▲
Blade Length 1.6" (4.1 cm)
Overall Length 3.8" (9.7 cm)
Weight 0.8 oz.
UPC 044356228749

- + 3Cr13MoV High Carbon S.S.
- + Clip Point Blade
- + Pen Blade
- + Scissors



2.9"

IMP41 / **LOCKBACK** ▲
Blade Length 2.2" (5.6 cm)
Overall Length 5.1" (13.0 cm)
Weight 1.4 oz.
UPC 044356228756

- + 3Cr13MoV High Carbon S.S.
- + Clip Point Blade
- + Pen Blade
- + Shackle



2.8"

IMP42 / **DOG LEG JACK** ▲
Blade Length 2.1" (5.3 cm)
Overall Length 5" (12.7 cm)
Weight 1.2 oz.
UPC 044356228763

- + 3Cr13MoV High Carbon S.S.
- + Clip Point Blade
- + Sheepfoot Blade
- + Pen Blade



2.75"

IMP43 / **FOLDER** ▲
Blade Length 2.1" (5.3 cm)
Overall Length 4.8" (12.2 cm)
Weight 1.2 oz.
UPC 044356228770



2.75"

IMP44 / **FOLDER** ▲
Blade Length 2" (5.1 cm)
Overall Length 4.8" (12.2 cm)
Weight 1.0 oz.
UPC 044356228787



3.25"

IMP45 / **STOCKMAN** ▲
Blade Length 2.4" (6.2 cm)
Overall Length 5.7" (14.4 cm)
Weight 1.7 oz.
UPC 044356229081

- + 3Cr13MoV Stainless Steel
- + Drop Point Blade
- + Pen Blade
- + Stainless Steel Bolsters



IMP1011 SMALL CANOE ⚠️
 Blade Length 2.2" (5.6 cm) Weight 1.8 oz.
 Overall Length 5.2" (13.2 cm) UPC 044356215459

- + 3Cr13MoV Stainless Steel
- + Drop Point Blade
- + Pen Blade
- + Stainless Steel Bolsters



IMP11 LARGE CANOE ⚠️
 Blade Length 2.5" (6.4 cm) Weight 2.5 oz.
 Overall Length 6.1" (15.5 cm) UPC 044356215442

- + 3Cr13MoV Stainless Steel
- + Spear Point Blade
- + Coping Blade
- + Pen Blade
- + Stainless Steel Bolsters



IMP9 CIGAR WHITTLES ⚠️
 Blade Length 3" (7.6 cm) Weight 2.3 oz.
 Overall Length 6.9" (17.5 cm) UPC 044356215466

- + 3Cr13MoV Stainless Steel
- + Sheepsfoot Blade (2)
- + Coping Blade
- + Pen Blade
- + Stainless Steel Bolsters



IMP20CI CONGRESS ⚠️
 Blade Length 2.2" (5.6 cm) Weight 2.3 oz.
 Overall Length 5.8" (14.7 cm) UPC 044356205696

- + 3Cr13MoV Stainless Steel
- + Clip Point Blade
- + Spey Blade
- + Stainless Steel Bolsters



IMP13 TRAPPER ⚠️
 Blade Length 2.2" (5.6 cm) Weight 1.4 oz.
 Overall Length 5" (12.7 cm) UPC 044356204767

- + 3Cr13MoV Stainless Steel
- + Clip Point Blade
- + Spey Blade
- + Stainless Steel Bolsters



IMP13L LARGE TRAPPER ⚠️
 Blade Length 3" (7.6 cm) Weight 3.0 oz.
 Overall Length 7" (17.8 cm) UPC 044356204774

IMPERIAL®



- + 3Cr13MoV Stainless Steel
- + Clip Point Blade
- + Small Clip Point Blade
- + Pen Blade
- + Stainless Steel Bolsters

IMP24 WHITTLES ⚠️
 Blade Length 2.3" (5.9 cm) Weight 2.5 oz.
 Overall Length 5.8" (14.8 cm) UPC 044356222723

- + 3Cr13MoV Stainless Steel
- + Drop Point Blade
- + Lockback
- + Stainless Steel Bolsters



IMP23 LOCKBACK ⚠️
 Blade Length 2.6" (6.5 cm) Weight 2.8 oz.
 Overall Length 6.3" (15.9 cm) UPC 044356222716

- + 3Cr13MoV Stainless Steel
- + Clip Point Blade
- + Sheepsfoot Blade
- + Spey Blade
- + Stainless Steel Bolsters



IMP14 STOCKMAN ⚠️
 Blade Length 1.8" (4.6 cm) Weight 1.1 oz.
 Overall Length 4.5" (11.4 cm) UPC 044356204781

- + 3Cr13MoV Stainless Steel
- + Clip Point Blade
- + Sheepsfoot Blade
- + Spey Blade
- + Stainless Steel Bolsters



IMP14L LARGE STOCKMAN ⚠️
 Blade Length 3" (7.6 cm) Weight 2.8 oz.
 Overall Length 6.9" (17.5 cm) UPC 044356204798

- + 3Cr13MoV Stainless Steel
- + Clip Point Blade
- + Sheepsfoot Blade
- + Spey Blade
- + Stainless Steel Bolsters



IMP25 SOWBELLY ⚠️
 Blade Length 2.7" (6.7 cm) Weight 3.0 oz.
 Overall Length 6.4" (16.2 cm) UPC 044356222730

- + 3Cr13MoV Stainless Steel
- + Clip Point Blade
- + Spey Blade
- + Stainless Steel Bolsters



IMPI5T / **TRAPPER** 

Blade Length 2.7" (6.8 cm) Weight 2.5 oz.
Overall Length 6.2" (15.7 cm) UPC 044356205504

- + 3Cr13MoV Stainless Steel
- + Clip Point Blade
- + Spey Blade
- + Stainless Steel Bolsters



IMPI6T / **TRAPPER** 

Blade Length 2.7" (6.8 cm) Weight 2.5 oz.
Overall Length 6.2" (15.7 cm) UPC 044356205528

- + 3Cr13MoV Stainless Steel
- + Clip Point Blade
- + Spey Blade
- + Stainless Steel Bolsters



IMPI7T / **TRAPPER** 

Blade Length 2.7" (6.8 cm) Weight 2.5 oz.
Overall Length 6.2" (15.7 cm) UPC 044356205542

- + 3Cr13MoV Stainless Steel
- + Clip Point Blade
- + Spey Blade
- + Stainless Steel Bolsters



IMPI9PRT / **TRAPPER** 

Blade Length 2.2" (5.6 cm) Weight 1.4 oz.
Overall Length 5" (12.7 cm) UPC 044356205580

- + 3Cr13MoV Stainless Steel
- + Clip Point Blade
- + Sheepsfoot Blade
- + Spey Blade
- + Stainless Steel Bolsters



IMPI5S / **STOCKMAN** 

Blade Length 2.5" (6.4 cm) Weight 1.9 oz.
Overall Length 5.9" (15.0 cm) UPC 044356205511

- + 3Cr13MoV Stainless Steel
- + Clip Point Blade
- + Sheepsfoot Blade
- + Spey Blade
- + Stainless Steel Bolsters



IMPI6S / **STOCKMAN** 

Blade Length 2.5" (6.4 cm) Weight 1.9 oz.
Overall Length 5.9" (15.0 cm) UPC 044356205535

- + 3Cr13MoV Stainless Steel
- + Clip Point Blade
- + Sheepsfoot Blade
- + Spey Blade
- + Stainless Steel Bolsters



IMPI7S / **STOCKMAN** 

Blade Length 2.5" (6.4 cm) Weight 1.9 oz.
Overall Length 5.9" (15.0 cm) UPC 044356205559

- + 3Cr13MoV Stainless Steel
- + Clip Point Blade
- + Sheepsfoot Blade
- + Spey Blade
- + Stainless Steel Bolsters



IMPI9PRS / **STOCKMAN** 

Blade Length 1.8" (4.6 cm) Weight 1.1 oz.
Overall Length 4.5" (11.4 cm) UPC 044356205597

- + 3Cr13MoV Stainless Steel
- + Sheepsfoot Blade (2)
- + Coping Blade
- + Pen Blade
- + Stainless Steel Bolsters



IMPI5CON / **CONGRESS** 

Blade Length 2.1" (5.3 cm) Weight 2.5 oz.
Overall Length 5.7" (14.5 cm) UPC 044356206549

- + 3Cr13MoV Stainless Steel
- + Sheepsfoot Blade (2)
- + Coping Blade
- + Pen Blade
- + Stainless Steel Bolsters



IMPI6CON / **CONGRESS** 

Blade Length 2.1" (5.3 cm) Weight 2.5 oz.
Overall Length 5.7" (14.5 cm) UPC 044356206556

- + 3Cr13MoV Stainless Steel
- + Sheepsfoot Blade (2)
- + Coping Blade
- + Pen Blade
- + Stainless Steel Bolsters



IMPI7CON / **CONGRESS** 

Blade Length 2.1" (5.3 cm) Weight 2.5 oz.
Overall Length 5.7" (14.5 cm) UPC 044356206532

- + 3Cr13MoV Stainless Steel
- + Clip Point Blade
- + Stainless Steel Bolsters



IMP2ICI / **PEANUT** 

Blade Length 1.9" (4.8 cm) Weight 0.9 oz.
Overall Length 4.7" (11.9 cm) UPC 044356206730

- + 3Cr13MoV Stainless Steel
- + Clip Point Blade
- + Spey Blade
- + Stainless Steel Bolsters



IMP18PT TRAPPER 

Blade Length	2.2" (5.6 cm)	Weight	1.4 oz.
Overall Length	5" (12.7 cm)	UPC	044356205566

- + 3Cr13MoV Stainless Steel
- + Clip Point Blade
- + Sheepfoot Blade
- + Spey Blade
- + Stainless Steel Bolsters



IMP18PS STOCKMAN 

Blade Length	1.8" (4.6 cm)	Weight	1.1 oz.
Overall Length	4.5" (11.4 cm)	UPC	044356205573

- + 7Cr17MoV Stainless Steel
- + Drop Point Blade
- + Stainless Steel Bolsters



IMP22 FOLDER 

Blade Length	2.7" (6.8 cm)	Weight	2.1 oz.
Overall Length	6.4" (16.2 cm)	UPC	044356207171

- + 7Cr17MoV Stainless Steel
- + Drop Point Blade
- + Stainless Steel Bolsters



IMP22L LARGE FOLDER 

Blade Length	3.6" (9.2 cm)	Weight	3.5 oz.
Overall Length	8.3" (21.1 cm)	UPC	044356207188

- + 7Cr17MoV Stainless Steel
- + Drop Point Blade
- + Stainless Steel Bolsters



IMP22Y FOLDER 

Blade Length	2.7" (6.8 cm)	Weight	2.1 oz.
Overall Length	6.4" (16.2 cm)	UPC	044356207195

- + 3Cr13MoV Stainless Steel
- + Clip Point Blade
- + Pen Blade
- + Stainless Steel Bolsters



278 JACKMASTER BARLOW 

Blade Length	2.4" (6.1 cm)	Weight	2.3 oz.
Overall Length	5.7" (14.5 cm)	UPC	044356108032



Display included, orders of 12 only

- + 3Cr13MoV Stainless Steel
- + Plastic w/Rubber Insert Handle
- + Ambidextrous Thumb Hole
- + Lockback
- + Pocket Clip



IMP35 APEX 

Blade Length	2.4" (6 cm)	Weight	1.2 oz.
Overall Length	5.5" (14 cm)	UPC	044356224956

SS102 

SAMPLER FRUIT

- + 3Cr13 Stainless Steel
- Blade Length 3.7" (9.4 cm)
- Overall Length 8.3" (21.1 cm)
- Weight 1.8 oz.
- UPC 044356005234



SS105 

SAMPLER FRUIT LONG

- + 7Cr17MoV Stainless Steel
- Blade Length 4.7" (11.9 cm)
- Overall Length 10.5" (26.7 cm)
- Weight 2.6 oz.
- UPC 044356005241

IMPCOM5CP IMP35 COMBO PACK

3Cr13MoV Stainless Steel Blade Plastic w/Rubber Insert Handle

- + Ambidextrous Thumb Hole
- + Lockback
- + Pocket Clip

Blade Length
2.4" (6.0 cm)
Overall Length
5.5" (14.0 cm)
Weight
1.2 oz.
UPC
044356229432

Only available in clam pack



3.22"

IMPCOM6CP IMPERIAL® FOLDING KNIFE COMBO

3Cr13MoV High Carbon S.S. Blades Plastic Handles

- + Lockback
- + Lanyard Hole

SP1

Blade Length
2.1" (5.3 cm)
Overall Length
4.3" (10.9 cm)
Weight
1.7 oz.

SP2

Blade Length
2.5" (6.4 cm)
Overall Length
5.4" (13.7 cm)
Weight
2.3 oz.

SP3

Blade Length
3" (7.6 cm)
Overall Length
6.6" (16.8 cm)
Weight
2.8 oz.
UPC
044356229449

Only available in clam pack



IMP4SBCP SNOWBLIND FOLDING KNIFE

3Cr13MoV Stainless Steel Blade Aluminum & Rubber Handle

- + Ambidextrous Thumb Hole
- + Liner Lock
- + Pocket Clip

Blade Length
3" (7.6 cm)
Overall Length
7" (17.8 cm)
Weight
3.8 oz.
UPC
044356229425

Only available in clam pack



3.9"

IMPCOM11CP SNOWBLIND FOLDING KNIFE COMBO

3Cr13MoV Stainless Steel Blade Aluminum & Rubber Handle

- + Ambidextrous Thumb Hole
- + Liner Lock
- + Pocket Clip

Blade Length
3" (7.6 cm)
Overall Length
7" (17.8 cm)
Weight
3.8 oz.
UPC
044356229777

Only available in clam pack



3.9"

IMPI00MCP FOLDING KNIFE

3Cr13MoV S.S. Blade Aluminum Handle

- + Thumb Knob
- + Liner Lock
- + Pocket Clip

Blade Length
3.2" (8.1 cm)
Overall Length
7.3" (18.6 cm)
Weight
4.6 oz.
UPC
044356229685

Only available in clam pack



7.3"



4.2"

IMPI00MBSCP FOLDING KNIFE

3Cr13MoV S.S. Blade Aluminum Handle

- + Thumb Knob
- + Liner Lock
- + Pocket Clip

Blade Length
3.2" (8.1 cm)
Overall Length
7.3" (18.6 cm)
Weight
4.6 oz.
UPC
044356229692

Only available in clam pack



7.3"



4.2"

IMPCOM12CP FOLDING KNIFE COMBO

3Cr13MoV S.S. Blade Aluminum Handle

- + Thumb Knob
- + Liner Lock
- + Pocket Clip

IMP100
Blade Length
2.6" (6.6 cm)
Overall Length
6.2" (15.7 cm)
Weight
2.8 oz.

IMP100LBS
Blade Length
3.8" (9.5 cm)
Overall Length
8.6" (21.8 cm)
Weight
6.1 oz.

UPC
044356229784

Only available in clam pack



6.2"



8.6"



3.375"



4.875"

IMPI01TCP FOLDING KNIFE

3Cr13MoV S.S. Blade Rubberized Aluminum Handle

- + Dual Thumb Knobs
- + Liner Lock
- + Pocket Clip

Blade Length
2.6" (6.6 cm)
Overall Length
6.4" (16.3 cm)
Weight
3.3 oz.
UPC
044356229791

Only available in clam pack



6.4"



3.75"

IMPI04BCP FOLDING KNIFE

3Cr13MoV S.S. Blade Rubberized Aluminum Handle

- + Dual Thumb Knobs
- + Liner Lock
- + Pocket Clip

Blade Length
3.4" (8.5 cm)
Overall Length
7.9" (20.0 cm)
Weight
4.3 oz.
UPC
044356229821

Only available in clam pack



7.9"



4.5"

IMPI05BSCP LOCKBACK

3Cr13MoV S.S. Blade Rubberized Aluminum Handle

- + Dual Thumb Knobs
- + Lockback
- + Pocket Clip
- + Polyester Sheath

Blade Length
3.4" (8.5 cm)
Overall Length
8.1" (20.5 cm)
Weight
6.0 oz.
UPC
044356229838

Only available in clam pack



8.1"



4.75"

IMP102CP FOLDING UTILITY BLADE

3Cr13MoV S.S. Blade Rubberized Aluminum Handle

- + Dual Thumb Knobs
- + Liner Lock
- + Razor Blade
- + Strap Cutter
- + Pocket Clip

Blade Length
2.8" (7.0 cm)
Overall Length
7.2" (18.2 cm)
Weight
5.2 oz.

UPC
044356229807

Only available in clam pack



7.2"



4.5"

IMP103CP FOLDING HAWKBILL

3Cr13MoV S.S. Blade Rubberized Aluminum Handle

- + Dual Thumb Knobs
- + Liner Lock
- + Pocket Clip

Blade Length
3.4" (8.7 cm)
Overall Length
8.1" (20.5 cm)
Weight
6.0 oz.

UPC
044356229814

Only available in clam pack



8.1"



4.5"

IMPFI1CP FIXED BLADE

3Cr13MoV S.S. Blade Rubberized Aluminum Handle

- + Full Tang
- + Spine Drywall Saw
- + Polyester Belt Sheath

Blade Length
5.2" (13.3 cm)
Overall Length
10" (25.4 cm)
Weight
7.3 oz.

UPC
044356229845

Only available in clam pack



10"



IMPCOM9CP SP3 & MULTI-TOOL COMBO

Multi-Tool

17 Features

- + Needle Nose Pliers
- + Regular Pliers
- + Wire Cutter
- + Wire Strippers
- + Fine Edge Blade
- + Small Phillips Head
- + Can Opener/Bottle Opener/Scraping Blade
- + Fine Flat Head Screwdriver
- + Saw/Nail Puller
- + Fine Grit File/Large Flat Head Screwdriver
- + Awl
- + Small Flat Head Screwdriver
- + Locking Tools
- + Polyester Belt Sheath

Closed Length
4.2" (10.7 cm)

Overall Length
6.3" (16.0 cm)

Weight
10.5 oz.

UPC
044356229487

Only available
in clam pack



4.25"

SP3 Lockback

- + 3Cr13MoV Stainless Steel
- + Plastic Handle

Blade Length
3.0" (7.6 cm)

Overall Length
6.6" (16.8 cm)

Weight
2.8 oz.



IMPCOM10CP TRADESMAN® TM1 & TM2 COMBO

3Cr13MoV High Carbon S.S. Blades Plastic Handles

- + Lockblade
- + Screwdriver Tip
- + Shackle

TM1 Hawkbill

Blade Length
3" (7.6 cm)

Overall Length
7.1" (18.0 cm)

Weight
2.2 oz.

TM2 Electrician

Blade Length
2.7" (6.9 cm)

Overall Length
8.4" (21.3 cm)

Weight
2.2 oz.

UPC
044356229456

Only available in clam pack



IMPCOM10CP Clam Pack
UPC 044356229456



+ TM1

4.25"



+ TM2

3.75"

TRADESMAN®
QUALITY CUTTING TOOLS

ACCESSORIES

SHARPENERS, SHEATHS, PROMO ITEMS, DISPLAYS



DH40T



OLD TIMER® USA SPORTSMAN'S HONING SET

- + Mounted Soft/Hard Arkansas Stones
- + 1 oz. Bottle Premium Honing Oil

Overall Length
8.4" (21.3 cm)
Weight
9.9 oz.
UPC
044356227070



+ Soft Arkansas Stone + Hard Arkansas Stone

TH6UH



6" TRI-HONE

- + Three Stones: Coarse/Medium/Fine
- + 1 oz. Bottle Premium Honing Oil

Overall Length
8.1" (20.6 cm)
Weight
1 lb. 14.0 oz.
UPC
044356227124

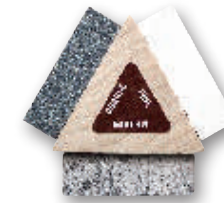

TH8UH



8" TRI-HONE

- + Three Stones: Coarse/Medium/Fine
- + 1 oz. Bottle Premium Honing Oil

Overall Length
10.1" (25.8 cm)
Weight
2 lb. 8.2 oz.
UPC
044356227131



+ 180/320 Grit

SSOTCP

DOUBLE SIDED SHARPENING STONE



Overall Length 6" (15.2 cm) UPC 044356218924
Weight 1 lb. 0.4 oz.



HS1

OLD TIMER® HONESTEEL



Overall Length 7" (17.8 cm) UPC 044356209649
Weight 6.2 oz.

HARD ARKANSAS TACTICAL SHARPENING STONE

SCTS3 

Overall Length
3" (7.6 cm)
Weight
2.4 oz.
UPC
044356227094



Paracord Lanyard



+ 360/600 Grit

SCHDDFSCP / **DOUBLE SIDED DIAMOND DUST SHARPENER**

Overall Length 8.9" (22.7 cm) UPC 044356229630
Weight 2.3 oz. 



+ 180 Grit

SCHDDS / **DIAMOND DUST SHARPENING STONE** 

Sharpening Rod 3.3" (8.4 cm) UPC 044356000253
Handle Length 1.4" (3.6 cm) **SCHDDSCP CLAM PACK**
Weight 1.2 oz. UPC 044356000277

SCHRADER®

SCHRADER® PREMIUM QUALITY LEATHER SHEATHS

CARRY WITH STYLE AND CONFIDENCE. EVERY SCHRADER®, UNCLE HENRY® AND OLD TIMER® PREMIUM LEATHER SHEATH HAS BEEN WELL-CRAFTED TO ENSURE YOUR KNIFE IS KEPT PROTECTED THROUGH THE TOUGHEST SITUATIONS.



LS1 / **OLD TIMER® LEATHER SHEATH** 

Overall Length 4.4" (11.1 cm) UPC 044356201667
Weight 1.6 oz.



LS2 / **OLD TIMER® LEATHER SHEATH** 

Overall Length 5.8" (14.7 cm) UPC 044356201674
Weight 1.9 oz.



LS6 / **UNCLE HENRY® LEATHER SHEATH**

Overall Length 5.9" (15.0 cm) UPC 044356228299
Weight 2.4 oz. 

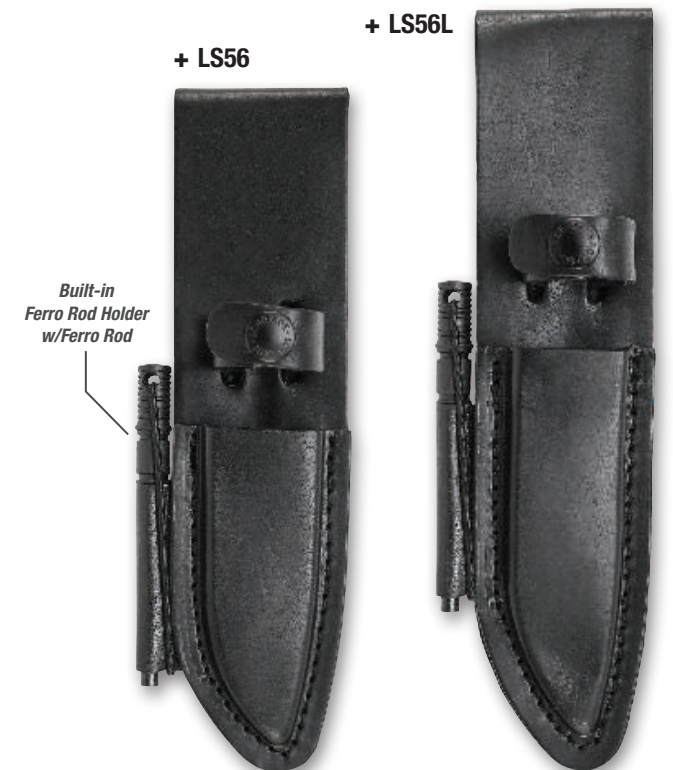

Built-in Ferro Rod Holder w/Ferro Rod

LS56/LS56L / **SCHRADER® LEATHER SHEATHS** 

LS56 (For SCHRADER® SCHF56)	LS56L (For SCHRADER® SCHF56L)
Overall Length 8.2" (20.8 cm)	Overall Length 9.2" (23.3 cm)
Weight 3.1 oz.	Weight 3.2 oz.
UPC 044356228558	UPC 044356228565

SCSK1 / **SCHRADE® SURVIVAL KIT** ⚠

Overall Length 3.4" (8.7 cm) UPC 044356223287
 Weight 1.1 oz.

- SCSK1 Includes**
- + Waterproof Case
 - + 2 - Needles
 - + Compass w/Whistle
 - + 2 - Fishing Hooks
 - + 6 - Matches
 - + 2 - Split Shots
 - + Match Strike
 - + Fishing Line



OLD TIMER® ⚠

OTD1 (Window Decal)
 UPC 044356221881
 OTS1 (Sticker)
 UPC 044356223812

SCHRADE® ⚠

SCHD1 (Window Decal)
 UPC 044356221867
 SCHS1 (Sticker)
 UPC 044356223799

UNCLE HENRY® ⚠

UHD1 (Window Decal)
 UPC 044356221874
 UHS1 (Sticker)
 UPC 044356223805

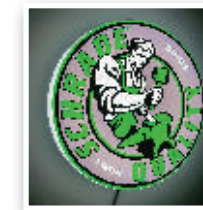

+ UL Approved
 + 110 Volt



SCHRADE / **6" WINDOW DECALS & STICKERS**

SCHQSI / **SCHRADE® 12W LED SIGN** ⚠

UPC 044356224161

550 PARACORD BRAIDED LANYARD ⚠

SCH550BK SCH550GR SCH550BKGR
 UPC 044356224451 UPC 044356224475 UPC 044356224468

+ SCH550BK



Striker Plate

SCHFS1 / **FERRO ROD FIRE STRIKER** ⚠

Overall Length 4" (10.1 cm) UPC 044356221016
 Weight 1.1 oz.

SCHFS2 / **LARGE FERRO ROD** ⚠

Overall Length 6" (15.2 cm) UPC 044356229616
 Weight 3.9 oz.

SCHRADE®

+ SCHRADE® Header For TBD1
 HSC UPC 044356224154



MAGNETIC DISPLAY



Extra Storage



+ PLEXBR

+ PLEXSD

TBD1 / **ROTATABLE COUNTER DISPLAY** ⚠

UPC 044356224079

SCHRADE / **PLEXIGLASS DISPLAYS** ⚠

PLEXBR (Resting Display) PLEXSD (Standing Display)
 UPC 044356224055 UPC 044356224048



SC204 - Panel 1 ▲

UPC 044356217613

- | | |
|------|--------|
| 44OT | 80T |
| 120T | 330T |
| 30T | 1080T |
| 340T | 10110T |
| 770T | 110T |
| 940T | 8580T |
| 50T | 90T |



SC204 - Panel 2 ▲

UPC 044356217620

- | | |
|-------|-------|
| 11UH | 804UH |
| 834UH | 285UH |
| 12UH | 16UH |
| 124UH | 5UH |
| 885UH | LB5 |
| 877UH | LB7 |
| 897UH | |



SC204 - Panel 3 ▲

UPC 044356217637

- | | |
|------|-------|
| 44OT | LB5 |
| 120T | 80T |
| 30T | 12UH |
| 940T | 897UH |
| 330T | 11UH |
| 340T | 124UH |
| 5UH | 285UH |



SC204 ROTATING COUNTER DISPLAY ▲

UPC 044356217606



SC500 FLOOR DISPLAY ▲

UPC 044356217644

DISPLAY UNITS

- + Vacuum formed panels
- + Each display utilizes steel panels with movable magnets for product placement
- + **SC204** Two-sided rotating display with lockable inside storage
- + **SC500** Lockable display with inside storage

SC500 - Panel 1 ▲

UPC 044356217651

- | | |
|-------|-------|
| 44OT | 80T |
| 125OT | 330T |
| 30T | 1080T |
| 340T | 180T |
| 770T | 110T |
| 940T | 8580T |
| 50T | 690T |



SC500 - Panel 2 ▲

UPC 044356217668

- | | |
|-------|-------|
| 834UH | 877UH |
| 897UH | 285UH |
| 885UH | 124UH |
| 707UH | 5UH |
| 11UH | LB5 |
| 16UH | LB7 |
| 804UH | |



SC500 - Panel 3 ▲

UPC 044356217675

- | | |
|-------|-------|
| 158OT | 510T |
| 152OT | 1560T |
| 1650T | 227UH |
| 1600T | 162UH |
| 150T | 153UH |



SC500 - Panel 4 ▲

UPC 044356217682

- | | |
|-------|--------|
| 180T | 897UHP |
| 1080T | 12UH |
| 940T | 834UH |
| 440T | 285UH |
| 80T | 885UH |
| 50T | LB7 |
| 124UH | |



SC500 - Panel 5 ▲

UPC 044356217699

- | | |
|-------|-------|
| 770TW | 30T |
| 340TW | 330T |
| 940TW | 11UH |
| 440TY | 340T |
| 940TY | 5UH |
| 80TY | LB5 |
| 8580T | 897UH |



SCHRADER® CUSTOM LASER ETCHING

BATTENFELD CUTLERY & TOOLS PROUDLY OFFERS THE ABILITY TO CUSTOM LASER ETCH AND CREATE FULL COLOR INSERTS ON A WIDE RANGE OF PRODUCTS.

SMALL MINIMUM ORDERS. CALL FOR MORE INFORMATION.



SCHRADER® FULL COLOR INSERTS

WE CAN CREATE A FULL COLOR INSERT USING YOUR EXISTING ARTWORK OR LET OUR TEAM OF EXPERIENCED ARTISTS CREATE SOMETHING NEW AND UNIQUE, ESPECIALLY FOR YOU.

SCH206, SCH207 & SCH208 MODELS ONLY. SMALL MINIMUM ORDERS.



+ SCH206



+ SCH207



+ SCH208

Steel Information

Steel is a critical component of any knife. The purpose of this guide is to provide a more detailed look into steel to help assist you in better defining what your own preferences are and why. As a word of caution this information is not intended to be all-inclusive nor could it ever be as the world of steel is ever evolving. The quest for higher performance steels has led to the development of many new, excellent materials over the years and there are currently over 3,000 different types of steel, each having its own positive and negative attributes.

Of course steel is not the only factor that determines a knife's performance. Blade geometry, heat treatment processes, handle geometry and other materials used in the production of the knife all contribute to how the end product will handle particular jobs. It is not possible to tell just by looking at a blade how well the item has been heat treated and it is only possible to make an educated guess as to how well the handle and blade geometry will work. However, by knowing the grade of steel used you are better able to understand the alloying elements involved giving you something measurable to go by when determining your own preferences.

The result of knowing the grade of steel can unfortunately put the end user into a trap of placing too much of an emphasis on the steel itself. A knife is more than just the steel that goes into it and it's important to recognize this. In fact, so many modern steels perform so well that knife decisions can often be made based on other factors than just the marginal increases in steel performances.

Often the question of "what's the best steel" or "which steels rank better than others in terms of best to worst" come up. There is never a truly correct and accurate response to this as the blade geometry of the product, the quality of the heat treatment, the materials used and the tasks, or goals, of the end user all will factor in to determine how well a product will perform and in turn how well the user will be satisfied with the product.

BTI Tools uses specific blade steels to create the most efficient balance of properties based on the anticipated applications of our products.

Steel is an alloy of iron, other metals and carbon. Stainless steel refers to a family of corrosion-resistant alloy steels which contain a minimum of 10.5% chromium. A common misconception is that stainless steels will not stain, rust, or corrode. Stainless steels will simply stain less than other steels that do not contain chromium. Each alloy in the various steels lends unique properties to the stainless steel.

When selecting the steel for the various products we factor in the overall performance requirements of what the tool will be used for, the goal price range for the end product and the costs of manufacturing and finishing the item(s). As with any materials there are generally trade-offs. For instance, while higher alloy levels and final hardness levels keep an edge longer they also will make it more difficult to field sharpen a blade. Some alloys can be found to be low in nickel, which will result in increased staining if not kept regularly oiled and cleaned after use. Knives that will be placed to hard use must be constructed with very tough steel materials so we will use steels that are considered to have high ductility (or toughness) over a higher hardened steel. Please note that final hardness levels are achieved not only by factors of composition but from proper heat treating and quenching, of which we pay great attention.

BTI Tools sources premium steel from many international suppliers. The information chart referenced below shows a reasonable range of the compositions of the various steels we utilize. The blade steel we use for each product is included in the catalog to help make this information easy for you to locate.

STEEL TERMS

Alloy: A material that is dissolved in another metal in a solid solution. A material that results when two or more elements combine in a solid solution.

Corrosion Resistance: The ability of a material to resist deterioration as a result of a reaction to its environment. Provided by the elements Chromium (Cr), Copper (Cu), Molybdenum (Mo), and Nitrogen (N).

Ductility: The ability of a material to be stretched or drawn, plastically deform appreciably before fracturing. Provided by the element Manganese (Mn).

Edge Retention: The ability of a material to resist abrasion and wear. Provided by the elements Carbon (C), Chromium (Cr), Manganese (Mn), Nitrogen (N), and Vanadium (V).

Hardness: The resistance of a steel to deformation or penetration analogous to strength. Provided by the elements Carbon (C), Chromium (Cr), Cobalt (Co), Molybdenum (Mo), Nitrogen (N), and Phosphorus (P).

Hardenability: The ability of a steel to be hardened by a heat treating process. Provided by the elements Manganese (Mn), Molybdenum (Mo), and Tungsten (W).

Heat Treating: A controlled heating and cooling process to prescribed temperatures and set limits for the purpose of changing the physical properties and behavior of the metal.

Impact Strength: The ability of a material to resist cracking due to a sudden force.

Rockwell Test (HRC): A measurement of steel hardness based on the depth of penetration of a small diamond cone pressed into the steel under a constant load.

Tensile Strength: Indicated by the force at which a material breaks due to stretching. Provided by the elements Chromium (Cr) and Manganese (Mn).

Toughness: The ability of a material to resist shock or impact. Provided by the element Chromium (Cr).

KNIFE STEEL SELECTION CHART

1070: This is a plain carbon steel which means it has a low resistance to corrosion and low to medium edge retention. The benefit of this steel is that it is very easy to sharpen and will take an extremely sharp edge.

1095: This is a plain carbon steel which means it has a low resistance to corrosion and low to medium edge retention. The benefit of this steel is that it is very easy to sharpen and will take an extremely sharp edge.

4034: A good quality grade of stainless steel. This steel is known for its ability to be honed to a razor sharp edge. While this steel has medium edge retention it is a very easy steel to field sharpen. A choice steel to use for an everyday carry product.

4116: A fine grained stainless steel. The balance of Carbon and Chromium content give it a high degree of corrosion resistance and also impressive physical characteristics of strength and edge holding. Edge retention in actual cutting tests exceeded blades made of 420 and 440 series of stainless steels. Other alloying elements contribute to grain refinement which increase blade strength and edge toughness and also allow for a finer, sharper edge.

420J2: A good quality stainless steel commonly used in knife blades as well as for impact cutting tools such as axes, hatchets and machetes. Known as a hard, strong steel, this steel has decent edge holding capabilities and is easy to resharpen, sticking a good balance of the most desirable traits for knife steel.

2Cr13: A good quality stainless steel commonly used in knife blades as well as for impact cutting tools such as axes, hatchets and machetes. Known as a hard, strong steel, this steel has decent edge holding capabilities and is easy to resharpen.

3Cr13: A good quality stainless steel commonly used in knife blades as well as for impact cutting tools such as axes, hatchets and machetes. Known as a hard, strong steel, this steel has decent edge holding capabilities and is easy to resharpen, sticking a good balance of the most desirable traits for knife steel.

7Cr17MoV: A good quality stainless steel that has a high tensile strength. This steel has excellent corrosion resistance and can be honed to a razor sharp edge.

8Cr13MoV: A high quality stainless steel similar in properties to AUS-8. This steel exhibits extreme toughness and excellent edge retaining capabilities.

9Cr14MoV: A high quality stainless steel. This steel has good corrosion resistance and excellent edge retaining capabilities.

9Cr18MoV: A higher end stainless steel commonly used in precision surgical instruments. This steel has good corrosion resistance and excellent edge retaining capabilities.

AUS-8: A very high quality stainless steel known for extreme toughness and excellent edge retaining capabilities. This steel has great corrosion resistance and is easy to sharpen.

D2: An air hardened tool steel. Sometimes called a "semi-stainless" steel because it does contain 12% Chromium. This steel offers exceptional edge retention as well as decent corrosion resistance. Somewhat difficult to sharpen, this steel can be finished to a high polish shine.

SK5: The Japanese equivalent of American 1080 steel, a high Carbon steel with carbon between 0.75%-0.85% and 0.60%-0.90% Manganese. This grade of steel has an ideal balance of very good blade toughness with superior edge holding ability and is used in a variety of hand tools and cutting products.

S30V: This steel contains carbon along with high amounts of Chromium, Molybdenum, and Vanadium. Double tempered for hardness and edge retention this steel has excellent corrosion resistance, but is somewhat difficult to sharpen.

Ceramic: A ceramic is an inorganic, nonmetallic solid prepared by the action of heat and subsequent cooling. When used in the application of a knife blade, the ceramic material will stay sharp for much longer than that of a steel knife. The only drawback is the ceramic material is more brittle than steel and can snap from a hard impact.

Stainless Steel Alloy Specifications													
Steel	HRC	C	CR	MN	MO	N	NI	P	S	SI	Cu	V	W
65Mn	52-56	0.6-0.71		0.8-1.1				0.04	0.05				
1070	54-56	0.65-0.75		0.6-0.9				0.03	0.05				
1095	57-59	0.9-1.03		0.3-0.5				0.03	0.05				
4034	56-58	0.42-0.5	12.5-14.5	1									
4116	55-57	0.45-0.55	14-15		0.5-0.8							0.1-0.2	
420J2	52-55	0.15-0.36	12-14	1			1	0.04	0.03	1			
440C		0.95-1.2	16-18	1	0.75			0.04	0.03	1			
2Cr13	51-53	0.15	12-14	1				0.04	0.03	1	0.09		
3Cr13	52-55	0.26-0.35	12-14	1			0.6	0.04	0.03	1			
7Cr17MoV	56-58	0.6-0.75	16-18	1	0.75		0.6	0.04	0.03	1		0.04	
8Cr13MoV	58-60	0.7-0.8	13-14.5	1	0.1-0.3		0.2	0.04	0.03	1		0.1-0.25	
9Cr14MoV	57-59	0.85-0.9	13.5-14	0.3-0.6	0.2-0.25			0.035	0.03	0.3-0.6		0.1-0.15	
9Cr18MoV	58-60	0.85-0.95	17-19	0.8	1-1.3		0.6	0.04	0.03	0.8		0.07-0.12	
AUS-8	58-59	0.7-0.75	13-14.5	0.5	0.1-0.3		0.49	0.04	0.03	1		0.1-0.26	
D2	57-61	1.5-1.6	11.5-12	0.15-0.45	0.6-0.9			0.03	0.03	0.1-0.4		0.9-1.1	
SK5	57-58	0.8-0.9	0.0-0.3	0.1-0.5			0.0-0.25	0.03	0.03	0.1-0.35	0.0-2.5		
S30V	59.5-61	1.45-1.46	14	0.5	2	0.1		0.03	0.03	.5		4	0.1-0.4

Various Benefits of Elements Used in Stainless Steels								
Element	Increases Corrosion Resistance	Increases Edge Retention	Increases Hardness	Increases Hardenability	Increases Tensile Strength	Increases Impact Strength	Increases Toughness	Increases Wear & Abrasion Resistance
Carbon		X	X		X			X
Chromium	X		X		X		X	X
Copper	X							
Manganese				X	X			X
Molybdenum			X	X	X		X	X
Nickel	X		X					
Nitrogen	X							
Phosphorus			X		X			
Silicon					X			
Tungsten						X	X	X
Vanadium			X		X	X		

Tough		All-Purpose			Edge Hold	
USA	420HC/425MOD		440A		440C/154CM	S30V
China	2Cr13/3Cr13/65Mn	5Cr15MoV/6Cr13	7Cr17MoV	8Cr13MoV	9Cr14MoV/9Cr18MoV	
Europe		4116				
Taiwan/Japan	420J2	AUS-6/4034		AUS-8	AUS-10/ATS34	
Hardness (HRC)	51-55	55-58	57-59	58-60	57-60	59-61

Handle & Sheath Materials

Saw Cut OT Handle Scales: This lightweight and durable polymer was engineered for its excellent long-term wear characteristics.

Staglon® Handle Scales: This lightweight and durable polymer was engineered for its excellent long-term wear characteristics. Cosmetically designed to mimic Stag Horn.

Aluminum: Relatively soft, durable, lightweight, corrosion resistant, non-metallic metal. Aluminum has about one-third the density and stiffness of steel and is easily machined, cast, drawn and extruded.

TPE: This black thermoplastic elastomer is basically a softer version of TPR and offers a superb flexibility and memory elasticity even under harsh conditions. Most often molded onto a harder sub structure, TPE material offers excellent grip and comfort.

TPR: This thermoplastic rubber is best described as a material which has both the characteristics of rubber as well as plastic. TPR rubber is usually light in weight, has good tear strength, flexible in low temperature, weather resistant, reusable and recyclable and it performs like vulcanized rubber.

PA: A plastic material Polyamides (PA) are semi-crystalline polymers. Polyamides have very good mechanical properties, are particularly tough and have excellent sliding and wear characteristics. Properties vary from the hard and tough PA 66 to the soft and flexible PA 12. Depending on the type, polyamides absorb different amounts of moisture which also affect the mechanical characteristics.

PP: Polypropylene (PP) is a thermoplastic polymer used in a wide variety of applications. Commonly used in manufacturing processes such as injection molding.

Carbon Fiber: This material is a woven composite of graphite fibers fused together with an epoxy resin. The result is an ultra lightweight handle with an extreme tensile strength. Most often seen with a visible weave-like pattern which can be varied, as can the color of the epoxy used.

G-10: An epoxy filled woven "E" glass composite, reinforced with glass fibers for strength. Originally designed for circuit boards, G-10 offers the knife industry a handle which is impervious to most elements such as oils, water and acids. It can be produced in many colors and finished in a variety of ways, offering different amounts of texture matched to different end users.

Grivory: Polyphthalamide is a thermoplastic synthetic resin that can be used to replace metals in high temperature applications. This material is suitable for other applications such as handle materials in knives and other cutting tools. Typical characteristics are high heat resistance, high chemical resistance, abrasion/corrosion resistance, high tensile strength, high dimensional stability and direct bonding to many elastomers to give plastic-rubber composites.

Leather Sheaths: Our leather sheaths are made of 100% vegetable tanned top grain genuine cowhide. No finished split leather, bonded or imitation leather, nor any chrome tanned leather that can cause corrosion to the knife blades. The leather is "roller coated" for durability with a rich top coat finish. The tough, durable "roller coated" finish provides for protection from the outdoor elements, is more scratch resistant and has shown proven long-lasting wear. The sheaths are stitched with heavy duty nylon thread in order to provide high tensile strength, durability and long term wear. The 24 and 20 line durable and baby durable all metal snap fasteners are nickel-plated to prevent rust and corrosion. No plastic snaps are used. Many of the styles receive nickel-plated metal rivets in strategic locations to provide added strength, durability and safety.

Micarta: Technically described as "fabric reinforced phenolic laminate", micarta is created by pouring a resin into a flat pan, then laying down a strip of linen or paper fabric, which then is saturated with the resin. This process is repeated until the desired thickness is achieved. Micarta can be in many different colors, is lightweight and can be finished in many ways.

Nylon Fiber: A synthetic thermoplastic polymer. Engineering grade nylon fiber is processed by extrusion, casting and injection molding and is available in glass-filled variants which increases structural, impact strength and rigidity.

Stainless Steel: A steel alloy with a minimum of 10.5% Chromium. Stainless steel does not readily corrode, rust or stain with water as ordinary steel does, it is not stain proof but rather stains less.

Titanium: A chemical element with the symbol Ti. It is a lustrous transition metal with a silver color, low density and high strength. Two of the most useful properties of the metal are corrosion resistance and the highest strength-to-weight ratio of any metal.

General Terms

Anodizing: An electro-chemical coating altering appearance and improving texture.

Black Oxide: A coating used mostly on military knives to avoid reflection.

Black or Grey Ti: A thin black or grey coating of titanium carbonitride, provides corrosion resistance.

Bolster: A piece of metal, generally nickel silver or stainless steel, that is located at one or both ends of a folding knife handle.

Button Lock: Found mainly on automatic knives, this type of lock uses a small push-button to open and release the blade.

Choil: A choil is a dip or cut out separating the cutting edge from the ricasso. It is also used to describe a cut out, molded or formed area where the handle and blade meet which positions/guards the index finger while gripping the opened knife.

Detent: A minute divot or dimple machined into the blade tang. A ball bearing drops into the detent hole when the knife is in the closed position, helping to hold the knife blade closed inside the handle.

Ergonomics: The applied science of equipment design intended to maximize productivity by reducing operator fatigue, safety, and discomfort. Knives which are designed to be comfortable and less fatiguing when used are labeled "ergonomic".

Finger Choil: A purposeful and specific area/curve cut out between the blade and handle. It creates a grip position point closer to the cutting edge for better control while cutting.

Frame Lock: Also known as the integral lock or monolock, this locking mechanism works in a manner similar to the liner lock but uses a partial cutout of the actual knife handle, rather than a separate liner inside the handle to hold the blade in place. To close you simply move the frame out of the way and rotate the blade into the closed position.

Handguard: Protrusion/expansion on the knife's handle proximal to the blade keeping the hand safely positioned on the handle inhibiting sliding forward.

Lanyard Hole: A small hole in a knife's handle for threading through a cord/string as a backup attachment when using the knife around water or where it may be dropped and lost.

Liner Lock: The liner lock's locking side liner is split from the top toward the bottom, similar to an automotive leaf spring (also called a lock bar) that when the blade is fully open will butt up against the tang of the blade to prevent the blade from closing. To release the lock, the user presses the lock bar back toward the handle side, at which time the blade is free to close. In the closed position the lock bar (leaf spring) rests alongside the handle and the blade.

Lockback: Also known as a spine lock, the lockback includes a pivoted latch affixed to a spring, and can be disengaged only by pressing the latch down to release the blade.

MOLLE: Modular Lightweight Load-carrying Equipment is the current system of loadbearing equipment based in the Pouch Attachment Ladder System (PALS) used by military and law enforcement. It consists of a grid of nylon webbing allowing the modular attachment of pouches and other equipment to achieve customized and mission-specific configurations.

Pommel: The knob or expansion found on the butt-end of a knife handle.

Quillion: A handguard protruding from both sides of the handle (where handle and blade meet) stopping the hand from slipping up onto the blade.

Ricasso: Unsharpened and thicker portion of the blade, just before the handle. Allows users to choke up on the blade for better control.

Scale: A knife handle made of scales or slabs of material that are riveted, screwed or bonded together.

Skeletonized Liners: Internal steel handle liners that are hollowed out (skeletonized). In removing sections of the steel, bulk and weight are reduced while allowing the liner to maintain its strength and rigidity.

Slip Joint: Non Locking Blade-a blade having a spring acting against it, which provides some resistance to its opening and closing as it pivots within the handle.

Spine Jimping: Small serrations, notching or texturing located on the spine of a blade where the hand or finger grips. Jimping creates tactile resistance, adds purchase, traction and slip resistance.

Swedge: Blade grind where a portion of the blade's spine is removed to reduce weight, add style to a blade or both.

Tang: The portion of the blade where it connects to the handle.

Tip-Up/Tip-Down: Refers to which direction the folded knife is positioned by its pocket clip. When closed and clipped in a pocket, whichever direction (up or down) the blade's tip sits defines if it is termed tip-up or tip-down.

