

# Weller®

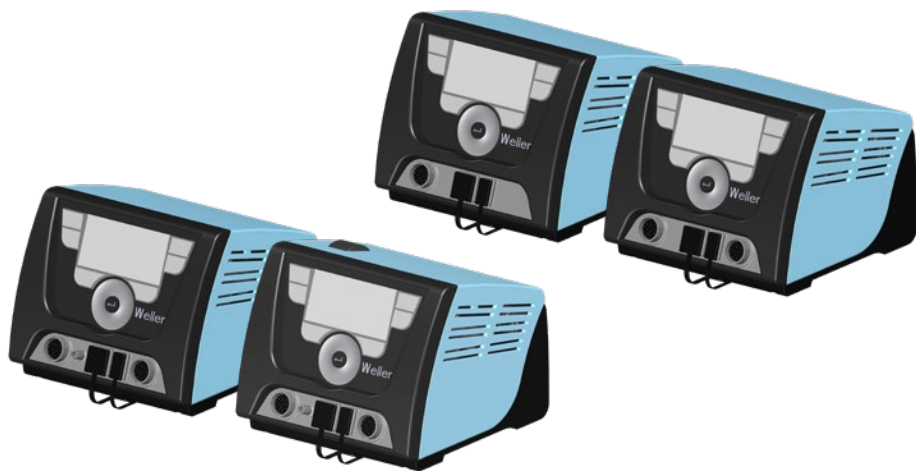

**WX 1**

**WX2**

**WXD 2**

**WXA 2**

**GB** Translation of the original instructions

**1**

**WX1 WX2 WXD 2 WXA 2**

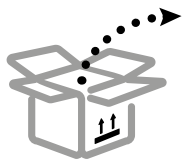

**WXD2**

5 87 657 76

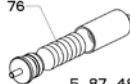

5 87 488 52

**2**



> 50 mm

3

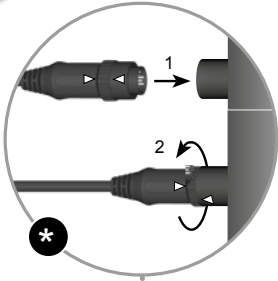

230 V / 110-120V

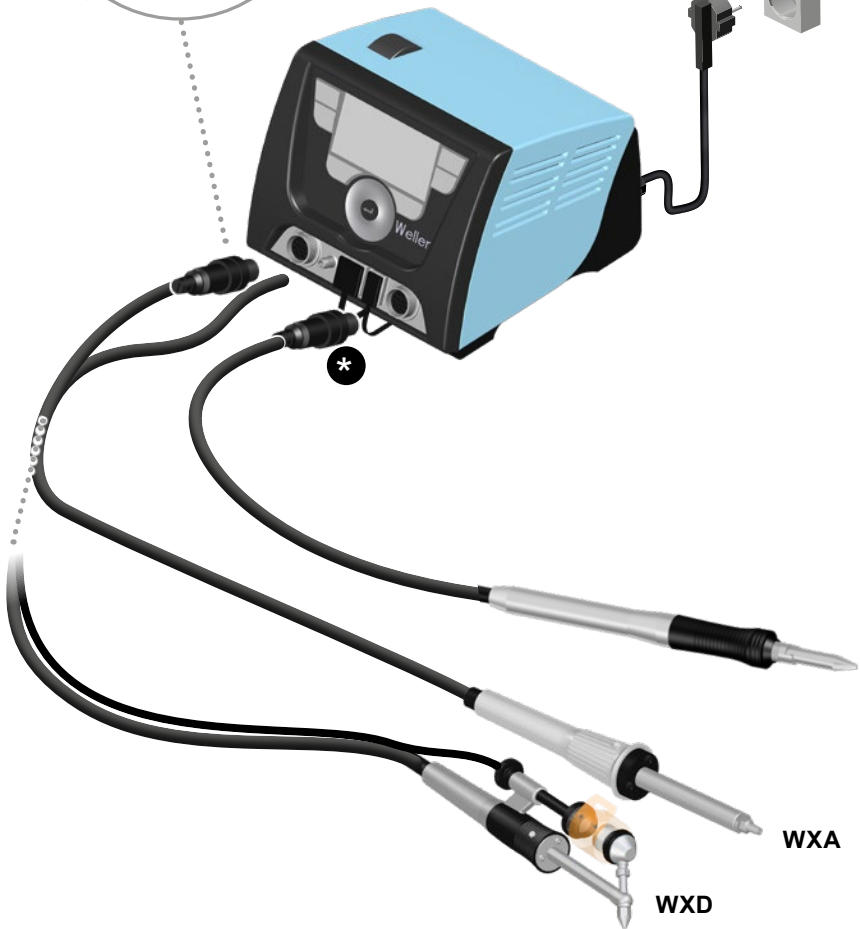

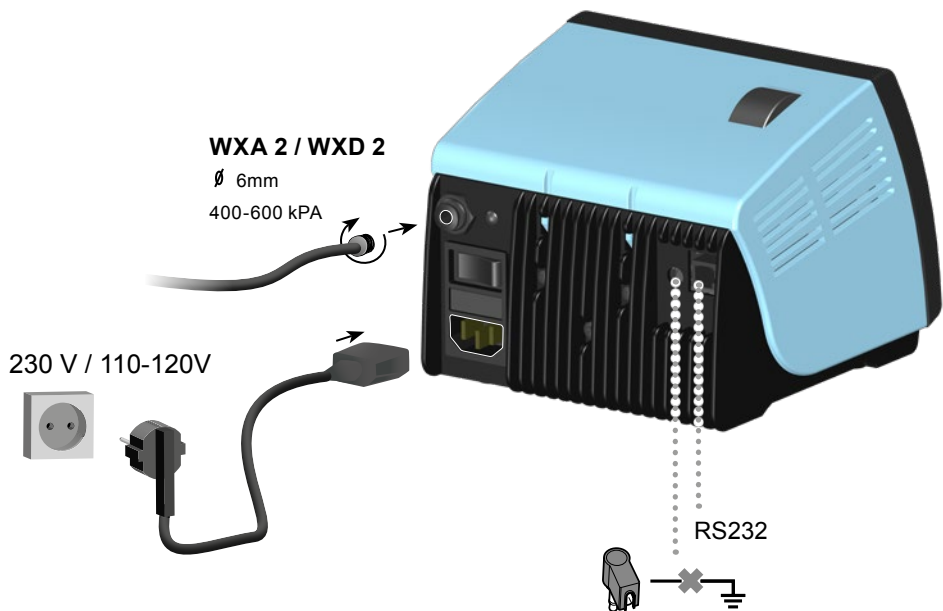
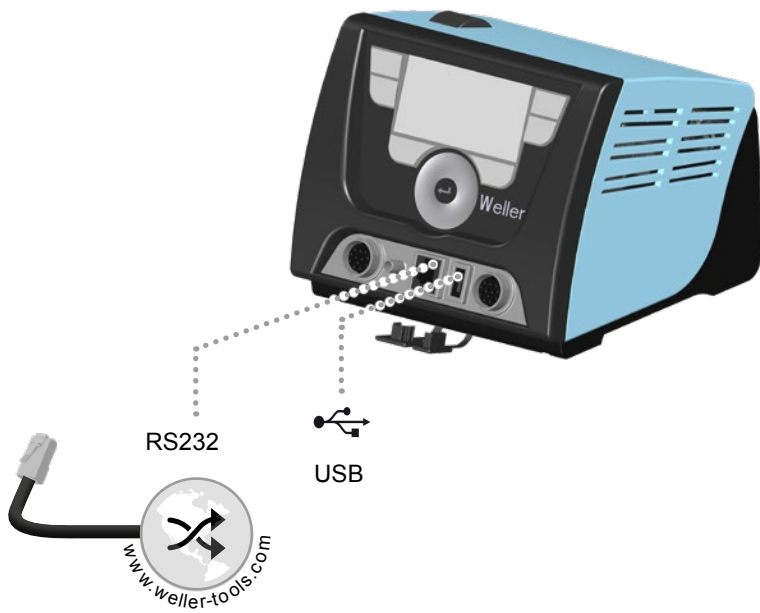

4

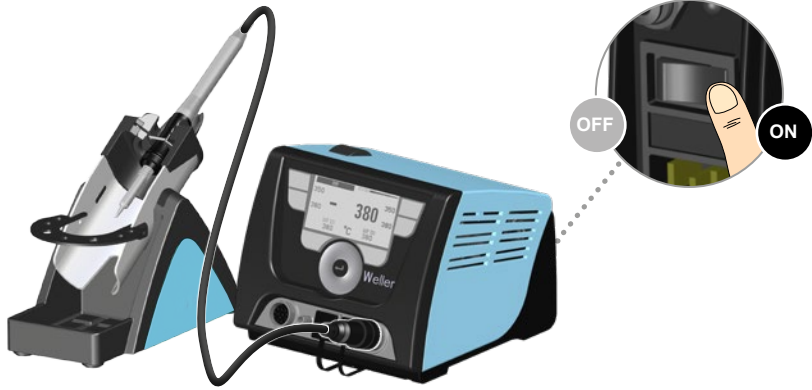

5

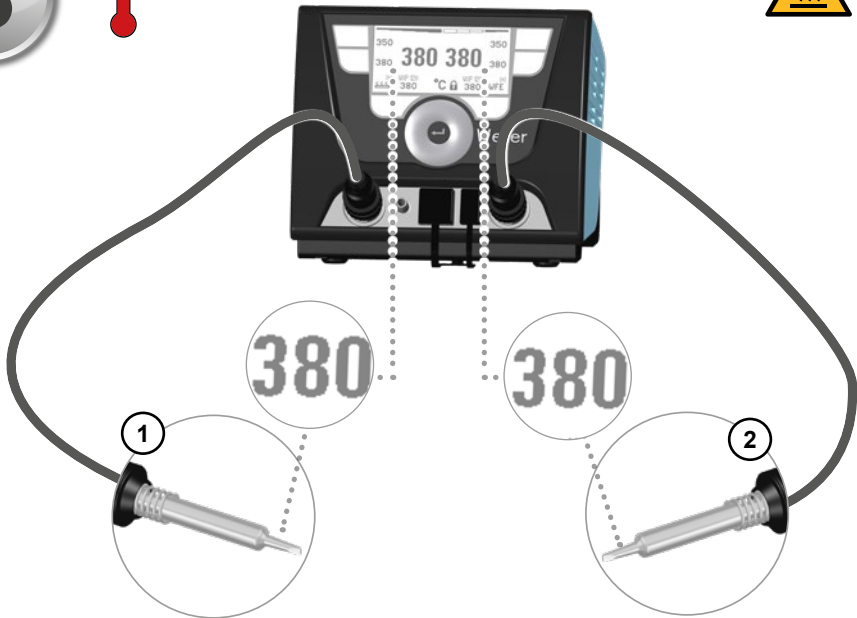

# 6

## WXA 2

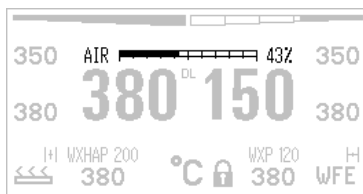

**10-100%**  
100% ≈ 20 l/min (6 bar)

### Typical airflow

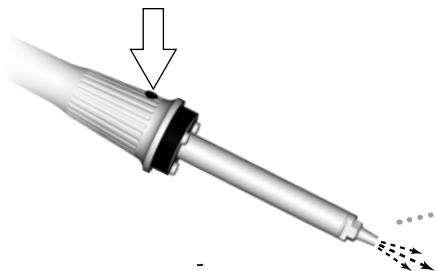
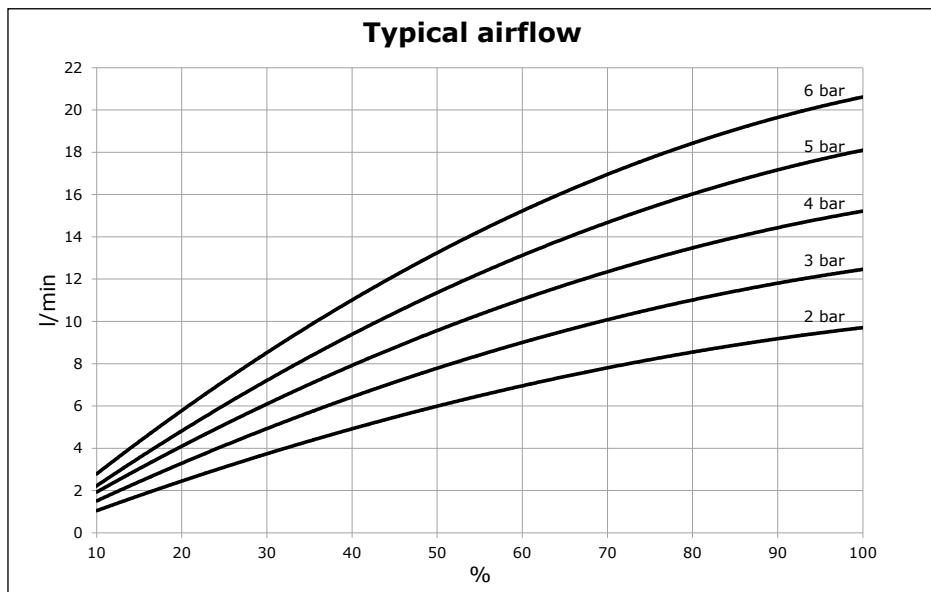

# 7

ON ↔ OFF

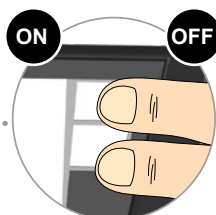
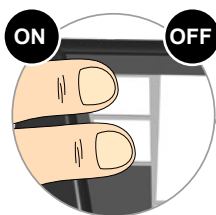

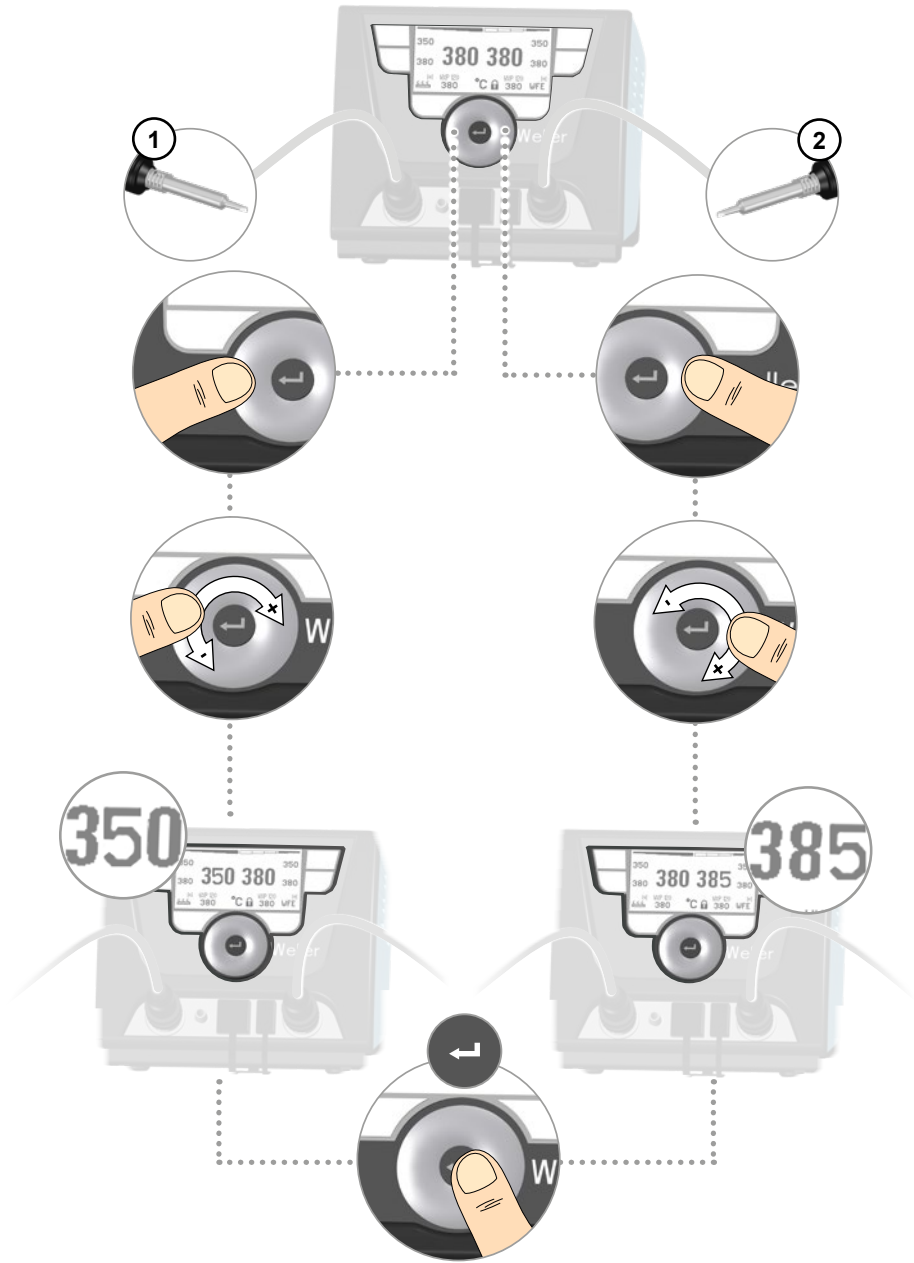



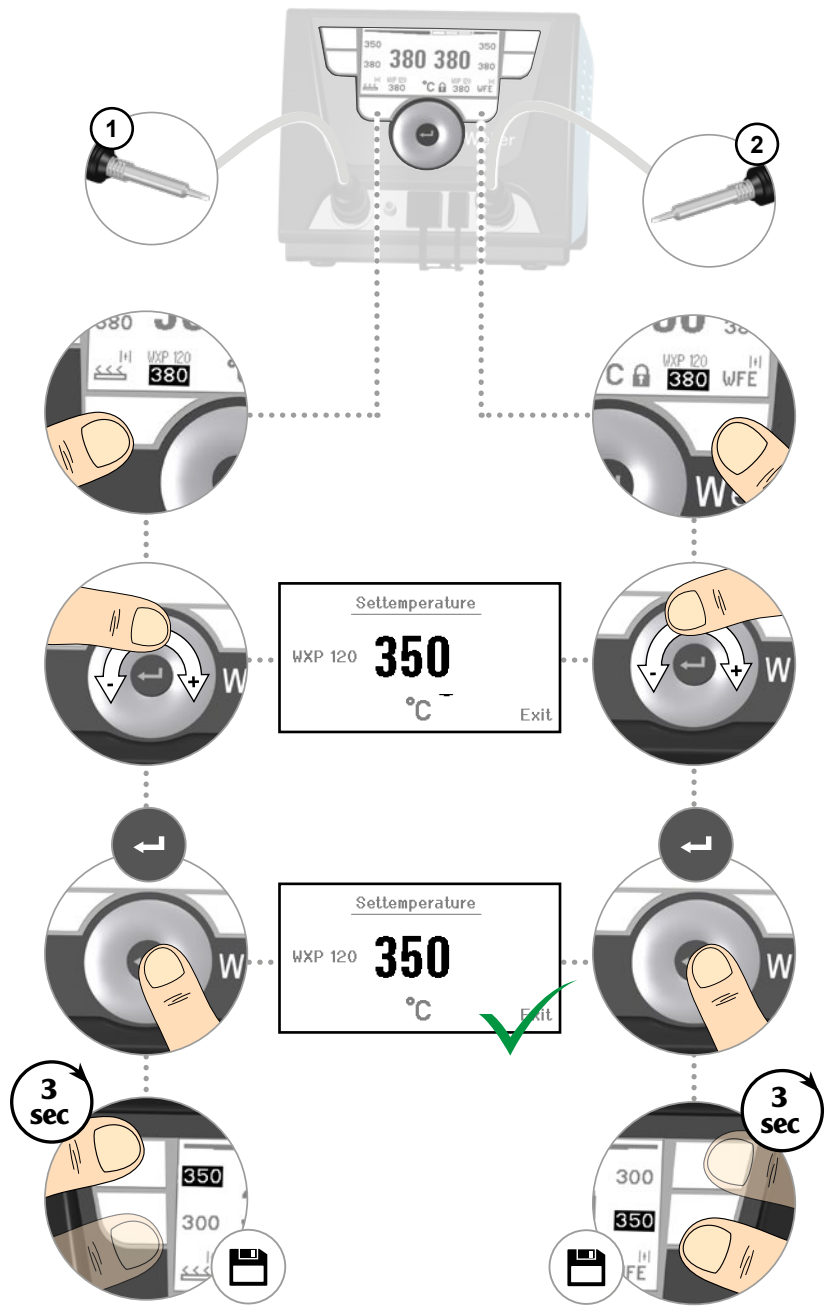

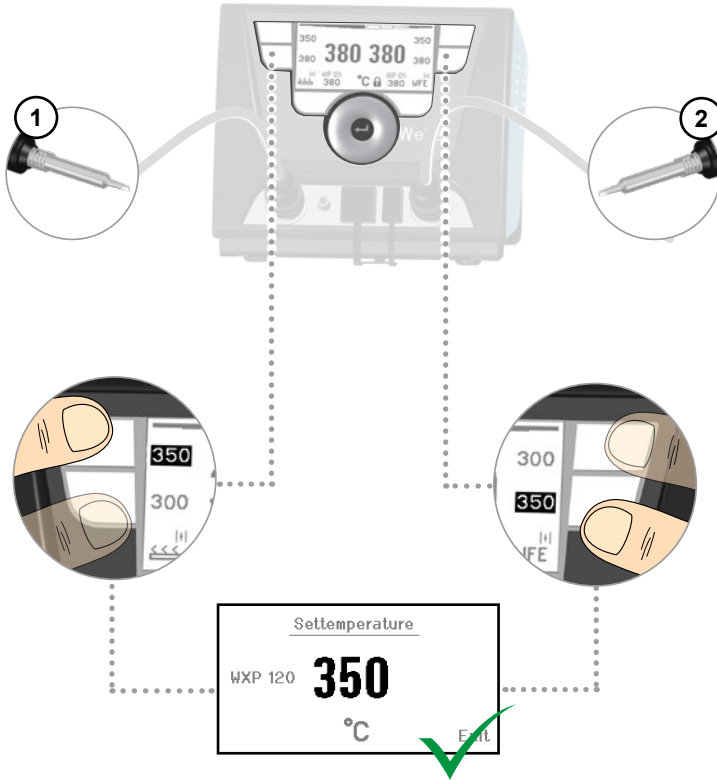

8

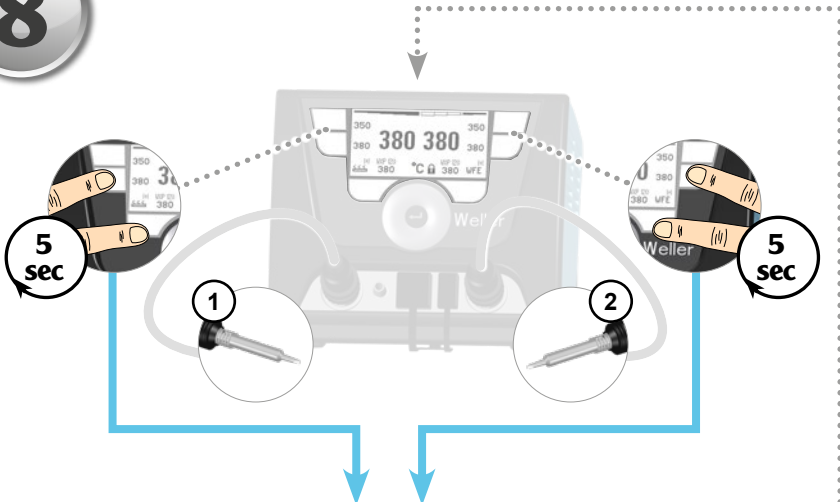

Parameters		WXP 120
Standby Temp.	150 °C	
Standby Time	010 min	
Auto-Off Time	020 min	
Sensitivity	normal	
On Time	010 sec	
Switch Mode	Off	
Offset	000 °C	
Perform. Mode	standard	
Temp. Window	020 °C	

Station Parameters	
Language	ENG
Unit	°C
Password	***
Button Sound	On
LCD-Contrast	032
LCD-Brightness	070 %
Screen saver	Off
Pot. free output	Off
Vacuum on-delay	000 sec
Vacuum off-delay	000 sec
□□□□□ Exit	

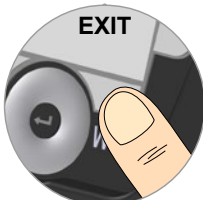
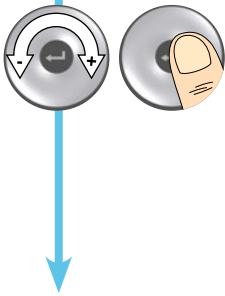

**Standby Temp.**  
Standby Time  
Auto-Off Time  
Sensitivity  
100 - 450 °C  
200 - 850 °F

EN Standby Temperature

**Standby Temp.**  
Standby Time  
Auto-Off Time  
Sensitivity  
1 - 999 min

EN Standby Time

**Standby Temp.**  
Standby Time  
Auto-Off Time  
Sensitivity  
1-999 min

EN OFF time

**Standby Temp.**  
Standby Time  
Auto-Off Time  
Sensitivity  
low  
normal  
high

EN Sensitivity

### WXHAP

**Standby Temp.**  
Standby Time  
Auto-Off Time  
On Time  
1-60 s

EN Max. hot air duration

**Offset**  
Perform. Mode  
Temp. Window  
-40 - 40 °C  
-72 - 72 °F

EN Offset

**Offset**  
Perform. Mode  
Temp. Window  
standard  
soft  
aggressive

EN Perform. Mode

**WXHAP**  
Offset  
Switch Mode  
Temp. Window  
ON / OFF

EN Button lock

**Offset**  
Perform. Mode  
Temp. Window  
100 - 450 °C  
200 - 850 °F

EN Process window

**Language**  
Unit  
Password  
Button Sound

EN Language

**Language**  
Unit  
Password  
Button Sound  
C/°F

EN Temperature units

**Language**  
Unit  
Password  
Button Sound  
1-999

EN Lock function

**Language**  
Unit  
Password  
Button Sound  
ON / OFF

EN Touchtones on/off

**LCD-Contrast**  
LCD-Brightness  
Screen saver  
Pot. free output  
10 - 60

EN LCD-Contrast

LCD-Contrast  
LCD-Brightness  
Screen saver  
Pot. free output

EN LCD background brightness

10 - 100 %

LCD-Contrast  
LCD-Brightness  
Screen saver  
Pot. free output

EN Robot output

100 - 450 °C  
200 - 850 °F

## WXD 2

Vacuum on-delay  
Vacuum off-delay

EN Vacuum run-on

0 - 10 s

LCD-Contrast  
LCD-Brightness  
Screen saver  
Pot. free output

EN Screen saver

ON / OFF

## WXD 2

Vacuum on-delay  
Vacuum off-delay

EN Vacuum pre-feed

0 - 10 s



Read these instructions and the safety guidelines carefully before starting up the unit and starting work.

Failure to observe the safety regulations results in a risk to life and limb.

Keep these instructions in a place that is accessible to all users. Please adhere to the operating instructions of the connected devices.

### Safety information

For safety reasons, children and youths under the age of 16, as well as persons who are not familiar with these operating instructions, may not use the device. Children should be supervised in order to ensure that they do not play with the tool.

This appliance can be used by children aged from 8 years and above and persons with reduced physical, sensory or mental capabilities or lack of experience and knowledge if they have been given supervision or instruction concerning use of the appliance in a safe way and understand the hazards involved. Children shall not play with the appliance.

Cleaning and user maintenance shall not be made by children without supervision.

**Keep other persons well away from your workplace.**

The work area is out of bounds for children and unauthorised persons. Never allow other persons to touch the soldering tool or cable.

#### **⚠ WARNING** Electrical shock

**Connecting the control unit incorrectly poses a risk of injury due to electric shock and can damage the device.**

- Carefully read the attached safety information, the safety information accompanying these operating instructions as well as the operating instructions for your control unit before putting the control unit into operation and observe the safety precautions specified therein.
- Only connect WELLER tools.

**If the device is faulty, active electrical conductors may be bare or the PE conductor may not be functional.**

- Repairs must always be referred to a Weller-trained specialist.
- If the electrical tool's power supply cord is damaged, this must be replaced with a specially prefabricated power supply cord available through the customer service organisation.

**Protect yourself against electric shocks.** The handles on soldering tools with an antistatic design are conductive.

- Avoid touching earthed objects such as pipes, heaters, cookers and refrigerators.
- Do not use the soldering tool in a damp or wet environment.
- Never work on voltage-carrying parts.

#### **⚠ WARNING** Risk of burns

**Risk of burns from the soldering tool while the control unit is operating. Tools may still be hot long after they have been switched off.**

- Always place the soldering tool in the safety rest while not in use. Make sure the safety holder is stable.
- Only connect the vacuum and hot air at the designated points.
- Do not direct hot air soldering tools at people or inflammable objects.
- Only replace solder tips when cold

**Risk of burning through liquid solder. Protect yourself against solder splashes.**

- Wear appropriate protective clothing to protect yourself against burns. Protect your eyes by wearing eye protectors.
- When working with adhesives, special attention must be paid to the warning information provided by the adhesive manufacturer.

**Store your soldering tool in a safe place.** When not in use, units and tools should be stored in a dry, high or locked area out of the reach of children. Make sure that unused soldering tools are free of voltage and de-pressurised.

**▲ WARNING** Fire hazard

**Covering the soldering iron or the safety holder poses a fire hazard. Always keep objects well away from the soldering iron and safety holder.**

- Always keep objects well away from the soldering iron and safety holder.
- Keep all combustible objects, liquids or gases well away from the hot soldering tool.

**The mains cable must only be plugged into the mains socket or adapter approved for this purpose.** Check to see if the mains voltage matches the ratings on the nameplate. Make sure the machine is switched off before plugging in.

**Do not use the cable for purposes other than those for which it is intended.** Never carry the unit by the cable. Do not use the cable to pull the plug out of the socket. Protect the cable against heat, oil and sharp edges..

**Be alert.** Pay attention to what you are doing. Be smart when using the unit. Do not use the soldering tool if you are having difficulty concentrating.

**Avoid abnormal posture.** Arrange your work station in an ergonomically correct way. Avoid bad posture when using the unit, as this can lead to postural problems.

**The soldering tool must be operated only in perfect technical working order.** Safety devices must not be deactivated.

**Faults and defects must be repaired immediately.**

Before using the unit / tool, safety devices must be carefully checked to make sure that they are functioning properly and in the manner intended. Check that moving parts are functioning properly and are not sticking, and whether parts are damaged. All parts must be correctly fitted and must satisfy all the requirements necessary to guarantee troublefree operation of the unit.

**Use the correct tool.** Use only accessories or auxiliary devices which are included in the list of accessories or approved for use by the manufacturer. Use WELLER accessories or auxiliary devices on original WELLER equipment only. The use of other tools and other accessories can cause injury.

**Secure the tool.** Use clamping fixtures to hold the workpiece.

**Use a solder fume extraction unit.** If appliances for connecting solder fume extraction units are available, ensure that they are connected and used properly.

**Specified Conditions Of Use**

Supply unit for WELLER WX soldering tools. Use the soldering station / desoldering station / hot air station exclusively for the purpose indicated in the operating instructions of soldering and desoldering under the conditions specified herein.

**▲ WARNING**

Flammable gases and liquids may not be extracted. The device may only be used with correctly fitted and suitable filter cartridges. Replace filter cartridges when full.

This device may only be used at room temperature and indoors. Protect against moisture and direct sunlight.

We hereby declare that the products described herein comply with the following guidelines:  
2014/30/EU, 2006/95/EG, 2011/65/EU (RoHS)

**User groups**

Due to differing degrees of risk and potential hazards, several work steps may only be performed by trained experts.

Work step	User groups
Default soldering parameters	Specialist personnel with technical training
Replacing electrical replacement parts	Electricians
Default maintenance intervals	Safety expert
Operation Filter change	Non-specialists
Operation Filter change Replacing electrical replacement parts	Technical trainees under the guidance and supervision of a trained expert

**Care and maintenance**

**▲ WARNING**



**Before doing any work on the machine, pull the plug out of the socket. Leave the unit to cool down.**

Clean the operator panel, if dirty, using a suitable cleaning cloth.

Seal ports which are not in use with covering caps.

Check all connected cables and hoses on a regular basis. If power tools are damaged, they must be immediately removed from use.

**▲ WARNING**

**Risk of burns**

- Only replace solder tips when cold
- Replace and clean suction nozzles only when hot and using the suitable tool
- Only replace hot air nozzles using the suitable tool
- Only clean or replace solder collection tubes when cold

**Filter change**

Regularly check the main filter for vacuum, and replace it if necessary.

Contaminated filters must be treated as special waste. Dispose of replaced equipment parts, filters or old devices in accordance with the rules and regulations applicable in your country. Wear suitable protective gear.

### Warning!

Working without a filter can result in irreparable damage to the vacuum unit.

- Check before starting soldering whether a main filter is inserted.

Repairs must always be referred to a Weller-trained specialist.



Use original replacement parts only.

## Symbols



Caution!



**Warning! Risk of burns!**



Read the operating instructions!



Before performing work of any kind on the unit, always disconnect the power plug from the socket.



ESD-compatible design and ESD-compatible workstation



Equipotential bonding



Soldering



Desoldering



Hot air



CE mark of conformity



Fuse



Safety transformer



### Disposal

Do not dispose of electric tools together with household waste material! In observance of European Directive 2012/19/EU on waste electrical and electronic equipment and its implementation in accordance with national law, electric tools that have reached the end of their life must be collected separately and returned to an environmentally compatible recycling facility.



## Technical Data

	soldering station WX 1	soldering station WX 2	desoldering station WXD 2	Hot air station WXA 2
Dimensions L x W x H	170 x 151 x 130 mm 6,69 x 5,94 x 5,12 inch			
Weight	ca. 3,2 kg	ca. 3,2 kg	ca. 3,8 kg	ca. 3,8 kg
Mains supply voltage	230 V, 50 Hz / 120 V, 60 Hz / 100 V 50/60 Hz			
Power consumption	200 W	200 W (255 W)	200 W (255 W)	200 W (255 W)
Safety class	I, antistatic housing III, Soldering tool			
Fuse	T2 A (230 V) T4 A (120 V)			
Temperature range Tool dependent	100 - 450°C (550°F) 200 - 850°F (999°F)			
Temperature accuracy	± 9 °C / ± 17 °F			
Temperature stability	± 2 °C / ± 4 °F			
Air consumption	-	-	35 l / min, max vacuum 55 kPa (8 psi)	-
Compressed air connection	-	-	Compressed air hose outer diameter 6 mm (0,24")	Compressed air hose outer diameter 6 mm (0,24")
Compressed air	-	-	Inlet pressure 400 - 600 kPa (58-87 psi); oil-free, dry compressed air	Inlet pressure 400 - 600 kPa (58-87 psi) oil free, dry compressed air or nitrogen (N2) *
Air flow:	-	-	-	approx. 0-18 l / min at 6 bar

\* WXA 2: Nitrogen N2 reduces oxidation and flux remains active for longer. We recommend the nitrogen N2 that is available in steel bottles. The bottle must be equipped with a 0-10 bar pressure reducer.

**Subject to technical alterations and amendments.**

# Weller®

**WX**  
compatible



Translation of the original instructions

.....  
**WXPP**  
**WXPP MS**  
**WXMP**  
**WXMP MS**  
**WXUP MS**  
**WXMT**  
**WXMT MS**  
.....

1

# Firmware Update

WXPP  
WXPP MS  
WXUP MS

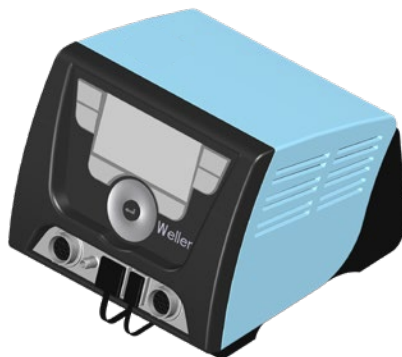

2

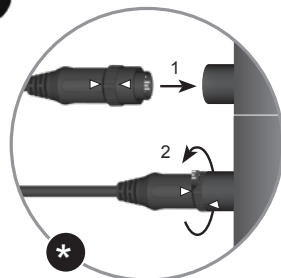

3

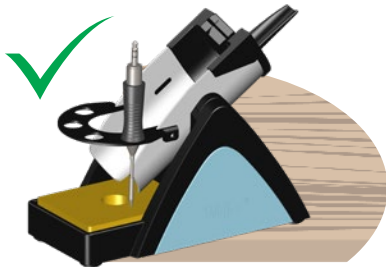
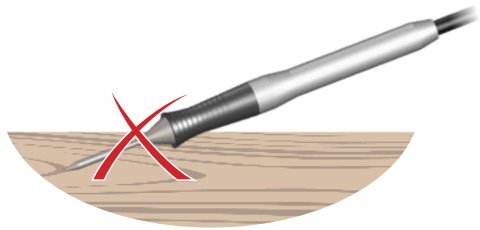

# WXMP

# WXMP MS

# WXPP

# WXPP MS

# WXUP MS



**WXMP / WXMP MS**



**& Set**

+ **WSR 200** T0051517499N



**WXPP / WXPP MS**



+ **WSR 208** T0051518299



**WXUP MS**



+ **WSR 205** T0051517999

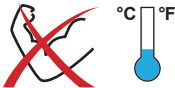

**WXMP  
WXMP MS**



**WXPP  
WXPP MS**



**WXUP MS**



# WXMT (MS)



**WXMT / WXMT MS**



 **RTW**  
**RTW ...MS**

**& Set**

+ **WSR 204**T0051517899

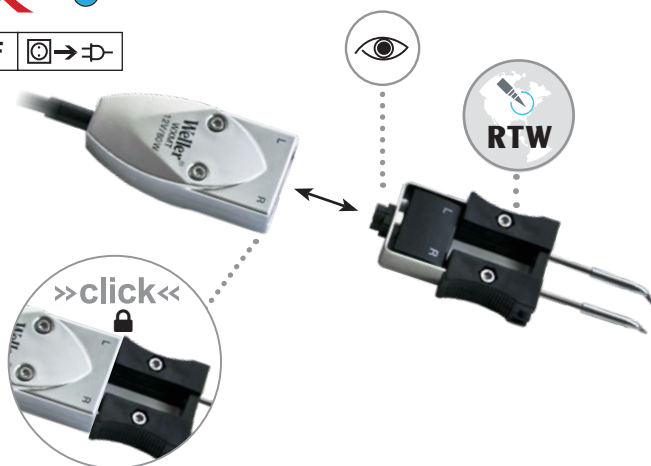



Read these instructions and the accompanying safety information carefully before starting up the device and starting work with the device.

Failure to observe the safety regulations results in a risk to life and limb.

Keep these instructions in a place that is accessible to all users. Please adhere to the operating instructions of the connected devices.

Please be sure to read and follow the operating instructions for your Weller Supply Unit.

## Safety information

For safety reasons, children and youths under the age of 16, as well as persons who are not familiar with these operating instructions, may not use the device. Children should be supervised in order to ensure that they do not play with the tool.

This device is not intended for use by persons (including children) with limited physical, sensory or mental aptitude, or by persons who lack knowledge or experience in handling the device.

Always place the soldering tool in the safety rest while not in use.

Keep other persons well away from your workplace.

The work area is out of bounds for children and unauthorised persons. Never allow other persons to touch the soldering tool or cable.



Use only original Weller soldering tips!

### **▲ WARNING** Electrical shock

**Protect yourself against electric shocks.** The handles on soldering tools with an antistatic design are conductive.

- Avoid touching earthed objects such as pipes, heaters, cookers and refrigerators.
- Do not use the soldering tool in a damp or wet environment.
- Never work on voltage-carrying parts.

### **▲ WARNING** Risk of burns

**The soldering tip becomes very hot during soldering work. There is a risk of burns from touching the tips. After the soldering process, the soldering tool and the workpiece holder are still hot.**

- Always place the soldering tool in the safety rest while not in use. Make sure the safety holder is stable.
  - Do not touch the hot soldering tips and keep them away from inflammable objects..
  - Only replace solder tips when cold
  - Only replace nozzles when cold
- Risk of burning through liquid solder. Protect yourself against solder splashes.**
- Wear appropriate protective clothing to protect yourself against burns. Protect your eyes by wearing eye protection.
  - When working with adhesives, special attention must be paid to the warning information provided by the adhesive manufacturer.
  - Only connect the vacuum and hot air at the designated points.

### **▲ WARNING** Fire hazard

**Covering the soldering iron or the safety holder poses a fire hazard. Always keep objects well away from the soldering iron and safety holder.**

- Always keep objects well away from the soldering iron and safety holder.
- Keep all combustible objects, liquids or gases well away from the hot soldering tool.
- Do not place or leave the hot soldering or desoldering tip on the worktop or on plastic surfaces.
- Avoid unintentional operation. Disconnect the soldering tool from the power supply while not in use.
- Keep explosive and flammable objects well away from the device.

**Store your soldering tool in a safe place.** When not in use, units and tools should be stored in a dry, high or locked area out of the reach of children. Make sure that unused soldering tools are free of voltage and de-pressurised.

**Do not use the cable for purposes other than those for which it is intended.** Never carry the unit by the cable. Do not use the cable to pull the plug out of the socket. Protect the cable against heat, oil and sharp edges.

**Be alert.** Pay attention to what you are doing. Be smart when using the unit. Do not use the soldering tool if you are having difficulty concentrating.

**Avoid abnormal posture.** Arrange your work station in an ergonomically correct way. Avoid bad posture when using the unit, as this can lead to postural problems.

**The soldering tool must be operated only in perfect technical working order.** Safety devices must not be deactivated.

**Faults and defects must be repaired immediately.**

Before using the unit / tool, safety devices must be carefully checked to make sure that they are functioning properly and in the manner intended. Check that moving parts are functioning properly and are not sticking, and whether parts are damaged. All parts must be correctly fitted and must satisfy all the requirements necessary to guarantee troublefree operation of the unit.

**Use the correct tool.** Use only accessories or auxiliary devices which are included in the list of accessories or approved for use by the manufacturer. Use WELLER accessories or auxiliary devices on original WELLER equipment only. The use of other tools and other accessories can cause injury.

**Secure the tool.** Use clamping fixtures to hold the workpiece.

**Use a solder fume extraction unit.** If appliances for connecting solder fume extraction units are available, ensure that they are connected and used properly.

**Specified Conditions Of Use**

Use the soldering iron exclusively for the purpose indicated in the Operating Instructions of soldering and desoldering under the conditions specified here.

The soldering iron may only be used in combination with Weller Supply Units.

This device may only be used at room temperature and indoors. Protect against moisture and direct sunlight.

**User groups**

Due to differing degrees of risk and potential hazards, several work steps may only be performed by trained experts.

Work step	User groups
Default soldering parameters	Specialist personnel with technical training
Replacing electrical replacement parts	Electricians
Default maintenance intervals	Safety expert
Operation Filter change	Non-specialists
Operation Filter change Replacing electrical replacement parts	Technical trainees under the guidance and supervision of a trained expert

**Care and maintenance**

Check all connected cables and hoses on a regular basis. If power tools are damaged, they must be immediately removed from use.

Do not use blocked nozzles.



**Repairs must always be referred to a Weller-trained specialist.**

Use original replacement parts only.

**▲ WARNING Risk of burns**

- Only replace the soldering tips when they are cold.

The soldering tool must be left switched off in the safety rest for at least 3 minutes until the soldering tip has cooled down. The LED status indicator must be at „OFF“.

**Temperature performance**

The soldering tool has an internal usage sensor which can be used to set an automatic switch-off function (Stand-by). The settings can be found in the station's operating instructions.



**Before doing any work on the machine, pull the plug out of the socket. Leave the unit to cool down.**



**Symbols**



Caution!



Warning! Risk of burns



Read the operating instructions!



ESD-compatible design and ESD-compatible workstation



CE mark of conformity



British Conformity Mark



**Disposal**

Do not dispose of electric tools together with household waste material! In observance of European Directive 2012/19/EU on waste electrical and electronic equipment and its implementation in accordance with national law, electric tools that have reached the end of their life must be collected separately and returned to an environmentally compatible recycling facility.



**Disposal - UK**

Do not dispose of electric tools together with household waste material! In observance of British Directive 2013 No. 3113 on waste electrical and electronic equipment and its implementation in accordance with national law, electric tools that have reached the end of their life must be collected separately and returned to an environmentally compatible recycling facility.

**Technical Data**

Soldering iron	Micro		Pico		Ultra
	WXMP	WXMP MS	WXPP	WXPP MS	WXUP MS
Temperature range °C	100 - 450	100 - 450	100 - 450	100 - 450	100 - 450
Temperature range °F	200 - 850	200 - 850	200 - 850	200 - 850	200 - 850
Power consumption	40 W (55 W)	40 W (55 W)	40 W	40 W	150 W
Mains supply voltage	12 V / AC	12 V / AC	12 V / AC	12 V / AC	24 V / AC
Heat-up time (50°C to 350°C) (120°F to 660°F)	5 s	5 s	3 s	3 s	7 s
Tip type series	RT RTM	RT MS RTM MS	RTP	RTP MS	RTU MS
Supply unit	WX / WXD / WXA / WXR				

Desoldering tweezers / Desoldering iron	WXMT WXMT (MS)
Temperature range °C	100 - 450
Temperature range °F	200 - 850
Power consumption	80 W (2x40 W)
Mains supply voltage	12 V / AC
Heat-up time (50°C to 350°C) (120°F to 660°F)	5 s
Tip type series	RTW / RTW (MS)
Supply unit	WX / WXD / WXA / WXR

Subject to technical alterations and amendments.