



Research, trends and Tork solutions for the Acute Care segment



What is acute care?

Acute care is a branch of healthcare that provides short-term medical treatment for patients with severe injuries or urgent health conditions. These facilities experience high daily traffic and often employ specialized departments to care for the volume and breadth of patient needs. Depending on treatment required, a patient’s typical length of stay ranges from a few hours to a week.

Acute Care

Unlike chronic care, this is short-term medical treatment for patients who are experiencing a severe episode of illness, or recovering from surgery.

Services Offered	Typical Stay	Patients Per Employee*
Specialized Emergency room, surgery, intensive care, recovery	ER: 2.3 hours Admitted: 4.5 days	146

Why does the acute care segment matter to us?

Healthcare is the fastest growing industry in America, with overall traffic reaching as much as 570 million people per year.¹ Acute care facilities, such as hospitals, play a vital role in healing patients and releasing them from care during life-threatening medical episodes. As the healthcare segment continues to evolve, the need to provide clean, efficient and affordable healthcare becomes even more essential.

5.7M
Employees

293M
Patients per year

271M
Visitors per year

6.3B
Hand washes

1.3B
Washroom visits

90M
Brand impressions*

* A brand impression is an event where the consumer comes in contact with away-from-home tissue products.

¹US Census Bureau

Acute care decision-makers

The acute care segment features several departments that heavily influence one another, so forming a strong bond with one group can often lead to a relationship with others.

Environmental services director/manager (EVS)

This person is responsible for the cleanliness and appearance of the facility's interior. They oversee waste removal and manage the housekeeping staff to ensure patients and visitors have a comfortable and clean experience. Most purchasing decisions for cleaning products go through this person.

Inside tip: While every facility is different, the EVS manager is typically the first call for any sales effort.

Infection control supervisor

This individual's responsibility is to identify sources of infection, prevent/control outbreaks and report any infections internally and to state agencies. They also monitor for and encourage staff hand washing and sanitizing compliance. Hygiene-related product purchases are approved by this role.

Inside tip: A highly influential role, this person works closely with the EVS manager to maximize environment hygiene and improve patient outcomes. Their buy-in on new products is crucial.

Purchasing/materials manager

This person controls costs and manages the hospital's spending. They order and maintain the flow of supplies, oversee GPO relationships and negotiate final price for new products. For some facilities, they are the mandatory entry point for all vendor relationships since they have a pulse on the hospital's constantly evolving supply needs.

Inside tip: This person is always looking for ways to reduce spending without sacrificing functional or hygienic benefits.

Foodservice director (or dietary/nutrition director)

This person is responsible for all aspects of hospital-provided food services, from individual patient meal plans and menus to cafeteria dining. They are key decision-makers for all foodservice-related purchases from center of the plate to napkins and kitchen supplies. Depending on the size of the hospital, this individual typically manages a staff that includes many roles: nutritionists, cooks, cafeteria attendants and meal delivery employees.

Inside tip: The foodservice department can fall outside of the GPO buying contract and therefore may be a good point of entry to a facility. Sell napkins, Xpressnap and foodservice wipers to this target.

The influencers

These individuals are not directly involved in purchasing decisions, but can impact which products are ultimately selected.

Physicians

Decision-makers rely heavily on physicians' personal preferences for products. They have great trust in this group, often looking to them for recommendations to influence product decisions.

Nursing

Since the nursing staff frequently uses hand hygiene products, new cleaning/sanitizing solutions are shared for their consideration. Skin irritation is a primary concern, so products must be vetted to ensure softness and strength.

Housekeeping/ Environmental Services Department (EVS)

The EVS department will often test new products with their housekeeping staff for evaluation before any changes are made. Housekeeping endorsements and recommendations are frequently taken into consideration in approval committees.

Recent facility trends

The acute care segment continues to evolve as new government regulations are implemented for hospitals and staff. Two key trends are shaping the way hospitals qualify to receive Medicare reimbursements.

Patient satisfaction

High patient satisfaction scores have become increasingly important to hospital bottom lines. As survey data is made available online, hospitals are implementing new processes and considering different products to improve patient experience and ensure maximum reimbursements.

- The HCAHPS® Survey was created to provide a standardized methodology for collecting and publicly reporting information about patient care experience
- Allows valid comparisons to be made across hospitals
- Survey questions focus on critical aspects of a patient's hospital experience including: cleanliness and quietness, staff responsiveness and communication, overall ratings
- Encourages accountability by increasing transparency of quality of care provided

Healthcare Associated Infections (HAIs)

Healthcare Associated Infections (HAIs) are infections that patients acquire while receiving healthcare treatment for other conditions. The Centers for Disease Control (CDC) now tracks HAIs to show how often hospital patients contract infection in the course of their treatment

- Annual direct medical costs of HAIs to hospitals ranges from B
- US hospitals experience 1.7M HAIs per year, resulting in almost 100,000 deaths and nearly B in lost revenue
- Patients who acquire infections from surgery typically spend an additional 6.5 days in care for which the facility is not reimbursed
- More and more states are mandating public HAI reporting



How Tork delivers better business

Tork systems offering quieter dispensing, enhanced image and touch-free, seamless dispensers designed to reduce the spread of infection can help hospitals achieve greater satisfaction scores.

Considerations and sales tips

- Acute care facilities have many specialized needs, so recommend solutions appropriate for specific areas (e.g., choose a quiet dispenser for neonatal ward or patient rooms, a dispenser with no sharp edges for psychiatric) rather than a one-solution-fits-all approach.
- Acute care facilities often have a range of old and new buildings. Look for opportunities to capitalize on outdated dispensing systems and planned renovations.
- Most facilities actively promote good hand hygiene—suggest using AD-a-Glance to communicate hand hygiene messaging in cafeterias and break rooms.
- Paper products in open systems typically have to be discarded upon patient turnover, so recognize that waste will be higher in patient rooms and critical care areas, where lower capacity systems may be a more cost effective option.
- With frequent hand washing, rough paper towels can cause microscopic tears in the skin that are uncomfortable and can spread infection. A higher quality, softer product can help reduce skin irritation.
- Hygiene is the key concern—closed and touch-free soap systems help promote better hand hygiene. 25% of open, refillable soap dispensers tested in public washrooms were contaminated with bacteria, while sealed systems are designed to block out bacteria and eliminate contamination.

Recommended Tork products

All areas



302020 Tork Xpress® Countertop Interfold/Multifold Hand Towel Dispenser



420554, 420558 Tork Advanced Soft Multifold Hand Towel 4-panel
Tork Advanced Soft Multifold Hand Towel 3-panel



571600 Tork Elevation Foam Soap Automatic Dispenser



TF6810 Tork Advanced Facial Tissue Flat Box

Public and administrative areas



5510202 Tork Elevation® Matic® Hand Towel Roll Dispenser



5511202 Tork Elevation Matic Hand Towel Roll Dispenser with Intuition® Sensor



290094, 290095, 290096 Tork Premium Extra Soft Matic Hand Towel Roll
Tork Advanced Soft Matic Hand Towel Roll
Tork Premium Soft Matic Hand Towel Roll



5555200 Tork Elevation Twin Mini Jumbo Bath Tissue Roll Dispenser



12024402 Tork Advanced Mini Jumbo Bath Tissue Roll



TC0020 Tork Universal Toilet Seat Cover



HB9201 Tork Perforated Roll Towel, Handi-Size Sheet



192191, 192192, 192193 Tork Antimicrobial Foodservice Cloth, 1/4 Fold
*Antimicrobial technology - inhibits the growth of odor-causing bacteria in the food service cloth, which keeps the cloth fresh longer. t



6234000, 6334000 Tork Xpressnap® Signature Tabletop Napkin Dispenser
Tork Xpressnap Signature Stand Napkin Dispenser

Patient care areas



552120 Tork Elevation Xpress Mini Hand Towel Dispenser



555620 Tork Elevation High Capacity Bath Tissue Roll Dispenser



110291A, 110292A Tork Advanced High-Capacity Bath Tissue Roll



654021 Tork Folded Wiper/Cloth Dispenser



510175A Tork Cleaning Cloth, Pop-Up Box



192136 Tork Heavy-Duty Paper Wiper, 1/4 Fold



430150A Tork Paper Wiper Plus, 1/4 Fold



Healthier hands, happier patients



Patient satisfaction and Hospital Acquired Infections (HAIs) are two key concerns affecting acute care facilities like yours. With results tied to reimbursements, and available for public review, hospitals are being held to higher standards. Tork products offering quieter dispensing and enhanced image help improve overall patient experience. Tork touch-free systems encourage proper hand hygiene to reduce the spread of infection—all helping acute care facilities achieve greater satisfaction to meet growing demands.

The high cost of HAIs

100K deaths
45B in lost revenue

Clean

Tork touch-free systems prevent the spread of infection, creating a healthier environment and reducing the chance of cross contamination.

Image

Our quieter operating dispensers support patient comfort and noise reduction (consistently one of the top complaints among patients¹). And attractive, streamlined product design adds a pleasing look.

Cost

Tork dispensing solutions help reduce consumption, waste and staff labor. Save money over time—up to 10% guaranteed².

Recommended Tork products

Public & administrative areas:

- Cafeteria
- Public restrooms
- Lobbies/waiting rooms

High touch areas in your facilities demand high quality and high care. Tork products present a streamlined image and ensure a safe, sanitary experience for everyone.

Patient care areas:

- Patient rooms
- Nurses stations
- Specialized floor/wing (i.e. mental health)

Making your patients comfortable and optimizing hand hygiene is critical to improving patient satisfaction ratings. Tork user-friendly systems and superior quality boost patient satisfaction.

Critical care areas:

- Isolation rooms
- Emergency rooms
- Operating rooms

One-at-a-time dispensing reduces cross-contamination in areas where good hand hygiene is crucial. Since product turnover can also be a concern here, Tork low-capacity dispensers are the perfect solution to minimize waste.

All areas



302020 Tork Xpress Countertop Interfold/Multifold Hand Towel Dispenser



571600 Tork Elevation Foam Skincare Automatic Dispenser



TF6810 Tork Advanced Facial Tissue Flat Box

Public and administrative areas

Patient & critical care areas



5510202 Tork Elevation Matic® Hand Towel Roll Dispenser



552120 Tork Elevation Xpress Mini Hand Towel Dispenser



5511202 Tork Elevation Matic Hand Towel Roll Dispenser With Intuition® Sensor



555620 Tork Elevation High Capacity Bath Tissue Roll Dispenser



5555200 Tork Elevation Twin Mini Jumbo Bath Tissue Roll Dispenser



654021 Tork Performance Folded Wiper/Cloth Dispenser



TC0020 Tork Universal Toilet Seat Cover



530178 Tork Heavy-Duty Cleaning Cloth, Top-Pak Box



192191, 192192, 192193 Tork Antimicrobial Foodservice Cloth



510175A Tork Cleaning Cloth, Pop-Up Box



6234000, 6334000 Tork Xpressnap® Signature
 - Tabletop Napkin Dispenser
 - Stand Napkin Dispenser



Helping you understand ADA guidelines



For the 2010 Americans with Disabilities Act Accessibility Guidelines (ADAAG) Requirements and the California Building Code



Introduction to ADA

The Americans with Disabilities Act (ADA) was signed into law on July 26, 1990, by President George H.W. Bush. The ADA is one of America's most comprehensive pieces of civil rights legislation that prohibits discrimination and guarantees that people with disabilities have the same opportunities as everyone else to participate in the mainstream of American life – to enjoy employment opportunities, to purchase goods and services, and to participate in State and local government programs and services. Modeled after the Civil Rights Act of 1964, which prohibits discrimination on the basis of race, color, religion, sex, or national origin – and Section 504 of the Rehabilitation Act of 1973 – the ADA is an “equal opportunity” law for people with disabilities.

Title III of the ADA provides that commercial facilities and places of public accommodation do not create or maintain barriers to access for a person with disabilities. To be protected by the ADA, one must have a disability, which is defined by the ADA as a physical or mental impairment that substantially limits one or more major life activities, a person who has a history or record of such an impairment, or a person who is perceived by others as having such an impairment. The ADA does not specifically name all of the impairments that are covered.

To get answers to questions about the ADA or to learn more about the law call the Department of Justice ADA Information Line, toll-free (1-800-514-0301 voice and 1-800-514-0383 TDD).



This document provides guidance to assist you in understanding the ADA and the California Building code regulation. However, this technical assistance does not constitute a legal interpretation of the statute.

Essity cares

Because Essity is a leading supplier of away-from-home hygiene products . . . and because we care . . . we are providing this document to educate and inform our sales representatives, distributor partners and customers about the Americans with Disabilities Act. We know these regulations can be complicated, so we broke it down to make it simple to understand how the ADA applies to properly installing Tork dispensers.



ADA requirements for hand drying and skincare

1

Protrusion from wall

Dispensers that are in a passageway, walkway, hall, corridor, or aisle, must protrude no more than 4 inches from the wall if their leading edge is between 27 and 80 inches from the finished floor. See drawing to the right.

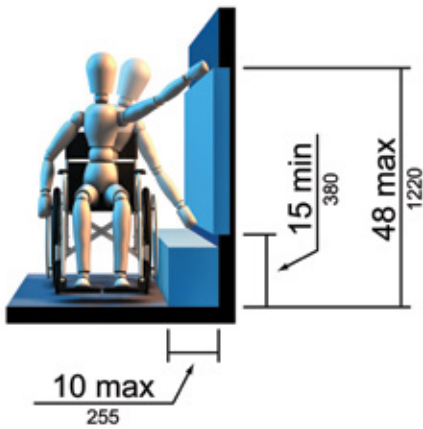
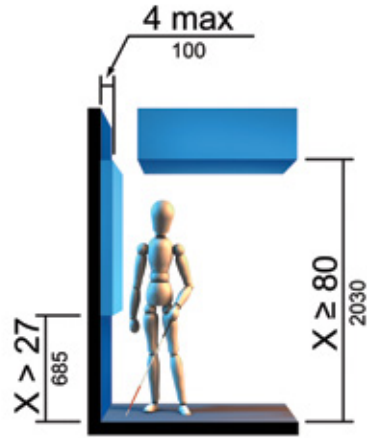

2

Maximum side reach, over an obstruction

If there are unobstructed floor spaces which allows a person in a wheelchair to pull up parallel to an obstruction, such as a counter, then the forward reach must have a minimum of 15 inches and a maximum of 48 inches from the operational part of the dispenser. See drawing to left.

For customers that operate in the State of California: California Building Code Proposition 24 requires that towel dispensers in the state of California be mounted within 40" (from operational part of dispenser) from the finished floor.

3

Maximum forward reach, unobstructed

If unobstructed floor space allows a person in a wheelchair to pull up with a forward approach, then the forward reach must have a minimum of 15 inches and a maximum of 48 inches from the operational part of the dispenser. See figure to the right.

For customers that operate in the State of California: California Building Code Proposition 24 requires that towel dispensers in the state of California be mounted at 40" (from operational part of dispenser) from the finished floor.

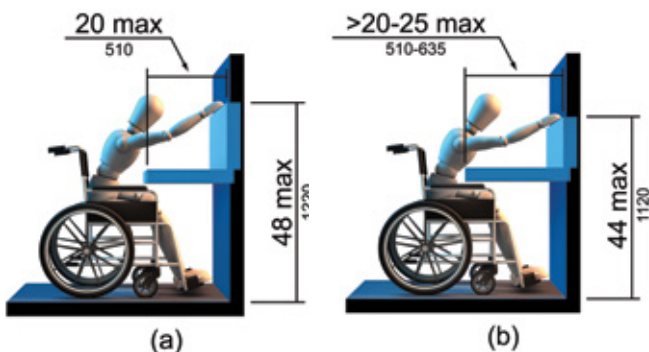
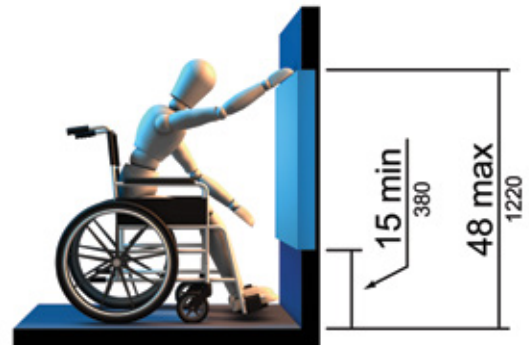

4

Maximum forward reach, with obstruction

If the forward reach is over an obstruction (like a countertop), then the obstruction can not exceed 25 inches deep and there must be knee space underneath the obstruction that is as deep as the obstruction itself.

Also, if the obstruction is less than 20 inches deep, then the forward reach can not exceed 48 inches high, figure (a); if the obstruction is 20-25 inches deep, then the forward reach cannot exceed 44 inches high figure (b). See figure to left.

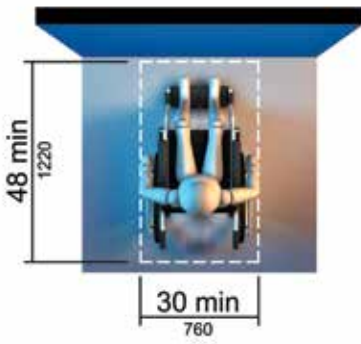

(a) forward

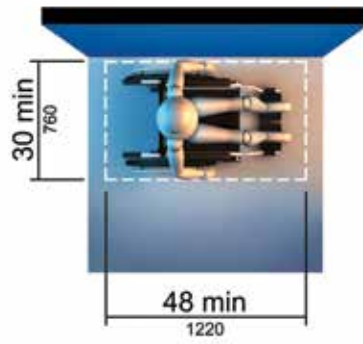

(b) parallel

5

Clear floor space

Any element, such as a towel dispenser, requires clear floor space of at least 30 by 48 inches. See drawing to left.

For customers that operate in the State of California:

California Building Code Proposition 24 requires that towel dispensers in the state of California be mounted at 40" (from operational part of dispenser) from the finished floor.



6

One hand operation

Operable parts must be operable with one hand.



7

5 pound force

The force required to activate operable parts shall not exceed 5 pounds.



8

No tight grasping, pinching or twisting required

Operable parts shall not require tight grasping, pinching or twisting of the wrist.

Essity ADA compliant dispensers

Hand drying

The following products are capable of being installed in a manner that would render them ADA compliant, provided that the ADA installation requirements are met.



552520



552528

Tork PeakServe™ Continuous™ Hand Towel Dispenser

Tork PeakServe Continuous Hand Towels are the latest innovation designed for high-traffic washrooms where staff needs to maximize cleaning time and maintain a good flow of people. Compatible with Tork PeakServe Continuous hand towels, the system has a very high capacity of over 2100 towels, which can be dispensed quickly and without interruption to keep the flow. The compressed refills are fast to fill, can be topped up at any time and are easy to store and transport, enabling staff to focus on cleaning, not refilling.

Dispenser Size (H x W x D): 28.74" x 14.57" x 3.98" (73.0 x 37.01 x 10.11 cm)



552020



552028

Tork Elevation™ Xpress® Hand Towel Dispenser

The Xpress dispenser is for multifold hand towels and works best for environments that demand both comfort and hygiene. The slim design saves space, and one-at-a-time dispensing means you touch only the towel you use – no cross-contamination from levers or cranks.

Dispenser Size (H x W x D): 17.5" x 11.9" x 4" (44.45 x 30.23 x 10.16 cm)



552120

Tork Elevation Xpress Mini Hand Towel Dispenser

The Xpress mini dispenser is for multifold hand towels and works best for environments that demand both comfort and hygiene and a small dispenser footprint. Tork Xpress Mini fits where other dispensers can't. Measuring just 12 inches high, the Xpress™ Mini is perfect for wall areas where space is at a premium.

Dispenser Size (H x W x D): 11.6" x 11.9" x 4" (29.46 x 30.23 x 10.16 cm)



463002

Tork Image Design™ Xpress Hand Towel Dispenser

Tork Image Design Xpress Hand Towel Dispenser system features a gently brushed stainless steel with fine lines; and subtle curves provide clean lines and smooth surfaces. Extra slim design is both space-saving and elegant. One at-a-time dispensing reduces costs and delivers optimal hygiene. Touch free dispensers, ideal for washrooms looking for a more sophisticated touch. Easy to clean anti-fingerprint stainless steel coating. Keeps the washroom clean and tidy, while complementing the unique design.

Dispenser Size (H x W x D): 18.625" x 13" x 9.9375" (47.31 x 33.02 x 10.0 cm)



302020

302030

302028

Tork Xpress Countertop Multifold Hand Towel Dispenser

These dispensers are stylish countertop towel dispensers that add a hygienic, upscale touch to restaurant restrooms. The dispenser utilizes a unique folded towel system with fully enclosed towels that deliver only one towel at a time, minimizing the risk of cross contamination while reducing waste and refilling expenses.

Dispenser Size (H x W x D): 7.92" x 12.68" x 4.56" (20.12 x 32.21 x 11.58 cm)



5510202



5510282

Tork Elevation Matic® Hand Towel Roll Dispenser

The Tork Matic Dispenser is a high capacity system that is ideal for busy washrooms. Hands-free dispensing provides a hygienic, one-at-a-time solution for your washroom. The user touches only the towel needed, reducing the risk of cross-contamination.

Dispenser Size (H x W x D): 14.65" x 13.2" x 8.1" (37.21 x 33.53 x 20.57 cm)



461002

461022

461023

Tork Image Design™ Matic Hand Towel Roll Dispenser

The Tork Matic Hand Towel Dispenser in Image Design creates a sophisticated impression in the washroom. No need to sacrifice function for style, because this dispenser delivers reliable performance and reduces consumption with one-at-a-time towel dispensing. High capacity serves more customers with fewer rolls. Viewing windows make it easy to see when to refill. Intuitive refilling saves time. Also available in recessed settings (461022 and 461023).

Dispenser Size (H x W x D): 15.75" x 13.58" x 8.07" (40.01 x 34.49 x 20.5 cm)

Hand drying



Tork Mechanical Hand Towel Roll Dispenser

Tork Mechanical Hand Towel Roll Dispenser is designed to last in busy restrooms and gives reliability you can count on. Durable and easy to maintain, it delivers a hygienic dispensing experience which reduces consumption with one at a time dispensing.

Dispenser Size (H x W x D): 15.955" x 12.32" x 9.32" (40.51 x 31.29 x 23.67 cm)



5511202

5511282

Tork Elevation Matic Hand Towel Roll Dispenser with Intuition® Sensor

Tork Elevation Intuition virtually eliminates cross contamination while cutting back on waste. Each unit features a choice of two dispensing modes, towel hand mode or towel sensor mode. The towel remains inside the cabinet until the user activates the sensor, delivering maximum hygiene. An adjustable towel length of 8, 10, 14 or 18 inches, and a stub roll compartment combine to deliver more precise control of consumption.

Dispenser Size (H x W x D): 14.5" x 13" x 8" (36.83 x 33.02 x 20.32 cm)



461102

461122

461123

Tork Image Design Matic Hand Towel Roll Dispenser with Intuition Sensor

Tork Image Design Matic Hand Towel Roll Dispenser with Intuition Sensor features a gently brushed stainless steel with fine lines; and subtle curves provide clean lines and smooth surfaces. Easy to use controls allow for sheet length adjustments. LED refill and low battery light indicators. Touch-free delivery of each soft towel enables hygiene at it's comforting best. One-at-a-time, no-touch towel dispensing improves hygiene. Large towel capacity and adjustable sheet lengths reduces run-outs and over-consumption. Also available in recessed settings (461122 and 461123).

Dispenser Size (H x W x D): 14.88" x 13.58" x 8.03" (37.31 x 34.49 x 20.40 cm)



771820

771828

771720

771728

Tork Electronic Hand Towel Roll Dispenser

Tork Electronic Hand Towel Roll Dispenser is designed to last in busy restrooms, so you can rest assured it will always function as smoothly as day one. The paper roll index allows for quick and easy loading. An intuitive, one-touch, control panel helps you manage the length of the hand towel being dispensed at either 10 inches and 18 inches, and Sensor Mode for patron-activated dispensing, or Hanging Mode for ready-for-use hanging towel. The roll consumption indicator informs your staff at a glance, when it's time to refill.

Dispenser Size (H x W x D): 15.955" x 12.32" x 9.32" (40.51 x 31.29 x 23.67 cm)



559020A

559028A

558028A

Tork Elevation Centerfeed Hand Towel Dispenser

The Tork Centerfeed Pro and Tork Centerfeed Mini Pro Dispensing Systems enable an easy, one-handed operation and controlled consumption with the enhanced pro feature. They are the ideal systems for areas where hand and light surface wiping are combined.

Tork Elevation Centerfeed Hand Towel Dispensers 559020A (White), 559028A (Black): Dispenser Size (H x W x D): 14.39" x 9.42" x 8.95" (36.55 x 23.93 x 22.73 cm)

Tork Elevation Mini Centerfeed Hand Towel Dispenser 558028A (Black Mini) Dispenser Size (H x W x D): 13.05" x 6.86" x 6.51" (33.15 x 17.42 x 16.54 cm)

Skincare



570020A



570028A

Tork Elevation Liquid Skincare Dispenser

The Tork Liquid Skincare System is suitable for all kinds of washrooms, including tough and demanding environments. The soap pump dispenses up to 1 ml every time, controlling portions. The high-capacity 1 liter bottle allows for 1000 hand washes.

Dispenser Size (H x W x D): 11.5" x 4.4" x 4.5" (29.21 x 11.18 x 11.43 cm)



571501



571508

Tork Elevation Foam Skincare Manual Dispenser

The perfect balance between luxury and value, our Foam Skincare Manual Dispensing System uses highly concentrated, rich foam in a controlled closed dispensing system. This new system delivers nearly four times more hand washes per refill than liquid soap while offering a unique, luxurious, refreshing, and hygienic experience. Controlled usage 0.4 ml per dose. Low maintenance easy and quick to replace refills. More hand washings per refill & high capacity results in low cost-in-use – Sealed collapsible bottle refills reducing contamination and ensuring complete usage of the product.

Dispenser Size (H x W x D): 11.26" x 4.45" x 4.13" (28.60 x 11.30 x 10.49 cm)



466000

Tork Image Design Foam Skincare Manual Dispenser

Tork Image Design Foam Skincare Manual Dispenser system features a gently brushed stainless steel with fine lines; and subtle curves provide clean lines and smooth surfaces. Easy to load, high capacity refill: 2,500 doses (0.4 ml per dosage). Enclosed system avoids cross contamination. Refill bottle reduces waste volume by up to 70%; recyclable plastic bottles. No batteries needed.

Dispenser Size (H x W x D): 11.375" x 4.45" x 4.25" (28.89 x 10.8 x 10.8 cm)



571600



571608

Tork Foam Skincare Automatic Dispenser

Tork Elevation automatic foam dispenser delivers a touchfree luxurious handwashing experience. The sealed refill bottle with a single use pump provides quick and easy maintenance while reducing any potential for cross contamination. 2,500 doses of soap provides a high capacity and minimizes maintenance time and LED indicators signal when a refill or new batteries are needed.

Dispenser Size (H x W x D): 10.94" x 4.45" x 5.12" (27.79 x 11.30 x 13.00 cm)

To ensure optimal dispenser performance, please follow ADA guidelines and sensor range requirements detailed in dispenser manual.



466100

Tork Image Design Foam Skincare Automatic Dispenser with Intuition Sensor

The Tork Image Design Foam Skincare Automatic Dispenser system features a gently brushed stainless steel with fine lines; and subtle curves provide clean lines and smooth surfaces. Touch free convenient dispensing. Easy to load, high capacity refill: 2,500 doses (0.4 ml per dosage). Enclosed system avoids cross contamination. LED indicators signal when a refill or new batteries are needed.

Dispenser Size (H x W x D): 11.69" x 4.13" x 4.02" (29.69 x 10.49 x 10.21 cm)

To ensure optimal dispenser performance, please follow ADA guidelines and sensor range requirements detailed in dispenser manual.

ADA requirements for bath tissue

1

Protrusion from the wall

The four inch depth requirement described in step one on page 3 does not apply if the product is installed on a toilet stall side wall or other area that is not a passageway, walkway, hall, corridor, or aisle.

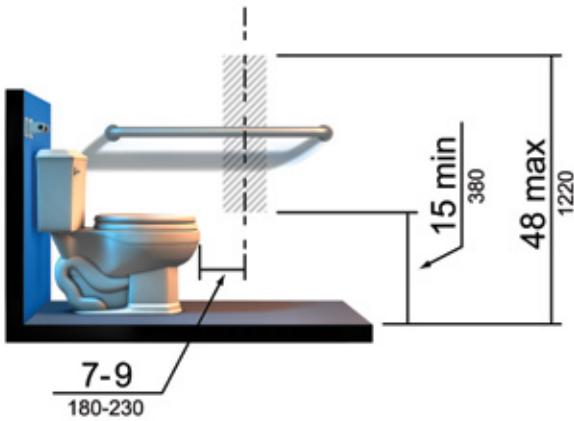
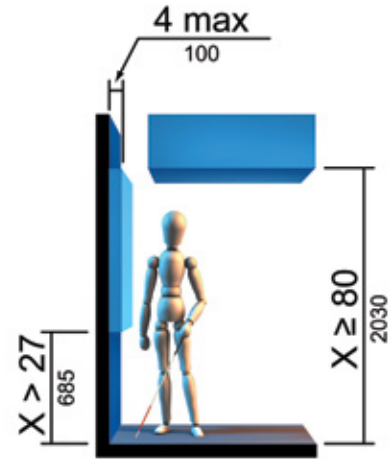

2

Toilet paper dispenser placement

To meet Federal ADA requirements, bath tissue dispensers must be installed in the following manner:

- A minimum of 7 inches and a maximum of 9 inches in front of the water closet, to the centerline of the dispenser.
- The permissible height is between 15 and 48 inches between the outlet of the dispenser and the floor.
- It shall not be located behind the grab bar. If toilet paper dispensers are installed above the side wall grab bar, the outlet of the toilet paper dispenser must be 48 inches (1220 mm) maximum above the finished floor and the top of the gripping surface of the grab bar must be 33 inches (840 mm) minimum and 36 inches (915 mm) maximum above the finished floor.

Dispensers shall not be of a type that controls delivery or that does not allow continuous paper flow.

For customers that operate in the State of California:

California requirements state that the toilet tissue dispenser shall be installed in the following manner:

- Within 12 inches of the front edge of the toilet seat.
- A minimum height of 19 inches.
- A maximum of 36 inches from the rear wall to the far edge of the dispenser.
- Below the grab bar.

Please note, to comply with both the federal AND California systems, the dispenser should be:

- Installed between 7 and 9 inches from the front of the toilet seat to the centerline of the dispenser.
- At a height of at least 19 inches or greater.
- Below the grab bar.
- Be of continuous flow.



Essity ADA compliant dispensers

Bath tissue

The following products are capable of being installed in a manner that would render them ADA compliant, provided that the ADA installation requirements are met.



565820



565828

Tork 3 Roll Bath Tissue Roll Dispenser for OptiCore®

The Tork 3 Roll Bath Tissue Roll Dispenser for OptiCore is designed to minimize maintenance and maximize cost savings for high-traffic areas. Revolving design and patented OptiCore tissue ensures that a roll is completely depleted before the dispenser will advance to the next roll, eliminating waste. Capacity for three full rolls of tissue allows for longer periods between maintenance. Features a locking cover to prevent product pilferage.

Dispenser Size (H x W x D): 14.56" x 14.12" x 6.31" (36.98 x 35.86 x 16.03 cm)



565720



565728

Tork Twin Bath Tissue Roll Dispenser for OptiCore

The Tork Twin Bath Tissue Roll Dispenser for OptiCore holds two rolls of patented OptiCore tissue. Controlled use design reduces waste and cost by ensuring each roll is completely utilized before the next roll is accessible. Features a locking cover to prevent product pilferage. Sleek, contemporary style for a wide range of restroom environments. Translucent cover allows service staff to see at-a-glance when it's time to refill.

Dispenser Size (H x W x D): 8.81" x 11.06" x 7.18" (22.37 x 28.09 x 18.24 cm)



565620



565628

Tork Twin Bath Tissue Roll Dispenser for OptiCore

The Tork Twin Bath Tissue Roll Dispenser for OptiCore is ideal for environments where horizontal space is limited. Holds two rolls of patented OptiCore tissue. Designed to ensure the lower roll is completely utilized before the upper roll can be accessed, eliminating waste and controlling cost. Features a locking cover to prevent product pilferage. 6.75-inch width allows for installation in facilities where horizontal space is limited. Front-facing tissue for easy access to the product.

Dispenser Size (H x W x D): 12.3125" x 6.75" x 7" (31.27 x 17.15 x 17.78 cm)



565520



565528

Tork High Capacity Bath Tissue Roll Dispenser for OptiCore

The Tork High Capacity Bath Tissue Roll Dispenser for OptiCore provides an attractive solution for high traffic accounts where the flow of traffic demands high footage rolls of product. Accommodates two 2,000-sheet rolls of high-quality perforated tissue to lower maintenance costs in the busiest washrooms. Patented OptiCore technology prevents stub roll waste and ensures complete utilization. Once a roll has been depleted, the core remains securely inside the dispenser, ensuring no cores are left on the floor or make their way into the plumbing system. Features sliding cover that securely protects both rolls and locks to prevent product pilferage. Glossy translucent finish for upscale design and rugged reliability.

Dispenser Size (H x W x D): 9.93" x 16.62" x 5.25" (25.22 x 42.21 x 13.34 cm)



473200



473208

Tork Elevation Coreless High Capacity Bath Tissue Dispenser

A perfect fit for washrooms with limited space. The T7 system ensures easy and intuitive maintenance, refilling and use – a great choice for higher traffic washrooms as well as environments where efficiency and reduced cost are priorities. Rolls are protected for less waste.

Dispenser Size (H x W x D): 8.228" x 14.173" x 5.078" (20.9 X 36.0 x 12.9 cm)

To ensure optimal dispenser performance, please follow ADA guidelines and recommended dispenser height placement detailed in dispenser manual.



555620



555628

Tork Elevation High-Capacity Bath Tissue Roll Dispenser

The innovative auto-transfer feature promotes hygiene and reduces refill maintenance time. Promotes hygiene with covered rolls. Prevents waste by dropping the reserve roll only after the primary roll is depleted and perfect for washrooms with limited space.

Dispenser Size (H x W x D): 14.2" x 6.3" x 6.46" (36.07 X 16.0 x 16.41 cm)

Bath tissue



465500

Tork Image Design Mini Jumbo Bath Tissue Roll Dispenser

Tork Image Design Mini Jumbo Bath Tissue Roll Dispenser with Reserve system features a gently brushed stainless steel with fine lines; and subtle curves provide clean lines and smooth surfaces. Roll break prevents paper over spin. Stub roll feature allows for full roll consumption. large capacity rolls allow service for high-traffic areas without adding extra dispensers. Roll is covered to minimize cross contamination.

Dispenser Size (H x W x D): 9.875" x 14" x 5.125" (25.08 x 35.56 x 13.02 cm)



555020A



555028A

Tork Elevation Mini Jumbo Bath Tissue Roll Dispenser

A perfect choice for high-traffic washrooms as well as environments where efficiency and reduced cost are priorities. Roll is protected creating less waste, improved hygiene and reduced pilferage. A new stub roll feature provides extra high capacity.

Dispenser Size (H x W x D): 10.8" x 13.6" x 5.2" (27.43 x 34.54 x 13.21 cm)



5555200



5555290

Tork Elevation Twin Mini Jumbo Bath Tissue Roll Dispenser

Featuring two high-capacity rolls and a roll brake, which exposes a second roll of bath tissue only after roll one has been depleted. That means less waste, less mess, and less effort. The dispensers simplify and complement any environment, providing a clean, hygienic appearance.

Dispenser Size (H x W x D): 10.125" x 17.0" x 5.6875" (25.72 x 43.18 x 14.45 cm)



554020A



554028A

Tork Elevation Jumbo Bath Tissue Roll Dispenser

A perfect choice for high-traffic washrooms as well as environments where efficiency and reduced cost are priorities. A new stub roll feature provides extra high capacity. Goes longer between refills and reduces maintenance costs.

Dispenser Size (H x W x D): 14.2" x 17.2" x 5.2" (36.07 x 43.69 x 13.21 cm)

ADA requirements for toilet seat covers

1

Toilet seat cover install location

Like the bath tissue dispenser, the toilet seat dispenser should be mounted between 15 and 48 inches (from the operational part of the dispenser) above the finish floor and clear of the grab bar. If this dispenser is installed above the grab bar, then the top of the grab bar must be between 33 and 36 inches from the finished floor. The top point, or the control, for pulling the seat cover, is the point that should be measured as no higher than 48 inches from the finished floor.

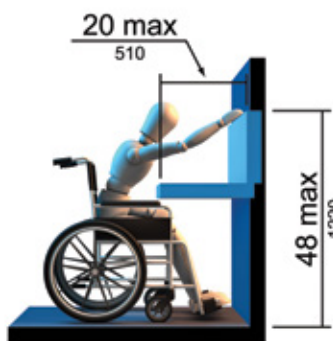
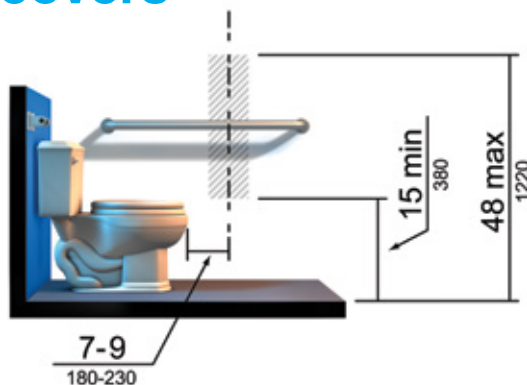

(a)

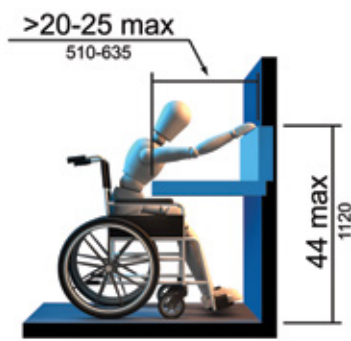

(b)

2

Toilet seat cover accessibility

The seat cover should be accessible for wheelchair use, thus should not be posted behind the toilet or on the wall beside the toilet sufficiently far back that the reach is beyond the forward reach restrictions described above. Thus, the best location is beside the toilet, such that the control, or the centerline of the point at which the seat cover is pulled out, is between 7 and 9 inches in front of the front point of the toilet.

Essity ADA compliant dispensers

Toilet seat covers



344080



344088



1951001



99A

Tork Toilet Seat Cover Dispenser

This Tork dispenser keeps toilet seat cover neat and sanitary for users and projects a clean image.

Dispenser Size (H x W x D): 12.40" x 16.65" x 2.28" (31.50 x 42.29 x 5.79 cm)
(344080 and 344088)

Dispenser Size (H x W x D): 11.5" x 16" x 3.125" (29.21 x 40.64 x 7.94 cm)
(1951001)

Dispenser Size (H x W x D): 11.5" x 16" x 3" (29.21 x 40.64 x 7.62 cm)
(99A)

ADA requirements for accessories

1

Protrusion from the wall

All protrusions must not exceed four inches if in a walkway, passageway, corridor or aisle.

2

Maximum reach with obstruction

The product may be installed such that the dispenser and the receptacle opening are no higher than 48 inches from the finished floor. In California, both the dispenser and the receptacle opening should not exceed 40 inches above the finished floor.

Essity ADA compliant dispensers

Accessories



309051

Recessed Unit with Bin for all Tork Elevation Matic Dispensers

The Tork Frame and Bin when combined with a Tork Roll Towel dispenser and its corresponding filler panel will make remodeling your bathroom much easier. This 2-in1 solution will provide you all the great benefits of Tork's roll towel dispensers, plus it includes a semi-recessed waste bin. This product should be recessed into its wall so as to be flush with the wall or not protrude from the wall by more than four inches.

Accessory Size (H x W x D): 56" x 17.125" x 9" (142.24 x 43.50 x 22.86 cm)

ADA requirements for free standing objects

1

Free standing object overhang

Objects attached to freestanding items, may not have an overhang in their design that exceeds 12 inches if the overhang is at a height somewhere between 27 and 80 inches from the finished floor.

Essity ADA compliant dispensers

Free standing objects

The following product is capable of being installed in a manner that would render it ADA compliant, provided that the ADA installation requirements above are met.

Tork Foam Skincare Automatic Dispenser Stand

Use with Tork Automatic Foam Skincare Dispensers 571600 and 571608.

Stand Size: 15 inch square base; height of stand including mounting plate is 58 inches.



570038





Identify the task,
find the right product



Identify the task, find the right product

Tork is focused on making your working day easier. Your task decides what product you choose, and all you really want are smart and efficient solutions to get the job done quickly and efficiently. It is as simple as this: if you know what task you have, we have an easy-to-find Tork product that helps you take care of it.

To help you, we have defined the following tasks:

- Wiping

Wiping is picking up spills, soaking up liquids and picking up dirt and dust with a paper-based wiper.

- Cleaning

Cleaning is removing dirt and stains from surfaces, machines or tools with cloths that are dry or used together with water, solvents or detergents.

- Polishing

Polishing is creating a protected and shiny surface with the help of a cloth that applies polish onto the surface and is rubbed to obtain a good finish.



What are your usage requirements?

Do several people use wipers during the day or is it just one person who occasionally needs to use them?

High



W1 Floor Stand

Suitable for high-traffic areas where a large capacity mobile solution is needed.



W1 Wall Stand

High-capacity dispenser suitable for all areas where space is at a premium and an easy-to-find fixed location is needed.



W2 Maxi Centerfeed

Ideal for one-at-a-time controlled dispensing. High-capacity dispenser.



W6 Washstation

Durable water-resistant design. High-capacity, hands free dispensing.

Medium



W4 Folded Wiper

Perfect for one-at-a-time controlled dispensing. Helps to eliminate airborne contaminants. Optional magnet kit available for mobile mounting.



M2 Centerfeed

Ideal for one-at-a-time controlled dispensing and tighter spaces.

Low



W24 Bracket

Great for controlled dispensing. Optional magnet kit available for mobile mounting.

Application Matrix

Task	Basic Paper Wiper	Windshield Paper Towel	Paper Wiper	Paper Wiper Plus	Heavy-Duty Paper Wiper	Industrial Paper Wiper	Cleaning Cloth	Heavy-Duty Cleaning Cloth	Low-Lint Cleaning Cloth	Industrial Cleaning Cloth	Industrial Heavy-Duty Cleaning Cloth	Industrial Low-Lint Cleaning Cloth	Polishing Cloth
Dry Wiping with Solvents				•	••	•••							
Wiping up large liquid spills and leaks	•		••	••	••	•••				•••			
Wiping Windshields and Glass	•••	•••	••			•••							
Machine and Tool Maintenance			•	•	••	•••	•	•	••	•••	•••	••	
Absorbing oils, fluids, and grease			•	•	••	•••	•	••		•••	•••		
Wiping/Cleaning Work Surfaces	•		•	••	••	•••	••	••		•••	•••	••	
Industrial Maintenance and Cleanup			•	•	••	•••	•	•	••	•••	•••	••	
Lubrication of Parts				•	•		••	••		•••			
Wiping/Cleaning Spray Guns				••	••		•	••	•••	•••	•••	•••	
Cleaning with Solvents							•	••	••	•••	•••	••	
Cleaning car interiors							•	••	••	•••		••	
Cleaning engine parts/tools							•	••	••	•••	•••	••	
Adhesive Cleaning							•	••	•••	••	•••	•••	
Waterborne Solvents									•••	•••	•••	•••	
Waxing/Polishing				•	•		•	•		•			•••

••• Product fits best •• Product works well • Product is acceptable

Tork wipers offer you . . .

- **Reduced consumption**
Fewer wipers are needed to attain the desired result
- **Reduced maintenance**
The need for refilling and maintenance will be lower, which leads to lower labor costs
- **Variety**
From light duty wiping to heavy duty cleaning tasks, Tork dispensing options fit various environments and products designed for specific customer tasks
- **Performance**
Tork wipers are free of contaminants, consistent in size and more absorbent than textile competitors with no hidden costs
- **Quality**
Wiper products are especially chosen for strength, speed and absorbency
- **Environmentally-responsible products**
Tork wipers are designed to meet specific requirements and have the lowest environmental impact. A variety of Tork Wipers are ECOLOGO® certified
- **Improved bottom line**
High quality Tork wipers provide a more cost-effective solution for your wiping needs

Bulk Rags and Rental Towels



Bulk Rags can vary in color, size and material which impacts performance and creates waste, driving up costs.



Rental Shop Towels can contain residual grease and oil and chemicals that inhibit performance and absorption.

Automotive

In the automotive industry, it is important to use wipers that are strong, low linting and absorbent to perform the task at hand.



From heavy duty to specialty cloths, high-performance Tork Wipers offer superior quality and cost-saving dispensing solutions for a range applications.

Cleaning surfaces prior to painting

Absolute care is needed to ensure the surface is completely clean prior to painting. Our range of Tork cleaning cloths work well with solvents while still feeling like a cloth. The Top Holder dispenser (W4) provides an ergonomic and easy-to-load solution so cloths are close-at-hand. The Top Holder can be mounted with a magnet kit to a paint booth wall or tool cabinet for easy access. Using one-at-a-time die-cut sheets through the W4 helps keep lint to a minimum.

Polishing painted surfaces

For a beautiful finish, it is important to have a cloth that works well with polishing compounds and does not leave residue or lint. The Tork Polishing Cloth's honeycomb structure smoothly removes dry polishing residue and then releases it efficiently and evenly for a perfect finish. The W4 Top Holder dispenser is ideal for one-at-a-time, controlled dispensing, protects the cloths from contaminants, and comes with an optional magnet kit for mobile mounting -- perfect for when you have to move from station to station.

Automotive Collision & Repair Shop Environments



Details

- Paper Wiper Plus
- Industrial Paper Wiper



Paint Booth

- Tork Low-Lint Cleaning Cloth
- Tork Paper Wiper

Washroom

- Other Tork dispensing needs
- Tork Matic
 - Tork Skincare
 - Tork Bath Tissue



Washstation

- Tork Basic Paper Wiper
- Tork Paper Wiper

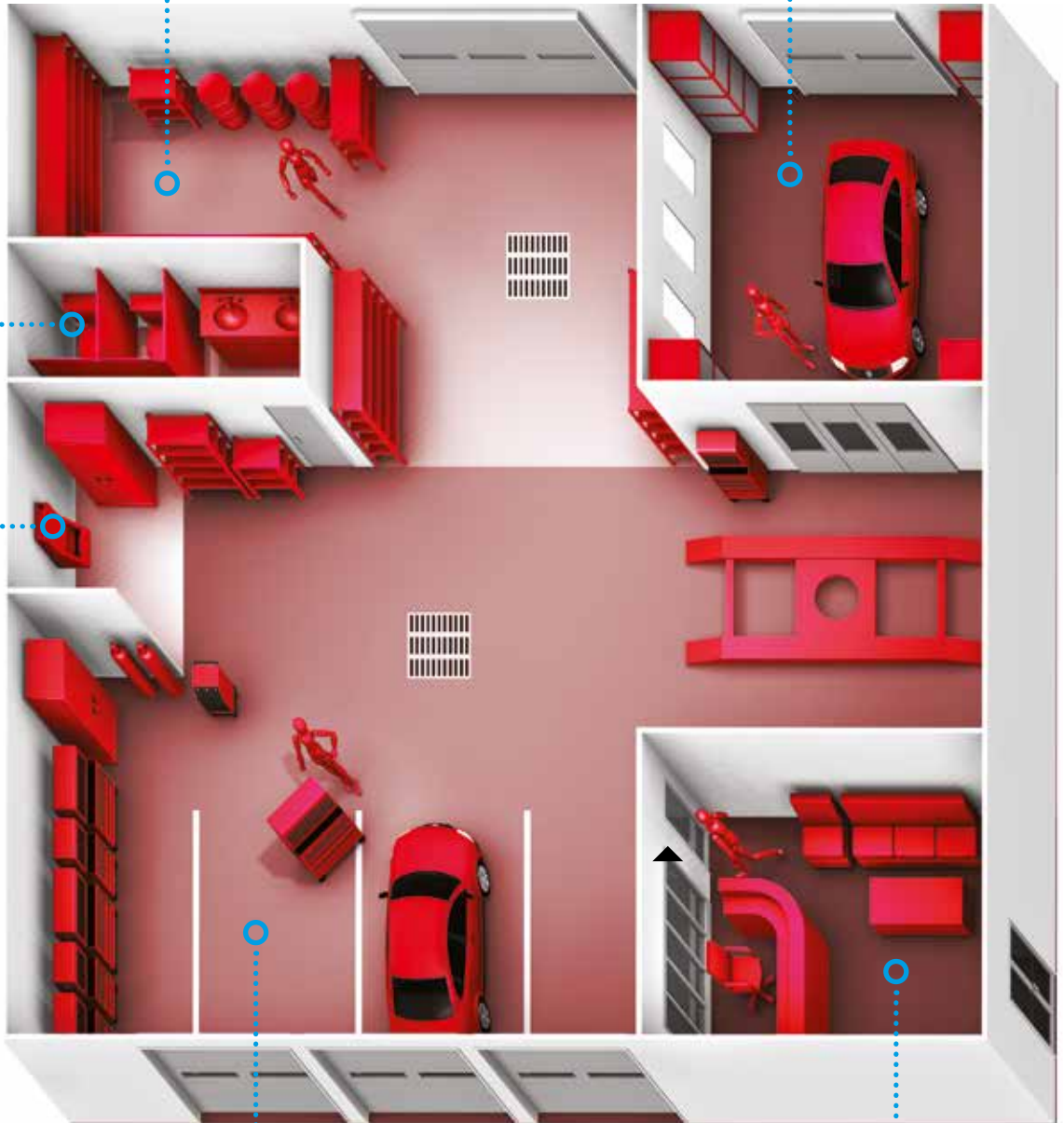

Body Shop

- Tork Heavy-Duty Paper Wiper
- Tork Industrial Cleaning Cloth



Office

- Other Tork paper product needs
- Tork Facial Tissue
 - Multisurface Wet Wipe

Industrial

Wiping and cleaning in the light and heavy manufacturing industries is a vital part of the production process that ensures quality.

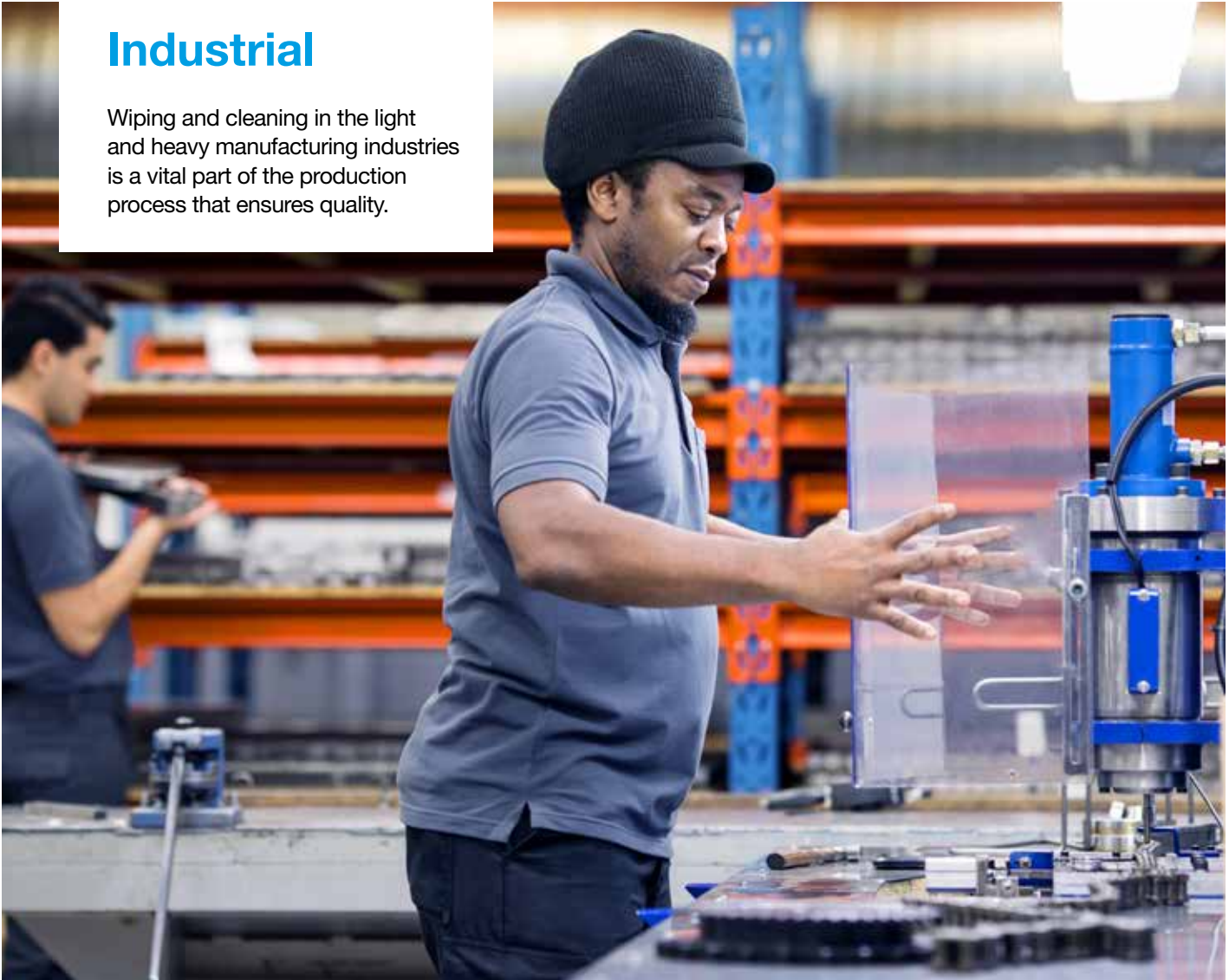

Tork Wipers, cloths and dispensers are designed to meet all the wiping needs in industrial and manufacturing environments.

Cleaning equipment with solvents

Cleaning grease off engines and parts is a common task in transportation and industrial environments. It's important to have a wiper that effectively stands up to and works with today's cleaners and solvents. Tork Heavy-Duty and Industrial Cleaning Cloths with the available floor stand are a perfect solution for these jobs, providing a high-capacity solution that is mobile and allowing you to always have product close by.

Wiping spills and metal shavings

Work areas frequently need to be wiped down to remove dirt, grease or metal shavings. It is important to make sure hands are protected from cuts or scratches, which requires a bulky and protective wiper. Tork Heavy-Duty and Industrial Paper Wipers are highly absorbent and thick to protect users hands from metal shavings while still effectively Wiping up any spills or dirt. In combination with the W1 wall stand, this solution will increase productivity.

Cleaning tools, wiping hands and face

Cleaning tools involves removing oil, grease or soil, and a dirty work environment means employees will need something to wipe their hands and face with throughout the day. Tork Industrial Cleaning Cloths provide good absorption and hand protection while being flexible enough to reach and clean small surfaces. The Top Holder dispenser (W4) protects the wipers and provides one-at-a-time dispensing reducing over consumption while offering a clean sheet every time.

Industrial Environment



Hazardous Waste storage

- Tork Industrial Paper Wiper
- Tork Heavy-Duty Cleaning Cloth

Washroom

- Other Tork dispensing needs
- Tork Centerfeed
 - Tork Skincare
 - Tork Bath Tissue



Washstation

- Tork Basic Paper Wiper
- Tork Paper Wiper

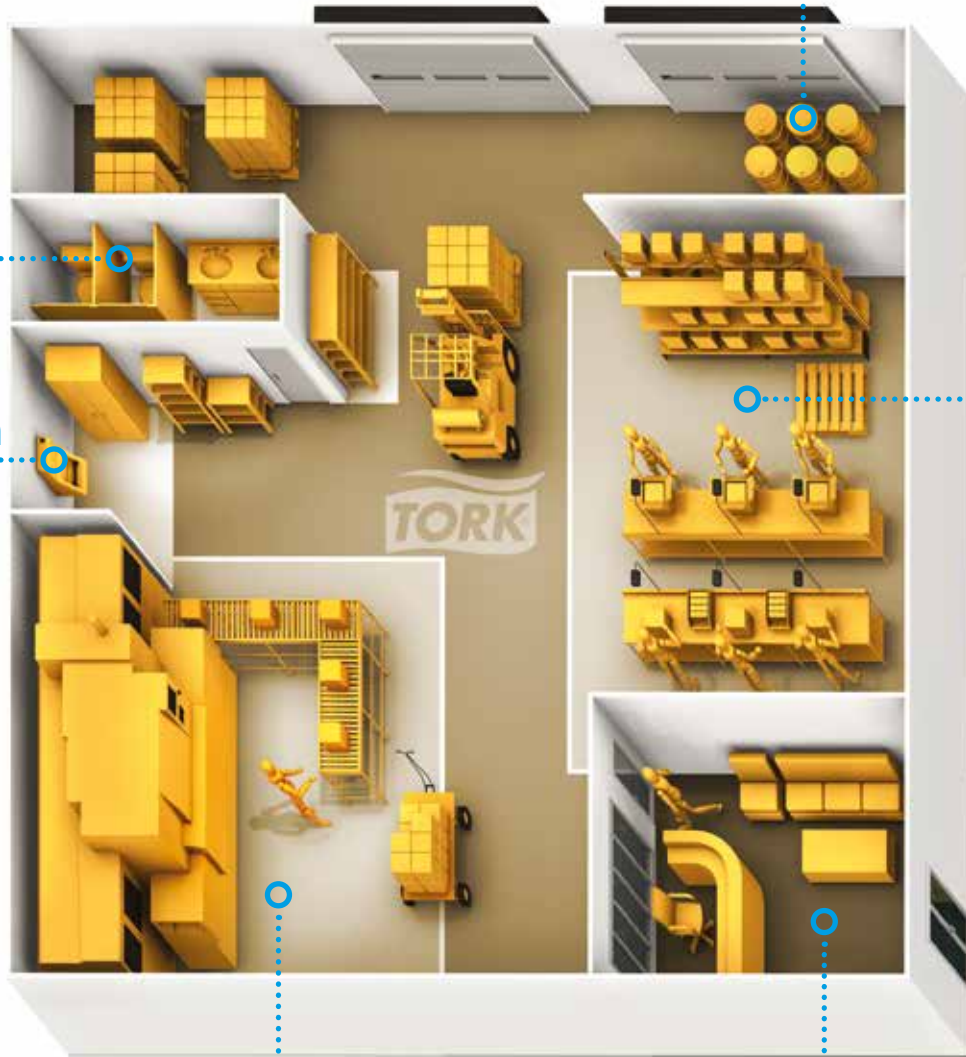

Assembly Area

- Tork Heavy-Duty Paper Wiper
- Tork Heavy-Duty Cleaning Cloth



Manufacturing Floor

- Tork Industrial Paper Wiper
- Tork Industrial Cleaning Cloth
- Tork Industrial Heavy-Duty Cleaning Cloth



Office

- Other Tork paper product needs
- Tork Facial Tissue
 - Multisurface Wet Wipe



Wipes and cloths for every task

When you want quick and efficient ways of dealing with your wiping, cleaning, polishing, or sanitizing needs, Tork has the perfect products for you. Our wide range includes all sorts of paper and cloth based products – from basic wipers to heat-resistant cloths, from multipurpose papers to highly specialized cleaning cloths that help you prevent cross-contamination.

Wiping



Basic

Tork Basic Paper Wiper

A 1 or 2-ply paper for basic wiping tasks.

Tork Windshield Paper Towel

A 1 or 2-ply paper for wiping glass.

Multipurpose

Tork Paper Wiper

A multipurpose paper for light wiping tasks.

Tork Paper Wiper Plus

A multipurpose paper that is ideal for picking up liquids and hand wiping.

Tork Heavy-Duty Paper Wiper

Our toughest multipurpose paper wiper absorbs both oil and water efficiently and has a high wet strength.

Industrial

Tork Industrial Paper Wiper

A multipurpose paper based wiper that is ideal for industrial wiping tasks and hand wiping.

Polishing



Tork Polishing Cloth

When you need a soft and low linting cloth for polishing – go for the Tork Polishing Cloth. This soft and flexible cloth has a structure designed for holding and releasing polishing agents. It is perfect when you want a professional result without leaving lint.

ShopMax



Wet Wipes

Tork ShopMax pre-moistened, disposable wipes in a convenient, portable bucket are available for cleaning hands and surfaces.

Dry Wipes

Tork ShopMax dry wipes are available in self-dispensing boxes, centerfeed rolls, and smaller towel rolls.

Cleaning



Multipurpose

Tork Cleaning Cloth

A soft and flexible multipurpose cloth that quickly absorbs liquids and oil. The cloth provides a professional cleaning result thanks to our excelCLEAN® wiper technology.

Tork Heavy-Duty Cleaning Cloth

This strong and absorbent multipurpose cloth works with most solvents. It is designed to protect your hands from heat and metal scraps. The cloth provides a professional cleaning result thanks to our excelCLEAN wiper technology.

Tork Low-Lint Cleaning Cloth

A low linting, flexible and drapable cloth that works well with solvents, detergents and disinfectants.

Industrial

Tork Industrial Cleaning Cloth

A soft and flexible cloth that is excellent in tight spaces, and ideal for cleaning oil and grease. The cloth provides a professional cleaning result thanks to our excelCLEAN wiper technology.

Tork Industrial Heavy-Duty Cleaning Cloth

The thickest and strongest Tork cloth has a high absorption capacity, works well with most solvents and protects your hands from heat and metal scraps. The cloth provides a professional cleaning result thanks to our excelCLEAN wiper technology.

Tork Industrial Low-Lint Cleaning Cloth

A low linting, flexible and anti-static cloth that works well with solvents, detergents, sanitizers and disinfectants.



Most **Tork Cleaning Cloths** have exelCLEAN® wiper technology to help you get cleaning tasks done more efficiently and professionally than other cloths, especially rags and rental cloths.

Thanks to using a patented foam-spun technology to create a unique internal structure they give you a quicker, more hygienic and professional cleaning result, while the risk of contamination is minimized.

Refills

From single and double-ply multipurpose wiping paper to advanced heavy duty cleaning cloths. Within our wiping and cleaning range, you'll find solutions that are extra absorbent, strong when wet, extra bulky for picking up and much more. Below you will find a selection of products from our range, including information on food contact suitability, environmental labeling and other product characteristics.

Wiping – Basic Paper Wipers



Tork Basic Paper Wiper

Refill No	Color	Format	System	Base Sheet	Ply	Sheet Size W x L (in)	Feet/Unit	Wipers/Unit	Units/Case	Wipers/Case	Approx Lbs/Case	Certification
291350	Natural	Roll Towel	W6	Paper	1	7.68 x 9.5 (19.51 x 24.13 cm)	1,150 (350.52 m)	1,452	4	5,808	27.8 (12.6 kg)	Recycling, NSF, P1, E
291370	White	Roll Towel	W6	Paper	1	7.68 x 9.5 (19.51 x 24.13 cm)	1,150 (350.52 m)	1,452	4	5,808	27.8 (12.6 kg)	Recycling, NSF, P1, E
192125A	White	Pop-Up Box	Self-Dispensing	Paper	2	9 x 10.25 (22.86 x 26.04 cm)	94 (28.65 m)	110	18	1,980	18.5 (8.4 kg)	Recycling, NSF, P1



Tork Windshield Paper Towel

Refill No	Color	Format	System	Base Sheet	Ply	Sheet Size W x L (in)	Feet/Unit	Wipers/Unit	Units/Case	Wipers/Case	Approx Lbs/Case	Certification
192121	Blue	Folded	H22	Paper	1	9.125 x 10.25 (23.18 x 26.04 cm)	213 (64.92 m)	250	9	2,250	13.8 (6.3 kg)	Recycling, NSF, P1
192122	Blue	Folded	H22	Paper	2	9.125 x 10.25 (23.18 x 26.04 cm)	119 (36.27 m)	140	16	2,240	17.1 (7.8 kg)	Recycling, NSF, P1

Wiping – Multipurpose Paper Wipers



Tork Paper Wiper

Refill No	Color	Format	System	Base Sheet	Ply	Sheet Size W x L (in)	Feet/Unit	Wipers/Unit	Units/Case	Wipers/Case	Approx Lbs/Case	Certification
291380	White	Roll Towel	W6	Paper	1	7.68 x 9.5 (19.51 x 24.13 cm)	1,150 (350.52 m)	1,452	4	5,808	20.2 (9.2 kg)	NSF, P1
130211B	White	Centerfeed	W1, W2	Paper	2	9 x 13 (22.86 x 33.02 cm)	866 (263.96 m)	800	2	1,600	14.9 (6.8 kg)	Recycling, NSF, P1
130251A	White	Centerfeed	M2	Paper	2	9 x 15.5 (22.86 x 39.37 cm)	419 (127.71 m)	325	4	1,300	14.8 (6.7 kg)	Recycling, NSF, P1



Tork Paper Wiper Plus

Refill No	Color	Format	System	Base Sheet	Ply	Sheet Size W x L (in)	Feet/Unit	Wipers/Unit	Units/Case	Wipers/Case	Approx Lbs/Case	Certification
192128	White	Centerfeed	W2	Paper/DRC	1	9.8 x 15.2 (24.89 x 38.61 cm)	380 (115.82 m)	300	2	600	8.2 (3.7 kg)	NSF, P1
192127	White	Pop-Up Box	W24	Paper/DRC	1	9.25 x 16.25 (23.50 x 41.28 cm)	135.4 (41.27 m)	100	8	800	13.7 (6.2 kg)	NSF, P1
430150A	White	1/4 Fold	--	Paper/DRC	1	12.5 x 13 (31.75 x 33 cm)	97.5 (29.72 m)	90	12	1080	15.3 (6.9 kg)	NSF, P1
430178	White	Top-Pak	W4	Paper/DRC	1	13.57 x 16.25 (34.47 x 41.28 cm)	203.12 (61.9 m)	150	5	750	15.3 (6.9 kg)	NSF, P1
430304	White	Giant Roll	W1	Paper/DRC	1	11.1 x 12 (28.19 x 30.48 cm)	800 (243.84 m)	800	1	800	12.6 (5.7 kg)	NSF, P1

Wiping – Multipurpose Paper Wipers



Tork Heavy-Duty Paper Wiper

Refill No	Color	Format	System	Base Sheet	Ply	Sheet Size W x L (in)	Feet/Unit	Wipers/Unit	Units/Case	Wipers/Case	Approx Lbs/Case	Certification
450304	Blue	Giant Roll	W1	Paper/DRC	1	11.1 x 12 (28.19 x 30.48 cm)	800 (243.84 m)	800	1	800	12.9 (5.9 kg)	Health Canada NSF P1
450175	White	Pop-Up Box	W24	Paper/DRC	1	9.25 x 16.25 (23.50 x 41.28 cm)	121 (36.88 m)	90	10	900	20.1 (9.1 kg)	Health Canada NSF P1
192136	White	1/4 Fold	--	Paper/DRC	1	12.5 x 13 (31.70 x 33.02 cm)	60 (18.29 m)	56	16	896	17.9 (8.1 kg)	Health Canada NSF P1

Wiping – Industrial Paper Wipers



Tork Industrial Paper Wiper

Refill No	Color	Format	System	Base Sheet	Ply	Sheet Size W x L (in)	Feet/Unit	Wipers/Unit	Units/Case	Wipers/Case	Approx Lbs/Case	Certification
13244101	Blue	Centerfeed	W1, W2	Paper	4	11 x 15.75 (27.94 x 40.01 cm)	492 (149.96 m)	375	2	750	15.6 (7.1 kg)	Health Canada
440278	Blue	Top-Pak	W4	Paper	4	12.8 x 16.4 (32.51 x 41.66 cm)	123 (37.49 m)	90	5	450	12 (5.4 kg)	Health Canada
132451A	Blue	Centerfeed	M2	Paper	4	10 x 15.75 (25.40 x 40.01 cm)	249 (75.90 m)	190	4	760	14.4 (6.5 kg)	Health Canada
440245A	Blue	Pop-Up Box	W24	Paper	4	8.54 x 16.5 (21.69 x 41.91 cm)	123.75 (32.72 m)	90	10	900	16 (7.3 kg)	Health Canada
13247501	Blue	Handy Box	Self-Dispensing	Paper	4	12.8 x 16.5 (32.51 x 41.91 cm)	247.5 (75.44 m)	180	1	180	5.4 (2.4 kg)	Health Canada

Cleaning – Multipurpose Cloths



Tork Cleaning Cloth

Refill No	Color	Format	System	Base Sheet	Ply	Sheet Size W x L (in)	Feet/Unit	Wipers/Unit	Units/Case	Wipers/Case	Approx Lbs/Case	Certification
510104	White	Giant Roll	W1	Spunlace	1	16.9 x 15.0 (42.93 x 38.10 cm)	1250.0 (381.0 m)	1,000	1	1,000	21.4 (9.7 kg)	Health Canada NSF P1
510137	White	Centerfeed	W2	Spunlace	1	12.6 x 10.0 (32.00 x 25.4 cm)	416.7 (127.01 m)	500	1	500	5.6 (2.5 kg)	Health Canada NSF P1
510175A	White	Pop-Up Box	W24	Spunlace	1	8.46 x 16.125 (21.49 x 40.96 cm)	134.4 (40.96 m)	100	5	500	7.67 (3.5 kg)	Health Canada NSF P1



Tork Heavy-Duty Cleaning Cloth

Refill No	Color	Format	System	Base Sheet	Ply	Sheet Size W x L (in)	Feet/Unit	Wipers/Unit	Units/Case	Wipers/Case	Approx Lbs/Case	Certification
530104	White	Giant Roll	W1	Spunlace	1	16.9 x 15.0 (42.93 x 38.10 cm)	887.5 (270.51 m)	710	1	710	22.3 (9.2 kg)	Health Canada
530137	White	Centerfeed	W2	Spunlace	1	12.6 x 10 (32.0 x 25.40 cm)	333.33 (101.59 m)	400	1	400	6.5 (2.9 kg)	Health Canada
530178	White	Top-Pak	W4	Spunlace	1	15.2 x 16.85 (38.61 x 42.80 cm)	140.4 (42.79 m)	100	5	500	16.3 (7.4 kg)	Health Canada
5301755	White	Pop-Up Box	W24	Spunlace	1	8.46 x 16.125 (21.49 x 40.96 cm)	107.5 (32.77 m)	80	5	400	8.45 (3.8 kg)	Health Canada
5301505	White	1/4 Fold	--	Spunlace	1	12.6 x 13 (32 x 33 cm)	54.16 (16.51 m)	50	6	300	6.6 (3 kg)	Health Canada

Cleaning – Multipurpose Cloths



192479



192482



192475

Tork Low-Lint Cleaning Cloth

Refill No	Color	Format	System	Base Sheet	Ply	Sheet Size W x L (in)	Feet/Unit	Wipers/Unit	Units/Case	Wipers/Case	Approx Lbs/Case	Certification
192479	Turquoise	Top-Pak	W4	Spunlace	1	13.5 x 16.4 (34.29 x 41.66 cm)	136.6 (41.64 m)	100	5	500	12.9 (5.9 kg)	Health Canada
192482	White	Top-Pak	W4	Spunlace	1	15.0 x 16.5 (38.10 x 41.91 cm)	165.0 (50.29 m)	120	5	600	14 (6.4 kg)	
192475	Turquoise	Pop-Up Box	W24	Spunlace	1	9 x 16.5 (22.86 x 41.91 cm)	137.5 (41.91 m)	100	8	800	15.6 (7.1 kg)	Health Canada

Cleaning – Industrial Cloths



192578

Tork Industrial Low-Lint Cleaning Cloth

Refill No	Color	Format	System	Base Sheet	Ply	Sheet Size W x L (in)	Feet/Unit	Wipers/Unit	Units/Case	Wipers/Case	Approx Lbs/Case	Certification
192578	Blue	Top-Pak	W4	Polypropylene	1	15.2 x 15.7 (38.61 x 39.88 cm)	104.6 (31.88)	80	5	400	11.4 (5.2 kg)	Society of Automotive Engineers (SAE) Aerospace Certified



520304



520337



520678



520371

Tork Industrial Cleaning Cloth

Refill No	Color	Format	System	Base Sheet	Ply	Sheet Size W x L (in)	Feet/Unit	Wipers/Unit	Units/Case	Wipers/Case	Approx Lbs/Case	Certification
520304	Grey	Giant Roll	W1	Spunlace	1	16.9 x 15.0 (42.93 x 38.10 cm)	1,187.5 (361.95 m)	950	1	950	23.8 (10.8 kg)	Health Canada
520337	Grey	Centerfeed	W2	Spunlace	1	12.6 x 10.0 (32.00 x 25.4 cm)	416.6 (127.01 m)	500	1	500	6.5 (2.9 kg)	Health Canada
520678	Grey	Top-Pak	W4	Spunlace	1	14 x 16.9 (35.56 x 42.93 cm)	169 (51.51 m)	120	5	600	19.5 (8.8 kg)	Health Canada
520371	Grey	Handy Box	Self-Dispensing	Spunlace	1	14 x 16.9 (35.56 x 42.93 cm)	394.3 (120.18 m)	280	1	280	7.3 (3.3 kg)	Health Canada



570104





570137



570478

Tork Industrial Heavy-Duty Cleaning Cloth

Refill No	Color	Format	System	Base Sheet	Ply	Sheet Size W x L (in)	Feet/Unit	Wipers/Unit	Units/Case	Wipers/Case	Approx Lbs/Case	Certification
570104	White	Giant Roll	W1	Spunlace	1	16.9 x 15.0 (42.93 x 38.10 cm)	475 (144.78 m)	380	1	380	15.74 (7.1 kg)	Health Canada 
570137	White	Centerfeed	W2	Spunlace	1	12.6 x 10.0 (32.0 x 25.4 cm)	133.3 (40.63 m)	160	1	160	5.63 (2.6 kg)	Health Canada 
570478	White	Top-Pak	W4	Spunlace	1	14 x 16.9 (35.56 x 42.93 cm)	91.5 (27.89 m)	65	5	325	13.95 (6.3 kg)	Health Canada 

Polishing – Polishing Cloths



197478

Tork Polishing Cloth

Refill No	Color	Format	System	Base Sheet	Ply	Sheet Size W x L (in)	Feet/Unit	Wipers/Unit	Units/Case	Wipers/Case	Approx Lbs/Case	Certification
197478	White	Top-Pak	W4	Spunlace	1	14 x 16.9 (35.56 x 42.93 cm)	176 (53.64 m)	125	5	625	12.95 (5.9 kg)	Health Canada

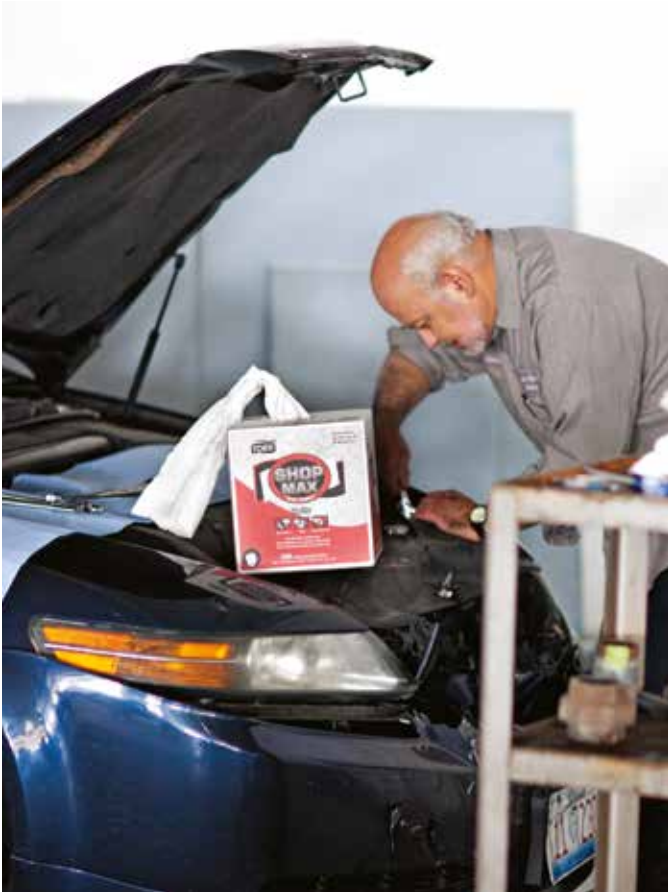

ShopMax – Wet and Dry Wipes



192592



192594



450137



450337



450138



450338



450160



450360



450340

Refill No	Color	Format	System	Base Sheet	Ply	Sheet Size W x L (in)	Feet/Unit	Wipers/Unit	Units/Case	Wipers/Case	Approx Lbs/Case	Certification
192592	White	Hand Cleaner Bucket	Self Dispensing	Spunlace	1	11.8 x 8.7 (29.97 x 22.10 cm)	52.2 (15.91 m)	72	4	288	11.2 (5.1 kg)	NSF E4
192594	White	Multi Surface Bucket	Self Dispensing	Spunlace	1	11.8 x 8.7 (29.97 x 22.10 cm)	52.2 (15.91 m)	72	4	288	10.8 (4.9 kg)	N/A
450137	White	Centerfeed	Self Dispensing	Paper/DRC	1	9 x 13 (22.86 x 33.02 cm)	216.6 (66.04 m)	200	4	800	11.8 (5.4 kg)	N/A
450337	Blue	Centerfeed	Self Dispensing	Paper/DRC	1	9 x 13 (22.86 x 33.02 cm)	216.6 (66.04 m)	200	4	800	11.8 (5.4 kg)	N/A
450138	White	Centerfeed Refill	W22	Paper/DRC	1	9.9 x 13.1 (25.15 x 33.27 cm)	218.3 (66.54 m)	200	2	400	6.4 (2.9 kg)	N/A
450338	Blue	Centerfeed Refill	W22	Paper/DRC	1	9.9 x 13.1 (25.15 x 33.27 cm)	218.3 (66.54 m)	200	2	400	7.0 (3.2 kg)	N/A
450160	White	Roll Towel	--	Paper/DRC	1	11 x 9.4 (27.94 x 23.88 cm)	47.0 (14.33 m)	60	30	1,800	24.1 (10.9 kg)	N/A
450360	Blue/White	Roll Towel	--	Paper/DRC	1	11 x 9.4 (27.94 x 23.88 cm)	47.0 (14.33 m)	60	30	1,800	24.1 (10.9 kg)	N/A
450340	Blue	Centerfeed Bucket	W22	Paper/DRC	1	9.9 x 13.1 (25.15 x 33.27 cm)	218.3 (66.54 m)	200	2	400	8.0 (3.6 kg)	N/A

Dispensers

Our dispenser assortment is sure to meet your needs and demands, regardless of what these are. We offer a wide range of wall-mounted, floor standing or fully portable systems. Many of them come in several colors, which makes it easy for you to choose a dispenser that not only gets the job done – but looks good in your facility too.

Tork Performance Dispensers



Dispenser No.	Format	Color	Refill ID	Material	Dispenser/Case	Dispenser Capacity	Approx Lbs/Case	Cubic Feet/Case	Size H x W x D (in)
653028	Tork Maxi Centerfeed Dispenser	Red/Smoke (Aqua/White also available)	W2	Plastic	1	1 Roll	7.1 (3.2 kg)	1.74 (0.0492 cubic meter)	17.6 x 12.91 x 11.89 (44.70 x 32.79 x 30.20 cm)
659028	Tork Centerfeed Dispenser	Red/Smoke (Aqua/White also available)	M2	Plastic	1	1 Roll	3.64 (1.7 kg)	0.82 (0.0232 cubic meter)	14.02 x 9.76 x 9.13 (35.61 x 24.79 x 23.19 cm)
6520281	Tork Floor Stand	Red/Smoke	W1	Plastic/Steel	1	1 Roll	18.84 (8.5 kg)	3.56 (0.1007 cubic meter)	39.6 x 25.43 x 20.87 (100.61 x 64.59 x 53.01 cm)
6521281	Tork Wall Stand	Red/Smoke	W1	Plastic/Steel	1	1 Roll	8.57 (3.9 kg)	1.78 (0.0504 cubic meter)	18.23 x 25.43 x 10.79 (46.30 x 64.59 x 27.41 cm)
6540281*	Tork Folded Wiper/Cloth Dispenser	Red/Smoke (Aqua/White also available)	W4	Plastic	1	225 Wipers	5.16 (2.3 kg)	1.07 (0.0303 cubic meter)	15.51 x 16.81 x 8.11 (39.40 x 42.70 x 20.60 cm)
651228	Tork Washstation Roll Towel Dispenser	Red/Smoke (Aqua/White also available)	W6	Plastic	1	1 Roll	10.96 (5.0 kg)	1.63 (0.0461 cubic meter)	18.09 x 12.56 x 10.57 (45.95 x 31.9 x 26.85 cm)

*For optional magnet kit order 206540

Tork Basic Dispensers



Dispenser No.	Format	Color	Refill ID	Material	Dispenser/Case	Dispenser Capacity	Approx Lbs/Case	Cubic Feet/Case	Size H x W x D (in)
207328**	Tork Top-Pak Bracket Dispenser	Black	W4	Plastic	1	1 Box	2.4 (1.1 kg)	0.69 (0.0195 cubic meter)	7.8 x 16 x 8.6 (19.81 x 40.64 x 21.84 cm)
2083281***	Tork Pop-Up Bracket Dispenser	Black	W24	Plastic	6	1 Box	2.61 (1.2 kg)	0.54 (0.0153 cubic meter)	5 x 13.5 x 3 (12.70 x 34.29 x 7.62 cm)
70WM1	Tork Folded Towel Dispenser	White	H22	White Enamel Painted Steel	1	450 towels	5.5 (2.5 kg)	0.36 (0.0102 cubic meter)	9.25 x 11.75 x 5.75 (23.50 x 29.85 x 14.61 cm)

For optional magnet kit order 202818 *For optional magnet kit order 2548975

Washroom Solutions

In addition to our innovative wiping solutions, Essity also offers a wide variety of Tork towel, tissue, and soap for your washrooms.

Tork Elevation Dispensers



Dispenser No.	Format	Color	Refill ID	Dispenser/Case	Size H x W x D (in)
5510282	Tork Elevation® Matic® Hand Towel Roll Dispenser	Black	H1	1	14.65 x 13.2 x 8.1 (37.21 x 33.53 x 20.57 cm)

Refill No.	Description	Color	Ply	Sheet Size (L x W in)	Towels/Roll	Rolls/Case	Certification
290088	Tork Universal Matic Hand Towel Roll	Natural	1	7.7 x 9.5 (19.56 x 24.1 cm)	884	6	
290089	Tork Advanced Matic Hand Towel Roll	White	1	7.7 x 9.5 (19.56 x 24.1 cm)	884	6	

Dispenser No.	Format	Color	Refill ID	Dispenser/Case	Size H x W x D (in)
552028	Tork Elevation Xpress Hand Towel Dispenser	Black	H2	1	17.5 x 11.9 x 4.0 (44.4 x 30.2 x 10.2 cm)

Refill No.	Description	Color	Ply	Sheet Size (L x W in)	Towels/Case	Packs/Case	Certification
420558	Tork Advanced Soft Mutifold Hand Towel	White w/Gray Leaf	1	9.125 x 10.875 (23.18 x 27.62)	3,200	16	FSC®

Dispenser No.	Format	Color	Refill ID	Dispenser/Case	Size H x W x D (in)
559028A	Tork Elevation Centerfeed Hand Towel Dispenser	Black	M2	1	14.39 X 9.42 X 8.95 (36.55 X 22.93 X 22.73 cm)

Refill No.	Description	Color	Ply	Sheet Size (L x W in)	Towels/Roll	Rolls/Case	Certification
121201	Tork Advanced Soft Centerfeed Hand Towel	White	2	9 x 11.8 (22.86 x 29.97 cm)	600	6	
121202	Tork Advanced Soft Centerfeed Hand Towel	White	2	8.25 x 11.8 (20.96 x 29.97 cm)	610	6	
120133	Tork Advanced Centerfeed Hand Towel	White	1	8.25 x 11.8 (20.96 x 29.97 cm)	1,000	6	
120932	Tork Advanced Soft Centerfeed Hand Towel	White	2	7.6 x 11.8 (19.30 x 29.97 cm)	500	6	

Dispenser No.	Format	Color	Refill ID	Dispenser/Case	Size H x W x D (in)
554028A	Tork Elevation Jumbo Bath Tissue Roll Dispenser	Black	T1	1	14.2 x 17.2 x 5.2 (36.0 x 43.7 x 13.3 cm)

Refill No.	Description	Color	Ply	Roll Width x Linear Ft. (W x L)	Rolls/Case	Certification
12021502	Tork Advanced Jumbo Bath Tissue Roll	White	2	3.55 inches x 1,600 linear ft.	6	

Dispenser No.	Format	Color	Refill ID	Dispenser/Case	Size H x W x D (in)
5555290	Tork Elevation Twin Mini Jumbo Bath Tissue Dispenser	Black	T2	1	10.125 x 17.0 x 5.7 (25.72 x 43.18 x 14.45 cm)

Refill No.	Description	Color	Ply	Roll Width x Linear Ft. (W x L)	Rolls/Case	Certification
12024402	Tork Advanced Mini Jumbo Bath Tissue Roll, Perforated	White	2	3.55 inches x 751 linear ft.	12	

Dispenser No.	Format	Color	Refill ID	Dispenser/Case	Size H x W x D (in)
570028A	Tork Skincare Liquid Dispenser	Black	S1	6	11.5 x 4.4 x 4.5 (29.1 x 11.2 x 11.4 cm)

Refill No.	Description	Color	Fragrance	Unit Size	Units/Case	Certification
400011	Tork Premium Extra Mild Liquid Soap	White	None	1 Liter	6	
400014	Tork Premium Antibacterial Liquid Soap (Not available in Canada)	Colorless	None	1 Liter	6	

Tork Basic Dispensers



73TR



84TR



93T



66TR



59TR

Dispenser No.	Format	Color	Refill ID	Dispenser/Case	Size H x W x D (in)
73TR	Tork Multifold/C-Fold Hand Towel Dispenser	Smoke	H2, H25	1	18 x 11.75 x 6.25 (45.72 x 29.85 x 15.88 cm)

Refill No.	Description	Color	Ply	Towel Size W x L (in)	Towels/Case	Certification
CB530	Tork Universal C-Fold Hand Towel	White	1	10.125 x 12.75 (25.72 x 32.39 cm)	2,400	
MB571	Tork Premium Soft Multifold Hand Towel	White w/Blue Leaf	2	9.125 x 9.5 (23.81 x 24.13 cm)	2,400	
MB540A	Tork Universal Multifold Hand Towel	White	1	9.125 x 9.5 (23.81 x 24.13 cm)	4,000	
MK530A	Tork Universal Multifold Hand Towel	Natural	1	9.125 x 9.5 (23.81 x 24.13 cm)	4,000	

Dispenser No.	Format	Color	Refill ID	Dispenser/Case	Size H x W x D (in)
84TR	Tork Roll Hand Towel Dispenser, Lever Auto Transfer	Smoke	H21	1	15.5 x 12.94 x 9.25 (39.37 x 32.87 x 23.50 cm)

Refill No.	Description	Color	Ply	Linear Feet/Roll	Rolls/Case	Certification
RB351	Tork Universal Roll Hand Towel	White	1	350 (106.7 m)	12	
RK350A	Tork Universal Roll Hand Towel	Natural	1	350 (106.7 m)	12	

Dispenser No.	Format	Color	Refill ID	Dispenser/Case	Size H x W x D (in)
93T	Tork Centerfeed Hand Towel Dispenser	Smoke	M23	1	12.75 x 10.125 x 10 (32.39 x 25.72 x 25.40 cm)

Refill No.	Description	Color	Ply	Linear Feet/Roll	Rolls/Case	Towels/Roll	Certification
RC530	Tork Universal Centerfeed Hand Towel	White	2	7.6 x 11.75 (19.30 x 29.85 cm)	530	6	

Dispenser No.	Format	Color	Refill ID	Dispenser/Case	Size H x W x D (in)
66TR	Tork Jumbo Bath Tissue Roll Dispenser, Single	Smoke	T22	1	12 x 10.63 x 5.75 (30.48 x 27.00 x 14.61 cm)

Refill No.	Description	Color	Ply	Roll Width x Linear Ft (W x L)	Rolls/Case	Certification
TJ0922A	Tork Universal Jumbo Bath Tissue Roll	White	2	3.55 (9.02 cm) x 1,000 (304.8)	12	
TJ0928	Tork Universal Jumbo Bath Tissue Roll	White	2	3.55 (9.02 cm) x 750 (228.6)	12	

Dispenser No.	Format	Color	Refill ID	Dispenser/Case	Size H x W x D (in)
59TR	Tork Twin Bath Tissue Roll Dispenser	Smoke	T24	1	8.25 x 12.75 x 5.57 (20.96 x 32.39 x 14.61 cm)

Refill No.	Description	Color	Ply	Sheet Size (W x L in)	Sheets/Roll	Rolls/Case	Certification
TM1616S	Tork Universal Bath Tissue Roll	White	2	4.0 x 3.75 (10.16 x 9.53 cm)	500	96	
TM1602	Tork Universal Bath Tissue Roll	White	2	4.0 x 3.75 (10.16 x 9.53 cm)	420	48	
TM6512	Tork Premium Bath Tissue Roll	White	2	4.0 x 3.75 (10.16 x 9.53 cm)	460	48	
TM6510	Tork Premium Bath Tissue Roll	White	2	4.5 x 3.75 (11.43 x 9.53 cm)	400	96	

Research, trends and Tork solutions for the Aviation Maintenance Repair and Overhaul segment



What is Aviation Maintenance, Repair and Overhaul (MRO)?

Aviation maintenance, repair and overhaul (MRO) are the essential services required to ensure that aircraft are maintained in airworthy condition and can safely transport passengers and cargo. MRO service companies provide these services.

Maintenance keeps an aircraft in an airworthy condition.

Repair or replacement of damaged parts that do not function properly.

Overhaul or reconditioning of a system that has deteriorated due to worn-out parts or decreased performance/strength back to their original characteristics.

How is the market structured?

MRO service companies are most often structured in the following ways; Airline owned, recognized chains, plane producer owned and independent companies.

Some organizations specialize in certain areas of the aircraft (i.e. engines, avionics etc.) Some companies also have flying teams that can offer global service.

Why does the Aviation MRO segment matter to us?

- The Aviation MRO cleaning and wiping market is a big opportunity at M USD globally.
- The current civil air transport fleet consists of over 27,000 aircraft and demand is growing.

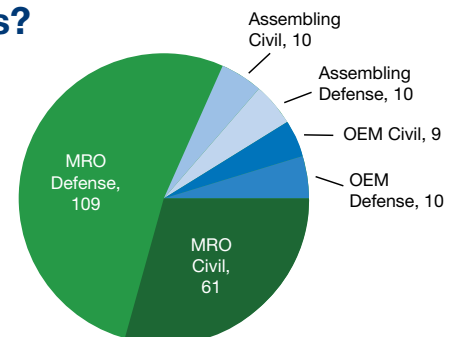

Wiping and cleaning products market for Aviation: **M globally**

Key player profiles

The workforce is the most valuable asset for an MRO company. Engineers require many years of training and are in high demand.

1. Aviation Maintenance Engineer (AMEs)

The AMEs are highly skilled professionals with up to 8 years of training required for certification. They are well paid and are in high demand. This individual is responsible for the safety of millions of lives and is crucial to the functioning of the Aviation industry.

They are also referred to as technicians or operators.

Inside tip: Technicians should not be overloaded or stressed, as it may result in shortcuts in procedures as well as mistakes that risk human lives.

2. Production/Operations Managers

These managers are responsible for planning, steering and overseeing production and operations at the MRO. Their key focus is work optimization/efficiency and therefore must maximize the time and utilization of the Aviation Maintenance Engineers.

They holistically think about costs and areas of savings.

Inside tip: Open to talk and interested in innovations and improvements.

3. Health and Safety Manager

This manager can be a good contact, especially if the company is focused on sustainability. They are very involved in product testing and audits. The Health and Safety Manager is responsible for this highly valuable workforce.

Inside tip: They are concerned about high solvent usage as it relates to health and safety as well as sustainability.

Remember:

Always aim to speak with the Production Manager and use Safety Manager as a second alternative.

Try to schedule meetings with both Production and Safety Managers together to secure buy in from both early in the process.

Competitive factors on the MRO market

The two most important competitive factors for MROs are (in order of priority):

- Safety
- Speed of service



What do MROs use for wiping and cleaning now?

To effectively sell disposable wipers, it's important to understand what is used in the Aviation MRO segment currently: **textile rags**.

<p>What are textile rags</p> <ul style="list-style-type: none"> • These textile scraps, mill ends, remnants and secondhand clothing come in various sizes, fabric types and quality levels. • They can be classified as mixed colors, white and cotton. Rags are purchased in bags or boxes by the pound. 	<p>Barriers for trying something new</p> <ul style="list-style-type: none"> • Long testing cycle (requires determination and willingness for modernization from Operations Manager) • Internal approval procedures
<p>Why textile rags</p> <ul style="list-style-type: none"> • It is what they have always used. • Knowledge about the market is limited, purchases are being made on "autopilot" • Wiping and cleaning is not considered important to review as customers do not expect it to have a positive impact on lowering costs or increasing efficiency 	<p>Tork wipers vs textile rags</p> <ul style="list-style-type: none"> • Tork Industrial wipers include a range of highly-professional tools designed for modern industrial facilities, such as MROs. • Tork industrial wipers are designed with different capabilities for a wide range of tasks. Low lint, extreme absorption or antistatic. • No matter what, you can trust that the product in hand, will deliver the same consistent performance every time.

The right product for the right task.

When visiting a MRO facility, emphasize how Tork products are designed to handle wiping and cleaning task such as:

General maintenance



Mechanical area

Usually the biggest and dirtiest section of the company. Biggest opportunity for Tork. The MRO team removes and repairs or replaces parts in this area regularly. A lot of hand wiping.

Sensitive tasks



Paint shops

Preparation of the aircraft for painting. Degreasing and dedusting large surfaces before coating and painting. There is a need for hand wiping.

Composites

Used widely in all parts of the plane. Wipers are often used for cleaning excess adhesive material with solvents. Wipers should remove excess of sealant well and not leave any residue or lint. If residue or lint is left behind coating will not stick. Need for hand wiping.

Static charge sensitive areas



Avionics and instruments

Avionics refer to the electronic systems in an aircraft. Avionics and instrument systems can be damaged by static discharge. Instruments/avionics are first cleaned with compressed air. Tough dirt is then cleaned with a dry wiper and alcohol for fast evaporation.

Fuel systems

Maintenance of interior of tanks and overall fuel systems. Fumes can build up in tight spaces. Static sparks would be highly dangerous.

Product Certification Review AMS, BMS and ESD

BMS 15-5G (Boeing Manufacturing Standard)

Developed by Boeing to ensure standardization of parts used in production. There are many different BMS standards. 15-5G is the standard for wipers and cloths.

Chemical testing is done to see how wipers work with a number of different chemicals, to detect the presence of silicone and oils, and to validate performance with commonly used solvents and how it works with solvents.

Chemical and physical testing is performed to identify lint characteristics. Also shows indication if the product lints.

AMS 3819C (Aerospace Material Standard, SAE)

AMS standard was developed by the Society of Automotive Engineers, a U.S.-based, globally active professional association and standards developing organization. This standard was developed as alternative to BMS.

The AMS 3819C is the standard which is used for wipers. Only white nonwoven wipers are accepted for certifications.

Testing is done for physical properties such as weight, absorption, linting, integrity, chemical test, pH of material, tests are also done to determine strength, absorption and performance.

ESD certified products meet the requirements of EPA – Electrostatic Protection Area

Tests indicates whether or not a material collects a static charge. If a static charge is not collected, the risk of discharge (giving off a spark) is low and the product can be used in and electrostatic protected area.

ESD sensitive areas in an aircraft are Avionics (electronics) and fuel systems.

Note: this is not strictly an aviation standard, this standard applies for users looking for products with antistatic properties.

To choose the right Tork solution, ask yourself these three questions:

- 1. What is your main task?**
- 2. What are your usage requirements?** Do several people use wipers during the day or is it just one person who occasionally needs to use them?
- 3. What is your work environment?** Are you at a fixed workstation where you and others need equal access to a dispenser, or do you need a mobile solution to move around to carry out different tasks?

Wiper dispensers



Tork Top-Pak Bracket Dispenser

207328



Tork Folded Wiper/Cloth Dispenser

6540281



Tork Floor Stand

6520281

Wiper refills



Tork Low-Lint Cleaning Cloth
510175A, White

Health Canada NSF P1 BMS 15-5G



Tork Low-Lint Cleaning Cloth
192482, White

Health Canada BMS 15-5G AMS 3819C



Tork Low-Lint Cleaning Cloth
192578, Turquoise

Health Canada BMS 15-5G AMS 3819C



Tork Heavy-Duty Cleaning Cloth
530178, White

Health Canada BMS 15-5G



Tork Heavy-Duty Cleaning Cloth
530104, White

Health Canada BMS 15-5G

HACCP International Certified

BMS 15-5G Boeing Manufacturing Standard

Health Canada Food Directorate

NSF National Sanitation Foundation Rated

AMS 3819C Aerospace Material Standard



Put the right tools in the right hands – get the aircraft back in the air faster

It's time to stop cleaning 21st century equipment with tools from the 1950's.

Your engineers are responsible for some of the most advanced maintenance jobs in the world and every second counts in the aviation business. When an aircraft check demands tens of thousands of man-hours, working with outdated tools can steal a lot of time.

Tork industrial wipers are the next generation of industrial cleaning tools. They are engineered and tested to cope with the world's highest safety standards* and efficiency goals. Compared to rags, they make cleaning and wiping easier and more efficient. . . Or in other words: they save your highly skilled professionals valuable time without compromising on safety. The net result: you minimize aircraft downtime and get the aircraft back in the air faster.

Tork Industrial wipers feature a range of products developed with the aviation industry in mind. They absorb much better than rags, are low-linting and antistatic. In the end it all adds up to more efficient use of your crew.

Up to...

30% less time

20% less effort

40% less solvent

...compared to rags**



To choose the right Tork solution, ask yourself these three questions:

- 1. What is your main task?**
- 2. What are your usage requirements?** Do several people use wipers during the day or is it just one person who occasionally needs to use them?
- 3. What is your work environment?** Are you at a fixed workstation where you and others need equal access to a dispenser, or do you need a mobile solution to move around to carry out different tasks?

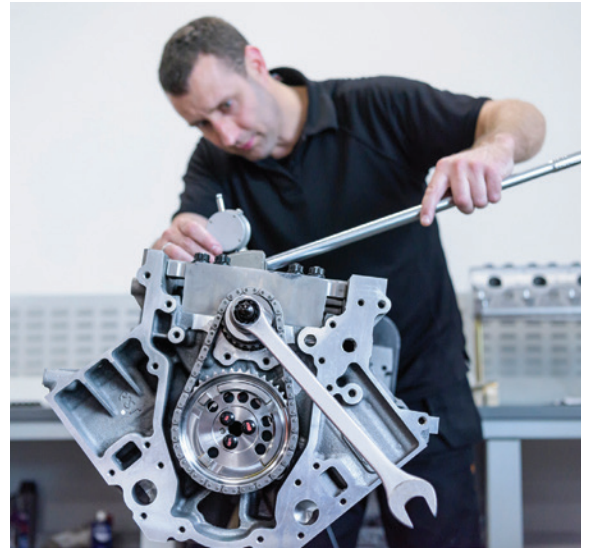

Wiper dispensers



Tork Top-Pak Bracket Dispenser
207328



Tork Folded Wiper/Cloth Dispenser
6540281



Tork Floor Stand
6520281

Wiper refills



Tork Low-Lint Cleaning Cloth
510175A, White

Health Canada NSF P1 BMS 15-5G



Tork Low-Lint Cleaning Cloth
192482, White

Health Canada BMS AMS 15-5G 3819C



Tork Low-Lint Cleaning Cloth
192578, Turquoise



Tork Heavy-Duty Cleaning Cloth
530178, White

Health Canada BMS 15-5G



Tork Heavy-Duty Cleaning Cloth
530104, White

Health Canada BMS 15-5G

HACCP International Certified

BMS 15-5G Boeing Manufacturing Standard

Health Canada Food Directorate

National Sanitation Foundation Rated

AMS 3819C Aerospace Material Standard



Hygienic bath tissue solutions



Tork® Bath Tissue Dispensing Systems

Tork offers a variety of bath tissue dispensing options to meet all your washroom needs.

- “Never-empty” bath tissue dispensing
- Hygienic covered roll for reduced risk of cross-contamination
- Space-saving footprint
- One clean look; every product in the Tork family is designed to complement your space—and each other



Tork Elevation Coreless High Capacity Bath Tissue Dispensing System

Eliminate the unnecessary with our new Tork Elevation Coreless High Capacity Bath Tissue Dispensing System. We increase the value of our offer simply by giving less. And by less we mean no wraps, no waste, no plugs and no cores to deal with. It's 100% toilet paper – nothing more, nothing less.

With less time spent on refilling and less risk of run outs, your staff can focus on what really matters – your guests' and employee experience.

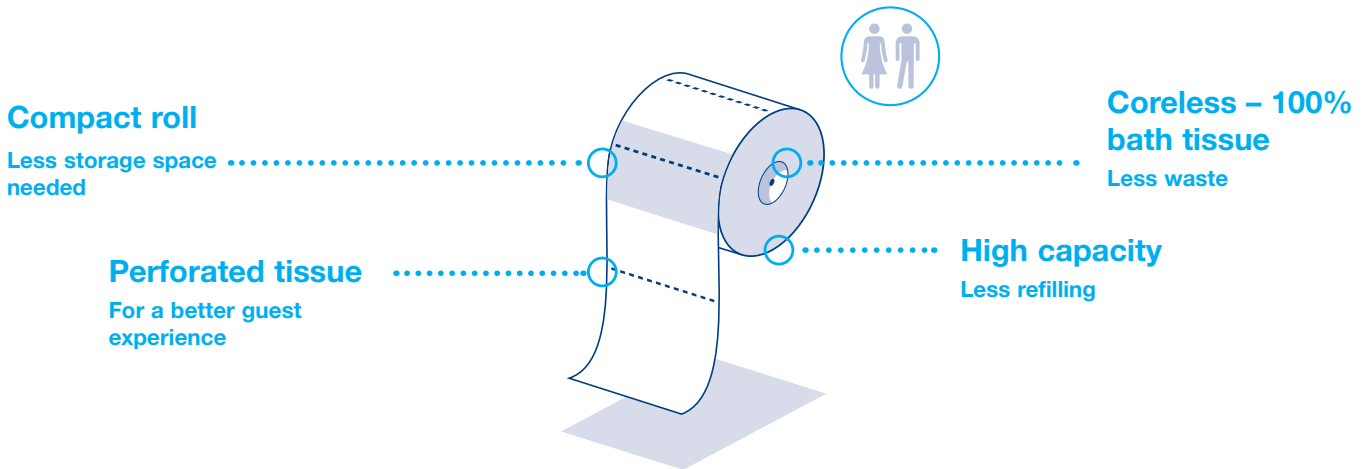

Tork Elevation Coreless High Capacity Bath Tissue Dispensers – T7 System

SKU	Description	Color	Size H x W x D (in)	Case
473200	Tork Elevation Coreless High Capacity Bath Tissue Dispenser	White	8.225 x 14.173 x 5.078 (20.9 x 36.0 x 12.9 cm)	1
473208	Tork Elevation Coreless High Capacity Bath Tissue Dispenser	Black	8.225 x 14.173 x 5.078 (20.9 x 36.0 x 12.9 cm)	1

Refill SKU	Description	Color	Ply	Sheet Size W x L (in)	Sheets/Roll	Case	Certification
472886	Tork Advanced High Capacity Coreless Bath Tissue Roll	White	2	3.66 x 4.9 (9.3 x 12.45 cm)	900	36	FSC®

Tork High Capacity Coreless Spindle Kits – T7



SKU	Description	Spindle Size H x W x D (in)	Spindles/Kit	Kits/Case
473030	Tork High Capacity Coreless Spindle Kit, Type A	5.6 x 1.6 x 1.6 (14.22 x 4.06 x 4.06 cm)	2	25
473020	Tork High Capacity Coreless Spindle Kit, Type B	5.9 x 1.6 x 1.6 (14.99 x 4.06 x 4.06 cm)	2	25
473040	Tork High Capacity Coreless Spindle Kit, Type C	6.1 x 1.4 x 1.4 (15.49 x 3.56 x 3.56 cm)	2	25
473060	Tork High Capacity Coreless Spindle Kit, Type D	4.7 x 1.4 x 1.4 (11.94 x 3.56 x 3.56 cm)	2	25

Tork Bath Tissue Dispensing Systems for OptiCore®

OptiCore technology ensures maximum use of each roll in the dispenser before advancing to the next roll. This controlled-use reduces product waste and cost.

OptiCore technology offers a two-part core for controlled-use and more than 25% reduction in core material for more environmentally preferable packaging.

High sheet count for maximum capacity

Attractive floral embossing on most 2-ply products.

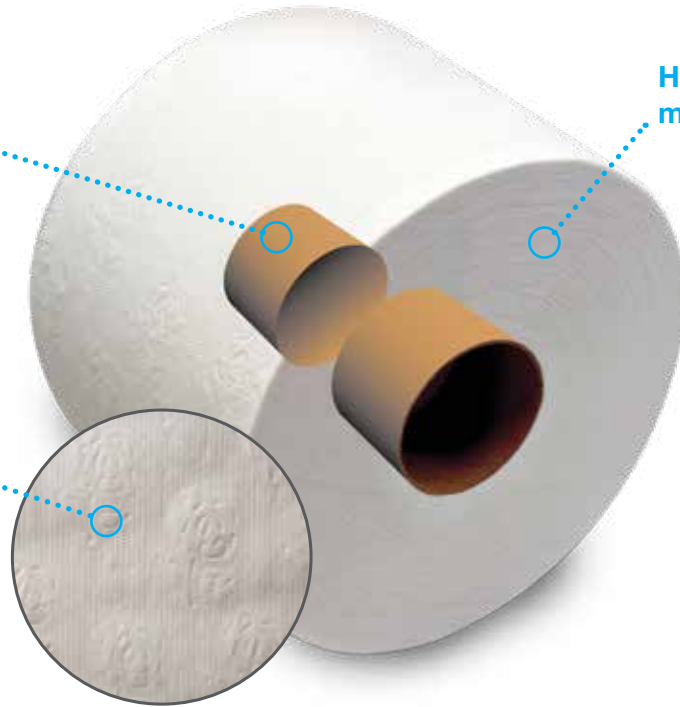



Tork Bath Tissue Dispensing Systems for OptiCore—T10 System

- Highest Capacity OptiCore System

The Tork High Capacity Bath Tissue Roll Dispenser for OptiCore Provides an attractive solution for high traffic accounts where the flow of traffic demands high footage rolls of product.



SKU	Description	Color	Size H x W x D (in)	Case
565520	Tork High Capacity Bath Tissue Roll Dispenser for OptiCore	White	9.93 x 16.62 x 5.25 (25.22 x 42.21 x 13.34 cm)	1
565528	Tork High Capacity Bath Tissue Roll Dispenser for OptiCore	Black	9.93 x 16.62 x 5.25 (25.22 x 42.21 x 13.34 cm)	1

Refill SKU	Description	Color	Ply	Sheet Size W x L (in)	Sheets/Roll	Case	Certification
160090	Tork Universal High Capacity Bath Tissue Roll with OptiCore	White	2	3.75 x 3.5 (9.53 x 8.89 cm)	2,000	12	E   

Tork Easy Handling



Carry a box with each hand and save time



Use two hands for a comfortable grip



Boxes open quickly and easily without cutting

Tork Bath Tissue Dispensing Systems for OptiCore—T11 System



- High-Traffic OptiCore Dispensing

The Tork 3 Roll Bath Tissue Roll Dispenser for OptiCore is designed to minimize maintenance and maximize cost savings for high-traffic areas.

SKU	Description	Color	Size H x W x D (in)	Case
565820	Tork 3 Roll Bath Tissue Roll Dispenser for OptiCore	White	14.56 x 14.12 x 6.31 (36.98 x 35.86 x 16.03 cm)	1
565828	Tork 3 Roll Bath Tissue Roll Dispenser for OptiCore	Black	14.56 x 14.12 x 6.31 (36.98 x 35.86 x 16.03 cm)	1



- Traditional Footprint OptiCore Dispensing

The Tork Twin Bath Tissue Roll Dispenser for OptiCore holds two rolls of patented OptiCore tissue.

SKU	Description	Color	Size H x W x D (in)	Case
565720	Tork Twin Bath Tissue Roll Dispenser for OptiCore	White	8.81 x 11.06 x 7.18 (22.37 x 28.09 x 18.24 cm)	1
565728	Tork Twin Bath Tissue Roll Dispenser for OptiCore	Black	8.81 x 11.06 x 7.18 (22.37 x 28.09 x 18.24 cm)	1



- OptiCore Dispensing for Smaller Spaces

The Tork Twin Bath Tissue Roll Dispenser for OptiCore is ideal for environments where horizontal space is limited.

SKU	Description	Color	Size H x W x D (in)	Case
565620	Tork Twin Bath Tissue Roll Dispenser for OptiCore	White	12.31 x 6.75 x 7 (31.27 x 17.15 x 17.78 cm)	1
565628	Tork Twin Bath Tissue Roll Dispenser for OptiCore	Black	12.31 x 6.75 x 7 (31.27 x 17.15 x 17.78 cm)	1



Refill SKU	Description	Color	Ply	Sheet Size W x L (in)	Sheets/Roll	Case	Certification
106390	Tork Premium Bath Tissue Roll with OptiCore	White	2	3.75 x 4 (9.53 x 10.16 cm)	800	36	
162090	Tork Advanced Bath Tissue Roll with OptiCore	White	2	3.75 x 4 (9.53 x 10.16 cm)	865	36	E, Recycled, Green
161990	Tork Universal Bath Tissue Roll with OptiCore	White	2	3.75 x 4 (9.53 x 10.16 cm)	865	36	E, Recycled, Green
112990	Tork Universal Bath Tissue Roll with OptiCore	White	1	3.75 x 4 (9.53 x 10.16 cm)	1,755	36	E, Recycled, Green



Tork Jumbo and Mini Jumbo Bath Tissue Dispensing Systems

Tork Jumbo Bath Tissue dispensers simplify and complement any environment, providing a clean, hygienic appearance. Our design ensures easy and intuitive maintenance, refilling and use. A perfect choice for high-traffic washrooms as well as environments where efficiency and reduced cost are priorities. Rolls are protected so there is improved hygiene, reduced pilferage and less waste.

- Less maintenance

Large capacity rolls allow you to service high-traffic areas without adding extra maintenance check-ins. Lock operates in key or keyless push button mode.

- Less waste

The paper brake prevents overspin of each roll which means less waste, clutter and overall cost.

- Fewer germs

The reserve roll in the Mini Twin remains protected until the first one is completely gone, ensuring it stays hygienic.

- One clean look

Every product in the Tork family is designed to complement your space and each other.













Tork Mini Jumbo Roll Bath Tissue – T2 System



SKU	Description	Color	Size H x W x D (in)	Case
555020A	Tork Elevation Mini Jumbo Bath Tissue Roll Dispenser	White	10.8 x 13.6 x 5.2 (27.5 x 34.5 x 13.2 cm)	1
555028A	Tork Elevation Mini Jumbo Bath Tissue Roll Dispenser	Black	10.8 x 13.6 x 5.2 (27.5 x 34.5 x 13.2 cm)	1
5555200	Tork Elevation Twin Mini Jumbo Bath Tissue Roll Dispenser	White	10.125 x 17 x 5.6875 (25.72 x 43.18 x 14.45 cm)	1
5555290	Tork Elevation Twin Mini Jumbo Bath Tissue Roll Dispenser	Black	10.125 x 17 x 5.6875 (25.72 x 43.18 x 14.45 cm)	1
465500	Tork Image Design™ Mini Jumbo Bath Tissue Roll Dispenser	Stainless Steel	9.875 x 14 x 5.125 (25.08 x 35.56 x 13.02 cm)	1









Refill SKU	Description	Color	Ply	Linear Feet/Roll	Roll Width (in)	Case	Certification
11020602	Tork Advanced Soft Mini Jumbo Bath Tissue Roll 	White	2	751 (228.9 m)	3.55 (9.02 cm)	12	
12024402	Tork Advanced Mini Jumbo Bath Tissue Roll 	White	2	751 (228.9 m)	3.55 (9.02 cm)	12	 
120246	Tork Advanced Mini Jumbo Bath Tissue Roll 	White	2	751 (228.9 m)	3.55 (9.02 cm)	12	 
12013903	Tork Advanced Mini Jumbo Bath Tissue Roll 	White	1	1,200 (365.7 m)	3.55 (9.02 cm)	12	 

Tork Bath Tissue Jumbo Roll – T1 System



SKU	Description	Color	Size H x W x D (in)	Case
554020A	Tork Elevation Jumbo Bath Tissue Roll Dispenser	White	14.2 x 17.2 x 5.2 (36.0 x 43.7 x 13.2 cm)	1
554028A	Tork Elevation Jumbo Bath Tissue Roll Dispenser	Black	14.2 x 17.2 x 5.2 (36.0 x 43.7 x 13.2 cm)	1
247549A	Tork Twin Jumbo Bath Tissue Roll Dispenser	Black	13 x 21.5 x 5.5 (33.02 x 54.61 x 13.97 cm)	4



Refill SKU	Description	Color	Ply	Linear Feet/Roll	Roll Width (in)	Case	Certification
12021502	Tork Jumbo Advanced Bath Tissue Roll 	White	2	1,600 (487.68 m)	3.55 (9.02 cm)	6	 
11010402	Tork Jumbo Advanced Bath Tissue Roll 	White	1	2,247 (684.89 m)	3.55 (9.02 cm)	6	 

Tork Elevation High Capacity Bath Tissue Dispensing System

The Tork High Capacity Bath Tissue Dispensing System is a perfect fit for washrooms with limited space. The innovative auto-transfer feature promotes hygiene and reduces refill maintenance time.







- **Less waste**
Prevents waste by dropping the reserve roll only after the primary roll is depleted.
- **High capacity**
Holds up to 2,000 two-ply sheets or 4,000 one-ply sheets. Contains 60 percent more tissue than conventional bath tissue dispensers.
- **Lower cost**
Permits quicker, easier loading and fewer refills, reducing maintenance time.



Tork Elevation High Capacity Bath Tissue – T26 System

SKU	Description	Color	Size H x W x D (in)	Case
555620	Tork High Capacity Bath Tissue Roll Dispenser	White	14.2 x 6.3 x 6.46 (36.07 X 16.0 x 16.41 cm)	1
555628	Tork High Capacity Bath Tissue Roll Dispenser	Black	14.2 x 6.3 x 6.46 (36.07 X 16.0 x 16.41 cm)	1



Refill SKU	Description	Color	Ply	Sheet Size W x L (in)	Sheets/Roll	Case	Certification
110292A	Tork Advanced High Capacity Bath Tissue Roll 	White	2	3.94 x 3.75 (10.01 x 9.53 cm)	1,000	36	  
110291A	Tork Advanced High Capacity Bath Tissue Roll 	White	1	3.94 x 3.75 (10.01 x 9.53 cm)	2,000	36	  



SKU	Description	Color	Case
AT26BT*	T26 Spindle for 2-Ply Bath Tissue, only for 110292A	Black	20

* Spindle for Bobrick B-347/3471/3474/3479 Partition-Mounted Seat Cover, Sanitary Napkin Disposal and Tissue Dispenser and for B-357/3571/3574/3579 Partition-Mounted Seat Cover and Toilet Tissue Dispenser



BOMA 360 brings your building *full circle* – and helps you gain a distinct competitive advantage



The BOMA 360 Performance Program® sets the standard worldwide for operational best practices in the commercial real estate industry. For building owners and managers who want to help their properties stand out from the crowd, there is no clearer mark of excellence than achieving the BOMA 360 designation.

Essity is proud to partner with BOMA and the 360 Performance program to help your building be part of a sustainable and thriving community.

INCREASED INCOME PER SQUARE FOOT

BUILDINGS with the BOMA 360 designation are averaging

more per sq. ft.*
in Total Rental Income than buildings without the designation

more per sq. ft.*
in Total Rental Income (-) Total Operating Expenses than buildings without the designation

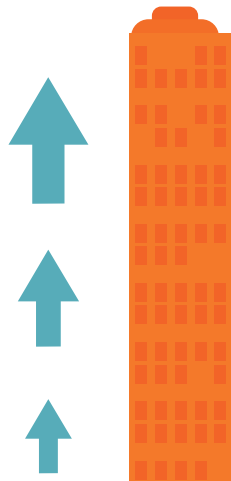

INCREASED TENANT SATISFACTION

BOMA 360 BUILDINGS scored higher than Kingsley Index in

93%
of tenant satisfaction categories*

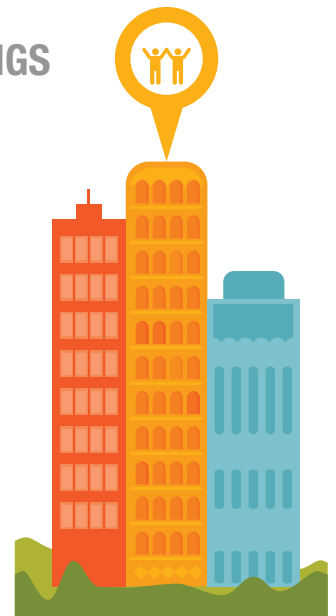

Essity and the Tork brand of products can help a facility attain **BOMA 360** designation in the following operations and management practice areas:

Building Operations and Management

- **Green Purchasing (up to 2 points)**
 - Minimize generation of waste and releases of pollutants, such as:
Other: Tork paper towel and napkin dispensers with guaranteed reduction in paper product usage by 10-25%, depending on dispenser chosen
 - Using products made from recycled materials and that can be reused or recycled, such as:
Recycled Content Products - the majority of Tork paper products are 100% recycled



Environmental/Sustainability

- **Waste Management and Recycling Programs (up to 2 points)**
 - Waste Management and Recycling Program - *possible Tork Closed Loop Recycling Program*
 - Alternative Food Waste/Organic Material Disposal - *separating and composting Tork compostable towels and napkins with food waste and other organics*
- **Green Cleaning (2 points)**
 - *By using Tork products that are third party certified by Green Seal™, ECOLOGO®, or FSC®*



Tenant Relations/Community Involvement

- **Tenant Relations/Community Involvement**
 - Tenant Communication Program (1 point)
Educating tenants/occupants about new building amenities or services – Education, signage and proper messaging is key to successfully changing behavior and implementing new sustainable programs with occupants. Our experienced marketers can design materials to create a smooth launch.





Use Tork compostable napkins to support your commitment to go green



SCA is the first AFH paper manufacturer to attain Biodegradable Products Institute™ (BPI) certification for its napkins, enabling your business to improve its environmental footprint.

- All Tork Universal and Advanced napkins, including custom print, are now certified compostable
- Compostable certification approval based on testing in a BPI-approved, independent lab and are third-party certified
- Confirms napkins can be safely disposed of and are quickly biodegradable in municipal and commercial composting facilities
- Along with the ECOLOGO™ and Green Seal™ certifications, provides an even higher standard of cost-effective sustainable product solutions
- Valuable to any business incorporating a composting program – particularly in the foodservice and food-related industries.”

CARE



What is Tork® CARE?

It's the suite of services that come standard with value-added Tork products. With CARE, we:

Consult with you to find the right tools for your business

Analyze your needs to develop custom solutions

Reassure you of our dedication to delivering value

Educate and inform you of market news and trends

Tork is the leading global brand in workplace hygiene.

From paper towels in hospital washrooms to napkin dispensers in restaurant dining rooms, Tork delivers a great experience for the user and a simple experience for the buyer. And as part of Essity, we're dedicated to serving your needs in a sustainable way – saving you time, money and effort, so you can focus on what matters most to your business.



Who CAREs about your business?

We CARE this much

We've got your back.

Supporting customers like you is the foundation of our commitment to your business. It's why we make the extra effort to listen to you and ensure your needs are met. We're dedicated to serving you so you can focus on more important things—like managing and growing your business.

Tork products make your working life surprisingly simple. Because that's what partners do.

What's in it for you?

Tork CARE is designed to help you manage, predict and enhance your business. These tools and services provide extra information and support, so you can get the most out of our products and navigate your market with confidence.

Free trials

Put our dispensers and products to the test with a free trial.

Dispenser installation

We offer a variety of installation tools and services to best suit your needs.

Dispenser warranties

Get our five-year warranty for free with a signed Tork Advantage agreement.

Product guarantees

Reduce cost and/or usage with Tork products backed by our savings guarantee.

Expert training

Our team is equipped with industry tips and best practices to maximize your products and dispensers.

Site assessment

Our Tork Solutions Experts help you determine the best application of our products/services.

Environmental evaluator

Calculate the resource savings of using recycled fiber paper products.*

Tork Newsroom

Stay on top of industry trends and news with timely and targeted emails from your Solutions Expert.

Tork Online

Your go-to resource for Tork products and information.

AD-a-Glance® customizer

Create Xpressnap® AD-a-Glance display inserts online, from a template or completely custom.

*When compared to virgin fiber



Cost-in-use calculator*

34 unique calculators give you product comparisons based on usage trends and analysis for more informed purchase decisions.



Snapshot app*

See which dispenser is right for your space with the snap of a photo.



Decision Tree app*

The Tork Decision Tree app is an interactive guide to selecting the right Tork dispenser for your customer's business.



Better Business Center

The Tork BBC offers expert insights and tips to help you reach your business goals.

*Service delivered by your Tork Solutions Expert



We can help you turn walk-in customers into sit-down regulars



As a restaurateur, there's a lot to manage. We take some of the worries off your plate, so you can focus on what's really important—the repeat business and referrals that are your bread and butter.

Over 50% of people would tell others to avoid a restaurant due to a dirty washroom or unhygienic kitchen.¹

72% of patrons say that tabletop marketing about loyalty programs increases repeat visits.²

Cost

Tork dispensing solutions help keep consumption, waste, and staff labor in check so you don't have to sacrifice quality or raise menu prices.

Hygiene

Touch-free systems reduce the spread of germs, keeping patrons happy, healthy, and returning to eat again

Image

It's the little things like a clean, clutter-free restroom and dining area that stimulate repeat business.

Sustainability

Switching to Tork 100% recycled and third party certified products improves patrons' perceptions at no extra cost to restaurants.

Recommended Tork products

Front of the house



The perceived cleanliness of the dining area could be the key to building customer loyalty and word-of-mouth buzz, which means strong business growth. Tork systems help you maintain a sanitary environment for your patrons while decreasing labor and improving efficiency for your waitstaff.



Tork Xpressnap® Signature Tabletop Napkin Dispenser (N4) – 6232000



Tork Advanced Plus Xpressnap Dispenser Napkin (N4) – DX990



Tork Xpressnap Café Image Napkin Dispenser (N10)
– 75350 aluminum
– 75900 walnut



Tork Universal Dinner Napkin
– NP310A



Tork Universal Beverage Napkin
– B1141A

Back of the house



Cleanliness starts in the kitchen. It's essential that keeping the back of the house sanitary doesn't distract staff from their main focus: preparing great food. With Tork systems, kitchen issues like preventing cross-contamination have never been easier.



Tork Antimicrobial Foodservice Cloth, 1/4 Fold – 192191



Tork Elevation Centerfeed Hand Towel Dispenser (M2) – 559020A



Tork Elevation Liquid Skincare Dispenser (S1)
– 570020A

Restroom



These days, everyone's a critic. 46% of restaurant visitors say they'd avoid going to a restaurant because of a bad experience with the restroom.* Tork no-touch, controlled consumption dispensers reduce waste and create a more sanitary environment, while improving the image of your restroom.



Tork Elevation® Twin Mini Jumbo Bath Tissue Roll Dispenser (T2) – 5555200



Tork Elevation Matic® Hand Towel Roll Dispenser (H1)
– 5510202



Tork Elevation Liquid Skincare Dispenser (S1)
– 570020A



Tork Elevation Foam Skincare Automatic Dispenser (S4)
– 571600

*Harris Poll, August, 2008



Easy one-handed operation and controlled consumption



When you need the most flexible system, choose from a wide variety of Tork centerfeed dispensing options with a range of capacities, colors and styles . . .

Tork Elevation Centerfeed Towel Dispensing Systems

Sleek black or white dispensers complement any environment, providing a clean, hygienic appearance. The design ensures easy and intuitive maintenance, refilling and use. The enhanced Pro feature enables an easy, one-handed operation and controlled consumption (limits over consumption and limits waste). Ideal for hand and light surface wiping.

Tork Performance Centerfeed Wiper Dispensing Systems

Durable dispensers, ergonomically designed to enhance performance. High-performing dispensers in either red/black or aqua/white color combinations are optimized for Tork wipers and support the user in the task at hand. Great for cleaning and drying objects.

Tork ShopMax Buckets and Boxes

These convenient centerfeed packages are perfect when you need a portable solution for your wiping needs. Portion controlled for one wipe-at-a-time dispensing.

To help select the right centerfeed system for your needs, consider the following questions:

1

Where is the dispenser being used?

Portable or Fixed



2

Who will be using the dispenser?

Employee or Patron



3

What are your main tasks & applications?

Mostly hand wiping or mostly surface wiping/cleaning



4

How much capacity do you need?

Low (M1)
Medium (M2)/(W22)
High (W2)





Tork Elevation Centerfeed Hand Towel Dispenser—M2



SKU	Description	Color	Size H x W x D (inches)	Dispensers/Case
559020A	Tork Centerfeed Hand Towel Dispenser	White	14.3 x 9.4 x 8.9 (36.5 x 22.9 x 22.7 cm)	1
559028A	Tork Centerfeed Hand Towel Dispenser	Black	14.3 x 9.4 x 8.9 (36.5 x 22.9 x 22.7 cm)	1

Refill	Description	Ply	Towel Size W x L (inches)	Towels/Roll	Towels/Case	Certification
100230	Tork Premium Extra Soft Centerfeed Hand Towel	1-Ply DRC	7.7 x 11.8 (19.5 x 29.9 cm)	305	1,830	
121201	Tork Advanced Soft Centerfeed Hand Towel	2	9 x 11.8 (22.8 x 29.9 cm)	600	3,600	
121202	Tork Advanced Soft Centerfeed Hand Towel	2	8.2 x 11.8 (20.9 x 29.9 cm)	610	3,660	
121204	Tork Advanced Soft Centerfeed Hand Towel	2	7.6 x 11.8 (19.3 x 29.9 cm)	600	3,600	
120932	Tork Advanced Soft Centerfeed Hand Towel	2	7.6 x 11.8 (19.3 x 29.9 cm)	500	3,000	
121211	Tork Advanced Soft Centerfeed Hand Towel	2	7.1 x 11.8 (18.3 x 29.9 cm)	600	3,600	
120133	Tork Advanced Soft Centerfeed Hand Towel	1	8.2 x 11.8 (20.9 x 29.9 cm)	1,000	6,000	



Tork Elevation Mini Centerfeed Hand Towel Dispenser—M1

SKU	Description	Color	Size H x W x D (inches)	Dispensers/Case
558028A	Tork Mini Centerfeed Hand Towel Dispenser	Black	13.0 x 6.8 x 6.5 (33.1 x 17.4 x 16.5 cm)	1

Refill	Description	Ply	Towel Size W x L (inches)	Towels/Roll	Towels/Case	Certification
121225	Tork Advanced Soft Mini Centerfeed Hand Towel	2	8.3 x 11.8 (21.0 x 29.9 cm)	266	3,192	

Tork Easy Handling



Carry a box with each hand and save time



Use two hands for a comfortable grip



Boxes open quickly and easily without cutting



Tork Performance Maxi Centerfeed Dispensers—W2

SKU	Description	Color	Size H x W x D (inches)	Dispensers/Case
653028	Tork Maxi Centerfeed Roll Dispenser	Red/Smoke	17.6 x 12.9 x 11.8 (44.7 x 32.8 x 32.2 cm)	1
653020	Tork Maxi Centerfeed Roll Dispenser	Aqua/ White	17.6 x 12.9 x 11.8 (44.7 x 32.8 x 32.2 cm)	1



Refill	Description	Color	Ply	Sheet Size W x L (in)	Wipers/ Roll	Rolls/ Case	Wipers/ Case	Optional Funnel	Certification
Cleaning – Multipurpose Cloths									

510137	Tork Cleaning Cloth - Centerfeed	White	1	12.6 x 10 (32.0 x 25.4 cm)	500	1	500	202853	NSF P1 Health Canada
530137	Tork Heavy-Duty Cleaning Cloth - Centerfeed	White	1	12.6 x 10 (32.0 x 25.4 cm)	400	1	400	202855	Health Canada



Cleaning – Industrial Cloths									
520337	Tork Industrial Cleaning Cloth - Centerfeed	Gray	1	12.6 x 10.0 (32.0 x 25.4 cm)	500	1	500	202855	Health Canada
570137	Tork Industrial Heavy-Duty Cleaning Cloth - Centerfeed	White	1	12.6 x 10.0 (32.0 x 25.4 cm)	160	1	160	202856	Health Canada



Wiping – Multipurpose Paper Wipers									
130211B	Tork Paper Wiper - Centerfeed	White	2	9 x 13 (22.8 x 33.0 cm)	800	2	1,600	202855	Recycling, NSF P1, Health Canada
192128	Tork Paper Wiper Plus - Centerfeed	White	1	9.8 x 15.2 (24.8 x 38.6 cm)	300	2	600	202853	NSF P1, Health Canada



Wiping – Industrial Paper Wiper									
13244101	Tork Industrial Paper Wiper - Centerfeed	Blue	4	11 x 15.75 (27.9 x 40.0 cm)	375	2	750	202855	Recycling, Health Canada

Tork Performance Centerfeed Dispensers—M2



SKU	Description	Color	Size H x W x D (inches)	Dispensers/Case
659028	Tork Centerfeed Dispenser	Red/Smoke	14.0 x 9.7 x 9.1 (35.6 x 24.8 x 23.2 cm)	1
659020	Tork Centerfeed Dispenser	Aqua/ White	14.0 x 9.7 x 9.1 (35.6 x 24.8 x 23.2 cm)	1



Refill	Description	Color	Ply	Sheet Size W x L (in)	Wipers/Roll	Rolls/ Case	Wipers/ Case	Optional Funnel	Certification
Wiping – Industrial Paper Wiper									

132451A	Tork Industrial Paper Wiper - Centerfeed	Blue	4	10 x 15.75 (25.4 x 40.0 cm)	190	4	760	202856	Recycling, Health Canada
---------	--	------	---	-----------------------------	-----	---	-----	--------	--------------------------



Wiping – Multipurpose Paper Wiper									
130251A	Tork Paper Wiper - Centerfeed	White	2	9 x 15.5 (22.8 x 39.3 cm)	325	4	1,300	202855	Recycling, Health Canada

Tork Advanced ShopMax Wiper 450 Centerfeed Dry Wipe Bucket—W22



SKU	Description	Color	Case Dimension L x W x H (inches)	Dispensers/Case
450340	Tork Advanced ShopMax Wiper 450, Centerfeed, Dry Wipe Bucket	Blue	17.5 x 9.0 x 10.7 (44.4 x 22.8 x 27.3 cm)	2



Refill	Description	Color	Ply	Sheet Size W x L (inches)	Wipers/Roll	Rolls/Case	Wipers/Case
450138	Tork Advanced ShopMax Wiper 450, Centerfeed Refill	White	1	9.9 x 13.1 (25.1 x 33.2 cm)	200	2	400
450338	Tork Advanced ShopMax Wiper 450, Centerfeed Refill	Blue	1	9.9 x 13.1 (25.1 x 33.2 cm)	200	2	400

Tork Advanced ShopMax Wiper—Self-Dispensing



Refill	Description	Color	Ply	Sheet Size W x L (inches)	Wipers/Roll	Rolls/Case	Wipers/Case
450137	Tork Advanced ShopMax Wiper 450, Centerfeed	White	1	9 x 13 (22.8 x 33.0 cm)	200	4	800
450337	Tork Advanced ShopMax Wiper 450, Centerfeed	Blue	1	9 x 13 (22.8 x 33.0 cm)	200	4	800



Tork competitive reference guide

Q2 2018



Environmental attributes and product certifications

Tork® is a leader in offering responsible products. Throughout this catalog, products with certain attributes or third-party certifications are identified in the specification charts with the following symbols.



ECOLOGO® Certified

ECOLOGO is one of North America's most widely recognized and respected certifications of environmental leadership. By setting stringent, multi-attribute, environmental performance standards across a wide variety of product types, ECOLOGO helps you identify, trust, buy, and sell environmentally preferable goods and services. Products are certified for reduced environmental impact.



Forest Stewardship Council® (FSC®) certified

FSC certification ensures that products come from responsibly managed forests that provide environmental, social and economic benefits. FSC Chain-of-Custody certification traces the path of products from forests through the supply chain.



HACCP International

HACCP International is a leading food science organization specializing in the HACCP food safety methodology and its application within food and related industries. HACCP International operates a world-renowned product certification scheme - certification of food safe equipment, materials and services - confirming a product's suitability for use within food businesses that operate to the world's highest standards.



Green Seal™ certified

Green Seal is an independent non-profit organization that is dedicated to safeguarding the environment and transforming the marketplace by promoting the manufacture, purchase and use of environmentally responsible products and services. Green Seal certified Tork products fall into the following 2 categories:

- GS-1: This product meets Green Seal™ Standard GS-1 based on chlorine-free processing, energy and water efficiency, and content of 100% recovered material with a minimum of 50% post-consumer material for towels and napkins, 25% post-consumer material for bath tissue.
- GS-41: This product meets Green Seal™ Standard GS-41A based on effective performance and protective limits on VOCs and human & environmental toxicity.



EPA CPG program compliant

Many Tork products meet the requirements the United States Environmental Protection Agency Comprehensive Procurement Guidelines (CPG) program that has set for the minimum amount of post-consumer waste to be used in recycled products.

- Hand Towels contain a minimum of 40% post-consumer fiber.
- Facial Tissue contain a minimum of 10% post-consumer fiber.
- Bath Tissue contain a minimum of 20% post-consumer fiber.
- Napkins contain a minimum of 30% post-consumer fiber.
- Wipers contain a minimum of 40% post-consumer fiber.

Some products without this symbol may also be EPA CPG program compliant. Contact your Essity Sales Rep for details.



Made from 100% recycled material

Almost 1,000,000 tons of recycled paper (of which more than 600,000 is post-consumer fiber) is used each year to make our recycled Tork products in North America. Essity has been using recycled paper since 1927.

ITEM NO.	DESCRIPTION	OPEN SIZE W X L (IN.)	PLY	COUNT	CASE WT. (LB.)	ESSITY CLOSEST EQUIVALENT
----------	-------------	--------------------------	-----	-------	-------------------	------------------------------

Dispenser Napkins

Essity





DX600		Tork Advanced Xpressnap Café White Dispenser Napkin	8.5 x 8.5	1	12/500/Bag 6M	13.6	N/A
DX606E		Tork Universal Xpressnap Café Natural Dispenser Napkin	8.5 x 8.5	1	12/500/Bag 6M	14.6	N/A
DX900		Tork Advanced Xpressnap White Dispenser Napkin	13 x 8.5	1	12/500/Bag 6M	20.2	N/A
DX906E		Tork Universal Xpressnap Natural Dispenser Napkin	13 x 8.5	1	12/500/Bag 6M	21.5	N/A
DX990		Tork Advanced Plus Xpressnap White Dispenser Napkin	6.5 x 8.5	2	12/400/Bag 4.8M	16.59	N/A
908EX		Tork Universal Xpressnap Print Natural Dispenser Napkin	13 x 8.5	1	12/500/Bag 6M	21.5	N/A
DR7050A		Tork Advanced RollNap White Dispenser Napkin	17 x 7.5	1	12/500/Roll 6M	23.1	N/A
D820		Tork Advanced Soft White Minifold Dispenser Napkin	13 x 12	1	12/500/Bag 6M	28.3	N/A
D826E		Tork Advanced Soft Natural Minifold Dispenser Napkin	13 x 12	1	12/500/Bag 6M	30.5	N/A
D802A		Tork Advanced Soft White Masterfold Dispenser Napkin	12 x 17	1	12/500/Bag 6M	36.6	N/A
D806E		Tork Advanced Soft Natural Masterfold Dispenser Napkin	12 x 17	1	12/500/Bag 6M	39.4	N/A
D780		Tork Universal White Masterfold Dispenser Napkin	13 x 12	1	12/500/Bag 6M	27.83	N/A
D786E		Tork Universal Natural Masterfold Dispenser Napkin	13 x 12	1	12/500/Bag 6M	30.5	N/A
D3052B		Tork Universal White Tallfold Dispenser Napkin	6.0 x 13.5	1	16/625/Bag 10M	24.51	N/A
D3056B		Tork Universal Natural Tallfold Dispenser Napkin	6.0 x 13.5	1	16/625/Bag 10M	26.48	N/A
D3061B		Tork Universal White Lowfold Dispenser Napkin	7 x 12	1	24/334/Sleeve 8M	20.11	N/A
D6311A		Tork Universal White Lowfold Dispenser Napkin	5.5 x 12	1	24/334/Sleeve 8M	16.16	N/A

Cascades

T400		Perform Interfold Dispenser Napkins for Tandem, White	12.6 x 8.5	1	32/188/6016	20	DX900
T401		Perform Interfold Dispenser Napkins for Tandem, Natural	12.6 x 8.5	1	32/188/6016	20	DX906E
T410		Perform Interfold Dispenser Napkins for Tandem, White	12.6 x 8.5	1	16/376/6016	20	DX900
T411		Perform Interfold Dispenser Napkins for Tandem, Natural	12.6 x 8.5	1	16/376/6016	20	DX906E
N070		Select Tallfold Dispenser Napkin, White	6 x 13.5	1	18/500/9000	--	D3052B
N090		Select Full Fold II Dispenser Napkin, White	13 x 12	1	18/334/6012	27	D780
N095		Select Full Fold II Dispenser Napkin, Natural	13 x 12	1	16/375/6000	26.5	D786E
N110		Select Low Fold I Dispenser Napkin, White	8.7 x 12.0	1	32/250/8000	23.7	D3061B
N130		Select Low Fold III Dispenser Napkin, White	5.5 x 12	1	24/333/8000	15.5	D6311A
N230		Select Junior Tall Fold Dispenser Napkin, White	6.5 x 13.25	1	20/500/10000	25	D3052B

2733		North River Serv-Rite II, Moca	13 x 12	1	18/334/6012	28	D786E
2750		North River Serv-Rite III, White	13 x 12	1	20/300/6000	28	D820
4802		North River Serv-Rite I, White	12 x 17	1	12/500/6000	37	D802A

Georgia Pacific

32005		EasyNap Jr. Dispenser Napkin, White	4 x 9.85	1	36/250/9000	17.95	DX600
32019		Dixie Ultra Interfold Dispenser Napkin, Natural	6.5 x 9.85	2	24/250/6000	22.3	DX906E, DX990
32055		EasyNap Jr. Dispenser Napkin, Natural	4 x 9.85	1	36/250/9000	17.95	DX606E
33201		Hynap Tallfold, White	7 x 13.5	1	40/250/10000	29.5	D3052B
37000		Mini Mornap Fullfold, White	13 x 12	1	12/500/6000	30.1	D820
37025		Mini MorNap Full Fold Disp Napkin, White	13 x 12	1	24/250/6000	26.16	D820
37406		MorNap Full Fold Disp Napkin, White	12 x 17	1	24/250/6000	33.73	D802A
37603		Mornap Acclaim Fullfold, White	13 x 8.5	1	12/900/10800	36.5	N/A
37604		Mornap Acclaim Fullfold, Natural	13 x 8.5	1	12/900/10800	37.6	D3056B
37803		Mornap Jr., Full Fold, White	13 x 12	1	12/600/7200	34.63	D780
37835		Mornap Jr. Fullfold, Natural	13 x 12	1	12/600/7200	34.47	D786E
39202		Tidynap Lowfold, White	7 x 12	1	32/250/8000	26.35	D3061B

Kimberly-Clark

98730		Scott Full Fold, White	12 x 17	1	24/250/6000	39.4	D802A
98740		Scott Full Fold, White	13 x 12	1	16/375/6000	28.6	D780
98908		Scott MegaCARTRIDGE, White	6.5 X 8.4	1	6/875/5250	22	DX900
98710		Scott Tall Fold, White	7 x 13.5	1	40/250/10000	31.3	D3052B
98720		Scott Low Fold, White	7 x 12	1	32/250/8000	22.6	D3061B

ITEM NO.	DESCRIPTION	OPEN SIZE W X L (IN.)	PLY	FOLD	COUNT	CASE WT. (LB.)	ESSITY CLOSEST EQUIVALENT
----------	-------------	--------------------------	-----	------	-------	-------------------	------------------------------

Dispenser Napkins (cont.)

Kruger Products

06650	White Swan Interfold Dispenser Napkin, White	6.5 x 9	2		24/250/6000	20.5	DX900
06700	White Swan Mealmates, Dispenser Napkin, White	11.9 x 13	1		18/300/5400	26	D780
06785	Esteem Mealmates, Dispenser Napkin, Natural	11.9 x 13	1		18/300/5400	26.4	D786E
06786	 Esteem Mealmates, Dispenser Napkin, Natural	11.9 x 13	1		12/300/3600	17.4	DX906E
06800	White Swan Mealmates, Dispenser Napkin, White	10.3 x 16.9	1		24/250/6000	34.4	D802A
06850	White Swan Jr Lowfold, Dispenser Napkin, White	11.75 x 7	1		20/400/8000	18.5	D3061A
08100	White Swan Tallfold Jr. Dispenser Napkin, White	6 x 13.5	1		12/750/9000	22	D3052B
08150	Esteem Tallfold Junior Dispenser Napkin, White	6.0 x 13.5	1		18/500/9000	21.6	D3052B

Single-Ply Beverage Napkins

Essity

B1141A	  Tork Universal White Beverage Napkin	9.375 x 9.375	1	1/4	8/500/Poly 4M	10.9	N/A
--------	--	---------------	---	-----	---------------	------	-----

Cascades

N010	  Select Beverage Napkin, White	8.5 x 8.5	1	1/4	4/1000/4000	10	B1141A
------	---	-----------	---	-----	-------------	----	--------



Georgia Pacific

96019	Acclaim Beverage Napkin, White	9.5 x 9.5	1	1/4	8/500/4000	11.06	B1141A
21444	GP Core Beverage Napkin, White	9.5 x 9.5	1	1/4	8/500/4000	11.06	B1141A
96021	Beverage Napkin, Brown	9.5 x 9.5	1	1/4	8/500/4000	11.21	N/A

Hoffmaster

046115	Linen Like Beverage Napkin, White	10 x 10	1	1/4	8/125/1000	--	171PRP
345000	Beverage Napkin, White	9.5 x 9.5	1	1/4	16/250/4000	--	B1141A

Kruger Products

06200	 White Swan Beverage Napkin, White, (West)	9.4 x 9.4	1	1/4	20/250/5000	14.22	B1141A
07200	 White Swan Beverage Napkin, White, (East)	9.5 x 9.5	1	1/4	10/500/5000	15.37	B1141A
07201	White Swan Beverage Napkin, White	9 x 9	1	1/4	8/500/4000	12.2	B1141A

Single-Ply Luncheon Napkins

Essity

L3141	 	Tork Universal White Luncheon Napkin	13 x 11.5	1	1/4	12/500/Poly 9M	26.7	N/A
-------	---	--------------------------------------	-----------	---	-----	----------------	------	-----

Cascades

N020	 	Select Luncheon Napkin, White	11.25 x 12.5	1	1/4	12/500/6000	24.9	L3141
------	---	-------------------------------	--------------	---	-----	-------------	------	-------

Georgia Pacific

37707		Acclaim Lunch Napkin, White	12.5 x 11.5	1	1/4	12/500/6000	26.1	L3141
-------	--	-----------------------------	-------------	---	-----	-------------	------	-------

Hoffmaster

7401153		Linen-Like Luncheon Napkin, White	13 x 13	1	1/4	2/100/200	--	N/A
---------	--	-----------------------------------	---------	---	-----	-----------	----	-----





Kruger Products

06040		White Swan Luncheon Napkin, White, (West)	12 x 12.8	1	1/4	18/180/3240	16.49	L3141
07400		White Swan Luncheon Napkin, White	12 x 12	1	1/4	16/250/4000	18.9	L3141







ITEM NO.	DESCRIPTION	OPEN SIZE W X L (IN.)	PLY	FOLD	COUNT	CASE WT. (LB.)	ESSITY CLOSEST EQUIVALENT
----------	-------------	--------------------------	-----	------	-------	-------------------	------------------------------

Single-Ply Dinner Napkins

Essity

N5140A	 Tork Universal White Dinner Napkin	15 x 17	1	1/4	12/334/Sleeve 4M	30.4	N/A
N5181A	 Tork Universal White Dinner Napkin	15 x 17	1	1/8	12/250/Sleeve 3M	23.2	N/A
N5183A	 Tork Universal White Dinner Napkin	15 x 16.25	1	1/8	4/500/Bag 2M	15.1	N/A
N5186	 Tork Universal Natural Dinner Napkin	15 x 17	1	1/8	12/250/Sleeve 3M	30.67	N/A
N7141A	 Tork Universal White Dinner Napkin	17x17	1	1/4	12/334/Sleeve 4M	34.3	N/A

Cascades

N050	 Select Dinner Napkin, White	16 x 15.5	1	1/8	12/250/3000	21.7	N5181A
N031	 Select Dinner Napkin, White	16.75 x 17	1	1/4	8/375/3000	25	N7141A
2403	  North River Dinner Napkin, White	15.5 x 16	1	1/8	12/250/3000	22	N5183A
2414	 Cascades Dinner Napkin, White	16 x 12	1	1/8	6/320/1920	11	N5183A
N055	 Select Dinner Napkin, Natural	15.5 x 16	1	1/8	12/250/3000	22.6	N5186
3616	Privilege DRC Napkin-Guest Hand Towel, Flat	15 x 15	1	Flat	1/1000	19	N/A

Georgia Pacific

31558	Acclaim Dinner Napkin, White	15 x 17	1	1/8	12/350/4200	32.84	N5181A
31558	Acclaim Dinner Napkin, White	15 x 17	1	1/8	12/350/4200	32.84	N5181A
36202	Acclaim Dinner Napkin, White	16x16	1	1/4	8/500/4000	30.98	N7141A

Kimberly-Clark

98171	 Scott Dinner, White	16.75 x 17	1	1/4	16/250/4000	46.9	N7141A
-------	---	------------	---	-----	-------------	------	--------

Kruger Products

07900		White Swan Dinner Napkin, White	15.8 x 16.8	1	1/8	12/250/3000	25	N5181A
07955		White Swan Dinner Napkin, White	15 x 16.2	1	1/8	10/300/3000	22	N5181

Multi-Ply Beverage Napkins

Essity

B1242	 	Tork Advanced Soft White Beverage Napkin	10 x 9.25	2	1/4	40/150/6000	26.7	N/A
-------	---	--	-----------	---	-----	-------------	------	-----

Cascades

2678		Cascades Elite Beverage Napkin, White	9.5 x 10	2	1/4	10/450/4500	22	B1242
------	--	---------------------------------------	----------	---	-----	-------------	----	-------

Georgia Pacific

95603		Preference 2-ply, Bevnap, White	10 x 10	2	1/4	6/500/3000	14.6	B1242
-------	--	---------------------------------	---------	---	-----	------------	------	-------

Hoffmaster

010102		Beverage Napkin, White	10 x 10	3	1/4	4/200/800	--	171PRP
046118		Linen-Like Select Beverage Napkin, White	10 x 10	1	1/4	8/125/1,000	--	171PRP
046128		Linen-Like Beverage Napkin, Natural	10 x 10	1	1/4	8/125/1,000	--	N/A

Kimberly-Clark

98210		Scott Beverage Napkin, White	10 x 10	2	1/4	4/750/3000	16.6	B1242
-------	---	------------------------------	---------	---	-----	------------	------	-------







Kruger Products

07300		White Swan Beverage Napkin, White	9.5 x 9.5	2	1/4	6/600/3600	16.9	B1242
07301		White Swan Beverage Napkin, White	9 x 9	2	1/4	12/300/3600	16.9	B1242

ITEM NO.	DESCRIPTION	OPEN SIZE W X L (IN.)	PLY	FOLD	COUNT	CASE WT. (LB.)	ESSITY CLOSEST EQUIVALENT
----------	-------------	--------------------------	-----	------	-------	-------------------	------------------------------

Multi-Ply Dinner Napkins



Essity

NP310A	 Tork Advanced Soft White Dinner Napkin	15 x 16.25	2	1/8	8/375/Sleeve 3M	35.6	N/A
NP528PA	 Tork Advanced Soft White Dinner Napkin	15 x 17	2	1/8	28/100/Poly 2.8M	31.7	N/A
NP5240C	 Tork Advanced Soft White Dinner Napkin	15 x 16.25	2	1/4	8/375/Sleeve 3M	35.5	N/A
NP7340P	 Tork Advanced Extra Soft White Dinner Napkin	17 x 16.25	3	1/4	20/100/Poly 2M	39.7	N/A
NP7380A	 Tork Advanced Extra Soft White Dinner Napkin	17 x 16.125	3	1/8	6/290/Bag 1.74M	34.1	N/A
NP3260	 Tork Advanced Soft White Dinner Napkin	12.75 x 16.25	2	1/6	6/467/2802	26	N/A
9935705	 Tork Universal Natural Dinner Napkin	15 x 16.25	2	1/8	24/126/3,024	45.1	N/A

Cascades

N040	Select Dinner Napkin, White	16.75 x 14.75	2	1/8	8/375/3000	15.9	NP5240C
N210	 Select Dinner Napkin, White	15 x 17	2	1/8	30/100/3000	33.6	NP528PA
N060	Select Dinner Napkin, White	15 x 15	2	1/8	30/100/3000	33	NP528PA

Georgia Pacific

31436	 Preference Dinner Napkin, White	16 x 15	2	1/8	30/100/3000	33.64	NP528PA
31437	 Preference Dinner Napkin, Natural	15 x 17	2	1/8	12/250/3000	37.27	9935705
31628	Preference Dinner Napkin, White	16 x 16	2	1/4	8/400/3200	37.43	NP5240C
31734	Preference Dinner Napkin, White	17 x 17	3	1/4	8/250/2000	39.66	NP7340A
31739	Preference Dinner Napkin, White	17 x 17	3	1/8	10/200/2000	40.3	NP7340A
21481	GP Core Dinner Napkin, White	15 x 16.9	2	1/8	12/250/3000	34.07	NP528PA

Kimberly-Clark

98200	 Scott Dinner, White	14.63 x 17	2	1/8	10/300/3000	40	NP310A, NP528PA
-------	---	------------	---	-----	-------------	----	-----------------

Kruger

07600	White Swan Dinner Napkin, White	15.8 x 16.8	2	1/8	12/200/2400	33.3	NP310A
07655	White Swan Dinner Napkin, White	15 x 16	2	1/8	16/188/3008	35	NP310A

Premium Napkins

Essity

NC7100	Tork Premium LinStyle White Dinner Napkin	17 x 16.25	1	Flat Pack	5/60/Box 300	13.4	N/A
NC7140P	Tork Premium LinStyle White Dinner Napkin	16.25 x 17	1	1/4	6/60/Poly 360	8.3	N/A
NC7180P	Tork Premium LinStyle White Dinner Napkin	16.25 x 17	1	1/8	6/60/Poly 360	8.3	N/A
NC7160P	Tork LinStyle Valet Guest Towel, White	12 x 17	1	1/6	8/80/Poly 640	11.2	N/A
7140PRP	Tork Custom Print LinStyle White Dinner Napkin	16.25 x 17	1	1/4	5/60/Box 300	8.9	N/A
7160PRP	Tork Custom Print LinStyle White Dinner Napkin	12 x 17	1	1/6	8/80/Box 640	11.2	N/A
7180PRP	Tork Custom Print LinStyle White Dinner Napkin	16.25 x 17	1	1/8	5/60/Box 300	8.9	N/A

Cascade

N691	Signature DRC Dinner Napkin, White	12 x16.75	1	1/6	5/100/500	8.1	NC7160P
N695	Signature Airlaid Dinner Napkin, White	15 x 16.5	1	1/4	1/1000	20	NC7100
N696	Signature Airlaid Dinner Napkin, White	15 x 16.75	1	1/8	5/315/1575	10.5	NC7180P

Georgia Pacific

92113	Essence Impressions Guest Towel, White	13 x 17	1	1/6	4/200/800	15.25	NC7160P
92114	Essence Impressions Dinner, White	17 x 17	1	1/4	8/100/800	22.4	N7140P
92117	Essence Impressions Dinner, White	17 x 17	1	1/8	4/100/400	12.7	NC7180P
92126	Essence Impressions Dinner, White Printed	17 x 17	1	1/8	4/100/400	12.17	7180PRP
92120	Essence Impressions Dinner, White	16 x 15	1	Flat	Bulk/1000	16	NC7100

Hoffmaster

066033	QuickSet Dinner Napkin, White	15 x 17	1	1/8	4/75/300	--	N/A
066038	Linen-Like Dinner, White	15 x 17	1	1/8	4/75/300	7	N/A
066072	Linen-Like Dinner, Natural	15.5 x 17	1	1/8	4/75/300	--	N/A
120051	Linen-Like Dinner, White	17 x 17	1	1/8	4/75/300	7.8	NC7180P
120052	Linen-Like Dinner, White	17 x 17	1	1/4	4/75/300	9.3	NC7140P
120053	Linen-Like Dinner, White	17 x 17	1	1/4	4/75/300	9.25	NC7140P
120072	Linen-Like Select Dinner, White	17 x 17	1	1/8	4/75/300	--	NC7180P

ITEM NO.	DESCRIPTION	OPEN SIZE W X L (IN.)	PLY	FOLD	COUNT	CASE WT. (LB.)	ESSITY CLOSEST EQUIVALENT
----------	-------------	--------------------------	-----	------	-------	-------------------	------------------------------

Premium Napkins cont:

Hoffmaster

120060	Linen-Like Dinner, White	17 x 17	1	1/8	4/75/300	9.3	NC7180P
125006	Linen-Like Dinner, White	17 x 20	1	1/8	4/75/300	10.5	N/A
125023	Linen-Like Dinner, White	16 x 16	1	Flat	1/1000 Bulk	19.6	NC7100
125040	Linen-Like Dinner, Silver Prestige	17 x 17	1	1/4	4/75/300	--	N/A
125043	Linen-Like Dinner, White	14.5 x 14.5	1	Flat	1/1000 Bulk	23	NC7100
125046	Linen-Like Dinner, Gold Prestige	17 x 17	1	1/4	4/75/300	--	N/A
125086	Linen-Like Dinner, Natural	16 x 16	1	Flat	1/1000 Bulk	--	N/A
125089	Linen-Like Dinner, Natural	14.5 x 14.5	1	Flat	1/1000 Bulk	--	N/A
702048	Guest Towel, White	13 x 17	2	1/6	8/125/1,000	--	N/A
856460	Linen-Like Select Guest Towel, White	12 x 17	1	1/6	10/50/500	--	NC7160P
856499	Linen-Like Guest Towel, White	12 x 17	1	1/6	5/100/500	19	NC7160P
856787	Linen-Like Guest Towel, Natural	12 x 17	1	1/6	4/125/500	--	N/A

ITEM NO.	DESCRIPTION	PLY	SHEET SIZE W X L (IN.)	SHEETS/ ROLL	ROLLS/ CASE	CASE WT. (LB.)	ESSITY CLOSEST EQUIVALENT
----------	-------------	-----	---------------------------	-----------------	----------------	-------------------	------------------------------

Conventional Bath Tissue

Essity

US CANADA

High Capacity System Specific SKUs

110291A	Tork Advanced High-Capacity Bath Tissue Roll, White	1	3.94 x 3.75	2000	36	28.4	N/A	N/A
110292A	Tork Advanced High-Capacity Bath Tissue Roll, White	2	3.94 x 3.75	1000	36	25.1	N/A	N/A
472886	Tork Advanced High-Capacity Coreless Bath Tissue Roll, White	2	3.66 x 4.9	900	36	26.15	N/A	N/A
106390	Tork Premium Bath Tissue Roll with OptiCore, White	2	3.75 x 4	800	36	20.06	N/A	N/A
162090	Tork Advanced Bath Tissue Roll with OptiCore, White	2	3.75 x 4	865	36	21.14	N/A	N/A
161990	Tork Universal Bath Tissue Roll with OptiCore, White	2	3.75 x 4	865	36	21.14	N/A	N/A
112990	Tork Universal Bath Tissue Roll with OptiCore, White	1	3.75 x 4	1755	36	25.82	N/A	N/A
160090	Tork Universal High Capacity Bath Tissue Roll w/OptiCore, Wht	2	3.75 x 3.5	2000	12	14.74	N/A	N/A





















Standard SKUs

TM6510	Tork Premium Bath Tissue Roll, White	2	4.5 x 3.75	400	96	37.2	N/A	N/A
TM6511S	Tork Premium Bath Tissue Roll, White	2	4.0 x 3.75	460	96	30.6	N/A	N/A
TM6512	Tork Premium Bath Tissue Roll, White	2	4.0 x 3.75	460	48	16.7	N/A	N/A
TM6184	Tork Advanced Soft Bath Tissue Roll, White	2	4.0 x 3.75	550	80	30.2	N/A	N/A
TM6120S	Tork Advanced Bath Tissue Roll, White	2	4.0 x 3.75	500	96	32.9	N/A	N/A
TM6130S	Tork Advanced Bath Tissue Roll, White	2	4.0 x 3.75	500	48	17.1	N/A	N/A
TM1602	Tork Universal Bath Tissue Roll, White	2	4.0 x 3.75	420	48	14.7	N/A	N/A
TM1604	Tork Universal Bath Tissue Roll, White	2	3.875 x 3.75	750	48	23.9	N/A	N/A
TM1616S	Tork Universal Bath Tissue Roll, White	2	4.0 x 3.75	500	96	33	N/A	N/A
TM1619	Tork Universal Bath Tissue Roll, White	2	4.0 x 3.75	500	96	32.9	N/A	N/A
TS1635S	Tork Universal Bath Tissue Roll, White	1	4.0 x 3.75	1500	48	28.4	N/A	N/A
TS1636S	Tork Universal Bath Tissue Roll, White	1	4.0 x 3.75	1000	96	38.5	N/A	N/A
TM1601A	Tork Universal Bath Tissue Roll, White	2	4.2 x 3.75	500	48	18	N/A	N/A
TS1639S	Tork Universal Bath Tissue Roll, White	1	4.0 x 3.75	1000	48	19.8	N/A	N/A
240123	Tork Universal Bath Tissue Roll, White	1	4.0 x 3.75	1232	48	23.72	N/A	N/A
240616	Tork Universal Bath Tissue Roll, White	2	4.0 x 3.75	616	48	19.8	N/A	N/A
245949	Tork Universal Bath Tissue Roll, White	2	4.0 x 3.75	500	48	16.9	N/A	N/A
245989	Tork Universal Bath Tissue Roll, White	2	4.0 x 3.75	500	80	28.6	N/A	N/A
246325	Tork Universal Bath Tissue Roll, White	2	4.0 x 3.75	625	48	20.62	N/A	N/A

ITEM NO.	DESCRIPTION	PLY	SHEET SIZE W X L (IN.)	SHEETS/ ROLL	ROLLS/ CASE	CASE WT. (LB.)	ESSITY CLOSEST EQUIVALENT
----------	-------------	-----	---------------------------	-----------------	----------------	-------------------	------------------------------







Conventional Bath Tissue (cont.)

Cascades















							US	CANADA
T144		Perform High Capacity Bath Tissue for Tandem, Beige	2	3.9 x 4.0	865	24	14 472886~,110292A~	N/A
T140		Perform High Capacity Bath Tissue for Tandem, White	2	3.9 x 4.0	1110	24	18 472886~,110292A~	N/A
B011		Select Standard Bath Tissue, White	1	4.25 x 3.8	1000	48	18 TS1636S	TS1639S
B160		Select Standard Bath Tissue, White	2	4.25 x 4	420	48	14.4 TM1602	N/A
B150		Select Standard Bath Tissue, White	1	4.3 x 3.25	1210	80	30 TS1636S	N/A
B180		Select Standard Bath Tissue, White	2	4.2 x 4.1	500	48	19 TM1602	TM1601A
B010		Select Standard Bath Tissue, White	1	4.25 x 3.8	1000	96	36.6 TS1636S	N/A
B200		Select Standard Bath Tissue, White (US Only)	2	4.3 x 3.75	550	80	31 TM1616S	N/A
B340		Perform Standard Bath Tissue, White	2	4 x 3.5	336	48	9.5 TM1602	N/A
B042		Select Standard Bath Tissue, White	2	4 x 3.2	500	48	13 TM1602	N/A
B640		Signature Standard Bath Tissue, White	2	4.2 x 4	420	48	14 TM6130S	N/A
B400		Perform Standard Bath Tissue, Beige	2	4.25 x 4	400	80	26 N/A	N/A
B641		Signature Standard Bath Tissue, White	2	4.25 x 4	420	96	28 TM6130S	N/A
B660		Signature Standard Bath Tissue, White	2	4.25 x 3.75	500	96	31 TM1616S	N/A
B661		Signature Standard Bath Tissue, White	2	4.25 x 3.75	500	48	15 TM1601A	N/A
B020		Select Standard Bath Tissue, White	2	4.2 x 3	420	96	22 TM1619	N/A
B021		Select Standard Bath Tissue, White	2	4.2 x 3	420	48	11 TM1602	N/A
B040		Select Standard Bath Tissue, White	2	4.2 x 3	500	96	26 TM1616S	N/A
B041		Select Standard Bath Tissue, White	2	4.25 x 3.25	500	96	28 TM1616	N/A
B201		Select Standard Bath Tissue, White	2	4.3 x 3.25	500	80	27.6 TM6810	N/A

Georgia Pacific

System Specific





























19020		Rollmastr High Capacity Bath Tissue, White	1	3.9 x 4	1540	48	30.18	112990~	N/A
19027		Rollmastr High Capacity Facial Quality, White	2	3.9 x 4	770	48	26.1	106390~	N/A
19029		Never-Out Executive High Capacity Facial Quality, White	2	3.9 x 4	770	48	26.1	106390~	N/A
19371		Angel Soft ps Compact Coreless Premium Bath Tissue, White	2	3.85 x 4.05	750	36	21	472886~,110292A~	N/A
19372		Angel Soft ps Compact Coreless Premium Bath Tissue, White	2	3.85 x 4.05	1125	18	15.8	472886~,110292A~	N/A
1937300		Angel Soft ps Compact Coreless Premium Bath Tissue, White	2	3.85 x 4.05	750	12	7.1	472886~,110292A~	N/A
19374		Compact Coreless High Capacity Bath Tissue, White	1	3.85 x 4.05	3000	18	21.15	110291A~	N/A
19375		Compact Coreless, White	2	3.85 x 4.05	1000	36	27.5	472886~,110292A~	N/A
19378		Compact Coreless High Capacity Bath Tissue, White	2	3.85 x 4.05	1500	18	22.2	472886~,110292A~	N/A

Standard Rolls



14448-01		Envision High Capacity Bath Tissue, White	1	3.95 x 4.05	1500	48	29.77	TS1635S	N/A
14580-01		Envision Bath Tissue, White	1	4.0 x 4.05	1210	80	41.81	TS1636S	N/A
16560		Angel Soft ps Ultra Premium Bath Tissue, White	2	4.5 x 4.05	400	60	26.8	TM6510	N/A
16880		Angel Soft ps Premium Bath Tissue, White	2	4.0 x 4.05	450	80	29.6	TM6511S, TM6184	N/A
16620		Angel Soft ps Premium Bath Tissue, White	2	4.0 x 4.05	450	20	8	TM6512	N/A
16840		Angel Soft ps Premium Bath Tissue, White	2	4.0 x 4.05	450	40	15.6	TM6512	N/A
18240-01		Preference Bath Tissue, White (Half Case)	2	4.0 x 4.05	550	40	17.3	TM6130S	N/A
18280-01		Preference Bath Tissue, White	2	4.0 x 4.05	550	80	33.8	TM6120S, TM6184	N/A
19448-01		Envision Capacity Bath Tissue	2	3.9 x 4.05	1000	48	33.7	TM1604	N/A
19880-01		Envision Bath Tissue, White	2	4.0 x 4.05	550	80	34.6	TM1616S	N/A
19881-01		Envision Bath Tissue, White	1	4.0 x 4.05	550	80	28.8	TM1616S, TS1636S	N/A
19841-01		Envision Bath Tissue, White (Half Case)	1	4.0 x 4.05	550	40	14.4	TM1602	N/A
19885		Envision Bath Tissue, White	2	4.0 x 3.5	550	80	27	TM1616S	N/A
1632014		Angel Soft Ultra Professional Series Premium, White	2	4.5 x 4.0	400	20	8.79	TM6510	N/A
21491		GP Core Bath Tissue, White	2	4.0 x 3.5	550	80	30.2	TM1616S	N/A

ITEM NO.		DESCRIPTION	PLY	SHEET SIZE W X L (IN.)	SHEETS/ ROLL	ROLLS/ CASE	CASE WT. (LB.)	ESSITY CLOSEST EQUIVALENT
----------	--	-------------	-----	---------------------------	-----------------	----------------	-------------------	------------------------------

Kimberly-Clark

05102	  FSC®	Scott Bath Tissue, White	1	4.1 x 4.0	1210	80	42.9	TS1636S N/A	
04460	  FSC®	Scott Bath Tissue, White	2	4.1 x 4.0	550	80	32.5	TM1616S, TM6184 N/A	
12456	  FSC®	Kleenex Cottonelle Ultra Soft, White	1	4.2 x 4.0	165	48	11.5	TM6510 N/A	
13135	  FSC®	Kleenex Cottonelle Bath Tissue, White	2	4.09 x 4.0	451	20	9.1	N/A N/A	
13217	  FSC®	Scott Bath Tissue, White	2	4.1 x 4.0	506	80	30.3	TM1616S N/A	
13607	  FSC®	Scott Bath Tissue, White	2	4.1 x 4.0	550	20	8	TM6130S N/A	
17713	  FSC®	Kleenex Cottonelle Bath Tissue, White	2	4.09 x 4.0	451	60	21.5	TM6511S N/A	
54080>	  FSC®	Kleenex Cottonelle Bath Tissue, White	2	4.09 x 4.0	400	48	16.2	TM6512 N/A	
40592	  FSC®	Scott 100% Recycled Bath Tissue, White	2	4.1 x 4.0	506	80	30.3	TM1619 N/A	
42108	  FSC®	Scott Bath Tissue, White	2	4.1 x 4.0	550	80	32.5	TM1616S N/A	
48040>	  FSC®	Scott Bath Tissue, White	2	4.1 x 4.06	550	40	18.3	N/A TM1601A	
48070>	  FSC®	Scott Bath Tissue, White	1	4.1 x 4.0	1210	40	22	N/A TS1639S	
System Specific SKUs									
4007	  FSC®	Scott Coreless Bath Tissue, White	2	4.0 x 3.94	1000	36	22	472886~,110292A~ N/A	
7001	  FSC®	Kleenex Cottenelle Coreless Bath Tissue, White	2	4.0 x 4.4	800	36	21.1	472886~,110292A~ N/A	

Kruger Products

							US	CANADA
5012		Esteem Bath Tissue, White	1	4 x 3.75	1000	48	16.7	TS1636S TS1639S
5103		White Swan Bath Tissue, White, (East)	1	4.2 x 4	1000	48	22.4	TS1636S TS1639S
5113		White Swan Bath Tissue, White	1	4.2 x 3.8	1000	48	18.7	TS1636S TM1639S
5120		Esteem Bath Tissue, White	2	4.0 x 3.8	500	48	15.75	TM6130S TM6130S
5131		Embassy Bath Tissue, White (West)	2	4.2 x 4.0	500	48	18.4	TM1602 TM1601A
5144		White Swan Bath Tissue, White	2	4.2 x 3.8	429	48	14.4	TM1602 TM1602
5185		Embassy Bath Tissue, White	2	4.5 x 3.8	600	80	35.4	TM6180 TM6184
5440		Embassy Bath Tissue, White	2	4.2 x 4.0	418	40	14.4	TM6512 TM6512
5480		Metro Bath Tissue, White	1	4.2 x 3.8	1000	48	21	TS1639S TS1639S
5482		Metro Bath Tissue, White	2	4.2 x 3.8	420	48	13.4	TM1602 TM1602
5485		Metro Bath Tissue, White	2	4.2 x 3.8	500	48	17.5	TM1601A TM1601A
5705		Purex Bath Tissue, White	2	4.2 x 4.0	506	60	23.9	TM6120S TM1601A
5780		Embassy Bath Tissue, White	2	4.2 x 4.0	506	80	29.6	TM1616S TM1616S











> Canada Only
 ~ Replacement Dispenser Required

ITEM NO.	DESCRIPTION	PLY	ROLL WIDTH (IN.)	LINEAR FT./ ROLL	ROLLS/ CASE	CASE WT. (LB.)	ESSITY CLOSEST EQUIVALENT
----------	-------------	-----	---------------------	---------------------	----------------	-------------------	------------------------------

Mini Jumbo Bath Tissue - up to 7.5" Roll Diameter

Essity

7.4" Diameter, 2.34" Core ID

11020602	 Tork Advanced Soft Mini Jumbo Bath Tissue Roll, White, Perf.	2	3.55	751	12	17.4	N/A
12013903	   Tork Advanced Mini Jumbo Bath Tissue Roll, White	1	3.55	1200	12	21.6	N/A
12024402	   Tork Advanced Mini Jumbo Bath Tissue Roll, White	2	3.55	751	12	17.4	N/A
120246	   Tork Advanced Mini Jumbo Bath Tissue Roll, White	2	3.55	751	12	17.4	N/A















Kruger Products

05615	Mini-Max Jumbo Bath Tissue 7 in. dia., White	1	3.7	1,500	18	31.2	12013903~
05625	Mini-Max Jumbo Bath Tissue, 7 in. dia., White	2	3.7	750	18	26.6	12024402~, 120246~
05629	Mini-Max Jumbo Bath Tissue, 7 in. dia., White	2	3.7	750	18	28.1	12024402~, 120246~
05649	Micro-Max Jumbo Bath Tissue, White	2	3.7	475	18	18.6	12024402~

Jr. Jumbo Bath Tissue - from 7.6" to 9" Roll Diameter

Essity









8.8" Diameter, 3.3" Core ID

TJ0921A	   Tork Advanced Jumbo Bath Tissue Roll, White	2	3.55	1000	12	23.2	N/A
TJ0912A	   Tork Universal Jumbo Bath Tissue Roll, White	1	3.55	2000	12	27.1	N/A
TJ0922A	   Tork Universal Jumbo Bath Tissue Roll, White	2	3.55	1000	12	23.2	N/A
TJ0924	   Tork Universal Jumbo Bath Tissue Roll, White	2	3.55	1000	12	23.2	N/A
TJ0928	   Tork Universal Jumbo Bath Tissue Roll, White	2	3.55	750	12	18	N/A

Cascades

B070	 Select Jumbo Bath Tissue, 9 in. dia., White	1	3.5	1470	12	18.5	TJ0912A
B080	 Select Jumbo Bath Tissue, 9 in. dia., White	2	3.3	500	12	10	TJ0928
B085	 Select Jumbo Bath Tissue, 9 in. dia., White	2	3.5	523	8	7.4	TJ0928
B100	 Select Jumbo Bath Tissue, 9 in. dia., White	2	3.5	722	8	11	TJ0928
B101	 Select Jumbo Bath Tissue, 9 in. dia., White	2	3.3	750	12	16.3	TJ0928
B120	 Select Jumbo Bath Tissue, 9 in. dia., White	2	3.5	812	8	11.5	TJ0928
B140	 Select Jumbo Bath Tissue, 9 in. dia., White	2	3.25	1000	12	21	TJ0924

~ Replacement Dispenser Required



























ITEM NO.	DESCRIPTION	PLY	ROLL WIDTH (IN.)	LINEAR FT./ ROLL	ROLLS/ CASE	CASE WT. (LB.)	ESSITY CLOSEST EQUIVALENT
B210	  Select Jumbo Bath Tissue, 9 in. dia., White	1	3.4	2000	12	22	TJ0912A
B220	  Select Jumbo Bath Tissue, 9 in. dia., White	2	3.4	750	12	17	TJ0928
B240	  Select Jumbo Bath Tissue, 9 in. dia., White	2	3.4	1000	12	22.4	TJ0922A, TJ0924
B500	  Perform Jumbo Bath Tissue 9 in. dia., Beige	2	3.4	1000	12	22.4	N/A

Jr. Jumbo Bath Tissue - from 7.6" to 9" Roll Diameter (cont.)



Georgia Pacific

12798	  Envision Jumbo Bath Tissue, 9 in. dia., White	2	3.5	1000	8	15.4	TJ0922A
13718	Acclaim Jumbo Bath Tissue, 9 in. dia.	1	3.5	2000	8	17.2	TJ0912A
13728	Acclaim Jumbo Bath Tissue, 9 in. dia.	2	3.5	1000	8	15.4	TJ0922A
21458	GP Core Jumbo Jr. BT	2	3.5	1000	8	15.3	TJ09922A
System Specific SKU's							
19510	  SofPull High Capacity Centerpull BT	2	5.25	700	6	12.8	12024402~
19516	  SofPull Mini High Capacity Centerpull BT	2	5.25	500	16	16.9	120246~

Kimberly-Clark

02129	   FSC® Scott Jr Jumbo Bath 8.8 in. dia., White.	2	3.55	1000	12	23	TJ0922A
03148	   FSC® Scott Jr Jumbo Bath 8.8 in. dia., White	2	3.55	1000	4	10.3	TJ0922A
07223	   FSC® Scott JRT Jr. Jumbo Bath 8.8 in. dia., White	1	3.55	2000	12	27	TJ0912A
07304	   FSC® Kleenex Cottonelle Jr. Jumbo Bath 8.8 in. dia., White	2	3.55	750	12	18	TJ0921A
07805	   FSC® Scott Jr Jumbo Bath 8.8 in. dia., White	2	3.55	1000	12	24	TJ0922A
67805	   FSC® Scott 100% Recycled Jr Jumbo Bath 8.8 in. dia., White	2	3.55	1000	12	23.2	TJ0922A
System Specific SKU's							
07005	   FSC® Scott Coreless Jr Jumbo Bath, White	1	3.78	2300	12	30	TJ0912A~
07006	   FSC® Scott Coreless Jr Jumbo Bath, White	2	3.78	1150	12	26.3	TJ0922A~
07007	   FSC® Scott Coreless Jr Jumbo Bath, White	2	3.78	1000	12	19.2	TJ0922A~

Kruger Products

05610	 White Swan Jumbo Bath Tissue Jr., 9 in. dia., White	1	3.7	2000	8	18.6	TJ0912A
05611	 Esteem Jumbo Bath Tissue, White	1	3.3	2000	8	16.9	TJ0912A

05619		Mini Max Jumbo Bath Tissue, White	1	3.7	1500	18	28.1	TJ0912A
05620		Purex Jumbo Bath Tissue Jr., 9 in. dia., White	2	3.7	1000	8	15.9	TJ0921A
05621		Embassy Jr. Jumbo Bath Tissue, White	2	3.7	1000	8	15.9	TJ0922A
05662		Esteem Jr. Jumbo Bath Tissue, White	2	3.3	1000	8	13.8	TJ0922A

Sr. Jumbo Bath Tissue - greater than 9.125" Roll Diameter

Essity





10" Diameter, 2.34" Core ID

11010402	 	Tork Advanced Jumbo Bath Tissue Roll, White	1	3.55	2247	6	19.7	N/A
12021502	 	Tork Advanced Jumbo Bath Tissue Roll, White	2	3.55	1600	6	17.9	N/A

12" Diameter, 3.3" Core ID

TJ1212A	 	Tork Universal Jumbo Bath Tissue Roll, White	1	3.55	4000	6	26.3	N/A
TJ1222A	 	Tork Universal Jumbo Bath Tissue Roll, White	2	3.55	2000	6	22.4	N/A

Cascades

B260	 	Select Jumbo Bath Tissue, 12 in. dia., White	2	3.5	1900	6	20.6	TJ1222A
T263	 	Perform Jumbo Bath Tissue for Tandem 10 in. dia. Beige	2	3.5	1400	6	16	12021502

Georgia Pacific

13102		Envision Jumbo Bath Tissue, 12 in. dia., White	2	3.5	2000	6	22.79	TJ1222A
13105	 	Acclaim Jumbo Bath Tissue, 12 in. dia., White	1	3.5	4000	6	25.63	TJ1212A
2172114		Professional Series 9 in. dia., White	2	3.5	1,000	4	7.83	TJ0922A

Kimberly-Clark

07202	 	Scott JRT Jumbo Bath Tissue, 12 in. dia., White	1	3.55	4000	6	26.1	TJ1212A
07827	 	Scott Jumbo Bath 12 in. dia., White	2	3.55	2000	6	22.6	TJ1222A

Kruger Products

05653		White Swan Jumbo Bath Tissue, 12 in. dia., White	1	3.7	4000	4	18.6	TJ1212A
05660		Purex Jumbo Bath Tissue, 12 in. dia., White	2	3.7	2000	4	17	TJ1222A
05661		Embassy Jumbo Bath Tissue, 12 in. dia., White	2	3.7	2000	4	17	TJ1222A

ITEM NO.	DESCRIPTION	SHEET SIZE W X L (IN.)	TISSUES/ BOX	BOXES/ CASE	CASE WT. (LB.)	ESSITY CLOSEST EQUIVALENT
----------	-------------	---------------------------	-----------------	----------------	-------------------	------------------------------

Facial Tissue

Essity

TF6910A	Tork Premium Facial Tissue Cube Box, White	8 x 8	94	36	12	N/A
TF6920A	Tork Premium Facial Tissue Flat Box, White	8 x 8	100	30	10.8	N/A
TF6830	Tork Advanced Soft Facial Tissue Cube Box, White	8 x 8	94	36	14	N/A
TF6810	Tork Advanced Facial Tissue Flat Box, White	8.2 x 7.9	100	30	11.4	N/A
TF6710A	Tork Universal Facial Tissue Flat Box, White	8.2 x 7.9	100	30	11.4	N/A

Cascades

F150	Signature Facial Tissue, White, Flat Box	8 x 8	100	30	9	TF6710A
F300	Perform Facial Tissue, White, Flat Box	7.4 x 8.2	100	30	9	TF6710A
F600	Signature Facial Tissue, White, Flat Box	7.4 x 8.2	100	30	9.5	TF6810
F700	Signature Facial Tissue, White, Cube Box	7.8 x 9	95	36	15.5	TF6910A









Georgia Pacific

21424	GP Core Facial Tissue, White, Flat Box	8 x 8.3	100	30	11.7	TF6710A
46200	Preference Facial Tissue, White, Cube	7.65 x 8.85	100	36	15.7	TF6830
46580	Angel Soft ps Premium Facial Tissue, White, Cube	7.65 x 8.85	96	36	15	TF6910A, TF6830
46560	Angel Soft ps Premium Ultra Facial Tissue, White, Cube	7.6 x 8.5	96	36	13.1	TF6910A
47410	Envision Facial Tissue, White, Flat Box	8 x 8.33	100	30	11.7	TF6710A
47510	Envision Facial Tissue, White, Cube Box	8 x 8.3	85	36	12.2	TF6830
47580	Angel Soft ps Premium PolyFlex Facial Tissue, White	8.3 x 7.7	96	54	15	N/A
48100	Preference Facial Tissue, White, Flat Box	7.65 x 8.85	100	30	12.3	TF6810
48560	Angel Soft ps Ultra Premium White, Flat Box	7.4 x 8.8	125	30	12.7	TF6920A
48550	Angel Soft ps Premium Facial Tissue, White, Flat Box	5.6 x 7.2	50	60	8.23	TF6920A
48580	Angel Soft ps Premium Facial Tissue, White, Flat Box	7.65 x 8.85	100	30	11.3	TF6920A
4636014	Angel Soft Ultra Professional Series Facial Tissue, White, Cube	7.6 x 8.5	96	10	3.79	TF6910A
4836014	Angel Soft Ultra Professional Series Facial Tissue, White, Flat	7.4 x 8.8	125	10	3.67	TF6920A

Kimberly-Clark

03076	Kleenex Convenience Case Facial Tissue, White, Flat Box	8.4 x 8.0	125	12	6.1	TF6920A
03131	Surpass Convenience Case Facial Tissue, White, Flat Box	8.0 x 8.3	100	12	5.5	TF6810
21272	Kleenex Naturals Boutique Facial Tissue, White, Cube	8.4 x 8.2	95	36	6.1	TF6380

Facial Tissue (cont.)

21195		Kleenex Junior Facial Tissue, White, Flat Box	8.4 x 5.5	68	48	10	N/A
21269	FSC*	Kleenex Boutique Facial Tissue, White, Cube Box	8.4 x 8.0	95	36	15.8	TF6910A
21270	FSC*	Kleenex, Boutique Facial Tissue, White/Decorative, Cube Box	8.4 x 8.0	95	36	14.5	TF6910A
21272	 FSC*	Kleenex, Naturals Boutique Facial Tissue, White, Cube Box	8.4 x 8.2	95	36	16.1	TF6830
21285	 FSC*	Surpass 100% Recycled Facial Tissue, White, Flat Box	8 x 8.3	125	60	25.8	TF6810
21295	 FSC*	Surpass Boutique 100% Recycled Facial Tissue, White, Cube	8 x 8.3	110	36	14.4	TF6830
21320	  FSC*	Surpass Facial Tissue, White, Cube Box	8 x 8.3	110	36	14.4	TF6830
21340	  FSC*	Surpass Facial Tissue, White, Flat Box	8 x 8.3	100	30	11.9	TF6810
21390	  FSC*	Surpass Facial Tissue, White, Flat Box	8 x 8.3	125	60	25.8	TF6810
21400	FSC*	Kleenex Facial Tissue, White, Flat Box	8.4 x 8.0	100	36	14.3	TF6920A
21601	FSC*	Kleenex Naturals Facial Tissue, White, Flat Box	8.4 x 8.0	125	48	23	TF6710A
21606	FSC*	Kleenex Facial Tissue, White, Flat Box	8.4 x 8.0	125	48	23	TF6920A
25829	FSC*	Kleenex Boutique Lotion Facial Tissue, White, Cube Box	8.4 x 8.2	75	27	12	N/A
25836	FSC*	Kleenex Boutique Anti Viral Facial Tissue, White, Cube Box	8.2 x 8.2	68	27	11.2	TF6910A
25837		Kleenex Boutique Anti Viral Facial Tissue, White, Cube Box	8.2 x 8.2	68	27	14.5	TF6910A
29388	FSC*	Kleenex Cool Touch Facial Tissue, White, Cube Box	8.4 x 8.2	50	27	10.8	N/A
37303		Kleenex Boutique Anti Viral Facial Tissue, White, Cube Box	8.2 x 8.2	68	27	14.5	N/A









































Kruger Products

08300		White Swan Facial Tissue, White, Flat Box	7.5 x 8.4	100	36	12.8	TF6810
08500		White Swan Quick-Wipes, Facial Tissue, White, Flat Box	8.3 x 4.5	80	135	17.9	N/A
08906		Embassy Supreme Facial Tissue, White, Cube Box	8.4 x 8.2	100	36	15	TF6910A
08920		Embassy Supreme Facial Tissue, White, Flat Box	7.5 x 8.4	100	36	13.8	TF6920A

ITEM NO.	DESCRIPTION	TYPE	OPEN SIZE	TWLS/ PKG.	PKGS./ CASE	TWLS/ CASE	CASE WT. (LB.)	ESSITY CLOSEST EQUIVALENT
----------	-------------	------	-----------	---------------	----------------	---------------	-------------------	------------------------------

Folded Towels

Essity

100297	 FSC	Tork Premium Extra Soft Xpress Hand Towel, 4 Panel, White	Multifold	8.35 x 13.4	100	21	2100	14.1	N/A
101293	 	Tork Advanced Xpress Hand Towel, 3-Panel, White	Multifold	9.125 x 9.5	189	16	3024	16.3	N/A
221845	 	Tork Universal Hand Towel, Natural White	Singlefold	9.125 x 10.25	250	16	4000	20.3	N/A
250510	 	Tork Premium Hand Towel, White	C-Fold	10.125 x 12.75	125	16	2000	15.3	N/A
250630	 	Tork Universal Hand Towel, Natural White	C-Fold	10.125 x 12.75	150	16	2400	17	N/A
420483	 	Tork Universal Hand Towel, Natural White	Multifold	9.125 x 9.5	250	16	4000	18.6	N/A
420570	 	Tork Premium Hand Towel, 3-Panel, White	Multifold	9.0 x 9.5	250	12	3000	14.1	N/A
420544		Tork Advanced Soft Hand Towel, 4-Panel, White w/Grey Leafs	C-Fold	8.4 x 14.5	150	16	2400	13.9	N/A
420558		Tork Advanced Soft Hand Towel, 3-Panel, White w/Grey Leafs	C-Fold	9.125 x 10.875	200	16	3200	14.8	N/A
424814	 	Tork Advanced Hand Towel, White	Multifold	9.0 x 9.5	250	16	4000	15.8	N/A
424864	  FSC	Tork Advanced Hand Towel, White	Multifold	8.0 x 9.5	12	250	3000	10.6	N/A
CB520	 	Tork Advanced Hand Towel, White	C-Fold	10.125 x 12.75	150	16	2400	19	N/A
CB530	 	Tork Universal Hand Towel, White	C-Fold	10.125 x 12.75	150	16	2400	17.6	N/A
MB572	 FSC	Tork Premium Soft Xpress Hand Towel, 4-Panel, White	Multifold	9.125 x 14.5	94	32	3008	29.94	N/A
MB574	 	Tork Premium Soft Xpress Hand Towel, 4-Panel, White	Multifold	8.4 x 14.5	94	32	3008	27.74	N/A
MB576	 FSC	Tork Premium Soft Hand Towel, 3-Panel, White	Multifold	10.1 x 10.875	135	16	2160	17.96	N/A
MB578	 FSC	Tork Premium Soft Xpress Hand Towel, 3-Panel, White	Multifold	9.125 x 10.875	135	16	2160	16.31	N/A
MB540A		Tork Universal Hand Towel, White	Multifold	9.125 x 9.5	250	16	4000	19	N/A
MB538	 	Tork Universal Hand Towel, White	Multifold	8.1 x 9.5	250	16	4000	17	N/A
MK530A	 	Tork Universal Hand Towel, Natural	Multifold	9.125 x 9.5	250	16	4000	20.9	N/A
MK520A	 	Tork Universal Hand Towel, Natural	Multifold	9.125 x 9.5	250	16	4000	19.1	N/A
MK518A	 	Tork Universal Hand Towel, Natural	Multifold	8.1 x 9.5	250	16	4000	16.9	N/A
SB1840A	 	Tork Universal Hand Towel, White	Singlefold	9.125 x 10.25	250	16	4000	22.4	N/A
SB1842	 	Tork Universal Hand Towel, White	Singlefold	9.125 x 10.25	250	16	4000	20.6	N/A
SK1850A	 	Tork Universal Hand Towel, Natural	Singlefold	9.125 x 10.25	250	16	4000	20.6	N/A

Cascades

H110		Select Singlefold Paper Towel, White	Singlefold	9 x 9.45	250	16	4000	15.8	SB1840A
H115		Select Singlefold Paper Towel, Natural	Singlefold	9 x 9.45	250	16	4000	15.8	SK1850A
H160	 	Select Singlefold Paper Towel, White	Singlefold	9.1 x 10.25	250	16	4000	18.9	SB1840A





H120		Select Multifold Paper Towel, White	Multifold	8.1 x 9.45	250	16	4000	15	MB538
H125		Select Multifold Paper Towel, Natural	Multifold	8.1 x 9.45	250	16	4000	15	MK518A
H130		Select C-Fold Paper Towel, White	C-Fold	10 x 11.4	150	16	2400	12.7	N/A
H165		Select Singlefold Paper Towel, Natural	Singlefold	9.1 x 10.25	250	16	4000	19.8	SK1850A
H170		Select Multifold Paper Towel, White	Multifold	9.1 x 9.5	250	16	4000	17.4	MB540A, MB538
H175		Select Multifold Paper Towel, Natural	Multifold	9.1 x 9.5	250	16	4000	18.3	MK530A
H180		Select C-Fold Paper Towel, White	C-Fold	10.25 x 13	150	16	2400	16	CB530, 424814

Georgia Pacific























20204		Pacific Blue Basic Multifold Towel, White	Multifold	9.2 x 9.4	250	16	4000	19.1	MB540A, MB538
20241		Pacific Blue Select C-Fold Towel, White	C-Fold	10.1 x 13.2	200	12	2400	22.5	CB520, 420554
20389+		Pacific Blue Select Multifold Towel, White	Multifold	9.2 x 9.4	334	12	4008	22.5	424814
20603		Pacific Blue Basic C-Fold Towel, White	C-Fold	10.1 x 13.2	240	10	2400	17.6	CB530, 420554
20885		Pacific Blue Ultra BigFold Z Folded Towel, White	Multifold	8.0 x 11.0	260	10	2600	14.7	424814
20886		Pacific Blue Ultra BigFold Jr. Folded Towel, White	Multifold	9.25 x 11.0	220	10	2200	15.6	420558, MB578
20887		Pacific Blue Ultra BigFold Z Folded Towel, White	Multifold	10.2 x 10.8	220	10	2200	19.2	MB576, MB578
20904		Pacific Blue Basic Singlefold Towel, White	Singlefold	9.25 x 10.25	250	16	4000	20.5	SB1840A
21000		Pacific Blue Select Premium Multifold Towel, White	Multifold	9.2 x 9.4	125	16	2000	15.4	424814, 101293
21442		GP Core, White	Multifold	9.2 x 9.4	250	16	4000	19	MB540A
21443		GP Core, Natural	Multifold	9.2 x 9.4	250	16	4000	18.8	MK520A
23000		Pacific Blue Select Premium C-Fold Towel, White	C-Fold	10.1 x 13.2	120	12	1440	14.9	250510, MB572, MB574
23303		Pacific Blue Basic Starbucks Multifold Towel, Brown	Multifold	8 x 9.4	250	16	4000	16.6	MK518A
23304		Pacific Blue Basic Multifold Towel, Natural	Multifold	9.2 x 9.4	250	16	4000	19.1	MK520A

ITEM NO.	DESCRIPTION	TYPE	OPEN SIZE	TWLS/ PKG.	PKGS./ CASE	TWLS/ CASE	CASE WT. (LB.)	ESSITY CLOSEST EQUIVALENT
----------	-------------	------	-----------	---------------	----------------	---------------	-------------------	------------------------------







Folded Towels (cont.)

23504	 Pacific Blue Basic Singlefold Towel, Natural	Singlefold	9.25 x 10.25	250	16	4000	20.5	SK1850A
24590	 Pacific Blue Basic Recycled Multifold Towel, White	Multifold	9.2 x 9.4	250	16	4000	19	MB540A, MB538
25190	 Pacific Blue Basic Recycled C-Fold Towel, White	C-Fold	10.1 x 13.2	240	10	2400	20.9	CB530, 420554
33587	 Pacific Blue Ultra BigFold Folded Towel, White	Multifold	10.2 x 10.8	220	10	2200	12	MB576, MB578
2112014	Professional Series Premium, White	C-Fold	10 x 13	200	6	2,000	10.8	CB530
2212014	Professional Series Premium, White	Multifold	9.2 x 9.4	250	8	2,000	11.9	420570, 101293

Kimberly-Clark

01500	 FSC* Kleenex, White	C-Fold	10.125 x 13.15	150	16	2400	19.1	250510, MB574
01510	 FSC* Scott, White	C-Fold	10.125 x 13.15	200	12	2400	14.6	CB520, 420554
01700	 FSC* Scott, White	Singlefold	9.3 x 10.5	250	16	4000	17.6	SB1840A
01701	 FSC* Kleenex Pop-Up Box	Singlefold	9 x 10.5	120	18	2160	15	420570, 101293
01801	 FSC* Scott 100% Recycled, Natural	Multifold	9.2 x 9.4	250	16	4000	17.8	MK520A
01804	 FSC* Scott, White	Multifold	9.2 x 9.4	250	16	4000	15	424814
01807	 FSC* Scott 100% Recycled, White	Multifold	9.2 x 9.4	250	16	4000	18.7	MB540A
01840	 FSC* Scott, White	Multifold	9.2 x 9.4	250	16	4000	14.9	MB540A
01860	Scott, White	Multifold	9.2 x 9.4	250	16	4000	15.2	MB540A
01890	 FSC* Kleenex, White	Multifold	9.2 x 9.4	150	16	2400	13.1	420570, 424814, 101293
01960	 FSC* Scott, White	Scottfold	7.8 x 12.4	175	25	4375	19.8	420558
01980	 FSC* Scott, White	Scottfold	9.4 x 12.4	175	25	4375	22.8	420554
02046	 FSC* Kleenex, White (Convenience Case)	Multifold	9.2 x 9.4	150	8	1200	7.5	420570, 424814, 101293
02920	 FSC* Scott 100% Recycled, White	C-Fold	10.1 x 13.2	200	12	2400	16.9	CB520, CB530
03623	 FSC* Scott, White (Convenience Case)	C-Fold	10.125 x 13.15	200	9	1800	12.1	CB520, CB530
03650	 FSC* Scott, White (Convenience Case)	Multifold	9.25 x 9.4	250	12	3,000	12	424814
04442	 FSC* Kleenex Slimfold, White	Narrowfold	7.5 x 11.6	90	24	2160	10.5	420570, 101293
11268	Kleenex Ultra Soft Hand Towel, White	Interfold	9 x 10.5	70	18	1260	15.7	100297~
11829	 FSC* Scott, Soft Wheat, Absorbency Pockets, 20% Plant Fiber	Multifold	9.2 x 9.4	250	16	4,000	18.5	MK530A
13253	 FSC* Kleenex, White	Scottfold	7.84 x 12.4	120	25	3000	19.8	MB576
13254	 FSC* Kleenex, White	Scottfold	9.4 x 12.4	120	25	3000	21.1	MB574
28791	Kleenex Super Soft	Multifold	8.5 x 16.3	94	30	2820	24.2	N/A
29575	 FSC* Scott Slimfold, White	Narrowfold	8.7 x 16.9	110	24	2640	10.5	420570, 101293
37490	 FSC* Scott, White	Multifold	8.0 x 9.4	250	16	4,000	12.6	MB538
43751	 FSC* Scott, Soft Wheat, Absorbency Pockets, 20% Plant Fiber	Multifold	9.2 x 9.4	250	16	4,000	18.5	MK530A
43752	 FSC* Kleenex Ultra Soft, White	Multifold	9.2 x 9.4	150	16	2,400	12.5	MB578
46321	Kleenex Reveal Ultra, White	Multifold	8.0 x 9.4	150	16	2,400	-	424864

Kruger Products

1000		Metro, White	C-Fold	10 x 13	200	12	2400	16	CB530
1010 ⁺		Embassy, White	Singlefold	9.0 x 10.7	250	16	4000	21.6	SB1840A
1014 [^]		Embassy, White	Singlefold	9.5 x 10.7	250	16	4000	22.1	SB1840A
1020 ⁺		Embassy Industrial, White	Singlefold	9.4 x 10.6	268	15	4020	20.8	SB1840A
1024		Metro, White	Singlefold	9 x 9	250	16	4000	15	SB1840A
1095		White Swan, White	C-Fold	10 x 13	200	12	2400	14.9	CB530, 420554
1097		Embassy, White	C-Fold	10 x 13	150	16	2400	19	CB520, 420554
1250		Embassy Supreme (Perforated), White	Singlefold	9 x 10.7	188	16	3008	19.2	SB1840A
1265		Embassy Supreme, White	Multifold	9 x 9.5	250	12	3000	15.7	424814
1540		Embassy, White	Multifold	9 x 9.5	334	12	4008	18.4	424814
1800		Esteem, Natural	Singlefold	9 x 10.7	250	16	4000	18.3	SK1850A
1802		Esteem, Natural	Singlefold	9 x 9	250	16	4000	17.7	SK1850A
1820		Esteem, Natural	Multifold	9 x 9.5	334	12	4008	16.5	MK520A
1900 ⁺		White Swan, White	Singlefold	9 x 10.6	250	16	4000	17.5	SB1840A
1904 [^]		White Swan, White	Singlefold	9 x 10.7	250	16	4000	17.8	SB1840A
1920		White Swan, White	Multifold	9 x 9.5	334	12	4008	16	MB540A





















































** Natural White, midway between natural and white + West Coast Only ^ East Coast Only ~ Replacement Dispensers Required

ITEM NO.	DESCRIPTION	DIMENSION (IN. X FT.)	CORE INSIDE DIAMETER	LINEAR FT./ CASE	ROLLS/ CASE	CASE WT. (LB.)	ESSITY CLOSEST EQUIVALENT
----------	-------------	--------------------------	-------------------------	---------------------	----------------	-------------------	------------------------------

Hardwood Towels

Essity

System Specific SKUs

214250	                                                   
--------	---

8620100		Tork Universal Hand Towel Roll, Natural, 1-Ply	7.5 x 425	1.925	5100	12	32.8	N/A
8621400		Tork Universal Hand Towel Roll, Natural White, 1-Ply	7.5 x 425	1.925	5100	12	28.4	N/A
8631060		Tork Universal Hand Towel Roll, Natural, 1-Ply	7.5 x 550	1.925	3300	6	17	N/A
8634540		Tork Advanced Hand Towel Roll, White, 1-Ply	8 x 450	1.925	5400	12	22.2	N/A

Standard SKUs

RB350A		Tork Advanced Roll Hand Towel, White	7.87 x 350	1.8	4200	12	23.5	N/A
RB600		Tork Advanced Roll Hand Towel, White	7.87 x 600	1.8	7200	12	42.7	N/A
RB800		Tork Advanced Roll Hand Towel, White	7.87 x 800	1.8	4800	6	27.9	N/A
RB351		Tork Universal Roll Hand Towel, White	7.87 x 350	1.8	4200	12	21.7	N/A
RB6002		Tork Universal Roll Hand Towel, White	7.87 x 600	1.8	7200	12	36.5	N/A
RB8002		Tork Universal Roll Hand Towel, White	7.87 x 800	1.8	4800	6	24.8	N/A
RB8004		Tork Universal Roll Hand Towel, White	7.875 x 800	1.8	4800	6	24.8	N/A
RB10002		Tork Universal Roll Hand Towel, White	7.87 x 1000	1.8	6000	6	30.6	N/A
RK350A		Tork Universal Roll Hand Towel, Natural	7.875 x 350	1.8	4200	12	21.7	N/A
RK600E		Tork Universal Roll Hand Towel, Natural	7.87 x 600	1.8	7200	12	39.6	N/A
RK800E		Tork Universal Roll Hand Towel, Natural	7.87 x 800	1.8	4800	6	26.8	N/A
RK8002		Tork Universal Roll Hand Towel, Natural	7.875 x 800	1.8	4800	6	24.8	N/A
RK1000		Tork Universal Roll Hand Towel, Natural	7.87 x 1000	1.8	6000	6	30.6	N/A
RB206>		Tork Universal Roll Hand Towel, White	7.87 x 206	1.8	4944	24	26	N/A
RK206E>		Tork Universal Roll Hand Towel, Natural	7.87 x 206	1.8	4944	24	26	N/A

Cascade

























System Specific SKUs

T110		Perform Roll Towel for Tandem, White	7.5 x 775	--	4650	6	26	290087~
T111		Signature Antibacterial Roll Towel for Tandem, Mint Green	7.5 x 775	--	4650	6	27	N/A
T112		Signature Antibacterial Roll Towel for Tandem, Mint Green	7.5 x 775	--	4650	6	27	N/A
T114		Perform Roll Towel for Tandem, Ivory	7.5 x 775	--	4650	6	27	290088~,290089~
T115		Perform Roll Towel for Tandem, Moka	7.5 x 775	--	4650	6	26	290088~
T116		Signature Roll Towel for Tandem, White	7.5 x 775	--	4650	6	19.3	290096~
T220		Perform Roll Towel for Tandem, White	7.5 x 1,050	--	6300	6	29	RB10002
T225		Perform Roll Towel for Tandem, Moka	7.5 x 1,050	--	6300	6	29	N/A
T260		Perform Roll Towel for Tandem, White	3.5 x 1,400	--	8400	6	15.8	N/A
T330		Perform Roll Towel for Tandem, White	7.5 x 600	--	7200	12	32.8	290087~
T335		Perform Roll Towel for Tandem, Natural	7.5 x 600	--	7200	12	32.8	290088~

ITEM NO.	DESCRIPTION	DIMENSION (IN. X FT.)	CORE INSIDE DIAMETER	LINEAR FT./ CASE	ROLLS/ CASE	CASE WT. (LB.)	SCA CLOSEST EQUIVALENT
----------	-------------	--------------------------	-------------------------	---------------------	----------------	-------------------	---------------------------









Cascade

Standard SKUs

























H020	 Select Roll Paper Towel, White	7.5 x 205	--	4920	24	23.7	RB206
H025	 Select Roll Paper Towel, Natural	7.5 x 205	--	4920	24	23.5	RK206E
H040	 Select Roll Paper Towel, White	7.9 x 425	--	5100	12	23.8	214250
H045	 Select Roll Paper Towel, Natural	7.9 x 425	--	5100	12	23.8	N/A
H055	 Select Roll Paper Towel, Natural	7.5 x 500	--	6000	12	26.5	RK600E
H060	 Select Roll Paper Towel, White	7.9 x 600	--	6000	12	31.5	RB600
H065	 Select Roll Paper Towel, Natural	7.9 x 600	--	6000	12	31.5	RK600E
H080	 Select Roll Paper Towel, White	7.9 x 800	--	4800	6	21	RB800
H085	 Select Roll Paper Towel, Natural	7.9 x 800	--	4800	6	21	RK800E
H105	 Select Roll Paper Towel, Natural	7.5 x 1,000	--	6000	6	26.5	RK1000
H225	  Select Roll Paper Towel, Natural	7.5 x 205	--	4920	24	23.5	RK206E
H230	  Select Roll Paper Towel, White	7.9 x 350	--	4200	12	20.3	RB351
H235	  Select Roll Paper Towel, Natural	7.9 x 350	--	4200	12	21.2	RK350A
H240	  Select Roll Paper Towel, White	7.9 x 425	--	5100	12	24.6	214250
H245	  Select Roll Paper Towel, Natural	7.9 x 425	--	5100	12	24.6	RK350A
H280	  Select Roll Paper Towel, White	7.9 x 800	--	4800	6	23.8	RB8002
H285	  Select Roll Paper Towel, Natural	7.9 x 800	--	4800	6	23.8	RK800E, RK8002
H670	 Signature Roll Paper Towel, White	7.8 x 700	--	4200	6	17.8	RB800

Georgia Pacific

Standard SKUs

26007	Pacific Blue Basic Hardwound Roll Towel, White	7.875 x 350	2.0	4200	12	25.01	RB351
26008	 Pacific Blue Basic Hardwound, Natural	7.875 x 350	2.0	4200	12	23.25	RK350A
26100	 Pacific Blue Select Hardwound Roll Towel, White	7.875 x 1000	1.625	6000	6	28.73	RB10002
26301	 Pacific Blue Basic High Capacity Hardwound, Natural	7.875 x 800	1.625	4800	6	24.29	RK8002, RK1000
26302	 Pacific Blue Basic Hardwound, Natural	7.875 x 800	2.0	4800	6	24.28	RK8002, RK1000
26401	 Pacific Blue Basic Hardwound, Natural	7.875 x 350	1.625	4200	12	21.32	RK350A
26601	  Pacific Blue Basic Hardwound Roll Towel, White	7.875 x 800	1.625	4800	6	25.4	RB8002, RB10002
26602	 Pacific Blue Basic High Capacity Hardwound Roll Towel, White	7.875 x 800	2.0	4800	6	24.28	RB8002, RB10002
28000	Pacific Blue Select Premium Hardwound Towel, 2-Ply, White	7.875 x 350	1.625	4200	12	29.2	RB350A
28706	 Pacific Blue Basic Hardwound Roll Towel, White	7.87 x 350	1.625	4200	12	22.2	RB351

System Specific SKUs









19524		Towlmastr Series 2000 Hardwound, White X Series	7.4 x 450	1.625	5400	12	31.1	290089~, 290087~
19724		Towlmastr Series 2000 Hardwound, Natural	7.4 x 450	1.625	5400	12	34	290088~
21461		GP Core High Capacity Hardwound Towel, Natural	7.875 x 350	2	4200	6	24.29	290088
21825		Towlmastr Series 2000 Hardwound, White Y Series	7.4 x 450	1.625	5400	12	31.16	290089~, 290087~
22025		Towlmastr Series 2000 Hardwound, Natural Y Series	7.4 x 450	1.625	5400	12	34	290088~
26470		SofPull Hardwound, White	7.87 x 1000	1.5	6000	6	27.43	RB10002
26480		SofPull Hardwound, Natural	7.87 x 1000	1.5	6000	6	34.65	290088~
26490		Pacific Blue Ultra Roll Towel, White	7.8 x 1150	--	6900	6	25.2	290089~
26491		Pacific Blue Ultra Roll Towel, White	7.8 x 1150	--	3450	3	12.7	290089~
26495		Pacific Blue Ultra Roll Towel, Brown	7.8 x 1150	--	6900	6	39.9	290088~
26496		Pacific Blue Ultra Roll Towel, Brown	7.8 x 1150	--	3450	3	20.1	290088~
26610		SofPull Hardwound, White	9 x 400	1.75	2400	6	15.9	290089~
26910		SofPull Hardwound, White	7 x 1000	1.5	6000	6	26.59	RB10002
26915		SofPull Hardwound, White	7 x 1000	1.5	6000	6	19.59	RB10002
26920		SofPull Hardwound, Natural	7.09 x 1000	1.5	6000	6	26.59	290088~
2910P		Cormatic Hardwound, Natural	8.25 x 702	--	4212	6	29.6	290088~
2930P		Cormatic Hardwound, White	8.25 x 700	--	4200	6	26.09	290089~
34526		Towlsavr Series 2000 Hardwound, White Z Series	7.4 x 450	1.625	5400	12	31.16	290089~, 290087~
34726		Towlsavr Series 2000 Hardwound, Natural Z Series	7.4 x 450	1.625	5400	12	34.02	290088~
81464		Towlmastr Max 2000 Hardwound, Natural X Series	7.4 x 700	--	4200	6	26.60	290088~
81764		Towlmastr Max 2000 Hardwound, White, X Series	7.4 x 700	--	4200	6	23.1	290089~, 290087~
82165		Towlmastr Max 2000 Hardwound, Natural Y Series	7.4 x 700	--	4200	6	26.60	290088~
82765		Towlmastr Max 2000 Hardwound, White Y Series	7.4 x 700	--	4,200	6	21	290089~, 290087~
84266		Towlsaver Max 2000 Hardwound, Natural Z Series	7.4 x 700	--	4200	6	26.59	290088~
84566		Towlmastr Max 2000 Hardwound, White Z Series	7.4 x 700	--	4,200	6	24.64	290089~, 290087~
89410		enMotion Hardwound, White (Recessed)	8.2 x 425	1.56	2550	6	17	290096~, 290092A~
84266		Towlsaver Max 2000 Hardwound, Natural Z Series	7.4 x 700	--	4200	6	26.59	290088~
89410		enMotion Hardwound, White (Recessed)	8.2 x 425	1.56	2550	6	17	290096~, 290092A~
89415		enMotion Premium Hardwound, White	8.2 x 525	1.56	3150	6	21.42	290096~
89420		enMotion Hardwound, White (Recessed)	8.2 x 700	1.56	4200	6	19.5	290095~, 290089~, 290087~
89430		enMotion Hardwound, White, EPA Compliant, (Recessed)	8.2 x 700	1.56	4200	6	19.5	290095~, 290089~, 290087~
89440		enMotion Hardwound, Natural, EPA Compliant	8.2 x 700	1.56	4200	6	29.1	290088~
89460		enMotion Hardwound, White (Wall Mount)	10 x 800	1.625	4800	6	29.37	290095~, 290089~, 290087~
89470		enMotion Hardwound High Capacity, White	10 x 800	1.625	4800	6	37.37	290095~, 290089~, 290087~
89480		enMotion Hardwound, Natural EPA Compliant	10 x 800	1.75	4800	6	40	290088~
89485		enMotion Hardwound, Natural	10 x 800	1.75	2400	3	20.1	290088~
89490		enMotion Hardwound, White EPA Compliant, (Wall Mount)	10 x 800	1.625	4800	6	28.7	290089~, 290087~
2170114		Professional Series Hardwound, White	7.87 x 350	--	2100	6	12.6	RB350

~ Replacement Dispenser Required















ITEM NO.	DESCRIPTION	DIMENSION (IN. X FT.)	CORE INSIDE DIAMETER	LINEAR FT./ CASE	ROLLS/ CASE	CASE WT. (LB.)	SCA CLOSEST EQUIVALENT
----------	-------------	--------------------------	-------------------------	---------------------	----------------	-------------------	---------------------------

Kimberly-Clark

System Specific SKUs

02001	 FSC® Scott Essential Hardwound, White	8 x 950	--	5700	6	24.5	290095, 290087~
25630	 FSC® Kleenex Hardwound, White	8 x 700	--	4200	6	24.6	290096~
25637	 FSC® Kleenex Hardwound, White	8 x 700	--	4200	6	25	290096~
25639	 FSC® Kleenex Hardwound, White	8 x 700	--	4200	6	25	290096~
25700	 FSC® Scott Hardwound, White	7.5 x 1150	--	6900	6	26	RB10002
25702	 FSC® Scott Hardwound, White	7.5 x 1150	--	6900	6	26	RB10002
25703	 FSC® Scott Hardwound, White	7.5 x 1150	--	6900	6	26	RB10002
43961	 FSC® Scott Hardwound, Mocha, Mod System	7.5 x 800	1.75	4800	6	25	290088~

Standard SKUs

01000	 FSC® Scott High Capacity Hardwound, White	8 x 1000	1.5	12000	12	49.5	RB10002
01005	 FSC® Scott High Capacity Hardwound, White	8 x 1000	1.5	6000	6	26	RB10002
01040	 FSC® Scott Hardwound, White	8 x 800	1.5	9600	12	39.9	RB800
01052	 FSC® Scott 100% Recycled Hardwound, White	8 x 800	1.5	9600	12	52	RB800
01080	 FSC® Kleenex Hardwound, White	8 x 425	1.5	5100	12	30.5	214250
02000	 FSC® Scott High Capacity Hardwound, White	8 x 950	1.75	5700	6	24.5	RB10002
02021	 FSC® Scott Hardwound, Natural	8 x 400	1.5	4800	12	24.8	RK350A, RK600E
02068	 FSC® Scott Hardwound, White	8 x 400	1.5	4800	12	23.3	RB350A, RB600
04142	 FSC® Scott Hardwound, Natural	8 x 800	1.5	9600	12	48	RK8002, RK800E
11090	 FSC® Kleenex Hardwound, White	8 x 600	1.5	3600	6	21.7	RB600, 214250
12388	 FSC® Scott SlimRoll Hardwound, White	8 x 580	1.75	3480	6	15	RB350A
32848	 FSC® Scott 100% Recycled Hardwound, Natural	8 x 800	2	4800	6	22.5	RK8002
43753	 FSC® Kleenex Ultra Soft SlimRoll Hardwound, White	8 x 262	--	1572	6	10.6	RB206
50500>	 FSC® Kleenex Hardwound, White (Canada Only)	8 x 425	1.75	5100	12	30.5	214250, RB600
50606	 FSC® Kleenex Hardwound, White (1.75" Core)	7.9 x 600	1.75	3600	6	21.4	290096

> Canada Only



~ Replacement Dispenser Required

ITEM NO.	DESCRIPTION	DIMENSION (IN. X FT.)	CORE INSIDE DIAMETER	LINEAR FT./ CASE	ROLLS/ CASE	CASE WT. (LB.)	ESSITY CLOSEST EQUIVALENT
----------	-------------	--------------------------	-------------------------	---------------------	----------------	-------------------	------------------------------









Hardwound Towels (cont.)

Kruger Products

System Specific SKUs

01110	Embassy Supreme TAD Hardwound Long Roll, White	8 x 800	2.0	4200	6	22.3	290095~
01210	Embassy Supreme TAD Hardwound Roll, White	8 x 350	2.0	4200	12	20.8	290094~
01169	 Embassy 2 Ultra Hardwound, White	8 x 1000	2.0	6000	6	32.8	RB10002
01249	Embassy Supreme TAD Hardwound, White	8 x 600	2.0	3600	6	18.6	290094~
01269	Embassy Supreme Hardwound, White	8 x 1000	2.0	6000	6	25.8	RB10002
01859	Esteem Long Roll Hardwound, White	8 x 800	2.0	4800	6	21.7	RB8002
01959	 White Swan Hardwound Long, White	8 x 800	2.0	4800	6	20.5	RB8002
01969	 White Swan Ultra Hardwound, White	8 x 1200	2.0	7200	6	30	RB10002







Standard SKUs

01155	 Embassy Hardwound, White	8 x 350	2.0	4200	12	23	RB350A
01161	 Embassy ULTRALong, White	8 x 1000	2.0	6000	6	29.6	RB10002
01190	 Embassy Hardwound, White	8 x 500	2.0	6000	12	30.5	RB600
01240	Embassy Supreme Hardwound, White	8 x 600	2.0	3600	6	18	RB600
01261	Embassy Ultralong TAD Hardwound, White	8 x 1000	2.0	6000	6	25.6	RB1002
01290	Embassy Hardwound Roll, White	10 x 168	2.0	4032	24	32.7	RB351
01564	 Embassy Hardwound, White	8 x 205	2.0	4920	24	27.4	RB351
01600	 White Swan Hardwound, White	8 x 500	2.0	6000	12	26.4	RB6002
01830	Esteem Hardwound, Natural	8 x 205	2.0	4920	24	23.7	RK206E
01845	Esteem Hardwound, Natural	8 x 425	2.0	5100	12	23.3	RK350A
01855	Esteem Hardwound, Natural	8 x 800	2.0	4800	6	21.7	RK800E, RK8002
01860	Esteem Hardwound, Natural	8 x 350	2.0	4200	12	20.4	RK350A
01930	 White Swan Hardwound, White	8 x 205	2.0	4920	24	22.2	RB206
01950	White Swan Hardwound Long, White	8 x 800	2.0	4800	6	20.5	RB8002
01961	 White Swan Ultra Long Hardwound, White	8 x 1200	2.0	7200	6	30	RB10002
01970	 White Swan Hardwound, White	8 x 350	2.0	4200	12	18.8	RB351

ITEM NO.	DESCRIPTION	PLY	SHEET SIZE (INCHES)	TOWELS /ROLL	ROLLS /CASE	TOWELS /CASE	ESSITY CLOSEST EQUIVALENT
----------	-------------	-----	------------------------	-----------------	----------------	-----------------	------------------------------

Centerfeed Towels

Essity

100230								
121201	  	Tork Premium Extra Soft Centerfeed Hand Towel, White	1, DRC	7.7 x 11.8	305	6	1800	N/A
121202	  	Tork Advanced Soft Centerfeed Hand Towel, White	2	9 x 11.8	600	6	3540	N/A
121204	  	Tork Advanced Soft Centerfeed Hand Towel, White	2	8.25 x 11.8	610	6	3660	N/A
121204	  	Tork Advanced Soft Centerfeed Hand Towel, White	2	7.6 x 11.8	600	6	3600	N/A
120133	  	Tork Advanced Centerfeed Hand Towel, White	1	8.25 x 11.8	1000	6	5904	N/A
120932	  	Tork Advanced Soft Centerfeed Hand Towel, White	2	7.6 x 11.8	500	6	3000	N/A
121211	  	Tork Advanced Soft Centerfeed Hand Towel, White	2	7.1 x 11.8	600	6	3600	N/A
121225	  	Tork Advanced Soft Mini Centerfeed Hand Towel, White	2	8.3 x 11.8	266	12	3192	N/A
RC530	  	Tork Universal Centerfeed Hand Towel, White	2	7.6 x 11.75	530	6	3114	N/A





Cascade

H140		Select Centerpull Paper Towel, White	2	7.9 x 8	500	6	3000	120932
H141	 	Select Centerpull Paper Towel, White	2	7.3 x 11	1080	6	6480	120133
H150	 	Select Centerpull Paper Towel, White	2	7.3 x 11	600	6	3600	RC530

Georgia Pacific

21446		GP Core Center Pull Towel, White	2	8.25 x 12	520	6	3120	120932
28124		SofPull Regular Capacity Center Pull Towel, White	1	7.8 x 15	320	6	2400	120932~, 121202~
28125		SofPull Jr Capacity Ceter Pull Towel, White	1	7.8 x 12	275	8	2200	121225~
28143		SofPull Premium High Capacity Center Pull Towel, White	1	7.8 x 15	560	4	2800	121204~
44000		Pacific Blue Select Center Pull Towel, White	2	8.25 x 12	520	6	3120	RC530
44110		Pacific Blue Basic Center Pull Towel, White	1	7.5 x 12	1000	6	6000	120133~

Kimberly-Clark

01010		Scott Center Pull Towel, White	2	8 x 15	500	4	2500	RC530
01020		Scott Center Pull Towel, White	2	8 x 15	250	6	1875	RC530
01032		Scott Roll Control Center Pull Towel, White	1	8 x 12	700	6	4200	RC530
01051		Scott Center Pull Towel, White	1	8 x 15	500	4	2500	RC530
01061		Scott Center Pull Towel, White	1	8 x 15	250	6	1875	RC530
01076		Kleenex Premiere Center Pull Towel, White	1	8 x 15	150	6	1125	100230~
01320		Kleenex Premiere Center Pull Towel, White	1	8 x 15	250	4	1250	100230~

Kruger Products







01300		White Swan Center Pull Towel, White	1	7.8 x 11.9	900	6	5400	120133~
01320		Embassy Center Pull Towel, White	2	7.8 x 11.9	600	6	3600	RC530
01322		Esteem Center Pull Towel, White	2	7.8 x 8	600	6	2400	121204~

** Natural White, midway between natural and white
~ Replacement Dispenser Required





ITEM NO.	DESCRIPTION	SHEET SIZE W X L (IN.)	TOWELS/ ROLL	ROLLS/ CASE	TOWELS/ CASE	CASE WT. (LB.)	ESSITY CLOSEST EQUIVALENT
----------	-------------	---------------------------	-----------------	----------------	-----------------	-------------------	------------------------------

Perforated Roll Towels



Essity

HB9201		Tork Perforated Towel Roll, Handi-Size Sheet, White	11 x 6.75	120	30	3600	21.6	N/A
HB1990A		Tork Perforated Towel Roll, White	11 x 9	84	30	2520	18.2	N/A
HB1995A		Tork Perforated Towel Roll, Jumbo Roll, White	11 x 9	210	12	2520	17	N/A
HK1975A		Tork Perforated Towel Roll, Jumbo Roll, Natural	11 x 9	210	30	2520	18.3	N/A
421900		Tork Perforated Towel Roll, White	11 x 9	100	30	3000	20	N/A
421970		Tork Perforated Towel Roll, White	11 x 9	70	30	2100	15	N/A



Cascades

K070		Select Kitchen Roll Towel, White	11 x 8	70	30	2100	11	421970
K085		Select Kitchen Roll Towel, White	11 x 8	85	30	2550	14.5	HB1990A, HB1995A
K250		Select Kitchen Roll Towel, White	11 x 8	250	12	3000	14.9	HB1995A
K251		Select Kitchen Roll Towel, White	11 x 8.8	250	12	3000	15.7	HB1995A
K300		Perform Kitchen Roll Towel, White	11 x 8.8	70	15	1050	6.4	421970







Georgia Pacific

27300		Pacific Blue Select Perf Roll Towel, White	11 x 8.8	100	30	3000	21	HB1990A, HB1995A
27315		Pacific Blue Select Perf Roll Towel WiseSize, White	11 x 8.8	85	15	1275	9.22	HB1990A, HB1995A
27385		Pacific Blue Select Perf Roll Towel, White	11 x 8.8	85	30	2550	18.5	HB1990A, HB1995A
27700		Pacific Blue Select Jumbo Perf Roll Towel, White	11 x 8.8	250	12	3000	20.2	HB1995A, HB1990A
28290		Pacific Blue Basic High Capacity Perf Roll Towel, Natural	11 x 8.8	250	12	3000	21.4	HK1975A
28290SP		Pacific Blue Basic High Capacity Perf Roll Towel, Natural (Heavy Corrugate Case)	11 x 8.8	250	12	3000	21.4	HK1975A
2717201		Sparkle Premium Perf Roll Towel, White	11 x 8.8	70	30	2100	15.9	421970
2717714		Sparkle Professional Series Perf Roll Towel, White	11 x 8.8	85	15	1,275	9.6	HB1995A

Kimberly-Clark

13608		Scott Kitchen Towel, White	11 x 8.78	96	15	1440	9.9	HB1990A, HB1995A
13964		Kleenex Premiere Kitchen Towel, White	10.4 x 11	70	24	1680	21.1	HB9201, 421970
41482		Scott Kitchen Towel, White	11 x 8.78	128	20	2560	18.6	HB1995A, HB1990A

Kruger Products

01122		Chalet Household Towel, White	11 x 8	210	12	3530	15.5	HB1995A
01650 ⁺		White Swan Kitchen Towel, White	10.9 x 8.6	90	24	2160	12.8	HB1990A, HB1995A
01655		White Swan Kitchen Towel, White	10.9 x 8.6	85	30	2550	15.5	HB1990A, HB1995A
01656		White Swan Professional Towel, White	10.9 x 8.6	80	30	2400	13.3	HB1990A
01702		White Swan Professional Towel, White	11 x 8.3	70	30	2100	13.6	421970
01844		Embassy Supreme Kitchen Towel, White	10.9 x 10.8	72	24	1728	16.6	HB9201
01870 [^]		White Swan (12-2's) Kitchen Towel, White	10.9 x 8.6	80	24	1920	11.7	HB1990A, HB1995A
01880		White Swan Kitchen Towel, White	10.9 x 8.6	150	24	3600	20.6	HB1995A, HB1990A
01890 [^]		White Swan Kitchen Towel, White	10.9 x 8.6	90	24	2160	11.8	HB1990A, HB1995A

ITEM NO.	DESCRIPTION	OPEN SIZE W X L (IN.)	COVERS/ PKG.	PKGS./ CASE	CASE WT. (LB.)	ESSITY CLOSEST EQUIVALENT
----------	-------------	--------------------------	-----------------	----------------	-------------------	------------------------------

Seat Covers

Essity

TC0020	Tork Universal Toilet Seat Cover, White	14.5 x 17	250	20	28	N/A
--------	---	-----------	-----	----	----	-----

Cascade

W130	Tuff-Job Toilet Seat Covers Half-Fold, White	14 x 17	250	20	29	TC0020
------	--	---------	-----	----	----	--------

Georgia Pacific

47046	Safe T Gard 1/2 Fold Seatcovers, White	14.5 x 17	250	20	28.4	TC0020
47047	Safe T Gard 1/4 Fold Seatcovers, White	14.5 x 17	200	25	29.32	N/A
47052	Safe T Gard 1/2 Fold Seatcovers, White	14.5 x 17.44	250	4	6.25	TC0020

Kimberly-Clark

07410	Scott Personal Seats	15 x 18	125	24	19	N/A
39000	Scott Personal Seats Half Fold	14.5 x 17	250	20	30	TC0020

ITEM NO.	DESCRIPTION	PLY	OPEN SIZE W X L (IN.)	SHEETS/ PKG.	PKGS/ CASE	CASE WT. (LB.)	ESSITY CLOSEST EQUIVALENT
----------	-------------	-----	--------------------------	-----------------	---------------	-------------------	------------------------------

Door Tissue

Georgia Pacific

10440	Safe-T-Guard, Interfold Door Tissue, White	1	4 x 10	200	40	23	N/A~
-------	--	---	--------	-----	----	----	------

~ Replacement Dispenser Required

ITEM NO.	DESCRIPTION	SHEET SIZE W X L (IN.)	WIPERS/ PKG.	PKGS./ CSE	WIPERS/ CASE	ESSITY CLOSEST EQUIVALENT
----------	-------------	---------------------------	-----------------	---------------	-----------------	------------------------------

Wiper Products

































Essity

192181A	Tork Foodservice Cloth, 1/4 Fold, Blue/White	13 x 21.5	240	1 Box	240	N/A
192183	Tork Foodservice Cloth, Z-Fold, Blue/White	11.75 x 14.75	80	4	320	N/A
192184	Tork Foodservice Cloth, Z-Fold, Green/White	11.75 x 14.75	80	4	320	N/A
192185	Tork Foodservice Cloth, 1/4 Fold, Green/White	11.5 x 21	600	1 Box	600	N/A
192191	Tork Antimicrobial Foodservice Cloth, 1/4 Fold, White/Red Stripe	13 x 24	150	1 Box	150	N/A
192192	Tork Antimicrobial Foodservice Cloth, 1/4 Fold, Blue/Blue Stripe	13 x 24	150	1 Box	150	N/A
192193	Tork Antimicrobial Foodservice Cloth, 1/4 Fold, Red/Red Stripe	13 x 24	150	1 Box	150	N/A
192194	Tork Antimicrobial Heavy-Duty Foodservice Cloth 1/4 Fold, White/Red Stripe	13 x 21	50	1 Box	50	N/A
192195	Tork Quat Friendly Foodservice Cloth, 1/4 Fold, White/Red Stripe	13 x 21	150	1 Box	150	N/A
192196	Tork Quat Friendly Foodservice Cloth, 1/4 Fold, Blue/Blue Stripe	13 x 21	150	1 Box	150	N/A
192291	Tork Antimicrobial Foodservice Cloth, Z-Fold, White/Red Stripe	11.75 x 14.75	50	4	200	N/A
192292	Tork Antimicrobial Foodservice Cloth, Z-Fold, Blue/Blue Stripe	11.75 x 14.75	50	4	200	N/A
192293	Tork Antimicrobial Foodservice Cloth, Z-Fold, Red/Red Stripe	11.75 x 14.75	50	4	200	N/A
192482	Tork Low Lint Cleaning Cloth, Top-Pak, White	15 x 16.5	120	5 Packs	600	N/A
192578	Tork Industrial Low Lint Cleaning Cloth, Top-Pak, Blue	15.2 x 15.7	80	5 Packs	400	N/A
192592	Tork Premium ShopMax Wet Wipes, Hand Cleaner, Bucket	11.8 x 8.7	72	4 Buckets	288	N/A
192594	Tork Premium ShopMax Wet Wipes, Multi Surface, Bucket	11.8 x 8.7	72	4 Buckets	288	N/A
192475	Tork Low-Lint Cleaning Cloth, Pop-Up, Turquoise	9 x 16.5	100	8 Boxes	800	N/A
192479	Tork Low-Lint Cleaning Cloth, Top Pak, Turquoise	13.5 x 16.4	100	5 Packs	500	N/A
197478	Tork Polishing Cloth, Top-Pak, White	14 x 16.9	125	5 Packs	625	N/A
291350	Tork Basic Paper Wiper, Roll, Natural	7.68 x 9.5	121	4 Roll	484	N/A
291370	Tork Basic Paper Wiper, Roll, White	7.68 x 9.5	121	4 Roll	484	N/A
291380	Tork Paper Wiper, Roll, White	7.68 x 9.5	121	4 Roll	484	N/A
510104	Tork Cleaning Cloth, Giant Roll, White	15.0 x 16.9	1000	1 Roll	1000	N/A
510137	Tork Cleaning Cloth, Centerfeed, White	10 x 12.6	608	1 Roll	608	N/A
510175A	Tork Cleaning Cloth, Pop-Up, White	8.46 x 16.125	100	5 Boxes	500	N/A
520304	Tork Industrial Cleaning Cloth, Giant Roll, Grey	15.0 x 16.9	1000	1 Roll	1000	N/A
520337	Tork Industrial Cleaning Cloth, Centerfeed, Grey	12.6 x 15	390	1 Roll	390	N/A
520371	Tork Industrial Cleaning Cloth, Handy Box, Grey	15 x 16.5	280	1 Box	280	N/A
520678	Tork Industrial Cleaning Cloth, Top-Pak, Grey	16.9 x 14	120	5 Packs	600	N/A

ITEM NO.	DESCRIPTION	SHEET SIZE W X L (IN.)	WIPERS/ PKG.	PKGS./ CSE	WIPERS/ CASE	ESSITY CLOSEST EQUIVALENT
----------	-------------	---------------------------	-----------------	---------------	-----------------	------------------------------

Wiper Products (cont.)

Essity

530104	 Tork Heavy-Duty Cleaning Cloth, Giant Roll, White	15.0 x 16.9	710	1 Roll	710	N/A
530137	 Tork Heavy-Duty Cleaning Cloth, Centerfeed, White	10 x 12.6	400	1 Roll	400	N/A
5301505	 Tork Heavy-Duty Cleaning Cloth, 1/4 Fold, White	12.5 x 13	50	6 Packs	300	N/A
5301755	 Tork Heavy-Duty Cleaning Cloth, Pop-Up, White	8.46 x 16.125	80	5 Boxes	400	N/A
530178	 Tork Heavy-Duty Cleaning Cloth, Top Pak, White	15.2 x 16.85	150	5 Packs	750	N/A
570104	 Tork Industrial Heavy-Duty Cleaning Cloth, Giant Roll, White	15 x 16.9	380	1 Roll	380	N/A
570137	 Tork Industrial Heavy-Duty Cleaning Cloth, Centerfeed, White	12.6 x 15	160	1 Roll	160	N/A
570478	 Tork Industrial Heavy-Duty Cleaning Cloth, Top-Pak, White	14 x 16.9	65	5 Packs	325	N/A
132451A	  Tork Industrial Paper Wiper, Centerfeed, Blue	10 x 15.75	190	4 Rolls	760	N/A
13244101	  Tork Industrial Paper Wiper, Centerfeed, Blue	11 x 15.75	375	2 Rolls	750	N/A
13247501	  Tork Industrial Paper Wiper, Handy Box, Blue	12.8 x 16.5	180	1 Box	180	N/A
192127	 Tork Paper Wiper Plus, Pop-Up, White	9.5 x 16.5	100	8 Boxes	800	N/A
192128	 Tork Paper Wiper Plus, Centerfeed, White	9.8 x 15.75	300	2 Rolls	600	N/A
192136	Tork Heavy-Duty Paper Wiper, 1/4 Fold, White	12.5 x 13	56	16 Packs	896	N/A
430150A	 Tork Paper Wiper Plus, 1/4 Fold, White	12.5 x 13	90	12 Packs	1080	N/A
430178	 Tork Paper Wiper Plus, Top-Pack, White	13.57 x 16.25	150	5 Packs	750	N/A
430304	 Tork Paper Wiper Plus, Giant Roll, White	11.1 x 12	800	1 Roll	800	N/A
440245A	Tork Industrial Paper Wiper, Pop-Up, Blue	8.9 x 16.5	90	10 Boxes	900	N/A
440278	  Tork Industrial Paper Wiper, Top-Pak, Blue	12.8125 x 16.4	90	5 Boxes	450	N/A
450137	Tork Advanced ShopMax Wiper, 450, Centerfeed, White	9 x 13	200	4 Rolls	800	N/A
450138	Tork Advanced Shopmax Wiper, 450, Centerfeed Refill, White	9.9 x 13.1	200	2 Rolls	400	N/A
450160	Tork Advanced ShopMax Wiper, 450, Roll Towel, White	11 x 9.4	60	30 Rolls	1800	N/A
450175	Tork Heavy-Duty Paper Wiper, Pop-Up, White	9.25 x 16.25	90	10 Boxes	900	N/A
450337	Tork Advanced ShopMax Wiper, 450, Centerfeed, Blue	9 x 13	200	4 Rolls	800	N/A
450338	Tork Advanced Shopmax Wiper, 450, Centerfeed Refill, Blue	9.9 x 13.1	200	2 Rolls	400	N/A
450304	Tork Heavy-Duty Paper Wiper, Giant Roll, Blue	11.1 x 12	800	1 Roll	800	N/A
450340	Tork Advanced ShopMax Wiper, 450, Centerfeed Dry Wipe, Bucket, Blue	9.9 x 13.1	200	2 Buckets	400	N/A
450360	Tork Advanced ShopMax, 450, Roll Towel, Blue/White	11 x 9.4	60	30 Rolls	1800	N/A
130211B	   Tork Paper Wiper, Centerfeed, White	9 x 15.75	800	2 Rolls	1600	N/A
130251A	   Tork Paper Wiper, Centerfeed, White	9 x 15.75	325	4 Rolls	1300	N/A
192121	 Tork Windshield Paper Towel, Singlefold, Blue	9.125 x 10.25	250	9 Sleeves	2250	N/A
192122	  Tork Windshield Paper Towel, Singlefold, Blue	9 x 10.25	140	16 Sleeves	2240	N/A
192125A	  Tork Basic Paper Wiper, Pop-Up, White	9 x 10.25	125	15 Boxes	1875	N/A

303362	 Tork Paper Wiper, Pop-Up, White	9.75 x 16.75	125	8 Boxes	1000	N/A
2225000	Tork Singlefold Dairy Towel, Natural White	9 x 10	150	15 Packs	2250	N/A
2234001	Tork Singlefold Dairy Towel, Pre-Drip Natural	9 x 10	268	10 Packs	2680	N/A
2247010	Tork Singlefold Dairy Towel, Natural	9.125 x 10.25	250	16 Packs	4000	N/A

Atlantic Mills

101S	Super Wipe, Blue, Low Lint, Solvent resist.	12 x 13	50	10	500	5301505
104S	Super Wipe, White, Low Lint, Solvent resist.	12 x 13	50	10	500	5301505
108P	Rayon Washcloth, Blue/White, non apt	10 x 13.5	50	10	500	5301505
1113P	Rayon Washcloth, Pink/White, non apt	11.5 x 13.5	50	10	500	5301505
2133PU	Nylon Reinforced Wiper, White	9 x 16.5	113	8	904	440245A
312A	Reinf, FS Wipe, B/W, Aperture with scrim	13.5 x 21	--	--	150	192191, 192292
3310	X-TRA, Airlaid, White	9 x 15	--	--	300	192128
3315	X-TRA, Scrim, White	9 x 15	--	--	400	440245A
3320	X-TRA, DRC, White	9 x 15	--	--	250	450137, 450340,
450138						
3325	X-TRA, Spunlace, Blue	9 x 15	--	--	320	510137, 530137
3330	Kerri Klean 3330, White	9.25 x 10.25	--	--	2250	N/A
419	MW, Airlaid, White	10 x 13.5	50	16	800	430150A
420A	Airlaid, White, washcloth	12 x 13.5	50	16	800	430150A
420PU	Airlaid Pop-Up, White	9 x 16.5	100	9	900	192127
529	HW Airlaid, White	12 x 13	50	18	900	192136
529PU	Airlaid, White	12 x 13.5	50	18	900	530178
8250A	Hydro-entangled, White	13.5 x 24	150	1	150	192191, 192291
8251A	Hydro-entangled, Blue	13.5 x 24	150	1	150	192191, 192291
8254A	HEF, Pizza Towel, Rust	13.5 x 24	150	1	150	192193, 192293
8255A	Fresh Towel, Yellow	13.5 x 21	--	--	150	192191, 192291
8290A	Kerri Klean Deluxe	13.5 x 24	--	--	72	192191, 192291
8311A	Wet Wipe P/W pattern Aperture	13 x 20	50	4	200	192181A, 192183
8481A	Kerri Klen Works Best Wiper, White	14.6 x 13.5	--	--	100	192191, 192292
8483A	Kerri Klen Works Best Wiper, White	14.6 x 13.5	--	--	300	530178
8484A	1/4 Fold Kerri Klean Works Best, Blue	14.6 x 12.5	--	--	100	192136, 5301505
8487A	1/4 Fold Kerri Klean Works Best, Blue	14.6 x 13.5	--	--	300	192136, 5301505
8A	Zapper, Blue, HD, Bulk Pack	13 x 15	--	--	45	530178, 192479
9500	Microbe Guard™, Green, Treated	16.5 x 13.25	--	--	100	192291, 192292, 192293
9504	Simple Solutions®, Green, Treated	16.25 x 13.25	--	--	100	N/A

Cascades

W140	Tuff-Job All-Purpose Teat Wipe, Singlefold	9.1 x 10.25	250	16	4000	N/A
W141	Tuff-Job All-Purpose Dairy Towel, Singlefold	9.1 x 10.25	250	16	4000	N/A

ITEM NO.	DESCRIPTION	SHEET SIZE W X L (IN.)	WIPERS/ PKG.	PKGS./ CSE	WIPERS/ CASE	ESSITY CLOSEST EQUIVALENT
----------	-------------	---------------------------	-----------------	---------------	-----------------	------------------------------

Wiper Products (cont.)

Cascades

W904	Tuff-Job Economy Foodservice Towels, Quarterfold, Winter Green	12 x 21	200	1	200	192185,192184
W912	Tuff-Job Durable Foodservice Towel, Quarterfold, Salmon	12 x 21	150	1	150	192193, 192293
W903	Tuff-Job Economy Foodservice Towels, Quarterfold, Soft Pink	12 x 21	200	1	200	192193, 192293
W431	Tuff-Job DRC Double Recrepe Wiper, Medium, Multifold, Pop-Up, White	9.25 x 12.5	110	12	1320	192127
W510	Tuff-Job High Performance Wiper, S500, Multifold, Pop-Up, White	9.25 x 12.5	176	10	1760	5301755
W201	Tuff-Job Scrim Reinforced Wiper, Interfold, Pop-Up, White	9.25 x 12.5	150	10	1500	13247501
W922	Tuff-Job Antimicrobial Foodservice Towels, Quarterfold, Sky Blue	12 x 21	150	1	150	192196
W511	Tuff-Job High Performance Wiper, S500, Multifold, Pop-Up, White	9.25 x 12.5	176	10	1760	530178
W410	Tuff-Job DRC Double Recrepe Wiper, Medium, Jumbo Roll, White	12 x 13	877	1	877	530104
W411	Tuff-Job DRC Double Recrepe Wiper, Medium, Centerpull, White	8 x 13	369	6	2214	192128
W412	Tuff-Job DRC Double Recrepe Wiper, Medium, Jumbo Roll, White	12 x 13	749	1	749	530104
W420	Tuff-Job DRC Double Recrepe Wiper, Medium, Quarterfold, White	12 x 13	60	18	1080	192136
W421	Tuff-Job DRC Double Recrepe Wiper, Heavy, Quarterfold, White	12 x 13	60	18	1080	192136
W600	Tuff-Job High Performance Wiper, S600, Jumbo Roll, Sky Blue	12 x 13	955	1	955	450304
W700	Tuff-Job High Performance Wiper, S700, Jumbo Roll, White	9.75 x 16.75	100	10	1000	510175A
W710	Tuff-Job High Performance Wiper, S700, Interfold, Pop-Up, White	12 x 13	870	1	870	530104
W120	Tuff-Job Windshield Paper Towel, Singlefold, Pop-Up, Sky Blue	10.25 x 9.25	168	12	2016	192122
W030	Tuff-Job Hand Cleaning Wet Towels, Canister, White	9.8 x 12.5	72	6	432	192592
W010	Tuff-Job Wiper & Refillable Bucket Cleaning System, White	12 x 12.5	110	5	550	192592
W011	Tuff-Job Wiper & Bucket Cleaning System, Refill Rolls, White	12 x 12.5	110	6	660	N/A
W810	Tuff-Job High Performance Wiper, S800, Interfold, Pop-Up, White	9.75 x 16.75	400	5	2000	520371
W800	Tuff-Job High Performance Wiper, S800, Jumbo Roll, White	12 x 13	475	1	475	570104
W811	Tuff-Job High Performance Wiper, S800, Interfold, Pop-Up, Sky Blue	9.75 x 16.75	400	5	2000	520371
W802	Tuff-Job High Performance Wiper, S800, Jumbo Roll, Sky Blue	12 x 13	475	1	475	570104
W940	Tuff-Job Quat Control Foodservice Towel, Quarterfold, Red	13 x 21	150	1	150	192193,192293

Wiper Products (cont.)

Cascades

W900	Tuff-Job Economy Foodservice Towels, Quarterfold, Soft Pink	12 x 24	200	1	200	192181A,192183
W902	Tuff-Job Economy Foodservice Towels, Quarterfold, Blue/White	12 x 24	200	1	200	192181A,192183
W501	Tuff-Job High Performance Wiper, S500, Jumbo Roll, White	10 x 13	1,100	1	1,100	570137
W631	Tuff-Job High Performance Wiper, S600, Crumple Pack, Sky Blue	14.4 x 14	250	1	250	N/A
W630	Tuff-Job High Performance Wiper, S600, Crumple Pack, White	14.4 x 14	250	1	250	N/A
W100	Tuff-Job All-Purpose Paper Wiper, Quarterfold, Brown	12 x 13	50	16	800	430150A
W300	Tuff-Job Airlaid Wiper, Medium Weight, Quarterfold, White	12 x 13	50	16	800	N/A
W310	Tuff-Job Airlaid Wiper, Medium Weight, Flat, White	12 x 13	900	1	900	192136
W302	Tuff-Job Airlaid Wiper, Medium Weight, Quarterfold, White	10 x 13	50	18	900	192136
W601	Tuff-Job High Performance Wiper, S600, Centerpull Roll, White	8 x 13	369	6	2214	510137
W202	Tuff-Job Scrim Reinforced Wiper, Interfold, Pop-Up, 4-Ply, White	9.75 x 16.75	150	6	900	440245A
W220	Tuff-Job Scrim Reinforced Wiper, Non-perforated Roll, 4-Ply, White	9.75 x 275'	275'	6	1650'	N/A
W221	Tuff-Job Scrim Reinforced Wiper, Non-perforated Roll, 4-ply, Sky Blue	9.75 x 275'	275'	6	1650'	N/A
W910	Tuff-Job Durable Foodservice Towel, Quarterfold, White	12.25 x 24	150	1	150	192195
W911	Tuff-Job Durable Foodservice Towel, Quarterfold, Salmon	12 x 24	150	1	150	192193,192293
W920	Tuff-Job Antimicrobial Foodservice Towels, Quarterfold, Sky Blue	12 x 24	150	1	150	192196
W110	Tuff-Job All-Purpose Paper Wiper, Singlefold, Pop-Up, White	10.25 x 8.1	125	18	2250	192125A
W301	Tuff-Job Airlaid Wiper, Heavy Weight, Quarterfold, White	12 x 13	50	18	900	N/A
W430	Tuff-Job DRC Double Recrepe Wiper, Medium, Interfold, Pop-Up, White	9.75 x 16.5	100	8	800	192127
W923	Tuff-Job Antimicrobial Foodservice Towels, Quarterfold, White	12 x 21	150	1	150	192191,192291
W610	Tuff-Job High Performance Wiper, S600, Interfold, Pop-Up, White	9.75 x 16.75	126	10	1260	510175A
W620	Tuff-Job High Performance Wiper, S600, Quarterfold, White	12 x 13	50	18	900	5301505
W711	Tuff-Job High Performance Wiper, S700, Interfold, Pop-Up, Turquoise	9.75 x 16.75	125	6	750	5301505
W930	Tuff-Job Premium Foodservice Towel, Quarterfold, White	13 x 24	72	1	72	192194
W021	Tuff-Job Disinfectant Wet Wipes, Bucket, White	6 x 8	800	1	800	N/A
W413	Tuff-Job Double Recrepe Wiper, Heavy, Centerpull Box, White	9 x 13	200	8	1600	450137
W022	Tuff-Job Disinfectant Wet Wipes, Bucket Refills, White	6 x 8	800	2	1600	N/A
W020	Tuff-Job Disinfectant Wet Wipes, Canister, White	8 x 7	75	6	450	N/A

ITEM NO.	DESCRIPTION	SHEET SIZE W X L (IN.)	WIPERS/ PKG.	PKGS./ CSE	WIPERS/ CASE	ESSITY CLOSEST EQUIVALENT
----------	-------------	---------------------------	-----------------	---------------	-----------------	------------------------------

S.U.D.S. Sanitizing Towel

Wiper Products (cont.)

Chicopee

0011	Dwell Light-Duty Healthcare Towel, White	12 x 13	25	12	300	N/A
0021	Dwell Med-Duty Healthcare Towel, White	12 x 13	25	12	300	N/A
0041	Chix SC Foodservice Towel, Light-Duty, White	13 x 21	150	1	150	192195
0051	Chix SC Foodservice Towel, Med-Duty, White	13 x 21	100	1	100	192195
0052	Chix SC Foodservice Towel, Med-Duty, Blue	13 x 21	100	1	100	192196
0053	Chix SC Foodservice Towel, Med-Duty, Red	13 x 21	100	1	100	192195
0054	Chix SC Foodservice Towel, Med-Duty, Yellow	13 x 21	100	1	100	N/A
0059	Chix SC Chicken Towel, Medium Duty, Yellow	13 x 21	150	1	150	N/A
0061	Chix Pro-Quat, Med-Duty, White/Red Stripe	13 x 21	150	1	150	192195
0065	Chix Pro-Quat, Med-Duty, Blue/Blue Stripe	13 x 21	150	1	150	192196
0067	Chix Pro-Quat, Med-Duty, Red/Red Stripe	13 x 21	150	1	150	192196
0071	Chix Pro-Quat, Med-Hvy Duty, White/Red Stripe	13 x 21	150	1	150	192195
0073	Chix Pro-Quat, Heavy-Duty, White/Red	13 x 21	72	1	72	192194
0075	Chix Pro-Quat, Med-Hvy Duty, Blue/Blue Stripe	13 x 21	150	1	150	192196
0077	Chix Pro-Quat, Med-Duty, Red/Red Stripe	13 x 21	150	1	150	192196
0078	Chix Pro-Quat, Fresh Guy, Heavy-Duty, Red w/Logo	12.5 x 17	150	1	150	192196
0079	Chix Pro-Quat, Heavy-Duty, Red/Red Stripe	12.5 x 21	100	1	100	192196
0081	Chix Pro-Chlor, Med-Hvy-Duty, White/Red	13 x 21	150	1	150	192193, 192191, 192291, 192293
0085	Chix Pro-Chlor, Med-Hvy-Duty, Blue/Blue Stripe	13 x 21	150	1	150	192192, 192292
0091	Chix Pro-Quat, Heavy-Duty, White/Red	13 x 21	100	1	100	192191, 192291
0312	Chix Tough Towel Med-Duty, Blue	13.25 x 21	150	1	150	192192, 192292
0721	S.U.D.S. Sanitizing Towel for Quat, White	12 x 10	110	6	660	N/A
0722	S.U.D.S. Cleaning Towel, White	12 x 10	110	6	660	N/A
0724	S.U.D.S. Sanitizing Towel for Chlorine, White	12 x 10	110	6	660	N/A
0733	S.U.D.S. Sanitizing Towel for Quat, White	12 x 10	110	2	220	N/A
0742	S.U.D.S. Sanitizing Towel for Quat light, White	12 x 10	220	6	1,320	N/A
0930	Shop Towel, Light Duty, 1/4 Fold, White	12 x 17	100	12	1,200	N/A

3000	Chix 3000 Compostable Foodservice Towel, Light-Duty, Green	12.75 x 21	50	10	500	N/A
6116	VERACLEAN Sealant Super Wipe, Almond	12 x 15	50	12	600	N/A
6270	Chix Economy Towel, Light-Duty, Green	11.5 x 24	150	1	150	192185,192184
6275	Chix Foodservice Towel Med-Duty Almond/Red Stripe	12 x 24	100	1	100	192191,192291
6278	Chix Foodservice Towel Med-Duty, Blue/Blue Stripe	12 x 21	150	1	150	192192,192292
6279	Chix Foodservice Towel Med-Duty, Blue/Blue Stripe	12 x 24	100	1	100	192192, 192292
6282	Chix Foodservice Towel Med-Duty, Blue/Blue Stripe	24 x 24	50	1	50	192192, 192292
8007	Chicopee Soft Cloth, White	13 x 15	40	30	1200	197478
8020	Chicopee Soft Cloth, White	11 x 13.5	40	10	400	430150A
8220	Chix All Day Economy Towel, Light Duty, White	12.25 x 24	200	1	200	N/A
8230	Chix All Day Towel, Light Duty, White/Red Stripe	12.25 x 21	200	1	200	192191,192291
8240	Chix Foodservice Towel, Medium Duty, White/Red Stripe	13 x 24	150	1	150	192191,192291
8241	Chix Foodservice Towel, Medium Duty, Blue/Blue Stripe	13 x 24	150	1	150	192192, 192292
8242	Chix Foodservice Towel, Medium Duty, White/Red Stripe	13 x 21	150	1	150	192191,192291
8243	Chix Foodservice Towel, Medium Duty, Blue/Blue Stripe	13 x 21	150	1	150	192192, 192292
8244	Chix Foodservice Towel, Med-Duty, Red/Red Stripe	13 x 24	100	1	100	192193, 192293
8245	Chix Pizza Towel, Medium Duty, Red/Red Stripe	13 x 21	100	1	100	192193, 192293
8249	Chix Plus Foodservice Kitchen Towel, Heavy Duty, White/Red Stripe	13 x 24	72	1	72	192194
8250	Chix Foodservice Towel, Medium Duty, White/Red Stripe	13 x 24	150	1	150	192191,192291
8251	Chix Foodservice Towel, Medium Duty, Blue/Blue Stripe	13 x 24	150	1	150	192192, 192292
8252	Chix Foodservice Towel, Medium Duty, White/Red Stripe	13 x 21	150	1	150	192191,192291
8253	Chix Foodservice Towel, Medium Duty, Blue/Blue Stripe	13 x 21	150	1	150	192192, 192292
8254	Chix Pizza Towel, Medium Duty, Red/Red Stripe	13 x 24	150	1	150	192191,192291
8255	Chix Fresh Guy Towel, Medium Duty, Yellow	12.5 x 21	150	1	150	192191,192291
8289	Chix Plus Foodservice Kitchen Towel, Heavy Duty, White/Red Stripe	13 x 21	50	1	50	192194
8290	Chix Plus Foodservice Kitchen Towel, Heavy Duty, White/Red Stripe	13 x 24	72	1	72	192194
8294	Quix Plus Sanitizing Towel, Medium Duty, Pink	13.5 x 20	72	1	72	N/A
8295	Quix Cleaning & Sanitizing Towel, Medium Duty, Green	13.5 x 20	144	1	144	N/A
8296	Quix Multipurpose Cleaning Towel, Medium Duty, Blue	13.5 x 20	144	1	144	N/A
8301	Chix Wet Wipe, Light Duty Green	14 x 21	200	1	200	192185,192184
8303	Chix Blue Diamond Wet Wipes, Light Duty, Blue	11.5 x 24	100	3	300	N/A
8310	Chix Wet Wipe, Light Duty, Pink	11.5 x 24	100	9	900	192181A ,192183
8311	Chix Wet Wipe, Light Duty, Pink	11.5 x 24	200	1	200	192181A,192183
8312	Chix Wet Wipe, Light Duty,Green	11.5 x 24	100	9	900	192185, 192184
8481	Durawipe Shop Towel, Heavy Duty, White	13 x 15	100	1	100	530178

ITEM NO.	DESCRIPTION	SHEET SIZE W X L (IN.)	WIPERS/ PKG.	PKGS./ CSE	WIPERS/ CASE	ESSITY CLOSEST EQUIVALENT
----------	-------------	---------------------------	-----------------	---------------	-----------------	------------------------------

Wiper Products (cont.)

8482	Durawipe Shop Towel, Heavy Duty, White	17 x 17	100	1	100	530178
8483	Durawipe Shop Towel, Heavy Duty, White	13 x 15	300	1	300	530178
8484	Chix Worxwell Towel, Heavy Duty, Blue	13 x 15	100	1	100	520678
8487	Durawipe Shop Towel, Heavy Duty, Blue	13 x 15	300	1	300	520678
8506	Chix Competitive Wet Wipe, Light Duty, Pink	13.5 x 24	100	9	900	192181A, 192183
8507	Chix Competitive Wet Wipe, Light Duty, Pink	13.5 x 24	200	1	200	192181A, 192183
8700	VERACLEAN Critical Cleaning Wipe, Medium Duty, Low Lint, Blue	12 x 13.5	400	1	400	192479
8701	VERACLEAN Critical Cleaning Wipe, Medium Duty, Low Lint, Blue	17.5 x 17	400	1	400	192479
8710	VERACLEAN Critical Cleaning Wipe, Medium Duty, Low Lint, Blue	12 x 13	400	1	400	192479
8711	VERACLEAN Critical Cleaning Wipe, Medium Duty, Low Lint, Blue	12 x 13	50	8	400	192479
8725	VERACLEAN Critical Cleaning Wipe Creped, Medium Duty, Blue	12 x 12	400	1	400	192475
8727	VERACLEAN Critical Cleaning Wipe Creped, Medium Duty, Blue	12 x 12	26	18	400	192475
8783	VERACLEAN Critical Cleaning Wipe, Medium Duty, Low Lint, Blue	9 x 17	150	4	600	192479
8784	VERACLEAN Critical Cleaning Wipe, Medium Duty, Low Lint, Blue	12 x 13.5	50	20	1000	192479
8785	VERACLEAN Critical Cleaning Wipe, Medium Duty, Low Lint, White	12 x 13.5	50	20	1000	192479
8789	DuraWipe Creped Rags, Medium Duty, Blue	14 x 14	250	1	250	192479
8938	VERACLEAN Multipurpose Plus, Low Lint Wipe, White	9 x 9	150	18	2,700	192482
9036	Chux Double Creped (DRC) Industrial Wipe, Heavy Duty, 1/4 Fold, White	11.9 x 13	56	18	1,008	N/A
9100	Chux Airlaid Medium Duty Wipe, 1/4 Fold, White	12 x 13	50	18	900	N/A
74733	Microfiber Light Cloths, White	11.8 x 15.7	40	8	320	N/A
7410108	VERACLEAN Polish Plus Wipe, White	12.5 x 13.5	100	8	800	N/A
7412104	VERACLEAN Multipurpose Plus SoftWipe, White	21 x 17	50	8	400	N/A
741302	VERACLEAN Sealant Plus Wipe, Blue	21 x 24	25	12	300	N/A
7421602	VERACLEAN Tack Light Wipe, Green	14.5 x 24	50	10	500	N/A
7421703	VERACLEAN Tack Plus Wipe, Green	14.5 x 24	50	12	600	N/A
7423001	VERACLEAN Sealant Super Wipe, Blue	12 x 13.5	700	1	700	N/A
7423504	VERACLEAN Tack Plus Wipe, Green	14.5 x 24	25	16	400	N/A
7427701	VERACLEAN Sealant Plus Wipe, Blue	21 x 24	440	1	440	N/A
7620305	VERACLEAN Cartex Solvent Plus Wipe, Beige	21 x 24	50	8	400	N/A
7620505	VERACLEAN Cartex Solvent Plus Wipe, Beige	21 x 24	40	6	240	N/A
8461600	S.U.D.S. Industrial Wipe, White	6 x 15	50	12	600	N/A

D511W	Durawipe Light Duty Industrial Wipe, Pop-Up Box, White	8.8 x 12.8	152	12	1,824	450175
D522W	Durawipe Light Duty Industrial Wipe, 1/4 Fold, White	9.5 x 12	25	32	800	192136
D550205	VERACLEAN Solvent Light Wet Wipe, White (1100 ml) 85% IPA / 15% H2O	14.5 x 17	50	12	600	N/A
D550347	VERACLEAN Solvent Light Wet Wipe, White (750 ml) 85% IPA / 15% H2O	11 x 17	50	12	600	N/A
D550370	VERACLEAN Solvent Light Wet Wipe, White (1100 ml) 70% IPA / 30% H2O	14.5 x 17	50	12	600	N/A
D550390	VERACLEAN Solvent Light Wet Wipe, White (525 ml) 70% IPA / 30% H2O	11 x 17	50	12	600	N/A
D550399	VERACLEAN Solvent Light Wet Wipe, White (1000 ml) 100% Acetone	11 x 17	50	12	600	N/A
D611W	Durawipe Medium Duty Industrial Wiper, Pop-Up Box, White	8.8 x 17	110	12	1,320	510175A
D622W	Durawipe Medium Duty Industrial Wiper, 1/4 Fold, White	11.6 x 13	60	16	960	5301505
D633B	Durawipe Medium Duty Industrial Wiper, Jumbo Roll, Blue	13.1 x 12.6	910	1	910	450304
D633W	Durawipe Medium Duty Industrial Wiper, Jumbo Roll, White	13.1 x 12.6	910	1	910	430304
D641W	Durawipe Medium Duty Industrial Wiper, Dual Pop-Up Box, White	11.6 x 17	188	1	188	N/A
D711W	Durawipe Medium Duty Industrial Wiper, Pop-Up Box, White	8.8 x 17	86	12	1,032	5301755
D722W	Durawipe Medium Duty Industrial Wiper, 1/4 Fold, White	11.6 x 13	40	24	960	5301505
D733W	Durawipe Medium Duty Industrial Wiper, Jumbo Roll, White	13.1 x 12.6	650	1	650	520304
D811R	Durawipe Heavy Duty Industrial Wiper, Pop-Up Box, Red	8.8 x 17	70	6	420	N/A
D811W	Durawipe Heavy Duty Industrial Wiper, Pop-Up Box, White	8.8 x 17	70	6	420	5301755
D822B	Durawipe Heavy Duty Industrial Wiper, 1/4 Fold, Blue	11.6 x 13	40	5	200	N/A
D822R	Durawipe Heavy Duty Industrial Wiper, 1/4 Fold, Red	11.6 x 13	40	5	200	N/A
D822W	Durawipe Heavy Duty Industrial Wiper, 1/4 Fold, White	11.6 x 13	40	5	200	192136
D823R	Durawipe Heavy Duty Industrial Wiper, 1/4 Fold, Red	11.6 x 13	20	10	200	N/A
D833B	Durawipe Heavy Duty Industrial Wiper, Jumbo Roll, Blue	13.1 x 12.6	500	1	500	450304
D833R	Durawipe Heavy Duty Industrial Wiper, Jumbo Roll, Red	13.1 x 12.6	500	1	500	N/A
D841B	Durawipe Heavy Duty Industrial Wiper, Dual Pop-Up Box, Blue	11.6 x 17	168	1	168	N/A

Georgia Pacific

00350	Interstate Windshield Towel, Blue, 2-ply	9.5 x 10.25	250	9	2250	192122
02350	Interstate, Windshield Towel, Blue, 1-ply	9.5 x 10.25	250	9	2250	192121
20000	Brawny Industrial Med Wt, 1/4 Fold, DRC Wiper, Oatmeal	13 x 12.5	65	18	1170	430150A
20023	Brawny Industrial MD, 1/4 Fold, All Purpose, DRC Wiper, White	13 x 12.5	65	18	1170	192136
20035	Brawny Industrial, goRag, Light Wt All Purpose, DRC Wiper, White	10 x 12	330	6	1980	192128
20040	Brawny Industrial Premium All Purpose, Bucket, DRC Wiper, Orange	9.9 x 13	200	2	400	450340
20041	Brawny Industrial Premium All Purpose, Refill, DRC Wiper, Orange	9.9 x 13	200	2	400	450338
20042	Brawny Industrial HD, Premium All Purpose, Bucket, DRC Wiper, Grey	9.9 x 13	140	2	280	450340
20043	Brawny Industrial HD, Premium All Purpose, Refill, DRC Wiper, Grey	9.9 x 13	140	2	280	450338
20045	Brawny Industrial Light Duty All Purpose Bucket Refill, White	9.9 x 13	300	2 Rolls	600	450138
20050	Brawny Industrial Med Wt, DRC Centerpull Wiper, White	7.8 x 13.25	260	4	1040	450137
20060	Brawny Industrial Med Wt, All Purpose, DRC Long Roll Wiper, White	9.8 x 13.25	800	1	800	450304

ITEM NO.	DESCRIPTION	SHEET SIZE W X L (IN.)	WIPERS/ PKG.	PKGS./ CSE	WIPERS/ CASE	ESSITY CLOSEST EQUIVALENT
----------	-------------	---------------------------	-----------------	---------------	-----------------	------------------------------

Wiper Products (cont.)

Georgia Pacific

20065	Brawny Industrial, goRag, Med Wt All Purpose, DRC Wiper, White	10 x 12	250	6	1500	192128, 450137, 440278
20067	Brawny Industrial, goRag, Wed Wt All Purpose, DRC Wiper, Orange	10 x 12	250	6	1500	450337, 450338, 440278
20068	goRag Heavy Duty Premium All Purpose DRC Touchless Roll Wiper, Gray	10 x 12	185	3	555	440278, 530278
20070/03	Brawny Industrial Med Wt, All Purpose, DRC Wiper, White	9.25 x 16.3	90	10	900	450175
20072	Brawny Industrial Med Wt, All Purpose, DRC Wiper, Orange	9.25 x 16	90	10	900	450175
20075	Brawny Industrial Light Wt, All Purpose, DRC Wiper, White	9.25 x 16	110	10	1100	192127
20077	Brawny Industrial Med Wt All Purpose, DRC Wiper, White	9.25 x 12.2	120	10	1200	450175
20080/03	Brawny Industrial Med Wt, All Purpose, DRC Wiper, White	12.5 x 16.3	152	1	152	450138
20085	Brawny Industrial Light Wt, All Purpose, Perf Roll, DRC Wiper, White	11 x 9.3	84	20	1680	450160
21501	Brawny Industrial Wet Hand Towels, Blue	8.6 x 12.2	84	6	504	192592
25023	Brawny Industrial Med Wt, Shop Towel, HEF, Flat Pack, White	15 x 10	300	1	300	530178
25024	Brawny Industrial Med Wt, Shop Towel, HEF, White	13 x 13	70	12	840	5301505
25060	Brawny Industrial, Med Wt, Shop Towels, HEF, White	9.8 x 13.25	800	1	800	530104, 520304
25065	Brawny Industrial, goRag, Hvy Wt Shop Towels, HEF, White	10 x 12	250	3	750	530137
25070	Brawny Industrial, Med Wt, Shop Towels, HEF, Pop-up, White	9.1 x 16.5	100	5	500	5301755
28611	Brawny Industrial, Light Wt, All Purpose Airlaid, Light, 1/4 Fold, White, Poly Pk	12.5 x 13	50	18	900	192136
29000	Brawny Industrial, 4-Ply, 1/4 Fold Scrim, Reinforced Paper Wipers, White	13 x 13	80	12	960	440245A
29050/03	Brawny Industrial, Scrim Reinforced Paper Wiper, White	9.25 x 16.7	166	5	830	440245A
29215	Brawny Industrial, Medium Wt, General Purpose, Airlaid, White	13 x 13	50	16	800	192136, 430150A
29222	Brawny Industrial, Light Duty Paper Wiper, Brown	13 x 13	50	12	600	440245A
29221	Brawny Industrial, Light Duty, 2-Ply, Paper Wipers	8 x 12.5	148	20	2960	192125A
29223	Brawny Industrial, Medium Wt, General Purpose, Airlaid, Blue	13 x 13	50	8	400	192136
29227	Brawny goRag Roll Paper Wiper, Brown	10 x 500	500'	6	3000'	130251A
29290/03	Brawny Industrial, Medium Wt, General Purpose, Airlaid, Pop-up, White	9.25 x 16.5	66	10	660	192127
29302	Brawny Industrial, H800 HEF Long Distance Roll Shop Towel, White	10.2 x 6.25	1050	2	2200	570137
29303	Brawny Industrial, H800 HEF Long Distance Roll Shop Towel, Blue	10.2 x 6.25	1050	2	2200	520337
29311	Brawny Industrial Heavy Duty Shop Towels, 1/4 Fold, White	9 x 16.8	176	1	176	570478
29316	Brawny Industrial, Light Wt, HEF Shop Towel, White	9.1 x 12.5	200	10	2000	450175
29317	Brawny Industrial Pick-a-Size Light Wt, HEF Long Roll, White	--	1776	1	1776	510104
29318	Brawny Industrial, Light Wt, HEF Shop Towel, White	9.1 x 16.7	148	10	1480	450175
29321	Brawny Industrial, H800 HEF Disposable Shop Towel, Blue	9 x 16.8	100	10	1000	520371
29322	Brawny Industrial, Hvy Wt, HEF Shop Towel, White	9.1 x 12.5	176	10	1760	450175

29325	Brawny Industrial, H800 HEF Disposable Shop Towel, White	9 x 16.8	100	10	1000	520371
29408	Brawny Dine-A-Wipe, Foodservice 1/4 Fold Busing Towel (HEF)	14 x 21	55	6	330	192181A,192183
29414	Brawny Dine-A-Wipe, Foodservice Busing Towel, White/Red	14 x 21.5	160	1	160	192181A,192183
29416	Brawny Dine-A-Max All Purpose, Food Prep/Bar Towel, White/Green Stripe	13 x 24	150	1	150	192185,192184
29418	Brawny Dine-A-Wipe Foodservice Busing Towel, Blue	13 x 17	40	6	240	192181A,192183
29421	Brawny Dine-A-Cloth Heavy Duty, Foodservice Towel, White/Blue	13 x 24	72	1	72	192194
29422	Brawny Dine-A-Max Food Prep/Bar Towel, Yellow	13 x 21	150	1	150	192191,192291
29423	Brawny Dine-A-Max Food Prep/Bar Towel, White/Red Stripe	13 x 24	150	1	150	192191,192291
29424	Brawny Dine-A-Max Food Prep/Bar Towel, Blue/Blue Stripe	13 x 24	150	1	150	192192,192292
29425	Brawny Dine-A-Max Pizza Food Prep/Bar Towel Red/Red Stripe	13 x 24	150	1	150	192193,192293
29426	Brawny Dine-A-Wipe Foodservice Busing Towel, White	12 x 24	150	1	150	192191,192291
29427	Brawny Dine-A-Wipe Foodservice Busing Towel Carded Rayon, Pink/White	13 x 17	60	4	240	192181A,192183
29429	Brawny Dine-A-Max, Food Prep/Bar Towel, White/Green Stripe	13 x 21	150	1	150	192191,192291
29430	Brawny Dine-A-Max All Purpose Food Prep and Bar Towel, White/Red Stripe	13 x 21	150	1	150	192191,192291
29434	Brawny Dine-A-Wipe Foodservice Busing Towel, White	12.5 x 21	200	1	200	192195
29505	Soft-N-Fresh, Airlaid Medium Wipe, White	12.5 x 13	55	18	990	430150A
29508	Soft-n-Fresh Airlaid Light Wiper, White	12.5 x 13	110	18	1980	N/A
29516	Brawny goRag Light Wt, Airlaid Roll Wiper, White	10 x 220'	220'	6	1320'	N/A
29518	Brawny Industrial Medium Wt General Purpose Airlaid Wiper, White	9.2 x 12.4	128	10	1,280	520371
29601	Brawny Industrial FLAX Cloth Roll Wiper, Perf, White	10.8 x 6.7	730	1	730	N/A
29602	Brawny Industrial FLAX 900 Heavy Duty Cloth Roll Wiper, Perf, White	10.6 x 6.7	690	2	1380	N/A
29603	Brawny Industrial FLAX 700 Medium Duty Cloth Roll Wiper, Perf, White	10.4 x 6.7	825	2	1650	N/A
29604	Brawny Industrial FLAX 500 Light Duty Cloth Roll Wiper, Perf, White	10.5 x 6.7	1130	2	2260	N/A
29607	Brawny Industrial FLAX 800 Heavy Duty Cloths, White	9 x 16.8	80	5	400	N/A
29608	Brawny Industrial FLAX 900 Heavy Duty Cloths, White	9 x 16.5	72	10	720	N/A
29609	Brawny Industrial FLAX 700 Medium Duty Cloth, White	9 x 16.5	94	10	940	N/A
29610	Brawny Industrial FLAX 500 Light Duty Cloth, White	9 x 16.5	132	10	1320	N/A
29616	Brawny Speciality Dusting Cloth, Yellow	17 x 24	50	4	200	N/A
29624	Brawny Speciality Dusting Cloth, Yellow	24 X 24	50	4	200	N/A
29651	Brawny Dine-A-Cloth FLAX 700 MD Fdsrv Wiper, 1/4 Fold, White/Green Stripe	12.75 x 21	150	1	150	N/A
29656	Brawny Dine-A-Cloth FLAX 500 LD Fdsrv Wiper, 1/4 Fold, White/Blue Stripe	12.37 x 21	200	1	200	N/A
29662	Brawny Dine-A-Cloth FLAX 900 HD, Fdsrv Wiper, 1/4 Fold, White	12.75 x 21	144	1	144	N/A
29700	Brawny Industrial Surface System Wiper, Centerpull, White	12 x 12	90	6	540	450138
29712	AccuWipe, 1-ply Delicate Task Wiper, White	4.5 x 8.25	60	280	16800	N/A
29756/03	AccuWipe, 1-ply Delicate Task Wiper, White	15 x 16.5	20	140	2800	N/A
29778/03	AccuWipe, 3-ply Delicate Task Wiper, White	15 x 16.7	20	70	1400	N/A

ITEM NO.	DESCRIPTION	SHEET SIZE W X L (IN.)	WIPERS/ PKG.	PKGS./ CSE	WIPERS/ CASE	ESSITY CLOSEST EQUIVALENT
29812	Accuwipe 1-Ply Premium Delicate Task Wipers	4.5 x 8.25	280	60	16800	N/A
29834	Accuwipe 1-Ply Premium Delicate Task Wipers	11.25 x 8.4	290	15	4350	N/
29856	Accuwipe 1-Ply Premium Technical Cleaning Wipers	15 x 16.70	140	15	2100	N/A
29880	Accuwipe 2-Ply Premium Delicate Task Wipers	15 x 16.7	90	15	1350	N/A
29890	Accuwipe 3-Ply Premium Delicate Task Wipers	15 x 16.7	70	15	1050	N/A
29922	Brawny Industrial, Light Duty, Natural	13 x 13	50	12	800	13247501
29934	Accuwipe MicroPremium, 1-Ply, Light Duty Technical Cleaning Wipers	8.4 x 11.25	290	12	3480	N/A
29971	Brawny Industrial, Light Duty, 3-ply Paper Wiper, Pop-up, Natural	9.25 x 16.75	80	10	800	440245A
33050-01	Brawny Industrial Giant Durable Wipes, Blue	8 x 7	30	10	300	N/A
33071-01	Brawny Giant Durable Wipes, Blue	8 x 7	60	4	240	N/A
44500	Brawny Industrial, Light Wt, Airlaid, Center Pull, White	9 x 13.25	200	6	1200	192128
80534	Soft-N-Fresh, Airlaid Premium Medium Wper, White	13 x 13	50	20	1000	192136
80538	Soft-N-Fresh, Patient Care Hand Towel, White	14 x 21.5	20	16	320	N/A
80540	Soft-N-Fresh, Patient Care Bath Towel, White	19.5 x 39	200	1	200	N/A

Kimberly-Clark

01770	Wypall, L10, Singlefold, Paper, White	9.3 x 10.5	200	12	2400	192125A
01772	Wypall, L10, Pop-up, Paper, White	9 x 10.5	110	18	1980	192125A
03046	Wypall, L40 All Purpose, Pop-up, DRC, White	10.8 x 10	90	9	810	450175
03086	Wypall, L30, Pop-up, DRC Lt, White	10.8 x 10	120	10	1200	192127
05007	Wypall, L40 All Purpose, Jumbo Roll, DRC, White	12.5 x 13.4	750	1	750	450304
05027	Wypall, L40 All Purpose, Wipers on a Roll, Small Roll, DRC, White	11 x 10.4	70	24	1680	450160
05120	WypAll L10 Windshield Towel, Singlefold, Paper, Blue	9.3 x 10.5	140	16	2240	192122
05123	WypAll L10 Windshield Towel, Blue	9.1 x 10.25	224	10	2240	192121
05320	WypAll L10, Pop-up, Paper, White	9 x 10.5	125	18	2250	192125A
05322	WypAll L10, Pop-up, Paper, White	12 x 10.5	125	18	2,250	192125A
05511	KimTech Science Precision Wipes Tissue Wipers, Pop-up, White	4.4 x 8.4	280	60	16800	N/A
05517	KimTech Science Precision Wipes Tissue Wipers, Pop-up, White	14.7 x 16.6	90	15	1350	N/A
05600	WypAll L40 All Purpose, Q-Fold, DRC, White	12.5 x 14.4	56	12	672	192136
05701	WypAll L40 All Purpose, Q-Fold, DRC, White	12.5 x 14.4	56	18	1,008	192136
05740	WypAll L40 All Purpose, Pop-up, DRC, Blue	16.4 x 9.8	100	9	900	450175
05770	WypAll Professional Towels, DRC, White	12 x 23	12	12	540	N/A
05776	Wypall, L40 All Purpose, Q-Fold, DRC, Blue	12.5 x 14.4	56	12	672	192136

Wiper Products (cont.)

Kimberly-Clark

05790	WypAll L40 All Purpose, Pop-up, DRC, White	16.4 x 9.8	100	9	900	450175
05796	WypAll Plus, L40 All Purpose, Center Pull, DRC, White	10 x 13.2	200	2	400	450137
05800	WypAll Economizer L30, Pop-up, DRC-Lt, White	16.4 x 9.8	100	8	800	192127
05810	WypAll Economizer L30, Pop-up, DRC-Lt, Blue	16.4 x 9.8	100	8	800	192127
05812	WypAll Economizer L30, 1/4 Fold, DRC-Lt, White	12.5 x 14.4	90	12	1,080	430150A
05820	WypAll Economizer L30, Center Pull, DRC-Lt, White	9.8 x 15.2	300	2	600	192128
05830	Wypall, L30, Center Pull, DRC-Lt, White	8 x 15	150	6	900	192128
05841	WypAll L30, Jumbo Roll, DRC-Lt, White	12.4 x 13.3	950	1	950	450304
05843	Wypall L30 Wipers, White	11 x 10.4	70	24	1,680	450160
05860	WypAll Professional Towels, DRC, White	19.5 x 42	200	1	200	N/A
05925	WypAll X80 Foodservice Wipers, White/Blue Stripe	12.5 x 23.5	150	2	300	192195
05927	WypAll X70 Foodservice Wiper, 1/4 Fold, Blue	12.5 x 23.5	300	1	300	192196
05930	WypAll X80 Shop Towel, Pop-up, Hydroknit, Red	9.75 x 16.75	80	5	400	530178, 5301755
06006	KimTech Prep WetTask Wipers for Solvents	9 x 15	275	2	550	N/A
06053	WypAll X50 Foodservice Wipers, White	12.5 x 23.5	200	1	200	192191, 192291
06121	KimTech Prep ScottPure Critical Task Wipers, Spunlace	12 x 15	100	4	400	N/A
06151	KimTech Prep ScottPure Critical Task Wipers, Spunlace	12 x 23	50	8	400	N/A
06179	KimTech Pure W5 Dry Wipers, White	9 x 9	100	5	500	N/A
06193	KimTech Prep ScottPure Critical Task Wipers, White	7 x 7	225	6	1350	130251A
06211	KimTech Prep Wipers for Disinfectants and Sanitizers	12 x 12.5	90	6	540	N/A
06411	KimTech Prep WetTask Wipers for Bleach Disinfectants and Sanitizers, White	12 x 12.5	90	6	540	N/A
06280	WypAll X80 Foodservice Wipers, White/Blue Stripe	12.5 x 23.5	150	1	150	192195
06350	WypAll X80 Foodservice Wipers, White/Blue	13.5 x 24	150	1	150	192195
06351	WypAll X80 Foodservice Wipers, Blue	13.5 x 24	150	1	150	192192, 192292
06354	WypAll X80 Foodservice Wipers, Red	13.5 x 24	150	1	150	192193, 192293
12889	WypAll X90 Cloths, Jumbo Roll, Hydroknit, Blue	11.1 x 13.4	450	1	450	570104
12890	WypAll X90 Cloths, Pop-Up Box, Hydroknit, White	8.3 x 16.8	68	5	340	570478
12891	WypAll X90 Cloths, Brag Box, Hydroknit, White	11.1 x 16.8	136	1	136	570478
33241	Kimtix Prep Kimtix Wipers, Jumbo Roll, Meltdown, Blue	9.8 x 13.4	717	1	717	192578
33330	KimTech Pure W4 Dry Wipers 10-100	11.5 x 12	50	10	500	N/A
33352	KimTech Prep Kimtix Wipers, Brag Box, Meltdown, Blue	12.1 x 16.8	180	1	180	192578
33390	KimTech Pure W4 Dry Wipers, White	9 x 9	100	5	500	N/A

ITEM NO.	DESCRIPTION	SHEET SIZE W X L (IN.)	WIPERS/ PKG.	PKGS./ CSE	WIPERS/ CASE	ESSITY CLOSEST EQUIVALENT
33560	Kimtex Surf Prep Towels, Blue	12 x 14.4	66	8	528	192578
33570	Kimtex Surf Prep Towels, Blue	8.8 x 16.8	100	5	500	192578
34015	WypAll X60, White	12.5 x 16.8	180	1	180	510175A, 520371
34120	KimTech Science Kimwipes Delicate Task Wiper, White	4.4 x 8.4	280	30	8400	N/A
34133	KimTech Science Kimwipes Delicate Task Wiper, White	11.8 x 11.8	196	15	2940	N/A
34155	KimTech Science Kimwipes Delicate Task Wiper, White	4.4 x 8.4	280	60	16800	N/A
34256	KimTech Science Kimwipes Delicate Task Wiper, White	15 x 16.8	140	15	2100	N/A
34623	KimTech Science Lens Cleaning Station, White	--	2	4	8	N/A
34644	KimTech Science KimWipes Lens Cleaning Station, White	4.5 x 8.5	4	4	16	N/A
34705	KimTech Science Kimwipes Delicate Task Wiper	11.8 x 11.8	119	15	1785	N/A
34721	KimTech Science Kimwipes Delicate Task Wiper	15 x 16.8	90	15	1350	N/A
34743	KimTech Science Kimwipes Delicate Task Wiper	11.8 x 11.8	119	15	1785	N/A
34607	WypAll L20 Wipers, Brag Box, 4-Ply, Paper, White	12.5 x 16.8	176	1	176	13247501
34770	WypAll X60, Q-Fold,, Hydroknit, White	11 x 23	100	9	900	5301505
34790	WypAll X60, Pop-up, Hydroknit, White	9.1 x 16.8	126	10	1,260	510175A
34865	WypAll X60, Q-Fold, Hydroknit, White	12.5 x 14.4	76	12	912	5301505
34900	WypAll X60, Flat Sheet, Hydroknit, White	12.5 x 16.8	150	6	900	510178
34955	WypAll X60, Jumbo Roll, Hydroknit, White	12.5 x 13.4	1100	1	1100	510104
34965	WypAll X60, Jumbo Roll, Hydroknit, Blue	12.5 x 13.4	1100	1	1100	510104
35010	WypAll Teri Professional Shower Towels, Hydroknit, White	22.5 x 43.75	100	3	300	N/A
35015	WypAll X50, Jumbo Roll, Hydroknit, White	9.8 x 13.4	1100	1	1,100	510104
35025	WypAll X50 Wipers, Hydroknit, White	10 x 12.5	26	32	832	5301505
35401	WypAll X60, Small Roll, Hydroknit, White	9.8 x 13.4	130	12	1,560	510137
35411	WypAll X60, Small Roll, Hydroknit, Blue	9.8 x 13.4	130	12	1,560	510137
35421	WypAll X60, Small Roll, Hydroknit, White	19.6 x 13.4	130	6	780	510137
35431	WypAll X60, Small Roll, Hydroknit, Blue	19.6 x 13.4	130	6	780	510137
40587	WypAll X70 Foodservice Wiper, Pop-Up, White	9.1 x 12.5	10	120	1,200	192191,192291
41025	WypAll X80, Jumbo Roll, Hydroknit, White	12.5 x 13.4	475	1	475	570104
41026	WypAll X80, 1/4 Fold, Hydroknit, White	12.5 x 14.4	50	4	200	5301505
41029	WypAll X80, 1/4 Fold, Hydroknit, Red	12.5 x 14.4	50	4	200	5301505
41041	WypAll X80, Brag Box, Hydroknit, Blue	12.5 x 16.8	160	1	160	530178, 5301755
41043	WypAll X80, Jumbo Roll, Hydroknit, Blue	12.5 x 13.4	475	1	475	530104
41044	WypAll X80, Brag Box, Hydroknit, White	12.5 x 16.8	160	1	160	530178, 5301755
41048	WypAll X80, Pop-up, Hydroknit, White	9.1 x 16.8	5	80	400	530178, 5301755

Wiper Products (cont.)

Kimberly-Clark

41055	WypAll X80, Jumbo Roll, Hydroknit, Red	12.5 x 13.4	475	1	475	530104
41061	WypAll X70 Manufactured Rags, Flat Sheet, Hydroknit, White	29.8 x 16	300	1	300	530178
41083	WypAll X60 Teri, Hygienic Washcloth, White	12.5 x 10	70	8	560	5301505
41100	WypAll X70, Flat Sheet, Hydroknit, White	14.9 x 16.6	300	1	300	530178
41200	WypAll X70, 1/4 Fold, Hydroknit, White	12.5 x 13	76	12	912	5301505
41300	WypAll X70, Brag Box, Hydroknit, White	12.5 x 16.8	152	1	152	530178
41412	WypAll X70, Pop-up, Hydroknit, Blue	9.1 x 16.8	100	10	1,000	5301755
41455	WypAll X70, Pop-up, Hydroknit, White	9.1 x 16.8	100	10	1,000	5301755
41600	WypAll X70, Jumbo Roll, Hydroknit, White	12.5 x 13.4	870	1	870	530104
41611	WypAll X70, Jumbo Roll, Hydroknit, Blue	12.5 x 13.4	870	1	870	530104
41702	WYPALL X70 Manufactured Rags, Center Pull, Hydroknit, White	9.8 x 13.4	275	3	825	530137
42346	WypAll L10 Lightweight Utility Wiper, White	9 x 10.25	250	24	6,000	192125A
47000	WypAll L20, 1/4 Fold, Multiply Paper, Tan	12.5 x 14.4	68	12	816	192125A
47011	WypAll L20, 1/4 Fold, Multiply Paper, Tan	12.5 x 14.4	68	12	816	13247501
47022	WypAll L20, 1/4 Fold, 4-Ply Paper, White	12.5 x 14.4	68	12	816	440245A
47033	WypAll L20, Pop-up, Multiply Paper, Tan	9.1 x 16.8	88	10	888	13247501
47044	WypAll L20, Pop-up, 4-Ply Paper, White	9.1 x 16.8	88	10	888	440245A
47758	WypAll L20, Center Pull, 2-Ply Paper, White	9.8 x 13.4	550	3	1,650	132451A
49812	WypAll X80 Application Wipes, White	--	158	1	158	450137
58310	Heavy Duty Hand Cleaning Wipes	--	50	8	--	N/A
58040	KimTech Prep Surface Sanitizer Wipes Bucket	12 x 12	30	8	240	192594
58399	WypAll L20, Brag Box, Multiply Paper, Tan	12.5 x 16.8	160	1	160	13247501
75130	Scott Shop Towels On-A-Roll	11 x 10.4	55	30	1650	450360
75147	Scott Shop Towels On-A-Roll, BLue	--	55	12	660	450360
75190	Scott Shop Towels In-A-Box	10 x 13	200	8	1600	450337
75260	Scott Rags In-A-Box	10 x 13	200	8	1600	450137
75512	KimTech Science Precision Tissue Wipers, White	11.8 x 11.8	196	15	2940	N/A
77320	KimTech Prep WetTask Wipers, White	--	35	12	420	N/A
83550	WypAll X50 Wipers, Hydroknit, White	9.1 x 12.5	176	10	1,760	510175A
83561	WypAll Wipers in a Bucket	10 x 13	220	2	440	450340

83571	WypAll Wipers in a Bucket Refill	10 x 13	220	3	660	450138
83610	WypAll Microfiber Cloths with Mircoban, Yellow	15.75 x 15.75	6	4	24	N/A
83620	WypAll Microfiber Cloths with Mircoban, Blue	15.75 x 15.75	6	4	24	N/A
83630	WypAll Microfiber Cloths with Mircoban, Green	15.75 x 15.75	6	4	24	N/A
83680	WypAll Microfiber Cloths with Mircoban, Red	15.75 x 15.75	6	4	24	N/A
91367	WypAll Waterless Cleaning Wipes Refill, Green	10.5 12	75	6	450	N/A
91371	WypAll Waterless Hand Towels, Bucket, Green	10.5 x 12	75	6	450	192592

Kruger Products

02130	Scrim Works Roll Wiper, White	9.75 x 175'	--	6	--	510137
02150	Scrim Works Roll Wiper, White	19.75 x 175'	--	4	--	510137
02180	Scrim Works 1/4 Fold, Wiper, White	13 x 15	50	12	600	440245A
02361	Food Works Antimicrobial, Wiper, Blue/Blue Stripe	13.5 x 21	150	1	150	192192,192292
02363	Food Works, Wiper, White/Blue Stripe	13.5 x 21	150	1	150	192191,192291
02510	General-Works, 1/4 Fold, Wiper, Beige	13 x 15	30	20	600	13247501, 192125A
02660	Econo-Works, Center Pull, Roll, Wiper, White	8.9 x 13.1	375	2	750	192128
02670	Econo-Works, Center Pull, Jr. Roll, Wiper, White	8 x 13.1	175	6	1050	192128
02710	All-Works, 1/4 fold Wiper, White	12.5 x 13	56	18	1008	192136
02720	All-Works, Tote-Pack, Wiper, White	9.5 x 16.5	100	8	800	5301755
02750	All-Works, 11" Roll, Wiper, White	9.4 x 11	74	12	888	450160
02770	General-Works, 1/4 fold, Wiper, White	13 x 15	50	24	1200	192136
02821	All-Works, Easy-Up, Wiper, White	9.5 x 16.5	180	4	720	5301755
02941	Sontara Multipurpose Shop Towel, Easy-Up, Wiper	12 x 16.5	250	1	250	520678, 192479
02942	Sontara Multipurpose Towel, Easy-Up, Wiper, Blue/Green	12 x 16.5	250	1	250	530178, 192479

ITEM NO.	DESCRIPTION	UNIT SIZE	COLOR	FRAGRANCE	UNITS/ CASE	CASE WT. (LB.)	ESSITY CLOSEST EQUIVALENT
----------	-------------	-----------	-------	-----------	----------------	-------------------	------------------------------

Skincare Essity

400011	  Tork Premium Extra Mild Non-Perfumed Soap	1000ml	White	None	6	14.93	N/A
400012	Tork Premium Luxury Soft Liquid Soap	1000ml	Violet	Soft Rose	6	14.93	N/A
400013	Tork Premium Hair and Body Liquid Soap	1000ml	Light Blue	Apricot	6	14.93	N/A
400014	Tork Premium Antibacterial Liquid Soap	1000ml	Clear	None	6	14.93	N/A
400016	Tork Premium Alcohol Gel Hand Sanitizer	1000ml	Colorless	Light	6	14.93	N/A
401211	 Tork Premium Extra Mild Foam Soap	1000ml	Colorless	None	6	15.15	N/A
401212	Tork Premium Antibacterial Foam Soap	1000ml	Colorless	None	6	15.5	N/A
401213	Tork Premium Foam Alcohol-Free Hand Sanitizer	1000ml	Colorless	None	6	15.27	N/A
400216	 Tork Premium Foam Alcohol Hand Sanitizer	950ml	Colorless	Fresh Light	6	13.65	N/A
12503	OptiSource Foam Lotion Soap	1250ml	White	Light Fragrance	4	13	N/A
12504	OptiSource Antibacterial Foam Lotion Soap	1250ml	White	Amine	4	13	N/A
95100	Silhouette Lotion Soap	500ml	White	Light Fragrance	12	15.7	N/A

DEB Stoko

807	Microsan Encore Foaming Alcohol Handrub	1 Liter	--	--	3	--	401213
1801	InstantFoam Alcohol-based Hand Sanitizer	47ml	Clear	None	12	2.2	400216
1815	Instant Foam Alcohol Pump Bottle	400ml	Clear	None	12	14	400216
1827	Proline 1L Cartridge Instant Alcohol Foam Soap	1 liter	Clear	None	6	14	400216
29885	Refresh Lotion Foam Soap	400ml	--	Lt Fresh Fragrance	12	--	401211
29932	Refresh Moisturing Foam Soap	800ml	--	Lt Fresh Fragrance	6	--	401211

< - Not Available in Canada

> - Canada Only

ITEM NO.	DESCRIPTION	UNIT SIZE	COLOR	FRAGRANCE	UNITS/ CASE	CASE WT. (LB.)	ESSITY CLOSEST EQUIVALENT
----------	-------------	-----------	-------	-----------	----------------	-------------------	------------------------------

Skincare (cont.)

Deb Stoko

32068<	Refresh Food Handler's Wash	800ml	--	--	6	--	400212
32084	Refresh Dye & Fragrance Free Foam	800ml	--	Fragrance Free	6	--	401211
32085	Refresh Hair & Body Wash	800ml	--	--	6	--	400013
33200	Refresh Moisturing Foam Soap	1100ml	--	Lt Fresh Fragrance	6	--	401211
33247	Antibacterial Foam Soap	1100ml	--	--	6	--	401212
34295	Antibacterial Foam Soap	800ml	--	--	6	--	401212
55815	Instant Foam Non-Alcohol PURE Hand Sanitizer	400ml	Clear	None	12	--	401213
55851	Instant Foam Non-Alcohol PURE Hand Sanitizer	47ml	Clear	None	12	--	401213
55857	Instant Foam Non-Alcohol PURE	1 Liter	Clear	None	6	--	400213
56827	Instant Foam Soap Non-Alcohol	1 Liter	-	--	6	14	400213
56801	InstantFoam Non-Alcohol Hand Sanitizer	47ml	Blue	Light	12	--	401213
56815	InstantFoam Non-Alcohol Hand Sanitizer	400ml	Blue	Light	12	--	401213
56827	Instant Foam Soap Non-Alcohol	1 Liter	Blue	Light	6	14	401213
59220	Refresh Azure Foam Wash	1 Liter	Blue	Light	4	--	401211
59250	Aero Green Antibacterial Foam Soap w/Triclosan	1 Liter	Blue	Light	4	10	401212

ITEM NO.	DESCRIPTION	UNIT SIZE	COLOR	FRAGRANCE	UNITS/ CASE	CASE WT. (LB.)	ESSITY CLOSEST EQUIVALENT
----------	-------------	-----------	-------	-----------	----------------	-------------------	------------------------------

Skincare (cont.)

Deb Stoko

AFS120TP	InstantFoam Non-Alcohol PURE Hand Sanitizer	1200ml	Clear	None	3	--	401213
ANT120TF	Refresh AntiBac Foam Wash	1200ml	Blue	Light	6	--	401212
ANT1L	Refresh AntiBac Foam Wash	1 Liter	Blue	Light	6	--	401212
ANT2L	Refresh AntiBac Foam Wash	2 Liter	Blue	Light	4	--	401212
AZU120TF	Refresh Azure Foam Wash	1200ml	Blue	Light	3	--	401211
AZU1L	Refresh Azure Foam Wash	1 Liter	Blue	Light	6	--	401211
AZU2LT	Refresh Azure Foam Wash	2 Liter	Blue	Light	4	--	401211
CIT2LT	Kresto Citrus	2 Liter	Cream	Orange	4	--	N/A
CIT4LT	Kresto Citrus	4 Liter	Cream	Orange	4	--	N/A
CLR1L	Refresh Clear Foam Wash	1 Liter	Clear	None	6	--	401211
CLR2LT	Refresh Clear Foam Wash	2 Liter	Clear	None	4	--	401211
CMW1L	Refresh Luxury 3-in-1 Hair & Body	1 Liter	Clear	Light	6	--	400013
CMW2LT	Refresh Luxury 3-in-1 Hair & Body	2 Liter	Clear	Light	4	--	400013
ENG1L	Refresh Energie Foam	1 Liter	Green	Citrus Spice	6	--	401211
GPF3LNA	Solopol GrittyFOAM	3250ml	Cream	Commeal	2	--	N/A
HAB1L	Estesol Hair & Body Wash	1 Liter	Blue	Rainforest	6	--	400013
HAB2LT	Estesol Hair & Body Wash	2 Liter	Blue	Rainforest	4	--	400013
HAB4LT	Estesol Hair & Body Wash	4 Liter	Blue	Rainforest	4	--	400013
HBG1L	Refresh Hair & Body Wash	1 Liter	Green	Light	6	--	400013
HBG2LT	Refresh Hair & Body Wash	2 Liter	Green	Light	4	--	400013
IFS1L	InstantFoam Hand Sanitizer	1 Liter	Clear	None	3	--	N/A
IFS1TF	InstantFoam Touch Free Hand Sanitizer	1 Liter	Clear	None	3	--	N/A
KCH2LT	Kresto Cherry	2 Liter	Red	Cherry	4	--	N/A
KCH4LT	Kresto Cherry	4 Liter	Red	Cherry	4	--	N/A
KCL2LT	Refresh Hair & Body Wash	2 Liter	Beige	Walnut	4	--	400013
KCL4LT	Refresh Hair & Body Wash	4 Liter	Beige	Walnut	4	--	400013
KKU2LT	Kresto Kolor ULTRA	2 Liter	Beige	Fragrance	4	--	N/A
KSP2LT	Kresto Special ULTRA	2 Liter	White	Fragrance	4	--	N/A
LIM2LT	Solopol Lime Wash	2 Liter	Light Green	Lime	4	--	N/A
LIM4LT	Solopol Lime Wash	4 Liter	Light Green	Lime	4	--	N/A
LTW1L	Estesol Lotion Wash	1 Liter	Blue	Light	6	--	400011

ITEM NO.	DESCRIPTION	UNIT SIZE	COLOR	FRAGRANCE	UNITS/ CASE	CASE WT. (LB.)	ESSITY CLOSEST EQUIVALENT
LTW2LTR	Estesol Lotion Wash	2 Liter	Blue	Light	4	--	400012
LTW4LTR	Estesol Lotion Wash	4 Liter	Blue	Light	4	--	400012
NPW2LT	Natural POWER WASH	2 Liter	Cream	Sunflower	4	--	N/A
PBF1L	Refresh PureBac Foam Wash	1 Liter	Colorless	None	6	--	401211
PBF2L	Refresh PureBac Foam Wash	2 Liter	Colorless	None	4	--	401211
PUW1L	Estesol Lotion PURE Wash	1 Liter	Clear	None	6	--	400012
PUW2LTR	Estesol Lotion PURE Wash	2 Liter	Clear	None	4	--	400012
PUW4LTR	Estesol Lotion PURE Wash	4 Liter	Clear	None	4	--	400012
RFW120TF	Refresh Rose Foam Wash	1200ml	Pink	Rose	3	--	401211
RFW1L	Refresh Rose Foam Wash	1 Liter	Pink	Rose	6	--	401211
RFW2LT	Refresh Rose Foam Wash	2 Liter	Pink	Rose	4	--	401211
SCP2LT	Solopol Classic PURE	2 Liter	Brown	None	4	--	N/A
SFW2LT	Sunflower WASH	2 Liter	White	Sunflower	4	--	N/A
SOL2LT	Solopol Classic	2 Liter	Beige	Walnut	4	--	N/A
SOL4LT	Solopol Classic	4 Liter	Beige	Walnut	4	--	N/A

Ecolab

6000028	Endure Clear and Soft Hand Soap	1 Liter	Colorless	None	10	--	400012
6000056	Wash Mild Skin Cleanser	1 Liter	Green	Light	10	--	400011
6000061	Endure Mild Foam Hand Soap	750ml	Pink	Clean	6	--	401211
6000063	Endure Sensitive Skin Foam Hand Soap	750ml	Colorless	None	6	--	401211
6000064	Total Body Shampoo	750ml	Peach	Clean	6	--	400013
6000069	Endure Mild Foam Hand Soap	1250ml	Pink	Clean	4	--	401211
6000070	Antimicrobial Bacti-Foam Hand Soap	750ml	Light Green	Aloe	6	--	401212
6000073	Quick-Care Foam Hand Sanitizer	750ml	None	None	6	--	400216
6000082	Quick-Care Nourishing Foam Hand Sanitizer	750ml	None	None	6	--	401213
6000083	Express Gel Hand Sanitizer	750ml	Clear	None	6	--	N/A
6000084	Endure Sensitive Skin Foam Hand Soap	1250ml	Colorless	None	4	--	401211
6000090	Bacti-Foam Antimicrobial Hand Soap	1250ml	Light Green	Aloe	4	--	401212
6000094	Quick-Care Foam Hand Sanitizer	1200ml	None	--	4	--	400216
6000098	Quick-Care Nourishing Foam Hand Sanitizer	1200ml	none	--	4	--	401213

Ecolab

6000099	Express Gel Hand Sanitizer	1200ml	Clear	None	4	--	N/A
6000143	Equi-Soft Antimicrobial Foam Hand Soap	1250ml	Clear	None	6	--	401212
6000144	Equi-Soft Antimicrobial Foam Hand Soap	750ml	Clear	None	6	--	401212
6025773	Total Body Shampoo	1000ml	Peach	Clean	10	--	400013
6030447	Scrub-Stat 4% Hand Scrub	1000ml	Orange	Foral	12	--	N/A
6042750	Scrub-Stat 2% Foam Hand Scrub	750ml	Orange	Foral	6	--	N/A
6082719	Medi-Stat Mild Hand Wash	1200ml	Pink	Light	8	--	400012
6083121	Gel Hand Sanitizer	1000ml	Colorless	Light	8	--	N/A
6083650	Bacti-Foam Plus Antimicrobial Hand Wash	1200ml	Green	Clean	8	--	401212
6083911	Endure Sensitive Skin Foam Hand Soap	1200ml	White	Light	8	--	401211
6084252	Endure Mild Moisturizing Hand Soap	1200ml	White	Light	8	--	400012
6085124	Endure Wash Hand Soap	1200ml	White	Light	8	--	400011
6086289	Bacti-Stat AE Antimicrobial Hand Soap	1200ml	Light Green	Clean	8	--	400014
6087925	Endure 50 General Use Hand Soap	1200ml	White	Light	8	--	400011
6089344	Endure Mild Moisturizing Hand Soap	1200ml	White	Light	8	--	400012
6100706	Clean & Smooth Lotion Skin Cleanser	750ml	White	Light	6	--	N/A
6100707	Clean & Smooth Lotion Skin Cleanser	1200ml	White	Light	8	--	N/A
61023426	Bacti-Stat Antimicrobial Hand Soap	1000ml	Red	Clean	10	--	401212
61061251	Bacti-Stat AE Antimicrobial Hand Soap	1000ml	Light Green	Clean	10	--	401212
61067102	Medi-Stat Mild Hand Wash	1000ml	Pink	Light	10	--	400012
61067202	Episoft Mild Cleanser	1000ml	Pink	Light	12	--	N/A

Georgia Pacific

42331	enMotion E3 Rated Foam Hand Sanitizer	1000ml	Light Green	None	2	6.6	400216
42334	enMotion Gen 2 Foam Hand Sanitizer	1000ml	Green	None	2	4,23	401213
42336	enMotion Gen 2 High Frequency Use Foam Hand Sanitizer	1000ml	Green	None	2	4,23	401213
42344	enMotion E3 Rated Gel Hand Sanitizer	950ml	Clear	None	2	6.6	N/A
42711	enMotion Gentle Foam Soap w/Moisturizers	1200ml	Clear	--	2	5.82	401211
42712	enMotion Gentle Foam Soap w/Moisturizers	1200ml	Green	Pacific Citrus	2	5.82	401211
42714	enMotion Gen 2 Gentle Foam Soap w/Moisturizers	1200ml	Clear	None	2	5.82	401211









ITEM NO.	DESCRIPTION	UNIT SIZE	COLOR	FRAGRANCE	UNITS/ CASE	CASE WT. (LB.)	ESSITY CLOSEST EQUIVALENT
42714	enMotion Gen 2 Gentle Foam Soap w/Moisturizers	1200ml	Clear	None	2	5.82	401211
42715	enMotion Gen 2 Gentle Foam Soap w/Moisturizers	1200ml	Green	Aloe	2	5.82	401211
42815	enMotion E2 Rated Antimicrobial Foam Soap	1200ml	Clear	--	2	5.82	401212
42816	enMotion Antimicrobial Foam Soap w/Moisturizers	1200ml	Green	Tranquil Aloe	2	5.82	401212
42818	enMotion Gen 2 Antimicrobial Foam Soap w/Moisturizers	1200ml	Clear	None	2	5.82	401212
42819	enMotion Gen 2 Antimicrobial Foam Soap w/Moisturizers	1200ml	Green	Tranquil Aloe	2	5.82	401212
42910	enMotion Antimicrobial Foam Healthcare Personal Handwash w/PCMX	1200ml	Orange	--	2	6.6	N/A
43023	Pacific Garden Body Wash and Shampoo	1200ml	Aqua	Floral	4	14	400013
43024	Pacific Blue Ultra Foam Hair and Body Wash	1200ml	Green	Refreshing Aloe	4	11.62	--
43332	Pacific Garden Gentle Foam Hand Sanitizer	950ml	Clear	None	4	10.54	401213
43335	Pacific Blue Ultra Foam Hand Sanitizer	1000ml	Clear	None	4	8.5	400216
43340	Gel Hand Sanitizer	532ml	Green	Tranquil Aloe	12	15.99	N/A
43711	Pacific Garden Gentle Foam Soap	1200ml	Clear	--	4	11.56	401211
43712	Pacific Garden Gentle Foam Soap	1200ml	Gold	Citrus	4	11.56	401211
43713	Pacific Garden Gentle Foam Soap	1200ml	Clear	None	4	14	401211
43714	Pacific Blue Ultra Gentle Foam Soap	1200ml	Clear	None	4	11.62	401211
43715	Pacific Blue Ultra Pacific Citrus Foam Soap	1200ml	Orange	Citrus	4	11.62	401211
43815	Pacific Garden E2 Rated Foam Antimicrobial Soap	1200ml	Clear	--	4	11.56	401212
43816	Pacific Garden Foam Antimicrobial Soap	1200ml	Gold	Citrus	4	11.56	401212
43331	Pacific Garden E3 Rated Foam Hand Sanitizer	1000ml	Clear	--	4	10.54	400216
43340	Gel Hand Sanitizer	532ml	Tranquil Aloe	--	12	15.99	N/A
43818	Pacific Blue Ultra Antimicrobial Foam Soap	1200ml	Clear	None	4	11.62	401212
43819	Pacific Blue Ultra Pacific Citrus Antimicrobial Foam Soap	1200ml	Orange	Citrus	4	11.62	401212
48003	Pacific Garden Foam Hand Sanitizer	45ml	Clear	None	24	3.93	N/A
48113	Handi-Fresh Liquid General Purpose Soap	800ml	Pink	Floral	12	23.8	400011
48114	Handi-Fresh Alcohol Gel No Rinse Sanitizer	800ml	Clear	Light	4	8	400016
48211	Pacific Garden® Foam Antimicrobial Soap	1200ml	Clear	--	4	11.8	401212
48222	Pacific Garden 1200ml Gel Hand Sanitizer	1200ml	--	Lavender	8	20.18	400016
48223	Pacific Garden 1200ml Body Wash and Shampoo Gel	1200ml	--	Peach	8	23.14	400013
48227	Pacific Garden 1200ml Food Processing Soap	1200ml	--	Unscented	8	23.14	400014
48232	Pacific Garden 1200ml Hand Lotion	1200ml	White	--	8	22.25	N/A
48310	Pacific Garden 1200ml Foam General Purpose Soap	1200 ml	--	Unscented	4	12.26	401211
48314	Pacific Garden Clear Fragrance Free 7oz General Purpose Foam Soap	7 oz	Clear	None	12	7.51	401211
48517	Pacific Garden 1200ml Foam Hand Sanitizer	1200 ml	--	Unscented	4	12.26	401213

ITEM NO.	DESCRIPTION	UNIT SIZE	COLOR	FRAGRANCE	UNITS/ CASE	CASE WT. (LB.)	ESSITY CLOSEST EQUIVALENT
----------	-------------	-----------	-------	-----------	----------------	-------------------	------------------------------

Skincare (cont.)

GoJo

0208-24	Purell Advanced Instant Hand Sanitizer with Biobased Content, 2 fl.oz. Bottle	59.2ml	Clear	None	24	--	N/A
0272-08	Purell Advanced Instant Hand Sanitizer with Biobased Content	1000ml	Clear	None	8	--	400016
0903-12	GoJo Lemon Hand Cleaner, 22 fl.oz.	650.6ml	Yellow	Lemon	12	--	N/A
0905-06	GoJo Lemon Hand Cleaner, 4.5 lbs.	2131.2ml	Yellow	Lemon	6	--	N/A
0913-12	GoJo Lemon Pumice Hand Cleaner, 22 fl.oz.	650.6ml	Yellow	Lemon	12	--	N/A
0915-06	GoJo Lemon Pumice Hand Cleaner, 4.5 lbs.	2131.2ml	Yellow	Lemon	6	--	N/A
0937-04	GoJo Ecopreferred Pumice Hand Cleaner, 1/2 Gallon	1892.8ml	--	--	4	18.9	N/A
0938-04	GoJo Ecopreferred Pumice Hand Cleaner, 1Gallon	3785.4ml	--	--	4	38	N/A
0945-04	GoJo Natural Orange Smooth Hand Cleaner, 1Gallon	3785.4ml	White	Citrus	4	--	N/A
0947-12	GoJo Natural Orange Smooth Hand Cleaner, 14 fl.oz.	414ml	White	Citrus	12	--	N/A
0948-06	GoJo Natural Orange Smooth Hand Cleaner, 1/2 Gallon	1892.7ml	White	Citrus	6	--	N/A
0951-15	GoJo Natural Orange Pumice Hand Cleaner, 7.5 fl.oz.	220ml	--	--	15	9.1	N/A
0955-02	GoJo Natural Orange Pumice Hand Cleaner, 1 Gallon	3785.4ml	White	Citrus	2	--	N/A
0955-04	GoJo Natural Orange Pumice Hand Cleaner, 1 Gallon	3785.4ml	White	Citrus	4	--	N/A
0957-12	GoJo Natural Orange Pumice Hand Cleaner, 14 fl.oz.	414.4ml	White	Citrus	12	--	N/A
0958-06	GoJo Natural Orange Pumice Hand Cleaner, 1/2 Gallon	1892.7ml	White	Citrus	6	--	N/A
0972-04	GoJo Super Max Hand Cleaner, 1/2 Gallon	1892.7ml	--	--	4	--	N/A
0987-12	GoJo Power Gold Hand Cleaner, 14 fl.oz.	414ml	Green	Citrus	12	--	N/A
0988-04	GoJo Power Gold Hand Cleaner, Pump Bottle, 1/2 Gallon	1892.7ml	Green	Citrus	4	18.9	N/A
1016-12	GoJo Professional Paint & Body Shop Hand Cleaner, 5 fl.oz.	147.9ml	Tan	Floral	12	--	N/A
1018-06	GoJo Professional Paint & Body Shop Hand Cleaner, 22 fl.oz.	650.6ml	Tan	Floral	6	--	N/A
1109-12	GoJo Original Formula Hand Cleaner, 14 oz.	414ml	Yellow	Solvent	12	--	N/A
1111-06	GoJo Original Formula Hand Cleaner, 4.5 lbs.	2131.2ml	Yellow	Solvent	6	--	N/A
1115-06	GoJo Original Formula Hand Cleaner, 4.5 lbs.	2131.2ml	Yellow	Solvent	6	--	N/A
1132-12	GoJo Fine Italian Pumice Hand Cleaner, 14 oz.	414ml	Yellow	Citrus	12	--	N/A
1134-06	GoJo Fine Italian Pumice Hand Cleaner, 28 oz.	828.1ml	Yellow	Citrus	6	--	N/A
1135-06	GoJo Fine Italian Pumice Hand Cleaner, 4.5 lbs.	2131.2ml	Yellow	Citrus	6	--	N/A
1141-12	GoJo Creme Hand Cleaner, 14 oz.	414ml	Yellow	Solvent	12	--	N/A
1148-06	GoJo Creme Hand Cleaner, 28 oz.	828.1ml	Yellow	Solvent	6	--	N/A
1303-03	 Purell Advanced Green Certified Instant Hand Sanitizer Foam	700ml	Clear	None	3	--	N/A

1304-03		Purell Advanced Green Certified Instant Hand Sanitizer Foam	700ml	Clear	None	3	--	N/A
1305-03		Purell Advanced Green Certified Instant Hand Sanitizer Foam	700ml	Clear	None	3	--	N/A
1306-03		Purell Advanced Skin Nourishing Instant Hand Sanitizer Foam	700ml	Clear	None	3	--	N/A
1309-03		Purell Advanced Hand Sanitizer Ultra Nourishing Foam	700ml	Clear	Floral	3	--	N/A
1310-03		Micrell Antibacterial Foam Handwash	700ml	Blue Green	Floral	3	--	401212
1311-03		Gojo Clear and Mild Foam Handwash	700ml	Clear	Light	3	--	401211
1312-03		Gojo Antibacterial Plum Foam Handwash	700ml	Purple	Plum	3	--	401211
1316-03		Gojo Pomeberry Foam Handwash	700ml	Blue	Pomegranite	3	--	401211
1340-03		Gojo Antimicrobial Foam Handwash with PCMX	700ml	Blue	Floral	3	--	401212
1341-03		Provon Clear & Mild Foam Handwash	700ml	Clear	Floral	3	--	401211
1342-03		Provon Antibacterial Foam Handwash	700ml	Clear	None	3	--	401212
1343-03		Provon Ultra Mild Foam Handwash	700ml	Blue	Floral	3	--	401211
1344-03		Provon Foaming Antimicrobial Handwash w/PCMX	700ml	Light Blue	Floral	3	--	401212
1346-03		Provon Antibacterial Plum Foam Handwash	700ml	Purple	Plum	3	--	401212
1450-06		Purell Advanced Instant Hand Sanitizer Gel	450ml	--	--	6	6.4	400016
1450-08		Purell Advanced Instant Hand Sanitizer Gel, 2 Pack	450ml	Clear	--	8	18.46	400016
1902-02		Purell SF607 Instant Hand Sanitizer Alcohol-Free Foam	1200ml	Clear	None	2	--	401213
1903-02		Purell Advanced Green Certified Instant Hand Sanitizer	1200ml	Clear	None	2	--	400016
1904-02		Purell Advanced Green Certified Instant Hand Sanitizer Foam	1200ml	--	--	2	--	N/A
1905-02		Purell Advanced Instant Hand Sanitizer Foam	1200ml	--	--	2	--	N/A
1906-02		Purell Advanced Skin Nourishing Instant Hand Sanitizer Foam	1200ml	--	--	2	--	N/A
1907-02		Purell Waterless Surgical Scrub	1200ml	Clear	None	2	--	N/A
1908-02		Purell Advanced Instant Hand Sanitizer E3 Rated Gel	1200ml	Clear	--	2	--	400016
1909-02		Purell Advanced Hand Sanitizer Ultra Nourishing Foam	1200ml	Clear	Floral	2	--	401211
1911-02		Gojo Clear & Mild Handwash Foam	1200ml	Clear	--	2	--	401211
1912-02		Gojo Antibacterial Plum Foam Handwash	1200ml	Purple	Plum	2	--	401212
1916-02		Gojo Pomeberry Foam Handwash	1200ml	--	Pomeberry	2	--	401211
1922-02		Provon Antibacterial Foam Handwash with 2% CHG	1200ml	Beige	--	2	--	401212
1940-02		Gojo Antimicrobial Foam Handwash w/Chloroxylenol	1200ml	Blue	Floral	2	--	401212
1941-02		Provon Clear & Mild Foam Handwash Clear & Mild Foam Handwash	1200ml	Clear	Floral	2	--	401211

ITEM NO.	DESCRIPTION	UNIT SIZE	COLOR	FRAGRANCE	UNITS/ CASE	CASE WT. (LB.)	ESSITY CLOSEST EQUIVALENT
----------	-------------	-----------	-------	-----------	----------------	-------------------	------------------------------

Skincare (cont.)

GoJo

1942-02	Provon Antibacterial Foam Handwash	1200ml	--	--	2	--	401212
1943-02	Provon Ultra Mild Foam Handwash	1200ml	Blue	Floral	2	--	401211
1944-02	Provon Antimicrobial Handwash with PCMX	1200ml	Blue	Floral	2	--	401212
1946-02	Provon Antimicrobial Plum Foam Handwash	1200ml	Purple	Plum	2	--	401212
2056-12	Purell Advanced Instant Hand Sanitizer	473ml	Clear	None	12	--	400016
2104-08	GoJo White Premium Lotion Soap	1000ml	White	Rain	8	--	400012
2108-08	Provon Mild Liquid Soap	1000ml	Blue	Orchid	8	--	400011
2110-08	Provon 3 in 1 Wash Cream	1000ml	Clear	Clean	8	--	400013
2112-08	GoJo Ultra Mild Antimicrobial Lotion Soap with Chloroxylenol	1000ml	Yellow	Light	8	--	400014
2113-08	Provon Enriched Lotion Cleanser	1000ml	Pink	Floral	8	--	400011
2117-08	GoJo Deluxe Lotion Soap with Moisturizers	1000ml	Pink	Floral	8	--	400012
2118-08	Provon Antimicrobial Lotion Soap with 0.3% PCMX	1000ml	Yellow	Citrus	8	--	400014
2134-08	Provon Tearless Shampoo & Body Wash	1000ml	Blue	Clean	8	--	400013
2137-08	Purell Instant Hand Sanitizer with Aloe	1000ml	Clear	None	8	--	400016
2151-08 	Purell Advanced Instant Hand Sanitizer Skin Nourishing	1000ml	Clear	None	8	--	400016
2152-08	Gojo Spa Bath Body and Hair Shampoo	1000ml	Peach	Herbal	8	--	400013
2156-04	Purell Advanced Instant Hand Sanitizer	1000ml	Light Blue	None	4	--	400016
2156-08	Purell Advanced Instant Hand Sanitizer	1000ml	Light Blue	None	8	--	400016
2156-08-CAN00	Purell Hand Sanitizer	1000ml	Light Blue	None	8	--	N/A
2157-04	Micrell Antibacterial Lotion Soap	1000ml	Yellow	Light	4	--	400014
2157-08	Micrell Antibacterial Lotion Soap	1000ml	Yellow	Light	8	--	400014
2158-08	Provon Medicated Lotion Soap with Triclosan	1000ml	Yellow	Citrus	8	--	400014
2163-08	Purell Advanced E3 Rated Instant Hand Sanitizer	1000ml	Clear	None	8	--	400016
2165-08  	GoJo Green Certified Lotion Hand Cleaner	1000ml	Clear	Floral	8	--	400011
2204-04	GoJo White Premium Lotion Soap	2000ml	White	Rain	4	--	400012
2208-04	Provon Mild Liquid Soap	2000ml	Blue	Orchid	4	--	400011
2212-04	GoJo Ultra Mild Antimicrobil Lotion Soap with Chloroxylenol	2000ml	Yellow	Light	4	--	400014
2213-04	Provon Enriched Lotion Cleanser	2000ml	Pink	Floral	4	--	400011
2217-04	GoJo Deluxe Lotion Soap with Moisturizers	2000ml	Pink	Floral	4	--	400012
2218-04	Provon Antimicrobial Lotion Soap with 0.3% Chloroxylenol	2000ml	Yellow	Citrus	4	--	400014

2234-04	Provon Tearless Shampoo & Body Soap	2000ml	Blue	Clean	4	--	400013
2237-04	Purell Advanced with Aloe Instant Hand Sanitizer	2000ml	Clear	None	4	--	400016
2252-04	GoJo Spa Bath Body and Hair Shampoo	2000ml	Peach	Herbal	4	--	400013
2256-04	Purell Advanced Instant Hand Sanitizer	2000ml	Clear	None	4	--	400016
2257-04	Micrell Antibacterial Lotion Soap	2000ml	Yellow	Light	4	--	400014
2258-04	Provon Medicated Lotion Soap with Triclosan	2000ml	Clear	None	4	--	400014
2280-04	GoJo E-2 Sanitizing Lotion Soap	2000ml	Yellow	None	4	--	400014
2313-12	Provon Enriched Lotion Cleanser, 16 oz	470ml	Pink	Floral	12	15.2	400011
2356-02	GoJo Cherry Gel Pumice Hand Cleaner	1892.7ml	Pink	Cherry	4	--	N/A
2358-02	GoJo Cherry Gel Pumice Hand Cleaner, 1 Gallon Pump Bottle	3785.4ml	Pink	Cherry	2	--	N/A
2533-08	Provon Moisturizing Hand and Body Lotion	1000ml	White	None	8	--	N/A
2548-04	Aquell Moisturizing Lotion	500ml	White	Floral	4	--	N/A
3012-12	Purell Hand Sanitizer Gel, 8 oz	240ml	Blue	Ocean Mist	12	7	400016
3014-12	Purell Hand Sanitizer Gel 8 oz	240ml	Rose	Spring Bloom	12	7	400016
3023-12	Purell Instant Hand Sanitizer, 20 fl.oz., Pump Bottle	591.5ml	Clear	Floral	12	--	N/A
3227-04	Provon Ultimate Shampoo and Body Wash	2000ml	White	Herbal	4	--	400013
3639-12	Purell Advanced with Aloe Instant Hand Sanitizer, 12 fl. oz.	354.9ml	Light Green	Floral	12	--	N/A
3646-12	Provon Advanced Hand Sanitizer Skin Nourishing Gel, 12 oz	354.9ml	Clear	--	12	11	400016
3659-12	Purell Advanced Hand Sanitizer Skin Nourishing Gel, 12 oz	354.9ml	Clear	--	12	11	400016
3691-12	 Purell Advanced Hand Sanitizer Green Certified, 12 oz	354.9ml	Clear	--	12	11	400016
4253-12	Provon Medicated Lotion Soap w/Triclosan	473.2ml	Clear	None	12	--	N/A
4301-48	Provon Antimicrobial Lotion Soap w/0.3% PCMX	118.3ml	Yellow	Citrus	48	--	N/A
4303-12	Provon Antimicrobial Lotion Soap w/0.3% PCMX	473.2ml	Yellow	Citrus	12	--	N/A
4560-48	Provon 3 in 1 Wash Cream	236.6ml	White	Floral	48	--	N/A
5091-03	  Purell Advanced Green Certified Instant Hand Sanitizer	1200ml	Clear	None	3	--	400016
5157-03	Micrell FMX-12 Antibacterial Foam Handwash	1250ml	Blue	Floral	3	--	401212
5161-03	GoJo FMX-12 Luxury Foam Handwash	1250ml	Pink	Cranberry	3	--	401211
5162-03	GoJo FMX-12 Luxury Foam Antibacterial Handwash	1250ml	Orange	Fruit	3	--	401212
5163-03	 GoJo FMX-12 Green Certified Hair and Body Wash Foam Soap	1250ml	Orange	Fruit	3	--	400013
5164-03	GoJo FMX-12 E2 Foam Sanitizing Soap	1250ml	Clear	None	3	--	401212
5165-03	 GoJo FXM-12 Green Certified Foam Hand Cleaner	1250ml	Clear	None	3	--	401211
5167-03	 GoJo FMX-12 E1 Foam Handwash	1250ml	Clear	None	3	--	401211
5169-03	GoJo E2 Foam Handwash w/PCMX	1250ml	Clear	None	3	--	N/A
5182-03	 Provon FMX-12 Green Certified Foam Hand Cleaner	1250ml	Clear	None	3	--	401211
5183-03	Provon Ultra Mild Foam Handwash	1250ml	Light Blue	--	3	--	401211
5184-03	Purell SF607 Hand Sanitizer Foam	1200ml	Clear	None	3	--	401213
5185-03	Provon FMX-12 Foaming Handwash w/ Moisturizers	1250ml	Light Pink	Cranberry	3	--	401211
5186-03	Provon FMX-12 Foaming Antimicrobial Handwash w/Moisturizers	1250ml	Light Yellow	Light Floral	3	--	401212

ITEM NO.	DESCRIPTION	UNIT SIZE	COLOR	FRAGRANCE	UNITS/ CASE	CASE WT. (LB.)	ESSITY CLOSEST EQUIVALENT
----------	-------------	-----------	-------	-----------	----------------	-------------------	------------------------------

Skincare (cont.)

GoJo

5192-03	Purell FMX-12 Advanced Instant Hand Sanitizer Foam	1200ml	Clear	Floral	3	--	401213
5193-03	Purell Advanced E3 Rated Instant Hand Sanitizer	1200ml	Clear	Floral	3	--	N/A
5187-03	Provon FMX-12 Foaming Hair & Body Wash w/ Moisturizers	1250ml	Light Green	Cucumber Melon	3	--	400013
5188-03	Provon FMX-12 Foaming Medicated Handwash w/Moisturizers & Triclosan	1250ml	Light Blue	Floral	3	--	401212
5190-03	Purell FXM-12 Advanced Instant Hand Sanitizer Foam	1000ml	Clear	Floral	3	--	401213
5191-03	Purell FXM-12 Advanced Green Certified Instant Hand Sanitizer	1200ml	Clear	Floral	3	--	N/A
5190-03	Purell Advanced Instant Hand Sanitizer Gel	1000ml	Clear	Floral	3	--	N/A
5191-03	Purell Advanced Green Certified Instant Foam Hand Sanitizer	1200ml	Clear	None	3	--	N/A
5192-03	Purell Advanced Instant Hand Sanitizer Gel	1200ml	Clear	Floral	3	--	N/A
5193-03	Purell Advanced E3 Rated Instant Hand Sanitizer	1200ml	Clear	Floral	3	--	N/A
5198-03	Purell Advanced Skin Nourishing Instant Hand Sanitizer Gel	1200ml	Clear	None	3	--	N/A
5199-03	Purell Advanced Skin Nourishing Instant Hand Sanitizer Gel	1000ml	Clear	None	3	--	N/A
5220-02	GoJo J R Watkins Foam Shampoo & Body Wash	2000ml	Orange	Grapefruit	2	--	400013
5261-02	GoJo FMX-20 Luxury Foam Handwash	2000ml	Pink	Cranberry	2	--	401211
5262-02	GoJo FMX-20 Luxury Foam Antibacterial Handwash	2000ml	Orange	Fruit	2	--	401212
5263-02	GoJo FMX-20 Green Certified Hair and Body Wash Foam Soap	2000ml	Green	Cucumber Melon	2	--	400013
5264-02	GoJo FMX-20 E2 Foam Sanitizing Soap	2000ml	Clear	Light	2	--	401212
5265-02	GoJo FXM-20 Green Certified Foam Hand Cleaner	2000ml	Clear	Floral	2	--	401211
5267-02	GoJo FMX-20 E1 Foam Handwash	2000ml	Clear	Floral	2	--	401211
5268-03	Gojo Eco Soy Foaming Hand Cleaner	2000ml	Blue	Clean	3	--	N/A
5269-02	Gojo E2 Foam Handwash with PCMX	2000ml	Clear	--		10.2	401212
5285-02	Provon FMX-20 Foaming Handwash w/Moisturizers	2000ml	Light Pink	Cranberry	2	--	401211
5286-02	Provon FMX-20 Foaming Antimicrobial Handwash w/Moisturizers	2000ml	Orange	Light Floral	2	--	401212
5287-02	Provon FMX-20 Foaming Hair & Body Wash w/ Moisturizers	2000ml	Green	Cucumber Melon	2	--	400013
5288-02	Provon FMX-20 Foaming Medicated Handwash w/Moisturizers & Triclosan	2000ml	Light Blue	Floral	2	--	401212
5289-02	Purell Advanced Hand Sanitizer Ultra Nourishing Foam	1200ml	Clear	Floral	2	--	N/A
5304-03	Provon FMX-12 Antimicrobial Skin Cleanser	1200ml	Peach	Floral	3	--	N/A
5306-04	Provon TFX Antimicrobial Skin Cleanser	120ml	Peach	Floral	3	--	N/A
5357-02	Micrell TFX Antibacterial Foam Handwash	1200ml	Blue	Floral	2	--	401212
5361-02	GoJo TFX Premium Foam Handwash w/ Skin Conditioners	1200ml	Purple	Cranberry	2	--	401211
5362-02	GoJo TFX Premium Foam Antibacterial Handwash	1200ml	Apricot	Fresh Fruit	2	--	401212
5364-02	GoJo TFX E2 Foam Sanitizing Soap, Refill	1200ml	Clear	None	2	--	401212

ITEM NO.	DESCRIPTION	UNIT SIZE	COLOR	FRAGRANCE	UNITS/ CASE	CASE WT. (LB.)	ESSITY CLOSEST EQUIVALENT
----------	-------------	-----------	-------	-----------	----------------	-------------------	------------------------------

Skincare (cont.)

GoJo

5369-02	GoJo TFX E2 Foam Handwash w/PCMX	1200ml	Clear	None	2	--	N/A
5382-02	Provon TFX Green Certified Foam Hand Cleaner	1200ml	Clear	None	2	--	401211
5383-02	Provon TFX Ultra Mild Foam Handwash	1200ml	Light Blue	Light	2	--	401211
5384-02	Purell SF607 Instant Hand Sanitizer Foam Non-Alcohol	1200ml	Clear	None	2	--	401213
5385-02	Provon TFX Foam Handwash w/ Advanced Moisturizers	1200ml	Purple	Cranberry	2	--	401211
5388-02	Provon TFX Medicated Foam Handwash w/ Advanced Moisturizers & Triclosan	1200ml	Clear	None	2	--	401212
5391-02	 Purell Advanced Green Certified Instant Hand Sanitizer Foam	1200ml	Clear	None	2	--	401213
5392-02	Purell TFX Advanced Instant Hand Sanitizer Foam	1200ml	Clear	Floral	2	--	401213
5393-02	Purell TFX Advanced E3 Rated Instant Hand Sanitizer Foam	1200ml	Clear	Floral	2	--	N/A
5398-02	 Purell TFX Advanced Skin Nourishing Instant Hand Sanitizer Foam	1200ml	Clear	None	2	--	401213
5399-02	 Purell TFX Advanced Skin Nourishing Instant Hand Sanitizer Foam	1000ml	Clear	None	2	--	401213
5451-04	Purell Advanced Instant Hand Sanitizer Skin Nourishing Gel	1200ml	Clear	Floral	4	--	400016
5456-04	Purell Advanced Instant Hand Sanitizer Gel	1200ml	Clear	Floral	4	--	400016
5456-04-CAN	Purell Instant Hand Sanitizer	1200ml	Clear	Floral	4	--	400016
5457-04	Purell Advanced Instant Hand Sanitizer with Aloe	1200ml	Light Green	Aloe	4	--	400016
5483-04	Purell Waterless Surgical Scrub	1000ml	Clear	None	4	--	N/A
5491-04	Purell Advanced Green Certified Instant Hand Sanitizer Gel	1200ml	Clear	None	4	--	400016
5496-04	Purell Instant Hand Sanitizer VF481 Gel	1200ml	Light Blue	FLoral	4	--	N/A
5592-02	Purell Advanced Instant Hand Sanitizer Foam	1000ml	Clear	Floral	2	--	401212
5665-02	 GoJo TFX Green Certified Foam Hand Cleaner	1200ml	Clear	None	2	--	401211
5692-24	Purell Advanced Instant Hand Sanitizer Foam , Pump Bottle	45ml	Clear	Floral	24	--	N/A
5698-24	 Purell Advanced Skin Nourishing Instant Hand Sanitizer Foam, Pump Bottle	45ml	Clear	None	24	--	N/A
5710-06	GoJo Premium Foam Antibacterial Handwash, Foamer Bottle w/Pump	221.8ml	Apricot	Fresh Fruit	6	--	N/A
5715-06	 GoJo Green Certified Foam Hand Cleaner, Foamer Bottle w/Pump	221.8ml	Clear	None	6	--	N/A
5742-06	Provon Antimicrobial Foam Handwash with 2% CHG	535ml	--	--	6	--	401212
5762-04	GoJo Luxury Foam Antibacterial Handwash, Pump Bottle	535ml	Orange	Orange Blossom	4	--	401212
5770-04-CAN00	 Purell Advanced Hand Rub Gel	1200ml	Clear	Floral	4	--	N/A
5783-04	 Provon Ultra Mild Foam Handwash	535ml	--	Fresh	4	6.1	401211
5784-04	Purell SF607 Hand Sanitizer Foam	535ml	Clear	None	4	6.1	401213
5785-04	Provon Foaming Handwash w/Moisturizers, Pump Bottle	535ml	Light Pink	Cranberry	4	--	401212

5788-04	Provon Foaming Medicated Handwash w/Moisturizers & Triclosan, Pump Bottle	535ml	Light Blue	Floral	4	--	N/A
5791-04	Purell Advanced Green Certified Instant Hand Sanitizer Foam	535ml	--	--	4	6.1	400216
5792-04	Purell Advanced Instant Hand Sanitizer Foam, Pump Bottle	535ml	Clear	Floral	4	--	400216
5798-04	Purell Advanced Skin Nourishing Instant Hand Sanitizer Foam, Pump Bottle	535ml	Clear	None	4	--	400216
5799-04	Purell Advanced Hand Sanitizer Ultra Nourishing Luxurious Foam	535ml	--	--	4	5.25	401213
6196-03	Purell Instant Hand Sanitizer VF481	1200ml	Blue Green	Light	3	--	400216
7220-04	GoJo Rich Pink Antibacterial Lotion Soap	2000ml	Pink	Floral	4	--	400014
7220-04-CAN00	GoJo Rich Pink Lotion Soap	2000ml	Pink	Floral	4	--	400012
7230-04	GoJo Shower Up Soap & Shampoo	2000ml	Rose	Clean	4	--	400013
7250-04	GoJo Natural Orange Smooth Hand Cleaner	2000ml	White	Citrus	4	--	N/A
7255-04	GoJo Natural Orange Pumice Hand Cleaner	2000ml	White	Citrus	4	--	N/A
7265-04	GoJo Multi Green Hand Claner	2000ml	Green	Citrus	4	--	400011
7272-04	Gojo Supro Max Hand Cleaner	2000ml	White	Floral	4	--	N/A
7280-04	Gojo E2 Sanitizing Lotion Soap	2000ml	White	None	4	--	400014
7282-04	Gojo Supro Max Cherry Hand Cleaner	2000ml	Pink	Cherry	4	--	N/A
7290-04	Gojo Cherry Gel Pumice Hand Cleaner	2000ml	Pink	Cherry	4	--	N/A
7295-04	GoJo Power Gold Hand Cleaner	2000ml	White	Floral	4	--	N/A
7520-02	GoJo Rich Pink Antibacterial Lotion Soap	5000ml	Pink	Floral	2	--	400014
7530-02	GoJo Shower Up Soap & Shampoo	5000ml	Rose	Citrus	2	--	400013
7556-02	GoJo Natural Orange Pumice Hand Cleaner	5000ml	White	Citrus	2	--	N/A
7565-02	GoJo Multi Green Hand Claner	5000ml	White	Citrus	2	--	N/A
7572-02	GoJo Supro Max Hand Cleaner	5000ml	Tan	Floral	2	--	N/A
7580-02	GoJo E-2 Sanitizing Lotion Soap	5000ml	Clear	None	2	--	N/A
7582-02	GoJo Supro Max Cherry Hand Cleaner	5000ml	White	Cherry	2	--	N/A
7590-02	Gojo Cherry Gel Pumice Hand Cleaner	5000ml	--	--	2	24	N/A
7596-02	GoJo Power Gold Hand Cleaner	5000ml	White	Citrus	2	--	N/A
8240-06	Gojo Skin Lotion Bag-in-Box	800ml	White	Floral	6	--	N/A
8516-04	Gojo Pomeberry Foam Handwash	2300ml	Blue	Pomegranite	4	--	401211
8545-04	Gojo Green Certified Foam Hand Cleaner	2300ml	Clear	None	4	--	401211
8561-02	GoJo CX Luxury Foam Handwash	1500ml	Pink	Cranberry	2	--	N/A
8562-02	GoJo CX Luxury Foam Antibacterial Handwash	1500ml	Orange	Fruit	2	--	401212
8562-02-CAN00	GoJo CX Antibacterial Luxury Foam Handwash Chloroxylenol Liquid	1500ml	Orange	Fruit	2	--	N/A
8565-02	GoJo CX Green Certified Foam Hand Cleaner	1500ml	Clear	None	2	--	401211

ITEM NO.	DESCRIPTION	UNIT SIZE	COLOR	FRAGRANCE	UNITS/ CASE	CASE WT. (LB.)	ESSITY CLOSEST EQUIVALENT
----------	-------------	-----------	-------	-----------	----------------	-------------------	------------------------------

Skincare (cont.)

GoJo

8703-04	Purell Advanced Green Certified Instant Hand Sanitizer Gel	700ml	Clear	Light	4	--	400016
8704-04	Purell Advanced Green Certified Instant Hand Sanitizer Foam	700ml	Clear	Light	4	--	401212
8705-04	Purell Advanced Instant Hand Sanitizer Foam	700ml	Clear	Fruit	4	--	401212
8706-04	Purell Advanced Hand SanitizerSkin Nourishing Foam	700ml	--	--	4	6.5	401211
8711-04	GoJo Clear & Mild Handwash Foam	700ml	Clear	None	4	--	401211
8712-04	GoJo Antibacterial Plum Foam Handwash	700ml	Purple	Plum	4	--	401211
8713-04	GoJo Citrus Ginger Foam Hand and Showerwash	700ml	Yellow	Citrus Ginger	4	--	401211
8716-04	GoJo Botanical Foam Handwash	700ml	Green	Botanical	4	--	401211
8718-04	GoJo Antimicrobial Foam Handwash w/PCMX	700ml	Blue	Floral	4	--	N/A
8721-04	Provon Clear & Mild Foam Handwash	700ml	Clear	None	4	--	401212
8722-04	Provon Antibacterial Foam Handwash	700ml	Clear	None	4	--	401212
8723-04	Provon Ultra Mild Foam Handwash	700ml	Light Blue	Light	4	--	401211
8725-04	Provon Foaming Antimicrobial Handwash w/PCMX	700ml	Light Blue	Floral	4	--	N/A
8726-04	Provon Antibacterial Plum Foam Handwash	700ml	Purple	Plum	4	--	401212
8732-04	Micrell Antibacterial Foam Handwash	700ml	Blue Green	Floral	4	--	401212
8802-03	Purell SF607 Instant Hand Sanitizer Foam, Non Alcohol	1200ml	Clear	None	4	--	401213
8803-03	Purell Advanced Green Certified Instant Hand Sanitizer	1200ml	Clear	None	4	--	N/A
8804-03	Purell Advanced Green Certified Instant Hand Sanitizer Foam	1200ml	Clear	None	3	--	N/A
8805-03	Purell Advanced Instant Hand Sanitizer Foam	1200ml	Clear	Floral	3	--	400216
8806-03	Purell Advanced Skin Nourishing Instant Hand Sanitizer Foam	1250ml	Clear	None	3	--	N/A
8808-03	Purell Advanced Hand Sanitizer E3 Rated Gel	1200ml	--	--	3	--	400016
8811-03	GoJo Clear & Mild Handwash Foam	1250ml	Clear	None	3	--	401211
8812-03	GoJo Antibacterial Plum Foam Handwash	1250ml	Purple	Plum	3	--	401212
8813-03	GoJo Citrus Ginger Foam Hand and Shower Wash	1250ml	Yellow	Citrus/Ginger	3	--	400013
8816-03	GoJo Botanical Foam Handwash	1250ml	Green	Botanical	3	--	401211
8818-03	GoJo Antimicrobial Foam Handwash w/PCMX	1250ml	Blue	Floral	3	--	401212
8821-03	Provon Clear & Mild Foam Handwash	1250ml	Clear	None	3	--	401211
8822-03	Provon Antibacterial Foam Handwash	1250ml	Clear	None	3	--	401212
8824-03	Provon Citrus Ginger Foam Hand & Showerwash	1250ml	Yellow	Citrus Ginger	3	--	N/A
8825-03	Provon Foaming Antimicrobial Handwash	1250ml	Light Blue	Floral	3	--	N/A



ITEM NO.	DESCRIPTION	UNIT SIZE	COLOR	FRAGRANCE	UNITS/ CASE	CASE WT. (LB.)	ESSITY CLOSEST EQUIVALENT
----------	-------------	-----------	-------	-----------	----------------	-------------------	------------------------------

Skincare (cont.)

GoJo

8826-03	Provon Antimicrobial Plum Foam Handwash	1250ml	Purple	Plum	3	--	N/A
8833-03	Provon Ultra Mild Foam Handwash	1250ml	Light Blue	Light	3	--	N/A
8842-03	Provon Antibacterial Foam Handwash with 2% CHG	1250ml	Beige	--	3	--	401212
9112-12	Gojo Lotion Skin Cleanser	800ml	--	--	12	24	400012
9132-12	Gojo E-2 Sanitizing Lotion Soap	800ml	--	--	12	--	400014
9142-12	Gojo Moisturizing Hand Cream	800ml	White	None	12	--	N/A
9165-12	GoJo Green Certified Lotion Hand Cleaner, Bag-in-Box	800ml	White	Floral	12	--	400011
9172-12	Gojo Multi Green Hand Cleaner	800ml	--	--	12	--	400011
9605-24	Purell Instant Hand Sanitizer, 2 fl.oz.Squeeze Bottle	59.1ml	Clear	Floral	24	--	N/A
9606-24	Purell Instant Hand Sanitizer, 2 fl.oz., Pump Bottle	59.1ml	Clear	Floral	24	--	N/A
9614-12	Purell Classic Holder and Purell Instant hand Sanitizer, 8 fl.oz., Pump Bottle	236.8ml	Clear	Floral	12	--	N/A
9624-24	Purell Instant Hand Sanitizer FST Military Bottle, 3 fl.oz.	88.7ml	Clear	None	24	--	N/A
9624--24-CAN00	Purell Hand Sanitizer - Military Bottle	88.7ml	Clear	None	24	--	N/A
9625-04	Purell Instant Hand Sanitizer, Economy Size Pump Bottle	2000ml	Clear	Floral	4	--	400016
9631-24	Purell Advanced Instant Hand Sanitizer with Aloe, 4 fl.oz. Bottle	118.4ml	Green	Floral	24	--	N/A
9637-12	Purell Advanced Hand Sanitizer Aloe Gel	800ml	--	--	12	--	N/A
9648-24	Purell Advanced Instant Hand Sanitizer Skin Nourishing, 2 fl.oz. Pump Bottle	59.1ml	Clear	Floral	24	--	N/A
9650-24-CAN	Purell Advanced Hand Sanitizer, 2 fl.oz. Pump Bottle	59.1ml	Clear	Floral	24	--	N/A
9651-24	Purell Advanced Instant Hand Sanitizer, 4fl. oz. Bottle	118.3ml	Clear	Floral	24	--	N/A
9651-24-CAN00	Purell Advanced Instant Hand Sanitizer, 4fl. oz. Bottle	118.3ml	Clear	Floral	24	--	N/A
9652-12	Purell Advanced Instant Hand Sanitizer, 8 fl.oz. Pump Bottle	236.8ml	Clear	Floral	12	--	N/A
9652-12-CAN00	Purell Advanced Instant Hand Sanitizer, 8 fl.oz. Pump Bottle	236.8ml	Clear	Floral	12	--	N/A
9674-12	Purell Advanced Instant Hand Sanitizer with Aloe, 8 fl.oz. Pump Bottle	236.8ml	Green	Floral	12	--	N/A
9682-24	Purell Advanced with Aloe Hand Sanitizer, 2 fl.oz. Squeeze Bottle	59.2ml	Green	Floral	24	--	N/A
9698-12	Purell Foaming Hand Sanitizer, Canister	443.6ml	White	Light	12	--	N/A
9752-12	Micrell Antibacterial Lotion Soap, 8 fl.oz.	236.8ml	Amber	Floral	12	--	400014
9757-12	Micrell Antibacterial Lotion Soap with Chloroxylenol, Bag-in-Box	800ml	Amber	Floral	12	--	N/A
9759-12	Micrell Antibacterial Lotion Soap, 12 fl.oz., Pump Bottle	354.9ml	Amber	Floral	12	--	400014
9759-12-CAN00	Micrell Antibacterial Lotion Soap with Chloroxylenol, 12 fl.oz., Pump Bottle	354.9ml	Amber	Floral	12	--	400014



Kimberly-Clark

11279		KLEENEX Antibacterial Foam Skin Cleanser	1500ml	Clear	Fruit	2	8	401212
11280		KLEENEX Foam Skin Cleanser w/Moisturizers	1500ml	Light Pink	Citrus Floral	2	8	401211
12977		KLEENEX Alcohol Free Foam Hand Sanitizer	1000ml	Clear	None	6	15	401213
12979		KLEENEX Alcohol Free Foam Hand Sanitizer	1200ml	Clear	None	2	6.5	401213
34643		KLEENEX ULTRA Moisturizing Foam Hand Sanitizer	1200ml	Clear	None	2	6.5	N/A
34700		KLEENEX ULTRA Moisturizing Foam Hand Sanitizer	1 Liter	Clear	None	6	15	N/A
35042		KLEENEX Green Certified Foam Skin Cleanser	800ml	Clear	None	4	9.2	401211
35362		KLEENEX Moisturizing Hand and Body Lotion	1 Liter	White	Fresh	6	15	N/A
35365		Scott Skin Relief Lotion	1 Liter	White	Fresh	6	15	N/A
41860		Scott Naturally Tuff Orange Skin Cleaner with Grit	3500ml	White	Orange	2	18	N/A
41861		Scott Naturally Tuff Orange Skin Cleaner with Grit	8000ml	White	Orange	2	40	N/A
41863		Scott Super Duty Skin Cleanser with Grit	3500ml	Green	Citrus	2	18	N/A
41864		Scott Super Duty Skin Cleanser with Grit	8000ml	Green	Citrus	2	40	N/A
91045		Scott Naturally Tuff Orange Hand Cleaner with Grit	8000ml	White	Orange	2	40	N/A
91047		Kimcare Industrie Naturally Tuff Orange Hand Cleaner with Grit	3500ml	White	Orange	2	18	N/A
91057		Scott Naturally Tuff Orange Hand Cleaner with Grit, 1 Gallon	3785.4ml	White	Orange	4	37	N/A
91300		Scott Pink Lotion Skin Cleanser, 1 Gallon	3785.4ml	Pink	Peach	4	37	400012
91325		Scott Hair & Body Wash, 1 Gallon	3785.4ml	Yellow	Citrus	4	37	400013
91388		Scott Super Duty Skin Cleanser with Grit, 1 Gallon	3785.4ml	Green	Citrus	4	37	N/A
91437		Scott Golden Lotion Skin Cleanser	1000ml	Yellow	Citrus	3	8.25	400012
91439		Scott Pearlized Lotion Skin Cleanser	1000ml	Blue	Floral	3	8.25	400012
91552		KLEENEX Foam Skin Cleanser w/Moisturizers	1000ml	Light Pink	Citrus Floral	6	15	401211
91553		KLEENEX Foam Hair & Body Wash	1000ml	Light Blue	Floral	6	15	400013
91554		KLEENEX Antibacterial Foam Skin Cleanser	1000ml	Clear	Fruit	6	15	401212
91555		KLEENEX E-2 Foam Skin Cleanser	1000ml	Clear	None	6	15	401212
91556		KLEENEX Gentle Lotion Skin Cleanser	1000ml	Pink	Floral	6	15	400011

ITEM NO.	DESCRIPTION	UNIT SIZE	COLOR	FRAGRANCE	UNITS/ CASE	CASE WT. (LB.)	ESSITY CLOSEST EQUIVALENT
----------	-------------	-----------	-------	-----------	----------------	-------------------	------------------------------

Skincare (cont.)

Kimberly-Clark

91557	KLEENEX Hair & Body Wash	1000ml	Yellow	Citrus	6	15	400013
91560	KLEENEX Moisturizing Foam Hand Sanitizer	1000ml	Clear	Fresh	6	15	401213
91562	KLEENEX Moisturizing Instant Hand Sanitizer	1000ml	White	Fruit	6	15	400216
91565	 KLEENEX Green Certified Foam Skin Cleanser	1000ml	Clear	None	6	15	401211
91590	KLEENEX Moisturizing Foam Hand Sanitizer	1200ml	Clear	Fruit	2	6.5	400216
91591	 KLEENEX Green Certified Foam Skin Cleanser	1200ml	Clear	None	2	6.5	401211
91592	KLEENEX Foam Skin Cleanser w/Moistizers	1200ml	Light Pink	Citrus Floral	2	6.5	401211
91594	KLEENEX Antibacterial Foam Skin Cleanser 5% Triclosan	1200ml	Clear	Fruit	2	6.5	401212
91595	KLEENEX E-2 Foam Skin Cleanser, 1.75% PCMX	1200 ml	Clear	None	2	6.5	401212
91600	KLEENEX Moisturizing Instant Hand Sanitizer	1200ml	White	Fruit	2	6.5	401213
91721	Scott Gentle Lotion Hand Soap	8000ml	Pink	Floral	2	40	400011
91726	Scott Hair & Body Wash	8000ml	Yellow	Citrus	2	40	400013
91748	Scott Super Duty Hand Cleanser with Grit	8000ml	Green	Citrus	2	40	N/A
91757	Scott Super Duty Skin Cleanser with Grit	3500ml	Green	Citrus	2	18	N/A
93060	KLEENEX Instant Hand Sanitizer, 8 fl.oz.	236.8ml	Clear	Citrus	12	6.92	N/A

Kruger Products

03400	Hands-Fresh Luxury Foam Soap	800ml	Clear	Light	12	25	401211
03420	Hands-Fresh Anti-Bac Foam Soap	800ml	Clear	None	12	25	401212
03470	FeelFresh Hand Sanitizing Spray Soap	300ml	Clear	Light	6	5	400016
03473	Hands-Fresh Anti-Bac Spray Soap	400ml	Clear	None	12	12.5	400014
03475	Hands-Fresh Spray Soap	400ml	Pink	Light	12	12.5	400011
03500	Hands-Fresh Luxury Foam Soap	1000mil	Blue	Light	4	11.8	401211
03530	Hands-Fresh Antibacterial Foam Soap w/Moisturizers	1000mil	Clear	None	4	11.8	401212
03570	Hands-Fresh Alcohol-Free Foam Sanitizer	1000mil	Clear	Light	4	11.8	401213

Steris

1105-87	Kindest Kare Skin Cleanser	1000ml	White	Herbal	12	--	400012
1105-K6	Kindest Kare Skin Cleanser, 4. oz.	118.3ml	White	Herbal	72	--	400012
1105-R2	Kindest Kare Skin Cleanser, 15 oz.	443.6ml	White	Herbal	18	--	400012
1117-03	Kindest Kare Hand & Body Wash, 4 oz.	118.3ml	Peach	Floral	72	--	N/A
1117-87	Kindest Kare Hand & Body Wash	1000ml	Peach	Floral	12	--	N/A
1117-R2	Kindest Kare Hand & Body Wash, 15 oz.	443.6ml	Peach	Floral	18	--	N/A
1119-87	Soft N Sure Cleanser	1000ml	Off-White	Lavendar	12	--	400011
1119-R2	Soft N Sure Cleanser, 15 oz.	443.6ml	Off-White	Lavendar	18	--	400011
1152-F6	Kindest Kare Foaming Handwash	1000ml	Clear	Citrus	6	--	401211
1152-FM	Kindest Kare Foaming Handwash	2000ml	Clear	Citrus	12	--	401211
1152-RF	Kindest Kare Foaming Handwash	443.6ml	Clear	Citrus	18	--	401211
1181-03	Cal Stat Plus antiseptic Handrub w/Enhanced Emollients, 4 oz.	118.3ml	Clear	Light	72	--	N/A
1181-49	Cal Stat Plus antiseptic Handrub w/Enhanced Emollients, 2 oz.	59.1ml	Clear	Light	96	--	N/A
1181-87	Cal Stat Plus antiseptic Handrub w/Enhanced Emollients	1000ml	Clear	Light	12	--	N/A
1181-RP	Cal Stat Plus antiseptic Handrub w/Enhanced Emollients, 15 oz.	443.6ml	Clear	Light	18	--	N/A
1199-FH	Kindest Kare Foaming Handwash w/62% Alcohol, 15 oz	443.6ml	Clear	Alcohol	18	--	N/A
1199-FM	Kindest Kare Foaming Handwash w/62% Alcohol	1000ml	Clear	Alcohol	12	--	N/A
1206-87	Acute Kare Healthcare Personnel Hand Wash	1000ml	White	Herbal	12	--	401211
1206-K6	Acute Kare Healthcare Personnel Hand Wash, 4 oz.	118.3ml	White	Herbal	72	--	401211
1206-R2	Acute Kare Healthcare Personnel Hand Wash, 15 oz.	443.6ml	White	Herbal	18	--	401211

ITEM NO.	DESCRIPTION	UNIT SIZE	COLOR	FRAGRANCE	UNITS/ CASE	CASE WT. (LB.)	ESSITY CLOSEST EQUIVALENT
----------	-------------	-----------	-------	-----------	----------------	-------------------	------------------------------

Skincare (cont.)

Steris

1229-87	Medicated Soft N' Sure Healthcare Personnel Hand Wash	1000ml	Off-White	Lavendar	12	--	N/A
1229-R2	Medicated Soft N' Sure Healthcare Personnel Hand Wash, 15 oz.	443.6ml	Off-White	Lavendar	18	--	N/A
1445-73	Soft N Sure Antiseptic Hand Gel, 32 oz.	946.4ml	Clear	Light	6	--	N/A
1445-87	Soft N Sure Antiseptic Hand Gel	1000ml	Clear	Light	12	--	N/A
1445-92	Soft N Sure Antiseptic Hand Gel, 2 oz.	59.1ml	Clear	Light	48	--	N/A
1445-A6	Soft N Sure Antiseptic Hand Gel, 15 oz.	443.6ml	Clear	Light	6	--	N/A
1452-F6	Kindest Kare Antimicrobial Foaming Handwash	1000ml	Clear	Floral	6	--	401212
1452-FM	Kindest Kare Antimicrobial Foaming Handwash	1000ml	Clear	Floral	12	--	401212
1452-RF	Kindest Kare Antimicrobial Foaming Handwash, 15 oz.	443.6ml	Clear	Floral	18	--	401212
6240-87	CV Lotion Soap	100ml	Off-White	Lavendar	12	--	400011
6262-24	CV Medicated Lotion Soap w/0.5% Triclosan, 1 qt.	946.4ml	White	Lavendar	12	--	N/A
6262-87	CV Medicated Lotion Soap w/0.5% Triclosan	1000ml	White	Lavendar	12	--	N/A
6262-K6	CV Medicated Lotion Soap w/0.5% Triclosan, 4 Oz.	118.3ml	White	Lavendar	72	--	N/A
6262-R2	CV Medicated Lotion Soap w/0.5% Triclosan, 15 Oz.	443.6ml	White	Lavendar	18	--	N/A
6396-80	Alcare OR Foamed Antiseptic Handrub, 17 oz.	502.7ml	White	Mild Alcohol	12	--	401213

ITEM NO.	DESCRIPTION	DISPENSER SIZE H X W X D (IN.)	COLOR	MATERIAL	DISPENSERS/ CASE	CASE WT. (LB.)	SCA CLOSEST EQUIVALENT
----------	-------------	-----------------------------------	-------	----------	---------------------	-------------------	---------------------------

Washroom Dispensers

Essity

91210	OptiSource Convertible® Manual Soap Dispenser	6.6875 x 11.125 x 4	Black	Plastic	6	10	N/A
91218	OptiSource Convertible® Electronic Soap Dispenser	6.6875 x 11.125 x 4	Black	Plastic	6	10	N/A
247549A	Tork Twin Jumbo Bath Tissue Roll Dispenser	13.0 x 21.5 x 5.5	Black	Pastic	1	19.05	N/A
302020	Tork Xpress Countertop Multifold Hand Towel Dispenser	7.92 x 12.68 x 4.56	White	Plastic	1	3.9	N/A
302028	Tork Xpress Countertop Multifold Hand Towel Dispenser	7.92 x 12.68 x 4.56	Black	Plastic	1	3.9	N/A
302030	Tork Image Design Xpress Countertop Multifold Hand Towl Disp	7.92 x 12.68 x 4.56	Stainless Steel	Metal/Plastic	1	4.9	N/A
461002	Tork Image Design Matic Hand Towl Roll Dispenser	15.75 x 13.58 x 8.07	Stainless Steel	Metal	1	9.9	N/A
461022	Tork Image Design Matic Hand Towl Roll Disp. Recess	26.97 x 17.64 x 7.87	Stainless Steel	Metal	1	23.8	N/A
461023	Tork Image Design MaticHand Towl Roll Disp in-Wall Recessed	20.55 x 17.64 x 7.87	Stainless Steel	Metal	1	20.7	N/A
461102*	Tork Image Design Matic Disp w/ Intuition Sensor	14.69 x 13.58 x 8.03	Stainless Steel	Metal/Plastic	1	11	N/A
461122*	Tork Image Design Matic Disp w/ Intuition Sensor, in-Wall Recessed	26.97 x 17.60 x 7.99	Stainless Steel	Metal/Plastic	1	24.9	N/A
461123*	Tork Image Design Matic Disp w/ Intuition Sensor, in-Wall Recessed	20.55 x 17.64 x 7.87	Stainless Steel	Metal	1	22	N/A
466000	Tork Image Design Foam Skincare Manual Disp	11.375 x 4.25 x 4.25	Stainless Steel	Metal	4	6.42	N/A
466100	Tork Image Design Foam Skincare Auto Disp-Intuition Sensor	10.625 x 4.5 x 5.125	Stainless Steel	Metal	4	12.88	N/A
466200	Tork Image Design Foam Skincare Auto Disp Intuition® Sensor, EasyCube™	10.625 x 4.5 x 5.125	Stainless Steel	Metal	4	12.88	N/A
463002	Tork Image Design Xpress Hand Towel Dispenser	18.625 x 13 x 3.9375	Stainless Steel	Metal	1	5.93	N/A
465500*	Tork Image Design Mini Jumbo Bath Tissue Roll Disp.	9.875 x 14 x 5.125	Stainless Steel	Metal	1	3.7	N/A
473200	Tork Coreless Elevation High Capacity Bath Tissue Disp.	8.228 x 14.173 x 5.078	White	Plastic	1	2.9	N/A
473208	Tork Coreless Elevation High Capacity Bath Tissue Disp.	8.228 x 14.173 x 5.078	Black	Plastic	1	2.9	N/A
5511202*	Tork Elevation Matic Roll Hand Towel Dispenser-Intuition Sensor	14.6 x 13.2 x 8.1	White	Plastic	1	10.9	N/A
5511282*	Tork Elevation Matic Roll Hand Towel Dispenser-Intuition Sensor	14.6 x 13.2 x 8.1	Black	Plastic	1	10.9	N/A
5510202*	Tork Elevation Matic Roll Hand Towel Dispenser	14.65 x 13.26 x 7.99	White	Plastic	1	7.28	N/A
5510282*	Tork Elevation Matic Roll Hand Towel Dispenser	14.65 x 13.26 x 7.99	Black	Plastic	1	7.28	N/A
552020	Tork Elevation Xpress Hand Towel Dispenser	17.5 x 11.9 x 4	White	Plastic	1	3.3	N/A
552028	Tork Elevation Xpress Hand Towel Dispenser	17.5 x 11.9 x 4	Black	Plastic	1	3.3	N/A
552120	Tork Elevation Xpress Mini Hand Towel Dispenser	11.6 x 11.9 x 4	White	Plastic	1	2.46	N/A
554020A*	Tork Elevation Jumbo Bath Tissue Roll Dispenser	14.2 x 17.2 x 5.2	White	Plastic	1	4.41	N/A
554028A*	Tork Elevation Jumbo Bath Tissue Roll Dispenser	14.2 x 17.2 x 5.2	Black	Plastic	1	4.44	N/A

555020A*	Tork Elevation Mini Jumbo Bath Tissue Roll Dispenser	10.8 x 13.6 x 5.2	White	Plastic	1	2.73	N/A
555028A*	Tork Elevation Mini Jumbo Bath Tissue Roll Dispenser	10.8 x 13.6 x 5.2	Black	Plastic	1	2.75	N/A
5555200	Tork Elevation Twin Mini Jumbo Bath Tissue Roll Disp.	10.125 x 17.0 x 5.6875	White	Plastic	1	4	N/A
5555290	Tork Elevation Twin Mini Jumbo Bath Tissue Roll Disp.	10.125 x 17.0 x 5.6875	Black	Plastic	1	4	N/A
555620	Tork Elevation High-Capacity Bath Tissue Roll Dispenser	14.2 x 6.3 x 6.46	White	Plastic	1	3.03	N/A
555628	Tork Elevation High-Capacity Bath Tissue Roll Dispenser	14.2 x 6.3 x 6.46	Black	Plastic	1	3.03	N/A
556020	Tork Elevation Folded Bath Tissue Dispenser (DoorMate)	10.67 x 6.26 x 5.04	White	Plastic	4	6.97	N/A
556028	Tork Elevation Folded Bath Tissue Dispenser (DoorMate)	10.67 x 6.26 x 5.04	Black	Plastic	4	6.97	N/A
558028A	Tork Elevation Mini Centerfeed Hand Towel Dispenser	13.05 x 6.86 x 6.51	Black	Plastic	1	2.32	N/A
559020A	Tork Elevation Centerfeed Hand Towel Dispenser	14.39 x 9.42 x 8.95	White	Plastic	1	3.97	N/A
559028A	Tork Elevation Centerfeed Hand Towel Dispenser	14.39 x 9.42 x 8.95	Black	Plastic	1	3.97	N/A
565520	Tork High Capacity Bath Tissue Roll Dispenser for OptiCore	9.93 x 16.62 x 5.25	White	Plastic	1	3.43	N/A
565528	Tork High Capacity Bath Tissue Roll Dispenser for OptiCore	9.93 x 16.62 x 5.25	Black	Plastic	1	3.43	N/A
565820	Tork 3 Roll Bath Tissue Roll Dispenser for OptiCore	14.56 x 14.12 x 6.31	White	Plastic	1	4.3	N/A
565828	Tork 3 Roll Bath Tissue Roll Dispenser for OptiCore	14.56 x 14.12 x 6.31	Black	Plastic	1	4.3	N/A
565720	Tork Twin Bath Tissue Roll Dispenser for OptiCore	8.81 x 11.06 x 7.18	White	Plastic	1	2.68	N/A
565728	Tork Twin Bath Tissue Roll Dispenser for OptiCore	8.81 x 11.06 x 7.18	Black	Plastic	1	2.68	N/A
565620	Tork Twin Bath Tissue Roll Dispenser for OptiCore	12.31 x 6.75 x 7	White	Plastic	1	2.41	N/A
565628	Tork Twin Bath Tissue Roll Dispenser for OptiCore	12.31 x 6.75 x 7	Black	Plastic	1	2.41	N/A
570020A	Tork Elevation Liquid Skincare Dispenser	11.5 x 4.4 x 4.5	White	Plastic	6	7.55	N/A
570028A	Tork Elevation Liquid Skincare Dispenser	11.5 x 4.4 x 4.5	Black	Plastic	6	7.55	N/A
571501	Tork Elevation Foam Skincare Manual Dispenser	11.26 x 4.45 x 4.13	White	Plastic	4	4.84	N/A
571508	Tork Elevation Foam Skincare Manual Dispenser	11.26 x 4.45 x 4.13	Black	Plastic	4	4.84	N/A
571600	Tork Elevation Foam Skincare Automatic Dispenser	10.94 x 4.45 x 5.12	White	Plastic	4	7.77	N/A
571608	Tork Elevation Foam Skincare Automatic Dispenser	10.94 x 4.45 x 5.12	Black	Plastic	4	7.77	N/A
682830	Tork Elevation® Foam Skincare Auto Disp w/ Intuition Sensor, EasyCube™	10.94 x 4.45 x 5.12	White	Plastic	4	7.7	N/A
682840	Tork Elevation® Foam Skincare Auto Disp w/ Intuition Sensor, EasyCube™	10.94 x 4.45 x 5.12	Black	Plastic	4	7.7	N/A
771720	Tork Electronic Hand Towel Roll Dispenser	15.95 x 12.32 x 9.32	White	Plastic	1	11.8	N/A
771728	Tork Electronic Hand Towel Roll Dispenser	15.95 x 12.32 x 9.32	Black	Plastic	1	11.8	N/A
771820	Tork Electronic Hand Towel Roll Dispenser	15.95 x 12.32 x 9.32	White	Plastic	1	11.8	N/A
771828	Tork Electronic Hand Towel Roll Dispenser	15.95 x 12.32 x 9.32	Black	Plastic	1	11.8	N/A
774720	Tork Mini Mechanical Hand Towel Roll Dispenser	12.5 x 11.75 x 7.5	White	Plastic	1	6.27	N/A
774728	Tork Mini Mechanical Hand Towel Roll Dispenser	12.5 x 11.75 x 7.5	Black	Plastic	1	6.27	N/A
774820	Tork Mini Mechanical Hand Towel Roll Dispenser	12.5 x 11.75 x 7.5	White	Plastic	1	6.27	N/A
774828	Tork Mini Mechanical Hand Towel Roll Dispenser	12.5 x 11.75 x 7.5	Black	Plastic	1	6.27	N/A

ITEM NO.	DESCRIPTION	DISPENSER SIZE H X W X D (IN.)	COLOR	MATERIAL	DISPENSERS/ CASE	CASE WT. (LB.)	SCA CLOSEST EQUIVALENT
----------	-------------	-----------------------------------	-------	----------	---------------------	-------------------	---------------------------

Washroom Dispensers (cont.)

Basic Dispensers

56TR	Tork Twin Jumbo Bath Tissue Roll Dispenser, 9 inch	11.83 x 19.29 x 5.51	Smoke	Plastic	1	3.55	N/A
59TR	Tork Twin Bath Tissue Roll Dispenser	12.75 x 5.75 x 8.25	Smoke	Plastic	1	2.74	N/A
66TR	Tork Jumbo Bath Tissue Roll Dispenser, 9 inch	12 x 10.63 x 5.75	Smoke	Plastic	1	3.3	N/A
67TR	Tork Jumbo Bath Tissue Roll Dispenser, 12 inch	14.9 x 12.9 x 5.8	Smoke	Plastic	1	2.75	N/A
70WM1	Tork Singlefold Hand Towel Dispenser	9.25 x 11.75 x 5.75	White	Metal	1	5.5	N/A
73TR	Tork Multifold/C-Fold Hand Towel Dispenser	18 x 11.75 x 6.25	Smoke	Plastic	1	3.5	N/A
78T1	Tork Multifold Hand Towel Dispenser	13.0 x 12.36 x 4.82	Smoke/Grey	Plastic	1	3.38	N/A
83TR	Tork Roll Hand Towel Dispenser, Lever	12.82 x 12.49 x 8.6	Smoke	Plastic	1	3.9	N/A
84TR	Tork Roll Hand Towel Dispenser, Lever, Auto Transfer	15.5 x 12.94 x 9.25	Smoke	Plastic	1	8	N/A
86ECO	Tork Roll Hand Towel Dispenser, Electronic, Touch-Free Auto Transfer	14.93 x 11.78 x 9.12	Smoke	Plastic	1	6.21	N/A
87T	Tork Roll Hand Towel Dispenser, Push Bar, Auto Transfer	15.75 x 10.5 x 8.75	Smoke/Grey	Plastic/Metal	1	8.5	N/A
93T	Tork Centerfeed Hand Towel Dispenser	12.75 x 10.125 x 10	Smoke	Plastic	1	3.5	N/A
99A	Tork Toilet Seat Cover Dispenser	11.5 x 16 x 3	White	Plastic	12	29.02	N/A
651220	Tork Performance Washstation Dispenser	18.09 x 12.56 x 10.57	Aqua/White	Plastic	1	10.86	N/A
651228	Tork Performance Washstation Dispenser	18.09 x 12.56 x 10.57	Smoke/Red	Plastic	1	10.86	N/A

*Includes stub roll feature.

ITEM NO.	DESCRIPTION	DISPENSER SIZE H X W X D (IN.)	COLOR	MATERIAL	DISPENSERS/ CASE	CASE WT. (LB.)	SCA CLOSEST EQUIVALENT
----------	-------------	-----------------------------------	-------	----------	---------------------	-------------------	---------------------------

Bath Tissue Dispenser

Cascade

C270	Pro Tandem High Capacity Bathroom Tissue X2 Dispenser	7 x 7 x 11.9	Black	Plastic	1	2.3	565628
C271	Pro Tandem High Capacity Bathroom Tissue X2 Dispenser	7 x 7 x 11.9	White	Plastic	1	2.3	565620
C272	Pro Tandem High Capacity Bathroom Tissue X2S Dispenser	5.4 x 10.9 x 7.3	Black	Plastic	1	2.9	565528
C273	Pro Tandem High Capacity Bathroom Tissue X2S Dispenser	5.4 x 10.9 x 7.3	White	Plastic	1	2.9	565520
C274	Pro Tandem High Capacity Bathroom Tissue X4 Dispenser	6.3 x 13.2 x 15.2	Black	Plastic	1	4.2	N/A
C275	Pro Tandem High Capacity Bathroom Tissue X4 Dispenser	6.3 x 13.2 x 15.2	White	Plastic	1	4.2	N/A
DB18	Universal Standard Bath Tissue Dispenser, Double Roll	19.0 x 12.0 x 5.2	Black	Plastic	1	4	59TR

Georgia Pacific

50011	Compact Spindle	--	Grey/Black	Plastic	100	4.6	N/A
50012	Compact Spindle	--	Grey/Black	Plastic	100	4.6	N/A
50030	Compact Spindle Telescoping	--	Grey	Plastic	100	4.6	N/A
56743	Compact Quad Vertical 4 Roll Coreless Tissue Dispenser	13.25 x 11.75 x 6.9	Splash Blue	Plastic	1	4.62	N/A
56744	Compact Quad Vertical 4 Roll Coreless Tissue Dispenser	13.25 x 11.75 x 6.9	Translucent Smoke	Plastic	1	4.62	473028
56744A	Compact Quad Vertical 4 Roll Coreless Tissue Dispenser	--	Black	Plastic	1	4.09	473028
56746	Compact Quad Vertical 4 Roll Coreless Tissue Dispenser	13.25 x 11.75 x 6.9	Stainless Steel	Metal	1	4.62	N/A
56747	Compact Quad Vertical 4 Roll Coreless Tissue Dispenser	13.25 x 11.75 x 6.9	Translucent White	Plastic	1	4.62	473200
56747A	Compact Quad Side-By-Side Double Roll Bath Tissue Disp	--	White	Plastic	1	4.09	565720
56748	Compact Quad Vertical 4 Roll Coreless Tissue Dispenser	13.25 x 11.75 x 6.9	Stainless Steel	Metal	1	4.62	N/A
56767A	Compact Vertical Double Roll Bath Tissue Dispenser	--	White	Plastic	1	2.55	565620
56780	Compact High Capacity Coreless BT Dispenser (Keyless)	13 x 14 x 5.5	Splash Blue	Plastic	1	4.42	N/A
56781	Compact High Capacity Coreless BT Dispenser (Keyless)	13 x 14 x 5.5	Translucent Smoke	Plastic	1	4.42	N/A
56782	Compact Vertical 2 Roll Bath Tissue Dispenser	13.5 x 6 x 6.5	Stainless Steel	Metal	1	5.17	N/A
56783	Compact Side-By-Side 2 Roll Bath Tissue Disp	7.12 x 10.12 x 6.75	Splash Blue	Plastic	1	1.94	N/A
56783A	Compact Side-By-Side Double Roll Bath Tissue Dispenser	--	Gray	Plastic	1	1.99	565720
56784	Compact Side-By-Side 2 Roll Bath Tissue Disp	7.12 x 10.12 x 6.75	Translucent Smoke	Plastic	1	1.94	N/A
56784A	Compact Side-By-Side Double Roll Bath Tissue Dispenser	--	Black	Plastic	1	1.94	565728
56787	Compact High Capacity Coreless BT Dispenser (Key Lock)	13 x 14 x 5.5	Splash Blue	Plastic	1	4.42	N/A
56788	Compact High Capacity Coreless BT Dispenser (Key Lock)	13 x 14 x 5.5	Translucent Smoke	Plastic	1	4.42	N/A
56789	Compact Vertical 2 Roll Bath Tissue Dispenser	13.5 x 6 x 7	Splash Blue	Plastic	1	2.9	555620

ITEM NO.	DESCRIPTION	DISPENSER SIZE H X W X D (IN.)	COLOR	MATERIAL	DISPENSERS/ CASE	CASE WT. (LB.)	ESSITY CLOSEST EQUIVALENT
----------	-------------	-----------------------------------	-------	----------	---------------------	-------------------	------------------------------

Bath Tissue Dispenser (cont.)

Georgia Pacific

56790	Compact Verticle 2 Roll Bath Tissue Dispenser	13.5 x 6 x 6.5	Translucent Smoke	Plastic	1	2.9	555628
56790A	Compact Verticle Double Roll Bath Tissue Disp	--	Black	Plastic	1	2.55	565628
56796	Compact Side-By-Side 2 Roll Bath Tissue Disp	7.12 x 10.12 x 6.75	Brushed Stainless	Metal	1	1.94	N/A
56796A	Compact Side-By-Side Bath Tissue Disp	--	Stainless Finish	Metal	1	1.99	N/A
57120-01	Open Self Lock 2-Roll Disp	2.75 x 12.375 x 4.375	Chrome	Metal	12	31.2	N/A
56500	SofPull High Capacity Centerpull BT Dispenser	10.5 x 10.5 x 6.75	Splash Blue	Plastic	1	2.54	N/A
56501	SofPull High Capacity Centerpull BT Dispenser	10.5 x 10.5 x 6.75	Smoke	Plastic	1	2.54	N/A
56507	SofPull High Capacity Centerpull BT Dispenser	10.5 x 10.5 x 6.75	Translucent White	Plastic	1	2.54	N/A
56508	SofPull Twin High Capacity Centerpull BT Dispenser	10.75 x 20.125 x 7	Splash Blue	Plastic	1	5.55	N/A
56509	SofPull Twin High Capacity Centerpull BT Dispenser	10.75 x 20.125 x 7	Smoke	Plastic	1	5.55	N/A
56513	SofPull Mini High Capacity Centerpull BT Dispenser	9 x 8.75 x 7	Smoke	Plastic	1	2.54	N/A
56514	SofPull Mini High Capacity Centerpull BT Dispenser	9 x 8.75 x 7	Splash Blue	Plastic	1	2.54	N/A
56515	SofPull Mini High Capacity Centerpull BT Dispenser	9 x 8.75 x 7	White	Plastic	1	2.54	N/A
56516	SofPull Mini Twin High Capacity Centerpull BT Dispenser	9 x 16.1 x 7	Smoke	Plastic	1	5	N/A
56518	SofPull Mini Twin High Capacity Centerpull BT Dispenser	9 x 16.1 x 7	White	Plastic	1	5	N/A
56767	Compact Vertical 2 Roll BT Dispenser	13.5 x 6 x 6.5	Translucent White	Plastic	1	2.9	N/A
56797	Compact Side by Side 2 Roll BT Dispenser	7.12 x 10.12 x 6.75	Translucent White	Plastic	1	1.94	N/A
56798	Compact Side by Side 2 Roll BT Dispenser	7.12 x 10.12 x 6.75	Stainless Steel	Metal	1	1.94	N/A
57220-01	Open Self Lock 1-Roll Disp	2.75 x 6 x 4.25	Chrome	Metal	20	21.8	N/A
57320	Covered Key Lock 2-Roll Disp	6 x 10 x 6.25	Chrome	Metal	6	16.8	N/A
57893	Coverd Vertical 2-Roll Disp	12.75 x 7 x 6.25	Stainless Steel	Metal	6	31.2	N/A
58701	Singlefold Interfold Bath Tissue Disp	8.25 x 5 x 3.125	White	Metal	24	36.2	N/A
59206	Two Roll Side by Side Covered Bath Tissue Disp	8.59 x 13.58 x 5.73	Translucent Smoke	Plastic	1	2.52	N/A
59448	Jumbo Jr. Bath Tissue Dispenser	10.75 x 10.75 x 4.44	Stainless Steel	Metal	1	3.19	N/A
59449	12 inch Jumbo Bath Tissue Dispenser	14.25 x 14.25 x 4.44	Stainless Steel	Metal	1	--	N/A
59503	Safe-T-Guard Door Tissue Dispenser	11.0 x 4.0 x 6.5	Brushed Stainless	Metal	1	1.16	N/A
59506	Safe-T-Guard Door Tissue Dispenser	11.0 x 4.0 x 6.5	Smoke	Plastic	1	1.16	556028
59509	Safe-T-Guard Door Tissue Dispenser	11.0 x 4.0 x 6.5	Splash Blue	Plastic	1	2.08	556020

Kimberly-Clark

09021	Standard Roll Bath Tissue Disp, Double Roll	13.7 x 6 x 6.7	Smoke Grey	Plastic	1	5.95	59TR, 555628
09604	IN-SIGHT® Series-i Double Roll Coreless Dispenser	7.6 x 11.1 x 6	Smoke Grey	Plastic	1	2.35	N/A
09605	WINDOWS® Series-i Double Roll Coreless Dispenser	7.6 x 11.1 x 6	Pearl White	Plastic	1	6.2	N/A
09606	REFLECTIONS® Covered Double Roll Coreless Dispenser	7.1 x 10.1 x 6.4	Stainless Steel	Metal	1	--	N/A
09217	WINDOWS® Series-i Double Roll Coreless Dispenser	9 x 10.75 x 4.5	Pearl White	Plastic	1	2.35	N/A
39728	Mod Hygienic Folded Bath Tissue Dispenser	13.33 x 7 x 5.725	Black	Plastic	1	2	556028
39729	Mod Hygienic Folded Bath Tissue Dispenser	13.33 x 7 x 5.725	Faux Stainless	Metal	1	2	N/A
40407	Mod Hygienic Folded Bath Tissue Dispenser	13.33 x 7 x 5.725	White	Plastic	1	2	556020

Kruger Products

09652	NOIR Twin Bathroom Tissue Dispenser	7.1 x 11.6 x 6.8	Smoke Black	Plastic	1	2.4	555628
-------	-------------------------------------	------------------	-------------	---------	---	-----	--------

Georgia Pacific

59503	Safe-T-Gard Door Tissue Dispenser	11 x 6.6 x 4	Brushed Stainless	Metal	1	1.16	N/A
59506	Safe-T-Gard Door Tissue Dispenser	11 x 6.6 x 4	Translucent Smoke	Plastic	1	1.16	N/A
59509	Safe-T-Gard Door Tissue Dispenser	11 x 6.6 x 4	Splash Blue	Plastic	1	1.16	N/A
58701	Singlefold Interfold Tissue Dispenser	8.25 x 5 x 3.125	White	Metal	24	36	N/A

ITEM NO.	DESCRIPTION	DISPENSER SIZE H X W X D (IN.)	COLOR	MATERIAL	DISPENSERS/ CASE	CASE WT. (LB.)	ESSITY CLOSEST EQUIVALENT
----------	-------------	-----------------------------------	-------	----------	---------------------	-------------------	------------------------------

Centerfeed Roll Towel Dispenser

Cascades

DH09	Universal Centerpull Twister Hand Towel Dispenser	9.5 x 10.2 x 12.2	Smoke Grey	Plastic	1	3	93T
------	---	-------------------	------------	---------	---	---	-----

Georgia Pacific

52109	SofPull CenterPull Large Capacity Towel Disp	11.46 x 10.875 x 10.375	Splash Blue	Plastic	1	3	N/A
52409	SofPull CenterPull Regular Capacity Towel Disp	11.5 x 9.25 x 8.75	Splash Blue	Plastic	1	2.5	N/A
53009	SofPull CenterPull Junior Capacity Towel Disp	10.77 x 7.10 x 6.68	Splash Blue	Plastic	1	1.7	558028A
54050	Centerpull Towel Disp	12.625 x 10.25 x 10.75	Smoke	Plastic	1	1.7	93T
58008	SofPull CenterPull Junior Capacity Towel Disp	10.77 x 7.10 x 6.68	Translucent Smoke	Plastic	1	2.5	558028A
58201	SofPull High Capacity Centerpull Towel Disp	11.46 x 10.875 x 10.375	Translucent Smoke	Plastic	1	3	559028A
58204	SofPull CenterPull Regular Capacity Towel Disp	11.5 x 9.25 x 8.75	Translucent Smoke	Plastic	1	2.5	93T
58217	SofPull High Capacity Centerpull Towel Disp	11.46 x 10.875 x 10.375	Translucent White	Plastic	1	3	559020A
58237	SofPull Regular Capacity Centerpull Towel Disp	11.5 x 9.25 x 8.75	Translucent White	Plastic	1	2.54	N/A

Kimberly-Clark

09335	In-Sight The Protector Center Pull Disp	13 x 10 x 10.6	Smoke Grey	Plastic	1	4.75	93T, 558028A
09989	Roll Control Center Pull Disp	11.8 x 10.3 x 9.2	Smoke/Grey	Plastic	1	4.45	93T, 558028A

Kruger Products

09410	NOIR Center Pull Towel Dispenser	13.4 x 9.9 x 9.8	Smoke Black	Plastic	1	3.2	93T, 559028A
-------	----------------------------------	------------------	-------------	---------	---	-----	--------------

Folded Towel Dispenser

Cascades

DH39	Universal Multifold/C-Fold Hand Towel Dispenser	11.7 x 6.1 x 17.5	Grey	Plastic	1	4	73TR
1381	Wire Wall Rack Disp	10.25 x 4.4 x 6	Stainless Steel	Metal	1	1	--

Georgia Pacific

51000	Singlefold Dispenser	9.25 x 11.75 x 5.625	White	Steel	1	6	70WM1
53270	Universal Compact Folded Towel Disp	13 x 12.375 x 4.875	Stainless Finish	Metal	1	3	N/A
53500	Silhouette® Folded Towel Disp	15.25 x 11.25 x 5	Black Translucent	Plastic	1	5	73TR
53570	Universal Compact Folded Towel Disp	16.75 x 12.25 x 5	Stainless Finish	Metal	1	5.4	N/A
50235	MultiSaver Multifold Recessed Folded Towl Disp	12.25 x 10.5 x 3.5	Grey	Plastic	6	1	N/A
54701	Multifold Towl Disp	8.5 x 11.63 x 4.25	White	Metal	10	31	N/A
54720	Multifold Towl Disp	8.5 x 11.63 x 4.25	Chrome	Metal	10	31	463002
56601	Combination C-Fold/Multifold Towl Disp	15.5 x 11.25 x 4.43	White	Metal	1	5.78	N/A
56620	Combination C-Fold/Multifold Towl Disp	15.5 x 11.25 x 4.43	Chrome	Metal	1	3.16	463002
56630-01	Combi-Fold Combination Towl Disp	15.4 x 11.1 x 5.5	White	Plastic	1	22.5	N/A
56640	Vista C-Fold Countertop Towl Disp	7 x 11 x 4.375	See-Through-Grey	Plastic	6	18	302020
56650-01	Vista Combi-Fold Combination Towl Disp	15.4 x 11 x 5.25	See-Through-Grey	Plastic	1	3.14	73TR
56701	Singlefold Towl Disp	8.125 x 11.625 x 6.625	White	Metal	6	25.8	70WM1
56720	Singlefold Towl Disp	8.125 x 11.625 x 6.625	Chrome	Metal	6	25.8	N/A

ITEM NO.	DESCRIPTION	DISPENSER SIZE H X W X D (IN.)	COLOR	MATERIAL	DISPENSERS/ CASE	CASE WT. (LB.)	ESSITY CLOSEST EQUIVALENT
----------	-------------	-----------------------------------	-------	----------	---------------------	-------------------	------------------------------

Kimberly-Clark

09214	Windows Scottfold Compact Towl Disp	9 x 10.9 x 4.8	Pearl White	Plastic	1	2.35	552120
09215	Windows Scottfold Compact Towl Disp	9 x 10.9 x 4.8	Smoke/Grey	Plastic	1	2.35	N/A
09216	REFLECTIONS® SCOTTFOLD® Compact Dispenser	8.9 x 10.6 x 4.4	Stainless Steel	Metal	1	3.25	463002
09352	The Grabber Disp	2.75 x 9.31 x 5.88	White	Metal	12	17.45	N/A
09905	IN-SIGHT® Series i Universal Towel Dispenser	18.9 x 13.3 x 5.9	Smoke Grey	Plastic	1	--	73TR, 552028
09906	WINDOWS® Series i Universal Towel Dispenser	18.9 x 13.3 x 5.9	Pearl White	Plastic	1	--	552020
09924	Box Cover for Pop-Up Folded Towels	6.1 x 10.4 x 5.4	Stainless Steel	Metal	2	3.4	N/A
34828	Mod SlimFold Folded Towel Dispenser	13.67 x 9.83 x 2.88	Black	Plastic	1	2.9	N/A
34830	Mod SlimFold Folded Towel Dispenser	13.67 x 9.83 x 2.88	White	Plastic	1	2.9	N/A
39710	Mod Universal Folded Towel Dispenser	18.8 x 12.69 x 5.52	Faux Stainless	Metal	1	3	463002
39711	Mod Scottfold Folded Towel Dispenser	18.79 x 10.6 x 5.48	Black	Plastic	1	3.8	552028
39712	Mod Scottfold Folded Towel Dispenser	18.79 x 10.6 x 5.48	Faux Stainless	Metal	1	3.8	463002
39719	Mod Universal Folded Towel Dispenser	18.8 x 12.69 x 5.52	Black	Plastic	1	3	N/A
51904	Kleenex Reveal Folded Towel Dispenser	13.3 x 9 x 5.2	Soft Grey	Plastic	1	--	302030

Kruger

09110	NOIR Folded Towel Dispenser	10.8 x 14.7 x 4.2	Smoke Black	Plastic	1	2.9	552028
-------	-----------------------------	-------------------	-------------	---------	---	-----	--------

ITEM NO.	DESCRIPTION	DISPENSER SIZE H X W X D (IN.)	COLOR	MATERIAL	DISPENSERS/ CASE	CASE WT. (LB.)	ESSITY CLOSEST EQUIVALENT
----------	-------------	-----------------------------------	-------	----------	---------------------	-------------------	------------------------------

Hardwood Roll Towel Dispenser

Cascades

DH37	Universal Lever Roll Towel Dispenser	13.0 x 15.8 x 9.8	Smoke Grey	Plastic	1	7	84TR, 5514009
C331	Pro Tandem Small Footprint Roll Towel Dispenser	11.8 x 13 x 8	Black	Plastic	1	4	774728, 774828
C223	Pro Tandem Mechanical No-Touch Towel Dispenser	11.2 x 15.2 x 9	Black	Plastic	1	6	5510282, 651228
DH55	Universal Mechanical No Touch Roll Towel Dispenser	12.25 x 9.2 x 15.8	Black	Plastic	1	7	N/A
C339	Pro Tandem Small Footprint Roll Towel Dispenser	11.8 x 13.0 x 8.0	White	Plastic	1	6	5510202
DH05	Universal Easy Out Roll Towel Dispenser	11.4 x 11.0 x 13.4	Smoke Grey	Plastic	1	5	N/A
C228	Pro Tandem Electronic Hybrid Roll Towel Dispenser	16.4 x 12.3 x 9.3	Black	Plastic	1	9	5511282
C225	Pro Tandem Mechanical No Touch Roll Towel Dispenser	11.2 x 15.2 x 9.0	White	Plastic	1	6	5510202

Georgia Pacific

0203CH	Cormatic HACCP Guardian Roll Towl Disp	14 x 13.9 x 9.3	White	P8/Plastic	1	9.05	5511202, 651220
0257UH	Cormatic HACCP Guardian Food Processing Towel Disp	13.34 x 13.69 x 8.62	White	P12G/Plastic	6	57	N/A
0258K	Cormatic Service Station Roll Disp	14.75 x 9.65 x 14.75	Smoke	SS-1/Plastic	1	8.36	5510282
54338	Vista Translucent Smoke Hygienic Push Paddle Roll Towl Disp	14.4 x 12.5 x 10.6	Translucent Smoke	Plastic	1	7.6	87T, 84TR, 5514009
56201	Crank Hardwood Roll Towl Disp	10.625 x 10.75 x 8.5	White	Metal	1	10	N/A
58443	MAX 3000 Single Roll Towl Disp	12.85 x 13.25 x 10	Smoke/Black	Plastic	1	8.3	87T, 5510282
58445	MAX 3000 2 Roll Towl Disp (X-Series)	13.16 x 20.53 x 9.1	Black	Plastic	1	10.61	N/A
58446	MAX 3000 2 Roll Towl Disp (Y-Series)	13.16 x 20.53 x 9.1	Black	Plastic	1	10.61	N/A
58447	MAX 3000 2 Roll Towl Disp (Z-Series)	13.16 x 20.53 x 9.1	Black	Plastic	1	10.61	N/A
58461	MAX 3000 Single Roll Towl Disp	12.85 x 13.25 x 10	Smoke/Black	Plastic	1	8.3	87T, 5510282
58467	MAX 3000 Single Roll Towl Disp	12.85 x 13.25 x 10	Smoke/Black	Plastic	1	8	87T, 5510282
58470	SofPull Auto Touchless Towel Dispenser	10.5 x 12.8 x 6.6	Black	Plastic	1	11.88	774728, 774828
58487	SofPull Automated Touchless Towel Disp	10.5 x 12.8 x 6.6	Translucent White	Plastic	1	11.88	774820, 774720
59010	SofPull High-Capacity Automated Roll Towel Dispenser	16 x 12 x 9.75	Black	Plastic	1	8.53	5511282
59316	SofPull Recessed Mechanical Towel Disp	17.1 x 13.6 x 8.75	Stainless Steel	Metal	1	8.75	N/A
59317	SofPull Mechanical Hardwood Roll Towel Dispenser	16.7 x 12.6 x 9.3	Translucent White	Plastic	1	8.53	5510202

ITEM NO.	DESCRIPTION	DISPENSER SIZE H X W X D (IN.)	COLOR	MATERIAL	DISPENSERS/ CASE	CASE WT. (LB.)	ESSITY CLOSEST EQUIVALENT
59407	enMotion Automated Touchless Towel Dispenser	16.75 x 14.8 x 9.75	Translucent White	Plastic	1	11.8	771720, 771820
59437	enMotion Impulse 8 Automated Roll Towel Dispenser	13.12 x 13.23 x 9.5	Translucent White	Plastic	1	8.75	5511202
59437A	enMotion 8 Inch Automated Towel Dispenser	13.12 x 13.23 x 9.5	Translucent White	Plastic	1	9.07	N/A
59447	enMotion Impulse 10 Automated Towel Dispenser	13.3 x 14.8 x 9.75	Translucent White	Plastic	1	9.07	5511202
59450	enMotion Automated Water Resistant Touchless Towel Disp	16.75 x 14.8 x 9.75	Splash Blue	Plastic	1	11.8	N/A
59452	enMotion Automated Touchless Towel Dispenser	16.75 x 14.8 x 9.75	Translucent Smoke	Plastic	1	11.8	N/A
59460	enMotion Automated Touchless Towel Dispenser	16.75 x 14.8 x 9.75	Splash Blue	Plastic	1	11.8	5511202
59462	enMotion Automated Touchless Towel Dispenser	16.75 x 14.8 x 9.75	Translucent Smoke	Plastic	1	11.8	771728, 771828
59466A	enMotion 8 Inch Recessed Automated Touchless Towel Disp	16.4 x 13.3 x 8	Stainless Steel	Metal	1	10.8	N/A
59487	enMotion Impulse 10 Automated Towel Dispenser	13.3 x 14.8 x 9.75	Splash Blue	Plastic	1	9.07	N/A
59488	enMotion Impulse 10 Automated Towel Dispenser	13.3 x 14.8 x 9.75	Translucent Smoke	Plastic	1	9.07	5511282
59489	SofPull Roll Towel Dispenser	16.6 x 12.6 x 9.3	Translucent Smoke	Plastic	1	8.53	5514009
59497	enMotion Impulse 8 Automated Roll Towel Dispenser	13.12 x 13.23 x 9.5	Splash Blue	Plastic	1	8.75	N/A
59497A	enMotion 8 Inch Automated Towel Dispenser	13.2 x 13.25 x 9.5	Splash Blue	Plastic	1	8.75	N/A
59498	enMotion Impulse 8 Automated Roll Towel Dispenser	13.12 x 13.23 x 9.5	Translucent Smoke	Plastic	1	8.75	5511282
59498A	enMotion 8 Inch Automated Towel Dispenser	13.2 x 13.25 x 9.5	Translucent Smoke	Plastic	1	8.75	5511282
59499	SofPull Mechanical Water Resistant Roll Towel Dispenser	16.7 x 12.6 x 9.3	Translucent Smoke	Plastic	1	8.53	651228
59589	Pacific Blue Ultra Mechanical Roll Towel Dispenser	16.7 x 12.6 x 9.3	Black	Plastic	1	7.7	5510282
59590	Pacific Blue Ultra Automated Roll Towel Dispenser	15.5 x 12.9 x 8.7	Black	Plastic	1	--	771728, 771828
ADS200B	Cormatic Automated Designer Series Towel Dispenser	15.5 x 14.25 x 9.10	Black	Plastic	1	10.4	86ECO
ADS200K	Cormatic® Automated Designer Series Towel Dispenser	18 x 14.3 x 9	White	Plastic	1	11.84	5511202
HDS200B	Cormatic Mechanical Designer Series Towel Dispenser	13.6 x 13.8 x 9.2	Black	Plastic	1	8.05	84TR
HDS200K	Cormatic High-Capacity Designer Series Roll Towel Disp	13.6 x 13.8 x 9.2	White	Plastic	1	8.05	5510282
HV200K	Cormatic VuAll High Capacity Roll Disp	14.75 x 9.375 x 13.875	Smoke	P15/Plastic	1	6.64	5510282

Kimberly-Clark

09073	D-2 Hard Roll Towl Disp	17.4 x 16 x 9.7	Smoke Putty	Plastic	1	10.68	87T
09746	IN-SIGHT® OMNI® Roll Towel Dispenser	10 x 10.5 x 10	Smoke Grey	Plastic	1	--	N/A
09765	IN-SIGHT® Series-i LEV-R-MATIC® Roll Towel Dispenser	13.5 x 13.3 x 9.8	Smoke Grey	Plastic	1	7.5	87T, 5514009
09990	IN-SIGHT® SANITOUCH® Hard Roll Towel Dispenser	16.1 x 12.6 x 10.2	Smoke Grey	Plastic	1	7.85	87T, 5510282
09991	WINDOWS® SANITOUCH® Hard Roll Towel Dispenser	16.1 x 12.6 x 10.2	Pearl White	Plastic	1	7.85	5510202
09992	IN-SIGHT® SANTOUCH® Elec Touchless Hard Roll Towl Disp - 1.75 in. Hub	16.1 x 12.6 x 10.2	Smoke Grey	Plastic	1	9.85	5511282

09993	WINDOWS® SANITOUCH® Elec Touchless Hard Roll Twl Disp - 1.75 in. Hub	16.1 x 12.6 x 10.2	Pearl White	Plastic	1	9.9	5511202
09994>	SANITOUCH® Hands-Free Recessed Hard Roll Twl Disp - 1.75 in. Hub	16.6 x 13.3 x 5.1	Stainless Steel	Steel	1	16.85	N/A
09995	WINDOWS® SANITOUCH® Hard Roll Towel Disp - 1.75 in. Hub	16.1 x 12.6 x 10.2	Pearl White	Plastic	1	7.85	5510202, 5511202, 651228
09996	IN-SIGHT® SANITOUCH® Hard Roll Towel Disp - 1.75 in. Hub	16.1 x 12.6 x 10.2	Smoke Grey	Plastic	1	7.85	5510282, 5511282, 651228
09998>	SANITOUCH® Elec Touchless Roll Twl Recessed Disp - 1.75 in. Hub	16.6 x 13.3 x 5.1	Stainless Steel	Steel	1	19.25	N/A
010441	Scott SLIMROLL Roll Towel Dispenser	12 x 12.5 x 7.0	Smoke	Plastic	1	5.3	N/A
10442	Scott SLIMROLL Roll Towel Dispenser	12 x 12.5 x 7.0	White	Plastic	1	5.3	N/A
29734	Mod M Series Manual Hard Roll Dispenser (Green Code)	16.44 x 12.66 x 9.18	Smoke	Plastic	1	12.8	5510282
29735	Mod M Series Manual Hard Roll Dispenser (Green Code)	16.44 x 12.66 x 9.18	White	Plastic	1	7	5510202
29736	Mod M Series Manual Hard Roll Dispenser (Green Code)	16.44 x 12.66 x 9.18	Faux Stainless	Plastic	1	7	461002
29737	Mod E Series Electronic Hard Roll Dispenser (Green Code)	16.44 x 12.66 x 9.18	Smoke	Plastic	1	12.8	771728, 771828
29738	Mod E Series Electronic Hard Roll Dispenser (Green Code)	16.44 x 12.66 x 9.18	White	Plastic	1	9	771720, 771820
29740	Mod NG Electronic Hard Roll Dispenser (Green Code)	16.44 x 12.66 x 9.18	Smoke	Plastic	1	9.4	5511282
29741	Mod NG Electronic Hard Roll Dispenser (Green Code)	16.44 x 12.66 x 9.18	White	Plastic	1	9.2	5511202
34346	Mod M Series Manual Hard Roll Dispenser (Blue Code)	16.44 x 12.66 x 9.18	Black	Plastic	1	7	5510282
34347	Mod M Series Manual Hard Roll Dispenser (Blue Code)	16.44 x 12.66 x 9.18	White	Plastic	1	7	5510202
34348	Mod E Series Electronic Hard Roll Dispenser (Blue Code)	16.44 x 12.66 x 9.18	Smoke	Plastic	1	12.8	771728, 771828
34349	Mod E Series Electronic Hard Roll Dispenser (Blue Code)	16.44 x 12.66 x 9.18	White	Plastic	1	9	771720, 771820
34351	Mod NG Electronic Hard Roll Dispenser (Blue Code)	16.44 x 12.66 x 9.18	Smoke	Plastic	1	9.4	771728, 771828
34354	Mod NG Electronic Hard Roll Dispenser (Blue Code)	16.44 x 12.66 x 9.18	White	Plastic	1	9.2	771720, 771820
34364	Mod M Series Manual Hard Roll Dispenser (Grey Code)	16.44 x 12.66 x 9.18	Black	Plastic	1	7	5510282
34367	Mod M Series Manual Hard Roll Dispenser (Grey Code)	16.44 x 12.66 x 9.18	White	Plastic	1	7	5510202
34369	Mod E Series Electronic Hard Roll Dispenser (Grey Code)	16.44 x 12.66 x 9.18	White	Plastic	1	9	771720,
771820							
34370	Mod NG Electronic Hard Roll Dispenser (Grey Code)	16.44 x 12.66 x 9.18	Smoke	Plastic	1	9.4	5511282
34371	Mod NG Electronic Hard Roll Dispenser (Grey Code)	16.44 x 12.66 x 9.18	White	Plastic	1	9.2	771720, 771820
35610	Mod M Series Manual Hard Roll Dispenser (Grey Code)	16.44 x 12.66 x 9.18	Faux Stainless	Plastic	1	7	461002
35612	Mod M Series Manual Hard Roll Dispenser (Grey Code)	16.44 x 12.66 x 9.18	Faux Stainless	Plastic	1	7	461002
36016	Mod SlimRoll Compact Hard Roll Twl Dispenser	13.02 x 12.65 x 7.18	Black	Plastic	1	5	774728, 774828
36034	Mod SlimRoll Compact Hard Roll Twl Dispenser	13.02 x 12.65 x 7.18	Faux Stainless	Metal	1	5	N/A
36035	Mod SlimRoll Compact Hard Roll Twl Dispenser	13.02 x 12.65 x 7.18	White	Plastic	1	5	774820, 774720
46253	Sott Essential Touchless Roll Twl Dispenser	16.13 x 12.63 x 10.2	Smoke	Plastic	1	7.85	5510282
46254	Sott Essential Touchless Roll Twl Dispenser	16.13 x 12.63 x 10.2	White	Plastic	1	7.85	5510202

>Canada Only

ITEM NO.	DESCRIPTION	DISPENSER SIZE H X W X D (IN.)	COLOR	MATERIAL	DISPENSERS/ CASE	CASE WT. (LB.)	ESSITY CLOSEST EQUIVALENT
----------	-------------	-----------------------------------	-------	----------	---------------------	-------------------	------------------------------

Hardwound Roll Towel Dispenser (cont.)

Kruger

09709	Designer2 Push Bar Roll Towel Dispenser	15.75 x 10.5 x 8.75	Smoke Grey	Plastic	1	7.5	87T
09729	Mini Titan Mechanical Touchless Roll Towel Dispenser	11.8 x 14 x 8.9	Stainless Steel	Metal	1	8.5	N/A
09739	Easy-Flow2 Roll Towel Dispenser	12.9 x 9.8 x 9.5	Smoke Grey	Plastic	1	4	86ECO
09740	NOIR Touchless Mechanical Towel Dispenser	14.8 x 13.6 x 9.4	Smoke Black	Plastic	1	9	5514009
09759	Mini Titan Mechanical Touchless Towel Dispenser	14 x 11.8 x 8.9	Black Smoke Grey	Plastic	1	8.5	N/A
09772	Designer Push Bar Roll Towel Dispenser	15.75 x 10.5 x 8.75	Smoke Grey	Plastic	1	7.8	87T
09789	Mini Titan Mechanical Touchless Roll Towel Dispenser	11.8 x 14 x 8.9	White	Plastic	1	8.5	N/A
09799	Titan Mechanical Touchless Towel Dispenser	14.8 x 13.4 x 9	White	Plastic	1	3.05	5510202
09840	Autoflow Electronic Touchless Towel Dispenser	12.5 x 8.75 x 12.1	Smoke Grey	Plastic	1	7.1	86ECO
09850	NOIR Touchless Electric Roll Towel Dispenser	14.8 x 13.4 x 9.4	Smoke Black	Plastic	1	9.2	5511282
09909	Titan2 Electronic Touchless Towel Dispenser	14.2 x 13.4 x 8.8	Smoke Grey	Plastic	1	8	5511282
09949	Mini Titan Touchless Electronic Roll Towel Dispenser	14 x 12.4 x 8.9	Black Smoke Grey	Plastic	1	8.7	5511282

ITEM NO.	DESCRIPTION	DISPENSER SIZE H X W X D (IN.)	COLOR	MATERIAL	DISPENSERS/ CASE	CASE WT. (LB.)	ESSITY CLOSEST EQUIVALENT
----------	-------------	-----------------------------------	-------	----------	---------------------	-------------------	------------------------------

Jumbo Bath Tissue Dispenser

Cascades

DB09	Universal Jumbo Bath Tissue Dispenser Single Roll 9 in.	9.1 x 5.5 x 11.8	Black	Plastic	1	3	66TR
DB12	Universal Jumbo Bath Tissue Dispenser Double Roll 9 in.	13.6 x 6 x 6	Black	Plastic	1	2	5555290
C259	Tandem+ Single JRT Dispenser	14.6 x 5.9 x 11.6	Black	Plastic	1	2.5	554028A
C264	Tandem+ Single JRT Dispenser	14.6 x 5.9 x 11.6	White	Plastic	1	2.5	554020A
C233	Tandem Jumbo Bath Tissue Dispenser, Double Roll	15 x 22.1 x 5.9	Black	Plastic	1	6	5555290
C244	Tandem Jumbo Bath Tissue Dispenser, Double Roll	15 x 22.1 x 5.9	White	Plastic	1	6	5555200

Georgia Pacific

56500	Sof Pull Center Pull Jrt Bath Tissue Dispenser	10.5 x 10.5 x 6.75	Splash Blue	Plastic	1	2.54	N/A
56501	Sof Pull Center Pull Jrt Bath Tissue Dispenser	10.5 x 10.5 x 6.75	Smoke	Plastic	1	2.54	N/A
58150	Jumbo Jr. BT Disp w/Stub Roll	14.125 x 16.875 x 6.375	Translucent Smoke	Plastic	4	15	N/A
59009	Jumbo Jr. 9" Bathroom Tissue Dispenser	11.29 x 10.61 x 5.39	Translucent Smoke	Plastic	1	2.08	66TR
59012	Jumbo Sr. 12" Bathroom Tissue Dispenser	14.29 x 13.69 x 5.75	Translucent Smoke	Plastic	1	3.10	67TR
59209	Jumbo Jr. 9" Two Roll Bathroom Tissue Dispenser	12.26 x 20.02 x 5.67	Translucent Smoke	Plastic	1	4.24	56TR
59350	Jumbo Sr. BT Disp w/Stub Roll	16.75 x 21.5 x 5.875	Translucent Smoke	Plastic	1	8	N/A
59448	Jumbo Jr. 9" BT Disp	10.75 x 10.75 x 4.44	Stainless Steel	Metal	1	3.19	465500
59449	Jumbo Sr. 12 in. Jumbo Bath Tissue	14.25 x 14.25 x 4.44	Stainless Steel	Metal	6	4.71	N/A

Kimberly-Clark

09078	D-2 JRT Jr Tissue Disp w/Stub Roll	13.1 x 20 x 6	Smoke Putty	Plastic	1	--	N/A
09507	IN-SIGHT® Series-i JRT® Jr. ESCORT® Jumbo Roll Tissue Disp	16 x 13.88 x 5.75	Smoke Putty	Plastic	1	3.3	555028A
09508	WINDOWS® Series-i JRT® Jr. ESCORT® Jumbo Roll Tissue Disp	16 x 13.88 x 5.75	Pearl White	Plastic	1	3.5	555020A
09551	IN-SIGHT® JRT Combo Unit Tissue Dispenser	13.1 x 20.4 x 5.8	Smoke/Grey	Plastic	1	5.95	5555290
09554	In-Sight® Jr. JRT Tissue Dispenser	10.8 x 10.6 x 5.5	Smoke/Grey	Plastic	1	2.35	555028A
09601	IN-SIGHT® Coreless JRT Bath Tissue Disp	9.8 x 14.3 x 6	Stainless Steel	Steel	1	4.4	N/A
09602	IN-SIGHT® Series-i Coreless JRT® E-Z Load Disp	9.68 x 14.125 x 5.25	Smoke Grey	Plastic	1	3.6	554028A
09603	WINDOWS® Coreless JRT Bath Tissue Dispenser	9.8 x 14.3 x 6	Pearl White	Plastic	1	5	554020A
09608	IN-SIGHT® JRT Coreless Jtwin umbo Roll Tissue Disp	10.9 x 20.1 x 5.9	Smoke/Grey	Plastic	1	5	5555290
09609	IN-SIGHT® JRT Coreless Jtwin umbo Roll Tissue Disp	10.9 x 20.1 x 5.9	Pearl White	Plastic	1	5	5555200

ITEM NO.	DESCRIPTION	DISPENSER SIZE H X W X D (IN.)	COLOR	MATERIAL	DISPENSERS/ CASE	CASE WT. (LB.)	ESSITY CLOSEST EQUIVALENT
09612	IN-SIGHT® Series-i JRT® Jumbo Roll Tissue Disp	16 x 14 x 5.8	Smoke Grey	Plastic	1	3.15	67TR, 554028A
09618	IN-SIGHT® Electronic Coreless JRT Dispenser	12.97 x 12.64 x 6.81	Smoke/Grey	Plastic	1	9	N/A
34831	Mod Coreless JRT Jr Bath Tissue Dispenser	10.39 x 14.13 x 5.87	Black	Plastic	1	3.9	N/A
34832	Mod Coreless JRT Jr Bath Tissue Dispenser	10.39 x 14.13 x 5.87	White	Plastic	1	3.9	N/A
39709	Mod Coreless JRT Jr Bath Tissue Dispenser	10.39 x 14.13 x 5.87	Faux Stainless	Metal	1	3	N/A
39730	Mod Coreless JRT Bath Tissue Dispenser	11.6 x 20.25 x 6.25	White	Plastic	1	4	473000
39731	Mod Coreless JRT Bath Tissue Dispenser	11.6 x 20.25 x 6.25	Black	Plastic	1	4	473008
39732	Mod Coreless JRT Bath Tissue Dispenser	11.6 x 20.25 x 6.25	Faux Stainless	Metal	1	4	N/A

Kruger Products

09615	Mini-Max Stainless Steel Bathroom Tissue Dispenser	8.4 x 15.6 x 5.6	Stainless Steel	Metal	1	4.9	N/A
09619	Mini Max2 Stainless Steel Bathroom Tissue Dispenser	8.4 x 15.6 x 5.2	Stainless Steel	Metal	1	4.9	N/A
09632	NOIR JBT Jr. Bathroom Tissue Dispenser	11.2 x 10.4 x 5.0	Smoke Black	Plastic	1	2.4	554028A
09635	JBT Jr. Stainless Steel Bathroom Tissue Dispenser	10.6 x 10.6 x 4.5	Stainless Steel	Metal	1	3.9	465500
09645	NOIR JBT Jr. Twin Bathroom Tissue Dispenser	12.8 x 20 x 5.4	Smoke Black	Plastic	1	7	5555290
09655	NOIR Mini Max JBT Bathroom Tissue Dispenser	10.4 x 15.7 x 5.3	Smoke Black	Plastic	1	8	5555290
09659	Mini-Max Bathroom Tissue Dispenser	9.6 x 15.9 x 5.7	White/Smoke Grey	Plastic	1	3	5555200
09669	Mini-Max Bathroom Tissue Dispenser	9.6 x 15.9 x 5.7	Black Smoke Grey	Plastic	1	2	5555290
09669	Mini-Mas Bathroom Tissue Dispenser	15.6 x 9.1 x 5.5	Black/Smoke Grey	Plastic	1	2	555528A
09672	Da Vinci JRT Jr. Dispenser	11 x 11 x 5.25	White	Plastic	1	2.4	555020A
09675	Da Vinci Mini-Max Dispenser	9.75 x 15.75 x 5.25	White	Plastic	1	4	5555200
09689	Micro-Max Dispenser	8.6 x 13.6 x 5.3	Black	Plastic	1	2.4	5555290
09692	NOIR JBT Sr. Bathroom Tissue Dispenser	14.7 x 13 x 5.4	Smoke Black	Plastic	1	3.8	554028A
09699	Micro-Max Dispenser	7.8 x 13.3 x 5.3	White	Plastic	1	2.4	5555200

Kitchen Towel Dispenser

Georgia Pacific

52720	Perforated Kitchen Towl Disp	3 x 13.25 x 4.75	Chrome	Metal	24	19.2	N/A
-------	------------------------------	------------------	--------	-------	----	------	-----

ITEM NO.	DESCRIPTION	DISPENSER SIZE H X W X D (IN.)	COLOR	MATERIAL	DISPENSERS/ CASE	CASE WT. (LB.)	ESSITY CLOSEST EQUIVALENT
----------	-------------	-----------------------------------	-------	----------	---------------------	-------------------	------------------------------

Skincare Dispensers

Ecolab

92021183	Nexa Compact Touch Free	--	Black	Plastic	6	--	571608
92021184	Nexa Compact Touch Free	--	White	Plastic	6	--	571600
92021188	Nexa Compact Touch Free	--	White	Plastic	8	--	571600
92021189	Nexa Compact Touch Free	--	Black	Plastic	8	--	571608
9202-2510	Touch Free Hand Hygiene Dispenser	--	Grey & Black	Plastic	--	--	571608
9263-4278	Digi Clean Foam Dispenser	--	White	Plastic	--	--	571501

Deb Stoko

827	CliniShield Soap Dispenser	--	White	Plastic	--	--	N/A
29187	Vario Ultra Dispenser	--	White	Plastic	--	--	570020A
29591	Refresh Foam Dispenser	--	Black	Plastic	--	--	571508
30290	Refresh Foam Dispenser	--	White	Plastic	--	--	571501
33098	Refresh Foam Dispenser	--	Chrome	Metal	--	--	466000
33198	Refresh Touch-Free Foam Soap Dispenser	--	White	Plastic	--	--	571600
59808	Vario Ultra Soap Dispenser	--	Black	Plastic	--	--	570028A
89741	Mat Vario Soap Dispenser	--	White	Plastic	--	--	570020A
91128	Proline Curve 1000 Foam Manual Dispenser	--	Black	Plastic	15	--	571508
98123	Proline 1000 Foam Manual Dispenser	--	Stainless Steel	Metal	15	--	466000
433198	Refresh Touch-Free Foam Dispenser	--	--	Plastic	--	--	571501, 571508
28974101	Mat Vario Dispenser	--	Metal	Metal	--	--	466000
55980806	Vario Ultra Dispenser	--	Black	Plastic	--	--	570028A
ANT1LDS	Cleanse Antibac 1000 Foam Manual Dispenser	--	White/Blue	Plastic	15	--	571501
ANT2LDP	Cleanse Antibac 2000 Foam Manual Dispenser	--	White/Blue	Plastic	15	--	571501
AUTOINFCON	Instant FOAM TouchFREE Foam Dispenser with Batteries	--	White	Plastic	8	--	571600
BLK2LDP	Proline Curve 2000 Foam Dispenser	--	Black	Plastic	8	--	571508
BLK4LDR	Proline Curve 4000 Black Liquid Dispenser	--	Black	Plastic	6	--	570028A
BLKS2LDP	Proline Curve 2000 Black Non-Foam Liquid Dispenser	--	Black	Plastic	8	--	570028A

ITEM NO.	DESCRIPTION	DISPENSER SIZE H X W X D (IN.)	COLOR	MATERIAL	DISPENSERS/ CASE	CASE WT. (LB.)	ESSITY CLOSEST EQUIVALENT
----------	-------------	-----------------------------------	-------	----------	---------------------	-------------------	------------------------------

Deb Stoko

GPF3LDQ	Heavy Duty FOAM 3250 Manual Dispenser	--	Black/Purple	Plastic	6	--	571508
HVY2LDB	Cleanse Heavy 2000 Manual Dispenser	--	Black/Purple	Plastic	8	--	N/A
HVY2LDP	Cleanse Heavy 2000 Manual Dispenser	--	White/Purple	Plastic	8	--	N/A
HVY4LDB	Cleanse Heavy 4000 Manual Dispenser	--	Black/Purple	Plastic	6	--	N/A
HVY4LDR	Cleanse Heavy 4000 Manual Dispenser	--	White/Purple	Plastic	6	--	N/A
IFS1LDS	InstantFoam 1000 Foam Manual Dispenser	--	White	Plastic	15	--	571501
LGT1LDS	Cleanse Light 1000 Liquid Manual Dispenser	--	White/Blue	Plastic	15	--	570020A
LGT2LDP	Cleanse Light 2000 Liquid Manual Dispenser	--	White/Blue	Plastic	8	--	570020A
LGT4LDR	Cleanse Light 4000 Liquid Manual Dispenser	--	White/Blue	Plastic	6	--	570020A
RSH1LDS	Refresh Luxury Shower 1000 Liquid Dispenser	--	White	Plastic	15	--	570020A
RSH2LDP	Refresh Luxury Shower 2000 Liquid Dispenser	--	White	Plastic	8	--	570020A
SAN1LDS	Sanitize 1000 Foam Manual Dispenser	--	White/Red	Plastic	15	--	571501
SHW1LDS	Cleanse Shower 1000 Liquid Dispenser	--	White/Blue	Plastic	15	--	570020A
SHW2LDP	Cleanse Shower 2000 Liquid Dispenser	--	White/Blue	Plastic	8	--	570020A
SHW4LDR	Cleanse Shower 4000 Liquid Dispenser	--	White/Blue	Plastic	6	--	570020A
TBK1LDS	Proline Curve 1000 Translucent Liquid Dispenser	--	Black with Chrome	Metal	15	--	570028A
TF2CHR	TouchFREE Foam Dispenser with Batteries	--	Black	Plastic	8	--	571608
TF2WHI	TouchFREE Foam Dispenser with Batteries	--	White	Plastic	8	--	571600
TWH1LDS	Proline Curve 1000 Translucent Liquid Dispenser	--	White with Chrome	Metal	15	--	570020A
ULT2LDP	Cleanse Ultra 2000 Manual Dispenser	--	White/Black	Plastic	8	--	N/A
WHB1LDS	Proline Curve 1000 Liquid Dispenser	--	White	Plastic	15	--	570020A
WHB2LDP	Proline Curve 2000 Foam Dispenser	--	White	Plastic	8	--	571501
WHB4LDR	Proline Curve 4000 Liquid Dispenser	--	White	Plastic	6	--	570020A
WRM1LDS	Cleanse Washroom 1000 Manual Foam Dispenser	--	White/Blue	Plastic	15	--	571501
WRM2LDP	Cleanse Washroom 2000 Manual Foam Dispenser	--	White/Blue	Plastic	8	--	571501
WTS2LDP	Proline Curve 2000 Non-Foam Liquid Dispenser	--	White	Plastic	8	--	570020A
WYH1LDS	Proline Curve 1000 Kids Wash Liquid Dispenser	--	Green/Purple	Plastic	15	--	N/A

ITEM NO.	DESCRIPTION	DISPENSER SIZE H X W X D (IN.)	COLOR	MATERIAL	DISPENSERS/ CASE	CASE WT. (LB.)	ESSITY CLOSEST EQUIVALENT
----------	-------------	-----------------------------------	-------	----------	---------------------	-------------------	------------------------------

Skincare Dispensers

Georgia Pacific

52052	enMotion Auto Touchless Soap Dispenser	11 x 6.7 x 3.9	Splash Blue	Plastic	6	23.94	N/A
52053	enMotion Auto Touchless Soap Dispenser	11 x 6.7 x 3.9	Smoke	Plastic	6	23.94	571608
52054	enMotion Auto Touchless Soap Dispenser	11 x 6.7 x 3.9	Brushed Steel	Metal	1	3.85	466100
52055	enMotion Auto Touchless Sanitizer Disp	11 x 6.7 x 3.9	White	Plastic	1	3.85	571600
52057	enMotion Automated Touchless Soap and Sanitizer Disp	14.062 x 4.625 x 7.125	Black	Plastic	1	3.85	571508
52058	enMotion Automated Touchless Soap and Sanitizer Disp	14.062 x 4.625 x 7.125	White	Plastic	1	3.85	571600
52060	enMotion Automated Touchless Soap and Sanitizer Disp	14.062 x 4.625 x 7.125	Brushed Stainless	Metal	1	3.85	466100
52087	enMotion Auto Touchless Soap Disp	11 x 6.7 x 3.9	White	Plastic	1	3.85	571600
53010	Auto Soap and Sanitizer Disp	10.75 x 5.68 x 5.25	Black	Plastic	1	3.85	571600
53015	Auto Soap and Sanitizer Disp	10.75 x 5.68 x 5.25	Translucent White	Plastic	1	3.85	571600
53052	Manual 1200 ML Soap and Sanitizer Dispenser	10.7 x 5.6 x 4.6	Splash Blue	Plastic	1	1.85	N/A
53053	Manual 1200 ML Soap and Sanitizer Dispenser	10.7 x 5.6 x 4.6	Smoke	Plastic	1	1.85	570028A
53057	Pacific Blue Ultra Soap/Sanitizer Dispenser	12.125 x 5.063 x 6.188	Black	Plastic	1	1.95	571508
53057P	Pacific Blue Ultra Soap/Sanitizer Dispenser	12.125 x 5.063 x 6.188	Black	Plastic	6	--	571508
53058	Pacific Blue Ultra Soap/Sanitizer Dispenser	12.125 x 5.063 x 6.188	White	Plastic	1	1.95	571501
53060	Pacific Blue Ultra Soap/Sanitizer Dispenser	12.125 x 5.063 x 6.188	Brushed Stainless	Metal/Plastic	1	1.95	466000
53087	Manual 1200 ML Soap and Sanitizer Disp	10.7 x 5.6 x 4.6	Translucent White	Plastic	1	1.85	570020A
53250	Handi Fresh 800 ml Soap Disp	10 x 4.5 x 4.75	Gloss Black	Plastic	12	12.1	570028A
53251	Handi Fresh 800 ml Soap Disp	10 x 4.5 x 4.75	Ivory	Plastic	12	12.1	570020A
54010	Automated Touchless Industrial Hand Cleaner Dispenser	6.06 x 11.22 x 7.09	Blue	Plastic	1	--	N/A
54011	Manual Industrial Hand Cleaner Dispenser	4.69 x 7.2 x 3.66	Blue	Plastic	1	--	N/A
GP521	enMotion Automated Touchless Soap & Sanitizer Dispenser	11.0 x 6.7 x 3.9	Birds Eye Maple	Plastic	1	3.85	N/A
GP522	enMotion Automated Touchless Soap & Sanitizer Dispenser	11.0 x 6.7 x 3.9	Black Granite	Plastic	1	3.85	571608
GP523	enMotion Automated Touchless Soap & Sanitizer Dispenser	11.0 x 6.7 x 3.9	Burl Walnut	Plastic	1	3.85	N/A
GP524	enMotion Automated Touchless Soap & Sanitizer Dispenser	11.0 x 6.7 x 3.9	Carbon Fiber	Plastic	1	3.85	571608
GP525	enMotion Automated Touchless Soap & Sanitizer Dispenser	11.0 x 6.7 x 3.9	Mahogany	Plastic	1	3.85	N/A
GP526	enMotion Automated Touchless Soap & Sanitizer Dispenser	11.0 x 6.7 x 3.9	White Marble	Plastic	1	3.85	571600

GoJo

1204-01	Creme Style Soap Dispenser	--	Black	--	1	--	N/A
12125-06 CAN00	Micrell NXT Space Saver Dispenser, 1,000ml	--	Dove Grey	Plastic	6	--	N/A

ITEM NO.	DESCRIPTION	DISPENSER SIZE H X W X D (IN.)	COLOR	MATERIAL	DISPENSERS/ CASE	CASE WT. (LB.)	ESSITY CLOSEST EQUIVALENT
----------	-------------	-----------------------------------	-------	----------	---------------------	-------------------	------------------------------

Skincare Dispensers

GoJo

1275-01	Flat Top Gallon Soap Dispenser	--	Beige	Plastic	1	--	N/A
1279-01	Prof Paint & Body Shop Hand Cleaner Flat Top Gallon Soap Disp	--	Silver	Brushed Aluminum	1	--	N/A
1371-04	Provon LTX-7 Touch Free Dispenser	--	Gray/White	Plastic	4	--	570020A
1372-04	Provon LTX-7 Foam Touch Free Dispenser	--	Chrome/Black	Metal	4	--	466100 1380-04
LTX-7 Foam Touch Free Dispenser		--	White	Plastic	4	--	571600
1384-04	LTX-7 Foam Touch Free Dispenser	--	Gray/White	Plastic	4	--	571600
1386-04	LTX-7 Touch Free Dispenser	--	Black	Plastic	4	--	571608
1388-04	LTX-7 Touch Free Dispenser	--	Chrome/Black	Metal	4	--	466100
1390-04	MICRELL LTX-7 Foam Touch Free Dispenser	--	White	Plastic	4	--	571600
1919-04	LTX-12 Foam Touch Free Dispenser	--	Chrome/Black	Metal	4	--	466100
1971-04	Provon LTX-12 Foam Touch Free Dispenser	--	Gray/White	Plastic	4	--	571600
1972-04	Provon LTX-12 Foam Touch Free Dispenser	--	Chrome/Black	Metal	4	--	466100
1980-04	LTX-12 Foam Touch Free Dispenser	--	White	Plastic	4	--	571600
1984-04	LTX-12 Foam Touch Free Dispenser	--	Gray/White	Plastic	4	--	571600
1986-04	LTX-12 Foam Touch Free Dispenser	--	Black	Plastic	4	--	571608
2115-06	Provon NXT Space Saver Soap Dispenser	--	Dove Gray	Plastic	6	--	N/A
2115-06 CAN00	Provon NXT Space Saver Dispenser, 1,000ml	--	Dove Grey	Plastic	6	--	N/A
2120-06	Purell NXT Space Saver Soap Dispenser	--	Dove Gray	Plastic	6	--	N/A
2120-06 CAN00	Purell NXT Space Saver Dispenser, 1,000ml	--	Dove Grey	Plastic	6	--	N/A
2125-06	Micrell NXT Space Saver Soap Dispenser	--	Dove Gray	Plastic	6	--	N/A
2125-06-CAN00	Micrell NXT Space Saver Soap Dispenser	--	Dove Gray	Plastic	6	--	N/A
2130-06	NXT Space Saver Soap Dispenser	--	Dove Gray	Plastic	6	--	N/A
2135-06	NXT Space Saver Soap Dispenser	--	Black	Plastic	6	--	N/A
2140-06	Aquell NXT Space Saver Soap Dispenser	--	Dove Gray	Plastic	6	--	N/A
2215-08	Provon NXT Maximum Capacity Soap Dispenser	--	Dove Gray	Plastic	8	--	N/A
2215-08 CAN00	Provon NXT Maximum Capacity Dispenser, 2,000ml	--	Dove Grey	Plastic	8	--	N/A
2220-08	Purell NXT Maximum Capacity Soap Dispenser	--	Dove Gray	Plastic	8	--	N/A
2225-08	Micrell NXT Maximum Capacity Soap Dispenser	--	Dove Gray	Plastic	8	--	N/A
2225-08 CAN00	Micrell NXT Maximum Capacity Dispenser, 2,000ml	--	Dove Grey	Plastic	8	--	N/A

2230-08	NXT Maximum Capacity Soap Dispenser	--	Dove Gray	Plastic	8	--	571501
2235-08	NXT Maximum Capacity Soap Dispenser	--	Black	Plastic	8	--	571508
2315-06	Provon NXT Sid-By-Side Soap Dispenser	--	Dove Gray	Plastic	6	--	N/A
2315-06 CAN00	Provon NXT Side by Side Dispenser, 1,000ml	--	Dove Grey	Plastic	6	--	N/A
2325-06	NXT Side-By-Side Soap Dispenser	--	Dove Gray	Plastic	6	--	N/A
2720-12	Purell TFX Foam Soap Touch Free Dispenser, 1,200ml	--	Gray	Plastic	12	--	571600
2720-12 CAN00	Purell TFX Touch Free Dispenser, 1,200ml	--	Gray	Plastic	12	--	N/A
2730-12	TFX Foam Soap Touch Free Dispenser, 1,200ml	--	Black	Plastic	12	--	571608
2730-12 CAN00	TFX Touch Free Dispenser, 1,200ml	--	Black	Plastic	12	--	N/A
2740-12	TFX Foam Soap Touch Free Dispenser, 1,200ml	--	Gray	Plastic	12	--	571600
2740-12 CAN00	TFX Touch Free Dispenser, 1,200ml	--	Gray	Plastic	12	--	N/A
2745-12	Provon TFX Foam Soap Touch Free Dispenser, 1,200ml	--	Gray	Plastic	12	--	571600
2745-12 CAN00	Provon TFX Touch Free Dispenser, 1,200ml	--	Gray	Plastic	12	--	N/A
2750-12	Micrell TFX Foam Soap Touch Free Dispenser, 1,200ml	--	Gray	Plastic	12	--	571600
2780-12	Purell TFX Foam Touch Free Dispenser	--	Nickel	Metal	12	--	466100
2785-12	Purell Surgical Scrub TFX Touch Free Soap Dispenser	--	Gray	--	12	--	N/A
2789-12	TFX Foam Touch Free Dispenser	--	Nickel	Metal	12	--	466100
2789-12-EEU00	TFX Foam Touch Free Dispenser	--	Brushed Metallic	Metal	12	--	466100
2790-12-EEU00	Purell TFX Foam Touch Free Dispenser	--	Brushed Metallic	Metal	12	--	466100
4031-01	Provon Pro 2000 Soap Dispenser	--	White	Plastic	1	--	N/A
4298-06	Provon Foot Pump Soap Dispenser	--	Blue	--	6	--	N/A
5120-06	Purell FMX-12 Foam Soap Dispenser, 1,200ml	--	Dove Gray	Plastic	12	--	571501
5150-06	FMX-12 Foam Soap Dispenser, 1,250 ml	--	Dove Gray	Plastic	6	--	571501
5155-06	FMX-12 Foam Soap Dispenser, 1,250 ml	--	Black	Plastic	6	--	571508
5158-06	FMX-12 Foam Soap Clean Gene Dispenser, 1,250 ml	--	Grey	Plastic	6	--	571501
5160-06	Provon FMX-12 Foam Soap Dispenser, 1,250 ml	--	Dove Gray	Plastic	6	--	571501

ITEM NO.	DESCRIPTION	DISPENSER SIZE H X W X D (IN.)	COLOR	MATERIAL	DISPENSERS/ CASE	CASE WT. (LB.)	ESSITY CLOSEST EQUIVALENT
----------	-------------	-----------------------------------	-------	----------	---------------------	-------------------	------------------------------

Skincare Dispensers (cont.)

Go Jo

5170-06	Micrell FMX-12 Foam Soap Dispenser, 1,250ml	--	Dove Gray	Plastic	6	--	571501
5172-06	Provon FMX-12 Liquid Manual Dispenser	--	Gray	Plastic	6	--	570020A
5250-06	FMX-20 Foam Soap Dispenser, 2,000ml	--	Dove Gray	Plastic	6	--	N/A
5255-06	FMX-20 Foam Soap Dispenser, 2,000ml	--	Black	Plastic	6	--	N/A
5260-06	Provon FMX-20 Foam Soap Dispenser, 2,000ml	--	Dove Gray	Plastic	6	--	N/A
5270-06	FMX-20 Foam Manual Dispenser	--	White/Gray	Plastic	6	--	571501
5271-06	FMX-20 Foam Manual Dispenser	--	Chrome/Black	Metal	6	--	466000
5277-06	Provon FMX-20 Foam Manual Dispenser	--	White/Gray	Plastic	6	--	571501
7200-01	Pro 2000 Soap Dispenser	--	Black	Plastic	1	--	N/A
7205-01	Pro 2000 Soap Dispenser	--	White	Plastic	1	--	N/A
7500-01	Pro 5000 Soap Dispenser	--	Black	Plastic	1	--	N/A
8200-12	Hand Medic Soap Dispenser	--	Black	Plastic	12	--	571508
8500-01	CX Foam Soap Counter Mount Dispenser, 1,500 ml	--	Silver	Chrome	1	--	N/A
8520-01	CXi Foam Soap Free Counter Mount Dispenser	--	Silver	Chrome	1	--	N/A
8530-01	Cxac Touch Free AC Powered Counter Mount Foam Soap Disp	--	Silver	Chrome	1	--	N/A
8720-06	Purell ADX-7 Foam Manual Dispenser	--	White	Plastic	6	--	571501
8728-06	Purell ADX-7 Foam Manual Dispenser	--	Chrome/Black	Metal	6	--	466000
8771-06	Provon ADX-7 Foam Manual Dispenser	--	Gray/White	Plastic	6	--	571501
8772-06	Provon ADX-7 Foam Manual Dispenser	--	Chrome/Black	Metal	6	--	466000
8780-06	ADX-7 Foam Manual Dispenser	--	White	Plastic	6	--	571501
8781-06	Hand Medic ADX-7 Liquid Manual Dispenser	--	White	Plastic	6	--	570020A
8782-06	Hand Medic ADX-7 Liquid Manual Dispenser	--	Chrome/Black	Metal	6	--	466000
8784-06	ADX-7 Foam Manual Dispenser	--	Gray/White	Plastic	6	--	571501
8786-06	ADX-7 Foam Manual Dispenser	--	Black	Plastic	6	--	571508
8788-06	ADX-7 Foam Manual Dispenser	--	Chrome/Black	Metal	6	--	466000
8790-06	Micrell ADX-7 Foam Manual Dispenser	--	White	Plastic	6	--	571501
8820-06	Purell ADX-12 Foam Manual Dispenser	--	White	Plastic	6	--	571501
8828-06	Purell ADX-12 Foam Manual Dispenser	--	Chrome/Black	Metal	6	--	466000
8871-06	Provon ADX-12 Foam Manual Dispenser	--	Gray/White	Plastic	6	--	571501
8872-06	Provon ADX-12 Foam Manual Dispenser	--	Chrome/Black	Metal	6	--	466000

8880-06	ADX-12 Foam Manual Dispenser	--	White	Plastic	6	--	571501
8881-06	ADX-12 Foam Manual Dispenser	--	White w/Orange	Plastic	6	--	571501
8882-06	ADX-12 Foam Manual Dispenser	--	White w/Graphics	Plastic	6	--	571501
8884-06	ADX-12 Foam Manual Dispenser	--	Gray/White	Plastic	6	--	571501
9005-12	Places Soap Holder	--	Clear	--	12	--	N/A
9023-06 CAN00	Purell Sanitizing Hand Wipe Dispenser	--	Clear Acrylic	Plastic	6	--	N/A
9601-12	Purell Instant Hand Sanitizer 8 fl.oz. Soap Dispenser	--	White	--	12	--	N/A
9699-12	Purell APXX Foam Soap Aerosol Dispensing System	--	Dove Gray	Plastic	12	--	N/A

Kimberly-Clark

11329	Electronic Cassette Skincare Dispenser	11.48 x 7.25 x 4.0	Brushed Metallic	Metal	1	3.75	466100
11430	Electronic Skin Care Cassette Dispenser Floor Stand	57.4 x 17.7 x 1	Black	Plastic	1	14.9	570038
91936	SURETOUCH® Counter Mount Soap Dispenser	2.4 x 1.3 x 2.4	Polished Chrome	Metal	1	1.3	N/A
92013	IN-SIGHT® Sanituff PUSH Soap Dispenser	17.5 x 10.75 x 7.0	Smoke Grey	Plastic	1	4	N/A
92144	KimCare Cassette Skincare Dispenser, 1,000ml	8.375 x 5 x 5.25	White	Plastic	1	1.25	570020A
92145	KimCare Cassette Skincare Dispenser, 1,000ml	8.375 x 5 x 5.25	Black	Plastic	1	1.25	570028A
92147	Touchless Cassette Skincare Dispenser	7.25 x 11.48 x 4.0	White	Plastic	1	4	571600
92148	Touchless Cassette Skincare Dispenser	7.25 x 11.48 x 4.0	Black	Plastic	1	4	571608
32499	Mod Electronic Touchless Cassette Skin Care Dispenser	11.69 x 7.29 x 4	White	Plastic	1	4.4	571600
32508	Mod Electronic Touchless Cassette Skin Care Dispenser	11.69 x 7.29 x 4	Faux Stainless	Metal	1	4.4	466100

Kruger Products

09250	Da Vinci hands-Fresh Foam Soap Dispenser	8.3 x 4.8 x 3.75	White	Plastic	1	1.5	571508
09260	Da Vinci FeelFresh Hand Sanitizing System	8.3 x 4.8 x 3.75	White	Plastic	1	0.8	570020A
09275	Da Vinci Spay Soap Dispenser	8.3 x 4.8 x 3.75	White	Plastic	1	0.8	570020A
09430	Hands-Fresh Touchless Foam Soap Dispenser	5.2 x 5.2 x 10.9	Stainless Black	Plastic	1	0.2	466100
09450	Hands-Fresh Touchless Foam Soap Dispenser	5.2 x 5.2 x 10.9	Black	Plastic	1	0.2	571608
09470	Hands-Fresh Touchless Foam Soap Dispenser	5.2 x 5.2 x 10.9	White	Plastic	1	0.2	571600

ITEM NO.	DESCRIPTION	DISPENSER SIZE H X W X D (IN.)	COLOR	MATERIAL	DISPENSERS/ CASE	CASE WT. (LB.)	ESSITY CLOSEST EQUIVALENT
----------	-------------	-----------------------------------	-------	----------	---------------------	-------------------	------------------------------

Skincare Dispensers (cont.)

Steris

1173Q2	EZ Touch Dispenser	--	White	--	6	--	571501
1174Q2	EZ Touch Dispenser	--	Beige	--	6	--	571501
1307Q5	SDS Dispenser	--	White	--	12	--	570020A
3D60-Q5	Air Infused Manual Foam Dispenser	--	White	Plastic	12	--	571501
3D65-Q5	Air Infused Touchless Dispenser	--	White	Plastic	12	--	571600
4D40-Q5	SDS Manual Dispenser	--	White	Plastic	12	--	N/A
T521-Q2	FSD Foam Manual Dispenser	--	White	Plastic	6	--	571501

Toilet Seat Cover Dispenser

Georgia Pacific

57710	Safe-T-Gard 1/2 Fold Seatcover Disp	11.75 x 16.375 x 2.5	White	Plastic	10	14	99A
57725	Safe-T-Gard 1/2 Fold Seatcover Disp	11.25 x 16.125 x 2	Chrome	Metal	12	33.7	N/A
57726	Safe-T-Gard 1/4 Fold Seatcover Disp	12.5 x 8.25 x 3	White	Plastic	12	10	N/A
57737	Safe-T-Gard 1/2 Fold Seatcover Disp	11.75 x 16.375 x 2.5	Grey	Plastic	10	14	99A
57748	Safe-T-Gard 1/2 Fold Seatcover Disp	11.75 x 16.375 x 2.5	Black	Plastic	10	14	344088

Kimberly-Clark

09505	WINDOWS Toilet Seat Cover Dispenser	13.25 x 17.5 x 2.25	White	Metal	1	3.35	344080
09506	WINDOWS Toilet Seat Cover Dispenser	13.25 x 17.5 x 2.25	Black	Metal	1	3.35	344088
09512	Toilet Seat Cover Dispenser	12.25 x 16.63 x 2.5	Stainless Steel	Metal	1	5.35	N/A
19510	Silhouette® Toilet Seat Cover Disp	11.875 x 16.125 x 3.125	Black Translucent	Plastic	10	16	99A
19517	Elegance Series Toilet Seat Cover Disp	11.875 x 16.125 x 3.125	Stainless Finish	Metal	--	16	N/A

ITEM NO.	DESCRIPTION	DISPENSER SIZE H X W X D (IN.)	COLOR	MATERIAL	DISPENSERS/ CASE	CASE WT. (LB.)	ESSITY CLOSEST EQUIVALENT
----------	-------------	-----------------------------------	-------	----------	---------------------	-------------------	------------------------------

Waste Bins

Essity

309051	Recess Unit with Bin is used for Recessed Dispensers	56.0 x 17.125 x 9.0	Stainless Steel	Metal	1	40.8	N/A
--------	--	---------------------	-----------------	-------	---	------	-----

Georgia Pacific

59451	Trash Receptacle (12 inch on center stud)	56 x 17 x 8	Stainless Steel	Metal	1	44	309051
59471	Trash Receptacle (12-16 inch on center stud)	60.1 x 17.2 x 7.88	Stainless Steel	Metal	1	40	309051
59491	Trash Receptacle (16 inch on center stud)	56 x 17.2 x 7.75	Stainless Steel	Metal	1	44	309051
59502	Saft-T-Guard Tissue Trash Receptacle	11.0 x 6.6 x 4.0	Stainless Steel	Metal	1	3.76	N/A
59508	Saft-T-Guard Tissue Trash Receptacle	11.0 x 6.6 x 4.0	Splash Blue	Plastic	1	3.76	N/A
59513	Saft-T-Guard Tissue Trash Receptacle	11.0 x 6.6 x 4.0	Smoke	Plastic	1	3.76	N/A

Wiper Dispensers

Essity

70WM1	Tork Singlefold Dispenser	9.25 x 11.75 x 5.75	White	Metal	1	5.5	N/A
207328	Tork Top-Pak Bracket Dispenser	7.8 x 16 x 8.6	Black	Plastic	1	2.4	N/A
2083281	Tork Pop-Up Bracket Dispenser	5 x 13.5 x 3	Black	Plastic	6	2.61	N/A
651120	Tork Performance Washstation Dispenser	18 x 12 x 10	Aqua/White	Plastic	1	10	N/A
651128	Tork Performance Washstation Dispenser	18 x 12 x 10	Red/Smoke	Plastic	1	10	N/A
6520281	Tork Performance Floor Stand Wiper Dispenser	39.6 x 25.43 x 20.87	Red/Smoke	Plastic/Steel	1	18.84	N/A
6521281	Tork Performance Wall Mount Wiper Dispenser	18.23 x 25.43 x 10.79	Red/Smoke	Plastic/Steel	1	8.57	N/A
653020	Tork Performance Maxi Centerfeed Towel Dispenser	17.6 x 12.91 x 11.89	Aqua/White	Plastic	1	7.1	N/A
653028	Tork Performance Maxi Centerfeed Towel Dispenser	17.6 x 12.91 x 11.89	Red/Smoke	Plastic	1	7.1	N/A
654021	Tork Performance Folded Wiper Cloth Dispenser	15.1 x 16.81 x 8.11	Aqua/White	Plastic	1	5.16	N/A
6540281	Tork Performance Folded Wiper Cloth Dispenser	15.1 x 16.81 x 8.11	Red/Smoke	Plastic	1	5.16	N/A
659020	Tork Performance Centerfeed Wiper Dispenser	14.02 x 9.76 x 9.13	Aqua/White	Plastic	1	3.64	N/A
659028	Tork Performance Centerfeed Wiper Dispenser	14.02 x 9.76 x 9.13	Red/Smoke	Plastic	1	3.64	N/A
651220*	Tork Performance Washstation Dispenser	18.09 x 12.56 x 10.57	Aqua/White	Plastic	1	10.96	N/A
651228*	Tork Performance Washstation Dispenser	18.09 x 12.56 x 10.57	Red/Smoke	Plastic	1	10.96	N/A
655300	Tork Small Bracket Wiper Dispenser	5.74 x 8.42 x 4.22	White	Plastic	4	3.35	N/A

*Competitor equivalent dispensers found in Hardwound Roll Towel Dispenser Section

Chicopee

D111	DuraWipe XTRA Floor Stand	--	Black/White	--	5	36	6520281
D112	DuraWipe XTRA Wall Mount	--	Black/White	--	3	10	6521281

Georgia Pacific

20044	Brawny Industrial All Purp Refillable Lt Duty Wiper in Bucket Disp	--	White	Plastic	2	7.77	450340
50313	Multi-Plate Wiper Disp	8 x 10.75 x 0.375	White	Metal	10	20	N/A
54006	Brawney Industrial Surface System Disp Bucket	7 x 7.8 x 7.8	White	Plastic	6	3.86	450340
54140	Brawny Bucket Dispenser Bracket	11.25 x 8.0 x 9.125	Chrome	Metal	6	12.71	N/A
54300	Vista Wiper Dispenser for 1/4 Fold Wipers	6.875 x 8.0 x 5.875	Clear	Plastic	6	13	N/A
54560	Long Distance Roll Wiper Disp	37.75 x 19.5 x 32	Red	Metal	1	25	6520281
54565	Long Distance Roll Wiper Disp	37.75 x 19.5 x 32	Blue	Metal	1	25	6520281
54566	Wall Mount Long Distance Roll Wiper Disp	9.625 x 13.375 x 12.125	Blue	Metal	1	5.89	6521281
54621	21 in. Cleaning Cloth Dust-N-Clean Tool	59 x 21 x 4.5	White	Metal	1	4.2	N/A
54912	Wire Wall Mount Boxed Wiper Disp	10.5 x 5.625 x 5.5	Chrome	Metal	6	3.9	N/A
54916	Box Wipes Dispenser	11.625 x 9 x 5.25	White	Plastic	1	7.5	N/A
59465	goRag Auto Wiper Dispenser	13.3 x 14.8 x 9.75	Crimson	Plastic	1	9.07	N/A
59850	Vista Wiping Twl Disp	10.75 x 11.25 x 5.63	See-Through-Grey	Plastic	1	4	302028

Kimberly-Clark

73900	ACCESS® Wall Mount Wiper Dispenser	8 x 10.75 x 6.3	White	Metal	10	--	N/A
80579	WYPALL® Jumbo Wall Mount Wiper Dispenser	8.75 x 16.75 x 10.75	Blue	Metal	1	--	6521281
80596	WYPALL® Jumbo Roll Dispenser	33 x 16.75 x 18.5	Black	Metal	1	--	6520281
83561	WypAll Wipers in a Bucket	--	White	Plastic	2	--	450340

ITEM NO.	DESCRIPTION	DISPENSER SIZE H X W X D (IN.)	COLOR	MATERIAL	DISPENSERS/ CASE	CASE WT. (LB.)	ESSITY CLOSEST EQUIVALENT
----------	-------------	-----------------------------------	-------	----------	---------------------	-------------------	------------------------------

Dispenser Napkin Dispensers

Essity

1TBS	Tork Tallfold Napkin Dispenser	7.325 x 3.75 x 4.125	Brushed Steel	Metal	12	14.1	N/A
13CBS	Tork Minifold Counter Napkin Dispenser	4.5 x 7.625 x 11.625	Brushed Steel	Metal	6	24.2	N/A
13TBS	Tork Minifold Tabletop Napkin Dispenser	4.5 x 7.5 x 6	Brushed Steel	Metal	12	29.2	N/A
17CBS	Tork Masterfold Counter Napkin Dispenser	5.625 x 7.625 x 11.75	Brushed Steel	Metal	6	28.7	N/A
17TBS	Tork Masterfold Tabletop Napkin Dispenser	5.625 x 7.5 x 6.25	Brushed Steel	Metal	12	30.5	N/A
21B	Tork RollNap Napkin Dispenser	10 x 8.25 x 11	Black	Plastic	1	3.7	N/A
21GR	Tork RollNap Napkin Dispenser	10 x 8.25 x 11	Granite	Plastic	1	3.7	N/A
31XRT	Tork Xpressnap Classic Café Tabletop Napkin Dispenser	6.2 x 5.875 x 5.875	Granite	Plastic	4	7.36	N/A
32XRT	Tork Xpressnap Classic Café Tabletop Napkin Dispenser	6.2 x 5.875 x 5.875	Black	Plastic	4	7.36	N/A
41XRT	Tork Xpressnap Classic Café Tabletop Napkin Dispenser	6.2 x 5.875 x 5.875	Red	Plastic	4	7.36	N/A
45XRT	Tork Xpressnap Classic Café Tabletop Napkin Dispenser	6.2 x 5.875 x 5.875	Green	Plastic	4	7.36	N/A
8TBS	Tork Lowfold Tabletop Napkin Dispenser	5.5 x 4.0 x 4.75	Brushed Steel	Metal	12	19.8	N/A
72900	Tork Xpressnap Image Napkin Dispenser	7.6 x 8 x 5.5	Walnut	Wood	1	2.56	N/A
73350	Tork Xpressnap Image Napkin Dispenser	8.23 x 7.1 x 5.91	Aluminum	Metal	1	4.35	N/A
75350	Tork Xpressnap Image Cafe Napkin Dispenser	5.44 x 4.77 x 5.67	Aluminum	Metal	4	10.06	N/A
75900	Tork Xpressnap Image Cafe Napkin Dispenser	4.6 x 5.75 x 5.4	Walnut	Wood	4	6.77	N/A
6035050*	Tork Xpressnap Signature In-Counter Napkin Dispenser (5")	6.5 x 9.9 x 7.0	Stainless Finish	Plastic	1	2.69	N/A
6035120	Tork Xpressnap Signature In-Counter Napkin Dispenser (12")	13.5 x 9.9 x 7.0	Stainless Finish	Plastic	1	3.82	N/A
6035200	Tork Xpressnap Signature In-Counter Napkin Dispenser (20")	21.5 x 9.9 x 7.0	Stainless Finish	Plastic	1	4.71	N/A
6032050*	Tork Xpressnap Signature In-Counter Napkin Dispenser (5")	6.5 x 9.9 x 7.0	Black	Plastic	1	2.69	N/A
6032120	Tork Xpressnap Signature In-Counter Napkin Dispenser (12")	13.5 x 9.9 x 7.0	Black	Plastic	1	3.82	N/A
6032200	Tork Xpressnap Signature In-Counter Napkin Dispenser (20")	21.5 x 9.9 x 7.0	Black	Plastic	1	4.71	N/A
6232000	Tork Xpressnap Signature Tabletop Napkin Dispenser	6.1 x 7.9 x 5.9	Black	Plastic	4	8	N/A
6233001	Tork Xpressnap Signature Tabletop Napkin Dispenser	6.1 x 7.9 x 5.9	Blue	Plastic	4	8	N/A
6234000	Tork Xpressnap Signature Tabletop Napkin Dispenser	6.1 x 7.9 x 5.9	Gray	Plastic	4	8	N/A
6235000	Tork Xpressnap Signature Tabletop Napkin Dispenser	6.1 x 7.9 x 5.9	Stainless Finish	Plastic	4	8	N/A
6236000	Tork Xpressnap Signature Tabletop Napkin Dispenser	6.1 x 7.9 x 5.9	Red	Plastic	4	8	N/A
6239000	Tork Xpressnap Signature Tabletop Napkin Dispenser	6.1 x 7.9 x 5.9	Green	Plastic	4	8	N/A
6332000	Tork Xpressnap Signature Stand Napkin Dispenser	24.5 x 9.25 x 9.25	Black	Plastic	1	6.65	N/A

6333001	Tork Xpressnap Signature Stand Napkin Dispenser	24.5 x 9.25 x 9.25	Blue	Plastic	1	6.65	N/A
6334000	Tork Xpressnap Signature Stand Napkin Dispenser	24.5 x 9.25 x 9.25	Gray	Plastic	1	6.65	N/A
6336000	Tork Xpressnap Signature Stand Napkin Dispenser	24.5 x 9.25 x 9.25	Red	Plastic	1	6.65	N/A
6339000	Tork Xpressnap Signature Stand Napkin Dispenser	24.5 x 9.25 x 9.25	Green	Plastic	1	6.65	N/A
6432000	Tork Xpressnap Signature Counter Napkin Dispenser	5.7 x 7.5 x 12.1	Black	Plastic	1	3.49	N/A
6434000	Tork Xpressnap Signature Counter Napkin Dispenser	5.7 x 7.5 x 12.1	Gray	Plastic	1	3.49	N/A
6435000	Tork Xpressnap Signature Counter Napkin Dispenser	5.7 x 7.5 x 12.1	Stainless Finish	Plastic	1	3.49	N/A
6436000	Tork Xpressnap Signature Counter Napkin Dispenser	5.7 x 7.5 x 12.1	Red	Plastic	1	3.49	N/A
6532000	Tork Xpressnap Signature Drive Thru Napkin Dispenser	25 x 9 x 10	Black	Plastic	1	7.32	N/A

*Special Order

Cascade

2260	ServRite Tabletop Dispenser Caddy	6.1 x 14.3 x 2.75	Black	Plastic	1	1	--
2565	ServRite Table Model Napkin Dispenser 6 inch	--	Brushed Metal	Metal	6	34	17TBS
2566	ServRite Table Model Napkin Dispenser	--	Black	Plastic	4	7	17TBS
2567	ServRite In-Counter Top Dispenser 20 inch	--	Smoked Grey / Metal	Metal	1	8	6032200
2568	ServOne Table Top Dispenser	6.5 x 7.6 x 6	Grey	Plastic	4	7	6234000
2575	ServOne Counter and Wall Dispenser	15.8 x 7.5 x 8	Grey	Plastic	1	3	6334000
2576	ServRite 3-in-1 Dispenser	7.25 x 8 x 15.75	Black	Plastic	1	3	6432000
C402	Pro Tandem Tabletop Interfold Napkin Dispenser	8.2 x 6.1 x 6.3	Grey	Plastic	4	8.3	6234000
C431	Pro Tandem Countertop Interfold Napkin Dispenser	8.3 x 16.3 x 6.5	Black	Plastic	1	5.2	6432000
C440	Pro Tandem Stand/Wall Interfold Napkin Dispenser	9.1 x 12.4 x 20.3	Black	Plastic	1	5.5	6332000

ITEM NO.	DESCRIPTION	DISPENSER SIZE H X W X D (IN.)	COLOR	MATERIAL	DISPENSERS/ CASE	CASE WT. (LB.)	ESSITY CLOSEST EQUIVALENT
----------	-------------	-----------------------------------	-------	----------	---------------------	-------------------	------------------------------

Dispenser Napkin Dispensers (cont.)

Georgia Pacific

50002	Hynap Tall fold, Open Face Napkin Dispenser	7.375 x 3.875 x 4.375	Black Metal	Metal	24	1.6	1TBS
50223-01	EasyNap Freestanding Counter Placement Support Stand	29.1 x 8.0 x 6.3	Black	Plastic	1	6.8	N/A
51202	Mornap Cafeteria Model Napkin Dispenser	5.88 x 7.88 x 11.9	Black Chrome Metal	Metal	6	4.8	17CBS
51605	Mornap Table Model Napkin Dispenser	5.375 x 7.5 x 6	Black	Plastic	12	30.46	13TBS
51202	Mornap Cafeteria Model Napkin Dispenser	5.88 x 7.88 x 11.9	Black Chrome Metal	Metal	6	4.8	17CBS
51602	Mornap Tabletop Dispenser	5.375 x 7.5 x 6	Chrome	Metal	12	39.6	17TBS
51703	Mornap High-Capacity Tower Napkin Dispenser	26.50 x 8.0 x 13.8	Black/Grey	Plastic	1	11	6332000
51760	Mornap Drive Thru Napkin Dispenser	26.5 x 8 x 13.65	Black	Plastic	1	8.94	6532000
54114	Dixie Ultra In-Counter Interfold 6 Inch Napkin Dispenser	6 x 5.37 x 7.25	Black	Plastic	1	2.6	6032050
54116	Dixie Ultra In-Counter Interfold 6 Inch Napkin Dispenser	6 x 5.37 x 7.25	Brushed Stainless	Metal/Plastic	1	2.6	6035050
54214	Dixie Ultra In-Counter Interfold 10 Inch Napkin Dispenser	10 x 5.37 x 7.25	Black	Plastic	1	3.6	6032120
54216	Dixie Ultra In-Counter Interfold 10 Inch Napkin Dispenser	10 x 5.37 x 7.25	Brushed Stainless	Metal/Plastic	1	3.6	6035120
54219	Dixie Ultra In-Counter Interfold 23 Inch Napkin Dispenser	7.06 x 8.79 x 23.08	Brushed Stainless	Metal/Plastic	1	4.75	6032200
54221	Dixie Ultra In-Counter Interfold 23 Inch Napkin Dispenser	7.06 x 8.79 x 23.08	Black	Metal/Plastic	1	4.75	6032200
54314	Dixie Ultra In-Counter Interfold 18 Inch Napkin Dispenser	18 x 5.37 x 7.25	Black	Plastic	1	4.4	6032200
54316	Dixie Ultra In-Counter Interfold 18 Inch Napkin Dispenser	18 x 5.37 x 7.25	Black	Plastic	1	4.4	6032200
54223	Dixie Ultra Tower Napkin Dispenser	21.5 x 10.5 x 10.9	Black/Smoke	Plastic	1	3.57	6332000
54460	EasyNap DRIVE-THRU Tower Napkin Dispenser	26.5 x 8 x 13.65	Black	Plastic	1	8.94	6352000
54510	Dixie Ultra Counter Top Napkin Dispenser	7.25 x 9.25 x 13.625	Black	Plastic	1	4.4	6432000
54511	Dixie Ultra Counter Top Napkin Dispenser	7.25 x 9.25 x 13.625	Stainless - Gray	Metal/Plastic	1	4.4	6434000
54512	Dixie Ultra Counter Top Napkin Dispenser	7.25 x 9.25 x 13.625	Stainless - Red	Metal/Plastic	1	4.4	6436000
54514	Dixie Ultra Counter Top Napkin Dispenser	7.25 x 9.25 x 13.625	Stainless - Black	Metal/Plastic	1	4.4	6435000
54527	Dixie Ultra Tabletop Napkin Dispenser	6.64 x 5.9 x 7.48	Grey/Black	Plastic	6	10.5	6232000
54528	Dixie Ultra Tabletop Napkin Dispenser	6.64 x 5.9 x 7.48	Stainless Finish	Metal/Plastic	6	13.6	6235000
54530	EasyNap Jr., Tabletop Dispenser	5.188 x 7.25 x 6.125	Black	Plastic	6	10.3	32XRT
54531	EasyNap Jr., Tabletop Dispenser	5.188 x 7.25 x 6.125	Blue	Plastic	6	10.3	N/A
54532	EasyNap Jr., Tabletop Dispenser	5.188 x 7.25 x 6.125	Red	Plastic	6	10.3	41XRT
54550	Dixie Ultra Tower Napkin Dispenser	28.78 x 8.04 x 8.11	Black	Plastic	1	6.74	6332000
54551	Dixie Ultra Tower Napkin Dispenser	28.78 x 8.04 x 8.11	Grey	Plastic	1	6.74	6334000
54552	Dixie Ultra Tower Napkin Dispenser	28.78 x 8.04 x 8.11	Red	Plastic	1	6.74	6336000

Kimberly-Clark

09023	MegaCartridge Disp	8 x 22.625 x 5.75	Grey	Plastic	1	--	6334000
09064	MegaCartridge In-Counter Disp	20 x 7.5 x 5.4	Stainless Steel	Metal	--	--	6032200

Kruger Products

09311	Onliwon Mealmate Napkin Dispenser - Counter Model	8 x 7.25 x 15.75	Silver Finish	Plastic	1	4	6435000
09333	Onliwon Mealmate Napkin Dispenser - Tabletop Model	7.3 x 6.1 x 6.3	Smoke/Grey	Plastic	1	1.8	6232000



Upgrade bath tissue dispensers to Tork High Capacity Coreless Bath Tissue



How to use the Tork Spindle Guide

Ask these 5 easy questions:

If they have this current spindle . . .

		1	2	3
		WHAT COLOR IS THE CURRENT SPINDLE?	IS THE BODY COLLAPSIBLE OR SOLID?	IS THE BODY SHAPE ROUND OR OVAL?
Manufacturer	Spindle SKU	Body Color	Body Collapsible	Body Shape
ASI+Frost		Black	No	Round
Bobrick	B 4288-9 	Black	No	Round
Bobrick	B 283-604 	Black	No	Round
Bobrick	B 273-103 	Black	No	Flat/oval
Bobrick	B283-504 	Silver/Chrome	Yes	Round
Bradley	PIO-571 	White	No	Round
Bradley	P10-560 	White	Yes	Round
Bradley	P10-550 	Grey (light or dark)	No	Flat/oval
Georgia-Pacific	50012 	Grey (light or dark)	Yes	Round
Georgia-Pacific	50030 <small>(new)</small> 	Grey (light or dark)	Yes	Round
Georgia-Pacific	50030 <small>(old)</small> 	Grey (light or dark)	Yes	Round
Georgia-Pacific	50040 	Grey (light or dark)	Yes	Round
Georgia-Pacific	50011 	Black/Grey	Yes	Round











4

DOES IT HAVE METAL END PINS OR LARGE END FLANGES?

5

IS THE BODY SURFACE SMOOTH OR RIBBED?

Choose this Tork Spindle

End Pin(s) Metal	Large End Flanges	Body Surface	Spindle SKU	Description	Alternative Adapter Option
Yes	No	Ribbed	473030-00 	Type A	
No	No	Ribbed	473020-00 	Type B	
No	No	Smooth	473060-00 	Type D	Type C or B*
Yes	No	Smooth	473040-00 	Type C	
No	No		473060-00 	Type D	Type C or B*
No	No	Smooth	None	None	
No	No	Smooth	473060-00 	Type D	Type C or B*
Yes	No	Ribbed	None	None	
No	Yes	Smooth	473030-00 	Type A	
No	No	Smooth	473040-00 	Type C	Type D
No	Partial	Smooth/Ribbed	473040-00 	Type C	
No	No	Smooth	473040-00 	Type C**	Type D or B*
No	Yes	Smooth	473020-00 	Type B	

*If found in a partition style dispenser
 **Bobrick dispensers

You want to accommodate your guests' needs—with higher capacity, more efficiency and less waste. The new Tork Elevation Coreless High Capacity Bath Tissue Dispensing System delivers two compact rolls of quality bath tissue that last longer, complement your environment and meet your guests' expectations.

Go coreless

Without the core, you gain more. You get two high capacity bath tissue rolls equivalent to five conventional bath tissue rolls—in a compact dispensing system designed to fit your space. That's additional bath tissue your guests will appreciate and a lower chance of paper run-out.

Save more

When you reduce waste in your operation, it pays off. Tork Elevation Coreless High Capacity Bath Tissue rolls allow you to manage waste effectively and responsibly, so your staff has less trash to remove and more time for the tasks that keep your business running smoothly.

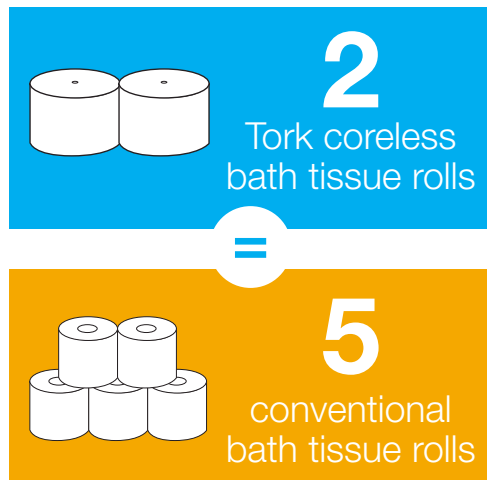

Tork Elevation Coreless High Capacity Bath Tissue Dispensing System

- High capacity compact rolls
- No core for more sheets per roll
- Soft quality tissue with an embossed pattern
- Compact, contemporary design
- White and black dispenser color options
- Transfer door ensures full roll usage before new roll can be accessed



The savings add up when you deliver more

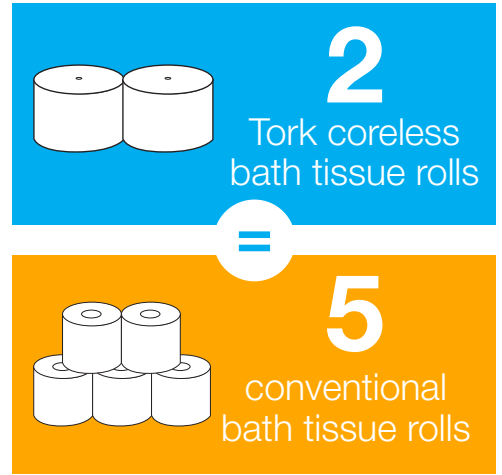

You want to accommodate your guests' needs— with higher capacity, more efficiency and less waste. The new Tork Coreless High Capacity Bath Tissue Dispensing System delivers two compact rolls of quality bath tissue that last longer, complement your environment and meet your guests' expectations.

Go coreless

Without the core, you gain more. You get two high capacity bath tissue rolls equivalent to five conventional bath tissue rolls—in a compact dispensing system designed to fit your space. That's additional bath tissue your guests will appreciate and a lower chance of paper run-out.

Save more

When you reduce waste in your operation, it pays off. Tork Coreless High Capacity Bath Tissue rolls allow you to manage waste effectively and responsibly, so your staff has less trash to remove and more time for the tasks that keep your business running smoothly.



Tork Coreless High Capacity Bath Tissue Dispensers – T7

SKU	Description	Color	Size H x W x D (in)	Case
473000	Tork Coreless High Capacity Bath Tissue Dispenser	White	13 x 9 x 6 (33.02 X 22.86 x 15.24 cm)	1
473008	Tork Coreless High Capacity Bath Tissue Dispenser	Black	13 x 9 x 6 (33.02 X 22.86 x 15.24 cm)	1



Tork Advanced Coreless High Capacity Bath Tissue Refill – T7

Refill SKU	Description	Color	Ply	Sheet Size W x L (in)	Sheets/Roll	Case	Certification
472886	Tork Advanced Coreless High Capacity Bath Tissue Roll	White	2	3.66 x 4.9 (9.3 x 12.45 cm)	900	36	E FSC®

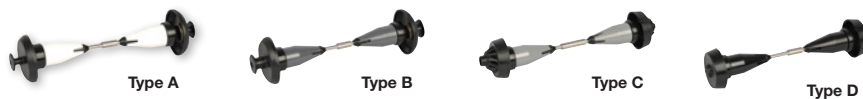

Tork Coreless High Capacity Spindle Kits – T7

SKU	Description	Spindle Size H x W x D (in)	Spindles/Kit	Kits/Case
473030	Tork Coreless High Capacity Spindle Kit, Type A	5.6 x 1.6 x 1.6 (14.22 x 4.06 x 4.06 cm)	2	25
473020	Tork Coreless High Capacity Spindle Kit, Type B	5.9 x 1.6 x 1.6 (14.99 x 4.06 x 4.06 cm)	2	25
473040	Tork Coreless High Capacity Spindle Kit, Type C	6.1 x 1.4 x 1.4 (15.49 x 3.56 x 3.56 cm)	2	25
473060	Tork Coreless High Capacity Spindle Kit, Type D	4.7 x 1.4 x 1.4 (11.94 x 3.56 x 3.56 cm)	2	25

Tork Coreless High Capacity Bath Tissue Dispensing System

- High capacity compact rolls
- No core for more sheets per roll
- Soft quality tissue with an embossed pattern
- Compact, contemporary design
- White and black dispenser color options
- Transfer door ensures full roll usage before new roll can be accessed

EPA compliant FSC® Forest Stewardship Council®



Connect with your customers in a way that only you can



77%

of restaurant-goers agree that restaurants with custom printed napkins try harder than other restaurants.

How do you build a standout brand?

Research shows that restaurant-goers feel more positive about an establishment if it carries custom printed napkins, making it more likely for them to return and recommend your business.

Tork can now help you connect with your customers in a new way that displays your unique brand personality and messaging.

With our new digital print technology, businesses can print multiple designs and messages within one napkin pack, giving them the opportunity to inform, educate and entertain.

New digital custom print technology helps you make your mark

Low minimums allow you to move beyond logos and be more opportunistic by changing marketing messages more frequently.

- Multiple designs in one pack give more marketing opportunities to resonate with customers
- Digital custom print technology allows for more complex and colorful custom prints, including photographs
- The first quality dinner napkin on the market with digital custom print capabilities and a quicker turnaround time

Lower minimums
More colors
Multiple designs – all
in one pack

Create a unique, memorable experience

The digital custom print capabilities of Tork Digital Custom Print Dinner Napkins enable your business to print unique, complex designs that are more impactful to customers, giving you the freedom to amplify your brand personality and create a memorable dining experience, all with lower costs and a quicker turnaround time.



Tork Digital Custom Print Dinner Napkins show attention to detail, which positively reflects on your business. Amplify brand messaging, create an unforgettable experience, and entice customers back through your doors without sacrificing the quality you're expected to deliver.

All in the details

This technology uses state of the art techniques to create unique, personalized, printed designs on quality dinner napkins for a better overall impression, service and atmosphere, which drives repeat business and recommendations.

Messaging matters

Digital customization technology allows your business to create designs and messages that express your brand, feature menu items, and communicate your story and environmental messages for subtle marketing that leaves a lasting impression on guests.

Delivery

As delivery continues to grow rapidly, many of your customers never visit your establishment. Tork Digital Custom Print Dinner Napkins allow you to reach these important customers in a way that is unique to your brand.



7140PRP - Tork Premium LinStyle® Dinner Napkin, 1/4 Fold

Color	Ply	Emboss	Napkin Size W x L (in)	Folded Size W x L (in)	Napkins/ Package	Napkins/ Case	Approx Lbs/ Case	Cubic Feet/ Case	Min. Order	Certification
White	1	Linen	16.25 x 17 (41.28 x 43.18 cm)	8.125 x 8.5 (20.64 x 21.59 cm)	60/poly	360	8.2 (3.7 kg)	1.02 (0.0289 CBM)	20M	☉

7160PRP - Tork Premium LinStyle Guest Towels, 1/6 Fold

Color	Ply	Emboss	Napkin Size W x L (in)	Folded Size W x L (in)	Napkins/ Package	Napkins/ Case	Approx Lbs/ Case	Cubic Feet/ Case	Min. Order	Certification
White	1	Linen	12 x 17 (30.48 x 43.18 cm)	4.0 x 8.5 (10.16 x 21.59 cm)	80/poly	640	11.2 (5.1 kg)	1.33 (0.0376 CBM)	15M	☉

7180PRP - Tork Premium LinStyle Dinner Napkin, 1/8 Fold

Color	Ply	Emboss	Napkin Size W x L (in)	Folded Size W x L (in)	Napkins/ Package	Napkins/ Case	Approx Lbs/ Case	Cubic Feet/ Case	Min. Order	Certification
White	1	Linen	16.25 x 17 (41.28 x 43.18 cm)	4.25 x 8.125 (10.80 x 20.64 cm)	60/poly	360	8.3 (3.8 kg)	1.02 (0.0289 CBM)	20M	☉

357QFP - Tork Advanced Dinner Napkin, 1/4 Fold

Color	Ply	Emboss	Napkin Size W x L (in)	Folded Size W x L (in)	Napkins/ Package	Napkins/ Case	Approx Lbs/ Case	Cubic Feet/ Case	Min. Order	Certification
White	2	Pin	15 x 16.25 (38.10 x 41.28 cm)	7.5 x 8.125 (19.05 x 20.64 cm)	125/poly	3,000	35.3 (16.0 kg)	3.41 (0.0965 CBM)	20M	♻️ ☉ ☉

357SNP - Tork Advanced Dinner Napkin, 1/8 Fold

Color	Ply	Emboss	Napkin Size W x L (in)	Folded Size W x L (in)	Napkins/ Package	Napkins/ Case	Approx Lbs/ Case	Cubic Feet/ Case	Min. Order	Certification
Natural	2	Pin	15 x 16.25 (38.10 x 41.28 cm)	3.75 x 8.125 (9.53 x 20.64 cm)	126/poly	3,024	45.1 (20.5 kg)	3.41 (0.0965 CBM)	20M	♻️ ☉ ☉ ☉

357TFP - Tork Advanced Dinner Napkin, 1/8 Fold

Color	Ply	Emboss	Napkin Size W x L (in)	Folded Size W x L (in)	Napkins/ Package	Napkins/ Case	Approx Lbs/ Case	Cubic Feet/ Case	Min. Order	Certification
White	2	Pin	15 x 16.25 (38.10 x 41.28 cm)	3.75 x 8.125 (9.53 x 20.64 cm)	126/poly	3,024	35.5 (16.13 kg)	3.41 (0.0965 CBM)	20M	♻️ ☉ ☉

376QFP - Tork Advanced Dinner Napkin, 1/4 Fold

Color	Ply	Emboss	Napkin Size W x L (in)	Folded Size W x L (in)	Napkins/ Package	Napkins/ Case	Approx Lbs/ Case	Cubic Feet/ Case	Min. Order	Certification
White	3	Pin	15 x 16.25 (38.10 x 41.28 cm)	8.5 x 8.125 (21.59 x 20.64 cm)	100/poly	2,400	42.0 (19.1 kg)	3.83 (0.1084 CBM)	20M	♻️ ☉ ☉

376TFP - Tork Advanced Dinner Napkin, 1/8 Fold

Color	Ply	Emboss	Napkin Size W x L (in)	Folded Size W x L (in)	Napkins/ Package	Napkins/ Case	Approx Lbs/ Case	Cubic Feet/ Case	Min. Order	Certification
White	3	Pin	16.25 x 17 (41.28 x 43.18 cm)	4.25 x 8.125 (10.80 x 20.64 cm)	100/poly	2,400	48.2 (21.9 kg)	3.83 (0.1084 CBM)	20M	♻️ ☉ ☉

377QFP - Tork Advanced Dinner Napkin, 1/4 Fold

Color	Ply	Emboss	Napkin Size W x L (in)	Folded Size W x L (in)	Napkins/ Package	Napkins/ Case	Approx Lbs/ Case	Cubic Feet/ Case	Min. Order	Certification
White	2	Pin	16.25 x 17 (41.28 x 43.18 cm)	8.5 x 8.125 (21.59 x 20.64 cm)	125/poly	3,000	39.8 (18.1 kg)	3.83 (0.1084 CBM)	20M	♻️ ☉ ☉

377TFP - Tork Premium Dinner Napkin, 1/8 Fold

Color	Ply	Emboss	Napkin Size W x L (in)	Folded Size W x L (in)	Napkins/ Package	Napkins/ Case	Approx Lbs/ Case	Cubic Feet/ Case	Min. Order	Certification
White	2	Pin	16.25 x 17 (41.28 x 43.18 cm)	4.06 x 8.5 (10.31 x 21.59 cm)	126/poly	3,024	40.1 (18.2 kg)	3.83 (0.1084 CBM)	20M	♻️ ☉ ☉

381M4P - Tork Advanced Dinner Napkin, 1/8 Fold

Color	Ply	Emboss	Napkin Size W x L (in)	Folded Size W x L (in)	Napkins/ Package	Napkins/ Case	Approx Lbs/ Case	Cubic Feet/ Case	Min. Order	Certification
White	1	Pin	15 x 16.25 (38.10 x 41.28 cm)	3.75 x 8.125 (9.53 x 20.64 cm)	200/poly	4,800	34.2 (15.5 kg)	3.41 (0.0965 CBM)	20M	♻️ ☉ ☉

389P - Tork Advanced Dinner Napkin, 1/8 Fold

Color	Ply	Emboss	Napkin Size W x L (in)	Folded Size W x L (in)	Napkins/ Package	Napkins/ Case	Approx Lbs/ Case	Cubic Feet/ Case	Min. Order	Certification
Natural	1	Pin	15 x 16.25 (38.10 x 41.28 cm)	3.75 x 8.125 (9.53 x 20.64 cm)	200	4,800	36.3 (16.5 kg)	3.41 (0.0965 CBM)	20M	♻️ ☉ ☉ ☉

Large variety of ink colors for all
Digital Custom print dinner napkins.



ECOLOGO®
PRODUCT CERTIFIED FOR REDUCED
ENVIRONMENTAL IMPACT. VIEW SPECIFIC
ATTRIBUTES EVALUATED: EL UL-175

☉ EPA Compliant
☉ Compostable
♻️ 100% Recycled



Keep your drive-thru running like clockwork



Tork Xpressnap Drive Thru Napkin Dispenser

We know your customers expect a fast and efficient drive-thru experience. The new Tork Xpressnap® Drive Thru Dispenser easily dispenses multiple napkins in controlled quantities to keep your business moving and customers happy.



Be quick.

Accelerate your drive-thru with faster, multi-napkin dispensing.



Be consistent.

Keep your operation simple and streamlined.

- Neatly folded napkins offer better customer experience
- Enclosed system improves and protects napkin hygiene
- High-capacity dispenser saves time on refills and labor
- Combine front and back of house operations under one napkin SKU
- May be placed on countertop or wall-mounted

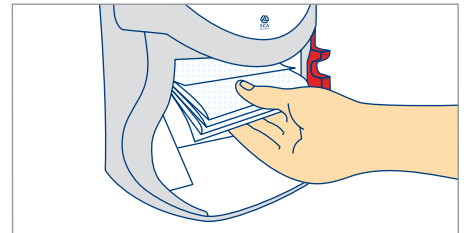
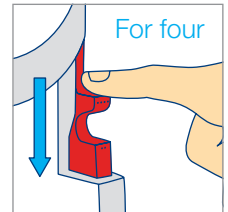
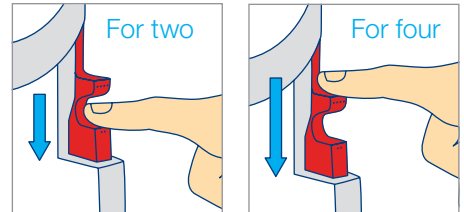
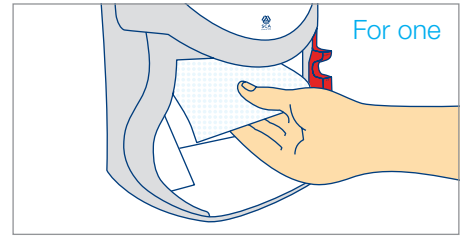

“I like the neat presentation of this dispenser, the ease and the customer satisfaction. Just hit the button and send them on their way.”

—Assistant Store Manager,
Top 50 QSR



Use real-time, actionable data to revolutionize your work facility cleaning operation with Tork EasyCube

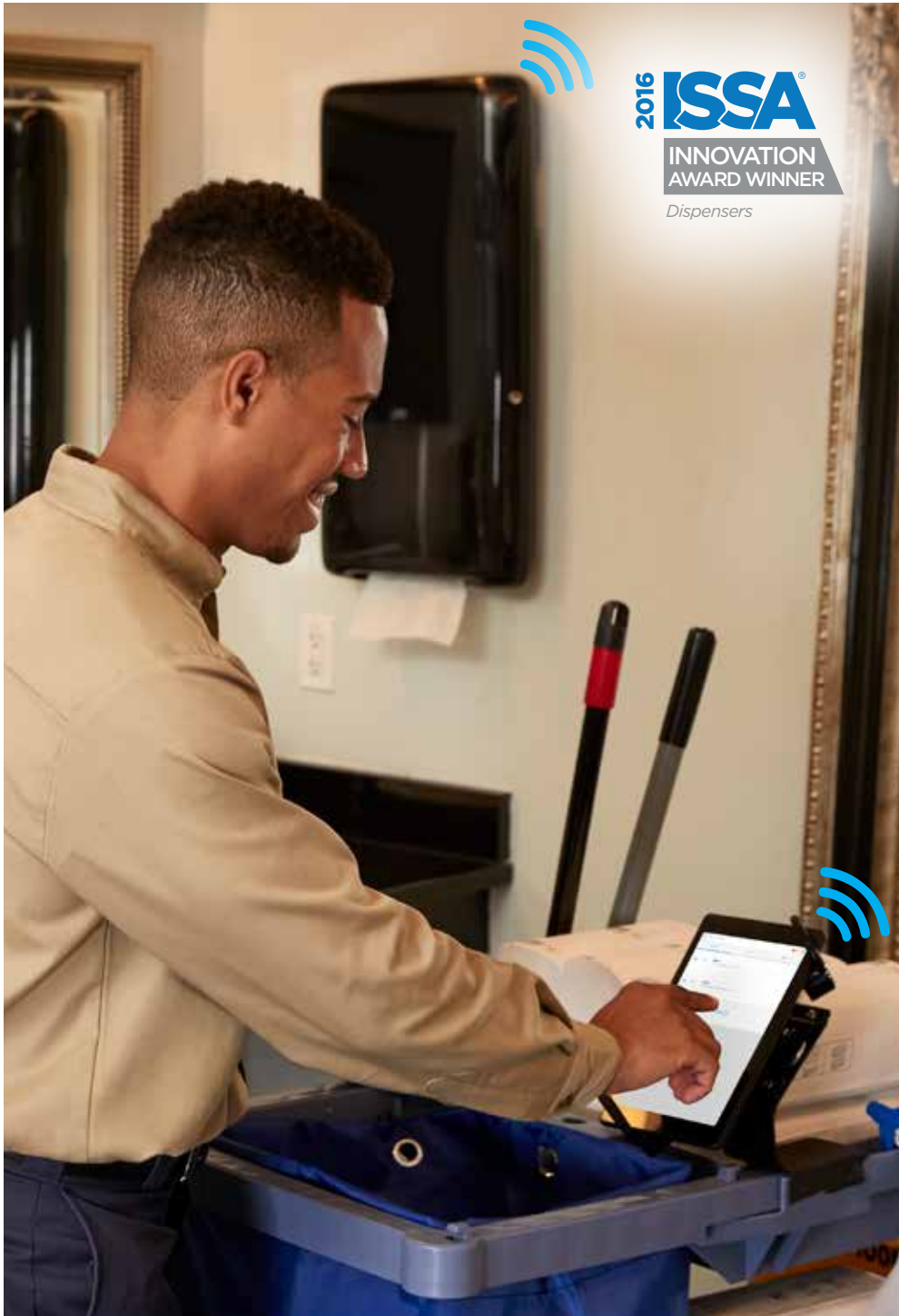

Welcome to a new way of working with Tork EasyCube®



Managers get more results with less effort

With instant access to data on visitor numbers and refill levels, staying in control is easy:

- Optimize your cleaning needs based on real-time data in monitored areas
- Monitor cleaning performance and quality against key performance indicators
- Communicate directly by sending messages to your cleaners' tablets
- Boost quality and eliminate complaints by promoting constant cleanliness and availability of paper and soap



Cleaners work smarter, not harder

Tork EasyCube empowers you to be proactive, solving problems before they even arise:

- Stock your cart based on real-time info on what's needed
- Eliminate unnecessary work when you can see refill levels and cleaning needs in real-time on your tablet
- Keep track of tasks and mark as completed
- Less stress when you can do exactly what's needed, when and where



Connected devices with sensor technology provide real-time actionable data

Connected Devices

Sensor technology and Visitor Registration Units monitor supply levels and traffic patterns then transmit the data



Powered by



Easy Access

Your cleaning management software is accessible from any web-enabled smartphone, tablet or computer



Data Collection

Powered by Microsoft Azure, the data collected by the sensors is sent to your EasyCube account

Tork EasyCube intelligent facility cleaning system incorporates the Internet of Things (IoT) to enhance the efficiency of managing facility cleaning, staff and ordering supplies. The system combines sensor technology, software tools and services to transform cleaning operations into a fact-based science for more informed decisions, increased user satisfaction and budget savings.

How it works

Sensors placed on entrances, as well as towel, tissue, soap and sanitizer dispensers monitor visitor traffic and supply status in real-time by transmitting information wirelessly to a cloud-based data collection system.

Cleaning Management Software aggregates the data and displays it to facility managers and cleaners through two user-friendly web-enabled applications: The Facility Manager Web Application delivers an intuitive dashboard and the Cleaner Web Application digitizes cleaning routes to support more informed and automated task planning and cleaning schedules.

Tork EasyCube installations are customized to meet each facility manager's requirements and specifications, and come with dedicated Customer Success. A systematic onboarding process includes initial benchmarking, building cleaner plans, training and consulting with each customer through data analytics and insights.



Take your team to optimal efficiency

Tork EasyCube Cleaning Management Software aggregates data and displays it to facility managers and cleaners through two user-friendly web-enabled applications: The Facility Manager Web Application delivers an intuitive dashboard, and the Cleaner Web Application supports more informed and automated task planning and cleaning schedules.

Facility Manager Web Application – Total Visibility

Easy access enables administrators to view the entire facility's towel, tissue, soap and sanitizer supply level status and manage refills more efficiently, while promoting better management of the entire facility, cleaning staff and supply budget. This real-time actionable data, drill-down status view, analytics and is available in a single, convenient dashboard via any web-enabled device.

Key Features



My Dashboard is a snapshot of current dispenser supply status, facility foot traffic and flags any immediate issues.



Messaging Center* for administrators to send enterprise communications or direct instructions to specific cleaners.



Status provides visibility to all connected devices for more informed decision making.



Zones* to combine cleaning plans by multiple buildings or locations.



Plans* store your digitized cleaner plans.



Follow Up for analytics and historical data to allow for better reporting and KPI's.

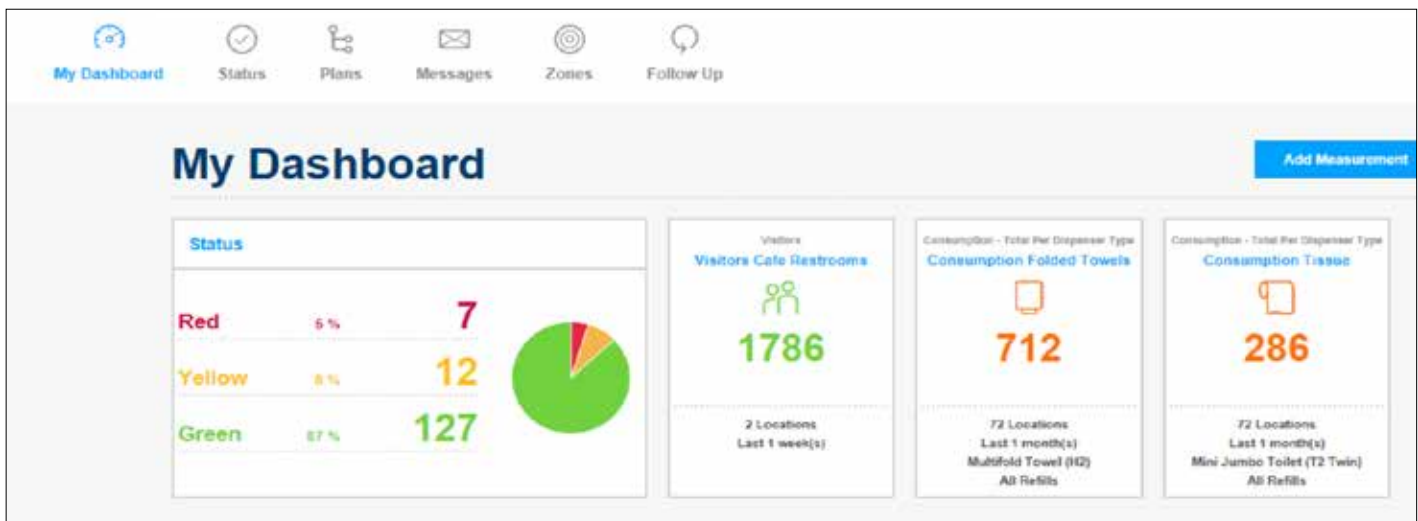

Cleaner Web Application Digitized Cleaning Plans and More

Tork EasyCube enables managers to take manual cleaning plans and make them digital. Instead of using a printed copy of the cleaner plan to track their progress, EasyCube allows cleaners to use any web-enabled device to pack their cart, identify which dispensers need attention, perform a quality assessment, report completed areas and retain a digital history.

Key Features



Staff Communication – Communicate with individual cleaner or send enterprise-wide messaging to all users. This feature can be used for mandatory safety messages or updates on any anticipated change in the facility or policy.



Staff Reporting and Quality Assessments – Cleaning staff is required to mark task assignments as completed and provide a quality assessment rating prior to cleaning a location.



Elevate the Cleaner Experience – The Tork EasyCube Cleaner Web Application user interface is intuitive for your cleaning staff. Iconography is used to overcome any language challenges but, multiple language plans can be incorporated. Simple training helps guarantee successful implementation.



Task Management – Customize your team's cleaning plans whether fixed, needs-based or combined. EasyCube provides efficiency that fits your business.

Fixed – Predetermined cleaning plans are populated with real-time data that give the cleaner the status upon opening the plan. Supply needs are calculated for easy cart preparation for a route.

Needs-based – Cleaner plans utilize the data collected for actionable results. Cleaning route is calculated to address immediate facility needs and can change during a route for the ultimate efficiency. Daily instructions for stocking a cart are based on the real-time need.

Combined – Plans utilize the structure of a fixed-based plan with the immediacy of a needs-based program and can be customized for each facility.



Let's get you started

Our dedicated team tailors a solution for you, installs it and provides all the support you need to use it.



1 Evaluation
Based on your specific needs, we recommend a solution

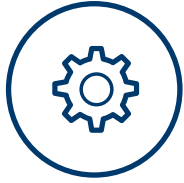

2 Installation
We install and configure Tork EasyCube in your facility



3 Get started
We provide training and support to get you and your staff started with Tork EasyCube



4 Business review
Together we review the results and business impact achieved

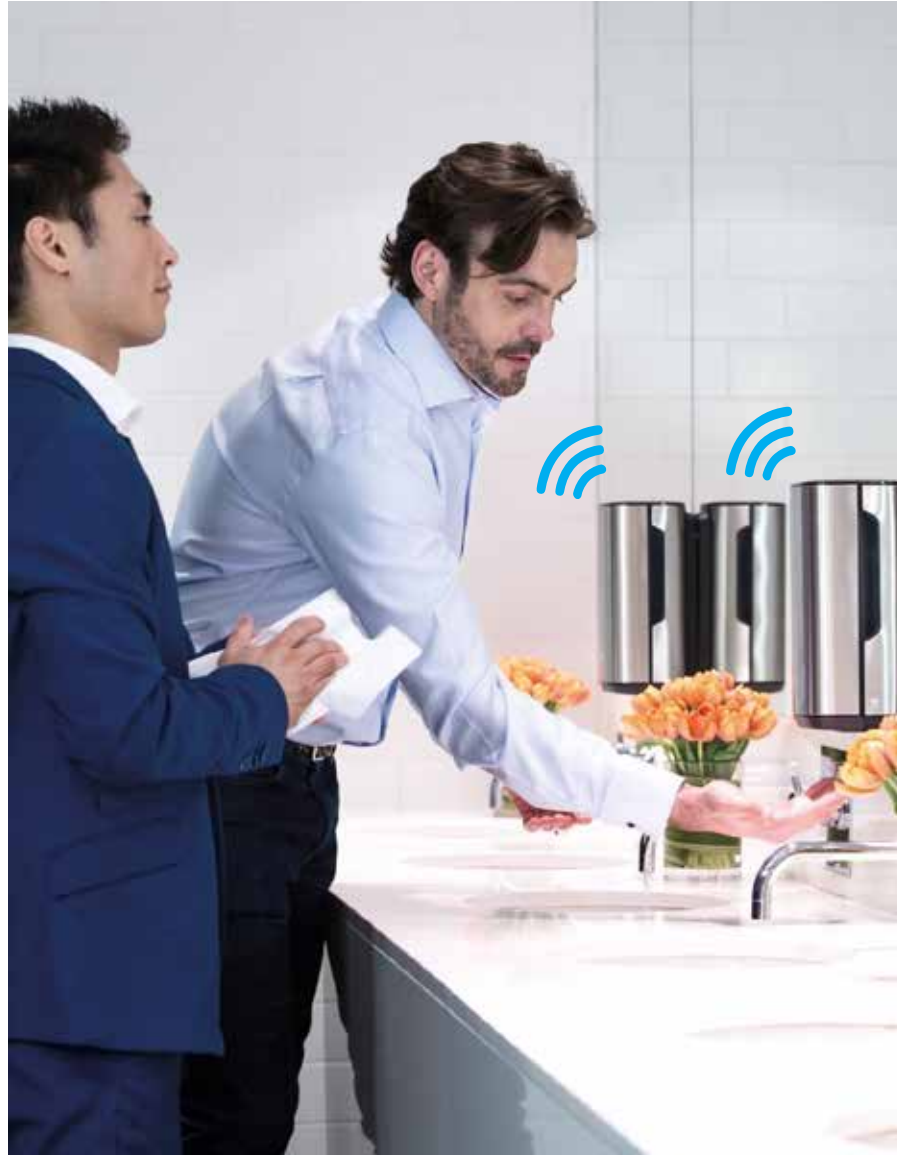

Cleaning activities increased by 60% or more in frequently used areas*

“We found that areas that were used more frequently also received more cleaning attention when cleaners used Tork EasyCube.”

92% less time dispensers are empty when using Tork EasyCube*

“I would quit my job if they took away Tork EasyCube.”

77% fewer dispenser openings when using Tork EasyCube*

“We found that the number of dispenser opening to check if a dispenser needs refilling or not decreased significantly when cleaners used Tork EasyCube.”

Tork EasyCube enabled dispensers

The solution is compatible with a wide range of high-quality paper and soap dispensers from Tork

Tork PeakServe™ Continuous™ Hand Towel Dispensers

A new standard of high-traffic dispensing for a superior guest experience



SKU	Description	Color	Size H x W x D (in)	Units/Case
552520	Tork Elevation PeakServe Hand Towel Dispenser	White	28.74 x 14.57 x 3.98 (73.0 x 37.01 x 10.11 cm)	1
552528	Tork Elevation PeakServe Hand Towel Dispenser	Black	28.74 x 14.57 x 3.98 (73.0 x 37.01 x 10.11 cm)	1

Tork Matic® Hand Towel Roll Dispensers

High capacity that is ideal for busy restrooms



SKU	Description	Color	Size H x W x D (in)	Units/Case
461002	Tork Image Design Matic® Hand Towel Roll Dispenser - H1	Stainless Steel	15.75 x 13.58 x 8.07 (40.01 x 34.49 x 20.5 cm)	1
5510202	Tork Elevation Matic Hand Towel Roll Dispenser - H1	White	14.65 x 13.26 x 7.99 (37.2 x 33.7 x 20.3 cm)	1
5510282	Tork Elevation Matic Hand Towel Roll Dispenser - H1	Black	14.5 x 13 x 8 (36.83 x 33.02 x 20.32 cm)	1

Tork Xpress® Multifold Hand Towel Dispensers

One-at-a-time dispensing for extra hygiene care



SKU	Description	Color	Size H x W x D (in)	Units/Case
463002	Tork Image Design Xpress Hand Towel Dispenser - H2	Stainless Steel	18.625 x 13 x 9.9375 (47.31 x 33.02 x 10.0 cm)	1
552020	Tork Xpress Hand Towel Dispenser - H2	White	17.5 x 11.9 x 4.0 (44.4 x 30.2 x 10.2 cm)	1
552028	Tork Xpress Hand Towel Dispenser - H2	Black	17.5 x 11.9 x 4.0 (44.4 x 30.2 x 10.2 cm)	1

Tork Auto Foam Soap & Sanitizer Dispenser

Sealed touch-free system with 2,500 soap doses per refill



SKU	Description	Color	Size H x W x D (in)	Units/Case
466200	Tork Image Design Foam Skincare Automatic Dispenser with Intuition Sensor - S4	Stainless Steel	10.625 x 4.5 x 5.125 (26.99 x 11.43 x 13.02 cm)	4
682830	Tork Elevation Foam Skincare Automatic Dispenser - S4	White	11.5 x 4.4 x 4.5 (29.21 x 11.18 x 11.43 cm)	4
682840	Tork Elevation Foam Skincare Automatic Dispenser - S4	Black	10.94 x 4.45 x 5.12 (27.79 x 11.30 x 13.00 cm)	4

Tork Coreless Bath Towel Roll Dispensers

Extra high-capacity and convenience



SKU	Description	Color	Size H x W x D (in)	Units/Case
473200	Tork Elevation Coreless High Capacity Bath Tissue Dispenser	White	8.228 x 14.173 x 5.078 (20.9 x 36.0 x 12.9 cm)	1
473208	Tork Elevation Coreless High Capacity Bath Tissue Dispenser	Black	8.228 x 14.173 x 5.078 (20.9 x 36.0 x 12.9 cm)	1

Tork Jumbo Bath Tissue Roll Dispensers

High capacity for minimizing maintenance



SKU	Description	Color	Size H x W x D (in)	Units/Case
465500	Tork Image Design Mini Jumbo Bath Tissue Roll Dispenser - T2	Stainless Steel	9.875 x 14 x 5.125 (25.08 x 35.56 x 13.02 cm)	1
5555290	Tork Twin Mini Jumbo Bath Tissue Roll Dispenser - T2	Black	10.12 x 17.0 x 5.68 (25.72 x 43.18 x 14.45 cm)	1
5555200	Tork Twin Mini Jumbo Bath Tissue Roll Dispenser - T2	White	10.12 x 17.0 x 5.68 (25.72 x 43.18 x 14.45 cm)	1

Tork EasyCube adapters

Tork Cabinet Towel Adapters reduce towel waste from product fall out, helping eliminate associated costs



SKU	Description	Color	Size H x W x D (in)	Units/Case
309696	Tork Xpress Medium Recessed Cabinet Towel Adapter	White	17.32 x 10.039 x 3.7 (43.99 x 25.5 x 9.4 cm)	1
309695	Tork Xpress Large Recessed Cabinet Towel Adapter	White	19.65 x 10.039 x 3.7 (20.75 x 25.5 x 9.4 cm)	1

Calculate the efficiencies and cleaning cost savings you gain with Tork EasyCube

We have been tracking the results experienced by our customers who use the Tork EasyCube Intelligent Facility Cleaning System. With additional third-party research, we gained an understanding to help measure the impact of Tork EasyCube on individual facilities.

This impact calculator is designed to give you an approximate sense of what Tork EasyCube can do for your facility.

Enter the number of cleaners on your staff

Adjust the working hours per cleaner

Update the operating days each year

Number of dispensers: towel, tissue and soap

Number of routes/dispenser checks

Approximate dollar savings based on time saved

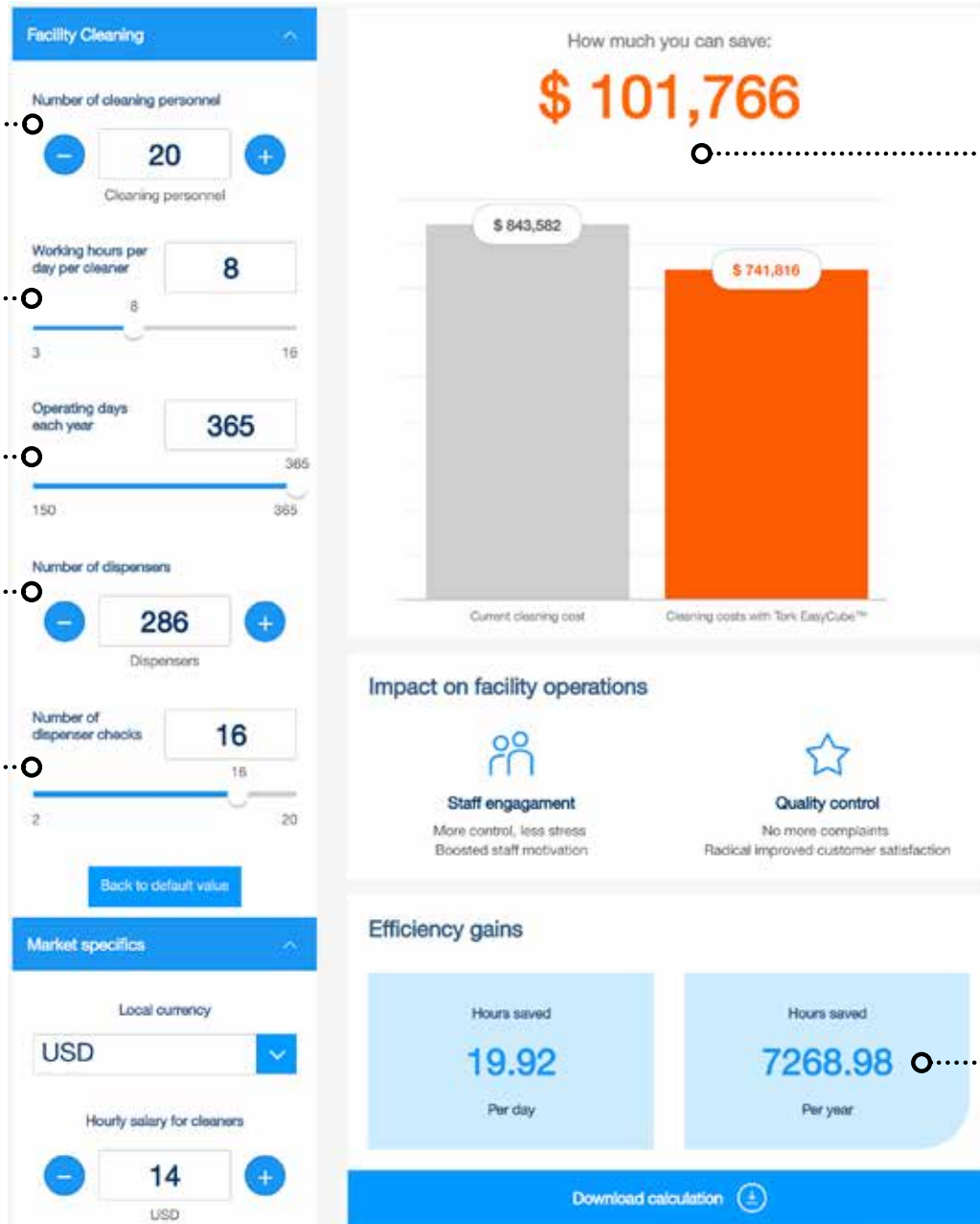

Hours saved and available to redeploy cleaner for time critical tasks



The insider's guide to data-driven cleaning

How to put the new evolution of facility cleaning into practice for your business

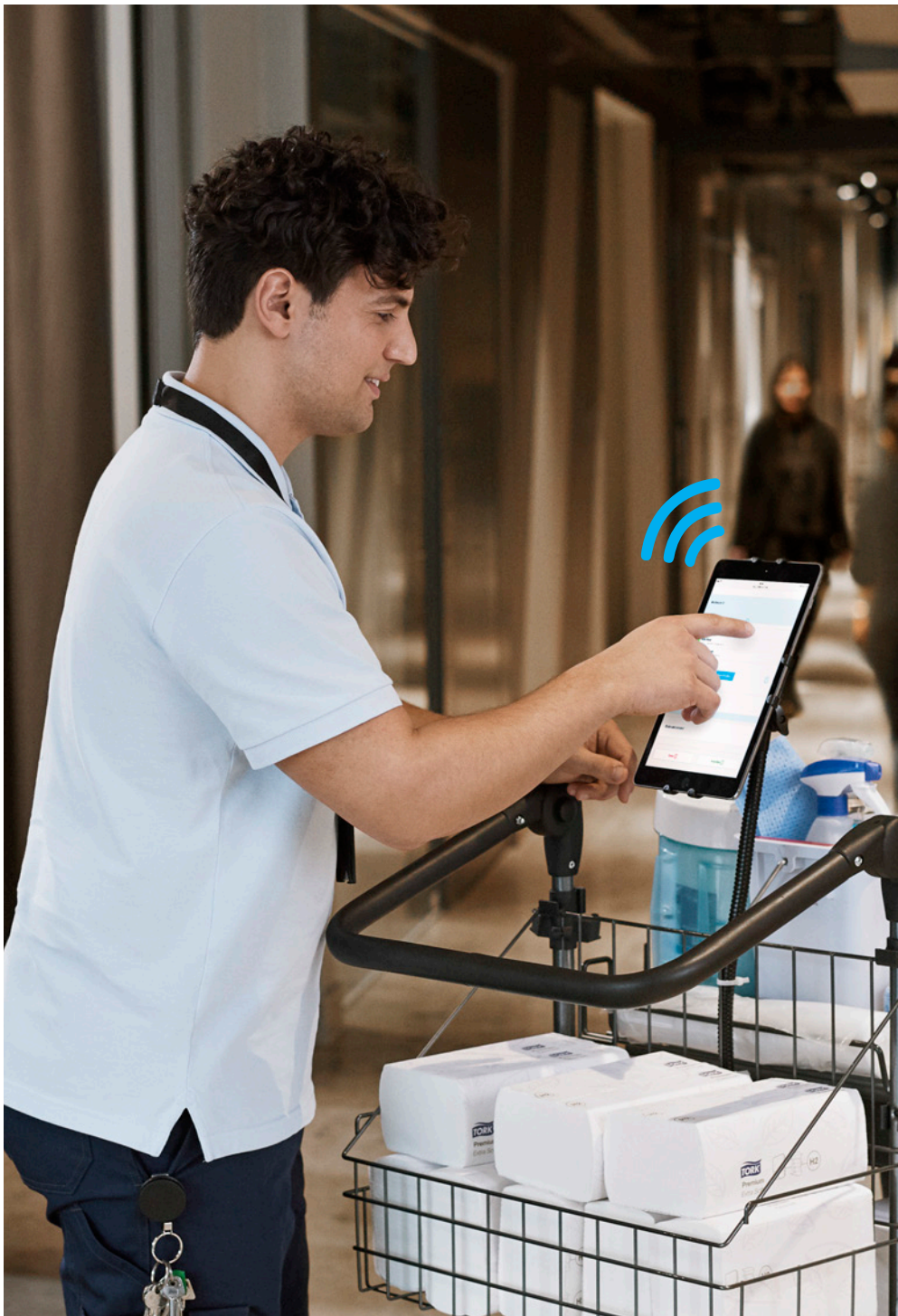

 **Industry outlook**

 **Customer experiences**

 **Practical tips**

What is data-driven cleaning?

As societies and facilities have developed, new cleaning tools have developed with them. However, the next leap in professional cleaning is not a new tool as we're used to thinking about them. Rather, it's something that helps you make more out of the resources you've already got. Welcome to the era of data-driven cleaning.

Everything from coffee machines to restroom dispensers are being connected to the internet. Yet the value lies not in connectivity itself, but in the actions you can take based on the new information collected. When cleaning staff and their managers get real-time data about cleaning needs, the very logic for how cleaning can be done changes. It becomes possible to stay ahead of the game and do exactly what's needed when and where. This is data-driven cleaning. Handling a complex facility like a hospital or university is transformed into a fact-based science.



"If you keep doing what you've always done, you'll keep getting what you've always got. Now suppliers are bringing new technology to the market, and it's time for end users – in this case the customers – to get on board."

Dorothee Stein

Head of Facility Care, Airport Company

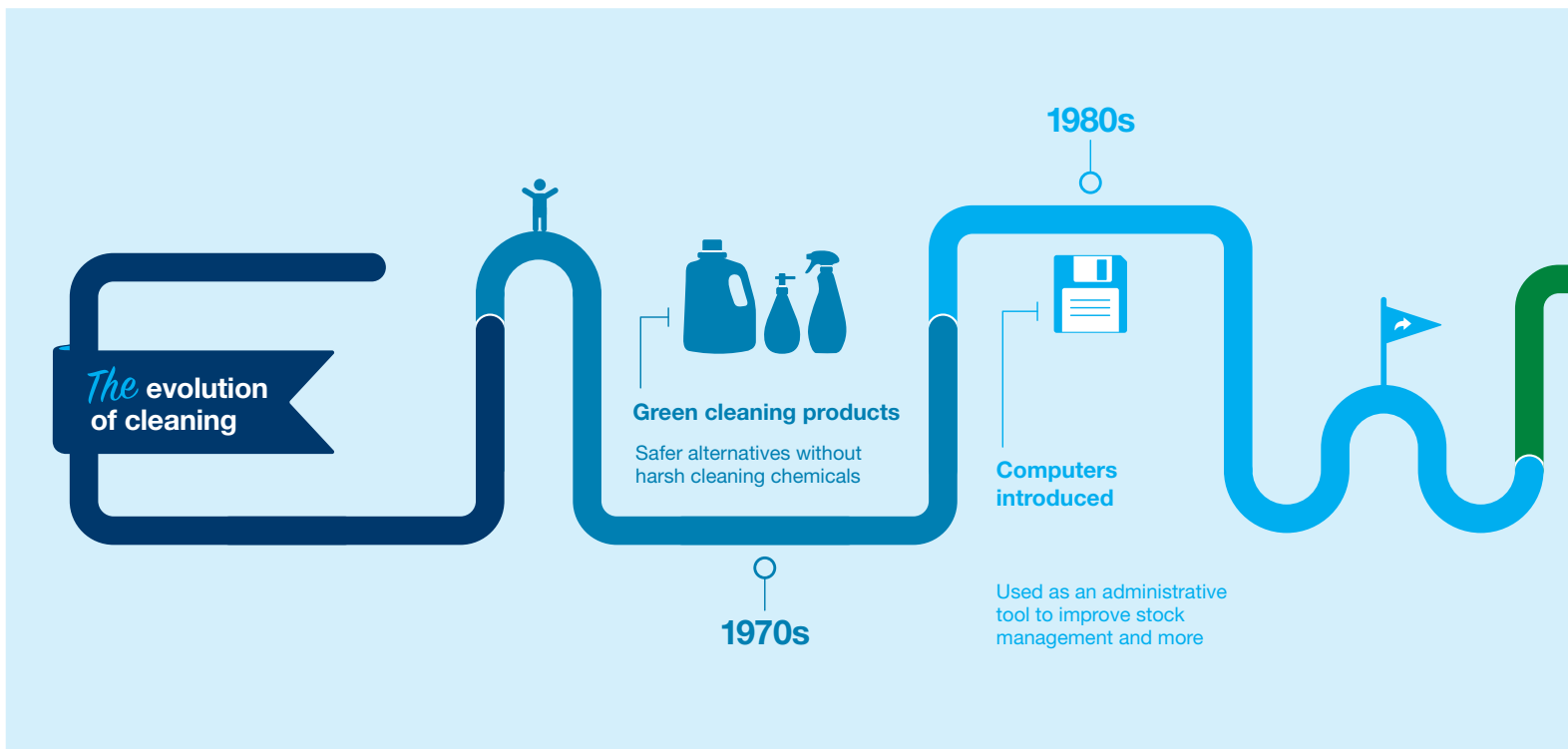

How can data-driven cleaning benefit business?

Real-time data on actual cleaning needs makes it possible to dramatically improve cleaning operations in three important ways:

1

Take staff to maximum efficiency

Knowing exactly what's needed means no time is wasted. More time means staff can go the extra mile when cleaning. Managers can feel safe that nothing is neglected, and analyze data over time to improve planning, purchasing and logistics.

2

Boost staff engagement

Your people are your most important resource. Work feels meaningful when they know that every task matters, and better control means less stress and a more balanced working situation.

3

Set a new standard of customer satisfaction

Data-driven cleaning enables higher quality – no more empty dispensers and untidy areas. Instead it becomes possible to eliminate complaints and radically increase customer satisfaction.

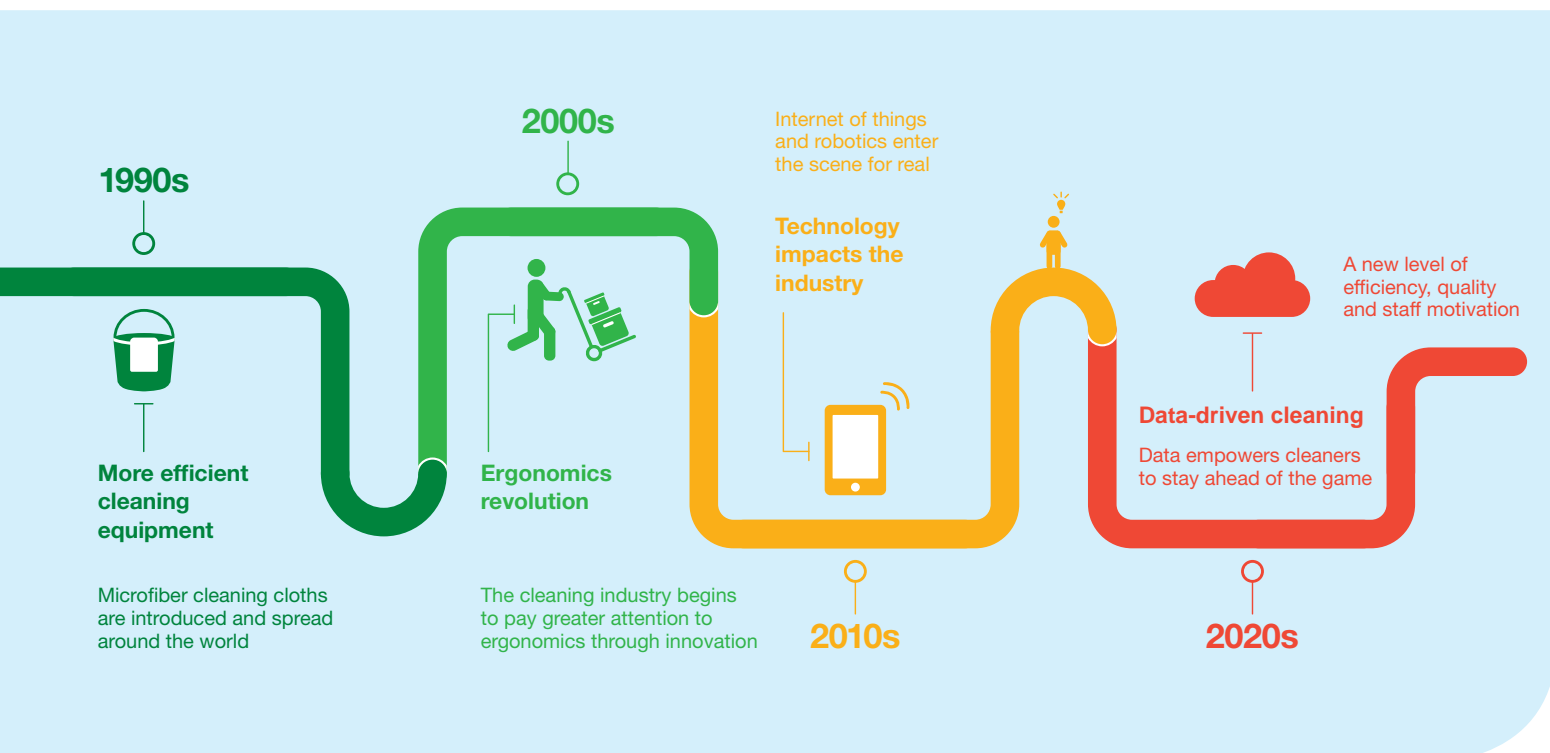



A revolution on a global scale

Cleaning is not unique – data is driving change in almost every industry, improving efficiency by allowing better use of resources. Leading companies in the shipping business have recently brought their fleets online, tracking both ships and containers. With data on exactly where they have empty containers and shipping needs, the companies have been able to streamline the refilling process to avoid unnecessary transports of empty containers. By using data to rationalize their empty container management, one shipping company is already reporting savings of over 100 million.*

Buildings also stand to make massive efficiency gains using data. Seeing the potential, tech giants have entered the field with products such as smart thermostats. Smart thermostats automatically learn your temperature preferences and keep track of when you are away to avoid heating or cooling more than necessary. With buildings currently using about 40% of global energy**, these kinds of improvements make a real difference. As data becomes the driver of development in industry after industry, we are becoming more efficient as a whole.

“This is a major trend, taking place not only in the cleaning industry, but everywhere. New technology will allow cleaning companies to solve problems right when they appear – or even before they appear.”

Andreas Lill
General Director, European Federation of Cleaning Industries

From man vs. machine to man + machine

In recent years, the cleaning industry has seen a boom of technology overall, such as automated cleaning robots. But the latest shift, toward data-driven cleaning, is not about replacing humans with machines – it's about them working together.

Machines can perform specific, well-defined tasks much more reliably than humans, like a robot vacuuming the same clearly delineated area over and over again or a sensor keeping track of exactly how many people visit a restroom at all times. In such cases, automation can free up valuable time for cleaners to focus on tasks that add more value.

However, machines are bad at handling uncertainty. You can't pre-program a response to an event that you didn't know was going to happen. Then you have to improvise, which requires judgment and intuition, quintessentially human skills. The more uncertainty a task involves, the harder it is to automate.

But that doesn't mean machines can't help in complex situations. Machines can gather and calculate vast amounts of reliable information nearly instantly, providing an invaluable aid to human decision making. Leading academics studying human-machine interaction, such as MIT and Duke University researcher Mary Cummings, emphasize this collaborative approach: "As a team, the human and computer are far more powerful than either alone, especially under uncertainty."^{*}

Professional cleaners have to handle uncertainty all the time, especially in large, complex environments such as universities or airports. With technology providing information like which restrooms are getting traffic and which dispensers need refilling, cleaners get the overview they need to rapidly respond to shifting circumstances. Data-driven cleaning changes the entire logic of how facility managers and cleaners can work, relieving them of the stress of not knowing what is needed. It allows cleaners to focus entirely on addressing existing cleaning needs and predicting future ones, rather than having to spend time and energy finding out what those needs are.

"People are what this industry is all about. Embracing new technology giving them the tools to do a more efficient job is key not only to raise productivity, but also to decrease stress levels and make the industry a more attractive employer overall."

Andreas Lill

General Director, European Federation of Cleaning Industries

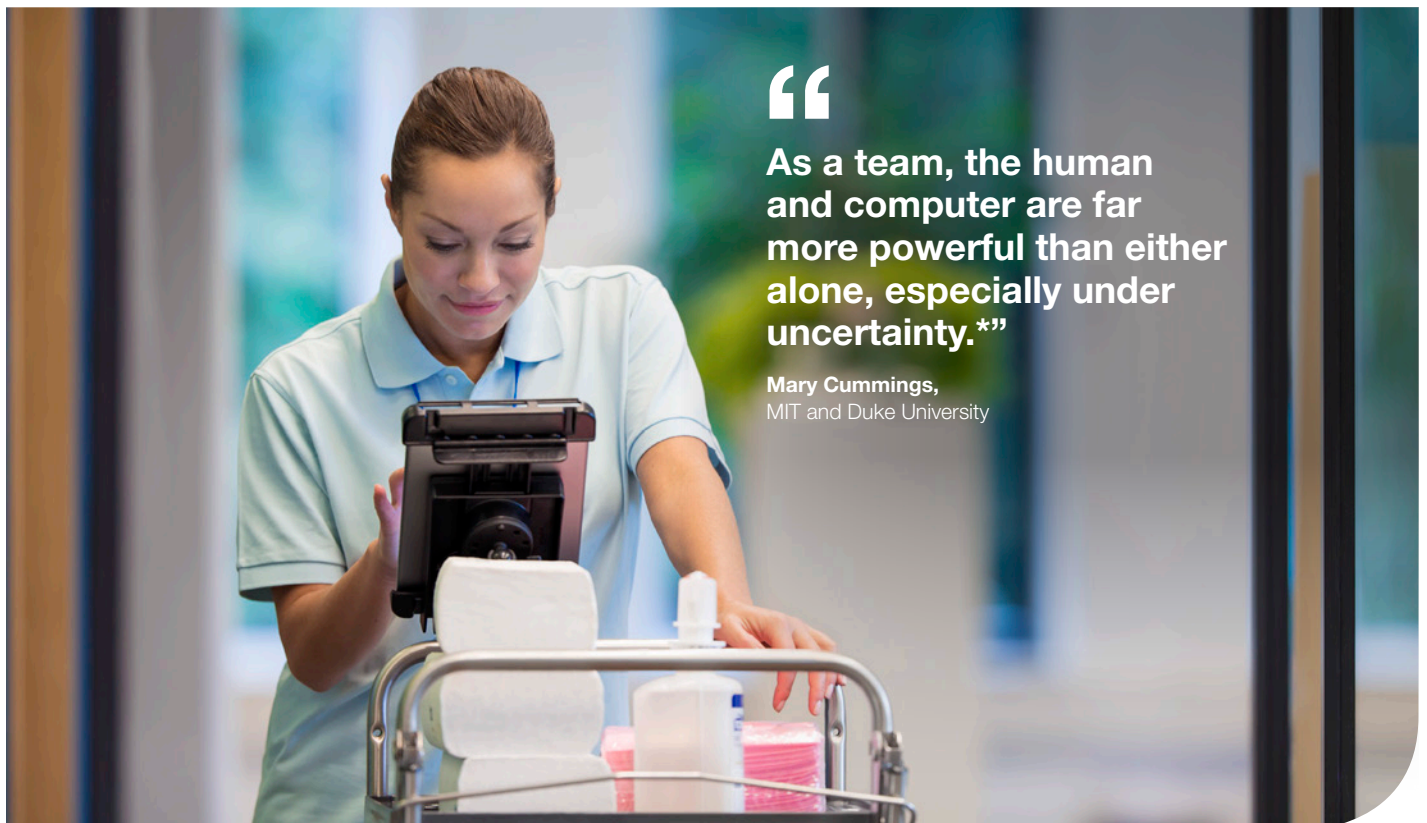

“

As a team, the human and computer are far more powerful than either alone, especially under uncertainty.^{*}”

Mary Cummings,
MIT and Duke University



Data-Driven Cleaning Navy Pier

50 acres

Of parks, restaurants, attractions, retail shops, sightseeing and dining cruise boats, exposition facilities and more.

9 million

Guests annually

12,000

Daily restroom visitors

Data-driven cleaning creates a world-class entertainment experience

Located on Lake Michigan, Navy Pier is one of the top-attended nonprofit cultural destinations in the Midwest, stretching more than six city blocks. Pressure is constant on the facility management team to maintain a spotless image. This venue shifted to data-driven cleaning with Tork EasyCube™ intelligent facility cleaning system. We talked to J.R. Westveer, Aramark General Manager, about the impact on their business with Navy Pier.

Why is cleaning so important?

Navy Pier is a combination of an amusement park, food court, mall and convention center all in one... But we are also much more than that - we consider ourselves a global attraction with millions of visitors. Everyone who visits the venue uses the restroom at least once, if not more. An untidy venue would have an immediate effect on everyone, and even the smallest imperfection can have a huge impact on our reputation and relationship with our client.

What were your challenges before?

Synchronizing our cleaning efforts with inconsistent visitor flow and major events did not work as well as we wanted. Even if the grounds were kept clean, we would still get complaints about things like empty dispensers or paper on the floor in the restrooms.

“We have the visibility to improve cleaning efforts and be proactive with real-time data.”

J.R. Westveer

Aramark General Manager

What have been the results from working with Tork EasyCube so far?

We have seen a variety of different benefits. It is a big relief that we can act immediately if issues arise – before it is elevated to a complaint. We have the visibility to improve cleaning efforts and be proactive with real-time data. Thanks to the data from Tork EasyCube, we can see which restroom needs attention and which doesn't.

How has your staff reacted to data-driven cleaning?

When we begin working with the system, we immediately saw the benefit to having access to real-time data. We keep a large screen dashboard in our situation room for all to see. With the ability to clean an area before it became a problem, the staff feels like they are making an impact on customer satisfaction and efficiency.

Practical tips

How to shift successfully to data-driven cleaning

Changing how you work can be a complicated process, so approaching it methodically is important. We've gathered some key insights from our customers across the world on how to ensure the shift is as efficient as possible – making it easier to reap the benefits of data-driven cleaning right away.



Evaluate challenges

What is crucial to the success of your facility cleaning program, and what areas need improvement? Evaluate any issues you want to address.



Involve key stakeholders

Shifting to new ways of working affects all levels of your organization. Especially cleaners who will use the solution should be involved early on to secure easier implementation.



Choose the right partner

If you are self-managed or partner with a Building Services Contractor, it is important to align with some proven solutions that have had real business impact for other customers.



Request a demonstration

Make sure adequate time is dedicated to explaining the solution so that you and your teams are making full use of its potential, maximizing positive business impact.



Set specific goals

What do you want to accomplish with data-driven cleaning? Setting specific goals and prioritizing helps you focus initial efforts on what's most important.



Support everybody in implementation

Consider who is going to use the new solution in practice. For example, you might think everybody is comfortable using smartphones and tablets, but this is not always the case. Keep a close dialogue with users to ensure they get the right support throughout implementation.

Stay ahead of the game with Tork EasyCube

Tork EasyCube™ intelligent facility cleaning system empowers your staff with data on cleaning needs, letting them see on a tablet exactly what's needed, when and where. The result is a whole new level of efficiency, staff engagement and customer satisfaction. Tork EasyCube already connects over 4000 devices for customers across North America and Europe.



1

Sensors measure visits and refill levels in real-time.

2

Real-time information lets cleaners act on what's needed, when and where.

3

Managers are in control and can plan and follow up with less time and effort.



Are you ready to use data-driven cleaning to improve efficiency while providing a better visitor experience?





Performance you can count on



The hand towel dispenser that never quits.



Your restrooms should function like a well-oiled machine. Meet the new, single roll Tork Electronic Hand Towel Roll Dispenser that's engineered for demanding restrooms and work environments.

Durable and easy to maintain, it delivers a hygienic, efficient, stylish and seamless dispensing experience—all with a simple wave of the hand.



A worry-free experience.

Ready. Set. Install. Now sit back and let the Tork Electronic Hand Towel Roll Dispenser do all the work. It's designed to last in busy restrooms, so you can rest assured it always functions as smoothly as it did on day one.

The dispenser delivers up to 80 rolls of 1,000 foot toweling with recommended batteries*. And the sensor technology designed for the dispenser ensures a towel with each wave activation.



A hassle-free system.

While it's built to handle the pressures of everyday use, the Tork Electronic Hand Towel Roll Dispenser is also simple to clean and maintain. The paper roll index allows for quick and easy loading.

An intuitive, one-touch, control panel helps you manage the length of the hand towel at 10" or 18". It also offers On Demand Mode for patron-activated dispensing or Valet Mode for a ready-to-use hanging towel.

The translucent styling and a low battery indicator light allow your staff to see at a glance when it's time to refill or service. And hygienic, one-at-a-time dispensing encourages guests to only use as many hand towels as they need, helping you reduce waste and save on cost.







*Recommended batteries: standard retail brand, alkaline, 4 D-cell batteries.

Tork Electronic Hand Towel Roll Dispenser - H80





SKU	Description	Color	Size H x W x D (in)	Dispensers/Case
771828	Tork Electronic Hand Towel Roll Dispenser	Black	15.95 x 12.32 x 9.32 (40.51 x 31.29 x 23.67cm)	1
771820	Tork Electronic Hand Towel Roll Dispenser	White	15.95 x 12.32 x 9.32 (40.51 x 31.29 x 23.67cm)	1

Refill No.	Description	Color	Ply	Roll Width (in)	Linear Feet	Case	Certification
8030620	Tork Premium Hand Towel Roll 	White	1	8 (20.32 cm)	600 (182.88 m)	6	 
8031040	Tork Advanced Hand Towel Roll 	White	1	8 (20.32 cm)	1,000 (304.8 m)	6	 
8038040	Tork Advanced Hand Towel Roll 	White	1	8 (20.32 cm)	800 (243.84 m)	6	 
8031900	Tork Universal Hand Towel Roll 	White	1	8 (20.32 cm)	800 (243.84 m)	6	
8031600	Tork Universal Hand Towel Roll 	White	1	8 (20.32 cm)	630 (192.02 m)	6	
8031400	Tork Universal Hand Towel Roll 	Natural White	1	8 (20.32 cm)	800 (243.84 m)	6	 
8031300	Tork Universal Hand Towel Roll 	Natural	1	8 (20.32 cm)	800 (243.84 m)	6	 
8031500	Tork Universal Hand Towel Roll 	Natural	1	8 (20.32 cm)	630 (192.02 m)	6	
8031000	Tork Universal Hand Towel Roll 	Natural	1	8 (20.32 cm)	1,000 (304.8 m)	6	 

Tork Electronic Hand Towel Roll Dispenser - H71



SKU	Description	Color	Size H x W x D (in)	Dispensers/Case
771728	Tork Electronic Hand Towel Roll Dispenser	Black	15.95 x 12.32 x 9.32 (40.51 x 31.29 x 23.67cm)	1
771720	Tork Electronic Hand Towel Roll Dispenser	White	15.95 x 12.32 x 9.32 (40.51 x 31.29 x 23.67cm)	1

Refill No.	Description	Color	Ply	Roll Width (in)	Linear Feet	Case	Certification
7170620	Tork Premium Hand Towel Roll 	White	1	7.5 (19.05 cm)	600 (182.88 m)	6	 
7171040	Tork Advanced Hand Towel Roll 	White	1	7.5 (19.05 cm)	1,000 (304.8 m)	6	 
7178040	Tork Advanced Hand Towel Roll 	White	1	7.5 (19.05 cm)	800 (243.84 m)	6	 
7171600	Tork Universal Hand Towel Roll 	White	1	7.5 (19.05 cm)	630 (192.02 m)	6	
7171400	Tork Universal Hand Towel Roll 	Natural White	1	7.5 (19.05 cm)	800 (243.84 m)	6	 
7171300	Tork Universal Hand Towel Roll 	Natural	1	7.5 (19.05 cm)	800 (243.84 m)	6	 
7171020	Tork Universal Hand Towel Roll 	Natural	1	7.5 (19.05 cm)	1,000 (304.8 m)	6	 

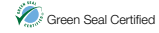
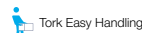



Less is less

Less run outs, less refilling, less waste.



2
Tork coreless
bath tissue rolls



5
conventional
bath tissue rolls



Tork takes pride in saving customers time, effort and money

Eliminate the unnecessary with our new Tork Elevation Coreless High Capacity Bath Tissue Dispensing System. We increase the value of our offer simply by giving less. And by less we mean no wraps, no waste, no plugs and no cores to deal with. It's 100% toilet paper – nothing more, nothing less.

With less time spent on refilling and less risk of run outs, your staff can focus on what really matters – your guests' and employee experience.



Prepare to be surprised by getting less.

Less of the unnecessary

Our coreless bath tissue rolls are compact and last more than twice as long as conventional bath tissue rolls. Less time is needed to be spent on checking if bath tissue is available for your guests.

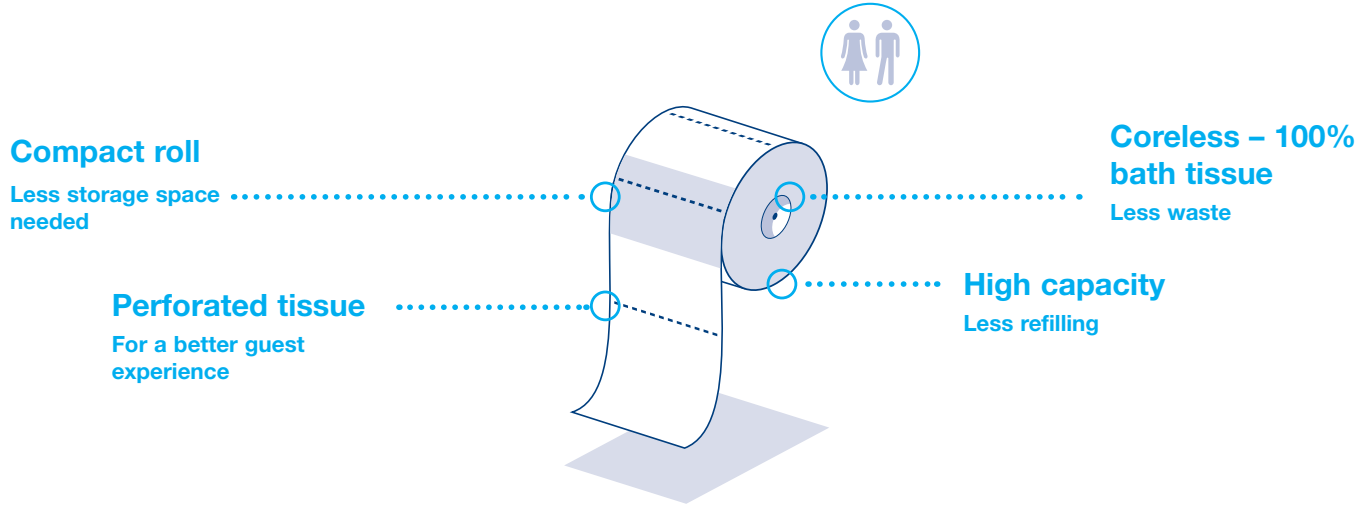

Help your staff focus on your guests

Try Tork Elevation Coreless High Capacity Bath Tissue Dispensing System

Whether your business is a full-service restaurant, a big university or a large office building, you can rely on Tork to help you and your staff focus on what's really important – your guests.

So let go of the conventional and try our Tork Elevation Coreless High Capacity Bath Tissue Dispensing System. We assure you that there will be less to worry about and more satisfied guests.



Are you ready for less?

Good looking and hardworking, the Tork Elevation Coreless High Capacity Bath Tissue Dispensing System delivers more through less. It's efficient, reliable and smart. Choose your dispensers and refills and ensure that a great guest experience starts here.



Tork Elevation Coreless High Capacity Bath Tissue Dispensers – T7

SKU	Description	Color	Size H x W x D (in)	Case
473200	Tork Elevation Coreless High Capacity Bath Tissue Dispenser	White	8.225 x 14.173 x 5.078 (20.9 x 36.0 x 12.9 cm)	1
473208	Tork Elevation Coreless High Capacity Bath Tissue Dispenser	Black	8.225 x 14.173 x 5.078 (20.9 x 36.0 x 12.9 cm)	1



Tork Advanced Coreless High Capacity Bath Tissue Refill – T7

Refill SKU	Description	Color	Ply	Sheet Size W x L (in)	Sheets/Roll	Case	Certification
472886	Tork Advanced Coreless High Capacity Bath Tissue Roll	White	2	3.66 x 4.9 (9.3 x 12.45 cm)	900	36	FSC®



Tork Coreless High Capacity Spindle Kits – T7

SKU	Description	Spindle Size H x W x D (in)	Spindles/Kit	Kits/Case
473030	Tork Coreless High Capacity Spindle Kit, Type A	5.6 x 1.6 x 1.6 (14.22 x 4.06 x 4.06 cm)	2	25
473020	Tork Coreless High Capacity Spindle Kit, Type B	5.9 x 1.6 x 1.6 (14.99 x 4.06 x 4.06 cm)	2	25
473040	Tork Coreless High Capacity Spindle Kit, Type C	6.1 x 1.4 x 1.4 (15.49 x 3.56 x 3.56 cm)	2	25
473060	Tork Coreless High Capacity Spindle Kit, Type D	4.7 x 1.4 x 1.4 (11.94 x 3.56 x 3.56 cm)	2	25



Tork EasyCube compatible



EPA compliant



FSC® Forest Stewardship Council®



A complete family of washroom dispensing systems





Your customers know they're appreciated

From lighting and color to tissue and soap, when you consider all the details in your restroom, people notice. The Tork® Elevation® suite of dispensers tell your customers you care about their entire experience.



Tork Elevation PeakServe™ Continuous™ Hand Towel—H5 System

SKU	Description	Color	Dispenser Size H x W x D (Inches)	Dispensers/Case
552528	Tork Elevation PeakServe Hand Towel Dispenser	Black	28.74 x 14.57 x 3.98 (73 x 37.01 x 10.11 cm)	1
552520	Tork Elevation PeakServe Hand Towel Dispenser	White	28.74 x 14.57 x 3.98 (73 x 37.01 x 10.11 cm)	1

Refill No.	Description	Color	Ply	Sheet Size W x L (Inches)	Towels/Case Packages/ Case	Certification
105065	Tork Advanced PeakServe Continuous Hand Towel	White	1	7.91 x 8.85 (20.09 x 22.48 cm)	4,920 / 12	FSC®



Tork Elevation Matic® Hand Towel Roll—H1 System

SKU	Description	Color	Dispenser Size H x W x D (Inches)	Dispensers/Case
5510282	Tork Matic Hand Towel Roll Dispenser	Black	14.6 x 13.2 x 8.1 (37.21 x 33.53 x 20.57 cm)	1
5510202	Tork Matic Hand Towel Roll Dispenser	White	14.6 x 13.2 x 8.1 (37.21 x 33.53 x 20.57 cm)	1



Tork Elevation Matic Hand Towel Roll Dispenser with Intuition®—H1 System

SKU	Description	Color	Dispenser Size H x W x D (Inches)	Dispensers/Case
5511282	Tork Matic Hand Towel Roll Dispenser with Intuition Sensor	Black	14.5 x 13 x 8 (36.83 x 33.02 x 20.32 cm)	1
5511202	Tork Matic Hand Towel Roll Dispenser with Intuition Sensor	White	14.5 x 13 x 8 (36.83 x 33.02 x 20.32 cm)	1

Refill No.	Description	Color	Ply	Sheet Size W x L (Inches)	Sheets/Roll	Rolls/Case	Certification
290094	Tork Premium Extra Soft Matic Hand Towel Roll	White w/leaf	2	7.7 x 9.5 (19.56 x 24.1 cm) 7.7 x 8.0 (with Intuition Sensor)	379 450	6	FSC®
290096	Tork Premium Soft Matic Hand Towel Roll	White w/leaf	2	7.7 x 9.5 (19.56 x 24.1 cm) 7.7 x 8.0 (with Intuition Sensor)	726 862	6	FSC®
290095	Tork Advanced Soft Matic Hand Towel Roll	White	1	7.7 x 9.5 (19.56 x 24.1 cm) 7.7 x 8.0 (with Intuition Sensor)	1,136 1,350	6	FSC®
290092A	Tork Advanced Matic Hand Towel Roll	White	2	7.7 x 9.5 (19.56 x 24.1 cm) 7.7 x 8.0 (with Intuition Sensor)	663 787	6	FSC®
290089	Tork Advanced Matic Hand Towel Roll	White	1	7.7 x 9.5 (19.56 x 24.1 cm) 7.7 x 8.0 (with Intuition Sensor)	884 1,050	6	FSC®
290087	Tork Advanced Matic Hand Towel Roll	White	1	7.7 x 9.5 (19.56 x 24.1 cm) 7.7 x 8.0 (with Intuition Sensor)	884 1,050	6	FSC®
290088	Tork Universal Matic Hand Towel Roll	Natural	1	7.7 x 9.5 (19.56 x 24.1 cm) 7.7 x 8.0 (with Intuition Sensor)	884 1,050	6	FSC®

The complete look

From tissue and hand towel dispensers to skin care, the Tork Elevation suite of dispensers provides customers a simpler, consistent experience they appreciate.



Elevation Xpress® Multifold Hand Towel—H2 System

SKU	Description	Color	Dispenser Size H x W x D (Inches)	Dispensers/Case
552028	Tork Xpress Hand Towel Dispenser	Black	17.5 x 11.9 x 4.0 (44.4 x 30.2 x 10.2 cm)	1
552020	Tork Xpress Hand Towel Dispenser	White	17.5 x 11.9 x 4.0 (44.4 x 30.2 x 10.2 cm)	1
552120	Tork Xpress Hand Towel Mini Dispenser	White	11.6 x 11.9 x 4.0 (29.5 x 30.2 x 10.1 cm)	1

Refill No.	Description	Color/ Panels	Ply	Sheet Size W x L (Inches)	Towels/Case Packages/ Case	Certification
100297	Tork Premium Extra Soft Xpress Multifold Hand Towel	White/4	2	8.35 x 13.4 (21.21 x 34.04 cm)	2,100 / 21	FSC®
101293	Tork Advanced Soft Xpress Multifold Hand Towel	White/3	2	9.125 x 9.5 (23.18 x 14.13 cm)	3,024 / 16	
420570	Tork Premium Multifold Hand Towel	White/3	1	9.0 x 9.5 (22.86 x 24.13 cm)	3,000 / 12	
424814	Tork Advanced Multifold Hand Towel	White/3	1	9.0 x 9.5 (22.86 x 24.13 cm)	4,000 / 16	FSC®
424864	Tork Advanced Multifold Hand Towel	White/3	1	8 x 9.5 (20.32 x 24.13 cm)	3,000 / 12	FSC®



Tork Elevation Mini Centerfeed Hand Towel—M1 System

SKU	Description	Color	Dispenser Size H x W x D (Inches)	Dispensers/Case
558028A	Tork Mini Centerfeed Hand Towel Dispenser	Black	13.05 x 6.86 x 6.51 (33.15 x 17.42 x 16.54 cm)	1

Refill No.	Description	Color	Ply	Sheet Size W x L (Inches)	Towels/ Roll	Rolls/ Case	Certification
121225	Tork Advanced Soft Mini Centerfeed Hand Towel	White	2	8.3 x 11.8 (21.08 x 29.97 cm)	266	12	



Tork Elevation Centerfeed Hand Towel—M2 System

SKU	Description	Color	Dispenser Size H x W x D (Inches)	Dispensers/Case
559028A	Tork Centerfeed Hand Towel Dispenser	Black	14.39 X 9.42 X 8.95 (36.55 X 22.93 X 22.73 cm)	1
559020A	Tork Centerfeed Hand Towel Dispenser	White	14.39 X 9.42 X 8.95 (36.55 X 22.93 X 22.73 cm)	1

Refill No.	Description	Color	Ply	Sheet Size W x L (Inches)	Towels/ Roll	Rolls/ Case	Certification
100230	Tork Premium Extra Soft Centerfeed Hand Towel	White	1-DRC	7.7 x 11.8 (19.56 x 29.97 cm)	305	6	N/A
121201	Tork Advanced Soft Centerfeed Hand Towel	White	2	9 x 11.8 (22.86 x 29.97 cm)	600	6	
121202	Tork Advanced Soft Centerfeed Hand Towel	White	2	8.25 x 11.8 (20.96 x 29.97 cm)	610	6	
121204	Tork Advanced Soft Centerfeed Hand Towel	White	2	7.6 x 11.8 (19.30 x 29.97 cm)	600	6	
120133	Tork Advanced Centerfeed Hand Towel	White	1	8.25 x 11.8 (20.96 x 29.97 cm)	1,000	6	
121211	Tork Advanced Soft Centerfeed Hand Towel	White	2	7.1 x 11.8 (18.3 x 29.97 cm)	600	6	
120932	Tork Advanced Soft Centerfeed Hand Towel	White	2	7.6 x 11.8 (19.30 x 29.97 cm)	500	6	

Tork Easy Handling



Carry a box with each hand and save time



Use two hands for a comfortable grip



Boxes open quickly and easily without cutting



Tork Elevation Coreless High Capacity Bath Tissue Dispensers – T7 System

SKU	Description	Color	Dispenser Size H x W x D (Inches)	Dispensers/Case
473208	Tork Elevation Coreless High Capacity Bath Tissue Dispenser	Black	8.225 x 14.173 x 5.078 (20.9 x 36.0 x 12.9 cm)	1
473200	Tork Elevation Coreless High Capacity Bath Tissue Dispenser	White	8.225 x 14.173 x 5.078 (20.9 x 36.0 x 12.9 cm)	1

Refill No.	Description	Color	Ply	Sheet Size W x L (in)	Sheets/Roll	Rolls/Case	Certification
472886	Tork Advanced Coreless High Capacity Bath Tissue Roll	White	2	3.66 x 4.9 (9.3 x 12.45 cm)	900	36	FSC®



Tork Elevation Bath Tissue Jumbo Roll with Reserve – T1 System

SKU	Description	Color	Dispenser Size H x W x D (Inches)	Dispensers/Case
554028A	Tork Jumbo Bath Tissue Roll Dispenser with Reserve	Black	14.2 x 17.2 x 5.2 (36.0 x 43.7 x 13.3 cm)	1
554020A	Tork Jumbo Bath Tissue Roll Dispenser with Reserve	White	14.2 x 17.2 x 5.2 (36.0 x 43.7 x 13.3 cm)	1

Refill No.	Description	Color	Ply	Roll Width x Linear Ft. (W x L)	Rolls/Case	Certification
11010402	Tork Jumbo Advanced Bath Tissue Roll 	White	1	3.55 inches x 2,247 linear ft.	6	♻️ ♻️ E
12021502	Tork Jumbo Advanced Bath Tissue Roll 	White	2	3.55 inches x 1,600 linear ft.	6	♻️ ♻️ E



Tork Elevation Bath Tissue Jumbo Roll Mini with Reserve – T2 System

SKU	Description	Color	Dispenser Size H x W x D (Inches)	Dispensers/Case
555028A	Tork Mini Jumbo Bath Tissue Roll Dispenser with Reserve	Black	10.8 x 13.6 x 5.2 (27.5 x 34.5 x 13.2 cm)	1
555020A	Tork Mini Jumbo Bath Tissue Roll Dispenser with Reserve	White	10.8 x 13.6 x 5.2 (27.5 x 34.5 x 13.2 cm)	1



Tork Elevation Bath Tissue Jumbo Roll Mini Twin – T2 System



SKU	Description	Color	Dispenser Size H x W x D (Inches)	Dispensers/Case
5555290	Tork Twin Mini Jumbo Bath Tissue Roll Dispenser	Black	10.12 x 17.0 x 5.68 (25.72 x 43.18 x 14.45 cm)	1
5555200	Tork Twin Mini Jumbo Bath Tissue Roll Dispenser	White	10.12 x 17.0 x 5.68 (25.72 x 43.18 x 14.45 cm)	1

Refill No.	Description	Color	Ply	Roll Width x Linear Ft. (W x L)	Rolls/Case	Certification
11020602	Tork Advanced Soft Mini Jumbo Bath Tissue Roll 	White	2	3.55 inches x 751 linear ft.	12	E
12024402	Tork Advanced Mini Jumbo Bath Tissue Roll 	White	2	3.55 inches x 751 linear ft.	12	♻️ ♻️ E
120246	Tork Advanced Mini Jumbo Bath Tissue Roll 	White	2	3.55 inches x 751 linear ft.	12	♻️ ♻️ ♻️ E
12013903	Tork Advanced Mini Jumbo Bath Tissue Roll 	White	1	3.55 inches x 1,200 linear ft.	12	♻️ ♻️ E



Tork Elevation High-Capacity Bath Tissue Roll – T26 System

SKU	Description	Color	Dispenser Size H x W x D (Inches)	Dispensers/Case
555628	Tork High-Capacity Bath Tissue Roll Dispenser	Black	14.2 x 6.3 x 6.46 (36.07 x 16.0 x 16.41 cm)	1
555620	Tork High-Capacity Bath Tissue Roll Dispenser	White	14.2 x 6.3 x 6.46 (36.07 x 16.0 x 16.41 cm)	1

Refill No.	Description	Color	Ply	Sheet Size W x L (in)	Sheets/Roll	Rolls/Case	Certification
110291A	Tork Advanced High-Capacity Bath Tissue Roll 	White	1	3.94 x 3.75 (10.01 x 9.53 cm)	2,000	36	♻️ ♻️ E
110292A	Tork Advanced High-Capacity Bath Tissue Roll 	White	2	3.94 x 3.75 (10.01 x 9.53 cm)	1,000	36	♻️ ♻️ E



Tork Elevation Liquid Skincare—S1 System

SKU	Description	Color	Dispenser Size H x W x D (Inches)	Dispensers/Case
570028A	Tork Skincare Liquid Dispenser	Black	11.5 x 4.4 x 4.5 (29.21 x 11.18 x 11.43 cm)	6
570020A	Tork Skincare Liquid Dispenser	White	11.5 x 4.4 x 4.5 (29.21 x 11.18 x 11.43 cm)	6

Refill No.	Description	Color	Fragrance	Unit Size	Units/Case	Certification
400011	Tork Premium Extra Mild Liquid Soap	White	None	1 Liter	6	E1 Rated Health Canada
400012	Tork Premium Luxury Soft Liquid Soap	Violet	Soft Rose	1 Liter	6	N/A
400013	Tork Premium Hair and Body Liquid Soap	Light Blue	Apricot	1 Liter	6	N/A
400014	Tork Premium Extra Hygiene Liquid Soap	Clear	None	1 Liter	6	E2 Rated
400016	Tork Premium Alcohol Gell Hand Sanitizer (U.S. only)	Colorless	Light	1 Liter	6	E3 Rated



Tork Elevation Foam Skincare Manual—S4 System

SKU	Description	Color	Dispenser Size H x W x D (Inches)	Dispensers/Case
571508	Tork Elevation Foam Skincare Manual Dispenser	Black	11.26 x 4.45 x 4.13 (28.60 x 11.30 x 10.49 cm)	4
571501	Tork Elevation Foam Skincare Manual Dispenser	White	11.26 x 4.45 x 4.13 (28.60 x 11.30 x 10.49 cm)	4



Tork Elevation Foam Skincare Automatic—S4 System

SKU	Description	Color	Dispenser Size H x W x D (Inches)	Dispensers/Case
571608	Tork Elevation Foam Skincare Automatic Dispenser	Black	10.94 x 4.45 x 5.12 (27.79 x 11.30 x 13.00 cm)	4
571600	Tork Elevation Foam Skincare Automatic Dispenser	White	11.5 x 4.4 x 4.5 (29.21 x 11.18 x 11.43 cm)	4

Refill No.	Description	Color	Fragrance	Unit Size	Units/Case	Certification
401211	Tork Premium Extra Mild Foam Soap	Colorless	None	1 Liter	6	E1 Rated Health Canada
401212	Tork Premium Extra Hygiene Foam Cleanser	Colorless	None	1 Liter	6	E2 Rated
401213	Tork Premium Alcohol-Free Foam Hand Sanitizer (U.S. only)	Colorless	None	1 Liter	6	N/A
400216	Tork Premium Alcohol Foam Hand Sanitizer	Colorless	Light	950 ml	6	E3 Rated Health Canada

Tork Elevation Suite of Dispensers

- Stylish design
- Delivers a perfectly harmonious experience
- Low maintenance
- Fits in with a wide variety of washroom environments



Coordinating Tork washroom solutions

These dispensers, while not officially in the Elevation design line, have a complementary style and coordinate well with the dispenser family.

Tork Xpress Countertop Multifold Dispensers—H2/H23 System



SKU	Description	Color	Dispenser Size H x W x D (Inches)	Dispensers/Case
302028	Tork Xpress Countertop Multifold Hand Towel Dispenser	Black	14.76 x 6.69 x 10.43 (37.49 x 16.99 x 26.49 cm)	1
302020	Tork Xpress Countertop Multifold Hand Towel Dispenser	White	14.76 x 6.69 x 10.43 (37.49 x 16.99 x 26.49 cm)	1
302030	Tork Image Design™ Xpress Countertop Multifold Hand Towel Dispenser	Stainless Steel	14.76 x 6.69 x 10.43 (37.49 x 16.99 x 26.49 cm)	1

Refills: 100297, MB572, MB574, MB578, 101293, 420570

Tork Bath Tissue Dispensing Systems for OptiCore®—T10 System



SKU	Description	Color	Size H x W x D (in)	Dispensers/Case
565520	Tork High Capacity Bath Tissue Roll Dispenser for OptiCore	White	9.93 x 16.62 x 5.25 (25.22 x 42.21 x 13.34 cm)	1
565528	Tork High Capacity Bath Tissue Roll Dispenser for OptiCore	Black	9.93 x 16.62 x 5.25 (25.22 x 42.21 x 13.34 cm)	1

Refills: 160090

Tork Bath Tissue Dispensing Systems for OptiCore—T11 System



SKU	Description	Color	Size H x W x D (in)	Dispensers/Case
565820	Tork 3 Roll Bath Tissue Roll Dispenser for OptiCore	White	14.56 x 14.12 x 6.31 (36.98 x 35.86 x 16.03 cm)	1
565828	Tork 3 Roll Bath Tissue Roll Dispenser for OptiCore	Black	14.56 x 14.12 x 6.31 (36.98 x 35.86 x 16.03 cm)	1

Refills: 106390, 162090, 161990, 112990



SKU	Description	Color	Size H x W x D (in)	Dispensers/Case
565720	Tork Twin Bath Tissue Roll Dispenser for OptiCore	White	8.81 x 11.06 x 7.18 (22.37 x 28.09 x 18.24 cm)	1
565728	Tork Twin Bath Tissue Roll Dispenser for OptiCore	Black	8.81 x 11.06 x 7.18 (22.37 x 28.09 x 18.24 cm)	1

Refills: 106390, 162090, 161990, 112990



SKU	Description	Color	Size H x W x D (in)	Dispensers/Case
565620	Tork Twin Bath Tissue Roll Dispenser for OptiCore	White	12.31 x 6.75 x 7 (31.27 x 17.15 x 17.78 cm)	1
565628	Tork Twin Bath Tissue Roll Dispenser for OptiCore	Black	12.31 x 6.75 x 7 (31.27 x 17.15 x 17.78 cm)	1

Refills: 106390, 162090, 161990, 112990

Tork Bath Tissue Jumbo Roll Twin—T1 System



SKU	Description	Color	Dispenser Size H x W x D (Inches)	Dispensers/Case
247549A	Tork Bath Tissue Jumbo Roll Twin Dispenser	Black	13.0 x 21.5 x 5.5 (33.02 x 54.61 x 13.97 cm)	4

Refills: 11010402, 12021502

Tork Toilet Seat Cover—V1 System



SKU	Description	Color	Dispenser Size H x W x D (Inches)	Dispensers/Case
1951001	Tork Toilet Seat Cover Dispenser	Smoke	11.5 x 16 x 3.125 (29.21 x 40.64 x 7.94 cm)	12

Refills: TC0020



Essity's vision is "Dedicated to improving well-being through leading hygiene and health solutions."

Essity (formerly SCA) is a leading global hygiene and health company that develops, produces and sells Personal Care (Baby Care, Feminine Care, Incontinence Products and Medical Solutions), Consumer Tissue and Professional Hygiene products and solutions. Sales are conducted under many strong brands, including the leading global brands Tork and TENA, and other brands, such as Leukoplast, Libero, Libresse, Lotus, Nosotras, Saba, Tempo, Vinda and Zewa. The business operations are based on a sustainable business model with focus on value creation for people and nature.

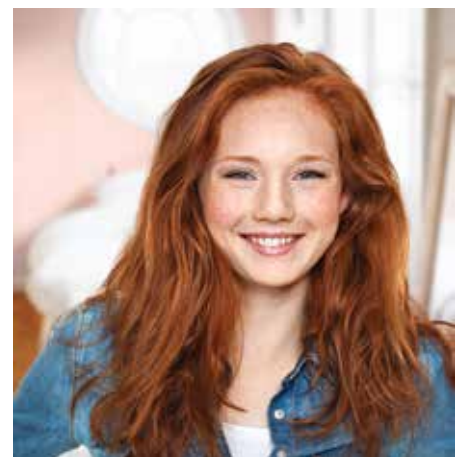

Headquarters in Stockholm.

Sales are conducted in about 150 countries



#HygieneMatters is an initiative that aims to drive and support a global dialogue around hygiene, health and well-being. It focuses on breaking taboos around menstruation and incontinence, highlighting the economic impact of hygiene and encouraging innovation in the hygiene sector in order to support sustainable progress.



Did you know that....

... Essity partners with the United Nations Foundation in support of the Sustainable Development Goals to improve hygiene, health and well-being worldwide?



- 48,000 Employees
- 2016 Net Sales 12 Billion
- 2,000,000 women, men, children and caregivers received hygiene education in 2016.



Essity's Sustainability Commitment

- **Sustainability has been an integral part** of SCA and our hygiene operations for many years, now we bring this to Essity.
- **We remain committed** to raising the hygiene standards in the markets where we are active, and to contributing to a sustainable and circular society (reduce, reuse, recycle).
- **We pursue ambitious targets** in areas which are important for Essity and our stakeholders: people & nature innovations, hygiene solutions, health & safety, climate & energy, water.
- Through our sustainable solutions **we improve quality of life** for millions of people and create shared value for society.



Some of our Global Partners



2015 Constituent
MSCI Global
Sustainability Indexes



100% solid production waste to be recovered by 2030



40% of Essity's innovations improved social and/or environmental impact



15.5% reduction of CO2 emissions by 2016



Essity has used Life Cycle Analysis since **1990**



0% sourcing policy on using pulp from controversial sources



1 Million tons of recycled content used per year in North America to make Tork hygiene products



Increase efficiency and improve productivity



Helping your business reach ever-higher levels of performance takes continuous improvement of work processes. After streamlining systems and methods, there is an opportunity for saving time, money and effort that is often overlooked: your wiping and cleaning tasks.

Tork® Cleaning Cloths with exelCLEAN® deliver performance advantages over rags and rental shop towels you can test.



New, improved cleaning cloths work harder

Compressed packs reduce handling, storage and transportation costs, plus increase dispenser capacity

Turn preparation time into production time with new, improved Tork Cleaning Cloths with exelCLEAN.

Purpose-made Tork Cleaning Cloths with exelCLEAN plus a handy dispenser nearby will help save time, money and effort. Their consistent, high quality assures more efficient wiping and cleaning so workers spend less time cleaning and more time producing.

Improved cleaning performance

Make tough jobs easier. In the spirit of continuous improvement, Tork Cleaning Cloths with exelCLEAN have been refined to improve durability with a new, uniform construction.

Easier loading and storage

For easier loading and storage, packs of our new, folded cloths are now compressed and "right-sized" to deliver more from less space. Now load two packs at once and avoid refilling W4 dispensers as often. Compressed packs also save valuable storage and freight space, by up to 26% versus our previous packs. Less freight space means more efficient or fewer trips therefore reducing your environmental impact.

Easier handling

For easier use in tougher environments, our portable handy boxes have a new design, reinforced handle and a larger opening—so you can easily take a Tork wiper even with gloves on.



Key benefits

- More durable cleaning cloths last longer and are even more efficient than our current products
- Compressed packs save space and increase dispenser capacity
- Wipers are close at hand where you need them

Tork Cleaning Cloths with exelCLEAN



SKU#	Description	Color	Ply	Sheet Size W x L (in)	Wipers/Unit	Units/Case	Certification
510104	Tork Cleaning Cloth, Giant Roll	White	1	16.9 x 15.0 (42.93 x 38.10 cm)	1,000	1	Health Canada NSF P1
510137	Tork Cleaning Cloth, Centerfeed	White	1	12.6 x 10.0 (32.00 x 25.4 cm)	500	1	Health Canada NSF P1
510175A	Tork Cleaning Cloth, Pop-Up Box	White	1	8.46 x 16.125 (21.49 x 40.96 cm)	100	5	Health Canada NSF P1
530104	Tork Heavy-Duty Cleaning Cloth, Giant Roll	White	1	16.9 x 15.0 (42.93 x 38.10 cm)	710	1	Health Canada BMS 15-5G
530137	Tork Heavy-Duty Cleaning Cloth, Centerfeed	White	1	12.6 x 10 (32.0 x 25.40 cm)	400	1	Health Canada BMS 15-5G
530178	Tork Heavy-Duty Cleaning Cloth, Top-Pak	White	1	14 x 16.9 (35.56 x 42.93cm)	100	5	Health Canada BMS 15-5G
5301755	Tork Heavy-Duty Cleaning Cloth, Pop-Up Box	White	1	8.46 x 16.125 (21.49 x 40.96 cm)	80	5	Health Canada BMS 15-5G
5301505	Tork Heavy-Duty Cleaning Cloth, 1/4 Fold	White	1	12.6 x 13 (32 x 33 cm)	50	6	Health Canada BMS 15-5G
520304	Tork Industrial Cleaning Cloth, Giant Roll	Grey	1	16.9 x 15.0 (42.93 x 38.10 cm)	950	1	Health Canada
520337	Tork Industrial Cleaning Cloth, Centerfeed	Grey	1	12.6 x 10.0 (32.00 x 25.4 cm)	500	1	Health Canada
520678	Tork Industrial Cleaning Cloth, Top-Pak	Grey	1	14 x 16.9 (35.56 x 42.93cm)	120	5	Health Canada
520371	Tork Industrial Cleaning Cloth, Handy Box	Grey	1	14 x 16.9 (35.56 x 42.93cm)	280	1	Health Canada
570104	Tork Industrial Heavy-Duty Cleaning Cloth, Giant Roll	White	1	16.9 x 15.0 (42.93 x 38.10 cm)	380	1	Health Canada BMS 15-5G
570137	Tork Industrial Heavy-Duty Cleaning Cloth, Centerfeed	White	1	12.6 x 15.0 (32.0 x 38.10 cm)	160	1	Health Canada BMS 15-5G
570478	Tork Industrial Heavy-Duty Cleaning Cloth, Top-Pak	White	1	14 x 16.9 (35.56 x 42.93cm)	65	5	Health Canada BMS 15-5G
197478	Tork Polishing Cloth, Top-Pak	White	1	14 x 16.9 (35.56 x 42.93cm)	125	5	Health Canada

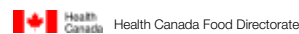



Research, trends and Tork solutions for the Food Processing segment



What is Food Processing?

Food processing is defined as the handling or processing of any food in any manner of preparation for sale and consumption.¹ Food products manufactured in a Food Processing environment are typically sold to wholesalers or retailers for distribution to consumers. Establishments primarily engaged in selling bakery and candy products made on the premises and not for immediate consumption are also included.² Food prepared, cooked and served for immediate consumption is not our primary concentration in this segment. Other opportunities in this space include establishments where food is prepared for sale and/or consumed on-site.

Here's a breakdown of the food processing industry:

Market share ⁴	Industry	Examples	Market share ⁴	Industry	Examples
31%	Animal slaughtering and processing	Tyson®	4%	Sugar and confectionery product manufacturing	Hershey's®
16%	Bakeries and tortilla manufacturing	Hostess®	4%	Seafood product preparation and packaging	Tri Marine®
11%	Other food manufacturing	ConAgra Foods®	3%	Grain and oilseed milling	Cargill®
10%	Fruit and vegetable preserving and specialty food manufacturing	Dole®	3%	Animal food manufacturing (pet and livestock)	Purina®
9%	Dairy product manufacturing	Nestle®	1%	Tobacco manufacturing	Philip Morris®
8%	Beverage manufacturing	Pepsico®			

Why does Food Processing matter to us?

The Food Processing segment is forecast to **grow at 3% annually** from 2016-2020, with the top 100 producers ranging from **610 million** to **38.2 billion**.⁵ As a result, Food Processing facilities are already requiring—and going to require— more wipers, towels, and napkins to support their workers' needs.

What is HACCP International?

Mandated by the USDA, FDA and CFIA, Hazard Analysis Critical Control Point (HACCP) protocols are a process control system designed to enhance food safety by identifying and preventing physical, chemical or biological hazards in food production. HACCP includes steps to prevent problems before they occur and to correct problems as soon as they are detected.¹



HACCP Certified vs. HACCP Compliant

Certain Tork products are certified by HACCP International. In contrast, competitive products can only claim to be in compliance with the Seven Principles of the HACCP approach.

Essity helps food processors adhere to their HACCP plan

There are critical control points within the process where cross-contamination can occur from touching machines with unclean hands, or bacteria harboring as a result of an improper spray-down process. Essity helps food processors take preventive measures by providing products that are touch-free and water-resistant.

Food Processing decision-makers

In larger facilities, decision-makers tend to have more defined roles while smaller factories employ those who wear many different hats. Like most industries, there is an overwhelming need to reduce risks and improve efficiencies without sacrificing quality. But Food Processing professionals must also contend with ever-changing government regulations.

1. Sanitation Services

Sanitation workers clean, sanitize and refill dispensers as necessary. They are the “feet on the ground,” but it’s the sanitation supervisor who’s usually in charge of ordering cleaning supplies and maintaining inventory. Together, this department knows these products and is best able to identify needs and recommendations. In smaller plants, quality assurance or quality control managers might also fill the role of the sanitation manager/supervisor, and should be the first call.

2. Operations/Quality Assurance Managers

This person oversees the Food Processing activities like canning, baking, freezing, dehydrating, packaging and more. They also spearhead activities aimed at improving efficiencies in costs and operations. They monitor budgets and financial reports and are decision-makers when it comes to purchasing products for the facility. It is their job to make sure the products and services being used in the plant are HACCP compliant to avoid any risk of cross-contamination—while improving productivity and lowering costs at the same time.

3. Plant Manager

The plant manager¹ is the person who needs to be sold (unless they delegate the change to one of their supervisors) on increasing efficiencies for his employees and operations as well as cost-reduction measures. They generally want buy-in from their staff for this recommended product. They need to be on board with any program and products we are selling to ensure there is support.

Inside tip:

This department occasionally makes purchasing decisions, but often influences operations managers to try and purchase the products that get the job done right.

Inside tip:

These individuals have the ability to influence purchasing decisions. They will evaluate solutions based on efficiency.

Inside tip:

These individuals are most receptive to labor savings and process improvement. They understand the importance of HACCP-Approved products, and that higher capacity dispenser solutions will help keep their plant running more efficiently.

A closer look inside the Food Processing facility

Depending on the type of products being prepared, Food Processing facilities can be a mix of extremes: wet and dry, loud and quiet, fast and slow. Exposure to food by-products like fats, hot oils, blood, sugar solutions and natural food acids means these environments are not for the faint of heart. But there's always a method to the mayhem—these facilities must constantly be kept clean and hygienic to keep workers and consumers safe.

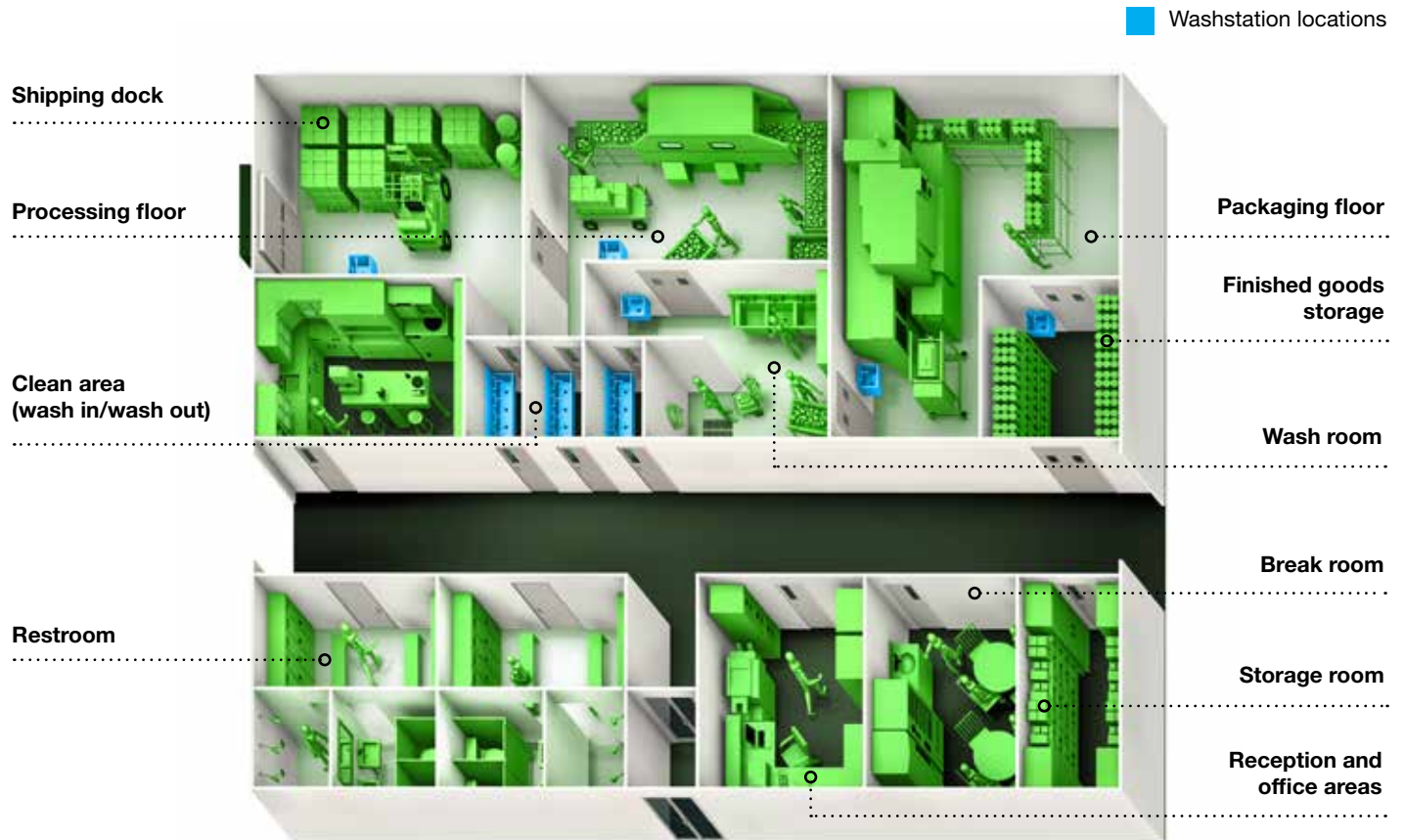

- Within the processing area, equipment and floors are sprayed with high powered washers to clean them.
- Wipers or rags are not frequently used to clean or sanitize in the processing area. A spray-down using water with sanitizer is considered more hygienic and efficient.
- Dispensers need to be water-resistant since they're sometimes purposefully (or accidentally) sprayed during routine cleaning.
- Facilities are required to have two doors between the processing floor and adjacent rooms such as restrooms or offices.
- "Clean Areas" serve as barriers between the germ-free processing floor and the outside world. Employees must "wash in" and "wash out" for their shift.
- No-scent soap is required in processing areas—and preferred in other areas of these facilities.
- Always use the word "restroom" to refer to the bathroom, since "wash room" is actually an industry term for an area commonly used to wash equipment.
- Cleaning supplies such as sanitizers, wipers and towels are often stored together in a locked cabinet away from the processing area to reduce contamination risks. This may mean storage space is at a premium and needs to be taken into consideration when recommending products.

Recommended Tork wiping and cleaning products



Tork Washstation Dispenser
651220, White/ Aqua



Tork Washstation Dispenser
651228, Red/ Smoke



Tork Paper Wiper*
291380, White



Tork Basic Paper Wiper*
291370, White
291350, Kraft



**Tork Folded Wiper/
Cloth Dispenser**
654021, White
6540281, Red



**Tork Industrial Heavy-
Duty Cleaning Cloth**
570478



Tork Paper Wiper Plus*
192127



**Tork Quat Friendly
Foodservice Cloth**
192195, White
192196, Blue



**Tork Antimicrobial Heavy-
Duty Foodservice Cloth**
192194

Recommended Tork restroom and break room products



**Tork Elevation Matic
Hand Towel
Roll Dispenser**
5510202, White
5510282, Black



**Tork Elevation Bath
Tissue Jumbo Roll Mini
Twin Dispenser**
5555200, White
5555290, Black



**Tork Foam Soap
Automatic
Touch-Free Dispenser**
571600, White
571608, Black



**Tork Advanced
Hand Roll Towel**
290089
290088



**Tork Advanced Bath
Tissue Mini Jumbo Roll**
2-Ply, 12024402
1-Ply, 12013903



**Tork Premium
Antibacterial
Foam Soap****
401212

**Tork Premium Foam
Alcohol Hand Sanitizer**
400216



**Tork Xpressnap®
Signature Tabletop
Napkin Dispenser**
6232000, Black
6233001, Blue
6234000, Gray
6235000, Stainless Finish
6236000, Red
6239000, Green



**Tork Xpressnap®
Signature Stand
Napkin Dispenser**
6332000, Black
6333001, Blue
6334000, Gray
6336000, Red
6339000, Green



**Tork Advanced
Xpressnap Dispenser
Napkin, Interfold**
DX900, White
DX906E, Kraft



Foodservice cloths that keep your operation running smoothly



Conveniently
available
wherever you
need them





Good food—and clean, hygienic facilities—keep restaurants in business. That means having the right tools for the right tasks. Tork® compact format Foodservice cloths are convenient to use, easy to store, and now available in a smaller size, so you're always ready to make a good impression.

Keep your wipers handy.

The new compact format Tork Foodservice Cloth is designed to fit into space-saving dispenser brackets at server stations, back of house or in storage areas. So they're available where you need them, when you need them, for an easy clean-and-go. They arrive in convenient Tork Easy Handling™ boxes with shelf-ready packaging that's just as easy to store as it is to access, helping your staff instantly find Tork Foodservice Cloths among all their supplies.



Keep hygiene top-of-mind.

Maintaining compliance with Foodservice regulations is easy with the new compact format Tork Foodservice Cloth. They're packaged in a poly pack that protects them from dust, dirt, moisture and spills. Designed to work better with quat sanitizers than cotton based textiles, they rinse clean and are odorless for a better front-of-house impression. Each pack of Tork Foodservice Cloths are color-coded to help avoid the risk of cross-contamination.



Perforated for easy access and storage



655300

192183

192184

192291

192292

192293

SKU	Description	Color	Material	Size H x W x D (in)	Capacity	Dispensers/Case
655300	Tork Small Pack Dispenser Bracket	White	Plastic	5.74 x 8.42 x 4.22	1 Poly Pack	4

Refill SKU	Description	Color	Sheet Size W x L (in)	Wipers/Poly	Poly/Case	Wipers/Case
192183	Tork Foodservice Cloth, Multifold	Blue/White	11.75 x 14.75	80	4	320
192184	Tork Foodservice Cloth, Multifold	Green/White	11.75 x 14.75	80	4	320
192291	Tork Antimicrobial* Foodservice Cloth, Multifold	White w/Red Stripe	11.75 x 14.75	50	4	200
192292	Tork Antimicrobial* Foodservice Cloth, Multifold	Blue w/Blue Stripe	11.75 x 14.75	50	4	200
192293	Tork Antimicrobial* Foodservice Cloth, Multifold	Red w/Red Stripe	11.75 x 14.75	50	4	200

*Antimicrobial technology – inhibits the growth of odor-causing bacteria in the food service cloth, which keeps the cloth fresh longer.



HACCP International's Food Safety Certification for Tork

What is HACCP?

HACCP is a common-sense methodology for managing food safety hazards. It is used all over the world by food manufacturers. The methodology underpins all of the 'world's best practice' food safety schemes such as SQF, AIB, BRC and ISO 22000.

How does HACCP International Certification relate to non-food products such as ours?

HACCP International high food safety standards don't just address risks from ingredients and handling processes, they also take into account risks from other sources such as materials and equipment. For these non-food items, food businesses cannot ask their suppliers to have HACCP based food safety programs because they don't actually make food.

In these situations, the food business is obliged to have protocols in place that address any possible risks that could be introduced by items such as equipment and materials.

If the food business has this expertise they can do this themselves. When they don't have the expertise or they want to simplify the process, then they look for 3rd party certification. This confirms to the food business that, the equipment or material is fit for use in food production..

HACCP International's product certification is designed to meet this precise need.

How does this fit with Essity's certified products

Essity's certified products have been evaluated against the requirements of HACCP International by experienced and expert food scientists and HACCP practitioners to ensure that the product is food safe and will not compromise the food safety requirements of food businesses. HACCP International has looked at 10 key criteria which, among others, include the following:

- Design
- Batch & process controls
- Cleanability
- Contamination risks
- Materials and specifications
- Toxicity of the product and its components



Particular to Essity's dispenser

HACCP international understands that Essity has looked closely at design and production requirements of the HACCP International certified Tork Washstation dispensers and refills.

Certification not only confirms the food safety attributes of Essity's products but also identifies Essity as a company that is aware and responsive to the particular needs of the food and beverage industry.



Information sourced from HACCP International's Food Safety Certification for Tork®.

Tork HACCP Intl Certified product range



Tork Washstation Dispensers

Product	Name	Color	Size (H x W x D)	Dispenser capacity	Units/case	System
651220	Tork Washstation Dispenser	Aqua/White	18.1 x 12.5 x 10.6 in (45.9 x 31.9 x 26.8 cm)	1	1	W6
651228	Tork Washstation Dispenser	Red/Smoke	18.1 x 12.5 x 10.6 in (45.9 x 31.9 x 26.8 cm)	1	1	W6



Tork Paper Wipers

Product	Name	Material	Linear ft/roll	Linear ft/case	Units/case	System
291380	Roll Towel	White	1150 ft (350.52 m)	4,600 ft (1,402.02 m)	4	W6
291370	Roll Towel	White	1150 ft (350.52 m)	4,600 ft (1,402.02 m)	4	W6
291350	Roll Towel	Kraft	1150 ft (350.52 m)	4,600 ft (1,402.02 m)	4	W6



Tork Multipurpose Paper Wiper

Product	Name	Color	Sheet Size W x L (in)	Feet/Unit	Units/Case	System
130211B	Centerfeed	White	9 x 13 (22.86 x 33.02 cm)	866 (263.96 m)	2	W1, W2
130251A	Centerfeed	White	9 x 15.5 (22.86 x 39.37 cm)	419 (127.71 m)	4	M2



Tork Paper Wiper Plus

Product	Name	Color	Sheet Size W x L (in)	Feet/Unit	Units/Case	System
192127	Pop-Up Box	White	9.25 x 16.25 (23.50 x 41.28 cm)	135.4 (41.27 m)	8	W24
192128	Centerfeed	White	9.8 x 15.2 (24.18 x 38.61 cm)	380 (115.82 m)	2	W2
430150A	1/4 Fold	White	12.5 x 13 (31.75 x 33 cm)	97.5 (29.72 m)	12	--
430178	Top-Pak	White	13.57 x 16.25 (34.47 x 41.28 cm)	203.12 (61.9 m)	5	W4
430304	Giant Roll	White	11.1 x 12 (28.19 x 30.48 cm)	800 (243.84 m)	2	W1



Tork Heavy-Duty Cleaning Cloth

Product	Name	Color	Sheet Size W x L (in)	Feet/Unit	Units/Case	System
530104	Giant Roll	White	16.9 x 15.0 (42.93 x 38.10 cm)	887.5 (270.51 m)	1	W1
530137	Centerfeed	White	12.6 x 10 (32.0 x 25.40 cm)	333.33 (101.59 m)	1	W2
530178	Top-Pak	White	15.2 x 16.85 (38.61 x 42.80 cm)	140.4 (42.79 m)	5	W4
5301755	Pop-up Box	White	8.46 x 16.125 (21.49 x 40.96 cm)	107.5 (32.77 m)	5	W24
5301505	1/4 Fold	White	12.6 x 13 (32 x 33 cm)	54.16 (16.51 m)	6	--



Tork Industrial Heavy-Duty Cleaning Cloth

Product	Name	Color	Sheet Size W x L (in)	Feet/Unit	Units/Case	System
570104	Giant Roll	White	16.9 x 15.0 (42.93 x 38.10 cm)	475 (144.78 m)	1	W1
570137	Centerfeed	White	12.6 x 10.0 (32.0 x 25.4 cm)	133.3 (40.63 m)	1	W2
570478	Top-Pak	White	14 x 16.9 (35.56 x 42.93 cm)	91.5 (27.89 m)	5	W4



Tork High-End Leaf Towels

Impressions make
the difference





This is the Leaf.

It represents the very nature of simple elegance.

That's why we're offering a collection of high-end towels with the Leaf, to provide your customers a luxurious experience.

Soft, strong and smart—our towels deliver complete comfort in a way you can feel good about.

Best of all, customers who see and feel the Leaf on our towels know your business upholds the same high-end image.

Because your restroom makes an impression, and impressions make the difference.



We know your customers expect a high-end restroom experience. And since restrooms reflect on your entire business, every impression counts. That means providing the finest amenities to ensure you maintain an elegant image.



Our high-end hand towels show your customers what luxury feels like.

Soft

Comfort and image go hand-in-hand. That's why our high-end towels offer both superior softness and a better experience. So your restroom makes an impression you and your customers can feel good about.



Strong

High-end restrooms demand high performance.

That means stronger, more absorbent towels to help customers dry their hands completely. It also means peace of mind knowing your restroom can handle high-traffic use with ease.



Larger, stronger towels don't tab or break apart, providing reliable one-at-a-time dispensing



Customers' hands dry faster thanks to greater absorbency and overall better performance



High-performance towels help customers use fewer, resulting in greater cost savings

Smart

Our towels are held responsible.

We developed our collection of Leaf towels to deliver true, sustainable comfort. Using renewable and recycled content, as well as one-at-a-time dispensing, Tork solutions can reduce waste, and leave a positive impression on customers and the planet.



Maintain a high-end image with reduced waste and clutter



Combine softness with sustainability for quick dry performance



Complement any restroom décor with compatible design

A solution for every restroom

Tork Image Design™ Dispensing Systems



Tork Image Design™ Xpress® Countertop Multifold Hand Towel Dispenser - H2/H23

302030, Stainless Steel



Tork Image Design Xpress Hand Towel Dispenser - H2



463002, Stainless Steel



Tork Image Design Matic Hand Towel Roll Dispenser - H1



461022, Recessed, Stainless Steel



461023, In Wall Recessed, Stainless Steel



461002, Stainless Steel



Tork Image Design Matic Hand Towel Roll Dispenser with Intuition Sensor - H11

461122, Recessed, Stainless Steel

461123, In Wall Recessed, Stainless Steel

461102, Stainless Steel

Tork Elevation® Dispensing Systems



Tork Xpress Countertop Multifold Hand Towel Dispenser - H2/H23

302020, White

302028, Black



Tork Elevation Xpress Hand Towel Dispenser - H2



552020, White



552028, Black



Tork Elevation Matic® Hand Towel Roll Dispenser - H1



5510202, White



5510282, Black



Tork Elevation Matic Hand Towel Roll Dispenser with Intuition® Sensor - H1

5511202, White

5511282, Black

Tork offers multiple solutions for recessed cabinets. Please ask your Essity sales representative for more details.



Tork Easy Handling™
With Tork Carry Box™ and Carry Pack™, boxes and bags are easier to carry, open and dispose—designed to improve ergonomics and staff efficiency.

Satisfaction guaranteed
If you're not 100% satisfied with any of our Tork towels, we'll refund your purchase with up to 1,000 in the Tork towel product of your choice. No questions asked.

10% usage reduction guaranteed
We guarantee at least a 10% Usage Reduction in 90 days when you switch from any folded towel to Tork Premium Soft Multifold Hand Towels or we'll compensate you with up to 1,000 in Tork products.

Guaranteed



QuickDry products offer a quick and highly absorbent hand drying experience.



Compatible with Tork EasyCube™ Intelligent Restroom System

High-End Towel Collection

Look for the leaf



The best you can get. A premium hand towel with unequalled softness and performance for a restroom that lets customers know you care.



The right touch of softness and performance for your restroom. A range of efficient, high-quality towels providing complete comfort and convenience.



A standard range of reliable towels. Combines a soft experience with cost efficiency.

Premium Extra Soft



Refill SKU	Description		Color	Ply	Sheet Size W x L (in)	Towels/Pkg or Roll	Towels/Case	Case	Certification
100297	Tork Xpress Premium Extra Soft Multifold Towel 4-Panel, H2		White	2	8.35 x 13.4 (21.21 x 34.04 cm)	100	2,100	21	FSC®
290094	Tork Premium Extra Soft Hand Towel Roll, H1		White	2	7.7 x 9.5 (19.56 x 24.1 cm) – 7.7 x 8 (19.56 x 20.32 cm) w/ Intuition sensor (8" setting)	379 – 450 with Intuition sensor (8" setting)	2,274 – 2,700 with Intuition sensor (8" setting)	6	FSC®
290015	Tork Premium Extra Soft Matic Hand Towel Roll, H11		White	2	8.27 x 10 (21.01 x 25.4 cm) – w/Intuition sensor (10" setting)	393 with Intuition sensor (10" setting)	2,358 with Intuition sensor (10" setting)	6	FSC®

Premium Soft



Refill SKU	Description		Color	Ply	Sheet Size W x L (in)	Towels/Pkg or Roll	Towels/Case	Case	Certification
MB572	Tork Xpress Premium Soft Multifold Towel, 4-Panel, H23		White	2	9.125 x 14.5 (23.18 x 36.86 cm)	94	3,008	32	FSC®
MB574	Tork Xpress Premium Soft Multifold Towel, 4-Panel, H23		White	2	8.4 x 14.5 (21.34 x 36.86 cm)	94	3,008	32	FSC®
MB576	Tork Premium Soft Multifold Towel, 3-Panel, H23		White	2	10.1 x 10.875 (25.65 x 27.62 cm)	135	2,160	16	FSC®
MB578	Tork Premium Soft Multifold Towel, 3-Panel, H23		White	2	9.125 x 10.875 (23.18 x 27.62 cm)	135	2,160	16	FSC®
290096	Tork Premium Soft Hand Towel Roll, H1		White	2	7.7 x 9.5 (19.56 x 24.1 cm) – 7.7 x 8 (19.56 x 20.32 cm) w/ Intuition sensor (8" setting)	726 – 862 with Intuition sensor (8" setting)	4,356 – 5,175 with Intuition sensor (8" setting)	6	FSC®
290019	Tork Premium Soft Matic Hand Towel Roll, H11		White	2	8.27 x 10 (21.01 x 25.4 cm) – w/Intuition sensor (10" setting)	690 with Intuition sensor (10" setting)	4,140 with Intuition sensor (10" setting)	6	FSC®

Advanced Soft



Refill SKU	Description		Color	Ply	Sheet Size W x L (in)	Towels/Pkg	Towels/Case	Case	Certification
420554	Tork Advanced Soft Multifold Hand Towel, 4-panel, H23		White	1	8.4 x 14.5 (21.34 x 36.83 cm)	150	2,400	16	FSC®
420558	Tork Advanced Soft Xpress Multifold Hand Towel, 3-panel, H23		White	1	9.125 x 10.875 (23.18 x 27.62 cm)	200	3,200	16	FSC®



Tork Easy Handling



QuickDry™



EPA compliant.

FSC® Forest Stewardship Council™



How else can we help?
Get in touch to talk
about your business.





We help you renew your most valuable resource: good students



These days, students and staff demand sustainable practices from their school. You need to do more with your shrinking budget. The great news is we provide both.

65% of applicants care about a college's commitment to the environment.¹

36% of students said illness affected their academic performance.²

74% of students believe it is important for dining services to maintain environmentally friendly practices.³

Cost

Tork dispensing solutions help keep consumption, waste, and staff labor in check.

Hygiene

Touch-free systems reduce the spread of germs, keeping students happy, healthy and attending class.

Image

It's the little things like clean, clutter-free restrooms and facilities that students appreciate.

Sustainability

Switching to Tork 100% recycled and third-party certified products improves student perception at no extra cost to institutions.

Recommended Tork products

Foodservice operations

Your cafeteria and foodservice venues serve high volumes of students practically 24/7. Without the proper systems and procedures in place, the uncontrolled spread of germs has the potential to wreak havoc on campus. Tork task-specific wipers – coupled with proper hand-washing stations – make it easy to prevent cross-contamination.

34% of foodborne illnesses can be traced back to the hands of foodservice employees.⁴



Tork Signature Xpressnap® Tabletop Napkin Dispenser (N4) – 6232000



Tork Signature Xpressnap Stand Napkin Dispenser (N4) – 6332000



Tork Antimicrobial Foodservice Cloth, 1/4 Fold – 192191



Tork Elevation Foam Skincare Automatic Dispenser (S4) – 571608

Restrooms & common areas

Keeping high-traffic areas clean will help protect students by minimizing the spread of germs during cold and flu season. Tork hygienic systems help you maintain a sanitary environment for your students while reducing operating costs and improving efficiency for your staff.

21% of cold and flu cases can be reduced with a proper hand sanitizing program.⁵



Tork Elevation Matic® Hand Towel Roll Dispenser (H1) – 5510282



Tork Elevation® Twin Mini Jumbo Bath Tissue Roll Dispenser (T2) – 5555290



Tork Elevation Coreless High Capacity Bath Tissue Dispenser (T7) – 473208



Tork Coreless High Capacity Spindle Kits
Type A – 473030
Type B – 473020
Type C – 473040
Type D – 473060



Tork Elevation Foam Skincare Automatic Dispenser (S4) – 571608

Athletic center

Students deserve to exercise on clean equipment in an appealing environment. Tork touch-free, controlled consumption dispensers provide just the right amount of product and create a more sanitary facility, while improving the image of your athletic center.

In a random selection of fitness centers, at least 63% of the equipment was found to contain rhinoviruses—a germ that spreads the common cold.⁶



Tork Elevation Matic® Hand Towel Roll Dispenser (H1) – 5510282



Tork Elevation® Twin Mini Jumbo Bath Tissue Roll Dispenser (T2) – 5555290



Tork Elevation Liquid Skincare Dispenser (S1) – 570028A



Sanitizer Stand, (S4) – 570038



Tork Image Design Washroom
Dispensing Systems

The art of creating impressions



2016 **ISSA**[®]

INNOVATION
AWARD WINNER

Dispensers

Tork Image Design™ Matic® Hand Towel Roll Dispenser with Intuition® Sensor – H11

The touch-free, fully automatic dispensers are ideal for washrooms that demand optimal hygiene or simply a more sophisticated touch.



461102



461122 (Recessed)





461123 (In wall recessed)

Features

- Sensor-activated
- High capacity with LED refill indicator
- One-at-a-time dispensing
- Available in surface mount and recessed formats

Recommended refills

-  290015 – Tork Premium Extra Soft Matic Hand Towel Roll, FSC®
-  290019 – Tork Premium Soft Matic Hand Towel Roll,  FSC®

Tork Image Design Matic Hand Towel Roll Dispenser – H1

Reliable and durable, the mechanical hands-free dispenser eliminates cross-contamination and improves hygiene.



461002



461022 (Recessed)





461023 (In wall recessed)

Features

- High capacity
- One-at-a-time dispensing
- Available in surface mount and recessed formats

Recommended refills

-  290094 – Tork Premium Extra Soft Matic Hand Towel Roll, FSC®
-  290096 – Tork Premium Soft Matic Hand Towel Roll,  FSC®

Tork Image Design Xpress® Hand Towel Dispenser – H2

Sleek and subtle, with stainless steel integrity, the extra slim design is both space-saving and elegant.



463002

Features

- Easy-to-refill design prevents towel run-outs
- Overfill and bundle protection
- See-through window for easy refilling

Recommended refills

 100297 – Tork Premium Extra Soft Xpress Multifold Hand Towel, 4-Panel, FSC®

420570 – Tork Premium Multifold Hand Towel, 3-Panel,    

Tork Image Design Xpress Countertop Multifold Hand Towel Dispenser – H2/H23

The gently brushed, stainless steel body, fine lines and subtle curves of this countertop towel dispenser complete the high-end experience.



302030

Features

- Perfect for washroom countertops
- One-at-a-time dispensing
- Protects towels for improved hygiene and reduced waste
- Anti-slip pads for improved dispensing

Recommended refills

 100297 – Tork Premium Extra Soft Xpress Multifold Hand Towel, 4-Panel, FSC®

420570 – Tork Premium Multifold Hand Towel, 3-Panel,    

Tork Image Design Mini Jumbo Bath Tissue Roll Dispenser – T2

The slim design of this dispenser is space-saving, elegant and holds enough capacity so paper is always available.



465500

Features

- Roll brake ensures smooth dispensing
- See-through window on both sides
- Smart stub-roll holder allows for full roll consumption
- High capacity, low maintenance

Recommended refills

11020602 – Tork Advanced Soft Mini Jumbo Bath Tissue Roll, 

12024402 – Tork Advanced Mini Jumbo Bath Tissue Roll,   

Tork Image Design Foam Skincare – S4

Manual Dispenser

This highly refined manual dispenser is designed for ease-of-use while making a great impression.

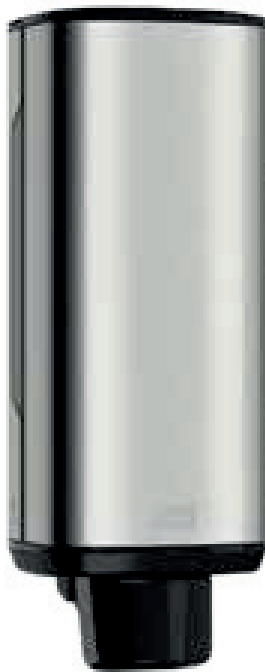

466000

Features

- One-at-a-time dispensing
- Fully collapsible bottle reduces waste and makes refilling quick and easy
- High capacity, hygienic, sealed system

Automatic Dispenser with Intuition Sensor

This touch-free, fully automatic dispenser delivers luxurious foam soap with sophistication.



466100

Features

- Touch free, sensor-activated dispensing
- High capacity refill with controlled dispensing
- LED indicator makes refilling quick and easy
- Hygienic, sealed system
- Tork EasyCube™ version available - 466200

Recommended refills

401211 – Tork Premium Extra Mild Foam Soap,   

400216 – Tork Premium Alcohol Foam Hand Sanitizer,  

A timeless design that fits
with your style and delivers
an elegant impression.



Soft, strong, smart towels
that show guests what
luxury feels like.



Look for the leaf



The best you can get.

A premium hand towel with unequaled softness and performance for a restroom that lets customers know you care.



The right touch of softness and performance for your restroom.

A range of efficient, high-quality towels providing complete comfort and convenience.



The sophisticated, touch-free delivery of each soft towel enhances your image.





Good hand hygiene has never been more stylish.





The luxurious lather
of a rich experience.

Tork Image Design





The art of creating impressions





Enhance your image with a sophisticated washroom experience

If you work hard to make the right impression on your guests, your washrooms should do the same. And in a busy working environment, the last thing you need is washroom hassle. Everything has to run smoothly, efficiently and with minimum maintenance. So we designed a complete line of dispensers to fit with your style and give your guests a great experience.

Trust Tork® Image Design™ to keep your washrooms running smoothly and your image sharp.

The art of image

Of course, you want your interior design to reflect the image and style of your business. Every part of the experience should contribute to a flawless impression. This means dispensers should complement your washroom design. But they should also be outstanding examples of form and function.

For this reason, each Tork Image Design dispenser has a gently brushed stainless steel body, fine lines and subtle curves. The design language is discrete yet bold. Performance is sophisticated yet simple. This way your guests experience nothing but your best.

Clean lines, smooth surfaces and anti-fingerprint protection help to maintain a first class impression.



The window on the side of the dispenser simplifies the task of keeping the washroom stocked and running smoothly.

Softer, thicker, quick-drying towels and other premium refills are all part of the experience.

One form with many functions



Go beyond beautiful design and provide an elegant, hand towel dispenser. Refill with premium quality Tork Premium Extra Soft Roll Towels.

The gently brushed stainless steel body, fine lines and subtle curves of this countertop towel dispenser complete the high-end experience. To pamper guests, fill it with Tork Xpress® Extra Soft Multifold Hand Towels.



The touch-free, fully automatic dispensers are ideal for washrooms that demand optimal hygiene or simply a more sophisticated touch. There's also a manual soap dispenser that's easy to use (left). Add the sophisticated rich lather of the new Tork Premium Foam Soap refills.

Extra-slim design is both space-saving and elegant. These items can keep almost any washroom clean, tidy and running smoothly.



Smart dispensers that feature the Tork EasyCube™ Intelligent Restroom System – offering real-time data analysis, 24/7 visibility and ensuring the perfect restroom experience. Tork EasyCube is one of the first systems to integrate the advanced Internet of Things technology trend with restroom maintenance.









Discover how our range of new
Tork Image Design dispensers can
enhance your washroom.

A range of refills designed with your image in mind

There is a moment of truth when the guest reaches out for a paper towel. What they find next can make or break their impression of your establishment. This is why Tork has a wide range of refills allowing you to create the washroom experience your guests deserve.



Tork Image Design Dispensers and Refills

SKU	Description	Color	Size H x W x D (in)	Units/Case	System
461002	Tork Image Design Matic® Hand Towel Roll Dispenser	Stainless Steel	15.75 x 13.58 x 8.07 (40.01 x 34.49 x 20.5 cm)	1	H1
461022	Tork Image Design Matic Hand Towel Roll Dispenser, Recessed	Stainless Steel	26.97 x 17.64 x 7.87 (68.5 x 44.81 x 19.99 cm)	1	H1
461023	Tork Image Design Matic Hand Towel Roll Dispenser, in Wall Recessed	Stainless Steel	20.55 x 17.64 x 7.87 (52.2 x 44.81 x 19.99 cm)	1	H1

Refill SKU	Description	Color	Ply	Linear Feet/Roll	Roll Width (in)	Units/Case	Certification	System
290094	Tork Premium Extra Soft Matic Hand Towel Roll	White with Blue Leaf	2	300 (91.44 m)	7.7 (19.56 cm)	6	FSC®	H1
290096	Tork Premium Soft Matic Hand Towel Roll	White with Blue Leaf	2	575 (175.26 m)	7.7 (19.56 cm)	6	FSC®	H1

SKU	Description	Color	Size H x W x D (in)	Units/Case	System
461102	Tork Image Design Matic Hand Towel Roll Dispenser with Intuition® Sensor	Stainless Steel	14.69 x 13.58 x 8.03 (37.31 x 34.49 x 20.40 cm)	1	H11
461122	Tork Image Design Matic Hand Towel Roll Dispenser with Intuition Sensor, Recessed	Stainless Steel	26.97 x 17.60 x 7.99 (68.50 x 44.70 x 20.29 cm)	1	H11
461123	Tork Image Design Matic Hand Towel Roll Dispenser with Intuition Sensor, in Wall Recessed	Stainless Steel	20.55 x 17.64 x 7.87 (52.2 x 44.81 x 19.99 cm)	1	H11

Refill SKU	Description	Color	Ply	Linear Feet/Roll	Roll Width (in)	Units/Case	Certification	System
290015	Tork Premium Extra Soft Matic Hand Towel Roll	White with Blue Leaf	2	328	8.27 (21.01 cm)	6	FSC®	H11
290019	Tork Premium Soft Matic Hand Towel Roll	White with Blue Leaf	2	575	8.27 (21.01 cm)	6	FSC®	H11

SKU	Description	Color	Size H x W x D (in)	Units/Case	System
463002	Tork Image Design Xpress Hand Towel Dispenser	Stainless Steel	18.625 x 13 x 9.9375 (47.31 x 33.02 x 10.0 cm)	1	H2

Refill SKU	Description	Color	Ply	Towel Size W x L (in)	Towels/Pkg	Towels/Case	Certification	System
100297	Tork Premium Extra Soft Xpress Multifold Hand Towel, 4-Panel	White with Pink Leaf	2	8.35 x 13.4 (21.21 x 34.04 cm)	100	2,100	FSC®	H2
MB571	Tork Premium Soft Multifold Hand Towel, 3-Panel	White with Blue Leaf	2	9.125 x 9.5 (23.18 x 24.13 cm)	150	2,400	FSC®	H2



461123



463002



302030



466000



466100



465500



SKU	Description	Color	Size H x W x D (in)	Units/Case	System
302030	Tork Xpress Image Design Countertop Multifold Hand Towel Dispenser	Stainless Steel	7.92 x 12.68 x 4.56 (20.12 x 32.21 x 11.58 cm)	1	H2/H23

Refill SKU	Description	Color	Ply	Towel Size W x L (in)	Towels/Pkg	Towels/Case	Certification	System
100297	Tork Premium Extra Soft Xpress Multifold Hand Towel, 4-Panel	White with Pink Leaf	2	8.35 x 13.4 (21.21 x 34.04 cm)	100	2,100	FSC®	H2
MB571	Tork Premium Soft Multifold Hand Towel, 3-Panel	White with Blue Leaf	2	9.125 x 9.5 (23.18 x 24.13 cm)	150	2,400	E FSC®	H2

SKU	Description	Color	Size H x W x D (in)	Units/Case	System
466000	Tork Image Design Foam Skincare Manual Dispenser	Stainless Steel	11.375 x 4.25 x 4.25 (28.89 x 10.80 x 10.80 cm)	4	S4
466100	Tork Image Design Foam Skincare Automatic Dispenser with Intuition Sensor	Stainless Steel	10.625 x 4.5 x 5.125 (26.99 x 11.43 x 13.02 cm)	4	S4

Refill SKU	Description	Color	Fragrance	Unit/Size	Units/Case	Certification	System
400216	Tork Premium Alcohol Foam Hand Sanitizer	Colorless	Fresh Light	950ml	6	NSF E3 Rated	S4
401211	Tork Premium Extra Mild Foam Soap	Colorless	None	1 Liter	6	E NSF E1 Rated	S4
401212	Tork Premium Antibacterial Foam Soap	Colorless	None	1 Liter	6	NSF E2 Rated	S4
401213	Tork Premium Alcohol-Free Foam Hand Sanitizer	Colorless	None	1 Liter	6		S4

SKU	Description	Color	Size H x W x D (in)	Units/Case	System
465500	Tork Image Design Mini Jumbo Bath Tissue Roll Dispenser	Stainless Steel	9.875 x 14 x 5.125 (25.08 x 35.56 x 13.02 cm)	1	T2

Refill SKU	Description	Color	Ply	Linear Feet/Roll	Roll Width (in)	Units/Case	Certification	System
11020602	Tork Advanced Soft Mini Jumbo Bath Tissue Roll, Perforated	White	2-Ply	751 (228.9 m)	3.55 (9.02 cm)	12	E	T2
12024402	Tork Advanced Mini Jumbo Bath Tissue Roll	White	2-Ply	751 (228.9 m)	3.55 (9.02 cm)	12	E ♻️	T2



Tork EasyCube compatible



ECOLOGO®
PRODUCT CERTIFIED FOR REDUCED ENVIRONMENTAL IMPACT.
NEW SPECIFIC ATTRIBUTES EVALUATED:
CCD-082 Toilet Tissue, CCD-083 Facial Tissue,
CCD-084 Table Napkins, CCD-085 Kitchen Towels, CCD-086 Hand Towels.

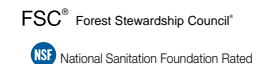





A more efficient facility, without question



To keep your facility running, wiping and cleaning tasks must be handled efficiently. With Tork, you get a consistent, high-performing wiper that's effective and safe. Tork disposable wipers manage a variety of tasks and are free from contaminants sometimes found in rental towels, which keeps your employees healthy. And since you only pay for the wipers used, you can reduce costs too. How's that for efficiency?

Tork wipers
save 10%
more in overall
costs vs textile
towels

Efficiency

Process improvement and cost savings are important to every manufacturing facility. Tork wipers let you select the right wiper for the right task, while improving both portability and storage, to deliver better productivity overall.

Health and safety

Tork wipers are a sanitary solution that protects the health and safety of your workers. Shop towels and rags can carry chemical residue from past users, or hazards such as metal shavings that can damage machinery. Tork products ensure a clean, fresh wiper every time.

Quality

Tork wipers provide the high level of quality your facility demands. They're purpose-made to tackle any job in the factory environment and deliver consistent wiping performance every time.

The right product for the right task.

Tork wipers are more efficient and perform better than cloth because they are designed specifically for the task at hand.

Preparing parts before production



Wiping oil-covered metal parts and other pieces of metal that can be oily or dirty

Machine maintenance



Removing cooling liquids, oil and metal scraps from the machine, and cleaning wrenches and other tools

Cleaning before painting



Cleaning oil, grease, solvents, fingerprints and dust prior to painting

Wiper dispensers



**Tork Folded Wiper/
Cloth Dispenser**

6540281



**Tork Maxi
Centerfeed Dispenser**

653028



**Tork Wall
Stand Dispenser**

6521281



Tork Floor Stand

6520281

Wiper refills



**Tork Industrial
Paper Wiper**

440278, Blue



**Tork Industrial
Cleaning Cloth**

520678, Grey



**Tork Industrial Heavy-
Duty Cleaning Cloth**

570478, White



**Tork Low-Lint
Cleaning Cloth**

192479, Turquoise



Tork Polishing Cloth

197478, White

Other products



**Tork Elevation Matic
Hand Towel
Roll Dispenser**

5510282, Black



**Tork Elevation Bath
Tissue Jumbo Roll Mini
Twin Dispenser**

5555290, Black



**Tork Elevation Foam
Soap Automatic
Touch-Free Dispenser**

571608, Black



**Tork Xpressnap® Signature
Tabletop and Stand
Napkin Dispenser**

6232000, Black
6332000, Black



Tork Elevation Matic Hand Towel Roll Dispenser With Intuition Sensor

**Less waste, lower cost
and better hygiene**







Innovative dispensing helps you be ready for business

The Tork Elevation® Matic Dispenser With Intuition® Sensor will allow you to spend less time on washroom maintenance so you can focus on more pressing matters.

- One-at-a-time automated dispensing means less towels being used in your restrooms, which means less waste, cost and clutter.
- The highest quality motor in the industry creates less noise to keep things quiet.
- No special tools needed to adjust sheet length. LED refill and low battery light indicators alert your staff. Lock operates in key or keyless push button mode.
- Adjustable towel length settings 8, 10, 14, 18 inches.
- Sensor Mode for patron-activated dispensing, or “Hanging Mode” for ready-for-use hanging towel.
- 100% recycled and third-party certified towel refills.
- The reliable electronic motor, superior sensor response, intuitive user graphics, and integrated brake arm for beter dispensing make it easy to use.
- Spirit level and slotted mounting keep setup simple.
- All refills come in Tork Easy Handling™ packaging, easier to lift, open and dispose.



Tork® Elevation Matic Hand Towel Roll Dispenser With Intuition Sensor – H1

SKU	Description	Color	Size H x W x D (in)	Dispensers/Case
5511202	Tork Elevation Matic Hand Towel Roll Dispenser With Intuition Sensor  	White	14.5 x 13 x 8 (36.83 x 33.02 x 20.32 cm)	1
5511282	Tork Elevation Matic Hand Towel Roll Dispenser With Intuition Sensor  	Black	14.5 x 13 x 8 (36.83 x 33.02 x 20.32 cm)	1



Refill #	Description	Color	Ply	Sheet Size W x L (in)	Sheets/Roll (8" setting)	Linear Ft/Roll	Case	Certification
290094	Tork Premium Extra Soft Matic Hand Towel Roll 	White w/Leaf	2	7.7 x 8 (19.56 x 20.32 cm)	450	300 (91.44 m)	6	FSC®
290096	Tork Premium Soft Matic Hand Towel Roll 	White w/Leaf	2	7.7 x 8 (19.56 x 20.32 cm)	862	575 (175.26 m)	6	FSC®
290095	Tork Advanced Soft Matic Hand Towel Roll 	White	1	7.7 x 8 (19.56 x 20.32 cm)	1,350	900 (247.32 m)	6	FSC®
290092A	Tork Advanced Matic Hand Towel Roll 	White	2	7.7 x 8 (19.56 x 20.32 cm)	787	525 (160.02 m)	6	  
290089	Tork Advanced Matic Hand Towel Roll 	White	1	7.7 x 8 (19.56 x 20.32 cm)	1,050	700 (213.36 m)	6	 
290087	Tork Advanced Matic Hand Towel Roll 	White	1	7.7 x 8 (19.56 x 20.32 cm)	1,050	700 (213.36 m)	6	  
290088	Tork Universal Matic Hand Towel Roll 	Natural	1	7.7 x 8 (19.56 x 20.32 cm)	1,050	700 (213.36 m)	6	  

Tork Easy Handling



Carry a box with each hand and save time



Use two hands for a comfortable grip



Boxes open quickly and easily without cutting



ECOLOGO®
PRODUCT CERTIFIED FOR REDUCED ENVIRONMENTAL IMPACT.
VIEW SPECIFIC ATTRIBUTES EVALUATED:
CCD-082 Toilet Tissue, CCD-083 Facial Tissue,
CCD-084 Table Napkins CCD-085 Kitchen Towels, CCD-086 Hand Towels.



100% Recycled



Compostable



Tork Easy Handling



Green Seal Certified



EPA compliant.



CE Certified



FSC® Forest Stewardship Council®



ROHS Compliant

Tork Elevation
suite of dispensers





Research, trends and Tork solutions for the Lodging segment



What is Lodging?

The Lodging industry includes everything from large international chains to small independent boutiques and five-star, luxury beach resorts and hotel casinos to one-star, economy, highway motels. Most properties offer foodservice of some kind. All know that a clean and hygienic hotel—including guest rooms, dining areas and public spaces—is a big influencer on how a traveler decides where to stay.

Lodging properties are categorized by tiers based on level-of-comfort, amenities and offerings. **Midscale properties are the best match for the Tork value proposition, while Upscale properties will benefit from Tork dispensing systems in high traffic areas.** Focusing your efforts there might reap the most immediate rewards. Ultimately, the largest volume opportunity is the bath and facial tissue in Guest Rooms.

	Property tier	Average rooms/property	Examples
Price & Functionality	Economy «« Least expensive, most basic hotels; limited facilities; one or two-star quality; predominantly domestic guests	64	Days Inn, EconoLodge, Motel 6, Howard Johnson
	Midscale ««« Full-service but with fewer amenities than upscale; predominantly domestic guests, both business and leisure; most, but not all, offer food and beverage (F&B) service	88	Best Western, Comfort INN, Four Points, Drury Inn & Suites
	Upscale «««« High quality, mostly full-service hotels; usually located in major cities; predominantly business customers in urban locations; ample conference and event space; also appealing to the leisure guests	276	Hilton, Hyatt, Westin, Radisson
Image & Experience	<i>Note: Common areas and foodservice are best opportunities for Tork in this tier.</i>		
	Luxury ««««« Hotels with the highest level of amenities; often boutiques or small chains; top-class facilities and services; mix of business and leisure customers; high proportion of international guests	320	Four Seasons, The Ritz-Carlton, St. Regis, Park Hyatt

Lodging matters to us

The Lodging industry is healthy and robust with 176 billion in sales revenue annually. With the demographic trends strong, the industry expects 10-20 years of solid growth. This means large opportunities for Tork products.

58,000
properties
(annually)



5.3MM+
guest rooms
(annually)



6.7B+
bathroom visits
for guests and
employees
(annually)



2MM+
employees
(annually)



980MM+
employee hand
washes
(annually)



1.6B+
paper napkins used for
breakfast (annually)



Independent vs. Nationally branded hotels

Independent/Boutique and Regional Chains properties have more flexibility in purchasing decisions and are more likely to experiment.

They are expected to grow faster than the overall lodging segment over the next 3-5 years.

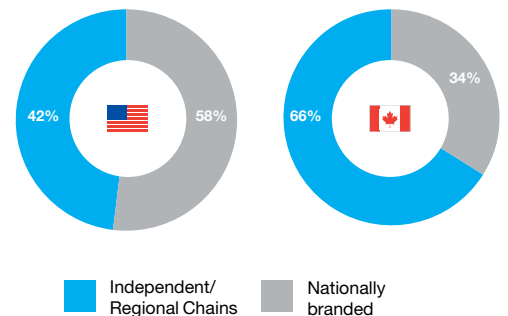

Recent trends in Lodging

Renovations and Focus on Foodservice

- 47% of operators plan to renovate their washrooms in the next three years, which means more opportunity for Tork.
- Renovated and new-build bars and restaurants are now designed to attract local patrons with ease-of-street-side access. Upscale bar food and shareable dishes are in high demand.
- 77% of hotels provide a dedicated breakfast area. Breakfast has become an important consideration for guests when choosing a hotel.
- Hotels are targeting increased catering and meeting events as this is high volume, high margin business. Many are increasing food and beverage minimums in contracts.
- Fast, portable meals that guests pick up from the lobby shops and restaurant are replacing room service.
- Hotels are designing public space to be more comfortable for work, dining and social interaction.

Labor

- As labor is the top operating cost, new properties are designed to minimize the labor required for lobby, foodservice and housekeeping.

Sustainability

- Nearly 62% of travelers consider the environment when choosing hotels, transportation and meals. Companies looking to host meetings and events are increasingly taking sustainability into account.
- More hotels are applying for LEED certification for their building.
- The TripAdvisor Green Leaders and Green Key program are becoming increasingly relevant to sustainability minded travelers.



Trend Opportunity

Tork dispensers help reduce usage and waste and Tork paper products are made with post recyclable materials. All of these factors can help a hotel earn industry green certifications—like GreenLeaders from TripAdvisor.

Lodging decision-makers

The purchase process in Lodging is based on key roles and functions within the facility. Key players work together with Purchasing to make decisions that impact guest satisfaction--and their bottom line.

 General Manager/Owner <p>With dynamic roles--their duties range from administration, daily scheduling, human resources and management to security, accounting, marketing and overseeing daily operations.</p>	 Head of Housekeeping <p>Responsible for common areas, guest room cleanliness and maintenance, as well as overseeing the cleaning crew and staff needs. They also track paper product and cleaning supply inventories and engages with guests to ensure that they are satisfied.</p>	 Foodservice Director or Food & Beverage Manager <p>Key contact if foodservice is offered on the property. This individual may refer you to housekeeping for items purchased for guest rooms. Many products including napkins, towels, soap and wipers are sourced from broadline foodservice distribution.</p>
Inside tip: GM's are extremely busy and typically rely on management for new product recommendations.	Inside tip: Have limited interactions with salespeople, default to past orders. Samples & trials will be important to build confidence in Tork offerings.	Inside tip: For properties with Food Service, leverage relationship to expand in other areas.

GPO and Hospitality Management Companies

GPOs leverage the buying power of their customers to negotiate deals with suppliers. Product is ordered through and delivered by broadline and other distributors that service lodging properties. Branded properties have corporate guidelines and are additionally incented to buy through the GPO agreement through rebates.

Hotel owners often hire Hospitality Management Companies that manage both branded and independent properties.

Considerations and Sales Tips

- Lodging properties' primary job is to delight their guests, drive repeat business and attract new customers.
- The best opportunities will be with independents/boutiques and regional chains. There is some flexibility in purchasing with nationally branded chains, many of which are operated by franchisees.
- Many properties are part of a franchisee owner group or managed by a hospitality management group and purchasing decisions are made at a group level.
- Properties are enhancing sustainability to attract guests. Tork products are 100% recycled and our dispensing systems reduce usage and waste.
- The largest volume opportunities are the bath and facial tissue in guest rooms. On average, assume usage of 2 cases of bath/facial tissue per room per year.
- Messy stacks of paper towels in common area washrooms are a huge opportunity for Tork Elevation and Xpress Countertop dispensers which reduce waste, mess and meet demand during peak periods.
- Often different higher quality hygiene products are used in Guest areas (front of house) and less costly items are used in Employee areas (back of house).
- Properties with large Conference/Event areas are the best opportunities for Tork value added dispensing systems. These properties have more Guest Rooms representing larger overall opportunities.
- Searching Google maps for hotels in a specific geography will quickly identify properties and their ratings. Visit their websites to learn about size, rate, conference space and sustainability initiatives.
- Hardly anyone books a hotel without researching online. Research includes customer reviews, ratings, and cleanliness of a hotel.
- Use social media to discover hotels in your territory that need solutions to improve their ratings for sustainability, cleanliness and hygiene.
- Historically lodging properties have preferred retail brand bath and facial tissue. With the rise of importance in sustainability and the increase in private label offerings, consumer brands are becoming less relevant. Midscale properties are more interested in offering the right level of quality for their guests. Sampling and trials will be the best way to familiarize management with Tork products.

Recommended Tork products

Lobby/Common Areas



Common washrooms – With heavily trafficked areas are also where hotels are making lasting impressions. Tork no-touch controlled consumption dispensers reduce waste and create a more hygienic environment, while improving image and experience.

Foodservice



Front of house – Tork systems help maintain an attractive and hygienic environment for guests while decreasing labor and improving efficiency for staff.

Back of house – Tork systems prevent cross contamination within the kitchen and create a more hygienic environment.

Guest Room/Housekeeping



Guest rooms – Represent a large opportunity for bath and facial tissue along with disposable wipers. Offer samples and trials to help properties get familiar with Tork offerings.



TF6910A
Tork Premium Facial Tissue Cube Box



5555200, White
5555290, Black
Tork Elevation Twin Mini Jumbo Bath Tissue Roll Dispenser



12024402
Tork Advanced Mini Jumbo Bath Tissue Roll



472886
Tork Advanced Coreless High Capacity Bath Tissue Roll



Tork Coreless Spindles



571600, White
571608, Black
Tork Elevation Foam Skincare Automatic Dispenser



401211
Tork Premium Extra Mild Foam Soap



400216
Tork Premium Alcohol Foam Hand Sanitizer



552028, Black
Tork Elevation® Xpress® Hand Towel Dispenser



302030, Stainless
Tork Image Design Xpress Countertop Multifold Hand Towel Dispenser



424814, Advanced
Tork Multifold Hand Towel



75350, Aluminum
75900, Wood
Tork Image Xpressnap Café® Napkin Dispenser



13681
Tork Premium Extra Soft Xpressnap® Café Leaf Design White Dispenser Napkin



192191
Tork Antimicrobial Foodservice Cloth



73350, Aluminum
72900, Wood
Tork Image Xpressnap® Napkin Dispenser



13680
Tork Premium Extra Soft Xpressnap® Leaf Design White Dispenser Napkin



6232000, Black
Tork Signature Xpressnap® Tabletop Napkin Dispenser



DX900, Advanced
DX990, Advanced Plus
Tork Xpressnap® Dispenser Napkin



NC7180P, Premium Linstyle
NP528PA, Advanced Soft
Tork Dinner Napkin



B1242, Advanced Soft
Tork Beverage Napkin



5510202, White
5510282, Black
Tork Elevation® Matic® Hand Towel Roll Dispenser



290089
Tork Advanced Matic® Hand Towel Roll



559020A, White
559028A, Black
Tork Elevation Centerfeed Dispenser



121202
Tork Centerfeed Dispenser



570020A, White – 570028A, Black
Tork Elevation Liquid Skincare Dispenser



571501, White – 571508, Black
Tork Foam Skincare Manual Dispenser



400014
Tork Premium Antibacterial Liquid Soap



TF6910A
Tork Premium Facial Tissue Cube Box



TF6920A
Tork Premium Facial Tissue Flat Box



TM6120S
Tork Advanced Bath Tissue Roll



TM6511S
Tork Premium Bath Tissue Roll



520371
Tork Industrial Cleaning Cloth, Handy Box



450175
Tork Heavy-Duty Paper Wiper, Pop-Up Box



Delight your hotel guests with an exceptional experience



At a hotel, there's a lot to manage. Tork can take some of the worries off of your plate, so you can focus on what is really important — guest satisfaction, repeat business and attracting new customers.

Over 62% of travelers consider the environment when choosing hotels, transportation and meals.

With 50% travelers using online reviews to select a hotel, it is essential for reputation management to keep common areas clean and attractive.

How Tork can help decision makers get ready for business

Guest experience needs

Hotels are redesigning common areas to make a favorable impression with guests. Stylish Tork dispensers enhance image, all while helping hotels provide the sustainable solutions that attract guests.

Cost management needs

The largest concern and expense for hotel operators is labor. Tork systems can positively impact labor costs. Controlled usage, high capacity dispensers such as Tork Elevation Matic Hand Towel and Xpressnap napkin dispensers help keep areas stocked with product, reducing annoying outages and labor requirements.

Hygiene needs

Guests remember the cleanliness of the guest room, bathroom and common areas of their hotels. It affects future lodging decisions. Tork products ensure your guests enjoy a clean and hygienic experience that keeps them coming back.

Eco-friendly needs

Controlled use dispensers for hand towels, bath tissue, soap and Xpressnap napkin dispensers make Tork products part of an overall strategy to reduce your environmental footprint.

Recommended Tork products

Lobby/Common Areas



Common washrooms – With heavily trafficked areas are also where hotels are making lasting impressions. Tork no-touch controlled usage dispensers reduce waste and create a more hygienic environment, while improving image and experience.

Foodservice



Front of house – Tork systems help maintain an attractive and hygienic environment for guests while decreasing labor and improving efficiency for staff.

Back of house – Tork systems prevent cross contamination within the kitchen and create a more hygienic environment.

Guest Room/Housekeeping



Guest rooms – Represent a large opportunity for bath and facial tissue along with disposable wipers. Offer samples and trials to help properties get familiar with Tork offerings.

-  **TF6910A**
Tork Premium Facial Tissue Cube Box
-  **5555200, White**
5555290, Black
Tork Elevation Twin Mini Jumbo Bath Tissue Roll Dispenser
-  **12024402**
Tork Advanced Mini Jumbo Bath Tissue Roll
-  **472886**
Tork Advanced Coreless High Capacity Bath Tissue Roll
-  Tork Coreless Spindles
-  **571600, White**
571608, Black
Tork Elevation Foam Skincare Automatic Dispenser
-  **401211**
Tork Premium Extra Mild Foam Soap
-  **400216**
Tork Premium Alcohol Foam Hand Sanitizer
-  **552028, Black**
Tork Elevation Xpress Hand Towel Dispenser
-  **302030, Stainless**
Tork Image Design Xpress Countertop Multifold Hand Towel Dispenser
-  **MB560A, Advanced**
Tork Multifold Hand Towel
-  **75350, Aluminum**
75900, Wood
Tork Image Xpressnap Café Napkin Dispenser
-  **13681**
Tork Premium Extra Soft Xpressnap Café Leaf Design White Dispenser Napkin
-  **192191**
Tork Antimicrobial Foodservice Cloth

-  **73350, Aluminum**
72900, Wood
Tork Image Xpressnap Napkin Dispenser
-  **13680**
Tork Premium Extra Soft Xpressnap Leaf Design White Dispenser Napkin
-  **6232000, Black**
Tork Signature Xpressnap Tabletop Napkin Dispenser
-  **DX900, Advanced**
DX900, Advanced Plus
Tork Xpressnap Dispenser Napkin
-  **NC7180A, Premium Linstyle**
NP528PA, Advanced Soft
Tork Dinner Napkin
-  **B1242, Advanced Soft**
Tork Beverage Napkin
-  **5510202, White**
5510282, Black
Tork Elevation Matic Hand Towel Roll Dispenser
-  **290089**
Tork Advanced Matic Hand Towel Roll
-  **559020A, White**
559028A, Black
Tork Elevation Centerfeed Dispenser
-  **121202**
Tork Centerfeed Dispenser
-  **570020A, White – 570028A, Black**
571501, White – 571508, Black
Tork Elevation Liquid Skincare Dispenser
Tork Foam Skincare Manual Dispenser
-  **400014**
Tork Premium Antibacterial Liquid Soap

-  **TF6910A**
Tork Premium Facial Tissue Cube Box
-  **TF6920A**
Tork Premium Facial Tissue Flat Box
-  **TM6120S**
Tork Advanced Bath Tissue Roll
-  **TM6511S**
Tork Premium Bath Tissue Roll
-  **520371**
Tork Industrial Cleaning Cloth, Handy Box
-  **450175**
Tork Heavy-Duty Paper Wiper, Pop-Up Box



Research, trends and Tork solutions for the Long Term Care segment



What is Long Term Care?

Long Term Care facilities focus on caring for and assisting patients and residents with various medical conditions and daily activities. The level of care that's provided varies from hands-off support to comprehensive help with all daily activities, and the length of stay ranges from a one-hour trip to the emergency room to years in a Long Term Care facility. The Long Term Care segment is made up of Skilled Nursing, Assisted Living and Independent Living.

Category	Services Offered	Typical Stay	Patients Per Employee*
Skilled Nursing Senior housing that provides a continuum of personal care, including medical and skilled nursing care, rehabilitation services, and assistance with daily living activities	Many Constant medical care, assistance with daily activities	2.4 years	1.8
Assisted Living A senior living facility that combines housing, supportive services and healthcare, but emphasizes residents' privacy and choice	Some Meals, transportation, housekeeping, nursing staff	2-2.5 years	5-10
Independent Living Residential housing that may provide supportive services such as meals, housekeeping, maintenance and social activities. Requires minimal or no extra medical assistance.	Few Community activities, laundry, maintenance, landscaping	4 Years	10-50

Why does the Long Term Care segment matter to us?

Healthcare is the fastest growing industry in North America, with overall traffic reaching as much as 3.7 billion people per year. The key growth segments, Skilled Nursing and Assisted Living, show no sign of waning due to the country's aging population. From 2000-2010, 65-and-over has been the fastest growing demographic at 15.1% per year* and this age group is expected to almost double by 2030. In the years to come, there is a 40% chance that people aged 65 and older will need long term care service and support for two or more years.



* All values approximate and costs are annual

** A brand impression is an event where the consumer comes in contact with away-from-home tissue products.

Source: BLS, Essity CI Team analysis

Long Term Care decision-makers

Long Term Care involves many different decision-makers for hygiene and paper products. It's important to form relationships with as many key people as possible, since missing a major influencer can derail a sale later on.

Executive Management

Oversee facility operations and take personal responsibility for everything. This person has a 360-degree vision of the facility needs and has the final say on all purchasing decisions. Since they are very involved with resident care, they will typically defer to the purchasing team to make recommendations. They have the best interests of residents in mind and often know each one on a personal level. Because they are most concerned with the business side of things, they care about 1) cost 2) image and 3) hygiene, in this order.

Needs to: Manage overall budgets and staffing, keep current residents happy and attract new ones and interact with all staff, residents and families.

Purchasing

Responsible for all facility purchases. This person is more business-minded and does the least direct interfacing with residents. It's their job to work with suppliers to purchase products and field orders, as well as to ensure that everything is delivered and invoiced correctly. In some facilities, this role may be tied to a broader executive role. Budget issues and cutbacks are considerations before quality. Budgets are often fixed.

Needs to: Manage all vendor relationships, interact with facility personnel to buy products and maintain product supply and financials based on input from other key players.



Environmental Services

Oversee the safety and cleanliness of the physical facility operations and manage maintenance personnel. This person is usually the final decision-maker about paper products. Their biggest pain points surround manpower and labor issues. Cold calls are often directed here, but sometimes this is the second person consulted after Foodservice or Purchasing.

Needs to: Maintain a clean and safe environment to ensure compliance and maintain a close relationship with care staff in managing daily "accidental" cleanups.

Foodservice director

Coordinates meal plans and purchases cafeteria products, from "center-of-plate" to napkins. Foodservice professionals are concerned with price, functionality and performance. One of their top priorities is maintaining the cleanliness of the dining areas and kitchen. Larger facilities (100+ rooms) will have a foodservice director responsible for paper towels. Otherwise, paper products in all areas including foodservice usually fall under Environmental Services. Relationships with foodservice could get the doors opened to the rest of the facility.

Needs to: Develop and monitor the dietary and nutritional plans for residents and manage all aspects of kitchen operations.

Resident Care

Ensure that products are in compliance with protocol and regulations. An influencer for paper products, but not a direct decision-maker, this person is most concerned with hygiene and patient safety. They care about quality products that prevent infection, reduce smell and help staff stay clean. This department has increased in importance over time, as caregivers aim to avoid legal ramifications and penalties for facility-borne infections.

Needs to: Manage all aspects of daily resident care (a resident's "Care Plan") and interact with all personnel regarding health, compliance and safety.

Recent facility trends

The Long Term Care and Assisted Living segments are rapidly evolving to meet the changing profile of senior housing residents and healthcare reform. Here's an overview of what's trending in the coming years.

Infection control and hygiene are main concerns

- New insurance regulations are imposing harsher penalties for facility-contracted infections¹
- Infections are a leading reason for hospital transfer to Long Term Care Facilities²
- Elderly people are more susceptible to infection and serious complications³

How Tork delivers better business

Tork hygienic solutions, combined with proper hand hygiene, provide a safe environment for residents by minimizing the spread of germs and creating more efficient spaces for staff



Considerations and sales tips

- Residents with limited strength may have difficulty operating dispensers that require pulling or levels
- Clinical-looking dispensers may make residents feel less at home and can get in the way or cause mobility issues
- Loud dispensers can be disruptive to residents and guests
- Less durable dispensers break easily, resulting in more labor and maintenance
- Touching levers with bare hands breaks hand hygiene protocol
- Germs on levers can survive up to 48 hours and transfer to clean hands, increasing risk of contamination
- With frequent hand washing, rough paper towels can cause microscopic tears in the skin that are uncomfortable and can spread infection. A higher quality, softer product can help reduce skin irritation for care givers.
- Hygiene is the key concern—closed and touch-free soap systems help promote better hand hygiene. 25% of open, refillable soap dispensers tested in public washrooms were contaminated with bacteria, while sealed systems are designed to block out bacteria and eliminate contamination.
- Remind customers of Tork Advantage coverage, which guarantees defective or broken dispensers for 5 years

Residents are staying independent longer

- Over the past decade, Skilled Nursing home utilization has steadily decreased while Assisted Living communities continue to see growth⁴
- Many Assisted Living communities offer multi-dimensional wellness programs and amenities to serve their active population

How Tork delivers better business

Low-profile Tork tissue and folded towel dispensers offer quiet dispensing and a soft, clean look to compliment a facility's home-like environment

Cost pressures rise as health declines

- Facilities are experiencing higher acuity levels (severity of illnesses) for prospective residents because seniors are delaying assisted care due to economic reasons⁵
- Providers may need to raise their costs as a result of increased health risks for older patients⁵

How Tork delivers better business

Demonstrate the guaranteed cost-in-use benefits associated with Tork solutions. The Tork Advantage Agreement rewards our customers' loyalty for an extended period of time by managing price escalations

Recommended Tork products

Common and staff areas:

- Lobbies
- Public restrooms
- Staff offices and areas
- Common/day room

Everyone deserves to enjoy a warm and welcoming atmosphere in resident care facilities. Tork products delight the eye and ensure a clean and healthy experience for residents, guests and staff alike.



Tork Elevation Matic® Hand Towel Roll Dispenser
5510202



Tork Elevation Matic Hand Towel Roll Dispenser with Intuition® Sensor
5511202



Tork Elevation Twin Mini Jumbo Bath Tissue Roll Dispenser
5555200



Tork Automatic Foam Dispenser and portable dispenser stand
571600
570038 (stand)



Tork Premium Facial Tissue Flat Box
TF6920A



Tork Cleaning Cloth
510175A

Resident care areas:

- Resident rooms
- Restrooms
- Treatment/care rooms
- Nursing stations

Making elderly residents feel safe and at home is paramount to providing the very best care. Tork user-friendly systems make it easy to prevent cross-contamination while improving image.



Tork Elevation® Xpress® Mini Hand Towel Dispenser
552120



Tork High-Capacity Bath Tissue Roll Dispenser
555620



Tork Automatic Foam Dispenser
571600



Tork Premium Facial Tissue Flat Box
TF6920A



Tork Advanced Bath Tissue Roll
TM6120S



Tork Folded Wiper Cloth Dispenser
654021



Tork Heavy-Duty Paper Wiper
192136

Foodservice areas:

- Kitchen
- Dining Area

Foodservice areas are often the busiest gathering spots in patient care facilities. Tork solutions ensure the very best practices for cleanliness and comfort, especially when it comes to delicate immune systems.



Tork Elevation Centerfeed Hand Towel Dispenser
559020A



Tork Advanced Soft White Dinner Napkin
NP310A



Tork Automatic Foam Dispenser
571600



Tork Xpressnap Signature Countertop
6434000



Tork Antimicrobial Foodservice cloth
192191



Tork Perforated Roll Towel
HB9201



Take a clean approach to healthy living



Creating an at-home feel for senior residents is as much about infection protection as it is about a clean image. We contribute to a healthier, more comfortable environment while helping you manage your daily costs.

1/3

One-third of all healthcare related infections are preventable.

Source: Centers for Disease Control

30K in lost revenue
Every infection caught in a hospital, nursing home, or other healthcare setting can cost upwards of 30,000 to treat and contain.

Source: Centers for Disease Control

Clean

Tork touch-free systems reduce the spread of germs to protect delicate immune systems.

Image

Attractive dispensers are designed to look less commercial, providing a more at-home feel for residents and guests. Waste-reducing solutions keep your facility looking tidy.

Cost

Tork dispensing solutions can help reduce consumption, waste and staff labor, while Tork customer programs can manage long-term price escalations.

Sustainability

Switching to Tork 100% recycled and third-party certified products improves perception among patients and their families at no extra cost.

Recommended Tork products

Common and staff areas:

- Lobbies
- Public restrooms
- Staff offices and areas
- Common/day room

Everyone deserves to enjoy a warm and welcoming atmosphere in resident care facilities. Tork products delight the eye and ensure a clean and healthy experience for residents, guests and staff a like.



Tork Elevation Matic® Hand Towel Roll Dispenser

5510202



Tork Elevation Matic Hand Towel Roll Dispenser with Intuition® Sensor

5511202



Tork Elevation Twin Mini Jumbo Bath Tissue Roll Dispenser

5555200



Tork Automatic Foam Dispenser and portable dispenser stand

571600
570038 (stand)



Tork Premium Facial Tissue Flat Box

TF6920A



Tork Cleaning Cloth

510175A

Resident care areas:

- Resident rooms
- Restrooms
- Treatment/care rooms
- Nursing stations

Making elderly residents feel safe and at home is paramount to providing the very best care. Tork user-friendly systems make it easy to prevent cross-contamination while improving image.



Tork Elevation® Xpress® Mini Hand Towel Dispenser

552120



Tork High-Capacity Bath Tissue Roll Dispenser

555620



Tork Automatic Foam Dispenser

571600



Tork Premium Facial Tissue Flat Box

TF6920A



Tork Advanced Bath Tissue Roll

TM6120S



Tork Folded Wiper Cloth Dispenser

654021



Tork Heavy-Duty Paper Wiper

192136

Foodservice areas:

- Kitchen
- Dining Area

Foodservice areas are often the busiest gathering spots in patient care facilities. Tork solutions ensure the very best practices for cleanliness and comfort, especially when it comes to delicate immune systems.



Tork Elevation Centerfeed Hand Towel Dispenser

559020A



Tork Advanced Soft White Dinner Napkin

NP310A



Tork Automatic Foam Dispenser

571600



Tork Xpressnap Signature Countertop

6434000



Tork Antimicrobial Foodservice cloth

192191



Tork Perforated Roll Towel

HB9201



Get pristine results for sensitive surfaces and technical tasks



Extremely low-lint cloths for clean performance



Tork Industrial Low-Lint Cleaning Cloth

The finishing touch starts here

Get professional results for your most sensitive surfaces with our new, Tork Industrial Low-Lint Cleaning Cloth. Designed to clean without leaving residue, this extremely low-lint cloth is ideal for cleaning sensitive components, tools and surfaces. This Cleaning Cloth is not meant to be used dry but performs best when used in combination with the oil or water-based solvents. It absorbs the solvent and without smearing, leaves your surface dust and residue-free.

Our lowest-linting cloth

With extremely low-lint and anti-static properties plus excellent solvent-use compatibility, this cloth can help you take care of most critical tasks while protecting sensitive surfaces, electronics and processes.

Key Features

- Extremely low-lint tested and approved for low lint using SAE lint test protocol*
- Anti-static (ESD Protective Products, SP-Method 2472)
- Solvent suitable, ASTM D-543 tested
- Good absorption of oil and water
- Compressed inner packs allows you to top-up at any time with a second pack in the dispenser

Refills and dispensing systems

Tork Industrial Low-Lint Cleaning Cloth – W4 System

Product	Color	Size H x W x D (in)	Wipers/Package	Wipers/Case
192578	Blue	15.2 x 15.7 (38.61 x 39.88 cm)	80	1



6540281 (W4)



654021 (W4)



Industrial Low-Lint Cleaning Cloth



“Low lint should be as close to ‘no lint’ as possible.”

Multiple Industries

*SAE lint test protocol 4.5.4.1



**Improved hygiene
and reduced waste**

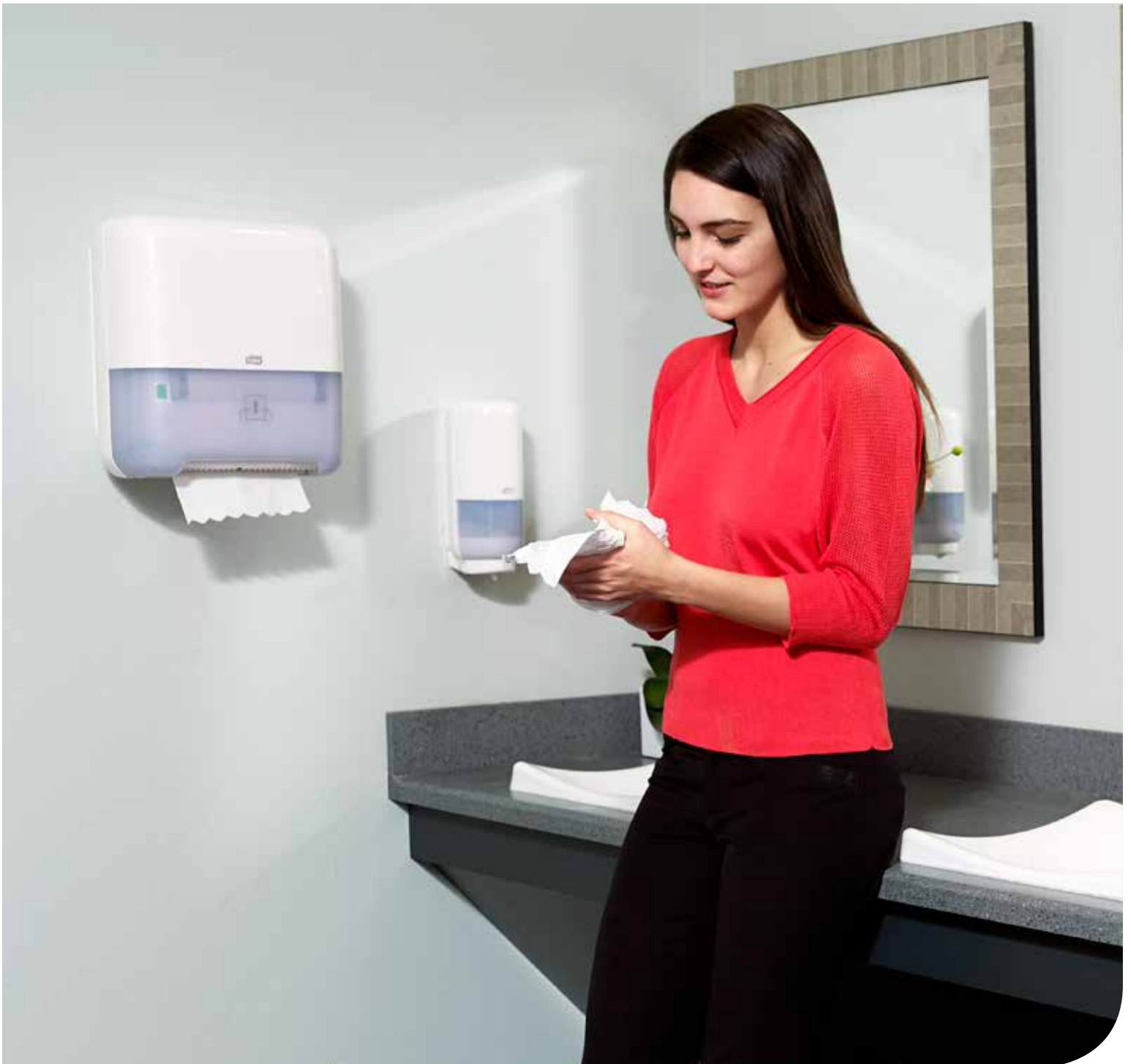

Hands-free, controlled consumption

The Tork Elevation® Matic Dispenser improves hygiene, reduces waste and helps save money with hands-free, controlled-consumption dispensing. Just one less thing to worry about.

- Reliable and durable, the Tork Matic®, hands-free dispenser eliminates cross-contamination and improves hygiene.
- One-towel-at-a-time dispensing reduces usage and waste and saves you money by controlling consumption. Matic dispenses 9.5" sheets.
- High-capacity dispenser is ideal for busy washrooms and the refill options provide from 379 (Premium Extra Soft) up to 1,136 (Advanced Soft) towels per refill.
- Mechanical hands-free dispensing produces a towel smoothly every time. No batteries needed; powered by your patrons. 100% recycled, third-party certified towel refills.
- Contemporary design ensure easy and intuitive maintenance and easy to read level indicator makes refilling paper rolls quick and easy.
- All refills come in Tork Easy Handling™ packaging, easier to lift, open and dispose.



Tork® Elevation Matic Dispensing System – H1

SKU	Description	Color	Size H x W x D (in)	Dispensers/Case
5510202	Tork Elevation Matic Hand Towel Roll Dispenser	White	14.65 x 13.26 x 7.99 (37.2 x 33.7 x 20.3 cm)	1
5510282	Tork Elevation Matic Hand Towel Roll Dispenser	Black	14.5 x 13 x 8 (36.83 x 33.02 x 20.32 cm)	1



Refill No.	Description	Color	Ply	Sheet Size W x L (in)	Sheets/Roll	Case	Certification
290094	Tork Premium Extra Soft Matic Hand Towel Roll	White w/Leaf	2	7.7 x 8 (19.56 x 20.32 cm)	450	6	FSC®
290096	Tork Premium Soft Matic Hand Towel Roll	White w/Leaf	2	7.7 x 8 (19.56 x 20.32 cm)	862	6	FSC®
290095	Tork Advanced Soft Matic Hand Towel Roll	White	1	7.7 x 8 (19.56 x 20.32 cm)	1,350	6	FSC®
290092A	Tork Advanced Matic Hand Towel Roll	White	2	7.7 x 8 (19.56 x 20.32 cm)	787	6	FSC®
290089	Tork Advanced Matic Hand Towel Roll	White	1	7.7 x 8 (19.56 x 20.32 cm)	1,050	6	FSC®
290087	Tork Advanced Matic Hand Towel Roll	White	1	7.7 x 8 (19.56 x 20.32 cm)	1,050	6	FSC®
290088	Tork Universal Matic Hand Towel Roll	Natural	1	7.7 x 8 (19.56 x 20.32 cm)	1,050	6	FSC®

Tork Accessory



SKU	Description	Color	Accessory Size (in)	Case
3096020	Steel Filler Panel for Tork Elevation Matic Dispenser	Stainless Steel	Fits Recessed Opening 17.125 to 17.4375 x 3.8125 to 4 (W x D) in (43.50 to 44.29 x 9.68 to 10.16 cm)	1 Panel/Box

Tork Easy Handling



Carry a box with each hand and save time



Use two hands for a comfortable grip



Boxes open quickly and easily without cutting



ECOLOGO®:
PRODUCT CERTIFIED FOR REDUCED ENVIRONMENTAL IMPACT.
VIEW SPECIFIC ATTRIBUTES EVALUATED:
CCD-082 Toilet Tissue, CCD-083 Facial Tissue,
CCD-084 Table Napkins CCD-085 Kitchen Towels, CCD-086 Hand Towels.



100% Recycled



Compostable



Green Seal Certified



Tork Easy Handling



EPA compliant.

FSC® Forest Stewardship Council®

Tork Elevation
suite of dispensers





Tork Mechanical Hand Towel Roll Dispenser

High performance in heavy traffic



Reliability you
can count on



Tork Mechanical Hand Towel Roll Dispenser



You need an affordable dispenser that runs like clockwork. Introducing the Tork Mechanical Hand Towel Dispenser: the lasting solution for high-traffic areas, recently reengineered for optimal performance.

Best of all, it's a dispenser you never have to worry about – guaranteed to run well over 360,000 hand dries*, saving you time, money and hassle over its lifespan.

*Hand dries based on Essity's internal lab testing.

Works hard, runs easy.

Engineered to meet the demands of high-traffic environments, this upgraded dispenser runs smoothly for thousands and thousands of hand dries. And because it dispenses individual towels, it helps eliminate cross contamination in your busiest areas.

This workhorse also makes your life simple, requiring minimal effort for operation and maintenance. The dispenser is easy to load, with a translucent cover for quick refill checks. It needs no settings or batteries, and requires very little pull force to use effectively.



Rolls like clockwork.

Every feature is carefully designed for maximum reliability to keep your restrooms up and running. It works: a 10" towel is consistently available, ensuring your guests one towel, every time. This also allows you to control usage with precision, helping you reduce waste and save money.

































Best of all, this dispenser is as durable as they come. It won't jam or break down, even after hundreds of thousands of hand dries – effortless for them, hassle-free for you.



Tork Mechanical Hand Towel Roll Dispenser - H80





























SKU	Description	Color	Size H x W x D (in)	Dispensers/Case
772828	Tork Mechanical Hand Towel Roll Dispenser	Black	15.95 x 12.32 x 9.32 (40.51 x 31.29 x 23.67cm)	1
772820	Tork Mechanical Hand Towel Roll Dispenser	White	15.95 x 12.32 x 9.32 (40.51 x 31.29 x 23.67cm)	1

Refill No.	Description	Color	Ply	Roll Width (in)	Linear Feet	Case	Certification
8030620	Tork Premium Hand Towel Roll 	White	1	8 (20.32 cm)	600 (182.88 m)	6	  
8031040	Tork Advanced Hand Towel Roll 	White	1	8 (20.32 cm)	1,000 (304.8 m)	6	  
8038040	Tork Advanced Hand Towel Roll 	White	1	8 (20.32 cm)	800 (243.84 m)	6	  
8031900	Tork Universal Hand Towel Roll 	White	1	8 (20.32 cm)	800 (243.84 m)	6	 
8031600	Tork Universal Hand Towel Roll 	White	1	8 (20.32 cm)	630 (192.02 m)	6	 
8031400	Tork Universal Hand Towel Roll 	Natural White	1	8 (20.32 cm)	800 (243.84 m)	6	  
8031300	Tork Universal Hand Towel Roll 	Natural	1	8 (20.32 cm)	800 (243.84 m)	6	  
8031500	Tork Universal Hand Towel Roll 	Natural	1	8 (20.32 cm)	630 (192.02 m)	6	 
8031000	Tork Universal Hand Towel Roll 	Natural	1	8 (20.32 cm)	1,000 (304.8 m)	6	  

Tork Mechanical Hand Towel Roll Dispenser - H71



SKU	Description	Color	Size H x W x D (in)	Dispensers/Case
772728	Tork Mechanical Hand Towel Roll Dispenser	Black	15.95 x 12.32 x 9.32 (40.51 x 31.29 x 23.67cm)	1
772720	Tork Mechanical Hand Towel Roll Dispenser	White	15.95 x 12.32 x 9.32 (40.51 x 31.29 x 23.67cm)	1

Refill No.	Description	Color	Ply	Roll Width (in)	Linear Feet	Case	Certification
7170620	Tork Premium Hand Towel Roll 	White	1	7.5 (19.05 cm)	600 (182.88 m)	6	  
7171040	Tork Advanced Hand Towel Roll 	White	1	7.5 (19.05 cm)	1,000 (304.8 m)	6	  
7178040	Tork Advanced Hand Towel Roll 	White	1	7.5 (19.05 cm)	800 (243.84 m)	6	  
7171600	Tork Universal Hand Towel Roll 	White	1	7.5 (19.05 cm)	630 (192.02 m)	6	 
7171400	Tork Universal Hand Towel Roll 	Natural White	1	7.5 (19.05 cm)	800 (243.84 m)	6	  
7171300	Tork Universal Hand Towel Roll 	Natural	1	7.5 (19.05 cm)	800 (243.84 m)	6	  
7171020	Tork Universal Hand Towel Roll 	Natural	1	7.5 (19.05 cm)	1,000 (304.8 m)	6	  

 Tork Easy Handling

 100% Recycled.

 EPA compliant.

 Green Seal Certified



Perfect solution for small spaces



Improve hygiene and
save space





The Tork Mini Mechanical Hand Towel Roll Dispenser is ideal for environments where space is limited. Designed to fit tight spaces previously reserved for folded towels, the Tork Mini Mechanical Dispenser provides the operational benefits of a larger roll towel dispenser in a compact and attractive design.



Fits virtually anywhere

At just over 12 inches high, the Tork Mini Mechanical Dispenser is nearly six inches shorter than full-size dispensers so it can fit into tight spaces like those between cabinets and countertops. The Tork Mini Mechanical Dispenser does not require external electricity, wiring or batteries and the reversible cover can be installed to open from the left or right, increasing the options for placement.



Simple to operate and maintain

With each pull of the slightly exposed towel, the Tork Mini Mechanical Dispenser dispenses and cuts a single 11-inch towel so a new towel is ready and waiting for the next patron. There are no settings to adjust and no levers or buttons are required to operate the dispenser, reducing the risk of cross-contamination. The translucent cover saves maintenance time as staff can see at a glance when it is time to refill the dispenser, and the locking cover prevents pilferage.



Versatile

A variety of towel grades and lengths provide multiple options to fit every preference or budget. The Tork Mini Mechanical Dispenser is available in black or white translucent colors to complement any facility's design for a unique, coordinated washroom experience.

The Tork Mini Mechanical Dispenser promotes hygiene

Hands free

You touch only your personal towel, greatly reducing the risk of cross-contamination

Reduces bacteria

Paper towels help reduce the number of bacteria on hands and support good hand hygiene practices

HACCP

The hands-free design supports the principles of HACCP (Hazard Analysis and Critical Control Point) as an important preventative measure in avoiding cross-contamination



The Tork Mini Mechanical Dispenser is environmentally preferable

Controls usage

Hygienic, one-at-a-time dispensing helps you reduce waste and save on cost

Green Seal™ certified towels

A variety of 100% recycled Green Seal™ certified towels are available

Small footprint

Ideal for tight areas, the Tork Mini Mechanical Dispenser features a compact design that uses minimal space to dispense towels

The Tork Mini Mechanical Dispenser controls costs

High capacity rolls

High capacity supplies of up to 550 feet ensure uptime and reduce maintenance costs

Locking cover

Locking cover prevents pilferage and waste

Maintenance at a glance

The translucent cover saves maintenance time, as staff can see at a glance when it is time to refill the dispenser



**For more information,
speak to a Tork Solutions Expert.**

Tork Mini Mechanical Hand Towel Roll Dispenser - H86



SKU	Description	Color	Size H x W x D (in)	Dispensers/Case
774828	Tork Mini Mechanical Hand Towel Roll Dispenser	Black	12.5 x 11.75 x 7.5 (31.75 x 29.85 x 19.05cm)	1
774820	Tork Mini Mechanical Hand Towel Roll Dispenser	White	12.5 x 11.75 x 7.5 (31.75 x 29.85 x 19.05cm)	1

Refill No.	Description	Color	Ply	Roll Width	Linear Feet	Case	Certification
8634540	Tork Advanced Hand Towel Roll 	White	1	8.0 (20.32cm)	450 (137.16 m)	12	E 
8621400	Tork Universal Hand Towel Roll 	Natural White	1	8.0 (20.32cm)	425 (129.54 m)	12	E 
8620100	Tork Universal Hand Towel Roll 	Natural	1	8.0 (20.32cm)	425 (129.54 m)	12	E 
8631060	Tork Universal Hand Towel Roll 	Natural	1	8.0 (20.32cm)	550 (167.64 m)	6	E 

Tork Mini Mechanical Hand Towel Roll Dispenser - H76



SKU	Description	Color	Size H x W x D (in)	Dispensers/Case
774728	Tork Mini Mechanical Hand Towel Roll Dispenser	Black	12.5 x 11.75 x 7.5 (31.75 x 29.85 x 19.05cm)	1
774720	Tork Mini Mechanical Hand Towel Roll Dispenser	White	12.5 x 11.75 x 7.5 (31.75 x 29.85 x 19.05cm)	1

Refill No.	Description	Color	Ply	Roll Width	Linear Feet	Case	Certification
7674540	Tork Advanced Hand Towel Roll 	White	1	7.5 (19.05cm)	450 (137.16 m)	12	E 

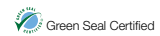
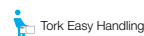



Tabletop marketing messages that drive repeat business and inspire recommendations

New restaurant patron survey identifies most compelling marketing messages and assets to drive repeat business and inspire recommendations.

MARKETING MESSAGES:



MARKETING ASSETS:

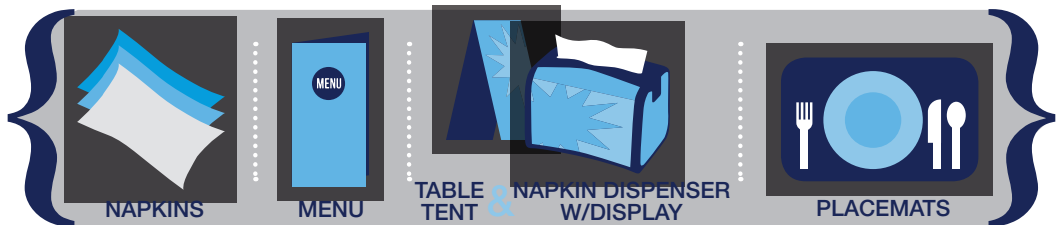

Findings:

Table tents & napkin dispensers with display appear to be the most versatile.

- **Placemats** are also versatile assets, especially for showcasing the restaurant's *story/history*, support for specific *causes or charities*, as well as *environmental* messages.
- **Menus** are appropriate for a narrower range of message types, especially *specials/events* and the restaurant's *story/history*.
- **4 Napkins, table tents/napkin dispensers with display, placemats** perceived as a strong fit for *environmental* messages.
- **Loyalty programs** are seen as highly appropriate for Fast Casual restaurants, while messages highlighting the restaurant's *specials/events* and its *story/history* are seen as highly appropriate for Full Service Restaurants.

Most effective messages for these assets

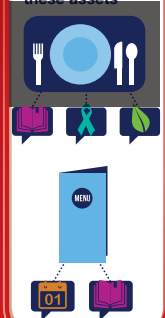



72%

Extremely/Very Likely to Drive Behavior

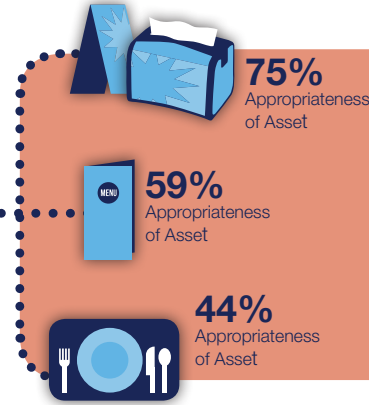

1

Messages about **loyalty programs** are the strongest way to inspire repeat visits. *Table tents/napkin dispensers with display, menus, and placemats* are the best assets to use to communicate these messages.

62%

Extremely/Very Likely to Drive Behavior

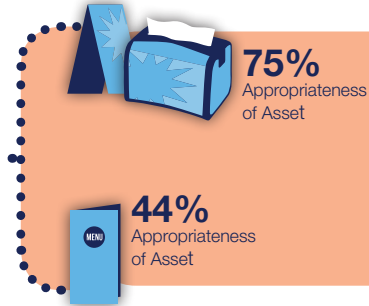

2

Specials or events also inspire repeat visits. *Table tents/napkin dispensers with display, and menus* are the best assets to advertise specials or events.

56%

Extremely/Very Likely to Drive Behavior

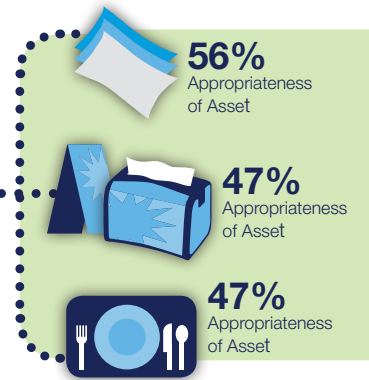

3

Messages about the **environment** can inspire repeat visits and recommendations. These messages would be appropriate on napkins, table tents/napkin dispensers with display, and placemats (paper products).



How to Inspire Recommendations

58%

Extremely/Very Likely to Drive Behavior



55%

Extremely/Very Likely to Drive Behavior



54%

Extremely/Very Likely to Drive Behavior

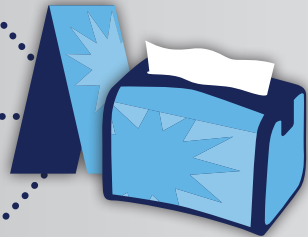

Several types of messages can encourage patron recommendations, including messages about **loyalty programs**, support for **causes/charities**, or news about **specials/events**. *Table tents/napkin dispensers with display* are the best marketing assets for communicating **loyalty programs** and **causes/charities**.



Women are significantly more likely to recommend restaurant based messages on environmental initiatives, causes/charities and loyalty clubs.

Women aged 18-34 are more likely recommend based on environmental initiatives and loyalty clubs.

Women are significantly more likely to visit restaurant again based on messaging about loyalty clubs.





Research, trends and Tork solutions for the Office Building segment



What are office buildings?

An office building is a commercial property containing spaces designed for offices, primarily for administrative and managerial workers. It may be divided among different companies or dedicated to one, and may include a combination of common and private reception areas, meeting rooms, workspaces and restrooms. Office buildings are grouped into three tiers of quality—A, B and C—which suggest the level of amenities and services they offer to attract and retain tenants.

Class	Description	Examples
A	Characterized by exceptional accessibility and market presence, featuring state-of-the-art finishes. They attract premier tenants and are professionally managed.	Downtown high-rises
B	These have good (vs. excellent) locations, management and construction. Buildings have little functional deterioration.	Suburban business complexes, office parks
C	Typically older buildings but maintain steady occupancy. Many are walk-up office spaces above retail or service businesses.	Lofts, buildings converted from industrial use

Why do they matter to us?

There are close to **600,000 office buildings** spanning 11.7 billion total square feet in North America. They see nearly **22 million people** in foot traffic, including: building employees (property managers, maintenance workers and lobby receptionists), contractors (janitorial and security staff) and employees of companies within the building. As the office building market continues to improve across North America, our opportunity to reach tenants looking for high-end restroom amenities increases.¹

105 thousand employees** > **24 million** hand washes

23 million office workers > **10.7 billion** washroom visits***

Key player profiles

In office buildings, there are many decision makers weighing in on restroom products and solutions, with an overwhelming need to lower budgets without sacrificing quality. We earn their trust by recognizing their responsibilities, making decisions easier and their tenants happier.

60%
of facility managers
said they've received
restroom complaints
from their tenants.²

Tenants

In office buildings, tenants don't buy our products, but they influence every decision. These companies are looking for comfortable, productive and streamlined environments, and openly lobby for improvement dollars and green services. Helping our customers serve their needs is crucial to our success.

“ For what we pay in rent, our building needs to be a place that's **comfortable for our employees** and presentable to our clients. **A dirty restroom is a dealbreaker.**”

Property manager

Serves as the “CEO” of the building and is the primary decision maker. Their chief responsibility is to lead building operations, but they wear many hats in a day and take pride in “running a tight ship.” Balancing amenities, quality, budgets and image to maintain a clean and comfortable experience for demanding tenants is a key focus.

“ Retaining tenants, **keeping them happy and monitoring feedback from tenant surveys** is something I take seriously. There's no point in building upkeep if you don't have tenants.”

Assistant property manager

Supports the property managers by managing the administrative workflow. Preparing reports, assigning engineers to work orders and helping to manage tenant relationships are key parts of their job.

“ I have to be mindful of the **daily responsibilities our building PM can't get to** in their busy day. The more corners I can see around the better. It's also going to put me in a better position to become a PM myself.”

Building service contractor (BSC)

Operates in and around the physical space of the building. Often, they are responsible for sanitation and general maintenance of restrooms. They understand and use these products frequently, and may be empowered by the property manager to purchase product in some instances.

“ 24/7 building maintenance can be stressful. You have day and night shifts and long hours. In a **high-traffic building, falling behind in your service is noticed almost instantly.**”

Building engineers

Perform maintenance on office building equipment and systems. These individuals serve as the “labor landlords” for office buildings, inspecting and performing both routine and preventive maintenance to the building's mechanical and electrical systems. They are also responsible for system and product installation.

“ We're relied upon pretty heavily to do an exceptional job. **We need to do our job, so tenants can do theirs.** If a floor doesn't have working heat, power or restroom facilities, it hinders a workforce pretty significantly, which is unacceptable.”

Architects

Specify all the building-related products for a job. They use advanced design software programs, and relate 100% to CAD or BIM objects. They are a high-tech group that uses Google for inspiration and also to share projects. Architects and interior designers perceive themselves as artists so appearance of specified products is key to their designs.

“ **I don't care too much about the brand of items I'm specifying as long as they are within a similar budgetary limit.** I generally choose what I'm most familiar with due to lack of time.”

Office building trends

The U.S. commercial real estate market continues to be a significant contributor to the nation's economic engine, driven in part by the office building sector. For each \$ spent on office building expenditures the U.S. economy gained, resulting in \$1 billion in annual operating expenses.

While not yet at pre-recession levels, it's clear the market is gaining momentum. Here's an overview of recent trends:

Office space and spending

- Building vacancy is decreasing due to the improving economy, falling from 15.6% in Q1 2015 to 15.1% Q3 2015.³
- Tenants are downsizing their offices, particularly larger public firms, as they adopt policies for sharing non-dedicated offices and utilize technology so employees can work anywhere and at any time.⁴

How Tork delivers better business:

Cost cutting is important to buildings of any class. Tork can improve a building's bottom line by providing cost efficient amenities that are still attractive to tenants.

Sustainability vs. cost

- Once a fringe concern, reducing a building's carbon footprint is now mainstream. It's also a recruitment factor for new tenants.⁵
- LEED certified spaces doubled in one year from 1 million sq ft per day certified in 2014 to 1.85 million sq ft per day in 2015.⁶
- USGBC reported that 40%-48% of new, non-residential building starts were green compared to 2% in 2005.⁷

How Tork delivers better business:

Tork products are designed to deliver sustainable results without increasing cost. With a guaranteed usage reduction and less maintenance, office restrooms can boast green products without affecting the bottom line.

Building Automation System (BAS)

- Building automation is the automatic monitoring and control of building's HVAC, lighting and other systems.
- Internet of Things (IoT) is the network of physical objects of "things" embedded with electronics, software, sensors and connectivity to enable a greater value or service by exchanging data.

How Tork delivers better business:

Tork EasyCube™ Intelligent Restroom System offers real-time data analysis and 24/7 visibility, ensuring the perfect washroom experience. It is one of the first systems to integrate the advanced IoT technology trend with restroom maintenance.

The importance of collaborative and comfortable work spaces

- Companies are looking for collaborative environments for their employees to feel more comfortable and at home.⁹
- In most office buildings, the restroom generates more complaints than any other area, and can affect the image of the entire building.¹⁰
- Features, services and amenities of office buildings are extremely important to tenants in the performance of their business within the space leased.¹¹

How Tork delivers better business:

Tork products feature a unique, modern design that's eye-catching, functional and space-saving. The office restroom should look and feel as comfortable as one's home.

The tenant is king

- Today's market favors tenants, who are asking for improvement dollars to be spent on better working environments.
- LEED certified buildings generate 13%-80% higher rent and 20%-55% higher resale.¹²
- Tenants are reducing their office space needs for each employee. The need or desire to cut expenses has led tenants to look for flexibility in office space.

How Tork delivers better business:

Well designed, high-performing products improve the overall customer experience. Tork offers products that are soft, strong and smart—delivering complete comfort in a way you can feel good about.

Recommended Tork products

Class A office buildings



Tork Image Design™ Matic Hand Towel Roll Dispenser with Intuition® Sensor – 461102



Tork Image Design Xpress® Hand Towel Dispenser – 463002



Tork Xpress Image Design Countertop Multifold Hand Towel Dispenser – 302030



Tork Image Design Mini Jumbo Bath Tissue Roll Dispenser – 465500



Tork Image Design Foam Skincare Automatic Dispenser with Intuition Sensor – 466100

Class B office buildings



Tork Elevation® Matic® Hand Towel Roll Dispenser with Intuition Sensor – 5511281*



Tork Elevation Matic Hand Towel Roll Dispenser – 5510282*



Tork Elevation Twin Mini Jumbo Bath Tissue Dispenser – 5555290*



Tork Coreless High Capacity Bath Tissue Dispenser – 473208*



Tork Elevation Foam Skincare Automatic Dispenser – 571608*

Class C office buildings



Tork Elevation Matic Hand Towel Roll Dispenser – 5510282*



Tork Elevation Xpress® Hand Towel Dispenser – 552028*



Tork Elevation Mini Jumbo Bath Tissue Roll Dispenser – 555028A*



Tork Elevation High Capacity Bath Tissue Dispenser – 555628*



Tork Elevation Liquid Skincare Dispenser – 570028A*

Breakrooms



Tork Xpress Countertop Multifold Hand Towel Dispenser – 302028*



Tork Perforated Roll Towel, Handi-Size™ Sheet – HB9201

Janitorial & Maintenance



Tork Industrial Paper Wiper, Pop-Up Box – 440245A



Tork Industrial Cleaning Cloth, Handy Box – 520371



Tork Heavy-Duty Cleaning Cloth – 5301505



Tork Polishing Cloth, Top-Pak – 197478

*Available in black or white finish



Maximum usage reduces waste and cost



Patented OptiCore technology

OptiCore® technology ensures maximum use of each roll in the dispenser before advancing to the next roll. This controlled-use reduces product waste and cost.

OptiCore technology offers a two-part core for controlled-use and more than 25% reduction in core material for more environmentally preferable packaging

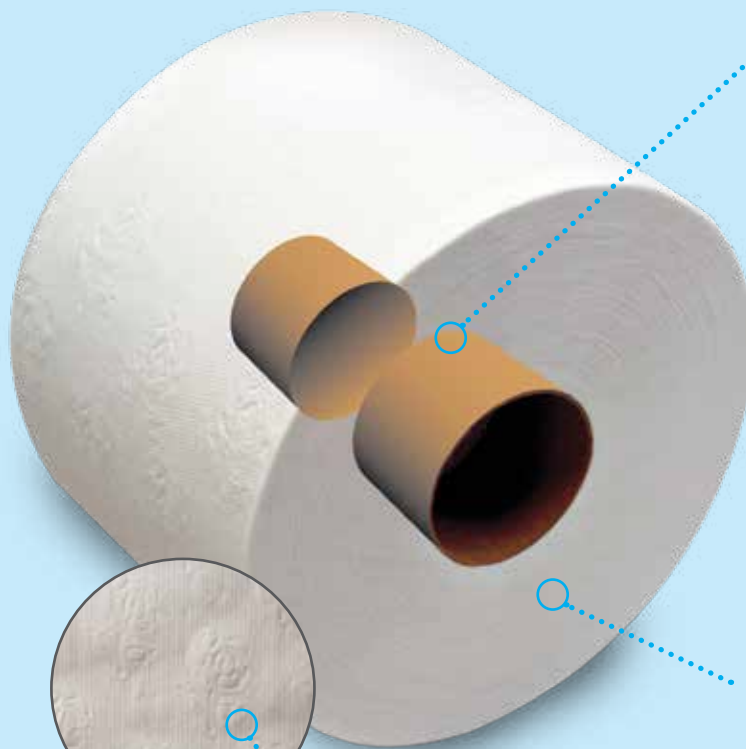

High sheet count for maximum capacity

Attractive floral embossing on most 2-ply products

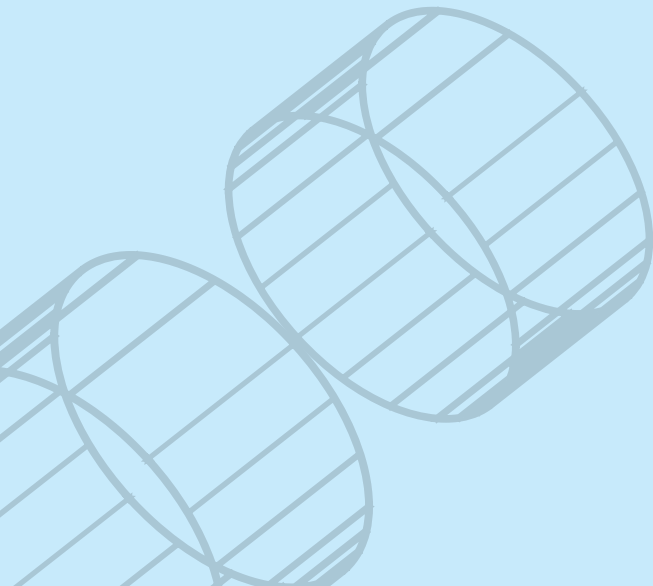

Tork Bath Tissue Dispensing Systems for OptiCore



High-Traffic OptiCore Dispensing

The **Tork® 3 Roll Bath Tissue Roll Dispenser for OptiCore** is designed to minimize maintenance and maximize cost savings for high-traffic areas.

- Revolving design and patented OptiCore tissue ensures that a roll is completely depleted before the dispenser will advance to the next roll, eliminating waste
- Capacity for three full rolls of tissue allows for longer periods between maintenance
- Features a locking cover to prevent product pilferage



Traditional Footprint OptiCore Dispensing

The **Tork Twin Bath Tissue Roll Dispenser for OptiCore** holds two rolls of patented OptiCore tissue.

- Controlled use design reduces waste and cost by ensuring each roll is completely utilized before the next roll is accessible
- Features a locking cover to prevent product pilferage
- Sleek, contemporary style for a wide range of restroom environments
- Translucent cover allows service staff to see at-a-glance when it's time to refill



OptiCore Dispensing for Smaller Spaces

The **Tork Twin Bath Tissue Roll Dispenser for OptiCore** is ideal for environments where horizontal space is limited.

- Holds two rolls of patented OptiCore tissue
- Designed to ensure the lower roll is completely utilized before the upper roll can be accessed, eliminating waste and controlling cost
- Features a locking cover to prevent product pilferage
- 6.75-inch width allows for installation in facilities where horizontal space is limited
- Front-facing tissue for easy access to the product



Highest Capacity OptiCore System

The **Tork High Capacity Bath Tissue Roll Dispenser for OptiCore** Provides an attractive solution for high traffic accounts where the flow of traffic demands high footage rolls of product.

- Accommodates two 2,000-sheet rolls of high-quality perforated tissue to lower maintenance costs in the busiest washrooms
- Patented OptiCore technology prevents stub roll waste and ensures complete utilization
- Once a roll has been depleted, the core remains securely inside the dispenser, ensuring no cores are left on the floor or make their way into the plumbing system
- Features sliding cover that securely protects both rolls and locks to prevent product pilferage
- Glossy translucent finish for upscale design and rugged reliability

Controlled-use tissue features the patented two-part core technology, ensuring maximum use of each roll to reduce waste and cost

Tork Premium Bath Tissue with OptiCore



- Attractive floral embossing pattern
- Designed for those customers who demand the maximum in strength, brightness and softness
- Ideal for office buildings, hotels and restaurants

Tork Advanced Bath Tissue with OptiCore



- 100% recycled, ECOLOGO® and Green Seal™ certified, and exceeds EPA guidelines for post-consumer waste
- Embossed tissue featuring premium brightness
- Ideal for those seeking to achieve green status for their facility

Tork Universal Bath Tissue with OptiCore



- 100% recycled, ECOLOGO and Green Seal certified, and exceeds EPA guidelines for post-consumer waste
- Made with de-inking and bleaching processes free of chlorine and other harmful chemicals
- Offered in traditional and high-capacity rolls
- Designed for government or other facilities that seek to achieve green status or comply with environmental mandates

Tork Bath Tissue Dispensing Systems for OptiCore - T10



SKU	Description	Color	Size H x W x D (in)	Dispensers/Case
565520	Tork High Capacity Bath Tissue Roll Dispenser for OptiCore	White	9.93 x 16.62 x 5.25 (25.22 x 42.21 x 13.34 cm)	1
565528	Tork High Capacity Bath Tissue Roll Dispenser for OptiCore	Black	9.93 x 16.62 x 5.25 (25.22 x 42.21 x 13.34 cm)	1



Refill No.	Description	Color	Ply	Sheet Size W x L (in)	Sheets/Roll	Case	Certification
160090	Tork Universal High Capacity Bath Tissue Roll with OptiCore	White	2	3.75 x 3.5 (9.53 x 8.89 cm)	2,000	12	E

Tork Bath Tissue Dispensing Systems for OptiCore - T11



SKU	Description	Color	Size H x W x D (in)	Dispensers/Case
565820	Tork 3 Roll Bath Tissue Roll Dispenser for OptiCore	White	14.56 x 14.12 x 6.31 (36.98 x 35.86 x 16.03 cm)	1
565828	Tork 3 Roll Bath Tissue Roll Dispenser for OptiCore	Black	14.56 x 14.12 x 6.31 (36.98 x 35.86 x 16.03 cm)	1



SKU	Description	Color	Size H x W x D (in)	Dispensers/Case
565720	Tork Twin Bath Tissue Roll Dispenser for OptiCore	White	8.81 x 11.06 x 7.18 (22.37 x 28.09 x 18.24 cm)	1
565728	Tork Twin Bath Tissue Roll Dispenser for OptiCore	Black	8.81 x 11.06 x 7.18 (22.37 x 28.09 x 18.24 cm)	1



SKU	Description	Color	Size H x W x D (in)	Dispensers/Case
565620	Tork Twin Bath Tissue Roll Dispenser for OptiCore	White	12.31 x 6.75 x 7 (31.27 x 17.15 x 17.78 cm)	1
565628	Tork Twin Bath Tissue Roll Dispenser for OptiCore	Black	12.31 x 6.75 x 7 (31.27 x 17.15 x 17.78 cm)	1



Refill SKU	Description	Color	Ply	Sheet Size W x L (in)	Sheets/Roll	Case	Certification
106390	Tork Premium Bath Tissue Roll with OptiCore	White	2	3.75 x 4 (9.53 x 10.16 cm)	800	36	
162090	Tork Advanced Bath Tissue Roll with OptiCore	White	2	3.75 x 4 (9.53 x 10.16 cm)	865	36	E
161990	Tork Universal Bath Tissue Roll with OptiCore	White	2	3.75 x 4 (9.53 x 10.16 cm)	865	36	E
112990	Tork Universal Bath Tissue Roll with OptiCore	White	1	3.75 x 4 (9.53 x 10.16 cm)	1,755	36	E



ECOLOGO®
 PRODUCT CERTIFIED FOR REDUCED ENVIRONMENTAL IMPACT.
 VIEW SPECIFIC ATTRIBUTES EVALUATED:
 CCD-062 Toilet Tissue, CCD-063 Facial Tissue,
 CCD-064 Table Napkins, CCD-065 Kitchen Towels, CCD-066 Hand Towels.

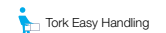
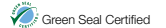



Bring on the crowds

Take on high-traffic restrooms confidently with Tork PeakServe



250%
more towels for
less refilling and
better restroom
flow*



*Compared to traditional towel dispensing systems

1 in 3

guests who avoid going to the restrooms limit how much they eat and drink to do so

The number one issue bothering your guests? Restrooms.

Research* shows that dirty, overcrowded restrooms are the primary concern for guests at busy venues such as transportation hubs, concert arenas and sports stadiums – even more than long lines or traffic to and from venues. In fact:

71% of guests at high-traffic venues have had a bad restroom experience

1 in 3 guests who avoid going to the restrooms limit how much they eat and drink to do so

Many visitors dread using restrooms in crowded venues for fear of poorly-maintained facilities.

What if managers could easily upgrade visitors' experiences? Tork developed a solution to specifically address these problems.

Introducing Tork PeakServe® Continuous™ Hand Towel System

This revolutionary dispensing system is designed to better serve high-traffic restrooms. Neither a roll towel nor a folded towel system, Tork PeakServe is setting a new standard for hand towel dispensing that will improve both end-user and cleaning staff experiences.





25%**

more capacity to
avoid run outs

600*

more guests
served between
refills

Let's get you crowd-ready with Tork PeakServe Continuous Hand Towel

A new standard of high-traffic dispensing for a superior guest experience



More flexibility means more time to clean

- **Refill when it suits you**
with up to 600 more guests served
between dispenser servicing*
- **Double the towels you can carry**
as they're compressed by 50%*
- **Cut refill time in half**
with more than 2,100 towels per dispenser*



Fewer restroom delays get guests in and out faster

- **Avoid run outs with 250% more hand towels***
and lower consumption thanks to one-at-a-time
dispensing
- **Faster dispensing serves guests in 3 seconds**
– quicker than jet air drying time
- **Taking a towel is always smooth and easy**
with our patented continuous towel system

Our latest innovation explained

Tork PeakServe combines two key components for a unique dispensing experience:

1. **Continuous dispensing technology:** bundles latch onto each other when loaded for smooth and **continuous towel flow**; they load from underneath for **fast refilling any time**.
2. **Hand towels** that have been **compressed by 50%** to deliver the **highest-capacity dispensing system on the market**, holding more than 2,100 towels per dispenser

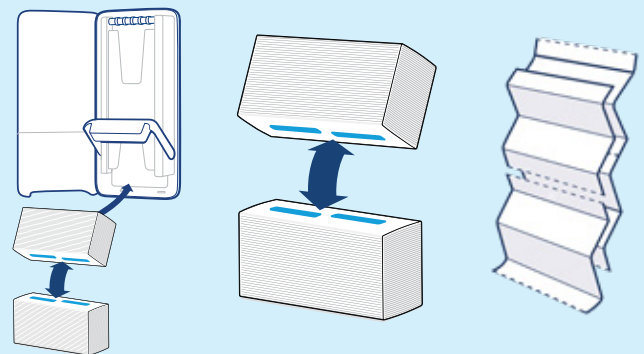

Bundles are compressed by 50% giving more than 2,100 towels per dispenser*. Compressed bundles load from underneath for fast refilling any time.

Continuous bundles latch together when loaded

Bundles dispense without interruption one towel at a time

* Compared to traditional folded towel dispensing systems.
** More than any other system on the market when comparing dispenser capacity in linear footage.

Choose your dispensers and refills

Ensuring a great guest experience starts here



Tork PeakServe Continuous Hand Towel – H5

SKU	Description	Color	Size H x W x D (in)	Dispenser Capacity	Case
552520	Tork Elevation PeakServe Hand Towel Dispenser	White	28.74 x 14.57 x 3.98 (73.0 x 37.01 x 10.11 cm)	1,500' (Linear ft)	1
552528	Tork Elevation PeakServe Hand Towel Dispenser	Black	28.74 x 14.57 x 3.98 (73.0 x 37.01 x 10.11 cm)	1,500' (Linear ft)	1



Refill SKU	Description	Color	Ply	Sheet Size	Towels/Pack	Case	Certification
105065	Tork Advanced PeakServe Continuous Hand Towel	White	1	7.91 x 8.85 (20.09 x 22.48 cm)	410	12	FSC®

Tork Mini Jumbo Roll Bath Tissue – T2

SKU	Description	Color	Size H x W x D (in)	2-Ply Dispenser Capacity	Case
465500	Tork Image Design™ Mini Jumbo Bath Tissue Roll Dispenser	Stainless Steel	9.875 x 14 x 5.125 (25.08 x 35.56 x 13.02 cm)	751' plus stub	1
555020A	Tork Elevation Mini Jumbo Bath Tissue Roll Dispenser	White	10.8 x 13.6 x 5.2 (27.5 x 34.5 x 13.2 cm)	751' plus stub	1
555028A	Tork Elevation Mini Jumbo Bath Tissue Roll Dispenser	Black	10.8 x 13.6 x 5.2 (27.5 x 34.5 x 13.2 cm)	751' plus stub	1
5555200	Tork Elevation Twin Mini Jumbo Bath Tissue Roll Dispenser	White	10.125 x 17 x 5.6875 (25.72 x 43.18 x 14.45 cm)	1502'	1
5555290	Tork Elevation Twin Mini Jumbo Bath Tissue Roll Dispenser	Black	10.125 x 17 x 5.6875 (25.72 x 43.18 x 14.45 cm)	1502'	1

Refill SKU	Description	Color	Ply	Linear Feet/Roll	Roll Width (in)	Case	Certification
11020602	Tork Advanced Soft Mini Jumbo Bath Tissue Roll	White	2	751 (228.9 m)	3.55 (9.02 cm)	12	E
12024402	Tork Advanced Mini Jumbo Bath Tissue Roll	White	2	751 (228.9 m)	3.55 (9.02 cm)	12	E, ♻️
120246	Tork Advanced Mini Jumbo Bath Tissue Roll	White	2	751 (228.9 m)	3.55 (9.02 cm)	12	E, ♻️, ♻️
12013903	Tork Advanced Mini Jumbo Bath Tissue Roll	White	1	1,200 (365.7 m)	3.55 (9.02 cm)	12	E, ♻️, ♻️

Tork Bath Tissue Jumbo Roll – T1

SKU	Description	Color	Size H x W x D (in)	2-Ply Dispenser Capacity	Case
554020A	Tork Elevation Jumbo Bath Tissue Roll Dispenser	White	14.2 x 17.2 x 5.2 (36.0 x 43.7 x 13.2 cm)	1,600' plus stub	1
554028A	Tork Elevation Jumbo Bath Tissue Roll Dispenser	Black	14.2 x 17.2 x 5.2 (36.0 x 43.7 x 13.2 cm)	1,600' plus stub	1
247549A	Tork Twin Jumbo Bath Tissue Roll Dispenser	Black	13 x 21.5 x 5.5 (33.02 x 54.61 x 13.97 cm)	3,200	4

Refill SKU	Description	Color	Ply	Linear Feet/Roll	Roll Width (in)	Case	Certification
12021502	Tork Jumbo Advanced Bath Tissue Roll	White	2	1,600 (487.68 m)	3.55 (9.02 cm)	6	E, ♻️, ♻️
11010402	Tork Jumbo Advanced Bath Tissue Roll	White	1	2,247 (684.89 m)	3.55 (9.02 cm)	6	E, ♻️, ♻️

Tork Foam Skincare Manual Dispensers – S4

SKU	Description	Color	Size H x W x D (in)	Case
466000	Tork Image Design™ Foam Skincare Manual Dispenser	Stainless Steel	11.375 x 4.25 x 4.25 (28.89 x 10.8 x 10.8 cm)	4
571501	Tork Elevation Foam Skincare Manual Dispenser	White	11.26 x 4.45 x 4.13 (28.60 x 11.30 x 10.49 cm)	4
571508	Tork Elevation Foam Skincare Manual Dispenser	Black	11.26 x 4.45 x 4.13 (28.60 x 11.30 x 10.49 cm)	4

Tork Foam Skincare Automatic Dispensers with Intuition® Sensor – S4

SKU	Description	Color	Size H x W x D (in)	Case
466100	Tork Image Design Foam Skincare Automatic Dispenser with Intuition Sensor (Batteries included)	Stainless Steel	10.625 x 4.5 x 5.125 (26.99 x 11.43 x 13.02 cm)	4
571600	Tork Elevation Foam Skincare Automatic Dispenser, with Intuition Sensor (Batteries not included)	White	10.94 x 4.45 x 5.12 (27.79 x 11.30 x 13.00 cm)	4
571608	Tork Elevation Foam Skincare Automatic Dispenser, with Intuition Sensor (Batteries not included)	Black	10.94 x 4.45 x 5.12 (27.79 x 11.30 x 13.00 cm)	4

Refills – S4

For Tork EasyCube™ enabled versions order SKU# 466200, 682830 or 682840

SKU	Description	Color	Fragrance	Unit Size	Case	Dispenser Capacity	Certification
401211	Tork Premium Extra Mild Foam Soap	Colorless	None	1 Liter	6	2500 doses/bottle	♻️, ♻️, NSF E1 Rated
401212	Tork Premium Antibacterial Foam Soap (U.S. only)	Colorless	None	1 Liter	6	2500 doses/bottle	NSF E2 Rated
401213	Tork Premium Alcohol-Free Foam Hand Sanitizer (U.S. only)	Colorless	None	1 Liter	6	2500 doses/bottle	NA
400216*	Tork Premium Alcohol Foam Hand Sanitizer	Colorless	Light	950 ml	6	2,375 doses/bottle	♻️, NSF E3 Rated

* With 72% Alcohol Strength



ECOLOGO®
PRODUCT CERTIFIED FOR REDUCED ENVIRONMENTAL IMPACT.
VIEW SPECIFIC ATTRIBUTES EVALUATED
CCD-065 Toilet Tissue, CCD-063 Facial Tissue,
CCD-084 Table Napkins, CCD-085 Kitchen Towels, CCD-086 Hand Towels.



100% Recycled

Tork Easy Handling



Compostable

EPA compliant.



Green Seal Certified

FSC® Forest Stewardship Council®



Compatible with Tork EasyCube® Intelligent Facility Cleaning System

The feel of cloth without the cost.

For establishments looking to add a finer touch to their tables, Tork Premium Dinner Napkins feature the luxury of linen without the constant cleaning and replacing. Each napkin is substantially softer and thicker than standard napkins, offering guests a superior experience at mealtime.

Don't make your customers choose between cloth and convenience.

Tork Premium Dinner Napkins have a lot to offer:

- The look and feel of real cloth for a touch of elegance
- No hidden costs for linen service, laundering or replacement
- Stronger and more absorbent than standard paper napkins
- Digital custom print capabilities
- Each napkin is used only once for a clean, disposable solution
- Independent Verified and Certified Compostable by BPI
- A smart alternative to linen at lunch



Luxurious look and feel of real cloth napkins

Tork Guest Towels make the right impression in the restroom:

- Look and feel of linen for a refined guest experience
- Soft, absorbent material to deliver a premium performance
- 1/6 fold design opens to a generous 12"x17" size
- So versatile it can be used in your dining room as well as your restroom



**New!
Tork Guest Towel**



Tork Premium Dinner Napkins

SKU	Description	Napkin Size (WxL)	Color	Ply	Napkins/ Pack	Packs/ case	Napkins/ Case
NC7180P	Tork Premium LinStyle® Dinner Napkin, 1/8 Fold	16.25 x 17 (41.28 x 43.18 cm)	White	1	60	6 Poly	360
NC7140P	Tork Premium LinStyle Dinner Napkin, 1/4 Fold	16.25 x 17 (41.28 x 43.18 cm)	White	1	60	6 Poly	360
NC7100	Tork Premium LinStyle Dinner Napkin, Flat Pack	17 x 17 (43.18 x 43.18 cm)	White	1	-	-	500

Tork Guest Towel - New!

SKU	Description	Napkin Size (WxL)	Color	Ply	Poly Packs/Case	Napkins/Poly
NC7160P	Tork LinStyle Guest Towel, 1/6 Fold	12 x 17 (30.48 x 43.18 cm)	White	1	8	80



Tork Premium LinStyle Guest Towel

Hand your customers the best



**High quality
guest towels
designed to
impress your
customers**





Luxurious look and feel

Towels designed to impress

For establishments who appreciate the value of a great impression, Tork Guest Towels serve up the softness of linen with the convenience and cleanliness of disposable towels. Thanks to their generous size and superior absorbency, your guests' experience is improved – as well as your bottom line.

Designed for customers who aim to impress:

- Look and feel of linen for a refined guest experience
- Soft, absorbent material delivers a premium performance
- Can be digitally custom printed with your company name or logo
- 1/6 fold design opens to a generous 12"x17" size
- Disposables are clean, convenient and cost-effective



Tork Premium LinStyle® Guest Towel

SKU	Color	Ply	Folded W x L	Poly Packs/Case	Napkins/Poly
NC7160P	White	1	12 x 17 (30.48 x 43.18 cm)	8	80



Unlock your hidden potential

Find the right Tork® solution to update your current stainless washroom systems





Upgrade your current hand towel cabinets and bath tissue dispensers in 3 easy steps:



Step 1.
Identify your current dispenser type

Step 2.
Select your upgrade

Step 3.
Unlock your hidden potential with our recommended solution

Transformation without renovation

– With Tork® you can unlock the hidden potential in your current Stainless Washroom systems

Your visitors evaluate your business based on the standard of your washrooms. With Tork Stainless Washroom upgrade solutions you can unlock the hidden potential of your current stainless washroom solutions and offer a better experience for staff and visitors. Not to mention save money along the way.



Unlock a better experience for your guests



Improved one-at-a-time dispensing and high quality refills provides a better and more hygienic experience for your guests.

Unlock hidden savings

Tork hand towel dispensers reduce your towel consumption and Tork Coreless High Capacity Bath Tissue Rolls have more than twice the capacity compared to standard rolls, which means lower maintenance costs.



Unlock smarter ways of working for your staff

Less storage
Fewer refills
Less waste



Tork EasyCube™

Most Tork Stainless Washroom upgrade solutions are compatible with Tork EasyCube™ – a cloud-based service that collects real-time data about cleaning and refill needs from connected devices. Instant oversight through the user-friendly web portal equals 77% fewer dispenser checks* needed, improved washroom quality and boosted staff satisfaction.



* 3rd party market research with observation studies and interviews before and after Tork EasyCube™ implementation at facility with 20,000 visitors/week.

The Tork Stainless Washroom Upgrade Solutions consist of products for upgrading your current hand towel cabinets and bath tissue dispensers. The following pages provide an overview of the Tork products included in the offer and their main benefits.

Roll towel upgrades

Upgrading to one of our many high capacity roll towel dispensers helps reduce maintenance costs. Ideal for busy restrooms, hands free dispensing eliminates cross-contamination and improves hygiene.

Tork stainless roll towel dispensers are available in versions for recessed cabinets as well as for in-wall mounting.



The image to the right shows a common type of stainless washroom hand towel cabinet, which has been upgraded with a recessed Tork Matic® Hand Towel Dispenser.



Recessed stainless roll towel dispensers:



461122 Tork Image Design™ Matic® Hand Towel Roll Dispenser with Intuition® Sensor, Recessed

The Recessed Tork Image Design Matic Hand Towel Roll Dispenser with Intuition Sensor easily adapts your existing in-wall folded towel and waste dispenser to a touch-free sensor roll towel system in beautiful stainless steel. Give your guests the ultimate no-touch hand drying experience.



461022 Tork Image Design Matic Hand Towel Dispenser, Recessed

The Recessed Tork Image Design Matic Hand Towel Dispenser in beautiful stainless steel easily adapts many recessed in-wall folded towel and waste dispensers to a high capacity roll towel system. Get excellent function and reduced towel consumption with one-at-a-time dispensing, while giving your guests a hygienic, no-touch hand drying experience.

Benefits:

- Adjustable towel length allows you to select the towel size that's right for your business.
- Reliable performance and intuitive maintenance delivers peace of mind.

Benefits:

- High capacity serves more customers with fewer rolls.
- Viewing windows make it easy to see when to refill.
- Intuitive refilling saves time.
- Semi-recessed design for a sleek, compact look.

In-wall recessed stainless roll towel dispensers:



461123 Tork Image Design Matic Hand Towel Dispenser with Intuition Sensor, In-Wall Recessed

The In-Wall Recessed Tork Image Design Matic Hand Towel Dispenser with Intuition Sensor in beautiful stainless steel can be mounted directly into your wall. The touch free, one-at-a-time dispensing reduces consumption and improves hygiene. This sensor roll towel system gives guests the ultimate no-touch hand drying experience.

Benefits:

- Adjustable towel length allows you to select the towel size that's right for your business.
- Reliable performance and intuitive maintenance with an LED refill indicator that shows when a refill is needed, delivers peace of mind.
- Semi-recessed design is ADA compliant.



461023 Tork Image Design Matic Hand Towel Dispenser, In-Wall Recessed

The In-Wall Recessed Tork Image Design Matic Hand Towel Dispenser in beautiful stainless steel can be mounted directly into your wall. Get excellent function and reduced towel consumption with one-at-a-time dispensing, while giving your guests a hygienic, no-touch hand drying experience.

Benefits:

- High capacity serves more customers with fewer rolls.
- Viewing windows make it easy to see when to refill.
- Intuitive refilling saves time.
- Semi-recessed design is ADA compliant.

Accessories



Recessed Trim Ring Kit for Tork Elevation Matic Dispenser

SKU	Color	Accessory Size H x W x D	Case Dimensions L x W x D (in)	Units/Case	Use with Tork Dispensers
3106220	Stainless Steel	19.75 x 15.75 x 3.25 (50.17 x 40.01 x 9.53 cm)	16.563 x 4.438 x 22.50 (42.07 x 11.27 x 57.15 cm)	1	5510202, 5510282



Recessed Trim Ring Kit for Tork Elevation Matic Dispenser with Intuition Sensor

SKU	Color	Accessory Size W x L (in)	Case Dimensions L x W x H (in)	Units/Case	Use with Tork Dispensers
3106440	Stainless Steel	16.0 x 3.75 x 18.25 (40.64 x 9.53 x 46.36 cm)	16.75 x 4.875 x 19.625 (42.55 x 12.38 x 49.85 cm)	1	5511202, 5511282



Steel Filler Panel for Tork Elevation Matic Dispenser

SKU	Color	Filler Panel Size (H x W x D in)	Case Dimensions (L x W x H in)	Units/Case	Use with Tork Dispensers
3096020	Stainless Steel	22.56 x 17.63 x 3.88 (57.30 x 44.78 x 9.86 cm)	18.25 x 4.5 x 23.75 (46.36 x 11.43 x 60.33 cm)	1 Panel/Box	5510202, 5510282



Filler Panel for Tork Elevation Matic Hand Towel Roll Dispenser with Intuition Sensor

SKU	Color	Filler Panel Size (H x W x D in)	Case Dimensions (L x W x H in)	Units/Case	Use with Tork Dispensers
3096040	Stainless Steel	22.56 x 17.63 x 3.88 (57.30 x 44.78 x 9.86 cm)	18.25 x 4.5 x 23.75 (46.36 x 11.43 x 60.33 cm)	1 Panel/Box	5511202, 5511282



Tork Recessed Frame and Bin – H11 & H1

(H1 to be used, along with corresponding filler panel, during new construction or remodeling)

SKU	Color	Frame Size W x L (in)	Units/Case	Use with Tork Dispensers
309051	Stainless Steel	56.0 x 17.125 x 9.0 (142.24 x 43.50 x 22.86 cm)	1 Box	5510202, 5510282 5511202, 5511282, 461122

ACC-001 Tork Hanging Bracket

Works with all current Tork Elevation roll towel dispensers.



Color	Material	Adapter Size H x W x D (in)	Approx Lbs/Case	Cubic Ft/Case	Adapters/Case	Case Dimensions L x W x H (in)
Stainless Steel	Stainless Steel	9.0 x 10.20 x 1.21 (22.86 x 25.91 x 3.07)	N/A	N/A	1	N/A

NOTE: The dispenser is surface-mounted. Customer is responsible for ensuring all ADA guidelines are met.

Folded towel upgrades

- Available in 3 easy-to-fit sizes

Tork Xpress™ Stainless Cabinet Towel Adapters reduce towel waste from product fall out, helping eliminate associated costs.



309695
Tork Xpress Large Stainless
Cabinet Towel Adapter



309696
Tork Xpress Medium Stainless
Cabinet Towel Adapter



309697
Tork Xpress Small Stainless
Cabinet Towel Adapter



All Tork Xpress Stainless Cabinet Towel Adapters help you unlock these unique benefits:

- One-at-a-time dispensing controls consumption and reduces waste.
- No need to renovate. Quick and easy to install in most folded stainless steel towel cabinets.
- Go ahead and fill it up - our unique design ensures smooth dispensing with no messy paper tabs on the floor. From the first to the last towel, your users will have a great experience.
- Cost-effective upgrade for most towel cabinets. Big and small, on or in the wall, they fit most designs and styles.

Need more capacity? Add a Tork Xpress Countertop Dispenser:



302030 Tork Image Design Xpress Countertop Multifold Hand Towel Dispenser

The Tork Image Design Xpress Countertop Multifold Hand Towel Dispenser provides a great way of adding backup capacity, rather than placing loose hand towels on top of cabinets or between the basins. The compact, stylish design in smudge proof stainless steel will add an upscale touch to the washroom.

Benefits:

- Fully enclosed towels with one-at-a-time dispensing improve hygiene and reduce waste.
- Overfill protection and spring-loaded bottom improve dispensing.
- Quick check refill level indicator and easy access buttons for fast refills.
- **The same refills work in our Towel Adapter and Countertop dispensers.**

Coreless Bath Tissue Adapters

– For commercial bath tissue dispensers

Upgrading your stainless steel bath tissue dispensers with a Tork High Capacity Coreless Spindle Kit allows you to use Tork Advanced High Capacity Coreless Bath Tissue Rolls, which will give you increased capacity and lower maintenance costs.



473030
Type A

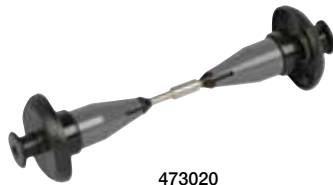

473020
Type B



473040
Type C



473060
Type D

Tork High Capacity Coreless Spindle Kits for Tork Advanced High Capacity Coreless Bath Tissue Rolls are available in 4 types to fit most commercial bath tissue dispensers. Two-piece plastic spindles have durable stainless steel rods inside for smooth, quiet dispensing.

2

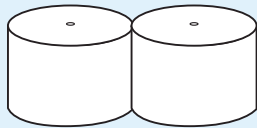

Tork coreless
bath tissue rolls

=

5

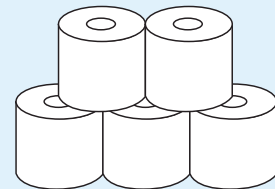

conventional
bath tissue rolls

Tork Advanced Coreless High Capacity Bath Tissue has more than twice the capacity compared to standard rolls. This means fewer maintenance intervals and reduced risk of run-outs for improved patron satisfaction. Ideal for low to medium traffic washrooms.

Benefits:

- Without the core, you gain more – two high-capacity rolls are equivalent to five conventional rolls.
- No cardboard cores like in standard toilet rolls and no wrappers means there's less waste to handle.
- Less frequent refilling means lower maintenance costs.
- Offers the comfort of 2-ply softness with reliable performance you can count on.
- EPA compliant and FSC® certified.

Tork stainless washroom upgrade solutions guide

This simple guide helps you customize your current stainless washroom accessories. Start by choosing the hand towel cabinet (below) or the bath tissue dispenser (opposite page) that most closely resembles your current dispenser:

Your current hand towel dispenser:

Recessed Towel and Waste Cabinet – Half Door, Tall Height



Recessed Towel and Waste Cabinet – Full Door, Tall Height



Recessed Towel and Waste Cabinet – Short Height



Recessed Towel Cabinet



Surface-Mounted Stainless Steel Towel Cabinet



Additional solution:

**Direct Mount
– In-Wall Recessed**

High-capacity sensor or manual roll towel dispensers that mount directly into the wall

Your current bath tissue dispenser:

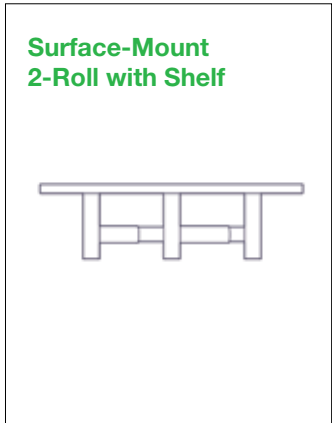
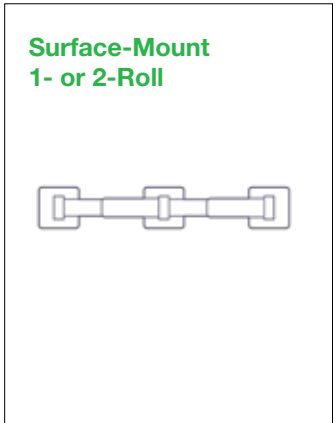
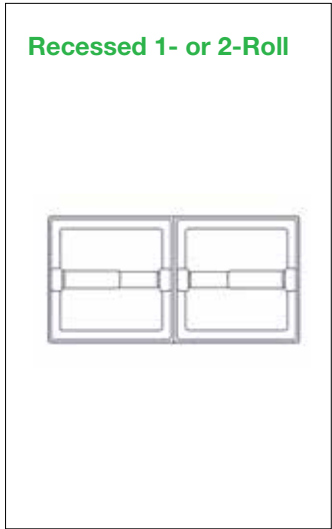
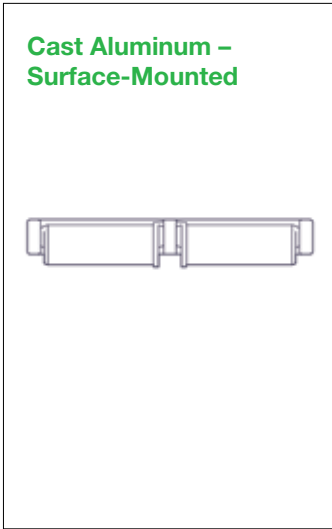
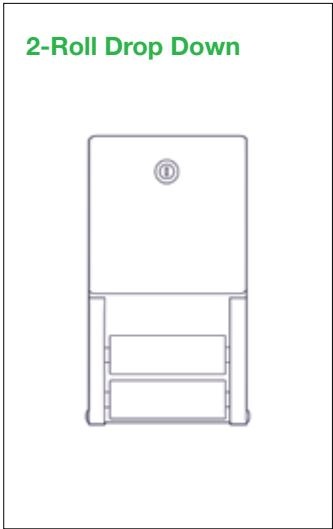

When you know the manufacturer and model of your dispenser, use the Tork Coreless Spindle Replacement Guide.





Your current dispenser:
Recessed Towel and Waste Cabinet
– Half Door, Tall Height

Identifying features:



Tall, stainless cabinet with a half door that covers only the hand towel area. This type of cabinet has a separate, removable, waste bin.

Approximate Size:

Width – 17” (43.2 cm), outside edge to outside edge
 Height – 54” to 56” (137.2 to 142.2 cm)
 Depth – 4” to 9” (10.2 to 22.9 cm)

Unlock your hidden potential with these possible upgrades from Tork:



SKU Number	461122	461022	309695	309696
Description	Tork Matic Hand Towel Dispenser – Recessed with Intuition Sensor – H11 Roll Towel	Tork Matic Hand Towel Dispenser – Recessed – H1 Roll Towel	Tork Xpress Large Stainless Cabinet Towel Adapter – H2 Folded towel	Tork Xpress Medium Stainless Cabinet Towel Adapter – H2 Folded towel
Main benefits	<ul style="list-style-type: none"> - Adjustable towel length - Reliable performance and intuitive maintenance. 	<ul style="list-style-type: none"> - High capacity - Easy to see when to refill - Intuitive refilling - Semi-recessed design 	<ul style="list-style-type: none"> - One-at-a-time dispensing controls consumption and reduces waste - Quick and easy to install (no need to drill or cut) - Excellent dispensing without tabbing or double dispensing 	
Tork EasyCube compatible				
Refill Options	290015 Tork Premium Extra Soft Matic Hand Towel Roll (White with Blue Leaf Print) 290019 Tork Premium Soft Matic Hand Towel Roll (White with Blue Leaf Print)	290094 Tork Premium Extra Soft Matic Hand Towel Roll, 2-Ply (White with Blue Leaf) 290096 Tork Premium Soft Matic Hand Towel Roll (White with Blue Leaf Print)	100297 Tork Premium Extra Soft Xpress Multifold Hand Towel, 4-Panel (White with Pink Leaf) MB574 Tork Premium Soft Xpress Multifold Hand Towel, 4-Panel (White with Blue Leaf Print)	





Your current dispenser:
Recessed Towel and Waste Cabinet
– Full Door, Tall Height

Identifying features:

Tall, stainless cabinet with a full height door that covers both the hand towel area and the waste bin. It may be wide or narrow.

Unlock your hidden potential with these possible upgrades from Tork:



SKU Number	309695	309696
Description	Tork Xpress™ Large Stainless Cabinet Towel Adapter – H2 Folded towel	Tork Xpress™ Medium Stainless Cabinet Towel Adapter – H2 Folded towel
Main benefits	<ul style="list-style-type: none"> - One-at-a-time dispensing controls consumption and reduces waste - Quick and easy to install (no need to drill or cut) - Excellent dispensing without tabbing or double dispensing 	
Tork EasyCube compatible		
Refill Options	100297 Tork Premium Extra Soft Xpress® Multifold Hand Towel, 4-Panel (White with Pink Leaf) MB574 Tork Premium Soft Xpress® Multifold Hand Towel, 4-Panel (White with Blue Leaf Print)	



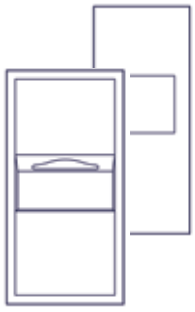

Your current dispenser:

Recessed Towel and Waste Cabinet – Short Height

Identifying features:

Short overall cabinet height (<32", 81.2 cm), with either a full height door or a short half door.

Unlock your hidden potential with this possible upgrade from Tork:



SKU Number	309697
Description	Tork Xpress Small Stainless Cabinet Towel Adapter – H2 Folded towel
Main benefits	<ul style="list-style-type: none"> - One-at-a-time dispensing controls consumption and reduces waste - Quick and easy to install (no need to drill or cut) - Excellent dispensing without tabbing or double dispensing
Refill Options	100297 Tork Premium Extra Soft Xpress Multifold Hand Towel, 4-Panel (White with Pink Leaf) MB574 Tork Premium Soft Xpress Multifold Hand Towel, 4-Panel (White with Blue Leaf Print)

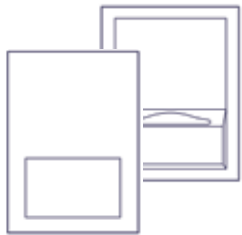

Your current dispenser:

Recessed Towel Cabinet

Identifying features:

These cabinets have towel dispensers, but no waste bins. Doors can be either split or of a full surround type.

Unlock your hidden potential with this possible upgrade from Tork:



SKU Number	309697
Description	Tork Xpress Small Stainless Cabinet Towel Adapter – H2 Folded towel
Main benefits	<ul style="list-style-type: none"> - One-at-a-time dispensing controls consumption and reduces waste - Quick and easy to install (no need to drill or cut) - Excellent dispensing without tabbing or double dispensing
Refill Options	100297 Tork Premium Extra Soft Xpress Multifold Hand Towel, 4-Panel (White with Pink Leaf) MB574 Tork Premium Soft Xpress Multifold Hand Towel, 4-Panel (White with Blue Leaf Print)



Your current dispenser:
Surface-Mounted Stainless Steel Towel Cabinet

Identifying features:
 Surface-mounted, stainless steel, folded towel cabinet. May be full or half height.

Unlock your hidden potential with this possible upgrade from Tork:



SKU Number	309697
Description	Tork Xpress Small Stainless Cabinet Towel Adapter – H2 Folded towel
Main benefits	<ul style="list-style-type: none"> - One-at-a-time dispensing controls consumption and reduces waste - Quick and easy to install (no need to drill or cut) - Excellent dispensing without tabbing or double dispensing
Refill Options	100297 Tork Premium Extra Soft Xpress Multifold Hand Towel, 4-Panel (White with Pink Leaf) MB574 Tork Premium Soft Xpress Multifold Hand Towel, 4-Panel (White with Blue Leaf Print)

Additional solution:
Direct Mount – In-Wall Recessed

This solution provides a stand-alone, semi-recessed roll towel dispenser, perfect for when the desired placement is directly into the wall. This is not a recommended replacement for any of the current solutions shown, but a great option for any washroom. Waste bin is separate and not included.



Tork Image Design Matic Hand Towel Dispenser with Intuition Sensor, In-Wall Recessed



Tork Image Design Matic Hand Towel Dispenser, In-Wall Recessed

SKU Number	461123	461023
Description	Tork Matic Hand Towel Dispenser – In-wall Recessed with Intuition Sensor – H11 Roll Towel	Tork Matic Hand Towel Dispenser – In-wall Recessed – H1 Roll Towel
Main benefits	<ul style="list-style-type: none"> - Adjustable towel length - LED refill indicator - Semi-recessed design is ADA compliant 	<ul style="list-style-type: none"> - High capacity - Easy to see when to refill - Intuitive refilling - Semi-recessed design
Refill Options	290015 Tork Premium Extra Soft Matic Hand Towel Roll (White with Blue Leaf Print) 290019 Tork Premium Soft Matic Hand Towel Roll (White with Blue Leaf Print)	290094 Tork Premium Extra Soft Matic Hand Towel Roll, 2-Ply (White with Blue Leaf) 290096 Tork Premium Soft Matic Hand Towel Roll (White with Blue Leaf Print)

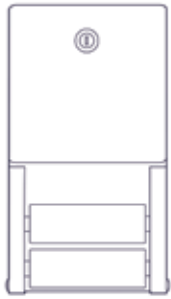

Your current dispenser:
2-Roll Drop Down

Identifying features:

These can have a flat or a curved cover. There are also versions that are recessed (cut) into the wall. But the mechanism is the same. The spindle will automatically drop down from the upper (reserve) position when there are only a few sheets of tissue remaining on the bottom refill.

Unlock your hidden potential with these possible upgrades from Tork:

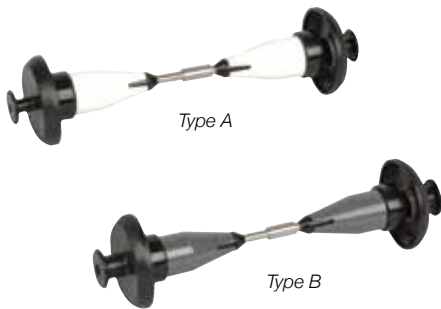

SKU Number	473030	473020
Description	<i>Primary choice:</i> Tork Coreless High Capacity Spindle Kit, Type A	<i>Secondary choice:</i> Tork Coreless High Capacity Spindle Kit, Type B
Main benefits	<ul style="list-style-type: none"> - High capacity compact rolls - No core for more sheets per roll - Soft quality tissue with an embossed pattern 	
Note	Both the Type A and B spindle may work in your dispenser. The correct one depends on arm width. Your Tork representative will supply you with both.	
Refill Options	472886 Tork Advanced High Capacity Coreless Bath Tissue Roll (White)	

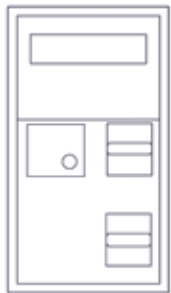

Your current dispenser:
Multi-Function, Partition Mounted

Identifying features:

These are large units that can be either cut into a toilet partition (the panel dividing two toilet stalls), or cut directly into the wall. They may have a napkin disposal unit and toilet seat cover dispenser but will always have two rolls to service one toilet stall. There are also some partition-mounted units that contain just bath tissue, with two rolls on either side, to service two toilet stalls. The spindles in these units may have been changed from a standard spring-loaded spindle to a theft-resistant spindle that requires a key to loosen.

Unlock your hidden potential with these possible upgrades from Tork:

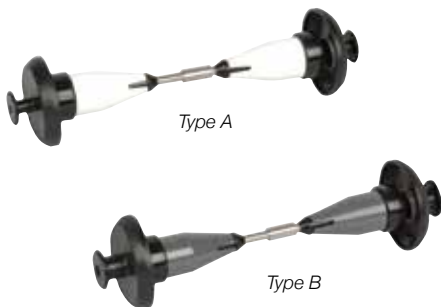

SKU Number	473030	473020
Description	<i>Primary choice:</i> Tork Coreless High Capacity Spindle Kit, Type A	<i>Secondary choice:</i> Tork Coreless High Capacity Spindle Kit, Type B
Main benefits	<ul style="list-style-type: none"> - High capacity compact rolls - No core for more sheets per roll - Soft quality tissue with an embossed pattern 	
Note	Both the Type A and B spindle may work in your dispenser. Your Tork representative will supply you with both.	
Refill Options	472886 Tork Advanced High Capacity Coreless Bath Tissue Roll (White)	



Your current dispenser:

Cast Aluminum – Surface-Mounted

Identifying features:

These are available in single or double roll versions. The spindles are oval shaped. Some of these are “controlled delivery” where there is a small pin that protrudes from both of the aluminum “arms” which stops the spindle from rotating a full 360 degrees. If the dispenser has these controlled delivery pins on them, the adapter will not work.

Unlock your hidden potential with this possible upgrade from Tork:

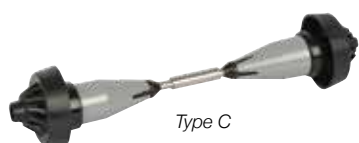

Type C

SKU Number	473040
Description	Tork Coreless High Capacity Spindle Kit, Type C
Main benefits	<ul style="list-style-type: none"> - High capacity compact rolls - No core for more sheets per roll - Soft quality tissue with an embossed pattern
Note	The adapter will only work in cast aluminum fixtures that don't have the pin for portion control.
Refill Options	472886 Tork Advanced Coreless High Capacity Bath Tissue Roll (White)

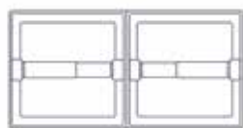

Your current dispenser:

Recessed 1- or 2-Roll

Identifying features:

These dispensers are recessed (cut) directly into the wall and are available in single or 2-roll side-by-side. They have a simple round, spring-loaded spindle.

Unlock your hidden potential with these possible upgrades from Tork:

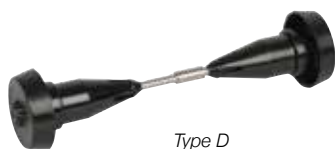

Type D



Type C

SKU Number	473060	473040
Description	<i>Primary choice:</i> Tork Coreless High Capacity Spindle Kit, Type D	<i>Secondary choice:</i> Tork Coreless High Capacity Spindle Kit, Type C
Main benefits	<ul style="list-style-type: none"> - High capacity compact rolls - No core for more sheets per roll - Soft quality tissue with an embossed pattern 	
Note	Both the Type D and C spindle may work in your dispenser. The correct one depends on arm width and roll diameter. Your Tork representative will supply you with both.	
Refill Options	472886 Tork Advanced Coreless High Capacity Bath Tissue Roll (White)	



Your current dispenser:
Surface-Mount 1- or 2-Roll

Identifying features:

These dispensers are available in either 2-roll or 1-roll versions. They have a simple, spring-loaded spindle.

Unlock your hidden potential with these possible upgrades from Tork:



SKU Number	473060	473040
Description	<i>Primary choice:</i> Tork Coreless High Capacity Spindle Kit, Type D	<i>Secondary choice:</i> Tork Coreless High Capacity Spindle Kit, Type C
Main benefits	<ul style="list-style-type: none"> - High capacity compact rolls - No core for more sheets per roll - Soft quality tissue with an embossed pattern 	
Note	Note: Both the Type D and C spindle may work in your dispenser. The correct one depends on arm width. Your Tork representative will supply you with both.	
Refill Options	472886 Tork Advanced Coreless High Capacity Bath Tissue Roll (White)	

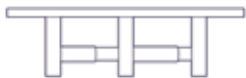

Your current dispenser:
Surface-Mount 2-Roll with Shelf

Identifying features:

This type of dispenser has a shelf on top and two side-by-side rolls. They are held in place by simple, spring-loaded spindles.

Unlock your hidden potential with this possible upgrade from Tork:

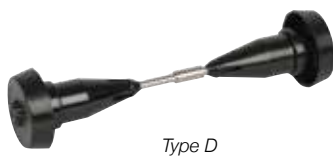

SKU Number	473060
Description	Tork Coreless High Capacity Spindle Kit, Type D
Main benefits	<ul style="list-style-type: none"> - High capacity compact rolls - No core for more sheets per roll - Soft quality tissue with an embossed pattern
Refill Options	472886 Tork Advanced Coreless High Capacity Bath Tissue Roll (White)

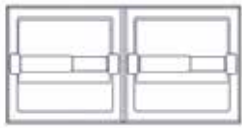

Your current dispenser:

Recessed 1- or 2-Roll with Hood

Identifying features:

These dispensers are recessed (cut) directly into the wall. They are available in single or 2-roll side-by-side. They have a simple round, spring-loaded spindle and a protective hood that covers the top of the toilet roll.

[Contact your Tork Representative for more information for a possible upgrade.](#)

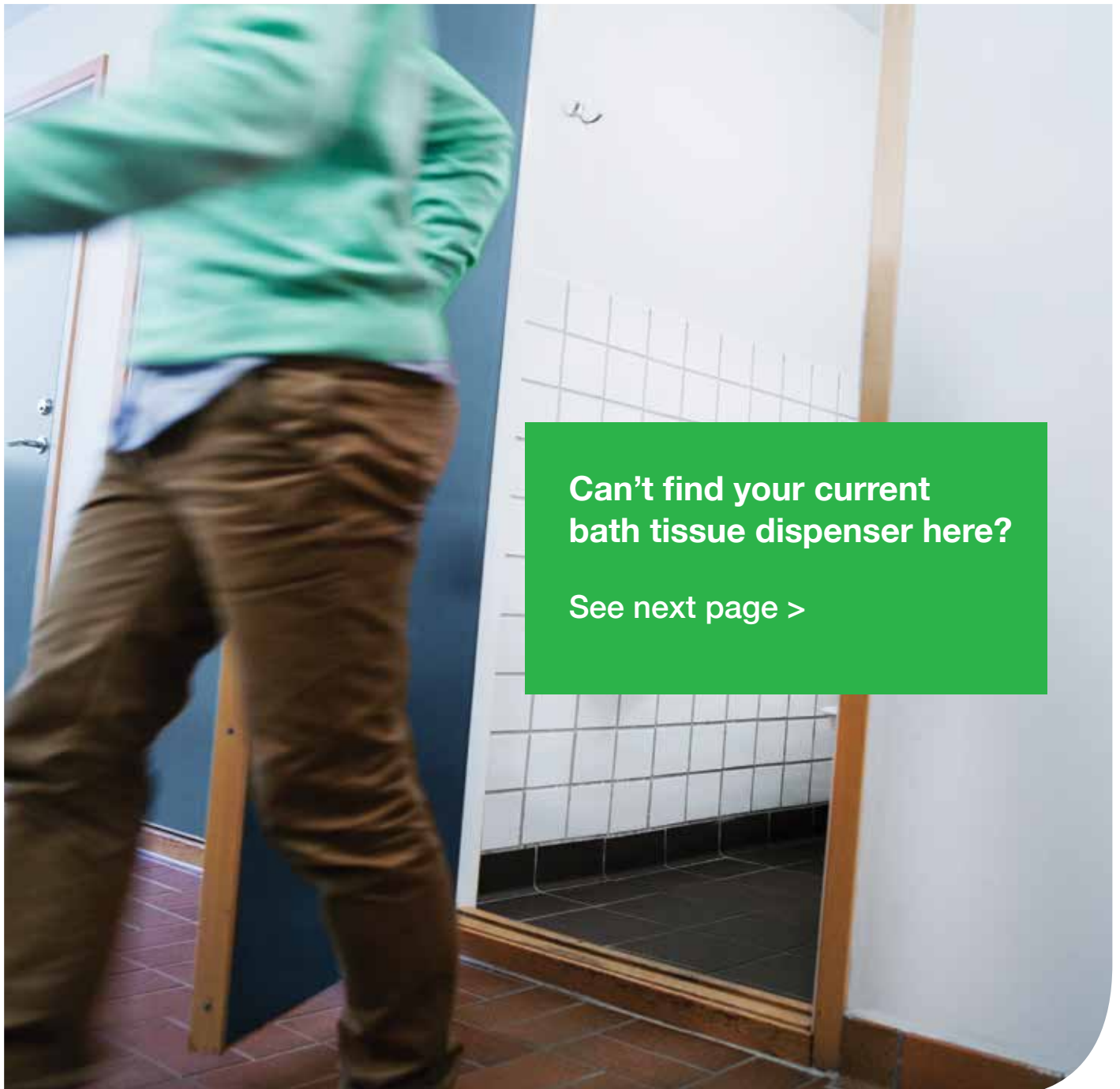

**Can't find your current
bath tissue dispenser here?**

See next page >

Tork Coreless Spindle Replacement Guide

If you know the name of the manufacturer or the model number of your current dispenser, you can use the Tork Coreless Spindle Replacement Guide to find the correct Tork Coreless High Capacity spindle.

If they have this current spindle . . .

Manufacturer		Spindle SKU		Body Color		Body Collapsible		Body Shape	
ASI+Frost				Black		No		Round	
Bobrick		B 4288-9 		Black		No		Round	
Bobrick		B 283-604 		Black		No		Round	
Bobrick		B 273-103 		Black		No		Flat/oval	
Bobrick		B283-504 		Silver/Chrome		Yes		Round	
Bradley		PIO-571 		White		No		Round	
Bradley		P10-560 		White		Yes		Round	
Bradley		P10-550 		Grey (light or dark)		No		Flat/oval	
Georgia-Pacific		50012 		Grey (light or dark)		Yes		Round	
Georgia-Pacific		50030 <small>(new)</small> 		Grey (light or dark)		Yes		Round	
Georgia-Pacific		50030 <small>(old)</small> 		Grey (light or dark)		Yes		Round	
Georgia-Pacific		50040 		Grey (light or dark)		Yes		Round	
Georgia-Pacific		50011 		Black/Grey		Yes		Round	











4

DOES IT HAVE METAL END PINS OR LARGE END FLANGES?

5

IS THE BODY SURFACE SMOOTH OR RIBBED?

Choose this Tork Spindle

End Pin(s) Metal	Large End Flanges	Body Surface	Spindle SKU	Description	Alternative Adapter Option
Yes	No	Ribbed	473030 	Type A	
No	No	Ribbed	473020 	Type B	
No	No	Smooth	473060 	Type D	Type C or B*
Yes	No	Smooth	473040 	Type C	
No	No		473060 	Type D	Type C or B*
No	No	Smooth	None	None	
No	No	Smooth	473060 	Type D	Type C or B*
Yes	No	Ribbed	None	None	
No	Yes	Smooth	473030 	Type A	
No	No	Smooth	473040 	Type C	Type D
No	Partial	Smooth/Ribbed	473040 	Type C	
No	No	Smooth	473040 	Type C**	Type D or B*
No	Yes	Smooth	473020 	Type B	

*If found in a partition style dispenser
 **Bobrick dispensers



Find the right upgrade with our easy-to-use digital Tork Stainless Washroom Upgrade Solutions Decision Tool!



With Tork Stainless Washroom Upgrade Solutions you can upgrade without renovating. Find out how to unlock a better washroom experience for staff and visitors and save money along the way with our new Tork Stainless Washroom Upgrade Solutions Decision Tool.

Step 1

Identify your current dispenser type

Step 2

Select your upgrade

Step 3

Unlock your hidden potential with our recommended solution





Tork Guide for Recessed Solutions

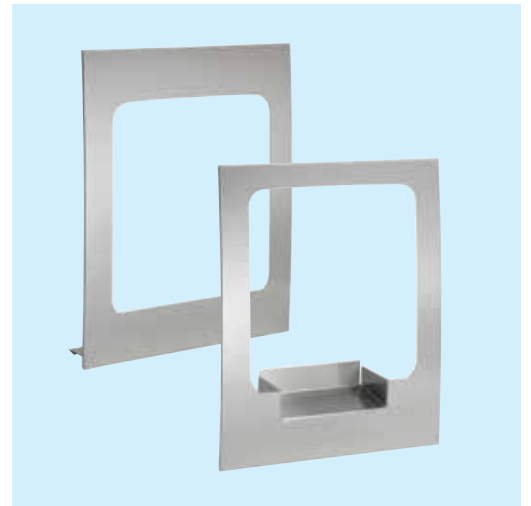

Tork recessed solutions

This resource is designed to help educate and guide you in selling our Tork® recessed solutions. It will assist you in deciding which option is right for the end customer with confidence and conviction! Our recessed solutions enhance image in the washroom and improve overall customer experience. For more information go to SMART or contact your dispenser team.

Table of contents

Folded towel adapters

We offer adapters that will improve folded towel dispensing on existing cabinets and surface mounted dispensers.



Pages 3–4

Stainless Steel Trim Ring (Intuition)

We offer a stainless steel trim ring to finish the wall for a semi recessed application. (Available for Elevation Intuition Dispensers)



Page 5

Recessed roll towel solutions

We offer our one-size-fits-most filler panels that can be used to retrofit common recessed cabinets with our popular Tork Matic® and Tork Intuition® dispensers.



Pages 6–7

Stainless steel frame and bin

We offer a complete recessed solution. Select the stainless steel frame and bin, choice of the Tork Intuition or Tork Matic dispensers and the corresponding filler panel.



Page 8

Surface-mounted hanging bracket

We offer this hanging bracket which offers easy Tork roll towel dispenser installation over the top of an existing recessed towel cabinet door.



Page 9

Examples of non-retrofitable recessed cabinets

We offer Tork dispensing solutions for non-retrofitable recessed cabinets.

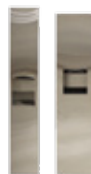

Page 10

Recessed cabinet information collection sheet

We offer an easy-to-use measuring sheet for custom projects.

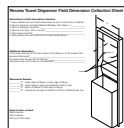

Page 11

Folded towel adapters

Situation:

Your end customer currently has a recessed cabinet. They are looking for improved dispensing and higher capacity.

Solution:

Offer your end customer a Tork folded towel adapter and one of our high-end towel products. The SCA adapter program is easy and cost efficient. It helps to eliminate the expense of purchasing new dispensers and improves dispensing from most cabinets by reducing waste due to tearing and fallout. It is also a great option for cabinets that can not be retrofitted for a Tork roll-towel dispenser.

For increased capacity, offer your customer one of the new Tork Xpress® Counter Top Multi-fold Hand Towel dispensers.

Manufacturer/Dispenser	Tork Products	Adapter
Large Stainless Steel Recessed Cabinet 12" - 16" wide x 4" deep (works in most manufacturer's cabinets, such as GAMCO, Bradley and Bobrick.	100297, MB572, MB574, MB576, MB578, MB570, MB554, MB556, MB568, MB560A, MB550A, MB640, MB540A, MB538, MK530A, MK520A, MK518A	309691
Small Stainless Steel Recessed Cabinet or surface mounted towel dispensers 12" - 16" wide x 4" deep (works in most manufacturer's cabinets, such as GAMCO, Bradley and Bobrick.	100297, MB572, MB574, MB576, MB578, MB570, MB554, MB556, MB568, MB560A, MB550A, MB640, MB540A, MB538, MK530A, MK520A, MK518A	309692

Adapter details



309691 – Tork Folded Towel Dispenser Adapter for Recessed, Semi Recessed and Surface Mounted Folded Towel Dispensers

Designed for larger recessed folded towel cabinets. This adapter helps remove the weight of the bundle to prevent tabbing, tearing and multiple dispensing.

Color	Material	Adapter Size W x L x D (in)	Approx Lbs/Case	Cubic Ft/Case	Adapters/Case	Case Dimensions L x W x H (in)
Stainless Steel	Metal	16.0 x 10.5625 x 3.625 (40.64 x 26.83 x 9.21 cm)	3.04 (1.4 kg)	0.46 (0.0131 cm)	1	11.125 x 4.25 x 16.875 (28.26 x 10.80 x 42.86 cm)



309692 – Tork Folded Towel Dispenser Adapter for Recessed Surface Mounted Folded Towel Dispensers

Designed for smaller recessed folded towel cabinets and surface mounted folded towel dispensers. This adapter helps remove the weight of the bundle to prevent tabbing, tearing and multiple dispensing.

Color	Material	Adapter Size W x L x D (in)	Approx Lbs/Case	Cubic Ft/Case	Adapters/Case	Case Dimensions L x W x H (in)
Stainless Steel	Metal	9.0 x 10.5625 x 3.625 (22.86 x 26.83 x 9.21 cm)	1.86 (0.8 kg)	0.28 (0.0079 cm)	1	9.625 x 4.5 x 11.375 (24.45 x 11.43 x 28.89 mc)

Folded towel adapter installation instructions

- Open recessed cabinet door.
- Clean surface.
- Remove protective tape backing and install adapter into recessed cabinet.

Cabinet Style



+

Adapter



309691

=

Adapter installed inside cabinet



Cabinet Style



+

Adapter



309692

=

Adapter installed inside cabinet



Stainless steel trim ring – Tork Intuition and Matic

Situation:

Your end customer wants to semi-recess a Tork Elevation Intuition or Matic dispenser directly into the wall. Waste bin is separate and not included.

Solution:

Offer the end customer our Trim Ring Kit solution for our Tork Intuition dispenser (5511201 & 5511281) or the Tork Matic dispenser (5510200 & 5510282).

NOTE: For direct-wall installation of the Elevation Matic dispensers, a solution will be coming soon.

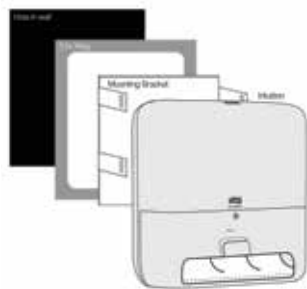

Installing New Dispenser

1. Contractor cuts rough opening in wall – 14 1/2" wide x 15 1/8" high.
2. Install galvanized mounting bracket.
3. Install dispenser into recessed rough opening over threaded studs on mounting bracket, then secure using flanged nuts.
4. Install trim ring caulking in place if necessary to ensure a gap-free contact between wall and trim ring.
5. Follow instructions provided to install batteries and paper. Set paper length as required. Close cover and test paper delivery.

Trim ring details



Tork Elevation® Matic® Hand Towel Roll Dispenser

SKU	Color	Dispenser Size W x L x D (in)	Dispenser Capacity	Cubic Ft/Case	Dispensers/Tier
5511202	White	14.65 x 13.2 x 8.1 (37.21 x 33.53 x 20.57 cm)	1 Roll	1.32 (0.0374 cubic meter)	15
5511282	Black	14.65 x 13.2 x 8.1 (37.21 x 33.53 x 20.57 cm)	1 Roll	1.32 (0.0374 cubic meter)	15



Recessed Trim Ring Kit for Tork Elevation Matic Dispenser

SKU	Color	Accessory Size W x L (in)	Case Dimensions L x W x D (in)	Units/Case	Use with Tork Dispensers
3106220	Stainless Steel	19.75 x 15.75 x 3.25 (50.17 x 40.01 x 9.53 cm)	16.563 x 4.438 x 22.50 (42.07 x 11.27 x 57.15 cm)	4	5510202, 5510282



Tork Elevation Matic Hand Towel Roll Dispenser with Intuition® Sensor

SKU	Color	Dispenser Size W x L x D (in)	Dispenser Capacity	Cubic Ft/Case	Dispensers/Tier
5511202	White	14.5 x 13 x 8 (36.83 x 33.02 x 20.32 cm)	1 Roll	1.38 (0.0391 cubic meter)	12
5511282	Black	14.5 x 13 x 8 (36.83 x 33.02 x 20.32 cm)	1 Roll	1.38 (0.0391 cubic meter)	12



Recessed Trim Ring Kit for Tork Elevation Matic Dispenser with Intuition Sensor

SKU	Color	Accessory Size W x L (in)	Case Dimensions L x W x D (in)	Units/Case	Use with Tork Dispensers
3106440	Stainless Steel	16.0 x 3.75 x 18.25 (40.64 x 9.53 x 46.36 cm)	16.75 x 4.875 x 19.625 (42.55 x 12.38 x 49.85 cm)	4	5511201, 5511281

Stainless steel filler panels

Situation:

Your end customer has a recessed folded towel and waste bin cabinet and wants to convert to a semi-recessed roll towel dispenser.

Solution:

First confirm that your end customer has one of the following recessed cabinet models as seen in the table below. If so, you can offer them one of our one-size-fits-most filler panels. This option allows for the reuse of the existing recessed frame and waste bin, with an attractive semi-recessed conversion to one of our Tork roll towel systems. If your customer's recessed cabinet is not listed in the table or you aren't sure, please complete the dimension collection sheet (page 11) and submit to dispenser team.

Recessed dimension comparison

Manufacturer	Model
ASI	0469
ASI	20469
Bobrick	B-3944
Bobrick	B-43944
Bradley	234
Gamco	TW1

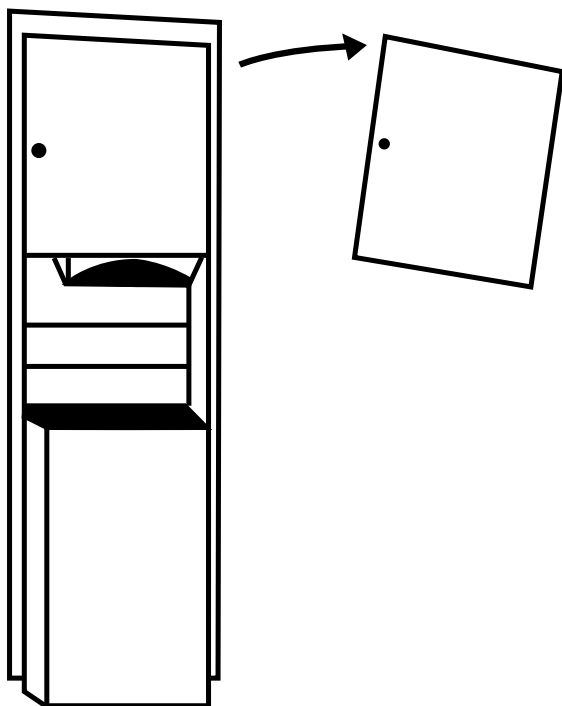

Removing Current Unit

1. Identify the Tork roll towel system your customer desires.
2. Match corresponding filler panel.
3. Remove existing cabinet door. Hinge half on cabinet may remain - it will be covered by Tork filler panel.
4. Remove towel tray guide to allow for clear space to install dispenser above the towel tray.
5. Towel tray may be left in place once guide has been removed. When installed, the Tork filler panel will cover the existing towel tray.
6. Install dispenser.

NOTE: For additional information on how to install filler panels, please reference the respective dispenser manual available in SMART.

Recessed roll towel solutions (continued)

Tork Image Design Matic Hand Towel Roll Dispenser with Intuition Sensor, Recessed



SKU	Color	Filler Panel Size (W x L x D in)	Fits 4" Deep Recessed Towel Cabinets (W x D in)	Units/Case
461122	Stainless Steel	26.97 x 17.60 x 7.99 (68.50 x 44.70 x 20.29 cm)	17.125 to 17.4375 x 3.8125 to 4 (43.50 to 44.29 x 9.68 to 10.16 cm)	1 Panel/Box

Tork Elevation Matic Hand Towel Roll Dispenser



SKU	Color	Filler Panel Size (W x L x D in)	Fits 4" Deep Recessed Towel Cabinets (W x D in)	Units/Case	Use with Tork Dispensers
3096020	Stainless Steel	17.63 x 22.56 x 3.88 (44.78 x 57.30 x 9.86 cm)	17.125 to 17.4375 x 3.8125 to 4 (43.50 to 44.29 x 9.68 to 10.16 cm)	1 Panel/Box	5510202, 5510282

Tork Elevation Matic Hand Towel Roll Dispenser with Intuition Sensor

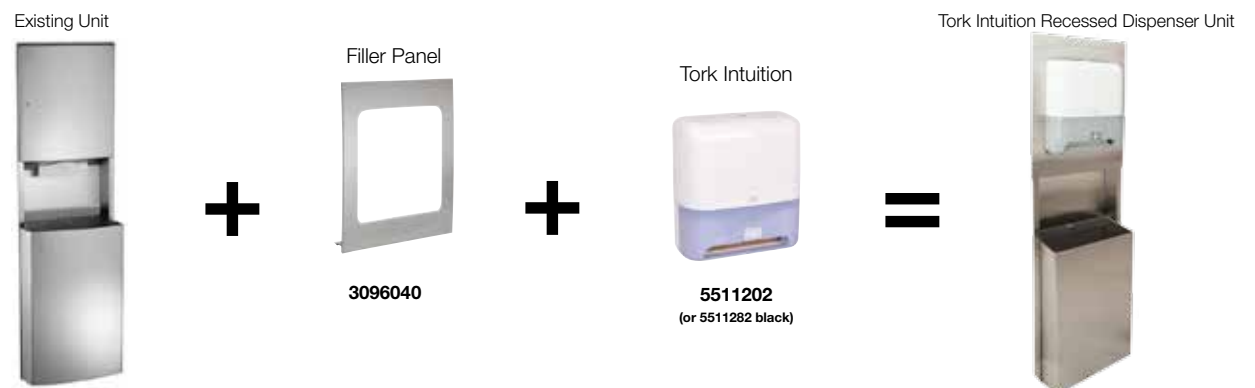

SKU	Color	Filler Panel Size (W x L x D in)	Fits 4" Deep Recessed Towel Cabinets (W x D in)	Units/Case	Use with Tork Dispensers
3096040	Stainless Steel	17.63 x 22.56 x 3.88 (44.78 x 57.30 x 9.86 cm)	17.125 to 17.4375 x 3.8125 to 4 (43.50 to 44.29 x 9.68 to 10.16 cm)	1 Panel/Box	5511201, 5511281

Stainless Steel Frame and Bin

Situation:

Your end customer is remodeling their washroom or is replacing an existing 16' wide recessed cabinet and would like to install a recessed frame and bin with a Tork roll towel.

Solution:

Offer the end customer our versatile frame and bin system which can be combined with a Tork semi-recessed roll towel system and it's corresponding filler panels.

NOTE: The Tork 309051 complete frame and waste bin must be included on a TKAD with a Tork filler panel, Tork Matic or Intuition dispenser, or the Tork Image Recessed Intuition dispenser.

Installation instructions

1. Remove old recessed cabinet if applicable.
2. Cut rough opening per installation instructions included in the box.
3. Set recessed cabinet in the rough opening and fasten according to instructions.
4. Install appropriate filler panel per dispenser type being installed. (Follow FP instructions.)
5. Install H1 or H11 roll towel dispenser.

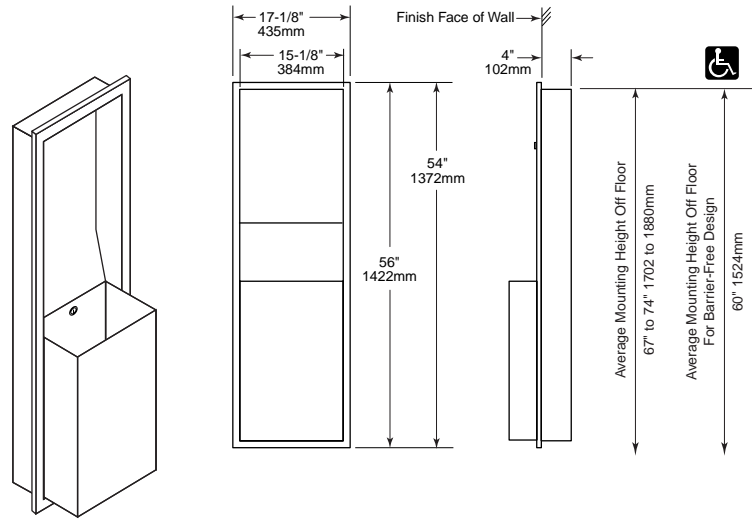

Construction

Fabricated type 304 heavy-gauge stainless steel. All welded construction with exposed surfaces having a #4 satin finish. One piece seamless 22-gauge (0.8mm) flange provided with 1/4" (102mm) return for rigidity. EXTRA HEAVY 18-gauge (1.2mm) door, warp free, hung on continuous stainless steel piano hinge, and fitted with tumbler lock. Waste receptacle is 22-gauge (0.8mm) and secured to cabinet with tumbler lock and is removable for servicing; top and bottom edges hemmed for safe handling.

Capacity

Waste receptacle is 12-gallons (45.4-L) capacity.

ADA Guide

Access to paper towels should be 15" to 48" (381 to 1219mm) above the finish floor to allow forward and side reach by people in wheelchairs. Units should not project more than 4" (102mm) from the wall.

Frame and Bin product details



Tork Recessed Frame and Bin – H11 & H1

(H1 to be used, along with corresponding filler panel, during new construction or remodeling)

SKU	Color	Frame Size W x L (in)	Units/Case	Use with Tork Dispensers
309051	Stainless Steel	56.0 x 17.125 x 9.0 (142.24 x 43.50 x 22.86 cm)	1 Box	5510202, 5510282 5511201, 5511281, 461122

Surface-Mounted Hanging Bracket

Situation:

Your end customer has a recessed cabinet and doesn't want to remove the door or drill holes into the wall.

Solution:

Offer your end customer the Tork hanging bracket which allows any Tork roll towel dispensers to be mounted to the bracket and hung from the recessed unit.

NOTE: The dispenser is surface-mounted. Customer is responsible for ensuring all ADA guidelines are met.

Installation Instructions

1. Open Cabinet Door
2. Remove protective strip from 2-sided tape.
3. Hang bracket so it's centered on the door.
4. Install machine screws on back to secure to the door.
5. Close door.
6. Install dispenser following the normal wall mounting procedures.



ADA Illustration

ADAAG 4.4.1* General. Objects projecting from walls (for example, telephones) with their leading edges between 27 in and 80 in (685 mm and 2030 mm) above the finished floor shall protrude no more than 4 in (100 mm) into walks, halls, corridors, passageways, or aisles (see Fig. 8(a)).

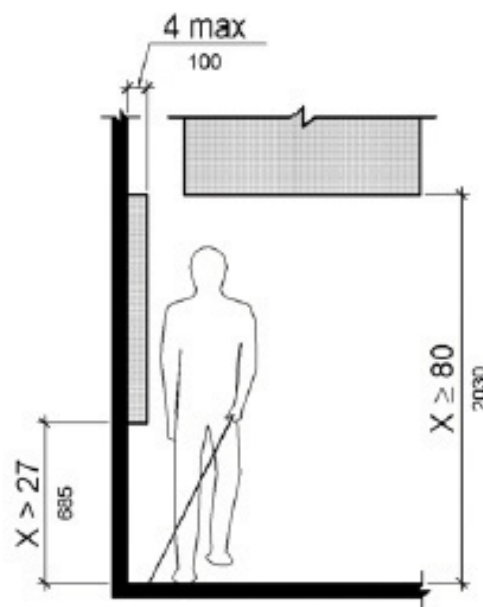

Hanging Bracket product details



ACC-001 Tork Hanging Bracket

Order this product through fulfillment. Works with all current Tork Nickelite and Elevation roll towel dispensers.

Color	Material	Adapter Size H x W x D (in)	Approx Lbs/Case	Cubic Ft/Case	Adapters/Case	Case Dimensions L x W x H (in)
Stainless Steel	Stainless Steel	9.0 x 10.20 x 1.21 (22.86 x 25.91 x 3.07)	N/A	N/A	1	N/A

NOTE: The dispenser is surface-mounted. Customer is responsible for ensuring all ADA guidelines are met.

Other recessed cabinets

Situation:

Your end customer has a cabinet in which the towel and waste bin are covered with a full length door, a cabinet that is less than 15" wide or a folded cabinet that is 6", 8" or 9" deep.

Solution:

The below recessed cabinets are examples of cabinets that can not be retrofitted to take one of our standard filler panels. Therefore they can not be converted to fit a roll towel dispenser. For cabinets that have a full door and are 4" deep, offer a high-end folded towel and corresponding adapter for best performance. For end customers who have a full door cabinet that is 15" wide and/or is deeper than 4" please contact the dispenser team.

Examples of non-retrofitable recessed cabinets

Full Door Recessed Cabinet Examples



Narrower Than 15" Recessed Cabinet Example.



Deeper than 4" Recessed Cabinet Example.



Recessed cabinet information collection sheet

Situation:

You are not sure if the recessed towel and waste cabinet will work with our standard Tork filler panels.

Solution:

In this case you will need to check for fit using our easy-to-use measuring sheet which is located in SMART under Forms. Also take a picture of their recessed frame and bin and contact your dispenser team for assistance.

NOTE: Requests for non-standard or custom parts require submission of a Business Request Handling System Form (BRHS) which is located in SMART under Forms.

Recess Towel Dispenser Field Dimension Collection Sheet

Instructions for field information collection:

1. Open cabinet door and check label inside (on door or back side of cabinet)
2. Record dispenser and brand (Bobrick/Bradley, ASI, Gamco...) _____
3. Record dispenser model No. _____
4. Record door style - flat or curved? _____
5. Note hinge side (L/R): _____
6. Take pictures and send with this information sheet filled in.

Additional Information:

Is the hinge attached on the front surface of the flange or on the inside of the recessed side panel? _____

Are there holes through the front flange? _____

Are there bump outs or tabs on the perimeter? _____

Dimensions Needed:

_____ "A" - Outer edge of flange to outer edge of flange.

_____ "B" - Inside edge to edge (recessed) from side to side.

_____ "C" - Back of cabinet to front edge of flange.

_____ "D" - Recessed top edge of cabinet to bottom of folded towel tray.

Items to have on hand:

- Digital camera
- Tape measure
- Print out of this sheet

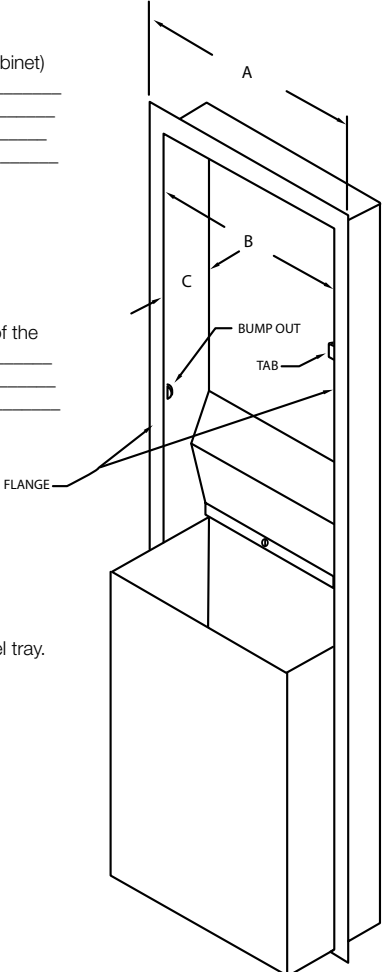

The diagram shows a 3D perspective view of a cabinet door with a recessed area. Dimension lines indicate: 'A' is the total width of the door; 'B' is the width of the recessed area; 'C' is the depth of the cabinet; and 'D' is the height of the recessed area. Labels include 'FLANGE' pointing to the front edge of the door, 'BUMP OUT' pointing to a protrusion on the inner edge, and 'TAB' pointing to a small rectangular feature on the inner edge.



Deliver a simple,
safe skincare experience



We've got you covered

Tork® offers a complete line of products designed to meet all your skincare needs and improve your washroom image and appearance. Whether you prefer foam or liquid soaps and sanitizers, manual or automatic dispensers, Tork has the right solutions to meet your needs.



The cleaning strength you need

Tork Foam and Liquid Skincare Refills are formulated for strong performance. Yet, they are gentle on skin and mild enough for frequent hand washing, especially in environments like foodservice and healthcare.

All formulas are gluten-free and triclosan-free. Dye-free, fragrance-free, Green Seal™, ECOLOGO®, and NSF certified selections are also available to meet your specific washroom needs.

Tork hand sanitizers provide additional hygiene without the use of water and are available in 72% alcohol for hygiene critical environments and alcohol-free formulas for traditional use.



The easy maintenance and stylish look you want

Tork Elevation Foam and Liquid Skincare Dispensers are part of the Tork Elevation family of dispensers, providing sleek, hygienic dispensing and creating a coordinated washroom design.

Both manual and automatic dispensing systems hold a high-capacity bottle, delivering more hand washes per refill, which helps manage usage and reduce overall costs.

Collapsible bottles ensure complete consumption of the refill and quick and easy refilling of the system. This helps reduce waste and unnecessary spills while refilling the dispenser, saving time and labor. And hygienic nozzles prevent the risk of cross-contamination, so your guests can enjoy a fresher experience.



A hygienic, sealed system

Tork soap and sanitizers come in sealed bottles and have a fresh nozzle with every refill for a more hygienic hand wash. The fully collapsible bottle ensures refills are completely used, reducing waste.

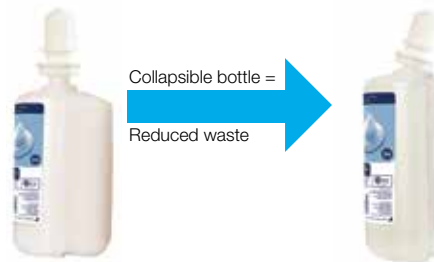

Dosage and battery life

- 1 liter liquid refill = 1000 doses
- 1 liter foam refill = 2500 doses
- 950 ml foam sanitizer refill = 2375 doses
- Amount dispensed per push = 1 ml for liquid refill
- Amount dispensed per push = .4 ml for foam refill
- Approx battery life = 90,000 doses or up to two years from 4 standard C-size alkaline batteries*

Quick and easy refilling

Changing a refill takes just three seconds, simplifying maintenance. Open the dispenser and take out the empty bottle. Twist the foam nozzle or end tip on liquid caps to open, put in the refill and close. Ready to use.



Tork Skincare

- Touch-free, automatic dispenser option
- High-capacity
- Controlled dispensing
- Collapsible bottle
- Quick and easy refilling
- Sealed system
- Hygienic nozzle
- No drip
- Environmentally responsible
- Gluten-free
- NSF, ECOLOGO and Green Seal certified options
- Refills available that meet LEED requirements
- Sleek Elevation design matching other Tork dispensers in your washroom



Tork Liquid Skincare Dispensers – S1

SKU	Description	Color	Size H x W x D (in)	Case
570020A	Tork Elevation Liquid Skincare Dispenser	White	11.5 x 4.4 x 4.5 (29.21 x 11.18 x 11.43 cm)	6
570028A	Tork Elevation Liquid Skincare Dispenser	Black	11.5 x 4.4 x 4.5 (29.21 x 11.18 x 11.43 cm)	6



Refills – S1

SKU	Description	Color	Fragrance	Unit Size	Case	Certification
400011	Tork Premium Extra Mild Liquid Soap	White	None	1 Liter	6	NSF E1 Rated
400012	Tork Premium Luxury Soft Liquid Soap	Violet	Soft Rose	1 Liter	6	NA
400013	Tork Premium Hair and Body Liquid Soap	Light Blue	Apricot	1 Liter	6	NA
400014	Tork Premium Antibacterial Liquid Soap (U.S. only)	Colorless	None	1 Liter	6	NSF E2 Rated
400016*	Tork Premium Alcohol Gel Hand Sanitizer (U.S. only)	Colorless	Light	1 Liter	6	NSF E3 Rated



Tork Foam Skincare Manual Dispensers – S4

SKU	Description	Color	Size H x W x D (in)	Case
466000	Tork Image Design™ Foam Skincare Manual Dispenser	Stainless Steel	11.375 x 4.25 x 4.25 (28.89 x 10.8 x 10.8 cm)	4
571501	Tork Elevation Foam Skincare Manual Dispenser	White	11.26 x 4.45 x 4.13 (28.60 x 11.30 x 10.49 cm)	4
571508	Tork Elevation Foam Skincare Manual Dispenser	Black	11.26 x 4.45 x 4.13 (28.60 x 11.30 x 10.49 cm)	4



Tork Foam Skincare Automatic Dispensers with Intuition® Sensor – S4

SKU	Description	Color	Size H x W x D (in)	Case
466100	Tork Image Design Foam Skincare Automatic Dispenser with Intuition Sensor (Batteries included)	Stainless Steel	10.625 x 4.5 x 5.125 (26.99 x 11.43 x 13.02 cm)	4
571600	Tork Elevation Foam Skincare Automatic Dispenser, with Intuition Sensor (Batteries not included)	White	10.94 x 4.45 x 5.12 (27.79 x 11.30 x 13.00 cm)	4
571608	Tork Elevation Foam Skincare Automatic Dispenser, with Intuition Sensor (Batteries not included)	Black	10.94 x 4.45 x 5.12 (27.79 x 11.30 x 13.00 cm)	4



For Tork EasyCube™ enabled versions order SKU# 466200, 682830 or 682840



Refills – S4

SKU	Description	Color	Fragrance	Unit Size	Case	Certification
401211	Tork Premium Extra Mild Foam Soap	Colorless	None	1 Liter	6	NSF E1 Rated
401212	Tork Premium Antibacterial Foam Soap (U.S. only)	Colorless	None	1 Liter	6	NSF E2 Rated
401213	Tork Premium Alcohol-Free Foam Hand Sanitizer (U.S. only)	Colorless	None	1 Liter	6	NA
400216**	Tork Premium Alcohol Foam Hand Sanitizer	Colorless	Light	950 ml	6	NSF E3 Rated



Accessories – S4

SKU	Description	Color	Size (L x W x H)	Case
570038	Tork Foam Skincare Automatic Dispenser Stand	Black	58.25 x 15 x 15 (147.96 x 38.10 x 38.10 cm)	1
570010	Mounting Kit for Tork Skincare Dispenser	White	11 x 7 x 0.4 (27.94 x 17.78 x 1.02 cm)	4
570018	Mounting Kit for Tork Skincare Dispenser	Black	11 x 7 x 0.4 (27.94 x 17.78 x 1.02 cm)	4



ECOLOGO®: PRODUCT CERTIFIED FOR REDUCED ENVIRONMENTAL IMPACT. VIEW SPECIFIC ATTRIBUTES EVALUATED: CCD-062 Toilet Tissue, CCD-063 Facial Tissue, CCD-084 Table Napkins, CCD-085 Kitchen Towels, CCD-086 Hand Towels.



EPA compliant.

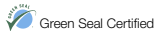

*With 76% Alcohol Strength

**With 72% Alcohol Strength



Third-party verification

Sustainable third-party verification



Objective assurance that products and processes meet or exceed environmental standards

Tork is putting sustainability to work for you with products certified by the below trusted organizations. See the following full list of Tork SKUs that have earned verifications.



Green Seal is an independent non-profit organization dedicated to safeguarding the environment and transforming the marketplace by promoting the manufacture, purchase, and use of environmentally responsible products and services.

- The Green Seal Standard for Sanitary Paper Products, GS-1, establishes environmental, health, and social requirements for products such as bathroom tissue, facial tissue, paper towels, napkins, and placemats for both institutional and retail markets.
- The standard addresses the life cycle issues for sanitary paper products. The life-cycle approach is used to ensure that all significant environmental impacts are considered in the development of a standard, from raw materials extraction through manufacturing to use and disposal.



UL Environment's ECOLOGO® Program helps build and strengthen trust in sustainable products. Certification to one of UL's rigorous, multi-attribute, lifecycle-based standards indicates that a product has undergone third-party auditing and verification to stringent, science-based performance criteria, making it a more sustainable choice.

- UL certifies commercial and household toilet and facial tissue, napkins, and hand and kitchen towel products under its UL-175 Sanitary Paper Standards for an overall reduced environmental impact.
- These standards address recycled content and chlorine-free bleaching processes.
- Standard criteria also includes "downstream" effects such as effluent content, air emissions, solid waste reduction, and energy consumption.
- The holistic approach incorporated in this certification matches our philosophy of environmental stewardship.



Biodegradable Products Institute™ (BPI) compostability testing reviews the materials to ensure they will properly break down in the commercial composting process. One of the largest independent compost certification groups in North America.

- Ensures that our napkins' product lifecycle from development, production, use and disposal remains environmentally responsible.
- All Tork Universal and Advanced napkins, including custom print, are certified compostable. These napkins can be safely disposed of and are compostable in municipal or industrial aerobic facilities.



We also have independent verification from a commercial composting facility that all Tork paper towels will effectively break down in their composting process.



Over the past 20 years, FSC® has earned a reputation as the most rigorous, credible forest certification system. FSC is the only forest certification system governed by an open membership (General Assembly) where interests are equally balanced by economic, social and environmental chambers.

- Certifiers assess forest management using the FSC standards. Certifiers are independent of FSC and the companies they are auditing. This third-party verification is crucial to the integrity of the FSC system.
- Forest Management certification provides assurance that forests are being managed to the highest environmental and social standards.
- Chain-of-Custody certification provides assurance that products bearing the FSC label directly support responsible forest management.
- **FSC Mix and FSC Recycled** certifications are available for most Essity mills in North America. Product certifications are in progress.

Third-party certified Tork products:

Hardwound Roll Towels

SKU #	System	Certification
214250	H21	E
214404	H21	E
214650	H21	E
218004	H21	E
290015	H11	FSC* E
290019	H11	FSC* E
290025	H11	FSC* E
290087	H1	E
290088	H1	E
290089	H1	E
290092A	H1	E
290094	H1	FSC* E
290095	H1	FSC* E
290096	H1	FSC* E
7170620	H71	E
7171020	H71	E
7171040	H71	E
7171300	H71	E
7171400	H71	E
7171600	H71	E
7178040	H71	E
7674540	H76	E
8030620	H80	E
8031000	H80	E
8031040	H80	E
8031300	H80	E
8031400	H80	E
8031500	H80	E
8031600	H80	E
8031900	H80	E
8038040	H80	E
8620100	H86	E
8621400	H86	E
8631060	H86	E
8634540	H86	E
RB206	H21	E
RB350A	H21	E
RB351	H21	E
RB600	H21	E
RB800	H21	E
RB6002	H21	E
RB8002	H21	E
RB8004	H21	E
RB10002	H21	E
RK206E	H21	E
RK350A	H21	E
RK600E	H21	E
RK800E	H21	E
RK1000	H21	E
RK8002	H21	E

Multifold Towels

SKU #	System	Certification
100297	H2	FSC* E
101293	H2	E
420483	H2	E
420554	H23	FSC* E
420558	H23	FSC* E
420570	H2	E
424814	H2	FSC* E
424864	H2	FSC* E
MB572	H23	FSC* E
MB574	H23	FSC* E
MB576	H23	FSC* E
MB578	H23	FSC* E
MB538	H2	E
MB540A	H2	E
MK518A	H2	E
MK520A	H2	E
MK530A	H2	E

PeakServe Continuous Towel

SKU #	System	Certification
105065	H5	FSC* E

C-Fold Towels

SKU #	System	Certification
250510	H25	E
250630	H25	E
CB520	H25	E
CB530	H25	E

Singlefold Towels

SKU #	System	Certification
221845	H22	E
SB1840A	H22	E
SB1842	H22	E
SK1850A	H22	E

Centerfeed Towels

SKU #	System	Certification
121225	M1	E
120133	M2	E
120932	M2	E
121201	M2	E
121202	M2	E
121204	M2	E
121211	M2	E
RC530	M23	E

Facial Tissue

SKU #	System	Certification
TF6710A	N/A	E
TF6810	N/A	E

Perforated Roll Towels

SKU #	System	Certification
421900	H1	E
421970	H1	E
HB1990A	N/A	E
HB1995A	N/A	E
HB9201	N/A	E
HK1975A	N/A	E

Skincare

SKU #	System	Certification
12503	N/A	E
400011	S1	E
401211	S4	E
400216	S4	E



Third-party certified Tork products:

Dispenser Napkins

SKU #	System	Certification
908EX	N4	☑️ Ⓢ E
DX900	N4	☑️ Ⓢ
DX906E	N4	☑️ Ⓢ 🌱 E
DX990	N4	☑️ Ⓢ
DR7050A	N5	☑️ Ⓢ
D820	N6	☑️ Ⓢ
D826E	N6	☑️ Ⓢ 🌱 E
D780	N7	☑️ Ⓢ
D786E	N7	☑️ Ⓢ 🌱 E
D802A	N7	☑️ Ⓢ
D806E	N7	☑️ Ⓢ 🌱 E
D826E	N7	☑️ Ⓢ 🌱 E
D3052B	N8	☑️ Ⓢ
D3056B	N8	☑️ Ⓢ 🌱 E
D3061B	N9	☑️ Ⓢ
D6311A	N9	☑️ Ⓢ
DX600	N10	☑️ Ⓢ
DX606E	N10	☑️ Ⓢ 🌱 E

High-Capacity Bath Tissue

SKU #	System	Certification
110291A	T26	☑️ E
110292A	T26	☑️ E

Jumbo Bath Tissue

SKU #	System	Certification
11010402	T1	☑️ E
11020602	T2	☑️ E
12021502	T1	☑️ E
120246	T2	☑️ 🌱 E
12013903	T2	☑️ E
12024402	T2	☑️ E
TJ1212A	T21	☑️ E
TJ1222A	T21	☑️ E
TJ0912A	T22	☑️ E
TJ0921A	T22	☑️ E
TJ0922A	T22	☑️ E
TJ0924	T22	☑️ 🌱 E
TJ0928	T22	☑️ E

Wipers (Paper wipers only)

SKU #	System	Certification
130211B	W1, W2	☑️
130251A	M2	☑️
132451A	M2	☑️
192121	H22	☑️
192122	H22	☑️
192125A	W24	☑️
291350	W6	☑️ Ⓢ E
291370	W6	☑️ Ⓢ
13244101	W1, W2	☑️
440278	W4	☑️
440245A	W24	☑️
13247501	N/A	☑️

Single Serve Napkins

SKU #	System	Certification
B1141A	N/A	☑️ Ⓢ
B1242	N/A	☑️ Ⓢ
L3141	N/A	☑️ Ⓢ
N5140A	N/A	☑️ Ⓢ
N5181A	N/A	☑️ Ⓢ
N5183A	N/A	☑️ Ⓢ
N5186	N/A	☑️ Ⓢ E
N7141A	N/A	☑️ Ⓢ
NC7100	N/A	☑️
NC7140	N/A	☑️
NC7180A	N/A	☑️
NP310A	N/A	☑️ Ⓢ
NP528PA	N/A	☑️ Ⓢ
NP3260	N/A	☑️ Ⓢ
NP5240C	N/A	☑️ Ⓢ
NP7340A	N/A	☑️ Ⓢ
NP7380A	N/A	☑️ Ⓢ

OptiCore® Bath Tissue

SKU #	System	Certification
112990	T11	☑️ 🌱 E
160090	T10	☑️ 🌱 E
161990	T11	☑️ 🌱 E
162090	T11	☑️ 🌱 E

SmallCore Bath Tissue

SKU #	System	Certification
115019	N/A	☑️ E

Conventional Bath Tissue

SKU #	System	Certification
240123	T34	☑️ E
240616	T34	☑️ E
245949	T24	☑️ 🌱 E
245989	T24	☑️ 🌱 E
246325	T34	☑️ FSC®
TM1601A	T24	☑️ E
TM1602	T24	☑️ E
TM1604	T24	☑️ 🌱 E
TM1616	T24	☑️ E
TM1616S	T24	☑️ E
TM1619	T24	☑️ 🌱 E
TM6120S	T24	☑️ E
TM6130S	T24	☑️ E
TS1635S	T24	☑️ E
TS1636S	T24	☑️ E
TS1639S	T24	☑️ E

Coreless High Capacity Bath Tissue

SKU #	System	Certification
472886	T7	☑️ FSC® E





Objective assurance that products and processes meet or exceed environmental standards

Tork is putting sustainability to work for you with over **135 products** certified by the below organizations. See back for a full list of which Tork SKUs have earned verifications.



Green Seal is an independent non-profit organization dedicated to safeguarding the environment and transforming the marketplace by promoting the manufacture, purchase, and use of environmentally responsible products and services.

- It establishes environmental, health, and social requirements for products such as bathroom tissue, facial tissue, paper towels, napkins, and placemats for both institutional and retail markets.
- The standard addresses the life cycle issues for sanitary paper products. The life-cycle approach is used to ensure that all significant environmental impacts are considered in the development of a standard, from raw materials extraction through manufacturing to use and disposal.



UL Environment's ECOLOGO® Program helps build and strengthen trust in sustainable products Certification to one of UL's rigorous, multi-attribute, lifecycle-based standards indicates that a product has undergone third-party auditing and verification to stringent, science-based performance criteria, making it a more sustainable choice.

- UL certifies commercial and household toilet and facial tissue, napkins, and hand and kitchen towel products under its Sanitary Paper Standards for an overall reduced environmental impact.
- These standards address recycled content and chlorine-free bleaching processes.
- Standard criteria also includes "downstream" effects such as effluent content, air emissions, solid waste reduction, and energy consumption.
- The holistic approach incorporated in this certification matches our philosophy of environmental stewardship.



Biodegradable Products Institute™ (BPI) compostability testing reviews the materials to ensure they will properly break down in the commercial composting process. One of the largest independent compost certification groups in North America.

- Ensures that our napkins' product lifecycle from development, production, use and disposal remains environmentally responsible.
- All Tork Universal and Advanced napkins, including custom print, are certified compostable. These napkins can be safely disposed of and are compostable in municipal or industrial aerobic facilities.



We also have independent verification from a commercial composting facility that all Tork paper towels will effectively break down in their composting process.



Over the past 20 years, FSC® has earned a reputation as the most rigorous, credible forest certification system. FSC is the only forest certification system governed by an open membership (General Assembly) where interests are equally balanced by economic, social and environmental chambers.

- Certifiers assess forest management using the FSC standards. Certifiers are independent of FSC and the companies they are auditing. This third-party verification is crucial to the integrity of the FSC system.
- Forest Management certification provides assurance that forests are being managed to the highest environmental and social standards.
- Chain-of-Custody certification provides assurance that products bearing the FSC label directly support responsible forest management.
- FSC Mix and FSC Recycled certifications are available for most SCA mills in North America. Product certifications are in progress.

Third-party certified Torq products:

Hardwound Roll Towels

SKU #	System	Certification
290070	H14	FSC*
290087	H1	
290088	H1	
290089	H1	
290092A	H1	
290094	H1	FSC*
290095	H1	FSC*
290096	H1	FSC*
RB206	H21	
RB350A	H21	
RB351	H21	
RB425	H21	
RB600	H21	
RB800	H21	
RB6002	H21	
RB8002	H21	
RB8004	H21	
RB10002	H21	
RK206E	H21	
RK350A	H21	
RK600E	H21	
RK800E	H21	
RK1000	H21	
RK8002	H21	

Multifold Towels

SKU #	System	Certification
100297	H2	FSC*
101293	H2	
MB554	H23	FSC*
MB558	H23	FSC*
MB571	H2	FSC*
MB572	H23	FSC*
MB574	H23	FSC*
MB578	H23	FSC*
MB538	H2	
MB540A	H2	
MB550A	H2	
MB560A	H2	
MB576	H23	FSC*
MB640	H2	
MK518A	H2	
MK520A	H2	
MK530A	H2	

Singlefold Towels

SKU #	System	Certification
SB1840A	H22	
SK1850A	H22	

C-Fold Towels

SKU #	System	Certification
CB520	H25	
CB530	H25	

Centerfeed Towels

SKU #	System	Certification
121225	M1	
120133	M2	
120932	M2	
121201	M2	
121202	M2	
121204	M2	
121211	M2	
RC530	M23	

Jumbo Bath Tissue

SKU #	System	Certification
11010402	T1	
12021502	T1	
120246	T2	
12013903	T2	
12024402	T2	
TJ1212A	T21	
TJ1222A	T21	
TJ0912A	T22	
TJ0921A	T22	
TJ0922A	T22	
TJ0924	T22	
TJ0928	T22	

High-Capacity Bath Tissue

SKU #	System	Certification
110291A	T26	
110292A	T26	

Conventional Bath Tissue

SKU #	System	Certification
TM1601A	T24	
TM1602	T24	
TM1604	T24	
TM1610	T24	
TM1616	T24	
TM1616S	T24	
TM1619	T24	
TM6120S	T24	
TM6130S	T24	
TS1635S	T24	
TS1636S	T24	
TS1639S	T24	

Coreless High Capacity Bath Tissue

SKU #	System	Certification
472886	T7	FSC*

Folded Bath Tissue

SKU #	System	Certification
120229	T3	
120255	T3	

Perforated Roll Towels

SKU #	System	Certification
HB1990A	N/A	
HB1995A	N/A	
HB9201	N/A	
HK1975A	N/A	

Skincare

SKU #	System	Certification
400011	S1	
401211	S4	
400216	S4	

Facial Tissue

SKU #	System	Certification
TF6710A	N/A	
TF6810	N/A	

Dispenser Napkins

SKU #	System	Certification
908EX	N4	
DX900	N4	
DX906E	N4	
DX990	N4	
DR7050A	N5	
D820	N6	
D826E	N6	
D780	N7	
D786E	N7	
D802A	N7	
D806E	N7	
D3052B	N8	
D3056B	N8	
D3061B	N9	
D6311A	N9	
DX600	N10	
DX606E	N10	

Single Serve Napkins

SKU #	System	Certification
B1141A	N/A	
B1242	N/A	
L3141	N/A	
N5140A	N/A	
N5181A	N/A	
N5183A	N/A	
N5186	N/A	
N7141A	N/A	
NC7100	N/A	
NC7140	N/A	
NC7180A	N/A	
NP310A	N/A	
NP528PA	N/A	
NP3260	N/A	
NP5240C	N/A	
NP7340A	N/A	
NP7380A	N/A	

Wipers

SKU #	System	Certification
192121	H22	
192122	H22	
130251A	M2	
132451A	M2	
130211B	W1, W2	
13244101	W1, W2	
440278	W4	
192125A	W24	
440245A	W24	
13247501	N/A	

Environmental affiliation key



ECOLOGO®
PRODUCT CERTIFIED FOR REDUCED ENVIRONMENTAL IMPACT
VIEW SPECIFIC ATTRIBUTES EVALUATED:
UL-COMEEL, CCD-082 Toilet Tissue, CCD-083 Facial Tissue,
CCD-084 Table Napkins CCD-085 Kitchen Towels, CCD-086 Hand Towels.



Green Seal Paper Products:
These products meet Green Seal® Standard GS-1 based on chlorine-free processing, energy and water efficiency, and content of 100% recovered material with a minimum of 25% post-consumer material for bath tissue and 50% post-consumer material for napkins and towel.

Green Seal Certified Hand Soaps:
These products meet Green Seal® Standard GS-41A based on effective performance and protective limits on VOCs and human & environmental toxicity.



Compostable Verified

FSC® Forest Stewardship Council®





An agreement that will benefit you and your customers



Essity's Tork® Advantage™ Dispenser Program gives you a unique opportunity to promote the innovative line of TorkSelect™ dispensing systems. You can proudly stand behind these dispensing systems which offer **improved image, reliable performance, maximum hygiene and significant cost savings.** This program provides you with a sustainable competitive advantage that will enhance account retention.



A mutually beneficial program

Tork Advantage will positively impact both your bottom line and your customer's bottom line.

Benefits to you, the distributor

- Access new customers; increase presence with existing customers
- No need to warehouse dispensers
- No shipping or handling costs
- Security and account retention

Benefits for your customers

- Controlled dispensing decreases usage and waste, which saves money
- No-touch dispensers help eliminate cross contamination
- Easy-to-load, high-capacity dispensers reduce labor
- High-quality, precision-built dispensers need less maintenance
- Sleek, stylish design complements decor



Tork Advantage Program details

- Lease **15** or more TorkSelect dispensers which may include any combination of:

- TorkSelect washroom dispensers (towel, tissue or soap)
- TorkSelect tabletop dispensers (Xpressnap® Classic, Xpressnap Signature, Xpressnap Café or RollNap)
- Tork Performance wiper dispensers

OR

Lease **8** or more Tork Performance wiper dispensers only

- Refill pricing is guaranteed for one full year; refills will not increase more than 7% for each additional year of the agreement
- Dispensers ship direct to the end customer
- Lease agreement must be signed by the end customer
- **Agreement must be received by Essity before placing P.O.**
- Automatic enrollment in 5-year TorkSelect dispenser warranty*
- Large installations may qualify for support. Please contact your local Essity Sales Representative.



Here's how to get started with the Tork Advantage Dispenser Program

1 Essity sales representative and distributor sales representative call on end customer account and gather necessary information.

End Customer



Essity Rep/Dist. DSR



2 Upon approval, a contract price confirmation and a Tork Advantage dispenser agreement is generated and sent to the Essity sales representative for end customer signature.

Contract



Tork Advantage Agreement



End Customer



3 The signed Tork Advantage agreement is emailed/faxed and the original mailed to the Essity dispenser administrator. Distributor purchase order is faxed to Essity customer service.

Distributor P.O.



Tork Advantage Agreement



Essity



4 Essity will ship the dispensers directly to the end customer and will invoice the distributor at the agreed-upon contract price.

Essity



Contracts not signed by the end customer within 45 days will be cancelled.

End Customer



Tork® tools at your fingertips.

Say hello to Tork Connect, SCA's new customized distributor website. It's a central hub for a variety of value-added Tork tools and resources — when you need them, where you need them.



Five ways Tork Connect works for you:

1 Access Tork product details and specs

With the entire Tork product database now only a click away, you can easily review product details and instantly share spec sheets with your customers.

2 Create a Customer Specific Tork Catalog

Put your own spin on the Tork catalog. Add your logo and customize the catalog to suit your customers' business needs so they can enjoy a personalized experience.

3 Find a Tork product for every need

Use the Competitive Reference Guide to quickly discover and share comparable Tork products that fit your customers' space and needs.

4 Continue to learn

Access all things Tork to help sharpen your knowledge of all Tork products and develop your skills.

5 Stay up-to-date with Tork

Keep up with the latest products and services from Tork.

Exciting features now at your fingertips:

- News
- Competitive Reference Guide
- Customer Specific Catalog
- Distributor/Tork Cross Reference Guide
- Product Details and Spec Sheets



A wealth of resources at your fingertips.

Everything you need to manage your business with ease.

Tork Connect

- News
- Competitive Reference Guide
- Product Details and Spec Sheets
- Customer Specific Catalog
- Distributor/Tork Cross Reference Guide



Distributor iPad Apps*

- **Tork Insider:** An asset management tool that helps you easily find, view and share materials, videos and customer presentations.
- **Tork Snapshot:** An easy way to envision Tork products in a variety of real world settings.
- **Tork Decision Tree:** An interactive guide for selecting the right Tork dispensers for your end-customer's business.



Tork Product Catalog

The complete catalog of all Tork products.





Easy Handling™ packaging is easier to **lift, carry, open** and **dispose**



SCA has introduced Tork Easy Handling product packaging, a patented assortment of innovative and ergonomic solutions to ease the workload of facility staff while saving time and money.

The Easy Handling packaging includes the **Tork Carry Box™** and **Tork Carry Pack™** for a selection of Tork roll and folded towel products. Additional towels and napkins will be offered in the Easy Handling design in the future.

Tork Carry Box™



Carry a box with each hand and save time



Use two hands for a comfortable grip



Boxes open quickly and easily without cutting

Includes products: 290094, 290096
MB572, MB574, MB576, MB578, MB554, MB558

Tork Carry Pack™



Smart handles make carrying a breeze



Easy to open, thanks to perforated wrapping



Used bags can be recycled in the same manner as plastic shopping bags

Includes product: 100297



**Spend more time producing,
less time cleaning**



Reduce cost

Improve efficiency

**Protect health
and safety**

If you're using rental shop towels for wiping and cleaning, Tork products can offer you measurable improvement

Small changes can add up. Save a few seconds here or a few cents there and soon you'll have a real competitive advantage. The right tools could be the difference.

Our purpose-made wipers provide real value you can test. They're always consistent in quality, more effective and require less energy. Unlike rental shop towels, Tork cleaning cloths have never been used – so they are not stained, they don't smell and there are no surprises that could harm workers/equipment or delay production.

Do you really want to reuse another company's towels? Read on. We'll show you how the Tork range of cleaning cloths and convenient dispensers can help you realize performance efficiencies that used rentals can't deliver. We'll show you why shop towel renters are switching to Tork.

“It's simple. I make money making valves, not cleaning. A trusty cleaning cloth helps me and my machine get back to work faster.”

**Mike Getoor, Leadman,
Richards Industries,
Cincinnati, Ohio**

Do you have the right tool for the job?

We make a range of professional wipers for wiping, cleaning and polishing. 100% new, each one is made for a specified task yet versatile enough for multi-purpose use. But like all tools, Tork industrial wipers are designed to do one job right, time after time, without the risk of damaging equipment or your finished product. Consistency is key. Quality and performance never vary.

With the best wipe for the job selected and a handy dispenser nearby, your people save energy for what matters: production. No time is wasted going back and forth to get rental towels to use.



**Saving time
adds value**



**Save time for
the work that
adds value**

- Improve workstation productivity
- Minimize downtime
- Reduce clutter

Tests confirm our promise

We asked an independent research company to define some real tough tasks to test the performance of Tork wipers versus rental shop towels. The results were significant: less time and less solvent were used with Tork, less energy, too. These tests confirm our promise: Tork cleaning cloths can save you money and speed up your tasks so you can be ready sooner for production.

Tork wins over rentals

Cleaning time in seconds

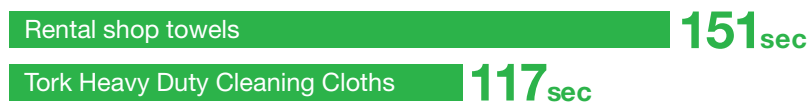

up to **23%**
less time

Used amount of solvent (ml)



up to **27%**
less solvent*

The toughest tasks are easier with Tork

We wanted to test the limits of our wipers and measure the energy it took to master an even tougher task. A test using asphalt mixed with grease was prepared by the Swerea Research Institute. When this tough task was done, Tork cleaning cloths required up to 20% less energy to do the same job**. So not only do our cloths outperform rental shop towels, they even make tough jobs easier.

Energy



up to **20%**
less energy**

easy tough

***Test one:** Removing paint that had dried for 4 minutes from a metal surface 60 x 90 cm with the aid of a solvent, white spirit. The paint, alkyd based primer, was applied by a roller. Panel participant started off by using 10 ml solvent and was able to add more solvent into the cloth in steps of 5 ml per occasion. Rental shop towels were compared to Tork Heavy-Duty Cleaning Cloths. Panel test conducted by Swerea Research Institute, Sweden, 2014.

****Test two:** Removing 10 g of a mix of asphalt 2/3 and grease 1/3 that had dried for 1 hour, from a metal surface 60 x 90 cm with the aid of a degreaser, CRC brake degreaser. After the task, panel participants were asked to evaluate the energy/work needed on a 1-4 scale with perceived energy being: **1)** very easy, **2)** easy, **3)** tough, **4)** very tough. Rental shop towels were compared to Tork Heavy Duty Cleaning Cloths and Tork Industrial Heavy-Duty Cleaning Cloths. Panel test conducted by Swerea Research Institute, Sweden, 2014.

Safety is a priority

In addition to Tork performance advantages, there are also health and safety benefits. For example, Tork wipers are always new out of the box. This makes them cleaner and safer* compared to used rental shop towels because Tork wipers have:

- No chemical residue or stains from prior-usage
- No shards of metal to injure hands, damage equipment or finished goods
- No suspicious odors to endure while working
- No frayed edges that can catch in a machine

* 1. Market research; Endeavour Light Industry IPSOS; DE, FR, & USA, 2011

2. Light and Heavy manufacturing Segment research; Psyma International, USA, 2013, 3. Essity, Tork maintenance IPSOS, Germany, 2013, 4. Replay study IPSOS; DE, 2013

“Health and Safety is number one. I don’t want anything dangerous in my employee’s hands.”

Sr. Operations Manager*

*Light and heavy manufacturing segment research, Psyma International, USA, 2013

Environmental impact

Essity has conducted a life cycle assessment (LCA)* looking at the environmental impact between rental shop towels and Tork cleaning cloths with exelCLEAN®. This LCA shows that the environmental impact of the two systems are on par, on a cloth to cloth basis.

*The LCA has been reviewed by an external expert panel, 2014



Improve workplace functionality – for people and profits

Today's lean manufacturing principles are making workplaces safer and more efficient.

If you're working with the 20 keys concept, key one – making work easier by creating a functional, visually organized workplace that inspires productivity – is where Tork systems, cleaning cloths and dispensers, can help you make a difference.

If rental shop towels are your standard, now is the time to challenge that standard and develop better methods. We can help you do more to reduce cost, increase efficiency and improve safety with a clean, orderly, more efficient working environment.

**Turn preparation
time into
production time**



Are you ready to test the Tork system?

Tools are a source of pride for many workers. Put a better tool in a worker's hands and they'll do a better job. The same goes for their workplace. A well-organized environment with well-maintained machines inspires productivity and improves quality – that's real value your customers will pay for.





Tork Industrial wiping and cleaning systems raise the bar. They help minimize downtime to increase output – so you're ready to be more competitive. Ask your colleagues to test and compare Tork purpose-made industrial tools to working with rental shop towels. When everything is evaluated, the advantages for people and profits will be clear.



**Put us
to the test**



Tork wipers and dispensers

Mobile	Wall mounted		
			
Tork Floor Stand SKU 6520281	Tork Wall Stand SKU 6521281	Tork Folded Wiper/ Cloth Dispenser: SKU 654021, 6540281	Tork Maxi Centerfeed Dispenser: SKU 653020, 653028

Cleaning

Tork Cleaning Cloth

Tork Cleaning Cloth is a soft and flexible multipurpose cloth that quickly absorbs liquids and oil. The cloth provides a professional cleaning result thanks to our excelCLEAN® wiper technology.



SKU
510104



SKU
510137



SKU
510175A

Tork Heavy-Duty Cleaning Cloth

This strong and absorbent multipurpose cloth works with most solvents. It is designed to protect your hands from heat and metal scraps. The cloth provides a professional cleaning result thanks to our excelCLEAN® wiper technology.



SKU
530104



SKU
530137



SKU
530178



SKU
5301755



SKU
5301505

Tork Industrial Cleaning Cloth

Soft and flexible for light-to-medium tasks. Excellent in tight spaces. Ideal for oil and grease. Made with tork excelCLEAN® for faster professional results



SKU
520304



SKU
520337



SKU
520678



SKU
520371

Tork Industrial Heavy-Duty Cleaning Cloth

Our thickest and strongest cloths. Protects hands from heat and metal. High absorption capacity. Made with Tork excelCLEAN® for quicker, professional results



SKU
570104



SKU
570137







SKU
570478



Tork wipers and dispensers



(continued)

Mobile	Wall mounted		
			
Tork Floor Stand SKU 6520281	Tork Wall Stand SKU 6521281	Tork Folded Wiper/ Cloth Dispenser: SKU 654021, 6540281	Tork Maxi Centerfeed Dispenser: SKU 653020, 653028

Cleaning (continued)

Tork Low-Lint Cleaning Cloth A low-lint, flexible and drapable cloth that works well with solvents, detergents and disinfectants. Multipurpose. Handles most cleaning tasks		SKU 192479			●	
		SKU 192475				
Tork Industrial Low-Lint Cleaning Cloth An extremely low-linting, flexible and drapable cloth with anti-static properties that works well with solvents, detergents and disinfectants.		SKU 192578			●	
ShopMax Hand Cleaner Bucket Convenient solution and time savings – clean hands are just a wipe away for on the go on site professionals since no added water or cleanser is required.		SKU 192592				
ShopMax Multi surface Bucket Convenient solution and time savings – surfaces are just a wipe away for on the go on site professionals since no added water or cleanser is required.		SKU 192594				

Wiping

Tork Industrial Paper Wiper A paper with excellent absorbency and wet strength that efficiently handles industrial spills, while being soft enough for glass cleaning.		SKU 13244101	●	●		●
		SKU 440278			●	
		SKU 440245A				

Polishing

Tork Polishing Cloth Soft and flexible. Precision fabric holds and releases polishing agents. Professional results without leaving a trace		SKU 197478			●	
--	---	------------	--	--	---	--

Tork cleaning cloths with exelCLEAN® outperform textiles

Get professional results faster compared to rags and rental shop towels by using our exelCLEAN® cloths. Tests prove that with exelCLEAN®, our patented foam-spun technology you can:

- **Save time** – go from cleaning & preparation to production faster
- **Use less solvent** – save money, reduce solvent exposure and waste
- **Spend less energy** – make work easier, finish cleaning tasks sooner
- **Trust fresh-from-the-box quality** – feel safe, confident, get right to the task.



Contact

Sign up for a product trial so your workers can evaluate our products. Contact your Tork representative.





Working hard to reduce risks



Purpose-built
for wet, harsh
environments



You face some of the toughest challenges.
 That's why you need dispensers you can rely on.
 The new, purpose-built Tork® Washstation
 Dispenser is precisely engineered to help mitigate
 risks, increase operational efficiencies, and
 handle the pressures of a rigorous environment.

Minimize risks

Designed from the ground up, the Tork Washstation Dispenser fits seamlessly into your cleaning or HACCP protocols. It's built to withstand wet environments and does not require removal during spray-downs, keeping refills safe and hygienic for every use. And with a smooth, durable, plastic casing, it's easier to maintain and keep clean.

Maximize efficiencies

Save on cost, labor and waste with a water-resistant dispenser that protects refills during spray-downs and in wet areas—all while delivering a stylish impression. At 1,150 linear feet of quick-absorbent wipers per roll, the Tork Washstation Dispenser holds the longest refills on the market, so you don't have to reload as often.

Tork Washstation Dispensers – W6 System

Product	Name	Color	Size H x W x D (in)	Dispenser capacity	Units/case
651220	Tork Washstation Dispenser	Aqua/White	18.1 x 12.5 x 10.6 (45.9 x 31.9 x 26.8 cm)	1	1
651228	Tork Washstation Dispenser	Red/Smoke	18.1 x 12.5 x 10.6 (45.9 x 31.9 x 26.8 cm)	1	1

Tork Washstation Towel Refills – W6 System

Product	Name	Color	Sheet size W x L (in)	Wipers/roll	Rolls/case	Certification
291380	Tork Paper Wiper	White	7.68 x 9.5 (19.51 x 24.13 cm)	1,452	4	♻️
291370	Tork Basic Paper Wiper	White	7.68 x 9.5 (19.51 x 24.13 cm)	1,452	4	♻️ © ♻️
291350	Tork Basic Paper Wiper	Natural	7.68 x 9.5 (19.51 x 24.13 cm)	1,452	4	♻️ © ♻️ ♻️

Tork Washstation Dispenser

Key features

- Durable water-resistant design
- One of the highest refill capacities on the market
- Hands free dispensing—touch only what you take
- Easy wipe or spray down
- Water guiding channels and smooth edges direct water away from refill
- Smooth edges channel water away from refill
- Stainless steel parts won't corrode
- Clear back plate allows for easy mounting
- Push button or keyed lock



Aqua/White
651220



Red/Smoke
651228

Tork Paper Wiper

Key features

- High footage rolls
- Basic and higher performance sheets
- Stands up to high humidity



291380



291370



291350



Wipers and cloths for every task



Your needs always come first

Tork is focused on making your working day easier. Your task decides what product you choose, and all you really want are smart and efficient solutions to get the job done quickly and efficiently. It is as simple as this: if you know what task you have, we have an easy-to-find Tork product that helps you take care of it.



Identify the task, find the right product

Finding the right product for your needs starts with looking at what job it does. To help you, we have defined the following tasks.

- **Wiping**
Wiping is picking up spills, soaking up liquids and picking up dirt and dust with a paper-based wiper.
- **Cleaning**
Cleaning is removing dirt and stains from surfaces, machines or tools with cloths that are dry or used together with water, solvents or detergents.
- **Polishing**
Polishing is creating a protected and shiny surface with the help of a cloth that applies polish onto the surface and is rubbed to obtain a good finish.
- **Sanitizing**
Sanitizing is hygienically cleaning a surface by removing harmful microorganisms with the help of a cloth used in conjunction with a sanitizing agent.



Names and packaging made easy

To give you the best possible support, we have a very simple philosophy. You will always understand what task a wiper is designed for just by reading the name. When you look at the packaging, icons tell you about the benefits of the product, and there is additional, easy-to-read information that makes choosing the right Tork product easier than ever before.



To choose the right Tork solution, ask yourself these three questions

1. What are your main tasks and applications?

Do you want a wiper for dry or wet wiping, cleaning to remove oil and grease, applying a polish, or sanitizing a surface?



2. What is your work environment?

Are you at a fixed workstation where you and others need equal access to a dispenser, or do you need a mobile solution to move around to carry out different tasks?



3. What are your usage requirements?

Do several people use wipers during the day or is it just one person who occasionally needs to use them?



Tork Dispensing Systems

Our dispensers are conveniently matched with our wipers to control usage, maintain hygiene, and ensure optimum performance. The systems are identified by unique letter and number combinations for easy, fool-proof pairing.



W1



W2



M2



W4



W6

Tork wipers offer you . . .

Tork wipers are specifically designed for the tasks at hand, making them easier and faster to use.

Each one is made for a specified task yet versatile enough for multi-purpose use.

There are different dispenser options for each Tork quality and size, so you can tailor a solution that best fits your needs.



Bulk Rags and Rental Towels



Bulk Rags can vary in color, size and material which impacts performance and creates waste, driving up costs.



Rental Shop Towels can contain residual grease and oil and chemicals that inhibit performance and absorption.

Wipers and cloths for every task

When you want quick and efficient ways of dealing with your wiping, cleaning, polishing, or sanitizing needs, Tork has the perfect products for you. Our wide range includes all sorts of paper and cloth based products – from basic wipers to heat-resistant cloths, from multipurpose papers to highly specialized cleaning cloths that help you prevent cross-contamination.

Wiping



Basic

Tork Basic Paper Wiper

A 1 or 2-ply paper for basic wiping tasks.

Tork Windshield Paper Towel

A 1 or 2-ply paper for wiping glass.

Multipurpose

Tork Paper Wiper

A multipurpose paper for light wiping tasks.

Tork Paper Wiper Plus

A multipurpose paper that is ideal for picking up liquids and hand wiping.

Tork Heavy-Duty Paper Wiper

Our toughest multipurpose paper wiper absorbs both oil and water efficiently and has a high wet strength.

Industrial

Tork Industrial Paper Wiper

A multipurpose paper based wiper that is ideal for industrial wiping tasks and hand wiping.

Perforated Roll

When you want to wipe up water and other spills, Tork Perforated Roll Towels offer a soft and high bulk solution. Thanks to its high absorbency, the spill holding is superb, which reduces the number of towels you need to use. The towel is strong enough for wiping all surfaces, and is available in a Handi size sheet option.

Sanitizing



Sanitizing

Tork Foodservice Cloth

These foodservice cloths are color-coded to help reduce the risk of cross-contamination. These cloths are also designed for use with sanitizing agents. The cloth picks up dirt and absorbs spills effectively, is easy to rinse, dries quickly and is low linting, making it ideal for wiping, cleaning, degreasing and sanitizing in foodservice environments.

Tork Antimicrobial Foodservice Cloth

This foodservice cloth is specially treated to help inhibit the growth of odor causing microorganisms in the cloth so the cloth stays fresher longer. This cloth is also designed for use with sanitizing agents.

Tork Quat Friendly Foodservice Cloth

A foodservice cloth that is specially treated to ensure that the cloth does not degrade your sanitizing solution. This helps to maintain the efficacy of your sanitizer buckets between bucket refreshing.

Cleaning



Multipurpose

Tork Cleaning Cloth

A soft and flexible multipurpose cloth that quickly absorbs liquids and oil. The cloth provides a professional cleaning result thanks to our excelCLEAN® wiper technology.

Tork Heavy-Duty Cleaning Cloth

This strong and absorbent multipurpose cloth works with most solvents. It is designed to protect your hands from heat and metal scraps. The cloth provides a professional cleaning result thanks to our excelCLEAN wiper technology.

Tork Low-Lint Cleaning Cloth

A low linting, flexible and drapable cloth that works well with solvents, detergents and disinfectants.



Industrial

Tork Industrial Cleaning Cloth

A soft and flexible cloth that is excellent in tight spaces, and ideal for cleaning oil and grease. The cloth provides a professional cleaning result thanks to our excelCLEAN wiper technology.

Tork Industrial Heavy-Duty Cleaning Cloth

The thickest and strongest Tork cloth has a high absorption capacity, works well with most solvents and protects your hands from heat and metal scraps. The cloth provides a professional cleaning result thanks to our excelCLEAN wiper technology.

Tork Industrial Low-Lint Cleaning Cloth

A low linting, flexible and anti-static cloth that works well with solvents, detergents, sanitizers and disinfectants.



Most **Tork Cleaning Cloths** have excelCLEAN® wiper technology to help you get cleaning tasks done more efficiently and professionally than other cloths, especially rags and rental cloths.

Thanks to our patented foam-spun technology to create a unique internal structure they give you a quicker, more hygienic and professional cleaning result, while minimizing the risk of contamination.

Polishing



Polishing

Tork Polishing Cloth

When you need a soft and low linting cloth for polishing – go for the Tork Polishing Cloth. This soft and flexible cloth has a structure designed for holding and releasing polishing agents. It is perfect when you want a professional result without leaving lint.

ShopMax



ShopMax

Wet Wipes

Tork ShopMax pre-moistened, disposable wipes in a convenient, portable bucket are available for cleaning hands and surfaces.

Dry Wipes

Tork ShopMax dry wipes are available in self-dispensing boxes, centerfeed rolls, and smaller towel rolls.

Industrial

Wiping and cleaning in the light and heavy manufacturing industries is a vital part of the production process that ensures quality.



Attention to detail lets you do your job better

The wiping and cleaning tasks that our industrial products are asked to tackle can range from preparing parts, cleaning before painting, enhancing maintenance or quality control processes, and picking up leaked oil or other lubricants. Our range includes solutions that cover all these needs. Tork considers every detail – letting you get more done, more efficiently.

Products that make the difference



Preparing parts before production

Common tasks include wiping oil-covered metal parts and other pieces of metal that can be oily or dirty.



Maintenance of machines

Regular maintenance often includes getting rid of cooling liquids, oil, and metal scraps from the machine and cleaning wrenches and other tools.



Cleaning before painting

Prior to painting, the surface must be cleaned of oil, grease, solvents, finger-prints and dust to get the best possible result.

Recommended Products



440245A
Tork Industrial
Paper Wiper



520678
Tork Industrial
Cleaning Cloth



570478
Tork Industrial Heavy-
Duty Cleaning Cloth



192479
Tork Low-Lint
Cleaning Cloth



197478
Tork Polishing
Cloth

Food processing

In the food processing industry, effective wiping, cleaning, and sanitizing secures processes and supports vital hygiene practices. Wherever they're used, Tork products help you achieve this.



Wiping that leaves nothing to chance

Thorough hand washing and drying to remove harmful bacteria from workers' hands is critical. Keeping work areas and machinery clean is as mission critical as performing on-going maintenance and quality control. In the food processing industry, wiping and cleaning tasks are varied but the requirement for effective, hygiene-focused solutions remains constant. Using the Tork wiper and dispenser range ensures you can tackle these tasks with confidence.

Products that make the difference



Food processing/hand wiping

To avoid spreading bacteria, it is important that hands are scrupulously washed and dried – both before entering the production unit and when needed.



Wiping spills in production area

During the production process, food spills must be removed as needed.



Machinery Maintenance and Cleaning

Equipment must be cleaned and sanitized regularly, often this involves spray down procedures.

Recommended Products



192127
Tork Paper
Wiper Plus



530178
Tork Heavy-Duty
Cleaning Cloth



570178
Tork Industrial Heavy-
Duty Cleaning Cloth



192191
Tork Antimicrobial
Foodservice Cloth

Foodservice

As well as maintaining hygiene, our range of wipers keep your kitchen, restaurant, bar or café looking fresh at all times.



Solutions that keep up with your pace

We understand the high-tempo nature of working in a modern restaurant or catering facility. In these environments, wiping and cleaning tasks can involve everything from grease-covered stove tops, grills and working surfaces of different kinds to cleaning dining areas, service counters and other areas that guests and staff come into contact with.

Products that make the difference



Back of house wiping

During the day, there's a need for running maintenance such as wiping off water, oil, fat and food particles – and of course hand wiping.



Back of house cleaning

Throughout the day, oil and grease, stains and spills must be thoroughly cleaned from various surfaces, stainless steel equipment and tiles.



Front of house sanitizing

Tables and service counters must be kept clean and fresh all day, and this calls for differently colored cloths to avoid cross-contamination.

Recommended Products



192127
Tork Paper
Wiper Plus



530178
Tork Heavy-Duty
Cleaning Cloth



192191
Tork Antimicrobial
Foodservice Cloth



197478
Tork Polishing Cloth

Healthcare

Tork systems are hygienic, minimizing excessive waste and the spread of germs to meet the ever-changing needs of healthcare.



Diverse tasks demand flexible solutions

Hygiene is the number one priority in healthcare environments. Maintaining a high standard is a tough task with so many visitors, patients and staff coming and going throughout the day. Tork Performance dispensers provide touch-free, hygienic solutions that minimize the risk of cross-contamination, while dispensing is limited to what you need to ensure a low cost-in-use.

Products that make the difference



Wiping up spills and cleaning when spills occur, fast action is often required to minimize the safety and hygiene risks.



Patient and hand hygiene Frequent hand washing and patient bathing requires wiper dispensers that dispense hygienically and are easy to clean.



Surface and object cleaning is important in preventing the transmission of bacteria.

Recommended Products



530178
Tork Heavy-Duty
Cleaning Cloth



192136
Tork Heavy-Duty
Paper Wiper



192191
Tork Antimicrobial
Foodservice Cloth



HB9201
Tork Perforated
Roll Towel



510175A
Tork Cleaning Cloth

Automotive

In the automotive industry, it is important to use wipers that are strong, low linting and absorbent to perform the task at hand.

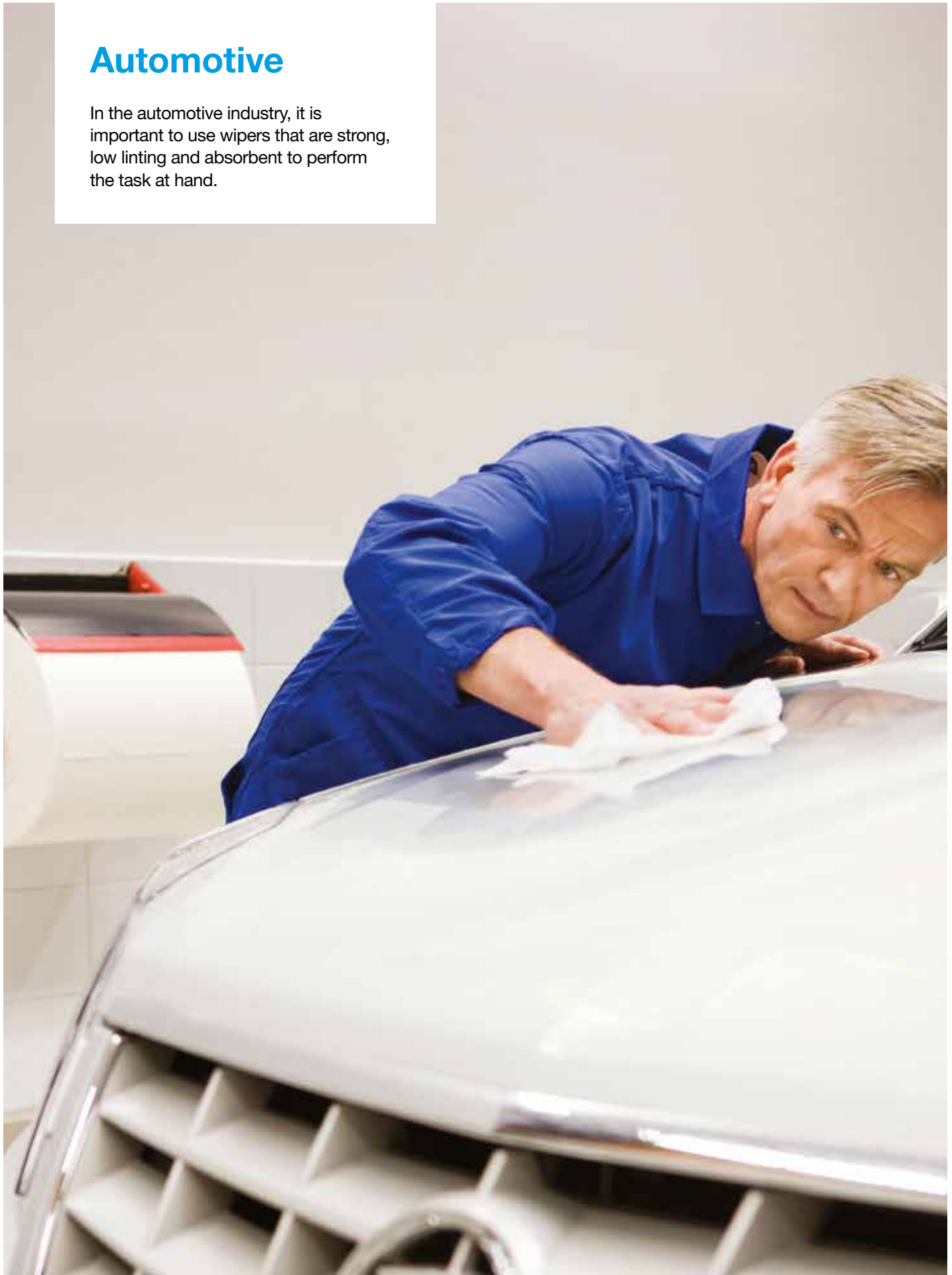

Professional tools for a quality result and finish

From heavy duty to specialty cloths, high-performance Tork wipers offer superior quality and cost-saving dispensing solutions for a range of applications.

Products that make the difference



Cleaning and wiping surfaces
Fast and efficient cleaning of tools, and work surfaces requires a close-at-hand solution exactly where you need it.



Wiping hands and face
Tork wipers provide a safe and hygienic way to keep clean.



Removing oil, grease and lubricants
Strong, absorbent wipers are needed for tough cleaning tasks and spills.

Recommended Products



440278
Tork Industrial
Paper Wiper



192479
Tork Low-Lint
Cleaning Cloth



197478
Tork Polishing
Cloth



520678
Tork Industrial
Cleaning Cloth

Office Building and Facilities Maintenance

Janitorial services keep your business running smoothly. Tork offers portable solutions for all your needs.



Meeting the task whatever the environment

From multipurpose paper-based wipers to industrial cleaning cloths, Tork wipers provide you with the right tools to get the job done in your office building or facility.

Products that make the difference



Surface wiping

Fast and efficient cleaning of surfaces requires a close-at-hand solution exactly where you need it.



A variety of cleanups

Strong, absorbent wipers are needed for tough cleaning tasks and spills.



Routine maintenance jobs

From small to large jobs, Tork wipers provide a hygienic, cost-effective way to handle the complete range of maintenance tasks.

Recommended Products



440245A
Tork Industrial
Paper Wiper



450175
Tork Heavy-Duty
Paper Wiper



520371
Tork Industrial
Cleaning Cloth



197478
Tork Polishing
Cloth

Flexible dispensing solutions

There is a Tork paper wiper or cleaning cloth for every task. And, we support our wipers with a wide range of dispensers to make sure you can always find the best possible combination for your wiping needs. This ensures that you will always get the most out of our products – whether your workplace is an upscale restaurant, industrial workshop, or an automotive repair facility.



Tork Floor Stand – W1 System

This mobile floor stand offers easy, ergonomic loading and thanks to the fiberglass reinforced teeth, dispensing is safe and reliable.



Tork Wall Stand – W1 System

This wall stand saves floor space, offers easy, ergonomic loading and thanks to the fiberglass reinforced teeth, dispensing is safe and reliable.



Tork Folded Wiper/Cloth Dispenser – W4 System

This hygienic dispenser protects the wipes, reduces consumption by dispensing one sheet at a time and fits almost any wall.

Finding the right combination – the easy way

In the matrix below, we have listed our refills and matched them with our dispenser systems. Choosing what's best for you is easy: simply pick the wipe you need and follow the line to see which dispensing systems it works with.

	Mobile	Wall mounted		
				
	W1 Tork Floor Stand	W1 Tork Wall Stand	W2 Tork Maxi Centerfeed Dispenser	W4 Tork Folded Wiper/Cloth Dispenser

Wiping					
Basic paper	Tork Basic Paper Wiper				
	Tork Basic Paper Wiper (Washstation)				
	Tork Windshield Paper Towel				
Multipurpose paper	Tork Paper Wiper	130211B	130211B	130211B	
	Tork Paper Wiper (Washstation)				
	Tork Paper Wiper Plus	430304	430304	192128	430178
	Tork Heavy-Duty Paper Wiper	450304	450304		
Industrial paper	Tork Industrial Paper Wiper	13244101	13244101	13244101	440278
Cleaning					
Multipurpose cloths	Tork Cleaning Cloth	510104	510104	510137	
	Tork Heavy-Duty Cleaning Cloth	530104	530104	530137	530178
	Tork Low-Lint Cleaning Cloth				192479, 192482
Industrial cloths	Tork Industrial Low-Lint Cleaning Cloth				192578
	Tork Industrial Cleaning Cloth	520304	520304	520337	520678
	Tork Industrial Heavy-Duty Cleaning Cloth	570104	570104	570137	570178
Wet Wipes	Tork Foodservice Cleaning Wet Wipe				
Polishing					
Polishing cloth	Tork Polishing Cloth				197478
Sanatizing					
Foodservice cloths	Tork Foodservice Cloth				
	Tork Antimicrobial Foodservice Cloth				
	Tork Antimicrobial Heavy-Duty Foodservice Cloth				
	Tork Quat Friendly Foodservice Cloth				
Wet Wipes	Tork Foodservice Sanitizing Wet Wipe				



Tork Maxi Centerfeed Dispenser – W2 System

A hygienic dispenser for Maxi Centerfeed rolls that is optimized for single hand dispensing.



Tork Washstation Dispenser – W6 System

Water resistant, large capacity with one at a time dispensing. Built to withstand wet environments and does not require removal during spray-downs. Certified by HACCP International.



Tork Centerfeed Dispenser – M2 System

A hygienic and space saving dispenser for Centerfeed rolls that is optimized for single hand dispensing.



Tork Top-Pak Bracket Dispenser – W4 System

Durable and slim, perfect for wall-mounted convenience.



Tork Small Pack Dispenser Bracket – W8 System

Space-saving dispenser bracket for server stations, back of house or in storage areas



Tork Pop-Up Bracket Dispenser – W24 System

Durable and slim, perfect for wall-mounted convenience.



Folded Towel Dispenser – H22 System

Strong and durable steel dispenser designed to cut maintenance costs and provide trouble free service.

						Portable	Other
	W6 Tork Washstation Dispenser	M2 Tork Centerfeed Dispenser	W24 Tork Pop-Up Bracket Dispenser	W8 Tork Small Pack Dispenser Bracket	H22 Tork Folded Towel Dispenser	Self-Dispensing	
	291370, 291350				192121, 192122		192125A
		130251A					
	291380						
			192127				430150A
			450175				192136
		132451A	440245A			13247501	
			510175A				
			5301755				5301505
			192475				
						520371	
				192183, 192184		192181A, 192182	
				192291, 192292, 192293		192191, 192192, 192193	
						192194	
						192195, 192196	

Refills

From single and double-ply multipurpose wiping paper to advanced heavy duty cleaning cloths. Within our wiping and cleaning range, you'll find solutions that are extra absorbent, strong when wet, extra thick for picking up and much more. Below you will find a selection of products from our range, including information on food contact suitability, environmental labeling and other product characteristics.

Wiping – Basic Paper Wipers

Tork Basic Paper Wiper



Refill No	Color	Format	System	Base Sheet	Ply	Sheet Size W x L (in)	Feet/Unit	Wipers/Unit	Units/Case	Wipers/Case	Approx Lbs/Case	Certification
291350	Natural	Roll Towel	W6	Paper	1	7.68 x 9.5 (19.51 x 24.13 cm)	1,150 (350.52 m)	1,452	4	5,808	27.8 (12.6 kg)	♻️ ♻️ E C
291370	White	Roll Towel	W6	Paper	1	7.68 x 9.5 (19.51 x 24.13 cm)	1,150 (350.52 m)	1,452	4	5,808	27.8 (12.6 kg)	♻️ ♻️ C
192125A	White	Pop-Up Box	Self-Dispensing	Paper	2	9 x 10.25 (22.86 x 26.04 cm)	94 (28.65 m)	110	18	1,980	18.5 (8.4 kg)	♻️ ♻️ NSF P1

Tork Windshield Paper Towel



Refill No	Color	Format	System	Base Sheet	Ply	Sheet Size W x L (in)	Feet/Unit	Wipers/Unit	Units/Case	Wipers/Case	Approx Lbs/Case	Certification
192121	Blue	Folded	H22	Paper	1	9.125 x 10.25 (23.18 x 26.04 cm)	213 (64.92 m)	250	9	2,250	13.8 (6.3 kg)	♻️ ♻️ NSF P1
192122	Blue	Folded	H22	Paper	2	9.125 x 10.25 (23.18 x 26.04 cm)	119 (36.27 m)	140	16	2,240	17.1 (7.8 kg)	♻️ ♻️ NSF P1

Wiping – Multipurpose Paper Wipers

Tork Dairy Towel



Refill No	Color	Format	System	Base Sheet	Ply	Sheet Size W x L (in)	Feet/Unit	Wipers/Unit	Units/Case	Wipers/Case	Approx Lbs/Case	Certification
2225000	Natural White	Folded	H22	Paper	2	9 x 10 (22.86 x 25.40 cm)	125 (38.1 m)	150	15	2,250	24.26 (11.0 kg)	♻️ E
2247010	Natural	Folded	H22	Paper	1	9.125 x 10.25 (23.18 x 26.04 cm)	213.5 (65.07 m)	250	16	4,000	21.31 (9.7 kg)	♻️ E

Tork Dairy Towel, Pre-Drip

Refill No	Color	Format	System	Base Sheet	Ply	Sheet Size W x L (in)	Feet/Unit	Wipers/Unit	Units/Case	Wipers/Case	Approx Lbs/Case	Certification
2234001	Natural	Folded	H22	Paper	1	9 x 10 (22.86 x 25.40 cm)	223.3 (68.06 m)	268	10	2,680	16.15 (7.3 kg)	♻️ E

Tork Paper Wiper



Refill No	Color	Format	System	Base Sheet	Ply	Sheet Size W x L (in)	Feet/Unit	Wipers/Unit	Units/Case	Wipers/Case	Approx Lbs/Case	Certification
303362	White	Pop-Up Box	Self-Dispensing	Paper	4	9.75 x 16.75 (24.77 x 42.55 cm)	174.4 (53.16 m)	125	8	1,000	20.6 (9.3 kg)	♻️ E
291380	White	Roll Towel	W6	Paper	1	7.68 x 9.5 (19.51 x 24.13 cm)	1,150 (350.52 m)	1,452	4	5,808	20.2 (9.2 kg)	♻️
130211B	White	Centerfeed	W1, W2	Paper	2	9 x 13 (22.86 x 33.02 cm)	866 (263.96 m)	800	2	1,600	14.9 (6.8 kg)	♻️ ♻️ ♻️
130251A	White	Centerfeed	M2	Paper	2	9 x 15.5 (22.86 x 39.37 cm)	419 (127.71 m)	325	4	1,300	14.8 (6.7 kg)	♻️ ♻️ ♻️

Tork Paper Wiper Plus



Refill No	Color	Format	System	Base Sheet	Ply	Sheet Size W x L (in)	Feet/Unit	Wipers/Unit	Units/Case	Wipers/Case	Approx Lbs/Case	Certification
192128	White	Centerfeed	W2	Paper/DRC	1	9.8 x 15.2 (24.89 x 38.61 cm)	380 (115.82 m)	300	2	600	8.2 (3.7 kg)	NSF P1 ♻️
192127	White	Pop-Up Box	W24	Paper/DRC	1	9.25 x 16.25 (23.50 x 41.28 cm)	135.4 (41.27 m)	100	8	800	13.7 (6.2 kg)	NSF P1 ♻️
430150A	White	1/4 Fold	--	Paper/DRC	1	12.5 x 13 (31.75 x 33 cm)	97.5 (29.72 m)	90	12	1080	15.3 (6.9 kg)	NSF P1 ♻️
430178	White	Top-Pak	W4	Paper/DRC	1	13.57 x 16.25 (34.47 x 41.28 cm)	203.12 (61.9 m)	150	5	750	15.3 (6.9 kg)	NSF P1 ♻️
430304	White	Giant Roll	W1	Paper/DRC	1	11.1 x 12 (28.19 x 30.48 cm)	800 (243.84 m)	800	1	800	12.6 (5.7 kg)	NSF P1 ♻️

Wiping – Multipurpose Paper Wipers



Tork Heavy-Duty Paper Wiper

Refill No	Color	Format	System	Base Sheet	Ply	Sheet Size W x L (in)	Feet/Unit	Wipers/Unit	Units/Case	Wipers/Case	Approx Lbs/Case	Certification
450304	Blue	Giant Roll	W1	Paper/DRC	1	11.1 x 12 (28.19 x 30.48 cm)	800 (243.84 m)	800	1	800	12.9 (5.9 kg)	Health Canada NSF P1 BMS 15-5G
450175	White	Pop-Up Box	W24	Paper/DRC	1	9.25 x 16.25 (23.50 x 41.28 cm)	121 (36.88 m)	90	10	900	20.1 (9.1 kg)	Health Canada NSF P1 BMS 15-5G
192136	White	1/4 Fold	--	Paper/DRC	1	12.5 x 13 (31.70 x 33.02 cm)	60 (18.29 m)	56	16	896	17.9 (8.1 kg)	Health Canada NSF P1 BMS 15-5G

Wiping – Industrial Paper Wipers



Tork Industrial Paper Wiper

Refill No	Color	Format	System	Base Sheet	Ply	Sheet Size W x L (in)	Feet/Unit	Wipers/Unit	Units/Case	Wipers/Case	Approx Lbs/Case	Certification
13244101	Blue	Centerfeed	W1, W2	Paper	4	11 x 15.75 (27.94 x 40.01 cm)	492 (149.96 m)	375	2	750	15.6 (7.1 kg)	Health Canada
440278	Blue	Top-Pak	W4	Paper	4	12.8 x 16.4 (32.51 x 41.66 cm)	123 (37.49 m)	90	5	450	12 (5.4 kg)	Health Canada
132451A	Blue	Centerfeed	M2	Paper	4	10 x 15.75 (25.40 x 40.01 cm)	249 (75.90 m)	190	4	760	14.4 (6.5 kg)	Health Canada
440245A	Blue	Pop-Up Box	W24	Paper	4	8.54 x 16.5 (21.69 x 41.91 cm)	123.75 (32.72 m)	90	10	900	16 (7.3 kg)	Health Canada
13247501	Blue	Handy Box	Self-Dispensing	Paper	4	12.8 x 16.5 (32.51 x 41.91 cm)	247.5 (75.44 m)	180	1	180	5.4 (2.4 kg)	Health Canada

Wiping – Perforated Roll Towels



Tork Perforated Roll Towel

Refill No	Color	Format	Ply	Sheet Size W x L (in)	Towels/Roll	Towels/Case	Rolls/Case	Approx Lbs/Case	Certification
HB1990A	White	Perforated Roll	2	11 x 9 (27.94 x 22.86 cm)	84	2,520	30	18.2 (8.3 kg)	Health Canada NSF P1
HB1995A	White	Perforated Roll Jumbo Roll	2	11 x 9 (27.94 x 22.86 cm)	210	2,520	12	17.0 (7.7 kg)	Health Canada NSF P1
HK1975A	Natural	Perforated Roll Jumbo Roll	2	11 x 9 (27.94 x 22.86 cm)	210	2,520	12	18.3 (8.3 kg)	Health Canada NSF P1
HB9201	White	Perforated Roll Handi-Size Sheet	2	11 x 6.75 (27.94 x 17.15 cm)	120	3,600	30	21.6 (9.8 kb)	Health Canada NSF P1
421900	White	Perforated Roll	2	11 x 9 (27.94 x 22.86 cm)	100	3,000	30	18.1 (8.2 kg)	Health Canada
421970	White	Perforated Roll	2	11 x 9 (27.94 x 22.86 cm)	70	2,100	30	13.1 (8.2 kg)	Health Canada

Cleaning – Multipurpose Cloths



510104



510137



510175A

Tork Cleaning Cloth

Refill No	Color	Format	System	Base Sheet	Ply	Sheet Size W x L (in)	Feet/Unit	Wipers/Unit	Units/Case	Wipers/Case	Approx Lbs/Case	Certification
510104	White	Giant Roll	W1	Spunlace	1	16.9 x 15.0 (42.93 x 38.10 cm)	1250.0 (381.0 m)	1,000	1	1,000	21.4 (9.7 kg)	Health Canada NSF P1
510137	White	Centerfeed	W2	Spunlace	1	12.6 x 10.0 (32.00 x 25.4 cm)	416.6 (126.98 m)	500	1	500	5.6 (2.5 kg)	Health Canada NSF P1
510175A	White	Pop-Up Box	W24	Spunlace	1	8.46 x 16.125 (21.49 x 40.96 cm)	134.4 (40.96 m)	100	5	500	7.67 (3.5 kg)	Health Canada NSF P1



530104



530137



530178



5301755



5301505

Tork Heavy-Duty Cleaning Cloth

Refill No	Color	Format	System	Base Sheet	Ply	Sheet Size W x L (in)	Feet/Unit	Wipers/Unit	Units/Case	Wipers/Case	Approx Lbs/Case	Certification
530104	White	Giant Roll	W1	Spunlace	1	16.9 x 15.0 (42.93 x 38.10 cm)	887.5 (270.51 m)	710	1	710	22.4 (9.7 kg)	Health Canada BMS 15-5G
530137	White	Centerfeed	W2	Spunlace	1	12.6 x 10 (32.0 x 25.40 cm)	333.33 (101.59 m)	400	1	400	6.5 (2.9 kg)	Health Canada BMS 15-5G
530178	White	Top-Pak	W4	Spunlace	1	14 x 16.9 (35.56 x 42.93 cm)	140.4 (42.79 m)	100	5	500	16.3 (7.4 kg)	Health Canada BMS 15-5G
5301755	White	Pop-Up Box	W24	Spunlace	1	8.46 x 16.125 (21.49 x 40.96 cm)	107.5 (32.77 m)	80	5	400	8.45 (3.8 kg)	Health Canada BMS 15-5G
5301505	White	1/4 Fold	--	Spunlace	1	12.6 x 13 (32 x 33 cm)	54.16 (16.51 m)	50	6	300	6.6 (3 kg)	Health Canada BMS 15-5G

Tork Low-Lint Cleaning Cloth



192479



192482



192475

Refill No	Color	Format	System	Base Sheet	Ply	Sheet Size W x L (in)	Feet/Unit	Wipers/Unit	Units/Case	Wipers/Case	Approx Lbs/Case	Certification
192479	Turquoise	Top-Pak	W4	Spunlace	1	13.5 x 16.4 (34.29 x 41.66 cm)	136.6 (41.64 m)	100	5	500	12.9 (5.9 kg)	Health Canada
192482	White	Top-Pak	W4	Spunlace	1	15.0 x 16.5 (38.10 x 41.91 cm)	165.0 (50.29 m)	120	5	600	14. (6.4 kg)	BMS AMS 15-5G 3819C
192475	Turquoise	Pop-Up Box	W24	Spunlace	1	9 x 16.5 (22.86 x 41.91 cm)	137.5 (41.91)	100	8	800	15.6 (7.1 kg)	Health Canada

Cleaning – Industrial Cloths

Tork Industrial Low-Lint Cleaning Cloth



192578

Refill No	Color	Format	System	Base Sheet	Ply	Sheet Size W x L (in)	Feet/Unit	Wipers/Unit	Units/Case	Wipers/Case	Approx Lbs/Case	Certification
192578	Blue	Top-Pak	W4	Polypropylene	1	15.2 x 15.7 (38.61 x 39.88 cm)	104.6 (31.88)	80	5	400	11.44 (5.2 kg)	N/A

Tork Industrial Cleaning Cloth



520304



520337



520678



520371

Refill No	Color	Format	System	Base Sheet	Ply	Sheet Size W x L (in)	Feet/Unit	Wipers/Unit	Units/Case	Wipers/Case	Approx Lbs/Case	Certification
520304	Grey	Giant Roll	W1	Spunlace	1	16.9 x 15.0 (42.93 x 38.10 cm)	1,187.5 (361.95 m)	950	1	950	23.8 (10.8 kg)	Health Canada
520337	Grey	Centerfeed	W2	Spunlace	1	12.6 x 10.0 (32.00 x 25.4 cm)	416.6 (127.01 m)	500	1	500	6.5 (2.9 kg)	Health Canada
520678	Grey	Top-Pak	W4	Spunlace	1	14 x 16.9 (38.10 x 41.91 cm)	169 (51.51 m)	120	5	600	14.5 (6.6 kg)	Health Canada
520371	Grey	Handy Box	Self-Dispensing	Spunlace	1	14 x 16.9 (335.56 x 42.93 cm)	394.3 (120.18 m)	280	1	280	7.3 (3.3 kg)	Health Canada



570104



570137



570478

Tork Industrial Heavy-Duty Cleaning Cloth

Refill No	Color	Format	System	Base Sheet	Ply	Sheet Size W x L (in)	Feet/Unit	Wipers/Unit	Units/Case	Wipers/Case	Approx Lbs/Case	Certification
570104	White	Giant Roll	W1	Spunlace	1	16.9 x 15.0 (42.93 x 38.10 cm)	475 (144.78 m)	380	1	380	15.74 (7.1 kg)	Health Canada
570137	White	Centerfeed	W2	Spunlace	1	12.6 x 10 (32.0 x 25.4 cm)	133.3 (40.63 m)	160	1	160	5.63 (2.6 kg)	Health Canada
570478	White	Top-Pak	W4	Spunlace	1	14 x 16.9 (335.56 x 42.93 cm)	91.5 (27.89 m)	65	5	325	13.95 (6.3 kg)	Health Canada

Polishing – Polishing Cloths

Tork Polishing Cloth



197478

Refill No	Color	Format	System	Base Sheet	Ply	Sheet Size W x L (in)	Feet/Unit	Wipers/Unit	Units/Case	Wipers/Case	Approx Lbs/Case	Certification
197478	White	Top-Pak	W4	Spunlace	1	14 x 16.9 (335.56 x 42.93 cm)	176 (53.64 m)	125	5	625	12.95 (5.9 kg)	Health Canada

Sanitizing – Foodservice Cloths

Tork Foodservice Cloth



192181A



192183



192182



192184

Refill No	Color	Format	System	Base Sheet	Ply	Sheet Size W x L (in)	Feet/Unit	Units/Case	Wipers/Case	Approx Lbs/Case	Certification
192181A	Blue/ White	1/4 Fold	Self Dispensing	Carded Rayon	1	13 x 21.5 (33.02 x 54.61 cm)	430 (131.06 m)	1	240	4.3 (2.0 kg)	Health Canada NSF P1
192183	Blue/ White	Z Fold	Self Dispensing	Carded Rayon	1	11.75 x 14.75 (29.85 x 37.47 cm)	98.3 (29.96 m)	4	320	4.13 (1.9 kg)	Health Canada
192182	Green/ White	1/4 Fold	Self Dispensing	Carded Rayon	1	11.5 x 21 (29.2 x 53.3 cm)	1050 (320.04 m)	1	600	10.74 (4.9 kg)	Health Canada NSF P1
192184	Green/ White	Z Fold	Self Dispensing	Carded Rayon	1	11.75 x 14.75 (29.85 x 37.47 cm)	98.3 (29.96 m)	4	320	4.13 (1.9 kg)	Health Canada



192191



192291



192192



192292



192193



192293

Tork Antimicrobial Foodservice Cloth

Refill No	Color	Format	System	Base Sheet	Ply	Sheet Size W x L (in)	Feet/Unit	Units/Case	Wipers/Case	Approx Lbs/Case	Certification
192191	White/Red Stripe	1/4 Fold	Self Dispensing	Spunlace	1	13 x 24 (33.02 x 60.96 cm)	300 (91.44 m)	1	150	5.49 (2.5 kg)	N/A
192291	White/Red Stripe	Z Fold	Self Dispensing	Spunlace	1	11.75 x 14.75 (29.85 x 37.47 cm)	98.3 (29.96 m)	4	200	4.93 (2.2 kg)	N/A
192192	Blue/Blue Stripe	1/4 Fold	Self Dispensing	Spunlace	1	13 x 24 (33.02 x 60.96 cm)	300 (91.44 m)	1	150	5.49 (2.5 kg)	N/A
192292	Blue/Blue Stripe	Z Fold	Self Dispensing	Spunlace	1	11.75 x 14.75 (29.85 x 37.47 cm)	98.3 (29.96 m)	4	200	4.93 (2.2 kg)	N/A
192193	Red/Red Stripe	1/4 Fold	Self Dispensing	Spunlace	1	13 x 24 (33.02 x 60.96 cm)	300 (91.44 m)	1	150	5.49 (2.5 kg)	N/A
192293	Red/Red Stripe	Z Fold	Self Dispensing	Spunlace	1	11.75 x 14.75 (29.85 x 37.47 cm)	98.3 (29.96 m)	4	200	4.93 (2.2 kg)	N/A



192194

Tork Antimicrobial Heavy-Duty Foodservice Cloth

Refill No	Color	Format	System	Base Sheet	Ply	Sheet Size W x L (in)	Feet/Unit	Units/Case	Wipers/Case	Approx Lbs/Case	Certification
192194	White/Red Stripe	1/4 Fold	Self Dispensing	Spunlace	1	13 x 21 (33.02 x 53.34 cm)	87 (26.52 m)	1	50	2.77 (1.3 kg)	N/A



192195



192196

Tork Quat Friendly Foodservice Cloth

Refill No	Color	Format	System	Base Sheet	Ply	Sheet Size W x L (in)	Feet/Unit	Units/Case	Wipers/Case	Approx Lbs/Case	Certification
192195	White/Red Stripe	1/4 Fold	Self Dispensing	Spunlace	1	13 x 21 (33.02 x 53.34 cm)	262 (79.86 m)	1	150	5.63 (2.6 kg)	Health Canada
192196	Blue/Blue Stripe	1/4 Fold	Self Dispensing	Spunlace	1	13 x 21 (33.02 x 53.34 cm)	262 (79.86 m)	1	150	5.63 (2.6 kg)	Health Canada

Dispensers

Our dispenser assortment is sure to meet your needs and demands, regardless of what these are. We offer a wide range of wall-mounted, floor standing or fully portable systems. Many of them come in several colors, which makes it easy for you to choose a dispenser that not only gets the job done – but looks good in your facility too.

Tork Performance Dispensers



Dispenser No.	Format	Color	Refill ID	Material	Dispenser/Case	Dispenser Capacity	Approx Lbs/Case	Cubic Feet/Case	Size H x W x D (in)
653028	Tork Maxi Centerfeed Dispenser	Red/Smoke	W2	Plastic	1	1 Roll	7.1 (3.2 kg)	1.74 (0.0492 cubic meter)	17.6 x 12.91 x 11.89 (44.70 x 32.79 x 30.20 cm)
653020	Tork Maxi Centerfeed Dispenser	Aqua/White	W2	Plastic	1	1 Roll	7.1 (3.2 kg)	1.74 (0.0492 cubic meter)	17.6 x 12.91 x 11.89 (44.70 x 32.79 x 30.20 cm)
659028	Tork Centerfeed Dispenser	Red/Smoke	M2	Plastic	1	1 Roll	3.64 (1.7 kg)	0.82 (0.0232 cubic meter)	14.02 x 9.76 x 9.13 (35.61 x 24.79 x 23.19 cm)
659020	Tork Centerfeed Dispenser	Aqua/White	M2	Plastic	1	1 Roll	3.64 (1.7 kg)	0.82 (0.0232 cubic meter)	14.02 x 9.76 x 9.13 (35.61 x 24.79 x 23.19 cm)
6520281	Tork Floor Stand	Red/Smoke	W1	Plastic/Steel	1	1 Roll	18.84 (8.5 kg)	3.56 (0.1007 cubic meter)	39.6 x 25.43 x 20.87 (100.61 x 64.59 x 53.01 cm)
6521281	Tork Wall Stand	Red/Smoke	W1	Plastic/Steel	1	1 Roll	8.57 (3.9 kg)	1.78 (0.0504 cubic meter)	18.23 x 25.43 x 10.79 (46.30 x 64.59 x 27.41 cm)
6540281*	Tork Folded Wiper/Cloth Dispenser	Red/Smoke	W4	Plastic	1	225 Wipers	5.16 (2.3 kg)	1.07 (0.0303 cubic meter)	15.51 x 16.81 x 8.11 (39.40 x 42.70 x 20.60 cm)
654021*	Tork Folded Wiper/Cloth Dispenser	Aqua/White	W4	Plastic	1	225 Wipers	5.16 (2.3 kg)	1.07 (0.0303 cubic meter)	15.51 x 16.81 x 8.11 (39.40 x 42.70 x 20.60 cm)
651228	Tork Washstation Roll Towel Dispenser	Red/Smoke	W6	Plastic	1	1 Roll	10.96 (5.0 kg)	1.63 (0.0461 cubic meter)	18.09 x 12.56 x 10.57 (45.95 x 31.9 x 26.85 cm)
651220	Tork Washstation Roll Towel Dispenser	Aqua/White	W6	Plastic	1	1 Roll	10.96 (5.0 kg)	1.63 (0.0461 cubic meter)	18.09 x 12.56 x 10.57 (45.95 x 31.9 x 26.85 cm)

*For optional magnet kit order 206540

Tork Basic Dispensers



Dispenser No.	Format	Color	Refill ID	Material	Dispenser/Case	Dispenser Capacity	Approx Lbs/Case	Cubic Feet/Case	Size H x W x D (in)
207328**	Tork Top-Pak Bracket Dispenser	Black	W4	Plastic	1	1 Box	2.4 (1.1 kg)	0.69 (0.0195 cubic meter)	7.8 x 16 x 8.6 (19.81 x 40.64 x 21.84 cm)
655300	Tork Small Pack Dispenser Bracket	White	W8	Plastic	4	1 Poly Pack	3.35 (1.5 kg)	0.65 (0.015384 cubic meter)	5.74 x 8.42 x 4.22 (14.58 x 21.39 x 10.72 cm)
2083281***	Tork Pop-Up Bracket Dispenser	Black	W24	Plastic	6	1 Box	2.61 (1.2 kg)	0.54 (0.0153 cubic meter)	5 x 13.5 x 3 (12.70 x 34.29 x 7.62 cm)
70WM1	Tork Folded Towel Dispenser	White	H22	White Enamel Painted Steel	1	450 towels	5.5 (2.5 kg)	0.36 (0.0102 cubic meter)	9.25 x 11.75 x 5.75 (23.50 x 29.85 x 14.61 cm)

For optional magnet kit order 202818 *For optional magnet kit order 2548975

ShopMax – Wet and Dry Wipes



Refill No	Color	Format	System	Base Sheet	Ply	Sheet Size W x L (in)	Feet/Unit	Wipers/Unit	Units/Case	Wipers/Case	Approx Lbs/Case	Certification
192592	White	Hand Cleaner Bucket	Self Dispensing	Spunlace	1	11.8 x 8.7 (29.97 x 22.10 cm)	52.2 (15.91 m)	72	4	288	11.2 (5.1 kg)	NSF E4
192594	White	Multi Surface Bucket	Self Dispensing	Spunlace	1	11.8 x 8.7 (29.97 x 22.10 cm)	52.2 (15.91 m)	72	4	288	10.8 (4.9 kg)	N/A
450137	White	Centerfeed	Self Dispensing	Paper/DRC	1	9 x 13 (22.86 x 33.02 cm)	216.6 (66.04 m)	200	4	800	11.8 (5.4 kg)	N/A
450337	Blue	Centerfeed	Self Dispensing	Paper/DRC	1	9 x 13 (22.86 x 33.02 cm)	216.6 (66.04 m)	200	4	800	11.8 (5.4 kg)	N/A
450138	White	Centerfeed Refill	W22	Paper/DRC	1	9.9 x 13.1 (25.15 x 33.27 cm)	218.3 (66.54 m)	200	2	400	6.4 (2.9 kg)	N/A
450338	Blue	Centerfeed Refill	W22	Paper/DRC	1	9.9 x 13.1 (25.15 x 33.27 cm)	218.3 (66.54 m)	200	2	400	7.0 (3.2 kg)	N/A
450160	White	Roll Towel	--	Paper/DRC	1	11 x 9.4 (27.94 x 23.88 cm)	47.0 (14.33 m)	60	30	1,800	24.1 (10.9 kg)	N/A
450360	Blue/White	Roll Towel	--	Paper/DRC	1	11 x 9.4 (27.94 x 23.88 cm)	47.0 (14.33 m)	60	30	1,800	24.1 (10.9 kg)	N/A
450340	Blue	Centerfeed Bucket	W22	Paper/DRC	1	9.9 x 13.1 (25.15 x 33.27 cm)	218.3 (66.54 m)	200	2	400	8.0 (3.6 kg)	N/A

ShopMax Wet Wipes

Tork ShopMax pre-moistened, disposable wipes in a convenient, portable bucket are available for cleaning hands and surfaces.

- Tough on grease and dirt
- Silicone opening and smart re-sealable lid – keeps your wipes from drying out
- Portion control with easy one-wipe-at-a-time dispensing
- No need to rinse afterward; won't leave a residue
- The hand cleaner is gentle enough on your skin for frequent usage

ShopMax Dry Wipes

Tork ShopMax dry wipes are available in self-dispensing boxes, centerfeed rolls, and smaller towel rolls.

- Strong enough to power through oil, grease and solvents, yet versatile enough to be an ideal everyday solution for general cleanup and spills
- Highly absorbent, offering excellent wipe-dry capabilities
- Softness provides cloth-like feel
- Strong construction offers durability, won't tear easily
- Low-linting towels perfect for a variety of tasks





Reduce cost and improve efficiency



If you're still using traditional rags for wiping and cleaning, Tork products can offer you measurable improvement

Tork cleaning cloths provide real, production-line advantages you can test. They're always consistent in quality and size, and are more effective using less energy to do the job. Unlike rags, Tork cleaning cloths are specifically designed for the job – with no risk of surprises that can slow routine maintenance or delay production. Rags are textile scraps, mill ends, remnants and secondhand clothing that come in various sizes, fabric types and quality levels.

Pound for pound, Tork cleaning cloths work smarter

One rag weighs an average of eight times as much as one Tork Industrial Cleaning Cloth. They both can do the same job. Switch to Tork and your waste handling costs can be reduced by up to 80%.

Box versus bundle, packages of Tork cloths are easier to manage and store: Compressed bundles of rags use more than 4.5 times the space (when opened, even more).

When you add the operator's time and solvent costs saved as well, you can see how Tork cleaning cloths can **save time, money and energy** while helping to **minimize environmental impact**.

Up to
80%
savings in space,
freight and
disposal costs.



Save time,
money and
energy!

Tests confirm our promise

We asked an independent research company to define some real tough tasks to test the performance of our cloths versus rags. The results were significant: less time and less solvent were used with Tork, less energy, too. These tests confirm our promise: Tork cleaning cloths can save you money and speed up your tasks so you can be ready sooner for production.

Tork wins over rags

Cleaning time in seconds



up to
32%
less time*

Used amount of solvent (ml)



up to
40%
less solvent*

The toughest tasks are easier with Tork

We wanted to test the limits of our cloths and measure the energy it took to master an even tougher task. A test using asphalt mixed with grease was prepared by the Swerea Research Institute. When this tough task was done, Tork cloths required up to 20% less energy to do the same job**. So not only do our cloths outperform rags, they even make tough jobs easier.

Energy



up to
20%
less energy**

easy tough

***Test one:** Removing paint that had dried for 4 minutes from a metal surface 60 x 90 cm with the aid of a solvent, white spirit. The paint, alkyd based primer, was applied by a roller. Panel participants started off by using 10 ml solvent and were able to add more solvent into the cloth in steps of 5 ml per occasion. Cotton rags and mixed rags were compared to Tork Heavy-Duty Cleaning Cloths. Panel test conducted by Swerea Research Institute, Sweden, 2014.

****Test two:** Removing 10 g of a mix of asphalt 2/3 and grease 1/3 that had dried for 1 hour, from a metal surface 60 x 90 cm with the aid of a degreaser, CRC brake degreaser. After the task, panel participants were asked to evaluate the energy/work needed on a 1–4 scale with perceived energy being: **1)** very easy, **2)** easy, **3)** tough, **4)** very tough. Cotton rags and mixed rags were compared to Tork Heavy Duty Cleaning Cloths and Tork Industrial Heavy-Duty Cleaning Cloths. Panel test conducted by Swerea Research Institute, Sweden, 2014.



Spend more time producing less time cleaning



If you're using rental shop towels for wiping and cleaning, Tork products can offer you measurable improvement.

Tork purpose-made wipers provide real value you can test. They're always consistent in quality, more effective and require less energy. Unlike rental shop towels, Tork cleaning cloths have never been used – so they are not stained, they don't smell and there are no surprises that could harm workers/equipment or delay production.

Safety is a priority

In addition to Tork performance advantages, there are also health and safety benefits. For example, Tork wipers are always new out of the box. This makes them cleaner and safer* compared to used rental shop towels because Tork wipers have:

- No chemical residues or stains from prior-usage
- No shards of metal to injure hands, damage equipment or finished goods
- No suspicious odors to endure while working
- No frayed edges that can catch in a machine

Reduce cost

Improve efficiency

Protect health and safety

Tests confirm our promise

We asked an independent research company to define some real tough tasks to test the performance of Tork wipers versus rental shop towels. The results were significant: less time and less solvent were used with Tork, less energy, too. These tests confirm our promise: Tork cleaning cloths can save you money and speed up your tasks so you can be ready sooner for production.

Tork wins over rentals

Cleaning time in seconds

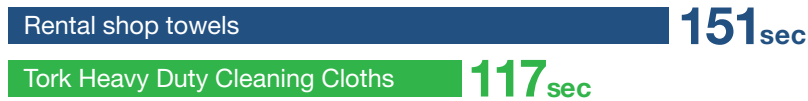

up to
23%
less time

Used amount of solvent (ml)



up to
27%
less solvent*

The toughest tasks are easier with Tork

We wanted to test the limits of our wipers and measure the energy it took to master an even tougher task. A test using asphalt mixed with grease was prepared by the Swerea Research Institute. When this tough task was done, Tork cleaning cloths required up to 20% less energy to do the same job**. So not only do our cloths outperform rental shop towels, they even make tough jobs easier.

Energy

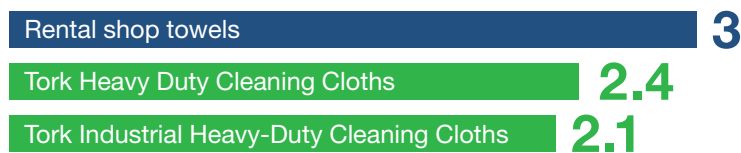

up to **20%**
less energy**

easy tough

***Test one:** Removing paint that had dried for 4 minutes from a metal surface 60 x 90 cm with the aid of a solvent, white spirit. The paint, alkyd based primer, was applied by a roller. Panel participant started off by using 10 ml solvent and was able to add more solvent into the cloth in steps of 5 ml per occasion. Rental shop towels were compared to Tork Heavy-Duty Cleaning Cloths. Panel test conducted by Swerea Research Institute, Sweden, 2014.

****Test two:** Removing 10 g of a mix of asphalt 2/3 and grease 1/3 that had dried for 1 hour, from a metal surface 60 x 90 cm with the aid of a degreaser, CRC brake degreaser. After the task, panel participants were asked to evaluate the energy/work needed on a 1-4 scale with perceived energy being; **1)** very easy, **2)** easy, **3)** tough, **4)** very tough. Rental shop towels were compared to Tork Heavy Duty Cleaning Cloths and Tork Industrial Heavy-Duty Cleaning Cloths. Panel test conducted by Swerea Research Institute, Sweden, 2014.



**Spend more time producing,
less time cleaning**



**Reduce cost
and improve
efficiency**

If you're still using traditional rags for wiping and cleaning, Tork products can offer you measurable improvement

Small changes can add up. Save a few seconds here or a few cents there and soon you'll have a real competitive advantage. The right tools could be the difference.

Tork cleaning cloths provide real, production-line advantages you can test. They're always consistent in quality and size, and are more effective using less energy to do the job. Unlike rags, Tork cleaning cloths are specifically designed for the job – with no risk of surprises that can slow routine maintenance or delay production.

Is it time to retire your old rags? Read on. We'll show you how the Tork range of cleaning cloths and convenient dispensers can help you realize performance efficiencies that your good-old rags can't deliver. We'll show you why customers like you are switching to Tork.

“It's simple. I make money making valves, not cleaning. A trusty cleaning cloth helps me and my machine get back to work faster.”

Mike Getoor, Leadman, Richards Industries, Cincinnati, Ohio



Saving time adds value

Do you have the right tool for the job?

We make a range of professional wipes for wiping, cleaning and polishing. Each one is designed for a specified task yet versatile enough for multi-purpose use. But like all tools, Tork wipers are designed to do the job right, time after time, without the risk of damaging equipment or your finished product. Consistency is key. Quality and performance never vary.

With the best wiper for the job selected and a handy dispenser nearby, your people save energy for what matters: production. No time is wasted going back and forth searching for the right one.



Save time for the work that adds value

- Improve workstation productivity
- Reduce workplace clutter
- Minimize downtime

Tests confirm our promise

We asked an independent research company to define some real tough tasks to test the performance of our cloths versus rags. The results were significant: less time and less solvent were used with Tork, less energy, too. These tests confirm our promise: Tork cleaning cloths can save you money and speed up your tasks so you can be ready sooner for production.

Tork wins over rags

Cleaning time in seconds



up to
32%
less time*

Used amount of solvent (ml)



up to
40%
less solvent*

The toughest tasks are easier with Tork

We wanted to test the limits of our cloths and measure the energy it took to master an even tougher task. A test using asphalt mixed with grease was prepared by the Swerea Research Institute. When this tough task was done, Tork cloths required up to 20% less energy to do the same job**. So not only do our cloths outperform rags, they even make tough jobs easier.

Energy



up to
20%
less energy**

easy tough

***Test one:** Removing paint that had dried for 4 minutes from a metal surface 60 x 90 cm with the aid of a solvent, white spirit. The paint, alkyd based primer, was applied by a roller. Panel participants started off by using 10 ml solvent and were able to add more solvent into the cloth in steps of 5 ml per occasion. Cotton rags and mixed rags were compared to Tork Heavy-Duty Cleaning Cloths. Panel test conducted by Swerea Research Institute, Sweden, 2014.

****Test two:** Removing 10 g of a mix of asphalt 2/3 and grease 1/3 that had dried for 1 hour, from a metal surface 60 x 90 cm with the aid of a degreaser, CRC brake degreaser. After the task, panel participants were asked to evaluate the energy/work needed on a 1-4 scale with perceived energy being: **1)** very easy, **2)** easy, **3)** tough, **4)** very tough. Cotton rags and mixed rags were compared to Tork Heavy Duty Cleaning Cloths and Tork Industrial Heavy-Duty Cleaning Cloths. Panel test conducted by Swerea Research Institute, Sweden, 2014.

Create less waste. Add more value.

Pound for pound, Tork cleaning cloths work smarter.

One rag weighs an average of eight times as much as one Tork Industrial Cleaning Cloth. They both can do the same job. Switch to Tork and your waste handling costs can be reduced by up to 80%.

Box versus bundle, packages of Tork cloths are easier to manage and store: Compressed bundles of rags use more than 4.5 times the space (when opened, even more).

When you add the operator's time and solvent costs saved as well, you can see how Tork cleaning cloths can save time, money and energy while helping to minimize environmental impact.

up to
80%
less waste and
handling cost



Rags use **4.5**
times more space



Improve workplace functionality – for people and profits

Today's lean manufacturing principles are making workplaces safer and more efficient.

If you're working with 5S, a workplace organization method which aims to create a functional, visually organized workplace that inspires productivity – then Tork systems, cleaning cloths and dispensers, can help you make a difference.

If rags are your standard, now is the time to challenge that standard and develop better methods. We can help you do more to reduce cost, improve efficiency and improve safety with a clean, orderly, more efficient working environment.



Put us
to the test



Are you ready to test the Tork system?

Tools are a source of pride for many workers. Put a better tool in a worker's hands and they'll do a better job. The same goes for their workplace. A well-organized environment with well-maintained machines inspires productivity and improves quality – that's real value your customers will pay for.







Tork Industrial wiping and cleaning systems raise the bar. They help minimize downtime to increase output – so you're ready to be more competitive. Ask your colleagues to test and compare Tork purpose-made industrial tools to working with rags. When everything is evaluated, the advantages for people and profits will be clear.



Turn preparation
time into
production time





Tork wipers and dispensers

Mobile	Wall mounted		
			
Tork Floor Stand SKU 6520281	Tork Wall Stand SKU 6521281	Tork Folded Wiper/ Cloth Dispenser: SKU 654021, 6540281	Tork Maxi Centerfeed Dispenser: SKU 653020, 653028



Cleaning						
<p>Tork Cleaning Cloth Tork Cleaning Cloth is a soft and flexible multi-purpose cloth that quickly absorbs liquids and oil. The cloth provides a professional cleaning result thanks to our excelCLEAN® wiper technology.</p> 		SKU 510104	●	●		
		SKU 510137				●
		SKU 510175A				
<p>Tork Heavy-Duty Cleaning Cloth This strong and absorbent multipurpose cloth works with most solvents. It is designed to protect your hands from heat and metal scraps. The cloth provides a professional cleaning result thanks to our excelCLEAN® wiper technology.</p> 		SKU 530104	●	●		
		SKU 530137				●
		SKU 530178			●	
		SKU 5301755				
		SKU 5301505				
		SKU 520304	●	●		
<p>Tork Industrial Cleaning Cloth Soft and flexible for light-to-medium tasks. Excellent in tight spaces. Ideal for oil and grease. Made with tork excelCLEAN® for faster professional results</p> 		SKU 520337	●	●		●
		SKU 520678			●	
		SKU 520371				
		SKU 570104	●	●		
<p>Tork Industrial Heavy-Duty Cleaning Cloth Our thickest and strongest cloths. Protects hands from heat and metal. High absorption capacity. Made with Tork excelCLEAN® for quicker, professional results</p> 		SKU 570137	●	●		●
		SKU 570478			●	

Tork wipers and dispensers

(continued)

Mobile	Wall mounted		
			
Tork Floor Stand SKU 6520281	Tork Wall Stand SKU 6521281	Tork Folded Wiper/ Cloth Dispenser: SKU 654021, 6540281	Tork Maxi Centerfeed Dispenser: SKU 653020, 653028

Cleaning (continued)						
Tork Low-Lint Cleaning Cloth A low-lint, flexible and drapable cloth that works well with solvents, detergents and disinfectants. Multipurpose. Handles most cleaning tasks		SKU 192479				
		SKU 192475				
Tork Industrial Low-Lint Cleaning Cloth An extremely low-linting, flexible and drapable cloth with anti-static properties that works well with solvents, detergents and disinfectants.		SKU 192578				
		SKU 192592				
ShopMax Hand Cleaner Bucket Convenient solution and time savings – clean hands are just a wipe away for on the go on site professionals since no added water or cleanser is required.		SKU 192592				
		SKU 192594				

Wiping						
Tork Industrial Paper Wiper A paper with excellent absorbency and wet strength that efficiently handles industrial spills, while being soft enough for glass cleaning.		SKU 13244101				
		SKU 440278				
		SKU 440245A				

Polishing						
Tork Polishing Cloth Soft and flexible. Precision fabric holds and releases polishing agents. Professional results without leaving a trace		SKU 197478				

Tork cleaning cloths with exelCLEAN® outperform textiles

Get professional results faster compared to rags and rental shop towels by using our exelCLEAN® cloths. Tests prove that with exelCLEAN®, our patented foam-spun technology you can:

- **Save time** – go from cleaning & preparation to production faster
- **Use less solvent** – save money, reduce solvent exposure and waste
- **Spend less energy** – make work easier, finish cleaning tasks sooner
- **Trust fresh-from-the-box quality** – feel safe, confident, get right to the task.



Contact

Sign up for a test so your workers will have the chance to evaluate our products. Contact your Tork representative.





Impress your customers, express your brand

The **Xpressnap AD-a-Glance**[®] feature is your window of opportunity—use the display panels to turn your dispenser into an onsite marketing tool.



One dispenser, Endless opportunities

Promote your products

- Broadcast food/drink specials
- List weekly specials
- Announce special events (farmhouse dinner, holiday hours, street fest)
- Highlight new menu items
- Create excitement for limited-time items
- Inform about extra services (catering, special events, party room)
- Boost sales of specialty items (desserts, appetizers)
- List entertainment/live music schedule

Showcase your business

- Promote your loyalty program
- Highlight your uniqueness (organic food, family values)
- Honor your employee of the month
- Share your environmental/green message
- Boast about your community involvement
- Explain your mission/history
- List additional locations or satellites
- Reinforce your legacy and traditions
- Remind guests of the breadth of your company (hotel, casino, spa)



Sell, barter & donate ad space

- Sell ad space to other local businesses (hardware store, accountant, pet sitter, museum)
- Sell ad space to community groups (high school theater, Little League, charities)
- Sell entire dispenser to co-sponsor (soda/beer, film distributor, TV network)
- Trade ad space for in-kind services/goods from other businesses (maintenance/repair, fresh flowers, radio ads)
- Offer ad space to local organizations; write off donation at tax time



Dispensing simple ways to get you ready for business



Customization

Custom-print napkins offer opportunities to make the most of every customer impression.

Napkins

Patented One Napkin, Every Time™ dispensing reduces napkin use by at least 25% Guaranteed!* and delivers hygiene and environmental benefits.

Operations

Keeps labor to a minimum— high-capacity, fewer refills, intuitive opening and loading.



Design

Streamlined design and stylish, contemporary colors seamlessly fit with the décor of any establishment.

Endless opportunities

AD-a-Glance® display panels present a marketing window of opportunity—use them to promote products, boost your brand or sell ad space.

Control consumption, capture attention

Every single Tork Xpressnap napkin dispenser performs double-duty making it easier for you to be ready for the next customer.



Maximize potential

Tork Xpressnap® is the world's most versatile tabletop display because it offers limitless opportunities for customization. A diverse palette of designer colors. The ability to custom print napkins. The space to make the most of every impression.

And best of all: AD-a-Glance display panels that help you boost your brand, promote products and make money.

It's a marketer's dream.

Minimize waste

Tork Xpressnap is North America's best-selling line of napkin dispensers because it reduces napkin usage by at least 25%—Guaranteed!* That means fewer refills and lower labor costs. Better hygiene for customers. A smaller footprint for the environment.

And thanks to the One-at-a-Time™ dispensing system, patrons touch and take only the napkins they use.

It's an accountant's best friend.



25%
reduction in
napkin use
guaranteed

* When compared to traditional napkin dispensers. Up to 250 money-back guarantee, when claimed within 90 days of purchase.

A dispenser that reduces waste, a display that boosts revenue

Tork Xpressnap can do twice as much for your business.

For more than 10 years, Tork Xpressnap has served up built-in value from foodservice counters across North America. Our innovative One-at-a-Time dispensing system **reduces napkin usage by at least 25% – Guaranteed!*** – saving you time, money, and effort, so you can be ready for what's next.

Product benefits

- Controls costs by reducing napkin usage by at least 25%
- Minimizes labor costs
- New stylish, modern, sleek design
- Improved operational functionality
- Increased napkin capacity
- Reduces waste, makes a smaller environmental footprint
- Offers improved hygiene to patrons and employees
- Range of models and colors perfectly suited for a variety of venues
- Boosts image and branding with AD-a-Glance panels
- Napkin refills are 100% recycled, compostable and third party certified

Additionally, the Xpressnap AD-a-Glance feature turns your dispenser into an on-site marketing tool to boost your business. Approximately 1/3 of 'napkin users' notice the AD-a-Glance promotion messaging on the table, and almost 1 in 10 take up the offer.



Reduce napkin usage by at least 25% - Guaranteed!*



Impress your customers, express your brand

Tork Xpressnap is the sleekest, smartest, most versatile napkin dispensing system out there. Add elegance and aesthetic appeal to your establishment while also controlling consumption. Improved operational functionality and increased napkin capacity delivers more value than ever.

Dispenser Models



Tabletop

- Smaller footprint is ideal for use at individual tables
- Improved lid opening makes it easy to load napkins
- Perfect for casual dining, quick service restaurants and cafes



Stand

- Side opening door makes loading napkins easy
- Door can also be hinged to open from either the left or right side
- Versatile wall mounting capability
- Great for high-traffic areas
- Perfect for stadiums, amusement parks and cafeterias



Counter

- Dispenses in both the horizontal and vertical position; adapts to any environment
- Ideal on busy counters
- Units can be stacked for added capacity
- Great for coffee shops, convenience stores and bakeries
- AD-a-Glance panels on both sides for display in vertical position



In-Counter

- Varying dispenser depths to fit most counter cabinets
- Easy mounting – no glue, caulk or tape required
- Adapts to existing in-counter fixtures
- Easy maintenance – removable lid for easy clean up



Café

- Perfect for small tables and crowded counters
- Ideal for ice cream stands, coffee/donut shops, pizza shops and bagel shops



Xpressnap Dispensers

Tabletop Napkin Dispensers



Dispenser size H x W x D (in)	Dispenser capacity	Units/Case
Image Aluminum 8.23 x 7.1 x 5.91 (20.90 x 18.03 x 15.01 cm)	Up to 150 (1-ply napkins)	1
Image Walnut 7.6 x 8 x 5.5 (19.30 x 20.32 x 13.97 cm)	Up to 150 (1-ply napkins)	1
Signature (black, gray, red, blue, green, stainless) 6.1 x 7.9 x 5.9 (15.49 x 20.07 x 14.99 cm)	Up to 250 (1-ply napkins)	4

Counter Napkin Dispensers



Dispenser size H x W x D (in)	Dispenser capacity	Units/Case
5.7 x 7.5 x 12.125 (14.48 x 19.05 x 30.73 cm)	Up to 500 (1-ply napkins)	1

Stand Napkin Dispensers

Wall Mount – The Signature stand can be easily mounted to the wall without any additional hardware. If you need to frequently remove the stand dispenser from the wall for cleaning, we offer a **Quick Release Bracket**. Please contact your Essity Sales Representative for more information.



Dispenser size H x W x D (in)	Dispenser capacity	Units/Case
24.5 x 9.25 x 9.25 (62.23 x 23.5 x 23.5 cm)	Up to 1,000 (1-ply napkins)	1

In-Counter Napkin Dispensers - 5" (Special order only)



Dispenser size H x W x D (in)	Dispenser capacity	Dispensers/Case
6.5" x 9.9" x 7.0" (16.51 x 25.15 x 17.78 cm)	Up to 250 (1-ply napkins)	1

In-Counter Napkin Dispensers - 12"



Dispenser size H x W x D (in)	Dispenser capacity	Dispensers/Case
13.5" x 9.9" x 7.0" (34.29 x 25.15 x 17.78cm)	Up to 600 (1-ply napkins)	1

In-Counter Napkin Dispensers - 20"



Dispenser size H x W x D (in)	Dispenser capacity	Dispensers/Case
21.5" x 9.9" x 7.0" (54.61 x 25.15 x 17.78cm)	Up to 1,000 (1-ply napkins)	1

Xpressnap Café Napkin Dispensers



Dispenser size H x W x D (in)	Disp. capacity	Units/Case
Image Aluminum 5.44 x 4.77 x 5.67 (13.82 x 12.12 x 14.4 cm)	Up to 75 (1-ply napkins)	4
Image Walnut 4.6 x 5.75 x 5.4 (11.68 x 14.61 x 13.72 cm)	Up to 75 (1-ply napkins)	4
Classic (black, granite, red, green) 6.2 x 5.875 x 5.875 (15.75 x 14.92 x 14.92 cm)	Up to 75 (1-ply napkins)	4

Tabletop, Counter, Stand, In-Counter Napkin Refills



SKUs	Description	Color	Ply	Size (W X L)	Napkins/Bag	Napkins/Case	Certification
13680	Tork Premium Extra Soft Xpressnap Dispenser Napkin, Interfold - N4	White w/ Leaf	2	12.9" x 8.5" (32.77 x 21.59cm)	500 / Poly Bag	4000	N/A
DX990	Tork Advanced Plus Xpressnap Dispenser Napkin, Interfold - N4	White	2	6.5" x 8.5" (16.51 x 21.59cm)	400 / Bag	4800	C ♻️
DX900	Tork Advanced Xpressnap Dispenser Napkin, Interfold - N4	White	1	13" x 8.5" (33.02 x 21.59cm)	500 / Bag	6000	C ♻️
DX906E	Tork Universal Xpressnap Dispenser Napkin, Interfold - N4	Natural	1	13" x 8.5" (33.02 x 21.59cm)	500 / Bag	6000	C E ♻️
908EX	Tork Universal Xpressnap Environmental Print Dispenser Napkin, Interfold - N4	Natural	1	13" x 8.5" (33.02 x 21.59cm)	500 / Bag	6000	C E ♻️

Café Napkin Refills



SKUs	Description	Color	Ply	Size (W X L)	Napkins/Bag	Napkins/Case	Certification
13681	Tork Premium Extra Soft Xpressnap Café Dispenser Napkin, Interfold - N10	White w/ Leaf	2	8.5" x 8.5" (21.59 x 21.59cm)	500 / Poly Bag	4000	N/A
DX600	Tork Advanced Xpressnap Café Dispenser Napkin, Interfold - N10	White	1	8.5" x 8.5" (21.59 x 21.59cm)	500 / Bag	6000	C ♻️
DX606E	Tork Universal Xpressnap Café Dispenser Napkin, Interfold - N10	Natural	1	8.5" x 8.5" (21.59 x 21.59cm)	500 / Bag	6000	C E ♻️

Tabletop, Counter, Stand, In-Counter Custom Print Napkin Refills

Promote your brand and increase customer satisfaction. Add your logo or message in up to two colors.



Sample registered



Sample random

SKUs	Description	Color/Pattern	Ply	Ink Colors	Size (W X L)	Napkins/Bag	Napkins/Case	Certification
991	Tork Advanced Plus Xpressnap Custom Print Dispenser Napkin, Interfold - N4	White, Random & Registered	2	1-2	6.5" x 8.5" (16.51 x 21.59cm)	400 / Bag	4800	C ♻️
901	Tork Advanced Xpressnap Custom Print Dispenser Napkin, Interfold - N4	White, Random	1	1-2	13" x 8.5" (33.02 x 21.59cm)	500 / Bag	6000	C ♻️
902	Tork Advanced Xpressnap Custom Print Dispenser Napkin, Interfold - N4	White, Registered	1	1-2	13" x 8.5" (33.02 x 21.59cm)	500 / Bag	6000	C ♻️
907	Tork Universal Xpressnap Custom Print Dispenser Napkin, Interfold - N4	Natural, Random	1	1-2	13" x 8.5" (33.02 x 21.59cm)	500 / Bag	6000	C E ♻️
908	Tork Universal Xpressnap Custom Print Dispenser Napkin, Interfold - N4	Natural, Registered	1	1-2	13" x 8.5" (33.02 x 21.59cm)	500 / Bag	6000	C E ♻️

Café Custom Print Napkin Refills



Sample registered



Sample random

SKUs	Description	Color/Pattern	Ply	Ink Colors	Size (W X L)	Napkins/Bag	Napkins/Case	Certification
607	Tork Universal Xpressnap Café Custom Print Dispenser Napkin, Interfold - N10	White Random & Registered	1	1-2	8.5" x 8.5" (21.59 x 21.59cm)	500 / Bag	6000	C ♻️
608	Tork Universal Xpressnap Café Custom Print Dispenser Napkin, Interfold - N10	Natural Random & Registered	1	1-2	8.5" x 8.5" (21.59 x 21.59cm)	500 / Bag	6000	C E ♻️



ECOLOGO®
PRODUCT CERTIFIED FOR REDUCED ENVIRONMENTAL IMPACT.
VIEW SPECIFIC ATTRIBUTES EVALUATED:
CCD-082 Toilet Tissue, CCD-083 Facial Tissue,
CCD-084 Table Napkins, CCD-085 Kitchen Towels, CCD-086 Hand Towels.



100% Recycled



Compostable



Green Seal Certified



EPA compliant. Contains a minimum of 40% post-consumer waste.

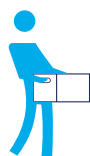

Xpressnap available in Tork Easy Handling™ packaging

Essity offers Easy Handling packaging, a patented assortment of innovative and ergonomic solutions to ease the workload of facility staff while saving time and money. Easy Handling packaging includes the Tork Carry Box™ for our Tork Xpressnap napkins. (Easy Handling packaging not included with custom printed napkins.)



Easy to carry thanks to perforated fold-outs.



Boxes open quickly without cutting.



Use 2 hands for a comfortable grip.



Fold box for easy disposal.

One dispenser, endless opportunities

The Xpressnap AD-a-Glance feature is your window of opportunity. Use the display panels to turn your dispenser into an onsite marketing tool that gets you ready for business.

Boost Your Sales

In a recent study of the AD-a-Glance system, Essity found that customers are not only receptive to the advertising on the dispenser, but they act on it as well.

Tabletop marketing

Tabletop marketing messages drive repeat business and inspire recommendations.** Choose to promote your loyalty program, cross sell other menu items or generate revenue by selling the advertising space to other businesses.

Templates Made Easy

It takes just seconds to insert your printed menu or advertisement into the transparent display frame. Create your own template or simply choose from our large selection of online templates.



Approximately
1/3 of 'napkin
users' notice
the AD-a-Glance
promotion and
almost 1 in 10
take up the offer.*



Promote your products

- Highlight new items
- Feature LTO's
- Announce special events



Showcase your Business

- Explain your history
- List other locations
- Share your green message



Sell & Donate Ad Space

- Sell ad space
- Trade ad space for goods/services
- Offer space to local organizations

*Intermetra Business & Market research Group August 2012

**Tork/NRA Tabletop Marketing Research May 2013



Small footprint, big savings



Reduce cost, save space

The space-saving design of our Tork Xpressnap® Café dispenser makes it perfect for establishments with small tables and limited countertops. One Napkin, Every Time™ dispensing delivers better hygiene and reduces napkin usage by 25%—guaranteed!*

AD-a-Glance® insert panels help to promote your messages and boost your business. Dispensers are available in four stylish colors to match your decor. Tork 100% recycled napkins in white and kraft can be custom printed with your logo and message.

- Reduces napkin usage, controls costs
- Minimizes labor costs
- Reduces waste
- Offers improved hygiene to patrons and employees
- Ideal for ice cream stands, coffee/donut shops, pizza shops and bagel shops



Tork Xpressnap Classic Café Napkin Dispensing System – N10

SKU	Description	Color	Size H x W x D (in)	Case
32XRT	Tork Xpressnap Café Napkin Dispenser	Black	6.2 x 5.875 x 5.875 (15.75 x 14.92 x 14.92 cm)	4
31XRT	Tork Xpressnap Café Napkin Dispenser	Granite	6.2 x 5.875 x 5.875 (15.75 x 14.92 x 14.92 cm)	4
41XRT	Tork Xpressnap Café Napkin Dispenser	Red	6.2 x 5.875 x 5.875 (15.75 x 14.92 x 14.92 cm)	4
45XRT	Tork Xpressnap Café Napkin Dispenser	Green	6.2 x 5.875 x 5.875 (15.75 x 14.92 x 14.92 cm)	4

Café napkin refills



SKU	Description	Color	Ply	Napkin Size W x L (in)	Napkins/Bag	Case	Certification
DX600	Tork Advanced Xpressnap Café Dispenser Napkin, Interfold	White	1	8.5 x 8.5 (21.59 x 21.59 cm)	500/bag	6,000	C ♻️
DX606E	Tork Advanced Xpressnap Café Dispenser Napkin, Interfold	Natural	1	8.5 x 8.5 (21.59 x 21.59 cm)	500/bag	6,000	C E ♻️

Café custom print napkin refills



Sample registered



Sample random

SKU	Description	Color	Ply	Ink Colors	Napkin Size W x L (in)	Napkins/Bag	Case	Certification
607	Tork Advanced Xpressnap Café Custom Print Dispenser Napkin, Interfold	White Random & Registered	1	1-2	8.5 x 8.5 (21.59 x 21.59 cm)	500/bag	6,000	C ♻️
608	Tork Advanced Xpressnap Café Custom Print Dispenser Napkin, Interfold	Natural Random & Registered	1	1-2	8.5 x 8.5 (21.59 x 21.59 cm)	500/bag	6,000	C E ♻️

Tork Easy Handling™

With Tork Carry Box™, cases are easier to carry, open and dispose—designed to improve ergonomics and staff efficiency.





Details matter, make them count





You know that look

It's your guest—enjoying your establishment, delighted by the attention to detail, appreciating every comfort you've considered. It's how you know you've served a memorable experience. It's the moment Tork Xpressnap® Image is made for.

Tork Xpressnap Image Napkin Dispensing Systems

Available in:

- Aluminum and Walnut
- Traditional and Café



reddot award 2014
winner





Serve your guests a memorable experience

A touch of style

Genuine aluminium and wood materials complement your space and show customers you care.

A luxurious feel

Premium 2-ply napkins are crafted to deliver unequaled softness, along with an elegant leaf design.

Attractive savings

One-at-a-time dispensing reduces napkin usage by at least 25% compared to traditional dispensers—guaranteed*.

Award-winning design

Winner of the 2014 Red Dot award for Product Design.

Premium Extra Soft Napkins

Available in:

- White Leaf design
- Traditional and Café



For added elegance, our premium, extra soft napkins feature a white print leaf design, with 6 different repeating leaf patterns throughout each napkin sleeve.

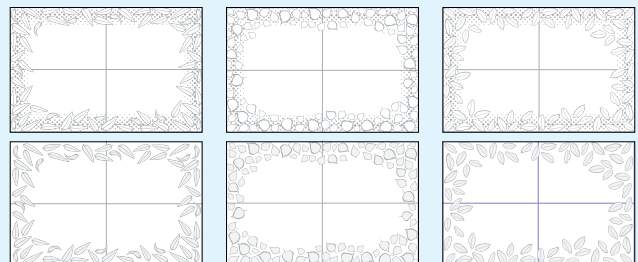

Eucalyptus Leaf

Birch Leaf

Walnut Leaf

“Guests notice the details at my hotel. When we wanted a better napkin dispensing method, we chose Tork Xpressnap Image—it looks modern and well-suited to our décor.”

Owner, 3-Star Hotel and Spa Grand Palais, Lille, France



Tork Xpressnap Image Napkin Dispensers (N4)

SKU	Color	Dispenser/Case
73350	Aluminum	1
Dispenser Dimensions		Dispenser Capacity
8.23 x 7.1 x 5.91 in (20.9 x 17.8 x 15 cm)		up to 150

SKU	Color	Dispenser/Case
72900	Walnut	1
Dispenser Dimensions		Dispenser Capacity
7.6 x 8 x 5.5 in (19.3 x 20.3 x 13.6 cm)		up to 150



73350
Aluminum



72900
Walnut

Tork Premium Extra Soft Xpressnap Dispenser Napkin Refills

SKU	Description		
13680	Tork Extra Soft Xpressnap Dispenser Napkin, Interfolded - N4		
Ply	Color	Open Size (W X L)	Easy Handling
2	White with Leaf	13 x 8.5 (33 x 21.6 cm)	Carry Box
Napkins/Sleeve	Sleeves/Poly Bag	Poly Bags/Case	Napkins/Case
100	5	8	4000



13680

Tork Xpressnap Café Image Napkin Dispenser (N10)

SKU	Color	Dispenser/Case
75350	Aluminum	4
Dispenser Dimensions		Dispenser Capacity
5.44 x 4.77 x 5.67 in (13.8 x 12.1 x 14.4 cm)		up to 75

SKU	Color	Dispenser/Case
75900	Walnut	4
Dispenser Dimensions		Dispenser Capacity
4.6 x 5.75 x 5.4 in (11.6 x 14.6 x 13.6 cm)		up to 75



75350
Aluminum



75900
Walnut

Tork Premium Extra Soft Xpressnap Café Dispenser Napkin Refills

SKU	Description		
13681	Tork Extra Soft Xpressnap Café Dispenser Napkin, Interfolded - N10		
Ply	Color	Open Size (W X L)	Easy Handling
2	White with Leaf	8.5 x 8.5 (21.6 x 21.6 cm)	Carry Box
Napkins/Sleeve	Sleeves/Poly Bag	Poly Bags/Case	Napkins/Case
100	5	8	4000



13681



Details matter in your restaurant, make them count



reddot award 2014
winner



SCA
Care of Life

Serve your guests a memorable experience

A touch of style

Genuine aluminium and wood materials complement your space and show customers you care.

A luxurious feel

Premium 2-ply napkins are crafted to deliver unequaled softness, along with an elegant leaf design.

Attractive savings

One-at-a-time dispensing reduces napkin usage by at least 25% compared to traditional dispensers — guaranteed*.

Award-winning design

Winner of the 2014 Red Dot award for Product Design.

“Guests notice the details at my hotel. When we wanted a better napkin dispensing method, we chose Tork Xpressnap Image—it looks modern and well-suited to our décor.” **Owner, 3-Star Hotel and Spa Grand Palais, Lille, France**

Tork Xpressnap® Image Napkin Dispensers (N4)



SKU	Color	Dispenser/Case
73350	Aluminum	1
Dispenser Dimensions		Dispenser Capacity
8.23 x 7.1 x 5.91 in (20.9 x 17.8 x 15 cm)		up to 150

SKU	Color	Dispenser/Case
72900	Walnut	1
Dispenser Dimensions		Dispenser Capacity
7.6 x 8 x 5.5 in (19.3 x 20.3 x 13.6 cm)		up to 150

Tork Premium Extra Soft Xpressnap Dispenser Napkin Refills



SKU	Description		
13680	Tork Extra Soft Xpressnap Dispenser Napkin - N4		
Ply	Color	Open Size (W X L)	Easy Handling
2	White with leaf	13 x 8.5 (33 x 21.6 cm)	Carry Box
Napkins/Sleeve	Sleeves/Poly Bag	Poly Bags/Case	Napkins/Case
100	5	8	4000

Tork Xpressnap Café Image Napkin Dispenser (N10)



SKU	Color	Dispenser/Case
75350	Aluminum	4
Dispenser Dimensions		Dispenser Capacity
5.44 x 4.77 x 5.67 in (13.8 x 12.1 x 14.4 cm)		up to 75

SKU	Color	Dispenser/Case
75900	Walnut	4
Dispenser Dimensions		Dispenser Capacity
4.6 x 5.75 x 5.4 in (11.6 x 14.6 x 13.6 cm)		up to 75

Tork Premium Extra Soft Xpressnap Café Dispenser Napkin Refills



SKU	Description		
13681	Tork Extra Soft Xpressnap Café Dispenser Napkin - N10		
Ply	Color	Size (W X L)	Easy Handling
2	White with leaf	4.25 x 4.25 (10.80 x 10.80 cm)	Carry Box
Napkins/Sleeve	Sleeves/Poly Bag	Poly Bags/Case	Napkins/Case
100	5	8	4000

For added elegance, our premium, extra soft napkins feature a white print leaf design, with 6 different repeating leaf patterns throughout each napkin sleeve.

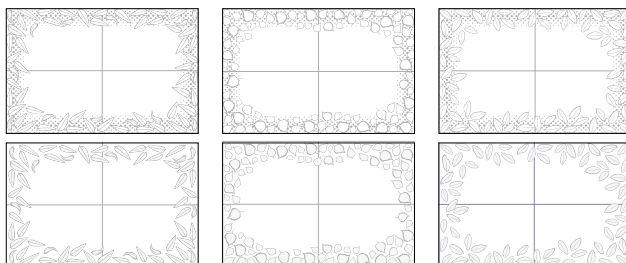

Eucalyptus Leaf

Birch Leaf

Walnut Leaf





Versatile, space-saving design



Hands-free, controlled consumption

Tork Xpressnap® became one of North America's bestselling napkin dispensers by making the most of every napkin. The new, versatile, space-saving Xpressnap Signature In-Counter dispensing system helps you make the most of every counter. With various depth options, our innovative design is ideal for high-traffic areas or wherever space is at a premium. Just drop it into a new or pre-existing counter opening and it's good to go.

Product benefits

- Varying dispenser depths
- Versatile cut out area fits most pre-existing openings
- Easily mounts without caulk, glue or tape
- No latches, keys or locks for opening
- Red base provides distinct fill indicator

In-Counter Napkin Dispensers - 12"



6032120
black



6035120
stainless finish

Dispenser size H x W x D (in)	Dispenser capacity	Dispensers/Case
13.5" x 9.9" x 7.0" (34.29 x 25.15 x 17.78cm)	Up to 600 (1-ply napkins)	1

In-Counter Napkin Dispensers - 5" (Special order only)



6032050
black



6035050
stainless finish

Dispenser size H x W x D (in)	Dispenser capacity	Dispensers/Case
6.5" x 9.9" x 7.0" (16.51 x 25.15 x 17.78 cm)	Up to 250 (1-ply napkins)	1

In-Counter Napkin Dispensers - 20"



6032200
black



6035200
stainless finish

Dispenser size H x W x D (in)	Dispenser capacity	Dispensers/Case
21.5" x 9.9" x 7.0" (54.61 x 25.15 x 17.78cm)	Up to 1,000 (1-ply napkins)	1

In-Counter Napkin Refills



SKUs	Description	Color	Ply	Size (W X L)	Napkins/Bag	Napkins/Case	Certification
13680	Tork Premium Extra Soft Xpressnap Dispenser Napkin, Interfold - N4	White w/ Leaf	2	12.9" x 8.5" (32.77 x 21.59cm)	500 / Poly Bag	4000	N/A
DX990	Tork Advanced Plus Xpressnap Dispenser Napkin, Interfold - N4	White	2	6.5" x 8.5" (16.51 x 21.59cm)	400 / Bag	4800	C ♻️
DX900	Tork Advanced Xpressnap Dispenser Napkin, Interfold - N4	White	1	13" x 8.5" (33.02 x 21.59cm)	500 / Bag	6000	C ♻️
DX906E	Tork Universal Xpressnap Dispenser Napkin, Interfold - N4	Natural	1	13" x 8.5" (33.02 x 21.59cm)	500 / Bag	6000	C E ♻️
908EX	Tork Universal Xpressnap Environmental Print Dispenser Napkin, Interfold - N4	Natural	1	13" x 8.5" (33.02 x 21.59cm)	500 / Bag	6000	C E ♻️

In-Counter Custom Print Napkin Refills

Promote your brand and increase customer satisfaction. Add your logo or message in up to two colors.



Sample registered



Sample random

SKUs	Description	Color/Pattern	Ply	Ink Colors	Size (W X L)	Napkins/Bag	Napkins/Case	Certification
991	Tork Advanced Plus Xpressnap Custom Print Dispenser Napkin, Interfold - N4	White, Random & Registered	2	1-2	6.5" x 8.5" (16.51 x 21.59cm)	400 / Bag	4800	C ♻️
901	Tork Advanced Xpressnap Custom Print Dispenser Napkin, Interfold - N4	White, Random	1	1-2	13" x 8.5" (33.02 x 21.59cm)	500 / Bag	6000	C ♻️
902	Tork Advanced Xpressnap Custom Print Dispenser Napkin, Interfold - N4	White, Registered	1	1-2	13" x 8.5" (33.02 x 21.59cm)	500 / Bag	6000	C ♻️
907	Tork Universal Xpressnap Custom Print Dispenser Napkin, Interfold - N4	Natural, Random	1	1-2	13" x 8.5" (33.02 x 21.59cm)	500 / Bag	6000	C E ♻️
908	Tork Universal Xpressnap Custom Print Dispenser Napkin, Interfold - N4	Natural, Registered	1	1-2	13" x 8.5" (33.02 x 21.59cm)	500 / Bag	6000	C E ♻️



ECOLOGO®
PRODUCT CERTIFIED FOR REDUCED ENVIRONMENTAL IMPACT.
VIEW SPECIFIC ATTRIBUTES EVALUATED:
CCD-082 Toilet Tissue, CCD-093 Facial Tissue,
CCD-084 Table Napkins CCD-085 Kitchen Towels, CCD-086 Hand Towels.



100% Recycled



Compostable



EPA compliant. Contains a minimum of 40% post-consumer waste.



Control consumption capture attention



Tork Xpressnap® is the sleekest, smartest, most versatile napkin dispensing system out there. The streamlined profile adds elegance and aesthetic appeal while the improved operational functionality and increased napkin capacity delivers more value than ever.

25%

reduction in
napkin use
guaranteed



Minimize waste

Tork Xpressnap is North America's best-selling line of napkin dispensing systems because it reduces napkin usage by at least 25%—Guaranteed!* That means fewer refills and lower labor costs. Better hygiene for customers. A smaller footprint for the environment. And thanks to the One Napkin, Every Time™ dispensing system, patrons touch and take only the napkins they use.

Maximize potential

AD-a-Glance® is our unique display-advertising feature that gives you the creative space to sell your specials and beef up your brand image. Choose to cross sell other menu items or generate revenue by selling the advertising space to other businesses.

Tabletop Napkin Dispensers



73350 aluminum 72900 walnut 6232000 black 6234000 gray



6236000 red 6233001 blue 6239000 green 6235000 stainless finish

Dispenser size H x W x D (in)	Dispenser capacity	Units/Case
Image Aluminum 8.23 x 7.1 x 5.91 (20.90 x 18.03 x 15.01 cm)	Up to 150 (1-ply napkins)	4
Image Walnut 7.6 x 8 x 5.5 (19.30 x 20.32 x 13.97 cm)	Up to 150 (1-ply napkins)	4
Signature (black, gray, red, blue, green, stainless) 6.1 x 7.9 x 5.9 (15.49 x 20.07 x 14.99 cm)	Up to 250 (1-ply napkins)	4

Stand Napkin Dispensers

Wall Mount – The Signature stand can be easily mounted to the wall without any additional hardware. If you need to frequently remove the stand dispenser from the wall for cleaning, we offer a **Quick Release Bracket**. Please contact your Essity Sales Representative for more information.



6332000 black 6334000 gray 6336000 red 6333001 blue 6339000 green

Dispenser size H x W x D (in)	Dispenser capacity	Units/Case
24.5 x 9.25 x 9.25 (62.23 x 23.5 x 23.5 cm)	Up to 1,000 (1-ply napkins)	1

Café Napkin Dispensers



75350 aluminum 75900 walnut 32XRT black 31XRT granite 41XRT red 45XRT green

Dispenser size H x W x D (in)	Disp. capacity	Units/Case
Image Aluminum 5.44 x 4.77 x 5.67 (13.82 x 12.12 x 14.4 cm)	Up to 75 (1-ply napkins)	4
Image Walnut 4.6 x 5.75 x 5.4 (11.68 x 14.61 x 13.72 cm)	Up to 75 (1-ply napkins)	4
Classic (black, granite, red, green) 6.2 x 5.875 x 5.875 (15.75 x 14.92 x 14.92 cm)	Up to 75 (1-ply napkins)	4

Xpressnap Café Refills

Tork Premium Extra Soft, White w/Leaf – 13681
Tork Advanced, White – DX600
Tork Universal, Natural – Dx606E



Counter Napkin Dispensers



6432000 black 6434000 gray 6436000 red 6435000 stainless finish

Dispenser size H x W x D (in)	Dispenser capacity	Units/Case
5.7 x 7.5 x 12.125 (14.48 x 19.05 x 30.73 cm)	Up to 500 (1-ply napkins)	1

In-Counter Napkin Dispensers

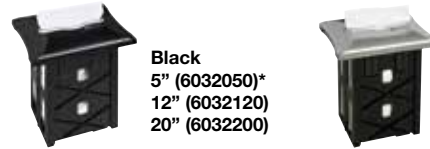

*Special order only

Black
5" (6032050)*
12" (6032120)
20" (6032200)

Stainless finish
5" (6035050)*
12" (6035120)*
20" (6035200)*

Dispenser size H x W x D (in)	Dispenser capacity	Units/Case
5" 6.5 x 9.9 x 7.0 (16.51 x 25.15 x 17.78 cm)	Up to 250 (1-ply napkins)	1
12" 13.5" x 9.9" x 7.0" (34.29 x 25.15 x 17.78cm)	Up to 600 (1-ply napkins)	1
20" 21.5" x 9.9" x 7.0" (54.61 x 25.15 x 17.78cm)	Up to 1,000 (1-ply napkins)	1

Xpressnap Refills

Tork Premium Extra Soft, White w/Leaf – 13680
Tork Advanced Plus White – DX990
Tork Advanced, White – DX900
Tork Universal, Natural – DX906E
Tork Universal, Natural – 908EX
w/Environmental Print



Packaging that's easier to handle

Tork Xpressnap napkins are packaged in Tork Carry Box™ which is part of Tork Easy Handling™ packaging, a patented assortment of innovative and ergonomic solutions to ease the workload of facility staff while saving time and money.



Easy to carry thanks to perforated fold-outs.



Use 2 hands for a comfortable grip.



Boxes open quickly without cutting.



Fold box for easy disposal.



ECOLOGO®
PRODUCT CERTIFIED FOR REDUCED ENVIRONMENTAL IMPACT.
VIEW SPECIFIC ATTRIBUTES EVALUATED:
CCD-062 Toilet Tissue, CCD-063 Facial Tissue,
CCD-084 Table Napkins CCD-085 Kitchen Towels, CCD-086 Hand Towels.

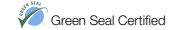



Unlock your hidden potential



All Tork Xpress Recessed Towel Cabinet Adapters help you unlock these unique benefits:

- One-at-a-time dispensing controls consumption and reduces waste.
- No need to renovate. Quick and easy to install in most folded stainless steel towel cabinets.
- Go ahead and fill it up. Our unique design ensures smooth dispensing with no messy paper tabs on the floor. From the first to the last towel, your users will have a great experience.
- Cost-effective upgrade for most towel cabinets. Big and small, on or in the wall, they fit most designs and styles.



Transform any standard cabinet into an efficient, high-capacity Tork Folded Towel dispenser, delivering one-at-a-time, consumption controlled dispensing!

Folded towel upgrades available in 3 easy-to-fit sizes

Tork® Xpress Recessed Towel Cabinet Adapters reduce towel waste from product fall out, helping eliminate associated costs.



309695
Tork Xpress® Large Recessed Cabinet Towel Adapter



309696
Tork Xpress Medium Recessed Cabinet Towel Adapter



309697
Tork Xpress Small Recessed Cabinet Towel Adapter

SKU	Description	Color	Material	Adapter Size H x W x D (in)	Adapters/Case
309695	Tork Xpress Large Recessed Cabinet Towel Adapter (works with all H2 and H23 refills except for the MB576)	White	Plastic	19.65 x 10.039 x 3.7 (49.91 x 25.5 x 9.4 cm)	1
309696	Tork Xpress Medium Recessed Cabinet Towel Adapter (works with all H2 and H23 refills except for the MB576)	White	Plastic	17.32 x 10.039 x 3.7 (43.99 x 25.5 x 9.4 cm)	1
309697	Tork Xpress Small Recessed Cabinet Towel Adapter (works with all H2 and H23 refills except for the MB576)	White	Plastic	5.078 x 10.94 x 3.7 (12.9 x 27.79 x 9.4 cm)	1



Compatible with Tork EasyCube™ Intelligent Restroom System



One-at-a-time dispensing improves hygiene and reduces waste



Ideal for high-end washrooms

The Tork Xpress® Countertop dispenser comes in finger-proof stainless steel or in high-gloss white/black plastic. It delivers self-presenting single hand towels that offer a cost-effective and hygienic solution for your needs.



Impress your customers with an elegant washroom

This dispenser is designed as a superior alternative to loose stacks of towels in a basket or tray. This enclosed dispenser will prevent towels from getting wet or damaged, which helps to reduce waste. The one-at-a-time dispensing will improve hygiene and ensure a high-end towel dispensing experience.

- Modern design and compact size perfect for washroom countertops
- One-at-a-time dispensing for improved hygiene helps minimize overconsumption
- 25% usage reduction, guaranteed, when compared to a stack of loose towels
- Finger-proof stainless steel or high-gloss white/black plastic for easy maintenance
- Compatible with most high-end Tork hand towels, providing the best customer experience
- Enclosed housing protects towels inside the dispenser for improved hygiene and reduced waste
- Refill level indicator and overfill protection for easy maintenance
- Anti-slip pads for improved dispensing
- 2013 ISSA Innovation Award Dispensers Category Winner



Tork Xpress Countertop Multifold Hand Towel Dispensers

SKU	Name	Color	Material	Size H x W x D (in)	Units/Case	System ID
302030	Tork Image Design™ Xpress Countertop Multifold Hand Towel Dispenser	Stainless Steel	Metal/Plastic	7.92 x 12.68 x 4.56 (20.12 x 32.21 x 11.58 cm)	1	H2/H23
302028	Tork Xpress Countertop Multifold Hand Towel Dispenser	Black	Plastic	7.92 x 12.68 x 4.56 (20.12 x 32.21 x 11.58 cm)	1	H2/H23
302020	Tork Xpress Countertop Multifold Hand Towel Dispenser	White	Plastic	7.92 x 12.68 x 4.56 (20.12 x 32.21 x 11.58 cm)	1	H2/H23

The Tork Xpress Countertop dispensers are compatible with Tork high-end multifold hand towel refills: 100297, 101293, 420554, 420558, 420570, 424814, 424864, MB572, MB574, MB578, MB554, MB558, and MB568



Tork Xpressnap Image Napkin Dispensing Systems **FREQUENTLY ASKED QUESTIONS**

They're here! We are excited to announce the North American launch of the award-winning Tork Xpressnap Image Napkin Dispensing Systems, designed to meet the needs of upscale, design-conscious, self-service establishments.

What is the launch timing?

The Internal launch announcement date is March 16, 2015; dispensers and napkin refills will be available to distribution and customers beginning April 1, 2015.

What is included in this launch?

The comprehensive Tork Xpressnap Image launch includes 4 dispensers and 2 extra soft napkin refills.

Dispensers:

- 73350 - Tork Xpressnap Image Napkin Dispenser Aluminum
- 72900 - Tork Xpressnap Image Napkin Dispenser Walnut
- 75350 - Tork Xpressnap Cafe Image Napkin Dispenser Aluminum
- 75900 - Tork Xpressnap Cafe Image Napkin Dispenser Walnut

Refills:

- 13680 - Tork Premium Extra Soft Xpressnap Dispenser Napkin Refills
- 13681 - Tork Premium Extra Soft Xpressnap Cafe Dispenser Napkin Refills

Are any current items being discontinued?

No.

How are the napkin refills packed?

Each case contains 4,000 napkins packed 100 per bundle, 5 bundles per poly pack, and 8 poly packs per case.

Will the napkin refill packaging include the new Tork Carry Pack feature?

Yes. The new napkin refills will feature the Tork Easy Handling Carry Box feature.

Is custom printing available for the Extra Soft napkin refills?

Not at this time. The new Extra Soft napkin refills feature an elegant leaf design printed in white ink on the napkin. There are 6 different repeating leaf patterns throughout each napkin bundle adding an elegant touch

What are the dispenser capacities?

The large dispensers hold up to 150 2-ply Extra Soft dispenser napkins. The Cafe dispensers hold up to 75 2-ply Extra Soft dispenser napkins. Dispenser capacities will vary depending on the napkin refill used.

Where should the dispensers be placed?

The large dispenser is more appropriate for countertop placements, while the Cafe dispenser will work well on tables or in small areas.

Are the refills and dispensers interchangeable with the existing Xpressnap refills and dispensers?

Yes. However, while the new Extra Soft refills will fit in to the existing Signature and Cafe dispensers, we believe they are best suited for use in the new Tork Xpressnap Image dispenser line, and vice versa.

Do we guarantee 25% usage reduction?

Yes. The Tork Xpressnap Image napkin dispensing system guarantees a usage reduction of at least 25% guaranteed – when compared to traditional napkin dispensers. We believe that most of the targets for the Xpressnap Image line will not be using traditional dispensers, so the guarantee would not apply. But, we do believe they will see some sort of usage reduction.

How do I know when to lead with Xpressnap Image instead of Xpressnap Signature?

Xpressnap Signature is well suited to a more functional, higher volume type of customer. These establishments are lower price point customers, who care more about cost and expect a discounted dispenser. These establishments might include: QSRs, Education, Sports & Entertainment, Hospitals, Offices, Self-service cafeterias.

Tork Xpressnap Image is targeting self-service, more upscale/design conscious establishments who are willing to pay a bit more for the right napkin dispensing system. These customers are looking for a napkin dispenser system made from high quality, genuine materials, delivering one-at-a-time dispensing.

Quality oriented LSRs, Airport VIP lounges, Hotel bar, lounge; buffet, Contract Catering, Premium conference centers, Retail grocery market cafés, Country clubs, and Cafés are the best targets for this new dispensing system.

Are the napkins exposed on the side of the walnut dispenser?

Yes. The sides of the walnut dispenser are exposed, and this was an intentional part of the design. The target customers for these dispensers are looking for dispensers that fit within their environment and add to the overall customer experience.

How do I open and load the dispensers?

Both dispenser systems open from the bottom. For ease, the Tork Select label inside each dispenser contains a QR code that will direct you to a loading video.

To open the Walnut dispenser, place the dispenser upside down on a counter. Locate the opening on the bottom panel and pull up to open the dispenser. Place the Tork Xpressnap Extra Soft dispenser napkins into the dispenser. Once the napkins are loaded, close the bottom panel and turn the dispenser over. Start the first napkin by reaching into the mouth of the dispenser lid with your thumb and finger. Pull through the mouth and the napkin is ready to use.

To open the aluminum dispenser, place the dispenser on its side on a counter. Locate the button on the bottom of the aluminum sleeve. Push in the button, and then push one side of the plastic tray to slide the tray out of the aluminum sleeve. Place the Tork Xpressnap Extra Soft dispenser napkins into the dispenser. Once the napkins are loaded, slide the plastic tray back into the aluminum sleeve until the button clicks back into place. Start the first napkin by reaching into the mouth of the dispenser lid with your thumb and finger. Pull through the mouth and the napkin is ready to use.

A quick tip to avoid over stuffing: in the same way that Xpressnap Signature Tabletop cannot hold one full sleeve, the Xpressnap Image Cafe cannot hold one full sleeve.

Instructional videos for opening and loading have been developed for this launch. You can find these on the Tork Insider App and SMART.

What does the FSC certification mean for the walnut dispensers?

Similarly to FSC certification on our paper products, the FSC® trademarks offer a guarantee that products come from responsible sources.

What should I do with my sample kit?

Your sample kit should be utilized for distributor presentations, end customer calls and shows. The dispensers in this kit are your samples to keep *and reuse* for all of your sales calls. Please do not give your samples away, as we have limited dispenser quantities available for samples. Additional napkins and brochures can be ordered through fulfillment as needed.

What is the sample policy?

Samples will be available through fulfillment beginning March 23rd.

Due to the cost the dispensers, as well as the on-going effort to better manage our dispenser inventory, sample availability will be limited for the Xpressnap Image line through fulfillment and customer service.

Sales will only be able to order samples through fulfillment. For dispensers, the maximum order quantity will be 1 per sku per rep per month, with a total annual allowance per sku of 4.

The maximum order quantity for refills will be 1 poly sleeve (500) per sku per month.

Any requests beyond the sample policy will need to be submitted to Susan Murphy.

Can I order samples for my broker?

Should you have a need for broker samples, please request through Susan Murphy. All brokers will be required to take the e-learning webinar prior to samples shipping.

Are these dispensers included in the “Large Volume Dispenser Process”?

Yes, we have added Tork Xpressnap Image to the process at the 50 dispenser threshold.

Any opportunity requiring **50 or more dispensers** will be required to follow this process, which includes a communication to our Planning team when 50 or more dispensers is involved in the opportunity. For questions, or more information on this process, please reach out to Cheryl Tyler or Herb Giebisch.

What is the “Red Dot Award”?

The Tork Xpressnap Image Napkin Dispensers have been awarded the Red Dot Award for product design, an internationally recognized seal of quality in product design.

Manufacturers and designers from around the world are invited to enter their products in the renowned design competition. An international jury of independent design experts evaluates every submission and awards only the best products with the sought-after “Red Dot” quality seal.

This is not our first win with the Red Dot award. The Elevation line received the same honor in 2009.

Are these dispensers included in the Tork Select program?

Yes. Only Tork Select distributors will have access to the new Image dispensers.

Will the price point keep us from being competitive?

This dispenser may not be a fit for all your distributors. Look at the target list, review your distributor’s customer base and determine if it is the right fit.

It is important to understand that deviations will be limited and highly scrutinized. Our pricing is structured to protect our investment and capture the value of this innovation.

If you find that your customer is focused on price or cost of the dispenser, this is most likely not the line for them and you should guide them to Xpressnap Signature.