



SIMPSON

**PROFESSIONAL PRESSURE WASHER
INSTRUCTION
MANUAL**



**LOOK BEFORE
YOU PUMP!**

Ethanol Percentage

<10% **OK** **NO** 15% - 30% - 85%

**DO NOT USE FUEL CONTAINING
GREATER THAN 10% ETHANOL!**

NOTE: Photographs and line drawings used in this manual are for reference only and do not represent a specific model.

IMPORTANT: Please make certain that the person who is to use this equipment carefully reads and understands these instructions before operating.

SAVE THIS MANUAL FOR FUTURE REFERENCE

SAFETY GUIDELINES - DEFINITIONS

This manual contains information that is important for you to know and understand. This information relates to protecting YOUR SAFETY and PREVENTING EQUIPMENT PROBLEMS. To help you recognize this information, we use the symbols below. Please read the manual and pay attention to these symbols.

⚠ DANGER: Indicates an imminently hazardous situation which, if not avoided, **will** result in **death or serious injury**.

⚠ WARNING: Indicates a potentially hazardous situation which, if not avoided, **could** result in **death or serious injury**.

⚠ CAUTION: Indicates a potentially hazardous situation which, if not avoided, **may** result in **minor or moderate injury**.

NOTICE: Indicates a practice **not related to personal injury** which, if not avoided, **may** result in **property damage**.

IMPORTANT SAFETY INSTRUCTIONS

⚠ DANGER: Carbon Monoxide. Using an engine indoors can kill you in minutes. Engine exhaust contains high levels of carbon monoxide (CO), a poisonous gas you cannot see or smell. You may be breathing CO even if you do not smell engine exhaust.

- **NEVER** use an engine inside homes, garages, crawlspaces or other partly enclosed areas. Deadly levels of carbon monoxide can build up in these areas. Using a fan or opening windows and doors does **NOT** supply enough fresh air.
- **ONLY** use outdoors and far away from open windows, doors and vents. These openings can pull in engine exhaust.
- Even when the engine is used correctly, CO may leak into your home. **ALWAYS** use a battery-powered or battery backup CO alarm in your house. **Read and follow all directions for CO alarm before using.** If you feel sick, dizzy or weak at anytime, move to fresh air immediately. See a doctor. You could have carbon monoxide poisoning.

⚠ WARNING: Do not operate this unit until you read this instruction manual and the engine instruction manual for safety, operation and maintenance instructions.

⚠ DANGER: Risk of injection or severe injury. Keep clear of nozzle. Do not direct discharge stream at persons or live animals. This product is to be used only by trained operators.

⚠ WARNING: This product and its exhaust can expose you to chemicals including lead and lead compounds, and carbon monoxide, which are known to the State of California to cause cancer and birth defects or other reproductive harm.

⚠ WARNING: Always wear appropriate personal hearing and other protection during use. Under some conditions and duration of use, noise from this product may contribute to hearing loss.

⚠ WARNING: This product may not be equipped with a spark-arresting muffler. If the product is not equipped and will be used around flammable materials or on land covered with materials such as agricultural crops, forest, brush, grass or other similar items, then an approved spark arrester must be installed and is legally required in the state of California. It is a violation of California statutes section 130050 and/or sections 4442 and 4443 of the California Public Resources Code, unless the engine is equipped with a spark arrester, as defined in section 4442, and maintained in effective working order. Spark arresters are also required on some U.S. Forest Service land and may also be legally required under other statutes and ordinances.

SAVE THESE INSTRUCTIONS



⚠ DANGER: RISK OF EXPLOSION OR FIRE

WHAT CAN HAPPEN	HOW TO PREVENT IT
<ul style="list-style-type: none"> Spilled gasoline and its vapors can become ignited from cigarette sparks, electrical arcing, exhaust gases and hot engine components such as the muffler. 	<ul style="list-style-type: none"> Shut off engine and allow it to cool before adding fuel to the tank. Use care in filling tank to avoid spilling fuel. Move pressure washer away from fueling area before starting engine.
<ul style="list-style-type: none"> Heat will expand fuel in the tank which could result in spillage and possible fire explosion. 	<ul style="list-style-type: none"> Keep maximum fuel level 1/2" (12.7 mm) below bottom of filler neck to allow for expansion.
<ul style="list-style-type: none"> Operating the pressure washer in an explosive environment could result in a fire. 	<ul style="list-style-type: none"> Operate and fuel equipment in well-ventilated areas free from obstructions. Equip areas with fire extinguisher suitable for gasoline fires.
<ul style="list-style-type: none"> Materials placed against or near the pressure washer can interfere with its proper ventilation features causing overheating and possible ignition of the materials. 	<ul style="list-style-type: none"> Never operate pressure washer in an area containing dry brush or weeds.
<ul style="list-style-type: none"> Muffler exhaust heat can damage painted surfaces, melt any material sensitive to heat (such as siding, plastic, rubber, vinyl or the pressure hose, itself), and damage live plants. 	<ul style="list-style-type: none"> Always keep pressure washer a minimum of 4' (1.2 m) away from surfaces (such as houses, automobiles or live plants) that could be damaged from muffler exhaust heat.
<ul style="list-style-type: none"> Improperly stored fuel could lead to accidental ignition. Fuel improperly secured could get into the hands of children or other unqualified persons. 	<ul style="list-style-type: none"> Store fuel in an OSHA approved container, in a secure location away from work area.
<ul style="list-style-type: none"> Use of acids, toxic or corrosive chemicals, poisons, insecticides, or any kind of flammable solvent with this product could result in serious injury or death. 	<ul style="list-style-type: none"> Do not spray flammable liquids.



⚠ DANGER: RISK TO BREATHING (ASPHYXIATION)

WHAT CAN HAPPEN	HOW TO PREVENT IT
<ul style="list-style-type: none"> Breathing exhaust fumes will cause serious injury or death! Engine exhaust contains carbon monoxide, an odorless and deadly gas. 	<ul style="list-style-type: none"> Operate pressure washer in a well-ventilated area. Avoid enclosed areas such as garages, basements, etc. Never operate unit in or near a location occupied by humans or animals.
<ul style="list-style-type: none"> Some cleaning fluids contain substances which could cause injury to skin, eyes or lungs. 	<ul style="list-style-type: none"> Use only cleaning fluids specifically recommended for high pressure washers. Follow manufacturers recommendations. Do not use chlorine bleach or any other corrosive compound.



⚠ DANGER: RISK OF FLUID INJECTION AND LACERATION

WHAT CAN HAPPEN	HOW TO PREVENT IT
<ul style="list-style-type: none"> Your pressure washer operates at fluid pressures and velocities high enough to penetrate human and animal flesh which could result in amputation or other serious injury. Leaks caused by loose fittings or worn or damaged hoses can result in injection injuries. DO NOT TREAT FLUID INJECTION AS A SIMPLE CUT! See a physician immediately! 	<ul style="list-style-type: none"> Inspect the high pressure hose regularly. Replace the hose immediately if it is damaged, worn, has melted from contacting the engine, or shows any signs of cracks, bubbles, pinholes, or other leakage. Never grasp a high pressure hose that is leaking or damaged. Never touch, grasp or attempt to cover a pinhole or similar water leak on the high pressure hose. The stream of water IS under high pressure and WILL penetrate skin. Never place hands in front of nozzle. Direct spray away from self and others. Make sure hose and fittings are tightened and in good condition. Never hold onto the hose or fittings during operation. Do not allow hose to contact muffler. Never attach or remove wand or hose fittings while system is pressurized. When using replacement lances or guns with this pressure washer, DO NOT use a lance and/or lance/gun combination that is shorter in length than what was provided with this pressure washer as measured from the nozzle end of the lance to the gun trigger.
<ul style="list-style-type: none"> Injuries can result if system pressure is not reduced before attempting maintenance or disassembly. 	<ul style="list-style-type: none"> To relieve system pressure, shut off engine, turn off water supply and pull gun trigger until water stops flowing. Use only accessories rated equal to or higher than the rating of the pressure washer.



⚠ DANGER: RISK OF INJURY FROM SPRAY

WHAT CAN HAPPEN	HOW TO PREVENT IT
<ul style="list-style-type: none">• <i>High-velocity fluid spray can cause objects to break, projecting particles at high speed.</i>	<ul style="list-style-type: none">• <i>Always wear ANSI-approved Z87.1 safety glasses. Wear protective clothing to protect against accidental spraying.</i>• <i>Never point wand at or spray people or animals.</i>
<ul style="list-style-type: none">• <i>Light or unsecured objects can become hazardous projectiles.</i>	<ul style="list-style-type: none">• <i>Always secure trigger lock when wand is not in service to prevent accidental operation.</i>• <i>Never permanently secure trigger in pull-back (open) position.</i>



⚠ DANGER: RISK OF UNSAFE OPERATION

WHAT CAN HAPPEN	HOW TO PREVENT IT
<ul style="list-style-type: none">• <i>Unsafe operation of your pressure washer could lead to serious injury or death to you or others.</i>	<ul style="list-style-type: none">• <i>Do not use chlorine bleach or any other corrosive compound.</i>• <i>Become familiar with the operation and controls of the pressure washer.</i>• <i>Keep operating area clear of all persons, pets and obstacles.</i>• <i>Do not operate the product when fatigued or under the influence of alcohol or drugs. Stay alert at all times.</i>• <i>Never compromise the safety features of this product.</i>• <i>Do not operate machine with missing, broken or unauthorized parts.</i>• <i>Never leave wand unattended while unit is running.</i>
<ul style="list-style-type: none">• <i>If proper starting procedure is not followed, engine can kickback causing serious hand and arm injury.</i>	<ul style="list-style-type: none">• <i>If engine does not start after two pulls, squeeze trigger of gun to relieve pump pressure. Pull starter cord slowly until resistance is felt. Then pull cord rapidly to avoid kickback and prevent hand or arm injury.</i>
<ul style="list-style-type: none">• <i>The spray gun/wand is a powerful cleaning tool that could look like a toy to a child.</i>	<ul style="list-style-type: none">• <i>Keep children away from the pressure washer at all times.</i>
<ul style="list-style-type: none">• <i>Reactive force of spray will cause gun/wand to kickback, and could cause the operator to slip or fall or misdirect the spray. Improper control of gun/wand can result in injuries to self and others.</i>	<ul style="list-style-type: none">• <i>Do not overreach or stand on an unstable support.</i>• <i>Do not use pressure washer while standing on a ladder.</i>• <i>Grip gun/wand firmly with both hands. Expect the gun to kickback when triggered.</i>



⚠ DANGER: RISK OF INJURY OR PROPERTY DAMAGE WHEN TRANSPORTING OR STORING

WHAT CAN HAPPEN

HOW TO PREVENT IT

- | | |
|--|--|
| <ul style="list-style-type: none"> • Fuel or oil can leak or spill and could result in fire or breathing hazard. Serious injury or death can result. Fuel or oil leaks will damage carpet, paint or other surfaces in vehicles or trailers. • Oil could fill the cylinder and damage the engine if the unit is not stored or transported in an upright position. | <ul style="list-style-type: none"> • If pressure washer is equipped with a fuel shut-off valve, turn the valve to the OFF position before transporting to avoid fuel leaks. If pressure washer is not equipped with a fuel shut-off valve, drain the fuel from tank before transporting. Only transport fuel in an OSHA-approved container. • Always place pressure washer on a protective mat when transporting to protect against damage to vehicle from leaks. • Always transport and store unit in an upright position. Remove pressure washer from vehicle immediately upon arrival at your destination. |
|--|--|



⚠ DANGER: RISK OF ELECTRICAL SHOCK

WHAT CAN HAPPEN

HOW TO PREVENT IT

- | | |
|--|---|
| <ul style="list-style-type: none"> • Spray directed at electrical outlets or switches, or objects connected to an electrical circuit, could result in a fatal electrical shock. | <ul style="list-style-type: none"> • Unplug any electrically operated product before attempting to clean it. Direct spray away from electric outlets and switches. |
|--|---|



⚠ DANGER: RISK OF CHEMICAL BURN

WHAT CAN HAPPEN

HOW TO PREVENT IT

- | | |
|--|---|
| <ul style="list-style-type: none"> • Use of acids, toxic or corrosive chemicals, poisons, insecticides, or any kind of flammable solvent with this product could result in serious injury or death. | <ul style="list-style-type: none"> • Do not spray acids, gasoline, kerosene, or any other flammable materials with this product. Use only household detergents, cleaners and degreasers recommended for use with pressure washers. • Wear protective clothing to protect eyes and skin from contact with sprayed materials. |
|--|---|



⚠ WARNING: RISK OF BURSTING

WHAT CAN HAPPEN	HOW TO PREVENT IT
<ul style="list-style-type: none"> Over inflation of tires could result in serious injury and property damage. 	<ul style="list-style-type: none"> Use a tire pressure gauge to check the tires pressure before each use and while inflating tires; see the tire sidewall for the correct tire pressure. <p>NOTE: Air tanks, compressors and similar equipment used to inflate tires can fill small tires similar to these very rapidly. Adjust pressure regulator on air supply to no more than the rating of the tire pressure. Add air in small increments and frequently use the tire gauge to prevent over inflation.</p>
<ul style="list-style-type: none"> High-velocity fluid spray directed at pneumatic tire sidewalls (such as found on automobiles, trailers and the like) could damage the sidewall resulting in serious injury. 	<ul style="list-style-type: none"> On pressure washers rated above 1600 PSI (11032 kPa) use the widest fan spray (40° nozzle) and keep the spray a minimum of 8" (20 cm) from the pneumatic tire sidewall. Do not aim spray directly at the joint between the tire and rim.



⚠ WARNING: RISK OF HOT SURFACES

WHAT CAN HAPPEN	HOW TO PREVENT IT
<ul style="list-style-type: none"> Contact with hot surfaces, such as engine exhaust components, could result in serious burn. 	<ul style="list-style-type: none"> During operation, touch only the control surfaces of the pressure washer. Keep children away from the pressure washer at all times. They may not be able to recognize the hazards of this product.



⚠ WARNING: RISK OF INJURY FROM LIFTING

WHAT CAN HAPPEN	HOW TO PREVENT IT
<ul style="list-style-type: none"> Serious injury can result from attempting to lift too heavy an object. 	<ul style="list-style-type: none"> The pressure washer is too heavy to be lifted by one person. Obtain assistance from others before lifting.

**SAVE THESE INSTRUCTIONS
FOR FUTURE USE**

QUICK SETUP GUIDE

⚠ WARNING: To reduce the risk of injury, read the pressure washer instruction manual and the engine instruction manual before operating pressure washer.

A

Install the Handle

Slide the handle assembly onto the frame. (if equipped) Align holes in the top handle with the mounting holes in the handle assembly. Secure with saddle bolts and knobs.

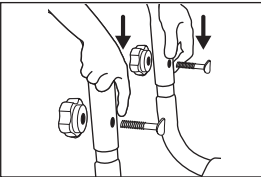

OR

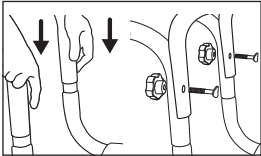

B

Add/Check Oil

The engine is shipped without oil. Before starting engine, add the oil provided. Check oil level prior to each use. Refer to **Engine Owner's Manual** for complete procedure.

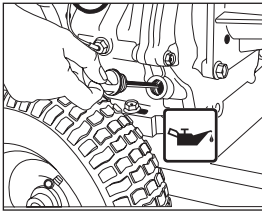

C

Add Gasoline

In a well ventilated outdoor area add fresh, high quality, unleaded gasoline with a pump octane rating of 86 or higher. Do not overfill. Wipe up spilled fuel before starting the engine. Refer to **Engine Owner's Manual** for complete procedure.

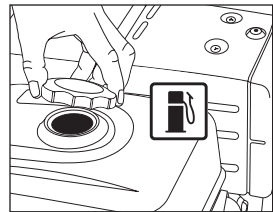

IMPORTANT: Ethanol Shield™ (sold separately) is a fuel stabilizer that helps eliminate and prevent ethanol related problems in power equipment. Follow the instructions on the container and add to the gasoline.

QUICK START GUIDE

⚠ DANGER:

- Never run engine indoors or in enclosed, poorly ventilated areas. Engine exhaust contains carbon monoxide, an odorless and deadly gas.
- Risk of fluid injection and laceration. When using the high-pressure setting, DO NOT allow the high-pressure spray to come in contact with unprotected skin, eyes or with any pets or animals. Serious injury will occur.

1**Connect Garden Hose to Pump**

Thread the garden hose to the pump inlet.

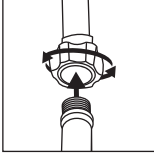
**2****Connect High Pressure Hose to Pump**

Connect the high pressure hose to the pump outlet.

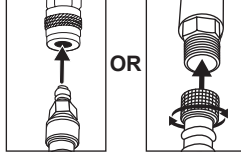
**3****Connect High Pressure Hose to Spray Gun**

Thread the other end of the high pressure hose to the spray gun.

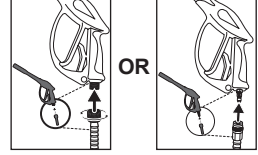
**4****Connect Spray Wand to Spray Gun**

Thread the spray wand into the end of the spray gun.

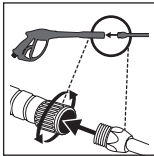
**5****Connect QC Nozzles to Spray Wand**

Pull quick connect coupler back and insert nozzle. Release quick connect coupler and twist nozzle to make sure it is secure in coupler.

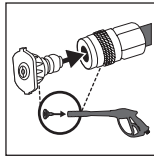
**6****Turn Water Faucet Completely On**

Do not run the unit without water supply connected and turned on. Use Cold Water Only.

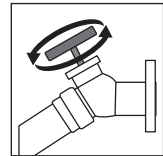
**7****Release Air from System**

Release all air from pump and high pressure hose by depressing trigger until a steady stream of water is present. Approximately 30 seconds.

**8**

Start engine. See **Engine Owner's Manual** for correct procedure.

⚠ WARNING: This Guide is not a substitute for reading the operator's manual. User must read and understand operator's manual before using this product.

GET TO KNOW THE PRESSURE WASHER

NOTE: Photographs and line drawings used in this manual are for reference only and do not represent a specific model.

Compare the illustrations with your unit to familiarize yourself with the location of various controls and adjustments. Save this manual for future reference.

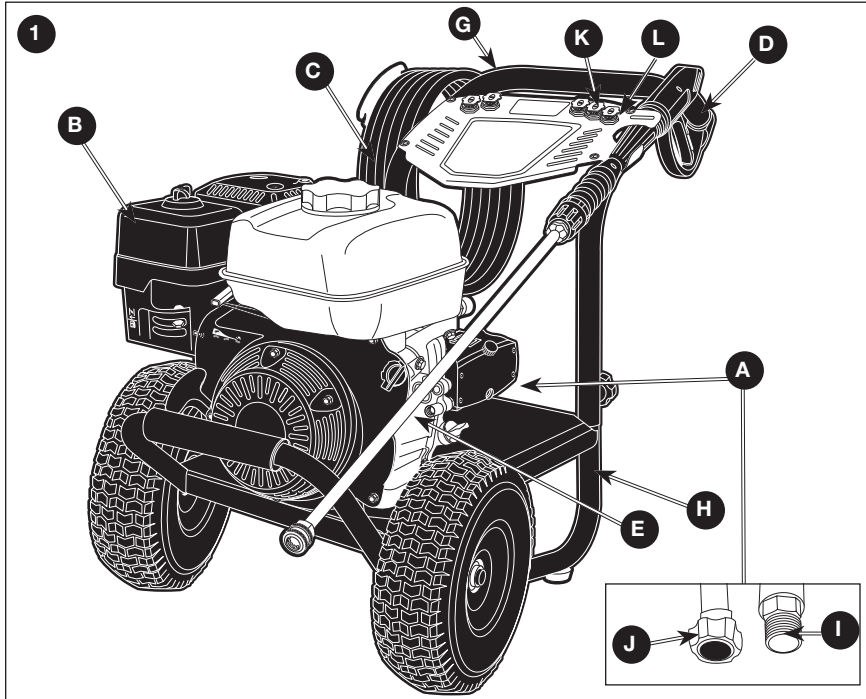

BASIC ELEMENTS OF A PRESSURE WASHER (FIG. 1)

- A. **High Pressure Pump:** Increases the pressure of the water supply.
- B. **Engine:** Drives the high pressure pump. Refer to the **Engine Owner's Manual** for location and operation of engine controls.
- C. **High Pressure Hose:** Carries the pressurized water from the pump to the gun and spray wand.
- D. **Spray Gun:** Connects with spray wand to control water flow rate, direction and pressure.
- E. **Quick-Connect Spray Wand:** Allows the user to quickly change out high pressure nozzles. See **How To Use Spray Wand** instructions in *Operation* section.
- F. **Detergent Siphon Hose (not shown):** Feeds cleaning agents into the pump to mix with the water. See **How To Apply Chemicals/Cleaning Solvents** instructions in *Operation* section.
- G. **Handle**
- H. **Frame**
- I. **Pump Outlet**

- J. Pump Inlet
- K. Quick Connect Nozzles
- L. Nozzle Holder

BASIC ELEMENTS OF AN ENGINE

Refer to the **Engine Owner's Manual** for location and operation of engine controls.

Choke Control: Opens and closes carburetor choke valve.

Starter Grip: Pulling starter grip operates recoil starter to crank engine.

Engine Switch: Enables and disables ignition system.

ASSEMBLY INSTRUCTIONS (FIG. 2-4)

1. Locate and remove all loose parts from the carton.
2. Cut four corners of the carton from top to bottom and lay the panels flat.
3. **(Figure 2)** Slide the handle assembly (G) onto the frame (H) and secure with saddle bolts and knobs.

OR

3. **(Figure 2A)** Align holes in the top handle (S) with the mounting holes in the handle assembly (G). Insert saddle bolts (DD) through aligned holes and secure top handle to handle assembly with knobs (EE). Tighten until snug.

NOTICE: Risk of personal injury. Avoid placing hands between handle and frame when assembling to prevent pinching.

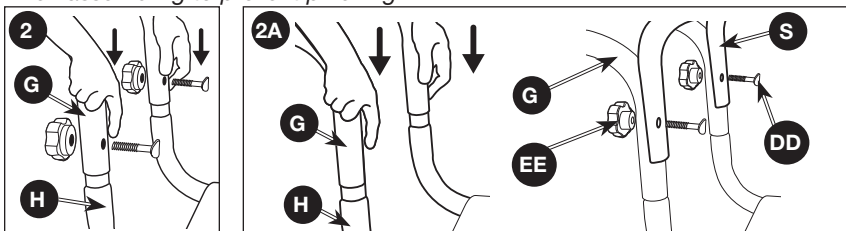

4. Remove the colored quick-connect nozzles (K) from the plastic bag and insert them into correct grommet on the nozzle holder (L). Nozzles are color coded to match colored nozzles on label.

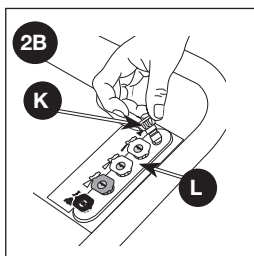

5. Connect wand (E) to gun (D). Tighten securely.

6. Attach high pressure hose (C) to gun (D). Tighten securely.

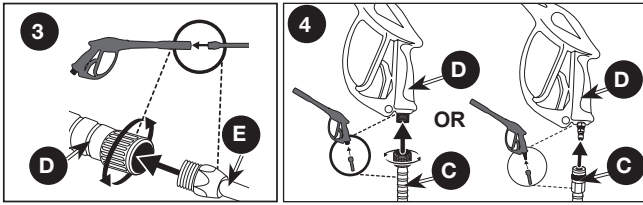

NOTICE: The engine is shipped without oil. Before starting engine, add the oil provided. Damage to the engine will occur if the engine is run without oil, this damage will not be covered under warranty.

NOTICE: The high-pressure pump was filled with oil at the factory. Always check oil level before using (refer to **Maintenance** for more information).

OPERATION

PRESSURE WASHER TERMINOLOGY

PSI: Pounds per Square Inch. The unit of measure for water pressure. Also used for air pressure, hydraulic pressure, etc.

PSI*: Pounds per Square Inch. The unit of measure for water pressure. Also used for air pressure, hydraulic pressure, etc.

GPM*: Gallons per Minute. The unit of measure for the flow rate of water.

* *Rated Pressure and Rated Water Flow is within manufacturing tolerance of (+/- 10%).*

Bypass Mode: Allows water to re-circulate within the pump when the gun trigger is not pulled. This feature allows the operator to release the trigger gun and reposition themselves without having to turn the engine off in between cleaning actions.

⚠ WARNING: Do not allow the unit to run for more than two minutes without the gun trigger being pulled. This could cause overheating and damage to the pump. When the temperature inside the pump rises too high, the thermal relief valve will open and release a spray of water from the pump to lower the internal temperature. The valve will then close.

Thermal Relief Valve (P, Fig. 5): When the temperature inside the pump rises too high, this valve will open and release a gush of water in an effort to lower the temperature inside the pump. The valve will then close. **NOTE:** Thermal relief valve location will vary depending on the pump type.

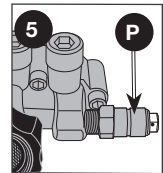

Detergent Injection System: Mixes cleaners or cleaning solvents with the water to improve cleaning effectiveness.

Water Supply: All pressure washers must have a source of water. The minimum requirements for a water supply are 20 PSI and 5 Gallons Per Minute. If your water source is a well, the garden hose length can only be 30 ft. (9 m) max.

⚠ WARNING: To reduce the possibility of contamination always protect against backflow when connected to a potable water system.

PRESSURE WASHER OPERATING FEATURES

PRESSURE ADJUSTMENTS (FIG. 6)

The pressure setting is preset at the factory to achieve optimum pressure and cleaning. If you need to lower the pressure, it can be accomplished by these methods.

1. **Back away from the surface to be cleaned.** The further away you are, the less the pressure will be on the surface to be cleaned.
2. **Change to the 40° nozzle (white).** This nozzle delivers a less powerful stream of water and a wider spray pattern. Refer to **How To Use Spray Wand**.
3. **(if equipped)** This pressure washer's high pressure pump is equipped with an additional feature that allows the pressure setting to be adjusted.

To lower the pressure, turn the pressure control knob on the pump counterclockwise to the desired pressure.

To return the pump pressure to the factory setting, turn the pressure control knob on the pump clockwise until it stops.

NOTICE: DO NOT overtighten the pressure control knob, if overtightened the knob COULD break and result in immediate loss of water pressure and costly repairs to the unit.

DIAL-N-WASH ADJUSTMENT (FIG. 7, 8) (IF EQUIPPED)

1. Choose the correct high pressure nozzle (0°, 15° or 40°) for the job to be performed. Refer to **How To Use Spray Wand**.
2. The Dial-N-Wash is shipped in the MAX pressure setting, the MAX pressure bar is aligned with the arrow (R) on the collar as shown in Figure 7.

Rotating the Dial-N-Wash (Q) counterclockwise until it stops places it in the MIN pressure setting, the arrow (R) will align with the MIN pressure bar as shown in Figure 8.

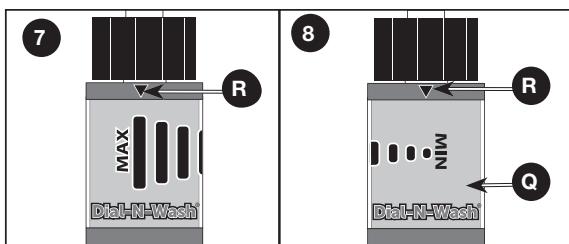

Adjust the pressure by rotating the Dial-N-Wash (Q) clockwise for higher pressure or counterclockwise for lower pressure, aligning the arrow with the desired pressure bar on the Dial-N-Wash.



NOTE: To apply chemicals the black low pressure nozzle must be installed and the Dial-N-Wash must be in the MAX pressure setting.

HOW TO USE SPRAY WAND

The nozzles for the spray wand are stored in the nozzle holder on the panel assembly. Colors on the panel identify nozzle location and spray pattern. Refer to the following chart to choose the correct nozzle for the job to be performed.

CHANGING NOZZLES ON SPRAY WAND (FIG. 9)

⚠ DANGER: Risk of fluid injection. Do not direct discharge stream toward persons, unprotected skin, eyes or any pets or animals. Serious injury will occur.

⚠ WARNING: Flying objects could cause risk of serious injury. Do not attempt to change nozzles while pressure washer is running. Turn engine off before changing nozzles.

1. Pull quick-connect coupler (E) back and insert nozzle (K).
2. Release quick-connect coupler and twist nozzle to make sure it is secure in coupler.

⚠ WARNING: Flying object could cause risk of serious injury. Ensure nozzle is completely inserted in quick-connect socket and quick-connect collar is fully engaged (forward) before squeezing gun trigger.

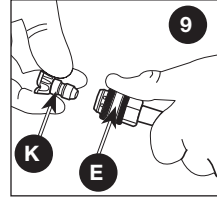

NOZZLE COLOR	SPRAY PATTERN	USES	SURFACES**
Red		powerful pinpoint for spot cleaning of hard, unpainted surfaces or for high reach areas	unpainted metal or concrete; DO NOT use on wood
Yellow		intense cleaning of unpainted hard surfaces	grills, driveways, concrete or brick walkways, unpainted brick or stucco
Green		standard cleaning nozzle for most applications	yard tools, sidewalks, lawn furniture, unpainted siding, stucco, gutters and eaves, concrete, brick surfaces
White		cleaning of painted or delicate surfaces	auto/RV, marine, wood, painted brick and stucco, vinyl, painted siding
Black		applies cleaning solutions	Low pressure spray is safe on all surfaces. Always verify compatibility of cleaning solution prior to use.

****NOTICE:** The high pressure spray from your pressure washer is capable of causing damage to surfaces such as wood, glass, automobile paint, auto striping and trim, and delicate objects such as flowers and shrubs. Before spraying, check the item to be cleaned to assure yourself that it is strong enough to resist damage from the force of the spray.

HOW TO APPLY CHEMICALS/CLEANING SOLVENTS (FIG. 10)

Applying chemicals or cleaning solvents is a low pressure operation. **NOTE:** Use only soaps and chemicals designed for pressure washer use. **Do not use bleach.**

To Apply Chemicals:

1. Ensure detergent siphon hose (F, Figure 10) is attached to barbed fitting location near high pressure hose connection of pump as shown. **NOTE:** The barbed fitting location will vary depending on the pump type.
2. Place other end of detergent siphon hose with filter on it into container holding chemical/cleaning solution. **NOTE:** For every 7 gallons of water pumped 1 gallon of chemical/cleaning solution will be used.
3. Install low pressure (black) nozzle into quick connect fitting of spray wand, see **How To Use Spray Wand** paragraph in this section.
4. After use of chemicals, place detergent siphon hose into container of clean water and draw clean water through chemical injection system to rinse system thoroughly. If chemicals remain in the pump, it could be damaged. Pumps damaged due to chemical residue will not be covered under warranty.

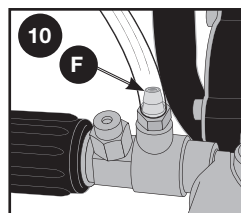

NOTE: Chemicals and soaps will not siphon if the black soap nozzle is not installed on the spray wand.

STARTING (FIG. 11–14)

⚠ WARNING: To reduce the risk of injury, read the pressure washer instruction manual and the engine instruction manual before starting pressure washer.

⚠ DANGER: Risk of fluid injection and laceration. When using the high pressure setting, **DO NOT** allow the high pressure spray to come in contact with unprotected skin, eyes, or with any pets or animals. Serious injury will occur.

- Your washer operates at fluid pressures and velocities high enough to penetrate human and animal flesh, which could result in amputation or other serious injury. Leaks caused by loose fittings or worn or damaged hoses can result in injection injuries. **DO NOT TREAT FLUID INJECTION AS A SIMPLE CUT!** See a physician immediately!

⚠ DANGER: Carbon Monoxide. Using an engine indoors can kill you in minutes. Engine exhaust contains high levels of carbon monoxide (CO), a poisonous gas you cannot see or smell. You may be breathing CO even if you do not smell engine exhaust.

- Breathing exhaust fumes will cause serious injury or death! Engine exhaust contains carbon monoxide, an odorless and deadly gas.
- Operate pressure washer in a well-ventilated area. Avoid enclosed areas such as garages, basements, etc.
- Never operate unit in or near a location occupied by humans or animals.

⚠ WARNING: Risk of Fire, Asphyxiation and Burn. Never fill fuel tank when engine is running or hot. Do not smoke when filling fuel tank.

- Never fill fuel tank completely. Fill tank to 1/2" (12.7 mm) below bottom of filler neck to provide space for fuel expansion. Wipe any fuel spillage from engine and equipment before starting engine.
- DO NOT let hoses come in contact with very hot engine muffler during or immediately after use of your pressure washer. Damage to hoses from contact with hot engine surfaces will NOT be covered by warranty.

NOTICE: Risk of property damage. Never pull water supply hose to move pressure washer. This could damage hose and/or pump inlet.

- DO NOT use hot water, use cold water only.
- Never turn water supply off while pressure washer engine is running or damage to pump will result.
- DO NOT stop spraying water for more than two minutes at a time. Pump operates in bypass mode when spray gun trigger is not pressed. If pump is left in bypass mode for more than two minutes internal components of the pump can be damaged.

Prior to starting, refer to your engine manual for proper starting procedure.

1. In a well ventilated outdoor area add fresh, high quality, unleaded gasoline with a pump octane rating of 86 or higher. Do not overfill. Wipe up spilled fuel before starting the engine. Refer to **Engine Owner's Manual** for correct procedure.

IMPORTANT: Ethanol Shield™ (sold separately) is a fuel stabilizer that helps eliminate and prevent ethanol related problems in power equipment. Follow the instructions on the container and add to the gasoline.

———— Ethanol Percentage ———— **NOTICE: Use of fuels with greater than 10% ethanol are not approved for use in this product per EPA regulations and will damage the unit and void the warranty.**



2. Check engine oil level. Refer to **Engine Owner's Manual** for correct procedure.
3. Check pump oil level. The oil level should come to the dot in the middle of the sight glass. Refer to the **Pump** paragraph under **Maintenance**.
4. Connect the water hose to the water source. Turn the water source on to remove all air from the hose. When a steady stream of water is present, turn the water source off.
5. Verify the filter screen (M) is in water inlet of pump. **NOTE:** Convex side faces out.
6. Connect water source (N) to pump inlet (J). **NOTE:** Water source must provide a minimum of 5 gallons per minute at 20 PSI.
7. Connect high pressure hose (C) to pump outlet (I).

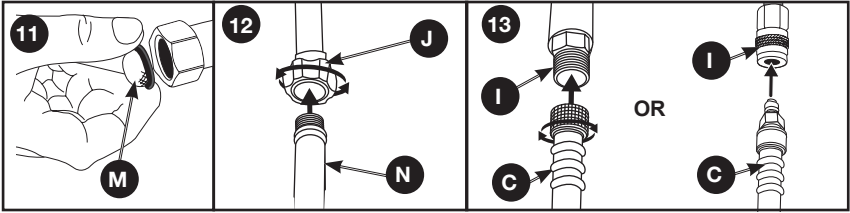

⚠ WARNING: To reduce the possibility of contamination always protect against backflow when connected to a potable water system.

- Choose the correct nozzle for the job to be performed. See **How To Use spray Wand** instructions in this section. **NOTE:** If applying a chemical or cleaning solution, see **How To Apply Chemicals/Cleaning Solvents** instructions in this section.
- Turn water source on.

NOTICE: Risk of property damage. Failure to do so could cause damage to the pump.

- Remove all air from the pump and high pressure hose by depressing trigger until a steady stream of water is present.
- Start engine. See **Engine Owner's Manual** for correct procedure.

⚠ WARNING: Risk of unsafe operation. If engine does not start after two pulls, squeeze trigger of gun to relieve pump pressure. Pull starter cord slowly until resistance is felt. Then pull cord rapidly to avoid kickback and prevent hand or arm injury.

NOTE: If the oil level in the engine is low, the engine will not start. If the engine does not start, check the oil level and add oil as needed.

- Depress trigger on gun to start water flow.

⚠ WARNING: Do not allow the unit to run for more than two minutes without the gun trigger being pulled. This could cause overheating and damage to the pump. When the temperature inside the pump rises too high, the thermal relief valve will open and release a spray of water from the pump to lower the internal temperature. The valve will then close.

⚠ WARNING: Risk of unsafe operation. Stand on a stable surface and grip gun/spray wand firmly with both hands. Expect the gun to kick when triggered.

- Release trigger to stop water flow.

⚠ WARNING: Risk of injury from spray. Always engage the trigger lock (O) when gun is not in use. Failure to do so could cause accidental spraying.

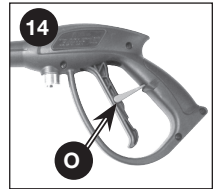

SHUTTING DOWN

- After each use, if you have applied chemicals, place detergent siphon hose into container of clean water and draw clean water through chemical injection system to rinse system thoroughly.

NOTICE: Risk of property damage. Failure to do so could cause damage to the pump.

- Turn engine off. See **Engine Owner's Manual**.

NOTICE: Risk of property damage. NEVER turn the water off with the engine running.

- Turn water source off.
- Pull trigger on spray gun to relieve any water pressure in hose or spray gun.
NOTE: Failure to release system pressure will prevent removal of high pressure hose from spray gun or pump connection.
- See **Storage** section in this manual for proper storage procedures.

MAINTENANCE

⚠ WARNING: Risk of burn hazard. When performing maintenance, you may be exposed to hot surfaces, water pressure or moving parts that can cause serious injury or death.

⚠ WARNING: Risk of fire hazard. Always disconnect, spark plug wire, let the engine cool and release all water pressure before performing any maintenance or repair. The engine contains flammable fuel. Do not smoke or work near open flames while performing maintenance.

To ensure efficient operation and longer life of your pressure washer, a routine maintenance schedule should be prepared and followed. If the pressure washer is used in unusual conditions, such as high-temperatures or dusty conditions, more frequent maintenance checks will be required.

ENGINE

Consult the **Engine Owner's Manual** for the manufacturer's recommendations for any and all maintenance. **NOTE:** The engine drain plug is located at the rear of the unit.

PUMP (FIG. 15)

NOTE: The Pump was filled with oil at the factory. The preferred oil is SIMPSON® Premium Pump Crankcase Oil. If this oil is not available, an SAE 15W-40 oil may be used. Change the pump oil after the first 50 hours of operation and every 100 hours thereafter, or every 3 months.

TO CHECK OIL

The oil level should come to the dot in the middle of the sight glass (AA).

HOW TO CHANGE PUMP OIL

1. Loosen pump oil fill plug (BB).
2. Place a container under the pump oil drain plug (CC).
3. Remove pump oil drain plug.
4. After oil is drained, replace pump oil drain plug. Tighten securely.
5. For AAA™ pumps, refill using SIMPSON® Premium Pump Crankcase Oil. If this oil is not available, an SAE 15W-40 oil may be used.
6. Replace pump oil fill plug and tighten securely.

*** CAT PUMPS® is a registered trademark of Diversified Dynamics Corporation.

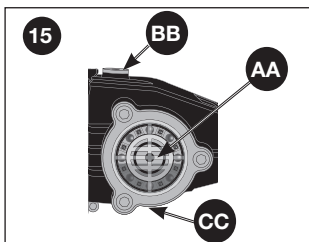

CONNECTIONS

Connections on pressure washer hoses, gun and spray wand should be cleaned regularly and lubricated with light oil or lithium grease to prevent leakage and damage to the o-rings.

NOZZLE CLEANING (FIG. 16)

If the nozzle becomes clogged with foreign materials, such as dirt, excessive pressure may develop. If the nozzle becomes partially clogged or restricted, the pump pressure will pulsate. Clean the nozzle immediately using the nozzle kit supplied and the following instructions:

1. Shut off the pressure washer and turn off the water supply.
2. Pull trigger on gun handle to relieve any water pressure.
3. Disconnect the spray wand from the gun.
4. Remove the high pressure nozzle (K) from the spray wand. Remove any obstructions with the nozzle cleaning tool provided and backflush with clean water.
5. Direct water supply (N) into nozzle to backflush loosened particles for 30 seconds.
6. Reassemble the nozzle to the wand.
7. Reconnect spray wand to gun and turn on water supply.
8. Start pressure washer and place spray wand into high pressure setting to test.

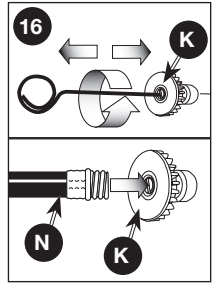

CLEAN THE WATER INLET FILTER (FIG. 11)

This screen filter should be checked periodically and cleaned if necessary.

1. Remove filter by grasping end and removing it from water inlet of pump.
2. Clean filter by flushing it with water on both sides.
3. Re-insert filter into water inlet of pump. **NOTE:** Convex side faces out.

NOTE: Do not operate the pressure washer without filter properly installed.

STORAGE

ENGINE

Consult the **Engine Owner's Manual** for manufacturer's recommendations for storage.

TO PREVENT FUEL-RELATED PROBLEMS

1. Add Ethanol Shield™ fuel stabilizer following the manufacturer's instructions. When adding a gasoline stabilizer, fill the fuel tank with fresh gasoline. If only partially filled, air in the tank will promote fuel deterioration during storage. If you keep a container of gasoline for refueling, be sure that it contains only fresh gasoline.
2. After adding a gasoline stabilizer, run the engine outdoors for 10 minutes to be sure that treated gasoline has replaced the untreated gasoline in the carburetor.
3. Turn the fuel valve to the OFF position.
4. Continue to run the engine until it stops from the lack of fuel in the carburetor fuel bowl. Running time should be less than 3 minutes.

PUMP

The manufacturer recommends using SIMPSON® / POWERWASHER® Pump Guard or equivalent when storing the unit for more than 30 days and/or when freezing temperatures are expected. SIMPSON® / POWERWASHER® Pump Guard is environmentally friendly.

NOTE: Using pump guard helps provide proper lubrication to the internal seals of the pump regardless of temperature or environment.

NOTICE: Risk of property damage. Use only SIMPSON® / POWERWASHER® Pump Guard or equivalent. Other products could be corrosive and/or contain alcohol which may cause pump damage.

1. Turn off pressure washer and disconnect hoses from pump.

2. Unscrew bottle valve from Pump Guard bottle and remove seal.
3. Screw bottle valve back onto bottle.
4. Attach bottle to water inlet of pump.
5. Squeeze bottle to inject contents into pump.
6. With ignition switch off, simultaneously pull starter rope and squeeze bottle. Repeat until protector fluid exits pump outlet. **NOTE:** This step may require two people.

ACCESSORIES

⚠ DANGER: *Risk of fluid injection. When using replacement spray wands or guns with this pressure washer, DO NOT use a spray wand and/or spray gun/wand combination that is shorter in length than what was provided with this pressure washer as measured from the nozzle end of the wand to the gun trigger.*

NOTICE: *The use of any other accessory not recommended for use with this tool could be hazardous. Use only accessories rated equal to or greater than the rating of the pressure washer.*