



Finex™ Gravity Feed Gun

312372J

For the spray application of paints and coatings. Includes Mini-HVLP, HVLP, and Conventional Models

100 psi (0.7 MPa, 7 bar) Maximum Working Air Pressure



Important Safety Instructions

Read all warnings and instructions in this manual.
Save these instructions.





Models

Model	Part No.	Needle/Nozzle Size
FX1000 Mini-HVLP	289200	1.0
	289221	1.2
	289222	1.4
FX2000 Conventional	288883	1.0
	288884	1.3
	288885	1.4
	288886	1.5
	288887	1.8
FX3000 HVLP	288878	1.0
	288879	1.3
	288880	1.4
	288881	1.5
	288882	1.8



Warnings

The following warnings are for the setup, use, grounding, maintenance, and repair of this equipment. The exclamation point symbol alerts you to a general warning and the hazard symbol refers to procedure-specific risk. Refer back to these warnings. Additional, product-specific warnings may be found throughout the body of this manual where applicable.

 WARNING	
	<p>FIRE AND EXPLOSION HAZARD</p> <p>Flammable fumes, such as solvent and paint fumes, in work area can ignite or explode. To help prevent fire and explosion:</p> <ul style="list-style-type: none"> • Use equipment only in well ventilated area. • Eliminate all ignition sources; such as pilot lights, cigarettes, portable electric lamps, and plastic drop cloths (potential static arc). • Keep work area free of debris, including solvent, rags and gasoline. • Do not plug or unplug power cords or turn lights on or off when flammable fumes are present. • Ground all equipment in the work area. See Grounding instructions. • If there is static sparking or you feel a shock, stop operation immediately. Do not use equipment until you identify and correct the problem. • Keep a working fire extinguisher in the work area.
	<p>EQUIPMENT MISUSE HAZARD</p> <p>Misuse can cause death or serious injury.</p> <ul style="list-style-type: none"> • Do not operate the unit when fatigued or under the influence of drugs or alcohol. • Do not exceed the maximum working pressure or temperature rating of the lowest rated system component. See Technical Data in all equipment manuals. • Use fluids and solvents that are compatible with equipment wetted parts. See Technical Data in all equipment manuals. Read fluid and solvent manufacturer's warnings. For complete information about your material, request MSDS forms from distributor or retailer. • Check equipment daily. Repair or replace worn or damaged parts immediately with genuine manufacturer's replacement parts only. • Do not alter or modify equipment. • Use equipment only for its intended purpose. Call your distributor for information. • Route hoses and cables away from traffic areas, sharp edges, moving parts, and hot surfaces. • Do not kink or over bend hoses or use hoses to pull equipment. • Keep children and animals away from work area. • Comply with all applicable safety regulations.
	<p>PRESSURIZED EQUIPMENT HAZARD</p> <p>Fluid from the gun/dispense valve, leaks, or ruptured components can splash in the eyes or on skin and cause serious injury.</p> <ul style="list-style-type: none"> • Follow Pressure Relief Procedure in this manual, when you stop spraying and before cleaning, checking, or servicing equipment. • Tighten all fluid connections before operating the equipment. • Check hoses, tubes, and couplings daily. Replace worn or damaged parts immediately.

⚠ WARNING



TOXIC FLUID OR FUMES HAZARD

Toxic fluids or fumes can cause serious injury or death if splashed in the eyes or on skin, inhaled, or swallowed.

- Read MSDS's to know the specific hazards of the fluids you are using.
- Store hazardous fluid in approved containers, and dispose of it according to applicable guidelines.
- Always wear impervious gloves when spraying or cleaning equipment.



PERSONAL PROTECTIVE EQUIPMENT

You must wear appropriate protective equipment when operating, servicing, or when in the operating area of the equipment to help protect you from serious injury, including eye injury, inhalation of toxic fumes, burns, and hearing loss. This equipment includes but is not limited to:

- Protective eyewear
- Clothing and respirator as recommended by the fluid and solvent manufacturer
- Gloves
- Hearing protection

Setup

 Reference numbers and letters in parentheses in the text refer to numbers and letters in the illustrations.

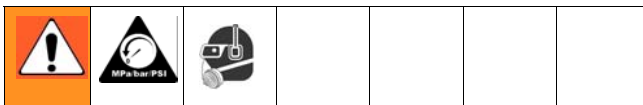

1. Install an air pressure regulator on gun air supply line to control air pressure.

2. Install a shutoff valve downstream of the air regulator to shut off gun air.
3. Connect a clean, dry, filtered air supply to air inlet fitting (13). Connect other end to shutoff valve.
4. Install fluid filter into fluid inlet.
5. Screw on gravity cup.
6. Remove gravity cup cover and fill cup with solvent to flush if this is first time using equipment. (See **Flushing**, page 5.)
7. After flushing, fill cup with fluid and attach cover.

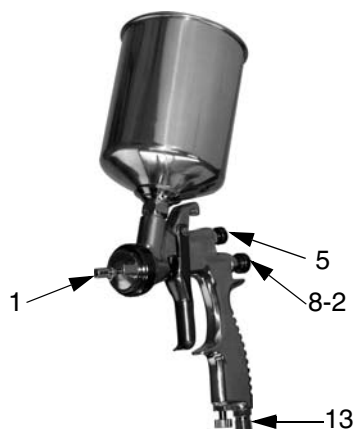

FIG. 1

Operation



Pressure Relief Procedure

1. Turn off gun air supply.
2. Hold a metal part of the gun firmly to a grounded metal pail. Trigger gun to relieve pressure.

Adjust Spray Pattern

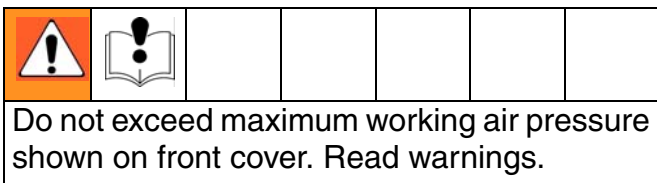

1. Rotate air cap (1) to change spray pattern direction.
2. For maximum fluid flow and to prevent premature fluid nozzle wear, turn fluid adjustment knob (8-2) counterclockwise until no trigger restriction is felt. Then turn knob out 1/2 turn more.
3. If further fluid flow restriction is needed, use different size needle/nozzle/air cap combination.

If necessary, fluid adjustment knob (8-2) can be turned clockwise to reduce volume of fluid output. However, continuously spraying with fluid adjustment knob closed causes accelerated abrasive wear on fluid needle and trigger/air valve shaft interface.

 If fluid adjustment knob (8-2) is turned in all the way, the gun emits only air.

4. Test spray pattern and atomization while holding gun about 6 to 8 inches (150 to 200 mm) from test piece.

- a. If pattern is too wide, turn pattern adjustment knob (5) clockwise to narrow pattern.
- b. To create a round pattern, turn pattern adjustment knob (5) fully clockwise.
- c. If pattern is too narrow, turn knob (5) counterclockwise.
- d. Check atomization. Increase gun air supply pressure in 5 psi (34 kPa, 0.3 bar) increments until you have the desired atomization.

Applying Paint

For the best results:

- Keep gun perpendicular to surface and consistent distance of about 6-8 inches (150-200 mm). Do not angle the gun as you spray.
- Use smooth, even strokes, with about 50% overlap.
- Mini-HVLP and HVLP Guns: Use a slightly slower hand movement and make fewer passes than you would with a conventional air spray gun. Take care to avoid runs or sags.

Maintenance

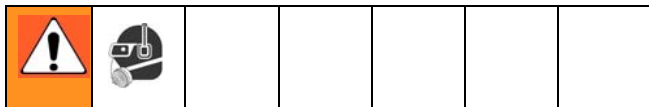

Flushing

Flush before changing colors, before fluid can dry in the equipment, at the end of the day, before storing, and before repairing equipment. Use solvent that is compatible with gun wetted parts and fluid that will be sprayed.

1. Follow **Pressure Relief Procedure**, page 4.
2. Dispose of any paint in the cup.
3. Fill the cup with a small amount of solvent.
4. Spray into a grounded metal waste container until clean solvent dispenses.
5. Follow **Pressure Relief Procedure**, page 4.

Daily Cleaning

CAUTION

- Do not submerge gun in solvent. Solvent dissolves lubricant, dries out packings, and may clog air passages. You can immerse front end of gun in solvent just until cup connection is covered.
- Do not use metal tools to clean air cap holes as this may scratch them and distort the spray pattern.
- Use a compatible solvent.

1. Follow **Pressure Relief Procedure**, page 4.
2. Clean fluid and air line filters.
3. Check for fluid leakage from gun and fluid hoses. Tighten fittings or replace equipment as needed.



4. Flush gun before changing colors and when you are done spraying.
5. Remove cup and filter and clean them.
6. Remove air cap (1) and nozzle (2) as instructed on page 7 and soak them in compatible solvent.

CAUTION

Trigger gun and use gun tool (27) whenever you tighten or remove nozzle (2) to avoid damaging needle seat and nozzle.

7. Use a rag moistened in solvent to wipe down outside of gun.
8. Before reinstalling air cap and nozzle, clean them and front of gun with a soft-bristle brush dipped into compatible solvent. Do not use a wire brush or metal tools. To clean out air cap holes, use a soft implement, such as a toothpick.
9. Lubricate gun.

Troubleshooting

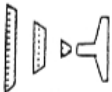
Problem	Cause	Solution
	One side of air cap (1) dirty or clogged.	Clean air cap orifices. See page 5. Blow air through orifices until clean. If air cap holes are damaged, replace air cap.
	a. Loose air cap (1).	a. Tighten.
	b. Dried or damaged air cap (1) or fluid nozzle (2).	b. Rotate air cap 180°. <i>If pattern follows air cap, problem is in air cap. Clean and inspect. See page 5. If pattern is not corrected, replace air cap. If pattern does not follow the air cap, the problem is with the fluid nozzle. Clean and inspect the nozzle. See page 5. If the pattern is not corrected, replace nozzle.</i>
	a. Atomization air pressure set too high.	a. Reduce air pressure.
	b. Spraying a thin material in too wide of a pattern.	b. Increase material control by turning fluid adjustment knob (8-2) counterclockwise, while reducing spray width by turning pattern adjustment knob (5) clockwise. Or increase material viscosity.
 Spitting	Air getting into paint stream.	
	a. Cup almost empty.	a. Fill cup.
	b. Dry needle packing (3-1 or 3-2).	b. Loosen packing nut and put a few drops of machine oil on packings (3-1 and 3-2). Retighten nut (4).
	c. Fluid nozzle (2) too loose.	c. Tighten.
	d. Dried material between nozzle (2) and gun body.	d. Clean nozzle and front of gun. See page 5.
	e. Damaged needle seal.	e. Replace seal. See page 7.
Other spray pattern problems.	a. Gun not properly adjusted.	a. See page 4.
	b. Sluggish needle (10).	b. Clean and lubricate.
Unable to get round pattern.	Pattern adjustment knob (5) not seating properly.	Clean or replace knob.
Will not spray.	a. No air pressure at gun.	a. Check air supply and air lines.
	b. Cup empty.	b. Fill cup.
	c. Fluid adjustment knob (8-2) turned too far clockwise.	c. Adjust knob (8-2) counterclockwise.
	d. Fluid too thick for gravity feed.	d. Thin material.

Problem	Cause	Solution
Fluid leaking from packing nut (4).	a. Packing nut (4) loose.	a. Tighten, but not so tight as to grip needle.
	b. Packing (3-1 or 3-2) worn or dry.	b. Lubricate or replace.
Fluid nozzle (2) dripping.	a. Dry packing (3-1 or 3-2).	a. Lubricate.
	b. Sluggish needle (10).	b. Clean and lubricate.
	c. Packing nut (4) too tight.	c. Loosen.
	d. Worn fluid nozzle or needle.	d. Replace.
Thin, coarse finish.	a. Gun held too far from surface.	a. Hold gun about 6-8 inches (150-200 mm) from surface.
	b. Atomization air pressure set too high.	b. Reduce air pressure.
Thick, dimpled finish (resembling orange peel).	Gun held too close to surface.	Hold gun about 6-8 inches (150-200 mm) from surface.

Service

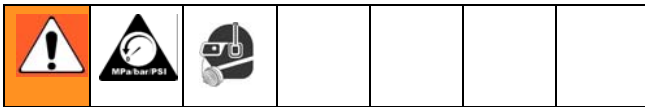

Preparation

1. Flush and clean gun before servicing.
2. Follow Pressure Relief Procedure, see page 4.

Air Cap, Nozzle, and Needle

1. Unscrew air cap (1).
2. Trigger gun while you remove the nozzle (2) with gun tool (27).

 Trigger gun and use gun tool (27) whenever you tighten or remove the nozzle (2) to avoid damage.

3. Remove fluid adjustment knob (8-2) and spring (9).
4. Pull needle (10) out of the back of the gun.

Air Valve and Needle Packings

1. Remove retaining rings (15), pin (16), and trigger (17).
2. Remove packing nut (4) and fluid needle packings (3-1 and 3-2).
3. Remove fluid needle guide (7).
4. Remove fluid adjusting guide (8-1).
5. Remove spring (18) and air valve (19).
6. Remove air valve seat (20) and o-ring.
7. Replace parts as needed.
8. Assemble gun in reverse order. Lubricate needle and o-rings. Be sure to trigger gun when installing nozzle (2).

Parts

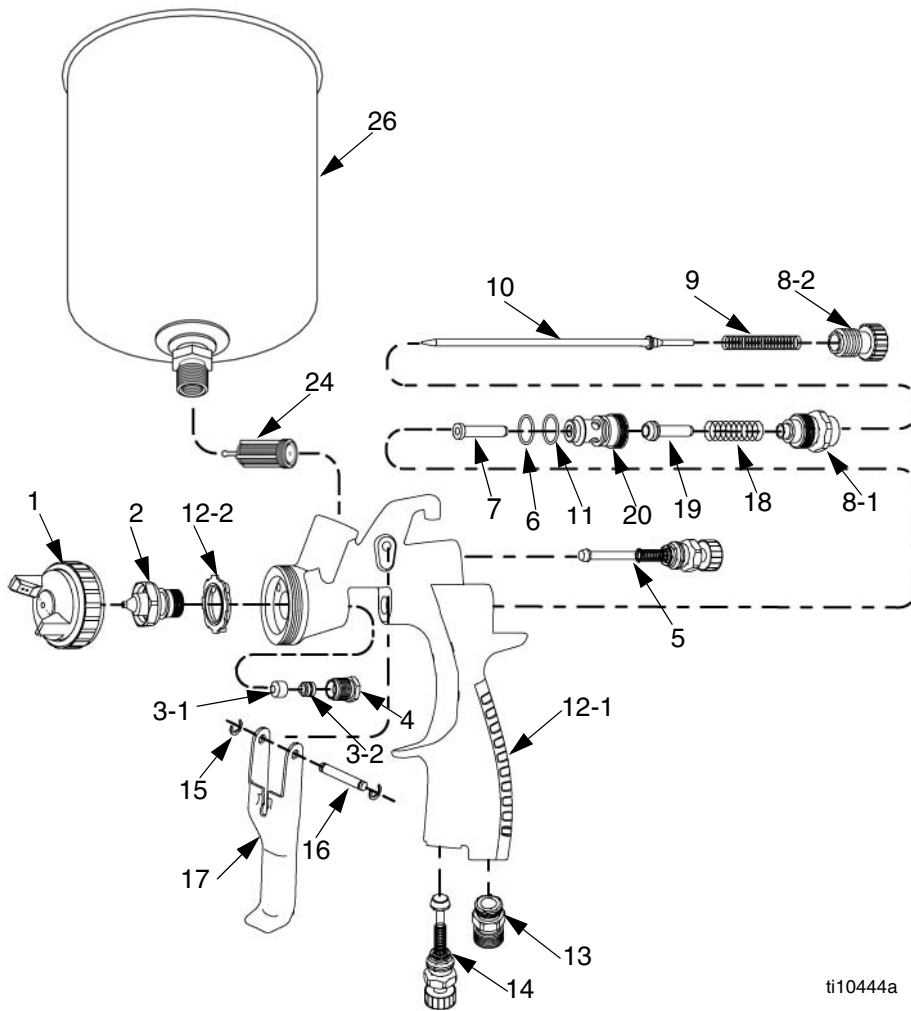

Ref.	Description	Qty
1	CAP, air	1
2	NOZZLE, fluid	1
3-1*	PACKING, fluid needle	1
3-2*	PACKING, fluid needle	1
4*	NUT, packing	1
5*	KNOB, pattern adjustment	1
6*	O-RING	1
7*	GUIDE, fluid needle	1
8-1*	GUIDE, fluid adjusting	1
8-2*	KNOB, fluid adjusting	1
9*	SPRING, fluid needle	1
10	NEEDLE, fluid	1
11*	O-RING	1
12-1	BODY, gun	1
12-2*	DISTRIBUTOR, air	1
13*	FITTING, air inlet	1
14*	VALVE, air adjustment	1
15*	RING, retaining	2
16*	PIN, trigger	1
17*	TRIGGER	1
18*	SPRING, air valve	1
19*	VALVE, air	1
20*	SEAT, air valve	1
24*	FILTER, fluid	1
26	CUP, gravity, aluminum	1
27	TOOL, gun (not shown)	1

ti10444a

Repair Kits

Model	Needle/ Nozzle Size	Needle, Nozzle, Air Cap Kit (Parts 1, 2, and 10)	Needle Packing Kit (parts 3-1, 3-2, and 4)	Gun Rebuild Kit (includes parts marked *)	Air Distributor Kit (pack of 5)
FX 1000 Mini-HVLP	0.6	289286	288890	288895	24C308
	0.8	289287			
	1.0	289288			
	1.2	289289			
	1.4	289290			
FX 2000 Conventional	1.0	289291	288891	288896	24C309
	1.3	289292			
	1.4	289293			
	1.5	289294			
	1.8	289295			
FX 3000 HVLP	1.0	289296	288891	288896	24C309
	1.3	289297			
	1.4	289298			
	1.5	289299			
	1.8	289300			

Accessory Kits

Model	Needle/ Nozzle Size	Gravity Cup (aluminum)	Gravity Cup Lid (Plastic)	PPS Adapter	Fluid Filter (pack of 10)	HVLP Test Kit	Glazing Nozzle Kit*
FX 1000 Mini-HVLP	0.6	289517 (125 cc)	289816 (125 cc)	289520	24A230	24B616	24F733 (Nozzle)
	0.8						
	1.0	Standard	289817 (250 cc)				24F734 (Nozzle and Air Cap)
	1.2						
	1.4	289321 (250 cc)					
FX 2000 Conventional	1.0	289320 (600 cc)	289818 (600 cc)	289520	24A230	N/A	NA
	1.3						
	1.4						
	1.5						
	1.8						
FX 3000 HVLP	1.0	289320 (600 cc)	289818 (600 cc)	289520	24A230	24B615	NA
	1.3						
	1.4						
	1.5						
	1.8						

* Glazing Nozzle Kits are for use with 1.0 in. needle.

Technical Data

Maximum Air Inlet Pressure	100 psi (0.7 MPa, 7 bar)
Maximum HVLP Inbound Air Pressure	29 psi (0.2 MPa, 2 bar)*
Air Consumption	
FX1000	7.0 SCFM at 29 psi (0.2 MPa, 2.0 bar)
FX2000	9.5 SCFM at 43 psi (0.3 MPa, 3.0 bar)
FX3000	9.5 SCFM at 29 psi (0.2 MPa, 2.0 bar)
Fluid and Air Operating Temperature Range	32-109°F (0-43° C)
Spray Gun	
Air Inlet Size	1/4 npsm (R1/4-19)
FX1000 Weight with cup	0.9 lb (0.4 kg)
FX2000/3000 Weight with cup	1.1 lb (0.5 kg)
Wetted Parts	Aluminum, stainless steel, engineered plastic
Noise Data**	
FX1000 sound pressure at 29 psi (0.2 MPa, 2.0 bar)	78.17 dB(A)
sound power at 29 psi (0.2 MPa, 2.0 bar)	85.32 dB(A)
FX2000 sound pressure at 43 psi (0.3 MPa, 3.0 bar)	81.91 dB(A)
sound power at 43 psi (0.3 MPa, 3.0 bar)	89.23 dB(A)
FX3000 sound pressure at 29 psi (0.2 MPa, 2.0 bar)	80.60 dB(A)
sound power at 29 psi (0.2 MPa, 2.0 bar)	87.74 dB(A)
Gravity Cup Sizes	
FX1000 aluminum	4 oz (125 cc); 8 oz (250 cc)
FX 2000/3000 aluminum	20 oz (600 cc)

* Produces 10 psi (0.07 MPa, 0.7 bar) spraying pressure at aircap.

** All readings were taken with the fan valve fully open (fan full size) at the assumed operator position. Sound power measured per ISO 9614-2.