



2019 CATALOG

Celebrating
35 Years!

ABRASIVES & WELDING





SHARK ABRASIVES & WELDING PRODUCT LINE

Introduction

Shark has been a supplier/manufacturer to the Automotive Aftermarket, Paint and Body and Industrial Marketplace for 35 years. Your complete product satisfaction as well as a high quality customer service standard is what has created this success.

Our products have been designed with the professional mechanic, technician, welder or fabricator in mind. All our products are manufactured for professional or production use; from our abrasives to our wire/electrodes and equipment.

Our trilingual, 4 color packaging is attention getting and designed to stand out in any retail setting. The package descriptions are designed to offer the customer the optimum in purchasing accuracy.

Our small diameter cut-off wheels are manufactured in our Rockford, Minnesota facility and will give you an edge in performance and endurance. Our surface conditioning discs and flap discs are also made at our facility and are designed to compete with all major brands in the market today.

All our other products are sourced in the US as well as Europe, China, Taiwan, Turkey, Pakistan and Mexico to our exacting specifications. We insure that our quality levels meet our customers' most demanding requirements.

We always welcome any suggestions on how we can improve our quality or our service level to you.

We look forward to servicing your needs for many years to come!

Shark Industries, LTD. is a registered trademark. Any use of the name without express written permission is prohibited. Any reproduction of this catalogue without the written permission of Shark is prohibited.

Shark is a manufacturer/repackager of its products. Any mention of any other manufacturer in this catalog is only for reference of part number and is not intended to imply that Shark products are made by, or for the mentioned manufacturer; nor is it our intention to infringe on that company's trademark or patents.

No returns will be accepted without prior written approval from Shark. All stock returns must be accompanied by an off-setting order of greater value by 50% or more.





NEW! DIAMOND EDGE CUT-OFF WHEELS

Use on all your current air tools and power tools at the same RPM's.

- 30 Times longer life than traditional abrasive cut-off wheels
- No need to continually change out wheels for different applications
- No odor and less dust
- Less sparking as only the metal is sparking and not the wheels
- One wheel meets all your different material needs

EXTENDED LIFE

The Shark Real-Cut diamond edge wheels are made of steel, using a high tech diamond technology for dramatic life extension in metal cutting applications. This decreases downtime, improves productivity, and lowers the cost of each cut in comparison to abrasive wheels.

APPLICATIONS

Designed for use on steel, sheet metal, stainless steel, rebar, cast iron, aluminum and all non-ferrous metals. When cutting aluminum use a form of lubricant for best results.



| Part# | Diameter | Thickness | Arbor | RPM |
|-------|----------|-----------|-------|--------|
| 13090 | 3" | .050 | 3/8" | 21,000 |
| 13091 | 4" | .050 | 5/8" | 15,300 |
| 13093 | 4" | .050 | 3/8" | 15,300 |
| 13092 | 4.5" | .050 | 7/8" | 13,300 |

CUT-OFF WHEELS

Fast cutting abrasive reinforced cut-off wheels are offered in a variety of formulas for different applications. The fiberglass reinforcement provides greater tensile strength as well as increased safety. All 3" and 4" wheels are American Made.

CUT-OFF WHEEL SHAPES

TYPE 1

Type 1 cut-off wheels are designed for cut-off applications that have easy access.



TYPE 27

Type 27 cut-off wheels are designed for use on angle grinders; incorporating the center depression which allows for flush grinding.



HOW TO CHOOSE THE RIGHT PRODUCT FOR YOUR APPLICATION

ALUMINUM OXIDE RESIN BONDED

Aluminum oxide bonded with resins, fiberglass reinforced for any steel cutting application.

ALUMINUM/SILICON CARBIDE

For use when cutting aluminum.

MASONRY/SILICON CARBIDE

Specially formulated for concrete cutting applications. Designed to reduce loading of the wheels.

STAINLESS STEEL/ZIRCONIA

For all stainless steel applications and harder metals. Offers extended life on regular steel.



CUT-OFF WHEELS



TYPE 1

Type 1 cut-off wheels are designed for all cut-off applications involving steel.

All wheels are double fiberglass reinforced, and are not designed for use on fiberglass or aluminum.

ALUMINUM OXIDE

| Item# | Old# | Size | Thickness | Arbor | Grit | RPM | Grain | Pk. Qty | MP |
|--------|--------|------|-----------|-------|------|--------|----------------|---------|----|
| 19 | | 2" | 1/32" | 3/8" | 54 | 30,000 | Aluminum Oxide | 10 | 5 |
| 20 | | 2" | 1/16" | 1/4" | 54 | 30,558 | Aluminum Oxide | 10 | 5 |
| 21 | | 2" | 1/16" | 3/8" | 54 | 30,558 | Aluminum Oxide | 10 | 5 |
| 22 | | 2" | 1/8" | 1/4" | 54 | 45,000 | Aluminum Oxide | 10 | 5 |
| 23 | | 2" | 1/8" | 3/8" | 54 | 45,000 | Aluminum Oxide | 10 | 5 |
| 24-10 | | 3" | 1/16" | 3/8" | 46 | 25,000 | Aluminum Oxide | 10 | 20 |
| 24-20 | | 3" | 1/16" | 3/8" | 46 | 25,000 | Aluminum Oxide | 20 | 25 |
| 24-50 | | 3" | 1/16" | 3/8" | 46 | 25,000 | Aluminum Oxide | 50 | 10 |
| 24-100 | | 3" | 1/16" | 3/8" | 46 | 25,000 | Aluminum Oxide | 100 | 10 |
| 25-5 | | 3" | 1/16" | 3/8" | 54 | 25,000 | Aluminum Oxide | 5 | 50 |
| 25-6 | | 3" | 1/16" | 3/8" | 54 | 25,000 | Aluminum Oxide | 6 | 50 |
| 12704 | 25-10 | 3" | 1/16" | 3/8" | 54 | 25,000 | Aluminum Oxide | 10 | 20 |
| 25-20 | | 3" | 1/16" | 3/8" | 54 | 25,000 | Aluminum Oxide | 20 | 20 |
| 25-25 | | 3" | 1/16" | 3/8" | 54 | 25,000 | Aluminum Oxide | 25 | 20 |
| 12705 | 25-50 | 3" | 1/16" | 3/8" | 54 | 25,000 | Aluminum Oxide | 50 | 10 |
| 13215 | 25-100 | 3" | 1/16" | 3/8" | 54 | 25,000 | Aluminum Oxide | 100 | 10 |
| 26-5 | | 3" | 1/32" | 3/8" | 54 | 25,000 | Aluminum Oxide | 5 | 50 |
| 26-6 | | 3" | 1/32" | 3/8" | 54 | 25,000 | Aluminum Oxide | 6 | 50 |
| 12700 | 26-10 | 3" | 1/32" | 3/8" | 54 | 25,000 | Aluminum Oxide | 10 | 20 |
| 26-20 | | 3" | 1/32" | 3/8" | 54 | 25,000 | Aluminum Oxide | 20 | 25 |
| 26-25 | | 3" | 1/32" | 3/8" | 54 | 25,000 | Aluminum Oxide | 25 | 20 |
| 12701 | 26-50 | 3" | 1/32" | 3/8" | 54 | 25,000 | Aluminum Oxide | 50 | 10 |
| 13216 | 26-100 | 3" | 1/32" | 3/8" | 54 | 25,000 | Aluminum Oxide | 100 | 10 |
| 12702 | 27-10 | 3" | 1/16" | 1/4" | 54 | 25,000 | Aluminum Oxide | 10 | 20 |
| 27-25 | | 3" | 1/16" | 1/4" | 54 | 25,000 | Aluminum Oxide | 25 | 20 |
| 12703 | | 3" | 1/16" | 1/4" | 54 | 25,000 | Aluminum Oxide | 50 | 10 |
| 27-100 | | 3" | 1/16" | 1/4" | 54 | 25,000 | Aluminum Oxide | 100 | 10 |
| 12706 | 28-5 | 3" | 1/8" | 1/4" | 46 | 25,000 | Aluminum Oxide | 5 | 10 |
| 12707 | 28-50 | 3" | 1/8" | 1/4" | 46 | 25,000 | Aluminum Oxide | 50 | 4 |
| 12708 | 29-5 | 3" | 1/8" | 3/8" | 46 | 25,000 | Aluminum Oxide | 5 | 10 |
| 29-10 | | 3" | 1/8" | 3/8" | 46 | 25,000 | Aluminum Oxide | 10 | 20 |
| 12709 | 29-50 | 3" | 1/8" | 3/8" | 46 | 25,000 | Aluminum Oxide | 50 | 4 |
| 30-10 | | 3" | 1/32" | 1/4" | 54 | 25,000 | Aluminum Oxide | 10 | 20 |
| 30-100 | | 3" | 1/32" | 1/4" | 54 | 25,000 | Aluminum Oxide | 100 | 10 |
| 37-10 | | 3" | 3/32" | 3/8" | 54 | 25,000 | Aluminum Oxide | 10 | 20 |
| 37-100 | | 3" | 3/32" | 3/8" | 54 | 25,000 | Aluminum Oxide | 100 | 5 |
| 38-5 | | 3" | 3/16" | 3/8" | 54 | 25,000 | Aluminum Oxide | 5 | 20 |
| 38-50 | | 3" | 3/16" | 3/8" | 54 | 25,000 | Aluminum Oxide | 50 | 4 |



CUT-OFF WHEELS



TYPE 1

Type 1 cut-off wheels are designed for all cut-off applications involving steel.

All wheels are double fiberglass reinforced. Not designed for use on fiberglass or aluminum.

| Item# | Old# | Size | Thickness | Arbor | Grit | RPM | Grain | Pkg. Qty. | MP |
|--------|------|--------|-----------|-------|------|--------|----------------|-----------|----|
| 41 | | 4" | 3/32" | 5/8" | 46 | 15,300 | Aluminum Oxide | 10 | 10 |
| 41-100 | | 4" | 3/32" | 5/8" | 46 | 15,300 | Aluminum Oxide | 100 | 5 |
| 12710 | 42 | 4" | 1/32" | 3/8" | 60 | 21,000 | Aluminum Oxide | 10 | 10 |
| 12711 | | 4" | 1/32" | 3/8" | 60 | 21,000 | Aluminum Oxide | 50 | 4 |
| 42-100 | | 4" | 1/32" | 3/8" | 60 | 21,000 | Aluminum Oxide | 100 | 5 |
| 43 | | 4" | 1/32" | 5/8" | 60 | 21,000 | Aluminum Oxide | 10 | 10 |
| 43-100 | | 4" | 1/32" | 5/8" | 60 | 21,000 | Aluminum Oxide | 100 | 5 |
| 12718 | 44 | 4" | 1/16" | 1/4" | 54 | 21,000 | Aluminum Oxide | 10 | 10 |
| 12719 | | 4" | 1/16" | 1/4" | 54 | 21,000 | Aluminum Oxide | 50 | 4 |
| 44-100 | | 4" | 1/16" | 1/4" | 54 | 21,000 | Aluminum Oxide | 100 | 5 |
| 12712 | 45 | 4" | 1/16" | 3/8" | 54 | 21,000 | Aluminum Oxide | 10 | 10 |
| 12713 | | 4" | 1/16" | 3/8" | 54 | 21,000 | Aluminum Oxide | 50 | 4 |
| 45-100 | | 4" | 1/16" | 3/8" | 54 | 21,000 | Aluminum Oxide | 100 | 5 |
| 12716 | 46 | 4" | 1/16" | 5/8" | 54 | 15,300 | Aluminum Oxide | 10 | 10 |
| 12717 | | 4" | 1/16" | 5/8" | 54 | 15,300 | Aluminum Oxide | 50 | 4 |
| 46-100 | | 4" | 1/16" | 5/8" | 54 | 15,300 | Aluminum Oxide | 100 | 5 |
| 12714 | 47 | 4" | 1/8" | 3/8" | 46 | 15,300 | Aluminum Oxide | 10 | 10 |
| 12715 | | 4" | 1/8" | 3/8" | 46 | 15,300 | Aluminum Oxide | 50 | 4 |
| 47-100 | | 4" | 1/8" | 3/8" | 46 | 15,300 | Aluminum Oxide | 100 | 5 |
| 48 | | 4" | 1/8" | 5/8" | 46 | 15,300 | Aluminum Oxide | 10 | 10 |
| 48-100 | | 4" | 1/8" | 5/8" | 46 | 15,300 | Aluminum Oxide | 100 | 5 |
| 49 | | 4" | 1/8" | 7/8" | 46 | 15,300 | Aluminum Oxide | 10 | 10 |
| 49-100 | | 4" | 1/8" | 7/8" | 46 | 15,300 | Aluminum Oxide | 100 | 5 |
| 50 | | 4" | 1/16" | 7/8" | 46 | 15,300 | Aluminum Oxide | 10 | 10 |
| 50-100 | | 4" | 1/16" | 7/8" | 46 | 15,300 | Aluminum Oxide | 100 | 5 |
| 12722 | 454 | 4 1/2" | 3/32" | 7/8" | 46 | 13,300 | Aluminum Oxide | 10 | 10 |
| 12723 | | 4 1/2" | 3/32" | 7/8" | 46 | 13,300 | Aluminum Oxide | 25 | 10 |
| 13067 | 455 | 4 1/2" | 1/16" | 7/8" | 60 | 17,500 | Aluminum Oxide | 10 | 10 |
| 13068 | 456 | 4 1/2" | .045" | 7/8" | 46 | 17,500 | Aluminum Oxide | 10 | 10 |
| 13152 | | 5" | .045" | 7/8" | 46 | 10,200 | Aluminum Oxide | 1 | 20 |
| 13153 | | 5" | .045" | 7/8" | 46 | 10,200 | Aluminum Oxide | 5 | 20 |
| 13154 | | 6" | .045" | 7/8" | 46 | 10,200 | Aluminum Oxide | 1 | 20 |
| 13155 | | 6" | .045" | 7/8" | 46 | 10,200 | Aluminum Oxide | 5 | 20 |
| 13055 | | 7" | .045" | 7/8" | 60 | 8,600 | Aluminum Oxide | 5 | 40 |
| 13082 | | 7" | .045" | 5/8" | 46 | 8,500 | Aluminum Oxide | 5 | 40 |
| 13057 | | 8" | .045" | 7/8" | 60 | 7,600 | Aluminum Oxide | 5 | 40 |

CUT-OFF WHEELS



SURE-LIFE CUT-OFF WHEELS

| Item# | Old# | Size | Thickness | Arbor | Grit | RPM | Type | Shape | Pk. Qty | MP |
|---------|------|------|-----------|-------|------|--------|----------|--------|---------|----|
| 12757 | 25SL | 3" | 1/16" | 3/8" | 36 | 25,000 | Zirconia | Type 1 | 6 | 10 |
| 25SL-10 | | 3" | 1/16" | 3/8" | 36 | 25,000 | Zirconia | Type 1 | 10 | 10 |
| 13217 | | 3" | 1/16" | 3/8" | 36 | 25,000 | Zirconia | Type 1 | 50 | 4 |
| 12758 | 26SL | 3" | 1/32" | 3/8" | 60 | 25,000 | Zirconia | Type 1 | 6 | 10 |
| 26SL-10 | | 3" | 1/32" | 3/8" | 60 | 25,000 | Zirconia | Type 1 | 10 | 10 |
| 13218 | | 3" | 1/32" | 3/8" | 60 | 25,000 | Zirconia | Type 1 | 50 | 4 |
| 29SL | | 3" | 1/8" | 3/8" | 46 | 25,000 | Zirconia | Type 1 | 6 | 10 |
| 37SL | | 3" | 3/32" | 3/8" | 54 | 25,000 | Zirconia | Type 1 | 6 | 10 |
| 38SL | | 3" | 3/16" | 3/8" | 54 | 25,000 | Zirconia | Type 1 | 6 | 10 |

FOR ALUMINUM CUTTING

| | | | | | | | | | | |
|-------|--|----|-------|------|----|--------|-----------------|--|---|----|
| 13178 | | 3" | 1/16" | 3/8" | 54 | 25,000 | Silicon Carbide | | 5 | 10 |
| 13179 | | 3" | 1/4" | 3/8" | 54 | 25,000 | Silicon Carbide | | 5 | 10 |

CUT-OFF WHEELS WITH MANDRELS

We offer two types of wheels that come packed with our standard mandrel. Attractive clamshell packaging allows for easy storage of wheels not in use.

| Item# | Old# | Size | Thickness | Arbor | Grit | RPM | Type | Shape | Pk. Qty | MP |
|---|-------|------|-----------|-------|------|--------|----------------|--------|---------|----|
| 12730 | 25-6M | 3" | 1/16" | 3/8" | 54 | 25,000 | Aluminum Oxide | Type 1 | 6 | 20 |
| Includes: 6 Cut-off Wheels and 1 Mandrel with a 3/8" Shoulder Screw | | | | | | | | | | |
| 128-83 | 26-6M | 3" | 1/32" | 3/8" | 54 | 25,000 | Aluminum Oxide | Type 1 | 6 | 20 |
| Includes: 6 Cut-off Wheels and 1 Mandrel with a 3/8" Shoulder Screw | | | | | | | | | | |
| 25SL-M | | 3" | 1/16" | 3/8" | 36 | 25,000 | Zirconia | Type 1 | 6 | 20 |
| Includes: 6 Cut-off Wheels and 1 Mandrel with a 3/8" Shoulder Screw | | | | | | | | | | |
| 26SL-M | | 3" | 1/32" | 3/8" | 60 | 25,000 | Zirconia | Type 1 | 6 | 20 |
| Includes: 6 Cut-off Wheels and 1 Mandrel with a 3/8" Shoulder Screw | | | | | | | | | | |



STAINLESS STEEL CUT-OFF WHEELS

| Item# | Size | Thickness | Arbor | Grit | RPM | Type | Shape | Pk. Qty | MP |
|-------|--------|-----------|-------|------|--------|-----------------|--------|---------|----|
| 13021 | 4" | .045" | 5/8" | 60 | 15,300 | Stainless Steel | Type 1 | 10 | 10 |
| 13022 | 4" | .045" | 5/8" | 60 | 15,300 | Stainless Steel | Type 1 | 25 | 10 |
| 13023 | 4 1/2" | .045" | 7/8" | 60 | 13,300 | Stainless Steel | Type 1 | 10 | 10 |
| 13024 | 4 1/2" | .045" | 7/8" | 60 | 13,300 | Stainless Steel | Type 1 | 25 | 10 |
| 13028 | 5" | .045" | 7/8" | 60 | 12,250 | Stainless Steel | Type 1 | 5 | 10 |
| 13029 | 5" | .045" | 7/8" | 60 | 12,250 | Stainless Steel | Type 1 | 25 | 10 |
| 13030 | 6" | .045" | 7/8" | 60 | 12,700 | Stainless Steel | Type 1 | 5 | 10 |
| 13031 | 6" | .045" | 7/8" | 60 | 12,700 | Stainless Steel | Type 1 | 25 | 10 |
| 13032 | 7" | .045" | 7/8" | 60 | 12,700 | Stainless Steel | Type 1 | 5 | 10 |
| 13033 | 7" | .045" | 7/8" | 60 | 12,700 | Stainless Steel | Type 1 | 25 | 10 |



CUT-OFF WHEELS TYPE 1 & 27



Type 27 Depressed Center

Type 1 Stainless Steel

Type 1 Diamond Arbor

Type 1 Masonry

TYPE 27 STAINLESS STEEL/ZIRCONIA CUT-OFF WHEELS

| Item# | Size | Thickness | Arbor | Grit | RPM | Shape | Grain | Pk. Qty | MP |
|-------|--------|-----------|-------|------|--------|---------|----------|---------|----|
| 13034 | 4" | .045" | 5/8" | 60 | 15,300 | Type 27 | Zirconia | 10 | 10 |
| 13035 | 4" | .045" | 5/8" | 60 | 15,300 | Type 27 | Zirconia | 25 | 4 |
| 13036 | 4 1/2" | .045" | 7/8" | 60 | 13,300 | Type 27 | Zirconia | 10 | 10 |
| 13037 | 4 1/2" | .045" | 7/8" | 60 | 13,300 | Type 27 | Zirconia | 25 | 4 |
| 13038 | 5" | .045" | 7/8" | 60 | 12,250 | Type 27 | Zirconia | 5 | 10 |
| 13039 | 5" | .045" | 7/8" | 60 | 12,250 | Type 27 | Zirconia | 25 | 4 |
| 13040 | 6" | .045" | 7/8" | 60 | 12,700 | Type 27 | Zirconia | 5 | 10 |
| 13041 | 6" | .045" | 7/8" | 60 | 12,700 | Type 27 | Zirconia | 25 | 4 |
| 13042 | 7" | .045" | 7/8" | 60 | 12,700 | Type 27 | Zirconia | 5 | 10 |
| 13043 | 7" | .045" | 7/8" | 60 | 12,700 | Type 27 | Zirconia | 25 | 4 |

TYPE 27 DEPRESSED CENTER CUT-OFF WHEELS (for use with angle grinders)

| | | | | | | | | | |
|--------|--------|-------|------|----|--------|---------|----------------|----|-----|
| SDP454 | 4 1/2" | .045" | 7/8" | 60 | 13,500 | Type 27 | Aluminum Oxide | 1 | N/A |
| 11134 | 4 1/2" | .045" | 7/8" | 60 | 13,500 | Type 27 | Aluminum Oxide | 5 | 10 |
| 11135 | 4 1/2" | .045" | 7/8" | 60 | 13,500 | Type 27 | Aluminum Oxide | 10 | 20 |
| 11136 | 4 1/2" | 1/16" | 7/8" | 46 | 13,300 | Type 27 | Aluminum Oxide | 5 | 40 |

TYPE 1/TYPE 27 CUTTING/GRINDING WHEELS FOR ALUMINUM

| | | | | | | | | | |
|-------|--------|-------|------|----|-------|---------|-----------------|---|----|
| 13180 | 4 1/2" | 3/32" | 7/8" | 36 | 8,700 | Type 1 | Silicon Carbide | 5 | 10 |
| 13181 | 4 1/2" | 1/8" | 7/8" | 36 | 8,700 | Type 27 | Silicon Carbide | 5 | 10 |
| 13063 | 4 1/2" | 1/4" | 7/8" | 36 | 8,700 | Type 27 | Silicon Carbide | 5 | 10 |

TYPE 1 GRINDING WHEELS WITH DIAMOND SHAPED ARBORS

| | | | | | | | | | |
|-------|----|------|-------|----|-------|--------|----------------|----|----|
| 12724 | 7" | 1/8" | 5/8** | 36 | 8,700 | Type 1 | Aluminum Oxide | 1 | 10 |
| 13069 | 7" | 1/8" | 5/8** | 36 | 8,700 | Type 1 | Aluminum Oxide | 5 | 10 |
| 12725 | 7" | 1/8" | 5/8** | 36 | 8,700 | Type 1 | Aluminum Oxide | 25 | 4 |
| 13070 | 8" | 1/8" | 5/8** | 36 | 7,600 | Type 1 | Aluminum Oxide | 5 | 10 |

TYPE 1 MASONRY CUT-OFF WHEELS

| | | | | | | | | | |
|-------|----|------|------|----|-------|--------|-----------------|----|----|
| 12694 | 7" | 1/8" | 5/8" | 24 | 8,700 | Type 1 | Silicon Carbide | 1 | 10 |
| 12695 | 7" | 1/8" | 5/8" | 24 | 8,700 | Type 1 | Silicon Carbide | 10 | 10 |

*Diamond center

MANDRELS

Shark mandrels can be used to convert any die grinder into a cut-off tool using either 1/4" or 3/8" I.D. wheels. Be sure to wear proper eye protection/face mask, gloves and safety gear. Shark offers 7 different types of mandrels for any application.

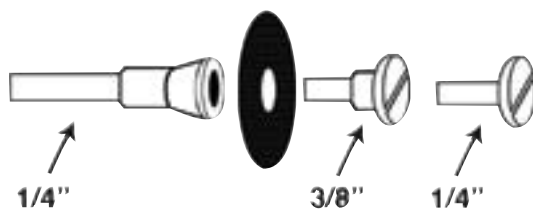

CUT-OFF WHEELS/MANDRELS

TYPE 1

12" & 14" CHOP SAW BLADES

| Item# | Old# | Size | Thickness | Arbor | Grit | RPM | Reinforcement/Type | Grain | Pk. Qty | MP |
|---------|-------|------|-----------|-------|------|-------|-----------------------------|-----------------|---------|----|
| 124D | | 12" | 3/32" | 1" | 36 | 5,000 | Double | Aluminum Oxide | 1 | 6 |
| 124-5 | | 12" | 3/32" | 1" | 36 | 5,000 | Double | Aluminum Oxide | 5 | 10 |
| 121-5 | | 12" | 1/8" | 1" | 36 | 5,100 | Single | Aluminum Oxide | 5 | 6 |
| 12726 | 122 | 12" | 1/8" | 1" | 36 | 6,300 | Double | Aluminum Oxide | 1 | 5 |
| 12727 | | 12" | 1/8" | 1" | 36 | 6,300 | Double | Aluminum Oxide | 10 | 3 |
| 122-5 | | 12" | 1/8" | 1" | 36 | 6,300 | Double | Aluminum Oxide | 5 | 6 |
| 123-5 | | 12" | 7/64" | 1" | 36 | 5,100 | Single | Aluminum Oxide | 5 | 6 |
| 13058 | | 12" | 5/32" | 20mm | 24 | 6,400 | Double/H.S. Gas/Elect. Saws | Zirconia | 5 | 6 |
| 13059 | | 12" | 5/32" | 1" | 24 | 6,400 | Double | Aluminum Oxide | 5 | 6 |
| 12696 | 122M | 12" | 1/8" | 1" | 36 | 5,100 | Double/Masonry | Silicon Carbide | 1 | 5 |
| 12697 | | 12" | 1/8" | 1" | 36 | 5,100 | Double/Masonry | Silicon Carbide | 10 | 3 |
| 122M-5 | | 12" | 1/8" | 1" | 36 | 5,100 | Double/Masonry | Silicon Carbide | 5 | 6 |
| 141-5 | | 14" | 1/8" | 1" | 36 | 4,400 | Single | Aluminum Oxide | 5 | 6 |
| 13159 | 144-5 | 14" | 3/32" | 1" | 36 | 4,400 | Double | Aluminum Oxide | 5 | 6 |
| 12728 | 142 | 14" | 1/8" | 1" | 36 | 4,400 | Double | Aluminum Oxide | 1 | 5 |
| 12729 | | 14" | 1/8" | 1" | 36 | 4,400 | Double | Aluminum Oxide | 10 | 3 |
| 12663 | 142-5 | 14" | 1/8" | 1" | 36 | 4,400 | Double | Aluminum Oxide | 5 | 6 |
| 143-5 | | 14" | 7/64" | 1" | 36 | 4,400 | Double | Aluminum Oxide | 5 | 6 |
| 13060 | | 14" | 5/32" | 20mm | 24 | 5,460 | Triple/H.S. Gas/Elect. Saws | Aluminum Oxide | 5 | 6 |
| 13061 | | 14" | 5/32" | 1" | 24 | 5,400 | Triple/H.S. Gas/Elect. Saws | Aluminum Oxide | 5 | 6 |
| 12698 | 142M | 14" | 1/8" | 1" | 24 | 4,400 | Double/Masonry | Silicon Carbide | 1 | 5 |
| 12699 | | 14" | 1/8" | 1" | 24 | 4,400 | Double/Masonry | Silicon Carbide | 10 | 3 |
| 142M-5 | | 14" | 1/8" | 1" | 24 | 4,400 | Double/Masonry | Silicon Carbide | 5 | 6 |
| 142MH-5 | | 14" | 1/8" | 1" | 24 | 4,400 | Double/HD Masonry | Silicon Carbide | 5 | 6 |

12782

Mandrel for 14607 Strip-Brite Disc (p. 34)



12431 (31)

Mandrel with 3/8" shoulder screw



12935 (32)

Mandrel with 1/4" & 3/8" shoulder screw



12433 (33)

Mandrel with 3/8" Extended Shoulder Screw. For use with wheels thicker than 3/8" with 3/8" arbor hole



12693 (34)

Mandrel with 1/2" adaptor



37L

Mandrel with 1/4" extended screw for wheels thicker than 3/8"



37S

Mandrel with only a 1/4" shoulder screw





GRINDING WHEELS

Shark offers various wheel styles for all your applications. Easy diagrams below for identifying the best wheel configuration for your project.

GRINDING WHEEL SHAPES

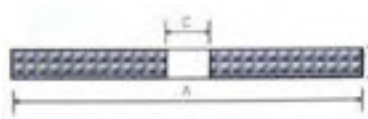

TYPE 1

An all around edge grinding wheel design; but not used for cutting.



TYPE 27

Grinding wheels with depressed centers used for grinding on flat surfaces and edge cleaning.



TYPE 28

This design offers great area coverage and improved user visibility for de-burring and other edge preparation work.

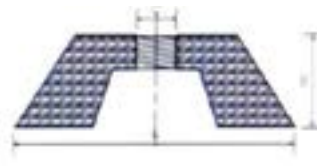

TYPE 11

Abrasive cup wheels offer even more area coverage than saucer shaped wheels. These are best for clearing material on large flat areas, also great for heavy welds.

HOW TO PICK THE RIGHT GRAIN TYPE



ALUMINUM OXIDE

This general purpose bond offers excellent stock removal. Recommended for use on regular steel, structural steel, metal and welds.



MASONRY

Silicon carbide grain for grinding masonry, concrete, stone, and non-ferrous metals.



ZIRCONIA FOR STAINLESS STEEL

High performance grinding excellent on ferrous metals, castings and stainless steel.

GRINDING WHEELS



TYPE 27

Type 27 grinding wheels with depressed centers are used for grinding on flat surfaces and edge cleaning.

| Item# | Old# | Size | Thickness | Arbor | Grit | RPM | Grain | Shape | Pk. Qty | MP |
|------------|------------|--------|-----------|---------|------|--------|----------------|---------|---------|----|
| SDP220 | | 2" | 3/16" | 3/8" | 120 | 25,000 | Aluminum Oxide | Type 27 | 5 | 20 |
| SDP280 | | 2" | 3/16" | 3/8" | 80 | 25,000 | Aluminum Oxide | Type 27 | 5 | 20 |
| SDP260 | | 2" | 3/16" | 3/8" | 60 | 25,000 | Aluminum Oxide | Type 27 | 5 | 20 |
| SDP301 | | 3" | 1/8" | 3/8" | 36 | 20,000 | Aluminum Oxide | Type 27 | 1 | 50 |
| SDP401 | | 4" | 1/8" | 5/8" | 36 | 13,700 | Aluminum Oxide | Type 27 | 1 | 50 |
| 12731 | SDP401-4 | 4" | 1/8" | 5/8" | 36 | 13,700 | Aluminum Oxide | Type 27 | 4 | 12 |
| SDP401-5 | | 4" | 1/8" | 5/8" | 36 | 13,700 | Aluminum Oxide | Type 27 | 5 | 15 |
| SDP401-25 | | 4" | 1/8" | 5/8" | 36 | 13,700 | Aluminum Oxide | Type 27 | 25 | 8 |
| SDP402 | | 4" | 1/4" | 3/8" | 24 | 13,700 | Aluminum Oxide | Type 27 | 1 | 50 |
| SDP402-3 | | 4" | 1/4" | 3/8" | 24 | 13,700 | Aluminum Oxide | Type 27 | 3 | 10 |
| SDP402-5 | | 4" | 1/4" | 3/8" | 24 | 13,700 | Aluminum Oxide | Type 27 | 5 | 15 |
| SDP402-25 | | 4" | 1/4" | 3/8" | 24 | 13,700 | Aluminum Oxide | Type 27 | 25 | 4 |
| SDP402-100 | | 4" | 1/4" | 3/8" | 24 | 13,700 | Aluminum Oxide | Type 27 | 100 | 4 |
| SDP404 | | 4" | 1/4" | 5/8" | 24 | 13,700 | Aluminum Oxide | Type 27 | 1 | 50 |
| 12732 | SDP404-3 | 4" | 1/4" | 5/8" | 24 | 13,700 | Aluminum Oxide | Type 27 | 3 | 10 |
| SDP404-5 | | 4" | 1/4" | 5/8" | 24 | 13,700 | Aluminum Oxide | Type 27 | 5 | 15 |
| 12733 | SDP404-25 | 4" | 1/4" | 5/8" | 24 | 13,700 | Aluminum Oxide | Type 27 | 25 | 4 |
| SDP404-100 | | 4" | 1/4" | 5/8" | 24 | 13,700 | Aluminum Oxide | Type 27 | 100 | 4 |
| SDP451 | | 4 1/2" | 1/8" | 7/8" | 36 | 11,900 | Aluminum Oxide | Type 27 | 1 | 50 |
| SDP451-3 | | 4 1/2" | 1/8" | 7/8" | 36 | 11,900 | Aluminum Oxide | Type 27 | 3 | 10 |
| SDP451-5 | | 4 1/2" | 1/8" | 7/8" | 36 | 11,900 | Aluminum Oxide | Type 27 | 5 | 15 |
| SDP451-25 | | 4 1/2" | 1/8" | 7/8" | 36 | 11,900 | Aluminum Oxide | Type 27 | 25 | 4 |
| SDP452 | | 4 1/2" | 1/4" | 7/8" | 24 | 11,900 | Aluminum Oxide | Type 27 | 1 | 50 |
| 12734 | SDP452-3 | 4 1/2" | 1/4" | 7/8" | 24 | 11,900 | Aluminum Oxide | Type 27 | 3 | 10 |
| SDP452-5 | | 4 1/2" | 1/4" | 7/8" | 24 | 11,900 | Aluminum Oxide | Type 27 | 5 | 15 |
| 12661 | | 4 1/2" | 1/4" | 7/8" | 24 | 11,900 | Aluminum Oxide | Type 27 | 10 | 4 |
| 12735 | SDP452-25 | 4 1/2" | 1/4" | 7/8" | 24 | 11,900 | Aluminum Oxide | Type 27 | 25 | 4 |
| SDP452-100 | | 4 1/2" | 1/4" | 7/8" | 24 | 11,900 | Aluminum Oxide | Type 27 | 100 | 4 |
| 12750 | SDP452H | 4 1/2" | 1/4" | 5/8"-11 | 24 | 11,900 | Aluminum Oxide | Type 27 | 1 | 20 |
| 12662 | | 4 1/2" | 1/4" | 5/8"-11 | 24 | 11,900 | Aluminum Oxide | Type 27 | 10 | 4 |
| 12751 | | 4 1/2" | 1/4" | 5/8"-11 | 24 | 11,900 | Aluminum Oxide | Type 27 | 25 | 4 |
| SDP501N | | 5" | 1/8" | 7/8" | 24 | 11,900 | Aluminum Oxide | Type 27 | 1 | 50 |
| SDP502 | | 5" | 1/4" | 5/8"-11 | 24 | 11,000 | Aluminum Oxide | Type 27 | 1 | 50 |
| SDP502-25 | | 5" | 1/4" | 5/8"-11 | 24 | 11,000 | Aluminum Oxide | Type 27 | 25 | 4 |
| 12736 | SDP502N | 5" | 1/4" | 7/8" | 24 | 12,000 | Aluminum Oxide | Type 27 | 1 | 50 |
| 12737 | | 5" | 1/4" | 7/8" | 24 | 11,000 | Aluminum Oxide | Type 27 | 25 | 8 |
| 13156 | | 6" | 1/4" | 7/8" | 24 | 10,200 | Aluminum Oxide | Type 27 | 1 | 25 |
| 13157 | | 6" | 1/4" | 7/8" | 24 | 10,200 | Aluminum Oxide | Type 27 | 5 | 10 |
| 12752 | SDP701 | 7" | 1/8" | 5/8"-11 | 24 | 8,500 | Aluminum Oxide | Type 27 | 1 | 10 |
| SDP701-10 | | 7" | 1/8" | 5/8"-11 | 24 | 8,500 | Aluminum Oxide | Type 27 | 10 | 5 |
| SDP701N | | 7" | 1/8" | 7/8" | 24 | 8,500 | Aluminum Oxide | Type 27 | 1 | 20 |
| 12753 | SDP702 | 7" | 1/4" | 5/8"-11 | 24 | 8,500 | Aluminum Oxide | Type 27 | 1 | 10 |
| 12754 | SDP702-10 | 7" | 1/4" | 5/8"-11 | 24 | 8,500 | Aluminum Oxide | Type 27 | 10 | 2 |
| 12738 | SDP702N | 7" | 1/4" | 7/8" | 24 | 8,500 | Aluminum Oxide | Type 27 | 1 | 25 |
| 12741 | SDP702N-10 | 7" | 1/4" | 7/8" | 24 | 8,500 | Aluminum Oxide | Type 27 | 10 | 10 |



GRINDING WHEELS

TYPE 27



ALUMINUM OXIDE

| Item# | Old# | Size | Thickness | Arbor | Grit | RPM | Shape | Pk. Qty | MP |
|-------|------------|------|-----------|---------|------|-------|---------|---------|----|
| 12689 | SDP901 | 9" | 1/8" | 5/8"-11 | 24 | 6,500 | Type 27 | 1 | 10 |
| 12755 | SDP902 | 9" | 1/4" | 5/8"-11 | 24 | 6,500 | Type 27 | 1 | 10 |
| 12756 | SDP902-10 | 9" | 1/4" | 5/8"-11 | 24 | 6,500 | Type 27 | 10 | 2 |
| 12739 | SDP902N | 9" | 1/4" | 7/8" | 24 | 6,500 | Type 27 | 1 | 10 |
| 12740 | SDP902N-10 | 9" | 1/4" | 7/8" | 24 | 6,500 | Type 27 | 10 | 5 |

ZIRCONIA DEPRESSED CENTER GRINDING WHEELS

| | | | | | | | | | |
|-------|------------|--------|------|---------|----|--------|---------|----|----|
| 12639 | SDP452Z | 4 1/2" | 1/4" | 7/8" | 24 | 11,900 | Type 27 | 1 | 25 |
| 12640 | SDP452Z-25 | 4 1/2" | 1/4" | 7/8" | 24 | 11,900 | Type 27 | 25 | 8 |
| 12641 | SDP452ZH | 4 1/2" | 1/4" | 5/8"-11 | 24 | 11,900 | Type 27 | 1 | 25 |
| 12642 | SDP702NZ-5 | 7" | 1/4" | 7/8" | 24 | 8,500 | Type 27 | 5 | 20 |
| 12643 | SDP702Z | 7" | 1/4" | 5/8"-11 | 24 | 8,500 | Type 27 | 1 | 20 |
| 12644 | SDP702Z-10 | 7" | 1/4" | 5/8"-11 | 24 | 8,500 | Type 27 | 10 | 2 |
| 12645 | SDP902Z | 9" | 1/4" | 5/8"-11 | 24 | 6,500 | Type 27 | 1 | 20 |
| 12646 | SDP902Z-10 | 9" | 1/4" | 5/8"-11 | 24 | 6,500 | Type 27 | 10 | 2 |

MASONRY DEPRESSED CENTER WHEELS

| | | | | | | | | | |
|-------|-------------|--------|------|---------|------|--------|---------|----|----|
| 12742 | SDP404SC | 4" | 1/4" | 5/8" | A24R | 13,500 | Type 27 | 1 | 25 |
| 12647 | SDP404SC-5 | 4" | 1/4" | 5/8" | A24R | 13,500 | Type 27 | 5 | 10 |
| 12743 | SDP404SC-25 | 4" | 1/4" | 5/8" | A24R | 13,500 | Type 27 | 25 | 8 |
| 12744 | SDP452SC | 4 1/2" | 1/4" | 7/8" | A24R | 10,850 | Type 27 | 1 | 25 |
| 12648 | SDP452SC-5 | 4 1/2" | 1/4" | 7/8" | A24R | 10,850 | Type 27 | 5 | 10 |
| 12745 | SDP452SC-25 | 4 1/2" | 1/4" | 7/8" | A24R | 10,850 | Type 27 | 25 | 8 |
| 12649 | SDP502SC-25 | 5" | 1/4" | 7/8" | A24R | 8,500 | Type 27 | 25 | 8 |
| 12746 | | 7" | 1/4" | 5/8"-11 | A24R | 6,600 | Type 27 | 1 | 10 |
| 12747 | SDP702SC-10 | 7" | 1/4" | 5/8"-11 | A24R | 6,600 | Type 27 | 10 | 2 |
| 12748 | | 9" | 1/4" | 5/8"-11 | A24R | 6,500 | Type 27 | 1 | 10 |
| 12749 | SDP902SC-10 | 9" | 1/4" | 5/8"-11 | A24R | 6,500 | Type 27 | 10 | 2 |

PIPELINE CUTTING/GRINDING WHEELS

These Metal / Stainless Steel wheels are specially designed for light grinding on welds and cutting of root pass.

| Item# | Old# | Size | Thickness | Arbor | Grit | RPM | Shape | Pk. Qty | MP |
|-------|------|--------|-----------|---------|------|--------|---------|---------|----|
| 13049 | | 4 1/2" | 1/8" | 7/8" | 24 | 13,300 | Type 27 | 10 | 5 |
| 13050 | | 4 1/2" | 1/8" | 5/8"-11 | 24 | 13,300 | Type 27 | 10 | 5 |
| 13051 | | 6" | 1/8" | 7/8" | 24 | 10,020 | Type 27 | 5 | 5 |
| 13052 | | 6" | 1/8" | 5/8"-11 | 24 | 10,020 | Type 27 | 5 | 5 |
| 13053 | | 7" | 1/8" | 7/8" | 24 | 8,600 | Type 27 | 5 | 5 |
| 13054 | | 7" | 1/8" | 5/8"-11 | 24 | 8,600 | Type 27 | 5 | 5 |

GRINDING WHEELS



TYPE 28

This design offers great area coverage and improved user visibility for de-burring work and other edge preparation work.

KOOLIE HAT WHEELS

| Item# | Old# | Size | Thickness | Arbor | Grit | RPM | Shape | Pk. Qty | MP |
|-------|-----------|------|-----------|---------|------|-------|---------|---------|----|
| 12759 | SKP702 | 7" | 1/4" | 5/8"-11 | 24 | 8,500 | Type 28 | 1 | 10 |
| 12760 | SKP702-10 | 7" | 1/4" | 5/8"-11 | 24 | 8,500 | Type 28 | 10 | 2 |
| 12761 | SKP902 | 9" | 1/4" | 5/8"-11 | 24 | 6,500 | Type 28 | 1 | 10 |
| 12762 | SKP902-10 | 9" | 1/4" | 5/8"-11 | 24 | 6,500 | Type 28 | 10 | 2 |

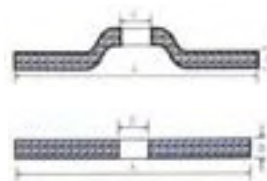

TYPE 27/TYPER 1

Grinding wheels with depressed centers are used for grinding on flat surfaces and edge cleaning.

GRINDING WHEELS FOR ALUMINUM

| Item# | Size | Thickness | Arbor | Grit | RPM | Shape | Pk. Qty | MP |
|-------|--------|-----------|---------|------|--------|---------|---------|----|
| 13063 | 4 1/2" | 1/4" | 7/8" | 24 | 13,300 | Type 27 | 5 | 10 |
| 13064 | 4 1/2" | 1/4" | 5/8"-11 | 24 | 13,300 | Type 27 | 1 | 5 |
| 12763 | 7" | 1/4" | 5/8"-11 | 24 | 8,600 | Type 27 | 1 | 10 |
| 12764 | 7" | 1/4" | 5/8"-11 | 24 | 8,600 | Type 27 | 5 | 2 |
| 13072 | 7" | 3/16" | 7/8" | 24 | 8,600 | Type 1 | 5 | 10 |



GRINDING WHEELS

CUP WHEELS



TYPE 11

A resinoid bonded, aluminum oxide cup wheel for use on portable grinders. For large weld grinding applications.

Abrasive cup wheels offer even more area coverage than saucer shaped wheels. These are best for clearing material on large flat areas requiring a very aggressive wheel.

| Item# | Size | Thickness | Arbor | Grit | RPM | Grain | Shape | Pk. Qty |
|-------|------|-----------|---------|-------|-------|----------------|---------|---------|
| 12690 | 4/3" | 2" | 5/8"-11 | 16-20 | 7,260 | Aluminum Oxide | Type 11 | 1 |
| 12691 | 5/4" | 2" | 5/8"-11 | 16-20 | 6,500 | Aluminum Oxide | Type 11 | 1 |
| 12692 | 6/5" | 2" | 5/8"-11 | 16-20 | 6,000 | Aluminum Oxide | Type 11 | 1 |

FLYWHEEL GRINDING WHEELS



Silicon Carbide flywheel grinding wheel. For use on DCM Tech, Kwik-Way, Peterson, Tobin Arp and Winona Machines.

| Item# | Size | Thickness | Arbor | Grit | RPM | Grain | Shape | Pk. Qty |
|-------|-----------|-----------|--------|------|-------|-----------------|---------|---------|
| 56 | 4" / 3" | 1 1/2" | 1 1/4" | 46 | 5,730 | Silicon Carbide | Type 11 | 1 |
| 57 | 6" / 4/5" | 2 5/8" | 1 1/2" | 36 | 4,775 | Silicon Carbide | Type 11 | 1 |



FLEXIBLE GRINDING WHEELS



Conforming, double reinforced Aluminum Oxide grinding wheel that becomes more pliable when used, and flexes to follow contoured surfaces.

FLEXI-WHEELS

| Item# | Old# | Size | Thickness | Arbor | Grit | RPM | Style | Shape | Pk. Qty | MP |
|----------|------|--------|-----------|---------|------|--------|-------------------------|---------|---------|----|
| 12765 | 4036 | 4" | 1/8" | 5/8" | 36 | 13,500 | Flexible Grinding Wheel | Type 27 | 1 | 10 |
| 4036-10 | | 4" | 1/8" | 5/8" | 36 | 13,500 | Flexible Grinding Wheel | Type 27 | 10 | 5 |
| 4046 | | 4" | 1/8" | 5/8" | 46 | 13,500 | Flexible Grinding Wheel | Type 27 | 1 | 10 |
| 4046-10 | | 4" | 1/8" | 5/8" | 46 | 13,500 | Flexible Grinding Wheel | Type 27 | 10 | 5 |
| 12766 | 4060 | 4" | 1/8" | 5/8" | 60 | 13,500 | Flexible Grinding Wheel | Type 27 | 1 | 10 |
| 4060-10 | | 4" | 1/8" | 5/8" | 60 | 13,500 | Flexible Grinding Wheel | Type 27 | 10 | 5 |
| 12767 | | 4 1/2" | 1/8" | 7/8" | 36 | 13,300 | Flexible Grinding Wheel | Type 27 | 1 | 10 |
| 4536-3 | | 4 1/2" | 1/8" | 7/8" | 36 | 13,300 | Flexible Grinding Wheel | Type 27 | 3 | 5 |
| 4536-10 | | 4 1/2" | 1/8" | 7/8" | 36 | 13,300 | Flexible Grinding Wheel | Type 27 | 10 | 5 |
| 4546-3 | | 4 1/2" | 1/8" | 7/8" | 46 | 13,300 | Flexible Grinding Wheel | Type 27 | 3 | 5 |
| 4546-10 | | 4 1/2" | 1/8" | 7/8" | 46 | 13,300 | Flexible Grinding Wheel | Type 27 | 10 | 5 |
| 12768 | | 4 1/2" | 1/8" | 7/8" | 60 | 13,300 | Flexible Grinding Wheel | Type 27 | 1 | 10 |
| 4560-3 | | 4 1/2" | 1/8" | 7/8" | 60 | 13,300 | Flexible Grinding Wheel | Type 27 | 3 | 5 |
| 4560-10 | | 4 1/2" | 1/8" | 7/8" | 60 | 13,300 | Flexible Grinding Wheel | Type 27 | 10 | 5 |
| 12769 | 7036 | 7" | 1/8" | 7/8" | 36 | 8,500 | Flexible Grinding Wheel | Type 27 | 1 | 5 |
| 7036-10 | | 7" | 1/8" | 7/8" | 36 | 8,500 | Flexible Grinding Wheel | Type 27 | 10 | 5 |
| 7036H-10 | | 7" | 1/8" | 5/8"-11 | 36 | 8,500 | Flexible Grinding Wheel | Type 27 | 10 | 2 |
| 7046 | | 7" | 1/8" | 7/8" | 46 | 8,500 | Flexible Grinding Wheel | Type 27 | 1 | 5 |
| 7046-10 | | 7" | 1/8" | 7/8" | 46 | 8,500 | Flexible Grinding Wheel | Type 27 | 10 | 5 |
| 7046H-10 | | 7" | 1/8" | 5/8"-11 | 46 | 8,500 | Flexible Grinding Wheel | Type 27 | 10 | 2 |
| 12770 | 7060 | 7" | 1/8" | 7/8" | 60 | 8,500 | Flexible Grinding Wheel | Type 27 | 1 | 5 |
| 7060-10 | | 7" | 1/8" | 7/8" | 60 | 8,500 | Flexible Grinding Wheel | Type 27 | 10 | 2 |
| 7060H-10 | | 7" | 1/8" | 5/8"-11 | 60 | 8,500 | Flexible Grinding Wheel | Type 27 | 10 | 2 |
| 7080 | | 7" | 1/8" | 7/8" | 80 | 8,500 | Flexible Grinding Wheel | Type 27 | 1 | 5 |
| 7080-10 | | 7" | 1/8" | 7/8" | 80 | 8,500 | Flexible Grinding Wheel | Type 27 | 10 | 2 |
| 7080H-10 | | 7" | 1/8" | 5/8"-11 | 80 | 8,500 | Flexible Grinding Wheel | Type 27 | 10 | 2 |





THERMOSTAT GASKET REMOVER

Cleans all hard to reach gasket surfaces. Also works for cleaning up oil pans, water pumps, and other inaccessible applications. Replaceable abrasive pad works in seconds. The tool is equipped with a floating guide shaft so the user can easily steer the abrasive pad around the gasket surface.



| Item# | Size | Type | Shank Diameter | Pk. Qty. | MP |
|-------|------------|---|------------------|----------|----|
| 13084 | 2" x7 1/2" | Type "R" Holder with Extended Shaft | 1/4" Guide Shaft | 1 | 5 |
| 13085 | 7 1/2" | Extended Guide Shaft | 1/4" Guide Shaft | 1 | 5 |
| 13012 | 2" | Type "R" Twist-to-Lock Holder (sold separately) | 1/4" Mandrel | 1 | 20 |

BACKING PADS/ADAPTORS

Shark Industries has several types of backing pads and adaptors to secure the abrasives for multiple jobs. Some pads can even make your tool more versatile by allowing you to use other abrasives on it.



TWIST-TO-LOCK VENTED BACKING PAD

2", 3" and 4" Twist-to-lock Type R vented backing pads.
Tool: Angle or straight grinders.
Use with: Mini grinding discs, mini flap discs and surface prep-discs.
 Page 15



Hook and Loop Fastener MINI BACKING PAD

For use on Snap-on, Mac, Matco, or other mini Sanders.
Tool: Any pistol style 3" sander using female threads.
Use with: 3" hook and loop fastener sanding discs. Page 16



TWIST-TO-LOCK BACKING PAD

2", 3" and 4" Twist-to-lock Type R quick change backing pad.
Tool: Right Angle Grinders and Die Grinders.
Use with: Surface prep, mini grinding, strip-it and mini flap discs. Page 15



RUBBER BACKING PAD

Quality backing pad to fit all 4-7" grinders. Turbo pad with vents affords users a cooler disc and longer life.
Tool: Angle grinders.
Use with: Resin fiber discs. Page 16



Hook and Loop Fastener BACKING PAD

2", 3" and 4" Hook and Loop Fastener backing pad.
Tool: Angle or straight grinders.
Use with: Mini grinding discs, mini flap discs and surface prep-discs with Hook and Loop Fastener backing. Page 15



TYPE R MINI GRINDER BACKING PAD

Add instant versatility to your 2" grinder. Twist-to-lock receptacle.
Tool: 2" Right Angle Mini Grinders; CP7500, Sunex SXC606, Mac Tools AG200, Matco and Snap-On.
Use with: Surface prep, mini grinding, strip-it and mini flap discs. Page 16

BACKING PADS/ADAPTORS

2" - 4" VENTED BACKING PAD (TYPE R)



2", 3" and 4" vented Twist-to-lock type backing pads.
Tool: Right Angle Grinders and Die Grinders.
Use with: Surface prep, mini grinding, strip-it and mini flap discs.
Made in USA.

| Item# | Size | Type | Style | Pk. Qty. | MP |
|-------|------|-------|--------------------------------------|----------|----|
| 44320 | 2" | Turbo | Twist-to-lock Holder w/ 1/4" Mandrel | 1 | 10 |
| 44321 | 3" | Turbo | Twist-to-lock Holder w/ 1/4" Mandrel | 1 | 10 |
| 44322 | 4" | Turbo | Twist-to-lock Holder w/ 1/4" Mandrel | 1 | 10 |

2" - 4" TWIST-TO-LOCK BACKING PAD (TYPE R)



2", 3" and 4" Twist-to-lock backing pad.
 Compatible with all twist-to-lock brands of discs, this high quality holder has a rigid rubber pad and twist-to-lock attachment.
Tool: Right Angle Grinders and Die Grinders.
Use with: Surface prep, mini grinding, strip-it and mini flap discs.

| Item# | Old# | Size | Type | Style | Pk. Qty. | MP |
|---------|------|------|---------------|-------------------------------------|----------|----|
| 13012 | 323T | 2" | Twist-to-Lock | Twist-to-lock Backing Pad w/Mandrel | 1 | 20 |
| 323T-50 | | 2" | Twist-to-Lock | Twist-to-lock Backing Pad w/Mandrel | 50 | 5 |
| 13013 | 333T | 3" | Twist-to-Lock | Twist-to-lock Backing Pad w/Mandrel | 1 | 20 |
| 333T-50 | | 3" | Twist-to-Lock | Twist-to-lock Backing Pad w/Mandrel | 50 | 5 |
| 13014 | 343T | 4" | Twist-to-Lock | Twist-to-lock Backing Pad w/Mandrel | 1 | 10 |
| 343T-50 | | 4" | Twist-to-Lock | Twist-to-lock Backing Pad w/Mandrel | 50 | 2 |

2" - 4" Hook and Loop Fastener BACKING PAD



2", 3" and 4" Hook and Loop Fastener backing pad.
Tool: Right Angle Grinders and Die Grinders. **Use with:** Hook and Loop Fastener backed sanding discs
Made in USA.

| Item# | Size | Type | Style | Pk. Qty. | MP |
|-------|------|------------------------|------------------------|----------|----|
| 323 | 2" | Hook and Loop Fastener | Holder with 1/4" Shank | 1 | 5 |
| 333 | 3" | Hook and Loop Fastener | Holder with 1/4" Shank | 1 | 5 |
| 343 | 4" | Hook and Loop Fastener | Holder with 1/4" Shank | 1 | 5 |

2" - 3" MINI GRINDER BACKING PADS (TYPE R)



Adds instant versatility to your 2" grinder.
Tool: 2" Right Angle Mini Grinders; CP7500, Sunex SXC606, Mac Tools AG200, Matco and Snap-On.
Use with: Surface prep, mini grinding, strip-it and mini flap discs.

| Item# | Size | Type | Style | Pk. Qty. | MP |
|-------|------|-----------------------|---------------|----------|----|
| 13025 | 2" | 3/8"-24 Thread | Twist-to-lock | 1 | 20 |
| 13026 | 3" | 3/8"-24 Female Thread | Twist-to-lock | 1 | 20 |



BACKING PADS/ADAPTORS



For use on Snap-on, Mac, and Matco Mini Sanders.

Tool: Any pistol style 3" sander using female threads.

Use with: 3" Hook and Loop Fastener sanding discs.

Hook and Loop Fastener MINI BACKING PAD

| Item# | Size | Type | Style | Pk. Qty. |
|-------|------|------------------------|--|----------|
| 333S | 3" | Hook and Loop Fastener | 1/4"-20 Female Thread Screw Backing Pad | 1 |
| 333SP | 3" | Hook and Loop Fastener | 5/16"-24 Female Thread Screw Backing Pad | 1 |



Quality backing pad to fit all 4-7" angle grinders. Turbo pad with vents affords users a cooler disc thereby offering you longer life.

Tool: 4"-7" Angle Grinder

Use with: 4"-7" Resin Fiber Discs

RUBBER BACKING PAD

| Item# | Size | Type | Style | Pk. Qty. |
|-------|------|--------|------------------------------------|----------|
| 13201 | 4" | Rubber | M10-1.25 Backing Pad for Sander | 1 |
| 13202 | 4" | Rubber | M10-1.50 Backing Pad for Sander | 1 |
| 13203 | 4" | Rubber | Backing Pad without nut for Sander | 1 |
| 13204 | 4.5" | Rubber | 5/8"-11NC Backing Pad for Sander | 1 |
| 13205 | 5" | Rubber | 5/8"-11NC Backing Pad for Sander | 1 |
| 13206 | 7" | Rubber | 5/8"-11NC Backing Pad for Sander | 1 |
| 13207 | 7" | Rubber | Backing Pad without nut for Sander | 1 |



SPINDLE NUT FOR RUBBER BACKING PAD

Nut used to attach the pad to the tool, which are frequently lost. One per pack.

| | |
|-------|---------------------|
| 13209 | M10-1.25 |
| 13210 | M10-1.50 |
| 13211 | Nut for 5/8"-11 Hub |



SPINDLE NUT WRENCH

Adjustable wrench used for installation and removal of spindle nuts with holes. One per pack.

| | |
|-------|--------------------|
| 13212 | Spindle Nut Wrench |
|-------|--------------------|

MANDRELS/ADAPTORS

DEPRESSED CENTER WHEEL ADAPTOR

Adaptor readily adapts any depressed center wheel with 7/8" hole to a 5/8"-11NC spindle for use with a standard right angle grinder. Wrench included.

13213 Kit Includes: Wrench, Adaptor, 2 washers and nut.



MANDRELS

Shark mandrels can be used to convert any die grinder into a cut-off tool using wheels with either 1/4" or 3/8" I.D. Be sure to wear proper eye protection/face mask, gloves and safety gear.

Shark offers 7 different types of Mandrels for any application.

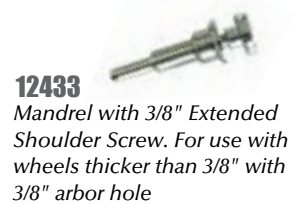
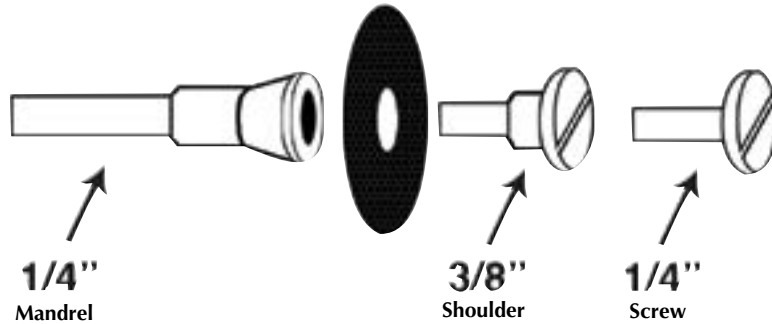

GRINDING DISCS

Surface preparation is the most important step in creating a quality bond. Surfaces are often covered with dust, dirt, grease, oil, oxide films, rust inhibitors, and in the case of plastics, mold release agents. All these contaminants, even at a microscopic level, interfere with the adhesive doing its job properly. In fact, poor surface preparation is the number one cause of bond failure.

GRAIN OPTIONS



ALUMINUM OXIDE

Properties:

- Aggressive cutting
- High cut performance
- Good productivity

Grinding and finishing of welding parts and all kinds of steel. Not optimum on stainless steel.



ZIRCONIA

Properties:

- Fast cutting performance, while long wearing
- Increased productivity
- Cool cutting as well as long life

Grinding heavy metals and stainless steel parts.



GREEN ZIRCONIA

Properties:

- High cut performance
- Increased productivity
- Cool cutting
- Extremely long life

Grinding of high alloy/stainless steel parts and edging. Use where heat absorbance is critical.



CERAMIC

Properties:

- Excellent grinding performance
- Cool & aggressive cutting
- Self sharpening for outstanding life

Grinding and finishing of stainless steel, high alloy steels, chrome, nickel, and titanium.

SURFACE PREP/GRINDING

SURFACE CONDITIONING DISCS



Specifications:
For general grinding, rust removal, clean-up and paint removal. Offering 6 different grits.
Tool: Right angle grinders or die grinders. Page 21-25

STAR-BRITE POLISHING DISCS



Best For: Polishing and finishing after grinding. 2 grits options offered.
Tool: 4 1/2" angle grinders. Page 27

STAR-BRITE SANDING PADS



Best For: For hard sanding and general clean-up. 3 grit options offered.
Page 27

STRIP-BRITE PADS



Specifications:
Available in 3 grades, 2" & 3" with a twist-to-lock backing.
Tool: Right angle grinders or die grinders. Page 27-28

TYPE 27 STRIP-BRITE DISCS



Specifications:
Available in 3 grades, 4 1/2" & 7".
Best For: Use in paint and rust removal. Will not damage the metal while grinding. Low sparking product.
Tool: 4 1/2" - 7" angle grinders. Page 27

CLOTH BACKED GRINDING DISCS



Specifications:
Aluminum Oxide or Zirconia in 2"-3", 24-120 grit.
Tool: Right angle grinders or die grinders. Page 28

ZIRCONIA MINI GRINDING DISCS



Specifications:
Zirconia long-life grain for Stainless Steel or regular steels.
Tool: For use with angle grinders or die grinders. Page 31

ALUMINUM OXIDE MINI GRINDING DISCS



Specifications:
For general purpose grinding. Available in grits from 24-120.
Tool: Right angle grinders or die grinders. Page 30

GREEN ZIRCONIA GRINDING DISCS



Specifications:
For grinding on steel or stainless steel. Long life grain from 24-120 grit.
Tool: Right angle grinders or die grinders. Page 29

CERAMIC MINI GRINDING DISCS



Specifications:
For very long life and heavy duty grinding jobs. Available in grits from 24-120.
Tool: Right angle grinders or die grinders. Page 29

RESIN FIBRE SANDING DISCS



Specifications:
Aluminum Oxide and Zirconia grain.
Tool: 4" - 9" angle grinders. PageS 34-36

SHEEPSKIN PADS



Specifications:
All natural sheepskin pad for use with Hook and Loop Fastener backing pads.
Best For: Eliminating defects while removing as little paint as possible. Can remove swirl marks, oxidation, scratches, bird etchings and acid rain.
Tool: Right angle grinders or die grinders. Page 37

WOOL FELT PADS



Specifications:
High quality wool felt will not fray.
Best For: Polishing metals or plastics.
Tool: Right angle grinders or die grinders. Page 37



SURFACE PREP/GRINDING



GENERAL PURPOSE DRY SANDING PAPER

Specifications:

A great general purpose sheet for dry sanding applications on plastic, metal or fiberglass.

Best For: Use for feather-edging, sanding scratches, finishing plastic fillers and paint removal.

Tool: Cut to fit power sander, block or hand sanding. Page 38



SILICON CARBIDE WET/DRY PAPER

Specifications:

Silicon carbide grit designed to prevent loading when sanding. A great purpose sheet for dry sanding applications on plastic, metal or fiberglass automotive surfaces.

Best For: Use for feather-edging, sanding scratches, finishing plastic fillers and paint removal.

Tool: Cut to fit power sander, block or hand sanding. Page 38



SANDBCREEN SHEETS

Specifications:

Open coat resin on resin bond.

Best For: Concrete or ceramic tile.

Tool: Power Sanders. Page 39



EMERY CLOTH SHEETS AND ROLLS

Specifications: Emery Grain with cloth backing.

Best For: Sanding and polishing

Tool: Use by hand. Page 39



GOLD PRO DISCS

Specifications: Aluminum Oxide on "C" weight backing.

Best For: Auto body or manufacturing sanding needs.

Tool: Orbital Sander. Page 40



SUPER BLUE DISCS

Specifications: Extra Open coating and Resin bonding also offers a Special Stearate top coat.

Best For: Use on polyurethanes, carbon fiber, polyesters, and acrylic resins.

Tool: Orbital Sander. Page 41



ABRASIVE FILE SHEETS AND ROLLS

Specifications: Aluminum Oxide with 3 different backings.

Best For: Auto body or flat surface sanding.

Tool: Long board sanders. Page 42

SURFACE PREP COLOR CHART



BROWN
COARSE



BURGUNDY
MEDIUM



BLUE
FINE



GREY
ULTRA-FINE



BROWN/BLUE BACK
EXTRA COARSE



BURGUNDY/BLUE BACK
HEAVY-DUTY MEDIUM

SURFACE CONDITIONING



620T

620TB / 13062

Thicker,
Longer
Lasting
Material



Specifications:
The Twist-To-Lock feature is great for quick-change and is compatible with all other brands of twist locking style holders.



STAR-BRITE SUPERIOR LIFE SURFACE PREP DISCS

| Item# | Old# | *3M# | Size | Color | Grit | Pk. Qty. | MP |
|------------|----------|-------|--------|----------|-------------------|----------|----|
| 610TB | | 37454 | 1 1/2" | Brown | Coarse | 25 | 4 |
| 612TB | | 37462 | 1 1/2" | Burgundy | Medium | 25 | 4 |
| 614TB | | 37470 | 1 1/2" | Blue | Fine | 25 | 4 |
| 616TB | | 37488 | 1 1/2" | Grey | Ultra-Fine | 25 | 4 |
| 13000 | | 07480 | 2" | Brown | Coarse | 10 | 8 |
| 13062 | 620TB | 07480 | 2" | Brown | Coarse | 25 | 8 |
| 13003 | 620TB-50 | 07480 | 2" | Brown | Coarse | 50 | 10 |
| 13219 | 620TBC | 07480 | 2" | Brown | Coarse | 100 | 10 |
| 620TB-500 | | 07480 | 2" | Brown | Coarse | 500 | 2 |
| 620TB-1000 | | 07480 | 2" | Brown | Coarse | 1000 | 1 |
| 621TB | | 92679 | 2" | Brown | Extra Coarse | 25 | 4 |
| 621TB-50 | | 92679 | 2" | Brown | Extra Coarse | 50 | 5 |
| 621TBC | | 92679 | 2" | Brown | Extra Coarse | 100 | 5 |
| 13001 | | 07481 | 2" | Burgundy | Medium | 10 | 8 |
| 13018 | 622TB | 07481 | 2" | Burgundy | Medium | 25 | 4 |
| 13004 | 622TB-50 | 07481 | 2" | Burgundy | Medium | 50 | 10 |
| 13220 | 622TBC | 07481 | 2" | Burgundy | Medium | 100 | 10 |
| 622TB-500 | | 07481 | 2" | Burgundy | Medium | 500 | 2 |
| 622TB-1000 | | 07481 | 2" | Burgundy | Medium | 1000 | 1 |
| 623TB | | 83987 | 2" | Burgundy | Heavy Duty Medium | 25 | 4 |
| 623TB-50 | | 83987 | 2" | Burgundy | Heavy Duty Medium | 50 | 5 |
| 623TBC | | 83987 | 2" | Burgundy | Heavy Duty Medium | 100 | 5 |
| 13002 | | 07515 | 2" | Blue | Fine | 10 | 8 |
| 624TB | | 07515 | 2" | Blue | Fine | 25 | 4 |
| 13005 | 624TB-50 | 07515 | 2" | Blue | Fine | 50 | 10 |
| 13221 | 624TBC | 07515 | 2" | Blue | Fine | 100 | 10 |
| 624TB-500 | | 07515 | 2" | Blue | Fine | 500 | 2 |
| 624TB-1000 | | 07515 | 2" | Blue | Fine | 1000 | 1 |
| 626TB | | 07516 | 2" | Grey | Ultra-Fine | 25 | 4 |
| 626TB-50 | | 07516 | 2" | Grey | Ultra-Fine | 50 | 10 |
| 626TBC | | 07516 | 2" | Grey | Ultra-Fine | 100 | 10 |
| 626TB-1000 | | 07516 | 2" | Grey | Ultra-Fine | 1000 | 1 |
| 13006 | | 07485 | 3" | Brown | Coarse | 10 | 8 |
| 13019 | 630TB | 07485 | 3" | Brown | Coarse | 25 | 4 |
| 13222 | 630TB-50 | 07485 | 3" | Brown | Coarse | 50 | 10 |
| 13223 | 630TBC | 07485 | 3" | Brown | Coarse | 100 | 5 |

*3M is a Registered Trademark of 3M Corporation.

(Continued)



SURFACE CONDITIONING



620TB

STAR-BRITE SUPERIOR LIFE SURFACE PREP DISCS

| Item# | Old# | **3M# | Size | Color | Grit | Pk. Qty. | MP |
|------------|----------|-------|------|----------|-------------------|----------|----|
| 630TB-1000 | | 07485 | 3" | Brown | Coarse | 1000 | 1 |
| 631TB | | 92695 | 3" | Brown | X-tra Coarse | 25 | 10 |
| 631TB-50 | | 92695 | 3" | Brown | X-tra Coarse | 50 | 10 |
| 631TBC | | 92695 | 3" | Brown | X-tra Coarse | 100 | 5 |
| 13007 | | 07486 | 3" | Burgundy | Medium | 10 | 10 |
| 13020 | 632TB | 07486 | 3" | Burgundy | Medium | 25 | 10 |
| 13224 | 632TB-50 | 07486 | 3" | Burgundy | Medium | 50 | 5 |
| 13225 | 632TBC | 07486 | 3" | Burgundy | Medium | 100 | 5 |
| 632TB-500 | | 07486 | 3" | Burgundy | Medium | 500 | 1 |
| 632TB-1000 | | 07486 | 3" | Burgundy | Medium | 1000 | 1 |
| 633TB | | 83995 | 3" | Burgundy | Heavy Duty Medium | 25 | 10 |
| 633TB-50 | | 83995 | 3" | Burgundy | Heavy Duty Medium | 50 | 10 |
| 633TBC | | 83995 | 3" | Burgundy | Heavy Duty Medium | 100 | 5 |
| 13008 | | 07513 | 3" | Blue | Fine | 10 | 10 |
| 634TB | | 07513 | 3" | Blue | Fine | 25 | 10 |
| 634TB-50 | | 07513 | 3" | Blue | Fine | 50 | 10 |
| 634TBC | | 07513 | 3" | Blue | Fine | 100 | 5 |
| 634TB-1000 | | 07513 | 3" | Blue | Fine | 1000 | 1 |
| 636TB | | 07514 | 3" | Grey | Ultra-Fine | 25 | 10 |
| 636TB-50 | | 07514 | 3" | Grey | Ultra-Fine | 50 | 10 |
| 636TBC | | 07514 | 3" | Grey | Ultra-Fine | 100 | 5 |
| 636TB-1000 | | 07514 | 3" | Grey | Ultra-Fine | 1000 | 1 |
| 13009 | | 07482 | 4" | Brown | Coarse | 10 | 5 |
| 640TB | | 07482 | 4" | Brown | Coarse | 25 | 4 |
| 640TB-50 | | 07482 | 4" | Brown | Coarse | 50 | 4 |
| 640TBC | | 07482 | 4" | Brown | Coarse | 100 | 2 |
| 13010 | | 21274 | 4" | Burgundy | Medium | 10 | 5 |
| 642TB | | 07484 | 4" | Burgundy | Medium | 25 | 4 |
| 642TB-50 | | 07484 | 4" | Burgundy | Medium | 50 | 4 |
| 642TBC | | 07484 | 4" | Burgundy | Medium | 100 | 2 |
| 644TB | | 07511 | 4" | Blue | Fine | 10 | 5 |
| 13011 | 646TB | 07512 | 4" | Grey | Ultra-Fine | 10 | 5 |
| 64520TB* | | 52162 | 4 ½" | Brown | Coarse | 10 | 5 |
| 64522TB* | | 23688 | 4 ½" | Burgundy | Medium | 10 | 5 |
| 64524TB* | | | 4 ½" | Blue | Fine | 10 | 5 |
| 64526TB* | | | 4 ½" | Grey | Ultra-Fine | 10 | 5 |
| 6520TB* | | 21282 | 5" | Brown | Coarse | 10 | 5 |
| 6522TB* | | 34053 | 5" | Burgundy | Medium | 10 | 5 |
| 6524TB* | | | 5" | Blue | Fine | 10 | 5 |
| 6526TB* | | | 5" | Grey | Ultra-Fine | 10 | 5 |

*Hook and Loop

**3M is a Registered Trademark of 3M Corporation.

SURFACE CONDITIONING



STAR-BRITE SUPERIOR LIFE SURFACE PREP DISCS

| Item# | **3M# | Size | Color | Grit | Pk. Qty. | MP |
|---------|-------|------|------------|------------|----------|----|
| 6620TB* | 35408 | 6" | ● Brown | Coarse | 10 | 5 |
| 6622TB* | 45869 | 6" | ● Burgundy | Medium | 10 | 5 |
| 6624TB* | | 6" | ● Blue | Fine | 10 | 5 |
| 6720TB* | 07943 | 7" | ● Brown | Coarse | 10 | 5 |
| 6722TB* | 23312 | 7" | ● Burgundy | Medium | 10 | 5 |
| 6724TB* | 53384 | 7" | ● Blue | Fine | 10 | 5 |
| 6726TB* | | 7" | ● Grey | Ultra-Fine | 10 | 5 |



Specifications:

These premium pads are softer, with a less aggressive performance.

Backing Type: Twist-to-lock

STAR-BRITE PREMIUM PADS

| Item# | **3M# | Size | Color | Grit | Pk. Qty. | MP |
|-----------|-------|------|------------|--------|----------|----|
| 610T | 37454 | 1 ½" | ● Brown | Coarse | 25 | 4 |
| 610T-100 | 37454 | 1 ½" | ● Brown | Coarse | 100 | 5 |
| 612T | 37462 | 1 ½" | ● Burgundy | Medium | 25 | 4 |
| 612T-100 | 37462 | 1 ½" | ● Burgundy | Medium | 100 | 5 |
| 614T | 37470 | 1 ½" | ● Blue | Fine | 25 | 4 |
| 614T-100 | 37470 | 1 ½" | ● Blue | Fine | 100 | 1 |
| 614T-1000 | 37470 | 1 ½" | ● Blue | Fine | 1000 | 1 |
| 620T | 07480 | 2" | ● Brown | Coarse | 25 | 4 |
| 620T-50 | 07480 | 2" | ● Brown | Coarse | 50 | 10 |
| 620TC | 07480 | 2" | ● Brown | Coarse | 100 | 10 |
| 620T-500 | 07480 | 2" | ● Brown | Coarse | 500 | 2 |
| 620T-1000 | 07480 | 2" | ● Brown | Coarse | 1000 | 1 |
| 622T | 07481 | 2" | ● Burgundy | Medium | 25 | 4 |
| 622T-50 | 07481 | 2" | ● Burgundy | Medium | 50 | 10 |
| 622TC | 07481 | 2" | ● Burgundy | Medium | 100 | 1 |
| 622T-500 | 07481 | 2" | ● Burgundy | Medium | 500 | 2 |
| 622T-1000 | 07481 | 2" | ● Burgundy | Medium | 1000 | 1 |
| 624T | 07515 | 2" | ● Blue | Fine | 25 | 4 |
| 624T-50 | 07515 | 2" | ● Blue | Fine | 50 | 10 |
| 624TC | 07515 | 2" | ● Blue | Fine | 100 | 10 |
| 624T-500 | 07515 | 2" | ● Blue | Fine | 500 | 2 |
| 624T-1000 | 07515 | 2" | ● Blue | Fine | 1000 | 1 |

*Hook and Loop

**3M is a Registered Trademark of 3M Corporation.



SURFACE CONDITIONING

STAR-BRITE PREMIUM PADS

Less aggressive than the TB series, these USA made pads offer more flexibility and a softer disc, provides a high quality user experience.



| Item# | *3M# | Size | Color | Grit | Pk. Qty. | MP |
|-----------|-------|------|------------|------------|----------|----|
| 626T | 07515 | 2" | ● Grey | Ultra Fine | 25 | 4 |
| 626T-50 | 07515 | 2" | ● Grey | Ultra Fine | 50 | 10 |
| 626TC | 07515 | 2" | ● Grey | Ultra Fine | 100 | 2 |
| 626T-500 | 07515 | 2" | ● Grey | Ultra Fine | 500 | 1 |
| 626T-1000 | 07515 | 2" | ● Grey | Ultra Fine | 1000 | 1 |
| 630T | 07485 | 3" | ● Brown | Coarse | 25 | 4 |
| 630T-50 | 07485 | 3" | ● Brown | Coarse | 50 | 10 |
| 630TC | 07485 | 3" | ● Brown | Coarse | 100 | 5 |
| 630T-500 | 07485 | 3" | ● Brown | Coarse | 500 | 1 |
| 630T-1000 | 07485 | 3" | ● Brown | Coarse | 1000 | 1 |
| 632T | 07486 | 3" | ● Burgundy | Medium | 25 | 4 |
| 632T-50 | 07486 | 3" | ● Burgundy | Medium | 50 | 10 |
| 632TC | 07486 | 3" | ● Burgundy | Medium | 100 | 5 |
| 632T-500 | 07486 | 3" | ● Burgundy | Medium | 500 | 1 |
| 632T-1000 | 07486 | 3" | ● Burgundy | Medium | 1000 | 1 |
| 634T | 07513 | 3" | ● Blue | Fine | 25 | 4 |
| 634T-50 | 07513 | 3" | ● Blue | Fine | 50 | 2 |
| 634TC | 07513 | 3" | ● Blue | Fine | 100 | 2 |
| 634T-500 | 07513 | 3" | ● Blue | Fine | 500 | 1 |
| 634T-1000 | 07513 | 3" | ● Blue | Fine | 1000 | 1 |
| 636T | 07514 | 3" | ● Grey | Ultra Fine | 25 | 4 |
| 636T-50 | 07514 | 3" | ● Grey | Ultra Fine | 50 | 2 |
| 636TC | 07514 | 3" | ● Grey | Ultra Fine | 100 | 2 |
| 636T-500 | 07514 | 3" | ● Grey | Ultra Fine | 500 | 1 |
| 636T-1000 | 07514 | 3" | ● Grey | Ultra Fine | 1000 | 1 |
| 640T | 07482 | 4" | ● Brown | Coarse | 25 | 4 |
| 640T-50 | 07482 | 4" | ● Brown | Coarse | 50 | 2 |
| 640TC | 07482 | 4" | ● Brown | Coarse | 100 | 2 |
| 640T-500 | 07482 | 4" | ● Brown | Coarse | 500 | 1 |
| 640T-1000 | 07482 | 4" | ● Brown | Coarse | 1000 | 1 |
| 642T | 07483 | 4" | ● Burgundy | Medium | 25 | 4 |
| 642T-50 | 07483 | 4" | ● Burgundy | Medium | 50 | 2 |
| 642TC | 07483 | 4" | ● Burgundy | Medium | 100 | 2 |
| 642T-500 | 07483 | 4" | ● Burgundy | Medium | 500 | 1 |
| 642T-1000 | 07483 | 4" | ● Burgundy | Medium | 1000 | 1 |
| 644T | 07511 | 4" | ● Blue | Fine | 10 | 5 |
| 644TC | 07511 | 4" | ● Blue | Fine | 100 | 2 |
| 646T | 07512 | 4" | ● Grey | Ultra Fine | 10 | 5 |
| 646TC | 07512 | 4" | ● Grey | Ultra Fine | 100 | 2 |

*3M is a Registered Trademark of 3M Corporation.

SURFACE PREP/GRINDING

STAR-BRITE/MINI GRINDING CLAMSHELL PACKAGES

Shark has compiled 6 prime clamshell display packages. These kits have great 4 color packaging that will stand out on the display shelves. The 6 kits are created of several different types of mini grinding discs and star-brite discs.



STAR-BRITE FINISHING KITS 2" & 3"

The Surface Conditioning Discs provide a burr-free finish while removing grinding marks, rust and surface coatings, while the professional Grinding Discs provide a fast, efficient method of grinding, blending, leveling and finishing metal surfaces.

| Item# | Description | Item# | Description |
|--|-----------------------------|--|-----------------------------|
| 16401 | 2" Mini Grinding Assortment | 16402 | 3" Mini Grinding Assortment |
| This 6 pcs Surface Prep Assortment kit includes the following: | | This 6 pcs Surface Prep Assortment kit includes the following: | |
| (1) 2" Coarse Disc | | (1) 3" Coarse Disc | |
| (1) 2" Medium Disc | | (1) 3" Medium Disc | |
| (1) 2" 24 Grit Mini Grinding Disc | | (1) 3" 24 Grit Mini Grinding Disc | |
| (1) 2" 36 Grit Mini Grinding Disc | | (1) 3" 36 Grit Mini Grinding Disc | |
| (1) 2" 50 Grit Mini Grinding Disc | | (1) 3" 50 Grit Mini Grinding Disc | |
| (1) 2" Holder | | (1) 3" Holder | |

| Item# | Description |
|---|--------------------------------|
| 620TBA | Surface Prep Assortment |
| This 26 pcs Surface Prep Assortment kit includes the following: (12) 2" Coarse Discs, (10) 2" Medium Discs, (3) 2" Fine Discs and (1) 2" Holder | |
| 6200 | Surface Prep Assortment |
| This 20 pcs Surface Prep Assortment kit includes the following: (10) 2" Coarse Discs, (8) 2" Medium Discs and (2) 2" Fine Discs | |

MINI GRINDING/STAR-BRITE ASSORTMENT KIT

| Item# | Description | Item# | Description |
|--|-------------------|---|------------------------|
| 6300 | 2" Assortment Kit | 6400 | 2" & 3" Assortment Kit |
| This 20 pcs Mini Grinding Assortment kit includes: | | This 20 pcs Surface Prep/Mini Grinding Assortment kit includes: | |
| (8) 2" 24 Grit Mini Grinding Disc | | (4) 2" Coarse Disc | |
| (5) 2" 36 Grit Mini Grinding Disc | | (4) 3" Coarse Disc | |
| (5) 2" 50 Grit Mini Grinding Disc | | (4) 2" 24 Grit Mini Grinding Disc | |
| (2) 2" 80 Grit Mini Grinding Disc | | (4) 2" 36 Grit Mini Grinding Disc | |
| | | (4) 2" 50 Grit Mini Grinding Disc | |





SURFACE PREP/GRINDING KITS

STAR-BRITE SURFACE PREP ASSORTMENT KIT

This set is perfect for sanding jobs in the paint shops. For use when preparing a car body prior to painting, this kit will accommodate a full range of customer needs.



S6600

S6600 Kit Includes

| Item# | Qty. | Description |
|---------|------|------------------------------------|
| 6666T | 1 | Angle Head Air Tool (Taiwan) |
| 13062-1 | 3 | 2" Coarse Star-Brite Discs |
| 13018-1 | 3 | 2" Medium Star-Brite Discs |
| 13019-1 | 3 | 3" Coarse Star-Brite Discs |
| 13020-1 | 3 | 3" Medium Star-Brite Discs |
| 13012 | 1 | 2" Twist-to-Lock Holder |
| 13013 | 1 | 3" Twist-to-Lock Holder |
| A25S | 1 | Salmon Mounted Point |
| W178S | 1 | Salmon Mounted Point |
| W236S | 1 | Salmon Mounted Point |
| 13109-1 | 1 | 1 1/2" x 1" - 40 Grit Flap Wheel |
| 13110-1 | 1 | 1 1/2" x 1/2" - 60 Grit Flap Wheel |

ANGLE HEAD AIR TOOL

Angled head design allows user to get into tight spaces. Designed for 2" and 3" holders.

6666T Shark Angle Head Air Tool 1.25 lb. 3" x 7" x 2"
Made in Taiwan

SANDING AND STAR-BRITE ASSORTMENT KIT

For sanding and surface prep before painting cars in body shops.



S6650

S6650 Kit Includes

| Item# | Qty. | Description |
|---------|------|--|
| 6666T | 1 | Angle Head Air Tool (Taiwan) |
| 13227-1 | 2 | 2" Aluminum Oxide Discs Coarse 36 grit |
| 13229-1 | 1 | 2" Aluminum Oxide Discs Medium 80 grit |
| 13235-1 | 2 | 3" Aluminum Oxide Discs Coarse 36 grit |
| 13237-1 | 1 | 3" Aluminum Oxide Discs Medium 80-grit |
| 13062-1 | 2 | 2" Coarse Star-Brite Discs |
| 13018-1 | 1 | 2" Medium Star-Brite Discs |
| 13019-1 | 2 | 3" Coarse Star-Brite Discs |
| 13020-1 | 1 | 3" Medium Star-Brite Discs |
| 13012 | 1 | 2" Twist-to-Lock Holder |
| 13013 | 1 | 3" Twist-to-Lock Holder |
| A25S | 1 | Salmon Mounted Point |
| W178S | 1 | Salmon Mounted Point |
| W236S | 1 | Salmon Mounted Point |
| 13109-1 | 1 | 1 1/2" x 1" - 40 Grit Flap Wheel |
| 13110-1 | 1 | 1 1/2" x 1/2" - 60 Grit Flap Wheel |



Uses all 1/4" Shaft Holders.
Twist-to-Lock Holders

SURFACE PREP/GRINDING

STAR-BRITE POLISHING DISC TYPE 27

This depressed center polishing disc is used for polishing on flat surfaces and edge cleaning. Provides excellent surface finishes on Stainless Steel.



| Item# | Length | Width | Color | Grit | Style | Pk. Qty | MP |
|-------|--------|-------|--------|--------|----------------|---------|----|
| 14601 | 4" | 5/8" | Maroon | Coarse | Polishing Disc | 1 | 10 |
| 14602 | 4 1/2" | 7/8" | Maroon | Coarse | Polishing Disc | 1 | 10 |
| 14603 | 4" | 5/8" | Grey | Medium | Polishing Disc | 1 | 10 |
| 14604 | 4 1/2" | 7/8" | Grey | Medium | Polishing Disc | 1 | 10 |

STAR-BRITE SANDING PADS



Specifications:

Non woven pads impregnated with resin and grain for many applications.

Best For: Hand sanding on parts and rust.

| Item# | *3M# | Length | Width | Color | Grit | Style | Pk. Qty | MP |
|------------------------|-------|--------|-------|---------------------|-------------------|--------------|---------|----|
| 13015 | 07445 | 6" | 9" | White | Cleaning | Sanding Pads | 10 Pads | 10 |
| 13016 | 07448 | 6" | 9" | Grey | Ultra Fine | Sanding Pads | 10 Pads | 10 |
| 13017 | 07447 | 6" | 9" | Maroon | Medium | Sanding Pads | 10 Pads | 10 |
| 13073 - 20 Pack | | 6" | 9" | Maroon | Medium | Sanding Pads | 20 Pads | 5 |
| 13074 - 20 Pack | | 6" | 9" | Grey | Ultra Fine | Sanding Pads | 20 Pads | 5 |
| 13075 - 20 Pack | | 6" | 9" | 10 Maroon & 10 Grey | Medium/Ultra Fine | Sanding Pads | 20 Pads | 5 |

STRIP-BRITE DISCS TYPE 27



Specifications:

Mounted on a depressed center backing plate. Use when grinding on flat or convex surfaces when removing rust or paint. It will not distort or disturb the metal.

| Item# | Size | Arbor | Color | Grit | Style | Pk. Qty | MP |
|-------|--------|-------|--------|--------------|------------------|---------|----|
| 14605 | 4 1/2" | 7/8" | Red | Coarse | Strip-Brite Disc | 1 | 5 |
| 14606 | 4 1/2" | 7/8" | Black | Medium | Strip-Brite Disc | 1 | 5 |
| 16208 | 4 1/2" | 7/8" | Purple | Extra Coarse | Strip-Brite Disc | 1 | 5 |
| 16209 | 7" | 7/8" | Purple | Extra Coarse | Strip-Brite Disc | 1 | 5 |

STRIP-BRITE DISC TYPE 1



Specifications:

Mounted on the 12782 mandrel, the disc is designed to be used on the edge for rust or paint removal in gutters, depressions, or concave areas when it is not desired to distort or change the metal dimensions.

| Item# | Size | Arbor | Color | Grit | Style | Pk. Qty | MP |
|-------|----------|------------|-------|--------|-------------------|---------|----|
| 14607 | 4 x 1/2" | 7/16" | Red | Coarse | Strip-Brite Disc | 1 | 5 |
| 12782 | 7/16" | Arbor Hole | | | Mandrel for 14607 | 1 | 5 |



MINI GRINDING

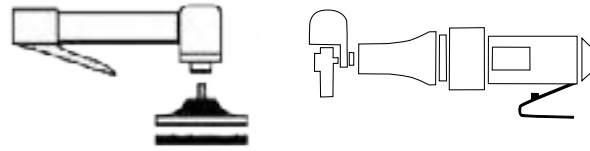

Tool: Right Angle Grinders or Die Grinders.

STRIP-BRITE PADS

These discs are typically used for paint or coating removal and feature the quick and easy twist-to-lock attachment system. The disc is an open-web construction impregnated with silicon carbide to provide aggressive and long-lasting performance. The extremely durable, three-dimensional web has a soft edge, allowing it to remove paint and other coatings in those unreachable creases and dents while removing very little metal. Great for stripping paint without damaging metal especially on aluminum.



BLACK
Good
For least aggressive grinding.



RED
Better
Medium Life Grinding



PURPLE
Best
Longest Life Grinding

Backing Type:
Twist-to-lock



| Item# | Size | Pk. Qty |
|-------|------|---------|
| 6202 | 2" | 2 |
| 6205 | 2" | 5 |
| 6206 | 2" | 10 |
| 6302 | 3" | 2 |
| 6305 | 3" | 5 |
| 6306 | 3" | 10 |

| Item# | Size | Pk. Qty |
|-------|------|---------|
| 16202 | 2" | 5 |
| 16201 | 2" | 10 |
| 16203 | 3" | 2 |
| 16204 | 3" | 5 |
| 16205 | 3" | 10 |

| Item# | Size | Pk. Qty |
|--------|---------------|---------|
| 16206 | 2" | 5 |
| 16210 | 2" | 10 |
| 16207 | 3" | 5 |
| 16211 | 3" | 10 |
| *16208 | 4 1/2" x 7/8" | 1 |
| *16209 | 7" x 7/8" | 1 |

*Type 27 - 7/8" hole.

CLOTH BACKED MINI GRINDING DISCS



Specifications:

Cloth-backed sanding/grinding discs are available in Aluminum Oxide or Zirconia. The cloth backing makes the disc softer and is good for less aggressive sanding/grinding applications.

Tool: Right Angle Grinders or Die Grinders.

Best For: Aluminum Oxide:

Any sanding or grinding application on steel or bondo.

Zirconia:

Any sanding or grinding application on stainless steel.

ALUMINUM OXIDE CLOTH BACKED GRINDING DISCS

| Item# | Size | Grit | Grain | Pk. Qty |
|-------|------|------|----------------|---------|
| 43220 | 2" | 24 | Aluminum Oxide | 25 |
| 43221 | 2" | 36 | Aluminum Oxide | 25 |
| 43222 | 2" | 50 | Aluminum Oxide | 25 |
| 43223 | 2" | 80 | Aluminum Oxide | 25 |
| 43224 | 2" | 120 | Aluminum Oxide | 25 |
| 43225 | 3" | 24 | Aluminum Oxide | 25 |
| 43226 | 3" | 36 | Aluminum Oxide | 25 |
| 43227 | 3" | 50 | Aluminum Oxide | 25 |
| 43228 | 3" | 80 | Aluminum Oxide | 25 |
| 43229 | 3" | 120 | Aluminum Oxide | 25 |

ZIRCONIA CLOTH BACKED MINI GRINDING DISCS

| Item# | Size | Grit | Grain | Pk. Qty |
|-------|------|------|----------|---------|
| 44220 | 2" | 24 | Zirconia | 25 |
| 44221 | 2" | 36 | Zirconia | 25 |
| 44222 | 2" | 50 | Zirconia | 25 |
| 44223 | 2" | 80 | Zirconia | 25 |
| 44224 | 2" | 120 | Zirconia | 25 |
| 44225 | 3" | 24 | Zirconia | 25 |
| 44226 | 3" | 36 | Zirconia | 25 |
| 44227 | 3" | 50 | Zirconia | 25 |
| 44228 | 3" | 80 | Zirconia | 25 |
| 44229 | 3" | 120 | Zirconia | 25 |

GREEN ZIRCONIA MINI GRINDING DISCS

Longer life than Zirconia or Aluminum Oxide discs, these are great for a multitude of uses where a heavy duty abrasive is required. Excels on extra hard metals such as stainless steel.

2"

| Item# | Size | Grit | Style | Pk. Qty |
|-------|------|------------------|----------------|---------|
| 12612 | 2" | 24 | Green Zirconia | 25 |
| 13044 | 2" | 24 | Green Zirconia | 10 |
| 12613 | 2" | 36 | Green Zirconia | 25 |
| 13045 | 2" | 36 | Green Zirconia | 10 |
| 12614 | 2" | 50 | Green Zirconia | 25 |
| 13046 | 2" | 50 | Green Zirconia | 10 |
| 12615 | 2" | 80 | Green Zirconia | 25 |
| 13083 | 2" | Assorted w/13012 | Green Zirconia | 7 |



3"

| Item# | Size | Grit | Style | Pk. Qty |
|-------|------|------|----------------|---------|
| 12616 | 3" | 24 | Green Zirconia | 25 |
| 12617 | 3" | 36 | Green Zirconia | 25 |
| 12618 | 3" | 50 | Green Zirconia | 25 |
| 12619 | 3" | 80 | Green Zirconia | 25 |



13083

CERAMIC MINI GRINDING DISCS

Ceramic is the longest life grain available. This product has a laminated, tough backing for extra longevity. It eliminates the shredding or snagging you will experience with pressure sensitive discs. Use for grinding and finishing of stainless steel, high alloy steels, chrome, nickel and titanium.

2"

| Item# | Size | Grit | Style | Pk. Qty |
|-------|------|------------------|---------|---------|
| 12621 | 2" | 24 | Ceramic | 25 |
| 12622 | 2" | 36 | Ceramic | 25 |
| 13047 | 2" | 36 | Ceramic | 10 |
| 12623 | 2" | 40 | Ceramic | 25 |
| 12624 | 2" | 50 | Ceramic | 25 |
| 13048 | 2" | 50 | Ceramic | 10 |
| 12625 | 2" | 60 | Ceramic | 25 |
| 12626 | 2" | 80 | Ceramic | 25 |
| 12634 | 2" | 120 | Ceramic | 25 |
| 13086 | 2" | Assorted w/13012 | Ceramic | 7 |



3"

| Item# | Size | Grit | Style | Pk. Qty |
|-------|------|------|---------|---------|
| 12627 | 3" | 24 | Ceramic | 25 |
| 12628 | 3" | 36 | Ceramic | 25 |
| 12629 | 3" | 40 | Ceramic | 25 |
| 12630 | 3" | 50 | Ceramic | 25 |
| 12631 | 3" | 60 | Ceramic | 25 |
| 12632 | 3" | 80 | Ceramic | 25 |
| 12633 | 3" | 120 | Ceramic | 25 |



13086



MINI GRINDING DISCS

ALUMINUM OXIDE/RESIN BACKED 2" & 3" MINI GRINDING DISCS



Specifications:

Premium Aluminum Oxide grit bonded onto tough resin backing offers a very durable disc.

Best For: Weld grinding and finishing on steel & metals.

Tool: For use with angle and die grinders.

| Item# | Old# | Size | Grit | Grain | Pk. Qty | MP |
|------------|-----------|------|------|----------------|---------|----|
| 12840 | | 2" | 24 | Aluminum Oxide | 10 | 10 |
| 13226 | 3220GT | 2" | 24 | Aluminum Oxide | 25 | 4 |
| 13230 | 3220GT-50 | 2" | 24 | Aluminum Oxide | 50 | 10 |
| 3220GT-100 | | 2" | 24 | Aluminum Oxide | 100 | 5 |
| 12841 | | 2" | 36 | Aluminum Oxide | 10 | 10 |
| 13227 | 3230GT | 2" | 36 | Aluminum Oxide | 25 | 4 |
| 13231 | 3230GT-50 | 2" | 36 | Aluminum Oxide | 50 | 10 |
| 3230GT-100 | | 2" | 36 | Aluminum Oxide | 100 | 5 |
| 12842 | | 2" | 50 | Aluminum Oxide | 10 | 10 |
| 13228 | 3250GT | 2" | 50 | Aluminum Oxide | 25 | 4 |
| 13232 | 3250GT-50 | 2" | 50 | Aluminum Oxide | 50 | 10 |
| 3250GT-100 | | 2" | 50 | Aluminum Oxide | 100 | 5 |
| 12843 | | 2" | 80 | Aluminum Oxide | 10 | 10 |
| 13229 | 3280GT | 2" | 80 | Aluminum Oxide | 25 | 4 |
| 13233 | 3280GT-50 | 2" | 80 | Aluminum Oxide | 50 | 10 |
| 3280GT-100 | | 2" | 80 | Aluminum Oxide | 100 | 5 |
| 32120GT | | 2" | 120 | Aluminum Oxide | 25 | 4 |
| 12844 | | 3" | 24 | Aluminum Oxide | 10 | 10 |
| 13234 | 3320GT | 3" | 24 | Aluminum Oxide | 25 | 4 |
| 13238 | | 3" | 24 | Aluminum Oxide | 50 | 10 |
| 3320GT-100 | | 3" | 24 | Aluminum Oxide | 100 | 5 |
| 12845 | | 3" | 36 | Aluminum Oxide | 10 | 10 |
| 13235 | 3330GT | 3" | 36 | Aluminum Oxide | 25 | 4 |
| 13239 | | 3" | 36 | Aluminum Oxide | 50 | 10 |
| 3330GT-100 | | 3" | 36 | Aluminum Oxide | 100 | 5 |
| 12846 | | 3" | 50 | Aluminum Oxide | 10 | 10 |
| 13236 | 3350GT | 3" | 50 | Aluminum Oxide | 25 | 4 |
| 13240 | | 3" | 50 | Aluminum Oxide | 50 | 10 |
| 3350GT-100 | | 3" | 50 | Aluminum Oxide | 100 | 5 |
| 12847 | | 3" | 80 | Aluminum Oxide | 10 | 10 |
| 13237 | 3380GT | 3" | 80 | Aluminum Oxide | 25 | 4 |
| 13241 | | 3" | 80 | Aluminum Oxide | 50 | 10 |
| 3380GT-100 | | 3" | 80 | Aluminum Oxide | 100 | 5 |
| 33120GT | | 3" | 120 | Aluminum Oxide | 25 | 4 |

MINI GRINDING DISCS

ZIRCONIA RESIN BACKED 2" & 3" MINI GRINDING DISCS



Specifications:

Zirconia long-life grain for Stainless Steel or regular steels.

Best For: Weld grinding and finishing on Stainless Steel.

Tool: For use with angle grinders or die grinders.

| Item# | Old# | Size | Grit | Grain | Pk. Qty | MP |
|-------|------------|------|------|----------|---------|----|
| 13242 | 3220ZGT | 2" | 24 | Zirconia | 25 | 4 |
| 13246 | | 2" | 24 | Zirconia | 50 | 10 |
| 13243 | 3230ZGT | 2" | 36 | Zirconia | 25 | 4 |
| 13247 | 3230ZGT-50 | 2" | 36 | Zirconia | 50 | 10 |
| 13244 | 3250ZGT | 2" | 50 | Zirconia | 25 | 4 |
| 13248 | 3250ZGT-50 | 2" | 50 | Zirconia | 50 | 10 |
| 13245 | 3280ZGT | 2" | 80 | Zirconia | 25 | 4 |
| 13249 | | 2" | 80 | Zirconia | 50 | 10 |
| 13258 | 32120ZGT | 2" | 120 | Zirconia | 25 | 4 |
| 13250 | 3320ZGT | 3" | 24 | Zirconia | 25 | 4 |
| 13254 | | 3" | 24 | Zirconia | 50 | 10 |
| 13251 | 3330ZGT | 3" | 36 | Zirconia | 25 | 4 |
| 13255 | | 3" | 36 | Zirconia | 50 | 10 |
| 13252 | 3350ZGT | 3" | 50 | Zirconia | 25 | 4 |
| 13256 | 3350ZGT-50 | 3" | 50 | Zirconia | 50 | 10 |
| 13253 | 3380ZGT | 3" | 80 | Zirconia | 25 | 4 |
| 13257 | 3380ZGT-50 | 3" | 80 | Zirconia | 50 | 10 |
| 13259 | 33120ZGT | 3" | 120 | Zirconia | 25 | 4 |





NEW! ABRASIVE METAL SUPPLY CABINETS

Installers Most-Used 2" & 3" Abrasives, Cut-Off Wheels, and Accessories.

Includes:

- 3/8" Mandrel - 1
- 2" Twist Lock Holder - 1
- 3" Twist Lock Holder - 1
- Cut-Off Wheels 3"x1/32"x3/8" 54 Grit - 6
- Cut-Off Wheels 3"x1/16"x3/8" 54 Grit - 6
- 2" Green Mini Grinding Discs 50 Grit - 25
- 3" Green Mini Grinding Discs 50 Grit - 10
- 2" Surface Prep Discs Medium (Burgundy) - 25
- 3" Surface Prep Discs Medium (Burgundy) - 10
- 2" Surface Prep Discs Coarse (Brown) - 25
- 3" Surface Prep Discs Coarse (Brown) - 10
- Shark Commercial Cabinet 19"x4"x26" - 1



ITEM# 16990

Installers Most-Used 2" Abrasives, Cut-Off Wheels, and Accessories.

Includes:

- 3/8" Mandrel - 1
- 2" Twist Lock Holder - 1
- 2" Mini Flap Disc Zirc 60 Grit - 3
- Cut-Off Wheels 3"x1/32"x3/8" 54 Grit - 6
- Cut-Off Wheels 3"x1/16"x3/8" 54 Grit - 6
- 2" Green Mini Grinding Discs 36 Grit - 15
- 3" Green Mini Grinding Discs 50 Grit - 15
- 2" Surface Prep Discs Fine (Blue) - 15
- 3" Surface Prep Discs Medium (Burgundy) - 25
- 2" Surface Prep Discs Coarse (Brown) - 25
- 3" Strip Brite Discs Coarse (Purple) - 3
- Shark Commercial Cabinet 19"x4"x26" - 1



ITEM# 16993

SHARK ABRASIVE ASSORTMENT DISPLAY

Applications:

This 244 piece kit is ideal for cutting or sanding various metals. Our USA made cut-off wheels are reinforced with fiberglass for increased durability. This kit includes two of our most popular wheels made in the USA.

Our long lasting, aggressive zirconia discs are for heavy stock removal. Finer grits are used when blending and finishing metals. Ideal for deburring, oxidation, fire scale removal, cleaning, blending or smoothing. All our surface prep discs come with the Twist-to-Lock backing for secure and easy attachment.



16403

ITEM# **16403**

KIT INCLUDES:

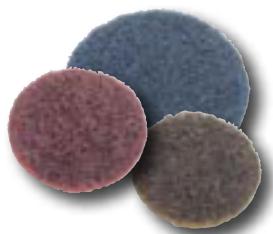

Star-Brite Surface Conditioning Discs:

13062 ■ 2" Brown, Coarse Grit - 10 each
 13018 ■ 2" Burgundy, Medium Grit - 8 each
 624TB ■ 2" Blue, Fine Grit - 8 each

13019 ■ 3" Brown, Coarse Grit - 10 each
 13020 ■ 3" Burgundy, Medium Grit - 8 each
 634TB ■ 3" Blue, Fine Grit - 8 each

Tools: Angle grinders
or die grinders

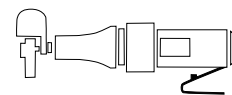

Aluminum Oxide & Zirconia Mini Grinding Discs:

13226 ■ 2" Aluminum Oxide 24 Grit - 10 each
 13228 ■ 2" Aluminum Oxide 50 Grit - 8 each
 13235 ■ 3" Aluminum Oxide 36 Grit - 10 each
 13236 ■ 3" Aluminum Oxide 50 Grit - 8 each

13243 ■ 2" Zirconia 36 Grit - 8 each
 13251 ■ 3" Zirconia 36 Grit - 8 each



Aluminum Oxide Resin Bonded Cut-Off Wheels:

12704 ■ 3" x 1/16" x 3/8" 54 Grit - 60 each
 12700 ■ 3" x 1/32" x 3/8" 54 Grit - 60 each



Strip-Brite Pads:

16202 ■ 2" Red Stripper Pad with Twist-To-Lock Backing Pad - 6 each
 16203 ■ 3" Red Stripper Pad with Twist-To-Lock Backing Pad - 4 each



Surface Prep Twist-To-Lock Holders:

13012 ■ 2" Twist-To-Lock Backing Pad - 6 each
 13013 ■ 3" Twist-To-Lock Backing Pad - 4 each



4" - 5" RESIN FIBER GRINDING DISCS

Specifications:

Premium Aluminum Oxide grit bonded onto tough resin backing offers a very durable disc.

Best For: Weld grinding, auto body work and general steel grinding.

Tool: 4" - 9" angle grinders



ALUMINUM OXIDE RESIN FIBER DISCS

| Item# | Old# | Size | Arbor | Grit | Grain | RPM | Pk. Qty | MP |
|--------|---------|--------|-------|------|----------------|--------|---------|----|
| 12805 | 40160-3 | 4" | 5/8" | 16 | Aluminum Oxide | 15,300 | 3 | 10 |
| 40160 | | 4" | 5/8" | 16 | Aluminum Oxide | 15,300 | 25 | 4 |
| 12806 | 40240-3 | 4" | 5/8" | 24 | Aluminum Oxide | 15,300 | 3 | 10 |
| 40240 | | 4" | 5/8" | 24 | Aluminum Oxide | 15,300 | 25 | 4 |
| 12807 | 40360-3 | 4" | 5/8" | 36 | Aluminum Oxide | 15,300 | 3 | 10 |
| 40360 | | 4" | 5/8" | 36 | Aluminum Oxide | 15,300 | 25 | 4 |
| 12808 | 40500-3 | 4" | 5/8" | 50 | Aluminum Oxide | 15,300 | 3 | 10 |
| 40500 | | 4" | 5/8" | 50 | Aluminum Oxide | 15,300 | 25 | 4 |
| 12809 | 40800-3 | 4" | 5/8" | 80 | Aluminum Oxide | 15,300 | 3 | 10 |
| 40800 | | 4" | 5/8" | 80 | Aluminum Oxide | 15,300 | 25 | 4 |
| 12810 | 40100-3 | 4" | 5/8" | 100 | Aluminum Oxide | 15,300 | 3 | 10 |
| 40100 | | 4" | 5/8" | 100 | Aluminum Oxide | 15,300 | 25 | 4 |
| 12811 | 40120-3 | 4" | 5/8" | 120 | Aluminum Oxide | 15,300 | 3 | 10 |
| 40120 | | 4" | 5/8" | 120 | Aluminum Oxide | 15,300 | 25 | 4 |
| 12812 | 45160-3 | 4 1/2" | 7/8" | 16 | Aluminum Oxide | 13,300 | 3 | 10 |
| 45160 | | 4 1/2" | 7/8" | 16 | Aluminum Oxide | 13,300 | 25 | 8 |
| 12813 | 45240-3 | 4 1/2" | 7/8" | 24 | Aluminum Oxide | 13,300 | 3 | 10 |
| 45240 | | 4 1/2" | 7/8" | 24 | Aluminum Oxide | 13,300 | 25 | 8 |
| 45240C | | 4 1/2" | 7/8" | 24 | Aluminum Oxide | 13,300 | 100 | 4 |
| 12814 | 45360-3 | 4 1/2" | 7/8" | 36 | Aluminum Oxide | 13,300 | 3 | 10 |
| 45360 | | 4 1/2" | 7/8" | 36 | Aluminum Oxide | 13,300 | 25 | 8 |
| 12815 | 45500-3 | 4 1/2" | 7/8" | 50 | Aluminum Oxide | 13,300 | 3 | 10 |
| 45500 | | 4 1/2" | 7/8" | 50 | Aluminum Oxide | 13,300 | 25 | 8 |
| 12816 | 45800-3 | 4 1/2" | 7/8" | 80 | Aluminum Oxide | 13,300 | 3 | 10 |
| 45800 | | 4 1/2" | 7/8" | 80 | Aluminum Oxide | 13,300 | 25 | 8 |
| 12817 | 45100-3 | 4 1/2" | 7/8" | 100 | Aluminum Oxide | 13,300 | 3 | 10 |
| 45100 | | 4 1/2" | 7/8" | 100 | Aluminum Oxide | 13,300 | 25 | 8 |
| 12818 | 45120-3 | 4 1/2" | 7/8" | 120 | Aluminum Oxide | 13,300 | 3 | 10 |
| 45120 | | 4 1/2" | 7/8" | 120 | Aluminum Oxide | 13,300 | 25 | 8 |
| 12819 | 50160-3 | 5" | 7/8" | 16 | Aluminum Oxide | 12,250 | 3 | 10 |
| 50160 | | 5" | 7/8" | 16 | Aluminum Oxide | 12,250 | 25 | 8 |
| 12820 | 50240-3 | 5" | 7/8" | 24 | Aluminum Oxide | 12,250 | 3 | 10 |
| 50240 | | 5" | 7/8" | 24 | Aluminum Oxide | 12,250 | 25 | 8 |
| 50240C | | 5" | 7/8" | 24 | Aluminum Oxide | 12,250 | 100 | 4 |
| 12821 | 50360-3 | 5" | 7/8" | 36 | Aluminum Oxide | 12,250 | 3 | 10 |
| 50360 | | 5" | 7/8" | 36 | Aluminum Oxide | 12,250 | 25 | 8 |
| 50360C | | 5" | 7/8" | 36 | Aluminum Oxide | 12,250 | 100 | 4 |

5"- 9" RESIN FIBER GRINDING DISCS

ALUMINUM OXIDE RESIN FIBER DISCS

| Item# | Old# | Size | Arbor | Grit | Grain | RPM | Pk. Qty | MP |
|--------|---------|------|-------|------|----------------|--------|---------|----|
| 12822 | 50500-3 | 5" | 7/8" | 50 | Aluminum Oxide | 12,250 | 3 | 10 |
| 50500 | | 5" | 7/8" | 50 | Aluminum Oxide | 12,250 | 25 | 8 |
| 12823 | 50800-3 | 5" | 7/8" | 80 | Aluminum Oxide | 12,250 | 3 | 10 |
| 50800 | | 5" | 7/8" | 80 | Aluminum Oxide | 12,250 | 25 | 8 |
| 12824 | 50100-3 | 5" | 7/8" | 100 | Aluminum Oxide | 12,250 | 3 | 10 |
| 50100 | | 5" | 7/8" | 100 | Aluminum Oxide | 12,250 | 25 | 8 |
| 12825 | 50120-3 | 5" | 7/8" | 120 | Aluminum Oxide | 12,250 | 3 | 10 |
| 50120 | | 5" | 7/8" | 120 | Aluminum Oxide | 12,250 | 25 | 8 |
| 12826 | 70160-3 | 7" | 7/8" | 16 | Aluminum Oxide | 8,500 | 3 | 10 |
| 70160 | | 7" | 7/8" | 16 | Aluminum Oxide | 8,500 | 25 | 8 |
| 12827 | 70240-3 | 7" | 7/8" | 24 | Aluminum Oxide | 8,500 | 3 | 10 |
| 70240 | | 7" | 7/8" | 24 | Aluminum Oxide | 8,500 | 25 | 8 |
| 70240C | | 7" | 7/8" | 24 | Aluminum Oxide | 8,500 | 100 | 2 |
| 12828 | 70360-3 | 7" | 7/8" | 36 | Aluminum Oxide | 8,500 | 3 | 10 |
| 70360 | | 7" | 7/8" | 36 | Aluminum Oxide | 8,500 | 25 | 8 |
| 70360C | | 7" | 7/8" | 36 | Aluminum Oxide | 8,500 | 100 | 2 |
| 12829 | 70500-3 | 7" | 7/8" | 50 | Aluminum Oxide | 8,500 | 3 | 10 |
| 70500 | | 7" | 7/8" | 50 | Aluminum Oxide | 8,500 | 25 | 8 |
| 70600 | | 7" | 7/8" | 60 | Aluminum Oxide | 8,500 | 25 | 8 |
| 12830 | 70800-3 | 7" | 7/8" | 80 | Aluminum Oxide | 8,500 | 3 | 10 |
| 70800 | | 7" | 7/8" | 80 | Aluminum Oxide | 8,500 | 25 | 8 |
| 12831 | 70100-3 | 7" | 7/8" | 100 | Aluminum Oxide | 8,500 | 3 | 10 |
| 70100 | | 7" | 7/8" | 100 | Aluminum Oxide | 8,500 | 25 | 8 |
| 12832 | 70120-3 | 7" | 7/8" | 120 | Aluminum Oxide | 8,500 | 3 | 10 |
| 70120 | | 7" | 7/8" | 120 | Aluminum Oxide | 8,500 | 25 | 8 |
| 12833 | 90160-3 | 9" | 7/8" | 16 | Aluminum Oxide | 6,650 | 3 | 10 |
| 90160 | | 9" | 7/8" | 16 | Aluminum Oxide | 6,650 | 25 | 8 |
| 12834 | 90240-3 | 9" | 7/8" | 24 | Aluminum Oxide | 6,650 | 3 | 10 |
| 90240 | | 9" | 7/8" | 24 | Aluminum Oxide | 6,650 | 25 | 8 |
| 12835 | 90360-3 | 9" | 7/8" | 36 | Aluminum Oxide | 6,650 | 3 | 10 |
| 90360 | | 9" | 7/8" | 36 | Aluminum Oxide | 6,650 | 25 | 8 |
| 12836 | 90500-3 | 9" | 7/8" | 50 | Aluminum Oxide | 6,650 | 3 | 10 |
| 90500 | | 9" | 7/8" | 50 | Aluminum Oxide | 6,650 | 25 | 8 |
| 12837 | 90800-3 | 9" | 7/8" | 80 | Aluminum Oxide | 6,650 | 3 | 10 |
| 90800 | | 9" | 7/8" | 80 | Aluminum Oxide | 6,650 | 25 | 8 |
| 12838 | 90100-3 | 9" | 7/8" | 100 | Aluminum Oxide | 6,650 | 3 | 10 |
| 90100 | | 9" | 7/8" | 100 | Aluminum Oxide | 6,650 | 25 | 8 |
| 12839 | | 9" | 7/8" | 120 | Aluminum Oxide | 6,650 | 3 | 10 |
| 90120 | | 9" | 7/8" | 120 | Aluminum Oxide | 6,650 | 25 | 8 |





RESIN FIBER GRINDING DISCS

Specifications:

Tough Zirconia grain with resins on a rugged fiber backing offers aggressive long-life grinding.

Best For: Grinding welds, auto body work and Stainless Steel.

Tool: 4" - 9" Angle Grinders



4" - 7" ZIRCONIA RESIN FIBER DISCS

| Item# | Size | Arbor | Grit | Grain | RPM | Pk. Qty | MP |
|----------|--------|-------|------|----------|--------|---------|----|
| 40240Z-3 | 4" | 5/8" | 24 | Zirconia | 15,300 | 3 | 10 |
| 40240Z | 4" | 5/8" | 24 | Zirconia | 15,300 | 25 | 8 |
| 40360Z-3 | 4" | 5/8" | 36 | Zirconia | 15,300 | 3 | 10 |
| 40360Z | 4" | 5/8" | 36 | Zirconia | 15,300 | 25 | 8 |
| 40500Z-3 | 4" | 5/8" | 50 | Zirconia | 15,300 | 3 | 10 |
| 40500Z | 4" | 5/8" | 50 | Zirconia | 15,300 | 25 | 8 |
| 40800Z-3 | 4" | 5/8" | 80 | Zirconia | 15,300 | 3 | 10 |
| 40800Z | 4" | 5/8" | 80 | Zirconia | 15,300 | 25 | 8 |
| 45240Z-3 | 4 1/2" | 7/8" | 24 | Zirconia | 13,300 | 3 | 10 |
| 45240Z | 4 1/2" | 7/8" | 24 | Zirconia | 13,300 | 25 | 8 |
| 45240ZC | 4 1/2" | 7/8" | 24 | Zirconia | 13,300 | 100 | 2 |
| 45360Z-3 | 4 1/2" | 7/8" | 36 | Zirconia | 13,300 | 3 | 10 |
| 45360Z | 4 1/2" | 7/8" | 36 | Zirconia | 13,300 | 25 | 8 |
| 45500Z-3 | 4 1/2" | 7/8" | 50 | Zirconia | 13,300 | 3 | 10 |
| 45500Z | 4 1/2" | 7/8" | 50 | Zirconia | 13,300 | 25 | 8 |
| 45800Z-3 | 4 1/2" | 7/8" | 80 | Zirconia | 13,300 | 3 | 10 |
| 45800Z | 4 1/2" | 7/8" | 80 | Zirconia | 13,300 | 25 | 8 |
| 50240Z-3 | 5" | 7/8" | 24 | Zirconia | 12,250 | 3 | 10 |
| 50240Z | 5" | 7/8" | 24 | Zirconia | 12,250 | 25 | 8 |
| 50240C | 5" | 7/8" | 24 | Zirconia | 12,250 | 100 | 2 |
| 50360Z-3 | 5" | 7/8" | 36 | Zirconia | 12,250 | 3 | 10 |
| 50360Z | 5" | 7/8" | 36 | Zirconia | 12,250 | 25 | 8 |
| 50360ZC | 5" | 7/8" | 36 | Zirconia | 12,250 | 100 | 2 |
| 50500Z-3 | 5" | 7/8" | 50 | Zirconia | 12,250 | 3 | 10 |
| 50500Z | 5" | 7/8" | 50 | Zirconia | 12,250 | 25 | 8 |
| 50800Z-3 | 5" | 7/8" | 80 | Zirconia | 12,250 | 3 | 10 |
| 50800Z | 5" | 7/8" | 80 | Zirconia | 12,250 | 25 | 8 |
| 70240Z-3 | 7" | 7/8" | 24 | Zirconia | 8,500 | 3 | 10 |
| 70240Z | 7" | 7/8" | 24 | Zirconia | 8,500 | 25 | 4 |
| 70240ZC | 7" | 7/8" | 24 | Zirconia | 8,500 | 100 | 2 |
| 70360Z-3 | 7" | 7/8" | 36 | Zirconia | 8,500 | 3 | 10 |
| 70360Z | 7" | 7/8" | 36 | Zirconia | 8,500 | 25 | 4 |
| 70500Z-3 | 7" | 7/8" | 50 | Zirconia | 8,500 | 3 | 10 |
| 70500Z | 7" | 7/8" | 50 | Zirconia | 8,500 | 25 | 4 |
| 70800Z-3 | 7" | 7/8" | 80 | Zirconia | 8,500 | 3 | 10 |
| 70800Z | 7" | 7/8" | 80 | Zirconia | 8,500 | 25 | 4 |

RESIN FIBER GRINDING DISCS

9" ZIRCONIA RESIN FIBER DISCS

| Item# | Size | Arbor | Grit | Grain | RPM | Pk. Qty | MP |
|----------|------|-------|------|----------|-------|---------|----|
| 90240Z-3 | 9" | 7/8" | 24 | Zirconia | 6,650 | 3 | 10 |
| 90240Z | 9" | 7/8" | 24 | Zirconia | 6,650 | 25 | 8 |
| 90360Z-3 | 9" | 7/8" | 36 | Zirconia | 6,650 | 3 | 10 |
| 90360Z | 9" | 7/8" | 36 | Zirconia | 6,650 | 25 | 8 |
| 90500Z-3 | 9" | 7/8" | 50 | Zirconia | 6,650 | 3 | 10 |
| 90500Z | 9" | 7/8" | 50 | Zirconia | 6,650 | 25 | 8 |
| 90800Z-3 | 9" | 7/8" | 80 | Zirconia | 6,650 | 3 | 10 |
| 90800Z | 9" | 7/8" | 80 | Zirconia | 6,650 | 25 | 8 |

PURE SHEEPSKIN AND WOOL MINI BUFFING BONNETS

These unique pads are Hook and Loop Fastener backed and made of pure wool and sheepskin for all your finishing jobs. Easily attaches to your angle grinder with a 1/4" mandrel backed Hook and Loop Fastener pad.



| Item# | Description: | Pk. Qty |
|-------|---------------------|---------|
| SK450 | 2" Sheepskin Bonnet | 2 |
| SK475 | 3" Sheepskin Bonnet | 2 |

| Item# | Description: | Pk. Qty |
|-------|----------------------------------|---------|
| FT450 | 2" Wool Felt Pad For Compounding | 2 |



| Item# | Description: | Kit Includes: |
|-------|-------------------------|-------------------|
| SKA | 2" Sheepskin Bonnet Kit | 2 Pads & 1 Holder |

| Item# | Description: | Kit Includes: |
|-------|----------------------|-------------------|
| FTA | 2" Wool Felt Pad Kit | 2 Pads & 1 Holder |



SANDING SHEETS

ALUMINUM OXIDE GENERAL PURPOSE DRY SANDING SHEETS

Specifications:

Aluminum Oxide grit on a tough paper backing is designed to prevent loading when sanding. A great general purpose sheet for dry sanding applications on plastic, metal, wood, paint and fiberglass surfaces.

Best For: Any type of sanding including feather-edging, sanding scratches or paint removal.

Tool: Cut to fit power sanders, block or hand sanders as well as hand sanding.

| Item# | Size | Grit | Grain | Pk. Qty |
|-------|--------|------|----------------|------------|
| 00036 | 9"x11" | 36 | Aluminum Oxide | 100/Sleeve |
| 00040 | 9"x11" | 40 | Aluminum Oxide | 100/Sleeve |
| 00060 | 9"x11" | 60 | Aluminum Oxide | 100/Sleeve |
| 00080 | 9"x11" | 80 | Aluminum Oxide | 100/Sleeve |
| 00100 | 9"x11" | 100 | Aluminum Oxide | 100/Sleeve |
| 00120 | 9"x11" | 120 | Aluminum Oxide | 100/Sleeve |
| 00150 | 9"x11" | 150 | Aluminum Oxide | 100/Sleeve |
| 00180 | 9"x11" | 180 | Aluminum Oxide | 100/Sleeve |
| 00220 | 9"x11" | 220 | Aluminum Oxide | 100/Sleeve |



SILICON CARBIDE WET/DRY PAPER

Specifications:

Silicon carbide moisture resistant sheets designed for a sharp cut and fine finish. Designed for wet or dry sanding applications such as lacquers, body fillers, glass, metal, plastic, stone or marble.

Best For: Use on lacquers, body fillers, glass, metal, plastic, stone and marble.

Tool: Cut to fit power sander, block or hand sanders as well as general hand sanding.



| Item# | Size | Grit | Grain | Pk. Qty |
|-------|--------|------|-----------------|-----------|
| 15000 | 9"x11" | 60 | Silicon Carbide | 50/Sleeve |
| 15001 | 9"x11" | 80 | Silicon Carbide | 50/Sleeve |
| 15002 | 9"x11" | 100 | Silicon Carbide | 50/Sleeve |
| 15003 | 9"x11" | 120 | Silicon Carbide | 50/Sleeve |
| 15004 | 9"x11" | 150 | Silicon Carbide | 50/Sleeve |
| 15005 | 9"x11" | 180 | Silicon Carbide | 50/Sleeve |
| 15006 | 9"x11" | 220 | Silicon Carbide | 50/Sleeve |
| 15007 | 9"x11" | 240 | Silicon Carbide | 50/Sleeve |
| 15008 | 9"x11" | 280 | Silicon Carbide | 50/Sleeve |
| 15009 | 9"x11" | 320 | Silicon Carbide | 50/Sleeve |
| 15010 | 9"x11" | 360 | Silicon Carbide | 50/Sleeve |
| 15011 | 9"x11" | 400 | Silicon Carbide | 50/Sleeve |
| 15012 | 9"x11" | 500 | Silicon Carbide | 50/Sleeve |
| 15013 | 9"x11" | 600 | Silicon Carbide | 50/Sleeve |
| 15014 | 9"x11" | 800 | Silicon Carbide | 50/Sleeve |
| 15015 | 9"x11" | 1000 | Silicon Carbide | 50/Sleeve |
| 15016 | 9"x11" | 1200 | Silicon Carbide | 50/Sleeve |
| 15017 | 9"x11" | 1500 | Silicon Carbide | 50/Sleeve |
| 15018 | 9"x11" | 2000 | Silicon Carbide | 50/Sleeve |

SANDING SHEETS/SHOP ROLLS

SANDSCREEN SHEETS

Specifications:

Sandscreen sheets are an open-coat screen made with a silicon carbide grain. It's a resin on resin bond, long lasting, fast cutting and non-loading. Mesh-cloth backing can be cleaned and re-used.

Best For: Concrete, ceramic tiles and hardwood floors.

Tool: Power Sander.



| Item# | Size | Grit | Grain | Pk. Qty |
|-------|------------|------|------------|-----------|
| 88000 | 4 1/2"x11" | 120 | Sandscreen | 50/Sleeve |
| 88001 | 4 1/2"x11" | 100 | Sandscreen | 50/Sleeve |
| 88002 | 4 1/2"x11" | 80 | Sandscreen | 50/Sleeve |

EMERY CLOTH SHEETS

Specifications:

Natural emery grain on a flexible cloth backing that tears easily.

Best For: Sanding, polishing and rust removal.

Tool: For hand use.

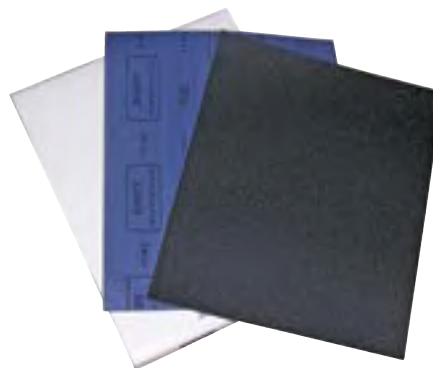

| Item# | Size | Grit | Grain | Pk. Qty |
|-------|--------|--------------|-------------|-----------|
| 80000 | 9"x11" | Fine | Emery Cloth | 50/Sleeve |
| 80001 | 9"x11" | Medium | Emery Cloth | 50/Sleeve |
| 80002 | 9"x11" | Coarse | Emery Cloth | 50/Sleeve |
| 80003 | 9"x11" | Extra Coarse | Emery Cloth | 50/Sleeve |

GENERAL PURPOSE EMERY CLOTH SHOP ROLLS

Specifications:

- Economical, easy tear-off, cotton "J" weight, resin bonded cloth rolls made with premium aluminum oxide grain.
- Self cut strips for hand sanding.
- Cleaning, deburring and polishing a wide variety of materials.



| Item# | Size | Grit | Grain | Pk. Qty |
|-------|--------------|------|----------------|---------|
| 12924 | 1" x 10 Yds. | 80 | Aluminum Oxide | 1 Roll |
| 12925 | 1" x 10 Yds. | 120 | Aluminum Oxide | 1 Roll |
| 12926 | 1" x 10 Yds. | 180 | Aluminum Oxide | 1 Roll |
| 12927 | 1" x 10 Yds. | 320 | Aluminum Oxide | 1 Roll |
| 12928 | 1" x 25 Yds. | 80 | Aluminum Oxide | 1 Roll |
| 12929 | 1" x 25 Yds. | 120 | Aluminum Oxide | 1 Roll |
| 12930 | 1" x 25 Yds. | 180 | Aluminum Oxide | 1 Roll |
| 12931 | 1" x 25 Yds. | 320 | Aluminum Oxide | 1 Roll |
| 12986 | 1" x 50 Yds. | 60 | Aluminum Oxide | 1 Roll |
| 12987 | 1" x 50 Yds. | 80 | Aluminum Oxide | 1 Roll |
| 12988 | 1" x 50 Yds. | 100 | Aluminum Oxide | 1 Roll |

| Item# | Size | Grit | Grain | Pk. Qty |
|-------|----------------|------|----------------|---------|
| 12989 | 1" x 50 Yds. | 120 | Aluminum Oxide | 1 Roll |
| 12990 | 1" x 50 Yds. | 180 | Aluminum Oxide | 1 Roll |
| 12998 | 1" x 50 Yds. | 240 | Aluminum Oxide | 1 Roll |
| 12991 | 1" x 50 Yds. | 320 | Aluminum Oxide | 1 Roll |
| 12997 | 1" x 50 Yds. | 400 | Aluminum Oxide | 1 Roll |
| 12992 | 1.5" x 50 Yds. | 60 | Aluminum Oxide | 1 Roll |
| 12993 | 1.5" x 50 Yds. | 80 | Aluminum Oxide | 1 Roll |
| 12994 | 1.5" x 50 Yds. | 100 | Aluminum Oxide | 1 Roll |
| 12995 | 1.5" x 50 Yds. | 120 | Aluminum Oxide | 1 Roll |
| 12996 | 1.5" x 50 Yds. | 180 | Aluminum Oxide | 1 Roll |
| 12999 | 1.5" x 50 Yds. | 320 | Aluminum Oxide | 1 Roll |



NEW! GOLD PRO DISCS



PSA BACKING

PSA Style: Pressure Sensitive Adhesive for a tight hold.

| | Item# | Size | Backing | Grit | Pk. Qty |
|-----------|---------|------|---------|------|---------|
| 3" | 45095 | 3" | PSA | 80 | 25 |
| | 45096 | 3" | PSA | 100 | 25 |
| | 45097 | 3" | PSA | 180 | 25 |
| | 45098 | 3" | PSA | 220 | 25 |
| | 45099 | 3" | PSA | 320 | 25 |
| 5" | 23536 | 5" | PSA | 36 | 50 |
| | 23540 | 5" | PSA | 40 | 50 |
| | 23580* | 5" | PSA | 80 | 100 |
| | 235100* | 5" | PSA | 100 | 100 |
| | 235120* | 5" | PSA | 120 | 100 |
| | 235150* | 5" | PSA | 150 | 100 |
| | 235180* | 5" | PSA | 180 | 100 |
| | 235220* | 5" | PSA | 220 | 100 |
| | 235240* | 5" | PSA | 240 | 100 |
| | 235320* | 5" | PSA | 320 | 100 |
| 6" | 235400* | 5" | PSA | 400 | 100 |
| | 23636 | 6" | PSA | 36 | 50 |
| | 23640 | 6" | PSA | 40 | 50 |
| | 23680 | 6" | PSA | 80 | 100 |
| | 236100 | 6" | PSA | 100 | 100 |
| | 236120 | 6" | PSA | 120 | 100 |
| | 236150 | 6" | PSA | 150 | 100 |
| | 236180 | 6" | PSA | 180 | 100 |
| | 236220 | 6" | PSA | 220 | 100 |
| | 236240 | 6" | PSA | 240 | 100 |
| | 236320 | 6" | PSA | 320 | 100 |
| | 236400 | 6" | PSA | 400 | 100 |

*Linked rolls, subject to change

Strong "C" weight backing on grits 150 and up and "D" weight on grits 40-120, this extra open coated.

Paper with a Resin bond and tough Aluminum Oxide will meet your demanding requirements. It has a stearate top coat for extended life. These discs offer long life, aggressive, sharp and fast cutting action.

Excellent for use on clear coats, putty, primers, wood and plastic applications.

Metals: Aluminum and Stainless Steel sanding.

Hook and Loop Fastener BACKING

Hook and Loop Fastener Style: Easy and quick changeability. No adhesive to collect dust from grinding.

| | Item# | Size | Backing | Grit | Pk. Qty |
|-----------|----------|------------------------|------------------------|------|---------|
| 3" | 45085 | 3" | hook and loop fastener | 36 | 25 |
| | 45086 | 3" | hook and loop fastener | 40 | 25 |
| | 45087 | 3" | hook and loop fastener | 60 | 25 |
| | 45088 | 3" | hook and loop fastener | 80 | 25 |
| | 45089 | 3" | hook and loop fastener | 100 | 25 |
| | 45090 | 3" | hook and loop fastener | 120 | 25 |
| | 45091 | 3" | hook and loop fastener | 160 | 25 |
| | 45092 | 3" | hook and loop fastener | 180 | 25 |
| | 45093 | 3" | hook and loop fastener | 220 | 25 |
| | 45094 | 3" | hook and loop fastener | 320 | 25 |
| 5" | 23536V | 5" | hook and loop fastener | 36 | 50 |
| | 23540V | 5" | hook and loop fastener | 40 | 50 |
| | 23580 | 5" | hook and loop fastener | 80 | 100 |
| | 235100V | 5" | hook and loop fastener | 100 | 100 |
| | 235120V | 5" | hook and loop fastener | 120 | 100 |
| | 235150V | 5" | hook and loop fastener | 150 | 100 |
| | 235180V | 5" | hook and loop fastener | 180 | 100 |
| | 235220V | 5" | hook and loop fastener | 220 | 100 |
| | 235240V | 5" | hook and loop fastener | 240 | 100 |
| | 235320V | 5" | hook and loop fastener | 320 | 100 |
| 6" | 235400V* | 5" | hook and loop fastener | 400 | 100 |
| | 23636V | 6" | hook and loop fastener | 36 | 50 |
| | 23640V | 6" | hook and loop fastener | 40 | 50 |
| | 23680V | 6" | hook and loop fastener | 80 | 100 |
| | 236100V | 6" | hook and loop fastener | 100 | 100 |
| | 236120V | 6" | hook and loop fastener | 120 | 100 |
| | 236150V | 6" | hook and loop fastener | 150 | 100 |
| | 236180V | 6" | hook and loop fastener | 180 | 100 |
| | 236220V | 6" | hook and loop fastener | 220 | 100 |
| | 236240V | 6" | hook and loop fastener | 240 | 100 |
| 236320V | 6" | hook and loop fastener | 320 | 100 | |
| 236400V* | 6" | hook and loop fastener | 400 | 100 | |

NEW! SUPER BLUE DISCS

Super Blue, Polyester Film Discs

The NEW Shark Blue discs use Aluminum Oxide Grain on a Polyester film backing. Their Extra Open coating and Resin bonding also offers a Special Stearate top coat.

Excellent for use on polyurethanes, carbon fiber, polyesters, and acrylic resins. In Automotive applications, use with putty, primer and clear coat sanding. Also designed for use on polyester, acrylic and poly-acrylic, water and solvent-based paints. **Made in Italy.**

Hook and Loop Fastener BACKING

Hook and Loop Fastener Style: Easy and quick changeability. No adhesive to collect dust from grinding.

| Item# | Size | Backing | Grit | Pk. Qty |
|-------|------|------------------------|------|---------|
| 23699 | 6" | hook and loop fastener | 40 | 50 |
| 23700 | 6" | hook and loop fastener | 60 | 50 |
| 23701 | 6" | hook and loop fastener | 80 | 100 |
| 23702 | 6" | hook and loop fastener | 100 | 100 |
| 23703 | 6" | hook and loop fastener | 120 | 100 |
| 23704 | 6" | hook and loop fastener | 150 | 100 |
| 23705 | 6" | hook and loop fastener | 180 | 100 |
| 23706 | 6" | hook and loop fastener | 220 | 100 |
| 23707 | 6" | hook and loop fastener | 240 | 100 |
| 23708 | 6" | hook and loop fastener | 320 | 100 |
| 23709 | 6" | hook and loop fastener | 400 | 100 |
| 23710 | 6" | hook and loop fastener | 500 | 100 |
| 23711 | 6" | hook and loop fastener | 600 | 100 |
| 23712 | 6" | hook and loop fastener | 800 | 100 |
| 23713 | 6" | hook and loop fastener | 1000 | 100 |
| 23714 | 6" | hook and loop fastener | 1200 | 100 |
| 23715 | 6" | hook and loop fastener | 1500 | 100 |
| 23716 | 6" | hook and loop fastener | 2000 | 100 |

6"

PSA BACKING

PSA Style: Pressure Sensitive Adhesive for a tight hold.

| Item# | Size | Backing | Grit | Pk. Qty |
|-------|------|---------|------|---------|
| 23681 | 6" | PSA | 40 | 50 |
| 23682 | 6" | PSA | 60 | 50 |
| 23683 | 6" | PSA | 80 | 100 |
| 23684 | 6" | PSA | 100 | 100 |
| 23685 | 6" | PSA | 120 | 100 |
| 23686 | 6" | PSA | 150 | 100 |
| 23687 | 6" | PSA | 180 | 100 |
| 23688 | 6" | PSA | 220 | 100 |
| 23689 | 6" | PSA | 240 | 100 |
| 23690 | 6" | PSA | 320 | 100 |
| 23691 | 6" | PSA | 400 | 100 |
| 23692 | 6" | PSA | 500 | 100 |
| 23693 | 6" | PSA | 600 | 100 |
| 23694 | 6" | PSA | 800 | 100 |
| 23695 | 6" | PSA | 1000 | 100 |
| 23696 | 6" | PSA | 1200 | 100 |
| 23697 | 6" | PSA | 1500 | 100 |
| 23698 | 6" | PSA | 2000 | 100 |

6"





LONG BOARD SHEETS

ABRASIVE FILE SHEETS

Specifications:

File sheets for long boards are an economical abrasive that delivers "Best in Class" performance on a variety of substrates. This product allows for easy attachment and removal. It can be re-attached and used for sanding and shaping plastic filler.

Plain Backing, PSA Backing or Hook and Loop Fastener Backing



PLAIN BACKING

| Item# | Size | Grit | Pk. Qty |
|-------|------------------|------|---------|
| 27036 | 2 3/4" x 17 1/2" | 36 | 50 |
| 27040 | 2 3/4" x 17 1/2" | 40 | 50 |
| 27060 | 2 3/4" x 17 1/2" | 60 | 50 |
| 27080 | 2 3/4" x 17 1/2" | 80 | 50 |
| 27120 | 2 3/4" x 17 1/2" | 120 | 50 |
| 27150 | 2 3/4" x 17 1/2" | 150 | 50 |

PSA BACKING

| Item# | Size | Grit | Pk. Qty |
|-------|------------------|------|---------|
| 24036 | 2 3/4" x 16 1/2" | 36 | 50 |
| 24040 | 2 3/4" x 16 1/2" | 40 | 50 |
| 24060 | 2 3/4" x 16 1/2" | 60 | 50 |
| 24080 | 2 3/4" x 16 1/2" | 80 | 50 |
| 24120 | 2 3/4" x 16 1/2" | 120 | 50 |
| 24180 | 2 3/4" x 16 1/2" | 180 | 50 |

Hook and Loop Fastener BACKING

| Item# | Size | Grit | Pk. Qty |
|--------|------------------|------|---------|
| 24036V | 2 3/4" x 16 1/2" | 36 | 50 |
| 24040V | 2 3/4" x 16 1/2" | 40 | 50 |
| 24060V | 2 3/4" x 16 1/2" | 60 | 50 |
| 24080V | 2 3/4" x 16 1/2" | 80 | 50 |
| 24120V | 2 3/4" x 16 1/2" | 120 | 50 |

EXTRA DURABLE ABRASIVE FILE PADS

Specifications:

This multi-purpose sanding sheet comes with a plain backing and is made of a long lasting aluminum oxide.

Best For: Sanding wood or steel.

Tool: Cut-to-fit power sanders or block sanders.



| Item# | Size | Grit | Grain | Pk. Qty |
|-------|---------|------|----------------|---------|
| 13142 | 3" x 8" | 36 | Aluminum Oxide | 100 |
| 13143 | 3" x 8" | 40 | Aluminum Oxide | 100 |
| 13144 | 3" x 8" | 80 | Aluminum Oxide | 100 |
| 13145 | 3" x 8" | 120 | Aluminum Oxide | 100 |
| 13146 | 3" x 8" | 150 | Aluminum Oxide | 100 |
| 13147 | 3" x 8" | 180 | Aluminum Oxide | 100 |

PSA BACKED GOLD SANDING ROLLS

Specifications:

Cut to fit Gold Sanding rolls delivers fast, exceptionally long life that increases your productivity. Provides exceptional sanding performance, so you can get the job done fast; saving you time and money!

Best For: Shaping body filler, removing paint, rough feather edging, primer/metal sanding.

Tool: Pneumatic air files, hand sanding blocks, firm or flexible longboard file boards.



12635

| Item# | Size | Grit | Grain | Pk. Qty |
|-------|-----------------|------|----------------|---------|
| 12635 | 2 3/4" x 45 Yds | 80 | Aluminum Oxide | 1 Roll |
| 12636 | 2 3/4" x 45 Yds | 120 | Aluminum Oxide | 1 Roll |
| 12637 | 2 3/4" x 45 Yds | 180 | Aluminum Oxide | 1 Roll |
| 12638 | 2 3/4" x 45 Yds | 320 | Aluminum Oxide | 1 Roll |

ZIRCONIA MINI BELTS FOR BELT SANDERS A MUST FOR FORD F-150 WORK

3/8" x 13" and 1/2" x 18"

- Seam Seal Removal
- Self Piercing Rivet Sanding
- Surface Prep in Rivet-bonded Repairs



These belts are designed to be used on any Mini Belt Sander of either 3/8" x 13" or 1/2" x 18" size. The Zirconia belts are perfect for aluminum sanding of self-piercing rivets, as well as seam seal removal and preparing surfaces in the cases of rivet-bonded material repairs on the new Ford F-150 Trucks. The belts will work with any manufacturer's tool using the above mentioned sizes.

- Durable Poly/Cotton Backing
- Long Life Zirconia will outlast Aluminum Oxide
- Performs better on Aluminum than Aluminum Oxide

3/8" x 13" Length Belts

| Part# | Grit | Material | Pkg. Qty. |
|-------|------|----------|-----------|
| 13182 | 40 | Zirconia | 10 |
| 13183 | 60 | Zirconia | 10 |
| 13184 | 80 | Zirconia | 10 |
| 13185 | 120 | Zirconia | 10 |

1/2" x 18" Length Belts

| Part# | Grit | Material | Pkg. Qty. |
|-------|------|----------|-----------|
| 13186 | 40 | Zirconia | 10 |
| 13187 | 60 | Zirconia | 10 |
| 13188 | 80 | Zirconia | 10 |
| 13189 | 120 | Zirconia | 10 |



UNITIZED WHEELS

Designed to offer the best finish combined with high tear resistance and long life, Unitized Wheels are produced by compressing several layers of Abrasive Non Woven material impregnated with resin.

Aluminum Oxide for use on all ferrous metals/ steel and Stainless Steel.

Silicon Carbide for use on non-ferrous metals / alloys, copper, aluminum, and brass.



Benefits

Long Lasting - The incredible resistance working on sharp edges gives maximum productivity

Best Finishing - A consistent and uniform finishing, close to mirror finishing surface can be reached without smearing in one step operation, saving time and additional steps. Improve surfaces without significantly changing the shape or dimension of the work piece.

No Loading, Low Temperature - The Non Woven structure gives high resistance to loading and minimizes heat buildup. Flexible and Conforming - Depending on the density, the user can have a soft and flexible material, with high conformability or tough aggressive action. In all densities, Unitized Wheels can be dressed to follow the shape of the worked piece and work in narrow areas.

Low Noise - The soft structure reduces the noise level during the application.

Twist-to-lock Style Holder - Universal Type "R" button works with any brand holder.

Applications

Soft Density



Maximum resistance to loading soft density gives the best finishing with an easy to control cut action.

Best For:

- Polishing mechanical parts (jet blades, threads, casted parts, welds, surgical instruments)
- Cleaning loading materials (rust, discolorations, resin, coating)
- Blending marks or scratches

Medium Density

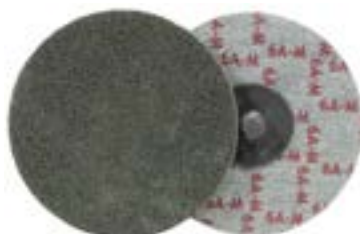

High edge durability and faster cutting action.

Best For:

- Removing burrs (on stainless steel parts, gears) or reducing edges
- Blending marks or scratches
- Cleaning heavy scale or oxidations

Hard Density



Available in coarse grit to allow high pressure for fast cutting action and longevity on heavy applications.

Best For:

- Removing heavy burrs or reducing sharp edges
- Blending heavy marks or scratches
- Faster cleaning on heavy scale or oxidations

The characteristics of each disc are identified by a 3-digit code.



| Density | | | |
|----------|-------------|----------|----------|
| S | M/S | M | H |
| Soft | Medium/Soft | Medium | Hard |

| Type of Abrasive Grain | |
|------------------------|-----------------|
| A | S |
| Aluminum Oxide | Silicon Carbide |

| Grit | | |
|----------|----------|----------|
| F | M | C |
| Fine | Medium | Coarse |

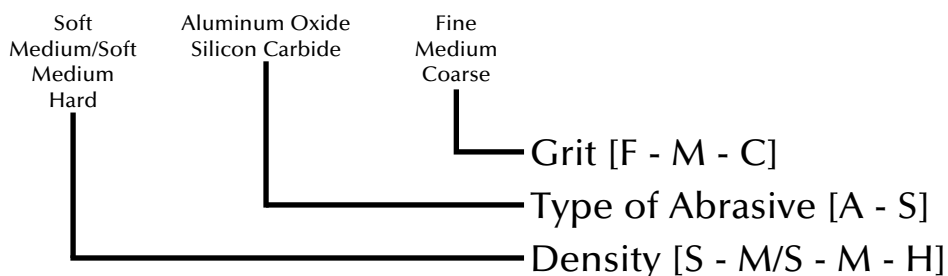

2" DIAMETER UNITIZED WHEELS

| Item# | Code | Density | Type | Grit | Thickness | Pkg. Qty. |
|-------|-------|-------------|-----------------|--------|-----------|-----------|
| 13160 | SSF | Soft | Silicon Carbide | Fine | 1/4" | 3 |
| 13161 | SAM | Soft | Aluminum Oxide | Medium | 1/4" | 3 |
| 13162 | M/SSF | Medium/Soft | Silicon Carbide | Fine | 1/4" | 3 |
| 13163 | MSF | Medium | Silicon Carbide | Fine | 1/4" | 3 |
| 13164 | MAM | Medium | Aluminum Oxide | Medium | 1/4" | 3 |
| 13165 | HAC | Hard | Aluminum Oxide | Coarse | 1/4" | 3 |



3" DIAMETER UNITIZED WHEELS

| Item# | Code | Density | Type | Grit | Thickness | Pkg. Qty. |
|-------|-------|-------------|-----------------|--------|-----------|-----------|
| 13166 | SSF | Soft | Silicon Carbide | Fine | 1/4" | 3 |
| 13167 | SAM | Soft | Aluminum Oxide | Medium | 1/4" | 3 |
| 13168 | M/SSF | Medium/Soft | Silicon Carbide | Fine | 1/4" | 3 |
| 13169 | MSF | Medium | Silicon Carbide | Fine | 1/4" | 3 |
| 13170 | MAM | Medium | Aluminum Oxide | Medium | 1/4" | 3 |
| 13171 | HAC | Hard | Aluminum Oxide | Coarse | 1/4" | 3 |

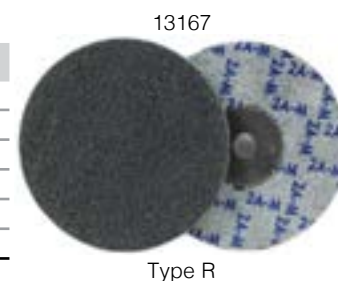

4 1/2" DIAMETER DEPRESSED CENTER UNITIZED WHEELS

| Item# | Code | Density | Type | Grit | Thickness | Pkg. Qty. |
|-------|-------|-------------|-----------------|--------|-----------|-----------|
| 13172 | SSF | Soft | Silicon Carbide | Fine | 1/2" | 1 |
| 13173 | SAM | Soft | Aluminum Oxide | Medium | 1/2" | 1 |
| 13174 | M/SSF | Medium/Soft | Silicon Carbide | Fine | 1/2" | 1 |
| 13175 | MSF | Medium | Silicon Carbide | Fine | 1/2" | 1 |
| 13176 | MAM | Medium | Aluminum Oxide | Medium | 1/2" | 1 |
| 13177 | HAC | Hard | Aluminum Oxide | Coarse | 1/2" | 1 |





ABRASIVE FLAP DISCS

Flap discs use diagonal layers of sandpaper on resin fiber backing. Flaps are glued onto multi-layer fiberglass, plastic or aluminum backing plates. As the flaps wear down, new grit is continuously being exposed for consistent performance throughout the life of the disc. Flap discs are designed to run cooler, thereby reducing warping of thin metals such as body panels. Unlike ordinary grinding wheels, these discs won't gouge your work.

FLAP DISC SHAPES



TYPE 27 FLAT

- Used primarily on flat surfaces
- The best choice for blending and smooth finishing



TYPE 29 BEVELED

- Conical flap discs are angled and may be used on both contoured and edge work
- The angle provides greater surface contact for stock removal on flat surfaces
- The best choice when speed and stock removal are primary considerations.

FLAP DISC TYPES



ALUMINUM OXIDE FLAP DISCS

Features: The original metalworking abrasive grain, this product is recommended for many jobs where a consistent, low cost product is needed. For steel applications.



ZIRCONIA FLAP DISCS

Features: Zirconia provides a very good cut rate to cost ratio. This is a long life grain and works well on stainless steel applications; providing longer life than Aluminum Oxide. Pages 50-52



TYPE 27 MINI FLAP DISCS

Features: Mini Flap discs provide all the same benefits of regular flap discs and work great in tight areas, for hard to reach spots, making it easier to maneuver.



HIGH DENSITY JUMBO DISCS

Features: High Density Zirconia flap discs offer an increased number of flaps with larger flap sizes compared to standard discs. Especially suitable for industrial applications.



MINI CUP FLAP DISCS

Features: Mini cup flap discs are suited for contoured surfaces. More flexible and conformable compared to mini grinding discs or Type 27 Mini Flap discs.



CERAMIC FLAP DISCS

Features: Tough, durable, long life grain, with very fine crystal structure to create many more cutting edges in each grain. Used for highest rate of stock removal in hard metals or stainless steel. Page 48



ZIRCONIA PLASTIC BACKED FLAP DISCS

Features: These high performance plastic backed Zirconia discs are made for one-step operation on a variety of materials, from grinding welds to detailed finishing. Page 47

APPLICATION/GRIT RECOMMENDATION GUIDE

HEAVY STOCK REMOVAL

EDGE CHAMFERING/BEVELING

WELDING BLEND

DEBURRING/DEFLASHING

24 Grit

36 Grit

40 Grit

50 Grit

PLASTIC BACKED ZIRCONIA FLAP DISCS

These **plastic-backed flap discs** are a replacement for sanding discs and enable a one-step operation. From grinding welds to detailed blending and finishing, the improved plastic backing plate evenly wears down with the abrasive flaps while new surfaces are exposed, maintaining a uniform cutting action.

Applications:

Ferrous and non-ferrous materials, stainless steel, high tensile steels, aluminum, structural steel, cast iron, plastic, fiberglass, and brass.

TYPE 27 FLAP DISCS



| Item# | Size | Arbor | Grit | Grain |
|-------|------|---------|------|----------|
| 47000 | 4.5" | 7/8" | 36 | Zirconia |
| 47001 | 4.5" | 7/8" | 40 | Zirconia |
| 47002 | 4.5" | 7/8" | 60 | Zirconia |
| 47003 | 4.5" | 7/8" | 80 | Zirconia |
| 47004 | 4.5" | 7/8" | 120 | Zirconia |
| 47005 | 4.5" | 5/8"-11 | 36 | Zirconia |
| 47006 | 4.5" | 5/8"-11 | 40 | Zirconia |
| 47007 | 4.5" | 5/8"-11 | 60 | Zirconia |
| 47008 | 4.5" | 5/8"-11 | 80 | Zirconia |
| 47009 | 4.5" | 5/8"-11 | 120 | Zirconia |

TYPE 29 FLAP DISCS



| Item# | Size | Arbor | Grit | Grain |
|-------|------|---------|------|----------|
| 47010 | 4.5" | 7/8" | 36 | Zirconia |
| 47011 | 4.5" | 7/8" | 40 | Zirconia |
| 47012 | 4.5" | 7/8" | 60 | Zirconia |
| 47013 | 4.5" | 7/8" | 80 | Zirconia |
| 47014 | 4.5" | 7/8" | 120 | Zirconia |
| 47015 | 4.5" | 5/8"-11 | 36 | Zirconia |
| 47016 | 4.5" | 5/8"-11 | 40 | Zirconia |
| 47017 | 4.5" | 5/8"-11 | 60 | Zirconia |
| 47018 | 4.5" | 5/8"-11 | 80 | Zirconia |
| 47019 | 4.5" | 5/8"-11 | 120 | Zirconia |

RUST REMOVAL/BLENDING

CLEANING AND FINISHING

60 Grit

80 Grit

100 Grit

120 Grit



CERAMIC

- Longest life grain
- For use on flat or curved surfaces
- Aggressive shape disc



Premium Ceramic Grain has Extended Life over Zirconia. Our Premium Ceramic discs are designed for use on Stainless Steel or other very hard steels. This tough, durable grain with very fine crystal structure creates many more cutting edges per grain.

TYPE 27

| Item# | Size | Arbor | Grit | Style | Grain | Shape | Pk. Qty | MP |
|-------|--------|-------|------|----------|---------|---------|---------|----|
| 46180 | 4 1/2" | 7/8" | 36 | Standard | Ceramic | Type 27 | 1 | 5 |
| 46181 | 4 1/2" | 7/8" | 36 | Standard | Ceramic | Type 27 | 10 | 2 |
| 46182 | 4 1/2" | 7/8" | 40 | Standard | Ceramic | Type 27 | 1 | 5 |
| 46183 | 4 1/2" | 7/8" | 40 | Standard | Ceramic | Type 27 | 10 | 2 |
| 46184 | 4 1/2" | 7/8" | 60 | Standard | Ceramic | Type 27 | 1 | 5 |
| 46185 | 4 1/2" | 7/8" | 60 | Standard | Ceramic | Type 27 | 10 | 2 |
| 46186 | 4 1/2" | 7/8" | 80 | Standard | Ceramic | Type 27 | 1 | 5 |
| 46187 | 4 1/2" | 7/8" | 80 | Standard | Ceramic | Type 27 | 10 | 2 |
| 46188 | 4 1/2" | 7/8" | 120 | Standard | Ceramic | Type 27 | 1 | 5 |
| 46189 | 4 1/2" | 7/8" | 120 | Standard | Ceramic | Type 27 | 10 | 2 |

TYPE 29

| Item# | Size | Arbor | Grit | Style | Grain | Shape | Pk. Qty | MP |
|-------|--------|-------|------|----------|---------|---------|---------|----|
| 46190 | 4 1/2" | 7/8" | 36 | Standard | Ceramic | Type 29 | 1 | 5 |
| 46191 | 4 1/2" | 7/8" | 36 | Standard | Ceramic | Type 29 | 10 | 2 |
| 46192 | 4 1/2" | 7/8" | 40 | Standard | Ceramic | Type 29 | 1 | 5 |
| 46193 | 4 1/2" | 7/8" | 40 | Standard | Ceramic | Type 29 | 10 | 2 |
| 46194 | 4 1/2" | 7/8" | 60 | Standard | Ceramic | Type 29 | 1 | 5 |
| 46195 | 4 1/2" | 7/8" | 60 | Standard | Ceramic | Type 29 | 10 | 2 |
| 46196 | 4 1/2" | 7/8" | 80 | Standard | Ceramic | Type 29 | 1 | 5 |
| 46197 | 4 1/2" | 7/8" | 80 | Standard | Ceramic | Type 29 | 10 | 2 |
| 46198 | 4 1/2" | 7/8" | 120 | Standard | Ceramic | Type 29 | 1 | 5 |
| 46199 | 4 1/2" | 7/8" | 120 | Standard | Ceramic | Type 29 | 10 | 2 |

ALUMINUM OXIDE

- For use on flat or curved surfaces. Aggressive shape disc.

FLAT



Aluminum Oxide: Made of the highest grade Aluminum Oxide paper, this is the most price competitive product. It is designed to be used on steels and non-ferrous metals. Not designed for use on Stainless Steel, it will not perform or last as long as a Zirconia grain wheel.

TYPE 27

| Item# | Old# | Size | Arbor | Grit | Style | Grain | Shape | Pk. Qty | MP |
|-------|----------|------|-------|------|----------|----------------|---------|---------|----|
| 45819 | F436 | 4" | 5/8" | 36 | Standard | Aluminum Oxide | Type 27 | 1 | 10 |
| 45820 | F436-10 | 4" | 5/8" | 36 | Standard | Aluminum Oxide | Type 27 | 10 | 2 |
| 45821 | | 4" | 5/8" | 40 | Standard | Aluminum Oxide | Type 27 | 1 | 10 |
| 45822 | | 4" | 5/8" | 40 | Standard | Aluminum Oxide | Type 27 | 10 | 2 |
| 45823 | F460 | 4" | 5/8" | 60 | Standard | Aluminum Oxide | Type 27 | 1 | 10 |
| 45824 | F460-10 | 4" | 5/8" | 60 | Standard | Aluminum Oxide | Type 27 | 10 | 2 |
| 45825 | F480 | 4" | 5/8" | 80 | Standard | Aluminum Oxide | Type 27 | 1 | 10 |
| 45826 | F480-10 | 4" | 5/8" | 80 | Standard | Aluminum Oxide | Type 27 | 10 | 2 |
| 45827 | F4120 | 4" | 5/8" | 120 | Standard | Aluminum Oxide | Type 27 | 1 | 10 |
| 45828 | F4120-10 | 4" | 5/8" | 120 | Standard | Aluminum Oxide | Type 27 | 10 | 2 |

(Continued)

ALUMINUM OXIDE

TYPE 27

| Item# | Old# | Size | Arbor | Grit | Style | Grain | Shape | Pk. Qty | MP |
|-------|-----------|--------|-------|------|----------|----------------|---------|---------|----|
| 12900 | F4536 | 4 1/2" | 7/8" | 36 | Standard | Aluminum Oxide | Type 27 | 1 | 10 |
| 45829 | F4536-10 | 4 1/2" | 7/8" | 36 | Standard | Aluminum Oxide | Type 27 | 10 | 5 |
| 45830 | | 4 1/2" | 7/8" | 40 | Standard | Aluminum Oxide | Type 27 | 1 | 10 |
| 45831 | | 4 1/2" | 7/8" | 40 | Standard | Aluminum Oxide | Type 27 | 10 | 5 |
| 12901 | F4560 | 4 1/2" | 7/8" | 60 | Standard | Aluminum Oxide | Type 27 | 1 | 10 |
| 45832 | F4560-10 | 4 1/2" | 7/8" | 60 | Standard | Aluminum Oxide | Type 27 | 10 | 5 |
| 12902 | F4580 | 4 1/2" | 7/8" | 80 | Standard | Aluminum Oxide | Type 27 | 1 | 10 |
| 45833 | F4580-10 | 4 1/2" | 7/8" | 80 | Standard | Aluminum Oxide | Type 27 | 10 | 5 |
| 45834 | F45120 | 4 1/2" | 7/8" | 120 | Standard | Aluminum Oxide | Type 27 | 1 | 10 |
| 45835 | F45120-10 | 4 1/2" | 7/8" | 120 | Standard | Aluminum Oxide | Type 27 | 10 | 5 |
| 12903 | F736 | 7" | 7/8" | 36 | Standard | Aluminum Oxide | Type 27 | 1 | 10 |
| 45856 | F736-10 | 7" | 7/8" | 36 | Standard | Aluminum Oxide | Type 27 | 10 | 5 |
| 45857 | | 7" | 7/8" | 40 | Standard | Aluminum Oxide | Type 27 | 1 | 10 |
| 45858 | | 7" | 7/8" | 40 | Standard | Aluminum Oxide | Type 27 | 10 | 5 |
| 12904 | F760 | 7" | 7/8" | 60 | Standard | Aluminum Oxide | Type 27 | 1 | 10 |
| 45859 | F760-10 | 7" | 7/8" | 60 | Standard | Aluminum Oxide | Type 27 | 10 | 5 |
| 12905 | F780 | 7" | 7/8" | 80 | Standard | Aluminum Oxide | Type 27 | 1 | 10 |
| 45860 | F780-10 | 7" | 7/8" | 80 | Standard | Aluminum Oxide | Type 27 | 10 | 5 |
| 45861 | F7120 | 7" | 7/8" | 120 | Standard | Aluminum Oxide | Type 27 | 1 | 10 |
| 45862 | F7120-10 | 7" | 7/8" | 120 | Standard | Aluminum Oxide | Type 27 | 10 | 5 |

BEVELED



- For use on flat or curved surfaces
- Angle built into the disc - offers the user easier grinding action.

Aluminum Oxide: Made of the highest grade Aluminum Oxide paper, this grain is the most price competitive product. It is designed to be used on steels and non-ferrous metals. Not designed for use on Stainless Steel, it will not perform or last as long as a Zirconia grain wheel.

TYPE 29

| Item# | Size | Arbor | Grit | Style | Grain | Shape | Pk. Qty | MP |
|-------|--------|---------|------|----------|----------------|---------|---------|----|
| 45863 | 4" | 5/8" | 36 | Standard | Aluminum Oxide | Type 29 | 1 | 10 |
| 45864 | 4" | 5/8" | 40 | Standard | Aluminum Oxide | Type 29 | 1 | 10 |
| 45865 | 4" | 5/8" | 60 | Standard | Aluminum Oxide | Type 29 | 1 | 10 |
| 45866 | 4" | 5/8" | 80 | Standard | Aluminum Oxide | Type 29 | 1 | 10 |
| 45867 | 4" | 5/8" | 120 | Standard | Aluminum Oxide | Type 29 | 1 | 10 |
| 45736 | 4 1/2" | 7/8" | 36 | Standard | Aluminum Oxide | Type 29 | 1 | 10 |
| 45868 | 4 1/2" | 7/8" | 40 | Standard | Aluminum Oxide | Type 29 | 1 | 10 |
| 45738 | 4 1/2" | 7/8" | 60 | Standard | Aluminum Oxide | Type 29 | 1 | 10 |
| 45740 | 4 1/2" | 7/8" | 80 | Standard | Aluminum Oxide | Type 29 | 1 | 10 |
| 45742 | 4 1/2" | 7/8" | 120 | Standard | Aluminum Oxide | Type 29 | 1 | 10 |
| 45737 | 4 1/2" | 5/8"-11 | 36 | Standard | Aluminum Oxide | Type 29 | 1 | 5 |
| 45744 | 4 1/2" | 5/8"-11 | 40 | Standard | Aluminum Oxide | Type 29 | 1 | 5 |
| 45739 | 4 1/2" | 5/8"-11 | 60 | Standard | Aluminum Oxide | Type 29 | 1 | 5 |
| 45741 | 4 1/2" | 5/8"-11 | 80 | Standard | Aluminum Oxide | Type 29 | 1 | 5 |
| 45743 | 4 1/2" | 5/8"-11 | 120 | Standard | Aluminum Oxide | Type 29 | 1 | 5 |



PREMIUM PLATINUM ZIRCONIA

- For use on flat or curved surfaces
- Aggressive shape disc

Premium Zirconia: Made of our Premium 100% Zirconia, this grain is the highest quality and designed specifically for Stainless Steel or harder metals; lasting extremely long if used on regular steel.

FLAT



TYPE 27

| Item# | Old# | Size | Arbor | Grit | Style | Grain | Shape | Pk. Qty | MP |
|-------|------------|--------|---------|------|----------|---------------|---------|---------|----|
| 13137 | F436Z | 4" | 5/8" | 36 | Standard | 100% Zirconia | Type 27 | 1 | 50 |
| 45870 | F436Z-10 | 4" | 5/8" | 36 | Standard | 100% Zirconia | Type 27 | 10 | 10 |
| 45871 | | 4" | 5/8" | 40 | Standard | 100% Zirconia | Type 27 | 1 | 50 |
| 45872 | | 4" | 5/8" | 40 | Standard | 100% Zirconia | Type 27 | 10 | 10 |
| 13138 | F460Z | 4" | 5/8" | 60 | Standard | 100% Zirconia | Type 27 | 1 | 50 |
| 45873 | F460Z-10 | 4" | 5/8" | 60 | Standard | 100% Zirconia | Type 27 | 10 | 10 |
| 13139 | F480Z | 4" | 5/8" | 80 | Standard | 100% Zirconia | Type 27 | 1 | 50 |
| 45874 | F480Z-10 | 4" | 5/8" | 80 | Standard | 100% Zirconia | Type 27 | 10 | 10 |
| 45875 | F4120Z | 4" | 5/8" | 120 | Standard | 100% Zirconia | Type 27 | 1 | 50 |
| 45876 | F4120Z-10 | 4" | 5/8" | 120 | Standard | 100% Zirconia | Type 27 | 10 | 10 |
| 13134 | F4536Z | 4 1/2" | 7/8" | 36 | Standard | 100% Zirconia | Type 27 | 1 | 50 |
| 45877 | F4536Z-10 | 4 1/2" | 7/8" | 36 | Standard | 100% Zirconia | Type 27 | 10 | 10 |
| 45879 | | 4 1/2" | 7/8" | 40 | Standard | 100% Zirconia | Type 27 | 1 | 50 |
| 45880 | | 4 1/2" | 7/8" | 40 | Standard | 100% Zirconia | Type 27 | 10 | 10 |
| 13135 | F4560Z | 4 1/2" | 7/8" | 60 | Standard | 100% Zirconia | Type 27 | 1 | 50 |
| 45881 | F4560Z-10 | 4 1/2" | 7/8" | 60 | Standard | 100% Zirconia | Type 27 | 10 | 10 |
| 13136 | F4580Z | 4 1/2" | 7/8" | 80 | Standard | 100% Zirconia | Type 27 | 1 | 10 |
| 45882 | F4580Z-10 | 4 1/2" | 7/8" | 80 | Standard | 100% Zirconia | Type 27 | 10 | 10 |
| 45883 | F45120Z | 4 1/2" | 7/8" | 120 | Standard | 100% Zirconia | Type 27 | 1 | 50 |
| 45884 | F45120Z-10 | 4 1/2" | 7/8" | 120 | Standard | 100% Zirconia | Type 27 | 10 | 10 |
| 12906 | F4536ZH | 4 1/2" | 5/8"-11 | 36 | Standard | 100% Zirconia | Type 27 | 1 | 10 |
| 45869 | | 4 1/2" | 5/8"-11 | 40 | Standard | 100% Zirconia | Type 27 | 1 | 10 |
| 12907 | F4560ZH | 4 1/2" | 5/8"-11 | 60 | Standard | 100% Zirconia | Type 27 | 1 | 10 |
| 12908 | F4580ZH | 4 1/2" | 5/8"-11 | 80 | Standard | 100% Zirconia | Type 27 | 1 | 10 |
| 45878 | F45120ZH | 4 1/2" | 5/8"-11 | 120 | Standard | 100% Zirconia | Type 27 | 1 | 10 |
| 13140 | F736Z | 7" | 7/8" | 36 | Standard | 100% Zirconia | Type 27 | 1 | 10 |
| 45895 | F736Z-10 | 7" | 7/8" | 36 | Standard | 100% Zirconia | Type 27 | 10 | 5 |
| 45896 | | 7" | 7/8" | 40 | Standard | 100% Zirconia | Type 27 | 1 | 10 |
| 45897 | | 7" | 7/8" | 40 | Standard | 100% Zirconia | Type 27 | 10 | 4 |
| 13141 | F760Z | 7" | 7/8" | 60 | Standard | 100% Zirconia | Type 27 | 1 | 10 |
| 45898 | F760Z-10 | 7" | 7/8" | 60 | Standard | 100% Zirconia | Type 27 | 10 | 4 |
| 13148 | F780Z | 7" | 7/8" | 80 | Standard | 100% Zirconia | Type 27 | 1 | 10 |
| 45899 | F780Z-10 | 7" | 7/8" | 80 | Standard | 100% Zirconia | Type 27 | 10 | 4 |
| 45900 | F7120Z | 7" | 7/8" | 120 | Standard | 100% Zirconia | Type 27 | 1 | 10 |
| 45901 | F7120Z-10 | 7" | 7/8" | 120 | Standard | 100% Zirconia | Type 27 | 10 | 4 |
| 12909 | F736ZH | 7" | 5/8"-11 | 36 | Standard | 100% Zirconia | Type 27 | 1 | 10 |
| 12958 | | 7" | 5/8"-11 | 40 | Standard | 100% Zirconia | Type 27 | 1 | 10 |
| 12910 | F760ZH | 7" | 5/8"-11 | 60 | Standard | 100% Zirconia | Type 27 | 1 | 10 |
| 12911 | F780ZH | 7" | 5/8"-11 | 80 | Standard | 100% Zirconia | Type 27 | 1 | 10 |
| 45902 | F7120ZH | 7" | 5/8"-11 | 120 | Standard | 100% Zirconia | Type 27 | 1 | 10 |

PREMIUM PLATINUM ZIRCONIA

- For use on flat or curved surfaces
- Angle built into the disc - offers the user easier grinding action.

BEVELED



Premium Zirconia: Made of our Premium 100% Zirconia, this grain is the highest quality and designed specifically for Stainless Steel or harder metals; lasting extremely long if used on regular steel.

TYPE 29

| Item# | Size | Arbor | Grit | Style | Grain | Shape | Pk. Qty | MP |
|-------|--------|---------|------|----------|---------------|---------|---------|----|
| 45903 | 4" | 5/8" | 36 | Standard | 100% Zirconia | Type 29 | 1 | 10 |
| 45904 | 4" | 5/8" | 40 | Standard | 100% Zirconia | Type 29 | 1 | 10 |
| 45905 | 4" | 5/8" | 60 | Standard | 100% Zirconia | Type 29 | 1 | 10 |
| 45906 | 4" | 5/8" | 80 | Standard | 100% Zirconia | Type 29 | 1 | 10 |
| 45907 | 4" | 5/8" | 120 | Standard | 100% Zirconia | Type 29 | 1 | 10 |
| 45836 | 4 1/2" | 7/8" | 36 | Standard | 100% Zirconia | Type 29 | 1 | 10 |
| 45908 | 4 1/2" | 7/8" | 36 | Standard | 100% Zirconia | Type 29 | 10 | 5 |
| 45909 | 4 1/2" | 7/8" | 40 | Standard | 100% Zirconia | Type 29 | 1 | 10 |
| 45910 | 4 1/2" | 7/8" | 40 | Standard | 100% Zirconia | Type 29 | 10 | 5 |
| 45838 | 4 1/2" | 7/8" | 60 | Standard | 100% Zirconia | Type 29 | 1 | 10 |
| 45912 | 4 1/2" | 7/8" | 60 | Standard | 100% Zirconia | Type 29 | 10 | 5 |
| 45840 | 4 1/2" | 7/8" | 80 | Standard | 100% Zirconia | Type 29 | 1 | 10 |
| 45913 | 4 1/2" | 7/8" | 80 | Standard | 100% Zirconia | Type 29 | 10 | 5 |
| 45842 | 4 1/2" | 7/8" | 120 | Standard | 100% Zirconia | Type 29 | 1 | 10 |
| 45914 | 4 1/2" | 7/8" | 120 | Standard | 100% Zirconia | Type 29 | 10 | 5 |
| 45837 | 4 1/2" | 5/8"-11 | 36 | Standard | 100% Zirconia | Type 29 | 1 | 10 |
| 45915 | 4 1/2" | 5/8"-11 | 40 | Standard | 100% Zirconia | Type 29 | 1 | 10 |
| 45839 | 4 1/2" | 5/8"-11 | 60 | Standard | 100% Zirconia | Type 29 | 1 | 10 |
| 45841 | 4 1/2" | 5/8"-11 | 80 | Standard | 100% Zirconia | Type 29 | 1 | 10 |
| 45843 | 4 1/2" | 5/8"-11 | 120 | Standard | 100% Zirconia | Type 29 | 1 | 10 |
| 45926 | 7" | 7/8" | 36 | Standard | 100% Zirconia | Type 29 | 1 | 10 |
| 45927 | 7" | 7/8" | 36 | Standard | 100% Zirconia | Type 29 | 10 | 2 |
| 45928 | 7" | 7/8" | 40 | Standard | 100% Zirconia | Type 29 | 1 | 10 |
| 45929 | 7" | 7/8" | 40 | Standard | 100% Zirconia | Type 29 | 1 | 10 |
| 45930 | 7" | 7/8" | 60 | Standard | 100% Zirconia | Type 29 | 1 | 10 |
| 45931 | 7" | 7/8" | 80 | Standard | 100% Zirconia | Type 29 | 1 | 10 |
| 45932 | 7" | 7/8" | 120 | Standard | 100% Zirconia | Type 29 | 1 | 10 |
| 45933 | 7" | 7/8" | 120 | Standard | 100% Zirconia | Type 29 | 10 | 2 |



ECONOMY ZIRCONIA

ECONOMY GRADE 60% ZIRCONIA

- For use on flat or curved surfaces
- Aggressive shape disc

Economy 60% Zirconia: This grain is very high quality at our most affordable price point. It is designed specifically for Stainless Steel or harder metals; and will last very long when used on regular steel.

FLAT



TYPE 27

| Item# | Size | Arbor | Grit | Style | Grain | Shape | Pk. Qty | MP |
|-------|--------|---------|------|----------|-------------------|---------|---------|----|
| 46023 | 4" | 5/8" | 36 | Standard | 60% Econ Zirconia | Type 27 | 1 | 10 |
| 46024 | 4" | 5/8" | 36 | Standard | 60% Econ Zirconia | Type 27 | 10 | 5 |
| 46025 | 4" | 5/8" | 40 | Standard | 60% Econ Zirconia | Type 27 | 1 | 10 |
| 46026 | 4" | 5/8" | 40 | Standard | 60% Econ Zirconia | Type 27 | 10 | 5 |
| 46027 | 4" | 5/8" | 60 | Standard | 60% Econ Zirconia | Type 27 | 1 | 10 |
| 46028 | 4" | 5/8" | 60 | Standard | 60% Econ Zirconia | Type 27 | 10 | 5 |
| 46029 | 4" | 5/8" | 80 | Standard | 60% Econ Zirconia | Type 27 | 1 | 10 |
| 46030 | 4" | 5/8" | 80 | Standard | 60% Econ Zirconia | Type 27 | 10 | 5 |
| 46031 | 4 1/2" | 7/8" | 36 | Standard | 60% Econ Zirconia | Type 27 | 1 | 10 |
| 46032 | 4 1/2" | 7/8" | 36 | Standard | 60% Econ Zirconia | Type 27 | 10 | 5 |
| 46033 | 4 1/2" | 7/8" | 40 | Standard | 60% Econ Zirconia | Type 27 | 1 | 10 |
| 46034 | 4 1/2" | 7/8" | 40 | Standard | 60% Econ Zirconia | Type 27 | 10 | 5 |
| 46035 | 4 1/2" | 7/8" | 60 | Standard | 60% Econ Zirconia | Type 27 | 1 | 10 |
| 46036 | 4 1/2" | 7/8" | 60 | Standard | 60% Econ Zirconia | Type 27 | 10 | 5 |
| 46037 | 4 1/2" | 7/8" | 80 | Standard | 60% Econ Zirconia | Type 27 | 1 | 10 |
| 46038 | 4 1/2" | 7/8" | 80 | Standard | 60% Econ Zirconia | Type 27 | 10 | 5 |
| 46039 | 4 1/2" | 5/8"-11 | 36 | Standard | 60% Econ Zirconia | Type 27 | 1 | 10 |
| 46040 | 4 1/2" | 5/8"-11 | 40 | Standard | 60% Econ Zirconia | Type 27 | 1 | 10 |
| 46041 | 4 1/2" | 5/8"-11 | 60 | Standard | 60% Econ Zirconia | Type 27 | 1 | 10 |
| 46042 | 4 1/2" | 5/8"-11 | 80 | Standard | 60% Econ Zirconia | Type 27 | 1 | 10 |
| 46051 | 7" | 7/8" | 36 | Standard | 60% Econ Zirconia | Type 27 | 1 | 10 |
| 46052 | 7" | 7/8" | 40 | Standard | 60% Econ Zirconia | Type 27 | 1 | 10 |
| 46053 | 7" | 7/8" | 60 | Standard | 60% Econ Zirconia | Type 27 | 1 | 10 |
| 46054 | 7" | 7/8" | 80 | Standard | 60% Econ Zirconia | Type 27 | 1 | 10 |



PREMIUM PLATINUM JUMBO ZIRCONIA

- For use on flat or curved surfaces
- Aggressive shape disc
- 20% more flaps than standard discs

FLAT



Premium 100% Zirconia: Premium High Density Zirconia discs come with more flaps per wheel and give you extremely long life products. Made of our best 100% Premium Zirconia, this grain is the highest quality grain and designed specifically for Stainless Steel or harder metals, and will last extremely long if used on regular steel.

TYPE 27

| Item# | Size | Arbor | Grit | Style | Grain | Shape | Pk. Qty | MP |
|-------|--------|-----------|------|--------------|---------------|---------|---------|----|
| 46084 | 4" | 5/8" | 36 | High-Density | 100% Zirconia | Type 27 | 1 | 5 |
| 46085 | 4" | 5/8" | 40 | High-Density | 100% Zirconia | Type 27 | 1 | 5 |
| 46086 | 4" | 5/8" | 60 | High-Density | 100% Zirconia | Type 27 | 1 | 5 |
| 46087 | 4" | 5/8" | 80 | High-Density | 100% Zirconia | Type 27 | 1 | 5 |
| 46088 | 4" | 5/8" | 120 | High-Density | 100% Zirconia | Type 27 | 1 | 5 |
| 46089 | 4 1/2" | 7/8" | 36 | High-Density | 100% Zirconia | Type 27 | 1 | 5 |
| 46090 | 4 1/2" | 7/8" | 40 | High-Density | 100% Zirconia | Type 27 | 1 | 5 |
| 46091 | 4 1/2" | 7/8" | 60 | High-Density | 100% Zirconia | Type 27 | 1 | 5 |
| 46092 | 4 1/2" | 7/8" | 80 | High-Density | 100% Zirconia | Type 27 | 1 | 5 |
| 46093 | 4 1/2" | 7/8" | 120 | High-Density | 100% Zirconia | Type 27 | 1 | 5 |
| 46094 | 4 1/2" | 5/8"-11NC | 36 | High-Density | 100% Zirconia | Type 27 | 1 | 5 |
| 46095 | 4 1/2" | 5/8"-11NC | 40 | High-Density | 100% Zirconia | Type 27 | 1 | 5 |
| 46096 | 4 1/2" | 5/8"-11NC | 60 | High-Density | 100% Zirconia | Type 27 | 1 | 5 |
| 46097 | 4 1/2" | 5/8"-11NC | 80 | High-Density | 100% Zirconia | Type 27 | 1 | 5 |
| 46098 | 4 1/2" | 5/8"-11NC | 120 | High-Density | 100% Zirconia | Type 27 | 1 | 5 |
| 46104 | 7" | 7/8" | 36 | High-Density | 100% Zirconia | Type 27 | 1 | 5 |
| 46105 | 7" | 7/8" | 40 | High-Density | 100% Zirconia | Type 27 | 1 | 5 |
| 46106 | 7" | 7/8" | 60 | High-Density | 100% Zirconia | Type 27 | 1 | 5 |
| 46107 | 7" | 7/8" | 80 | High-Density | 100% Zirconia | Type 27 | 1 | 5 |
| 46108 | 7" | 7/8" | 120 | High-Density | 100% Zirconia | Type 27 | 1 | 5 |





ALUMINUM OXIDE/ZIRCONIA MINI FLAP DISCS

These Mini Flap Discs are perfect for small grinding needs in tight spots. They replace Mini Grinding Discs, giving you improved longevity and a continual new surface! Available in 2" & 3" in either Aluminum Oxide or Zirconia, they come with a Twist-To-Lock backing.

- Non-Loading/ Never Curls
- Heavy Duty Built in Backing Pad
- Flat Face for Maximum Aggressiveness
- Outlast Mini Grinding Discs by 4-6 Times
- Uses 100% of the Grain Surface



TYPE 27

| | Item# | Size | Grit | Grain | Pk. Qty |
|-----------------------|-------|------|------|----------------|---------|
| ALUMINUM OXIDE | 73752 | 2" | 40 | Aluminum Oxide | 5 |
| | 73753 | 2" | 60 | Aluminum Oxide | 5 |
| | 73754 | 2" | 80 | Aluminum Oxide | 5 |
| | 73755 | 2" | 120 | Aluminum Oxide | 5 |
| | 73757 | 3" | 40 | Aluminum Oxide | 5 |
| | 73758 | 3" | 60 | Aluminum Oxide | 5 |
| | 73759 | 3" | 80 | Aluminum Oxide | 5 |
| | 73760 | 3" | 120 | Aluminum Oxide | 5 |
| ZIRCONIA | 73762 | 2" | 40 | Zirconia | 5 |
| | 73763 | 2" | 60 | Zirconia | 5 |
| | 73764 | 2" | 80 | Zirconia | 5 |
| | 73765 | 2" | 120 | Zirconia | 5 |
| | 73767 | 3" | 40 | Zirconia | 5 |
| | 73768 | 3" | 60 | Zirconia | 5 |
| | 73769 | 3" | 80 | Zirconia | 5 |
| | 73770 | 3" | 120 | Zirconia | 5 |

ZIRCONIA MINI CUP FLAP DISCS

Suited for contoured surfaces. More flexible and conformable compared to mini discs.

- Non-Loading
- Heavy Duty Built in Backing Pad
- Works on all High Speed Grinders
- Beveled Face for Maximum Contact
- Perfect for Rounded and Curved Surfaces
- Uses 100% of the Grain Surface



CUP STYLE

| | Item# | Size | Grit | Grain | Pk. Qty |
|-----------------|-------|------|------|----------|---------|
| ZIRCONIA | 82751 | 2" | 40 | Zirconia | 2 |
| | 82752 | 2" | 60 | Zirconia | 2 |
| | 82753 | 2" | 80 | Zirconia | 2 |
| | 82754 | 2" | 120 | Zirconia | 2 |
| | 83751 | 3" | 40 | Zirconia | 2 |
| | 83752 | 3" | 60 | Zirconia | 2 |
| | 83753 | 3" | 80 | Zirconia | 2 |
| | 83754 | 3" | 120 | Zirconia | 2 |

MINI FLAP DISC KITS

These 6 piece Mini Flap Disc kits are a great mixture of grits for any type of job. The discs are designed for use on right angle die grinders, providing smooth grinding and enhanced conformability in tight areas where typical discs do not hold up.

| Item# | Description |
|-------|--|
| 13056 | 2" Mini Flap Disc Kit includes: 2 - 40 Grit, 2 - 60 Grit & 2 - 80 Grit discs |
| 73750 | 2" Mini Flap Disc Kit includes: 2 - 40 Grit discs, 1 - 60 Grit disc, 1 - 80 Grit disc, 1 - 120 Grit disc and 1 - 2" holder. |
| 73780 | 3" Mini Flap Disc Kit includes: 2 - 40 Grit discs, 1 - 60 Grit disc, 1 - 80 Grit disc, 1 - 120 Grit disc and 1 - 3" holder. |



13056

ALUMINUM OXIDE FLAP WHEELS

These mini grinding flap wheels replace many wire brushes, cartridge rolls, and mounted points in metal removal applications. Made of Aluminum Oxide abrasive grain for excellent performance, they are resin bonded to a cloth back. Excellent for polishing, contouring, dry sanding and grinding applications. Also used in rust removal, descaling and deburring. All have a 1/4" shank.



Cloth Backing:

Cloth backings are strong and durable. The wheel is designed for long life; and coarse grits offer heavy stock removal.

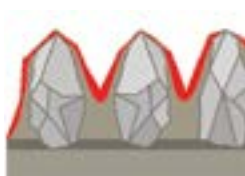

Resin Bonded:

Strongest and most resistant bond available. Stands up to high speed and pressure sanding or grinding applications.

| Item# | Old # | Dia. | Height | Grit | RPM | Pk. Qty |
|-------|--------|------|--------|------|--------|---------|
| 13099 | F1140 | 1" | 1/2" | 40 | 30,000 | 5 |
| 13100 | F1160 | 1" | 1/2" | 60 | 30,000 | 5 |
| 13101 | F1180 | 1" | 1/2" | 80 | 30,000 | 5 |
| 13102 | F1100 | 1" | 1/2" | 10 | 30,000 | 5 |
| 13103 | F1200 | 1" | 1/2" | 120 | 30,000 | 5 |
| 13104 | F1340 | 1" | 1" | 40 | 30,000 | 5 |
| 12912 | | 1" | 1" | 60 | 30,000 | 1 |
| 13105 | F1360 | 1" | 1" | 60 | 30,000 | 5 |
| 12913 | | 1" | 1" | 80 | 30,000 | 1 |
| 13106 | F1380 | 1" | 1" | 80 | 30,000 | 5 |
| 13107 | F13100 | 1" | 1" | 100 | 30,000 | 5 |
| 12914 | | 1" | 1" | 120 | 30,000 | 1 |
| 13108 | F13120 | 1" | 1" | 120 | 30,000 | 5 |

| Item# | Old# | Dia. | Height | Grit | RPM | Pk. Qty |
|-------|--------|--------|--------|------|--------|---------|
| 13109 | F1340 | 1 1/2" | 1/2" | 40 | 30,000 | 5 |
| 12915 | | 1 1/2" | 1/2" | 60 | 30,000 | 1 |
| 13110 | F1460 | 1 1/2" | 1/2" | 60 | 30,000 | 5 |
| 12916 | | 1 1/2" | 1/2" | 80 | 30,000 | 1 |
| 13111 | F1480 | 1 1/2" | 1/2" | 80 | 30,000 | 5 |
| 13112 | F14100 | 1 1/2" | 1/2" | 100 | 30,000 | 5 |
| 12917 | | 1 1/2" | 1/2" | 120 | 30,000 | 1 |
| 13113 | F14120 | 1 1/2" | 1/2" | 120 | 30,000 | 5 |
| 13114 | F1540 | 1 1/2" | 1" | 40 | 30,000 | 5 |
| 13115 | F1560 | 1 1/2" | 1" | 60 | 30,000 | 5 |
| 13116 | F1580 | 1 1/2" | 1" | 80 | 30,000 | 5 |
| 13117 | F15100 | 1 1/2" | 1" | 100 | 30,000 | 5 |
| 13118 | F15120 | 1 1/2" | 1" | 120 | 30,000 | 5 |
| 13119 | F240 | 2" | 1" | 40 | 25,000 | 5 |
| 12918 | | 2" | 1" | 60 | 25,000 | 1 |
| 13120 | F260 | 2" | 1" | 60 | 25,000 | 5 |
| 12919 | | 2" | 1" | 80 | 25,000 | 1 |
| 13121 | F280 | 2" | 1" | 80 | 25,000 | 5 |
| 13122 | F2100 | 2" | 1" | 100 | 25,000 | 5 |
| 12920 | | 2" | 1" | 120 | 25,000 | 1 |
| 13123 | F2120 | 2" | 1" | 120 | 25,000 | 5 |
| 13124 | F2140 | 2 1/2" | 1" | 40 | 25,000 | 5 |
| 13125 | F2160 | 2 1/2" | 1" | 60 | 25,000 | 5 |
| 13126 | F2180 | 2 1/2" | 1" | 80 | 25,000 | 5 |
| 13127 | F21100 | 2 1/2" | 1" | 100 | 25,000 | 5 |
| 13128 | F21200 | 2 1/2" | 1" | 120 | 25,000 | 5 |
| 13129 | F3140 | 3" | 1" | 40 | 20,000 | 5 |
| 12921 | | 3" | 1" | 60 | 20,000 | 1 |
| 13130 | F3160 | 3" | 1" | 60 | 20,000 | 5 |
| 12922 | | 3" | 1" | 80 | 20,000 | 1 |
| 13131 | F3180 | 3" | 1" | 80 | 20,000 | 5 |
| 13132 | F31100 | 3" | 1" | 100 | 20,000 | 5 |
| 12923 | | 3" | 1" | 120 | 20,000 | 1 |
| 13133 | F31120 | 3" | 1" | 120 | 20,000 | 5 |



ALUMINUM OXIDE FLAP WHEELS

FLAP WHEEL ASSORTMENT PACK

A handy assortment of sizes and grits in an attractive clam shell package! Made from Aluminum Oxide cloth backed sandpaper, this wheel assortment will be a great starter kit for the person who requires a variety of sizes and grits. All have a 1/4" shank.

Tool: Electric Angle Grinder, Pneumatic Die Grinders or Drills

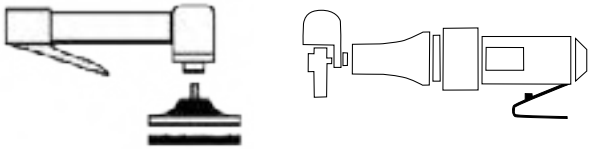

| Item# | Description |
|-------------|--|
| 7000 | Item# Size Grit Qty. |
| | 13103 (1) 1" x 1/2" 120 1 |
| | 13104 (1) 1" x 1" 40 1 |
| | 12913 1" x 1" 80 1 |
| | 13115 (1) 1 1/2" x 1" 60 1 |
| | 13116 (1) 1 1/2" x 1" 80 1 |
| | 12918 2" x 1" 60 2 |
| | 12919 2" x 1" 80 1 |



ZIRCONIA CARTRIDGE ROLLS

The Zirconia cartridge rolls are best for deburring and blending in small, hard to reach places. The handy rolls are constructed of Zirconia with a cloth back and sealed with a heat-resistant resin bond.

These long-life rolls can be used on ferrous metals, high-tensile materials, aircraft grade aluminum, and stainless steel, as well as heat treated steels. Harder and stronger than aluminum oxide, their performance will impress you.

Made in the U.S.A.

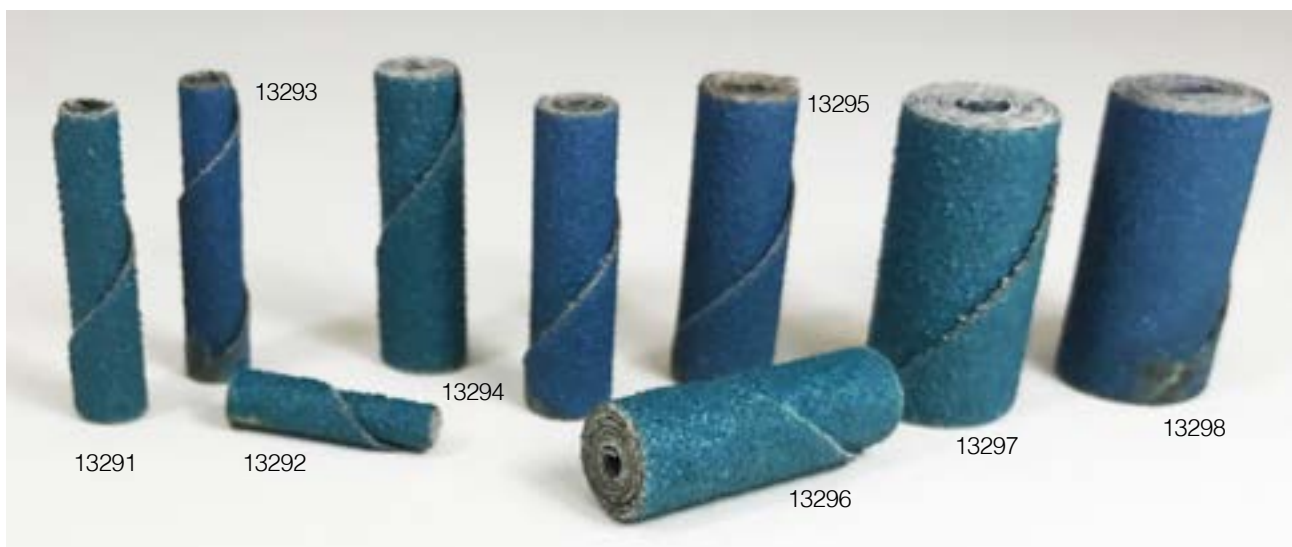

| Item# | Description | Grit | Qty. |
|-------|----------------------|------|------|
| 13290 | 1/4" x 1-1/2" x 1/8" | 60 | 50 |
| 13291 | 1/4" x 1-1/2" x 1/8" | 80 | 50 |
| 13292 | 3/16" x 1" x 3/32" | 60 | 50 |
| 13293 | 3/8" x 1-1/2" x 1/8" | 60 | 50 |
| 13294 | 3/8" x 1-1/2" x 1/8" | 80 | 50 |
| 13295 | 1/2" x 1-1/2" x 1/8" | 60 | 50 |
| 13296 | 1/2" x 1-1/2" x 1/8" | 80 | 50 |
| 13297 | 3/4" x 1-1/2" x 1/4" | 60 | 50 |
| 13298 | 3/4" x 1-1/2" x 1/4" | 80 | 50 |
| 13299 | 3/8" x 1-1/2" x 1/4" | 36 | 50 |
| 13300 | 3/4" x 1-1/2" x 1/4" | 36 | 50 |
| 13301 | 3/4" x 2" x 1/4" | 36 | 50 |
| 13302 | 1" x 1" x 3/16" | 36 | 50 |
| 13303 | 3/4" x 2" x 1/4" | 60 | 50 |

PILOT LENGTH FOR MANDRELS

Rolls 1" Long - 3/4" pilot length.

Rolls 1/2" Long - 1" pilot length.

Rolls 2" Long - 1 1/2" pilot length.

| Item# | Size | Description |
|-------|---------------------|-------------|
| 13312 | 3/32" x 3/4" x 1/4" | OAL 2-3/4 |
| 13313 | 1/8" x 1" x 1/4" | OAL 2-3/4 |
| 13314 | 1/4" x 1" x 1/4" | OAL 3" |
| 13315 | 1/4" x 1" x 1/4" | OAL 6" |
| 13316 | 1/8" x 1" x 1/4" | OAL 8" |





MOUNTED POINTS

Shark Mounted Points are high quality, vitrified mounted points. Typical applications include blending contours, deburring molded parts and mold finishing, ID grinding, off hand bench grinding, and tool and die applications. All mounted points are sold separately or in various assortments.

STANDARD SHAPES

Series A: Shapes are mounted on 1/4" diameter by 1 1/2" long shanks. Available in all shapes.

Series W: Cylindrical point shapes.

SELECTION OF HARDNESS GRADE

Below is a Hardness chart to help gauge what level will work best for your project.

| | | | | | | | | | | | | | | | | | |
|----------|----------|----------|-----------|----------|----------|----------|----------|----------|----------|----------|----------|----------|----------|----------|-----------|----------|----------|
| I | J | K | L | M | N | O | P | Q | R | S | T | U | V | W | X | Y | Z |
| | | | very soft | soft | | medium | | | hard | | | | | | very hard | | |

Vitrified Bond Types



Salmon: They are typically used in medium (**R**) hardness for stock removal of steel.



Pink: Used in almost every industry but primarily in tool and die shops, and foundries. General applications: Deburring, tool sharpening, finishing cavities, and removing mold marks and parting lines. The semi-friable pink PA abrasive is used to produce sharp, consistent cutting action. Typically is a medium (**O thru Q**) hardness stock.



White: They are typically used in soft to medium (**L thru R**) wheels for stock removal of harder steel. They are also frequently used in very soft wheels for jig grinding or internal grinding



Salmon Coarse: Typically used in hard (**U**) hardness applications. For use in very aggressive and durable material application.



Grey: Hardness grade (**R**) mounted points are noted for their durability and used primarily for grinding welds.

Size Diagram & Terms

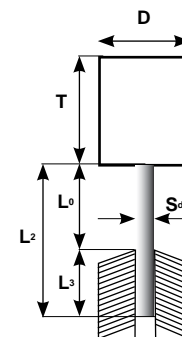

- D = Point Diameter
- T = Point Length
- S_d = Shank Diameter
- L₀ = Overhang
- L₂ = Shank Length
- L₃ = Shank Clamping Depth

MOUNTED POINTS

Series A: Shapes are mounted on 1/4" diameter by 1 1/2" long shanks. Available in most shapes.

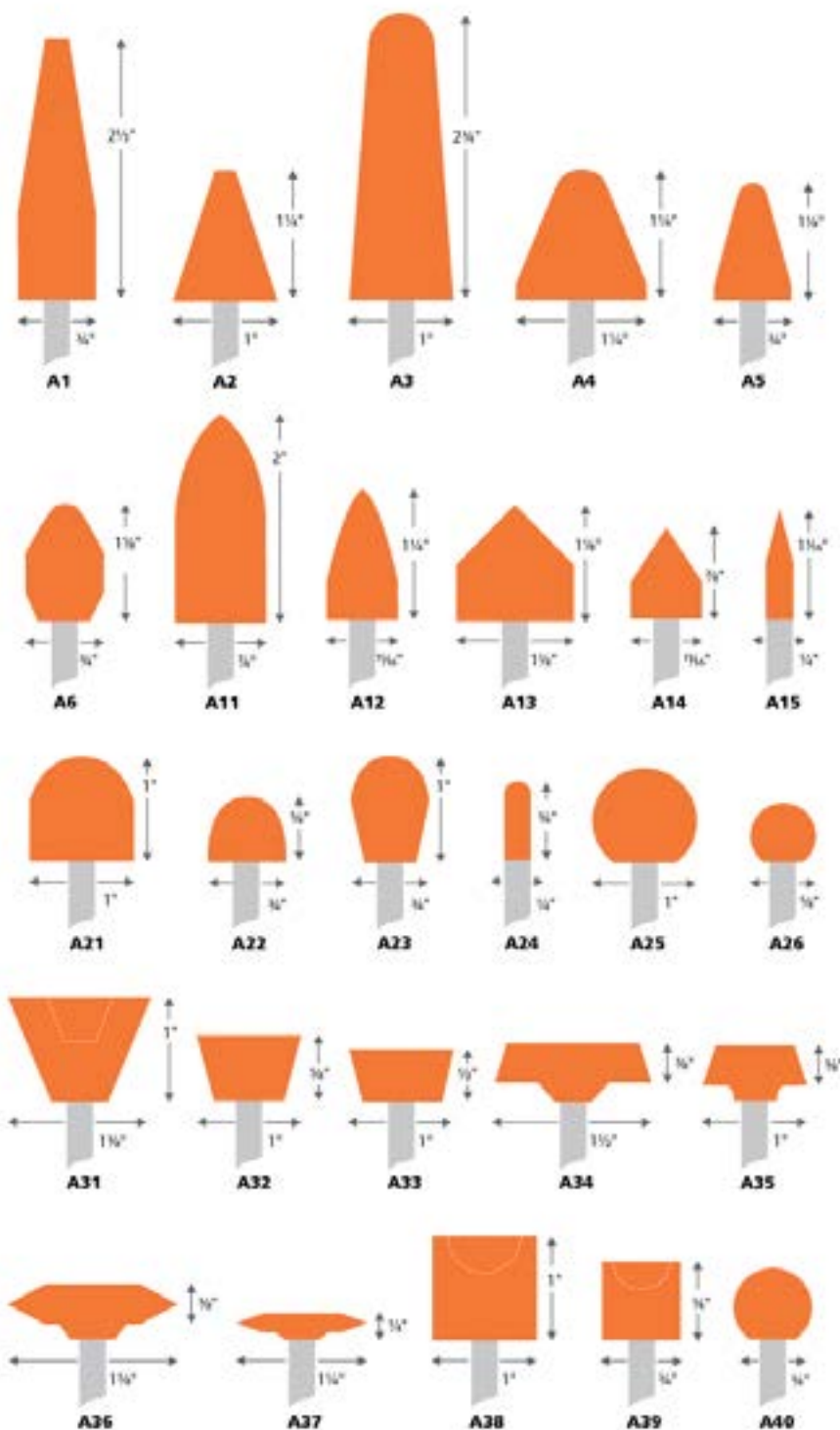

Series W: (Cylindrical point)

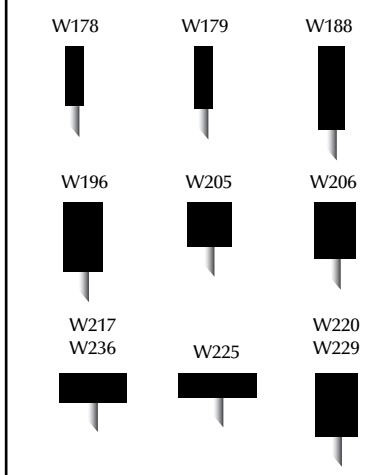



MOUNTED POINTS

Below is a chart showing the wide range of mounted points that we offer. The 5 different types of Aluminum Oxide will fit with all your project needs. All mounted points are sold separately or in various assortments.

Shark Important Notice: Use caution at all times. Comply with ANSI B7-1 and OSHA Regulations. Shark cannot be held liable for personal injury incurred when not complying with OSHA Regulations.

| Style# | Dia. | Height | RPM | Salmon | Salmon Coarse | Pink | White | Grey |
|--------|--------|---------|--------|--------------|---------------|--------------|--------------|--------------|
| | | | | Shark Part # | Shark Part # | Shark Part # | Shark Part # | Shark Part # |
| A1 | 3/4" | 2 1/2" | 19,800 | A1S | | A1P | A1W | |
| A2 | 1" | 1 1/4" | 38,000 | A2S | | A2P | A2W | 12800 |
| A3 | 1" | 2 3/4" | 16,100 | A3S | | A3P | A3W | |
| A4 | 1 1/4" | 1 1/4" | 30,560 | A4S | | A4P | A4W | 12793 |
| A5 | 3/4" | 1 1/8" | 45,000 | A5S | A5SC | A5P | A5W | 12794 |
| A11 | 7/8" | 2" | 19,860 | A11S | | A11P | A11W | 12795 |
| A12 | 11/16" | 1 1/4" | 48,000 | A12S | A12SC | A12P | A12W | 12796 |
| A13 | 1 1/8" | 1 1/8" | 33,950 | A13S | | A13P | A13W | |
| A14 | 11/16" | 7/8" | 55,560 | A14S | | A14P | A14W | |
| A15L | 1/4" | 1 1/16" | 26,250 | A15LS | | A15LP | A15LW | |
| A15 | 1/4" | 1 1/16" | 72,750 | A15S | | A15P | A15W | 12797 |
| A21 | 1" | 1" | 34,500 | A21S | | A21P | A21W | |
| A23 | 3/4" | 1" | 39,370 | A23S | | A23P | A23W | 12798 |
| A24 | 1/4" | 3/4" | 76,500 | A24S | | A24P | A24W | 12799 |
| A25 | 1" | 1" | 35,610 | A25S | A25SC | A25P | A25W | 12801 |
| A26 | 5/8" | 5/8" | 61,120 | A26S | | A26P | A26W | |
| A31 | 1 3/8" | 1" | 27,780 | A31S | | A31P | A31W | |
| A32 | 1" | 5/8" | 38,200 | A32S | A32SC | A32P | A32W | |
| A34 | 1 1/2" | 3/8" | 25,470 | A34S | | A34P | A34W | |
| A36 | 1 5/8" | 3/8" | 23,520 | A36S | | A36P | A36W | |
| A37 | 1 1/4" | 1/4" | 30,560 | A37S | | A37P | A37W | |
| A38 | 1" | 1" | 34,500 | A38S | A38SC | A38P | A38W | 12802 |
| A39 | 3/4" | 3/4" | 47,250 | A39S | | A39P | A39W | |
| W178 | 3/8" | 1" | 55,200 | W178S | | W178P | W178W | |
| W179 | 3/8" | 1 1/4" | 45,750 | W179S | W179SC | W179P | W179W | |
| W187 | 1/2" | 1" | 40,500 | W187S | | W187P | W187W | |
| W188 | 1/2" | 1 1/2" | 30,370 | W188S | | W188P | W188W | |
| W196 | 5/8" | 1" | 35,250 | W196S | W196SC | W196P | W196W | |
| W205 | 3/4" | 1" | 34,500 | W205S | W205SC | W205P | W205W | |
| W206 | 3/4" | 1 1/4" | 28,720 | W206S | | W206P | W206W | |
| W216 | 1" | 1/4" | 38,200 | W216S | | W216P | W216W | |
| W217 | 1" | 3/8" | 38,200 | W217S | W217SC | W217P | W217W | |
| W218 | 1" | 1/2" | 38,200 | W218S | | W218P | W218W | 12803 |
| W220 | 1" | 1" | 25,500 | W220S | | W220P | W220W | 12804 |
| W225 | 1 1/4" | 1/4" | 30,560 | W225S | W225SC | W225P | W225W | |
| W229 | 1 1/4" | 1" | 24,000 | W229S | | W229P | W229W | |
| W235 | 1/2" | 1/4" | 25,470 | W235S | W235SC | W235P | W235W | |
| W236 | 1 1/2" | 1/2" | 25,470 | W236S | | W236P | W236W | |

MOUNTED POINT KITS

MOUNTED POINT DISPLAY BOX

PART # 114

Specifications:

This 48 Piece Assortment of Mounted Points comes in a convenient display pack. These professional points are the finest quality and shouldn't be confused with inexpensive mounted points usually offered in displays such as this.

Set Includes:

A1S, A3S, A4S, A11S, A12S, A13S, A21S, A23S, A25S, A31S, A36S, A37S, A38S, W178S, W188S, W206S, W225S, W236S



48 Piece Assortment Set

10 PIECE COARSE STONE SET

PART # AW10

Specifications:

This 10 Piece Assortment of Mounted Points comes in a convenient display box. These professional points are for faster stock removal.

Coarseness: 24 - 36 Grit

Set Includes:

A5SC, A12SC, A32SC, A38SC, W179SC, W196SC, W205SC, W127SC, W225SC, W235SC



MOUNTED POINT STONE SETS

PART# AW7

General Purpose Salmon Stone for Professional General Use

Kit Includes:

A1S, A12S, A37S, A38S, W178S, W188S, W225S



PART# AW5S

General Purpose Salmon Stone for Professional General Use

Kit Includes:

A1S, A12S, A38S, W178S, W188S



PART# AW5

Extra Hard Pink Stone for Machine Shop Engine Rebuilding Use

Kit Includes:

A1P, A12P, A38P, W178P, W188P



ALUMINUM OXIDE MINI-MOUNTED GRINDING WHEELS

Specifications:

Made from vitrified Aluminum Oxide. All wheels use a 1/4" diameter mandrel and work with any electric drill. (Mandrel included.)

Best For:

Use on carbon steel, wrought iron or bronze.

| Item# | Size | Grit | RPM | Qty. |
|-------|---------------------------------------|------|-------|------|
| 12787 | 1" x 1" | 60 | 3,450 | 1 |
| 12788 | 1 1/2" x 1" | 60 | 3,450 | 1 |
| 12789 | 2" x 1/4" | 60 | 3,450 | 1 |
| 12790 | 2" x 1/2" | 60 | 3,450 | 1 |
| 12791 | 2 1/2" x 1/4" | 60 | 3,450 | 1 |
| 12792 | 2 1/2" x 1/2" | 60 | 3,450 | 1 |
| 12936 | Mounted Wheel Mandrel With 1/4" Arbor | | | |



12792

12791

12790

12787

12788

12936



BENCH SEAT GRINDING WHEEL ACCESSORIES

GRINDING WHEEL SHAPES

TYPE 1 An all around edge grinding wheel design. Not used for cutting.

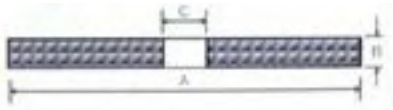

HOW TO PICK THE RIGHT GRAIN TYPE

ALUMINUM OXIDE

This bond offers longer life and excellent stock removal. Recommended on structural steel, metal and welds.

SILICON CARBIDE

Silicon carbide grain for resharpening and dressing tools.

BENCH SEAT GRINDING WHEEL-ACCESSORIES

GRINDING WHEEL DRESSER

Made of heavy cast iron, this dresser is for use with wheels up to 10" diameter and widths up to 2".



| Item# | Size | Pk. Qty. |
|-------|--------------|----------|
| 12932 | 10 1/2" Long | 1 |

DRESSING STONE

Grinding wheel dressing stone is used when redressing Type 1 bench grinding wheels.



| Item# | Diameter | Grit | Pk. Qty. |
|-------|----------|------|----------|
| 12934 | 6"x1"x1" | 24 | 1 |

REPLACEMENT CUTTERS

Made from high carbon steel with long lasting teeth. Hardened for long life service and proper dressing action. Also includes two spacers.



| Item# | Diameter | Hole | Face | Pk. Qty. |
|-------|----------|------|-------|----------|
| 12933 | 1 1/4" | 1/4" | .426" | 1 |

BENCH GRINDER ADAPTORS

These adaptors are designed to nest or telescope to fit the various needs of your arbor. Made from heavy duty plastic, they are designed to adapt wheels with 1" or 1-1/4" arbors to fit 1/2", 5/8", 3/4" or 1" shafts. Three thickness options available!



| Item# | Description | Pk. Qty. |
|-------|---|-------------|
| 12783 | 1/2" Thick, 3/4", 5/8", 1/2" O.D. | 1 unit of 3 |
| 12784 | 3/4" Thick, 3/4", 5/8", 1/2" O.D. | 1 unit of 3 |
| 12785 | 1" Thick, 3/4", 5/8", 1/2" O.D. | 1 unit of 3 |
| 12786 | 1" Thick, 1-1/4", 1", 3/4", 5/8", 1/2" O.D. | 1 unit of 4 |

BENCH SEAT GRINDING WHEELS

TYPE 1 - VITRIFIED BENCH GRINDING WHEELS

Made from Aluminum Oxide or *Silicon Carbide, vitrified bonded grinding wheels with a 1" arbor hole are used on stationary bench grinders. All Wheels include adaptors to fit 1/2", 5/8" & 3/4" arbors eliminating costly inventory duplication. Use for general purpose sharpening and grinding of mild steel.



| Item# | Old#/Description | Diameter | Width | Grit | Arbor | Insert | RPM |
|-----------|------------------|----------|--------|------|--------|--------------|------|
| 2012G* | Silicon Carbide | 6" | 1/2" | 120 | 1" | 1/2-5/8-3/4" | 3850 |
| 2016G* | Silicon Carbide | 6" | 3/4" | 120 | 1" | 1/2-5/8-3/4" | 3850 |
| 2004 | | 4" | 1/2" | 46 | 1/2" | No Insert | 6500 |
| 2009 | | 5" | 1/2" | 36 | 1/2" | No Insert | 4900 |
| 2010 | | 5" | 1/2" | 46 | 1/2" | No Insert | 4900 |
| 2011 | | 5" | 1/2" | 60 | 1/2" | No Insert | 4900 |
| 2006 | | 5" | 3/4" | 46 | 1/2" | No Insert | 4900 |
| 2007 | | 5" | 1" | 24 | 1/2" | No Insert | 4900 |
| 2008 | | 5" | 1" | 36 | 1/2" | No Insert | 4900 |
| 2012** | | 6" | 1/2" | 36 | 1" | 1/2-5/8-3/4" | 3850 |
| 2013** | | 6" | 1/2" | 46 | 1" | 1/2-5/8-3/4" | 3850 |
| 2014** | | 6" | 1/2" | 60 | 1" | 1/2-5/8-3/4" | 3850 |
| 2015** | | 6" | 1/2" | 80 | 1" | 1/2-5/8-3/4" | 3850 |
| 12771** | 2016 | 6" | 3/4" | 36 | 1" | 1/2-5/8-3/4" | 3850 |
| 2017** | | 6" | 3/4" | 46 | 1" | 1/2-5/8-3/4" | 3850 |
| 12772** | 2018 | 6" | 3/4" | 60 | 1" | 1/2-5/8-3/4" | 3850 |
| 12773** | 2019 | 6" | 3/4" | 80 | 1" | 1/2-5/8-3/4" | 3850 |
| 2019-10 | | 6" | 3/4" | 100 | 1" | 1/2-5/8-3/4" | 3850 |
| 12774** | 2020 | 6" | 1" | 36 | 1" | 1/2-5/8-3/4" | 3850 |
| 2021** | | 6" | 1" | 46 | 1" | 1/2-5/8-3/4" | 3850 |
| 12775** | 2022 | 6" | 1" | 60 | 1" | 1/2-5/8-3/4" | 3850 |
| 12776** | | 6" | 1" | 80 | 1" | 1/2-5/8-3/4" | 3850 |
| 2022-10** | | 6" | 1" | 100 | 1" | 1/2-5/8-3/4" | 3850 |
| 2023 | | 7" | 3/4" | 36 | 1" | 1/2-5/8-3/4" | 3600 |
| 2024 | | 7" | 3/4" | 46 | 1" | 1/2-5/8-3/4" | 3600 |
| 2025 | | 7" | 1" | 24 | 1" | 1/2-5/8-3/4" | 3600 |
| 12777 | 2026 | 7" | 1" | 36 | 1" | 1/2-5/8-3/4" | 3600 |
| 2027 | | 7" | 1" | 46 | 1" | 1/2-5/8-3/4" | 3600 |
| 12778 | 2028 | 7" | 1" | 60 | 1" | 1/2-5/8-3/4" | 3600 |
| 12779 | 2028-80 | 7" | 1" | 80 | 1" | 1/2-5/8-3/4" | 3600 |
| 2029 | | 8" | 3/4" | 36 | 1" | 1/2-5/8-3/4" | 3450 |
| 2030 | | 8" | 3/4" | 46 | 1" | 1/2-5/8-3/4" | 3450 |
| 2031 | | 8" | 3/4" | 60 | 1" | 1/2-5/8-3/4" | 3450 |
| 2032-24 | | 8" | 1" | 24 | 1" | 1/2-5/8-3/4" | 3450 |
| 12780 | 2032 | 8" | 1" | 36 | 1" | 1/2-5/8-3/4" | 3450 |
| 2033 | | 8" | 1" | 46 | 1" | 1/2-5/8-3/4" | 3450 |
| 12781 | 2034 | 8" | 1" | 60 | 1" | 1/2-5/8-3/4" | 3450 |
| 2035-24 | | 10" | 1" | 24 | 1 1/4" | 1-1 1/4" | 2483 |
| 2035 | | 10" | 1" | 36 | 1 1/4" | 1-1 1/4" | 2483 |
| 2035-46 | | 10" | 1" | 46 | 1 1/4" | 1-1 1/4" | 2483 |
| 2036 | | 10" | 1 1/4" | 36 | 1 1/4" | 1-1 1/4" | 2483 |
| 2037 | | 10" | 1 1/2" | 36 | 1 1/4" | 1-1 1/4" | 2483 |
| 2038 | | 12" | 2" | 24 | 1 1/4" | 1-1 1/4" | 2069 |
| 2039 | | 12" | 2" | 36 | 1 1/4" | 1-1 1/4" | 2069 |

**Comes in a clam shell package



WELDERS

SW-MIG/STICK 140 KIT

The new upgraded Shark SW-140 Mig/Stick Welder (115 volt) is the medium duty to professional grade welder that can now do stick as well as MIG welding. This upgraded welder offers a 10 foot removable MIG torch with Tweco style replacement parts. It features a 10 foot detachable ground cable. It will weld up to 1/4" thick metal and is great for automotive users. (See accessories below).

Features & Benefits:

- Dual groove drive roller
- Thermostatic heat protection
- Infinite wire speed control
- Inverter

| Item# | Welder with Kit Includes |
|-------|--|
| 17024 | 10 ft. Tweco® style mig torch, 10 ft. grounding cable and 200 Amp earth clamp, .035 & .023 contact tips, 1/2 lb. .030 flux core wire, dual gauge regulator, gas hose and 2 hose clamps. Shipping weight: 40 lbs. |



| Max. Output | Duty Cycle | Current range | Wire diameter range | Input voltage/ settings. | Max welding thickness | Shipping wt. |
|-------------|----------------|---------------|---------------------|--------------------------|-----------------------|--------------|
| 140 Amps | 30% at 90 Amps | 30-130 Amps | .023-.035 | 115/5 | 1/4" | 40 lbs. |

MIG/STICK 200

The new upgraded Shark 230 Volt Mig/Stick/Tig Welder is our top-of-the-line professional grade welder. It's now a 3-in-1 welder accomodating both Stick and Tig welding as well as Mig. This heavy duty welder achieves 160 amps at 30% duty cycle. It will weld up to 1/4" thick metal. It includes a 10 foot detachable Tweco Style Mig Gun compatible with Tweco replacement parts and 10 foot removable ground clamp. The unit includes a dual groove drive roller for ease of welding. (See accessories below)

Features & Benefits:

- Dual groove drive roller
- Thermostatic heat protection
- Infinite wire speed control
- Inverter
- Tig Torch not included

| Item# | Includes |
|-------|--|
| 17025 | 10 ft. Tweco® style mig torch, 10 ft. grounding cable and 200 Amp earth clamp, .035 & .023 contact tips, 1/2 lb. .030 flux core wire, dual gauge regulator, gas hose and 2 hose clamps. Shipping weight: 44 lbs. |



| Max. Output | Duty Cycle | Current Range | Wire diameter range | Input voltage/ Settings | Max welding thickness | Shipping wt. |
|-------------|-----------------|---------------|---------------------|-------------------------|-----------------------|--------------|
| 180 Amps | 30% at 160 Amps | 30-200 Amps | .023-.035 | 230/5 | 1/4" | 44 lbs. |

WELDING SPOOL GUN

3 CONNECTOR SPOOL GUN

This spool gun has three specialized connectors for use with multiple Shark welders. The 3 connector spool gun can work with the MIG/STICK 140W, the MIG /STICK/TIG 200W, the SK 140i, as well as the new SK 180i.

Designed for use with wire that is difficult to feed through the standard MIG gun (such as aluminum). The 4" spool is mounted inside the gun instead of in the machine; which greatly reduces the spool-to-tip distance and eliminates most wire feeding issues.



17016

Ideal for light fabrication.

| Item# | Cord Length | Wt. |
|-------|-------------|--------|
| 17016 | 10 Ft. | 5 lbs. |

| Max. Output | Cooling Method | Duty Cycle | Suggested Wire | Spool Diameter | Wire Speed | Cord Length | MIG Gun connection | Contact Tips & Nozzle |
|---|----------------|------------|---|----------------|--------------|-------------|--------------------|------------------------|
| 200 Amps using CO2 Gas 160Amps using Argon/Argon Mix Gas | Air-Cooled | 35% | .023-.035 MIG (solid) wire .030-.035 Flux core wire .030-.035 Aluminum wire | 4" spool | 0 to 630 IPM | 10 ft. | TWECO® Style | TWECO® Style Series 11 |

NEW! PLASMA CUTTER

The plasma cutter is an IGBT inverter with thermal overload protection, a Trafimont torch, and a built-in gas regulator. This easy to use plasma cutter has the power to cut up to 6mm. materials and a pilot arc that makes cutting expanded metal possible.

PN 17027



17027

| Output Range | Duty Cycle | Dual Voltage | Air Pressure |
|--------------|---------------|--------------|------------------|
| 40 Amps | 35% @ 40 Amps | 120V/230v | 4.5 CFM @ 60 PSI |



PLASTIC WELDER

PRO-TACK MINI PLASTIC WELDER

Now ETL approved!



The Mini Pro-Tack Welder is eco-friendly like the Pro-Tack Welder and is great for repairing almost anything plastic. Two new functions give you the ability to heat/cut, repair holes, and solder lead-tin items. The 110 volt tool gives you a 45 amp output when welding and a 5-10 amp output when stapling. Uses all 7 styles of staples.

Features & Benefits:

- Easy to use
- Low voltage output
- Safe and Reliable (with overheating protection)
- Quick heating and cooling
- Convenient

17046



| Item# | Welder with Kit Includes |
|-------|--|
| 17046 | Storage case with welding/stapling tool, and 1 ironing blade. Includes 4 staple shapes (17031, 17033, 17034, 17036) with 10 of each. Staples are made of chromium alloy. |
| 17043 | Replacement ironing blade |

| Max. Output | Voltage | Weight |
|-------------|----------|--------|
| 45 Amps | 110 Volt | 3 lbs. |

17043 (Included)

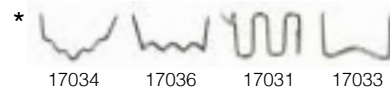

*Note: Staples are made of a chromium alloy

• Welds Plastic without Staples

Welding cracks and filling holes. (Shark does not supply plastic rods.)

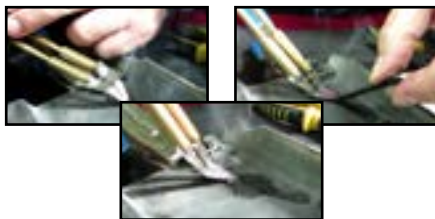

• Repairing Holes

Good for repairing different holes with stainless netting



• Tacking with Staples

Various staple configurations allow you to sew and seam all types of cracks.



STAINLESS STEEL MESH

| Item# | Description | Pkg. Qty. |
|-------|--------------------------------|-----------|
| 17044 | 12" x 12" Stainless Steel Mesh | 1 |

• Heat Cutting

Easily cuts plastic tape, nylon strips, or rope.



• Lead-Tin Soldering

For quicker, higher efficiency than normal soldering guns or irons.



PLASTIC WELDER

PRO-TACK PLASTIC WELDER

The new Pro-Tack Welder is an eco-friendly welder, drawing only 5 amps with a maximum output of 65 amps, and is great for repairing virtually anything made of plastic. It can fix everything from car bumpers to wheelbarrows. It is as good for Industrial use as it is for automotive and soldering applications. Unlike most other plastic welders, it is rated to a maximum of 65 amps, giving it the capability of ironing plastic, and has 4 power settings. Our unique core-cut staples easily break off without cutting, affording an advantage over other staples. It comes with 2 additional patented ironing tools that go over the 2 probes for smoothing the plastic after welding.

When you compare this welder to the time-consuming plastic welders requiring plastic rods, this is a much quicker fix that adds the stability of metal staples; making the end result much stronger!

Features & Benefits:

- 4 heat settings
- LED read out
- Repairs bumpers and plastic auto parts* (car & motorcycle)
- Capable of ironing plastic to a smooth finish
- Rapid heating and cooling
- Soldering capabilities
- LED light for illuminating dark work areas







| Item# | Description |
|-------|---|
| 17045 | Welder, 4 staple shapes (17031 (20), 17033 (20), 17034 (20), 17036 (40)), 2 ironing blades, plastic box for staples, and a plastic storage case. Shipping weight: 10 lbs. |
| 17039 | Pro-Tack Plastic Welder (Separate Non-Kit) |
| 17040 | Plastic Tack Welder Flat Iron Blade |
| 17041 | Plastic Tack Welder Angle Iron Blade |

Now ETL approved!

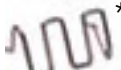

Staple Options

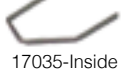
Staples sold separately. 100 Per Pack.

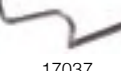
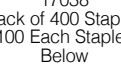
-  17031 Flat square *
-  17032-Outside corner small wave
-  17033-Outside corner no wave *
-  17034-Inside corner small wave *
-  17035-Inside corner no wave
-  17036 Flat small wave *
-  17037 Flat S type *
-  17038 Pack of 400 Staples 100 Each Staples Below

• Stapling

A large variety of core cut staples for tacking or seaming.

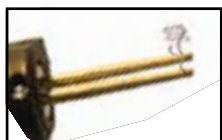

• Ironing Surface

Heating / melting / ironing the surface, to strengthen the durability and life. 2 Types-Flat and 45°



| Max. Output | Current range | Input voltage/settings. | Dimension: | Shipping wt. |
|-------------|---------------|-------------------------|--------------------------|--------------|
| 65 Amps | 10-65 Amps | 115/5 | 8 3/4" x 5 1/4" x 4 3/4" | 10 lbs. |

*Not to be used on fiberglass

**Welder's appearance may vary

*Included with welder 17045



WELDING CARTS

ECONOMICAL GAS CYLINDER HAND TRUCK

For standard and medium cylinders. Easy to use, lightweight truck fits most needs and will carry up to 122 cubic foot tanks. Made in USA. Cart bed is 8" x 16 3/4" - Large Tool Tray

| Item# | Description | Wt. |
|-------|--------------------------------|---------|
| 14475 | Axle | |
| 14476 | 10" Wheel | |
| 14480 | 21" Wide x 44" High x 14" Deep | 30 lbs. |



14480

HEAVY DUTY HAND TRUCK FOR LARGE CYLINDERS

Our heavy duty 18" rugged steel wheel truck moves easily over all surfaces. For use with Oxygen/Acetylene tanks. This is our work horse of carts, self-leveling tool shelf on back. Made in U.S.A. Cart bed is 12" x 24" - Large Tool Tray

| Item# | Description | Wt. |
|-------|--------------------------------|---------|
| 14478 | Axle | |
| 14479 | 18" Wheel | |
| 14482 | 34" Wide x 47" High x 22" Deep | 60 lbs. |



14482

WELDING CARTS

MIG WELDING CART

MIG welding cart for easy storage and use of mig welders. Durable steel construction will give you years of use. Chain included with the cart for easy securing of gas bottles. Assembly required.

Features & Benefits:

- Solid steel construction
- Securing chains for gas bottles
- Two storage shelves

| Item# | Description | Wt. |
|-------|--------------------------------|---------|
| 14483 | 11" Wide x 28" High x 28" Deep | 30 lbs. |



TANDEM CYLINDER TRUCK

16" Wide tandem cylinder truck is compact and useful in small aisles and crowded spaces. Designed for use with 2 cylinders, no greater than 8" diameter tanks. Made in USA. Cart Bed is 9" Wide x 17.5" Deep.

Features & Benefits:

- Narrow for use of maneuverability
- Fits (1) 80 to 150 cubic foot oxygen tank
- Fits (1) small or medium acetylene cylinder
- Cylinders load separately from front or rear
- Cylinders are secured with steel placement band for positive and safe containment

| Item# | Description | Wt. |
|-------|--------------------------------|---------|
| 14477 | 10" Wheel | |
| 14481 | 16" Wide x 42" High x 25" Deep | 34 lbs. |





AUTO-DARKENING HELMETS

OFFERED IN FIXED SHADE 10 OR 3 AUTO-DARKENING OPTIONS



The Shark Anniversary 9/11 Helmet

The Shark 9/11 Patriotic helmet gives you a chance to exhibit your patriotism. The helmet features the World Trade Towers, American Eagle and American Flag. Graphics are painted and not a decal.

Helmet includes:

- Lens options from fixed shade 10 to full auto-darkening. See details on page 98 and 99.
- Ratcheting Head Gear
- 4 Color Graphic Box
- Outside Cover Lens
- Inside Safety Lens

The Shark Red Racing Motif Helmet

The Shark Red Racing Helmet will put you ahead of the crowd! This exciting helmet is candy-apple red and features a checkered flag breaking through the sides. Graphics are painted and not a decal.

Helmet includes:

- Lens options from fixed shade 10 to full auto-darkening. See details on page 98 and 99.
- Ratcheting Head Gear
- 4 Color Graphic Box
- Outside Cover Lens
- Inside Safety Lens

The Shark Black Flame Motif Helmet

The Shark Black Flame Helmet featuring 3 dimensional chrome flames will make the old flames look out-dated! Grab this new approach on a favorite theme and claim it as yours. Graphics are painted and not a decal.

Helmet includes:

- Lens options from fixed shade 10 to full auto-darkening. See details on page 98 and 99.
- Ratcheting Head Gear
- 4 Color Graphic Box
- Outside Cover Lens
- Inside Safety Lens

Replacements for Above Helmets

| | | |
|----------------------|------------|----------|
| Headgear | Item 14142 | Page 101 |
| Outside Cover Lenses | Item 14137 | Page 77 |
| Inside Safety lenses | Various | Page 77 |

HELMETS/LENS SPECIFICATIONS

Fixed Shade
5.24" x 4.49"
Part# 14213
 (lens only)



Part# 14262 Part# 14264 Part# 14266

Economy Auto-Darkening
3.82" x 1.85"
Part# 14268
 ADF 810S (Lens only)



Part# 14263 Part# 14265 Part# 14267

| Features | Non Auto Darkening Shade 10 | Good/Variable Auto Dark 9-13 |
|----------------------------|--|---|
| Optical Class | ---- | 1/1/1/2 |
| Viewing Area | 5.24"x4.49" (133x114mm) | 3.82"x1.85" (97x47mm) |
| Size of Cartridge | 5.24"x4.49" (133x114mm) | 5.24"x4.50"x.35" (133x114x9mm) |
| Lens Shade | Shade 10 | 9-13 variable |
| Light State | ---- | Shade 3.5 |
| Shade Control | ---- | Internal |
| Sensors | ---- | 2 |
| On/Off | ---- | Automatic |
| Power Supply | ---- | Solar cell, no battery change req. |
| Switch Time | ---- | 1/25,000 |
| Sensitivity Control | ---- | Adjust by infinity knob |
| Delay Time (Dark to Light) | ---- | 0.35-0.45s |
| Grind Mode | ---- | Yes |
| Low TIG Amps Rated | ---- | >5 amps/DC; >5 amps/AC |
| Operating Temperature | -10°C - +55°C | -10°C - +55°C |
| Storing Temperature | -20°C - +70°C | -20°C - +70°C |
| Packing | 4 Color Graphic Box | 4 Color Graphic Box |
| Application Range | Stick Welding (DC&AC); Not for Grinding; Not for Laser Welding or Oxy Acetylene Welding/Cutting | Stick Welding (DC&AC); TIG(DC, DC Pulse); TIG AC(Pulse), Excellent low amperage TIG response, MIG/MAG; MIG/MAG Pulse; Plasma Cutting/Welding; Grinding; Not for Laser Welding or Oxy Acetylene Welding/Cutting |
| Standard | ANSI Z87.1, CSA Z94.3 Approved | ANSI Z87.1, CSA Z94.3 Approved |

(Continued)



HELMETS/LENS SPECIFICATIONS

**Expert Large
Auto-Darkening
3.82" x 1.85"
Part# 14269**

ADF 800S (lens only)



Part# 14252 Part# 14254 Part# 14256

**Expert Pro
Auto-Darkening
3.82" x 2.44"
Part# 14270**

ADF 820S (Lens only)



Part# 14253 Part# 14255 Part# 14257

| Features | Better/Variable Expert Large Auto View Dark | Best/Variable Expert Pro Full View Auto Dark |
|----------------------------|--|---|
| Optical Class | 1/1/1/2 | 1/2/1/1 |
| Viewing Area | 3.82"x1.85" (97x47mm) | 3.82"x2.44" (97x62mm) |
| Size of Cartridge | 5.24"x4.50"x.35" (133x114x9mm) | 5.24"x4.50"x.35" (133x114x9mm) |
| Lens Shade | 9-13 variable | 9-13 variable |
| Light State | Shade 3.5 | Shade 3.5 |
| Shade Control | Internal | Internal |
| Sensors | 2 | 4 |
| On/Off | Automatic | Automatic |
| Power Supply | Solar cell+Battery Replacable | Solar cell+Battery Replacable |
| Switch Time | 1/25,000 | 1/25,000 |
| Sensitivity Control | Adjust by infinity dial knob | Adjust by infinity dial knob |
| Delay Time (Dark to Light) | 0.1-1.0s by infinity dial control knob | 0.1-1.0s by infinity dial control knob |
| Grind Mode | Yes | Yes |
| Low TIG Amps Rated | >2 amps/DC; >2 amps/AC | >2 amps/DC; >2 amps/AC |
| Operating Temperature | -10°C - +55°C | -10°C - +100°C |
| Storing Temperature | -20°C - +70°C | -20°C - +100°C |
| Packing | 4 Color Graphic Box | 4 Color Graphic Box |
| Application Range | Stick Welding (DC&AC); TIG(DC, DC Pulse); TIG AC(Pulse), Excellent low amperage TIG response , MIG/MAG; MIG/MAG Pulse; Plasma Cutting/Welding; Grinding; Oxy Acetylene Welding/Cutting; Not for Laser Welding. | Stick Welding (DC&AC); TIG(DC, DC Pulse); TIG AC(Pulse), Excellent low amperage TIG response , MIG/MAG; MIG/MAG Pulse; Plasma Cutting/Welding; Grinding; Not for Laser Welding or Oxy Acetylene Welding/Cutting |
| Standard | ANSI Z87.1, CSA Z94.3 Approved | ANSI Z87.1, CSA Z94.3 Approved |

WELDING HELMETS

BLUE/RED NYLON LIFT FRONT HELMETS

Helmets are available in 2 lens sizes - shade 10 - with a clear plastic cover lens. Ratchet type headgear with a flip-up lens so helmet does not need to be removed or raised while viewing work. Helmets ship in graphic boxes.

| Item# | Style | Headgear | Lens Size | Color |
|-------|------------|----------|------------------|-------|
| 14107 | Lift Front | Ratchet | 2" x 4 1/4" | Blue |
| 14106 | Lift Front | Ratchet | 4" 1/2" x 5 1/4" | Blue |
| 14272 | Lift Front | Ratchet | 4" 1/2" x 5 1/4" | Red |



14272



14107





WELDING HELMETS

ECONOMY WELDING HELMETS

These helmets are our most economical style, and include a shade 10 lens and ratcheting headgear.

| Item# | Style | Head Gear | Lens Size | Description |
|-------|-------------|-----------|-------------|----------------------------|
| 14109 | Fixed Front | Ratchet | 2" x 5 1/4" | Black Nylon Helmet |
| 14114 | Fixed Front | Ratchet | 2" x 4 1/4" | Black Nylon Helmet |
| 14116 | Lift Front | Ratchet | 2" x 4 1/4" | Black Polypropelene Helmet |



14114



14116

SILVER COATED, COOL LIFT FRONT WELDING HELMET

This lift front helmet has a 2" x 4 1/4" lens. 30% cooler than uncoated helmets, it comes with a ratcheting headgear and shade 10 lens. Meets ANSI standards.

| Item# | Style | Head Gear | Lens Size | Color |
|-------|------------|-----------|-------------|--------|
| 14112 | Lift Front | Ratchet | 2" x 4 1/4" | Silver |



14112

WELDING HELMETS

POWERED AIR PURIFYING RESPIRATOR

Helmet with Powered Air Purifying Respirator
Item# 14250

Flame Retardant

Helmet is equipped with Expert Large Auto Darkening Lens
Item# 14269

ADF 800S Lens
 (See page 99 for full lens specifications)



SPECIFICATIONS

Air Flow Rate

Low Speed: 170 litres/min
 High Speed: 210 litres/min

Battery

Battery Type: Rechargeable Li-ion Battery
 Battery Duration: 9 hours
 Battery Life: 550 charges

Filter

Filter Efficiency: 99.97% of certain airborne contaminants, pollutants, fine particles, welding dust, and metal dust.

Alarms:

Visible, Audible, and Vibrate

Operating Temperature:

23° to 131° F
 (-5 to 55° C)

Weight:



1.2 kg (2.65 lbs)

Standard:

EN 12941 TH3

HOW TO OPERATE



-  Power on/off
 Push and hold the Power Button for 3 Seconds.
-  Switch the airflow:
 Push the Button to switch the airflow between 170 l/min and 210 l/min.
-  Warning lights help to check the filter status. The more lights turned on, the dirtier the filter. When the warning lights flash, replace the filter.

| Item# | Operating Temperature | Weight | Battery Life | Standard | Air Flow Rate | Pkg. Qty |
|-------|----------------------------------|------------------|--------------|--------------|--------------------|----------|
| 14250 | 23° to 131° F (-5° to 55° C) | 2.6 lbs (1.2 kg) | 550 Charges | EN 12941 TH3 | 170-210 litres/min | 1 |
| Item# | Description | | | | | Pkg. Qty |
| 14251 | Replacement Air Filter for 14250 | | | | | 1 |



WELDING LENSES

These lenses provide maximum protection from ultraviolet and infrared radiation. The darker lenses are for higher amperage, where the lighter lenses are for indoor and light welding. Clear cover lenses are made of high quality material to protect shaded lenses, where gold lenses reflect radiated energy from arcs.

Sizes 2" x 4 1/4"

| Item# | Size | Shade | Pkg. Qty |
|-------|-------------|---------------------|----------|
| 14200 | 2" x 4 1/4" | #5 Glass | 1 |
| 14201 | 2" x 4 1/4" | #8 Glass | 1 |
| 14202 | 2" x 4 1/4" | #9 Glass | 1 |
| 14203 | 2" x 4 1/4" | #10 Glass | 1 |
| 14204 | 2" x 4 1/4" | #11 Glass | 1 |
| 14205 | 2" x 4 1/4" | #12 Glass | 1 |
| 14206 | 2" x 4 1/4" | Clear Polycarbonate | 1 |
| 14207 | 2" x 4 1/4" | Clear Polycarbonate | 3 |
| 14208 | 2" x 4 1/4" | Clear Glass | 1 |
| 14209 | 2" x 4 1/4" | Gold #9 Glass | 1 |
| 14210 | 2" x 4 1/4" | Gold #10 Glass | 1 |



Sizes 4 1/2" x 5 1/4"

| Item# | Size | Shade | Pkg. Qty |
|-------|-----------------|----------------|----------|
| 14211 | 4 1/2" x 5 1/4" | #8 Glass | 1 |
| 14212 | 4 1/2" x 5 1/4" | #9 Glass | 1 |
| 14213 | 4 1/2" x 5 1/4" | #10 Glass | 1 |
| 14214 | 4 1/2" x 5 1/4" | #11 Glass | 1 |
| 14215 | 4 1/2" x 5 1/4" | #12 Glass | 1 |
| 14216 | 4 1/2" x 5 1/4" | Polycarbonate | 1 |
| 14217 | 4 1/2" x 5 1/4" | Clear Glass | 1 |
| 14218 | 4 1/2" x 5 1/4" | Gold #9 Glass | 1 |
| 14219 | 4 1/2" x 5 1/4" | Gold #10 Glass | 1 |

50MM ROUND LENSES

These high quality lenses are 50 millimeters in diameter and are sold in pairs.



14225/14226

| Item# | Shade | Pkg. Qty. |
|-------|---------------------------|-----------|
| 14220 | Green Shade #4-Poly | 1 Pair |
| 14221 | Green Shade #5-Poly | 1 Pair |
| 14222 | Green Shade #6-Poly | 1 Pair |
| 14223 | Clear Glass | 1 Pair |
| 14224 | Clear Polycarbonate Cover | 1 Pair |

| Item# | Size | Magnification | Pkg. Qty. |
|-------|-------------|---------------|-----------|
| 14225 | 2" x 4 1/4" | F 1.50 | 1 |
| 14226 | 2" x 4 1/4" | F 2.00 | 1 |

WELDING LENSES

CLEAR REPLACEMENT COVER LENSES



14275



14340



14341

REPLACEMENT INSIDE COVER LENS FOR AUTO-DARKENING FILTERS

| Item# | Description | Size | Pkg. Qty. |
|-------|-------------------|-----------------|-----------|
| 14275 | ADF810S & ADF600S | 2" x 3 3/4" | 1 |
| 14277 | AF200A | 1 3/4" x 3 3/4" | 1 |
| 14340 | ADF800S | 2 1/2" x 3 3/4" | 1 |
| 14341 | ADF820S | 3 1/2" x 3 3/4" | 1 |



14274



14137

REPLACEMENT FRONT COVER LENS FOR AUTO-DARKENING HELMETS

| Item# | Description | Size | Pkg. Qty. |
|-------|-----------------------------|-----------------|-----------|
| 14137 | ADF800S / ADF810S / ADF820S | 5 1/4" x 4 1/2" | 1 |
| 14135 | ADF600S | 4 1/4" x 4 5/8" | 1 |
| 14274 | AF200A | 3 5/8" x 4 3/8" | 1 |

*To find the appropriate ADF/AF#, look on the inside of the auto-darkening lens housing.



ROD & WIRE

6010 WELDING ELECTRODE

This all position, mild steel rod provides smoother arc characteristics. Used for out of position welding, maintenance welding, galvanized steel, ship building and pipe line welding.



11004

| Item# | Size | Rec Amperage | Pkg. Qty. |
|-------|-------|--------------|-----------|
| 11000 | 3/32" | 60-85 | 1 lb. |
| 11001 | 3/32" | 60-85 | 5 lb. |
| 11002 | 3/32" | 60-85 | 10 lb. |
| 11003 | 1/8" | 65-120 | 1 lb. |
| 11004 | 1/8" | 65-120 | 5 lb. |
| 11005 | 1/8" | 65-120 | 10 lb. |
| 11006 | 5/32" | 110-170 | 1 lb. |
| 11007 | 5/32" | 110-170 | 5 lb. |
| 11008 | 5/32" | 110-170 | 10 lb. |

6011 WELDING ELECTRODE

This all position, all purpose, mild steel electrode has strong arc characteristics for deep penetration.

Used for tanks, steel castings, machinery parts, construction and pressure pipe.



11014

| Item# | Size | Rec Amperage | Pkg. Qty. |
|-------|-------|--------------|-----------|
| 11009 | 3/32" | 40-80 | 1 lb. |
| 11010 | 3/32" | 40-80 | 5 lb. |
| 11011 | 3/32" | 40-80 | 10 lb. |
| 11012 | 3/32" | 40-80 | 50 lb. |
| 11013 | 3/32" | 40-80 | 4 Rods |
| 11014 | 1/8" | 75-120 | 1 lb. |
| 11015 | 1/8" | 75-120 | 5 lb. |
| 11016 | 1/8" | 75-120 | 10 lb. |
| 11017 | 1/8" | 75-120 | 50 lb. |
| 11018 | 1/8" | 75-120 | 3 Rods |
| 11019 | 5/32" | 110-170 | 1 lb. |
| 11020 | 5/32" | 110-170 | 5 lb. |
| 11021 | 5/32" | 110-170 | 10 lb. |
| 11022 | 5/32" | 110-170 | 50 lb. |
| 11023 | 5/32" | 110-170 | 3 Rods |

6013 WELDING ELECTRODE

This all position, all purpose, mild steel electrode has a stable arc designed for welding on clean, new metal.

Used for general purpose welding, build-up of shafts and machine parts.



11034

| Item# | Size | Rec Amperage | Pkg. Qty. |
|-------|-------|--------------|-----------|
| 11024 | 3/32" | 50-100 | 1 lb. |
| 11025 | 3/32" | 50-100 | 5 lb. |
| 11026 | 3/32" | 50-100 | 10 lb. |
| 11027 | 3/32" | 50-100 | 50 lb. |
| 11028 | 3/32" | 50-100 | 4 Rods |
| 11029 | 1/8" | 80-130 | 1 lb. |
| 11030 | 1/8" | 80-130 | 5 lb. |
| 11031 | 1/8" | 80-130 | 10 lb. |
| 11032 | 1/8" | 80-130 | 50 lb. |
| 11033 | 1/8" | 80-130 | 3 Rods |
| 11034 | 5/32" | 105-180 | 1 lb. |
| 11035 | 5/32" | 105-180 | 5 lb. |
| 11036 | 5/32" | 105-180 | 10 lb. |
| 11037 | 5/32" | 105-180 | 50 lb. |
| 11038 | 5/32" | 105-180 | 3 Rods |

ROD & WIRE

E7014 WELDING ELECTRODE

This all position, mild steel iron powder type electrode has smooth arc characteristics for medium penetration.

Used for tanks, steel castings, machinery parts, construction and pressure pipe. Works best on clean steel applications.



11040

E7018 WELDING ELECTRODE

This all position, low hydrogen electrode provides high strength and toughness without cracking down the center of the bead. For use on high carbon and cold rolled steel. Joins hard to weld steels easily.



11055

| Item# | Size | Rec Amperage | Pkg. Qty. |
|-------|-------|--------------|-----------|
| 11054 | 3/32" | 55-85 | 1 lb. |
| 11055 | 3/32" | 55-85 | 5 lb. |
| 11056 | 3/32" | 55-85 | 10 lb. |
| 11057 | 3/32" | 55-85 | 50 lb. |
| 11058 | 3/32" | 55-85 | 4 Rods |
| 11059 | 1/8" | 90-140 | 1 lb. |
| 11060 | 1/8" | 90-140 | 5 lb. |
| 11061 | 1/8" | 90-140 | 10 lb. |
| 11062 | 1/8" | 90-140 | 50 lb. |
| 11063 | 1/8" | 90-140 | 3 Rods |
| 11064 | 5/32" | 110-185 | 1 lb. |
| 11065 | 5/32" | 110-185 | 5 lb. |
| 11066 | 5/32" | 110-185 | 10 lb. |
| 11067 | 5/32" | 110-185 | 50 lb. |
| 11083 | 5/32" | 110-185 | 3 Rods |
| 11132 | 3/16" | 110-185 | 50 lb. |

| Item# | Size | Rec Amperage | Pkg. Qty. |
|-------|-------|--------------|-----------|
| 11039 | 3/32" | 50-100 | 1 lb. |
| 11040 | 3/32" | 50-100 | 5 lb. |
| 11041 | 3/32" | 50-100 | 10 lb. |
| 11042 | 3/32" | 50-100 | 50 lb. |
| 11043 | 3/32" | 50-100 | 4 Rods |
| 11044 | 1/8" | 90-140 | 1 lb. |
| 11045 | 1/8" | 90-140 | 5 lb. |
| 11046 | 1/8" | 90-140 | 10 lb. |
| 11047 | 1/8" | 90-140 | 50 lb. |
| 11048 | 1/8" | 90-140 | 3 Rods |
| 11049 | 5/32" | 140-210 | 1 lb. |
| 11050 | 5/32" | 140-210 | 5 lb. |
| 11051 | 5/32" | 140-210 | 10 lb. |
| 11052 | 5/32" | 140-210 | 50 lb. |
| 11053 | 5/32" | 140-210 | 3 Rods |

E7018 AC WELDING ELECTRODE

All position rod for AC or DC reverse polarity current.



11073

| Item# | Size | Rec Amperage | Pkg. Qty. |
|-------|-------|--------------|-----------|
| 11068 | 3/32" | 55-85 | 1 lb. |
| 11069 | 3/32" | 55-85 | 5 lb. |
| 11070 | 3/32" | 55-85 | 10 lb. |
| 11071 | 3/32" | 55-85 | 50 lb. |
| 11072 | 3/32" | 55-85 | 4 Rods |
| 11073 | 1/8" | 90-140 | 1 lb. |
| 11074 | 1/8" | 90-140 | 5 lb. |
| 11075 | 1/8" | 90-140 | 10 lb. |
| 11076 | 1/8" | 90-140 | 50 lb. |
| 11077 | 1/8" | 90-140 | 3 Rods |
| 11078 | 5/32" | 130-185 | 1 lb. |
| 11079 | 5/32" | 130-185 | 5 lb. |
| 11080 | 5/32" | 130-185 | 10 lb. |
| 11081 | 5/32" | 130-185 | 50 lb. |
| 11082 | 5/32" | 130-185 | 3 Rods |



ROD & WIRE



11094



11085

HARDFACING WELDING ELECTRODES

High quality, graphite coated, hardfacing material, produces outstanding impact and abrasion resistance. This all position, AC or DC rod is designed to run at low temperature (53 to 57 "C").

Ideal for repairing all types of agriculture, construction equipment and concrete mixers.

| Item# | Size | Rec Amperage | Pkg. Qty. |
|-------|------------|--------------|-----------|
| 11094 | 1/8" x 14" | 80-125 | 1 lb. |
| 11095 | 1/8" x 14" | 80-125 | 5 lb. |
| 11096 | 1/8" x 14" | 80-125 | 3 Rods |



11089



11092

99% NICKEL CAST IRON ELECTRODES

The highest quality nickel electrode available. The high nickel content has a natural attraction to cast iron, giving it superior performance when welding cast iron material. No preheating or post-heating. For machinable welds.

Used for engine blocks, surface build up, cracked castings, cylinder heads and exhaust manifolds.

| Item# | Size | Rec Amperage | Pkg. Qty. |
|-------|------|--------------|-----------|
| 11088 | 1/8" | 100-135 | 1 lb. |
| 11089 | 1/8" | 100-135 | 5 lb. |
| 11090 | 1/8" | 100-135 | 3 Rods |

NOMACAST ELECTRODES

Made from mild steel-nickel alloy. Not machinable.

Used for welding cast iron and great for use on parts that do not expand from heat.

| Item# | Size | Rec Amperage | Pkg. Qty. |
|-------|------|--------------|-----------|
| 11085 | 1/8" | 70-105 | 1 lb. |
| 11086 | 1/8" | 70-105 | 5 lb. |
| 11087 | 1/8" | 70-105 | 3 Rods |

55% NICKEL CAST IRON ELECTRODE

The most versatile cast iron electrode, nickel wire designed for making non-machinable welds in cast iron. Welds well on dirty or corroded surfaces with a smooth arc at low amperages.

Used for repairing cylinder blocks, exhaust manifolds and machine bases.

| Item# | Size | Rec Amperage | Pkg. Qty. |
|-------|------------|--------------|-----------|
| 11091 | 1/8" x 14" | 100-135 | 1 lb. |
| 11092 | 1/8" x 14" | 100-135 | 5 lb. |
| 11093 | 1/8" x 14" | 100-135 | 3 Rods |

ROD & WIRE



11097

ER 4043 ALUMINUM ELECTRODES

Flux coated aluminum electrode used for alloy and aluminum welding. Applications include: castings, plates, aluminum, sheet metal, piping and tanks. For flat horizontal and vertical welding.

| Item# | Size | Rec Amperage | Pkg. Qty. |
|-------|------|--------------|-----------|
| 11097 | 1/8" | 70-120 | 1 lb. |
| 11098 | 1/8" | 70-120 | 5 lb. |
| 11099 | 1/8" | 70-120 | 3 Rods |



11101

BARE BRAZING RODS

Made from a balance of zinc and copper alloy. These high quality, low fuming rods tin easily and offer great wear resistance. Brazing flux required. Good for brazing fenders, radiators, sheet metal and water tanks.

| Item# | Size | Pkg. Qty. |
|-------|--------------------------|-----------|
| 11101 | 3/32" x 36" Long | 1 lb. |
| 11102 | 1/8" x 36" Long | 1 lb. |
| 11122 | 3/32" x 18" Long Job Pk. | 4 Rods |
| 11123 | 1/8" x 18" Long Job Pk. | 3 Rods |



11109

ER 5356 BARE ALUMINUM RODS

Used for aluminum repair. For use with torch and aluminum flux.

| Item# | Size | Pkg. Qty. |
|-------|---------------------------|-----------|
| 11109 | 3/32" x 36" Long | 1 lb. |
| 11110 | 1/8" x 36" Long | 1 lb. |
| 11124 | 3/32" x 36" Long Job Pack | 4 Rods |
| 11125 | 1/8" x 18" Long Job Pack | 3 Rods |



11107

FLUX COATED BRAZING RODS

This flux coated, low fuming brazing rod is strong and wear resistant. High quality and easy to tin, fuses well with cast iron, galvanized iron, steel, brass and copper. Good for use on autos, tanks and pipes.

| Item# | Size | Pkg. Qty. |
|-------|--------------------------|-----------|
| 11107 | 3/32" x 36" Long | 1 lb. |
| 11108 | 1/8" x 36" Long | 1 lb. |
| 11127 | 1/8" x 18" Long Job Pack | 3 Rods |



ROD & WIRE



11103



11104

HARDFACING ELECTRODE

Alloy produces long wear and a mirror finish when polished. High abrasion resistance with moderate impact. Bonds easily. Great for thin wear edges on farm implements.

| Item# | Size | Pkg. Qty. |
|-------|------------------|-----------|
| 11103 | 3/16" x 14" Long | 1 lb. |
| 11128 | 3/16" x 18" Long | 2 Rods |

RG45 OXY - ACETYLENE RODS

Copper coating prevents rusting and improves corrosion resistance. An excellent all purpose rod for use in shops, home, maintenance and commercial.

| Item# | Size | Pkg. Qty. |
|-------|------------------|-----------|
| 11104 | 1/16" x 36" Long | 1 lb. |
| 11105 | 3/32" x 36" Long | 1 lb. |
| 11106 | 1/8" x 36" Long | 1 lb. |



11100

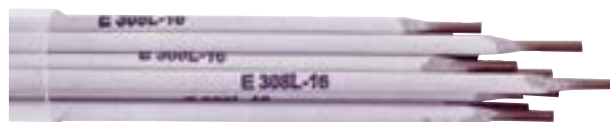

11118

SUPER SIL-FLO

Self fluxing on copper. Substitute for 6% to 15% silver content brazing alloys for copper installations. Not recommended for iron or steel. Applications include: joints, couplings, pipe and copper tubing extensions and copper and brass control valves.

| Item# | Size | Rec. Amperage | Pkg. Qty. |
|-------|--------------------|---------------|-----------|
| 11100 | 1/8" x 20" | 75-130 | 1/2 lb. |
| 11121 | 1/8" x 20" Job Pk. | 75-130 | 2 Rods |

E308L-16 SUPER 3 STAINLESS STEEL RODS

All position, high strength chromium and nickel alloy electrode. Corrosion resistant in high and low temperatures.

Crack resistant even on high carbon, manganese, stainless and dissimilar steels.

| Item# | Size | Rec. Amperage | Pkg. Qty. |
|-------|-------|---------------|-----------|
| 11112 | 1/16" | 25-35 | 1 lb. |
| 11113 | 1/16" | 25-35 | 5 lb. |
| 11114 | 1/16" | 25-35 | 4 Rods |
| 11115 | 3/32" | 50-70 | 1 lb. |
| 11116 | 3/32" | 50-70 | 5 lb. |
| 11117 | 3/32" | 50-70 | 4 Rods |
| 11118 | 1/8" | 75-100 | 1 lb. |
| 11119 | 1/8" | 75-100 | 5 lb. |
| 11120 | 1/8" | 75-100 | 3 Rods |



12050

STORAGE TUBE

Partitioned plastic storage tube allows you to keep 4 different types of electrodes in one container. Tight seal gasket prevents moisture from penetrating the rod. 14" maximum rod length. Convenient built-in belt hook.

| Item# | Size | Pkg. Qty. |
|-------|--------------|-----------|
| 12050 | 15" x 3 1/4" | 1 |

ROD & WIRE



12011

ALUMINUM MIG WIRE - ER 5356

Excellent for all types of aluminum welding. Made from premium aluminum. For use with aluminum alloys using MIG and TIG welding processes.

| Item# | Wire Type | Wire Size | Spool Sz. | Pkg. Qty |
|-------|-----------|-----------|-----------|----------|
| 12011 | Aluminum | .030 | 1 lb. | 1 |
| 12012 | Aluminum | .035 | 1 lb. | 1 |
| 12061 | Aluminum | .030 | 16 lb. | 1 |
| 12062 | Aluminum | .035 | 16 lb. | 1 |



12042

ALUMINUM MIG WIRE - ER 4043

Made from premium aluminum. For use with aluminum alloys using MIG and TIG welding processes. Excellent for all types of aluminum welding.

| Item# | Wire Type | Wire Size | Spool Sz. | Pkg. Qty |
|-------|-----------|-----------|-----------|----------|
| 12042 | Aluminum | .030 | 1 lb. | 1 |
| 12043 | Aluminum | .035 | 1 lb. | 1 |
| 12063 | Aluminum | .030 | 16 lb. | 1 |
| 12064 | Aluminum | .035 | 16 lb. | 1 |



12008

GASLESS FLUX CORED MIG WIRE (E 71T-GS)

This flux-cored steel wire is used without gas as a shielding agent on migwelders with reverse polarity. Produces a deep penetrating weld.

| Item# | Wire Type | Wire Size | Spool Sz. | Pkg. Qty |
|-------|------------------|-----------|-----------|----------|
| 12008 | Flux-cored/Steel | .030 | 2 lb. | 1 |
| 12021 | Flux-cored/Steel | .030 | 10 lb. | 1 |
| 12009 | Flux-cored/Steel | .035 | 2 lb. | 1 |
| 12010 | Flux-cored/Steel | .035 | 10 lb. | 1 |



12000

MILD STEEL MIG WIRE (ER70S-6)

Made from a premium mild steel, this wire has powerful deoxidizers for surface cleaning. Used for automobile repair, truck bodies, tanks, fabrication and construction jobs, Shielding gas required.

| Item# | Wire Type | Wire Size | Spool Sz. | Pkg. Qty |
|-------|-----------|-----------|-----------|----------|
| 12000 | Steel | .023 | 2 lb. | 1 |
| 12001 | Steel | .023 | 11 lb. | 1 |
| 12051 | Steel | .023 | 33 lb. | 1 |
| 12002 | Steel | .030 | 2 lb. | 1 |
| 12003 | Steel | .030 | 11 lb. | 1 |
| 12004 | Steel | .030 | 33 lb. | 1 |
| 12005 | Steel | .035 | 2 lb. | 1 |
| 12006 | Steel | .035 | 11 lb. | 1 |
| 12007 | Steel | .035 | 33 lb. | 1 |
| 12052 | Steel | .035 | 44 lb. | 1 |

STAINLESS MIG WIRE - ER308L

Made from premium stainless steel. Designed for horizontal and vertical welding. Use with 100% Argon/Shielding gas or 75% Argon/25% CO₂. Excellent for the food and beverage industry, fabrication, tanker trucks and general maintenance and repair.

| Item# | Wire Type | Wire Size | Spool Sz. | Pkg. Qty |
|-------|-----------------|-----------|-----------|----------|
| 12013 | Stainless Steel | .030 | 2 lb. | 1 |
| 12014 | Stainless Steel | .035 | 2 lb. | 1 |



12013



SOLDER

ACID FLUX CORE SOLDER

Best used for non-electrical applications such as sheet metal joint and fitting connections. 3.3 Tin - 2.2 Antimony - 95.5 lead

| Item# | Size | Grade | Tensile Strength | Melting Temp | Wt. |
|-------|------|-----------------|------------------|--------------|---------|
| 12024 | 1/8" | 40/60% Tin-Lead | 4900 | 460° F | 1/4 lb. |
| 12025 | 1/8" | Commercial | 4900 | 575° F | 1 lb. |



12024

LEAD FREE WIRE SOLDER

100% Lead Free - 95% tin and 5% antimony alloy. Complies with federal and state laws prohibiting lead in water systems. Used for non-electrical applications such as: refrigeration and plumbing system repairs.

| Item# | Size | Grade | Tensile Strength | Melting Temp | Wt. |
|-------|-------|---------------|------------------|--------------|---------|
| 12015 | 1/8" | 95/5% Tin-Ant | 6000 | 464° F | 1 lb. |
| 12016 | 1/8" | 95/5% Tin-Ant | 6000 | 464° F | 1/2 lb. |
| 12017 | 1/8" | 95/5% Tin-Ant | 6000 | 464° F | 1/4 lb. |
| 12018 | 3/32" | 95/5% Tin-Ant | 6000 | 464° F | 1/4 lb. |
| 12019 | 3/32" | 95/5% Tin-Ant | 6000 | 464° F | 1/2 lb. |
| 12020 | 3/32" | 95/5% Tin-Ant | 6000 | 464° F | 1 lb. |



12015

ROSIN FLUX CORE SOLDER

Flux is a mild cleaning agent, but it is completely non-corrosive and electrically non-conductive. Works well on all types of electrical connections.

| Item# | Size | Grade | Tensile Strength | Melting Temp | Wt. |
|-------|-------|-----------------|------------------|--------------|---------|
| 12026 | 1/16" | 60/40% Tin-Lead | 7600 | 460° F | 1/4 lb. |
| 12027 | 3/32" | 40/60% Tin-Lead | 5400 | 460° F | 1/4 lb. |
| 12028 | 3/32" | 30/70% Tin-Lead | 5400 | 491° F | 1/2 lb. |
| 12029 | 1/8" | Commercial | 3600 | 575° F | 1 lb. |



12026

SOLID WIRE SOLDER

This solder must be used with paste or liquid flux. Used for general, non-electrical applications such as: radiator repairs and other general jobs.

| Item# | Size | Grade | Tensile Strength | Melting Temp | Wt. |
|-------|-------|-----------------|------------------|--------------|---------|
| 12031 | 1/8" | 30/70% Tin-Lead | 4500 | 491° F | 1/2 lb. |
| 12032 | 1/8" | 40/60% Tin-Lead | 4900 | 460° F | 1/4 lb. |
| 12033 | 1/8" | 50/50% Tin-Lead | 5500 | 413° F | 1/2 lb. |
| 12034 | 3/32" | 50/50% Tin-Lead | 5500 | 421° F | 1/4 lb. |
| 12035 | 3/32" | 40/60% Tin-Lead | 4900 | 460° F | 1/4 lb. |



12031

SOLDER

NEW! ROSIN CORE SOLDER

A general purpose cleaning/bonding agent for soldering jobs.

| Item# | Size | Pkg. Qty. |
|-------|--------|-----------|
| 12039 | SN99.3 | 1 |



12039

PASTE FLUX

A general purpose cleaning/bonding agent for soldering jobs.

| Item# | Size | Pkg. Qty. |
|-------|-------|-----------|
| 12038 | 2 oz. | 1 |



12038

BRAZING FLUX

General purpose brazing flux for stronger bond.

| Item# | Size | Pkg. Qty. |
|-------|----------------------------|-----------|
| 12040 | 1/2 lb. - Dry Brazing Flux | 1 |
| 12041 | 1 lb. - Dry Brazing Flux | 1 |



12040

SILVER SOLDER

Lead free (non-toxic) metal only. Stored in pin pack to keep solder roll neat. For use with chrome plate, brass, nickel, copper and stainless steel. PSI: 8000.

| Item# | Size | Description | Pkg. Qty. |
|-------|----------------------|-----------------------------------|-----------|
| 12036 | .50 oz. | 3/64" Diameter | 1 |
| 12037 | 4 oz. bottle of Flux | 1050°-1600° F Melting Temperature | 1 |



12036



PIPE TEMPLATE/GEL/SPRAY/COLD FIRE



12248

WRAP-AROUND PIPE TEMPLATE

This pipe template is made of a tough, flexible material with a protractor, scale and 45 degree angle markings. Used by all layout men, fitters and welders.

| Item# | Dimensions | Wt. | Pkg. Qty. |
|-------|------------|--------|-----------|
| 12248 | 4" x 60" | .4 lb. | 1 |



12295

COLD FIRE WELDING SURFACE PROTECTANT

Puts out flames and cools hot surfaces in heat sensitive welding applications. Cold Fire is an excellent aerosol spray that instantly cools hot surfaces. It is environmentally safe, used by welders, plumbers and homeowners alike. Used in plumbing applications to pre-spray an area before soldering to help prevent heat damage or reduce hidden fire risks.

| Item# | Description | Pkg. Qty. |
|-------|----------------------|-----------|
| 12295 | 12 oz. Aerosol Spray | 1 |



12253

12254

ANTI-SPATTER SPRAY AND NOZZLE GEL

Anti-Spatter Spray: Environmentally safe spray reduces welding spatter. Made of non-toxic ingredients.

Nozzle Gel: Provides excellent protection against weld spatter build-up on MIG gun nozzles, contact tips, positioners, stud welding chucks and electrode holders. Can be used on all automatic and semi-automatic welding apparatus. Will not cause porosity.

All Water Based, Biodegradable materials

| Item# | Description | Pkg. Qty. |
|-------|--------------------|-----------|
| 12253 | Nozzle Gel | 1 |
| 12254 | Anti-Spatter Spray | 1 |



12296

COLD FIRE WELDING SURFACE PROTECTANT

This 32 oz. aerosol pump is excellent as a spot fire extinguisher for Class A, B and D (metal) fires. Saves time in welding process. Helps eliminate disassembly of parts where heat damage is an issue. Used for the same applications as the 12 oz. aerosol spray only in a larger size pump.

| Item# | Description | Pkg. Qty. |
|-------|-------------|-----------|
| 12296 | 32 oz. pump | 1 |

SPARK SUPPRESSOR/CABLE CUTTERS/CONNECTORS/CLAMPS



14444

WELDER'S SPARK SUPPRESSOR

12 Volt Surge Protector System Protects Car Computers from Possible Damage caused by Voltage Sparks while working on Vehicles!

A necessary welder's tool which can save you thousands of dollars in computer replacements. Easily connects to the car battery. Eliminates transient spikes while welding. Reduces the risk of blowing the electronics of the vehicle when you strike a welding arc.

| Item# | Dimensions | Wt. | Pkg. Qty. |
|-------|-----------------|---------|-----------|
| 14444 | 2 1/2" x 2 1/2" | .25 lb. | 1 |



12234

CABLE CUTTER

Heavy duty shears for cutting through cable and rubber hose. Designed for copper or aluminum cable.

| Item# | Dimensions | Wt. | Pkg. Qty. |
|-------|--------------|---------|-----------|
| 12234 | 10 1/2" x 2" | 1.1 lb. | 1 |

CONNECTORS

Cable Connector Sets

Fits cable sizes 6 - 2, Male and Female.

Heavy duty brass construction, locking cam-type connectors are used for light or heavy duty connecting applications, such as replacing old connectors or joining cables without soldering.

| Item# | Size | Range | Pkg. Qty. |
|-------|------------|-----------|-----------|
| 12226 | #4 - 1/0 | 300A-400A | 1 Set |
| 12227 | #1/0 - 2/0 | 400A-500A | 1 Set |



12230

CABLE

Exceptional abrasive resistance with maximum flexibility. Yellow safety liner for added protection.

| Item# | Amps/Length Rating | Size | Gauge |
|-------|---|----------|-------|
| 12230 | 100 amps up to 75' | 100' Box | 4 |
| 12231 | 150 amps up to 100' | 100' Box | 2 |
| 12232 | 100 amps up to 125' | 100' Box | 1 |
| 12233 | 150 amps up to 125' | 100' Box | 1/0 |
| 12298 | Battery and Automotive Cable - 105 Amps | 100' Box | 6 |



12104

BATTERY CLAMPS

Heavy gauged steel, battery charger clamps are used up to 400 Amps. They come equipped with cable lug- one red and one black with insulated handles.

| Item# | Dimensions | Wt. | Pkg. Qty. |
|-------|-------------|-------|-----------|
| 12104 | 1 1/4" x 6" | 1 lb. | 1 Pair |



12226



ELECTRODE HOLDERS/CLAMPS



12101



12103

ELECTRODE HOLDER

These heat resistant, light weight holders have fiberglass handles and jaws. Highly conductive copper tongs are insulated for safe operation.

| Item# | Amperage | Pkg. Qty. |
|-------|----------|-----------|
| 12100 | 200 | 1 |
| 12101 | 300 | 1 |
| 12102 | 500 | 1 |

STUB TYPE ELECTRODE HOLDER

This holder has jaws that lock onto the rod with a one quarter turn of the handle.

| Item# | Amperage | Pkg. Qty. |
|-------|----------|-----------|
| 12103 | 400 | 1 |



12106



STEEL GROUND CLAMPS

Steel clamp is used for cable sizes to 2/0. The connection is made right to the wide grip jaws.

| Item# | Type | Amperage | Pkg. Qty. |
|-------|-------|----------|-----------|
| 12105 | Steel | 200 | 1 |
| 12106 | Steel | 300 | 1 |
| 12107 | Steel | 500 | 1 |

BRASS GROUND CLAMPS

Brass Clamp is highly conductive and has a broad base for sliding under flat, heavy work.

| Item# | Type | Amperage | Pkg. Qty. |
|-------|-------|----------|-----------|
| 12108 | Brass | 200-300 | 1 |
| 12109 | Brass | 300-400 | 1 |



12113

HEAVY DUTY COPPER GROUND CLAMP

This copper jaw clamp has a long-life rear spring and wide Jaw for versatile positioning and positive grounding.

| Item# | Type | Amperage | Pkg. Qty. |
|-------|-------------------|----------|-----------|
| 12113 | Copper Alloy Jaws | 300-500 | 1 |

CHIPPING HAMMERS/SOAPSTONE & HOLDER



12110

WOODEN HANDLE CHIPPING HAMMER

Wooden handle straight head hammer used for cleaning slag off metal.

| Item# | Type | Pkg. Qty. |
|-------|-------------------------------|-----------|
| 12110 | Straight Head Chipping Hammer | 1 |



12111

SPRING HANDLE CHIPPING HAMMER

Metal spring handle with cross chisel hammer has a head the opposite of the straight head.

| Item# | Type | Pkg. Qty. |
|-------|------------------------------|-----------|
| 12111 | Cross Chisel Chipping Hammer | 1 |



12112



14020

WIRE BRUSH AND CHIPPING HAMMER

Chipping hammer with a detachable wire brush offers quick slag removal and weld cleaning. Replaceable brush.

| Item# | Type | Pkg. Qty. |
|-------|--|-----------|
| 12112 | Chipping Hammer w/Wire Brush | 1 |
| 14020 | Replaceable Wire Brush 4 3/4" Long x 3/4" Wide | 1 |



12214



12211

SOAPSTONE AND SOAPSTONE HOLDERS

Choose from our Round or Flat holders.

| Item# | Type | Size | Pkg. Qty. |
|-------|-------------------|-------------------|-----------|
| 12211 | Round Holder | 3/8" x 4 3/4" | 1 |
| 12212 | Round Refill | 1/4" x 5" | 10 |
| 12213 | Bulk Round Refill | 1/4" x 5" | 144 |
| 12214 | Flat Holder | 5/8" x 5 1/2" | 1 |
| 12215 | Flat Refill | 3/16" x 1/2" x 5" | 10 |
| 12216 | Bulk Flat Refill | 3/16" x 1/2" x 5" | 144 |



TIP CLEANER/DRILL SET/DEBURRING TOOL/PENCIL/LIGHTERS



OXY-ACETYLENE TIP CLEANERS

Both types are easy to use. Kit features circle design to provide 60 cleaning edges per inch. Kit includes file which fits all tip sizes. Long cleaner has longer files for hard to reach areas. Recommended for heavy duty cutting attachments.

| Item# | Style | Dimensions | Pkg. Qty. |
|-------|-----------------|------------------|-----------|
| 12241 | Regular Cleaner | 3 1/2" x 3 9/16" | 1 |
| 12242 | Long Cleaner | 4" x 3 13/16" | 1 |



DEBURRING TOOL

Tool has a heat treated, tempered steel cutting edge that swivels to ensure a good cutting action. Used to debur metal and plastic pipe.

| Item# | Size | Pkg. Qty. |
|-------|------|-----------|
| 12210 | 5" | 1 |



TIP DRILL SET

This pencil type holder has 12 drills inside. Comes with a pocket clip. Cleans and trues acetylene cutting and welding orifices. (.5 through 1.5mm)

| Item# | Type | Pkg. Qty. |
|-------|------------------------|-----------|
| 12243 | Tip Drill Set | 1 |
| 12244 | Replacement Tip Drills | 1 |



MARKING PENCIL

This thin line pencil resists breakage and requires no sharpening.

| Item# | Description | Pkg. Qty. |
|-------|---|-----------|
| 12207 | Marking Pencil - with 3 silver, 3 red refills | 1 |
| 12208 | Refill - Silver | 6 |
| 12209 | Refill - Red | 6 |

OXY-ACETYLENE LIGHTERS

The one flint lighter is lightweight, dependable and has a large round file and hood. This is the most popular in the welding industry.

The three flint lighter has a round file with three large flints and a bright plated finish. Rotate new flint into position when used flint is worn out.

| Item# | Type | Pkg. Qty. |
|-------|-----------------------------------|-----------|
| 12237 | 1 Flint Oxy - Acetylene Lighter | 1 |
| 12238 | Single Striker Replacement Flints | 5 |
| 12239 | 3 Flint Oxy - Acetylene Lighter | 1 |
| 12240 | Triple Striker Replacement Flints | 1 |

CLAMPS

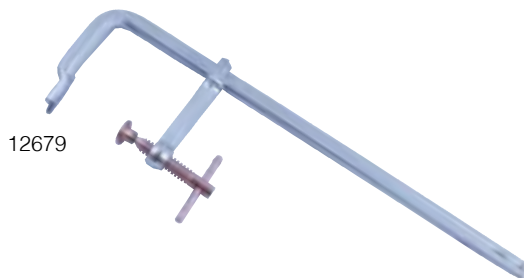

C - CLAMPS

Clamps are made with a high tensile frame and copper plated steel screws. The handle has a sliding pin and a rocking pad at the screw end.

| Item# | Size | Pkg. Qty. |
|-------|------|-----------|
| 12217 | 2" | 1 |
| 12218 | 3" | 1 |
| 12219 | 4" | 1 |
| 12220 | 5" | 1 |
| 12221 | 6" | 1 |
| 12673 | 8" | 1 |
| 12674 | 10" | 1 |
| 12675 | 12" | 1 |

F - CLAMPS

The "F" Clamp has a very rapid set up time. It is 90% faster than "C" Clamps. Made from drop forged, heat treated, plated steel with a screw and handle that are copper coated to protect against weld spatter.

| Item# | Size | Pkg. Qty. |
|-------|------|-----------|
| 12676 | 8" | 1 |
| 12677 | 10" | 1 |
| 12678 | 12" | 1 |
| 12679 | 16" | 1 |



LOCKING C - CLAMP

Holds work tightly where you want it, allowing room to work around large pieces.

| Item# | Size | Pkg. Qty. |
|-------|--------------|-----------|
| 12222 | 10 1/2" long | 1 |

LOCKING WELDING CLAMP

Made of plated steel, this is the most secure method of holding two pieces of metal together for welding. Can be adjusted to different thicknesses.

| Item# | Size | Pkg. Qty. |
|-------|-----------------------|-----------|
| 12223 | Locking Welding Clamp | 1 |



LIGHTER/MAGNETS/PICKS/SCRIBES



12245

LIGHTNIN' BUG TORCH LIGHTER

Electrically generates a spark. Tested to 30,000 strikes this patented lighter ignites all fuel gases quickly and easily, again and again. Well worth the investment as it never needs replacement flints.

Corrosion and rust resistant.

| Item# | Description | Pkg. Qty. |
|-------|-----------------------------|-----------|
| 12245 | Skin Packaged Lightnin' Bug | 1 |



12202

SCRIBES

Premium scribe has a sharp tungsten carbide tip which leaves clear markings on metal, plastic, glass and tools. Comes with a replaceable tip and pocket clip.

| Item# | Description | Pkg. Qty. |
|-------|----------------|-----------|
| 12202 | Premium Scribe | 1 |



12250

MULTI-PURPOSE MAGNETS

These magnets have an anisotropic ferrite magnet and a steel plate finish. Designed to hold ferrous metals at 45, 90 and 135 degree angles.

Used for welding, soldering, assembly, pipe installation and holding of metal parts while welding.

| Item# | Size | Net. Wt. | Supports | Direct | Qty. |
|-------|-------------------------|----------|----------|---------|------|
| 12250 | 2" x 2 1/2" x 1/2" | 0.50 | 30 lbs. | 20 lbs. | 1 |
| 12251 | 2 3/4" x 3 1/4" x 9/16" | 0.75 | 45 lbs. | 33 lbs. | 1 |
| 12252 | 3 5/8" x 4 1/16" x 3/4" | 1.65 | 80 lbs. | 55 lbs. | 1 |



12201

4 WAY PICK KIT

This four way repair kit has a knurled aluminum handle with four tempered steel picks. Comes in a plastic pouch.

| Item# | Description | Pkg. Qty. |
|-------|-----------------|-----------|
| 12201 | Repair Pick Kit | 1 |



12206

12205

MAGNET & MIRROR WITH FLEXIBLE HANDLE

The 17" long magnet can reach into tight places for ferrous metal objects. The mirror allows quick, clear inspection of obscure areas and can swivel 360 degrees. Plastic break resistant mirror.

| Item# | Description | Pkg. Qty. |
|-------|-----------------------------------|-----------|
| 12205 | Magnet with Flexible Handle / USA | 1 |
| 12206 | Mirror with Flexible Handle / USA | 1 |

PLIERS/LEVEL/KNIFE/RECEPTACLES & PLUGS



12256

MIG WELDER PLIERS FOR MULTIPLE JOBS

This special designed Mig Plier is a must for all welders. It acts as a multi-purpose tool with multiple functions.

| Item# | Description | Pkg. Qty. |
|-------|-------------|-----------|
| 12256 | Mig Plier | 1 |



12258

WELDERS UTILITY KNIFE

This general purpose knife comes in handy for many jobs. A welder's essential tool.

| Item# | Description | Pkg. Qty. |
|-------|---------------------------------|-----------|
| 12258 | Knife with 4 replacement blades | 1 |

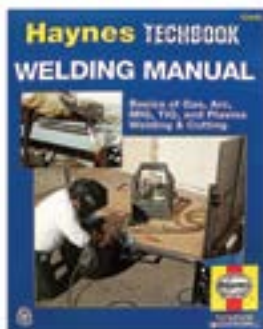

10999

WELDING MANUAL

Contains basic guidelines for arc welding.

| Item# | Description | Qty. |
|-------|----------------|------|
| 10999 | Welding Manual | 1 |

WALL RECEPTACLE AND PLUGS

Choose from the pin style used for 2 pole, 3 wire grounding and surface mounted; or the crowfoot style with 3 equal slots and used for 2 pole, 3 wire grounding.

Male pin type plug has two brass blades and half pin, where the male crowfoot plug has three heavy duty brass blades.

Both are made of hardened bakelite and use 125/250 volt, 50 amps (pin type requires 250 volt). Made in México.

| Item# | Description | Pkg. Qty. |
|-------|---|-----------|
| 12224 | Pin Type Wall Receptacle (Parallel Blade) | 1 |
| 12225 | Crowfoot Type Wall Receptacle | 1 |
| 12235 | Male Pin Type Plug (Parallel Blade) | 1 |
| 12236 | Male Crowfoot Plug | 1 |



12235

12224

12225

RECEPTACLES

20 Amp, U.L. Listed Receptacles. Made in México

| Item# | Description | Pkg. Qty. |
|-------|----------------------|-----------|
| 12246 | 20 Amp Max, 250 Volt | 1 |
| 12249 | 20 Amp Max, 125 Volt | 1 |



12246

12249

12236



CRIMPING TOOL/CABLE LUGS/TANK ADAPTERS



CRIMPING TOOL

For crimping of copper terminal lugs. This heavy duty crimping tool is designed for ease. The spring action plunger quickly crimps lugs with the use of a hammer.

| Item# | Dimensions | Net Weight | Pkg. Qty. |
|-------|-------------|------------|-----------|
| 12247 | 2" x 3 1/4" | 1.6 lb. | 1 |



CABLE LUGS

Made from copper and designed for a solid connection. Easy to swage and/or crimp.

| Item# | Cable Size | Supports | Pkg. Qty. |
|-------|------------|----------|-----------|
| 12300 | 8 | #10 | 2 |
| 12301 | 6 | 1/4" | 2 |
| 12302 | 4 | 5/16" | 2 |
| 12303 | 4 | 3/8" | 2 |
| 12304 | 2-3 | 5/16" | 2 |
| 12305 | 1 | 3/8" | 2 |
| 12306 | 1/0 | 3/8" | 2 |
| 12308 | 2/0 | 3/8" | 2 |
| 12309 | 2-6 | 3/8" | 2 |
| 12310 | 2/0 | 1/2" | 2 |
| 12311 | 3/0 | 1/2" | 2 |
| 12312 | 4/0 | 1/2" | 2 |
| 12313 | 1-2 | 1/2" | 2 |
| 12314 | 2-6 | 1/2" | 2 |
| 12315 | 1/0-2/0 | 1/2" | 2 |



TANK ADAPTERS

Made for connections of oxygen and acetylene cylinders. For use in connecting a regulator to a tank with dissimilar connections.

| Item# | Description | Pkg. Qty. |
|-------|------------------------------------|-----------|
| 12412 | Adapts CGA580 to CGA320 | 1 |
| 12413 | Adapts CGA520 to CGA510 - B Tanks | 1 |
| 12414 | Adapts CGA520 to CGA200 | 1 |
| 12415 | Adapts CGA510 to CGA520 - B Tanks | 1 |
| 12416 | Adapts CGA510 to CGA510 Rt. Angle | 1 |
| 12418 | Adapts CGA510 to CGA300 | 1 |
| 12419 | Adapts CGA320 to CGA580 | 1 |
| 12421 | Adapts CGA200 to CGA510 - MC Tanks | 1 |



HAND TORCHES

Two levels of torches - for the do-it-yourselfer and the everyday professional.

| Item# | Description | Pkg. Qty. |
|-------|---|-----------|
| 12464 | Do-it-yourself pencil flame solid brass construction flame control valve. For use on 1 lb. propane tanks. Use for soldering - thawing pipes light maintenance. One year warranty. | 1 |
| 12465 | 180 degree swivel tip, safety trigger lock. Use with standard mapp and 1 lb propane tank. Swirl combustion design, UL listed CGA600 Connection. One year warranty - Made in USA | 1 |

TORCH CARBONS/CYLINDER WRENCHES/HOSE/CRIMPING TOOL



12462

ARC TORCH CARBONS

Copper coated, these carbons are break resistant.

| Item# | Size | Pkg. Qty. |
|-------|-------|-----------|
| 12462 | 1/4" | 10 |
| 12463 | 3/16" | 10 |



16100

10-WAY CYLINDER WRENCH

Made from forged steel, this wrench has 10 openings. Sizes include: 7/16", 1/2", 9/16", 5/8", 11/16", 7/8", 1", 1 1/8" plus a 1/4" socket and a 3/8" square BMC.

| Item# | Dimensions | Wt. | C.O.O. | Pkg. Qty. |
|-------|-----------------|---------|---------------|-----------|
| 16100 | 8 1/2" x 2 1/2" | .85 lbs | Made in China | 1 |



16101

CYLINDER WRENCH

3/8" square opening for use on acetylene tanks.

| Item# | Size | C.O.O. | Pkg. Qty. |
|-------|---------|----------------|-----------|
| 16101 | 5" Long | Made in Taiwan | 1 |



16102

16103

T-TYPE CYLINDER WRENCH

For use on acetylene tanks. Durable steel construction. 5" T-bar and 6" shank.

| Item# | Size | C.O.O. | Pkg. Qty. |
|-------|------|----------------|-----------|
| 16102 | 3/8" | Made in Taiwan | 1 |
| 16103 | 1/4" | Made in China | 1 |



12263

OXY-ACETYLENE HOSE SET

This rugged Type "R", flexible hose is kink proof and has a neoprene cover. Rated to 100 PSI.

| Item# | Diameter | Length | Pkg. Qty. |
|-------|----------|--------|-----------|
| 12263 | 3/16" | 12.5' | 1 |
| 12264 | 3/16" | 20' | 1 |
| 12265 | 3/16" | 25' | 1 |
| 12266 | 3/16" | 50' | 1 |
| 12268 | 1/4" | 12.5' | 1 |
| 12270 | 1/4" | 25' | 1 |
| 12271 | 1/4" | 50' | 1 |



12261

HOSE REPAIR CRIMPING TOOL

Used to perform hose fitting repairs

| Item# | Dimensions | Wt. | Pkg. Qty. |
|-------|------------------------|-----|-----------|
| 12261 | 8 3/4" x 2 1/2" x 1/2" | 1.3 | 1 |



REPAIR KIT/CLAMPS/FERRULES/BRACES/COUPLERS/NUTS



12260

OXY-ACETYLENE HOSE REPAIR KIT

Kit is complete with splicers, hose nuts, nipples, ferrules and couplers. Also includes a vise grip type crimping tool.

| Item# | Dimensions | Wt. | Pkg. Qty. |
|-------|---------------------------|----------|-----------|
| 12260 | 10 3/4" x 6 1/2" x 1 1/2" | 3.7 lbs. | 1 |



12283

OXY-ACETYLENE HOSE END REPAIR KIT

Set includes two complete hose end sets for 3/16" or 1/4" hose.

| Item# | Size | Sets |
|-------|-------|------|
| 12283 | 3/16" | 2 |
| 12284 | 1/4" | 2 |



12274



12275

HOSE BRACE

| Item# | Size | Type | Pkg. Qty. |
|-------|-------|-----------------|-----------|
| 12274 | 3/16" | Oxy - Acetylene | 5 |
| 12275 | 1/4" | Oxy - Acetylene | 5 |



12287



12290

HOSE CLAMPS

Hose clamps available in 2 sizes.

| Item# | Size | Pkg. Qty. |
|-------|-------|-----------|
| 12290 | 3/16" | 2 |
| 12289 | 1/4" | 2 |



12272

BRASS HOSE FERRULES

| Item# | Size | Type | Pkg. Qty. |
|-------|-------|-----------------|-----------|
| 12272 | 3/16" | Oxy - Acetylene | 5 |
| 12273 | 1/4" | Oxy - Acetylene | 5 |



12278

HOSE COUPLERS "B" FITTING

| Item# | Type | Pkg. Qty. |
|-------|-----------|-----------|
| 12278 | Acetylene | 2 |
| 12279 | Oxygen | 2 |

HOSE NUTS

| Item# | Size | Type | Pkg. Qty. |
|-------|-------|-----------|-----------|
| 12287 | 9/16" | Acetylene | 2 |
| 12288 | 9/16" | Oxygen | 2 |

SPLICERS/CONNECTORS/NIPPLES/GAUGES



12281



12285

OXY-ACETYLENE HOSE SPLICERS

Used for joining 3/16" or 1/4" ends.

| Item# | Size | Type | Pkg. Qty. |
|-------|-------|-----------------|-----------|
| 12280 | 3/16" | Oxy - Acetylene | 2 |
| 12281 | 1/4" | Oxy - Acetylene | 2 |

OXY-ACETYLENE HOSE SPLICER KIT

Set includes one splice coupler for connecting a 3/16" torch to a 1/4" hose.

| Item# | Size | Set/Pcs. |
|-------|-------|----------|
| 12285 | 3/16" | 1 |
| 12286 | 1/4" | 1 |



12294



12276

OXY - ACETYLENE CONNECTORS

Used for joining 3/16" or 1/4" ends.

| Item# | Hose Size | Type/Connection Sz. | Set |
|-------|-----------|---------------------|-----|
| 12291 | 1/4" ID | Oxygen to 1/4" | 1 |
| 12292 | 1/4" ID | Acetylene to 1/4" | 1 |
| 12293 | 3/16" ID | Oxygen to 3/16" | 1 |
| 12294 | 3/16" ID | Acetylene to 3/16" | 1 |

BARBED HOSE NIPPLES

| Item# | Size | Type | Pkg. Qty. |
|-------|-------|---------------|-----------|
| 12276 | 3/16" | Oxy-Acetylene | 2 |
| 12277 | 1/4" | Oxy-Acetylene | 2 |

OXY-ACETYLENE GAUGES

High quality, bourdon-tube style gauges.

1 1/2" Acetylene For Light Duty Kit #150

| Item# | Type | Size | Pounds | Pkg. Qty. |
|-------|----------------|---------|--------|-----------|
| 12440 | Acetylene Only | 1/8"NPT | 0-400 | 1 |
| 12441 | Acetylene Only | 1/8"NPT | 0-4000 | 1 |

2" For Medium Duty Kit #250

| Item# | Type | Size | Pounds | Pkg. Qty. |
|-------|----------------|---------|--------|-----------|
| 12422 | Acetylene Only | 1/4"NPT | 0-30 | 1 |
| 12423 | All Gases | 1/4"NPT | 0-60 | 1 |
| 12424 | All Gases | 1/4"NPT | 0-100 | 1 |
| 12425 | All Gases | 1/4"NPT | 0-400 | 1 |
| 12426 | All Gases | 1/4"NPT | 0-4000 | 1 |

2 1/2" for Heavy Duty Kit #350

| Item# | Type | Size | Pounds | Pkg. Qty. |
|-------|----------------|---------|--------|-----------|
| 12427 | Acetylene Only | 1/4"NPT | 0-30 | 1 |
| 12428 | All Gases | 1/4"NPT | 0-200 | 1 |
| 12429 | All Gases | 1/4"NPT | 0-400 | 1 |
| 12430 | All Gases | 1/4"NPT | 0-4000 | 1 |



12440



12422



12428



ARRESTORS/VALVES/REGULATORS



12447



12449

FLASHBACK ARRESTORS

| Item# | Type | Description | Pkg. Qty. |
|-------|--------------|----------------------|-----------|
| 12446 | Torch | with check valves | 2 |
| 12447 | Regulator | with check valves | 2 |
| 12448 | Kwik-Connect | "B" 9/16"-18 Threads | 2 |

REVERSE FLOW CHECK VALVES

Valves used to prevent gases from backing up and mixing in the regulators. For use on single or two stage regulators with 1/4" NPT outlet.

| Item# | Description | Pkg. Qty. |
|-------|------------------|-----------|
| 12449 | 1/4" NPT - 2 pcs | 2 |



12454

SINGLE STAGE REGULATORS

Replacements For Series 150 Kits-UL Listed

| Item# | Type | Size | Pounds |
|-------|-----------|-------|--------------------|
| 12454 | Oxygen | 50 mm | 540 CGA, 4-60 PSIG |
| 12455 | Acetylene | 50 mm | 510 CGA, 2-15 PSIG |

Replacements For Series 250 Kits-UL Listed

| Item# | Type | Size | Pounds |
|-------|-----------|------|---------------------|
| 12459 | Oxygen | 2" | 540 CGA, 5-125 PSIG |
| 12460 | Acetylene | 2" | 510 CGA, 2-15 PSIG |

Replacements For Series 350 Kits-UL Listed

| Item# | Type | Size | Pounds |
|-------|-----------|--------|----------------------|
| 12442 | Oxygen | 2 1/2" | 540 CGA, 2-125 PSIG |
| 12443 | Oxygen | 2 1/2" | 540 CGA, 10-200 PSIG |
| 12444 | Acetylene | 2 1/2" | 510 CGA, 2-15 PSIG |
| 12445 | Acetylene | 2 1/2" | 300 CGA, 2-15 PSIG |



12444

GLOVES

BLACK MAMBA TORQUE GRIP GLOVES

Features & Benefits:

- Raised Torque Grip
- Finished 6.25 mil between Torque Grips and 10.25 mil thick at Torque Grip
- 3X the chemical and puncture resistance of a comparable thickness latex or vinyl glove

| Item# | Description |
|-------|--|
| 12896 | Mamba Torque Grip Gloves - 100 Box Small |
| 12897 | Mamba Torque Grip Gloves - 100 Box Medium |
| 12898 | Mamba Torque Grip Gloves - 100 Box Large |
| 12899 | Mamba Torque Grip Gloves - 100 Box X-Large |



BLACK MAMBA NITRILE GLOVES

Features & Benefits:

- Made with a patented NITREX® polymer
- Over 6.0 mil thick
- 3X the chemical and puncture resistance of a comparable thickness latex or vinyl glove

| Item# | Description |
|-------|-----------------------------------|
| 12888 | Black Mamba Nitrile Gloves/Small |
| 12889 | Black Mamba Nitrile Gloves/Medium |
| 12890 | Black Mamba Nitrile Gloves/Large |
| 12891 | Black Mamba Nitrile GlovesX-Large |



BLUE MAMBA NITRILE GLOVES

Features & Benefits:

- Made from heavy duty professional-grade latex
- Thickness of an incredible 5.75 mil
- Lighter color makes it easier to see certain chemicals and solvents

| Item# | Description |
|-------|----------------------------------|
| 12892 | Blue Mamba Nitrile Gloves/Small |
| 12893 | Blue Mamba Nitrile Gloves/Medium |
| 12894 | Blue Mamba Nitrile Gloves/Large |
| 12895 | Blue Mamba Nitrile GlovesX-Large |





WELDING SHIELDS



14315

DELUXE WELDERS HAND HELD FACE SHIELD

This easy hand held shield is ergonomically designed with a hand hole large enough to fit a gloved hand. It is light weight and can fit in either hand.

The viewing area is 2" x 4 1/4" with a shade 10 lens and cover plate. Ideal for small jobs or as protection when other people are welding. Meets ANSI Z87.1-1989 and CSA-Z94.3-92 SEI Certified

| Item# | Description | Pkg. Qty. |
|-------|--------------------------|-----------|
| 14315 | Hand Held Welding Shield | 1 |



14316

ECONOMY WELDERS HAND HELD FACE SHIELD

Easy, economical hand held shield is an inexpensive way to protect yourself on small welding jobs.

The viewing area is 2" x 4 1/4" with a shade 9 lens and cover plate. Ideal for small jobs or as protection when other people are welding. Meets ANSI Z87.1-1989 and CSA-Z94.3-92 SEI Certified

| Item# | Description | Pkg. Qty. |
|-------|----------------------------------|-----------|
| 14316 | Economy Hand Held Welding Shield | 1 |



14319

GRINDING SHIELD

These grinding shields are designed for use while using various power tools. Protects from harmful exposure to dangerous wheels and flying debris.

| Item# | Description | Pkg. Qty. |
|-------|-------------------------------------|-----------|
| 14317 | Clear Pinlock Headgear 8" x 12" | 1 |
| 14318 | Green Pinlock Headgear 8" x 12" | 1 |
| 14319 | Clear Ratchet Headgear 8" x 15 1/2" | 1 |
| 14320 | Green Ratchet Headgear 8" x 15 1/2" | 1 |



14332
14312
14313

REPLACEMENT GRINDING SHIELD

Replacement face shield comes in 8" x 12" or 8" x 15 1/2" and made from plastic.

| Item# | Description | Pkg. Qty. |
|-------|---------------------------------|-----------|
| 14312 | Clear 8" x 12" | 1 |
| 14313 | Green 8" x 12" | 1 |
| 14310 | Clear 8" x 15 1/2" | 1 |
| 14311 | Green 8" x 15 1/2" | 1 |
| 14331 | Clear 8" x 15 1/2" w/ Metal Rim | 1 |
| 14332 | Green 8" x 15 1/2" w/ Metal Rim | 1 |

HEADGEAR



14333



14314



14117

REPLACEMENT HEADBAND AND HEADGEAR

Headband will work on item #14317 - #14320 welding shields.

| Item# | Description | Pkg. Qty. |
|-------|---|-----------|
| 14314 | Comfortable Headband Cover | 1 |
| 14333 | Visor Headband Ratchet Headgear (no shield) | 1 |
| 14334 | Visor Headband Pinlock Headgear (no shield) | 1 |



14118

RATCHET HEADGEAR

This headgear has a ratchet type adjustment for headband and pin type for crown strap. Use with item #14101-14105, 14109, 14112.

Also works with all Sellstrom helmets.

| Item# | Description | Pkg. Qty. |
|-------|---------------------|-----------|
| 14118 | Ratcheting Headgear | 1 |

PIN HEADGEAR

This headgear has a pin type adjustment for headband and crown strap. Use with item number #14101-14105, #14109, 14112.

Also works with all Sellstrom helmets.

| Item# | Description | Pkg. Qty. |
|-------|-----------------------------------|-----------|
| 14117 | Pin Headgear - Crown and Headband | 1 |



14119

RATCHET HEADGEAR

This headgear is made from pliable, long lasting plastic that won't stiffen. Straps are easy adjusting for head size and crown fit. There are pivot points for the helmet that are extended from the headband to eliminate pressure on sides of the head.

| Item# | Description | Pkg. Qty. |
|-------|---|-----------|
| 14119 | Headgear-Ratcheting for Jackson/Morsafe | 1 |
| 14120 | Headgear-Universal Ratcheting for Off-Shore Helmets | 1 |
| 14142 | Replacement Headgear for Shark Graphic Helmets | 1 |
| 14278 | Replacement Headgear for Shark 14272 | 1 |



WELDING SAFETY GOGGLES



14306

50MM STATIONARY ACETYLENE GOGGLES

Made from soft vinyl that forms to the head. Six vents prevent fogging. Goggles have a 50 mm, #5 lens and a pit resistant cover lens.

| Item# | Pkg. Qty. |
|-------|-----------|
| 14306 | 1 |



14307

50MM FLIP-UP OXY-ACETYLENE GOGGLES

Made from soft vinyl that forms to the head. Six vents prevent fogging. Goggles have a 50 mm, #5 flip-up lens and a pit resistant cover lens.

| Item# | Pkg. Qty. |
|-------|-----------|
| 14307 | 1 |



14308

BOX STYLE STATIONARY ACETYLENE GOGGLES

Made from soft vinyl that forms to the head. Six vents prevent fogging. Goggles have a 2" x 4 1/4", #5 lens and a pit resistant cover lens. Rectangle shape designed to be worn over regular eyeglasses or with a magnifying lens.

| Item# | Pkg. Qty. |
|-------|-----------|
| 14308 | 1 |



14309

BOX STYLE FLIP-UP ACETYLENE GOGGLES

Made from soft vinyl with a 2" x 4 1/4", #5 flip-up lens and air vents to prevent fogging.

| Item# | Pkg. Qty. |
|-------|-----------|
| 14309 | 1 |



14302

EYE CUP GOGGLES

These 50 mm goggles are heat treated, #5 shade lenses. Easily folds up to carry in your pocket.

| Item# | Pkg. Qty. |
|-------|-----------|
| 14302 | 1 |



14305

CUP STYLE ACETYLENE GOGGLES

Made from soft vinyl with #5 heat treated lenses on this aviator shaped goggle. Air vents to prevent fogging. Designed to be worn over regular eyeglasses.

| Item# | Pkg. Qty. |
|-------|-----------|
| 14305 | 1 |

SAFETY GOGGLES/GLASSES*



14300

CLEAR PLASTIC GOGGLES

Goggles fit over regular eyeglasses and are perforated for good ventilation. Good for use as general purpose safety protector in industry, workshop, farming and sports.

| Item# | Pkg. Qty. |
|-------|-----------|
| 14300 | 1 |



14303

FOG-FREE VENTED GOGGLES

Made for easy viewing, ventilation and comfort. The acetate lens conforms to the eye area for a light-tight seal. Can be used over glasses.

| Item# | Pkg. Qty. |
|-------|-----------|
| 14303 | 1 |



14301

LIGHT GREEN PLASTIC GOGGLES

Lens is light green shaded with clear sides. Not for oxy-acetylene welding.

| Item# | Pkg. Qty. |
|-------|-----------|
| 14301 | 1 |



14329

CAMOUFLAGE GOGGLES

Camouflage goggles! Lens is dark green #5 shade for protection. Comfort head strap has Hook and Loop Fastener closure.

| Item# | Pkg. Qty. |
|-------|-----------|
| 14329 | 1 |



14330

ELASTIC HEADBAND FOR GOGGLES

Adjustable, replacement headband for many type of goggles.

| Item# | Pkg. Qty. |
|-------|-----------|
| 14330 | 4 |



14338

PROTECTIVE GLASSES

These clear, stylish wrap-around design frame glasses have a curved lens for a snug, secure fit. Durable/scratch-resistant. ANSI Z87.1

| Item# | Pkg. Qty. |
|-------|-----------|
| 14338 | 1 |

*Not for any welding use.



SAFETY GLASSES*



14339



14342

COMFORT DESIGNED SAFETY GLASSES

Innovative frame design fits all face shapes. Impact and scratch resistant lens. UV400 coating & ANSI Z87.

| Item# | Shade | Pkg. Qty. |
|-------|-------|-----------|
| 14339 | Clear | 1 |

FASHIONABLE GLOSS FINISH SAFETY GLASSES

Curve style safety glasses with two piece anti-scratch PC lens. Rubber leg foot and nose bridge. UV400 coating & ANSI Z87.1

| Item# | Shade | Pkg. Qty. |
|-------|-------|-----------|
| 14342 | Clear | 1 |



14344



14343



14321



14322

FRAMELESS SAFETY GLASSES

Economical fashionable light weight frameless style safety glasses with slim temple leg and soft rubber temple cover. ANSI Z87.1 + CE EN 166.

| Item# | Shade | Pkg. Qty. |
|-------|--------|-----------|
| 14343 | Smoked | 1 |
| 14344 | Clear | 1 |

PROTECTIVE TRI-SHIELD GLASSES

Glasses have a top and flat folding side shield with a polycarbonate safety lens.

| Item# | Shade | Pkg. Qty. |
|-------|----------|-----------|
| 14321 | Clear | 1 |
| 14322 | #5 Green | 1 |



14323



14327

21ST CENTURY PROTECTIVE GLASSES

Glasses have a flat folding side shield with a safety lens.

| Item# | Shade | Pkg. Qty. |
|-------|----------|-----------|
| 14323 | #3 Green | 1 |
| 14324 | #5 Green | 1 |

PROTECTIVE TRI-SHIELD GLASSES

Clear visitor safety glasses are inexpensive, one-size-fits-all glasses that will easily fit over regular eyeglasses.

| Item# | Type | Shade | Pkg. Qty. |
|-------|---------|-------|-----------|
| 14327 | Visitor | Clear | 1 |
| 14328 | Visitor | Smoke | 1 |

*Not for any welding use.

EAR/AIR PROTECTION



14425

NOISE PROTECTION EAR MUFFS

Comfortable and lightweight ear muffs with a self-aligning adjustable strap. For maximum protection and safety from the worst levels of noise. Also has self-aligning ear cups. Can be used for most common levels of industrial noise.

| Item# | Pkg. Qty. |
|-------|-----------|
| 14425 | 1 |



14422



14463

REUSABLE EAR PLUGS

Comfortable ear plugs with or without neck string.

| Item# | Description | Pkg. Qty. |
|-------|-----------------------------------|-----------|
| 14422 | Ear plugs with neck string in box | 1 pair |
| 14423 | Ear plugs in plastic box-Medium | 1 pair |
| 14424 | Ear plugs in plastic box-Large | 1 pair |
| 14463 | Disposable Ear Plugs | 12 pair |



14418

14421



14417

HALF MASK RESPIRATORS

Half Mask respirator comes with either a metal fume cartridge for welding or a cartridge set-up for paint fume protection.

| Item# | Description | Pkg. Qty. |
|-------|--|-----------|
| 14416 | Paint Fume Respirator | 1 |
| 14417 | Welding Fume Respirator | 1 |
| 14418 | Paint Fume Replacement Cartridge | 2 |
| 14419 | Welding Fume Replacement Cartridge | 2 |
| 14421 | Welding Fume Replacement White Filters | 10 |



MASKS/EYE WASH STATION/HARD HATS



14426



14428

CUSTOM FIT DUST MASKS

Masks are made from an extremely absorbent filter material and are lightweight. Metal tab to secure tightly to your nose. Use for lab work, grinding, sanding and dusty work areas. Not for use when toxic fumes or other harmful dust is present.

| Item# | Old# | Pkg. Qty. |
|-------|-------|-----------|
| 14426 | 80-10 | 10 |
| 14427 | 80 | 50/bx. |

ACID RESISTANT DUST MASKS

NIOSH approved N95 Valved Particulate Mask with 95% filtration. Effective against particulate aerosols free of oils.

| Item# | Description | Pkg. Qty. |
|-------|-------------------|-----------|
| 14428 | Valved respirator | 10 |



14432



14439



14448



14440



14441

GRAVITY FEED PORTABLE EYE WASH STATION

This SEI Certified 16 gallon eye wash unit comes with a zinc plated steel wall mounting bracket, drain hose and one bottle of Redi-Sep bacteriostatic additive with test log card. Flow activates in less than 1 second. Unit weighs only 16 lbs and has a flow duration of over 15 minutes at a rate of .4 gallons per minute

| Item# | Description | Pkg. Qty |
|-------|--|----------|
| 14432 | 16 gallon unit with bottle of Redi-Sep | 1 |
| 14433 | 8 oz. bottle of Redi-Sep | 1 |
| 14435 | Dust Cover for 16 gallon Station | 1 |

HARD HATS

For maximum protection from electrical hazards or general impact and penetration protection. Meets ANSI Z89.2 regulations and CS-22. ABS or HDPE material. Woven Band or Ratcheting Suspension. Hats and headgear sold separately.

| Item# | Description | Pkg. Qty. |
|-------|------------------------------------|-----------|
| 14438 | Red HDPE Shell No Headgear | 1 |
| 14439 | Yellow ABS Shell No Headgear | 1 |
| 14448 | White ABS Shell No Headgear | 1 |
| 14440 | Woven Suspension & Headgear-Medium | 1 |
| 14441 | PE suspension Headgear-Medium | 1 |
| 14442 | Chin Strap (not shown) | 1 |

LINED LEATHER WELDING GLOVES



14402

BROWN LEATHER WELDING GLOVES

Brown leather welding gloves. Protect against sparks, hot metal and slag.

| Item# | Size | Pkg.Qty. |
|-------|-------|----------|
| 14402 | Large | 1 |



14401

GREY ECONOMY LEATHER WELDING GLOVES

These 15 1/2" long gloves are heavy duty, heat resistant and have a gauntlet for protection. They offer average protection while welding. Protects against sparks and hot metal.

| Item# | Size | Pkg.Qty. |
|-------|-------|----------|
| 14401 | Large | 1 |



14403

BLUE DELUXE WELDING GLOVES

These 15 1/2" long gloves are superior quality. They have a fully lined interior to insulate against heat and have a gauntlet for protection. One piece back is made of shoulder split leather.

| Item# | Size | Pkg.Qty. |
|-------|-------|----------|
| 14403 | Large | 1 |



14525

BLUE EXTRA HEAVY DUTY GLOVES

This top-of-the-line, Kevlar lined glove is 15 1/2" long. The gun cut with wing thumb construction offers you extra life. These 2-toned welding gloves are extra thick for added protection when you need it while welding or moving hot items.

| Item# | Size | Pkg.Qty. |
|-------|-------|----------|
| 14525 | Large | 1 |



LEATHER WELDING/WORK GLOVES



14404



14400

LEATHER WELDING GLOVES

These deluxe red thermal lined gloves protect against sparks, hot metal and slag. Gun cut with wing thumb, lock stitch construction has a one-piece back and are 16" long. Made with shoulder split leather, these are our better gloves.

| Item# | Size | Pkg. Qty. |
|-------|-------|-----------|
| 14404 | Large | 1 |

TIG GLOVES

These premium leather gloves are made of top grain leather. They will withstand moisture, unlined for maximum dexterity and are 14" long.

| Item# | Size | Pkg. Qty. |
|-------|-------|-----------|
| 14400 | Large | 1 |



14414



14399



14415

LEATHER WORK/DRIVER GLOVES

These gloves are made of select, side split cowhide. Gloves are lightweight, soft and pliable. 9" Length.

| Item# | Size | Pkg. Qty. |
|-------|-------|-----------|
| 14414 | Large | 1 |

TWO-TONE GOAT/SHEEP SKIN DRIVER GLOVES

Driver glove made of goat/sheep skin and a heavy duty spandex material on the top for comfort.

| Item# | Size | Pkg. Qty. |
|-------|-------|-----------|
| 14399 | Large | 1 |

LEATHER PALMED ECONOMY WORK GLOVES

Shoulder split cowhide on palms, thumb and index finger. Gun cut with cotton band and back.

| Item# | Size | Pkg. Qty. |
|-------|-------|-----------|
| 14415 | Large | 1 |

WELDING APPAREL



14519

PROTECTIVE LEATHER WELDING SLEEVES

These 18" slide on leather sleeves have an elastic cuff and an adjustable tab at the bicep. Great for forearm protection while welding as well as working in the yard cutting prickly bushes, and other situations where arm protection is required.

- **Welding/Work Sleeves**
- **100% Cowhide Leather**
- **18" Length**
- **Elastic Cuff with Adjustable Biceps**
- **Heat Resistant**
- **Good for Over-Head Welding**

| Item# | Description | Pkg.Qty. |
|-------|------------------------------|----------|
| 14519 | Leather welding/work sleeves | 1 Pair |



14520

LEATHER WELDING JACKET

Leather is the best form of protection when it comes to Welding. Exceptionally good when welding overhead, our top quality grain leather jackets will offer an extended life protection over sateen. Available in sizes from Large to 3-XL, these jackets are comfortable and easy to wear.

| Item# | Size | Pkg. Qty. |
|-------|-----------|-----------|
| 14520 | Large | 1 |
| 14521 | X-Large | 1 |
| 14522 | XX-Large | 1 |
| 14523 | XXX-Large | 1 |



14524

LEATHER WELDING APRON

Our quality top grain leather welding apron will afford you protection when and where you need it. Available in large, the ties are long enough to fit most sizes.

| Item# | Size | Pkg.Qty. |
|-------|-------|----------|
| 14524 | Large | 1 |



WELDING APPAREL

WELDING JACKET



14503

Jacket is 30" long and is made from green 9 oz. fire resistant 100% sateen cotton with a snap front, full length sleeves that have a snap cuff and a stand up collar.

| Item# | Size | Pkg.Qty. |
|-------|-----------|----------|
| 14503 | Large | 1 |
| 14504 | X-Large | 1 |
| 14505 | XX-Large | 1 |
| 14510 | XXX-Large | 1 |



WELDER'S CAPE SLEEVE WITHOUT BIB

Cape sleeves are made from green 9 oz. fire resistant 100% sateen cotton with a snap front. Full length sleeves have a snap cuff and a stand up collar.

| Item# | Size | Pkg.Qty. |
|-------|----------|----------|
| 14506 | Large | 1 |
| 14507 | X-Large | 1 |
| 14508 | XX-Large | 1 |

WELDING APRON



14500

Apron Material is green 9 oz. fire resistant 100% sateen cotton and has standard sewn ties.

| Item# | Size | Pkg.Qty. |
|-------|-----------|----------|
| 14500 | Large | 1 |
| 14501 | X-Large | 1 |
| 14502 | XX-Large | 1 |
| 14511 | XXX-Large | 1 |



WELDER'S BIB

This 20" long, 100% sateen cotton bib is made to snap on to the cape sleeves for lower body protection while welding.

| Item# | Size | Pkg.Qty. |
|-------|-------|----------|
| 14509 | Large | 1 |

WELDING APPAREL

ASSORTED WELDING HATS



14452



14455



14458

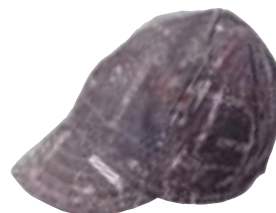

14468

Made of breathable cotton, these hats will offer protection with their wide, soft brims. Available in popular prints and colors.

| Item# | Description | Size | Pkg. Qty. |
|-------|-------------------|--------|-----------|
| 14452 | Red – Polka Dot | 7 1/4" | 1 |
| 14453 | Red – Polka Dot | 7 3/8" | 1 |
| 14454 | Red – Polka Dot | 7 1/2" | 1 |
| 14455 | Green – Polka Dot | 7 1/4" | 1 |
| 14456 | Green – Polka Dot | 7 3/8" | 1 |
| 14457 | Green – Polka Dot | 7 1/2" | 1 |

| Item# | Description | Size | Pkg. Qty. |
|-------|----------------------|--------|-----------|
| 14458 | Assorted Wild Prints | 7 1/4" | 1 |
| 14459 | Assorted Wild Prints | 7 3/8" | 1 |
| 14460 | Assorted Wild Prints | 7 1/2" | 1 |
| 14466 | Camo Print | 7 1/4" | 1 |
| 14467 | Camo Print | 7 3/8" | 1 |
| 14468 | Camo Print | 7 1/2" | 1 |



14461

BLACK QUILTED SKULL CAP

This flat crowned, firm brimmed hat is quilted and perfect for welding.

| Item# | Size | Pkg. Qty. |
|-------|--------|-----------|
| 14461 | 7 1/4" | 1 |



14450

BLACK COTTON WELDING BEANIES

Black cotton welding beanie for light weight protection under your helmet when a brim is not required.

| Item# | Size | Pkg. Qty. |
|-------|-------------|-----------|
| 14450 | Large | 1 |
| 14451 | Extra Large | 1 |



14469

Underside view

ORANGE WELDING HAT

This hat provides lightweight protection, while also remaining breathable. One size fits all!

- Washable
- Cotton flame-retardant fabric
- Breathable mesh lining
- Wide brim

| Item# | Description | Pkg. Qty. |
|-------|-----------------------|-----------|
| 14469 | Cotton mesh-lined hat | 1 |



WELDING SCREENS

WELDER'S STUR-D-SCREEN

Square steel tubing adds stability and support to this special orange heavy duty vinyl welding screen. Provides 100% of far U.V. Radiation and 100% of Blue Light protection. Portable, light weight design makes this an easy product to use and transport.

| Item# | Size | Weight |
|--------|-------------------|---------|
| 14443* | 6' High x 4' Wide | 23 lbs. |
| 14866* | 6' High x 6' Wide | 27 lbs. |
| 14868* | 6' High x 8' Wide | 31 lbs. |

*The item number represents only a single panel.



WELDING BLANKETS

These fiberglass and silicone welding blankets afford spark and molten metal protection.

Offered in a variety of sizes and materials, they allow for different working temperature ranges of up to 1500 degrees Fahrenheit.



12255



12394

| Item# | Old# | Description | Working Temperature | Size | Pkg. Qty. |
|-------|--------|---|---------------------|-----------|-----------|
| 12395 | 906-46 | Vermiculite Coated Fiberglass Blanket - Single Layer, 25 oz. | 1500° F | 4' x 6' | 1 |
| 12396 | 906-66 | Vermiculite Coated Fiberglass Blanket - Single Layer, 25 oz. | 1500° F | 6' x 6' | 1 |
| 12398 | 640-46 | Vermiculite Coated Fiberglass Blanket - Double Layer, 50 oz. | 1500° F | 4' x 6' | 1 |
| 12399 | 640-66 | Vermiculite Coated Fiberglass Blanket - Double Layer, 50 oz. | 1500° F | 6' x 6' | 1 |
| 12255 | | Silicone Coated Fiberglass Welding Blanket - Single Layer with Pocket | 500° F | 38" x 24" | 1 |
| 12394 | | Black Carbon Fiber Welding Blanket | 3000° F | 54" x 60" | 1 |

PAINT PENS

- Most durable nib in the industry
- Marks won't chip, peel, fade or rub off
- Precision valve accurately meters flow
- Twelve pens per box (one color per box)
- Marks on metal, plastic, glass, wood, etc.
- Withstands temperatures in excess of -50°F - 150°F / -46°C - 66°C
- Easily writes on any surface: porous or non-porous, rough or smooth, wet, oily or dry
- Made in the USA

NEW! PAINT PENS IN CLAMSHELL PACKAGING

| Item# | Description |
|-------|-------------|
| 16510 | White |
| 16511 | Black |
| 16512 | Blue |
| 16513 | Red |
| 16514 | Yellow |
| 16515 | Green |
| 16516 | Silver |
| 16517 | Orange |



16515

PAINT PENS

- Must be purchased in quantities of 12
- One color per box

| Item# | Description |
|-------|-------------|
| 16501 | White |
| 16502 | Black |
| 16503 | Blue |
| 16504 | Red |
| 16505 | Yellow |
| 16506 | Green |
| 16507 | Silver |
| 16508 | Orange |



16502

PAINT PENS - DISPLAY BOX (HOLDS 48)

- Attractive display
- Paint Pens sold separately
- Free with purchase of 48 pens

16500
(box only)





VICTOR STYLE WELDING & CUTTING KITS W/BUILT-IN FLASH BACK ARRESTORS

250 BASIC VICTOR STYLE MEDIUM DUTY WELDING & CUTTING KIT



12402

This medium duty kit with toolbox case was designed for the craftsman or mechanic. Welds up to 5/64" thick or up to 1 1/4" with optional nozzles. Cuts up to 1/2" thick with supplied tip or up to 5" with optional cutting tips. Includes a larger welding handle than the light duty kit, #0 welding tip, larger cutting attachment and 0-3-101 cutting tip, medium duty oxygen and acetylene regulators, 1/4" x 15' twin hose, goggles and striker. Built-in flash back arrestors for added safety!

Dimension: 20" x 10 1/2" x 10 1/2" • Weight: 16 lbs.

| Item# | Description | Pkg. Qty. |
|--------------|---------------------------------------|-----------|
| 12402 | Total Kit with Hose | 1 |
| 12577 | #0 Cutting Tip cuts up to 1/2" | 1 |
| 12599 | #0 Welding Tip | 1 |
| 12490 | Medium Duty Cutting Attachment | 1 |
| 12491 | Medium Duty Torch Handle | 1 |
| 12459 | Single Stage 250 Oxygen Regulators | 1 |
| 12460 | Single Stage 250 Acetylene Regulators | 1 |
| 12237 | Striker | 1 |
| 12242 | Tip Cleaner | 1 |
| 14302 | Goggles | 1 |
| | 1/4" x 15' Twin Hose** | 1 |

**Reorder 12270 hose which is 1/4" x 25'. 15' not available as regular number.

250 DELUXE VICTOR STYLE MEDIUM DUTY WELDING & CUTTING KIT INCLUDES ADDITIONAL ROSEBUD TIP AND 2 WELDING TIPS



12403

This Victor comparable kit with toolbox case was designed for automotive or construction use. Welds up to 1/4" thick up to 1 1/4" with optional nozzles. Cuts up to 1/2" thick - or 6" with optional cutting tips. Includes a medium duty torch handle, #0, #2, and #4 welding nozzle, medium duty cutting attachment and medium duty oxygen and acetylene regulators, 1/4" x 15' twin hose, goggles and striker complete the kit. Compared to the basic kit #12402, this includes an additional rosebud tip and 2 welding tips. Built-in flash back arrestors for added safety!

Dimension: 20" x 10 1/2" x 10 1/2" • Weight: 17 lbs.

| Item# | Description | Pkg. Qty. |
|--------------|---------------------------------------|-----------|
| 12403 | Total Kit with Hose | 1 |
| 12577 | #0 Cutting Tip cuts up to 1/2" | 1 |
| 12599 | #0 Welding Tip | 1 |
| 12601 | #2 Welding Tip | 1 |
| 12603 | #4 Welding Tip | 1 |
| 12604 | #6 Heating Rosebud | 1 |
| 12490 | Medium Duty Cutting Attachment | 1 |
| 12491 | Medium Duty Torch Handle | 1 |
| 12459 | Single Stage 250 Oxygen Regulators | 1 |
| 12460 | Single Stage 250 Acetylene Regulators | 1 |
| 12237 | Striker | 1 |
| 12242 | Tip Cleaner | 1 |
| 14302 | Goggles | 1 |
| | 1/4" x 15' Twin Hose** | 1 |

**Reorder 12270 hose which is 1/4" x 25'. 15' not available as regular number.

350 VICTOR STYLE HEAVY DUTY KIT

This heavy duty Victor-Journeyman compatible kit with toolbox case was designed for industrial or commercial use. Welds up to 1/2" (3" capability with optional nozzles). Cuts up to 3/4" thick with supplied #1 tip or up to 8" with optional cutting tips. Includes a larger welding handle than the medium duty kit, #1, #3 and #5 welding nozzles included. Heavy duty regulators, 1/4" x 15' twin hose, goggles and striker complete the kit. Built-in flash back arrestors for added safety!



12401

Dimension: 24" x 12" x 10" • Weight: 28 lbs.

| Item# | Description | Pkg. Qty. |
|--------------|--|-----------|
| 12401 | Total Kit with Hose | 1 |
| 12555 | #1 Cutting Tip cuts up to 3/4" | 1 |
| 12570 | #1 Welding Tip | 1 |
| 12572 | #3 Welding Tip | 1 |
| 12670 | #5 Welding Tip | 1 |
| 12574 | #8 Heating Rosebud | 1 |
| 12671 | Heavy Duty Torch Handle | 1 |
| 12672 | Heavy Duty Journeyman Style Cutting Attachment | 1 |
| 12443 | Heavy Duty Oxygen Regulators | 1 |
| 12444 | Heavy Duty Acetylene Regulators | 1 |
| 12237 | Striker | 1 |
| 14302 | Goggles | 1 |
| | 1/4" x 15' Twin Hose** | 1 |

**Reorder 12270 hose which is 1/4" x 25'. 15' not available as regular number.

OXYGEN-ACETYLENE TOTE KIT

This super range compatible kit welds up to 3/16" (expandable to 1 1/4") and cuts up to 1/2" (6" with optional tips). Designed for portability, this medium to light weight outfit allows you to take the torch to the job. Includes everything except the gas. Made in Taiwan.

Weight: 37 lbs.

| Item# | Description | Pkg. Qty. |
|--------------|--|-----------|
| 12411 | Tote with Cylinders | 1 |
| 12491 | 260C Series Torch Handle | 1 |
| 12490 | 250 Series Cutting Attachment | 1 |
| 12599 | #0 Welding Nozzle up to 3/16" | 1 |
| 12577 | #0 Cutting Tip Cuts to 1/2" | 1 |
| 12470 | Light Duty Oxygen Regulators (CGA540) | 1 |
| 12471 | Light Duty Acetylene Regulators (CGA200) | 1 |
| 12263 | 3/16" x 12.5' Dualine Hose | 1 |
| 12237 | Striker | 1 |
| 14302 | Shade #5 Goggles | 1 |



12411

(Cylinders Shipped Empty)



AIRCO/HARRIS WELDING & CUTTING TIPS



12502



12504



12509



12513

AIRCO STYLE CUTTING TIPS

Available in 2 types of tips. Both tips have a medium preheat and are used for general cutting. The Acetylene tip is a 144 series and the Propane/Natural Gas is a 261 series.

| Item# | Tip Size | Type | Series | Pkg. Qty. |
|-------|----------|---------------------|--------|-----------|
| 12500 | 0 | Acetylene | 144 | 1 |
| 12501 | 1 | Acetylene | 144 | 1 |
| 12502 | 2 | Acetylene | 144 | 1 |
| 12503 | 3 | Acetylene | 144 | 1 |
| 12504 | 1 | Propane/Natural Gas | 261 | 1 |

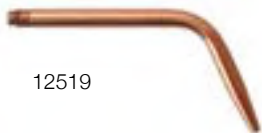

12519

HARRIS STYLE CUTTING TIPS

Available in 2 types of tips. Both tips have a medium preheat and are used for general cutting. The Acetylene tip is a 6290 series and the Propane/Natural Gas is a 6290-NX series. Fits a Harris model 85 torch handle.

| Item# | Tip Size | Type | Series | Pkg. Qty. |
|-------|----------|---------------------|---------|-----------|
| 12505 | 000 | Acetylene | 6290 | 1 |
| 12506 | 00 | Acetylene | 6290 | 1 |
| 12507 | 0 | Acetylene | 6290 | 1 |
| 12508 | 1 | Acetylene | 6290 | 1 |
| 12509 | 2 | Acetylene | 6290 | 1 |
| 12510 | 3 | Acetylene | 6290 | 1 |
| 12511 | 4 | Acetylene | 6290 | 1 |
| 12512 | 00 | Propane/Natural Gas | 6290-NX | 1 |
| 12513 | 0 | Propane/Natural Gas | 6290-NX | 1 |
| 12514 | 1 | Propane/Natural Gas | 6290-NX | 1 |
| 12515 | 2 | Propane/Natural Gas | 6290-NX | 1 |
| 12516 | 3 | Propane/Natural Gas | 6290-NX | 1 |
| 12517 | 4 | Propane/Natural Gas | 6290-NX | 1 |

HARRIS STYLE ACETYLENE WELDING TIP

This elbow style is a 23-A-90 series and is used with the E-43 mixer.

| Item# | Tip Size | Type | Pkg. Qty. |
|-------|----------|-----------|-----------|
| 12518 | 0 | Acetylene | 1 |
| 12519 | 1 | Acetylene | 1 |
| 12520 | 2 | Acetylene | 1 |
| 12521 | 3 | Acetylene | 1 |



12525

ACETYLENE/OXYGEN EASY SIZE CHART

| Metal Thickness | Tip Size | Pressures: ACT | Oxygen |
|-----------------|----------|----------------|--------|
| 1/8" | 0 | 3-5 | 20-25 |
| 1/4" | 00 | 3-5 | 20-25 |
| 3/8" | 0 | 3-5 | 25-35 |
| 1/2" | 0 | 3-5 | 30-35 |
| 3/4" | 1 | 3-5 | 30-35 |
| 1" | 2 | 3-5 | 35-40 |
| 2" | 3 | 4-8 | 40-45 |

HARRIS STYLE OXY-ACETYLENE MIXER

This mixer is an E-43 series and is used with the 23-A-90 elbow.

| Item# | Type | Series | Pkg. Qty. |
|-------|---------------|--------|-----------|
| 12525 | Oxy-Acetylene | E-43 | 1 |

MARQUETTE/PUROX/SMITH CUTTING TIPS



12528



12530

MARQUETTE STYLE STAR JET CUTTING TIP

This one piece, medium duty tip is made from solid copper and has a slip-in design. The seat is tapered for a positive gas seal and has four preheat holes to ensure efficient cutting results. Tip has a medium preheat.

General purpose tip.

| Item# | Tip Size | Type | Series | Pkg. Qty. |
|-------|----------|-----------|--------|-----------|
| 12527 | 1 | Acetylene | GW4 | 1 |
| 12528 | 3 | Acetylene | GW4 | 1 |
| 12529 | 4 | Acetylene | GW4 | 1 |

MARQUETTE STYLE STAR JET CUTTING TIP

This one piece, heavy duty tip is made from solid copper and has a slip-in design. The seat is tapered for a positive gas seal and has six preheat holes for fast starting and cutting. Tip has a heavy preheat. **General purpose tip.**

| Item# | Tip Size | Type | Series | Pkg. Qty. |
|-------|----------|-----------|--------|-----------|
| 12530 | 2 | Acetylene | GW6 | 1 |



12532



12538



12607

PUROX STYLE CUTTING TIPS

This cutting tip is a 4202 series with medium heat.

General purpose tip.

| Item# | Tip Size | Type | Series | Pkg. Qty. |
|-------|----------|-----------|--------|-----------|
| 12532 | 3 | Acetylene | 4202 | 1 |
| 12533 | 4 | Acetylene | 4202 | 1 |
| 12534 | 5 | Acetylene | 4202 | 1 |
| 12535 | 7 | Acetylene | 4202 | 1 |

SMITH STYLE CUTTING TIPS

Available in 2 types of tips. Both tips have a medium preheat and are used for general cutting. The Acetylene tip is a SC12 series and the Propane/Natural Gas tip is a SC40 series.

| Item# | Tip Size | Type | Series | Pkg. Qty. |
|-------|----------|---------------------|--------|-----------|
| 12536 | 00 | Acetylene | SC12 | 1 |
| 12537 | 0 | Acetylene | SC12 | 1 |
| 12538 | 1 | Acetylene | SC12 | 1 |
| 12539 | 2 | Acetylene | SC12 | 1 |
| 12540 | 3 | Acetylene | SC12 | 1 |
| 12541 | 4 | Acetylene | SC12 | 1 |
| 12606 | 00 | Propane/Natural Gas | SC40 | 1 |
| 12607 | 0 | Propane/Natural Gas | SC40 | 1 |
| 12608 | 1 | Propane/Natural Gas | SC40 | 1 |
| 12609 | 2 | Propane/Natural Gas | SC40 | 1 |
| 12610 | 3 | Propane/Natural Gas | SC40 | 1 |
| 12611 | 4 | Propane/Natural Gas | SC40 | 1 |



CUTTING/GOUGING TIP/NOZZLES



12543
Acetylene



12548
Propane & Natural Gas



12556
Acetylene



12562
Propane & Natural Gas

SMITH STYLE CUTTING TIPS

Available in 2 types of tips. Both tips have a medium preheat and are used for general cutting. The Acetylene tip is a MC12 series and the Propane/Natural Gas is an MC40 series.

| Item# | Tip Size | Type | Series | Pkg. Qty. |
|-------|----------|---------------------|--------|-----------|
| 12542 | 0 | Acetylene | MC12 | 1 |
| 12543 | 1 | Acetylene | MC12 | 1 |
| 12544 | 2 | Acetylene | MC12 | 1 |
| 12545 | 3 | Acetylene | MC12 | 1 |
| 12546 | 4 | Acetylene | MC12 | 1 |
| 12547 | 0 | Propane/Natural Gas | MC40 | 1 |
| 12548 | 1 | Propane/Natural Gas | MC40 | 1 |
| 12549 | 2 | Propane/Natural Gas | MC40 | 1 |
| 12550 | 3 | Propane/Natural Gas | MC40 | 1 |
| 12551 | 4 | Propane/Natural Gas | MC40 | 1 |

VICTOR STYLE CUTTING TIPS

Available in 2 types of tips. Both tips have a medium preheat and are used for general cutting. The Acetylene tip is a 1-101 series and the Propane/Natural Gas is an GPN series.

| Item# | Tip Size | Type | Series | Pkg. Qty. |
|-------|----------|---------------------|--------|-----------|
| 12552 | 000 | Acetylene | 1-101 | 1 |
| 12553 | 00 | Acetylene | 1-101 | 1 |
| 12554 | 0 | Acetylene | 1-101 | 1 |
| 12555 | 1 | Acetylene | 1-101 | 1 |
| 12556 | 2 | Acetylene | 1-101 | 1 |
| 12557 | 3 | Acetylene | 1-101 | 1 |
| 12558 | 4 | Acetylene | 1-101 | 1 |
| 12559 | 0 | Propane/Natural Gas | GPN | 1 |
| 12560 | 1 | Propane/Natural Gas | GPN | 1 |
| 12561 | 2 | Propane/Natural Gas | GPN | 1 |
| 12562 | 3 | Propane/Natural Gas | GPN | 1 |
| 12563 | 4 | Propane/Natural Gas | GPN | 1 |



12565



12569

VICTOR STYLE ACETYLENE GOUGING TIPS

This is a 1-118 series gouging tip. Used for general purpose gouging, scarfing, weld removal, plate gouging and rivet removal.

| Item# | Tip Size | Type | Series | Pkg. Qty. |
|-------|----------|-----------|--------|-----------|
| 12564 | 0 | Acetylene | 1-118 | 1 |
| 12565 | 2 | Acetylene | 1-118 | 1 |
| 12566 | 4 | Acetylene | 1-118 | 1 |

VICTOR STYLE ACETYLENE WELDING NOZZLE

This is a complete Type W series assembly with mixer. Used for general purpose welding-and preheating.

| Item# | Tip Size | Type | Series | Pkg. Qty. |
|-------|----------|-----------|--------|-----------|
| 12567 | 000 | Acetylene | Type W | 1 |
| 12568 | 00 | Acetylene | Type W | 1 |
| 12569 | 0 | Acetylene | Type W | 1 |
| 12570 | 1 | Acetylene | Type W | 1 |
| 12571 | 2 | Acetylene | Type W | 1 |
| 12572 | 3 | Acetylene | Type W | 1 |
| 12573 | 4 | Acetylene | Type W | 1 |

TIPS/HEATING/ROSEBUDS/NOZZLES



12578

VICTOR STYLE CUTTING TIPS

Available in 2 types of tips. Both tips have a medium preheat and are used for general cutting. The Acetylene tip is a 3-101 series and the Propane/Natural Gas is a 3-GPN series.

| Item# | Tip Size | Type | Series | Pkg. Qty. |
|-------|----------|---------------------|--------|-----------|
| 12575 | 000 | Acetylene | 3-101 | 1 |
| 12576 | 00 | Acetylene | 3-101 | 1 |
| 12577 | 0 | Acetylene | 3-101 | 1 |
| 12578 | 1 | Acetylene | 3-101 | 1 |
| 12579 | 2 | Acetylene | 3-101 | 1 |
| 12580 | 3 | Acetylene | 3-101 | 1 |
| 12581 | 4 | Acetylene | 3-101 | 1 |
| 12582 | 5 | Acetylene | 3-101 | 1 |
| 12583 | 6 | Acetylene | 3-101 | 1 |
| 12585 | 00 | Propane/Natural Gas | 3-GPN | 1 |
| 12586 | 0 | Propane/Natural Gas | 3-GPN | 1 |
| 12587 | 1 | Propane/Natural Gas | 3-GPN | 1 |
| 12588 | 2 | Propane/Natural Gas | 3-GPN | 1 |
| 12589 | 3 | Propane/Natural Gas | 3-GPN | 1 |
| 12590 | 4 | Propane/Natural Gas | 3-GPN | 1 |



12591

VICTOR STYLE ACETYLENE WELDING TIPS

This elbow style, ET series tip replaces the W series. Used for general purpose welding and preheating.

| Item# | Tip Size | Type | Series | Pkg. Qty. |
|-------|----------|-----------|--------|-----------|
| 12591 | 000 | Acetylene | ET | 1 |
| 12592 | 00 | Acetylene | ET | 1 |
| 12593 | 0 | Acetylene | ET | 1 |
| 12594 | 1 | Acetylene | ET | 1 |
| 12595 | 2 | Acetylene | ET | 1 |
| 12596 | 3 | Acetylene | ET | 1 |



12600

VICTOR STYLE ACETYLENE WELDING NOZZLES

This W-1 series is complete with tip and mixer. Used for general purpose welding and preheating.

| Item# | Tip Size | Type | Series | Pkg. Qty. |
|-------|----------|-----------|--------|-----------|
| 12597 | 000 | Acetylene | W-1 | 1 |
| 12598 | 00 | Acetylene | W-1 | 1 |
| 12599 | 0 | Acetylene | W-1 | 1 |
| 12600 | 1 | Acetylene | W-1 | 1 |
| 12601 | 2 | Acetylene | W-1 | 1 |
| 12602 | 3 | Acetylene | W-1 | 1 |
| 12603 | 4 | Acetylene | W-1 | 1 |



12574

VICTOR STYLE ACETYLENE HEATING ROSEBUD ASSEMBLY

This heating rosebud assembly is a MFA series. Used for general purpose heating, bending and straightening.

| Item# | Tip Size | Type | Series | Pkg. Qty. |
|-------|----------|-----------|--------|-----------|
| 12574 | 8 | Acetylene | MFA | 1 |



12605

VICTOR STYLE ACETYLENE ROSEBUD

This rosebud assembly is a MFA-1 series. Used for general purpose heating, bending and straightening.

| Item# | Tip Size | Type | Series | Pkg. Qty. |
|-------|----------|-----------|--------|-----------|
| 12604 | 6 | Acetylene | MFA-1 | 1 |
| 12605 | 8 | Acetylene | MFA-1 | 1 |



TORCH LINERS/NOZZLES

MIG WELDER TORCH LINERS



12854

| Item No. | Style | Fits Marquette | Size. |
|----------|-------|--|--------|
| 12854 | Steel | M12205 M12206 M12207 M12209 M12210 | 15 Ft. |



12855

FIREPOWER MIG GUN NOZZLES

| Item# | Model No. | Size | Pkg. Qty. |
|-------------------------|-------------|--------------------|-----------|
| FOR 180 AMP GUNS | | | |
| 12855 | FP21-37 | 3/8" Bore | 1 |
| 12856 | FP21-50 | 1/2" Bore | 1 |
| 12857 | FP21-62 | 5/8" Bore | 1 |
| 12858 | FP21-62FAS | 5/8" Bore-Arc Spot | 1 |
| FOR 250 AMP GUNS | | | |
| 12866 | FP22-50 | 1/2" Bore | 1 |
| 12867 | FP22-62 | 5/8" Bore | 1 |
| 12868 | FP22-62FAS | 5/8" Bore-Arc Spot | 1 |
| FOR 400 AMP GUNS | | | |
| 12870 | FP24A-50 | 1/2" Bore | 1 |
| 12871 | FP24A-62 | 5/8" Bore | 1 |
| 12872 | FP24A-62FAS | 5/8" Bore-Arc Spot | 1 |

SPOT WELD NOZZLES



12859

| Item# | OEM | Fits Marquette | Size |
|-------|-------------|--|-------------|
| 12859 | Binzel | M12179 M12180 M12183 | 3/8" (16mm) |
| 12848 | Binzel | M12179 M12180 M12183 | 1/2" (12mm) |
| 12849 | Binzel | M12204 M12205 M12206 M12207 M12209 | 5/8" (16mm) |
| 12850 | Binzel | M12210 M12209 | 3/4" (20mm) |
| 12851 | Tweco | M12175 M12185 M121801 | 5/8" (16mm) |
| 12879 | MillerMatic | 185-M25 Torch | 1/2" (12mm) |
| 12880 | MillerMatic | 185-M15 Torch | 1/2" (12mm) |

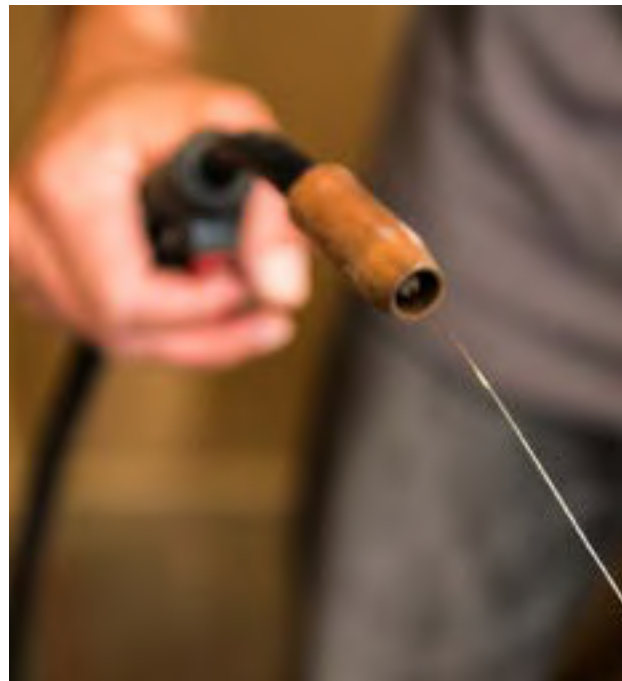

TIPS

MIG WELDER CONTACT TIPS

Solid copper tips thread into diffusers. Match the tip to the wire size. **All tips packaged in 10 per pack.**

BINZEL & TWECO STANDARD TIPS (10 PK)

For All Except M12210



12937

| Item# | Tip Size | Size/I.D. |
|-------|----------|-----------|
| 12937 | .023 | (.6mm) |
| 12938 | .030 | (.8mm) |
| 12939 | .035 | (.9mm) |
| 12940 | .040 | (1mm) |

BINZEL & TWECO HEAVY DUTY TIPS (10 PK)

For M12210



12941

| Item# | Tip Size | Size/I.D. |
|-------|----------|-----------|
| 12941 | .023 | (.6mm) |
| 12942 | .030 | (.8mm) |
| 12943 | .035 | (.9mm) |
| 12944 | .040 | (1mm) |

BERNARD STANDARD TIPS (10 PK)



12966

| Item# | Tip Size | Size/I.D. |
|-------|----------|-----------|
| 12964 | .023 | (.6mm) |
| 12965 | .030 | (.8mm) |
| 12966 | .035 | (.9mm) |

HOBART STANDARD TIPS (10 PK)



12967

| Item# | Tip Size | Size/I.D. |
|-------|----------|-----------|
| 12967 | .023 | (.6mm) |
| 12968 | .030 | (.8mm) |
| 12969 | .035 | (.9mm) |

LINCOLN STANDARD TIPS (10 PK)



12873

| Item# | Tip Size | Size/I.D. |
|-------|----------|-----------|
| 12873 | .023 | (.6mm) |
| 12874 | .030 | (.8mm) |
| 12875 | .035 | (.9mm) |

MILLER STANDARD TIPS (10 PK)



12877

| Item# | Tip Size | Size/I.D. |
|-------|----------|-----------|
| 12876 | .023 | (.6mm) |
| 12877 | .030 | (.8mm) |
| 12878 | .035 | (.9mm) |

FIREPOWER 180 AMP STANDARD TIPS (10 PK)

For All Except M12210



12976

| Item# | Tip Size | Size/I.D. |
|-------|----------|-----------|
| 12976 | .023 | (.031) |
| 12977 | .030 | (.038) |
| 12978 | .035 | (.044) |
| 12979 | .040 | (.048) |
| 12980 | .045 | (.054) |

250/400 AMP GUNS HEAVY DUTY TIPS (10 PK)

For M12210



12981

| Item# | Tip Size | Size/I.D. |
|-------|----------|-----------|
| 12981 | .023 | (.031) |
| 12982 | .030 | (.038) |
| 12983 | .035 | (.044) |
| 12984 | .040 | (.048) |
| 12985 | .045 | (.054) |



CARBIDE BURS

SHARK OFFERS A COMPLETE LINE OF CARBIDE BURS

- Mini Carbide Burs
- Mini Carbide Bur Kits
- Cross References to other Brands
- Attractive Boxes for Kits

ALUMA CUT



Aluma-Cut

Application:

Sometimes described as "Non-Ferrous" this bur is typically used on aluminum, plastics, brass, magnesium or lead.

Features:

Large flutes prevent loading of material or clogging up the flutes with the material you're removing.



16000

DOUBLE CUT



Double

Application:

Sometimes described as "Super Cut" use this bur for general purpose stock removal or deburring of cast iron, steel or other ferrous materials.

Features:

The cross-cut look to the bur acts like rows of teeth producing a fast stock removal as well as offering better control of the work. Excellent in most applications.

DIAMOND CUT



Diamond

Application:

Typical applications include steel or cast iron where extremely aggressive cutting action is required.

Features:

Deep cross-cut pattern is excellent in tire applications as well as many other uses when cutting extremely hard metals, etc.

MINI CARBIDE BURS WITH 1/8" SHANKS

9 PIECE MINI BUR SET

This 1/8" shank mini carbide bur kit comes with 9 of the most popular shapes to meet all your smaller cutting needs.



16016 / BTM

| Item# | Old# | IR# | Shape | Dia. Head | Flute Length | Cut |
|--------------|------------|------|------------------------|-----------|--------------|--------|
| 16016 | BTM | | 9 Piece Bur Kit | | | |
| 16020 | BTM-1 | SA51 | Cylinder | 1/4" | 1/2" | Double |
| 16021 | BTM-2 | SB51 | End Cut Cylinder | 1/4" | 3/16" | Double |
| 16019 | BTM-3 | SN51 | Inverted Cone | 1/4" | 1/4" | Double |
| 16025 | BTM-4 | SC51 | Rose Nose Cylinder | 1/4" | 1/2" | Double |
| 16026 | BTM-5 | SD51 | Ball | 1/4" | 3/16" | Double |
| 16023 | BTM-6 | SE51 | Oval | 1/4" | 3/8" | Double |
| 16018 | BTM-7 | SF51 | Tree Radius | 1/4" | 1/2" | Double |
| 16017 | BTM-8 | SG51 | Tree Pointed | 1/4" | 1/2" | Double |
| 16024 | BTM-9 | SM51 | Cone | 1/4" | 5/8" | Double |

CARBIDE BUR SETS

1/4" SHANK

These burs can be used to cut all types of steel, plastics, ferrous and machinable metals of all kinds. They are designed for use when deburring, removing metal, or enlarging holes and are for use with air tools and grinders. For best results do not put pressure on the burs. Always use protective eyewear when cutting with burs. All burs are double cut or aluma-cut as noted.

| Item# | Old# | Description | Pkg. Qty. |
|--------------|------------|--------------------------------------|-----------|
| 16014 | BT5 | 5 Piece Bur Set | |
| 16000 | BT14 | 1/4" Cylinder - Double Cut | 1 |
| 16004 | BT20 | 3/8" Ball Nose Cylinder - Double Cut | 1 |
| 16010 | BT40 | 3/8" Tree Radius - Aluma-Cut | 1 |
| 16011 | BT10 | 1/4" Tree Pointed - Double Cut | 1 |
| 16022 | BT27 | 1/2" Ball Nose Flame - Double Cut | 1 |



BT10, BT14, BT20, BT27, BT40
16014 / BT5

| Item# | Old# | Description | Pkg. Qty. |
|--------------|------------|--------------------------------------|-----------|
| 16015 | BT8 | 8 Piece Bur Set | |
| 16000 | BT14 | 1/4" Cylinder - Double Cut | 1 |
| 16004 | BT20 | 3/8" Ball Nose Cylinder - Double Cut | 1 |
| 16005 | BT21 | 1/2" Ball Nose Cylinder - Double Cut | 1 |
| 16007 | BT33 | 1/2" Ball - Aluma-Cut | 1 |
| 16010 | BT40 | 3/8" Tree Radius - Aluma-Cut | 1 |
| 16011 | BT10 | 1/4" Tree Pointed - Double Cut | 1 |
| 16012 | BT24 | 3/8" Tree Pointed - Double Cut | 1 |
| 16022 | BT27 | 1/2" Ball Nose Flame - Double Cut | 1 |



BT10, BT14, BT20, BT21, BT24, BT27, BT33, BT40
16015 / BT8

5-PIECE ALUMINUM BUR SET

| Item# | Old# | Description | Pkg. Qty. |
|--------------|-------------|--|-----------|
| 16027 | BT5A | 5 Piece Aluminum Bur Set | |
| 16031 | BT13 | 1/4" x 3/4" Cylinder Shape Diamond-Cut | 1 |
| 16007 | BT33 | 1/2" x 1/2" Ball Aluma-Cut | 1 |
| 16039 | BT35 | 1/2" x 1" Cylinder Shape Aluma-Cut | 1 |
| 16040 | BT36 | 1/2" x 7/8" Oval Aluma-Cut | 1 |
| 16010 | BT40 | 3/8" x 3/4" Tree Shaped Aluma-Cut | 1 |



BT13, BT33, BT35, BT36, BT40
16027 / BT5A



CARBIDE BURS 1/4" SHANK



BT9 BT10 BT24 BT48 BT68



BT50 BT22 BT23 BT40 BT41 BT49

TREE-SHAPED POINTED CARBIDE BURS

| Item# | Old# | IR# | Dia. | Flute Length | Overall Length | Cut |
|-------|------|---------|------|--------------|----------------|--------|
| 16028 | BT9 | IRSG-42 | 1/8" | 5/8" | 1 1/2" | Double |
| 16011 | BT10 | IRSG-1 | 1/4" | 5/8" | 2" | Double |
| 16012 | BT24 | IRSG-3 | 3/8" | 3/4" | 2 1/2" | Double |
| 16046 | BT48 | IRSG-5 | 1/2" | 1" | 2 3/4" | Double |
| 16076 | BT68 | IRSG-7 | 3/4" | 1" | 3" | Double |

TREE-SHAPED RADIUS CARBIDE BURS

| Item# | Old# | IR# | Dia. | Flute Length | Overall Length | Cut |
|-------|------|----------|------|--------------|----------------|-----------|
| 16008 | BT50 | IRSF-1 | 1/4" | 5/8" | 2" | Double |
| 16009 | BT22 | IRSF-3 | 3/8" | 3/4" | 2 1/2" | Double |
| 16034 | BT23 | IRSF-5 | 1/2" | 1" | 3" | Double |
| 16047 | BT49 | IRSF-1NF | 1/4" | 3/4" | 2" | Aluma-Cut |
| 16010 | BT40 | IRSF-3NF | 3/8" | 3/4" | 2 3/4" | Aluma-Cut |
| 16043 | BT41 | IRSF-5NF | 1/2" | 1" | 3" | Aluma-Cut |



BT52 BT25



BT26 BT27 BT28 BT54 BT55

CONE CARBIDE BURS

| Item# | Old# | IR# | Dia. | Flute Length | Overall Length | Cut |
|-------|------|--------|----------------|--------------|----------------|--------|
| 16049 | BT52 | IRSM-4 | 3/8" - 28 deg. | 3/4" | 2 3/4" | Double |
| 16035 | BT25 | IRSM-5 | 1/2" - 35 deg. | 7/8" | 2 3/4" | Double |

BALL NOSED CONE (FLAME) CARBIDE BURS

| Item# | Old# | IR# | Dia. | Flute Length | Overall Length | Cut |
|-------|------|----------|------|--------------|----------------|-----------|
| 16013 | BT26 | IRSL-2 | 3/8" | 1 1/16" | 3" | Double |
| 16022 | BT27 | IRSL-4 | 1/2" | 1 1/8" | 3" | Double |
| 16036 | BT28 | IRSF-6 | 5/8" | 1 5/16" | 3 1/4" | Double |
| 16068 | BT54 | IRSH-2NF | 3/8" | 3/4" | 2 1/2" | Aluma-Cut |
| 16069 | BT55 | IRSH-5NF | 1/2" | 1 1/4" | 3 1/4" | Aluma-Cut |

CARBIDE BURS 1/4" SHANK



BT11 BT13 BT14 BT15 BT16

CYLINDER-SHAPED CARBIDE BURS

| Item# | Old# | IR# | Dia. | Flute Length | Overall Length | Cut |
|-------|------|--------------|------|--------------|----------------|--------------|
| 16029 | BT11 | IRSA-1 LEC | 1/4" | 5/8" | 2" | Dble/End Cut |
| 16031 | BT13 | IRSA-1 LDia. | 1/4" | 3/4" | 2" | Diamond |
| 16000 | BT14 | IRSA-1L | 1/4" | 3/4" | 2" | Double |
| 16032 | BT15 | IRSA-1LD | 1/4" | 1" | 2" | Double |
| 16001 | BT16 | IRSA-3 | 3/8" | 3/4" | 2 3/4" | Double |
| 16002 | BT17 | IRSA-5 | 1/2" | 1" | 3" | Double |
| 16033 | BT18 | IRSA-6 | 5/8" | 1" | 3" | Double |
| 16072 | BT58 | IRSA-1NF | 1/4" | 3/4" | 1 3/4" | Aluma-Cut |
| 16042 | BT38 | IRSA-3NF | 3/8" | 3/4" | 2 3/4" | Aluma-Cut |
| 16039 | BT35 | IRSA-5NF | 1/2" | 1" | 3" | Aluma-Cut |
| 16041 | BT37 | IRSA-6NF | 5/8" | 1" | 3" | Aluma-Cut |



BT64 BT31 BT45 BT32 BT53 BT33

BALL CARBIDE BURS

| Item# | Old# | IR# | Dia. | Flute Length | Overall Length | Cut |
|-------|------|----------|-------|--------------|----------------|-----------|
| 16075 | BT64 | IRSD-1 | 1/4" | 7/32" | 2" | Double |
| 16006 | BT31 | IRSD-2 | 5/16" | 1/4" | 2 1/4" | Double |
| 16045 | BT45 | IRSD-3 | 3/8" | 5/16" | 2 5/16" | Double |
| 16038 | BT32 | IRSD-5 | 1/2" | 7/16" | 2 7/8" | Double |
| 16067 | BT53 | IRSD-3NF | 3/8" | 5/16" | 2 5/16" | Aluma-Cut |
| 16007 | BT33 | IRSC-5NF | 1/2" | 7/16" | 2 1/2" | Aluma-Cut |



BT12

CYLINDER-SHAPED ROUTER CARBIDE BUR

| Item# | Old# | IR# | Dia. | Flute Length | Overall Length | Cut |
|-------|------|---------|------|--------------|----------------|---------|
| 16030 | BT12 | IRSG-33 | 1/4" | 1" | 2 1/2" | Diamond |



BT19 BT20 BT21 BT57 BT42 BT56

BALL-NOSED CYLINDER CARBIDE BURS

| Item# | Old# | IR# | Dia. | Flute Length | Overall Length | Cut |
|-------|------|----------|------|--------------|----------------|-----------|
| 16003 | BT19 | IRSC-1 | 1/4" | 5/8" | 2 1/2" | Double |
| 16004 | BT20 | IRSC-3 | 3/8" | 3/4" | 2 3/4" | Double |
| 16005 | BT21 | IRSC-5 | 1/2" | 3/4" | 3" | Double |
| 16071 | BT57 | IRSC-1NF | 1/4" | 3/4" | 2" | Aluma-Cut |
| 16044 | BT42 | IRSC-3NF | 3/8" | 3/4" | 2 1/2" | Aluma-Cut |
| 16070 | BT56 | IRSC-5NF | 1/2" | 1" | 3" | Aluma-Cut |



BT59 BT29 BT36 BT63

OVAL SHAPED CARBIDE BURS

| Item# | Old# | IR# | Dia. | Flute Length | Overall Length | Cut |
|-------|------|----------|------|--------------|----------------|-----------|
| 16073 | BT59 | IRSE-3 | 3/8" | 5/8" | 2 5/8" | Double |
| 16037 | BT29 | IRSE-5 | 1/2" | 7/8" | 2 3/4" | Double |
| 16074 | BT63 | IRSE-3NF | 3/8" | 5/8" | 2 5/8" | Aluma-Cut |
| 16040 | BT36 | IRSE-5NF | 1/2" | 7/8" | 2 5/8" | Aluma-Cut |



EXTENDED CARBIDE BURS 1/4" SHANK

For applications where added length is required, these bur kits come with 6" extended burs in popular 4 or 6 piece kits; as well as a 4 piece all Aluminum Cutting kit.

Perfect for many applications, these burs come in Aluma-Cut or Double Cut.



16077



16088

16087

16086

16084

16085

16083

16082

16081

16080

EXTENDED CARBIDE BUR KITS

| Item# | Old# | Quantity | Description | Kit Includes |
|-------|------|----------|---------------------------|--|
| 16077 | BTE4 | 4 pieces | Extended Bur Kit | BT20E, BT22E, BT23E, BT32E |
| 16078 | BTE6 | 6 pieces | Extended Bur Kit | BT20E, BT21E, BT22E, BT23E, BT32E, BT43E |
| 16079 | BTA4 | 4 pieces | Aluminum Extended Bur Kit | BT33E, BT40E, BT41E, BT42E |

| Item# | Old# | Diameter | Shape | Description |
|-------|-------|----------|---------------------|--------------------|
| 16080 | BT20E | 3/8" | Cylinder/Radius End | Double Cut - 6" |
| 16081 | BT21E | 1/2" | Cylinder/Radius End | Double Cut - 6" |
| 16082 | BT22E | 3/8" | Tree Shaped | Double Cut - 6" |
| 16083 | BT23E | 1/2" | Tree Shaped Radius | Double Cut - 6" |
| 16084 | BT32E | 1/2" | Ball End | Double Cut - 6" |
| 16085 | BT33E | 1/2" | Ball End | Aluma-Cut - 6" |
| 16086 | BT40E | 3/8" | Tree Shaped | Aluma-Cut - 6 3/4" |
| 16087 | BT41E | 1/2" | Tree Shaped | Aluma-Cut - 7" |
| 16088 | BT42E | 3/8" | Cylinder/Radius End | Aluma-Cut - 6 3/4" |
| 16089 | BT43E | 3/8" | Ball End | Double-Cut - 6" |

GENERAL PURPOSE FILES / HIGH SPEED STEEL FILES

MULTIPLE USE GENERAL PURPOSE FILES

Multi-purpose files can be used for many different applications. Consisting of the most useful sizes, these are display packaged for ease of retail sale.

| Item# | Description | Pkg. Qty. |
|-------|---------------------------------|-----------|
| 16050 | 6" Mill Bastard | 1 |
| 16051 | 6" Half Round Bastard | 1 |
| 16052 | 6" Round Bastard | 1 |
| 16053 | 6" Slim Taper | 1 |
| 16054 | 6" Extra Slim Taper | 1 |
| 16055 | 8" Mill Bastard | 1 |
| 16056 | 8" Half Round Bastard | 1 |
| 16057 | 8" Round Bastard | 1 |
| 16058 | 8" Slim Taper | 1 |
| 16059 | 8" All Purpose File | 1 |
| 16060 | 8" x 7/32" Round Chain Saw File | 1 |
| 16061 | 8" x 3/16" Round Chain Saw File | 1 |
| 16062 | 10" Mill Bastard | 1 |
| 16063 | 12" Mill Bastard | 1 |



PLASTIC HANDLE FOR FILE

Replacement plastic handle for files. Comes with adaptors for different shaped files.

| Item# | Description | Pkg. Qty. |
|-------|---------------------|-----------|
| 16064 | For 6" - 8" Files | 1 |
| 16066 | For 10" - 12" Files | 1 |



16066

MULTI - PURPOSE ROTARY FILE SET

High quality steel tool set includes:

5 most popular shapes and sizes: Cylindrical, Round Tree, Ball, Ball Nose Cylinder and 14 Degree Angle Included. Shipped in a plastic reusable case.

Can be used in drill presses, lathes, air-operated hand tools, hand drills and flexible shaft equipment.

| Item# | Description | Pkg. Qty. |
|--------------|--|-----------|
| 12950 | Multi-purpose rotary file set includes: | 1 |
| 12952 | Round Tree | 1 |
| 12953 | Ball | 1 |
| 12954 | Ball Nose Cylinder | 1 |
| 12955 | 14 Degree Angle | 1 |
| 12957 | 1/2" Cylinder | 1 |



12950



HIGH SPEED STEEL FILES



ROTARY FILES

Mounted on 1/4" shanks, these files are made from high-speed steel for tough jobs. Most files are 1/2" diameter and can be used on bronze, mild steel, plastic and fiberglass.

| Item# | Shape | RPM | Pkg. Qty. |
|-------|-----------------------|-------|-----------|
| 12951 | 1/4" Cylindrical | 2,500 | 1 |
| 12952 | Round Tree | 2,500 | 1 |
| 12953 | Ball | 2,500 | 1 |
| 12954 | Cylindrical Ball Nose | 2,500 | 1 |
| 12955 | 14 Degree Angle | 2,500 | 1 |
| 12956 | Flame Rounded | 2,500 | 1 |
| 12957 | 1/2" Cylindrical | 2,500 | 1 |



ROTARY WOOD RASPS

1/4" shank wood rasps are perfect for hard to reach areas. Used for material removal.

| Item# | Shape | RPM | Pkg. Qty. |
|-------|------------------------|-------|-----------|
| 12959 | 3/8" Cylinder | 2,500 | 1 |
| 12960 | 1/4" Cylinder | 2,500 | 1 |
| 12961 | Round Nose Cylindrical | 2,500 | 1 |
| 12962 | Ball | 2,500 | 1 |
| 12963 | 14 Degree Taper | 2,500 | 1 |

TUBE BRUSHES

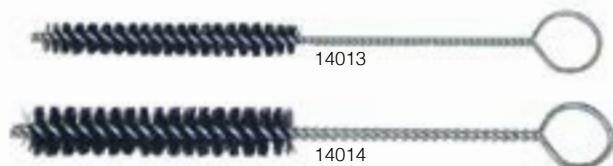

TUBE BRISTLE BRUSHES

Firm bristle brush is 8 1/2" long with 1/2" and 3/4" diameter x 3" nylon bristles. Used for cleaning carburetors, brake cylinders and bottles.

| Item# | Description |
|-------|---------------|
| 14013 | 1/2" Diameter |
| 14014 | 3/4" Diameter |

SPRAY GUN CLEANING BRUSHES

| Item# | Description |
|-------|---|
| 13992 | 3 Piece Brush Assortment Includes: |
| 13993 | Fluid Tube Brush |
| 14014 | External Cleaning Brush |
| 14013 | Spray Gun Body Brush |

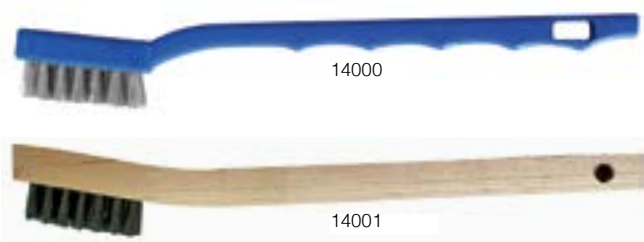

STAINLESS STEEL TOOTH BRUSHES

| Item# | Description |
|-------|---|
| 14000 | This compact style brush has a plastic 7 1/4" handle and is rustproof. Use for aggressive cleaning action (3 x 7 rows). |
| 14001 | This wooden handle brush has stainless steel bristles and a 7 3/4" handle. Used for aluminum welding clean-up (3 x 7 rows). |

STAINLESS & BRASS TINNING BRUSHES

These brushes have a 3/8" x 2 1/2" bristle area and a 8 3/4" handle (2 x 9 row). Great for general cleaning.

| Item# | Description |
|-------|-----------------------------|
| 14002 | Stainless 8 3/4" x 2x9 rows |
| 14003 | Brass 8 3/4" x 2x9 rows |



COMPACT BRASS SCRATCH BRUSHES

Brass bristled brushes for use on non-ferrous materials. 7 1/4" (3 x 7 rows). Great for general cleaning.

| Item# | Description |
|-------|--------------------------------|
| 14004 | Brass/Wooden Handle/Aggressive |
| 14005 | Brass/Plastic Handle/Gentle |

NEW! ANGLED APPLICATOR BRUSH

This brush is angled to allow easy access to the "toe area" of the bead most commonly damaged during mounting. (Equivalent to the Hunter RP6-1506.)

| Item# | Description |
|-------|-------------------------------------|
| 15218 | Mounting Paste Brush, Wooden Handle |



WIRE BRUSHES



14019



14021



14022



14020

WIRE SOLVENT BRUSHES

| Item# | Description |
|-------|---|
| 14019 | 5 1/2" long and 1 1/4" wide. Long, wire bristle brush is resistant to solvents where firm bristles are needed. |
| 14021 | Parts Cleaning Brush 10 1/2" Length |
| 14022 | Deluxe Cleaning Brush 11 1/2" Length |

CHIPPING HAMMER REPLACEMENT WIRE BRUSH

| Item# | Size |
|-------|---------------|
| 14020 | 4 3/4" x 3/4" |



14023



14017

WIRE PARTS CLEANING BRUSH

A wire bristled premium parts cleaning brush with aggressive cleaning action that helps to remove cleaning gasket material and varnish.

| Item# | Description |
|-------|-------------------------------|
| 14023 | 9" Long x 1" Bristle Diameter |

PLASTIC HANDLED FITTING BRUSHES

For cleaning copper fittings or plumbing joints prior to soldering. Also effective on corrosive battery cable terminals.

| Item# | Size |
|-------|---------------|
| 14017 | 1/2" x 6 1/2" |
| 14018 | 3/4" x 6 1/2" |

END BRUSHES

1/4" SHAFT

For use with a 1/4" diameter air or electric tool, these brushes can get into hard to reach locations. Use on rubber or plastic, rust, weld cleaning, scale removal etc.



14073

14070

| Item# | Old# | Size | Style | Wire | RPM |
|-------|-----------|--------|---------|------|--------|
| 708E | | 1" | Crimped | .014 | 22,000 |
| 709E | | 3/4" | Crimped | .006 | 22,000 |
| 720E | | 1/2" | Crimped | .006 | 22,000 |
| 14024 | 711E (SS) | 1" | Crimped | .020 | 20,000 |
| 14070 | 713E | 3/4" | Crimped | .020 | 20,000 |
| 14071 | 710E | 1" | Crimped | .020 | 20,000 |
| 13988 | (SS) | 1" | Knotted | .020 | 20,000 |
| 14072 | 711F | 3/4" | Knotted | .020 | 20,000 |
| 14073 | 718E | 1" | Knotted | .020 | 20,000 |
| 719E | | 1" | Knotted | .014 | 20,000 |
| 14074 | 714E (SS) | 1 1/4" | Knotted | .020 | 20,000 |

WIRE BRUSHES



SCRATCH BRUSHES

These brushes have tempered steel, stainless steel, or brass bristles, with a 1/2" x 5" bristle area, and a 4 1/2" plastic handle. 10 1/4" overall length. Great for general cleaning.

| Item# | Description |
|-------|------------------------------|
| 14098 | Red Handle/Steel |
| 14099 | Yellow Handle/Brass |
| 14141 | Green Handle/Stainless Steel |



LONG HANDLE "V" BRUSH

The "V" bristle shape of this 13 1/2" 3x14 row brush makes it perfect for corners and other areas after welding. Extremely heavy duty paint/rust removal brush with hundreds of strong bristles.

| Item# | Description |
|-------|---|
| 17005 | Wooden Handled "V" Brush For Channel Cleaning and Welding Applications in tight corners |



LONG HANDLE SCRATCH BRUSHES

These are extremely heavy duty paint/rust removal brushes with hundreds of strong bristles imbedded in the handles. Bristle Options.

| Item# | Description | Rows |
|-------|-------------------------------------|--------|
| 14040 | Long Handled Bow Shape Carbon Steel | 4 x 19 |
| 14006 | Long Handled Carbon | 3 x 19 |
| 14007 | Long Handled Carbon w/Scraper | 3 x 19 |
| 14008 | Long Handled Brass | 3 x 19 |
| 14009 | Long Handled Stainless Steel | 3 x 19 |
| 14010 | Shoe Handled Carbon Steel | 4 x 16 |
| 14011 | Shoe Handled Brass | 4 x 16 |
| 14012 | Shoe Handled Stainless Steel | 4 x 16 |
| 13999 | Plastic Handled Carbon Steel | 3 x 19 |



ACID BRUSHES

Available in two sizes and used for the application of solder flux to work area.

| Item# | Description | Pkg. Qty. |
|-------|--------------------------|-------------|
| 14025 | 3/8" | 3 per Pk. |
| 14026 | 1/2" | 3 per Pk. |
| 14069 | 2- 14025 and 1-14026 Kit | 3 per Pk. |
| 13997 | 3/8" | 144 per Pk. |
| 13998 | 1/2" | 144 per Pk. |

NEW! HEAVY DUTY WIRE BRUSHES



14165



14170



14171



14172

3" - 10" POWER BRUSHES

These brushes provide heavy-duty brushing action with some flexibility; and are ideal for demanding cleaning applications on somewhat irregular surfaces.

| Item# | Weiler# | Style | Size | Width/ Face | Arbor | Fill Wire | Wire Dia. | Trim Length | RPM |
|-------|---------|------------------|--------|----------------|-------------|-----------|--------------|----------------|--------|
| 14165 | 08014 | Twist Knot | 3" | 3/8" | 1/2" - 3/8" | Steel | 0.014 | 5/8" | 25,000 |
| 14182 | 17682 | Mounted Knot | 3 1/4" | 3/8" | 1/4" Shank | Steel | 0.020 | 5/8" | 25,000 |
| 14170 | 17681 | Mounted Knot | 3 1/4" | 3/8" | 1/4" Shank | Steel | 0.014 | 5/8" | 25,000 |
| 14175 | 08064 | Twist Knot | 4" | 1/2" | 1/2" - 3/8" | Steel | 0.020 | 7/8" | 20,000 |
| 14176 | 08534 | Cable Twist Knot | 4" | 1/4" | 1/2" - 3/8" | Steel | 0.020 | 7/8" | 20,000 |
| 14173 | 13120 | Twist Knot | 4" | 1/2" | 5/8"-11 | Steel | 0.020 | 7/8" | 20,000 |
| 14172 | 08044 | Twist Knot | 4" | 1/2" | 1/2" - 3/8" | Steel | 0.014 | 7/8" | 20,000 |
| 14171 | 08034 | Twist Knot | 4" | 1/2" | 1/2" - 3/8" | Steel | 0.0118 | 7/8" | 20,000 |
| 14179 | 94008 | Cable Twist Knot | 10" | 1 3/4" | 2" | Steel | 0.023 | 1 3/4" | 4,500 |

2" - 3" POWER CRIMPED WHEELS

Identifiable by their copper center, these small diameter crimped wire wheels feature a plain arbor hole for use on a variety of portable tools and stationary machines. Featuring solid ring construction for high-speed use.



14161



14163

| Item# | Weiler# | Style | Size | Width/ Face | Arbor | Fill Wire | Wire Dia. | Trim Length | RPM |
|-------|---------|---------|------|----------------|-------------|-----------|--------------|----------------|--------|
| 14160 | 15463 | Crimped | 2" | 3/8" | 1/2" - 3/8" | Steel | 0.0118 | 1/2" | 20,000 |
| 14162 | 15533 | Crimped | 3" | 5/8" | 1/2" | Steel | 0.006 | 1" | 20,000 |
| 14163 | 15543 | Crimped | 3" | 5/8" | 1/2" - 3/8" | Steel | 0.008 | 1" | 20,000 |
| 14161 | 15563 | Crimped | 3" | 5/8" | 1/2" - 3/8" | Steel | 0.0118 | 1" | 20,000 |

CRIMPED ENCAPSULATED WIRE WHEELS

Elastomer gradually wears exposing consistent short trim for maximum aggression and long life.



14164



14181

| Item# | Weiler# | Style | Size | Width/ Face | Arbor | Fill Wire | Wire Dia. | Trim Length | RPM |
|-------|---------|--------------|------|----------------|-------|-----------|--------------|----------------|--------|
| 14164 | 35250 | Encapsulated | 3" | 1/4" | 1/2" | Steel | 0.0118 | 1" | 20,000 |
| 14181 | 35260 | Encapsulated | 3" | 1/4" | 1/2" | Steel | 0.014 | 1" | 20,000 |

NEW! HEAVY DUTY WIRE BRUSHES

KNOTTED END AND POWER BRUSHES

Features a hollow end and heavy-duty brushing action with some flexibility; ideal for more demanding cleaning applications in recessed areas.



14174

14178

| Item# | Weiler# | Style | Size | Arbor | Fill Wire | Wire Dia. | Trim Length | RPM |
|-------|---------|-----------------------------------|--------|--------------|-----------|-----------|-------------|--------|
| 14178 | 10212 | Knotted End Brush | 1 1/8" | 1/4" Shank | Steel | 0.0104 | 1 1/8" | 20,000 |
| 14185 | 10028 | Knotted End Brush | 1 1/8" | 1/4" Shank | Steel | 0.020 | 7/8" | 22,000 |
| 14174 | 13156 | Single Row Knotted Wire Cup Brush | 3 1/2" | 5/8"-11NC | Steel | 0.023 | 7/8" | 13,000 |
| 14177 | 13153 | Single Row Knotted Wire Cup Brush | 3 1/2" | 3/8"- 24 UNF | Steel | 0.023 | 7/8" | 13,000 |

SCRATCH BRUSH

Common applications include cleaning dirt, rust, scale, chips and paint, as well as plating and welding operations.



14159

| Item# | Weiler# | Style | Size | Width/Face | Rows | Fill Wire | Wire Dia. | Trim Length |
|-------|---------|---------------|--------|------------|-------|-----------------|-----------|-------------|
| 14159 | 44075 | Scratch Brush | 7 1/2" | 1/2" | 3 x 7 | Stainless Steel | 0.006 | 1/2" |

TUBE BRUSHES

For internal cleaning and deburring of copper tube fittings.

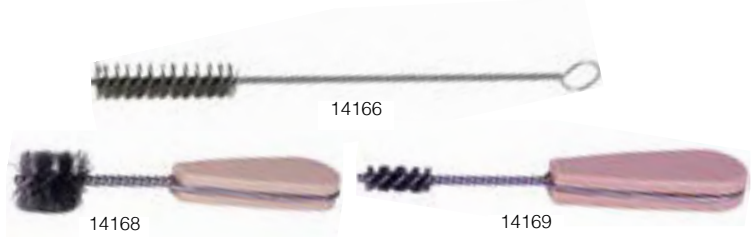

14166

14168

14169

| Item# | Weiler# | Style | Diameter | Length | Fill Wire | Trim Length | Brush Length |
|-------|---------|------------|----------|--------|-----------|-------------|--------------|
| 14168 | 44081 | Tube Brush | 5/8" | 6 1/2" | Steel | | 1" |
| 14169 | 44080 | Tube Brush | 1/2" | 6 1/2" | Steel | | 1" |
| 14180 | 44082 | Tube Brush | 3/4" | 6 1/2" | Steel | | 1" |
| 14166 | 21096 | Tube Brush | 1/2" | 8" | Steel | .004" | 2" |



14183

TIRE CLEANING BRUSHES

Features protective bumpers, foam blocks and handle holes.

| Item# | Weiler# | Style | Rows | Fill Wire | Wire Dia. | Length |
|-------|---------|---------------|-------|-----------|-----------|--------|
| 14183 | 99593 | Tire Cleaning | 8 x 9 | Brass | .008 | 8 1/2" |



CIRCULAR AND CUP WIRE BRUSHES

1/4" HEX SHAFT

A general purpose brush with 1/4" hex shaft used with electric drills. Brushes have many applications around the shop and home environments. Coarse brushes are .012" wire and fine brushes are .008".

| Item# | Diameter | Style | Wire | Description | Shank |
|-------|----------|---------------------|------|-------------|----------|
| 13962 | 1" | End Brush/Crimped | .012 | Coarse | 1/4" Hex |
| 13963 | 1" | End Brush/Crimped | .008 | Fine | 1/4" Hex |
| 13964 | 1 1/2" | Crimped-Round | .012 | Coarse | 1/4" Hex |
| 13965 | 1 1/2" | Crimped-Round | .008 | Fine | 1/4" Hex |
| 13966 | 2" | Crimped-Round | .012 | Coarse | 1/4" Hex |
| 13967 | 2" | Crimped-Round | .008 | Fine | 1/4" Hex |
| 13968 | 2 1/2" | Crimped-Round | .012 | Coarse | 1/4" Hex |
| 13969 | 2 1/2" | Crimped-Round | .008 | Fine | 1/4" Hex |
| 13970 | 3" | Crimped-Round | .012 | Coarse | 1/4" Hex |
| 13971 | 3" | Crimped-Round | .008 | Fine | 1/4" Hex |
| 13972 | 4" | Crimped-Round | .012 | Coarse | 1/4" Hex |
| 13973 | 4" | Crimped-Round | .008 | Fine | 1/4" Hex |
| 13974 | 2" | Crimped Cup on Stem | .012 | Coarse | 1/4" Hex |
| 13975 | 2" | Crimped Cup on Stem | .008 | Fine | 1/4" Hex |
| 13976 | 3" | Crimped Cup on Stem | .012 | Coarse | 1/4" Hex |
| 13977 | 3" | Crimped Cup on Stem | .008 | Fine | 1/4" Hex |



13962



13971



13975

CIRCULAR AND CUP WIRE BRUSHES

1/4" SHAFT

A general purpose brush used with electric drills. Brushes have many applications around the shop and home environments. Coarse brushes are .020" wire and fine brushes are .014".

| Item# | Old# | Size | Style | Wire | Description | RPM |
|-------|-------|--------|---------------------|------|-------------|--------|
| 712E | | 1 1/4" | Crimped Cup on Stem | .014 | Fine | 13,000 |
| 14027 | 715F | 1 1/2" | Crimped-Round | .020 | Coarse | 6,000 |
| 14028 | 720F | 2" | Crimped-Round | .020 | Coarse | 6,000 |
| 14029 | 725F | 2 1/2" | Crimped-Round | .020 | Coarse | 6,000 |
| 14030 | 730F | 3" | Crimped-Round | .020 | Coarse | 6,000 |
| 14031 | 730SF | 3" | Crimped-Round | .014 | Fine | 4,500 |
| 14032 | 740SF | 4" | Crimped-Round | .014 | Fine | 15,000 |
| 14095 | 715E | 1 1/2" | Crimped Cup on Stem | .020 | Coarse | 13,000 |
| 14096 | 721E | 2 1/2" | Crimped Cup on Stem | .020 | Coarse | 4,500 |
| 14097 | 722E | 2 1/2" | Crimped Cup on Stem | .014 | Fine | 4,500 |



14028



14095

CIRCULAR CRIMPED WHEELS

Choose between a 3" or 4" diameter with a 1/2" arbor .008" wire

| Item# | Size | RPM |
|-------|------|-------|
| 14034 | 3" | 4,500 |
| 14035 | 4" | 4,500 |



14034

CRIMPED WIRE/KNOTTED CUP BRUSHES



14033

CRIMPED WIRE TIRE BRUSHES

Heavy duty 3" diameter cup brush for rim/hub cleaning. .016" Brass coated wire.

| Item# | Size | Arbor | Wire | RPM |
|-------|------|----------------|------|--------|
| 14033 | 3" | 1/4" Hex Shank | .016 | 10,000 |



14077

CRIMPED WIRE CUP BRUSHES

For use in cleaning metal parts and hard surfaces in hard to reach places. Use with angle grinders. Always follow correct speed ratings.

| Item# | Old# | Size | Arbor | Wire | RPM |
|-------|------|------|------------|------|--------|
| 14075 | 735C | 3" | 1/2"-13 | .014 | 12,500 |
| 14076 | 730C | 3" | 5/8-11NC | .014 | 12,500 |
| 14077 | 723C | 3" | M10 x 1.25 | .020 | 12,500 |
| 14078 | 725C | 3" | M10 x 1.50 | .014 | 12,500 |
| 14079 | | 3" | M14 x 2.0 | .014 | 12,500 |
| 14080 | 740C | 4" | 5/8-11NC | .014 | 9,000 |
| 14081 | 750C | 5" | 5/8-11NC | .020 | 6,600 |
| 14082 | 760C | 6" | 5/8-11NC | .020 | 6,500 |



13995



13996

MINI KNOTTED WIRE BRUSHES

Mini Knotted Circular Wire brush with 1/4" Mandrel.

| Item# | Size | Wire | RPM |
|-------|------|------|--------|
| 13995 | 2" | .020 | 7,500 |
| 13996 | 3" | .020 | 12,500 |



14043



14038

SINGLE ROW KNOTTED CUP BRUSHES

Available with standard or metric arbor sizes in various diameters. Use for general cleaning, welding and removal of paint and rust. Use with angle grinders.

| Item# | Old# | Size | Arbor | Wire | RPM |
|-------|-----------------|------|------------|------|--------|
| 14041 | 723K | 3" | 1/2"-13 | .020 | 12,500 |
| 14042 | 730K | 3" | 5/8-11NC | .014 | 12,500 |
| 14043 | 722K | 3" | 5/8-11NC | .020 | 12,500 |
| 13991 | Stainless Steel | 3" | 5/8-11NC | .014 | 12,500 |
| 14044 | 724K | 3" | M10 x 1.25 | .020 | 12,500 |
| 14045 | 725K | 3" | M10 x 1.50 | .014 | 12,500 |
| 14046 | | 3" | M14 -2.0 | .020 | 12,500 |
| 14038 | Carbon Wire | 3.5" | 5/8-11NC | .020 | 13,000 |
| 14047 | 740K | 4" | 5/8-11NC | .020 | 9,000 |
| 13989 | Stainless Steel | 4" | 5/8-11NC | .020 | 9,000 |
| 14048 | 760K | 6" | 5/8-11NC | .020 | 6,500 |
| 13990 | Stainless Steel | 6" | 5/8-11NC | .020 | 6,500 |

DOUBLE ROW KNOTTED WIRE CUP BRUSHES

Extremely durable and aggressive. Use with an appropriate size angle grinder.



14049

| Item# | Old# | Size | Arbor | Wire | RPM |
|-------|------|------|----------|------|-------|
| 14049 | | 4" | 5/8-11NC | .014 | 9,000 |
| 14050 | | 5" | 5/8-11NC | .014 | 7,000 |
| 14051 | | 6" | 5/8-11NC | .014 | 6,500 |



13979

ENCAPSULATED WIRE WHEELS

3" Plastic encapsulated wire wheel on 1/4" Mandrel

| Item# | Description | Size | RPM |
|-------|---------------|------|-------|
| 13961 | Hex Mandrel | 3" | 4,500 |
| 13979 | Round Mandrel | 3" | 4,500 |



WIRE WHEEL BRUSHES

CRIMPED WIRE WHEELS

Choose from 4" to 10" diameters with .014" wire size.

| Item# | Old# | Size | Arbor | RPM |
|-------|------|-----------------|-------------|--------|
| 14052 | | 4" | 5/8-11NC | 8,500 |
| 14053 | | 4" | M10-1.25 | 12,500 |
| 14054 | | 4" | M10-1.50 | 12,500 |
| 14056 | | 4" | M14-2.0 | 12,500 |
| 14057 | 762S | 6" Narrow Width | 1/2" - 5/8" | 6,000 |
| 14058 | 767S | 6" Medium Width | 1/2" - 5/8" | 6,000 |
| 777S | | 7" | 1/2" - 5/8" | 6,000 |
| 14059 | 780S | 8" | 1/2" - 5/8" | 4,500 |
| 14140 | | 10" | 1 1/4" | 3,600 |



14058

TWIST KNOTTED WIRE WHEEL BRUSHES

These brushes are available with standard center thread sizes with a width of 5/16" and .020 wire. Use on hard materials for general purpose cleaning and polishing.

| Item# | Old# | Size | Wire | Wire Type | Arbor | RPM |
|-------|------|--------|------|-----------|----------|--------|
| 14064 | 743S | 4" | .020 | Steel | 5/8-11NC | 20,000 |
| 14065 | | 4" | .020 | SS | 5/8-11NC | 20,000 |
| 13980 | | 4 1/2" | .020 | Steel | 5/8-11NC | 12,500 |
| 13981 | | 4 1/2" | .020 | SS | 5/8-11NC | 12,500 |
| 14130 | | 5" | .020 | Steel | 5/8-11NC | 12,500 |
| 14134 | | 5" | .020 | SS | 5/8-11NC | 12,500 |
| 14066 | | 6" | .020 | Steel | 5/8-11NC | 9,000 |
| 14067 | | 6" | .020 | SS | 5/8-11NC | 9,000 |
| 13982 | | 7" | .020 | Steel | 5/8-11NC | 9,000 |
| 13983 | | 7" | .020 | SS | 5/8-11NC | 9,000 |



14064

KNOTTED WIRE WHEEL BRUSHES WITH ADAPTORS

These brushes are available with standard or metric center thread sizes with a width of 5/16" and .014 to .020 wire. Use on hard materials for general purpose cleaning and polishing.

| Item# | Old# | Size | Wire | Style | Arbor | RPM |
|-------|------|---------------|------|------------|------------|--------|
| 14060 | 748S | 4" | .014 | Knotted | 1/2"-3/8" | 20,000 |
| 14061 | | 4" | .014 | Knotted | M10-1.25 | 20,000 |
| 14062 | | 4" | .014 | Knotted | M10-1.50 | 20,000 |
| 14063 | | 4" | .014 | Knotted | M14-2.0 | 20,000 |
| 14068 | | 6" | .020 | Knotted | 5/8"-1/2" | 9,000 |
| 760S | | 6" Full Cable | .014 | Full Cable | 1/2", 5/8" | 6,000 |
| 787S | | 8" | .014 | Knotted | 1/2", 5/8" | 9,000 |



14068

STRINGER BEAD TWIST WIRE WHEEL BRUSHES

These brushes are available with standard or metric arbor sizes and .020" heavy duty wire. Used for aggressive cleaning.

| Item# | Old# | Size | Wire | Wire Type | Arbor | RPM |
|-------|------|--------|------|-----------|-----------|--------|
| 13984 | | 4 1/2" | .020 | Steel | 5/8-11NC | 12,500 |
| 13985 | | 4 1/2" | .020 | SS | 5/8-11NC | 12,500 |
| 13986 | | 7" | .020 | Steel | 5/8-11NC | 9,000 |
| 13987 | | 7" | .020 | SS | 5/8-11NC | 9,000 |
| 14083 | | 4" | .020 | Steel | 1/2" - 13 | 20,000 |
| 14084 | 744S | 4" | .020 | Steel | 5/8-11NC | 20,000 |
| 14085 | | 4" | .020 | SS | 5/8-11NC | 20,000 |
| 14086 | | 4" | .020 | Steel | M10 -1.25 | 20,000 |
| 14087 | | 4" | .020 | Steel | M10 -1.25 | 20,000 |
| 14088 | | 4" | .020 | Steel | M14 -2.0 | 9,000 |
| 14089 | | 5" | .020 | Steel | 5/8-11NC | 12,500 |
| 14138 | | 5" | .020 | SS | 5/8-11NC | 12,500 |
| 14128 | 745S | 6" | .020 | Steel | 5/8-11NC | 9,000 |
| 14139 | | 6" | .020 | SS | 5/8-11NC | 9,000 |



14083

LUG BRUSH/ARBOR ADAPTORS



14155

CABLE LUG CLEANING BRUSH

This brush will clean an I.D. of 1/2", 5/8" and 7/8" fittings. It will also do an O.D. of 1/2", 5/8" and 7/8" tubing. This brush is great for cleaning rust off battery terminals. Use it to clean and scratch the ID of tubing in plumbing and building applications.

| Item# | Description | Length |
|-------|-----------------------------|-------------|
| 14155 | Double sided cleaning brush | 7 3/4" Long |



14093

ADAPTOR NUTS

Nuts adapt 5/8 - 11 arbor brushes to fit M10-1.25 and 1.50 high speed grinder spindles.

| Item# | OD Size | I.D. Size |
|-------|-----------|--------------|
| 14093 | 5/8-11 NC | M10 - 1.25 |
| 14094 | 5/8-11 NC | M10 - 1.50 |
| 14129 | 5/8-11 NC | 3/8" - 24 NF |



14090

14136

ARBOR ADAPTORS

These adaptors are available with various arbor sizes and a 2" outside diameter with plain hole centers. Use for mounting wire wheels to bench grinders.

| Item# | Description | Size |
|-------|------------------------------------|------|
| 14090 | Set of 2 | 1/2" |
| 14091 | Set of 2 | 5/8" |
| 14092 | Set of 2 | 3/4" |
| 14136 | Adaptor Kit For 3/4" thick wheels* | |

* The adaptor kit will start with a 2" hole on your wire wheel and adapt it from 1/2"-5/8"-3/4"-1". Kit includes center telescoping adaptors and 2 arbor rings.



AUTO BODY TOOLS



18061

4" AUTO BODY PIN STRIPE ERASER

Quick, effective removal of pin striping without paint damage! Has an effective spoke design, and is available with mandrel and eraser only for added cost savings.

4" Diameter x 11/16" thick.

| Item# | Description |
|-------|--|
| 18060 | Eraser only |
| 18061 | Eraser and Mandrel with threaded adaptor |
| 18062 | Mandrel Only |



60

ALL PURPOSE SCRAPER

3-Position multi-use scraper is ideal for Sticker and Decal removal.

| Item# | Description |
|-------|---------------------|
| 60 | All Purpose Scraper |



61

RETRACTABLE SCRAPER

Retractable blade for ease and portability

| Item# | Description |
|-------|---------------------|
| 61 | Retractable scraper |



65

RAZOR BLADES

A box of 100 American Made Razor Blades for all your needs. A must for every body shop!

| Item# | Description |
|-------|--------------------------|
| 65 | Pack of 100 razor blades |
| 65-10 | Pack of 10 razor blades |



66

PLASTIC RAZOR BLADES

For use on GM cars with plastic coated windows. Also used for oversprays and wherever any painted surface needs to be cleaned.

| Item# | Description |
|--------|---------------------------|
| 66 | 10 pack of plastic blades |
| 66-100 | 100 box of plastic blades |



66H

RETRACTABLE SCRAPER WITH 3 PLASTIC BLADES

The above plastic blades combined with our most popular scraper.

| Item# | Description |
|-------|---|
| 66H | Retractable Scraper with 3 plastic blades |

UNIVERSAL MOLDING RELEASE TOOL

Used in cemented and rear windshields.

| Item# | Description |
|-------|--------------------------------|
| 51 | Universal Molding Release Tool |



51

TRIM PAD REMOVING TOOL

Facilitates removal of plastic trim pad fasteners without damaging the fastener or the backboard.

| Item# | Description |
|-------|------------------------|
| 52 | Trim Pad Removing Tool |



52

DOOR HANDLE CLIP TOOL

For door handles and window regulator clips. Eliminates upholstery damage.

| Item# | Description |
|-------|-----------------------|
| 53 | Door Handle Clip Tool |



53

DOOR AND WINDOW HANDLE CLIP TOOLS

Reversible tool handles all GM cars, as well as most foreign.

| Item# | Description |
|-------|-----------------------------------|
| 54 | Door and Window Handle Clip Tools |



54

STUBBY BODY PANEL 1/8" DRILL BITS

High Speed Steel drill bits for use on sheet metal. 135 degree split point for fast drilling without center punching.

| Item# | Description |
|-------|---|
| 76 | Pouch of 12 - 1/8" Double Ended Bits |
| 15216 | Pouch of 12 - 3/16" Double Ended Drill Bits |
| 15217 | Pouch of 12 - 1/4" Double Ended Drill Bits |



76

3/8" DOUBLE ENDED SPOT WELD CUTTER

Removes spot welds without damage to underlying panels. Invaluable to auto body restoration.

| Item# | Description |
|-------|--|
| 10060 | 3/8" Double Ended Cutter with Special Tip Design |
| 10059 | 3/8" Double Ended Replacement Cutter |



10060



10059



AUTO BODY TOOLS

SHARK PISTOL VAC

Turns any Shop Air into a powerful Vacuum Cleaner or Air Cleaning Gun!

Designed for high powered industrial vacuum cleaning with air pressure, the Pistol Vac connects to your air line and can be used in many applications in the vacuum mode or blow mode.

Vacuum Cleaning Power with Shop-Air!

- Out performs inexpensive imports
- Dust bag and Crevice Tool included
- No electrical connection needed
- Fits many PBE applications
- Easy and Convenient to use
- Simple construction is maintenance free
- Inexpensive and quiet

| Item# | Description |
|-------|--|
| 64000 | Pistol Vac w/ Bag and Crevice Tool |
| 64001 | Crevice Tool |
| 64002 | Vacuum Bag |
| 64003 | 3' Hose Section |
| 64004 | 8' Hose Section |
| 64005 | Brush |
| 64006 | 20" Extension Tube |
| 64007 | 2" Diameter Fitting for Steel Drum |
| 64008 | Replacement Trigger |
| S3660 | Shark Quick Spray Tip with 6' Vinyl Hose |
| S3665 | Tip Alone |
| S3670 | 6' Vinyl Hose |



Picks up:

- Glass
- Sawdust
- Metal Chips
- Dust Spills



Works with all Vacula, Snap-on, Mac, Matco, Shark and NAPA type blow guns!

ALUMINUM BLENDING HAMMER

- Lightweight aluminum hammer is suitable for dent removal of aluminum body repairs
- Four interchangeable Polyoxymethylene tips, stored inside the handle, are available for different applications

| Item# | Description |
|--------------|---|
| 13284 | Aluminum Blending Hammer with 4 POM Tips |
| 13285 | Aluminum Blending Hammer (no tips) |
| 13286 | Ball Tip |
| 13287 | Mushroom Head |
| 13288 | Blunt Tip |
| 13289 | Sharp tip |



NEW! SPOT WELD DRILL BITS

Our new Spot Weld Drill Bits are made of tungsten carbide and designed to penetrate high strength steels such as boron. It's triple fluted bit with it's friction-free coating spreads the torque over a greater surface area.

| Item# | Description |
|-------|---------------------------------|
| 10995 | 10 mm Flat Spot Weld Drill Bit |
| 10996 | 10 mm Round Spot Weld Drill Bit |
| 10997 | 6.7 mm Spot Weld Drill Bit |



Use with DF-15 Spot Annihilator* & Other Spot Drills!

* Not sold at Shark.

STANDARD BLOW GUNS

- Insulated Grip with Comfortable Design
- An assortment of sizes in outlet tubes
- A wide variety of safety conscious, interchangeable nozzles
- Infinite variable flow control
- Multi-use as well as fluid dispensing
- OSHA approved tips

| Item# | Description |
|--------|------------------------------------|
| S1050A | Full Flow Blow Gun |
| S1060A | Full Flow Blow Gun with Rubber Tip |
| S1150A | 13" Full Flow Blow Gun |
| S1250A | 20" Full Flow Blow Gun |



RUBBER TIP FOR SPECIAL APPLICATIONS

Non-scratching rubber-tipped adaptor fits on the gun and allows you to use it in holes or for blowing out cylinders, pistons, etc. when working on any mechanical job.

| Item# | Description |
|-------|-------------|
| S4010 | Rubber Tip |



CHIP SHIELD

Chip Shield prevents chips or particles from blowing back in your face when using the blow gun. Also makes the gun OSHA approved as the air flows out the sides if placed against your hand.

| Item# | Description |
|-------|-------------|
| S4030 | Chip Shield |



ALUMINUM AUTO BODY TOOLS

7 PIECE RUBBER COATED DOLLY SET

- This rubber dolly set works well in recessed or sharp corners and wide radii. Also works well on lighter metal sheets and panels. They help return the metal to its original shape.
- The weighted hard rubber coating allows for a cushion effect to match the hammer without stretching the metal and damaging the car body paint, suitable for aluminum body repairs.
- Drop forged steel construction for long life. They are used behind any sheet metal you are using a hammer on.

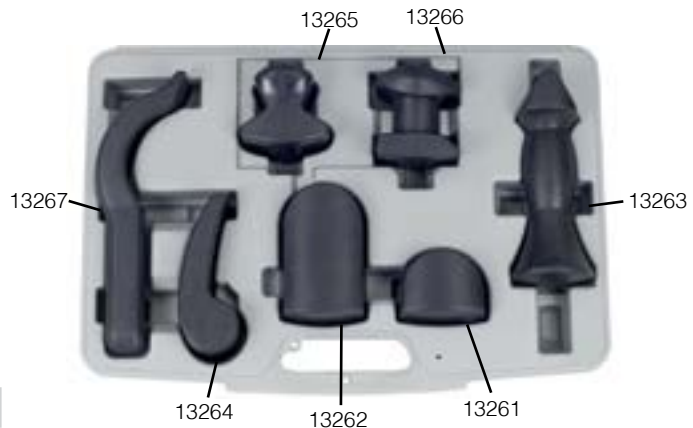

13260 Contents: heel dolly, long type heel dolly, double end dolly, curved dolly, utility dolly, double end hand dolly, long type curved dolly. Comes in blow mold case.

| Item# | Description |
|--------------|--|
| 13260 | 7 Piece Rubber Coated Dolly Set |
| 13261 | Heel Dolly |
| 13262 | Long Type Heel Dolly |
| 13263 | Double End Dolly |
| 13264 | Curved Dolly |
| 13265 | Utility Dolly (General Purpose) |
| 13266 | Double End Hand Dolly |
| 13267 | Long Type Curved Dolly |

12 PIECE DOLLY SET

- Suitable for aluminum body repairs
- Works well in recessed corners, sharp corners, and wide radii
- Made of Polyoxymethylene and non-marking when impacting against metal



13270 Contents: double end dolly, round head chisel dolly, bolster head dolly, crease alignment tool, profile arranging block I + II, hand fist flat+curved dolly, large toe dolly, heel dolly, general purpose dolly, block dolly, curved dolly, wedge dolly. Comes in blow mold case.

| Item# | Description |
|--------------|--------------------------------|
| 13270 | 12 Piece POM Dolly Set |
| 13271 | Double End Dolly |
| 13272 | Round Head Chisel Dolly |
| 13273 | Bolster Head Dolly |
| 13274 | Crease Alignment Tool |
| 13275 | Profile Arranging Block I & II |
| 13276 | Hand Fist Flat & Curved Dolly |
| 13277 | Large Toe Dolly |
| 13278 | Heel Dolly |
| 13279 | General Purpose Dolly |
| 13280 | Block Dolly |
| 13281 | Curved Dolly |
| 13282 | Wedge Dolly |

BLASTING MEDIA

WALNUT SHELL BLASTING MEDIA

All natural, real walnut shells are used as a blasting media for the removal of surface contaminants without damaging the base metal.

Available in Medium Grit. USA made.

- For blasting intake valves to remove carbon build-up
- Use on Audi, BMW and Minis for manifold intake cleaning
- Safely removes carbon without damaging engine
- Made in USA



| Item# | Description | Grit | Weight |
|-------|-----------------------------|--------|---------|
| 13076 | Walnut Shell Blasting Media | Medium | 25 lbs. |

GLASS BEAD BLASTING MEDIA

Glass beads are used as blasting media for a variety of applications.

Available in Coarse and Medium Grits. USA Made.

- Removes:
 - Surface Rust
 - Debris and Corrosion
 - Paint in Auto Body Applications
- Made in USA



| Item# | Description | Grit | Weight |
|-------|---------------------------|--------|---------|
| 13077 | Glass Bead Blasting Media | Coarse | 25 lbs. |
| 13078 | Glass Bead Blasting Media | Medium | 25 lbs. |



3M/FIREPOWER/FORNEY/SHARK CROSSOVER

| 3M | Shark | Firepower | Shark | Firepower | Shark | Firepower | Shark | Firepower | Shark | Firepower | Shark |
|-----------|------------|------------|-------|-----------|-------|------------|---------|------------|-------|------------|-------|
| 01396 | 12614 | 0387-0136 | 12556 | 1423-1420 | 12220 | 1423-2224 | 12957 | 1440-0097 | 11021 | 1443-0002* | 12300 |
| 01397 | 12613 | 0387-0144 | 12576 | 1423-1421 | 12221 | 1423-2225 | 12952 | 1440-0098 | 11022 | 1443-0003* | 12303 |
| 01398 | 12612 | 0387-0145 | 12577 | 1423-1422 | 12202 | 1423-2226 | 12953 | 1440-0105 | 11014 | 1443-0004* | 12309 |
| 01406 | 12618 | 0387-0146 | 12578 | 1423-1423 | 12245 | 1423-2227 | 12954 | 1440-0106 | 11015 | 1443-0005* | 12315 |
| 01407 | 12617 | 0387-0147 | 12579 | 1423-1424 | 12250 | 1423-2228 | 12955 | 1440-0107 | 11016 | 1443-0015 | 12100 |
| 01408 | 12616 | 0387-0172 | 12559 | 1423-1425 | 12251 | 1423-2229 | 12950 | 1440-0108 | 11017 | 1443-0016 | 12101 |
| 01410 | 9989 | 0387-0173 | 12560 | 1423-1426 | 12252 | 1423-2232 | 12750 | 1440-0115 | 11009 | 1443-0026 | 12106 |
| 01411 | 9989-12 | 0387-0182 | 12585 | 1423-1428 | 12256 | 1423-2234 | 14074 | 1440-0116 | 11010 | 1443-0027 | 12107 |
| 01987 | 26-10 | 0387-0184 | 12587 | 1423-1432 | 12222 | 1423-2237 | 12726 | 1440-0117 | 11011 | 1443-0035 | 12226 |
| 01988 | 25-10 | 0387-0185 | 12588 | 1423-1435 | 12201 | 1423-2238 | 12728 | 1440-0118 | 11012 | 1444-0025 | 12976 |
| 01989 | 26SL | 0387-0487 | 12242 | 1423-1442 | 14012 | 1423-2271 | 12787 | 1440-0124 | 11034 | 1444-0026 | 12977 |
| 01990 | 25SL | 0387-1227 | 12501 | 1423-1452 | 14017 | 1423-2272 | 12788 | 1440-0125 | 11035 | 1444-0027 | 12978 |
| 01991 | 38SL | 0387-1228 | 12532 | 1423-1459 | 14019 | 1423-2274 | 12790 | 1440-0126 | 11036 | 1444-0028 | 12979 |
| 02145 | 13144 | 0387-1229 | 12533 | 1423-2100 | 14027 | 1423-2275 | 12791 | 1440-0127 | 11037 | 1444-0029 | 12980 |
| 05001 | 12997 | 0387-1233 | 12538 | 1423-2101 | 14028 | 1423-2102 | 12792 | 1440-0134 | 11029 | 1444-0050 | 12855 |
| 05002 | 12991 | 0387-1234 | 12539 | 1423-2102 | 14030 | 1423-2311 | 12771 | 1440-0135 | 11030 | 1444-0051 | 12856 |
| 05006 | 12990 | 0387-1236 | 12543 | 1423-2103 | 14031 | 1423-2312 | 12773 | 1440-0136 | 11031 | 1444-0052 | 12857 |
| 05008 | 12989 | 0387-1237 | 12544 | 1423-2104 | 14070 | 1423-2327 | 14052 | 1440-0137 | 11032 | 1444-0053 | 12858 |
| 05010 | 12987 | 0387-1238 | 12545 | 1423-2105 | 14072 | 1423-3135 | 12928 | 1440-0145 | 11024 | 1444-0170 | 12854 |
| 05539 | 323T | 1412-0012 | 12263 | 1423-2106 | 14025 | 1423-3136 | 12909 | 1440-0146 | 11025 | 1444-0220 | 12981 |
| 05540 | 333T | 1412-0020 | 12265 | 1423-2107 | N/A | 1423-3137 | 12910 | 1440-0147 | 11026 | 1444-0221 | 12982 |
| 05541 | 343T | 1412-0021 | 12270 | 1423-2108 | 14097 | 1423-3142* | 12702 | 1440-0148 | 11027 | 1444-0222 | 12983 |
| 07447 | 13017 | 1412-0022 | 12271 | 1423-2109 | 14076 | 1423-3143* | 12704 | 1440-0151 | 11050 | 1444-0223 | 12984 |
| 07450 | 640TPDB-25 | 1420-0293 | 16100 | 1423-2110 | 14042 | 1423-3144* | 12708 | 1440-0152 | 11051 | 1444-0224 | 12985 |
| 07451 | 642TPDB-25 | 1420-0295 | 12261 | 1423-2111 | 14083 | 1423-3145* | 12712 | 1440-0155 | 11118 | 1444-0407 | 14483 |
| 07453 | 620TPDB-25 | 1421-0038 | 14480 | 1423-2112 | 14128 | 1423-3146* | 12714 | 1440-0156 | 11119 | CSMC121 | 12543 |
| 07453 | 620TPDB-C | 1421-0062 | 12050 | 1423-2113 | 14064 | 1423-3147* | 12716 | 1440-0165 | 11115 | CSMC122 | 12544 |
| 07455 | 630TPDB-25 | 1423-0001 | 14401 | 1423-2114 | 14081 | 1423-3148* | 12722 | 1440-0181 | 11065 | CSMC123 | 12545 |
| 07455 | 630TPDB-C | 1423-0016 | 12241 | 1423-2115 | 14047 | 1423-3149* | 12700 | 1440-0182 | 11066 | CSSC121 | 12538 |
| 07456 | 632TPDB-25 | 1423-0017 | 14308 | 1423-2116 | 14048 | 1423-3150* | 12710 | 1440-0183 | 11067 | CSSC122 | 12539 |
| 07456 | 632TPDB-C | 1423-0018 | 14309 | 1423-2117 | 14071 | 1423-3151* | 12731 | 1440-0185 | 11059 | Forney | Shark |
| 07457 | 622TPDB-25 | 1423-0019 | 14302 | 1423-2118 | 14073 | 1423-3152* | 12732 | 1440-0186 | 11060 | 1687 | 12403 |
| 07457 | 622TPDB-C | 1423-0020 | 14300 | 1423-2119 | 14066 | 1423-3153* | 12734 | 1440-0187 | 11061 | 1702 | Disc. |
| 07480 | 620TBC | 1423-0026 | 12237 | 1423-2120 | 14068 | 1423-3154* | 12702 | 1440-0188 | 11062 | 1705 | 12405 |
| 07481 | 622TBC | 1423-0032 | 12238 | 1423-2121 | 14058 | 1423-3155* | 12704 | 1440-0195 | 11054 | 1720 | 12407 |
| 07482 | 640TB-10 | 1423-0050 | 12239 | 1423-2122 | 14057 | 1423-3156* | 12712 | 1440-0196 | 11055 | 1753 | Disc. |
| 07483 | 642TB-10 | 1423-0051 | 14402 | 1423-2123 | 14059 | 1423-3157* | 12716 | 1440-0197 | 11056 | 1754 | 12411 |
| 07485 | 630TB | 1423-0052 | 12240 | 1423-2124 | 14093 | 1423-3158 | 14080 | 1440-0200 | 11044 | 12761 | 12834 |
| 07486 | 632TB | 1423-0081 | 14002 | 1423-2125 | 14094 | 1423-3159 | 14137 | 1440-0201 | 11045 | 36062 | 12015 |
| 07492 | 343 | 1423-0082 | 14009 | 1423-2126 | 14043 | 1423-3161 | 14136 | 1440-0202 | 11046 | 37025 | Disc. |
| 07493 | 333 | 1423-0083 | 14010 | 1423-2127 | 14084 | 1423-3162 | 45836 | 1440-0203 | 11047 | 37028 | 12254 |
| 07494 | 323 | 1423-0084 | 14000 | 1423-2136 | 12929 | 1423-3163 | 45838 | 1440-0205 | 11039 | 37030 | 12254 |
| 07511 | 644TB | 1423-0085 | 12112 | 1423-2137 | 12930 | 1423-3164 | 45840 | 1440-0206 | 11040 | 37031 | 12253 |
| 07512 | 646TB | 1423-0086 | 12111 | 1423-2138 | 12931 | 1423-3165 | 45841 | 1440-0207 | 11041 | 37101 | 12041 |
| 07513 | 634TBC | 1423-0087 | 14006 | 1423-2140 | 13006 | 1423-3166 | 45842 | 1440-0210 | 12000 | 37250 | 12040 |
| 07514 | 636TBC | 1423-0088 | 12213 | 1423-2141 | 13007 | 1423-3167 | 45843 | 1440-0211 | 12001 | 38060 | 12017 |
| 07515 | 624TBC | 1423-0089 | 12216 | 1423-2142 | 13008 | 1423-3168 | 45844 | 1440-0212 | 12051 | 38061 | 12016 |
| 07516 | 626TBC | 1423-0092 | 14020 | 1423-2143 | 13013 | 1423-3169 | 45845 | 1440-0215 | 12002 | 38062 | 12015 |
| 19484 | 6202 | 1423-0093 | 14026 | 1423-2151 | 12921 | 1423-3171 | 12925 | 1440-0216 | 12003 | 38070 | 12029 |
| 19344 | 6302 | 1423-0094 | 12212 | 1423-2152 | 12922 | 1423-3177 | 12959 | 1440-0217 | 12004 | 38071 | 12028 |
| Firepower | Shark | 1423-0095 | 12215 | 1423-2153 | 12923 | 1423-3178 | 12961 | 1440-0220 | 12005 | 38072 | 12027 |
| 0323-0360 | 12599 | 1423-0096 | 12211 | 1423-2154 | 12918 | 1423-3180 | 12960 | 1440-0221 | 12006 | 38073 | 12026 |
| 0323-0361 | 12600 | 1423-0097 | 12214 | 1423-2155 | 12919 | 1423-3181* | 12700 | 1440-0222 | 12007 | 38101 | 12025 |
| 0323-0362 | 12601 | 1423-1100 | 14135 | 1423-2156 | 12920 | 1423-3182* | 12710 | 1440-0230 | 12008 | 38102 | Disc. |
| 0323-0363 | 12602 | 1423-1101 | 12038 | 1423-2157 | 13110 | 1423-3184 | 12722 | 1440-0231 | 12021 | 38103 | 12024 |
| 0324-0112 | 12605 | 1423-1102 | 12025 | 1423-2158 | 13111 | 1423-3185 | 454 | 1440-0235 | 12009 | 38106 | Disc. |
| 0324-0150 | 12569 | 1423-1103 | 12033 | 1423-2159 | 12917 | 1423-3208* | 12706 | 1440-0236 | 12010 | 38107 | 12031 |
| 0324-0151 | 12570 | 1423-1105 | 12032 | 1423-2160 | 12912 | 1423-3209* | 12706 | 1440-0240 | 12011 | 38108 | 12035 |
| 0324-0152 | 12571 | 1423-1107 | 12030 | 1423-2161 | 12913 | 1423-4103 | 14212 | 1440-0241 | 12012 | 38109 | 11034 |
| 0324-1053 | 12572 | 1423-1108 | 12024 | 1423-2162 | 12914 | 1423-4107 | 14207 | 1440-0245 | 12013 | 38115 | 11036 |
| 0324-1054 | 12573 | 1423-1109 | 12023 | 1423-2164 | 12820 | 1423-4118 | 14210 | 1440-0296 | 12254 | 38125 | 12038 |
| 0330-0002 | 12557 | 1423-1110 | 12026 | 1423-2165 | 12821 | 1423-4119 | 14323 | 1440-0297 | 12253 | 38140 | 14025 |
| 0330-0007 | 12558 | 1423-1112 | 12027 | 1423-2166 | 12822 | 1423-4120 | 14324 | 1440-0402 | 11125 | 40301 | 11024 |
| 0330-0620 | 12554 | 1423-1113 | 12028 | 1423-2167 | 12823 | 1423-4123 | 14326 | 1440-0406 | 11028 | 40305 | 11025 |
| 0330-0621 | 12555 | 1423-1115 | 12015 | 1423-2170 | 12833 | 1423-4124 | 14200 | 1440-0411 | 11093 | 40350 | 11027 |
| 0330-0622 | 12556 | 1423-1116 | 12016 | 1423-2171 | 12834 | 1423-4125 | 14330 | 1440-0419 | 11096 | 40401 | 11029 |
| 0330-0623 | 12557 | 1423-1117 | 12017 | 1423-2172 | 12835 | 1423-4126 | 14321 | 1440-0420 | 11098 | 40405 | 11030 |
| 0330-0624 | 12558 | 1423-1205 | 12108 | 1423-2173 | 12836 | 1423-4127 | 14322 | 1440-0423* | 11090 | 40410 | 11031 |
| 0331-0016 | 12580 | 1423-1206 | 12224 | 1423-2174 | 12837 | 1423-4128 | 14400 | 1440-0424 | 11090 | 40450 | 11032 |
| 0331-0017 | 12581 | 1423-1207 | 12235 | 1423-2177 | 12702 | 1423-4131 | 14506 | 1440-0425 | 11088 | 40501 | 11034 |
| 0331-0179 | 12576 | 1423-1212 | 12236 | 1423-2180 | 12708 | 1423-4132 | 14509 | 1440-0427* | 11101 | 40505 | 11035 |
| 0331-0180 | 12577 | 1423-1213 | 12225 | 1423-2185 | 12935 | 1423-4133 | 14403 | 1440-0428* | 11102 | 40510 | 11036 |
| 0331-0181 | 12578 | 1423-1216* | 12230 | 1423-2186 | 12731 | 1423-4134 | 14452 | 1440-0429 | 11107 | 40550 | 11037 |
| 0331-0182 | 12579 | 1423-1217 | 12232 | 1423-2187 | 12732 | 1423-4135 | 14453 | 1440-0430 | 11108 | 40680 | 11068 |
| 0331-0183 | 12580 | 1423-1219* | 12232 | 1423-2188 | 12744 | 1423-4136 | 14454 | 1440-0431 | 11107 | 40681 | 11069 |
| 0331-0184 | 12581 | 1423-1220* | 12233 | 1423-2189 | 12737 | 1423-4137 | 14455 | 1440-0432* | 11104 | 40683 | 11071 |
| 0333-0305 | 12557 | 1423-1300 | 12284 | 1423-2190 | 12746 | 1423-4138 | 14456 | 1440-0433* | 11105 | 40684 | 11073 |
| 0333-0402 | 12580 | 1423-1304* | 12288 | 1423-2191 | 12738 | 1423-4145 | 14202 | 1440-0434 | 11097 | 40685 | 11074 |
| 0333-0408 | 12564 | 1423-1305* | 12287 | 1423-2192 | 12748 | 1423-4146 | 14112 | 1440-0441 | 11013 | 40686 | 11075 |
| 0333-0409 | 12565 | 1423-1310 | 12281 | 1423-2193 | 12739 | 1423-4157 | 14500 | 1440-0442* | 11104 | 40687 | 11076 |
| 0333-0550 | 12585 | 1423-1311 | 12280 | 1423-2194 | 13205 | 1423-4158 | 14404 | 1440-0443 | 11086 | 40688 | 11078 |
| 0333-0551 | 12587 | 1423-1314 | 12273 | 1423-2195 | 13206 | 1423-4173 | 14303 | 1440-0445* | 12012 | 40689 | 11079 |
| 0333-0552 | 12588 | 1423-1315 | 12272 | 1423-2197 | 12726 | 1423-4175 | 14319 | 1440-0447 | 12054 | 40690 | 11080 |
| 0333-0553 | 12589 | 1423-1318 | 12276 | 1423-2198 | 12728 | 1424-0013 | 12422 | 1440-0449 | 11085 | 40691 | 11081 |
| 0333-0560 | 12599 | 1423-1319 | 12277 | 1423-2199 | 12800 | 1424-0014 | 12423</ | | | | |

FORNEY/SHARK CROSSOVER

| Forney | Shark | Forney | Shark | Forney | Shark | Forney | Shark | Forney | Shark | Forney | Shark |
|--------|-------|--------|-------|--------|-------|--------|-------|--------|-------|--------|-------|
| 41150 | 11012 | 55910 | Disc. | 70221 | Disc. | 71754 | 12810 | 72302 | 13211 | 86791 | 12537 |
| 41201 | 11014 | 55971 | 14427 | 70225 | 12217 | 71755 | 12811 | 72303 | 13207 | 86792 | 12538 |
| 41205 | 11015 | 55984 | 14425 | 70226 | 12218 | 71757 | 12819 | 72317 | 12724 | 86793 | 12539 |
| 41210 | 11016 | 55991 | 14422 | 70227 | 12219 | 71758 | 12820 | 72322 | 13205 | 86794 | 12540 |
| 41250 | 11017 | 56000 | 12100 | 70228 | 12220 | 71759 | 12821 | 72323 | 13206 | 86801 | 12542 |
| 41301 | 11019 | 56200 | 12101 | 70229 | 12221 | 71760 | 12822 | 72325 | 14050 | 86802 | 12543 |
| 41305 | 11020 | 56205 | 12103 | 70301 | 12223 | 71761 | 12823 | 72327 | 14049 | 86803 | 12544 |
| 41310 | 11021 | 56800 | 14206 | 70326 | 16051 | 71762 | 12824 | 72328 | 14051 | 86804 | 12545 |
| 41350 | 11022 | 56801 | 14208 | 70365 | 16050 | 71763 | 12825 | 72329 | 14071 | 86810 | 12547 |
| 42001 | 11039 | 56900 | 14221 | 70367 | 16052 | 71765 | 12826 | 72330 | 14073 | 86811 | 12548 |
| 42005 | 11040 | 56901 | 14223 | 70368 | 16053 | 71766 | 12827 | 72331 | 14066 | 86812 | 12549 |
| 42050 | 11042 | 57005 | 14200 | 70369 | 16054 | 71767 | 12828 | 72332 | 14068 | 87109 | 12506 |
| 42101 | 11044 | 57008 | 14201 | 70371 | 16055 | 71768 | 12829 | 72335 | 14057 | 87110 | 12507 |
| 42105 | 11045 | 57009 | 14202 | 70372 | 16056 | 71769 | 12830 | 72336 | 14058 | 87111 | 12508 |
| 42110 | 11046 | 57010 | 14203 | 70373 | 16057 | 71770 | 12831 | 72338 | 14059 | 87112 | 12509 |
| 42150 | 11047 | 57011 | 14204 | 70374 | 16058 | 71771 | 12832 | 72341 | 12726 | 87113 | 12510 |
| 42210 | 11051 | 57012 | 14205 | 70375 | 16060 | 71780* | 12702 | 72343 | 12696 | 87119 | 12512 |
| 42205 | 11050 | 57050 | 14211 | 70376 | 16061 | 71786* | 12708 | 72345 | 12728 | 87120 | 12513 |
| 42210 | 11051 | 57051 | 14212 | 70377 | 16059 | 71798 | 12730 | 72347 | 12698 | 87121 | 12514 |
| 42250 | 11052 | 57052 | 14213 | 70378 | 16064 | 71803 | 12924 | 72352 | 12727 | 87122 | 12515 |
| 42276 | 12004 | 57053 | 14214 | 70379 | Disc. | 71804 | 12925 | 72354 | 12697 | 87123 | 12516 |
| 42281* | 12007 | 57054 | 14215 | 70385 | 16062 | 71805 | 12926 | 72356 | 12729 | 87131 | 12526 |
| 42285 | 12001 | 57055 | 14216 | 70386 | 16063 | 71806 | 12927 | 72358 | 12699 | 87200 | 12518 |
| 42286 | 12003 | 57056 | 14217 | 70469 | 14014 | 71818 | 12750 | 72363 | 14090 | 87201 | 12519 |
| 42287* | 12006 | 57060 | 14209 | 70470 | Disc. | 71819 | 12751 | 72364 | 14091 | 87202 | 12520 |
| 42290 | 12000 | 57061 | 14210 | 70471 | 14017 | 71820* | 12731 | 72365 | 14092 | 87203 | 12521 |
| 42291 | 12002 | 57070 | 14218 | 70472 | 14018 | 71821* | 12732 | 72375 | 12691 | 87204 | 12522 |
| 42292 | 12005 | 57071 | 14219 | 70483 | 14019 | 71822 | 12734 | 72376* | 12726 | 87205 | 12523 |
| 42293 | 12011 | 57103 | 14225 | 70484 | Disc. | 71823 | 12736 | 72377* | 12728 | 87206 | 12524 |
| 42294 | 12012 | 57105 | 14226 | 70485 | 14013 | 71824 | 12753 | 72380 | 12742 | 87496 | 12428 |
| 42298 | 12013 | 57601 | 12236 | 70488 | 14000 | 71826 | 12759 | 72381 | 12744 | 87727 | 12426 |
| 42300 | 12008 | 57602 | 12235 | 70489 | 14005 | 71827 | 12738 | 72382 | 12746 | 87728 | 12425 |
| 42301 | 12021 | 57710 | 12226 | 70490 | 14004 | 71830 | 12755 | 72383 | 12748 | 87729 | 12436 |
| 42302 | 12009 | 58400 | 12225 | 70491 | 14003 | 71833 | 12739 | 72385 | 12936 | 87730 | 12422 |
| 42303 | 12010 | 58402 | 12224 | 70500 | 12113 | 71834 | 12761 | 72386 | 12935 | 87791 | 12605 |
| 42330 | 11104 | 58601 | 14314 | 70501 | 14020 | 71835 | 12752 | 72390 | 12932 | 87805 | 12415 |
| 42335 | 11105 | 58602 | 14312 | 70503 | 14002 | 71840* | 12702 | 72391 | 12933 | 87806 | 12413 |
| 42340 | 11106 | 58603 | 14313 | 70504 | 14006 | 71841* | 12704 | 72395 | 12784 | 87807 | Disc. |
| 42397 | 11097 | 58612 | 14317 | 70505 | 14010 | 71842* | 12706 | 72396 | 12785 | 87808 | 12419 |
| 43096 | 11096 | 58613 | 14318 | 70506 | 14001 | 71843* | 12708 | 72397 | 12781 | 87809 | Disc. |
| 43097 | 11094 | 58617 | 14310 | 70507 | N/A | 71844* | 12712 | 72398 | 12780 | 87810 | 12421 |
| 43400 | 11087 | 58618 | 14311 | 70508 | 14021 | 71845* | 12714 | 72400 | 12772 | 87811 | 12416 |
| 43401 | 11085 | 58619 | 14319 | 70509 | 14023 | 71847* | 12722 | 72401 | 12771 | 87814 | 12414 |
| 44556 | 11117 | 58620 | 14320 | 70511 | 14007 | 71855 | 12700 | 72402 | 12773 | 87820 | 12591 |
| 44557 | 11115 | 60001 | 14070 | 70518 | 14008 | 71856 | 12710 | 72403 | 12774 | 87821 | 12592 |
| 44559 | 11120 | 60013 | 14027 | 70519 | 14011 | 71876 | 12733 | 72404 | 12775 | 87822 | 12593 |
| 44560 | 11118 | 60014 | 14028 | 70520 | 14012 | 71877 | 12735 | 72405 | 12776 | 87823 | 12594 |
| 44564 | 11119 | 60015 | 14029 | 70521 | 14009 | 71878 | 12737 | 72406 | 12777 | 87824 | 12595 |
| 45400 | 11090 | 60016 | 14030 | 70525 | 14043 | 71879 | 12754 | 72407 | 12778 | 87825 | 12596 |
| 45401 | 11088 | 60017 | 14031 | 70529 | 14085 | 71883 | 12756 | 72408 | 12779 | 87831 | 12568 |
| 45405 | 11089 | 60018 | Disc. | 70533 | 14065 | 71890 | 12763 | 72485 | 12959 | 87832 | 12569 |
| 45464 | 11093 | 60025 | 12800 | 70537 | 14074 | 71891 | 12764 | 72486 | 12961 | 87832 | 12599 |
| 45465 | 11091 | 60026 | 12793 | 70541 | 14067 | 71894* | 12726 | 72487 | 12962 | 87833 | 12570 |
| 45466 | 11092 | 60027 | 12794 | 70550 | 14093 | 71895* | 12728 | 72488 | 12963 | 87833 | 12600 |
| 45902 | 11109 | 60028 | 12795 | 70551 | 14094 | 71896 | 12747 | 72489 | 12954 | 87833 | 12600 |
| 46002 | 11110 | 60030 | 12797 | 70601 | 12112 | 71897 | 12745 | 72491 | 12952 | 87834 | 12571 |
| 46111 | 11125 | 60031 | 12798 | 70610 | 12111 | 71899 | 12749 | 72492 | 12953 | 87834 | 12601 |
| 47305 | 11102 | 60032 | 12799 | 70710 | 12201 | 71915 | 13013 | 72493 | 12957 | 87835 | 12572 |
| 48305 | 11101 | 60033 | 12801 | 70714 | 12202 | 71986 | 45838 | 72494 | 12955 | 87835 | 12602 |
| 48495 | 11107 | 60034 | 12804 | 70716* | 12250 | 71987 | 45840 | 72495 | 12952 | 87836 | 12573 |
| 48504 | 11108 | 60035 | 12803 | 70717* | 12252 | 72234 | 14052 | 72496 | 12957 | 87850 | 12575 |
| 48571 | 11100 | 60036 | 12802 | 70718 | Disc. | 72235 | 14053 | 73148 | 13212 | 87851 | 12576 |
| 52002 | 12231 | 60050 | 12787 | 70722 | 12205 | 72236 | 14054 | 75200 | 10999 | 87852 | 12577 |
| 52004 | 12230 | 60051 | 12788 | 70795 | 12207 | 72237 | Disc. | 85333 | 12849 | 87853 | 12578 |
| 52010 | 12233 | 60052 | 12789 | 70796 | 12208 | 72238 | 14056 | 85338 | 12851 | 87854 | 12579 |
| 53001 | 12232 | 60053 | 12790 | 70797 | 12209 | 72239 | 13202 | 86101 | 12264 | 87855 | 12580 |
| 54300 | 12108 | 60054 | 12791 | 70801 | 12213 | 72240 | 13201 | 86102 | 12237 | 87856 | 12558 |
| 54400 | 12109 | 60055 | 12792 | 70802 | 12214 | 72241 | 13203 | 86103 | 12239 | 87856 | 12581 |
| 54410 | 12106 | 60090 | 12300 | 70803 | 12216 | 72242 | 13209 | 86104 | 12240 | 87900 | 12554 |
| 54510 | 12107 | 60091 | 12301 | 70804 | 12212 | 72243 | 13210 | 86105 | 12265 | 87901 | 12553 |
| 54722 | 12104 | 60092 | 12302 | 70805 | 12215 | 72266 | 14072 | 86109 | 12266 | 87902 | 12554 |
| 55200 | 14402 | 60093 | 12303 | 70807 | 12211 | 72270 | 14097 | 86113 | 12260 | 87903 | 12555 |
| 55203 | 14403 | 60094 | 12304 | 70815 | 12248 | 72271 | 14060 | 86116 | 12261 | 87904 | 12556 |
| 55280 | 14324 | 60095 | 12305 | 71685 | 12921 | 72272 | 14063 | 86119 | 12242 | 87905 | 12557 |
| 55286 | Disc. | 60096 | 12306 | 71686 | 12922 | 72273 | 14083 | 86120 | 12241 | 87917 | 12559 |
| 55301 | 14308 | 60097 | Disc. | 71687 | 12923 | 72274 | 14088 | 86121 | Disc. | 87918 | 12560 |
| 55302* | 14330 | 60098 | 12308 | 71688 | 12918 | 72275 | 14076 | 86122 | 12238 | 87919 | 12561 |
| 55304 | 14305 | 60099 | 12310 | 71689 | 12919 | 72276 | 14075 | 86124 | 12287 | 87920 | 12562 |
| 55307 | 14300 | 60100 | 12311 | 71690 | 12920 | 72277 | 14078 | 86125 | 12288 | 87932 | 12586 |
| 55308 | 14301 | 60101 | 12312 | 71691 | 12915 | 72278 | 14077 | 86126 | 12272 | 87933 | 12587 |
| 55310 | 14303 | 60120 | 16000 | 71692 | 12916 | 72279 | 14079 | 86127 | 12274 | 87934 | 12588 |
| 55311 | 14302 | 60121 | 16001 | 71693 | 12917 | 72282 | 14042 | 86128 | 12276 | 87935 | 12589 |
| 55315 | 14307 | 60122 | 16006 | 71694 | 12912 | 72283 | 14041 | 86129 | 12279 | 87936 | 12590 |
| 55320 | 14309 | 60124 | 16008 | 71695 | 12913 | 72284 | 14045 | 86130 | 12278 | 87940 | 12564 |
| 55660 | Disc. | 60125 | 16009 | 71696 | 12914 | 72285 | 14044 | 86131 | 12280 | 87942 | 12565 |
| 55663 | 14101 | 60126 | 16011 | 71736 | 12812 | 72286 | 14046 | 86134 | 12267 | 87944 | 12566 |
| 55664 | Disc. | 60127 | 16012 | 71737 | 12813 | 72287 | 14086 | 86135 | 12273 | 88031 | 12527 |
| 55666 | 14118 | 60170 | 12937 | 71738 | 12814 | 72288 | 14084 | 86136 | 12275 | 88033 | 12528 |
| 55671 | 14103 | 60171 | 12938 | 71739 | 12815 | 72290 | 14089 | 86137* | 12277 | 88034 | 12529 |
| 55672 | 14109 | 60172 | 12939 | 71740 | 12816 | 72291 | 14087 | 86138 | 12281 | 88049 | 12530 |
| 55672 | 14112 | 60300 | 14026 | 71741 | 12817 | 72292 | 14062 | 86139 | 12244 | 88051 | 12531 |
| 55676 | 14119 | 60325 | 12283 | 71742 | 12818 | 72293 | 14061 | 86140 | 12243 | 88070 | 12500 |
| 55686 | 14105 | 60326 | 12284 | 71749 | 12805 | 72294 | 14064 | 86141 | 16100 | 88071 | 12501 |
| 55692 | Disc. | 60330 | 12285 | 71750 | 12806 | 72295 | 12765 | 86142 | 16101 | 88072 | 12502 |
| 55816 | 14466 | 60331 | 12286 | 71751 | 12807 | 72296 | 12766 | 86144 | 16103 | 88073 | 12503 |
| 55905 | 14416 | 60332 | Disc. | 71752 | 12808 | 72297 | 12769 | 86145 | 12270 | 88075 | 12504 |
| 55854 | 14461 | 70201 | 12222 | 71753 | 12809 | 72298 | 12770 | 86146 | 12271 | 88078 | 12532 |



FORNEY/R&B/SHARK CROSSOVER

| Forney | Shark | R&B | Shark | R&B | Shark | R&B | Shark | R&B | Shark | R&B | Shark |
|----------------|--------------|---------|-------|--------|-------|------|-------|--------|-------|--------|-------|
| 88079 | 12533 | 7235 | 11093 | 07587* | 12313 | 8121 | 12516 | 8504 | 12702 | 8724 | 12793 |
| 88080 | 12534 | 7239 | 11097 | 07588* | 12314 | 8122 | 12517 | 8506 | 12703 | 8725 | 12794 |
| 93097 | 12050 | 7240 | 11098 | 07589* | 12315 | 8123 | 12518 | 8508 | 12704 | 8726 | 12796 |
| R&B | Shark | 7241 | 11099 | 07590* | 12316 | 8124 | 12519 | 8510 | 12705 | 8727 | 12794 |
| 7100 | 11000 | 7242 | 11100 | 7600 | 12224 | 8125 | 12520 | 8512 | 12706 | 8728 | 12801 |
| 7101 | 11001 | 7260 | 12040 | 7601 | 12235 | 8126 | 12521 | 8514 | 12707 | 8729 | 12803 |
| 7102 | 11002 | 7261 | 12041 | 7602 | 12225 | 8127 | 12522 | 8516 | 12708 | 8730 | 12802 |
| 7105 | 11003 | 7262 | 12039 | 7603 | 12236 | 8128 | 12523 | 8518 | 12709 | 8731 | 12804 |
| 7106 | 11004 | 7265 | 12000 | 7610 | 12250 | 8129 | 12524 | 8520 | 12710 | 8732 | 16008 |
| 7107 | 11005 | 7266 | 12001 | 7612 | 12252 | 8130 | 12525 | 8522 | 12711 | 8733 | 16009 |
| 7110 | 11006 | 7267 | 12002 | 7616 | 12248 | 8131 | 12526 | 8524 | 12712 | 8734 | 16011 |
| 7111 | 11007 | 7268 | 12003 | 7701 | 12937 | 8140 | 12527 | 8526 | 12713 | 8735 | 16012 |
| 7112 | 11008 | 7269 | 12004 | 7702 | 12938 | 8141 | 12528 | 8528 | 12714 | 8740 | 12954 |
| 7120 | 11009 | 7270 | 12005 | 7703 | 12939 | 8142 | 12529 | 8530 | 12715 | 8742 | 12952 |
| 7121 | 11010 | 7271 | 12006 | 7710 | 12851 | 8143 | 12530 | 8532 | 12716 | 8743 | 12953 |
| 7122 | 11011 | 7272 | 12007 | 7730 | 12964 | 8144 | 12531 | 8534 | 12717 | 8744 | 12951 |
| 7123 | 11012 | 7276 | 12008 | 7731 | 12965 | 8150 | 12532 | 8540 | 12718 | 8745 | 12955 |
| 7124 | 11013 | 7277 | 12009 | 7732 | 12966 | 8151 | 12533 | 8542 | 12719 | 8746 | 12956 |
| 7125 | 11014 | 7278 | 12010 | 7733 | 12967 | 8152 | 12534 | 8546 | 12722 | 8747 | 12960 |
| 7126 | 11015 | 7281 | 12011 | 7734 | 12968 | 8153 | 12535 | 8548 | 12723 | 8750 | 12659 |
| 7127 | 11016 | 7282 | 12012 | 7736 | 12969 | 8160 | 12536 | 18550 | 12724 | 8751 | 12961 |
| 7128 | 11017 | 7286 | 12013 | 7737 | 12873 | 8161 | 12537 | 8551 | 12725 | 8752 | 12962 |
| 7129 | 11018 | 7287 | 12014 | 7738 | 12874 | 8162 | 12538 | 8556 | 12726 | 8753 | 12963 |
| 7130 | 11019 | 7296 | 12034 | 7739 | 12875 | 8163 | 12539 | 8557 | 12727 | 8760 | 12936 |
| 7131 | 11020 | 7296 | 12035 | 7740 | 12876 | 8164 | 12540 | 8559 | 12728 | 8762 | 12935 |
| 7132 | 11021 | 7298 | 12031 | 7741 | 12877 | 8165 | 12541 | 8560 | 12729 | 8765 | 12805 |
| 7133 | 11022 | 7299 | 12030 | 7742 | 12878 | 8166 | 12542 | 8570 | 12694 | 8766 | 12806 |
| 7134 | 11023 | 7300 | 12022 | 7787 | 12253 | 8167 | 12543 | 8571 | 12695 | 8767 | 12807 |
| 7140 | 11024 | 7301 | 12023 | 8000 | 12401 | 8168 | 12544 | 8574 | 12696 | 8768 | 12808 |
| 7141 | 11025 | 7302 | 12025 | 8001 | 12403 | 8168 | 12545 | 8575 | 12697 | 8769 | 12809 |
| 7142 | 11026 | 7306 | 12026 | 8002 | 12405 | 8170 | 12546 | 8578 | 12698 | 8770 | 12810 |
| 7143 | 11027 | 7307 | 12027 | 8004 | 12406 | 8171 | 12547 | 8579 | 12699 | 8771 | 12811 |
| 7144 | 11028 | 7308 | 12028 | 8008 | 14480 | 8172 | 12548 | 08595* | 12731 | 8773 | 12812 |
| 7145 | 11029 | 7309 | 12029 | 8010 | 12237 | 8173 | 12549 | 08598* | 12732 | 8774 | 12813 |
| 7146 | 11030 | 7310 | 12036 | 8011 | 12238 | 8174 | 12550 | 8599 | 12733 | 8775 | 12814 |
| 7147 | 11031 | 7317 | 12038 | 8012 | 12239 | 8175 | 12551 | 08605* | 12734 | 8776 | 12815 |
| 7148 | 11032 | 7330 | 12018 | 8013 | 12240 | 8180 | 12552 | 8606 | 12735 | 8777 | 12816 |
| 7149 | 11033 | 7331 | 12019 | 8014 | 12245 | 8181 | 12553 | 8607 | 12736 | 8778 | 12817 |
| 7150 | 11034 | 7350 | 11103 | 8020 | 12241 | 8182 | 12554 | 8608 | 12737 | 8779 | 12818 |
| 7151 | 11035 | 7351 | 11101 | 8021 | 12242 | 8183 | 12555 | 8609 | 12738 | 8781 | 12819 |
| 7152 | 11036 | 7352 | 11102 | 8023 | 12243 | 8184 | 12556 | 08610* | 12739 | 8782 | 12820 |
| 7153 | 11037 | 7353 | 11104 | 8025 | 12244 | 8185 | 12557 | 8611 | 12740 | 8783 | 12821 |
| 7154 | 11038 | 7354 | 1110 | 8030 | 16100 | 8186 | 12558 | 08612* | 12741 | 8784 | 12822 |
| 7160 | 11039 | 7355 | 11106 | 8031 | 16101 | 8192 | 12564 | 8625 | 12742 | 8785 | 12823 |
| 7161 | 11040 | 07356* | 11107 | 8032 | 16102 | 8193 | 12565 | 08626* | 12743 | 8786 | 12824 |
| 7162 | 11041 | 07357* | 11108 | 8033 | 16103 | 8194 | 12566 | 8628 | 12744 | 8787 | 12825 |
| 7163 | 11042 | 07358* | 11109 | 8040 | 12260 | 8195 | 12567 | 08629* | 12745 | 08790* | 12826 |
| 7164 | 11043 | 07359* | 11110 | 8041 | 12261 | 8196 | 12568 | 8640 | 12750 | 08791* | 12827 |
| 7165 | 11044 | 7500 | 12100 | 8042 | 12264 | 8197 | 12569 | 8641 | 12751 | 08792* | 12828 |
| 7166 | 11045 | 7501 | 12100 | 8043 | 12265 | 8198 | 12570 | 8642 | 12752 | 08793* | 12829 |
| 7167 | 11046 | 7502 | 12102 | 8044 | 12266 | 8199 | 12571 | 8643 | 12753 | 08794* | 12830 |
| 7168 | 11047 | 7503 | 12103 | 8045 | 12262 | 8200 | 12572 | 8644 | 12754 | 08795* | 12831 |
| 7169 | 11048 | 7508 | 12104 | 8046 | 12267 | 8201 | 12573 | 8649 | 12755 | 08796* | 12832 |
| 7170 | 11049 | 7509 | 12105 | 8047 | 12270 | 8202 | 12574 | 8650 | 12756 | 08798* | 12833 |
| 7171 | 11050 | 7510 | 12106 | 8048 | 12271 | 8260 | 12575 | 8656 | 12746 | 08799* | 12834 |
| 7172 | 11051 | 7511 | 12107 | 8049 | 12263 | 8261 | 12576 | 8656 | 12759 | 08800* | 12835 |
| 7173 | 11052 | 7512 | 12108 | 8050 | 12287 | 8262 | 12577 | 8657 | 12747 | 08801* | 12836 |
| 7174 | 11053 | 7513 | 12109 | 8051 | 12288 | 8263 | 12578 | 8657 | 12760 | 08802* | 12837 |
| 7180 | 11054 | 7516 | 12111 | 8055 | 12272 | 8264 | 12579 | 8658 | 12749 | 08802* | 12838 |
| 7181 | 11055 | 7517 | 12112 | 8056 | 12273 | 8265 | 12580 | 8658 | 12762 | 08804* | 12839 |
| 7182 | 11056 | 7518 | 12113 | 8060 | 12274 | 8266 | 12581 | 8659 | 12748 | 8813 | 13013 |
| 7183 | 11057 | 7524 | 12234 | 8061 | 12275 | 8267 | 12582 | 8659 | 12761 | 8816 | 13008 |
| 7184 | 11058 | 7525 | 12201 | 8065 | 12276 | 8268 | 12583 | 8670 | 12763 | 8817 | 13007 |
| 7185 | 11059 | 7527 | 12202 | 8066 | 12277 | 8270 | 12585 | 8671 | 12764 | 8819 | 13006 |
| 7186 | 11060 | 7528 | 12203 | 8070 | 12278 | 8271 | 12586 | 8675 | 12765 | 8825 | 12912 |
| 7187 | 11061 | 7530 | 12205 | 8071 | 12279 | 8271 | 12589 | 8676 | 12766 | 8826 | 12913 |
| 7188 | 11062 | 7531 | 12206 | 8072 | 12280 | 8272 | 12587 | 8677 | 12767 | 8827 | 12914 |
| 7189 | 11063 | 7532 | 12207 | 8073 | 12281 | 8272 | 12590 | 8678 | 12768 | 8828 | 12915 |
| 7190 | 11064 | 7533 | 12208 | 8075 | 12282 | 8273 | 12588 | 8679 | 12769 | 8829 | 12916 |
| 7191 | 11065 | 7534 | 12209 | 8076 | 12289 | 8273 | 12561 | 8680 | 12770 | 8830 | 12917 |
| 7192 | 11066 | 7535 | 12210 | 8077 | 12283 | 8274 | 12589 | 8690 | 12771 | 8832 | 12918 |
| 7193 | 11067 | 7542 | 12211 | 8078 | 12284 | 8274 | 12562 | 8691 | 12772 | 8833 | 12919 |
| 7200 | 11068 | 07543/4 | 12212 | 8079 | 12290 | 8275 | 12563 | 8692 | 12773 | 8834 | 12920 |
| 7201 | 11069 | 7545 | 12213 | 8080 | 12422 | 8275 | 12590 | 8694 | 12774 | 8836 | 12921 |
| 7202 | 11070 | 7550 | 12214 | 8087 | 12427 | 8276 | 12591 | 8695 | 12775 | 8837 | 12922 |
| 7203 | 11071 | 7551 | 12050 | 8088 | 12428 | 8277 | 12592 | 8696 | 12776 | 8838 | 12923 |
| 7204 | 11073 | 07552/3 | 12215 | 8089 | 12429 | 8278 | 12593 | 8698 | 12777 | 8850 | 12924 |
| 7205 | 11074 | 7553 | 12216 | 8091 | 12420 | 8279 | 12594 | 8699 | 12778 | 8851 | 12925 |
| 7206 | 11075 | 7580 | 12217 | 8091 | 12430 | 8280 | 12595 | 8700 | 12779 | 8852 | 12926 |
| 7207 | 11076 | 7581 | 12218 | 8092 | 12433 | 8281 | 12596 | 8702 | 12780 | 8853 | 12927 |
| 7208 | 11077 | 7582 | 12219 | 8092 | 12425 | 8282 | 12597 | 8703 | 12781 | 8871 | 13201 |
| 7209 | 11078 | 7583 | 12220 | 8100 | 12500 | 8283 | 12598 | 8706 | 12933 | 8872 | 13202 |
| 7210 | 11079 | 7584 | 12221 | 8101 | 12501 | 8284 | 12599 | 8708 | 12691 | 8873 | 13204 |
| 7211 | 11080 | 7570 | 12222 | 8102 | 12502 | 8285 | 12600 | 8708 | 12782 | 8875 | 13205 |
| 7212 | 11081 | 7571 | 12223 | 8103 | 12503 | 8286 | 12601 | 8710 | 12787 | 8878 | 13206 |
| 7214 | 11082 | 07575* | 12300 | 8104 | 12504 | 8287 | 12602 | 8711 | 12788 | 8883 | 13210 |
| 7215 | 11083 | 07576* | 12301 | 8110 | 12505 | 8288 | 12603 | 8712 | 12789 | 8884 | 13209 |
| 7216 | 11084 | 07577* | 12302 | 8111 | 12506 | 8291 | 12605 | 8713 | 12790 | 8885 | 13211 |
| 7226 | 11085 | 07578* | 12303 | 8112 | 12507 | 8310 | 12420 | 8714 | 12791 | 9000 | 14000 |
| 7227 | 11086 | 07579* | 12304 | 8113 | 12508 | 8312 | 12416 | 8715 | 12792 | 9001 | 14001 |
| 7228 | 11087 | 07580* | 12305 | 8114 | 12509 | 8315 | 12421 | 8716 | 16000 | 9002 | 14002 |
| 7229 | 12254 | 07581* | 12306 | 8115 | 12510 | 8316 | 12417 | 8717 | 16001 | 9003 | 14005 |
| 7230 | 11088 | 07582* | 12307 | 8116 | 12511 | 8317 | 12415 | 8718 | 16006 | 9004 | 14003 |
| 7231 | 11089 | 07583* | 12308 | 8117 | 12512 | 8318 | 12413 | 8720 | 12800 | 9006 | 14004 |
| 7232 | 11090 | 07584* | 12310 | 8118 | 12513 | 8319 | 12412 | 8721 | 12798 | 9010 | 14006 |
| 7233 | 11091 | 07585* | 12311 | 8119 | 12514 | 8500 | 12700 | 8722 | 12797 | 9011 | 14010 |
| 7234 | 11092 | 07586* | 12312 | 8120 | 12515 | 8502 | 12701 | 8723 | 12795 | 9017 | 14009 |

R&B/US FORGE/SHARK CROSSOVER

| R&B | Shark | R&B | Shark | US FORGE | Shark | US FORGE | Shark | US FORGE | Shark | US FORGE | Shark |
|--------|-------|----------|-----------|----------|-----------|----------|-----------|----------|-------|----------|----------|
| 9018 | 14012 | 09547B | 14239 | 00210 | 12107 | 00754 | A12G | 01423 | 11040 | 08952 | 12266 |
| 9020 | 14022 | 9548 | 14213 | 00301 | 12112 | 00755 | A23P | 01424 | 11041 | 08954 | 12270 |
| 9021 | 14021 | 09548B | 14240 | 00302 | 14006 | 00756 | A24G | 01433 | 11045 | 08955 | 12271 |
| 9022 | 14023 | 9549 | 14214 | 00303 | 14007 | 00757 | A25G | 01434 | 11046 | 10872 | 12014 |
| 9025 | 14018 | 09549B | 14241 | 00400 | 14403 | 00758 | A38G | 01443 | 11050 | 50222 | 11115 |
| 9025 | 14024 | 9550 | 14215 | 00401 | 14404 | 00759 | W218P | 01444 | 11051 | 50223 | 11116 |
| 9026 | 14013 | 09550B | 14242 | 00502 | 10999 | 00760 | W220G | 01602 | 12254 | 50632 | 11118 |
| 9027 | 14019 | 9551 | 14216 | 00504 | 12938 | 00761 | A15G | 01823 | 11055 | 50633 | 11119 |
| 9028 | 14020 | 09551B | 14244 | 00505 | 12939 | 00762 | 12764 | 01824 | 11056 | 50832 | 11118 |
| 9030 | 14025 | 9552 | 14217 | 00506 | 12237 | 00765 | 12724 | 01833 | 11060 | 50833 | 11119 |
| 9031 | 14026 | 09552B | 14243 | 00507 | 12238 | 00766 | 12726 | 01834 | 11061 | 50932 | 11118 |
| 9040 | 14073 | 9553 | 14218 | 00509 | 12239 | 00768 | 12710 | 01843 | 11065 | 50933 | 11119 |
| 9041 | 14071 | 09553B | 14245 | 00511 | 12980 | 00769 | 12711 | 01844 | 11066 | 88100 | 14107 |
| 9043 | 14070 | 9554 | 14219 | 00518 | 12208 | 00771 | 12700(10) | 01932 | 11097 | 88122 | 14272 |
| 9044 | 14072 | 09554B | 14246 | 00547 | 12256 | 00775 | 12702 | 01933 | 11098 | 88126 | 14278 |
| 9052 | 14027 | 9555 | 14221 | 00548 | 12213 | 00777 | 12706 | 02350 | 12040 | 91132 | 14078 |
| 9053 | 14028 | 9558 | 14225 | 00549 | 12216 | 00778 | 12707 | 02352 | 12253 | 91133 | 14077 |
| 9054 | 14029 | 9559 | 14226 | 00551 | 12214 | 00779 | 12708(5) | 03001 | 12028 | 91134 | 14045 |
| 9055 | 14030 | 9570 | 14306 | 00600 | 12236 | 00780 | 12709 | 03002 | 12027 | 91137 | 14078 |
| 9056 | 14031 | 9571 | 14308 | 00601 | 12235 | 00781 | 12712 | 03003 | 12026 | 99075 | 14275 |
| 9057 | 14032 | 9572 | 14305 | 00602 | 12225 | 00782 | 12713 | 03023 | 12024 | 99077 | 14219 |
| 9058 | 14036 | 9575 | 14301 | 00603 | 12224 | 00783 | 12704(10) | 03031 | 12031 | 99078 | 14219 |
| 9059 | 14034 | 9576 | 14300 | 00604 | 12304 | 00785 | 12714 | 03032 | 12035 | 99081 | 14201 |
| 9060 | 14035 | 9577 | 14302 | 00606 | 12313(2) | 00786 | 12715 | 03033 | 12034 | 99126 | 14120 |
| 9080 | 14060 | 9578 | 14307 | 00610 | 12311 | 00789 | 13067(10) | 03034 | 12033 | 99128 | 14312 |
| 9081 | 14063 | 9579 | 14309 | 00611 | 16101 | 00792 | 45838 | 03040 | 12016 | 99129 | 14313 |
| 9082 | 14062 | 9580 | 14330 | 00613 | 16100 | 00793 | 45840 | 03041 | 12017 | 99200 | 12805 |
| 9083 | 14061 | 9585 | 14317 | 00614 | 16102 | 00794 | F436Z | 03042 | 12020 | 99201 | 12806 |
| 9084 | 14064 | 9586 | 14312 | 00615 | 12222 | 00795 | F460Z | 03051 | 12037 | 99202 | 12807 |
| 9085 | 14066 | 9587 | 14318 | 00616 | 12202 | 00796 | F480Z | 03052 | 12038 | 99203 | 12808 |
| 9090 | 14083 | 9588 | 14313 | 00617 | 12219 | 00797 | 13069(5) | 03054 | 12015 | 99205 | 12809 |
| 9091 | 14088 | 9589 | 14314 | 00618 | 12221 | 00799 | 12728(1) | 06633 | 11015 | 99206 | 12810 |
| 9092 | 14086 | 9595 | 14327 | 00619 | 12217 | 00800 | 12243 | 07331 | 11099 | 99207 | 12811 |
| 9093 | 14084 | 9599 | 14328 | 00620 | 12218 | 00801 | 12242 | 08015 | 12444 | 99210 | 12812 |
| 9094 | 14087 | 9604 | 14323 | 00621 | 12226 | 00802 | 12241 | 08016 | 12444 | 99211 | 12813(3) |
| 9095 | 14089 | 9605 | 14324 | 00634 | 12231 | 00812 | 12201 | 08026 | 12459 | 99212 | 12814(3) |
| 9100 | 14052 | 9607 | 14322 | 00637 | 12230 | 00885 | 13130 | 08027 | 12460 | 99213 | 12815 |
| 9101 | 14053 | 9616 | 14401 | 00652 | 12000 | 00886 | 13131 | 08028 | 12491 | 99215 | 12816 |
| 9102 | 14054 | 9617 | 14402 | 00657 | 12051 | 00887 | 13122 | 08029 | 12490 | 99216 | 12817 |
| 9103 | 14055 | 9618 | 14404 | 00662 | 12002 | 00888 | 13120 | 08030 | 12426 | 99217 | 12818 |
| 9104 | 14056 | 9619 | 14403 | 00667 | 12004 | 00889 | 13121 | 08032 | 12425 | 99220 | 12819(3) |
| 9105 | 14057 | 9655 | 14425 | 00669 | 12043 | 00890 | 13123 | 08036 | 12422 | 99221 | 12820(3) |
| 9106 | 14058 | 9657 | 14423 | 00672 | 12005 | 00891 | 13110 | 08044 | 12525 | 99222 | 12821(3) |
| 9107 | 14059 | 9658 | 14424 | 00676 | 12013 | 00892 | 13111 | 08100 | 12552 | 99223 | 12822(3) |
| 9110 | 14090 | 9674 | 14432 | 00677 | 12007 | 00893 | 13113 | 08101 | 12553 | 99225 | 12823(3) |
| 9111 | 14091 | 9714 | 14417 | 00678 | 12011 | 00894 | 13105 | 08102 | 12554 | 99226 | 12824 |
| 9112 | 14092 | 9715 | 14418 | 00679 | 12012 | 00895 | 13106 | 08103 | 12555 | 99227 | 12825 |
| 9115 | 14093 | 9726 | 14453 | 00680 | 12300 | 00896 | 13108 | 08104 | 12556 | 99230 | 12826 |
| 9116 | 14094 | 9730 | 14458 | 00681 | 12301 (2) | 00910 | 12856 | 08105 | 12557 | 99231 | 12827 |
| 9120 | 14075 | 9730 | 14459 | 00682 | 12302 | 01103 | 14066 | 08106 | 12558 | 99232 | 12828 |
| 9121 | 14078 | 9730 | 14460 | 00683 | 12303 | 01104 | 14084 | 08322 | 12518 | 99233 | 12829 |
| 9122 | 14076 | 9755 | 14452 | 00685 | 12308 | 01107 | 14128 | 08323 | 12519 | 99235 | 12830 |
| 9123 | 14077 | 9757 | 14454 | 00686 | 12305 | 01108 | 14067 | 08324 | 12520 | 99236 | 12831 |
| 9124 | 14079 | 9843 | 14414 | 00687 | 12306 | 01114 | 14079 | 08325 | 12596 | 99237 | 12832 |
| 9125 | 14081 | 9853 | 14415 | 00688 | 12308 | 01115 | 14061 | 08326 | 12522 | 99240 | 31 |
| 9126 | 14080 | 9897 | 14503 | 00689 | 12310 | 01116 | 14086 | 08331 | 12585 | 99244 | 13212 |
| 9127 | 14082 | 9898 | 14504 | 00690 | 12311 | 01117 | 14087 | 08332 | 12586 | 99245 | 13201 |
| 9130 | 14042 | 9680 | 14462 | 00691 | 12312 | 01123 | 11010 | 08333 | 12587 | 99247 | 13204 |
| 9131 | 14041 | | | 00700 | 12772 | 01124 | 11011 | 08334 | 12588 | 99248 | 13205 |
| 9132 | 14045 | US FORGE | Shark | 00701 | 12771 | 01130 | 14076 | 08335 | 12589 | 99249 | 13206 |
| 9133 | 14044 | 00031 | 11120 | 00702 | 12773 | 01131 | 14082 | 08336 | 12590 | 99254 | 12924 |
| 9134 | 14046 | 00033 | 11119 | 00704 | 12734 | 01133 | 11015 | 08350 | 12575 | 99255 | 12925 |
| 9135 | 14047 | 00064 | 12021 | 00705 | 12731 | 01134 | 11016 | 08351 | 12576 | 99257 | 12927 |
| 9136 | 14048 | 00074 | 12010 | 00706 | 12736 | 01135 | 14057 | 08352 | 12577 | 99304 | 12111 |
| 9139 | 14049 | 00077 | N/A | 00707 | 12738 | 01136 | 14042 | 08353 | 12578 | 99401 | 14415 |
| 9145 | 14074 | 00088 | 14208 | 00708 | 12754 | 01138 | 14041 | 08354 | 12579 | 99402 | 14401 |
| 9146 | 14043 | 00089 | 14217 | 00709 | 12755 | 01143 | 11020 | 08355 | 12580 | 99408 | 14402 |
| 9147 | 14085 | 00090 | 14200 | 00710 | 12753 | 01144 | 11021 | 08356 | 12581 | 99903 | 14225 |
| 9149 | 14067 | 00091 | 14202 | 00711 | 12755 | 01145 | 14075 | 08608 | 12505 | 99904 | 14226 |
| 9504 | 14116 | 00092 | 14204 | 00712 | 12765 | 01146 | 14080 | 08609 | 12506 | | |
| 9509 | 14439 | 00093 | 14205 | 00713 | 12766 | 01148 | 14081 | 08610 | 12507 | | |
| 9512 | 14103 | 00094 | 14220 | 00717 | 12769 | 01149 | 14046 | 08611 | 12509 | | |
| 9513 | 14109 | 00095 | 14212 | 00718 | 12770 | 01150 | 14073 | 08613 | 12510 | | |
| 9514 | 14105 | 00096 | 14214 | 00719 | 12732 | 01151 | 14071 | 08614 | 12511 | | |
| 9530 | 14200 | 00097 | 14215 | 00722 | 12742 | 01153 | 14031 | 08619 | 12512 | | |
| 09530B | 14227 | 00102 | 14203 | 00723 | SDP702SC | 01160 | 14093 | 08620 | 12513 | | |
| 9531 | 14201 | 00103 | 14206 | 00725 | 12744 | 01161 | 14094 | 08621 | 12514 | | |
| 09531B | 14228 | 00104 | 14213 | 00726 | 12963 | 01162 | 14070 | 08622 | 12515 | | |
| 9532 | 14202 | 00105 | 14217 | 00728 | 12961 | 01163 | 14072 | 08623 | 12516 | | |
| 09532B | 14229 | 00106 | 14339 | 00729 | 12959 | 01165 | 14095 | 08624 | 12517 | | |
| 9533 | 14203 | 00108 | 14302 | 00730 | 12960 | 01166 | 14097 | 08625 | 12518 | | |
| 09533B | 14230 | 00109 | 14308 | 00731 | 12954 | 1168 | 14027 | 08626 | 12594 | | |
| 9534 | 14204 | 00110 | 14101 | 00732 | 12953 | 01173 | 14020 | 08627 | 12595 | | |
| 09534B | 14231 | 00113 | 14300 | 00734 | 12952 | 1173 | 14020 | 08701 | 12542 | | |
| 9535 | 14205 | 00118 | 14327 | 00735 | 12955 | 01174 | 14002 | 08702 | 12543 | | |
| 09535B | 14232 | 00119 | 14309 | 00736 | 12957 | 01175 | 14010 | 08910 | 12446 | | |
| 9537 | 14206 | 00125 | 14119 | 00738 | 12750 | 01176 | 14001 | 08915 | 12447 | | |
| 9538 | 14208 | 00126 | 14118 | 00740 | 12787 | 1177 | 14021 | 08916 | 12277 | | |
| 09538B | 14233 | 00127 | 14117 | 00741 | 12788 | 01180 | 14000 | 08920 | 12247 | | |
| 9539 | 14433 | 00140 | 14467 | 00742 | 12789 | 01184 | 14017 | 08922 | 12283 | | |
| 9540 | 14209 | 00172 | 12050 | 00743 | 12790 | 01185 | 14018 | 08923 | 12284 | | |
| 09540B | 14236 | 00200 | 12100 (1) | 00744 | 12791 | 01323 | 11025 | 08924 | 11025 | | |
| 9541 | 14210 | 00201 | 12106 | 00745 | 12792 | 01324 | 11026 | 08925 | 12286 | | |
| 09541B | 14237 | 00203 | 12100 | 00748 | 12752 | 01333 | 11030 | 08927 | 12274 | | |
| 9546 | 14211 | 00206 | 12250 | 00751 | A4G | 01334 | 11031 | 08928 | 12275 | | |
| 09546B | 14238 | 00207 | 12252 | 00752 | A5P | 01343 | 11035 | 08950 | 12263 | | |
| 9547 | 14212 | 00208 | 12102 | 00753 | A11 | 01344 | 11036 | 08951 | 12265 | | |



INDEX

| Item | Page | Item | Page | Item | Page | Item | Page | Item | Page | Item | Page |
|-------|------|-------|------|-------|------|-------|--------------|-------|----------|-------|---------------|
| 19 | 3 | 11017 | 78 | 11115 | 82 | 12220 | 91 | 12414 | 94 | 12562 | 118 |
| 20 | 3 | 11018 | 78 | 11116 | 82 | 12221 | 91 | 12415 | 94 | 12563 | 118 |
| 21 | 3 | 11019 | 78 | 11117 | 82 | 12222 | 91 | 12416 | 94 | 12564 | 118 |
| 22 | 3 | 11020 | 78 | 11118 | 82 | 12223 | 91 | 12418 | 94 | 12565 | 118 |
| 23 | 3 | 11021 | 78 | 11119 | 82 | 12224 | 93 | 12419 | 94 | 12566 | 118 |
| 41 | 4 | 11022 | 78 | 11120 | 82 | 12225 | 93 | 12421 | 94 | 12567 | 118 |
| 43 | 4 | 11023 | 78 | 11121 | 82 | 12226 | 87 | 12422 | 97 | 12568 | 118 |
| 48 | 4 | 11024 | 78 | 11122 | 81 | 12227 | 87 | 12423 | 97 | 12569 | 118 |
| 49 | 4 | 11025 | 78 | 11123 | 81 | 12230 | 87 | 12424 | 97 | 12570 | 115, 118 |
| 50 | 4 | 11026 | 78 | 11124 | 81 | 12231 | 87 | 12425 | 97 | 12571 | 118 |
| 51 | 139 | 11027 | 78 | 11125 | 81 | 12232 | 87 | 12426 | 97 | 12572 | 115, 118 |
| 52 | 139 | 11028 | 78 | 11127 | 81 | 12233 | 87 | 12427 | 97 | 12573 | 118 |
| 53 | 139 | 11029 | 78 | 11128 | 82 | 12234 | 87 | 12428 | 97 | 12574 | 115, 119 |
| 54 | 139 | 11030 | 78 | 11132 | 79 | 12235 | 93 | 12429 | 97 | 12575 | 119 |
| 56 | 12 | 11031 | 78 | 11134 | 6 | 12236 | 93 | 12430 | 97 | 12576 | 119 |
| 57 | 12 | 11032 | 78 | 11135 | 6 | 12237 | 90, 114, 115 | 12431 | 7, 17 | 12577 | 114, 115, 119 |
| 60 | 138 | 11033 | 78 | 11136 | 6 | 12238 | 90 | 12433 | 7, 17 | 12578 | 119 |
| 61 | 138 | 11034 | 78 | 12000 | 83 | 12239 | 90 | 12440 | 97, 128 | 12579 | 119 |
| 65 | 138 | 11035 | 78 | 12001 | 83 | 12240 | 90, 97 | 12441 | 97, 128 | 12580 | 119 |
| 66 | 138 | 11036 | 78 | 12002 | 83 | 12241 | 90 | 12442 | 98 | 12581 | 119 |
| 76 | 139 | 11037 | 78 | 12003 | 83 | 12242 | 90, 114 | 12443 | 98, 115 | 12582 | 119 |
| 114 | 61 | 11038 | 78 | 12004 | 83 | 12243 | 90 | 12444 | 98, 115 | 12583 | 119 |
| 323 | 15 | 11039 | 79 | 12005 | 83 | 12244 | 90 | 12445 | 98 | 12585 | 119 |
| 333 | 15 | 11040 | 79 | 12006 | 83 | 12245 | 92 | 12446 | 98 | 12586 | 119 |
| 343 | 15 | 11041 | 79 | 12007 | 83 | 12246 | 93 | 12447 | 98 | 12587 | 119 |
| 2004 | 63 | 11042 | 79 | 12008 | 83 | 12247 | 94 | 12448 | 98 | 12588 | 119 |
| 2006 | 63 | 11043 | 79 | 12009 | 83 | 12248 | 86 | 12449 | 98 | 12589 | 119 |
| 2007 | 63 | 11044 | 79 | 12010 | 83 | 12249 | 93 | 12454 | 98 | 12590 | 119 |
| 2008 | 63 | 11045 | 79 | 12011 | 83 | 12250 | 92 | 12455 | 98 | 12591 | 119 |
| 2009 | 63 | 11046 | 79 | 12012 | 83 | 12251 | 92 | 12459 | 98, 114 | 12592 | 119 |
| 2010 | 63 | 11047 | 79 | 12013 | 83 | 12252 | 92 | 12460 | 98, 114 | 12593 | 119 |
| 2011 | 63 | 11048 | 79 | 12014 | 83 | 12253 | 86 | 12462 | 95 | 12594 | 119 |
| 2012 | 63 | 11049 | 79 | 12015 | 84 | 12254 | 86 | 12463 | 95 | 12595 | 119 |
| 2013 | 63 | 11050 | 79 | 12016 | 84 | 12255 | 112 | 12464 | 94 | 12596 | 119 |
| 2014 | 63 | 11051 | 79 | 12017 | 84 | 12256 | 93 | 12465 | 94 | 12597 | 119 |
| 2015 | 63 | 11052 | 79 | 12018 | 84 | 12258 | 93 | 12470 | 115 | 12598 | 119 |
| 2017 | 63 | 11053 | 79 | 12019 | 84 | 12260 | 96 | 12471 | 115 | 12599 | 114, 115, 119 |
| 2021 | 63 | 11054 | 79 | 12020 | 84 | 12261 | 95 | 12490 | 114, 115 | 12600 | 119 |
| 2023 | 63 | 11055 | 79 | 12021 | 83 | 12263 | 95, 115 | 12491 | 114, 115 | 12601 | 114, 119 |
| 2024 | 63 | 11056 | 79 | 12024 | 84 | 12264 | 95 | 12500 | 116 | 12602 | 119 |
| 2025 | 63 | 11057 | 79 | 12025 | 84 | 12265 | 95 | 12501 | 116 | 12603 | 114, 119 |
| 2027 | 63 | 11058 | 79 | 12026 | 84 | 12266 | 95 | 12502 | 116 | 12604 | 114, 119 |
| 2029 | 63 | 11059 | 79 | 12027 | 84 | 12268 | 95 | 12503 | 116 | 12605 | 119 |
| 2030 | 63 | 11060 | 79 | 12028 | 84 | 12270 | 95 | 12504 | 116 | 12606 | 117 |
| 2031 | 63 | 11061 | 79 | 12029 | 84 | 12271 | 95 | 12505 | 116 | 12607 | 117 |
| 2033 | 63 | 11062 | 79 | 12031 | 84 | 12272 | 96 | 12506 | 116 | 12608 | 117 |
| 2035 | 63 | 11063 | 79 | 12032 | 84 | 12273 | 96 | 12507 | 116 | 12609 | 117 |
| 2036 | 63 | 11064 | 79 | 12033 | 84 | 12274 | 96 | 12508 | 116 | 12610 | 117 |
| 2037 | 63 | 11065 | 79 | 12034 | 84 | 12275 | 96 | 12509 | 116 | 12611 | 117 |
| 2038 | 63 | 11066 | 79 | 12035 | 84 | 12276 | 97 | 12510 | 116 | 12612 | 29 |
| 2039 | 63 | 11067 | 79 | 12036 | 85 | 12277 | 97 | 12511 | 116 | 12613 | 29 |
| 4046 | 13 | 11068 | 79 | 12037 | 85 | 12278 | 96 | 12512 | 116 | 12614 | 29 |
| 6200 | 25 | 11069 | 79 | 12038 | 85 | 12279 | 96 | 12513 | 116 | 12615 | 29 |
| 6202 | 28 | 11070 | 79 | 12039 | 85 | 12280 | 97 | 12514 | 116 | 12616 | 29 |
| 6205 | 28 | 11071 | 79 | 12040 | 85 | 12281 | 97 | 12515 | 116 | 12617 | 29 |
| 6206 | 28 | 11072 | 79 | 12041 | 85 | 12283 | 96 | 12516 | 116 | 12618 | 29 |
| 6300 | 25 | 11073 | 79 | 12042 | 83 | 12284 | 96 | 12517 | 116 | 12619 | 29 |
| 6302 | 28 | 11074 | 79 | 12043 | 83 | 12285 | 97 | 12518 | 116 | 12621 | 29 |
| 6305 | 28 | 11075 | 79 | 12050 | 82 | 12286 | 97 | 12519 | 116 | 12622 | 29 |
| 6306 | 28 | 11076 | 79 | 12051 | 83 | 12287 | 96 | 12520 | 116 | 12623 | 29 |
| 6400 | 25 | 11077 | 79 | 12052 | 83 | 12288 | 96 | 12521 | 116 | 12624 | 29 |
| 7000 | 56 | 11078 | 79 | 12061 | 83 | 12289 | 96 | 12525 | 116 | 12625 | 29 |
| 7046 | 13 | 11079 | 79 | 12062 | 83 | 12290 | 96 | 12527 | 117 | 12626 | 29 |
| 7080 | 13 | 11080 | 79 | 12063 | 83 | 12291 | 97 | 12528 | 117 | 12627 | 29 |
| 00036 | 38 | 11081 | 79 | 12064 | 83 | 12292 | 97 | 12529 | 117 | 12628 | 29 |
| 00040 | 38 | 11082 | 79 | 12100 | 88 | 12293 | 97 | 12530 | 117 | 12629 | 29 |
| 00060 | 38 | 11083 | 79 | 12101 | 88 | 12294 | 97 | 12532 | 117 | 12630 | 29 |
| 00080 | 38 | 11085 | 80 | 12102 | 88 | 12295 | 86 | 12533 | 117 | 12631 | 29 |
| 00100 | 38 | 11086 | 80 | 12103 | 88 | 12296 | 86 | 12534 | 117 | 12632 | 29 |
| 00120 | 38 | 11087 | 80 | 12104 | 87 | 12298 | 87 | 12535 | 117 | 12633 | 29 |
| 00150 | 38 | 11088 | 80 | 12105 | 88 | 12300 | 94 | 12536 | 117 | 12634 | 36 |
| 00180 | 38 | 11089 | 80 | 12106 | 88 | 12301 | 94 | 12537 | 117 | 12635 | 42 |
| 00220 | 38 | 11090 | 80 | 12107 | 88 | 12302 | 94 | 12538 | 117 | 12636 | 42 |
| 10059 | 139 | 11091 | 80 | 12108 | 88 | 12303 | 94 | 12539 | 117 | 12637 | 42 |
| 10060 | 139 | 11092 | 80 | 12109 | 88 | 12304 | 94 | 12540 | 117 | 12638 | 42 |
| 10995 | 141 | 11093 | 80 | 12110 | 89 | 12305 | 94 | 12541 | 117 | 12639 | 10 |
| 10996 | 141 | 11094 | 80 | 12111 | 89 | 12306 | 94 | 12542 | 118 | 12640 | 10 |
| 10997 | 141 | 11095 | 80 | 12112 | 89 | 12308 | 94 | 12543 | 118 | 12641 | 10 |
| 10999 | 93 | 11096 | 80 | 12113 | 88 | 12309 | 94 | 12544 | 118 | 12642 | 10 |
| 11000 | 78 | 11097 | 81 | 12201 | 92 | 12310 | 94 | 12545 | 118 | 12643 | 10 |
| 11001 | 78 | 11098 | 81 | 12202 | 92 | 12311 | 94 | 12546 | 118 | 12644 | 10 |
| 11002 | 78 | 11099 | 81 | 12205 | 92 | 12312 | 94 | 12547 | 118 | 12645 | 10 |
| 11003 | 78 | 11100 | 82 | 12206 | 92 | 12313 | 94 | 12548 | 118 | 12646 | 10 |
| 11004 | 78 | 11101 | 81 | 12207 | 90 | 12314 | 94 | 12549 | 118 | 12647 | 10 |
| 11005 | 78 | 11102 | 81 | 12208 | 90 | 12315 | 94 | 12550 | 118 | 12648 | 10 |
| 11006 | 78 | 11103 | 82 | 12209 | 90 | 12394 | 112 | 12551 | 118 | 12649 | 10 |
| 11007 | 78 | 11104 | 82 | 12210 | 90 | 12395 | 112 | 12552 | 118 | 12661 | 9 |
| 11008 | 78 | 11105 | 82 | 12211 | 89 | 12396 | 112 | 12553 | 118 | 12662 | 9 |
| 11009 | 78 | 11106 | 82 | 12212 | 89 | 12398 | 112 | 12554 | 118 | 12663 | 7 |
| 11010 | 78 | 11107 | 81 | 12213 | 89 | 12399 | 112 | 12555 | 115, 118 | 12670 | 115 |
| 11011 | 78 | 11108 | 81 | 12214 | 89 | 12401 | 115 | 12556 | 118 | 12671 | 115 |
| 11012 | 78 | 11109 | 81 | 12215 | 89 | 12402 | 114 | 12557 | 118 | 12672 | 115 |
| 11013 | 78 | 11110 | 81 | 12216 | 89 | 12403 | 114 | 12558 | 118 | 12673 | 91 |
| 11014 | 78 | 11112 | 82 | 12217 | 91 | 12411 | 115 | 12559 | 118 | 12674 | 91 |
| 11015 | 78 | 11113 | 82 | 12218 | 91 | 12412 | 94 | 12560 | 118 | 12675 | 91 |
| 11016 | 78 | 11114 | 82 | 12219 | 91 | 12413 | 94 | 12561 | 118 | 12676 | 91 |

INDEX

| Item | Page | Item | Page | Item | Page | Item | Page | Item | Page | Item | Page |
|-------|-----------|-------|------|-------|------------|-------|--------|-------|--------|-------|--------|
| 12677 | 91 | 12784 | 62 | 12907 | 50 | 13014 | 15 | 13125 | 55 | 13238 | 30 |
| 12678 | 91 | 12785 | 62 | 12908 | 50 | 13015 | 27 | 13126 | 55 | 13239 | 30 |
| 12679 | 91 | 12786 | 62 | 12909 | 50 | 13016 | 27 | 13127 | 55 | 13240 | 30 |
| 12689 | 10 | 12787 | 61 | 12910 | 50 | 13017 | 27 | 13128 | 55 | 13241 | 30 |
| 12690 | 12 | 12788 | 61 | 12911 | 50 | 13018 | 21, 33 | 13129 | 55 | 13242 | 31 |
| 12691 | 12 | 12789 | 61 | 12912 | 55 | 13019 | 21, 33 | 13130 | 55 | 13243 | 31, 33 |
| 12692 | 12 | 12790 | 61 | 12913 | 55, 56 | 13020 | 22, 33 | 13131 | 55 | 13244 | 31 |
| 12693 | 7, 17 | 12791 | 61 | 12914 | 55 | 13021 | 5 | 13132 | 55 | 13245 | 31 |
| 12694 | 6 | 12792 | 61 | 12915 | 55 | 13022 | 5 | 13133 | 55 | 13246 | 31 |
| 12695 | 6 | 12805 | 34 | 12916 | 55 | 13023 | 5 | 13134 | 50 | 13247 | 31 |
| 12696 | 7 | 12806 | 34 | 12917 | 55 | 13024 | 5 | 13135 | 50 | 13248 | 31 |
| 12697 | 7 | 12807 | 34 | 12918 | 55, 56 | 13025 | 15 | 13136 | 50 | 13249 | 31 |
| 12698 | 7 | 12808 | 34 | 12919 | 55, 56 | 13026 | 15 | 13137 | 50 | 13250 | 31 |
| 12699 | 7 | 12809 | 34 | 12920 | 55 | 13028 | 5 | 13138 | 50 | 13251 | 31, 33 |
| 12700 | 3, 33 | 12810 | 34 | 12921 | 55 | 13029 | 5 | 13139 | 50 | 13252 | 31 |
| 12701 | 3 | 12811 | 34 | 12922 | 55 | 13030 | 5 | 13140 | 50 | 13253 | 31 |
| 12702 | 3 | 12812 | 34 | 12923 | 55 | 13031 | 5 | 13141 | 50 | 13254 | 31 |
| 12703 | 3 | 12813 | 34 | 12924 | 39 | 13032 | 5 | 13142 | 55 | 13255 | 31 |
| 12704 | 3, 33 | 12814 | 34 | 12925 | 39 | 13033 | 5 | 13143 | 55 | 13256 | 31 |
| 12705 | 3 | 12815 | 34 | 12926 | 39 | 13034 | 6 | 13144 | 55 | 13257 | 31 |
| 12706 | 3 | 12816 | 34 | 12927 | 39 | 13035 | 6 | 13145 | 55 | 13258 | 31 |
| 12707 | 3 | 12817 | 34 | 12928 | 39 | 13036 | 6 | 13146 | 55 | 13259 | 31 |
| 12708 | 3 | 12818 | 34 | 12929 | 39 | 13037 | 6 | 13147 | 55 | 13260 | 142 |
| 12709 | 3 | 12819 | 34 | 12930 | 39 | 13038 | 6 | 13148 | 50, 55 | 13261 | 142 |
| 12710 | 4 | 12820 | 34 | 12931 | 39 | 13039 | 6 | 13152 | 4 | 13262 | 142 |
| 12711 | 4 | 12821 | 34 | 12932 | 62 | 13040 | 6 | 13153 | 4 | 13263 | 142 |
| 12712 | 4 | 12822 | 35 | 12933 | 62 | 13041 | 6 | 13154 | 4 | 13264 | 142 |
| 12713 | 4 | 12823 | 35 | 12934 | 62 | 13042 | 6 | 13155 | 4 | 13265 | 142 |
| 12714 | 4 | 12824 | 35 | 12935 | 7, 17 | 13043 | 6 | 13156 | 9 | 13266 | 142 |
| 12715 | 4 | 12825 | 35 | 12936 | 61 | 13044 | 29 | 13157 | 9 | 13267 | 142 |
| 12716 | 4 | 12826 | 35 | 12937 | 121 | 13045 | 29 | 13159 | 7 | 13270 | 142 |
| 12717 | 4 | 12827 | 35 | 12938 | 121 | 13046 | 29 | 13160 | 45 | 13271 | 142 |
| 12718 | 4 | 12828 | 35 | 12939 | 121 | 13047 | 29 | 13161 | 45 | 13272 | 142 |
| 12719 | 4 | 12829 | 35 | 12940 | 121 | 13048 | 29 | 13162 | 45 | 13273 | 142 |
| 12722 | 4 | 12830 | 35 | 12941 | 121 | 13049 | 10 | 13163 | 45 | 13274 | 142 |
| 12723 | 4 | 12831 | 35 | 12942 | 121 | 13050 | 10 | 13164 | 45 | 13275 | 142 |
| 12724 | 6 | 12832 | 35 | 12943 | 121 | 13051 | 10 | 13165 | 45 | 13276 | 142 |
| 12725 | 6 | 12833 | 35 | 12944 | 121 | 13052 | 10 | 13166 | 45 | 13277 | 142 |
| 12726 | 7 | 12834 | 35 | 12950 | 127 | 13053 | 10 | 13167 | 45 | 13278 | 142 |
| 12727 | 7 | 12835 | 35 | 12951 | 128 | 13054 | 10 | 13168 | 45 | 13279 | 142 |
| 12728 | 7 | 12836 | 35 | 12952 | 127, 128 | 13055 | 4 | 13169 | 45 | 13280 | 142 |
| 12729 | 7 | 12837 | 35 | 12953 | 127, 128 | 13056 | 54 | 13170 | 45 | 13281 | 142 |
| 12730 | 5 | 12838 | 35 | 12954 | 127, 128 | 13057 | 4 | 13171 | 45 | 13282 | 142 |
| 12731 | 9 | 12839 | 35 | 12955 | 127, 128 | 13058 | 7 | 13172 | 45 | 13284 | 140 |
| 12732 | 9 | 12840 | 30 | 12956 | 128 | 13059 | 7 | 13173 | 45 | 13285 | 140 |
| 12733 | 9 | 12841 | 30 | 12957 | 127, 128 | 13060 | 7 | 13174 | 45 | 13286 | 140 |
| 12734 | 9 | 12842 | 30 | 12958 | 50 | 13061 | 7 | 13175 | 45 | 13287 | 140 |
| 12735 | 9 | 12843 | 30 | 12959 | 128 | 13062 | 21, 33 | 13176 | 45 | 13288 | 140 |
| 12736 | 9 | 12844 | 30 | 12960 | 128 | 13063 | 6, 11 | 13177 | 45 | 13289 | 140 |
| 12737 | 9 | 12845 | 30 | 12961 | 128 | 13064 | 11 | 13178 | 5 | 13290 | 57 |
| 12738 | 9 | 12846 | 30 | 12962 | 128 | 13067 | 4 | 13179 | 5 | 13291 | 57 |
| 12739 | 10 | 12847 | 30 | 12963 | 128 | 13068 | 4 | 13180 | 6 | 13292 | 57 |
| 12740 | 10 | 12848 | 120 | 12964 | 121 | 13069 | 6 | 13181 | 6 | 13293 | 57 |
| 12741 | 9 | 12849 | 120 | 12965 | 121 | 13070 | 6 | 13182 | 43 | 13294 | 57 |
| 12742 | 10 | 12850 | 120 | 12966 | 121 | 13072 | 11 | 13183 | 43 | 13295 | 57 |
| 12743 | 10 | 12851 | 120 | 12967 | 121 | 13073 | 27 | 13184 | 43 | 13296 | 57 |
| 12744 | 10 | 12854 | 120 | 12968 | 121 | 13074 | 27 | 13185 | 43 | 13297 | 57 |
| 12745 | 10 | 12855 | 120 | 12969 | 121 | 13075 | 27 | 13186 | 43 | 13298 | 57 |
| 12746 | 10 | 12856 | 120 | 12976 | 121 | 13076 | 143 | 13187 | 43 | 13299 | 57 |
| 12747 | 10 | 12857 | 120 | 12977 | 121 | 13077 | 143 | 13188 | 43 | 13300 | 57 |
| 12748 | 10 | 12858 | 120 | 12978 | 121 | 13078 | 143 | 13189 | 43 | 13301 | 57 |
| 12749 | 10 | 12859 | 120 | 12979 | 121 | 13082 | 4 | 13201 | 16 | 13302 | 57 |
| 12750 | 9 | 12866 | 120 | 12980 | 121 | 13083 | 29 | 13202 | 16 | 13303 | 57 |
| 12751 | 9 | 12867 | 120 | 12981 | 121 | 13084 | 14 | 13203 | 16 | 13312 | 57 |
| 12752 | 9 | 12868 | 120 | 12982 | 121 | 13085 | 14 | 13204 | 16 | 13313 | 57 |
| 12753 | 9 | 12870 | 120 | 12983 | 121 | 13086 | 29 | 13205 | 16 | 13314 | 57 |
| 12754 | 9 | 12871 | 120 | 12984 | 121 | 13090 | 2 | 13206 | 16 | 13315 | 57 |
| 12755 | 10 | 12872 | 120 | 12985 | 121 | 13091 | 2 | 13207 | 16 | 13316 | 57 |
| 12756 | 10 | 12873 | 121 | 12986 | 39 | 13092 | 2 | 13209 | 16 | 13961 | 135 |
| 12757 | 5 | 12874 | 121 | 12987 | 39 | 13093 | 2 | 13210 | 16 | 13962 | 134 |
| 12758 | 5 | 12875 | 121 | 12988 | 39 | 13099 | 55 | 13211 | 16 | 13963 | 134 |
| 12759 | 11 | 12876 | 121 | 12989 | 39 | 13100 | 55 | 13212 | 16 | 13964 | 134 |
| 12760 | 11 | 12877 | 121 | 12990 | 39 | 13101 | 55 | 13213 | 17 | 13965 | 134 |
| 12761 | 11 | 12878 | 121 | 12991 | 39 | 13102 | 55 | 13215 | 3 | 13966 | 134 |
| 12762 | 11 | 12879 | 120 | 12992 | 39 | 13103 | 55, 56 | 13216 | 3 | 13967 | 134 |
| 12763 | 11 | 12880 | 120 | 12993 | 39 | 13104 | 55, 56 | 13217 | 5 | 13968 | 134 |
| 12764 | 11 | 12882 | 121 | 12994 | 39 | 13105 | 55 | 13218 | 5 | 13969 | 134 |
| 12765 | 13 | 12888 | 99 | 12995 | 39 | 13106 | 55 | 13219 | 21 | 13970 | 134 |
| 12766 | 13 | 12889 | 99 | 12996 | 39 | 13107 | 55 | 13220 | 21 | 13971 | 134 |
| 12767 | 13 | 12890 | 99 | 12997 | 39 | 13108 | 55 | 13221 | 21 | 13972 | 134 |
| 12768 | 13 | 12891 | 99 | 12998 | 39 | 13109 | 55 | 13222 | 21 | 13973 | 134 |
| 12769 | 13 | 12892 | 99 | 12999 | 6 | 13110 | 55 | 13223 | 21 | 13974 | 134 |
| 12770 | 13 | 12893 | 99 | 13000 | 21 | 13111 | 55 | 13224 | 22 | 13975 | 134 |
| 12771 | 63 | 12894 | 99 | 13001 | 21 | 13112 | 55 | 13225 | 22 | 13976 | 134 |
| 12772 | 63 | 12895 | 99 | 13002 | 21 | 13113 | 55 | 13226 | 30, 33 | 13977 | 134 |
| 12773 | 63 | 12896 | 99 | 13003 | 21 | 13114 | 55 | 13227 | 30 | 13979 | 135 |
| 12774 | 63 | 12897 | 99 | 13004 | 21 | 13115 | 55, 56 | 13228 | 30, 33 | 13980 | 136 |
| 12775 | 63 | 12898 | 99 | 13005 | 21 | 13116 | 55, 56 | 13229 | 30 | 13981 | 136 |
| 12776 | 63 | 12899 | 99 | 13006 | 21 | 13117 | 55 | 13230 | 30 | 13982 | 136 |
| 12777 | 63 | 12900 | 49 | 13007 | 22 | 13118 | 55 | 13231 | 30 | 13983 | 136 |
| 12778 | 63 | 12901 | 49 | 13008 | 22 | 13119 | 55 | 13232 | 30 | 13984 | 137 |
| 12779 | 63 | 12902 | 49 | 13009 | 22 | 13120 | 55 | 13233 | 30 | 13985 | 137 |
| 12780 | 63 | 12903 | 49 | 13010 | 22 | 13121 | 55 | 13234 | 30 | 13986 | 137 |
| 12781 | 63 | 12904 | 49 | 13011 | 22 | 13122 | 55 | 13235 | 30, 33 | 13987 | 137 |
| 12782 | 7, 17, 27 | 12905 | 49 | 13012 | 14, 15, 33 | 13123 | 55 | 13236 | 30, 33 | 13988 | 130 |
| 12783 | 62 | 12906 | 50 | 13013 | 15, 33 | 13124 | 55 | 13237 | 30 | 13989 | 135 |



INDEX

| Item | Page | Item | Page | Item | Page | Item | Page | Item | Page | Item | Page |
|-------|---------|-------|--------|-------|---------------|-------|---------------|-------|----------|-------|--------|
| 13990 | 135 | 14093 | 137 | 14267 | 71 | 14475 | 68 | 16037 | 125 | 17032 | 67 |
| 13991 | 135 | 14094 | 137 | 14268 | 71 | 14476 | 68 | 16038 | 125 | 17033 | 66, 67 |
| 13992 | 129 | 14095 | 134 | 14269 | 72, 75 | 14477 | 69 | 16039 | 123, 125 | 17034 | 66, 67 |
| 13993 | 129 | 14096 | 134 | 14270 | 72 | 14478 | 68 | 16040 | 123, 125 | 17035 | 67 |
| 13995 | 135 | 14097 | 134 | 14272 | 73 | 14479 | 68 | 16041 | 125 | 17036 | 66, 67 |
| 13996 | 135 | 14098 | 131 | 14274 | 77 | 14480 | 68 | 16042 | 125 | 17037 | 67 |
| 13997 | 131 | 14099 | 131 | 14275 | 77 | 14481 | 69 | 16043 | 124 | 17038 | 67 |
| 13998 | 131 | 14106 | 73 | 14277 | 77 | 14482 | 68 | 16044 | 125 | 17039 | 67 |
| 13999 | 131 | 14107 | 73 | 14278 | 101 | 14483 | 69 | 16045 | 125 | 17040 | 67 |
| 14000 | 129 | 14109 | 74 | 14300 | 103 | 14500 | 110 | 16046 | 124 | 17041 | 67 |
| 14001 | 129 | 14112 | 74 | 14301 | 103 | 14501 | 110 | 16047 | 124 | 17043 | 66 |
| 14002 | 129 | 14114 | 74 | 14302 | 102, 114, 115 | 14502 | 110 | 16049 | 124 | 17044 | 66 |
| 14003 | 129 | 14116 | 74 | 14303 | 103 | 14503 | 110 | 16050 | 127 | 17045 | 67 |
| 14004 | 129 | 14117 | 101 | 14305 | 102 | 14504 | 110 | 16051 | 127 | 17046 | 66 |
| 14005 | 129 | 14118 | 101 | 14306 | 102 | 14505 | 110 | 16052 | 127 | 17050 | 153 |
| 14006 | 131 | 14119 | 101 | 14307 | 102 | 14506 | 110 | 16053 | 127 | 17051 | 153 |
| 14007 | 131 | 14120 | 101 | 14308 | 102 | 14507 | 110 | 16054 | 127 | 17052 | 153 |
| 14008 | 131 | 14128 | 137 | 14309 | 102 | 14508 | 110 | 16055 | 127 | 18060 | 138 |
| 14009 | 131 | 14129 | 137 | 14310 | 100 | 14509 | 110 | 16056 | 127 | 18061 | 138 |
| 14010 | 131 | 14130 | 136 | 14311 | 100 | 14510 | 110 | 16057 | 127 | 18062 | 138 |
| 14011 | 131 | 14134 | 136 | 14312 | 100 | 14511 | 110 | 16058 | 127 | 23536 | 40 |
| 14012 | 131 | 14135 | 77 | 14313 | 100 | 14519 | 109 | 16059 | 127 | 23540 | 40 |
| 14013 | 129 | 14136 | 137 | 14314 | 101 | 14520 | 109 | 16060 | 127 | 23580 | 40 |
| 14014 | 129 | 14137 | 77 | 14315 | 100 | 14521 | 109 | 16061 | 127 | 23636 | 40 |
| 14017 | 130 | 14138 | 137 | 14316 | 100 | 14522 | 109 | 16062 | 127 | 23640 | 40 |
| 14018 | 130 | 14139 | 137 | 14317 | 100 | 14523 | 109 | 16063 | 127 | 23680 | 40 |
| 14019 | 130 | 14140 | 136 | 14318 | 100 | 14524 | 109 | 16064 | 127 | 23681 | 41 |
| 14020 | 89, 130 | 14141 | 131 | 14319 | 100 | 14525 | 107 | 16066 | 127 | 23682 | 41 |
| 14021 | 130 | 14142 | 101 | 14320 | 100 | 14601 | 27 | 16067 | 124, 125 | 23683 | 41 |
| 14022 | 130 | 14155 | 137 | 14321 | 104 | 14602 | 27 | 16068 | 124 | 23684 | 41 |
| 14023 | 130 | 14159 | 133 | 14322 | 104 | 14603 | 27 | 16069 | 124 | 23685 | 41 |
| 14024 | 130 | 14160 | 132 | 14323 | 104 | 14604 | 27 | 16070 | 125 | 23686 | 41 |
| 14025 | 131 | 14161 | 132 | 14324 | 104 | 14605 | 27 | 16071 | 125 | 23687 | 41 |
| 14026 | 131 | 14162 | 132 | 14327 | 104 | 14606 | 27 | 16072 | 125 | 23688 | 41 |
| 14027 | 134 | 14163 | 132 | 14328 | 104 | 14607 | 27 | 16073 | 125 | 23689 | 41 |
| 14028 | 134 | 14164 | 132 | 14329 | 103 | 14866 | 112 | 16074 | 125 | 23690 | 41 |
| 14029 | 134 | 14165 | 132 | 14330 | 103 | 14868 | 112 | 16075 | 125 | 23691 | 41 |
| 14030 | 134 | 14166 | 133 | 14331 | 100 | 15000 | 38 | 16076 | 124 | 23692 | 41 |
| 14031 | 134 | 14168 | 133 | 14332 | 100 | 15001 | 38 | 16077 | 126 | 23693 | 41 |
| 14032 | 134 | 14169 | 133 | 14333 | 101 | 15002 | 38 | 16078 | 126 | 23694 | 41 |
| 14033 | 135 | 14170 | 132 | 14334 | 101 | 15003 | 38 | 16079 | 126 | 23695 | 41 |
| 14034 | 134 | 14171 | 132 | 14338 | 103 | 15004 | 38 | 16080 | 126 | 23696 | 41 |
| 14035 | 134 | 14172 | 132 | 14339 | 104 | 15005 | 38 | 16081 | 126 | 23697 | 41 |
| 14038 | 135 | 14173 | 132 | 14340 | 77 | 15006 | 38 | 16082 | 126 | 23698 | 41 |
| 14040 | 131 | 14174 | 133 | 14341 | 77 | 15007 | 38 | 16083 | 126 | 23699 | 41 |
| 14041 | 135 | 14175 | 132 | 14342 | 104 | 15008 | 38 | 16084 | 126 | 23700 | 41 |
| 14042 | 135 | 14176 | 132 | 14343 | 104 | 15009 | 38 | 16085 | 126 | 23701 | 41 |
| 14043 | 135 | 14177 | 133 | 14344 | 104 | 15010 | 38 | 16086 | 126 | 23702 | 41 |
| 14044 | 135 | 14178 | 133 | 14399 | 108 | 15011 | 38 | 16087 | 126 | 23703 | 41 |
| 14045 | 135 | 14179 | 132 | 14400 | 108 | 15012 | 38 | 16088 | 126 | 23704 | 41 |
| 14046 | 135 | 14180 | 133 | 14401 | 107 | 15013 | 38 | 16089 | 126 | 23705 | 41 |
| 14047 | 135 | 14181 | 132 | 14402 | 107 | 15014 | 38 | 16100 | 95 | 23706 | 41 |
| 14048 | 135 | 14182 | 132 | 14403 | 107 | 15015 | 38 | 16101 | 95 | 23707 | 41 |
| 14049 | 135 | 14183 | 133 | 14404 | 108 | 15016 | 38 | 16102 | 95 | 23708 | 41 |
| 14050 | 135 | 14184 | 133 | 14414 | 108 | 15017 | 38 | 16103 | 95 | 23709 | 41 |
| 14051 | 135 | 14185 | 133 | 14415 | 108 | 15018 | 38 | 16201 | 28 | 23710 | 41 |
| 14052 | 136 | 14200 | 76 | 14416 | 105 | 15216 | 139 | 16202 | 28, 33 | 23711 | 41 |
| 14053 | 136 | 14201 | 76 | 14417 | 105 | 15217 | 139 | 16203 | 28, 33 | 23712 | 41 |
| 14054 | 136 | 14202 | 76 | 14418 | 105 | 15218 | 129 | 16204 | 28 | 23713 | 41 |
| 14056 | 136 | 14203 | 76 | 14419 | 105 | 16000 | 122, 123, 125 | 16205 | 28 | 23714 | 41 |
| 14057 | 136 | 14204 | 76 | 14421 | 105 | 16001 | 125 | 16206 | 28 | 23715 | 41 |
| 14058 | 136 | 14205 | 76 | 14422 | 105 | 16002 | 125 | 16207 | 28 | 23716 | 41 |
| 14059 | 136 | 14206 | 76 | 14423 | 105 | 16003 | 125 | 16208 | 27, 28 | 24036 | 42 |
| 14060 | 136 | 14207 | 76 | 14424 | 105 | 16004 | 123, 125 | 16209 | 27, 28 | 24040 | 42 |
| 14061 | 136 | 14208 | 76 | 14425 | 105 | 16005 | 123, 125 | 16210 | 28 | 24060 | 42 |
| 14062 | 136 | 14209 | 76 | 14426 | 106 | 16006 | 125 | 16211 | 28 | 24080 | 42 |
| 14063 | 136 | 14210 | 76 | 14427 | 106 | 16007 | 123, 125 | 16401 | 25 | 24120 | 42 |
| 14064 | 136 | 14211 | 76 | 14428 | 106 | 16008 | 124 | 16402 | 25 | 24180 | 42 |
| 14065 | 136 | 14212 | 76 | 14432 | 106 | 16009 | 124 | 16403 | 33 | 27036 | 42 |
| 14066 | 136 | 14213 | 71, 76 | 14433 | 106 | 16010 | 123, 124 | 16501 | 113 | 27040 | 42 |
| 14067 | 136 | 14214 | 76 | 14435 | 106 | 16011 | 123, 124 | 16502 | 113 | 27060 | 42 |
| 14068 | 136 | 14215 | 76 | 14438 | 106 | 16012 | 123, 124 | 16503 | 113 | 27080 | 42 |
| 14069 | 131 | 14216 | 76 | 14439 | 106 | 16013 | 124 | 16500 | 113 | 27120 | 42 |
| 14070 | 130 | 14217 | 76 | 14440 | 106 | 16014 | 123 | 16504 | 113 | 27150 | 42 |
| 14071 | 130 | 14218 | 76 | 14441 | 106 | 16015 | 123 | 16505 | 113 | 40100 | 34 |
| 14072 | 130 | 14219 | 76 | 14442 | 106 | 16016 | 122 | 16506 | 113 | 40120 | 34 |
| 14073 | 130 | 14220 | 76 | 14443 | 112 | 16017 | 122 | 16507 | 113 | 40160 | 34 |
| 14074 | 130 | 14221 | 76 | 14444 | 87 | 16018 | 122 | 16508 | 113 | 40240 | 34 |
| 14075 | 135 | 14222 | 76 | 14448 | 106 | 16019 | 122 | 16510 | 113 | 40360 | 34 |
| 14076 | 135 | 14223 | 76 | 14450 | 111 | 16020 | 122 | 16511 | 113 | 40500 | 34 |
| 14077 | 135 | 14224 | 76 | 14451 | 111 | 16021 | 122 | 16512 | 113 | 40800 | 34 |
| 14078 | 135 | 14225 | 76 | 14452 | 111 | 16022 | 123, 124 | 16513 | 113 | 43220 | 28 |
| 14079 | 135 | 14226 | 76 | 14453 | 111 | 16023 | 122 | 16514 | 113 | 43221 | 28 |
| 14080 | 135 | 14250 | 75 | 14454 | 111 | 16024 | 122 | 16515 | 113 | 43222 | 28 |
| 14081 | 135 | 14251 | 75 | 14455 | 111 | 16025 | 122 | 16516 | 113 | 43223 | 28 |
| 14082 | 135 | 14252 | 72 | 14456 | 111 | 16026 | 122 | 16517 | 113 | 43224 | 28 |
| 14083 | 137 | 14253 | 72 | 14457 | 111 | 16027 | 123 | 16990 | 32 | 43225 | 28 |
| 14084 | 137 | 14254 | 72 | 14458 | 111 | 16028 | 124 | 16993 | 32 | 43226 | 28 |
| 14085 | 137 | 14255 | 72 | 14459 | 111 | 16029 | 125 | 17005 | 131 | 43227 | 28 |
| 14086 | 137 | 14256 | 72 | 14460 | 111 | 16030 | 125 | 17008 | 153 | 43228 | 28 |
| 14087 | 137 | 14257 | 72 | 14461 | 111 | 16031 | 123, 125 | 17009 | 153 | 43229 | 28 |
| 14088 | 137 | 14262 | 71 | 14463 | 105 | 16032 | 125 | 17016 | 65 | 44220 | 28 |
| 14089 | 137 | 14263 | 71 | 14466 | 111 | 16033 | 125 | 17024 | 64 | 44221 | 28 |
| 14090 | 137 | 14264 | 71 | 14467 | 111 | 16034 | 124 | 17025 | 64 | 44222 | 28 |
| 14091 | 137 | 14265 | 71 | 14468 | 111 | 16035 | 124 | 17027 | 65 | 44223 | 28 |
| 14092 | 137 | 14266 | 71 | 14469 | 111 | 16036 | 124 | 17031 | 66, 67 | 44224 | 28 |

INDEX

| Item | Page | Item | Page | Item | Page | Item | Page | Item | Page | Item | Page |
|-------|------|-------|------|--------|------|------------|-------|------------|--------|------------|------|
| 44225 | 28 | 45898 | 50 | 47007 | 47 | 123-5 | 7 | 40800Z | 36 | 631TB-50 | 22 |
| 44226 | 28 | 45899 | 50 | 47008 | 47 | 124-5 | 7 | 40800Z-3 | 36 | 631TBC | 22 |
| 44227 | 28 | 45900 | 50 | 47009 | 47 | 124D | 7 | 41-100 | 4 | 632T | 24 |
| 44228 | 28 | 45901 | 50 | 47010 | 47 | 128-83 | 5 | 42-100 | 4 | 632T-1000 | 24 |
| 44229 | 28 | 45902 | 50 | 47011 | 47 | 141-5 | 7 | 43-100 | 4 | 632T-50 | 24 |
| 44320 | 15 | 45903 | 51 | 47012 | 47 | 142M-5 | 7 | 44-100 | 4 | 632T-500 | 24 |
| 44321 | 15 | 45904 | 51 | 47013 | 47 | 142MH-5 | 7 | 45-100 | 4 | 632TB-1000 | 22 |
| 44322 | 15 | 45905 | 51 | 47014 | 47 | 143-5 | 7 | 45240C | 34 | 632TB-500 | 22 |
| 45085 | 40 | 45906 | 51 | 47015 | 47 | 2012G | 63 | 45240Z | 36 | 632TC | 24 |
| 45086 | 40 | 45907 | 51 | 47016 | 47 | 2016G | 63 | 45240Z-3 | 36 | 633TB | 22 |
| 45087 | 40 | 45908 | 51 | 47017 | 47 | 2019-10 | 63 | 45240ZC | 36 | 633TB-50 | 22 |
| 45088 | 40 | 45909 | 51 | 47018 | 47 | 2022-10 | 63 | 4536-10 | 13 | 633TBC | 22 |
| 45089 | 40 | 45910 | 51 | 47019 | 47 | 2032-24 | 63 | 4536-3 | 13 | 634T | 24 |
| 45090 | 40 | 45912 | 51 | 50100 | 35 | 2035-24 | 63 | 45360Z | 36 | 634T-50 | 24 |
| 45091 | 40 | 45913 | 51 | 50120 | 35 | 2035-46 | 63 | 45360Z-3 | 36 | 634T-500 | 24 |
| 45092 | 40 | 45914 | 51 | 50160 | 34 | 235100V | 40 | 4546-10 | 36 | 634T-1000 | 24 |
| 45093 | 40 | 45915 | 51 | 50240 | 34 | 235120V | 40 | 4546-3 | 13 | 634TB | 22 |
| 45094 | 40 | 45926 | 51 | 50360 | 34 | 235150V | 40 | 45500Z | 13, 36 | 634TB-1000 | 22 |
| 45095 | 40 | 45927 | 51 | 50500 | 35 | 235180V | 40 | 45500Z-3 | 36 | 634TB-50 | 22 |
| 45096 | 40 | 45928 | 51 | 50800 | 35 | 235220V | 40 | 4560-10 | 13 | 634TBC | 22 |
| 45097 | 40 | 45929 | 51 | 64000 | 140 | 235240V | 40 | 4560-3 | 13 | 634TC | 24 |
| 45098 | 40 | 45930 | 51 | 64001 | 140 | 235320V | 40 | 45800Z | 36 | 636T | 24 |
| 45099 | 40 | 45931 | 51 | 64002 | 140 | 23536V | 40 | 45800Z-3 | 36 | 636T-1000 | 24 |
| 45100 | 34 | 45932 | 51 | 64003 | 140 | 235400V | 40 | 46-100 | 4 | 636T-50 | 24 |
| 45120 | 34 | 45933 | 51 | 64004 | 140 | 23540V | 40 | 47-100 | 4 | 636T-500 | 24 |
| 45160 | 34 | 46023 | 52 | 64005 | 140 | 23580V | 40 | 48-100 | 4 | 636TB | 22 |
| 45240 | 34 | 46024 | 52 | 64006 | 140 | 236100V | 40 | 49-100 | 4 | 636TB-1000 | 22 |
| 45360 | 34 | 46025 | 52 | 64007 | 140 | 236120V | 40 | 50-100 | 4 | 636TB-50 | 22 |
| 45500 | 34 | 46026 | 52 | 64008 | 140 | 236150V | 40 | 50240C | 34 | 636TBC | 22 |
| 45736 | 49 | 46027 | 52 | 70100 | 35 | 236180V | 40 | 50240Z | 36 | 636TC | 24 |
| 45737 | 49 | 46028 | 52 | 70120 | 35 | 236220V | 40 | 50240ZC | 36 | 640T | 24 |
| 45738 | 49 | 46029 | 52 | 70160 | 35 | 236240V | 40 | 50240Z-3 | 36 | 640T-1000 | 24 |
| 45739 | 49 | 46030 | 52 | 70240 | 35 | 236320V | 40 | 50360C | 34 | 640T-50 | 24 |
| 45740 | 49 | 46031 | 52 | 70360 | 35 | 23636V | 40 | 50360Z | 36 | 640T-500 | 24 |
| 45741 | 49 | 46032 | 52 | 70500 | 35 | 236400V | 40 | 50360Z-3 | 36 | 640TB | 22 |
| 45742 | 49 | 46033 | 52 | 70600 | 35 | 23640V | 40 | 50360ZC | 36 | 640TB-50 | 22 |
| 45743 | 49 | 46034 | 52 | 70800 | 35 | 23680V | 40 | 50500Z | 36 | 640TBC | 22 |
| 45744 | 49 | 46035 | 52 | 73750 | 54 | 24-10 | 3 | 50500Z-3 | 36 | 640TC | 24 |
| 45800 | 34 | 46036 | 52 | 73752 | 54 | 24-100 | 3 | 50800Z | 36 | 642T | 24 |
| 45819 | 48 | 46037 | 52 | 73753 | 54 | 24-20 | 3 | 50800Z-3 | 36 | 642T-1000 | 24 |
| 45820 | 48 | 46038 | 52 | 73754 | 54 | 24-50 | 3 | 610T | 23 | 642T-50 | 24 |
| 45821 | 48 | 46039 | 52 | 73755 | 54 | 24036V | 42 | 610T-100 | 23 | 642T-500 | 24 |
| 45822 | 48 | 46040 | 52 | 73757 | 54 | 24040V | 42 | 610TB | 21 | 642TB | 22 |
| 45823 | 48 | 46041 | 52 | 73758 | 54 | 24060V | 42 | 612T | 23 | 642TB-50 | 22 |
| 45824 | 48 | 46042 | 52 | 73759 | 54 | 24080V | 42 | 612T-100 | 23 | 642TBC | 22 |
| 45825 | 48 | 46051 | 52 | 73760 | 54 | 24120V | 42 | 612TB | 21 | 642TC | 24 |
| 45826 | 48 | 46052 | 52 | 73762 | 54 | 25-20 | 3 | 614T | 23 | 644T | 24 |
| 45827 | 48 | 46053 | 52 | 73763 | 54 | 25-25 | 3 | 614T-100 | 23 | 644TB | 22 |
| 45828 | 48 | 46054 | 52 | 73764 | 54 | 25-5 | 3 | 614T-1000 | 23 | 644TC | 24 |
| 45829 | 49 | 46084 | 53 | 73765 | 54 | 25-6 | 3 | 614TB | 21 | 64520TB | 22 |
| 45830 | 49 | 46085 | 53 | 73767 | 54 | 25SL-10 | 5 | 616TB | 21 | 64522TB | 22 |
| 45831 | 49 | 46086 | 53 | 73768 | 54 | 25SL-M | 5 | 620T | 23 | 64524TB | 22 |
| 45832 | 49 | 46087 | 53 | 73769 | 54 | 26-20 | 3 | 620T-1000 | 23 | 64526TB | 22 |
| 45833 | 49 | 46088 | 53 | 73770 | 54 | 26-25 | 3 | 620T-50 | 23 | 646T | 24 |
| 45834 | 49 | 46089 | 53 | 73780 | 54 | 26-5 | 3 | 620T-500 | 23 | 646TC | 24 |
| 45835 | 49 | 46090 | 53 | 80000 | 39 | 26-6 | 3 | 620TB-1000 | 21 | 65-10 | 138 |
| 45836 | 51 | 46091 | 53 | 80001 | 39 | 26SL-10 | 5 | 620TB-500 | 21 | 6520TB | 22 |
| 45837 | 51 | 46092 | 53 | 80002 | 39 | 26SL-M | 5 | 620TBA | 25 | 6522TB | 22 |
| 45838 | 51 | 46093 | 53 | 80003 | 39 | 27-100 | 3 | 620TC | 23 | 6524TB | 22 |
| 45839 | 51 | 46094 | 53 | 82751 | 54 | 27-25 | 3 | 621TB | 21 | 6526TB | 22 |
| 45840 | 51 | 46095 | 53 | 82752 | 54 | 29-10 | 3 | 621TB-50 | 21 | 66-100 | 138 |
| 45841 | 51 | 46096 | 53 | 82753 | 54 | 29SL | 5 | 621TBC | 21 | 6620TB | 23 |
| 45842 | 51 | 46097 | 53 | 82754 | 54 | 30-10 | 3 | 622T | 23 | 6622TB | 23 |
| 45843 | 51 | 46098 | 53 | 83751 | 54 | 30-100 | 3 | 622T-1000 | 23 | 6624TB | 23 |
| 45856 | 49 | 46104 | 53 | 83752 | 54 | 32120GT | 30 | 622T-50 | 23 | 6666T | 26 |
| 45857 | 49 | 46105 | 53 | 83753 | 54 | 3220GT-100 | 30 | 622T-500 | 23 | 66H | 138 |
| 45858 | 49 | 46106 | 53 | 83754 | 54 | 3230GT-100 | 30 | 622TB-1000 | 21 | 6720TB | 23 |
| 45859 | 49 | 46107 | 53 | 88000 | 39 | 323T-50 | 15 | 622TB-500 | 21 | 6722TB | 23 |
| 45860 | 49 | 46108 | 53 | 88001 | 39 | 3250GT-100 | 30 | 622TC | 23 | 6724TB | 23 |
| 45861 | 49 | 46180 | 48 | 88002 | 39 | 3280GT-100 | 30 | 623TB | 21 | 6726TB | 23 |
| 45862 | 49 | 46181 | 48 | 90100 | 35 | 33120GT | 30 | 623TB-50 | 21 | 70240C | 35 |
| 45863 | 49 | 46182 | 48 | 90120 | 35 | 3320GT-100 | 30 | 623TBC | 21 | 70240Z | 36 |
| 45864 | 49 | 46183 | 48 | 90160 | 35 | 3330GT-100 | 30 | 624T | 23 | 70240Z-3 | 36 |
| 45865 | 49 | 46184 | 48 | 90240 | 35 | 333S | 16 | 624T-1000 | 23 | 70240ZC | 36 |
| 45866 | 49 | 46185 | 48 | 90360 | 35 | 333SP | 16 | 624T-50 | 23 | 7036-10 | 13 |
| 45867 | 49 | 46186 | 48 | 90500 | 35 | 333T-50 | 15 | 624T-500 | 23 | 70360C | 35 |
| 45868 | 49 | 46187 | 48 | 90800 | 35 | 3350GT-100 | 30 | 624TB | 21, 33 | 70360Z | 36 |
| 45869 | 50 | 46188 | 48 | 235100 | 40 | 3380GT-100 | 30 | 624TB-1000 | 21 | 70360Z-3 | 122 |
| 45870 | 50 | 46189 | 48 | 235120 | 40 | 343T-50 | 15 | 624TB-500 | 21 | 7036H-10 | 13 |
| 45871 | 50 | 46190 | 48 | 235150 | 40 | 37-10 | 3 | 624TC | 23 | 7046-10 | 13 |
| 45872 | 50 | 46191 | 48 | 235180 | 40 | 37-100 | 3 | 626T | 24 | 7046H-10 | 13 |
| 45873 | 50 | 46192 | 48 | 235220 | 40 | 37L | 7, 17 | 626T-1000 | 24 | 70500Z | 36 |
| 45874 | 50 | 46193 | 48 | 235240 | 40 | 37S | 7, 17 | 626T-50 | 24 | 70500Z-3 | 36 |
| 45875 | 50 | 46194 | 48 | 235320 | 40 | 37SL | 5 | 626T-500 | 24 | 7060-10 | 13 |
| 45876 | 50 | 46195 | 48 | 235400 | 40 | 38-5 | 3 | 626TB | 21 | 7060H-10 | 13 |
| 45877 | 50 | 46196 | 48 | 236100 | 40 | 38-50 | 3 | 626TB-1000 | 21 | 7080-10 | 13 |
| 45878 | 50 | 46197 | 48 | 236120 | 40 | 38SL | 5 | 626TB-50 | 21 | 70800Z | 36 |
| 45879 | 50 | 46198 | 48 | 236150 | 40 | 40240Z | 36 | 626TBC | 21 | 70800Z-3 | 36 |
| 45880 | 50 | 46199 | 48 | 236180 | 40 | 40240Z-3 | 36 | 626TC | 24 | 7080H-10 | 13 |
| 45881 | 50 | 47000 | 47 | 236220 | 40 | 4036-10 | 13 | 630T | 24 | 708E | 130 |
| 45882 | 50 | 47001 | 47 | 236240 | 40 | 40360Z | 36 | 630T-1000 | 24 | 709E | 130 |
| 45883 | 50 | 47002 | 47 | 236320 | 40 | 40360Z-3 | 36 | 630T-50 | 24 | 712E | 134 |
| 45884 | 50 | 47003 | 47 | 236400 | 40 | 4046-10 | 13 | 630T-500 | 24 | 719E | 130 |
| 45895 | 50 | 47004 | 47 | 121-5 | 7 | 40500Z | 36 | 630TB-1000 | 22 | 720E | 130 |
| 45896 | 50 | 47005 | 47 | 122-5 | 7 | 40500Z-3 | 36 | 630TC | 24 | 760S | 136 |
| 45897 | 50 | 47006 | 47 | 122M-5 | 7 | 4060-10 | 13 | 631TB | 22 | 777S | 136 |

INDEX

| Item | Page | Item | Page |
|------------|-------|------------|------|
| 787S | 136 | 64526TB | 29 |
| 90240Z | 37 | 646T | 31 |
| 90240Z-3 | 37 | 646TC | 31 |
| 90360Z | 37 | 65-10 | 183 |
| 90360Z-3 | 37 | 6520TB | 29 |
| 90500Z | 37 | 6522TB | 29 |
| 90500Z-3 | 37 | 6524TB | 29 |
| 90800Z | 37 | 6526TB | 29 |
| 90800Z-3 | 37 | 66-100 | 183 |
| A1 | 60 | 6620TB | 30 |
| A11 | 60 | 6622TB | 30 |
| A12 | 60 | 6624TB | 30 |
| A13 | 60 | 6666T | 33 |
| A14 | 60 | 66H | 183 |
| A15 | 60 | 6720TB | 30 |
| A15L | 60 | 6722TB | 30 |
| A2 | 60 | 6724TB | 30 |
| A21 | 60 | 6726TB | 30 |
| A23 | 60 | 70240C | 40 |
| A24 | 60 | 70240Z | 41 |
| A25 | 60 | 70240Z-3 | 41 |
| A25S | 60 | 70240ZC | 41 |
| A26 | 60 | 7036-10 | 16 |
| A3 | 60 | 70360C | 40 |
| A31 | 60 | 70360Z | 41 |
| A32 | 60 | 70360Z-3 | 41 |
| A34 | 60 | 7036H-10 | 16 |
| A36 | 60 | 7046-10 | 16 |
| A37 | 60 | 7046H-10 | 16 |
| A38 | 60 | 70500Z | 41 |
| A39 | 60 | 70500Z-3 | 41 |
| A4 | 602 | 7060-10 | 16 |
| A5 | 60 | 7060H-10 | 16 |
| AW5 | 60,61 | 7080-10 | 16 |
| AW5S | 60,61 | 70800Z | 41 |
| AW7 | 60,63 | 70800Z-3 | 41 |
| AW10 | 61 | 7080H-10 | 16 |
| FT450 | 37 | 708E | 175 |
| FTA | 37 | 709E | 175 |
| S1050A | 141 | 712E | 174 |
| S1060A | 141 | 719E | 175 |
| S1150A | 141 | 720E | 175 |
| S1250A | 141 | 760S | 136 |
| S3660 | 140 | 761T | 177 |
| S3665 | 140 | 767S | 176 |
| S3670 | 140 | 777S | 176 |
| S4010 | 141 | 787S | 136 |
| S4030A | 141 | 90240Z | 42 |
| SDP220 | 9 | 90240Z-3 | 42 |
| SDP260 | 9 | 90360Z | 42 |
| SDP280 | 9 | 90360Z-3 | 42 |
| SDP301 | 9 | 90500Z | 42 |
| SDP401 | 9 | 90500Z-3 | 42 |
| SDP401-25 | 9 | 90800Z | 42 |
| SDP401-5 | 9 | 90800Z-3 | 42 |
| SDP402 | 9 | FT450 | 37 |
| SDP402-100 | 9 | FTA | 37 |
| SDP402-25 | 9 | S1050A | 141 |
| SDP402-3 | 9 | S1060A | 141 |
| SDP402-5 | 9 | S1150A | 141 |
| SDP404 | 9 | S1250A | 141 |
| SDP404-100 | 9 | S3660 | 140 |
| SDP404-5 | 9 | S3665 | 140 |
| SDP451 | 9 | S3670 | 140 |
| SDP451-25 | 9 | S6600 | 26 |
| SDP451-3 | 9 | S6650 | 25 |
| SDP451-5 | 9 | S4010 | 141 |
| SDP452 | 9 | S4030 | 141 |
| SDP452-100 | 9 | SDP220 | 9 |
| SDP452-5 | 9 | SDP260 | 9 |
| SDP454 | 9 | SDP280 | 9 |
| SDP501N | 9 | SDP301 | 9 |
| SDP502 | 9 | SDP401 | 9 |
| SDP502-25 | 9 | SDP401-25 | 9 |
| SDP701-10 | 9 | SDP401-5 | 9 |
| SDP701N | 9 | SDP402 | 9 |
| 640T-50 | 31 | SDP402-100 | 9 |
| 640T-500 | 31 | SDP402-25 | 9 |
| 640TB | 29 | SDP402-3 | 9 |
| 640TB-50 | 29 | SDP402-5 | 9 |
| 640TBC | 29 | SDP404 | 9 |
| 640TC | 31 | SDP404-100 | 9 |
| 642T | 31 | SDP404-5 | 9 |
| 642T-1000 | 31 | SDP451 | 9 |
| 642T-50 | 31 | SDP451-25 | 9 |
| 642T-500 | 31 | SDP451-3 | 9 |
| 642TB | 29 | SDP451-5 | 9 |
| 642TB-50 | 29 | SDP452 | 9 |
| 642TBC | 29 | SDP452-100 | 9 |
| 642TC | 31 | SDP452-5 | 9 |
| 644T | 31 | SDP454 | 6 |
| 644TB | 29 | SDP501N | 9 |
| 644TC | 31 | SDP502 | 9 |
| 64520TB | 29 | SDP502-25 | 9 |
| 64522TB | 29 | SDP701-10 | 9 |
| 64524TB | 29 | SDP701N | 9 |

| Item | Page |
|-------|-------|
| SK450 | 37 |
| SK475 | 37 |
| SKA | 37 |
| W178 | 60 |
| W179 | 76/77 |
| W187 | 76/77 |
| W188 | 76/77 |
| W196 | 76/77 |
| W205 | 76/77 |
| W206 | 76/77 |
| W216 | 76/77 |
| W217 | 76/77 |
| W218 | 76/77 |
| W220 | 76/77 |
| W225 | 76/77 |
| W229 | 76/77 |
| W235 | 76/77 |
| W236 | 76/77 |



MERCHANDISING DISPLAYS

Shark has the perfect formula for successful sales. Our welding planograms and display racks have been updated to include the fastest selling products in some of our latest packaging. Included in the assortments are Abrasives, Wire Wheels, Rod, Wire, Electrode Holders, Cutting Tips, Mig Tips, Cutting Kits (on some), Helmets, and Welding Hose.

| Item# | Description |
|-------|-----------------------|
| 17008 | Small 2 Sided Spinner |
| 17009 | Large 4 Sided Spinner |
| 17050 | 4' x 5' Planogram |
| 17051 | 8' x 5' Planogram |
| 17052 | 12' x 5' Planogram |



17009



17008



17050



NEW! PRODUCTS FROM SHARK

BLACK MAMBA TORQUE GRIP GLOVES

Features & Benefits:

- Raised Torque Grip
- Finished 6.25 mil between Torque Grips and 10.25 mil thick at Torque Grip
- 3X the chemical and puncture resistance of a comparable thickness latex or vinyl glove

Page 99



BLACK MAMBA NITRILE GLOVES

Features & Benefits:

- Made with a patented NITREX® polymer
- Over 6.0 mil thick
- 3X the chemical and puncture resistance of a comparable thickness latex or vinyl glove

Page 99



BLUE MAMBA NITRILE GLOVES

Features & Benefits:

- Made from heavy duty professional-grade latex
- Thickness of an incredible 5.75 mil
- Lighter color makes it easier to see certain chemicals and solvents

Page 99



ANGLED APPLICATOR BRUSH

Item# 15218

Features & Benefits:

Our newest brush provides proper application of mounting paste. It's angled to allow easy access to the "toe area" of the bead most commonly damaged during mounting. This brush is equivalent to the Hunter RP6-1506.

Page 129



PLASMA CUTTER

Item# 17027

Features & Benefits:

- Dual voltage, 120V/230V
- Easy to use
- Cuts up to 6mm materials
- Includes IGBT inverter with thermal overload protection

Page 65



NEW!

ABRASIVE METAL SUPPLY CABINETS

Item# 16990 & 16993

Features & Benefits:

- Easy storage and refill
- Most popular shop supplies
- Assorted grits

Page 32



GOLD PRO DISCS

Features & Benefits:

- Heavy aluminum oxide
- Long life
- European made
- Paper backed

Page 40



SUPER BLUE DISCS

Features & Benefits:

- Fired aluminum oxide
- PSA or Hook and Loop Fastener
- Non-loading
- Film backing

Page 41





Clip-It-In USA



RETAINER CLIPS
2018



INTRODUCTION

HISTORY

Clip-it-in, owned and operated by Shark Industries, a leading supplier to the Automotive Aftermarket is now your convenient source for the most popular aftermarket clips, screws and fasteners for a variety of Auto Body and Undercar repairs.

Our new items are offered individually, as well as in convenient kits.

Our full line of Carbide Inserts and Tire Changer Parts and Accessories are also available in our Brake Lathe Catalog. Contact your nearest Distributor for all of our OEM alternative products.

ALPHABETICAL CATEGORIES

| | PAGE | | PAGE |
|---|-------|---|--------|
| Assortments - Retainer | 3-9 | Push Type Retainers | 44-59 |
| Body Shims | 89 | Radiator Grille Retainers | 59-60 |
| Bolts/Body-Metric | 10-11 | Rivets/Aluminum & Steel | 60-63 |
| Bumper Cover Retainer/Liner Pins | 11 | Rivets/Nylon | 63-64 |
| Bumper Cushion/Door Rod Clips, Radiator Grille/Nut/Splash Shield Retainers | 12-13 | Rivet Double Ended Drill Bits | 64 |
| Cable Straps | 13-14 | Screw/Locking Grommet & Moulding Inserts | 65-73 |
| Cowl Top Retainers | 14 | Screws, Nuts, & Washers | 74-77 |
| Door Rod Retainers | 15 | Screws/Sem | 78-79 |
| Door Trim Retainers | 16-19 | Screw/Sheet Metal | 79-80 |
| Floor Mat Clips | 19 | Tail Light Clips | 80 |
| Headlight Adjusting Nut/Housing Clips | 20 | Trim Retainers | 81-87 |
| Hood Pad Retainers | 20-23 | U-Nut Extruded | 88 |
| License Plate Clips | 24 | U-Nut/Spring Type & Body Shims | 88-89 |
| Moulding Clips | 24-33 | Weatherstrip Retainers | 89-92 |
| Nuts/Metric | 34 | Wheel Well Clips | 93 |
| Nut/Nylon | 35 | Window Glass Guide Mount | 93 |
| Oil Drain Plug Gaskets | 36 | Index | 94-97 |
| Panel Retainers | 36-40 | Auveco/Disco Part # Crossovers | 98-107 |
| Panel Retaining Clips | 41-43 | | |
| Plug Buttons/Plastic | 43 | | |

SHARK, SHARK WELDING, and CLIP-IT-IN are registered trademarks of Shark Industries Ltd. Any use of the name without express written permission is prohibited. Any reproduction of this catalogue without the permission of Shark is prohibited. Shark is a manufacturer/repackager of its own products. Any mention of any other manufacturer in this catalogue is only for reference purposes of part number, etc., and is not intended in any way to imply that Shark are manufactured by any of the mentioned manufacturers.

90721 115 Piece Black Nylon Blind Pop Rivet Assortment in 12 Compartments

| Part # | Qty | Assortment Includes: |
|--------|-----|---|
| 90980 | 25 | Rivet 1/4" (6.3mm) Hole Size, 3/32" - 3/16" Panel Range, 1/2" Flange Size |
| 90979 | 15 | Rivet 1/4" (6.3mm) Hole Size, 5/32" - 13/32" Panel Range, 1/2" Flange Size |
| 90654 | 25 | Rivet 3/16" (5mm) Hole Size, 1/8" - 15/64" Panel Range, 15/32" Flange Size |
| 90981 | 15 | Rivet 17/64" (6.6mm) Hole Size, 3/32" - 3/16" Panel Range, 45/64" Flange Size |
| 90978 | 15 | Rivet 1/4" (6.3mm) Hole Size, 5/32" - 1-3/32" Panel Range, 21/32" Flange Size |
| 90649 | 20 | Rivet 3/16" (5mm) Hole Size, 15/64" - 25/64" Panel Range, 15/32" Flange Size |



90713 120 Piece Door Trim Panel Retainer Assortment in 12 Compartments

| Part # | Qty | Assortment Includes: |
|--------|-----|---|
| 90077 | 8 | Natural Nylon Door Trim Panel Retainer 7/8" |
| 90083 | 10 | White Nylon Door Trim Panel Retainer 9/16-11/16" |
| 90130 | 10 | Natural Nylon Door Trim Panel Retainer 3/4" |
| 90072 | 8 | Natural Nylon Door Trim Panel Retainer 15/16" |
| 90076 | 10 | Natural Nylon Door Trim Panel Retainer 3/4" x 7/8" |
| 90070 | 10 | Natural Nylon Door Trim and Headliner Panel Retainer 3/4" |
| 90064 | 10 | Black Nylon Door Trim Panel Retainer 25/32" |
| 90056 | 10 | Natural Nylon Door Trim Panel Retainer 3/4" |
| 90055 | 12 | Black Nylon Door Trim Panel Retainer 3/4" |
| 90074 | 14 | Natural Nylon Door Trim Panel Retainer 1/2" |
| 90075 | 8 | White Nylon Door Trim Panel Retainer 20mm |
| 90063 | 10 | Natural Nylon Door Trim Panel Retainer 3/4" |



90633 311 Piece Universal Nylon Retainer Assortment in 24 Compartments

| Part # | Qty | Assortment Includes: |
|--------|-----|--|
| 90017 | 20 | Black Universal Nylon Shield Retainer 23/64" |
| 90033 | 20 | Black Universal Nylon Weather-Strip Retainer 7/16" |
| 90041 | 20 | Black Universal Nylon Weather-Strip Retainer 3/8" |
| 90809 | 18 | Black Universal Nylon Dash Panel Retainer 7/16" |
| 90860 | 20 | Black Nylon Screen Shroud Vent Grille To Panel Retainer 19/32" |
| 90839 | 10 | Black Universal Nylon Trim Panel Retainer 1" |
| 90831 | 20 | Black Universal Nylon Weather-Strip Retainer 10mm |
| 90822 | 20 | Black Universal Nylon Weather-Strip Retainer 3/8" |
| 90073 | 8 | Black Universal Nylon Shield Retainer 1" |
| 90882 | 12 | Black Universal Nylon Trim Panel /Bumper Filler Retainer 1/2" |
| 90808 | 15 | Black Universal Nylon Shield Retainer 11/16" |
| 90852 | 10 | Black Universal Nylon Hood Seal Retainer 3/4" |
| 90976 | 15 | Black Universal Nylon Shield Retainer 11/16" |
| 90866 | 15 | Black Universal Nylon Shield Retainer 11/16" |
| 90821 | 10 | Black Universal Nylon Fascia Panel Retainer 25mm |
| 90823 | 10 | Black Universal Nylon Shield Retainer 1" |
| 90856 | 10 | Black Universal Nylon Bumper Fascia Retainer 3/4" |
| 90841 | 8 | Black Universal Nylon Textured Head Panel 26mm |
| 90850 | 10 | Black Universal Nylon Panel Retainer 1" |
| 90832 | 10 | Black Universal Nylon Hood Seal Retainer 3/4" |
| 90826 | 12 | Black Universal Nylon Trim Panel Retainer 5/8" |
| 90185 | 8 | Black Universal Nylon Panel Retainer 5/16" |
| 90847 | 10 | Black Universal Nylon Fascia Bumper Retainer 22mm |



91004 60 Piece Import Door Trim Panel Retainer Assortment in 6 Compartments

| Part # | Qty | Assortment Includes: |
|--------|-----|---|
| 90267 | 10 | White Nylon Door Trim Panel Retainer 16mm |
| 90268 | 10 | Natural Nylon Door Trim Panel Retainer 3/4" |
| 90349 | 10 | Black Nylon Door Trim Panel Retainer 18mm |
| 90351 | 10 | White Nylon Door Trim Panel Retainer 18mm |
| 90372 | 10 | Natural Nylon Door Trim and Garnish Retainer 13mm |
| 90356 | 10 | White Nylon Door Trim Panel Retainer 18mm |



91005 62 Piece Door Rod Lock Clip Assortment in 12 Compartments

| Part # | Qty | Assortment Includes: |
|--------|-----|--|
| 90048 | 5 | Left-Hand Door Lock Rod Clip, 5/32" (4mm) Rod Size Gray Nylon |
| 90193 | 5 | Right-Hand Door Lock Rod Clip, 5/32" (4mm) Rod Size Red Nylon |
| 90047 | 8 | Left-Hand Nylon Door Lock Rod & Hood Latch Locking Push Rod Clip, 5/32" (4mm) Rod Size |
| 90172 | 3 | Right-Hand Nylon Door Lock Rod and Hood Latch |
| 90173 | 2 | Locking Push Rod Clip, 5/32" (4mm) Rod Size |
| 90174 | 6 | Nylon Door Lock Rod End Clip Door Lock Rod Clip, Yellow Nylon |
| 90052 | 6 | Nylon Rod End Clip, 5/32" (4mm) Rod Size, Snaps Into 6mm Hole |
| 90025 | 6 | Door Lock Rod Clip, GM 1964 - On |
| 90175 | 6 | Door Lock Rod Clip, GM 1956 - On |
| 90176 | 6 | Nylon Door Lock Rod Clip, 10mm Head Diameter |
| 90194 | 4 | Nylon Door Lock Rod Clip, 3/16" Rod Size |
| 90053 | 5 | Nylon Rod End Clip, 5/32" (4mm) Rod Size, Snaps Into 6mm Hole |



91006 120 Piece Domestic Door Trim Panel Retainer Assortment in 12 Compartments

| Part # | Qty | Assortment Includes: |
|--------|-----|---|
| 90077 | 10 | Natural Nylon Door Trim Panel Retainer 7/8" |
| 90083 | 10 | White Nylon Door Trim Panel Retainer |
| 90080 | 10 | Natural Nylon Retainer ConDuct To Sheet Metal In Doors 15/16" |
| 90130 | 10 | Natural Nylon Door Trim Panel Retainer 3/4" |
| 90072 | 10 | Natural Nylon Door Trim Panel Retainer 15/16" |
| 90076 | 10 | Natural Nylon Door Trim Panel Retainer 3/4" x 7/8" |
| 90070 | 10 | Natural Nylon Door Trim and Headliner Panel Retainer 3/4" |
| 90068 | 10 | White Nylon Door Trim Panel Retainer 3/4" |
| 90064 | 10 | Black Nylon Door Trim Panel Retainer 25/32" |
| 90069 | 10 | Black Nylon Seat Door Trim Panel 5/8" |
| 90054 | 10 | Natural Nylon Door Trim Panel Retainer 15/16" |
| 90056 | 10 | Natural Nylon Door Trim Panel Retainer 3/4" |



91007 90 Piece Domestic Door Trim Panel Retainer Assortment in 12 Compartments

| Part # | Qty | Assortment Includes: |
|--------|-----|---|
| 90055 | 10 | Black Nylon Door Trim Panel Retainer 3/4" |
| 90074 | 10 | Natural Nylon Door Trim Panel Retainer 1/2" |
| 90075 | 10 | White Nylon Door Trim Panel Retainer 20mm |
| 90063 | 10 | Natural Nylon Door Trim Panel Retainer 3/4" |
| 90078 | 10 | White Nylon Door Trim Panel Retainer 20mm |
| 90497 | 10 | White Nylon Door Trim Panel Retainer 9/16" |
| 90266 | 10 | White Nylon Door Trim Panel Retainer 23/32" |
| 90067 | 10 | White Nylon Door Trim Panel Retainer 17/32" |
| 90346 | 10 | White Nylon Door Trim Panel Retainer 15mm |



91008 168 Piece Universal Retainer Assortment in 12 Compartments

| Part # | Qty | Assortment Includes: |
|--------|-----|---|
| 90839 | 10 | Black Universal Nylon Trim Panel Retainer 1" |
| 90073 | 8 | Black Universal Nylon Shield Retainer 1" |
| 90808 | 20 | Black Universal Nylon Shield Retainer 11/16" |
| 90976 | 30 | Black Universal Nylon Shield Retainer 11/16" |
| 90821 | 10 | Black Universal Nylon Fascia Panel Retainer 25mm |
| 90823 | 10 | Black Universal Nylon Shield Retainer 1" |
| 90856 | 10 | Black Universal Nylon Bumper Fascia Retainer 3/4" |
| 90832 | 15 | Black Universal Nylon Hood Seal Retainer 3/4" |
| 90826 | 15 | Black Universal Nylon Trim Panel Retainer 5/8" |
| 90850 | 15 | Black Universal Nylon Panel Retainer 1" |
| 90847 | 10 | Black Universal Nylon Fascia Bumper Retainer 22mm |
| 90866 | 15 | Black Universal Nylon Shield Retainer 11/16" |



91009 282 Piece Master Tech Retainer Assortment in 24 Compartments

| Part # | Qty | Assortment Includes: |
|--------|-----|--|
| 90839 | 10 | Black Universal Nylon Trim Panel Retainer 1" |
| 90073 | 8 | Black Universal Nylon Shield Retainer 1" |
| 90808 | 15 | Black Universal Nylon Shield Retainer 11/16" |
| 90976 | 30 | Black Universal Nylon Shield Retainer 11/16" |
| 90866 | 15 | Black Universal Nylon Fascia Panel Retainer 25mm |
| 90821 | 10 | Black Universal Nylon Shield Retainer 1" |
| 90823 | 10 | Black Universal Nylon Bumper Fascia Retainer 3/4" |
| 90856 | 15 | Black Universal Nylon Hood Seal Retainer 3/4" |
| 90832 | 15 | Black Universal Nylon Trim Panel Retainer 5/8" |
| 90826 | 15 | Black Universal Nylon Panel Retainer 1" |
| 90850 | 15 | Black Universal Nylon Fascia Bumper Retainer 22mm |
| 90847 | 15 | Black Universal Nylon Fascia Bumper Retainer 22mm |
| 90977 | 8 | Black Nylon Front Fender Mud Skirt and Fender Liner Push Type 11/16" |
| 90569 | 10 | Black Nylon Push Type Retainer 20mm |
| 90511 | 8 | Black Nylon Rocker Panel Retainer 15mm |
| 90476 | 10 | Black Nylon Inner Fender Shield Blind Rivet 20mm |
| 90964 | 15 | Black Nylon Push Type Retainer 20mm |
| 90974 | 10 | Black Nylon Front Bumper Push Type Retainer 20mm |
| 90185 | 8 | Black Universal Nylon Panel Retainer 5/16" |
| 90458 | 8 | Black Nylon Push Type Retainer 11/16" |
| 90512 | 8 | Black Nylon Wheel Opening Moulding Push Type Retainer 19/32" |
| 90469 | 8 | Black Nylon Radiator Shroud Blind Rivet 11/16" |
| 90471 | 8 | Black Universal Nylon Splash Shield Blind Rivet 1" |
| 90470 | 8 | Black Universal Spare Tire Blind Rivet 1" |



91010 339 Piece Large GM Door and Panel Retainer Assortment in 18 Compartments

| Part # | Qty | Assortment Includes: |
|--------|-----|--|
| 90809 | 20 | Black Universal Nylon Dash Panel Retainer 7/16" |
| 90808 | 20 | Black Universal Nylon Shield Retainer 11/16" |
| 90852 | 20 | Black Universal Nylon Hood Seal Retainer 3/4" |
| 90976 | 20 | Black Universal Nylon Shield Retainer 11/16" |
| 90866 | 20 | Black Universal Nylon Shield Retainer 11/16" |
| 90832 | 20 | Black Universal Nylon Hood Seal Retainer 3/4" |
| 90850 | 20 | Black Universal Nylon Panel Retainer 1" |
| 90077 | 20 | Natural Nylon Door Trim Retainer 7/8" |
| 90130 | 20 | Natural Nylon Door Trim Retainer 3/4" |
| 90076 | 20 | Natural Nylon Door Trim Retainer 3/4" x 7/8" |
| 90163 | 10 | Black Nylon Hood Insulation Clip 1-21/32" |
| 90109 | 8 | Black PolyPropylene Hood Insulation Clip 2" |
| 90853 | 20 | Black Nylon Seat Back Retainer 25/32" |
| 90855 | 20 | Black Nylon Trim Panel Retainer 1" |
| 90859 | 20 | Black Nylon Front End Stone Shield Retainer 7/8" |
| 90834 | 20 | Black Nylon Splash Shield & Wheel Well Cover Retainer 7/8" |
| 90083 | 26 | White Nylon Trim Panel Retainer 9/16"-11/16" |
| 90168 | 15 | Black Nylon Hood Insulation Retainer 1-3/16" |



91011 118 Piece GM Door and Panel Retainer Assortment in 12 Compartments

| Part # | Qty | Assortment Includes: |
|--------|-----|---|
| 90809 | 10 | Black Universal Nylon Dash Panel Retainer 7/16" |
| 90808 | 10 | Black Universal Nylon Shield Retainer 11/16" |
| 90976 | 10 | Black Universal Nylon Shield Retainer 11/16" |
| 90850 | 9 | Black Universal Nylon Panel Retainer 1" |
| 90077 | 10 | Natural Nylon Door Trim Retainer 7/8" |
| 90130 | 10 | Natural Nylon Door Trim Retainer 3/4" |
| 90076 | 11 | Natural Nylon Door Trim Retainer 3/4" x 7/8" |
| 90070 | 10 | Windshield and Backlight Reveal Moulding Clip |
| 90054 | 10 | Natural Nylon Door Trim and Headlight Panel Retainer 3/4" |
| 90833 | 10 | Black Nylon Seat Back Retainer 25/32" |
| 90853 | 9 | Black Nylon Front End Stone Shield Retainer 7/8" |
| 90859 | 9 | Black Nylon Front End Stone Shield Retainer 7/8" |



91012 340 Piece Large Ford Door and Panel Retainer Assortment in 18 Compartments

| Part # | Qty | Assortment Includes: |
|--------|-----|---|
| 90809 | 20 | Black Universal Nylon Dash Panel Retainer 7/16" |
| 90843 | 20 | Black Nylon Fascia to Bumper Retainer 1" |
| 90808 | 25 | Black Universal Nylon Shield Retainer 11/16" |
| 90976 | 25 | Black Universal Nylon Shield Retainer 11/16" |
| 90840 | 20 | Black Nylon Fascia Retainer 7/16" |
| 90826 | 20 | Black Nylon Trim Panel Retainer 5/8" |
| 90064 | 20 | Black Universal Nylon Shield Retainer 25/32" |
| 90069 | 20 | Black Nylon Seat Back Door Trim Panel Retainer 5/8" |
| 90918 | 20 | Black Nylon Weather-Strip Retainer |
| 90866 | 15 | Black Nylon Shield Retainer, Battery Post Cable Shield, Engine Splash Shield, Radiator Side Air Baffle 11/16" |
| 90829 | 20 | Black Nylon Door Trim Panel Retainer 15/16" |
| 90066 | 20 | White Nylon Door Trim Panel Retainer 3/4" |
| 90839 | 20 | Black Universal Nylon Trim Panel Retainer Head Diameter 1" |
| 90841 | 20 | Black Universal Nylon Textured Head Panel Retainer 26mm |
| 90106 | 15 | Black Nylon Hood Insulation Retainer Chrysler 1972-on Grille to Radiator Retainer Ford 1973-on, 1/2" x 1-1/2" |
| 90167 | 10 | Black Nylon Hood Insulation Retainer 1-3/4" |
| 90107 | 15 | Black Nylon Hood Insulation Retainer 1-3/16" |
| 90845 | 15 | Black Nylon Mud Flap Retainer 11/16" |



91013 350 Piece Large Chrysler Door & Panel Retainer Assortment in 18 Compartments

| Part # | Qty | Assortment Includes: |
|--------|-----|---|
| 90041 | 20 | Black Universal Nylon Weather-Strip Retainer 3/8" |
| 90831 | 20 | Black Universal Nylon Weather-Strip Retainer 10mm |
| 90808 | 20 | Black Universal Nylon Shield Retainer 11/16" |
| 90976 | 20 | Black Universal Nylon Shield Retainer 11/16" |
| 90821 | 20 | Black Universal Nylon Fascia Panel Retainer 25mm |
| 90832 | 20 | Black Universal Hood Seal Retainer 3/4" |
| 90826 | 15 | Black Universal Nylon Trim Panel Retainer 5/8" |
| 90054 | 20 | Natural Nylon Door Trim Panel Retainer 15/16" |
| 90266 | 25 | White Nylon Door Trim Panel Retainer 23/32" |
| 90346 | 25 | White Nylon Door Trim Panel Retainer 20mm |
| 90164 | 15 | White Nylon Hood Weather-Strip Retainer 1/4" x 21/32" |
| 90829 | 20 | Black Nylon Door Trim Panel Retainer 15/16" |
| 90834 | 20 | Black Nylon Splash Shield & Wheel Well Cover Retainer 7/8" |
| 90866 | 20 | Black Nylon Shield Retainer, Battery Post Cable Shield, Engine Splash Shield, Radiator Side Air Baffle 11/16" |
| 90168 | 15 | Black Nylon Hood Insulation Retainer 1-3/16" |
| 90106 | 15 | Black Nylon Hood Insulation Retainer Chrysler 1972-on Grille to Radiator Retainer Ford 1973-on, 1/2" x 1-1/2" |
| 90104 | 15 | Black Nylon Hood Insulation & Fender Shield Retainer 1-5/16" |
| 90935 | 25 | Green Nylon Trim Panel Retainer 23/32" |



91014 80 Piece Toyota Retainer Assortment in 12 Compartments

| Part # | Qty | Assortment Includes: |
|--------|-----|--|
| 90349 | 5 | Black Nylon Door Trim Panel Retainer 18mm |
| 90372 | 5 | Natural Universal Door Trim & Garnish Retainer 13mm |
| 90356 | 5 | White Nylon Door Trim Panel Retainer 18mm |
| 90559 | 10 | Black Nylon Push Type Retainer 15mm |
| 90418 | 5 | 15mm Black Nylon Retaining Clip |
| 90421 | 10 | Black Nylon Retaining Clip 13mm |
| 90420 | 10 | Black Nylon Retainer Fits 5mm Hole, Head Diameter 14mm |
| 90123 | 5 | Black Nylon Hood Insulation Retainer Fits 7mm Hole, Head Diameter 30mm, Stem Length: 17mm |
| 90602 | 5 | Black Nylon Bumper Cover Push Type Retainer Head Diameter: 15mm |
| 90966 | 10 | Black Nylon Toyota Push Type Retainer Fits 9mm Hole Head Diameter: 18mm, Stem Length: 28mm |
| 90600 | 10 | Black Nylon Front Fender Liner Push Type Retainer Fits 7mm Hole Head Diameter: 20mm |



91015 80 Piece Honda Retainer Assortment in 12 Compartments

| Part # | Qty | Assortment Includes: |
|--------|-----|---|
| 90520 | 5 | Black Nylon Push Type Retainer 18mm |
| 90519 | 5 | Black Nylon Bumper Fascia Retainer 20mm |
| 90974 | 10 | Black Nylon Front Bumper Push Type Retainer 20mm |
| 90924 | 10 | Orange Nylon Weather-Strip Retainer 5mm x 15mm |
| 90394 | 5 | Black Nylon Hood and Trunk Moulding Clip 12mm |
| 90101 | 5 | Black Nylon Acura '91 - On Hood Insulation Retainer Head Diameter: 30mm, Stem Diameter: 10mm Stem Length: 6mm |
| 90971 | 10 | Black Nylon Front Fender Push Type Retainer Head Diameter 14mm |
| 90522 | 5 | Black Nylon Splash Shield Retainer, Diameter: 30mm Stem Diameter 10mm, Stem Length: 6mm |
| 90431 | 5 | Black Nylon Push Type Retainer, Head Diameter: 20mm |
| 90534 | 5 | Black Nylon Push Type Bumper Retainer 1mm Hole Head Diameter: 20mm |
| 90430 | 5 | Black Nylon Push Type Bumper Retainer Fits 10mm Hole, Head Diameter: 20mm, Stem Length: 24mm |
| 90973 | 10 | Black Nylon Push Type Retainer 10mm Hole Head Diameter: 20mm |



91016 59 Piece All Metal Rivet Assortment in 15 Compartments

| Part # | Qty | Assortment Includes: |
|--------|-----|--|
| 90177 | 3 | All Aluminum Pop Rivet 1/4" Flange Size Industrial #44 |
| 90178 | 5 | All Aluminum Pop Rivet 3/8" Flange Size Industrial #66 |
| 90179 | 2 | All Steel Bright Zinc Finish Headlight Retainer Rivet 1/2" Flange Size |
| 90635 | 3 | Aluminum Rivet - Steel Mandrel Black Outside Door Handle Rivet 1/2" Flange Size |
| 90180 | 2 | Aluminum-Steel Black Door Handle Rivet 1/2" Flange Size |
| 90181 | 2 | Aluminum Rivet - Steel Mandrel Door Glass Peel Rivet 5/8" Flange Size |
| 90969 | 3 | Black Universal Aluminum Split-Type Rivet and Wheel House Moulding 7/16" Flange Size |
| 90634 | 3 | Black Aluminum Rivet - Steel Mandrel Windshield Rail Rivet 3/8" Flange Size |
| 90182 | 5 | All Aluminum Pop Rivet 5/8" Flange Size Industrial #66L |
| 90630 | 10 | Short Aluminum Window Regulator Peel Rivet, Flange Size 1/2" 10 |
| 90629 | 4 | Black Universal Aluminum Split-Type Rivet and Bumper Cover 1/16" Flange Size Stem Length: 24mm |
| 90631 | 8 | Long Aluminum Glass STop Peel Rivet, Steel Mandrel 1/2" Flange Size |
| 90183 | 3 | Aluminum Rivet - Steel Mandrel Outside Door Handle Rivet 1/2" Flange Size |
| 90186 | 3 | All Steel Black Bumper Assembly Rivet 3/4" Flange Size |
| 90632 | 3 | All Aluminum Pop Rivet 9/16" Flange Size |



91017 263 Piece Push Type Rivet and Retainer Assortment in 24 Compartments

| Part # | Qty | Assortment Includes: |
|--------|-----|--|
| 90980 | 10 | Black Nylon Blind Rivet 1/2" Flange Size |
| 90177 | 50 | All Aluminum Pop Rivet 1/4" Flange Size Industrial #44 |
| 90178 | 20 | All Aluminum Pop Rivet 3/8" Flange Size Industrial #66 |
| 90979 | 10 | Black Nylon Blind Rivet 1/2" Flange Size |
| 90654 | 12 | Black Nylon Blind Rivet 15/32" Flange Size |
| 90981 | 10 | Black Nylon Blind Rivet 45/64" Flange Size |
| 90658 | 12 | Black Nylon Blind Rivet 15/32" Flange Size |
| 90635 | 10 | Aluminum Rivet - Steel Mandrel Black Outside Door Handle Rivet 1/2" Flange Size |
| 90978 | 8 | Rivet 1/4" (6.3mm) Hole Size, 5/32" -1-3/32" Panel Range, 21/32" Flange Size |
| 90653 | 8 | Black Nylon Blind Rivet 43/64" Flange Size |
| 90969 | 10 | Black Universal Aluminum Split-Type Rivet and Wheel House Moulding 7/16" Flange Size |
| 90634 | 25 | Black Aluminum Rivet 5/8" Flange Size Industrial #66 |
| 90182 | 15 | All Aluminum Pop Rivet - Steel Mandrel Outside Door Handle Rivet 1/2" Flange Size |
| 90630 | 10 | Short Aluminum Window Regulator Peel Rivet, 1/2" Flange Size |
| 90629 | 8 | Black Universal Aluminum Split-Type Rivet and Bumper Cover 1/16" Flange Size |
| 90649 | 12 | Black Nylon Blind Rivet 15/32" Flange Size |
| 90186 | 8 | All Steel Black Bumper Assembly Rivet |
| 90631 | 10 | Long Aluminum Glass STop Peel Rivet, Steel Mandrel 1/2" Flange Size |
| 90632 | 15 | All Aluminum Pop Rivet 9/16" Flange Size |



91018 125 Piece Push Type Rivet and Retainer Assortment in 24 Compartments

| Part # | Qty | Assortment Includes: |
|--------|-----|---|
| 90497 | 5 | White Nylon Push Type Door Trim Panel Retainer 9/16" |
| 90977 | 5 | Black Nylon Front Fender Mud Skirt & Fender Liner Push Type Retainer 11/16" |
| 90458 | 5 | Black Nylon Push Type Retainer 11/16" |
| 90512 | 5 | Black Nylon Wheel Opening Moulding Push Type Retainer 19/32" |
| 90496 | 5 | Black Universal Nylon Radiator and Windshield Bottle Retainer 21/32" |
| 90533 | 5 | Black Nylon Push Type Retainer 20mm |
| 90569 | 5 | Black Nylon Push Type Retainer 20mm |
| 90511 | 5 | Black Nylon Rocker Panel Retainer 15mm |
| 90571 | 5 | Black Nylon Push Type Retainer 16mm 16mm |
| 90490 | 5 | Black Nylon Front Bumper Fascia Retainer 18mm |
| 90295 | 5 | Natural Nylon Push Type Retainer 16mm |
| 90508 | 5 | Black Nylon Push Type Retainer 14mm |
| 90469 | 5 | Black Nylon Radiator Shroud Blind Rivet 11/16" |
| 90559 | 5 | Black Nylon Push Type Retainer 15mm |
| 90532 | 5 | Black Nylon Splash Shield Blind Rivet 20mm |
| 90520 | 5 | Black Nylon Push Type Retainer 18mm |
| 90476 | 5 | Black Nylon Inner Fender Shield Blind Rivet 20mm |
| 90964 | 5 | Black Nylon Push Type Retainer 20mm |
| 90519 | 5 | Black Nylon Bumper Fascia Retainer 20mm |
| 90471 | 5 | Black Universal Nylon Splash Shield Blind Rivet 1" |
| 90523 | 5 | Black Nylon Vent Panel Blind Rivet 18mm |
| 90470 | 5 | Black Universal Spare Tire Blind Rivet 1" |
| 90967 | 5 | Black Universal Nylon Fascia Retainer 1" |
| 90974 | 5 | Black Nylon Front Bumper Push Type Retainer 20mm |
| 90548 | 5 | Black Nylon Bumper Cover Blind Rivet 15mm |



PN 90000

Chrysler: 6100539

Hex Head Sems
Thread Cutting Screw with
Dog Point
Phosphate
8mm Hex
M5-0.8 x 20mm
Outside Diameter: 12mm
(1/2") Washer

Applications:
Chrysler



Pkg. Qty: 50

PN 90001

Indented Hex Head Bolt

Zinc
Head Diameter: 12mm
M8-1.25 x 15mm

Applications:
Indented Hex



Pkg. Qty: 25

PN 90002

Hex Head Bolt

Yellow Zinc
Grade 4
Head Diameter: 12mm
8-1.25 x 15mm

Applications:
Hex Head



Pkg. Qty: 25

PN 90003

Hex Head Bolt

Split Lock Washer
Black E-Coat
6.0-1.0 x 16mm
16mm Loose Washer

Applications:
Hex Head



Pkg. Qty: 25

PN 90663

Hex Size: 10mm
Length: 16mm
Flange Size: 15mm
Thread Size: M6-1.0
Bright Zinc Finish



Pkg. Qty: 50

PN 90005

Metric Bolt Zinc

Class 4
Head Diameter: 14mm
Size: M10-1.25 x 25mm
Flange: 20mm

Applications:
Metric



Pkg. Qty: 25

PN 90006

Metric bolt

Yellow Zinc
Head Diameter: 10mm
Size: M6-1.0 x 15mm
Flange: 13.5mm

Applications:
Metric



Pkg. Qty: 25

PN 90007

GM: 11503834, 20351035

Hex Head Sems
Phosphate
Class 9.8
10mm Hex
M6-1.0 x 25mm
Outside Diameter:
17mm (21/32") Washer

Applications:
GM



Pkg. Qty: 50

PN 90008

GM: 11503619

Hex Head Sems
Phosphate
Class 9.8
13mm Hex
M8-1.25 x 25mm
Outside Diameter:
24mm (15/16") Washer

Applications:
GM



Pkg. Qty: 25

PN 90009

GM: 11501188

Hex Head Sems
Phosphate
Class 9.8
13mm Hex
M8-1.25 x 30mm
Outside Diameter: 24mm (15/16")
Washer

Applications:
GM



Pkg. Qty: 25

PN 90010

GM: 11502941, 11506174

Hex Head Sems
Phosphate
Class 9.8
10mm Hex
M6-1.0 x 20mm
Outside Diameter: 17mm (21/32")
Washer

Applications:
GM



Pkg. Qty: 25

PN 90011

GM: 11503982

Hex Head Sems
Phosphate
Class 9.8
10mm Hex
M6-1.0 x 25mm
Outside Diameter: 24mm (15/16")
Washer

Applications:
GM



Pkg. Qty: 50

PN 90012

GM: 11505044

Hex Head Sems
Black Phosphate
Class 9.8
10mm Hex
M6-1.0 x 35mm
Outside Diameter: 17mm (21/32")
Washer

Applications:
GM



Pkg. Qty: 50

PN 90013

Toyota: 90105-06037

Head Diameter: 10mm
Stem Diameter: 5.5mm
Stem Length: 10mm
Flange Size: 15mm
Thread Pitch: 1.0

Applications:
Lexus
Toyota: 2001-up



Pkg. Qty: 25

BUMPER COVER RETAINER/LINER PINS

PN 90014

GM: 92139147

Front & Rear Bumper
Fascia Retainer
Black Nylon
Head Diameter: 21mm x 14mm
Stem Length: 16mm
Fits into 8mm Hole

Applications:
Chevrolet: Caprice
Pontiac: G8, GTO 2004-2011



Pkg. Qty: 25

PN 90015

Honda: 91505-TM8-003

Honda Front & Rear Bumper Clip
Retainer Inner Wheel, Well Liner
Retaining Clip, Black Nylon
Head Diameter: 20mm
Stem Diameter: 9.6mm
Stem Length: 14mm
Overall Length: 17.3mm

Applications:
Acura: ILX 2013, Honda: Insight
2012-up



Pkg. Qty: 25

PN 90016

Lexus: 90467-05125

Front Bumper Extension
Mounting Bracket Clip
Black Nylon
Head Diameter: 16mm
Stem Diameter: 4.7mm x 4.7mm
Stem Length: 12mm

Applications:
Lexus: GS300, GS450H, LS400
1995-2011



Pkg. Qty: 10

PN 90985

Lexus: 47749-50090

Front Bumper Cover &
Fender Liner Pins
Black Nylon
Head Diameter: 10mm
Stem Length: 24mm
(Use with 90018)

Applications:
Lexus



Pkg. Qty: 15

PN 90018

Lexus: 53879-50020

Front Bumper Cover &
Fender Liner Retainers
Black Nylon
Width: 35mm
Length: 25mm
(Use with 90985)

Applications:
Lexus



Pkg. Qty: 10

PN 90019

Lexus/Toyota: 51454-48010, 51454-0E010

Front Bumper Extension
Mounting Bracket Clip
Black Nylon
Head Diameter: 20mm
Stem Diameter: 10mm
Stem Length: 12mm

Applications:
Lexus: IS CV, F, RX330, RX400 Hybrid
2006-up, Toyota: Highlander, Sienna,
Venza 2009-up



Pkg. Qty: 15

PN 90020

Mitsubishi: MB879499

Front Bumper Clip
Black Nylon
Head Diameter: 18mm
Stem Length: 9mm
Fits into 9mm Hole Size

Applications:
Mitsubishi: All Models



Pkg. Qty: 25

PN 90221

Toyota: 47749-58010

Front Bumper Cover &
Fender Liner Pins
Black Nylon
Head Diameter: 15mm
Stem Length: 25mm
(Use with 90332)

Applications:
Lexus & Toyota 4 Runner, Highlander,
Sienna, & Solara
2000 Up



Pkg. Qty: 10

PN 90332

Toyota: 53879-58010

Front Bumper Cover &
Fender Liner Retainers
Black Nylon
Width: 25mm
Length: 34mm
(Use with 90221)

Applications:
Lexus & Toyota 4 Runner,
Highlander, Sienna, & Solara
2000 Up



Pkg. Qty: 5

PN 90021

Audi/VW:
1H0-867-199-01C

Front Radiator Grille Scuff Plate
& Sill Panel Trim Retainer
Black Nylon
Head Diameter: 23mm
Stem Diameter: 11mm
Stem Length: 16mm

Applications:
Audi/VW: All Models 1997-up



Pkg. Qty: 25

PN 90022

**Audi, VW: N90-796-501,
N90-796-502**

Radiator Support & Shield
Push-on Retainer
Dacromet Plated
Stud Size: 5mm
Outside Diameter: 30mm

Applications:
Audi: A4,A6,A8
Seat: Altea, Arosa, Cordoba, Ibiza,
Toledo, Skoda, VW: All Models



Pkg. Qty: 25

PN 90023

Audi, VW: N90-335-006

Splash Shield & Wheel
Well Push-on Retainer
Dacromet Plated
Stud Size: 5mm
Outside Diameter: 30mm

Applications:
Audi/VW



Pkg. Qty: 25

PN 90025

**GM: 4234830,
12337868**

Door Lock Rod Clip
Applications:
GM: 1964-up



Pkg. Qty: 25

PN 90024

GM: 15686142

Radiator Grille Nut
Zinc Phosphate
#8 Screw Size

Applications:
GM: Trucks, C, K, 1, 2 & 3
1993-up



Pkg. Qty: 25

PN 90026

**Infiniti/Nissan:
01553-02923**

Fender Flare
Bumper Cover Clip with Sealer
White Nylon
Head Diameter: 14mm x 18mm
Stem Length: 13mm

Applications:
Infiniti: M45, Q45 1999-up
Nissan: Armada, Frontier, Pathfinder,
Xterra 1996-up



Pkg. Qty: 25

PN 90027

**Infiniti/Nissan:
66820-61U00**

Cowl Grille Clip
Gray Nylon
Head Diameter: 11mm
Stem Diameter: 4.5mm
Stem Length: 15mm
Overall Length: 30mm

Applications:
Infiniti: M45, Q45 1997-up
Nissan: Sentra 2000-up



Pkg. Qty: 25

PN 90028

**Lexus/Scion/Toyota:
90467-05138**

Front Bumper & Fender Liner U-Nut
Black Nylon
Size: 19.6mm x 43.4mm
Stem Diameter: 9.7mm
Overall Height: 24mm

Applications:
Lexus: GX460, GX470, LX 570
2003-up, **Scion:** tC 2005-up, **Toyota:**
4Runner, Corolla, FJ Cruiser, Land Cruiser,
Matrix, Sequoia, Tacoma,
Tundra 2003-up



Pkg. Qty: 15

PN 90029

Toyota: 90467-08136

Fender Seal Retaining Clip
Black Nylon
Head Diameter: 20mm
Stem Diameter: 8mm
Stem Length: 8mm
Snaps into 7mm Hole

Applications:
Toyota: Yaris 2009-up



Pkg. Qty: 25

PN 90030

Toyota: 90468-04030

Bumper Strip Retainer
Applications:
Toyota: 1984-up



Pkg. Qty: 25

PN 90031

Toyota: 90183-03001

Front Bumper Cushion Clip
Applications:
Toyota: 1982-up



Pkg. Qty: 25

PN 90032

**Toyota:
76879-44010**

Front and Rear Spoiler Clip
Spring Locking Clip

Applications:
Toyota: Corolla, Matrix,
Prius, Solara 2003-up
Applications:
GM



Pkg. Qty: 15

BUMPER CUSHION, DOOR ROD, RADIATOR GRILLE, NUT & SPLASH SHIELD RETAINER

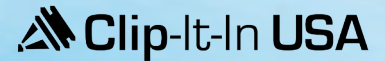

PN 90033

GM: 10169777

Black Nylon
Weather Strip Retainer
Head Diameter: 7/16"
Stem Diameter: 7/32"
Stem Length: 5/16"

Applications:
GM



Pkg. Qty: 25

PN 90173

**Ford: E6DZ-5421952A,
E83Z-5421952B**

White Nylon
Nylon Door Lock
Rod End Clip
Rod Size: 5/32"

Applications:
Ford



Pkg. Qty: 10

PN 90174

**Ford: 390523S,
E6AZ-5421952-A**

Door Lock Rod Clip
Yellow Nylon
Rod Size: 5/32"

Applications:
Ford



Pkg. Qty: 25

PN 90175

**GM: 3998009,
9711304**

Door Lock Rod Clip
Applications:
GM 1956-on



Pkg. Qty: 50

PN 90176

**GM: 16606936,
16633853**

Nylon Door Lock Rod Clip
10mm Head Diameter
Rod Size: 4mm

Applications:
GM



Pkg. Qty: 100

PN 90193

Chrysler: 3454220

Door Lock Rod Clip
Right Hand Side
Rod Size: 5/32" (4mm)
Red Nylon

Applications:
Chrysler



Pkg. Qty: 50

PN 90194

**GM: 14037239,
15545178**

Natural Nylon
Tailgate Rod Clip 3/16"

Applications:
GM: Trucks C, K1, 2, 3
1981-up



Pkg. Qty: 10

PN 90646

Toyota: 53384-68010

Front Grille Clip Retainer
Black Nylon w/ Rubber Cap
Upper Head Diameter: 20mm
Head Flange Diameter: 18mm
Stem Length: 29mm
Overall Length: 49mm
Fits into 9mm Hole Size

Applications:

Toyota: RAV4 2006-2014
Scion: TC 2005-2014



Pkg. Qty: 15

PN 90172

Chrysler: 2945108R

White Nylon
Right Hand Door
Lock Rod & Hood Latch
Locking Push Clip
5/32" (4mm) Rod Size

Applications:
Chrysler



Pkg. Qty: 25

CABLE STRAP

PN 90034

**Honda: 90669-671-0000;
90669-671-0030,
Toyota: 90463-10337**

Nylon Cable Strap
Max Bundle Diameter: 23mm
Length: 110mm (5-5/16")

Applications:
Toyota, Honda



Pkg. Qty: 15

PN 90035

Toyota: 82711-12200

Wiring Harness CLamp
Strap Diameter: 7mm
Strap Length: 170mm

Applications:

Toyota: 4Runner, Camry,
Celica, Corolla, Cressida,
Land Cruiser, MR-2,
Paseo, Previa, RAV4,
Supra, T-100, Tercel
1998-up



Pkg. Qty: 25

PN 90036

Universal Push Mount

Universal Push Mount
Cable Strap
Black Nylon
Max Bundle Diameter: 1-3/4" (44.45mm)
Length: 8" (200mm)
Width: 5mm (3/16")
Fits into a 1/4" (6.3mm) Hole

Applications:
Import/Universal
Vehicles



Pkg. Qty: 25

PN 90217

Releaseable Cable Strap

148mm

Applications:

Honda, Mazda



Pkg. Qty: 25

COWL TOP RETAINER

PN 90037

Acura/Honda:

90602-TA0-003

Cowl Vent Retainer

Blue Nylon

Top Head Size: 10mm x 14mm

Bottom Head Diameter: 16mm

Stem Diameter: 8mm

Stem Length: 13mm

Applications:

Acura: TSX, ZDX

Honda: Accord, Fit 2008-up



Pkg. Qty: 10

PN 90038

Acura/Honda:

90602-SX0-003

Cowl Retainer

White Nylon

Head Diameter: 12mm x 16mm

Stem Diameter: 4mm

Applications:

Acura: MDX

Honda: Civic, Insight, Odyssey &

Prelude 1995-up



Pkg. Qty: 10

PN 90039

VW: 4A0-805-121-A,

Audi:

Front Fender,

Bumper & Engine Retainer

Slotted Drive

Black Nylon

Head Diameter: 25mm

Stem Length: 22mm

Applications:

Audi: 1992-2011

VW: Passat



Pkg. Qty: 25

PN 90040

Honda:

90602-S2A-003

Engine Hood Cowl Top Clip

Natural Nylon

Upper Head Diameter: 14mm

Lower Head Diameter: 16mm

Stem Diameter: 4mm

Overall Height: 11.5mm

Applications:

Honda: Civic, Element, Fit,

Insight, S2000 2001-up



Pkg. Qty: 25

PN 90043

Nissan: 66820-88E00

Cowl Screen Pin Retainer

Black Nylon

Head Diameter: 10mm

Stem Diameter: 4mm

Stem Length: 15mm

Applications:

Nissan: Maxima 1990-up



Pkg. Qty: 25

PN 90044

Subaru: 95022-AC040ML

Headliner and Floor Trim

Spacer Retaining Clip

Black Nylon

Head Diameter: 20mm

Stem Diameter: 6mm

Stem Length: 22mm

Applications:

Subaru: Forester, Impreza,

Outback 2010-up



Pkg. Qty: 25

PN 90045

Subaru: 91167-AA000

Cowl Quarter Panel Glass

Exterior Trim, Belt Moulding Cap

Trunk Lid Spoiler

Rear Lamp Finisher

Assembly w/ Sealer

Black Nylon, Head Diameter: 17.5mm

Overall Height: 15mm

Fits into 8mm Hole Size

Applications:

Subaru: Baja, Forester, Impreza,

Legacy, Outback,

SVX 1992-2009



Pkg. Qty: 25

PN 90046

Toyota: 90467-09212

Cowl Trim Retainer

White Nylon

Upper Head Size: 13mm x 18mm

Middle Head Size: 16mm

Lower Head Size: 18mm

Stem Diameter: 10.7mm

Stem Length: 12mm

Applications:

Toyota: Camry 2010-up



Pkg. Qty: 25

PN 90047

AMC: 4003673L;
Chrysler: 2945109L,
 4658677;
Ford: D2VZ-6521952A,
 N804344S
GM: 9815325,16607593;
 Clip for Left-Hand Side only
 Black Nylon, Rod Size: 5/32"
 Fits into: 1/4" Hole
Applications:
 AMC/Chrysler/Ford/GM



Pkg. Qty: 50

PN 90048

Chrysler: 3454221,
 4658677
GM: 8891030
 Door Lock Rod Clip
 Left-Hand Side
 Green Nylon
 Rod Size: 5/32"
Applications:
Chrysler: 1972-up
GM: C, K Pickups 1999-2007



Pkg. Qty: 50

PN 90049

GM: 16629990,
 16675980
 Door Lock Rod Clip
 Gray Nylon
 Rod Size: 5/32"
Applications:
GM: Buick, Cadillac,
 Chevrolet, Oldsmobile,
 Pontiac, Trucks 1996-up



Pkg. Qty: 15

PN 90053

Mazda: 9927-80-404
 Rod End Clip
 Light Blue Nylon
 Holds 4mm Rods
 Snaps into 6mm Hole
Applications:
 Mazda



Pkg. Qty: 25

PN 90050

Lexus/Toyota:
 69293-12050
 Door Lock Rod Clip
 Natural Nylon
 Rod Size: 5mm
 Fits into 8.5mm Hole
 Right (passenger) Side
Applications:
Lexus: ES250, ES300, RX300
Toyota: Tacoma 1990-up



Pkg. Qty: 10

PN 90051

Lexus/Toyota:
 69293-12060
 Door Lock Rod Clip
 Yellow Nylon
 Rod Size: 5mm
 Fits into 8.5mm Hole
 Left (Driver) Side
Applications:
Lexus: ES250, 300, RX300
Toyota: Tacoma 1990-up



Pkg. Qty: 10

PN 90052

Mazda:
 9927-80-405
 Rod End Clip
 Dark Gray Nylon
 Holds 4mm Rods
 Snaps into 6mm Hole
Applications:
 Mazda



Pkg. Qty: 25

PN 90054

**6003349, 9685057;
4005470, N98905101
Chrysler, GM, AMC, VW**

Door Trim Panel Retainer
Natural Nylon
Upper Head Diameter: 29/32"
Lower Head Diameter: 15/16"
Stem Diameter: 5/16"
Stem Length: 11/16"

Applications:
AMC/Chrysler/GM/VW



Pkg. Qty: 25

PN 90055

**AMC: 4005099;
Chrysler: 6033862;
GM: 796255**

Door Panel Retainer
Upper Head Diameter: 19/32"
Lower Head Diameter: 3/4"
Stem Diameter: 5/16"
Stem Length: 11/16"

Applications:
AMC/Chrysler/GM



Pkg. Qty: 25

PN 90056

**AMC: 8934-202-599;
Ford: N805612-S100;
GM: 10143422**

Trim Panel Retainer
White Nylon
Upper Head Diameter: 1/2"
Lower Head Diameter: 3/4"
Stem Diameter: 5/16"
Stem Length: 1"

Applications:
AMC/Ford/GM



Pkg. Qty: 50

PN 90057

**Renault: 8934-201-681
VW:175-867-299**

Trim Panel Retainer
White Nylon
Head Diameter: 19mm
Stem Diameter: 9mm
Stem Length: 18mm

Applications:
AMC/Renault: 1984-up
VW: 1982-up



Pkg. Qty: 50

PN 90058

**Euro Ford: 1008068
VW: 7M0-867-299-K,
7M3-867-299;
Land Rover: DYC500020**

Door Trim Panel Retainer
Yellow Nylon
Upper Head Size: 13.1mm
Lower Head Size: 17.4mm
Overall Height: 21mm
Fits into 10mm Hole Size

Applications:
Audi/VW: 1999-up
Land Rover: 1997-up



Pkg. Qty: 25

PN 90059

**BMW:
07-14-9-158-194,
51-41-821-58-06**

Door Lateral Trim Plug Retainer
Clear Nylon with
Metal Retainer
Size: 17.3mm x 15.2mm
Head Size: 15mm & 17mm
Stem Length: 7mm
Overall Length: 11mm
Height: 11.3mm

Applications:
BMW: 3 Series 1997-up



Pkg. Qty: 15

PN 90060

BMW: 51477117532

Door Entry Scuff Plate
Retaining Clip with Sealer
Brown Nylon

Upper Head Size: 11mm x 15mm
Lower Diameter: 20mm
Overall Height: 16mm
Fits into 10 mm Hole Size

Applications:
BMW: 1 Series 2006-2012, 3 Series
2004-2012, 5 Series 2002-2010, 6
Series 2002-2011,
X Series 2006-2012



Pkg. Qty: 15

PN 90061

**BMW:
51-41-8-224-768,
51-41-0-407-984**

Front/Rear Door Panel, Lining & Rear
Window blind, Retainer with Sealer
White Nylon
Head Diameter: 14.9mm
Stem Diameter: 9.9mm
Overall Length: 19.4mm

Applications:
BMW: 3, 5, 6, 7, X, Z Series 1997-up
Mini-Cooper: 2002-up



Pkg. Qty: 25

PN 90062

**Chrysler:
55157055-AA, 55156447AA,
55156447AB,55157086AA,
55157065-AA, Jeep, Dodge**

Front & Rear Door Flare/Quarter &
Door Cladding Clip Retainer
Gray Nylon
Upper Head Size: 14mm x 38mm
Stem Length: 15mm
Fits into 9mm Hole Size

Applications:
Chrysler: Sebring, Dodge: Nitro, Ram
Jeep: Liberty 2002-up



Pkg. Qty: 15

PN 90063

Chrysler: 6503709

Trim Panel Retainer
Natural Nylon
Upper Head Diameter: 1/2"
Lower Head Diameter: 3/4"
Stem Diameter: 11/32"
Stem Length: 3/4"

Applications:
Dodge: Ram 1994-up



Pkg. Qty: 50

PN 90064

Ford: N801925-S

Door Trim Panel Retainer
Black Nylon
Upper Head Diameter: 1/2"
Lower Head Diameter: 25/32"
Stem Diameter: 5/16"
Stem Length: 5/8"

Applications:
Ford



Pkg. Qty: 25

PN 90065

Ford: 387496-S

Trim Panel Retainer
White Nylon
Upper Head Diameter: 29/32"
Lower Head Diameter: 15/16"
Stem Diameter: 5/16"
Stem Length: 15/16"

Applications:
Ford



Pkg. Qty: 25

PN 90066

Ford: N802900

Door Trim Panel Retainer
White Nylon
Upper Head Diameter: 1/2"
Lower Head Diameter: 3/4"
Stem Diameter: 5/16"
Stem Length: 5/8"

Applications:
Ford



Pkg. Qty: 25

PN 90067

Ford: 389144-S

Trim Panel Retainer
White Nylon
Small Upper Head
Diameter: 17/32"
Upper Head Diameter: 33/64"
Lower Head Diameter: 3/4"
Stem Diameter: 5/16"
Stem Length: 13/16"

Applications:
Ford



Pkg. Qty: 50

PN 90068

Ford: 387477-S

Interior Trim Panel Retainer
White Nylon
Upper Head Diameter: 1/2"
Lower Head Diameter: 3/4"
Stem Diameter: 11/32"
Stem Length: 9/16"

Applications:
Ford



Pkg. Qty: 50

PN 90069

Ford: 387182-S

Seat Back Panel Retainer
Black Nylon
Upper Head Diameter: 1/2"
Lower Head Diameter: 5/8"
Stem Diameter: 11/32"
Stem Length: 1-1/8"

Applications:
Ford: 1977-up



Pkg. Qty: 25

PN 90070

GM: 2064891; 9818648; 9883583

Door Trim Panel &
Headliner Retainer
Upper Head Diameter: 11/16"
Lower Head Diameter: 3/4"
Stem Diameter: 5/16"
Stem Length: 1/2"

Applications:
GM: 1971-up



Pkg. Qty: 50

PN 90071

GM: 20480475

Rear Quarter Panel Retainer
White Nylon
Upper Head Diameter: 29/32"
Lower Head Diameter: 15/16"
Stem Diameter: 5/16"
Stem Length: 11/16"

Applications:
GM



Pkg. Qty: 50

PN 90072

GM: 10126901

Trim Panel Retainer
White Nylon
Upper Head Diameter: 29/32"
Lower Head Diameter: 15/16"
Stem Diameter: 5/16"
Stem Length: 1-1/14"

Applications:
GM



Pkg. Qty: 50

PN 90074

GM: 15545202

Door Trim Panel Retainer
White Nylon
Upper Head Diameter:
1/4" x 29/64"
Lower Head Diameter: 1/2"
Stem Diameter: 5/16"
Stem Length: 3/4"

Applications:
GM: Trucks 1988 and up



Pkg. Qty: 50

PN 90075

GM: 10153057

Front Door Trim Panel Retainer
White Nylon
Upper Head Diameter: 18mm
Lower Head Diameter: 20mm
Stem Diameter: 8mm
Stem Length: 23mm

Applications:
GM



Pkg. Qty: 25

PN 90076

GM: 15600382, 10073833, 20421800

Door Trim Panel Retainer
White Nylon
Upper Head Diameter: 9/32" x 19/32"
Lower Head Diameter: 3/4" x 7/8"
Stem Diameter: 5/16"
Stem Length: 3/4"

Applications:
GM



Pkg. Qty: 25

PN 90077

GM: 3065575

Door Trim Panel Retainer
White Nylon
Upper Head Diameter:
29/32"
Lower Head Diameter: 7/8"
Stem Diameter: 5/16"
Stem Length: 3/4"

Applications:
GM: 1978-up



Pkg. Qty: 50

PN 90078

GM: 363137

Trim Panel Retainer
White Nylon
Upper Head Diameter: 5/8"
Lower Head Diameter: 3/4"
Stem Diameter: 5/16"
Stem Length: 1"

Applications:
Chevy: Trucks
GMC: 1976-up



Pkg. Qty: 100

PN 90079

GM: 10285935

Trim Panel Retainer
White Nylon
Upper Head Diameter: 18mm
Lower Head Diameter: 20mm
Stem Diameter: 8mm
Stem Length: 24mm

Applications:

Buick: Century, Regal, **Chevrolet:** Venture
GM: Express, Savanna, Trucks
Oldsmobile: Silhouette
Pontiac: Transport
1997-up



Pkg. Qty: 50

PN 90080

GM: 20451401

Trim Panel Retainer
White Nylon
Retains Conduit to Sheet Metal in Doors
Top Head Diameter: 29/32"
Bottom Head Diameter: 15/16"
Stem Diameter: 5/16"
Stem Length: 1-1/8"

Applications:
GM



Pkg. Qty: 25

PN 90081

GM: 10421018

Door Trim Panel Retainer
White Nylon
Top Head Diameter: 11/16"
Bottom Head Diameter: 25/32"
Stem Diameter: 5/16"
Stem Length: 1-1/4"

Applications:
GM: 1997-up



Pkg. Qty: 25

PN 90082

GM: 22646099

Trim Panel Retainer with Sealer
White Nylon
Bottom Head Diameter: 20mm
Top Head Diameter: 18mm
Stem Diameter: 8mm
Stem Length: 19mm

Applications:

Chevrolet: Cavalier
Pontiac: Sunfire 1995-up



Pkg. Qty: 25

PN 90083

GM 15607165, 15612948

White Nylon Door Trim Panel Retainer
Bottom Head Diameter: 9/16-11/16"
Top Head Diameter: 9/32-1/2"
Stem Diameter: 5/16"
Stem Length: 3/4"

Applications:
GM: Trucks



Pkg. Qty: 25

PN 90084

Lexus/Toyota: 90467-07042, Mazda: G032-68-865A-00

Roof HeadLining Wind Deflector & Luggage Inner Trim Clip
Black Nylon, Head Diameter: 20mm, Stem Size: 7mm, Overall Height: 17mm

Applications:

Lexus: 1992-2001, **Toyota:** 1986-2011, **Mazda:** 626, 929, B2000, B2600, CX-7, CX-9, Mazda 3, 5, 6, Mazda Speed 6, Miata, Millennia, MX-3, MX-6, Protégé, RX-7, RX-8 1987-up



Pkg. Qty: 25

PN 90085

Lexus/Scion/Toyota: 67771-32120

Trim Panel Retainer Sealer, Green Nylon, Top Head Size: 13mm x 16mm, Middle Head Diameter: 16mm
Bottom Head Diameter: 18mm
Stem Diameter: 9mm, Stem Length: 9mm

Applications: **Toyota:** Prius 2001-2003, **Lexus:** ES300 2002-2006, GS300 2006-2011, GS450H 2007-2011, IS F, 250 2006-2011, LS460, LS600HL 2007-2011, RX350 2010-up, **Scion:** XA 2004-2006



Pkg. Qty: 25

PN 90086

Mercedes-Benz: 124-988-94-78

Front and Rear Door Upper Moulding Trim Retainer
White Nylon
Nylon Clip Length: 14.5mm x 47mm
Metal Clip Length: 43mm

Applications:
Mercedes-Benz: 300E, 300D, 300TE, 400E, 500E 1990-95



Pkg. Qty: 10

PN 90087

Mitsubishi: MB416090

Side Moulding Clip Retainer
White Nylon
Upper Head Size: 13mm x 11mm
Lower Head Diameter: 16mm
Overall Length: 13mm

Applications:
Mitsubishi: 1994-2004



Pkg. Qty: 25

PN 90088

Subaru: 94078FA080

Door Trim Clip
White Nylon
Upper Head Diameter: 13mm
Middle Head Diameter: 16mm
Bottom Head Diameter: 18mm
Stem Length: 11mm
Stem Diameter: 9mm x 9.5mm

Applications:

Subaru: Forester 2014-up, Impreza 1994-2014, XV Crosstrek 2013-2014



Pkg. Qty: 25

PN 90089

VW 7L6-868-243

Door Trim Panel Retainers w/ Sealer
Black Nylon
Top Head Diameter: 22mm
Stem Length: 11mm
5/16" (8mm) Hole Size

Applications:

Audi: A5, A6, A7, S5, S6, S7
VW: Beetle, Cabrio, Golf, GTI, Toureg, Jetta, Passat, 2004 and up



Pkg. Qty: 15

PN 90090

VW 6Q0-868-243

Door Trim Panel Retainers
Black Nylon with Sealer
5/16" (8mm) Hole Size
Top Head Diameter: 16mm
Stem Length: 10.5mm

Applications:
VW



Pkg. Qty: 15

PN 90091

VW 191-853-577A

Door Moulding Clip
White Nylon
Top Head Diameter:
11.5mm x 15mm
Stem Length: 14mm
Fits into 5mm Hole Size

Applications:

VW: Golf A1/A2, Jetta,
Passat B2 1987-up



Pkg. Qty: 25

PN 90266

Chrysler: 6504014

White Nylon
Door Trim Panel Retainer
Bottom Head Diameter:
23/32"
Top Head Diameter: 1/2"
Stem Diameter: 5/16"
Stem Length: 9/16"

Applications:

Chrysler



Pkg. Qty: 50

PN 90267

Honda: 91560-SM4-003

White Nylon
Door Trim Panel Retainer
Bottom Head Diameter: 16mm
Top Head Diameter: 13mm
Stem Diameter: 9mm
Stem Length: 15mm

Applications:

Honda 1987-up



Pkg. Qty: 25

PN 90268

Nissan: 01553-S3500

Natural Nylon
Door Trim Panel Retainer
Bottom Head Diameter: 19mm
Top Head Diameter: 15mm
Stem Diameter: 9mm
Stem Length: 18mm

Applications:

Nissan



Pkg. Qty: 50

PN 90882

GM: 411700

Black Nylon Trim Panel/
Bumper Filler Retainer
Head Diameter: 1/2"
Stem Diameter: 9/32"
Stem Length: 3/4"

Applications:

GM



Pkg. Qty: 50

FLOOR MAT CLIPS

PN 90092

**BMW: 51478116564,
51472499935,**

51478183031, 51471881521

Floor Mat Lock with Washer
Black Nylon, Head Diameter: 24mm
Slotted Head Diameter: 18.5mm
Washer Diameter: 20.5mm
Stem Length: 21mm

Applications:

BMW: 3, 5, 7, 8 Series
1997-up



Pkg. Qty: 10

PN 90094

VW: 191-941-142
 Headlight Adjusting Screw Grommet
 White Nylon
 Overall Length: 15mm
 Fits into 10mm Hole Size
Applications:
 Audi: 100 1991-1994
 VW: Golf 1986-2006



Pkg. Qty: 25

PN 90095

GM: 343543, 343555, 354076, 362379
 Headlight Adjusting Nut
 Natural Nylon
Applications:
 GM: 1962-up



Pkg. Qty: 50

PN 90096

Nissan: 26398-2Y001
 Headlight Housing Clip
 Black/White Nylon
 Width: 25mm
 Length: 38mm
 Stem Length: 11mm
Applications:
 Nissan: Sentra 2000-up



Pkg. Qty: 2

PN 90097

Toyota
 Headlight Adjusting Screw Nut
 Natural Nylon
 Pick-up Truck
Applications:
 Toyota: 1984-up



Pkg. Qty: 25

PN 90098

Toyota: 81124-89101
 Headlight Spacer
 White Nylon
 Width: 15mm
 Length: 18mm Long
 Fits into 7mm Square Hole
Applications:
 Toyota: Truck 1984-up



Pkg. Qty: 25

HOOD PAD RETAINER

PN 90163

GM: 20064875
 Black Nylon Hood Insulation Clip
 Head Diameter: 1-21/32"
 Stem Diameter: 5/16"
 Stem Length: 3/4"
Applications:
 GM



Pkg. Qty: 25

PN 90167

Ford: 388908-S
 Black Nylon Hood Insulation Retainer
 Head Diameter: 1-3/4"
 Stem Diameter: 3/8"
 Stem Length: 3/4"
Applications:
 Ford 1975-on



Pkg. Qty: 50

PN 90168

Chrysler: 6502842, GM: 21039129
 Black Nylon Hood Insulation Retainer
 Head Diameter: 1-3/16"
 Stem Diameter: 5/16"
 Stem Length: 1/2"
Applications:
 Chrysler 1993-on, GM



Pkg. Qty: 50

PN 90452

Chrysler: 6504098
Ford: N808842S,
 Black Nylon Hood Insulation Retainer
 1/4" (6.3mm) Hole Size
 Head Diameter: 32mm
 Stem Length: 17mm
Applications:
 Chrysler, Ford



Pkg. Qty: 50

PN 90101

Acura/Honda: 90700-SJ4-000
 Hood Insulation Retainer
 Black Nylon
 Head Diameter: 30mm
 Stem Diameter: 15mm x 18mm
 Stem Length: 10mm
Applications:
 Acura: 1991-up
 Honda: 1998-up



Pkg. Qty: 15

PN 90102

Acura/Honda: 91501-S1K-003, 91501-STK-003
 Hood Insulation Retainer
 Black Nylon
 Head Diameter: 30mm
 Stem Diameter: 15mm x 20mm
 Stem Length: 14mm
Applications:
 Acura: 3.5RL & RSX
 Honda: Civic, CR-V 2000-up



Pkg. Qty: 25

PN 90103

Audi/VW: 8E0-863-727A,
Volvo: 9182822

Hood Insulation Retaining Clip
Black Nylon, Head Size: 20mm x 10.3mm
Overall Height: 15.6mm
Stem Diameter: 16mm

Applications:

Audi: A3, A4, A5, A6, A7, A8, Q5, Q7
1998-up **Volvo:** C30, C70, S40, S60,
S70, S80, V50, V70, XC60, XC70, XC90
1998-up **VW:** Touareg 2011-up



Pkg. Qty: 15

PN 90104

Chrysler: 4341060

Hood Insulation &
Fender Shield Retainer
Black Nylon
Head Diameter: 1-5/16"
Stem Diameter: 3/8"
Stem Length: 3/4"

Applications:

Chrysler: 1985-up



Pkg. Qty: 25

PN 90105

Chrysler: 4878883AA

Hood Insulation Retainer
Black Nylon
Head Diameter: 30mm
Stem Length: 12mm

Applications:

Chrysler: LH, LHS Series 1997-up



Pkg. Qty: 50

PN 90106

Chrysler: 6003351
Ford: 385330-S,
D30Z-16776-A

Hood Insulation Retainer,
Grille to Radiator Retainer
Black Nylon
Head Diameter: 1/2" x 1-1/2"
Stem Diameter: 9/32"
Stem Length: 5/8"

Applications:

Chrysler: 1972-up
Ford: 1973-up



Pkg. Qty: 25

PN 90107

Ford: 386553-S

Hood Insulation Retainer
Black Nylon
Head Diameter: 1-3/16"
Stem Diameter: 3/8"
Stem Length: 3/4"

Applications:

Ford: 1975-up



Pkg. Qty: 25

PN 90108

Ford: N803613S

Hood Insulation Retainer
Black Nylon
Head Diameter: 1-3/4"
Stem Diameter: 5/16"
Stem Length: 29/32"

Applications:

Ford: Bronco, Explorer,
Ranger 1988-up



Pkg. Qty: 25

PN 90109

GM: 3977775,
3078511

Hood Insulation Retainer
Black Nylon
Head Diameter: 2"
Stem Diameter: 5/16"
Stem Length: 3/4"

Applications:

GM



Pkg. Qty: 25

PN 90110

GM: 21039141

Hood Insulation Retainer
Black Nylon
Head Diameter: 40mm
Stem Diameter: 8mm
Stem Length: 13mm

Applications:

Saturn: 1991-up



Pkg. Qty: 25

PN 90111

Honda:
90700-SB2-003

Hood Insulation Retainer
Black Nylon
Head Diameter: 30mm
Stem Length: 9mm
Fits into 6mm Hole

Applications:

Honda: Prelude 1985-up



Pkg. Qty: 15

PN 90112

Hyundai:
81126-37010

Hood Insulation Retainer
Black Nylon
Head Diameter: 26mm
Stem Diameter: 12mm
Stem Length: 14mm

Applications:

Hyundai: Elantra, Sonata
Kia: Optima 1995-up



Pkg. Qty: 15

PN 90113

Infiniti/Nissan:
01553-02903

Front Side Lower Fender
Panel Bracket Clip, White Nylon
Upper Head Diameter: 13mm
Lower Head Diameter: 11.5mm
Overall Height: 21mm
Fits into 6mm Hole Size

Applications:

Infiniti QX4: 1997-2003, QX56:
2007-2010, **Nissan:** Pathfinder,
Frontier, Xterra
1997-2004



Pkg. Qty: 25

PN 90114

Infiniti/Nissan:
65810-K2002

Hood Seal Retaining Clip
Black Nylon
Head Size: 15.9mm x 6.5mm
Stem Diameter: 5.5mm x 3.5mm
Stem Length: 8.1mm

Applications:

Infiniti: 1997-2003
Nissan: 1996-2003



Pkg. Qty: 25

PN 90115

Lexus/Toyota: 90467-09050

Hood Insulation Retainer
Black Nylon
Head Diameter: 25mm
Stem Length: 10mm
Stem Diameter: 9mm

Applications:
Lexus/Toyota: 1998-up



Pkg. Qty: 15

PN 90116

Mitsubishi: MB655630

Hood Insulation Retainer
Black Nylon
Head Diameter: 26mm
Stem Length: 14mm
Fits into 9mm Hole

Applications:
Mitsubishi Diamonte & Montero 1992-2004



Pkg. Qty: 15

PN 90118

Subaru: 91167FA010

Front Hood Cowl Pin Clip
Black Nylon
Head Size: 14.6mm x 9.3mm
Overall Length: 17.2mm
Fits into 7mm Hole Size

Applications:
Subaru: Impreza 1993-2001



Pkg. Qty: 25

PN 90119

Subaru: 90814-FC001,

Hood Clip Insulator
Black Nylon
Head Diameter: 30mm
Stem Length: 13mm
Fits into 7mm Hole

Applications:
Subaru: Forester, Impreza, Legacy, Outback, Tribeca 1999-2014



Pkg. Qty: 10

PN 90121

**Suzuki: 09409-04304
Mazda: 9924-90-512B**

Garnish & Hood Vent Clip
Black Nylon
Head Diameter: 12mm
Overall Length: 13.5mm
Fits into 5mm Hole Size

Applications:
Suzuki: Grand Vitara, Swift, XL7



Pkg. Qty: 25

PN 90122

Suzuki: 09409-06309-5ES

Hood Insulation & Component Clip
Black Nylon
Head Diameter: 24mm
Stem Diameter: 6mm x 6mm
Stem Length: 13mm

Applications:
Suzuki: Grand Vitara, Swift, XL7 1990-up



Pkg. Qty: 25

PN 90123

Toyota: 90467-09006

Hood Insulation Retainer
Black Nylon
Head Diameter: 30mm
Stem Diameter: 17mm
Fits into 7mm Hole Size

Applications:
Lexus: 1998-up
Toyota: Avalon, Camry



Pkg. Qty: 15

PN 90124

Toyota: 90467-09008

Retaining Clip
Black Nylon
Head Diameter: 30mm
Stem Length: 17mm
Fits into 7mm Hole
Panel Range: 6mm

Applications:
Toyota



Pkg. Qty: 25

PN 90125

Volvo: 9133073-8

Hood Insulation, Radiator Seal Push Type Retainer
Black Nylon
Head Size: 8mm x 25mm
Stem Length: 10mm
Fits into 5mm Hole

Applications:
Volvo: 850, 940, 960, S80, S90, V90 1991-up



Pkg. Qty: 25

PN 90126

Audi/VW: 6N0-823-397 A/C

Hood Prop Rod Clip
Black Nylon
Rod Size: 8mm
Overall Length: 26mm
Fits into 7mm Square Hole

Applications:
Audi/VW



Pkg. Qty: 25

PN 90127

GM: 8911472

Wire Loom Routing Clip
Black Nylon
Outside Diameter: 11/16"
Inside Diameter: 1/2"

Applications:
GM



Pkg. Qty: 25

PN 90128

GM: 8917320

Wire Loom routing Clip
Black Nylon
Outside Diameter: 1"
Inside Diameter: 3/4"

Applications:
GM



Pkg. Qty: 25

PN 90129

GM: 8911497

Wire Loom Routing Clip
Black Nylon
Outside Diameter: 19/32"
Inside Diameter: 13/32"

Applications:
GM



Pkg. Qty: 25

PN 90130

GM: 12337920, 20374473

Natural Nylon Door Trim
Panel Retainer
Lower Head Diameter: 3/4"
Top Head Diameter: 21/32"
Stem Length: 3/4"

Applications:
GM



Pkg. Qty: 50

PN 90132

Honda: 90677-SE0-003

Hood Prop Rod Clip
Black Nylon
Holds 8mm Prop Rod

Applications:
Honda: Accord



Pkg. Qty: 5

PN 90131

Honda: 91512-SE0-003

Windshield Washer hose Clip
Gray Nylon
Width: 11mm
Length: 42mm
Holds 6.3mm (1/4") hose Size

Applications:
Acura/Honda



Pkg. Qty: 15

PN 90133

Honda: 90652-SB2-023

Windshield Washer
Hose Retainer
White Nylon
For 3mm (7/64") I.D.
Outside Diameter: 5mm
(13/64") Hose
Fits into 7mm (9/32")
Square Hole

Applications:
Honda: 1986-up



Pkg. Qty: 15

PN 90134

Honda: 91504-SR3-003

Windshield Washer Hose Clip
Black Nylon
15mm wide, 66mm Long
Holds 6.3mm (1/4") Hose

Applications:
Honda: Accord, Civic, CR-V,
Del Sol 1993-up



Pkg. Qty: 10

PN 90135

Mazda: 9927-70-901

Tube & Cable
Routing Bundle Clip
Windshield Washer Hose Retainer
White Nylon
Bundle Diameter: 8mm
Fits into 6mm Hole

Applications:
Mazda



Pkg. Qty: 25

PN 90136

Mazda: S084-58-502

Door Glass
Screw Grommet
Natural Nylon
#12 Screw Size
18mm Wide, 32mm Long
Stem Length: 10mm

Applications:
Mazda: 626 2000-up



Pkg. Qty: 10

PN 90137

Toyota: 53455-14020

Hood Prop Rod Clip
White Nylon
Fits into 14mm Square Hole
Holds 8mm Diameter Rod

Applications:
Toyota



Pkg. Qty: 15

PN 90138

VW: 1H0-823-397

Hood Prop Rod Clip
White Nylon
Fits into 7mm Square Hole
Holds 8mm Rod Size
Stem Length: 10mm

Applications:
VW: Golf A2, Jetta



Pkg. Qty: 25

PN 90975

Nissan: 65846-30F00, 65832-F5000

Hood Insulation Retainer
3/16" (5mm) Hole Size
Stem Length: 9mm
Outside Head Diameter: 38mm
Black Nylon

Applications:
Nissan



Pkg. Qty: 15

PN 90099

Honda: 91501-SWA-003

Hood Insulation Retainer
Black Nylon
Head Diameter: 30mm
Stem Diameter: 21mm
Stem Length: 14mm

Applications:
Acura: ILX, RDX, TSX 2011-up
Honda: Accord, Civic, CR-V,
Crosstour, Fit,
Insight 2010-up



Pkg. Qty: 25

PN 90139

Lexus/Toyota:
90467-11117

Rear Trunk License Plate
Trim Retaining Clip
Natural Nylon
Size: 7.7mm x 7.7mm
Overall Height: 11.4mm
Diameter at Widest Angle: 10.8mm

Application:

Lexus: 1998-2007
Toyota: 2003-2009



Pkg. Qty: 15

PN 90552

License Plate Screw

Slotted Washer Head
License Plate Screw with
Nylon Nut
Black Nylon
Screw Size: 1/4" - 20" x 5/8"
Hex width: 7/16"
Washer Head Outside Diameter: 19/32"
Washer Nut Outside Diameter: 9/16"

Applications:

License Plate Screw



Pkg. Qty: 25

MOULDING CLIPS

PN 90142

Acura: 90661-ST7-003

Bumper Clip
Natural Nylon

Applications:

Acura: Integra



Pkg. Qty: 5

PN 90145

Acura:

91537-SP0-013

Windshield Clip
White Nylon

Applications:

Acura: LegEnd 1991-up



Pkg. Qty: 10

PN 90143

Acura/Honda:
91541-SM4-003,
91542-SP0-003

Rear Window Adjustable
Side Moulding Clip
Aqua Nylon

Applications:

Acura: LegEnd 1991-95
Honda: Accord 1990-93



Pkg. Qty: 10

PN 90144

Acura/Honda:
90666-SS0-003

Roof Moulding Clip
White Nylon

Applications:

Acura: LegEnd 1992-1995,
TL 1995-1998
Honda: Prelude 1992-1996



Pkg. Qty: 10

PN 90140

Acura/Honda:
91530-S0A-003

Roof Rail, Side Sill Weatherstrip
Moulding Clip, Black Nylon
Head Size: 11mm x 5mm
Stem Diameter: 9.4mm
Overall Length: 10.2mm
Stem Diameter: 6.2mm
Snaps into 6mm Hole

Applications:

Acura: LegEnd, MDX, RDX,
RL, TL, ZDX 1998-up, **Honda:**
Accord, Civic, CRV, Element,
Odyssey 2001-up



Pkg. Qty: 25

PN 90146

Acura/Honda:
71598-S30-013

Rear Bumper
Moulding Clip w/ Sealer
Black Nylon
Width: 34mm
Length: 30mm
Overall Height: 31mm

Applications:

Acura: MDX 2001-2006, TL 1999-03,
Honda: Accord 1998-2002,
Element 2003-2008,
Prelude 1997-2001



Pkg. Qty: 5

PN 90147
GM: 9731301,
AMC: 4005540

Windshield to Panel (Lower Side)
 Moulding Clip
 White Nylon

Applications:
AMC: 1975-up
GM: 1975-up



Pkg. Qty: 100

PN 90141
Honda:
76222-SP1-003

Body Side Moulding, Fender Flares,
 Roof Garnish, Side Sill Moulding Clip
 White Nylon w/ Sealer
 Upper Head Diameter: 14mm x 10mm
 Bottom Head Diameter: 13.8mm
 Overall Height: 12.8mm
 Stem Diameter: 7mm

Applications:
Acura: LegEnd, MDX, RDX, TL, RL,
 ZDX 1991-up, **Honda:** Civic, Odyssey,
 Element, Pilot 2004-up



Pkg. Qty: 25

PN 90150
Audi/VW:
3A0-853-575

Exterior Body Moulding Clip
 White Nylon
 Width: 35mm
 Length: 38mm

Applications:
Audi
VW: Passat B4



Pkg. Qty: 15

PN 90151
Audi/VW:
3B0-853-575

Exterior Body Moulding
 Clip with Grommet
 White Nylon
 Width: 17.5mm
 Length: 21mm
 Stem Length: 12mm

Applications:
Audi
VW: Passat B5



Pkg. Qty: 25

PN 90152
BMW: 51717066226

Rocker Moulding Door
 Sill Spacer Cover Clip
 Black Nylon
 Head Diameter: 30mm
 Overall Height: 26mm
 Stem Diameter: 14mm

Applications:
BMW: 5 Series 2002-2010, 6 Series
 2002-2011



Pkg. Qty: 15

PN 90153
BMW: 51-13-1-829-904,
51-13-6-440-146

Rocker Panel Moulding
 Clip Retainer, White Nylon
 Size: 28mm x 20.75mm
 Stem Length: 6.5mm
 Stem Diameter: 8.5mm
 Overall Height: 13.5mm

Applications:
BMW: 3 Series 1974-1993, Series
 1974-1981, Model 1602-2002,
 2002Ti 1967-1975



Pkg. Qty: 25

PN 90154
BMW: 51-13-8-231-13

Moulding Clip Retainer
 Size: 35.3mm x 20.5mm
 Stem Length: 10.5mm

Applications:
BMW: 3 Series 1997-2004



Pkg. Qty: 25

PN 90155
BMW: 51-41-1-973-500

Door Panel Moulding Clip
 White Nylon
 Upper Head Diameter: 14mm
 Middle Head Diameter: 15mm
 Bottom Head Diameter: 18mm
 Stem Length: 9mm
 Fits into 8mm Hole Size

Applications:
BMW: E34, E36, E39, E38,
 E46, X3, X5, Z8, 3, 5, 7 Series
 1987-up



Pkg. Qty: 50

PN 90148
VW: 443-853-909-A

Door Side
 Moulding Retainer
 Natural Nylon
 Width: 20mm
 Length: 41.5mm

Applications:
Audi: 80, 90, 100, 200,
 A6, Cabriolet, Coupe



Pkg. Qty: 25

PN 90149
VW: 4A0-853-825

Moulding Strip Retainer
 White Nylon
 Width: 22mm
 Length: 35mm

Applications:
Audi: 100, A3, A4, A6,
 A8 1991-1994



Pkg. Qty: 25

PN 90156
BMW:
51-13-1-960-054

Interior Trim
 Door Moulding Clip with
 Grommet, White Nylon
 Width: 22mm
 Length: 35mm
 Stem Length: 11mm

Applications:
BMW: 3 Series, 2 Door &
 Convertible Models, E36, E46



Pkg. Qty: 25

PN 90157
BMW:
51-13-2-251-394

Front Door Side
 Moulding Retainer w/ Grommet
 White Nylon
 Width: 18mm
 Length: 30.5mm
 Stem Length: 10mm

Applications:
BMW: 318 (1996-1999), 318Ti (1995-
 1996), 325iS (1992-1995),
 M3 (1995-up)



Pkg. Qty: 25

PN 90158

BMW:
51-13-8-166-675
Fiat: 71717421

Door Moulding Clip
White Nylon
Width: 25.5mm
Length: 34mm
Stem Length: 11mm

Applications:
BMW: 525i (2001-2003), 528i (1997-2000), 530i (2000-2003), 740i, 5 Series, 7 Series



Pkg. Qty: 25

PN 90159

Chrysler:
55157069-AB

Rocker Moulding Clip
White Nylon
Upper Head Size: 14mm x 27mm
Lower Head Size: 13mm x 26mm
Stem Length 15mm
Hole Size: 9mm

Applications:
Jeep: Liberty 2002-up



Pkg. Qty: 25

PN 90161

Fiat: 71741894
Suzuki: 09409-15302

Wheel Opening
Moulding Clip Retainer
Black Nylon
Head Size: 22mm
Stem Diameter: 15mm
Overall Length: 26.5mm

Applications:
Fiat: 2007-up
Suzuki: 2006-up



Pkg. Qty: 25

PN 90191

Ford: N-800387-S

Black Nylon
Dashboard Retainer
Head Diameter: 1-1/4"
Stem Diameter: 5/16"
Stem Length: 1-3/16"

Applications:
Ford 1979-on



Pkg. Qty: 25

PN 90224

GM: 20175051, 15633873

Quarter Belt Reveal
Moulding Clip
Natural Nylon

Applications:
GM: 1980-up



Pkg. Qty: 50

PN 90225

GM: 9838109

Body Side Moulding Clip
Gray Nylon

Applications:
Buick/Chevrolet/
Oldsmobile: 1967-up



Pkg. Qty: 100

PN 90226

GM: 20199675

Quarter belt reveal
Moulding Clip
White Nylon
7/16" Wide
31/32" Long

Applications:
GM: 1980-up



Pkg. Qty: 50

PN 90972

GM: 10443956

Rocker Panel Moulding Clip
White Nylon
Top Head Size: 9/16" x 13/16"
Bottom Head Size: 13/16" x 13/16"
Stem Length: 9/16"
Fits into 7/16" Hole

Applications:
Chevrolet: C/K Trucks, Impala, Lumina, Monte Carlo 2000-up



Pkg. Qty: 15

PN 90228

GM: 1654047

Windshield & Rear
Window Reveal
Moulding Clip
Light Green Nylon

Applications:
GM: 1974-up



Pkg. Qty: 100

PN 90229

GM: 10437565

Rocker Panel Moulding Clip
Black Nylon
Head Size: 15/32" x 1-5/16"
Stem Length: 9/16"
Snaps into 5/16" Hole

Applications:
Chevrolet: Impala, Lumina, Monte Carlo 2000-up



Pkg. Qty: 10

PN 90230

GM: 10431761

Rocker Panel Moulding Clip
Gray Nylon
Upper Head Size: 11/16" x 1-1/2"
Lower Head Size: 7/8 x 1-9/16"
Stem Length: 1-1/4"
Fits into 7/16" Hole

Applications:
Chevrolet: Impala, Lumina, Monte Carlo 2000-up



Pkg. Qty: 15

PN 90231

GM: 25693852

Rocker Panel Moulding Clip
Gray Nylon
Upper Head: 9/16" x 3/4"
Lower Head: 5/8" x 3/4"
Stem Length: 9/16", Fits into 7/16" Hole

Applications:
Buick: LeSabre Cadillac: Concourse, DeVille, Eldorado, Seville Chevrolet: Impala, Lumina, Monte Carlo Oldsmobile: Aurora, Pontiac: Bonneville 1995-up



Pkg. Qty: 25

PN 90232

GM: 11518357

Rocker Panel Moulding Clip
w/ Sealer
White Nylon
Upper Head Size: 9/16" x 13/16"
Lower Head Size: 13/16" x 13/16"
Stem Length: 9/16"
Fits into 7/16" Hole

Applications:

Chevrolet: Avalanche 2002-up



Pkg. Qty: 15

PN 90233

GM: 94530742

Fender, Wheel, Side &
Bumper Moulding Clip
w/ Sealer
White Nylon
Upper Head Size: 11mm x 5mm
Lower Head Size: 16mm
Stem Diameter: 6.2mm
Stem Length: 10mm
Snaps into 8mm Hole

Applications:

Saturn: Vue 2008-up



Pkg. Qty: 15

PN 90234

GM: 88970495

**Toyota: 76924-02020,
76924-12040**

Rocker Moulding Retainer
Black Nylon
Head Diameter: 32mm
Stem Length: 10mm
Fits into 22mm Hole

Applications:

Pontiac: Vibe

Toyota: Corolla 2003-up



Pkg. Qty: 25

PN 90235

Honda:

75306-SDA-A01

Moulding Clip
White Nylon
Head Size: 21mm x 27mm
Stem Length: 11mm

Applications:

Honda: Accord 2003-up



Pkg. Qty: 10

PN 90236

Honda:

91530-ST5-003

Weatherstrip Retainer
White Nylon
Head Size: 5mm x 15mm
Stem Length: 10mm
Fits into 6mm Hole

Applications:

Honda: Civic



Pkg. Qty: 10

PN 90237

Honda:

91534-SE0-000

Body Side Moulding Clip

Applications:

Honda: Accord 1986-up



Pkg. Qty: 25

PN 90238

Honda:

34355-SD2-003

Side Marker Clip

Applications:

Honda: Accord 1986-up



Pkg. Qty: 25

PN 90239

Honda:

91501-SG0-003

Body Side Moulding Clip

Applications:

Acura: LegEnd 1987-up



Pkg. Qty: 15

PN 90241

Honda:

**91527-SM4-003,
91527-SZ3-003,
91561-S84-A01**

Belt Moulding Clip
White Nylon

Applications:

Honda: Accord,
Odyssey 1990-up



Pkg. Qty: 10

PN 90242

Honda:

91528-S01-A01

Drip Moulding Clip
Blue Nylon

Applications:

Honda: Civic 4-Door
2001-up



Pkg. Qty: 15

PN 90243

Honda:

90601-SH3-014

Door Belt
Moulding Clip
Natural Nylon

Applications:

Honda: Civic 1988-up



Pkg. Qty: 10

PN 90244

Honda:

91512-S50-003

License Plate Housing
Garnish Clip with Sealer
Head Diameter: 17mm x 16mm
Overall Height: 20mm
Stem Diameter: 13mm

Applications:

Honda: Accord, Civic,
Crosstour, Fit, Insight, Odyssey,
Pilot 2005-up



Pkg. Qty: 25

PN 90245
Honda: 75305-SM4-A01

 Side Moulding Fender
 Protector Assembly Clip
 White Nylon

 Head Diameter: 15mm x 13mm
 Overall Height: 17mm

Applications:
Honda: Accord 1990-1993,
 Civic 1992-2000

Pkg. Qty: 25

PN 90246
Honda:
75316-S9A-004

 Lower Door Side Sill Protector
 Garnish Clip
 White Nylon
 Head Diameter: 14mm x 15mm
 Overall Height: 14mm
 Base Diameter: 12mm

Applications:
Honda: CR-V 2002-up

Pkg. Qty: 25

PN 90247
Honda: 91504-SP1-003

 Side Rocker & Front
 Fender Lower Clip with Sealer
 White Nylon
 Upper Head Size: 18mm x 16mm
 Lower Head Size: 19mm x 17mm
 Overall Height: 22mm
 Fits into 10mm Hole

Applications:
Honda: Civic 2004-2005, CR-V
 2002-2004, Odyssey 2011-up

Pkg. Qty: 25

PN 90248
Honda: 91512-SJ6-J01

 Lower Rocker/Tail Light &
 License Plate Housing
 Garnish Clip with Sealer
 Black Nylon

 Upper Head Diameter: 12mm x 9mm
 Lower Head Diameter: 13mm
 Overall Height: 14mm

Applications:
Honda: Civic 2006-up, CR-V 1997-up

Pkg. Qty: 25

PN 90249
Honda:
71591-S5A-000

 Rear Bumper Seal Retainer
 Assembly with Sealer
 White Nylon
 Top Head Diameter: 13mm x 17mm
 Lower Head Diameter: 19mm x 22mm
 Stem Length: 15mm

Applications:
Honda: Civic 2000-up

Pkg. Qty: 15

PN 90250
Honda:
72431-S2X-003

 Center Pillar Garnish Clip
 White Nylon
 Top Head Diameter: 8mm x 10.5mm
 Lower Head Diameter: 11mm x 16mm
 Overall Height: 14.6mm

Applications:
Honda: Civic, CR-Z, Insight 2001-up

Pkg. Qty: 25

PN 90251
Hyundai: 87719-3D000

 Body Side Moulding Clip
 Natural Nylon
 Small Head: 6mm x 14mm
 Base Diameter: 14mm
 Overall Height: 6mm

Applications:
Hyundai: Elantra, Sonata
 2004-up

Pkg. Qty: 15

PN 90252
Infiniti/Nissan:
76882-6P000

 Rocker Moulding Clip
 White Nylon
 Upper Head Size: 8mm x 15mm
 Lower Head Size: 15mm
 Stem Length: 9mm

Applications:
Infiniti/Nissan: 2005-up

Pkg. Qty: 25

PN 90253
Lexus/Toyota:
75392-35220

 Front & Rear Spoiler Rocker
 Moulding Retainer
 White Nylon
 Head Diameter: 10mm x 20mm
 Stem Length: 24mm
 Overall Length: 27mm

Applications:
Lexus: HS250, RX350 2010-up,
Toyota: Camry, Corolla, FJ Cruiser,
 Highlander 2010-up

Pkg. Qty: 25

PN 90254
Lexus: 90467-12074

 Moulding Clip
 White Nylon
 Head Size: 23.2mm x 10mm
 Overall Height: 14.6mm
 Stem Size: 12mm

Applications:
Lexus: LX470 1998-2007

Pkg. Qty: 25

PN 90255
Lexus: 90467-12071

 Moulding Clip
 White Nylon
 Head Size: 12mm
 Bottom Head: 18mm x 26mm
 Overall Height: 13.3mm
 Stem Size: 10mm

Applications:
Lexus: LX470 1998-2007

Pkg. Qty: 25

PN 90256
Lexus: 75396-30260

 Trim Moulding Clip
 White Nylon
 Head Diameter: 17mm
 Overall Height: 12.7mm
 Stem Size: 10mm
 Fits into 12mm Hole Size

Applications:
Lexus: LX470 1998-2007

Pkg. Qty: 25

PN 90257

Lexus: 90467-12072

Rocker Moulding
Clip w/ Sealer
Red Nylon
Head Size: 25mm
Overall Height: 18mm
Stem Size: 12mm

Applications:

Lexus: LX470 1998-2007



Pkg. Qty: 25

PN 90258

Lexus: 75049-33010

Side Moulding Retainer

Applications:

Lexus: ES300 1992-1996



Pkg. Qty: 5

PN 90259

Lexus: 75039-33060

Door Lower Moulding Clip
Brown & White Nylon

Applications:

Lexus: ES300 1991-up



Pkg. Qty: 10

PN 90260

Lexus: 75395-33030

Moulding Clip
Pink Nylon
Head Diameter: 18mm
Overall Height: 17.6mm

Applications:

Lexus: ES300, RX300
1999-up



Pkg. Qty: 15

PN 90261

Lexus: 75392-60030

Lexus Rocker Panel
Moulding Clip
Gray Nylon
Head Diameter: 18mm
Overall Length: 19mm

Applications:

Lexus: 2000-up



Pkg. Qty: 15

PN 90262

Lexus: 75492-60030

Fender Moulding
Clip w/ Sealer
Gray Nylon
Head Diameter: 18mm
Stem Length: 20mm

Applications:

Lexus: 2000-up



Pkg. Qty: 10

PN 90263

Lexus: 75393-60030

Moulding Clip
Black Nylon
Head Diameter: 18mm
Overall Length: 24.5mm

Applications:

Lexus: 2000-up



Pkg. Qty: 15

PN 90264

Lexus: 75397-48010

Moulding Clip
Red Nylon

Applications:

Lexus: ES300, RX300
1999-up



Pkg. Qty: 15

PN 90265

Lexus: 75397-48030

Moulding Clip with Sealer
Orange Nylon
Head Size: 15mm x 20mm
Stem Length: 15mm

Applications:

Lexus: 1999-up



Pkg. Qty: 10

PN 90269

**Lexus/Toyota:
75545-32020**

Windshield Outside
Moulding Clip
Width: 12mm
Length: 66mm

Applications:

Lexus: ES250 1990-1991
Toyota: Camry 1987-up



Pkg. Qty: 10

PN 90270

**Mazda:
BP4L-51-SJ3**

Moulding Clip with Sealer
Gray Nylon
Top Head Size: 14mm x 20mm
Bottom Head Diameter: 36.5mm
Stem Length: 10mm

Applications:

Mazda: 3, 5, 6, CX-7, CX-9 & RX-8
2004-up



Pkg. Qty: 10

PN 90271

Mazda: E11451W24

Body Moulding,
Stone Guard &
Side Moulding Protector Clip
White Nylon
Upper Head Diameter: 15mm x 10mm
Lower Head Diameter: 17mm
Overall Height: 15mm

Applications:

Mazda: CX-7 2007-2011



Pkg. Qty: 25

PN 90272

Mercedes-Benz:
006-988-89-78

Moulding Clip Insert to Lower Trim Moulding
White Nylon
Flange Width: 49.9 x 10.8mm
Overall Length: 16.5mm

Applications:
Mercedes-Benz



Pkg. Qty: 25

PN 90273

Mercedes-Benz:
001-988-50-81

Garnish Moulding Grille Clip
White Nylon
Size: 22.5mm x 15.5mm

Applications:
Mercedes-Benz: 190 and 201



Pkg. Qty: 25

PN 90274

Mercedes-Benz:
001-988-44-81

Garnish Moulding Grille Clip
White Nylon
Head Diameter: 5mm
Flange Size: 15.5mm x 12.2mm
Overall Length: 16mm
Fits into 8.3mm Hole Size

Applications:
Mercedes-Benz



Pkg. Qty: 25

PN 90275

Mercedes-Benz:
007-988-71-78

Body Moulding Clip
White Nylon
Width: 32.5mm
Length: 48mm
Overall Height: 15mm

Applications:
Mercedes-Benz: E55
AMG, E300D, E320
1996-up, 202, VITO



Pkg. Qty: 25

PN 90276

Mercedes-Benz:
001-988-80-81

Door Moulding Clip
White Nylon

Applications:
Mercedes-Benz: 210, W202



Pkg. Qty: 15

PN 90277

Mercedes-Benz:
124-988-04-78

Side Moulding Clip
White Nylon
Width: 19mm
Length: 20mm
Overall Height: 20mm

Applications:
Mercedes-Benz: 124 Series



Pkg. Qty: 25

PN 90278

Mercedes-Benz:
001-988-63-81

Garnish Moulding Grille Clip
White Nylon
Width: 19mm
Length: 32mm
Overall Height: 25.5mm

Applications:
Mercedes-Benz: 190, 201



Pkg. Qty: 25

PN 90279

Mercedes-Benz:
001-988-60-81

Garnish Moulding Grille Clip
Yellow Nylon
Head Size: 12.5mm x 15.5mm
Stem Length: 7mm

Applications:
Mercedes-Benz: 190, W201



Pkg. Qty: 25

PN 90280

Mercedes-Benz:
001-988-46-81

Door Moulding Clip
White Nylon
Head Size: 25mm x 18.5mm
Overall Length: 18.5mm
Fits into 8mm Hole

Applications:
Mercedes-Benz: E250, E400,
E420, E500 1992-up



Pkg. Qty: 25

PN 90281

Mercedes-Benz:
001-988-49-81

Moulding Clip
White Nylon
Head Size: 16mm x 16mm
Overall Length: 21.5mm

Applications:
Mercedes-Benz: 124, 201 1995-1984



Pkg. Qty: 25

PN 90282

Mini-Cooper:
51-71-1-496-621

Rocker Moulding Retainer
Wheel Arch & Sill Cover
Retaining Clip
Black Nylon
Head Size: 8.5mm x 14mm
Stem Size: 5mm x 7.5mm
Stem Length: 14mm

Applications:
Mini-Cooper



Pkg. Qty: 25

PN 90284

Nissan:
76848-54C00

Rear Taillight Assembly & Exterior Rocker Moulding Grommet w/ Sealer
Black Nylon
Head Diameter: 17.8mm
Overall Length: 16mm
Stem Diameter: 8.6mm

Applications:
Nissan: 2003-up



Pkg. Qty: 25

PN 90285

Nissan: 76882-0E700

Front/Side
Rocker Moulding Clip
White Nylon

Applications:

Nissan: Altima 1996-up



Pkg. Qty: 15

PN 90286

Nissan: 76882-0M060

Finishing Panel Clip
Black Nylon

Applications:

Nissan: Cube S/SL,
Krom 2010-up



Pkg. Qty: 15

PN 90287

Subaru: 90913-0008

Side Moulding Clip
Pink Nylon w/ Sealer
Head Diameter: 22mm
Stem Length: 15mm
Fits into 9mm Hole

Applications:

Subaru: Baja, Forester,
Legacy, Impreza, Outback,
Tribeca, 2000-up



Pkg. Qty: 25

PN 90288

Subaru: 57160FC010

Upper Front Bumper,
Moulding Extension Clip
White Nylon

Head Size: 16mm x 14mm
Overall Height: 17mm
Stem Diameter: 7.3mm

Applications:

Subaru: Forester 1998-2005



Pkg. Qty: 25

PN 90289

Subaru: 91059FC110

Side Garnish, Fender,
Exterior Trim Assembly Clip
White Nylon

Applications:

Subaru: Forester 2001-2002

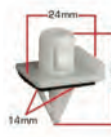

Pkg. Qty: 25

PN 90290

Subaru: 909130007

Pillar rocker & Floor Exterior
Trim rocker Moulding Clip,
Rear Lamp Reflector Retaining Clip,
Rear Door Exterior Corner Cover Clip
Gray Nylon

Upper Head Size: 11mm x 15mm
Lower Head Size: 18mm
Overall Height: 17mm, Fits into 10mm Hole

Applications:

Subaru: B9 Tribeca 2006-2011, Forester
2009-2012, Impreza WRX STI 2005-2012,
Legacy, Outback 2005-2011



Pkg. Qty: 25

PN 90291

Subaru: 91059FC030

Fender Exterior Trim,
Pillar Rocker
Moulding Assembly, Front/Rear Door
Exterior Moulding Assembly,
Quarter Panel Exterior Trim, Lift Gate
Finish Moulding Retaining
Clip w/ Sealer, White Nylon
Upper Head Diameter: 14mm x 11mm
Lower Head Diameter: 17mm
Overall Height: 19mm

Applications:

Subaru: B9 Tribeca, Forester, Impreza

Pkg. Qty: 25



PN 90292

Suzuki:
77553-65D10

Moulding Clip
White Nylon
Head Diameter: 18mm
Overall Height: 17.7mm
Stem Size: 11.3mm

Applications:

Suzuki: Grand Vitara, Swift,
XL7 1990-up



Pkg. Qty: 15

PN 90293

Toyota: 75867-02010

Rocker Moulding Retainer
Black Nylon
Top Head Diameter: 13mm
Bottom Head Diameter: 18mm
Stem Diameter: 9mm
Stem Length: 10mm

Applications:

Toyota: Corolla 2009-up



Pkg. Qty: 25

PN 90294

Toyota: 52197-52010

Front Bumper Moulding Clip
w/ Sealer
Black Nylon
Width: 30mm
Overall Height: 25mm
Stem Length: 13mm

Applications:

Toyota: Highlander 2001-up



Pkg. Qty: 10

PN 90296

Toyota: 90904-67036

Fender Moulding Clip
Blue Nylon
Head Diameter: 17mm
Stem Length: 17mm

Applications:

Toyota: Highlander, Land
Cruiser, Tacoma, Tundra,
2001-up



Pkg. Qty: 10

PN 90297

Toyota: 90904-67037

Fender Moulding Clip
Red Nylon
Head Diameter: 17mm
Stem Length: 13mm

Applications:

Toyota: Highlander, Land
Cruiser, Tacoma, Tundra
2001-up



Pkg. Qty: 10

PN 90298

Toyota: 90467-11100

Fender & Wheel Flare
Moulding Clip
Yellow Nylon
Head Diameter: 17mm
Stem Length: 17mm

Applications:

Toyota: Highlander,
Land Cruiser, Tacoma,
Tundra 2000-up



Pkg. Qty: 10

PN 90299

Toyota: 75495-35010

Fender & Wheel Flare
Moulding Clip
Blue Nylon
Head Diameter: 17mm
Stem Length: 10mm

Applications:

Toyota: 4Runner 2003-up



Pkg. Qty: 10

PN 90300

Toyota: 75397-35010

Fender & Wheel Flare
Moulding Clip
Orange Nylon
Head Diameter: 17mm
Stem Length: 17mm

Applications:

Toyota: 4Runner 2003-up



Pkg. Qty: 10

PN 90301

Toyota: 90467-11063

Rocker Panel
Moulding Clip w/ Sealer
White Nylon
Head Diameter: 18mm
Stem Length: 9mm

Applications:

Toyota: Previa 1990-up



Pkg. Qty: 15

PN 90302

Toyota: 90467-11099

Hood/Front & Rear Side
Moulding Clip
Head Diameter: 17mm
Overall Height: 17mm
Stem Size: 9mm x 9mm Square Hole

Applications:

Toyota: 4Runner 1996-2002



Pkg. Qty: 25

PN 90303

Toyota: 76853-10010

Ground Effects Kit Retainer
White Nylon

Applications:

Toyota: Corolla S-Type,
Matrix, Solara, Tundra 2001-up



Pkg. Qty: 25

PN 90304

Toyota: 76817-12060

Rear Door, Hatch Garnish &
Luggage Compartment Door
Moulding Clip
White Nylon

Applications:

Toyota: Camry, Corolla, Matrix
2003-up



Pkg. Qty: 15

PN 90305

Toyota: 90467-12073

Lower Rocker Trim
Clip Retainer
Natural Nylon
Head Diameter: 23mm x 28mm
Stem Length: 14mm
Stem Diameter: 9.75mm x 9.70mm
Overall Length: 16mm

Applications:

Toyota: Land Cruiser 1998-2007



Pkg. Qty: 15

PN 90306

Volvo: 30784514

Exterior Side Moulding Clip
White Nylon
Head Size: 9.5mm x 9.5mm
Stem Length: 14mm
Fits into 6.5mm x 7mm Hole

Applications:

Volvo: S80, V70, XC70, XC90
2007-up



Pkg. Qty: 25

PN 90307

Volvo: 30624192

Bottom Rail Moulding Clip
Black Nylon
Head Diameter: 18mm
Stem Length: 16mm
Fits into 8mm Hole

Applications:

Volvo: S60, V60 2011-up



Pkg. Qty: 25

PN 90308

VW: 1H0-853-585

Exterior Door Trim
Moulding Clip
White Nylon w/ Rubber
Moulding Grommet Insert
Stem Length: 10mm
Fits into 8mm Hole Size

Applications:

VW: Golf A3



Pkg. Qty: 15

PN 90309

VW: 1H0-853-858A

Exterior Door
Moulding Clip
White Nylon
Stem Length: 11mm
8mm Hole Size

Applications:

VW: Golf A3



Pkg. Qty: 15

PN 90310

VW: 1H0-853-585B

Exterior Door Trim
Moulding Clip
Stem Length: 19mm
Fits into 8mm Hole Size

Applications:

VW: Golf A3



Pkg. Qty: 15

PN 90311

VW: 1H0-853-733B

Windshield Reveal
Moulding Clip
White Nylon
Width: 10.2mm
Length: 32.5mm

Applications:
VW



Pkg. Qty: 15

PN 90312

VW: 191-853-733-A

Seat: 6V085373, 6K0854721
Roof Rail Moulding
Trim Retainer
White Nylon
Width: 9mm
Length: 31mm

Applications:

VW: Golf A2, Ibiza 1993-1999,
Jetta A2, Passat B3, Toledo B4
1992-1999 Skoda: Favorite,
Felecia



Pkg. Qty: 25

PN 90313

VW: 3B0-853-576

Door Panel Moulding Clip
White Nylon w/ Grommet
Width: 24.5mm
Length: 27mm
Stem Length: 12mm

Applications:

VW: Golf A3, Passat B5, Vento



Pkg. Qty: 15

PN 90314

VW: 3A0-853-575-A

Body Moulding
Clip w/ Grommet
White Nylon

Applications:

VW: Passat B5



Pkg. Qty: 25

PN 90315

VW: 4A0-853-825-C

Decorative Trim Strip
Retainer
White Nylon

Applications:

Audi: 100 1991-1994
VW



Pkg. Qty: 25

PN 90316

VW: 4A0-853-825-A

Decorative Trim Strip
Mounting
Screw Plate
White Nylon

Applications:

Audi: 100 1991-1994



Pkg. Qty: 25

PN 90317

VW: 7L0-839-069

Rocker Panel
Moulding Clip
White Nylon
Head Size: 28mm x 10mm
Fits into 10.5mm Hole Size

Applications:

VW: Touareg 2005-up



Pkg. Qty: 25

PN 90726

**Lexus/Toyota:
75867-AA010**

Rocker Panel & Scuff Plate
Retainer Black Nylon
Top Head Diameter: 13mm
Bottom Head Diameter: 18mm
Stem Diameter: 9.5mm
Stem Length: 14mm

Applications:

Lexus: ES300, ES330 2002-up
Toyota: 2004-up



Pkg. Qty: 15

PN 90318

Chrysler: 6100049

Free Spinning Washer Nut
Phosphate
Thread Size: M6-1.0
Washer Outside Diameter: 20mm
Hex Size: 10mm
Height: 9mm

Applications:
Chrysler



Pkg. Qty: 50

PN 90319

Ford: N90100001

GM: 11505329, 11503752
Free Spinning Washer Nut
Phosphate
Thread Size: M6-1.0
Type: B
Washer Outside Diameter: 16mm
Hex Size: 10mm
Height: 7mm

Applications:
Ford/GM



Pkg. Qty: 25

PN 90324

GM: 11503745

Phosphate
Height: 6mm
Hex Size: 13mm
Thread Size: M6-1.0
Flange Outside Diameter: 10mm

Applications:
Metric Hex Flange Nut



Pkg. Qty: 100

PN 90320

Hex Head Nut

Zinc Plated
Hex Head Size: 10mm
6mm x 1.0mm Thread

Applications:
Hex Head Nut



Pkg. Qty: 25

PN 90321

Hex Head Nut

Black E-Coat
Hex Head Size: 10mm
6mm x 1.0mm Thread

Applications:
Hex Head Nut



Pkg. Qty: 25

PN 90322

Metric Hex Head Nut

Yellow Zinc
8mm x 1.25mm
Hex Head Size: 12mm

Applications:
Metric Hex Head Nut



Pkg. Qty: 25

PN 90323

M4 Metric Sheet, Metal Speed Nut

Black E-Coat
Panel Range: .8mm-3mm
Center to Edge: 10mm

Applications:
M4 Metric Nut



Pkg. Qty: 25

PN 90325

Metric Hex Flange Nut

GM: 11502722
Black Oxide
Height 5mm
Hex Size: 8mm
Thread Size: M5-.8
Flange Outside Diameter: 11.5mm

Applications:
GM



Pkg. Qty: 50

PN 90326

Metric Nut Zinc Plated

Yellow Zinc
Size: 10mm x 1.25mm
Hex Head Size: 14mm
Flange: 19mm

Applications:
Metric Nut Zinc



Pkg. Qty: 50

PN 90327

Metric Nut Zinc Plated

Yellow Zinc
Size: 6mm x 1mm
Hex Head Size: 10mm
Flange: 13.5mm

Applications:
Metric Nut Zinc



Pkg. Qty: 25

PN 90328

Metric Spin Lock

Nuts with Serrations
Case Hardened
Phosphate
Hex Size: 10mm
Thread Size: M6-1.0
Flange Outside Diameter: 17mm

Applications:
Metric Spin Lock



Pkg. Qty: 100

PN 90329

Metric Spin Lock

Nuts with Serrations
Case Hardened
Phosphate
Hex Size: 13mm
Thread Size: M8-1.25
Outside Diameter: 19mm

Applications:
Metric Spin Lock



Pkg. Qty: 100

PN 90331

BMW: 51711958025

Heater/Air Conditioning Duct
Plastic Nut, Black Nylon
Flange Diameter: 24mm
Hex Size: 10mm
Overall Height: 10.4mm

Applications:

BMW: 1 Series 2006-2012, 3 Series 1990-2012, 5 Series 1988-1996, 7 Series 1986-2009, 8 Series 1989-1998, X Series 1998-2012, Z Series 1995-2009



Pkg. Qty: 25

PN 90333

BMW: 16-13-1-176-747

Mercedes Benz:
003-990-02-51
Nylon Flange Nut
Black Nylon
Stud Size: 5mm
Hex Size: 10mm
Flange Diameter: 16mm
Overall Height: 11mm

Applications:

BMW/Mercedes-Benz: 1995-up



Pkg. Qty: 25

PN 90334

Mercedes Benz:
201-990-00-50

Rear Compartment Carpet Retainer
Black Nylon
Head Diameter: 24mm
Hex Size: 10mm
Overall Height: 5mm

Applications:

BMW: Z3, Z4, Z5
Mercedes-Benz: E32, E34, E36, E46
VW: Golf, Jetta, Passat



Pkg. Qty: 25

PN 90335

Nissan: 01553-05131

Cowl Insulator, Wheel Liner
Cover & Cowl Trim Clip Retainer
Black Nylon
Hex Size: 10mm
Washer Diameter: 20mm
Overall Height: 12.5mm

Applications:

Nissan: 370Z, Altima, Cube, Frontier, GT-R, Juke, Leaf, Maxima, Murano, NV-1500, 2500, 3500, Pathfinder, Quest, Rogue, Sentra, Versa, Xterra



Pkg. Qty: 15

PN 90330

VW: 171-201-969

Windshield Washer Reservoir,
Floor Air, Flow Duct, Fuel Line Strap
Fixing Nut
Black Nylon
Stud Size: 5mm, Hex Size: 10mm
Flange Diameter: 18.5mm
Overall Height: 10.5mm

Applications:

Audi: 80/90 1979-1996, 200 1984-1991, 700 1983-1994, A8 1989-1994, Coupe 1981-1996,
RS2, RS4, S6



Pkg. Qty: 25

PN 90336

Ford: F5TZ-6734-BA

Oil Drain Plug Rubber Gasket
 Inside Diameter: 13mm
 Outside Diameter: 22mm

Applications:

Ford: Aerostar, Explorer, Ranger
 6 Cylinder 4.0L Engine 1996-up



Pkg. Qty: 10

PN 90337

GM: 3536964, 3538469, 11519408, 11562588, 24100042

Isuzu: 8-11519-408-0

Oil Drain Plug Rubber Gasket
 Inside Diameter: 10mm
 Outside Diameter: 20mm
 Thickness: 2.55mm

Applications:

GM/Isuzu



Pkg. Qty: 10

PANEL RETAINER

PN 90970

AMC/Chrysler/Jeep: 5023173-AA

White Nylon
 Door Trim Panel Retainer
 Overall Length: 30mm

Applications:

Jeep: Liberty 2002-up



Pkg. Qty: 15

PN 90338

Acura/Honda: 91560-S9A-A01

Door Panel Retainer, Blue Nylon
 Top Head Diameter: 13mm
 Middle Head Diameter: 16mm
 Bottom Head Diameter: 15mm
 Stem Diameter: 9.5mm
 Stem Length: 13mm

Applications:

Acura: TL & TSX, **Honda:** Accord, Civic, CRV, Odyssey 2002-up



Pkg. Qty: 25

PN 90339

Audi/VW: 1H0-868-243

Trim Retainer
 Green & Black Nylon
 Large Head Diameter: 28mm
 Small Head Diameter: 19mm
 Overall Length: 31mm

Applications:

VW: Cabrio, Golf, Jetta 1993-1999



Pkg. Qty: 25

PN 90340

Audi/VW: 357-853-585

Exterior Body Moulding Retaining Clip with Grommet
 Upper Head Diameter: 12mm
 Lower Head Diameter: 18mm
 Overall Length: 25.2mm
 Fits into 9mm Hole

Applications:

Audi
VW: Golf, A2, A3



Pkg. Qty: 25

PN 90341

BMW: 51-46-7-002-606

Expanding Rear Window Shelf Front Bumper & Grille Trunk Panel Expanding Rivet
 Black Nylon, Upper Head Size: 16.2mm
 Lower Head Size: 17.8mm
 Stem Length: 13.3mm
 Stem Diameter: 10.6mm
 Overall Length: 21.3mm

Applications:

BMW: 3, 5, 7, Z Series 1997-up



Pkg. Qty: 25

PN 90342

BMW: 51717066229

Door Sill Cover Securing Pin
 Black Nylon
 Head Diameter: 22mm
 Stem Length: 26.6mm
 Stem Diameter: 7.2mm

Applications:

BMW: 5 Series 2002-2010, 6 Series 2002-2011



Pkg. Qty: 15

PN 90343

BMW: 51-77-7-171-003

Rocker Panel Trim Wheel Housing Clip Retainer
 Black Nylon
 Size: 40.4mm x 25.3mm

Applications:

BMW: X Series 2006-up



Pkg. Qty: 25

PN 90344

BMW: 51-41-8-172-050

Door Panel, Door Frame Trunk Lid Trim Retaining Clip
 Black Nylon
 Upper Head Diameter: 14mm
 Lower Head Diameter: 17mm
 Stem Length: 19mm
 Fits into 8mm Hole Size

Applications:

BMW/Mercedes-Benz



Pkg. Qty: 50

PN 90345

BMW: 51471911992, Mercedes-Benz: 2019900292

Panel Trim Retainer, Black Nylon
 Head Diameter: 20mm
 Stem Length: 14mm
 Fits into 8mm Hole

Applications:

BMW: 1, 3, Z4 Series 1991-up
Mercedes-Benz: 300, 400, 500, 600, B, C, CL, CLC, CLK, CLS, E, G, GL, GLK, Maybach, ML, R, S, SLK 1989-2013



Pkg. Qty: 25

PN 90346

Chrysler: 6505292AA

Door Trip Panel Retainer
Natural Nylon
Top Head Diameter: 15mm
Bottom Head Diameter: 20mm
Stem Diameter: 9mm
Stem Length: 15mm

Applications:

Chrysler: Vans 1998-up



Pkg. Qty: 25

PN 90347

Chrysler: 6502991

Trim Panel & Tail Gate Retainer
Yellow Nylon
Top Head Diameter: 1/2"
Middle Head Diameter: 5/8"
Bottom Head Diameter: 11/16"
Stem Diameter: 5/16"
Stem Length: 1"
Overall Length: 1-1/4"

Applications:

Jeep: Cherokee 1993-up



Pkg. Qty: 25

PN 90348

Ford: W704958-S300

Rear Door Lower Trim Panel
Push Type Retainer
White Nylon
Head Diameter: 19/32"
Wedge Shaped
Head Diameter: 29/32"
Stem Length: 11/16"
Fits into 3/8" Hole

Applications:

Lincoln: Town Car 1998-up



Pkg. Qty: 25

PN 90349

GM: 95005064

Toyota: 67771-01010

Door Panel Retainer
Black Nylon
Upper Head Diameter: 13mm
Middle Head Diameter: 15.5mm
Lower Head Diameter: 18mm
Stem Diameter: 9.5mm
Stem Length: 14mm
Overall Length: 20.5mm

Applications:

GM/Toyota



Pkg. Qty: 25

PN 90350

GM: 30006620

Toyota: 67771-12050

Front & Rear Door Trim
Board Retainer
Maroon Nylon
Upper Head Diameter: 13mm
Middle Head Diameter: 16mm
Lower Head Diameter: 18mm
Stem Diameter: 9.5mm
Overall Length: 20.5mm

Applications:

GM/Toyota



Pkg. Qty: 15

PN 90351

Honda: 91566-SP0-00

Trim Panel Retainer
White Nylon
Upper Head Diameter: 13mm
Lower Head Diameter: 18mm
Stem Length: 9.5mm
Fits into 9mm Hole

Applications:

Honda: 1990-up



Pkg. Qty: 15

PN 90352

Honda: 91560-S7A-003

Trim Panel Retainer with Sealer
Black Nylon
Upper Head Diameter: 13mm
Middle Head Diameter: 16mm
Lower Head Diameter: 15mm
Stem Diameter: 9.5mm
Stem Length: 11mm

Applications:

Honda: Crosstour, Fit, Odyssey
2010-2005



Pkg. Qty: 25

PN 90353

Honda: 91560-S0X-A01

Door Lining Retaining Clip
w/ Sealer
White Nylon
Upper Head Diameter: 13mm
Middle Head Diameter: 16.5mm
Lower Head Diameter: 15mm
Stem Length: 12mm
Fits into 9mm Hole

Applications:

Honda: Accord, Crosstour, CR-V,
Fit, Odyssey 2000-up



Pkg. Qty: 15

PN 90354

Infiniti/Nissan:

01553-07111

Trim Panel Retainer
Black Nylon
Upper Head Diameter: 13mm
Middle Head Diameter: 15mm
Lower Head Diameter: 18mm
Stem Diameter: 9mm
Stem Length: 15mm

Applications:

Infiniti: G35, Q45 1997-up
Nissan: Altima



Pkg. Qty: 25

PN 90355

Infiniti: 84953-AU100

Door Trim Clip Retainer
w/ Sealer
Black Nylon
Top Head Diameter: 13mm
Middle Head Diameter: 16mm
Bottom Head Diameter: 18mm
Stem Diameter: 8.85mm x 7.10mm
Stem Length: 15mm
Overall Length: 20mm

Applications:

Infiniti: FX35, FX45, G35,
G37 2003-2008



Pkg. Qty: 15

PN 90356

Isuzu: 8942264920

Mazda: 9927-40-825H

**Toyota: 67771-01010,
67771-12010**

Door Panel Retainer, White Nylon
Upper Head Diameter: 13mm
Middle Head Diameter: 15.5mm
Lower Head Diameter: 18mm
Stem Diameter: 9.5mm
Stem Length: 14mm
Overall Length: 20.5mm

Applications:

Isuzu/Mazda/Toyota



Pkg. Qty: 25

PN 90357

Land Rover: MXC1800

Door Panel Retainer
Black Nylon
Head Diameter: 10.5mm
Overall Length: 18mm
Fits into 5mm Hole Size

Applications:

Land Rover: Defender Series,
Discovery Series 1997-up



Pkg. Qty: 15

PN 90358

Lexus: 90467-10190

Front Grille Clip

Upper Head Diameter: 10mm x 10mm

Lower Head Diameter: 15mm

Height: 16mm

Fits into 10mm Hole Size

Applications:

Lexus: RX300, RX330, RX400 Hybrid
1999-2009



Pkg. Qty: 25

PN 90359

Lexus/Toyota:

62217-13010

Garnish Moulding Retainer

White Nylon

Top Head Diameter: 13mm

Middle Head Diameter: 16mm

Bottom Head Diameter: 15mm

Stem Diameter: 9mm x 9mm

Stem Length: 11mm

Overall Length: 17mm

Applications:

Lexus

Toyota: Corolla, Matrix,

4Runner 2003-up

Pkg. Qty: 25



PN 90361

Mazda: 9927-40-822

Toyota: 62581-14020

Trim Panel Retainer

White Nylon

Small Upper Head Diameter: 14mm

Lower Head Diameter: 18mm

Stem Length: 14mm

Fits into 8mm Hole

Applications:

Mazda/Toyota



Pkg. Qty: 25

PN 90362

Mitsubishi: MR435918

Rocker Panel Retainer

White Nylon

Top Head Diameter: 13mm

Bottom Head Diameter: 18mm

Stem Diameter: 9mm

Stem Length: 9mm

Applications:

Mitsubishi: Montero 2001-up



Pkg. Qty: 15

PN 90363

Mitsubishi: MB846992

Rocker Panel Retainer

White Nylon

Top Head Diameter: 12mm

Bottom Head Diameter: 16mm

Stem Length: 14mm

Fits into 7mm Hole

Applications:

Mitsubishi: Montero 2001-up



Pkg. Qty: 10

PN 90364

Mitsubishi: MB566720

Pillar Trim & Air Inlet

Grille Retainer

Natural Nylon

Upper Head Diameter: 12mm

Lower Head Diameter: 16mm

Stem Diameter: 9mm

Stem Length: 15mm

Applications:

Mitsubishi: Eclipse 1994-up



Pkg. Qty: 15

PN 90365

Mitsubishi: MR322000

Quarter Panel Exterior Trim Belt

Moulding Retainer with Sealer

White Nylon

Upper Head Size: 12.5mm

Lower Head Size: 16mm

Overall Length: 19mm

Applications:

Mitsubishi: Diametermante, Eclipse,

Galant, Montero, Outlander 2000-up



Pkg. Qty: 25

PN 90366

Nissan: 80999-VE000

Trim Panel Retainer w/ Sealer

White Nylon

Top Head Diameter: 13mm

Middle Head Diameter: 16mm

Bottom Head Diameter: 18mm

Stem Diameter: 9mm

Stem Length: 13mm

Applications:

Infiniti: FX35, FX45, G20, G35, G37, I30,

I35, M45, Q45 & QX4

Nissan: 240SX, 350Z, Altima, Armada,

Frontier, Maxima, Murano, Pathfinder,

Quest, Sentra,

Xterra 1993-2011

Pkg. Qty: 25



PN 90367

Nissan: 01553-08911

Front & Rear Scuff Plate Clip

White Nylon

Upper Head Diameter: 12mm x 15mm

Lower Head Diameter: 16mm

Stem Length: 12mm

Fits into 8mm Hole

Applications:

Nissan: Maxima 1999-Up



Pkg. Qty: 15

PN 90368

Renault: 7001053516

VW: 7L5-853-994

Trim Panel Retainer

Blue Nylon

Top Head Diameter: 13mm

Bottom Head Diameter: 18mm

Stem Diameter: 9mm

Stem Length: 14mm

Applications:

Audi/Renault



Pkg. Qty: 25

PN 90369

Subaru: 693005370

Interior Lift Gate Trim Panel

Retaining Clip Natural Nylon

Upper Head Diameter: 13mm

Lower Head Diameter: 18mm

Fits into 9mm Hole

Applications:

Subaru: Impreza 2002-2007,

Legacy 2000-2003, Outback

2000-2003

Pkg. Qty: 25



PN 90370

Subaru: 909130034

Pillar Rocker & Floor

Interior Trim Clip

Upper Head Diameter: 13mm

Lower Head Diameter: 16mm

Overall Height: 18mm

Fits into 10mm Hole

Applications:

Subaru: Baja, Forester, Legacy,

Outback 2000-2008



Pkg. Qty: 25

PN 90371

Suzuki: 77259-71B00

Moulding Clip with Sealer
White Nylon

Upper Head Diameter: 13mm
Lower Head Diameter: 16mm
Stem Length: 13mm

Applications:

Suzuki



Pkg. Qty: 10

PN 90372

**Toyota: 67771-30070,
67771-3208**

Door Trim Panel &
Garnish Retainer
White Nylon
Small Upper Head Diameter: 13mm
Lower Head Diameter: 16mm
Stem Length: 11mm
Fits into 9mm Hole

Applications:

Toyota: Tacoma



Pkg. Qty: 25

PN 90373

**Toyota:
62955-20020**

Panel Retainer w/
Sealer
White Nylon
Head Diameter: 15mm
Stem Length: 9mm
Fits into 8mm Hole

Applications:

Toyota: Trucks



Pkg. Qty: 25

PN 90374

Toyota: 67771-12040

Door Trim Panel Retainer
Dark Gray Nylon

Upper Head Diameter: 13mm
Middle Head Diameter: 16mm
Lower Head Diameter: 18mm
Stem Diameter: 10mm
Stem Length: 15mm
Overall Height: 21mm

Applications:

Toyota: Cressida 1988-1992



Pkg. Qty: 15

PN 90375

**Toyota:
67771-02030**

Door Trim Retainer
White Nylon
Upper Head Diameter: 13mm
Middle Head Diameter: 16mm
Lower Head Diameter: 17.5mm
Stem Diameter: 9.5mm
Overall Length: 21mm

Applications:

Toyota: Corolla 1990-up



Pkg. Qty: 50

PN 90376

Toyota: 90467-08179

Garnish Retainer
Yellow Nylon
Top Head Diameter: 13mm
Middle Head Diameter: 16mm
Bottom Head Diameter: 18mm
Stem Diameter: 9mm x 9mm
Stem Length: 14mm
Overall Length: 20mm

Applications:

Toyota: Tundra 1999-up



Pkg. Qty: 25

PN 90377

Toyota: 75395-0T010

Moulding Clip with Sealer
White Nylon

Upper Head Size: 5mm x 10mm
Lower Head Diameter: 18mm
Stem Diameter: 10mm
Stem Length: 13mm

Applications:

Toyota: Corolla, Venza 2008-2011



Pkg. Qty: 25

PN 90378

Toyota: 75867-33030

Rocker Moulding Retainer
Charcoal Nylon
Upper Head Diameter: 13mm
Lower Head Diameter: 18mm
Stem Diameter: 9.5mm
Stem Length: 13mm

Applications:

Toyota: Avalon, Camry, Prius,
Scion, Sienna, Solara, Venza
2000-up



Pkg. Qty: 25

PN 90379

Toyota: 90467-12075

Lower Rocker
Trim Clip Retainer
Yellow Nylon
Upper Head Diameter: 11mm x 13mm
Lower Head Diameter: 15mm x 25mm
Stem Diameter: 9.65mm x 9.65mm
Overall Length: 17.75mm

Applications:

Toyota: Land Cruiser 1998-2007



Pkg. Qty: 15

PN 90380

Toyota: 90467-09206

Deck, Front Door Trim &
Rear Door Trim Board Clip Retainer
w/ Sealer
White Nylon

Top Head Diameter: 13mm
Middle Head Diameter: 16mm
Bottom Head Diameter: 18mm
Stem Diameter: 8.5mm x 8.5mm
Stem Length: 15mm, Overall Length: 20mm

Applications:

Toyota: Camry, Corolla, Highlander, Matrix,
Tundra, Venza 2007-up



Pkg. Qty: 15

PN 90381

Toyota: 90467-10188

Trim Panel Retainer
Turquoise Nylon
Upper Head Diameter: 13mm
Lower Head Diameter: 18mm
Stem Diameter: 8.5mm x 9mm
Stem Length: 14mm

Applications:

Toyota: Sienna 2004-up



Pkg. Qty: 25

PN 90382

Toyota: 90467-09204

Rear Hatch Door Side Garnish &
Front Body Pillar Garnish
Retaining Clip
White Nylon

Applications:

Toyota: Camry 2002-2006,
Highlander 2008-2011, Prius 2004-
2009, Sienna 2004-2011



Pkg. Qty: 25

PN 90383

Toyota: 90467-12080

Roof Inner Garnish, for Back Panel Trim, Rear Deck Trim Side Cover, Instrument Rear Cover, Rear Door Trim Board & Instrument Panel Cluster Retaining Clip, Pink Nylon

Applications:

Toyota: 4Runner, Avalon, Camry, Corolla, Echo, FJ Cruiser, Highlander, Matrix, Prius, RAV4, Sequoia, Sienna, Tacoma, Tundra, Venza, Yaris 2000-up



Pkg. Qty: 25

PN 90384

Volvo: 30653441

Door Side Panel Luggage Compartment & Armrest Tray Trim Retainer Black Nylon Head Diameter: 14mm Stem Length: 18mm Fits into 9mm Hole

Applications:

Volvo: C30, S40, V50, V60, XC60 2004-up



Pkg. Qty: 25

PN 90385

VW: 3C0-853-585, 3C9-827-407, 3C9-827-408, 5N0853135AE9B9,

Upper Door Cover Strip Scuff Protection Clip Retainer White Nylon Upper Head Size: 16.2mm x 12.9mm Lower Head Size: 17.8mm Stem Length: 13.3mm Stem Diameter: 10.6mm Overall Length: 21.3mm

Applications:

VW: Passat, Tiguan, Touareg 2006-up



Pkg. Qty: 25

PN 90386

VW: 6Q0-868-297

Door Panel Clip Retainer Black Nylon Top Head Diameter: 16mm Lower Head Diameter: 16mm Stem Diameter: 10mm Stem Length: 9mm

Applications:

VW: Golf, GTI, R32, Rabbit 2006-up



Pkg. Qty: 15

PN 90387

VW: 1H0-868-243-B

Adjustable Door Trim Panel Retainer Tan & White Nylon Head Diameter: 28.5mm Stem Diameter: 9.5mm Stem Length: 11mm Overall Length: 31mm

Applications:

VW: Golf 1993-2002



Pkg. Qty: 25

PN 90390

Citroen: 95667895

Opel: 174854
Peugeot: 6991W4
Seat: 191853585A
VW: 357-853-575

Moulding Clips White Nylon w/ Gray Grommet Upper Head Diameter: 12mm Lower Head Diameter: 18mm Stem Diameter: 10mm Stem Length: 16mm

Applications:

VW: Golf, Jetta, Passat, Scirocco



Pkg. Qty: 25

PN 90388

VW: 6K0-868-243C

Trim Panel Retainer Black Nylon Top Head Diameter: 22mm Stem Length: 12.5mm Fits into 8mm Hole Size

Applications:

VW: Beetle, Golf, Jetta & Passat 1998-up



Pkg. Qty: 25

PN 90389

VW: 357-853-585A

Door Retaining Clip w/ Black Nylon Grommet Head Diameter: 17mm Stem Length: 17mm Fits into 7mm Hole

Applications:

VW: Golf, Passat B3



Pkg. Qty: 15

PN 90391

VW: 171-807-249-A

Trim Panel Retainers Natural Nylon Upper Head Diameter: 12mm Lower Head Diameter: 18mm Stem Diameter: 9.5mm Stem Length: 12mm

Applications:

Audi: 1978-up
VW: Golf



Pkg. Qty: 25

PN 90392

VW: 703-867-299

Side Panel & Interior Trim Retainer Black Nylon Upper Head Diameter: 13.5mm Lower Head Diameter: 18mm Stem Diameter: 9mm Stem Length: 14mm

Applications:

VW: 1993-2003



Pkg. Qty: 25

PN 90162

Ford:

F1TZ-7810182-A

Rocker Panel & Ground Effects Clip Retainer Black Nylon Hole Size: 9mm

Applications:

Ford: Explorer, Pickup Trucks



Pkg. Qty: 25

PN 90395

Audi/VW : N90642001, N90565301

Engine Compartment Engine Cover Locking Pin Retainer
Black Nylon
Head Size: 15.6mm
Overall Length: 27mm

Applications:

Audi: A4, A6, A8
VW: Passat



Pkg. Qty: 25

PN 90396

BMW: 51437001491, 51430141024, 51446969997

Door Panel Clip Retainer, Natural Nylon
Upper Head Diameter: 15mm
Center Head Diameter: 12mm
Lower Head Diameter: 18mm
Stem Diameter: 6mm

Applications:

BMW: 1 Series E82, E88, 3 Series E21, E30, E36, E46, E90, E91, E92, E93, 5 Series E12, E28, E34, E39, E60, E61, 6 Series E24, E63, E64, 7 Series E23, E32, E38, E65, E66, F01, F02, X Series E53, E70, E71, E83, Z Series E52, E85, E86, E89

Pkg. Qty: 25



PN 90397

BMW: 51-47-8-166-992

Rear Convertible Lid Compartment Trim & Front Side Wheel Well Opening Retaining Clip
Black Nylon
Size: 17.3mm x 15.2mm
Height: 11.3mm
Diameter: 11.8mm x 7.8mm

Applications:

BMW: 3, 5, M Series 1993-up

Pkg. Qty: 25



PN 90398

BMW: 5147-1-840-961

Door Sill Cover Retaining Clip
White Nylon
Head Size: 8.5mm x 12mm
Stem Diameter: 4.7mm x 7mm
Stem Length: 12.5mm

Applications:

BMW: 3 Series

Pkg. Qty: 25



PN 90393

Honda: 91520-SM4-C010

Black Nylon
Hood Insulation Retainer
Head Diameter: 10mm
Stem Diameter: 7.5mm
Stem Length: 10mm

Applications:

Acura/Honda: 1991-up

Pkg. Qty: 25



PN 90394

Honda: 91518-SM4-003

Black Nylon
Hood & Trunk Moulding Clip
Head Diameter: 12mm
Stem Diameter: 8.5mm
Stem Length: 9mm
Fits into 6mm Hole

Applications:

Acura: Integra
Honda: Civic 1994-up

Pkg. Qty: 10



PN 90399

Honda: 38529-689A-6300

Panel Retaining Clip
Black Nylon
Head Diameter: 18mm
Stem Length: 15mm
Fits into 7mm Hole
Panel Range: 4mm

Applications:

Honda

Pkg. Qty: 25



PN 90401

Honda: 90687-671-0030

Panel Retaining Clip
Black Nylon
Head Diameter: 20mm
Stem Length: 20mm
Fits into 10mm Hole
Panel Range: 6mm

Applications:

Honda

Pkg. Qty: 25



PN 90402

Honda: 90687-SA5-0030

Retaining Clip
Black Nylon
Head Diameter: 13mm
Stem Length: 15mm
Fits into 5mm Hole
Panel Range: 4mm

Applications:

Honda

Pkg. Qty: 50



PN 90403

Honda: 91501-SM4-003

Cowl Top Retaining Clip
Black Nylon
Head Diameter: 14mm
Stem Length: 15mm
Fits into 6mm Hole

Applications:

Honda

Pkg. Qty: 15



PN 90404

Honda: 90670-692-0030
Toyota: 90467-09065

Retaining Clip
Black Nylon
Head Diameter: 15mm
Stem Length: 20mm
Fits into 7mm Hole

Applications:

Honda/Toyota

Pkg. Qty: 25



PN 90405

Nissan/Infiniti: 65810-K2008

Hood Seal Clip Retainer
Black Nylon
Head Diameter: 10mm
Stem Length: 7.9mm
Stem Size: 6mm x 3.1mm

Applications:

Infiniti: FX35, FX45 2002-up,
Nissan: Pathfinder 1999-2004

Pkg. Qty: 25



PN 90406

Land Rover:

MWC9134

Door Panel Clip Grommet
White Nylon
Head Diameter: 14mm
Overall Height: 14mm
Stem Diameter: 9mm

Applications:

Land Rover: Discovery, Freelander, Range Rover 1995-2005
(Use w/ 90873)



Pkg. Qty: 25

PN 90407

Lexus/Toyota:

51453-48010, 51453-0E010

Front Side Lower
Fender Panel
Bracket Clip
Black Nylon
Head Size: 22mm
Overall Height: 36mm
Stem Diameter: 13mm

Applications:

Lexus: RX330 2004-2009



Pkg. Qty: 15

PN 90408

Lexus: 90467-07137

Front Side Lower
Fender Panel
Bracket Clip
Black Nylon
Head Size: 10.7mm x 4.4mm
Overall Height: 11mm
Fits into 6mm Hole Size

Applications:

Lexus: ES350, GS300, GS450H, IS250 2006-up



Pkg. Qty: 25

PN 90409

Lexus: 90467-09138

Retaining Clip
Black Nylon
Head Size: 14mm x 15mm
Stem Length: 19mm
Fits into 7mm Hole

Applications:

Lexus



Pkg. Qty: 5

PN 90410

Mazda:

8133-50-022

Panel Retaining Clip
Black Nylon
Head Diameter: 18mm
Stem Length: 18mm
Fits into 8mm Hole
Panel Range: 7mm

Applications:

Mazda



Pkg. Qty: 25

PN 90411

Mazda: 9926-40-543A

Nissan: 01553-00291
Retaining Clip
Black Nylon
Head Diameter: 11mm
Stem Length: 15mm
Fits into 5.5mm Hole
Panel Range 5mm

Applications:

Mazda/Nissan



Pkg. Qty: 50

PN 90412

Mazda: B001-68-302-00

Toyota: 90950-01248

Panel Retaining Clip
Black Nylon
Head Diameter: 15mm
Stem Length: 15mm
Fits into 8mm Hole
Panel Range: 2mm

Applications:

Mazda/Toyota



Pkg. Qty: 25

PN 90413

Mitsubishi: HB-121467

Panel Retaining Clip
Black Nylon
Head Diameter: 18mm
Stem Length: 15mm
Fits into 8mm Hole
Panel Range: 5mm

Applications:

Mitsubishi



Pkg. Qty: 25

PN 90414

Nissan: 76906-T3000

Panel Retaining Clip
Black Nylon
Head Diameter: 14mm
Stem Length: 16mm
Fits into 6mm Hole
Panel Range: 5mm

Applications:

Nissan



Pkg. Qty: 50

PN 90415

Nissan: 27948-M7002

Retaining Clip
Black Nylon
Head Diameter: 16mm
Stem Length: 15mm
Fits into 5mm Hole
Panel Range: 4mm

Applications:

Nissan



Pkg. Qty: 25

PN 90416

Nissan: 01553-00202

Retaining Clip
Black Nylon
Head Diameter: 18mm
Stem Length: 12mm
Fits into 7mm Hole
Panel Range: 4mm

Applications:

Nissan



Pkg. Qty: 50

PN 90417

Nissan: 01553-00051

Retaining Clip
Black Nylon
Head Diameter: 20mm
Stem Length: 16mm
Fits into 7mm Hole
Panel Range: 7mm

Applications:

Nissan



Pkg. Qty: 50

PN 90418

Nissan: 01553-00172

Toyota: 90467-07050

Panel Retaining Clip
Black Nylon
Head Diameter: 13mm
Stem Length: 15mm
Fits into 5mm Hole
Panel Range: 3mm

Applications:
Nissan/Toyota



Pkg. Qty: 25

PN 90419

Nissan: 62869-N4700

Panel Retaining Clip
Black Nylon
Head Diameter: 14mm
Stem Length: 11mm
Fits into 6mm Hole
Panel Range: 4mm

Applications:
Nissan



Pkg. Qty: 25

PN 90420

Toyota: 90467-06161-01

Retaining Clip
Black Nylon
Head Diameter: 14mm
Stem Length: 10mm
Panel: 3mm
Fits into 5mm Hole

Applications:
Toyota



Pkg. Qty: 25

PN 90421

Toyota: 90467-08004, 90467-08011

Panel Clip
Black Nylon
Head Diameter: 13mm
Stem Length: 11mm
Fits into 5mm Hole

Applications:
Toyota



Pkg. Qty: 50

PN 90422

Toyota: 90467-10186, 51001-35A00, 51001-35A10, 90467-T0023

Dash & Front Fender Apron
Seal Clip Retainer, Black Nylon
Head Diameter: 16.5mm
Stem Diameter: 9.5mm
Overall Length: 16mm

Applications:
Toyota: 4Runner, FJ Cruiser, Land Cruiser, RAV4, Sequoia, Tundra 1996-up



Pkg. Qty: 25

PN 90423

VW: 191-853-577

Door Trim Clip
Side & Under Door
Plastic Scuff Plate Retainer
White Nylon
Head Size: 15mm x 11mm
Stem Length: 22mm
Snaps into 8mm Hole

Applications:
VW: Golf A1/A2, Jetta A1



Pkg. Qty: 25

PLUG BUTTONS/PLASTIC

PN 90424

3/4" Plug Button

Black Polyethylene
Hole Size: 3/4"
Head Diameter: 1-5/32"
Thickness: .02"-.14"

Applications:
Plug: 3/4"



Pkg. Qty: 100

PN 90425

1/2" Plug Button

Black Polyethylene
Hole Size: 1/2"
Head Diameter: 7/8"
Thickness: .02"-.07"

Applications:
Plug: 1/2"



Pkg. Qty: 100

PN 90426

1/2" Flush Sheet Metal Plug

Black Polyethylene
Hole Size: 1/2"
Head Diameter: 7/8"

Applications:
Plug/Flush: 1/2"



Pkg. Qty: 100

PN 90427

3/4" Flush Sheet Metal Plug

Black Polyethylene
Hole Size: 3/8"
Head Diameter: 3/4"

Applications:
Plug/Flush: 3/8"



Pkg. Qty: 100

PN 90428

3/4" Flush Sheet Metal Plug

Black Polyethylene
Hole Size: 3/4"
Head Diameter: 1"

Applications:
Plug/Flush: 3/4"



Pkg. Qty: 100

PN 90430

Acura/Honda:
91504-SM4-00

Bumper Fascia Retainer
Black Nylon
Head Diameter: 20mm
Stem Length: 24mm
Fits into 10mm Hole

Applications:

Honda: Accord 1990-up



Pkg. Qty: 10

PN 90435

Acura/Honda:
91503-S7A-003

Front Bumper
Push Type Retainer
Black Nylon
Head Diameter: 20mm
Stem Length: 11mm
Fits into 10mm Hole

Applications:

Honda: Accord 2003-2007,
Civic 2006-2008, Crosstour



Pkg. Qty: 15

PN 90436

Acura: 90505-SL0-00
Mitsubishi: MB888869
Toyota: 90467-08155

Push Type Retainer
Head Diameter: 20mm
Stem Length: 21mm
Fits into 8mm Hole

Applications:

Acura/Mitsubishi/Toyota



Pkg. Qty: 5

PN 90971

Honda:
91512-SX0-003

Front Fender
Push Type Retainer
Black Nylon
Head Diameter: 20mm
Stem Length: 11mm
Fits into 8mm Hole

Applications:

Honda: Accord, Prelude,
Odyssey



Pkg. Qty: 25

PN 90431

Honda: 91503-SP0-003

Front & Rear Bumper
Push Type Retainer
Black Nylon
Head Diameter: 20mm
Stem Length: 15mm
Fits into 10mm Hole

Applications:

Acura: CL, Integra, LegEnd, RL, TL,
1991-2002; **Honda:** Accord, Civic,
Del Sol, Odyssey,
Prelude 1992-2006



Pkg. Qty: 15

PN 90973

Honda:
91503-SZ5-003

Front & Rear Bumper
Push Type Retainer
Black Nylon
Head Diameter: 20mm
Stem Length: 18mm
Fits into 10mm Hole

Applications:

Acura: 3.0 RL
Honda: Accord,



Pkg. Qty: 15

PN 90974

Honda:
91503-SZ3-003

Front Bumper
Push Type Retainer
Black Nylon
Head Diameter: 20mm
Stem Length: 13mm
Fits into 10mm Hole

Applications:

Acura: 3.5 RL Sedan
1996-up



Pkg. Qty: 15

PN 90434

Honda: 91503-S9A-003

Front Bumper
Push Type Retainer w/
Internal Metal Insert
Black Nylon
Head Diameter: 20mm
Stem Diameter: 13mm
Fits into 10mm Hole

Applications:

Acura: MDX 2007-08
Honda: Accord 2006-08,
Civic 2006-08, CR-V
2005-08, Fit 2007-08



Pkg. Qty: 15

PN 90437

Audi/VW: N90-229-301

Push Type Retainer
Black Nylon
Flange Diameter: 22mm
Stem Length: 13mm
Fits into 8mm Hole

Applications:

Audi/VW



Pkg. Qty: 25

PN 90438

Audi/VW:
4D0-807-300

Wheel Well Cover
Push Type Retainer
Black Nylon
Flange Diameter: 21.7mm
Stem Length: 13.5mm
Fits into 7mm Hole

Applications:

Audi/VW: 1995-2014



Pkg. Qty: 15

PN 90439

Audi/VW:
333-867-633-4FB

Front Lamp Washer
Component Nozzle Rivet
Black Nylon
Head Diameter: 14mm
Length: 12mm
Fits into 8mm Hole

Applications:

VW: Bora, Golf A3/A4,
Passat B3/B4, Polo, Vento
1995-up



Pkg. Qty: 25

PN 90440

Audi/VW:
1H0-867-199-A

Hood Push Type
Moulding Retainer Black Nylon
Head Diameter: 24mm
Stem Length: 15mm
Fits into 9mm Square Hole

Applications:

VW: Golf A3/A4, Passat B5, Vento,
Polo, T4



Pkg. Qty: 25

PN 90441

BMW:

51-11-1-908-077

Scuff Plate
Push Type Retainer
Black Nylon
Head Diameter: 15mm
Stem Length: 15mm
Fits into 6.3mm Hole

Applications:

BMW: Series 3, 5, 7
1984-up



Pkg. Qty: 50

PN 90442

BMW:

51-48-8-181-420

Interior, Trunk Lining,
Clip Retainer
Black Nylon
Head Diameter: 18mm
Stem Length: 16mm
Fits into 8mm Hole

Applications:

BMW: 3 Series 1990-2000,
5 Series 1988-2004



Pkg. Qty: 25

PN 90443

BMW: 51471919209

Interior Trim &
Engine Intake Duct
Push Type Retainer
Black Nylon
Head Diameter: 20mm
Stem Length: 19mm
Stem Diameter: 6mm

Applications:

BMW: 3 Series 1984-2012, 5 Series
1988-1993, 7 Series 1994-2009, 8
Series 1993-1998, X Series
1998-2012, Z Series 1998-2012



Pkg. Qty: 25

PN 90444

BMW:

51-77-7-171-002

Wheel Arch Cover &
Footboard
Retainer w/ Sealer
Size: 35.3mm x 20.5mm
Stem Length: 10.5mm

Applications:

BMW: X Series 2006-up
Mini-Cooper: Cooper, S,
SX 2011-up



Pkg. Qty: 25

PN 90445

BMW

Trim Panel Retainer
Black Nylon
Head Diameter: 14.8mm
Stem Diameter: 6.5mm
Stem Length: 15mm
Overall Height: 17mm

Applications:

BMW: All Models 2000-up



Pkg. Qty: 15

PN 90446

BMW: 61131378641

Citroen/Peugeot: 781324

Mercedes-Benz:

**1239900292, 0009902092;
0009902592; 0009904292;
0009904892**

Expansion Rivet, Black Nylon
Head Diameter: 20mm

Overall Height: 11mm, Stem Diameter: 8mm

Applications: **BMW:** 3 Series 1990-2000,
5 Series 1988-1996, 6 Series 2010-2012, 7
Series 2007-2012, 8 Series 1989-1998, X
Series 1998-2007, **Mercedes-Benz:** 1985-
2012



Pkg. Qty: 10

PN 90447

Chrysler: OH452KD5

Headliner Retainer
Nylon Quartz Matte Finish
Head Diameter: 1-1/4"
Stem Length: 7/16"
Fits into 1/4" Hole

Applications:

Chrysler



Pkg. Qty: 15

PN 90448

Chrysler: 6506132-AA

Side Radiator Shield
Push Type Retainer
Black Nylon
Head Diameter: 20mm
Stem Length: 17mm
Fits into 7mm (17/64") Hole

Applications:

Chrysler: Cirrus, Sebring 2001-
up



Pkg. Qty: 25

PN 90449

Chrysler: 4630253

Rear Fascia Push Type
Retainer
Black Nylon
Head Size: 7/8" x 1-25/32"
Stem Length: 1-1/16"
Fits into 1/2" Hole

Applications:

Chrysler



Pkg. Qty: 15

PN 90450

Chrysler: 472434C

GM: 6031390

Weatherstrip Retainer (GM)
Inner Plastic Fender Retainer
Black Nylon
Head Diameter: 11/16"
Stem Length: 5/8"
Hole Size: 1/4"

Applications:

Chrysler/GM



Pkg. Qty: 50

PN 90451

Chrysler: 6504521

Fascia Push Type Retainer
Black Nylon
Head Diameter: 23/32"
Stem Length: 29/32"
Fits into 5/16" Hole

Applications:

Chrysler: Concorde, LHS
Dodge: Intrepid
Eagle: Vision 1998-up



Pkg. Qty: 25

PN 90963

Chrysler: 6501590

Ford: N803421-S

Splash Shield &
Fascia Retainer
Black Nylon
Head Diameter: 1"
Shoulder Length: 1/8"
Stem Length: 7/8"
Fits into 5/16" Hole

Applications:

Ford/Chrysler



Pkg. Qty: 25

PN 90984

Chrysler: 6502871

Ford: N803946S

Push Type Retainer
Black Nylon
Head Diameter: 19/32"
Stem Diameter: 29/32"
Fits into 1/4" Hole

Applications:

Ford/Chrysler: 1987-up



Pkg. Qty: 50

PN 90454

Chrysler: 5GC71RC3AA,

5GF92RC3AA

Ford: N808791

Interior Trim, Dash & Console
Push Type Retainer, Gray Nylon
Head Diameter: 19mm
Shoulder Diameter: 10mm
Shoulder Length: 7mm
Stem Length: 22mm
Fits into 9mm Hole

Applications:

Dodge: Durango,
Ford: Pickups 1997-up



Pkg. Qty: 25

PN 90964

Chrysler: 6503598

Ford: N807389S

GM: 21030249

Air Baffle to Under Carriage
Push Type Retainer
Black Nylon
Head Diameter: 20mm
Stem Length: 20mm
Fits into 8mm (5/16") Hole

Applications:

GM, Saturn: 2DR/4DR Models 1991-up,



Pkg. Qty: 25

PN 90456

Chrysler: 6508863-AA

GM: 11589289

Air Distributor &
Windshield Defroster
Push Type Retainer, Black Nylon
Head Diameter: 18mm
Stem Length: 17.5mm
Panel Range: 2.0mm - 4.5mm
Fits into 6.5mm Hole

Applications:

Buick: Enclave, Chevrolet: Equinox
Chevrolet/GMC: S, T Trucks
GMC: Acadia, Pontiac:
Torrent 2002-2008



Pkg. Qty: 25

PN 90457

Chrysler: 16500308

GM: 6500787

Tail Light Retainer
Head Diameter: 3/8"
Stem Length: 7/16"
Fits into 3/16" Hole

Applications:

Chrysler/GM



Pkg. Qty: 25

PN 90458

Chrysler: 10134407

GM: 6501925

Push Type Retainer
Black Nylon
Head Diameter: 11/16"
Stem Length: 13/16"
Fits into 1/4" Hole

Applications:

Chrysler/GM



Pkg. Qty: 25

PN 90459

Chrysler: 6502625

GM: 10140480

Push Type Retainer
Black Nylon
Head Diameter: 21mm (27/32")
Shoulder Length: 3mm (1/8")
Stem Length: 25mm (1")
Fits into 12mm (1/2") Hole

Applications:

APV: Vans 1990-up



Pkg. Qty: 25

PN 90460

Chrysler: 6503106

Lower Sill Moulding
Push Type Retainer
Black Nylon
Large Head Diameter: 7/8"
Stem Length: 1"
Fits into 1/4" Hole

Applications:

Jeep: Grand Cherokee,
Laredo 1994-up



Pkg. Qty: 15

PN 90461

Ford: 387843-S

Fender Shield Retainer
Head Diameter: 19/32"
Stem Length: 5/8"
Fits into 1/4" Hole

Applications:

Ford



Pkg. Qty: 50

PN 90462

Ford: N803494S,

GM: 15679091

Fascia Trim & Grille Retainer
Head Size: 15/32" x 15/32"
Stem Length: 21/32"
Fits into 1/4" Square Hole

Applications:

GM: 15679091,
GM: 1994 UP



Pkg. Qty: 25

PN 90463

Ford: 383142-S

Grille to Headlight Bracket
Push Type Retainer
Black Nylon
Head Diameter: 5/8"
Stem Length: 7/16"
Fits into 1/4" Hole

Applications:

Ford



Pkg. Qty: 50

PN 90464

Ford: 387944-S

Grille to Metal Stamping
Push Type Retainer
Black Nylon
Head Diameter: 3/4"
Shoulder Length: 1/4"
Stem Diameter: 11/32"
Fits into 1/4" wide slot

Applications:

Ford: Trucks 1978-up



Pkg. Qty: 50

PN 90465

Ford: N804837S
 Push Type Retainer
 Black Nylon
 Head Diameter: 1"
 Stem Diameter: 29/32"
 Fits into 1/4" Hole
Applications:
 Ford: 1987-up



Pkg. Qty: 50

PN 90466

Ford: N804674-S
 Push Type Retainer
 Black Nylon
 Head Diameter: 25mm
 Stem Diameter: 27mm
 Fits into 7mm Hole
Applications:
 Ford: Capri, Mustang



Pkg. Qty: 50

PN 90467

Ford: N807578-S, N808332-S
 Trim Panel Push Type Retainer
 Black Nylon
 Head Diameter: 11/16"
 Stem Length: 3/4"
 Fits into 1/4" Hole
Applications:
 Ford



Pkg. Qty: 15

PN 90468

Ford: W713331-S300
GM: 11589291
 Air Dam & Grille
 Push Type Retainer
 Black Nylon
 Head Diameter: 18mm
 Stem Length: 22mm
 Panel Range: 7.0mm - 9.5mm
 Fits into 6.5mm Hole
Applications:
 Cadillac: CTS, SRX, STS 2008-2003



Pkg. Qty: 25

PN 90469

Ford: N804570S
GM: 20664092
 Radiator Shroud
 Push Type Retainer
 Black Nylon
 Head Diameter: 11/16"
 Stem Length: 7/8"
 Fits into 1/4" Hole
Applications:
 Ford/GM



Pkg. Qty: 25

PN 90470

Ford: N804614S
GM: 20570245
 Spare Tire Cover Retainer
 Head Diameter: 1"
 Panel Range: .138" - .315"
 Fits into 5/16" Hole
Applications:
 GM: 1984-up



Pkg. Qty: 25

PN 90471

Ford: N802781-S
GM: 14093088
 Splash Shield & Fascia Retainer
 Black Nylon
 Head Diameter: 1"
 Stem Length: 7/8"
 Panel Range: .098" - .350"
 Fits into 1/4" Hole
Applications:
 Ford/GM



Pkg. Qty: 25

PN 90472

Ford: N803709S
GM: 15681408
 Fascia Retainer
 Black Nylon
 Head Diameter: 15mm
 Stem Length: 23mm
 Fits into 6mm Hole
Applications:
 Ford/GM: 1986-up



Pkg. Qty: 50

PN 90473

Ford: W708530-S300
GM: 11518017
 Bumper Cover & Fender Shield
 Push Type Retainer
 Black Nylon
 Head Diameter: 20mm
 Stem Length: 26mm
 Fits into 8mm Hole
Applications:
 GM/Ford: 1997-up



Pkg. Qty: 15

PN 90475

Ford: MB-455-56143
Mazda: B092-51-833
 Push Type Retainer
 Black Nylon
 Head Diameter: 18mm
 Stem Length: 12mm
 Fits into 8mm Hole
Applications:
 Ford/Mazda



Pkg. Qty: 10

PN 90476

Ford: MNA01-56145, NA01-56145
Nissan: 63844-01A00
 Inner Fender Push Type Retainer
 Black Nylon
 Head Diameter: 20mm
 Stem Length: 18mm
 Fits into 8mm Hole
Applications:
 Ford: Aspire, Probe 1995-up
 Nissan: 1980-up



Pkg. Qty: 25

PN 90477

GM: 94858864
 Door Trim Panel
 Push Type Retainer
 Gray Nylon
 Head Diameter: 14mm
 Stem Length: 8mm
 Fits into 6mm Hole
Applications:
 Geo: Prizm 1998-up



Pkg. Qty: 15

PN 90478

GM: 11589292

Bumper Fascia,
Flares & Air Dam,
Push Type Retainer
Black Nylon
Head Diameter: 20mm
Stem Length: 20mm
Panel Range: 2.0mm-4.5mm
Fits into 8.5mm Hole

Applications:

Chevrolet/GMC: C, K Trucks
2008-2007



Pkg. Qty: 25

PN 90479

GM: 14103461

Bumper Fascia Retainer
Black Nylon
Head Diameter: 7/8"
Stem Length: 1-3/64"
Hole Size: 1/2"
Panel Range: 5/32"

Applications:

GM



Pkg. Qty: 25

PN 90977

GM: 14019205

Fender Mud Skirt
Retainer
Black Nylon
Head Diameter: 11/16"
Stem Length: 9/16"
Fits into 1/4" Hole

Applications:

GM: 1981-up



Pkg. Qty: 25

PN 90481

GM: 20590899

Exterior Body Retainer
Black Nylon
Head Diameter: 11/16"
Stem Length: 7/8"
Fits into 9/32" Hole

Applications:

GM



Pkg. Qty: 25

PN 90482

**GM: 20510029,
Ford: N803362-S**

Body Retainer
Black Nylon
Head Diameter: 11/16"
Stem Length: 7/8"
Fits into 1/4" Hole

Applications:

GM: 1984 up,
Ford: 1984 UP



Pkg. Qty: 25

PN 90483

**GM: 10207146,
21077323**

Rear Rocker Panel
Push Type Retainer
Black Nylon
Head Diameter: 15mm
Stem Length: 29mm
Fits into 8mm Hole

Applications:

GM/Saturn



Pkg. Qty: 25

PN 90484

GM: 96057847

Radiator Grille & Trim Panel
Push Type Retainer
Black Nylon
Head Diameter: 11mm
Stem Length: 14mm
Fits into 7mm Hole

Applications:

GM



Pkg. Qty: 10

PN 90485

GM: 10077283

Bumper Fascia Retainer
Black Nylon
Head Diameter: 1"
Stem Length: 1-1/8"
Fits into 1/2" Hole
Panel Range: 1/4"

Applications:

GM



Pkg. Qty: 25

PN 90486

GM: 10108746

Front Bumper Fascia
Push Type
Black Nylon
Head Diameter: 20mm
Stem Length: 20mm
Fits into 10mm Hole

Applications:

GM



Pkg. Qty: 25

PN 90487

GM: 5973996

Fascia Retainer
Brown Nylon
Head Diameter: 1"
Shoulder Length: 1/4"
Stem Length: 7/8"
Fits into 1/2" Hole

Applications:

GM



Pkg. Qty: 15

PN 90488

GM: 22535007

Bumper Fascia Retainer
Black Nylon
Head Diameter: 1"
Stem Length: 1"
Fits into 1/2" Hole
Panel Range: 1/8"

Applications:

GM



Pkg. Qty: 25

PN 90489

**GM: 10053388,
22542705**

Bumper Fascia Retainer
Black Nylon
Head Diameter: 1"
Stem Length: 1-7/64"
Panel Range: 1/8"
Fits into 1/2" Hole

Applications:

GM 1987-on



Pkg. Qty: 25

PUSH TYPE RETAINER



PN 90490

GM: 10157900

Front Bumper Fascia Retainer
Black Nylon
Head Diameter: 18mm
Stem Length: 23mm
Fits into 9.5mm Hole

Applications:
Oldsmobile



Pkg. Qty: 25

PN 90491

GM: 21077405

Door Handle to Door Hardware Attachment
Push Type Retainer
Black Nylon
Head Diameter: 7mm
Stem Length: 10mm
Fits into 5mm Hole

Applications:
GM/Saturn



Pkg. Qty: 25

PN 90492

GM: 1636632

Front Fascia Bumper Retainer
Black Nylon
Head Diameter: 7mm
Shoulder Length: 2mm
Stem Length: 18mm
Fits into 9.5mm (3/8") Hole

Applications:
GM



Pkg. Qty: 25

PN 90493

GM: 3540858

Radiator Air Baffle Push Type Retainer
Black Nylon
Head Diameter: 3/4"
Stem Length: 1-1/8"
Fits into 1/4" (6.4mm) Hole

Applications:
Cadillac



Pkg. Qty: 25

PN 90494

GM: 5973400

Fascia Retainer
Black Nylon
Head Diameter: 1"
Shoulder Length: 1/8"
Stem Length: 3/4"
Fits into 1/2" Hole

Applications:
GM: 1979-up



Pkg. Qty: 15

PN 90967

GM: 14045480

Fascia Retainer
Head Diameter: 1"
Stem Length: 23/32"
Panel Range: 1/4"
Fits into 3/8" Hole

Applications:
GM: 1982-up



Pkg. Qty: 25

PN 90496

GM: 14019226, 14071289

Radiator Overflow/Windshield Bottle Retainer
Black Nylon
Head Diameter: 21/32"
Stem Length: 9/16"
Fits into 5/16" Hole

Applications:
GM: 1981-up



Pkg. Qty: 25

PN 90497

GM: 15960325

Door Trim Push Type Retainer
White Nylon
Head Diameter: 9/16"
Stem Length: 41/64"
Fits into 1/4" Hole

Applications:
GM: C, K, 1, 2, 3 Trucks
1995-up



Pkg. Qty: 50

PN 90473

Ford: W708530-S300
GM: 11518017

Bumper Cover & Fender Shield Push Type Retainer
Black Nylon
Head Diameter: 20mm
Stem Length: 26mm
Fits into 8mm Hole

Applications:
GM/Ford: 1997-up



Pkg. Qty: 25

PN 90499

GM: 5973823

Fascia Retainer
Black Nylon
Head Diameter: 7/8"
Stem Diameter: 5/32"
Fits into 1/2" Hole

Applications:
GM: 1979-up



Pkg. Qty: 25

PN 90501

GM: 10053182

Push Type Retainer
Black Nylon
Head Diameter: 19/32"
Stem Length: 13/16"
Fits into 5/16" Hole

Applications:
GM: 1987-up



Pkg. Qty: 25

PN 90502

GM: 14101262

Engine Shroud Cover Push Type Retainer
Black Nylon
Head Diameter: 1"
Shoulder Length: 1/8"
Stem Diameter: 15/16"
Fits into 1/2" Hole

Applications:
Buick/Oldsmobile/
Pontiac: 1988-up



Pkg. Qty: 25

PN 90503

GM: 21077131

Bumper Fascia
Push Type Retainer
Black Nylon
Head Diameter: 1-3/16"
Stem Length: 2"
Fits into 7/16" Hole

Applications:

GM/Saturn: 1991-up



Pkg. Qty: 10

PN 90504

GM: 15959832

Front License Plate Bracket
Push Type Retainer
Black Nylon
Head Diameter: 1"
Shoulder Length: 9/64"
Stem Length: 1-5/8"
Fits into 1/2" Hole

Applications:

GM: Trucks 1994-up



Pkg. Qty: 5

PN 90505

GM: 15153415

Rear Bumper Cover
Push Type Retainer
Black Nylon
Large Head Diameter: 20mm
Stem Length: 21mm
Fits into 9mm Hole

Applications:

GM: C, K Trucks 1999-up



Pkg. Qty: 25

PN 90506

GM: 10246149; 22657634

Rocker Panel
Push Type Retainer
Black Nylon
Head Diameter: 11mm
Stem Length: 20mm
Fits into 6mm Hole

Applications:

GM: Achieva, Cutlass, Grand Am, Malibu 1999-up



Pkg. Qty: 25

PN 90507

GM: 15733971

Front Air Deflector Retainer
Black Nylon
Upper Head Diameter: 18mm
Lower Head Diameter: 26mm
Flange Diameter: 30mm
Stem Length: 24mm
(Use with 90694)

Applications:

GM: C, K Trucks 1996-up



Pkg. Qty: 15

PN 90508

GM: 94198687

Honda: 90657-SA6-0030

Mazda: N304-13-356-A

Push Type Retainer
Black Nylon
Head Diameter: 14mm
Stem Length: 11mm
Fits into 7mm Hole

Applications:

Honda/Mazda



Pkg. Qty: 25

PN 90509

GM: 88970767

Toyota: 90467-10183

Front Fender Liner
Push Type Retainer
Head Diameter: 18mm
Stem Diameter: 5mm
Fits into 7mm Hole

Applications:

Pontiac: Vibe
Toyota: Celica, Corolla, Matrix 1999-up



Pkg. Qty: 10

PN 90510

GM: 21095797

Bumper & Fascia
Push Type Retainer
Black Nylon
Head Diameter: 20mm
Stem Length: 28mm
Fits into 8mm Hole

Applications:

GM/Saturn



Pkg. Qty: 25

PN 90511

GM: 21075686

Rocker Panel
Wheel Liner & Air Inlet Duct
Push Type Retainer
Black Nylon
Head Diameter: 15mm
Stem Length: 20mm
Fits into 8mm Hole

Applications:

GM/Saturn: 2DR/4DR Models 1991-up



Pkg. Qty: 25

PN 90512

GM: 21077123

Wheel Opening Moulding
Push Type Retainer
Black Nylon
Head Diameter: 19/32"
Stem Diameter: 3/4"
Fits into 1/4" (6.4mm) Hole

Applications:

GM/Saturn: 1991-up



Pkg. Qty: 25

PN 90513

GM: 21047094

Push Type Retainer
Black Nylon
Pin plunger Head
Diameter: 14mm
Stem Length: 14mm
Fits into 6mm Hole

Applications:

GM/Saturn: 1991-up



Pkg. Qty: 25

PN 90514

GM: 96057846

Toyota: 90467-07041

Push Type Retainer
Black Nylon
Head Diameter: 15mm
Stem Length: 13mm
Fits into 6.3mm Hole

Applications:

Geo: Metro, Tracker
Toyota: 1989-up



Pkg. Qty: 10

PN 90515

Honda:
91501-TR0-003
 Inner Fender Wheel Well
 Liner Clip Retainer
 Fender Push Type Retainer
 Black Nylon
 Head Diameter: 20mm
 Stem Length: 10mm
 Fits into 8mm Hole
Applications:
 Honda: 2012-up



Pkg. Qty: 25

PN 90516

Honda:
91550-SH3-003
 Trunk Lining Retainer
 Black Nylon
 Head Diameter: 15mm
 Stem Length: 13mm
 Fits into 7mm Square Hole
Applications:
 Honda



Pkg. Qty: 5

PN 90517

Honda:
90683-SA5-003
 Front Fender Skirt Push
 Type Retainer
 Black Nylon
 Head Diameter: 15mm
 Stem Length: 13mm
 Fits into 6mm Hole
Applications:
 Honda



Pkg. Qty: 15

PN 90518

Honda:
91508-SR3-000
 Cowl Panel Retainer
 Black Nylon
 Head Diameter: 17mm
 Stem Length: 9mm
 Fits into 8mm Hole
Applications:
 Honda



Pkg. Qty: 10

PN 90519

Honda:
91502-SM4-000
 Bumper Fascia Retainer
 Black Nylon
 Head Diameter: 20mm
 Stem Length: 27mm
 Fits into 10mm Hole
Applications:
 Honda: Accord 1990-up



Pkg. Qty: 10

PN 90520

Honda:
90505-SM4-003
 Push Type Retainer
 Black Nylon
 Head Diameter: 18mm
 Stem Diameter: 21mm
 Panel Range: 4-8mm
 Fits into 8mm Hole
Applications:
 Honda



Pkg. Qty: 10

PN 90521

Honda:
91516-SK7-013
 Splash Shield Push Type
 Retainer
 Head Diameter: 20mm
 Stem Diameter: 15mm
 Fits into 8mm Hole
 Hex Size: 10mm
Applications:
 Honda: Civic 1992-up



Pkg. Qty: 10

PN 90522

Honda:
91512-SM4-003
 Fender Splash Shield
 Push Type Retainer
 Black Nylon
 Head Diameter: 20mm
 Stem Diameter: 9mm
 Fits into 8mm Hole
Applications:
 Honda: Accord



Pkg. Qty: 10

PN 90523

Honda:
90688-SB0-003
 Push Type Retainer
 Black Nylon
 Head Diameter: 18mm
 Stem Length: 11mm
 Fits into 6mm Hole
Applications:
 Honda: Civic 1992-2000, Odyssey
 1999-2004, Prelude 1983-1987



Pkg. Qty: 25

PN 90524

Honda:
90687-SB0-003,
90687-SB0-013
 Cowl Vent Panel
 Retainer
 Black Nylon
 Head Diameter: 13mm
 Stem Length: 11mm
 Fits into 6mm Hole
Applications:
 Honda



Pkg. Qty: 25

PN 90525

Honda:
91501-S04-003
 Front Fender Push Type
 Retainer
 Black Nylon
 Head Diameter: 20mm
 Stem Length: 10mm
 Fits into 8mm Hole
Applications:
 Honda: Civic, Del Sol
 1993-up



Pkg. Qty: 15

PN 90526

Honda:
91508-SM4-003
 Cowl Panel
 Push Type Retainer
 Black Nylon
 Head Diameter: 18mm
 Stem Length: 14mm
 Fits into 8mm Hole
Applications:
 Honda: Accord 1990-up



Pkg. Qty: 10

PN 90527

Honda:
90505-SX0-003
 Garnish Side Protector
 Push Type Retainer
 Black Nylon
 Head Diameter: 18mm
 Stem Length: 15mm
 (Not including the Pin)
 Fits into 8mm Hole

Applications:
 Honda: Odyssey 1995-up



Pkg. Qty: 15

PN 90528

Honda:
91506-S9A-003
 Bumper Retainer with
 Metal Insert
 Black Nylon
 Flange Diameter: 20mm
 Stem Length: 16mm
 Fits into 10mm Hole Size

Applications:
 Acura: MDX, RDX & TSX
 2004-2009



Pkg. Qty: 10

PN 90531

Honda:
90684-SA5-0030
Isuzu: 8942981190
Nissan: 10998-30880
 Push Type Retainer
 Black Nylon
 Head Diameter: 15mm
 Stem Diameter: 11mm
 Fits into 6mm Hole

Applications:
 Honda



Pkg. Qty: 25

PN 90532

Honda:
90675-SB3-003
Mazda: FB01-56-964
Nissan: 63876-95596
 Splash Shield Push Type
 Retainer
 Black Nylon
 Head Diameter: 20mm
 Stem Length: 9mm
 Fits into 8mm Hole

Applications:
 Honda/Mazda/Nissan



Pkg. Qty: 25

PN 90533

Honda:
91545-SE0-0030-W1
Nissan: 63848-01G00
 Push Type Retainer
 Black Nylon
 Head Diameter: 20mm
 Stem Length: 14mm
 Fits into 8mm Hole

Applications:
 Honda/Nissan



Pkg. Qty: 25

PN 90534

Honda:
91502-SP0-003
 Front & Rear Bumper
 Push Type Retainer
 Black Nylon
 Head Diameter: 20mm
 Stem Length: 25mm
 Hole Size: 10mm

Applications:
 Honda



Pkg. Qty: 10

PN 90535

Nissan:
01553-06721
 Front & Rear Bumper Cover
 Retainer
 Black Nylon
 Head Diameter: 20mm
 Stem Diameter: 15mm
 Fits into 8mm Hole

Applications:
 Infiniti: 1990-up
 Nissan: Maxima



Pkg. Qty: 15

PN 90536

Nissan:
11296-AG000
 Front Bumper & Radiator Support
 Push Type Retainer
 Black Nylon
 Head Diameter: 20mm
 Stem Length: 13mm
 Fits into 8mm Hole

Applications:
 Infiniti: FX35, FX45
 Nissan: Altima, Maxima &
 Quest 2002-up



Pkg. Qty: 25

PN 90537

Nissan:
01553-05323
 Cowl, Bumper & Fender
 Liner
 Push Type Retainer
 Black Nylon
 Head Diameter: 20mm
 Stem Length: 12mm
 Fits into 8mm Hole

Applications:
 Infiniti: FX35, FX45, G35
 Nissan: 2003-up



Pkg. Qty: 10

PN 90538

Nissan:
01553-08231
 Front Grille Support
 Retaining Clip, Black Nylon
 Head Diameter: 20mm
 Length with Pin: 24mm
 Fits into 8mm Hole

Applications:
 Nissan: 240SX 1994-1996,
 Murano 2007-2012
 Infiniti: FX45, FX35, Q45 2002-up



Pkg. Qty: 25

PN 90539

Nissan:
63844-00100
Isuzu: 8942211500
 Push Type Retainer
 Black Nylon
 Head Size: 14mm x 22mm
 Stem Length: 9mm
 Fits into 7mm Hole

Applications:
 Isuzu/Nissan



Pkg. Qty: 25

PN 90540

Lexus:
90467-07138
 Push Type Retainer
 Black Nylon
 Head Diameter: 20mm
 Stem Length: 12mm
 Fits into 7mm Hole

Applications:
 Lexus: 1990-up



Pkg. Qty: 10

PN 90541

Lexus:
90467-07117
 Push Type Retainer
 Black Nylon
 Head Diameter: 17mm
 Stem Length: 9mm
 Fits into 7mm Hole

Applications:
 Lexus



Pkg. Qty: 10

PN 90542

Lexus/Toyota:
90467-07164
 Fender Splash Shield Push Type Retainer
 Retainer Black Nylon
 Head Diameter: 20mm
 Stem Length: 10mm
 Fits into 7mm Hole Size

Applications:
Lexus: ES300, GX460, LS400, LX570, SC430 1997-up
Toyota: Camry, Echo, MR2, Sienna 1997-up



Pkg. Qty: 10

PN 90543

Lexus/Toyota:
90467-05136
 Inner Door Lock Plate Engine Cover, Outside, air Duct
 Push Type Retainer
 Head Size: 8mm
 Overall Height: 15mm
 Stem Diameter: 4.5mm

Applications:
 Lexus/Toyota: 2012-up



Pkg. Qty: 25

PN 90544

Lexus/Toyota:
90467-08196
 Front & Rear Fender Flare & mudguard
 Clip Retainer, Yellow Nylon
 Head Size: 22mm
 Stem Length: 19mm
 Stem Diameter: 8mm
 Overall Length: 27mm

Applications:
Lexus: GX470 2003-2009
Toyota: Land Cruiser 1998-2007



Pkg. Qty: 25

PN 90545

Lexus/Toyota:
90467-08195
 Front & Rear Fender, Flare Moulding Clip Retainer, White
 Head Diameter: 22mm
 Stem Length: 14mm
 Overall Length: 21mm
 Fits into 8mm Hole Size

Applications:
Lexus: GX470 2003-2009
Toyota: Land Cruiser 1998-2007



Pkg. Qty: 25

PN 90546

Lexus/Toyota:
53888-48010
 Front Fender Wheel Liner
 Push Type Retainer
 Black Nylon
 Head Diameter: 18mm
 Stem Length: 14mm
 Fits into 7mm Hole Size

Applications:
Toyota: 2001-2011
Lexus: 2004-2013



Pkg. Qty: 5

PN 90547

Lexus/Toyota:
90467-09101
 Bumper Cover Retainer
 Black Nylon
 Head Diameter: 18mm
 Stem Length: 23mm
 Fits into 9mm Hole

Applications:
Lexus: ES300
Toyota



Pkg. Qty: 25

PN 90548

Lexus/Toyota:
90467-09093
 Bumper Cover Retainer
 Black Nylon
 Head Diameter: 15mm
 Stem Length: 27mm
 Fits into 9mm Hole

Applications:
Lexus: LS400, LX400, SC430;
Toyota: Avalon, Camry, Celica, Corolla, Echo, MR-2, Paseo, Sequoia, Sienna, Supra, T100, Tacoma, Tercel, Tundra



Pkg. Qty: 10

PN 90549

Toyota:
90467-09143
 Push Type Retainer
 Black Nylon
 Head Diameter: 19mm
 Stem Diameter: 26mm
 Fits into 9mm Hole

Applications:
Lexus: ES300 1990-up
Toyota: Camry, Celica, Supra 1992-up



Pkg. Qty: 10

PN 90550

Toyota:
90467-07201
 Engine under Cover
 Push Type Retainer
 Black Nylon
 Head Diameter: 20mm
 Stem Diameter: 10mm
 Fits into 7mm Hole

Applications:
Lexus: ES300, ES330
Toyota: Avalon, Camry, Solara 2002-up



Pkg. Qty: 10

PN 90551

Lexus/Toyota:
90467-07211
 Bumper, Radiator Cover & Grille
 Push Type Retainer
 Black Nylon
 Head Diameter: 19mm
 Stem Length: 8mm
 Fits into 7mm Hole

Applications:
Lexus: IS, LS
Toyota: Avalon, Camry, Highlander 2005-up



Pkg. Qty: 10

PN 90553

Mazda:
B467-68-AC3-02
 Rear Trunk Liner Retainer
 Black Nylon
 Head Diameter: 18mm
 Overall Length: 22.6mm
 Stem Diameter: 6mm

Applications:
Mazda: CX-7, CX-9, Millennia, Miata, Mazda 5, MX-6, Protégé, RX-7



Pkg. Qty: 25

PN 90554

Mazda: G14S-50-EA1

Rear Spoiler & Radiator Grille
Push Type Retainer
Black Nylon
Head Diameter: 13mm
Stem Length: 17mm
Stem Diameter: 8mm

Applications:

Mazda: CX7 2007-up, Miata 2004-up



Pkg. Qty: 25

PN 90555

Mazda: 9926-50-635, 1395-68-676

Push Type Retainer
Black Nylon
Head Diameter: 20mm
Stem Length: 9mm
Fits into 9mm Hole

Applications:

Mazda



Pkg. Qty: 15

PN 90556

Mazda: GJ21-68-885B-02

Push Type Retainer
Black Nylon
Head Diameter: 18mm
Overall Length: 19mm
Stem Diameter: 6mm

Applications:

Mazda: 2, 3, 5, 6, 323, 626, 929, CX-7, CX-9, Miata, Millennia, MPV, MX3, MX6, Protégé, RX-7, RX-8 1990-up



Pkg. Qty: 15

PN 90557

Mazda: S51S-51-833, NE51-51-PS7

Splash Shield Rivet
Black Nylon
Head Diameter: 11mm
Stem Length: 11mm
Fits into 7mm Hole Size

Applications:

Mazda: 3, 5, Miata, RX8 2007-up



Pkg. Qty: 15

PN 90558

Mazda: BF82-50-233 Nissan: 01553-01393

Bumper Cover Retainer
Black Nylon
Head Size: 20mm x 30mm
Stem Length: 18mm
Fits into 10mm Hole

Applications:

Mazda/Nissan



Pkg. Qty: 10

PN 90559

Mazda: 9926-50-625 Toyota: 90467-06017

Trunk Lid & Component Lock Cover
Push Type Retainer
Black Nylon
Head Diameter: 15mm
Stem Length: 12mm
Fits into 7mm Hole

Applications:

Mazda/Toyota



Pkg. Qty: 15

PN 90560

Mercedes-Benz: 0009902992, 1149900192, 0019901692, 0009906092 Opel: 1104882, 1719245 Volvo: 9133417, 1268642

Push Type Retainer
Black Nylon,
Head Diameter: 16mm
Stem Diameter: 8mm
Stem Length: 14mm

Applications:

Mercedes-Benz/Opel/Volvo



Pkg. Qty: 15

PN 90561

Mercedes-Benz: 124-990-04-92

Push Type Retainer
Black Nylon
Head Diameter: 16mm
Stem Length: 18mm
Fits into 7mm Hole

Applications:

Mercedes-Benz: 2003-up



Pkg. Qty: 15

PN 90562

Mitsubishi: MR-138807

Front Bumper & Support
Push Type Retainer
Black Nylon
Head Diameter: 20mm
Stem Length: 26mm
Fits into 8mm Hole

Applications:

Mitsubishi



Pkg. Qty: 5

PN 90563

Mitsubishi: MR200300

Fender & Bumper
Push Type Retainer
Head Diameter: 18mm
Stem Diameter: 12mm
Fits into 9mm Hole

Applications:

Mitsubishi: 1998-up



Pkg. Qty: 15

PN 90564

Mitsubishi: MR280103

Front Bumper Support
Retaining Clip
Black Nylon
Head Diameter: 20mm
Stem Length: 13mm
Stem Diameter: 8mm

Applications:

Mitsubishi: Lancer, Mirage 1995-up



Pkg. Qty: 15

PN 90565

Mitsubishi: MR288150

Cooling Duct Radiator Air
Guide Support Clip
Black Nylon
Head Diameter: 15mm
Stem Length: 12mm
Stem Diameter: 6mm

Applications:

Mitsubishi: Eclipse, Galant, Lancer, Outlander, Mirage 1997-up



Pkg. Qty: 10

PN 90566

Mitsubishi: MB547806

Nissan: 63854-01A00

Front Bumper Fascia
Push Type Retainer
Black Nylon
Head Diameter: 20mm
Stem Length: 20mm
Fits into 8mm Hole

Applications:

Mitsubishi

Nissan: 300ZX 1990-up



Pkg. Qty: 15

PN 90567

Nissan: 01553-03101

Bumper & Fascia
Push Type Retainer
Black Nylon
Head Diameter: 22mm
Stem Length: 14mm
Fits into 11mm Hole

Applications:

Nissan



Pkg. Qty: 15

PN 90568

Nissan: 66824-01G00

Push Type Retainer
Black Nylon
Head Diameter: 12mm
Stem Length: 8mm
(Pin Length not included)
Fits into 6mm Hole

Applications:

Nissan



Pkg. Qty: 25

PN 90569

Nissan: 01553-09321

Front Fender Push Type
Retainer
Black Nylon
Head Diameter: 20mm
Stem Length: 9mm
Fits into 8mm Hole

Applications:

Nissan



Pkg. Qty: 15

PN 90570

Nissan: 01553-09241

Bumper Push Type
Retainer
Black Nylon
Head Diameter: 18mm
Stem Length: 15mm
Fits into 10mm Hole

Applications:

Nissan



Pkg. Qty: 15

PN 90571

Nissan: 76882-57A00

Side Moulding Drive Rivet
Black Nylon
Head Diameter: 16mm
Stem Diameter: 20mm
Fits into 8mm Hole

Applications:

Nissan: Sentra 1986-up



Pkg. Qty: 25

PN 90572

Nissan: 66814-01G00

Cowl Grille Retainer
Black Nylon
Head Size: 8mm x 12mm
Stem Length: 8mm
Fits into 6mm x 6mm Square Hole

Applications:

Nissan: 1986-up



Pkg. Qty: 25

PN 90573

Nissan: 66860-01W01

Cowl Panel to
Reinforcement Plate &
Engine Splash Shield Retainer
Black Nylon
Head Diameter: 14mm
Stem Length: 16mm
Fits into 6mm Hole

Applications:

Nissan



Pkg. Qty: 25

PN 90574

Nissan: 63844-01A99

Push Type Retainer
Black Nylon
Head Diameter: 17mm
Stem Diameter: 18mm
Fits into 8mm Hole

Applications:

Nissan



Pkg. Qty: 25

PN 90575

Nissan: 63848-9E001

Bumper Fascia
Push Type Retainer
Black Nylon
Head Diameter: 18mm
Stem Length: 22mm
Fits into 9mm Hole

Applications:

Nissan: Altima 1997-up



Pkg. Qty: 10

PN 90576

Nissan: 01553-09611

Toyota: 90476-08185

Bumper Clip
Push Type Retainer
Black Nylon
Head Diameter: 18mm
Stem Length: 10mm
Not Including the Pin
Fits into 8mm Hole

Applications:

Nissan: Maxima 1994-up,
Lexus & Toyota 2002
and up



Pkg. Qty: 15

PN 90577

Nissan:

01553-03201

Front & Rear Bumper
Push Type Retainer
Black Nylon
Head Diameter: 22mm
Stem Length: 21mm
Fits into 8mm Hole

Applications:

Nissan: 1982-up



Pkg. Qty: 10

PN 90578

Nissan: 01553-07151

Kick Plate
Push Type Retainer
Gray Nylon
Head Diameter: 18mm
Stem Length: 20mm
Fits into 9mm Hole

Applications:

Nissan: Frontier 1997-up



Pkg. Qty: 15

PN 90579

Nissan: 01553-06071

Rear Duct Finishing Panel
Push Type Retainer
Black Nylon
Head Diameter: 15mm
Stem Length: 14mm
Fits into 4.5mm Hole

Applications:

Nissan: Cube S/SL, Leaf & Krom 2012-up



Pkg. Qty: 15

PN 90580

Nissan: 84995-3J101

Trunk Right & Left Side
Trim Cover Clip
Black Nylon
Head Diameter: 20mm
Overall Length: 20mm
Stem Diameter: 8mm

Applications:

Nissan: Sentra 2007-up



Pkg. Qty: 15

PN 90582

Nissan: 01553-10051

Front Dash & Rear Trunk,
Trim Cover Clip Black Nylon
Head Diameter: 20mm
Overall Length: 21mm
Stem Diameter: 8mm

Applications:

Nissan: Altima, Maxima,
Sentra 2002-up



Pkg. Qty: 15

PN 90583

Nissan: 66824-W1000

Push Type Retainer
Black Nylon
Head Size: 12mm x 18mm
Stem Length: 10mm
Fits into 6mm Hole

Applications:

Nissan



Pkg. Qty: 15

PN 90584

Nissan: 80999-05N07

Toyota: 90467-07043
Push Type Retainer
Black Nylon
Head Diameter: 18mm
Stem Length: 11mm
(Pin Length not included)
Fits into 7mm Hole

Applications:

Nissan/Toyota



Pkg. Qty: 25

PN 90585

Subaru: 909130059

Front Bumper Clip
Push Type Retainer
Head Diameter: 20mm
Stem Diameter: 10mm
Overall Height: 24mm

Applications:

Subaru: Forester 2003-2005,
Impreza 2004-2005



Pkg. Qty: 25

PN 90586

Subaru: 909140007

Bumper, Engine Cover, Fender
& Grille, Push Type Retainer
Black Nylon
Head Diameter: 20mm
Stem Diameter: 10mm
Overall Height: 28mm

Applications:

Subaru: Baja, Forester,
Impreza, Legacy, Outback,
B9 Tribeca 2002-2012



Pkg. Qty: 15

PN 90587

Subaru: 91085TA030

Pillar Rocker & Floor Exterior,
Trim, Moulding, Black Nylon
Head Diameter: 16mm
Stem Length: 15mm
Stem Diameter: 7mm

Applications:

Subaru: Baja 2003-2006,
Impreza 2002-2011, Legacy
2000-2012, Outback 2000-2012



Pkg. Qty: 25

PN 90591

Subaru: 909130003

Upper Cowl Grille,
Retaining Clip
Black Nylon
Head Diameter: 10mm
(Length without Pin 8mm)
Fits into 4mm Hole

Applications:

Subaru: Baja, Legacy,
Outback 2000-2006



Pkg. Qty: 25

PN 90592

Subaru: 909140012

Rear Lamp Reflector,
Roof Spoiler
Push Type Retainer
Black Nylon

Applications:

Subaru: B9 Tribeca 2006-
2007, Impreza 2006-2012,
Legacy 2005-2012, Outback
2005-2012



Pkg. Qty: 25

PN 90593

Subaru: 59122FA010

Front Bumper Cover & Component,
Pillar Rocker, Floor Exterior
Rocker Moulding, Windshield Wiper Washer,
Fender Exterior, Lower & Upper Flare
Retaining Clip, Black Nylon
Head Diameter: 20mm
Overall Length: 20mm
Stem Diameter: 8mm

Applications:

Subaru: B9 Tribeca 2006-2011, Baja 2003-
2006, Forester 1998-2012, Impreza/WRX
STI 1997-2011, Legacy 1997-2012, Outback
2000-2012



Pkg. Qty: 25

PN 90594

Subaru: 909140002

Exterior Pillar Panel
Moulding Clip
w/ Sealer
Black Nylon
Head Diameter: 25mm
Stem Diameter: 10mm
Overall Height: 27mm

Applications:

Subaru: B9 Tribeca, Baja,
Legacy 2000-2007



Pkg. Qty: 25

PN 90595

Subaru: 57750AA090

Front Bumper & Component
Reinforcement Beam
Retaining Clip
Black Nylon
Head Diameter: 22mm
Length without Pin: 30mm
Fits into 10mm Hole

Applications:

Subaru: Impreza, Legacy
1995-1999



Pkg. Qty: 25

PN 90596

Subaru: 59122AC030

Fender Liner & Component
Retaining Clip
Black Nylon
Head Diameter: 20mm
Stem Length: 12mm
Fits into 7mm Hole

Applications:

Subaru: B9 Tribeca, Baja,
Forester, Legacy, Outback
1998-2004



Pkg. Qty: 25

PN 90597

Suzuki: 09409-08327

Push Type Retainer
Black Nylon
Head Diameter: 16mm
Stem Length: 20mm
Stem Diameter: 8mm

Applications:

Suzuki: Grand Vitara,
Swift, XL7



Pkg. Qty: 15

PN 90598

Toyota: 75867-06030

Rocker Panel
Push Type Retainer
Black Nylon
Head Diameter: 20mm
Stem Length: 16mm
Fits into 8mm Hole

Applications:

Lexus/Toyota: 2007-up



Pkg. Qty: 25

PN 90599

Toyota: 90467-09227

Bumper & Engine
Under Cover
Push Type Retainer
Black Nylon
Head Diameter: 22mm
Stem Length: 15mm
Fits into 9mm Hole

Applications:

Toyota: 4Runner, RAV4
Scion: xB 2006-up



Pkg. Qty: 10

PN 90600

Toyota: 90467-07166

Front Fender Liner Push
Type Retainer Black Nylon
Head Diameter: 20mm
Stem Length: 8mm
Fits into 7mm Hole

Applications:

Toyota



Pkg. Qty: 15

PN 90601

Toyota: 90467-07044

Quarter Panel
Wheel Opening
Moulding Push Type Retainer
Black Nylon
Head Diameter: 20mm
Stem Length: 9mm
Fits into 7mm Hole

Applications:

Toyota: T-100



Pkg. Qty: 10

PN 90602

Toyota: 90467-09145

Bumper Cover
Push Type Retainer
Black Nylon
Head Diameter: 15mm
Stem Length: 12mm
Fits into 9mm Hole

Applications:

Toyota: Camry 1992-up



Pkg. Qty: 15

PN 90966

Toyota: 52161-16010
52161-02020

Rear Bumper Cover
Push Type Retainer
Black Nylon
Head Diameter: 18mm
Stem Length: 28mm
Fits into 9mm Hole

Applications:

Toyota: Tercel 1988-up



Pkg. Qty: 6

PN 90604

Toyota: 53879-60010

Fender Liner
Push Type Retainer
Black Nylon
Head Diameter: 18mm
Stem Length: 7mm
Fits into 7mm Hole

Applications:

Toyota: Land Cruiser, RAV4
1998-up



Pkg. Qty: 15

PN 90605

Toyota:
90467-06133-C0

Belt Moulding
Push Type Retainers
Black Nylon
Head Diameter: 14mm
Stem Length: 8mm
Fits into 6mm Hole Size

Applications:

Toyota: 4Runner 1998-up



Pkg. Qty: 15

PN 90606

Toyota: 90467-07188

Push Type Retainers
Black Nylon
Flange Diameter: 15mm
Stem Length: 17mm
Fits into 7mm Hole Size

Applications:

Toyota: 4Runner 2002-up,
Camry, Tundra 2002-up



Pkg. Qty: 15

PN 90607

Toyota: 90467-09166

Push Type Retainer
Black Nylon
Flange Diameter: 20mm
Stem Length: 9mm
Fits into 9mm Hole Size

Applications:

Toyota: Camry 2006-up



Pkg. Qty: 15

PN 90608

Toyota: 90467-09185

Front Spoiler Piece Retainer
Black Nylon
Head Diameter: 18mm
Length with Pin: 17mm
Stem Length: 10mm
Fits into 9mm Hole

Applications:

Toyota: 4Runner 2003-2009,
Celica 1994-1999, Sequoia
2008-2011, Sienna 2011



Pkg. Qty: 25

PN 90610

Toyota: 90467-10206

Cowl Top Ventilator
Louver Clip
Black Nylon
Head Diameter: 15.5mm
Stem Length: 10mm
Fits into 8mm Hole

Applications:

Toyota: Camry, Sequoia,
Tundra, Yaris
2006-up



Pkg. Qty: 15

PN 90611

Volvo: 1268176-3

Bumper Cover
Push Type Retainer
Black Nylon
Head Diameter: 16mm
Stem Length: 14mm
Fits into 6mm Hole

Applications:

Volvo: 740 & 760 1993-up



Pkg. Qty: 15

PN 90612

VW: N0385501

Fender Splash Shield, Hood &
Truck insulator Rivet
Black Nylon
Flange: 12.5mm
Stem: 11mm
Fits into 8mm Hole Size

Applications:

VW: Corrado, Golf A1/A2/A3, Jetta,
New Beetle, Passat B3/B4, Touareg,
Transporter



Pkg. Qty: 25

PN 90613

VW: 1H0-819-055-C01C

Push Type Retainer
Black Nylon
Upper Head Diameter: 23mm
Lower Head Diameter: 16mm
Stem Length: 15mm
Fits into 8mm x 8mm Square Hole

Applications:

VW: Golf A3, Passat, Vento
Skoda: 1993-up



Pkg. Qty: 25

PN 90614

VW: 701-867-299

Trunk & cargo space
Interior Trim Sidewall &
Wall Plug Trim Panel
Push Type Retainer
Light Gray Nylon
Head Diameter: 18.5mm
Stem Length: 11mm
Fits into 9mm Hole

Applications:

VW: Golf A3/A4, Jetta, Passat,
Variant, Vento
1999-2001



Pkg. Qty: 25

PN 90192

Ford: N803716-S

Black Nylon
Fascia Retainer
Head Diameter: 18mm
Stem Length: 23mm
Fits into 7mm Hole

Applications:

Mustang/Capri 1985-on



Pkg. Qty: 25

PN 90295

Ford: XL3Z17E971-AA

Natural Nylon
Push Type Retainer
Head Diameter: 16mm
Stem Length: 12mm
Fits into 10mm (25/64") Hole

Applications:

Ford F150, F250 Trucks
1999-up



Pkg. Qty: 25

PN 90042

Honda: 91505-S9A-003

Front Bumper w/
Internal Metal Insert
Head Diameter: 20mm
Stem Length: 13mm
Fits into 10mm Hole

Applications:

Honda Civic 2006-up



Pkg. Qty: 10

PN 90195

Stud Flat Push Type Retainer
Stud Size: 3/16"
Flange: 7/16"



Pkg. Qty: 100

PUSH TYPE RETAINER



PN 90474

GM: 11609417

Black Nylon
Push Type Retainer
Head Diameter: 19mm
Stem Length: 14mm
Fits in Hole Size: 8.5mm



Pkg. Qty: 50

PN 90480

GM: 11589290

Black Nylon
Push Type Retainer
Head Diameter: 18mm
Stem Length: 20mm
Hole Size: 17/64" (6.5mm)
Panel Range: 4.5 - 7.0mm
Flange Diameter: 18mm
Fits into 6.5mm Hole



Pkg. Qty: 50

Applications:

Buick Enclave, Cadillac CTS & STS,
Chevrolet: Cobalt, Equinox & SSR, GM
Trucks, and Pontiac G5 &
Torrent 2002 - on

RADIATOR GRILLE RETAINER

PN 90615

Honda: 91578-SV4-003

Radiator Grille Clip
Black Nylon
Size: 18.5mm x 23.5mm
Overall Length: 40mm

Applications:

Honda: Accord 1994-up



Pkg. Qty: 5

PN 90616

Isuzu: 8942180270

Mazda: B092-50-715

Mitsubishi: MB153825

Toyota: 90467-13011

Grille & Head Lamp Clip
Black Nylon
Width: 13mm
Length: 22mm

Applications:

Isuzu/Mazda/Mitsubishi/Toyota



Pkg. Qty: 25

PN 90617

Lexus/Toyota:

53259-0E010,

53259-48010

Radiator Support to Frame Seal Clip

Black Nylon

Head Diameter: 19mm

Stem Length: 9mm, Fits into 7mm Hole

Applications:

Lexus: ES350, GS300, GS450, IS
F, IS250, LS460, LS600, RX330, RX
400H 2004-up, **Toyota:** All 2004-up



Pkg. Qty: 15

PN 90618

Mitsubishi: MR221507

Toyota: 90467-13075

Lower Radiator Grille

Assembly Clip

Grey Nylon

Size: 5.5mm x 13.5mm

Overall Length: 24mm

Applications:

Toyota: 4Runner, Highlander, Land
Cruiser 1998-up



Pkg. Qty: 25

PN 90619

Nissan: 01553-03831

Grille Clip

Black Nylon

Overall Height: 22mm (7/8")

Applications:

Nissan: Maxima, Stanza 1982-up



Pkg. Qty: 25

PN 90620

Subaru: 91059FC041

Front Grille Clip

Dark Gray Nylon

Head Size: 22.7mm x 13.9mm

Stem Length: 17mm

Stem Diameter: 10.3mm

Overall Height: 24mm

Fits into mm Hole Size

Applications:

Subaru: Forester 1998-2005



Pkg. Qty: 25

PN 90621

Subaru: 91017FA080

Grille Assembly Clip

Grey Nylon

Applications:

Subaru: Forester 1992-2002,
Impreza
1993-2001, SVX 1992-1997

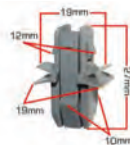

Pkg. Qty: 25

PN 90622

Subaru: 91059FC090

Grille Assembly &

Component Retaining Clip

Black Nylon

Applications:

Subaru: Forester 1998-2002,
Legacy 1992-1999



Pkg. Qty: 25

PN 90623

Subaru: 91017AA010

Upper Grille &

Component Retaining Clip

Black Nylon

Applications:

Subaru: Forester, Legacy
1990-2005

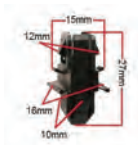

Pkg. Qty: 25

PN 90190

Chrysler: 2998430
 Black Nylon
 Radiator Grille Retainer
 Head Diameter: 1-1/4"
 Stem Diameter: 5/16"
 Stem Length: 1/2"
Applications:
 Chrysler



Pkg. Qty: 25

PN 90624

Toyota: 90467-13005
 Grille Clip
 Black Nylon
 Width: 13mm
 Length: 23mm
Applications:
 Toyota



Pkg. Qty: 25

PN 90625

Toyota: 90467-17004
 Radiator Grille Clip
 Black Nylon
 Width: 21.5mm
 Length: 22.3mm
Applications:
 Toyota: Cressida 1984-1987



Pkg. Qty: 10

PN 90626

Toyota: 90904-67021
 Radiator Grille Retainer
 Black Nylon
 Size: 5.5mm x 21mm
 Overall Length: 29mm
Applications:
 Toyota: T-100 1992-up



Pkg. Qty: 15

RIVETS/ALUMINUM & STEEL

PN 90627

Chrysler: 6032856
 Body Side Moulding
 Universal Application
 Aluminum Rivet (Black)
 Steel Mandrel
 Diameter: 1/8"
 Grip: 3/16"-3/8"
 Flange Diameter: 5/16"
Applications:
 Chrysler



Pkg. Qty: 50

PN 90628

Chrysler: 6036148-AA
 Split-Type Rivet
 Aluminum Rivet (Black)
 Aluminum Mandrel
 Front Bumper Trim Panel
 Instrument Panel &
 Running boards
 5/32" Diameter
 Grip: 3/64"-1/4"
 Flange Diameter: 7/16"
Applications:
 Chrysler: 1999-up



Pkg. Qty: 25

PN 90629

Chrysler: 6035201
Ford: N806830-S100
 Split-Type Rivet,
 Aluminum Rivet (Black) w/
 Aluminum Mandrel
 Attachment of Bumper Cover to
 Bumper & Front
 License Plate Bracket
 Diameter: 1/4", Grip: 3/16"-3/8"
 Flange Diameter: 11/16"
Applications:
 Chrysler: 1993-up
 Ford: Fascia 1992-up



Pkg. Qty: 15

PN 90630

Chrysler: 6031115;
Ford: 385189-S100
GM: 9436175
 Window regulators
 Peel-Type Rivet
 Aluminum Rivet
 Steel Mandrel
 1/4" Diameter
 Grip: 1/32"-1/4"
 Flange Diameter: 1/2"
Applications:
 Chrysler/Ford/GM:
 1971-up



Pkg. Qty: 25

PN 90631

Chrysler: 6031091
Ford: 385323-S100
GM: 9437938
 Window regulator
 Aluminum Rivet, Steel Mandrel
 Peel-Type Rivet
 1/4" Diameter
 Grip: 33/64"-19/32"
 Flange Diameter: 1/2"
Applications:
 Chrysler/Ford/GM: 1976-up



Pkg. Qty: 10

PN 90632

Ford: 388664-S100
 Aluminum Rivet (Black)
 Aluminum Mandrel
 Fascia & Bumper
 Diameter: 3/16"
 Grip: 3/8"-1/2"
 Flange Diameter: 9/16"
Applications:
 Ford: 1982-up



Pkg. Qty: 25

PN 90969

Ford: N805592-S100

GM: 25618730

Wheel House Moulding & General Purpose Aluminum Rivet (Black) Aluminum Mandrel, Split-Type Rivet Diameter: 3/16" Grip: 5/64"-15/64" Flange Diameter: 7/16"

Applications:

Ford/GM



Pkg. Qty: 25

PN 90634

Ford: N805759-S100

Aluminum Rivet (Black) Steel Mandrel Windshield Side Rail Rivets Diameter: 1/8" Grip: 1/16"-1/8" Flange Diameter: 3/8"

Applications:

Ford: Thunderbird

Mercury: Cougar 1998-up



Pkg. Qty: 50

PN 90635

GM: 388047-S102

Aluminum Rivet (Black), Steel Mandrel Door Handle Assembly Peel-Type Rivet Diameter: 1/4" Grip: 3/32"-1/8" Flange Diameter: 1/2"

Applications:

GM



Pkg. Qty: 25

PN 90636

Lexus: 90269-04060

Upper Door Pillar Side Moulding Steel Rivet, Steel Mandrel Diameter: 3.9mm Grip: 1mm-7mm Flange Diameter: 6mm

Applications:

Lexus: GS300, GS450 Hybrid 2006-up



Pkg. Qty: 25

PN 90637

Lexus: 90269-05065

Aluminum Rivet w/ Plastic Cap Steel Mandrel Bumpers & General Purpose 3/16" (5mm) Diameter Grip: 5/32"-9/32" (4mm-7mm) Flange Diameter: 1/2" (13mm)

Applications:

Lexus: 2004-up



Pkg. Qty: 10

PN 90638

Lexus/Toyota: 75547-51021

Aluminum with Steel Mandrel Windshield Rivet w/ Nylon Cap Diameter: 3.2mm Nylon shoulder Diameter: 6.3mm Nylon Flange Diameter: 10.3mm Grip Range: .8mm-1.5mm

Applications:

Lexus: ES350, GS300, GS450 Hybrid, GX460, IS F, IS250, LS460, LS600HL, LX570 2006-2013, Toyota: Land Cruiser 2008-2013



Pkg. Qty: 15

PN 90639

Lexus/Toyota:

90269-04051

Specialty Rivet, Aluminum Rivet w/ Plastic Cap Aluminum Mandrel Diameter: 1/8" (3.2mm) Grip Range: 3/64"-1/8" (1.2mm - 3.4mm)

Applications:

Lexus/Toyota



Pkg. Qty: 10

PN 90640

Toyota: 90269-05034, 90269-05056

Toyota Speaker Mount Rivet Aluminum with Plastic Cap Steel Mandrel Diameter: 4.9mm Grip: 1mm-12mm Flange Diameter: 12.9mm

Applications:

Lexus: IS300 Toyota: Celica, Corrola, Matrix, Prius, RAV4, Yaris



Pkg. Qty: 25

PN 90641

Toyota: 90269-06054 Specialty Aluminum Rivet

Specialty Aluminum Rivet w/ Steel Mandrel Diameter: 4mm Grip Range: 1mm-9.5mm Flange Diameter: 12mm

Applications:

Lexus/Toyota



Pkg. Qty: 25

PN 90642

Toyota: 90269-06013

Gas Filler Door & Gas Filler Tube Rivet Aluminum Rivet w/ Plastic Cap Aluminum Mandrel

Applications:

Toyota



Pkg. Qty: 15

PN 90643

Toyota: 90269-04053

Aluminum Rivet (Black) w/ Plastic Cap Steel Mandrel (Black) Moulding Diameter: 1/8" (3.2mm) Grip: 3/64"-3/16" (1mm - 4.8mm) Flange Diameter: 5/16" (8mm)

Applications:

Toyota: Landcruiser 1998-up



Pkg. Qty: 10

PN 90644

Toyota: 90269-04047

Mudguard Rivet Retainer Aluminum Rivet (Black) Steel Mandrel (Black) Diameter: 3.9mm Grip: 1mm-12mm Flange Diameter: 12mm

Applications:

Toyota: 4Runner, RAV4, Tacoma 1996-up



Pkg. Qty: 25

PN 90645

Toyota: 90269-A0005
 Fuel Door & General Purpose
 Specialty Rivet,
 Black Aluminum Rivet
 Steel Mandrel
 Diameter: 1/4" (6.3mm)
 Grip Range: 1/16" - 3/16"
 (1.6mm - 4.8mm)
 Flange Diameter: 1/2" (13mm)
Applications:
 Toyota: 2007-up



Pkg. Qty: 10

PN 90181

Ford: W525175-S
 Aluminum Rivet - Steel Mandrel
 Door Glass Peel Rivet
 Panel Range: 25/64" - 21/32"
 Hole Size: 1/4"
 Flange: 5/8"
Applications:
 Ford



Pkg. Qty: 15

PN 90182

All Aluminum Pop Rivet
 Grip Range: 1/4" - 3/8"
 Hole Size: 3/16"
 Flange Size: 3/8"
 Industrial #66L



Pkg. Qty: 25

PN 90183

Ford: 388047-S100
 Aluminum Rivet - Steel Mandrel
 Outside Door Handle Rivet
 Panel Range: 5/64" - 7/64"
 Hole Size: 1/4"
 Flange: 1/2"
Applications:
 Ford



Pkg. Qty: 25

PN 90177

All Aluminum Pop Rivet
 Grip Range: 3/16" - 1/4"
 Hole Size: 1/8"
 Flange Size: 1/4"
 Industrial #44



Pkg. Qty: 25

PN 90178

All Aluminum Pop Rivet
 Grip Range: 1/4" - 3/8"
 Hole Size: 3/16"
 Flange Size: 3/8"
 Industrial #66



Pkg. Qty: 25

PN 90180

Ford: W525172-S417
 Aluminum Steel Black
 Door Handle Rivet
 Panel Range: 1/32" - 7/32"
 Hole Size: 1/4"
 Flange: 1/2"
Applications:
 Ford



Pkg. Qty: 15

PN 90184

Aluminum Blind Rivet
 Hole Size: 3/16"
 Panel Range: 1/8" - 1/4"
 Dome: 3/8"



Pkg. Qty: 100

PN 90186

Ford: 388442-S100
 All Steel Black Bumper
 Assembly Rivet
 Panel Range: 1/8" - 1/4"
 Hole Size: 1/4"
 Flange: 3/4"
Applications:
 Ford



Pkg. Qty: 25

PN 90222

Aluminum Pop Blind Rivet
 Diameter: 1/8"
 Grip Range: 5/16" - 3/8"



Pkg. Qty: 100

PN 90581

Black Aluminum
 Steel Windshield Rail Rivet
 Grip Range: 1/16"-1/8"
 Flange: 3/8"



Pkg. Qty: 50

PN 90432

Black Aluminum
 Specialty Rivet
 Diameter: 1/8"
 Grip Range: 3/16"-1/4"



Pkg. Qty: 100

PN 90179

GM: 11610383

All Steel Bright Zinc Finish
Headlight Retainer Rivet
Diameter: 1/4"
Grip Range: 1/64" - 1/8"
Hole Size: 1/4"
Flange: 1/2"



Pkg. Qty: 25

PN 90661

All Aluminum Pop Rivet
Diameter: 5/32"
Grip Range: 3/16" - 1/4"
Hole Size: 5/32"
Flange: 5/16" (Dome Type)
Industrial #54



Pkg. Qty: 100

PN 90651

Steel Blind Rivet
Diameter: 1/4"
Rivet Length: 29/64"
Grip Range: 3/16" - 1/4"
Flange: 1/2" (Dome Type)
Industrial #84



Pkg. Qty: 25

PN 90652

Aluminum Rivet
Same dimensions as 90651 above
Industrial #84

RIVETS/NYLON

PN 90647

BMW: 51-11-942-789

Expansion Nylon Rivet
Black Nylon
Head Size: 11mm
Stem Length: 11mm
Stem Diameter: 4.9mm
Grip Range: 2mm-8.5mm
Overall Height: 41mm



Pkg. Qty: 25

PN 90648

Chrysler: 4630660

Nylon Rivet Type 2
Head Thickness: 3/32"
Head Diameter: 21/32"
Hole Size: 1/4"
Panel Range: 1/32"-3/16"
Length: 2-1/8"
Flange to Tip Length: 3/4"



Pkg. Qty: 25

PN 90649

Chrysler: 6500898

Blind Nylon Rivet Type 1
Head Diameter: 15/32"
Hole Diameter: 13/64"
Panel Range: 15/64"-25/64"
Length: 2"
Flange to Tip Length: 1"
Head Thickness: 1/16"



Pkg. Qty: 25

PN 90650

Chrysler: 4630088

Nylon Rivet, Type 2
Head Thickness: 3/32"
Head Diameter: 21/32"
Hole Size: 1/4"
Panel Range: 1/32"-11/64"
Length: 2-3/16"
Stem Length: 13/16"



Pkg. Qty: 25

Applications:
Chrysler

PN 90978

Chrysler: 6500911
Ford: N803043-S
GM: 14063981

Nylon Blind Rivet, Type 1
Head Thickness: 3/32"
Head Diameter: 21/32"
Hole Diameter: 1/4"
Panel Range: 5/32"-13/32"
Length: 2-3/16"
Flange to Tip Length: 1-3/32"



Pkg. Qty: 25

Applications:
Chrysler/Ford/GM

PN 90979

Chrysler: 6501559,
6506007-AA
Ford: N803862-S
GM: 10184895

Nylon Blind Rivet, Type 1
Head Thickness: 3/32"
Head Diameter: 1/2"
Hole Diameter: 1/4"
Panel Range: 5/32" - 13/32"
Length: 2-3/16"
Flange to Tip Length: 1-3/32"



Pkg. Qty: 25

Applications:
Chrysler/Ford/GM

PN 90653

Chrysler: 4370138
Ford: N804675S

Blind Nylon Rivet, Type 1
Head Thickness: 3/32"
Head Diameter: 21/32"
Hole Diameter: 1/4" (6.3mm)
Panel Range: 5/16"-15/32"
Length: 2-9/32"
Flange to Tip Length: 1-1/4"



Pkg. Qty: 25

Applications:
Chrysler/Ford

PN 90654

Chrysler: 6503800
Ford: N804343S
GM: 20432975
VW: 175-853-57701C

Nylon Blind Rivet, Type 1
Head Diameter: 15/32"
Head Thickness: 1/16"
Hole Diameter: 13/64"
Panel Range: 1/8"-15/64"
Length: 1-7/8"
Flange to Tip Length: 25/32"



Pkg. Qty: 25

Applications:
Chrysler/Ford/
GM/VW

PN 90655

Chrysler: 6004212
GM: 20465395

Nylon Blind Rivet, Type 1
Head Diameter: 11/32"
Head Height: 1/16"
Hole Size: 13/64"
Panel Grip: 1/8"-5/32"
Length: 1-13/16"
Stem Length: 21/32"



Pkg. Qty: 25

Applications:
Chrysler/GM

PN 90656

Ford: N804583S

Nylon Blind Rivet Type 6
 Diameter: 5/32" (4mm)
 Panel Range: 15/64"-13/32"
 (6mm-10.5mm)
 Flange Size: 11/32" x 5/8"
 8.5mm x 15.5mm)

Applications:

Ford



Pkg. Qty: 25

PN 90658

GM #20423647,

Ford #N804189S

Black Nylon
 Hole Size: 13/64"
 Panel Range: 1/16" – 11/64"
 Flange Size: 15/32"
 Length: 1 7/8"
 Stem: 23/32"
 Height: 1/8"

Applications:

GM, Ford



Pkg. Qty: 25

PN 90981

GM: 20433026

VW: 175-853-577A

Nylon Blind Rivet, Type 1
 Head Diameter: 23/32"
 Head Thickness: 3/32"
 Hole Diameter: 17/64"
 Panel Range: 3/32" - 3/16"
 Length: 1-7/8"
 Flange to Tip Length: 25/32"

Applications:

GM/VW



Pkg. Qty: 25

PN 90987

BMW: 07147391324

White Nylon
 Wheel Arch Trim Cover
 Nylon Rivet
 Diameter: 6mm
 Grip Range: 1.5mm-10mm
 Flange Diameter: 20mm

Applications:

BMW: X5 2013-on



Pkg. Qty: 25

PN 90988

BMW: 07147391323

White Nylon
 Wheel Arch Trim Cover
 Nylon Rivet
 Diameter: 6mm
 Grip Range: 2.5mm-10.75mm
 Flange Diameter: 20mm

Applications:

BMW: X3, X4, X5 Series 2010-on



Pkg. Qty: 25

PN 90660

GM: 10036503

Nylon Blind Rivet, Type 1
 Head Diameter: 1/2"
 Head Height: 3/32"
 Hole Size: 15/64"
 Panel grip: 5/32-5/16"
 Length: 2-1/8"
 Stem Length: 1-5/32"

Applications:

GM



Pkg. Qty: 25

PN 90659

GM: 25524005

Blind Nylon Rivet, Type 1
 Head Diameter: 1/2"
 Head Thickness: 3/32"
 Hole Diameter: 15/64"
 Panel Range: 11/64"-11/32"
 Length: 2-3/64"
 Flange to Tip Length: 1-1/8"

Applications:

GM



Pkg. Qty: 25

PN 90968

GM: 10109689,
12337915

Nylon Blind Rivet, Type 1
 Head Diameter: 23/32"
 Head Height: 3/32"
 Hole Diameter: 9/32"
 Panel Range: 3/32"-15/64"
 Length: 2-3/16"
 Stem Length: 15/16"

Applications:

GM



Pkg. Qty: 25

PN 90980

GM: 15955172, 20421672

Blind Nylon Rivet Type 1
 Head Diameter: 1/2"
 Head Thickness: 3/32"
 Hole Diameter: 17/64" (6.3mm)
 Panel Range: 3/32"-3/16"
 Length: 1-7/8"
 Flange to Tip Length: 25/32"

Applications:

GM



Pkg. Qty: 25

STUBBY BODY PANEL DRILL BITS FOR RIVETS

PN 76 - 1/8" Double Ended Drill Bits

PN 15216 - 3/16" Double Ended Drill Bits

PN 15217 - 1/4" Double Ended Drill Bits

High Speed Steel Drill Bits for use on Sheet Metal.

135 Degree Split Point for fast drilling without center punching.

Pkg. Qty: 12



PN 90667

Audi/VW: 4A0805163, 8A0863821Q

Upper & Lower Engine Protection
Cover Locking Pin Grommet
Black Nylon

Applications:

Audi/VW: 1998-up



Pkg. Qty: 25

PN 90668

Audi/VW: 4L0-886-373

Front/Rear Seat Bottom & Bench Locking Grommet
White w/ Black Nylon Insert
Head Size: 40mm x 27.5mm
Stem Length: 30.5mm
Fits into 27.8mm x 15.75 Hole

Applications:

Audi/VW: 2007-2013



Pkg. Qty: 10

PN 90670

Audi/VW: 1H0-853-586

Moulding Grommet Insert
Green Rubber
Inside Diameter: 7mm
Stem Length: 12mm
Fits into 8mm Hole Size
(Use with 90308, 90309, & 90310 Moulding Clips)

Applications:

Audi/VW



Pkg. Qty: 50

PN 90671

Audi: 811-807-557-C

VW: 867-809-966

Screw Grommet
Black Nylon
Head Diameter: 12mm
M4.8 (#10) Screw Size
Overall Length: 12.5mm
(Used in many VW / Audi models)

Applications:

Audi/VW



Pkg. Qty: 25

PN 90672

Austin: 13H2475

BMW: 51-44-7-780-135

Citroen: ZC961983U

Ford: 637628, Fiat: 4229652

MBZ: 108-988-00-27

Renault: 7703074022

Barrel Nut Grommet Insert, Clear Nylon
Head Diameter: 16.3mm Stem Length: 8.7mm, Overall Length: 16.7mm
(Use with 7.5mm Diameter Screw)

Applications:

Austin/BMW/Citroen/Ford/Fiat/Mercedes-Benz/ Renault



Pkg. Qty: 25

PN 90666

Honda:

90682-SEA-003

Fender Apron Grommet
Black Nylon
Head Diameter: 20mm
Overall Height: 12mm
Fits into 9mm Square Hole

Applications:

Acura: TSX

Honda: Civic, Odyssey 2004-up



Pkg. Qty: 25

PN 90669

VW: 811-807-577C

Trunk Lid Liner & Inner Fender
Nut Insert Grommet
Black Nylon
Stem Length: 11mm
Fits into 7mm Hole Size

Applications:

Audi: All models **VW:** Golf A2, A3, Jetta, Passat B3, B4, B5, B6



Pkg. Qty: 25

PN 90673

BMW: 51-41-700-16-29,

51-41-015-44-20,

51-45-030-47-03,

51-45-816-52-60

Interior Trim Carrier Mounting Grommet Retainer
Clear Nylon with Metal Retainer
Size: 17mm x 15mm, Height: 17mm
Stem Size: 11.8mm x 8.1mm

Applications:

BMW: 5, 7 Series 1995-up



Pkg. Qty: 15

PN 90674

BMW:

51-45-8-161-557,

51-45-0-396-330

Interior Trim Instrument Carrier Mounting Grommet Retainer
Clear Nylon
Head Size: 17mm x 15mm
Overall Height: 15mm
Stem Size: 12mm x 8mm

Applications:

BMW: 3, 5, 7 Series 1994-up



Pkg. Qty: 15

PN 90675

BMW:

51-45-8-266-814

Interior Trim Insert Grommet
Red Nylon

Applications:

BMW: 3, 7, X Series 1997-up



Pkg. Qty: 25

PN 90676

BMW: 07147201307,

51757271848

Expanding Nut/Heat Shield, Screw Grommet, Natural Nylon
Head Diameter: 16mm
Stem Diameter: 8.4mm
Overall Height: 15mm

Applications:

BMW: 1 Series

2006-2012, 3 Series



Pkg. Qty: 15

PN 90678

Chrysler:

8934-201-767

Tubular Nut
Black Nylon
Head Diameter: 5/16"
Head Thickness: 1/32"
3/16" Stud Size
Barrel Length: 17/64"
Fits into 17/64" Hole

Applications:

Chrysler



Pkg. Qty: 100

PN 90679

Chrysler: 6503339

Cowl Top Stud
Retainer Cover
Black Nylon
Head Diameter: 13/16"

Applications:

Dodge: Ram 1994-up



Pkg. Qty: 25

PN 90677

GM: 1355003

Headlight Door to Radiator
Grille Anchor Nut
Natural Nylon
#6 or #8 Screw Size

Applications:

Buick: 1964-up



Pkg. Qty: 50

PN 90680

Mitsubishi: MB645307

Back Glass lower Moulding,
Quarter Glass Moulding &
Spoiler Grommet w/ Sealer
Black Nylon
Head Size: 12mm x 16mm
Stem Length: 14mm

Applications:

Chrysler: Sebring 1991-up

Mitsubishi: Diametermante, Gallant
1991-up



Pkg. Qty: 15

PN 90681

Chrysler: 6029501

GM: 1370853

VW: 179-813-883

Headlight Bezel Nut
Natural Nylon
#6 Screw Size

Applications:

Chrysler/GM/VW: 1982-up



Pkg. Qty: 50

PN 90682

Chrysler: 6000943

Renault: 8934-201-263

Screw Grommet
Natural Nylon
Head Size: 10mm x 10mm
Overall Height: 10.5mm
#8 Screw Size
Fits into 6.8mm x 6.8mm Square Hole

Applications:

Chrysler/Renault



Pkg. Qty: 100

PN 90683

Ford: 379830-S

Screw Grommet
Natural Nylon
#8 or #10 Screw Size
Fits into 1/4" Square Hole

Applications:

Ford



Pkg. Qty: 50

PN 90684

Ford: N807994-S

Grille & Side Marker
Light Grommet
Black Nylon
Head Diameter: 12.7mm
Overall Height: 10.6mm
Fits into 10mm Hole

Applications:

Ford: 1994-up



Pkg. Qty: 50

PN 90685

Ford: 380707-S

License Plate Nut
Marker
Natural Nylon
#14 Screw Size

Applications:

Ford



Pkg. Qty: 50

PN 90686

Ford: W700566-S300

Back Panel Attachment
Screw Grommet
Natural Nylon
#12 Screw Size

Applications:

Ford: Contour

Lincoln

Mercury: Mystique 1995-up



Pkg. Qty: 25

PN 90687

Ford: W705590-S300

GM: 25649667

Screw Grommet w/ Sealer,
Back Glass Moulding &
Interior Trim
Natural Nylon
Head Size: 13mm x 22mm
Stem Length: 18mm
M4.2 (#8) Screw Size

Applications:

Cadillac



Pkg. Qty: 15

PN 90688

GM: 1254815

Screw Grommet
Natural Nylon
Square Hole: 6mm x 6mm
Panel Range: .60" - .150"
#6 Screw Size

Applications:

GM



Pkg. Qty: 50

PN 90689

**Screw Grille Nut
Grommet**

Head Size: 1/2"
#8 Or #10 Screw Size

Applications:

GM



Pkg. Qty: 50

PN 90690

GM: 14013246

Bezel Nut - Headlight Grommet
#8 Screw Size

Applications:

GM: 1982-up



Pkg. Qty: 50

PN 90691

GM: 3893980

Front End & Instrument Panel Nut Grommet
Natural Nylon
#8 Screw Size

Applications:

GM: 1967-up



Pkg. Qty: 100

PN 90693

GM: 380382

Headlight Bezel to Body Nut Screw Grommet
Natural Nylon
Head Size: 9.3mm x 9.5mm
Overall Height: 9mm
#6 or #8 Screw Size
Fits into 6mm x 7mm Square Hole

Applications:

GM



Pkg. Qty: 50

PN 90694

GM: 15733970

Front Air Deflector Grommet
Black Nylon
Head Diameter: 28mm
Stem Length: 13mm
(Use with 90507)

Applications:

GM: C, K Trucks 1999-up



Pkg. Qty: 25

PN 90695

GM: 380370

License Plate Nut Screw Grommet
Natural Nylon
Head Diameter: 15mm
Overall Height: 10mm
#14 Screw Size
Fits into 8mm x 8mm Square Hole

Applications:

GM



Pkg. Qty: 50

PN 90696

GM: 14032291

Grille Attachment Grommet
Natural Nylon
#6 Or #8 Screw Size

Applications:

GM



Pkg. Qty: 50

PN 90698

GM: 11517873

Door Handle Screw Grommet
Natural Nylon
Head Size: 5/8" x 3/4"
Stem Length: 9/16"
#12 Screw Size

Applications:

Chevrolet: Impala, Monte Carlo 2000-up



Pkg. Qty: 15

PN 90699

GM: 94854203

Toyota: 90189-06028
Front & Rear Wheel Fender Liner Screw Grommet
Black Nylon
Head Diameter: 16mm
Stem Length: 19mm
Fits into 9mm x 9mm Hole
#12 Screw Size

Applications:

Toyota: 4Runner, Tacoma, T100



Pkg. Qty: 15

PN 90700

GM: 3997391

VW: 179-813-881
Tail Light Screw Grommet
Black Nylon
Head Diameter: 13mm
Overall Height: 9mm
Fits into 7.5mm x 7.5mm Square Hole, #8 Screw Size

Applications:

GM/VW



Pkg. Qty: 25

PN 90701

Honda: 91620-SR2-003

Center Pillar Screw Grommet with Sealer
Natural Nylon
Flange Size: 13.25mm
Stem Size: 7mm x 7mm Square
Overall Height: 17.5mm
#4 Screw Size

Applications:

Honda



Pkg. Qty: 10

PN 90702

Honda: 90656-671-6310M1

Screw Grommet
Natural Nylon
Head Size: 13mm x 15mm
Fits into 8.5mm x 10.5mm Rectangular Hole
#14 (1/4") Screw Size

Applications:

Honda



Pkg. Qty: 50

PN 90703

Honda: 91635-SM4-003

Headlight to Grille Nylon Grommet
Black Nylon
#10 Screw Size

Applications:

Honda: Accord 1990-1993, Prelude 1992-1996



Pkg. Qty: 10

PN 90704

Honda: 90651-SL9-0130

Rear Bumper, Fascia
Grommet
Gray Nylon
#8 (M4.2) Screw Size

Applications:

Honda: Accord 1994-1996



Pkg. Qty: 15

PN 90705

Honda:

90107-S10-003

Wheel Well Moulding
Screw Grommet
Black Nylon
#10 Screw Size

Applications:

Honda: CR-V 1997-up,
Element 2003-2008



Pkg. Qty: 25

PN 90706

Honda:

90106-SW3-003

Bumper Grommet
White Nylon
Head Size: 18mm x 20mm
Stem Length 19mm
Fits into 8mm x 11mm Hole

Applications:

Honda: Accord, Odyssey &
Prelude 1995-up



Pkg. Qty: 10

PN 90707

Honda: 91603-SL0-000

Bumper & Grille Grommet
Natural Nylon
5mm Screw Size

Applications:

Honda: Insight 2000-up



Pkg. Qty: 25

PN 90708

Honda:

90665-SM4-000

Front Door Screw Grommet
Yellow Nylon
Head Diameter: 14mm
Stem Length: 10mm
#6 Screw Size
Fits into 7mm x 7mm Hole

Applications:

Honda: Accord, CR-V, Fit, Insight,
Odyssey, Pilot, Prelude, S-2000
1994-up



Pkg. Qty: 15

PN 90709

Honda:

91626-SP0-003

Front Pillar & Front Door Lining
Garnish Screw Grommet
(5mm Screw Size Grommet)
Yellow Nylon
Head Size: 16mm x 23mm
Overall Height: 17mm
Fits into 9mm Hole Size

Applications:

Acura: Integra, LegEnd, RSX
1994-2006



Pkg. Qty: 15

PN 90710

Honda: 91635-SE0-003

Screw Grommet (5mm)
Head Diameter: 13mm x 13mm
Overall Height: 17mm
Fits into 8mm Square Hole

Applications:

Honda: Accord 1988-2002, Civic
1988-1991, Insight 2000-2006



Pkg. Qty: 25

PN 90983

Honda: 90661-SC7-0030

Mazda: H001-50-841

Nissan: 01651-00481

Toyota: 90189-06042

Screw Grommet
Natural Nylon
#8 Screw Size
Fits into 8mm x 8mm Square Hole

Applications:

Honda/Mazda/Nissan/Toyota



Pkg. Qty: 25

PN 90712

Honda:

75521-611-0000

Mazda: 9991-00-601

Nissan: 96706-P0105

Toyota: 90189-06010

Nylon Grommet, Natural Nylon
Head Size: 13mm x 13mm
#10 Screw Size
Fits into 8.5mm x 8.5mm Square Hole

Applications:

Honda/Mazda/Nissan/Toyota



Pkg. Qty: 25

PN 90714

Honda:

90672-671-8110M1

Toyota: 90189-04013

Screw Grommet
White Nylon
Head Diameter: 14mm
Stem Length: 15mm
#6 Screw Size
Fits into 7mm x 7mm Hole

Applications:

Honda/Toyota



Pkg. Qty: 25

PN 90715

Honda:

90662-693-0030

Toyota: 90189-04066

Screw Grommet w/ Sealer
White Nylon
Head Diameter: 14mm
Stem Length: 10mm
#6 Screw Size
Fits into 7mm x 7mm Square Hole

Applications:

Honda/Toyota



Pkg. Qty: 25

PN 90716

Hyundai:

87759-27000

Rocker Moulding Grommet
with Sealer Yellow Nylon
Head Size: 17mm x 25mm
Stem Length: 16mm
M4.2 (#8) Screw Size

Applications:

Hyundai: Accent, Genesis,
Santa Fe, Sonata, Tiburon,
Vera Cruz 1995-up

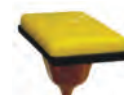

Pkg. Qty: 15

PN 90717

Infiniti/Nissan:
63846-5V000

Bumper Screw Grommet
White Nylon with Sealer
Head Diameter: 20mm
Stem Diameter: 9.4mm
Overall Length: 22mm
Snaps into 7mm Hole

Applications:

Nissan: Altima, Juke, Maxima, Murano, Quest, Sentra 2003-up
Infiniti: FX35, FX45, JX35, M35, M37, M36, M56, QX56 2003-up



Pkg. Qty: 25

PN 90718

Infiniti/Nissan:
01281-00331

Bumper, Rocker Panel & Light Mounting Screw Grommet w/ Sealer
Natural Nylon
Head Diameter: 20mm
Stem Length: 16mm
M6.3 (#14) Screw Size
Fits into 10mm Square Hole

Applications:

Infiniti: 1997-up
Nissan: 1996-up



Pkg. Qty: 25

PN 90719

Infiniti/Nissan:
80874-85E00

Screw Grommet w/ Sealer
Natural Nylon
Head Diameter: 28mm x 14mm
Overall Height: 15mm

Applications:

Infiniti/Nissan: 1993-up



Pkg. Qty: 25

PN 90720

Nissan: 01281-01321

Front Bumper Grommet
Natural Nylon
Overall Length: 22mm

Applications:

Nissan: Altima, Maxima, Quest 1996-2009



Pkg. Qty: 25

PN 90722

Isuzu: 8941340270
Toyota: 90189-05012

Screw Grommet
Natural Nylon
Head Size: 16mm x 12mm
#6 Screw Size
Fits into 6mm x 10mm Rectangular Hole

Applications:

Isuzu/Toyota



Pkg. Qty: 50

PN 90723

Lexus: 90189-04207

Outer Wheel Well Liner & Side Moulding Screw Grommet

Applications:

Lexus: GS300, GS450, LS430, LS460, SC300, SC430 1992-up



Pkg. Qty: 25

PN 90725

Lexus/Toyota:
52197-22020

Bumper Cover Screw Grommet
Black Nylon
Head Size 17.8mm x 16mm
Overall Height: 21.1mm
Fits into a 8mm x 10mm Rectangle Hole

Applications:

Lexus/Toyota: 2004-2014



Pkg. Qty: 15

PN 90727

Lexus/Toyota:
90189-06162

Front Clearance Lamp, Headlight Adjusting Nut
Natural Nylon

Applications:

Lexus: ES300 1992-1996
Toyota: Camry 1994-1991



Pkg. Qty: 10

PN 90728

Lexus: 90189-04059

Rocker Trim Screw Grommet
White Nylon
Hole Size: 6mm x 14mm
Stem Length: 7mm
#6 (3.5mm) Screw Size

Applications:

Lexus: ES300, ES330, RX330, RX400, SC300, SC400
Toyota: Avalon, FJ Cruiser 1992-up



Pkg. Qty: 25

PN 90729

Toyota: 90467-10152

Cowl Vent Grommet
Natural Nylon
Flange Diameter: 18mm
Stem Length: 16mm
Fits into 9mm Hole

Applications:

Lexus: ES300
Toyota: Camry, Tercel 1995-up



Pkg. Qty: 10

PN 90730

Lexus/Toyota:
90189-04102

Screw Grommet w/ Sealer
White Nylon
Head Diameter: 10mm x 10mm
Overall Length: 15mm
Fits into 7mm Square Hole

Applications:

Lexus: IS250, IS350, IS F
Toyota: Camry 1992-1996, Celica 1986-1989, Highlander 2001-2007, Land Cruiser 1998-2007, MR2 1985-1995



Pkg. Qty: 25

PN 90731

Toyota: 90189-06211

Grounds Effect Kit, Screw Grommet
Black Nylon
Head Diameter: 17mm
Overall Length: 10mm
Fits into 9mm Square Hole

Applications:

Toyota: Avalon, Camry, Solara, Venza 2005-up
Lexus: ES350, GX460, IS CV, IS250, LX470, SC430



Pkg. Qty: 25

PN 90732

Toyota: 90189-06177

Mudguard Screw Grommet
Black Nylon
Head Diameter: 20mm
Overall Length: 23 mm
Fits into 8mm Square Hole

Applications:

Lexus: IS300, SC430; Scion: XA, XB 2004-2006
Toyota: Avalon, Camry, Echo, Paseo, Prius, Solara, Tercel, Tundra, Venza 2000-up



Pkg. Qty: 15

PN 90733

Mazda: GJ6A58975, F15158975

Door Panel Screw Grommet with Sealer
Head Diameter: 20mm
Overall Length: 20.5mm
Stem Diameter: 10mm

Applications:

Mazda: 2, 3, 5, 6, CX-5, CX-7, CX-9, Mazda Speed, Miata, RX-8



Pkg. Qty: 10

PN 90734

Mazda: H260506K8, 8AB150612; 8AB150613; 8AG850612; 8AG950612; 8BE651160

Screw Grommet with Sealer
Natural Nylon, Head Size: 21.9mm x 16mm
Stem Diameter: 13mm, Overall Height: 22mm

Applications: Mazda: 323 1986-1995, 626 1988-1997, 929 1988-1995, Mazda 3 2004-2013, Mazda 6 2003-2008, Mazda Speed 6 2006-2007, MPV 1989-1998, MX-3 1992-1996, MX-6 1988-1997, Protégé 1990-1995, RX-8 2004-2011



Pkg. Qty: 10

PN 90735

Mazda: 999-00-412

Nissan: 96706-B0700

Screw Grommet
Natural Nylon
Width: 9.5mm
Length: 9.5mm
#8 Screw Size
Fits into 7mm x 7mm Hole

Applications:

Mazda/Nissan



Pkg. Qty: 50

PN 90736

Mercedes-Benz: 000-988-15-81

Moulding Insert Grommet
Red Nylon
Top radius: 10.5mm
Overall Height: 8mm

Applications:

Mercedes-Benz



Pkg. Qty: 50

PN 90737

Mercedes-Benz: 000-988-16-25

Cowl Vent Nylon Screw Grommet
Black Nylon
Head Size: 9.5mm x 9.5mm
Stem Length: 14mm
Fits into 6.5mm x 7mm Hole

Applications:

Mercedes-Benz: CL, S Class



Pkg. Qty: 25

PN 90738

Mercedes-Benz: 000-987-10-81

Moulding Insert
White Nylon

Applications:

Mercedes-Benz



Pkg. Qty: 50

PN 90739

Mitsubishi: MU480034

Rear Side & Trunk Trim Screw Grommet w/ Sealer
Natural Nylon
Flange Size: 16.50mm
Stem Size: 8.5mm x 8.5mm Square
Overall Height: 19mm
#8 Screw Size

Applications:

Mitsubishi



Pkg. Qty: 15

PN 90740

Mitsubishi: MB817060

Headliner Nylon Nut
White Nylon
Head Diameter: 15mm
Inside Diameter: 6mm
Stem Length: 11mm
Fits into 9mm Hole

Applications:

Mitsubishi: Montero 1997-up



Pkg. Qty: 15

PN 90741

Mitsubishi: MB888561

Drip Moulding Screw Grommet
Natural Nylon
#8 Screw Size

Applications:

Mitsubishi: Eclipse 1994-up



Pkg. Qty: 25

PN 90742

Mitsubishi: MU480001

Bumper Cover and Pad Screw Grommet
Natural Nylon

Applications:

Mitsubishi: Eclipse 1995-up



Pkg. Qty: 50

PN 90743

Mitsubishi: MB-098145
Nissan: 01281-00023

Toyota: 90189-06001
Screw Grommet
Natural Nylon
Head Size 18mm
Stem Length: 17mm
#10 Screw Size
Fits into 8.5mm x 8.5mm Square Hole

Applications:

Mitsubishi/Nissan/Toyota



Pkg. Qty: 25

PN 90216

Toyota: W711079-S300

Screw Grommet
Head Diameter: 20mm
Length: 17mm

Applications:
Toyota



Pkg. Qty: 25

PN 90744

Mitsubishi: MS-480002

Toyota: 90189-05013

Nylon Screw Grommet
Natural Nylon
Width: 12mm
Length: 12mm
#10 Screw Size
Fits into 8mm x 9mm Square Hole

Applications:
Mitsubishi/Toyota



Pkg. Qty: 50

PN 90745

Infiniti/Nissan:

01281-01081

Front Bumper Nylon Nut
Natural Nylon
Flange Diameter: 16mm
Overall Length: 22mm
M4.8 (#10) Screw Size

Applications:
Infiniti/Nissan: 1997-up



Pkg. Qty: 15

PN 90746

Nissan: 01281-00501

Body Side Moulding Screw,
Grommet w/ Sealer
Head Size: 9.5mm x 9.5mm
Stem Length: 16mm
#6 Screw Size (M3.5)

Applications:
Nissan



Pkg. Qty: 15

PN 90747

Nissan: 62380-U7400

Grille Fastener
Attachment Grommet
Black Nylon
Head Size: 22mm x 26mm

Applications:
Nissan



Pkg. Qty: 10

PN 90748

Nissan: 01281-00601

Body Side Moulding
Floor & Trunk
Screw Grommet
Natural Nylon
#10 Screw Size

Applications:
Nissan: 240SX, 300ZX,
Maxima, Sentra 1986-up



Pkg. Qty: 15

PN 90749

Nissan: 76988-3J000

Kick Plate Retainer
Grommet
White Nylon
Head Size: 14mm x 34mm
Overall Height: 14mm

Applications:
Nissan: Altima 1997-up



Pkg. Qty: 15

PN 90750

Nissan: 62319-0W000

Front Bumper Nylon Nut
Natural Nylon
M5.5 (#12) Screw Size
Head Diameter: 16mm
Stem Length: 11mm

Applications:
Nissan: Frontier 1997-up



Pkg. Qty: 10

PN 90751

Nissan: 01553-02913

Exterior Flare Retaining
Grommet w/ Sealer
Natural Nylon

Applications:
Nissan: Armada, Frontier
1998-up



Pkg. Qty: 15

PN 90752

Nissan: 76848-71S00

Exterior Pillar Moulding
Grommet with Sealer
Yellow Nylon

Applications:
Nissan: 240SX, 350Z, 370Z,
Maxima, Quest 1992-up



Pkg. Qty: 15

PN 90753

Subaru: 909300015

Rear Bumper Cover, Rear Body
Floor Rail Access, Cover Screw
Grommet, Natural Nylon
Head Diameter: 12mm
Overall Height: 16mm
Fits into 7mm Square Hole

Applications:
Subaru: Impreza/WRX STI 1996-
2011, Legacy 1996-2009, Outback
2005-2009, SVX 1992-1997



Pkg. Qty: 25

PN 90754

Subaru: 62731FA010

Screw Grommet
Blue Nylon
Head Size: 11mm x 11mm
Overall Height: 11mm
Fits into 8mm Square Hole

Applications:
Subaru: All Models 1993-2012



Pkg. Qty: 25

PN 90755

Subaru: 94081FA010

Screw Grommet
Natural Nylon
Head Diameter: 13mm
Overall Height: 13mm
Fits into 8mm Square Hole

Applications:

Subaru: All Models 1992-2012



Pkg. Qty: 25

PN 90756

Subaru: 57750FC010

Rear Bumper Reinforcement
Beam, Screw Grommet with
Sealer
Natural Nylon
Head Size: 16mm x 16mm
Overall Height: 20mm

Applications:

Subaru: Forester 1998-2008



Pkg. Qty: 25

PN 90758

Suzuki: 83942-65D00

Garnish Clip
White Nylon
Lower Head Size: 14.7mm
Overall Length: 16.4mm
Stem Size: 12mm

Applications:

Suzuki: Grand Vitara, Swift, XL7



Pkg. Qty: 25

PN 90760

Honda: 90662-671-0030

Mazda: 9991-00-503,

Toyota: 68425-H5000

Screw Grommet
Natural Nylon
#10 Screw Size
Fits into 8mm x 8.5mm
Square Hole

Applications:

Honda/Mazda/Toyota



Pkg. Qty: 25

PN 90761

Toyota: 90189-06018

Plastic Screw Grommet
Black Nylon
Head Size: 14mm x 14mm
#10 Screw Size
Fits into 9mm x 9mm
Square Hole

Applications:

Toyota



Pkg. Qty: 25

PN 90762

Toyota: 90189-04011

Screw Grommet
Natural Nylon
Head Size: 12mm x 12mm
#6 Screw Size
Fits into 7mm x 7.5mm
Square Hole

Applications:

Toyota



Pkg. Qty: 25

PN 90763

Toyota: 90189-06157

Fender Lining
Screw Grommet
Black Nylon
Head Diameter: 20mm
Stem Length: 22mm
#12 Screw Size
Fits into 8mm x 8mm Hole

Applications:

Toyota: Avalon, Camry,
RAV4, Solara
Tacoma 1995-up



Pkg. Qty: 15

PN 90764

Toyota: 90189-06006

Nylon Screw Grommet
Natural Nylon
Head Diameter: 17mm
#10 Screw Size
Fits into 9mm x 9mm
Square Hole

Applications:

Toyota



Pkg. Qty: 25

PN 90765

Toyota: 90189-06003

Nylon Screw Grommet
Natural Nylon
Head Diameter: 18mm
Stem Length: 21mm
#14 (1/4") or M6.3-1.81 Screw Size
Fits into 8mm x 8mm Square Hole

Applications:

Toyota



Pkg. Qty: 15

PN 90767

Toyota: 90189-06104

Fender Lining,
Screw Grommet
Natural Nylon
Head Diameter: 18mm
Stem Length: 15mm
#12 (M5.5) Screw Size
Fits into 9mm Square Hole

Applications:

Lexus: IS300
Toyota: Avalon, Camry,
Sienna 1997-up



Pkg. Qty: 15

PN 90768

Toyota: 90189-06114

White Nylon
Front Fender Liner
Screw Grommet
Head Diameter: 18mm
Stem Length: 15mm
#12 (M5.5) Screw Size
Fits into 9mm Square Hole

Applications:

Toyota: RAV4 1996-up



Pkg. Qty: 15

PN 90769

Toyota: 90189-05142

Headlight Mounting Nut
Natural Nylon
Head Diameter: 17mm
Stem Length: 8mm
M4.2 (#8) Screw Size
Fits into 9mm Square Hole

Applications:

Scion/Toyota: 2001-up



Pkg. Qty: 25

PN 90770

Toyota: 52535-30150

Front & Rear Bumper
Stay to Fender
Side Attachment
Screw Grommet
Natural Nylon
Head Size: 30mm
Overall Height: 11mm

Applications:

Lexus: ES300, ES350, IS430,
RX300 2000-up



Pkg. Qty: 25

PN 90771

Toyota: 90467-08184

Cowl Top Ventilator
Louver Clip,
M8 Hole - M15 Flange
(Use with Toyota: 90467-
07045-22)

Applications:

Toyota: 4Runner, Pre-Runner,
Tacoma, Tundra 1995-up



Pkg. Qty: 10

PN 90772

Toyota: 90189-04031

Grille & Rear Filler Nut
Natural Nylon
#8 Screw Size
Fits 11mm x 9mm Hole

Applications:

Toyota: Camry, RAV4 1991-2000



Pkg. Qty: 25

PN 90773

Toyota: 90189-06145

Front Fender Screw Grommet
Black Nylon

Applications:

Toyota: Prius, Sequoia,
Sienna & T-100
1993-up



Pkg. Qty: 15

PN 90774

Toyota: 81137-22530,
81150-1A750,
90075-10004

Headlamp Mounting Grommet
Natural Nylon

Applications:

Toyota: Avalon 1995-1999,
Camry 1992-1996, Land Cruiser
1998-2007, Tacoma 2000-2004,
Tundra 2000-up



Pkg. Qty: 25

PN 90775

Toyota: 5131-802-258

Barrel Nut Grommet
Brushed Clear Nylon
Flange Size: 16mm
Overall Height: 17.5mm
Stud Size: 7mm
Fits into 8mm Hole Size

Applications:

Toyota



Pkg. Qty: 50

PN 90776

VW: 165-827-592

Screw Grommet
Natural Nylon
M4.2 (#8) Screw Size
Head Diameter: 11mm
Overall Length: 13mm

Applications:

VW: Cabrio, Eurovan, Golf,
Jetta 1992-2003



Pkg. Qty: 25

PN 90777

VW: 357-853-586D

Moulding Insert Grommet
Black Rubber
Head Diameter: 13mm
Stem Length: 6mm
Snaps into 9mm Hole

Applications:

VW: Eurovan, Golf, Jetta,
Passat 1989-up



Pkg. Qty: 25

PN 90778

VW: 6N0-809-966A,
N080-966-A6

Expanding Trunk Clip
Wheel Well Arch
Cover Interchangeable
Screw Grommet
Black Nylon
Head Diameter: 18.3mm
Overall Length: 14.5mm
Fits into 9.8mm Square Hole

Applications:

VW: Derby, Polo

Pkg. Qty: 25



PN 90986

Ford: W711079-S300

Black Nylon
Tail Light Grommet
Head Size: 13mm x 17mm
Stem Length: 10mm

Applications:

Ford: Explorer, Mountaineer,
Pickup Trucks 2006-on



Pkg. Qty: 25

PN 90757

Phillips Truss Head Washer

License Plate Screw
Zinc and Yellow Dichromate
Washer Head O.D.: 1/2"
Head Diameter: 13mm
#14 (1/4") x 19/32"

Applications:

Phillips Truss Head



Pkg. Qty: 50

PN 90789

Slotted Hex Washer Head

License Plate Screw
Black E-Coat
Washer Head O.D.: 5/8"
5/16" Hex
#14 (1/4") x 5/8"

Applications:

Slotted Hex Washer Head



Pkg. Qty: 50

PN 90759

Phillips Hex Washer Head

License Plate Tapping Screw
Zinc and Yellow Dichromate
1/2" Washer Head O.D.
3/8" Hex
#14 (1/4") x 5/8"

Applications:

Phillips Hex Washer Head



Pkg. Qty: 50

PN 90766

Hex Flange Washer Head

License Plate Machine Screw
Zinc and Clear Finish
Washer Head O.D.: 9/16"
10mm Hex
M6 (1.0) x 5/8" (16mm)



Pkg. Qty: 50

PN 90811

Slotted Round Washer Head

License Plate Machine Screw
Zinc Finish
Washer Head O.D.: 9/16"
(14mm)
M6 (1.0) x 5/8" (16mm)



Pkg. Qty: 50

PN 90827

Duo Drive Truss Washer Head

License Plate Screw
Zinc Finish
Washer Head O.D.: 9/16"
Head Diameter: 14mm
M6.3-1.81 x 16mm (#14 x 5/8")

Applications:

GM



Pkg. Qty: 50

PN 90788

Slotted Truss Head

License Plate Screw
Head Diameter: 9/16"
#14 x 3/4"

Applications:

Slotted Truss Head



Pkg. Qty: 100

PN 90867

Slotted Truss Head

License Plate Screw
Black Finish
Head Diameter: 9/16"
1/4" (#14) x 3/4"

Applications:

Slotted Truss Head



Pkg. Qty: 100

PN 90874

Phillips Head

License Plate
Machine Screw
Black E-Coat
Washer Head O.D.: 15/32"
M6-1.0 x 25/32"

Applications:

Phillips Pan Head



Pkg. Qty: 50

PN 90925

Slotted Hex Washer Head

License Plate
Machine Screw
Zinc Finish
Washer Head O.D.: 1/2"
M6-1.0 x 25/32" (20mm)
Hex: 10mm

Applications:

Chrysler 34201287,
AMC 8934201287



Pkg. Qty: 50

PN 90927

Phillips Hex Washer

License Plate Tapping Screw
Zinc and Yellow Dichromate
Washer Head O.D.: 15/32"
1/4" (#14) x 25/32" (20mm)
Hex: 3/8"

Applications:

Honda 91500-SM4-999AH,
Toyota 93904-46320



Pkg. Qty: 50

PN 90930

Slotted Hex Washer

License Plate Screw
Zinc Finish
Washer Head O.D.: 1/2"
Hex: 3/8"

Applications:

Ford



Pkg. Qty: 50

PN 90949
Slotted Hex Washer Head

License Plate Screw
Black E-coat
Washer Head O.D.: 1/2"
Hex: 3/8"

Applications:
Ford



Pkg. Qty: 50

PN 90950
Slotted Hex Washer

Dealer License Plate
Thumb Screw
Zinc Die Cast
(#14) x 1/2"
1-1/8" Length

Applications:



Pkg. Qty: 25

PN 90692
GM: 4755299

License Plate Nut
Screw Grommet
Natural Nylon
Screw Size: 1/4" (#14)

Applications:
GM: 1965-up



Pkg. Qty: 50

PN 90982
GM: 3907444

License Plate Nut
Screw Grommet
Natural Nylon
Screw Size: 1/4" (#14)

Applications:
GM



Pkg. Qty: 50

PN 90093
Phillips Oval Head

Tap Screw
Chrome
Screw Size: #8 x 1-1/4" (#6 HD)



Pkg. Qty: 100

PN 90117
Phillips Oval Head

Tap Screw
Chrome
Screw Size: #8 x 1" (#6 HD)



Pkg. Qty: 100

PN 90165
Phillips Oval Head

Tap Screw
Chrome
Screw Size: #8 x 3/4" (#6 HD)



Pkg. Qty: 100

PN 90171
Thread Cutting Nut

1/4" Stud Size
Washer Diameter: 11/16"



Pkg. Qty: 200

PN 90196
2 Point Hex Washer Head

Screw #8 x 1/2"
Zinc



Pkg. Qty: 100

PN 90197
Phillips Oval Head

Tapping Screw
#8 (#6HD) x 3/4"
Black Oxide



Pkg. Qty: 100

PN 90198
Phillips Oval Head

Tapping Screw
#8 x 1" (#6HD)
Black Oxide



Pkg. Qty: 100

PN 90199
Thread Cutting Nuts

Stud: 5/16"
Hex: 1/2"
Flange: 7/8"
Zinc



Pkg. Qty: 100

PN 90202

GM: 11506101, 11501850

Hex Flange Nut

Screw Size: 10-1.50mm
Hex Size: 15mm
O.D. Washer: 21mm
Black Finish

Applications:

GM



Pkg. Qty: 25

PN 90203

Phillips Oval Head Washer Screw

Screw Size: 8 x 3/4" 13/32" 20mm
Black Phosphate



Pkg. Qty: 100

PN 90204

Phillips Washer Screw

Screw Size: 8 x 1/2"
With Teks® Point
Zinc



Pkg. Qty: 50

PN 90205

Phillips Flat Washer Head Tapping Screw

Screw Size: 8-18 x 1/2"
Black



Pkg. Qty: 100

PN 90206

Phillips Flat Washer Head Tapping Screw

Screw Size: #8 x 1"
Black E-Coat



Pkg. Qty: 100

PN 90207

Phillips Flat Washer Head Tapping Screw

Screw Size: #8 x 1-1/4"
Black E-Coat



Pkg. Qty: 50

PN 90208

Thread Cutting Nut

Stud Size: 6.3mm
Width: 1mm
Washer Diameter: 18mm
Zinc



Pkg. Qty: 50

PN 90209

GM: 10009923, Chrysler: 6501825 Pushnut Bolt

M8-1.25 24mm OD
Applications:
GM, Chrysler



Pkg. Qty: 50

PN 90210

Pushnut Bolt

M10-1.5 24mm OD



Pkg. Qty: 100

PN 90211

GM: 11503800 Hex Washer Bolt

6-1.0 X 20mm OD
Washer Head OD: 13mm
Hex: 10mm
Black Polyseal

Applications:

GM



Pkg. Qty: 50

PN 90213

Hex Washer Head Screw

8-1.25 X 30mm
17mm OD
Black Phosphate



Pkg. Qty: 25

PN 90214

Phillips Flat Washer Head Screw

8-1.25 X 30mm
17mm OD
Black Oxide



Pkg. Qty: 50

PN 90215
Phillips Flat Washer Head Screw
 8 X 3/4
 Black Oxide



Pkg. Qty: 100

PN 90218
Pushnut Bolt
 M6-1.0
 Outside Diameter: 17mm
 Zinc



Pkg. Qty: 100

PN 90219
Hex Nut with Washer
GM: 11503695
 8 - 1.25mm Screw Size
 13mm Hex Size
 24mm O.D. Loose Barbed Washer
 Black Finish
Applications:
 GM



Pkg. Qty: 25

PN 90223
Phillips Truss Head Tap Screw
 M4.8-1.61 X 15mm



Pkg. Qty: 50

PN 90227
Round Washer HD Teks® Tap Screw
 M4.2-1.41 X 25mm



Pkg. Qty: 100

PN 90429
Phillips Truss Head Tap Screw
 M6.3-1.81 X 16mm



Pkg. Qty: 50

PN 90433
Phillips Flat Washer Head Tap Screw
 10x3/4"
 Black



Pkg. Qty: 100

PN 90453
Phillips Flat Top OD Wash Head Tap Screw
 8x1"
 Black Phosphate



Pkg. Qty: 100

PN 90495
Phillips Washer Head Drill Screw
 M4.2-1.41X14mm
 Head Diameter: 11mm



Pkg. Qty: 50

PN 90529
Thread Cutting Nut
 Stud Size: 1/8"
 Hex: 5/16"
 Washer Diameter: 17/32"



Pkg. Qty: 100

PN 90530
Thread Cutting Nut
 Stud Size: 3/16"
 Hex: 3/8"
 Washer Diameter: 5/8"



Pkg. Qty: 100

PN 90779

Mercedes-Benz:
201-990-05-36

Front Bumper &
Moulding Strip
Hex Head Sems
Black E-Coat
26mm Washer O.D.
8mm Hex
M4.8-1.61 x 20mm
(#10 x 25/32")

Applications:

Mercedes-Benz: 1993-2013

Pkg. Qty: 25



PN 90780

Honda:
90114-SZ3-000,
90114-SE0-000

Phillips Truss Head Sems
Splash Shield & General
Purpose
Black E-Coat
M4.8-1.61 x 19mm (#10 x 3/4")
Washer Outside Diameter:
16mm (5/8")

Applications:

Honda: 1986-up

Pkg. Qty: 25



PN 90781

Phillips Flat Top
Washer Head

Tapping Screw
Black E-Coat
Size: 8 x 3/4"
Washer Head Outside
Diameter: 13/32"

Applications:

Phillips Flat Top

Pkg. Qty: 100



PN 90782

Mitsubishi: MF453091

Phillips Head Self Tapping
Panel Screw
Black Phosphate
Size: 5 x 12mm

Applications:

Mitsubishi

Pkg. Qty: 50



PN 90783

Phillips Washer Head

M4.2 - 1.41 x 13mm
(#8 x 33/64")
11mm (7/16")
Black Zinc

Applications:

GM 11505104

Pkg. Qty: 50



PN 90784

Phillips Round
Washer Head

Phosphate
#8 x 3/4"
With Tekes® Point
Outside Diameter: 7/16"
Washer HD

Applications:

Phillips Round Washer Head

Pkg. Qty: 50



PN 90785

Phillips Round
Washer Head

Phosphate
#8 x 1"
With Tekes® Point
Outside Diameter: 7/16"
Washer HD

Applications:

Phillips Round Washer Head

Pkg. Qty: 50



PN 90786

Chrysler: 9423950

Phillips Truss Head Screw
Black Oxide
Flange Size: 11.6mm
Height 15.6mm

Applications:

Chrysler

Pkg. Qty: 100



PN 90787

Ford: 381801-S2
GM: 20423550

Phillips Washer Head
With Tekes® Point
Black Phosphate
#8 x 1/2 "
7/16" Washer Head O.D.

Applications:

Ford/GM

Pkg. Qty: 50



PN 90166

Phillips Oval Head
Sems

Tap Screw Countersunk
Washer
Chrome
#8 x 3/4" (#6 HD) Screw Size

Pkg. Qty: 100



PN 90170

Phillips Oval Head
Sems

Tap Screw Countersunk
Washer
Chrome
#8 x 1" Screw Size

Pkg. Qty: 100



PN 90201

GM: 11501193
10-1.5 X 40mm
Hex Head Sems

15mm Indented Hex Head
28mm Outside Diameter
Loose Washer
Black Phosphate

Pkg. Qty: 25



PN 90212
Hex Head Sems
 6.3-1.81 X 25mm
 17mm OD
 Black Phosphate



Pkg. Qty: 50

PN 90455
Hex Head Sems Screw
 M 4.2-1.41 X 20mm
 Washer Head O.D. 11/16"
 Hex Size 7mm
 Length 25/32"
 Black Phosphate Finish



Pkg. Qty: 50

PN 90283
Hex Head TekS® Sems Screw
 M4.2-1.41 X 20mm
 Washer Head O.D. 15/32"
 Hex Size 7mm
 Length 25/32"
 Black Phosphate Finish



Pkg. Qty: 50

SCREW/SHEET METAL

PN 90791
GM: 11503892, 11500434
 Sheet Metal Screw
 Phosphate
 Hex Head Sems
 16mm (5/8") Washer Head
 Outside Diameter 7mm Hex
 M4.2-1.41 x 20mm
 (#8 x 25/32")
Applications:
 GM



Pkg. Qty: 50

PN 90792
GM: 11504981
 Hex Head Sems Screw
 Phosphate
 10mm Hex
 M6.3-1.81 x 30mm
 (#14 x 1-3/16")
 24mm (15/16") Washer O.D.
Applications:
 GM



Pkg. Qty: 50

PN 90793
GM: 11505022
 Hex Washer Head Sems Screw
 Black Poly Seal Finish
 M6.3-1.81 x 20mm
 (#14 x 25/32")
 17mm (11/16") Washer O.D.
 10mm Hex
Applications:
 GM



Pkg. Qty: 50

PN 90794
Lexus/Scion/Toyota: 90159-60488
 Front Bumper & Bumper Stay,
 Hood & Front Fender Self
 Tapping Screw with Washer
 Zinc finish, 10mm Hex
 M6 - 2.5 x 24mm
 Washer Outside Diameter: 16mm
Applications:
 Lexus: CT200, ES350, HS250, IS,
 SC430, Toyota, Scion: All Models
 1995-up



Pkg. Qty: 25

PN 90796
Lexus/Toyota: 90159-50316, 90159-A0001
 Front Bumper & Bumper Stay,
 Radiator Grille Self Tapping Screw
 with Washer
 Zinc Finish
 10mm Hex
 M5-2.0 x 18mm
 Washer Outside Diameter: 13mm
Applications:
 Lexus/Toyota: 2000-up



Pkg. Qty: 25

PN 90790
Phillips Hex Head
 With Loose Washer
 Black Zinc
 6.3-2.5 x 25mm
 16mm O.D. Loose Washer
 10mm Phillips Hex Head
 Sem Screw
Applications:
 Phillips Hex Head



Pkg. Qty: 50

PN 90603
GM:11503578, 11503785
Hex Washer Head Sems Screw with TekS® Point
 M4.2 - 1.41 x 16mm
 (#8 x 5/8")
 12mm (1/2") Washer O.D.
 7mm Hex
 Black Phosphate
Applications:
 GM



Pkg. Qty: 50

PN 90799
Mercedes-Benz: 0019949845
 Sheet Metal Nut Screw
 Zinc Chromate
 Head Size: 8.5mm x 14mm
 Stem Size: 5mm x 7.5mm
 Stem Length: 14mm
Applications:
 Mercedes-Benz: 2002-up



Pkg. Qty: 25

PN 90802
Mitsubishi: MS452348
 Inner Fender Splash Guard,
 Phillips Hex Head Screw
 With Loose Washer
 Black E-Coat
 M6-1.81 x 19mm
 Hex Size: 10mm
 Washer Size: 13mm
Applications:
 Mitsubishi



Pkg. Qty: 25

PN 90803

Nissan: 63849-2U000
 Nissan Phillips Hex Head, Fender Bolt
 Black E-Coat
 Hex Size: 10mm
 Washer Size: 18mm
 M6.3-2.5 x 16mm
Applications:
 Nissan



Pkg. Qty: 25

PN 90797

Toyota: 75392-42030
 Phillips Hex Head Front Bumper Moulding Screw with Washer
 Black E-Coat
 8mm Hex
 M5 - 2.0 x 20mm
 Washer Outside Diameter: 12mm
Applications:
 Lexus/Toyota: 2010-up



Pkg. Qty: 25

PN 90804

Toyota: 90159-60498
 Course Thread Bolt with 16mm Loose Washer
 Black E-Coat
 M6.3-2.5 x 15mm
Applications:
 Toyota



Pkg. Qty: 25

PN 90805

Toyota: 90159-60525
 Floor Pan & Lower Back Panel Moulding, Rear Bumper Stay, Suspension Cross Member & Under Cover Screw
 Black E-Coat
 10mm Hex
 M6.5 - 2.5 x 19mm (#14 x 3/4")
 Washer Outside Diameter: 20mm (25/32")
Applications:



Pkg. Qty: 25

PN 90801

Metric Hex Flange Nut
 Black Oxide
 Size: M6.3-2.5 x 23mm (#14 x 25/32")
 Washer O.D. 20mm
 10mm Hex Size (25/32")
Applications:
 Metric Hex Flange



Pkg. Qty: 50

PN 90609

GM: 11503396, 1150348
Hex Washer Head Sems Screw
 M4.2-1.41 x 20mm (#8 x 25/32")
 12mm (1/2") Washer O.D.
 7mm Hex
Applications:
 GM



Pkg. Qty: 100

PN 90835

Chrysler: 6503819, 6503401
GM: 25631448
 Square Drive Truss Head Foam to Bumper Fascia Retainer
 Black Nylon
 Head Diameter: 22mm
 Shoulder Diameter: 9mm
 M7.5 x 35mm
Applications:
 Chrysler: 1993-up



Pkg. Qty: 15

TAIL LIGHT CLIP

PN 90806

Infinity/Nissan: 26398-ED000
 Tail light Clip Assembly, White Nylon
 Upper Head Diameter: 12.5mm
 Lower Head Diameter: 19mm
 Overall Height: 19mm,
 Stem Diameter: 9.5 x 7.5mm
Applications:
Nissan: Armada, Juke, Pathfinder, Sentra, Versa 2006-up
Infiniti: M37, M56,
 M Hybrid 2013-up



Pkg. Qty: 25

PN 90807

AMC: 4006529
Chrysler: 5208743

Trim Panel Retainer
Black Nylon
Head Diameter: 3/4"
Stem Diameter: 7/32"
Stem Length: 11/16"

Applications:
AMC/Chrysler



Pkg. Qty: 50

PN 90808

AMC: 4004569;
Chrysler: 3691590, 6031321;
Ford: 389358 GM: 332364,
14093311,20732399;

Fender & Bumper Shield Retainer
Black Nylon
Head Diameter: 11/16"
Stem Diameter: 5/16"
Stem Length: 5/8"

Applications:
AMC/Chrysler/Ford/GM



Pkg. Qty: 50

PN 90809

AMC: 4006516
Ford: 388246S
GM: 20413107

Weatherstrip Retainer
Black Nylon
Head Diameter: 7/16"
Stem Diameter: 3/16"
Stem Length: 5/8"

Applications:
AMC/Ford/GM



Pkg. Qty: 50

PN 90810

Audi/VW:
6Q0-868-246-A

Clip-Upper Door Trim
Assembly
White Nylon
Size: 40.4mm x 25.3mm

Applications:
Audi: All 2004-up
VW: EOS, Golf, GTI, Jetta,
Passat, R32, Rabbit 2005-up



Pkg. Qty: 25

PN 90812

BMW: 07147122912

Body Trim rocker Panel
Wheelhousing Trim Clip
Black Nylon
Head Diameter: 30mm
Overall Height: 32mm
Stem Diameter: 22mm

Applications:
BMW: 1 Series 2006-2012, 3 Series
2004-2012, 6 Series 2010-2012, X
Series 2007-2012



Pkg. Qty: 15

PN 90813

BMW: 51498123832,
51490151605, 5149810599

Trim Clip, Black Nylon
Upper Head Diameter: 13mm
Lower Head Diameter: 18mm
Overall Height: 16mm
Stem Diameter: 8mm

Applications:
BMW: 3 Series 1990-2007, 5 Series
1989-2010, 6 Series 2011-2012,
7 Series 1986-2009, 8 Series 1989-
1998, X Series 2003-2011, Z Series
2008-2012



Pkg. Qty: 25

PN 90814

BMW: 51-71-8-184-574

Door Sill/Wheelhousing Rocker
Trim Retainer
White Nylon
Size: 32.5mm x 20.65mm
Height: 17.5mm
Stem Diameter: 6.5mm
Stem Length: 9.5mm

Applications:
BMW: 3 Series 1991-2009



Pkg. Qty: 25

PN 90815

BMW: 07147122913

Rocker Trim
Wheelhousing Retainer
Black Nylon
Head Diameter: 20mm
Stem Length: 33mm
Stem Diameter: 7mm

Applications:
BMW: 1, 3, 6, X Series
Performance Vehicle
2004-up



Pkg. Qty: 15

PN 90816

BMW: 51-12-7-004-445

Rear Bumper Support
Fixture Trim Retainer
Black Nylon
Head Size: 20mm x 10.3mm
Overall Height: 15.6mm
Stem Diameter: 16mm

Applications:
BMW: 3, 5, 6 Series 2002-up



Pkg. Qty: 25

PN 90817

BMW: 51-47-1-945-266

Trunk Luggage
Compartment
Sill Trim Retainer
Black Nylon
Head Size: 17mm x 15mm
Overall Height: 15mm
Stem Size: 12mm x 8mm

Applications:
BMW: 3, 5, M Series 1983-up



Pkg. Qty: 25

PN 90818

BMW: 51-11-7-160-451

Door Sill/Wheelhousing
Rocker
Trim Retainer
White Nylon
Size: 32.5mm x 20.65mm
Height: 17.5mm
Stem Length: 9.5mm
Stem Diameter: 6.5mm

Applications:
BMW: 7 Series 2004-up



Pkg. Qty: 15

PN 90819

BMW: 51-71-8-259-788,
51-71-0-391-077

Rocker Panel Air Duct
Compartment &
Wheelhousing Retainer
Black Nylon
Size: 17mm x 15mm
Height: 17mm
Stem Size: 11.8mm x 8.1mm

Applications:
BMW: 3, 5, 6, 7, Z Series 1994-up



Pkg. Qty: 25

PN 90820

Chrysler: 6003423
GM: 2048248,
 Interior Trim Panel Retainer
 Natural Nylon
 Head Diameter: 15/16"
 Stem Diameter: 5/16"
 Stem Length: 11/16"
Applications:
 Chrysler/GM



Pkg. Qty: 50

PN 90821

Chrysler: 6501067
 Fascia Retainer
 Black Nylon
 Head Diameter: 25mm
 Stem Diameter: 7.5mm
 Stem Length: 20mm
Applications:
 Chrysler



Pkg. Qty: 50

PN 90822

Chrysler: 4658673
 Weatherstrip Retainer
 Front & Rear Doors
 Black Nylon
 Head Diameter: 3/8"
 Stem Diameter: 7/32"
 Stem Length: 5/8"
Applications:
 Chrysler: Neon 1996-up



Pkg. Qty: 50

PN 90823

Chrysler: 6502104
 Headlight Mounting Panel to Cross Member, sight Shield Retainer
 Black Nylon
 Head Diameter: 1"
 Stem Diameter: 5/16"
 Stem Length: 17/16"
Applications:
 Dodge: Daytona 1993



Pkg. Qty: 25

PN 90824

Chrysler: 6502381
 Radiator Grille Sight Shield Retainer
 Black Nylon
 Head Diameter: 9/16"
 Stem Diameter: 5/16"
 Stem Length: 13/16"
Applications:
 Dodge: Caravan
 Plymouth: Voyager 1993-up



Pkg. Qty: 50

PN 90825

Chrysler: 4381395, 6501086
Ford: 388904-S
 Door frame, Spacer Retainer
 Black Nylon
 Head Diameter: 1"
 Stem Diameter: 5/16"
 Stem Length: 13/16"
Applications:
 Chrysler/Ford



Pkg. Qty: 50

PN 90826

Chrysler: 6504043
Ford: N807721-S
 Trim Panel Retainer, Trunk Lid Latch
 Black Nylon
 Head Diameter: 5/8"
 Stem Diameter: 3/8"
 Stem Length: 3/4"
Applications:
 Chrysler: 1996-up
 Ford: Explorer 1993-up



Pkg. Qty: 50

PN 90976

Chrysler: 6030441
Ford: 388577S
GM: 1605396
 Fender & Bumper Shield, Retainer
 Black Nylon
 Head Diameter: 23/32"
 Stem Diameter: 5/16"
 Stem Length: 13/16"
Applications:
 Chrysler/Ford/GM



Pkg. Qty: 25

PN 90828

Chrysler: 3861577
Ford: 387258-S
GM: 20032850
 Mud Shield Retainer
 Black Nylon
 Head Diameter: 3/4"
 Stem Diameter: 9/32"
 Stem Length: 1/2"
Applications:
 Chrysler/Ford/GM



Pkg. Qty: 100

PN 90829

Chrysler: 6032363
Ford: 385661-S
VW: N989022
 Door Trim Panel Retainer
 Head Diameter: 15/16"
 Stem Diameter: 5/16"
 Stem Length: 11/16"
Applications:
 Chrysler/Ford/VW



Pkg. Qty: 25

PN 90830

Chrysler: 6003587
GM: 25514221
 Roof Headliner Retainer
 Natural Nylon
 Head Diameter: 5/8"
 Stem Diameter: 5/16"
 Stem Length: 11/16"
Applications:
 Chrysler/GM



Pkg. Qty: 50

PN 90831

Chrysler: 6502328
GM: 20699808
 Door Weatherstrip Retainer
 Black Nylon
 Head Diameter: 10mm
 Stem Diameter: 6mm
 Stem Length: 12mm
Applications:
 Chrysler/GM



Pkg. Qty: 50

PN 90832

Chrysler: 6501301

GM: 21094146

Trim Panel Retainer
Black Nylon
Head Diameter: 3/4"
Stem Diameter: 11/32"
Stem Length: 7/8"

Applications:
Chrysler/GM



Pkg. Qty: 25

PN 90833

Chrysler: 6030538

**GM: 480534,
6270163**

Fender & Bumper Shield
Retainer
Gray Nylon
Head Diameter: 11/16"
Stem Diameter: 5/16"
Stem Length: 5/8"

Applications:
Chrysler/GM



Pkg. Qty: 50

PN 90834

Chrysler: 6501916

GM: 22547243

Splash Shield & Wheel Well
Cover, Hood Seal Retainer
Black Nylon
Head Diameter: 7/8"
Stem Diameter: 5/16"
Stem Length: 1-3/32"

Applications:
Chrysler: 1988-up
GM: 1989-up



Pkg. Qty: 50

PN 90836

Ford: N804448

Heat Shield Retainer
Black Nylon
Head Diameter: 1/2"
Stem Diameter: 1/4"
Stem Length: 15/16"

Applications:
Ford



Pkg. Qty: 25

PN 90837

Ford: N803857-S

Fascia Retainer
Front End
Stem Length: 3/8"

Applications:
Ford



Pkg. Qty: 50

PN 90838

Ford: W701380SSW

Trunk Liner, Rear Seat Carpet &
Radiator Side Shield Retainer
Black Nylon
Head Diameter: 23/32"
Stem Diameter: 5/16"
Stem Length: 7/8"

Applications:
Ford



Pkg. Qty: 25

PN 90839

Ford: 388930-S

Trim Panel Retainer
Black Nylon
Head Diameter: 1"
Stem Diameter: 9/32"
Stem Length: 1-1/16"

Applications:
Ford



Pkg. Qty: 50

PN 90840

Ford: N803170-S

Fascia Retainer
Black Nylon
Head Diameter: 7/16"
Stem Diameter: 7/32"
Stem Length: 1/2"

Applications:
Ford



Pkg. Qty: 25

PN 90841

Ford: N804349S

Interior Trim Retainer
Black Nylon
Head Diameter: 26mm
Stem Diameter: 8mm
Stem Length: 38mm

Applications:
Ford



Pkg. Qty: 25

PN 90842

**Ford: E9SB-
6302354-ACW**

Cowl Side Panel
Retainer
Black Nylon
Head Diameter: 1"
Stem Diameter: 1/4"
Stem Length: 1-1/8"

Applications:
Ford



Pkg. Qty: 25

PN 90843

Ford: 389443-S

Fascia to Bumper
Retainer
Black Nylon
Head Diameter: 1"
Stem Diameter: 5/16"
Stem Length: 13/16"

Applications:
Ford: 1981-up



Pkg. Qty: 25

PN 90844

**Ford:
W705955-S300**

Wheel Opening
Moulding Retainer
Light Grey Nylon
Head Diameter: 11/16"
Stem Diameter: 5/16"
Stem Length: 1-3/8"

Applications:
Ford



Pkg. Qty: 50

PN 90846

Ford: W709002-SAA

Fender Flare Retainer
Head Diameter: 18mm
Stem Diameter: 7.5mm
Stem Length: 33mm

Applications:

Ford: Expedition
Lincoln: Navigator
2003-up



Pkg. Qty: 25

PN 90847

Ford: N804379S

GM: 1631564

Bumper Fascia Retainer
Black Nylon
Head Diameter: 7/8" (22mm)
Stem Length: 28mm
Panel Range: .40 - .787

Applications:

Ford/GM



Pkg. Qty: 50

PN 90848

Ford: N802734S

GM: 22718305

Trim Panel & Hood
Insulation Retainer
Black Nylon
Head Diameter: 25mm
Stem Diameter: 8mm
Stem Length: 20mm

Applications:

Ford/GM



Pkg. Qty: 50

PN 90850

GM: 1619321

Radiator Apron Panel
Retainer

Black Nylon
Head Diameter: 1"
Stem Diameter: 7/16"
Stem Length: 13/16"

Applications:

GM



Pkg. Qty: 25

PN 90851

GM: 25601491

Door Trim Panel
Retainer

Radiator air Side baffle
Head Diameter: 3/4"
Stem Diameter: 5/16"
Stem Length: 7/8"

Applications:

GM



Pkg. Qty: 50

PN 90852

GM: 14074081

Rear Hood Seal
Retainer

Black Nylon
Head Diameter: 3/4"
Stem Diameter: 5/16"
Stem Length: 1-3/8"

Applications:

GM



Pkg. Qty: 25

PN 90845

Mud Flap Retainer

Black Nylon Mud Flap
Retainer

Head Diameter: 11/16"
Stem Diameter: 5/16"
Stem Length: 1-3/4"
Not available from O.E.M.

Applications:

Ford: Expedition, F-150
1997-up



Pkg. Qty: 25

PN 90853

GM: 20319841

Seat Back Retainer
Black Nylon

Head Diameter: 25/32"
Stem Diameter: 5/16"
Stem Length: 15/16"

Applications:

GM



Pkg. Qty: 25

PN 90854

GM: 20511451

Cowl Vent Retainer
Black Nylon

Head Diameter: 21/32"
Stem Diameter: 7/32"
Stem Length: 15/32"

Applications:

GM



Pkg. Qty: 25

PN 90855

GM: 14027471

Trim Panel Retainer
Black Nylon

Head Diameter: 1"
Stem Diameter: 9/32"
Stem Length: 1-7/16"

Applications:

GM: Trucks



Pkg. Qty: 25

PN 90856

GM: 10185925

Bumper Fascia Retainer
Black Nylon

Head Diameter: 3/4"
Stem Diameter: 11/32"
Stem Length: 1- 3/16"
Hole Size: 9/32"
(7.1mm)

Applications:

GM



Pkg. Qty: 25

PN 90857

GM: 15672328

Radiator Grille Retainer
Black Nylon

Head Diameter: 3/4"
Stem Diameter: 9/32 x 11/32"
Stem Length: 11/16"

Applications:

GM



Pkg. Qty: 25

PN 90858

GM: 20455900

Moulding Retainer
Black Nylon
Head Diameter: 3/8"
Stem Diameter: 1/4"
Stem Length: 1/2"

Applications:
GM



Pkg. Qty: 25

PN 90859

GM: 22512276

Front End Stone Shield Retainer
Black Nylon
Head Diameter: 7/8"
Stem Diameter: 7/16"
Stem Length: 13/16"

Applications:
GM: 1981-up



Pkg. Qty: 25

PN 90860

GM: 20514862

Screen shroud Vent Grille to Panel Retainer
Black Nylon
Head Diameter: 19/32"
Stem Diameter: 7/32"
Stem Length: 3/4"
Fits into: 3/16" (5mm) Hole

Applications:
GM



Pkg. Qty: 50

PN 90866

Ford 390018-S
GM: 10121502

Shield Retainer, Battery Post Cable Shield, Radiator Side Air Baffle
Black Nylon
Head Diameter: 11/16"
Stem Diameter: 5/16"
Stem Length: 1-1/16"

Applications:
GM: 1989-up



Pkg. Qty: 50

PN 90861

GM: 8731909

Door Weatherstrip Retainer
Black Nylon
Head Diameter: 13/32"
Stem Diameter: 5/32"
Stem Length: 3/8"

Applications:
GM: 1963-up



Pkg. Qty: 100

PN 90862

GM: 15975244

Wiring Harness & Headliner Retainer, Engine Wiring Harness, tailgate, Headliner & air cleaner
Black Nylon
Head Diameter: 3/4"
Stem Diameter: 5/16"
Stem Length: 1-1/16"

Applications:
GM: C, E, K, S, T Trucks 1994-up



Pkg. Qty: 50

PN 90863

GM: 15056810

Bumper Fascia Retainer
Black Nylon
Head Diameter: 25mm
Stem Diameter: 13mm
Stem Length: 15mm

Applications:
GM: S, T Trucks 2002-up



Pkg. Qty: 25

PN 90864

GM: 22189414

Engine Compartment & Front End Retainer,
Black Nylon
Head Diameter: 15/16"
Stem Diameter: 3/8", Stem Length: 3/4"

Applications:
Buick: LeSabre, Park Ave, Rendezvous, Riviera
Cadillac: DeVille, Seville
Chevrolet: Venture
Oldsmobile: Silhouette
Pontiac: Aztec, Bonneville, Montana 2000-up



Pkg. Qty: 25

PN 90865

GM: 10078274

Side Roof Rail Weatherstrip Retainer
Black Nylon

Applications:
Chevrolet: Beretta, Corsica 1989-1987



Pkg. Qty: 25

PN 90868

Honda: 90666-SA0-0030

Panel Retainer
Black Nylon
Head Diameter: 13mm
Stem Length: 16mm
Hole Size: 5mm

Applications:
Honda



Pkg. Qty: 25

PN 90935

Chrysler: 6503204

Trim Panel Retainer
Green Nylon
Upper Head Diameter: 19/32"
Lower Head Size: 23/32"
Stem Length: 5/8"
Stem Diameter: 5/16"

Applications:
Cirrus, Stratus 1995-2015



Pkg. Qty: 50

PN 90869

Honda: 90671-S0D-003ZK

Trunk Lid & Interior Trim Retainer
Black Nylon
Head Diameter: 18mm
Stem Diameter: 7mm x 7mm
Stem Length: 13mm

Applications:
Honda: Accord 2010



Pkg. Qty: 25

PN 90870

Honda:
90667-SA7-0030

Nissan: 89427-98070
Trim Panel Retainer
Black Nylon
Head Diameter: 20mm
Stem Length: 15mm
Fits into 5mm Hole

Applications:
Honda/Nissan



Pkg. Qty: 25

PN 90871

Infiniti/Nissan:
01553-06451

Upper Quarter Trim/Rear Trunk Seal Clip
Black Nylon, Head Diameter: 20mm,
Overall Length: 19mm,
Stem Diameter: 8.6mm

Applications:

Infiniti: G35 2002-up, Hybrid 2013-up,
J30 1992-up, JX60 2013-up, M35, M37,
M45, M56 2002-up, Q45 1996-up, Q50
2013-up, Q60 **Nissan:** Altima 2013-up,
Pathfinder 2013-up, Quest 2012-up



Pkg. Qty: 25

PN 90872

Land Rover:
DKP5279L

Trim Panel Fastener
Black Nylon
Upper Head Diameter: 12mm
Lower Head Diameter: 12.5mm
Overall Height: 22mm
Stem Diameter: 5.5mm
(The snap Grommet that these studs
Push in to are either MWC9136 or
EYC101460)



Pkg. Qty: 25

PN 90873

Land Rover:
MWC9134

Side Door Panel Trim Retainer
Black Nylon
Head Diameter: 13.75mm
Overall Length: 20.72mm
Stem Diameter: 5.75mm

Applications:

Land Rover: 1, 2, DeFender
1987-2006, Discovery 1989-2004,
Freelander 1996-2006, Range Rover
1995-2002
(Use with 90406)



Pkg. Qty: 25

PN 90875

Lexus/Toyota:
75819-33010

Rocker Panel & Scuff Plate Retainer
White Nylon, Head Diameter: 14.9mm
Stem Diameter: 9.9mm
Overall Length: 19.4mm

Applications:

Lexus: ES300, ES330, RX330, RX400
2002-up **Toyota:** Corolla, Prius,
Sequoia, Sienna 2009-up
Scion: All Models 2002-up



Pkg. Qty: 25

PN 90876

Mazda: B27K51PS7

Headlight Bracket
Rivet Retainer, Black Nylon
Head Diameter: 17.7mm
Stem Length: 22mm
Stem Diameter: 8.3mm
Fits into 8mm Hole

Applications:

Mazda: CX-7 2007-2012, CX-9
2007-2012, 3 Series 2004-2011,
Miata 2006-2013, MPV 2000-2001,
RX-8 2004-2011



Pkg. Qty: 15

PN 90878

Mini-Cooper:
07131480419

Interior Equipment
Lower Body and Trim
Rocker Panel
Trim for Wheel housing

Applications:

Mini-Cooper



Pkg. Qty: 15

PN 90879

Nissan: 01553-01182

Splash Shield Retainer
Black Nylon
Head Diameter: 15mm
Stem Diameter: 4.5mm
Stem Length: 14mm

Applications:

Nissan: Frontier 1997-up



Pkg. Qty: 50

PN 90880

Nissan: 01553-01A50

Upper Door Panel Retaining Clip
Black Nylon, Head Diameter: 12mm
Stem Diameter: 6mm
Stem Length: 15mm

Applications:

Nissan: 370Z, Altima, Armada,
Cube, Frontier, GT-R, Juke, Leaf,
Maxima, Murano, NV-1500, 2500,
3500, Pathfinder, Quest, Rogue,
Sentra, Versa, Xterra 2003-up



Pkg. Qty: 25

PN 90881

Subaru: 94415FA000NE

Rear Roof Spoiler Trim
Retainer
Gray/Black Nylon
Head Diameter: 25mm
Overall Length: 18.7mm
Stem Diameter: 7.7mm

Applications:

Subaru: Impreza 1998-2007



Pkg. Qty: 15

PN 90883

Toyota:
90467-05045-22

Weatherstrip Retainer
Black Nylon
Head Diameter: 12mm
Stem Diameter: 5mm Square
Stem Length: 6mm

Applications:

Toyota: Solara 1998-up



Pkg. Qty: 25

PN 90884

Toyota:
90467-08186

Luggage Compartment
Trim Retainer
Black Nylon
Head Diameter: 16mm
Stem Diameter: 8mm
Stem Length: 16mm

Applications:

Toyota: Camry 1999-up



Pkg. Qty: 25

PN 90885

Toyota:
90467-05096-22
 Luggage Compartment
 Trim Panel Retainer
 Black Nylon
 Head Diameter: 16mm
 Stem Diameter: 5mm
 Stem Length: 13mm

Applications:
Toyota: Paseo, Tercel 1994-up



Pkg. Qty: 25

PN 90886

VW:
801-867-299-01C
 Door Side Panel, Luggage,
 Compartment and Armrest
 Tray Trim Retainer
 Black Nylon
 Head Diameter: 14mm
 Stem Length: 18mm
 Fits into 9mm Hole

Applications:
VW: Golf, GTI R32, Jetta,
 Rabbit



Pkg. Qty: 25

PN 90887

VW:
1H0-819-055-B-01C
 Phillips Drive Textured Head
 Cowl Vent Screw
 Black Nylon
 Head Diameter: 23mm
 Stem Length: 18mm
 6.5-1.50mm x 16mm Screw Size

Applications:
VW: Golf A3



Pkg. Qty: 25

PN 90187

Chrysler: 6501948
 Black Universal
 Nylon Shield Retainer
 Head Diameter: 5/8"
 Stem Diameter: 1/4"
 Stem Length: 3/4"

Applications:
 Chrysler



Pkg. Qty: 50

PN 90188

GM: 15588078
 Black Nylon
 Pillar Cover Retainer
 Head Diameter: 3/4"
 Stem Diameter: 5/16"
 Stem Length: 1-1/4"

Applications:
 GM



Pkg. Qty: 10

PN 90017

GM: 10063599
 Black Universal Nylon
 Shield Retainer
 Head Diameter: 23/64"
 Stem Diameter: 3/16"
 Stem Length: 7/16"

Applications:
 GM



Pkg. Qty: 100

PN 90073

Ford: N808370-S
 Black Universal Nylon
 Shield Retainer
 Head Diameter: 1"
 Stem Diameter: 1/4"
 Stem Length: 25/32"

Applications:
 Ford



Pkg. Qty: 25

PN 90185

Chrysler: 34202335
 Black Nylon Panel
 Retainer
 Hole Size: 5/16"
 Panel Range: .080" - .270"

Applications:
 Chrysler



Pkg. Qty: 25

PN 90900

Chrysler: 6101283;
Ford: N623333-S2

GM: 11500660, 11502617

Extruded U-Nut M8-1.25 Screw Size
Phosphate
Panel Range: 0.80mm-4.00mm
(1/32"-5/32")
Center of Hole to Edge: 14.5mm (9/16")

Applications:

Chrysler/Ford/GM



Pkg. Qty: 25

PN 90901

Ford: 45263-S2

Extruded U-Nut
Phosphate
1/4"-20 Screw Size
Panel Range: .025"-.150"
Center of Hole to Edge: 17/32"

Applications:

Ford



Pkg. Qty: 25

PN 90902

Ford:
N623343-S2 & S100;
GM: 11500661,
11503317, 11516150,

Extruded U-Nut
Phosphate
M8-1.25 Screw Size
Panel Range: .80mm-4.50mm
(.030"-.170")
Center of Hole to Edge: 20mm (13/16")

Applications:

Ford/GM



Pkg. Qty: 25

PN 90903

Ford: N623332S2-S53
& S100

GM:1016937, 11503937

Metric Extruded U-Nut
Phosphate
Thread Size: M6-1.0
Panel Range: 0.80-4.00mm
(1/32"-5/32")
Center to Edge: 13.5mm
(.531")

Applications:

Ford/GM



Pkg. Qty: 25

PN 90904

GM: 11503715,
11508241

Extruded U-Nut
Phosphate
M6-1.0 Screw Size
Panel Range: 3.0mm-4.0mm
(.125"-.160")
Center to Edge: 19.5mm (25/32")

Applications:

GM



Pkg. Qty: 25

PN 90962

Toyota: 53879-17020,

Black Nylon
Fender/Wheel Housing
#10 Screw Size
20mm Wide, 31mm Long
Panel Range: Up to 2mm
Center of Hole to Edge: 10mm

Applications:

GM/Mazda/Toyota



Pkg. Qty: 10

PN 90965

GM: 94841226

Mazda: LA01-56-135

Toyota: 53879-14010-A,
53879-14020

Black Nylon
Fender/Wheel Housing
#10 Screw Size
20mm Wide, 31mm Long
Panel Range: Up to 1mm
Center of Hole to Edge: 11mm

Applications:

GM/Mazda/Toyota



Pkg. Qty: 15

PN 90200

GM: 22531616

Black Phosphate
Fender/Wheel Housing
M10-1.50 Screw Size
Range: 1.0mm-6.0mm
Center of Hole to Edge: 19mm

Applications:

GM



Pkg. Qty: 25

U-NUT/SPRING-TYPE & BODY SHIMS

PN 90905

Ford: 381863-S2

GM: 9440178,
11504531

Spring Type U-Nut
Phosphate
Panel Range: .025"-.150"
Center of Hole to Edge: 5/8"
#8 Screw Size

Applications:

Ford/GM



Pkg. Qty: 100

PN 90906

Ford: 381818-S2

GM: 9424837, 9431530

Spring Type U-Nut
Phosphate
Panel Range: .025"-.150"
Center of Hole to Edge: 3/8"
#8 Screw Size

Applications:

Ford/GM



Pkg. Qty: 100

PN 90907

Spring Type U-Nut

Phosphate
Panel Range: .025"-.125"
Center of Hole to Edge: 11/32"
#10 Screw Size

Applications:

General/U-Nut



Pkg. Qty: 25

PN 90220
Spring Type U-Nut
 #10 Screw Size
Applications:
 General/U-Nut



Pkg. Qty: 50

PN 90908
Body Shim
 Zinc
 Thickness: 1/8"
 Outside Diameter: 15/16"
 Slot: 3/8"
Applications:
 General/Body Shim



Pkg. Qty: 50

PN 90909
Body Shim
 Steel Body
 Zinc Finish
 Thickness: 1/8"
 Outside Diameter: 1-1/4" x 1-1/8"
 Slot: 3/8"
Applications:
 General/Body Shim



Pkg. Qty: 100

PN 90921
Body Shim
 Steel Body
 Zinc Finish
 Thickness: 1/8"
 Outside Diameter: 15/16"
 Slot: 3/4"
Applications:
 General/Body Shim



Pkg. Qty: 50

PN 90849
Body Shim
 Steel Body
 Zinc Finish
 Thickness: 1/16"
 Outside Diameter: 15/16"
 Slot: 3/8"
Applications:
 General/Body Shim



Pkg. Qty: 50

WEATHERSTRIP RETAINER

PN 90916
Acura: 91501-SL4-003
 Front Cowl Retaining Clip
 Black Nylon
 Head Diameter: 13mm
 Stem Diameter: 6mm
 Stem Length: 10mm
Applications:
 Acura: 3.5RL 1996-up



Pkg. Qty: 25

PN 90915
Acura/Honda:
91515-SR3-000
 Rear Hood Cowl Weatherstrip
 Retaining Clip
 Black Nylon
 Head Size: 8mm x 18mm
 Stem Length: 15mm
 Fits into 7mm Hole
Applications:
 Acura: Integra; Honda: Civic, CR-V
 & Del Sol 1992-up



Pkg. Qty: 25

PN 90918
Ford: N806289-S
 Weatherstrip Retainer
 Head Size: 5mm x 15mm
 Stem Diameter: 4mm
 Stem Length: 12mm
Applications:
 Lincoln: 1989-up



Pkg. Qty: 50

PN 90919

Ford: F1CZ-16774-A

Mazda: B455-56-741

Hood Insulation Retaining Clip

Black Nylon

Head Diameter: 14mm

Stem Length: 10mm

Fits into 6mm Hole

Applications:

Ford: Probe

Mazda: MX6 1988-1992



Pkg. Qty: 25

PN 90912

Honda: 72311-S5S-003

Door Weatherstrip Retainer

Green Nylon

Head Size: 15mm x 5mm

Stem Diameter: 6.6mm

Overall Length: 15mm

Applications:

Acura: RDX 2007-up

Honda: Civic, CR-V, Fit 2003-up



Pkg. Qty: 25

PN 90913

Honda: 91568-TR0-003, 90651-TP8-003

Front and Rear Door

Weatherstrip Retainer

Yellow Nylon

Head Size: 14.5mm x 5mm

Stem Diameter: 6mm

Overall Length: 11.5mm

Applications:

Acura: ILX, RDX 2013

Honda: Civic, CR-V 2012-up



Pkg. Qty: 25

PN 90914

Honda: 91502-S84-A11

Engine Hood Weatherstrip

Retainer

Black Nylon

Head Size: 6mm x 16mm

Stem Length: 14mm

Fits into 6mm Hole

Applications:

Acura/Honda: CL 2001-

2003, MDX 2001-2006, RSX

2002-2006, TL 1999-2003



Pkg. Qty: 15

PN 90917

Honda: 91563-SCV-003

Front & Rear Door

Weatherstrip Retainer

White Nylon

Head Size: 15mm x 5mm

Overall Height: 12.6mm

Fits into 6mm Hole Size

Applications:

Acura: TL 2013-up

Honda: Element, Odyssey,

Pilot 2003-up



Pkg. Qty: 25

PN 90920

GM: 4876498

Weatherstrip Retainer

Black Nylon

Head Size: 3/16" x 1/2"

Stem Diameter: 3/16"

Stem Length: 7/16"

Applications:

GM



Pkg. Qty: 100

PN 90922

Honda: 90651-S4N-003

Front Door Panel

Weatherstrip Retainer

White Nylon

Head Diameter: 15mm x 5mm

Stem Diameter: 6mm

Stem Length: 15mm

Applications:

Honda: Accord, Civic, Crosstour,

CR-V, CR-Z, 2001-up

Acura: TSX 2009-up



Pkg. Qty: 25

PN 90923

Honda: 91513-SE0-003

Hood Seal Retainer

Natural Nylon

Head Size: 7mm x 16mm

Stem Length: 12mm

Fits into 5mm Hole

Applications:

Honda: Accord, Prelude

1983-up



Pkg. Qty: 25

PN 90924

Honda: 91530-SP1-003

Orange Nylon

Weatherstrip Retainer

Head Diameter: 5mm x 15mm

Stem Diameter: 6mm

Stem Length: 10mm

Applications:

Honda: Accord, Civic, Odyssey



Pkg. Qty: 25

PN 90926

Honda: 90664-671-0030

Weatherstrip Retainer

White Nylon

Head Size: 7mm x 16mm

Stem Length: 10mm

Fits into 5mm (3/16") Hole

Applications:

Honda



Pkg. Qty: 50

PN 90928

Honda: 73862-672-0030

Weatherstrip Retainer

White Nylon

Head Size: 7mm x 16mm

Stem Length: 5.25mm

Fits into 6mm Hole

Applications:

Honda



Pkg. Qty: 50

PN 90929

Honda: 91568-SR2-003

Weatherstrip Retainer

Green Nylon

Head Size: 5mm x 15mm

Stem Length: 10mm

Fits into 5mm Hole

Applications:

Honda: Odyssey 1995-up



Pkg. Qty: 100

PN 90931

**Infiniti/Nissan:
76882-6P010**

Hood & Front Weatherstrip
Fender Bracket Clip
Natural Nylon
Head Size: 15mm
Overall Length: 21.6mm
Fits into 6mm Hole Size

Applications:
Infiniti: Q45 1996-1999,
Nissan: Maxima 2002-2004



Pkg. Qty: 25

PN 90932

Infiniti: 65810-K2000

Hood Seal Retaining Clip
Black Nylon
Head Size: 6.4mm x 16mm
Stem Diameter: 3.5mm x 6mm
Stem Length: 10mm

Applications:
Infiniti: I30, I35, Q45, QX4
Nissan: Maxima & Pathfinder
1996-2004



Pkg. Qty: 25

PN 90934

Lexus: 90467-06092

Retaining Clip
Black Nylon
Head Size: 8mm x 17mm
Stem Length: 14mm
Fits into 8mm Hole

Applications:
Lexus: 1990-up



Pkg. Qty: 10

PN 90933

Toyota: 67867-50020

Hood & Front Weatherstrip
Fender Bracket Clip
Black Nylon
Head Size: 13.7mm x 5mm
Overall Length: 8.5mm
Fits into 6mm Hole Size

Applications:
Lexus: GS300, LS400 1998-2005



Pkg. Qty: 25

PN 90936

Mazda: J001-56-741

Front Hood
Weatherstrip Retainer
Black Nylon
Head Diameter: 13.8mm
Stem Length: 12.2mm

Applications:
Mazda: 3, 5, 6, 626, 929, CX-7,
CX9, Millennia, MPV, MX-6 1992-up



Pkg. Qty: 25

PN 90164

**Chrysler: 4696129
GM: 21077575**

White Nylon
Weather-Strip Retainer
Head Diameter: 1/4" x 21/32"
Stem Diameter: 1/4"
Stem Length: 15/32"

Applications:
Chrysler



Pkg. Qty: 50

PN 90169

**Toyota: 678867-89103,
67867-28030**

Natural Nylon
Weather-Strip Retainer
Head Diameter: 5mm x 15mm
Stem Diameter: 10mm
Fits into 5mm Hole

Applications:
Toyota



Pkg. Qty: 50

PN 90189

Ford: C5AB-6220586A

Natural Nylon Door
Weatherstrip Retainer
Head Diameter: 3/16" x 1/2"
Stem Diameter: 3/16"
Stem Length: 5/8"

Applications:
Ford



Pkg. Qty: 50

PN 90937

**Nissan:
80850-89900**

Front & Rear Door,
Weatherstrip Retainer
White Nylon
Head Size: 5.75mm x 16mm
Stem Length: 12mm
Fits into 5mm x 6mm Hole

Applications:
Nissan: Maxima 2000-up



Pkg. Qty: 25

PN 90938

Subaru: 90331AA050

Front Door Weatherstrip,
Retaining Clip White Nylon
Head Size: 14mm x 5mm
Overall Height: 13mm
Fits into 6mm Hole

Applications:
Subaru: Forester 2001-2003



Pkg. Qty: 25

PN 90940

**Subaru:
90331GA090**

Roof Drip Rail, Front and Rear Door,
Weatherstrip Clip
Black Nylon
Head Diameter: 9mm
Overall Height: 15mm
Fits into 6mm Hole

Applications:
Subaru: Forester 1998-2008,
Legacy 1990-1994



Pkg. Qty: 25

PN 90941

Toyota: 90467-08045

Hood & Front Weatherstrip
Fender
Bracket Clip
Black Nylon
Head Diameter: 14mm
Overall Length: 13mm
Fits into 8mm Hole Size

Applications:
Toyota: Yaris 2007-up



Pkg. Qty: 25

PN 90942

Toyota: 67869-22030
Subaru: 909120024,
Honda: 91567-SR2-013

Quarter Lock Pillar
 Weatherstrip, Front & Rear Door, Glass
 Weatherstrip, Front Header Weatherstrip,
 Roof Side Rail Weatherstrip, Retaining Clip
 Black Nylon, Head Diameter: 10mm,
 Length: 12mm, Stem Diameter: 6mm

Applications:

Toyota: Camry 2002-2006, Celica 1990-2005, Corolla 2009-2011, Highlander 2001-2007, Matrix 2003-2008, MR2 1991-1995, Prius 2004-2009, RAV4 2006-2009, Solara 1999-2008, Supra 1993-1998



Pkg. Qty: 25

PN 90943

Toyota: 67869-12050

Front Door
 Weatherstrip Clip
 Black Nylon
 Head Diameter: 12mm
 Overall Height: 18mm

Applications:

Toyota: Corolla 2003-2007, Prius 2001-2003



Pkg. Qty: 25

PN 90951

Ford: 157979
Opel: 15979
VW: 1H0-837-719

Door Gasket,
 Weatherstrip Retainer
 Black with clear Nylon
 Grommet Insert
 Fits into 5.5mm Hole

Applications:

Ford; Opel: Corsa 2007-up; **VW:** Golf A3, Saharan, Transporter, Vento



Pkg. Qty: 25

PN 90944

Toyota: 90467-04034

Front & Rear Door Glass
 Weatherstrip Clip

Applications:

Toyota: Avalon 2005-2011, Corolla 2009-2011, Highlander 2008-11, Matrix 2003-2011, Prius 2009-2011, RAV4 2009-2011, Venza 2009-2011

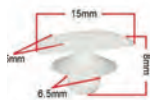

Pkg. Qty: 25

PN 90945

Toyota: 67867-12150

Weatherstrip Retainer
 White Nylon
 Head Size: 5mm x 15mm
 Stem Length: 10mm
 Fits into 6mm Hole

Applications:

Toyota: Avalon 1995-up



Pkg. Qty: 15

PN 90946

Toyota: 90467-06128

Hood to Radiator Grille
 Weatherstrip Seal Retainer
 Black Nylon
 Head Diameter: 12mm
 Stem Length: 11
 Fits into 6mm Hole

Applications:

Toyota: Camry, RAV4 1992-up



Pkg. Qty: 15

PN 90947

Toyota: 67868-30030

Front, Rear Door and
 Roof Rail Clip
 Black Nylon
 Head Diameter: 9mm
 Stem Length: 8mm
 Fits into 4mm Hole

Applications:

Toyota: Camry, Corolla, Corona, Land Cruiser 1974-1999



Pkg. Qty: 25

PN 90948

Toyota: 90467-08101

Hood to Cowl Top Seal Clip
 Black Nylon
 Head Size: 7mm x 13mm
 Stem Length: 13mm
 Fits into 6mm Hole

Applications:

Toyota: Camry, Sequoia, Solara, Tundra 1997-up



Pkg. Qty: 25

PN 90952

Mercedes-Benz: A901-988-00-25;
VW: 2D1867741

Rear Entry Scuff Plate
 Retaining Pin,
 Black Nylon
 Head Diameter: 14.7mm
 Overall Length: 30mm

Applications:

Mercedes-Benz: Sprinter 1995-up **VW:** LT Van 1987-2007



Pkg. Qty: 25

PN 90041

GM: 2964547

Black Universal Nylon
 Weather Strip Retainer
 Head Diameter: 3/8"
 Stem Diameter: 7/32"
 Stem Length: 3/8"

Applications:

GM



Pkg. Qty: 25

PN 90953

Mercedes-Benz:
0029948145,
0069883578

Fender Wheel Well
Retainer
White Nylon
Size: 30mm x 27mm

Applications:

Mercedes-Benz: C, CLK,
E, SL 1998-2013



Pkg. Qty: 10

WINDOW GLASS GUIDE MOUNT

PN 90954

BMW:
51-32-1-938-884
Volvo: 3509416

Door Window Left Mechanism
with Wire Clip Retainer, White Nylon
Size: 29mm x 33.7mm

Applications:

BMW: 3, 5, 7, M, Z Series 1996-up;
Volvo 960 1992-1997, S60 2001-
2009, S80 1999-2006, S90 1997-
1998, XC70, XC90 2000-up



Pkg. Qty: 2

PN 90955

**GM: 10051034,
20123070, 20328600**

Front Door Upper Window Guide
Black Nylon

Applications:

GM: Electra, Estate Wagon, LeSabre,
Skylark, DeVille, Impala Wagon,
Caprice, Citation, Delta 88, Custom,
Cruiser, Regency, Omega, Catalina &
Safari, Phoenix



Pkg. Qty: 25

PN 90956

GM: 20160591

Front Door Upper
Window Guide
Black Nylon

Applications:

Caprice 1980-1990, Cavalier 1987,
Cruiser 1980-1990, Custom, Delta
88, DeVille 1983-up, Electra 1984-up,
Fleetwood Brougham, LeSabre 1980-
1990, Parisians & Safari 1981-1989,
Regency 1980-1984, Sunbird 1987



Pkg. Qty: 25

PN 90957

**GM: 20162174,
22543363**

Front Door Window Guide
Black Nylon

Applications:

GM: Caprice, Catalina, Citation,
Cruiser, Custom, Delta 1988,
DeVilLe, Electra, Estate Wagon,
Impala Wagon, LeSabre,
Omega, Phoenix, Regency,
Skylark, Safari



Pkg. Qty: 25

PN 90958

**GM: 12337898,
20747508**

Front Door Window Guide
Front Glass
Black Nylon

Applications:

GM: Caprice, Catalina, Citation,
Cruiser, Custom, DeVilLe, Delta
88, Electra, Estate Wagon, Impala
Wagon, LeSabre, Omega, Phoenix,
Regency, Safari, Skylark



Pkg. Qty: 15

PN 90959

**GM: 20478733,
22539533**

Front Door Window Guide
Rear of Glass
Black Nylon

Applications:

Buick: Skylark, Somerset 1991-1985
Chevrolet: Lumina APV 1990-up
Oldsmobile: Calais 1991-1985,
Silhouette 1990-up **Pontiac:** Grand Am
1991-1985, Trans Sport 1990-up



Pkg. Qty: 15

PN 90960

**GM: 12353912,
20487630, 20712176**

Front Door Window Guide,
Front of Glass (4mm thick)
Black Nylon

Applications:

Buick: Skylark, Somerset 1991-1985
Chevrolet: Lumina APV 1990-up
Oldsmobile: Calais 1991-1985,
Silhouette 1990-up **Pontiac:** Grand
Am 1991-1985, Trans Sport 1990-up



Pkg. Qty: 15

PN 90961

Nissan: 69951-12180

Glass Mount Bracket
M-1.0 Thread Natural Nylon
Size: 40mm x 36mm

Applications:

Nissan



Pkg. Qty: 5

INDEX

| Shark # | Page # | Shark # | Page # | Shark # | Page # | Shark # | Page # | Shark # | Page # | Shark # | Page # |
|---------|--------|---------|--------|---------|--------|---------|--------|---------|--------|---------|--------|
| 76 | 64 | 90039 | 14 | 90080 | 18 | 90123 | 22 | 90165 | 75 | 90206 | 76 |
| 15216 | 64 | 90040 | 14 | 90081 | 18 | 90124 | 22 | 90166 | 78 | 90207 | 76 |
| 15217 | 64 | 90041 | 92 | 90082 | 18 | 90125 | 22 | 90167 | 20 | 90208 | 76 |
| 90000 | 10 | 90042 | 58 | 90083 | 18 | 90126 | 22 | 90168 | 20 | 90209 | 76 |
| 90001 | 10 | 90043 | 14 | 90084 | 18 | 90127 | 22 | 90169 | 91 | 90210 | 76 |
| 90002 | 10 | 90044 | 14 | 90085 | 18 | 90128 | 22 | 90170 | 78 | 90211 | 76 |
| 90003 | 10 | 90045 | 14 | 90086 | 18 | 90129 | 23 | 90171 | 75 | 90212 | 79 |
| 90005 | 10 | 90046 | 14 | 90087 | 18 | 90130 | 23 | 90172 | 13 | 90213 | 76 |
| 90006 | 10 | 90047 | 15 | 90088 | 18 | 90131 | 23 | 90173 | 13 | 90214 | 76 |
| 90007 | 10 | 90048 | 15 | 90089 | 18 | 90132 | 23 | 90174 | 13 | 90215 | 77 |
| 90008 | 10 | 90049 | 15 | 90090 | 18 | 90133 | 23 | 90175 | 13 | 90216 | 71 |
| 90009 | 10 | 90050 | 15 | 90091 | 19 | 90134 | 23 | 90176 | 13 | 90217 | 14 |
| 90010 | 10 | 90051 | 15 | 90092 | 19 | 90135 | 23 | 90177 | 62 | 90218 | 77 |
| 90011 | 10 | 90052 | 15 | 90093 | 75 | 90136 | 23 | 90178 | 62 | 90219 | 77 |
| 90012 | 11 | 90053 | 15 | 90094 | 20 | 90137 | 23 | 90179 | 63 | 90220 | 89 |
| 90013 | 11 | 90054 | 16 | 90095 | 20 | 90138 | 23 | 90180 | 62 | 90221 | 11 |
| 90014 | 11 | 90055 | 16 | 90096 | 20 | 90139 | 24 | 90181 | 62 | 90222 | 62 |
| 90015 | 11 | 90056 | 16 | 90097 | 20 | 90140 | 24 | 90182 | 62 | 90223 | 77 |
| 90016 | 11 | 90057 | 16 | 90098 | 20 | 90141 | 25 | 90183 | 62 | 90224 | 26 |
| 90017 | 87 | 90058 | 16 | 90099 | 23 | 90142 | 24 | 90184 | 62 | 90225 | 26 |
| 90018 | 11 | 90059 | 16 | 90101 | 20 | 90143 | 24 | 90185 | 87 | 90226 | 26 |
| 90019 | 11 | 90060 | 16 | 90102 | 20 | 90144 | 24 | 90186 | 62 | 90227 | 77 |
| 90020 | 11 | 90061 | 16 | 90103 | 21 | 90145 | 24 | 90187 | 87 | 90228 | 26 |
| 90021 | 12 | 90062 | 16 | 90104 | 21 | 90146 | 24 | 90188 | 87 | 90229 | 26 |
| 90022 | 12 | 90063 | 16 | 90105 | 21 | 90147 | 25 | 90189 | 91 | 90230 | 26 |
| 90023 | 12 | 90064 | 16 | 90106 | 21 | 90148 | 25 | 90190 | 60 | 90231 | 26 |
| 90024 | 12 | 90065 | 16 | 90107 | 21 | 90149 | 25 | 90191 | 26 | 90232 | 27 |
| 90025 | 12 | 90066 | 17 | 90108 | 21 | 90150 | 25 | 90192 | 58 | 90233 | 27 |
| 90026 | 12 | 90067 | 17 | 90109 | 21 | 90151 | 25 | 90193 | 13 | 90234 | 27 |
| 90027 | 12 | 90068 | 17 | 90110 | 21 | 90152 | 25 | 90194 | 13 | 90235 | 27 |
| 90028 | 12 | 90069 | 17 | 90111 | 21 | 90153 | 25 | 90195 | 58 | 90236 | 27 |
| 90029 | 12 | 90070 | 17 | 90112 | 21 | 90154 | 25 | 90196 | 75 | 90237 | 27 |
| 90030 | 12 | 90071 | 17 | 90113 | 21 | 90155 | 25 | 90197 | 75 | 90238 | 27 |
| 90031 | 12 | 90072 | 17 | 90114 | 21 | 90156 | 25 | 90198 | 75 | 90239 | 27 |
| 90032 | 12 | 90073 | 87 | 90115 | 22 | 90157 | 25 | 90199 | 75 | 90241 | 27 |
| 90033 | 13 | 90074 | 17 | 90116 | 22 | 90158 | 26 | 90200 | 88 | 90242 | 27 |
| 90034 | 13 | 90075 | 17 | 90117 | 75 | 90159 | 26 | 90201 | 78 | 90243 | 27 |
| 90035 | 13 | 90076 | 17 | 90118 | 22 | 90161 | 26 | 90202 | 76 | 90244 | 27 |
| 90036 | 13 | 90077 | 17 | 90119 | 22 | 90162 | 40 | 90203 | 76 | 90245 | 28 |
| 90037 | 14 | 90078 | 17 | 90121 | 22 | 90163 | 20 | 90204 | 76 | 90246 | 28 |
| 90038 | 14 | 90079 | 18 | 90122 | 22 | 90164 | 91 | 90205 | 76 | 90247 | 28 |

INDEX

| Shark # | Page # | Shark # | Page # | Shark # | Page # | Shark # | Page # | Shark # | Page # | Shark # | Page # |
|---------|--------|---------|--------|---------|--------|---------|--------|---------|--------|---------|--------|
| 90248 | 28 | 90289 | 31 | 90330 | 35 | 90372 | 39 | 90414 | 42 | 90455 | 79 |
| 90249 | 28 | 90290 | 31 | 90331 | 35 | 90373 | 39 | 90415 | 42 | 90456 | 46 |
| 90250 | 28 | 90291 | 31 | 90332 | 11 | 90374 | 39 | 90416 | 42 | 90457 | 46 |
| 90251 | 28 | 90292 | 31 | 90333 | 35 | 90375 | 39 | 90417 | 42 | 90458 | 46 |
| 90252 | 28 | 90293 | 31 | 90334 | 35 | 90376 | 39 | 90418 | 43 | 90459 | 46 |
| 90253 | 28 | 90294 | 31 | 90335 | 35 | 90377 | 39 | 90419 | 43 | 90460 | 46 |
| 90254 | 28 | 90295 | 58 | 90336 | 36 | 90378 | 39 | 90420 | 43 | 90461 | 46 |
| 90255 | 28 | 90296 | 31 | 90337 | 36 | 90379 | 39 | 90421 | 43 | 90462 | 46 |
| 90256 | 28 | 90297 | 31 | 90338 | 36 | 90380 | 39 | 90422 | 43 | 90463 | 46 |
| 90257 | 29 | 90298 | 32 | 90339 | 36 | 90381 | 39 | 90423 | 43 | 90464 | 46 |
| 90258 | 29 | 90299 | 32 | 90340 | 36 | 90382 | 39 | 90424 | 43 | 90465 | 47 |
| 90259 | 29 | 90300 | 32 | 90341 | 36 | 90383 | 40 | 90425 | 43 | 90466 | 47 |
| 90260 | 29 | 90301 | 32 | 90342 | 36 | 90384 | 40 | 90426 | 43 | 90467 | 47 |
| 90261 | 29 | 90302 | 32 | 90343 | 36 | 90385 | 40 | 90427 | 43 | 90468 | 47 |
| 90262 | 29 | 90303 | 32 | 90344 | 36 | 90386 | 40 | 90428 | 43 | 90469 | 47 |
| 90263 | 29 | 90304 | 32 | 90345 | 36 | 90387 | 40 | 90429 | 77 | 90470 | 47 |
| 90264 | 29 | 90305 | 32 | 90346 | 37 | 90388 | 40 | 90430 | 44 | 90471 | 47 |
| 90265 | 29 | 90306 | 32 | 90347 | 37 | 90389 | 40 | 90431 | 44 | 90472 | 47 |
| 90266 | 19 | 90307 | 32 | 90348 | 37 | 90390 | 40 | 90432 | 62 | 90473 | 47 |
| 90267 | 19 | 90308 | 32 | 90349 | 37 | 90391 | 40 | 90433 | 77 | 90474 | 59 |
| 90268 | 19 | 90309 | 32 | 90350 | 37 | 90392 | 40 | 90434 | 44 | 90475 | 47 |
| 90269 | 29 | 90310 | 33 | 90351 | 37 | 90393 | 41 | 90435 | 44 | 90476 | 47 |
| 90270 | 29 | 90311 | 33 | 90352 | 37 | 90394 | 41 | 90436 | 44 | 90477 | 47 |
| 90271 | 29 | 90312 | 33 | 90353 | 37 | 90395 | 41 | 90437 | 44 | 90478 | 48 |
| 90272 | 30 | 90313 | 33 | 90354 | 37 | 90396 | 41 | 90438 | 44 | 90479 | 48 |
| 90273 | 30 | 90314 | 33 | 90355 | 37 | 90397 | 41 | 90439 | 44 | 90480 | 59 |
| 90274 | 30 | 90315 | 33 | 90356 | 37 | 90398 | 41 | 90440 | 44 | 90481 | 48 |
| 90275 | 30 | 90316 | 33 | 90357 | 37 | 90399 | 41 | 90441 | 45 | 90482 | 48 |
| 90276 | 30 | 90317 | 33 | 90358 | 38 | 90401 | 41 | 90442 | 45 | 90483 | 48 |
| 90277 | 30 | 90318 | 34 | 90359 | 38 | 90402 | 41 | 90443 | 45 | 90484 | 48 |
| 90278 | 30 | 90319 | 34 | 90361 | 38 | 90403 | 41 | 90444 | 45 | 90485 | 48 |
| 90279 | 30 | 90320 | 34 | 90362 | 38 | 90404 | 41 | 90445 | 45 | 90486 | 48 |
| 90280 | 30 | 90321 | 34 | 90363 | 38 | 90405 | 41 | 90446 | 45 | 90487 | 48 |
| 90281 | 30 | 90322 | 34 | 90364 | 38 | 90406 | 42 | 90447 | 45 | 90488 | 48 |
| 90282 | 30 | 90323 | 34 | 90365 | 38 | 90407 | 42 | 90448 | 45 | 90489 | 48 |
| 90283 | 79 | 90324 | 34 | 90366 | 38 | 90408 | 42 | 90449 | 45 | 90490 | 49 |
| 90284 | 30 | 90325 | 34 | 90367 | 38 | 90409 | 42 | 90450 | 45 | 90491 | 49 |
| 90285 | 31 | 90326 | 34 | 90368 | 38 | 90410 | 42 | 90451 | 45 | 90492 | 49 |
| 90286 | 31 | 90327 | 34 | 90369 | 38 | 90411 | 42 | 90452 | 20 | 90493 | 49 |
| 90287 | 31 | 90328 | 34 | 90370 | 38 | 90412 | 42 | 90453 | 77 | 90494 | 49 |
| 90288 | 31 | 90329 | 34 | 90371 | 39 | 90413 | 42 | 90454 | 46 | 90495 | 77 |

INDEX

| Shark # | Page # | Shark # | Page # | Shark # | Page # | Shark # | Page # | Shark # | Page # | Shark # | Page # |
|---------|--------|---------|--------|---------|--------|---------|--------|---------|--------|---------|--------|
| 90496 | 49 | 90537 | 52 | 90577 | 55 | 90620 | 59 | 90663 | 11 | 90706 | 68 |
| 90497 | 49 | 90538 | 52 | 90578 | 56 | 90621 | 59 | 90666 | 65 | 90707 | 68 |
| 90498 | 49 | 90539 | 52 | 90579 | 56 | 90622 | 59 | 90667 | 65 | 90708 | 68 |
| 90499 | 49 | 90540 | 52 | 90580 | 56 | 90623 | 59 | 90668 | 65 | 90709 | 68 |
| 90501 | 49 | 90541 | 53 | 90581 | 62 | 90624 | 60 | 90669 | 65 | 90710 | 68 |
| 90502 | 49 | 90542 | 53 | 90582 | 56 | 90625 | 60 | 90670 | 65 | 90712 | 68 |
| 90503 | 50 | 90543 | 53 | 90583 | 56 | 90626 | 60 | 90671 | 65 | 90713 | 3 |
| 90504 | 50 | 90544 | 53 | 90584 | 56 | 90627 | 60 | 90672 | 65 | 90714 | 68 |
| 90505 | 50 | 90545 | 53 | 90585 | 56 | 90628 | 60 | 90673 | 65 | 90715 | 68 |
| 90506 | 50 | 90546 | 53 | 90586 | 56 | 90629 | 60 | 90674 | 65 | 90716 | 68 |
| 90507 | 50 | 90547 | 53 | 90587 | 56 | 90630 | 60 | 90675 | 65 | 90717 | 69 |
| 90508 | 50 | 90548 | 53 | 90591 | 56 | 90631 | 60 | 90676 | 65 | 90718 | 69 |
| 90509 | 50 | 90549 | 53 | 90592 | 56 | 90632 | 60 | 90677 | 66 | 90719 | 69 |
| 90510 | 50 | 90550 | 53 | 90593 | 56 | 90633 | 3 | 90678 | 65 | 90720 | 69 |
| 90511 | 50 | 90551 | 53 | 90594 | 57 | 90634 | 61 | 90679 | 66 | 90721 | 3 |
| 90512 | 50 | 90552 | 24 | 90595 | 57 | 90635 | 61 | 90680 | 66 | 90722 | 69 |
| 90513 | 50 | 90553 | 53 | 90596 | 57 | 90636 | 61 | 90681 | 66 | 90723 | 69 |
| 90514 | 50 | 90554 | 54 | 90597 | 57 | 90637 | 61 | 90682 | 66 | 90725 | 69 |
| 90515 | 51 | 90555 | 54 | 90598 | 57 | 90638 | 61 | 90683 | 66 | 90726 | 33 |
| 90516 | 51 | 90556 | 54 | 90599 | 57 | 90639 | 61 | 90684 | 66 | 90727 | 69 |
| 90517 | 51 | 90557 | 54 | 90600 | 57 | 90640 | 61 | 90685 | 66 | 90728 | 69 |
| 90518 | 51 | 90558 | 54 | 90601 | 57 | 90641 | 61 | 90686 | 66 | 90729 | 69 |
| 90519 | 51 | 90559 | 54 | 90602 | 57 | 90642 | 61 | 90687 | 66 | 90730 | 69 |
| 90520 | 51 | 90560 | 54 | 90603 | 80 | 90643 | 61 | 90688 | 66 | 90731 | 69 |
| 90521 | 51 | 90561 | 54 | 90604 | 57 | 90644 | 61 | 90689 | 66 | 90732 | 70 |
| 90522 | 51 | 90562 | 54 | 90605 | 57 | 90645 | 62 | 90690 | 67 | 90733 | 70 |
| 90523 | 51 | 90563 | 54 | 90606 | 58 | 90646 | 13 | 90691 | 67 | 90734 | 70 |
| 90524 | 51 | 90564 | 54 | 90607 | 58 | 90647 | 62 | 90692 | 75 | 90735 | 70 |
| 90525 | 51 | 90565 | 54 | 90608 | 58 | 90648 | 62 | 90693 | 67 | 90736 | 70 |
| 90526 | 51 | 90566 | 55 | 90609 | 80 | 90649 | 62 | 90694 | 67 | 90737 | 70 |
| 90527 | 52 | 90567 | 55 | 90610 | 58 | 90650 | 63 | 90695 | 67 | 90738 | 70 |
| 90528 | 52 | 90568 | 55 | 90611 | 58 | 90651 | 63 | 90696 | 67 | 90739 | 70 |
| 90529 | 77 | 90569 | 55 | 90612 | 58 | 90653 | 63 | 90698 | 67 | 90740 | 70 |
| 90530 | 77 | 90570 | 55 | 90613 | 58 | 90654 | 63 | 90699 | 67 | 90741 | 70 |
| 90531 | 52 | 90571 | 55 | 90614 | 58 | 90655 | 63 | 90700 | 67 | 90742 | 70 |
| 90532 | 52 | 90572 | 55 | 90615 | 59 | 90656 | 64 | 90701 | 67 | 90743 | 70 |
| 90533 | 52 | 90573 | 55 | 90616 | 59 | 90658 | 64 | 90702 | 67 | 90744 | 71 |
| 90534 | 52 | 90574 | 55 | 90617 | 59 | 90659 | 64 | 90703 | 67 | 90745 | 71 |
| 90535 | 52 | 90575 | 55 | 90618 | 59 | 90660 | 64 | 90704 | 68 | 90746 | 71 |
| 90536 | 52 | 90576 | 55 | 90619 | 59 | 90661 | 63 | 90705 | 68 | 90747 | 71 |

INDEX

| Shark # | Page # |
|---------|--------|
| 90748 | 71 |
| 90749 | 71 |
| 90750 | 71 |
| 90751 | 71 |
| 90752 | 71 |
| 90753 | 71 |
| 90754 | 71 |
| 90755 | 72 |
| 90756 | 72 |
| 90757 | 74 |
| 90758 | 72 |
| 90759 | 74 |
| 90760 | 72 |
| 90761 | 72 |
| 90762 | 72 |
| 90763 | 72 |
| 90764 | 72 |
| 90765 | 72 |
| 90766 | 74 |
| 90767 | 72 |
| 90768 | 72 |
| 90769 | 72 |
| 90770 | 73 |
| 90771 | 73 |
| 90772 | 73 |
| 90773 | 73 |
| 90774 | 73 |
| 90775 | 73 |
| 90776 | 73 |
| 90777 | 73 |
| 90778 | 73 |
| 90779 | 78 |
| 90780 | 78 |
| 90781 | 78 |
| 90782 | 78 |
| 90783 | 78 |
| 90784 | 78 |
| 90785 | 78 |
| 90786 | 78 |
| 90787 | 78 |

| Shark # | Page # |
|---------|--------|
| 90788 | 74 |
| 90789 | 74 |
| 90790 | 79 |
| 90791 | 79 |
| 90792 | 79 |
| 90793 | 79 |
| 90794 | 79 |
| 90796 | 79 |
| 90797 | 80 |
| 90799 | 79 |
| 90801 | 80 |
| 90802 | 79 |
| 90803 | 80 |
| 90804 | 80 |
| 90805 | 80 |
| 90806 | 80 |
| 90807 | 81 |
| 90808 | 81 |
| 90809 | 81 |
| 90810 | 81 |
| 90811 | 74 |
| 90812 | 81 |
| 90813 | 81 |
| 90814 | 81 |
| 90815 | 81 |
| 90816 | 81 |
| 90817 | 81 |
| 90818 | 81 |
| 90819 | 81 |
| 90820 | 82 |
| 90821 | 82 |
| 90822 | 82 |
| 90823 | 82 |
| 90824 | 82 |
| 90825 | 82 |
| 90826 | 82 |
| 90827 | 74 |
| 90828 | 82 |
| 90829 | 82 |
| 90830 | 82 |

| Shark # | Page # |
|---------|--------|
| 90831 | 82 |
| 90832 | 83 |
| 90833 | 83 |
| 90834 | 83 |
| 90835 | 80 |
| 90836 | 83 |
| 90837 | 83 |
| 90838 | 83 |
| 90839 | 83 |
| 90840 | 83 |
| 90841 | 83 |
| 90842 | 83 |
| 90843 | 83 |
| 90844 | 83 |
| 90845 | 84 |
| 90846 | 84 |
| 90847 | 84 |
| 90848 | 84 |
| 90850 | 84 |
| 90851 | 84 |
| 90852 | 84 |
| 90853 | 84 |
| 90854 | 84 |
| 90855 | 84 |
| 90856 | 84 |
| 90857 | 84 |
| 90858 | 85 |
| 90859 | 85 |
| 90860 | 85 |
| 90861 | 85 |
| 90862 | 85 |
| 90863 | 85 |
| 90864 | 85 |
| 90865 | 85 |
| 90866 | 85 |
| 90867 | 74 |
| 90868 | 85 |
| 90869 | 85 |
| 90870 | 86 |
| 90871 | 86 |

| Shark # | Page # |
|---------|--------|
| 90872 | 86 |
| 90873 | 86 |
| 90874 | 74 |
| 90875 | 86 |
| 90876 | 86 |
| 90878 | 86 |
| 90879 | 86 |
| 90880 | 86 |
| 90881 | 86 |
| 90882 | 19 |
| 90883 | 86 |
| 90884 | 86 |
| 90885 | 87 |
| 90886 | 87 |
| 90887 | 87 |
| 90900 | 88 |
| 90901 | 88 |
| 90902 | 88 |
| 90903 | 88 |
| 90904 | 88 |
| 90905 | 88 |
| 90906 | 88 |
| 90907 | 88 |
| 90908 | 89 |
| 90909 | 89 |
| 90912 | 90 |
| 90913 | 90 |
| 90914 | 90 |
| 90915 | 89 |
| 90916 | 89 |
| 90917 | 90 |
| 90918 | 89 |
| 90919 | 90 |
| 90920 | 90 |
| 90921 | 89 |
| 90922 | 90 |
| 90923 | 90 |
| 90924 | 90 |
| 90925 | 74 |
| 90926 | 90 |

| Shark # | Page # |
|---------|--------|
| 90927 | 74 |
| 90928 | 90 |
| 90929 | 90 |
| 90930 | 74 |
| 90931 | 91 |
| 90932 | 91 |
| 90933 | 91 |
| 90934 | 91 |
| 90935 | 85 |
| 90936 | 91 |
| 90937 | 91 |
| 90938 | 91 |
| 90940 | 91 |
| 90941 | 91 |
| 90942 | 92 |
| 90943 | 92 |
| 90944 | 92 |
| 90945 | 92 |
| 90946 | 92 |
| 90947 | 92 |
| 90948 | 92 |
| 90949 | 75 |
| 90950 | 75 |
| 90951 | 92 |
| 90952 | 92 |
| 90953 | 93 |
| 90954 | 93 |
| 90955 | 93 |
| 90956 | 93 |
| 90957 | 93 |
| 90958 | 93 |
| 90959 | 93 |
| 90960 | 93 |
| 90961 | 93 |
| 90962 | 88 |
| 90963 | 45 |
| 90964 | 46 |
| 90965 | 88 |
| 90966 | 57 |
| 90967 | 49 |

| Shark # | Page # |
|---------|--------|
| 90968 | 64 |
| 90969 | 61 |
| 90970 | 36 |
| 90971 | 44 |
| 90972 | 26 |
| 90973 | 44 |
| 90974 | 44 |
| 90975 | 23 |
| 90976 | 82 |
| 90977 | 48 |
| 90978 | 63 |
| 90979 | 63 |
| 90980 | 64 |
| 90981 | 64 |
| 90982 | 75 |
| 90983 | 68 |
| 90984 | 46 |
| 90985 | 11 |
| 90986 | 73 |
| 90987 | 64 |
| 90988 | 64 |
| 91004 | 4 |
| 91005 | 4 |
| 91006 | 4 |
| 91007 | 5 |
| 91008 | 5 |
| 91009 | 5 |
| 91010 | 6 |
| 91011 | 6 |
| 91012 | 7 |
| 91013 | 7 |
| 91014 | 8 |
| 91015 | 8 |
| 91016 | 8 |
| 91017 | 9 |
| 91018 | 9 |

Auveco Crossover

| Auveco # | Shark # | Page # |
|----------|---------|--------|
| 1423 | 90093 | 75 |
| 1483 | 90117 | 75 |
| 1799 | 90165 | 75 |
| 2751 | 90166 | 78 |
| 2772 | 90170 | 78 |
| 2895 | 90529 | 77 |
| 2896 | 90530 | 77 |
| 3000 | 90921 | 89 |
| 3156 | 90909 | 89 |
| 3405 | 90171 | 75 |
| 8300 | 90178 | 62 |
| 8311 | 90184 | 62 |
| 8312 | 90182 | 62 |
| 8418 | 90695 | 67 |
| 8853 | 90189 | 91 |
| 8865 | 90195 | 58 |
| 8925 | 90177 | 62 |
| 9069 | 90677 | 66 |
| 9288 | 90425 | 43 |
| 9289 | 90424 | 43 |
| 9377 | 90682 | 66 |
| 8435 | 90692 | 75 |
| 9603 | 90788 | 74 |
| 9611 | 90196 | 75 |
| 9829 | 90693 | 67 |
| 9862 | 90683 | 66 |
| 9879 | 90905 | 88 |
| 9880 | 90906 | 88 |
| 10050 | 90901 | 88 |
| 10066 | 90907 | 88 |
| 10164 | 90197 | 75 |
| 10166 | 90198 | 75 |
| 10330 | 90691 | 67 |
| 10332 | 90190 | 60 |
| 10621 | 90070 | 17 |
| 10571 | 90320 | 20 |
| 10733 | 90199 | 75 |
| 10744 | 90920 | 90 |
| 10831 | 90808 | 81 |
| 10832 | 90833 | 83 |
| 11120 | 90861 | 85 |

| Auveco # | Shark # | Page # |
|----------|---------|--------|
| 11129 | 90041 | 92 |
| 11130 | 90109 | 21 |
| 11136 | 90106 | 21 |
| 11146 | 90976 | 82 |
| 11152 | 90147 | 25 |
| 11245 | 90095 | 20 |
| 11288 | 90225 | 26 |
| 11345 | 90228 | 26 |
| 11349 | 90055 | 16 |
| 11351 | 90829 | 82 |
| 11368 | 90685 | 66 |
| 11369 | 90930 | 74 |
| 11612 | 90809 | 81 |
| 11620 | 90630 | 60 |
| 11621 | 90631 | 60 |
| 11629 | 90900 | 88 |
| 11630 | 90902 | 88 |
| 11631 | 90200 | 88 |
| 11641 | 90201 | 78 |
| 11645 | 90202 | 76 |
| 11671 | 90069 | 17 |
| 11672 | 90065 | 16 |
| 11673 | 90820 | 82 |
| 11675 | 90830 | 82 |
| 11678 | 90054 | 16 |
| 11679 | 90828 | 82 |
| 11699 | 90450 | 45 |
| 11705 | 90461 | 46 |
| 11706 | 90464 | 46 |
| 11719 | 90982 | 75 |
| 11721 | 90882 | 19 |
| 11746 | 90426 | 43 |
| 11747 | 90428 | 43 |
| 11796 | 90077 | 17 |
| 11797 | 90068 | 17 |
| 11838 | 90688 | 66 |
| 11842 | 90191 | 26 |
| 11852 | 90183 | 62 |
| 12060 | 90203 | 76 |
| 12065 | 90007 | 10 |
| 12066 | 90011 | 10 |

| Auveco # | Shark # | Page # |
|----------|---------|--------|
| 12068 | 90792 | 79 |
| 12095 | 90204 | 76 |
| 12137 | 90850 | 84 |
| 12213 | 90205 | 76 |
| 12215 | 90781 | 78 |
| 12216 | 90206 | 76 |
| 12217 | 90207 | 76 |
| 12232 | 90000 | 10 |
| 12255 | 90208 | 76 |
| 12259 | 90209 | 76 |
| 12260 | 90210 | 76 |
| 12324 | 90211 | 76 |
| 12339 | 90212 | 79 |
| 12348 | 90213 | 76 |
| 12351 | 90793 | 79 |
| 12563 | 90224 | 26 |
| 12565 | 90064 | 16 |
| 12567 | 90977 | 48 |
| 12571 | 90843 | 83 |
| 12575 | 90904 | 88 |
| 12595 | 90319 | 34 |
| 12652 | 90186 | 62 |
| 12653 | 90635 | 61 |
| 12669 | 90903 | 88 |
| 12693 | 90010 | 10 |
| 12731 | 90853 | 84 |
| 12735 | 90681 | 66 |
| 12737 | 90130 | 23 |
| 12742 | 90609 | 80 |
| 12756 | 90487 | 48 |
| 12757 | 90494 | 49 |
| 12759 | 90855 | 84 |
| 12766 | 90859 | 85 |
| 12909 | 90839 | 83 |
| 12954 | 90214 | 76 |
| 12992 | 90076 | 17 |
| 13026 | 90215 | 77 |
| 13141 | 90736 | 70 |
| 13157 | 90738 | 70 |
| 13170 | 90775 | 73 |
| 13172 | 90398 | 41 |

| Auveco # | Shark # | Page # |
|----------|---------|--------|
| 13179 | 90344 | 36 |
| 13453 | 90071 | 17 |
| 13454 | 90854 | 84 |
| 13461 | 90080 | 18 |
| 13470 | 90066 | 17 |
| 13475 | 90057 | 16 |
| 13613 | 90008 | 10 |
| 13614 | 90009 | 10 |
| 13712 | 90783 | 78 |
| 13747 | 90658 | 64 |
| 13748 | 90654 | 63 |
| 13750 | 90978 | 63 |
| 13751 | 90979 | 63 |
| 13752 | 90980 | 64 |
| 13753 | 90981 | 64 |
| 13755 | 90649 | 62 |
| 13922 | 90552 | 24 |
| 13930 | 90735 | 70 |
| 13932 | 90744 | 71 |
| 13933 | 90689 | 66 |
| 13945 | 90268 | 19 |
| 13960 | 90690 | 67 |
| 13966 | 90678 | 65 |
| 13993 | 90482 | 48 |
| 13994 | 90470 | 47 |
| 13996 | 90481 | 48 |
| 14004 | 90659 | 64 |
| 14005 | 90655 | 63 |
| 14006 | 90858 | 85 |
| 14009 | 90696 | 67 |
| 14010 | 90967 | 49 |
| 14011 | 90496 | 49 |
| 14016 | 90457 | 46 |
| 14018 | 90192 | 58 |
| 14019 | 90963 | 45 |
| 14020 | 90471 | 47 |
| 14021 | 90840 | 83 |
| 14023 | 90660 | 64 |
| 14030 | 90700 | 67 |
| 14032 | 90188 | 87 |
| 14036 | 90852 | 84 |

Auveco Crossover

| Auveco # | Shark # | Page # |
|----------|---------|--------|
| 14127 | 90632 | 60 |
| 14144 | 90349 | 37 |
| 14163 | 90167 | 20 |
| 14258 | 90761 | 72 |
| 14260 | 90559 | 54 |
| 14265 | 90764 | 72 |
| 14266 | 90765 | 72 |
| 14267 | 90216 | 71 |
| 14268 | 90714 | 68 |
| 14269 | 90356 | 37 |
| 14271 | 90762 | 72 |
| 14274 | 90712 | 68 |
| 14275 | 90743 | 70 |
| 14281 | 90715 | 68 |
| 14282 | 90402 | 41 |
| 14284 | 90034 | 13 |
| 14287 | 90702 | 67 |
| 14289 | 90868 | 74 |
| 14298 | 90217 | 14 |
| 14299 | 90928 | 90 |
| 14313 | 90760 | 72 |
| 14319 | 90401 | 41 |
| 14323 | 90399 | 41 |
| 14328 | 90926 | 90 |
| 14347 | 90416 | 42 |
| 14348 | 90415 | 42 |
| 14349 | 90411 | 42 |
| 14353 | 90414 | 42 |
| 14356 | 90417 | 42 |
| 14359 | 90052 | 15 |
| 14365 | 90053 | 15 |
| 14367 | 90121 | 22 |
| 14369 | 90555 | 54 |
| 14378 | 90135 | 23 |
| 14380 | 90410 | 42 |
| 14473 | 90811 | 58 |
| 14545 | 90129 | 23 |
| 14546 | 90127 | 22 |
| 14547 | 90128 | 22 |
| 14642 | 90226 | 26 |
| 14695 | 90983 | 68 |

| Auveco # | Shark # | Page # |
|----------|---------|--------|
| 14696 | 90531 | 52 |
| 14697 | 90508 | 50 |
| 14698 | 90523 | 51 |
| 14720 | 90413 | 42 |
| 14723 | 90419 | 43 |
| 14725 | 90583 | 56 |
| 14726 | 90574 | 55 |
| 14727 | 90539 | 52 |
| 14732 | 90137 | 23 |
| 14736 | 90420 | 43 |
| 14737 | 90418 | 43 |
| 14738 | 90124 | 22 |
| 14739 | 90722 | 69 |
| 14750 | 90965 | 88 |
| 14753 | 90469 | 47 |
| 14757 | 90836 | 83 |
| 14855 | 90328 | 34 |
| 14856 | 90329 | 34 |
| 14921 | 90831 | 82 |
| 14923 | 90427 | 43 |
| 14953 | 90462 | 46 |
| 14967 | 90047 | 15 |
| 14980 | 90218 | 77 |
| 14992 | 90984 | 46 |
| 14994 | 90465 | 47 |
| 14997 | 90501 | 49 |
| 15040 | 90807 | 81 |
| 15042 | 90485 | 48 |
| 15043 | 90479 | 48 |
| 15044 | 90488 | 48 |
| 15045 | 90489 | 48 |
| 15170 | 90950 | 75 |
| 15187 | 90656 | 64 |
| 15331 | 90318 | 34 |
| 15335 | 90219 | 77 |
| 15367 | 90860 | 85 |
| 15373 | 90791 | 79 |
| 15456 | 90163 | 20 |
| 15462 | 90959 | 93 |
| 15463 | 90960 | 93 |
| 15466 | 90956 | 93 |

| Auveco # | Shark # | Page # |
|----------|---------|--------|
| 15467 | 90955 | 93 |
| 15478 | 90847 | 84 |
| 15479 | 90841 | 83 |
| 15480 | 90848 | 84 |
| 15481 | 90821 | 82 |
| 15490 | 90968 | 64 |
| 15518 | 90025 | 12 |
| 15523 | 90842 | 83 |
| 15543 | 90834 | 83 |
| 15669 | 90072 | 17 |
| 15670 | 90074 | 17 |
| 15673 | 90193 | 13 |
| 15674 | 90048 | 15 |
| 15675 | 90174 | 13 |
| 15695 | 90373 | 39 |
| 15701 | 90466 | 47 |
| 15702 | 90502 | 49 |
| 15709 | 90375 | 39 |
| 15752 | 90220 | 89 |
| 15775 | 90283 | 79 |
| 15759 | 90175 | 13 |
| 15774 | 90787 | 78 |
| 15827 | 90786 | 78 |
| 15970 | 90083 | 18 |
| 15997 | 90238 | 27 |
| 15998 | 90111 | 21 |
| 16000 | 90532 | 52 |
| 16017 | 90078 | 17 |
| 16031 | 90222 | 62 |
| 16306 | 90031 | 12 |
| 16323 | 90867 | 74 |
| 16421 | 90789 | 74 |
| 16622 | 90490 | 49 |
| 16624 | 90492 | 49 |
| 16625 | 90486 | 48 |
| 16671 | 90030 | 12 |
| 16691 | 90097 | 20 |
| 16695 | 90075 | 17 |
| 16725 | 90572 | 55 |
| 16775 | 90870 | 86 |
| 16777 | 90412 | 42 |

| Auveco # | Shark # | Page # |
|----------|---------|--------|
| 16778 | 90361 | 38 |
| 16781 | 90404 | 41 |
| 16782 | 90533 | 52 |
| 16783 | 90568 | 55 |
| 16784 | 90584 | 56 |
| 16816 | 90513 | 50 |
| 16818 | 90832 | 83 |
| 16826 | 90925 | 74 |
| 16833 | 90269 | 29 |
| 16834 | 90634 | 61 |
| 16835 | 90459 | 46 |
| 16843 | 90558 | 54 |
| 16858 | 90476 | 47 |
| 16859 | 90573 | 55 |
| 16863 | 90108 | 21 |
| 16949 | 90133 | 23 |
| 16950 | 90132 | 23 |
| 16951 | 90098 | 20 |
| 16960 | 90927 | 74 |
| 17004 | 90104 | 21 |
| 17057 | 90520 | 51 |
| 17069 | 90176 | 13 |
| 17075 | 90067 | 17 |
| 17080 | 90447 | 45 |
| 17098 | 90757 | 74 |
| 17101 | 90653 | 63 |
| 17102 | 90056 | 16 |
| 17103 | 90472 | 47 |
| 17121 | 90969 | 61 |
| 17122 | 90173 | 13 |
| 17143 | 90519 | 51 |
| 17144 | 90430 | 44 |
| 17162 | 90514 | 50 |
| 17176 | 90957 | 93 |
| 17192 | 90526 | 51 |
| 17194 | 90624 | 60 |
| 17195 | 90616 | 59 |
| 17196 | 90747 | 71 |
| 17205 | 90403 | 41 |
| 17206 | 90602 | 57 |
| 17215 | 90110 | 21 |

Auveco Crossover

| Auveco # | Shark # | Page # |
|----------|---------|--------|
| 17216 | 90964 | 46 |
| 17222 | 90511 | 50 |
| 17226 | 90483 | 48 |
| 17227 | 90491 | 49 |
| 17237 | 90975 | 23 |
| 17267 | 90431 | 44 |
| 17287 | 90524 | 51 |
| 17316 | 90766 | 74 |
| 17339 | 90918 | 89 |
| 17341 | 90958 | 93 |
| 17347 | 90535 | 52 |
| 17350 | 90521 | 51 |
| 17378 | 90567 | 55 |
| 17379 | 90522 | 51 |
| 17383 | 90484 | 48 |
| 17438 | 90625 | 60 |
| 17439 | 90548 | 53 |
| 17440 | 90239 | 27 |
| 17442 | 90243 | 27 |
| 17443 | 90237 | 27 |
| 17472 | 90566 | 55 |
| 17481 | 90301 | 32 |
| 17599 | 90857 | 84 |
| 17609 | 90703 | 67 |
| 17612 | 90826 | 82 |
| 17615 | 90627 | 60 |
| 17616 | 90503 | 50 |
| 17632 | 90475 | 47 |
| 17633 | 90043 | 14 |
| 17639 | 90629 | 60 |
| 17650 | 90784 | 78 |
| 17664 | 90866 | 85 |
| 17685 | 90347 | 37 |
| 17975 | 90168 | 20 |
| 17980 | 90759 | 74 |
| 17988 | 90549 | 53 |
| 17989 | 90258 | 29 |
| 17990 | 90409 | 42 |
| 17991 | 90934 | 91 |
| 17992 | 90540 | 52 |

| Auveco # | Shark # | Page # |
|----------|---------|--------|
| 18028 | 90650 | 63 |
| 18029 | 90449 | 45 |
| 18030 | 90458 | 46 |
| 18031 | 90648 | 62 |
| 18033 | 90164 | 91 |
| 18113 | 90961 | 93 |
| 18114 | 90393 | 41 |
| 18119 | 90534 | 52 |
| 18153 | 90024 | 12 |
| 18165 | 90518 | 51 |
| 18174 | 90851 | 84 |
| 18236 | 90145 | 24 |
| 18249 | 90679 | 66 |
| 18253 | 90326 | 34 |
| 18261 | 90603 | 79 |
| 18265 | 90571 | 55 |
| 18266 | 90185 | 87 |
| 18268 | 90504 | 50 |
| 18269 | 90460 | 46 |
| 18270 | 90541 | 53 |
| 18294 | 90351 | 37 |
| 18296 | 90785 | 78 |
| 18297 | 90421 | 43 |
| 18301 | 90856 | 84 |
| 18304 | 90581 | 62 |
| 18308 | 90493 | 49 |
| 18340 | 90223 | 77 |
| 18353 | 90497 | 49 |
| 18354 | 90949 | 75 |
| 18379 | 90838 | 83 |
| 18383 | 90686 | 66 |
| 18416 | 90012 | 11 |
| 18456 | 90142 | 24 |
| 18457 | 90615 | 59 |
| 18458 | 90919 | 90 |
| 18512 | 90131 | 23 |
| 18683 | 90017 | 87 |
| 18692 | 90169 | 91 |
| 18729 | 90661 | |
| 18746 | 90101 | 20 |

| Auveco # | Shark # | Page # |
|----------|---------|--------|
| 18747 | 90727 | 69 |
| 18769 | 90874 | 74 |
| 18771 | 90823 | 82 |
| 18815 | 90824 | 82 |
| 18816 | 90684 | 66 |
| 18818 | 90923 | 90 |
| 18842 | 90123 | 22 |
| 18843 | 90772 | 73 |
| 18862 | 90935 | 85 |
| 18873 | 90966 | 57 |
| 18877 | 90924 | 90 |
| 18888 | 90600 | 57 |
| 18894 | 90467 | 47 |
| 18896 | 90510 | 50 |
| 18897 | 90865 | 85 |
| 18915 | 90266 | 19 |
| 18926 | 90194 | 13 |
| 18939 | 90547 | 53 |
| 18951 | 90562 | 54 |
| 19006 | 90227 | 77 |
| 19016 | 90374 | 39 |
| 19109 | 90372 | 39 |
| 19114 | 90394 | 41 |
| 19115 | 90242 | 27 |
| 19116 | 90236 | 27 |
| 19118 | 90525 | 51 |
| 19120 | 90259 | 29 |
| 19127 | 90073 | 87 |
| 19128 | 90601 | 57 |
| 19136 | 90311 | 33 |
| 19140 | 90436 | 44 |
| 19142 | 90516 | 51 |
| 19149 | 90822 | 82 |
| 19170 | 90429 | 77 |
| 19171 | 90929 | 90 |
| 19194 | 90699 | 67 |
| 19202 | 90432 | 63 |
| 19205 | 90324 | 34 |
| 19213 | 90063 | 16 |
| 19233 | 90974 | 44 |

| Auveco # | Shark # | Page # |
|----------|---------|--------|
| 19239 | 90971 | 44 |
| 19240 | 90433 | 77 |
| 19246 | 90570 | 55 |
| 19248 | 90611 | 58 |
| 19257 | 90350 | 37 |
| 19270 | 90079 | 18 |
| 19274 | 90569 | 55 |
| 19293 | 90748 | 71 |
| 19307 | 90701 | 67 |
| 19309 | 90325 | 34 |
| 19311 | 90517 | 51 |
| 19312 | 90885 | 87 |
| 19322 | 90739 | 70 |
| 19324 | 90741 | 70 |
| 19334 | 90364 | 38 |
| 19338 | 90452 | 20 |
| 19386 | 90346 | 37 |
| 19415 | 90241 | 27 |
| 19417 | 90835 | 80 |
| 19422 | 90451 | 45 |
| 19428 | 90082 | 18 |
| 19430 | 90626 | 60 |
| 19441 | 90162 | 40 |
| 19453 | 90527 | 52 |
| 19454 | 90704 | 68 |
| 19456 | 90181 | 62 |
| 19461 | 90180 | 62 |
| 19467 | 90916 | 89 |
| 19483 | 90915 | 89 |
| 19511 | 90348 | 37 |
| 19533 | 90705 | 68 |
| 19534 | 90729 | 69 |
| 19607 | 90295 | 58 |
| 19613 | 90507 | 50 |
| 19614 | 90694 | 67 |
| 19615 | 90505 | 50 |
| 19639 | 90498 | 49 |
| 19645 | 90477 | 47 |
| 19646 | 90708 | 68 |
| 19650 | 90706 | 68 |

Auveco Crossover

| Auveco # | Shark # | Page # |
|----------|---------|--------|
| 19655 | 90107 | 21 |
| 19658 | 90049 | 15 |
| 19670 | 90143 | 24 |
| 19683 | 90914 | 90 |
| 19686 | 90883 | 86 |
| 19721 | 90763 | 72 |
| 19727 | 90771 | 73 |
| 19729 | 90115 | 22 |
| 19736 | 90749 | 71 |
| 19740 | 90144 | 24 |
| 19742 | 90767 | 72 |
| 19749 | 90945 | 92 |
| 19777 | 90827 | 74 |
| 19788 | 90506 | 50 |
| 19800 | 90229 | 26 |
| 19801 | 90512 | 50 |
| 19821 | 90230 | 26 |
| 19822 | 90231 | 26 |
| 19833 | 90734 | 70 |
| 19834 | 90862 | 85 |
| 19847 | 90499 | 49 |
| 19893 | 90187 | 87 |
| 19899 | 90264 | 29 |
| 19900 | 90260 | 29 |
| 19905 | 90582 | 56 |
| 19910 | 90376 | 39 |
| 20164 | 90105 | 21 |
| 20177 | 90844 | 83 |
| 20184 | 90884 | 86 |
| 20185 | 90578 | 56 |
| 20192 | 90845 | 84 |
| 20196 | 90605 | 57 |
| 20199 | 90953 | 93 |
| 20234 | 90441 | 45 |
| 20247 | 90563 | 54 |
| 20250 | 90777 | 73 |
| 20253 | 90155 | 25 |
| 20256 | 90879 | 86 |
| 20259 | 90780 | 78 |
| 20266 | 90750 | 71 |

| Auveco # | Shark # | Page # |
|----------|---------|--------|
| 20273 | 90454 | 46 |
| 20310 | 90463 | 46 |
| 20311 | 90837 | 83 |
| 20316 | 90825 | 82 |
| 20327 | 90575 | 55 |
| 20328 | 90972 | 26 |
| 20335 | 90604 | 57 |
| 20338 | 90081 | 18 |
| 20344 | 90033 | 13 |
| 20349 | 90576 | 55 |
| 20360 | 90864 | 85 |
| 20362 | 90863 | 85 |
| 20376 | 90453 | 39 |
| 20377 | 90232 | 27 |
| 20380 | 90036 | 13 |
| 20390 | 90296 | 31 |
| 20391 | 90297 | 31 |
| 20407 | 90125 | 22 |
| 20412 | 90768 | 72 |
| 20429 | 90298 | 32 |
| 20432 | 90134 | 23 |
| 20437 | 90380 | 39 |
| 20448 | 90849 | 89 |
| 20449 | 90908 | 89 |
| 20452 | 90698 | 67 |
| 20453 | 90336 | 36 |
| 20458 | 90448 | 45 |
| 20463 | 90136 | 23 |
| 20466 | 90687 | 66 |
| 20476 | 90455 | 79 |
| 20534 | 90050 | 15 |
| 20535 | 90051 | 15 |
| 20543 | 90112 | 21 |
| 20556 | 90790 | 79 |
| 20557 | 90801 | 80 |
| 20558 | 90359 | 38 |
| 20563 | 90970 | 36 |
| 20564 | 90973 | 44 |
| 20571 | 90362 | 38 |
| 20572 | 90363 | 38 |

| Auveco # | Shark # | Page # |
|----------|---------|--------|
| 20573 | 90740 | 70 |
| 20578 | 90234 | 27 |
| 20605 | 90265 | 29 |
| 20609 | 90102 | 20 |
| 20610 | 90267 | 19 |
| 20624 | 90846 | 84 |
| 20627 | 90643 | 61 |
| 20629 | 90628 | 60 |
| 20632 | 90473 | 47 |
| 20633 | 90381 | 39 |
| 20637 | 90446 | 45 |
| 20638 | 90345 | 36 |
| 20645 | 90334 | 35 |
| 20647 | 90737 | 70 |
| 20669 | 90354 | 37 |
| 20675 | 90172 | 13 |
| 20677 | 90146 | 24 |
| 20687 | 90299 | 32 |
| 20688 | 90300 | 32 |
| 20736 | 90745 | 71 |
| 20744 | 90371 | 39 |
| 20753 | 90577 | 55 |
| 20757 | 90221 | 11 |
| 20758 | 90332 | 11 |
| 20782 | 90235 | 27 |
| 20788 | 90639 | 61 |
| 20826 | 90474 | 59 |
| 20827 | 90159 | 26 |
| 20834 | 90642 | 61 |
| 20869 | 90509 | 50 |
| 20876 | 90262 | 29 |
| 20877 | 90261 | 29 |
| 20880 | 90480 | 59 |
| 20886 | 90252 | 28 |
| 20887 | 90062 | 16 |
| 20908 | 90542 | 53 |
| 20909 | 90561 | 54 |
| 20953 | 90536 | 52 |
| 20954 | 90666 | 65 |
| 20955 | 90550 | 53 |

| Auveco # | Shark # | Page # |
|----------|---------|--------|
| 20959 | 90338 | 36 |
| 20986 | 90042 | 58 |
| 20988 | 90456 | 46 |
| 20989 | 90468 | 47 |
| 20991 | 90478 | 48 |
| 21010 | 90607 | 58 |
| 21011 | 90606 | 58 |
| 21012 | 90726 | 33 |
| 21024 | 90556 | 54 |
| 21025 | 90680 | 66 |
| 21038 | 90251 | 28 |
| 21046 | 90637 | 61 |
| 21082 | 90638 | 61 |
| 21107 | 90038 | 14 |
| 21111 | 90718 | 69 |
| 21121 | 90619 | 59 |
| 21122 | 90495 | 77 |
| 21124 | 90179 | 63 |
| 21133 | 90294 | 31 |
| 21138 | 90396 | 41 |
| 21143 | 90282 | 30 |
| 21145 | 90103 | 21 |
| 21151 | 90728 | 69 |
| 21171 | 90270 | 29 |
| 21173 | 90528 | 52 |
| 21179 | 90337 | 36 |
| 21191 | 90769 | 72 |
| 21192 | 90537 | 52 |
| 21201 | 90551 | 53 |
| 21225 | 90546 | 53 |
| 21226 | 90293 | 31 |
| 21229 | 90932 | 91 |
| 21251 | 90090 | 18 |
| 21254 | 90029 | 12 |
| 21292 | 90716 | 68 |
| 21295 | 90405 | 41 |
| 21297 | 90435 | 44 |
| 21303 | 90869 | 85 |
| 21314 | 90263 | 29 |
| 21315 | 90645 | 62 |

Auveco Crossover

| Auveco # | Shark # | Page # |
|----------|---------|--------|
| 21316 | 90233 | 27 |
| 21322 | 90119 | 22 |
| 21331 | 90731 | 69 |
| 21357 | 90985 | 11 |
| 21358 | 90018 | 11 |
| 21359 | 90962 | 88 |
| 21366 | 90599 | 57 |
| 21367 | 90746 | 71 |
| 21368 | 90986 | 73 |
| 21390 | 90091 | 19 |
| 21391 | 90612 | 58 |
| 21392 | 90887 | 87 |
| 21393 | 90339 | 36 |
| 21394 | 90308 | 32 |
| 21395 | 90310 | 33 |
| 21396 | 90309 | 32 |
| 21397 | 90670 | 65 |
| 21398 | 90388 | 40 |
| 21399 | 90669 | 65 |
| 21410 | 90046 | 14 |
| 21411 | 90732 | 70 |
| 21414 | 90366 | 38 |
| 21415 | 90387 | 40 |
| 21416 | 90312 | 33 |
| 21417 | 90037 | 14 |
| 21420 | 90586 | 56 |
| 21423 | 90954 | 93 |
| 21425 | 90720 | 69 |
| 21429 | 90156 | 25 |
| 21430 | 90157 | 25 |
| 21431 | 90333 | 35 |
| 21432 | 90158 | 26 |
| 21433 | 90281 | 30 |
| 21434 | 90272 | 30 |
| 21435 | 90277 | 30 |
| 21441 | 90273 | 30 |
| 21447 | 90313 | 33 |
| 21448 | 90314 | 33 |
| 21449 | 90151 | 25 |
| 21450 | 90392 | 40 |
| 21451 | 90439 | 44 |
| 21452 | 90613 | 58 |

| Auveco # | Shark # | Page # |
|----------|---------|--------|
| 21453 | 90377 | 39 |
| 21456 | 90330 | 35 |
| 21464 | 90274 | 30 |
| 21465 | 90276 | 30 |
| 21466 | 90280 | 30 |
| 21467 | 90275 | 30 |
| 21468 | 90279 | 30 |
| 21469 | 90278 | 30 |
| 21478 | 90150 | 25 |
| 21479 | 90614 | 58 |
| 21480 | 90776 | 73 |
| 21481 | 90315 | 33 |
| 21482 | 90440 | 44 |
| 21483 | 90138 | 23 |
| 21485 | 90022 | 12 |
| 21491 | 90148 | 25 |
| 21492 | 90149 | 25 |
| 21493 | 90149 | 25 |
| 21493 | 90316 | 33 |
| 21494 | 90391 | 40 |
| 21495 | 90368 | 38 |
| 21496 | 90389 | 40 |
| 21497 | 90951 | 92 |
| 21498 | 90094 | 20 |
| 21499 | 90672 | 65 |
| 21508 | 90423 | 43 |
| 21509 | 90390 | 40 |
| 21510 | 90671 | 65 |
| 21512 | 90317 | 33 |
| 21513 | 90023 | 12 |
| 21514 | 90126 | 22 |
| 21515 | 90039 | 14 |
| 21516 | 90340 | 36 |
| 21519 | 90880 | 86 |
| 21520 | 90936 | 91 |
| 21525 | 90617 | 59 |
| 21537 | 90358 | 38 |
| 21538 | 90378 | 39 |
| 21544 | 90730 | 69 |
| 21545 | 90538 | 52 |
| 21546 | 90382 | 39 |
| 21547 | 90608 | 58 |

| Auveco # | Shark # | Page # |
|----------|---------|--------|
| 21548 | 90942 | 92 |
| 21549 | 90383 | 40 |
| 21550 | 90302 | 32 |
| 21551 | 90943 | 92 |
| 21552 | 90944 | 92 |
| 21553 | 90035 | 13 |
| 21554 | 90352 | 37 |
| 21555 | 90244 | 27 |
| 21556 | 90245 | 28 |
| 21557 | 90246 | 28 |
| 21558 | 90247 | 28 |
| 21559 | 90248 | 28 |
| 21560 | 90084 | 18 |
| 21561 | 90271 | 29 |
| 21562 | 90621 | 59 |
| 21563 | 90585 | 56 |
| 21564 | 90289 | 31 |
| 21565 | 90938 | 91 |
| 21566 | 90587 | 56 |
| 21567 | 90290 | 31 |
| 21569 | 90753 | 71 |
| 21570 | 90592 | 56 |
| 21571 | 90593 | 56 |
| 21572 | 90622 | 59 |
| 21573 | 90940 | 91 |
| 21574 | 90370 | 38 |
| 21575 | 90755 | 72 |
| 21576 | 90594 | 57 |
| 21577 | 90756 | 72 |
| 21578 | 90595 | 57 |
| 21579 | 90045 | 14 |
| 21580 | 90569 | 55 |
| 21581 | 90291 | 31 |
| 21583 | 90770 | 73 |
| 21584 | 90369 | 38 |
| 21585 | 90591 | 56 |
| 21586 | 90303 | 32 |
| 21587 | 90754 | 71 |
| 21596 | 90598 | 57 |
| 21611 | 90032 | 12 |
| 21612 | 90304 | 32 |
| 21617 | 90285 | 31 |

| Auveco # | Shark # | Page # |
|----------|---------|--------|
| 21618 | 90367 | 38 |
| 21620 | 90579 | 56 |
| 21621 | 90751 | 71 |
| 21622 | 90752 | 71 |
| 21623 | 90618 | 59 |
| 21624 | 90610 | 58 |
| 21625 | 90773 | 73 |
| 21626 | 90946 | 92 |
| 21627 | 90947 | 92 |
| 21628 | 90774 | 73 |
| 21629 | 90286 | 31 |
| 21630 | 90044 | 14 |
| 21631 | 90580 | 56 |
| 21632 | 90742 | 70 |
| 21633 | 90937 | 91 |
| 21634 | 90422 | 43 |
| 21635 | 90707 | 68 |
| 21636 | 90249 | 28 |
| 21637 | 90335 | 35 |
| 21638 | 90353 | 37 |
| 21639 | 90250 | 28 |
| 21640 | 90355 | 37 |
| 21641 | 90305 | 32 |
| 21642 | 90379 | 39 |
| 21643 | 90948 | 92 |
| 21645 | 90445 | 45 |
| 21651 | 90515 | 51 |
| 21652 | 90099 | 20 |
| 21658 | 90565 | 54 |
| 21662 | 90557 | 54 |
| 21685 | 90723 | 69 |
| 21686 | 90085 | 18 |
| 21687 | 90028 | 12 |
| 21688 | 90026 | 12 |
| 21689 | 90027 | 12 |
| 21690 | 90365 | 38 |
| 21691 | 90122 | 22 |
| 21692 | 90408 | 42 |
| 21693 | 90016 | 11 |
| 21694 | 90933 | 91 |
| 21695 | 90941 | 91 |
| 21696 | 90040 | 14 |

Auveco/DISCO Crossover

| Auveco # | Shark # | Page # |
|----------|---------|--------|
| 21697 | 90254 | 28 |
| 21698 | 90255 | 28 |
| 21699 | 90256 | 28 |
| 21700 | 90709 | 68 |
| 21704 | 90912 | 90 |
| 21705 | 90913 | 90 |
| 21706 | 90015 | 11 |
| 21707 | 90917 | 90 |
| 21708 | 90089 | 18 |
| 21709 | 90878 | 86 |
| 21713 | 90640 | 61 |
| 21714 | 90636 | 61 |
| 21715 | 90644 | 61 |
| 21742 | 90641 | 61 |
| 21743 | 90733 | 70 |
| 21744 | 90802 | 79 |
| 21746 | 90782 | 78 |
| 21748 | 90875 | 86 |
| 21757 | 90442 | 45 |
| 21758 | 90886 | 87 |
| 21759 | 90086 | 18 |
| 21760 | 90810 | 81 |
| 21761 | 90385 | 40 |
| 21762 | 90059 | 16 |
| 21763 | 90674 | 65 |
| 21764 | 90673 | 65 |
| 21765 | 90814 | 81 |
| 21766 | 90154 | 25 |
| 21767 | 90153 | 25 |
| 21768 | 90717 | 69 |
| 21769 | 90554 | 54 |
| 21770 | 90873 | 86 |
| 21771 | 90287 | 31 |
| 21772 | 90141 | 25 |
| 21773 | 90140 | 24 |
| 21774 | 90779 | 78 |
| 21775 | 90675 | 65 |
| 21776 | 90343 | 36 |
| 21777 | 90817 | 81 |
| 21778 | 90816 | 81 |
| 21779 | 90341 | 36 |
| 21780 | 90397 | 41 |

| Auveco # | Shark # | Page # |
|----------|---------|--------|
| 21781 | 90819 | 81 |
| 21782 | 90818 | 81 |
| 21783 | 90386 | 40 |
| 21784 | 90306 | 32 |
| 21785 | 90307 | 32 |
| 21786 | 90384 | 40 |
| 21787 | 90444 | 45 |
| 21788 | 90061 | 16 |
| 21789 | 90021 | 12 |
| 21815 | 90667 | 65 |
| 21823 | 90799 | 79 |
| 21826 | 90778 | 73 |
| 21837 | 90805 | 80 |
| 21838 | 90794 | 79 |
| 21839 | 90796 | 79 |
| 21840 | 90013 | 11 |
| 21841 | 90797 | 80 |
| 21842 | 90386 | 40 |
| 21843 | 90952 | 92 |
| 21846 | 90544 | 11 |
| 21847 | 90545 | 53 |
| 21848 | 90257 | 29 |
| 21849 | 90543 | 53 |
| 21850 | 90806 | 80 |
| 21851 | 90092 | 19 |
| 21853 | 90058 | 16 |
| 21854 | 90815 | 81 |
| 21855 | 90357 | 37 |
| 21857 | 90253 | 28 |
| 21858 | 90553 | 53 |
| 21859 | 90560 | 54 |
| 21860 | 90407 | 42 |
| 21860 | 90647 | 62 |
| 22041 | 90014 | 11 |
| 22042 | 90288 | 31 |
| 22046 | 90118 | 22 |
| 22047 | 90881 | 86 |
| 22048 | 90088 | 18 |
| 22049 | 90876 | 86 |
| 22050 | 90620 | 59 |
| 22051 | 90139 | 24 |
| 22052 | 90443 | 45 |

| Auveco # | Shark # | Page # |
|----------|---------|--------|
| 22057 | 90813 | 81 |
| 22059 | 90284 | 30 |
| 22060 | 90114 | 21 |
| 22063 | 90113 | 21 |
| 22075 | 90871 | 86 |
| 22076 | 90931 | 91 |
| 22077 | 90020 | 11 |
| 22078 | 90758 | 72 |
| 22079 | 90292 | 31 |
| 22082 | 90116 | 22 |
| 22083 | 90597 | 57 |
| 22084 | 90676 | 65 |
| 22085 | 90406 | 42 |
| 22086 | 90812 | 81 |
| 22087 | 90331 | 35 |
| 22090 | 90060 | 16 |
| 22091 | 90342 | 36 |
| 22092 | 90152 | 25 |
| 22093 | 90872 | 86 |
| 22094 | 90668 | 65 |
| 22095 | 90437 | 44 |
| 22096 | 90725 | 69 |
| 22101 | 90438 | 44 |
| 22126 | 90646 | 13 |
| 22131 | 90987 | 64 |
| 22144 | 90988 | 64 |

| Disco # | Shark # | Page # |
|---------|---------|--------|
| 263 | 90530 | 77 |
| 265 | 90529 | 77 |
| 477 | 90788 | 74 |
| 592 | 90070 | 17 |
| 639 | 90190 | 60 |
| 856 | 90199 | 75 |
| 969 | 90106 | 21 |
| 972 | 90095 | 20 |
| 985 | 90147 | 25 |
| 986 | 90228 | 26 |
| 987 | 90225 | 26 |
| 996 | 90095 | 20 |
| 1017 | 90202 | 76 |
| 1024 | 90054 | 16 |
| 1042 | 90208 | 76 |
| 1077 | 90196 | 75 |
| 1083 | 90025 | 12 |
| 1087 | 90450 | 45 |
| 1091 | 90426 | 43 |
| 1149 | 90825 | 82 |
| 1159 | 90226 | 26 |
| 1172 | 90224 | 26 |
| 1184 | 90197 | 75 |
| 1186 | 90198 | 75 |
| 1195 | 90649 | 62 |
| 1201 | 90057 | 16 |
| 1202 | 90696 | 67 |
| 1228 | 90982 | 75 |
| 1234 | 90499 | 49 |
| 1238 | 90129 | 23 |
| 1239 | 90127 | 22 |
| 1240 | 90128 | 22 |
| 1249 | 90193 | 13 |
| 1250 | 90048 | 15 |
| 1263 | 90963 | 45 |
| 1265 | 90574 | 55 |
| 1276 | 90210 | 76 |
| 1296 | 90760 | 72 |
| 1297 | 90681 | 66 |
| 1302 | 90427 | 43 |
| 1310 | 90457 | 46 |
| 1350 | 90906 | 88 |

DISCO Crossover

| Disco # | Shark # | Page # |
|---------|---------|--------|
| 1374 | 90656 | 64 |
| 1379 | 90428 | 43 |
| 1390 | 90979 | 63 |
| 1399 | 90462 | 46 |
| 1410 | 90828 | 82 |
| 1415 | 90183 | 62 |
| 1436 | 90624 | 60 |
| 1446 | 90501 | 49 |
| 1447 | 90485 | 48 |
| 1448 | 90479 | 48 |
| 1466 | 90418 | 43 |
| 1467 | 90968 | 64 |
| 1558 | 90066 | 17 |
| 1560 | 90744 | 71 |
| 1562 | 90955 | 93 |
| 1563 | 90956 | 93 |
| 1566 | 90959 | 93 |
| 1568 | 90957 | 93 |
| 1572 | 90983 | 68 |
| 1573 | 90167 | 20 |
| 1575 | 90064 | 16 |
| 1576 | 90743 | 70 |
| 1577 | 90735 | 70 |
| 1579 | 90417 | 42 |
| 1583 | 90860 | 85 |
| 1584 | 90030 | 12 |
| 1585 | 90031 | 12 |
| 1588 | 90349 | 37 |
| 1597 | 90531 | 52 |
| 1601 | 90965 | 88 |
| 1603 | 90559 | 54 |
| 1605 | 90216 | 71 |
| 1609 | 90969 | 61 |
| 1610 | 90761 | 72 |
| 1612 | 90539 | 52 |
| 1614 | 90712 | 68 |
| 1620 | 90930 | 74 |
| 1621 | 90218 | 77 |
| 1634 | 90414 | 42 |
| 1636 | 90714 | 68 |
| 1644 | 90820 | 82 |

| Disco # | Shark # | Page # |
|---------|---------|--------|
| 1646 | 90074 | 17 |
| 1648 | 90065 | 16 |
| 1650 | 90950 | 75 |
| 1681 | 90958 | 93 |
| 1686 | 90195 | 58 |
| 1716 | 90078 | 17 |
| 1730 | 90459 | 46 |
| 1742 | 90056 | 16 |
| 1756 | 90572 | 55 |
| 1761 | 90833 | 83 |
| 1799 | 90634 | 61 |
| 1807 | 90075 | 51 |
| 1842 | 90683 | 66 |
| 1860 | 90964 | 46 |
| 1861 | 90511 | 50 |
| 1865 | 90104 | 21 |
| 1889 | 90177 | 62 |
| 1890 | 90222 | 62 |
| 1900 | 90184 | 62 |
| 1901 | 90178 | 62 |
| 1904 | 90182 | 62 |
| 1930 | 90163 | 20 |
| 1932 | 90625 | 60 |
| 1939 | 90789 | 74 |
| 1943 | 90547 | 53 |
| 1945 | 90237 | 27 |
| 1946 | 90239 | 27 |
| 1949 | 90535 | 52 |
| 1950 | 90124 | 22 |
| 1951 | 90629 | 60 |
| 1972 | 90521 | 51 |
| 1973 | 90520 | 51 |
| 1975 | 90571 | 55 |
| 1976 | 90522 | 51 |
| 1991 | 90920 | 90 |
| 1994 | 90131 | 23 |
| 1996 | 90421 | 43 |
| 1997 | 90700 | 67 |
| 1998 | 90558 | 54 |
| 1999 | 90583 | 56 |
| 2002 | 90403 | 41 |

| Disco # | Shark # | Page # |
|---------|---------|--------|
| 2015 | 90508 | 50 |
| 2016 | 90164 | 91 |
| 2025 | 90975 | 23 |
| 2026 | 90486 | 48 |
| 2027 | 90602 | 57 |
| 2028 | 90573 | 13 |
| 2029 | 90497 | 49 |
| 2034 | 90870 | 86 |
| 2045 | 90458 | 46 |
| 2048 | 90841 | 83 |
| 2050 | 90449 | 45 |
| 2056 | 90518 | 51 |
| 2057 | 90526 | 51 |
| 2060 | 90534 | 52 |
| 2062 | 90867 | 74 |
| 2063 | 90266 | 19 |
| 2076 | 90679 | 66 |
| 2080 | 90659 | 64 |
| 2108 | 90346 | 37 |
| 2111 | 90452 | 20 |
| 2123 | 90927 | 74 |
| 2124 | 90663 | 10 |
| 2128 | 90971 | 44 |
| 2133 | 90451 | 45 |
| 2143 | 90540 | 52 |
| 2144 | 90351 | 37 |
| 2145 | 90372 | 39 |
| 2153 | 90567 | 55 |
| 2155 | 90516 | 51 |
| 2156 | 90746 | 71 |
| 2157 | 90701 | 67 |
| 2161 | 90162 | 40 |
| 2167 | 90168 | 20 |
| 2940 | 90690 | 67 |
| 2969 | 90901 | 88 |
| 2970 | 90215 | 77 |
| 2975 | 90453 | 77 |
| 2980 | 90691 | 67 |
| 3010 | 90209 | 76 |
| 3204 | 90766 | 74 |
| 4002 | 90186 | 62 |

| Disco # | Shark # | Page # |
|---------|---------|--------|
| 4005 | 90632 | 60 |
| 4007 | 90630 | 60 |
| 4008 | 90631 | 60 |
| 4009 | 90635 | 61 |
| 4014 | 90180 | 62 |
| 4015 | 90181 | 62 |
| 4020 | 90076 | 17 |
| 5264 | 90077 | 17 |
| 5429 | 90808 | 81 |
| 5440 | 90109 | 21 |
| 5506 | 90882 | 19 |
| 5550 | 90791 | 79 |
| 5552 | 90455 | 79 |
| 5554 | 90283 | 79 |
| 5557 | 90902 | 88 |
| 5558 | 90200 | 88 |
| 5560 | 90900 | 88 |
| 5596 | 90903 | 88 |
| 5602 | 90017 | 87 |
| 5605 | 90033 | 13 |
| 5606 | 90393 | 41 |
| 5609 | 90822 | 82 |
| 5610 | 90187 | 87 |
| 5614 | 90073 | 87 |
| 5625 | 90976 | 82 |
| 5627 | 90839 | 83 |
| 5628 | 90823 | 82 |
| 5632 | 90821 | 82 |
| 5635 | 90848 | 84 |
| 5640 | 90185 | 87 |
| 5643 | 90826 | 82 |
| 5648 | 90847 | 84 |
| 5650 | 90904 | 88 |
| 5672 | 90494 | 49 |
| 5675 | 90977 | 48 |
| 5676 | 90496 | 49 |
| 5677 | 90967 | 49 |
| 5678 | 90295 | 58 |
| 5680 | 90488 | 48 |
| 5682 | 90211 | 76 |
| 5684 | 90010 | 10 |

DISCO Crossover

| Disco # | Shark # | Page # |
|---------|---------|--------|
| 5686 | 90007 | 10 |
| 5688 | 90009 | 10 |
| 5690 | 90011 | 10 |
| 5692 | 90012 | 11 |
| 5697 | 90213 | 76 |
| 5710 | 90850 | 84 |
| 5750 | 90905 | 88 |
| 5751 | 90907 | 88 |
| 5752 | 90220 | 89 |
| 5760 | 90166 | 78 |
| 5761 | 90170 | 78 |
| 5765 | 90204 | 76 |
| 5769 | 90654 | 63 |
| 5770 | 90978 | 63 |
| 5775 | 90981 | 64 |
| 5791 | 90205 | 76 |
| 5797 | 90325 | 34 |
| 5800 | 90328 | 34 |
| 5805 | 90329 | 34 |
| 5895 | 90548 | 53 |
| 5901 | 90476 | 47 |
| 5910 | 90319 | 34 |
| 5915 | 90318 | 34 |
| 5916X | 90219 | 77 |
| 5920 | 90532 | 52 |
| 5925 | 90609 | 80 |
| 5930 | 90523 | 51 |
| 5935 | 90471 | 47 |
| 5940 | 90470 | 47 |
| 5950 | 90793 | 79 |
| 5955 | 90212 | 79 |
| 5984 | 90781 | 78 |
| 5989 | 90206 | 76 |
| 5990 | 90207 | 76 |
| 5995 | 90852 | 84 |
| 6010 | 90787 | 78 |
| 6016 | 90909 | 89 |
| 6018 | 90921 | 89 |
| 6185 | 90495 | 77 |
| 6265 | 90784 | 78 |
| 6267 | 90227 | 77 |

| Disco # | Shark # | Page # |
|---------|---------|--------|
| 6401 | 90165 | 75 |
| 6402 | 90117 | 75 |
| 6403 | 90093 | 75 |
| 8172 | 90809 | 81 |
| 8862B | 90862 | 85 |
| 9021 | 90069 | 17 |
| 9050 | 90689 | 66 |
| 9053 | 90658 | 64 |
| 9054 | 90980 | 64 |
| 9064 | 90201 | 78 |
| 9067 | 90469 | 47 |
| 9074 | 90420 | 43 |
| 9081 | 90356 | 37 |
| 9082 | 90616 | 59 |
| 9085 | 90688 | 66 |
| 9101 | 90702 | 67 |
| 9108 | 90555 | 54 |
| 9111 | 90693 | 67 |
| 9112 | 90762 | 72 |
| 9113 | 90682 | 66 |
| 9114 | 90584 | 56 |
| 9118 | 90581 | 62 |
| 9128 | 90653 | 63 |
| 9130 | 90866 | 85 |
| 9132 | 90856 | 84 |
| 9145 | 90433 | 77 |
| 9146 | 90214 | 76 |
| 9147 | 90008 | 10 |
| 9160 | 90203 | 76 |
| 9178 | 90840 | 83 |
| 9195 | 90857 | 84 |
| 9199 | 90024 | 12 |
| 9202 | 90431 | 44 |
| 9208 | 90924 | 90 |
| 9226 | 90171 | 75 |
| 9242 | 90130 | 23 |
| 9243 | 90432 | 63 |
| 9256 | 90223 | 77 |
| 9260 | 90429 | 77 |
| 9262 | 90394 | 41 |
| 9264 | 90918 | 89 |

| Disco # | Shark # | Page # |
|---------|---------|--------|
| 9279 | 90217 | 14 |
| 9282 | 90974 | 44 |
| 9287 | 90475 | 47 |
| 9288 | 90627 | 60 |
| 9292 | 90525 | 51 |
| 9294 | 90570 | 27 |
| 9320 | 90472 | 47 |
| 9325 | 90036 | 13 |
| 9327 | 90966 | 57 |
| 9328 | 90123 | 22 |
| 9329 | 90541 | 53 |
| 9336 | 90236 | 27 |
| 9339 | 90083 | 18 |
| 9345 | 90855 | 84 |
| 9352 | 90859 | 85 |
| 9355 | 90684 | 66 |
| 9357 | 90510 | 50 |
| 9358 | 90517 | 17 |
| 9368 | 90072 | 17 |
| 9369 | 90482 | 48 |
| 9370 | 90490 | 49 |
| 9372 | 90068 | 17 |
| 9373 | 90055 | 16 |
| 9374 | 90853 | 84 |
| 9379 | 90347 | 37 |
| 9380 | 90935 | 85 |
| 9382 | 90973 | 44 |
| 9386 | 90425 | 43 |
| 9387 | 90424 | 43 |
| 9390 | 90533 | 52 |
| 9421 | 90960 | 93 |
| 9439 | 90194 | 55 |
| 9444 | 90267 | 19 |
| 9446 | 90836 | 83 |
| 9465 | 90600 | 57 |
| 9485 | 90829 | 82 |
| 9494 | 90685 | 66 |
| 9502 | 90080 | 18 |
| 9509 | 90465 | 47 |
| 9513 | 90108 | 21 |
| 9514 | 90067 | 17 |

| Disco # | Shark # | Page # |
|---------|---------|--------|
| 9522 | 90919 | 90 |
| 9539 | 90268 | 19 |
| 9540 | 90569 | 55 |
| 9547 | 90133 | 23 |
| 9554 | 90402 | 13 |
| 9559 | 90512 | 50 |
| 9560 | 90926 | 90 |
| 9572 | 90661 | 63 |
| 9588 | 90107 | 21 |
| 9591 | 90715 | 68 |
| 9592 | 90503 | 50 |
| 9617 | 90498 | 49 |
| 9418 | 90747 | 71 |
| 9636 | 90849 | 89 |
| 9637 | 90908 | 89 |
| 9694 | 90507 | 50 |
| 9695 | 90694 | 67 |
| 9696 | 90242 | 27 |
| 9725 | 90172 | 13 |
| 9726 | 90047 | 15 |
| 9728 | 90174 | 13 |
| 9731 | 90176 | 13 |
| 9745 | 90493 | 49 |
| 9752 | 90241 | 27 |
| 9763 | 90863 | 85 |
| 9783 | 90506 | 50 |
| 9820 | 90135 | 23 |
| 9849 | 90843 | 83 |
| 9854 | 90660 | 64 |
| 9857 | 90868 | 85 |
| 9858 | 90464 | 46 |
| 9861 | 90079 | 18 |
| 9862 | 90081 | 18 |
| 9863 | 90861 | 85 |
| 9872 | 90695 | 67 |
| 9873 | 90677 | 66 |
| 9875 | 90189 | 91 |
| 9878 | 90678 | 65 |
| 9886 | 90411 | 42 |
| 9901 | 90413 | 42 |
| 9912 | 90699 | 67 |

DISCO Crossover

| Disco # | Shark # | Page # |
|---------|---------|--------|
| 9913 | 90763 | 72 |
| 9915 | 90972 | 26 |
| 9934 | 90949 | 75 |
| 9935 | 90492 | 49 |
| 9943 | 90563 | 54 |
| 9945 | 90101 | 20 |
| 9946 | 90297 | 31 |
| 9947 | 90513 | 50 |
| 9968 | 90984 | 46 |
| 9969 | 90229 | 26 |
| 9980 | 90105 | 21 |
| 9981 | 90049 | 15 |
| 10058 | 90230 | 26 |
| 10060 | 90652 | 63 |
| 10064 | 90845 | 84 |
| 10075 | 90527 | 52 |
| 10078 | 90173 | 13 |
| 10096 | 90780 | 78 |
| 10112 | 90298 | 32 |
| 10113 | 90296 | 31 |
| 10116 | 90050 | 15 |
| 10117 | 90051 | 15 |
| 10127 | 90231 | 26 |
| 10129 | 90232 | 27 |
| 10141 | 90115 | 22 |
| 10223 | 90053 | 15 |
| 10224 | 90052 | 15 |
| 10239 | 90474 | 59 |
| 10247 | 90505 | 50 |
| 10356 | 90575 | 55 |
| 10366 | 90834 | 83 |
| 10367 | 90468 | 47 |
| 10368 | 90456 | 46 |
| 10369 | 90480 | 59 |
| 10371 | 90478 | 48 |
| 10379 | 90111 | 39 |
| 10382 | 90504 | 50 |
| 10388 | 90929 | 90 |
| 10392 | 90301 | 32 |
| 10393 | 90110 | 21 |
| 10396 | 90262 | 29 |

| Disco # | Shark # | Page # |
|---------|---------|--------|
| 10399 | 90071 | 17 |
| 10400 | 90837 | 83 |
| 10402 | 90807 | 81 |
| 10403 | 90851 | 84 |
| 10405 | 90361 | 38 |
| 10406 | 90739 | 70 |
| 10407 | 90410 | 42 |
| 10408 | 90399 | 41 |
| 10410 | 90484 | 48 |
| 10411 | 90419 | 43 |
| 10412 | 90401 | 41 |
| 10413 | 90601 | 57 |
| 10414 | 90412 | 42 |
| 10415 | 90415 | 42 |
| 10416 | 90404 | 41 |
| 10417 | 90416 | 42 |
| 10419 | 90461 | 46 |
| 10421 | 90373 | 39 |
| 10423 | 90447 | 45 |
| 10424 | 90463 | 46 |
| 10425 | 90491 | 49 |
| 10426 | 90703 | 67 |
| 10427 | 90858 | 85 |
| 10428 | 90549 | 53 |
| 10430 | 90626 | 60 |
| 10434 | 90844 | 83 |
| 10435 | 90102 | 20 |
| 10450 | 90509 | 50 |
| 10455 | 90827 | 74 |
| 10459 | 90642 | 61 |
| 10468 | 90467 | 47 |
| 10469 | 90864 | 85 |
| 10483 | 90062 | 16 |
| 10486 | 90159 | 26 |
| 10490 | 90299 | 32 |
| 10491 | 90261 | 29 |
| 10492 | 90300 | 32 |
| 10493 | 90260 | 29 |
| 10504 | 90473 | 47 |
| 10505 | 90460 | 46 |
| 10507 | 90639 | 61 |

| Disco # | Shark # | Page # |
|---------|---------|--------|
| 10509 | 90643 | 61 |
| 10512 | 90448 | 45 |
| 10536 | 90576 | 55 |
| 10537 | 90604 | 57 |
| 10538 | 90566 | 55 |
| 10539 | 90835 | 80 |
| 10551 | 90698 | 67 |
| 10552 | 90687 | 66 |
| 10563 | 90650 | 63 |
| 10564 | 90648 | 62 |
| 10565 | 90655 | 63 |
| 10568 | 90846 | 84 |
| 10569 | 90550 | 53 |
| 10570 | 90542 | 53 |
| 10573 | 90338 | 36 |
| 10576 | 90366 | 38 |
| 10608 | 90332 | 11 |
| 10609 | 90221 | 11 |
| 10616 | 90536 | 52 |
| 10620 | 90748 | 71 |
| 10623 | 90606 | 58 |
| 10624 | 90607 | 58 |
| 10635 | 90726 | 33 |
| 10655 | 90514 | 50 |
| 10656 | 90568 | 55 |
| 10659 | 90764 | 72 |
| 10678 | 90043 | 14 |
| 10681 | 90042 | 58 |
| 10687 | 90381 | 39 |
| 10714 | 90502 | 49 |
| 10719 | 90063 | 16 |
| 10723 | 90786 | 78 |
| 10751 | 90359 | 38 |
| 10756 | 90811 | 74 |
| 10764 | 90637 | 61 |
| 10765 | 90638 | 61 |
| 10772 | 90716 | 68 |
| 10776 | 90251 | 28 |
| 10782 | 90112 | 21 |
| 10807 | 90294 | 31 |
| 10808 | 90728 | 69 |

| Disco # | Shark # | Page # |
|---------|---------|--------|
| 10839 | 90377 | 39 |
| 10884 | 90387 | 40 |
| 10916 | 90090 | 18 |
| 10918 | 90669 | 65 |
| 10920 | 90089 | 18 |
| 10921 | 90308 | 32 |
| 10923 | 90670 | 65 |
| 10924 | 90391 | 40 |
| 10925 | 90309 | 32 |
| 10930 | 90339 | 36 |
| 10931 | 90388 | 40 |
| 10935 | 90091 | 19 |
| 10937 | 90022 | 12 |
| 10940 | 90612 | 58 |
| 10946 | 90310 | 33 |
| 10950 | 90311 | 33 |
| 10951 | 90312 | 33 |
| 10955 | 90528 | 52 |
| 10966 | 90628 | 60 |
| 10970 | 90000 | 10 |
| 10973 | 90777 | 73 |
| 10984 | 90925 | 74 |
| 10999 | 90706 | 68 |
| 11019 | 90537 | 552 |
| 11020 | 90718 | 69 |
| 11036 | 90745 | 71 |
| 11098 | 90651 | 63 |
| 11121 | 90880 | 86 |
| 11123 | 90293 | 31 |
| 11124 | 90551 | 53 |
| 11129 | 90720 | 69 |
| 11143 | 90769 | 72 |
| 11168 | 90932 | 91 |
| 11185 | 90704 | 68 |
| 11264 | 90666 | 65 |
| 11404 | 90874 | 74 |
| 11417 | 90029 | 12 |
| 11422 | 90561 | 54 |
| 11853 | 90263 | 29 |
| 11950 | 90985 | 11 |
| 11951 | 90018 | 11 |

DISCO Crossover

| Disco # | Shark # | Page # |
|---------|---------|--------|
| 12006 | 90037 | 14 |
| 12016 | 90192 | 58 |
| 12024 | 90986 | 73 |
| 12026 | 90233 | 27 |
| 12073 | 90731 | 69 |
| 12074 | 90599 | 57 |
| 12091 | 90586 | 56 |
| 12138 | 90435 | 44 |
| 12174 | 90270 | 29 |
| 12180 | 90442 | 45 |
| 12394 | 90441 | 45 |
| 12448 | 90099 | 20 |
| 12450 | 90869 | 85 |
| 12454 | 90914 | 90 |
| 12455 | 90405 | 41 |
| 12456 | 90515 | 51 |
| 12457 | 90247 | 28 |
| 12462 | 90157 | 25 |
| 12466 | 90156 | 25 |
| 12468 | 90038 | 14 |
| 12502 | 90732 | 70 |
| 12503 | 90945 | 92 |
| 12510 | 90619 | 59 |
| 12514 | 90314 | 33 |
| 12515 | 90151 | 25 |
| 12516 | 90886 | 87 |
| 12559 | 90350 | 37 |
| 12585 | 90671 | 65 |
| 12598 | 90188 | 87 |
| 12614 | 90951 | 92 |
| 12615 | 90392 | 40 |
| 12634 | 90723 | 69 |
| 12646 | 90331 | 35 |
| 12664 | 90692 | 75 |
| 12673 | 90446 | 45 |
| 12726 | 90375 | 39 |
| 12888 | 90015 | 11 |
| 12897 | 90884 | 86 |
| 12907 | 90617 | 59 |
| 12914 | 90705 | 68 |
| 12917 | 90941 | 91 |

| Disco # | Shark # | Page # |
|---------|---------|--------|
| 12918 | 90016 | 11 |
| 12920 | 90355 | 37 |
| 13314 | 90443 | 45 |
| 13382 | 90013 | 11 |
| 13523 | 90954 | 93 |
| D-123 | 90519 | 51 |
| D-124 | 90430 | 44 |
| JL-23 | 90831 | 82 |
| JL-32 | 90041 | 92 |

Clip-It-In USA

2018 Catalog

Drain Plugs

Gaskets

Hose Clamps

Fuses

Bulbs

Cable Ties



INTRODUCTION

HISTORY

Clip-it-in, owned and operated by Shark Industries, a leading supplier to the Automotive Aftermarket is now your convenient source for the most popular Drain Plugs, Gaskets, Bulbs, Fuses and Zip Ties! Offered individually as well as very convenient kits, we can make sourcing for these hard to find popular items a one-stop shop!

Let us offer you these new products in an easy-to-shop fashion. Look for your nearest Distributor and call us with any questions you have regarding any of the products. Remember, we guarantee your satisfaction by conforming with OEM specifications!

CATEGORIES

| | PAGE |
|--|-------|
| Drain Plug & Gasket Assortments | 2-7 |
| Aluminum Crushable Drain Plug Gaskets | 8 |
| Copper Crushable Drain Plug Gaskets | 9 |
| Copper Plain Drain Plug Gaskets | 9-10 |
| Fiber Drain Plug Gaskets | 10-11 |
| Nylon Drain Plug Gaskets | 11-12 |
| Rubber Drain Plug Gaskets | 12-13 |
| Steel Drain Plug Gaskets | 13 |
| Metal & Rubber Drain Plug Gaskets | 14 |
| Drain Plugs | 15-20 |
| Oil Change Accessories | 21 |
| Plastic Boxes | 21 |
| Cable Ties | 22 |
| Fuse Assortments | 23-24 |
| Fuses | 25-27 |
| Hose Clamps | 28 |
| Bulbs | 29-34 |

SHARK, SHARK WELDING, and CLIP-IT-IN are registered trademarks of Shark Industries Ltd. Any use of the name without express written permission is prohibited. Any reproduction of this catalogue without the permission of Shark is prohibited. Shark is a manufacturer/repackager of its own products. Any mention of any other manufacturer in this catalogue is only for reference purposes of part number, etc., and is not intended in any way to imply that Shark are manufactured by any of the mentioned manufacturers.

90989 114 Piece Drain Plug Assortment “For Newer Car Applications” in 12 Compartments

| Part # | Qty | Assortment Includes: |
|---------------|-----|--|
| G7161S | 15 | Aluminum Gasket 14mm Dead Soft Honda |
| G7407 | 3 | Rubber Gasket 12mm for G7868, G7869, G8005 |
| G7408 | 15 | Metal & Rubber GM Gasket 12 mm (Black) |
| G7409 | 15 | Metal & Rubber Ford Gasket 14 mm (Blue) |
| G7413 | 3 | Rubber Replacement Gasket for D8006 |
| G7414 | 3 | Rubber Replacement Gasket for D8007 |
| G7416 | 3 | Rubber Replacement Gasket for D8026 |
| G7417 | 3 | Rubber Replacement Gasket for D8031 |
| G7501 | 10 | Fiber Gasket 14mm |
| G7515 | 10 | Fiber Gasket 1/2" |
| G7525 | 10 | Fiber Gasket 12mm |
| D7815 | 3 | 1/2" - 20 Dog Point Zinc Finish |
| D7825 | 3 | 12mm - 1.75 Dog Point Zinc Plate |
| D7802 | 3 | 14mm - 1.50 Dog Point Zinc Plate - 16mm Hex |
| D7846 | 3 | 14mm - 1.50 Honda - 17mm Hex |
| D8006 | 2 | 14mm - 1.50 (13mm Hex Head) with Inset Rubber Gasket Ford 4.0L |
| D8007 | 2 | 14mm - 1.50 (16mm Hex Head) with Inset Rubber Gasket Ford 6.8L |
| D8022 | 2 | 14mm - 1.50 Honda OE Style Long Version |
| D8026 | 2 | 14mm - 1.50 with Inset Rubber Gasket |
| D8031 | 4 | 12mm x 1.75 with Inset Rubber Gasket - 15mm Hex |



90990 162 Piece Large Drain & Gasket Plug Assortment in 12 Compartments

| Part # | Qty | Assortment Includes: |
|---------------|-----|--|
| G6925 | 6 | Crushable Copper Gasket 12mm |
| G6901 | 6 | Crushable Copper Gasket 14mm |
| G80 | 12 | Nylon Gasket 1/2" I.D. 3/4" O.D. x .100 Thick |
| G7161S | 12 | Aluminum Gasket 14mm Dead Soft Honda |
| G7408 | 12 | Metal & Rubber GM Gasket 12mm (Black) |
| G7409 | 12 | Metal & Rubber Ford Gasket 14mm (Blue) |
| G7501 | 20 | Fiber Gasket 14mm |
| G7515 | 20 | Fiber Gasket 1/2" |
| G7525 | 20 | Fiber Gasket 12mm |
| G7539X | 6 | Fiber Gasket 16mm (5/8") |
| G7542 | 6 | Fiber Gasket 18mm & 11/16" Oversized |
| D7815 | 3 | 1/2" - 20 Dog Point Zinc |
| D7717 | 2 | 1/2" - 20 Regular Point Zinc Plate 7/8" Hex Head |
| D7825 | 3 | 12mm - 1.75 Dog Point Zinc Plate |
| D8033K | 2 | 1/2" - 20 Single Oversized Machined w/Fiber Gasket 3/4" Hex |
| D8034K | 2 | 1/2" - 20 Double Oversized Machined w/Fiber Gasket 3/4" Hex |
| D8035K | 2 | 1/2" - 20 Triple Oversized Machined w/ Fiber Gasket - 3/4" Hex |
| D7738X | 3 | 12mm - 1.25 Regular Point Zinc Plate 14mm Hex |
| D7739X | 2 | 16mm - 1.50 Regular Point Zinc Plate 19mm Hex |
| D7742 | 2 | 18mm - 1.50 Regular Point Zinc Plate 19mm Hex |
| D7801 | 7 | 14mm - 1.50 Regular Point Zinc Plate 13mm Hex |
| D7802 | 2 | 14mm - 1.50 Dog Point Zinc Plate 16mm Hex |



90991 10 Piece Drain Plug Assortment in 6 Compartments

| Part # | Qty | Assortment Includes: |
|--------|-----|--|
| D8033K | 5 | 1/2" - 20 Single Oversized Machined with Fiber Gasket - 3/4" Hex |
| D8034K | 2 | 1/2" - 20 Double Oversized Machined with Fiber Gasket - 3/4" Hex |
| D8035K | 1 | 1/2" - 20 Triple Oversized Machined with Fiber Gasket - 3/4" Hex |
| D7826K | 1 | 1/2" - 20 Single Oversized Piggy Bank |
| D7827K | 1 | 1/2" - 20 Double Oversized Piggy Bank |



90992 10 Piece Metric Drain Plug Assortment in 6 Compartments

| Part # | Qty | Assortment Includes: |
|--------|-----|---|
| D7825 | 2 | 12mm - 1.75 Dog Point Zinc Plate |
| D7738X | 2 | 12mm - 1.25 Regular Point Zinc Plate 14mm Hex |
| D7739X | 2 | 16mm - 1.50 Regular Point Zinc Plate 19mm Hex |
| D7742 | 2 | 18mm - 1.50 Regular Point Zinc Plate 19mm Hex |
| D7801 | 2 | 14mm - 1.50 Regular Point Zinc Plate 13mm Hex |



90993 10 Piece Top 10 Drain Plug Assortment in 1 Compartment

| Part # | Qty | Assortment Includes: |
|--------|-----|--|
| D7801 | 1 | 14mm - 1.50 Regular Point Zinc |
| D7815 | 1 | 1/2" - 20 Dog Point Zinc |
| D7825 | 1 | 12mm - 1.75 Dog Point Zinc Plate |
| D8033K | 1 | 1/2" - 20 Single Oversized Machined w/ Fiber Gasket - 3/4" Hex |
| D8034K | 1 | 1/2" - 20 Double Oversized Machined w/Fiber Gasket 3/4" Hex |
| D8035K | 1 | 1/2" - 20 Triple Oversized Machined w/Fiber Gasket 3/4" Hex |
| D7738X | 1 | 12mm - 1.25 Regular Point Zinc Plate 14mm Hex |
| D7739X | 1 | 16mm - 1.50 Regular Point Zinc Plate 19mm Hex |
| D7740 | 1 | 20mm - 1.50 Regular Point Zinc Plate 17mm Hex |
| D7742 | 1 | 18mm - 1.50 Regular Point Zinc Plate 19mm Hex |



90994 32 Piece Large O.E. Style Drain Plug Assortment in 12 Compartments

| Part # | Qty | Assortment Includes: |
|--------|-----|--|
| G7406 | 4 | Rubber Gasket 12mm Saturn for D7860 |
| G7407 | 8 | Rubber Gasket 12mm for G7868, G7869, G8005 |
| D7802 | 2 | 14mm - 1.50 Dog Point Zinc Plate - 16mm Hex |
| D7846 | 2 | 14mm - 1.50 Honda - 17mm Hex |
| D7855 | 2 | 14mm - 1.25 Jeep - 13mm Hex |
| D7860 | 2 | 12mm - 1.75 with Inset Rubber Gasket Saturn 14mm Hex |
| D7862 | 2 | 1/2" - 20 with Molded Rubber Washer Face - 5/8" Hex |
| D8006 | 2 | 14mm - 1.50 (13mm Hex Head with Inset Rubber Gasket Ford 4.0L |
| D8007 | 2 | 14mm - 1.50 (16mm Hex Head) with Inset Rubber Gasket Ford 6.8L |
| D8026 | 2 | 14mm - 1.50 with Inset Rubber Gasket |
| D8031 | 4 | 12mm x 1.75 with Inset Rubber Gasket - 15mm Hex |



90996 115 Piece Metric Drain Plug Gasket Assortment in 12 Compartments

| Part # | Qty | Assortment Includes: |
|--------|-----|--|
| G6925 | 5 | Crushable Copper Gasket 12mm |
| G6901 | 5 | Crushable Copper Gasket 14mm |
| G7101S | 10 | Aluminum Gasket 14mm Dead Soft |
| G7125 | 5 | Aluminum Gasket 12mm |
| G7161S | 10 | Aluminum Gasket 14mm Dead Soft Honda |
| G7201 | 5 | Copper Gasket 14mm |
| G7225 | 5 | Copper Gasket 12mm |
| G7406 | 5 | Rubber Gasket 12mm Saturn (Fits D7860) |
| G7407 | 5 | Rubber Gasket 12mm for G7868, G7869, G8005 |
| G7408 | 15 | Metal & Rubber GM Gasket 12mm (Black) |
| G7409 | 15 | Metal & Rubber Ford Gasket 14mm (Blue) |
| G7501 | 10 | Fiber Gasket 14mm |
| G7501G | 5 | Fiber Gasket 14mm Green Synthetic |
| G7525 | 10 | Fiber Gasket 12mm |
| G7525S | 5 | Fiber Gasket 12mm Double |



90995 100 Piece Nylon Drain Plug Gasket Assortment in 1 Compartment

| Part # | Qty | Assortment Includes: |
|--------|-----|---|
| G75 | 20 | Nylon Gasket 5/8" L.D. 1" O.D. x .100 Thick |
| G80 | 40 | Nylon Gasket 1/2" L.D. 3/4" O.D. x .100 Thick |
| G90 | 40 | Nylon Gasket 9/16" x 13/16" |



90997 50 Piece Copper Drain Plug Gasket Assortment in 1 Compartment

| Part # | Qty | Assortment Includes: |
|--------|-----|------------------------------|
| G6925 | 25 | Crushable Copper Gasket 12mm |
| G6901 | 25 | Crushable Copper Gasket 14mm |



90998 100 Piece Fiber Drain Plug Gasket Assortment in 1 Compartment

| Part # | Qty | Assortment Includes: |
|--------|-----|--------------------------|
| G7501 | 30 | Fiber Gasket 14mm |
| G7525 | 50 | Fiber Gasket 12mm |
| G7539X | 20 | Fiber Gasket 16mm (5/8") |



90999 50 Piece Combo Drain Plug Gasket Assortment in 1 Compartment

| Part # | Qty | Assortment Includes: |
|--------|-----|--|
| G6925 | 5 | Crushable Copper Gasket 12mm |
| G6901 | 5 | Crushable Copper Gasket 14mm |
| G80 | 5 | Crushable Copper Gasket 14mm |
| G90 | 5 | Nylon Gasket 9/16" x 13/16" |
| G7408 | 5 | Metal & Rubber GM Gasket 12mm (Black) |
| G7409 | 5 | 12mm - 1.75 with Inset Rubber Gasket Saturn 14mm Hex |
| G7501 | 5 | Fiber Gasket 14mm |
| G7525 | 5 | Fiber Gasket 12mm |
| G7539X | 5 | Fiber Gasket 16mm (5/8") |
| G7542 | 5 | Fiber Gasket 18mm & 11/16" Oversized |



91000 122 Piece Crushable Copper Gasket Assortment in 6 Compartments

| Part # | Qty | Assortment Includes: |
|--------|-----|------------------------------|
| G6925 | 40 | Crushable Copper Gasket 12mm |
| G6901 | 40 | Crushable Copper Gasket 14mm |
| G6939X | 15 | Crushable Copper Gasket 16mm |
| G6940 | 10 | Crushable Copper Gasket 20mm |
| G6942 | 10 | Crushable Copper Gasket 18mm |
| G6943 | 5 | Crushable Copper Gasket 10mm |
| G6944 | 2 | Crushable Copper Gasket 22mm |



91001 185 Piece Large Drain Plug Gasket Assortment in 24 Compartments

| Part # | Qty | Assortment Includes: |
|--------|-----|--|
| G6925 | 5 | Crushable Copper Gasket 12mm |
| G6901 | 5 | Crushable Copper Gasket 14mm |
| G75 | 10 | Nylon Gasket 5/8" I.D. 1" O.D. x .100 Thick |
| G80 | 10 | Nylon Gasket 1/2" I.D. 3/4" O.D. x .100 Thick |
| G90 | 10 | Nylon Gasket 9/16" x 13/16" |
| G6939X | 5 | Crushable Copper Gasket 20mm |
| G6940 | 5 | Crushable Copper Gasket 20mm |
| G6942 | 5 | Crushable Copper Gasket 18mm |
| G6943 | 5 | Crushable Copper Gasket 10mm |
| G6944 | 5 | Crushable Copper Gasket 22mm |
| G7101S | 5 | Aluminum Gasket 14mm Dead Soft |
| G7125 | 10 | Aluminum Gasket 12mm |
| G7161S | 5 | Aluminum Gasket 14mm Dead Soft Honda |
| G7406 | 5 | Rubber Gasket 12mm Saturn (Fits D7860) |
| G7407 | 5 | Rubber Gasket 12mm for G7868, G7869, G8005 |
| G7408 | 10 | Metal & Rubber GM Gasket 12mm (Black) |
| G7409 | 10 | 12mm - 1.75 with Inset Rubber Gasket Saturn 14mm Hex |
| G7501 | 10 | Fiber Gasket 14mm |
| G7501G | 5 | Fiber Gasket 14mm Green Synthetic |
| G7515 | 10 | Fiber Gasket 1/2" |
| G7515G | 5 | Fiber Gasket 1/2" Green Synthetic |
| G7525 | 10 | Fiber Gasket 12mm |
| G7525S | 5 | Fiber Gasket 12mm Double |
| G7526 | 5 | Fiber Gasket 1/2" Single Oversized |
| G7527 | 5 | Fiber Gasket 1/2" Double & Triple Oversized |
| G7539X | 5 | Fiber Gasket 16mm (5/8") |
| G7542 | 5 | Fiber Gasket 18mm (11/16") Oversized |
| G7542S | 5 | Fiber Gasket 18mm (11/16") Oversized Double Thick |



91002 90 Piece Fiber Drain Plug Gasket Assortment in 6 Compartments

| Part # | Qty | Assortment Includes: |
|---------------|-----|--------------------------------------|
| G7501 | 22 | Fiber Gasket 14mm |
| G7515 | 22 | Fiber Gasket 1/2" |
| G7525 | 22 | Fiber Gasket 12mm |
| G7539X | 12 | Fiber Gasket 16mm (5/8") |
| G7542 | 12 | Fiber Gasket 18mm (11/16") Oversized |



91003 55 Piece Rubber Inset Gasket Assortment in 6 Compartments

| Part # | Qty | Assortment Includes: |
|--------------|-----|--|
| G7406 | 5 | Rubber Gasket 12mm Saturn (Fits D7860) |
| G7407 | 10 | Rubber Gasket 12mm for G7868, G7869, G8005 |
| G7413 | 5 | Rubber Replacement Gasket for D8006 |
| G7414 | 10 | Rubber Replacement Gasket for D8007 |
| G7415 | 5 | Rubber Replacement Gasket |
| G7416 | 10 | Rubber Replacement Gasket for D8026 |
| G7417 | 10 | GM Rubber Drain Plug Gasket |



G7115

1/2" Aluminum Gasket



Pkg. Qty: 100

G7101S

14mm Aluminum Gasket, Dead Soft



Pkg. Qty: 100

G7125

12mm Aluminum Gasket



Pkg. Qty: 100

G7140S

20mm Aluminum Gasket, Dead Soft



Pkg. Qty: 50

G7143

18mm Aluminum Gasket



Pkg. Qty: 50

G7144

22mm Aluminum Gasket



Pkg. Qty: 50

G7146

20mm Aluminum Gasket



Pkg. Qty: 50

G7147

18mm Aluminum Gasket



Pkg. Qty: 50

G7148

24mm Aluminum Gasket



Pkg. Qty: 50

G7161S

14mm Aluminum Gasket
Dead Soft Honda



Pkg. Qty: 100

G7167

14mm Aluminum Gasket



Pkg. Qty: 100

G6901

14mm Crushable
Copper Gasket



Pkg. Qty: 50

G6925

12mm Crushable
Copper Gasket



Pkg. Qty: 50

G6939X

16mm Crushable
Copper Gasket



Pkg. Qty: 50

G6940

20mm Crushable
Copper Gasket



Pkg. Qty: 50

G6942

18mm Crushable
Copper Gasket



Pkg. Qty: 50

G6943

10mm Crushable
Copper Gasket



Pkg. Qty: 50

G6944

22mm Crushable
Copper Gasket



Pkg. Qty: 50

COPPER PLAIN DRAIN PLUG GASKETS

G6980

12mm Copper Foldover



Pkg. Qty: 50

G7201

14mm Copper Gasket



Pkg. Qty: 50

G7215

1/2" Copper Gasket



Pkg. Qty: 50

COPPER PLAIN DRAIN PLUG GASKETS



G7225

12mm Copper Gasket



Pkg. Qty: 50

G7253

14mm Copper Gasket,
I.D. 13.9 O.D. 20.0



Pkg. Qty: 50

FIBER DRAIN PLUG GASKETS

G7501

14mm Fiber Gasket



Pkg. Qty: 100

G7501G

14mm Fiber Gasket
Green Synthetic



Pkg. Qty: 50

G7515

1/2" Fiber Gasket



Pkg. Qty: 100

G7515G

1/2" Fiber Gasket Green
Synthetic



Pkg. Qty: 50

G7525

12mm Fiber Gasket



Pkg. Qty: 100

G7525G

12mm Green Synthetic
Gasket



Pkg. Qty: 50

G7525S

12mm Fiber Gasket
Double Thick



Pkg. Qty: 50

G7526

1/2" Fiber Gasket Single
Oversized



Pkg. Qty: 50

G7527

1/2" Fiber Gasket
Double and Triple
Oversized



Pkg. Qty: 50

G7539X

16mm/ 5/8" Fiber Gasket



Pkg. Qty: 100

G7540

20mm/ 3/4" Fiber Gasket Oversized



Pkg. Qty: 50

G7542

18mm/ 11/16" Fiber Gasket Oversized



Pkg. Qty: 50

G7542S

18mm/ 11/16" Fiber Gasket Oversized Double Thick



Pkg. Qty: 50

NYLON DRAIN PLUG GASKETS

G7015

1/2" Nylon Gasket



Pkg. Qty: 50

G7015S

1/2" Double Thick Nylon Gasket



Pkg. Qty: 50

G7025

12mm Nylon Gasket



Pkg. Qty: 50

G7025S

12mm Double Thick Nylon Gasket



Pkg. Qty: 50

G7001

14mm Nylon Gasket



Pkg. Qty: 50

G7001S

14mm Double Thick Nylon Gasket



Pkg. Qty: 50

NYLON DRAIN PLUG GASKETS



G7039

16mm Nylon Gasket



Pkg. Qty: 50

G7042

18mm Nylon Gasket



Pkg. Qty: 50

G7040

20mm Nylon Gasket



Pkg. Qty: 50

G75

5/8" I.D., 1" x .100 Thick Nylon Gasket



Pkg. Qty: 50

G80

1/2" I.D., 3/4" x .100 Thick Nylon Gasket



Pkg. Qty: 50

G90

1/2" I.D. x 5/8" O.D. Nylon Gasket



Pkg. Qty: 50

RUBBER DRAIN PLUG GASKETS

G7405

Rubber Replacement for 80-08K Plug

Applications:

GM: 90528145



Pkg. Qty: 50

G7406

12mm Rubber Replacement Gasket for D7860 Plug

Applications:

Saturn: 21007240



Pkg. Qty: 50

G7407

12mm Rubber Replacement Gasket for D7868, D7869, and D8005 Plug



Pkg. Qty: 50

G7413

14mm Rubber Replacement Gasket for D8006 Plug

Applications:

Ford: FSTZ-6734-BA



Pkg. Qty: 50

G7414

14mm Rubber Replacement Gasket for D8007 Plug

Applications:

Ford: F75Z-6734-AA



Pkg. Qty: 50

G7415

12mm Rubber Replacement Gasket for D8018 Plug



Pkg. Qty: 50

G7416

14mm Rubber Replacement Gasket for D8026 Plug



Pkg. Qty: 50

G7417

12mm Rubber Replacement Gasket for D8031 Plug



Pkg. Qty: 50

G7418

85mm Rubber Drain Plug Gasket Oil Pan



Pkg. Qty: 50

Applications:
GM: 10038854

G7424

16mm Rubber Washer for D8039



Pkg. Qty: 50

STEEL DRAIN PLUG GASKETS

G6992

16mm Foldover Washer for use with D8038 OEM 803916010



Pkg. Qty: 50

G6994

18mm Steel Foldover Gasket



Pkg. Qty: 50

G6996

14mm Foldover Steel Gasket



Pkg. Qty: 50

G6997

20mm Foldover Steel Gasket



Pkg. Qty: 50

G6998

12mm Foldover Steel Gasket



Pkg. Qty: 50

G7403

22mm Drain Plug
Dodge Cummins Gasket
for 5.9L

Applications:

Chrysler: 4882049



Pkg. Qty: 50

G7408

12mm Metal and
Rubber Gasket
Black

Applications:

GM: 14090908,
24571185



Pkg. Qty: 50

G7409

14mm Metal and
Rubber Gasket
Blue

Applications:

Ford: F3DZ-6734A



Pkg. Qty: 50

G7410

12mm Metal/Teflon
Gasket

Applications:

Toyota/Lexus: 90420-
12031



Pkg. Qty: 50

All Drain Plugs are Packaged as Each

D7310

1/2" Drain Plug Plain
Finish Square Head Pipe
Plug



D7312

1/2" Drain Plug Plain
Finish Square Counter
Sunk Pipe Plug



D7316

3/8" Drain Plug Plain
Finish Square Head
Counter Sunk Pipe Plug



D7334

3/4" Drain Plug Plain
Finish Square Head Pipe
Plug



D7387

Drain Plug
Chrysler Rubber
Rear End Differential
Plug Fits 7 1/4" and
8 1/4"



D7428

85mm Drain Plug
Crankcase Internal Oil
Filter Cover/Pan



Applications:
GM: 10044483

Applications:
Chrysler: 3723687

D7703

14mm 1.5 Short Body
Drain Plug
16mm Hex Head
Regular Point Zinc Plate



D7716

1/2" - 20 Drain Plug
3/4" Hex Head Regular
Point Zinc Plate



D7717

1/2" - 20 Drain Plug
7/8" Hex Head Regular
Point Zinc Plate



Applications:
Jeep: 83501425

D7738X

12mm - 1.25 DrainPlug
14mm Hex Head
Regular Point Zinc



D7739X

17mm - 1.50 Drain Plug
16mm Hex Head
Regular Point Zinc Plate



D7740

20mm - 1.50 Drain Plug
17mm Hex Head
Regular Point Zinc Finish



All Drain Plugs are Packaged as Each

D7742

18mm - 1.50 Drain Plug
19mm Hex Head
Regular Point Zinc Plate



D7801

14mm 1.50 Drain Plug
13mm Hex Head
Dog Point Zinc Plate



D7802

14mm - 1.50 Drain Plug
16mm Hex Head
Dog Point Zinc Plate



D7805

14mm - 1.25 Drain Plug
19mm Hex Head
with Inset Rubber
Gasket



D7815

1/2" - 20 Drain Plug
Dog Point Zinc Plate



D7817

1/2" - 20 Drain Plug
3/4" Hex Head
Dog Point Zinc



D7825

12mm - 1.75 Drain Plug
Dog Point Zinc Plated



D7826K

1/2" - 20 Drain Plug
Single Oversized Piggy
Back



D7827K

1/2" - 20 Drain Plug
Double Oversized Piggy
Back



D7838

12mm - 1.25 Drain Plug
14mm Hex Head
Dog Point Zinc Plated



D7845KA

12mm - 1.50 Drain Plug
13mm Hex Head
with Self Centering
Gasket



D7846

14mm - 1.50 Drain Plug
17mm Hex Head
Applications:
Honda: 90009-PH1-000



Applications:

BMW, Mercedes O.E.
Style

All Drain Plugs are Packaged as Each

D7847

12mm - 1.25 Drain Plug
14mm Hex Head
Yellow Di-Chrome

Applications:

Nissan: 11128-01M05

D7848

14mm - 1.50 Drain Plug
19mm Hex Head
Black Zinc

Applications:

VW: N90288901

D7853

14mm - 1.50 Drain Plug
13mm Hex

Applications:

BMW/Mercedes:
6019970230

D7854

3/4" - 16 Drain Plug

Applications:

Volvo: 948187-0

D7855

14mm - 1.25 Drain Plug
13mm Hex Head
Dog Point Zinc Plate

Applications:

Jeep

D7857

5/8-18 Reg Point Drain Plug, Zinc Plate- 13mm Hex Head

Applications:

Chrysler

D7860

12mm 1.75 Drain Plug
14mm Hex Head with
Inset Rubber Gasket

Applications:

Saturn: 21006725

D7862

1/2" - 20 Drain Plug
5/8" Hex Head with
Molded Rubber Washer
Face

Applications:

Chrysler/Jeep: 6034376

D7864

12mm 1.75 Drain Plug
15mm Hex Head with
Rubber Washer Face

Applications:

Ford: F5RZ-6730-B

D7866

14mm - 1.50 Drain Plug
17mm Hex Head with
Molded Rubber Gasket

Chrysler/Mitsubishi:

6503433

D7868

12mm 1.75 Drain Plug
15mm Hex Head with
Inset Gasket

Applications:

GM: 3536964

D7869

12mm 1.75 Drain Plug
15mm Hex Head with
Inset Gasket

Applications:

GM: 3538469



All Drain Plugs are Packaged as Each

D7870

14mm - 1.50 Drain Plug
19mm Hex Head
Zinc Oversized Tapping
Thread



D7871

12mm 1.75 Drain Plug
19mm Hex Head
Oversize Tapping
Thread Zinc



D7872

12mm - 1.25 Drain Plug
19mm Hex Head
Oversize Tapping Thread
Zinc Plate



D7880K

14mm - 1.50 Drain Plug
Piggy Back with Gasket



D7881K

12mm - 1.75 Drain Plug
Piggy Back with Gasket;
Oversized



D7882K

12mm - 1.25 Drain Plug
Piggy Back with Gasket;
Oversized Zinc



D7894KA

12mm - 1.50 Drain Plug
11/16" Hex Head
with Self Centering
Gasket



Applications:
BMW: 11-131-250-089

D8003

22mm 1.50 Drain Plug
10mm Internal Hex
Fits 5.9L



Applications:
Dodge Ram: 4778578

D8006

14mm - 1.50 Drain Plug
13mm Hex Head with
Inset Rubber Gasket



Applications:
Ford: F6TZ-6730BA

D8007

14mm - 1.50 Drain Plug
16mm Hex Head with
Inset Rubber Gasket



Applications:
Ford: F75Z-6730BA

D8008K

14mm - 1.50 Drain Plug
with O-Ring - Zinc Plate
for Cadillac Catera
Regular Point



Applications:
Catera: 90502556

D8009

14mm -1.50 Drain Plug
15mm Hex Head



Applications:
Mazda, Ford:
B6S7-10-404A

All Drain Plugs are Packaged as Each

D8017

Universal Winged Plug
(Not for Honda or VW)



D8018

12mm - 1.75 Drain Plug
13mm Hex Head with
Rubber Gasket

Applications:

Ford: YS4Z-6730-AA



D8020

26mm-1.50 VW Drain
Plug Yellow, 17mm Hex
Head

Applications:

VW/Audi: 059103193



D8022

14mm - 1.50 Drain Plug
17mm Hex Head

Applications:

Honda: 90009-PY3-000



D8024

12mm - 1.75 Drain Plug
15mm Hex Head with
Rubber Molded Around
Washer Face Dog Point

Applications:

Ford: XW4Z-6730-BA



D8026

14mm - 1.50 Drain Plug
13mm Hex Head with
Inset Rubber Gasket

Applications:

Chrysler: 6057741AA



D8027

14mm - 1.50 Drain Plug
19mm Hex Head
Zinc Plate - SEMS
Washer

Applications:

Audi, Volkswagon:
N90813201



D8031

12mm - 1.75 Drain Plug
15mm Hex with
Inset Rubber Gasket

Applications:

GM: 11562588



D8033K

1/2" - 20 Drain Plug
3/4" Hex Head with
Fiber Gasket Single
Oversized Machined



D8034K

1/2" - 20 Drain Plug
3/4" Hex Head with
Fiber Gasket Double
Oversized Machined



D8035K

1/2" - 20 Drain Plug
3/4" Hex Head with
Fiber Gasket Triple
Oversized Machined



D8036

18mm - 1.50 Drain Plug
17mm Hex Head
Regular Point

Applications:

Volvo: 982547-0



All Drain Plugs are Packaged as Each

D8037

14mm - 1.50 Drain Plug
17mm Hex Head
Zinc Plate

Applications:

Hyundai, Kia: 21512-23001



D8038

16mm - 1.50 Drain Plug
14mm Hex Head
Zinc Plate

Subaru: 807016160,
Scion: SU003-02194



D8039

Plastic Cam Locking for
2011 6.7L
Powerstroke

Applications:

Ford: BC3Z-6730-A



D8040

14mm - 1.50 Zinc Plate
10mm Hex Head

Applications:

Chevrolet Volt:
55568037



D8225S

18mm -1.50 Drain Plug
Pipe Plug with
Sealant, Yellow Zinc
Metric Thread Hex
Counter Sunk



D8228S

24mm - 1.50 Drain Plug
Pipe Plug
with Sealant, Yellow Zinc
Metric Thread Hex
Counter Sunk



D10

Warranty Seal
Yellow



D15

Warranty Seal
Red



D20

Warranty Seal
Blue



D25

Warranty Seal
White



PLASTIC BOXES

| Part # | UOM | Description: |
|--------|------|--|
| 16109 | Each | 1 Compartment - 3 1/4" x 3 1/8" x 1 3/8" |
| 16110 | Each | 2 Compartment - 6 5/8" x 3 1/8" x 1 3/8" |
| 16111 | Each | 6 Compartment - 6 5/8" x 3 1/8" x 1 3/8" |
| 16112 | Each | 12 Compartment - 10 3/4" x 6 1/4" x 1 3/4" |
| 16113 | Each | 18 Compartment - 12 3/4" x 8 1/2" x 2 1/8" |
| 16114 | Each | 24 Compartment - 10 5/8" x 6 1/4" x 1 1/2" |



Black Cable Ties

| Part # | UOM | Description: |
|--------|---------------|--|
| 16115 | 100 (per bag) | 4" Black Cable Tie - 18 lb. - Width 0.10" (2.4mm) |
| 16116 | 100 (per bag) | 6" Black Cable Tie - 40 lb. - Width 0.14"(3.6mm) |
| 16117 | 100 (per bag) | 8" Black Cable Tie - 50 lb. - Width 0.19" |
| 16118 | 100 (per bag) | 11" Black Cable Tie - 50 lb. - Width 0.19" |
| 16119 | 100 (per bag) | 14" Black Cable Tie - 50 lb. - Width 0.19" |
| 16121 | 100 (per bag) | 14" Wide Black Cable Tie - 120 lb. - Width 0.30" (7.6mm) |
| 16122 | 100 (per bag) | 17" Wide Black Cable Tie - 175 lb. - Width 0.35" |
| 16123 | 50 (per bag) | 24" Black Cable Tie - 175 lb. - Width 0.35" |
| 16124 | 50 (per bag) | 36" Black Cable Tie - 175 lb. - Width 0.35" |
| 16125 | 50 (per bag) | 48" Black Cable Tie - 175 lb. - Width 0.35" |



Natural Cable Ties

| Part # | UOM | Description: |
|--------|---------------|---|
| 16126 | 100 (per bag) | 4" Natural Cable Tie - 18 lb. - Width 0.10" (2.4mm) |
| 16127 | 100 (per bag) | 6" Natural Cable Tie - 40 lb. - Width 0.14" (3.6mm) |
| 16128 | 100 (per bag) | 8" Natural Cable Tie - 50 lb. - Width 0.19" |
| 16129 | 100 (per bag) | 11" Natural Cable Tie - 50 lb. - Width 0.19" |
| 16130 | 100 (per bag) | 14" Natural Cable Tie - 50 lb. - Width 0.19" |
| 16131 | 100 (per bag) | 14" Wide Natural Cable Tie - 120 lb. - Width 0.30" |
| 16132 | 100 (per bag) | 17" Wide Natural Cable Tie - 175 lb. - Width 0.35" |
| 16133 | 50 (per bag) | 24" Natural Cable Tie - 175 lb. - Width 0.35" |
| 16134 | 50 (per bag) | 36" Natural Cable Tie - 175 lb. - Width 0.35" |



16313 12 Piece Low Profile JCase Fuse Assortment in 1 Compartment

| Part # | Qty | Assortment Includes: |
|--------|-----|--|
| 16307 | 2 | JCase 20 Amp Low Profile Mini Fuse - 58V |
| 16308 | 2 | JCase 25 Amp Low Profile Mini Fuse - 58V |
| 16309 | 2 | JCase 30 Amp Low Profile Mini Fuse - 58V |
| 16310 | 2 | JCase 40 Amp Low Profile Mini Fuse - 58V |
| 16311 | 2 | JCase 50 Amp Low Profile Mini Fuse - 58V |
| 16312 | 2 | JCase 60 Amp Low Profile Mini Fuse - 58V |



16314 218 Piece Large Combination Fuse Assortment in 12 Compartments

| Part # | Qty | Assortment Includes: |
|--------|-----|------------------------|
| 16243 | 20 | 5 Amp ATC Blade Fuse |
| 16244 | 20 | 7.5 Amp ATC Blade Fuse |
| 16245 | 20 | 10 Amp ATC Blade Fuse |
| 16246 | 20 | 15 Amp ATC Blade Fuse |
| 16247 | 20 | 20 Amp ATC Blade Fuse |
| 16248 | 20 | 25 Amp ATC Blade Fuse |
| 16249 | 20 | 30 Amp ATC Blade Fuse |
| 16254 | 10 | 5 Amp Mini Fuse |
| 16255 | 10 | 7.5 Amp Mini Fuse |
| 16256 | 10 | 10 Amp Mini Fuse |
| 16257 | 10 | 15 Amp Mini Fuse |
| 16258 | 10 | 20 Amp Mini Fuse |
| 16259 | 10 | 25 Amp Mini Fuse |
| 16260 | 10 | 30 Amp Mini Fuse |
| 16282 | 2 | 20 Amp Maxi Fuse |
| 16283 | 2 | 30 Amp Maxi Fuse |
| 16284 | 2 | 40 Amp Maxi Fuse |
| 16285 | 2 | 50 Amp Maxi Fuse |



16315 100 Piece ATC/ATO Blade Fuse Assortment in 1 Compartment

| Part # | Qty | Assortment Includes: |
|--------|-----|------------------------|
| 16244 | 10 | 7.5 Amp ATC Blade Fuse |
| 16245 | 10 | 10 Amp ATC Blade Fuse |
| 16246 | 15 | 15 Amp ATC Blade Fuse |
| 16247 | 35 | 20 Amp ATC Blade Fuse |
| 16248 | 15 | 25 Amp ATC Blade Fuse |
| 16249 | 15 | 30 Amp ATC Blade Fuse |



16316 50 Piece Mini Fuse Assortment in 1 Compartment

| Part # | Qty | Assortment Includes: |
|--------|-----|----------------------|
| 16256 | 10 | 10 Amp Mini Fuse |
| 16257 | 10 | 15 Amp Mini Fuse |
| 16258 | 10 | 20 Amp Mini Fuse |
| 16259 | 10 | 25 Amp Mini Fuse |
| 16260 | 10 | 30 Amp Mini Fuse |



16317 10 Piece Maxi Fuse Assortment in 1 Compartment

| Part # | Qty | Assortment Includes: |
|--------|-----|----------------------|
| 16282 | 2 | 20 Amp Maxi Fuse |
| 16283 | 2 | 30 Amp Maxi Fuse |
| 16284 | 2 | 40 Amp Maxi Fuse |
| 16285 | 2 | 50 Amp Maxi Fuse |
| 16286 | 2 | 60 Amp Maxi Fuse |



16318 55 Piece Micro 2 and Micro 3 Fuse Assortment in 1 Compartment

| Part # | Qty | Assortment Includes: |
|--------|-----|--------------------------------|
| 16214 | 5 | 2 Leg Micro Fuse 5 Amp Brown |
| 16215 | 5 | 2 Leg Micro Fuse 7.5 Amp Amber |
| 16216 | 5 | 2 Leg Micro Fuse 10 Amp Red |
| 16217 | 5 | 2 Leg Micro Fuse 15 Amp Blue |
| 16218 | 5 | 2 Leg Micro Fuse 20 Amp Yellow |
| 16219 | 5 | 2 Leg Micro Fuse 25 Amp Clear |
| 16220 | 5 | 2 Leg Micro Fuse 30 Amp Green |
| 16237 | 5 | 3 Leg Micro Fuse 5 Amp Tan |
| 16238 | 5 | 3 Leg Micro Fuse 7.5 Amp Brown |
| 16239 | 5 | 3 Leg Micro Fuse 10 Amp Red |
| 16240 | 5 | 3 Leg Micro Fuse 15 Amp Blue |



2 Leg Micro Fuse

| Part # | UOM | Description: |
|--------|------|------------------------------------|
| 16214 | Each | 2 Leg Micro Fuse - 5 Amp - Brown |
| 16215 | Each | 2 Leg Micro Fuse - 7.5 Amp - Amber |
| 16216 | Each | 2 Leg Micro Fuse - 10 Amp - Red |
| 16217 | Each | 2 Leg Micro Fuse - 15 Amp - Blue |
| 16218 | Each | 2 Leg Micro Fuse - 20 Amp - Yellow |
| 16219 | Each | 2 Leg Micro Fuse - 25 Amp - Clear |
| 16220 | Each | 2 Leg Micro Fuse - 30 Amp - Green |



16216

ATC/ATO Blade Fuse

| Part # | UOM | Description: |
|--------|---------------|--------------------------------------|
| 16241 | 100 (per bag) | ATC/ATO Blade Fuse - 3 Amp - Violet |
| 16242 | 100 (per bag) | ATC/ATO Blade Fuse - 4 Amp - Pink |
| 16243 | 100 (per bag) | ATC/ATO Blade Fuse - 5 Amp - Tan |
| 16244 | 100 (per bag) | ATC/ATO Blade Fuse - 7.5 Amp - Brown |
| 16245 | 100 (per bag) | ATC/ATO Blade Fuse - 10 Amp - Red |
| 16246 | 100 (per bag) | ATC/ATO Blade Fuse - 15 Amp - Blue |
| 16247 | 100 (per bag) | ATC/ATO Blade Fuse - 20 Amp - Yellow |
| 16248 | 100 (per bag) | ATC/ATO Blade Fuse - 25 Amp - Clear |
| 16249 | 100 (per bag) | ATC/ATO Blade Fuse - 30 Amp - Green |
| 16250 | 100 (per bag) | ATC/ATO Blade Fuse - 40 Amp - Orange |



16230

3 Leg Micro Fuse

| Part # | UOM | Description: |
|--------|------|------------------------------------|
| 16237 | Each | 3 Leg Micro Fuse - 5 Amp - Tan |
| 16238 | Each | 3 Leg Micro Fuse - 7.5 Amp - Brown |
| 16239 | Each | 3 Leg Micro Fuse 10 Amp Red |
| 16240 | Each | 3 Leg Micro Fuse 15 Amp Blue |



16237

Mini Amp Fuse

| Part # | UOM | Description: |
|-----------------------|---------------|---------------------------------|
| 16251 | 100 (per bag) | Mini Fuse - 2 Amp - Gray |
| 16252 | 100 (per bag) | Mini Fuse - 3 Amp - Purple |
| 16253 | 100 (per bag) | Mini Fuse - 4 Amp - Pink |
| 16254 | 100 (per bag) | Mini Fuse - 5 Amp - Light Brown |
| 16255 | 100 (per bag) | Mini Fuse - 7.5 Amp - Brown |
| 16256 | 100 (per bag) | Mini Fuse - 10 Amp - Red |
| 16257 | 100 (per bag) | Mini Fuse - 15 Amp - Blue |
| 16258 | 100 (per bag) | Mini Fuse - 20 Amp - Yellow |
| 16259 | 100 (per bag) | Mini Fuse - 25 Amp - Natural |
| 16260 | 100 (per bag) | Mini Fuse - 30 Amp - Green |



16260

Bent Leg Bolt Fuse

| Part # | UOM | Description: |
|-----------------------|------|---|
| 16261 | Each | Bent Leg Bolt On Style Pal Fuse - 30 Amp - Pink |
| 16262 | Each | Bent Leg Bolt On Style Pal Fuse - 40 Amp - Green |
| 16263 | Each | Bent Leg Bolt On Style Pal Fuse - 50 Amp - Red |
| 16264 | Each | Bent Leg Bolt On Style Pal Fuse - 60 Amp - Yellow |
| 16265 | Each | Bent Leg Bolt On Style Pal Fuse - 80 Amp - Black |
| 16266 | Each | Bent Leg Bolt On Style Pal Fuse - 100 Amp - Blue |



16263

Female Pal Fuse

| Part # | UOM | Description: |
|-----------------------|------|-----------------------------------|
| 16267 | Each | Female Pal Fuse - 20 Amp - White |
| 16268 | Each | Female Pal Fuse - 30 Amp - Pink |
| 16269 | Each | Female Pal Fuse - 40 Amp - Green |
| 16270 | Each | Female Pal Fuse - 50 Amp - Red |
| 16271 | Each | Female Pal Fuse - 60 Amp - Yellow |
| 16272 | Each | Female Pal Fuse - 80 Amp - Black |
| 16273 | Each | Female Pal Fuse - 100 Amp - Blue |



16270

Male Pal Fuse

| Part # | UOM | Description: |
|-----------------------|------|---------------------------------|
| 16274 | Each | Male Pal Fuse - 20 Amp - White |
| 16275 | Each | Male Pal Fuse - 30 Amp - Pink |
| 16276 | Each | Male Pal Fuse - 40 Amp - Green |
| 16277 | Each | Male Pal Fuse - 50 Amp - Red |
| 16278 | Each | Male Pal Fuse - 60 Amp - Yellow |
| 16279 | Each | Male Pal Fuse - 80 Amp - Black |
| 16280 | Each | Male Pal Fuse - 100 Amp - Blue |
| 16281 | Each | Male Pal Fuse - 120 Amp - Gray |



16280

JCase Fuse

| Part # | UOM | Description: |
|--------|------|-----------------------------------|
| 16289 | Each | JCase Fuse - 20 Amp - 32V - Blue |
| 16290 | Each | JCase Fuse - 30 Amp - 32V - Pink |
| 16291 | Each | JCase Fuse - 40 Amp - 32V - Green |
| 16292 | Each | JCase Fuse - 50 Amp - 32V - Red |



16292

Low Profile Mini Fuse

| Part # | UOM | Description: |
|--------|------|--|
| 16293 | Each | Low Profile Mini Fuse - 5 Amp - Tan |
| 16294 | Each | Low Profile Mini Fuse - 7.5 Amp - Brown |
| 16295 | Each | Low Profile Mini Fuse - 10 Amp - Red |
| 16296 | Each | Low Profile Mini Fuse - 15 Amp - Blue |
| 16297 | Each | Low Profile Mini Fuse - 20 Amp - Yellow |
| 16298 | Each | Low Profile Mini Fuse - 25 Amp - Natural |
| 16299 | Each | Low Profile Mini Fuse - 30 Amp - Green |



16294

Maxi Fuse

| Part # | UOM | Description: |
|--------|------|----------------------------------|
| 16282 | Each | Maxi Fuse - 20 Amp - Yellow |
| 16283 | Each | Maxi Fuse - 30 Amp - Light Green |
| 16284 | Each | Maxi Fuse - 40 Amp - Orange |
| 16285 | Each | Maxi Fuse - 50 Amp - Red |
| 16286 | Each | Maxi Fuse - 60 Amp - Blue |
| 16287 | Each | Maxi Fuse - 70 Amp - Tan |
| 16288 | Each | Maxi Fuse - 80 Amp - Natural |



16286

Mini Pal Fuse

| Part # | UOM | Description: |
|--------|------|---------------------------------|
| 16300 | Each | Mini Pal Fuse - 20 Amp - Blue |
| 16301 | Each | Mini Pal Fuse - 30 Amp - Pink |
| 16302 | Each | Mini Pal Fuse - 40 Amp - Green |
| 16303 | Each | Mini Pal Fuse - 50 Amp - Red |
| 16304 | Each | Mini Pal Fuse - 60 Amp - Yellow |
| 16305 | Each | Mini Pal Fuse - 70 Amp - Brown |
| 16306 | Each | Mini Pal Fuse - 80 Amp - Black |



16304

JCase Mini Fuse

| Part # | UOM | Description: |
|--------|------|--|
| 16307 | Each | JCase Mini Fuse (Low Profile) - 20 Amp - 58V |
| 16308 | Each | JCase Mini Fuse (Low Profile) - 25 Amp - 58V |
| 16309 | Each | JCase Mini Fuse (Low Profile) - 30 Amp - 58V |
| 16310 | Each | JCase Mini Fuse (Low Profile) - 40 Amp - 58V |
| 16311 | Each | JCase Mini Fuse (Low Profile) - 50 Amp - 58V |
| 16312 | Each | JCase Mini Fuse (Low Profile) - 60 Amp - 58V |



16309

16150 15 Piece Fuel Injection Hose Clamp Assortment in 1 Compartment

| Part # | Qty | Assortment Includes: |
|--------|-----|----------------------------|
| 16147 | 5 | 1/4" Fuel Injection Clamp |
| 16148 | 5 | 5/16" Fuel Injection Clamp |
| 16149 | 5 | 3/8" Fuel Injection Clamp |



HOSE CLAMPS



16147



16135



16137

Mini Hose Clamps

| Part # | UOM | Description: |
|--------|--------------|--|
| 16135 | 10 (per box) | 7/32" to 5/8" Mini Hose Clamp Ventilated #4 Stainless Steel Band/Zinc Plated Housing |
| 16136 | 10 (per box) | 7/16" to 25/32" Mini Hose Clamp Ventilated #6 Stainless Steel Band/Zinc Plated Housing |

Standard Hose Clamps

| Part # | UOM | Description: |
|--------|--------------|--|
| 16137 | 10 (per box) | 9/16" to 11/16" Standard Hose Clamp Ventilated #10 Stainless Steel Band/Zinc Plated Housing |
| 16138 | 10 (per box) | 11/16" to 1-1/4" Standard Hose Clamp Ventilated #12 Stainless Steel Band/Zinc Plated Housing |
| 16139 | 10 (per box) | 13/16" to 1-1/2" Standard Hose Clamp Ventilated #16 Stainless Steel Band/Zinc Plated Housing |
| 16140 | 10 (per box) | 13/16" to 1-3/4" Standard Hose Clamp Ventilated #20 Stainless Steel Band/Zinc Plated Housing |
| 16141 | 10 (per box) | 11/16" to 2" Standard Hose Clamp Ventilated #24 Stainless Steel Band/Zinc Plated Housing |
| 16142 | 10 (per box) | 1-5/16" to 2-1/4" Standard Hose Clamp Ventilated #28 Stainless Steel Band/Zinc Plated Housing |
| 16143 | 10 (per box) | 1-9/16" to 2-1/2" Standard Hose Clamp Ventilated #32 Stainless Steel Band/Zinc Plated Housing |
| 16144 | 10 (per box) | 1-13/16" to 2-3/4" Standard Hose Clamp Ventilated #36 Stainless Steel Band/Zinc Plated Housing |
| 16145 | 10 (per box) | 7/16" to 25/32" Standard Hose Clamp Ventilated #6 Stainless Steel Band/Zinc Plated Housing |
| 16146 | 10 (per box) | 1/2" to 29/32" Standard Hose Clamp Ventilated #8 Stainless Steel Band/Zinc Plated Housing |

Fuel Injection Clamp

| Part # | UOM | Description: |
|--------|--------------|--------------------------------|
| 16147 | 10 (per box) | #12 1/4" Fuel Injection Clamp |
| 16148 | 10 (per box) | #14 5/16" Fuel Injection Clamp |
| 16149 | 10 (per box) | #15 3/8" Fuel Injection Clamp |

Dome Mini Bulb

| Part # | UOM | Description: |
|------------------------|--------------|----------------|
| B1003 | 10 (per box) | Dome Mini Bulb |
| B1004 | 10 (per box) | Dome Mini Bulb |
| B211-2 | 10 (per box) | Dome Mini Bulb |
| B89 | 10 (per box) | Dome Mini Bulb |

Double Contact Mini Bayonet

| Part # | UOM | Description: |
|-----------------------|--------------|---|
| B1076 | 10 (per box) | Double Contact Miniature Bayonet Bulb (12 Volt) |

Rear Turn Mini

| Part # | UOM | Description: |
|-----------------------|--------------|---------------------|
| B1141 | 10 (per box) | Rear Turn Mini Bulb |

Front Turn Mini

| Part # | UOM | Description: |
|-------------------------|--------------|----------------------------------|
| B1156 | 10 (per box) | Front Turn Miniature Bulb |
| B1156NA | 10 (per box) | Front Turn Miniature Bulb |
| B2057NA | 10 (per box) | Front Turn Miniature Import Bulb |
| B1157NA | 10 (per box) | Front Turn Miniature Bulb |

Stop & Turn Mini

| Part # | UOM | Description: |
|--------------------------|--------------|---|
| B1157 | 10 (per box) | Stop & Turn Miniature Bulb |
| B3057 | 10 (per box) | Stop & Turn Miniature Bulb, USA Made - Wagner |
| B3057NA | 10 (per box) | Stop & Turn Miniature Bulb, USA Made - Wagner |
| B3157 | 10 (per box) | Stop & Turn Miniature Bulb, USA Made - Wagner |
| B2357 | 10 (per box) | Stop & Turn Miniature Bulb |
| B2357NA | 10 (per box) | Stop & Turn Miniature Bulb |
| B2057 | 10 (per box) | Stop & Turn Miniature Bulb |
| B3057I | 10 (per box) | Stop & Turn Miniature Bulb Import |
| B3057NAI | 10 (per box) | Stop & Turn Miniature Bulb Import |
| B3157I | 10 (per box) | Stop & Turn Miniature Bulb Import |
| B3157NAI | 10 (per box) | Stop & Turn Miniature Bulb Import |
| B3457I | 10 (per box) | Stop & Turn Miniature Bulb Import |
| B3457NAI | 10 (per box) | Stop & Turn Miniature Bulb Import |



Universal Instrument Mini

| Part # | UOM | Description: |
|-------------|--------------|-------------------------------------|
| B168 | 10 (per box) | Universal Instrument Miniature Bulb |



Bulbs

| Part # | UOM | Description: |
|---------------|--------------|-------------------|
| B17035 | 10 (per box) | Bulb 17035/2721MF |
| B17037 | 10 (per box) | Bulb 17037/2721MF |
| B17097 | 10 (per box) | Bulb 17097/2821MF |
| B17125 | 10 (per box) | Bulb 17125/6418 |
| B17131 | 10 (per box) | Bulb 17131/3893 |
| B17171 | 10 (per box) | Bulb 17171/5007 |
| B17177 | 10 (per box) | Bulb 17177/2825 |
| B17311 | 10 (per box) | Bulb 17311/5008 |
| B17314 | 10 (per box) | Bulb 17314/6411 |
| B17635 | 10 (per box) | Bulb 17635/7506 |
| B17638 | 10 (per box) | Bulb 17638/7507 |
| B17881 | 10 (per box) | Bulb 17881/7225 |
| B17916 | 10 (per box) | Bulb 17916/7528 |

Instrument Mini

| Part # | UOM | Description: |
|--------------|--------------|----------------------|
| B1816 | 10 (per box) | Instrument Mini Bulb |
| B1895 | 10 (per box) | Instrument Mini Bulb |
| B194 | 10 (per box) | Instrument Mini Bulb |
| B57 | 10 (per box) | Instrument Mini Bulb |



Third Brake Light & Dome Mini

| Part # | UOM | Description: |
|-------------|--------------|------------------------------------|
| B921 | 10 (per box) | Third Brake Light & Dome Mini Bulb |



Courtesy Mini

| Part # | UOM | Description: |
|-----------------------|--------------|--------------------|
| B1891 | 10 (per box) | Courtesy Mini Bulb |

Radio Mini

| Part # | UOM | Description: |
|-----------------------|--------------|-----------------|
| B1893 | 10 (per box) | Radio Mini Bulb |
| B37 | 10 (per box) | Radio Mini Bulb |

Turn Marker Mini

| Part # | UOM | Description: |
|------------------------|--------------|-----------------------|
| B194NA | 10 (per box) | Turn Marker Mini Bulb |

Marker License Mini

| Part # | UOM | Description: |
|---------------------|--------------|--------------------------|
| B24 | 10 (per box) | Marker License Mini Bulb |

Parking Mini

| Part # | UOM | Description: |
|-----------------------|--------------|------------------------|
| B24NA | 10 (per box) | Parking Mini Bulb |
| B67 | 10 (per box) | Parking Miniature Bulb |
| B916 | 10 (per box) | Parking Mini Bulb |

Turn & Park Mini

| Part # | UOM | Description: |
|-------------------------|--------------|---|
| B3157NA | 10 (per box) | Turn & Park Miniature Bulb - U.S. Made - Wagner - USA |

Toyota Dome Light

| Part # | UOM | Description: |
|-----------------------|--------------|----------------------------------|
| B3175 | 10 (per box) | Toyota Dome Light Miniature Bulb |

Side Marker Mini

| Part # | UOM | Description: |
|------------------------|--------------|----------------------------------|
| B916NA | 10 (per box) | Toyota Dome Light Miniature Bulb |



Stop & Directional

| Part # | UOM | Description: |
|-----------------------|--------------|---|
| B3496 | 10 (per box) | Stop & Directional Honda 92 and up Miniature Bulb |
| B3497 | 10 (per box) | Stop & Directional Miniature Bulb |



GM/Chrysler Tail Lamp Bulb

| Part # | UOM | Description: |
|------------------------|--------------|----------------------------|
| B4057K | 10 (per box) | GM/Chrysler Tail Lamp Bulb |



GM Daytime Running Light Bulb

| Part # | UOM | Description: |
|------------------------|--------------|----------------------------|
| B4114K | 10 (per box) | GM/Chrysler Tail Lamp Bulb |



Krypton Gas Filled

| Part # | UOM | Description: |
|-------------------------|--------------|--|
| B4157K | 10 (per box) | Krypton Gas Filled, Sylvania Branded Bulbs |
| B4157NA | 10 (per box) | Amber - Krypton Gas Filled, Sylvania Branded Bulbs |



Indicator & Radio Mini Bulb

| Part # | UOM | Description: |
|---------------------|--------------|-----------------------------|
| B74 | 10 (per box) | Indicator & Radio Mini Bulb |



Cornering

| Part # | UOM | Description: |
|--------------------------|--------------|--|
| B7440 | 10 (per box) | Cornering, Driving/Fog & Turn Miniature Bulb |
| B7440NA | 10 (per box) | Cornering, Driving/Fog & Turn Miniature Bulb |
| B3156I | 10 (per box) | Cornering, Back-Up Miniature Bulb Import |
| B3156NAI | 10 (per box) | Cornering, Back-Up Miniature Bulb Import |



Tail Mini

| Part # | UOM | Description: |
|-------------------------|--------------|---------------------|
| B7443 | 10 (per box) | Tail Miniature Bulb |
| B7443NA | 10 (per box) | Tail Miniature Bulb |



Mini Halogen

| Part # | UOM | Description: |
|-------------|------|--|
| B880 | Each | Back-Up, Cornering Miniature Halogen Bulb |
| B881 | Each | Front Flasher, Cornering and Back-Up Mini Halogen Bulb |
| B885 | Each | Front Flasher, Cornering and Back-Up Mini Halogen Bulb |
| B889 | Each | Back-Up, High Mount Stop and Parking Mini Halogen Bulb |
| B890 | Each | Back-Up, Parking, Turn Signal Miniature Halogen Bulb |
| B891 | Each | High Mount Stop Mini Halogen Bulb |
| B893 | Each | Fog & Auto Mini Halogen Bulb |



B880

Halogen

| Part # | UOM | Description: |
|----------------|------|---------------------------------------|
| B9004 | Each | Halogen Bulb 12 Volt, 45 Watt |
| B9005 | Each | Imp. Halogen Bulb 12 Volt, 65 Watt |
| B9006 | Each | Imp. Halogen Bulb 12 Volt, 55 Watt |
| B9007 | Each | Imp. Halogen Bulb 12 Volt, 65/55 Watt |
| BH1 | Each | Halogen Bulb 55 Watt 12 Volt |
| BH10 | Each | Halogen/9145 45 Watt |
| BH11 | Each | Halogen (55W 12V) |
| BH12 | Each | Halogen Bulb/9055 55 Watt |
| BH13 | Each | Halogen Bulb/9008 55 Watt |
| BH3 | Each | Halogen Bulb (55W 12V) |
| BH4-100 | Each | Halogen Bulb 100/80 Watt 12 Volt |
| BH4-60 | Each | Halogen Bulb 60/55 Watt 12 Volt |
| BH7 | Each | Halogen 55 Watt 12 Volt |
| BH8 | Each | Halogen 35 Watt |
| BH9 | Each | Halogen 65 Watt |



BH9

Auto Bulbs

| Part # | UOM | Description: |
|----------------------|--------------|--------------------------------|
| B904 | 10 (per box) | Auto Bulb Wedge Base Mini Bulb |

Courtesy/Map

| Part # | UOM | Description: |
|----------------------|--------------|------------------------|
| B906 | 10 (per box) | Courtesy/Map Mini Bulb |



Third Light

| Part # | UOM | Description: |
|----------------------|--------------|-----------------------|
| B912 | 10 (per box) | Third Light Mini Bulb |

Rear Center High

| Part # | UOM | Description: |
|----------------------|--------------|---|
| B922 | 10 (per box) | Rear Center High Mounted Stop Mini Bulb |



Instrument Parking

| Part # | UOM | Description: |
|---------------------|--------------|-----------------------------------|
| B97 | 10 (per box) | Instrument Parking Miniature Bulb |

Long Life

| Part # | UOM | Description: |
|--------------------------|--------------|---|
| B3757NAI | 10 (per box) | Long Life 12V/ 26.9/8.3W Wedge Amber Bulb |



Import

| Part # | UOM | Description: |
|------------------------|--------------|---------------------------|
| B4157I | 10 (per box) | Import, Generic 4157 Bulb |

12V Side Prong

| Part # | UOM | Description: |
|-----------------------|------|--------------------------------|
| BH11B | Each | 12V 55W (side prong) Osram MFG |



Compact Fluorescent

| Part # | UOM | Description: |
|---------------------|------|-------------------------------------|
| B13 | Each | Compact Fluorescent for Drop Lights |

Rough Service

| Part # | Qty | Description: |
|------------------------|-----|-------------------------------------|
| BRS100 | 2 | Rough Service Bulb 100 Watt 13 Volt |
| BRS75 | 2 | Rough Service Bulb 75 Watt 130 Volt |

INDEX

| Part # | Page | Part # | Page | Part # | Page | Part # | Page | Part # | Page |
|--------|------|---------|------|---------|------|--------|------|---------|------|
| 90989 | 2 | G7039 | 12 | D7864 | 17 | 16313 | 23 | 16281 | 26 |
| 90990 | 2 | G7040 | 12 | D7866 | 17 | 16314 | 23 | 16282 | 27 |
| 90991 | 3 | G7042 | 12 | D7868 | 17 | 16315 | 23 | 16283 | 27 |
| 90992 | 3 | G7405 | 12 | D7869 | 17 | 16316 | 24 | 16284 | 27 |
| 90993 | 3 | G7406 | 12 | D7870 | 18 | 16317 | 24 | 16285 | 27 |
| 90994 | 4 | G7407 | 12 | D7871 | 18 | 16318 | 24 | 16286 | 27 |
| 90995 | 4 | G7413 | 12 | D7872 | 18 | 16214 | 25 | 16287 | 27 |
| 90996 | 4 | G7414 | 12 | D7880K | 18 | 16215 | 25 | 16288 | 27 |
| 90997 | 5 | G7415 | 12 | D7881K | 18 | 16216 | 25 | 16289 | 27 |
| 90998 | 5 | G75 | 12 | D7882K | 18 | 16217 | 25 | 16290 | 27 |
| 90999 | 5 | G80 | 12 | D7894KA | 18 | 16218 | 25 | 16291 | 27 |
| 91000 | 6 | G90 | 12 | D8003 | 18 | 16219 | 25 | 16292 | 27 |
| 91001 | 6 | G6992 | 13 | D8006 | 18 | 16220 | 25 | 16293 | 27 |
| 91002 | 7 | G6994 | 13 | D8007 | 18 | 16237 | 25 | 16294 | 27 |
| 91003 | 7 | G6996 | 13 | D8008K | 18 | 16238 | 25 | 16295 | 27 |
| G7101S | 8 | G6997 | 13 | D8009 | 18 | 16239 | 25 | 16296 | 27 |
| G7115 | 8 | G6998 | 13 | D8017 | 19 | 16240 | 25 | 16297 | 27 |
| G7125 | 8 | G7416 | 13 | D8018 | 19 | 16241 | 25 | 16298 | 27 |
| G7140S | 8 | G7417 | 13 | D8020 | 19 | 16242 | 25 | 16299 | 27 |
| G7143 | 8 | G7418 | 13 | D8022 | 19 | 16243 | 25 | 16300 | 27 |
| G7144 | 8 | G7424 | 13 | D8024 | 19 | 16244 | 25 | 16301 | 27 |
| G7146 | 8 | G7403 | 14 | D8026 | 19 | 16245 | 25 | 16302 | 27 |
| G7147 | 8 | G7408 | 14 | D8027 | 19 | 16246 | 25 | 16303 | 27 |
| G7148 | 8 | G7409 | 14 | D8031 | 19 | 16247 | 25 | 16304 | 27 |
| G7161S | 8 | G7410 | 14 | D8033K | 19 | 16248 | 25 | 16305 | 27 |
| G7167 | 8 | D7310 | 15 | D8034K | 19 | 16249 | 25 | 16306 | 27 |
| G6901 | 9 | D7312 | 15 | D8035K | 19 | 16250 | 25 | 16307 | 27 |
| G6925 | 9 | D7316 | 15 | D8036 | 19 | 16251 | 26 | 16308 | 27 |
| G6939X | 9 | D7334 | 15 | D8037 | 20 | 16252 | 26 | 16309 | 27 |
| G6940 | 9 | D7387 | 15 | D8038 | 20 | 16253 | 26 | 16310 | 27 |
| G6942 | 9 | D7428 | 15 | D8039 | 20 | 16254 | 26 | 16311 | 27 |
| G6943 | 9 | D7703 | 15 | D8040 | 20 | 16255 | 26 | 16312 | 27 |
| G6944 | 9 | D7716 | 15 | D8225S | 20 | 16256 | 26 | 16313 | 28 |
| G6980 | 9 | D7717 | 15 | D8228S | 20 | 16257 | 26 | 16136 | 28 |
| G7201 | 9 | D7738X | 15 | D10 | 21 | 16258 | 26 | 16137 | 28 |
| G7215 | 9 | D7739X | 15 | D15 | 21 | 16259 | 26 | 16138 | 28 |
| G7225 | 10 | D7740 | 15 | D20 | 21 | 16260 | 26 | 16139 | 28 |
| G7253 | 10 | D7742 | 16 | D25 | 21 | 16261 | 26 | 16140 | 28 |
| G7501 | 10 | D7801 | 16 | 16115 | 22 | 16262 | 26 | 16141 | 28 |
| G7501G | 10 | D7802 | 16 | 16116 | 22 | 16263 | 26 | 16142 | 28 |
| G7515 | 10 | D7805 | 16 | 16117 | 22 | 16264 | 26 | 16143 | 28 |
| G7515G | 10 | D7815 | 16 | 16118 | 22 | 16265 | 26 | 16144 | 28 |
| G7525 | 10 | D7817 | 16 | 16119 | 22 | 16266 | 26 | 16145 | 28 |
| G7525G | 10 | D7825 | 16 | 16121 | 22 | 16267 | 26 | 16146 | 28 |
| G7525S | 10 | D7826K | 16 | 16122 | 22 | 16268 | 26 | 16147 | 28 |
| G7526 | 10 | D7827K | 16 | 16123 | 22 | 16269 | 26 | 16148 | 28 |
| G7527 | 10 | D7838 | 16 | 16124 | 22 | 16270 | 26 | 16149 | 28 |
| G7001 | 11 | D7845KA | 16 | 16125 | 22 | 16271 | 26 | 16150 | 28 |
| G7001S | 11 | D7846 | 16 | 16126 | 22 | 16272 | 26 | B1003 | 29 |
| G7015 | 11 | D7847 | 17 | 16127 | 22 | 16273 | 26 | B1004 | 29 |
| G7015S | 11 | D7848 | 17 | 16128 | 22 | 16274 | 26 | B1076 | 29 |
| G7025 | 11 | D7853 | 17 | 16129 | 22 | 16275 | 26 | B1141 | 29 |
| G7025S | 11 | D7854 | 17 | 16130 | 22 | 16276 | 26 | B1156 | 29 |
| G7539X | 11 | D7855 | 17 | 16131 | 22 | 16277 | 26 | B1156NA | 29 |
| G7540 | 11 | D7857 | 17 | 16132 | 22 | 16278 | 26 | B1157 | 29 |
| G7542 | 11 | D7860 | 17 | 16133 | 22 | 16279 | 26 | B1157NA | 29 |
| G7542S | 11 | D7862 | 17 | 16134 | 22 | 16280 | 26 | B2057 | 29 |

INDEX/CROSSOVER

| Part # | Page | Part # | Page | TMR # | Shark # | Page # | TMR # | Shark # | Page # |
|-------------|------|----------|------|----------|---------|--------|-------------|----------|--------|
| B2057NA | 29 | B880 | 33 | BL11 | 16118 | 22 | BU57 | B57 | 30 |
| B211-2 | 29 | B881 | 33 | BL14 | 16119 | 22 | BU67 | B67 | 31 |
| B2357 | 29 | B885 | 33 | BL14W | 16121 | 22 | BU74 | B74 | 32 |
| B2357NA | 29 | B889 | 33 | BL17W | 16122 | 22 | BU7440 | B7440 | 32 |
| B3057 | 29 | B890 | 33 | BL24 | 16123 | 22 | BU7440NA | B7440NA | 32 |
| B3057I | 29 | B891 | 33 | BL36 | 16124 | 22 | BU7443 | B7443 | 32 |
| B3057NA | 29 | B893 | 33 | BL4 | 16115 | 22 | BU7443NA | B7443NA | 32 |
| B3057NAI | 29 | B9004 | 33 | BL48 | 16125 | 22 | BU880 | B880 | 33 |
| B3157 | 29 | B9005 | 33 | BL6 | 16116 | 22 | BU881 | B881 | 33 |
| B3157I | 29 | B9006 | 33 | BL8 | 16117 | 22 | BU885 | B885 | 33 |
| B3157NAI | 29 | B9007 | 33 | BU1003 | B1003 | 29 | BU889 | B889 | 33 |
| B3457I | 29 | BH1 | 33 | BU1004 | B1004 | 29 | BU89 | B89 | 29 |
| B3457NAI | 29 | BH10 | 33 | BU1076 | B1076 | 29 | BU890 | B890 | 33 |
| B89 | 29 | BH11 | 33 | BU1141 | B1141 | 29 | BU891 | B891 | 33 |
| B168 | 30 | BH12 | 33 | BU1156 | B1156 | 29 | BU893 | B893 | 33 |
| B17035 | 30 | BH13 | 33 | BU1156NA | B1156NA | 29 | BU9004 | B9004 | 33 |
| B17037 | 30 | BH3 | 33 | BU1157 | B1157 | 29 | BU9005 | B9005 | 33 |
| B17097 | 30 | BH4-100 | 33 | BU1157NA | B1157NA | 29 | BU9006 | B9006 | 33 |
| B17125 | 30 | BH4-60 | 33 | BU168 | B168 | 30 | BU9007 | B9007 | 33 |
| B17131 | 30 | BH7 | 33 | BU17035 | B17035 | 30 | BU904 | B904 | 34 |
| B17171 | 30 | BH8 | 33 | BU17037 | B17037 | 30 | BU906 | B906 | 34 |
| B17177 | 30 | BH9 | 33 | BU17097 | B17097 | 30 | BU912 | B912 | 34 |
| B17311 | 30 | B13 | 34 | BU17125 | B17125 | 30 | BU916 | B916 | 31 |
| B17314 | 30 | B3757NAI | 34 | BU17131 | B17131 | 30 | BU916NA | B916NA | 31 |
| B17635 | 30 | B4157I | 34 | BU17171 | B17171 | 30 | BU921 | B921 | 30 |
| B17638/7507 | 30 | B904 | 34 | BU17177 | B17177 | 30 | BU922 | B922 | 34 |
| B17881/7225 | 30 | B906 | 34 | BU17311 | B17311 | 30 | BU97 | B97 | 34 |
| B17916/7528 | 30 | B912 | 34 | BU17314 | B17314 | 30 | BUH1 | BH1 | 33 |
| B1816 | 30 | B922 | 34 | BU17635 | B17635 | 30 | BUH10 | BH10 | 33 |
| B1895 | 30 | B97 | 34 | BU17638 | B17638 | 30 | BUH11 | BH11 | 33 |
| B194 | 30 | BH11B | 34 | BU17881 | B17881 | 30 | BUH12 | BH12 | 33 |
| B57 | 30 | BRS100 | 34 | BU17916 | B17916 | 30 | BUH13 | BH13 | 33 |
| B921 | 30 | BRS75 | 34 | BU1816 | B1816 | 30 | BUH3 | BH3 | 33 |
| B1891 | 31 | B9007 | 33 | BU1891 | B1891 | 31 | BUH4-100 | BH4-100 | 33 |
| B1893 | 31 | BH1 | 33 | BU1893 | B1893 | 31 | BUH4-60 | BH4-60 | 33 |
| B194NA | 31 | BH10 | 33 | BU1895 | B1895 | 30 | BUH7 | BH7 | 33 |
| B24 | 31 | BH11 | 33 | BU194 | B194 | 30 | BUH8 | BH8 | 33 |
| B24NA | 31 | BH12 | 33 | BU194NA | B194NA | 31 | BUH9 | BH9 | 33 |
| B3157NA | 31 | BH13 | 33 | BU2057 | B2057 | 29 | BUIMP3057 | B3057I | 29 |
| B3175 | 31 | BH3 | 33 | BU2057NA | B2057NA | 29 | BUIMP3057NA | B3057NAI | 29 |
| B37 | 31 | BH4-100 | 33 | BU211-2 | B211-2 | 29 | BUIMP3156 | B3156I | 32 |
| B67 | 31 | BH4-60 | 33 | BU2357 | B2357 | 29 | BUIMP3156NA | B3156NAI | 32 |
| B916 | 31 | BH7 | 33 | BU2357NA | B2357NA | 29 | BUIMP3157 | B3157I | 29 |
| B916NA | 31 | BH8 | 33 | BU24 | B24 | 31 | BUIMP3157NA | B3157NAI | 29 |
| B3156I | 32 | BH9 | 33 | BU24NA | B24NA | 31 | BUIMP3457 | B3457I | 29 |
| B3156NAI | 32 | B904 | 34 | BU3057 | B3057 | 29 | BUIMP3457NA | B3457NAI | 29 |
| B3496 | 32 | B906 | 34 | BU3057NA | B3057NA | 29 | BUIMP3757NA | B3757NAI | 34 |
| B3497 | 32 | B912 | 34 | BU3157 | B3157 | 29 | BUIMP4157 | B4157I | 34 |
| B4057K | 32 | B922 | 34 | BU3157NA | B3157NA | 31 | BULBH11B | BH11B | 34 |
| B4114K | 32 | B97 | 34 | BU3175 | B3175 | 31 | BUPL13 | B13 | 34 |
| B4157K | 32 | B3757NAI | 34 | BU3496 | B3496 | 32 | BURS100-6 | BRS100 | 34 |
| B4157NA | 32 | B4157I | 34 | BU3497 | B3497 | 32 | BURS75-6 | BRS75 | 34 |
| B74 | 32 | BH11B | 34 | BU37 | B37 | 31 | CL11 | 16129 | 22 |
| B7440 | 32 | B13 | 34 | BU4057K | B4057K | 32 | CL14 | 16130 | 22 |
| B7440NA | 32 | BRS100 | 34 | BU4114K | B4114K | 32 | CL14W | 16131 | 22 |
| B7443 | 32 | BRS75 | 34 | BU4157K | B4157K | 32 | CL17W | 16132 | 22 |
| B7443NA | 32 | | | BU4157NA | B4157NA | 32 | CL24 | 16133 | 22 |

CROSSOVER

| TMR # | Shark # | Page # |
|---------|---------|--------|
| CL36 | 16134 | 22 |
| CL4 | 16126 | 22 |
| CL6 | 16127 | 22 |
| CL8 | 16128 | 22 |
| DP1 | G6925 | 9 |
| DP1079 | 91003 | 7 |
| DP5 | G6901 | 9 |
| DP500 | 90991 | 3 |
| DP501 | 90992 | 3 |
| DP502 | 90993 | 3 |
| DP600 | 90989 | 2 |
| DP6939X | G6939X | 9 |
| DP6940 | G6940 | 9 |
| DP6942 | G6942 | 9 |
| DP6943 | G6943 | 9 |
| DP6944 | G6944 | 9 |
| DP6980 | G6980 | 9 |
| DP6992 | G6992 | 13 |
| DP6994 | G6994 | 13 |
| DP6996 | G6996 | 13 |
| DP6997 | G6997 | 13 |
| DP6998 | G6998 | 13 |
| DP700 | 91001 | 6 |
| DP7001 | G7001 | 11 |
| DP7001S | G7001S | 11 |
| DP7015 | G7015 | 11 |
| DP7015S | G7015S | 11 |
| DP7025 | G7025 | 11 |
| DP7025S | G7025S | 11 |
| DP7039 | G7039 | 12 |
| DP7040 | G7040 | 12 |
| DP7042 | G7042 | 12 |
| DP7101S | G7101S | 8 |
| DP7115 | G7115 | 8 |
| DP7125 | G7125 | 8 |
| DP7140S | G7140S | 8 |
| DP7143 | G7143 | 8 |
| DP7144 | G7144 | 8 |
| DP7146 | G7146 | 8 |
| DP7147 | G7147 | 8 |
| DP7148 | G7148 | 8 |
| DP7161S | G7161S | 8 |
| DP7167 | G7167 | 8 |
| DP7201 | G7201 | 9 |
| DP7215 | G7215 | 9 |
| DP7225 | G7225 | 10 |
| DP7253 | G7253 | 10 |
| DP7310 | D7310 | 15 |
| DP7312 | D7312 | 15 |
| DP7316 | D7316 | 15 |
| DP7334 | D7334 | 15 |
| DP7387 | D7387 | 15 |
| DP7403 | G7403 | 14 |
| DP7405 | G7405 | 12 |
| DP7406 | G7406 | 12 |

| TMR # | Shark # | Page # |
|----------|---------|--------|
| DP7407 | G7407 | 12 |
| DP7408 | G7408 | 14 |
| DP7409 | G7409 | 14 |
| DP7410 | G7410 | 14 |
| DP7413 | G7413 | 12 |
| DP7414 | G7414 | 12 |
| DP7415 | G7415 | 12 |
| DP7416 | G7416 | 13 |
| DP7417 | G7417 | 13 |
| DP7418 | G7418 | 13 |
| DP7424 | G7424 | 13 |
| DP7428 | D7428 | 15 |
| DP75 | G75 | 12 |
| DP750 | 90994 | 4 |
| DP7501 | G7501 | 10 |
| DP7501G | G7501G | 10 |
| DP7515 | G7515 | 10 |
| DP7515G | G7515G | 10 |
| DP7525 | G7525 | 10 |
| DP7525G | G7525G | 10 |
| DP7525S | G7525S | 10 |
| DP7526 | G7526 | 10 |
| DP7527 | G7527 | 10 |
| DP7539X | G7539X | 11 |
| DP7540 | G7540 | 11 |
| DP7542 | G7542 | 11 |
| DP7542S | G7542S | 11 |
| DP7703 | D7703 | 15 |
| DP7716 | D7716 | 15 |
| DP7717 | D7717 | 15 |
| DP7726SK | D8033K | 19 |
| DP7727SK | D8034K | 19 |
| DP7728SK | D8035K | 19 |
| DP7738X | D7738X | 15 |
| DP7739X | D7739X | 15 |
| DP7740 | D7740 | 15 |
| DP7742 | D7742 | 16 |
| DP7801 | D7801 | 16 |
| DP7802 | D7802 | 16 |
| DP7805 | D7805 | 16 |
| DP7815 | D7815 | 16 |
| DP7817 | D7817 | 16 |
| DP7825 | D7825 | 16 |
| DP7826K | D7826K | 16 |
| DP7827K | D7827K | 16 |
| DP7838 | D7838 | 16 |
| DP7845KA | D7845KA | 16 |
| DP7846 | D7846 | 16 |
| DP7847 | D7847 | 17 |
| DP7848 | D7848 | 17 |
| DP7853 | D7853 | 17 |
| DP7854 | D7854 | 17 |
| DP7855 | D7855 | 17 |
| DP7857 | D7857 | 17 |
| DP7860 | D7860 | 17 |

| TMR # | Shark # | Page # |
|----------|---------|--------|
| DP7862 | D7862 | 17 |
| DP7864 | D7864 | 17 |
| DP7866 | D7866 | 17 |
| DP7868 | D7868 | 17 |
| DP7869 | D7869 | 17 |
| DP7870 | D7870 | 18 |
| DP7871 | D7871 | 18 |
| DP7872 | D7872 | 18 |
| DP7880K | D7880K | 18 |
| DP7881K | D7881K | 18 |
| DP7882K | D7882K | 18 |
| DP7894KA | D7894KA | 18 |
| DP80 | G80 | 12 |
| DP800 | 90990 | 2 |
| DP8003 | D8003 | 18 |
| DP8006 | D8006 | 18 |
| DP8007 | D8007 | 18 |
| DP8008K | D8008K | 18 |
| DP8009 | D8009 | 18 |
| DP8017 | D8017 | 19 |
| DP8018 | D8018 | 19 |
| DP8020 | D8020 | 19 |
| DP8022 | D8022 | 19 |
| DP8024 | D8024 | 19 |
| DP8026 | D8026 | 19 |
| DP8027 | D8027 | 19 |
| DP8031 | D8031 | 19 |
| DP8036 | D8036 | 19 |
| DP8037 | D8037 | 20 |
| DP8038 | D8038 | 20 |
| DP8039 | D8039 | 20 |
| DP8040 | D8040 | 20 |
| DP8225S | D8225S | 20 |
| DP8228S | D8228S | 20 |
| DP90 | G90 | 12 |
| FU10MC3 | 16239 | 25 |
| FU15MC3 | 16240 | 25 |
| FU2MC10 | 16216 | 25 |
| FU2MC15 | 16217 | 25 |
| FU2MC20 | 16218 | 25 |
| FU2MC25 | 16219 | 25 |
| FU2MC30 | 16220 | 25 |
| FU2MC5 | 16214 | 25 |
| FU2MC7.5 | 16215 | 25 |
| FU5MC3 | 16237 | 25 |
| FU7.5MC3 | 16238 | 25 |
| FUATC10 | 16245 | 25 |
| FUATC15 | 16246 | 25 |
| FUATC20 | 16247 | 25 |
| FUATC25 | 16248 | 25 |
| FUATC3 | 16241 | 25 |
| FUATC30 | 16249 | 25 |
| FUATC4 | 16242 | 25 |
| FUATC40 | 16250 | 25 |
| FUATC5 | 16243 | 25 |

| TMR # | Shark # | Page # |
|-----------|---------|--------|
| FUATC7.5 | 16244 | 25 |
| FUATM10 | 16256 | 26 |
| FUATM15 | 16257 | 26 |
| FUATM2 | 16251 | 26 |
| FUATM20 | 16258 | 26 |
| FUATM25 | 16259 | 26 |
| FUATM3 | 16252 | 26 |
| FUATM30 | 16260 | 26 |
| FUATM4 | 16253 | 26 |
| FUATM5 | 16254 | 26 |
| FUATM7.5 | 16255 | 26 |
| FUFL60 | 16271 | 26 |
| FUFLB100 | 16266 | 26 |
| FUFLB30 | 16261 | 26 |
| FUFLB40 | 16262 | 26 |
| FUFLB50 | 16263 | 26 |
| FUFLB60 | 16264 | 26 |
| FUFLB80 | 16265 | 26 |
| FUFLF100 | 16273 | 26 |
| FUFLF20 | 16267 | 26 |
| FUFLF30 | 16268 | 26 |
| FUFLF40 | 16269 | 26 |
| FUFLF50 | 16270 | 26 |
| FUFLF80 | 16272 | 26 |
| FUFLM100 | 16280 | 26 |
| FUFLM120 | 16281 | 26 |
| FUFLM20 | 16274 | 26 |
| FUFLM30 | 16275 | 26 |
| FUFLM40 | 16276 | 26 |
| FUFLM50 | 16277 | 26 |
| FUFLM60 | 16278 | 26 |
| FUFLM80 | 16279 | 26 |
| FUJCASE20 | 16289 | 27 |
| FUJCASE30 | 16290 | 27 |
| FUJCASE40 | 16291 | 27 |
| FUJCASE50 | 16292 | 27 |
| FULP10BX | 16295 | 27 |
| FULP15BX | 16296 | 27 |
| FULP20BX | 16297 | 27 |
| FULP25BX | 16298 | 27 |
| FULP30BX | 16299 | 27 |
| FULP5BX | 16293 | 27 |
| FULP7.5BX | 16294 | 27 |
| FUMATC20 | 16282 | 27 |
| FUMATC30 | 16283 | 27 |
| FUMATC40 | 16284 | 27 |
| FUMATC50 | 16285 | 27 |
| FUMATC60 | 16286 | 27 |
| FUMATC70 | 16287 | 27 |
| FUMATC80 | 16288 | 27 |
| FUMIN20 | 16300 | 27 |
| FUMIN30 | 16301 | 27 |
| FUMIN40 | 16302 | 27 |
| FUMIN50 | 16303 | 27 |
| FUMIN60 | 16304 | 27 |

| TMR # | Shark # | Page # |
|---------|---------|--------|
| FUMIN70 | 16305 | 27 |
| FUMIN80 | 16306 | 27 |
| FUMJC20 | 16307 | 27 |
| FUMJC25 | 16308 | 27 |
| FUMJC30 | 16309 | 27 |
| FUMJC40 | 16310 | 27 |
| FUMJC50 | 16311 | 27 |
| FUMJC60 | 16312 | 27 |
| HC1 | 16147 | 28 |
| HC10 | 16149 | 28 |
| HC2-10E | 16137 | 28 |
| HC2-12E | 16138 | 28 |
| HC2-16E | 16139 | 28 |
| HC2-20E | 16140 | 28 |
| HC2-24E | 16141 | 28 |
| HC2-28E | 16142 | 28 |
| HC2-32E | 16143 | 28 |
| HC2-36E | 16144 | 28 |
| HC2-6E | 16145 | 28 |
| HC2-8E | 16146 | 28 |
| HC5 | 16148 | 28 |
| HCM-4E | 16135 | 28 |
| HCM-6E | 16136 | 28 |
| OPK102 | 16315 | 23 |
| OPK1064 | 91002 | 7 |
| OPK17 | 16317 | 24 |
| OPK18 | 16150 | 28 |
| OPK20 | 16316 | 24 |
| OPK400 | 16314 | 23 |
| OPK435 | 16313 | 23 |
| OPK476 | 16318 | 24 |
| OPK501 | 90995 | 4 |
| OPK502 | 90997 | 5 |
| OPK503 | 90998 | 5 |
| OPK504 | 90999 | 5 |
| OPK62 | 90996 | 4 |
| OPK690 | 91000 | 6 |
| WS10Y | D10 | 21 |
| WS15R | D15 | 21 |
| WS20B | D20 | 21 |
| WS25W | D25 | 21 |



**Professional Brake Lathe
& Tire Accessories**



INTRODUCTION SHARK INDUSTRIES LTD.

HISTORY

Shark Industries has been in business for almost 35 years. We have been a quality Abrasive manufacturer and supplier to the Automotive Aftermarket for all that time; as well as a full line supplier of Welding Supplies and Accessories.

CARBIDE INSERTS FOR BRAKE LATHES

Shark was one of the first companies to supply carbide inserts for all brake lathes other than the OEM manufacturers and has been in the business of supplies and accessories for brake lathes since 1985.

WHEEL BALANCER AND TIRE CHANGER ACCESSORIES

Our accessories for Tire Changers, Brake Lathes and Wheel Balancers are guaranteed to perform up to OEM standards.

Best known for our on-time delivery, excellent customer service, and knowledge in the above fields, your customers will notice the difference in our quality from the first time they use our products.

CATALOGUE CATEGORIES BY SEQUENCE

| CATEGORY | PAGE | CATEGORY | PAGE |
|--|-------|---------------------------------|-------|
| Carbide Bits for Brake Lathes | 1-8 | Adaptor Plus Kit | 35 |
| Toolholders for Carbide Bits | 9-12 | Adapt-Rite System | 36 |
| Silencer Bands | 13-15 | Quick-Chuck Hubless Kits | 37-39 |
| Non-Directional Swirl Pads | 16-17 | Brake Fluid Tester/Ceramlub | 40 |
| Brake Lathe Accessories | 18-19 | Vacuum Brake Bleeder | 41 |
| Twin Cutters/Extenda-Feed | 20 | Tire Repair Burs/Mounted Points | 42 |
| Arbors | 21 | Tire Changer Accessories | 42-48 |
| Brake Lathe Repair Parts | 22-26 | Mount/Demount Heads | 49-52 |
| Flywheel Grinding Wheels/Honing Stones | 27 | Wheel Balancer Accessories | 53-56 |
| Brake & Engine Hones & Stones | 28 | Lift Pads | 57 |
| Adapt-All Rotor & Drum System | 29 | Paint Pens | 58 |
| Drum/Rotor Adaptors | 30-34 | Index | 59-61 |

SHARK AND SHARK WELDING are registered trademarks of Shark Industries Ltd. Any use of the name without express written permission is prohibited. Any reproduction of this catalogue without the permission of Shark is prohibited. Shark is a manufacturer/repackager of its own products. Any mention of any other manufacturer in this catalogue is only for reference purposes of part number, etc., and is not intended in any way to imply that Shark products are manufactured by any of the mentioned manufacturers.



CARBIDE BITS FOR BENCH AND ON-THE-CAR LATHES







Shark is the leader in Automotive Brake Lathe Bits since 1987.

Being the first Aftermarket Company to sell bits for all brand brake lathes in the market, Shark has offered Aftermarket bits for many brake lathe manufacturers since 1987.



All Shark bits are guaranteed to perform as well as any OEM bits. Most bits come with one, two and three dots in the corners for easy identification of the used corner on your bit.

Shark also offers bits in a large variety of package quantities, allowing you to meet the needs of every mechanic; from larger shops to very small users in service stations.



Accu-Turn

| | Part# | Qty. | OEM # | Description |
|--|---------------|-------|--------|---|
|  060 | 060-6 | 6 pk | 433796 | Accu-Turn/Bosch Style Positive Rake Bit for Disc/Drum Lathes. Use on models: 7700, 8911, 8922, 8944, 8989, 8991, 8993 and 8922L. Cutting Edges: 3 (6 by cross-indexing) |
| | 060-10 | 10 pk | 40435 | |
|  408 | 408-6 | 6 pk | N/A | Accu-Turn Style Positive Rake Bit with larger Radius for more aggressive action-longer life for Disc/Drum Lathes. Use on models: 8911, 8922, 8944, 8989, 8991 or 8993. Cutting Edges: 3 (6 by cross-indexing) |
| | 408-10 | 10 pk | N/A | |
|  409 | 409-6 | 6 pk | N/A | Accu-Turn Style Positive Rake Bit with .048 Radius and TiAlN coating for aggressive action-longer life. Use on models: 8911, 8922, 8944, 8989, 8991 or 8993. Cutting Edges: 3 (6 by cross-indexing) (Holders 422 / 423-424 set) |
| | 409-10 | 10 pk | N/A | |
|  068 | 068-6 | 6 pk | 878051 | Accu-Turn Style Negative Rake On-The-Car Bits, 1/8" thick. Use on models: Accu-Turn 8700, 8750, 8800, 8820 and 8750 On-The-Car lathes. Cutting Edges: 6 (12 by cross-indexing) |
| | 068-10 | 10 pk | 878052 | |

All Tool

| | | | | |
|--|---------------|-------|------|---|
|  064 | 064-6 | 6 pk | 3330 | All Tool Style Negative Bits for Disc/Drum Lathes. Use on models: 747 Cutting Edges: 6 (12 by cross-indexing) |
| | 064-10 | 10 pk | 3331 | |
|  065 | 065-6 | 6 pk | 8731 | All Tool Style Positive Bits for Disc/Drum Lathes. Use on models: 747 Cutting Edges: 3 (6 by cross-indexing) |
| | 065-10 | 10 pk | N/A | |

Ammco - Negative Rake

| | | | | |
|---|----------------|-------|---------|---|
|  062 | 062-6 | 6 pk | 6914-6 | Most Popular - Ammco Style Negative Rake Bits for Disc/Drum Lathes. Use on models: 1000, 1001, 3000, 4000, 4100, 7000, 7700. On-the-Car brake lathe models 700, 705 & 710. Drum Side on 3850 lathes. Cutting Edges: 6 (12 by cross-indexing) |
| | 062-10 | 10 pk | 6914-10 | |
|  062S | 062S-6 | 6 pk | 6914-6 | Extra Life - Super Ammco Style Negative Rake Bits. Precision Ground all over. Use in place of all 6914 bits. Use on all 062 applications Cutting Edges: 6 (12 by cross-indexing) |
| | 062S-10 | 10 pk | 6914-10 | |

CARBIDE BITS FOR BENCH AND ON-THE-CAR LATHES



Ammco - Negative Rake

| Description | OEM # | Qty. | Part # |
|--|-------------------|---------------|---------------------------------|
| Coated Ammco Style Negative Rake Bits. Use in place of all 6914 bits. Use on models: 1000, 1001, 3000, 4000, 4100, 7000, 7700. On-the-Car brake lathe Models 700, 705 & 710. Drum Side on 3850 lathes. Cutting Edges: 6 (12 by cross-indexing) | 6914-6 6914-10 | 6 pk 10 pk | 062C-6 062C-10 |
| Economy Ammco Style Negative Rake Bits. Use in place of all 6914 bits. Use on models: 1000, 1001, 3000, 4000, 4100, 7000, 7700. On-the-Car brake lathe Models 700, 705 & 710. Drum Side on 3850 lathes. Cutting Edges: 6 (12 by cross-indexing) | 6914-6 6914-10 | 6 pk 10 pk | 063-6 063-10 |
| Thicker - 1/8" Ammco Style Negative Rake Bits. Use in place of all 6914 bits. Use on models: 1000, 1001, 3000, 4000, 4100, 7000, 7700. On-the-Car brake lathe Models 700, 705 & 710. Drum Side on 3850 lathes. Cutting Edges: 6 (12 by cross-indexing) | 6914-6 6914-10 | 6 pk 10 pk | 068-6 068-10 |



Ammco - Positive Rake

| | | | |
|---|-------------------|---------------|-------------------------------|
| Most Popular Ammco Style Positive Rake Bits for Disc/Drum Lathes Twin Cutter & 9381 Facing Set. Cutting Edges: 3 (6 by cross-indexing) | 7681-6 7681-10 | 6 pk 10 pk | 103-6 103-10 |
| Coated Ammco Style Positive Rake Bits. Use in place of 6918 Ammco bits. Use on all above mentioned lathes. Cutting Edges: 3 (6 by cross-indexing) | 6918-6 6918-10 | 6 pk 10 pk | 104-6 104-10 |
| Heavy Duty Ammco Style Positive Rake Bits. Use on Drum Models in toolholder 9695. Cutting Edges: 3 (6 by cross-indexing) | 5677-2 | 2 pk | A5677-2 |
| Shark Style Positive Rake Bits for Ammco Disc/Drum Lathes .048 Radius. Use on models: 3850, 4000, 7000, 7500. Must change to Toolholder 422 & 423. Cutting Edges: 3 (6 by cross-indexing) | N/A N/A | 6 pk 10 pk | 408-6 408-10 |
| Ammco Style Positive Rake Bits for Disc/Drum Lathes. Use on models: 3850, 4000, 7000, 7500. Must change to Toolholder 426 & 427. Cutting Edges: 15-20 | 940610 940610 | 6 pk 10 pk | 066-6 066-10 |

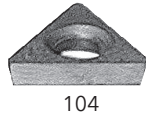
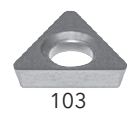

Bear

| | | | |
|---|-----------------|---------------|-------------------------------|
| Bear Style Negative Rake Bits for Disc/Drum Lathes. Use on models: 478 Disc or 1410, 1467, 1468, 1469 Drum Lathes. Cutting Edges: 6 (12 by cross-indexing) | 722-83-4 N/A | 6 pk 10 pk | 383-6 383-10 |
|---|-----------------|---------------|-------------------------------|



FMC



| | | | |
|--|--------------|---------------|-------------------------------|
| Most Popular FMC/John Bean/Barrett/Snap-on Style Positive Rake Bits for Disc/Drum Lathes-.020 Radius. Use on models: 67BSD, 67DLX, 67GSA, 69DLX, 701 ECF, 601PF. FMC/Barrett 400, 500, 600 or 700 Lathes. Cutting Edges: 3 (6 by cross-indexing) | N/A 90488 | 6 pk 10 pk | 407-6 407-10 |
| Superior Grade .048 Radius FMC/John Bean/Barrett/Snap-on Style Positive Rake Bits for Disc/Drum Lathes offers Extra Life. Use on same models as listed above. Cutting Edges: 3 (6 by cross-indexing) | N/A N/A | 6 pk 10 pk | 408-6 408-10 |







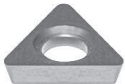

CARBIDE BITS FOR BENCH AND ON-THE-CAR LATHES

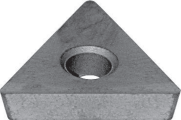

FMC

| Part# | Qty. | OEM # | Description |
|--|---------------|--------------|---|
|  409 | 6 pk 10 pk | N/A N/A | Superior Grade TiAlN Coated .048 Radius FMC/John Bean/Barrett/Snap-on Style. Positive Rake Bits for Disc/Drum Lathes. Extra Life. 67BSD, 67DLX, 67GSA, 69DLX, 701 ECF, 601PF. FMC/Barrett 400, 500, 600 or 700 Lathes. Cutting Edges: 3 (6 by cross-indexing) |
|  103 | 6 pk 10 pk | N/A 91212 | On-the Car Lathe FMC/John Bean/Barrett/Snap-on Style Positive Rake Bits. Use on all 500 Series On-the Car RTI Style lathes using positive rake bits. Cutting Edges: 3 (6 by cross-indexing) |
|  062 | 6 pk 10 pk | N/A 90817 | On-the Car Lathe FMC/John Bean/Barrett/Snap-on Style Negative Rake Bits. Use on all 500 Series On-the Car RTI Style lathes using negative rake bits. Cutting Edges: 6 (12 by cross-indexing) |

Hofmann/RJ West

| | | | |
|---|---------------|-----------------------------|---|
|  407 | 6 pk 10 pk | 000-90488-000 W139 | Most Popular Hofmann 400/401/201 True Cut-RJ WEST Style Positive Rake Bits for Disc Rotor Lathes. Use on models: 400/401/201 True Cut/RJ West Rotor & Drum Lathes - 1115HD, 1215S. Cutting Edges: 3 (6 by cross-indexing) |
|  409 | 6 pk 10 pk | N/A N/A | Shark TiAlN Coated .048 Radius Long-Life Positive Rake Bits for Hofmann 400/401 True Cut-RJ WEST Style Bits for Disc/Rotor Lathes. Use on same models as above. Cutting Edges: 3 (6 by cross-indexing) |
|  503 | 6 pk 10 pk | W136-1 | Hofmann -RJ WEST Style Bits Negative Rake Bits for Drum Cutting. Use on model 715. Cutting Edges: 6 (12 by cross-indexing) |
|  502 | 6 pk 10 pk | DRL90 | Hofmann -RJ WEST Style Bits Negative Rake Bits for Disc Cutting. Use on model 715 and RJ West 1115HD. Cutting Edges: 6 (12 by cross-indexing) |
|  062 | 6 pk 10 pk | 221-580-2 221-617-2(24) | Hofmann Style Negative Rake Bits for Disc/Drum Lathes. Use on model 660 lathes. Cutting Edges: 6 (12 by cross-indexing) |
|  062S | 6 pk 10 pk | 221-580-24 221-617-2(24) | Extra Life Hofmann Style Negative Rake Bits Precision ground all over insert. Use on model 660 lathes. Cutting Edges: 6 (12 by cross-indexing) |

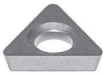
Hunter

| | | | |
|--|---------------|----------------------------|--|
|  064 | 6 pk 10 pk | 221-580-2 221-617-2(24) | Hunter Style Negative Rake Bits for Drums. Use on Hunter BL500, 501 & 505 Combination Lathe. Uses Shark 191 and 192 Toolholders. Cutting Edges: 6 (12 by cross-indexing) |
|  065 | 6 pk 10 pk | 221-639-3 221-640-3 | Hunter Style Positive Rake Bits Use on rotor models BL500, 501 & 505 Hunter Lathes. Uses Shark 468 and 469 Toolholder. Cutting Edges: 3 (6 by cross-indexing) |
|  103 | 6 pk 10 pk | 221-538-3 | Hunter Style Positive Rake Bits Use on models OCL400, OCL360, BL505 & BL501. Cutting Edges: 3 (6 by cross-indexing) |

CARBIDE BITS FOR BENCH AND ON-THE-CAR LATHES



| | | | Hunter |
|--|-----------|-------|---------------|
| Description | OEM # | Qty. | Part # |
| Hunter Style Positive Rake Micro-Round Inserts. For OCL360, OCL-400, BL505 & BL501 lathes. Screw Sold Separately. Cutting Edges: 15 - 20 | 221-626-3 | 6 pk | 709-6 |
| | 221-626-3 | 10 pk | 709-10 |
| | 75-556-2 | 1 pk | 709S |



| | | | |
|---|-----------|-------|---------------|
| Hunter Style Positive Rake Bits. Use on Rotor Models BL500, BL501 & BL505 Combo Lathes in Foreign Car Angled Toolholders. Use Toolholders RP8-8568, RP8-8569, 221-615-2, 221-616-2. Cutting Edges: 3 (6 by cross-indexing) | 221-651-2 | 6 pk | 067-6 |
| | | 10 pk | 067-10 |

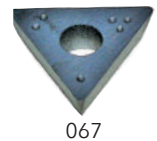

| | | | |
|--|-----------|-------|---------------|
| Shark positive rake bits for Hunter BL500 BL505 & BL501 Rotor Lathes TiaLN Coated Requires a toolholder change Use with Shark 422 & 423 Holders. .060 Radius. Cutting Edges: 3 (6 by cross-indexing) | 221-678-3 | 6 pk | 409-6 |
| | | 10 pk | 409-10 |



| | | | |
|---|-------------|-------|---------------|
| Most Popular Hunter Style Negative Rake Bits for Disc Rotors. Use on models: 201, 205 Disc Lathes. Cutting Edges: 6 (12 by cross-indexing) | V302-07-167 | 6 pk | 702-6 |
| | | 10 pk | 702-10 |

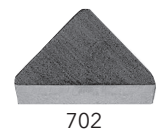

| | | | |
|---|-----------|-------|---------------|
| Hunter Style On-the-Car Negative Bits. For BL300 On-Car Lathes. Cutting Edges: 6 (12 by cross-indexing) | 221-538-3 | 6 pk | 703-6 |
| | 221-580-2 | 10 pk | 703-10 |



Kwik-Way/Snap-on/John Bean

| | | | |
|---|-------------|-------|---------------|
| Kwik-Way/Snap-on Style Positive Rake Bits for Disc Rotors. Use on models: SDL, DL, 850 Disc Lathes, ROTUNDA, Snap-on On-the-car YA180, YA281 Bench Lathes. Kwik-Way NCL, BDL, CBL108 & Kwik-Lathe On-the-Car 108-005-04 w/000-0171-91 Screws. Cutting Edges: 3 (6 by cross-indexing) | N/A | 6 pk | 802-6 |
| | 109-1092-23 | 10 pk | 802-10 |
| | 109-1092-45 | | |
| | BTK10A | | |



| | | | |
|---|-------------|-------|---------------|
| Kwik-Way Style Formula I Type Positive Rake Bits for Lightning Lathe .032 Radius Use on models: 104 Cutting Edges: 3 (6 by cross-indexing) | 109-1092-32 | 10 pk | 803-10 |
|---|-------------|-------|---------------|



| | | | |
|---|-------------|-------|---------------|
| Kwik-Way Style Formula I type Positive Rake Bits for Lightning Lathe. .045 Radius Use on models: 104 Cutting Edges: 3 (6 by cross-indexing) | 109-1092-45 | 10 pk | 809-10 |
|---|-------------|-------|---------------|

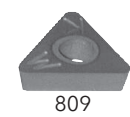

Pro-Cut

| | | | |
|---|--------|-------|---------------|
| Pro-Cut Style Positive Rake Bit. Use on Models: 610 Pro-Cut On Car Lathes. Toolholder: 29005. Cutting Edges: 3 (6 by cross-indexing) | N/A | 6 pk | 061-6 |
| | 50-701 | 10 pk | 061-10 |



| | | | |
|--|--------|-------|---------------|
| Pro-Cut Style Positive Rake Bit. For Ford lathes applications 610 Pro-Cut On Car Lathes; RJ West PFM 9.2 and FM900. Toolholder: 29005. Cutting Edges: 3 (6 by cross-indexing) | 50-741 | 6 pk | 069-6 |
| | 50-742 | 10 pk | 069-10 |



Perfect Equipment

| | | | |
|---|------|-------|---------------|
| Pro-Cut/Hofmann Style Positive Rake Bit for Twin Turn 400/P450 Lathes. For use on Models: 400 & 450 Twin Turn Comb. Lathes. Cutting Edges: 3 (6 by cross-indexing) | D139 | 6 pk | 407-6 |
| | | 10 pk | 407-10 |





CARBIDE BITS FOR BENCH AND ON-THE-CAR LATHES

Perfect Equipment

| Part# | Qty. | OEM # | Description |
|---------------|-------|--------|---|
| 502-6 | 6 pk | DR L90 | Perfect Hofmann Equipment/RJ West Style Negative Rake Bit for Rotor Cutting. For use on P300 Disc, P350 Combination & P450 Twin Turn Lathes; RJ West 1115 H.D. Cutting Edges: 6 (12 by cross-indexing) |
| 502-10 | 10 pk | | |

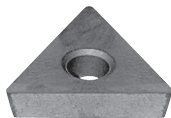

502



503

| | | | |
|---------------|-------|------|--|
| 503-6 | 6 pk | W136 | Perfect Hofmann Equipment Style Negative Bits for Disc/Drum Cutting. Use on: P300 Disc, P350 Combination & P450 Twin Turn Lathes. Cutting Edges: 6 (12 by cross-indexing) |
| 503-10 | 10 pk | | |

Performance



064

| | | | |
|---------------|-------|------|--|
| 064-6 | 6 pk | 3336 | Most Popular Performance Style Negative Rake Bit for Drum & Rotor Lathes. Use on models: 6600, 7100 7200 & 7600 lathes. Cutting Edges: 6 (12 by cross-indexing) |
| 064-10 | 10 pk | 3340 | |

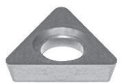

065

| | | | |
|---------------|-------|------|---|
| 065-6 | 6 pk | 8711 | Most Popular Performance Style Positive Rake Bit for Drum & Rotor Lathes. For use on all above mentioned lathes. Cutting Edges: 3 (6 by cross-indexing) |
| 065-10 | 10 pk | 8711 | |



067

| | | | |
|---------------|-------|------|--|
| 067-6 | 6 pk | 8712 | Most Popular Performance Style Positive Rake Bit for Foreign Car Rotor Cutting. Toolholders: 8587 & 9599. Cutting Edges: 3 (6 by cross-indexing) |
| 067-10 | 10 pk | 8712 | |

Ranger



408

| | | | |
|---------------|-------|-------|---|
| 408-6 | 6 pk | 45016 | Ranger Style Positive Rake Bit for Disc and Drum Cutting. Use on models RL8500 & RL8500 XLT Cutting Edges: 3 (6 by cross-indexing) |
| 408-10 | 10 pk | 45016 | |



409

| | | | |
|---------------|-------|-------|---|
| 409-6 | 6 pk | 45021 | Ranger Style.048 Radius TiaLN Coated Positive Rake Rotor Cutting Bit. Use on models RL8500 & RL8500 XLT Cutting Edges: 3 (6 by cross-indexing) |
| 409-10 | 10 pk | 45021 | |

RJ West - See Hofmann

Rels/Van Norman



802

| | | | |
|---------------|-------|------|---|
| 802-6 | 6 pk | Rels | Swing-Arm Style Rels Positive 15 degree Bit for Rotor & Drums. Use on models: SW504 Cutting Edges: 3 (6 by cross-indexing) |
| 802-10 | 10 pk | | |



902L

| | | | |
|----------------|-------|--------|--|
| 902L-6 | 6 pk | 302167 | Rels/Van Norman Style Parallelogram Left Hand Positive Rake Bit for 204 Lathes. For Flywheel/Drum Cutting. Use on: 204S Old Style, 205DR, 301, 303, 304, 305, 310, 404/405 Cutting Edges: 2 (4 by cross-indexing) |
| 902L-10 | 10 pk | | |



902R

| | | | |
|----------------|-------|--------|--|
| 902R-6 | 6 pk | 977572 | Rels/Van Norman Style Parallelogram Right Hand Positive Rake Bit for 204 Lathes. For Rotor Cutting. Use on: 204 New Style, 204C, 204S, 205DR, 300, 302 Lathes & Flywheel Machines. Cutting Edges: 2 (4 by cross-indexing) |
| 902R-10 | 10 pk | 129005 | |



903

| | | | |
|---------------|-------|--------|--|
| 903-6 | 6 pk | 866561 | Rels/Van Norman Style Positive Rake Rotor Cutting Bit. Use on models: 204C, 204D, 204S, 205DC & 415 Disc Cutting Lathes. Van Norman 243XV new Drum/Rotor Lathes & Some Snap-on. Cutting Edges: 3 (6 by cross-indexing) |
| 903-10 | 10 pk | | |

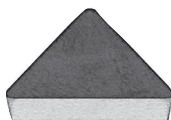









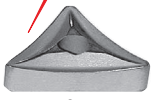

904

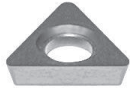
| | | | |
|---------------|-------|--------|--|
| 904-6 | 6 pk | 808406 | Rels/Van Norman Style Positive Rake Rotor Cutting Bit. Use on Models: 30473802 Flywheel Cutter/Toolholder 40822. Cutting Edges: 6 (12 by cross-indexing) |
| 904-10 | 10 pk | | |

CARBIDE BITS FOR BENCH AND ON-THE-CAR LATHES



| | | | | RELS/Van Norman | |
|---|-----------------------|---------------|-------------------------------|--|--|
| Description | OEM # | Qty. | Part # | | |
| RELS/Van Norman Style Negative Rake Flywheel Cutting Bit. Use on Models 30473802 Flywheel Cutter/ Toolholder 40822 . Cutting Edges: 6 (12 by cross-indexing) | 29005 | 6 pk 10 pk | 505-6 505-10 |  505 | |
| RELS Style Negative Rake Rotor Cutting Bit. Use on models 2000 Disc/Drum Lathes. Cutting Edges: 6 (12 by cross-indexing) | 45001 45001 | 6 pk 10 pk | 062-6 062-10 |  062 | |
| RELS Style .048 Radius Positive Rake Rotor Cutting Bit. Use on models 2000 Disc/Drum Lathes. 3 Cutting Edges: 3 (6 by cross-indexing) | 45016 45016 | 6 pk 10 pk | 408-6 408-10 |  408 | |
| RELS Style .048 Radius TialN Coated Positive Rake Rotor Cutting Bit. Use on models 2000 Disc/Drum Lathes. Use on same models as above. Cutting Edges: 3 (6 by cross-indexing) | 45021 45021 | 6 pk 10 pk | 409-6 409-10 |  409 | |
| RTI | | | | | |
| RTI Style On-The-Car Negative Rake Bits. Use on models BRC35 on-the-car lathes. Toolholder: 480-8001-00 (Black Color) Cutting Edges: 6 (12 by cross-indexing) | 080-80000-68 91212 | 6 pk 10 pk | 068-6 068-10 |  068 | |
| RTI Style On-The-Car Or Bench Lathes- Positive Rake Bits. Use on models BTC500, BRC550 Bench Lathes and BRC35 on-the-car lathes. Toolholder: (Silver) 450-80001-00 or 450-80002-00. Cutting Edges: 3 (6 by cross-indexing) | 080-80102-00 | 6 pk 10 pk | 103-6 103-10 |  103 | |
| SHARK | | | | | |
| SHARK Design .048 Radius TialN Coated Positive Rake Bits for Extra Long Life. Use on the following brake lathes after changing to toolholder #422/423. Ammco where 062's are used, FMC in place of 407, Accu-Turn in place of 060 RELS 2000 and Performance / All Tool Lathes. Cutting Edges: 3 (6 by cross-indexing) | 409 | 6 pk 10 pk | 409-6 409-10 |  409 | |
| SHARK Design Round Positive Rake Bits Use on Ammco lathes where 6914 tips are used. You must change to Toolholder 426 & 427 to use these bits. Also used with Snap- on Brake Lathes, All Tool, Rel and Performance. Cutting Edges: 6 (12 by cross-indexing) | 066 | 6 pk 10 pk | 066-6 066-10 |  066 | |
| STAR | | | | | |
| Star Style Negative Rake Carbide Bits. Use on models: 1776 Disc Lathes. Cutting Edges: 6 (12 by cross-indexing) | CD60 | 6 pk 10 pk | 808-6 808-10 |  808 | |
| Snap-On (See Kwik-Way) | | | | | |
| Sun Electric | | | | | |
| Sun Style Positive Rake Carbide Bit. Use on models EEBR105A Deluxe On-The Car Pro-Cut Rotor Cutting Sytem. Cutting Edges: 3 (6 by cross-indexing) | PC50701 | 6 pk 10 pk | 061-6 061-10 |  061 | |
| Van Norman (See RELS) | | | | | |
| VBG | | | | | |
| VBG Style Positive Rake Carbide Bit. Use on models Models 600 & 610 On-The-Car Lathes. Cutting Edges: 3 (6 by cross-indexing) | 50-701 50-742 | 6 pk | 908-6 908-10 |  908 | |



CARBIDE BITS FOR BENCH AND ON-THE-CAR LATHES

OEM NUMERIC CROSSOVERS

| OEM# | Brand | Shark# | OEM# | Brand | Shark# |
|----------------|------------------------|----------------|-------------|--------------------|-------------|
| 000-90488-00 | Hofmann/RJ West | 407-6 | 6914-10 | Economy Ammco | 063-10 |
| 080-80000-68 | RTI | 068-6 | 6914-10 | Super Ammco | 062S-10 |
| 080-80102-00 | RTI | 103-6/10 | 6914-10 | Coated Ammco | 062C-10 |
| 109-1092-23 | Kwik-Way/SNAP-ON/JB | 802-10 | 6914-10 | Ammco | 068-10 |
| 109-1092-32 | Kwik-Way/SNAP-ON/JB | 803-10 | 6914-6 | Ammco | 062-6 |
| 109-1092-45 | Kwik-Way/SNAP-ON/JB | 802-10 | 6914-6 | Economy Ammco | 063-6 |
| 109-1092-45 | Kwik-Way/SNAP-ON/JB | 809-10 | 6914-6 | Super Ammco | 062S-6 |
| 129005 | RELS/Van Norman | 902R-10 | 6914-6 | Coated Ammco | 062C-6 |
| 221-538-3 | Hofmann/Hunter | 703-6/062-6 | 6914-6 | Ammco | 068-6 |
| 221-538-3 | Hunter | 103-6 | 6918-10 | Coated Ammco | 104-10 |
| 221-580-2 | Hofmann/Hunter | 062-6 | 6918-6 | Coated Ammco | 104-6 |
| 221-580-2 | Hunter | 703-10 | 722-83-4 | Bear | 383-6 |
| 221-617-2 (24) | Hofmann/RJ/Hunter | 062/10/062S-10 | 75-556-2 | Hunter | 709S |
| 221-626-3 | Hunter | 709-6 | 7681-10 | Ammco | 103-10 |
| 221-639-3 | Hunter | 065-6 | 7681-6 | Ammco | 103-6 |
| 221-640-3 | Hunter | 065-10 | 808406 | RELS/Van Norman | 904-6 |
| 221-651-2 | Hunter | 067-6 | 866561 | RELS/Van Norman | 903-6 |
| 221-678-3 | Hunter | 409-6 | 866562 | RELS/Van Norman | 902R-6 |
| 29005 | RELS/Van Norman | 505-5 or 10 | 8711 | Performance | 065-6 or 10 |
| 3330 | All Tool | 064-6 | 8712 | Performance | 067-6 or 10 |
| 3331 | All Tool | 064-10 | 8731 | All Tool | 065-6 |
| 3334 | All Tool | 064-6 | 878051 | Accu-Turn | 068-6 |
| 3336 | Performance | 064-6 | 878052 | Accu-Turn | 068-10 |
| 3340 | Performance | 064-10 | 90488 | FMC | 407-10 |
| 3354 | Performance | 064-10 | 90817 | FMC | 062-10 |
| 302167 | RELS/Van Norman | 902L-6 | 91212 | RTI | 068-10 |
| 40435 | Accu-turn/Bosch | 060-10 | 940610 | Ammco | 066-10 |
| 433796 | Accu-turn/Bosch | 060-10 | 977572 | RELS/Van Norman | 902R-6 |
| 45001 | RELS/Van Norman | 062-6 | A5677-2 | Ammco | 5677-2 |
| 45016 | RELS/Van Norman | 408-6 | BTK10A | SNAP-ON | 802-10 |
| 45021 | Ranger/RELS/Van Norman | 409-6 | CD60 | Star | 808-6 |
| 50-701 | Pro-Cut/VGB | 061-10/908-6 | D139 | Perfect Equipment | 407-6 |
| 50-741 | Pro-Cut | 069-6 | DRL90 | Hofmann/RJ West/PE | 502-6 |
| 50-742 | VGB | 908-6 | PC50701 | SUN | 061-6 |
| 50-742 | Pro-Cut/VGB | 069-10 | V302-07-167 | Hunter | 702-6 |
| 5677-2 | Ammco | A5677-2 | W136-1 | Hofmann/RJ West | 503-6 |
| 06406-10 | Ammco | 066-10 | W139 | Hofmann/RJ West | 407-6 |
| 6914-10 | Ammco | 062-10 | | | |

CARBIDE BITS FOR BENCH AND ON-THE-CAR LATHES



| Quick Reference Chart of Bits and Manufacturers | | | | | | | | | | | | | | | | | | | | | | | | | | | |
|---|-----|-----|-----|-----|-----|-----|------|-----|-----|-----|-----|-----|-----|-----|-----|-----|-----|-----|---------------|-----|-----|------|------|-----|-----|--|-------------------|
| Part Numbers | | | | | | | | | | | | | | | | | | | Manufacturers | | | | | | | | |
| 060 | 061 | 062 | 063 | 064 | 065 | 066 | 066C | 067 | 068 | 103 | 104 | 383 | 407 | 408 | 409 | 502 | 503 | 702 | 703 | 802 | 808 | 902R | 902L | 903 | 904 | | |
| X | | | | | | | | | | | | | | X | X | | | | | | | | | | | | Accu-Turn |
| | | | | X | | | | | | X | | | | | | | | | | | | | | | | | All Tool |
| | | X | X | | | X | X | | X | X | X | | | | | | | | | | | | | | | | Ammco |
| | | | | | | | | | | | | X | | | | | | | | | | | | | | | Bear |
| X | | | | | | | | | | | | | | | | | | | | | | | | | | | Bosch |
| | | X | | | | | | | | X | | | X | X | X | | | | | | | | | | | | FMC |
| | | | | X | | | | | | | | | X | X | X | X | X | | | | | | | | | | Hofmann |
| | | | X | X | | | | X | | | | | | | | | | X | X | | | | | | | | Hunter |
| | | X | | | | | | | | X | | | X | X | X | | | | | | X | | | | | | John Bean |
| | | | | | | | | | | | | | | | | | | | | | | | | | | | Kwik-Way |
| | | | X | X | | | | X | | X | | | X | | X | | | | | | | | | | | | Performance |
| | | | | | | | | | | | | | X | | | | | | | X | X | X | X | X | X | | Perfect Equipment |
| | | | | | | | | | | | | | | X | | | | | | | | | | | | | Ranger |
| | | X | | | | | | | | | | | | X | | X | | | | | | | | | | | RELS |
| | | | | | | | | | | | | | X | | | X | X | | | | | | | | | | RJ West |
| | | X | | | | | | | | X | | | | | | | | | | | X | | | | | | RTI |
| | | | | | | | | | | | | | X | X | | | | | | | X | | | | | | Snap-On |
| | | | | | | | | | | | | | | | | | | | | | | | | | | | Star |
| | | | | | | | | X | | | | | | | | | | | | | | | | | | | VBG/Pro Cut |
| X | | | | | | | | | | | | | | | | | | | | | | X | X | X | X | | Van Norman |



CARBIDE TOOLHOLDERS FOR BENCH AND ON-THE-CAR LATHES

Shark Toolholders are guaranteed to perform as good as any OEM Toolholder. Made to exacting standards, we offer an alternative to OEM without the excessive cost. All toolholders come with bits.

Accu-Turn/FMC/Hunter Toolholders

| | Part# | OEM # | Description |
|--|------------|--|---|
|  190 | 190 | Accu 434286 FMC 8027134 | Positive Rake Zero Angle Toolholder Use on brake lathes when cutting rotors with hubs that prevent standard toolholders from reaching into the squared shoulders. Uses 407, 408, 409 or 060 Bit. |
|  404 | 404 | Accu 433763 FMC 90494 FMC 90490 | Positive Rake Right Hand Toolholder Use on Rotors, Flywheels & Heavy Duty Drum 8910, 8911, 8922, 8944, 8989 Combination Disc & Drum Lathes. Uses 407 408, 409 or 060 Bit. |
|  405 | 405 | Accu 433764 FMC 90494 FMC 90490 Hoffman/West W140 | Positive Rake Left Hand Toolholder Use on Rotors and Flyweels 8911, 8922, 8944, 8989 Combination Disc & Drum Lathes. Uses 407 408, 409 or 060 Bit. |
|  406 | 406 | Accu 433779 | Positive Rake Right Hand Short Toolholder Use on Passenger Car Drums. Lathe Models 8910, 8922, & 8944. Uses 407, 408, 409 or 060 Bit. |
|  444 | 444 | Accu 433763 FMC 90494 FMC 90490 | Positive Rake Round Right Hand Toolholder Use on Rotors, Flyweels & Heavy Duty Drum 8910, 8911, 8922, 8944, 8989 Combination Disc & Drum Lathes. Use 066 Bit. |
|  445 | 445 | Accu 433764 FMC 90494 FMC 90490 | Positive Rake Round Left Hand Toolholder Use on Rotors and Flyweels 8911, 8922, 8944, 8989 Combination Disc & Drum Lathes. Use 066 Bit. |
|  446 | 446 | Accu / FMC | Positive Rake Round Right & Left Hand Toolholder set. Use on All above mentioned models. Use 066 Bit. (444 & 445) |
|  464 | 464 | Accu 434056 FMC 8027164 Hunter RP8-8568 Hoffman/West W208 | Positive Rake Right Hand Offset Toolholder Use for rotors with mounting flanges such as Trooper, Isuzu, Toyota Tercel & Mazda Pick-ups. Uses 407, 408, 409 or 060 Bit |
|  465 | 465 | Accu 434057 FMC 8027165 Hunter RP8-8568 Hoffman/West W209 | Positive Rake Left Hand Offset Toolholder For use on above mentioned lathes. Uses 407, 408, 409 or 060 Bit. |
|  466 | 466 | Accu 90489 | Positive Rake Right & Left Hand Offset Toolholder Set Set of 2 (464 & 465) Uses 407, 408 or 060 Bit. |

CARBIDE TOOLHOLDERS FOR BENCH AND ON-THE-CAR LATHES



Ammco/All Tool/Hunter/Performance/RELS Toolholders

| Description | OEM # | Part # |
|---|---|-------------|
| Positive Rake Stubby Toolholder. Use on disc cutting brake lathes and combination lathes when cutting rotors. Use 802 Bits. | All Tool 8710 Performance 8710 Hunter RP8 8710 | 180 |
| Negative Rake Right Hand Toolholder. Use on disc cutting brake lathes and combination lathes when cutting rotors. Use with Ammco Models 3000, 4000, 4100 & 7000 Lathes. Rels 2000. Uses 062 and 064 Bits. | All Tool 8588 Performance 8688 Hunter RP8 8588 Ammco 10701 RELS 45005 | 191 |
| Negative Rake Left Hand Toolholder. Use on disc cutting brake lathes and combination lathes when cutting rotors. Use with Ammco Models 3000, 4000, 4100 & 7000 Lathes. Rels 2000. Uses 062 and 064 Bits. | All Tool 8586 Performance 8586 Hunter RP8 8586 Ammco 10702 RELS 45006 | 192 |
| Set of Negative Rake Right & Left Hand Toolholders Set For use on above mentioned models Uses 062 and 064 Bits. (191 & 192) | All Tool 8586 Performance 8586 Hunter RP8 8586 Ammco 6999 RELS 45701 All Tool 8708 | 193 |
| Positive Rake Right Hand Toolholder. Use on disc cutting brake lathes and combination lathes when cutting rotors. Use with Ammco Models 3850, 4000 & 7000 Lathes. Uses 065 and 104 Bits. | Performance 8708 Hunter RP8-8708 Ammco 25968 RELS 45012 | 968 |
| Positive Rake Left Hand Toolholder. Use on disc cutting brake lathes and combination lathes when cutting rotors. Use with Ammco Models 3850, 4000 & 7000 Lathes, Rels Swing-Arm. Uses 065 and 104 Bits. | All Tool 8709 Performance 8709 Hunter RP8-8709 Ammco 25969 RELS 45013 | 969 |
| Positive Rake Right Hand Toolholder. Use on disc cutting Ammco Model 3850 rotor cutting lathe. Use 104 Bits. | Ammco 5390 | 390 |
| Positive Rake Right Hand Small Drum Toolholder. Use on Ammco Model 3000,4000,41000 & 7700 drum cutting lathe. Use 103 Bits. | Ammco 5392 | 392B |



180



191



192



193



968



969



390



392B



CARBIDE TOOLHOLDERS FOR BENCH AND ON-THE-CAR LATHES

Ammco/All Tool/Hunter/Performance/RELS Toolholders

| Part# | OEM # | Description |
|--|--|--|
|  782 | Ammco 9872 RELS 45007 | Negative Rake Toolholder Use on drum cutting brake lathes and combination lathes when cutting rotors. Use with Ammco Models 3000, 4000 & 7000 Lathes. Uses 062 Bits. |
|  421 | RELS 45700 | Positive Rake Right & Left Hand Toolholder Set Use on Rels 2000. Ammco Model 3000, 4000 (422 & 423) |
|  422 | RELS 45015 | Positive Rake Right Hand Toolholder Use on all above mentioned lathes. Uses 408 & 409 Bits. |
|  423 | RELS 45014 | Positive Rake Left Hand Toolholder Use on all above mentioned lathes. Uses 408 & 409 Bits. |
|  426 | Ammco 40608 RELS 45009 | Positive Rake Right Hand Round Toolholder (Rotors Only) Use on Rels 2000. Ammco Model 3000, 4000, 4100 & 7000. Accu 8911, 8922, Uses 066 Bits. |
|  427 | Ammco 40609 RELS 45008 Hunter | Positive Rake Left Hand Round Toolholder (Rotors Only) Use on all above mentioned lathes Uses 066 Bits. |
|  428 | Ammco 40630 RELS 48010 Hunter | Positive Rake Right Hand & Left Hand Round Toolholder Set (Rotors Only) Use on all above mentioned lathes. Uses 066 Bits (426 & 427) |
|  467 | Hunter 57-499-2 | Positive Rake Right Hand Hunter On-Car Toolholder Uses 103 Bits. |
|  468 | Hunter 57-500-2 | Positive Rake Left Hand Hunter On-Car Toolholder Uses 103 Bits. |
|  783 | RELS 45035 | Positive Rake Drum Toolholder Use on RELS 2000 Drum Side. Uses bit #408 (45016 RELS) |
|  784 | All Tool 8584 Performance 8584 Hunter RP8-8584 | Negative Rake Toolholder Use on drum cutting brake lathes and combination lathes when cutting rotors. Uses 062 Bits |

CARBIDE TOOLHOLDERS FOR BENCH AND ON-THE-CAR LATHES



Bear/FMC Toolholders

| Description | OEM # | Part # |
|--|-------|-------------|
| Negative Rake Right Hand Toolholder For all FMC/Bear to convert to Negative Rake Bits. Uses 062 Bits. | N/A | 424B |
| Negative Rake Left Hand Toolholder For all FMC/Bear to convert to Negative Rake Bits. Uses 062 Bits. | N/A | 425B |



424B



425B

Kwik-Way/Snap-On Toolholders

| | | |
|---|------------------------------------|------------|
| Positive Rake Right Hand Toolholder For Models SDL,DL,850 Disc Kwik-Way and Snap-On Models YA277,YA279,YA281 Disc Lathes. 3/8" Square. Uses 802 Bits. | Kwik-Way Snap-on 109-1090-02 | 804 |
| Positive Rake Left Hand Toolholder For use on all above mentioned models. 3/8" Square. Uses 802 Bits. | Kwik-Way Snap-on 109-1091-00 | 805 |
| Positive Rake Right Hand Stubby Toolholder For use on Kwik-Lathe On-the-car Lathes, Snap-on On-Car YA180 Models. 3/8" Square. Uses 802 Bits. | Kwik-Way Snap-on 109-1009-15 | 806 |
| Positive Rake Left Hand Stubby Toolholder For use on Kwik-Lathe On-the-car Lathes, Snap-on On-Car YA180 Models. 3/8" Square. Uses 802 Bits. | Kwik-Way Snap-on 109-1009-16 | 807 |



804



805



806



807

Ammco/Alltool/FMC/Hunter/Performance/Rels/Van Norman Brazed Toolholders

| | | |
|--|--|------------|
| Positive Rake Right or Left Hand Brazed Toolholder Use on Ammco Model 5000 & 6000 Drum Lathes, Van Norman 310,404 & 405 Models. 5/8" Square. | Ammco 5725 RELS 45027 Van Norman | 720 |
| Positive Rake Brazed Right Hand Toolholder Use on Van Norman/RELS DBR204, 204H, 205, 300, 302, 302H, 303, 333, 333H Drum Lathes. 3/8" x 1/2" Shank. | Van Norman 2042 | K41 |
| Positive Rake Brazed Left Hand Toolholder For use on above mentioned lathes. 3/8" x 1/2" Shank. | Van Norman 2043 | K42 |
| Positive Rake Brazed Right Hand Toolholder Use on Accu-Turn, FMC, John Bean, Bear Disc Lathes. FMC, Barrett B-400 Rotor Drum, Fly-wheel & Heavy Duty Disc / Drum Lathes. 3/8" Square Shank. | Accu 434763 FMC | 41B |
| Positive Rake Brazed Left Hand Toolholder For use on above mentioned lathes. 3/8" Square Shank. | Accu 434764 FMC | 42B |



720

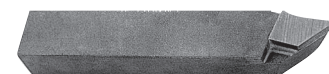

K41



K42



41B



42B



SILENCER BANDS FOR BRAKE LATHES

QUALITY SHARK SMALL DISC AND FOREIGN CAR ROTOR SILENCER BANDS



69 in package

Clam Shell packaged for easy display with competitive cross references on the back. All American made and guaranteed against premature wear or breakage.

- Increased Durability and Tensile Strength
- Long-life Rubber with Special Compound
- Made in the U.S.A.



68B

Disc Style Black Neoprene Rubber Silencer - NO LEAD

| Part# | OEM # | Description |
|-------|-------------------------|---|
| 68B | Ammco 6920 FMC 90984 | For small and large rotors. Adjustable band neoprene rubber for longer life, additional durability. Use with all vented rotors. 9" Diameter, 32" x 1/2" |



69

Disc Style Natural Rubber Silencer - NO LEAD

| Part# | OEM # | Description |
|-------|--|--|
| 69 | Ammco 6920 FMC 90984 Van Norman 111485 | For small and large rotors. Adjustable band has material finish on natural rubber for gripping power. 9" Diameter 32" x 1/2" Use with all vented rotors. |



70B

Chatter Depressing, Chip Deflecting Clamping Silencer

| Part# | OEM # | Description |
|-------|--|--|
| 70B | Andrews M-3 Accu-turn 434296 FMC 90198 Performance 8572 Pro-Cut 50-703 | IMPROVED Heavy Duty Pads Use this with any rotor on or off the car. Any brand. |



71B

| | | |
|-----|--|--|
| 71B | Andrews M-3 Accu-turn 434296 FMC 90198 Performance 8572 Pro-Cut 50-754 | IMPROVED Heavy Duty Pads For use with On-The-Car RTI Brake Lathes. |
|-----|--|--|



73B

| | | |
|-----|--|--|
| 73B | Andrews M-3 Accu-turn 434296 FMC 90198 Performance 8572 | IMPROVED Heavy Duty clamping silencer with strap. Use with all On-The-Car or bench brake lathes. |
|-----|--|--|

DISC ROTOR SILENCER BANDS

QUALITY SHARK SMALL DISC AND FOREIGN CAR ROTOR SILENCER BANDS.



Ammco Type Replacement Silencer Pads

| Part# | OEM # | Description |
|--------------|----------------------|--|
| 83B | Ammco 9183 2 / Pk | Used on: Ammco #7075 Silencer Assembly or Shark #63A or B. |
| 83B-2 | 4 / Pk | |



83B

Large & Small Neoprene Rubber Gasket Silencer

| Part# | OEM # | Description |
|-------------|---|----------------------------------|
| 94 | Ammco 6922 | For Solid Foreign Car Rotors (1) |
| 94-2 | Accu-turn 434061 FMC 90194, Performance 6922, Rels 11488 | 9" Diameter - 2 Pack |
| 96 | Ammco 6921 | For Solid Foreign Car Rotors (1) |
| 96-2 | Accu-turn 433789 FMC 90196, Performance 6921, RELS 11482 | 6 1/2" Diameter - 2 Pack |

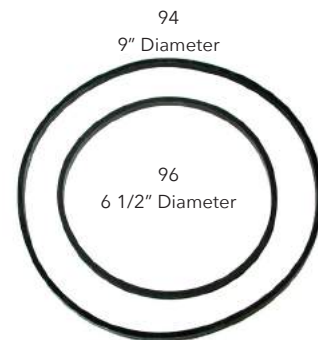

94
9" Diameter

96
6 1/2" Diameter

FMC Style Latex Tubing Silencer Band

| Part# | OEM # | Description |
|------------|-----------|---|
| 95 | FMC 90195 | Steel Tubes surround the rubber for maximum vibration dampening. 9" Diameter |
| 95S | FMC | Steel Tubes surround the rubber for maximum vibration dampening. 7" Diameter |

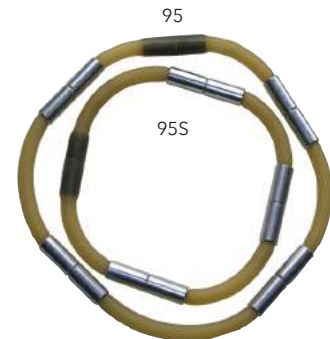

95

95S

Ammco Type Wider Natural Rubber Band - NO LEAD

| Part# | OEM # | Description |
|------------|------------|---|
| 930 | Ammco 6930 | Steel weights for larger wider rotors. 14" Diameter - 1 1/4" Wide. |



930



DISC ROTOR & DRUM SILENCER BANDS

Shark Latex Tubing Silencer Band



| Part# | OEM # | Description |
|-------|-------|---|
| 935 | N/A | Latex tubing with internal weights for effective vibration dampening. 9" Diameter. |
| 936 | N/A | Latex tubing with internal weights for effective vibration dampening. 7" Diameter. |



NOTE: NOT FOR SALE IN CALIFORNIA
THIS PRODUCT CONTAINS LEAD KNOWN TO THE STATE OF CALIFORNIA TO CAUSE
CANCER AND BIRTH DEFECTS OR OTHER REPRODUCTIVE HARM. WASH HANDS
THOROUGHLY AFTER HANDLING.

Ammco Type Silencer



| Part# | OEM # | Description |
|-------|------------|---|
| 980 | Ammco 9800 | Rubber inserts in a long-life spring for excellent vibration and noise reduction. 9" diameter, 5/8" spring diameter. |
| 980S | | Rubber inserts in a long-life spring for excellent vibration and noise reduction. 9" diameter, 1/4" spring diameter. |



DRUM SILENCER BANDS FOR CARS AND TRUCKS

Drum Silencer Band for Passenger Cars



| Part# | OEM # | Description |
|-------|--|---|
| 80B | Ammco 5280 FMC 90988 Performance 8574 Van Norman 866542 | Natural Rubber With riveted buckle. 6' x 1 3/4" x 1/8" |



Drum Silencer Band for Large Truck Drums

| Part# | OEM # | Description |
|-------|---|--|
| 81B | Accu-turn 433782 FMC 90988 RELS 11486 Performance 8575 | Band features pressed in buckle for extra strength. Natural Rubber 5' x 2 7/8" x 1/8" |



| | | |
|-----|-------------------------------|--|
| 82B | Accu-turn 434650 FMC 90983 | Band features pressed in buckle for extra strength. Natural Rubber 6' x 2 7/8" x 1/8" |
|-----|-------------------------------|--|

Drum Silencer Band for Trucks



| Part# | OEM # | Description |
|-------|------------|---|
| A5290 | Ammco 5290 | Made of natural rubber this is our largest band, for use on large truck drums. Natural Rubber 7' x 2 3/4" x 1/8". |



ABRASIVE PAD SWIRL GRINDER KIT

Swirl Finish Rotors after cutting for a non-directional finish

- Can be used on or off the car
- Helps eliminate brake squeal
- Improves braking power

Abrasive Pad Swirl Grinder Kit

| Part# | 3M# | Description |
|---------|-------|--|
| 9989 | 01410 | Kit with (9) 3" 120 grit pads and one 333T Backing Pad |
| 9989-12 | 01411 | 12 PACK of 120 Grit 3" Pads |
| 9989-20 | N/A | 20 PACK of 120 Grit 3" Pads |



9989

ABRASIVE PADS FOR NON-DIRECTIONAL FINISH

Replaces Ammco #8756 Pressure Sensitive Pads for the Ammco Swirl Grinding Tool
4" Diameter

Ammco Type Swirl Grinder

| Part# | Ammco# | Quantity | Grit |
|---------|--------|-----------------|------|
| 989 | 87566 | PACK of 6 Pads | 80 |
| 989-10 | 8756 | PACK of 10 Pads | 80 |
| 989-20 | 875620 | PACK of 20 Pads | 80 |
| 989C-20 | N/A | PACK of 20 Pads | 36 |
| 989F-20 | N/A | PACK of 20 Pads | 120 |
| 989-50 | | PACK of 20 Pads | 80 |
| 989-100 | | PACK of 20 Pads | 80 |



989

ROTOR & HUB CLEANING TOOL FOR BRAKE & ROTOR WORK

2" Brake and Rotor Hub Cleaning Tool

| Part# | Description |
|-------|--|
| 77002 | Hub Tool A necessary tool for brake and rotor installation. Uses electric drill to clean hubs for flush mounting area. Easily removes clamp marks. Comes with 10 abrasive pads. |
| 77200 | 2" Replacement Pads - 10 PACK |



77002



ABRASIVE PADS AND TOOLS FOR NON-DIRECTIONAL FINISHES

Shark Swirl Tool and Hook and Loop Fastener Sticky Backed Abrasive Pads for applying Non-Directional Finishes to Rotors after cutting.

This hand held swirl finish tool will put the required finish on your rotors to prevent come-backs on your brake jobs. The aluminum handle is knurled for easy grip. It is half the price of competitive tools. The pads are Hook and Loop Fastener-backed or pressure sensitive abrasive discs and come in coarse as well as fine and extra fine.

- Half the price of competitive products
- Lightweight aluminum handle
- Easy to use



Shark Swirl Tool and Hook and Loop Fastener Sticky Backed Abrasive Pads

| Part# | OEM # | Description | Pkg. Qty. |
|---------|---------|---|-------------------|
| 998 | 908740 | Swirl Tool Kit with Sticky Backed Discs (80 grit) Swirl | (6) |
| 999 | | Tool Kit with Hook and Loop Fastener Backed Discs | (3-999F & 3-999C) |
| 989 | | Ammco Style 80 Grit Pressure Sensitive Pads | (6) |
| 989-20 | B999CZ0 | Ammco Style 80 Grit Pressure Sensitive Pads | (20) |
| 989F | | Ammco Style 120 Grit Pressure Sensitive Pads | (6) |
| 989F-20 | | Ammco Style 120 Grit Pressure Sensitive Pads | (20) |
| 999C | | 60 Grit / Coarse Pad Hook and Loop Fastener Backed | (10) |
| 999C-20 | | 60 Grit / Coarse Pad Hook and Loop Fastener Backed | (20) |
| 999F | | 80 Grit / Fine Pad Hook and Loop Fastener Backed | (10) |
| 999F-20 | | 80 Grit / Fine Pad Hook and Loop Fastener Backed | (20) |
| 999H | | Handle | |
| 999P | | Backing Pad | |
| 999S | | Connecting Shaft | |

PATENTED SWIRL FINISH TOOL

Flex-Hone Rotor Finishing Tool uses Patented Technology for Brake Rotor finishing!



Produces an ideal surface finish on disc brake rotors and flywheels.

- More rotors per Hone-Lasts much longer than pad style products
- Ideal on new or resurfaced rotors and flywheels
- Produces a non-directional pattern on surface
- Lowers harmonic vibrations

Swirl Finish Rotor Tool

| Part# | OEM # | Description |
|-------|------------|---------------------|
| R60Z | RMFH60Z25 | Rotor Hone / Coarse |
| R120Z | RMFH120Z25 | Rotor Hone / Medium |
| R240Z | RMFH240Z25 | Rotor Hone / Fine |

SILENCER ASSEMBLY

Ammco Style Silencer Assembly for Brake Lathes

This unit comes with 2 long arms and non-asbestos pads for effective vibration dampening on solid rotors. Direct replacements for Ammco #7075. Also works on Performance 6600 and 7200, Hoffman Bulldog 660, all Ammco and All Tool 747 Lathes.



Ammco Style Silencer Assembly

| Part# | Description |
|------------|------------------------------|
| 63A | Complete Unit - Ammco # 7075 |

SPARE PARTS LISTING

| | |
|-------------|-----------------------------|
| 63B - 1 | Round Steel Pad Holders |
| 63B - 2 | Aluminum Castings / 3 ways |
| 63B - 3 | Steel Arm |
| 63B - 5 | Round Steel Shaft |
| 63B - 6 | Ball and Shaft |
| 63B - 7 | Metal Stamping |
| 63B - 9 | Snap Ring |
| 63B - 10 | Arm Lock Pin |
| 63B - 11 | Aluminum Casting w/ Arm |
| 63B - 12 | Square Headed Screw |
| 63B - 13 | Large Hex Head Socket Screw |
| 63B - 14 | Wrench |
| 63B - 15 | Small Hex Head Socket Screw |
| 83B / 83B-2 | Replacement pads / 2 or 4. |

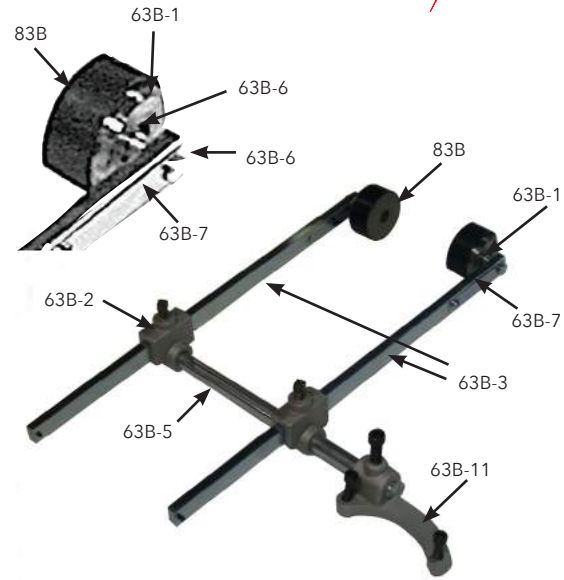

BRAKE LATHE ACCESSORIES



Clear Replacement Shield Assembly

Chip Shield with Brackets and Screws. Includes bracket, bolt and screws to use on Ammco Twin Cutter #6900 and #7900. Easily bolts adding protection for eyes from flying metal chips. Made of clear, durable plastic.

| Part# | Ammco# | Description |
|---------|--------|---------------------------------------|
| A9481 | 9481 | Complete Shield Assembly |
| A9481-1 | 9481-1 | Replacement Shield for the above unit |
| A3084 | 3084 | Knurled Locking Knob |
| A11150 | 11150 | Screw, Machine for Safety Shield |
| A11166 | 11166 | Shield Flange Hex Nut, Safety Shield |
| A29254 | 29254 | Shield Bracket |

Universal Chip Shield for Brake Lathes

Replacement Shield slips easily over light cover to prevent chips from entering eyes while cutting rotors or drums. Made of clear, durable plastic, it universally works on FMC, Ammco, Accu-turn, Performance, All Tool, Kwik-Way and RELS lathes.

| Part# | OEM# | Description |
|---------|--------|-------------------------|
| A-11154 | 436056 | Accu-turn |
| | 8865 | Performance Brake Lathe |

Brake Lathe Replacement Lights for Most Lathes

| Part# | OEM# | Description |
|---------|---------|--|
| A-07963 | 7-07963 | Ammco Style Replacement Light (Models 3000 & 4000) |
| H101 | | Hoffman style Replacement Light |
| P101 | | Performance style Replacement Light |
| R101 | | RELS 2000 style Replacement Light |
| V101 | | Van Norman style Replacement Light |



BRAKE LATHE ACCESSORIES

CONTINUED FROM PREVIOUS PAGE

Protective Spindle Boots

| Part# | Ammco # | Description |
|-------|---------|---|
| A3085 | 3085 | Replaces Front and Rear Ammco style Plastic Spindle Boot. For Models 3000, 4000, 4100 and 7700 Lathes |



A3085

Small/Large Cloth Protective Boot for Feed Screw

| Part# | Ammco # | Description |
|-------|---------|--|
| A3086 | 3086 | For Model 3000, 4000 and 7000 Lathes 1" Diameter small boot. |



A3086

| | | |
|-------|------|---|
| A3087 | 3087 | Replaces Ammco Style Cloth Boot For Model 3000, 4000, 4100, 7000 & 7700 Lathes. 3" Diameter large boot. |
|-------|------|---|



A3087

Boot Securing Rings and Springs

Ammco style replacement rings are made of high quality materials and guaranteed to perform as well as the OEM products. Shark Rings are used to secure the boots onto Ammco lathes.

| Part# | Ammco # | Description |
|--------|---------|--|
| 87B | 23682 | Bronze Spindle Ring for use with Ammco Style 3085 Boot |
| A2045 | 2045 | Wire Boot Ring for 3085 Spindle Boot |
| A3034R | 3034 | Steel Ring for use with old style Ammco Rubber Boot |
| A3159 | 3159 | Spindle Boot Snap Ring |
| A3595 | 3595 | Small Spring for Ammco Rubber Boot |
| A4435 | 4435 | Large Spring for Ammco Rubber Boot |



A3034R



87B



A3159



A4435



A2045



A3595

NEW Accu-turn Style Way Cover

| Part# | OEM # | Description |
|-------|--------|---|
| 43373 | 433735 | Way Cover with Wiper for Rotors & Drums on Model 944. |
| 43363 | 433635 | Wiper Kit Replacement 3/Wipers |



43363

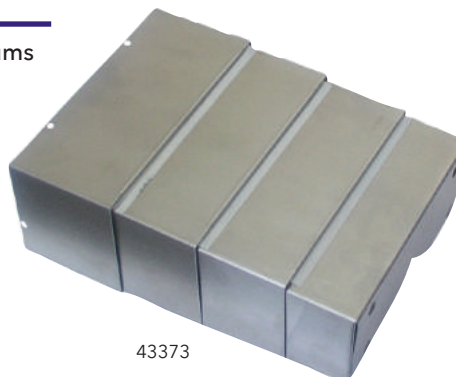

43373

EXTENDA-FEED ADAPTOR

TO INCREASE THE CROSS-FEED TRAVEL OF YOUR AMMCO TWIN CUTTER

The best way to extend your Ammco Cross-feed to Maximum Capacity!

This easy to use adaptor will increase the Cross-Feed capacity.
 Extenda-Feed works on all standard 4000 and 4100 Ammco brake lathes.



Extenda-Feed for Ammco Lathes - PART# A6936

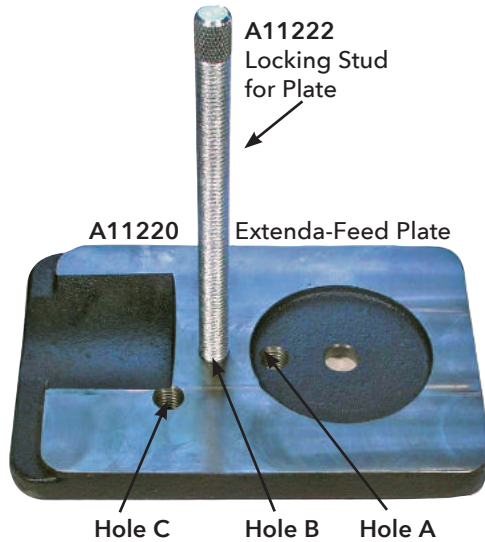

- Hole A** For rotors up to 15 1/4" Diameter
- Hole B** For rotors up to 16 1/4" Diameter
- Hole C** For rotors up to 17 15/32" Diameter

A6936 SET INCLUDES:

A25270 Flat Head Screw
 1/2" x 1" Hex Socket

A25271 Flat Head Screw
 1/2" x 2" Hex Socket

A11227 Nut/Washer

Allen Wrench



A25270



A11227



A25271

AMMCO STYLE TWIN CUTTER ASSEMBLY

For Use on Ammco Model 3850, 4000, 7000 or as upgrade for Model 3000* as alternative to Ammco twin cutters. Guaranteed to perform as good as OEM Quality if not better in some cases. It features inch/millimeter micrometers to set the depth-of-cut for resurfacing inner and outer rotor surfaces simultaneously. *(Requires other Items to upgrade a 3000 lathe.)

Ammco Type Twin Cutter Assembly - PART# A6950

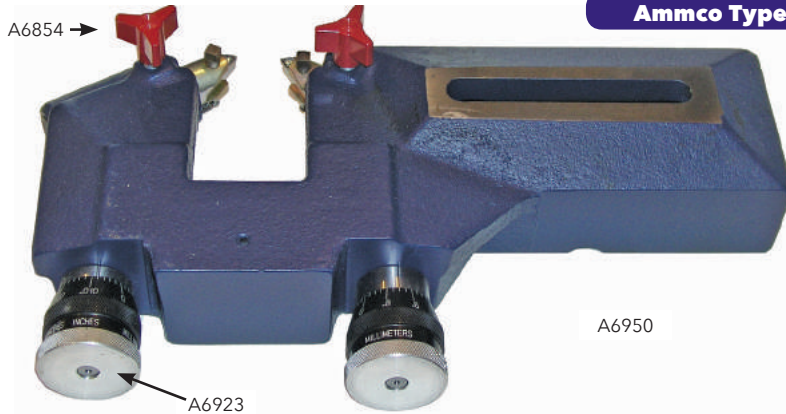

- Cast Iron Housing
- All Aluminum Dials

A6950 SET INCLUDES:

- (1) Twin Cutter
- (1) A-10650 Cutter Holder (LEFT)
- (1) A-10651 Cutter Holder (Right)
- (2) A6854 Red Knobs

Spare Parts list for the Twin Cutter (Not all items listed are included)



| Part# | Description |
|----------|---|
| A6905 | Spring for Twin Cutter |
| A6905-10 | Spring for Twin Cutter; 10 pack |
| A6906 | Threaded Plug for Twin Cutter |
| A6907 | Dial for Twin Cutter |
| A6923 | Dial Knob |
| A8584 | Brass Toolholder Gib (Internal) |
| A6929 | Washer Spring for Twin Cutter |
| A6977 | Plug Twin Cutter |
| A9879 | Locating Screw for Twin Cutter (NOT INCLUDED) |
| A11227 | Locking Knob for Twin Cutter (NOT INCLUDED) |



BRAKE LATHE ARBORS & NUTS

Replacement Brake Lathe Arbors

REPLACEMENT BRAKE LATHE ARBORS FOR MOST AMMCO MACHINES

Quality non OEM Replacement Arbors for Ammco Lathes
*1" Inside Diameter



PART# A9708 (Set)

| Part# | OEM# | Description |
|---------|--------|--|
| A3101A | 903101 | Standard Arbor Fits 2002, 3000, 4000, 4100, 7000, 7500, 7700 |
| A3102A | 903102 | Nut for 1" Arbor A3101A |
| A3118* | 903118 | Centering Cone - .750" x 1.375" - 19.05 x 34.93 |
| A3119* | 903119 | Arbor Nut - 1" Long 25.4 |
| A3120* | 903120 | Spacers (2) - 1/2" Long 12.7 |
| A3121 | 903121 | Spacer (1) - 1/16" 17.46 |
| A3122 | 903122 | 11/16" Arbor only for 2002, 3000, 4000, 4100, 7000 & 7700 Ammco Brake Lathes |
| A22138* | 922138 | Spherical Washer Set (2) |

REPLACEMENT ARBORS FOR OTHER OEM LATHES



Replacement Arbors and Nuts for Other OEM Lathes

| Part# | OEM# | Manufacturer Brand | Size |
|--------|----------------|---|-------------------------------|
| 85490 | 433701 | Accu-turn Arbor | 1" Arbor |
| A3101A | 3101/8542 or 3 | All Tool/Ammco/Performance | 1" Arbor |
| 8544 | 8544 | LM American 8500 / Early Hunter BL500 / All Tool / Hunter 747 | 1" Arbor |
| 8545 | 90043 | FMC / John Bean 600 & 700 Series | 1" Arbor |
| 8546 | CL538-1 | Hoffman 201 Standard 300, 350, 400, 401, 450 & RJ West | 1" Arbor |
| 8547 | N/A | 1115 HD Lathes | 1" Arbor / no Spacers & Nut |
| 8548 | 97-422-2 | Hunter BL 501 & BL505 | 1" Arbor |
| 40080 | 40080 | RELS 2000 | 1" Arbor w/ Spacers & Nut |
| 40162 | 40163A | RELS 2000 | 11/16" Arbor/no Spacers & Nut |
| 40163 | 40163 | RELS 2000 | 11/16" Arbor w/ Spacers & Nut |
| 24826 | 24826 | RELS 204/Van Norman 204 John Bean/FMC 800 Series | 1" Arbor / no Spacers & Nut |

| Part# | OEM# | 1" Arbor Nuts | Size |
|--------|--------|---|--------------|
| A3102A | 903102 | Ammco Style Nut for 1" Arbors | 1" Arbor Nut |
| 20442 | N/A | For All other Manufacturer Arbors mentioned above | 1" Arbor Nut |
| 5389 | N/A | Hofmann 5389 Only | 1" Arbor Nut |

BRAKE LATHE REPAIR PARTS

INTERNAL / EXTERNAL PARTS LISTING AND REPAIR PARTS



Bearings / Washers

| Part# | OEM# | Description |
|-------|------|----------------------------|
| A3391 | 3391 | Drum Feed Bearing |
| A3393 | 3393 | Drive Shaft Bearing |
| A6871 | 6871 | Thrust Bearing, Rotor feed |
| A6873 | 6873 | Thrust Bearing, Cross-feed |
| A6874 | 6874 | Thrust Washer, Rotor feed |



Brass Plugs for Ammco Lathes

| Part# | OEM# | Description | Qty. |
|------------|---------|-----------------------------|--------|
| 7-03142-25 | 9-03142 | Brass Plugs | 25 PKG |
| 7-03142-50 | | (FATTER PLUGS) | 50 PKG |
| 7-09836-25 | 9-09836 | Brass Plugs | 25 PKG |
| 7-09836-50 | | (THINNER PLUGS) | 50 PKG |
| A3141 | 9-03141 | Brass Plugs (.125 X .25) | 10 PKG |



Bushings - Motor Shaft

| Part# | OEM# | Description |
|-------|------|---|
| A3223 | 3223 | Bushing-Motor Shaft For use on Ammco 4000 and 4100 lathes. |



Clamps/Upper & Lower

| Part# | OEM# | Description |
|-------|------|------------------------|
| A3016 | 3016 | Lower Boring Bar Clamp |
| A3017 | 3017 | Upper Boring Bar Clamp |



Clutch Handle / Shaft Assembly

| Part# | OEM# | Description |
|-------|------|--|
| A3042 | 3042 | Clutch Handle Shaft Assembly for Drum Feed |
| A3058 | 3058 | Clutch Shifter Assembly/Drum Feed |



Cord

| Part# | OEM# | Description |
|-------|------|------------------------------------|
| A7209 | 7209 | Replacement Cord for *Ammco Lathes |



Coupling/Pinion Assembly

| Part# | OEM# | Description |
|-------|------|---|
| A7757 | 7757 | Coupling Assembly Rotor Feed |
| A9822 | 9822 | Coupling & Pinion Assembly / Rotor Feed |



Crossfeed/ Dial Spring

| Part# | OEM# | Description |
|-------|------|----------------------------------|
| A9611 | 9611 | Dial Spring for Crossfeed Handle |



Dial Assembly

| Part# | OEM# | Description |
|-------|---------|---------------------------------------|
| A6901 | 9-06901 | Dial Assembly for *Ammco Twin Cutters |
| A6907 | 906907 | Dial |
| A6908 | 906908 | Dial Rod |
| A6923 | 906923 | Dial Knob |
| A8584 | 28584 | Brass Toolholder Pressure Protector |



Draw Bar

| Part# | OEM# | Description |
|-------|------|------------------------------------|
| A7005 | 7005 | Draw Bar with Nut for Ammco Lathes |





BRAKE LATHE REPAIR PARTS INTERNAL / EXTERNAL PARTS LISTING AND REPAIR PARTS



A7774



A3394



A3046



A5843



A9918/9



A9444



A9443



A7338



A3069



A7343



A3078



A3081



A3077



A3166



A22006



A6853



A9837

Drive Rod / Rotor Feed

| Part# | OEM# | Description |
|-------|------|---------------------------------------|
| A7774 | 7774 | Rotor Feed Drive Rod for Ammco Lathes |

Driveshaft Race

| Part# | OEM# | Description |
|-------|------|-----------------|
| A3394 | 3394 | Driveshaft Race |

Drum Bar/Drum Feed Dial/Clutch Shifter/Drum

| Part# | OEM# | Description |
|-------|------|---|
| A3043 | 3043 | Drum Feed Dial (NOT PICTURED / CALL FOR AVAILABILITY) |
| A3046 | 3046 | Drum Feed Shut-off Rod |
| A5843 | 5843 | Drum Bar for Drum Tools on Ammco Lathes |

Drum Feed Miter Gear

| Part# | OEM# | Description |
|-------|------|---|
| A3069 | 5843 | Drum Feed Miter Gear |
| A7338 | 5843 | Drum Feed Pinion Bushing Assembly |
| A7343 | 5843 | Drum Feed Control Lever & Shifter Assembly |
| A9443 | 5843 | Drum Feed Lock Nut |
| A9444 | 5843 | Drum Feed Washer |
| A9918 | 5843 | Short Leadscrew & Miter Gear Assbly/4000 Drum |
| A9919 | 5843 | Long Leadscrew & Miter Gear Assbly/4100 Drum |

Drum Sliding Friction Discs/Clutch

| Part# | OEM# | Description |
|-------|------|----------------------------------|
| A3077 | 3077 | Drum Feed Clutch |
| A3078 | 3078 | Drum Feed Sliding Friction Disc |
| A3081 | 3081 | Drum Feed Friction Disc Assembly |

Freeze Plug

| Part# | OEM# | Description |
|-------|------|------------------|
| A3166 | 3166 | Freeze Type Plug |

Grease Fitting/Guide Bar

| Part# | OEM# | Description |
|--------|-------|--------------------------------------|
| A6853 | 6953 | Old Grease Fitting for *Ammco Lathes |
| A22006 | 22006 | New Style Grease Fitting |

Guide Bar

| Part# | OEM# | Description |
|-------|---------|---|
| A7782 | 9-07782 | Guide Bar (OLD MACHINES) (NOT PICTURED) |
| A9837 | 9837 | Guide Bar |

BRAKE LATHE REPAIR PARTS

INTERNAL / EXTERNAL PARTS LISTING AND REPAIR PARTS



Hand Wheel Parts

| Part# | OEM# | Description |
|-------|------|--|
| A2309 | 2309 | Handwheel Handle for Crossfeed Drum Feed |
| A3026 | 3078 | Handwheel Nut |
| A3214 | 3214 | Handwheel Washer |
| A6839 | 6839 | Thumb Screw for Hand Wheel |
| A9626 | 9626 | Handwheel Assembly/Crossfeed |
| A9633 | 9633 | Handwheel, Crossfeed |
| A9634 | 9634 | Dial, Crossfeed Handwheel |



Index Plate

| Part# | OEM# | Description |
|---------|---------|--|
| 7-07747 | 9-07747 | Index Plate for *Ammco Lathes (OLDER STYLE) Located by Gear Shift Handle - 5 Pack |



7-07747

Knobs

| Part# | OEM# | Description |
|---------|------|----------------------------------|
| A6854 | 6854 | Locking Knobs for Lathe - 1 EACH |
| A6854-2 | | 2 PACK |



A6854

Lamp Switch

| Part# | OEM# | Description |
|--------|-------|---|
| A22763 | 22763 | Lamp switch |
| A22764 | 22764 | Lamp switch Rubber Boot |
| 757 | | Lamp switch for Rotary Switches (NOT PICTURED) |



A22763

A22764

*Ammco is a registered trademark of Wheel Service Industries. Shark has no affiliation with Hennessy or Wheel Service Industries.

Leadscrew & Leadscrew Bushings/Nuts

| Part# | OEM# | Description |
|----------|--------|---|
| A4670 | 4670 | Leadscrew Nut/Drum Feed |
| A10868 | 10868 | *Ammco Type OLD STYLE Leadscrew Bushing |
| 7-032111 | 3211-1 | Leadscrew Assembly / Crossfeed |
| 97 | N/A | Extended Leadscrew Bushing FOR EXTRA TRAVEL |



97



A4670



7-032111

Motor and Mount/Shaft

| Part# | OEM# | Description |
|-------|------|---|
| A2165 | 2165 | 1 HP Motor Mount |
| A3009 | 3009 | Mount for Motor A2165 |
| A3023 | 3023 | Motor Mount Shaft |
| A2561 | 2561 | Combination A2165/A3009. Motor and Mount for Ammco 4000 and 4100 lathes |



A3009



A2165



A3023

Oil Seals

| Part# | OEM# | Description |
|-------|------|------------------------------------|
| A3089 | 3089 | Oil Seal Adaptor Ring |
| A3163 | 3163 | Oil Seal for *Ammco Lathes / Small |
| A3164 | 3164 | Oil Seal for *Ammco Lathes / Large |



A3163



A3164



A3089



BRAKE LATHE REPAIR PARTS INTERNAL / EXTERNAL PARTS LISTING

Pulleys and Belt



| Part# | OEM# | Description |
|-----------|---------|--|
| *7-3024 | 9-03024 | Pulley Drive/SMALL*Ammco Model 3000 & 4000 |
| *7-077841 | 9-07841 | Pulley Drive/LARGE *Ammco Model 3000 & 4000 |
| A3161 | 3161 | V Belt Replacement /SMALL *Ammco 3000 & 4000 |
| A3162 | N/A | Poly "V" Belt. (Larger) |
| 6000 | N/A | New Style Pulley Kit/Includes Belt |
| 6001 | 40142 | Serpentine Pulley/LARGE *Ammco 3000 & 4000 |
| 6002 | 40146 | Serpentine Pulley/SMALL *Ammco 3000 & 4000 |
| 6003 | 40141 | Poly V-Belt/Serpentine Belt |

*7-3024U is the USA Made Part Number
*7-077841U is the USA Made Part Number

Shear Gear



| Part# | OEM# | Description |
|-------|------|---|
| 93 | 7996 | Shear Gear for *Ammco model 3000 & 4000 |

Shift Handle/Shift Shaft



| Part# | OEM# | Description |
|---------|---------|--|
| 7-07744 | 9-07744 | Shift Handle for *Ammco Lathes |
| A7748 | 7748 | Shift Shaft/Rotor Feed for *Ammco Lathes |

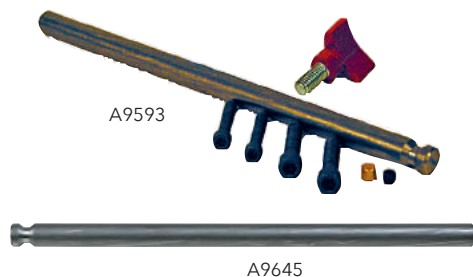

Spindle Lock

| Part# | OEM# | Description |
|-------|------|----------------------------|
| A6825 | 6825 | Socket head cap screw |
| A9645 | 9645 | Locking rod for model 4000 |
| A9593 | 9593 | Locking Rod for model 4100 |

Spindle / Thrust Washer & Key



| Part# | OEM# | Description |
|-------|------|-----------------------|
| A3033 | 3033 | Spindle Thrust Washer |



Studs

| Part# | OEM# | Description |
|----------|----------|---------------------------|
| 7-3031/1 | 7-3031/1 | Oversize Stud |
| 7-03031 | 703031 | Stud-Clip, Bar Boring |
| 7-03031S | 10347 | Stud-Clip for *Ammco 7000 |
| A11227 | 11227 | Locking Nut / No Washer |

Toggle Switch



| Part# | OEM# | Description |
|-------|------|--------------------|
| A6893 | 6893 | Main Toggle Switch |

BRAKE LATHE REPAIR PARTS INTERNAL / EXTERNAL PARTS LISTING



Trap

| Part# | OEM# | Description |
|-------|------|-----------------|
| A7775 | 7775 | Rotor Feed Trap |



A7775

Worm Gear

| Part# | OEM# | Description |
|---------|------|---|
| A9847 | 9847 | Drive Shaft Worm Gear for *Ammco Lathes Models 3000, 4000, 4100, 7000, 7500, 7700 |
| A9847-K | | Kit with Bearings and Race |

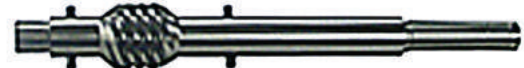

A9847

Wrench / Arbor Ammco Style

| Part# | OEM# | Description |
|-------|------|--|
| A3022 | 3022 | Large Wrench for *Ammco Lathes Models 3000, 4000, 4100, 7000, 7500, 7700 |
| A3218 | 3218 | Small Wrench |



A3022



A3218

Repair Parts Listing

| Part# | OEM# | Description |
|--------|-------|--|
| A213 | 213 | Set Screw, Lock Rod |
| A220 | 220 | Set Screw, Pulley 5/16"-18 x 3/8" (10 pk.) |
| A320 | 320 | Knob, Red Round |
| A1680 | 1680 | Set Screw Guide Bar |
| A2064 | 2064 | Cross Feed Spring |
| A3015 | 3015 | Belt Tension Lever |
| A3029 | 3029 | Old Style Clamp Nut |
| A3032 | 3032 | Rear Flange Shim |
| A3036 | 3036 | Drum Feed Roller |
| A3039 | 3039 | Drum Feed Stop Collar |
| A3084 | 3084 | Knurled Knob |
| A3088 | 3088 | Handle/Belt Release |
| A3092 | 3092 | Drum Feed Pin |
| A3176 | 3176 | Woodruff Key |
| A3180 | 3180 | Set Screw, Belt Release |
| A3214 | 3214 | Hand Wheel Washer |
| A3224 | 3224 | Set Screw, Spindle |
| A3528 | 3528 | Hex Nut/Jam Twin Cutter |
| A5689 | 5689 | Set Screw, Square Head Drum Bar (10) |
| A6109 | 6109 | Set Screw, Twin Cutter |
| A6825 | 6825 | Socket Head Cap Screw Spindle Lock |
| A6841 | 6841 | Groove Pin, Twin Cutter |
| A6929 | 6929 | Spring Washer/Twin Cutter / 5 Pk. |
| A6934 | 6934 | Square Head Screw/Twin Cutter |
| A9249 | 9249 | Set Screw for Toolholder |
| A9879 | 9879 | Locating Screw, Twin Cutter |
| A11227 | 11227 | Locking Nut Assembly |



A213



A220



A320



A1680



A2064



A3015



A3029



A3032



A3036



A3039



A3084



A3088



A3092



A3176



A3180



A3214



A3224



A3528



A5689



A6109



A6825



A6841



A6929



A6934



A9249



A9879



A11227

*Ammco is a registered trademark of Wheel Service Industries. Shark has no affiliation with Hennessy or Wheel Service Industries.

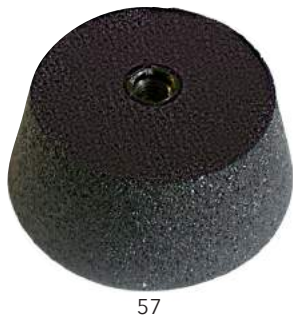

FLYWHEEL GRINDING WHEELS

For Use on DCM Tech, Kwik-Way, Peterson, Tobin Arp and Winona Machines

Flywheel Grinding Wheels

| Part# | Goodson# | Winona DMC# | Description |
|-------|----------|-------------|--|
| 56 | FGW-56 | 56 | For Steel and Cast Iron Aluminum Oxide for Small Flywheels such as imports Volkswagons, 4" diameter. |
| 57 | FGW-57 | 57 | For general Purpose 6" x 4/5" x 2 5/8". 1 1/4" center hole, requires little or no dressing in most instances |

VALVE SEAT GRINDING WHEELS

Shark offers a full assortment of replacement wheels for all manufacturer's equipment.

STONE TYPE:

General Purpose-recommended for Hard or Soft Seats, Roughing or Finishing.



Valve Seat Grinding Wheel

| Sioux Stone 30° PART # | Sioux Stone 45° PART # | Size (mm) | Angle | Sioux Stone 30° PART # | Sioux Stone 45° PART # | Size (mm) | Angle |
|---------------------------|---------------------------|---------------|--------|---------------------------|---------------------------|---------------|--------|
| SX330 | SX345 | 1 1/4" (31mm) | 30/45° | SX2030 | SX2045 | 2 1/8" (54mm) | 30/45° |
| SX430 | SX445 | 1 3/8" (33mm) | 30/45° | SX3030 | SX3045 | 2 1/4" (57mm) | 30/45° |
| SX530 | SX545 | 1 1/2" (38mm) | 30/45° | SX4030 | SX4045 | 2 3/8" (60mm) | 30/45° |
| SX630 | SX645 | 1 5/8" (41mm) | 30/45° | SX5030 | SX5045 | 2 1/2" (63mm) | 30/45° |
| SX730 | SX745 | 1 3/4" (44mm) | 30/45° | SX6030 | SX6045 | 2 5/8" (66mm) | 30/45° |
| SX830 | SX845 | 1 7/8" (47mm) | 30/45° | SX7030 | SX7045 | 2 3/4" (69mm) | 30/45° |
| SX1030 | SX1045 | 2" (50mm) | 30/45° | SX8030 | SX8045 | 2 7/8" (73mm) | 30/45° |

PLEASE NOTE: We reserve the right to ship 90 degree angle stones when others are not available.

ENGINE CYLINDER HONING STONES SHARK REPLACEMENT STONES FOR AMMCO HONES

For Model 3800 Hone - Range 2" to 7"

| Part# | Ammco# | Finish | Grit | Dimensions |
|-------|--------|-----------|------|------------|
| 38100 | 3810 | Fine | 280 | 4" x 5/8" |
| 40400 | 4040 | Standard | 100 | 4" x 5/8" |
| 38400 | 3840 | Medium | 180 | 4" x 5/8" |
| 38330 | 3833 | Finishing | 400 | 4" x 5/8" |

Contains 3 Stones

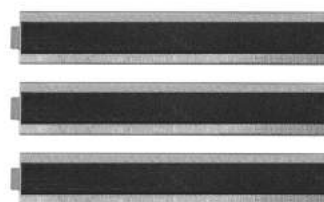

38400

For Model 8275 Hone - Range 1 3/8" to 2"

| Part# | Ammco# | Finish | Grit | Dimensions |
|-------|--------|--------|------|---------------|
| 82880 | 82888 | N/A | 220 | 2 1/2" x 3/8" |

Contains 3 Stones



82880

ENGINE/BRAKE HONES & STONES



SHARK HONES are manufactured to specifications that guarantee a long-life product.



115



39510

PART # 115 - Engine Hone

Spring tension adjusting nut for positive cutting action at any speed. Comes supplied with 4" stones/Medium grit.

| Part# | Description | Dimensions |
|-------|-----------------------------------|-----------------|
| 115 | Engine Hone 3 Stones Model | 4" Long |
| 115M | Medium Stones and Wipers (2 each) | |
| 115C | Coarse Stones and Wipers (2 each) | Range: 2" to 7" |

For Model 3950 Hone - Range 1 7/8" to 3 5/8"

| Part# | Ammco# | Finish | Grit | Range | Dimensions |
|-------|--------|-----------|------|-----------------|---------------|
| 39510 | 3951 | Roughing | 60 | 1 7/8" x 2 3/4" | 3 1/2" x 1/2" |
| 39520 | 3952 | Finishing | 220 | 1 7/8" x 2 3/4" | 3 1/2" x 1/2" |
| 39530 | 3953 | Roughing | 60 | 2 3/4" x 3 5/8" | 3 1/2" x 1/2" |
| 39540 | 3954 | Finishing | 220 | 2 3/4" x 3 5/8" | 3 1/2" x 1/2" |
| 39550 | 3955 | Aluminum | 320 | 1 7/8" x 2 3/4" | 3 1/2" x 1/2" |
| 39560 | 3956 | Aluminum | 320 | 2 3/4" x 3 5/8" | 3 1/2" x 1/2" |

Contains 2 Stones and 2 wipers. Felt must be Oiled.

SHARK HONES ARE MANUFACTURED TO SPECIFICATIONS THAT GUARANTEE A LONG-LIFE PRODUCT.

BRAKE CYLINDER HONES



110

112

111

Part# 110 - Brake Cylinder Hone

| Part# | Length | Range | Model |
|-------|--------|------------------------|---------|
| 110 | 1" | 3/4" - 2 1/2" Diameter | 3 Stone |

Use Replacement Stone #100

Knurled nut controls tension adjustment for honing and deglazing throughout the full range. Flexible Shaft - simplifies use on car.

Part# 111/112 -Small/Disc Car Brake Cylinder Hone

| Part# | Length | Range | Model |
|-------|--------|------------------------|----------------------------|
| 111 | 1" | 1/2" - 2 1/4" Diameter | 2 Stone |
| | | | Use Replacement Stone #100 |
| 112 | 1/2" | 1/2" - 2 1/4" Diameter | 2 Stone |
| | | | Use Replacement Stone #113 |

Knurled nut controls tension adjustment. Flexible Shaft-simplifies use on car.

REPLACEMENT STONES



100



17410 / 37600

Replacement Stones

| Part# | OEM# | Qty. | Length | Range | Model |
|-------|-------|------|--------------------|-----------------|---------|
| 100 | Below | 6/PK | 1" | 1 1/2" - 3 1/2" | 2 Stone |
| 113 | N/A | 3 | Replacement Stones | | 3 Stone |

Cal-Van Hone 360-#362, K-D Hone 265, Lisle Hone 10000, Snap-on Brake Hones, Ammco 9576

Replacement Stones for Ammco Hone Model 1650

| Part# | OEM# | Qty. | Length | Range | Model |
|-------|------|------|--------|---------------|---------|
| 17410 | 1741 | 6/PK | 1" | 3/4" - 1 1/2" | 3 Stone |

Replacement Stones for Ammco Hone Model 3760

| Part# | OEM# | Qty. | Length | Range | Model |
|-------|------|------|--------|----------------|---------|
| 37600 | 3760 | 8/PK | 1" | 9/16" - 2 1/4" | 2 Stone |



ECONOMICAL ADAPT-ALL ADAPTOR SYSTEM

ELIMINATES LOCATORS AND REPLACES THE ADAPTEK AND 91C SYSTEM... ALL WITHOUT A LOCATOR

ADAPT-ALL SYSTEM - Many Options for Composite Rotors - Small & Large

NEW DESIGN ELIMINATES THE LOCATOR AND CAN BE USED RIGHT ON ANY 1" ARBOR- WORKS ON ALL BRAND BRAKE LATHES.

More economical than the Adaptek or 91 C Adaptor Kit

Part# 30000 Basic 7 Piece Set

CENTER HOLES FROM 1-1/8" UP TO 3.975"

| Part# | Description |
|-------|------------------------------|
| 33001 | 5-1/4" Backing Plate |
| 33002 | 5-1/4" Front Cup with Spring |
| 33003 | Cone 1.187" - 2.250" |
| 33004 | Cone 2.032" - 3.975" |
| A9492 | Self Aligning Spacer |
| A3112 | 1" Spacer |
| A3114 | 2" Spacer |



Part# 30020 Composite Rotor & Truck Kit

COVERING 1/2 THRU 2 TON-TRUCKS WITH CENTER HOLES OVER 4"

| Part# | Description |
|-------|--------------------------|
| 33005 | 7" Backing Plate |
| 33006 | 7" Front Cup with Spring |
| 33007 | 7.55" Backing Plate |
| 35052 | 4-1/2" - 5-1/2" Cone |
| 35053 | 3-5/8" - 5 1/8" Cone |
| 35054 | 5" - 6 1/8" Cone |
| A3114 | 2" Spacer |



Part# 30022 Truck Set

FOR 1 TON COMPOSITE ROTORS

| Part# | Description |
|-------|--|
| 33005 | 7" Backing Plate (for use with any standard cone) |
| 33006 | 7" Front Cup with Spring |
| 33007 | 7.55" Backing Plate |
| 35052 | 4-1/2" - 5-1/2" Cone (ADD 35052 TO DO 1/2 TON TRUCKS) |



Part# 30023 Heavy Duty Truck Set -3 Pieces Part# 30024 Small Foreign Cars & Flywheel Kit

| Part# | Description |
|-------|-----------------------|
| 33014 | 5-7/8" to 7" Cone |
| 33015 | 8-3/4" Backing Plate |
| 33016 | 6-7/8" to 8 1/8" Cone |

| Part# | Description |
|-------|------------------------|
| 33009 | 4" Front Cup w/ Spring |
| 33019 | 4" Backing Plate |



BRAKE LATHE ADAPTORS SETS



Total Adaptor Set Required for Mounting Drums and Rotors on 1" Arbors

| Part# | OEM # | Description |
|--------|-------|---|
| A4347 | 4347 | Complete Basic Adaptor Set with Arbor & Nut |
| A4347N | N/A | A4347 Set without Arbor and Nut (3101 and 3102) |



BRAKE LATHE ADAPTORS PIECES



Required for Mounting Drums and Rotors on 1" Arbors

| Part# | Ammco # | Description | Size | mm | Weight |
|--------|---------|----------------------|-----------------|----------------|--------------------------|
| A3101A | 903101 | Standard Arbor | 1" | 25.4 | 6 lbs. (2.722 kg.) |
| A3102A | 903102 | Arbor Nut | 1" | 25.4 | 8 oz. (.22 kg.) |
| A3106 | 903106 | Centering Cone | 3.421" x 4.031" | 86.89 x 102.39 | 2 lbs. 5 oz. (1.022 kg.) |
| A3107 | 903107 | Centering Cone | 2.89" x 3.5" | 73.41 x 88.90 | 1 lbs. 13 oz. (.883 kg.) |
| A3108 | 903108 | Centering Cone | 2.328" x 2.968" | 59.13 x 75.39 | 1.8 lbs. |
| A3109 | 903109 | Hubless Drum Adaptor | 5.650" | 143.52 OD | 1 lb. 5 oz. (.583 kg.) |
| A3110 | 903110 | Spring | N/A | N/A | 4 oz. |
| A3123 | 903123 | Hubless Drum Adaptor | 5.75" | 146.05 OD | 1 lb. 6 oz. (.615 kg.) |
| A3125 | 903125 | Spacer | 1/2" | 12.70 | 4 oz. |
| A3178 | 903178 | Centering Cone | 2.65" x 3.224" | 67.31 x 81.89 | 1 lb. 10 oz. (.481 kg.) |
| A3902 | 903902 | Centering Cone | 1.25" x 1.75" | 31.75 x 44.45 | 7 oz. (.198 kg.) |
| A3903 | 903903 | Centering Cone | 1.18" x 2.25" | 30.16 x 57.15 | 12 oz. (.340 kg.) |
| A3904 | 903904 | Centering Cone | 1.703" x 2.750" | 43.26 x 69.85 | 1 lb. 7 oz. (.652 kg.) |
| A9232 | 909232 | Double Taper Set | SEE PAGE 86 | CHART ON 86 | 7 lbs. 1 oz. |
| A9489 | 909489 | Hubless Adaptor | 3.625" OD | 92.08 | 4 lbs. |
| A9490 | 909490 | Hubless Adaptor | 4.5" | 114.30 | 3 lbs. 7 oz. (1.65 kg) |
| A9492 | 909492 | Self Aligning Spacer | 1 5/8" x 1 5/8" | N/A | 11 oz. (.312kg.) |



BRAKE LATHE TRUCK PLATES AND TRUCK ADAPTOR SETS

INDIVIDUAL PLATES FOR MOUNTING DRUMS AND ROTORS ON 1" ARBORS

Part# A4781 - Ammco Style Cone - 1" Center Hole

Ammco type cone covers larger center holes.

| Part# | Description | Size | mm |
|-------|----------------|-----------------|-----------------|
| A4778 | Centering Cone | 3.828" x 4.421" | 97.23 x 112.29 |
| A4779 | Centering Cone | 4.500" x 5.125" | 110.72 x 126.19 |
| A4781 | Centering Cone | 4.891" x 5.500" | 123.46 x 139.70 |

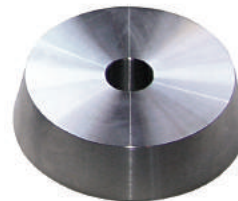

A4781

Part# A4790 - Reducer Bushings Set of 3

Reduces 1 7/8" center holes to 1".

| Part# | OEM# | Description |
|-------|------|---|
| A4790 | 4790 | Reduces 2" Center Holes On Cups Set of Three Reduces from 1 7/8" to 1" |

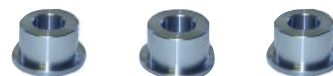

A4790

PART# A9199 TRUCK ADAPTOR SET

Part# A9199 6 Piece Combination Light Truck Adaptor Set.



APPLICATIONS FOR 3/4 TON AND 1 TON TRUCKS GMC CHEVROLET, JEEP AND IH SCOUT AND FORD TRUCKS

One set: Combining A9399 and A9499 but with an A3579 plate which covers 2 previous plates!

Same configuration as A9299 without an A4779 or A4732.

Uses A3579 centering cone that replaces two older numbers and covers everything with *one less part number*.

| Part# | Ammco# | Description | Size | mm |
|-------|--------|-------------------------|--------------------------------|--------------|
| A3577 | 3577 | Alignment Cup-Small (2) | 6.75" O.D. x 1" Bore | 171.45 OD |
| A3578 | 3578 | Alignment Cup (1) | 7.813" O.D. x 1" Bore | 198.45 OD |
| A3579 | 3579 | Centering Cone (1) | 4.625" x 5.250" O.D. x 1" Bore | N/A |
| A3590 | 3590 | Spring (1) | 2 1/2" Dia. x 4 1/8" | N/A |
| A4778 | 4778 | Centering Cone (1) | 3.828" x 4.421" | 97.2 x 112.3 |

BRAKE LATHE TRUCK ADAPTOR SETS



Part# A9299 - Complete set

COMBINING A9399 AND A9499
 APPLICATIONS FOR 3/4 TON AND 1 TON GMC,
 CHEVROLET, JEEP AND IH SCOUT
 AND FORD TRUCKS

Part# A9299 - 7 Piece Combination Light Truck Adaptor Set.

| Part# | Ammco # | Description | Size | mm | Weight |
|-------|---------|-------------------------|----------------------|-----------------|----------|
| A3577 | 3577 | Alignment Cup-Small (2) | 6.75"x 1" Bore | 171.45 OD | 7.1 lbs. |
| A3578 | 3578 | Alignment Cup (1) | 7.813" O.D. | 198.45 OD | 8.1 lbs. |
| A3590 | 3590 | Spring (1) | 2 1/2" Dia. x 4 1/8" | N/A | .2 lbs. |
| A4732 | 4732 | Centering Cone (1) | 4.5" x 5.50" | 118.26 x 133.35 | 5.9 lbs. |
| A4778 | 4778 | Centering Cone (1) | 3.828" x 4.421" | 97.2 x 112.3 | 4.9 lbs. |
| A4779 | 4779 | Centering Cone (1) | 4 1/2" x 5 1/8" | 110.7 x 126.2 | 6.1 lbs. |

PART# A9399 - 4 PIECE LIGHT TRUCK SET

FOR TURNING FORD ONLY LIGHT TRUCK DRUMS ON 1" ARBOR

- Fits Ford 3/4 Ton, 1 Ton.
- Also for Large Center Hole Hubless Drums.

A9399 Ford Light Truck Adapter Set

| Part# | Description | Size | mm |
|-------|--------------------|----------------------|-----------------|
| A3578 | Alignment Cups (2) | 7.813" | 198.45 |
| A3590 | Spring (1) | 2 1/2" Dia. x 4 1/8" | N/A |
| A4732 | Centering Cone (1) | 4.656" x 5.250" | 118.26 x 133.35 |



PART# A9499 - 5 PIECE LIGHT TRUCK SET

FOR TURNING MOST LIGHT TRUCK DRUMS ON 1" ARBOR

- Fits Ford 3/4 Ton, 1 Ton GMC, Chevrolet, Jeep and IH Scouts with up to 4.968 rotor holes.
- Also for Large Center Hole Hubless Drums.

A9499 Light Truck Adapter Set

| Part # | Description | Hole | Size | mm |
|--------|-------------------------|--------|-----------------|---------------|
| A3577 | Alignment Cup/Small (2) | 1" | 6 3/4" OD | 171.45 |
| A3590 | Spring (1) | 2 1/2" | 4 1/8" | N/A |
| A4778 | Centering Cone | 1" | 3.828" x 4.421" | 97.2 x 112.3 |
| A4779 | Centering Cone | 1" | 4 1/2" x 5 1/8" | 110.7 x 126.2 |

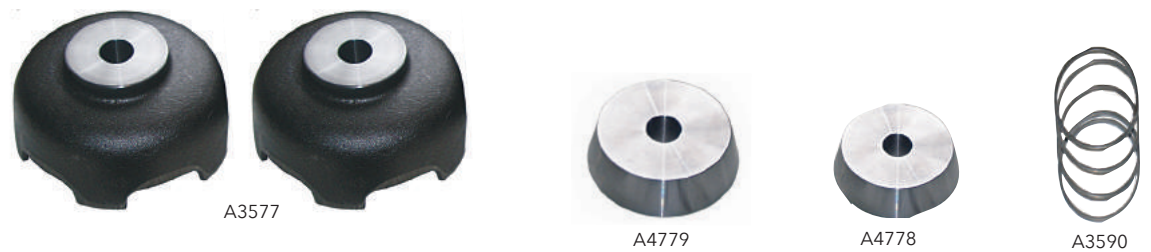



TRUCK KIT FOR HUBBED or HUBLESS ROTORS & DRUMS

PART # A5069-D Passenger Car to Small Light /Medium Truck Adaptor Set w/ 1" Hole

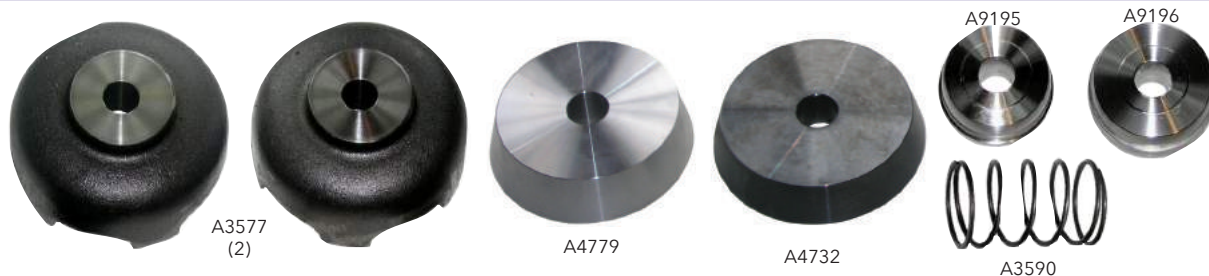

FOR TURNING HUBBED/HUBLESS ROTOR & DRUMS/LIGHT TO MEDIUM 3/4 TO 1 1/2 TON TRUCKS
COVERS MOST LIGHT TRUCK DRUMS ON 1"

Economical Set Made of Heavy Cast Iron - for use on CHEVROLET, JEEP AND IH SCOUT AND FORD TRUCKS

| Part# | Description | Size/mm | Weight |
|-------|----------------------|-------------------------------|------------|
| A3577 | Bell Clamp (2) | 6 3/4" O.D. x 1" Bore | 7.1 lbs |
| A4732 | Centering Cone | 4 1/2" x 5 1/2" | 5.9 lbs. |
| A4779 | Centering Cone | 3.63" x 5 1/8" | 6.1 lbs. |
| A3590 | Spring | 2 1/2 Dia." x 4 1/8" | 0.2 lbs. |
| A9195 | Double Taper Adaptor | 2.828" x 3.185" 71.83 x 80.90 | 3 lbs 11oz |
| A9196 | Double Taper Adaptor | 3.203" x 3.560" 81.36 x 90.42 | 4 lbs 12oz |

ROTOR ADAPTOR FOR FORD F150, DODGE RAM 4x4 & PRESSED BEARINGS

PART #A5532 - Rotor Adaptor for Ford F150 2 W/D

A MUST WHEN DOING FORD F-150 TRUCKS!

THE ONLY WAY TO PROPERLY CHUCK UP THESE ROTORS!

ALLOWS YOU TO MACHINE FRONT ROTORS WITHOUT HAVING TO REMOVE THE BEARINGS. A TIME SAVING MUST HAVE.

Part# APPLICATION

A5532 Ford F-150



PART # A436272 - Rotor Adaptor for Ford/Dodge Ram 4x4

ADAPTOR FOR DODGE RAM 4X4 & 99/2000 FORD EXPLORERS!

THE ONLY WAY TO PROPERLY CHUCK UP THESE ROTORS!

Part# OEM

A436272 Accu-Turn - RELS

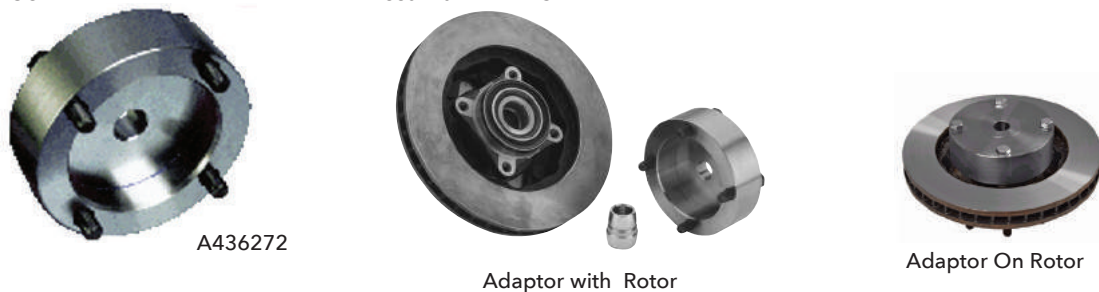

PART # A436271 - Rotor and Drum Drive Assembly

DRIVES THE ROTOR USING THE LUG BOLTS SO YOU DON'T HAVE TO REMOVE PRESSED BEARINGS FROM FORD PROBE, HONDA, MAZDA OR NISSANS.

Rotor and Drum Assembly. For use on any type of sealed or pressed in bearings such as Toyota Vans, Ford Probe, Renault Alliance and others. Controls the drum rotors with sealed or pressed bearing to prevent spinning for ease of cutting.

Part# OEM#

A436271 Accu-turn 436271 - RELS 44180 - Goodtool GT 5021

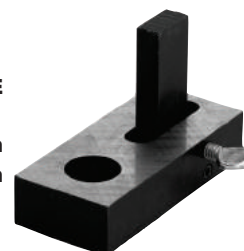

A436271

BRAKE LATHE DOUBLE TAPER COLLETS



For Mounting Hubbed Drums and Rotors on 1" and 1 7/8" Arbors. Covers Passenger Cars and Light Trucks.



A9195

A9196



A9194

A9193



A9192

A9922

A9921

Individual Double Taper Adaptors

| Part# | Size | mm | Weight |
|-------|-----------------|----------------------|-----------------------|
| A9921 | 1.322" x 1.670" | 33.58 x 42.42 | 10 oz / .283kg. |
| A9922 | 1.362" x 1.710" | 34.59 x 43.43 | 11oz / .312kg. |
| A9192 | 1.711" x 2.073" | 43.46 x 52.65 | 1 lbs 3oz / .539kg. |
| A9193 | 2.074" x 2.440" | 52.68 x 61.98 | 1 lbs 15oz / .879kg. |
| A9194 | 2.441" x 2.897" | 62.00 x 73.58 | 2 lbs 13oz / 1.286kg. |
| A9195 | 2.828" x 3.185" | 71.83 x 80.90 | 3 lbs 11oz / 1.673kg. |
| A9196 | 3.203" x 3.560" | 81.36 x 90.42 | 4 lbs 12oz / 2.155kg. |
| A9198 | 3.203" x 3.560" | 1 7/8" 81.36 x 90.42 | 3 lbs 11oz / 1.687kg. |



A9194

A9193

A9192

A9922

A9921

1" Arbor Double Taper Truck Set - PART# A9232

For Mounting Hubbed Drums and Rotors on 1" Arbors. Covers Passenger Cars and light Trucks (1" Hole)

Set includes 1 Each:

A9192, A9193, A9194, A9921 and A9922



A9195

A9196

1" Arbor Double Taper Truck Sets - PART# A9233

For Mounting Hubbed Drums and Rotors on 1" Arbors. Range: 2.841" x 3.552" (72.16 x 90.22mm)

| Part# | Size | mm |
|-------|-----------------|-----------------|
| A9195 | 2.828" x 3.185" | 71.831 x 80.899 |
| A9196 | 3.203" x 3.560" | 81.356 x 90.424 |



A9203

1 7/8" Double Taper Adaptor Set - PART# A9203

For Mounting Hubbed Drums and Rotors on 1 7/8" Arbors. Covers Passenger Cars and light Trucks

| Part# | Size | mm | Weight |
|-------|-----------------|-----------------|--------------------|
| A9203 | 3.203" x 3.560" | 81.356 x 90.424 | 3 lbs-11oz / 1.687 |

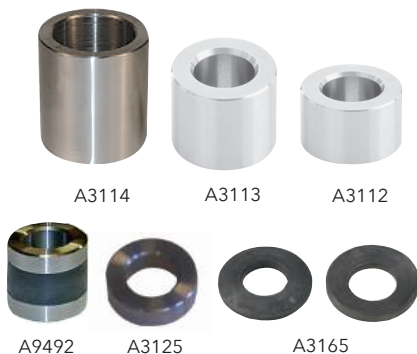

A3114

A3113

A3112

A9492

A3125

A3165

Brake Lathe Spacers

| Part# | Ammco# | Description | Size / Height |
|-------|--------|--------------------------|---------------|
| A3112 | 44100 | Spacer - 1" Dia. | 1" |
| A3113 | 44104 | Spacer - 1" Dia. | 1 1/2" |
| A3114 | 44102 | Spacer - 1" Dia. | 2" |
| A3125 | 903125 | Spacer - 1" Dia. | 1/2" |
| A3165 | 903165 | Self Aligning Washer Set | |
| A9492 | 909492 | Self aligning Spacer | 1" |



ADAPTOR PLUS SYSTEM

Part# 91Z - Adaptor Plus Hubless & Composite Rotor System!

THE MOST SIMPLE TO USE AND COMPLETE SYSTEM YOU CAN BUY!

Adds right to any All Tool, FMC, Hofman, Hunter, Performance, RELS, Shark or Van Norman Hubless Adaptor

- Does almost all of your hubless drum and rotor work
- Eliminates need for cones and bell clamps
- Built in springs so you can't lose them
- Six easy-to-use pieces fit all 1" arbors
- Does most hubless rotors
- For Taurus / Sable
- For GM "W" Cars
- For All Continentals
- Works with ANY Bolt Pattern
- Reduces Comebacks
- Always cuts true

WORKS ON:

PASSENGER CAR HUBLESS DRUMS AND ROTORS
2 5/32" to 4" Center Holes

ALL COMPOSITE ROTORS
Trucks and cars including Jeeps, Taurus/Sable, GM "W" Body and Lincoln Continental

LIGHT TO MEDIUM TRUCK DRUMS
4" to 5 7/8" Center Hole Size

SHARK FACT:
Simpler to use...
this kit does **EVERYTHING**
the complete *Ammco Adaptek
System
(9310, 9311, 9312 and 9313)
does for less money!

*Ammco is a registered trademark of Wheel Service Industries. Shark has no affiliation with Hennessy Industries or Wheel Service Industries



Composite Car and Truck Set

| Part# | RELS# | Description |
|-------|-------|---|
| 91Z | 47315 | TOTAL KIT PICTURED ABOVE WITH 12 PIECES (62 LBS.) |
| 91D | 47381 | Light & Medium Truck Set 4" - 5 7/8" Center Holes Includes 91-11, 91-15 & 91-16. |

Separate System Pieces

| Part# | RELS# | Description | Size | mm |
|-------|--------|-----------------------------------|----------------|--------------------|
| 91-1 | 44301 | Locator | | |
| 91-3A | 44303A | Small Adaptor Centering Cone | 2.125" x 3.25" | 53.97 x 82.55 mm |
| 91-3B | 44303B | Large Adaptor Centering Cone | 3.125" x 4.25" | 79.37 x 107.95 mm |
| 91-7 | 44309 | Spacer/Nut Combo | | |
| 91-8 | 25110 | Spanner Wrench | | |
| 91-11 | 1440A | Truck Cone / Sm | 4.25" x 5.25" | 104.77x133.35mm |
| 91-12 | 10435 | Large Passenger Car Backing Plate | 6.75" OD | 171.45 mm |
| 91-13 | 0439 | Large Adaptor Cup w / Spring | 6.75" OD | 171.45 mm |
| 91-14 | 10438 | Small Adaptor Cup w / Spring | 5.25" OD | 133.35mm |
| 91-15 | 10437 | Truck Backing Plate | 7.40" OD | 187.96mm |
| 91-16 | 10440B | Truck Cone / Lg. | 5.125" x 6.25" | 130.18 x 158.75 mm |
| | 10436 | Small Backing Plate | 5.25" OD | 133.35 mm |

ADAPT-RITE ADAPTOR SYSTEM

SIMILAR TO *AMMCO ADAPTEK SYSTEM



40312 Kit

- Heavy Fabrication reduces Chatter
- Works on most 1" Arbor Lathes
- Easy, Quick and Efficient

Adapt-Rite Adaptor Kits

| Part# | OEM# | Description |
|-------|------|---|
| 40310 | 9310 | Combination Passenger & Truck Kit 1.84" - 3.85" Range Weight- 62 lbs |
| 40311 | 9311 | Passenger Car Set 1.84" - 3.30" Range Weight- 36lbs |
| 40312 | 9312 | Light Truck Set 3.20" - 3.85" Range |
| 40313 | 9313 | Light Truck Set 3.75" - 5.23" Range |
| 40314 | 9314 | Odd Configuration Rotor Set 2.05" - 3.98" Range |



40314 Kit



40310 Kit



40313 Kit

Adapt-Rite Separate Systems



40606

40601

40630

40603

40602

| Part# | Ammco# | Description |
|-------|--------|------------------------------------|
| 40601 | 29572 | Hubless Rotor Hub Base |
| 40602 | 29573 | Double Sided Centering Cone |
| 40603 | 29574 | Arbor Spacer |
| 40605 | 29575 | Auto Composite Flange Plate |
| 40606 | 29576 | Light Truck Large Plate |
| 40607 | 29577 | Light Truck Large Plate |
| 40608 | 29578 | Light Truck Composite Flange Plate |
| 40610 | 29579 | Passenger Car Centering Cone |
| 40611 | 29580 | Passenger Car Centering Cone |
| 40612 | 29581 | Passenger Car Centering Cone |
| 40613 | 29582 | Passenger Car Centering Cone |
| 40614 | 29583 | Passenger Car Centering Cone |
| 40615 | 29584 | Light Truck Centering Cone |
| 40616 | 29585 | Light Truck Centering Cone |
| 40617 | 29586 | Large Light Truck Centering Cone |
| 40618 | 29587 | Large Light Truck Centering Cone |
| 40619 | 29588 | Large Light Truck Centering Cone |
| 40620 | 29589 | Large Light Truck Centering Cone |
| 40621 | 29590 | Large Light Truck Centering Cone |
| 40622 | 29727 | Largest Light Truck Centering Cone |
| 40630 | 29591 | Centering Cone Spring |

*Ammco is a registered trademark of Wheel Service Industries. Shark has no affiliation with Hennessy or Wheel Service Industries.



QUICK-CHUCK MEDIUM DUTY TRUCK SET

Kit for Previous Quick-Chuck Owner - Part# 85713

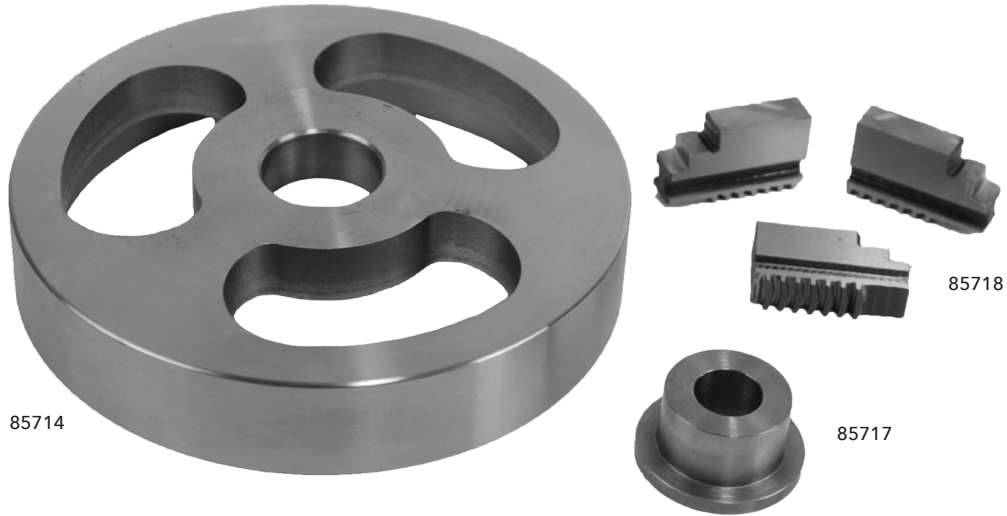

Quick-Chuck MDT Plate with 1" Adaptor - Part# 85719



Individual Truck Kits

| Item # | Description |
|--------|---|
| 85712 | Medium Duty Truck Kit w/ Extra Large Jaws, Quick-Chuck, Backing Plate and Step-Down Adaptor (4). Shown on page 38 |
| 85713 | Medium Duty Truck Kit for Quick-Chuck owners (5 Pieces) |
| 85714 | Quick-Chuck Medium Duty Truck Plate - 9.625" |
| 85715 | Large Quick-Chuck with 1 7/8" Hole |
| 85717 | (1) A4790 Step Down Adaptor for reducing a 1 7/8" hole down to 1" |
| 85718 | Extra Large Truck Jaws - Jaws Only |
| 85719 | Quick-Chuck Medium Duty Truck Upgrade Kit |
| 85720 | Quick-Chuck Medium Duty Truck for 1" Arbor Kit |
| 85721 | HD Truck Plate - 12" Dia. w/ 1 7/8" Hole |

QUICK-CHUCK MEDIUM DUTY TRUCK KIT



Quick-Chuck MDT Kit

- Covers a range of Hubless Drums & Rotor Center holes from 4.4" - 7"
- Easily and Cost-effectively Upgrades Quick-Chuck Adaptors
- Makes Machining Isuzu NPR Drums with 6.8" Hole Easy
- Works with Any 1" Quick-Chuck Adaptor



Part# 85712
Complete Kit

The New Medium Duty Truck Kit (MDT) can be added to your present Quick-Chuck Adaptor

The kit provides quick, error-free set up on medium Duty hubless drum and rotors with precision mounting and machining accuracy that is proven and patented.

The kit will enable you to machine Isuzu NPR drums 6.8" hole (below) with ease on your 1" arbor brake lathe

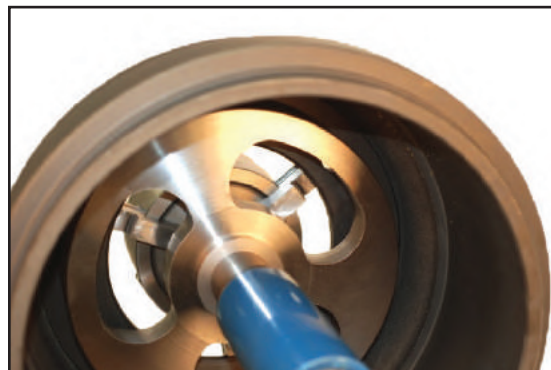
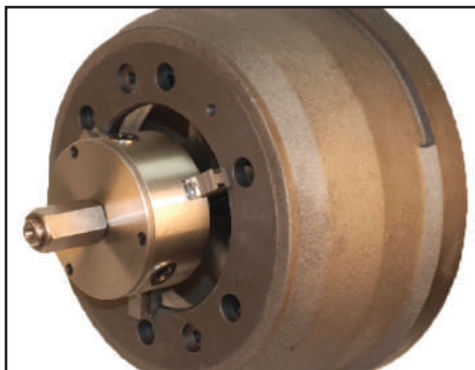



QUICK-CHUCK HUBLESS ADAPTOR/TWIN QUICK CHUCK

THE QUICK AND EASY WAY TO CHUCK UP YOUR HUBLESS ROTORS AND DRUMS. AN ALTERNATIVE TO THE ADAPTOR PLUS SYSTEM.

THIS SYSTEM IS SIMPLE AND FAST ON COMPOSITE ROTORS, HUBLESS ROTORS AND DRUMS!

- Works on ANY 1" Arbor
- Works with any standard arbor, spacers or nuts
- Mounts almost all foreign and domestic hubless rotors, drums and flywheels
- Works on Hole Sizes 2 1/8" to 3 3/4" range
- Versatile, simple and easy to use
- Optional Jaws & Truck Plate
- Optional Small Plate

85708 Kit

Set Including Wrench (85707), Quick Chuck (85708) and Plate (85703)



85701 Kit

Set Including (2) Wrenches (85707), Quick Chuck (85708) and Plate (86705)



Always have a Quick-Chuck ready to do truck or car rotors.

Quick Chuck Adaptor

| Part# | Old# | Description |
|-------|--------|--|
| 85708 | (880) | Quick-Chuck Kit w/ Standard Jaws, Plate and Wrench |
| 85709 | (880K) | Car and Truck Quick Chuck |
| 85710 | N/A | Quick-Chuck Truck Kit w/ Jaws/Plate & Wrench |
| 85711 | (881) | Quick-Chuck w/ Standard Jaws & Wrench (No Plate) |
| 85712 | N/A | Medium Duty Truck Kit w/ extra Large Jaws, Quick-Chuck, Backing Plate & Step-Down Adaptor (4 pcs.) |
| 85713 | N/A | Medium Duty Truck UPGRADE Kit for Quick-Chuck (5 pcs.) |
| 85714 | N/A | Medium Duty Truck Plate ONLY for Quick-Chuck (9.625" diameter) |
| 86715 | N/A | Large Quick-Chuck with 1 7/8" Hole |
| 85716 | (887) | Standard Truck Jaws Only |
| 85717 | | Step Down Adaptor for reducing a 1 7/8" hole down to 1" |

Twin Quick Chuck Adaptor

| Part# | Old# | Description |
|-------|------|--|
| 85701 | | Twin Quick Chuck Kit Contains: |
| | | (1) 85708 Quick-Chuck w/ standard Jaws, Plate and Wrench |
| | | (1) 85710 Quick-Chuck w/ truck Jaws, Large Truck Plate, Wrench |
| | | (1) 85706 Toyota Backing Plate - 6 1/8" diameter |
| | | (1) 85705 Small Backing Plate - 4 3/4" diameter |

SEPERATE COMPONENTS

| Part# | Old# | Description |
|-------|--------|------------------------------------|
| 85702 | (886J) | Standard Jaws |
| 85703 | (882) | Standard Quick-Chuck Backing Plate |
| 85704 | (886T) | Large Truck Backing Plate - 7 1/4" |
| 85705 | (882S) | Small Backing Plate - 4 3/4" |
| 85706 | (888T) | Toyota Backing Plate - 6 1/8" |
| 85707 | (880W) | Wrench for Quick-Chuck |

COMPARITOR BRAKE FLUID TESTER

DETERMINE THE PRESENCE OF CORROSION CAUSING CONTAMINANTS IN YOUR BRAKE FLUID.



Comparator Brake Fluid Tester - PART# 901S

More than 3% water content is above factory safe specifications for water content

- Works on Dot 3, Dot 4, and Dot 5 Brake Fluid
- Detects water contamination in your brake system
- Excellent for safety checks
- Critical on ABS systems
- Easy to use

The brake fluid tester will leave no question as to the water contamination in your brake fluid. Water can dangerously effect the boiling point of your fluid, causing water vapor to form in the brake system. When it does this, it lowers the boiling point of the fluid to unsafe levels.

You could eventually experience total brake loss when it reaches levels greater than 3-4%.
Uses 9V Battery (Included).



901S

CERAMLUB 2800 - The Brake Jobs Best Friend

CERAMLUB 2800

O.E.M. APPROVED EXTREME TEMPERATURE LUBRICANT GUARANTEED TO STOP BRAKE NOISE!

- 100% Real Synthetic Original Swiss Formula
- Extreme Pressure Solids-Over 35%
- Unbeatable in Extreme Temperatures (2800 Degree F Rating)
- Non Petroleum or Silicone based.
- OEM Approved by Pad & Vehicle Manufacturers
- Stops Costly Service Comebacks on Brake Jobs
- The Final Step to a Perfect Brake Service

This proprietary high solids ceramic formula leaves no doubts as to costly brake noise comebacks. It likewise properly lubricates all moving and mating parts for the entire life of the pads.

Approved by the biggest OEM brake parts manufacturers, Ceramlub 2800 is a brake job's *best friend*.

Most importantly, it contains no Petroleums or Silicones to break down or get contaminated with dirt and water.



90888



90891

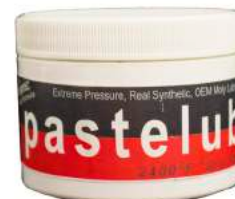

90892

| Part# | Description | Quantity | Weight |
|-------|------------------------------|-----------------|----------------------------|
| 90888 | Ceramlub 2800 | 6 Jar Case | 7 Ounces per Jar- 2.6 lbs. |
| 90889 | Ceramlub 2800 | Case of 72 Jars | 31.2 lbs. |
| 90890 | Brake Soap | | |
| 90891 | Brake Silencer Aerosol Spray | | |
| 90892 | Pastelub 2400 | 6 Pack | |
| 90893 | Pastelub 2400 | 72 Pack | |



VACUUM BRAKE BLEEDER

AN AMERICAN MADE 2 QUART VACUUM BRAKE BLEEDER FOR ABS AND NON-ABS BRAKE BLEEDING

PART# S0061M - Vacuum Brake Bleeder

- Gravity feed refiller system
- Simple air operated system for ease of use
- No spilling of corrosive brake fluid
- Large stable base so it won't tip easily
- Makes bleeding a one person job
- Requires no special adaptors
- Works on all ABS systems
- Will not damage seals
- Easy drain plug

This very easy-to-use affordable brake bleeder is a must for every shop doing brake jobs. Just hook it up to a shop air line and away you go. Buy the unit with an automatic refiller, or top off the master cylinder yourself as you bleed the system down.

Clean and safe, you never have to worry about damaged seals. There is an easy to use drain plug on the unit so you never have to remove the lid.

Please remember, removing the lid damages the seal! Great for brake flushes as well as bench top bleeding.



COMPLETE KIT OF BLEEDER, REFILLER AND (2) BLEEDER SCREW FITTINGS

Brake Bleeder Breakdown

| Part# | Description | Part# | Description |
|----------|---|-----------|---|
| S0051A | Bleeder Unit without Refiller Kit | BB12100E | Trigger |
| S0061AP | Pro Unit with Adaptors (NOT PICTURED) | BB12100N | 3/8" NPT Plug |
| S0061M | Complete Bleeder INCLUDING REFILLER KIT | BB12100O | Muffler for Bleeder |
| S0052 | Automatic Gravity Refiller | BB12100R | Drain Plug for S0051A/S0061A |
| 86262 | Lid "O" Ring | BB12100T | Wire Bale to Depress Handle |
| BBA-18 | 18" Brake Hose Assembly | BB12100U | Small Bleeder Adaptor #1 |
| BB12150 | Update Kit-for "O" Rings (INCLUDES 7 O-RINGS) | BB12100V | Bleeder Adaptor #2 |
| BB12156 | Red Tee Knob - 1 1/4" Dia. (PRO GRADE) | BB12100W | 3 Bleeder Adaptors/Screw Cover |
| BB12100A | 2 1/4 Quart Container | BB12100X | Brass Bulk Head Fitting |
| BB12100B | Screw On Lid | BB12300 | Round & Square Refiller System Bottle (OLD STYLE) |
| BB12100C | Handle Housing | BB12300O | Black Bungee Cord for Bleeder (OLD STYLE) |
| BB12100D | Handle | BB12300CC | Refiller Bottle Assembly (OLD STYLE) |

TIRE REPAIR BURS



Shark's Carbide Burs are an important piece for proper tire repair. Manufactured in the U.S.A., use these burs to remove damaged steel cables and loose wires in radial tires and for cleaning holes before patching.



Tire Repair Burs

| Part# | Tech.# | Flute | Dia. | Injury Size | Cut | Shank | Overall Length |
|-------|--------|-------|-------|-------------|---------|---------|----------------|
| BT9 | 280 | 5/8" | 1/8" | 1/8"- 3 mm | Notched | Round | 1 1/2"- 38 mm |
| BT10 | 282 | 5/8" | 1/4" | 1/4"- 6 mm | Notched | Round | 2"- 50 mm |
| BT15 | 284 | 1" | 1/4" | 1/4"- 6 mm | Diamond | Round | 2"- 50 mm |
| BT30 | 271 | 2" | 5/16" | 1/4"- 6 mm | Notched | 3 Flats | 4"- 100 mm |
| BT34 | 271P | 2" | 1/4" | 1/4"- 6 mm | Notched | Round | 3"- 75 mm |
| BT34S | N/A | 2" | 3/16" | 3/16"- 8 mm | Notched | Round | 3"- 75 mm |

TIRE REPAIR MOUNTED POINTS

White Aluminum Oxide Tire Repair Stones
60 Grit Wheels - 1/4" Shank

Most Popular Stone Shapes for Tire Repair

| Part# | Description |
|-------|--|
| A1W | 3/4" x 2 1/2" - White |
| A4W | 1 1/4" x 1 1/4" - White |
| A12W | 11-16" x 1 1/4" - White Pointed |
| A15W | 1/4" x 1 1/16" - White Pencil |
| A15LW | 1/4" x 1 1/16" - White Extended Pencil |
| A36W | 1 5/8" x 3/8" - White Large Mushroom |
| A37W | 1 1/4" x 1/4" - White Small Mushroom |

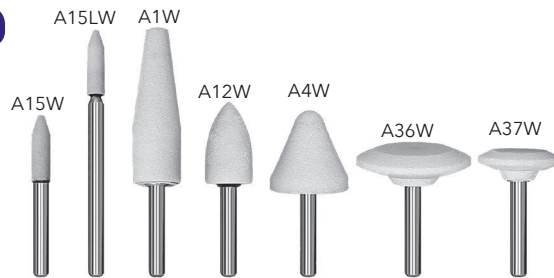

Tire Swabs for Coats or Other Tire Changers

Used for Lubricating Tire Beads when removing or Mounting Tires on Rims

| Part# | OEM# | Description |
|----------|--------|--------------------------------|
| C000491 | 491 | Short Swab - 11 1/2" |
| C120366 | 120366 | Long Swab - 14 1/2" |
| C000491P | 491 | Short Swab - 11 1/2" - 25 Pack |
| C120366P | 120366 | Long Swab - 14 1/2" - 25 Pack |



Replacement Lube Buckets for Coats Tire Changers

| Part# | OEM# | Description |
|---------|------------------------------|--|
| C106259 | 8106259 | Coats Rim Clamp Style Straight Lube Bucket RC15,RC20,5060,5070 |
| C106572 | 8106572 | Coats 4040 Tire Changer Angled Lube Bucket 4040,4040SA,4050 |
| C106576 | 0014466 66006 116-35-2 | Straight Bucket/Accu-turn FMC/John Bean Hunter |



Pressure Gauges for FMC & Coats Tire Changers

REPLACEMENT AIR GAUGES FOR TIRE CHANGERS

| Part# | OEM# | Description |
|---------|----------|---|
| 90588 | AG107518 | Ammco Old Style, Bolt on back Air Gauge for Coats 1010, 2020, 2020a |
| 90589 | AG107985 | 4040 Newer Style Flange Mounting 4040, 4040a, 4040SA & 4040A |
| 90590 | AG66170 | FMC Air Gauge for Tire Changers |
| C107517 | LC107517 | Lens Cover for Air Gauge |

(NOT PICTURED)





TIRE CHANGER ACCESSORIES

Time-Saving Portable Tire Spreader

Designed to spread Tire Beads quickly and in Mobile Service Applications.

| Part# | OEM# | Description |
|-------|-------|---------------|
| 51678 | TC630 | Tire Spreader |

Note: Use with 1/2" Impact Gun with 1 1/4" Socket.

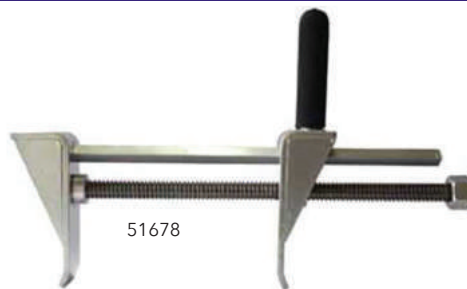

51678

Adjustable Tire Spreader

For use on Coats Model 4040; 40 FMC 600; 8800

| Part# | OEM# | Description |
|---------|---------|--|
| C108028 | 8108028 | Tire Spreader |
| C108029 | 8181329 | Tire Spreader STAND 7 3/4" height, U&L Case |



C108028

C108029

Tire Changer Tool Tray

For Use with all Swing Arm Style Rim Tire Changers with the Round Rear Post Characteristic.

FITS: Coats RC15A, 5030 & 5060
Hofmann 1510, 1610 and 1550
FMC 8700, 8955 & 8965

| Part# | Description |
|-------|-----------------------------|
| PT401 | Tool Tray for Tire Changers |



PT401

Ergonomic Stem Removing Tool

| Part# | OEM# | Description |
|-------|------|---|
| 22985 | T165 | USA Made TV-2 Screwdriver Valve Core Tool for inserting and removing Valve Cores. |



22985

Wheel Weight Scraper

| Part# | TMR# | Description |
|-------|------|---|
| 22986 | T174 | Wheel Weight Scraper Tool For scraping sticky weights off Aluminum Rims Durable Hard Plastic Tool |



22986

Lug Nut Removing Tool

| Part# | Description |
|-------|--|
| 72 | Our Lug Nut tool is designed to safely remove chrome lug nuts. It safely fits ALL sizes of chrome lug nut covers on motor homes to over-the-road trucks. |



72

TIRE CHANGER ACCESSORIES



Bead Lifting Tool & Sock

Bead Lifting tool has a sock cover
Sold in 10 packs



80767



80765



80766



80768



C108397



C108398



33700

| Part# | Manufacturer | OEM# |
|-------|--------------------|------------------|
| 80767 | Ammco | 0001418 - 1 Tool |
| | Coats | 8181354 |
| | Corgi | 444238 |
| | FMC/John Bean | 87111 |
| | Hunter | RP6-0322 |
| | Kwik-Way | 580-2991-11 |
| 80765 | Sice | 3009516 |
| | Snap-on | EAA0247G02A |
| | Long Sock/4 Pack | Corgi 246241 |
| 80766 | Hunter | RP11-8-11400098 |
| | Sice | 2201655 |
| 80766 | Short Sock/10 Pack | Coats 8183605 |
| | Hunter | RP6-0326 |

Combo Tool

Specifically designed to Mount and Demount Tires
Use with Mount and Demount booties.

| Part# | OEM# | Description |
|-------|--------|------------------|
| 80768 | Coats | 8000768 - 1 Tool |
| | Hunter | RP6-1828 |
| | TMR | CT768 |

Demount & Mount Booties for Tire Changers

Attaches to the Tire Changer Bar to prevent
scratching Aluminum Rims

| Part# | OEM# | Description |
|---------|---------|--------------------|
| C108397 | 8108397 | Short Mount Bootie |
| C108398 | 8108398 | Long Mount Bootie |

Bead Depressing Tool

Bead Depressor Drop Center Tool for Tire Changers

| Part# | Qty. | Manufacturer | OEM # |
|-------|--------|--------------|-------------|
| 33700 | 1 Pack | TMR | TC435685 |
| | | Accu-turn | SM103261 |
| | | Coats | 8435685 |
| | | Corgi | 435685A |
| | | Hofmann | 6410190 |
| | | Hunter | RP6-70210E |
| | | Kwik-Way | 580008413 |
| | | Snap-on | EAA0247G70A |
| | | SICE | 2018505 |

AIR LINE ACCESSORIES - WHEEL WEIGHT TOOL

Protective Wheel Weight Tool/Air Line Accessories

Unique replaceable "Soft Head" is designed to easily
install or remove coated wheel weights without damaging
the wheel or coating.



1471C



SLP7



SLP4

| Part# | Description |
|-------|--------------------------|
| 1471C | Wheel Weight Tool |
| SLP4 | Straight Tire Chuck |
| SLP7 | Tire Inflator with Gauge |



TIRE CHANGER ACCESSORIES

Beadkeepers

BEADKEEPERS LOCK ON TO THE FLANGE OF THE WHEEL & HOLD THE TIRE BEAD IN PLACE. ELIMINATES STANDING ON THE TIRES OR CHASE THE BEAD AROUND THE WHEEL



51675



51676



51677

Part#

Description

| | |
|-------|---|
| 51675 | Beadkeeper - Drop Forged Steel |
| 51676 | Beadkeeper - Rubber Head to Protect Aluminum Wheels |
| 51677 | Beadkeeper - Pair Connected by Nylon Rope made of Drop Forged Steel |

Jaw Clamping Kits

JAWS CLAMPING KITS X-OUT CLAMP KIT FOR CLAMPING 23" & 24" ALLOY WHEELS ON COATS TIRE CHANGERS.

13"-24" Range.
2 Position Clamps.
Outside Clamping Only



51639



51637



51638

| Part# | Coats # | Description | Applications |
|-------|---------|----------------------------------|---|
| 51637 | N/A | Kit of 18 pieces including: | 4 X-Out Clamps, 4 push buttons & 10 Quilted Clamp Socks |
| 51638 | 8182250 | Position Push Buttons (4 PIECES) | 50X - 60X - 70X |
| 51639 | 8183604 | Quilted Clamp Socks (10 PIECES) | 50X - 60X - 70X All Coats Tire Changers except 9010 & 9024E |

Coats Extension Jaw- Externally Clamp Wheels

UP TO AND INCLUDING 28" WHEELS WITHOUT DAMAGING THE WHEEL 16"-28" WHEELS



51641(4 Pack)



51642(4 pk.w/buttons)

| Part# | Coats # | Description / Applications |
|-------|----------|--|
| 51641 | 8184958 | 28" Extension Jaw, Externally Clamp up to and Including 28" Wheels (16" - 28")50X 60X 70X |
| 51642 | 8113125C | 3 Position X-Tended X-Clamp Kit for Coats X-Models w/Adjustable Carriers. External(outside/in) Wheel Clamping 6"-22". Kit Includes |
| 51643 | | 4 - Position Push Buttons (Not Pictured) |
| 51644 | | 4 - 3 Position X-Clamps (Not Pictured) |

TIRE CHANGER ACCESSORIES



Replacement Pedal Switch & Cooling Fan Motor

FOR COATS WHEEL BALANCERS AND TIRE CHANGERS

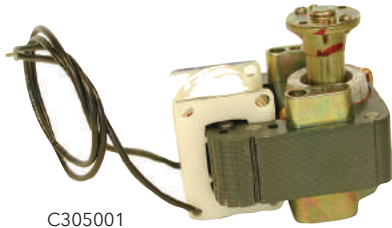

C305001

| Part# | OEM# | Description |
|---------|--------------|---|
| C109873 | TMR SW182958 | Forward/Reverse Switch 40 Amp For Corgi, Coats RC1,5,10,15,20, 5000,6000,7000 Series, 9010 & 9024 (Modifications required on RC Machines RC15 Rim Clamp Tire Changer) |
| C305001 | 305001 | Cooling Fan Motor for Coats Old Style Wheel Balancers |

Plastic Inserts for Heads - Coats/Corghi/Hunter



| Part# | Coats/Corghi/Hunter# | Description | Tire Changer |
|-------|----------------------|------------------|---------------------------------|
| 51640 | 89209611 | 10 Pack w/wrench | Coats For RC1 5 10 20 9010 9024 |
| | 254341A | 10 Pack w/wrench | Corghi 2024 9220 9824 |
| | 8-11100369 | 10 Pack w/wrench | Hunter TCX Series |

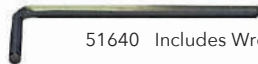

51640 Includes Wrench

Plastic Inserts for Heads - Accu-turn

| Part# | Accu turn# | Pkg. Qty. | Tire Changer |
|-------|------------|-----------|--|
| 51645 | 24016079 | 4 PACK | 3402, 3450, 3602, 4602, 5802HP, 5850HP, 5602 |
| 51646 | 20011064 | Bulk/EA | 3402, 3450, 3602, 4602, 5802HP, 5850HP, 5602 |
| 51647 | 20011064 | 10 PACK | 3402, 3450, 3602, 4602, 5802HP, 5850HP, 5602 |



51645/47

Plastic Longer Inserts for Heads - Snap-on/Hofmann

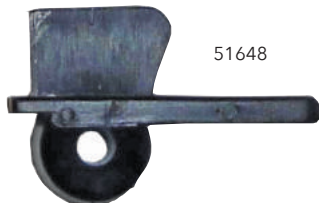

51648

FOR STAINLESS MOUNT AND DEMOUNT HEADS.

| Part# | OEM # | Pkg. Qty. | Tire Changer |
|-------|-------------|-----------|--------------------|
| 51648 | ST4024181 | 10 Pk | Hofmann all Models |
| | EAA0247G15A | 10 Pk | Snap-on All Models |

Jaw/Clamp Covers & Plastic Inserts for Snap-on Clamps



51650



51651

| Part# | Snap-on # | Description | Models |
|-------|-------------|----------------------|-----------------|
| 51650 | EAA0304G21A | Jaw Clamp Covers (4) | Fits All Models |
| 51651 | ST4027591 | Plastic Inserts (1) | Fits All Models |

Rim Clamp Jaw



51659

| Part# | Coats # | Description |
|-------|---------|--|
| 51659 | 8181677 | Rim Clamp Angled Jaw for Coats Tire Changers |

SET OF 4



TIRE CHANGER ACCESSORIES

PLASTIC RIM PROTECTORS FOR COATS 182788 MOUNT/DEMOUNT HEAD

THESE REPLACEMENT PLASTIC INSERTS WILL PROTECT THE RIMS.

| Part# | Coats # | Quantity | Tire Changer Models |
|--------|---------|----------|--|
| A18277 | 8182961 | 2 Pack | For RC1 5 10 15 20 Early 5060 |
| A18278 | 8182963 | 12 Pack | 5030, 5040, 5050, 5060 5065, 5070, 6050, 6060 6065, 7050, 7055, 7060 7065, 7655, 7660, 7665 |



A18277

Plastic Inserts for Hunter Steel Mount Heads

| Part# | TMR # | Quantity | Description |
|-------|------------|----------|---------------------------------|
| 35044 | T14096-10 | 10 Pack | Front Inserts for Mount Heads |
| 35045 | T14636-10 | 10 Pack | Rear Inserts for Mount Heads |
| 35046 | T111400096 | 20 Pack | Kit with Front and Rear Inserts |



35044



35045

Hunter Style TCX Replacement Plastic Inserts

| Part# | Hunter # | Quantity | Description |
|-------|-----------|----------|--------------------|
| 35047 | 20-2684-3 | 10 Pack | Right Side Inserts |
| 35048 | 20-2685-3 | 10 Pack | Left Side Inserts |



35047



35048

Hunter Style TCX High Grip Jaw Protectors

| Part# | Hunter # | Quantity | Description |
|-------|----------|----------|--|
| 51652 | 1405001 | 8 Pack | High Grip jaw protectors for use on TCX500 Series Tire Changers: TCX575, TCX53L, TCX53, TCX51L, TCX51, TCX50 |



51652

Coats Tire Changer Pads

| Part# | Coats # | TMR# | Description |
|-------|---------|----------|---|
| 51654 | 8181065 | T1181065 | Center Rubber Pad for Coats Tire Changers |
| 51655 | 8181855 | T1181855 | Large Center Rubber Pad for Coats Tire Changers |
| 51657 | 8181173 | T1181173 | Small Bead Loosener Nylon Front Pad for Coats |
| 51658 | 8181851 | T1181851 | Large Bead Loosener Nylon Front Pad for Coats |

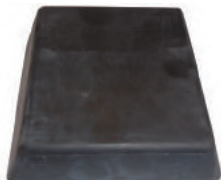

51654



51655



51657



51658

Hunter Tire Changer Pads

| Part# | Hunter # | TMR# | Description |
|-------|----------|--------|-------------------------------------|
| 51656 | RP60066 | TC0066 | Hunter Rubber Pad for Tire Changers |



51656



TIRE CHANGER ACCESSORIES

Inflator Hose Assemblies

Shark's Inflator Hose Assemblies are an important replacement part for tire repair machines. Manufactured to precise standards to perform as good as all OEM hoses.



| Part# | Qty. | OEM # | Description |
|----------------|------|------------------------------------|---|
| C106871 | 1 Pk | Coats 106871 TMR HA106871 | Coats Inflator Hose 60" Long 1/4" ID -19 BSP with Euro Chuck-1/4 MPT |



| | | | |
|---------------|------|---------------------------|--|
| C71410 | 1 pk | 714100 TMR HA714100 | Corgi 714100/Hofmann 2407055 Corgi/Hofmann Open End Barbed Style Euro Chuck 1/4" Hose - 1/8" MPT x 60" with Euro Cou- pling |
|---------------|------|---------------------------|--|



| | | | |
|---------------|------|---------------------------|--|
| C71411 | 1 pk | 200132 TMR HA200132 | Corgi X-Tra Long for Safety Hofmann for Exploding Tire Precautions Open End Barbed style Euro chuck 1/4"x 11 Foot Hose - Euro Chuck WITH Blank END. |
|---------------|------|---------------------------|--|



| | | | |
|---------------|------|---|--|
| C67715 | 1 pk | 67715 TMR HA67715 FMC/ John Bean 67715 | Open End Barbed style Euro chuck 52" x 1/4" Female Swivel w/Spring Guard 1/4" ID-19 BSP |
|---------------|------|---|--|



| | | | |
|---------------|------|--|--|
| C24083 | 1 pk | TMR HA2408318 Hofmann 2408318 | Open End Barbed style Euro chuck 60" x 1/4" Hose/Metric PT x Euro End |
|---------------|------|--|--|



| | | | |
|---------------|------|---------------------------------------|--|
| C13786 | 1 pk | Hunter 137-86-2 TMR HA137862 | Hunter Open End female style 60" x 1/4" Hose - 1/4 MPT both ends. |
|---------------|------|---------------------------------------|--|

Air Hose & Chuck Assemblies for Tire Changers

REPLACEMENT AIR HOSE ASSEMBLIES AND CHUCKS FOR FMC AND COATS TIRE CHANGERS.

| Part# | OEM | Part# | Description |
|----------------|----------------------------|----------------------------------|---|
| C410419 | Coats Hunter Snap-on | 8410419 145-341-2 ST006993 | For many brand 1/4" Hose Open End Type Euro-Chuck for Tire Changers. |
| C410420 | Hunter | 145-341-2 | Female - Open End Type Euro Coupling for Tire Changers (NOT PICTURED) |



C410419



TIRE CHANGER ACCESSORIES

MOUNT/DEMOUNT HEADS

| Part# | OEM Part# | Qty. | Description |
|-------|--|------|--|
| 35036 | | 1 pk | SS Mount/Demount for FMC/John Bean EHPII (system) Hoffman, Ranger and SNAP-ON 35049 - 6 pk. of Yellow Front Roller 35051 - 1 pk. of Black Rear Mount/Demount Protector |
| | | |   |
| 35036 | | | |
| 35038 | Coats 8184432 TMR TC184432 | 1 pk | GREY Nylon Mount / Demount w/ Washers & Nut For Low Profile Tires For Use on Wheels with a Larger Lip. Also use on Tapered Shaft 182767/182812 Coats Tire Changer Models 5030 5040 5050 5060 5065 6050 6060 6065 7050 7055 7060 7065 7655 7660 7665 50XEH3 |
| | | |  |
| 35038 | | | |
| 35039 | | 1 pk | Premium Yellow Nylon Mount/Demount Duckhead ONLY for Accuturn, John Bean, FMC, Hofmann, Ranger & Snap-on. |
| | | |  |
| 35039 | | | |
| 33431 | Accu-turn SM102529 Hunter RP6 0343B Ranger 5150523 TMR TC0343-6 | 6 pk | Accu-turn / Hunter Nylon Mount/Demount Head Accu-turn Models 220A. (other models requires a 102765 Adaptor.) TC250 • TC300 • TC325 • TC350 TC2000 • TC3250 • TC3500 TC3000 & TC3100 Series (Require Adaptor.) Most Models Except R980A, R980A (Some Require Adaptors) |
| | | |  |
| 33431 | | | |

TIRE CHANGER ACCESSORIES



MOUNT/DEMOUNT HEADS

| Description | Qty. | OEM Part# | Part# |
|--|------|-------------------------------|--------------|
| Nylon Mount/Demount Tapered Hole Head Kit with Hardware. For use on Tapered Shaft 182767/182812. Coats Tire Changer Models 5030 5040 5050 5060 5065 6050 6060 6065 7050 7055 7060 7065 7655 7660 7665 | 1 pk | Coats 8183061 TMR TC183061 | 38306 |



38306
Hardware Included

| | | | |
|---|------|---|--------------|
| Nylon Mount/Demount Kit with Round Hole Washers & Bracket Included. NOT FOR USE on Hofmann 1550 1620 1625. All Tool - All Models Coats - RC1 5 10 15 20 Early 5060 9010 9024 APX90 Corgi - All Rim Clamp (Optional Accessory) Hofmann All Earlier Models except 1550 1620 1625 SICE M39 S40 S41 S42 S43 S45 S408MAXI S435 S436 S436TOP | 1 pk | All Tool 20084012 Coats 82008402 Corgi 250309 Hofmann 2200981 TMR TC250309 Guiliano G2008402 | 35030 |
|---|------|---|--------------|



35030

| | | | |
|--|------|---|--------------|
| Nylon Mount/Demount Only with Round Hole (Washers & Nut NOT Included) NOT FOR USE on Hofmann 1550 1620 1625 All Tool - All Models Coats - RC1 5 10 15 20 Early 5060 9010 9024 APX90 Corgi - All Rim Clamp (Optional Accessory) Hofmann All Earlier Models except 1550 1620 1625 Hunter TCX550** TCX557** SICE M39 S40 S41 S42 S43 S45 S408MAXI S435 S436 S436TOP | 1 pk | All Tool 2008401 Coats 83008403 Corgi 450310 Cemb 3008403/2008402 Hofmann 8314813 Hunter RP118314813 TMR TC450310 Guiliano G3008403 | 35031 |
|--|------|---|--------------|

****REQUIRES RP11-S-400-100 ADAPTER.**



35031



TIRE CHANGER ACCESSORIES

MOUNT/DEMOUNT HEADS

| Part# | OEM Part# | Qty. | Description |
|-------|-------------------------------|------|---|
| 33788 | Coats 8182788 TMR TC182788 | 1 pk | <p>Coats Stainless Steel Mount/Demount Tapered Hole Head Covers. Coats Tire Changer Models 5030 5040 5050 5060 5065 6050 6060 6065 7050 7055 7060 7065 7655 7660 & 7665. (Does not work with 9010 & 9024)</p> <p>Can be used with: 35051 - 1 pk of Black Rear Mount/Demount Protector</p> |



NOTE: WASHERS & NUT NOT INCLUDED FOR HUNTER TIRE CHANGERS

| | | | |
|-------|--|------|---|
| 38305 | Coats 8183429 Corghi 258458 TMR TC183429 | 1 pk | <p>Coats/Corghi Stainless Steel Mount/Demount with Round Hole Coats Tire Changer Models RC 1 5 10 15 20 & Early 5060 Corghi All Models.</p> <p>Can be used with: 35051 - 1 pk of Black Rear Mount/Demount Protector</p> |
|-------|--|------|---|



| | | | |
|-------|--|------|------------------------------------|
| 35049 | | 6 pk | Front Yellow Roller Protector |
| 35050 | | 6 pk | Rear Yellow Insert |
| 35051 | | 1 pk | Black Rear Mount/Demount Protector |





TIRE CHANGER ACCESSORIES

MOUNT/DEMOUNT HEADS

| Description | Qty. | OEM Part# | Part# |
|---|------|---|--------------|
| Nylon Mount/Demount Kit w/Hardware Accu-turn 14024784 Accu-turn - 4260 4560MR 4602 5602HP 3602 3602HP Hofmann - 1520 1565 1620 1625 1625EM 3300 3300EM Monty 1270 2300 3000 3000GP John Bean- EHP System IVE IV III IIE Snap-On All Models. | 1 pk | Accu-turn 14024784 Hofmann 4024784 John Bean EAA 0247G20A Snap-on EAA 0247G20A TMR TC14024784 | 35032 |

Part# 35035 Separate Hardware for 35032



35032

| | | | |
|---|------|---|--------------|
| Nylon Mount / Demount Only WASHERS & NUT NOT INCLUDED. Accu-turn 3602 3602HP 4260 4560MR 4602 5602 5602HP Hofmann 1520 1550 1565 1620 1625 1625EM 3300 3300EM John Bean EHP System IVE IV III II Monty 1270 2300 3000 3000GP All Models. | 1 pk | Accu-turn 20024335 Hofmann ST0024335 John Bean 24335 Snap-on 24335 TMR TC20024335 | 35033 |
|---|------|---|--------------|



35033

| | | | |
|---|------|--------------------------------|--------------|
| Nylon Mount/Demount Head ONLY Tire Changer: TC250 • TC300 • TC325 TC250 • TC300 • TC352 • TC350 • TC2000 TC3250 • TC3500 TC300 & TC3100 Series (Required Adapter) TC3700 with wider lip for flats and low profile tires | 1 pk | Hunter 221-675-2 TMR TCR343 | 35034 |
|---|------|--------------------------------|--------------|



35034

| | | | |
|---|------|--|--------------|
| Corghi Premium Yellow Nylon Mount/Demount Duckhead with Sicam, Gulliane | 1 pk | | 35041 |
|---|------|--|--------------|



35041



WHEEL BALANCER ACCESSORIES

18046



18077

28 mm Fits These OEM's

Accu-turn 5223 5500 5100 & 5600
 Series #51-0001 thru 51-0622
 Coats All Models (Excluding 6401)
 Mondolfo Ferro All Models Except Trucks
 Norton All Models
 Snap-On All Models
 Sun 1742 1762

36 mm Fits These OEM's

Accu-turn 1060 6100 6600 6700 6800
 Ammco 1030
 CEMB All Models Except Trucks
 Focus All Models Except Trucks
 Phoenix CB-114
 RAV All Models
 Werther All Models Except Trucks

38 mm Fits These OEM's

Corghi All Models Except Trucks
 Faip All Models Except Trucks

40 mm Fits These OEM's

Balancer Shaft Accu-turn 1200 1250 1400
 1500 1550
 1650 1850 5100 5600
 (Serial#51-0623-51-1457)
 Bear 80-100, 80-303
 Beissbarth All Models
 CEMB Truck Balancers Since June 2000
 Coats With Optional 40mm Shaft
 RAV All Models
 All Models FMC, Hofmann, Hunter, John
 Bean, Kwik-Way, Performance, Phoenix
 CB-113

| Part# | Range | 28 mm |
|-------|-------------------------------|-------|
| 18040 | 1.70 - 2.25 | 28mm |
| 18041 | 1.75 - 2.58 | 28mm |
| 18042 | 2.25 - 2.62 | 28mm |
| 18043 | 2.44 - 3.06 | 28mm |
| 18044 | 2.62 - 3.00 | 28mm |
| 18045 | 3.00 - 3.25 | 28mm |
| 18046 | 2.95 - 3.63 | 28mm |
| 18047 | 3.375 - 5.25 | 28mm |
| 18048 | 3.375 - 5.88 | 28mm |
| 18049 | 5.03 - 6.88 | 28mm |
| 18051 | 5.875 - 7.315 | 28mm |
| 18052 | 28 mm WB Spacer/Backing Plate | |

| Part# | Range | 36 mm |
|-------|-------------------------------|-------|
| 18053 | 1.75 - 2.58 | 36mm |
| 18054 | 2.44 - 3.06 | 36mm |
| 18055 | 2.95 - 3.63 | 36mm |
| 18056 | 3.375 - 5.25 | 36mm |
| 18057 | 3.375 - 5.88 | 36mm |
| 18058 | 5.03 - 6.88 | 36mm |
| 18059 | 5.875 - 7.315 | 36mm |
| 18063 | 36 mm WB Spacer/Backing Plate | |

| Part# | Range | 38 mm |
|-------|-------------------------------|-------|
| 18064 | 1.75 - 2.58 | 38mm |
| 18065 | 2.44 - 3.06 | 38mm |
| 18066 | 2.95 - 3.63 | 38mm |
| 18067 | 3.375 - 5.25 | 38mm |
| 18068 | 3.375 - 5.88 | 38mm |
| 18069 | 5.03 - 6.88 | 38mm |
| 18070 | 38 mm WB Spacer/Backing Plate | |

| Part# | Range | 40 mm |
|-------|-------------------------------|-------|
| 18071 | 1.75 - 2.58 | 40mm |
| 18072 | 2.44 - 3.06 | 40mm |
| 18073 | 2.95 - 3.63 | 40mm |
| 18074 | 3.375 - 5.25 | 40mm |
| 18075 | 5.03 - 6.88 | 40mm |
| 18076 | 5.875 - 7.315 | 40mm |
| 18077 | 40 mm WB Spacer/Backing Plate | |

Basic Wheel Balancer Adaptor Kits for Basic Vehicle Coverage



Part# 18028

Fits 28 mm Shafts - Includes:

- 18040 Wheel Balancer Cone 1.70 - 2.25
- 18043 Wheel Balancer Cone 2.44 - 3.06
- 18046 Wheel Balancer Cone 2.95 - 3.63
- 18047 Wheel Balancer Cone 3.375 - 5.25
- 15147 Wheel Caliper Tool
- 15144 Manual Hub Nut
- 10542 Small Pressure Cup for Hub Nut-5 1/4"
- 18079 Wheel Balancer Spring
- 18050 Wheel Balancer Stub Shaft
- 1471C Wheel Weight Tool

Part# 18029

Kit Fits 36 mm Shafts

Includes above items for 36mm shafts.

Part# 18030

Kit Fits 40 mm Shafts

Includes above items for 40mm shafts.

WHEEL BALANCER ACCESSORIES

Conversion Wheel Balancer Shaft



Converts COATS 28 mm to 40 mm

Part# 13080 Complete Kit

Includes:

- 18078 Conversion Shaft w/Coupler
- 15146 Hub Nut - 40mm
- 18071 1.75 - 2.58 Range - 40mm
- 18072 2.44 - 3.06 Range - 40mm
- 18073 2.95 - 3.63 Range - 40mm
- 18074 3.375 - 5.25 Range -40mm
- 15201 Pressure Cup

Part# 13081 Shaft, Coupler & Hub Nut Kit

Includes:

- 18078 Conversion Shaft w/Coupler
- 15146 Hub Nut - 40mm
- 15201 Pressure Cup

Part# 18078 Conversion Shaft w/Coupler

- 18078 Conversion Shaft w/Coupler



WHEEL BALANCER TRUCK CONE SET

Wheel Balancer Truck Cone Sets and Quick Lock Nut Kits

| Part# | Description |
|-------|--|
| 15128 | Set - 28mm fits COATS Applications (2 pieces) |
| 15129 | 28mm Cup - 8.5" |
| 15130 | 28mm Cone - 4.7" x 6.8" |
| 15136 | Set - 36mm fits RELS, CHEM, All Tool & Accu-turn Wheel Balancers |
| 15137 | 36mm Cup - 8.5" |
| 15138 | 36mm Cone - 4.7" x 6.8" |
| 15140 | Set - 40mm fits HUNTER, FMC, JBC, HOFMANN & Accu-turn |
| 15131 | 40mm Cup - 8.5" |
| 15132 | 40mm Cone - 4.7" x 6.8" |



MANUAL HUB NUTS FOR WHEEL BALANCERS

Replacement Hub Nuts for Balancers

| Part# | Description |
|-------|---|
| 15144 | 28mm fits COATS Applications |
| 15145 | 38mm fits Older Corghi |
| 15146 | 40mm fits FMC, John Bean, HOFMANN - 8mm Pitch |
| 15149 | 40mm fits FMC, John Bean, HOFMANN - 4 mm Pitch (NOT Hunter) (Different Thread Pitch than 15146) |
| 15150 | 40mm/8mm Pitch Manual Hub Nut For Coats Wheel Balancers |
| 15220 | 36mm fits RELS, Ranger, Launch and other Chinese made wheel balancers. |





Individual Parts / Wheel Balancer Springs and Shafts

| Part# | Description |
|-------|---|
| 11058 | 40mm Pressure Cup For 15150 Hub Nut |
| 10542 | Small Pressure Cup for 15144 Hub Nut |
| 15211 | 4.5" Pressure Cup for Hunter Quick Release Nuts |
| 15212 | 4.5" Rubber Ring for Hunter Quick Release Nuts |
| 15213 | 6" Pressure Cup for Hunter Quick Release Nuts |
| 15214 | 6" Rubber Ring for Hunter Quick Release Nuts |
| 15215 | Spacer for Hunter Pressure Cups |



| Part# | Description |
|-------|---|
| 18050 | Shaft for 28mm Balancers |
| 18079 | Spring for 28mm & 36mm Shafts |
| 18080 | Spring for 38mm & 40mm Shafts |
| 18082 | Shaft for 38mm Balancers |
| 18083 | Shaft for 40mm Balancers |
| 18084 | Shaft for 40mm HUNTER with Different Thread Pitch |

WHEEL BALANCER ACCESSORIES Hub Nuts For Balancers

Wheel Balancer Quick Lock Nuts



| Part# | Description |
|-------|---|
| 15151 | 28mm/3mm Pitch Haweka ProGrip Quick Release Nut |
| 15152 | 36mm/3mm Pitch Haweka ProGrip Quick Release Nut |
| 15153 | 38mm/3mm Pitch Haweka ProGrip Quick Release Nut |
| 15154 | 40mm/3mm Pitch Haweka ProGrip Quick Release Nut |
| 15155 | 40mm/4mm Pitch Haweka ProGrip Quick Release Nut |



Quick Release Nut Kits

| Part# | Description |
|-------|---|
| 15160 | 28mm/3mm Pitch Haweka ProGrip Quick Nut Kit (4 pcs) |
| 15151 | ProGrip Quick Nut |
| 15156 | Pressure Cup |
| 15157 | Spacer/Pressure Ring |
| 15162 | Replacement Shaft |
| 15161 | 40mm/4mm Pitch Haweka ProGrip Quick Nut Kit (4 pcs) |
| 15155 | ProGrip Quick Nut |
| 15156 | Pressure Cup |
| 15157 | Spacer/Pressure Ring |
| 15158 | Rubber Sleeve |



Haweka Quick Nut Accessories

| Part# | Description |
|-------|--|
| 15156 | Pressure Cup for Haweka Quick Release Nuts |
| 15157 | Spacer Pressure Ring for Haweka Quick Release Nuts |
| 15158 | Rubber Cap for Haweka Quick Release Nuts |





WHEEL BALANCER ACCESSORIES

HUNTER STYLE WHEEL BALANCER LOW PROFILE CONE SET

SIMILAR TO HUNTER #20-1626-1 IN-BETWEEN CONE & SPACER KIT

WHEN MANUFACTURER RECOMMENDS NOT TO USE STANDARD CONES.

Works on ANY 40mm Diameter Shaft Balancer - For Passenger Cars & Light Trucks-
Up to 3/4 Ton Capacity - Range 1.69" - 5.18"

Kit with 5 Car Cones and 2 Light Truck Cones

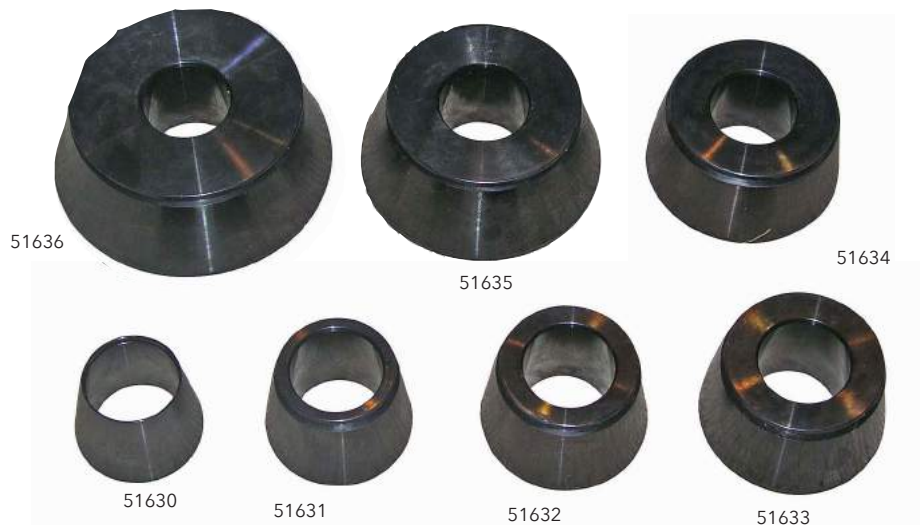

Kits Available in 3 Sizes - 28, 36 and 40 mm for Coverage of Three Manufacturers Wheel Balancer

| 28mm | 36mm | 40mm | Hunter # | Description | Size # | mm | Weight |
|-------|-------|-------|-----------|--|---------------|---------------|----------|
| 52626 | 52600 | 51626 | 20-1626-1 | Kit of 5 passenger car and 2 light truck cones | | | 28 lbs. |
| 52630 | 52601 | 51630 | 192-51-2 | Cone | 1.69" - 2.23" | 43mm - 57mm | 1.1 lbs. |
| 52631 | 52602 | 51631 | 192-52-2 | Cone | 2.15" - 2.58" | 55mm - 66mm | 1.8 lbs. |
| 52632 | 52603 | 51632 | 192-53-2 | Cone | 2.50" - 2.94" | 64mm - 75mm | 2.6 lbs. |
| 52633 | 52604 | 51633 | 192-54-2 | Cone | 2.85" - 3.28" | 72mm - 83mm | 3.4 lbs. |
| 52634 | 52605 | 51634 | 192-55-2 | Cone | 3.20" - 3.63" | 81mm - 92mm | 4.3 lbs. |
| 52635 | 52606 | 51635 | 192-56-2 | Cone | 3.45" - 4.36" | 88mm - 111mm | 5.2 lbs. |
| 52636 | 52607 | 51636 | 192-57-2 | Cone | 4.24" - 5.18" | 108mm - 132mm | 8.5 lbs. |

CAR AND TRUCK CALIPERS

Car & Truck Calipers

Part# Description

15147 Car Wheel Caliper

15148 Truck Wheel Caliper





LIFT PADS

A Complete Offering of Lift Pads for Any Lift - Sets of 4

| Part# | TMR# | Models | Description |
|-------|-------|-------------------------------------|--|
| 51660 | LP600 | Ammco/Ben Pearson/Challenger/Weaver | Molded Rubber Pad |
| 51661 | LP602 | Challenger/VBM | Lift pad - Round Heavy Die Cut Material |
| 51662 | LP601 | Benwil/Bishamon | Lift Pad - Molded Rubber Pad |
| 51663 | LP603 | Forward/Eagle/Gemini/Worth/American | Lift pad - Rough Heavy Die Cut Material |
| 51664 | LP605 | Nussbaum/Phoenix/Force(old) | Lift - Molded Rubber Pad |
| 51665 | LP607 | Western/American | Lift - Slip On Molded Rubber Pad |
| 51666 | LP608 | Bend Pak | Lift - Square Slip-on Molded Rubber Pad |
| 51667 | LP609 | Rotary SPO12 | Lift pad - Kit/Heavy Duty Cut Material |
| 51668 | LP606 | N/A | Lift pad - Heavy Die Cut/Flip up Height Extensions |
| 51669 | LP610 | Snap-on/Ammco/Wheeltronics | Square Lift - Molded Rubber Pad |
| 51670 | LP612 | Globe | Heavy Die Cut Material |
| 51671 | LP613 | N/A | Solid Molded Rubber Block Pad |
| 51672 | LP615 | N/A | Solid Molded Rubber Block Pad |



51660
Ammco/Ben Pearson/
Challenger/Weaver
3-3/4" x 5-3/4" x 7/8"



51661
Challenger/VBM
5-7/8" x 5-7/8" x 1/4"



51662
Benwil/Bishamon
4-1/2" x 3-5/8" x 3/4"



51663
Eagle/Forward/Gemini/
Worth/American
5" x 5" x 1/4"



51664
Nussbaum/Phoenix
Force (Old)
5" x 1"



51665
Western/American Slip-on
4-1/2" x 4" x 1"



51666
Bend Pak
5-1/2" x 5-1/2" x 1"



51667
Rotary SPO 12
4" x 3-1/4" x 1/4"



51668
3" x 6" for Flip Up Height
5-1/2" x 3" x 1-1/4"



51669
Ammco/Snap-on/Wheeltronics
5-1/4" x 4-1/2" x 1"



51670
Globe
4-1/2" x 3/8"



51671
Molded Rubber Block
6" x 4-3/4" x 3"



51672
Molded Rubber Block
6 1/4" x 4 3/4" x 1 1/2"



NEW! SHARK PAINT PENS

- Most durable nib in the industry.
- Marks won't chip, peel, fade or rub off.
- Marks on metal, plastic, glass, wood, etc.
- Precision valve accurately meters paint flow.
- Withstands temperatures in excess of 400°F/204°C.
- Works on porous or non-porous, rough or smooth, wet, oily or dry surfaces.

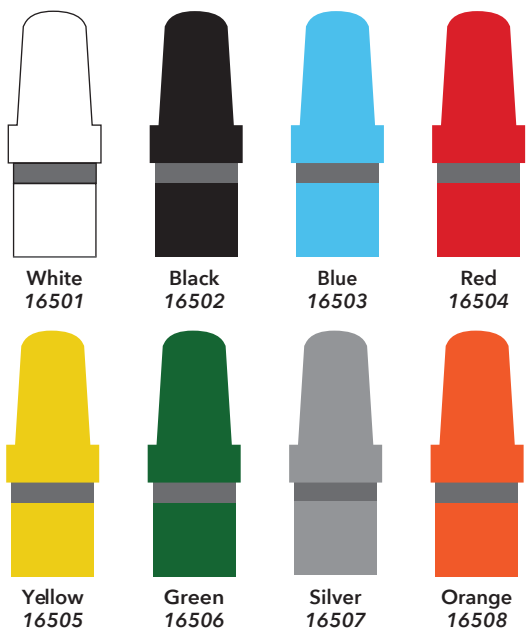

**All markers come in boxes of twelve.
One color per box.**

| Part # | Color |
|--------|--------|
| 16501 | White |
| 16502 | Black |
| 16503 | Blue |
| 16504 | Red |
| 16505 | Yellow |
| 16506 | Green |
| 16507 | Silver |
| 16508 | Orange |

16500

Display Box free with purchase of 48 pens.



| Part# | Page | Part# | Page | Part# | Page | Part# | Page | Part# | Page |
|-------|------|-------|-------|-------|-------|-------|------|-------|------|
| 56 | 27 | 989 | 17 | 16502 | 58 | 22986 | 43 | 39560 | 28 |
| 57 | 27 | 998 | 17 | 16503 | 58 | 24826 | 21 | 40080 | 21 |
| 69 | 13 | 999 | 17 | 16504 | 58 | 30000 | 29 | 40162 | 21 |
| 72 | 43 | 5389 | 21 | 16505 | 58 | 30020 | 29 | 40163 | 21 |
| 93 | 25 | 6000 | 25 | 16506 | 58 | 30022 | 29 | 40310 | 36 |
| 94 | 14 | 6001 | 25 | 16507 | 58 | 30023 | 29 | 40311 | 36 |
| 95 | 14 | 6002 | 25 | 16508 | 58 | 30024 | 29 | 40312 | 36 |
| 96 | 14 | 6003 | 25 | 17410 | 28 | 33001 | 29 | 40313 | 36 |
| 97 | 24 | 8544 | 21 | 18028 | 53 | 33002 | 29 | 40314 | 36 |
| 100 | 28 | 8545 | 21 | 18029 | 53 | 33003 | 29 | 40400 | 27 |
| 110 | 28 | 8546 | 21 | 18030 | 53 | 33004 | 29 | 40601 | 36 |
| 112 | 28 | 8547 | 21 | 18040 | 53 | 33005 | 29 | 40602 | 36 |
| 113 | 28 | 8548 | 21 | 18041 | 53 | 33006 | 29 | 40603 | 36 |
| 115 | 28 | 9989 | 16 | 18042 | 53 | 33007 | 29 | 40605 | 36 |
| 180 | 10 | 10542 | 53/55 | 18043 | 53 | 33009 | 29 | 40606 | 36 |
| 190 | 9 | 11058 | 55 | 18044 | 53 | 33014 | 29 | 40607 | 36 |
| 191 | 10 | 13080 | 54 | 18045 | 53 | 33015 | 29 | 40608 | 36 |
| 192 | 10 | 13081 | 54 | 18046 | 53 | 33016 | 29 | 40610 | 36 |
| 193 | 10 | 15128 | 54 | 18047 | 53 | 33019 | 29 | 40611 | 36 |
| 390 | 10 | 15129 | 54 | 18048 | 53 | 33431 | 49 | 40612 | 36 |
| 404 | 9 | 15130 | 54 | 18049 | 53 | 33700 | 44 | 40613 | 36 |
| 405 | 9 | 15131 | 54 | 18050 | 53/55 | 33788 | 51 | 40614 | 36 |
| 406 | 9 | 15132 | 54 | 18051 | 53 | 35030 | 50 | 40615 | 36 |
| 421 | 11 | 15136 | 54 | 18052 | 53 | 35031 | 50 | 40616 | 36 |
| 422 | 11 | 15137 | 54 | 18053 | 53 | 35032 | 52 | 40617 | 36 |
| 423 | 11 | 15138 | 54 | 18054 | 53 | 35033 | 52 | 40618 | 36 |
| 426 | 11 | 15140 | 54 | 18055 | 53 | 35034 | 52 | 40619 | 36 |
| 427 | 11 | 15143 | 55 | 18056 | 53 | 35036 | 49 | 40620 | 36 |
| 428 | 11 | 15144 | 53/54 | 18057 | 53 | 35038 | 49 | 40621 | 36 |
| 444 | 9 | 15145 | 54 | 18058 | 53 | 35039 | 49 | 40622 | 36 |
| 445 | 9 | 15146 | 54 | 18059 | 53 | 35040 | 51 | 40630 | 36 |
| 446 | 9 | 15147 | 53/56 | 18063 | 53 | 35041 | 52 | 43363 | 19 |
| 464 | 9 | 15148 | 56 | 18064 | 53 | 35044 | 47 | 43373 | 19 |
| 465 | 9 | 15149 | 54 | 18065 | 53 | 35045 | 47 | 51626 | 56 |
| 466 | 9 | 15150 | 54 | 18066 | 53 | 35046 | 47 | 51630 | 56 |
| 467 | 11 | 15151 | 55 | 18067 | 53 | 35047 | 47 | 51631 | 56 |
| 468 | 11 | 15152 | 55 | 18068 | 53 | 35048 | 47 | 51632 | 56 |
| 720 | 12 | 15153 | 55 | 18069 | 53 | 35049 | 51 | 51633 | 56 |
| 757 | 24 | 15154 | 55 | 18070 | 53 | 35050 | 51 | 51634 | 56 |
| 782 | 11 | 15155 | 55 | 18071 | 53/54 | 35051 | 51 | 51635 | 56 |
| 783 | 11 | 15156 | 55 | 18072 | 53/54 | 35052 | 29 | 51636 | 56 |
| 784 | 11 | 15157 | 55 | 18073 | 53/54 | 35053 | 29 | 51637 | 45 |
| 804 | 12 | 15158 | 55 | 18074 | 53/54 | 35054 | 29 | 51638 | 45 |
| 805 | 12 | 15160 | 55 | 18075 | 53 | 37600 | 28 | 51639 | 45 |
| 806 | 12 | 15161 | 55 | 18076 | 53 | 38100 | 27 | 51640 | 46 |
| 807 | 12 | 15162 | 55 | 18077 | 53 | 38305 | 51 | 51641 | 45 |
| 930 | 14 | 15201 | 54 | 18078 | 54 | 38306 | 50 | 51642 | 45 |
| 935 | 15 | 15211 | 55 | 18079 | 53/55 | 38330 | 27 | 51643 | 45 |
| 936 | 15 | 15212 | 55 | 18080 | 55 | 38400 | 27 | 51644 | 45 |
| 968 | 10 | 15213 | 55 | 18082 | 55 | 39510 | 28 | 51645 | 46 |
| 969 | 10 | 15214 | 55 | 18083 | 55 | 39520 | 28 | 51646 | 46 |
| 980 | 15 | 15215 | 55 | 18084 | 55 | 39530 | 28 | 51647 | 46 |
| 980S | 115 | 15220 | 54 | 20442 | 21 | 39540 | 28 | 51648 | 46 |
| 989 | 16 | 16501 | 58 | 22985 | 43 | 39550 | 28 | 51650 | 46 |



| Part# | Page | Part# | Page | Part# | Page | Part# | Page | Part# | Page |
|-------|------|---------|-----------|------------|-------------|------------|-------|---------|----------|
| 51651 | 46 | 85706 | 39 | 104-6 | 2/7 | 709-6 | 4/7 | 989-50 | 16 |
| 51652 | 47 | 85707 | 39 | 115C | 28 | 7-09836-25 | 22 | 989C-10 | 16 |
| 51654 | 47 | 85708 | 39 | 115M | 28 | 7-09836-50 | 22 | 989F-20 | 16/17 |
| 51655 | 47 | 85709 | 39 | 1471C | 44/53 | 709S | 4 | 9989-12 | 16 |
| 51656 | 47 | 85710 | 39 | 383-10 | 2 | 71B | 13 | 9989-20 | 16 |
| 51657 | 47 | 85711 | 39 | 383-4 | 7 | 7-3024U | 25 | 999C | 17 |
| 51658 | 47 | 85712 | 38/39 | 383-6 | 2 | 7-3031/1 | 25 | 999C-20 | 17 |
| 51659 | 46 | 85713 | 39 | 392B | 10 | 73B | 13 | 999F | 17 |
| 51660 | 57 | 85714 | 39 | 407-10 | 2/3/4/7 | 802-10 | 4/5/7 | 999F-20 | 17 |
| 51661 | 57 | 85715 | 39 | 407-6 | 2/3/4/7 | 802-6 | 4/5 | 999H | 17 |
| 51662 | 57 | 85716 | 39 | 408-10 | 1/2/5/6 | 802R-2 | 7 | 999P | 17 |
| 51663 | 57 | 85717 | 39 | 408-6 | 1/2/5/6/7 | 803-10 | 4/7 | 999S | 17 |
| 51664 | 57 | 85718 | 37 | 409-10 | 1/3/4/5/6 | 808-10 | 6 | A-07963 | 18 |
| 51665 | 57 | 85719 | 37 | 409-6 | 1/3/4/5/6/7 | 808-6 | 6/7 | A-10650 | 20 |
| 51666 | 57 | 85720 | 37 | 41B | 12 | 809-10 | 4/7 | A-10651 | 20 |
| 51667 | 57 | 90588 | 42 | 424B | 12 | 80B | 15 | A10868 | 24 |
| 51668 | 57 | 90589 | 42 | 425B | 12 | 81B | 15 | A11150 | 18 |
| 51669 | 57 | 90590 | 42 | 42B | 12 | 83B | 14 | A-11154 | 18 |
| 51670 | 57 | 90888 | 40 | 502-10 | 3/5 | 83B | 18 | A11166 | 18 |
| 51671 | 57 | 90889 | 40 | 502-6 | 3/5/7 | 83B-2 | 14/18 | A11220 | 20 |
| 51672 | 57 | 90890 | 40 | 503-10 | 3/5 | 87B | 19 | A11222 | 20 |
| 51675 | 45 | 90891 | 40 | 503-6 | 3/5/7 | 901S | 40 | A11227 | 20/25/26 |
| 51676 | 45 | 90892 | 40 | 505-10 | 6 | 902L-10 | 5 | A12W | 42 |
| 51677 | 45 | 90893 | 40 | 505-6 | 6 | 902L-6 | 5/7 | A15LW | 42 |
| 51678 | 43 | 98920 | 17 | 602S-6 | 1 | 902R-10 | 5/7 | A15W | 42 |
| 52600 | 56 | 7-3024 | 25 | 63A | 18 | 902R-6 | 5/7 | A1680 | 26 |
| 52601 | 56 | 060-10 | 1/7 | 63B-1 | 18 | 903-10 | 5 | A18277 | 47 |
| 52602 | 56 | 060-6 | 1 | 63B-10 | 18 | 903-6 | 5/7 | A18278 | 47 |
| 52603 | 56 | 061-10 | 4/6/7 | 63B-11 | 18 | 904-10 | 5 | A1W | 42 |
| 52604 | 56 | 061-6 | 4/6/7 | 63B-12 | 18 | 904-6 | 5/7 | A2045 | 19 |
| 52605 | 56 | 062-10 | 1/3/6/7 | 63B-13 | 18 | 908-10 | 6 | A2064 | 26 |
| 52606 | 56 | 062-6 | 1/3/6/7 | 63B-14 | 18 | 908-6 | 6 | A213 | 26 |
| 52607 | 56 | 062C-10 | 2 | 63B-15 | 18 | 91-1 | 35 | A2165 | 24 |
| 52626 | 56 | 062C-10 | 7 | 63B-2 | 18 | 91-11 | 35 | A220 | 26 |
| 52630 | 56 | 062C-6 | 2/7 | 63B-3 | 18 | 91-12 | 35 | A22006 | 23 |
| 52631 | 56 | 062S-10 | 1/3/7 | 63B-5 | 18 | 91-13 | 35 | A22138 | 21 |
| 52632 | 56 | 062S-6 | 3/7 | 63B-6 | 18 | 91-14 | 35 | A22763 | 24 |
| 52633 | 56 | 063-10 | 2/7 | 63B-7 | 18 | 91-15 | 35 | A22764 | 24 |
| 52634 | 56 | 063-6 | 2/7 | 63B-9 | 18 | 91-16 | 35 | A2309 | 24 |
| 52635 | 56 | 064-10 | 1/3/5/7 | 68B | 13 | 91-18 | 35 | A25270 | 20 |
| 52636 | 56 | 064-6 | 1/3/5/7 | 702-10 | 4 | 91-3A | 35 | A25271 | 20 |
| 77002 | 16 | 065-10 | 1/3/5/7 | 702-6 | 4/7 | 91-3B | 35 | A2561 | 24 |
| 77200 | 16 | 065-6 | 1/3/5/7 | 7-030031 | 25 | 91-7 | 35 | A29254 | 18 |
| 80765 | 44 | 066-10 | 2/6/7 | 7-03031S | 25 | 91-8 | 35 | A3009 | 24 |
| 80766 | 44 | 066-6 | 2/6 | 703-10 | 4/7 | 91D | 35 | A3015 | 26 |
| 80767 | 44 | 067-10 | 4/5/7 | 7-03142-25 | 22 | 91Z | 35 | A3016 | 22 |
| 80768 | 44 | 067-6 | 4/5/7 | 7-03142-50 | 22 | 94-2 | 14 | A3017 | 22 |
| 82880 | 27 | 068-10 | 1/2/6/7 | 7-032111 | 24 | 95 | 14 | A3022 | 26 |
| 85490 | 21 | 068-6 | 1/2/3/6/7 | 703-6 | 4/7 | 95S | 14 | A3023 | 24 |
| 85701 | 39 | 069-10 | 2/4/6/7 | 7-07744 | 25 | 96-2 | 14 | A3026 | 24 |
| 85702 | 39 | 069-6 | 4/7 | 7-07747 | 24 | 980S | 15 | A3029 | 26 |
| 85703 | 39 | 103-10 | 2/3/6/7 | 7-077841 | 25 | 989-10 | 16 | A3032 | 26 |
| 85704 | 39 | 103-6 | 2/3/6/7 | 7-077841U | 25 | 989-100 | 16 | A3033 | 25 |
| 85705 | 39 | 104-10 | 2/7 | 709-10 | 4 | 989-20 | 16 | A3034R | 19 |



| Part# | Page | Part# | Page | Part# | Page | Part# | Page | Part# | Page |
|--------|-------|----------|-------|----------|----------|----------|------|---------|-------|
| A3036 | 26 | A3528 | 26 | A7209 | 22 | BB12100R | 41 | A3120 | 21 |
| A3039 | 26 | A3577 | 31-33 | A7338 | 23 | BB12100T | 41 | A3121 | 21 |
| A3042 | 22 | A3578 | 31/32 | A7343 | 23 | BB12100U | 41 | A3122 | 21 |
| A3043 | 23 | A3579 | 31 | A7748 | 25 | BB12100V | 41 | A3123 | 30 |
| A3046 | 23 | A3590 | 31/32 | A7757 | 22 | BB12100W | 41 | A3125 | 30 |
| A3047 | 23 | A3595 | 19 | A7774 | 23 | BB12100X | 41 | A3125 | 34 |
| A3058 | 22 | A36W | 42 | A7775 | 26 | BB12150 | 41 | A3141 | 26 |
| A3069 | 23 | A37W | 42 | A7782 | 23 | BB12156 | 41 | A3159 | 19 |
| A3077 | 23 | A3902 | 30 | A8584 | 20/22 | BB12300 | 41 | A3161 | 24 |
| A3078 | 23 | A3903 | 30 | A9191 | 34 | BBA-18 | 41 | A3162 | 24 |
| A3081 | 23 | A3904 | 30 | A9192 | 34 | BT10 | 42 | A3163 | 24 |
| A3084 | 18/26 | A4347 | 30 | A9193 | 34 | BT15 | 42 | A3164 | 24 |
| A3085 | 19 | A4347N | 30 | A9194 | 34 | BT30 | 42 | A3165 | 34 |
| A3086 | 19 | A436271 | 33 | A9195 | 33/34 | BT34 | 42 | A3166 | 23 |
| A3087 | 19 | A436272 | 33 | A9196 | 33/34 | BT34S | 42 | A3176 | 26 |
| A3088 | 26 | A4435 | 19 | A9198 | 34 | BT9 | 42 | A3178 | 30 |
| A3089 | 24 | A45069-D | 33 | A9199 | 31 | C000491 | 42 | A3180 | 26 |
| A3092 | 26 | A4670 | 24 | A9203 | 34 | C000491P | 42 | A320 | 26 |
| A3101A | 21/30 | A4732 | 32-33 | A9232 | 30/34 | C106259 | 42 | A3214 | 26 |
| A3102A | 21/30 | A4778 | 31/32 | A9233 | 34 | C106572 | 42 | A3214 | 23 |
| A3106 | 30 | A4779 | 31/32 | A9249 | 26 | C106576 | 42 | A3218 | 25 |
| A3107 | 30 | A4781 | 31 | A9299 | 32 | C106871 | 48 | A3223 | 26 |
| A3108 | 30 | A4790 | 31 | A9399 | 32 | C107517 | 42 | A3224 | 26 |
| A3109 | 30 | A4W | 42 | A9443 | 23 | C108028 | 43 | A3391 | 26 |
| A3110 | 30 | A5069-D | 33 | A9444 | 23 | C108029 | 43 | A3393 | 26 |
| A3112 | 29/34 | A5532 | 33 | A9481 | 18 | C108397 | 44 | A3394 | 22 |
| A3113 | 34 | A5677 | 2 | A9481-1 | 18 | C108398 | 44 | A35045 | 47 |
| A3114 | 29/34 | A5677-2 | 7 | A9489 | 30 | C109873 | 46 | A3528 | 26 |
| A3118 | 21 | A5689 | 26 | A9490 | 30 | C120366 | 42 | A3577 | 31/32 |
| A3119 | 21 | A5843 | 23 | A9492 | 29/30/34 | C120366P | 42 | A3577 | 31/32 |
| A3120 | 21 | A6109 | 26 | A9499 | 32 | C13786 | 48 | A3578 | 31/32 |
| A3121 | 21 | A6825 | 25/26 | A9593 | 25 | C24083 | 48 | A3578 | 31/32 |
| A3122 | 21 | A6839 | 24 | A9611 | 22 | C305001 | 46 | A3579 | 31 |
| A3123 | 30 | A6841 | 26 | A9633 | 24 | C410419 | 48 | A3590 | 31/32 |
| A3125 | 30/34 | A6853 | 23 | A9634 | 24 | C410420 | 48 | A3590 | 31/32 |
| A3141 | 22 | A6854 | 20/24 | A9636 | 24 | C67715 | 48 | A3590 | 31/32 |
| A3159 | 19 | A6854-2 | 24 | A9645 | 25 | C71410 | 48 | A3595 | 19 |
| A3161 | 25 | A6871 | 22 | A9708 | 21 | C71411 | 48 | A36W | 42 |
| A3162 | 25 | A6873 | 22 | A9822 | 22 | H101 | 18 | A37W | 42 |
| A3163 | 24 | A6874 | 22 | A9837 | 23 | K41 | 12 | A3877 | 33 |
| A3164 | 24 | A6893 | 25 | A9847 | 26 | K42 | 12 | A3902 | 30 |
| A3165 | 34 | A6901 | 22 | A9847-K | 26 | P101 | 18 | A3903 | 30 |
| A3166 | 23 | A6905 | 20 | A9879 | 20/26 | PT401 | 43 | A3904 | 30 |
| A3176 | 26 | A6905-10 | 20 | A9918 | 23 | R101 | 18 | A4347 | 30 |
| A3178 | 30 | A6906 | 20 | A9919 | 23 | R120Z | 17 | A4347N | 30 |
| A3180 | 26 | A6907 | 20/22 | A9921 | 34 | R240Z | 17 | A436271 | 33 |
| A320 | 26 | A6908 | 22 | A9922 | 34 | R60Z | 17 | A436272 | 33 |
| A3214 | 24/26 | A6923 | 20/22 | BB12100A | 41 | S0051A | 41 | A4435 | 19 |
| A3218 | 26 | A6929 | 20/26 | BB12100B | 41 | S0052 | 41 | A4670 | 24 |
| A3223 | 22 | A6934 | 26 | BB12100C | 41 | S0061AP | 41 | A4732 | 32 |
| A3224 | 26 | A6936 | 20 | BB12100D | 41 | S0061M | 41 | A4732 | 33 |
| A3391 | 22 | A6950 | 20 | BB12100E | 41 | S6262 | 41 | | |
| A3393 | 22 | A6977 | 20 | BB12100N | 41 | SLP4 | 44 | | |
| A3394 | 23 | A7005 | 22 | BB12100O | 41 | SLP7 | 44 | | |



| Part# | Page | Part# | Page | Part# | Page | Part# | Page |
|----------|-------|----------|------|----------|------|--------|------|
| A4778 | 31/32 | A9193 | 34 | BB12100R | 41 | SX1045 | 27 |
| A4779 | 31/32 | A9193 | 34 | BB12100T | 41 | SX2030 | 27 |
| A4779 | 31/32 | A9194 | 34 | BB12100U | 41 | SX2045 | 27 |
| A4781 | 31 | A9194 | 34 | BB12100V | 41 | SX3030 | 27 |
| A4781 | 31 | A9195 | 33 | BB12100W | 41 | SX3045 | 27 |
| A4790 | 31 | A9195 | 34 | BB12100X | 41 | SX330 | 27 |
| A4W | 42 | A9195 | 34 | BB12150 | 41 | SX345 | 27 |
| A5069-D | 33 | A9196 | 33 | BB12156 | 41 | SX4030 | 27 |
| A5532 | 33 | A9196 | 34 | BB12300 | 41 | SX4045 | 27 |
| A5677 | 2 | A9196 | 34 | BBA-18 | 41 | SX430 | 27 |
| A5677-2 | 7 | A9198 | 34 | BT10 | 42 | SX445 | 27 |
| A5689 | 26 | A9199 | 31 | BT15 | 42 | SX5030 | 27 |
| A5843 | 22 | A9203 | 34 | BT23A | 42 | SX5045 | 27 |
| A6109 | 26 | A9232 | 30 | BT30 | 42 | SX530 | 27 |
| A6825 | 26 | A9232 | 34 | BT34 | 42 | SX545 | 27 |
| A6825 | 25 | A9249 | 26 | BT9 | 42 | SX6030 | 27 |
| A6839 | 23 | A9299 | 32 | C000491 | 42 | SX6045 | 27 |
| A6841 | 26 | A9399 | 32 | C000491P | 42 | SX630 | 27 |
| A6853 | 23 | A9443 | 22 | C106259 | 42 | SX645 | 27 |
| A6854 | 20 | A9444 | 22 | C106572 | 42 | SX7030 | 27 |
| A6854 | 23 | A9481 | 18 | C106576 | 42 | SX7045 | 27 |
| A6854-2 | 23 | A9481-1 | 18 | C106871 | 48 | SX730 | 27 |
| A6871 | 26 | A9489 | 30 | C107517 | 42 | SX745 | 27 |
| A6873 | 26 | A9490 | 30 | C108028 | 43 | SX8030 | 27 |
| A6874 | 26 | A9492 | 30 | C108029 | 43 | SX8045 | 27 |
| A6893 | 25 | A9492 | 29 | C108397 | 44 | SX830 | 27 |
| A6901 | 22 | A9492 | 34 | C108398 | 44 | SX845 | 27 |
| A6905-10 | 20 | A9499 | 32 | C109873 | 46 | V101 | 18 |
| A6906 | 20 | A9593 | 25 | C120366P | 42 | | |
| A6907 | 20 | A9611 | 22 | C13786 | 48 | | |
| A6907 | 22 | A9633 | 23 | C24083 | 48 | | |
| A6908 | 22 | A9634 | 23 | C305001 | 46 | | |
| A6923 | 20 | A9645 | 25 | C410419 | 48 | | |
| A6923 | 22 | A9708 | 21 | C410420 | 48 | | |
| A6929 | 20 | A9822 | 22 | C67715 | 48 | | |
| A6929 | 26 | A9837 | 23 | C71410 | 48 | | |
| A6934 | 26 | A9847 | 25 | C71411 | 48 | | |
| A6936 | 20 | A9847-K | 25 | H101 | 18 | | |
| A6950 | 20 | A9879 | 20 | K41 | 12 | | |
| A6977 | 20 | A9879 | 26 | K42 | 12 | | |
| A69905 | 20 | A9918 | 22 | P101 | 18 | | |
| A7005 | 22 | A9919 | 22 | PT401 | 43 | | |
| A7209 | 22 | A9921 | 34 | R101 | 18 | | |
| A7338 | 22 | A9921 | 34 | R120Z | 17 | | |
| A7343 | 22 | A9922 | 34 | R240Z | 17 | | |
| A7748 | 24 | A9922 | 34 | R60Z | 17 | | |
| A7757 | 22 | AA6936 | 20 | S0051A | 41 | | |
| A7774 | 22 | BB12100A | 41 | S0052 | 41 | | |
| A7775 | 25 | BB12100B | 41 | S0061AP | 41 | | |
| A7782 | 23 | BB12100C | 41 | S0061M | 41 | | |
| A8584 | 20 | BB12100D | 41 | S6262 | 41 | | |
| A8584 | 22 | BB12100E | 41 | SLP4 | 44 | | |
| A9191 | 34 | BB12100N | 41 | SLP7 | 44 | | |
| A9192 | 34 | BB12100O | 41 | SX1030 | 27 | | |



MECHANIC'S CHOICE ABRASIVE ITEMS

Popular Abrasive Items



25SL-10



12757



13090

USA Made Cut-Off Wheels

| Shark # | Description | 3M# | Pk. Qty. |
|----------------|---|-------|----------|
| 12757 | 3" x 1/16" Sure-Life Cut-Off Wheels | 01990 | 6 |
| 25SL-10 | 3" x 1/16" Sure-Life Cut-Off Wheels | N/A | 10 |
| 13217 | 3" x 1/16" Sure-Life Cut-Off Wheels | N/A | 50 |
| 12758 | 3" x 1/32" Sure-Life Cut-Off Wheels | 01989 | 6 |
| 26SL-10 | 3" x 1/32" Sure-Life Cut-Off Wheels | N/A | 10 |
| 13218 | 3" x 1/32" Sure-Life Cut-Off Wheels | N/A | 50 |
| 12431 | Mandrel with 3/8" Shoulder Screw | N/A | 1 |
| 12935 | Mandrel with 1/4" & 3/8" Shoulder Screw | N/A | 1 |
| 13090 | 3" x 1/16" x 3/8" Diamond Cut-Off Wheel | N/A | 1 |



13000



13001



13002

Shark Surface Preparation Discs

| Shark # | Description | 3M# | Pk. Qty. |
|-----------------|--------------------------------------|-------|----------|
| 13062 | 2" Roloc Disc Brown Coarse | 07480 | 25 |
| 13003 | 2" Roloc Disc Brown Coarse | N/A | 50 |
| 13219 | 2" Roloc Disc Brown Coarse | N/A | 100 |
| 13018 | 2" Roloc Disc Burgundy Medium | 07481 | 25 |
| 13004 | 2" Roloc Disc Burgundy Medium | N/A | 50 |
| 13220 | 2" Roloc Disc Burgundy Medium | N/A | 100 |
| 624TB | 2" Roloc Disc Blue Fine | 07515 | 25 |
| 13005 | 2" Roloc Disc Blue Fine | N/A | 50 |
| 13221 | 2" Roloc Disc Blue Fine | N/A | 100 |
| 13019 | 3" Roloc Disc Brown Coarse | 07485 | 25 |
| 13222 | 3" Roloc Disc Brown Coarse | N/A | 50 |
| 13223 | 3" Roloc Disc Brown Coarse | N/A | 100 |
| 13020 | 3" Roloc Disc Burgundy Medium | 07486 | 25 |
| 13224 | 3" Roloc Disc Burgundy Medium | N/A | 50 |
| 13225 | 3" Roloc Disc Burgundy Medium | N/A | 100 |
| 634TB | 3" Roloc Disc Blue Fine | N/A | 25 |
| 634TB-50 | 3" Roloc Disc Blue Fine | N/A | 50 |
| 634TB-C | 3" Roloc Disc Blue Fine | N/A | 100 |
| 13012 | 2" Twist-To-Lock Backing Pad | N/A | 1 |
| 13213 | 3" Twist-To-Lock Backing Pad | N/A | 1 |
| 13017 | 6"x 9" Star Brite Medium Sanding Pad | 07447 | 1 |

PRO-TACK PLASTIC WELDER



Part No. 17030 Pro-Tack Plastic Welder

The new Pro-Tack Welder is an Eco-friendly welder that is great for repairing virtually anything made of plastic. It can fix everything from car bumpers to wheel barrels. It is as good for Industrial use as it is for Automotive applications.

Unlike most other plastic welders, it is rated to a maximum of 65 Amps and has 4 power settings. Our unique core-cut staples easily break off without cutting, affording an advantage over

other staples. It comes with 2 additional adaptors that go over the 2 probes and act as an iron for smoothing the plastic after welding.

Unlike the time-consuming plastic welders requiring plastic rods, this is a much quicker fix that adds the stability of metal staples; making the end result much stronger!

Dimension: 8 3/4" x 5 1/4" x 4 3/4"

| <u>PART NO.</u> | <u>VOLTAGE</u> | <u>MAX CURRENT</u> | <u>ADJUSTMENTS</u> | <u>WEIGHT</u> |
|-----------------|----------------|--------------------|--------------------|---------------|
| 17030 | 110V | 65A | 4 settings | 10 pounds |
| 17029 | 240V | 65A | 4 settings | 10 pounds |

Kit Includes:

- 4 Staple Styles (*20 each)
- 2 Ironing Blades
- Plastic Box for Staples
- Plastic Storage Case
- *2 Position Probe-90° and Straight

Features & Benefits:

- 4 Heat Settings
- LED Read Out
- Repairs Bumpers and Plastic Auto Parts (car & motorcycle)
- Capable of Ironing Plastic to a Smooth Finish.
- Rapid Heating and Cooling.
- LED Light in Handle



Staple Options

Staples sold separately. 100 Per Pack.



17031
Flat square



17032
Outside corner small wave



17033
Outside corner no wave



17034
Inside corner small wave



17035
Inside corner no wave



17036
Flat small wave



17037
Flat S type

* Included in kit

17038
Pack of 400 Staples
100 Each Staples
Below



17031 17033 17034 17036

• Stapling

A large variety of core cut staples for tacking or seaming.

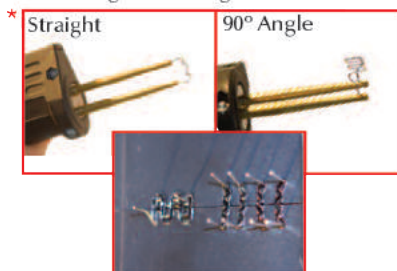

• Ironing Surface

Heating / melting / ironing the surface, to strengthen the durability and life. 2 Types-Flat and 45°

