

**5-hole
Solar Panel
Mounting
Bracket Kit**

SM5-KIT

**Owner's
Manual**

Please read this
manual before
installing your kit

INTRODUCTION

The SM5-KIT includes four sturdy 5-hole Aluminum mounting brackets (Fig. 1) with stainless steel hardware required to securely fasten a solar panel to the roof of your Recreational Vehicle (RV) or any other flat surface.

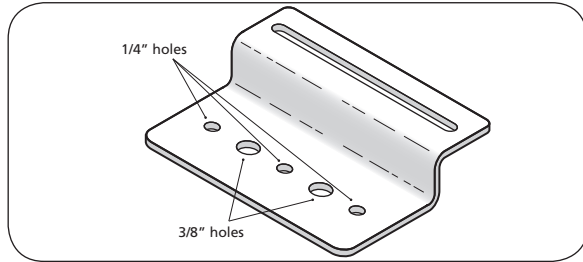

Fig.1. 5-hole mounting bracket

List of Parts (Included in the kit)

Part Description	Quantity	Illustration
1. 5-hole aluminum mounting bracket	4	Fig. 1
2. Stainless steel serrated flange bolt 1/4"-20 x 3/4"	4	Fig. 7
3. Stainless steel nylon insert locknut, 1/4"	4	Fig. 7
4. Stainless steel flat washer, 1/4"-20	8	Fig. 7
5. Well Nut-Nut thread: 1/4"-20, length: 1", shank dia.: 1/2"	4	Fig. 2
6. Stainless steel serrated flange bolt, 1/4"-20 x 1 1/4"	4	Fig. 8

Required Tools (Not included in the kit)

7/16" wrench
Hand Drill
Pliers

3/8" wrench
1/2" drill bit
Punch or Awl

Pre-installation

With the incidence of sunlight on all photovoltaic modules, a voltage appears at the output terminals of the photovoltaic module turning it into a live power source. To avoid a shock hazard make sure the solar module is covered with an opaque (dark) material such as paper / cloth.

Stainless Steel can be subject to a process called "thread galling" in which bolts can twist off and/or the bolt threads seize to the nut's thread. Apply anti-galling lubricant available at most hardware or auto-parts stores to all the stainless steel fasteners before installation. If anti-galling lubricant is not available, any standard lubricant will minimize the occurrence of "thread galling".

Well Nut for anchoring mounting bracket to the RV Roof or flat surface

A Well-Nut is a bushing of tough neoprene rubber with a flange at the top end and a captive brass nut mounted within the bore at the bottom end (Fig. 2). This is used to anchor the mounting bracket (Fig. 1) on to the roof of the RV or to other flat surface. Typical installation is shown in Figs 3 to 6. Tightening a conventional machine bolt or screw engages the captive nut thereby causing the bushing to expand outwards. This fastens securely to thinner RV roofs by bulging up and against the bottom surface of the roof (Fig. 5). If used in a blind hole in a solid surface material, the rubber will expand outwards to create a secure fastening (Fig. 6). The neoprene and brass resist most environmental conditions. Additionally, the Well-Nut seals the drilled hole effectively against air and liquid leakage.

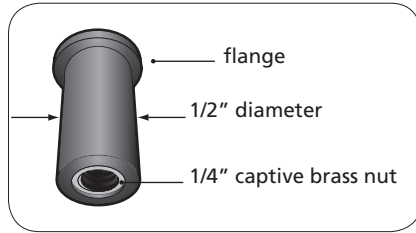

Fig. 2. Construction of a Well Nut

Typical Installation of a Well-Nut

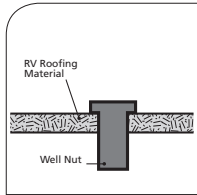

Fig. 3. Well-Nut is inserted into a pre-drilled hole with its flange against the outer surface. There is no need for access to the inner side.

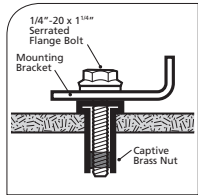

Fig. 4. The 5-hole mounting bracket is placed against the flange of the Well-Nut and is secured by the 1/4\"-20 x 1 1/4\" serrated flange bolt engaging the captive brass nut.

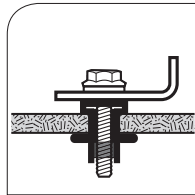

Fig. 5. As the bolt is tightened, the neoprene body of the Well-Nut is compressed and expanded, forcing it tightly into the bolt's threads and against the inner surface of the thin RV roof material.

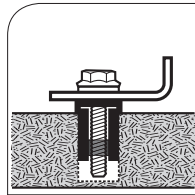

Fig. 6. Installed in a blind hole in a solid material, the body of the Well-Nut expands tightly against the walls of the hole, effecting a secure, dependable fastening.

INSTALLATION PROCEDURE

1. Determine the position of the solar panel on the RV roof or flat surface. While positioning panels, avoid shading of the solar panel by neighbouring obstacles such as vents, air-conditioners, TV antennas etc. As far as possible, position the panels to minimize wiring distance between the solar panel and the charge controller. Place the panel at least 8-10 inches away from the RV roof edges and leave sufficient space to walk around the panel and access the mounting hardware.
2. Make sure the thickness of the roof at the installation location is at least 1/2\" thick and the material is strong enough to provide mechanical support to the solar panel and mounting hardware against possible wind loading. Place the panel length-wise to reduce the effects of wind loading on the RV.
3. Fix the mounting brackets to the frame of the previously positioned solar panel using the slotted opening and the 1/4\"-20 x 3/4\" Flange Bolt, Nylon Locknut and flat washer (Fig. 7). Using a 7/16\" wrench, tighten the nuts to secure the mounting brackets to the PV panel. Recommended tightening torque is 15 lbs.

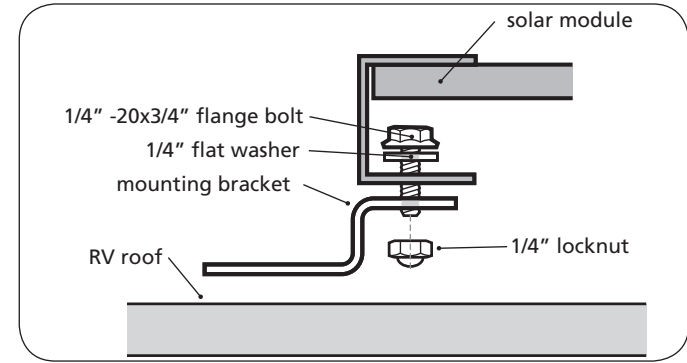

Fig. 7. Attaching solar panel to 5-hole mounting bracket

4. Position the panel with the attached mounting brackets at the desired location on the RV roof and mark the position of the mounting holes by tracing the hole in the mounting bracket. Please ensure that the mounting surface on the RV roof is strong enough to support the mounting hardware, solar panel and wind loads.
5. The centre and end holes on the mounting brackets (Fig. 1) are sized to accept the 1/4\" hardware supplied with the kit. If the use of larger sized hardware is desired, holes 2 and 4 can be used.
6. To install the Well-Nuts, for anchoring the brackets to the RV roof or a flat surface, drill holes 1/4\" deep at the marked positions using a 1/2\" size drill bit. Make sure that drilling does not interfere with pre-existing wiring installations.
7. Apply silicone or any appropriate sealant recommended by your RV dealer generously to the drilled holes for water-proofing.
8. Insert the 1/4\" Well-Nut into the drilled holes so that only the flange section remains above the roof surface (Fig. 3).
9. Fasten the mounting brackets to the roof surface by inserting the 1/4\" x 1 1/4\" serrated flange bolt into the Well-Nut. Tighten using a 3/8\" wrench to a recommended torque of 15 lbs. When the serrated flange bolt is screwed into the Well-Nut, the material surrounding the well nut bulges slightly securing the structure to the RV roof (Fig. 5, 8).
10. Ensure that all fasteners are tightened to the recommended tightening torque.
11. Make sure all bolts and mounting brackets are covered by good amounts of suitable RV sealant recommended by your local RV dealer.

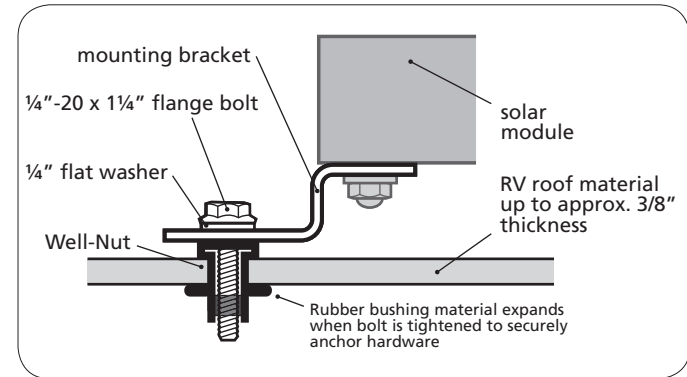

Fig. 8. Attaching 5-hole mounting bracket to RV roof