

Sabelt

CATALOGUE 2022



CATALOGUE 2022

Sabelt

70s

Market leader
in seatbelts production.

1972

Piero and Giorgio Marsiaj founded Sabelt.
Sabelt stands for "Safety belt".

sabelt

80s

International
expansion.





2000s

First OEM sport seat - Ferrari.

READY FOR THE NEXT CHALLENGE!



90s

Sabelt expanded the range of products with the addition of suits, seats and accessories for motorsport.

TODAY

FROM F1 TO SPACE

3 business units:

- Racing
- Automotive Seating
- Special Applications.





Sabelt[®]

12**HARNESSES****58****NETS****60****SEATS****104****RACEWEAR****134****STEERING WHEELS****138****ACCESSORIES**

THE COMPANY



Sabelt, founded in 1972 by Piero and Giorgio Marsiaj, specializes in the development and production of car seats for performance road cars, racing products for motor racing and seatbelts for aerospace. The quality of Sabelt products is the result of intense research and development, which allows it to reach the highest levels of performance and safety. Sabelt invests 8% of its resources annually in research and development and is the only company in its sector to have an internal dynamic test laboratory to perform ECE and FIA tests, aimed at verifying the strength and effectiveness of its products.

HERITAGE



We have provided the top historical car manufacturers with innovative restraint systems for decades.

SAFETY



For Sabelt, safety is of the utmost importance: first in the car, supplying the best seat belts in the world, second for drivers all over categories and championships.

DESIGN



Sabelt offers high performance levels integrated with style and design. Each component is designed and engineered either exclusively by Sabelt in support with external Design&Style centres or in partnership with the client.

INNOVATION



We transform ideas into products. We collaborate with our customers to study new and better solutions and meet specific needs and new requirements. All our products are the result of a process that brings together various novel ideas with engineering and technology.

SUSTAINABILITY

SABELT SUSTAINABILITY OBJECTIVES

" We believe there is no alternative to this approach: playing our part, taking responsibility for our actions in building a wider economic and social system and creating a sustainable business for future generations.."

Giorgio Marsiaj

Chairman and Chief Executive Officer

Sabelt focus on 4 major goals:

Organizational structure and economic performance

Innovation and Quality

People and Territory

Environment

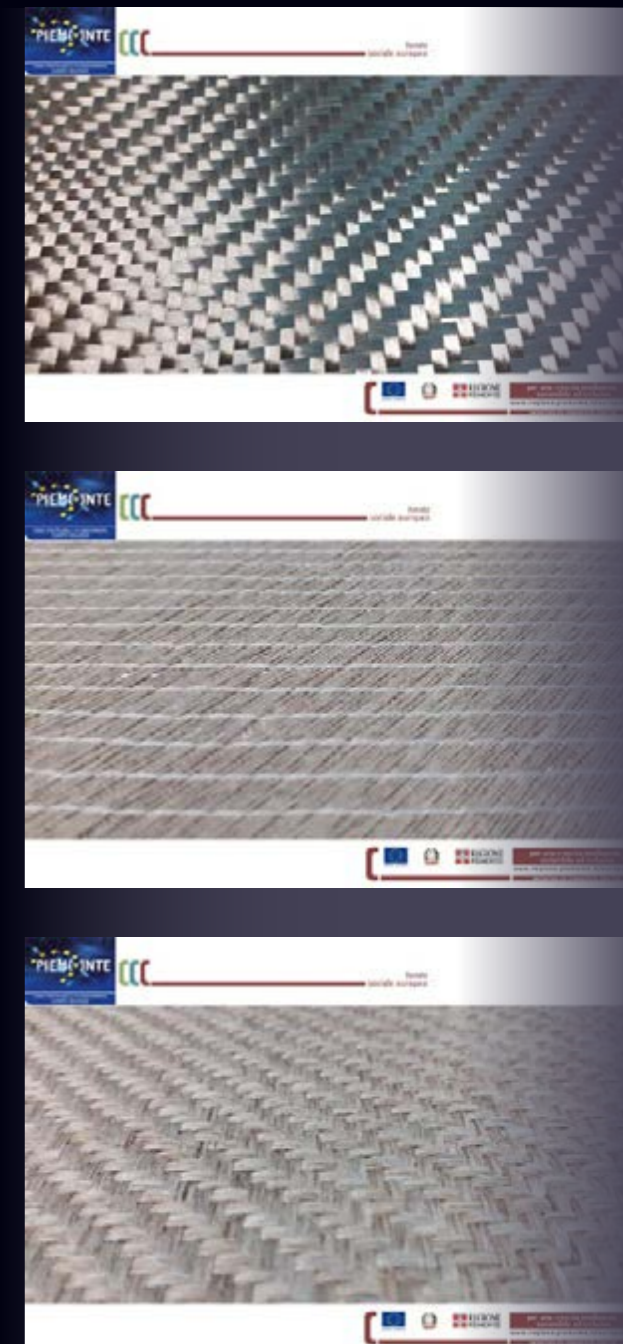

• Carbogreen Project

Since 2019 Sabelt has been working in reducing the environmental impact of its production. The aim is to develop and produce a new line of seats made with innovative and "green" materials. Thanks to the Carbogreen project, financed within the "IR²" call issued by the Piedmont Region in Italy and supported by the European Fund for Regional Development, the company is evolving to become a low environmental impact manufacturer.

SAFETY AND LABORATORY



The pursuit of safety has played a key role since the foundation of Sabelt. We have been the first to equip the laboratories of our plant with a dynamic test which simulates crashes and pre-homologates products for the strict automotive standards: an innovative system prescribed by ECE and FIA regulations. All tests are conducted with the specific intent to maintain a bigger margin to the minimum required, with outstanding performance levels built with style and design.

PRODUCTION



All Sabelt products are designed and engineered exclusively by Sabelt in the operational headquarters in Turin, in collaboration with external design centers or in partnership with clients car makers.

AUTOMOTIVE SEATING



From the world of motorsport, Sabelt has developed a range of premium sports seats for the world's top car manufacturers. It designs and manufactures safety belts and seats for vehicles with a strong sporting connotation, dedicated to an advanced and demanding driver, that is sports oriented and has a particular attention to quality. Its main partners are: Ferrari, McLaren, Alpine, Abarth, Alfa Romeo, Jaguar, Cupra, Maserati and Aston Martin.

SPECIAL APPLICATIONS



Sabelt is able to develop and implement new technologies dedicated to various applications of safety seatbelts in niche markets, such as the military, aviation, aerospace, exceptional transport and many other fields where technical and customized products are required. Since 2010, Sabelt has been the supplier of Thales Alenia Space Italia for the restraint systems of the Cygnus Orbital-ATK module (belts and nets).

HARNESSES



TECHNICAL PARTNER
SCUDERIA FERRARI

FIA 8853-2016

GT / RALLY



WRC HARNESS



CCG632SRD



CCA622SRDLPM



CCA622SRDN1



CCA622SRUN1



CCA633SRUN



CCS632SRDN



CCS622SRUN



CCS633SRUN

FORMULA



F1 HARNESS



CCG832FSR



CCG622FSR



CCA622FRUN1



CCS622FRUN



CCS622FRUN1

SFI 16.1



CCS622SNUSFI



CCS533SNULLSFI

FIA 8854/98

GT / RALLY



CCA433SRDN



CCS433SRDN



CCS433SRUN

RACING NET



CFRN2008 NEW



CFRN2002



CFRN2003

ECE 16

CLUBMAN



CFCC4046 (no ECE)



CFCC904001NP_A



CFCC904070NP_B



CFCC904059NP_B



CFCC904005N_B



CFCC904002N_A

WINDOW NET

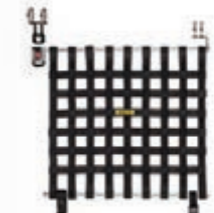

Z280988

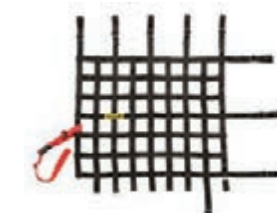

Z280985

BUCKLES

**B1**

Tongues entry designed to simplify the driver fastening. Machined from solid aluminium.

**B5**

Tongues entry designed to simplify the driver fastening. Quick release with spring ejectors. 255 g

**B2**

With integrated crotch belt "T" type attachment. Aluminium. Patented buckle. 219 g

**B6**

Developed with Formula 1 Teams. Superlight buckle in machined from solid aluminium.

**B3**

For "Formula" safety belt developed in Formula 1. Aluminium. Protection for the lever. 192 g

**B4**

Buckle for 4 points safety belt. Aluminium. 184 g

**B7**

Developed for Endurance applications. 2019 and 2021 24h Le Mans winner. 266 g

**B8**

Latch buckle with leather pad and adjuster. 514 g

ADJUSTERS

**A9**

2" Quick release adjuster machined from solid aluminium. Developed in Formula1. 54 g

**A10**

2" Quick release adjuster machined from solid aluminium. Developed for double shoulder belt. 74 g

**A1**

Quick release adjuster for 3" webbing. Forged and anodized aluminium. 2021 24h Le Mans winner. 95 g

**A2**

Quick release adjuster for 2" webbing. Forged and anodized aluminium. 70 g

**A13**

Aluminium quick adjuster 2" with webbing guide. 2019 24h Le Mans winner. 78 g

**A16**

Lap strap tongue with integrated adjuster for 2" width webbing. Steel. 2021 24h Le Mans winner. 113 g

**A3**

Adjuster integrated to the buckle tongue designed for 2" webbing. Developed for GT/Endurance cars. Steel-aluminium. 2019 24h Le Mans winner. 123 g

**A4**

Adjuster for 2" webbing. Steel-aluminium. 113 g

NEW**A5**

"America" adjuster for 3" webbing. Steel. 147 g

**A6**

"America" adjuster for 2" webbing. Steel. 94 g

**A14**

Ergal "Tribar" adjuster for 2" webbing. Steel. 46 g

**A7**

"Tribar" adjuster for 3" webbing. Steel. 110 g

**A8**

"Tribar" adjuster for 2" webbing. Steel. 80 g

**A12**

"Bufflug" steel adjuster. 63 g

**A11**

Steel "Stop" adjuster for 2" webbing. 24 g

**A15**

Ergal "Tribar" adjuster for 3" webbing. Steel. 64 g

FIXINGS

**F1**

Carabiner. Inox Steel. 24 g

**F2A**

Snap hook in combination with A7 or A8. Steel. 77 g

**F2B**

Sewn snap hook. Steel. 77 g

**F3A**

Fixing plate in combination with A7 or A8. Steel. 63 g

**F3B**

Sewn fixing plate. Steel. 63 g

**F4**

Sewn "P" type steel fixing plate. 47 g

**F5**

"Wrap around" fixing in combination with A7 or A8.

**F6**

"Sewn loop" fixing.

**F7**

Titanium double fixing plate for 2" webbing. For M8 screw. 38 g

**F8**

Small Sewn fixing plate. 45 g

**F9**

Small fixing plate. 44 g

**F10**

Double hole fixing plate. 38 g

**F11**

Sewn double hole fixing plate. 38 g

**F12**

X2 double hole fixing plate. 76 g

TONGUES

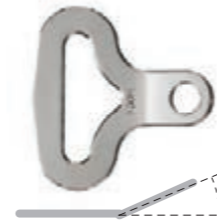
**T1**

Lap belt tongue with ergonomic bend. Steel. 32 g

**T2**

Shoulder belt tongue for 3" webbing. Steel. 30 g

**T3**

Shoulder belt tongue for 2" webbing. Steel. 23 g

**T4**

Titanium mini-tongue for CCG622FSR, CCG832FSR harnesses. 7 g

**T5**

Titanium tongue for E1 harnesses. 9 g

**T6**

Lap belt tongue with ergonomic bend. Titanium. 18 g

**T7**

Steel shoulder belt tongue +5 mm. 38 g

**T8**

Lap strap link. 86 g

**T9**

Left shoulder strap link. 69 g

**T10**

Right shoulder strap link. 69 g

**T11**

Crotch strap link. 57 g

OPTIONALS

**02**

Logo printed directly on the webbing in high grip material for FHR.

**04**

Closure hook and loop fastener for adjustable straps.

**05**

Ergonomic handle.

**06**

Intercom or Drink System cord.

**07**



hook and loop fastener on upper shoulder belt.

**08**

Vintage logo

CCG632SRD

STANDARD FEATURES

GT/RALLY				GOLD	FIA 8853-2016		
STANDARD MEASURES (mm)				STANDARD COLOURS/CODES			
A	B	C	D				
430	790	620	330	CCG632SRD	CCG632SND	CCG632SBD	

CONFIGURATIONS ON DEMAND



CCA622SRDLPM

STANDARD FEATURES

GT/RALLY				SILVER	FIA 8853-2016	
STANDARD MEASURES (mm)				STANDARD COLOURS/CODES		
A	B	C	D			
380	1700	680	850	CCA622SRDLPM	CCA622SNDLPM	CCA622SBDLPM

CONFIGURATIONS ON DEMAND

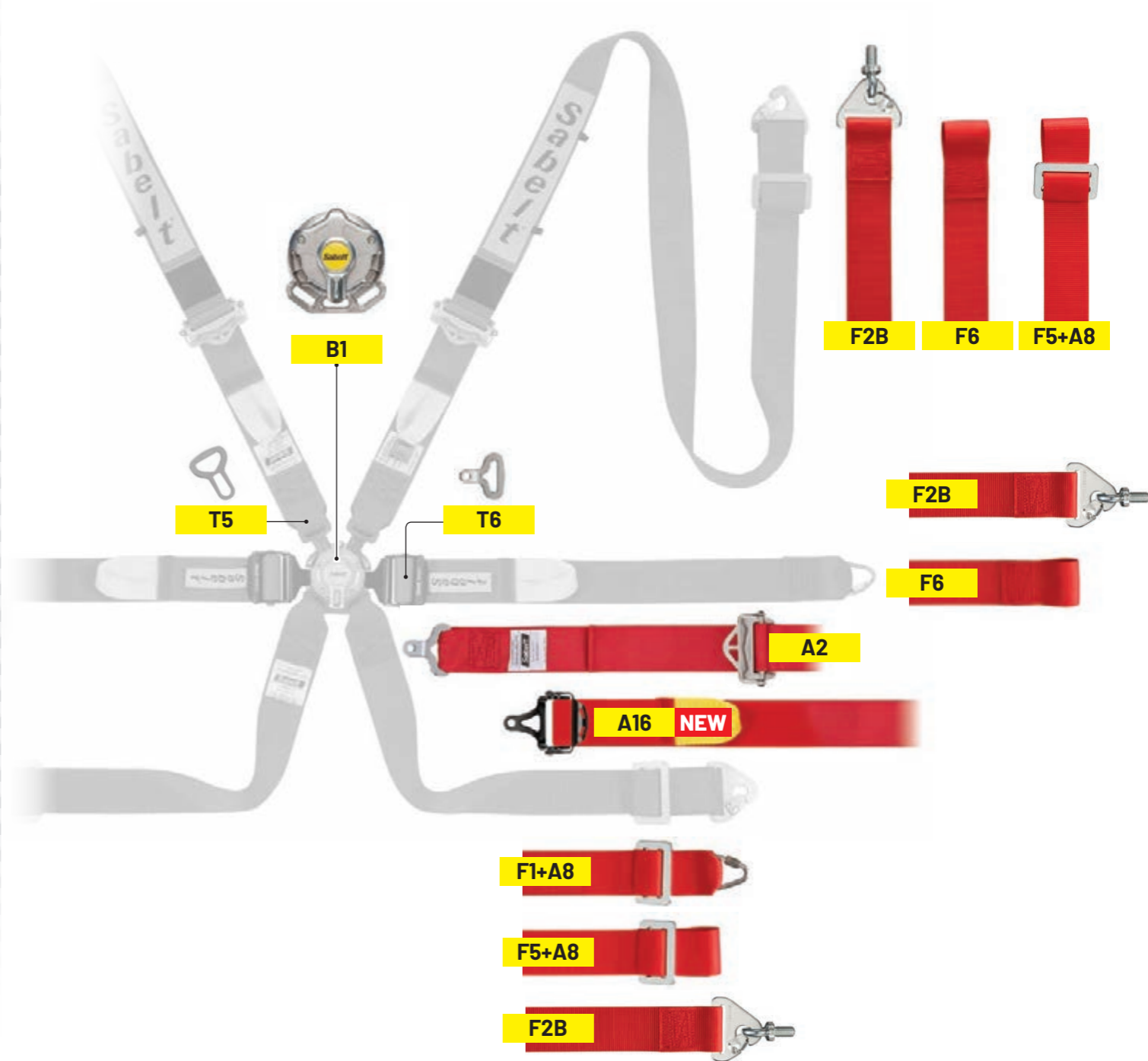
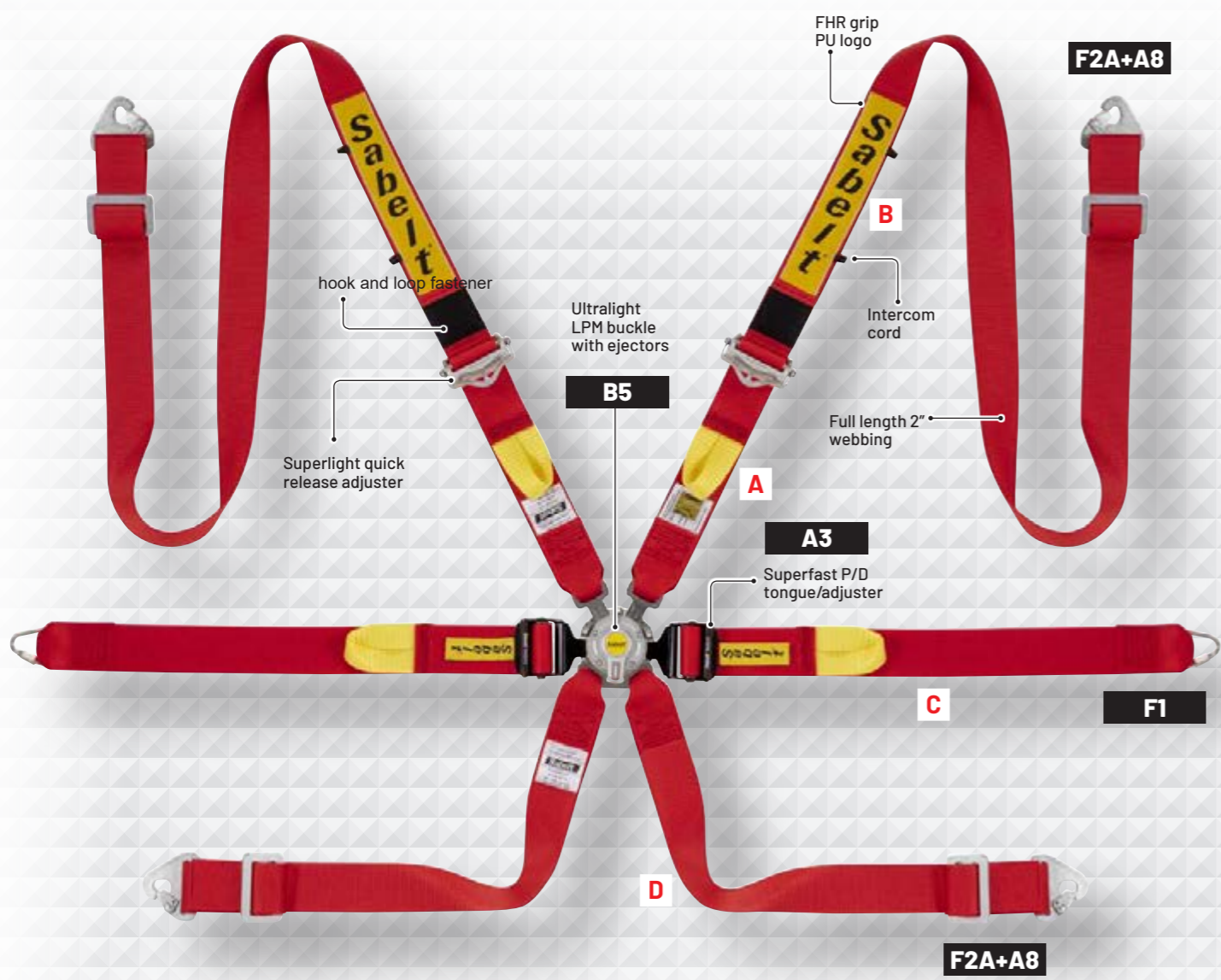
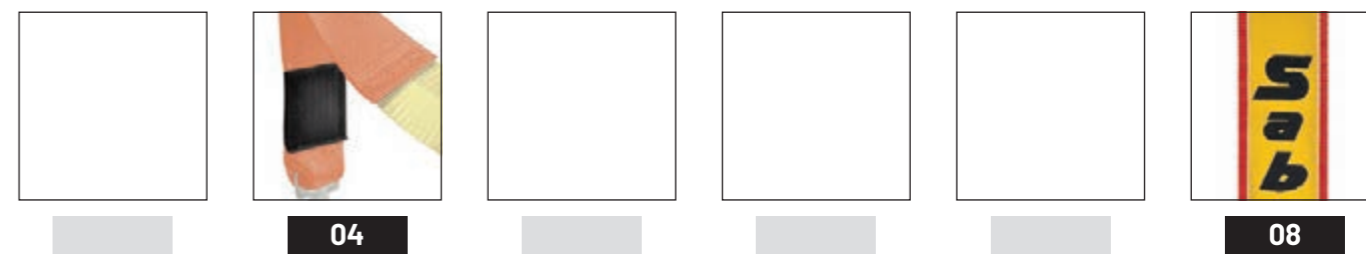

CCA622SRDN1

STANDARD FEATURES

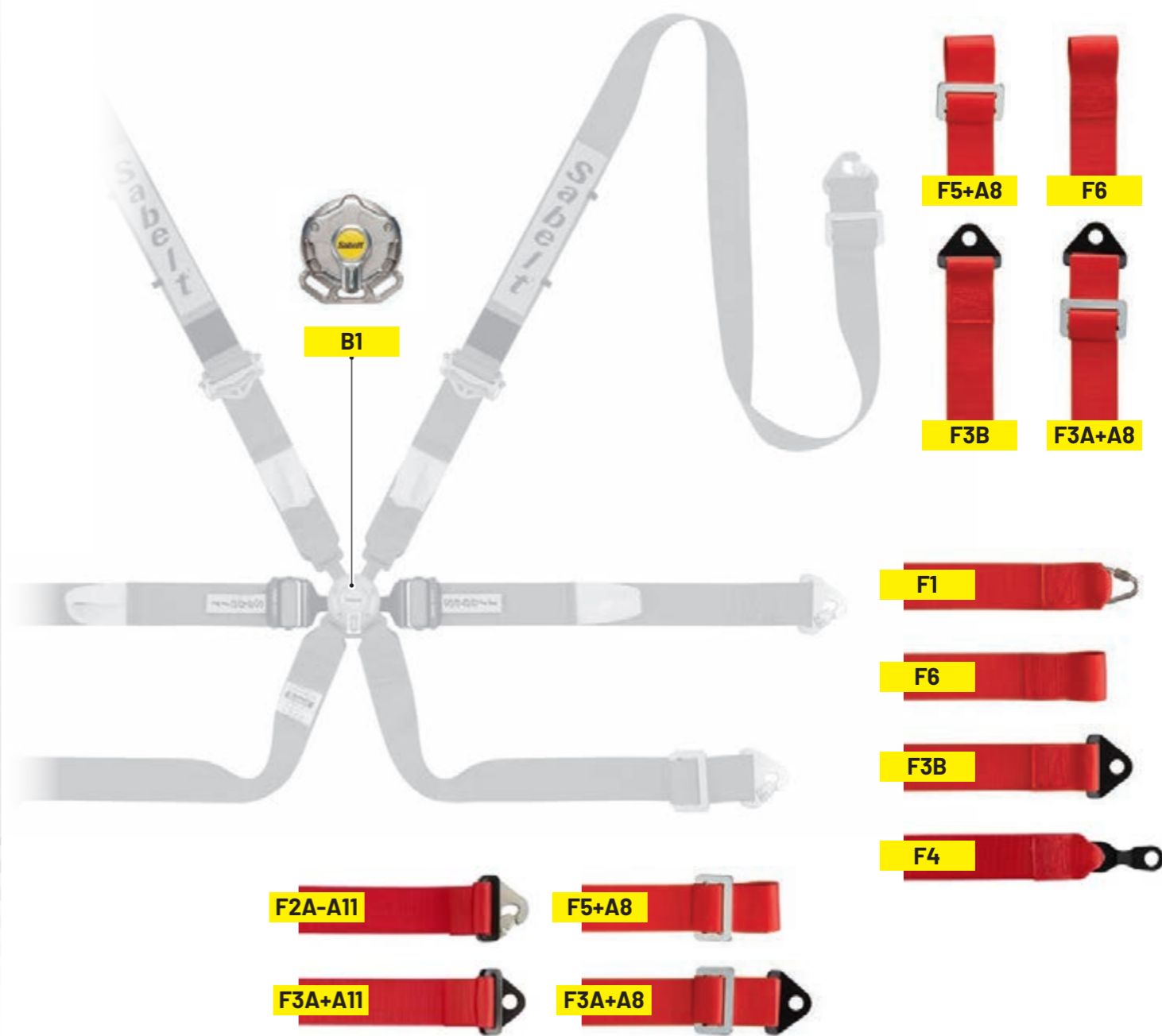
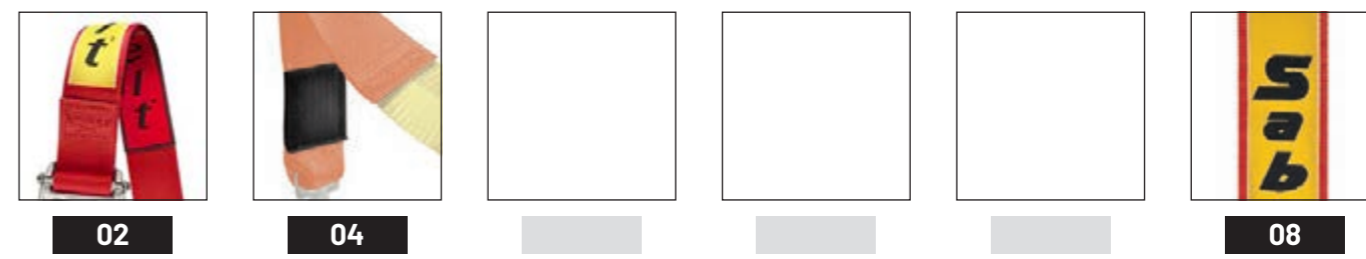

GT/RALLY				SILVER	FIA 8853-2016		
STANDARD MEASURES (mm)				STANDARD COLOURS/CODES			
A	B	C	D				
380	1700	680	850	CCA622SRDN1	CCA622SNDN1	CCA622SBDN1	

CONFIGURATIONS ON DEMAND



CCA622SRUN1

STANDARD FEATURES

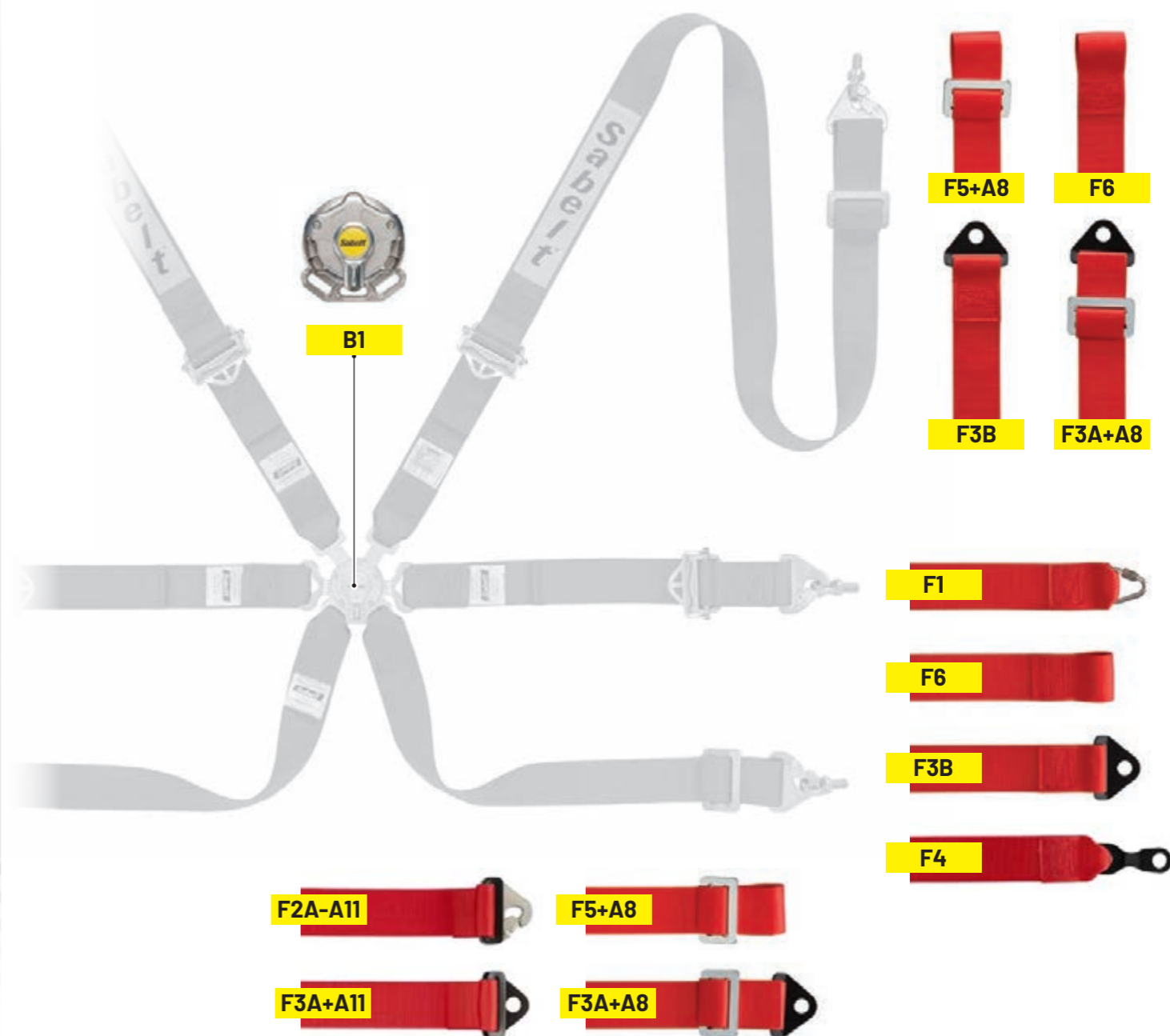

GT/RALLY				SILVER	FIA 8853-2016	
STANDARD MEASURES (mm)				STANDARD COLOURS/CODES		
A	B	C	D			
380	1700	560+120	850	CCA622SRUN1	CCA622SNUN1	CCA622SBUN1

CONFIGURATIONS ON DEMAND



CCA633SRUN

STANDARD FEATURES

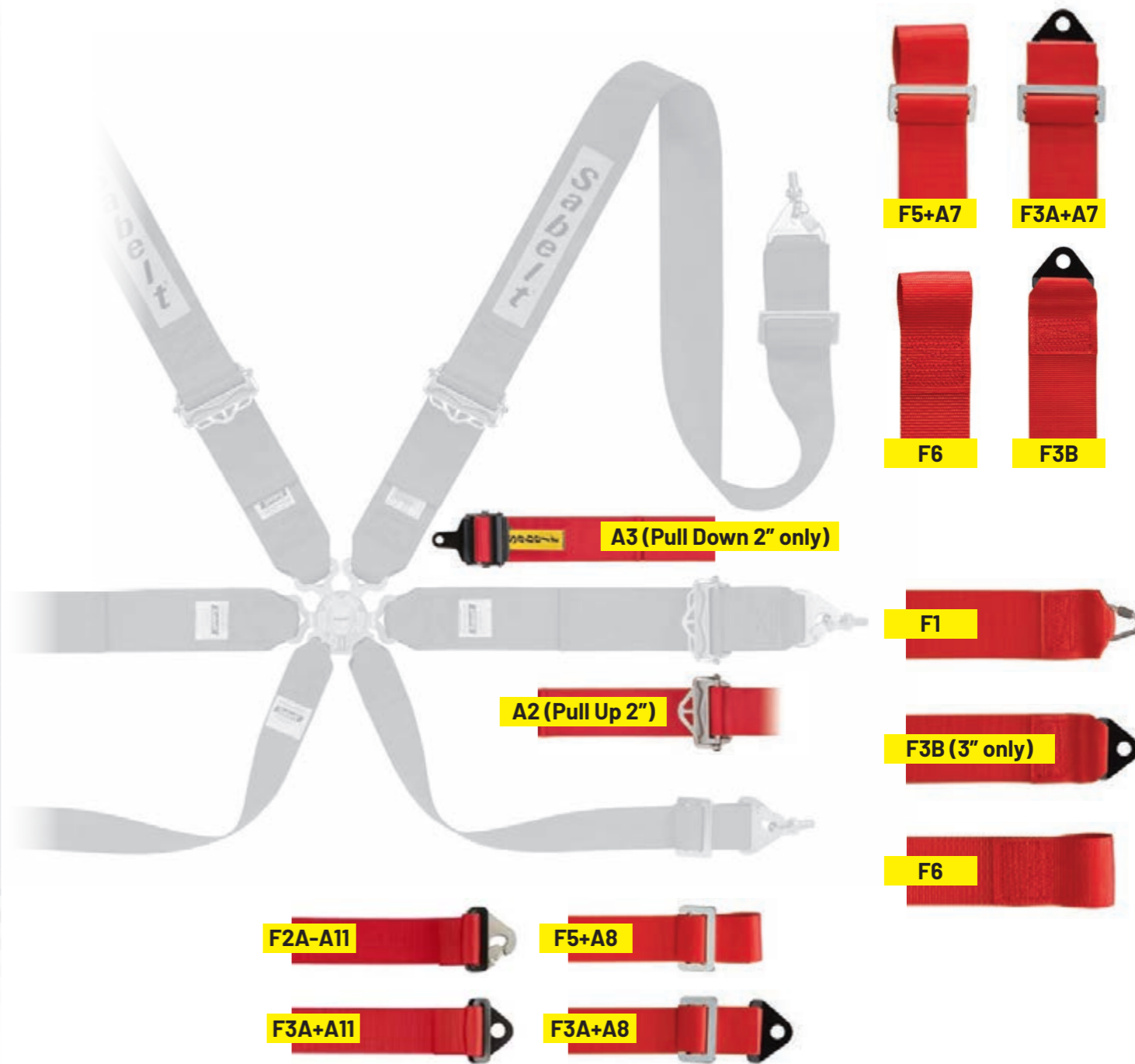

GT/RALLY				SILVER	FIA 8853-2016	
STANDARD MEASURES (mm)				STANDARD COLOURS/CODES		
A	B	C	D			
380	1700	560+120	850	CCA633SRUN	CCA633SNUN	CCA633SBUN

CONFIGURATIONS ON DEMAND



CCS632SRDN

STANDARD FEATURES

GT/RALLY				STEEL	FIA 8853-2016		
STANDARD MEASURES (mm)				STANDARD COLOURS/CODES			
A	B	C	D				
380	1700	680	850	CCS632SRDN	CCS632SNDN	CCS632SBDN	





CONFIGURATIONS ON DEMAND



CCS622SRUN

STANDARD FEATURES

GT/RALLY				STEEL	FIA 8853-2016	
STANDARD MEASURES (mm)				STANDARD COLOURS/CODES		
A	B	C	D			
380	1700	560+120	850	CCS622SRUN	CCS622SNUN	CCS622SBUN

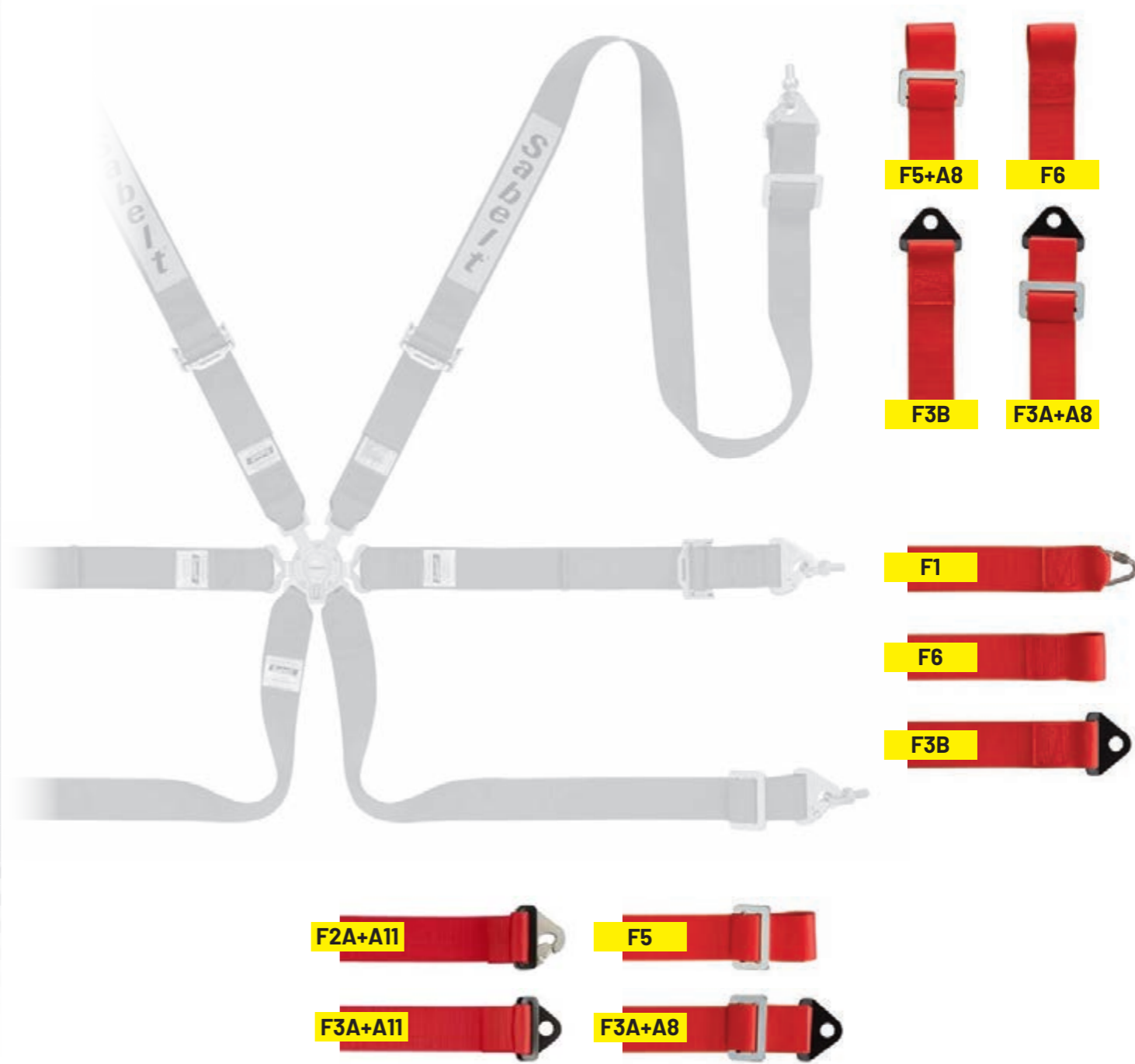
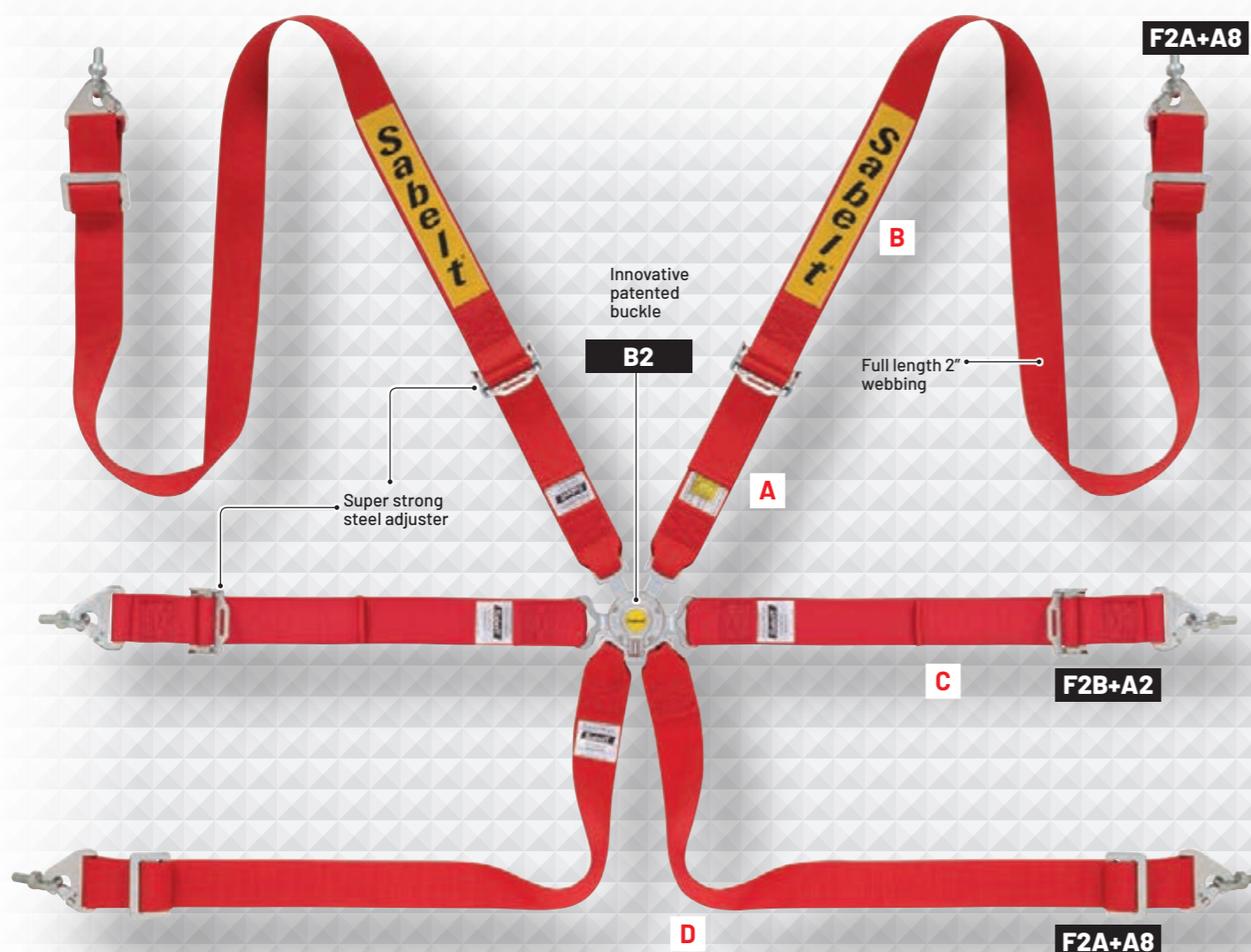

CONFIGURATIONS ON DEMAND



MANUFACTURER: SABELT
 MODEL: NEW SPEC SALOON
 HOM. NO: SH.001.16-T-6
 FIA STANDARD: 8853-2016

CCS633SRUN

STANDARD FEATURES

GT/RALLY				STEEL	FIA 8853-2016	
STANDARD MEASURES (mm)				STANDARD COLOURS/CODES		
A	B	C	D			
380	1700	560+120	850	CCS633SRUN	CCS633SNUN	CCS633SBUN

CONFIGURATIONS ON DEMAND

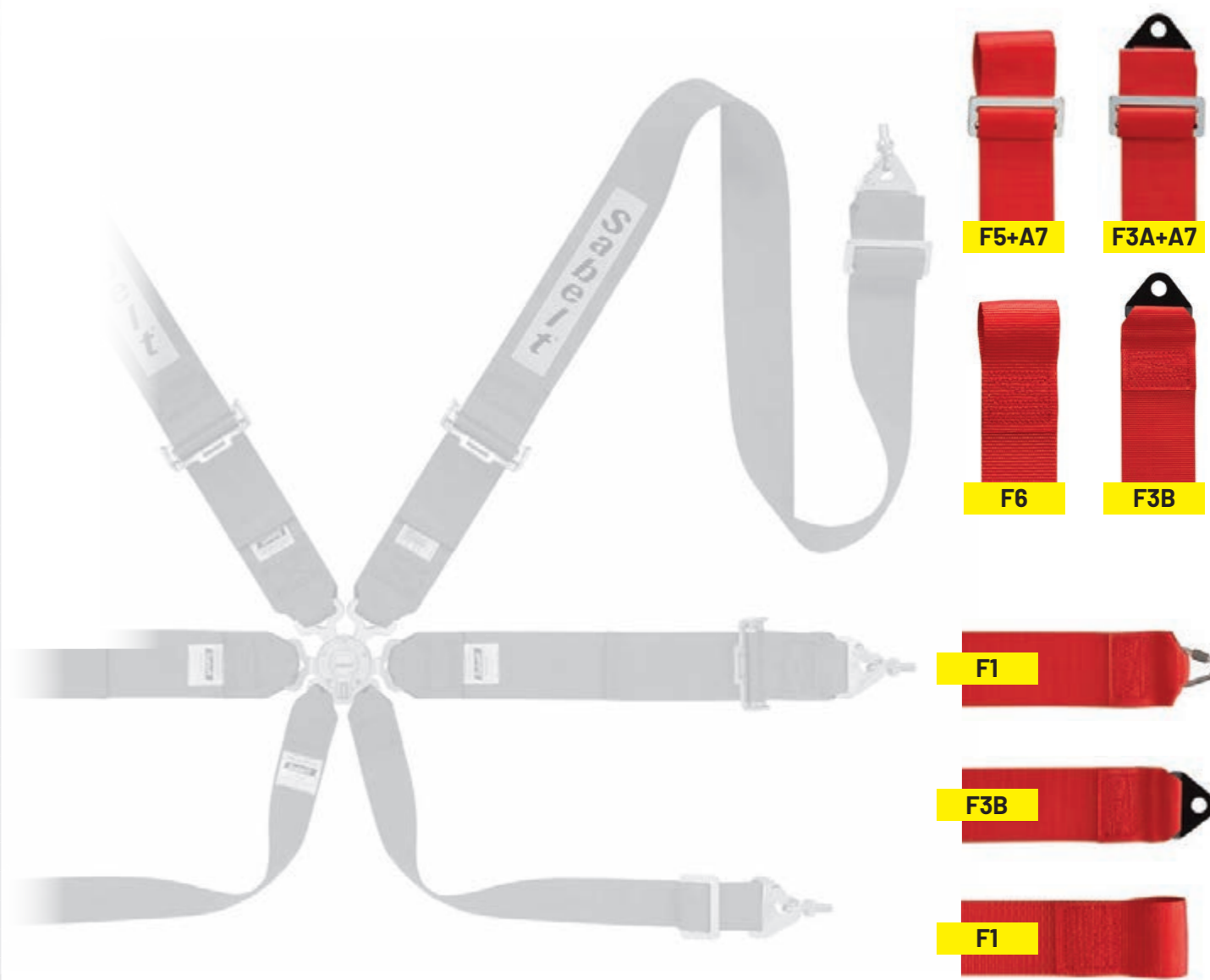

CCG832FSR

STANDARD FEATURES

FORMULA					GOLD	FIA 8853-2016	
STANDARD MEASURES (mm)					STANDARD COLOURS/CODES		
A	B2	B3	C	D			
360	495+105	430	975 FULL Length	960 FULL Length	CCG832FSR	CCG832FSN	

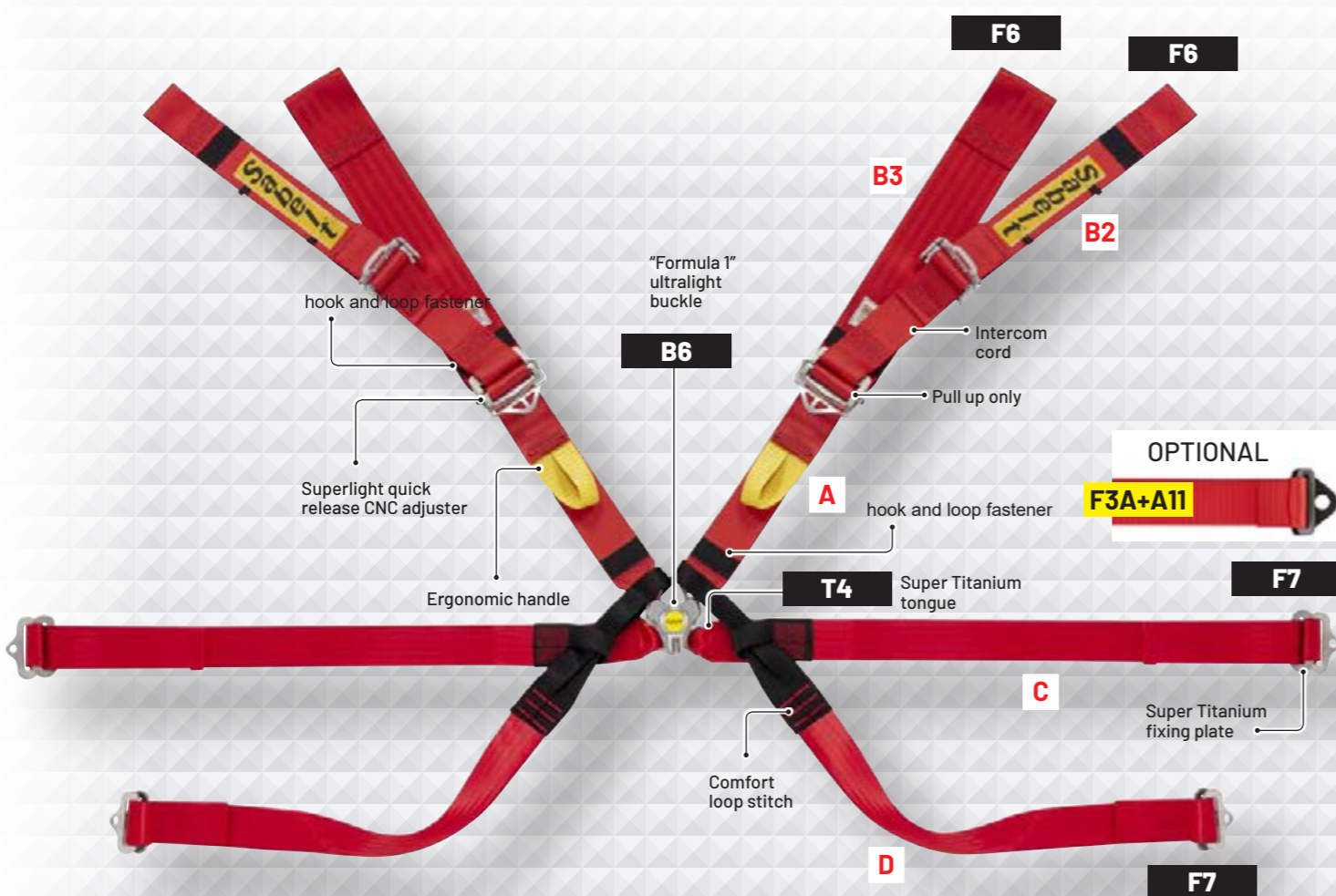

MANUFACTURER: SABELT
 MODEL: NEW SPEC F4
 HOM. NO: SH.061.19-T-8
 FIA STANDARD: 8853-2016

CCG622FSR

STANDARD FEATURES

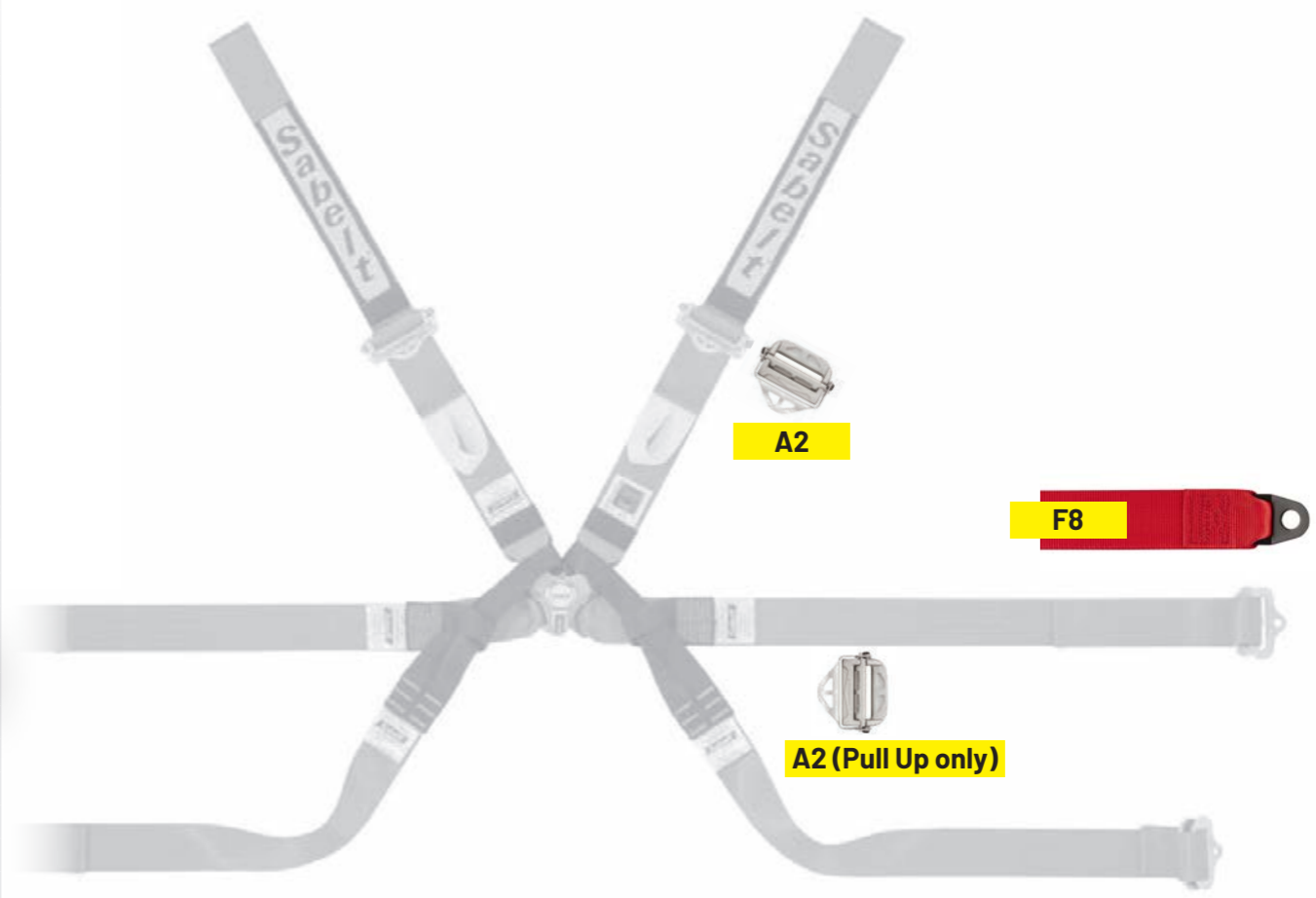
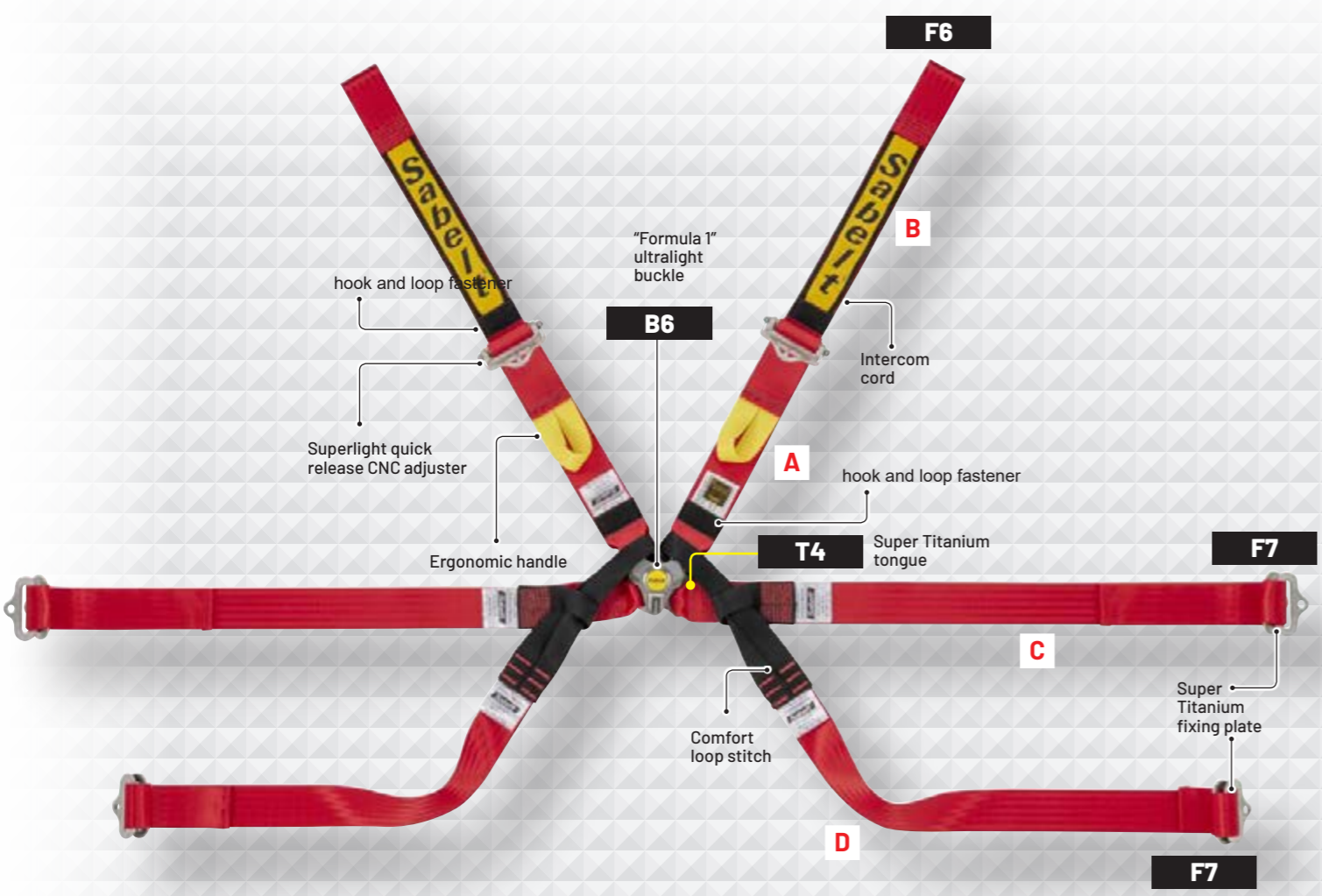
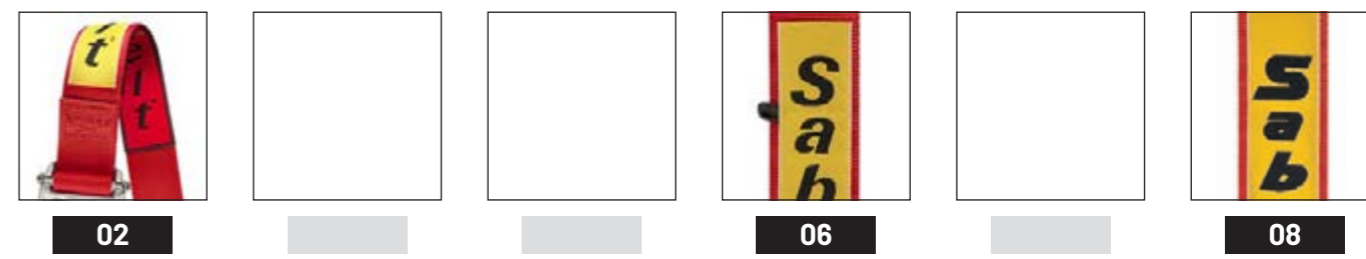

FORMULA				GOLD	FIA 8853-2016	
STANDARD MEASURES (mm)				STANDARD COLOURS/CODES		
A	B	C	D			
360	370	975 FULL Length	960 FULL Length	CCG622FSR	CCG622FSN	

CONFIGURATIONS ON DEMAND



CCA622FRUN1

STANDARD FEATURES

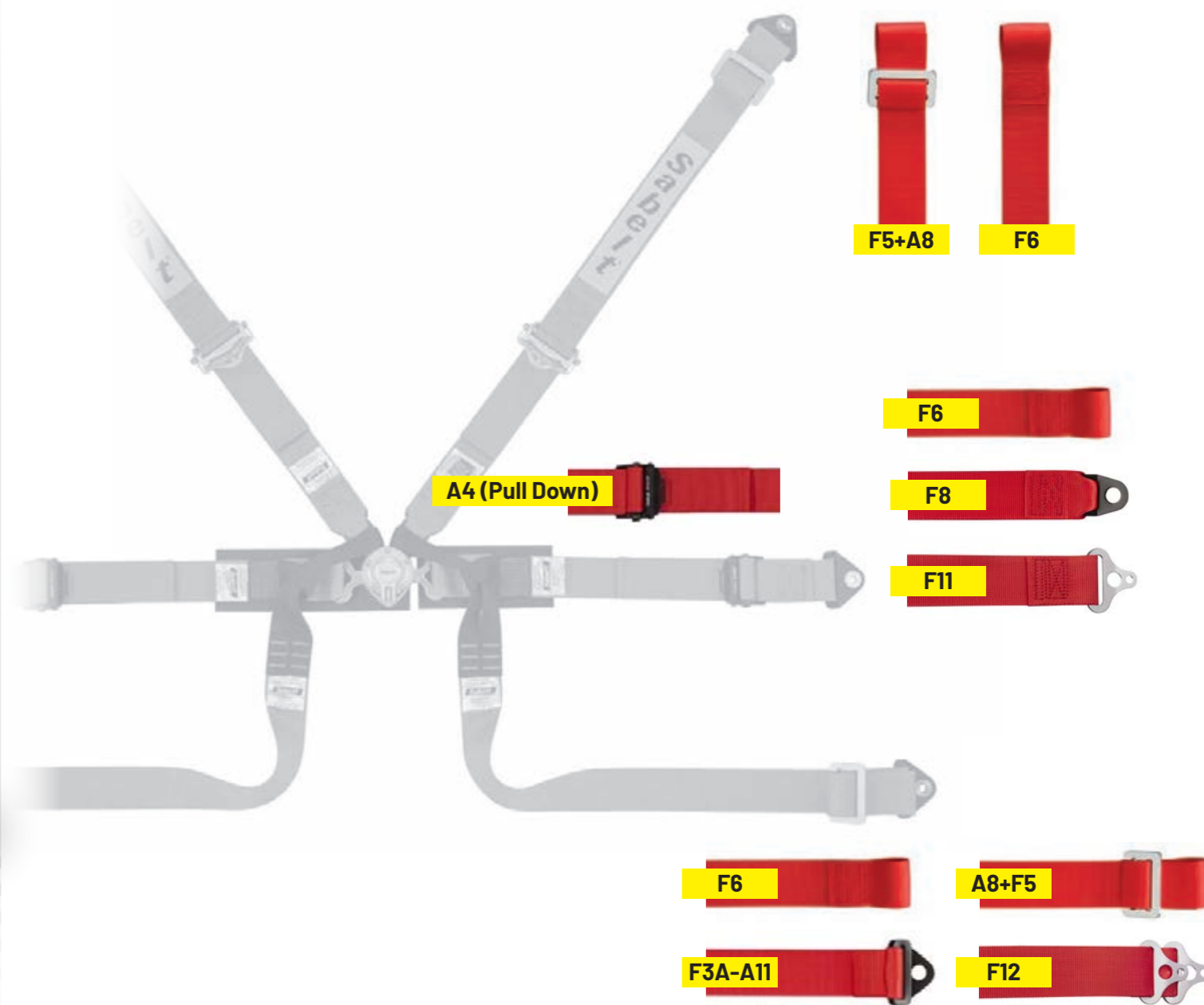
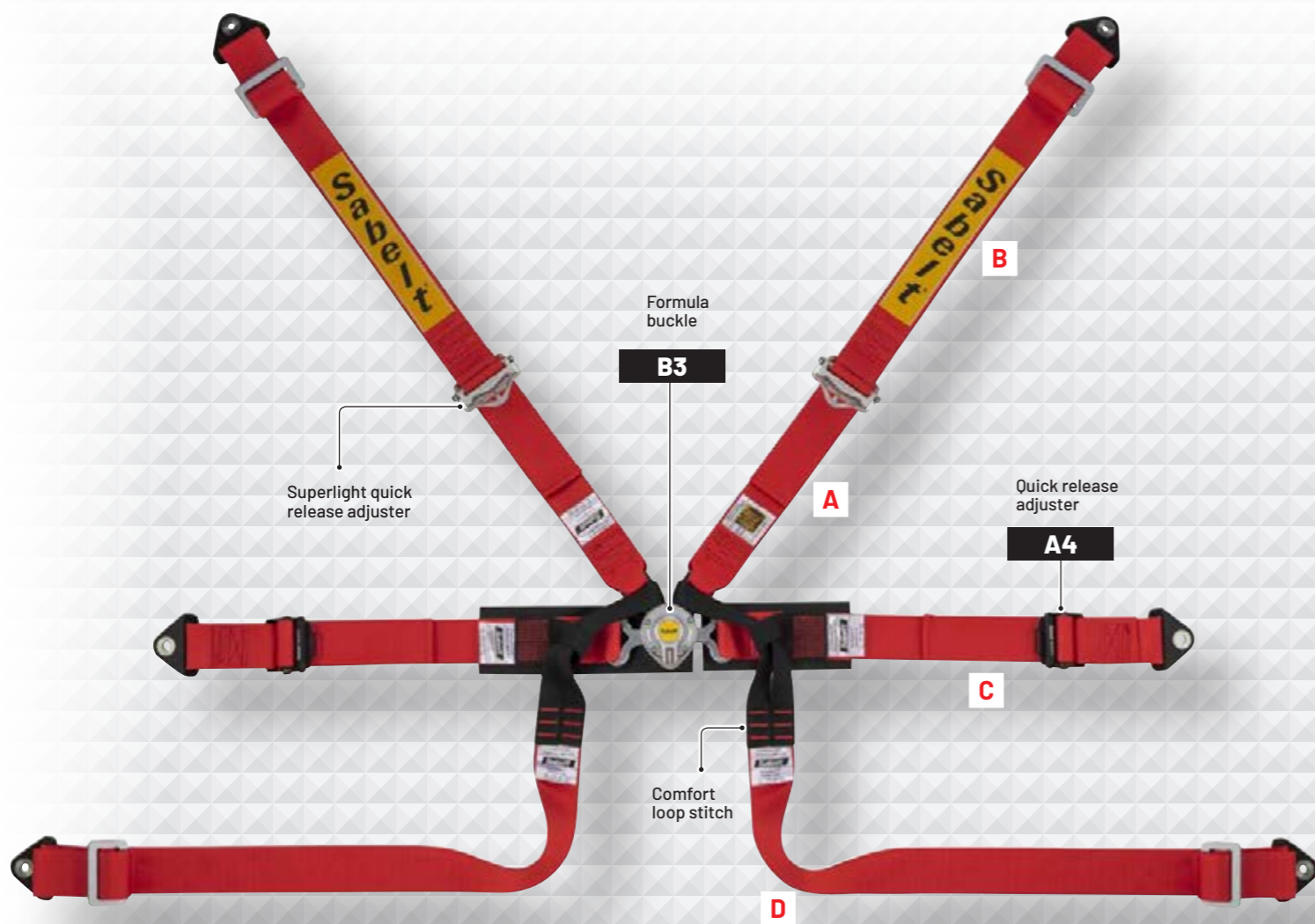

FORMULA				SILVER	FIA 8853-2016	
STANDARD MEASURES (mm)				STANDARD COLOURS/CODES		
A	B	C	D			
440	700	530+120	1200	CCA622FRUN1	CCA622FNUN1	CCA622FBUN1

CONFIGURATIONS ON DEMAND



CCS622FRUN

STANDARD FEATURES

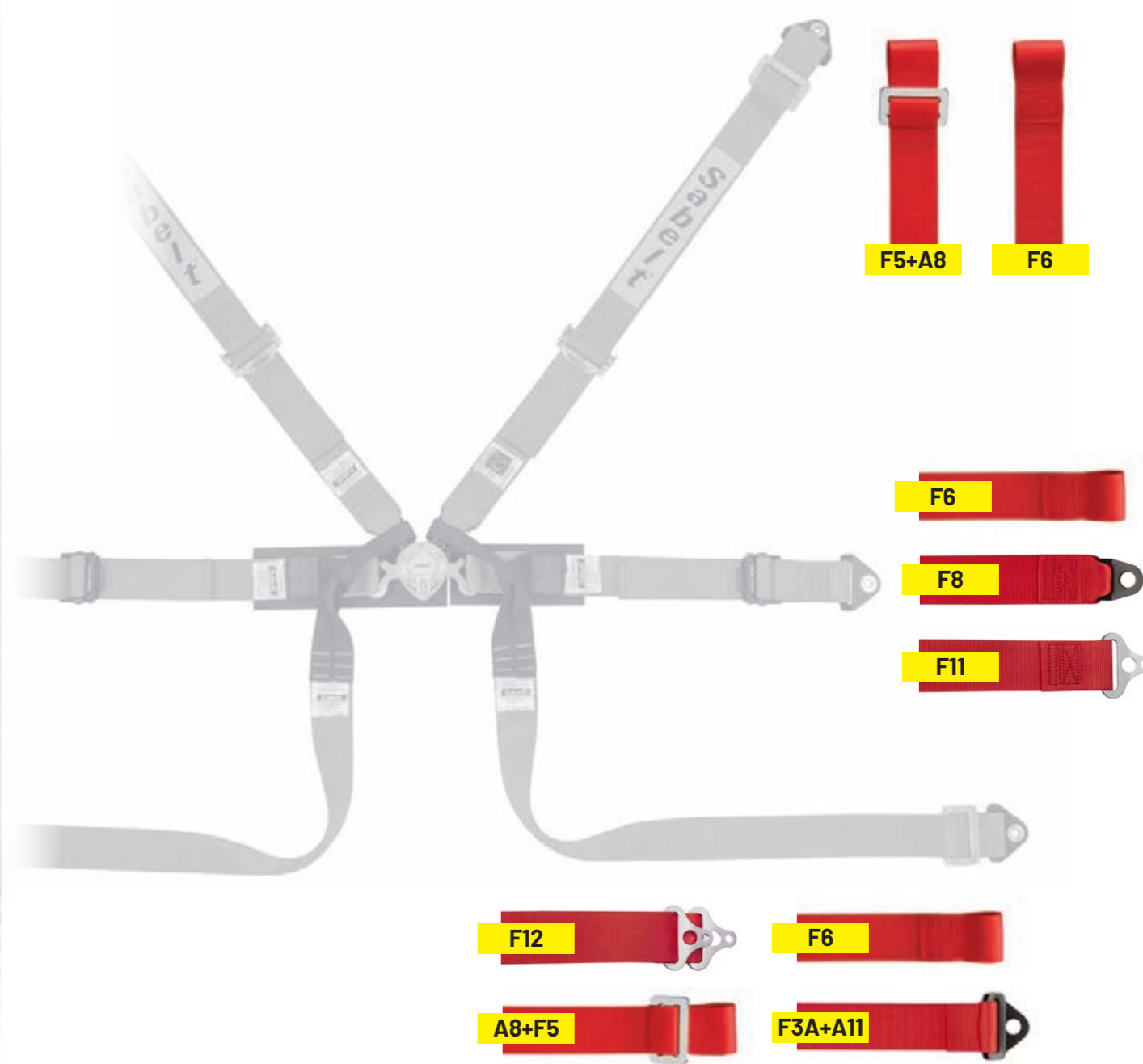
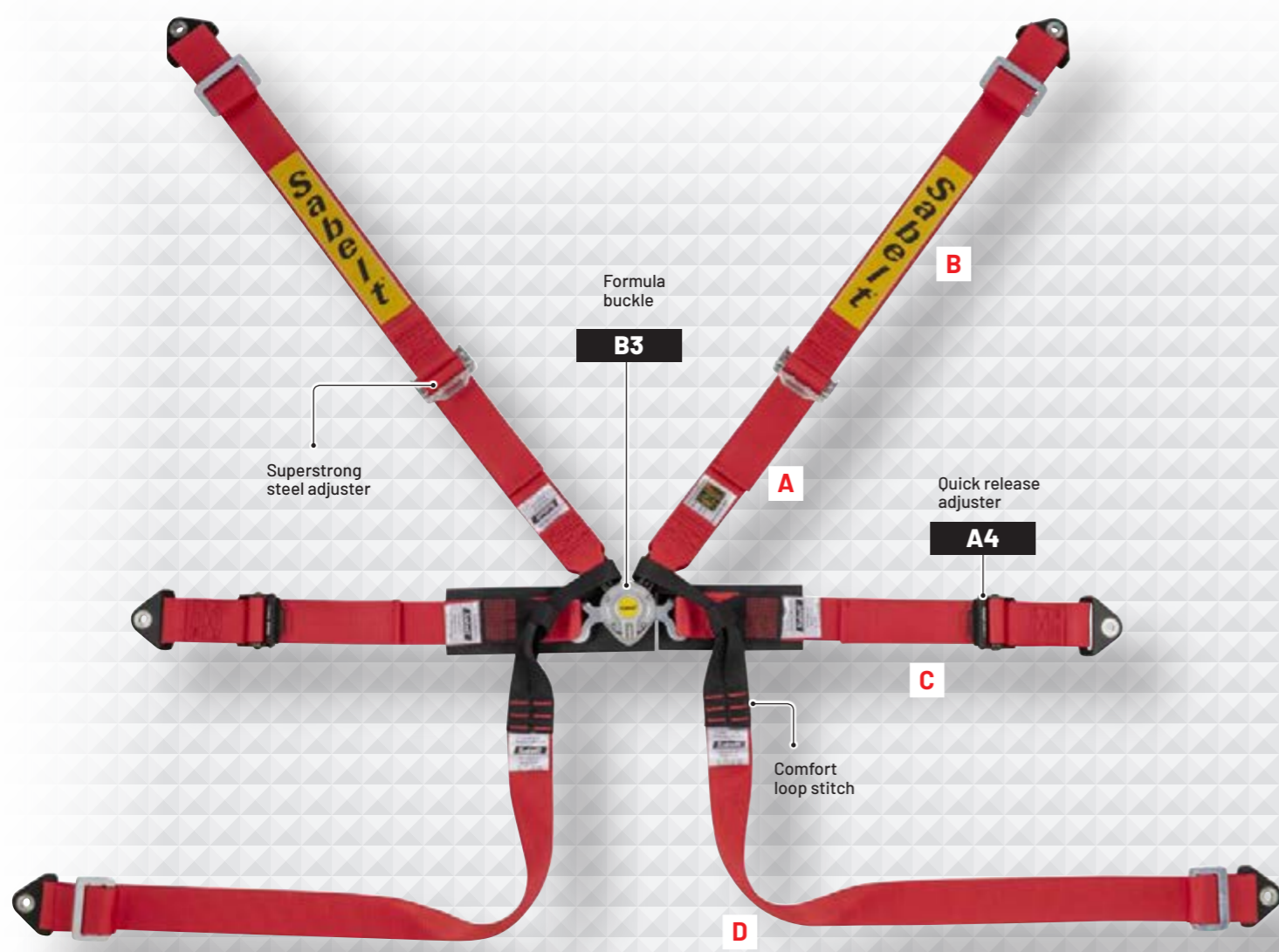

FORMULA				STEEL	FIA 8853-2016		
STANDARD MEASURES (mm)				STANDARD COLOURS/CODES			
A	B	C	D				
440	700	530+120	1200	CCS622FRUN	CCS622FNUN	CCS622FBUN	

CONFIGURATIONS ON DEMAND



CCS622FRUN1

STANDARD FEATURES

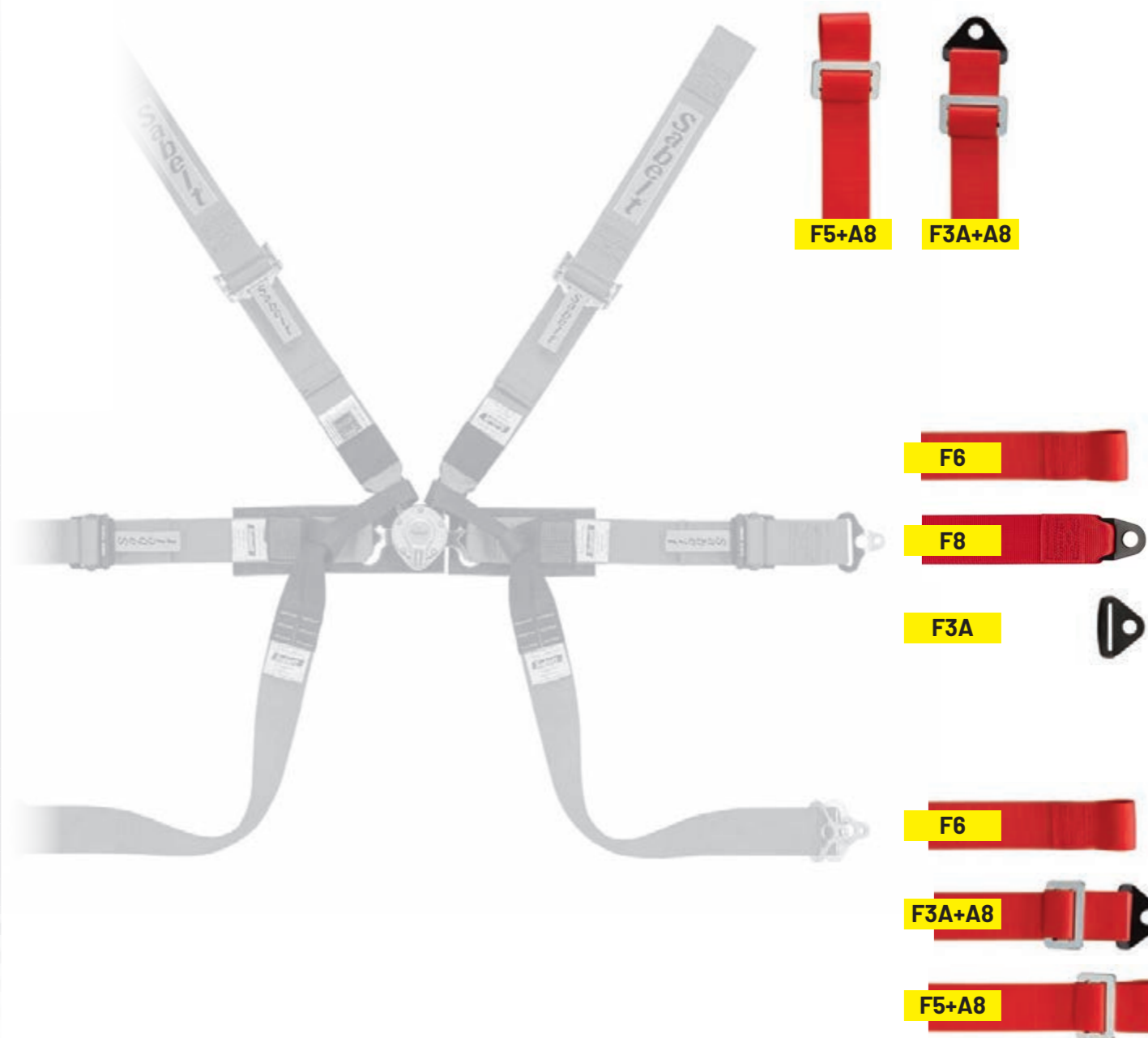
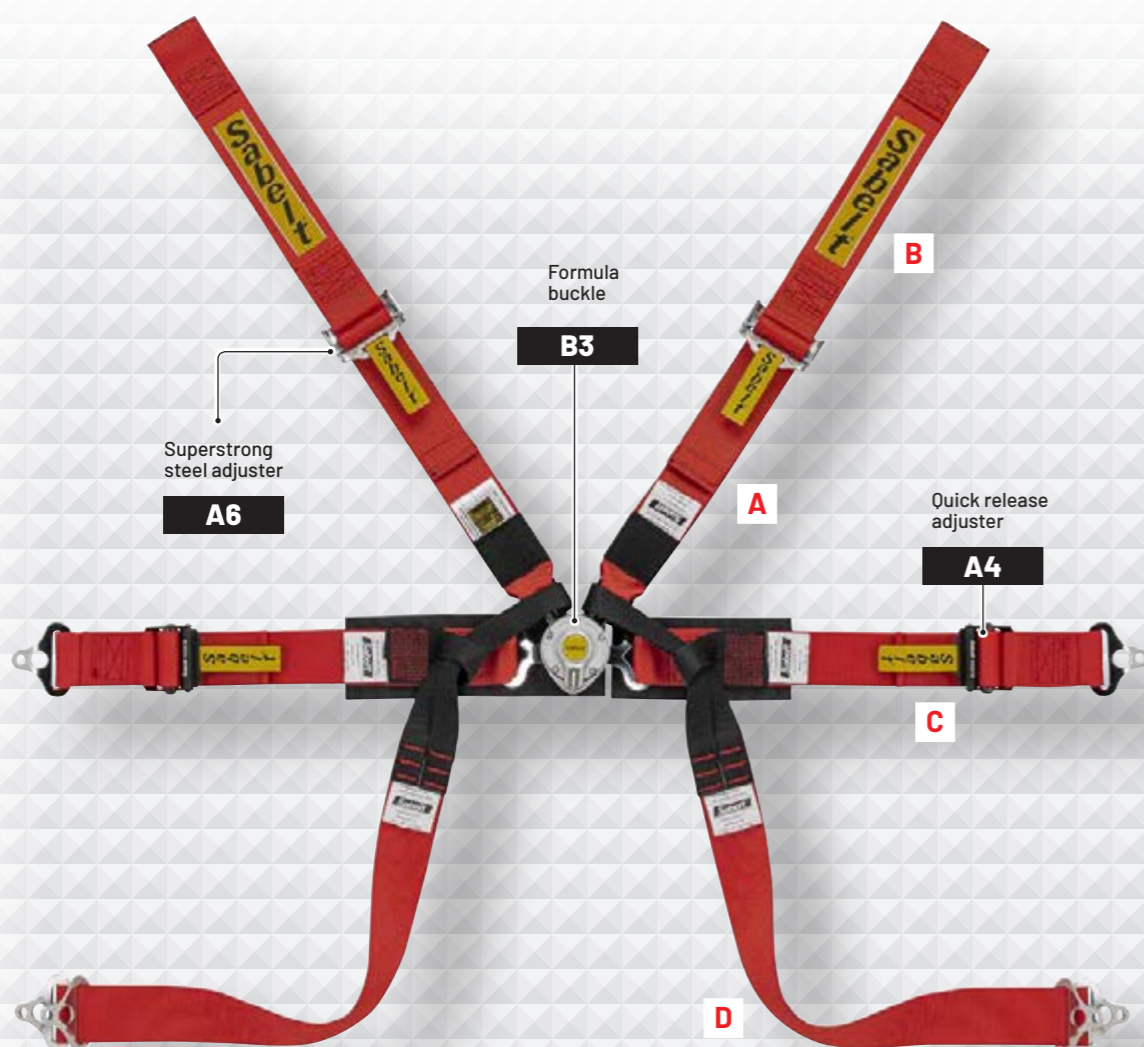

FORMULA				STEEL	FIA 8853-2016		
STANDARD MEASURES (mm)				STANDARD COLOURS/CODES			
A	B	C	D				
440	320	400+120	950	CCS622FRUN1	CCS622FNUN1	CCS622FBUN1	

CONFIGURATIONS ON DEMAND



CCA433SRDN

STANDARD FEATURES

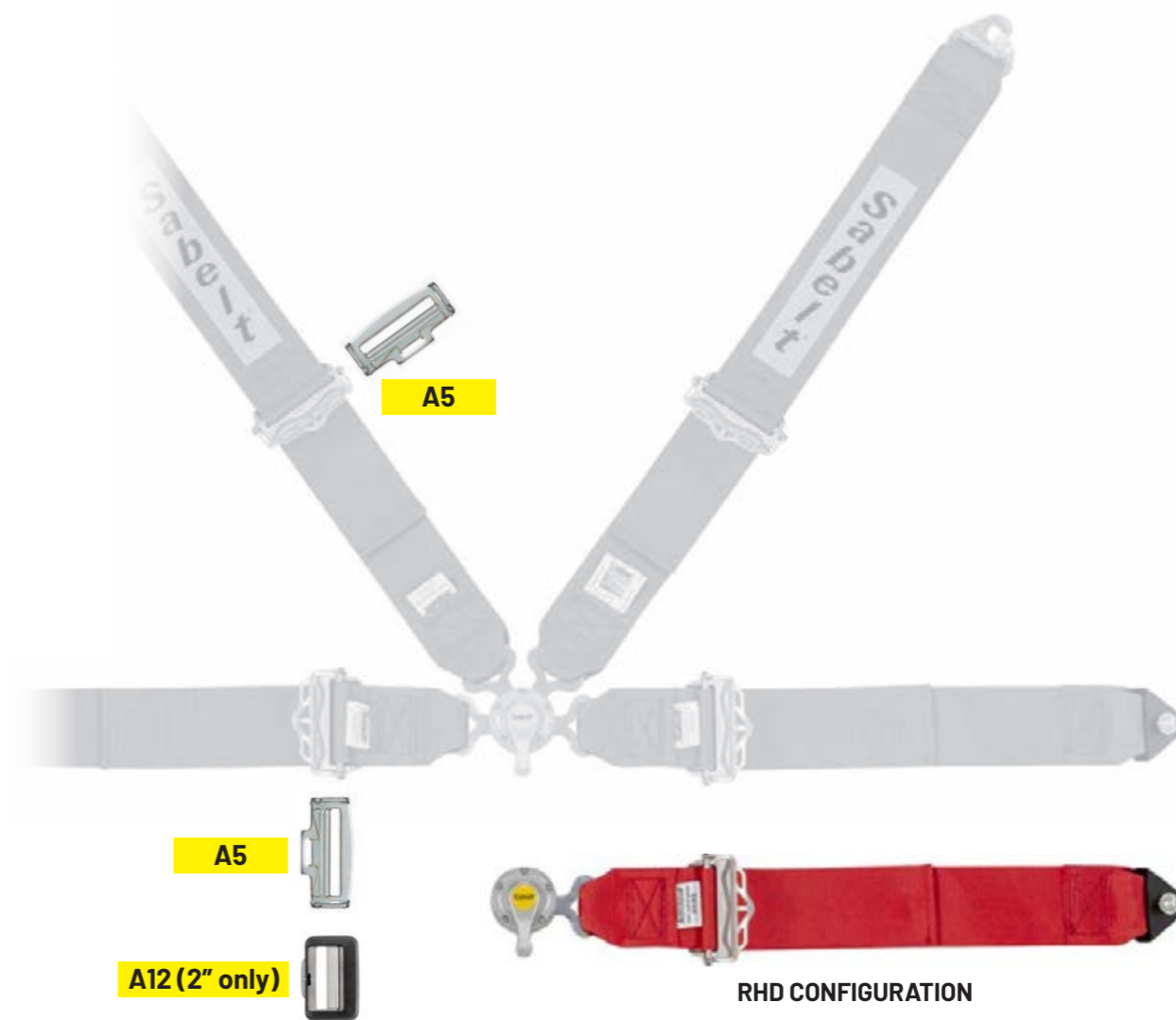
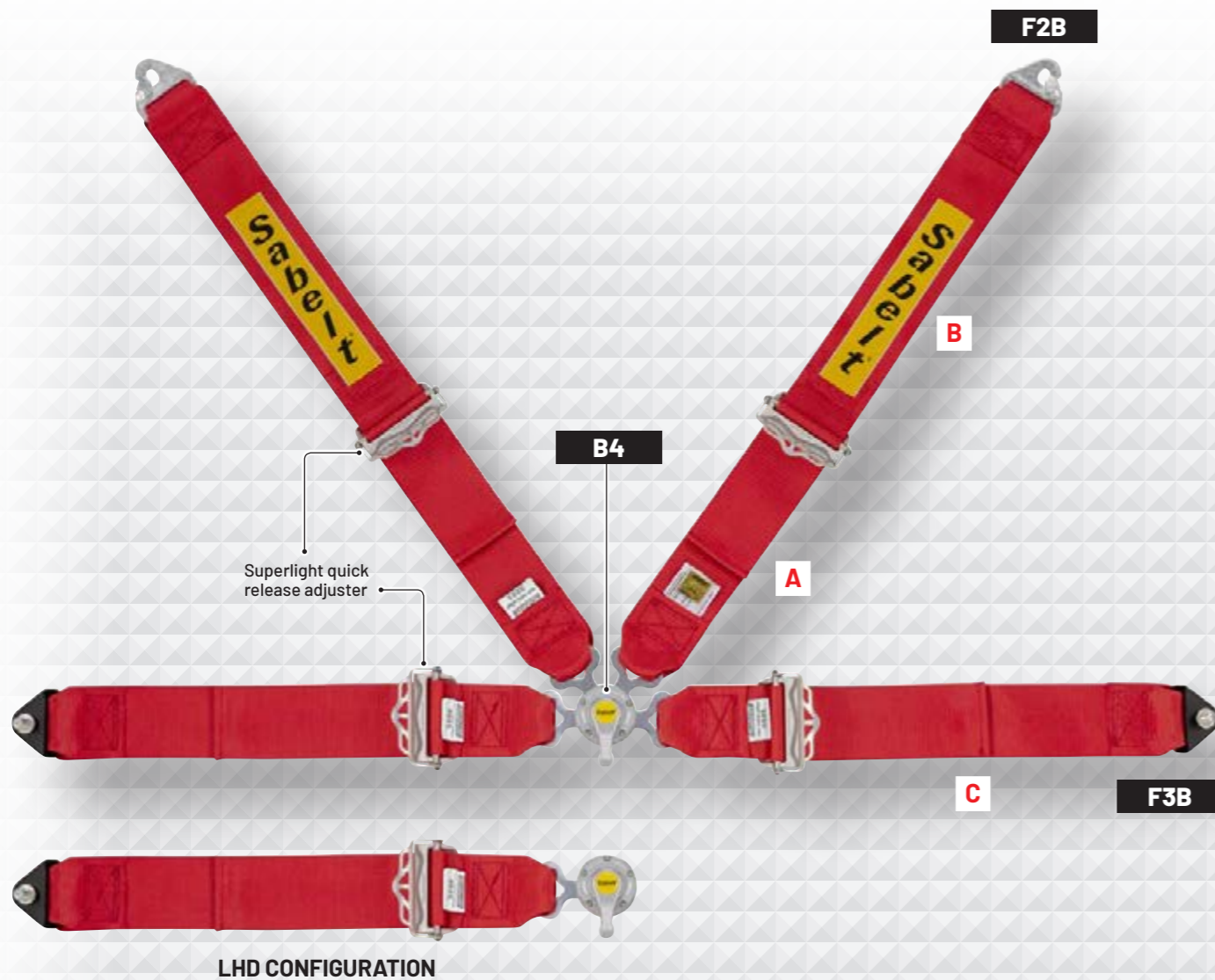

SALOON - FOR KIT CAR "W"				SILVER	FIA 8854/98	
STANDARD MEASURES (mm)				STANDARD COLOURS/CODES		
A	B	C				
480	450	130+610		CCA433SRDN	CCA433SNDN	CCA433SBDN

CONFIGURATIONS ON DEMAND



CCS433SRDN

STANDARD FEATURES

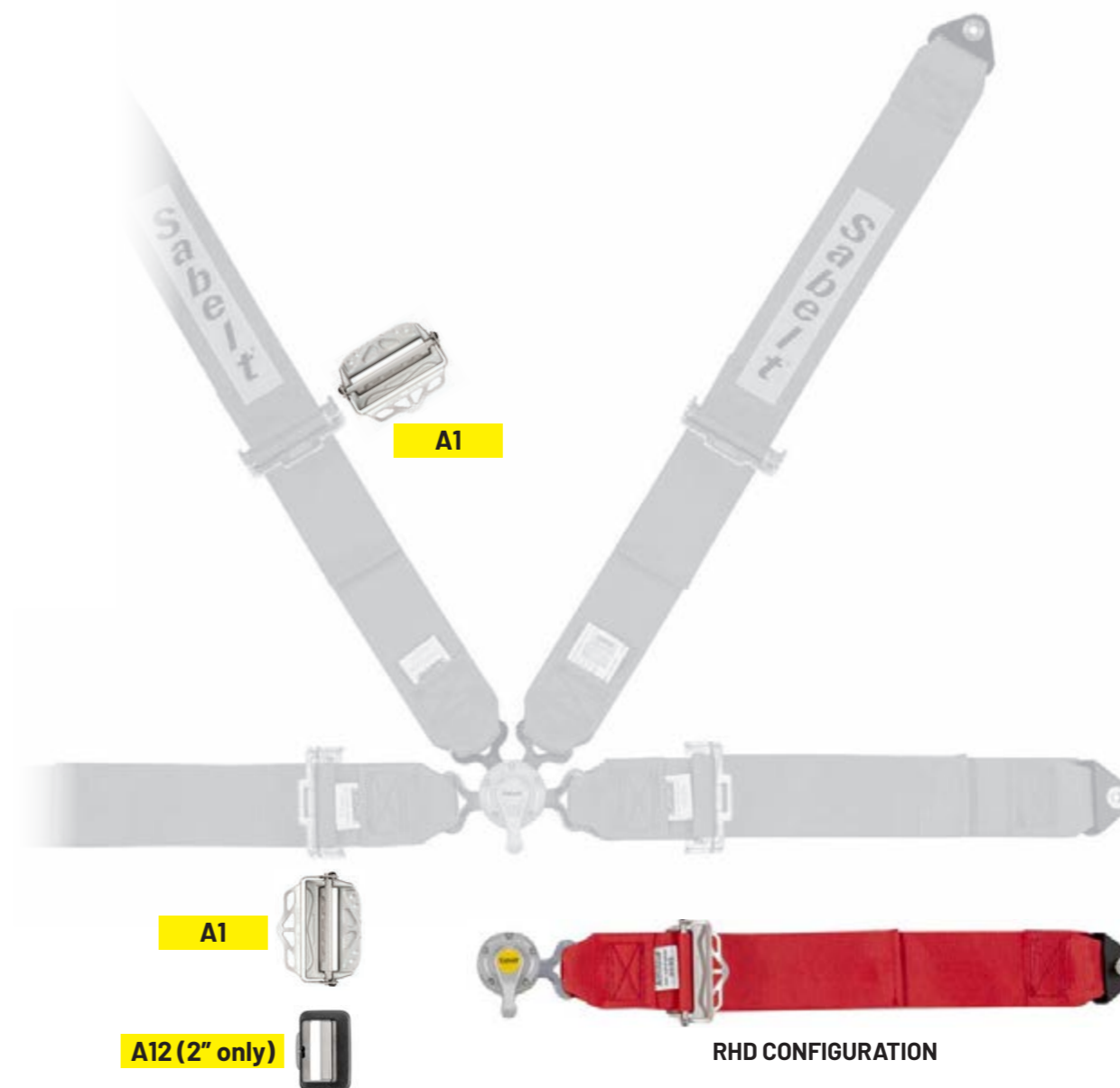
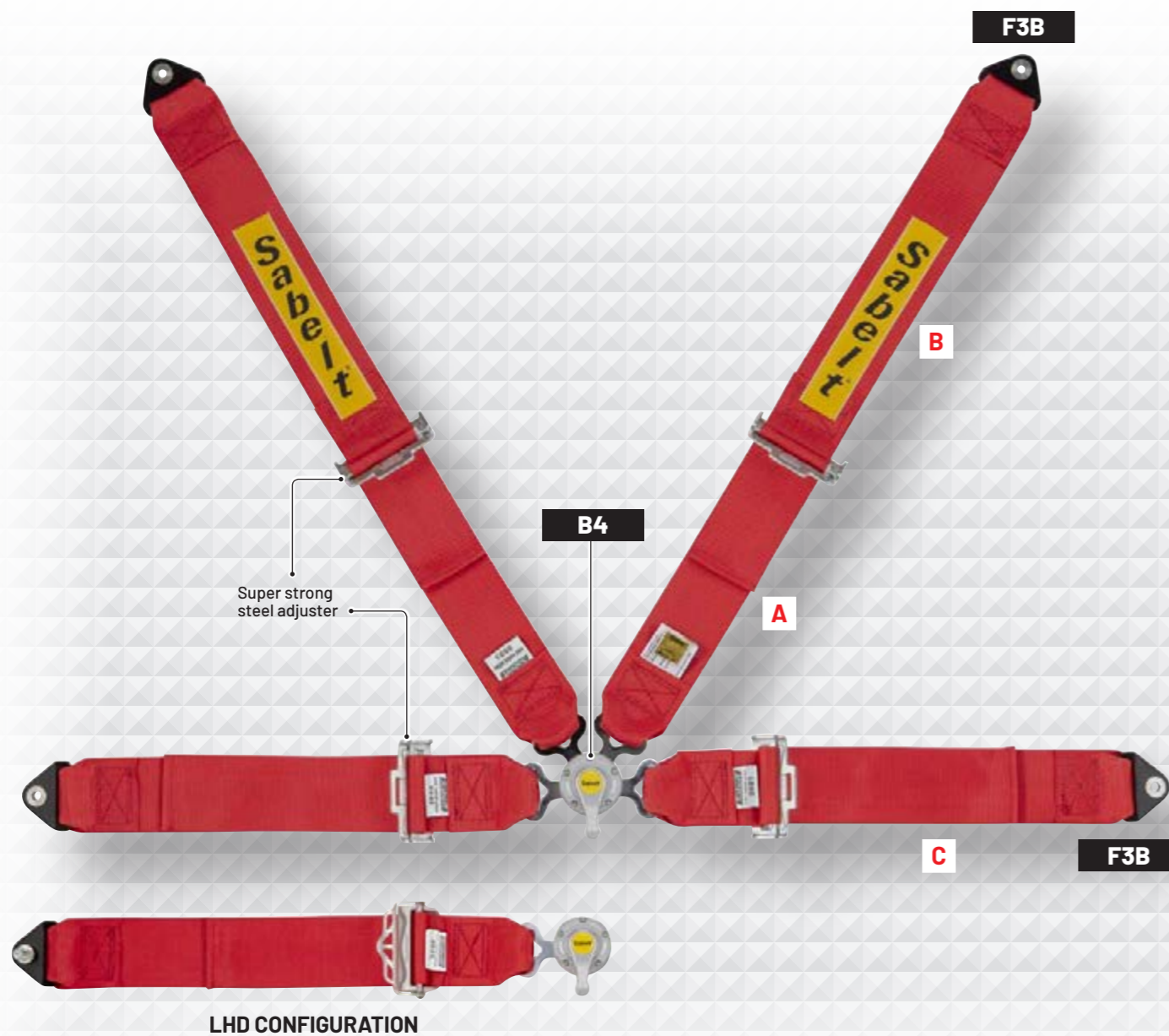

SALOON - FOR KIT CAR "C"				STEEL	FIA 8854/98	
STANDARD MEASURES (mm)				STANDARD COLOURS/CODES		
A	B	C				
480	450	130+610		CCS433SRDN	CCS433SNDN	CCS433SBDN

CONFIGURATIONS ON DEMAND



CCS433SRUN

STANDARD FEATURES

SALOON				STEEL	FIA 8854/98	
STANDARD MEASURES (mm)				STANDARD COLOURS/CODES		
A	B	C				
380	1700	560+120		CCS433SRUN	CCS433SNUN	CCS433SBUN



EYE BOLTS AND PLATES



407005_C
Standard eye-bolt diam. 7/16" UNF thread length 23 mm, 25 mm tot., 8.8.



CCM10023
Eye-bolt metric M10 x 1.5 thread length 23 mm, 8.8. Does not comply with FIA requirements.



CCM10017_A WESTFIELD
Eye-bolt 50 mm. long, 7/16", 8.8





CCM10016
Eye-bolt back plate 65 mm x 65 mm x 3 mm 7/16" UNF thread welded nut, 40 mm². Complies with FIA requirements.

PADS



Vep fabric shoulder cover. 75 mm (3") width. hook and loop fastener fastening.

		
475040	475020	475010



Vep fabric shoulder cover. 50 mm (2") width. hook and loop fastener fastening.

		
450040/S	450020/S	450010/S

COLORED GADGET KIT FOR ENDURANCE BUCKLES B1 TYPE





CCAC0104_KIT
Straps.
NEW

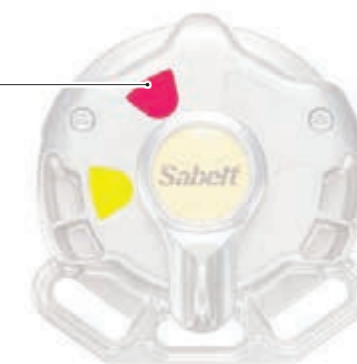

CCET0408_KIT
Stickers.
NEW





CFCC4046**SALOON**

FIXING POINTS	4
HOMOLOGATION	NOT HOMOLOGATED
STANDARD COLOURS/CODES	
	CFCC4046
	CFCC2046
	CFCC1046



Available on demand buckle with switch for SBR sensor

**CFCC904001NP_A****SALOON**

FIXING POINTS	4
HOMOLOGATION	ECE
Homologation updated to series 08	
STANDARD COLOURS/CODES	
	CFCC904001NP_A
	CFCC902001NP_A
	CFCC901001NP_A



Available on demand buckle with switch for SBR sensor

**CFCC904070NP_B****SALOON**

FIXING POINTS	4
HOMOLOGATION	ECE
Homologation updated to series 08	
STANDARD COLOURS/CODES	
	CFCC904070NP_B
	CFCC902070NP_B
	CFCC901070NP_B



Available on demand buckle with switch for SBR sensor

**CFCC904059NP_B****SALOON**

FIXING POINTS	3
HOMOLOGATION	ECE
Homologation updated to series 08	
STANDARD COLOURS/CODES	
	CFCC904059NP_B
	CFCC902059NP_B
	CFCC901059NP_B



Available on demand buckle with switch for SBR sensor

**CFCC904005N_B****SALOON**

FIXING POINTS	3
HOMOLOGATION	ECE
Homologation updated to series 08	
STANDARD COLOURS/CODES	
	CFCC904005N_B
	CFCC902005N_B
	CFCC901005N_B

Available on demand buckle with switch for SBR sensor

**CFCC904002NP_A****SALOON**



FIXING POINTS	3
HOMOLOGATION	ECE
Homologation updated to series 08	
STANDARD COLOURS/CODES	
	CFCC904002NP_A
	CFCC902002NP_A
	CFCC901002NP_A

Available on demand buckle with switch for SBR sensor



CCS622SNUSFI

STANDARD FEATURES

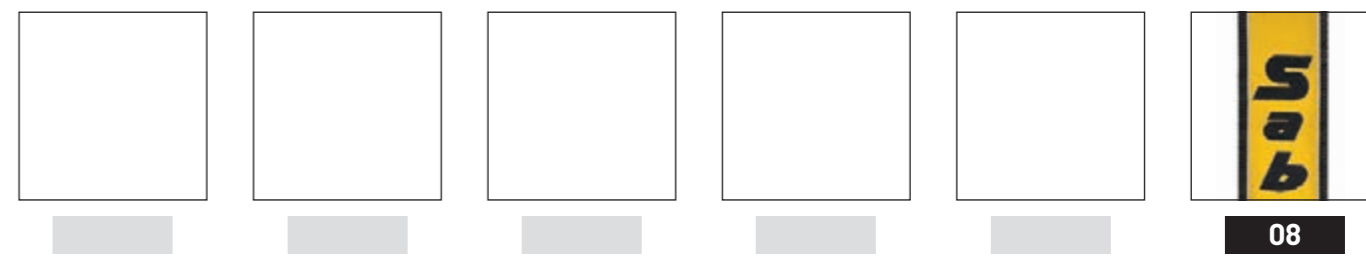

				STEEL	SFI 16.1	
STANDARD MEASURES (MM)				STANDARD COLOURS/CODES		
A	B	C	D			
440	1700	560+120	1080	CCS622SRUSFI	CCS622SNUSFI	CCS622SBUSFI

CONFIGURATIONS ON DEMAND



CCS533SNULLSFI

STANDARD FEATURES

				STEEL	SFI 16.1	
STANDARD MEASURES (mm)				STANDARD COLOURS/CODES		
A	B	C	D			
380	1700	680	770	CCS533SRULLSFI	CCS533SNULLSFI	CCS533SBULLSFI

CONFIGURATIONS ON DEMAND

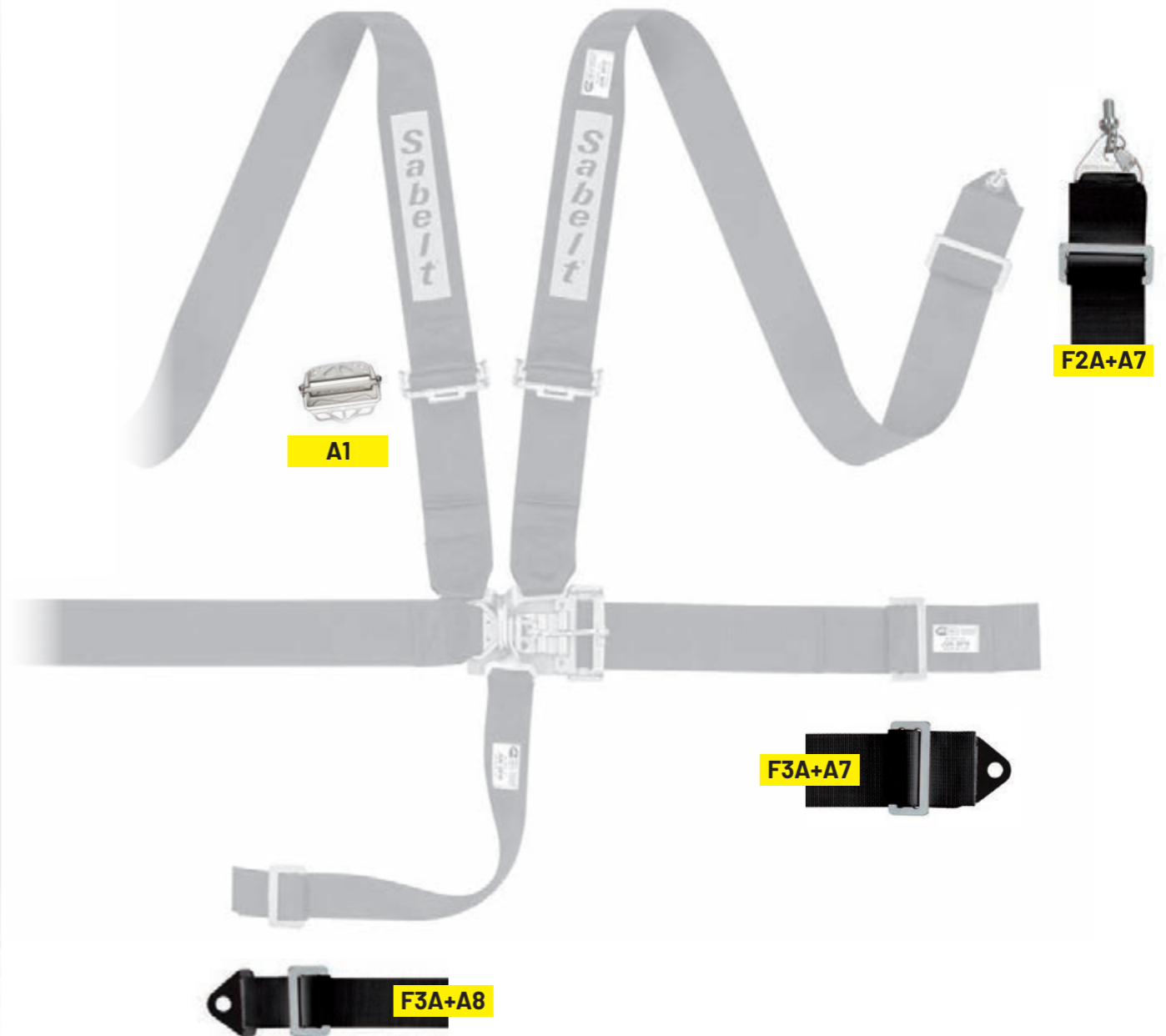
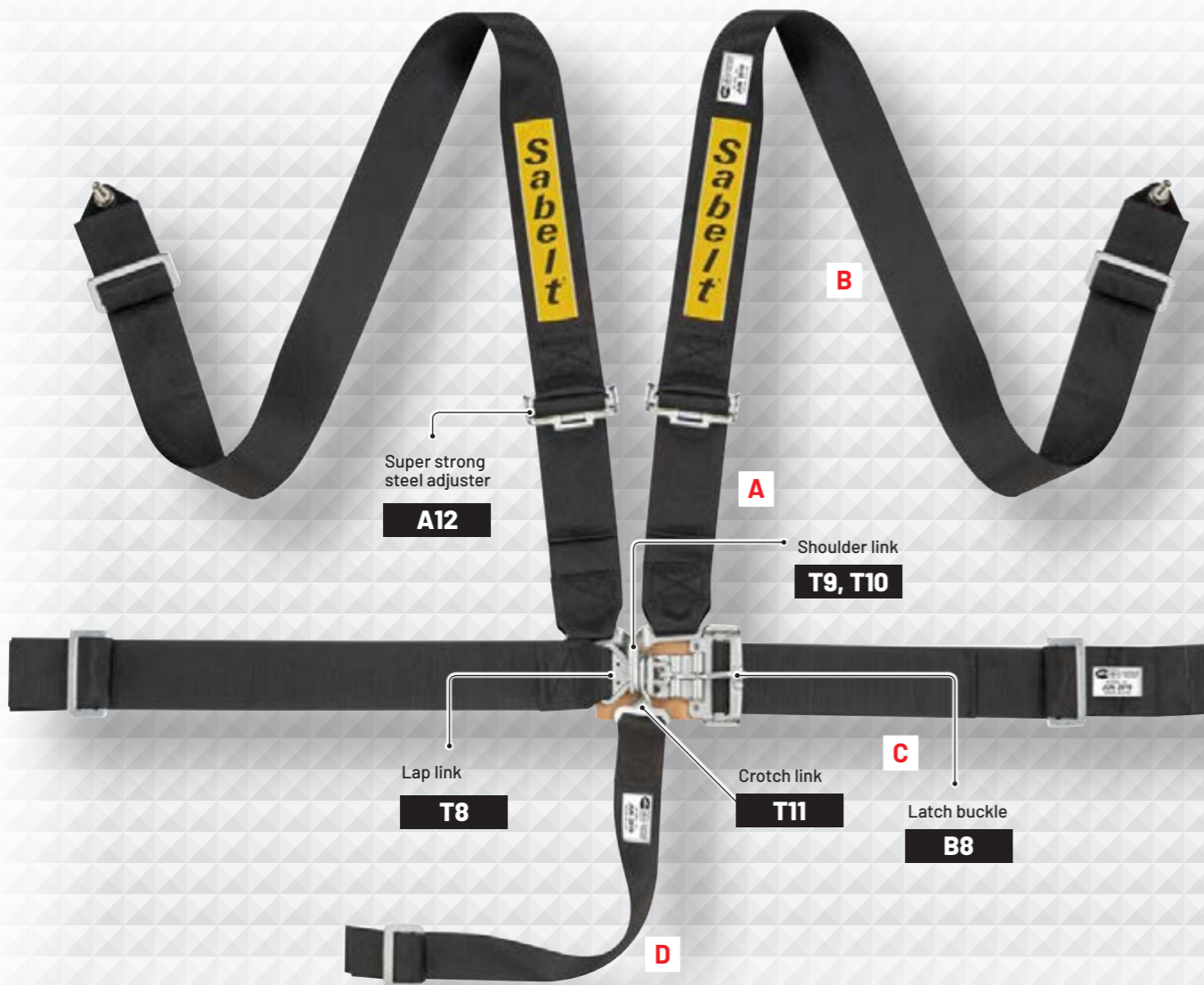
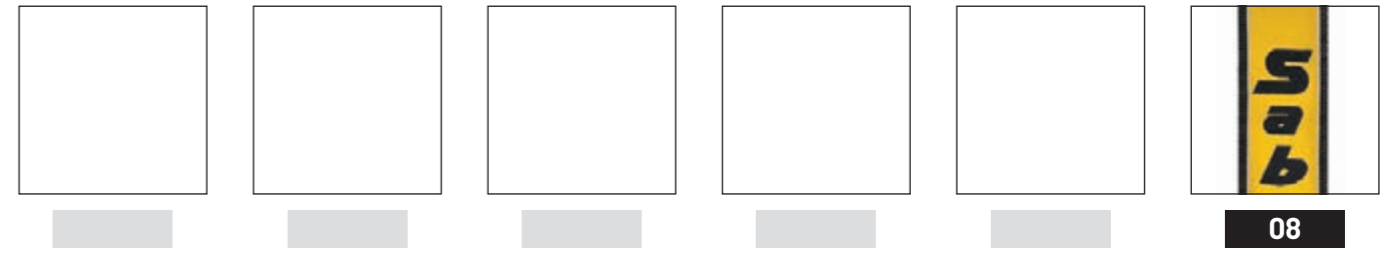

CFRN2008

RACING NET

NEW



MANUFACTURER: SABELT
MODEL: CFRN2008
HOM. NO: RN.025.21
FIA STANDARD: 8863-2013

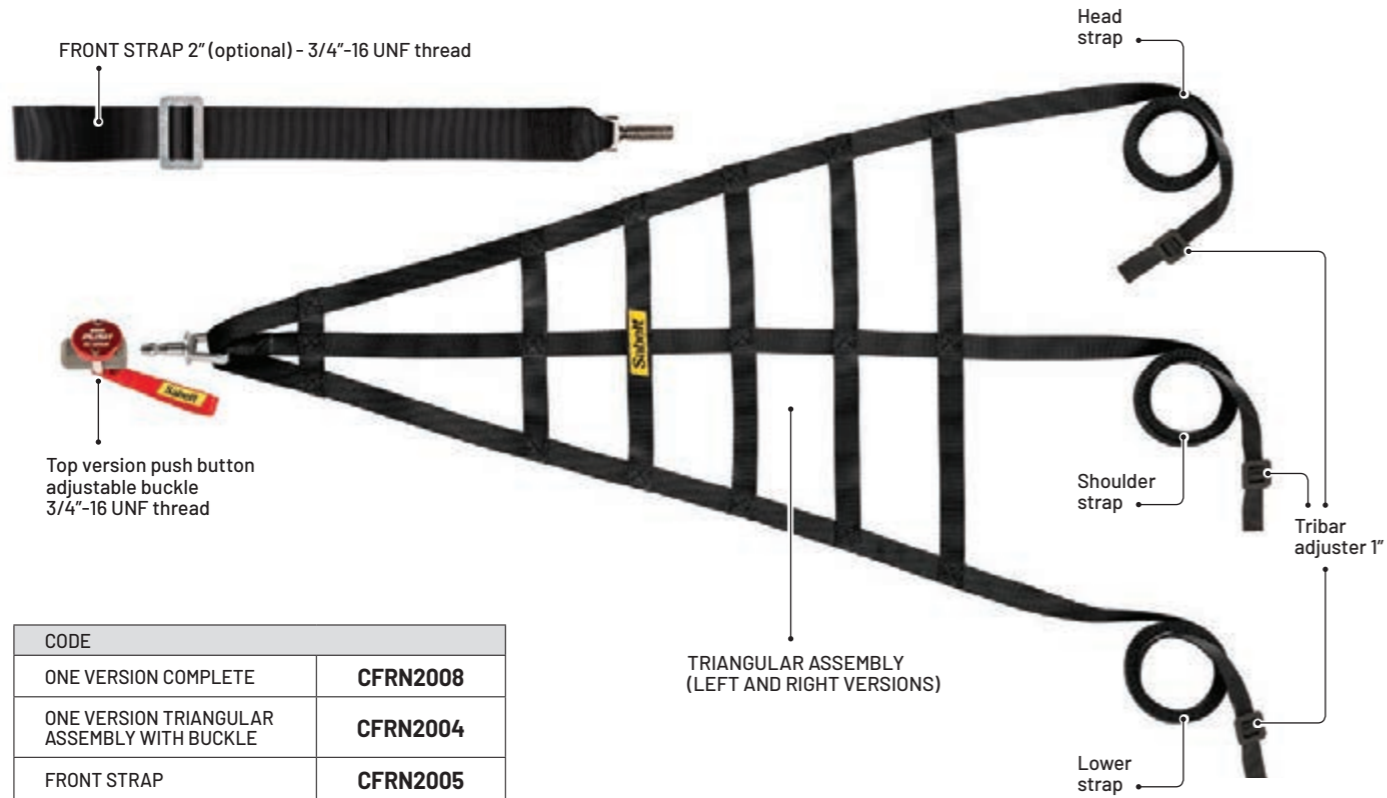

CODE	
ONE VERSION COMPLETE	CFRN2008
ONE VERSION TRIANGULAR ASSEMBLY WITH BUCKLE	CFRN2004
FRONT STRAP	CFRN2005

CFRN2002

RACING NET



MANUFACTURER: SABELT
MODEL: CFRN2002
HOM. NO: RN.020.20
FIA STANDARD: 8863-2013

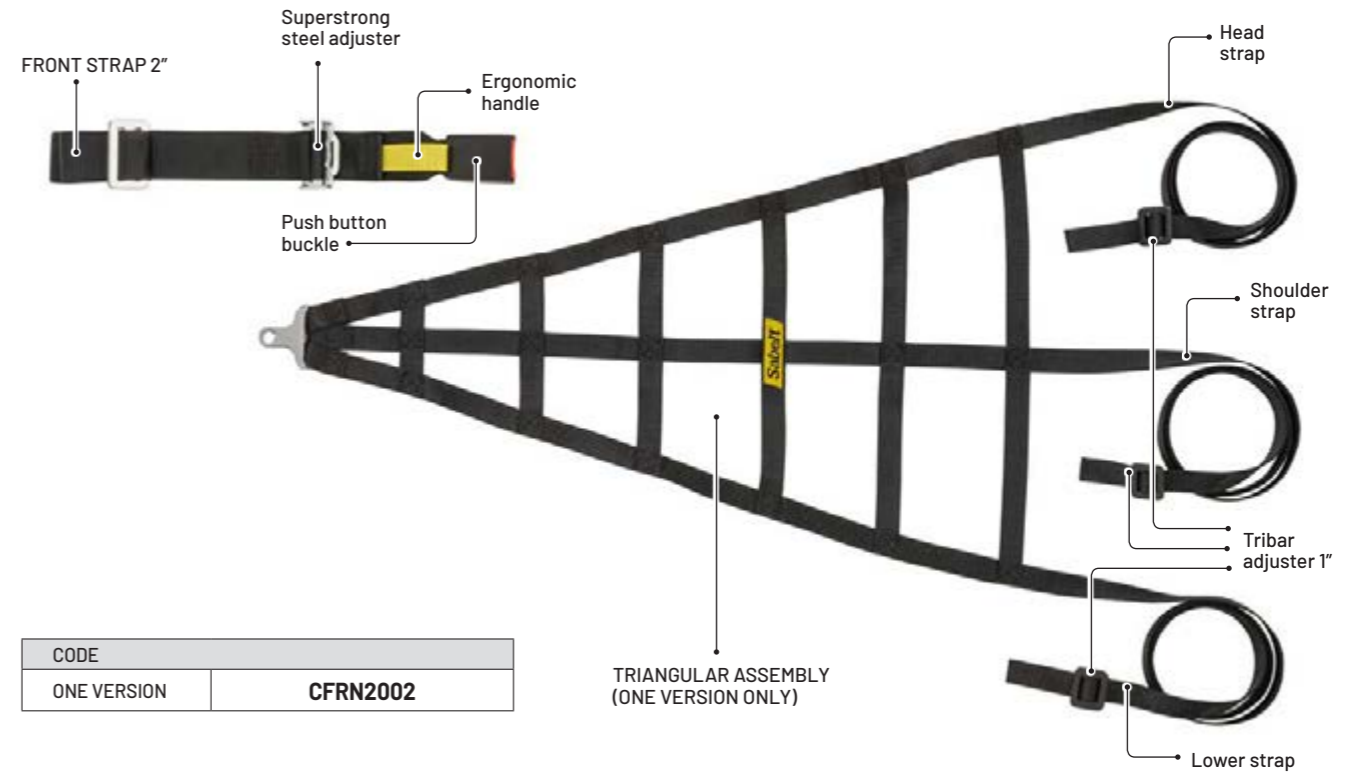

CODE	
ONE VERSION	CFRN2002

CFRN2003

RACING NET



MANUFACTURER: SABELT
MODEL: CFRN2003
HOM. NO: RN.015.18
FIA STANDARD: 8863-2013

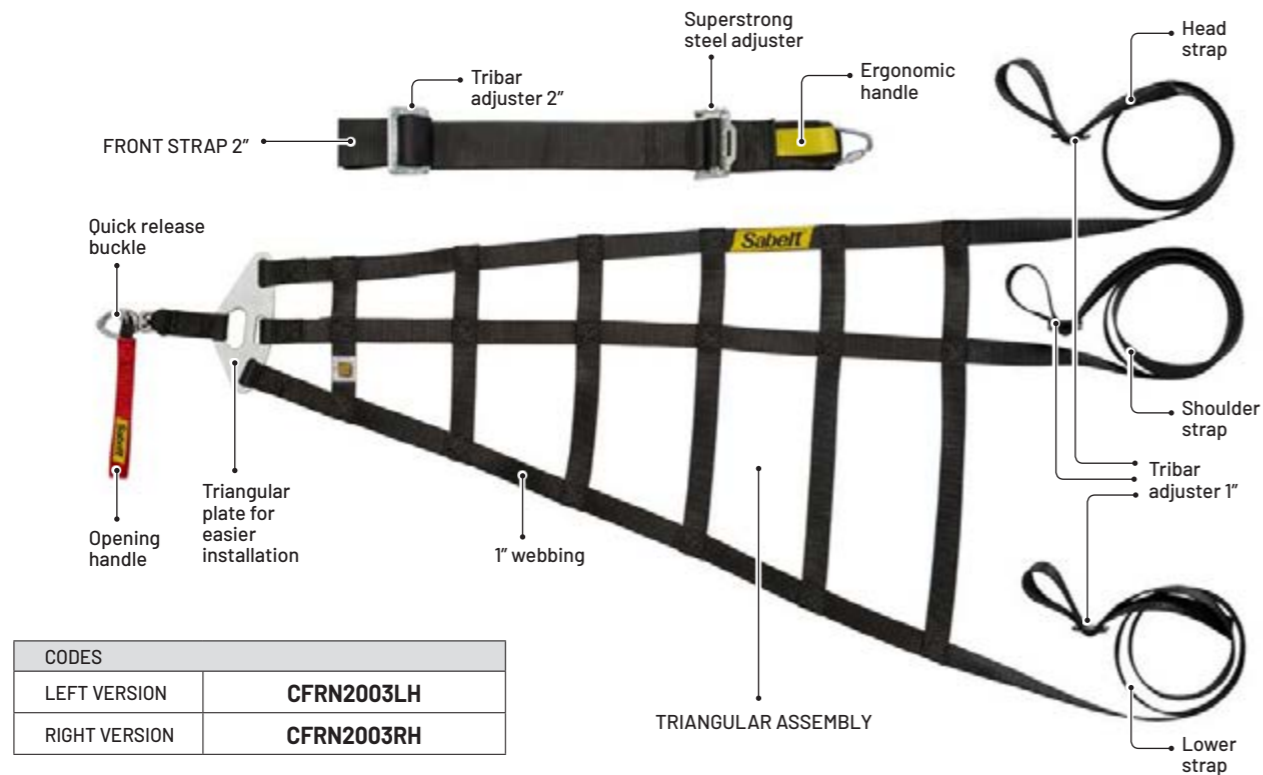

CODES	
LEFT VERSION	CFRN2003LH
RIGHT VERSION	CFRN2003RH

Z280988

WINDOW NET

Professional window net. • Quick release with push button
• Rollcage fixing clamps • Tightening adjusters
• Rigid metal bars • Polyester webbing
In compliance with Fia regulation.

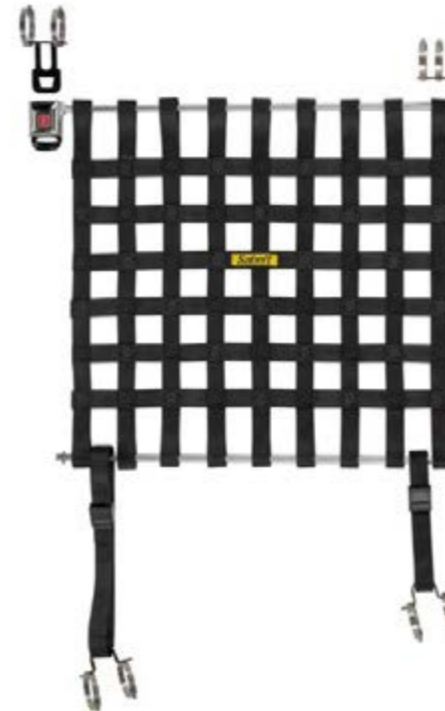

Z280985

WINDOW NET

Professional window net • Red webbing opening System • Rollcage mounting
• Tightening adjusters • Polyester webbing
In compliance with Fia regulation.

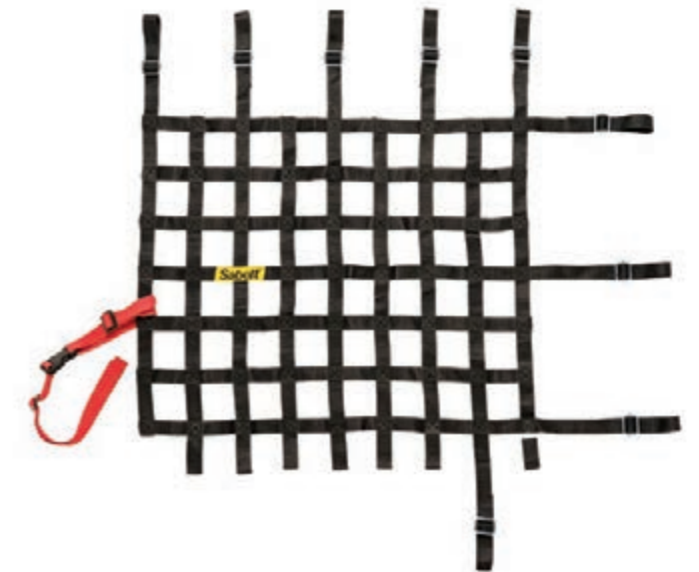

SEATS

Sabelt

Sabelt



OFFICIAL SUPPLIER

PORSCHE
MOTORSPORT

FIA 8862-2009

GT/RALLY/CIRCUIT

**GT-PRO**

- Shell: CARBON
- Fixing: BRACKETS
- Size: M-L-XL

**GT-635**

- Shell: CARBON
- Fixing: BRACKETS
- Size: M-L-XL

**GT-621**

- Shell: CARBON
- Fixing: BRACKETS
- Size: M-L

CIRCUIT ONLY

**GT-PRO XL 6-POINT**

- Shell: CARBON
- Fixing: BRACKETS
- Size: XL

**GT-635**

- Shell: CARBON
- Fixing: BRACKETS/SLIDING TRACKS
- Size: M-L-XL

**GT-E**

- Shell: CARBON
- Fixing: BRACKETS
- Size: M

SFI 39.1

NASCAR

**GT-910**

- Shell: CARBON
- Fixing: BRACKETS
- Size: M

FIA 8855-2021 • NEW HOMOLOGATION

HEAD PROTECTION

**SPINE**

- Shell: FIBERGLASS
- Fixing: BRACKETS
- Size: L-XL

NEW**GT-AM**

- Shell: FIBERGLASS
- Fixing: BRACKETS
- Size: M-L-XL

NEW

FIA 8855-1999

HEAD PROTECTION

**X-PAD CARBON**

- Shell: CARBON
- Fixing: BRACKETS
- Size: L

**X-PAD RALLYCROSS**

- Shell: FIBERGLASS
- Fixing: BRACKETS
- Size: L

**X-PAD**

- Shell: FIBERGLASS
- Fixing: BRACKETS
- Size: L

**GT-PAD**

- Shell: FIBERGLASS
- Fixing: BRACKETS
- Size: M-L-XL

**TAURUS**

- Shell: FIBERGLASS
- Fixing: BRACKETS
- Size: M-L-XL

NO HEAD PROTECTION

**TITAN CARBON**

- Shell: CARBON
- Fixing: BRACKETS
- Size: L-XL

**TITAN**

- Shell: FIBERGLASS
- Fixing: BRACKETS
- Size: XL

**GT-3**

- Shell: FIBERGLASS
- Fixing: BRACKETS
- Size: L

**RACER DUO**

- Shell: STEEL TUBE
- Fixing: BRACKETS
- Size: L

CUSHIONS - TITAN / TAURUS

**S1**

Seatback cushion th. 20 mm

TITAN	RRTITAU002_A
TITAN MAX	RRTITAU003_A
TAURUS	RRTITAU002_A
TAURUS MAX	RRTITAU003_A

**CS1**

Lower cushion th. 20 mm

TITAN	RRTITAU004_A
TITAN MAX	RRTITAU007_A
TAURUS	RRTITAU004_A
TAURUS MAX	RRTITAU007_A

**CS2**

Lower cushion th. 40 mm

TITAN	RRTITAU005_A
TITAN MAX	RRTITAU008_A
TAURUS	RRTITAU005_A
TAURUS MAX	RRTITAU008_A

**CS3**

Lower cushion th. 50 mm

TITAN	RRTITAU006_A
TITAN MAX	RRTITAU009_A
TAURUS	RRTITAU006_A
TAURUS MAX	RRTITAU009_A

**PG1**

Leg cushion th. 40 mm

TITAN	RRTITAU010_A
TITAN MAX	RRTITAU012_A
TAURUS	RRTITAU010_A
TAURUS MAX	RRTITAU012_A

**PG2**

Leg cushion th. 50 mm

TITAN	RRTITAU011_A
TITAN MAX	RRTITAU013_A
TAURUS	RRTITAU011_A
TAURUS MAX	RRTITAU013_A

**CPR**

Lower back support

RRTITAU014_A

**CL**

Lumbar support

RRTITAU001_A

CUSHIONS - GT-PRO / GT-AM

**S3**

Seatback cushion th. 20 mm

RRGTPRO0014

NEW**CS5**

Seat cushion

th. 20 mm	RRGTPRO0016
th. 40 mm	RRGTPRO0040

NEW**CS4**

Leg cushion

th. 20 mm	RRGTPRO0015
th. 40 mm	RRGTPRO0045

NEW**S2**

Size pads

th. 10 mm	RRGTPRO0041
th. 20 mm	RRGTPRO0042
th. 25 mm	RRGTPRO0043
th. 30 mm	RRGTPRO0044

NEW

SET

**KF**

Seat cover kit.

GT-621 Size M	RRGT621019
GT-621 Size L	RRGT621020
GT-625 Size L	RRGT625018
GT-635 Size M	RRGT635015
GT-635 Size L	RRGT635016
GT-635 Size XL	RRGT635017

**KFP**

Seat cover kit with bezels.

TITAN	RRTITAN021
TITAN MAX	RRTITAN022
TITAN CARBON	RRTITCAR026
TITAN MAX CARBON	RRTITCAR027
TAURUS M	RRTAURUS023
TAURUS	RRTAURUS024
TAURUS MAX	RRTAURUS025

HARNESS SLOT

**KP1**

Bezels for 8855 seats.

RCB00009 - RCB00010

**KP2**

Bezels for 8855 seats.

RCB00007 - RCB00008

**MP**

Bezel for GT-635 and GT-625.

RCB00011

INDI SEAT - Sabelt Official Distributor



Inner seat customization kit

RCIM0002

NEW

FIXING FRAMES



F1
Steel brackets, th. 3mm, in compliance with FIA.
Z200087_A



F2
Aluminium brackets, th. 5 mm, in compliance with FIA.
Z20005_C



F3
Sliding tracks, travel 230 mm. No FIA.
Z200002_A



F4
Steel brackets for GT-635, Fia homologated. Bolts included.
Note: Specify the seat size during the order.
RCST635FIX



F5
Sliding tracks for GT-635. FIA Homologated. Bolts included.
Size M: **RCST635SLIDINGM**
Size L/XL: **RCST635SLIDINGXL**



F6
Steel brackets for GT-621, FIA homologated. Bolts included.
XRFST0007



F8
Brackets for GT-PRO M. FIA Homologated. Bolts included.
RFST0025



F10
Steel brackets for GT-E, FIA homologated. Bolts included.
RCST0005



F11 **NEW**
Brackets for GT-PRO XL. FIA Homologated. Bolts included.
RFST0032 - RFST0033 - RFST0036
RFST0038 - RFST0047



F12 **NEW**
Steel bracket for 8855-2021 homologated seats. Bolts included.
RFST0051

LEGEND SEAT DIMENSIONS CHART

SHELL DIMENSIONS (mm)

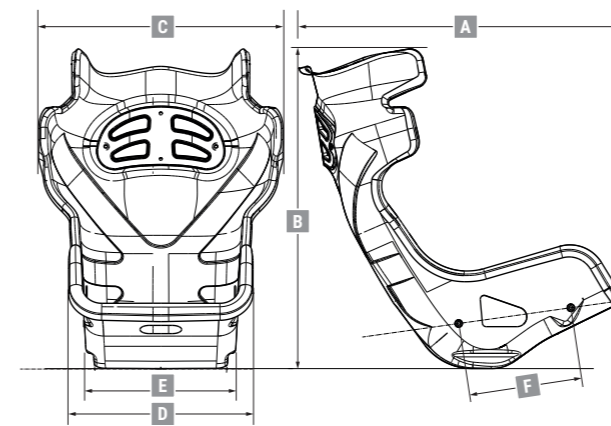

A	Length
B	Height
C	External shoulder width
D	External lower frontal width
E	External lower rear width
F	Lateral interaxis distance
⊞	Shell weight (kg)

INTERNAL SEAT DIMENSIONS (mm)



G	Rear lower cushion width
H	Frontal lower cushion width
I	Internal shoulder width
L	Central seatback width
M	Internal head protection width
N	Central bezel height
⊞	Seat weight (kg)

SEAT FLOOR FIXING INTERAXIS

8862-2009 / 8855-2021

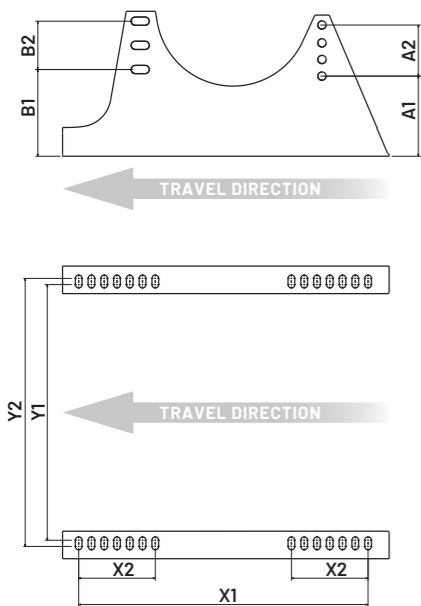

8855-1999

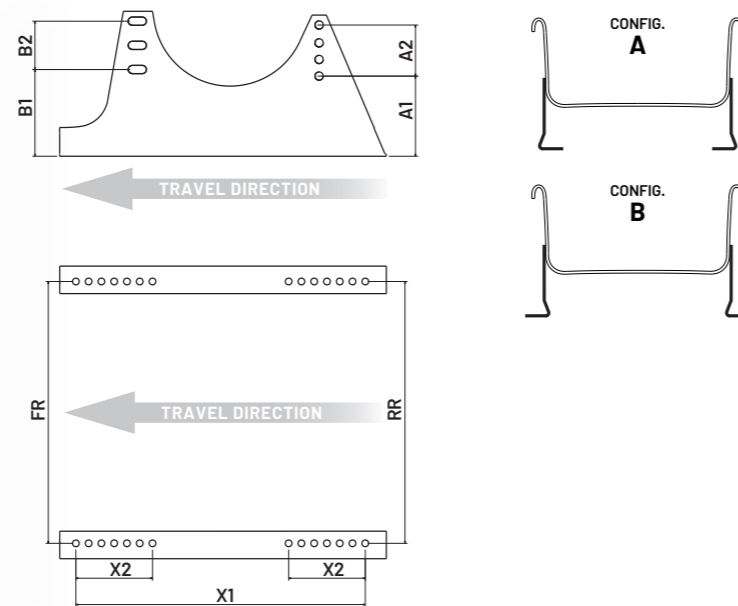

8862-2009

GTPRO

		A1(mm)	A2(mm)	B1(mm)	B2(mm)	Y1(mm)	Y2(mm)	X1(mm)	X2(mm)	CHASSIS FIXING			SEAT FIXING		
										SCREW	Q.TY	STRENGTH CLASS	SCREW	Q.TY	STRENGTH CLASS
F8	RFST0025	58,5	20	105	22	428,5	435,5	406,5	40	M8	8	12,9	M12	4	12,9
	RFST0028	73		119,5	22,5	416	448	406,5	40	M8	8	12,9	M12	4	12,9
	RFST0032	67,5	30	84,5	60	475,4	488,4	401	59	M8	8	12,9	M12	4	12,9
F11	RFST0033	127	30	144	60	475,4	488,4	401	59	M8	8	12,9	M12	4	12,9
	RFST0036	94	/	124,5	23	418,5	445	406,5	40	M8	8	12,9	M12	4	12,9
	RFST0038	50,5	20	84	20	473	483	391,8	40	M8	8	12,9	M12	4	12,9
	RFST0047	90,5	20	124	40	472,7	482,5	391,8	40	M8	8	12,9	M12	4	12,9

GT-635 M e XL

		A1(mm)	A2(mm)	B1(mm)	B2(mm)	Y1(mm)	Y2(mm)	X1(mm)	X2(mm)	CHASSIS FIXING			SEAT FIXING		
										SCREW	Q.TY	STRENGTH CLASS	SCREW	Q.TY	STRENGTH CLASS
F4	RFST0011	106	18	146	34	432		406,5	40	M8	8	12,9	M12	4	12,9
F5	RFST635M_LA RFST635XL_LA	106	18	146	34	432		406,5		M8	8	12,9	M12	4	12,9

GT-621

		A1(mm)	A2(mm)	B1(mm)	B2(mm)	Y1(mm)	Y2(mm)	X1(mm)	X2(mm)	CHASSIS FIXING			SEAT FIXING		
										SCREW	Q.TY	STRENGTH CLASS	SCREW	Q.TY	STRENGTH CLASS
F6	XRFST0007	26,7	18,5	109,5	17	484	499,7	380	/	M10	4	MIN 10.9	M12	4	12,9

GTE

		A1(mm)	A2(mm)	B1(mm)	B2(mm)	Y1(mm)	Y2(mm)	X1(mm)	X2(mm)	CHASSIS FIXING			SEAT FIXING		
										SCREW	Q.TY	STRENGTH CLASS	SCREW	Q.TY	STRENGTH CLASS
F10	RCST0005	170,5	20	160	20	479	/	382,5	50	M12	4	12,9	M12	4	12,9

8855-2021

SPINE

		A1(mm)	A2(mm)	B1(mm)	B2(mm)	Y1(mm)	Y2(mm)	X1(mm)	X2(mm)	CHASSIS FIXING			SEAT FIXING		
										SCREW	Q.TY	STRENGTH CLASS	SCREW	Q.TY	STRENGTH CLASS
F12	RFST0051	125,5	80	136	75,5	419	438,5	453	120	M10	4	12,9	M12	4	12,9

GT-AM

		A1(mm)	A2(mm)	B1(mm)	B2(mm)	Y1(mm)	Y2(mm)	X1(mm)	X2(mm)	CHASSIS FIXING			SEAT FIXING		
										SCREW	Q.TY	STRENGTH CLASS	SCREW	Q.TY	STRENGTH CLASS
F12	RFST0051	125,5	80	136	75,5	413	429	453	120	M10	4	12,9	M12	4	12,9

8855-1999

X-PAD

		CONFIG.	A1(mm)	A2(mm)	B1(mm)	B2(mm)	FR(mm)	RR(mm)	X1(mm)	X2(mm)	CHASSIS FIXING		SEAT FIXING	
											SCREW	Q.TY	SCREW	Q.TY
F1	Z200087_A	A	70,5	54	72	72	356	349	329,5	36	M8	4	M8	4
	Z200087_A	B	70,5	54	72	72	444	438	329,5	36	M8	4	M8	4
F2	Z20005_C	A	63	79,5	63	79,5	348	343,4	324	34	M8	4	M8	4
	Z20005_C	B	63	79,5	63	79,5	456	447,6	324	34	M8	4	M8	4

GT-PAD

		CONFIG.	A1(mm)	A2(mm)	B1(mm)	B2(mm)	FR(mm)	RR(mm)	X1(mm)	X2(mm)	CHASSIS FIXING		SEAT FIXING	
											SCREW	Q.TY	SCREW	Q.TY
F1	Z200087_A	A	70,5	54	72	72	426	418	329,5	36	M8	4	M8	4
	Z200087_A	B	70,5	54	72	72	518	508	329,5	36	M8	4	M8	4
F2	Z20005_C	A	63	79,5	63	79,5	422	415	324	34	M8	4	M8	4
	Z20005_C	B	63	79,5	63	79,5	534	518	324	34	M8	4	M8	4

TAURUS M

		CONFIG.	A1(mm)	A2(mm)	B1(mm)	B2(mm)	FR(mm)	RR(mm)	X1(mm)	X2(mm)	CHASSIS FIXING		SEAT FIXING	
											SCREW	Q.TY	SCREW	Q.TY
F1	Z200087_A	A	70,5	54	72	72	352,6	335,3	329,5	36	M8	4	M8	4
	Z200087_A	B	70,5	54	72	72	441,8	424,5	329,5	36	M8	4	M8	4
F2	Z20005_C	A	63	79,5	63	79,5	345,2	329,9	324	34	M8	4	M8	4
	Z20005_C	B	63	79,5	63	79,5	453,2	433,9	324	34	M8	4	M8	4

TAURUS L

		CONFIG.	A1(mm)	A2(mm)	B1(mm)	B2(mm)	FR(mm)	RR(mm)	X1(mm)	X2(mm)	CHASSIS FIXING		SEAT FIXING	
											SCREW	Q.TY	SCREW	Q.TY
F1	Z200087_A	A	70,5	54	72	72	358,8	350,7	329,5	36	M8	4	M8	4
	Z200087_A	B	70,5	54	72	72	448	439,9	329,5	36	M8	4	M8	4
F2	Z20005_C	A	63	79,5	63	79,5	351,4	345,3	324	34	M8	4	M8	4
	Z20005_C	B	63	79,5	63	79,5	459,4	449,3	324	34	M8	4	M8	4

TAURUS XL

		CONFIG.	A1(mm)	A2(mm)	B1(mm)	B2(mm)	FR(mm)	RR(mm)	X1(mm)	X2(mm)	CHASSIS FIXING		SEAT FIXING	
											SCREW	Q.TY	SCREW	Q.TY
F1	Z200087_A	A	70,5	54	72	72	381,5	350,7	329,5	36	M8	4	M8	4
	Z200087_A	B	70,5	54	72	72	470,7	439,9	329,5	36	M8	4	M8	4
F2	Z20005_C	A	63	79,5	63	79,5	374,1	345,3	324	34	M8	4	M8	4
	Z20005_C	B	63	79,5	63	79,5	482,1	449,3	324	34	M8	4	M8	4

TITAN XL

		CONFIG.	A1(mm)	A2(mm)	B1(mm)	B2(mm)	FR(mm)	RR(mm)	X1(mm)	X2(mm)	CHASSIS FIXING		SEAT FIXING	
											SCREW	Q.TY	SCREW	Q.TY
F1	Z200087_A	A	70,5	54	72	72	382,3	373,9	329,5	36	M8	4	M8	4
	Z200087_A	B	70,5	54	72	72	471,5	463,1	329,5	36	M8	4	M8	4
F2	Z20005_C	A	63	79,5	63	79,5	374,9	368,5	324	34	M8	4	M8	4
	Z20005_C	B	63	79,5	63	79,5	482,9	472,5	324	34	M8	4	M8	4

GT-3

		CONFIG.	A1(mm)	A2(mm)	B1(mm)	B2(mm)	FR(mm)	RR(mm)	X1(mm)	X2(mm)	CHASSIS FIXING		SEAT FIXING	
											SCREW	Q.TY	SCREW	Q.TY
F1	Z200087_A	A	70,5	54	72	72	390,1	374,2	329,5	36	M8	4	M8	4
	Z200087_A	B	70,5	54	72	72	479,3	463,4	329,5	36	M8	4	M8	4
F2	Z20005_C	A	63	79,5	63	79,5	382,7	368,8	324	34	M8	4	M8	4
	Z20005_C	B	63	79,5	63	79,5	490,7	472,8	324	34	M8	4	M8	4

RACER DUO

		CONFIG.	A1(mm)	A2(mm)	B1(mm)	B2(mm)	FR(mm)	RR(mm)	X1(mm)	X2(mm)	CHASSIS FIXING		SEAT FIXING	
											SCREW	Q.TY	SCREW	Q.TY
F1	Z200087_A	A	70,5	54	72	72	381,8	380,4	329,5	36	M8	4	M8	4
	Z200087_A	B	70,5	54	72	72	471	469,6	329,5	36	M8	4	M8	4
F2	Z20005_C	A	63	79,5	63	79,5	374,4	375	324	34	M8	4	M8	4
	Z20005_C	B	63	79,5	63	79,5	482,4	479	324	34	M8	4	M8	4

GT-PRO

8862-2009

GT/RALLY/CIRCUIT

CARBON	SHELL SIZE	FIXING	FIA
	M - XL	BRACKETS	8862-2009

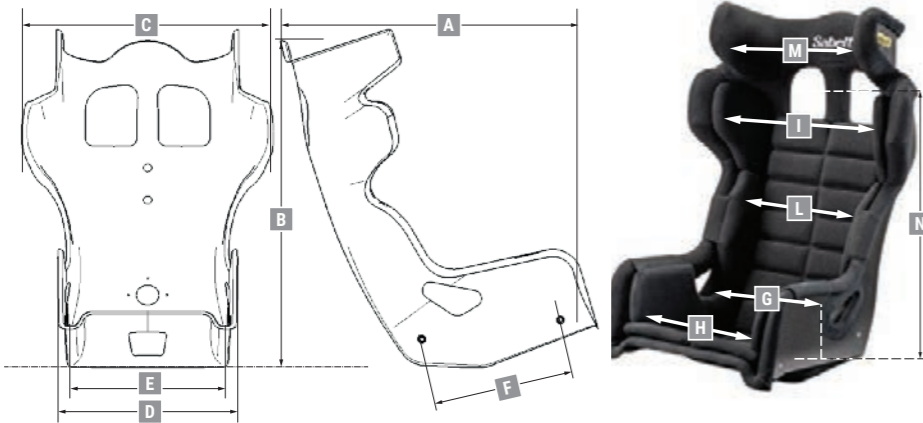

	Sizes		
	M	L	XL
SHELL DIMENSIONS (mm)			
A	825	795	
B	770	770	
C	625	644	
D	443	482	
E	389	427	
F	340	340	
Ⓜ	8,5	9,3	
INTERNAL SEAT DIMENSIONS (mm)			
G	302	325	340
H	343	335	350
I	430	440	450
L	321	340	370
M	328	330	330
N	512	512	512
Ⓜ	10,1	11,2	11,2



FIXING BRACKETS



FLOOR FIXING

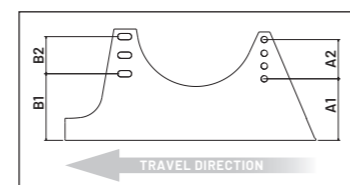

SEE SCHEME ON PAGE 68



• Size: **M**
• Cod: **RFSEGTPROPADM**



MANUFACTURER: SABELT
MODEL: GT-PRO M
HOM. NO: AS.081.19
FIA STANDARD: 8862-2009

• Size: **L**
• Cod: **RFSEGTPROPADL**



MANUFACTURER: SABELT
MODEL: GT-PRO XL
HOM. NO: AS.086.20
FIA STANDARD: 8862-2009

• Size: **XL**
• Cod: **RFSEGTPROPADXL**



MANUFACTURER: SABELT
MODEL: GT-PRO XL
HOM. NO: AS.086.20
FIA STANDARD: 8862-2009

GT-635

8862-2009

CIRCUIT ONLY (with sliding tracks) - GT/RALLY/CIRCUIT (with fixed brackets)

CARBON	SHELL SIZE	FIXING	FIA
	M - XL	BRACKETS	8862-2009

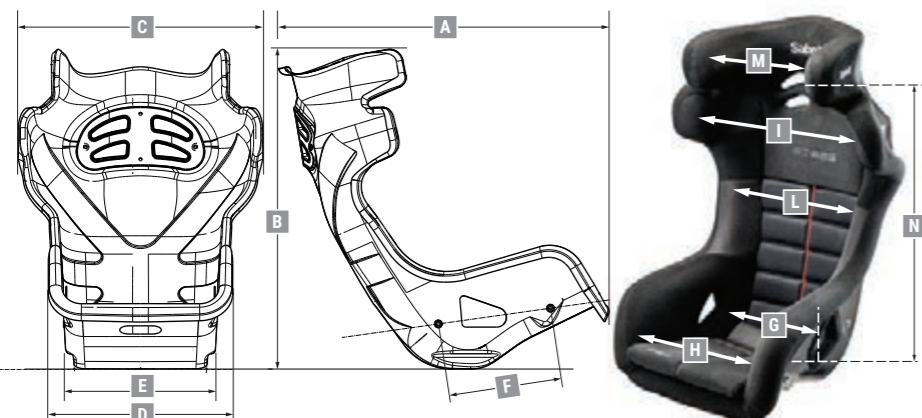

	Sizes		
	M	L	XL
SHELL DIMENSIONS (mm)			
A	530	540	
B	910	930	
C	656	676	
D	472	502	
E	400	430	
F	290	290	
⊕	8,4	11,3	
INTERNAL SEAT DIMENSIONS (mm)			
G	316	337	357
H	349	364	384
I	541	546	566
L	368	417	437
M	317	325	325
N	670	656	656
⊕	10,9	13,8	13,5

SPARES AND ACCESSORIES



KF



FIXING BRACKETS



F4 GT/CIRCUIT



F5 CIRCUIT ONLY

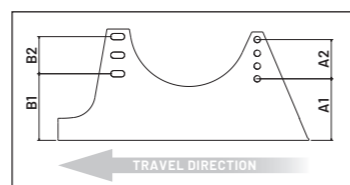

SEE SCHEME ON PAGE 68

FLOOR FIXING



• CIRCUIT ONLY

• with sliding tracks

• Size: **M**

• Cod: **RFSEGT635DMN**



MANUFACTURER: SABELT
MODEL: GT-635 M
HOM. NO: AS.057.16
FIA STANDARD: 8862-2009

• Size: **L**

• Cod: **RFSEGT635DLN**



MANUFACTURER: SABELT
MODEL: GT-635 XL
HOM. NO: AS.058.16
FIA STANDARD: 8862-2009

• Size: **XL**

• Cod: **RFSEGT635DXLN**



MANUFACTURER: SABELT
MODEL: GT-635 XL
HOM. NO: AS.058.16
FIA STANDARD: 8862-2009

• GT/RALLY/CIRCUIT

• with fixed brackets

• Size: **M**

• Cod: **RFSEGT635MN**



MANUFACTURER: SABELT
MODEL: GT-635 M
HOM. NO: AS.060.16
FIA STANDARD: 8862-2009

• Size: **L**

• Cod: **RFSEGT635LN**



MANUFACTURER: SABELT
MODEL: GT-635 XL
HOM. NO: AS.061.16
FIA STANDARD: 8862-2009

• Size: **XL**

• Cod: **RFSEGT635XLN**



MANUFACTURER: SABELT
MODEL: GT-635 XL
HOM. NO: AS.061.16
FIA STANDARD: 8862-2009

GT-PRO XL 6-POINT

8862-2009

CIRCUIT ONLY

CARBON	SHELL SIZE	FIXING	FIA
	XL	BRACKETS	8862-2009

Sizes	
XL	
SHELL DIMENSIONS (mm)	
A	795
B	770
C	644
D	482
E	427
F	340
Ⓛ	9,3
INTERNAL SEAT DIMENSIONS (mm)	
G	346
H	350
I	510
L	372
M	350
N	512
Ⓛ	11

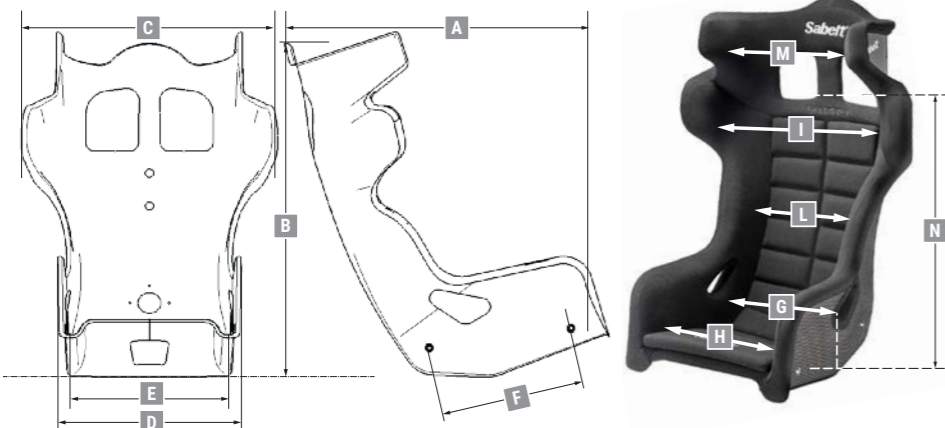

FIXING BRACKETS



F11



--

FLOOR FIXING

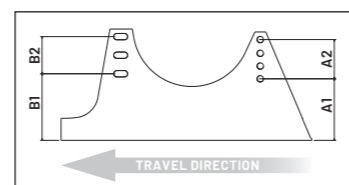

SEE SCHEME ON PAGE 68



• Size: **XL**
 • Cod: **RFSEGTPROXP6PN**



MANUFACTURER: SABELT
 MODEL: GT-PRO XL 6-POINT
 HOM. NO.: AS.087.20
 FIA STANDARD: 8862-2009

GT-621

8862-2009

GT/RALLY/CIRCUIT

CARBON	SHELL SIZE	FIXING	FIA
	L	BRACKETS	8862-2009

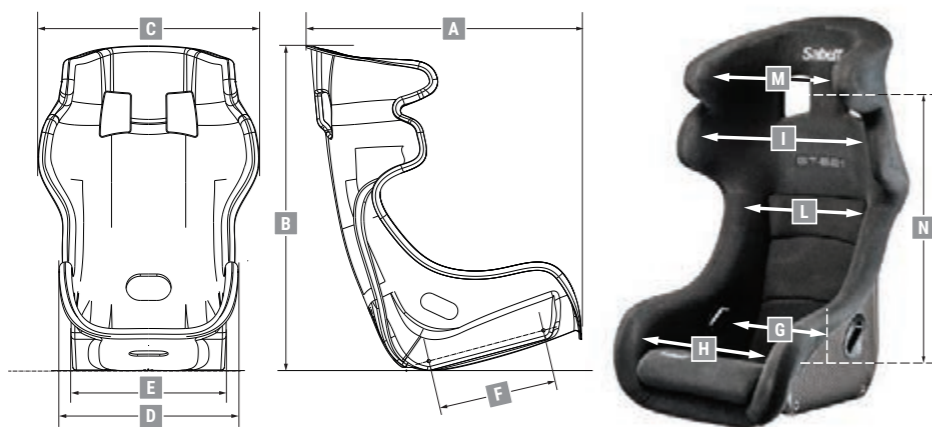

	Sizes	
	M	L
SHELL DIMENSIONS (mm)		
A	567	
B	930	
C	611	
D	497	
E	409	
F	320	
⊕	8,5	
INTERNAL SEAT DIMENSIONS (mm)		
G	331	361
H	348	378
I	495	525
L	335	365
M	350	350
N	642	642
⊕	11,5	11,0

SPARES AND ACCESSORIES



KF



CPR



CL

FIXING BRACKETS



F6

FLOOR FIXING

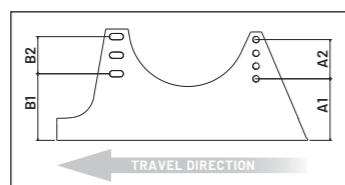

SEE SCHEME ON PAGE 68



• Size: **M**
 • Cod: **RFSEGT621MN**

 MANUFACTURER: SABELT
 MODEL: GT-621
 HOM. NO: AS.056.16
 FIA STANDARD: 8862-2009

• Size: **L**
 • Cod: **RFSEGT621LN**

 MANUFACTURER: SABELT
 MODEL: GT-621
 HOM. NO: AS.056.16
 FIA STANDARD: 8862-2009

GT-E

8862-2009

CIRCUIT ONLY

CARBON	SHELL SIZE	FIXING	FIA
	M	BRACKETS	8862-2009

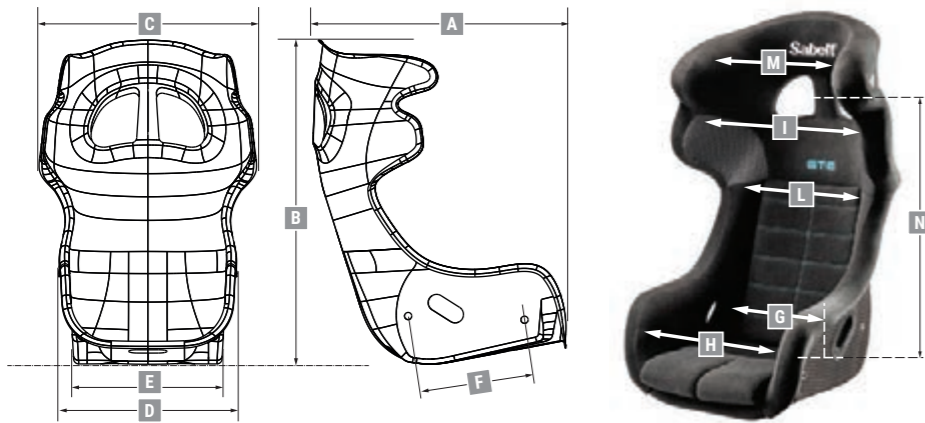

Sizes	
M	
SHELL DIMENSIONS (mm)	
A	580
B	890
C	595
D	540
E	418
F	320
📏	12,6
INTERNAL SEAT DIMENSIONS (mm)	
G	340
H	370
I	495
L	330
M	370
N	700
📏	15,0



FIXING BRACKETS



F10

FLOOR FIXING

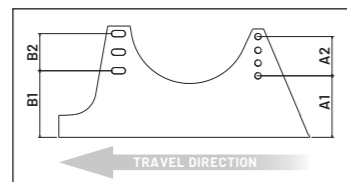

SEE SCHEME ON PAGE 68

• Size: M

• Cod: RFSEGTE



MANUFACTURER: SABELT
 MODEL: GT-E
 HOM. NO: AS.071.18
 FIA STANDARD: 8862-2009

GT-910

NASCAR

SFI 39.1

CARBON	SHELL SIZE	SFI
	M	39.1

MADE IN USA

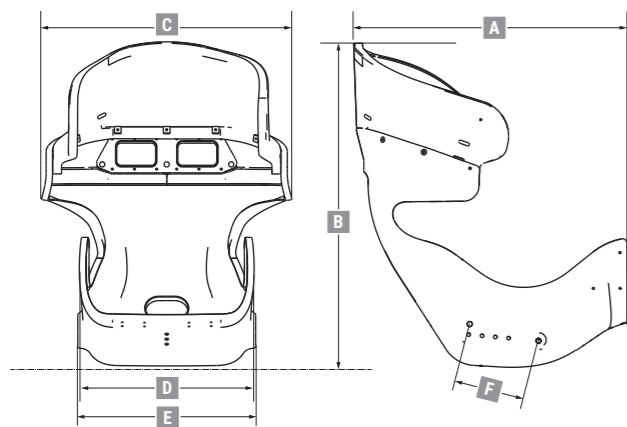

Sizes	
M	
SHELL DIMENSIONS (mm)	
A	779
B	925
C	714
D	499
E	508
F	202
⊕	19,0

Full Carbon, Textreme external layer (unique design).
 Weight in compliance with new standards (42 lbs weight). Headrest included.
 Low COG (center of gravity).
 NASCAR Approved
 (69G sled test - SFI homologation - NASCAR 2015 quasi-static test).
 Shell made of seat + asymmetric headrest.
 Designed along with one of the most prestigious NASCAR Team.
 The seat is used and appreciated by several Top Drivers.



- Size: **M**
- SHELL - Cod: **RFGT910M**
- HEADREST - Cod: **RCGT911AM**
- HEADREST+1" - Cod: **RCGT913AM**

SPINE

8855-2021 **NEW**

FIBERGLASS	SHELL SIZE	FIXING	FIA
	XL	BRACKETS	8855-2021

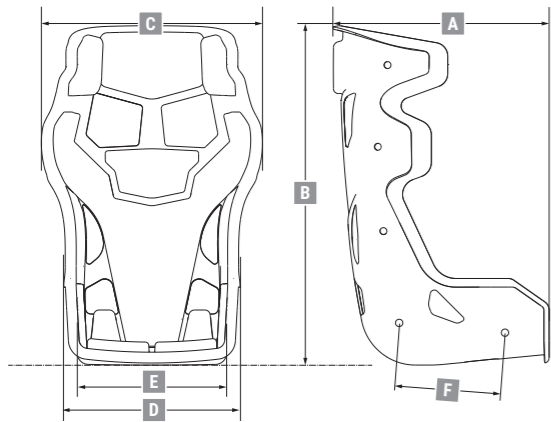

	Sizes	
	L	XL
SHELL DIMENSIONS (mm)		
A	590	
B	924	
C	610	
D	508,5	
E	433,5	
F	290	
Ⓜ	9,5	
INTERNAL SEAT DIMENSIONS (mm)		
G	386,5	406,5
H	383,5	403,5
I	475	490
L	370	385
M	325	325
N	592	592
Ⓜ	11,5	11,3

COMING
SOON
SIZE M



FIXING BRACKETS



F12

FLOOR FIXING

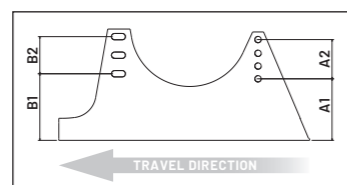

SEE SCHEME ON PAGE 68



• Size: **L**
 • Cod: **RFSESPINEL**

 MANUFACTURER: SABELT
 MODEL: SPINE
 HOM. NO.:
 FIA STANDARD: 8855-2021

• Size: **XL**
 • Cod: **RFSESPINEXL**

 MANUFACTURER: SABELT
 MODEL: SPINE
 HOM. NO.:
 FIA STANDARD: 8855-2021

GT-AM

8855-2021 **NEW**

FIBERGLASS	SHELL SIZE	FIXING	FIA
	XL	BRACKETS	8855-2021

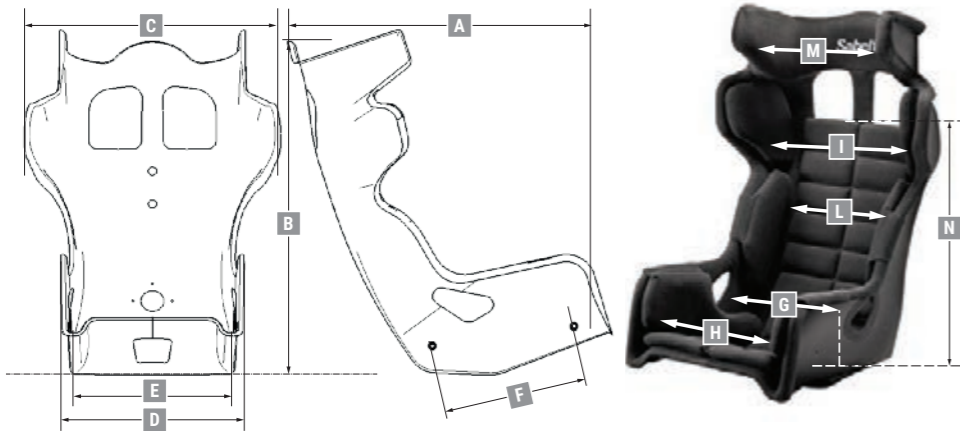

	Sizes		
	M	L	XL
SHELL DIMENSIONS (mm)			
A	795		
B	770		
C	644		
D	482		
E	427		
F	340		
📏	9,5		
INTERNAL SEAT DIMENSIONS (mm)			
G	315	325	340
H	320	335	350
I	432	452	462
L	320	340	370
M	342	342	342
N	512	512	512
📏	11,5	11,5	11,5



FIXING BRACKETS

FLOOR FIXING



F12

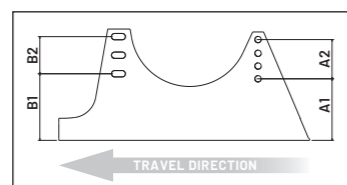

SEE SCHEME ON PAGE 68



• Size: **M**
 • Cod: **RFSEGTAMM**

FIA APPROVED

MANUFACTURER: SABELT
 MODEL: GT-AM
 HOM. NO.:
 FIA STANDARD: 8855-2021

• Size: **L**
 • Cod: **RFSEGTAML**

FIA APPROVED

MANUFACTURER: SABELT
 MODEL: GT-AM
 HOM. NO.:
 FIA STANDARD: 8855-2021

• Size: **XL**
 • Cod: **RFSEGTAMXL**

FIA APPROVED

MANUFACTURER: SABELT
 MODEL: GT-AM
 HOM. NO.:
 FIA STANDARD: 8855-2021

X-PAD CARBON

8855-1999

CARBON	SHELL SIZE	FIXING	FIA
	L	BRACKETS	8855-1999

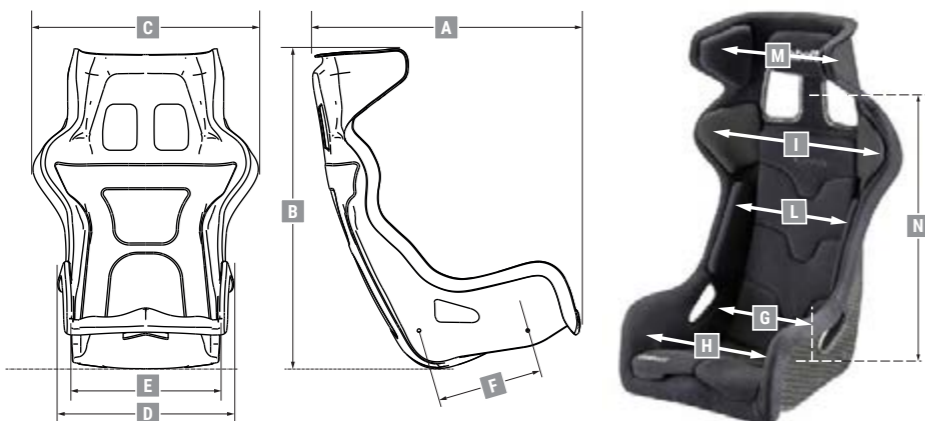

Sizes	
L	
SHELL DIMENSIONS (mm)	
A	550
B	900
C	600
D	396
E	390
F	290
🔒	4,9
INTERNAL SEAT DIMENSIONS (mm)	
G	362
H	368
I	447
L	358
M	338
N	661
🔒	6,3

PAD KIT

THE KIT INCLUDES ALL THE PADS VISIBLE IN THE PICTURE

COLOUR	SIZE	CODE
■	L	RCXPADNR



FLOOR FIXING

FIXING BRACKETS



F1



F2

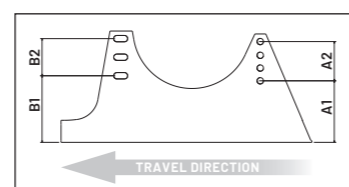

SEE SCHEME ON PAGE 68



• Size: L
• Cod: RFSEXPADCARBON



MANUFACTURER: SABELT
MODEL: X-PAD CARBON
HOM. NO: CS.418.19
FIA STANDARD: 8855-1999

X-PAD RALLYCROSS

8855-1999

RALLYCROSS

FIBERGLASS	SHELL SIZE	FIXING	FIA
	L	BRACKETS	8855-1999

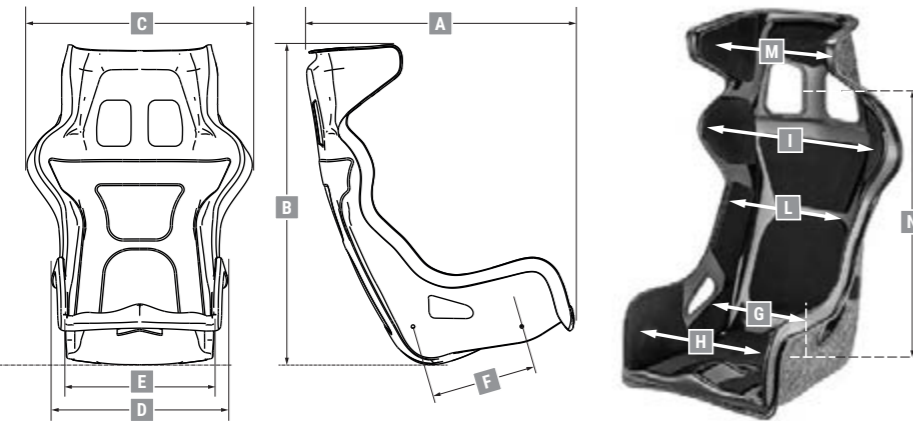

Sizes	
L	
SHELL DIMENSIONS (mm)	
A	550
B	900
C	600
D	396
E	390
F	290
⊥	6,5
INTERNAL SEAT DIMENSIONS (mm)	
G	372
H	378
I	460
L	370
M	340
N	661
⊥	7,3

PAD KIT

THE KIT INCLUDES ALL THE PADS VISIBLE IN THE PICTURE

COLOUR	SIZE	CODE
■	L	RCXPADRCROSS3C

EXTRA 2 PADS 30 x 30 cm INCLUDED



FLOOR FIXING

FIXING BRACKETS

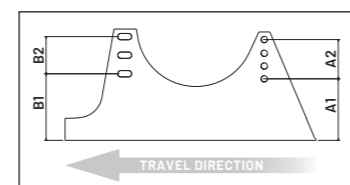

SEE SCHEME ON PAGE 68



EASY TO CLEAN

• Size: L
 • Cod: RFSEXPADRCROSS
 (SEAT ONLY WITHOUT PADDING KIT)

FIA APPROVED

MANUFACTURER: SABELT
 MODEL: X-PAD
 HOM. NO: CS.419.19-
 FIA STANDARD: 8855-1999

X-PAD

8855-1999

FIBERGLASS	SHELL SIZE	FIXING	FIA
	L	BRACKETS	8855-1999

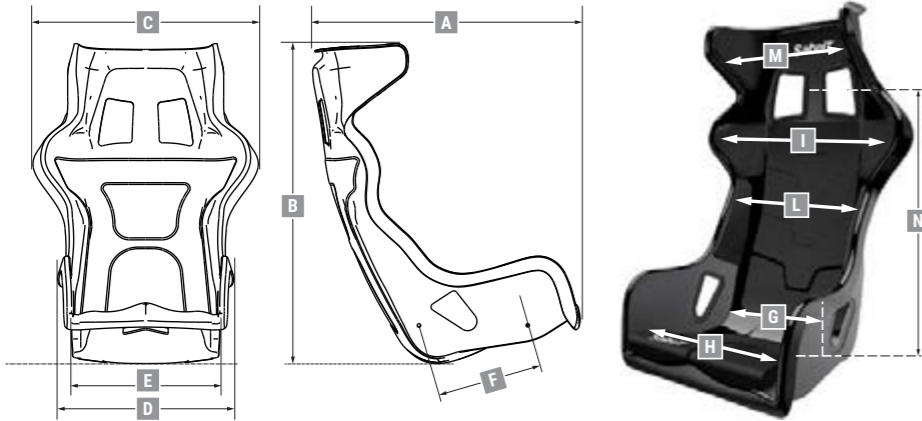

Sizes	
L	
SHELL DIMENSIONS (mm)	
A	550
B	900
C	600
D	396
E	390
F	290
Ⓛ	6,0
INTERNAL SEAT DIMENSIONS (mm)	
G	362
H	368
I	447
L	358
M	338
N	661
Ⓛ	7,7

PAD KIT

THE KIT INCLUDES ALL THE PADS VISIBLE IN THE PICTURE

COLOUR	SIZE	CODE
■	L	RCXPADNR



FLOOR FIXING

FIXING BRACKETS

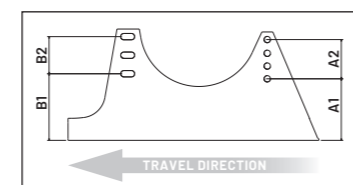

SEE SCHEME ON PAGE 68



• Size: L
• Cod: RFSEXPADNR



MANUFACTURER: SABELT
MODEL: X-PAD
HOM. NO: CS.419.19
FIA STANDARD: 8855-1999

GT-PAD

8855-1999

FIBERGLASS	SHELL SIZE	FIXING	FIA
	XL	BRACKETS	8855-1999

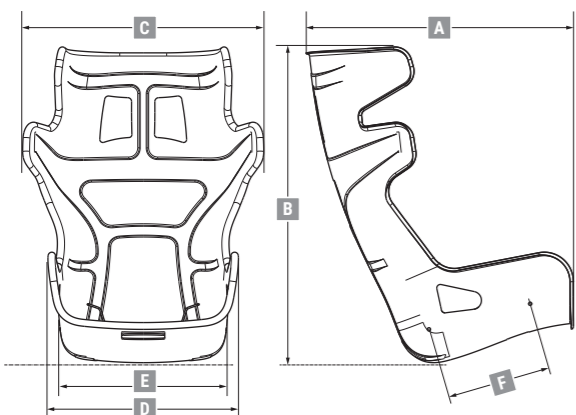

	Sizes		
	M	L	XL
SHELL DIMENSIONS (mm)			
A	744		
B	878		
C	670		
D	529		
E	471		
F	290		
⊕	8,9		
INTERNAL SEAT DIMENSIONS (mm)			
G	365	380	395
H	405	420	435
I	540	550	560
L	346	356	366
M	380	380	380
N	660	660	660
⊕	10,7	10,6	10,5

PAD KITS

THE KIT INCLUDES ALL THE PADS VISIBLE IN THE PICTURE

COLOUR	SIZE	CODE
Black	M	RCGTPADKITMN
Black	L	RCGTPADKITLN
Black	XL	RCGTPADKITXLN
Red	M	RCGTPADKITMR
Red	L	RCGTPADKITLR
Red	XL	RCGTPADKITXLR



ACCESSORIES



Lower cushion thickness 40 mm
RRGTPAD028

FIXING BRACKETS



F1



F2

FLOOR FIXING

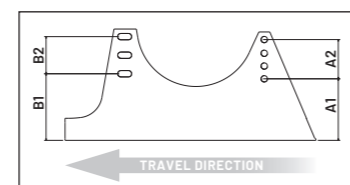

SEE SCHEME ON PAGE 68



* Attention: this code refers to the seat excluding the pad kits. The pad kits are provided/supplied separately.

- Size: L
- Cod: RFSEGTPAD*



MANUFACTURER: SABELT
MODEL: GT-PAD
HOM. NO: CS.391.18
FIA STANDARD: 8855-1999

TAURUS

8855-1999

FIBERGLASS	SHELL SIZE	FIXING	FIA
	M - L - XL	BRACKETS	8855-1999

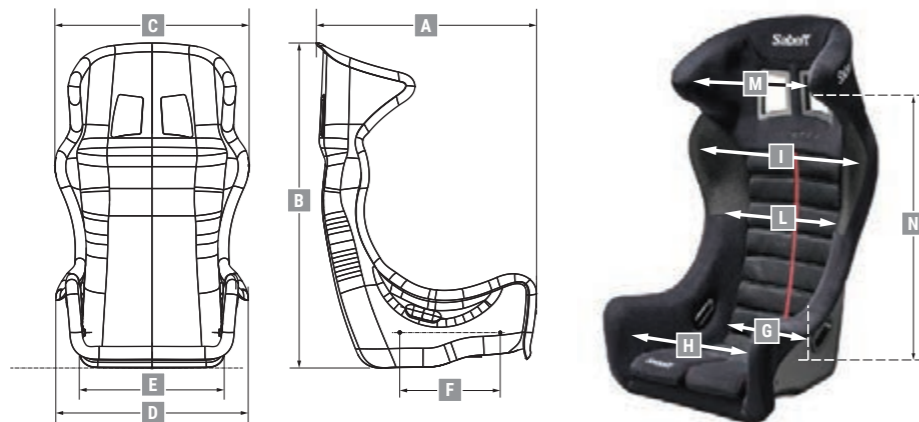

	Sizes		
	M	L	XL
SHELL DIMENSIONS (mm)			
A	543	550	586
B	925	979	980
C	579	582	588
D	475	481	519
E	377	392	411
F	290	290	290
⊞	8,4	9,0	9,7
INTERNAL SEAT DIMENSIONS (mm)			
G	300	318	326
H	364	373	393
I	486	501	512
L	345	362	393
M	341	357	394
N	685	717	716
⊞	10,5	11,4	11,4

SPARES AND ACCESSORIES



FIXING BRACKETS



FLOOR FIXING

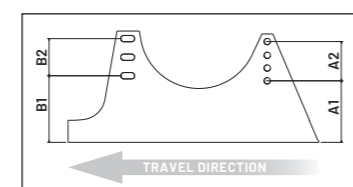

SEE SCHEME ON PAGE 68



• Size: **M**
 • Cod: **RFSETAURUSMN**

 MANUFACTURER: SABELT
 MODEL: TAURUS TG M
 HOM. NO: CS.368.17
 FIA STANDARD: 8855-1999

• Size: **L**
 • Cod: **RFSETAURUSN**

 MANUFACTURER: SABELT
 MODEL: TAURUS
 HOM. NO: CS.346.16
 FIA STANDARD: 8855-1999

• Size: **XL**
 • Cod: **RFSETAURUSMAXN**

 MANUFACTURER: SABELT
 MODEL: TAURUS MAX
 HOM. NO: CS.347.16
 FIA STANDARD: 8855-1999

TITAN CARBON

8855-1999

CARBON	SHELL SIZE	FIXING	FIA
	XL	BRACKETS	8855-1999



SPARES AND ACCESSORIES



FIXING BRACKETS



FLOOR FIXING

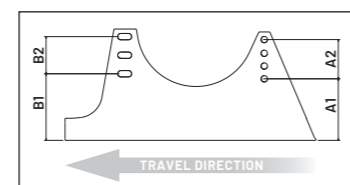

SEE SCHEME ON PAGE 68



• Size: **L**
 • Cod: **RFSETITANCARBONN**

 MANUFACTURER: SABELT
 MODEL: TITAN CARBON
 HOM. NO.: CS.370.17
 FIA STANDARD: 8855-1999

• Size: **XL**
 • Cod: **RFSETITANCARBONMAXN**

 MANUFACTURER: SABELT
 MODEL: TITAN CARBON
 HOM. NO.: CS.370.17
 FIA STANDARD: 8855-1999

TITAN

8855-1999

FIBERGLASS	SHELL SIZE	FIXING	FIA
	XL	BRACKETS	8855-1999

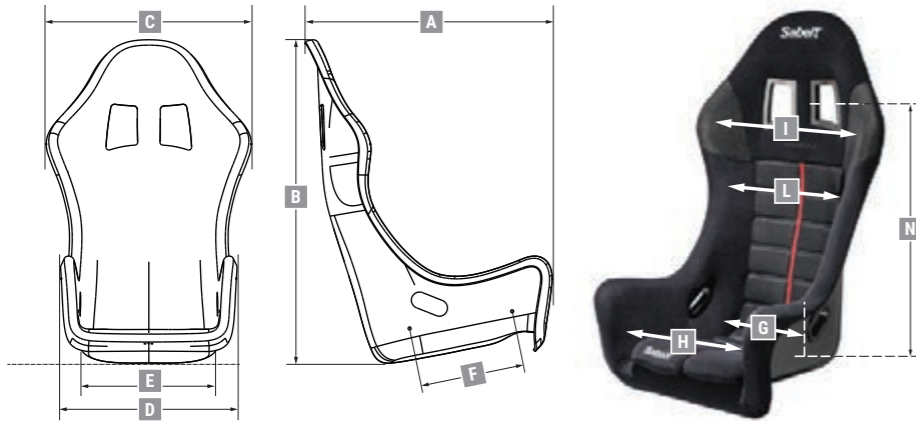

Sizes	
XL	
SHELL DIMENSIONS (mm)	
A	602
B	957
C	606
D	506
E	415
F	290
Ⓛ	7,8
INTERNAL SEAT DIMENSIONS (mm)	
G	313
H	367
I	517
L	379
M	-
N	690
Ⓛ	9,9

SPARES AND ACCESSORIES



FIXING BRACKETS



FLOOR FIXING

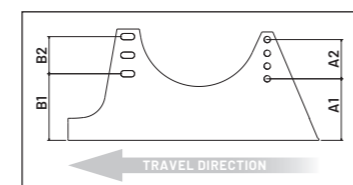

SEE SCHEME ON PAGE 68



• Size: **XL**
 • Cod: **RFSETITANMAXN**



MANUFACTURER: SABELT
 MODEL: TITAN MAX
 HOM. NO: CS.350.16
 FIA STANDARD: 8855-1999

GT-3

8855-1999

FIBERGLASS	SHELL SIZE	FIXING	FIA
	L	BRACKETS	8855-1999

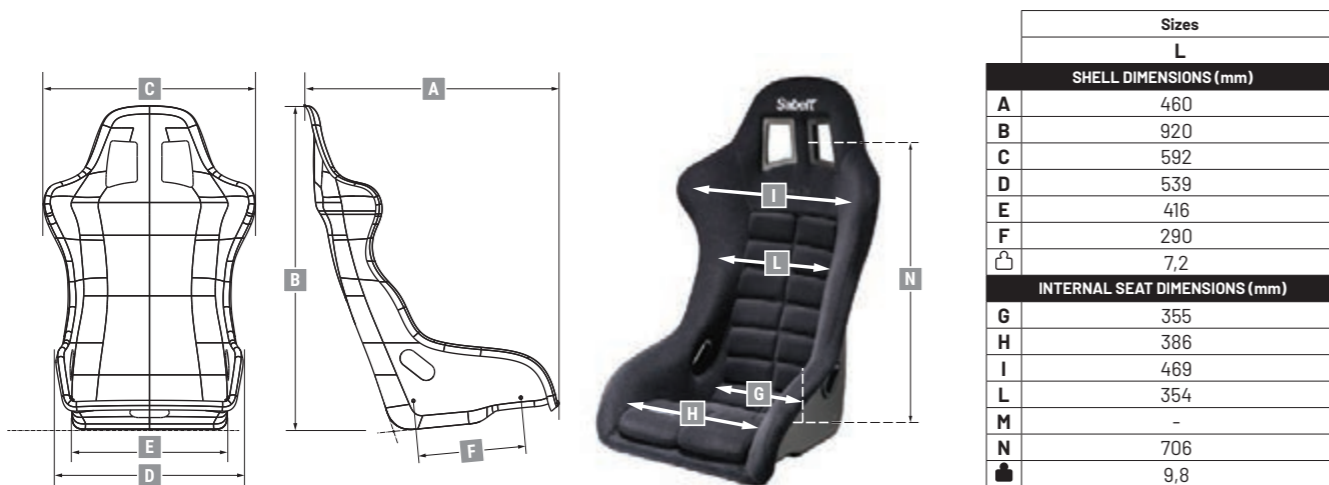

SPARES AND ACCESSORIES



FIXING BRACKETS

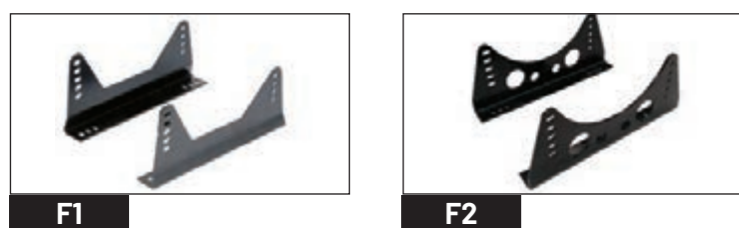

FLOOR FIXING

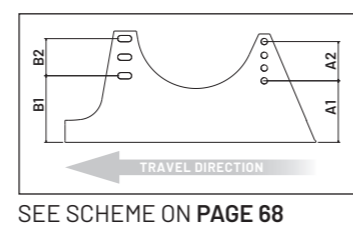

• Size: L
• Cod: RFSEGT3N



MANUFACTURER: SABELT
MODEL: GT-3
HOM. NO: CS.355.17
FIA STANDARD: 8855-1999

RACER DUO

8855-1999

STEEL TUBE	SHELL SIZE	FIXING	FIA
	L	BRACKETS	8855-1999

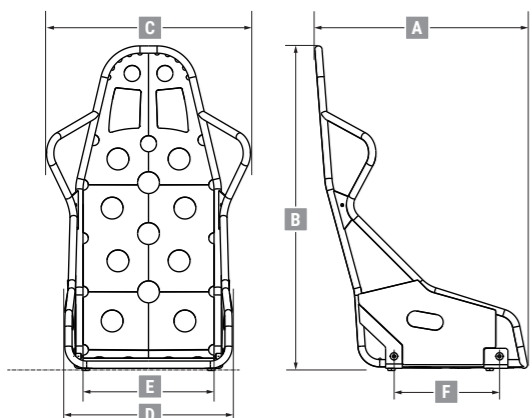

Sizes	
L	
SHELL DIMENSIONS (mm)	
A	463
B	890
C	582
D	489
E	422
F	290
⊕	10,0
INTERNAL SEAT DIMENSIONS (mm)	
G	324
H	377
I	509
L	374
M	-
N	637
⊕	12,0

SPARES AND ACCESSORIES



FIXING BRACKETS

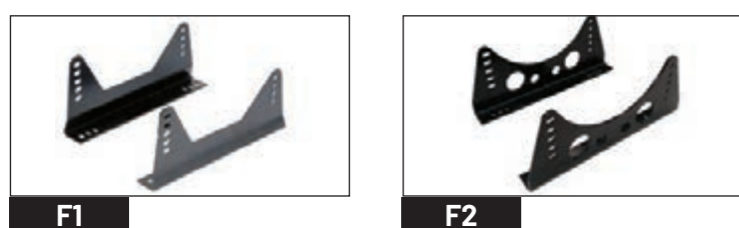

FLOOR FIXING

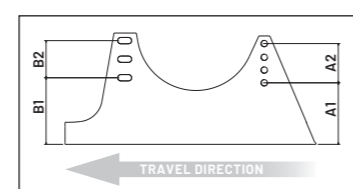

SEE SCHEME ON PAGE 68



• Size: L
• Cod: RFSERACERN



MANUFACTURER: SABELT
MODEL: RACER DUO
HOM. NO: CS.387.17
FIA STANDARD: 8855-1999

RACEWEAR





SUITS

SHOES

GLOVES

UNDERWEAR



FIA 8856-2018

SUITS



HERO SUPERLIGHT TS-10



- Shell size: 44-66
- Weight: 265 g/m²
- SFI: 3.2A/5 - 3.4 available
- : available

NEW



CHALLENGE TS-2



- Shell size: 44-66
- Weight: 360 g/m²
- SFI: 3.2A/5 - 3.4 available
- : available

NEW



ROCKET TS-1



- Shell size: S-XXXL
- Weight: 400 g/m²

NEW

UNDERWEAR



UI-600



- Balaclava: ONE SIZE
- Top/Pant: XS-XXL (slim fit)
- Socks: 38-46

NEW



UI-600 RF



- Top/Pant: S-XXXL (regular fit)

NEW



UI-200



- Balaclava: ONE SIZE
- Top/Pant: XS-XXL (slim fit)

NEW

FIA 8856-2018

SHOES



ZERO GRAVITY TB-11



- Shell size: 36-48

NEW



HERO PRO TB-10



- Shell size: 36-48

NEW



LASER TB-3



- Shell size: 36-48

- : available

NEW



CHALLENGE TB-2



- Shell size: 36-48

NEW



CLASSIC TB-2



- Shell size: 36-46

GLOVES



HERO SUPERLIGHT TG-10



- Shell size: 8-12

NEW



CHALLENGE TG-2



- Shell size: 8-12

NEW



LASER TG-3



- Shell size: 9-12

- : available

NEW

CREW

SUITS



ROCKET TM-1



- Shell size: S-XXXL
- Hom: n/a

NEW

GLOVES



Z120760

- Shell size: ONE SIZE
- Hom: n/a



Z120560

- Shell size: ONE SIZE
- Hom: n/a

MADE TO MEASURE SUIT TEMPLATE

NAME: _____ FLAG: _____

HEIGHT: _____ WEIGHT: _____

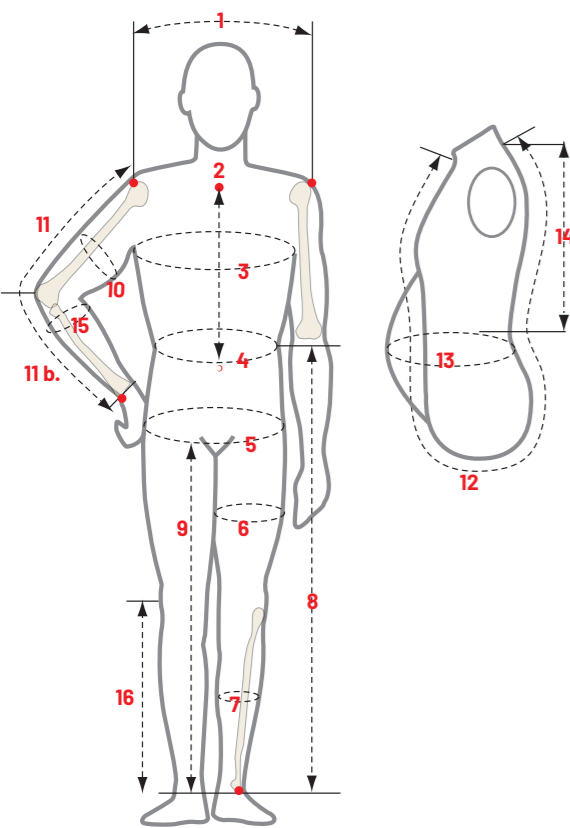

- 1 Shoulder breadth (from points of shoulders bones across back)
- 2 Body length from inside shoulder to waist
- 3 Maximum chest circumference
- 4 Waist circumference measured at the narrowest point
- 5 Hip circumference
- 6 Thigh circumference
- 7 Calf circumference
- 8 Outside leg length from waist to malleolus
- 9 Desired length from the crotch to ankle
- 10 Biceps circumference
- 11 Sleeve length from point of shoulder bone to wrist (arm bent)
- 11 b Forearm length from elbow to wrist
- 12 Crotch length from front collar bone through top of inside leg to back neck
- 13 Maximum waist circumference
- 14 Length from neck to waist
- 15 Forearm circumference
- 16 Length from the knee center to malleolus

1	4	7	10	12	15
2	5	8	11	13	16
3	6	9	11 b	14	

BELT: YES NO

DESIRED FIT: SLIMFIT REGULAR LOOSE

NASCAR BOOTCUT: YES NO

COOLING HOLE: YES NO ...if YES LEFT RIGHT

POCKETS: CELL. NORMAL NONE

LOGOS: PRINT EMBROIDERY

MECHANIC FEATURES: YES NO



- DOUBLE BELT LOOP
- RADIO OR ACCESSORIES LOOP
- SHOULDER WIRE CORD
- BOOT CUT

SUITS - STANDARD SIZE CHART Sizes listed are in cm and are for body measurements, not for the suit.

TS-10 (SLIM FIT) - SIZE	TS-2 (REGULAR FIT) - SIZE	CHEST	WAIST	HIPS	WEIGHT	HEIGHT	TS-1 / TM-1 SIZE
44	44	82-86	69-73	81-85	43-48	160-163	XS
46	46	86-90	73-77	85-89	49-54	164-166	S
48	48	90-94	77-81	89-93	55-60	167-169	
50	50	94-98	81-85	93-97	61-66	170-172	M
52	52	98-102	85-89	97-101	67-72	173-175	
54	54	102-106	89-93	101-105	73-78	176-179	L
56	56	106-110	93-97	105-109	79-84	180-184	
58	58	110-114	97-101	109-113	85-90	185-187	XL
60	60	114-118	101-105	113-117	91-96	188-190	
62	62	118-122	105-109	117-121	97-102	191-193	XXL
64	64	122-126	109-113	121-125	103-108	194-196	
66	66	126-130	113-117	125-129	109-114	197-199	XXXL
-	-	130-134	117-121	129-133	115-118	n/a	
-	-	134-138	121-125	133-137	119-122	n/a	

SUITS - STANDARD SIZE CHART (WOMAN) - ON DEMAND Sizes listed are in cm and are for body measurements, not for the suit.

SIZE	SIZE	SHOULDERS	BREAST	CHEST	WAIST	HIPS	WEIGHT	HEIGHT
XS	38	35-37	78-82	74-78	58-62	82-86	40-45	154-158
	40	36-38	82-86	78-82	62-66	86-90	45-50	157-161
S	42	37-39	86-90	82-86	66-70	90-94	50-55	160-164
	44	38-40	90-94	86-90	70-74	94-98	55-60	163-167
M	46	39-41	94-98	90-94	74-78	98-102	60-65	166-170
	48	40-42	98-102	94-98	78-82	102-106	65-70	168-172
L	50	41-43	102-106	98-102	82-86	106-110	70-75	170-174
	52	42-44	106-110	102-106	86-90	110-114	75-80	173-177
XL	54	43-45	110-114	106-110	90-94	114-118	80-85	176-180
	56	44-46	114-118	110-114	94-98	118-122	85-90	179-183
XXL	58	45-48	118-122	114-118	98-102	122-126	90-95	180-184
	60	46-49	122-126	118-122	102-106	126-130	95-100	182-186

UNDERWEAR - STANDARD SIZE CHART Sizes listed are in cm and are for body measurements, not for the underwear.

	SIZE					
UI-600 (SLIM FIT)	XS-S	M-L		XL-XXL		
UI-600 RF (REGULAR FIT)	S	M	L	XL	XXL	XXXL
UI-200 (SLIM FIT)	S	M-L		XL-XXL		
CHEST	82-90	90-102	102-114	114-122	122-130	130-138
WAIST	69-77	77-89	89-101	101-109	109-117	117-125
HIPS	81-89	89-101	101-113	113-121	121-129	129-137
HEIGHT	162-166	167-175	176-187	188-193	194-199	n/a
WEIGHT (kg)	43-54	55-72	73-90	91-102	103-114	115-122

SHOES, SOCKS, GLOVES - STANDARD SIZE CHARTS

SHOES				SOCKS
FOOT LENGTH (cm)	EU SIZE	US SIZE	UK SIZE	SIZE
23	36	4	3,5	38/39
23,5	37	5	4	
24	38	6	5	
25	39	6,5	5,5	
25,5	40	7,5	6,5	40/41
26	41	8	7	
27	42	9	8	42/43
27,5	43	10	9	
28	44	10,5	9,5	44/45
29	45	11,5	10,5	
29,5	46	12	11	
30	47	13	12	
31	48	14	13	46

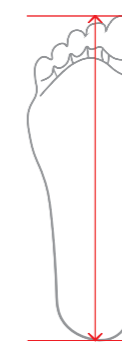

GLOVES		
HAND DIMENSIONS (cm)	SIZE	
20-21	8	XS
21-22	9	S
22-23	10	M
23-24	11	L
24-25	12	XL



- DOUBLE BELT LOOP
- RADIO OR ACCESSORIES LOOP
- SHOULDER WIRE CORD
- BOOT CUT

SUITS



HERO SUPERLIGHT TS-10

Size	Sandwich weight	FIA	Available SFI	Made in Italy	Available	EXCLUSIVE TECHNICAL SOLUTION MADE IN SABELT
44-66	265 g/m ²	8856-2018	3.2A/5 - 3.4		FRIENDLY	

NEW FITTING



COLOURS/CODES	
	RFTITS10BLAZ..
	RFTITS10NRBI..
	RFTITS10RSBI..
	RFTITS10BINR..
	RFTITS10NRGL.. NEW



MANUFACTURER: SABELT
MODEL: HERO SUPERLIGHT TS-10
HOM. NO: DC.108.20-O
FIA STANDARD: 8856-2018

CHALLENGE TS-2

Size	Sandwich weight	FIA	Available SFI	Made in Italy	Available	EXCLUSIVE TECHNICAL SOLUTION MADE IN SABELT
44-66	360 g/m ²	8856-2018	3.2A/5 - 3.4		FRIENDLY	



COLOURS/CODES	
	RFTITS2NR..
	RFTITS2RS..
	RFTITS2BI..
	RFTITS2BL.. NEW
	RFTITS2NRGFL.. NEW



MANUFACTURER: SABELT
MODEL: CHALLENGE TS-2
HOM. NO: DC.116.21-O
FIA STANDARD: 8856-2018

ROCKET TS-1

NEW

Size	Sandwich weight	FIA	Made in Italy	EXCLUSIVE TECHNICAL SOLUTION MADE IN SABELT
S-XXXL	400 g/m ²	8856-2018		



COLOURS/CODES	
	RFTITS1NR..





MANUFACTURER: SABELT
MODEL: TS-1
HOM. NO: DC.xxx.xx-O
FIA STANDARD: 8856-2018

SHOES



ZERO GRAVITY TB-11

NEW

Size	FIA	Made in Italy	 EXCLUSIVE TECHNICAL SOLUTION MADE IN SABELT
36-48	8856-2018		





COLOURS/CODES	
	RFTB11NR..







 **APPROVED**
 MANUFACTURER: SABELT
 MODEL: TB-11
 HOM. NO: DC.xxx.xx-Z
 FIA STANDARD: 8856-2018

HERO PRO TB-10

Size	FIA	Made in Italy	 EXCLUSIVE TECHNICAL SOLUTION MADE IN SABELT
36-48	8856-2018		



COLOURS/CODES	
	RFTB10NR..
	RFTB10RS..
	RFTB10BL..
	RFTB10BI..



OPTIONAL



RCTB10SOL..
Reinforced Insole
NEW





MANUFACTURER: SABELT
MODEL: HERO PRO TB-10
HOM. NO: DC.098.20-Z
FIA STANDARD: 8856-2018

LASER TB-3

Size	FIA	Made in Italy	Available	 EXCLUSIVE TECHNICAL SOLUTION MADE IN SABELT
36-48	8856-2018		 FRIENDLY	





COLOURS/CODES	
	RFTB03LASERNR..
	RFTB03LASERBI.. NEW





MANUFACTURER: SABELT
MODEL: LASER TB-3
HOM. NO: DC.115.21-Z
FIA STANDARD: 8856-2018

CHALLENGE TB-2

Size	FIA	Made in Italy	 EXCLUSIVE TECHNICAL SOLUTION MADE IN SABELT
36-48	8856-2018		





COLOURS/CODES	
	RFTB02NR..
	RFTB02RS.. NEW
	RFTB02BL.. NEW





 **APPROVED**

MANUFACTURER: SABELT
 MODEL: TB-2
 HOM. NO: DC.118.21-Z
 FIA STANDARD: 8856-2018

CLASSIC TB-2

Size	FIA	Made in Italy	 EXCLUSIVE TECHNICAL SOLUTION MADE IN SABELT
36-46	8856-2018		



COLOURS/CODES	
	RFTB02CLASSICNR..
	RFTB02CLASSICRS..



 **APPROVED**

MANUFACTURER: SABELT
 MODEL: TB-2
 HOM. NO: DC.118.21-Z
 FIA STANDARD: 8856-2018

GLOVES

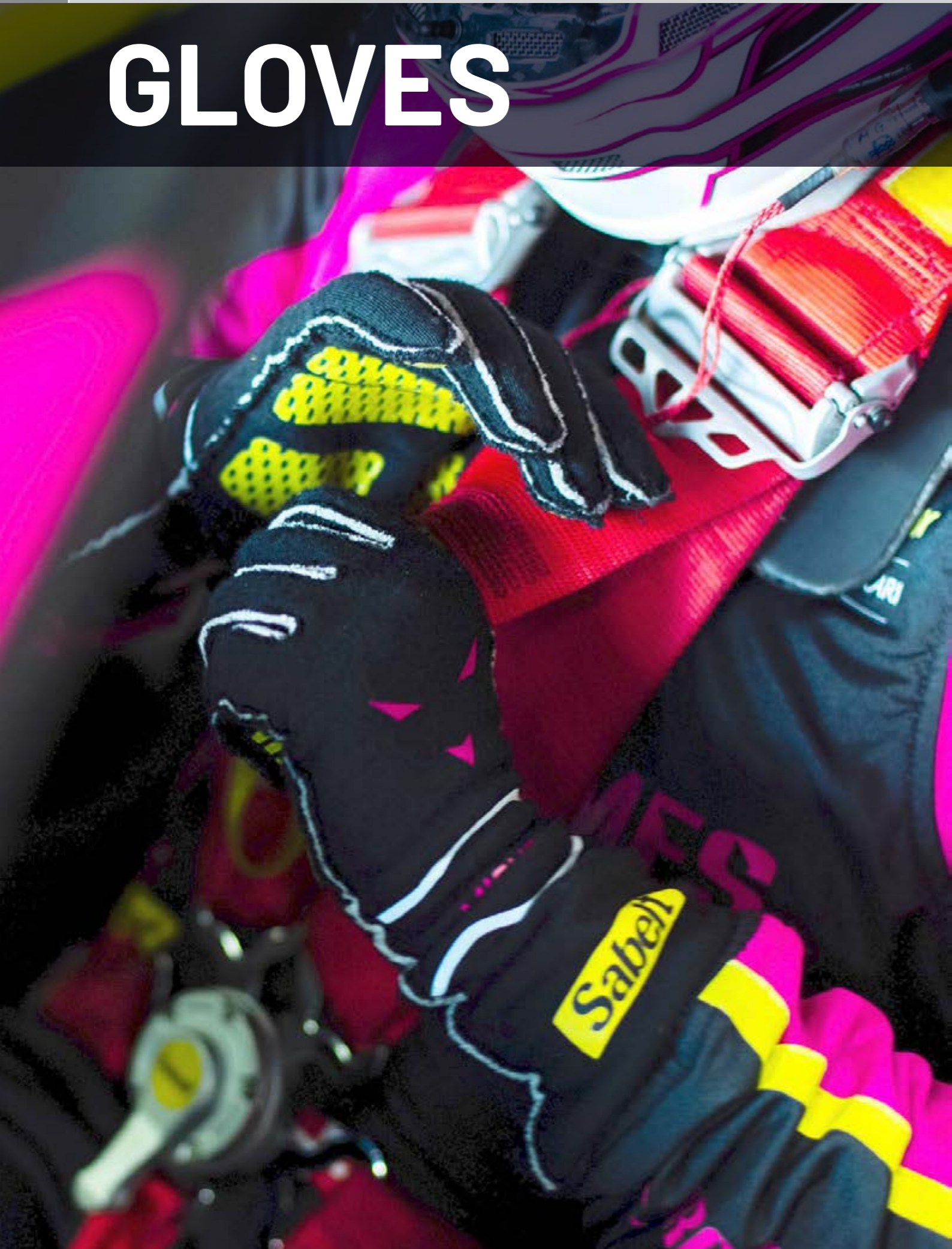

HERO SUPERLIGHT TG-10

Size	FIA	Made in Italy
8-12	8856-2018	



COLOURS/CODES	
	RFTG10NR..
	RFTG10RS..
	RFTG10BL..
	RFTG10BI..
	RFTG10GFL.. NEW

APPROVED

MANUFACTURER: SABELT
 MODEL: HERO SUPERLIGHT TG-10
 HOM. NO.: DC.081.20-G
 FIA STANDARD: 8856-2018



LASER TG-3

Size	FIA	Made in Italy	Available	EXCLUSIVE TECHNICAL SOLUTION MADE IN SABELT
9-12	8856-2018		FRIENDLY	



COLOURS/CODES	
	RFTG03LASERNR..
	RFTG03LASERGFL.. NEW



APPROVED
 MANUFACTURER: SABELT
 MODEL: LASER TG-3
 HOM. NO: DC.122.21-G
 FIA STANDARD: 8856-2018

CHALLENGE TG-2

Size	FIA	Made in Italy
8-12	8856-2018	



COLOURS/CODES	
	RFTG02NR..
	RFTG02RS.. NEW
	RFTG02BL.. NEW



APPROVED
 MANUFACTURER: SABELT
 MODEL: CHALLENGE TG-2
 HOM. NO: DC.113.20-G
 FIA STANDARD: 8856-2018

UNDERWEAR



UI-600

FIA
8856-2018

EXCLUSIVE TECHNICAL SOLUTION
MADE IN SABELT



BALACLAVA
<input type="checkbox"/> RFUI600BALBI
<input checked="" type="checkbox"/> RFUI600BALNR
Sizes: ONE SIZE

TOP	NEW FITTING
<input type="checkbox"/> RFUI600TOPBI..	NEW
<input checked="" type="checkbox"/> RFUI600TOPNR..	NEW
Sizes: XS-XXL	

PANT
<input type="checkbox"/> RFUI600PANTBI..
<input checked="" type="checkbox"/> RFUI600PANTNR..
Sizes: XS-XXL

SOCK
<input type="checkbox"/> Z150UI600SOCKSB..
<input checked="" type="checkbox"/> Z150UI600SOCKSN..
Sizes: 39-46

FIA APPROVED

MANUFACTURER: SABELT
MODEL: UI-600 BALACLAVA
HOM. NO: DC.099.20-B
FIA STANDARD: 8856-2018

FIA APPROVED

MANUFACTURER: SABELT
MODEL: UI-600 TOP
HOM. NO: DC.100.20 -T
FIA STANDARD: 8856-2018

FIA APPROVED

MANUFACTURER: SABELT
MODEL: UI-600 PANT
HOM. NO: DC.101.20-L
FIA STANDARD: 8856-2018

FIA APPROVED

MANUFACTURER: SABELT
MODEL: UI-600 SOCKS
HOM. NO: DC.088.20-S
FIA STANDARD: 8856-2018

UI-600 RF

NEW

FIA
8856-2018

EXCLUSIVE TECHNICAL SOLUTION
MADE IN SABELT



TOP	
<input type="checkbox"/>	RFUI600TOPRFBI..
<input checked="" type="checkbox"/>	RFUI600TOPRFNR..
Sizes: S-XXXL	

PANT	
<input type="checkbox"/>	RFUI600PANTRFBI..
<input checked="" type="checkbox"/>	RFUI600PANTRFNR..
Sizes: S-XXXL	



UI-200

NEW

FIA
8856-2018

EXCLUSIVE TECHNICAL SOLUTION
MADE IN SABELT



BALACLAVA	
<input type="checkbox"/>	RFUI200BALBI
<input checked="" type="checkbox"/>	RFUI200BALNR
Sizes: ONE SIZE	

TOP	
<input type="checkbox"/>	RFUI200TOPBI..
<input checked="" type="checkbox"/>	RFUI200TOPNR..
Sizes: XS-XXL	

PANT	
<input type="checkbox"/>	RFUI200PANTBI..
<input checked="" type="checkbox"/>	RFUI200PANTNR..
Sizes: XS-XXL	



CREW

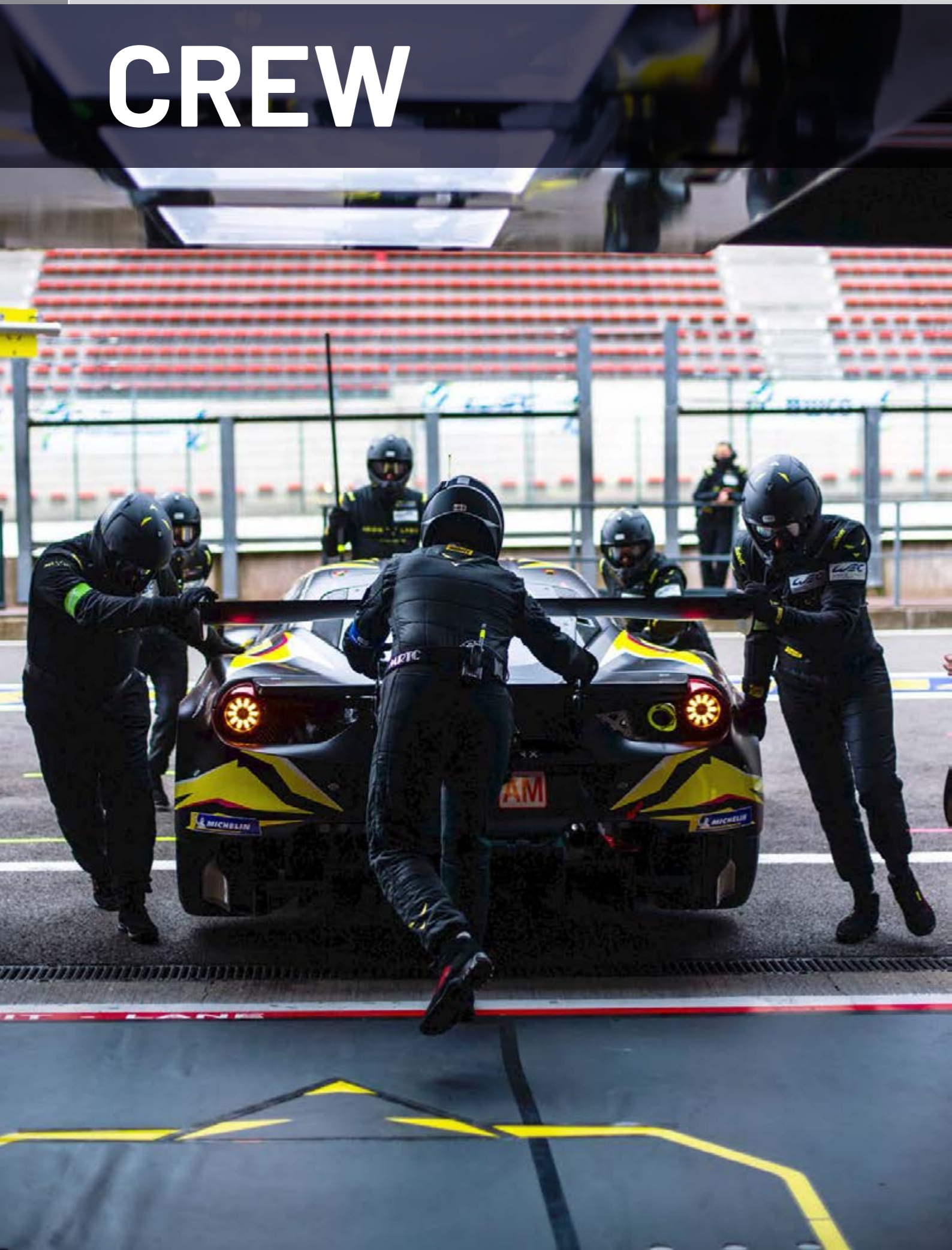

ROCKET TM-1

NEW

Size	Sandwich weight	Hom.	Made in Italy	Colour/Code	
S-XXXL	400 g/m ²	n/a			RFTUTMINR..

EXCLUSIVE TECHNICAL SOLUTION
MADE IN SABELT



CODE	SIZE	HOM.
Z120560	ONE SIZE	n/a



Protective gloves and arm protections against mechanical and thermal risks. Cotton and Kevlar fabric. Protects till 300° C. In compliance with European directives: -89/686 (dexterity 4) EN420:2003, -EN388:2003. Cut resistance (5/5). Abrasion resistance (2/4). Tearing resistance (4/4). Flammability resistance (4/4). Heat contact resistance (2/4).

CODE	SIZE	HOM.
Z120760	ONE SIZE	n/a



ABARTH COLLECTION

NEW



**Only the best
become Abarth**

We choose our partners with the same care that we use to tune every single Abarth. That's why only brands who share our values, passion for competition and determination to outdo themselves in every daily challenge enter our "workshops".



Size	FIA	Code
XS-XXL	8856-2018	RFUI200TOPABBI..

FIA APPROVED
 MANUFACTURER: SABELT
 MODEL: UI-200 TOP
 HOM. NO: DC.XXX.XX-T
 FIA STANDARD: 8856-2018



Size	FIA	Code
46-66	8856-2018	RFTUTS2ABRS..

FIA APPROVED
 MANUFACTURER: SABELT
 MODEL: CHALLENGE TS-2
 HOM. NO: DC.116.21-O
 FIA STANDARD: 8856-2018



Size	FIA	Code
8-12	8856-2018	RFTG02ABRS..

FIA APPROVED
 MANUFACTURER: SABELT
 MODEL: CHALLENGE TG-2
 HOM. NO: DC.113.20-G
 FIA STANDARD: 8856-2018



Size	FIA	Code
36-46	8856-2018	RFTB02CLASSICABRS..

FIA APPROVED
 MANUFACTURER: SABELT
 MODEL: CHALLENGE TB-2
 HOM. NO: DC.118.21-Z
 FIA STANDARD: 8856-2018



STEERING WHEELS



SW-833
 Ø 330 mm
 CODE RFV02010X
30% LIGHTER



SW-633
 Ø 330 mm
 CODE RFV02010X
NO STITCHING



SW-465
 Ø 350 mm
 CODE RFV02009X
NO STITCHING



SW-732 **NEW**
 Ø 320 mm
 CODE RFV02038
NO STITCHING



SW-733
 Ø 330 mm
 CODE RFV02007X
NO STITCHING



SW-635
 Ø 350 mm
 CODE RFV02007X
NO STITCHING



SW-390
 Ø 350 mm
 CODE RFV02005X
NO STITCHING



ACCESSORIES



QUICK RELEASE



M220SR6GRN
Quick release steering boss for group N cars, conformity to FIA regulation, compatible with all Sabelt 6-slot steering wheels.



M220SR6B
Quick release steering boss to be welded for Touring/Rally cars, conformity to FIA regulation, compatible with all Sabelt 6-slot steering wheels.

TOW STRAP

Length: 260 mm.
Hole diameter: 15,5 mm.



CCAC0023_A CCAC0027_A CCAC0024_A CCAC0028_A CCAC0026_A CCAC0025_A

DOOR STRAP



CCAC0043_A
Door strap to be fixed on the door panel. Length: 220 mm. Hole diameter: 9.5 mm.

NOTEBOOK



Z240600
Size 22 x 17,5 cm

CO-DRIVER POCKET

Nomex fabric.
hook and loop fastener locking.
Size 17 x 23 cm.



RFTINAVRS RFTINAVBR RFTINAVBI RFTINAVNR

CO-DRIVER BAG

Co-Driver bag, very thin. hook and loop fastener back panel for door bars universal fixation, phone compartment and external pockets.



COLOURS/CODES		
■	RFBS0039	27x36x7 cm

SUIT BAG



COLOURS/CODES		
■	RFBS0015	46x34x10 cm

WEEKEND BAG



COLOURS/CODES		
■	RFBS0016NR	55x37x23 cm
■	RFBS0016RS	

K-WAY



COLOURS/CODES	Sizes
 RSPW014BL...	XS-XXL

Regular fit

Nylon ripstop
water repellent

Taped seams

PININFARINA PF-1



COLOURS/CODES	Sizes
 RFTBR4PIN..	39-45

Shoe born from the collaboration between Sabelt and Pininfarina. The union of two Italian excellences to create an exclusive and iconic product. This model is characterized by Sabelt's Racing experience and by a unique and cool design which distinguishes Pininfarina's style.

