

Pro-Grade®

Professional Hand Tools

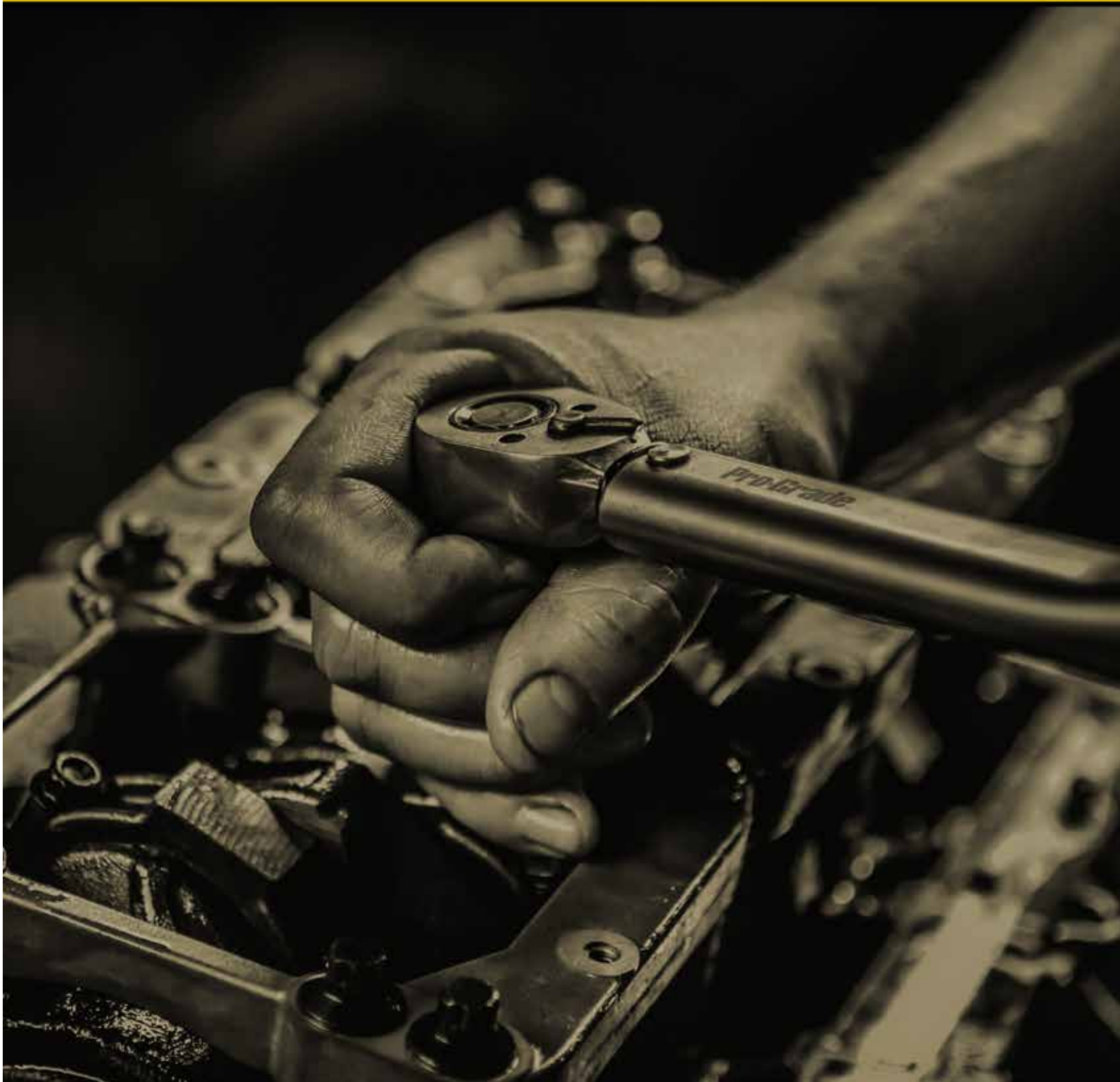

Designed to Perform... Built to Last

Pro-Grade products are designed and built with one goal in mind - to equip your customers with the best value available in Professional Quality Hand Tools.

To ensure long-lasting durability and performance, we start by using only premium quality raw materials like Chrome Vanadium, Chrome Nickel, and High Carbon Steel. We then employ the latest in design innovation and ergonomic styling because a professional quality hand tool should not only work hard, it should look good doing it.

Precise manufacturing techniques and strict quality controls are then added so that every product meets or exceeds A.N.S.I. (American National Standards Institute) or U.S. Federal Specifications for quality and performance. In fact, we're so confident of our quality, over 90% of our products are covered by an Unconditional Replacement Warranty for the life of the tool.

The net result is quite simple... a professional quality tool your customers will be proud to own at a price they can afford.



Table of Contents

	<i>Page</i>
Ratchets, Sockets & Accessories	4 - 30
<i>1/4, 3/8, 1/2, 3/4" Ratchets, Sockets & Accessories, Socket Sets, Tool Sets, Impact Sockets & Accessories</i>	
Wrenches	31 - 35
<i>Combination, Open End, Flare Nut, Ratcheting, Adjustable, Torque, Pipe Wrenches, Wrench Sets</i>	
Pliers & Cutters	36 - 38
<i>Slip Joint, Tongue & Groove, Diagonal, Lineman's, Long Nose, Switch Grip, Multi Function, Locking, Snips, Bolt Cutters</i>	
Driving Tools	39 - 43
<i>Screwdrivers, Torx Drivers, Nut Drivers, Square Drivers, Hex Drivers, Driver Sets</i>	
Cutting Tools	44 - 46
<i>Utility Knives, Replacement Blades, Scrapers, Glass Cutter, Precision Knives & Sets</i>	
Saws	47 - 48
<i>Hacksaws, Hand Saws, Mitre Back, Coping Saws, Jab & Wallboard Saws, Replacement Blades</i>	
Measuring Tools	49 - 50
<i>Tape Measures, Reel Tapes, Plumb Bob, Chalk Lines</i>	
Striking Tools	51 - 52
<i>Claw, Rip, Ball Pein, Dead Blow, Soft Face Hammers, Pry Bar, Wood Chisels</i>	
Wrecking Bars	53
<i>Goose Neck, Aligning, T-Type, Utility Bars, Nail Pullers, Moulding Bars, Ripping Chisel & Jumbo Pry Bar</i>	
Gear Pullers	54 - 55
<i>Adjustable Gear Pullers & Specialty Pullers</i>	
Vises & Clamps	56 - 59
<i>Mechanic's Vises, Workshop Vises, Multi-Purpose Vise, C-Clamps, Wood Bar Clamps, Ratcheting Bar Clamps, Spring Clamps</i>	

Ratchets, Sockets & Accessories

Ratchets

Precision Machined Gear Assemblies
Smooth Ratcheting Action
Heavy Duty Design



Chrome Plated
Mirror Polish Finish

Heat Treated Chrome Vanadium
Steel for Maximum Durability

Sockets



Heat Treated
Chrome Vanadium Steel
for Strength and Durability



DYNA-DRIVE™
TORQUE SYSTEM

**Directs Torque to the
sides of the fastener for
more surface contact.**

- 20% More Torque
- Eliminates Slippage
- Prevents Damage to Fasteners

Accessories

Full Assortment of
Socket Bits, Adaptors,
and Extensions





12009



12011



12012



12015

1/4" Drive Ratchets

ITEM NO.	DESCRIPTION	TEETH	PACKAGE	INNER QTY.	CASE QTY.
12009	Round Head Ratchet	45	Hang Tag	6	48
12011	Round Head Reversible Ratchet	72	Hang Tag	6	96
12012	Quick Release Oval Head Ratchet	72	Hang Tag	6	96
12015	5" Stubby Flex Head Ratchet	45	Hang Tag	6	48



12012

1/4" Drive Extensions

ITEM NO.	DESCRIPTION	PACKAGE	INNER QTY.	CASE QTY.
12001	1/4" Dr. 3" Extension	Hang Tag	6	96
12002	1/4" Dr. 6" Extension	Hang Tag	6	96



12001

1/4" Drive Universal Joint

ITEM NO.	DESCRIPTION	PACKAGE	INNER QTY.	CASE QTY.
12010	1/4" Dr. Universal Joint	Hang Tag	6	96



12010



12014

1/4" Drive Adaptor

ITEM NO.	DESCRIPTION	PACKAGE	INNER QTY.	CASE QTY.
12014	1/4" Dr. 1/4" x 3/8" Increasing Adaptor	Hang Tag	12	96



12013

1/4" Drive Spinner Handle

ITEM NO.	DESCRIPTION	PACKAGE	INNER QTY.	CASE QTY.
12013	1/4" Dr. Spinner Handle	Hang Tag	6	96



12205

1/4" Drive 6 Pt. SAE Standard Sockets

SAE

ITEM NO.	DESCRIPTION	PACKAGE	INNER QTY.	CASE QTY.
12199	1/4" Dr. 6 Pt. 3/16" Socket	Hang Tag	12	96
12200	1/4" Dr. 6 Pt. 7/32" Socket	Hang Tag	12	96
12201	1/4" Dr. 6 Pt. 1/4" Socket	Hang Tag	12	96
12202	1/4" Dr. 6 Pt. 9/32" Socket	Hang Tag	12	96
12203	1/4" Dr. 6 Pt. 5/16" Socket	Hang Tag	12	96
12204	1/4" Dr. 6 Pt. 11/32" Socket	Hang Tag	12	96
12205	1/4" Dr. 6 Pt. 3/8" Socket	Hang Tag	12	96
12206	1/4" Dr. 6 Pt. 7/16" Socket	Hang Tag	12	96
12207	1/4" Dr. 6 Pt. 1/2" Socket	Hang Tag	12	96



12305

1/4" Drive 6 Pt. SAE Deep Sockets

SAE

ITEM NO.	DESCRIPTION	PACKAGE	INNER QTY.	CASE QTY.
12301	1/4" Dr. 6 Pt. Deep 1/4" Socket	Hang Tag	12	96
12302	1/4" Dr. 6 Pt. Deep 9/32" Socket	Hang Tag	12	96
12303	1/4" Dr. 6 Pt. Deep 5/16" Socket	Hang Tag	12	96
12304	1/4" Dr. 6 Pt. Deep 11/32" Socket	Hang Tag	12	96
12305	1/4" Dr. 6 Pt. Deep 3/8" Socket	Hang Tag	12	96
12306	1/4" Dr. 6 Pt. Deep 7/16" Socket	Hang Tag	12	96
12307	1/4" Dr. 6 Pt. Deep 1/2" Socket	Hang Tag	12	96

1/4" Drive 6 Pt. Metric Standard Sockets

MM

ITEM NO.	DESCRIPTION	PACKAGE	INNER QTY.	CASE QTY.
12505	1/4" Dr. 6 Pt. 5mm Socket	Hang Tag	12	96
12506	1/4" Dr. 6 Pt. 6mm Socket	Hang Tag	12	96
12507	1/4" Dr. 6 Pt. 7mm Socket	Hang Tag	12	96
12508	1/4" Dr. 6 Pt. 8mm Socket	Hang Tag	12	96
12509	1/4" Dr. 6 Pt. 9mm Socket	Hang Tag	12	96
12510	1/4" Dr. 6 Pt. 10mm Socket	Hang Tag	12	96
12511	1/4" Dr. 6 Pt. 11mm Socket	Hang Tag	12	96
12512	1/4" Dr. 6 Pt. 12mm Socket	Hang Tag	12	96
12513	1/4" Dr. 6 Pt. 13mm Socket	Hang Tag	12	96



12509

1/4" Drive 6 Pt. Metric Deep Sockets

MM

ITEM NO.	DESCRIPTION	PACKAGE	INNER QTY.	CASE QTY.
12707	1/4" Dr. 6 Pt. Deep 7mm Socket	Hang Tag	12	96
12708	1/4" Dr. 6 Pt. Deep 8mm Socket	Hang Tag	12	96
12709	1/4" Dr. 6 Pt. Deep 9mm Socket	Hang Tag	12	96
12710	1/4" Dr. 6 Pt. Deep 10mm Socket	Hang Tag	12	96
12711	1/4" Dr. 6 Pt. Deep 11mm Socket	Hang Tag	12	96
12712	1/4" Dr. 6 Pt. Deep 12mm Socket	Hang Tag	12	96
12713	1/4" Dr. 6 Pt. Deep 13mm Socket	Hang Tag	12	96



12708

1/4" Drive Internal Torx® Sockets



ITEM NO.	DESCRIPTION	PACKAGE	INNER QTY.	CASE QTY.
12910	1/4" Dr. T10 Internal Torx Socket	Hang Tag	12	96
12915	1/4" Dr. T15 Internal Torx Socket	Hang Tag	12	96
12920	1/4" Dr. T20 Internal Torx Socket	Hang Tag	12	96
12925	1/4" Dr. T25 Internal Torx Socket	Hang Tag	12	96
12927	1/4" Dr. T27 Internal Torx Socket	Hang Tag	12	96
12930	1/4" Dr. T30 Internal Torx Socket	Hang Tag	12	96



12930

Torx® is a Registered Trademark of Accument Intellectual Properties, LLC.

LIFETIME GUARANTEE



3/8" Drive Ratchets

ITEM NO.	DESCRIPTION	TEETH	PACKAGE	INNER QTY.	CASE QTY.
13009	Round Head Ratchet	45	Hang Tag	6	48
13011	Quick Release Round Head Ratchet	72	Hang Tag	6	48
13012	Quick Release Oval Head Ratchet	72	Hang Tag	6	48
13013	11" Flex Head Ratchet	72	Hang Tag	6	48
13014	4" Stubby Oval Head Ratchet	72	Hang Tag	6	48
13019	10" Round Head Ratchet	45	Hang Tag	6	48
13020	11" Quick Release Round Head Flex Ratchet	45	Hang Tag	6	36
13022	4" Stubby Round Head Ratchet	45	Hang Tag	6	48



3/8" Drive Extensions

ITEM NO.	DESCRIPTION	PACKAGE	INNER QTY.	CASE QTY.
13001	3/8" Dr. 3" Extension	Hang Tag	12	192
13002	3/8" Dr. 6" Extension	Hang Tag	6	96
13003	3/8" Dr. 12" Extension	Hang Tag	6	48
13004	3/8" Dr. 3" Wobble Extension	Hang Tag	12	48
13005	3/8" Dr. 6" Wobble Extension	Hang Tag	6	96
13006	3/8" Dr. 10" Wobble Extension	Hang Tag	6	48
13007	3/8" Dr. 24" Extension	Hang Tag	6	36
13018	3 Pc. 3/8" Dr. Locking Extension Set	Hang Tag	6	48

3/8" Drive Universal Joints

ITEM NO.	DESCRIPTION	PACKAGE	INNER QTY.	CASE QTY.
13010	3/8" Dr. Universal Joint	Hang Tag	12	48



13010

3/8" Drive Flex Handle

ITEM NO.	DESCRIPTION	PACKAGE	INNER QTY.	CASE QTY.
13015	3/8" Dr. Flex Handle	Hang Tag	6	48



13015

3/8" Drive Adaptors

ITEM NO.	DESCRIPTION	PACKAGE	INNER QTY.	CASE QTY.
13016	3/8" Dr. 3/8" x 1/4" Reducing Adaptor	Hang Tag	12	96
13017	3/8" Dr. 3/8" x 1/2" Increasing Adaptor	Hang Tag	12	96



13016

3/8" Drive Oil Sending Unit Sockets

ITEM NO.	DESCRIPTION	PACKAGE	INNER QTY.	CASE QTY.
13254	3/8" Dr. Oil Sending Unit Socket	Hang Tag	6	96



13254



13207

3/8" Drive 6 Pt. SAE Standard Sockets

SAE

ITEM NO.	DESCRIPTION	PACKAGE	INNER QTY.	CASE QTY.
13201	3/8" Dr. 6 Pt. 3/8" Socket	Hang Tag	12	96
13202	3/8" Dr. 6 Pt. 7/16" Socket	Hang Tag	12	96
13203	3/8" Dr. 6 Pt. 1/2" Socket	Hang Tag	12	96
13204	3/8" Dr. 6 Pt. 9/16" Socket	Hang Tag	12	96
13205	3/8" Dr. 6 Pt. 5/8" Socket	Hang Tag	12	96
13206	3/8" Dr. 6 Pt. 11/16" Socket	Hang Tag	12	96
13207	3/8" Dr. 6 Pt. 3/4" Socket	Hang Tag	12	96
13208	3/8" Dr. 6 Pt. 13/16" Socket	Hang Tag	12	96
13209	3/8" Dr. 6 Pt. 7/8" Socket	Hang Tag	12	96
13210	3/8" Dr. 6 Pt. 15/16" Socket	Hang Tag	12	96



13305

3/8" Drive 6 Pt. SAE Deep Sockets

SAE

ITEM NO.	DESCRIPTION	PACKAGE	INNER QTY.	CASE QTY.
13301	3/8" Dr. 6 Pt. Deep 3/8" Socket	Hang Tag	12	192
13302	3/8" Dr. 6 Pt. Deep 7/16" Socket	Hang Tag	12	192
13303	3/8" Dr. 6 Pt. Deep 1/2" Socket	Hang Tag	12	192
13304	3/8" Dr. 6 Pt. Deep 9/16" Socket	Hang Tag	6	96
13305	3/8" Dr. 6 Pt. Deep 5/8" Socket	Hang Tag	6	96
13306	3/8" Dr. 6 Pt. Deep 11/16" Socket	Hang Tag	6	96
13307	3/8" Dr. 6 Pt. Deep 3/4" Socket	Hang Tag	6	96
13308	3/8" Dr. 6 Pt. Deep 13/16" Socket	Hang Tag	6	96
13309	3/8" Dr. 6 Pt. Deep 7/8" Socket	Hang Tag	6	96

3/8" Drive 6 Pt. Metric Standard Sockets

MM

ITEM NO.	DESCRIPTION	PACKAGE	INNER QTY.	CASE QTY.
13507	3/8" Dr. 6 Pt. 7mm Socket	Hang Tag	12	192
13508	3/8" Dr. 6 Pt. 8mm Socket	Hang Tag	12	192
13509	3/8" Dr. 6 Pt. 9mm Socket	Hang Tag	12	192
13510	3/8" Dr. 6 Pt. 10mm Socket	Hang Tag	12	192
13511	3/8" Dr. 6 Pt. 11mm Socket	Hang Tag	12	192
13512	3/8" Dr. 6 Pt. 12mm Socket	Hang Tag	12	192
13513	3/8" Dr. 6 Pt. 13mm Socket	Hang Tag	12	192
13514	3/8" Dr. 6 Pt. 14mm Socket	Hang Tag	12	192
13515	3/8" Dr. 6 Pt. 15mm Socket	Hang Tag	12	192
13516	3/8" Dr. 6 Pt. 16mm Socket	Hang Tag	12	192
13517	3/8" Dr. 6 Pt. 17mm Socket	Hang Tag	12	192
13518	3/8" Dr. 6 Pt. 18mm Socket	Hang Tag	12	192
13519	3/8" Dr. 6 Pt. 19mm Socket	Hang Tag	12	192



13515

3/8" Drive 6 Pt. Metric Deep Sockets

MM

ITEM NO.	DESCRIPTION	PACKAGE	INNER QTY.	CASE QTY.
13710	3/8" Dr. 6 Pt. Deep 10mm Socket	Hang Tag	12	192
13711	3/8" Dr. 6 Pt. Deep 11mm Socket	Hang Tag	12	192
13712	3/8" Dr. 6 Pt. Deep 12mm Socket	Hang Tag	12	192
13713	3/8" Dr. 6 Pt. Deep 13mm Socket	Hang Tag	6	96
13714	3/8" Dr. 6 Pt. Deep 14mm Socket	Hang Tag	6	96
13715	3/8" Dr. 6 Pt. Deep 15mm Socket	Hang Tag	6	96
13716	3/8" Dr. 6 Pt. Deep 16mm Socket	Hang Tag	6	96
13717	3/8" Dr. 6 Pt. Deep 17mm Socket	Hang Tag	6	96
13718	3/8" Dr. 6 Pt. Deep 18mm Socket	Hang Tag	6	96
13719	3/8" Dr. 6 Pt. Deep 19mm Socket	Hang Tag	6	96



13714



13222

3/8" Drive Universal Sockets

SAE

ITEM NO.	DESCRIPTION	PACKAGE	INNER QTY.	CASE QTY.
13220	3/8" Dr. 3/8" Universal Socket	Hang Tag	6	48
13221	3/8" Dr. 7/16" Universal Socket	Hang Tag	6	48
13222	3/8" Dr. 1/2" Universal Socket	Hang Tag	6	48
13223	3/8" Dr. 9/16" Universal Socket	Hang Tag	6	48
13224	3/8" Dr. 5/8" Universal Socket	Hang Tag	6	48



13252

3/8" Drive Spark Plug Sockets

SAE

MM

ITEM NO.	DESCRIPTION	PACKAGE	INNER QTY.	CASE QTY.
13250	3/8" Dr. 13/16" Universal Spark Plug Socket	Hang Tag	6	96
13251	3/8" Dr. 5/8" Universal Spark Plug Socket	Hang Tag	6	96
13252	3/8" Dr. 5/8" Spark Plug Socket	Hang Tag	6	96
13253	3/8" Dr. 13/16" Spark Plug Socket	Hang Tag	6	96
13255	3/8" Dr. 18mm Spark Plug Socket	Hang Tag	6	96



13876



3/8" Drive SAE Hex Bit Sockets

SAE

ITEM NO.	DESCRIPTION	PACKAGE	INNER QTY.	CASE QTY.
13873	3/8" Dr. 1/8" Hex Bit Socket	Hang Tag	12	192
13874	3/8" Dr. 5/32" Hex Bit Socket	Hang Tag	12	192
13875	3/8" Dr. 3/16" Hex Bit Socket	Hang Tag	12	192
13876	3/8" Dr. 7/32" Hex Bit Socket	Hang Tag	12	192
13877	3/8" Dr. 1/4" Hex Bit Socket	Hang Tag	12	192
13878	3/8" Dr. 5/16" Hex Bit Socket	Hang Tag	12	192
13879	3/8" Dr. 3/8" Hex Bit Socket	Hang Tag	12	192



13886



3/8" Drive Metric Hex Bit Sockets

MM

ITEM NO.	DESCRIPTION	PACKAGE	INNER QTY.	CASE QTY.
13883	3/8" Dr. 3mm Hex Bit Socket	Hang Tag	12	192
13884	3/8" Dr. 4mm Hex Bit Socket	Hang Tag	12	192
13885	3/8" Dr. 5mm Hex Bit Socket	Hang Tag	12	192
13886	3/8" Dr. 6mm Hex Bit Socket	Hang Tag	12	192
13887	3/8" Dr. 7mm Hex Bit Socket	Hang Tag	12	192
13888	3/8" Dr. 8mm Hex Bit Socket	Hang Tag	12	192
13889	3/8" Dr. 10mm Hex Bit Socket	Hang Tag	12	192

3/8" Drive Internal Torx® Sockets

ITEM NO.	DESCRIPTION	PACKAGE	INNER QTY.	CASE QTY.
12940	3/8" Dr. T-40 Internal Torx Socket	Hang Tag	12	96
12945	3/8" Dr. T-45 Internal Torx Socket	Hang Tag	12	96
12947	3/8" Dr. T-47 Internal Torx Socket	Hang Tag	12	96
12950	3/8" Dr. T-50 Internal Torx Socket	Hang Tag	12	96
12955	3/8" Dr. T-55 Internal Torx Socket	Hang Tag	12	96
12960	3/8" Dr. T-60 Internal Torx Socket	Hang Tag	12	96



3/8" Drive Tamper Proof Torx® Sockets

ITEM NO.	DESCRIPTION	PACKAGE	INNER QTY.	CASE QTY.
12939	3/8" Dr. T-40 Tamper Proof Torx Socket	Hang Tag	12	96
12944	3/8" Dr. T-45 Tamper Proof Torx Socket	Hang Tag	12	96
12946	3/8" Dr. T-47 Tamper Proof Torx Socket	Hang Tag	12	96
12949	3/8" Dr. T-50 Tamper Proof Torx Socket	Hang Tag	12	96
12954	3/8" Dr. T-55 Tamper Proof Torx Socket	Hang Tag	12	96
12959	3/8" Dr. T-60 Tamper Proof Torx Socket	Hang Tag	12	96



3/8" Drive External Torx® Sockets

ITEM NO.	DESCRIPTION	PACKAGE	INNER QTY.	CASE QTY.
12968	3/8" Dr. E8 External Torx Socket	Hang Tag	6	96
12970	3/8" Dr. E10 External Torx Socket	Hang Tag	6	96
12972	3/8" Dr. E12 External Torx Socket	Hang Tag	6	96
12974	3/8" Dr. E14 External Torx Socket	Hang Tag	6	96



3/8" Drive Slotted Bit Sockets

ITEM NO.	DESCRIPTION	PACKAGE	INNER QTY.	CASE QTY.
13867	3/8" Dr. 3/16" Slotted Bit Socket	Hang Tag	12	192
13868	3/8" Dr. 7/32" Slotted Bit Socket	Hang Tag	12	192
13869	3/8" Dr. 1/4" Slotted Bit Socket	Hang Tag	12	192



3/8" Drive Phillips Bit Sockets

ITEM NO.	DESCRIPTION	PACKAGE	INNER QTY.	CASE QTY.
13861	3/8" Dr. #1 Phillips Bit Socket	Hang Tag	12	192
13862	3/8" Dr. #2 Phillips Bit Socket	Hang Tag	12	192
13863	3/8" Dr. #3 Phillips Bit Socket	Hang Tag	12	192



Torx® is a Registered Trademark of Accument Intellectual Properties, LLC.

LIFETIME GUARANTEE



14012

1/2" Drive Ratchets

ITEM NO.	DESCRIPTION	TEETH	PACKAGE	INNER QTY.	CASE QTY.
14009	Round Head Ratchet	45	Hang Tag	6	36
14011	Quick Release Round Head Ratchet	72	Hang Tag	6	24
14012	Quick Release Oval Head Ratchet	72	Hang Tag	6	24
14013	6" Flex Head Stubby Ratchet	72	Hang Tag	6	36
14017	10" Flex Head Ratchet	45	Hang Tag	6	36
14018	14" Round Head Ratchet	45	Hang Tag	6	36



14000

1/2" Drive Extensions

ITEM NO.	DESCRIPTION	PACKAGE	INNER QTY.	CASE QTY.
14000	1/2" Dr. 3" Extension	Hang Tag	6	96
14001	1/2" Dr. 5" Extension	Hang Tag	6	96
14002	1/2" Dr. 10" Extension	Hang Tag	6	48
14004	1/2" Dr. 5" Wobble Extension	Hang Tag	12	96
14005	1/2" Dr. 10" Wobble Extension	Hang Tag	6	48

1/2" Drive Adaptors

ITEM NO.	DESCRIPTION	PACKAGE	INNER QTY.	CASE QTY.
14003	1/2" Dr. 1/2" x 3/4" Increasing Adaptor	Hang Tag	6	48
14014	1/2" Dr. 1/2" x 3/8" Reducing Adaptor	Hang Tag	12	192



14014

1/2" Drive Universal Joint

ITEM NO.	DESCRIPTION	PACKAGE	INNER QTY.	CASE QTY.
14010	1/2" Dr. Universal Joint	Hang Tag	6	48



14010

1/2" Drive Spark Plug Sockets

ITEM NO.	DESCRIPTION	PACKAGE	INNER QTY.	CASE QTY.
14250	1/2" Dr. 13/16" Spark Plug Socket	Hang Tag	6	96
14251	1/2" Dr. 5/8" Spark Plug Socket	Hang Tag	6	96



14251

1/2" Drive Flex Handles

ITEM NO.	DESCRIPTION	PACKAGE	INNER QTY.	CASE QTY.
14015	1/2" Dr. 15" Flex Handle	Hang Tag	6	24
14016	1/2" Dr. 24" Flex Handle	Hang Tag	6	24



14015



14205

1/2" Drive 12 Pt. SAE Standard Sockets

SAE

ITEM NO.	DESCRIPTION	PACKAGE	INNER QTY.	CASE QTY.
14200	1/2" Dr. 12 Pt. 7/16" Socket	Hang Tag	6	96
14201	1/2" Dr. 12 Pt. 1/2" Socket	Hang Tag	6	96
14202	1/2" Dr. 12 Pt. 9/16" Socket	Hang Tag	6	96
14203	1/2" Dr. 12 Pt. 5/8" Socket	Hang Tag	6	96
14204	1/2" Dr. 12 Pt. 11/16" Socket	Hang Tag	6	96
14205	1/2" Dr. 12 Pt. 3/4" Socket	Hang Tag	6	96
14206	1/2" Dr. 12 Pt. 13/16" Socket	Hang Tag	6	96
14207	1/2" Dr. 12 Pt. 7/8" Socket	Hang Tag	6	96
14208	1/2" Dr. 12 Pt. 15/16" Socket	Hang Tag	6	96
14209	1/2" Dr. 12 Pt. 1" Socket	Hang Tag	6	96
14210	1/2" Dr. 12 Pt. 1-1/16" Socket	Hang Tag	6	96
14211	1/2" Dr. 12 Pt. 1-1/8" Socket	Hang Tag	6	96
14212	1/2" Dr. 12 Pt. 1-1/4" Socket	Hang Tag	6	96

1/2" Drive 12 Pt. SAE Deep Sockets

SAE



14307

ITEM NO.	DESCRIPTION	PACKAGE	INNER QTY.	CASE QTY.
14301	1/2" Dr. 12 Pt. Deep 1/2" Socket	Hang Tag	6	96
14302	1/2" Dr. 12 Pt. Deep 9/16" Socket	Hang Tag	6	96
14303	1/2" Dr. 12 Pt. Deep 5/8" Socket	Hang Tag	6	96
14304	1/2" Dr. 12 Pt. Deep 11/16" Socket	Hang Tag	6	96
14305	1/2" Dr. 12 Pt. Deep 3/4" Socket	Hang Tag	6	96
14306	1/2" Dr. 12 Pt. Deep 13/16" Socket	Hang Tag	6	96
14307	1/2" Dr. 12 Pt. Deep 7/8" Socket	Hang Tag	6	96
14308	1/2" Dr. 12 Pt. Deep 15/16" Socket	Hang Tag	6	48
14309	1/2" Dr. 12 Pt. Deep 1" Socket	Hang Tag	6	48
14310	1/2" Dr. 12 Pt. Deep 1-1/16" Socket	Hang Tag	6	48
14311	1/2" Dr. 12 Pt. Deep 1-1/8" Socket	Hang Tag	6	48
14312	1/2" Dr. 12 Pt. Deep 1-1/4" Socket	Hang Tag	6	48

1/2" Drive 12 Pt. Metric Standard Sockets

MM

ITEM NO.	DESCRIPTION	PACKAGE	INNER QTY.	CASE QTY.
14512	1/2" Dr. 12 Pt. 12mm Socket	Hang Tag	6	96
14513	1/2" Dr. 12 Pt. 13mm Socket	Hang Tag	6	96
14514	1/2" Dr. 12 Pt. 14mm Socket	Hang Tag	6	96
14515	1/2" Dr. 12 Pt. 15mm Socket	Hang Tag	6	96
14516	1/2" Dr. 12 Pt. 16mm Socket	Hang Tag	6	96
14517	1/2" Dr. 12 Pt. 17mm Socket	Hang Tag	6	96
14518	1/2" Dr. 12 Pt. 18mm Socket	Hang Tag	6	96
14519	1/2" Dr. 12 Pt. 19mm Socket	Hang Tag	6	96
14520	1/2" Dr. 12 Pt. 20mm Socket	Hang Tag	6	96
14521	1/2" Dr. 12 Pt. 21mm Socket	Hang Tag	6	96
14522	1/2" Dr. 12 Pt. 22mm Socket	Hang Tag	6	96
14523	1/2" Dr. 12 Pt. 23mm Socket	Hang Tag	6	96
14524	1/2" Dr. 12 Pt. 24mm Socket	Hang Tag	6	96



14517

1/2" Drive 12 Pt. Metric Deep Sockets

MM

ITEM NO.	DESCRIPTION	PACKAGE	INNER QTY.	CASE QTY.
14712	1/2" Dr. 12 Pt. Deep 12mm Socket	Hang Tag	6	96
14713	1/2" Dr. 12 Pt. Deep 13mm Socket	Hang Tag	6	96
14714	1/2" Dr. 12 Pt. Deep 14mm Socket	Hang Tag	6	96
14715	1/2" Dr. 12 Pt. Deep 15mm Socket	Hang Tag	6	96
14716	1/2" Dr. 12 Pt. Deep 16mm Socket	Hang Tag	6	96
14717	1/2" Dr. 12 Pt. Deep 17mm Socket	Hang Tag	6	96
14718	1/2" Dr. 12 Pt. Deep 18mm Socket	Hang Tag	6	96
14719	1/2" Dr. 12 Pt. Deep 19mm Socket	Hang Tag	6	96
14721	1/2" Dr. 12 Pt. Deep 21mm Socket	Hang Tag	6	48
14722	1/2" Dr. 12 Pt. Deep 22mm Socket	Hang Tag	6	48
14724	1/2" Dr. 12 Pt. Deep 24mm Socket	Hang Tag	6	48



14717



14575

1/2" Drive 6 Pt. SAE Standard Sockets

SAE

ITEM NO.	DESCRIPTION	PACKAGE	INNER QTY.	CASE QTY.
14570	1/2" Dr. 6 Pt. 1/2" Socket	Hang Tag	6	96
14571	1/2" Dr. 6 Pt. 9/16" Socket	Hang Tag	6	96
14572	1/2" Dr. 6 Pt. 5/8" Socket	Hang Tag	6	96
14573	1/2" Dr. 6 Pt. 11/16" Socket	Hang Tag	6	96
14574	1/2" Dr. 6 Pt. 3/4" Socket	Hang Tag	6	96
14575	1/2" Dr. 6 Pt. 13/16" Socket	Hang Tag	6	96
14576	1/2" Dr. 6 Pt. 7/8" Socket	Hang Tag	6	96
14577	1/2" Dr. 6 Pt. 15/16" Socket	Hang Tag	6	96
14578	1/2" Dr. 6 Pt. 1" Socket	Hang Tag	6	96
14579	1/2" Dr. 6 Pt. 1-1/16" Socket	Hang Tag	6	96
14580	1/2" Dr. 6 Pt. 1-1/8" Socket	Hang Tag	6	96
14581	1/2" Dr. 6 Pt. 1-1/4" Socket	Hang Tag	6	96



14693

1/2" Drive 6 Pt. SAE Deep Sockets

SAE

ITEM NO.	DESCRIPTION	PACKAGE	INNER QTY.	CASE QTY.
14690	1/2" Dr. 6 Pt. Deep 1/2" Socket	Hang Tag	6	96
14691	1/2" Dr. 6 Pt. Deep 9/16" Socket	Hang Tag	6	96
14692	1/2" Dr. 6 Pt. Deep 5/8" Socket	Hang Tag	6	96
14693	1/2" Dr. 6 Pt. Deep 11/16" Socket	Hang Tag	6	96
14694	1/2" Dr. 6 Pt. Deep 3/4" Socket	Hang Tag	6	96
14695	1/2" Dr. 6 Pt. Deep 13/16" Socket	Hang Tag	6	96
14696	1/2" Dr. 6 Pt. Deep 7/8" Socket	Hang Tag	6	96
14697	1/2" Dr. 6 Pt. Deep 15/16" Socket	Hang Tag	6	96

3/4" Drive Ratchets

ITEM NO.	DESCRIPTION	TEETH	PACKAGE	INNER QTY.	CASE
16011	3/4" Dr. 20" Reversible Ratchet	43	Label	5	10
16012	3/4" Dr. 20" Heavy Duty Quick Release Ratchet	24	Label	5	10



16011

3/4" Drive Flex Handle

ITEM NO.	DESCRIPTION	PACKAGE	INNER QTY.	CASE QTY.
16015	3/4" Dr. 20" Flex Handle	Label	5	10
16016	3/4" Dr. 40" Flex Handle	Label	3	6



16015

3/4" Drive Sliding T Handle

ITEM NO.	DESCRIPTION	PACKAGE	INNER QTY.	CASE QTY.
16013	3/4" Dr. 20" Sliding T Handle	Label	10	20



16013

3/4" Drive Extensions

ITEM NO.	DESCRIPTION	PACKAGE	INNER QTY.	CASE QTY.
16000	3/4" Dr. 4" Extension	Hang Tag	12	48
16001	3/4" Dr. 8" Extension	Hang Tag	20	40
16002	3/4" Dr. 16" Extension	Hang Tag	10	20



16001

3/4" Drive Adaptors

ITEM NO.	DESCRIPTION	PACKAGE	INNER QTY.	CASE QTY.
16014	3/4" Dr. 3/4" x 1/2" Reducing Adaptor	Hang Tag	12	48



16014



16010

3/4" Drive Universal Joints

ITEM NO.	DESCRIPTION	PACKAGE	INNER QTY.	CASE QTY.
16010	3/4" Dr. Universal Joint	Hang Tag	12	48



16211

3/4" Drive 12 Pt. SAE Standard Sockets

SAE

ITEM NO.	DESCRIPTION	PACKAGE	INNER QTY.	CASE QTY.
16201	3/4" Dr. 12 Pt. 7/8" Socket	Hang Tag	12	48
16202	3/4" Dr. 12 Pt. 15/16" Socket	Hang Tag	12	48
16203	3/4" Dr. 12 Pt. 1" Socket	Hang Tag	12	48
16204	3/4" Dr. 12 Pt. 1-1/16" Socket	Hang Tag	12	48
16205	3/4" Dr. 12 Pt. 1-1/8" Socket	Hang Tag	12	48
16206	3/4" Dr. 12 Pt. 1-3/16" Socket	Hang Tag	12	48
16207	3/4" Dr. 12 Pt. 1-1/4" Socket	Hang Tag	12	48
16208	3/4" Dr. 12 Pt. 1-5/16" Socket	Hang Tag	12	48
16209	3/4" Dr. 12 Pt. 1-3/8" Socket	Hang Tag	12	48
16210	3/4" Dr. 12 Pt. 1-7/16" Socket	Hang Tag	12	48
16211	3/4" Dr. 12 Pt. 1-1/2" Socket	Hang Tag	12	48
16212	3/4" Dr. 12 Pt. 1-9/16" Socket	Hang Tag	12	48
16213	3/4" Dr. 12 Pt. 1-5/8" Socket	Hang Tag	12	48
16214	3/4" Dr. 12 Pt. 1-11/16" Socket	Hang Tag	12	48
16215	3/4" Dr. 12 Pt. 1-3/4" Socket	Hang Tag	12	48
16216	3/4" Dr. 12 Pt. 1-13/16" Socket	Hang Tag	12	48
16217	3/4" Dr. 12 Pt. 1-7/8" Socket	Hang Tag	12	48
16218	3/4" Dr. 12 Pt. 2" Socket	Hang Tag	12	48

Socket & Tool Sets

1/4
DRIVE

3/8
DRIVE

1/2
DRIVE

1/4" Drive Socket Sets

ITEM NO.	DESCRIPTION	PACKAGE	INNER QTY.	CASE QTY.
19200	8 Pc. 1/4" Dr. SAE Socket Set with Rail Contents: 3/16, 7/32, 1/4, 9/32, 5/16, 3/8, 7/16, 1/2"	Rack	6	12
19201	8 Pc. 1/4" Dr. Metric Socket Set with Rail Contents: 5, 6, 7, 8, 9, 10, 11, 12mm	Rack	6	12
19202	7 Pc. 1/4" Dr. Deep SAE Socket Set with Rail Contents: 1/4, 9/32, 5/16, 11/32, 3/8, 7/16, 1/2"	Rack	6	12
19203	7 Pc. 1/4" Dr. Deep Metric Socket Set with Rail Rack Contents: 7, 8, 9, 10, 11, 12, 13mm	Rack	6	12
19204	13pc 1/4" Dr. SAE Socket Set in Case Contents: 1/4" Dr. Quick Release Ratchet, Spinner Handle, 2" & 6" Extensions, 6pt SAE Sockets: 3/16, 7/32, 1/4, 9/32, 5/16, 11/32, 3/8, 7/16, 1/2", Case	Case	6	6
19205	13pc 1/4" Dr. Metric Socket Set in Case Contents: 1/4" Dr. Quick Release Ratchet, Spinner Handle, 3" & 6" Extensions, 6pt Metric Sockets: 5, 6, 7, 8, 9, 10, 11, 12, 13mm, Case	Case	6	6
19206	21pc 1/4" Dr. SAE Socket Set in Case Contents: 1/4" Dr. Quick Release Ratchet, Spinner Handle, Universal Joint, 3" & 6" Extensions, 6pt SAE Sockets: 3/16, 7/32, 1/4, 9/32, 5/16, 11/32, 3/8, 7/16, 1/2", 6pt Deep SAE Sockets: 1/4, 9/32, 5/16, 11/32, 3/8, 7/16, 1/2", Case	Case	6	6
19021	7pc 1/4" x 3/8" Dr. Internal Torx Socket Set Contents: 1/4" Dr. T15, T20, T25, T27, T30 3/8" Dr. Tamper Proof T40 & T45	Rack	6	12
19216	37pc 1/4" Dr. Socket Set with Case Contents: (1) Quick Release Ratchet, (2) 3" & 6" Extensions, (1) Universal Joint, (1) Spinner Handle, (9) 6pt. SAE Sockets: 3/16, 7/32, 1/4, 9/32, 5/16, 11/32, 3/8, 7/16, 1/2", (7) 6pt. Deep SAE Sockets: 1/4, 9/32, 5/16, 11/32, 3/8, 7/16, 1/2", (9) 6pt. Metric Sockets: 5, 6, 7, 8, 9, 10, 11, 12, 13mm, (7) 6pt. Deep Metric Sockets: 7, 8, 9, 10, 11, 12, 13mm	Case	8	8



19200



19201



19204



19216



11918



11920

Sockets Rails

ITEM NO.	DESCRIPTION	PACKAGE	INNER QTY.	CASE QTY.
11917	1/4" Dr. Socket Rail	Hang Tag	6	96
11918	3/8" Dr. Socket Rail	Hang Tag	6	96
11919	1/2" Dr. Socket Rail	Hang Tag	6	96
11920	3pc Socket Rail Set : 1/4, 3/8, 1/2"	Hang Tag	6	36



19301



19304



19305



19311



19316

3/8" Drive Socket Sets

ITEM NO.	DESCRIPTION	PACKAGE	INNER QTY.	CASE QTY.
----------	-------------	---------	------------	-----------

19301	13pc 3/8" Dr. Metric Socket Set with Rail	Rack	6	6
-------	---	------	---	---

Contents: 3/8" Dr. Sockets: 7, 8, 9, 10, 11, 12, 13, 14, 15, 16, 17, 18, 19mm

19302	7pc 3/8" Dr. SAE Socket Set with Rail	Rack	6	12
-------	---------------------------------------	------	---	----

Contents: 3/8" Dr. Sockets: 3/8, 7/16, 1/2, 9/16, 5/8, 11/16, 3/4"

19303	7pc 3/8" Dr. Deep SAE Socket Set with Rail	Rack	6	12
-------	--	------	---	----

Contents: 3/8" Dr. Sockets: 3/8, 7/16, 1/2, 9/16, 5/8, 11/16, 3/4"

19304	8pc 3/8" Dr. Deep Metric Socket Set with Rail	Rack	6	12
-------	---	------	---	----

Contents: 3/8" Dr. Sockets: 10, 12, 13, 14, 15, 16, 18, 19mm

19305	12pc 3/8" Dr. SAE Socket Set with Case	Case	6	12
-------	--	------	---	----

Contents: 3/8" Dr. Quick Release Ratchet, 3" & 6" Extensions, 5/8" Spark Plug Socket, 6pt SAE Sockets: 3/8, 7/16, 1/2, 9/16, 5/8, 11/16, 3/4, 13/16", Case

19306	12pc 3/8" Dr. Metric Socket Set with Case	Case	6	6
-------	---	------	---	---

Contents: 3/8" Dr. Quick Release Ratchet, 3" & 6" Extensions, 5/8" Spark Plug Socket, 6pt Metric Sockets: 10, 11, 12, 13, 14, 15, 16, 18mm, Case

19307	18pc 3/8" Dr. SAE Socket Set with Case	Case	6	6
-------	--	------	---	---

Contents: 3/8" Dr. Quick Release Ratchet, 3" & 6" Extensions, 5/8" Spark Plug Socket, 6pt SAE Sockets: 3/8, 7/16, 1/2, 9/16, 5/8, 11/16, 3/4" 6pt Deep SAE Sockets: 3/8, 7/16, 1/2, 9/16, 5/8, 11/16, 3/4", Case

19308	18pc 3/8" Dr. Metric Socket Set with Case	Case	6	6
-------	---	------	---	---

Contents: 3/8" Dr. Quick Release Ratchet, 3" & 6" Extensions, 5/8" Spark Plug Socket, 6pt Deep Metric Sockets: 10, 12, 13, 14, 15, 16, 18mm 6pt Metric Sockets: 10, 12, 13, 14, 15, 16, 18mm, Case

19311	58pc 3/8" Dr. Socket Set with Case	Case	6	6
-------	------------------------------------	------	---	---

Contents: (1) 3/8" Dr. Quick Release Ratchet, (7) 3/8" Dr. 6pt. SAE Sockets: 3/8, 7/16, 1/2, 9/16, 5/8, 11/16, 3/4", (6) 3/8" Dr. 6pt. Deep SAE Sockets: 3/8, 7/16, 1/2, 9/16, 11/16, 3/4", (12) 3/8" Dr. 6pt. Metric Sockets: 8, 9, 10, 11, 12, 13, 14, 15, 16, 17, 18, 19mm, (7) 3/8" Dr. 6pt. Deep Metric Sockets: 10, 12, 13, 15, 17, 18, 19mm, (2) 3/8" Dr. 3" & 6" Extensions, (22) Hex Keys with Holders: SAE: 1/4, 7/32, 3/16, 5/32, 9/64, 1/8, 7/64, 3/32, 5/64, 1/16, 0.05in. Metric: 10, 8, 6, 5, 4, 3, 2.5, 2, 1.5mm, (1) Case

19312	2pc 3/8" Dr. Spark Plug Socket Set	Hang Tag	6	72
-------	------------------------------------	----------	---	----

Contents: 5/8 and 3/16"

19316	73pc 3/8" Dr. Socket Set with Case	Case	3	3
-------	------------------------------------	------	---	---

Contents: (1) Quick Release Ratchet, (1) Flex Handle, (3) 3", 6", & 12" Extensions, (1) 3/8" x 1/4" Reducing Adaptor, (1) 3/8" x 1/2" Increasing Adaptor, (1) Universal Joint, (10) 6pt. SAE Sockets: 3/8, 7/16, 1/2, 9/16, 5/8, 11/16, 3/4, 13/16, 7/8, 15/16", (9) 6pt. Deep SAE Sockets: 3/8, 7/16, 1/2, 9/16, 5/8, 11/16, 3/4, 13/16, 7/8", (13) 6pt. Metric Sockets: 7, 8, 9, 10, 11, 12, 13, 14, 15, 16, 17, 18, 19mm, (10) 6pt. Deep Metric Sockets: 10, 11, 12, 13, 14, 15, 16, 17, 18, 19mm, (3) Spark Plug Sockets: 5/8", 13/16", 18mm, (5) SAE Hex Bit Sockets: 5/32, 3/16, 1/4, 5/16, 3/8", (3) Metric Hex Bit Sockets: 6, 8, 10mm, (6) Internal Torx Sockets: T40, T45, T47, T50, T55, T60, (4) Tamper Proof Torx Sockets: T40, T45, T50, T55, (1) Phillips Bit Socket, (1) Slotted Bit Socket

3/8" Drive Socket Bit Sets

ITEM NO.	DESCRIPTION	PACKAGE	INNER QTY.	CASE QTY.
19023	10 Pc. External Torx Socket Set Contents: E4, E5, E6, E7, E8, E10, E12, E14, E16, E18	Rack	6	24
19029	7 Pc. 3/8" Dr. Hex Bit Socket Set Contents: 3/8" Dr. Sockets: 1/8, 5/32, 3/16, 7/32, 1/4, 5/16, 3/8"	Rack	6	24
19030	7 Pc. 3/8" Dr. Hex Bit Socket Set Contents: 3/8" Dr. Sockets: 3-8, 10mm	Rack	6	24
19031	6 Pc. Bit Socket Set Contents: Slotted: 3/16, 7/32, 1/4" Phillips: #1, #2, #3	Rack	6	24
19027	13 Pc. Tamper Resistant Torx® Bit Set Contents: T-8, T-10, T-15, T-20, T-25, T-27, T-30, T-40, T-45, T-50, T-55, 1/4" Dr. Bit Adaptor, 3/8" Dr. Bit Adaptor	Card	6	24

Torx® is a Registered Trademark of Accument Intellectual Properties, LLC.



19029



19027

Accessory Sets

ITEM NO.	DESCRIPTION	PACKAGE	INNER QTY.	CASE QTY.
19024	10pc 3/8" Dr. Crowfoot Set Contents: 3/8, 7/16, 1/2, 9/16, 5/8, 11/16, 3/4, 13/16, 7/8, 1"	Clam	6	24
19025	3pc Universal Joint Set Contents: 1/4, 3/8, 1/2"	Hang Tag	6	72
19026	4pc Socket Adaptor Set Contents: 3/8(F) X 1/4 (M), 1/2(F) X 3/8(M), 3/8(F) X 1/2(M), 1/4(F) X 3/8(M)"	Hang Tag	6	72



19026

1/2" Drive Socket Sets

ITEM NO.	DESCRIPTION	PACKAGE	INNER QTY.	CASE QTY.
19401	9 Pc. 1/2" Dr. SAE Socket Set With Rail Contents: 1/2, 9/16, 5/8, 11/16, 3/4, 13/16, 7/8, 15/16, 1"	Rack	6	12
19405	10 Pc. 1/2" Dr. Metric Socket Set With Rail Contents: 12, 14, 15, 16, 17, 18, 19, 21, 22, 24mm	Rack	6	12
19402	8 Pc. 1/2" Dr. SAE Deep Socket Set With Rail Contents: 1/2, 9/16, 5/8, 11/16, 3/4, 13/16, 7/8, 15/16"	Rack	6	12
19403	12pc 1/2" Dr. SAE Socket Set in Case Contents: 1/2" Dr. Quick Release Ratchet, 5" Extension, 5/8" Spark Plug Socket, 12pt SAE Sockets: 7/16, 1/2, 9/16, 5/8, 11/16, 3/4, 13/16, 7/8, 15/16", Case	Case	6	6
19404	16pc 1/2" Dr. SAE Socket Set in Case Contents: 1/2" Dr. Quick Release Ratchet, 5" Extension, 15" Flex Handle, 12pt SAE Sockets: 7/16, 1/2, 9/16, 5/8, 11/16, 3/4, 13/16, 7/8, 15/16, 1, 1-1/16, 1-1/8, 1-1/4", Case	Case	4	4



19401



19402



19405



19404

1/4
DRIVE

3/8
DRIVE

1/2
DRIVE

Socket & Tool Sets

Mechanic's Tool Sets

ITEM NO.	DESCRIPTION	PACKAGE	INNER QTY.	CASE QTY.
19037	171pc Mechanic's Tool Set	Case	2	2



19037

1/4" DRIVE

(1) Quick Release Full Polish Oval Head Ratchet

(20) 6pt Standard Sockets: 3/16, 7/32, 1/4, 9/32, 5/16, 11/32, 3/8, 7/16, 1/2, 9/16", 4-13mm

3/8" DRIVE

(1) Quick Release Full Polish Oval Head Ratchet

(1) 3" Extension, (2) Spark Plug Sockets: 5/8" & 13/16"

(21) 6pt Standard Sockets: 1/4, 5/16, 11/32, 3/8, 7/16, 1/2, 9/16, 5/8, 11/16, 3/4", 7-15, 17, 19mm

(6) 12pt Standard Sockets: 3/8, 7/16, 1/2", 10, 12, 13mm

(8) 6pt Standard Sockets: 3/8, 7/16, 1/2, 9/16", 10, 12, 13, 14mm

1/2" DRIVE

(1) Quick Release Full Polish Oval Head Ratchet

(12) 12pt Standard Sockets: 1/2, 9/16, 5/8, 11/16, 3/4, 7/8", 14, 15, 17, 18, 19, 21mm

(12) Full Polish Combination Wrenches: 5/16, 3/8, 7/16, 1/2, 9/16, 5/8", 8, 10, 12-15mm

(1) Cushion Grip Magnetic Bit Driver

(44) 1" Driver Bits with Holders: (2) 1/4" Dr to Hex Adaptor,

Phillips #0 (2), #1 (2), #2 (2), #3 (2), Slotted 1/8, 5/32, 3/16 (2), 1/4 (2), 5/16", Square S1, S2, S3, Torx T10, T15, T20, T25, T27, T30, T40, Pozi PZ1, PZ2, PZ3

Hex 3/32, 1/8, 5/32, 3/16, 1/4", 3-7mm.

(18) Hex Keys with Holders: 1/16, 5/64, 3/32, 1/8, 5/32, 3/16, 7/32, 1/4", 1.5, 2, 2.5, 3, 3.5, 4, 5, 6mm

(20) Nut-Driver Bits: 5/32, 3/16, 7/32, (2) 1/4, 9/32, (2) 5/16, 11/32, 3/8, 7/16",

(1) 5-9, (2) 10, 11, 12mm

(1) 2-1/4" Bit Driver Extension, (1) 3" Magnetic Parts Tray

(1) Case

ITEM NO.	DESCRIPTION	PACKAGE	INNER QTY.	CASE QTY.
19416	57pc 1/2" Drive Mechanic's Tool Set with Case	Case	2	2



19416

1/2" DRIVE

(1) Quick Release Oval Head Ratchet

(3) 3", 5", & 10" Extensions

(1) Universal Joint

(1) 1/2" Drive X 3/8" Drive Reducing Adaptor

(2) 13/16" & 5/8" Spark Plug Sockets

(13) 12pt. Standard SAE Sockets: 7/16, 1/2, 9/16, 5/8, 11/16, 3/4, 13/16, 7/8, 15/16, 1, 1-1/16, 1-1/8, 1-1/4"

(12) 12pt. Deep SAE Sockets: 1/2, 9/16, 5/8, 11/16, 3/4, 13/16, 7/8, 15/16, 1, 1-1/16, 1-1/8, 1-1/4"

(13) 12pt. Metric Sockets: 12, 13, 14, 15, 16, 17, 18, 19, 20, 21, 22, 23, 24mm

(11) 12pt. Deep Metric Sockets: 12, 13, 14, 15, 16, 17, 18, 19, 21, 22, 24mm

Mechanic's Tool Sets

ITEM NO.	DESCRIPTION	PACKAGE	INNER QTY.	CASE QTY.
19040	130pc Mechanic's Tool Set	Case	2	2

1/4" DRIVE

(9) 6pt SAE Sockets: 3/16, 7/32, 1/4, 9/32, 5/16, 11/32, 3/8, 7/16, 1/2"

(9) 6pt Metric Sockets: 5-13mm

(5) 6pt Deep SAE Sockets: 1/4, 9/32, 5/16, 11/32, 3/8"

(5) 6pt Deep Metric Sockets: 7-11mm

(1) Spinner Handle, (1) Hex Coupler, (1) Round Head Ratchet,

(20) Driver Bits, (2) Bit Holders

(1) 3" Extension Bar, (1) Increasing Adaptor 1/4" x 3/8"

3/8" DRIVE

(9) 6pt SAE Sockets: 3/8, 7/16, 1/2, 9/16, 5/8, 11/16, 3/4, 13/16, 7/8"

(13) 6pt Metric Sockets: 7-19mm

(7) 6pt Deep SAE Sockets: 3/8, 7/16, 1/2, 9/16, 5/8, 11/16, 3/4"

(8) 6pt Deep Metric Sockets: 10-16, 18mm

(2) Spark Plug Sockets: 5/8, 13/16"

(1) 3" Extension, (1) 6" Extension, (1) Round Head Ratchet

(1) Reducing Adaptor: 3/8" x 1/4"

(12) **SAE Hex Keys:** 0.05, 1/16, 5/64, 3/32, 7/64, 1/8, 9/64, 5/32, 3/16, 7/32, 1/4" with Holder

(10) **Metric Hex Keys:** 1.5, 2, 2.5, 3, 4, 5, 6, 8, 10mm with Holder

(2) **Phillips Screwdrivers:** #1x3", #2x4"

(2) **Slotted Screwdrivers:** 3/16"x3", 1/4"x4"

(5) **Combination Wrenches:** 1/4, 5/16, 3/8, 7/16, 1/2"

(1) **Case**



19040

ITEM NO.	DESCRIPTION	PACKAGE	INNER QTY.	CASE QTY.
19039	106pc Mechanic's Tool Set	Case	2	2

1/4" DRIVE

(1) 1/4" Dr. Round Head Ratchet, (1) 3" Extension

(18) 6pt Standard Sockets: 3/16, 7/32, 1/4, 9/32, 5/16, 11/32, 3/8, 7/16, 1/2", 5-13mm.

3/8" DRIVE

(1) 3/8" Dr. Round Head Ratchet, (1) 6" Extension, (1) 3/8" x 1/4" Reducing Adaptor

(2) Spark Plug Sockets 5/8" & 13/16"

(22) 6pt Standard Sockets: 3/8, 7/16, 1/2, 9/16,

5/8, 11/16, 3/4, 13/16, 7/8", 7-19mm.

(14) 6pt Deep Sockets: 3/8, 7/16, 1/2, 9/16, 5/8, 11/16, 3/4", 10-16mm.

(1) Spinner Handle, (1) 1/4" Hex Bit Coupler

(22) **Driver Bits with Holders**

Slotted Bits: 1/8, 5/32, 3/16 (2), 1/4 (2), 5/16",

Square Bits: S1, S2, S3

Torx Bits: T10, T15, T20, T25, T27, T30, T40,

Pozi Bits: PZ1, PZ2, PZ3

(18) **Hex Keys with Holders:** 1/16, 5/64, 3/32, 1/8, 5/32, 3/16, 7/32,

1/4", 1.5, 2, 2.5, 3, 4, 5, 5.5, 6mm

(1) **Phillips Screwdriver** #2x4"

(1) **Slotted Screwdriver** 1/4"x4"

(1) **Case**



19039

3/8
DRIVE**1/2**
DRIVE

Impact Sockets & Accessories



13324

3/8" Drive 6 Pt. SAE Deep Impact Sockets

SAE

ITEM NO.	DESCRIPTION	PACKAGE	INNER QTY.	CASE QTY.
13320	3/8" Dr. 6 Pt. Deep 5/16" Impact Socket	Hang Tag	6	144
13321	3/8" Dr. 6 Pt. Deep 3/8" Impact Socket	Hang Tag	6	144
13322	3/8" Dr. 6 Pt. Deep 7/16" Impact Socket	Hang Tag	6	144
13323	3/8" Dr. 6 Pt. Deep 1/2" Impact Socket	Hang Tag	6	144
13324	3/8" Dr. 6 Pt. Deep 9/16" Impact Socket	Hang Tag	6	144
13325	3/8" Dr. 6 Pt. Deep 5/8" Impact Socket	Hang Tag	6	144
13326	3/8" Dr. 6 Pt. Deep 11/16" Impact Socket	Hang Tag	6	144
13327	3/8" Dr. 6 Pt. Deep 3/4" Impact Socket	Hang Tag	6	96



13021

3/8" Drive Impact Universal Joint

ITEM NO.	DESCRIPTION	PACKAGE	INNER QTY.	CASE QTY.
13021	3/8" Dr. Impact Universal Joint	Hang Tag	6	144

1/2" Drive 6 Pt. SAE Standard Impact Sockets

SAE

ITEM NO.	DESCRIPTION	PACKAGE	INNER QTY.	CASE QTY.
14600	1/2" Dr. 6 Pt. 7/16" Impact Socket	Hang Tag	6	144
14601	1/2" Dr. 6 Pt. 1/2" Impact Socket	Hang Tag	6	96
14602	1/2" Dr. 6 Pt. 9/16" Impact Socket	Hang Tag	6	96
14603	1/2" Dr. 6 Pt. 5/8" Impact Socket	Hang Tag	6	96
14604	1/2" Dr. 6 Pt. 11/16" Impact Socket	Hang Tag	6	96
14605	1/2" Dr. 6 Pt. 3/4" Impact Socket	Hang Tag	6	96
14606	1/2" Dr. 6 Pt. 13/16" Impact Socket	Hang Tag	6	96
14607	1/2" Dr. 6 Pt. 7/8" Impact Socket	Hang Tag	6	96
14608	1/2" Dr. 6 Pt. 15/16" Impact Socket	Hang Tag	6	96
14609	1/2" Dr. 6 Pt. 1" Impact Socket	Hang Tag	6	96



14607

1/2" Drive 6 Pt. SAE Deep Impact Sockets

SAE

ITEM NO.	DESCRIPTION	PACKAGE	INNER QTY.	CASE QTY.
14650	1/2" Dr. 6 Pt. Deep 7/16" Impact Socket	Hang Tag	6	96
14651	1/2" Dr. 6 Pt. Deep 1/2" Impact Socket	Hang Tag	6	96
14652	1/2" Dr. 6 Pt. Deep 9/16" Impact Socket	Hang Tag	6	96
14653	1/2" Dr. 6 Pt. Deep 5/8" Impact Socket	Hang Tag	6	96
14654	1/2" Dr. 6 Pt. Deep 11/16" Impact Socket	Hang Tag	6	96
14655	1/2" Dr. 6 Pt. Deep 3/4" Impact Socket	Hang Tag	6	48
14656	1/2" Dr. 6 Pt. Deep 13/16" Impact Socket	Hang Tag	6	48
14657	1/2" Dr. 6 Pt. Deep 7/8" Impact Socket	Hang Tag	6	48
14658	1/2" Dr. 6 Pt. Deep 15/16" Impact Socket	Hang Tag	6	72
14659	1/2" Dr. 6 Pt. Deep 1" Impact Socket	Hang Tag	6	72
14661	1/2" Dr. 3/4" x 13/16" Impact Flip Socket	Label	12	120



14659

1/2" Drive 6 Pt. Metric Standard Impact Sockets

MM

ITEM NO.	DESCRIPTION	PACKAGE	INNER QTY.	CASE QTY.
14613	1/2" Dr. 6 Pt. 13mm Impact Socket	Hang Tag	6	96
14614	1/2" Dr. 6 Pt. 14mm Impact Socket	Hang Tag	6	96
14615	1/2" Dr. 6 Pt. 15mm Impact Socket	Hang Tag	6	96
14616	1/2" Dr. 6 Pt. 16mm Impact Socket	Hang Tag	6	96
14617	1/2" Dr. 6 Pt. 17mm Impact Socket	Hang Tag	6	96
14618	1/2" Dr. 6 Pt. 18mm Impact Socket	Hang Tag	6	96
14619	1/2" Dr. 6 Pt. 19mm Impact Socket	Hang Tag	6	96



14618

1/2" Drive 6 Pt. Metric Deep Impact Sockets

MM

ITEM NO.	DESCRIPTION	PACKAGE	INNER QTY.	CASE QTY.
14670	1/2" Dr. 6 Pt. Deep 13mm Impact Socket	Hang Tag	6	96
14671	1/2" Dr. 6 Pt. Deep 14mm Impact Socket	Hang Tag	6	96
14672	1/2" Dr. 6 Pt. Deep 15mm Impact Socket	Hang Tag	6	96
14673	1/2" Dr. 6 Pt. Deep 16mm Impact Socket	Hang Tag	6	96
14674	1/2" Dr. 6 Pt. Deep 17mm Impact Socket	Hang Tag	6	96
14675	1/2" Dr. 6 Pt. Deep 18mm Impact Socket	Hang Tag	6	96
14676	1/2" Dr. 6 Pt. Deep 19mm Impact Socket	Hang Tag	6	48
14660	1/2" Dr. 6 Pt. 19mm x 21mm Impact Socket	Hang Tag	12	120



14676



14555

1/2" Drive Impact Extensions

ITEM NO.	DESCRIPTION	PACKAGE	INNER QTY.	CASE QTY.
14006	1/2" Dr. 3" Impact Extension	Hang Tag	6	144
14555	1/2" Dr. 5" Impact Extension	Hang Tag	6	48



14556

1/2" Drive Impact Adaptors

ITEM NO.	DESCRIPTION	PACKAGE	INNER QTY.	CASE QTY.
14556	1/2" Dr. 1/2" x 3/8" Impact Reducing Adaptor	Hang Tag	6	96
14557	1/2" Dr. 1/2" x 3/4" Impact Increasing Adaptor	Hang Tag	6	48



14558

1/2" Drive Impact Universal Joint

ITEM NO.	DESCRIPTION	PACKAGE	INNER QTY.	CASE QTY.
14558	1/2" Dr. Impact Universal Joint	Hang Tag	6	48

1/2" Drive 7 Pc. Impact Socket Sets

SAE **MM**

ITEM NO.	DESCRIPTION	PACKAGE	INNER QTY.	CASE QTY.
19611	7 Pc. 1/2" Dr. SAE Standard Impact Socket Set Contents: 1/2, 9/16, 5/8, 11/16, 3/4, 13/16, 7/8"	Rack	6	12
19612	7 Pc. 1/2" Dr. SAE Deep Impact Socket Set Contents: 1/2, 9/16, 5/8, 11/16, 3/4, 13/16, 7/8"	Rack	6	12
19615	7 Pc. 1/2" Dr. Metric Standard Impact Socket Set Contents: 13, 14, 15, 16, 17, 18, 19mm	Rack	6	24
19616	7 Pc. 1/2" Dr. Metric Deep Impact Socket Set Contents: 13, 14, 15, 16, 17, 18, 19mm	Rack	6	12



19611

3/4" Drive 6 Pt. SAE Standard Impact Sockets

SAE

ITEM NO.	DESCRIPTION	PACKAGE	INNER QTY.	CASE QTY.
16250	3/4" Dr. 6 Pt. 1" Impact Socket	Hang Tag	10	40
16251	3/4" Dr. 6 Pt. 1-1/16" Impact Socket	Hang Tag	10	40
16252	3/4" Dr. 6 Pt. 1-1/8" Impact Socket	Hang Tag	10	40
16253	3/4" Dr. 6 Pt. 1-1/4" Impact Socket	Hang Tag	10	40
16254	3/4" Dr. 6 Pt. 1-5/16" Impact Socket	Hang Tag	10	40
16255	3/4" Dr. 6 Pt. 1-3/8" Impact Socket	Hang Tag	10	40
16256	3/4" Dr. 6 Pt. 1-7/16" Impact Socket	Hang Tag	10	40
16257	3/4" Dr. 6 Pt. 1-1/2" Impact Socket	Hang Tag	10	40



16250

3/4" Drive 6 Pt. SAE Deep Impact Sockets

SAE

ITEM NO.	DESCRIPTION	PACKAGE	INNER QTY.	CASE QTY.
16261	3/4" Dr. 6 Pt. Deep 1" Impact Socket	Hang Tag	10	20
16262	3/4" Dr. 6 Pt. Deep 1-1/16" Impact Socket	Hang Tag	10	20
16263	3/4" Dr. 6 Pt. Deep 1-1/8" Impact Socket	Hang Tag	10	20
16264	3/4" Dr. 6 Pt. Deep 1-1/4" Impact Socket	Hang Tag	10	20
16265	3/4" Dr. 6 Pt. Deep 1-5/16" Impact Socket	Hang Tag	10	20
16266	3/4" Dr. 6 Pt. Deep 1-3/8" Impact Socket	Hang Tag	10	20
16267	3/4" Dr. 6 Pt. Deep 1-7/16" Impact Socket	Hang Tag	10	20
16268	3/4" Dr. 6 Pt. Deep 1-1/2" Impact Socket	Hang Tag	10	20



16261

3/4" Drive 6 Pt. Metric Standard Impact Sockets

MM

ITEM NO.	DESCRIPTION	PACKAGE	INNER QTY.	CASE QTY.
16284	3/4" Dr. 6 Pt. 22mm Impact Socket	Hang Tag	10	20
16285	3/4" Dr. 6 Pt. 24mm Impact Socket	Hang Tag	10	20
16286	3/4" Dr. 6 Pt. 25mm Impact Socket	Hang Tag	10	20
16287	3/4" Dr. 6 Pt. 26mm Impact Socket	Hang Tag	10	20
16288	3/4" Dr. 6 Pt. 27mm Impact Socket	Hang Tag	10	20
16289	3/4" Dr. 6 Pt. 30mm Impact Socket	Hang Tag	10	20
16290	3/4" Dr. 6 Pt. 32mm Impact Socket	Hang Tag	10	20
16291	3/4" Dr. 6 Pt. 33mm Impact Socket	Hang Tag	10	20
16292	3/4" Dr. 6 Pt. 35mm Impact Socket	Hang Tag	10	20
16293	3/4" Dr. 6 Pt. 36mm Impact Socket	Hang Tag	10	20
16294	3/4" Dr. 6 Pt. 38mm Impact Socket	Hang Tag	10	20
16295	3/4" Dr. 6 Pt. 41mm Impact Socket	Hang Tag	10	20



16288

3/4" Drive 6 Pt. Metric Deep Impact Sockets

MM



16300

ITEM NO.	DESCRIPTION	PACKAGE	INNER QTY.	CASE QTY.
16296	3/4" Dr. 6 Pt. Deep 22mm Impact Socket	Hang Tag	5	10
16297	3/4" Dr. 6 Pt. Deep 24mm Impact Socket	Hang Tag	5	10
16298	3/4" Dr. 6 Pt. Deep 25mm Impact Socket	Hang Tag	5	10
16299	3/4" Dr. 6 Pt. Deep 26mm Impact Socket	Hang Tag	5	10
16300	3/4" Dr. 6 Pt. Deep 27mm Impact Socket	Hang Tag	5	10
16301	3/4" Dr. 6 Pt. Deep 30mm Impact Socket	Hang Tag	5	10
16302	3/4" Dr. 6 Pt. Deep 32mm Impact Socket	Hang Tag	5	10
16303	3/4" Dr. 6 Pt. Deep 33mm Impact Socket	Hang Tag	5	10
16304	3/4" Dr. 6 Pt. Deep 35mm Impact Socket	Hang Tag	5	10
16305	3/4" Dr. 6 Pt. Deep 36mm Impact Socket	Hang Tag	5	10
16306	3/4" Dr. 6 Pt. Deep 38mm Impact Socket	Hang Tag	5	10
16307	3/4" Dr. 6 Pt. Deep 41mm Impact Socket	Hang Tag	5	10



16275

3/4" Drive Impact Extensions

ITEM NO.	DESCRIPTION	PACKAGE	INNER QTY.	CASE QTY.
16275	3/4" Dr. 4" Impact Extension	Hang Tag	6	36
16277	3/4" Dr. 7" Impact Extension	Hang Tag	6	24



16276

3/4" Drive O-Ring & Retainer Pin

ITEM NO.	DESCRIPTION	PACKAGE	INNER QTY.	CASE QTY.
16276	3/4" Dr. O-Ring & Retainer Pin	Card	12	288



16279

3/4" Drive Impact Adaptors

ITEM NO.	DESCRIPTION	PACKAGE	INNER QTY.	CASE QTY.
16279	3/4" Dr. 3/4" x 1/2" Impact Reducing Adaptor	Hang Tag	6	48



16281

3/4" Drive Impact Universal Joints

ITEM NO.	DESCRIPTION	PACKAGE	INNER QTY.	CASE QTY.
16281	3/4" Dr. Impact Universal Joint	Hang Tag	6	24

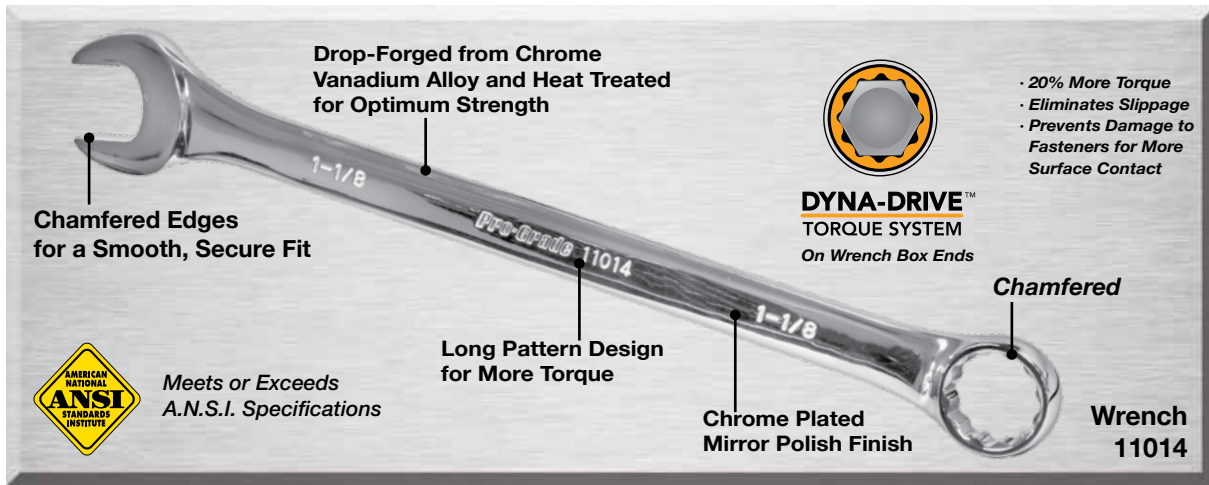

SAE Combination Wrenches

SAE

ITEM NO.	DESCRIPTION	PACKAGE	INNER QTY.	CASE QTY.
11000	1/4" Combination Wrench	Label	12	192
11001	5/16" Combination Wrench	Label	12	192
11002	3/8" Combination Wrench	Label	12	192
11003	7/16" Combination Wrench	Label	12	192
11004	1/2" Combination Wrench	Label	6	96
11005	9/16" Combination Wrench	Label	6	96
11006	5/8" Combination Wrench	Label	6	96
11007	11/16" Combination Wrench	Label	6	48
11008	3/4" Combination Wrench	Label	6	48
11009	13/16" Combination Wrench	Label	6	48
11010	7/8" Combination Wrench	Label	6	48
11011	15/16" Combination Wrench	Label	6	48
11012	1" Combination Wrench	Label	6	48
11013	1-1/16" Combination Wrench	Label	6	24
11014	1-1/8" Combination Wrench	Label	6	24
11015	1-1/4" Combination Wrench	Label	6	24
11016	1-5/16" Combination Wrench	Label	6	12
11017	1-3/8" Combination Wrench	Label	6	12
11018	1-7/16" Combination Wrench	Label	6	12
11019	1-1/2" Combination Wrench	Label	6	12
11020	1-5/8" Combination Wrench	Label	2	6
11021	1-3/4" Combination Wrench	Label	2	6
11022	1-7/8" Combination Wrench	Label	2	6
11023	2" Combination Wrench	Label	2	6



11014

LIFETIME GUARANTEE

Wrenches



11210

Metric Combination Wrenches

MM

ITEM NO.	DESCRIPTION	PACKAGE	INNER QTY.	CASE QTY.
11207	7mm Combination Wrench	Label	12	48
11208	8mm Combination Wrench	Label	12	48
11209	9mm Combination Wrench	Label	12	48
11210	10mm Combination Wrench	Label	12	48
11211	11mm Combination Wrench	Label	12	48
11212	12mm Combination Wrench	Label	6	48
11213	13mm Combination Wrench	Label	6	48
11214	14mm Combination Wrench	Label	6	48
11215	15mm Combination Wrench	Label	6	48
11216	16mm Combination Wrench	Label	6	48
11217	17mm Combination Wrench	Label	6	48
11218	18mm Combination Wrench	Label	6	48
11219	19mm Combination Wrench	Label	6	48
11220	20mm Combination Wrench	Label	6	48
11221	21mm Combination Wrench	Label	6	48
11222	22mm Combination Wrench	Label	6	48
11223	23mm Combination Wrench	Label	6	48
11224	24mm Combination Wrench	Label	6	48



19004

Combination Wrench Sets

ITEM NO.	DESCRIPTION	PACKAGE	INNER QTY.	CASE QTY.
19004	10 Pc. SAE Combination Wrench Set Contents: 1/4, 5/16, 3/8, 7/16, 1/2, 9/16, 5/8, 11/16, 3/4, 7/8"	Tray	6	12
19005	10 Pc. Metric Combination Wrench Set Contents: 10, 11, 12, 13, 14, 15, 16, 17, 18, 19mm"	Tray	6	12
19043	8 Pc. SAE Black Combination Wrench Set Contents: 5/16, 3/8, 7/16, 1/2, 9/16, 5/8, 11/16, 3/4"	Rack	6	12
19044	8 Pc. Metric Black Combination Wrench Set Contents: 8, 10, 11, 12, 13, 15, 17, 18mm"	Rack	6	12



19043

SAE Open End Wrenches

SAE

ITEM NO.	DESCRIPTION	PACKAGE	INNER QTY.	CASE QTY.
11301	1/4" x 5/16" Open End Wrench	Hang Tag	12	48
11302	3/8" x 7/16" Open End Wrench	Hang Tag	6	48
11303	1/2" x 9/16" Open End Wrench	Hang Tag	6	48
11304	9/16" x 11/16" Open End Wrench	Hang Tag	6	48
11305	5/8" x 3/4" Open End Wrench	Hang Tag	6	48
11306	13/16" x 7/8" Open End Wrench	Hang Tag	6	48



11303

Metric Open End Wrenches

MM

ITEM NO.	DESCRIPTION	PACKAGE	INNER QTY.	CASE QTY.
11501	8 x 9mm Open End Wrench	Hang Tag	6	192
11502	10 x 11mm Open End Wrench	Hang Tag	6	96
11503	12 x 13mm Open End Wrench	Hang Tag	6	96
11504	14 x 15mm Open End Wrench	Hang Tag	6	96
11505	16 x 18mm Open End Wrench	Hang Tag	6	48
11506	17 x 19mm Open End Wrench	Hang Tag	6	48



11503

SAE Flare Nut Wrenches

SAE

ITEM NO.	DESCRIPTION	PACKAGE	INNER QTY.	CASE QTY.
11401	3/8" x 7/16" Flare Nut Wrench	Rack	6	48
11402	1/2" x 9/16" Flare Nut Wrench	Rack	6	96
11403	5/8" x 3/4" Flare Nut Wrench	Rack	6	96
19016	3 Pc. SAE Flare Nut Wrench	Rack	6	12



11402

Metric Flare Nut Wrenches

MM

ITEM NO.	DESCRIPTION	PACKAGE	INNER QTY.	CASE QTY.
11601	10 x 12mm Flare Nut Wrench	Hang Tag	6	96
11602	13 x 14mm Flare Nut Wrench	Hang Tag	6	96
11603	15 x 17mm Flare Nut Wrench	Hang Tag	6	96
19017	3 Pc. Metric Flare Nut Wrench Set	Rack	6	12

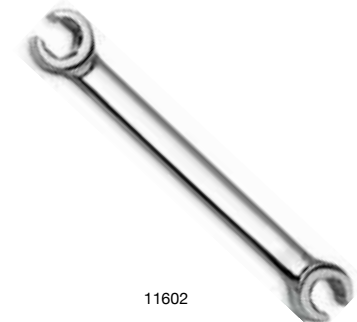

11602

LIFETIME GUARANTEE

Wrenches



11621

SAE Ratcheting Combination Wrenches

SAE

ITEM NO.	DESCRIPTION	PACKAGE	INNER QTY.	CASE QTY.
11621	5/16" Ratcheting Combination Wrench	Hang Tag	6	48
11622	3/8" Ratcheting Combination Wrench	Hang Tag	6	48
11623	7/16" Ratcheting Combination Wrench	Hang Tag	6	48
11624	1/2" Ratcheting Combination Wrench	Hang Tag	6	48
11625	9/16" Ratcheting Combination Wrench	Hang Tag	6	48
11626	5/8" Ratcheting Combination Wrench	Hang Tag	6	48
11627	11/16" Ratcheting Combination Wrench	Hang Tag	6	48
11628	3/4" Ratcheting Combination Wrench	Hang Tag	6	48

Metric Ratcheting Combination Wrenches

MM

ITEM NO.	DESCRIPTION	PACKAGE	INNER QTY.	CASE QTY.
11651	8mm Ratcheting Combination Wrench	Hang Tag	6	48
11652	9mm Ratcheting Combination Wrench	Hang Tag	6	48
11653	10mm Ratcheting Combination Wrench	Hang Tag	6	48
11654	11mm Ratcheting Combination Wrench	Hang Tag	6	48
11655	12mm Ratcheting Combination Wrench	Hang Tag	6	48
11656	13mm Ratcheting Combination Wrench	Hang Tag	6	48
11657	14mm Ratcheting Combination Wrench	Hang Tag	6	48
11658	15mm Ratcheting Combination Wrench	Hang Tag	6	48
11659	16mm Ratcheting Combination Wrench	Hang Tag	6	48
11660	17mm Ratcheting Combination Wrench	Hang Tag	6	48
11661	18mm Ratcheting Combination Wrench	Hang Tag	6	48
11662	19mm Ratcheting Combination Wrench	Hang Tag	6	48



11651

SAE Offset Double Box End Wrenches

SAE

ITEM NO.	DESCRIPTION	PACKAGE	INNER QTY.	CASE QTY.
11250	1/4" x 5/16" Offset Double Box End Wrench	Label	6	96
11251	3/8" x 7/16" Offset Double Box End Wrench	Label	6	24
11252	1/2" x 9/16" Offset Double Box End Wrench	Label	6	24
11253	5/8" x 11/16" Offset Double Box End Wrench	Label	6	24
11254	3/4" x 13/16" Offset Double Box End Wrench	Label	6	24
11255	7/8" x 15/16" Offset Double Box End Wrench	Label	6	24



11253

Metric Offset Double Box End Wrenches

MM

ITEM NO.	DESCRIPTION	PACKAGE	INNER QTY.	CASE QTY.
11260	6 x 7mm Offset Double Box End Wrench	Label	6	96
11261	8 x 9mm Offset Double Box End Wrench	Label	6	96
11262	10 x 11mm Offset Double Box End Wrench	Label	6	24
11263	12 x 13mm Offset Double Box End Wrench	Label	6	24
11264	14 x 15mm Offset Double Box End Wrench	Label	6	24
11265	16 x 17mm Offset Double Box End Wrench	Label	6	24
11266	18 x 19mm Offset Double Box End Wrench	Label	6	24
11267	20 x 22mm Offset Double Box End Wrench	Label	6	24



11264

Ratcheting Combination Wrench Sets

ITEM NO.	DESCRIPTION	PACKAGE	INNER QTY.	CASE QTY.
18050	7 Pc. SAE Ratcheting Combination Wrench Set Contents: 5/16, 3/8, 7/16, 1/2, 9/16, 5/8, 3/4"	Rack	6	24
18051	7 Pc. Metric Ratcheting Combination Wrench Set Contents: 8, 10, 12, 13, 14, 15, 18mm	Rack	6	24



18050

Adjustable Wrenches

ITEM NO.	DESCRIPTION	PACKAGE	INNER QTY.	CASE QTY.
15006	6" Satin Finish Adjustable Wrench	Card	6	48
15008	8" Satin Finish Adjustable Wrench	Card	6	48
15010	10" Satin Finish Adjustable Wrench	Card	3	36
15012	12" Satin Finish Adjustable Wrench	Card	3	24
15015	15" Satin Finish Adjustable Wrench	Label	2	16
15018	18" Satin Finish Adjustable Wrench	Label	1	10



15006

Torque Wrenches

ITEM NO.	DESCRIPTION	PACKAGE	INNER QTY.	CASE QTY.
11850	3/8" Dr. Micro Adjusting Torque Wrench	Box	6	12
11851	3/8" Dr. Round Beam Torque Wrench	Tag	6	12
11852	1/2" Dr. Micro Adjusting Torque Wrench	Box	6	6
11853	1/2" Dr. Round Beam Torque Wrench	Tag	6	12
11854	1/4" Dr. Micro Adjusting Torque Wrench	Box	6	12
11856	1/2" Dr. Micro Adjusting Torque Wrench	Box	6	6



11851



11854

Pipe Wrenches

ITEM NO.	DESCRIPTION	PACKAGE	INNER QTY.	CASE QTY.
11708	8" Heavy Duty Pipe Wrench	Label	6	36
11710	10" Heavy Duty Pipe Wrench	Label	6	36
11714	14" Heavy Duty Pipe Wrench	Label	5	20
11718	18" Heavy Duty Pipe Wrench	Label	2	12
11719	18" Heavy Duty Offset Aluminum Pipe Wrench	Label	6	12
11724	24" Heavy Duty Pipe Wrench	Label	1	6
11736	36" Heavy Duty Pipe Wrench	Label	1	4
11814	14" Aluminum Heavy Duty Pipe Wrench	Label	6	24
11818	18" Aluminum Heavy Duty Pipe Wrench	Label	6	12
11824	24" Aluminum Heavy Duty Pipe Wrench	Label	6	6
11836	36" Aluminum Heavy Duty Pipe Wrench	Label	1	3



11708



11814

Pliers and Cutters

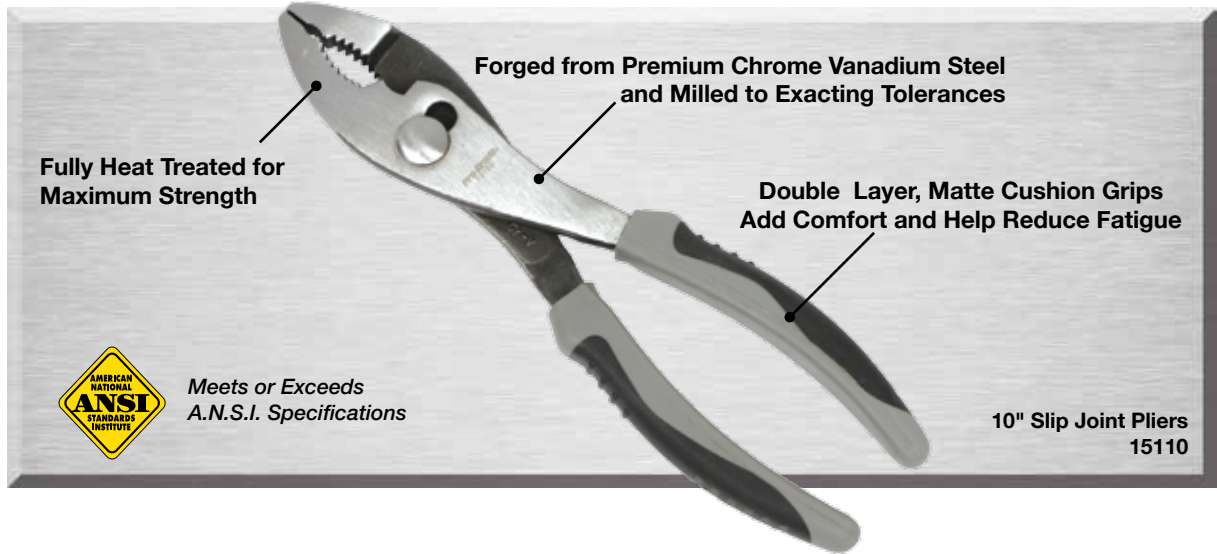

10" Slip Joint Pliers
15110



15151



15202



15206

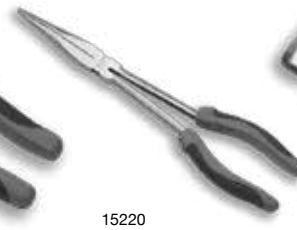

15220



15411

Pliers

- Induction hardened chrome vanadium
- Precision machined teeth and cutting edges
- Non-slip molded grips



15108

ITEM NO.	DESCRIPTION	PACKAGE	INNER QTY.	CASE QTY.
15106	6" Slip Joint Pliers	Card	6	48
15108	8" Slip Joint Pliers	Card	6	48
15110	10" Slip Joint Pliers	Card	6	48
15150	8" Tongue & Groove Pliers	Card	6	48
15151	10" Tongue & Groove Pliers	Card	6	48
15152	12" Tongue & Groove Pliers	Card	6	24
15201	6" Diagonal Pliers	Card	6	48
15202	7-1/2" Diagonal Pliers	Card	6	48
15205	7" Lineman's Pliers	Card	6	48
15206	8" Lineman's Pliers	Card	6	48
15210	6" Long Nose Pliers	Card	6	48
15211	8" Long Nose Pliers	Card	6	48
15220	11" Straight Long Reach Pliers	Card	12	48
15221	11" Bent Nose Long Reach Pliers	Card	12	48
15411	10" Fence Pliers	Card	6	30

Locking Grip Pliers

- Drop forged heat treated chrome molybdenum jaws
- Precision machined and hardened adjustment screw

ITEM NO.	DESCRIPTION	PACKAGE	INNER QTY.	CASE QTY.
15230	5" Curve Jaw Lock Grip Pliers	Card	6	48
15231	7" Curve Jaw Lock Grip Pliers	Card	6	48
15232	10" Curve Jaw Lock Grip Pliers	Card	6	36



15231

StripGrip

- 2 different jaws for fast wire cutting and stripping
- Stripper jaw grips and strips
- Diagonal cutting jaw cuts wire cleanly
- Ergonomically designed grips for comfort and performance

ITEM NO.	DESCRIPTION	PACKAGE	INNER QTY.	CASE QTY.
15091	StripGrip Dual Jaw Pliers	Clam	4	24



15091

Aviation Tin Snips

- Drop forged chrome molybdenum steel
- Compound cutting action
- Non-slip color grips with swivel lock

ITEM NO.	DESCRIPTION	PACKAGE	INNER QTY.	CASE QTY.
31681	Aviation Tin Snips Straight - yellow grips	Card	4	24



31681

7" Multi-Purpose Shears

- Hardened stainless steel serrated edges
- Wire cutter for up to 12 AWG
- Non-slip molded grips with thumb swivel lock
- Cuts plastic, cardboard, leather, fabric, and wire

ITEM NO.	DESCRIPTION	PACKAGE	INNER QTY.	CASE QTY.
82024	7" Multi-Purpose Shears	Card	6	24



82024

LIFETIME GUARANTEE

Pliers and Cutters



15414

Bolt Cutters

-Induction hardened chrome vanadium jaw

-Adjustable jaw cutting depth

-Available replacement jaws

ITEM NO.	DESCRIPTION	PACKAGE	INNER QTY.	CASE QTY.
15408	8" Mini Bolt Cutter	Label	6	48
15414	14" Heavy Duty Bolt Cutter	Label	1	20
15418	18" Heavy Duty Bolt Cutter	Label	1	20
15424	24" Heavy Duty Bolt Cutter	Label	1	10
15430	30" Heavy Duty Bolt Cutter	Label	1	6
15436	36" Heavy Duty Bolt Cutter	Label	1	5



15415

15419

Bolt Cutter Replacement Jaws

ITEM NO.	DESCRIPTION	PACKAGE	INNER QTY.	CASE QTY.
15415	14" Bolt Cutter Replacement Jaws	Label	1	20
15419	18" Bolt Cutter Replacement Jaws	Label	1	10
15425	24" Bolt Cutter Replacement Jaws	Label	1	10
15431	30" Bolt Cutter Replacement Jaws	Label	1	6
15437	36" Bolt Cutter Replacement Jaws	Label	1	5

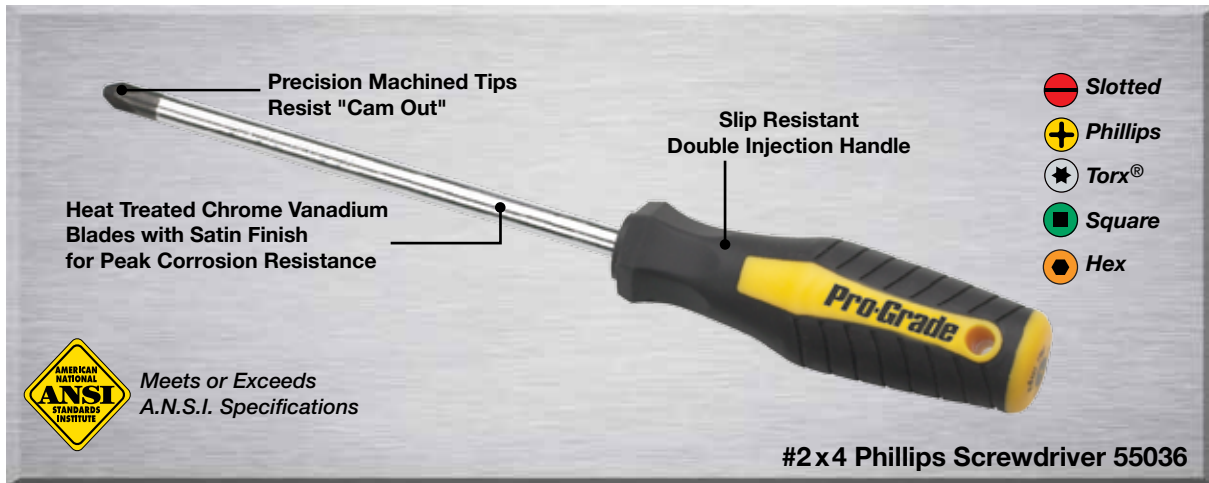

Phillips Screwdrivers Single Injection Handle

ITEM NO.	DESCRIPTION	PACKAGE	INNER QTY.	CASE QTY.
17001	#1 x 3" Phillips Screwdriver	Hang Tag	12	96
17002	#2 x 4" Phillips Screwdriver	Hang Tag	12	96
17003	#3 x 6" Phillips Screwdriver	Hang Tag	12	96
17004	#2 x 1-1/2" Phillips Screwdriver	Hang Tag	12	96
17005	#2 x 8" Phillips Screwdriver	Hang Tag	12	96



17002

Phillips Screwdrivers Double Injection Handle

ITEM NO.	DESCRIPTION	PACKAGE	INNER QTY.	CASE QTY.
55033	#0 x 3" Phillips Screwdriver	Hang Tag	12	96
55034	#1 x 3" Phillips Screwdriver	Hang Tag	12	96
55035	#2 x 1-1/2" Phillips Screwdriver	Hang Tag	12	96
55036	#2 x 4" Phillips Screwdriver	Hang Tag	12	96
55010	#2 x 8" Phillips Screwdriver	Hang Tag	12	96
55037	#3 x 6" Phillips Screwdriver	Hang Tag	12	96



55037

Torx® is a Registered Trademark of Accument Intellectual Properties, LLC.

LIFETIME GUARANTEE

Driving Tools



17008

Slotted Screwdrivers Single Injection Handle



ITEM NO.	DESCRIPTION	PACKAGE	INNER QTY.	CASE QTY.
17008	3/16" x 4" Slotted Screwdriver	Hang Tag	12	96
17009	3/16" x 6" Slotted Screwdriver	Hang Tag	12	96
17006	1/4" x 1-1/2" Slotted Screwdriver	Hang Tag	12	96
17010	1/4" x 4" Slotted Screwdriver	Hang Tag	12	96
17011	1/4" x 6" Slotted Screwdriver	Hang Tag	12	96
17013	5/16" x 6" Slotted Screwdriver	Hang Tag	12	96



55030

Slotted Screwdrivers Double Injection Handle



ITEM NO.	DESCRIPTION	PACKAGE	INNER QTY.	CASE QTY.
55026	1/8" x 3" Slotted Screwdriver	Hang Tag	12	96
55020	3/16" x 3" Slotted Screwdriver	Hang Tag	12	96
55028	3/16" x 4" Slotted Screwdriver	Hang Tag	12	96
55029	3/16" x 6" Slotted Screwdriver	Hang Tag	12	96
55023	1/4" x 6" Slotted Screwdriver	Hang Tag	12	96
55024	1/4" x 8" Slotted Screwdriver	Hang Tag	12	96
55027	1/4" x 1-1/2" Slotted Screwdriver	Hang Tag	12	96
55030	1/4" x 4" Slotted Screwdriver	Hang Tag	12	96
55031	5/16" x 6" Slotted Screwdriver	Hang Tag	12	96
55032	3/8" x 10" Slotted Screwdriver	Hang Tag	12	96



17220

Torx Screwdrivers Single Injection Handle



ITEM NO.	DESCRIPTION	PACKAGE	INNER QTY.	CASE QTY.
17210	T10 x 4" Torx Screwdriver	Hang Tag	12	96
17215	T15 x 4" Torx Screwdriver	Hang Tag	12	96
17220	T20 x 4" Torx Screwdriver	Hang Tag	12	96
17225	T25 x 4" Torx Screwdriver	Hang Tag	12	96
17227	T27 x 4" Torx Screwdriver	Hang Tag	12	96
17230	T30 x 4" Torx Screwdriver	Hang Tag	12	96

Torx Screwdrivers Double Injection Handle



ITEM NO.	DESCRIPTION	PACKAGE	INNER QTY.	CASE QTY.
55061	T10 x 4" Torx Screwdriver	Hang Tag	12	96
55062	T15 x 4" Torx Screwdriver	Hang Tag	12	96
55063	T20 x 4" Torx Screwdriver	Hang Tag	12	96
55064	T25 x 4" Torx Screwdriver	Hang Tag	12	96
55065	T27 x 4" Torx Screwdriver	Hang Tag	12	96
55066	T30 x 4" Torx Screwdriver	Hang Tag	12	96



55063

Nut Drivers Double Injection Handle



ITEM NO.	DESCRIPTION	PACKAGE	INNER QTY.	CASE QTY.
55051	3/16" x 3" Nut Driver	Hang Tag	12	96
55052	1/4" x 3" Nut Driver	Hang Tag	12	96
55053	5/16" x 3" Nut Driver	Hang Tag	12	96
55054	11/32" x 3" Nut Driver	Hang Tag	12	96
55055	3/8" x 3" Nut Driver	Hang Tag	12	96
55056	7/16" x 3" Nut Driver	Hang Tag	12	96
55057	1/2" x 3" Nut Driver	Hang Tag	12	96



55051

Nut Driver Sets



ITEM NO.	DESCRIPTION	PACKAGE	INNER QTY.	CASE QTY.
55039	4 Pc. SAE Nut Driver Set Contents: 1/4, 5/16, 3/8, 7/16"	Clam	6	48



55039

6-in-1 Drivers

ITEM NO.	DESCRIPTION	PACKAGE	INNER QTY.	CASE QTY.
17101	6-in-1 Torx Driver	Clam	6	48
55100	6-in-1 Screwdriver (Double Injection)	Clam	12	48



55100

Torx® is a Registered Trademark of Accument Intellectual Properties, LLC.

LIFETIME GUARANTEE

Driver Sets



85339

Hex Key Sets



ITEM NO.	DESCRIPTION	PACKAGE	INNER QTY.	CASE QTY.
85336	9 Pc. Metric Long Arm Hex Key Set Contents: 1.5, 2, 2.5, 3, 4, 5, 6, 8, 10mm	Clam	4	24
85339	13 Pc. SAE Long Arm Hex Key Set Contents: .05, 1/16, 5/64, 3/32, 7/64, 1/8, 9/64, 5/32, 3/16, 7/32, 1/4, 5/16, 3/8"	Clam	4	24



85331

Folding Driver Sets



ITEM NO.	DESCRIPTION	PACKAGE	INNER QTY.	CASE QTY.
55070	8pc Folding Torx Set Contents: T9, T10, T15, T20, T25, T27, T30, T40	Tag	4	24
85332	9pc SAE Folding Hex Key Set Contents: 1/4, 7/32, 3/16, 5/32, 9/64, 1/8, 7/64, 3/32, 5/64"	Tag	4	24
85331	8pc Metric Folding Hex Key Set Contents: 1.5, 2, 2.5, 3, 4, 5, 6, 8mm	Tag	4	24



55059

Square Drivers



ITEM NO.	DESCRIPTION	PACKAGE	INNER QTY.	CASE QTY.
55059	S2 x 4" Square Driver	Hang Tag	12	96

Driver/Bit Sets

ITEM NO.	DESCRIPTION	PACKAGE	INNER QTY.	CASE QTY.
35039CD	XLDriver™ II Stubby Ratcheting Driver Contents: 6 Double-end Driver Bits	Bulk	12	96
35037	XL Driver, 12-in-1 Ratcheting Driver Contents: Slotted: 3/16, 1/4, Phillips: #1, #2, Hex: 3, 4mm, Torx: T15, T20, Square: S1, S2, Pozi: PZ1, PZ2, Ratcheting Driver	Card	6	48
35042	XLDriver™ Precision Contents: Slotted: 3/32, 9/64, Phillips: #00, #0, #1, #2, Hex: 1/8, 3/32, Torx: T7, T8, T10, T15, Driver	Card	6	48
19110	4pc. Impact Bit Driver Set Contents: Slotted: 5/16", 3/8", Phillips: #2, #3	Card	6	192



35039

35042



19110



19101



55041

Driver Sets



ITEM NO.	DESCRIPTION	PACKAGE	INNER QTY.	CASE QTY.
19101	5 Pc. Torx Screwdriver Set with Aluminum Rack Contents: T10x4", T15x4", T20x4", T25x4", T30x4"	Clam	6	12
19104	6 Pc. Screwdriver Set with Aluminum Rack Contents: Slotted: 3/16x3", 1/4x4", 5/16x6", Phillips: #1x3", #2x4", 3x6"	Clam	6	12
55041	6 Pc. Screwdriver Set Contents: Slotted: 1/8x3", 3/16x3", 1/4x4", Phillips: #0x3", #1x3", #2x4"	Clam	6	36

1/2" Drive Impact Driver Set with Case

ITEM NO.	DESCRIPTION	PACKAGE	INNER QTY.	CASE QTY.
19620	1/2" Dr. Impact Driver Set With Holder Contents: Slotted: 5/16", 3/8" Phillips: #2, #3, Bit Impact Driver, Bit Adapter, Metal Case	Box	6	24



19620

Cutting Tools

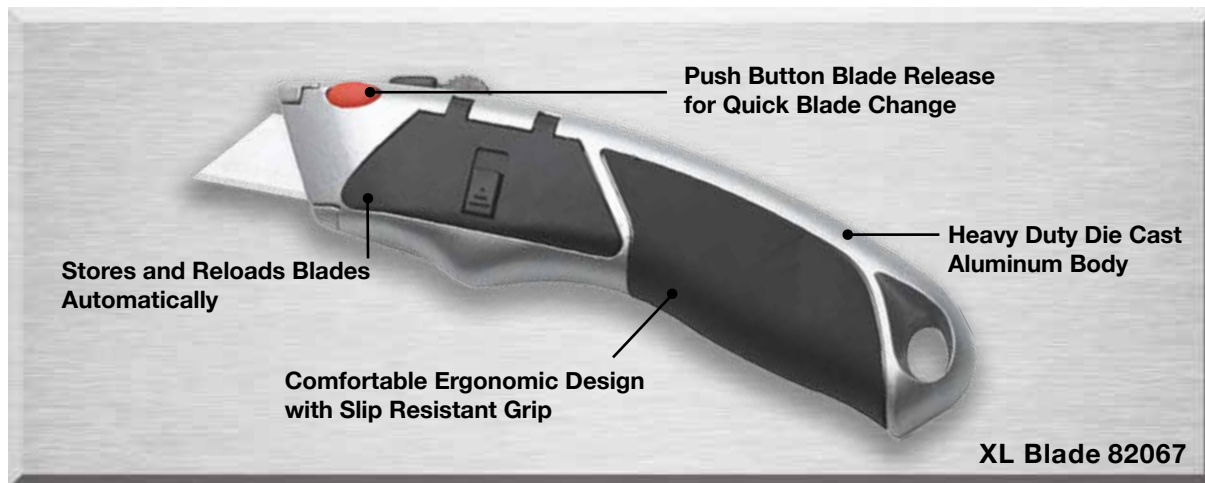

XL Blade® Auto Loading Utility Knife

- Stores and reloads blades automatically • Push button blade release for quick blade change • Comfortable ergonomic design with non-slip rubber grip
- Includes 8 high quality blades



82067

ITEM NO.	DESCRIPTION	PACKAGE	INNER QTY.	CASE QTY.
82067	XL Blade® Auto Loading Utility Knife	Card	6	48

FastBack® Utility Knife

- Heavy duty die cast zinc body • Push button blade release for quick blade change
- Spring loaded quick deploy blade chamber • Includes 5 high quality blades



82069

ITEM NO.	DESCRIPTION	PACKAGE	INNER QTY.	CASE QTY.
82069	Fastback® Utility Knife	Card	6	24

FastBack® Folding Utility Knife

- Lightweight aluminum body • Comfortable non-slip grip • Spring loaded blade chamber stores two spare blades
- Includes 3 high quality blades



82026

ITEM NO.	DESCRIPTION	PACKAGE	INNER QTY.	CASE QTY.
82026	Fastback® Folding Utility Knife	Card	4	24

Folding Utility Knife With 50 Blades

- Compact design folds down to 4" • Non-slip rubber grip
- Accepts standard utility blades • Lightweight aluminum construction



82025

ITEM NO.	DESCRIPTION	PACKAGE	INNER QTY.	CASE QTY.
82025	Folding Utility Knife with 50 Blades	Card	12	24

Power Blade Utility Knives

- Lightweight aluminum construction • Compact design folds down to 4"
- Non-slip rubber grip • Quick blade release • Includes 5 Blades

ITEM NO.	DESCRIPTION	PACKAGE	INNER QTY.	CASE QTY.
82020	Folding Utility Knife	Card	8	48
82021	Dual Blade Folding Utility Knife	Card	8	48



82020



82021

Pro-Grip Heavy Duty Utility Knife

- Heavy duty die cast zinc body • Non-slip rubber grip for increased safety
- Blade change requires no tools

ITEM NO.	DESCRIPTION	PACKAGE	INNER QTY.	CASE QTY.
82061	Heavy Duty Utility Knife	Card	6	48



82061

Retractable Utility Knife

- Four position retractable blade. • Durable die cast metal body

ITEM NO.	DESCRIPTION	PACKAGE	INNER QTY.	CASE QTY.
82081	Retractable Utility Knife	Card	6	120



82081

Self Retracting Utility Knife

- Blade returns automatically when switch is released • Safe over / under blade guide
- Heavy duty die cast metal body

ITEM NO.	DESCRIPTION	PACKAGE	INNER QTY.	CASE QTY.
82066	Self Retracting Utility Knife	Card	6	48



82066

Fixed Blade Utility Knife

- Blades store securely in handle • Durable die cast metal body

ITEM NO.	DESCRIPTION	PACKAGE	INNER QTY.	CASE QTY.
82087	Fixed Blade Utility Knife	Card	6	72



82087

Cutting Tools



82084

Snap Knife

- Snap-off blade for continuous sharp edge
- Non-slip rubber grip for safety and comfort.
- Auto-loading blade chamber.

ITEM NO.	DESCRIPTION	PACKAGE	INNER QTY.	CASE QTY.
82084	18mm Snap Knife	Card	6	72



82028

Hobby Precision Knives and Sets

- Lightweight durable aluminum construction

ITEM NO.	DESCRIPTION	PACKAGE	INNER QTY.	CASE QTY.
82027	30 Pc. Deluxe Precision Hobby Knife Set	Card	6	24
82028	14 Pc. Precision Knife Set	Card	6	48
82032	#1 Precision Knife	Card	12	144
82033	#1 Comfort Grip Precision Knife	Card	12	144
82034	5 Pc. #1 Replacement Blades in Tube	Card	12	144
82035	#2 Precision Knife	Card	12	144
82037	5 Pc. #11 Replacement Blades in Tube	Card	12	144



82062

Replacement Blades

- Fits standard size utility blades • High grade SK2 steel blades

ITEM NO.	DESCRIPTION	PACKAGE	INNER QTY.	CASE QTY.
82062	100 pc. Blade Pack with Dispenser	Card	6	36
82073	5 pc. Utility Knife Blades	Card	12	240
82094	10 Pc. Single Edge Razor Blades	Card	12	240

High Tension Hacksaw

- Heavy duty construction for stability and strength
- Comfortable dual non-slip rubber grip
- Includes 45° and 90° blade settings

ITEM NO.	DESCRIPTION	PACKAGE	INNER QTY.	CASE QTY.
31912	High Tension Hacksaw with Rubber Grip	Sleeve	4	24



31912

Bow Saw/Hacksaw

- Two saws in one: bow saw for wood, hacksaw for metal and plastic
- Sturdy tubular steel construction
- Includes: (2) Twelve Inch Blades (1) Hack Saw (1) Bow Saw

ITEM NO.	DESCRIPTION	PACKAGE	INNER QTY.	CASE QTY.
31913	Bow Saw / Hacksaw	Sleeve	4	12
31915	2 Pc. Bow Saw Replacement Blades	Card	12	144



31913

Mini Hack/Coping Saw

- Sturdy I-beam construction for stability and strength
- 6 blade angle settings for cutting at any angle
- Ideal for cutting wood, metal and plastic

ITEM NO.	DESCRIPTION	PACKAGE	INNER QTY.	CASE QTY.
31910	Mini Hack / Coping Saw	Sleeve	6	24



31910

Utility Hacksaw

- Impact resistant ABS handle with comfortable cushion grip
- Adjustable blade length

ITEM NO.	DESCRIPTION	PACKAGE	INNER QTY.	CASE QTY.
31916	Utility Hacksaw	Card	6	48



31916



31972

All Purpose Hand Saws

- Precision ground induction hardened teeth stay sharp up to 5 times longer than standard teeth
- Hardened and tempered steel blade for strength and durability
- Ergonomic hardwood handle

ITEM NO.	DESCRIPTION	PACKAGE	INNER QTY.	CASE QTY.
31970	15" / 12 Pt. Tool Box Saw, Wood Handle	Sleeve	4	24



31963

Coping Saw

- Carbon steel frame with comfortable hardwood handle
- Blade can be turned 360 degrees for cutting at any angle
- Heat treated blade stays sharp longer than traditional blades

ITEM NO.	DESCRIPTION	PACKAGE	INNER QTY.	CASE QTY.
31963	6-3/4" Coping Saw, Wood Handle	Sleeve	6	24
31962	5 Pc. Coping Saw Blades	Card	6	48

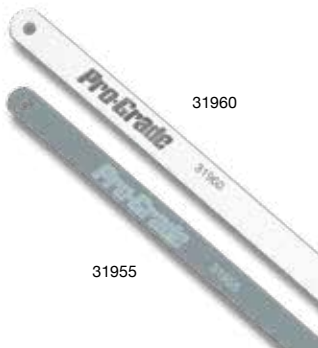

31960

31955

Hacksaw Blades

- Cuts mild steel, cast iron, aluminum, copper, etc.

ITEM NO.	DESCRIPTION	PACKAGE	INNER QTY.	CASE QTY.
31955	10" / 24 TPI Hacksaw Blade - Carbon Steel	Card	10	100
31956	10" / 18 TPI Hacksaw Blade - Carbon Steel	Card	10	100
31957	12" / 18 TPI Hacksaw Blade - Carbon Steel	Card	10	100
31958	12" / 32 TPI Hacksaw Blade - Carbon Steel	Card	10	100
31959	12" / 24 TPI Hacksaw Blade - Carbon Steel	Card	10	100
31960	12" / 32 TPI Hacksaw Blade - Bi Metal	Card	10	100
31961	12" / 24 TPI Hacksaw Blade - Bi Metal	Card	10	100



Powerule™ Tape Measures

- Pro-Stop blade brake for smooth controlled blade return
- Comfortable non-slip rubber palm grip
- Non-slip locking thumb latch

ITEM NO.	DESCRIPTION	PACKAGE	INNER QTY.	CASE QTY.
82821	3/4" x 16' Powerule Tape Measure	Card	6	24
82822	1" x 30' Powerule Tape Measure	Card	6	24
82826	1" x 25' Powerule Tape Measure	Card	6	24



82826

Chrome Case Tape Measures

- High impact chrome plated ABS case
- Fractional read-outs in 1/8" increments

ITEM NO.	DESCRIPTION	PACKAGE	INNER QTY.	CASE QTY.
42800	1/4" x 10' Tape Measure	Card	6	48



42800

LIFETIME GUARANTEE

Measuring Tools



82823

Speed Reel™ 100' Tape Measure

- Rewinds 3x faster than conventional reel tapes
- Plastic coated fiberglass tape
- Comfortable non-slip rubber grip

ITEM NO.	DESCRIPTION	PACKAGE	INNER QTY.	CASE QTY.
82823	3/8" x 100' Fiberglass Tape Measure with Rubber Grip Card		4	24



82806

Digital Caliper

- 6" / 150mm internal and external measuring capacity
- Measures SAE to 0.0005", and metric to 0.01mm, 0.001 accuracy
- Floating zero function and position lock
- Hardened stainless steel
- Includes storage case and two batteries

ITEM NO.	DESCRIPTION	PACKAGE	INNER QTY.	CASE QTY.
82806	Electronic Digital Caliper	Clam	4	24



Solid Steel Hammers

- Molded grip increases comfort and reduces fatigue
- Induction hardened face and claw for strength and durability
- Magnetic nail holder for hard to reach places

ITEM NO.	DESCRIPTION	PACKAGE	INNER QTY.	CASE QTY.
61341	16 oz. Claw Hammer	Label	4	24
61346	22 oz. Rip Hammer	Label	4	16



61346

Jacketed Fiberglass Handle Hammers

- Induction hardened face and claw for strength and durability
- Jacketed fiberglass handle for overstrike protection
- Magnetic nail holder for starting nails in hard to reach places

ITEM NO.	DESCRIPTION	PACKAGE	INNER QTY.	CASE QTY.
61339	16 oz. Claw Hammer, Jacketed Fiberglass Handle	Label	4	24
61340	16 oz. Rip Hammer, Jacketed Fiberglass Handle	Label	4	24
31358	20 oz. Rip Framing Hammer, Jacketed Fiberglass Handle	Label	4	24



31358

Ball Pein Hammers

- Forged high carbon steel head with polished striking head and pein
- Jacketed fiberglass handle with rubber grip

ITEM NO.	DESCRIPTION	PACKAGE	INNER QTY.	CASE QTY.
15608	8 oz. Ball Pein Hammer, Fiberglass Handle	Label	6	48
15616	16 oz. Ball Pein Hammer, Fiberglass Handle	Label	6	36
15624	24 oz. Ball Pein Hammer, Fiberglass Handle	Label	6	24
15632	32 oz. Ball Pein Hammer, Fiberglass Handle	Label	6	24



15616

LIFETIME GUARANTEE

Striking Tools



31361

20 oz. Rip Hammer, Graphite Handle

- Graphite core adds strength and reduces shock
- Magnetic nail holder

ITEM NO.	DESCRIPTION	PACKAGE	INNER QTY.	CASE QTY.
31361	20 oz. Rip Hammer, Graphite Handle	Label	4	24



61376

16 oz. Soft Face Hammer

- PVC and soft impact rubber faces
- Genuine American Hickory handle

ITEM NO.	DESCRIPTION	PACKAGE	INNER QTY.	CASE QTY.
61376	16 oz. Soft Face Hammer	Label	4	24



61372

Dead Blow Hammers

- High visibility, non-sparking, non-marring PVC
- Steel reinforced handle with no exposed metal
- Carbon steel shot fill

ITEM NO.	DESCRIPTION	PACKAGE	INNER QTY.	CASE QTY.
61372	1 Lb. Dead Blow Hammer	Label	4	24
61373	2 Lb. Dead Blow Hammer	Label	4	24
61374	3 Lb. Dead Blow Hammer	Label	4	24
61375	4 Lb. Dead Blow Hammer	Label	4	24



63032

Wood Chisels

- Fully hardened and tempered blades
- Strike plate on handle for use with mallets

ITEM NO.	DESCRIPTION	PACKAGE	INNER QTY.	CASE QTY.
63026	1/4" Wood Chisel	Card	6	24
63027	1/2" Wood Chisel	Card	6	24
63028	3/4" Wood Chisel	Card	6	24
63029	1" Wood Chisel	Card	6	24
63030	1-1/4" Wood Chisel	Card	6	24
63031	1-1/2" Wood Chisel	Card	6	24
63032	4 Pc. Wood Chisel Set	Card	6	24

Wrecking Bars

Wrecking Bars

• Forged and heat treated carbon steel

ITEM NO.	DESCRIPTION	PACKAGE	ITEM WT.	CASE QTY.
63112	12in Wrecking Bar	Label	0.86	10
63118	18in Wrecking Bar	Label	1.9	10
63124	24in Wrecking Bar	Label	3.5	10
63130	30in Wrecking Bar	Label	4.26	10
63136	36in Wrecking Bar	Label	5	10
63148	48in Stripping Bar	Label	12	Bulk

Jumbo Pry Bar

ITEM NO.	DESCRIPTION	PACKAGE	ITEM WT.	CASE QTY.
63151	36in Jumbo Pry Bar with Comfort Grip Handle	Label	4.2	10

Aligning Bar

ITEM NO.	DESCRIPTION	PACKAGE	ITEM WT.	CASE QTY.
63102	30in Aligning Bar	Label	4.18	10

T-Type Bars

ITEM NO.	DESCRIPTION	PACKAGE	ITEM WT.	CASE QTY.
63104	24in T-Type Bar	Label	4.15	12
63106	30in T-Type Bar	Label	5.02	10

Utility Bars

ITEM NO.	DESCRIPTION	PACKAGE	ITEM WT.	CASE QTY.
61328	7in Utility Bar	Label	0.35	120
61329	15in Utility Bar	Label	1.34	36

Offset Ripping Chisel

ITEM NO.	DESCRIPTION	PACKAGE	ITEM WT.	CASE QTY.
63107	17in Offset Ripping Chisel	Label	2.21	20

Double Ended Nail Puller

ITEM NO.	DESCRIPTION	PACKAGE	ITEM WT.	CASE QTY.
63111	10in Double Ended Nail Puller	Label	0.96	48

Nail Puller / Moulding Bars

ITEM NO.	DESCRIPTION	PACKAGE	ITEM WT.	CASE QTY.
63108	8in Nail Puller/ Moulding Bar	Label	0.46	48
63110	10in Nail Puller/ Moulding Bar	Label	1.64	48

Wrecking Bar Rack

• Free Rack with Purchase of Wrecking Bar Program



63150

Gear Pullers

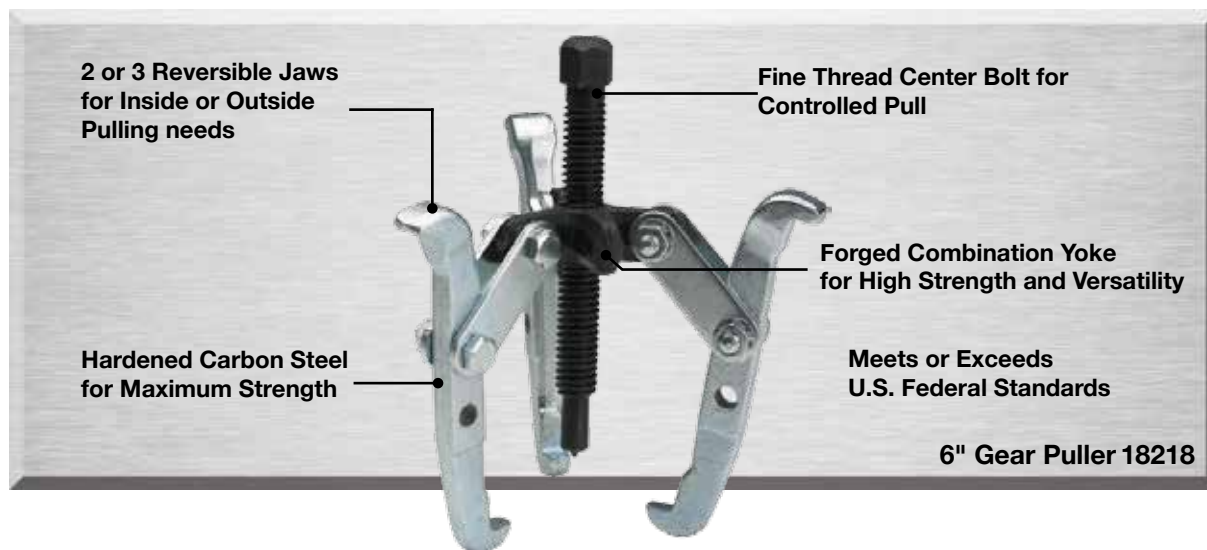

Gear Pullers

- Hardened carbon steel for maximum strength
- Reversible jaws for inside or outside pulling needs



18218



18209



18204

ITEM NO.	DESCRIPTION	PACKAGE	INNER QTY.	CASE QTY.
18217	6" Reversible 2 Jaw Gear Puller	Clam	6	6
18210	8" Reversible 2 Jaw Gear Puller	Box	6	6
18211	10" Reversible 2 Jaw Gear Puller	Box	6	6
18212	4" Reversible 3 Jaw Gear Puller	Clam	6	6
18218	6" Reversible 2 & 3 Jaw Gear Puller	Clam	6	6
18203	8" Reversible 2 & 3 Jaw Gear Puller	Box	6	6
18221	10" Reversible 2 & 3 Jaw Gear Puller	Box	6	6

Steering Wheel Puller

- Includes drop forged main frame, center screw with floating (4) bolts 1/2" x 3-5/8"L., (2) bolts 9/16" x 3-5/8"L. and flat washers.

ITEM NO.	DESCRIPTION	PACKAGE	INNER QTY.	CASE QTY.
18209	Steering Wheel Puller	Clam	6	6

Tie Rod Puller

- 21/32" opening x 12" long
- Made from heat treated carbon steel
- Use to separate tie rod ends from steering arms

ITEM NO.	DESCRIPTION	PACKAGE	INNER QTY.	CASE QTY.
18204	Tie Rod End Puller, 12" L x 21/32" Opening	Clam	6	6

Ball Joint Separator

- Use to remove ball joint from steering knuckle
- Made from forged carbon steel
- 15/16" opening X 12" long

ITEM NO.	DESCRIPTION	PACKAGE	INNER QTY.	CASE QTY.
18205	Ball Joint Separator, 12" L x 15/16" Opening	Clam	6	6



18205

Pitman Arm Puller

- Made from forged heat treated carbon steel
- For use with full sized Pitman arms

ITEM NO.	DESCRIPTION	PACKAGE	INNER QTY.	CASE QTY.
18206	Pitman Arm Puller, 1-5/16" Opening, 2-1/2" Pull	Clam	6	6



18206

Harmonic Balancer Puller

- Made from hardened carbon steel
- Four slot yoke for use in 2 or 3 hole applications
- Steel center screw with floating removable swivel

ITEM NO.	DESCRIPTION	PACKAGE	INNER QTY.	CASE QTY.
18208	Harmonic Balancer Puller	Clam	6	6



18208

PRO

Vises & Clamps

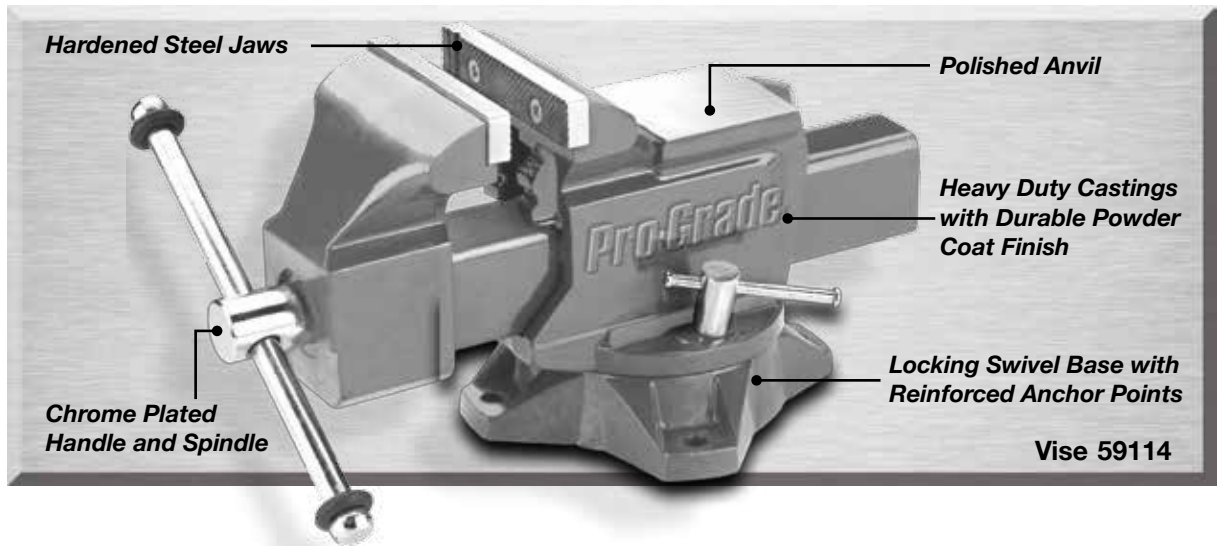

59124

3" Hobby Vise

- Lightweight aluminum with durable powder coat finish
- Head rotates 360° and tilts at 45° and 90° angles
- Clamp-on base with productive rubber pads
- Chrome plated spindle and hardware

ITEM NO.	DESCRIPTION	PACKAGE	INNER QTY.	CASE QTY.
59124	3" Hobby Vise	Tag	4	8

Workshop Vises

- Heavy duty 20,000-PSI castings with durable powder coat finish
- Replaceable hardened steel jaws with permanent pipe jaws and polished anvil
- 270° locking swivel base with four reinforced anchor points



59111

ITEM NO.	DESCRIPTION	PACKAGE	INNER QTY.	CASE QTY.
59109	3" Workshop Clamp Vise	Box	1	6
59110	4" Workshop Bench Vise	Box	1	2
59111	5" Workshop Bench Vise	Box	1	2
59112	6" Workshop Bench Vise	Box	1	1



59101

Anvils

- Heavy duty cast iron Anvil
- Polished surface area
- Pritchel and Hardy holes

ITEM NO.	DESCRIPTION	PACKAGE	INNER QTY.	CASE QTY.
59100	11lb Anvil	Box	4	4
59101	25lb Anvil	Box	1	1
59102	55lb Anvil	Box	1	1

Mechanic's Bench Vises

- Heavy duty 30,000-PSI castings with durable powder coat finish
- Replaceable hardened steel jaws with permanent pipe jaws and polished anvil
- 270° locking swivel base with four reinforced anchor points
- Chrome plated handle and spindle

ITEM NO.	DESCRIPTION	PACKAGE	INNER QTY.	CASE QTY.
59113	4" Mechanic's Bench Vise	Box	1	2
59114	5" Mechanic's Bench Vise	Box	1	1
59115	6" Mechanic's Bench Vise	Box	1	1
59116	7" Mechanic's Bench Vise	Box	1	1
59117	8" Mechanic's Bench Vise	Box	1	1



59114

Multi Purpose Workshop Vise

- Versatile design provides 360° rotating jaws and base
- Hardened, replaceable jaw inserts
- Chrome plated handle and spindle

ITEM NO.	DESCRIPTION	PACKAGE	INNER QTY.	CASE QTY.
59108	5" Multi Purpose Workshop	Box	1	1

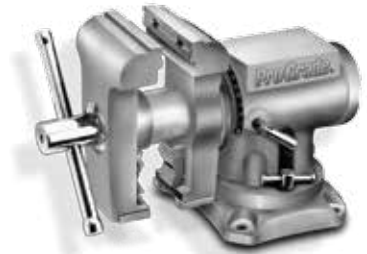

59108

Drill Press Vise

- Specially designed for drill press applications such as drilling, tapping, milling and grinding
- Replaceable steel jaw faces, with vertical and horizontal v-grooves for holding round work pieces
- Durable powder coat finish and black oxide handle and spindle

ITEM NO.	DESCRIPTION	PACKAGE	INNER QTY.	CASE QTY.
59120	4" Flat Drill Press Vise	Box	1	8
59121	3-1/2" Angle Drill Press Vise	Box	1	4



59120

Woodworking Vise

- Pre-drilled holes in jaws for attaching wood facings
- Continuous screw and steel guide bars for smooth operation
- Moveable metal dog for clamping large pieces of wood
- Durable powder coat finish and black oxide handle and spindle

ITEM NO.	DESCRIPTION	PACKAGE	INNER QTY.	CASE QTY.
59122	6-1/2" Woodworkers Vise	Box	1	10



59122

Hitch Mount Vise Plate

- Mounting plate designed to accommodate most vises
- 8" x 8" Vise plate, 22" receiver bar
- Includes mounting hardware and 5/8" hitch pin

ITEM NO.	DESCRIPTION	PACKAGE	INNER QTY.	CASE QTY.
59105	Hitch Mount Vise Plate	Box	2	2

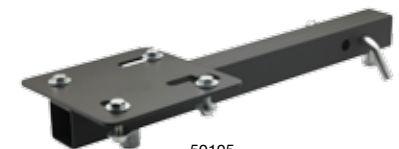

59105

Vises & Clamps



59134



59141



59163

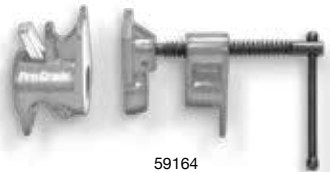

59164



59162

C-Clamps

- Ductile iron frames and black oxide steel spindle
- Durable powder coat finish

ITEM NO.	DESCRIPTION	PACKAGE	INNER QTY.	CASE QTY.
59128	1"x1" C-Clamp	Card	6	36
59129	1-1/2"x1-1/2" C-Clamp (deep throat)	Card	6	36
59130	2"x1" C-Clamp	Card	6	36
59131	2"x3-1/2" C-Clamp (deep throat)	Card	6	36
59132	2-1/2"x1-3/8" C-Clamp	Card	6	36
59133	2-1/2"x2-1/2" C-Clamp	Card	6	36
59134	3"x2" C-Clamp	Card	6	36
59135	3"x4-1/2" C-Clamp (deep throat)	Card	6	24
59136	4"x3" C-Clamp	Card	6	24
59137	5"x3-1/4" C-Clamp	Card	6	18
59138	6"x3-1/2" C-Clamp	Card	6	18
59139	8"x4" C-Clamp	Card	6	6
59141	4"x2" Quick Release C-Clamp	Card	4	12
59143	6"x3" Quick Release C-Clamp	Card	4	16
59163	2-1/2" 3-way C-Clamp	Card	6	18

Pipe Clamps

- Powder coated malleable steel body
- Quick release sliding jaw

ITEM NO.	DESCRIPTION	PACKAGE	INNER QTY.	CASE QTY.
59164	1/2" Pipe Clamp	Clam	4	12
59165	3/4" Pipe Clamp	Card	4	12

Corner Clamps

- Die cast aluminum frame with black oxide steel spindles
- Holds pieces up to 3" thick at a fixed 90° angle

ITEM NO.	DESCRIPTION	PACKAGE	INNER QTY.	CASE QTY.
59162	90° Corner Clamp	Clam	6	24

Wood Bar Clamps

- Quick release sliding jaw
- Protective clamp pads
- Precision steel bar and jaw

ITEM NO.	DESCRIPTION	PACKAGE	INNER QTY.	CASE QTY.
59147	2-1/2"x6" Wood Bar Clamp	Card	4	48
59148	2-1/2"x12" Wood Bar Clamp	Card	4	36
59149	2-1/2"x18" Wood Bar Clamp	Card	4	24
59150	2-1/2"x24" Wood Bar Clamp	Card	3	24
59151	2-1/2"x30" Wood Bar Clamp	Card	2	12
59152	2-1/2"x36" Wood Bar Clamp	Card	2	12
59175	Wood Bar Clamp Pad Set	Card	6	24



Ratcheting Bar Clamps

- Quick release button allows easy opening and closing
- Reversible jaw converts to a ratcheting spreader
- One hand operation

ITEM NO.	DESCRIPTION	PACKAGE	INNER QTY.	CASE QTY.
59154	4" Mini Ratcheting Bar Clamp (2 pk)	Card	6	36
59155	6" Ratcheting Bar Clamp	Card	6	48
59156	12" Ratcheting Bar Clamp	Card	6	36
59157	18" Ratcheting Bar Clamp	Card	6	24
59158	24" Ratcheting Bar Clamp	Card	6	24
59160	36" Ratcheting Bar Clamp	Card	6	12
59176	Ratcheting Bar Clamp Pad Set	Card	6	48



Nylon Spring Clamps

- Durable nylon polymer construction
- Soft touch pivoting tips
- Comfortable molded rubber grips

ITEM NO.	DESCRIPTION	PACKAGE	INNER QTY.	CASE QTY.
59180	1" Nylon Spring Clamp	Tag	6	36
59181	2" Nylon Spring Clamp	Tag	6	36
59182	3" Nylon Spring Clamp	Tag	6	18
59126	2" Ratcheting Hand Clamp	Tag	6	60
59127	4" Ratcheting Hand Clamp	Tag	6	48



Metal Spring Clamps

- Extra thick PVC tips and grips
- Heavy gauge chrome plated steel
- High tension metal springs

ITEM NO.	DESCRIPTION	PACKAGE	INNER QTY.	CASE QTY.
59177	1" Metal Spring Clamp	Label	6	36
59178	2" Metal Spring Clamp	Label	6	36
59179	3" Metal Spring Clamp	Label	6	18



Discover other tool sets and kits on our website.