



BRINGING THE BEST OF THE WORLD TO YOU[®]

SAFETY PRODUCTS CATALOG

PROTECTIVE INDUSTRIAL PRODUCTS, INC.

HAND PROTECTION

- 11** Cut Resistant Gloves
- 55** General Purpose Gloves
- 83** Chemical Resistant Gloves
- 95** Disposable Gloves
- 101** Critical Environment Gloves
- 109** High Performance Gloves
- 119** Cold Protection Gloves
- 123** Heat Protection Gloves
- 127** Emergency Responder Gloves
- 129** Parade & Uniform Gloves

ARM PROTECTION

- 132** Smart-Fit™ Technology Sleeves
- 134** Form-Fit Seamless Knit Sleeves
- 142** Loose Fitting Sleeves
- 141** Duo-Pro™ T-shirt with Integrated Sleeve
- 144** Specialty Applications Sleeves
- 146** Custom Sleeves

HEAD PROTECTION

- 150** Type II Hard Hats
- 151** Type I Hard Hats
- 157** Hard Hat Accessories
- 160** Bump Caps
- 162** Gear Bags & Rescue Helmets
- 163** Fire Helmets
- 164** Winter Liners
- 166** Flame & Fire Resistant Hoods

HEARING PROTECTION

- 168** Ear Muffs
- 170** Ear Plugs
- 172** Additional Styles & Accessories

EYE & FACE PROTECTION

- 174** Lens Technologies
- 178** Safety Glasses
- 208** Safety Goggles
- 212** Face Protection
- 214** Eyewear Accessories

HI-VIS APPAREL

- 216** ANSI Standards
- 218** Hi-Vis Vests
- 228** Hi-Vis T-Shirts
- 229** Duo-Pro™ T-shirt with Integrated Sleeve
- 230** Hi-Vis Sweatshirts
- 232** Hi-Vis Jackets & Coats
- 234** Hi-Vis Overpants

RAINWEAR & SPLASHWEAR

- 236** Hi-Performance Protective Clothing
- 239** Hi-Vis Rainwear
- 240** Protective Rainwear

APRONS & DISPOSABLE CLOTHING

- 241** Custom Aprons
- 242** Disposable Clothing

FLAME RESISTANT & ARC RATED CLOTHING

- 244** AR/FR Sweatshirts
- 245** AR/FR Shirts
- 246** AR/FR Hi-Vis Vests
- 247** AR/FR Additional Clothing
- 248** Dual Certified Clothing
- 250** Arc Flash Protection Kits
- 254** Arc Flash Head Gear
- 256** Arc Flash Accessories

RUBBER INSULATING GLOVES

- 258** Rubber Insulating Gloves & Sleeves
- 260** Leather Protectors
- 260** Accessories

ERGONOMICS

- 262** Wrist & Elbow Supports
- 263** Knee Pads & Supports
- 264** Back Supports

RESPIRATORY & FIRST AID

- 266** N95 Respirators
- 267** Disposable Nuisance & Face Mask
- 268** Personal & Contractor Kits
- 269** Bloodborne Pathogens Kits
- 270** Burn Kit

SAFETY & EMERGENCY BEACONS

- 272** E-Flare™ Beacons
- 274** Flash Batons

HEAT STRESS

- 276** Phase Change
- 276** Evaporative
- 280** Absorptive
- 280** Sun Protection

Protective Industrial Products is a proud member of



AFFILIATED DISTRIBUTORS
The Largest Distributor Network in North America.



EVERGREEN MARKETING GROUP
An alliance of over 60 independent construction and industrial tool distribution companies located throughout the United States.



INDUSTRIAL BUYER'S CONSORTIUM
Alliance of Leading Industrial Supply Distributors in the U.S.



INDUSTRIAL SUPPLY ASSOCIATION
Formerly the Industrial Distributor Association (IDA) and the Industrial Supply Manufacturer Association (ISMA).



NETPLUS ALLIANCE
Alliance for Distributors and Manufacturers.



SAFETY MARKETING GROUP
The World's Largest Consortium of Independently Owned Safety Equipment Distributors.



SPHERE 1
A cooperative of independent tool and fastener distributors working together to achieve competitive and sustainable advantages in the marketplace.



STAFDA
STAFDA is an international educational association comprised of distributors, manufacturers, rep agents, and affiliates (trade press) serving the construction/ industrial market.

PROTECTIVE INDUSTRIAL PRODUCTS

BRINGING THE BEST OF THE WORLD TO YOU®



PROTECTIVE INDUSTRIAL PRODUCTS OR PIP, AS WE HAVE BECOME KNOWN, IS A US-BASED COMPANY WITH OPERATIONS AROUND THE WORLD.

PIP is jointly owned by the families of Joe Milot, President, and his partner, Wellson Tao. Initially started as a supplier of work gloves, today we are a global provider of a vast array of consumable personal protective equipment (PPE) to multiple industries and channels of distribution.

PIP STARTED AS A SUPPLIER OF GLOVES. TODAY WE ARE A GLOBAL PROVIDER OF A VAST ARRAY OF CONSUMABLE PERSONAL PROTECTIVE EQUIPMENT TO MULTIPLE INDUSTRIES AND CHANNELS OF DISTRIBUTION.



WE FIND REASONS TO SAY "YES" TO CUSTOMERS

WE PLACE THE CUSTOMER EXPERIENCE ABOVE ALL ELSE. WE SUCCEED AT HELPING DISTRIBUTORS ENHANCE THEIR PRODUCT OFFERING, WHILE MAINTAINING THE ABILITY TO PROVIDE CUSTOMERS WITH COMPETITIVELY PRICED, QUALITY SAFETY PRODUCTS.



AN EASE OF DOING BUSINESS

We strive to be the easiest company that our customers do business with in any industry.



OUR PEOPLE

We employ people trained and experienced in the business and recognized among the best in the industry.

A GLOBAL PROVIDER OF INNOVATIVE SAFETY PRODUCTS

As the referenced leader in hand protection, we continue to expand our above-the-neck, electrical, traffic safety and first responder product lines.

- Three manufacturing facilities along with three distribution centers in the US
- Export operation from Asia/Pacific to over 10 sales and distribution subsidiaries around the world
- Expertise in sourced manufacturing driven by a team of technical product managers and on-site quality inspection personnel
- R&D capabilities include specialty yarns and seamless knitting technology, joint development in new lens/fit applications in eyewear, as well as ergonomic garment design
- Collaborative development with global partner ATG® for hand protection, JSP® for head and respiratory protection, Hellberg® for hearing protection and Pacific Helmets for first responder head protection

BRINGING THE BEST OF THE WORLD TO YOU®

1984 to 1999



1984

- Joe Milot and Wellson Tao formed Protective Industrial Products in a 400 sq. ft. space in Albany, NY.

1991

- Purchased assets of Intermarket Imports, Inc. and expanded head office and distribution center into a 28,000 sq. ft. facility in Guilderland, NY.



1998

- Acquired L.A. Sinotech & established a distribution center in California

2000 to 2005

2001

- Acquired Georgia Safety Group and Gloves Unlimited, Inc.
- Opened a distribution center in Memphis, TN.

2002

- PIP Mexico formed



2003

- Acquired PRI Industries – a US manufacturer of specialty seamless knits



2004

- Expanded New York operations to 125,000 sq. ft. and Tennessee distribution center to 90,000 sq. ft.
- Established exclusive sales partnership with ATG® Gloves in North America
- PIP Latin America formed

2006 to 2010

2006

- Brahma Glove Co. acquired – consumer division established
- Mud® consumer glove brand and business acquired
- DSM Dyneema® license acquired



2008

- West County Gardener® consumer glove brand and business acquired
- PIP Italy established in Rome



2009

- SafetyGear™ USA acquired to extend safety products offering to protective and hi-vis garments

2011 to 2016



2011

- H.L. Bouton® Eyewear brand and business acquired
- Established exclusive sales partnership with JSP® in North America
- McHenry Knitting and Manufacturing acquired
- Certified Insulating Products assets acquired to enter the electrical safety market
- DuPont™ Kevlar® license acquired
- PIP Balkans formed
- PIP Iberia formed

2012

- ISSI Eyewear acquired
- PIP Canada established
- PIP Asia/Pacific operations expanded from Hong Kong to include sales and distribution centers in Malaysia and China

2014

- Acquisition of Safe Industries - manufacturer of knitted sleeves

2016

- Acquisition of Safety Works



PIP TODAY

Over 300 employees

Global presence in the Americas, Europe and Asia/Pacific

Referenced global leader in hand protection

Over 3,500 products available from distribution centers totaling 500,000 sq. ft. in the US alone



PIP VENDING READY PROGRAM

BRINGING THE BEST OF THE WORLD TO YOU®

PIP VEND READY PACKAGED FOR VEND MACHINE



VEND-READY GLOVES: STOCKED & READY TO SHIP

Over twenty of our most popular glove styles are now available in vend-ready packaging. These are stocked and ready to go. Consistent width and thickness ensures proper dispensing.

MANY OF PIP'S PRODUCTS ARE VEND-READY IN THEIR STANDARD PACKAGING

HI-VIS VESTS AND T-SHIRTS

All PIP Hi-Vis Vests and T-shirts are or soon will be in vend-ready packaging! See page 218 for our complete product selection.

BOUTON® OPTICAL

All PIP safety glasses and safety goggles are vend-ready! See page 178 for our complete product selection.



WE CAN VEND-READY ALMOST ANYTHING. Our Black Pearl manufacturing facility specializes in custom logoing, packaging and testing. We can do any configuration to meet your special needs.

CUSTOMIZED RETAIL READY™ PROGRAM

PIP IS YOUR SAFETY PRODUCT PARTNER FOR MAXIMIZING YOUR SHOWROOM PRODUCT SALES.

No two showrooms are the same, constricted sometimes by space and other times by location, it is our job to adapt to your needs. That's what PIP's customized Retail Ready™ Program is all about.

Over 30 years of industrial and do-it-yourself retail market experience has allowed us to develop an extensive line of PPE products individually packaged and ready to retail, out the door.

PIP RETAIL READY TAILORED TO YOU.

**PIP
RETAIL
READY**

PIP RETAIL READY PROGRAM

BRINGING THE BEST OF THE WORLD TO YOU®



SHELF TALKER



BASKET TALKER



PEG TALKER

PIP RETAIL READY DISPLAY TALKERS

Laminated and durable, these display talkers come complete with mounting ties and mention features that resonate with customers. Clear bullet points identify the product, key features and ideal use. That's all that's needed to make the difference.

FOR YOU. BY YOU.



THINK LIKE A RETAILER

To do Retail Ready right, you have to think like a retailer. It's all about taking advantage of seasonality and trends. PIP already offers you the most comprehensive early-buy program in the industry. We now include separate early-buy special point-of-sale deals that are tailored to take maximum advantage of your walk-in traffic. Take for example the first storm of winter; think of how many customers forget their gloves. Maximize sales with a winter glove rack sitting on your counter ready to pump those impulse sales.

EYE-CATCHING POINT-OF-PURCHASE DISPLAYS ARE THE KEY

Standard available displays are meant to be versatile and adaptable in all showrooms.



GONDOLA DISPLAY



DUMP DISPLAY



TOWER DISPLAY

CUSTOMIZED PLANOGRAMS JUST FOR YOU

PIP can tailor your slat wall or gondola display unit to hold key products. With over 30 years of experience and core expertise in our PIP consumer products division, we're sure to help you in putting together a fast-turning product configuration that meets your needs.

Working with your PIP representative, we can provide you with top sellers in each market channel and our recommendations for optimizing your point-of-purchase displays.



PIP CUSTOM IMPRINTING

BRINGING THE BEST OF THE WORLD TO YOU®

CUSTOM IMPRINTING IS AVAILABLE ON MOST SAFETY EYEWEAR, HARD HATS, GLOVES, VESTS, T-SHIRTS, SWEATSHIRTS, JACKETS, COOLING TOWELS AND BANDANAS.

We use the most advanced technique and quality ink that ensure your logo pops and will not wear off. It's not just our image – it's yours too.

CUSTOM IMPRINTING

FAST. DEPENDABLE. QUALITY PRINTING.

PIP CUSTOM IMPRINTING

BRINGING THE BEST OF THE WORLD TO YOU®

6-DAY TURNAROUND TIME



STATE-OF-THE-ART FACTORY

- 6-day turnaround*
- Low minimums
- Over 12 standard PMS colors available
- Ordering software backed by a specialized core team

**Following approval of logo artwork*



OVER 40% OF COMMON PPE IS LOGOED

- Builds brand presence
- Promotes security on job sites
- Reduces waste

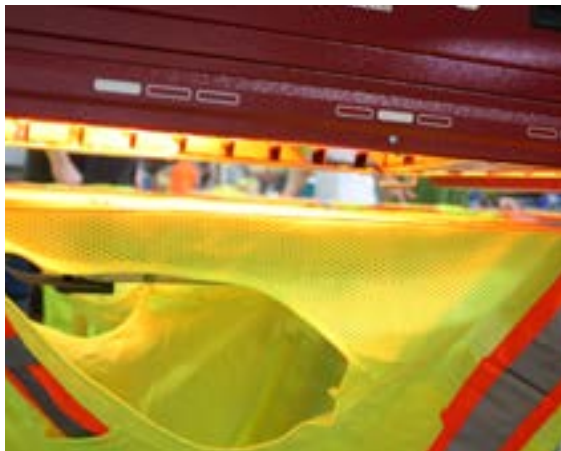
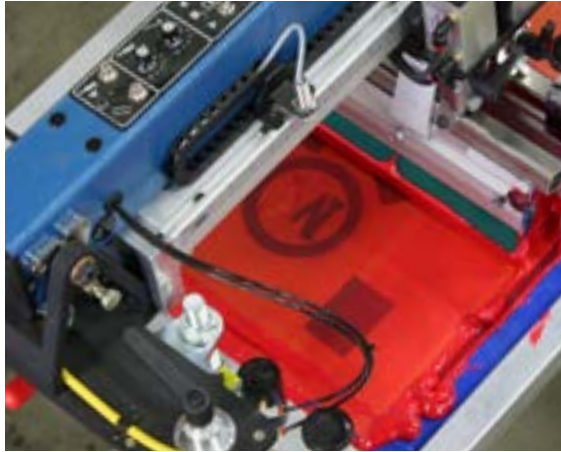

EXPERIENCE THE DIFFERENCE

FAST, EASY AND PRECISE. If you don't associate these words with your custom order requests, you're not taking advantage of PIP's logo and imprinting services. With exceptionally quick turnaround times and top quality results, PIP delivers the value-added service you and your customers expect. Put us to the test on your next logo order and experience the difference.

PIP SALES & MARKETING LEADERS

BRINGING THE BEST OF THE WORLD TO YOU®



Forward-Thinking Customer Service

- PIP's Customer Service team has a mission that is beyond J-I-T delivery and world class service; it extends to cover accuracy in information and flawless data transfer and elimination of redundancy.
- EDI order placement, confirmation and payment
- Accuracy plus updated pricing, inventory and product revisions
- Dedicated technical support



Best Trained Sales Team in the Industry

Training is our mission. Customers don't feel confident selling or using product if they're not trained. Lack of confidence leads to mistakes. PIP is dedicated to training all customers.

- Over 100 representatives on the road
- Backed by 30 Regional Sales Managers and National Account Representatives
- SR management team with a combined 120 years of experience in Safety

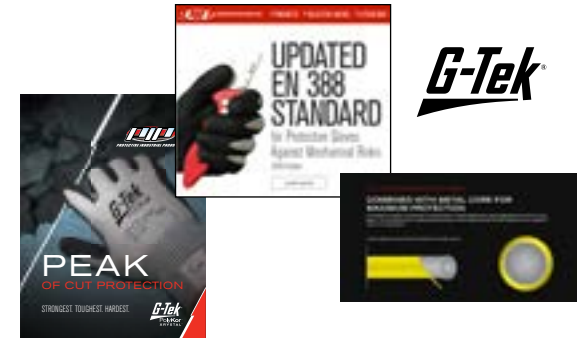

Marketing – Sales Tools and Promotions to Give You the Edge

- Powerful brands
- Communication
- Digital and print collateral
- Complete product launches
- Advertising and promotions
- Enhanced brand packaging
- Expert pages & videos



Manufacturing Capability

PIP owns three US-based manufacturing operations:

1. **PR Industries (PRI)**, in Chaska, Minnesota produces high-quality specialty knitted gloves for applications requiring cut resistance and resistance to heat. PRI is capable of designing and producing coating patterns that meet specifications on string-knit shells to fit with customers' needs.
2. **McHenry Manufacturing's** knitting and sewing operation in Bluffton, Indiana specializes in protective sleeves, work aprons and hoods.
3. **Black Pearl** Guilderland Center, New York facility offers custom packaging, imprinting and labeling as well as dielectric testing for electrical insulating gloves and is a manufacturer of specialty insulated electrical tools.



GO TO WEBSITE

4 EASY WAYS TO FIND THE PERFECT PRODUCT

- 1 SEARCH THE PRODUCT SELECTOR GUIDE
- 2 BROWSE BY PRODUCT CATEGORY
- 3 BROWSE BY INDUSTRY CHANNEL
- 4 SEARCH BY SKU NUMBER

Product Selector Guides



WE MAKE IT EASY FOR YOU

Our product selector guides will give you the proper answer in just a few clicks and seconds.



CHEMICAL RESISTANT GLOVES SELECTOR GUIDE

Type in your CAS# or select the chemical from our chemical list and we will show you all of our gloves that have been tested against that chemical.



CUT PROTECTION GLOVES SELECTOR GUIDE

Answer four quick questions and we'll give you the product that gets the job done.



EYE PROTECTION SELECTOR GUIDE

This guide will provide you with the right safety eyewear for your working conditions. Just answer four simple questions and you're done!

BRINGING THE BEST OF THE WORLD TO YOU®

Other Exciting Website Features

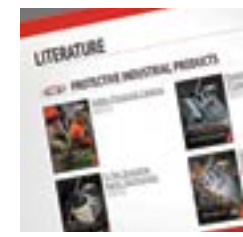

DOWNLOAD SPEC SHEETS & LITERATURE

All the valuable information you need at your fingertips. Helping you lose those stacks of papers with easy to download spec sheets and literature.



VIDEO FEATURETTES

Informative, short videos that pack a lot of punch and are loaded with product features and benefits.



ICONS THAT ARE INFORMATIVE

What does that icon or rating mean? Scroll over our enhanced icons to learn more about our products' capabilities.



WORLDWIDE LOCATIONS

Conducting international business? We provide country – and language-specific websites for over 10 countries.



TOUCH SCREEN FRIENDLY

Access our website on the go from your smart phone or tablet without losing any of the website's capabilities.

PIP 3SP™ PROGRAM

BRINGING THE BEST OF THE WORLD TO YOU®



SIMPLE SAFETY SOLUTIONS

ON SITE

ASSESSMENT SURVEY

Working collaboratively with our distributor-partners, we perform all 3SP™ site surveys. This assures industrial customers that they are done effectively and without any downtime. 3SP™ trained representatives have a broad understanding of complex manufacturing environments and processes. Chances are they've met many similar challenges before with proven solutions.

TRAINING SEMINARS

The PIP 3SP™ team consists of Product Specialists, Product Managers and PIP Sales Partners, who most often are providers of finished and raw-material products. Qualified and ready to train at your facility, or at our PIP headquarters in Latham, NY or our facility in Memphis, TN where you can experience our customer training center, complete with hands-on activities.

TOOLS TO

MAKE THE JOB SAFER

Today's work environment is dynamic. Aging workforce, transient and diverse workers, and increased reliance on automation create challenges related to communication, distraction, stress, and fatigue – all operating at a higher intensity. Training and orientation is short, and we rely on quick and comprehensive tools for answers.



3SP™ IS A MULTIFACETED, LEARNING-BASED PROGRAM DESIGNED AND TAILORED TO MEET THE NEEDS OF OUR CUSTOMERS.

BRINGING THE BEST OF THE WORLD TO YOU®

- 11 CUT RESISTANT GLOVES
- 55 GENERAL PURPOSE GLOVES
- 83 CHEMICAL RESISTANT GLOVES
- 95 DISPOSABLE GLOVES
- 101 CRITICAL ENVIRONMENT GLOVES
- 109 HIGH PERFORMANCE GLOVES
- 119 COLD PROTECTION GLOVES
- 123 HEAT PROTECTION GLOVES
- 127 EMERGENCY RESPONDER GLOVES
- 129 PARADE & UNIFORM GLOVES

HAND PROTECTION



ADVANCED

CUT RESISTANT FIBER AND YARN



G-Tek[®]
PolyKor[®]
XRYSTAL[™]

Represents the latest iteration of PolyKor[®] in which it is combined with naturally hardened crystallized minerals. The result is a super tough, durable, cut resistant fiber that is at the peak of performance.



G-Tek[®]
PolyKor[®]

PolyKor[®] Engineered Yarns optimize performance, function, and protection using proprietary blends of select fibers to exceed industry standards. The ultimate objective is affordable cut resistant gloves for practically every application.

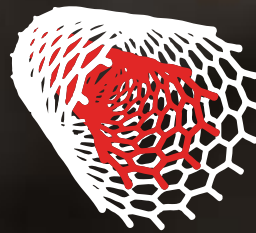

G-Tek[®]
Suprene[™]

The latest breakthrough in nanofabrication has resulted in Suprene[™] – an affordable fiber with unparalleled strength and physical properties.

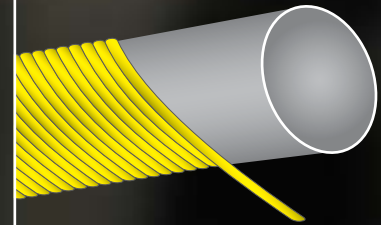

G-Tek[®]
KEV[™]

Takes the power of DuPont[™] Kevlar[®] and combines it with proprietary core technology for maximum cut strength and protection in light heat applications.

CUT PROTECTION MATERIAL BASICS

NAME	ADVANTAGES	DISADVANTAGES
HIGH-PERFORMANCE POLYETHYLENE HPPE	- High strength, high cut and abrasion resistance - Cool and comfortable	- Low heat tolerance
KEVLAR® Aramid fiber	- Good mechanical and cut resistance - Lightweight - Inherent heat properties	- Low resistance to UV rays and moisture
GRAPHENE	- Tough, strong and highly cut resistant	- High thermal conductivity
STAINLESS STEEL Metal yarn	- Excellent cut resistance	- Heavyweight - Poor flexibility - Heat and electricity conductor
GLASS FIBER Textile-grade glass fibers (silica)	- Strong, high initial cut resistance	- Poor wear performance as a result of fiber breakage causing reduced protection and possible skin irritation.

GENERAL PURPOSE MATERIAL BASICS

NAME	ADVANTAGES	DISADVANTAGES
NYLON Synthetic fiber	- High resistance to abrasion and fatigue - Higher durability and strength	- Low resistance to heat
POLYESTER Synthetic fiber	- Good resistance to abrasion - Chemical resistance	- Low resistance to heat
COTTON Natural fiber	- Low price - Comfortable	- Low mechanical resistance
ELASTANE FIBER SPANDEX® / LYCRA® Additive fiber	- High degree of elasticity and comfort - Resistant to abrasion	- Loses elastic properties with heat and wear
NATURAL LEATHER Tanned animal pelt	- Good resistance to tension, puncture and abrasion - Flexible, soft & breathable	- Cuts easily – no cut protection - Inconsistent quality

TECHNOLOGIES

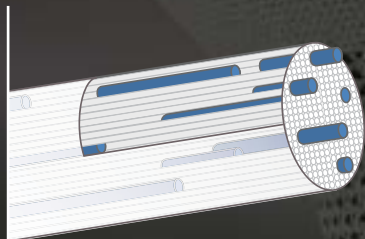

G-Tek®
3GX®

Embedded micro-particles strengthen fibers by up to two times, for higher cut scores. 3GX® offers cool touch comfort and lightweight for improved productivity.

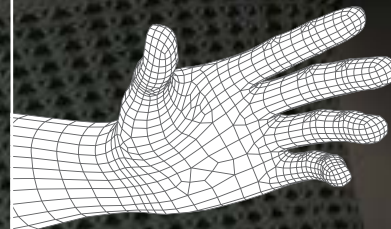

MaxiFlex®
CUT™

Maxiflex® Cut™ gloves synergize proprietary yarns with advanced glove design - applying coatings, technologies, and processes that are above-and-beyond when compared to conventional coatings and manufacturing processes. The result is the ultimate in comfort and durability.



A COMPLETE LINE OF COATINGS LIKE NEVER SEEN BEFORE

Coating grip is key in preventing razor sharp objects from slipping and making contact with hands or arms. Polymer coatings offer some degree of extra protection, however, they will slice easily with razor sharp blades and cannot be relied upon for boosting cut protection. Thicker, tougher materials such as latex and nitrile offer added protection when handling heavier objects with rough edges or burrs.

GET A GRIP



TOUCH SCREEN COMPATIBILITY

Resistive touchscreens, such as those found on most industrial controls, rely on resistive pressure and are unaffected by the use of gloves.

Capacitive touchscreens typically used in tablets, smartphones and laptops rely on the electrical field effect from our finger. PIP trials have found that our disposable gloves and many of our coated seamless knit gloves with thinner coatings will work with today's latest mobile devices. However, we recommend trials prior to equipping teams with gloves. For guaranteed bare-finger precision and sensitivity on any device, we provide the PU coated G-Tek® 33-GT125, featuring conductive fingertip touch technology.

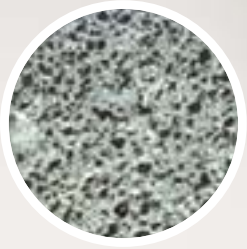

MICROSURFACE

2 LAYERS

- Flexible and tough
- No breathability

1 LAYER

- Thin with maximum dexterity
- Slight breathability



MICRO-FOAM

1 LAYER

- Thin and tough-wearing
- Maximum 360° breathability

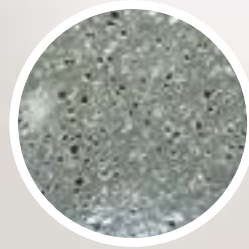

FOAM

1 LAYER

- Flexible and tough
- Fair breathability

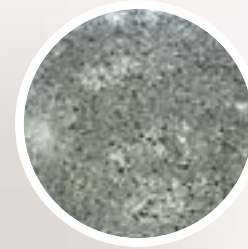

NEOFOAM™

1 LAYER

- Highly flexible and tough
- Good breathability

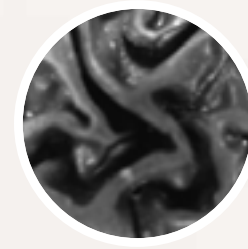

CRINKLE

1 LAYER

- Flexible and tough
- No breathability



FLAT/SMOOTH

1 LAYER

- Thin, high tactility
- Fair breathability

COATING	COATING MATERIAL	DRY GRIP					SUCTION ACTION ON WET/OILY	BREATHABILITY				DURABILITY			LIQUID PENETRATION		
		1	2	Fair	Good	Excellent		None/Slight	Fair	Good	Maximum 360°	Low	Medium	High	None	Minimal	Some
MICROSURFACE*	Latex Nitrile top layer		●		●		Good, oily surfaces	●					●		●		
MICROSURFACE*	Latex Latex top layer		●			●	Good, wet surfaces	●						●	●		
MICROSURFACE*	Nitrile	●		●			Good, oily surfaces		●			●			●		
MICRO-FOAM	Nitrile Proprietary Formulation	●			●		Superior, wet or oily surfaces				●		●				●
FOAM	Nitrile	●			●		Fair, wet or oily surfaces		●				●				●
NEOFOAM™	Co-Polymer	●			●		Good, wet or oily surfaces			●			●				●
CRINKLE	Latex	●				●	Good, wet surfaces	●					●	●			
FLAT/SMOOTH	Nitrile	●				●	Poor, wet or oily surfaces	●				●		●			
FLAT/SMOOTH	Polyurethane	●			●		Good, wet or oily surfaces		●			●					●

*MicroSurface is equivalent to MicroFinish® by Towa.

COMPLIANCE TESTING

UNDERSTANDING CUT SCORES

UNDERSTANDING CUT SCORES

PIP GLOVES ARE TESTED TO THE ANSI 105 AND THE EN 388 STANDARD.

Both standards test gloves for Abrasion, Cut, Tear and Puncture. While compliance is not mandated in the U.S., safety managers demand that products are tested and labeled in order to select the best possible equipment for the job being performed.

The European Union (EU) developed a standards and regulatory body that requires anyone wanting to sell products in Europe to attain the CE (Conformité Européene) compliance/markings through the performance testing described in EN 388 "Protective Gloves Against Mechanical Risks." EN 388 is widely recognized internationally.

PIP tests all cut resistant gloves at recognized labs and our test facility in Minnesota.

ANSI-105

FOR DETERMINING CUT SCORE ANSI-105-2006 EDITION USES THE ASTM F2992-15 TEST METHOD

TDM-100 TEST

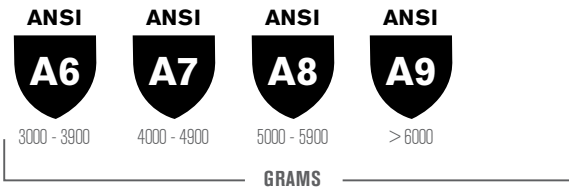
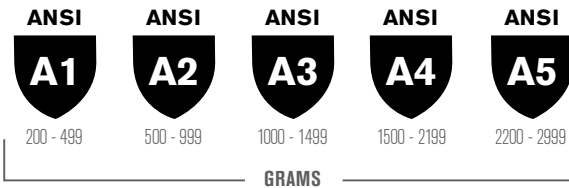
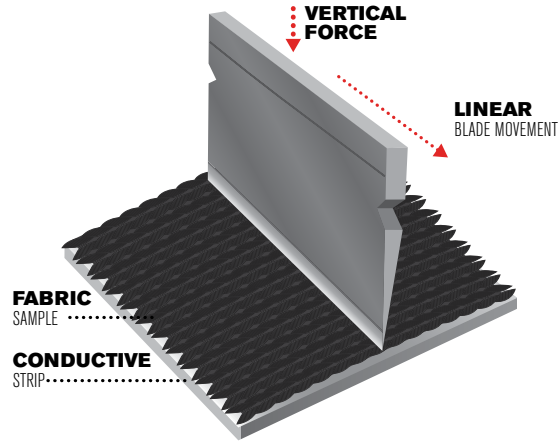

EN 388

FOR DETERMINING CUT SCORE EN 388:2003 CALLS FOR THE EN-COUP TEST

COUP TEST

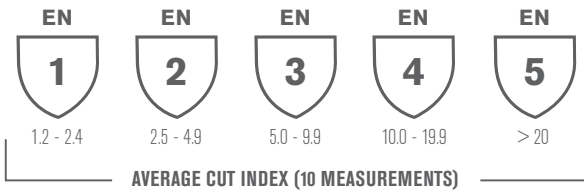
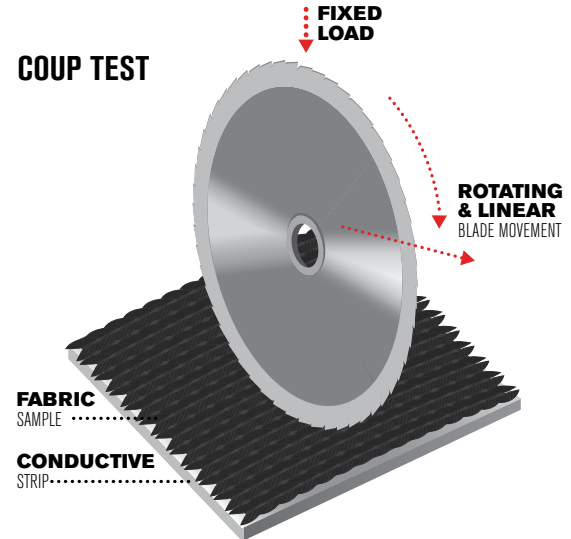

	EN 388
Rating	4 4 4 2 C X
Abrasion	1-4
Cut (Coup Test)	1-5
Tear	1-4
Puncture	1-4
Cut (TDM-100 Test)	A-F
Impact Protection	P, F, X

P: Passed F: Failed X: Not Tested

EN 388 2016 edition added a second cut test, the ISO 13997 cut method, using the same TDM-100 machine as the ANSI Standard outlined in the ASTM F2992-15 test method. An alpha letter will appear within the new EN Shield indicating this extra score. The test score will equate closely to the new ANSI score allowing customers to feel more comfortable about the two standards. The updated EN 388 2016 standard will also include an impact resistance test.

SCALE TO DETERMINE CUT SCORES

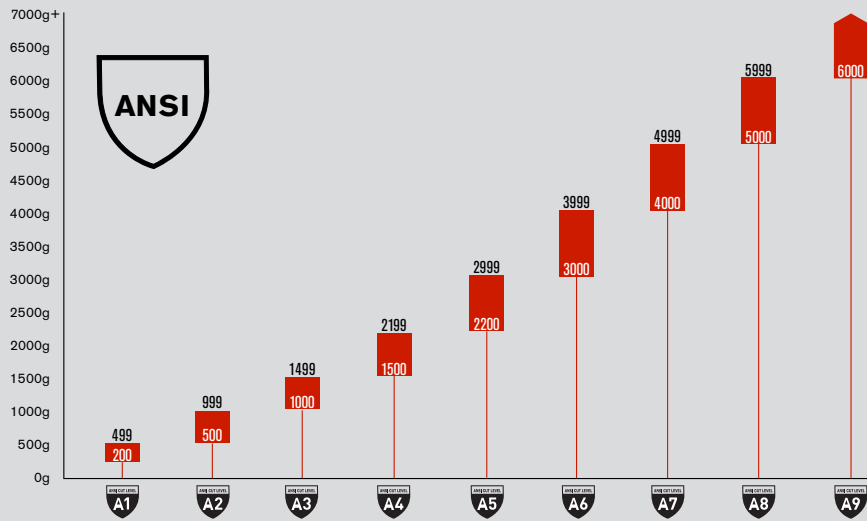

UNDERSTANDING THE ISO 13997 TEST METHOD

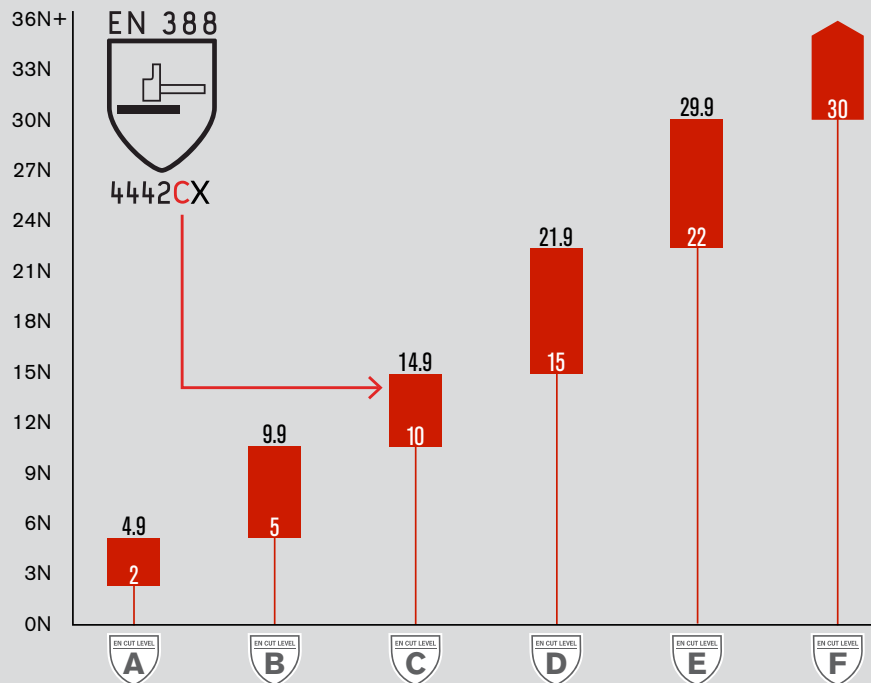

CONVERT

NEWTONS TO GRAMS

PIP has been testing all of its cut resistant gloves with the TDM-100 machine since 2005, which is (and has been) compliant with the new test method, enabling us to easily convert to the new EN 388 2016 standard. The table below illustrates how the new EN 388 2016 standard is now in-line with the ANSI/ISEA 105 standard for cut resistance when converting Newtons to grams.

EN 388 RATING	RANGE (NEWTONS)	CONVERTED RANGE (GRAMS)	ANSI/ISEA 105 LEVEL	RANGE (GRAMS)
EN CUT LEVEL A	2 - 4.9	204 - 508	ANSI CUT LEVEL A1	200 - 499
EN CUT LEVEL B	5 - 9.9	509 - 1,019	ANSI CUT LEVEL A2	500 - 999
EN CUT LEVEL C	10 - 14.9	1,020 - 1,529	ANSI CUT LEVEL A3	1,000 - 1,499
EN CUT LEVEL D	15 - 21.9	1,530 - 2,242	ANSI CUT LEVEL A4	1,500 - 2,199
EN CUT LEVEL E	22 - 29.9	2,243 - 3,058	ANSI CUT LEVEL A5	2,200 - 2,999
EN CUT LEVEL F	30+	3,059+	ANSI CUT LEVEL A6	3,000 - 3,999
---	---	---	ANSI CUT LEVEL A7	4,000 - 4,999
---	---	---	ANSI CUT LEVEL A8	5,000 - 5,999
---	---	---	ANSI CUT LEVEL A9	6,000+

CUT RISK HAZARD MATRIX™

CHOOSING THE RIGHT PROTECTION



THICKER, TOUGHER COATING

resists tears and protects against abrasion cuts when rough edge contact is part of the task



MAXIMUM GRIP COATING

necessary to prevent slippage and any chance of contact with sharp edges

10
HIGH

FORCE EXPOSURE

LOW
0

LIGHT to MEDIUM CUT HAZARDS

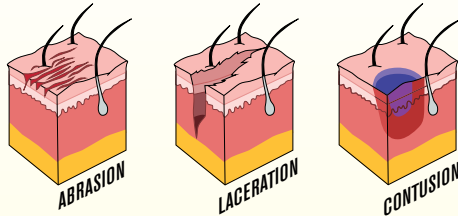

- Low gauge, thicker liner means more fabric loft to absorb and resist abrasion
- Spun yarns loftier to mitigate abrasion effects to skin
- TPR* impact protection to help protect against impact injuries

HIGH CUT HAZARDS

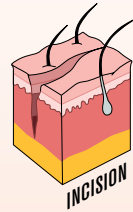

- Medium gauge, thicker liner to absorb pressing edge and allow yarn to roll
- Spun or high strength filament yarns

LIGHT CUT HAZARDS



- Low to medium gauge, thicker liner means more fabric loft to absorb and resist abrasion
- Spun yarns loftier to mitigate abrasion effects to skin

MEDIUM to HIGH CUT HAZARDS

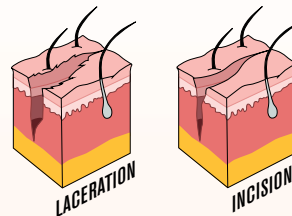

- Higher gauge liner means more yarns per inch
- Filament yarns preferred as sharp edge slides across smooth yarn without catching to cut

0

EDGE SHARPNESS

10

ROUGH

RAZOR

YOUR GUIDE TO THE RIGHT CHOICE

INTRODUCING THE CUT RISK HAZARD MATRIX™

The **Cut Risk Hazard Matrix™** is a unique and logical method to guide users in selecting a glove or sleeve with the right cut resistant material and score. Once a safety manager can identify where their application fits on the **Cut Risk Hazard Matrix™**, they can more confidently correlate the task to the glove or sleeve best suited for their job.



We deemed it necessary to develop a unique approach to help determine the risk and possible severity of an injury.

CALCULATING THE CRH: FACTOR™

1. Assess the **EDGE SHARPNESS** with "Rough" equating to the edge of a brick and "Razor" to that of a sharp knife.
2. **FORCE** is relative to the different tasks being performed. Tasks such as deboning large animals require a high degree of force compared to working with box cutters in a repacking operation.
3. Mapping the two will place you in one of the four quadrants of **RISK** where you can determine your CRH: Factor™ and proceed to selecting the optimal coating for maximum grip.

CUT RISK HAZARD MATRIX™

CHOOSING THE RIGHT PROTECTION



THICKER, TOUGHER COATING
resists tears and protects against abrasion cuts when rough edge contact is part of the task



MAXIMUM GRIP COATING
necessary to prevent slippage and any chance of contact with sharp edges

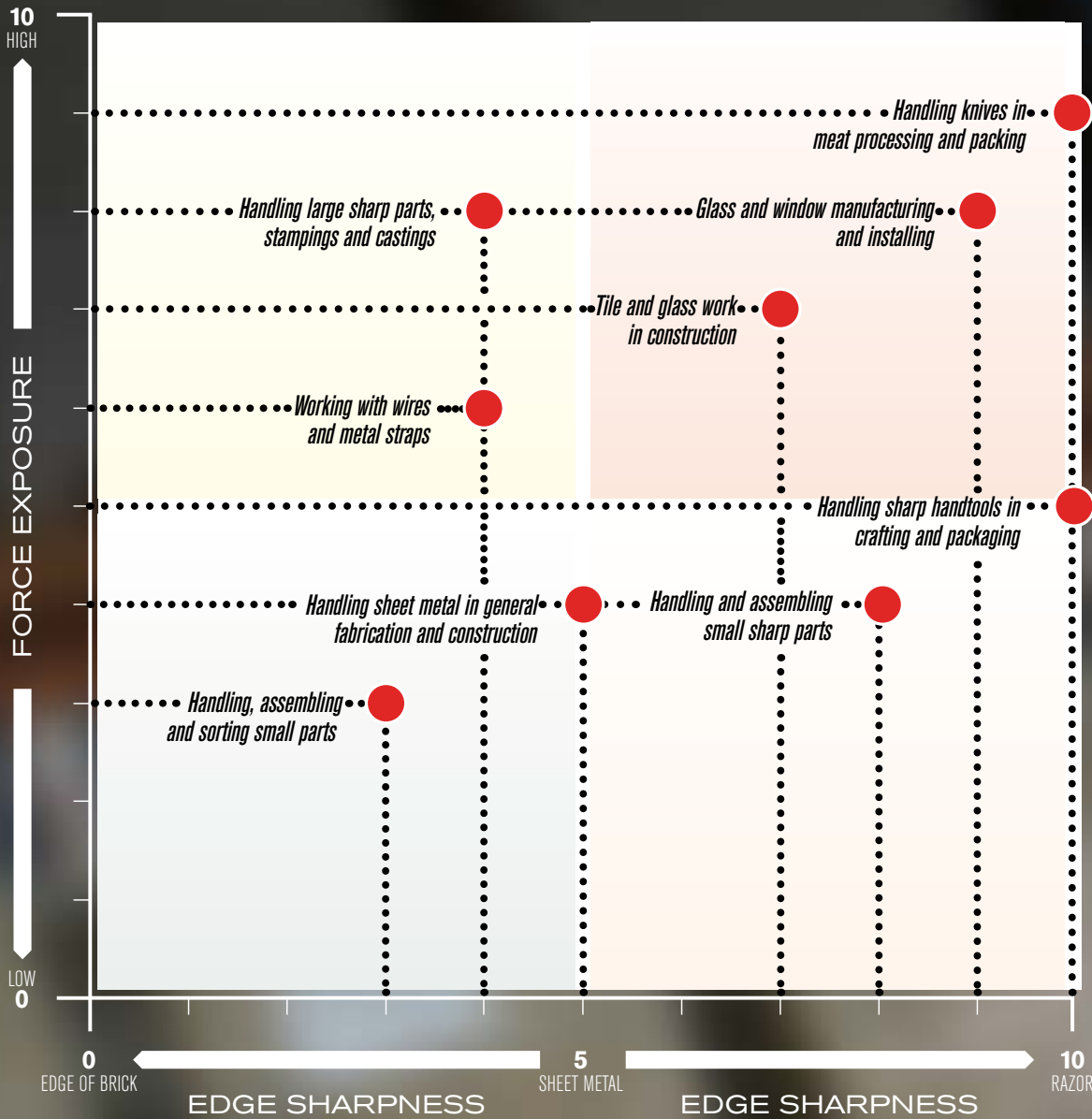

WE'VE EQUATED CUT SCORE FACTORS WITH REAL WORLD TASKS AND APPLICATIONS AS EXAMPLES

By plotting the tasks and applications, we determine a **Cut Risk Hazard Factor™** (CRH: Factor™) as outlined on the right side. The CRH: Factor™ is a comparative indicator that helps safety managers determine the level of potential hazard related to the task or application.

CRH: FACTOR	TASK
9:10	HANDLING KNIVES IN MEAT PROCESSING AND PACKING
8:9	GLASS AND WINDOW MANUFACTURING AND INSTALLING
7:7	TILE AND GLASS WORK IN CONSTRUCTION
8:4	HANDLING LARGE SHARP PARTS, STAMPINGS AND CASTINGS
6:4	WORKING WITH WIRES AND METAL STRAPS
5:10	HANDLING SHARP HANDTOOLS IN CRAFTING AND PACKING
4:8	HANDLING AND ASSEMBLING SMALL SHARP PARTS
4:5	HANDLING SHEET METAL IN GENERAL FABRICATION AND CONSTRUCTION
3:3	HANDLING, ASSEMBLING AND SORTING SMALL PARTS

NEW PRODUCTS

COATED SEAMLESS KNIT GLOVES



G-Tek[®]
PolyKor[®]
XRYSTAL[™]

POLYKOR[®] XRYSTAL[™] IS AN ENGINEERED YARN THAT REPRESENTS THE NEXT GENERATION IN MAXIMUM CUT PROTECTION AND COMFORT.

It is a blend of high-modulus polyethylene and mineral-based fibers. These mineral-based fibers have a similar chemical composition to glass, but are inherently better in terms of strength, heat and oxidation resistance, as well as compression and shear.



G-Tek[®]
Supreme[™]

A BOLD NEW WORLD OF GRAPHENE-BASED FIBERS.

Similar to graphite, graphene is remarkably strong for its weight – being 100 times stronger than steel – it outperforms any other material. Structurally it is very different than other fibers in that it is made up of micro-structured graphene sheets well-aligned along the fiber axis.



G-Tek[®]
KEV[™]

KEVLAR[®] – A UNIQUE COMBINATION OF HIGH STRENGTH, HIGH MODULUS, & THERMAL STABILITY.

From athletes to astronauts, first responders to industrial workers, Kevlar[®] enables anyone, with an imagination and a job to do, to Dare Bigger[™]. PIP, the leading provider of coated seamless knit gloves in America teamed up with DuPont[®] to develop the new G-TEK[®] KEV[™] series of cut resistant gloves.



ATG[®]
Intelligent Glove Solutions

ATG[®] DESIGNS, DEVELOPS AND MANUFACTURES GLOVES WITH ENHANCED PERFORMANCE

All gloves are skin-friendly, extremely comfortable and highly durable.



ATG[®] introduces two new cut gloves based on advanced fiber technologies. DuPont[™] Kevlar[®] aramid fiber offers strength and light heat protection and Dyneema[®] Diamond based super thin liners offers unprecedented strength-to-weight ratio.

NEW CUT PROTECTION FROM PIP

HIGH CUT HAZARDS – INCISION RISK

COATED SEAMLESS KNIT GLOVES

CUT RISK HAZARD MATRIX™

LIGHT to MEDIUM CUT HAZARDS

LIGHT CUT HAZARDS

HIGH CUT HAZARDS

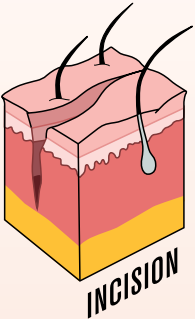

- Medium gauge, thicker liner to absorb pressing edge and allow yarn to roll
- Spun or high strength filament yarns

MEDIUM to HIGH CUT HAZARDS

HIGH CUT HAZARDS INCISION RISK

STYLE NUMBER	ANSI	EN 388
G-TEK® POLYKOR® XRYSTAL™		
16-X310	A4	4544
16-X320	A4	4543
16-X540	A4	4542
16-X570	A4	4542
16-X575	A4	4542
G-TEK® SUPRENE™		
15-210	A4	4544
15-215	A4	4544
15-340	A4	4544
15-440	A4	4544
G-TEK® 3GX®		
19-D340LG	A4	4544
19-D340OR	A4	4544
19-D534B	A4	4542
19-D313	A4	3544
19-D315	A4	3543
19-D526B	A4	4542
19-D330	A4	4542

STYLE NUMBER	ANSI	EN 388
G-TEK® POLYKOR®		
16-560*	A4	4543
G-TEK® KEV™		
09-K1600	A7	4543
09-K1640	A4	4532
09-K1630	A4	4532
73-K1800	A4	2542
09-K1300	A4	3544
09-K1700	A5	3543
ATG® MAXICUT® 5		
19-D470	A4	4543
19-D475	A4	4543

HIGH CUT HAZARDS – INCISION RISK

COATED SEAMLESS KNIT GLOVES

INCISION
RISK

NEXT GENERATION
MAXIMUM PROTECTION



HIGH CUT HAZARDS – INCISION RISK

COATED SEAMLESS KNIT GLOVES



G-Tek
PolyKor
XRYSTAL™

Represents the latest iteration of PolyKor® in which it is combined with naturally hardened crystallized minerals. The result is a super tough, durable, cut resistant fiber that is at the peak of performance.



ANSI **A4** EN **5** NITRILE MICROSURFACE COATING

G-TEK® POLYKOR® XRYSTAL™ 16-X310

- Tough, flexible coating
- Excellent dry grip, and good grip in oily conditions
- Black coating on gray liner hides dirt

APPLICATIONS: *Electronics, Small Parts Handling, Construction, General Maintenance*



ANSI **A4** EN **5** NITRILE FOAM COATING

G-TEK® POLYKOR® XRYSTAL™ 16-X320

- High tactile and sensitive coating
- Excellent dry grip, and good grip in oily conditions
- Durable & hard-wearing coating
- Black coating on gray liner hides dirt

APPLICATIONS: *Electronics, Sheet Metal Handling, Parts Assembly, General Maintenance*



ANSI **A4** EN **5** NEOFOAM™ COATING

G-TEK® POLYKOR® XRYSTAL™ 16-X570

- Super durable cut resistant fiber
- Good grip on dry, wet or oily surfaces
- Tactile and flexible
- Touchscreen compatible
- Breathable, flexible coating
- Black coating on gray liner hides dirt

APPLICATIONS: *Glass Cutting, Metal Handling, Fastening, Construction*



ANSI **A4** EN **5** POLYURETHANE COATING

G-TEK® POLYKOR® XRYSTAL™ 16-X540

- Thin coating for maximum dexterity and tactile sensitivity
- Good grip on dry, wet or oily surfaces
- Black coating on gray liner hides dirt

APPLICATIONS: *Glass Cutting, Metal Handling, Fastening, Small Sharp Parts Handling, Construction*

PEAK OF CUT PROTECTION

HIGH CUT HAZARDS

STYLE NUMBER	ANSI	EN 388	COATING	COATING COVERAGE	COATING COLOR	LINER MATERIAL	LINER COLOR	CONSTRUCTION	GAUGE	SIZES
16-X310	A4	4544	Nitrile MicroSurface	Palm & Fingertips	Black	G-Tek® PolyKor® Xrystal™	Gray	Coated Seamless Knit	13	XS - XXL
16-X320	A4	4543	Nitrile Foam	Palm & Fingertips	Black	G-Tek® PolyKor® Xrystal™	Gray	Coated Seamless Knit	13	XS - XXL
16-X540	A4	4542	Polyurethane	Palm & Fingertips	Black	G-Tek® PolyKor® Xrystal™	Gray	Coated Seamless Knit	13	XS - XXL
16-X570	A4	4542	Neofoam™	Palm & Fingertips	Black	G-Tek® PolyKor® Xrystal™	Gray	Coated Seamless Knit	13	XS - XXL
16-X575	A4	4542	Neofoam™	Palm & Fingertips	Black	G-Tek® PolyKor® Xrystal™	Gray	Coated Seamless Knit with Reinforced Thumb Crotch	13	XS - XXL

HIGH CUT HAZARDS – INCISION RISK

COATED SEAMLESS KNIT GLOVES



GRAPHENE NANOTECHNOLOGY

NEW SCIENCE
IN CUT PROTECTION

HIGH CUT HAZARDS – INCISION RISK

COATED SEAMLESS KNIT GLOVES



G-TEK® SUPRENE™ 15-210

- Exceptionally strong liner
- Excellent dry grip, and good grip in oily conditions
- Black coating on gray liner hides dirt

APPLICATIONS: *Electronics, Glass Cutting, Metal Handling, Fastening, General Maintenance*



G-TEK® SUPRENE™ 15-215

- Extended coating coverage for better protection
- Excellent dry grip, and good grip in oily conditions
- Black coating on gray liner hides dirt

APPLICATIONS: *Heavy Duty Industrial, Metal and Castings Handling, Glass and Tile Work, General Maintenance*



G-TEK® SUPRENE™ 15-340

- Thin coating for precision and dexterity
- Good grip in dry, wet, and slightly oily conditions

APPLICATIONS: *Glass Cutting, Metal Handling, Fastening, Construction*



G-TEK® SUPRENE™ 15-440

- High breathability coating for maximum comfort
- Good grip in dry, wet, and slightly oily conditions
- Touchscreen compatible
- Breathable, flexible coating
- Black coating on gray liner hides dirt

APPLICATIONS: *Glass Cutting, Sheet Metal Handling, Fastening, Small Sharp Parts Handling, Construction*

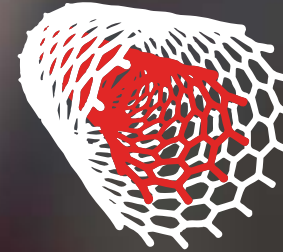

G-Tek®
Suprene™

Latest breakthrough in nanofabrication has resulted in Supreme™ – an affordable fiber with unparalleled strength and physical properties.

UNPARALLELED STRENGTH

HIGH CUT HAZARDS

STYLE NUMBER	ANSI	EN 388	COATING	COATING COVERAGE	COATING COLOR	LINER MATERIAL	LINER COLOR	CONSTRUCTION	GAUGE	SIZES
15-210	A4	4544	Nitrile MicroSurface	Palm & Fingertips	Black	G-Tek® Suprene™	Tan	Coated Seamless Knit	13	XS - XXL
15-215	A4	4544	Nitrile MicroSurface	Palm, Full Finger & Knuckle	Black	G-Tek® Suprene™	Tan	Coated Seamless Knit	13	XS - XXL
15-340	A4	4544	Polyurethane	Palm & Fingertips	Gray	G-Tek® Suprene™	Tan	Coated Seamless Knit	13	XS - XXL
15-440	A4	4544	Neof foam™	Palm & Fingertips	Black	G-Tek® Suprene™	Tan	Coated Seamless Knit	13	XS - XXL

HIGH CUT HAZARDS – INCISION RISK

COATED SEAMLESS KNIT GLOVES

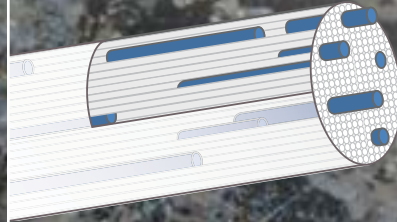

G-Tek® 3GX®

Embedded micro-particles strengthen fibers by up to two times, for higher cut scores. 3GX® offers cool touch comfort and are lightweight for improved productivity.



HI-VISIBILITY



**G-TEK® 3GX®
19-D340LG**

- High tactile sensitivity and dexterity
- Excellent dry grip and resistance to oils
- High puncture resistance for industrial applications
- Excellent durability

APPLICATIONS: *Handling Metal Parts, Assembly, Fastening, Industrial Construction*



HEAVY DUTY



**G-TEK® 3GX®
19-D313**

- Heavy duty, tough wearing performance
- Superior grip in dry and slightly wet, non-oily conditions
- High puncture resistance
- Good durability

APPLICATIONS: *Ceramics, Glass and Sheet Metal Handling, Construction, General Maintenance*

STRONGER. SAFER. BETTER. CUT PROTECTION WITH DYNEEMA® DIAMOND TECHNOLOGY

HIGH CUT HAZARDS – INCISION RISK

COATED SEAMLESS KNIT GLOVES



HI-VISIBILITY



**G-TEK® 3GX®
19-D340OR**

- High tactile sensitivity and dexterity
- Excellent dry grip and resistance to oils
- High puncture resistance for industrial applications
- Excellent durability

APPLICATIONS: *Handling Metal Parts, Assembly, Fastening, Industrial Construction*



**G-TEK® 3GX® BLACK
19-D534B**

- Tough wearing, oil and solvent resistant coating
- Good cut protection and tactility
- Good dry grip, fair grip in oily conditions

APPLICATIONS: *Glass Cutting, Construction, Fastening, Metal and Castings, General Maintenance*

G-TEK® 3GX® WITH DYNEEMA® DIAMOND TECHNOLOGY



**G-TEK® 3GX® BLACK
19-D526B**

- Black liner hides dirt and extends life of glove
- Good cut protection and tactility
- Good grip in dry, wet and slightly oily conditions

APPLICATIONS: *Electronics, Glass Cutting, Metal Handling, General Maintenance, Small Parts Handling*



**G-TEK® 3GX®
19-D330**

- High tactile sensitivity and dexterity
- Good grip in dry, wet, and slightly oily conditions
- Excellent durability

APPLICATIONS: *Electronics and Metal Assembly, Small Sharp Parts Handling*

HIGH CUT HAZARDS

STYLE NUMBER	ANSI	EN 388	COATING	COATING COVERAGE	COATING COLOR	LINER MATERIAL	LINER COLOR	CONSTRUCTION	GAUGE	SIZES
19-D340LG	A4	4544	Nitrile Foam	Palm & Fingertips	Black	G-Tek® 3GX®	Hi-Vis Lime	Coated Seamless Knit	13	XS - XXL
19-D340OR	A4	4544	Nitrile Foam	Palm & Fingertips	Black	G-Tek® 3GX®	Hi-Vis Orange	Coated Seamless Knit	13	XS - XXL
19-D534B	A4	4542	Nitrile Foam	Palm & Fingertips	Black	G-Tek® 3GX®	Black	Coated Seamless Knit	15	S - XL
19-D313	A4	3544	Latex Crinkle	Palm & Fingertips	Blue	G-Tek® 3GX®	White	Coated Seamless Knit	13	S - XL
19-D315	A4	3543	Latex Crinkle	Palm & Fingertips	Blue	G-Tek® 3GX®	White	Coated Seamless Knit	15	S - XL
19-D526B	A4	4542	Polyurethane	Palm & Fingertips	Black	G-Tek® 3GX®	Black	Coated Seamless Knit	15	XS - XXL
19-D330	A4	4542	Polyurethane	Palm & Fingertips	Gray	G-Tek® 3GX®	White	Coated Seamless Knit	13	XS - XXXL
16-560	A4	4543	Polyurethane	Palm & Fingertips	Gray	G-Tek® PolyKor®	Gray	Coated Seamless Knit	13	XS - XXL

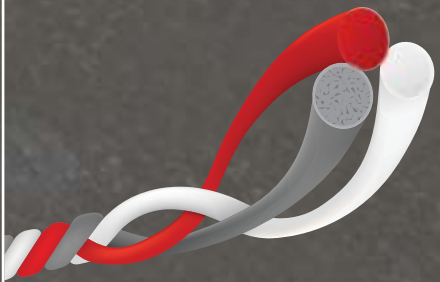

G-Tek®
PolyKor®

PolyKor® Engineered Yarns optimize performance, function, and protection using proprietary blends of select fibers to exceed industry standards. The ultimate objective is affordable cut resistant gloves for practically every application.

PROVEN & TRUSTED



**G-TEK® POLYKOR®
16-560**

- High tactile sensitivity and dexterity
- Good grip in dry, wet, and slightly oily conditions
- Good puncture resistance for industrial applications
- Excellent durability

APPLICATIONS: *Electronics, Glass Cutting, Metal Handling, Fastening, Construction*

HIGH CUT HAZARDS – INCISION RISK

COATED SEAMLESS KNIT GLOVES

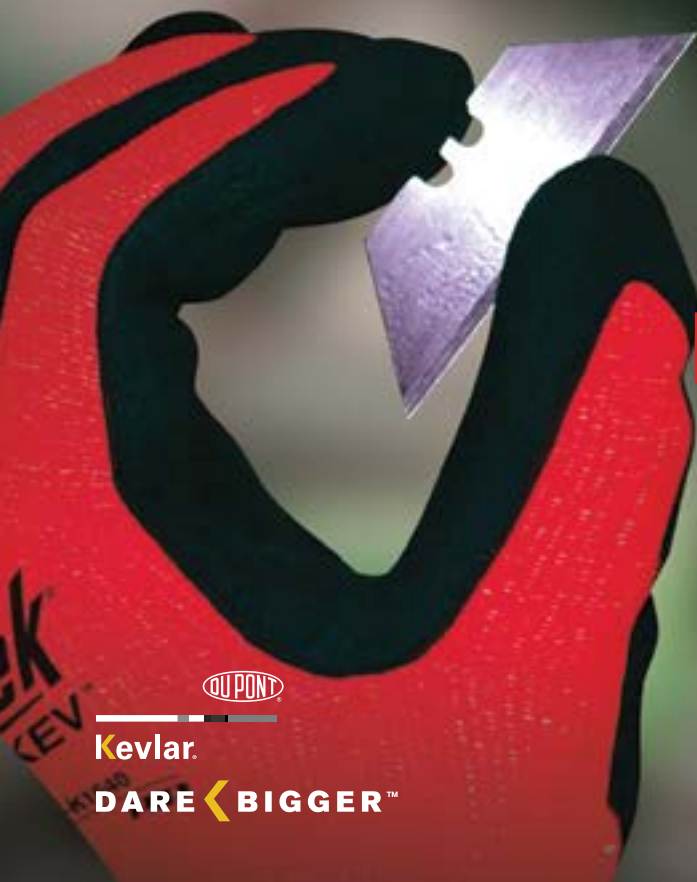

Kevlar.

DARE  BIGGER™

MAXIMUM CUT PROTECTION



ANSI
A7

EN
5

NITRILE FOAM
COATING 

◀ **G-TEK® KEV™
09-K1600**

- Superior cut resistance
- Good grip on dry, wet or oily surfaces
- Protection in light heat applications

APPLICATIONS: *Glass Cutting, Metal Handling, Fastening, Construction*



ANSI
A4

EN
5

NITRILE FOAM
COATING 

◀ **G-TEK® KEV™
09-K1640**

- Red liner for easy compliance detection on job site
- Good grip on dry, wet or oily surfaces
- Protection in light heat applications

APPLICATIONS: *Glass Cutting, Metal Handling, Small Sharp Parts Handling, Fastening*



ANSI
A4

EN
5

LATEX CRINKLE
COATING 

◀ **G-TEK® KEV™
09-K1300**

- Excellent grip in dry and wet, non-oily conditions
- Fully coated thumb to increase wear
- High puncture resistance
- Good durability

APPLICATIONS: *Ceramics, Glass Cutting, Metal Handling, General Maintenance*

TOUGH WEARING



ANSI
A5

EN
5

LATEX MICROFINISH®
COATING 

◀ **09-K1700**

- Excellent grip in dry and wet, non-oily conditions
- Steel core Kevlar® liner for additional cut protection
- Good puncture resistance
- Good durability

APPLICATIONS: *Ceramics, Glass Cutting, Metal Handling, General Maintenance*

STEEL CORE KEVLAR®

THE POWER OF KEVLAR® CUT & HEAT PROTECTION

HIGH CUT HAZARDS – INCISION RISK

COATED SEAMLESS KNIT GLOVES



**G-TEK® KEV™
09-K1630**

- Excellent durability and abrasion resistance
- Good grip on dry, wet or oily surfaces
- Protection in light heat applications

APPLICATIONS: *Metal Handling, Fastening, Construction, General Maintenance*



**MAXIMUM SAFETY®
73-K1800**

- Arc rated with high cut protection
- Seamless knit aramid liner is comfortable and flexible
- Nitrile coated palm and finger tips for enhanced grip

APPLICATIONS: *Oil and Gas Protection Against Arc and Flash Fires*

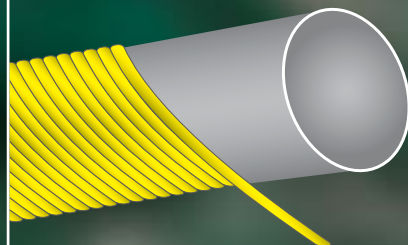

**G-Tek®
KEV™**

Takes the power of DuPont™ Kevlar® and combines it with proprietary core technology for maximum cut strength and protection in light heat applications.



DEFYING LIMITS

CHALLENGING THE CONVENTIONAL

PIP data demonstrates that more often than not arm protection is left to long-sleeved daily work wear. **This is not protection.** Only a Kut Gard® sleeve designed and conforming to the latest cut standards will do the job.

KUT GARD® MADE WITH KEVLAR® SLEEVES

STYLE NUMBER	ANSI	COLOR	CONSTRUCTION	PLY	LENGTHS
10-KVSRD	A6	Red	Blousy	1	12", 18"
10-KVSDGH	A6	Dark Gray	Blousy	1	12", 18"
10-KVSYBH	A6	Yellow / Black	Blousy	1	12", 18"

HIGH CUT HAZARDS

STYLE NUMBER	ANSI	EN 388	COATING	COATING COVERAGE	COATING COLOR	LINER MATERIAL	LINER COLOR	CONSTRUCTION	GAUGE	SIZES
09-K1600	A7	4543	Nitrile Foam	Palm & Fingertips	Black	G-Tek® KEV™	Yellow / Black	Coated Seamless Knit	13	S - XXL
09-K1640	A4	4532	Nitrile Foam	Palm & Fingertips	Black	G-Tek® KEV™	Red	Coated Seamless Knit	13	S - XXL
09-K1630	A4	4532	Nitrile Foam	Palm & Fingertips	Black	G-Tek® KEV™	Gray	Coated Seamless Knit	13	S - XXL
73-K1800	A4	2542	Nitrile Foam	Palm & Fingertips	Black	Aramid	Yellow	Coated Seamless Knit	13	S - XXL
09-K1300	A4	3544	Latex Crinkle	Palm & Fingertips	Blue	G-Tek® KEV™	Yellow	Coated Seamless Knit	10	S - XXL
09-K1700	A5	3543	Latex MicroFinish®	Palm & Fingertips	Blue	DuPont™ Kevlar®	Yellow	Coated Seamless Knit	10	S - XXL

HIGH CUT HAZARDS – INCISION RISK

COATED SEAMLESS KNIT GLOVES



BREATHABLE CUT RESISTANCE



▲ 19-D470

▲ 19-D475



MAXICUT® 5

- Good dexterity and tactility
- Patented micro-foam nitrile coating offers 360° breathability
- Excellent dry grip and compatibility with light oils
- Thumb reinforcement for durability
- Good puncture resistance
- Excellent durability

APPLICATIONS: Electronics, Metal Handling, Small Sharp Parts Handling, Maintenance, Repair

HIGH CUT HAZARDS

STYLE NUMBER	ANSI	EN 388	COATING	COATING COVERAGE	COATING COLOR	LINER MATERIAL	LINER COLOR	CONSTRUCTION	GAUGE	SIZES
19-D470	A4	4543	Nitrile Micro-Foam	Palm & Fingertips	■ Gray	Engineered Yarn	■ Gray	Coated Seamless Knit	13	XS - XXL
19-D475	A4	4543	Nitrile Micro-Foam	Palm, Full Finger & Knuckle	■ Gray	Engineered Yarn	■ Gray	Coated Seamless Knit	13	XS - XXL

COMFORT & PERFORMANCE

MEDIUM TO HIGH CUT HAZARDS – LACERATION & INCISION RISK

COATED SEAMLESS KNIT GLOVES

LIGHT to MEDIUM
CUT HAZARDS

HIGH
CUT HAZARDS

MEDIUM TO HIGH CUT HAZARDS

LACERATION & INCISION RISK

LIGHT
CUT HAZARDS

MEDIUM to HIGH CUT HAZARDS

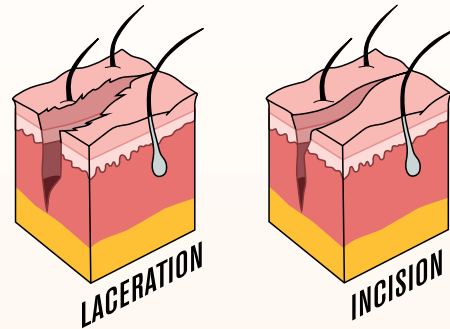

- Higher gauge liner means more yarns per inch
- Filament yarns preferred as sharp edge slides across smooth yarn without catching to cut

CRH
MATRIX™

STYLE NUMBER	ANSI	EN 388
G-TEK® 3GX®		
19-D334	A3	4443
19-D355	A3	4343
19-D322	A3	4442
19-D320	A3	4442
19-D310	A3	4442
19-D325	A3	4542
19-D326	A3	4442
19-D360	A3	4442
19-D327	A3	4542
G-TEK® POLYKOR®		
16-340LG	A3	4544
16-340OR	A3	4544
16-350	A3	4543
16-520HY	A3	4542
16-815	A3	3543
16-747	A3	3341
16-820	A3	2543

STYLE NUMBER	ANSI	EN 388
G-TEK® KEV™		
09-K1618	A3	4421
09-K1350	A3	2342
09-K1444	A3	2444
09-K1310	A3	2444
09-K1218	A3	4331
ATG® MAXICUT® ULTRA™		
44-3745	A3	4542
44-3755	A3	4542
44-3445	A3	4542
44-3455	A3	4542
44-1745	A3	4542
44-6745	A3	4542

MEDIUM TO HIGH CUT HAZARDS – LACERATION & INCISION RISK

COATED SEAMLESS KNIT GLOVES

LACERATION
INCISION
RISK

GREAT WHITE
3GX
ANSI A3 EN 388
CUT 4442 L 19-D322
PPI

G-Tek[®]
3GX[®]

REDEFINE[®]
CUT PROTECTION



MEDIUM TO HIGH CUT HAZARDS – LACERATION & INCISION RISK

COATED SEAMLESS KNIT GLOVES



HIDES DIRT



G-TEK® 3GX®
19-D334

- High tactile sensitivity and dexterity
- Excellent dry grip and resistance to oils
- Liner and dark coating hides dirt
- Good puncture resistance
- Excellent durability

APPLICATIONS: *Handling Metal Parts, Assembly, Fastening, Industrial, Construction*



ENHANCED PROTECTION



G-TEK® 3GX®
19-D355

- High tactile sensitivity and dexterity
- Excellent dry grip and resistance to oils
- Dark colors hides dirt
- Greater coating coverage for enhanced abrasion and liquid protection
- Good puncture resistance
- Excellent durability

APPLICATIONS: *Heavy Duty Handling Metal Parts, Assembly, Fastening Industrial, Construction*



BEST SELLER



G-TEK®
GREAT WHITE® 3GX®
19-D322

- High tactile sensitivity and dexterity
- Good grip in dry, wet, and slightly oily conditions
- Excellent durability

APPLICATIONS: *Electronics Assembly, Metal Handling, Small and Medium Sharp Parts Handling, Industrial, Construction*



G-TEK® 3GX®
19-D320

- High tactile sensitivity and dexterity
- Good grip in dry, wet, and slightly oily conditions
- Gray coating on gray liner hides dirt
- Excellent durability

APPLICATIONS: *Electronics Assembly, Metal Handling, Small and Medium Sharp Parts Handling, Maintenance, Repair*



FOR CLEAN WORK



G-TEK® 3GX®
19-D325

- High tactile sensitivity and dexterity
- Good grip in dry, wet, and slightly oily conditions
- White coating on white liner ideal for cleaner work
- Excellent durability

APPLICATIONS: *Electronics Assembly, Metal Handling, Small and Medium Sharp Parts Handling*



G-TEK® 3GX®
19-D326

- High tactile sensitivity and dexterity
- Good grip in dry, wet, and slightly oily conditions
- Excellent durability

APPLICATIONS: *Electronics Assembly, Metal Handling, Small and Medium Sharp Parts Handling, Maintenance, Repair*



HIDES DIRT



G-TEK® 3GX®
19-D327

- Excellent tactile sensitivity and dexterity
- Good grip in dry, wet, and slightly oily conditions
- Gray coating on gray liner hides dirt
- Excellent durability

APPLICATIONS: *Electronics Assembly, Metal Handling, Small Sharp Parts Handling, Maintenance, Repair Operations*

MEDIUM TO HIGH CUT HAZARDS

STYLE NUMBER	ANSI	EN 388	COATING	COATING COVERAGE	COATING COLOR	LINER MATERIAL	LINER COLOR	CONSTRUCTION	GAUGE	SIZES
19-D334	A3	4443	Nitrile Foam	Palm & Fingertips	Black	G-Tek® 3GX®	Salt & Pepper	Coated Seamless Knit	13	S - XL
19-D355	A3	4343	Nitrile Foam	Palm, Full Finger & Knuckle	Black	G-Tek® 3GX®	Salt & Pepper	Coated Seamless Knit	13	S - XL
19-D322	A3	4442	Polyurethane	Palm & Fingertips	Gray	G-Tek® 3GX®	White	Coated Seamless Knit	13	XS - XXL
19-D320	A3	4442	Polyurethane	Palm & Fingertips	Gray	G-Tek® 3GX®	Gray	Coated Seamless Knit	13	XS - XXL
19-D310	A3	4442	Polyurethane	Palm & Fingertips	Gray	G-Tek® 3GX®	White	Coated Seamless Knit	13	XS - XXL
19-D325	A3	4542	Polyurethane	Palm & Fingertips	White	G-Tek® 3GX®	White	Coated Seamless Knit	13	XXS - XXL
19-D326	A3	4442	Polyurethane	Palm & Fingertips	Black	G-Tek® 3GX®	Salt & Pepper	Coated Seamless Knit	13	XS - XXL
19-D360	A3	4442	Polyurethane	Palm & Fingertips	Gray	G-Tek® 3GX®	Gray	Coated Seamless Knit	13	S - XL
19-D327	A3	4542	Polyurethane	Palm & Fingertips	Gray	G-Tek® 3GX®	Gray	Coated Seamless Knit	15	XS - XXL

MEDIUM TO HIGH CUT HAZARDS – LACERATION & INCISION RISK

COATED SEAMLESS KNIT GLOVES



HI-VISIBILITY



**G-TEK® POLYKOR®
16-340LG**

- High tactile sensitivity and dexterity
- Excellent dry grip and resistance to oils
- Hi-Vis for enhanced hand visibility
- Good puncture resistance
- Excellent durability
- Double-dipped coating for added wear protection

APPLICATIONS: *Electronics, Glass Cutting, Metal Handling, Fastening, Construction*



HIDES DIRT



**G-TEK® POLYKOR®
16-350**

- High tactile sensitivity and dexterity
- Excellent dry grip and resistance to oils
- Better comfort against skin
- Good puncture resistance
- Excellent durability
- Double-dipped coating for added wear protection

APPLICATIONS: *Electronics, Sheet Metal Handling, Parts Assembly, Small Sharp Parts Handling, Construction, Maintenance*



HI-VISIBILITY

EASY COMPLIANCE



**G-TEK® POLYKOR®
16-520HY**

- High tactile sensitivity and dexterity
- Good grip in dry, wet, and slightly oily conditions
- Hi-Vis yellow for easy compliance detection

APPLICATIONS: *Electronics, Metal Handling, Fastening, Construction*



DOUBLE-DIPPED COATING



**G-TEK® POLYKOR®
16-815**

- High tactile sensitivity and dexterity
- Excellent grip in dry and wet, non-oily conditions
- Better comfort against skin
- Good puncture resistance
- Good durability
- Double-dipped coating for added wear protection

APPLICATIONS: *Ceramics, Glass Cutting, Metal Handling, General Maintenance*



16-747

- Good cut resistance
- Good grip in greasy or oily conditions
- Black coating and liner hides dirt

APPLICATIONS: *Metal Handling, Fastening, Assembly, Construction*



**G-TEK® POLYKOR®
16-820**

- High tactile sensitivity and dexterity
- Excellent grip in dry and wet, non-oily conditions
- Better comfort against skin
- Greater coating coverage for enhanced protection
- Inner acrylic liner for cold weather use
- Good puncture resistance

APPLICATIONS: *Ceramics, Glass Cutting, Metal Handling, General Maintenance, Construction*

PROTECTION. PERFORMANCE. VALUE.



MEDIUM TO HIGH CUT HAZARDS

STYLE NUMBER	ANSI	EN 388	COATING	COATING COVERAGE	COATING COLOR	LINER MATERIAL	LINER COLOR	CONSTRUCTION	GAUGE	SIZES
16-340LG	A3	4544	Nitrile MicroSurface	Palm & Fingertips	☐ Black	G-Tek® PolyKor®	■ Hi-Vis Lime	Coated Seamless Knit	13	S - XXL
16-340OR	A3	4544	Nitrile MicroSurface	Palm & Fingertips	☐ Black	G-Tek® PolyKor®	■ Hi-Vis Orange	Coated Seamless Knit	13	S - XXL
16-350	A3	4543	Nitrile MicroSurface	Palm & Fingertips	☐ Black	G-Tek® PolyKor®	■ Salt & Pepper	Coated Seamless Knit	13	XS - XXL
16-520HY	A3	4542	Polyurethane	Palm & Fingertips	■ Hi-Vis Lime	G-Tek® PolyKor®	■ Hi-Vis Lime	Coated Seamless Knit	13	XS - XXL
16-815	A3	3543	Latex MicroSurface	Palm & Fingertips	☐ Black	G-Tek® PolyKor®	■ Salt & Pepper	Coated Seamless Knit	13	XS - XXL
16-747	A3	3341	PVC	Palm & Fingertips	☐ Black	PolyKor® Blend	☐ Black	Coated Seamless Knit	13	XS - XXL
16-820	A3	2543	Latex MicroSurface	Palm, Full Finger & Knuckle	☐ Black	G-Tek® PolyKor®	■ Salt & Pepper	Coated Seamless Knit	13	S - XXL

MEDIUM TO HIGH CUT HAZARDS – LACERATION & INCISION RISK

COATED SEAMLESS KNIT GLOVES



ANSI **A3** EN **4** NITRILE FOAM COATING

G-TEK® KEV™
09-K1618

- Thin coating for maximum dexterity
- Excellent dry grip, and good grip on wet or oily surfaces
- Protection in light heat applications

APPLICATIONS: *Glass Cutting, Electronics, Metal Handling, Fastening, Construction*



ANSI **A3** EN **3** LATEX MICROFINISH® COATING

09-K1350

- Excellent grip in dry and wet, non-oily conditions
- Fully coated thumb to increase wear
- Acrylic blended Kevlar® shell to provide warmth in cold environments

APPLICATIONS: *Ceramics, Glass Cutting, Metal Handling, General Maintenance, Cold Protection*

STAY WARM



ANSI **A3** EN **4** LATEX MICROFINISH® COATING

09-K1444

- Excellent grip in dry and wet, non-oily conditions
- High puncture resistance
- Fully coated thumb to increase wear

APPLICATIONS: *Ceramics, Glass Cutting, Metal Handling, General Maintenance*

EXCELLENT DRY GRIP



ANSI **A3** EN **4** LATEX CRINKLE COATING

09-K1310

- Excellent grip in dry and wet, non-oily conditions
- Fully coated thumb to increase wear
- High puncture resistance

APPLICATIONS: *Ceramics, Glass Cutting, Metal Handling, General Maintenance*



ANSI **A3** EN **3** NEOFOAM™ COATING

G-TEK® KEV™
09-K1218

- High breathability and comfort
- Excellent dry grip, and good grip in oily conditions
- Protection in light heat applications

APPLICATIONS: *Glass Cutting, Metal Parts, Fastening, Construction*



CUT & HEAT PROTECTION



Kevlar.

DARE < BIGGER™

MEDIUM TO HIGH CUT HAZARDS

STYLE NUMBER	ANSI	EN 388	COATING	COATING COVERAGE	COATING COLOR	LINER MATERIAL	LINER COLOR	CONSTRUCTION	GAUGE	SIZES
09-K1618	A3	4421	Nitrile Foam	Palm & Fingertips	☐ Black	G-Tek® KEV™	☐ Gray	Coated Seamless Knit	18	S - XXL
09-K1350	A3	2342	Latex MicroFinish®	Palm & Fingertips	☐ Brown	DuPont™ Kevlar®	■ Yellow	Coated Seamless Knit	10	S - XXL
09-K1444	A3	2444	Latex MicroFinish®	Palm & Fingertips	■ Blue	DuPont™ Kevlar®	■ Yellow	Coated Seamless Knit	10	S - XXL
09-K1310	A3	2444	Latex Crinkle	Palm & Fingertips	■ Blue	DuPont™ Kevlar®	■ Yellow	Coated Seamless Knit	10	S - XL
09-K1218	A3	4331	Neofoam™	Palm & Fingertips	☐ Black	G-Tek® KEV™	☐ Gray	Coated Seamless Knit	18	S - XXL

MEDIUM TO HIGH CUT HAZARDS – LACERATION & INCISION RISK

COATED SEAMLESS KNIT GLOVES



CUT PROTECTION AND MAXIMUM COMFORT



SILICONE FREE

▲ 44-3745



MAXICUT® ULTRA™

- High tactile sensitivity and dexterity
- Patented Micro-Foam nitrile coating offers 360° breathability for increased comfort
- Micro-cup finish provides excellent dry grip and compatibility with light oils
- Thumb reinforcement for durability
- Excellent durability

APPLICATIONS: Handling Ceramics, Corrugated Sheets, Non-Deburred Parts, Glass Panels, Plastics Injection Moulds, Sharp Edged Metal Sheets, Small Sharp Components, Logistics, Warehousing, Maintenance, Primary, Secondary and Final Assembly



MICRO DOT PALM

▲ 44-3445



DUPONT™ KEVLAR®

▲ 44-1745



DYNEEMA® DIAMOND TECHNOLOGY

▲ 44-6745

MEDIUM TO HIGH CUT HAZARDS

STYLE NUMBER	ANSI	EN 388	COATING	COATING COVERAGE	COATING COLOR	LINER MATERIAL	LINER COLOR	CONSTRUCTION	GAUGE	SIZES
44-3745	A3	4542	Nitrile Micro-Foam	Palm & Fingertips	□ Black	Engineered Yarn	■ Blue	Coated Seamless Knit	15	XS - XXL
44-3755	A3	4542	Nitrile Micro-Foam	Palm, Full Finger & Knuckle	□ Black	Engineered Yarn	■ Blue	Coated Seamless Knit	15	XS - XXL
44-1745	A3	4542	Nitrile Micro-Foam	Palm & Fingertips	□ Black	DuPont™ Kevlar®	■ Yellow	Coated Seamless Knit	15	S - XXL
44-6745	A3	4542	Nitrile Micro-Foam	Palm & Fingertips	□ Black	Dyneema® Diamond Technology	■ Light Blue	Coated Seamless Knit	15	S - XXL

MEDIUM TO HIGH CUT HAZARDS – MAXICUT® ULTRA DT™

44-3445	A3	4542	Nitrile Micro-Foam	Palm & Fingertips – Micro Dot Palm	□ Black	Engineered Yarn	■ Blue	Coated Seamless Knit	15	XS - XXL
44-3455	A3	4542	Nitrile Micro-Foam	Palm, Full Finger & Knuckle – Micro Dot Palm	□ Black	Engineered Yarn	■ Blue	Coated Seamless Knit	15	XS - XXL

LIGHT CUT HAZARDS – ABRASION RISK

COATED SEAMLESS KNIT GLOVES

LIGHT CUT HAZARDS ABRASION RISK

LIGHT to MEDIUM
CUT HAZARDS

HIGH
CUT HAZARDS

MEDIUM to HIGH
CUT HAZARDS

STYLE NUMBER	ANSI	EN 388
G-TEK® 3GX®		
19-D350	A2	4342
19-D324	A2	4542
19-D318	A2	3342
G-TEK® POLYKOR®		
16-343LG	A2	4344
16-343OR	A2	4344
16-330	A2	4342
16-334	A2	4343
16-355	A2	4343
16-323	A2	4332
16-813	A2	3343
16-D622	A2	4342
16-318V	A2	4342
16-150	A2	4342
16-530	A2	4343
19-D650	A2	4342
19-D655	A2	4341

STYLE NUMBER	ANSI	EN 388
G-TEK® KEV™		
09-K1660	A2	4343
09-K1400	A2	2342
09-K1450	A2	3221
09-K1250	A2	4231
ATG® MAXICUT® 3		
18-570	A2	4331
18-575	A2	4331
ATG® MAXIFLEX® CUT™		
34-8443	A2	4331
34-8453	A2	4331
34-8743	A2	4331
34-8743FY	A2	4331
34-8753	A2	4331
34-1743	A2	4331
34-6743	A2	4331

LIGHT CUT HAZARDS

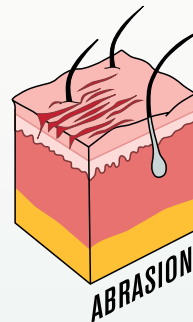

- Low to medium gauge, thicker liner means more fabric loft to absorb and resist abrasion
- Spun yarns loftier to mitigate abrasion effects to skin

CRH MATRIX™

LIGHT CUT HAZARDS – ABRASION RISK

COATED SEAMLESS KNIT GLOVES

ABRASION
RISK

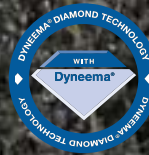

DEPENDABLE CUT PROTECTION

LIGHT CUT HAZARDS

STYLE NUMBER	ANSI	EN 388	COATING	COATING COVERAGE	COATING COLOR	LINER MATERIAL	LINER COLOR	CONSTRUCTION	GUAGE	SIZES
19-D350	A2	4342	Nitrile Foam	Palm & Fingertips	Gray	G-Tek® 3GX®	Salt & Pepper	Coated Seamless Knit	13	S - XL
19-D324	A2	4542	Polyurethane	Palm & Fingertips	Black	G-Tek® 3GX®	White	Coated Seamless Knit	13	XS - XXL
19-D318	A2	3342	Polyurethane	Palm & Fingertips	Black	G-Tek® 3GX®	Blue	Coated Seamless Knit	18	XS - XXL



ANSI **A2** EN **3**
NITRILE FOAM COATING

G-TEK® 3GX® 19-D350

- High tactile sensitivity and dexterity
- Excellent dry grip and resistance to oils
- Better comfort against skin
- Dark liner and coating hides dirt
- Excellent durability

APPLICATIONS: *Handling Metal Parts, Assembly, Fastening, Industrial, Construction*



ANSI **A2** EN **5**
POLYURETHANE COATING

G-TEK® 3GX® 19-D324

- High tactile sensitivity and dexterity
- Good grip in dry, wet, and slightly oily conditions
- Excellent durability

APPLICATIONS: *Electronics and Metal Assembly, Small and Medium Sharp Parts Handling*

MAXIMUM DEXTERITY & COMFORT



ANSI **A2** EN **3**
POLYURETHANE COATING

G-TEK® 3GX® 19-D318

- Super thin cut resistant glove for the ultimate dexterity and tactile sensitivity
- Good grip in dry, wet, and slightly oily conditions
- Good durability

APPLICATIONS: *Small Parts Handling and Assembly, Packaging, Fastening, Wiring*

ULTRA THIN

LIGHT CUT HAZARDS – ABRASION RISK

COATED SEAMLESS KNIT GLOVES



HI-VISIBILITY



**G-TEK® POLYKOR®
16-343LG**

- High tactile sensitivity and dexterity
- Excellent dry grip and resistance to oils
- Better grip in wet conditions
- Better comfort against skin
- High puncture resistance
- Excellent durability

APPLICATIONS: *Electronics, Sheet Metal Handling, Parts Assembly, Small Sharp Parts Handling, Construction, General Maintenance*



DOUBLE-DIPPED COATING



**G-TEK® POLYKOR®
16-330**

- High tactile sensitivity and dexterity
- Excellent dry grip and resistance to oils
- Better grip in wet conditions
- Better comfort against skin
- Excellent durability
- Double-dipped coating for added wear protection

APPLICATIONS: *Electronics, Sheet Metal Handling, Parts Assembly, Small Sharp Parts Handling, Construction, General Maintenance*



**G-TEK® POLYKOR®
16-334**

- High tactile sensitivity and dexterity
- Excellent dry grip and resistance to oils
- Better comfort against skin
- Good puncture resistance
- Excellent durability

APPLICATIONS: *Electronics, Sheet Metal Handling, Parts Assembly, Small Sharp Parts Handling, Construction, General Maintenance*



CONFIDENCE TO DO THE JOB



ENHANCED PROTECTION



**G-TEK® POLYKOR®
16-355**

- High tactile sensitivity and dexterity
- Excellent dry grip and resistance to oils
- Better comfort against skin
- Greater coating coverage for enhanced protection
- Good puncture resistance
- Excellent durability

APPLICATIONS: *Electronics, Sheet Metal Handling, Parts Assembly, Small Sharp Parts Handling, Construction, General Maintenance*



HI-VISIBILITY



**G-TEK® POLYKOR®
16-323**

- High tactile sensitivity and dexterity
- Good dry grip and resistance to oils
- Better comfort against skin
- High abrasion resistance
- Reinforced thumb crotch provides added durability

APPLICATIONS: *Electronics, Sheet Metal Handling, Parts Assembly, Small Sharp Parts Handling, Construction, General Maintenance*

LIGHT CUT HAZARDS

STYLE NUMBER	ANSI	EN 388	COATING	COATING COVERAGE	COATING COLOR	LINER MATERIAL	LINER COLOR	CONSTRUCTION	GAUGE	SIZES
16-343LG	A2	4344	Nitrile MicroSurface	Palm & Fingertips	Black	G-Tek® PolyKor®	Hi-Vis Lime	Coated Seamless Knit	13	XS - XXL
16-343OR	A2	4344	Nitrile MicroSurface	Palm & Fingertips	Black	G-Tek® PolyKor®	Hi-Vis Orange	Coated Seamless Knit	13	XS - XXL
16-330	A2	4342	Nitrile MicroSurface	Palm & Fingertips	Black	G-Tek® PolyKor®	Blue	Coated Seamless Knit	13	XS - XXL
16-334	A2	4343	Nitrile Foam	Palm & Fingertips	Black	G-Tek® PolyKor®	Salt & Pepper	Coated Seamless Knit	13	XS - XXL
16-355	A2	4343	Nitrile Foam	Palm, Full Finger & Knuckle	Black	G-Tek® PolyKor®	Salt & Pepper	Coated Seamless Knit	13	XS - XXL
16-323	A2	4332	Nitrile Foam	Palm & Fingertips	Gray	G-Tek® PolyKor®	Hi-Vis Lime	Coated Seamless Knit	13	XS - XXXL
16-813	A2	3343	Latex Crinkle	Palm & Fingertips	Yellow	G-Tek® PolyKor®	White	Coated Seamless Knit	13	XS - XXL



**G-TEK® POLYKOR®
16-813**

- High tactile sensitivity and dexterity
- Excellent grip in dry and wet, non-oily conditions
- Better comfort against skin
- Good puncture resistance
- Good durability

APPLICATIONS: *Ceramics, Glass Cutting, Metal Handling, General Maintenance*

LIGHT CUT HAZARDS – ABRASION RISK

COATED SEAMLESS KNIT GLOVES



G-Tek[®]
PolyKor[®]

PROVEN & TRUSTED[®]
CUT PROTECTION

LIGHT CUT HAZARDS – ABRASION RISK

COATED SEAMLESS KNIT GLOVES



**G-TEK® POLYKOR®
16-D622**

- High tactile sensitivity and dexterity
- Good grip in dry, wet, and slightly oily conditions
- Good puncture resistance

APPLICATIONS: *Electronics, Sheet Metal Handling, Parts Assembly, Small Sharp Parts Handling, Construction, General Maintenance*



SUPER THIN



**G-TEK® POLYKOR®
16-318V**

- Super thin cut resistant glove for the ultimate dexterity and tactile sensitivity
- Good grip in dry, wet and slightly oily conditions
- Good durability

APPLICATIONS: *Finishing and Inspection, Small Parts Handling, Maintenance*



**G-TEK® POLYKOR®
16-150**

- High tactile sensitivity and dexterity
- Good grip in dry, wet, and slightly oily conditions
- Dark liner and coating hides dirt
- Excellent durability

APPLICATIONS: *Electronics, Sheet Metal Handling, Parts Assembly, Small Sharp Parts Handling, Construction, General Maintenance*



HIDES DIRT



**G-TEK® POLYKOR®
16-530**

- High tactile sensitivity and dexterity
- Good grip in dry, wet, and slightly oily conditions
- Dark liner and coating hides dirt
- Good puncture resistance
- Excellent durability

APPLICATIONS: *Electronics, Sheet Metal Handling, Parts Assembly, Small Sharp Parts Handling, Construction, General Maintenance*



**G-TEK® POLYKOR®
19-D650**

- High tactile sensitivity and dexterity
- Good grip in dry, wet, and slightly oily conditions
- Dark liner and coating hides dirt
- Spun fiber enhances comfort
- Excellent durability

APPLICATIONS: *Electronics, Sheet Metal Handling, Parts Assembly, Small Sharp Parts Handling, Construction, General Maintenance*



ENHANCED PROTECTION



**G-TEK® POLYKOR®
19-D655**

- High tactile sensitivity and dexterity
- Good grip in dry, wet, and slightly oily conditions
- Dark liner and coating hides dirt
- Greater coating coverage for enhanced protection
- Spun fiber enhances comfort
- Excellent durability

APPLICATIONS: *Electronics, Sheet Metal Handling, Parts Assembly, Small Sharp Parts Handling, Construction, General Maintenance*

LIGHT CUT HAZARDS

STYLE NUMBER	ANSI	EN 388	COATING	COATING COVERAGE	COATING COLOR	LINER MATERIAL	LINER COLOR	CONSTRUCTION	GAUGE	SIZES
16-D622	A2	4342	Polyurethane	Palm & Fingertips	■ Gray	G-Tek® PolyKor®	■ White	Coated Seamless Knit	13	XS - XXL
16-318V	A2	4342	Polyurethane	Palm	■ Blue	G-Tek® PolyKor®	■ Blue	Coated Seamless Knit	18	XS - XXL
16-150	A2	4342	Polyurethane	Palm & Fingertips	□ Black	G-Tek® PolyKor®	□ Salt & Pepper	Coated Seamless Knit	13	XS - XXXL
16-530	A2	4343	Polyurethane	Palm & Fingertips	■ Gray	G-Tek® PolyKor®	□ Salt & Pepper	Coated Seamless Knit	13	XS - XXL
19-D650	A2	4342	Polyurethane	Palm & Fingertips	■ Gray	G-Tek® PolyKor®	■ Gray	Coated Seamless Knit	13	S - XXL
19-D655	A2	4341	Polyurethane	Palm, Full Finger & Knuckle	□ Black	G-Tek® PolyKor®	□ Salt & Pepper	Coated Seamless Knit	13	S - XL

LIGHT CUT HAZARDS – ABRASION RISK

COATED SEAMLESS KNIT GLOVES

G-Tek
KEV™

HIGH STRENGTH
& THERMAL
STABILITY



Kevlar
DARE **BIGGER**™



G-TEK® KEV™
09-K1660

- Higher dexterity
- Excellent dry grip and resistance to oils
- Better grip in wet conditions
- Excellent durability

APPLICATIONS: *Ceramics, Glass Cutting, Metal Handling, General Maintenance*



09-K1400

- Excellent dry grip conditions and resistance to oils

APPLICATIONS: *Ceramics, Glass Cutting, Metal Handling, General Maintenance*

100% KEVLAR® SHELL



09-K1450

- Higher dexterity
- Excellent dry grip and resistance to oils
- Good durability

APPLICATIONS: *Ceramics, Glass Cutting, Metal Handling, General Maintenance*

EXCELLENT DRY GRIP



G-TEK® KEV™
09-K1250

- Higher dexterity
- Good grip in wet and dry conditions with light oils
- Excellent durability

APPLICATIONS: *Electronics, Parts Assembly, Small Sharp Parts Handling, Construction, General Maintenance*

LIGHT CUT HAZARDS

STYLE NUMBER	ANSI	EN 388	COATING	COATING COVERAGE	COATING COLOR	LINER MATERIAL	LINER COLOR	CONSTRUCTION	GAUGE	SIZES
09-K1660	A2	4343	Nitrile MicroSurface	Palm & Fingertips	☐ Black	G-Tek® KEV™	■ Yellow	Coated Seamless Knit	13	S - XXL
09-K1400	A2	2342	Nitrile	Palm & Fingertips	☐ Black	DuPont™ Kevlar®	■ Yellow	Coated Seamless Knit	10	XS - XL
09-K1450	A2	3221	Nitrile	Palm & Fingertips	☐ Black	DuPont™ Kevlar®	■ Yellow	Coated Seamless Knit	15	XS - XXXL
09-K1250	A2	4231	Polyurethane	Palm & Fingertips	■ Gray	G-Tek® KEV™	■ Yellow	Coated Seamless Knit	13	XS - XXL

LIGHT CUT HAZARDS – ABRASION RISK

COATED SEAMLESS KNIT GLOVES



CUT PROTECTION FOR TOUGH JOBS



▲ 18-570

▲ 18-575



◀ MAXICUT® 3

- Good dexterity and tactility
- Patented micro-foam nitrile coating offers 360° breathability
- Excellent dry grip and compatibility with light oils
- Thumb reinforcement for durability
- Good puncture resistance
- Excellent durability

APPLICATIONS: *Electronics, Metal Assembly, Small Sharp Parts Handling, Maintenance, Repair*

LIGHT CUT HAZARDS

STYLE NUMBER	ANSI	EN 388	COATING	COATING COVERAGE	COATING COLOR	LINER MATERIAL	LINER COLOR	CONSTRUCTION	GAUGE	SIZES
18-570	A2	4331	Nitrile Micro-Foam	Palm & Fingertips	■ Gray	Engineered Yarn	■ Green	Coated Seamless Knit	15	XS - XXXL
18-575	A2	4331	Nitrile Micro-Foam	Palm, Full Finger & Knuckle	■ Gray	Engineered Yarn	■ Green	Coated Seamless Knit	15	XS - XXL

LIGHT CUT HAZARDS – ABRASION RISK

COATED SEAMLESS KNIT GLOVES

TRIED & TRUSTED



▲ 34-8743

▲ 34-8443



▲ 34-1743

▲ 34-6743



MAXIFLEX® CUT™

- High dexterity and tactility
- Patented Micro-Foam nitrile coating offers 360° breathability for increased comfort
- Micro-cup finish provides excellent dry grip and compatibility with light oils

- Made with component materials that comply with federal regulations for food contact 21 CFR, 170-199

APPLICATIONS: *Electronics and Metal Assembly, Small Sharp Parts Handling, Maintenance, Repair Operations, Logistics, Warehousing, Construction*

#1 INDUSTRIAL GLOVE WITH CUT PROTECTION

LIGHT CUT HAZARDS

STYLE NUMBER	ANSI	EN 388	COATING	COATING COVERAGE	COATING COLOR	LINER MATERIAL	LINER COLOR	CONSTRUCTION	GAUGE	SIZES
34-8443	A2	4331	Nitrile Micro-Foam	Palm & Fingertips - Micro Dot Palm	□ Black	Engineered Yarn	■ Green	Coated Seamless Knit	15	XS - XXL
34-8453	A2	4331	Nitrile Micro-Foam	Palm, Full Finger & Knuckle - Micro Dot Palm	□ Black	Engineered Yarn	■ Green	Coated Seamless Knit	15	XS - XXL
34-8743	A2	4331	Nitrile Micro-Foam	Palm & Fingertips	□ Black	Engineered Yarn	■ Green	Coated Seamless Knit	15	XS - XXXL
34-8743FY	A2	4331	Nitrile Micro-Foam	Palm & Fingertips	■ Hi-Vis Yellow	Engineered Yarn	■ Hi-Vis Yellow	Coated Seamless Knit	15	XS - XXXL
34-8753	A2	4331	Nitrile Micro-Foam	Palm, Full Finger & Knuckle	□ Black	Engineered Yarn	■ Green	Coated Seamless Knit	15	XS - XXL
34-1743	A2	4331	Nitrile Micro-Foam	Palm & Fingertips	□ Black	DuPont™ Kevlar®	■ Hi-Vis Yellow	Coated Seamless Knit	15	S - XXL
34-6743	A2	4331	Nitrile Micro-Foam	Palm & Fingertips	□ Black	Dyneema® Diamond Technology	■ Powder Blue	Coated Seamless Knit	15	S - XXL



LIGHT TO MEDIUM CUT HAZARDS – ABRASION, LACERATION & CONTUSION RISK

COATED SEAMLESS KNIT GLOVES

STYLE NUMBER	ANSI	EN 388
MAXIMUM SAFETY®		
120-5150	A3	4544
120-5130	A2	4344

LIGHT to MEDIUM CUT HAZARDS

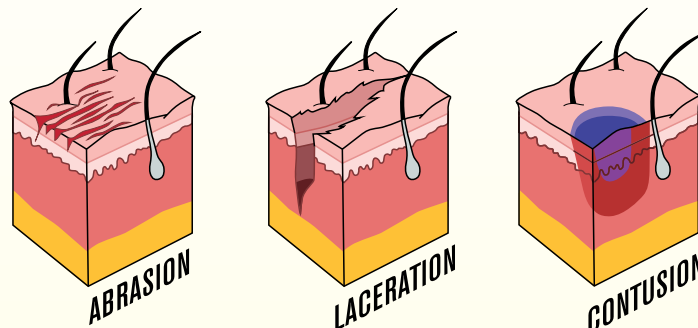

- Low gauge, thicker liner means more fabric loft to absorb and resist abrasion
- Spun yarns loftier to mitigate abrasion effects to skin
- TPR* impact protection to help protect against impact injuries

CRH MATRIX™

HIGH
CUT HAZARDS

LIGHT TO MEDIUM CUT HAZARDS
**ABRASION, LACERATION
& CONTUSION RISK**

LIGHT
CUT HAZARDS

MEDIUM to HIGH
CUT HAZARDS

*Thermoplastic Rubber

LIGHT TO MEDIUM CUT HAZARDS – ABRASION, LACERATION & CONTUSION RISK

COATED SEAMLESS KNIT GLOVES

ABRASION
LACERATION
CONTUSION
RISK



▲ 120-5150



▲ 120-5130



MAXIMUM SAFETY® TUFFMAX5™ AND TUFFMAX3™

- Lightweight HPPE knit liner provides excellent dexterity and tactile sensitivity
- Thermoplastic rubber (TPR) guards for pinch point protection
- MicroSurface nitrile for enhanced grip in wet, dry and oily applications
- Dorsal protection against impact to the back of the hand
- Excellent puncture resistance
- Extended cuff for additional protection

APPLICATIONS: *Petrochemical, Heavy/Light Construction, Demolition, Manufacturing, Mining, Rigging, Fabrication*



MAXIMUM PROTECTION

LIGHT TO MEDIUM CUT HAZARDS

STYLE NUMBER	ANSI	EN 388	COATING	COATING COVERAGE	COATING COLOR	LINER MATERIAL	LINER COLOR	CONSTRUCTION	GAUGE	SIZES
120-5150	A3	4544	Nitrile MicroSurface	Palm & Fingertips	<input type="checkbox"/> Black	HPPE	<input checked="" type="checkbox"/> Hi-Vis Orange	Coated Seamless Knit	13	M - XXL
120-5130	A2	4344	Nitrile MicroSurface	Palm & Fingertips	<input type="checkbox"/> Black	HPPE	<input checked="" type="checkbox"/> Hi-Vis Green	Coated Seamless Knit	13	M - XXL



Made in the U.S.A., Kut Gard® seamless knit gloves are designed to provide the highest possible cut protection and because they comply with both the US and Canadian standards for food contact, Kut Gard® gloves can be used for operations where direct, indirect, and incidental contact with food may occur.

**KUT GARD®
WITH DYNEEMA®**

Dyneema® is 15 times stronger than steel on a weight for weight basis! It's a High Performance Polyethylene (HPPE) fiber made from Ultra-High Molecular Weight Polyethylene (UHMWPE). Dyneema® fiber is much thinner and more flexible than traditional materials, such as leather and cotton, while offering higher protection.

**KUT GARD®
PolyKor®**

Products constructed with PolyKor® engineered yarn are suitable for protection against mechanical hazards in the toughest environments. PolyKor® products can be designed for different protection levels, up to the highest levels, while maintaining an unprecedented level of comfort.

**KUT GARD®
MADE WITH
KEVLAR®**

Kevlar® is light, comfortable and provides enduring protection against heat, cuts, lacerations and abrasions. Protective gloves and sleeves bearing this brand name provide assurance of compliance to strict performance and quality standards, and are produced only by Kevlar® licensed manufacturers.

**KUT GARD®
ACP™**

Proprietary ACP™ Technology raises the standards for performance knit products offering an increase in overall performance and value compared to traditional Aramid products. ACP™ provides excellent abrasion and cut resistance for lower cost per use. ACP™ Technology gloves and sleeves are 100% silicone free.



HIGH CUT HAZARDS – INCISION RISK

SEAMLESS KNIT GLOVES

INCISION
RISK



HIGH CUT HIGH-VISIBILITY



22-760



22-760OR



22-760BG



22-760GRN



22-760G



22-760NP



KUT GARD® 22-760BB

- Excellent cut protection
- Made with component materials that comply with federal regulations for food contact 21 CFR 170-199
- Ambidextrous

APPLICATIONS: *Food Service, Food Processing, Glass and Metal Handling*



SILAGRIP



KUT GARD® 22-751

- Excellent cut protection
- Made with component materials that comply with federal regulations for food contact 21 CFR 170-199
- Silagrip coating provides superior wet and dry grip

APPLICATIONS: *Food Service, Food Processing, Pulp and Paper Processing, Plastic Molding, Glass and Metal Handling*



KUT GARD® 08-KA740PD

- Excellent cut resistance
- Light heat protection
- Dotted palm for enhanced grip and abrasion resistance

APPLICATIONS: *Sheet Metal Fabrication, Recycling, Metal Fabrication, Pulp and Paper Processing*



PROTECT AGAINST INCISION

HIGH CUT HAZARDS

STYLE NUMBER	ANSI	21 CFR	MATERIAL	COLOR	CONSTRUCTION	GAUGE	WEIGHT	COATING	COATING COVERAGE	SIZES
22-760	A7	Yes	Kut Gard® with Dyneema®	■ White	Seamless Knit	10	Medium	---	---	XS - XL
22-760BB	A7	Yes	Kut Gard® with Dyneema®	■ Bright Blue	Seamless Knit	10	Medium	---	---	XS - XXL
22-760BG	A7	Yes	Kut Gard® with Dyneema®	■ Bright Green	Seamless Knit	10	Medium	---	---	XS - XXL
22-760G	A7	Yes	Kut Gard® with Dyneema®	■ Gray	Seamless Knit	10	Medium	---	---	XS - XL
22-760GRN	A7	Yes	Kut Gard® with Dyneema®	■ Dark Green	Seamless Knit	10	Medium	---	---	XS - XXL
22-760NP	A7	Yes	Kut Gard® with Dyneema®	■ Neon Pink	Seamless Knit	10	Medium	---	---	XS - XXL
22-760OR	A7	Yes	Kut Gard® with Dyneema®	■ Orange	Seamless Knit	10	Medium	---	---	XS - XXL
18-SD385	A6	Yes	Kut Gard® with Dyneema®	■ Gray	Seamless Knit	7	Medium	Blue PVC Dense Dot	Double-Sided	XS - XL
22-770	A6	Yes	Kut Gard® with Dyneema®	■ White	Seamless Knit	7	Heavy	---	---	XS - XL
22-750	A5	Yes	Kut Gard® with Dyneema®	■ White	Seamless Knit	13	Light	---	---	XS - XL
22-751	A5	Yes	Kut Gard® with Dyneema®	■ White	Seamless Knit, Hand Specific	13	Light	Silagrip Palm	Single-Sided	XS - XL
22-600	A9	Yes	Kut Gard® PolyKor®	■ White	Seamless Knit	7	Heavy	---	---	XS - XL
22-600BK	A9	Yes	Kut Gard® PolyKor®	■ Black	Seamless Knit	7	Heavy	---	---	S - L
22-601	A9	Yes	Kut Gard® PolyKor®	■ White	Seamless Knit, Hand Specific	7	Heavy	Silagrip Palm	Single-Sided	XS - XL
22-615	A9	Yes	Kut Gard® PolyKor®	■ White	Seamless Knit, Half-Finger, Hand Specific	7	Heavy	Silagrip Palm	Single-Sided	XS - XL
22-650	A7	Yes	Kut Gard® PolyKor®	■ Blue	Seamless Knit	7	Heavy	---	---	XS - XL
22-900	A7	Yes	Kut Gard® PolyKor®	■ Gray	Seamless Knit	7	Medium	---	---	XS - XL
22-720	A6	Yes	Kut Gard® PolyKor®	■ White	Seamless Knit	10	Medium	---	---	XS - XL
07-K390	A6	No	Kut Gard® made with Kevlar®	■ Yellow	Seamless Knit	7	Heavy	---	---	S - XL
08-K385	A6	No	Kut Gard® made with Kevlar®	■ Yellow	Seamless Knit	7	Heavy	Blue PVC Dot	Double-Sided	L
07-KA720	A6	No	Kut Gard® ACP™	■ Green	Seamless Knit	7	Medium	---	---	S - XL
08-KA720PD	A6	No	Kut Gard® ACP™	■ Green	Seamless Knit	7	Medium	Blue PVC Dot	Single-Sided	S - XL
08-KA720PDD	A6	No	Kut Gard® ACP™	■ Green	Seamless Knit	7	Medium	Blue PVC Dense Dot	Double-Sided	S - XL
08-KA728PD	A6	No	Kut Gard® ACP™	■ Green	Seamless Knit, Extended Cuff	7	Medium	Blue PVC Dot	Single-Sided	S - XL
08-KA728PDD	A6	No	Kut Gard® ACP™	■ Green	Seamless Knit, Extended Cuff	7	Medium	Blue PVC Dense Dot	Double-Sided	S - XL
07-KA730	A5	No	Kut Gard® ACP™	■ Green	Seamless Knit	7	Medium	---	---	S - XL
08-KA700PD	A5	No	Kut Gard® ACP™	■ Green	Seamless Knit	7	Heavy	Blue PVC Dot	Single-Sided	S - XL
08-KA700PDD	A5	No	Kut Gard® ACP™	■ Green	Seamless Knit	7	Heavy	Blue PVC Dense Dot	Double-Sided	S - XL

MEDIUM TO HIGH CUT HAZARDS - LACERATION & INCISION RISK

SEAMLESS KNIT GLOVES

LACERATION
INCISION
RISK



MEDIUM TO HIGH
CUT HAZARDS

MEDIUM TO HIGH CUT HAZARDS – LACERATION & INCISION RISK

SEAMLESS KNIT GLOVES



◀ KUT GARD® 14-PK700

- Excellent cut resistance to protect against minor cuts and scrapes
- Exceptional comfort and fit
- Superior abrasion and fatigue resistance
- 100% silicone free

APPLICATIONS: *Automotive Manufacturing, Metal Fabrication, Assembly, Plastic Molding, Glass Handling, Food Processing, And Metal Stamping*



◀ KUT GARD® 14-ASP700PDD

- Excellent cut resistance to protect against minor cuts and scrapes
- Exceptional comfort and fit
- Double-sided PVC dots provided enhanced grip and extra cut and abrasion resistance
- 100% silicone free

APPLICATIONS: *Automotive Manufacturing, Metal Fabrication, Assembly, Plastic Molding, Glass Handling, Food Processing, And Metal Stamping*

DOUBLE-SIDED PVC DOT GRIP



◀ KUT GARD® 07-KA710

- Excellent cut resistance
- Light heat protection
- Ambidextrous
- Heavier gauge for increased durability

APPLICATIONS: *Sheet Metal Fabrication, Recycling, Metal Fabrication, Pulp and Paper Processing*



HEAVY DUTY PERFORMANCE

MEDIUM TO HIGH CUT HAZARDS

STYLE NUMBER	ANSI	21 CFR	MATERIAL	COLOR	CONSTRUCTION	GAUGE	WEIGHT	COATING	COATING COVERAGE	SIZES
14-PK700	A4	Yes	Kut Gard® PolyKor®	☐ Black / White	Seamless Knit	7	Heavy	---	---	XS - XL
17-DA700	A4	Yes	Kut Gard® PolyKor®	☐ Gray	Seamless Knit	7	Medium	---	---	S - XL
17-DA720	A4	Yes	Kut Gard® PolyKor®	☐ Gray	Seamless Knit	13	Light	---	---	S - XL
22-730	A4	Yes	Kut Gard® PolyKor®	■ White	Seamless Knit	13	Light	---	---	XS - XL
14-ASP700	A4	Yes	Antimicrobial Engineered Yarn	☐ Black / White Heather	Seamless Knit	10	Medium	Green PVC Dot	Single-Sided	XXS - XL
14-ASP700PDD	A4	Yes	Antimicrobial Engineered Yarn	☐ Black / White Heather	Seamless Knit	10	Medium	PVC Dense Dot	Double-Sided	XXS - XL
07-KA710	A4	No	Kut Gard® ACP™	■ Green	Seamless Knit	10	Medium	---	---	S - XL
09-K300LP	A4	No	Kut Gard® made with Kevlar®	■ Yellow	Seamless Knit	7	Medium	Leather Palm	Single-Sided	S - XL
07-KA700	A4	No	Kut Gard® ACP™	■ Green	Seamless Knit	7	Heavy	---	---	S - XL
08-KA740RT	A4	No	Kut Gard® ACP™	■ Green	Seamless Knit	7	Economy	Blue PVC Dot	Single-Sided	S - XL
08-KA740PD	A4	No	Kut Gard® ACP™	■ Green	Seamless Knit	7	Economy	Blue PVC Dot	Single-Sided	S - XL
08-KA740PDD	A4	No	Kut Gard® ACP™	■ Green	Seamless Knit	7	Economy	Blue PVC Dense Dot	Double-Sided	S - XL
07-KA740	A4	No	Kut Gard® ACP™	■ Green	Seamless Knit	7	Economy	---	---	S - XL
08-KA750PD	A4	No	Kut Gard® ACP™	■ Green	Seamless Knit	13	Light	Blue PVC Dot	Single-Sided	S - XL
08-KA750PDD	A4	No	Kut Gard® ACP™	■ Green	Seamless Knit	13	Light	Blue PVC Dense Dot	Double-Sided	S - XL

LIGHT TO MEDIUM CUT HAZARDS – ABRASION, LACERATION & INCISION RISK

SEAMLESS KNIT GLOVES

ABRASION
LACERATION
INCISION
RISK



LIGHT TO MEDIUM
CUT HAZARDS

LIGHT TO MEDIUM CUT HAZARDS – ABRASION, LACERATION & INCISION RISK

SEAMLESS KNIT GLOVES



KUT GARD® 17-D350

- Good cut protection
- Made with component materials that comply with federal regulations for food contact 21 CFR 170-199
- Breathable and comfortable
- Heavyweight for added durability
- Ambidextrous

APPLICATIONS: *Food Processing, Use As A Glove Liner*



KUT GARD® 07-K350

- Good cut protection
- Light heat protection
- Ambidextrous

APPLICATIONS: *Glass Handling, Canning, Bottling, Sheet Metal Handling, Recycling, Automotive Plants*



KUT GARD® 07-KA744

- Good cut resistance
- Light heat protection
- Ambidextrous
- Heavier gauge for increased durability

APPLICATIONS: *Sheet Metal Fabrication, Recycling, Metal Fabrication, Pulp and Paper Processing*



RIGHT GLOVE FOR THE RIGHT JOB

LIGHT TO MEDIUM CUT HAZARDS

STYLE NUMBER	ANSI	21 CFR	MATERIAL	COLOR	CONSTRUCTION	GAUGE	WEIGHT	COATING	COATING COVERAGE	SIZES
17-D350	A3	Yes	Kut Gard® with Dyneema®	White	Seamless Knit	7	Heavy	---	---	XS - XL
17-DL300	A3	Yes	Kut Gard® with Dyneema®	White	Seamless Knit	7	Medium	---	---	XS - XXL
17-SD350	A3	Yes	Kut Gard® with Dyneema®	White	Seamless Knit	7	Heavy	---	---	XS - XL
07-K350	A3	No	Kut Gard® made with Kevlar®	Yellow	Seamless Knit	7	Heavy	---	---	XS - XXL
08-K350PDD	A3	No	Kut Gard® made with Kevlar®	Yellow	Seamless Knit	7	Heavy	Blue PVC Dense Dot	Double-Sided	S - XL
08-K412PDD	A3	No	Kut Gard® made with Kevlar®	Yellow	Seamless Knit, Extended Cuff	7	Heavy	Blue PVC Dense Dot	Double-Sided	S - XL
07-KA744	A3	No	Kut Gard® ACP™	Green	Seamless Knit	7	Economy	---	---	S - XL
08-KA744PD	A3	No	Kut Gard® ACP™	Green	Seamless Knit	7	Economy	Blue PVC Dot	Single-Sided	S - XL
08-KA744PDD	A3	No	Kut Gard® ACP™	Green	Seamless Knit	7	Economy	Blue PVC Dense Dot	Double-Sided	S - XL

LIGHT CUT HAZARDS – ABRASION RISK

SEAMLESS KNIT GLOVES

ABRASION
RISK



LIGHT CUT HAZARDS

STYLE NUMBER	ANSI	21 CFR	MATERIAL	COLOR	CONSTRUCTION	GAUGE	WEIGHT	COATING	COATING COVERAGE	SIZES
17-D200	A2	Yes	Kut Gard® with Dyneema®	■ White	Seamless Knit	13	Light	---	---	XS - XL
17-DL200	A2	Yes	Kut Gard® with Dyneema®	■ White	Seamless Knit	13	Light	---	---	XS - XL
17-SD200	A2	Yes	Kut Gard® with Dyneema®	■ White	Seamless Knit	13	Light	---	---	XS - XL
17-D300	A2	Yes	Kut Gard® with Dyneema®	■ White	Seamless Knit	7	Medium	---	---	XS - XL
17-SD300	A2	Yes	Kut Gard® with Dyneema®	■ White	Seamless Knit	7	Medium	---	---	XS - XL
07-K200	A2	No	Kut Gard® made with Kevlar®	■ Yellow	Seamless Knit	13	Light	---	---	XS - XXL
07-K259	A2	No	Kut Gard® made with Kevlar®	■ Yellow	Seamless Knit, Half-Finger	13	Medium	---	---	XS - XXL
08-K259PDD	A2	No	Kut Gard® made with Kevlar®	■ Yellow	Seamless Knit, Half-Finger	7	Medium	Blue PVC Dense Dot	Double-Sided	S - XL
07-K300	A2	No	Kut Gard® made with Kevlar®	■ Yellow	Seamless Knit	7	Medium	---	---	XS - XXL
08-K300PD	A2	No	Kut Gard® made with Kevlar®	■ Yellow	Seamless Knit	7	Medium	Blue PVC Dot	Single-Sided	XS - XL
08-K300PDD	A2	No	Kut Gard® made with Kevlar®	■ Yellow	Seamless Knit	7	Medium	Blue PVC Dense Dot	Double-Sided	XS - XL
08-K300PS	A2	No	Kut Gard® made with Kevlar®	■ Yellow	Seamless Knit	7	Medium	Brown PVC Tiger Paw	Single-Sided	S - XL
08-K300XC	A2	No	Kut Gard® made with Kevlar®	■ Yellow	Seamless Knit	7	Medium	Blue PVC Criss-Cross	Single-Sided	M - XL
08-K312	A2	No	Kut Gard® made with Kevlar®	■ Yellow	Seamless Knit, Extended Cuff	7	Medium	Blue PVC Dense Dot	Double-Sided	S & L
08-K200PD	A2	No	Kut Gard® made with Kevlar®	■ Yellow	Seamless Knit	13	Light	Blue PVC Dot	Single-Sided	S - XL
08-K200PDD	A2	No	DuPont™ Kevlar®	■ Yellow	Seamless Knit	13	Light	Blue PVC Dense Dot	Double-Sided	S - XL
08-K252	A2	No	Kut Gard® made with Kevlar®	■ Yellow	Seamless Knit	7	Medium	Blue PVC Dense Dot	Double-Sided	S - XL
07-K320	A1	No	Kut Gard® made with Kevlar®	■ Yellow	Seamless Knit	7	Medium	---	---	S - XL
09-K3700	A2	No	Top Grain Goatskin	■ Tan	Kevlar® Lined - Straight Thumb	---	Light	---	---	S - XXXL
09-K3720	A4	No	Top Grain Goatskin, Split Cowhide Back	■ Natural	Kevlar® Lined - Keystone Thumb	---	Medium	---	---	S - XXL
09-K3750	A2	No	Maximum Safety®, AR/FR Top Grain Goatskin Leather	■ Natural	Kevlar® Lined - Straight Thumb	---	Medium	---	---	S - XXXL

LIGHT CUT HAZARDS



NEW PRODUCTS

COATED SEAMLESS KNIT GLOVES



G-Tek

NEW

GENERAL PURPOSE FROM PIP



NEOFOAM™
COATING

NEWEST INNOVATION IN
THE G-TEK® 34 SERIES OF
GENERAL PURPOSE GLOVES

The 34-600 features our proprietary Neofoam™ coating technology with superior grip in dry, wet and oily surface conditions. Flexible to -4°F and resists up to 12,000 cycles on abrasion test, this breathable highly dexterous glove is the new “go-to” glove for all jobs.



LATEX
MICROSURFACE
COATING

100% WATERPROOF

For jobs that require a little more palm and finger coverage, but still require grip and dexterity, there's the 55-1600. With a double-dipped latex MicroSurface grip, the coating is completely waterproof and extremely abrasion resistant. But, workers can still grab objects with ease while enjoying the all-day comfort of the nylon shell.



NITRILE
FOAM GRIP
COATING

COLD GLOVES AND WORK
GLOVES COMBINED INTO ONE

The new 41-1415 has the double-dipped, full coverage coating needed to provide workers with protection and a superior grip in wet dry and oily conditions, while an acrylic liner provides excellent protection in cold environments.



LATEX CRINKLE
COATING

THE IDEAL COLD WEATHER
WORK GLOVE

The 14-1425 is constructed with a Hi-Vis acrylic shell for easy detection while providing economical cold weather insulation without trapping in moisture. A latex crinkle coating gives workers an excellent grip in wet or dry and remains flexible in extreme cold conditions.

GENERAL PURPOSE GLOVES

ATG® NITRILE MICRO-FOAM COATED



MaxiFlex[®] ULTIMATE™
24-27 9(L)
CE
ATG
AD-APT

MAXIMUM COMFORT & COOLNESS

AD-APT[®] TO NEXT GENERATION COMFORT

- Exclusive AD-APT[®] technology keeps hands drier and smelling fresh and clean
- Proprietary nitrile Micro-Foam coating technology provides 360° breathability and up to twice the abrasion resistance
- Maximum comfort and dexterity helps increase worker productivity and compliance



#1 INDUSTRIAL GLOVE IN AMERICA JUST GOT BETTER

MAXIFLEX[®] ULTIMATE™ IS NOW THE “ULTIMATE” IN ALL-DAY COMFORT AND IMPROVED PRODUCTIVITY

GENERAL PURPOSE GLOVES

ATG® NITRILE MICRO-FOAM COATED



▲ 34-874

NITRILE
MICRO-FOAM
COATING

MAXIFLEX® ULTIMATE™

- High tactile sensitivity and dexterity
- Designed and developed with 360° breathability through the use of ATG's patented AIRtech® platform, now improved using game-changing technology. Introducing the next generation MaxiFlex® Ultimate™
- Micro-cup finish provides excellent dry grip and is compatible with light oils
- Made with component materials that comply with federal regulations for food contact 21CFR 170-199
- Silicone free

APPLICATIONS: *Finishing and Inspection, Handling of Small Components, Primary, Secondary and Final Assembly, Maintenance, Logistics and Warehousing, Operating Tools and Instruments, Wiring Operations*

25% THINNER
THAN MOST FOAM
NITRILE GLOVES
& OFFERS TWICE
THE MECHANICAL
PERFORMANCE



▲ 34-875



▲ 34-876



▲ 34-8014



HI-VISIBILITY

▲ 34-874FY

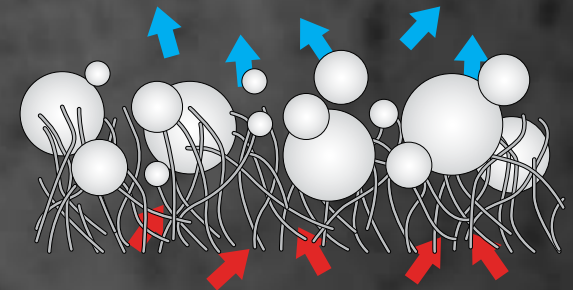

AIRtech®, which enables 360° breathability of the hand, is delivered through our patented foam technology.

MAXIFLEX® ULTIMATE™

STYLE NUMBER	EN 388	21 CFR	CFIA	COATING	COATING COVERAGE	COATING COLOR	LINER MATERIAL	LINER COLOR	CONSTRUCTION	GAUGE	SIZES
34-874	4131	Yes	Yes	Nitrile Micro-Foam	Palm & Fingertips	□ Black	Nylon / Lycra®	■ Gray	Coated Seamless Knit	15	XXS - XXXL
34-875	4131	Yes	Yes	Nitrile Micro-Foam	Palm, Full Finger & Knuckle	□ Black	Nylon / Lycra®	■ Gray	Coated Seamless Knit	15	XXS - XL
34-876	4131	Yes	Yes	Nitrile Micro-Foam	Full	□ Black	Nylon / Lycra®	■ Gray	Coated Seamless Knit	15	XXS - XXL
34-8014	4131	Yes	Yes	Nitrile Micro-Foam	Palm & Fingertips	□ Black	Nylon / Lycra®	■ Hi-Vis Orange	Coated Seamless Knit	15	S - XXL
34-874FY	4131	Yes	Yes	Nitrile Micro-Foam	Palm & Fingertips	■ Hi-Vis Yellow	Nylon / Lycra®	■ Hi-Vis Yellow	Coated Seamless Knit	15	S - XXL

GENERAL PURPOSE GLOVES

ATG® NITRILE MICRO-FOAM COATED

RAISED MICRO DOTS

FOR MORE DURABILITY



▲ 34-844



▲ 34-845



▲ 34-846



▲ 34-8745

NITRILE
MICRO-FOAM
COATING

MAXIFLEX® ENDURANCE™

- High tactile sensitivity and dexterity
- Patented micro-foam nitrile coating offers 360° breathability for increased comfort
- Micro-cup finish provides excellent dry grip and compatible with light oils
- Made with component materials that comply with federal regulations for food contact 21CFR 170-199
- Micro dots provide increased durability

APPLICATIONS: *Finishing and Inspection, Handling of Small Components, Primary, Secondary and Final Assembly, Maintenance, Logistics and Warehousing, Operating Tools and Instruments, Wiring Operations*

MAXIFLEX® ENDURANCE™

STYLE NUMBER	EN 388	21 CFR	CFIA	COATING	COATING COVERAGE	COATING COLOR	LINER MATERIAL	LINER COLOR	CONSTRUCTION	GAUGE	SIZES
34-844	4131	Yes	Yes	Nitrile Micro-Foam	Palm & Fingertips	☐ Black	Nylon / Lycra®	■ Gray	Coated Seamless Knit	15	XXS - XL
34-845	4131	Yes	Yes	Nitrile Micro-Foam	Palm, Full Finger & Knuckle	☐ Black	Nylon / Lycra®	■ Gray	Coated Seamless Knit	15	XXS - XL
34-846	4131	Yes	Yes	Nitrile Micro-Foam	Full	☐ Black	Nylon / Lycra®	■ Gray	Coated Seamless Knit	15	XXS - XXL
34-8745	4131	Yes	Yes	Nitrile Micro-Foam	Full	☐ Black	Nylon / Lycra®	■ Gray	Coated Seamless Knit	15	S - XXL

36% LIGHTER & 30% THINNER UNPARALLELED DEXTERITY & TACTILE SENSITIVITY



▲ 34-274

▲ 34-275



▲ 34-244

▲ 34-245



MAXIFLEX® ELITE™

- Maximum dexterity and tactility
- 360° breathability
- Micro-cup finish gives excellent dry grip and is compatible with light oils
- Silicone free
- Made with component materials that comply with federal regulations for food contact 21CFR 170-199

APPLICATIONS: *Finishing and Inspection, Handling of Small Components, Assembly, Maintenance, Logistics & Warehousing, Wiring Operations*



MAXIFLEX® ELITE™

STYLE NUMBER	EN 388	21 CFR	CFIA	COATING	COATING COVERAGE	COATING COLOR	LINER MATERIAL	LINER COLOR	CONSTRUCTION	GAUGE	SIZES
34-274	4121	Yes	Yes	Nitrile Micro-Foam	Palm & Fingertips	□ Blue	Nylon / Lycra®	□ Blue	Coated Seamless Knit	18	XS - XXL
34-275	4121	Yes	Yes	Nitrile Micro-Foam	Palm, Full Finger & Knuckle	□ Blue	Nylon / Lycra®	□ Blue	Coated Seamless Knit	18	XS - XL
34-244	4121	Yes	Yes	Nitrile Micro-Foam	Palm & Fingertips	□ Blue	Nylon / Lycra®	□ Blue	Coated Seamless Knit	18	XS - XL
34-245	4121	Yes	Yes	Nitrile Micro-Foam	Palm, Full Finger & Knuckle	□ Blue	Nylon / Lycra®	□ Blue	Coated Seamless Knit	18	XS - XL

GENERAL PURPOSE GLOVES

ATG® NITRILE MICRO-FOAM COATED



MAXIFOAM® PREMIUM 34-800

- High dexterity and tactility
- Tough foam nitrile coating for improved grip and durability
- Silicone free

APPLICATIONS: *Automotive, Handling Small Oily Parts and Components, General Assembly, Machining, Micro-engineering, Painting, Horticulture and Maintenance*



MAXIFOAM® LITE 34-900

- High dexterity and tactility
- Lighter coating for improved flexibility and dexterity
- Silicone free

APPLICATIONS: *Automotive, Handling Small Oily Parts and Components, General Assembly, Machining, Micro-engineering, Painting, Horticulture and Maintenance*



COTTON PLATED



MAXIFLEX® COMFORT™ 34-9025

- Maximum dexterity and tactility
- 360° breathability
- Micro-cup finish gives excellent dry grip and is compatible with light oils
- Cotton plated for additional comfort

APPLICATIONS: *Finishing and Inspection, Handling of Small Components, Assembly, Maintenance, Logistics and Warehousing, Wiring Operations*



MADE WITH ALOE VERA & VITAMIN E



MAXIFLEX® ACTIVE™ 34-8264

- High tactile sensitivity and dexterity
- 360° breathability
- Micro-cup finish provides excellent dry grip and is compatible with light oils
- Silicone free
- Delivers a "well-being" effect through the release of special ingredients, including aloe vera and Vitamin E

APPLICATIONS: *Finishing and Inspection, Handling of Small Components, Primary, Secondary and Final Assembly, Maintenance, Logistics and Warehousing, Operating Tools and Instruments, Wiring Operations*

MAXIFOAM®

STYLE NUMBER	EN 388	21 CFR	CFIA	COATING	COATING COVERAGE	COATING COLOR	LINER MATERIAL	LINER COLOR	CONSTRUCTION	GAUGE	SIZES
34-800	4131	Yes	Yes	Nitrile Micro-Foam	Palm & Fingertips	☐ Gray	Nylon / Lycra®	■ White	Coated Seamless Knit	15	XS - XXL
34-900	3121	Yes	Yes	Nitrile Micro-Foam	Palm & Fingertips	☐ Black	Nylon / Lycra®	☐ Gray	Coated Seamless Knit	15	XXS - XL

MAXIFLEX® COMFORT™

34-9025	3121	Yes	Yes	Nitrile Micro-Foam	Palm, Full Finger & Knuckle	☐ Blue	Nylon / Cotton / Lycra®	☐ Gray	Coated Seamless Knit	13	XS - XL
---------	------	-----	-----	--------------------	-----------------------------	--------	-------------------------	--------	----------------------	----	---------

MAXIFLEX® ACTIVE™

34-824	4131	Yes	Yes	Nitrile Micro-Foam	Palm & Fingertips	☐ Light Blue	Nylon / Lycra®	■ Light Blue	Coated Seamless Knit	15	XS - XL
34-8264	4131	Yes	Yes	Nitrile Micro-Foam	Palm & Fingertips	☐ Pink	Nylon / Lycra®	■ Light Pink	Coated Seamless Knit	15	XXS - XL

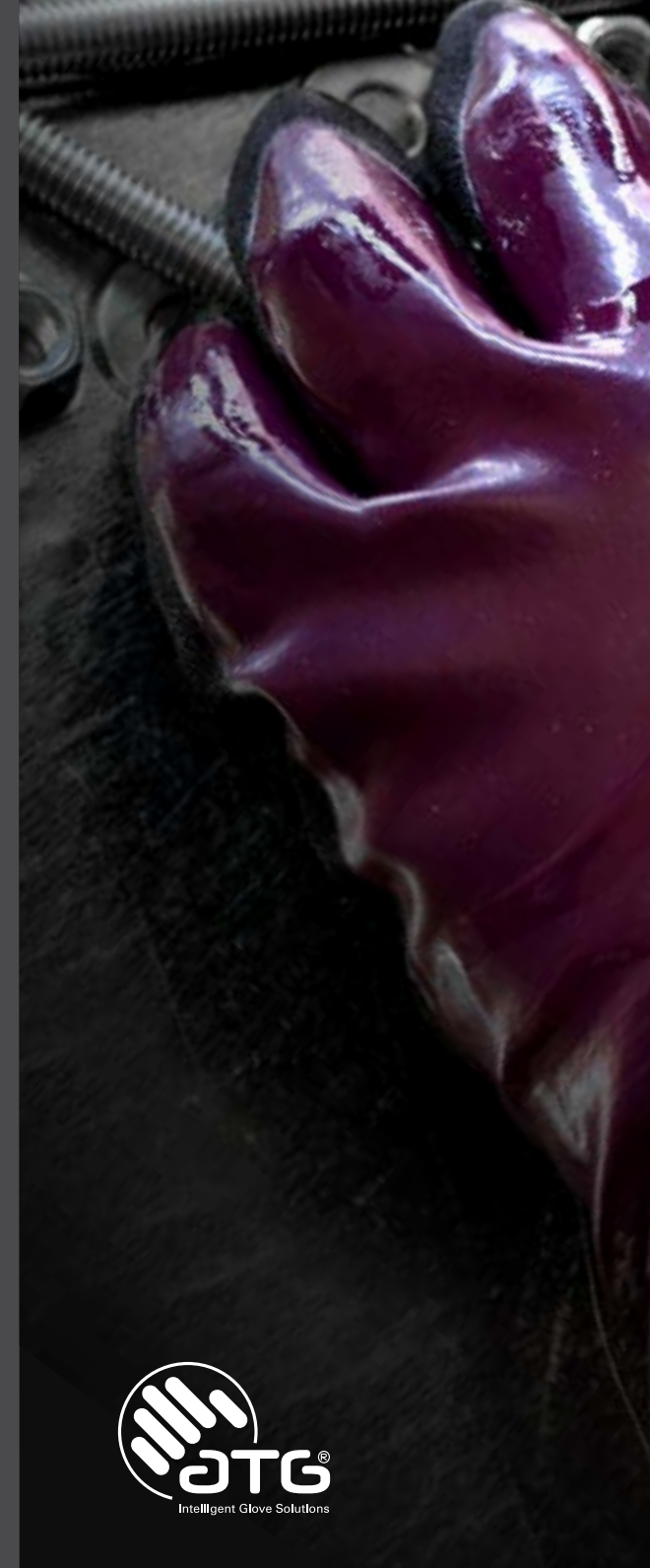

GENERAL PURPOSE GLOVES

ATG® NITRILE MICRO-FOAM COATED



▲ 56-424

THERMAL INSULATED

▲ 56-451

MAXIDRY® & MAXIDRY® ZERO

- High dexterity
- Comfortable
- Micro-cup, nonslip grip finish allows for a controlled and superior grip in oily and wet applications
- Dark colors hide dirt

APPLICATIONS: *Engine and Powertrain, Gearbox and Transmission Assembly, General Handling, Handling Small Castings, Handling of Small Components, Light Metal Fabrication and Parts Handling, Shock Absorber Assembly, Maintenance*



MAXIDRY® ZERO™ | 56-451
FLEXIBLE TO -22°F



MAXIDRY® PLUS™ | 56-530
LOW-LEVEL CHEMICAL RESISTANCE

SUPERIOR GRIP IN OILY & WET APPLICATIONS

MAXIDRY®

STYLE NUMBER	EN 388	EN 511	CFIA	COATING	COATING COVERAGE	COATING COLOR	LINER MATERIAL	LINER COLOR	CONSTRUCTION	GAUGE	SIZES
56-424	4121	---	Yes	Nitrile Micro-Foam	Palm & Fingertips	☐ Black / Purple	Nylon / Lycra®	☐ Gray	Coated Seamless Knit	15	XS - XXL
56-425	4121	---	Yes	Nitrile Micro-Foam	Palm, Full Finger & Knuckle	☐ Black / Purple	Nylon / Lycra®	☐ Gray	Coated Seamless Knit	15	S - XXL
56-426	4111	---	Yes	Nitrile Micro-Foam	Full	☐ Black / Purple	Nylon / Lycra®	■ Neutral	Coated Seamless Knit	15	S - XXL

MAXIDRY® ZERO™

56-451	4232	111	Yes	Nitrile Micro-Foam	Full	☐ Black / Purple	Nylon / Lycra®	☐ Gray	Coated Seamless Knit	15	S - XXL
--------	------	-----	-----	--------------------	------	------------------	----------------	--------	----------------------	----	---------

MAXIDRY® PLUS™

56-530	4121	---	Yes	Nitrile Micro-Foam	Full	☐ Black / Purple	Nylon / Lycra®	☐ Blue	Coated Seamless Knit	13	S - XXL
--------	------	-----	-----	--------------------	------	------------------	----------------	--------	----------------------	----	---------

GENERAL PURPOSE GLOVES

G-TEK® GP™ NITRILE COATED



34-500

- Excellent dexterity
- Comfortable
- Excellent dry grip
- Excellent abrasion protection

APPLICATIONS: *Assembly, Parts Handling, Manufacturing, Material Handling*



G-TEK® GP™ 34-400

- Superior dexterity and tactile sensitivity
- Comfortable
- Excellent dry grip and resistance to oils
- Excellent wet grip

APPLICATIONS: *Assembly, Electronics, Inspection, Small Parts Handling, Manufacturing, Material Handling, Oily Parts Handling*

18 GAUGE



G-TEK® GP™ 34-C229

- Excellent dexterity
- Comfortable
- Excellent dry grip
- Excellent abrasion protection

APPLICATIONS: *Assembly, Parts Handling, Manufacturing, Material Handling*



IDEAL FOR GENERAL ASSEMBLY & PARTS HANDLING

G-TEK® GP™

STYLE NUMBER	EN 388	COATING	COATING COVERAGE	COATING COLOR	LINER MATERIAL	LINER COLOR	CONSTRUCTION	GAUGE	SIZES
34-500	4121	Nitrile MicroSurface	Palm & Fingertips	☐ Black	Nylon	☐ Blue	Coated Seamless Knit	13	XS - XXL
34-400	2121	Nitrile MicroSurface	Palm & Fingertips	☐ Black	Nylon	☐ Green	Coated Seamless Knit	18	XS - XXL
34-300	4121	Nitrile MicroSurface	Palm & Fingertips	☐ Black	Polyester	☐ Gray	Coated Seamless Knit	13	XS - XXL
41-1415	4432	Nitrile Foam	Full, Double-Dipped	☑ Black / Blue	Polyester / Acrylic	☑ Hi-Vis Yellow	Coated Seamless Knit	13	S - XL
34-C232	4121	Nitrile Foam	Palm & Fingertips	☐ Black	Nylon	☐ Gray	Coated Seamless Knit	13	XS - XL
34-C234	4131	Nitrile Foam	Palm & Fingertips	☐ Gray	Nylon	☐ White	Coated Seamless Knit	13	XS - XL
34-225	4131	Nitrile Smooth	Palm & Fingertips	☐ Gray	Nylon	☐ White	Coated Seamless Knit	13	XS - XL
34-C229	4131	Nitrile Smooth	Palm & Fingertips	☐ Blue	Nylon	☐ White	Coated Seamless Knit	13	S - XL
38-1410	4131	Nitrile MicroFinish®	Palm & Fingertips	☐ Black	Cotton / Polyester	☐ Gray	Coated Seamless Knit	10	S - XL
38-1460	3122	Nitrile MicroFinish®	Palm & Fingertips	☐ Black	Cotton / Polyester	☐ Gray	Coated Seamless Knit	10	S - XXL
PRIME									
38-620	4131	Nitrile Foam	Palm & Fingertips	☐ Black	Nylon	☐ Gray	Coated Seamless Knit	15	XS - XXL
38-625	4131	Nitrile Foam	Palm, Full Finger & Knuckle	☐ Black	Nylon	☐ Gray	Coated Seamless Knit	15	XS - XXL
38-630	4131	Nitrile Foam - Micro Dots	Palm & Fingertips	☐ Black	Nylon	☐ Gray	Coated Seamless Knit	15	XS - XXL
38-635	4131	Nitrile Foam - Micro Dots	Palm, Full Finger & Knuckle	☐ Black	Nylon	☐ Gray	Coated Seamless Knit	15	XS - XXL



PRIME 38-620

- High comfort and dexterity
- Good grip in dry, wet and slightly oily conditions
- Knit wrist helps prevent dirt and debris from entering glove

APPLICATIONS: *Small Oily Parts and Components, Machining, General Assembly, Automotive*



G-TEK® GP™ 41-1415

- Nitrile foam coating provides superior grip in dry, wet and oily applications
- Hi-Vis color for better visibility
- Quickly evaporates moisture from the skin

APPLICATIONS: *General Maintenance, Cold Protection*

DOUBLE-DIPPED

GENERAL PURPOSE GLOVES

G-TEK® GP™ LATEX COATED

HEAVY DUTY WITH
ENHANCED GRIP IN
**WET OR DRY
CONDITIONS**

FULL WET PROTECTION



LATEX
MICROSURFACE
COATING

G-TEK® GP™ 55-1600

- Waterproof coating keeps hands dry
- Excellent dexterity and comfort
- Double-coated palm for added durability
- Micro-textured latex coating provides superior grip in wet or dry conditions

APPLICATIONS: *Assembly, Construction, Inspection, Material and Refuse Handling, Landscaping, Masonry and Concrete*



LATEX CRINKLE
COATING

G-TEK® GP™ 39-C1300

- Good grip in dry and slightly wet, non-oily conditions
- Better comfort against skin
- Fully coated thumb for extended wear
- Cotton blend for enhanced comfort

APPLICATIONS: *Assembly, Construction, Material Handling, Glass Handling, Refuse Handling, Landscaping*



LATEX
MICROSURFACE
COATING

G-TEK® GP™ 55-AG316

- High tactile sensitivity and dexterity
- Extremely light feel
- Excellent grip in dry and wet, non-oily conditions
- Better comfort against skin

APPLICATIONS: *Assembly, Construction, Inspection, Material Handling, Glass Handling, Landscaping*



LATEX CRINKLE
COATING

G-TEK® GP™ 41-1425

- Latex crinkle coating provides superior grip in wet and dry conditions
- Hi-Vis coloring makes product very easy to see
- Acrylic gloves provide economical cold weather protection

APPLICATIONS: *General Maintenance, Cold Protection*

COLD WEATHER USE

G-TEK® GP™

STYLE NUMBER	EN 388	COATING	COATING COVERAGE	COATING COLOR	LINER MATERIAL	LINER COLOR	CONSTRUCTION	GAUGE	SIZES
39-C1500	3242	Latex MicroFinish®	Palm & Fingertips	☐ Brown	Cotton / Polyester	☐ Brown	Coated Seamless Knit	10	XS - XL
39-C1600	3242	Latex MicroFinish®	Palm & Fingertips	☐ Blue	Cotton / Polyester	☐ Gray	Coated Seamless Knit	10	XS - XXL
55-AG315	2121	Latex MicroSurface	Palm & Fingertips	☐ Black	Polyester	■ Rose Pink	Coated Seamless Knit	13	XS - XL
55-AG316	2121	Latex MicroSurface	Palm & Fingertips	☐ Black	Polyester	■ Aqua Blue	Coated Seamless Knit	13	XS - XL
55-AG317	2121	Latex MicroSurface	Palm & Fingertips	☐ Black	Polyester	■ Hi-Vis Yellow	Coated Seamless Knit	13	XS - XL
55-1600	2131	Latex MicroSurface	Full, Double-Dipped	☐ Blue / Dark Blue	Nylon	■ Blue	Coated Seamless Knit	13	S - XXL
41-1425	4131	Latex Crinkle	Palm & Fingertips	☐ Black	Acrylic	■ Hi-Vis Yellow	Coated Seamless Knit	10	S - XXL
39-1310	2243	Latex Crinkle	Palm & Fingertips	☐ Blue	Cotton / Polyester	☐ Gray	Coated Seamless Knit	10	S - XL
39-C1300	2242	Latex Crinkle	Palm & Fingertips	☐ Blue	Premium Cotton / Polyester	☐ Gray	Coated Seamless Knit	10	XS - XXL
39-C1305	2242	Latex Crinkle	Palm & Fingertips	☐ Blue	Cotton / Polyester	☐ Gray	Coated Seamless Knit	10	XS - XL
39-C1375	2243	Latex Crinkle	Palm & Fingertips	☐ Black	Polyester	☐ Black	Coated Seamless Knit	10	S - XL
39-C122	2011	Latex Smooth	Palm & Fingertips	☐ Blue	Cotton / Polyester	■ Natural	Coated Seamless Knit	7	XS, S, L
39-C121	2011	Latex Smooth	Palm & Fingertips	☐ Red	Cotton / Polyester	■ Natural	Coated Seamless Knit	7	S & L
39-C120	2011	Latex Smooth	Palm & Fingertips	☐ Blue	Cotton / Polyester	■ Natural	Coated Seamless Knit	7	L

GENERAL PURPOSE GLOVES

G-TEK® GP™ POLYURETHANE COATED

G-Tek® Touch
Seamless Knit Polyester Glove with Polyurethane
& Fingers - Touch Screen Compatible
33-GT125
DESCRIPTION



G-TEK® TOUCH 33-GT125

- High dexterity
- Touch screen compatible
- Good grip in dry and wet conditions with light oils
- Good abrasion protection
- Dark colors hide dirt

APPLICATIONS: *Assembly, Parts Handling, Manufacturing, Material Handling*



FLEXIBLE, TOUGH & RELIABLE FOR ALL JOBS



ENHANCED TOUCH SCREEN PERFORMANCE

STATIC WIRED THUMB, INDEX FINGER & MIDDLE FINGER



G-TEK® GP™

STYLE NUMBER	EN 388	COATING	COATING COVERAGE	COATING COLOR	LINER MATERIAL	LINER COLOR	CONSTRUCTION	GAUGE	SIZES
33-115	3121	Polyurethane Smooth	Palm & Fingertips	■ White	Polyester	■ White	Coated Seamless Knit	13	XS - XXL
33-125	4131	Polyurethane Smooth	Palm & Fingertips	■ White	Nylon	■ White	Coated Seamless Knit	13	XS - XXL
33-325	4131	Polyurethane Smooth	Palm & Fingertips	□ Black	Nylon	□ Black	Coated Seamless Knit	13	XS - XXL
33-425LY	3131	Polyurethane Smooth	Palm & Fingertips	■ Bright Yellow	Nylon	■ Bright Yellow	Coated Seamless Knit	13	XS - XXL
33-425OR	3131	Polyurethane Smooth	Palm & Fingertips	■ Bright Orange	Nylon	■ Bright Orange	Coated Seamless Knit	13	XS - XXL
33-825	3121	Polyurethane Smooth	Palm & Fingertips	□ Black	Nylon	■ Green	Coated Seamless Knit	13	XS - XXL
33-B115	3121	Polyurethane Smooth	Palm & Fingertips	□ Black	Polyester	□ Black	Coated Seamless Knit	13	XS - XXL
33-B125	4131	Polyurethane Smooth	Palm & Fingertips	□ Black	Nylon	□ Black	Coated Seamless Knit	13	XS - XXL
33-G115	3121	Polyurethane Smooth	Palm & Fingertips	□ Gray	Polyester	□ Gray	Coated Seamless Knit	13	XS - XXL
33-G125	4131	Polyurethane Smooth	Palm & Fingertips	□ Gray	Nylon	□ Gray	Coated Seamless Knit	13	XS - XXXL

G-TEK® TOUCH

33-GT125	4131	Polyurethane Smooth	Palm & Fingertips	□ Gray	Polyester	□ Gray	Coated Seamless Knit	13	XS - XXL
----------	------	---------------------	-------------------	--------	-----------	--------	----------------------	----	----------

GENERAL PURPOSE GLOVES

G-TEK® GP™ NEOFOAM™ COATED



POLYURETHANE
COATING

◀ 33-425LY

- High dexterity
- Good grip in dry and wet conditions with light oils
- Good abrasion protection
- Hi-Vis for enhanced visibility

APPLICATIONS: *Assembly, Parts Handling, Manufacturing, Material Handling*



POLYURETHANE
COATING

◀ G-TEK® GP™ 33-825

- High dexterity
- Good grip in dry and wet conditions with light oils
- Good abrasion protection
- Dark colors hide dirt

APPLICATIONS: *Assembly, Parts Handling, Manufacturing, Material Handling*



POLYURETHANE
COATING

◀ G-TEK® GP™ 33-B125

- High dexterity
- Good grip in dry and wet conditions with light oils
- Excellent abrasion protection
- Thicker coating for increased abrasion resistance
- Dark colors hide dirt

APPLICATIONS: *Assembly, Parts Handling, Manufacturing, Material Handling*

ADVANCED NEOFOAM™ COATING



IDEAL FOR ALL USES



NEOFOAM™
COATING

◀ G-TEK® GP™ 34-600

- Excellent dexterity
- Comfortable
- Excellent dry grip
- Touch screen compatible
- Breathable, flexible coating
- Excellent abrasion protection

APPLICATIONS: *Assembly, Parts Handling, Manufacturing, Material Handling*

#1 IN VALUE



FLEXIBLE
TO -4°F



TOUCHSCREEN
COMPATIBLE



12,000
CYCLES OF
ABRASION

G-TEK® GP™

STYLE NUMBER	EN 388	COATING	COATING COVERAGE	COATING COLOR	LINER MATERIAL	LINER COLOR	CONSTRUCTION	GAUGE	SIZES
34-600	4121	Neofoam™	Palm & Fingertips	□ Black	Nylon	■ Blue	Coated Seamless Knit	15	XS - XXL

GENERAL PURPOSE GLOVES

COTTON POLYESTER STRING KNITS

ECONOMICAL KNIT GLOVES



COATED IN THE USA



NITRILE
PALM COAT
COATING

◀ 38-N2110PC

- Nitrile coating for improved grip and abrasion resistance
- Lightweight for increased dexterity

APPLICATIONS: *Medium Duty Packaging and Assembly*



PVC
DENSE DOT
COATING

◀ 36-C330PDD

- PVC dots provide enhanced grip, as well as cut and abrasion resistance
- Coated fingertips provide enhanced wear protection
- Ambidextrous

APPLICATIONS: *Light Duty Packaging and Assembly*



COATED IN THE USA



EVERGRIP™
NITRILE MW PATTERN
COATING

◀ 38-720

- "MW" pattern provides enhanced grip and abrasion protection
- Coating will resist melting
- Ambidextrous

APPLICATIONS: *Medium Duty Packaging and Assembly*



PVC DOTTED
COATING

◀ 36-112PD

- Dotted palm provides enhanced grip and abrasion resistance

APPLICATIONS: *Light Duty Packaging and Assembly*



COATED IN THE USA



PVC
BRICK PATTERN
COATING

◀ 37-C110BB

- PVC "brick" pattern provides enhanced grip, as well as cut and abrasion resistance
- Ambidextrous

APPLICATIONS: *Medium Duty Packaging and Assembly*



PVC
CRISS-CROSS
COATING

◀ 39-3013

































































- Criss-cross pattern provides enhanced grip and abrasion resistance
- Ambidextrous

APPLICATIONS: *Heavy Duty Material Handling*

GENERAL PURPOSE GLOVES

COTTON POLYESTER STRING KNITS

GLOVES WITH PVC GRIP

STYLE NUMBER	COATING	COATING COVERAGE	COATING COLOR	LINER MATERIAL	LINER COLOR	CONSTRUCTION	GAUGE	SIZES
38-N2110PC	Nitrile Palm	Single-Sided	 Rust	Cotton / Polyester	 Natural	Coated Seamless Knit	10	S - XL
38-720	EverGrip™ Nitrile "MW" Pattern	Double-Sided	 Rust	Cotton	 Natural	Coated Seamless Knit	7	S - L
36-110BB	PVC Brick Pattern	Double-Sided	 Blue	Cotton / Polyester	 Natural	Coated Seamless Knit	7	S, L
36-110PC-BK	PVC Palm	Single-Sided	 Black	Cotton / Polyester	 Natural	Coated Seamless Knit	7	S, L
36-110PC-BL	PVC Palm	Single-Sided	 Blue	Cotton / Polyester	 Natural	Coated Seamless Knit	7	S, L
36-110PD	PVC Dot	Single-Sided	 Black	Cotton / Polyester	 Natural	Coated Seamless Knit	7	S, L
36-110PDD	PVC Dense Dot	Double-Sided	 Black	Cotton / Polyester	 Natural	Coated Seamless Knit	7	S, L, XL
36-110PDD-WT	PVC Dense Dot	Double-Sided	 White	Cotton / Polyester	 Natural	Coated Seamless Knit	7	S, L
36-110VV	PVC "V" Pattern	Double-Sided	 Blue	Cotton / Polyester	 Natural	Coated Seamless Knit	7	S, L
36-112PDD	PVC Dense Dot	Double-Sided	 Black	Cotton / Polyester	 Natural	Coated Seamless Knit	7	L
36-C330PD	PVC Dot	Single-Sided	 Blue	Cotton / Polyester	 Natural	Coated Seamless Knit	7	S, L
36-C330PDD	PVC Dense Dot	Double-Sided	 Blue	Cotton / Polyester	 Natural	Coated Seamless Knit	7	S, L
37-C110B	PVC Brick Pattern	Single-Sided	 Blue	Cotton / Polyester	 Natural	Coated Seamless Knit	7	S, L
37-C110BB	PVC Brick Pattern	Double-Sided	 Blue	Cotton / Polyester	 Natural	Coated Seamless Knit	7	S, L
37-C110PC-BK	PVC Palm	Single-Sided	 Black	Cotton / Polyester	 Natural	Coated Seamless Knit	7	S, L
37-C110PC-BL	PVC Palm	Single-Sided	 Blue	Cotton / Polyester	 Natural	Coated Seamless Knit	7	L
37-C110PD	PVC Dot	Single-Sided	 Black	Cotton / Polyester	 Natural	Coated Seamless Knit	7	S, L
37-C110PDD	PVC Dense Dot	Double-Sided	 Black	Cotton / Polyester	 Natural	Coated Seamless Knit	7	XS, S, L
37-C110PDD-BL	PVC Dense Dot	Double-Sided	 Blue	Cotton / Polyester	 Natural	Coated Seamless Knit	7	S, L
37-C110PDD-WT	PVC Dense Dot	Double-Sided	 White	Cotton / Polyester	 Natural	Coated Seamless Knit	7	S, L
37-C112PDD	PVC Dense Dot	Double-Sided	 Black	Cotton / Polyester	 Natural	Coated Seamless Knit	7	S, L
37-C119PD	PVC Dot	Single-Sided	 Black	Cotton / Polyester	 Natural	Coated Seamless Knit, Half-Finger	7	S, L
37-C119PDD	PVC Dense Dot	Double-Sided	 Black	Cotton / Polyester	 Natural	Coated Seamless Knit, Half-Finger	7	S, L
37-C2110PC-BL	PVC Palm	Single-Sided	 Blue	Cotton / Polyester	 Natural	Coated Seamless Knit	7	S, L
37-C2110PC-RT	PVC Palm	Single-Sided	 Rust	Cotton / Polyester	 Natural	Coated Seamless Knit	7	S, L, XL
37-C2110PD	PVC Dot	Single-Sided	 Black	Cotton / Polyester	 Natural	Coated Seamless Knit	10	S, L
37-C2110PDD	PVC Dense Dot	Double-Sided	 Black	Cotton / Polyester	 Natural	Coated Seamless Knit	10	S, L
37-C2110PD-WT	PVC Dot	Single-Sided	 White	Cotton / Polyester	 Natural	Coated Seamless Knit	10	S, L
37-C500BB-BL	PVC Brick Pattern	Double-Sided	 Blue	Cotton / Polyester	 Gray	Coated Seamless Knit	7	L
37-C500PDD	PVC Dense Dot	Double-Sided	 Black	Cotton / Polyester	 Gray	Coated Seamless Knit	7	S, L, XL
37-C512PDD-BL	PVC Dense Dot	Double-Sided	 Blue	Cotton / Polyester	 Natural	Coated Seamless Knit	7	L
39-3013	PVC Honeycomb Criss-Cross	Double-Sided	 Orange	Polyester	 Orange	Coated Seamless Knit	10	S - XL

MULTIPLE PATTERNS TO MEET YOUR NEEDS

GENERAL PURPOSE GLOVES

COTTON POLYESTER STRING KNITS

MULTI-USE KNITS IN VARIOUS WEIGHTS



35-C103

- Ambidextrous
- Made with component materials that comply with federal regulations for food contact 21CFR 170-199
- Cotton blend for enhanced comfort

APPLICATIONS: *General Tasks, May Also Be Used as a Glove Liner*



35-CB604

- Ambidextrous
- Made with component materials that comply with federal regulations for food contact 21CFR 170-199
- Heavyweight for added durability
- Extended cuff for additional forearm protection
- Cotton blend for enhanced comfort

APPLICATIONS: *General Tasks, May Also Be Used as a Glove Liner*

UNCOATED COTTON/POLYESTER GLOVES

STYLE NUMBER	COATING	LINER MATERIAL	COLOR	CONSTRUCTION	GAUGE	WEIGHT	SIZES
35-C104	Uncoated	Cotton / Polyester	■ Natural	Seamless Knit	7	Standard	XS - L
35-C103	Uncoated	Cotton / Polyester	■ Natural	Seamless Knit	7	Economy	S, L
35-C510	Uncoated	Cotton / Polyester	■ Natural	Seamless Knit	7	Extra Heavy	S, L
35-G510	Uncoated	Cotton / Polyester	□ Gray	Seamless Knit	7	Extra Heavy	S, L
35-CB604	Uncoated	Cotton / Polyester	■ Bleached White	Seamless Knit, Extended Cuff	7	Extra Heavy	S, L
35-C410	Uncoated	Cotton / Polyester	■ Natural	Seamless Knit	7	Heavy	S, L
35-G410	Uncoated	Cotton / Polyester	□ Gray	Seamless Knit	7	Heavy	S, L
35-C110	Uncoated	Cotton / Polyester	■ Natural	Seamless Knit	7	Medium	XS, S, L
35-C115	Uncoated	Cotton / Polyester	■ Natural	Seamless Knit	7	Medium	S, L
35-CB110	Uncoated	Cotton / Polyester	■ Bleached White	Seamless Knit	7	Medium	S, L
35-C119	Uncoated	Cotton / Polyester	■ Natural	Seamless Knit, Half-Finger	7	Medium	S, L
35-C500	Uncoated	Cotton / Polyester	□ Gray	Seamless Knit	7	Medium	S - XL
35-C2110	Uncoated	Cotton / Polyester	■ Natural	Seamless Knit	10	Medium	S, L
35-C2113	Uncoated	Cotton / Polyester	■ Natural	Seamless Knit	13	Light	S, L

GREAT FOR HANDLING HEAVY OBJECTS AND EQUIPMENT



▲ 55-3253



▲ 55-3243



▲ 55-3271



▲ 55-3274



▲ **ARMOR® LATEX GLOVE**

- Latex coating provides good grip in dry and slightly wet, non-oily conditions
- Canvas lining for increased comfort
- Clute cut for a roomy fit
- Straight thumb for increased comfort in close-fisted work

APPLICATIONS: *Construction, Glass, Tile, Sheet Metal and Wood Handling, Construction*

ARMOR® LATEX

STYLE NUMBER	COATING	COATING COVERAGE	COATING COLOR	LINER MATERIAL	CUFF	CONSTRUCTION	WEIGHT	SIZES
55-3253	Latex Crinkle	Palm, Full Finger & Knuckle	Yellow	Canvas	Safety Cuff	Dipped Fabric	Standard	Men's
55-3271	Latex Crinkle	Palm, Full Finger & Knuckle	Yellow	Canvas	Knit Wrist	Dipped Fabric	Standard	Men's
55-3273	Latex Crinkle	Palm, Full Finger & Knuckle	Yellow	Canvas	Safety Cuff	Dipped Fabric	Standard	Men's
55-3243	Latex Crinkle	Palm, Full Finger & Knuckle	Yellow	Canvas	Safety Cuff	Dipped Fabric	Economy	Men's
55-3274	Latex Smooth	Palm, Full Finger & Knuckle	Yellow	Jersey	Safety Cuff	Dipped Fabric	Standard	Men's

GENERAL PURPOSE GLOVES

ARMOR® NITRILE DIPPED FABRIC



NITRILE HEAVY DUTY

ARMOR®

OIL RESISTANT



ARMORFLEX®

- Nitrile coating provides good grip in dry and wet conditions
- Ultra lightweight coating provides enhanced dexterity
- High abrasion resistance
- ActiFresh™ treated to reduce germs and odors

APPLICATIONS: *Handling of Parts, Equipment*



▲ 56-3180



ARMORTUFF®

- Nitrile coating provides good grip in dry and wet conditions
- Ultra lightweight coating provides enhanced dexterity
- High abrasion resistance
- ActiFresh™ treated to reduce germs and odors

APPLICATIONS: *Handling of Parts, Equipment*



▲ 56-3152



ARMORLITE®

- Nitrile coating provides good grip in dry and oily conditions
- Ultra lightweight coating provides enhanced dexterity
- 3" plasticized safety cuff for extra wrist protection and easy donning and doffing
- High abrasion resistance
- ActiFresh™ treated to reduce germs and odors

APPLICATIONS: *Handling of Parts, Equipment*



▲ 56-3176

GENERAL PURPOSE GLOVES

ARMOR® NITRILE DIPPED FABRIC



ARMORTUFF*

- Nitrile coating provides good grip in dry and wet conditions
- Standard-weight nitrile coating provides flexibility
- High abrasion resistance
- ActiFresh™ treated to reduce germs and odors

APPLICATIONS: Heavy Duty Handling of Oily Parts, Equipment

▲ 56-3154



ARMORTUFF XT*

- Nitrile coating provides good grip in dry and wet conditions
- Premium nitrile coating for flexibility and additional protection
- High abrasion resistance
- ActiFresh™ treated to reduce germs and odors

APPLICATIONS: Heavy Duty Handling of Parts, Equipment, Masonry Work

▲ 56-3185



ARMORGRIP*

- Nitrile coating provides good grip in dry and oily conditions
- Premium nitrile coating for flexibility and additional protection
- High abrasion resistance
- ActiFresh™ treated to reduce germs and odors

APPLICATIONS: General Handling, Assembly, Parts Handling, Masonry, Petrochemical, Sheet Metal Handling

▲ 56-3145

EFFECTIVE & AFFORDABLE

HIGH ABRASION RESISTANCE AND MAXIMUM WEARABILITY

ARMOR®

STYLE NUMBER	COATING	COATING COVERAGE	COATING COLOR	LINER MATERIAL	CUFF	CONSTRUCTION	WEIGHT	SIZES
56-3171	Nitrile Textured	Full	Blue	Interlock	Knit Wrist	Dipped Fabric	Light	XS - XL
56-3176	Nitrile Textured	Full	Blue	Interlock	3" Safety Cuff	Dipped Fabric	Light	M - XL
56-3170	Nitrile Textured	Palm, Full Finger & Knuckle	Blue	Interlock	Knit Wrist	Dipped Fabric	Light	XS - XL
56-3175	Nitrile Textured	Palm, Full Finger & Knuckle	Blue	Interlock	3" Safety Cuff	Dipped Fabric	Light	M - XL
56-3147	Nitrile Rough	Full	Blue	Jersey / Terry Cloth	Safety Cuff	Dipped Fabric	Heavy	L
56-3143	Nitrile Rough	Palm, Full Finger & Knuckle	Blue	Jersey / Terry Cloth	Knit Wrist	Dipped Fabric	Heavy	L - XL
56-3145	Nitrile Rough	Palm, Full Finger & Knuckle	Blue	Jersey / Terry Cloth	Safety Cuff	Dipped Fabric	Heavy	M - XL
56-3186	Nitrile Smooth	Full	Blue	Jersey	Knit Wrist	Dipped Fabric	Heavy	S - XL
56-3195	Nitrile Smooth	Palm, Full Finger & Knuckle	Blue	Jersey	Safety Cuff	Dipped Fabric	Heavy	S - XL
56-3185	Nitrile Smooth	Palm, Full Finger & Knuckle	Blue	Jersey	Knit Wrist	Dipped Fabric	Heavy	S - XL
56-3154	Nitrile Smooth	Full	Blue	Jersey	Safety Cuff	Dipped Fabric	Medium	M - XL
56-3152	Nitrile Smooth	Full	Blue	Jersey	Knit Wrist	Dipped Fabric	Medium	S - XL
56-3153	Nitrile Smooth	Palm, Full Finger & Knuckle	Blue	Jersey	Safety Cuff	Dipped Fabric	Medium	L
56-3151	Nitrile Smooth	Palm, Full Finger & Knuckle	Blue	Jersey	Knit Wrist	Dipped Fabric	Medium	S - XL
56-3180	Nitrile Smooth	Palm, Full Finger & Knuckle	Green	Interlock	Knit Wrist	Dipped Fabric	Ultraflight	S - XL

GENERAL PURPOSE GLOVES

DIPPED FABRIC & CLUTE CUT



◀ 59-2115

- Textured vinyl coating provides grip
- Better dexterity than leather
- Jersey lined for comfort
- Seams out
- Reinforced thumb crotch
- Liquid resistant

APPLICATIONS: *Parts Handling, Assembly Work, Dily Applications*



◀ 60-3105

- Nitrile coated cotton provides cut and abrasion protection
- Clute cut for a roomy fit
- Straight thumb increases comfort in close-fisted work
- Fully laminated back
- Cotton lining for enhanced comfort

APPLICATIONS: *Auto Assembly Operations, Sheet Metal, Light Fabrication*



◀ 61-249M

- Vinyl impregnated cotton offers wet and dry grip
- Clute cut for a roomy fit
- Straight thumb increases comfort in close-fisted work
- Stretch vinyl gives better dexterity

APPLICATIONS: *Parts Handling, Assembly Work, Dily Applications*

ECONOMICAL & COMPATIBLE WITH OIL

TEXTURED VINYL COATED GLOVE

STYLE NUMBER	COATING	COATING COVERAGE	COLOR	LINING	CUFF	CONSTRUCTION	SIZES
59-2115	Textured Vinyl	Full	Yellow	Jersey	Slip-On	Cut-and-Sewn	S - XL
59-2515	Soft Textured Vinyl	Full	Yellow	Interlock	Slip-On	Cut-and-Sewn	S - XL

NITRILE COATED COTTON GLOVE

60-3105	Nitrile	Full	Blue	Cotton	Slip-On	Clute Cut	Men's M - XL
60-3106	Nitrile	Full	Blue	Cotton	Slip-On	Clute Cut	Ladies' S - L
60-3107	Nitrile	Full - Nylon Mesh Back	Blue	Cotton	Slip-On	Clute Cut	Men's M - XL
60-3140	Nitrile	Full	Brown	Cotton	Slip-On	Clute Cut	S - XL

VINYL-IMPREGNATED COTTON GLOVE

61-249M	Textured Vinyl	Full	Red	Cotton	Slip-On	Clute Cut	Men's M - XL
61-249L	Textured Vinyl	Full	Red	Cotton	Slip-On	Clute Cut	Ladies' S - L

GENERAL PURPOSE GLOVES

CLUTE CUT DOTTED CANVAS



REFLECTIVE STRIP

▲ 91-910PDL-R



▲ 91-910PDO

CANVAS DOTTED

FOR ADDITIONAL GRIP IN DRY APPLICATIONS

CANVAS DOTTED PALM

STYLE NUMBER	DOT COLOR	FABRIC	FABRIC COLOR	THUMB	CUFF	CONSTRUCTION	FABRIC WEIGHT	GRADE	SIZES
91-910PDL-R	■ Hi-Vis Green	Canvas	■ Hi-Vis Green	Straight	Knit Wrist	Clute Cut	10 oz.	Premium	Men's
91-910PDL	■ Hi-Vis Green	Canvas	■ Hi-Vis Green	Straight	Knit Wrist	Clute Cut	10 oz.	Premium	Men's
91-910PDO	■ Orange	Canvas	■ Natural	Straight	Knit Wrist	Clute Cut	10 oz.	Premium	Men's
91-910PD	□ Black	Canvas	■ Natural	Straight	Knit Wrist	Clute Cut	10 oz.	Premium	Men's
91-908PDC	□ Black	Canvas	■ Natural	Straight	Knit Wrist	Clute Cut	8 oz.	Premium	Ladies'
91-908PD	□ Black	Canvas	■ Natural	Straight	Knit Wrist	Clute Cut	8 oz.	Premium	Men's
91-910PDI	□ Black	Canvas	■ Natural	Straight	Knit Wrist	Clute Cut	10 oz.	Economy	Men's
91-908PDI	□ Black	Canvas	■ Natural	Straight	Knit Wrist	Clute Cut	8 oz.	Economy	Men's

GENERAL PURPOSE GLOVES

UNCOATED CLUTE CUT FABRIC

CANVAS FABRIC GLOVES



▲ 90-908I



HI-VIS

▲ 92-918PCO

CANVAS SINGLE PALM GLOVES

STYLE NUMBER	FABRIC	COLOR	PALM	THUMB	CUFF	CONSTRUCTION	FABRIC WEIGHT	SIZES
90-908I	Canvas	■ Natural	Single	Straight	Knit Wrist	Clute Cut	8 oz.	Men's
90-908CI	Canvas	■ Natural	Single	Straight	Knit Wrist	Clute Cut	8 oz.	Ladies'
90-910I	Canvas	■ Natural	Single	Straight	Knit Wrist	Clute Cut	10 oz.	Men's
90-912I	Canvas	■ Natural	Single	Straight	Knit Wrist	Clute Cut	12 oz.	Men's
90-909I	Canvas	■ Natural	Single	Wing	Knit Wrist	Clute Cut	8 oz.	Men's
90-908	Canvas	■ Natural	Single	Straight	Knit Wrist	Clute Cut	8 oz.	Men's
90-908BW	Canvas	■ Natural	Single	Straight	Knit Wrist	Clute Cut	8 oz.	Men's
90-908/5KW	Canvas	■ Natural	Single	Straight	Extended Knit Wrist	Clute Cut	8 oz.	Men's
90-908C	Canvas	■ Natural	Single	Straight	Knit Wrist	Clute Cut	8 oz.	Ladies'
90-908BT	Canvas	■ Natural	Single	Straight	Band Top	Clute Cut	8 oz.	Men's
90-910	Canvas	■ Natural	Single	Straight	Knit Wrist	Clute Cut	10 oz.	Men's
90-910C	Canvas	■ Natural	Single	Straight	Knit Wrist	Clute Cut	10 oz.	Ladies'
90-910G	Canvas	■ Natural	Single	Straight	Gauntlet	Clute Cut	10 oz.	Men's
90-910GA	Canvas	■ Natural	Single	Straight	Gauntlet	Clute Cut	10 oz.	Men's
90-912	Canvas	■ Natural	Single	Straight	Knit Wrist	Clute Cut	12 oz.	Men's

CANVAS DOUBLE PALM GLOVES

92-918	Canvas - Nap In	■ Natural	Double	Straight	Knit Wrist	Clute Cut	18 oz.	Men's
92-918O	Canvas - Nap Out	■ Natural	Double	Straight	Knit Wrist	Clute Cut	18 oz.	Men's
92-918BT	Canvas - Nap In	■ Natural	Double	Straight	Band Top	Clute Cut	18 oz.	Men's
92-918BTO	Canvas - Nap Out	■ Natural	Double	Straight	Band Top	Clute Cut	18 oz.	Men's
92-918G	Canvas - Nap In	■ Natural	Double	Straight	Gauntlet	Clute Cut	18 oz.	Men's
92-918GO	Canvas - Nap Out	■ Natural	Double	Straight	Gauntlet	Clute Cut	18 oz.	Men's
92-918PC	Cotton / Polyester - Nap In	■ Natural	Double	Straight	Knit Wrist	Clute Cut	18 oz.	Men's
92-918PCO	Cotton / Polyester - Nap In	■ Hi-Vis Orange	Double	Straight	Knit Wrist	Clute Cut	18 oz.	Men's
92-918PCG	Cotton / Polyester - Nap In	■ Hi-Vis Green	Double	Straight	Knit Wrist	Clute Cut	18 oz.	Men's
92-918PCY	Cotton / Polyester - Nap In	■ Hi-Vis Yellow	Double	Straight	Knit Wrist	Clute Cut	18 oz.	Men's
92-918PCGB	Cotton / Polyester - Nap In	■ Natural / Hi-Vis Green	Double	Straight	Knit Wrist	Clute Cut	18 oz.	Men's

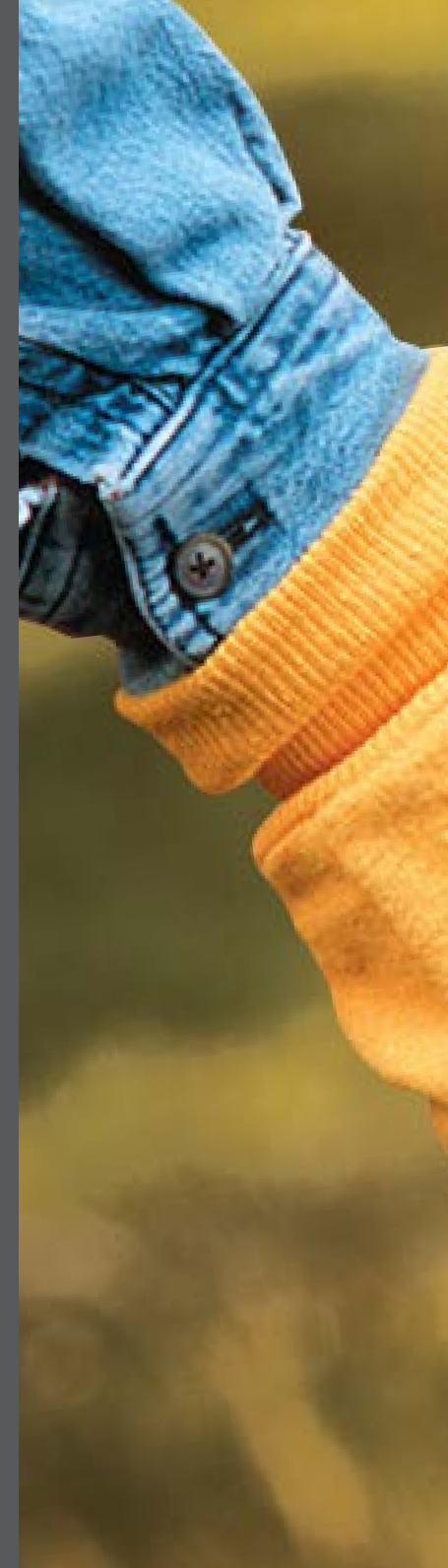

MULTI-PURPOSE CHORE & JERSEY GLOVES

CHORE GLOVES

STYLE NUMBER	FABRIC	PALM	COLOR	THUMB	CUFF	CONSTRUCTION	WEIGHT	SIZES
93-548	Cotton - Nap Out	Double	Green	Straight	Knit Wrist	Clute Cut	Heavy	Men's
93-578G	Cotton - Nap Out	Double	Gold	Straight	Gauntlet	Clute Cut	Heavy	Men's
93-589	Cotton - Nap Out	Double	Gold	Straight	Band Top	Clute Cut	Heavy	Men's
93-598	Cotton - Nap Out	Double	Gold	Straight	Knit Wrist	Clute Cut	Heavy	Men's
93-588	Cotton - Nap Out	Double	Gold	Straight	Knit Wrist	Clute Cut	Medium	Men's
93-568	Cotton - Nap Out	Single	Gold	Straight	Knit Wrist	Clute Cut	Light	Men's

▲ 93-568

JERSEY GLOVES

STYLE NUMBER	FABRIC	COLOR	THUMB	CUFF	CONSTRUCTION	WEIGHT	SIZES
95-890	100% Cotton	Brown	Straight	Knit Wrist	Clute Cut	Extra Heavy	Men's
95-890C	100% Cotton	Brown	Straight	Knit Wrist	Clute Cut	Heavy	Ladies'
95-809	100% Cotton	Brown	Straight	Knit Wrist	Clute Cut	Heavy	Men's
95-864	Cotton / Polyester, Red Jersey Lined	Brown	Straight	Slip-On	Gunn Pattern	Heavy	Men's
95-809PD	Cotton / Polyester with Dotted Palm	Brown	Straight	Knit Wrist	Clute Cut	Regular	Men's
95-809PDC	Cotton / Polyester with Dotted Palm	Brown	Straight	Knit Wrist	Clute Cut	Regular	Ladies'
95-808	Cotton / Polyester	Brown	Straight	Knit Wrist	Clute Cut	Regular	Men's
95-806C	Cotton / Polyester	Brown	Straight	Knit Wrist	Clute Cut	Economy	Ladies'
95-806	Cotton / Polyester	Brown	Straight	Knit Wrist	Clute Cut	Economy	Men's
95-606B	Cotton / Polyester	Brown	Straight	Knit Wrist	Two-Piece	Medium	Men's
95-606	Cotton / Polyester	Natural	Straight	Knit Wrist	Two-Piece	Medium	Men's
95-606C	Cotton / Polyester	Natural	Straight	Knit Wrist	Two-Piece	Medium	Ladies'

▲ 95-809

GENERAL PURPOSE GLOVES

TOP GRAIN LEATHER DRIVER STYLE

TOP GRAIN LEATHER DRIVERS



◀ **68-101**



- Cowhide leather construction provides comfort, durability, excellent abrasion resistance, and breathability
- Straight thumb increases comfort in close-fisted work

APPLICATIONS: *Pipe, Brick, Material Handling, Construction, Farming, General Maintenance*



◀ **70-368**



- Pigskin leather becomes softer with use and withstands moisture without stiffening
- Keystone thumb is ergonomic, providing better dexterity
- Breathable for added comfort

APPLICATIONS: *Construction, Machine Operation, Utility Work, General Maintenance*



◀ **71-3618**



- Goatskin leather is the most abrasion resistant leather
- Keystone thumb is ergonomic, providing better dexterity

APPLICATIONS: *Construction, Machine Operation, Utility Work, General Maintenance*

GENERAL PURPOSE GLOVES

TOP GRAIN LEATHER DRIVER STYLE

TRIED & TRUE PROTECTION



HI-VIS FINGERTIPS



◀ 68-165HV

- Cowhide leather construction provides comfort, durability, excellent abrasion resistance, and breathability
- Keystone thumb is ergonomic, providing better dexterity
- Hi-Vis color on fingertips and "Watch Your Hands" logo for visibility

APPLICATIONS: *Pipe, Brick, Material Handling, Construction, Farming, General Maintenance*



◀ 70-301

- Pigskin leather becomes softer with use and withstands moisture without stiffening
- Straight thumb increases comfort in close-fisted work
- Breathable for added comfort

APPLICATIONS: *Construction, Machine Operation, Utility Work, General Maintenance*



◀ 71-3601

- Goatskin leather is the most abrasion resistant leather
- Keystone thumb is ergonomic, providing better dexterity

APPLICATIONS: *Construction, Machine Operation, Utility Work, General Maintenance*

TOP GRAIN COWHIDE LEATHER DRIVERS

STYLE NUMBER	HIDE	GRADE	THUMB	CUFF	CLOSURE	STITCHING	SIZE
68-118	Cowhide	Premium	Straight	Slip-On	Elastic	Nylon	S - XL
68-168	Cowhide	Premium	Keystone	Slip-On	Elastic	Nylon	XS - XXL
68-101	Cowhide	Superior	Straight	Slip-On	Elastic	Nylon	XS - XXL
68-158	Cowhide	Superior	Straight	Slip-On	Pull Strap	Nylon	XS - XL
68-165	Cowhide	Superior	Keystone	Slip-On	Elastic	Nylon	S - XL
68-101G	Cowhide	Superior	Straight	Gauntlet	Elastic	Nylon	L & XL
68-116	Cowhide	Superior	Wing	Slip-On	Elastic	DuPont™ Kevlar®	S - XL
68-165HV	Cowhide / Hi-Vis Orange Tips	Superior	Keystone	Slip-On	Elastic	Nylon	XS - XXL
68-103	Cowhide	Regular	Straight	Slip-On	Elastic	Nylon	S - XXL
68-153	Cowhide	Regular	Straight	Slip-On	Pull Strap	Nylon	S - XL
68-163	Cowhide	Regular	Keystone	Slip-On	Elastic	Nylon	XS - XXXL
68-161SB	Cowhide / Split Cowhide Back	Regular	Keystone	Slip-On	Elastic	Nylon	S - XL
68-162SB	Cowhide / Split Cowhide Back	Regular	Wing	Slip-On	Elastic	DuPont™ Kevlar®	S - XL
68-163SB	Cowhide / Split Cowhide Back	Regular	Keystone	Slip-On	Elastic	DuPont™ Kevlar®	S - XL
68-163HV	Cowhide / Hi-Vis Orange Tips	Regular	Keystone	Slip-On	Elastic	Nylon	S - XXL
68-105	Cowhide	Economy	Straight	Slip-On	Elastic	Nylon	S - XXL
68-162	Cowhide	Economy	Keystone	Slip-On	Elastic	Nylon	S - XXL
68-106	Cowhide	Industry	Straight	Slip-On	Elastic	Nylon	S - XXL
68-160SB	Cowhide / Split Cowhide Back	Industry	Keystone	Slip-On	Elastic	Nylon	S - XXL

TOP GRAIN PIGSKIN LEATHER DRIVERS

70-318	Pigskin	Premium	Straight	Slip-On	Elastic	Nylon	S - XL
70-368	Pigskin	Premium	Keystone	Slip-On	Elastic	Nylon	S - XL
125-368	Pigskin / Hi-Vis Orange Tips	Premium	Keystone	Slip-On	Elastic	Nylon	S - XL
125-348	Pigskin / Hi-Vis Orange Tips	Premium	Wing	Slip-On	Elastic	Nylon	S - XL
70-301	Pigskin	Economy	Straight	Slip-On	Elastic	Nylon	S - XL
70-361	Pigskin	Economy	Keystone	Slip-On	Elastic	Nylon	S - XL
70-300	Pigskin	Industry	Straight	Slip-On	Elastic	Nylon	S - XL
70-360	Pigskin	Industry	Keystone	Slip-On	Elastic	Nylon	S - XXXL
70-360SB	Pigskin / Split Cowhide Back	Industry	Keystone	Slip-On	Elastic	Nylon	S - XL

TOP GRAIN GOATSKIN LEATHER DRIVERS

71-3618	Goatskin	Premium	Keystone	Slip-On	Elastic	Nylon	S - XL
71-3601	Goatskin	Economy	Keystone	Slip-On	Elastic	Nylon	S - XXXL
71-3600	Goatskin	Industry	Keystone	Slip-On	Elastic	Nylon	S - XXL

GENERAL PURPOSE GLOVES

SPLIT LEATHER DRIVER STYLE



◀ **69-189**

- Keystone thumb is ergonomic, providing better dexterity

APPLICATIONS: *Construction, Machine Operation, Utility Work, Farming, General Maintenance*



◀ **69-134**

- Straight thumb increases comfort in close-fisted work

APPLICATIONS: *Construction, Machine Operation, Utility Work, Farming, General Maintenance*







◀ **69-138**

- Split leather provides good abrasion resistance

APPLICATIONS: *Construction, Machine Operation, Utility Work, Farming, General Maintenance*

SPLIT LEATHER DRIVERS

SPLIT LEATHER DRIVERS

STYLE NUMBER	HIDE	GRADE	THUMB	COLOR	CUFF	STITCHING	SIZE
69-148	Cowhide	Premium	Straight	 Russet	Slip-On	Nylon	S - XL
69-189	Cowhide	Premium	Keystone	 Gray	Slip-On	Nylon	S - XL
69-134	Cowhide	Regular	Straight	 Tan	Slip-On	Nylon	S - XL
69-138	Cowhide	Regular	Straight	 Brown	Slip-On	Nylon	S - XL

GENERAL PURPOSE GLOVES

TOP GRAIN LEATHER PALM

TOP GRAIN LEATHER PALM



◀ 87-1563P

- Reinforced palm
- Cowhide leather construction provides comfort, durability, excellent abrasion resistance, and breathability

APPLICATIONS: *Pipe, Brick and Other Material Handling, Construction, Farming, General Maintenance*



◀ 87-3563

- Pigskin leather construction provides great breathability due to its porous texture, becomes softer with use and withstands moisture without stiffening

APPLICATIONS: *Pipe, Brick and Other Material Handling, Construction, Farming, General Maintenance*



◀ 87-1944

- Goatskin leather construction is the softest, most abrasion-resistant leather and is highly recommended for applications requiring tactile sensitivity

APPLICATIONS: *Pipe, Brick and Other Material Handling, Construction, Farming, General Maintenance*



TOP GRAIN COWHIDE LEATHER PALM

STYLE NUMBER	HIDE	GRADE	PATTERN	PALM	BACK	COLOR	CUFF	STITCHING	SIZE
87-2066	Cowhide	Premium	Gunn	Single	Full Leather	Leather	Gauntlet	DuPont™ Kevlar®	M - XL
87-1563	Cowhide	Regular	Gunn	Single	Canvas	Blue / Black / Red	Safety	Nylon	S - XXL
87-1663	Cowhide	Regular	Gunn	Single	Canvas	Blue / Black / Red	Gauntlet	Nylon	S - XL
87-1563P	Cowhide	Economy	Gunn	Reinforced	Canvas	Blue / Black / Red	Safety	Nylon	L

TOP GRAIN PIGSKIN LEATHER PALM

87-3563	Pigskin	Premium	Gunn	Single	Canvas	Blue / Black / Red	Safety	Nylon	L - XL
87-3501	Pigskin	Economy	Gunn	Single	Canvas	Blue / Black / Red	Safety	Nylon	L

TOP GRAIN GOATSKIN LEATHER PALM

87-1944	Goatskin	Premium	Gunn	Single	Canvas	Red	Safety	Nylon	L
---------	----------	---------	------	--------	--------	-----	--------	-------	---

GENERAL PURPOSE GLOVES

SPLIT LEATHER PALM

LEATHER GLOVE CLASSIFICATION

PLATINUM

- Leather palm gloves constructed of heavy side-split cowhide
- Rugged extra strength back and cuff
- Stitched with Kevlar®, adding strength and heat resistance

GOLD

- Leather palm gloves constructed of Grade A select shoulder-split cowhide
- Excellent quality and very affordable

SILVER

- Leather palm gloves constructed of Grade A/B shoulder-split cowhide
- Best value grade of leather palms

BRONZE

- Leather palm gloves constructed of Grade B shoulder-split cowhide
- High quality and outstanding value
- Size large is sized larger than most competitive gloves

COPPER

- Leather palm gloves constructed of Grade B/C split cowhide
- Consistent quality at an affordable price
- Cotton color binding denotes sizes

ECONOMY

- Leather palm gloves constructed of the most economical split cowhide available in the market today

SPLIT LEATHER PALM



80-8844

- Constructed of heavy side-split cowhide
- Cotton lined palm for extra comfort
- Wing thumb increases comfort in open-handed work
- Gunn cut pattern delivers excellent durability, wear and comfort

APPLICATIONS: *Construction, Road Work, Excavation, General Maintenance*



82-7663

- Constructed of Grade A/B shoulder-split cowhide
- Gunn cut pattern delivers excellent durability, wear and comfort
- Fabric back provides breathability and flexibility
- Leather knuckle strap and finger tips for extra protection

APPLICATIONS: *Construction, Road Work, Excavation, General Maintenance*



83-6563

- Wing thumb increases comfort in open-handed work
- Leather knuckle strap and fingertips provide additional protection
- Safety cuff helps protect wrist and allows for fast removal

APPLICATIONS: *Construction, Road Work, Excavation, General Maintenance*

GENERAL PURPOSE GLOVES

SPLIT LEATHER PALM



80-8846

- Constructed of heavy side-split cowhide
- Cotton lined palm for extra comfort
- Wing thumb increases comfort in open-handed work
- Gunn cut pattern delivers excellent durability, wear and comfort

APPLICATIONS: *Construction, Road Work, Excavation, General Maintenance*



81-7563YB

- Cowhide leather construction provides comfort, durability, excellent abrasion resistance, and breathability
- Wing thumb increases comfort in open-handed work
- Leather knuckle strap and finger tips for extra protection

APPLICATIONS: *Construction, Road Work, Excavation, General Maintenance*



125-7563

- Shoulder-split cowhide leather construction provides comfort, durability, excellent abrasion resistance, and breathability
- Leather palm and finger tips for extra protection
- Wing thumb increases comfort in open-handed work
- Gunn cut pattern delivers excellent durability, wear and comfort

APPLICATIONS: *Outdoor, General Work, Highway Construction*



SPLIT LEATHER PALM

STYLE NUMBER	HIDE	SERIES	GRADE	PATTERN	PALM	BACK	COLOR	CUFF	STITCHING	SIZE
80-8800	Cowhide	Platinum	Heavy Side	Gunn	Single	Heavy Canvas	■ White	Safety, Rubberized	DuPont™ Kevlar®	S - XL
80-8889	Cowhide	Platinum	Heavy Side	Gunn	Single	Canvas	■ White	Safety, Launderable	DuPont™ Kevlar®	S - XL
80-8844	Cowhide	Platinum	Heavy Side	Gunn	Single	Leather	■ Leather	Safety, Rubberized	DuPont™ Kevlar®	S - XL
80-8846	Cowhide	Platinum	Heavy Side	Gunn	Single	Leather	■ Leather	Gauntlet, Rubberized	DuPont™ Kevlar®	L - XL
81-7563YB	Cowhide	Gold	A Select Shoulder	Gunn	Single	Heavy Canvas	■ Gold	Safety, Rubberized	Nylon	L
82-7563	Cowhide	Silver	A/B Select Shoulder	Gunn	Single	Canvas	■ Blue / Green	Safety, Rubberized	Nylon	S - XL
82-7583	Cowhide	Silver	A/B Select Shoulder	Gunn	Single	Canvas	■ White	Safety, Rubberized	Nylon	S - XL
125-7563	Cowhide	Silver	Select Shoulder	Gunn	Single	Canvas	■ Hi-Vis Orange	Safety, Rubberized	Nylon	L
82-7663	Cowhide	Silver	A/B Select Shoulder	Gunn	Single	Canvas	■ Blue / Green	Gauntlet, Rubberized	Nylon	M - XL
82-5044	Cowhide	Silver	A/B Select Shoulder	Gunn	Single	Leather	■ Leather	Safety, Rubberized	Nylon	L
82-5066	Cowhide	Silver	A/B Select Shoulder	Gunn	Single	Leather	■ Leather	Gauntlet, Rubberized	Nylon	S - XL
86-4244	Cowhide	Bronze	Regular	Gunn	Single	Canvas	■ Green / Pink	Knit Wrist	Nylon	Men's
83-6563	Cowhide	Bronze	B Shoulder	Gunn	Single	Canvas	■ Green / Pink	Safety, Rubberized	Nylon	XS - XXL
83-6563/LHO	Cowhide	Bronze	B Shoulder	Gunn	Single	Canvas	■ Green / Pink	Safety, Rubberized	Nylon	S - L
83-6563/RHO	Cowhide	Bronze	B Shoulder	Gunn	Single	Canvas	■ Green / Pink	Safety, Rubberized	Nylon	S - L
83-6663	Cowhide	Bronze	B Shoulder	Gunn	Single	Canvas	■ Green / Pink	Gauntlet, Rubberized	Nylon	XS - XL
82-7683D	Cowhide	Bronze	B Shoulder	Gunn	Single	Heavy Canvas	■ White	Gauntlet, Launderable	Nylon	S, L & XXL
83-6033	Cowhide	Bronze	B Shoulder	Gunn	Single	Canvas, ¾ Leather	■ Green / Pink	Gauntlet	Nylon	L
86-6044	Cowhide	Bronze	B Shoulder	Gunn	Single	Leather	■ Leather	Safety, Rubberized	Nylon	L

GENERAL PURPOSE GLOVES

SPLIT LEATHER PALM & DOUBLE LEATHER PALM



84-7532

- Wing thumb increases comfort in open-handed work
- Fabric back provides breathability and flexibility
- Leather knuckle strap and finger tips for extra protection

APPLICATIONS: *Construction, Road Work, Excavation, General Maintenance*



85-7513P

- Wing thumb increases comfort in open-handed work
- Fabric back provides breathability and flexibility
- Leather knuckle strap and finger tips for extra protection

APPLICATIONS: *Construction, Road Work, Excavation, General Maintenance*

RUBBERIZED SAFETY CUFF



84-7533

- Constructed of B/C grade shoulder-split cowhide
- Double palm offers comfort, insulation and heat protection
- Fabric back provides breathability and flexibility
- Leather knuckle strap and finger tips for extra protection

APPLICATIONS: *Construction, Road Work, Excavation, General Maintenance*

SPLIT LEATHER PALM

STYLE NUMBER	HIDE	SERIES	GRADE	CONSTRUCTION	PALM	BACK	COLOR	CUFF	STITCHING	SIZE
84-7532	Cowhide	Copper	B/C Shoulder	Gunn	Single	Canvas	Blue / Black / Red	Safety, Rubberized	Nylon	S - XL
84-6532	Cowhide	Copper	B/C Shoulder	Gunn	Single	Canvas	Green / Pink	Safety, Rubberized	Nylon	L
85-7512	Cowhide	Copper	B/C Shoulder	Gunn	Single	Canvas	Gray / Red	Safety, Rubberized	Nylon	Men's
85-7512C	Cowhide	Copper	B/C Shoulder	Gunn	Single	Canvas	Gray / Red	Safety, Rubberized	Nylon	Ladies'
84-7532A	Cowhide	Copper	B/C Shoulder	Gunn	Single	Canvas	Blue / Green	Safety, Launderable	Nylon	XS, S, L, XL
85-7512CS	Cowhide	Copper	B/C Shoulder	Gunn	Single	Canvas	Gray / Red	Safety, Starched	Nylon	Ladies'
84-7632	Cowhide	Copper	B/C Shoulder	Gunn	Single	Canvas	Blue / Black / Red	Gauntlet, Rubberized	Nylon	S - XL
86-4144	Cowhide	Economy	Regular	Gunn	Single	Canvas	Blue / Black / Red	Knit Wrist	Nylon	Men's
86-4104	Cowhide	Economy	Regular	Clute	Single	Canvas	Blue / Black / Red	Knit Wrist	Nylon	Men's
86-4104C	Cowhide	Economy	Regular	Clute	Single	Canvas	Blue / Black / Red	Knit Wrist	Nylon	Ladies'
86-4104P	Cowhide	Economy	Economy	Clute	Reinforced	Canvas	Blue / Black / Red	Knit Wrist	Nylon	Men's
85-7513P	Cowhide	Economy	Economy	Gunn	Reinforced	Canvas	Yellow	Safety, Rubberized	Nylon	Men's
85-7500	Cowhide	Economy	Economy	Gunn	Single	Canvas	Blue / Black / Red	Safety, Rubberized	Nylon	S - XL
85-7500S	Cowhide	Economy	Economy	Gunn	Single	Canvas	Blue / Black / Red	Safety, Starched	Nylon	Men's
85-7500P	Cowhide	Economy	Economy	Gunn	Reinforced	Canvas	Blue / Black / Red	Safety, Starched	Nylon	Men's
85-DB7563	Cowhide	Economy	Economy	Gunn	Single	Denim	Blue	Safety, Denim	Nylon	Men's
85-DB7563P	Cowhide	Economy	Economy	Gunn	Reinforced	Denim	Blue	Safety, Denim	Nylon	Men's
85-7612S	Cowhide	Economy	Economy	Gunn	Single	Canvas	Gray / Red	Gauntlet, Starched	Nylon	Men's

SPLIT LEATHER DOUBLE PALM

80-8855	Cowhide	Platinum	Heavy Side	Gunn	Double	Heavy Canvas	White	Safety, Rubberized	DuPont™ Kevlar®	S - XL
80-8866	Cowhide	Platinum	Heavy Side	Gunn	Double	Heavy Canvas	White	Gauntlet, Rubberized	DuPont™ Kevlar®	XL
82-7763	Cowhide	Silver	A/B Select Shoulder	Gunn	Double	Canvas	Blue / Green	Safety, Rubberized	Nylon	S - XL
82-7563ID	Cowhide	Silver	A/B Select Shoulder	Gunn	Double	Canvas	Blue / Green	Safety, Rubberized	Nylon	L
83-6733	Cowhide	Bronze	B Shoulder	Gunn	Double	Canvas	Green / Pink	Safety, Rubberized	Nylon	L
83-6763	Cowhide	Bronze	B Shoulder	Gunn	Double	Canvas	Green / Pink	Gauntlet, Rubberized	Nylon	L
84-7533J	Cowhide	Bronze	B/C Shoulder	Gunn	Double	Canvas	Blue / Black / Red	Safety, Rubberized	Nylon	L
84-7533	Cowhide	Copper	B/C Shoulder	Gunn	Double	Canvas	Blue / Black / Red	Safety, Rubberized	Nylon	L
84-7633	Cowhide	Copper	B/C Shoulder	Gunn	Double	Canvas	Blue / Black / Red	Gauntlet, Rubberized	Nylon	L
85-7512J	Cowhide	Economy	B/C Shoulder	Gunn	Double	Canvas	Gray / Red	Safety, Rubberized	Nylon	S - XL

CHEMICAL RESISTANT GLOVES

POLYMER TECHNOLOGY

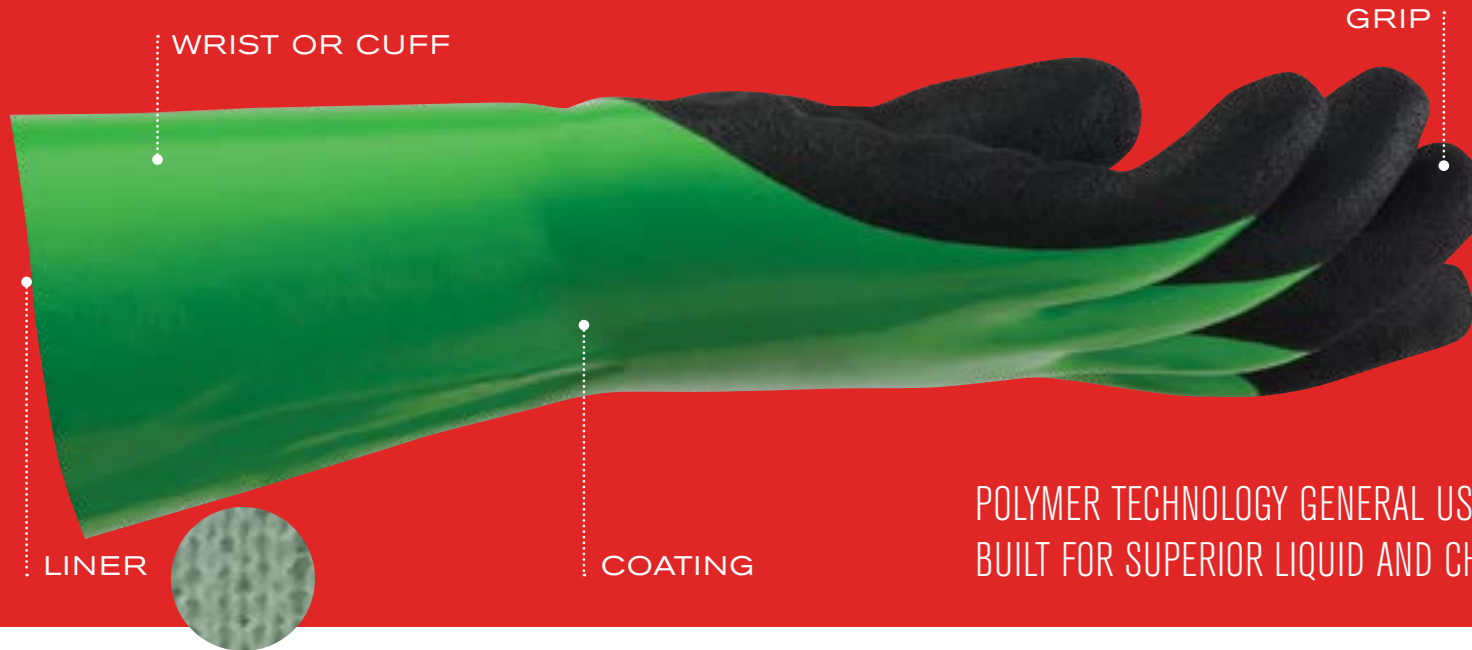

DESIGN FACTORS:

- Supported (liner) for added puncture resistance, durability and comfort
- Unsupported (no liner) for dexterity, hygiene and cleanliness
- Thickness of polymer alone or polymer/liner
- Wrist length and shape
- Coating variants range from 3/4-dipped to fully coated
- Coating textured for enhanced grip

POLYMER TECHNOLOGY GENERAL USE GLOVES,
BUILT FOR SUPERIOR LIQUID AND CHEMICAL RESISTANCE

POLYMER TECHNOLOGY GLOVES MAY BE SUPPORTED OR UNSUPPORTED.

- **Supported** gloves are made by dipping a knit or woven cloth liner into a liquid polymer for coating. The liner "supports" the coating and adds strength.
- **Unsupported** gloves are made on hand formers that are dipped directly into a liquid polymer compound and stripped off when cured.

POLYMER MATERIALS



LATEX

ADVANTAGE

- Good resistance to numerous acids and ketones
- Flexible, tear and snag resistant

PRECAUTION

- Avoid contact with hydrocarbon based oils or solvents
- Latex intolerance with some users



NITRILE

ADVANTAGE

- Good resistance to hydrocarbon derivatives
- Tough and resistant to abrasion, snags and perforation

PRECAUTION

- Smooth finish not recommended in oily conditions



NEOPRENE

ADVANTAGE

- Broad range resistance to acids, alcohols, fats, caustics, refrigerant, ketones and detergents
- Tough and resistant to abrasion, snags and perforation

PRECAUTION

- Degrades with some common chemicals such as bleach



PVC

ADVANTAGE

- Resists diluted aqueous solutions of bases or acids
- Reliable resistance to oils and organic solvents

PRECAUTION

- Less flexible, tacky and susceptible to snagging

CHEMICAL RESISTANT GLOVES

UNSUPPORTED LATEX

Assurance[®]
HAND PROTECTION

UNSUPPORTED

LATEX

FOR GENERAL MAINTENANCE APPLICATIONS

CHEMICAL RESISTANT GLOVES

UNSUPPORTED LATEX



STRAIGHT CUFF



ASSURANCE® 47-L170Y

- Raised diamond pattern for enhanced grip in wet or dry conditions
- Made with component materials that comply with federal regulations for food contact 21 CFR 170-199
- CFIA approved

APPLICATIONS: *Food Processing, Janitorial, Maintenance, Poultry*



PINKED CUFF



ASSURANCE® 48-L185B

- Honeycomb pattern for enhanced grip
- Made from component materials that comply with Federal Regulations for food contact 21 CFR, 170-199
- Flock lining provides easy on and off, plus moisture absorption
- Pinked cuff for tear resistance

APPLICATIONS: *Janitorial, Maintenance, Sanitation*



ROLLED CUFF

ASSURANCE® 47-L210T

- Roughened sandblast pattern for enhanced grip in wet conditions
- Longer cuff for additional forearm protection
- Made with component materials that comply with federal regulations for food contact 21 CFR 170-199

APPLICATIONS: *Janitorial, Maintenance, Diluted Acids and Caustic Solutions*

ASSURANCE® UNLINED LATEX

STYLE NUMBER	EN 374	21CFR	CFIA	POLYMER	COLOR	THICKNESS	CUFF	LENGTH	CONSTRUCTION	GRIP PATTERN	LINING	SIZES
47-L170Y	ABK	Yes	Yes	Latex	Yellow	18 mil	Rolled	12"	Unsupported	Raised Diamond	Unlined	S - XL
47-L171B	ABK	Yes	Yes	Latex	Blue	18 mil	Straight	12"	Unsupported	Raised Diamond	Unlined	S - XL
47-L171N	ABK	Yes	Yes	Latex	Natural	18 mil	Straight	12"	Unsupported	Raised Diamond	Unlined	S - XL
47-L161N	---	Yes	Yes	Latex	Natural	16 mil	Rolled	12"	Unsupported	Raised Diamond	Unlined	S - XL
47-L161B	---	Yes	Yes	Latex	Blue	16 mil	Rolled	12"	Unsupported	Raised Diamond	Unlined	S - XL
47-L210T	---	No	No	Latex	Orange	18 mil	Rolled	15"	Unsupported	Roughened Sandblast	Unlined	S - XL
47-L442	AKL	No	No	Latex	Black	44 mil	Rolled	17"	Unsupported	Smooth	Unlined	M - XL

ASSURANCE® FLOCK LINED LATEX

48-L140Y	---	Yes	Yes	Latex	Yellow	14 mil	Rolled	12"	Unsupported	Honeycomb	Flocked	S - XL
48-L160Y	---	Yes	Yes	Latex	Yellow	16 mil	Straight	12"	Unsupported	Honeycomb	Flocked	S - XXL
48-L162Y*	---	Yes	Yes	Latex	Yellow	16 mil	Straight	12"	Unsupported	Honeycomb	Flocked	S - XL
48-L185B	AKL	Yes	Yes	Latex	Blue	18 mil	Pinked	12"	Unsupported	Honeycomb	Flocked	S - XL
48-L185P	AKL	Yes	Yes	Latex	Pink	18 mil	Pinked	12"	Unsupported	Honeycomb	Flocked	S - XL
48-L185T	---	No	Yes	Latex	Orange	18 mil	Rolled	12"	Unsupported	Honeycomb	Flocked	S - XL
48-L185Y*	AKL	Yes	Yes	Latex	Yellow	18 mil	Rolled	12"	Unsupported	Honeycomb	Flocked	S - XL
48-L187Y*	AKL	Yes	No	Latex	Yellow	18 mil	Rolled	12"	Unsupported	Honeycomb	Flocked	S - XL
48-L212Y*	ABK	Yes	Yes	Latex	Yellow	21 mil	Rolled	12"	Unsupported	Raised Diamond	Flocked	S - XL
48-L2125Y	---	Yes	Yes	Latex	Yellow	20 mil	Rolled	15"	Unsupported	Super Diamond	Flocked	S - XXL
48-L300K	---	Yes	No	Latex	Black	28 mil	Rolled	12"	Unsupported	Super Diamond	Flocked	M - XXL
48-L302T*	---	No	No	Latex	Orange	28 mil	Rolled	12"	Unsupported	Super Diamond	Flocked	S - XL

ASSURANCE® SUPPORTED LATEX

55-1635	---	No	No	Latex	Blue	---	Straight	12"	Supported	Crinkle	Nylon	S - XXL
---------	-----	----	----	-------	------	-----	----------	-----	-----------	---------	-------	---------

*Pair Packed

CHEMICAL RESISTANT GLOVES

UNSUPPORTED NITRILE

UNSUPPORTED NITRILE



EN 374



AJKL

ASSURANCE® 50-N092B

- Lightweight to offer high dexterity and sensitivity
- Raised diamond pattern for enhanced grip in wet or dry conditions
- CFIA approved

APPLICATIONS: *Chemical Processing, Oil Refining and Petrochemicals, Food Processing, Aerospace, Automotive Assembly and Painting, Machine Operations, Metal Fabrication, Graphic Arts and Printing Cleanup, Furniture Manufacturing, Electronics*

Assurance
HAND PROTECTION

ASSURANCE® UNLINED NITRILE

STYLE NUMBER	EN 374	21 CFR	CFIA	POLYMER	COLOR	THICKNESS	CUFF	LENGTH	CONSTRUCTION	GRIP PATTERN	LINING	SIZES
50-N092B	AJKL	Yes	Yes	Nitrile	Blue	8 mil	Straight	13"	Unsupported	Raised Diamond	Unlined	S - XXL
50-NKH11	BFGHJ	Yes	No	Nitrile	Blue	11 mil	Straight	13"	Unsupported	Smooth	Unlined	S - XXL
50-N110G	ABK	Yes	Yes	Nitrile	Green	11 mil	Straight	13"	Unsupported	Raised Diamond	Unlined	S - XXL
50-N115G	---	Yes	Yes	Nitrile	Green	11 mil	Straight	13"	Unsupported	Super Diamond	Unlined	M - XXL
50-N140B	AJK	Yes	Yes	Nitrile	Blue	15 mil	Straight	13"	Unsupported	Raised Diamond	Unlined	S - XXL
50-N140G	AJK	Yes	Yes	Nitrile	Green	15 mil	Straight	13"	Unsupported	Raised Diamond	Unlined	S - XXL
50-N2250G	AKL	Yes	Yes	Nitrile	Green	22 mil	Straight	15"	Unsupported	Raised Diamond	Unlined	M - XXL
50-N2272G	AKJ	Yes	Yes	Nitrile	Green	22 mil	Straight	18"	Unsupported	Sandpatch	Unlined	M - XXL

ASSURANCE® FLOCK LINED NITRILE

50-N150G	AJKL	Yes	No	Nitrile	Green	15 mil	Straight	13"	Unsupported	Raised Diamond	Flocked	S - XXL
50-N160G	AJK	Yes	Yes	Nitrile	Green	15 mil	Straight	13"	Unsupported	Raised Diamond	Flocked	XS - XXL
50-N160B	AJK	Yes	Yes	Nitrile	Blue	15 mil	Straight	13"	Unsupported	Raised Diamond	Flocked	XS - XXL

PROTECTS FROM SOLVENTS & OIL BASED CHEMICALS

CHEMICAL RESISTANT GLOVES

UNSUPPORTED NEOPRENE

PROTECTS FROM ACIDS, CAUSTICS, SOLVENTS & OILS

UNSUPPORTED NEOPRENE



EN 374



AKL

ASSURANCE® 52-3670

- Heavyweight for enhanced protection
- Raised diamond pattern provides added grip on wet or dry surfaces
- Double-dipped glove provides the chemical resistance of neoprene with the comfort of latex

APPLICATIONS: *Petrochemical Industry, Battery Manufacturing, Janitorial, Aircraft Industry, Automotive, General Maintenance and Photo Finishing*

ASSURANCE® NEOPRENE FLOCK LINED CANNERS

STYLE NUMBER	EN 374	21CFR	CFIA	POLYMER	COLOR	THICKNESS	CUFF	LENGTH	CONSTRUCTION	GRIP PATTERN	LINING	SIZES
52-3665	AKL	Yes	No	Neoprene	□ Black	28 mil	Straight	12"	Unsupported	Raised Diamond	Flocked	S - XL
52-3672	---	Yes	No	Neoprene Over Latex	■ Blue / Yellow	19 mil	Straight	12"	Unsupported	Raised Diamond	Flocked	S - XL
52-3670	AKL	Yes	No	Neoprene Over Latex	■ Blue / Yellow	28 mil	Straight	12"	Unsupported	Raised Diamond	Flocked	S - XXL
52-3671	AKL	Yes	No	Neoprene Over Latex	■ Blue / Yellow	28 mil	Straight	12"	Unsupported	Honeycomb	Flocked	S - XL

CHEMICAL RESISTANT GLOVES

SUPPORTED BLENDED POLYMER



MAXICHEM[®]

ADVANCED PROTECTION

CHEMICAL RESISTANT GLOVES

SUPPORTED BLENDED POLYMER

DESIGNED & DEVELOPED FOR THOSE WORKING WITH CHEMICALS, WHO REQUIRE HIGHER LEVELS OF PROTECTION.



▲ 56-630

▲ 56-633

▲ 56-635



MAXICHEM®

- Lightweight design provides high dexterity and sensitivity
- Micro-cup non-slip grip provides superior grip in wet and oily conditions
- Tailored cuff enhances fit for superior control

APPLICATIONS: *Gearbox Assembly, General Handling, Handling Small Castings, Handling of Small Components, Light Metal Fabrication, Parts Handling, Maintenance*

MAXICHEM®

STYLE NUMBER	EN 374	EN 388	CFIA	POLYMER	POLYMER COLOR	GRIP COLOR	COATING COVERAGE	CUFF	LENGTH	CONSTRUCTION	GRIP PATTERN	LINING	SIZES
56-630	AKL	4121	Yes	Nitrile	Green	Black	Full	Gauntlet	12"	Supported	Non-Slip	Nylon	S - XXL
56-633	AKL	4342	No	Nitrile	Green	Black	Full	Gauntlet	12"	Supported	Non-Slip	Engineered Yarn	S - XXL
56-635	AKL	4121	Yes	Nitrile	Green	Black	Full	Gauntlet	14"	Supported	Non-Slip	Nylon	S - XXL

PROVIDES COMFORT AND FLEXIBILITY ALONG WITH MAXIMUM FINGERTIP TACTILE SENSITIVITY NOT FOUND IN OTHER CHEMICAL RESISTANT PRODUCTS

BLENDED POLYMER ON ULTRA FINE GAUGE SEAMLESS KNIT NYLON LINER

EXCLUSIVE GRIPTECH® COATING OFFERS NON-SLIP CAPABILITIES

LIQUITECH® BARRIER TECHNOLOGY PROVIDES RESISTANCE TO OILS AND LIQUIDS



LIQUID RESISTANT GLOVES

COATED SUPPORTED STYLES

LIQUID PROTECTION

PROCOAT®

GREAT FOR OILY & WET CONDITIONS



SMOOTH GRIP
COATING

58-8030Y

- Single-dipped construction
- Jersey liner provides better comfort
- Yellow color allows for glove degradation to be easily identified

APPLICATIONS: *Mining, Construction, Refining, Petrochemicals & Handling Oily Materials*



SEMI-ROUGH
COATING

58-8015R

- Single-dipped construction
- Semi-rough finish provides better grip in wet conditions
- Interlock lining dries quickly and offers better dexterity

APPLICATIONS: *Mining, Construction, Refining, Petrochemicals & Handling Oily Materials*



SANDY GRIP
COATING

58-8414R

- Double-dipped coating for superior liquid protection and extended wear
- Sandy finish provides better grip in wet conditions
- Jersey liner provides better comfort
- Longer cuff for additional forearm protection

APPLICATIONS: *Mining, Construction, Refining, Petrochemicals & Handling Oily Materials*

LONGER CUFF

LIQUID RESISTANT GLOVES

COATED SUPPORTED STYLES



58-8120DD

- Double-dipped coating for superior liquid protection and extended wear
- Sandy finish provides better grip in wet conditions
- Interlock lining dries quickly and offers better dexterity

APPLICATIONS: *Mining, Construction, Refining, Petrochemicals & Handling Oily Materials*



58-8035DD

- Double-dipped coating for superior liquid protection and extended wear
- Coating provides better grip in wet conditions
- Jersey liner provides better comfort

APPLICATIONS: *Mining, Construction, Refining, Petrochemicals & Handling Oily Materials*



58-8658K

- Kevlar® liner provides cut and light heat protection
- Seamless knit construction for enhanced dexterity and comfort
- Oil and liquid resistant

APPLICATIONS: *Mining, Construction, Refining, Petrochemicals & Handling Oily Materials*

KEVLAR® LINED

PROCOAT® GP - PVC DIPPED GLOVES

STYLE NUMBER	EN 388	POLYMER	COLOR	CUFF	LENGTH	CONSTRUCTION	GRIP PATTERN	LINING	SIZES
58-8015	4121	PVC	Black	Knit Wrist	10"	Supported, Single-Dipped	Smooth*	Interlock	Men's
58-8020	4121	PVC	Black	Straight	10"	Supported, Single-Dipped	Smooth*	Interlock	Men's
58-8030	4121	PVC	Black	Straight	12"	Supported, Single-Dipped	Smooth*	Interlock	Men's
58-8040	4121	PVC	Black	Straight	14"	Supported, Single-Dipped	Smooth*	Interlock	Men's
58-8060	4121	PVC	Black	Straight	18"	Supported, Single-Dipped	Smooth*	Interlock	Men's
58-8030Y	4121	PVC	Yellow	Straight	12"	Supported, Single-Dipped	Smooth*	Jersey	Men's
58-8040Y	4121	PVC	Yellow	Straight	14"	Supported, Single-Dipped	Smooth*	Jersey	Men's
58-8015R	4121	PVC	Black	Knit Wrist	10"	Supported, Single-Dipped	Semi-Rough	Interlock	Men's
58-8020R	4121	PVC	Black	Straight	10"	Supported, Single-Dipped	Semi-Rough	Interlock	Men's
58-8030R	4121	PVC	Black	Straight	12"	Supported, Single-Dipped	Semi-Rough	Interlock	Men's
58-8040R	4121	PVC	Black	Straight	14"	Supported, Single-Dipped	Semi-Rough	Interlock	Men's
58-8015DD	4121	PVC	Black	Knit Wrist	10"	Supported, Double-Dipped	Rough Acid	Jersey	Men's
58-8020DD	4121	PVC	Black	Straight	10"	Supported, Double-Dipped	Rough Acid	Jersey	Men's
58-8030DD	4121	PVC	Black	Straight	12"	Supported, Double-Dipped	Rough Acid	Jersey	Men's
58-8025DD	4121	PVC	Green	Straight	12"	Supported, Double-Dipped	Rough Acid	Jersey	Men's
58-8035DD	4121	PVC	Green	Straight	14"	Supported, Double-Dipped	Rough Acid	Jersey	Men's
58-8040DD	4121	PVC	Black	Straight	14"	Supported, Double-Dipped	Rough Acid	Jersey	Men's
58-8115DD	---	PVC	Black	Knit Wrist	10"	Supported, Double-Dipped	Sandy	Interlock	Men's
58-8120DD	4121	PVC	Black	Straight	10"	Supported, Double-Dipped	Sandy	Interlock	Men's
58-8130DD	4121	PVC	Black	Straight	12"	Supported, Double-Dipped	Sandy	Interlock	Men's
58-8140DD	4121	PVC	Black	Straight	14"	Supported, Double-Dipped	Sandy	Interlock	Men's
58-8215DD	---	PVC	Black	Knit Wrist	10"	Supported, Double-Dipped	Sandy	Jersey	Men's
58-8230DD	---	PVC	Black	Straight	12"	Supported, Double-Dipped	Sandy	Jersey	Men's
58-8240DD	---	PVC	Black	Straight	14"	Supported, Double-Dipped	Sandy	Jersey	Men's
58-8362	4121	PVC	Black	Straight	12"	Supported, Double-Dipped	Sandy	Jersey	Men's
58-8364	4121	PVC	Black	Straight	14"	Supported, Double-Dipped	Sandy	Jersey	Men's
58-8431R	4121	PVC	Red	Straight	24"	Supported, Double-Dipped	Sandy	Interlock	Men's
58-8414R	---	PVC	Red	Straight	14"	Supported, Double-Dipped	Sandy	Jersey	Men's

XTRATUFF™

STYLE NUMBER	EN 374	ANSI	EN 388	POLYMER	COLOR	CUFF	LENGTH	CONSTRUCTION	GRIP PATTERN	LINING	SIZES
58-8658K	AJK	A3	4342	PVC	Blue	Straight	12"	Supported	Rough	Kevlar®	M - XL

*Not recommended for oily conditions

LIQUID RESISTANT GLOVES

SUPPORTED PVC



◀ 58-7303

- Liquid-proof
- Foam insulated to keep hands warm and dry
- Hi-Vis for enhanced hand visibility

APPLICATIONS: *Handling Grease, Oils, Acids, Caustics, Solvents, Highway Construction, Traffic Control*

CHEMICAL PROTECTION FOR COLD ENVIRONMENTS



◀ 58-8658DL

- Liquid-proof
- Seamless knit construction for enhanced dexterity and comfort
- Cold-resistant outer shell
- Sandy finish provides better grip in wet conditions
- Foam insulated to keep hands warm and dry

APPLICATIONS: *Handling Grease, Oils, Acids, Caustics, Solvents*

REMOVABLE LINER

PROCOAT® INSULATED PVC DIPPED GLOVE

STYLE NUMBER	EN 374	EN 388	POLYMER	COLOR	CUFF	LENGTH	CONSTRUCTION	GRIP	LINING	SIZES
58-7303	---	---	PVC	Hi-Vis Orange	Knit Wrist	11"	Supported	Smooth	Foam	Men's
58-7304	---	---	PVC	Hi-Vis Orange	Straight	12"	Supported	Smooth	Foam	Men's
58-7305	---	---	PVC	Hi-Vis Orange	Safety	10"	Supported	Smooth	Foam	Men's
58-7313	---	---	PVC	Hi-Vis Orange	Knit Wrist	11"	Supported	Crystal	Foam	Men's
58-7315	---	---	PVC	Hi-Vis Orange	Safety	10"	Supported	Crystal	Foam	Men's
58-8658DL	AJK	4121	PVC	Blue	Straight	12"	Supported	Rough	Interlock / Terry	L - XL

SPECIALTY PVC BLENDS

58-8650	---	4121	PVC	Brown	Straight	10"	Supported	Rough	Interlock	S - XL
58-8651	---	4121	PVC	Brown	Straight	12"	Supported	Rough	Interlock	S - XL

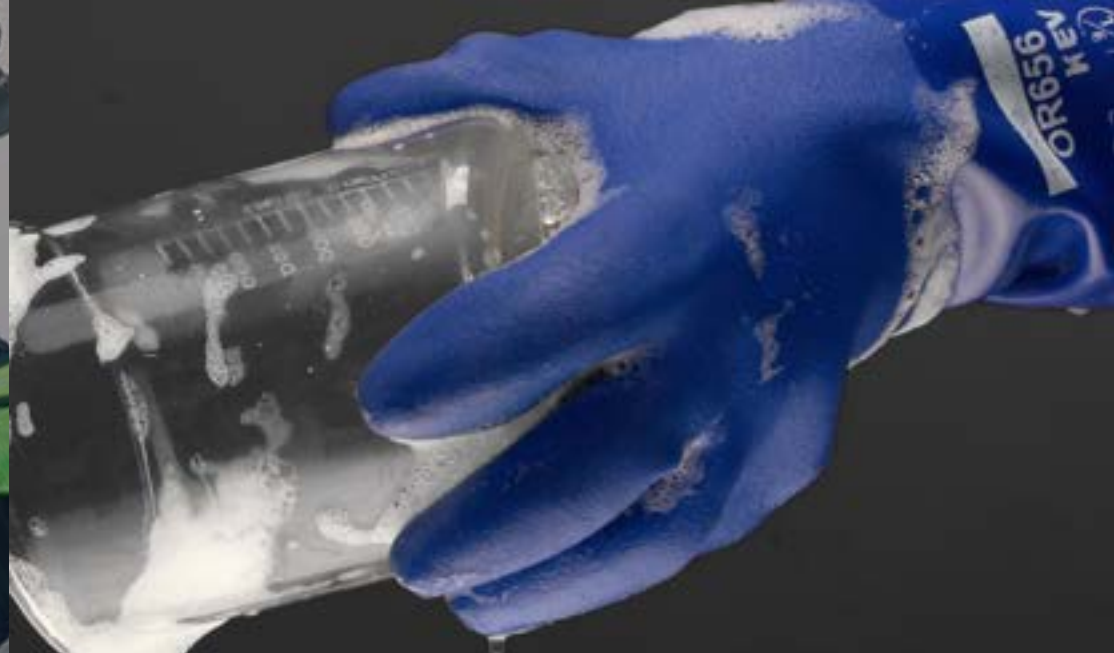

OILY & WET CONDITIONS



◀ 58-8655

- Special PVC blend that stays soft and flexible in oily applications
- Rough coated palm for enhanced grip
- Seamless liner provides tactile sensitivity
- Treated to resist germs and odors

APPLICATIONS: *Machine Oil, Petrochemicals, Maintenance, Landscaping*



▲ 58-8656

SPECIALTY PVC BLENDS

STYLE NUMBER	EN 374	EN 388	POLYMER	COLOR	CUFF	LENGTH	CONSTRUCTION	GRIP	LINING	SIZES
58-8655	---	4121	PVC	Blue	Straight	10"	Supported	Rough	Interlock	S - XL
58-8656	---	4121	PVC	Blue	Straight	12"	Supported	Rough	Interlock	S - XXL
58-8657	AJK	4121	PVC	Blue	Straight	25"	Supported	Rough	Interlock	M - XL

LIQUID & CHEMICAL RESISTANT GLOVES

SUPPORTED NEOPRENE & NITRILE COATED

ACTIVGRIP™ NITRILE COATED GLOVE

STYLE NUMBER	EN 388	POLYMER	COLOR	CUFF	LENGTH	CONSTRUCTION	GRIP	LINING	SIZES
56-AG566	4121	Nitrile	Green	Straight	12"	Supported	MicroFinish	Interlock	XS - XL
56-AG567	4121	Nitrile	Green	Straight	25"	Supported	MicroFinish	Interlock	S - XL
56-AG585	4121	Nitrile	Gray	Straight	10"	Supported	MicroFinish	Interlock	XS - XL
56-AG586	4121	Nitrile	Gray	Straight	12"	Supported	MicroFinish	Interlock	XS - XL
56-AG588	4121	Nitrile	Gray	Safety	10"	Supported	MicroFinish	Interlock	S - XL

ACTIVEGRIP™

FOR ADVANCED
CHEMICAL
PROTECTION

& CHEMGRIP™



57-8630

- Multi-dipped process provides fully liquid-proof protection
- Jersey liner for enhanced comfort
- Gauntlet cuff for added forearm protection
- Black color hides dirt

APPLICATIONS: Petrochemical, Refining, Material Handling, Degreasing, Chemical, Kitchen Cleanup, Plating, Galvanizing

CHEMGRIP™ NEOPRENE COATED GLOVE

STYLE NUMBER	EN 374	EN 388	POLYMER	COLOR	CUFF	LENGTH	CONSTRUCTION	GRIP PATTERN	LINING	SIZES
57-8615	AJKL	---	Neoprene	Black	Knit Wrist	10"	Supported, Multi-Dipped	Smooth	Jersey	L
57-8630	AJKL	---	Neoprene	Black	Straight	12"	Supported, Multi-Dipped	Smooth	Jersey	L
57-8645	AJKL	3121	Neoprene	Black	Straight	18"	Supported, Multi-Dipped	Smooth	Brushed Interlock	L
57-8675	AJKL	3121	Neoprene	Black	Straight	31"	Supported, Multi-Dipped	Smooth	Brushed Interlock	L
57-8630R	AJKL	3121	Neoprene	Black	Straight	12"	Supported, Multi-Dipped	Etched	Brushed Interlock	L
57-8640R	AJKL	3121	Neoprene	Black	Straight	14"	Supported, Multi-Dipped	Etched	Brushed Interlock	L
57-8645R	AJKL	3121	Neoprene	Black	Straight	18"	Supported, Multi-Dipped	Etched	Brushed Interlock	L
57-8643R	AJKL	3121	Neoprene	Black	Straight	18"	Supported, Multi-Dipped	Etched	Foam	L
57-8653R	AJKL	3121	Neoprene	Black	Straight	18"	Supported, Multi-Dipped	Etched	Foam	M - L

CHEMICAL RESISTANT GLOVES

SELECTOR GUIDE



ONLINE SELECTOR GUIDE: MATCHES GLOVE TO CHEMICAL FOR MAXIMUM SAFETY

PIP offers a user-friendly Selector Guide for Chemical Protection. The Chemical Permeation Guide allows you to search by chemical name, CAS number or by PIP glove style.

The chemical permeation of our product is measured in accordance to European Standard EN 374-3. This measures the resistance of protective gloves against chemicals and microorganisms. Part 3 of the standard determines the level of resistance to permeation by chemicals.

EN 374-3



AJK

WHAT IS THE ALPHA CODING LISTED BELOW PICTOGRAM?

EN 374-3 coding - In order for a glove to receive the pictogram as shown, the glove must achieve a breakthrough time >30 minutes for at least 3 chemicals from the 12 listed below.

BREAKTHROUGH TIME (BTT)

The number of minutes from initial contact with a test chemical until it is first detected on the inside of the glove

BREAKTHROUGH TIME - PROTECTION INDEX

Each chemical tested is classified in terms of breakthrough time (performance level 0 to 6)

PROTECTION INDEX

>	10 Minutes	Class 1
>	30 Minutes	Class 2
>	60 Minutes	Class 3
>	120 Minutes	Class 4
>	240 Minutes	Class 5
>	480 Minutes	Class 6

CODE LETTER	CHEMICAL	GAS NUMBER	CATEGORY
A	Methanol	67-56-1	Primary alcohol
B	Acetone	67-64-1	Ketone
C	Acetonitrile	75-05-8	Nitrile compound
D	Dichloromethane	75-09-2	Chlorinated paraffin
E	Carbon disulfide	75-15-0	Sulfur-containing organic compound
F	Toluene	108-88-3	Aromatic hydrocarbon
G	Diethylamine	109-89-7	Amine
H	Tetrahydrofurane	109-99-9	Heterocyclic and ethereal compound
I	Ethyl acetate	141-78-6	Ester
J	n-Heptane	142-85-5	Saturated hydrocarbon
K	Sodium hydroxide 40%	1310-73-2	Inorganic base
L	Sulfuric acid 96%	7664-93-9	Inorganic mineral acid

DISPOSABLE GLOVES

POLYMER TECHNOLOGY

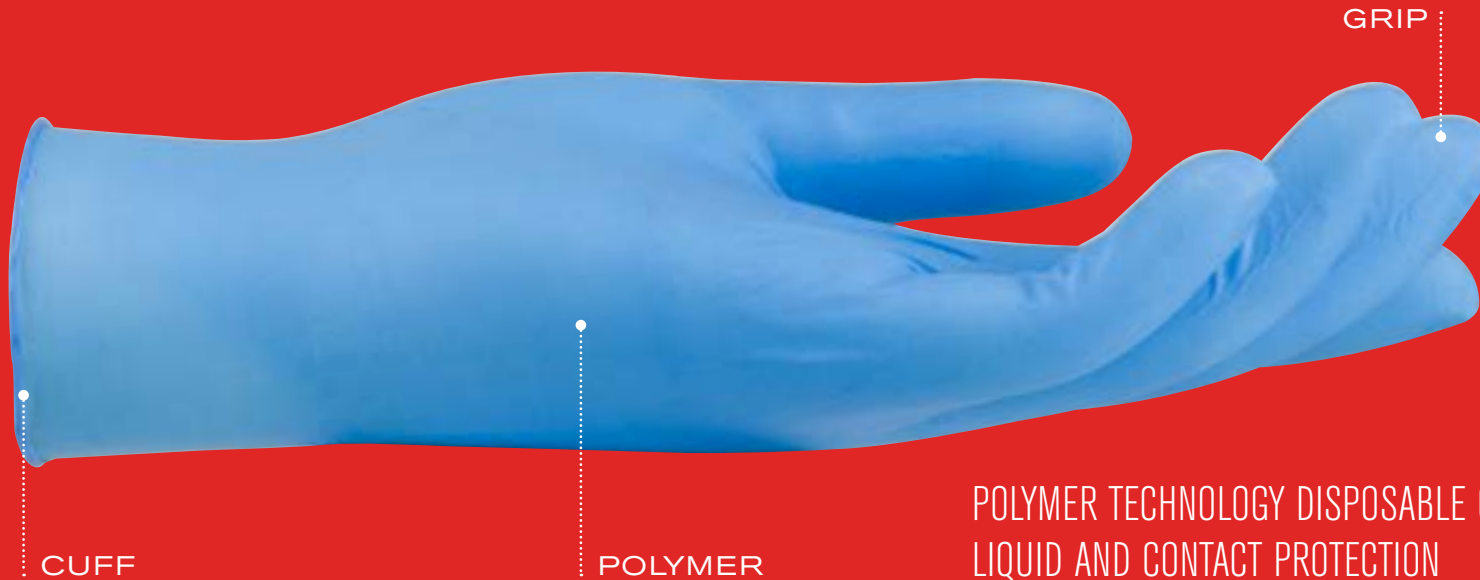

POLYMER TECHNOLOGY DISPOSABLE GLOVES, BUILT FOR LIQUID AND CONTACT PROTECTION

THE KEY TO PERFORMANCE IS SELECTING POLYMER MATERIAL AND THICKNESS

POLYMER MATERIALS

POLYMER COATING	ADVANTAGE	PRECAUTION
LATEX	- Superior flexibility and resistance to animal fats - Often used in cleaning, inspection, laboratory, and other light duty applications	- Latex intolerance with some users
NITRILE	- Good resistance to hydrocarbon derivatives as well as natural fats, oils and proteins. - Tough and resistant to abrasion, snags and perforation	- Avoid prolonged contact with ketones and aromatic solvents
VINYL	- Popular choice within the food industry as cost effective alternative for certain light duty tasks	- Less durable than nitrile or latex
POLYETHYLENE	- Most economical choice and is often used in food preparation	- Loose fitting and least durable

MIL THICKNESS

A "MIL" IS A UNIT OF THICKNESS EQUAL TO ONE THOUSANDTH OF AN INCH.

MIL	RECOMMENDED USE
13	- Exceptional tear and snag resistance for use in First Responder EMS or heavy duty industrial applications
5 to 8	- Food preparation, cleaning tasks, tattooing and industrial applications
3 to 4	- Single use food preparation and light duty
1 to 2	- Tasks that require constant glove change-outs such as in food service preparation

POWDERED: Lightly dusted with cornstarch or other dry lubricants to make donning gloves easier. Can leave residual traces on surfaces affecting adhesion or paint bonding in manufacturing. Banned for use in Medical, Surgical or Examination applications.

POWDER-FREE: Manufactured using a chlorination process that creates a less tacky glove surface facilitating donning and leaving no residual traces on surfaces.

DISPOSABLE GLOVES

AMBI-DEX® NITRILE



Ambi-dex®

NITRILE GLOVES

FOR GENERAL DUTY
APPLICATIONS, DIRT & OIL



▲ 63-732PF



▲ 63-331PF



TEXTURED
GRIP

AMBI-DEX® - NITRILE

STYLE NUMBER	21 CFR	CFIA	DUTY	THICKNESS	COLOR	GRIP PATTERN	POWDER	SIZES	BOX COUNT
63-338	Yes	No	Industrial	8 mil	Blue	Textured	Powdered	S - XL	50 pieces
63-338PF	Yes	No	Industrial	8 mil	Blue	Textured	Powder Free	S - XL	50 pieces
63-336	Yes	No	Industrial	6 mil	Blue	Textured	Powdered	S - XL	100 pieces
63-336PF	Yes	No	Industrial	6 mil	Blue	Textured	Powder Free	S - XL	100 pieces
63-3314PF	Yes	No	Industrial	6 mil	Blue	Textured	Powder Free	S - XL	50 pieces
63-332	Yes	Yes	Industrial	5 mil	Blue	Textured	Powdered	XS - XXL	100 pieces
63-332PF	Yes	Yes	Industrial	5 mil	Blue	Textured	Powder Free	XS - XXL	100 pieces
63-732PF	No	No	Industrial	5 mil	Black	Textured	Powder Free	S - XL	100 pieces
63-632PF	No	No	Industrial	4 mil	Black	Textured	Powder Free	S - XL	100 pieces
63-331PF	Yes	No	Medical	5 mil	Blue	Textured	Powder Free	S - XL	100 pieces
63-532	Yes	Yes	Food	4 mil	Blue	Textured	Powdered	S - XXL	100 pieces
63-532PF	Yes	Yes	Food	4 mil	Blue	Textured	Powder Free	S - XL	100 pieces
63-510PF	Yes	Yes	Food	4 mil	Blue	Textured	Powder Free	S - XL	10 pieces
63-550PF	Yes	Yes	Food	4 mil	Blue	Textured	Powder Free	S - XL	50 pieces
63-230PF	Yes	No	Food	3 mil	Blue	Textured	Powder Free	S - XL	100 pieces

DISPOSABLE GLOVES

AMBI-DEX® GRIPPAZ™



Ambi-dex®

Grippaz™

SUPERIOR AMBIDEXTROUS
NITRILE GLOVES WITH
STRENGTH AND GRIP



**AMBI-DEX®
GRIPPAZ™ SKINS
67-246**

- Chemical resistant
- Latex-free
- Fish scale surface for wet and dry grip
- Superb snug fit

APPLICATIONS: *Mechanics, Engineers, Agriculture, General Use and Chemical*



**AMBI-DEX®
GRIPPAZ™ JAN SAN
67-306**

- Chemical resistant
- Latex-free
- Fish scale surface for wet and dry grip
- Amazing fit

APPLICATIONS: *Janitorial and Cleaning*



**AMBI-DEX®
GRIPPAZ™ FOOD PLUS
67-308**

- Latex-free
- Fish scale surface for wet and dry grip
- Suitable for all food types
- Bagged for food environments

APPLICATIONS: *Food Handling, Janitorial, Cleaning and Agriculture*

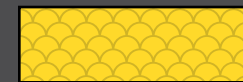

FISH SCALE TEXTURE FOR EXCELLENT GRIP



FISH SCALE
SURFACE FOR
WET & DRY GRIP



CHEMICAL
RESISTANT



LATEX-FREE

AMBI-DEX® GRIPPAZ™

STYLE NUMBER	21 CFR	GRADE	THICKNESS	COLOR	GRIP PATTERN	POWDER	SIZES	BOX COUNT
67-246	Yes	Industrial	6 mil	Black	Textured	Powder Free	S-XXL	50 pieces
67-306	Yes	Jan San	6 mil	Yellow	Textured	Powder Free	S-XXL	48 pieces
67-308	Yes	Food	8 mil	Blue	Textured	Powder Free	M-XXXL	48 pieces/bag

DISPOSABLE GLOVES

AMBI-DEX® LATEX

Ambi-dex

LATEX GLOVES

PERFORMANCE YOU CAN TRUST



AMBI-DEX® INDUSTRIAL GRADE

APPLICATIONS: *Production, Inspection, Cleaning*



AMBI-DEX® MEDICAL GRADE

APPLICATIONS: *Laboratories, Inspection, Examinations, Pharmacy*



AMBI-DEX® FOOD GRADE

APPLICATIONS: *Production, Inspection, Food Handling*



AMBI-DEX® - LATEX

STYLE NUMBER	21 CFR	CFIA	GRADE	THICKNESS	COLOR	GRIP PATTERN	POWDER	SIZES	BOX COUNT
62-310	Yes	No	Industrial	5 mil	■ Natural	Textured	Powdered	XS - XL	10 pieces
62-350	Yes	No	Industrial	5 mil	■ Natural	Textured	Powdered	XS - XL	50 pieces
62-322	Yes	No	Industrial	5 mil	■ Natural	Textured	Powdered	XS - XL	100 pieces
62-322PF	Yes	No	Industrial	5 mil	■ Natural	Textured	Powder Free	XS - XL	100 pieces
62-321PF	Yes	No	Medical	5 mil	■ Natural	Textured	Powder Free	S - XL	100 pieces
62-323	Yes	Yes	Food	5 mil	■ Natural	Textured	Powdered	S - XL	100 pieces
62-323PF	Yes	Yes	Food	5 mil	■ Natural	Textured	Powder Free	S - XL	100 pieces

WARNING: All styles listed on this page contain natural rubber latex which may cause allergic reactions.

Safe use by, or on latex-sensitive individuals has not been established. **POWDERED:** Lightly dusted with cornstarch or other dry lubricants to make donning gloves easier. Can leave residual traces on surfaces affecting adhesion or paint bonding in manufacturing. Banned for use in Medical, Surgical or Examination applications.

 The background of the advertisement features a pair of hands wearing blue latex gloves. One hand is holding a clear, curved object, possibly a piece of a glove or a tool. The overall scene is set against a blurred industrial or laboratory background.

Ambi-Thix™

THICKER LATEX

ADDED
STRENGTH FOR
DEMANDING JOBS



**AMBI-THIX®
EXTRA-THICK LATEX INDUSTRIAL GRADE
62-327**

- 13 mil thickness for heavy duty applications
- 11 inches long for added forearm protection

APPLICATIONS: *Production, Inspection, Cleaning*



**AMBI-THIX®
EXTRA-THICK LATEX MEDICAL GRADE
62-327PF**

- 13 mil thickness for heavy duty applications
- 11 inches long for added forearm protection
- Meets the emergency medical glove requirements of NFPA 1999 Standard on Protective Clothing for Emergency Medical Operations, 2003

APPLICATIONS: *Emergency Responders, Lab Applications*

AMBI-THIX® - EXTRA-THICK LATEX

STYLE NUMBER	21 CFR	CFIA	GRADE	THICKNESS	COLOR	GRIP PATTERN	POWDER	SIZES	BOX COUNT
62-327	No	No	Industrial	13 mil	Blue	Textured	Powdered	S - XL	50 pieces
62-327PF	No	No	Medical	13 mil	Blue	Textured	Powder Free	S - XL	50 pieces

WARNING: All styles listed on this page contain natural rubber latex which may cause allergic reactions. Safe use by, or on latex-sensitive individuals has not been established. **POWDERED:** Lightly dusted with cornstarch or other dry lubricants to make donning gloves easier. Can leave residual traces on surfaces affecting adhesion or paint bonding in manufacturing. Banned for use in Medical, Surgical or Examination applications.

DISPOSABLE GLOVES

AMBI-DEX® POLYETHYLENE / VINYL / NON-LATEX SYNTHETIC



AMBI-DEX® POLYETHYLENE EMBOSSED GRIP

- For better handling of wet or dry materials

APPLICATIONS: *Food Preparation and Services*



AMBI-DEX® POLYETHYLENE SILKY-FINISH GRIP

- Ensures effortless outer glove donning ability

APPLICATIONS: *Food Preparation and Services*

Ambi-dex®

POLYETHYLENE, VINYL & NON-LATEX SYNTHETIC GLOVES



▲ 64-V77B



▲ 64-436



▲ 64-V3000

AMBI-DEX® VINYL PREMIUM INDUSTRIAL GRADE

- Made from a soft virgin vinyl formulation specially compounded to deliver an optimal combination of comfort, fit, flexibility, tactile sensitivity and performance

APPLICATIONS: *Broad Range for Protection from Liquids and Debris, Food Processing, Inspections*

AMBI-DEX® VINYL INDUSTRIAL GRADE

APPLICATIONS: *Broad Range for Protection from Liquids and Debris, Food Processing, Inspections*



AMBI-DEX® NON-LATEX SYNTHETIC

- Have the look, fit and feel of latex without the concern of natural rubber latex proteins

APPLICATIONS: *Broad Range for Protection from Liquids and Debris, Food Processing, Inspections*

AMBI-DEX® - POLYETHYLENE

STYLE NUMBER	21 CFR	CFIA	GRADE	THICKNESS	COLOR	GRIP	POWDER	SIZES	BOX COUNT
65-543	Yes	Yes	Food	1 mil	■ Clear	Embossed	Powder Free	S - XL	100 pieces
65-544	Yes	Yes	Food	1 mil	■ Clear	Embossed	Powder Free	S - XL	500 pieces
65-545	Yes	No	Food	1 mil	■ Clear	Embossed	Powder Free	L	100 pieces
65-553	Yes	Yes	Food	1 mil	■ Clear	Silky Finish	Powder Free	S - XL	100 pieces

AMBI-DEX® - HEAVY DUTY VINYL

64-V77B	Yes	Yes	Industrial	5 mil	■ Blue	Smooth	Powdered	S - XL	100 pieces
64-V77BPF	Yes	Yes	Industrial	5 mil	■ Blue	Smooth	Powder Free	S - XL	100 pieces
64-436	Yes	No	Industrial	6 mil	■ Green	Smooth	Powdered	S - XL	100 pieces
64-433	Yes	No	Industrial	6 mil	■ Green	Smooth	Powdered	S - XL	300 pieces

AMBI-DEX® - VINYL

64-V3000	Yes	Yes	Industrial	3 mil	■ White	Smooth	Powdered	S - XL	100 pieces
64-V3000PF	Yes	Yes	Industrial	3 mil	■ White	Smooth	Powder Free	XS - XL	100 pieces
64-V2000	Yes	Yes	Industrial	5 mil	■ White	Smooth	Powdered	S - XXL	100 pieces
64-V2000PF	Yes	Yes	Industrial	5 mil	■ White	Smooth	Powder Free	S - XXL	100 pieces

AMBI-DEX® - NON-LATEX SYNTHETIC

64-346	Yes	No	Industrial	4 mil	■ White	Smooth	Powdered	S - XL	100 pieces
64-346PF	Yes	No	Industrial	4 mil	■ White	Smooth	Powder Free	S - XL	100 pieces

CONTROLLING CONTAMINATION

WHILE MORE THAN 30 DIFFERENT INDUSTRY SEGMENTS UTILIZE CLEANROOMS, 70% OF U.S. CLEANROOM FLOOR SPACE IS IN THE PHARMACEUTICAL, BIOTECHNOLOGY, SEMICONDUCTOR AND OTHER ELECTRONIC COMPONENT INDUSTRIES.

THERE ARE FOUR MAIN GROUPS OF CONTAMINANTS:



Particles, usually carried on air currents, are solid matter, such as human skin flakes, dust and fibers from clothing, particles from production materials or from tooling and equipment.



Microorganisms such as bacteria can be extremely dangerous if they are allowed to contaminate medicines or people that treat or are being treated.



Chemicals can react with the product and cause changes to the formulation or destroy the product.



Electrostatic discharge given off by the human body can be as high as 35,000 volts. The energy attracts particles and, as these particles colonize in one place, they cause particulate damage. The discharge itself can also cause severe damage.

CLASSIFICATION - PARTICLES PER M³

ISO 14644 CLASS	209E CLASS	0.5 MICRON	5 MICRON
3	1	35	---
4	10	352	---
5	100	3,520	29
6	1,000	35,200	293
7	10,000	352,000	2,930
8	100,000	3,520,000	29,300

102 AMBI-DEX®
STERILE LATEX GLOVES

103 CLEANTEAM®
SINGLE-USE GLOVES

104 CLEANTEAM®
SEAMLESS KNIT GLOVES
FOR FINE WORK

106 CLEANTEAM® LINT-FREE
GLOVES FOR INSPECTION

108 EXTREME TEMPERATURE
GLOVES & APRONS

108 MATS & PAPER

CRITICAL ENVIRONMENT

CRITICAL ENVIRONMENT GLOVES

AMBI-DEX® STERILE LATEX



AMBI-DEX® 100-3201PF

- Textured palm and finger enhance grip in wet and dry conditions
- Sterilized by gamma radiation
- Meets federal and ASTM standards for protein content
- Hand specific
- Powder free
- Pair packed

APPLICATIONS: *Surgeons and Medical*

HAND SPECIFIC
SURGEON STYLE
MEDICAL GRADE

STERILE LATEX

AMBI-DEX® MEDICAL GRADE STERILE LATEX

STYLE NUMBER	POLYMER	POWDER	GRIP	LENGTH	MIL	STERILE	COLOR	SIZING	GLOVES/BOX
100-3201PF	Latex	Powder Free	Textured Palm & Finger	11"	5	Yes	■ White	6.0 - 8.5	200 pair

SINGLE-USE

LATEX, NITRILE & VINYL



◀ **CLEANTEAM®**
100-323010

- Fully textured for a superior grip in wet and dry conditions
- Beaded cuff provides additional strength and protection
- Ambidextrous
- Powder free
- Double-bagged in sealed clean room bags

APPLICATIONS: *Biotechnology, Medical Device Manufacturing, Laboratory, Cleanroom*



◀ **CLEANTEAM®**
100-333010

- Textured finger for enhanced grip in wet and dry conditions
- Beaded cuff provides additional strength and protection
- Electrostatic Dissipative for improved performance in electronics assembly
- Ambidextrous
- Powder free
- Double-bagged in sealed clean room bags

APPLICATIONS: *Biotechnology, Medical Device Manufacturing, Laboratory, Computer Assembly, Cleanroom*



◀ **CLEANTEAM®**
100-2830

- Beaded cuff provides additional strength and protection
- Electrostatic Dissipative for improved performance in electronics assembly
- Ambidextrous
- Powder free
- Double-bagged in sealed clean room bags

APPLICATIONS: *Biotechnology, Medical Device Manufacturing, Laboratory, Computer Assembly, Cleanroom*

CLEANTEAM® SINGLE-USE LATEX

STYLE NUMBER	POLYMER	DESCRIPTION	GRIP	CLASS	LENGTH	MIL	COLOR	SIZING	GLOVES/BAG
100-323010	Latex	Powder Free	Textured Palm & Finger	10	12"	7	■ Natural	S - XL	100 gloves
100-323000	Latex	Powder Free	Textured Palm & Finger	100	12"	7	■ Natural	S - XL	100 gloves
100-322400	Latex	Powder Free	Textured Palm & Finger	100	9.5"	7	■ Natural	S - XL	100 gloves

CLEANTEAM® SINGLE-USE NITRILE

100-333010	Nitrile	Powder Free	Textured Palm & Finger	10	12"	5	■ White	S - XL	100 gloves
100-333000	Nitrile	Powder Free	Textured Palm & Finger	100	12"	5	■ White	S - XL	100 gloves
100-332400	Nitrile	Powder Free	Textured Palm & Finger	100	9.5"	5	■ White	S - XL	100 gloves

CLEANTEAM® SINGLE-USE VINYL

100-2824	Vinyl	Powder Free	Smooth	10	9.5"	5	■ Clear	S - XL	100 gloves
100-2830	Vinyl	Powder Free	Smooth	10	12"	5	■ Clear	S - XL	100 gloves

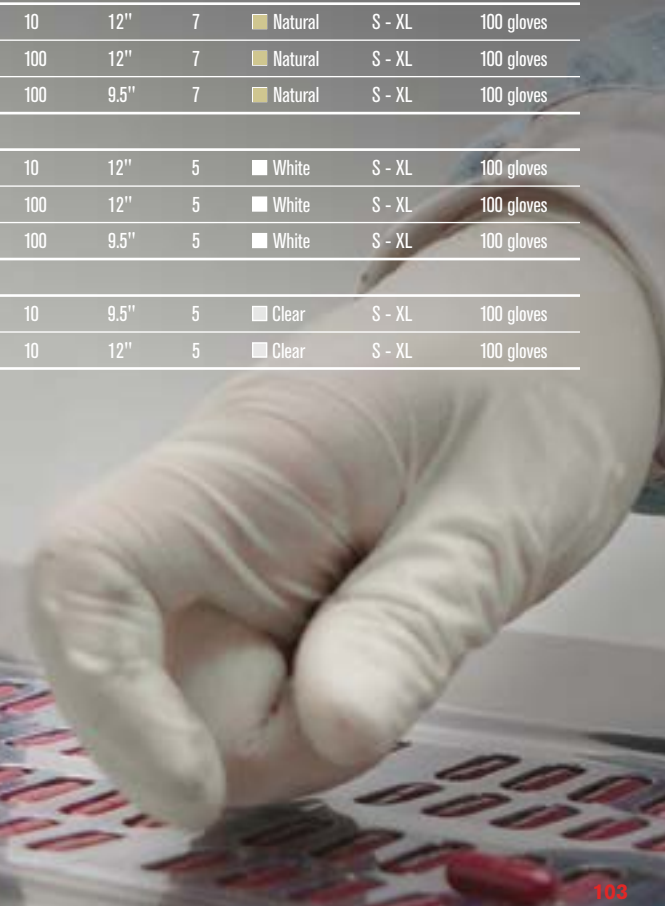

CRITICAL ENVIRONMENT GLOVES

CLEANTEAM® SEAMLESS KNIT GLOVES FOR FINE WORK

SEAMLESS KNIT

FOR CRITICAL ENVIRONMENT

CRITICAL ENVIRONMENT GLOVES

CLEANTEAM® SEAMLESS KNIT GLOVES FOR FINE WORK



◀ CLEANTEAM® 40-C125

- Polyurethane coated palm and fingers to provide puncture and abrasion resistance while offering excellent tactile sensitivity
- Comfortable seamless knit design provides superior comfort and dexterity

APPLICATIONS: *Product Handling, Finishing, Assembly, Electronics Assembly, Photography Labs, Computer Manufacturing*



◀ CLEANTEAM® 40-730

- Lightweight design can be worn under disposable and other liquid-proof gloves
- Nylon yarns absorb perspiration and leave hands cool and comfortable

APPLICATIONS: *Product Handling, Finishing, Assembly, Electronics Assembly, Photography Labs, Computer Manufacturing*



◀ CLEANTEAM® 40-6410

- Electrostatic Dissipative (ESD) fiber yarns blended with low lint nylon which reduces static build-up on the glove surface
- Seamless knit gloves provide great dexterity
- Launderable and reusable without losing ESD properties

APPLICATIONS: *Circuit Board Manufacturing, Munitions, Electronics Assembly, Aerospace*



◀ CLEANTEAM® 40-130

- Made in the USA
- Low linting
- Polyester can be UV irradiated to sterilize

APPLICATIONS: *Paint Rooms, Electronic Assembly, Pharmaceutical Production*

LOW LINTING



◀ CLEANTEAM® 40-6415

- Excellent properties in electrostatic dissipation, electromagnetic wave shielding and thermal conductance
- Copper fiber provides good thermal conductance

APPLICATIONS: *Circuit Board Manufacturing, Munitions, Electronics Assembly, Aerospace*

CLEANTEAM® NYLON SEAMLESS KNIT

STYLE NUMBER	MATERIAL	CONSTRUCTION	COLOR	GAUGE	COATING	COATING COLOR	COVERAGE	SIZES
40-C125	Nylon	Seamless Knit	■ White	13	Polyurethane	■ White	Palm & Fingers	XS - XXL
99-126	Nylon	Seamless Knit	■ White	13	Polyurethane	■ White	Fingertips	S - XL
40-736	Nylon	Seamless Knit, Half-Finger	■ White	13	---	---	---	S & L
40-732	Nylon	Seamless Knit, Half-Finger	■ White	13	---	---	---	S - XL
40-730	Nylon	Seamless Knit	■ White	13	---	---	---	S - XL
40-750	Nylon	Seamless Knit	■ White	10	---	---	---	S & L

CLEANTEAM® POLYESTER SEAMLESS KNIT

40-C2210	Polyester	Seamless Knit	■ White	10	---	---	---	S & L
40-C2130	Polyester	Seamless Knit	■ White	13	---	---	---	S - XL
40-130	Polyester	Seamless Knit	■ White	13	---	---	---	XS - XL
40-230	Polyester	Seamless Knit	■ White	13	---	---	---	S - XL

CLEANTEAM® NYLON ELECTROSTATIC DISSIPATIVE (ESD)

40-630	Nylon	Seamless Knit	■ White	13	---	---	---	XS - XL
40-6410	Nylon / Carbon	Seamless Knit	▣ White / Gray	13	---	---	---	S - XXL
40-6411	Nylon / Carbon	Seamless Knit	▣ White / Gray	13	PVC Dot	■ White	Palm	S & L
40-6416	Nylon / Copper	Seamless Knit	■ White	13	Polyurethane	■ Copper	Fingertips	S & L
40-6415	Nylon / Copper	Seamless Knit	■ White	13	Polyurethane	■ Copper	Palm & Fingertips	S & L

CRITICAL ENVIRONMENT GLOVES

CLEANTEAM® LINT-FREE GLOVES FOR INSPECTION



**CLEANTEAM®
97-500**

- Ambidextrous
- Unhemmed

APPLICATIONS: *Inspection,
Electronics Assembly*



**CLEANTEAM®
97-520R**

- Ambidextrous
- Rolled hem

APPLICATIONS: *Inspection,
Electronics Assembly*



**CLEANTEAM®
97-540H**

- Ambidextrous
- Hemmed

APPLICATIONS: *Inspection,
Electronics Assembly*

PIP IS A LEADER IN THE MANUFACTURING OF FABRIC INSPECTION

CLEANTEAM® COTTON SEAMLESS KNIT – LIGHTWEIGHT, ECONOMY

STYLE NUMBER	MATERIAL	CONSTRUCTION	HEM	LENGTH	COLOR	WEIGHT	SIZES
97-510	Cotton / Polyester	Cut-and-Sewn	Unhemmed	9"	■ White	Light	Men's
97-511	Cotton / Polyester	Cut-and-Sewn	Unhemmed	9"	■ White	Light	Ladies'
97-500I	Cotton	Cut-and-Sewn	Unhemmed	9"	■ White	Light	Men's
97-501I	Cotton	Cut-and-Sewn	Unhemmed	9"	■ White	Light	Ladies'
97-500/14I	Cotton	Cut-and-Sewn	Unhemmed	14"	■ White	Light	Men's
97-500/14NI	Cotton	Cut-and-Sewn	Unhemmed	14"	■ White	Light	Men's

CLEANTEAM® COTTON SEAMLESS KNIT – LIGHTWEIGHT, PREMIUM

97-500	Cotton	Cut-and-Sewn	Unhemmed	9"	■ White	Light	Men's
97-501	Cotton	Cut-and-Sewn	Unhemmed	9"	■ White	Light	Ladies'
97-500J	Cotton	Cut-and-Sewn	Unhemmed	9"	■ White	Light	Jumbo
97-500H	Cotton	Cut-and-Sewn	Hemmed	9"	■ White	Light	Men's
97-501H	Cotton	Cut-and-Sewn	Hemmed	9"	■ White	Light	Ladies'
97-500/10	Cotton	Cut-and-Sewn	Unhemmed	10.5"	■ White	Light	Men's
97-501/10	Cotton	Cut-and-Sewn	Unhemmed	10.5"	■ White	Light	Ladies'
97-501/12	Cotton	Cut-and-Sewn	Unhemmed	12"	■ White	Light	Ladies'
97-500/12	Cotton	Cut-and-Sewn	Unhemmed	12"	■ White	Light	Men's
97-500/14	Cotton	Cut-and-Sewn	Unhemmed	14"	■ White	Light	Men's

CLEANTEAM® COTTON SEAMLESS KNIT – MEDIUM WEIGHT

STYLE NUMBER	MATERIAL	CONSTRUCTION	HEM	LENGTH	COLOR	WEIGHT	SIZES
97-520	Cotton	Cut-and-Sewn	Unhemmed	9.5"	■ White	Medium	Men's
97-521	Cotton	Cut-and-Sewn	Unhemmed	9"	■ White	Medium	Ladies'
97-520J	Cotton	Cut-and-Sewn	Unhemmed	9.5"	■ White	Medium	Jumbo
97-520H	Cotton	Cut-and-Sewn	Hemmed	9.5"	■ White	Medium	Men's
97-521H	Cotton	Cut-and-Sewn	Hemmed	9"	■ White	Medium	Ladies'
97-520R	Cotton	Cut-and-Sewn	Rolled	9.5"	■ White	Medium	Men's
97-520/10	Cotton	Cut-and-Sewn	Unhemmed	10.5"	■ White	Medium	Men's
97-521/10	Cotton	Cut-and-Sewn	Unhemmed	10.5"	■ White	Medium	Ladies'
97-520/12	Cotton	Cut-and-Sewn	Unhemmed	12"	■ White	Medium	Men's
97-520/14	Cotton	Cut-and-Sewn	Unhemmed	14"	■ White	Medium	Men's
97-520/12R	Cotton	Cut-and-Sewn	Rolled	12"	■ White	Medium	Ladies'

CRITICAL ENVIRONMENT GLOVES

CLEANTEAM® LINT-FREE GLOVES FOR INSPECTION



98-702

- Stretch nylon, two piece pattern
- Zigzag stitched hem

APPLICATIONS: *Inspection, Electronics Assembly*



GLOVES FOR ALL CRITICAL ENVIRONMENTS

CLEANTEAM® COTTON SEAMLESS KNIT - HEAVYWEIGHT

STYLE NUMBER	MATERIAL	CONSTRUCTION	HEM	LENGTH	COLOR	WEIGHT	SIZES
97-540	Cotton	Cut-and-Sewn	Unhemmed	9"	■ White	Heavy	Men's
97-540H	Cotton	Cut-and-Sewn	Hemmed	9"	■ White	Heavy	Men's
97-540/12	Cotton	Cut-and-Sewn	Unhemmed	12"	■ White	Heavy	Men's
97-541/12	Cotton	Cut-and-Sewn	Unhemmed	12"	■ White	Heavy	Ladies'
97-540R	Cotton	Cut-and-Sewn	Rolled	10"	■ White	Heavy	Men's
97-541	Cotton	Cut-and-Sewn	Unhemmed	8.5"	■ White	Heavy	Ladies'
97-541H	Cotton	Cut-and-Sewn	Rolled	8.5"	■ White	Heavy	Ladies'
130-100WMNZ	Cotton	Cut-and-Sewn	Open Cuff, <i>no raised stitching on the back</i>	9"	■ White	Heavy	XS - XL

CLEANTEAM® NYLON SEAMLESS KNIT - HEAVYWEIGHT

STYLE NUMBER	MATERIAL	CONSTRUCTION	HEM	LENGTH	COLOR	WEIGHT	SIZES
98-740	Nylon	Cut-and-Sewn	Hemmed	9"	■ White	Light	Men's S -XXL
98-741	Nylon	Cut-and-Sewn	Hemmed	8.5"	■ White	Light	Ladies' S - L
98-702	Nylon	Cut-and-Sewn	Zigzag Stitch	9"	■ White	Light	Men's
98-702I	Nylon	Cut-and-Sewn	Zigzag Stitch	9"	■ White	Light	Men's
98-702/12	Nylon	Cut-and-Sewn	Zigzag Stitch	12"	■ White	Light	Men's
98-703	Nylon	Cut-and-Sewn	Zigzag Stitch	8.5"	■ White	Light	Ladies'
98-703I	Nylon	Cut-and-Sewn	Zigzag Stitch	8.5"	■ White	Light	Ladies'
98-703/12	Nylon	Cut-and-Sewn	Zigzag Stitch	12"	■ White	Light	Ladies'
98-700	Nylon	Cut-and-Sewn	Zigzag Stitch	9"	■ White	Heavy	Men's
98-701	Nylon	Cut-and-Sewn	Zigzag Stitch	8.5"	■ White	Heavy	Ladies'
98-712	Nylon	Cut-and-Sewn	Zigzag Stitch	9"	■ White	Heavy	Men's
98-713	Nylon	Cut-and-Sewn	Zigzag Stitch	8.5"	■ White	Heavy	Ladies'

CRITICAL ENVIRONMENT

EXTREME TEMPERATURE / MATS & PAPER

EXTREME TEMPERATURE PROTECTION



▲ 202-1027 ▲ 202-1019 ▲ 202-1015 ▲ 202-1012

TEMP-GARD® LIQUID-PROOF SILICONE EXTREME TEMPERATURE GLOVE

IDEAL FOR USE IN WORK ENVIRONMENTS TO PROTECT FROM EXTREME TEMPERATURES OF -321°F (-196°C) TO +500°F (+260°C), SUCH AS CRYOGENIC CLEANING, CRYOGENIC SYSTEMS MAINTENANCE, CONSERVATION OF FOOD PRODUCE

- Impervious to cryogenic liquids and most other liquids and chemicals
- Exceptional grip that does not become slippery, even at extreme temperatures
- Superior flexibility that will not stiffen
- Improved dexterity at all temperatures
- Easy to clean, will not absorb chemicals and will not stain. The silicone coating is on the outside of the gloves (rather than inside), so it prevents staining and can easily be rinsed off after use

ITEM NUMBER	COLOR	MATERIAL	LENGTH	SIZES
202-1012	■ Black	Liquid-Proof Silicone	Wrist	S - L
202-1015	■ Black	Liquid-Proof Silicone	Mid-Arm	S - L
202-1019	■ Black	Liquid-Proof Silicone	Elbow	S - L
202-1027	■ Black	Liquid-Proof Silicone	Shoulder	S - L



TEMP-GARD® EXTREME TEMPERATURE APRONS

- Multi-layered construction for maximum thermal protection
- Liquid-proof outer layer to protect from splashes
- Quick release buckles at neck and waist for added safety

ITEM NUMBER	COLOR	MATERIAL	LENGTH
202-2036	■ Black	Liquid-Proof Silicone	36"
202-2042	■ Black	Liquid-Proof Silicone	42"
202-2048	■ Black	Liquid-Proof Silicone	48"
202-2054	■ Black	Liquid-Proof Silicone	54"



CONTAMINATION CONTROL MATS

- Specially designed adhesive coated mats reduce foot borne dust and particulates from entering cleanrooms and controlled environments
- Available in white, blue or gray

ITEM NUMBER	SIZE	LAYERS	PACKS PER CASE
100-93-183638	18" x 36"	30	8
100-93-184538	18" x 45"	30	8
100-93-243638	24" x 36"	30	8
100-93-264538	26" x 45"	30	8
100-93-264564	26" x 45"	60	4
100-93-363638	36" x 36"	30	8
100-93-363664	36" x 36"	60	4
100-93-364538	36" x 45"	30	8
100-93-364564	36" x 45"	60	4
100-93-366064	36" x 60"	60	4

CLEANROOM PAPER

- Paper's antistatic properties reduce attraction of airborne particles and enhance its performance in photocopiers and converting processes
- Chemical and moisture resistant
- Available in white, light blue, yellow, green and pink

ITEM NUMBER	SIZE	WEIGHT	PACKAGING
100-95-501	8.5" x 11"	22#	250 sheets per pack 10 packs per case



HIGH PERFORMANCE **TASK SPECIFIC PROTECTION**

THE NEED FOR MULTI-FACETED PROTECTION IS SOMETHING ONLY CUT AND SEWN GLOVES, USING ADVANCED, COMPOSITE MATERIALS CAN ACHIEVE. KEY MARKETS THAT ARE IN NEED OF TASK SPECIFIC GLOVES ARE OIL & GAS, CONSTRUCTION, ELECTRICAL AND GAS UTILITY, AND MECHANICAL TRADES.

EACH OF THESE MARKETS HAS SPECIFIC NEEDS



Impact Resistance

Impact resistant gloves aim to reduce injury from blunt force against the top of the hand and fingers. Thermoplastic Rubber (TPR) is the common material found on impact resistant gloves to reduce top of hand injuries. Key applications include: Oil & Gas, Heavy Industry, Mining, Trench Work and Construction



Flame & Heat Resistance

Covers everything from Flame Resistance, Arc Protection, Hot Mill and Welder's gloves, as well as gloves certified for fighting structural fires.



Cold Protection

Gloves for working in cold climates or in refrigerated warehouses rely on thermal lining or winterized membranes.



Ergonomic Design

Advancement in pattern engineering software and sewing machinery combine to produce gloves that mimic the natural hand. When constructed with advanced, composite materials, task specific gloves offer features that can solve almost any hand protection problem.

110 OIL & GAS GLOVES

112 MINING GLOVES

113 CONSTRUCTION & INDUSTRIAL GLOVES

115 MECHANICS GLOVES

116 LIFTING & SHOCK ABSORBING GLOVES

117 UTILITY GLOVES

118 ELECTRICAL ARC RATED GLOVES

HIGH PERFORMANCE GLOVES

HIGH PERFORMANCE GLOVES

OIL & GAS

MAXIMUM SAFETY® MAD MAX™

- Synthetic leather palm for good grip in dry and slightly oily conditions
- Thermoplastic rubber (TPR) guards for pinch point protection
- Dorsal protection against impact to the back of the hand
- Reinforced thumb joint
- Foam padded knuckle
- Reinforced index finger

APPLICATIONS: Petrochemical, Heavy/Light Construction, Demolition, Manufacturing, Mining, Rigging, Fabrication



ANSI A3

MAXIMUM SAFETY® TUFFMAX™

- Lightweight HPPE knit liner provides excellent dexterity and tactile sensitivity
- Thermoplastic rubber (TPR) guards for pinch point protection
- MicroSurface nitrile for enhanced grip in wet, dry and oily applications
- Dorsal protection against impact to the back of the hand
- Excellent puncture resistance
- Extended cuff for additional protection

APPLICATIONS: Petrochemical, Heavy/Light Construction, Demolition, Manufacturing, Mining, Rigging, Fabrication



MAXIMUM SAFETY

MAXIMUM SAFETY® MAD MAX™

STYLE NUMBER	ANSI	EN388	GRIP	BACK	CUFF	COLOR	SIZES
120-4000	A2	3121	PVC Diamond Grip	Spandex	Slip-On	Hi-Vis Yellow / Black	S - XXL
120-4050	---	4121	PVC Dot	Spandex	Slip-On	Hi-Vis Yellow / Black	S - XXL
120-4070	---	3121	PVC Sandy Grip	Spandex	Slip-On	Hi-Vis Yellow / Black	S - XXL

MAXIMUM SAFETY® TUFFMAX™

120-5150	A3	4544	Nitrile MicroSurface	HPPE	Slip-On with Hook & Loop Closure	Hi-Vis Orange / Black	M - XXL
120-5130	A2	4344	Nitrile MicroSurface	HPPE	Slip-On with Hook & Loop Closure	Hi-Vis Green / Black	M - XXL



HIGH PERFORMANCE GLOVES

OIL & GAS



KEVLAR® STITCHED

▲ 120-5200



KEVLAR® LINED

▲ 120-5250



WATERPROOF LINER

▲ 120-5275



REFLECTIVE BACK

▲ 120-5300

MAXIMUM SAFETY® ROUSTABOUT™

- Synthetic leather palm with silicone for enhanced grip in wet and dry applications
- Thermoplastic rubber (TPR) guards
- Dorsal protection
- Padding in palm for added comfort
- Kevlar® stitched for added durability
- Kevlar® fabric reinforced thumb joint for extended glove life
- ID badge on wrist

APPLICATIONS: Petrochemical, Heavy/Light Construction, Fleet and Mechanical Repair, Demolition, Manufacturing, Mining, Rigging, Fabrication, Landscaping

MAXIMUM SAFETY® ROUSTABOUT™

STYLE NUMBER	EN388	GRIP	BACK	CUFF	COLOR	SIZES
120-5200	3132	Silicone	Spandex	Slip-On	Hi-Vis Yellow / Black	M - XXL
120-5250	3333	Silicone	Spandex	Slip-On	Hi-Vis Yellow / Black	M - XXL
120-5275	3333	Silicone	Spandex	Slip-On	Hi-Vis Yellow / Black	M - XXL
120-5300	3132	Silicone	Spandex	Slip-On	Hi-Vis Orange / Black	M - XXL

**MAXIMUM
SAFETY**

HIGH PERFORMANCE GLOVES

OIL, GAS & MINING



▲ 120-5900

MAXIMUM SAFETY® MOG™

- Synthetic leather palm with reinforcements, for an enhanced grip in dry and slightly oily conditions
- Thermoplastic rubber (TPR) guards for pinch point protection
- Dorsal protection against impact to the back of the hand
- Back of the hand guard

APPLICATIONS: *Petrochemical, Light Construction, Auto Repair, Demolition, Manufacturing, Mining, Fabrication, Landscaping*



▲ 120-4720

MAXIMUM SAFETY® DERRICKMEN™

- Thermoplastic rubber (TPR) guards for pinch point protection
- Polycord canvas for additional comfort
- Rubber bumper for knuckle protection
- Reflective knuckle
- Double stitching at seams for additional durability and strength

APPLICATIONS: *Petrochemical, Light Construction, Auto Repair, Demolition, Manufacturing, Mining, Fabrication, Landscaping*



▲ 120-4700

MAXIMUM SAFETY® MINER'S MIRACLE™

- Synthetic leather palm with reinforcements for an enhanced grip in dry and slightly oily conditions
- Thermoplastic rubber (TPR) guards for pinch point protection
- Rubber bumper knuckle protection
- Reflective knuckle
- Double stitching at seams

APPLICATIONS: *Petrochemical, Light Construction, Auto Repair, Demolition, Manufacturing, Mining, Fabrication, Landscaping*

MAXIMUM SAFETY® MOG™

STYLE NUMBER	EN 388	GRIP	BACK	CUFF	COLOR	SIZES
120-5900	3111	PVC Sandy Grip	Spandex	Slip-On with Hook & Loop	Hi-Vis Orange / Black	M - XXXL

MAXIMUM SAFETY® DERRICKMEN™

120-4720	1221	Polycord Canvas	Spandex	Slip-On with Hook & Loop	Hi-Vis Orange / Black	M - XXL
----------	------	-----------------	---------	--------------------------	-----------------------	---------

MAXIMUM SAFETY® MINER'S MIRACLE™

120-4700	4131	PVC Popcorn	Spandex	Slip-On with Hook & Loop	Hi-Vis Orange / Black	S - XXL
----------	------	-------------	---------	--------------------------	-----------------------	---------

MAXIMUM
SAFETY



GLOVES FOR CONSTRUCTION



▲ 120-4200

▲ 120-4100

▲ 120-4150

KEVLAR® LINED

MAXIMUM SAFETY®

- Reinforced goatskin leather palm and back provides abrasion resistance and comfort
- Thermoplastic rubber (TPR) guards for added protection
- Internal foam padded palm absorbs and dampens shock
- Reinforced thumb joint for extended glove life
- Reflective knuckle tape for visibility in low-light applications

APPLICATIONS: *Heavy/Light Construction, Excavation, Demolition, Manufacturing, Mining, Fabrication, Landscaping*

MAXIMUM SAFETY®

STYLE NUMBER	EN 388	GRIP	BACK	CUFF	COLOR	SIZES
120-4200	2112	Goatskin Leather	Reinforced Goatskin Leather	Slip-On	☑ Brown / Black	S - XXL
120-4100	2332	Goatskin Leather	Reinforced Goatskin Leather	Slip-On	☑ Brown / Black	S - XXL
120-4150	2332	Goatskin Leather	Reinforced Goatskin Leather	Slip-On	☑ Brown / Black	S - XXXL

HIGH PERFORMANCE GLOVES

CONSTRUCTION & INDUSTRIAL



▲ 120-4400

MAXIMUM SAFETY® GUNNER-AV™

- Synthetic leather palm provides dexterity and a good grip in dry and slightly oily applications
- PVC sandy grip on palm, thumb joint, upper knuckle and fingertips
- Reinforced thumb joint for extended glove life
- Reflective piping across back for visibility in low-light applications

APPLICATIONS: *Heavy/Light Construction, Excavation, Demolition, Manufacturing, Mining, Fabrication, Landscaping*



▲ 120-4300

MAXIMUM SAFETY® GUNNER™

- Half-finger design for dexterity
- Synthetic leather pull-off hooks on fingers for easy on/off
- PVC sandy grip on palm & thumb joint
- Reinforced thumb joint for extended glove life

APPLICATIONS: *Heavy/Light Construction, Excavation, Demolition, Manufacturing, Mining, Fabrication, Landscaping*



▲ 120-4500

MAXIMUM SAFETY® TORQUE™

- Silicone triangle grip palm for enhanced grip
- Reinforced thumb joint for extended glove life
- Reflective tape on fingertips and back of hand for visibility in low-light applications

APPLICATIONS: *Heavy/Light Construction, Excavation, Demolition, Manufacturing, Mining, Fabrication, Landscaping*



▲ 120-4600

MAXIMUM SAFETY® VIZ™

- Silicone grip on index finger and thumb for small parts handling
- Reinforced thumb joint for extended glove life
- Hi-Vis color for enhanced visibility

APPLICATIONS: *Road Construction, Traffic Safety, Highway Maintenance, Manufacturing, Fleet maintenance*



▲ 120-4900

MAXIMUM SAFETY® BRICKYARD™

- Silicone grip on palm for improved grip
- Thermoplastic rubber (TPR) finger guards for pinch-point protection and hand guard for back of the hand protection

APPLICATIONS: *Road Construction, Traffic Safety, Highway Maintenance, Manufacturing, Fleet Maintenance*

TAILORED TO THE JOB



MAXIMUM SAFETY® GUNNER™

STYLE NUMBER	GRIP	BACK	CUFF	COLOR	SIZES
120-4400	PVC Sandy Grip	Neoprene / Nylon	Slip-On with Hook & Loop Closure	<input type="checkbox"/> Black / Gray	S - XXL
120-4300	PVC Sandy Grip	Neoprene / Nylon	Slip-On with Hook & Loop Closure	<input checked="" type="checkbox"/> Gray / Yellow	S - XXL

MAXIMUM SAFETY® TORQUE™

120-4500	Silicone	Neoprene / Nylon	Slip-On with Hook & Loop Closure	<input type="checkbox"/> Gray / Black	S - XXL
----------	----------	------------------	----------------------------------	---------------------------------------	---------

MAXIMUM SAFETY® VIZ™

120-4600	Silicone	Spandex	Slip-On	<input checked="" type="checkbox"/> Hi-Vis Orange / Black	S - XXL
----------	----------	---------	---------	---	---------

MAXIMUM SAFETY® BRICKYARD™

120-4900	Silicone	Neoprene / Nylon	Slip-On with Hook & Loop Close	<input type="checkbox"/> Black / Gray	S - XXL
----------	----------	------------------	--------------------------------	---------------------------------------	---------

FOR PROFESSIONALS & ENTHUSIASTS

MECHANIC'S GLOVES

WITH TOUCH SCREEN CAPABILITY



▲ 120-MX2805



▲ 120-MX2820



▲ 120-MX2830



▲ 120-MX2840

**MAXIMUM SAFETY®
MECHANIC'S GLOVES**

- Synthetic leather palm provides dexterity and a good grip in dry and slightly oily applications
- Protection from heat, cold, cut and abrasions
- Stretch fabric back provides snug fit for increased grip and finger control
- Reinforced index finger for added durability

APPLICATIONS: Protects the Professional Mechanic or Enthusiast From Heat, Cold, Cuts and Abrasions

MAXIMUM SAFETY® MECHANIC'S GLOVES

STYLE NUMBER	GRIP	BACK	CUFF	COLOR	SIZES
120-MX2805	Amara® Synthetic Leather	Elastane / Polyester	Slip-On with Hook & Loop Closure	□ Black	S - XXL
120-MX2820	Amara® Synthetic Leather	Elastane / Polyester	Slip-On with Hook & Loop Closure	■ Yellow / Black	S - XL
120-MX2830	Amara® Synthetic Leather	Elastane / Polyester	Slip-On with Hook & Loop Closure	■ Blue / Black	S - XL
120-MX2840	Amara® Synthetic Leather	Elastane / Polyester	Slip-On with Hook & Loop Closure	■ Red / Black	S - XL



PROTECTS FROM HEAT, COLD, CUTS & ABRASIONS

HIGH PERFORMANCE GLOVES

LIFTING & SHOCK ABSORBING



MAXIMUM SAFETY® 122-AV14

- Good durability
- Half-finger for increased dexterity and sensitivity
- Reinforced palm to help absorb and dampen shock
- Mesh back for breathability and additional comfort

APPLICATIONS: *Lifting, Material Handling*



MAXIMUM SAFETY® 122-AV70

- Good durability
- Half-finger for increased dexterity and sensitivity
- Reinforced palm to help absorb and dampen shock
- Terry cloth back for breathability

APPLICATIONS: *Lifting, Material Handling*



MAXIMUM SAFETY® 122-AV71

- Half-finger for increased dexterity and sensitivity
- Reinforced palm to help absorb and dampen shock
- Lycra® construction for increased comfort
- Can be used as a glove liner

APPLICATIONS: *Lifting, Material Handling*

ERGONOMIC LIFTING GLOVES



MAXIMUM SAFETY® 122-169

- Good comfort and durability
- Reinforced palm to help absorb and dampen shock
- Leather driver's style

APPLICATIONS: *Lifting, Material Handling*



ENHANCED WRIST SUPPORT

▲ 122-AV20

▲ 122-AV40

MAXIMUM SAFETY® ANTI-VIBRATION LIFTING GLOVES

- Good durability
- Features heavy duty leather palm and knuckles
- Half-finger for increased dexterity and sensitivity
- Reinforced palm to help absorb and dampen shock
- Wraparound wrists for added support

APPLICATIONS: *Lifting, Material Handling*

MAXIMUM SAFETY LIFTING GLOVES

STYLE NUMBER	GRIP	BACK	CUFF	COLOR	SIZES
122-AV14	Leather	Crocheted Cotton	Hook & Loop Closure	■ Black	S - XXL
122-AV70	Sheepskin Leather	Stretch Fabric	Hook & Loop Closure	■ Black / Gold	S - XXL
122-AV71	Goatskin Leather	Lycra®	Hook & Loop Closure	■ Black	S - XXL
122-169	Top Grain Cowhide Leather	Top Grain Cowhide Leather	Slip-On	■ Natural / Gray	XS - XXL

MAXIMUM SAFETY ANTI-VIBRATION LIFTING GLOVES

122-AV20	Heavy Duty Leather	Cotton	Hook & Loop Closure	■ Black	S - XXL
122-AV40	Heavy Duty Leather	Cotton	Hook & Loop Closure	■ Black / Gold	S - XXL

**MAXIMUM
SAFETY**

DESIGNED TO
REDUCE
FATIGUE

HIGH PERFORMANCE GLOVES

UTILITY

GLOVES FOR UTILITY

MAXIMUM SAFETY® UTILITY GLOVES

STYLE NUMBER	ANSI	EN 388	FLAME RESISTANT	GRIP	LINED	CUFF	COLOR	SIZES
73-1703	A3	3342	Yes	FR Synthetic Leather	Kevlar®	Slip-On	□ Black	S - XXXL
39-C1375	---	2243	No	Latex Crinkle	Unlined	Knit Wrist	□ Black	S - XL
120-4800	---	3121	No	Goatskin Leather with PVC Diamond Patches	Thinsulate	Knit Wrist	▣ Black / Brown	S - XXL

LEATHER UTILITY GLOVES

09-K3700	A2	2241	No	Top Grain Goatskin Leather	Kevlar®	Slip-On	▣ Brown	S - XXXL
73-2000	---	3122	Yes	FR Synthetic Leather	Unlined	Slip-On	▣ Gray	S - XXL
09-K3720	---	2344	No	Top Grain Goatskin Leather	Kevlar®	Slip-On	■ Natural	M - XL



ANSI
A3

MAXIMUM SAFETY® 73-1703

- Inherently FR Nomex® material used in construction of glove
- Kevlar® lined and stitched for light heat and cut protection
- Fourchettes between the fingers provide a better fit
- Double palm enhances comfort and protection
- Reinforced thumb joint provides added durability

APPLICATIONS: *Material Handling, Stamping, Grinding, Cut Resistance, Multitasking Where Welding Could Be Part of the Task*



MAXIMUM SAFETY® 39-C1375

- Seamless knit construction is comfortable and flexible
- Latex crinkle coating provides superior grip in dry and wet, non-oily conditions
- Ergonomic shaped finger pattern reduces hand fatigue
- Fabric back provides breathability and flexibility
- Launderable

APPLICATIONS: *Light Construction, Auto Repair, Manufacturing, Fabrication Landscaping*



WATERPROOF LINER

MAXIMUM SAFETY® 120-4800

- Provides high abrasion resistance and tactility
- 3M™ Thinsulate™ lining provides superior insulation without the bulk of fleece
- PVC diamond grip pattern on fingers and palm for enhanced grip
- Neoprene pad provides additional knuckle protection
- Breathable, waterproof liner keeps hands dry and comfortable
- Fourchettes between the fingers provide a better fit

APPLICATIONS: *Cold Weather Work, Petrochemical, Construction, Manufacturing, Mining, Fabrication*

MAXIMUM
SAFETY

ARC RATED GLOVES

ELECTRICAL



ELECTRICAL ARC RATED HAND PROTECTION

MAXIMUM SAFETY® ELECTRICAL ARC RATED GLOVES

STYLE NUMBER	ANSI	EN 388	EN 407	CAL/CM²	FLAME RESISTANT	GRIP	LINED	CUFF	COLOR	SIZES
09-K3750	A2	3342	---	28.5	Yes	Top Grain Goatskin Leather	Kevlar®	Slip-On	■ Natural	S - XXXL
73-K1800	A4	2542	41212	6.3	Yes	Nitrile Smooth	---	Knit Wrist	■ Yellow / Black	S - XXL
73-1700	---	2332	---	30	Yes	Goatskin Leather	Kevlar®	Slip-On	■ Black / Brown	S - XXL



MAXIMUM SAFETY® 09-K3750

- Arc rated with high cut protection
- Kevlar® lined for light heat and cut protection
- Provides high abrasion resistance
- Top grain goatskin leather is soft, abrasion resistant and provides tactility
- Straight thumb is ergonomic, providing better dexterity

APPLICATIONS: *Material Handling, General Maintenance, Woodworking, Recycling*



MAXIMUM SAFETY® 73-K1800

- Arc rated with high cut protection
- Seamless knit aramid liner is comfortable and flexible
- Nitrile coated palm and finger tips for enhanced grip

APPLICATIONS: *Oil and Gas Protection Against Arc and Flash Fires*



MAXIMUM SAFETY® 73-1700

- Arc rated
- Kevlar® lined for light heat and cut protection
- Mechanics drivers style glove
- Goatskin palm provides comfort
- Aramid fiber back for additional heat protection
- Wing thumb increases comfort in open-handed work

APPLICATIONS: *Oil and Gas Protection Against Arc and Flash Fires*

COLD PROTECTION GLOVES

LATEX COATED SEAMLESS KNIT

KEEP YOUR HANDS WARM & DRY

MINI HAND WARMERS



▲ 399-HEATPACK

- Ideal size for our headwear and gloves
- Generates over 8 hours of warmth
- Heating can be suspended at any time by resealing the inserts in an airtight container



REMOVE FROM PACKAGE TO ACTIVATE



STARTS WORKING IN MINUTES



PROVIDES 8+ HOURS OF WARMTH

HEAT PACKS MINI HAND WARMERS

STYLE NUMBER	QUANTITY
399-HEATPACK	40 pair/box



▶ POWERGRAB™ THERMO

- Latex MicroFinish® coating provides a superior grip in dry and wet, non-oily conditions
- Moisture wicking material to keep hands dry
- Fully coated thumb increases protection
- Stays flexible in cold weather

APPLICATIONS: Refrigerated Warehouses, Food Processing Facilities, Utilities, Construction, Outdoor Winter Tasks



▲ 41-1400

▲ 41-1405

▲ 41-1475

▲ 41-1430

ENHANCED PROTECTION

DOUBLE LINER

POWERGRAB™ THERMO

STYLE NUMBER	EN 388	COATING	COATING COVERAGE	COATING COLOR	LINER MATERIAL	LINER COLOR	CONSTRUCTION	GAUGE	SIZES
41-1400	2231	Latex MicroFinish®	Palm & Fingertips	☐ Brown	Acrylic	■ Orange	Coated Seamless Knit	10	S - XXL
41-1405	1231	Latex MicroFinish®	Palm & Fingertips	☐ Brown	Acrylic	■ Lime	Coated Seamless Knit	10	S - XXL
41-1475	2121	Latex MicroFinish®	Palm, Full Finger & Knuckle	☐ Brown	Acrylic	■ Orange	Coated Seamless Knit	10	S - XXL
41-1430	3231	Latex MicroFinish®	Palm & Fingertips	☐ Brown	Acrylic/Nylon	☐ Black	Coated Seamless Knit	10	S - XXL

COLD PROTECTION GLOVES

COATED SEAMLESS KNIT



EN 388
4432



LATEX
FOAM CRINKLE
COATING



41-1420

- Latex foam crinkle coating provides a superior grip in dry and wet, non-oily conditions
- Moisture wicking material to keep hands dry
- Hi-Vis color for better visibility
- Stays flexible in cold weather

APPLICATIONS: Refrigerated Warehouses, Food Processing Facilities, Utilities, Construction, Outdoor Winter Tasks



EN 388
2342



ANSI
A3

LATEX
MICROFINISH®
COATING



POWERGRAB™ KEV THERMO 09-K1350

- Excellent grip in dry and slightly wet, non-oily conditions
- Fully coated thumb to increase wear
- Acrylic blended Kevlar® shell to provide warmth in cold environments

APPLICATIONS: Ceramics, Glass Cutting, Metal Handling, General Maintenance, Cold Protection

CUT RESISTANT

EXCELLENT INSULATION



EN 388
4432



NITRILE FOAM
COATING



41-1415

- Nitrile foam coating provides superior grip in dry, wet and oily applications
- Hi-Vis color for better visibility
- Quickly evaporates moisture from the skin

APPLICATIONS: General Maintenance, Cold Protection

DOUBLE-DIPPED



EN 388
3132



LATEX
FOAM CRINKLE
COATING



G-TEK® GP™ 41-1425

- Latex crinkle coating provides superior grip in wet and dry conditions
- Hi-Vis color makes product very easy to see
- Acrylic gloves provide economical cold weather protection

APPLICATIONS: General Maintenance, Cold Protection

ALSO CHECK OUT OUR COLD PROTECTION GLOVE STYLES BY MAXIMUM SAFETY®



MAXIMUM
SAFETY



PAGE
110

Thinsulate
INSULATION
Mad Max™ Thermo
with Thinsulate™
120-4070

PAGE
117

Thinsulate
INSULATION
Insulated Professional
Workmans' Glove
120-4800

SEAMLESS KNIT COATED

STYLE NUMBER	EN 388	ANSI	COATING	COATING COVERAGE	COATING COLOR	LINER MATERIAL	LINER COLOR	CONSTRUCTION	GAUGE	SIZES
41-1420	1221	---	Latex MicroFinish®	Palm & Fingertips	<input type="checkbox"/> Black	Acrylic	<input checked="" type="checkbox"/> Lime	Coated Seamless Knit	10	S - XL
09-K1350	2342	A3	Latex MicroFinish®	Palm & Fingertips	<input checked="" type="checkbox"/> Brown	DuPont™ Kevlar® / Acrylic	<input checked="" type="checkbox"/> Yellow	Coated Seamless Knit	10	S - XXL
41-1415	4432	---	Nitrile Foam	Palm, Full Finger & Knuckle	<input checked="" type="checkbox"/> Black / Blue	Polyester / Acrylic	<input checked="" type="checkbox"/> Hi-Vis Yellow	Coated Seamless Knit	10	S - XL
41-1425	3132	---	Latex Crinkle	Palm & Fingertips	<input type="checkbox"/> Black	Acrylic	<input checked="" type="checkbox"/> Hi-Vis Yellow	Coated Seamless Knit	10	S - XXL

COLD PROTECTION GLOVES

SEAMLESS KNIT GLOVES & LINERS / PVC COATED



4121

58-8650

- Special PVC blend that stays soft and flexible in cold applications
- Rough finish provides good grip in wet and dry applications
- Gauntlet cuff for additional forearm protection

APPLICATIONS: *Cold Environments, Fishing, Maintenance*



58-7313

- Foam insulation keeps hands warm and dry
- Liquid-proof
- Crystal grip provides excellent grip in wet applications
- Hi-Vis color for better visibility

APPLICATIONS: *Cold Environments, Handling Grease, Oils, Acids, Caustics, Solvents, Warehousing, Highway Construction, Traffic Control*



41-130

- Merino® Wool provides superior insulating properties even when wet, and withstands moderately high temperatures
- Great liner for use with Novax® electrical gloves
- Ambidextrous

APPLICATIONS: *Refrigeration, Utilities, Outdoor Winter Activities and Recreation, Food Processing, Construction*



GREAT LINER FOR NOVAX® ELECTRICAL GLOVES

41-001W

- Thermax® helps keep moisture away from the hands, keeping hands warm, dry and comfortable
- Can be used as a glove or as a glove liner in cold weather
- Extra softness for non-chafing comfort
- Ambidextrous

APPLICATIONS: *Refrigeration, Utilities, Outdoor Winter Activities and Recreation, Food Processing, Construction*



PVC GLOVES FOR COLD & WET CONDITIONS

SEAMLESS KNIT GLOVES AND LINERS

STYLE NUMBER	MATERIAL	COLOR	GAUGE	WEIGHT	SIZES
41-005	Polypropylene	Dark Blue	13	Light	XS - XL
41-070	75% Wool, 25% Nylon	Natural	7	Medium	L
41-075	75% Wool, 25% Nylon, Half-Finger	Natural	7	Medium	L
41-010	100% Acrylic	Natural	7	Medium	XS, S, L
41-013	100% Acrylic	Orange	7	Medium	XS, S, L
41-011	100% Acrylic	Black	7	Medium	S - XL
41-001	Thermax®	Black	13	Light	M - L
41-001NB	Thermax®	Navy Blue	13	Light	L
41-001W	Thermax®	White	13	Light	L
41-002	Thermal Yarn / Lycra®	White	13	Light	L
41-130	Merino Wool	Black	13	Light	L

PVC

STYLE NUMBER	EN 388	POLYMER	COLOR	CUFF	LENGTH	CONSTRUCTION	GRIP	LINING	SIZES
58-7303	---	PVC	Hi-Vis Orange	Knit Wrist	11"	Supported	Smooth	Foam	Men's
58-7304	---	PVC	Hi-Vis Orange	Straight	12"	Supported	Smooth	Foam	Men's
58-7305	---	PVC	Hi-Vis Orange	Safety	11"	Supported	Smooth	Foam	Men's
58-7313	---	PVC	Hi-Vis Orange	Knit Wrist	11"	Supported	Crystal	Foam	Men's
58-7315	---	PVC	Hi-Vis Orange	Safety	11"	Supported	Crystal	Foam	Men's

SPECIALTY PVC BLENDS

58-8650	4121	PVC	Brown	Straight	10"	Supported	Rough	Interlock	S - XL
58-8651	4121	PVC	Brown	Straight	12"	Supported	Rough	Interlock	S - XL

COLD PROTECTION GLOVES

INSULATED LEATHER

INSULATED LEATHER

TOP GRAIN COWHIDE LEATHER DRIVERS

STYLE NUMBER	HIDE	GRADE	INSULATION	PATTERN	THUMB	BACK	COLOR	CUFF	SIZE
77-218	Cowhide	Premium	White Thermal	---	Straight	---	---	Slip-On	S - XL
77-265	Cowhide	Premium	White Thermal	---	Keystone	---	---	Slip-On	S - XL
77-268	Cowhide	Premium	Red Thermal	---	Keystone	---	---	Slip-On	S - XL
77-208	Cowhide	Premium	Red Foam	---	Straight	---	---	Slip-On	S - XXL
77-269	Cowhide	Premium	3M™ Thinsulate™	---	Keystone	---	---	Slip-On	S - XL
77-298	Cowhide	Premium	Fleece Pile	---	Keystone	---	---	Slip-On	S - XXL

TOP GRAIN PIGSKIN LEATHER DRIVERS

77-418	Pigskin	Premium	White Thermal	---	Straight	---	---	Slip-On	S - XL
77-468	Pigskin	Premium	Red Thermal	---	Keystone	---	---	Slip-On	S - XL
77-469	Pigskin	Premium	3M™ Thinsulate™	---	Keystone	---	---	Slip-On	S - XL

SPLIT COWHIDE LEATHER DRIVERS

77-238	Cowhide	Regular	White Thermal	---	Straight	---	---	Slip-On	S - XL
77-289TL	Cowhide	Regular	3M™ Thinsulate™	---	Keystone	---	---	Slip-On	S - XXL
77-289	Cowhide	Regular	Fleece Pile	---	Keystone	---	---	Slip-On	S - XXL

SPLIT COWHIDE LEATHER PALM

78-7863B	Cowhide	Regular	Fleece Pile	Gunn	Wing	Canvas	Blue / Yellow	Safety, Rubberized	L - XL
78-7825	Cowhide	Regular	Red Foam	Gunn	Wing	Canvas	Gray / Red	Safety, Rubberized	L - XL

TOP GRAIN PIGSKIN LEATHER PALM

78-3927	Pigskin	Premium	3M™ Thinsulate™	Gunn	Straight	Canvas	Blue / Green	Safety, Rubberized	M - XL
78-3927KW	Pigskin	Premium	3M™ Thinsulate™	Gunn	Straight	Canvas	Blue / Green	Knit Wrist	M - XL

TYPES OF LINING

WHITE THERMAL

BASIC INSULATION

RED THERMAL

DENSER, HEAVIER FABRIC FOR BETTER INSULATION

RED FOAM

ENHANCED INSULATION & MOISTURE PROTECTION

FLEECE PILE

EXTRA THICK FOR SUPERIOR WARMTH

3M™ THINSULATE™

SUPERIOR WARMTH WITHOUT BULK



WHITE THERMAL LINING



77-218

- White thermal liner provides insulation
- Straight thumb increases comfort in close-fisted work

APPLICATIONS: Cold Storage, Construction, Farming



3M™ THINSULATE™ LINING



77-469

- 3M™ Thinsulate™ liner for superior warmth without the bulk
- Keystone thumb is ergonomic, providing better dexterity
- Breathable for added comfort

APPLICATIONS: Cold Storage, Construction, Farming



FLEECE PILE LINING



78-7863B

- Fleece pile lining provides superior warmth
- Fabric back provides breathability and flexibility
- Rubberized safety cuff for easy donning and doffing, and water resistance

APPLICATIONS: Cold Weather Farming, Construction, Machine Operation and Refrigeration

HANDLE THE HEAT



◀ RED VIPER™ 73-7015

- One piece back for extended life
- Fully welted to protect seams from abrasions
- Wing thumb increases comfort in open-handed work
- Reinforced thumb joint for additional wear protection

APPLICATIONS: *Welding and Hot, Heavy Material Handling*



◀ BLUE BISON™ 73-7250

- One piece back for extended life
- Fully welted
- Cotton foam lining provides additional heat protection while absorbing moisture
- Double reinforced palm and thumb for increased durability and protection
- Kevlar® stitched for strength and burn resistance

APPLICATIONS: *Welding and Hot, Heavy Material Handling*

WELDING GLOVES

STYLE NUMBER	HIDE	GRADE	STITCHING	COLOR	LINING	CUFF	REINFORCED THUMB JOINT	SIZES
73-888A	Split Cowhide	Economy	Nylon	■ Gray	Cotton	Straight	No	L
73-888	Split Cowhide	Shoulder	Nylon	■ Gray	Cotton	Straight	No	L
73-888LHO	Split Cowhide	Shoulder	Nylon	■ Gray	Cotton	Straight	No	L (Left Hand)
73-888RHO	Split Cowhide	Shoulder	Nylon	■ Gray	Cotton	Straight	No	L (Right Hand)
73-7088	Split Cowhide	Shoulder	Nylon	■ Golden Brown	Cotton	Straight	No	L
73-7015A	Split Cowhide	Shoulder	Nylon	■ Russet	Cotton	Straight	No	L
73-7018	Split Cowhide	Shoulder	Kevlar®	■ Blue	Cotton Foam	Straight	Yes	L
73-7085	Split Cowhide	Shoulder	Kevlar®	■ Brown	Cotton Foam	Straight	Yes	L
73-7007	Split Cowhide	Select Shoulder	Kevlar®	■ Blue	Cotton	Straight	Yes	L
73-7007LHO	Split Cowhide	Select Shoulder	Kevlar®	■ Blue	Cotton	Straight	Yes	L (Left Hand)
73-7007RHO	Split Cowhide	Select Shoulder	Kevlar®	■ Blue	Cotton	Straight	Yes	L (Right Hand)
73-7015	Split Cowhide	Select Shoulder	Kevlar®	■ Russet	Cotton	Straight	Yes	L
73-7080	Split Cowhide	Side Split	Kevlar®	■ Blue	Cotton Foam	Straight	Yes	L
73-7150	Split Cowhide	Side Split	Kevlar®	■ Brown	Cotton Foam	Straight	Yes	L
73-7250	Split Cowhide	Side Split	Kevlar®	■ Blue	Cotton Foam	Straight	Yes	L

HEAT PROTECTION GLOVES

LEATHER WELDING & FOUNDRY

MIG TIG WELDING & FOUNDRIES



AVAILABLE IN LHO & RHO

75-320

- Unlined palm provides dexterity
- Kevlar® stitched for strength and burn resistance
- Split leather gauntlet cuff provides additional forearm protection
- Straight thumb increases comfort in close-fisted work

APPLICATIONS: Mig Tig, Welding, Metal Fabrication, Automotive



KEVLAR® STITCHING

74-SC7104

- Heavier construction for increased durability
- Leather gauntlet cuff provides additional forearm protection
- Thick wool lining for thermal insulation
- Straight thumb increases comfort in close-fisted work

APPLICATIONS: Foundries and Hot Metal Handling

MIG TIG WELDER'S GLOVES

STYLE NUMBER	HIDE	GRADE	STITCHING	COLOR	LINING	CUFF	SIZES
75-2022	Top Grain Cowhide	Premium	Kevlar®	■ Natural	Unlined	Split Leather Band Top	M - XL
75-2026	Top Grain Cowhide	Premium	Kevlar®	■ Natural	Unlined	Leather Gauntlet	M - XL
75-320	Top Grain Pigskin	Premium	Kevlar®	■ Natural	Unlined	Split Leather Gauntlet	S - XL
75-320/LHO	Top Grain Pigskin	Premium	Kevlar®	■ Natural	Unlined	Split Leather Gauntlet	M - XL (Left Hand)
75-320/RHO	Top Grain Pigskin	Premium	Kevlar®	■ Natural	Unlined	Split Leather Gauntlet	M - XL (Right Hand)
75-4904	Top Grain Goatskin	Premium	Kevlar®	■ Gray	Unlined	Goatskin Band Top Cuff	S - XL
75-4854	Top Grain Goatskin	Premium	Kevlar®	■ Gray / Blue	Unlined	Blue Cowhide Split Gauntlet	XS - XL

FOUNDRY GLOVES

74-SC7104	Split Cowhide	Premium	Kevlar®	■ Gray	Wool	Split Leather Gauntlet Cuff	L
-----------	---------------	---------	---------	--------	------	-----------------------------	---

TERRYCLOTH LOOP-OUT DESIGN



94-928G

- Multi-layer construction provides comfort, insulation, and superior heat protection
- Burlap lining creates an air pocket providing increased heat protection
- Knuckle strap for enhanced protection
- Gauntlet cuff for additional forearm protection

APPLICATIONS: *Forging, Hot Metal Handling, Castings, Molds and other operations that require heat protection*



42-C700

- Seamless construction offers increased comfort and breathability
- Provides comfortable resistance to cuts, abrasions and heat
- Loop out design helps protect against intermittent contact with hot surfaces
- Ambidextrous pattern

APPLICATIONS: *Operations that require heat and abrasion protection*



42-853

- Seamless construction offers increased comfort and breathability
- Provides comfortable resistance to cuts, abrasions and heat
- Loop out design helps protect against intermittent contact with hot surfaces
- 13" length provides additional forearm protection
- Double-insulated for excellent thermal protection

APPLICATIONS: *Food Service, Bakeries*

FABRIC HOT MILL GLOVES

STYLE NUMBER	WEIGHT	COLOR	LAYERS	CUFF	BURLAP	SIZES
94-924	24 oz.	■ Natural	Two	Band Top	No	Men's
94-924I	24 oz.	■ Natural	Two	Band Top	No	Men's
94-924R	24 oz.	■ Natural	Two	Band Top	No	Men's
94-924G	24 oz.	■ Natural	Two	Starched Gauntlet	No	Men's
94-928	28 oz.	■ Natural	Three	Band Top	Yes	Men's
94-928I	28 oz.	■ Natural	Three	Band Top	Yes	Men's
94-928G	28 oz.	■ Natural	Three	Starched Gauntlet	Yes	Men's
94-930	30 oz.	■ Natural	Three	Band Top	No	Men's
94-932	32 oz.	■ Natural	Three	Band Top	Yes	Men's
94-932G	32 oz.	■ Natural	Three	Starched Gauntlet	Yes	Men's
94-934	34 oz.	■ Natural / ■ Denim	Three	Band Top	No	Men's

TERRYCLOTH GLOVES

STYLE NUMBER	WEIGHT	COLOR	CUFF	SIZES
42-C700	24 oz.	■ Natural	Knit Wrist	S & L
42-C750	24 oz.	■ Gray	Knit Wrist	L
42-C713	18 oz.	■ Natural	Knit Wrist	S & L
42-C753	18 oz.	■ Gray	Knit Wrist	S & L
42-C920	32 oz.	■ Brown	Gauntlet Cuff	L

TERRYCLOTH SLEEVES

42-215	Heavy Weight	■ Natural	Knit Wrist	15"
42-329	Heavy Weight	■ Natural	Open	19"

TERRYCLOTH BAKERS PADS & MITTS

42-811	Heavy Weight, 2-Ply	■ Natural	Pad	10" x 11"
42-857	Heavy Weight, 2-Ply	■ Natural	Gauntlet Cuff	L
42-853	Heavy Weight, 2-Ply	■ Natural	Gauntlet Cuff	L

PROTECTS FROM INTERMITTENT CONTACT WITH HOT SURFACES

HEAT PROTECTION GLOVES

COATED FABRIC HOT MILL

HOT MILL SEAMLESS KNITS



▲ 43-500



▲ 43-502

▶ HOT MILL GLOVES

- EverGrip™ nitrile coating resists melting while providing improved grip
- Double-layered for increased heat protection
- Ambidextrous

APPLICATIONS: *Glass Handling, Hot Metal Handling, Forging Operations*



▲ 43-858



▶ 43-851

- Kevlar® / Preox blend provides cut, abrasion and heat protection
- Flame resistant
- Silagrip coating for enhanced grip and resists melting
- Ambidextrous
- Meets CFR 1910.269 standards
- Complies with NFPA 70E standards

APPLICATIONS: *Glass Handling, Hot Metal Handling, Forging Operations*

HOT MILL KNIT GLOVES

STYLE NUMBER	COATING	COATING COVERAGE	COATING COLOR	LINER MATERIAL	LINER COLOR	CONSTRUCTION	CUFF	WEIGHT	SIZES
43-502	EverGrip™ Nitrile	Single-Sided	■ Rust	100% Cotton	■ Natural	Coated Double-Layered Seamless Knit	Open	24 oz.	S, L
43-500	Uncoated	Uncoated	Uncoated	100% Cotton	■ Natural	Coated Double-Layered Seamless Knit	Open	24 oz.	S, L
43-802	EverGrip™ Nitrile	Single-Sided	■ Rust	100% Cotton	■ Natural	Coated Double-Layered Seamless Knit	Open	32 oz.	S, L
43-552	EverGrip™ Nitrile	Single-Sided	■ Rust	Kevlar® / Cotton Blend	■ Yellow	Coated Double-Layered Seamless Knit	Open	24 oz.	S, L
38-720	EverGrip™ Nitrile	Double-Sided	■ Rust	Cotton / Polyester	■ Natural	Coated Seamless Knit	Knit Wrist	Heavy	S, L
43-850	Uncoated	Uncoated	Uncoated	Kevlar® / Preox Blend, Terry Cotton Lined	■ Green	Coated Double-Layered Seamless Knit	Open	32 oz.	L
43-851	Silagrip	Double-Sided	□ Black	Kevlar® / Preox Blend, Terry Cotton Lined	■ Green	Coated Double-Layered Seamless Knit	Open	32 oz.	L
43-858	Uncoated	Uncoated	Uncoated	Kevlar® / Preox Blend, Terry Cotton Lined	■ Green	Coated Double-Layered Seamless Knit	Open	32 oz.	S, L, XL
43-859	Silagrip	Double-Sided	□ Black	Kevlar® / Preox Blend, Terry Cotton Lined	■ Green	Coated Double-Layered Seamless Knit	Open	32 oz.	L

FIREFIGHTING GLOVES



SMOKESCREEN™
910-P735

- Superior protection and thermal resistance
- Palm provides good grip with abrasion resistance, and remains soft after repeated use and laundering
- Rounded fingertips
- Formed knuckle guard for flexibility, grip and less hand fatigue
- Heavy duty ½" elastic zigzag around the entire glove at wrist

APPLICATIONS: *Structural Firefighting*



SMOKESHOW™
910-P775

- Superior protection and thermal resistance
- Palm provides good grip with abrasion resistance, and remains soft after repeated use and laundering
- Rounded fingertips
- Kangaroo knuckles and fourchettes on all sides of each finger & thumb
- Formed knuckle guard for flexibility, grip and less hand fatigue
- Heavy duty ½" elastic zigzag around the entire glove at wrist

APPLICATIONS: *Structural Firefighting*

STRUCTURAL FIREFIGHTING GLOVES

STYLE NUMBER	NFPA 1971	BACK	PALM	INSIDE	OUTSIDE	INSERT	STITCHING	COLOR	SIZES
910-P735	Yes	Elk Skin	Split Cowhide	100% Kanecaron Fleece	50% Kanecaron 50% Cotton Scrim	PYROTECT®	Kevlar®	☑ Gold / Black	S - XL
910-P775	Yes	Elk Skin	Eversoft Split Cowhide	35% Kevlar® / 65% Nomex®	---	PYRO-PRO™	Kevlar®	☐ Black	S - XL

SUPERIOR PROTECTION & THERMAL RESISTANCE

EMERGENCY RESPONDER GLOVES

EXTRICATION & RESCUE

EXTRICATION GLOVES

MELT-RESISTANT FINGERTIPS



AUTO X™

- Fingertips won't melt and will withstand contact with hot materials up to 212°F (100°C)
- Puncture-resistant palm pads
- Kevlar® stitching
- Abrasion-resistant fingers/knuckles
- Maintains grip when wet and does not harden after drying

APPLICATIONS: *Emergency Rescue Situations Requiring Cut Protection, Heat Resistance and Close-Range Dexterity*



AUTO X™ PLUS 911-AX9P

- Includes a breathable vapor barrier, making the gloves bloodborne pathogen resistant

APPLICATIONS: *Emergency Rescue Situations Requiring Cut Protection, Heat Resistance and Close-Range Dexterity*

AUTO X™ EXTRICATION GLOVE

STYLE NUMBER	PALM	BARRIER	COLOR	SIZES
911-AX9	Polyurethane & Synthetic	None	Orange / Black	S - XL

AUTO X™ PLUS EXTRICATION GLOVE

911-AX9P	Polyurethane & Synthetic	PTFE Breathable Vapor Barrier	Orange / Black	S - XL
----------	--------------------------	-------------------------------	----------------	--------

SERVE & PROTECT



▲ 130-600WM



▲ 130-650BM

100% STRETCH NYLON DRESS GLOVE

- Constructed in full fashion pattern with fourchettes and set-in thumbs for a tailored fit
- Three lines of raised stitching on back

APPLICATIONS: For Formal Occasions by Police, Firemen, Waiters, Marching Bands, Military, Pallbearers

CABARET™ - 100% STRETCH NYLON DRESS GLOVE

STYLE NUMBER	COLOR	CUFF STYLE	SIZES
130-600WM	■ White	Open Cuff	Men's
130-600WL	■ White	Open Cuff	Ladies'
130-650WM	■ White	Snap Closure	Men's
130-650WL	■ White	Snap Closure	Ladies'
130-650BM	□ Black	Snap Closure	Men's

PARADE & UNIFORM GLOVES

COTTON DRESS

100% COTTON - THAT EXTRA TOUCH



▲ 130-100WM



▲ 130-100GM



DOTTED PALM

▲ 130-100WMPD

CABARET™ - 100% COTTON DRESS GLOVE

STYLE NUMBER	COLOR	CUFF STYLE	PALM	RAISED STITCHING	SIZES
130-100WM	■ White	Open Cuff	Standard	With	S - XL
130-100GM	□ Gray	Open Cuff	Standard	With	Men's
130-150WM	■ White	Snap Closure	Standard	With	S - XL
130-100WMPD	■ White	Open Cuff	Plastic Dotted	With	S - XL
130-100WMNZ	■ White	Open Cuff	Standard	Without	XS - XL

MEDIUM WEIGHT TWO-PIECE AMBIDEXTROUS COTTON GLOVE

STYLE NUMBER	COLOR	HEM STYLE	SIZES
97-520R	■ White	Rolled	Men's
97-520H	■ White	Overlock Stitched	Men's
97-520	■ White	Unhemmed	Men's
97-521	■ White	Unhemmed	Ladies'

FUNDAMENTALS OF **ARM PROTECTION**

WHEN WEARING CUT RESISTANT GLOVES, ALSO CONSIDER ARM PROTECTION TO EXTEND YOUR SAFETY COVERAGE AND PROTECT AGAINST OTHER POTENTIAL INJURIES. WHETHER YOU HANDLE LARGE AND/OR SHARP OBJECTS, ARE EXPOSED TO SPARKS, OR JUST NEED TO HAVE YOUR FOREARMS COVERED, PROTECTIVE SLEEVES CAN PROVIDE VARIOUS SOLUTIONS TO MEET YOUR SAFETY NEEDS.

APPLICATIONS

The most common application need for arm protection is **cut resistance**. In addition to **cut protection**, you can also achieve options that provide:

- **Maximum comfort**
- **Heat protection**
- **Food handling Capabilities**
- **Arc-rated protection**

Several customizable options are also available to help maximize protection by ensuring the sleeve stays in place as consistently as possible.

- Options such as **thumb holes** or **thumb slots** can help hold the sleeve up to the heel of your hand.
- Options can also help hold the sleeve up on your arm, such as **elastic bands** or **hook and loop closures**.

PRODUCTION

PIP manufactures sleeves in our facilities in Bluffton, IN and Chaska, MN, and we take pride in providing what we consider to be the most comprehensive offering of arm protection. And, because we manufacture these great products domestically, we have the ability to **custom make sleeves** for your particular application. See Page 146 for more details.

- 132** SMART-FIT™ TECHNOLOGY SLEEVES
- 134** FORM-FIT SEAMLESS KNIT SLEEVES
- 141** DUO-PRO™
- 142** LOOSE FITTING SLEEVES
- 144** SPECIALTY APPLICATIONS SLEEVES
- 146** CUSTOM SLEEVES

ARM PROTECTION

SMART FIT™ TECHNOLOGY SLEEVES

ONE-SIZE-FITS-ALL COMFORT



QUICK TUG
ADJUSTING KNIT

SMART-FIT™ ONE-SIZE-FITS-ALL

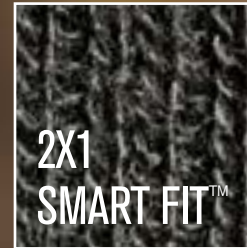

2x1 KNIT SMART FIT™ SLEEVE

A one size fits all technology. Smart Fit™ technology provides workers of all arm sizes to wear the same size sleeve and enjoy comfortable, form-fitting all-day protection.



STRETCH TO FIT ANY SIZE

Whether large or small, Smart Fit™ is designed to cover and protect the most commonly exposed areas of a worker's arm. Worn on a bare arm, or over layers, a single sleeve is right for most jobs.

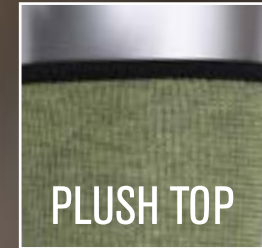

PLUSH TOP OPTION

Only Smart Fit™ sleeves are available with a plush top cuff option that comfortably and securely fits without the need to fasten or adjust.



SMART FIT™ TECHNOLOGY SLEEVES

ONE-SIZE-FITS-ALL COMFORT



ANSI
A4

KUT GARD® SMART FIT™ TECHNOLOGY
10-21KVACPMBK18-ET

ANSI
A4

KUT GARD® SMART FIT™ TECHNOLOGY
15-21KVBK18TH

ANSI
A4

KUT GARD® SMART FIT™ TECHNOLOGY
15-21KVBK18

ANSI
A3

KUT GARD® SMART FIT™ TECHNOLOGY
10-21HACPNY18-ET

ANSI
A3

KUT GARD® SMART FIT™ TECHNOLOGY
20-21DACP18-ET

ANSI
A2

KUT GARD® SMART FIT™ TECHNOLOGY
15-21PRIBPS18-ET

ACP™ WITH ARAMID ENGINEERED YARNS
CUT AND HEAT RESISTANT

ACP™ WITH HPPE ENGINEERED YARNS
CUT & COOLER COMFORT

PRITEX™ YARNS WITH ANTIMICROBIAL
LIGHT ABRASION RISK -
COOLER COMFORT SLEEVE

KUT GARD® SMART FIT™ TECHNOLOGY

STYLE NUMBER	ASTM	MATERIAL	CONSTRUCTION	PLY	TOP CUFF	BOTTOM CUFF	COLOR	STANDARD LENGTH
10-21KVACPMBK18-ET	A4	ACP™ / Kevlar® Blend	Smart Fit™ Seamless Knit	1	Serged	Thumb Elastic	Yellow / Black	18"
15-21KVBK18TH	A4	ACP™ / Kevlar® / Pritex™ Blend	Smart Fit™ Seamless Knit	1	Serged	Thumb Hole	Yellow / Black	18"
15-21KVBK18	A4	ACP™ / Kevlar® / Pritex™ Blend	Smart Fit™ Seamless Knit	1	Serged	Straight	Yellow / Black	18"
10-21HACPNY18-ET	A3	ACP™ / Kevlar® Blend	Smart Fit™ Seamless Knit	1	Serged	Thumb Elastic	Neon Yellow	18"
10-21KVACPM18-ET	A5	ACP™ / Kevlar® Blend	Smart Fit™ Seamless Knit	1	Serged	Thumb Elastic	Yellow / Black	18"
10-21KVHACP18TH	A3	ACP™ / Kevlar® Blend	Smart Fit™ Seamless Knit	1	Serged	Thumb Hole	Yellow	18"
10-21ACPCB18TH	A3	ACP™ / Kevlar® with Cotton	Smart Fit™ Seamless Knit	1	Serged	Thumb Hole	Green	18"
20-21DACP18-ET	A3	ACP™ / Dyneema® Blend	Smart Fit™ Seamless Knit	1	Serged	Thumb Elastic	Gray	18"
15-21PRIBPS18-ET	A2	Pritex™	Smart Fit™ Seamless Knit	1	Serged	Thumb Elastic	Black	18"
15-21PRIWPS18-ET	A2	Pritex™	Smart Fit™ Seamless Knit	1	Serged	Thumb Elastic	White	18"

Replace standard 18" length with any custom length from 10" - 24"

FORM-FIT SEAMLESS KNIT SLEEVES

SECURE CLOSE-TO-SKIN COMFORT



CUT RESISTANT
HEAT & SPARK PROPERTIES

2X THE CUT PROTECTION



10-KA24SCTOT

- Excellent cut protection
- Light heat protection
- 2-ply for additional wear protection

APPLICATIONS: Sheet Metal and Stamping, Glass Handling, Assembly, Plastic Molding, Automotive



ACP™ Technology offers an increase in overall performance and value, compared to traditional Para-Aramid products. ACP™ provides excellent abrasion and cut resistance for lower cost per use. ACP™ Technology sleeves are 100% silicone free.

KUT GARD® ACP™ TECHNOLOGY & DUPONT™ KEVLAR®

STYLE NUMBER	ASTM	MATERIAL	CONSTRUCTION	PLY	COLOR	STANDARD LENGTH
10-KA18	A5	ACP™ / Kevlar® Blend	Seamless Knit	2	Green	18"
10-KA18CL	A5	ACP™ / Kevlar® Blend	Seamless Knit, with Cotton Liner	2	Green	18"
10-KA18KL	A5	ACP™ / Kevlar® Blend	Seamless Knit, with DuPont™ Kevlar® Liner	2	Green	18"
10-KA24SCTOT	A4	ACP™ / Kevlar® Blend	Seamless Knit	2	Green	24"
10-KANY18	A5	ACP™ / Kevlar® Blend	Seamless Knit	2	Neon Yellow	18"
10-KANY18CL	A5	ACP™ / Kevlar® Blend	Seamless Knit, with Cotton Liner	2	Neon Yellow	18"
10-KANY18KL	A5	ACP™ / Kevlar® Blend	Seamless Knit, with DuPont™ Kevlar® Liner	2	Neon Yellow	18"
10-KANO18	A5	ACP™ / Kevlar® Blend	Seamless Knit	2	Neon Orange	18"
10-KANO18CL	A5	ACP™ / Kevlar® Blend	Seamless Knit, with Cotton Liner	2	Neon Orange	18"
10-KANO18KL	A5	ACP™ / Kevlar® Blend	Seamless Knit, with DuPont™ Kevlar® Liner	2	Neon Orange	18"
10-KANP18	A5	ACP™ / Kevlar® Blend	Seamless Knit	2	Neon Pink	18"
10-KANP18CL	A5	ACP™ / Kevlar® Blend	Seamless Knit, with Cotton Liner	2	Neon Pink	18"
10-KANP18KL	A5	ACP™ / Kevlar® Blend	Seamless Knit, with DuPont™ Kevlar® Liner	2	Neon Pink	18"
10-KA18S	A3	ACP™ / Kevlar® Blend	Seamless Knit	1	Green	18"
10-KANY18S	A3	ACP™ / Kevlar® Blend	Seamless Knit	1	Neon Yellow	18"
10-KANO18S	A3	ACP™ / Kevlar® Blend	Seamless Knit	1	Neon Orange	18"
10-KANP18S	A3	ACP™ / Kevlar® Blend	Seamless Knit	1	Neon Pink	18"

Replace standard 18" length with any custom length from 10" - 24"

FORM-FIT SEAMLESS KNIT SLEEVES

SECURE CLOSE-TO-SKIN COMFORT



CUT & HEAT RESISTANCE
FOR MAXIMUM PROTECTION

FORM-FIT SEAMLESS KNIT SLEEVES

SECURE CLOSE-TO-SKIN COMFORT



TRUSTED & PROVEN MAXIMUM CUT RESISTANCE



**KUT GARD®
MADE WITH KEVLAR®
10-KS18**

- High cut protection
- Light heat protection
- 2-ply for additional wear protection

APPLICATIONS: *Glass Operations,
Metal Stamping, Sheet Metal,
Automotive, Construction*



**KUT GARD®
MADE WITH KEVLAR®
10-BKDS18**

- High cut protection
- Light heat protection
- Dark color hides dirt
- 2-ply for additional wear protection

APPLICATIONS: *Glass Operations,
Metal Stamping, Sheet Metal,
Automotive, Construction*



Sleeves with DuPont™ Kevlar® provide excellent cut protection and protection from light heat for the wrists and arms. Available in single-ply or double-ply for added protection. Cotton inner ply styles offers added comfort. MTO options available for all sleeves in any length.

KUT GARD® MADE WITH KEVLAR®

STYLE NUMBER	ASTM	MATERIAL	CONSTRUCTION	PLY	COLOR	STANDARD LENGTH
10-KS18	A3	DuPont™ Kevlar®	Seamless Knit	2	■ Yellow	18"
10-KS18CL	A3	DuPont™ Kevlar®	Seamless Knit, 1-Ply Cotton Liner	2	■ Yellow	18"
10-BKDS18	A3	DuPont™ Kevlar®	Seamless Knit	2	□ Black	18"
10-KS18S	A2	DuPont™ Kevlar®	Seamless Knit	1	■ Yellow	18"
10-BKS18	A2	DuPont™ Kevlar®	Seamless Knit	1	□ Black	18"

Replace standard 18" length with any custom length from 10" - 24"

FORM-FIT SEAMLESS KNIT SLEEVES

SECURE CLOSE-TO-SKIN COMFORT



UNPARALLELED
COMFORT & COOLNESS
MAXIMUM CUT RESISTANCE

FORM-FIT SEAMLESS KNIT SLEEVES

SECURE CLOSE-TO-SKIN COMFORT

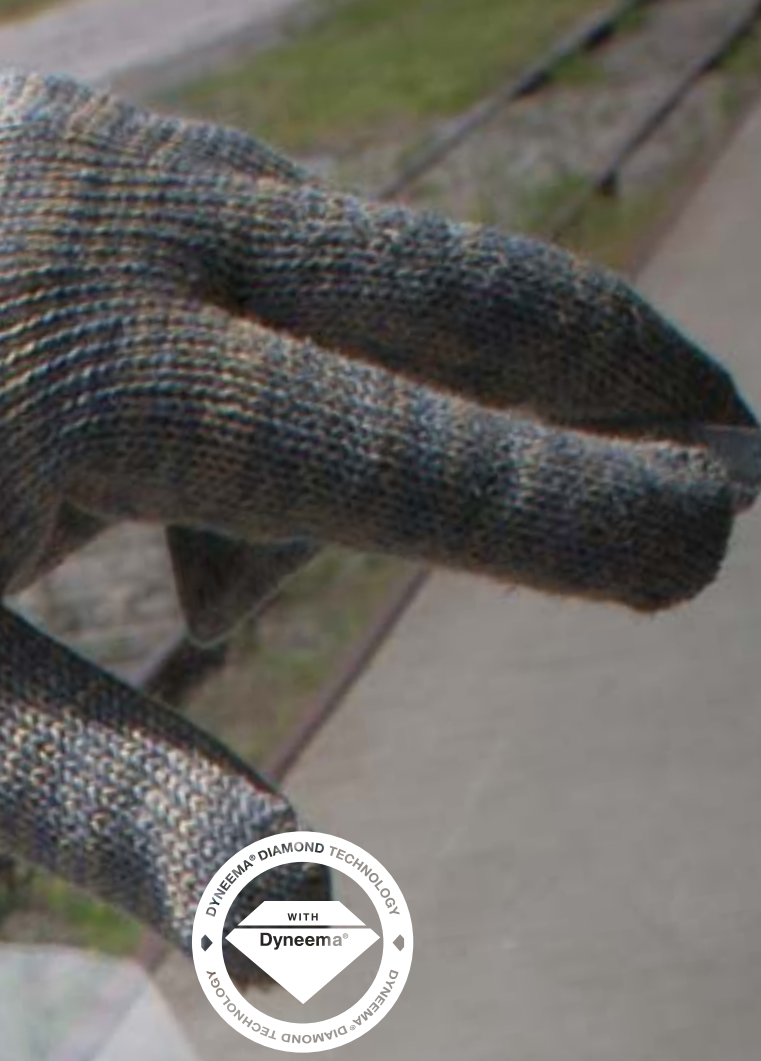

Sleeves made with Dyneema® Technology offer unparalleled comfort and coolness, while providing cut and abrasion resistance.



ANSI
A6

**KUT GARD®
WITH DYNEEMA®
20-DA4210**

- Excellent cut resistance to protect against minor cuts and scrapes
- Exceptional comfort and fit

APPLICATIONS: *Automotive, Plastic Molding, Glass Handling and Metal Stamping*



ANSI
A4

**KUT GARD®
WITH DYNEEMA®
20-DAPB22TOV**

- Excellent cut resistance to protect against minor cuts and scrapes
- Exceptional comfort and fit
- Thumb hole for additional protection all the way to the knuckle, without sacrificing dexterity

APPLICATIONS: *Automotive, Plastic Molding, Glass Handling and Metal Stamping*



ANSI
A4

**KUT GARD®
WITH DYNEEMA®
20-DA18**

- Excellent cut resistance
- Excellent abrasion protection
- 2-ply for additional wear protection
- Breathable
- Made from component materials that comply with federal regulations for food contact 21CFR 170-199

APPLICATIONS: *Electronics Manufacturing, Glass Cutting, Paper Processing, Food Processing*



ANSI
A2

**KUT GARD®
WITH DYNEEMA®
20-D18**

- Good cut protection
- High abrasion protection
- Elastic top provides a snug fit to prevent debris from entering the sleeve
- Made from component materials that comply with federal regulations for food contact 21CFR 170-199

APPLICATIONS: *Electronics Manufacturing, Glass Cutting, Paper Processing, Food Processing*

KUT GARD® WITH DYNEEMA®

STYLE NUMBER	ASTM	MATERIAL	CONSTRUCTION	PLY	COLOR	STANDARD LENGTH
20-DA4210	A6	ACP™ / Dyneema® Blend	Seamless Knit	1	■ Gray	21"
20-DAPB22TOV	A4	ACP™ / Dyneema® Blend	Seamless Knit	1	■ Gray	22"
20-DA18	A4	ACP™ / Dyneema® Blend	Seamless Knit	2	■ Gray	18"
20-DA18CL	A4	ACP™ / Dyneema® Blend	Seamless Knit, 1-Ply Cotton Liner	2	■ Gray	18"
20-DA18S	A3	ACP™ / Dyneema® Blend	Seamless Knit	1	■ Gray	18"
20-D18	A2	Dyneema® Diamond	Seamless Knit	1	■ White	18"
20-TG18	A2	Spun Dyneema®	Seamless Knit	2	■ Gray	18"
20-SD18	A2	Spun Dyneema®	Seamless Knit	1	■ White	18"
20-TG18S	A2	Spun Dyneema®	Seamless Knit	1	■ Gray	18"

Replace standard 18" length with any custom length from 10" - 24"

FORM-FIT SEAMLESS KNIT SLEEVES

SECURE CLOSE-TO-SKIN COMFORT

LIGHT ABRASION COMFORT SLEEVE



Pritex™ is proprietary textured filament polyester, plus Antimicrobial fiber that provides exceptional comfort, will not cause skin irritation, and offers excellent abrasion protection and ANSI Cut Level 2 cut resistance.

KUT GARD® PRITEX™

STYLE NUMBER	ASTM	MATERIAL	CONSTRUCTION	PLY	COLOR	WIDTH	STANDARD LENGTH
15-21PRI18KVBL*	A4	Pritex™ / Kevlar® Blend	2x1 Knit	1	Yellow / Black	---	18"
15-21PRI18BL	A2	Pritex™	2x1 Knit	1	Black	---	18"
15-21PRI18WL	A2	Pritex™	2x1 Knit	1	White	---	18"
15-218BKL	A2	Pritex™	Textured Filament Polyester	1	Black	6.5"	18"
15-218BKS	A2	Pritex™	Textured Filament Polyester	1	Black	5"	18"
15-218WL	A2	Pritex™	Textured Filament Polyester	1	White	6.5"	18"
15-218WS	A2	Pritex™	Textured Filament Polyester	1	White	5"	18"
15-218NYL	A2	Pritex™	Textured Filament Polyester	1	Neon Yellow	6.5"	18"
15-218NYS	A2	Pritex™	Textured Filament Polyester	1	Neon Yellow	5"	18"
15-218NOL	A2	Pritex™	Textured Filament Polyester	1	Neon Orange	6.5"	18"
15-218NOS	A2	Pritex™	Textured Filament Polyester	1	Neon Orange	5"	18"
15-218NPL	A2	Pritex™	Textured Filament Polyester	1	Neon Pink	6.5"	18"
15-218NPS	A2	Pritex™	Textured Filament Polyester	1	Neon Pink	5"	18"

COTTON SLEEVES

31-C-18	---	Cotton	Seamless Knit, Unsewn Ends	1	White	---	18"
31-CS18	---	Cotton	Seamless Knit, Overstitched at Both Ends	1	White	---	18"
31-CDS18	---	Cotton	Seamless Knit	2	White	---	18"

* Does not comply with federal regulations for food contact

Replace standard 18" length with any custom length from 10" - 24"



ANSI
A4

KUT GARD® PRITEX™ 15-21PRI18KVBL

- Excellent abrasion and fatigue resistance
- Silicone and latex free
- Manufactured with proprietary ACP™ Technology, featuring DuPont™ Kevlar® and fully encapsulated glass plus polyester
- Exceptional comfort and fit, will fit comfortably over clothing or directly on the arm

APPLICATIONS: *Sheet Metal Fabrication, Painting, Canning, Recycling, Assembly, Plastic Molding*



ANSI
A2

KUT GARD® PRITEX™ 15-218BKL

- Special blend of textured filament polyester plus Antimicrobial provides exceptional comfort and will not cause skin irritation
- Excellent abrasion and fatigue resistance
- 100% silicone and latex free
- Superior washability—can be washed repeatedly in chlorine bleach and caustic detergents
- Features a patented NSF/ANSI Standard 51 Conformant Antimicrobial that is FDA/EPA approved for food contact

APPLICATIONS: *Sheet Metal Fabrication, Painting, Canning, Recycling, Assembly, Plastic Molding*



DUO-PRO™

HI-VIS T-SHIRT WITH SEWN-IN INTEGRATED PROTECTIVE SLEEVES

ANSI 107 HI-VIS
SHORT SLEEVE
T-SHIRT



PRITEX™
2x1 KNIT
PROTECTIVE
SLEEVE



SEWN-IN
SLEEVES

DUO-PRO™

HI-VIS T-SHIRT WITH INTEGRATED PROTECTIVE SLEEVES

APPLICATIONS

CONSTRUCTION
MUNICIPALITIES
SHIPYARDS
RECYCLING
HVAC



SHORT SLEEVE T-SHIRT

2x1 KNIT PROTECTIVE SLEEVE

STYLE NUMBER	ANSI 107	COLOR	SIZE	ANSI 105	LENGTH	COLOR
313-CNTSELY*-PRI18W	Type R Class 2	Hi-Vis Lime Yellow	S - 5X	A2	18"	White

Put the desired size of the shirt in place of the asterisk () in the part number

Patent pending design

Integrated protective sleeves help protect against cuts, scrapes, and abrasions

Eliminates the need for a vest and keeps sleeves in place for maximum arm protection coverage

LOOSE FITTING SLEEVES

COOLER FOR LONG WEAR APPLICATIONS



PAIR WITH



ANSI
A6

**KUT GARD®
MADE WITH KEVLAR®
10-KVS18YBH**

- Optimal cut resistance and comfort
- Kevlar® engineered yarns maximize durability and abrasion resistance
- Protection in light heat applications

APPLICATIONS: *Glass Operations, Metal Stamping, Automotive, Appliance and Machinery Manufacturing*

ANSI **A7** EN **5** NITRILE FOAM COATING

**G-TEK® KEV™
09-K1600**

- Superior cut resistance
- Good grip on dry, wet or oily surfaces
- Protection in light heat applications

APPLICATIONS: *Glass Cutting, Metal Handling, Fastening, Construction*



PAIR WITH



ANSI
A6

**KUT GARD®
MADE WITH KEVLAR®
10-KVS18RD**

- Red color for easy compliance detection on job site
- Kevlar® engineered yarns maximize durability and abrasion resistance
- Protection in light heat applications

APPLICATIONS: *Glass Operations, Metal Stamping, Automotive, Appliance and Machinery Manufacturing*

ANSI **A4** EN **5** NITRILE FOAM COATING

**G-TEK® KEV™
09-K1640**

- Red liner for easy compliance detection on job site
- Good grip on dry, wet or oily surfaces
- Protection in light heat applications

APPLICATIONS: *Glass Cutting, Metal Handling, Small Sharp Objects, Fastening*

CUT & HEAT PROTECTION WITH MATCHING GLOVES

LOOSE FITTING SLEEVES

COOLER FOR LONG WEAR APPLICATIONS



ANSI
A6

**KUT GARD®
MADE WITH KEVLAR®
10-KVS18DGH**

- High cut protection and comfort
- Kevlar® engineered yarns maximize durability and abrasion resistance
- Protection in light heat applications

APPLICATIONS: *Glass Operations, Metal Stamping, Automotive, Appliance and Machinery Manufacturing*

ANSI **A4** EN **5**
NITRILE FOAM COATING

**G-TEK® KEV™
09-K1630**

- Excellent durability and abrasion resistance
- Good grip on dry, wet or oily surfaces
- Protection in light heat applications

APPLICATIONS: *Metal Handling, Fastening, Construction, General Maintenance*



ANSI
A2

**KUT GARD®
MADE WITH KEVLAR®
10-4IK157**

- Good cut protection
- Light heat protection
- Elastic top provides a snug fit to prevent debris from entering the sleeve
- Thumb hole for additional protection all the way to the knuckle, without sacrificing dexterity

APPLICATIONS: *Metal Stamping, Sheet Metal, Automotive, Construction*

ANSI
A1

**KUT GARD®
MADE WITH KEVLAR®
10-K4722**

- Cut protection
- Light heat protection
- Elastic top provides a snug fit to prevent debris from entering the sleeve
- Thumb hole for additional protection all the way to the knuckle, without sacrificing dexterity

APPLICATIONS: *Metal Stamping, Sheet Metal, Automotive, Construction*



Kevlar.

DARE **BIGGER™**

Sleeves with DuPont™ Kevlar® provide excellent cut protection and protection from light heat for the wrists and arms. Available in single-ply or double-ply for added protection. Cotton inner ply styles offers added comfort. MTO options available for all sleeves in any length.



KUT GARD® MADE WITH KEVLAR®

STYLE NUMBER	ASTM	MATERIAL	CONSTRUCTION	PLY	BOTTOM CUFF	TOP CUFF	COLOR	STANDARD LENGTH
10-KVS18RD	A6	DuPont™ Kevlar®	Blousy	1	Elastic	Elastic	■ Red	12" & 18"
10-KVS18DGH	A6	DuPont™ Kevlar®	Blousy	1	Elastic	Elastic	■ Dark Gray	12" & 18"
10-KVS18YBH	A6	DuPont™ Kevlar®	Blousy	1	Elastic	Elastic	■ Yellow / Black	12" & 18"
10-KSB18	A3	DuPont™ Kevlar®	Blousy	1	Elastic	Elastic	■ Yellow	18"
10-K4826	A2	DuPont™ Kevlar®	Blousy Interlock	1	Knit Wrist with Thumb Hole	Blue / Gold Elastic	■ Yellow	26"
10-4IK157	A2	DuPont™ Kevlar®	Blousy Interlock	1	Knit Wrist with Thumb Hole	Blue / Gold Elastic	■ Yellow	22"
10-K4726	A1	DuPont™ Kevlar®	Blousy Interlock	1	Knit Wrist with Thumb Hole	Blue / Gold Elastic	■ Yellow	26"
10-K4722	A1	DuPont™ Kevlar®	Blousy Interlock	1	Knit Wrist with Thumb Hole	Blue / Gold Elastic	■ Yellow	22"

Replace standard 18" length with any custom length from 10" - 24"

SPECIALTY APPLICATIONS SLEEVES

KUT GARD®



DUCK & DENIM LIGHT ABRASION RISK

DUCK & DENIM

STYLE NUMBER	ASTM	MATERIAL	CONSTRUCTION	PLY	COLOR	STANDARD LENGTH
31-48182	---	Duck	Elastic Overstitched at Both Ends	1	■ White	18"
23-44182	---	Denim	Elastic Overstitched at Both Ends	1	■ Blue	18"

Replace standard 18" length with any custom length from 10" - 24"



EXTRA MECHANICAL PROTECTION

Cane mesh provides protection from cuts and lacerations caused by glass, sheet or scrap metal, and other sharp objects

KUT GARD® CANE MESH

STYLE NUMBER	ASTM	MATERIAL	CONSTRUCTION	PLY	COLOR	LENGTH	SIZE
30-6775W	A4	Nylon Cane Mesh	Cut-and-Sewn	2	■ White	7"	S - 4XL
30-6775B	A4	Nylon Cane Mesh	Cut-and-Sewn	2	■ Black	7"	S - 4XL
30-6795W	A4	Nylon Cane Mesh	Cut-and-Sewn	2	■ White	9"	S - 4XL
30-6795B	A4	Nylon Cane Mesh	Cut-and-Sewn	2	■ Black	9"	S - 4XL



HIGH CUT PROTECTION FOR FOOD PROCESSING

KUT GARD® FOOD PROCESSING

STYLE NUMBER	ASTM	MATERIAL	CONSTRUCTION	PLY	COLOR	STANDARD LENGTH
25-612	A9	PolyKor® Blend	Seamless Knit	1	■ White	12"
25-618	A9	PolyKor® Blend	Seamless Knit	1	■ White	18"
25-621	A9	PolyKor® Blend	Seamless Knit	1	■ White	21"
25-7612BB	A7	Dyneema® Blend	Seamless Knit	1	■ Bright Blue	12"
25-7612BG	A7	Dyneema® Blend	Seamless Knit	1	■ Bright Green	12"
25-7612GRN	A7	Dyneema® Blend	Seamless Knit	1	■ Dark Green	12"
25-7612NP	A7	Dyneema® Blend	Seamless Knit	1	■ Neon Pink	12"

Replace standard 18" length with any custom length from 10" - 24"

AR/FR PROTECTION



KUT GARD® 10-KAM18

- Offers AR/FR and cut protection
- Excellent heat and flame resistance
- Thumb hole for additional protection all the way to the knuckle without sacrificing dexterity

APPLICATIONS: Sheet Metal, Glass Handling, High Heat Areas, Electrical Repair and Maintenance, Automotive Manufacturing, Plastic Molding

KUT GARD® ARC RATED ACP™ TECHNOLOGY & DUPONT™ KEVLAR®

STYLE NUMBER	PPE LEVEL	CAL RATING	ASTM	MATERIAL	CONSTRUCTION	PLY	COLOR	STANDARD LENGTH
10-KAM18	2	9.5	A5	ACP™ / Kevlar® Blend	Blousy Interlock	2	Yellow	18"

Replace standard 18" length with any custom length from 10" - 24"



SPECIALTY APPLICATIONS SLEEVES

KUT GARD®



IDEAL FOR WELDING



KUT GARD® 10-K4622

- Good cut protection
- Excellent thermal and flame protection from high heat
- Elastic top provides a snug fit to prevent debris from entering the sleeve
- Thumb hole for additional protection all the way to the knuckle without sacrificing dexterity

APPLICATIONS: Welding, Automotive, Aerospace and Metal Fabrication



11-45183

- Excellent thermal and flame protection from high heat
- Elastic top provides a snug fit to prevent debris from entering the sleeve

APPLICATIONS: Welding, Aerospace, Metal Fabrication



IDEAL FOR WELDING

FLAME, HEAT & SPARK PROTECTION

HEAT PROTECTION

STYLE NUMBER	ASTM	MATERIAL	CONSTRUCTION	PLY	COLOR	LENGTH
10-K4626	A2	60% FR Viscose / 40% DuPont™ Kevlar®	DuPont™ Kevlar® Wrist with Thumb Hole & Blue/Gold Elastic at Top	1	Yellow / Brown	26"
10-K4622	A2	60% FR Viscose / 40% DuPont™ Kevlar®	DuPont™ Kevlar® Wrist with Thumb Hole & Blue/Gold Elastic at Top	1	Yellow / Brown	22"
11-45182	---	FR Green Sateen	Elastic Overstitched at Both Ends	1	Green	18"
11-45183	---	FR Green Sateen	Blue/Gold Elastic at Both Ends	1	Green	18"
11-45153	---	FR Green Sateen	DuPont™ Kevlar® Wrist with Thumb Hole & Blue/Gold Elastic at Top	1	Green	15"

Replace standard 18" length with any custom length from 10" - 24"

ARM PROTECTION

CUSTOM OPTIONS

CUSTOM OPTIONS FOR

When it comes to arm protection, you don't have to settle for what's already out there.

Identify your safety need, then customize your solution by choosing the **Material, Size, and Option(s)** to maximize performance.

APPLICATION & MATERIAL

CUT PROTECTION

		MATERIAL	PLY	STRUCTURE
ANSI A9		PolyKor® Blend	1	Tube Knit
	ANSI A7	Dyneema® Blend	1	Tube Knit
		ACP™ / Dyneema® Blend	1	Tube Knit
	ANSI A6	DuPont™ Kevlar®	1	Tube Knit
		ACP™ / Kevlar® Blend	1 & 2	Tube Knit
	ANSI A5	ACP™ / Kevlar® Blend	1	Tube Knit
		ACP™ / Kevlar® / Pritex™ Blend	1	Tube Knit
		ACP™ / Dyneema® Blend	1 & 2	Tube Knit
	ANSI A4	Pritex™ / Kevlar® Blend	1	Tube Knit
		ACP™ / Kevlar® Blend	1	Tube Knit
ACP™ / Dyneema® Blend		1	Tube Knit	
ANSI A3	DuPont™ Kevlar®	1 & 2	Tube Knit	
	Pritex™	1	Tube Knit	
	DuPont™ Kevlar®	1	Tube Knit	
ANSI A2	Dyneema® Diamond Technology	1	Tube Knit	
	Spun Dyneema®	1 & 2	Tube Knit	
	FR Viscose / DuPont™ Kevlar®	1	Cut-and-Sewn	
	High Heat & Thermal	FR Viscose / DuPont™ Kevlar®	1	Cut-and-Sewn
FR Green Sateen		FR Green Sateen	1	Cut-and-Sewn
	Light Heat	DuPont™ Kevlar®	1	Tube Knit

HEAT PROTECTION*

FOOD HANDLING

High Heat & Thermal		FR Viscose / DuPont™ Kevlar®	1	Cut-and-Sewn
		FR Green Sateen	1	Cut-and-Sewn
Light Heat		DuPont™ Kevlar®	1	Tube Knit
Meets FDA 21CFR 170-199 Food Handling Requirements		ACP™ / Dyneema® Blend	2	Tube Knit
		Dyneema® Diamond Technology	1	Tube Knit
		Pritex™	1	Tube Knit
		PolyKor® Blend	1	Tube Knit
		Dyneema® Blend	1	Tube Knit

GENERAL PROTECTION

Light Abrasion Risk		Cotton	1 & 2	Tube Knit
		Duck	1	Cut-and-Sewn
		Denim	1	Cut-and-Sewn

SIZES

LENGTHS	STANDARD WIDTH
10" - 24"	3", 3.5" or 4"
10" - 24"	3", 3.5" or 4"
10" - 24"	3", 3.5" or 4"
10" - 24"	3", 3.5" or 4"
10" - 24"	3", 3.5" or 4"
10" - 24"	3", 3.5" or 4"
10" - 24"	3", 3.5" or 4"
10" - 24"	3", 3.5" or 4"
10" - 24"	3", 3.5" or 4"
10" - 24"	3", 3.5" or 4"
10" - 24"	3", 3.5" or 4"



Orders will ship within 2 weeks
(up to 4 weeks for Pritex™ sleeves).

*Not NFPA 2112 certified and not ARC-rated

Custom sizes available upon request

ENHANCED PERFORMANCE

ADDITIONAL OPTIONS

FINGER & THUMB OPTIONS



▲ Thumb Hole



▲ Thumb Slot (bar tack)



▲ Elastic Thumb



▲ Half Thumb



▲ Additional Bar Tacks for Fingers

TOP OF THE ARM OPTIONS



▲ Non-Slip Top

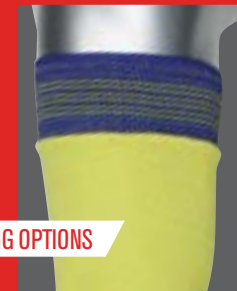

▲ 2" Blue/Gold Elastic



▲ 3/4" White Elastic



▲ Hook & Loop Closure



▲ Nylon Strap with Ring & Clip
(for shirt)



▲ Double Clip & Ring
110-SLEEVECLIP

BRINGING THE BEST OF THE WORLD TO YOU®

PERSONAL PROTECTIVE EQUIPMENT

UNDERSTANDING HEAD PROTECTION

PIP PROVIDES A COMPREHENSIVE OFFERING OF HEAD PROTECTION, INCLUDING HARD HATS, HELMETS, AND BUMP CAPS. WHEN SELECTING A HARD HAT, THE FIRST CONSIDERATION IS WHETHER YOU NEED ANSI TYPE I OR TYPE II PROTECTION, BASED ON OSHA REQUIREMENTS FOR YOUR GIVEN JOB AND/OR ENVIRONMENT. TYPE II MEETS REQUIREMENTS FOR ADDED SIDE IMPACT AND PENETRATION PROTECTION.

HARD HAT STYLES

Hard hats come in cap style and full brim, and both are available in vented and non-vented options.

- **Cap Style** hard hats shade your face and eyes.
- **Full Brim** hard hats shade your face, eyes, ears, and neck.
- **Non-Vented** Evolution® hard hats in this section meet **Class E** (Electrical) protection.
- **Vented** Evolution® hard hats in this section meet **Class C** (Conductive) protection. The vented option provides a cooler, more comfortable experience, though they are not intended for use near electrical hazards.

The size of the hard hat can be adjusted either by wheel ratchet or slip ratchet, depending on the option selected.

- The **wheel ratchet** provides a quicker and easier adjustment.
- The **slip ratchet** is a more economical solution that is still simple to adjust.



Class E (Electrical) protection means the hard hat is proof-tested at **20,000 volts**.



Class G (General) protection means the hard hat is proof-tested at **2,200 volts**.



Class C (Conductive) protection means the hard hat is not intended for use near electrical hazards, but is vented for breathability.

SPECIALTY HEAD PROTECTION

Specialty **helmets** are available for several industries, including fire, rescue, wildland, and high altitude workers, among others. These specialty helmets meet the stricter requirements for those specific work environments.

When head protection is not required but the risk of head injury persists, **bump caps** should be considered. While they are not ANSI rated, bump caps can help protect against incidental bumps and scrapes, especially if you're working in areas with a low vertical clearance. The low-profile baseball cap style increases user acceptability, giving workers a comfortable option that they will want to wear. Ranger style is ideal for outdoor workers, providing additional shade from the sun's UV rays.

150 TYPE II HARD HATS

151 TYPE I HARD HATS

157 HARD HAT ACCESSORIES

160 BUMP CAPS

162 GEAR BAGS & RESCUE HELMETS

163 FIRE HELMETS

164 WINTER LINERS

166 FLAME & FIRE RESISTANT HOODS

HEAD PROTECTION

TYPE II HARD HATS

MK8 EVOLUTION®

MK8 EVOLUTION® SERIES - TYPE II HARD HATS

CAP STYLE



MK8 EVOLUTION® CAP STYLE

KEY FEATURE	Type II Offering Side Impact & Penetration Protection		
APPLICATIONS	Construction / Oil & Gas / Demolition		
SUSPENSION	Polyester Textile Straps with Crown Pad Webbing		
IMPACT LINER	Expanded Polystyrene (EPS)		
SIZE ADJUSTMENT	Wheel Ratchet		
SHELL MATERIAL	High-Density Polyethylene (HDPE)		
SWEATBAND	Microfiber		
STANDARDS MET	ANSI Z89.1		
IMPACT TYPE	Type II		
ELECTRICAL CLASS	Class E (Non-Vented) Class C (Vented)		
STYLE NUMBER	COLOR	BRIM	SHELL
280-AHS150-10	■ White	Cap	Non-Vented
280-AHS150-20	■ Yellow	Cap	Non-Vented
280-AHS150-50	■ Blue	Cap	Non-Vented
280-AHS150V-10	■ White	Cap	Vented

MK8 EVOLUTION® LINESMAN

KEY FEATURE	Includes a Mounted 4-Point Chin Strap Harness		
APPLICATIONS	Linesman / Construction / Offshore Marine		
SUSPENSION	Polyester Textile Straps with Crown Pad Webbing		
IMPACT LINER	Expanded Polystyrene (EPS)		
SIZE ADJUSTMENT	Wheel Ratchet		
SHELL MATERIAL	High-Density Polyethylene (HDPE)		
SWEATBAND	Microfiber		
STANDARDS MET	ANSI Z89.1		
IMPACT TYPE	Type II		
ELECTRICAL CLASS	Class E (Non-Vented) Class C (Vented)		
STYLE NUMBER	COLOR	BRIM	SHELL
280-AHS240-10	■ White	Cap	Non-Vented
280-AHS240-20	■ Yellow	Cap	Non-Vented
280-AHS240-50	■ Blue	Cap	Non-Vented
280-AHS240V-10	■ White	Cap	Vented



IMPACT PROTECTION

Side, front and rear impact protection from the shock absorbing Expanded Polystyrene (EPS) impact liner meets **ANSI Type II standards**. Offers 20 times the coverage area of a Type I hard hat.

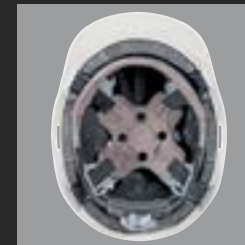

SUPREME COMFORT

Deluxe polyester textile strap suspension with a microfiber crown pad. Lightweight EPS liner reduces total weight to 19 ounces, while still offering maximum protection.



TOUGH OUTER SHELL

High strength outer shell with ribbed channels running across the top to dissipate impact energy. All around protection down 60° from vertical. Large imprint area on front "shield."



FIRM FIT ADJUSTMENT

Intuitive thumb and forefinger press points for easy adjustment of the wheel ratchet. The Linesman has an ANSI approved chin strap for retention on a Type II hard hat.

The three-rib design is a registered trademark of E.D. Bullard Company and used under license.

EVOLUTION® 6100 SERIES - TYPE I HARD HATS



CAP STYLE

TRADITIONAL STYLING WITH ENHANCED STRENGTH AND PROTECTION

FIVE RAISED CHANNELS

Modernizes the aesthetic look, but also strengthens the hard hat

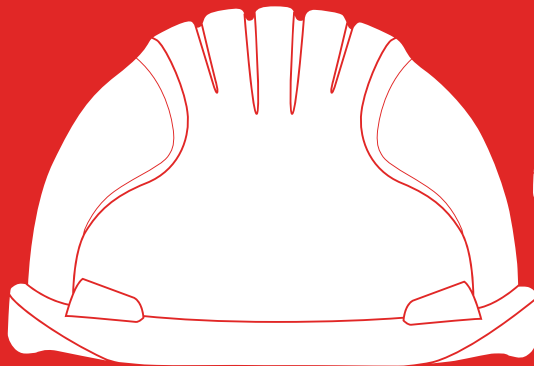

FRONT BRIM OPTIONS

Available in a short 1/2" brim style in addition to regular 1" cap style brim

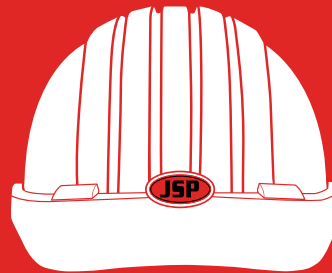

10%
MORE

EXTRA PROTECTION ZONE

Provides 10% more coverage at the back/sides of the head and neck for extra deflection protection



FULL BRIM

FOR ADDITIONAL PROTECTION AGAINST SUN, GLARE, RAIN AND FALLING DEBRIS

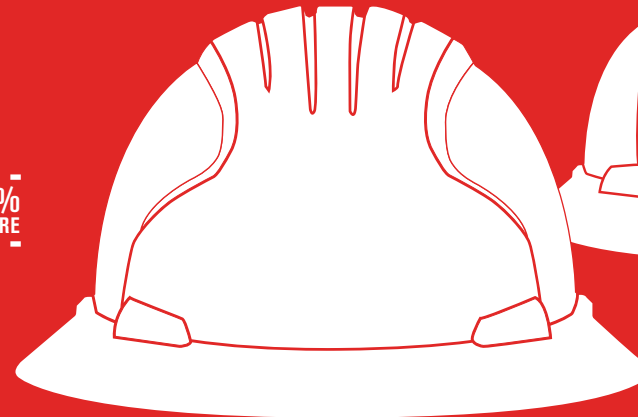

SHORTER FRONT BRIM

Shades the face while allowing excellent visibility



LONGER BACK BRIM

Helps protect neck and ears from the sun's UV rays, and functions as a run-off for rain and snow

TEXTURED UNDERSIDE

Helps reduce reflection and glare off the brim

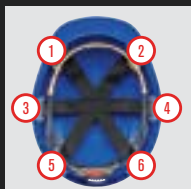

PRE-ASSEMBLED

All JSP® hard hats are packed ready-to-wear with no assembly of the 6-point suspension required.

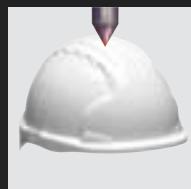

TOUGH HDPE SHELL

Modern design is enhanced with five raised channels that run across the top of the head down to the extended back area.



3D PRECISION FITTING

Never before has such a precise fit been attainable on an industrial safety hard hat, using the unique 3-position harness depth setting.



VENTILATION OPTION

Allows air movement inside the shell. This can reduce the inside hat temperature by an average of 4-6°F. Ideal when using cooling products.

TYPE I HARD HATS

EVOLUTION® 6100 SERIES – WHEEL RATCHET

EVOLUTION® DELUXE 6161 FULL BRIM

KEY FEATURE	Wheel Ratchet Creates a Firm Comfortable Fit		
APPLICATIONS	Construction / Industrial		
SUSPENSION	6-Point Polyester Textile		
SIZE ADJUSTMENT	Wheel Ratchet		
SHELL MATERIAL	High-Density Polyethylene (HDPE)		
SWEATBAND	Chamlon™		
EVOSPEC™ COMPATIBLE	Yes	CR2 KIT COMPATIBLE	Yes
STANDARDS MET	ANSI Z89.1		
IMPACT TYPE	Type I		
ELECTRICAL CLASS	Class E (Non-Vented), Class C (Vented)		
STYLE NUMBER	COLOR	BRIM	SHELL
280-EV6161-10	White	Full	Non-Vented
280-EV6161-20	Yellow	Full	Non-Vented
280-EV6161-30	Green	Full	Non-Vented
280-EV6161-40	Gray	Full	Non-Vented
280-EV6161-50	Blue	Full	Non-Vented
280-EV6161-60	Red	Full	Non-Vented
280-EV6161-OR	Bright Orange	Full	Non-Vented
280-EV6161-LY	Lime Yellow	Full	Non-Vented
280-EV6161V-10	White	Full	Vented
280-EV6161V-20	Yellow	Full	Vented
280-EV6161V-30	Green	Full	Vented
280-EV6161V-40	Gray	Full	Vented
280-EV6161V-50	Blue	Full	Vented
280-EV6161V-60	Red	Full	Vented
280-EV6161V-OR	Bright Orange	Full	Vented
280-EV6161V-LY	Lime Yellow	Full	Vented



EVOLUTION® 6100 SERIES

REVOLUTION® WHEEL RATCHET



US &
IMPORTED
MATERIALS

TYPE I HARD HATS

EVOLUTION® 6100 SERIES & COMFORT PLUS™ – WHEEL RATCHET



- Easy-to-use wheel ratchet adjustment system creates a firm, comfortable fit with added security
- The deep nape strap design enables firm retention, keeping the hard hat in place on the head even when fully inverted
- Closed ratchet design won't snag longer hair

EVOLUTION® DELUXE 6151 CAP STYLE

KEY FEATURE	Wheel Ratchet Creates a Firm Comfortable Fit		
APPLICATIONS	Construction / Industrial		
SUSPENSION	6-Point Polyester Textile		
SIZE ADJUSTMENT	Wheel Ratchet		
SHELL MATERIAL	High-Density Polyethylene (HDPE)		
SWEATBAND	Chamlon™		
EVOSPEC™ COMPATIBLE	Yes	CR2 KIT COMPATIBLE	Yes
STANDARDS MET	ANSI Z89.1		
IMPACT TYPE	Type I		
ELECTRICAL CLASS	Class E (Non-Vented), Class C (Vented)		
STYLE NUMBER	COLOR	BRIM	SHELL
280-EV6151-10	■ White	Standard	Non-Vented
280-EV6151-11	□ Black	Standard	Non-Vented
280-EV6151-20	■ Yellow	Standard	Non-Vented
280-EV6151-30	■ Green	Standard	Non-Vented
280-EV6151-39	■ Pink	Standard	Non-Vented
280-EV6151-40	■ Gray	Standard	Non-Vented
280-EV6151-50	■ Blue	Standard	Non-Vented
280-EV6151-60	■ Red	Standard	Non-Vented
280-EV6151-OR	■ Bright Orange	Standard	Non-Vented
280-EV6151-LY	■ Lime Yellow	Standard	Non-Vented
280-EV6151S-10	■ White	Short	Non-Vented
280-EV6151S-20	■ Yellow	Short	Non-Vented
280-EV6151V-10	■ White	Standard	Vented
280-EV6151V-20	■ Yellow	Standard	Vented
280-EV6151V-40	■ Gray	Standard	Vented
280-EV6151V-50	■ Blue	Standard	Vented
280-EV6151V-LY	■ Lime Yellow	Standard	Vented
280-EV6151V-OR	■ Bright Orange	Standard	Vented
280-EV6151SV-10	■ White	Short	Vented
280-EV6151SV-20	■ Yellow	Short	Vented
280-EV6151SV-50	■ Blue	Short	Vented

COMFORT PLUS™ 5151 CAP STYLE

KEY FEATURE	Economical Version with Pivoting Wheel Ratchet		
APPLICATIONS	Construction / Industrial		
SUSPENSION	6-Point Polyester Textile		
SIZE ADJUSTMENT	Wheel Ratchet		
SHELL MATERIAL	High-Density Polyethylene (HDPE)		
SWEATBAND	Nylon Backed Foam		
STANDARDS MET	ANSI Z89.1		
IMPACT TYPE	Type I		
ELECTRICAL CLASS	Class G		
STYLE NUMBER	COLOR	BRIM	SHELL
280-ML5151-10	■ White	Cap Style	Non-Vented
280-ML5151-20	■ Yellow	Cap Style	Non-Vented
280-ML5151-30	■ Green	Cap Style	Non-Vented
280-ML5151-39	■ Pink	Cap Style	Non-Vented
280-ML5151-50	■ Blue	Cap Style	Non-Vented
280-ML5151-60	■ Red	Cap Style	Non-Vented
280-ML5151-80	■ Orange	Cap Style	Non-Vented

COMFORT PLUS™
VALUE
WHEEL RATCHET



US &
IMPORTED
MATERIALS

TYPE I HARD HATS

EVOLUTION® 6100 SERIES – SLIP RATCHET

EVOLUTION® 6100 SERIES

EASYJUST® SLIP RATCHET



EVOLUTION® 6121 CAP STYLE

KEY FEATURE	Economical Polyethylene Suspension with Slip Ratchet		
APPLICATIONS	Construction / Industrial		
SUSPENSION	6-Point Polyethylene		
SIZE ADJUSTMENT	Slip Ratchet		
SHELL MATERIAL	High-Density Polyethylene (HDPE)		
SWEATBAND	Nylon Backed Foam		
EVOSPEC™ COMPATIBLE	No	CR2 KIT COMPATIBLE	Yes
STANDARDS MET	ANSI Z89.1		
IMPACT TYPE	Type I		
ELECTRICAL CLASS	Class E		

STYLE NUMBER	COLOR	BRIM	SHELL
280-EV6121-10	<input type="checkbox"/> White	Standard	Non-Vented
280-EV6121-20	<input type="checkbox"/> Yellow	Standard	Non-Vented
280-EV6121-30	<input type="checkbox"/> Green	Standard	Non-Vented
280-EV6121-39	<input type="checkbox"/> Pink	Standard	Non-Vented
280-EV6121-40	<input type="checkbox"/> Gray	Standard	Non-Vented
280-EV6121-50	<input type="checkbox"/> Blue	Standard	Non-Vented
280-EV6121-60	<input type="checkbox"/> Red	Standard	Non-Vented
280-EV6121-OR	<input type="checkbox"/> Bright Orange	Standard	Non-Vented
280-EV6121-LY	<input type="checkbox"/> Lime Yellow	Standard	Non-Vented

EVOLUTION® DELUXE 6131 CAP STYLE

KEY FEATURE	Polyester Textile Suspension with Slip Ratchet		
APPLICATIONS	Construction / Industrial		
SUSPENSION	6-Point Polyester Textile		
SIZE ADJUSTMENT	Slip Ratchet		
SHELL MATERIAL	High-Density Polyethylene (HDPE)		
SWEATBAND	Chamlon™		
EVOSPEC™ COMPATIBLE	Yes	CR2 KIT COMPATIBLE	Yes
STANDARDS MET	ANSI Z89.1		
IMPACT TYPE	Type I		
ELECTRICAL CLASS	Class E (Non-Vented), Class C (Vented)		

STYLE NUMBER	COLOR	BRIM	SHELL
280-EV6131-10	<input type="checkbox"/> White	Standard	Non-Vented
280-EV6131-20	<input type="checkbox"/> Yellow	Standard	Non-Vented
280-EV6131-30	<input type="checkbox"/> Green	Standard	Non-Vented
280-EV6131-50	<input type="checkbox"/> Blue	Standard	Non-Vented
280-EV6131-60	<input type="checkbox"/> Red	Standard	Non-Vented
280-EV6131-OR	<input type="checkbox"/> Bright Orange	Standard	Non-Vented
280-EV6131-LY	<input type="checkbox"/> Lime Yellow	Standard	Non-Vented
280-EV6131V-10	<input type="checkbox"/> White	Standard	Vented
280-EV6131V-20	<input type="checkbox"/> Yellow	Standard	Vented

EVOLUTION® DELUXE 6141 FULL BRIM

KEY FEATURE	Polyester Textile Suspension with Slip Ratchet		
APPLICATIONS	Construction / Industrial		
SUSPENSION	6-Point Polyester Textile		
SIZE ADJUSTMENT	Slip Ratchet		
SHELL MATERIAL	High-Density Polyethylene (HDPE)		
SWEATBAND	Chamlon™		
EVOSPEC™ COMPATIBLE	Yes	CR2 KIT COMPATIBLE	Yes
STANDARDS MET	ANSI Z89.1		
IMPACT TYPE	Type I		
ELECTRICAL CLASS	Class E (Non-Vented), Class C (Vented)		

STYLE NUMBER	COLOR	BRIM	SHELL
280-EV6141-10	<input type="checkbox"/> White	Full	Non-Vented
280-EV6141-20	<input type="checkbox"/> Yellow	Full	Non-Vented
280-EV6141-30	<input type="checkbox"/> Green	Full	Non-Vented
280-EV6141-50	<input type="checkbox"/> Blue	Full	Non-Vented
280-EV6141-60	<input type="checkbox"/> Red	Full	Non-Vented
280-EV6141-OR	<input type="checkbox"/> Bright Orange	Full	Non-Vented
280-EV6141-LY	<input type="checkbox"/> Lime Yellow	Full	Non-Vented
280-EV6141V-10	<input type="checkbox"/> White	Full	Vented
280-EV6141V-20	<input type="checkbox"/> Yellow	Full	Vented



**280-EV6121 CAP STYLE & 280-EV6141 FULL BRIM
AVAILABLE AS A GO-TO WORK KIT**



GO-TO-WORK KIT

PACKED READY TO WEAR

CHOOSE FROM 2
HARD HAT MODELS >



EVOLUTION 6141 FULL BRIM
280-EV6141



EVOLUTION 6121 CAP STYLE
280-EV6121

GET THESE PRE-PACKED INSIDE!



ANSI CLASS 2 VALUE MESH VEST
Hi-Vis Lime Yellow
302-MVGLY



BOUTON® OPTICAL ZENON Z12
Gray Lens/Black Temple
250-01-0001



G-TEK® NYLON FOAM NITRILE GRIP
Gray Liner/Black Grip
34-C232



DISPOSABLE CORDED EAR PLUGS
NRR 32 dB - Hi-Vis Orange
265-100C

GRAB, GO & GET TO WORK!

ITEM NUMBER	HARD HAT	GLOVES	VEST
289-GTW-6121-M/L	Cap Style	M	L
289-GTW-6141-M/L	Full Brim	M	L
289-GTW-6121-L/XL	Cap Style	L	XL
289-GTW-6141-L/XL	Full Brim	L	XL
289-GTW-6121-XL/XXL	Cap Style	XL	XXL
289-GTW-6141-XL/XXL	Full Brim	XL	XXL

CUSTOM KITS AVAILABLE

WANT TO CHANGE A COLOR OR SIZE?
OR DEVELOP YOUR OWN UNIQUE KIT?

ASK US FOR A QUOTE TODAY

TYPE I HARD HATS

GO-TO-WORK KIT



▲ 289-GTW-6121-M/M-39

PINKit GO-TO-WORK KIT

PRE-PACKED ITEMS:



EVOLUTION 6121 CAP STYLE
280-EV6121-39



ANSI CLASS 2 VALUE MESH VEST
Hi-Vis Lime Yellow
302-MVGLY/M



EVA®
Clear Lens/Clear & Pink Temple
250-10-0900



MAXIFLEX® ACTIVE™ NYLON
FOAM NITRILE GRIP
Light Pink Liner/Pink Grip
34-8264/M



DISPOSABLE COMPACT
X-EMBOSS CORDED EAR PLUGS
Pink
267-HPF300C

TYPE I HARD HATS

MINING / HIGH ALTITUDE



EVOLUTION® 6100 MINING

KEY FEATURE	Includes Mining Lamp Bracket & Cable Loop		
APPLICATIONS	Mining Industry		
SUSPENSION	6-Point Polyester Textile		
SIZE ADJUSTMENT	Wheel Ratchet		
SHELL MATERIAL	High-Density Polyethylene (HDPE)		
SWEATBAND	Chamlon™		
EVOSPEC™ COMPATIBLE	Yes	CR2 KIT COMPATIBLE	Yes
STANDARDS MET	ANSI Z89.1		
IMPACT TYPE	Type I		

STYLE NUMBER	COLOR	BRIM
280-EV6151M-10	White	Cap Style
280-EV6151M-20	Yellow	Cap Style
280-EV6151M-30	Green	Cap Style
280-EV6151M-50	Blue	Cap Style
280-EV6151M-60	Red	Cap Style
280-EV6151M-OR	Bright Orange	Cap Style
280-EV6151M-LY	Lime Yellow	Cap Style
280-EV6161M-10	White	Full
280-EV6161M-20	Yellow	Full
280-EV6161M-30	Green	Full
280-EV6161M-50	Blue	Full
280-EV6161M-60	Red	Full
280-EV6161M-OR	Bright Orange	Full
280-EV6161M-LY	Lime Yellow	Full

EVOLUTION® 6100 MINING WITH CR2 REFLECTIVE KIT

STYLE NUMBER	COLOR	BRIM	CR2 DECALS
280-EV6151MCR2-XX	All 7 Colors	Cap Style	Silver
280-EV6161MCR2-XX	All 7 Colors	Full	Silver

EVOLUTION® 6100 MINING

COMPATIBLE WITH 99% OF MINING LAMPS

*Lamp torch not included

EVOLITE® SKYWORKER™

KEY FEATURE	The Best Features from the Evolution Series Combined with the Aspects Required for High Altitude Workers		
APPLICATIONS	Industrial / Mountaineering / Rescue		
SUSPENSION	6-Point Polyester Textile		
SIZE ADJUSTMENT	Wheel Ratchet		
SHELL MATERIAL	Lightweight ABS Plastic		
IMPACT LINER	Expanded Polystyrene (EPS)		
CHIN STRAP	4-Point Cross-Over with Quick Release Buckle		
SWEATBAND	Chamlon™ with PU Coating		
EVOSPEC™ COMPATIBLE	No	CR2 KIT COMPATIBLE	Yes
STANDARDS MET	ANSI Z89.1 & EN 12492 Mountaineering		
IMPACT TYPE	Type I		
ELECTRICAL CLASS	Class C (Vented)		
STYLE NUMBER	COLOR	BRIM	SHELL
280-AJS260-10	White	Short	Vented



LIGHTWEIGHT COMFORT & STRENGTH

DESIGNED FOR HIGH-ALTITUDE WORKERS



HARD HAT ACCESSORIES

REFLECTIVE DECALS



FULL REFLECTIVE COVERAGE

PROTECTION

DAY & NIGHT

CR2 REFLECTIVE DECAL KITS FOR JSP® EVOLUTION® HARD HATS

Easy for user to apply; sold in packs of 10 applications

- Class R2 reflective material offers significantly more brightness than standard reflective material
- High-intensity prismatic pattern features enhanced brightness day or night, and better visibility in all weather conditions
- Offers full 360° reflective coverage, plus strips on top
- Six reflective colors are available in both a cap-style and full-brim configuration
- Decal colors can be used to indicate function, while stocking only a basic white hard hat
- Ideal for hazardous environments where workers must be seen: construction, mining, highway, civil engineering or offshore

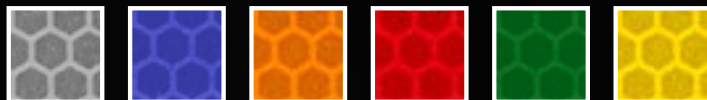

▲ 281-CR2-10



▲ 281-CR2FB-10

STYLE NUMBER	FITS	COLOR
281-CR2-10	Cap Style JSP® Evolution®	■ Silver
281-CR2-10-BL	Cap Style JSP® Evolution®	■ Blue
281-CR2-10-OR	Cap Style JSP® Evolution®	■ Orange
281-CR2-10-RE	Cap Style JSP® Evolution®	■ Red
281-CR2-10-GR	Cap Style JSP® Evolution®	■ Green
281-CR2-10-YE	Cap Style JSP® Evolution®	■ Yellow
281-CR2FB-10	Full Brim Style JSP® Evolution®	■ Silver
281-CR2FB-10-BL	Full Brim Style JSP® Evolution®	■ Blue
281-CR2FB-10-OR	Full Brim Style JSP® Evolution®	■ Orange
281-CR2FB-10-RE	Full Brim Style JSP® Evolution®	■ Red
281-CR2FB-10-GR	Full Brim Style JSP® Evolution®	■ Green
281-CR2FB-10-YE	Full Brim Style JSP® Evolution®	■ Yellow
281-CR2SW-10	Evollite® Skyworker™	■ Silver

HARD HAT ACCESSORIES

EYEWEAR / CLIP SET

EVOSPEC™

RETRACTABLE SAFETY GLASSES

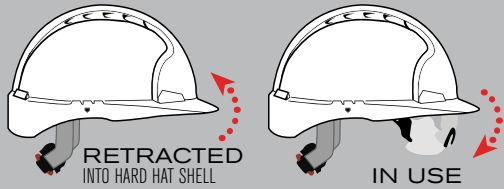

EVOSPEC™

- Easy assembly into any Evolution® Deluxe 6100 hard hat
- Retracts into helmet shell when not in use
- Anti-scratch/anti-fog lens coating
- Meets ANSI Z87.1 requirements

STYLE NUMBER	TEMPLES	LENS
250-EVS-0000	■ Black	□ Clear
250-EVS-0001	■ Black	■ Gray
250-EVS-0002	■ Black	■ Indoor/Outdoor



EXTEND THE LIFE & FUNCTIONS OF YOUR JSP® HARD HATS



HEAD LAMPS
2 SIDE CLIPS & 2 REAR CLIPS



GOGGLES
2 REAR CLIPS

LAMP / GOGGLE CLIP SET

- Allow the attachment of a head lamp or goggle to an Evolution® 6100 Cap Style hard hat
- The 2 rear clips are needed for attaching goggles to a helmet; all 4 clips are needed for attaching a head lamp to a helmet

ITEM NUMBER	SIDE CLIPS	REAR CLIPS
281-CL-SET	2	2

HARD HAT ACCESSORIES

REPLACEMENT / ENHANCEMENT



▲ 281-SB-CHN



▲ 281-SB-NBF



▲ 281-SB-NBF/CP

REPLACEMENT SWEATBANDS

ITEM NUMBER	FITS	MATERIAL	COLOR
281-SB-CHN	Evolution® Deluxe	Chamlon™	■ Tan
281-SB-NBF	Evolution® 6121	Nylon Backed Foam	■ Black
281-SB-NBF/CP	Comfort Plus™	Nylon Backed Foam	■ Black



◀ 281-CS-4PT



▲ 281-CS-2PT



▲ 281-CSD-2PT

OPTIONAL CHIN STRAPS

ITEM NUMBER	STRAP	FITS	COLOR
281-CS-2PT	2-Point Standard	All JSP® Hard Hats	■ Red / White / Blue
281-CSD-2PT	2-Point Deluxe	Evolution® 6100 Hard Hats	■ Red / White / Blue
281-CS-4PT	4-Point	Evolution® 6100 Hard Hats	■ Black



SUREFIT™ HARD HAT ADAPTER & SAFETY VISORS

- Clips into the universal accessory slots of the hard hat
- Curved plastic channel fits over standard and short brims
- Pivoting blades allow the visor to be lifted up when not in use
- Will fit the JSP® Surefit™ safety visors below
- Can also be used in conjunction with JSP® cap mounted ear muffs
- Meets ANSI Z87.1+ requirements when worn with safety glasses or goggles

HARD HAT ADAPTER

ITEM NUMBER	COLOR
251-01-6225	■ Black

SAFETY VISORS

ITEM NUMBER	COLOR	MATERIAL
251-01-6201	□ Clear	Polycarbonate
251-01-6211	□ Clear	Acetate

FOR FACESHIELDS SEE PAGE 212

SUN SHADE EXTENSIONS

- 40 mil dark green front and 30 mil white back
- Forms oval that simply slips over hard hat crown

ITEM NUMBER	FITS
281-SSE-CAP	Cap Style Hard Hats
281-SSE-FB	Full Brim Hard Hats



BUMP CAPS

HARDCAP A1+™

HDPE LINER
UNDER BASEBALL
CAP STYLE FOR
BUMP & SCRAPE
PROTECTION



HARDCAP A1+™

BUMP CAP HEAD PROTECTION

IDEAL FOR AREAS WHERE HARD HATS ARE NOT REQUIRED



LOW-PROFILE DESIGN

Ultra-sleek design means the HardCap A1+™ is almost indistinguishable from a low-profile baseball cap.

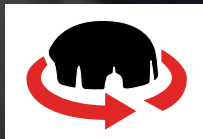

ALL AROUND PROTECTION

The HDPE liner provides protection from front-to-back and side-to-side. The liner is also removable so the outer cap can be washed.

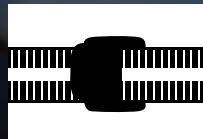

UNIQUE SIZE ADJUSTER

Unique size adjuster slides on an elastic strip to give a quick, secure fit. Angled downward to fit under nape of neck.



SWEATBAND

Terrycloth sweatband adds comfort and absorption for the wearer.



REFLECTIVE PIPING

Reflective piping adds extra visibility and therefore safety in all working environments.

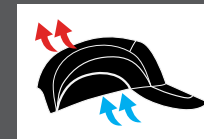

VENTILATION

Holes in the liner match up with mesh panels on the cap to provide added ventilation for coolness and comfort.

HARDCAP A1+™ BUMP CAP

KEY FEATURE	Stays On Your Head with Angled Elastic Strap	
APPLICATIONS	Assembly Line / Package Handling / Landscaping	
CAP STYLE	Low-Profile Baseball	
PROTECTIVE LINER	Inner HDPE Liner with Foam Cushioning	
SIZE ADJUSTMENT	Elastic Strap with Clamp Action Buckle	
VENTILATION	Mesh Panels Match Up with Liner Holes	
SWEATBAND	Terry Cloth	
STYLE NUMBER	COLOR	BRIM
282-ABR170-62	Gray / Red	Regular - 2.75"
282-ABR170-21	Navy / Navy	Regular - 2.75"
282-ABR170-18	Black / Hi-Vis Orange	Regular - 2.75"
282-ABR170-11	Black / Black	Regular - 2.75"
282-ABR170-52	Navy / Yellow	Regular - 2.75"
282-ABR170-12	Black / Gray	Regular - 2.75"
282-ABR170-CAMO	Camouflage	Regular - 2.75"
282-ABR170-OR	Hi-Vis Orange	Regular - 2.75"
282-ABR170-LY	Hi-Vis Lime Yellow	Regular - 2.75"
282-ABS150-11	Black / Black	Short - 2"
282-ABS150-12	Black / Gray	Short - 2"
282-ABS150-18	Black / Hi-Vis Orange	Short - 2"
282-ABS150-21	Navy / Navy	Short - 2"
282-ABS150-62	Gray / Red	Short - 2"
282-ABM130-11	Black / Black	Micro - 1"
282-ABM130-12	Black / Gray	Micro - 1"
282-ABM130-21	Navy / Navy	Micro - 1"

Bump Caps are **NOT** designed for use in ANSI hard hat designated areas

AVOID BUMPS & SCRAPES

Getting workers to wear head protection can be tough, especially in areas where hard hats are not required. It's estimated that a third of all impact injuries to the head are suffered by workers who bumped into stationary objects while not wearing any head protection. The sporty baseball cap style of the HardCap A1+™ is sure to increase wearer acceptability and reduce injuries.



REGULAR BRIM - 2.75"



REFLECTIVE PIPING+

▲ 282-AES150-21

▲ 282-AEM130-11



SHORT BRIM - 2"



MICRO BRIM - 1"



HI-VIS COLORS



CAMOUFLAGE

THE HARDCAP A1+™ BUMP CAP CAN BE EMBROIDERED WITH YOUR LOGO AND/OR PERSONALIZED MESSAGE.



HARDCAP AEROLITE™ BUMP CAP

KEY FEATURE	Lightweight & Cool - Weighs Less Than 5 oz.	
APPLICATIONS	Assembly / Maintenance / Aviation / Automotive	
CAP STYLE	Low-Profile Baseball with Reflective Piping+	
PROTECTIVE LINER	HDPE Shell with EPP Liner	
SIZE ADJUSTMENT	Adjustable Elastic Strap	
VENTILATION	Large Open Weaved Panels	
SWEATBAND	Treated with Polygiene® for Longer Life	
STYLE NUMBER	COLOR	BRIM
282-AES150-11	■ Black	Short - 2"
282-AES150-21	■ Navy	Short - 2"
282-AEM130-11	■ Black	Micro - 1"
282-AEM130-21	■ Navy	Micro - 1"



HARDCAP AEROLITE™ COMFORT PADS 10-PACK

- Replacement padding for hygiene

STYLE NUMBER	INCLUDES
282-AEP-10	10 Comfort Pads with Spare Hook & Loop Coins



▼ 282-AFB375-21

▼ 282-AFB375-LY

HARDCAP RANGER BUMP CAP

KEY FEATURE	Shades the Sun's UV Rays	
APPLICATIONS	Airlines / Landscapers / Pool Installers	
CAP STYLE	3" Wide Full Brim	
PROTECTIVE LINER	Inner HDPE Liner with Foam Cushioning	
SIZE ADJUSTMENT	Adjustable Chinstrap	
VENTILATION	Mesh Panels Match Up with Liner Holes	
SWEATBAND	Terrycloth	
STYLE NUMBER	COLOR	BRIM
282-AFB375-21	■ Navy / Navy	Full Brim - 3"
282-AFB375-LY	■ Hi-Vis Lime Yellow	Full Brim - 3"



CLIP-ON LED CAP LIGHT

- Securely clips onto brim of HardCap Bump Cap
- Includes 5 high-power white LEDs that are unbreakable and will last 100,000+ hours

STYLE NUMBER	COLOR
281-CAP-LED	■ Black

Batteries included

RESCUE HELMETS

GEAR BAGS / RESCUE HELMETS



▲ **903-GB653**
Wheels available only in this style

GEAR BAGS

- "U-shaped" metal stays on the top of the bag to help keep bag open for quick and easy donning and doffing of turn out gear
- Extra-heavy tarp-style bottom with five raised cleats
- Adjustable contoured padded shoulder strap

ITEM NUMBER	DESCRIPTION
903-GB651	Red Polyester
903-GB652	Blue Polyester
903-GB653	Red Polyester with Wheels

MULTI-PURPOSE HELMETS INDUSTRIAL / RESCUE



R5SL UTILITY RESCUE HELMET

KEY FEATURE	Lightweight Shell with Superior Strength and Durability	
APPLICATIONS	Rescue / Industrial	
SUSPENSION	Mesh 6-point Ribbon Cradle	
SIZE ADJUSTMENT	Ratchet Headband with Padding	
SHELL MATERIAL	DuPont® Kevlar™ Composite	
CHIN STRAP	3-Point Polyester with Quick Release Buckle	
SWEATBAND	Merino Leather	
CERTIFIED	NFPA 1951, EN 397	
COMPLIANT	ANSI/ISEA Z89.1	
STYLE NUMBER	COLOR	ACCESSORIES INCLUDED
856-6323	Red	ESS Goggle Mounts
856-6324	Yellow	ESS Goggle Mounts
856-6325	Blue	ESS Goggle Mounts
856-6326	White	ESS Goggle Mounts

R6 DOMINATOR RESCUE HELMET

KEY FEATURE	Elite Utility Rescue Helmet, Featuring the Open-Close Pacific DSVS™ Dynamic Sealed Ventilation System	
APPLICATIONS	Rescue / Industrial	
SUSPENSION	6-Point Ribbon Cradle	
SIZE ADJUSTMENT	Ratchet Headband with Padding	
SHELL MATERIAL	FiberTuff® Composite	
CHIN STRAP	4-Point Polyester with Quick Release Buckle	
EYE PROTECTOR	Internal Retractable	
CERTIFIED	EN 12492	
COMPLIANT	ANSI/ISEA Z89.1	
STYLE NUMBER	COLOR	ACCESSORIES INCLUDED
805-3455	White	Goggle Mounts/Straps, Light Base
805-3479	Red	Goggle Mounts/Straps, Light Base



FIRE & RESCUE HELMETS

STRUCTURAL FIRE HELMETS

UP TO 20% LIGHTER THAN EQUIVALENT WOVEN FIBERGLASS MATERIAL



INCLUDES REFLECTIVE TRIM



FIRE & RESCUE

F10 MKV JET-STYLE STRUCTURAL FIRE HELMET

KEY FEATURE	Internal Bubble Face Shield & One Touch™ Eye Protector	
APPLICATIONS	Fire & Rescue	
SUSPENSION	6-Point Ribbon Cradle	
SIZE ADJUSTMENT	Ratchet Headband with Easy-to-Adjust Dial	
SHELL MATERIAL	DuPont® Kevlar™ Composite	
CHIN STRAP	3-Point Nomex®	
SWEATBAND	Leather	
CERTIFIED	NFPA 1951, NFPA 1971, EN 443	
COMPLIANT	ANSI/ISEA Z89.1	
STYLE NUMBER	COLOR	ACCESSORIES INCLUDED
841-0401	■ White	Bubble Face Shield, Eye Protector
841-0398	■ Red	Bubble Face Shield, Eye Protector
841-0400	■ Black	Bubble Face Shield, Eye Protector
841-0399	■ Yellow	Bubble Face Shield, Eye Protector

F6 METRO STYLE STRUCTURAL FIRE HELMET

KEY FEATURE	Most Popular Structural Fire Helmet Style	
APPLICATIONS	Fire & Rescue	
SUSPENSION	Impact Liner with Mesh Cradle	
SIZE ADJUSTMENT	Ratchet Headband	
SHELL MATERIAL	FiberTuff® Composite Fiberglass	
CHIN STRAP	2-Point Nomex®	
CERTIFIED	NFPA 1971	
COMPLIANT	ANSI/ISEA Z89.1, EN 166	
STYLE NUMBER	COLOR	ACCESSORIES INCLUDED
828-0378	■ White	Retractable Eye Protector
828-0379	■ Red	Retractable Eye Protector
828-0382	■ Black	Retractable Eye Protector
828-0380	■ Yellow	Retractable Eye Protector

DUPONT™ KEVLAR® COMPOSITE RESIN SHELL FOR SUPERIOR STRENGTH & DURABILITY

WINTER LINERS

FR TREATED

WINTER LINERS FEATURES & BENEFITS



MATERIAL & CONSTRUCTION

Winter liners are available in 1, 2, or 3 layer constructions.

OUTER LAYERS

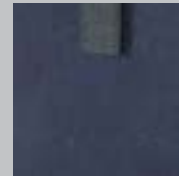

Cotton Twill

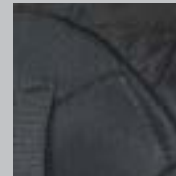

Polyester (Quilted)

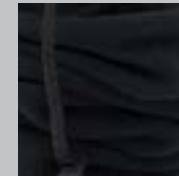

Polyester Fleece

INNER LAYERS



Fleece



Sherpa Pile Fleece

LENGTHS



Regular Length (Shorty):

Hits at base of head



Mid-Length (Middy)

Hits just below nape of neck



Shoulder Length (Extended):

Wraps around to front and can be tucked into jacket

FR TREATMENT

• FR Treated (Outer shells only):

- Outer shell tested to retain their FR characteristics for 1, 10, or 30 washes

• Non-FR:

- Hats, caps and a few select winter liners are not treated for use in applications that do not require the added protection



USE WITH **NEW HEAT PACKS** | PAGE 119

SELECT A LINER BY LEVEL OF WARMTH

WARM

WARMER

WARMEST

WARM

STYLE NUMBER	TYPE	LENGTH	COLOR	LAYERS	OUTER	MIDDLE	INNER
364-SL1FB	Non-FR	Extended	■ Navy	1	Fleece	---	---
363-1RL2B	1 Wash	Regular	■ Navy	2	Cotton Twill	---	Fleece
364-RL2B	30 Washes	Regular	■ Navy	2	Cotton Twill	---	Fleece

WARMER

364-1170	Non-FR	Extended Adjustable 3-in-1 Balaclava	■ Black	1	Polyester Fleece	---	---
363-1RL3QB	1 Wash	Regular - Quilted	■ Black	3	Polyester	Foam	Fleece
363-1ML2FB	1 Wash	Mid	■ Navy	2	Cotton Twill	---	Fleece
363-1SL2FB	1 Wash	Extended	■ Navy	2	Cotton Twill	---	Fleece
364-RL3QB	10 Washes	Regular Quilted	■ Black	3	Polyester	Foam	Fleece
365-1620	10 Washes	Mid Zipper 2-in-1	■ Navy	2	Cotton Twill	Fleece	Acrylic Neck
364-ML2FB	30 Washes	Mid	■ Navy	2	Cotton Twill	---	Fleece
364-SL2FB	30 Washes	Extended	■ Navy	2	Cotton Twill	---	Fleece

WARMEST

364-ML2FMP	30 Washes	Mid - Mouthpiece	■ Navy	2	Cotton Twill	---	Fleece
364-ML2SB	30 Washes	Mid	■ Navy	2	Cotton Twill	---	Sherpa Pile
364-SL2SB	30 Washes	Extended	■ Navy	2	Cotton Twill	---	Sherpa Pile

STYLES WITH ADDITIONAL FEATURES



▲ **364-ML2FMP**
Middy with Mouthpiece



▲ **364-1170**
3-in-1 Balaclava



▲ **365-1620**
Zippered On/Off FR Liner

BEST SELLER

PROTECTION FROM THE COLD OUTDOORS OR INDOORS

IDEAL FOR INDUSTRIAL, CONSTRUCTION & SERVICE WORKERS



▲ **365-1510FR-BK**



▲ **365-1520FR-BK**



▲ **360-BEANNIELY**



WINTER HAT LINERS

- Knit Material
- FR and Non FR
- One Size Fits Most

FR/AR WINTER HATS & LINERS (ARC RATED)

ITEM NUMBER	DESCRIPTION	ARC RATING	COLOR
360-1500FR-BK	FR Knit Watch Cap	33 cal/cm ²	■ Black
365-1510FR-BK	FR Knit Hard Hat Tube Liner	15 cal/cm ²	■ Black
365-1520FR-BK	FR Knit Full Face Tube Liner	15 cal/cm ²	■ Black

NON FR WINTER HATS & LINERS

365-1502-BK	Knit Full Face Tube Liner		■ Black
365-1505-BK	Knit Hard Hat Tube Liner		■ Black
360-BEANNIELY	Winter Beanie Cap with Reflective Stripe		■ Hi-Vis Lime Yellow
360-BEANNIEOR	Winter Beanie Cap with Reflective Stripe		■ Hi-Vis Orange

FLAME & FIRE RESISTANT HOODS

NOMEX® / NFPA 1971



FLAME RESISTANT HOODS



SLIT EYE

▲ 202-130

◀ NOMEX® FLAME RESISTANT HOODS

- Offer limited chemical splash protection along with excellent wear and durability
- Meets OSHA Requirements for flame resistance
- Protective properties will not wash out
- All Bibs are 6", front and back

APPLICATIONS: *Chemical Plants, Metal and Glass Manufacturing, Natural Gas Production and Distribution, Law Enforcement*



FULL FACE

▲ 202-101

100% NOMEX® FR HOODS

STYLE NUMBER	COVERAGE	LAYER	BIB	COLOR	SIZES
202-100	Full Face	Single	Without	■ White	OSFM
202-101	Full Face	Single	Without	□ Black	OSFM
202-102	Full Face	Double	Without	■ White	OSFM
202-110	Full Face	Single	With	■ White	OSFM
202-112	Full Face	Double	With	■ White	OSFM
202-130	Slit Eye	Single	With	■ White	OSFM
202-132	Slit Eye	Double	With	■ White	OSFM

FIRE RESISTANT HOODS



▲ 906-100NOM7BLKB

▲ 906-2080NOL7B

◀ 100% NOMEX® HOODS

- Excellent for flash protection along with superior wear and durability
- Protective properties will not wash out

APPLICATIONS: *Structural Firefighting, Chemical Plants, Metal and Glass Manufacturing, Natural Gas Production and Distribution, Law Enforcement*

◀ 20% NOMEX® / 80% LENZING FR® HOODS

- Fabric combination provides comfort and breathability

NFPA 1971 CERTIFIED HOODS

STYLE NUMBER	TPP RATING	MATERIAL	CUT	COVERAGE	LAYER	BIB	COLOR	SIZES
906-100NOM7	20-23	100% Nomex®	Tri-Cut	Full Face	Double	With	■ White	OSFM
906-100NOM7B	20-23	100% Nomex®	Straight Cut	Full Face	Double	With	■ White	OSFM
906-100NOM7BLKB	20-23	100% Nomex®	Straight Cut	Full Face	Double	With	□ Black	OSFM
906-2080NOL7	17	20% Nomex® / 80% Lenzing FR®	Tri-Cut	Full Face	Single	With	■ White	OSFM
906-2080NOL7B	17	20% Nomex® / 80% Lenzing FR®	Straight Cut	Full Face	Single	With	■ White	OSFM
906-2080NOL7BLK	23	20% Nomex® / 80% Lenzing FR®	Tri-Cut	Full Face	Single	With	□ Black	OSFM
906-2080NOL7BLKB	23	20% Nomex® / 80% Lenzing FR®	Straight Cut	Full Face	Single	With	□ Black	OSFM
906-8416CBX	28	84% Carbon® / 16% Technora®	Straight Cut	Full Face	Single	With	□ Black	OSFM
906-8416CT	28	84% Carbon® / 16% Technora®	Tri-Cut	Full Face	Single	With	□ Black	OSFM

HEARING PROTECTION & WHY IT'S CRITICAL

WHEN THE NOISE LEVELS OF A WORK ENVIRONMENT EXCEED 85 DECIBELS (dB), THE RISK OF HEARING LOSS BECOMES VERY PREVALENT AND HEARING PROTECTION SHOULD BE WORN. AT THE SAME TIME “TOO MUCH” HEARING PROTECTION CAN ALSO BE DANGEROUS, AS IT RESTRICTS THE WEARER FROM HEARING THEIR COLLEAGUES OR MOVING VEHICLES IN THEIR WORK AREA. TAKING THIS INTO CONSIDERATION, THE IDEAL NOISE LEVEL IS 70-85 dB.

Hearing loss is both cumulative and gradual, meaning hearing can continually worsen and that it is difficult for someone to be aware of if they are losing their hearing. Therefore, it is critical to wear hearing protection to better sustain one's hearing. By preserving the hearing one has, they help reduce the impact of hearing loss in their day-to-day life.

HEARING PROTECTION OPTIONS: EAR PLUGS AND EAR MUFFS

Ear plugs are the most popular choice because they are seen as the most economical solution and they can easily be worn with other PPE.

- **Single Use Ear Plugs** are ideal for use in high-contamination environments and by work-site visitors.
- **Multiple Use Ear Plugs** are reusable and easy to clean, making them ideal for use in manufacturing, construction, and MRO.
- **Corded and Uncorded** options are available in both families. Uncorded is more economical, while the corded plugs are easier to keep track of by allowing the user to wear the ear plugs around their neck when they are not in use.

The correct use of ear plugs is critical to ensuring optimal performance, and we encourage proper training and practice to achieve this. Improper use can minimize or negate the hearing protection properties of the ear plug and expose the wearer to potential hearing loss.

ALL PIP HEARING PROTECTION PRODUCTS HAVE A NOISE REDUCTION RATING (NRR)

Ear muffs provide a more secure form of hearing protection, especially because they are easier to use and allow the user to gain maximum protection from the product. There are two types of ear muffs: passive and active.

- **Electronic** Ear Muffs feature an electronic protection system that digitally limits all sound through the internal speakers to a safe level. Models with Active Listening, allow you to communicate with others or hear warning signals while protected against impulsive or intermittent hazardous noise.
- **Passive** muffs do not have any electronic features, and are available in headband, neckband, and cap mounted styles – the latter two can be worn with a hard hat.

168 EAR MUFFS

170 EAR PLUGS

172 ADDITIONAL STYLES & ACCESSORIES

HEARING PROTECTION

EAR MUFFS

SECURE™ PASSIVE



SECURE™ PASSIVE EAR MUFFS



	SECURE™ HEADBAND	SECURE™ CAP MOUNTED	SECURE™ NECKBAND
STYLE NUMBERS	263-41003 NRR 28 dB - Secure 3 - Orange 263-41002 NRR 26 dB - Secure 2 - Yellow 263-41001 NRR 23 dB - Secure 1 - Green	263-42003 NRR 27 dB - Secure 3 - Orange 263-42002 NRR 24 dB - Secure 2 - Yellow 263-42001 NRR 22 dB - Secure 1 - Green	263-43003 NRR 27 dB - Secure 3 - Orange 263-43002 NRR 25 dB - Secure 2 - Yellow 263-43001 NRR 23 dB - Secure 1 - Green
KEY FEATURE	Telescopic Single-Point Headband Size Adjustment	Easily Adjusts to Three Wearing Positions: Usage, Stand-By & Storage	Can Be Worn with Full Brim Hard Hats & Other Specialty Headgear
APPLICATIONS	Manufacturing / Construction / Industrial	Construction / Industrial	Manufacturing / Construction / Industrial
SIZE ADJUSTMENT	Single-Point 7-Position	Single-Point 5-Position	Head Support Hook & Loop Strap
CUSHIONS	Snap-In Ear & Headband Cushions	Snap-In Ear Cushions	Snap-In Ear Cushions
DIELECTRIC	Yes	Yes	Yes
PACKAGING	Boxed	Boxed	Boxed

- Offered in three levels of protection clearly indicated with bright safety colors for easy identification and performance selection
- Smooth telescopic single-point size adjustment increases comfort, performance and wear time
- Ear and headband cushions feature snap-in system for easy replacement
- All models are dielectric, non-conductive

AVAILABLE WITH
ACTIVE LISTENING | **AM/FM RADIO**

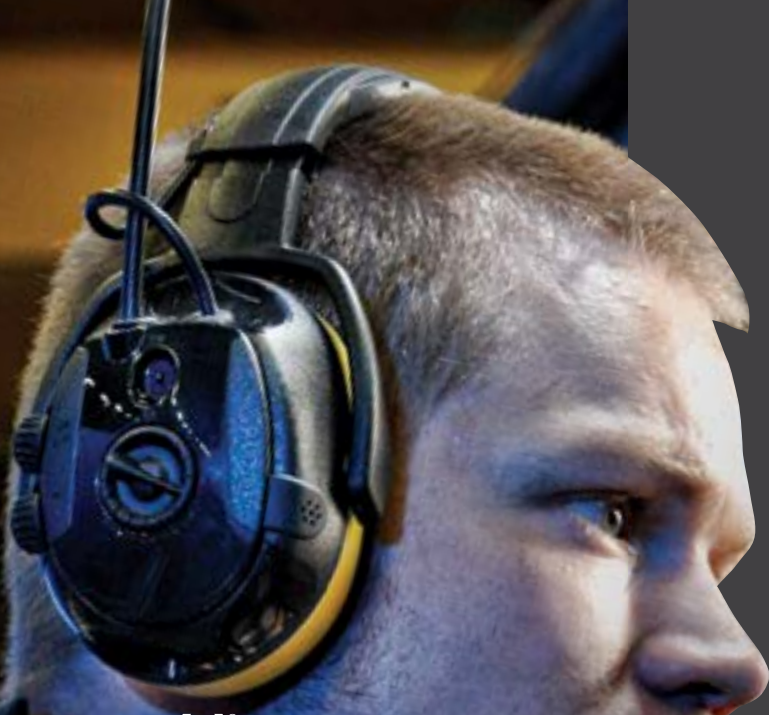

SECURE™



ELECTRONIC EAR MUFFS

- Active Listening is a Level Dependent System that allows you to communicate with others or hear warning signals while protected against impulsive or intermittent hazardous noise
- Level-dependent microphones mounted on each ear cup ensure excellent directional hearing
- Electronic Protection System (EPS) limits all sounds reproduced through the speakers to a safe sound level
- All electronic models include a 3.5 mm external sound input for radio communications, as well as MP3 players and other common devices



HEAD BAND



CAP MOUNTED



	SECURE™ ACTIVE	SECURE™ RELAX	SECURE™ REACT
STYLE NUMBERS	264-47002 NRR 24 dB - Headband - ■ Yellow	264-45002 NRR 24 dB - Headband - ■ Yellow	264-46002 NRR 24 dB - Headband - ■ Yellow
	264-47102 NRR 23 dB - Cap Mount - ■ Yellow	264-45102 NRR 23 dB - Cap Mount - ■ Yellow	264-46102 NRR 23 dB - Cap Mount - ■ Yellow
KEY FEATURE	Level Dependent System Allows You to Communicate with Others	Offers Hearing Protection with Built-In AM/FM Radio	Includes Both Level Dependent System & AM/FM Radio
APPLICATIONS	Manufacturing / Construction / Industrial	Manufacturing / Construction / Industrial	Manufacturing / Construction / Industrial
ACTIVE LISTENING	Yes	No	Yes
AM/FM RADIO WITH AFC	No	Yes	Yes
SIZE ADJUSTMENT	Single-Point Telescopic	Single-Point Telescopic	Single-Point Telescopic
EAR CUSHIONS	Snap-In Ear and/or Headband Cushions	Snap-In Ear and/or Headband Cushions	Snap-In Ear and/or Headband Cushions
EXTERNAL SOUND INPUT	3.5 mm	3.5 mm	3.5 mm
BATTERIES	Two "AA" Included	Two "AA" Included	Two "AA" Included
PACKAGING	Boxed	Boxed	Boxed

EAR PLUGS

SINGLE-USE

SINGLE-USE

COMMONLY USED & PROVIDE ADDED HYGIENIC VALUE



NRR
32



NRR
30



NRR
30



NRR
32

X-EMBOSS

COMPACT X-EMBOSS

TRADITIONAL PVC

ECONOMY BULLET

STYLE NUMBERS	267-HPF200 NRR 32 dB - Uncorded - 200 pair 267-HPF200C NRR 32 dB - Corded - 100 pair 267-HPF200-1 Dispenser Refill Pack NRR 32 dB - Uncorded - 300 pair	267-HPF300 NRR 30 dB - Uncorded - 200 pair 267-HPF300C NRR 30 dB - Corded - 100 pair 267-HPF300-1 Dispenser Refill Pack NRR 30 dB - Uncorded - 300 pair	267-HPF700 NRR 30 dB - Uncorded - 200 pair 267-HPF700C NRR 30 dB - Corded - 100 pair	265-200U NRR 32 dB - Uncorded - 200 pair 265-100C NRR 32 dB - Corded - 100 pair
KEY FEATURE	X-Embossed on End, Reduces Pressure at Ear Canal Opening	Smaller Contoured Design for Narrower Ear Canals	Classic Cylindrical Design in PVC Foam Plug	Economical Choice
APPLICATIONS	Manufacturing / Construction / Industrial	Manufacturing / Construction / Industrial	Manufacturing / Construction / Industrial	Manufacturing / Construction / Industrial
STYLE	Disposable	Disposable	Disposable	Disposable
COLOR	■ Lime	■ Magenta	■ Orange	■ Orange
MATERIAL	Polyurethane Foam (PU)	Polyurethane Foam (PU)	PVC Foam	Polyurethane Foam (PU)
SHAPE	Tapered with X-Emboss	Compact Contoured with X-Emboss	Cylindrical	Tapered
CORD TYPE	Uncorded or Black PVC Cord	Uncorded or Black PVC Cord	Uncorded or Black PVC Cord	Uncorded or Red PVC Cord
PACKAGING	Individual Poly Bagged Pairs in Dispenser Box	Individual Poly Bagged Pairs in Dispenser Box	Individual Poly Bagged Pairs in Dispenser Box	Individual Poly Bagged Pairs in Dispenser Box

MULTIPLE USE

EASY TO CLEAN, REDUCE WASTE & SAVE MONEY



	REUSABLE		DETECTABLE		BANDED	
	FLANGE CLASSIC	FLANGE/DISC COMBO	METAL DETECTABLE X-EMBOSS	METAL DETECTABLE FLANGE/DISC COMBO	BANDED OVAL FOAM	BANDED FLANGE REUSABLE
STYLE NUMBERS	267-HPR200 NRR 23 dB - Uncorded - 100 pair	267-HPR300 NRR 25 dB - Uncorded - 100 pair	267-HPF200D NRR 32 dB - Corded - 100 pair	267-HPR300D NRR 25 dB - Corded - 100 pair	267-HPB200 NRR 20 dB - 10 pair	267-HPB300 NRR 20 dB - 10 pair
	267-HPR200C NRR 23 dB - Corded - 100 pair	267-HPR300C NRR 25 dB - Corded - 100 pair				
KEY FEATURE	Pre-Formed Plug Shape with No Rolling Required	Self-Sealing Flanges & Discs with a Higher NRR	Includes Traceable Metal Insert	Bright Blue Color Makes it Easier to See In Production Areas	Oval Foam Plug Fits Shape of the Ear Canal Snugly	Reusable Version Can Be Worn Under Chin or Behind the Neck
APPLICATIONS	Manufacturing / Construction / Dirty Environments	Manufacturing / Construction / Dirty Environments	Food Industry	Food Industry	Frequent Use / Visitors / Industrial	Frequent Use / Visitors / Industrial
STYLE	Reusable	Reusable	Disposable	Reusable	Banded - Disposable	Banded - Reusable
COLOR	Orange	Lime	Blue	Blue	Lime	Red
MATERIAL	TPE (thermoplastic elastomer)	TPE (thermoplastic elastomer)	Polyurethane Foam (PU)	TPE (thermoplastic elastomer)	Polyurethane Foam (PU)	TPE (thermoplastic elastomer)
SHAPE	Self-Sealing Flanges	Self-Sealing Flanges & Discs	Tapered w/ X-Emboss	Self-Sealing Flanges & Discs	Oval Cap	Self-Sealing Flanges
CORD TYPE	Uncorded or Textile Cord	Uncorded or Textile Cord	Blue PVC Cord	Blue PVC Cord	Ergonomic Blue Band	Black Band
PACKAGING	Individual Poly Bagged Pairs in Box	Individual Poly Bagged Pairs in Box	Individual Poly Bagged Pairs in Box	Individual Poly Bagged Pairs in Box	Individual Poly Bagged Pairs in Box	Individual Poly Bagged Pairs in Box

HEARING PROTECTION

ADDITIONAL STYLES / ACCESSORIES



INTER GPV™ GENERAL PURPOSE

STYLE NUMBERS	262-AEK010HV NRR 20 dB - Cap Mounted - Orange	262-AEK020HV NRR 24 dB - Cap Mounted - Orange	262-AEJ030-50 NRR 21 dB - Cap Mounted - Blue
KEY FEATURE	Hi-Vis Orange for Extra Visibility	Hi-Vis Orange for Extra Visibility	Allow Attachment of Safety Visor When Used with Surefit™ Adapter
APPLICATIONS	Construction / Industrial	Construction / Industrial	Construction / Industrial
SIZE ADJUSTMENT	Twin-Point Mount with Tilt	Twin-Point Mount with Tilt	Single-Point with Pivot/Slide
PACKAGING	Boxed	Boxed	Boxed

INTER EXV™ EXTREME

SUREFIT™ CONTOUR™

EAR PLUG DISPENSER

Wall-mounted dispenser holds 600 pairs (not included)

- Controlled-release mechanism ensures the correct number of plugs is dispensed into a collection tray
- Audible 1-2-click system prevents oversupply and reduces waste costs
- Simple to open and fill dispenser with disposable PU foam ear plug refill packs, HPF200 (NRR 32 dB) or compact HPF300 (NRR 30 dB)

STYLE NUMBER	STYLE
267-HPD100	Dispenser
267-HPF200-1	Refill Pack - HPF200 (300 pair)
267-HPF300-1	Refill Pack - HPF300 (300 pair)



ECONOMY HEADBAND

One of the lightest ear muffs on the market, weighing in at only 5.5 oz.

- Intended for long-term use in low noise levels, or shorter periods in medium-noise environments
- Single-point attachment distributes pressure and seal evenly around the ear
- Comfortable pressure-equalizing headband ensures the cups remain in proper position during use

STYLE NUMBER	NRR	STYLE	COLOR
263-11001	22 dB	Headband	Red



HYGIENE KITS - SECURE™ EAR MUFFS

Ear and headband cushions feature snap-in system for easy replacement

- All Hellberg® Secure™ hygiene kits include one pair of replacement ear cushions, one pair of foam inserts and one headband cushion
- Ear cushions should be replaced twice a year, or when the cushion shows signs of damage

STYLE NUMBER	STYLE
263-99400	Secure™ 1 & 2
263-99401	Secure™ 3
264-99403	Secure™ Electronic

FUNDAMENTALS OF EYE PROTECTION

EYE PROTECTION IS DESIGNED TO HELP SHIELD YOUR EYES FROM CERTAIN IMPACTS, DEBRIS, DUST, SPLASHES, AND OTHER POTENTIAL HAZARDS THAT COULD PRESENT SEVERE INJURY TO THE EYES, INCLUDING POTENTIAL BLINDNESS. PIP'S BOUTON® OPTICAL PROVIDES A COMPREHENSIVE LINE OF POTENTIAL SOLUTIONS FOR SAFETY EYEWEAR NEEDS.

SAFETY GLASSES

In addition to temples and nose pads to improve fit and comfort, there are several options also available to meet specific needs:

- **Readers** are available in different diopters and help magnify text so it becomes easier to read.
- **Foam-Lined Safety Glasses** seal better against the wearer's face, helping better protect against dust and other small debris. This style of eye protection is not recommended for splash protection.
- **Over-The-Glass (OTG) Safety Glasses** can be worn over prescription eyewear to provide the required protection. Standard eyeglasses cannot act as safety glasses and should not be treated as such.
- **Dielectric Safety Glasses** do not contain any metal components, making them non-conductive for those who are working near or around electricity.

Once the style of protective eyewear is chosen, the next consideration should be the lens technology for the task at hand. Depending on the work environment and lighting conditions, there are several different options for lenses. This information is detailed in the Bouton® Optical Lens Treatment Quick Guide on the subsequent pages.

GOGGLES & FACE SHIELDS

With goggles, the type of venting required for the work environment is the most critical consideration.

- **Direct Vented** goggles help minimize fogging and should be used when there is no liquid splash risk. Direct vented goggles have straight-line perforations that allow direct airflow from the work environment.
- **Indirect Vented** goggles help minimize fogging and should be used when there is liquid splash risk. Indirect vented goggles have hooded vents to allow indirect airflow from the work environment.
- **Non-Vented** have no openings for airflow or ventilation.

Face shields do just that – they protect the face from debris, such as sparks, or certain impacts. Face shields should not be used as a replacement for safety eyewear, as they are designed to be used in conjunction with eye protection products. Face shields can be worn with standard head gear or they can be fitted on your hard hat with the assistance of an adapter or bracket.

174 LENS TECHNOLOGIES

178 SAFETY GLASSES

208 SAFETY GOGGLES

212 FACE PROTECTION

214 ACCESSORIES

bouton
OPTICAL

ALL BOUTON SAFETY EYEWEAR
MEETS ANSI Z87.1-2015 STANDARDS

EYE & FACE PROTECTION



bouton[®] OPTICAL

FOR OVER 60 YEARS,
BOUTON[®] HAS BUILT ITS NAME
BY DEVELOPING SAFETY GLASSES
WORKERS WANT TO WEAR. BY
FOCUSING ON INNOVATION AND
STYLE, THE BOUTON[®] LEGACY
CONTINUES TO GROW TODAY.

BOUTON[®]
LENS TECHNOLOGIES



ANTI-REFLECTIVE PLUS[™]
TECHNOLOGY

THE CLOSEST THING TO
NOT WEARING GLASSES

Bouton[®] Anti-ReflectivePLUS[™] lenses allow an astounding 96% Visible Light Transmission (VLT) compared to the 88–90% VLT provided by standard clear lenses. Durable Anti-ReflectivePLUS[™] Anti-Reflective coating significantly reduces the amount of light that reflects back into the wearer's eyes, providing ultimate visual acuity. Inspect, distinguish and see with more clarity—and less eye fatigue.

Available in the Following Styles: Bullseye, Recon, Commander, Supersonic, Q-Vision, Radar, Captain

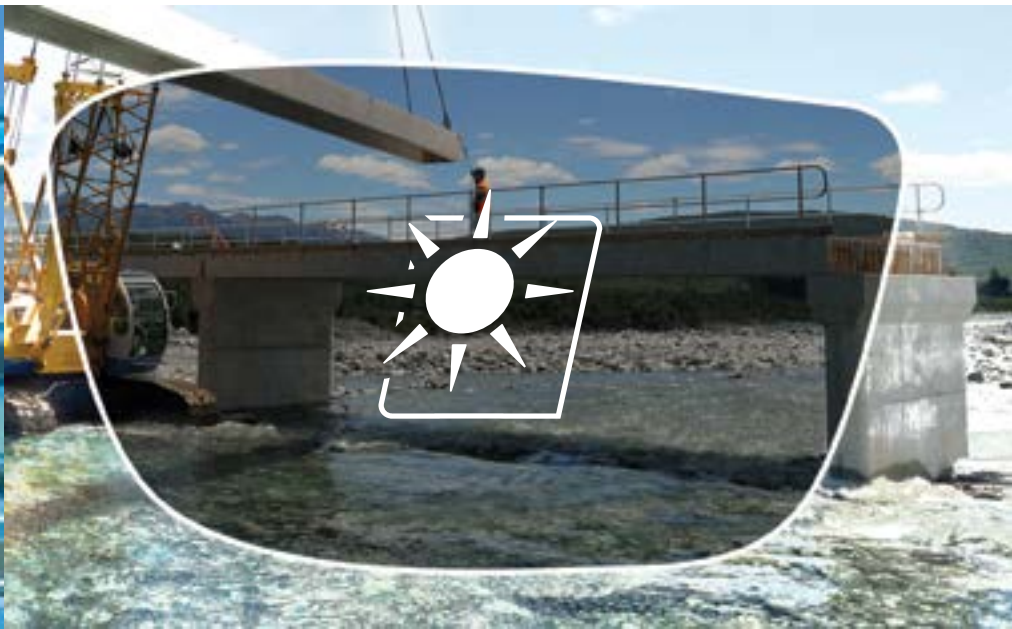

TAKE ANTI-REFLECTIVE PLUS™ TECHNOLOGY OUTDOORS WITH MIRROR PLUS LENSES

A mirror coating on the face of the lens will deflect sunlight from the wearer's eyes, delivering noticeably less glare and reflection than standard gray lenses. Anti-ReflectivePLUS™ coating on the back of the lens significantly reduces light reflecting back into the eye for enhanced comfort and performance.

Available in the Following Styles: Sunburst, Squadron, Bond



FILTER REFLECTED SUNLIGHT FOR A CLEAR VIEW

Reflected sunlight from smooth surfaces, such as water, pavement, and snow can dangerously hinder vision and cause significant eyestrain. PolarizedXL5™ lenses filter the scatter light by controlling the angle at which it enters the lens. The result is clearer vision of the surrounding area and greatly reducing eye glare.

Available in the Following Styles: Commander, Sunburst



I/O BLUE
TECHNOLOGY

PROTECT AGAINST HARMFUL BLUE LIGHT

Overexposure to blue light, including smart phones, tablets and computer screens, has been known to cause eyestrain, fatigue and possibly contribute to long term macular degeneration. I/O Blue lenses are uniquely coated to help filter out harsh blue light and improve worker comfort and visual acuity. Lenses are also treated with a contrast booster to enhance color contrast.

Available in the Following Styles: Bullseye, Recon, Commander, Supersonic, Q-Vision, Radar, Captain, Bond, Blizzard



GRADIENT™
TECHNOLOGY

REDUCE GLARE FROM OVERHEAD LIGHT

High-powered overhead lights, such as fluorescent and mercury lighting, can cause glare that increases eye strain. Gradient lenses feature a slight mirror coating on the top portion of the lens, reducing glare, while the remainder of the lens remains clear. As a result, workers are still able to see clearly when looking straight ahead or down at their work.

Available in the Following Styles: Bullseye, Recon, Supersonic

IT'S NOT LESS FOG IT'S FOGLESS®



Lenses fog for many reasons, all of which are related to ambient temperature and moisture in the air. When a rapid temperature change occurs, micro-water droplets in the air will collect on untreated lenses, causing the lenses to fog and impede vision.

FOGLESS® 3SIXTY™ TECHNOLOGY PROVIDES THE ULTIMATE FOG PREVENTION WHEN:

- Transitioning between warm and cool environments
- Working in a humid or wet environment
- Engaging in an activity that causes perspiration
- Eye protection is used with respiratory equipment

FogLess® 3Sixty™ Technology

Standard Anti-Fog

THE CHOICE IS CLEAR

BOUTON® FOGLESS® 3SIXTY™ was tested in accordance to procedures outlined in the European EN 166 standard in performing this test, lenses were pre-treated and repeatedly exposed to moisture for an extensive period, wiping continually to simulate harsh field conditions.

FOGLESS® 3SIXTY™ REMAINED CLEAR EVEN AFTER SIX MINUTES OF TESTING, NO OTHER PRODUCT WITH STANDARD ANTI-FOG TREATMENT CAME CLOSE.

PERFORMANCE

Most eyewear on the market has only a light anti-fog coating that wears away quickly. Only Bouton® FogLess® 3Sixty™ Technology applies a densely bonded coating that continues to bead away water and moisture, even after repeated cleaning.

CAUTION

Lens fogging inhibits vision and productivity, which may result in workers removing their safety glasses - exposing their eyes to debris and impact. PIP's advanced FogLess® 3Sixty™ formulation was developed to adhere permanently to the lens, ensuring long-lasting performance that is able to withstand multiple lens cleanings.

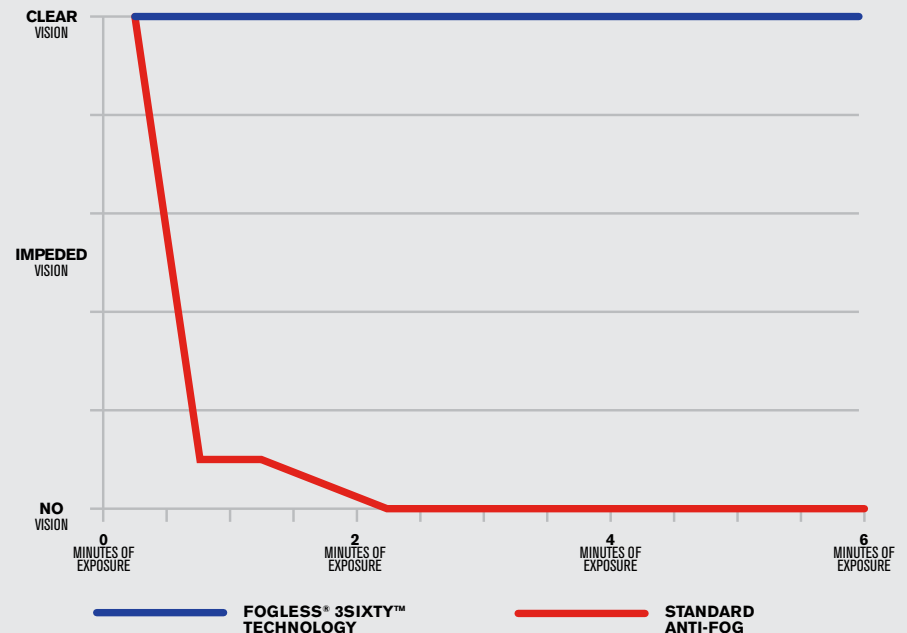



DARE TO BE BOLD



SUNBURST™

MEETS ANSI
Z87.1+

- :: Lightweight, full frame design offers all day comfort
- :: Bayonet temples are rubber co-molded for a secure fit
- :: Non-slip rubber nose pads provide long-wear comfort
- :: Anti-fog coating is standard on most models
- :: 8 base curve

LENS TECHNOLOGY



STYLE NUMBER	LENS	COATING	FRAME
250-47-0041	<input type="checkbox"/> Gray Polarized XL5™ Technology	Anti-Scratch / Anti-Fog	<input type="checkbox"/> Black
250-47-0004	<input checked="" type="checkbox"/> Red Mirror Plus™ Technology	Anti-Scratch	<input type="checkbox"/> Black
250-47-0005	<input checked="" type="checkbox"/> Silver Mirror Plus™ Technology	Anti-Scratch	<input type="checkbox"/> Black
250-47-0006	<input checked="" type="checkbox"/> Blue Mirror Plus™ Technology	Anti-Scratch	<input type="checkbox"/> Black
250-47-0007	<input checked="" type="checkbox"/> Gold Mirror Plus™ Technology	Anti-Scratch	<input type="checkbox"/> Black
250-47-0020	<input checked="" type="checkbox"/> Clear	Anti-Scratch / Anti-Fog	<input type="checkbox"/> Black
250-47-0021	<input checked="" type="checkbox"/> Gray	Anti-Scratch / Anti-Fog	<input type="checkbox"/> Black
250-47-1008	<input checked="" type="checkbox"/> Green Mirror Plus™ Technology	Anti-Scratch / Anti-Fog	<input type="checkbox"/> Brown
250-47-1042	<input type="checkbox"/> Brown Polarized XL5™ Technology	Anti-Scratch / Anti-Fog	<input type="checkbox"/> Brown



WORK & ADVENTURE

SQUADRON™

MEETS ANSI
Z87.1+

- :: Full frame style designed to provide a universally comfortable fit
- :: Nylon bayonet temples eliminate pressure for all day comfort
- :: Stylish design looks good for work and leisure
- :: Dielectric design contains no metal parts
- :: Anti-fog coating is standard on most models
- :: 8.5 base curve

LENS TECHNOLOGY



STYLE NUMBER	LENS	COATING	FRAME
250-53-0020	■ Clear	Anti-Scratch / Anti-Fog	□ Black
250-53-0021	■ Gray	Anti-Scratch / Anti-Fog	□ Black
250-53-0022	■ I/O	Anti-Scratch / Anti-Fog	□ Black
250-53-0006	■ Blue Mirror Plus™ Technology	Anti-Scratch	□ Black
250-53-1024	■ Brown	Anti-Scratch / Anti-Fog	■ Camo



CAMO FRAME AVAILABLE

bouton
OPTICAL

MODERN CLASSIC

BOND™

MEETS ANSI
Z87.1+

- :: Lightweight nylon frame provides ultimate comfort with practically no pressure behind the ear
- :: Keyhole bridge design sits naturally on the nose to fit many different faces
- :: Latest design trend in premium eye wear
- :: Dielectric materials and parts contain no metal
- :: Anti-fog coating is standard on most models
- :: 8.5 base curve

LENS TECHNOLOGY



STYLE NUMBER	LENS	COATING	FRAME
250-57-0020	■ Clear	Anti-Scratch / Anti-Fog	■ Charcoal
250-57-0021	■ Gray	Anti-Scratch / Anti-Fog	■ Charcoal
250-57-0226	■ I/O Blue Technology	Anti-Scratch / Anti-Fog	■ Charcoal
250-57-0004	■ Red Mirror Plus™ Technology	Anti-Scratch	■ Charcoal
250-57-0008	■ Green Mirror Plus™ Technology	Anti-Scratch	■ Charcoal

bouton
OPTICAL



COMMANDER™

- :: Lightweight, semi-rimless design offers extended eye coverage and all day comfort
- :: Bayonet style temples with non-slip rubber pads for a secure fit
- :: Adjustable rubber nose pads offer a custom fit
- :: Anti-fog coating is standard on most models
- :: 9.5 base curve

LENS TECHNOLOGY



MEETS ANSI Z87.1+ INDICATES
MEETS CSA Z94.3

STYLE NUMBER	LENS	COATING	FRAME
250-33-0020	■ Clear	Anti-Scratch / Anti-Fog	□ Black
250-33-0021	■ Gray	Anti-Scratch / Anti-Fog	□ Black
250-33-0010	■ Clear Anti-Reflective Plus™ Technology	Anti-Scratch	□ Black
250-33-0226	■ I/O Blue Technology	Anti-Scratch / Anti-Fog	□ Black
250-33-0041	■ Gray Polarized XL5™ Technology	Anti-Scratch	□ Black
250-33-1020	■ Clear	Anti-Scratch / Anti-Fog	■ Bronze
250-33-1024	■ Gray	Anti-Scratch / Anti-Fog	■ Bronze
250-33-1010	■ Clear Anti-Reflective Plus™ Technology	Anti-Scratch	■ Bronze
250-33-1226	■ I/O Blue	Anti-Scratch / Anti-Fog	■ Bronze
250-33-1042	■ Brown Polarized XL5™ Technology	Anti-Scratch	■ Bronze

bouton
OPTICAL



COMMAND ATTENTION



FIRST IN STYLING

bouton
OPTICAL



ANSER™

MEETS ANSI
Z87.1+

INDICATES
MEETS CSA
Z94.3

- :: Lightweight, semi-rimless design provides all day user comfort
- :: Sleek, sporty style with wraparound lens protection
- :: Bayonet temples with flexible rubber tips offer a comfortable, secure fit
- :: Soft rubber nose pads help keep the glasses in place
- :: Unique folding temples prevent arms from folding into and scratching the lenses
- :: 9 base curve

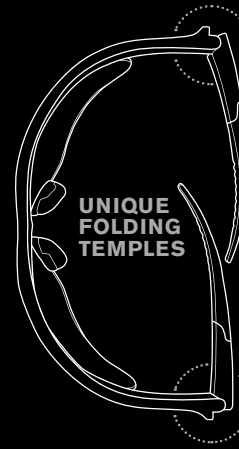

STYLE NUMBER	LENS	COATING	FRAME
250-AN-10110	■ Clear	Anti-Scratch	□ Black
250-AN-10111	■ Clear	Anti-Scratch / Anti-Fog	□ Black
250-AN-10112	■ Gray	Anti-Scratch	□ Black
250-AN-10113	■ Light Blue	Anti-Scratch	□ Black
250-AN-10114	■ I/O	Anti-Scratch	□ Black
250-AN-10115	■ Blue Mirror	Anti-Scratch	□ Black
250-AN-10116	■ Red Mirror	Anti-Scratch	□ Black
250-AN-10118	■ IR Filter 3.0	Anti-Scratch	□ Black
250-AN-10119	■ IR Filter 5.0	Anti-Scratch	□ Black
250-AN-10120	■ Amber	Anti-Scratch	□ Black
250-AN-10125	■ Silver Mirror	Anti-Scratch	□ Black
250-AN-10126	■ Gray	Anti-Scratch / Anti-Fog	□ Black
250-AN-10117	■ Gray	Anti-Scratch	■ Red
250-AN-10121	■ Brown	Anti-Scratch	■ Camouflage
250-AN-10122	■ Amber	Anti-Scratch	■ Camouflage
250-AN-10123	■ Gray	Anti-Scratch	■ Camouflage
250-AN-10124	■ Brown	Anti-Scratch / Anti-Fog	■ Camouflage
250-AN-10127	■ Amber	Anti-Scratch / Anti-Fog	■ Camouflage
250-AN-10128	■ Silver Mirror	Anti-Scratch	■ Camouflage
250-AN-10130	■ Clear	Anti-Scratch	■ Camouflage
250-AN-10131	■ Clear	Anti-Scratch / Anti-Fog	■ Camouflage



..... CAMO FRAME AVAILABLE



ATHLETIC DESIGN



Q-VISION™

- :: Rimless design offers improved field of vision and comfort
- :: Co-injected rubber temple ends provide excellent temple grip
- :: Flexible nose bridge for a comfortable fit
- :: Dielectric, non-conductive frame
- :: Anti-fog coating is standard on most models
- :: 9.75 base curve

LENS TECHNOLOGY



MEETS ANSI
Z87.1+



STYLE NUMBER	LENS	COATING	FRAME
250-36-0020	■ Clear	Anti-Scratch / Anti-Fog	■ Burgundy
250-36-0021	■ Gray	Anti-Scratch / Anti-Fog	■ Burgundy
250-36-0010	■ Clear Anti-Reflective Plus™ Technology	Anti-Scratch	■ Burgundy
250-36-0025	■ Silver Mirror	Anti-Scratch / Anti-Fog	■ Burgundy
250-36-0226	■ I/O Blue Technology	Anti-Scratch / Anti-Fog	■ Burgundy
250-36-1020	■ Clear	Anti-Scratch / Anti-Fog	■ Lime
250-36-1021	■ Gray	Anti-Scratch / Anti-Fog	■ Lime
250-36-1010	■ Clear Anti-Reflective Plus™ Technology	Anti-Scratch	■ Lime
250-36-1226	■ I/O Blue Technology	Anti-Scratch / Anti-Fog	■ Lime



RADAR™

MEETS ANSI
Z87.1+

- :: Lightweight, rimless design offers optimal protection
- :: Bayonet temples are rubber co-molded for a comfortable fit
- :: Non-slip rubber nose pads provide a secure fit
- :: Anti-fog coating is standard on most models
- :: 10 base curve

LENS TECHNOLOGY



STYLE NUMBER	LENS	COATING	FRAME
250-45-0020	■ Clear	Anti-Scratch / Anti-Fog	■ Gray
250-45-0021	■ Gray	Anti-Scratch / Anti-Fog	■ Gray
250-45-0010	■ Clear Anti-Reflective Plus™ Technology	Anti-Scratch	■ Gray
250-45-0226	■ I/O Blue Technology	Anti-Scratch / Anti-Fog	■ Gray
250-45-1020	■ Clear	Anti-Scratch / Anti-Fog	■ Red
250-45-1021	■ Gray	Anti-Scratch / Anti-Fog	■ Red
250-45-1010	■ Clear Anti-Reflective Plus™ Technology	Anti-Scratch	■ Red
250-45-1226	■ I/O Blue Technology	Anti-Scratch / Anti-Fog	■ Red

LOCKED IN LOCKED ON

bouton
OPTICAL

RUGGED & RAW

RECON™

MEETS ANSI Z87.1+  INDICATES MEETS CSA Z94.3





- :: Lightweight, rimless design for ergonomic fit
- :: Flexible bayonet temples contain rubber pads for a secure, non-slip fit
- :: Adjustable rubber nosepiece provides a comfortable fit
- :: Anti-fog coating is standard on most models
- :: 9 base curve

LENS TECHNOLOGY

 ANTI-REFLECTIVE PLUS™ TECHNOLOGY

 I/O BLUE TECHNOLOGY

 FOGLESS 3SIXTY™ TECHNOLOGY

STYLE NUMBER	LENS	COATING	FRAME
250-32-0020	■ Clear	Anti-Scratch / Anti-Fog	■ Clear 
250-32-0021	■ Gray	Anti-Scratch / Anti-Fog	□ Black 
250-32-0010	■ Clear Anti-Reflective Plus™ Technology	Anti-Scratch	■ Clear 
250-32-0226	■ I/O	Anti-Scratch / Anti-Fog	■ Brown 
250-32-0031	■ Gradient	Anti-Scratch / Anti-Fog	□ Black 
250-32-0520	■ Clear	Anti-Scratch / FogLess® 3Sixty™	■ Clear
250-32-0521	■ Gray	Anti-Scratch / FogLess® 3Sixty™	■ Gray



bouton
OPTICAL

CAPTAIN™

MEETS ANSI
Z87.1+

- :: Lightweight, rimless design provides all day user comfort
- :: Bayonet temples with end tips that curve out for ease of placement on face
- :: Non-slip rubber nose pads offer a secure fit
- :: Anti-fog coating is standard on most models
- :: 10 base curve

LENS TECHNOLOGY



STYLE NUMBER	LENS	COATING	FRAME
250-46-0020	■ Clear	Anti-Scratch / Anti-Fog	■ Clear
250-46-0021	■ Gray	Anti-Scratch / Anti-Fog	■ Gray
250-46-0010	■ Clear Anti-Reflective Plus™ Technology	Anti-Scratch	■ Clear
250-46-0226	■ I/O Blue Technology	Anti-Scratch / Anti-Fog	■ Brown
250-46-0520	■ Clear	Anti-Scratch / FogLess® 3Sixty™	■ Clear
250-46-0521	■ Gray	Anti-Scratch / FogLess® 3Sixty™	■ Gray

TAKE THE LEAD





BOUTON[®] LENS TREATMENT QUICK GUIDE

LENS TREATMENT/COLOR	VISIBLE LIGHT TRANSMISSION	DESCRIPTION	BENEFITS
ANTI-SCRATCH	---	"Hardcoat" treatment toughens lens surface	Longer product life with fewer scratches.
ANTI-FOG	---	Surface coating that reduces fogging	Maintains clear vision. Ideal for food plants or cleaning operations with high-humidity environments.
■ CLEAR	90%	Clear polycarbonate lens	No color distortion, all polycarbonate has 99.9% UV absorption. General use.
■ AMBER	82%	Polycarbonate made of bright amber/yellow color	Enhances visual acuity. Ideal for professional drivers in foggy, rainy or snowy conditions.
■ INDOOR/OUTDOOR	60%	Light mirror coating on clear lens	Enough light transmission for use indoors, reduces pupil adjustment time. Ideal for indoor-outdoor workers.
■ INDOOR/OUTDOOR BLUE	55%	Slight yellow tint + light mirror coating	Alleviates "digital eye strain" from screens, ideal for anyone working extended periods with computer screens or electronic devices.
■ LIGHT BLUE	58%	Light blue tinted polycarbonate	Relieves eye strain from bright, overhead fluorescent lighting.
■ GRAY	12%	Gray polycarbonate lens	Darkening effect with little color distortion, best used outdoors in bright sun.
■ DARK BROWN	12%	Brown polycarbonate lens	Darkening effect with improved color contrast. Best used outdoors in nature-green colors enhanced.
■ MIRROR	10-18%	Front surface coating reflects light from lens	Less light transmission for a darkening effect, great in bright environments: snow, sand, rocks, water.
■ IR FILTER SHADE 3.0	10%	Dark green polycarbonate lens	Protection from welding arc and IR light. Not to be used for welding or when operating vehicles.
■ IR FILTER SHADE 5.0	2%	Dark green polycarbonate lens	Protection from welding arc and IR light. Not to be used for welding or when operating vehicles.

bouton
OPTICAL

SAFETY EYEWEAR DESIGN EVOLUTION



1950 - 1960's



1970 - 1980's



1990 - 2000's



TODAY



LIGHTWEIGHT

Weighing only 16 grams, it is among the lightest in the market today



ENHANCED PROTECTION

Enhanced lens design extends field of vision and protection



MODERN STYLE

Squared lens shape with a slight taper, provides modern styling for the wearer



SECURE FIT

Sleek temples with strategically perforated design ensures a flexible, secure fit to multiple head shapes and sizes

ZENON Z-LYTE

KEY FEATURE	Lightweight – Only 16 grams		
FIT	Universal		
BRIDGE	Molded		
TEMPLE	Spatula		
BASE CURVE	9.5		
STANDARDS MET	ANSI Z87.1+		
STYLE NUMBER	LENS	COATING	FRAME
250-09-0000	■ Clear	Anti-Scratch	■ Clear
250-09-0001	□ Gray	Anti-Scratch	□ Gray
250-09-0002	■ I/O	Anti-Scratch	■ Clear
250-09-0020	■ Clear	Anti-Scratch / Anti-Fog	■ Clear
250-09-0021	□ Gray	Anti-Scratch / Anti-Fog	□ Gray

bouton
OPTICAL



















ZENON Z-LYTE
EVOLVED
EYE PROTECTION

NEVER-ENDING INNOVATION
WEIGHS ONLY
16 GRAMS



FOAM LINED STYLES
AVAILABLE
Go to page 205

ZENON Z12

KEY FEATURE	Popular Style - Fits Most Workers and Applications		
FIT	Universal		
BRIDGE	Molded		
TEMPLE	Spatula		
BASE CURVE	9.5		
STANDARDS MET	ANSI Z87.1+	CSA Z94.3 - <i>Styles Indicated Below</i> 	
STYLE NUMBER	LENS	COATING	FRAME
250-01-0000	 Clear	Anti-Scratch	<input type="checkbox"/> Black
250-01-0001	 Gray	Anti-Scratch	<input type="checkbox"/> Black
250-01-0002	 I/O	Anti-Scratch	<input type="checkbox"/> Black
250-01-0004	 Orange	Anti-Scratch	<input type="checkbox"/> Black
250-01-0005	 Silver Mirror	Anti-Scratch	<input type="checkbox"/> Black
250-01-0020	 Clear	Anti-Scratch / Anti-Fog	<input type="checkbox"/> Black
250-01-0021	 Gray	Anti-Scratch / Anti-Fog	<input type="checkbox"/> Black 
250-01-0080	 Clear	Uncoated	<input type="checkbox"/> Black
250-01-5503	 Light Blue	Anti-Scratch	<input type="checkbox"/> Light Blue
250-01-5504	 Dark Brown	Anti-Scratch	<input type="checkbox"/> Dark Brown
250-01-5509	 Amber	Anti-Scratch	<input type="checkbox"/> Amber
250-01-0900	 Clear	Anti-Scratch	<input type="checkbox"/> Clear 
250-01-0902	 I/O	Anti-Scratch	<input type="checkbox"/> Clear
250-01-0920	 Clear	Anti-Scratch / Anti-Fog	<input type="checkbox"/> Clear 
250-01-0980	 Clear	Uncoated	<input type="checkbox"/> Clear



bouton
OPTICAL

ZENON SERIES
#1 VALUE
FOR SAFETY
& COMFORT



NARROW
FIT



RUBBER
TEMPLE TIPS



RUBBER
NOSE BRIDGE

RUBBER
TEMPLE TIPS

ZENON Z11SM

KEY FEATURE	Redesigned Z12 for Narrower Faces		
FIT	Narrow		
BRIDGE	Molded		
TEMPLE	Spatula		
BASE CURVE	10		
STANDARDS MET	ANSI Z87.1+	CSA Z94.3 - <i>Styles Indicated Below</i> 🍁	
STYLE NUMBER	LENS	COATING	FRAME
250-00-0000	■ Clear	Anti-Scratch	□ Black
250-00-0020	■ Clear	Anti-Scratch / Anti-Fog	■ Clear
250-00-0001	■ Gray	Anti-Scratch	□ Black 🍁
250-00-0002	■ I/O	Anti-Scratch	□ Black
250-00-0900	■ Clear	Anti-Scratch	■ Clear 🍁
250-00-0920	■ Clear	Anti-Scratch / Anti-Fog	□ Black

ZENON Z13

KEY FEATURE	Flexible Rubber Temples		
FIT	Universal		
BRIDGE	Molded		
TEMPLE	Rubber Tips		
BASE CURVE	10		
STANDARDS MET	ANSI Z87.1+	CSA Z94.3 - <i>Styles Indicated Below</i> 🍁	
STYLE NUMBER	LENS	COATING	FRAME
250-06-0000	■ Clear	Anti-Scratch	■ Clear
250-06-0002	■ I/O	Anti-Scratch	■ Brown 🍁
250-06-0020	■ Clear	Anti-Scratch / Anti-Fog	■ Clear 🍁
250-06-0080	■ Clear	Uncoated	■ Clear
250-06-0005	■ Silver Mirror	Anti-Scratch	□ Black
250-06-0006	■ Blue Mirror	Anti-Scratch	□ Black
250-06-5501	■ Gray	Anti-Scratch	■ Dark Gray
250-06-5521	■ Gray	Anti-Scratch / Anti-Fog	■ Dark Gray 🍁
250-06-5503	■ Light Blue	Anti-Scratch	■ Light Blue
250-06-5504	■ Dark Brown	Anti-Scratch	■ Dark Brown
250-06-5509	■ Amber	Anti-Scratch	■ Amber

ZENON Z14SN

KEY FEATURE	Flexible Rubber Temples & Comfortable Rubber Nose Bridge		
FIT	Universal		
BRIDGE	Rubber		
TEMPLE	Rubber Tips		
BASE CURVE	10		
STANDARDS MET	ANSI Z87.1+	CSA Z94.3 - <i>Styles Indicated Below</i> 🍁	
STYLE NUMBER	LENS	COATING	FRAME
250-08-0000	■ Clear	Anti-Scratch	■ Clear
250-08-0002	■ I/O	Anti-Scratch	■ Clear
250-08-0020	■ Clear	Anti-Scratch / Anti-Fog	■ Clear 🍁
250-08-0001	■ Gray	Anti-Scratch	□ Black
250-08-0005	■ Silver Mirror	Anti-Scratch	□ Black
250-08-0021	■ Gray	Anti-Scratch / Anti-Fog	□ Black 🍁
250-08-5503	■ Light Blue	Anti-Scratch	■ Light Blue
250-08-5509	■ Amber	Anti-Scratch / Anti-Fog	■ Amber

LIGHTWEIGHT & UNOBSTRUCTED PERIPHERAL VISION



EVA®

KEY FEATURE	Safety Eyewear Designed Specifically for Women		
FIT	Women		
BRIDGE	Molded		
TEMPLE	Rubber Tips		
BASE CURVE	10		
STANDARDS MET	ANSI Z87.1+		
STYLE NUMBER	LENS	COATING	FRAME
250-10-0900	<input type="checkbox"/> Clear	Anti-Scratch	<input checked="" type="checkbox"/> Clear / Pink
250-10-0920	<input type="checkbox"/> Clear	Anti-Scratch / Anti-Fog	<input checked="" type="checkbox"/> Clear / Pink
250-10-0904	<input checked="" type="checkbox"/> Pink	Anti-Scratch	<input checked="" type="checkbox"/> Clear / Pink
250-10-5501	<input checked="" type="checkbox"/> Gray	Anti-Scratch	<input checked="" type="checkbox"/> Gray / Pink

EVA® PETITE

KEY FEATURE	Women's Style Designed for Slender Faces		
FIT	Women		
BRIDGE	Molded		
TEMPLE	Rubber Tips		
BASE CURVE	11		
STANDARDS MET	ANSI Z87.1+		
STYLE NUMBER	LENS	COATING	FRAME
250-11-0900	<input type="checkbox"/> Clear	Anti-Scratch	<input checked="" type="checkbox"/> Clear / Pink
250-11-0920	<input type="checkbox"/> Clear	Anti-Scratch / Anti-Fog	<input checked="" type="checkbox"/> Clear / Pink
250-11-0904	<input checked="" type="checkbox"/> Pink	Anti-Scratch	<input checked="" type="checkbox"/> Clear / Pink
250-11-5501	<input checked="" type="checkbox"/> Gray	Anti-Scratch	<input checked="" type="checkbox"/> Gray / Pink

LADY EVA® READER

KEY FEATURE	Safety Readers Engineered for Women			
FIT	Women			
BRIDGE	Molded			
TEMPLE	Rubber Tips			
BASE CURVE	10			
STANDARDS MET	ANSI Z87.1+			
STYLE NUMBER	LENS	COATING	FRAME	DIOPTRER
250-12-0100	<input type="checkbox"/> Clear	Anti-Scratch	<input checked="" type="checkbox"/> Clear / Pink	1.00
250-12-0125	<input type="checkbox"/> Clear	Anti-Scratch	<input checked="" type="checkbox"/> Clear / Pink	1.25
250-12-0150	<input type="checkbox"/> Clear	Anti-Scratch	<input checked="" type="checkbox"/> Clear / Pink	1.50
250-12-0175	<input type="checkbox"/> Clear	Anti-Scratch	<input checked="" type="checkbox"/> Clear / Pink	1.75
250-12-0200	<input type="checkbox"/> Clear	Anti-Scratch	<input checked="" type="checkbox"/> Clear / Pink	2.00
250-12-0225	<input type="checkbox"/> Clear	Anti-Scratch	<input checked="" type="checkbox"/> Clear / Pink	2.25
250-12-0250	<input type="checkbox"/> Clear	Anti-Scratch	<input checked="" type="checkbox"/> Clear / Pink	2.50
250-12-0275	<input type="checkbox"/> Clear	Anti-Scratch	<input checked="" type="checkbox"/> Clear / Pink	2.75
250-12-0300	<input type="checkbox"/> Clear	Anti-Scratch	<input checked="" type="checkbox"/> Clear / Pink	3.00

EVA® SERIES DESIGNED TO FIT



MAKING STRIDES
Against Breast Cancer®



A PORTION OF ALL PROCEEDS FROM OUR EVA® EYEWEAR IS PROUDLY DONATED TO THE **AMERICAN CANCER SOCIETY**.

Breast cancer has impacted everyone in one way or another and Eva® eyewear provides a great venue to promote awareness. Perhaps one more woman in the workplace will get a mammogram because she sees the pink ribbons on all of her co-workers' glasses. PIP has partnered with the American Cancer Society® and donates a portion of all proceeds to assist in finding a cure for breast cancer. Please help PIP support this wonderful cause as we provide a VISION FOR A CAUSE!



WOMEN

bouton
OPTICAL



bouton
OPTICAL

RIMLESS FRAME

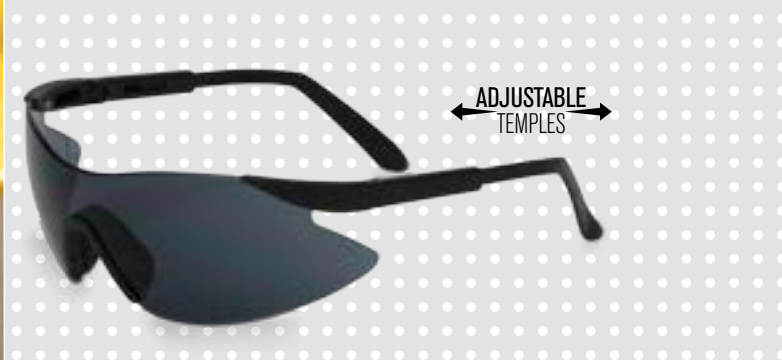

WILCO

KEY FEATURE	Panoramic View with Adjustable Length Temples		
FIT	Universal		
BRIDGE	Rubber		
TEMPLE	Adjustable Spatula		
BASE CURVE	8		
STANDARDS MET	ANSI Z87.1+		
STYLE NUMBER	LENS	COATING	FRAME
250-92-0000	<input type="checkbox"/> Clear	Anti-Scratch	■ Black
250-92-0001	<input type="checkbox"/> Gray	Anti-Scratch	■ Black
250-92-0002	<input type="checkbox"/> I/O	Anti-Scratch	■ Black
250-92-0005	<input type="checkbox"/> Silver Mirror	Anti-Scratch	■ Black
250-92-0009	<input type="checkbox"/> Amber	Anti-Scratch	■ Black
250-92-0020	<input type="checkbox"/> Clear	Anti-Scratch / Anti-Fog	■ Black
250-92-0021	<input type="checkbox"/> Gray	Anti-Scratch / Anti-Fog	■ Black

SUPERIOR SAFETY,



RUBBER
NOSE BRIDGE







RUBBER
NOSE BRIDGE



« UNIQUE TEMPLE »
DESIGN

PULSE

KEY FEATURE	Style and User Comfort in a Lightweight Design		
FIT	Universal		
BRIDGE	Rubber		
TEMPLE	Bayonet, Rubber Tips		
BASE CURVE	9.75		
STANDARDS MET	ANSI Z87.1+	CSA Z94.3 - <i>Styles Indicated Below</i> 	
STYLE NUMBER	LENS	COATING	FRAME
250-49-0000	<input type="checkbox"/> Clear	Anti-Scratch	<input type="checkbox"/> Clear
250-49-0020	<input type="checkbox"/> Clear	Anti-Scratch / Anti-Fog	<input type="checkbox"/> Clear 
250-49-0021	<input checked="" type="checkbox"/> Gray	Anti-Scratch / Anti-Fog	<input checked="" type="checkbox"/> Gray 
250-49-0022	<input checked="" type="checkbox"/> I/O	Anti-Scratch / Anti-Fog	<input type="checkbox"/> Brown 

MONTERAY II

KEY FEATURE	Modern Squared Lens Design with Rubber Temples and Bridge		
FIT	Universal		
BRIDGE	Rubber		
TEMPLE	Rubber Tips		
BASE CURVE	9.75		
STANDARDS MET	ANSI Z87.1+		
STYLE NUMBER	LENS	COATING	FRAME
250-MT-10070	<input type="checkbox"/> Clear	Anti-Scratch	<input checked="" type="checkbox"/> Black
250-MT-10071	<input type="checkbox"/> Clear	Anti-Scratch / Anti-Fog	<input checked="" type="checkbox"/> Black
250-MT-10072	<input checked="" type="checkbox"/> Gray	Anti-Scratch	<input checked="" type="checkbox"/> Black
250-MT-10074	<input checked="" type="checkbox"/> Amber	Anti-Scratch	<input checked="" type="checkbox"/> Black
250-MT-10075	<input type="checkbox"/> I/O	Anti-Scratch	<input checked="" type="checkbox"/> Black

TRANZMISSION

KEY FEATURE	Wraparound Style and Special Temple Design for Comfort		
FIT	Universal		
BRIDGE	Rubber		
TEMPLE	Rubber Tips		
BASE CURVE	10		
STANDARDS MET	ANSI Z87.1+		
STYLE NUMBER	LENS	COATING	FRAME
250-71-0000	<input type="checkbox"/> Clear	Anti-Scratch	<input checked="" type="checkbox"/> Black
250-71-0002	<input checked="" type="checkbox"/> I/O	Anti-Scratch	<input checked="" type="checkbox"/> Black
250-71-0020	<input type="checkbox"/> Clear	Anti-Scratch / Anti-Fog	<input checked="" type="checkbox"/> Black
250-71-0001	<input checked="" type="checkbox"/> Gray	Anti-Scratch	<input checked="" type="checkbox"/> Black
250-71-0005	<input type="checkbox"/> Silver Mirror	Anti-Scratch	<input checked="" type="checkbox"/> Black
250-71-0021	<input checked="" type="checkbox"/> Gray	Anti-Scratch / Anti-Fog	<input checked="" type="checkbox"/> Black

COMFORT & ENHANCED FEATURES



bouton
OPTICAL

RIMLESS FRAME ULTIMATE IN COMFORT & STYLE



BULLSEYE

KEY FEATURE	Modern Design Available in a Variety of Lenses		
FIT	Round		
BRIDGE	Molded		
TEMPLE	Bayonet, Rubber Tips		
BASE CURVE	9		
STANDARDS MET	ANSI Z87.1+	CSA Z94.3 - <i>Styles Indicated Below</i>	🍁
STYLE NUMBER	LENS	COATING	FRAME
250-31-0020	<input type="checkbox"/> Clear	Anti-Scratch / Anti-Fog	<input type="checkbox"/> Clear 🍁
250-31-0021	<input type="checkbox"/> Gray	Anti-Scratch / Anti-Fog	<input type="checkbox"/> Gray 🍁
250-31-0023	<input type="checkbox"/> Light Blue	Anti-Scratch / Anti-Fog	<input type="checkbox"/> Light Blue
250-31-0029	<input type="checkbox"/> Amber	Anti-Scratch / Anti-Fog	<input type="checkbox"/> Amber
250-31-0010	<input type="checkbox"/> Clear Anti-Reflective PLUS™	Anti-Scratch	<input type="checkbox"/> Clear
250-31-0026	<input type="checkbox"/> Blue Mirror	Anti-Scratch / Anti-Fog	<input type="checkbox"/> Gray 🍁
250-31-0226	<input type="checkbox"/> I/O Blue	Anti-Scratch / Anti-Fog	<input type="checkbox"/> Brown
250-31-0031	<input type="checkbox"/> Gradient	Anti-Scratch / Anti-Fog	<input type="checkbox"/> Clear



SUPERSONIC CONVERTS TO A DUST GOGGLE

CONVERSION KIT SOLD SEPARATELY



FULLY ADJUSTABLE FRAME DESIGN
MORPHS FROM
GLASSES TO DUST GOGGLES



SUPERSONIC

KEY FEATURE	Fully Adjustable Temples, and an Optional Dust Goggle Kit		
FIT	Universal		
BRIDGE	Rubber		
TEMPLE	Fully Adjustable, Rubber Tips		
BASE CURVE	9		
STANDARDS MET	ANSI Z87.1+		
STYLE NUMBER	LENS	COATING	FRAME
250-34-0020	<input type="checkbox"/> Clear	Anti-Scratch / Anti-Fog	■ Black
250-34-0021	<input type="checkbox"/> Gray	Anti-Scratch / Anti-Fog	■ Black
250-34-0010	<input type="checkbox"/> Clear Anti-Reflective PLUS™	Anti-Scratch	■ Black
250-34-0226	<input type="checkbox"/> I/O Blue	Anti-Scratch / Anti-Fog	■ Black
250-34-0031	<input type="checkbox"/> Gradient	Anti-Scratch / Anti-Fog	■ Black
250-34-FOAM	---	Foam/Strap Kit	■ Black



HI-VOLTAGE ARC

KEY FEATURE	Economic Eye Protection with Adjustable Length Temples		
FIT	Universal		
BRIDGE	Molded		
TEMPLE	Spatula		
BASE CURVE	4		
STANDARDS MET	ANSI Z87.1+		
STYLE NUMBER	LENS	COATING	FRAME
250-24-0000	■ Clear	Anti-Scratch	□ Black
250-24-0001	■ Gray	Anti-Scratch	□ Black
250-24-0080	■ Clear	Uncoated	□ Black
250-24-0300	■ Clear	Anti-Scratch	■ Red White Blue
250-24-0301	■ Gray	Anti-Scratch	■ Red White Blue

HI-VOLTAGE AC

KEY FEATURE	Contemporary Styling with Bayonet Temples for Excellent Fit		
FIT	Narrow		
BRIDGE	Rubber		
TEMPLE	Bayonet, Rubber Tips		
BASE CURVE	10		
STANDARDS MET	ANSI Z87.1+		
STYLE NUMBER	LENS	COATING	FRAME
250-21-0100	■ Clear	Anti-Scratch	■ Blue
250-21-0101	■ Gray	Anti-Scratch	■ Blue
250-21-0102	■ I/O	Anti-Scratch	■ Blue
250-21-0120	■ Clear	Anti-Scratch / Anti-Fog	■ Blue
250-21-0400	■ Clear	Anti-Scratch	□ Black
250-21-0401	■ Gray	Anti-Scratch	□ Black
250-21-0402	■ I/O	Anti-Scratch	□ Black
250-21-0403	■ Light Blue	Anti-Scratch	□ Black
250-21-0409	■ Amber	Anti-Scratch	□ Black
250-21-0420	■ Clear	Anti-Scratch / Anti-Fog	□ Black
250-21-0421	■ Gray	Anti-Scratch / Anti-Fog	□ Black

BLIZZARD

KEY FEATURE	Sporty White Frame Stands Out When Working Outdoors		
FIT	Universal		
BRIDGE	Rubber		
TEMPLE	Bayonet, Rubber Tips		
BASE CURVE	8		
STANDARDS MET	ANSI Z87.1+		
STYLE NUMBER	LENS	COATING	FRAME
250-48-0021	■ Gray	Anti-Scratch / Anti-Fog	■ White
250-48-0006	■ Blue Mirror	Anti-Scratch	■ White
250-48-0226	■ I/O Blue	Anti-Scratch / Anti-Fog	■ White

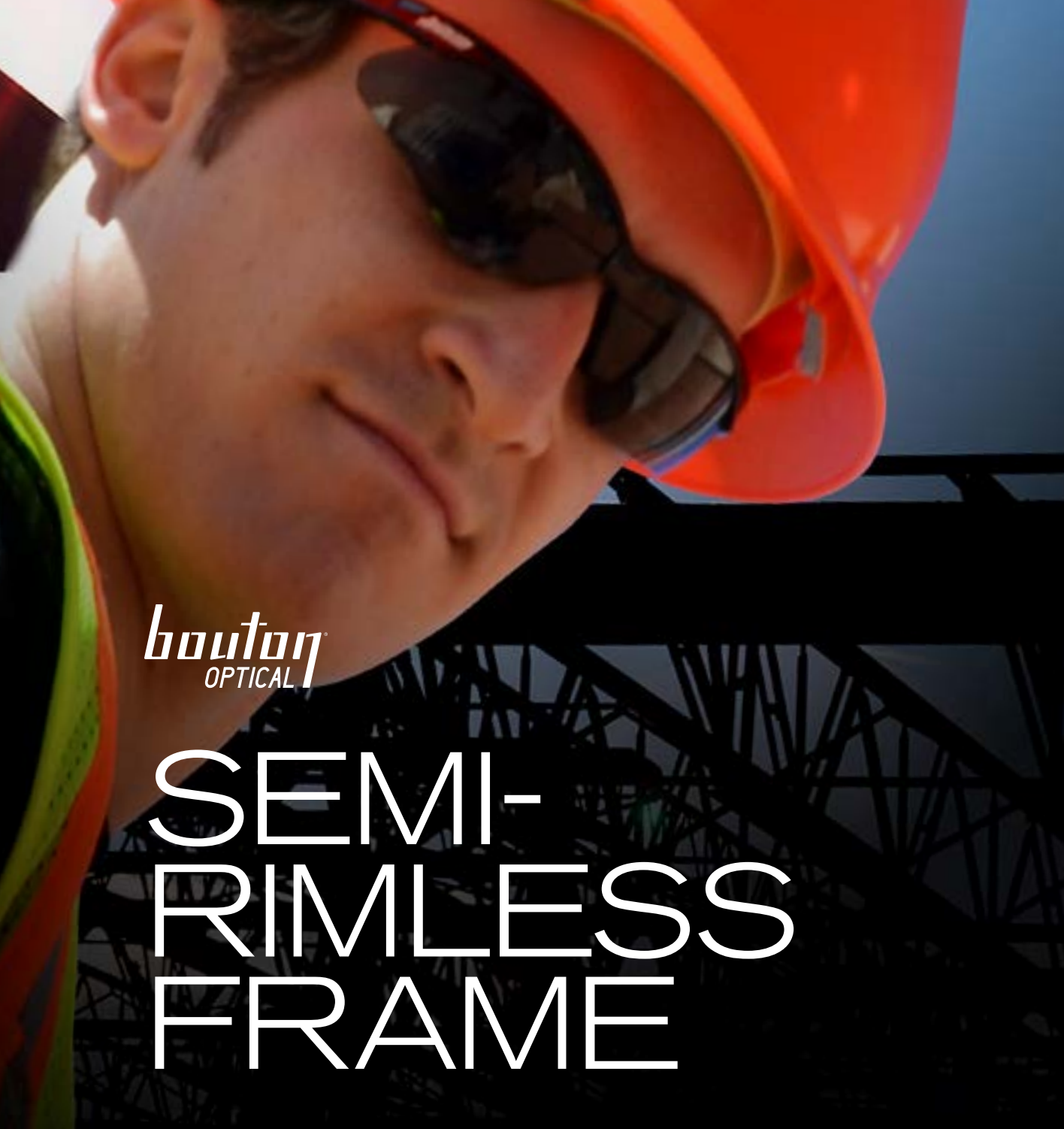

bouton
OPTICAL

SEMI-RIMLESS FRAME



RUBBER
NOSE BRIDGE

ADVERSARY

KEY FEATURE	Popular Wraparound Design Fits a Variety of Users		
FIT	Round		
BRIDGE	Rubber		
TEMPLE	Bayonet, Rubber Tips		
BASE CURVE	8		
STANDARDS MET	ANSI Z87.1+		
STYLE NUMBER	LENS	COATING	FRAME
250-28-0000	■ Clear	Anti-Scratch	<input type="checkbox"/> Black
250-28-0001	■ Gray	Anti-Scratch	<input type="checkbox"/> Black
250-28-0002	■ I/O	Anti-Scratch	<input type="checkbox"/> Black
250-28-0003	■ Light Blue	Anti-Scratch	<input type="checkbox"/> Black
250-28-0006	■ Silver Mirror	Anti-Scratch	<input type="checkbox"/> Black
250-28-0009	■ Amber	Anti-Scratch	<input type="checkbox"/> Black
250-28-0020	■ Clear	Anti-Scratch / Anti-Fog	<input type="checkbox"/> Black
250-28-0021	■ Gray	Anti-Scratch / Anti-Fog	<input type="checkbox"/> Black

WRAPAROUND LENS



bouton
OPTICAL

FULL
FRAME
STYLE



SIDE SHIELD
PROTECTION

TRADITIONAL SPECTACLE

KEY FEATURE	Classic Styling in a Durable Propionate Frame		
FIT	Universal		
BRIDGE	Molded		
TEMPLE	Spatula		
BASE CURVE	6		
STANDARDS MET	ANSI Z87.1+		
STYLE NUMBER	LENS	COATING	FRAME
249-5907-400	<input type="checkbox"/> Clear	Anti-Scratch / Anti-Fog	<input checked="" type="checkbox"/> Smoke
249-5907-401	<input type="checkbox"/> Gray	Anti-Scratch / Anti-Fog	<input checked="" type="checkbox"/> Smoke
249-5907-207	<input checked="" type="checkbox"/> IR Filter 3.0	Anti-Scratch / Anti-Fog	<input checked="" type="checkbox"/> Smoke

STYLISH DESIGN &



FLASHFIRE

KEY FEATURE	Padded Upper Brow Provides Additional Comfort		
FIT	Universal		
BRIDGE	Rubber		
TEMPLE	Rubber Tips		
BASE CURVE	8		
STANDARDS MET	ANSI Z87.1+		
STYLE NUMBER	LENS	COATING	FRAME
250-60-0620	<input type="checkbox"/> Clear	Anti-Scratch / Anti-Fog	<input checked="" type="checkbox"/> Silver / Blue
250-60-0020	<input type="checkbox"/> Clear	Anti-Scratch / Anti-Fog	<input checked="" type="checkbox"/> Black / Red
250-60-0630	<input checked="" type="checkbox"/> Green Mirror	Anti-Scratch / Anti-Fog	<input checked="" type="checkbox"/> Silver / Green
250-60-0625	<input checked="" type="checkbox"/> Red Mirror	Anti-Scratch / Anti-Fog	<input checked="" type="checkbox"/> Silver / Red
250-60-0628	<input type="checkbox"/> Silver Mirror	Anti-Scratch / Anti-Fog	<input checked="" type="checkbox"/> Black / Red
250-60-0626	<input checked="" type="checkbox"/> Blue Mirror	Anti-Scratch / Anti-Fog	<input checked="" type="checkbox"/> Silver / Blue

ALL DAY COMFORT

CUSTOM IMPRINTED EYEWEAR

FAST, EASY & PRECISE

PIP has the ability to custom imprint your logo and/or personalized message onto our safety eyewear. Most styles can be printed on the temples or the lenses.

Imprinted eyewear has many benefits. Using your logo or brand promotes corporate identity and provides a uniform appearance throughout your workforce.



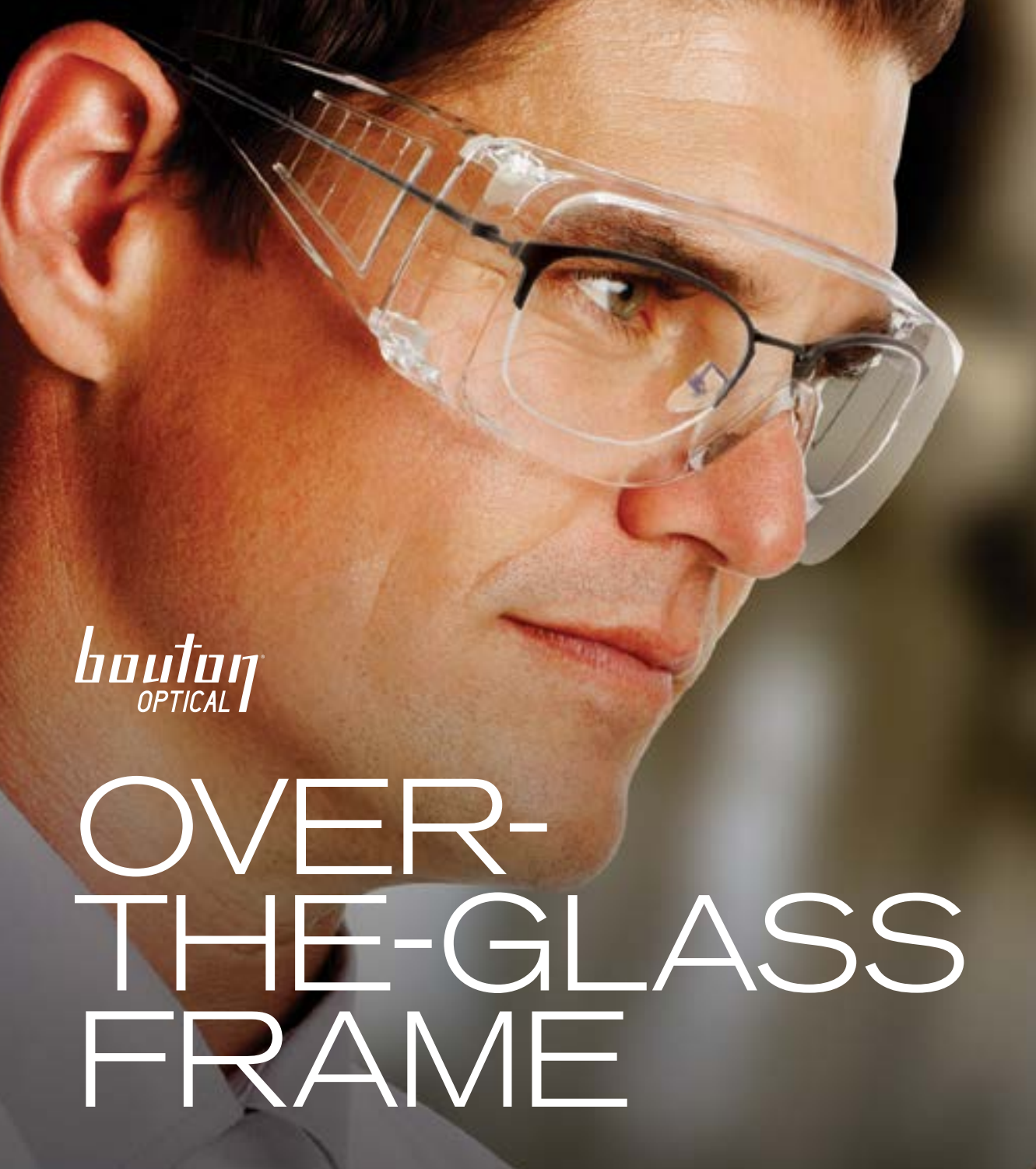









bouton
OPTICAL

OVER- THE-GLASS FRAME



SCOUT

KEY FEATURE	Popular Visitor Spec Designed to Fit Over All Personal Glasses		
FIT	Over-The-Glass		
BRIDGE	Molded		
TEMPLE	Spatula		
BASE CURVE	4		
STANDARDS MET	ANSI Z87.1+	CSA Z94.3 - <i>Styles Indicated Below</i> 	
STYLE NUMBER	LENS	COATING	FRAME
250-99-0900	 Clear	Anti-Scratch	 Clear
250-99-0901	 Gray	Anti-Scratch	 Gray
250-99-0980	 Clear	Uncoated	 Clear 

FITS OVER MOST

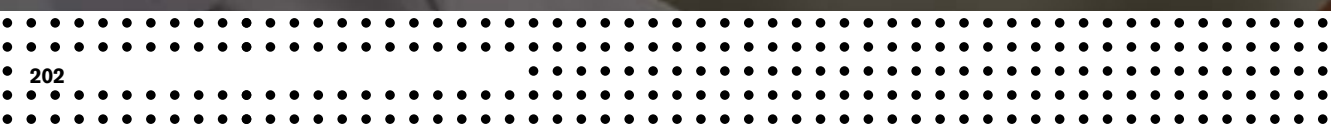



RANGER

KEY FEATURE	Slimmer Design Fits Over Smaller Personal Eyewear		
FIT	Over-The-Glass		
BRIDGE	Molded		
TEMPLE	Spatula		
BASE CURVE	6		
STANDARDS MET	ANSI Z87.1+		
STYLE NUMBER	LENS	COATING	FRAME
250-37-0900	■ Clear	Anti-Scratch	■ Clear
250-37-0980	■ Clear	Uncoated	■ Clear

ZENON Z28

KEY FEATURE	OTG Design with Adjustable Length Temples		
FIT	Over-The-Glass		
BRIDGE	Molded		
TEMPLE	Spatula		
BASE CURVE	4		
STANDARDS MET	ANSI Z87.1+		
STYLE NUMBER	LENS	COATING	FRAME
250-03-0000	■ Clear	Anti-Scratch	□ Black
250-03-0001	■ Gray	Anti-Scratch	□ Black
250-03-0080	■ Clear	Uncoated	□ Black

OVERSITE

KEY FEATURE	Fully Adjustable OTG Design for a Customized Fit		
FIT	Over-The-Glass		
BRIDGE	Molded		
TEMPLE	Fully Adjustable, Co-Molded		
BASE CURVE	3		
STANDARDS MET	ANSI Z87.1+		
STYLE NUMBER	LENS	COATING	FRAME
250-98-0080	■ Clear	Uncoated	□ Black / Gray
250-98-0000	■ Clear	Anti-Scratch	□ Black / Gray
250-98-0013	■ IR Filter 3.0	Anti-Scratch	□ Black / Gray
250-98-0020	■ Clear	Anti-Scratch / Anti-Fog	□ Black / Gray

PRESCRIPTION EYEWEAR OR USE AS A VISITOR SPECTACLE



bouton
OPTICAL

HYBRID STYLE



FUSELAGE

KEY FEATURE	Adapts to Any Working Condition with Dust Goggle Conversion		
FIT	Universal		
BRIDGE	Molded		
TEMPLE	Bayonet, Rubber Tips		
BASE CURVE	8		
STANDARDS MET	ANSI Z87.1+		
STYLE NUMBER	LENS	COATING	FRAME
250-50-0420	<input type="checkbox"/> Clear	Anti-Scratch / Anti-Fog	■ Black
250-50-0421	<input type="checkbox"/> Gray	Anti-Scratch / Anti-Fog	■ Black
250-50-0422	<input type="checkbox"/> I/O	Anti-Scratch / Anti-Fog	■ Black
250-50-0425	<input type="checkbox"/> Silver Mirror	Anti-Scratch / Anti-Fog	■ Black
250-50-0426	<input type="checkbox"/> Blue Mirror	Anti-Scratch / Anti-Fog	■ Black
250-50-0429	<input type="checkbox"/> Amber	Anti-Scratch / Anti-Fog	■ Black
250-50-0520	<input type="checkbox"/> Clear	Anti-Scratch / FogLess® 3Sixty™	■ Black
250-50-0521	<input type="checkbox"/> Gray	Anti-Scratch / FogLess® 3Sixty™	■ Black

FUSELAGE READERS

STYLE NUMBER	LENS	COATING	FRAME	DIOPTRER
250-51-0015	<input type="checkbox"/> Clear	Anti-Scratch / Anti-Fog	■ Black	1.50
250-51-0020	<input type="checkbox"/> Clear	Anti-Scratch / Anti-Fog	■ Black	2.00
250-51-0025	<input type="checkbox"/> Clear	Anti-Scratch / Anti-Fog	■ Black	2.50
250-51-0030	<input type="checkbox"/> Clear	Anti-Scratch / Anti-Fog	■ Black	3.00



CEFIRO

KEY FEATURE	Foam Padded Design Converts to a Dust Goggle		
FIT	Narrow		
BRIDGE	Rubber		
TEMPLE	Bayonet		
BASE CURVE	8		
STANDARDS MET	ANSI Z87.1+		
STYLE NUMBER	LENS	COATING	FRAME
250-CE-10090	<input type="checkbox"/> Clear	Anti-Scratch / Anti-Fog	■ Black
250-CE-10091	<input type="checkbox"/> Gray	Anti-Scratch / Anti-Fog	■ Black
250-CE-10092	<input type="checkbox"/> I/O	Anti-Scratch / Anti-Fog	■ Black
250-CE-10093	<input type="checkbox"/> Blue Mirror	Anti-Scratch / Anti-Fog	■ Black
250-CE-10095	<input type="checkbox"/> Silver Mirror	Anti-Scratch / Anti-Fog	■ Black

SUPERSONIC

KEY FEATURE	Fully Adjustable Temples, and an Optional Dust Goggle Kit		
FIT	Universal		
BRIDGE	Rubber		
TEMPLE	Fully Adjustable, Rubber Tips		
BASE CURVE	9		
STANDARDS MET	ANSI Z87.1+		
STYLE NUMBER	LENS	COATING	FRAME
250-34-0020	<input type="checkbox"/> Clear	Anti-Scratch / Anti-Fog	■ Black
250-34-0021	<input type="checkbox"/> Gray	Anti-Scratch / Anti-Fog	■ Black
250-34-0010	<input type="checkbox"/> Clear Anti-Reflective™ PLUS	Anti-Scratch	■ Black
250-34-0226	<input type="checkbox"/> I/O Blue	Anti-Scratch / Anti-Fog	■ Black
250-34-0031	<input type="checkbox"/> Gradient	Anti-Scratch / Anti-Fog	■ Black
250-34-FOAM	---	Foam / Strap Kit	■ Black

ZENON Z12F

KEY FEATURE	Foam Lined Version of the Popular Z12		
FIT	Universal		
BRIDGE	Molded		
TEMPLE	Spatula		
BASE CURVE	9.5		
STANDARDS MET	ANSI Z87.1+		
STYLE NUMBER	LENS	COATING	FRAME
250-01-F020	<input type="checkbox"/> Clear	Anti-Scratch / Anti-Fog	■ Black
250-01-F021	<input type="checkbox"/> Gray	Anti-Scratch / Anti-Fog	■ Black
250-01-F022	<input type="checkbox"/> I/O	Anti-Scratch / Anti-Fog	■ Black

FOAM LINING PROTECTS AGAINST DEBRIS & AIRBORNE PARTICLES



RUBBER
TEMPLE TIPS

ZENON Z12 READERS

KEY FEATURE	Reader Version of the Popular Z12 Style in +0.25 Diopters			
FIT	Universal			
BRIDGE	Rubber			
TEMPLE	Spatula, Co-Molded			
BASE CURVE	10			
STANDARDS MET	ANSI Z87.1+			
STYLE NUMBER	LENS	COATING	FRAME	DIOPTER
250-27-0010	<input type="checkbox"/> Clear	Anti-Scratch	<input type="checkbox"/> Clear	1.00
250-27-0012	<input type="checkbox"/> Clear	Anti-Scratch	<input type="checkbox"/> Clear	1.25
250-27-0015	<input type="checkbox"/> Clear	Anti-Scratch	<input type="checkbox"/> Clear	1.50
250-27-0017	<input type="checkbox"/> Clear	Anti-Scratch	<input type="checkbox"/> Clear	1.75
250-27-0020	<input type="checkbox"/> Clear	Anti-Scratch	<input type="checkbox"/> Clear	2.00
250-27-0022	<input type="checkbox"/> Clear	Anti-Scratch	<input type="checkbox"/> Clear	2.25
250-27-0025	<input type="checkbox"/> Clear	Anti-Scratch	<input type="checkbox"/> Clear	2.50
250-27-0027	<input type="checkbox"/> Clear	Anti-Scratch	<input type="checkbox"/> Clear	2.75
250-27-0030	<input type="checkbox"/> Clear	Anti-Scratch	<input type="checkbox"/> Clear	3.00
250-27-0115	<input type="checkbox"/> Gray	Anti-Scratch	<input type="checkbox"/> Gray	1.50
250-27-0120	<input type="checkbox"/> Gray	Anti-Scratch	<input type="checkbox"/> Gray	2.00
250-27-0125	<input type="checkbox"/> Gray	Anti-Scratch	<input type="checkbox"/> Gray	2.50
250-27-0130	<input type="checkbox"/> Gray	Anti-Scratch	<input type="checkbox"/> Gray	3.00

ZENON Z13 READERS

KEY FEATURE	Reader Version of the Popular Z13 Style in +0.25 Diopters			
FIT	Universal			
BRIDGE	Molded			
TEMPLE	Rubber Tips			
BASE CURVE	10			
STANDARDS MET	ANSI Z87.1+			
STYLE NUMBER	LENS	COATING	FRAME	DIOPTER
250-26-0010	<input type="checkbox"/> Clear	Anti-Scratch	<input type="checkbox"/> Clear	1.00
250-26-0012	<input type="checkbox"/> Clear	Anti-Scratch	<input type="checkbox"/> Clear	1.25
250-26-0015	<input type="checkbox"/> Clear	Anti-Scratch	<input type="checkbox"/> Clear	1.50
250-26-0017	<input type="checkbox"/> Clear	Anti-Scratch	<input type="checkbox"/> Clear	1.75
250-26-0020	<input type="checkbox"/> Clear	Anti-Scratch	<input type="checkbox"/> Clear	2.00
250-26-0022	<input type="checkbox"/> Clear	Anti-Scratch	<input type="checkbox"/> Clear	2.25
250-26-0025	<input type="checkbox"/> Clear	Anti-Scratch	<input type="checkbox"/> Clear	2.50
250-26-0030	<input type="checkbox"/> Clear	Anti-Scratch	<input type="checkbox"/> Clear	3.00

READING MAG

bouton
OPTICAL



LADY EVA® READER

KEY FEATURE	Safety Readers Engineered For Women			
FIT	Women			
BRIDGE	Molded			
TEMPLE	Rubber Tips			
BASE CURVE	10			
STANDARDS MET	ANSI Z87.1+			
STYLE NUMBER	LENS	COATING	FRAME	DIOPTER
250-12-0100	<input type="checkbox"/> Clear	Anti-Scratch	<input checked="" type="checkbox"/> Clear / Pink	1.00
250-12-0125	<input type="checkbox"/> Clear	Anti-Scratch	<input checked="" type="checkbox"/> Clear / Pink	1.25
250-12-0150	<input type="checkbox"/> Clear	Anti-Scratch	<input checked="" type="checkbox"/> Clear / Pink	1.50
250-12-0175	<input type="checkbox"/> Clear	Anti-Scratch	<input checked="" type="checkbox"/> Clear / Pink	1.75
250-12-0200	<input type="checkbox"/> Clear	Anti-Scratch	<input checked="" type="checkbox"/> Clear / Pink	2.00
250-12-0225	<input type="checkbox"/> Clear	Anti-Scratch	<input checked="" type="checkbox"/> Clear / Pink	2.25
250-12-0250	<input type="checkbox"/> Clear	Anti-Scratch	<input checked="" type="checkbox"/> Clear / Pink	2.50
250-12-0275	<input type="checkbox"/> Clear	Anti-Scratch	<input checked="" type="checkbox"/> Clear / Pink	2.75
250-12-0300	<input type="checkbox"/> Clear	Anti-Scratch	<input checked="" type="checkbox"/> Clear / Pink	3.00



RUBBER
NOSE BRIDGE

MAG READERS

KEY FEATURE	Safety Readers in a Semi-Rimless Design			
FIT	Universal			
BRIDGE	Rubber			
TEMPLE	Rubber Tips			
BASE CURVE	8			
STANDARDS MET	ANSI Z87.1+			
STYLE NUMBER	LENS	COATING	FRAME	DIOPTER
250-25-0010	<input type="checkbox"/> Clear	Anti-Scratch	<input checked="" type="checkbox"/> Black	1.00
250-25-0015	<input type="checkbox"/> Clear	Anti-Scratch	<input checked="" type="checkbox"/> Black	1.50
250-25-0020	<input type="checkbox"/> Clear	Anti-Scratch	<input checked="" type="checkbox"/> Black	2.00
250-25-0025	<input type="checkbox"/> Clear	Anti-Scratch	<input checked="" type="checkbox"/> Black	2.50
250-25-0030	<input type="checkbox"/> Clear	Anti-Scratch	<input checked="" type="checkbox"/> Black	3.00
250-25-0115	<input checked="" type="checkbox"/> Gray	Anti-Scratch	<input checked="" type="checkbox"/> Black	1.50
250-25-0120	<input checked="" type="checkbox"/> Gray	Anti-Scratch	<input checked="" type="checkbox"/> Black	2.00
250-25-0125	<input checked="" type="checkbox"/> Gray	Anti-Scratch	<input checked="" type="checkbox"/> Black	2.50
250-25-0130	<input checked="" type="checkbox"/> Gray	Anti-Scratch	<input checked="" type="checkbox"/> Black	3.00

DOUBLE MAG READERS - TOP & BOTTOM DIOPTER

STYLE NUMBER	LENS	COATING	FRAME	DIOPTER
250-25-1515	<input type="checkbox"/> Clear	Anti-Scratch / Anti-Fog	<input checked="" type="checkbox"/> Black	1.50
250-25-2020	<input type="checkbox"/> Clear	Anti-Scratch / Anti-Fog	<input checked="" type="checkbox"/> Black	2.00
250-25-2525	<input type="checkbox"/> Clear	Anti-Scratch / Anti-Fog	<input checked="" type="checkbox"/> Black	2.50



HYBRID

DUST GOGGLE
STRAP INCLUDED

FUSELAGE READERS

KEY FEATURE	Top Selling Fuselage Dust Goggle in a Reader Version			
FIT	Universal			
BRIDGE	Molded			
TEMPLE	Bayonet, Rubber Tips			
BASE CURVE	8			
STANDARDS MET	ANSI Z87.1+			
STYLE NUMBER	LENS	COATING	FRAME	DIOPTER
250-51-0015	<input type="checkbox"/> Clear	Anti-Scratch / Anti-Fog	<input checked="" type="checkbox"/> Black	1.50
250-51-0020	<input type="checkbox"/> Clear	Anti-Scratch / Anti-Fog	<input checked="" type="checkbox"/> Black	2.00
250-51-0025	<input type="checkbox"/> Clear	Anti-Scratch / Anti-Fog	<input checked="" type="checkbox"/> Black	2.50
250-51-0030	<input type="checkbox"/> Clear	Anti-Scratch / Anti-Fog	<input checked="" type="checkbox"/> Black	3.00

NIFIERS



FOGLESS³SIXTY[™]
TECHNOLOGY

CONTEMPO

KEY FEATURE	Modern Styling with Swivel Headband Adjustment
APPLICATIONS	Industrial, Construction, Medical
FRAME MATERIAL	PVC
FIT	Will Fit Over Prescription Glasses
BASE CURVE	5.75
STANDARDS MET	ANSI Z87.1+ CSA Z94.3 - <i>Styles Indicated Below</i> 🍁

INDIRECT VENTILATION

STYLE NUMBER	LENS	COATING	FRAME	HEADBAND
251-5300-000	■ Clear	Anti-Scratch	■ Blue	Elastic
251-5300-400	■ Clear	Anti-Scratch / Anti-Fog	■ Blue	Elastic
251-5300-400-RHB	■ Clear	Anti-Scratch / Anti-Fog	■ Blue	Neoprene Rubber 🍁
251-5300-402	■ Gray	Anti-Scratch / Anti-Fog	■ Blue	Elastic

FORTIS II

KEY FEATURE	Lightweight Goggle with Comfortable Sealing Properties
APPLICATIONS	Industrial, Construction, Medical
FRAME MATERIAL	Synthetic Rubber
FIT	Will Fit Over Some Prescription Glasses
BASE CURVE	5
STANDARDS MET	ANSI Z87.1+, ANSI D3 Droplet

INDIRECT VENTILATION

STYLE NUMBER	LENS	COATING	FRAME	HEADBAND
251-80-0020	■ Clear	Anti-Scratch / Anti-Fog	■ Gray	Elastic
251-80-0020-RHB	■ Clear	Anti-Scratch / Anti-Fog	■ Gray	Neoprene Rubber

STONE

KEY FEATURE	Optional Visor Attachment for Face Protection
APPLICATIONS	Industrial, Construction, Medical
FRAME MATERIAL	PVC
FIT	Will Fit Over Prescription Glasses
BASE CURVE	5
STANDARDS MET	ANSI Z87.1+, ANSI D3 Droplet

INDIRECT VENTILATION

STYLE NUMBER	LENS	COATING	FRAME	HEADBAND
251-60-0020	■ Clear	Anti-Scratch / FogLess [®] 3Sixty [™]	■ Gray	Elastic
251-60-000V	Visor Only - Polycarbonate - ANSI Z87.1+			



▼ 251-60-000V

EXTENDED FACE PROTECTION

Sold Separately

SUPERIOR COMFORT & HIGH PERFORMANCE

bouton
OPTICAL

PREMIUM GOGGLES

ELIMINATE FOGGING



ANTI-FOG
DOUBLE LENS
TECHNOLOGY

REACTION

KEY FEATURE	Dual Lens Design for Ultimate Anti-Fog Properties
APPLICATIONS	Industrial, Construction, Medical
FRAME MATERIAL	PVC
FIT	Will Not Fit Over Prescription Glasses
BASE CURVE	5.75
STANDARDS MET	ANSI Z87.1+, ANSI D3 Droplet

INDIRECT VENTILATION

STYLE NUMBER	LENS	COATING	FRAME	HEADBAND
251-65-0020	■ Clear	Anti-Scratch / Anti-Fog	■ Gray	Elastic
251-65-0020-RHB	■ Clear	Anti-Scratch / Anti-Fog	■ Gray	Neoprene Rubber
251-65-0021-RHB	■ Gray	Anti-Scratch / Anti-Fog	■ Gray	Neoprene Rubber





bouton
OPTICAL

ECONOMY GOGGLES

SOLUTIONS FOR ALL APPLICATIONS



BASIC

KEY FEATURE	Popular Design for Economical Applications
APPLICATIONS	Industrial, Construction, Medical
FRAME MATERIAL	Vinyl
FIT	Will Fit Over Prescription Glasses
BASE CURVE	Flat
STANDARDS MET	ANSI Z87.1+

INDIRECT VENTILATION

STYLE NUMBER	LENS	COATING	FRAME	HEADBAND
248-4401-300	<input type="checkbox"/> Clear	Uncoated	<input type="checkbox"/> Clear	Elastic
248-4401-400	<input type="checkbox"/> Clear	Anti-Scratch / Fog	<input type="checkbox"/> Clear	Elastic

DIRECT VENTILATION

STYLE NUMBER	LENS	COATING	FRAME	HEADBAND
248-4400-300	<input type="checkbox"/> Clear	Uncoated	<input type="checkbox"/> Clear	Elastic
248-4400-400	<input type="checkbox"/> Clear	Anti-Scratch / Fog	<input type="checkbox"/> Clear	Elastic

SOFTSIDES

KEY FEATURE	Soft, Flexible Vinyl Body Molds Comfortably to the Face
APPLICATIONS	Industrial, Construction, Medical
FRAME MATERIAL	Vinyl
FIT	Will Fit Over Prescription Glasses
BASE CURVE	Flat
STANDARDS MET	ANSI Z87.1+, ANSI D3 Droplet - <i>Styles Indicated Below</i>

INDIRECT VENTILATION

STYLE NUMBER	LENS	COATING	FRAME	HEADBAND
248-5190-300B	<input type="checkbox"/> Clear	Anti-Scratch	<input type="checkbox"/> Clear	Elastic
248-5190-400B	<input type="checkbox"/> Clear	Anti-Scratch / Fog	<input type="checkbox"/> Clear	Elastic

DIRECT VENTILATION

STYLE NUMBER	LENS	COATING	FRAME	HEADBAND
248-5090-300B	<input type="checkbox"/> Clear	Anti-Scratch	<input type="checkbox"/> Clear	Elastic
248-5090-400B	<input type="checkbox"/> Clear	Anti-Scratch / Fog	<input type="checkbox"/> Clear	Elastic

NON-VENTED

STYLE NUMBER	LENS	COATING	FRAME	HEADBAND
248-5290-300B	<input type="checkbox"/> Clear	Anti-Scratch	<input type="checkbox"/> Clear	Elastic
248-5290-400B	<input type="checkbox"/> Clear	Anti-Scratch / Fog	<input type="checkbox"/> Clear	Elastic

VENTILATION OPTIONS



NON-VENTED

Non-vented goggles have no openings for airflow or ventilation.



INDIRECT VENTILATION

Indirect vented goggles help minimize fogging and should be used when there is liquid splash risk. Indirect vented goggles have hooded vents to allow indirect airflow from the work environment.



DIRECT VENTILATION

Direct vented goggles help minimize fogging and should be used when there is no liquid splash risk. Direct vented goggles have straight-line perforations that allow direct airflow from the work environment.

SAFE & RELIABLE, FITS SNUG TO THE FACE



bouton
OPTICAL

FACE PROTECTION

FACE SHIELD MATERIALS

PETG Ideal for general grinding and liquid splash applications.

POLYCARBONATE Ideal for grinding and liquid splash applications, and suitable for high heat and heavier duty applications.

MOLDED POLYCARBONATE Provide enhanced optics, including peripheral vision. Aspherical design allows for more comfortable movement.

STEEL WIRE MESH Product of choice for forestry and lumber applications. Screen mesh provides air circulation.

PETG



251-01-5211
251-01-7214
251-01-5212

MOLDED POLYCARBONATE



251-01-7301
251-01-7401

251-01-7401 features an
ERGONOMIC
TAPERED DESIGN



251-01-7311
251-01-7312
251-01-7313
251-01-7315

FLAT SHEET POLYCARBONATE



251-01-5201
251-01-7206
251-01-7204

STEEL WIRE MESH



251-01-7701

SAFETY VISORS - UNIVERSAL FIT

STYLE NUMBER	MATERIAL	LENS	THICKNESS	SIZE	BINDING	SHAPE	STANDARDS
251-01-5211	PETG	☐ Clear	0.040"	8" x 15.5"	---	Flat	ANSI Z87
251-01-5212	PETG	■ Medium Green	0.040"	8" x 15.5"	---	Flat	ANSI Z87
251-01-7214	PETG	☐ Clear	0.040"	9" x 15.5"	Aluminum	Curved	ANSI Z87
251-01-5201	Polycarbonate	☐ Clear	0.040"	8" x 15.5"	---	Flat	ANSI Z87+
251-01-7206	Polycarbonate	☐ Clear	0.060"	8" x 15.5"	---	Flat	ANSI Z87+
251-01-7204	Polycarbonate	☐ Clear	0.040"	9" x 15.5"	Aluminum	Curved	ANSI Z87+
251-01-7301	Polycarbonate	☐ Clear	0.078"	8" x 15"	---	Molded-Cylindrical	ANSI Z87+
251-01-7401	Polycarbonate	☐ Clear	0.078"	8" x 15"	---	Molded-Aspherical	ANSI Z87+
251-01-7311	Polycarbonate	■ Medium Green	0.078"	8" x 15"	---	Molded-Cylindrical	ANSI Z87+
251-01-7312	Polycarbonate	■ Dark Green	0.078"	8" x 15"	---	Molded-Cylindrical	ANSI Z87+
251-01-7313	Polycarbonate	■ IR Filter 3.0	0.078"	8" x 15"	---	Molded-Cylindrical	ANSI Z87+
251-01-7315	Polycarbonate	■ IR Filter 5.0	0.078"	8" x 15"	---	Molded-Cylindrical	ANSI Z87+
251-01-7701	Steel Wire Mesh	---	24 Wire per in.	8" x 15.5"	Aluminum	Cylindrical	ANSI Z87

JSP® SUREFIT™ SAFETY VISORS

251-01-6201*	Polycarbonate	☐ Clear	0.047"	8" x 21"	---	Heat Formed	ANSI Z87+
251-01-6211*	Acetate	☐ Clear	0.047"	8" x 21"	---	Heat Formed	ANSI Z87+

JSP® Surefit™ Safety Visors only fit JSP® Surefit™ Hard Hat Bracket (251-01-6225)

HEADGEAR & BRACKETS

HEADGEAR Is used when a face shield is needed, but a hard hat is not

BRACKETS Allow the attachment of a safety visor to a hard hat

All Bouton® headgear and brackets are designed with a universal hole pattern.

HEADGEAR *Used without hard hats*



251-01-5200

BRACKETS *Used with hard hats*



251-01-5270
with 251-01-7401

251-01-5271
with 251-01-7401

251-01-6225
with 251-01-6201

HEADGEAR

STYLE NUMBER	STYLE	HOLE PATTERN	COLOR
251-01-5200	Premium Fine Tooth Ratchet	Universal	■ Blue
251-01-5400	Economy Ratchet	Universal	■ Blue

BRACKETS

STYLE NUMBER	COMPATIBLE WITH	HOLE PATTERN	MATERIAL
251-01-5270	Full Brim	Universal	Aluminum
251-01-5271	Cap Style	Universal	Aluminum
251-01-6230-JSP	JSP® Evolution® Cap Style	Universal	Aluminum
251-01-5225	Cap Style Hard Hat with Universal Slots	Universal	Plastic
251-01-6225**	JSP® Standard Brim & Short Brim	JSP® Surefit™ Safety Visors	Plastic

JSP® Surefit™ Hard Hat Bracket will only fit the JSP® Surefit™ Safety Visors (251-01-6201 & 251-01-6211)

DISPLAY YOUR BOUTON® EYEWEAR



252-CDS-12



252-CDL-06

BOUTON® EYEWEAR DISPLAYS

STYLE NUMBER	DESCRIPTION
252-CDL-06	Bouton® 6 Piece Diamond Plate Display
252-CDS-12	Bouton® 3 Sided Pop-Up Display



BLACK NECK CORDS

- Keeps glasses close at hand for a safer workplace

STYLE NUMBER

252-L401	Rugged Nylon
252-L404	Economy Slim Nylon
252-L407	Adjustable Sports Cord

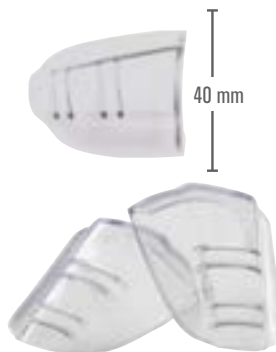

UNIVERSAL FLEX SIDESHIELDS

- Weaves through the temple for added side protection
- Molded to a bendable softness
- Temple will still fold correctly
- No parts or tools required
- Meets ANSI Z87.1+ requirements

STYLE NUMBER

252-FX-0001	<input type="checkbox"/> Clear
-------------	--------------------------------

Patented product of Vision Aid

IDEAL FOR SAFETY GLASSES, GOGGLES OR FACESHIELDS



INDIVIDUALLY PACKAGED



PREVENT FOGGING



STATIONARY DESIGN

LENS CLEANING TOWELETTE DISPENSER

STYLE NUMBER	CLEANING FUNCTION	MATERIALS	RESTRICTIONS	WALL MOUNT	PACKAGING
252-LCT100	Anti-Fog, Anti-Static, Anti-Streaking	Pre-Moistened Towelettes	None	Yes	100 individual towelettes, 10 dispensers per case

LENS CLEANING STATION

252-LCS08	Anti-Fog, Anti-Static, Alcohol-Free	Spray Cleaner & Lint-free Tissues	None	Yes	8 oz. bottle & two 300-count tissue boxes, 8 stations per case
-----------	-------------------------------------	-----------------------------------	------	-----	--

FOG BUSTER

252-FB30	Anti-Fog	Pre-Moistened Towelettes	Mirrored or Anti-Reflective Coated	No	30 applications per box, 6 boxes per case
----------	----------	--------------------------	------------------------------------	----	---

UNDERSTANDING THE ANSI STANDARD

THE ANSI/ISEA 107-2015 IS NOW THE APPROVED STANDARD ON HIGH VISIBILITY APPAREL OFFERING GARMENT CATEGORIES OF PERFORMANCE CLASSES. THIS STANDARD CONSOLIDATES THE ANSI/ISEA 107-2010 FOR HIGH-VISIBILITY SAFETY APPAREL (HVSA) AND THE ANSI/ISEA 207-2011 AMERICAN NATIONAL STANDARD FOR HIGH-VISIBILITY PUBLIC SAFETY VESTS INTO A SINGLE COMPREHENSIVE STANDARD GOING FORWARD.



ANSI TYPE O

CLASS 1

Off-Road Use - Provides added visibility to workers who are not exposed to traffic.



ANSI TYPE R

CLASS 2 & CLASS 3

Roadway Use - Enhanced visibility for workers who are exposed to traffic and working against complex backgrounds.



ANSI TYPE P

CLASS 2 & CLASS 3

Public Safety - Enhanced visibility for emergency and incident responders and law enforcement personnel in both roadway and off-road environments.



ANSI CLASS E

Class E apparel includes pants, bib overalls, shorts, and gaiters. These garments are not compliant when they are worn alone, though, when combined with Class 2 or Class 3 apparel, the combination satisfies Class 3 requirements.

216 ANSI STANDARDS

218 EVERYDAY VALUE SAFETY VESTS

220 BREAKAWAY SAFETY VESTS

221 EXPANDABLE VESTS

222 SURVEYOR VESTS

224 TWO TONE VESTS

225 LIMITED FLAMMABILITY TREATED VESTS

226 PUBLIC SAFETY / EMERGENCY MANAGEMENT VESTS

227 ADDITIONAL SAFETY VESTS

228 T-SHIRTS

229 DUO-PRO™

230 SWEATSHIRTS

HI-VIS APPAREL

HI-VIS APPAREL

ANSI STANDARDS

GARMENT LABEL REQUIREMENTS

The first marking (X) indicates the garment type in accordance with Table 1. The second marking (Y) indicates the Performance Class in accordance with Table 1. The third marking (Z) indicates the garment's flame resistance statement in accordance with Section 12.2(e) and shall be represented as either "FR" or "Not FR".

For supplemental items Performance Class E, only the marking Y (indicating Performance Class) and Z (indicating flame resistance statement) are required.



PIP
PROTECTIVE INDUSTRIAL PRODUCTS
BRINGING THE BEST OF THE WORLD TO YOU®

302-MVZPLY
LARGE
ANSI 107-2015

 TYPE R
CLASS 2
NOT FR

This garment is not flame resistant as defined by ANSI/ISEA 107-2015 Section 10.5

PIP
PROTECTIVE INDUSTRIAL PRODUCTS
BRINGING THE BEST OF THE WORLD TO YOU®

305-2100LY
LARGE
ANSI 107-2015

 TYPE R
CLASS 2
FR: ASTM F-1506

ARC RATING: 5.1 cal/cm² ATPV

MOST CLOTHING IS

**RETAIL
READY**

MINIMUM REQUIREMENTS

GARMENT TYPE	PERFORMANCE CLASS	BACKGROUND FABRIC	RETRO REFLECTIVE MATERIAL
Type O	Class 1	217 in ²	155 in ²
Type R	Class 2*	775 in ²	201 in ²
	Class 3*	1240 in ²	310 in ²
Type P	Class 2	450 in ²	201 in ²
	Class 3	775 in ²	310 in ²
Supplemental Items**	Class E	465 in ²	109 in ²

*For the smallest size offered in Type R, a minimum of 540 in² (Performance Class 2) or 1,000 in² (Performance Class 3) of background material may be used to accommodate small-sized workers

**When a Supplemental Class E is worn with Performance Class 2 or 3, the overall classification for the ensemble shall be Performance Class 3

GET TO KNOW

THE DIFFERENCE



SOLID TRICOT



HOOK & LOOP CLOSURE



2" SILVER REFLECTIVE



INTERNAL POCKETS



POLYESTER MESH



ZIPPER CLOSURE



2" TWO TONE REFLECTIVE



(ANSI COMPLIANT TRIM)

EXTERNAL POCKETS

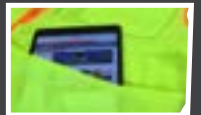

HI-VIS VESTS

EVERYDAY VALUE SAFETY VESTS

TOP-SELLING EVERYDAY VALUE VESTS

EVERYDAY VALUE VESTS

STYLE NUMBER	HI-VIS COLOR	ANSI 107	FABRIC	CLOSURE	POCKETS	REFLECTIVE	SIZE
302-V100-LY 302-V100-OR	 Lime Yellow  Orange	Type R Class 2	Mesh	Zipper	1	2" Silver Sewn-On	S/M, L/XL, 2X/3X, 4X/5X, 6X/7X
302-MVG-LY 302-MVG-OR	 Lime Yellow  Orange	Type R Class 2	Mesh	Hook & Loop	0	2" Silver Sewn-On	S - 5X
302-MVGZ-LY 302-MVGZ-OR	 Lime Yellow  Orange	Type R Class 2	Mesh	Zipper	0	2" Silver Sewn-On	S - 5X
302-WCENG-LY 302-WCENG-OR	 Lime Yellow  Orange	Type R Class 2	Solid Tricot	Hook & Loop	0	2" Silver Sewn-On	S - 5X
302-WCENGZ-LY 302-WCENGZ-OR	 Lime Yellow  Orange	Type R Class 2	Solid Tricot	Zipper	0	2" Silver Sewn-On	S - 5X
302-0702-LY 302-0702-OR	 Lime Yellow  Orange	Type R Class 2	Mesh	Hook & Loop	2	2" Silver Sewn-On	S - 5X
302-0702Z-LY 302-0702Z-OR	 Lime Yellow  Orange	Type R Class 2	Mesh	Zipper	2	2" Silver Sewn-On	S - 6X
302-MVGZ4P-LY 302-MVGZ4P-OR	 Lime Yellow  Orange	Type R Class 2	Mesh	Zipper	4	2" Silver Sewn-On	S - 5X
303-HSVE-LY 303-HSVE-OR	 Lime Yellow  Orange	Type R Class 3	Mesh	Hook & Loop	4	2" Silver Sewn-On	S - 6X
303-MVGZ4P-LY 303-MVGZ4P-OR	 Lime Yellow  Orange	Type R Class 3	Mesh	Zipper	4	2" Silver Sewn-On	S - 5X

HI-VIS VESTS

EVERYDAY VALUE SAFETY VESTS



ANSI 107
TYPE/CLASS
R2

MESH FABRIC

▲ 302-V100



ANSI 107
TYPE/CLASS
R2

▲ 302-MVGZ



ANSI 107
TYPE/CLASS
R2

▲ 302-WCENG



ANSI 107
TYPE/CLASS
R2

▲ 302-WCENGZ

UPPER & LOWER POCKETS KEEP YOUR EQUIPMENT & DEVICES CONVENIENT AND SECURE



POCKETS
2

ANSI 107
TYPE/CLASS
R2

▲ 302-0702



POCKETS
2

ANSI 107
TYPE/CLASS
R2

▲ 302-0702Z



POCKETS
4

ANSI 107
TYPE/CLASS
R2

▲ 302-MVGZ4P



POCKETS
4

ANSI 107
TYPE/CLASS
R3

▲ 303-HSVE



POCKETS
4

ANSI 107
TYPE/CLASS
R3

▲ 303-MVGZ4P



HI-VIS VESTS

BREAKAWAY SAFETY VESTS

FIVE POINT.....



▲ 302-5PMV



▲ 302-5PV



▲ 302-0210



▲ 302-0211



MEETS
CAN/CSA Z96

X-BACK STYLES

BREAKAWAY VESTS



▲ 302-0212



▲ 303-5PMTT

FIVE POINT BREAKAWAY VESTS

STYLE NUMBER	HI-VIS COLOR	ANSI 107	FABRIC	CLOSURE	POCKETS	REFLECTIVE	SIZE
302-5PMV-LY	■ Lime Yellow	Type R	Mesh	Hook & Loop	3	2" Silver	S - 5X
302-5PMV-OR	■ Orange	Class 2				Sewn-On	
302-5PV-LY	■ Lime Yellow	Type R	Solid Tricot	Hook & Loop	3	2" Silver	S - 5X
302-5PV-OR	■ Orange	Class 2				Sewn-On	
302-0212-LY	■ Lime Yellow	Type R	Mesh	Hook & Loop	5	2" Two Tone	S - 5X
302-0212-OR	■ Orange	Class 2				Sewn-On	
303-5PMTT-LY	■ Lime Yellow	Type R	Mesh	Hook & Loop	5	2" Two Tone	S - 5X
303-5PMTT-OR	■ Orange	Class 3				Sewn-On	

FIVE POINT BREAKAWAY & X-BACK VESTS

302-0210-LY	■ Lime Yellow	Type R	Mesh	Hook & Loop	3	2" Silver, X-Back	S - 5X
302-0210-OR	■ Orange	Class 2				Sewn-On	
302-0211-LY	■ Lime Yellow	Type R	Mesh	Hook & Loop	5	2" Two Tone, X-Back	S - 6X
302-0211-OR	■ Orange	Class 2				Sewn-On	

FOR ADDITIONAL SAFETY AROUND EXTREME TRAFFIC HAZARDS, MOVING MACHINERY OR EQUIPMENT

EXPANDABLE

FOR A UNIVERSAL FIT

EXPANDABLE VESTS

STYLE NUMBER	HI-VIS COLOR	ANSI 107	FABRIC	CLOSURE	POCKETS	REFLECTIVE	SIZE
302-0590E-LY	■ Lime Yellow	Type R	Mesh /	Hook &	5	2" Two Tone	S/XL, 2X/5X
302-0590E-OR	■ Orange	Class 2	Breakaway	Loop		Sewn-On	
302-USV5-LY	■ Lime Yellow	Type R	Mesh	Zipper	3	2" Two Tone	OSFM
302-USV5-OR	■ Orange	Class 2				Sewn-On	



◀ 302-USV5



SURVEYOR VESTS



SURVEYOR VESTS

STYLE NUMBER	HI-VIS COLOR	ANSI 107	FABRIC	CLOSURE	POCKETS	REFLECTIVE	SIZE
302-0750-LY 302-0750-OR	■ Lime Yellow ■ Orange	Type R Class 2	Mesh	Zipper	8 & ID	2" Silver Sewn-On	S - 5X
302-0500-YEL 302-0500-OR	■ Lime Yellow ■ Orange	Type R Class 2	Mesh / Solid	Zipper	11	2" Two Tone Sewn-On	S - 7X
302-0500S-LY 302-0500S-OR	■ Lime Yellow ■ Orange	Type R Class 2	Solid	Zipper	11	2" Two Tone Sewn-On	S - 5X
302-0500M-LY 302-0500M-OR	■ Lime Yellow ■ Orange	Type R Class 2	Mesh	Zipper	11	2" Two Tone Sewn-On	S - 5X
302-MAPM-LY 302-MAPM-OR	■ Lime Yellow ■ Orange	Type R Class 2	Mesh	Zipper	11	2" Two Tone Sewn-On	S - 5X
302-MAP-LY 302-MAP-OR	■ Lime Yellow ■ Orange	Type R Class 2	Solid	Zipper	11	2" Two Tone Sewn-On	S - 5X
302-0700-LY 302-0700-OR	■ Lime Yellow ■ Orange	Type R Class 2	Mesh / Solid	Zipper	10 & ID	2" Two Tone Sewn-On	S - 5X
 302-0650D-LY 302-0650D-OR	■ Lime Yellow / Black ■ Orange / Black	Type R Class 2	Rip Stop / Mesh	Zipper	11 & ID	2" Two Tone Sewn-On	S - 5X
 302-0800D-LY 302-0800D-OR	■ Lime Yellow ■ Orange	Type R Class 2	Rip Stop / Mesh	Zipper	11 & ID	2" Two Tone Sewn-On	S - 5X
 302-0800D-BK	□ Black with Hi-Vis Lime Yellow Trim	Type O Class 1	Rip Stop / Mesh	Zipper	11 & ID	2" Two Tone Sewn-On	S - 5X
302-0900-LY 302-0900-OR	■ Lime Yellow ■ Orange	Type R Class 2	Rip Stop / Mesh	Zipper	14	2" Two Tone Heat Applied	M - 5X
303-0500-YEL 303-0500-OR	■ Lime Yellow ■ Orange	Type R Class 3	Mesh / Solid	Zipper	11	2" Two Tone Sewn-On	S - 5X
303-0500M-LY 303-0500M-OR	■ Lime Yellow ■ Orange	Type R Class 3	Mesh	Zipper	11	2" Two Tone Sewn-On	S - 5X
 303-0800D-LY 303-0800D-OR	■ Lime Yellow ■ Orange	Type R Class 3	Rip Stop / Mesh	Zipper	11 & ID	2" Two Tone Sewn-On	S - 5X

OVERSIZED POCKETS
FOR TABLETS,
MAPS & MORE



HI-VIS VESTS

TWO TONE VESTS

ANSI COMPLIANT
CONTRASTING TRIM

2" REFLECTIVE
MATERIAL

TWO TONE

FOR IMPROVED
DAYTIME VISIBILITY

POCKETS

2



▲ 302-MV

POCKETS

2



▲ 302-0600D

▼ 302-0600D



POCKETS

3



▲ 302-MVAT

POCKETS

6



2 MIC TABS

▲ 302-MVZT

D-RING ACCESS

TWO TONE VESTS

STYLE NUMBER	HI-VIS COLOR	ANSI 107	FABRIC	CLOSURE	POCKETS	REFLECTIVE	SIZE
302-MV-LY	Lime Yellow	Type R	Mesh	Zipper	2	2" Two Tone	S - 5X
302-MV-OR	Orange	Class 2				Sewn-On	
302-0215-LY	Lime Yellow	Type R	Mesh	Zipper	2	2" Two Tone, X-Back	S - 5X
302-0215-OR	Orange	Class 2				Sewn-On	
302-0600D-LY	Lime Yellow	Type R	Mesh	Zipper	2	2" Two Tone	S - 5X
302-0600D-OR	Orange	Class 2				Sewn-On	
302-MVAT-LY	Lime Yellow	Type R	Mesh	Hook & Loop	3	2" Two Tone	S - 5X
302-MVAT-OR	Orange	Class 2				Sewn-On	
302-MVZP-LY	Lime Yellow	Type R	Mesh	Zipper	6	2" Two Tone	S - 5X
302-MVZP-OR	Orange	Class 2				Sewn-On	
302-MVZT-LY	Lime Yellow	Type R	Mesh	Zipper	6	2" Two Tone	S - 5X
302-MVZT-OR	Orange	Class 2				Sewn-On	



LIMITED FLAMMABILITY

PREVENTS AFTER-FLAME FOR UP TO 25 WASHES



LIMITED FLAMMABILITY TREATED POLYESTER VESTS (TEST METHOD ASTM D6413)

STYLE NUMBER	HI-VIS COLOR	ANSI 107	FABRIC	CLOSURE	POCKETS	REFLECTIVE	SIZE
305-WCENGFR-LY	Lime Yellow	Type R	Solid	Hook & Loop	0	2" FR Silver Sewn-On	Dual
305-WCENGFR-OR	Orange	Class 2					
305-HSSVFR-LY	Lime Yellow	Type R	Solid	Hook & Loop	0	2" FR Silver Sewn-On	Dual
305-HSSVFR-OR	Orange	Class 3					
305-MVFR-LY	Lime Yellow	Type R	Mesh	Hook & Loop	2	2" FR Two Tone Sewn-On	Dual
305-MVFR-OR	Orange	Class 2					
305-HSVPFR-LY	Lime Yellow	Type R	Mesh	Hook & Loop	2	2" FR Two Tone Sewn-On	Dual
305-HSVPFR-OR	Orange	Class 3					
305-USV5FR-LY	Lime Yellow	Type R	Mesh	Hook & Loop	3	2" FR Two Tone Sewn-On	OSFM
305-USV5FR-OR	Orange	Class 2					
305-5PVFR-LY	Lime Yellow	Type R	Solid	Hook & Loop	4	2" FR Silver Sewn-On	Dual
305-5PVFR-OR	Orange	Class 2					

ALL TREATED VESTS INCLUDE FR REFLECTIVE TAPE

TREATED VESTS ARE DESIGNED TO PREVENT AFTER-FLAME. THEY ARE NOT DESIGNED FOR USE IN ARC FLASH OR FLASH FIRE APPLICATIONS. WHEN A FLAME SOURCE IS REMOVED FROM THE TREATED MATERIAL, THE MATERIAL WILL SELF EXTINGUISH.

HI-VIS VESTS

PUBLIC SAFETY / EMERGENCY MANAGEMENT

ANSI 107 TYPE P CLASS 2 PUBLIC SAFETY VESTS

STYLE NUMBER	LOGO	COLOR	FABRIC	CLOSURE	POCKETS	REFLECTIVE	SIZE
302-PSV-RED-NL	No Logo	Red	Mesh / Solid	Zipper	2	1" Split Trim Sewn-On	M/XL, 2X/5X
302-PSV-RED	"FIRE" Logo	Red	Mesh / Solid	Zipper	2	1" Split Trim Sewn-On	M/XL, 2X/5X
302-PSV-BLU-NL	No Logo	Blue	Mesh / Solid	Zipper	2	1" Split Trim Sewn-On	M/XL, 2X/5X
302-PSV-BLU	"POLICE" Logo	Blue	Mesh / Solid	Zipper	2	1" Split Trim Sewn-On	M/XL, 2X/5X
302-PSV-BLK-NL	No Logo	Black	Mesh / Solid	Zipper	2	1" Split Trim Sewn-On	M/XL, 2X/5X
302-PSV-BLK	"SECURITY" Logo	Black	Mesh / Solid	Zipper	2	1" Split Trim Sewn-On	M/XL, 2X/5X
302-PSV-GRN	No Logo	Green	Mesh / Solid	Zipper	2 & ID	1" Split Trim Sewn-On	M/XL, 2X/5X
302-P070-LY	No Logo	Hi-Vis Lime Yellow	Mesh	Hook & Loop	2 & ID	2" Segmented Heat Applied	S/XL, 2X/5X

▼ 302-PSV-BLK



▼ 302-PSV-RED



▼ 302-PSV-BLU



5 POINT BREAKAWAY

▼ 302-PSV-RED



▼ 302-PSV-GRN-NL



POCKETS
2

NON-ANSI INCIDENT COMMAND VESTS

STYLE NUMBER	COLOR	FABRIC	CLOSURE	REFLECTIVE	SIZE
300-2501	Purple	Polyester / Cotton	Hook & Loop	1" White Gloss	M/XL, 2X/3X, 4X/5X
300-2502	Black	Polyester / Cotton	Hook & Loop	1" White Gloss	M/XL, 2X/3X, 4X/5X
300-2503	Dark Blue	Polyester / Cotton	Hook & Loop	1" White Gloss	M/XL, 2X/3X, 4X/5X
300-2504	Royal Blue	Polyester / Cotton	Hook & Loop	1" White Gloss	M/XL, 2X/3X, 4X/5X
300-2505	Kelly Green	Polyester / Cotton	Hook & Loop	1" White Gloss	M/XL, 2X/3X, 4X/5X
300-2506	Tan	Polyester / Cotton	Hook & Loop	1" White Gloss	M/XL, 2X/3X, 4X/5X
300-2507	Orange	Polyester / Cotton	Hook & Loop	1" White Gloss	M/XL, 2X/3X, 4X/5X
300-2508	Red	Polyester / Cotton	Hook & Loop	1" White Gloss	M/XL, 2X/3X, 4X/5X
300-2509	Light Blue	Polyester / Cotton	Hook & Loop	1" White Gloss	M/XL, 2X/3X, 4X/5X
300-2510	Yellow	Polyester / Cotton	Hook & Loop	1" White Gloss	M/XL, 2X/3X, 4X/5X
300-2511	White	Polyester / Cotton	Hook & Loop	1" Yellow Gloss	M/XL, 2X/3X, 4X/5X
300-2512	Hi-Vis Orange	100% Polyester	Hook & Loop	1" White Gloss	M/XL, 2X/3X, 4X/5X
300-2513	Hi-Vis Lime Yellow	100% Polyester	Hook & Loop	1" White Gloss	M/XL, 2X/3X, 4X/5X
300-2514	Forest Green	Polyester / Cotton	Hook & Loop	1" White Gloss	M/XL, 2X/3X, 4X/5X
300-2515	Gray	Polyester / Cotton	Hook & Loop	1" White Gloss	M/XL, 2X/3X, 4X/5X
300-1502	Black	100% Polyester	Hook & Loop	1" White Gloss	M/XL, 2X/3X
300-1504	Royal Blue	100% Polyester	Hook & Loop	1" White Gloss	M/XL, 2X/3X
300-1505	Kelly Green	100% Polyester	Hook & Loop	1" White Gloss	M/XL, 2X/3X
300-1507	Orange	100% Polyester	Hook & Loop	1" White Gloss	M/XL, 2X/3X
300-1508	Red	100% Polyester	Hook & Loop	1" White Gloss	M/XL, 2X/3X
300-1510	Yellow	100% Polyester	Hook & Loop	1" White Gloss	M/XL, 2X/3X
300-1511	White	100% Polyester	Hook & Loop	1" Yellow Gloss	M/XL, 2X/3X
300-1516	Pink	100% Polyester	Hook & Loop	1" White Gloss	M/XL, 2X/3X

▼ 300-2511



▼ 300-2504



POCKETS FRONT & BACK
4 ID POCKETS



SAFETY VESTS

COLOR ENHANCED FOR AN ADDITIONAL LEVEL OF SAFETY IN LOW RISK ACTIVITIES



▲ 301-0150



▲ 300-0800



▲ 300-EVOR-E



▲ 300-EVOR-P



▲ 300-0900

◀ 300-1000

PREMIUM VESTS

BRIGHT COLORS HELP DISTINGUISH SPECIALTY WORKERS OR NEW HIRES

NON-ANSI SAFETY VESTS

STYLE NUMBER	HI-VIS COLOR	ANSI 107	FABRIC	CLOSURE	POCKETS	REFLECTIVE	SIZE
300-1000-RD 300-1000-BL	Red Blue	Non-ANSI	Mesh / Solid	Zipper	4	1" Split Trim Sewn-On	S - 5X
300-0800-LY 300-0800-OR	Lime Yellow Orange	Non-ANSI	Mesh	Hook & Loop	0	---	OSFM
300-EVOR-E-LY 300-EVOR-E-OR	Lime Yellow Orange	Non-ANSI	Mesh	Hook & Loop	1	1" Silver Sewn-On	OSFM
300-EVOR-P-LY 300-EVOR-P-OR	Lime Yellow Orange	Non-ANSI	Mesh	Hook & Loop	0	1 3/8" Sewn-On	OSFM
300-0900-LY 300-0900-OR	Lime Yellow Orange	Non-ANSI	Mesh	Hook & Loop	0	1" Two Tone Sewn-On	OSFM
301-0150-LY 301-0150-OR	Lime Yellow Orange	Type O Class 1	Mesh	Zipper	4	1" Two Tone Sewn-On	S - 5X

HI-VIS APPAREL

T-SHIRTS



▲ 312-1200

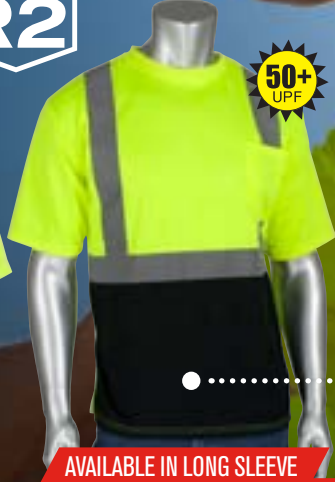

AVAILABLE IN LONG SLEEVE

▲ 312-1250B



SEGMENTED TAPE

▲ 312-1360B



AVAILABLE IN LONG SLEEVE

▲ 310-CNTSN



AVAILABLE IN SHORT SLEEVE

▲ 310-1150B

NON-ANSI SAFETY T-SHIRTS MADE WITH
ANSI COMPLIANT MATERIAL

50+
UPF

50+
UPF

50+
UPF

LIGHTWEIGHT & DURABLE PERFORMANCE WICKING MATERIAL



▲ 313-CNTSE



TWO TONE TAPE

▲ 313-CNTSP



▲ 313-1300



SEGMENTED TAPE

▲ 313-1375B



X-BACK

▲ 313-1400

SHORT & LONG SLEEVE T-SHIRTS

ANSI TYPE R CLASS 2 SHORT & LONG SLEEVE T-SHIRTS

STYLE NUMBER	HI-VIS COLOR	FEATURE	SLEEVES	ANSI 107	FABRIC	POCKETS	REFLECTIVE	SIZE
312-1200-LY	■ Lime Yellow	---	Short	Type R Class 2	Birdseye	1	2" Silver	S - 5X
312-1200-OR	■ Orange	---	Sleeve		Mesh		Sewn-On	
312-1250B-LY	■ Lime Yellow / Black	UV Protection	Short	Type R Class 2	Birdseye	1	2" Silver	S - 5X
312-1250B-OR	■ Orange / Black	---	Sleeve		Mesh		Sewn-On	
312-1350B-LY	■ Lime Yellow / Black	UV Protection	Long	Type R Class 2	Birdseye	1	2" Silver	S - 5X
312-1350B-OR	■ Orange / Black	---	Sleeve		Mesh		Sewn-On	
312-1360B-LY	■ Lime Yellow / Black	UV Protection,	Short	Type R Class 2	Birdseye	1	2" Segmented	S - 5X
312-1360B-OR	■ Orange / Black	Insect Repellent	Sleeve		Mesh		Heat Applied	

ANSI TYPE R CLASS 3 SHORT & LONG SLEEVE T-SHIRTS

313-CNTSE-LY	■ Lime Yellow	---	Short	Type R Class 3	Birdseye	1	2" Silver	S - 5X
313-CNTSE-OR	■ Orange	---	Sleeve		Mesh		Sewn-On	
313-CNTSP-LY	■ Lime Yellow	---	Short	Type R Class 3	Birdseye	1	2" Two Tone	S - 5X
313-CNTSP-OR	■ Orange	---	Sleeve		Mesh		Sewn-On	
313-1300-LY	■ Lime Yellow	---	Long	Type R Class 3	Birdseye	1	2" Silver	S - 5X
313-1300-OR	■ Orange	---	Sleeve		Mesh		Sewn-On	
313-1375B-LY	■ Lime Yellow / Black	UV Protection,	Long	Type R Class 3	Birdseye	1	2" Segmented	S - 5X
313-1375B-OR	■ Orange / Black	Insect Repellent	Sleeve		Mesh		Heat Applied	
313-1400-LY	■ Lime Yellow	---	Short	Type R Class 3	Birdseye	1	2" Silver, X-Back	S - 5X
313-1400-OR	■ Orange	---	Sleeve		Mesh		Sewn-On	
315-1350FR-LY	■ Lime Yellow	Flame Resistant (PPE 2)	Long	Type R Class 3	Cotton	1	FR Tape	S - 3X
			Sleeve		16 cal/cm ²		Sewn-On	

NON-ANSI SHORT & LONG SLEEVE T-SHIRTS - ANSI COMPLIANT MATERIAL

310-950B-LY	■ Lime Yellow with Black Trim	UV Protection, Insect Repellent	Short	Non-ANSI / ANSI Material	Birdseye	0	None	S - 5X
			Sleeve		Mesh			
310-1150B-LY	■ Lime Yellow with Black Trim	UV Protection, Insect Repellent	Long	Non-ANSI / ANSI Material	Birdseye	0	None	S - 5X
			Sleeve		Mesh			
310-CNTSN-LY	■ Lime Yellow	---	Short	Non-ANSI / ANSI Material	Birdseye	1	None	S - 5X
310-CNTSN-OR	■ Orange	---	Sleeve		Mesh			
310-1100-LY	■ Lime Yellow	---	Long	Non-ANSI / ANSI Material	Birdseye	1	None	S - 5X
310-1100-OR	■ Orange	---	Sleeve		Mesh			

ANSI 107 HI-VIS
SHORT SLEEVE
T-SHIRT

SEWN-IN SLEEVE

PRITEX™ 2x1 KNIT
PROTECTIVE
SLEEVE

APPLICATIONS

CONSTRUCTION
MUNICIPALITIES
SHIPYARDS
RECYCLING
HVAC



DUO-PRO™

HI-VIS T-SHIRT WITH INTEGRATED PROTECTIVE SLEEVES

STYLE NUMBER	SHORT SLEEVE T-SHIRT			2x1 KNIT PROTECTIVE SLEEVE		
	ANSI 107	COLOR	SIZE	ANSI 105	LENGTH	COLOR
313-CNTSELY*-PRI18W	Type R Class 2	■ Hi-Vis Lime Yellow	S - 5X	A2	18"	□ White

Put the desired size of the shirt in place of the asterisk () in the part number

HI-VIS APPAREL

SWEATSHIRTS

SWEATSHIRTS

ANSI 107 TYPE R CLASS 3



▼ 323-1330B

BLACK BOTTOM
HELPS HIDE DIRT



WATER REPELLENT
OUTER SHELL
ON BLACK BOTTOM STYLES

▲ 323-1350B



▲ 323-CNSSE



▲ 323-HSSP



▲ 323-HSSE

SIDE ACCESS HAND WARMER POCKETS

HI-VIS SWEATSHIRTS

STYLE NUMBER	HI-VIS COLOR	ANSI 107	FABRIC	CLOSURE	POCKETS	REFLECTIVE	SIZE
323-CNSSE-LY	■ Lime Yellow	Type R	8 oz. Polyester	Pullover	0	2" Silver	M - 5X
323-CNSSE-OR	■ Orange	Class 3	Fleece			Sewn-On	
323-HSSE-LY	■ Lime Yellow	Type R	8 oz. Polyester	Zipper	1	2" Silver	M - 5X
323-HSSE-OR	■ Orange	Class 3	Fleece			Sewn-On	
323-HSSP-LY	■ Lime Yellow	Type R	8 oz. Polyester	Zipper	2	2" Two Tone	M - 5X
		Class 3	Fleece			Sewn-On	
323-1330B-LY	■ Lime Yellow / Black	Type R	10 oz. Polyester	¼ Zipper	2	2" Silver	S - 5X
323-1330B-OR	■ Orange / Black	Class 3	Fleece			Sewn-On	
323-1350B-LY	■ Lime Yellow / Black	Type R	10 oz. Polyester	Pullover	2	2" Silver	S - 5X
323-1350B-OR	■ Orange / Black	Class 3	Fleece			Sewn-On	
323-1370B-LY	■ Lime Yellow / Black	Type R	10 oz. Polyester	Zipper	3	2" Silver	S - 5X
323-1370B-OR	■ Orange / Black	Class 3	Fleece			Sewn-On	
385-1370FR-LY	■ Lime Yellow / Black	Type R	12 oz. Modacrylic /	Zipper	3	FR Heat Applied	S - 5X
		Class 3	FR Cotton			Segmented Tape	



THE DANGERS OF COLD STRESS

KEEPING WORKERS WARM

With jackets, liners and pullovers, the principles of thermal energy are applied to ensure the worker stays as warm as possible, taking into consideration their environment.

- The wind resistance of the outer shell is critical, as it helps minimize the entrance of the denser cold air which would take the place of the warm air that is layered close to the body.
- Adding lofted or fleece insulation provides a layer that traps the warmer air beneath the shell and helps keep out the cold.
- Keeping dry also allows the worker to stay as warm as possible. Whether it's precipitation or water penetrating from the outside, or sweat generated by the worker, moisture can accelerate the effects of the cold environment and restrain the insulation's efficiency.

In order to stay warm it is important that work garments perform and remain adaptive to the work environment, activity, and duration.

- The effectiveness of the outer shell is the first consideration. High quality outer shells provide the desired resistance against wind and water, but also allow sweat to evaporate.
- In extremely cold conditions, it is better to dress in layers as opposed to wearing a jacket or coat with very thick lofts. The thicker lofts will restrict movement, which in turn means less body heat is generated. The proper insulation combined with fleece sweaters and wicking under-layers will provide optimal protection while remaining functional for the worker.
- The ability to remove layers and/or jacket linings becomes critical when there is a wide temperature differential. This will help reduce the risk of excessive wetness from sweating while still providing adequate cold protection in this environment.

CHOOSING A MATERIAL

There are various materials to consider when choosing the best thermal protection for your environment:

- **300 Denier Rip-Stop Shell Material** – durable and tear resistant material that provides wind and water resistance.
- **300 Denier Shell Material** – durable material that provides wind and water resistance
- **280 gram Polyester Fleece Insulation** – a versatile fabric that provides warmth and quick drying properties
- **Hi-Loft Polyester Fiberfill Insulation** – a built-in insulation that resists water absorption and is quilted to resist migration

THE COLD STRESS EQUATION

Low Temperature + Wind Speed + Wetness = Injuries & Illness

When the body is unable to warm itself, serious cold related illnesses and injuries may occur, and permanent tissue damage and death may result.

- Hypothermia can occur when land temperatures are above freezing or water temperatures are below 98.6°F / 37°C.
- Cold related illnesses can slowly overcome a person who has been chilled by low temperatures, brisk winds, or wet clothing.

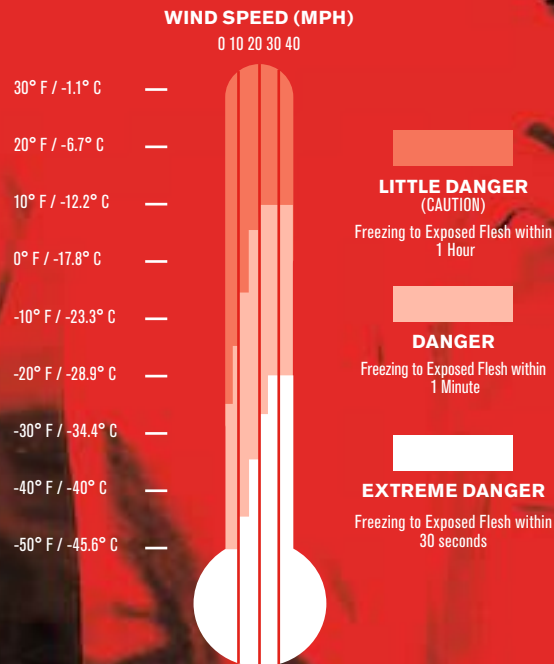

232 JACKETS & COATS

234 OVERPANTS

HI-VIS JACKETS & COATS

HI-VIS JACKETS & COATS

BOMBER JACKETS

JACKETS & COATS

TEAR RESISTANT
RIPSTOP SHELL

RIPSTOP SHELL

WATERPROOF COATING

INTERIOR LAYER

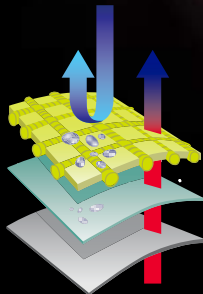

OUR RIPSTOP DIFFERENCE

Reinforcement threads are interwoven at regular intervals in a crosshatch pattern, making it resistant to tearing and ripping.

▼ 333-1770



▲ 333-1766



▲ 333-1762

REMOVABLE

BLACK FLEECE LINER



D-RING
ACCESS

LINER EASILY
ZIPS OUT



HI-VIS JACKETS & COATS

WINTER COATS / WINDBREAKER

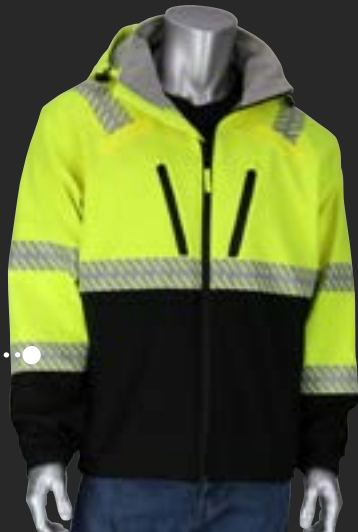

WATER RESISTANT & WINDPROOF

▲ 333-1550



▲ 333-1740



▲ 343-1755



▲ 343-1756



ANSI 107
TYPE CLASS
R2



INNER VEST & INNER JACKET - REVERSIBLE TO BLACK



SEGMENTED TAPE PROVIDES MORE BREATHABILITY

BUILT-IN

HIGH PERFORMANCE INSULATION



HI-VIS BOMBER JACKETS - REMOVABLE INSULATION

STYLE NUMBER	HI-VIS COLOR	ANSI 107	FABRIC	CLOSURE	POCKETS	REFLECTIVE	SIZE
333-1770-LY	■ Lime Yellow / Black	Type R Class 3	300 D Ripstop Polyester Shell	Zipper	9	2" Silver Sewn-On	S - 5X
333-1770-OR	■ Orange / Black						
333-1766-LY	■ Lime Yellow / Black	Type R Class 3	300 D Polyester Shell	Zipper	8	2" Silver Sewn-On	S - 6X
333-1766-OR	■ Orange / Black						
333-1762-LY	■ Lime Yellow	Type R Class 3	300 D Polyester Shell	Zipper	8	2" Silver Sewn-On	S - 6X
333-1762-OR	■ Orange						
343-1756-LY	■ Lime Yellow / Black	Type R Class 3 /	300 D	Zipper	6 Inner	2" Silver Sewn-On	S - 5X
343-1756-OR	■ Orange / Black	Type R Class 2	Polyester Shell		6 Outer		

HI-VIS COATS - BUILT-IN INSULATION

333-1550-LY	■ Lime Yellow / Black	Type R Class 3	3 Ply Ripstop Outer Soft Shell	Zipper	9	2" Segmented Heat Applied	S - 5X
333-1740-LY	■ Lime Yellow / Black	Type R Class 3	300 D Polyester Shell	Zipper	8	2" Silver Sewn-On	S - 5X
333-1740-OR	■ Orange / Black						
343-1755-LY	■ Lime Yellow	Type R Class 3	300 D Polyester Shell	Zipper	4	2" Silver Sewn-On	S - 5X
343-1755-OR	■ Orange						

HI-VIS WINDBREAKER

333-WB-LY	■ Lime Yellow	Type R Class 3	190 T Polyester Shell	Snaps	2	2" Silver Sewn-On	M - 5X
333-WB-OR	■ Orange						

ALL CONDITIONS

7-IN-1 COAT



LIGHTWEIGHT WINDBREAKER

▲ 333-WB

GO TO PAGE 235 FOR HIGH VISIBILITY RAINWEAR

HI-VIS APPAREL

OVERPANTS

OVERPANTS

TEAR RESISTANT
RIPSTOP

REINFORCED IN
HIGH WEAR AREAS



PAIR WITH RIPSTOP BOMBER

▲ PREVIOUS PAGE



▲ 318-1771



▲ 318-1757



▲ 319-MTP



▲ 319-GT1

ALSO AVAILABLE WITH TWO TONE TAPE



PANTS



GARMENT



COMPLIANT

HI-VIS OVERPANTS

STYLE NUMBER	HI-VIS COLOR	ANSI 107	FABRIC	CLOSURE	POCKETS	REFLECTIVE	SIZE
318-1771-LY	■ Lime Yellow	Class E	300 D Ripstop	Drawstring	5	2" Silver	S - 5X
318-1771-OR	■ Orange		Polyester Shell	Elastic		Sewn-On	
318-1757-LY	■ Lime Yellow	Class E	300 D	Elastic	2	2" Silver	S - 5X
318-1757-OR	■ Orange		Polyester Shell			Sewn-On	
319-MTP-LY	■ Lime Yellow	Class E	Mesh	Drawstring Elastic	3	2" Two Tone	Dual
						Heat Applied	

HI-VIS GAITER

319-GT1	■ Lime Yellow ■ Orange	Class E	Mesh	Elastic	5	2" Silver Sewn-On	OSFM
319-GT2	■ Lime Yellow ■ Orange	Class E	Mesh	Elastic	5	2" Two Tone Sewn-On	OSFM

PROTECTIVE WEAR DESIGNED FOR THE JOB

RAINWEAR AND SPLASHWEAR IS DESIGNED TO PROTECT WORKERS FROM LIQUID SPLASH AND CONTAMINANTS, DEFEND AGAINST HEAVY RAIN, AND PROVIDE SPLASH PROTECTION FOR PRESSURE WASHING APPLICATIONS. PRODUCTS ARE DESIGNED WITH ENHANCED FEATURES, CONSTRUCTION AND DURABILITY TO DELIVER SUPERIOR PERFORMANCE IN DEMANDING CONDITIONS.

Users are advised to conduct their own evaluations to determine the suitability of the protective clothing for each specific application. Previously worn suits should be inspected daily, especially before being put into use again, to ensure wear and tear, or prior chemical exposure has not reduced the integrity of the suit. Suits that show wear or have been in intimate contact with the chemicals should be properly disposed of.

All featured Falcon™ FR garments are treated to provide limited flammability and are self-extinguishing (ASTM D6413 test method).

236 HI-PERFORMANCE PROTECTIVE CLOTHING

239 HI-VIS RAINWEAR

240 PROTECTIVE RAINWEAR



FALCON™

HI-PERFORMANCE PROTECTIVE CLOTHING

FALCON™ CHEMFR

Liquid splash protection in harsher environments

FALCON™ FLEX

Heavy duty protection from rain and other elements

FALCON™ HYDROFR

Uniquely designed for pressure washing

HI-VISIBILITY PROTECTIVE RAINWEAR

FALCON™ VIZ

Be seen and stay dry with high visibility rainwear

FALCON™ VIZPLUS

Hi-Visibility rainwear for extreme conditions

FALCON™ VIZAR

Hi-Visibility rainwear with AR/FR protection

PROTECTIVE RAINWEAR

FALCON™ BASE

Proven, reliable rain protection

RAINWEAR & SPLASHWEAR

HI-PERFORMANCE PROTECTIVE CLOTHING

FALCON™ CHEMFR

LIQUID SPLASH PROTECTION

PROTECT AGAINST
INCIDENTAL CONTACT
WITH CONTAMINANTS

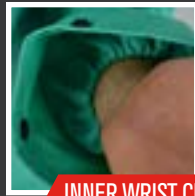

INNER WRIST CUFF

.....●
SNAP & ZIPPER
CLOSURE

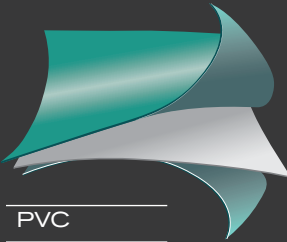

ENHANCED DURABILITY

PVC
NYLON
PVC

▲ 205-420JH

FALCON™ CHEMFR (TEST METHOD ASTM D6413)

STYLE NUMBER	COLOR	GARMENT	THICKNESS	FABRIC	CLOSURE	POCKETS	SIZE
205-420JH	Green	Jacket	0.42 mm	PVC / Nylon / PVC	Snap & Zipper	0	S - 5X
205-420B	Green	Bib Overalls	0.42 mm	PVC / Nylon / PVC	---	0	S - 5X
205-420CV	Green	Coveralls	0.42 mm	PVC / Nylon / PVC	Snap & Zipper	0	S - 5X



LIMITED FLAMMABILITY

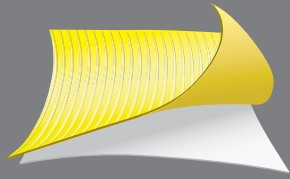

RIBBED PVC
POLYESTER

FALCON™ FLEX

STYLE NUMBER	COLOR	GARMENT	THICKNESS	FABRIC	CLOSURE	POCKETS	SIZE
201-650J	Yellow	Jacket	0.65 mm	PVC / Polyester	Snap	2	S - 5X
201-650B	Yellow	Bib Overalls	0.65 mm	PVC / Polyester	---	0	S - 5X
201-650C	Yellow	48" Coat	0.65 mm	PVC / Polyester	Snap	2	S - 5X

DURABLE & COMFORTABLE RAIN PROTECTION

WITH ADDED COMFORT AND FLEXIBILITY

201-650B ▼



201-650C ▼

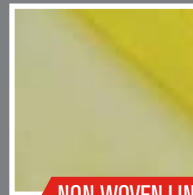

NON-WOVEN LINING

201-650J ▼



DETACHABLE
HOOD



HI-PERFORMANCE PROTECTIVE CLOTHING

FALCON™ HYDROFR

PRESSURE WASHING SPLASH PROTECTION

FALCON™ HYDROFR (TEST METHOD ASTM D6413)

STYLE NUMBER	COLOR	GARMENT	THICKNESS	FABRIC	CLOSURE	POCKETS	SIZE
205-375FR	Yellow	Jacket & Bib Overalls	0.33 mm	PVC / Polyester / PVC	Hook & Loop and Zipper	2	S - 8X

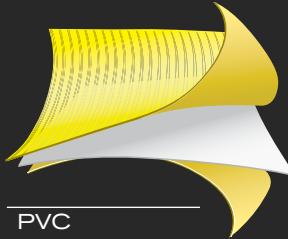

PVC
POLYESTER
PVC

EXTRA
PROTECTION

*Faceshield and headgear are not included with Falcon™ HydroFR.
GO TO PAGE 212 FOR AVAILABLE FACESHIELDS*



LIMITED FLAMMABILITY



FALCON™
HYDROFR

HI-VIS RAINWEAR

FALCON™ VIZ / FALCON™ VIZPLUS / FALCON™ VIZAR



FALCON™
VIZ

LIGHTWEIGHT
& WATERPROOF

FALCON™
VIZPLUS

BREATHABLE, DURABLE
& WATERPROOF

3M Scotchlite™
Reflective Material

FALCON™
VIZAR

ARC-RATED, DURABLE
& WATERPROOF

LIGHTWEIGHT & BREATHABLE

RAINWEAR

WITH ANSI 107 COMPLIANCE FOR HI-VIS

FALCON™ VIZ

STYLE NUMBER	HI-VIS COLOR	GARMENT	ANSI 107	FABRIC	CLOSURE	POCKETS	REFLECTIVE	SIZE
353-1000-LY	■ Lime Yellow	Jacket &	Type R	150 D	Zipper	2	2" Silver	S/M, L/XL,
353-1000-OR	■ Orange	Pant	Class 3	Polyester			Sewn-On	2X/3X, 4X/5X
353-1048-LY	■ Lime Yellow	48" Long	Type R	150 D	Zipper	2	2" Silver	S - 5X
353-1048-OR	■ Orange	Coat	Class 3	Polyester			Sewn-On	

FALCON™ VIZPLUS

353-2000-YEL	■ Lime Yellow	Jacket	Type R	300 D	Zipper	5	2" Silver	S - 5X
353-2000-OR	■ Orange		Class 3	Polyester			Sewn-On	
353-2001-YEL	■ Lime Yellow	Overalls	Class E	300 D	Zipper	1	2" Silver	S - 5X
353-2001-OR	■ Orange			Polyester			Sewn-On	
353-2002-YEL	■ Lime Yellow	Pants	Class E	300 D	Elastic &	2	2" Silver	S - 5X
353-2002-OR	■ Orange			Polyester	Drawstring		Sewn-On	

FALCON™ VIZAR PPE 2, 16 CAL/CM² TEST METHOD ASTM F1891

355-2500AR-LY	■ Lime Yellow	Jacket	Type R	0.75 mm	Hook & Loop	2	2" FR Silver	S - 5X
			Class 3	FR PU/Cotton	and Zipper		Heat Applied	
355-2501AR-LY	■ Lime Yellow	Bib	Class E	0.75 mm	Hook & Loop	2	2" FR Silver	S - 5X
		Overalls		FR PU/Cotton			Heat Applied	
355-2505AR-LY	■ Lime Yellow	48" Coat	Type R	0.75 mm	Hook & Loop	2	2" FR Silver	S - 5X
			Class 3	FR PU/Cotton	and Zipper		Heat Applied	



POCKETS
2

ANSI 107
TYPE/CLASS
R3

◀ 353-1000



POCKETS
2

ANSI 107
CLASS
E

◀ 353-2002



POCKETS
5

ANSI 107
TYPE/CLASS
R3

◀ 353-2000



POCKETS
2

ANSI 107
TYPE/CLASS
R3

◀ 353-1048



2
PPE

ANSI 107
TYPE/CLASS
R3

ARC-RATED PROTECTION

◀ 355-2500AR
& 355-2501AR

D-RING
ACCESS



FALCON™
VIZ

D-RING
ACCESS

PROTECTIVE RAINWEAR

FALCON™ BASE

PROVEN & RELIABLE

RAIN PROTECTION

100% WATERPROOF



▲ 201-355



▲ 201-360

CORDUROY COLLAR

▼ 205-322FR



TREATED TO PREVENT AFTER-FLAME

▼ 201-300

▼ 201-350B

FALCON™ BASE35

STYLE NUMBER	COLOR	GARMENT	THICKNESS	FABRIC	CLOSURE	POCKETS	SIZE
201-350	Yellow	Jacket & Bib Overalls	0.35 mm	PVC / Polyester	Snap	2	S - 8X
201-355	Hi-Vis Lime Yellow*	Jacket & Bib Overalls	0.35 mm	PVC / Polyester	Snap	2	S - 5X
201-360	Hi-Vis Orange*	Jacket & Bib Overalls	0.35 mm	PVC / Polyester	Snap	2	S - 5X
201-370	Yellow	Jacket & Bib Overalls	0.35 mm	PVC / Polyester	Snap	2	S - 5X
201-350J	Yellow	Jacket	0.35 mm	PVC / Polyester	Snap	2	S - 5X
201-350B	Yellow	Bib Overalls	0.35 mm	PVC / Polyester	Snap	0	S - 5X
201-350P	Yellow	Elastic Pants	0.35 mm	PVC / Polyester	Snap	0	S - 5X
201-340	Yellow	Jacket & Elastic Pants	0.35 mm	PVC / Polyester	Snap	2	S - 5X
201-300	Yellow	48" Coat	0.35 mm	PVC / Polyester	Snap	2	S - 5X
201-320	Yellow	60" Duster	0.35 mm	PVC / Polyester	Snap	2	S - 7X
201-322	Black	60" Duster	0.35 mm	PVC / Polyester	Snap	2	S - 7X

FALCON™ BASE35FR (TEST METHOD ASTM D6413)

205-370FR	Yellow	Jacket & Bib Overalls	0.35 mm	PVC / Polyester FR Treated	Snap	2	S - 7X
205-300FR	Yellow	48" Coat	0.35 mm	PVC / Polyester FR Treated	Snap	2	S - 5X
205-322FR	Black	60" Duster	0.35 mm	PVC / Polyester FR Treated	Snap	2	S - 7X
205-320FR	Yellow	60" Duster	0.35 mm	PVC / Polyester FR Treated	Snap	2	S - 7X

FALCON™ BASE25

201-250	Yellow	Jacket & Bib Overalls	0.25 mm	PVC	Snap	2	S - 5X
---------	--------	-----------------------	---------	-----	------	---	--------

FALCON™ BASE10

201-100	Yellow	Jacket & Bib Overalls	0.10 mm	PVC	Snap	2	S - 5X
---------	--------	-----------------------	---------	-----	------	---	--------

All jackets and coats feature a detachable hood

*Non-ANSI Hi-Vis Colors



FALCON™
BASE

FR & CUT RESISTANT APRONS MADE-TO-ORDER

APPLICATION & MATERIAL

CUT PROTECTION



Cane Mesh



DuPont™ Kevlar®

HEAT PROTECTION*

High Heat & Thermal

FR Green

Light Heat

DuPont™ Kevlar®

GENERAL PURPOSE

Duck

Denim

*Not NFPA Certified and Not Arc Rated

SIZES

LENGTH	WIDTH
36" - 50"	20" - 28"
36" - 50"	20" - 28"
36" - 50"	20" - 28"

ADDITIONAL OPTIONS

CLOSURE OPTIONS



▲ Hook & Loop Breakaway Ties



▲ Snap Closure



▲ Nylon Waist Strap with Buckle

POCKET OPTIONS



Identify your safety need, then customize your solution by choosing the **Material, Size, and Option(s)** to maximize performance.

Call PIP at 1-800-262-5755

For part numbers and pricing for your order, or if a custom option you need is not listed here.



CANE MESH

DUPONT™ KEVLAR®

FR GREEN

DUCK

DENIM

DENIM & DISPOSABLE CLOTHING

APRONS / CAPS / BEARD GUARDS / SLEEVES

APRONS

STYLE NUMBER	21 CFR	MATERIAL	COLOR	TYPE	WEIGHT	DIMENSIONS	POCKETS
200-010	No	100% Cotton Denim	■ Blue	Reusable	10 oz.	28" x 38"	0
200-011	No	100% Cotton Denim	■ Blue	Reusable	10 oz.	28" x 38"	1
200-012	No	100% Cotton Denim	■ Blue	Reusable	10 oz.	28" x 38"	2
200-07501	Yes	PVC / Vinyl	□ White	Reusable	8 mil	35" x 45"	0
200-08001	Yes	PVC / Vinyl	□ White	Reusable	8 mil	35" x 35"	0
200-20001	Yes	PVC / Vinyl	□ White	Reusable	20 mil	35" x 45"	0
200-12501	No	Neoprene	■ Black	Reusable	20 mil	33" x 45"	0
200-01001	Yes	Polyethylene Embossed	□ White	Single-Use	1 mil	24" x 42"	0
200-01002	Yes	Polyethylene Embossed	□ White	Single-Use	1 mil	28" x 46"	0
200-06001	Yes	Polyethylene Smooth	□ White	Single-Use	1 mil	28" x 46"	0
200-06002	Yes	Polyethylene Smooth	□ White	Single-Use	1.25 mil	28" x 46"	0

DISPOSABLE CAPS, BEARD GUARDS & SLEEVES



DISPOSABLE CAPS, BEARD GUARDS & SLEEVES

STYLE NUMBER	GARMENT	MATERIAL	SIZE	WEIGHT	PACKAGING
200-BC18	Bouffant Cap	Spun Bonded Polypropylene	18"	12 g/m ²	100/Bag; 1000/Case
200-BC21	Bouffant Cap	Spun Bonded Polypropylene	21"	12 g/m ²	100/Bag; 1000/Case
200-BC24	Bouffant Cap	Spun Bonded Polypropylene	24"	12 g/m ²	100/Bag; 1000/Case
200-BG01	Beard Guard	Spun Bonded Polypropylene	18" x 8"	12 g/m ²	100/Bag; 1000/Case
200-91018	Sleeve	Polyethylene Embossed	18" Long	1 mil	10/Roll; 10 Rolls/Bag; 1000/Case

REUSABLE & SINGLE USE APRONS



DENIM

200-010

- 100% cotton construction
- Serged seams
- Pre-shrunk
- Metal grommets to hold neck strap and waist ties

APPLICATIONS: *Manufacturing, Warehousing, Construction, Carpentry*

200-07501

- Superior flexibility
- Excellent resistance to punctures and abrasion
- Excellent resistance to oils, grease and chemicals

APPLICATIONS: *Food Handling, Industrial Maintenance, Chemical Processing*



PVC/VINYL



NEOPRENE

200-12501

- Chemical and oil resistant
- Rust-proof grommets
- Reinforced bib
- Hemmed over-edge

APPLICATIONS: *Chemical Plants, Plating Facilities, General Maintenance*

200-01001

- Resistant to fats, oil and grease
- Convenient individual packaging
- Die cut for consistent sizing

APPLICATIONS: *Food Handling and General Preparation*



POLYETHYLENE

THE DIFFERENCE BETWEEN FR AND AR

FLAME RESISTANT (FR)

Flame Resistant garments earn their designation because they are made of fabrics that are inherently resistant to or are treated to be resistant to catching fire when exposed directly to flame. The material will resist ignition and/or self-extinguish when ignited, and they will not melt. FR garments also create a thermal barrier to help protect the wearer's skin when exposed to direct heat energy and may minimize the amount of 2nd and 3rd degree burns incurred. FR fabrics include:

- **Modacrylics, Aramids and Para-aramids** are among the inherently flame resistant fabrics. They will not lose those characteristics through wear or laundering.
- **Treated Fabrics**, such as cotton and cotton blends, require FR treatment to achieve self-extinguishing properties. This treatment will eventually fade with washing but, if the garment is properly cared for, the treatment can last the life of the garment. FR treated cotton and cotton blends provide a more comfortable and affordable solution.

ARC RATED (AR)

Arc Rated (AR) garments help to provide flame and thermal protection from exposure to an electrical arc flash. AR fabrics and garments are designed and treated to help limit the exposure and burn percentage as a result of an electrical arc flash incident.

In 2015, the NFPA introduced the new term "**AR (Arc Rated)**" to help identify the critical difference between AR and FR (Flame Resistant) clothing as it applies to Arc Flash Protection.

Remember: All AR garments are flame resistant, however not all FR garments are rated for arc flash protection.

There are many variables to consider when selecting **AR** protective clothing. Most importantly the employer must perform a **Hazard Risk Analysis** for the workplace to identify risks and set the appropriate boundaries. The results of this analysis will then direct the employer into the level of protection needed.

Each AR garment is given an **Arc Thermal Performance Value (ATPV)** or **Energy Break-open Threshold (EBT)**. This value represents the level of protection the garment is tested to provide when exposed to variable levels of heat in an electric arc flash. Higher levels of protection typically require thicker and/or additional layers. The ATPV or EBT of the garment should be equal to or greater than the energy level of the work area as determined by the Hazard Risk Analysis.

The NFPA 70E should be reviewed thoroughly and regularly to ensure compliance and to be aware of any revisions or updates as they occur.

DUAL CERTIFIED PROTECTION

Dual Certified means that the materials have been tested and certified to meet both the NFPA 70E (Arc Flash Protection) and the NFPA 2112 (Flash Fire Protection) standards. The NFPA 2112-2012 requires third party certification of the garment, and all PIP NFPA 2112-2012 certified garments are UL certified. All PIP Dual-Certified apparel are identified as such.



- 244 AR/FR SWEATSHIRTS
- 245 AR/FR SHIRTS
- 246 AR/FR HI-VIS VESTS
- 247 AR/FR ADDITIONAL CLOTHING
- 248 DUAL CERTIFIED CLOTHING
- 250 ARC FLASH PROTECTION KITS
- 254 ARC FLASH HEAD GEAR
- 256 ARC FLASH ACCESSORIES

FLAME RESISTANT & ARC RATED CLOTHING

AR/FR CLOTHING

SWEATSHIRT

NFPA 70E PPE CATEGORIES

PPE CATEGORY	PROTECTIVE EQUIPMENT	PROTECTIVE CLOTHING	MIN ARC RATING
	<ul style="list-style-type: none"> • Hard hat • Safety glasses or safety goggles (SR) • Hearing protection (ear canal inserts) • Heavy duty leather gloves* • Leather work shoes 	<ul style="list-style-type: none"> • Arc rated long sleeve shirt and pants or arc rated coverall • Arc rated face shield or arc flash suit hood • Arc rated jacket, parka, rainwear or hard hat liner 	4 cal/cm ²
	<ul style="list-style-type: none"> • Hard hat • Safety glasses or safety goggles (SR) • Hearing protection (ear canal inserts) • Heavy duty leather gloves* • Leather work shoes 	<ul style="list-style-type: none"> • Arc rated long sleeve shirt and pants or arc rated coverall • Arc rated face shield and arc rated balaclava or arc flash suit hood • Arc rated jacket, parka, rainwear or hard hat liner 	8 cal/cm ²
	<ul style="list-style-type: none"> • Hard hat • Safety glasses or safety goggles (SR) • Hearing protection (ear canal inserts) • Heavy duty leather gloves* • Leather work shoes 	<ul style="list-style-type: none"> • Arc rated long sleeve shirt • Arc rated pants • Arc rated coverall • Arc rated arc flash suit jacket • Arc rated arc flash suit pants • Arc rated arc flash suit hood • Arc rated gloves • Arc rated jacket, parka, rainwear or hard hat liner 	25 cal/cm ²
	<ul style="list-style-type: none"> • Hard hat • Safety glasses or safety goggles (SR) • Hearing protection (ear canal inserts) • Heavy duty leather gloves* • Leather work shoes 	<ul style="list-style-type: none"> • Arc rated long sleeve shirt • Arc rated pants • Arc rated coverall • Arc rated arc flash suit jacket • Arc rated arc flash suit pants • Arc rated arc flash suit hood • Arc rated gloves • Arc rated jacket, parka, rainwear or hard hat liner 	40 cal/cm ²

* NFPA 70E Table 130.7(C)(16) Note 1 - The combination of rubber insulating gloves and leather protectors satisfies the arc flash protection requirements.

NFPA 70E 2015 NOTABLE CHANGES

When determining which arc rating of PPE is required, the term HRC (Hazard/Risk Category) is now referred to as **"PPE Category."**

The former HRC Level 0 no longer exists. The NFPA now requires arc rated clothing for tasks that were previously identified as **Category 0.**

Arc rated balaclava hoods are required when an individual's head is inside the arc boundary. Arc rated full hoods are required when clothing rated higher than 12 cal/cm² is worn.

ANSI 107 TYPE R CLASS 3 19 CAL PROTECTION



FLAME RESISTANT
SEGMENTED TAPE



+



ARC RATED FLAME RESISTANT HI-VIS BLACK BOTTOM SWEATSHIRT

GARMENT	Hoodie
PPE CATEGORY	2
ARC RATING	19 cal/cm ²
MATERIAL	Modacrylic / FR Cotton
WEIGHT	12 oz. Fleece Knit
POCKETS	3
STANDARD	ANSI 107 Type R Class 3, NFPA 70E, ASTM F1506
CLOSURE	Zipper
REFLECTIVE	2" FR Segmented Heat Applied
SIZE	S - 5X
STYLE NUMBER	COLOR
385-1370FR	 Hi-Vis Lime Yellow / Black



NEXT TO SKIN COMFORT & BREATHABILITY



ARC RATED FLAME RESISTANT SHIRTS (SHORT SLEEVE T-SHIRTS SHOULD BE WORN AS AN UNDERGARMENT ONLY)

STYLE NUMBER	COLOR	GARMENT	PPE CATEGORY	ARC RATING	MATERIAL	WEIGHT	POCKETS	STANDARD	CLOSURE	REFLECTIVE	SIZE
385-FRLS-LG 385-FRLS-NV 385-FRLS-OR	<input type="checkbox"/> Light Gray <input type="checkbox"/> Navy <input type="checkbox"/> Orange	Long Sleeve T-Shirt	2	11 cal/cm ²	100% Cotton	6.5 oz. Knit	1	NFPA 70E, ASTM F1506	Pullover	None	M - 3X
385-FRHN-LG 385-FRHN-NV 385-FRHN-OR	<input type="checkbox"/> Light Gray <input type="checkbox"/> Navy <input type="checkbox"/> Orange	Long Sleeve Henley	2	11 cal/cm ²	100% Cotton	6.5 oz. Knit	1	NFPA 70E, ASTM F1506	Pullover	None	M - 3X
385-FRSS-LG 385-FRSS-NV	<input type="checkbox"/> Light Gray <input type="checkbox"/> Navy	Short Sleeve T-Shirt	2	11 cal/cm ²	100% Cotton	6.5 oz. Knit	1	NFPA 70E, ASTM F1506	Pullover	None	M - 3X
315-1350FR	<input type="checkbox"/> Hi-Vis Lime Yellow	Long Sleeve T-Shirt	2	8.6 cal/cm ²	100% Cotton	8 oz. Knit	1	ANSI 107 Type R Class 3, NFPA 70E, ASTM F1506	Pullover	2" Silver Sewn-On	S - 3X

ARC RATED FLAME RESISTANT SWEATSHIRTS

385-FRPH-NV 385-FRPH-OR	<input type="checkbox"/> Navy <input type="checkbox"/> Orange	Hoodie	2	20 cal/cm ²	100% Cotton	12 oz. Fleece Knit	1	NFPA 70E, ASTM F1506	Pullover	None	M - 3X
385-FRZH-NV 385-FRZH-OR	<input type="checkbox"/> Navy <input type="checkbox"/> Orange	Hoodie	2	20 cal/cm ²	100% Cotton	12 oz. Fleece Knit	2	NFPA 70E, ASTM F1506	Zipper	None	M - 3X

AR/FR CLOTHING

HI-VIS VESTS

RESISTS IGNITION & SELF EXTINGUISHES

TO BE WORN OVER ARC RATED FR CLOTHING **ONLY.**

▼ 305-3000

▼ 305-2000



+



▼ 305-3100

▼ 305-2100

SOLID FABRIC



MESH FABRIC

NO MELT, NO DRIP

ARC RATED FLAME RESISTANT HI-VIS VESTS

STYLE NUMBER	HI-VIS COLOR	ANSI 107	PPE CATEGORY	ARC RATING	MATERIAL	WEIGHT	POCKETS	STANDARD	CLOSURE	REFLECTIVE	SIZE
305-2000	■ Lime Yellow	Type R Class 2	1	5.4 cal/cm ²	Modacrylic	6.2 oz. Woven Solid	0	ANSI 107, NFPA 70E, ASTM F1506	FR Hook & Loop	2" FR Silver Sewn-On	M - 5X
305-3000	■ Lime Yellow	Type R Class 3	1	5.4 cal/cm ²	Modacrylic	6.2 oz. Woven Solid	0	ANSI 107, NFPA 70E, ASTM F1506	FR Hook & Loop	2" FR Silver Sewn-On	M - 5X
305-2100	■ Lime Yellow	Type R Class 2	1	5.1 cal/cm ²	Modacrylic	6.2 oz. Mesh	1	ANSI 107, NFPA 70E, ASTM F1506	FR Hook & Loop	2" FR Silver Sewn-On	M - 5X
305-3100	■ Lime Yellow	Type R Class 3	1	5.1 cal/cm ²	Modacrylic	6.2 oz. Mesh	1	ANSI 107, NFPA 70E, ASTM F1506	FR Hook & Loop	2" FR Silver Sewn-On	M - 5X

FR HOOK AND LOOP CLOSURE & FR REFLECTIVE TAPE AND BINDING

ARC RATED CLOTHING

- ARAMID HIGH TENACITY THREAD
- BAR TACKED AT ALL STRESS POINTS
- ULTRALIGHT STYLES AVAILABLE (*)

ARC RATED FLAME RESISTANT COVERALLS (NFPA 70E, ASTM F1506)*

STYLE NUMBER	COLOR	MATERIAL	PPE CAT.	ARC RATING	POCKETS	CLOSURE	SIZE
9100-2160D	<input type="checkbox"/> Navy	Cotton / Nylon	2	8 cal/cm ²	2	Hook & Loop	S - 5X
9100-2170D	<input type="checkbox"/> Navy	Cotton / Nylon	2	12 cal/cm ²	2	Hook & Loop	S - 5X
9100-52772	<input type="checkbox"/> Navy	Cotton / Nylon	3	25 cal/cm ²	3	Hook & Loop	S - 5X
9100-52758	<input type="checkbox"/> Navy	Cotton / Nylon	3	33 cal/cm ²	3	Hook & Loop	S - 5X
9100-240ULT	<input type="checkbox"/> Navy	Protera® / Ultrasoft®	4	40 cal/cm ²	2	Hook & Loop	S - 5X

ARC RATED FLAME RESISTANT OVERALLS (NFPA 70E, ASTM F1506)

9100-52564	<input type="checkbox"/> Navy	Cotton / Nylon	2	12 cal/cm ²	2	Buckle	S - 5X
9100-21731	<input type="checkbox"/> Navy	Cotton / Nylon	3	25 cal/cm ²	2	Buckle	S - 5X
9100-53680	<input type="checkbox"/> Navy	Cotton / Nylon	3	33 cal/cm ²	2	Buckle	S - 5X
9100-52422	<input type="checkbox"/> Navy	Cotton / Nylon	4	40 cal/cm ²	2	Buckle	S - 5X
9100-75001	<input type="checkbox"/> Navy	Cotton / Nylon	4	75 cal/cm ²	2	Buckle	S - 5X
9100-53750	<input type="checkbox"/> Gray	Aramid / Cotton	4	100 cal/cm ²	2	Buckle	M - 2X

ARC RATED FLAME RESISTANT JACKETS (NFPA 70E, ASTM F1506)

9100-21782	<input type="checkbox"/> Navy	Cotton / Nylon	2	12 cal/cm ²	2	Hook & Loop	S - 5X
9100-21721	<input type="checkbox"/> Navy	Cotton / Nylon	3	25 cal/cm ²	2	Hook & Loop	S - 5X
9100-52680	<input type="checkbox"/> Navy	Cotton / Nylon	3	33 cal/cm ²	2	Hook & Loop	S - 5X
9100-52412	<input type="checkbox"/> Navy	Cotton / Nylon	4	40 cal/cm ²	2	Hook & Loop	S - 5X
9100-524ULT*	<input type="checkbox"/> Navy	Protera® / Ultrasoft®	4	40 cal/cm ²	2	Hook & Loop	S - 5X
9100-75000	<input type="checkbox"/> Navy	Cotton / Nylon	4	75 cal/cm ²	2	Hook & Loop	S - 5X
9100-52750	<input type="checkbox"/> Gray	Aramid / Cotton	4	100 cal/cm ²	2	Hook & Loop	M - 2X

ARC RATED FLAME RESISTANT OVERPANTS (NFPA 70E, ASTM F1506)

9100-22070	<input type="checkbox"/> Navy	Cotton / Nylon	2	12 cal/cm ²	2	Hook & Loop / Drawstring	S - 5X
9100-530ULT*	<input type="checkbox"/> Navy	Protera® / Ultrasoft®	4	40 cal/cm ²	4	Hook & Loop / Drawstring	S - 5X

*ADDITIONAL COVERALL STYLES ON FOLLOWING PAGES



DUAL CERTIFIED CLOTHING

SHIRTS / JEANS



DUAL CERTIFIED

DUAL CERTIFIED MEANS THE GARMENT AND MATERIAL HAVE BEEN TESTED AND CERTIFIED BY A THIRD PARTY AND INDICATES COMPLIANCE TO TWO STANDARDS.

NFPA 70E: STANDARD FOR ELECTRICAL SAFETY IN THE WORKPLACE

NFPA 2112: STANDARD FOR PROTECTION AGAINST FLASH FIRE



ARC RATED FLAME RESISTANT DUAL CERTIFIED CLOTHING

STYLE NUMBER	COLOR	GARMENT	PPE CATEGORY	ARC RATING	MATERIAL	WEIGHT	POCKETS	STANDARD	CLOSURE	SIZE
385-FRWS-NV 385-FRWS-KH	<input type="checkbox"/> Navy <input type="checkbox"/> Khaki	Button Down	2	8 cal/cm ²	90% Cotton 10% Nylon	7 oz. Woven FR Fabric	2	NFPA 70E, ASTM F1506 & NFPA 2112-2012	Buttons	S - 4X
385-FRRJ	<input type="checkbox"/> Denim	Relaxed Fit Jeans	2	16 cal/cm ²	100% Cotton Denim Twill	13 oz. Woven FR Fabric	5	NFPA 70E, ASTM F1506 & NFPA 2112-2012	Zipper	Waist: 30-50" Length: 30-36"
385-FRCJ	<input type="checkbox"/> Denim	Carpenter Jeans	2	16 cal/cm ²	100% Cotton Denim Twill	13 oz. Woven FR Fabric	6	NFPA 70E, ASTM F1506 & NFPA 2112-2012	Zipper	Waist: 30-50" Length: 30-36"

385-FRCJ ▶

DUAL CERTIFIED CLOTHING

COVERALLS



VENTED BACK

INSECT REPELLENT

ACTION BACK

2 EXTRA LARGE
CHEST FLAP
POCKETS

NON-LOCKING
BREAKAWAY
ZIPPER

ARC RATED FLAME RESISTANT DUAL CERTIFIED COVERALLS

STYLE NUMBER	COLOR	FEATURE	PPE CATEGORY	ARC RATING	MATERIAL	WEIGHT	POCKETS	STANDARD	CLOSURE	SIZE
385-FRSC-NV 385-FRSC-KH	<input type="checkbox"/> Navy <input type="checkbox"/> Khaki	Multiple Pockets	2	8 cal/cm ²	90% Cotton 10% Nylon	7 oz. Woven FR Fabric	8	NFPA 70E, ASTM F1506 & NFPA 2112-2012	Zipper	S - 5X
9100-2160D	<input type="checkbox"/> Navy	Action Back For Mobility	2	8 cal/cm ²	90% Cotton 10% Nylon	7 oz. Woven FR Fabric	2	NFPA 70E, ASTM F1506 & NFPA 2112-2012	Hook & Loop	S - 5X
9100-2100D	<input type="checkbox"/> Tan	Vented Back For Breathability	2	8 cal/cm ²	90% Cotton 10% Nylon	7 oz. Woven FR Fabric	2	NFPA 70E, ASTM F1506 & NFPA 2112-2012	Hook & Loop	S - 5X
9100-2120D	<input type="checkbox"/> Royal Blue	Vented Back For Breathability	2	8 cal/cm ²	90% Cotton 10% Nylon	7 oz. Woven FR Fabric	2	NFPA 70E, ASTM F1506 & NFPA 2112-2012	Hook & Loop	S - 5X
9100-2110D	<input type="checkbox"/> Tan	Built-In Insect Repellant	2	8 cal/cm ²	90% Cotton 10% Nylon	7 oz. Woven FR Fabric	2	NFPA 70E, ASTM F1506 & NFPA 2112-2012	Hook & Loop	S - 5X
9100-2170D	<input type="checkbox"/> Navy	Action Back For Mobility	2	12 cal/cm ²	90% Cotton 10% Nylon	9 oz. Woven FR Fabric	2	NFPA 70E, ASTM F1506 & NFPA 2112-2012	Hook & Loop	S - 5X



ARC FLASH PROTECTION KITS

KIT FEATURES

ARC KITS INCLUDE:

1 CAP STYLE HARD HAT
EVOLUTION® 280-EV6151-OR - NON-VENTED CLASS E



1 STORAGE BAG
CARRY BAG: 9400-52599 OR BACK PACK: 9400-52514



1 DIELECTRIC SAFETY GLASSES
CAPTAIN™ 250-46-0020



WITH AN ARC SHIELD & BALACLAVA OR ARC HOOD





8 & 12 CAL ARC KITS

PIP's 8 & 12 cal Arc Flash Kits are designed to meet your PPE 2 needs (insulating glove kits and arc rated hearing protection are not included). These kits provide you with the components needed to be in compliance with the NFPA 70E Standard.

PPE 2 ARC PROTECTION KITS

ITEM NUMBER	CLOTHING	CLOTHING STYLE NUMBER	FEATURE	BALACLAVA	ARC SHIELD	ARC RATING	STORAGE BAG
9150-5388E	Dual Certified Coverall	9100-2160D	Action Back	9100-HDFR15	9400-52505	8 cal/cm ²	Carry Bag
9150-5388EB	Dual Certified Coverall	9100-2160D	Action Back	9100-HDFR15	9400-52505	8 cal/cm ²	Back Pack
9150-5488E	Dual Certified Coverall	9100-2170D	Action Back	9100-HDFR15	9400-52505	12 cal/cm ²	Carry Bag
9150-5488EB	Dual Certified Coverall	9100-2170D	Action Back	9100-HDFR15	9400-52505	12 cal/cm ²	Back Pack
9150-52804	Jacket & Overall	9100-21780 & 9100-52564	2-Piece Set	9100-HDFR15	9400-52505	12 cal/cm ²	Back Pack
9150-52810	Jacket & Pant	9100-21780 & 9100-22070	2-Piece Set	9100-HDFR15	9400-52505	12 cal/cm ²	Carry Bag
9150-53871	Jacket & Overall	9100-21780 & 9100-52564	2-Piece Set	9100-HDFR15	9400-52505	12 cal/cm ²	Carry Bag



12 CAL ARC HEAD GEAR KITS

PIP's 12 & 20 cal Arc Flash Head Gear Kits are designed to meet PPE 2 needs for workers (insulating glove kits, and arc rated clothing and hearing protection are not included). These kits provide you with the above-the-neck components needed to be in compliance with the new NFPA 70E 2012 standard.

PPE 2 ARC HEAD GEAR KITS

ITEM NUMBER	BALACLAVA	ARC SHIELD	HEAD GEAR BAG	ARC RATING	STORAGE BAG
9150-52508	9100-HDFR15	9400-52505	9400-52509	12 cal/cm ²	None
9150-52512	9100-HDFR15	9400-52505	9400-52509	12 cal/cm ²	Carry Bag
9150-52500	9100-HDFR15	9400-52505	9400-52509	12 cal/cm ²	Back Pack
9150-56510	---	9400-52505	---	12 cal/cm ²	---
9150-56511	---	9400-52501	---	12 cal/cm ²	---

ARC FLASH PROTECTION KITS

25 & 33 CAL / 40-100 CAL ARC KITS



25 & 33 CAL ARC KITS

For higher voltage situations, PIP's 25 & 33 cal Arc Flash Kits are designed to meet your PPE 3 needs (insulating glove kits and arc rated hearing protection are not included). The kits come with safety helmet and arc hood in addition to the components needed to be in compliance with the NFPA 70E Standard.

PPE 3 ARC PROTECTION KITS

ITEM NUMBER	CLOTHING	CLOTHING STYLE NUMBER	FEATURE	HOOD	ARC RATING	STORAGE BAG
9150-52815	Coverall	9100-52772	Aramid Thread & Cuffs	9150-52515	25 cal/cm ²	Carry Bag
9150-52821	Coverall	9100-52772	Aramid Thread & Cuffs	9150-52515	25 cal/cm ²	Back Pack
9150-53003	Jacket & Overall	9100-21721 & 9100-21731	2-Piece Set	9150-52515	25 cal/cm ²	Carry Bag
9150-53018	Jacket & Overall	9100-21721 & 9100-21731	2-Piece Set	9150-52515	25 cal/cm ²	Back Pack
9150-52917	Coverall	9100-52758	Aramid Thread & Cuffs	9150-52685	33 cal/cm ²	Carry Bag
9150-52946	Coverall	9100-52758	Aramid Thread & Cuffs	9150-52685	33 cal/cm ²	Back Pack
9150-52609	Jacket & Overall	9100-52680 & 9100-53680	2-Piece Set	9150-52685	33 cal/cm ²	Carry Bag
9150-21712	Jacket & Overall	9100-21780 & 9100-52564	2-Piece Set	9150-52685	33 cal/cm ²	Back Pack



40-100 CAL ARC KITS

Serious protection demands serious products. PIP has worked to develop multiple kits for high risk environments. Together with you, we can help you meet compliance regulations by offering you turn-key kits. (Insulating glove kits and arc rated hearing protection are not included).

PPE 4 ARC PROTECTION KITS

ITEM NUMBER	CLOTHING	CLOTHING STYLE NUMBER	FEATURE	HOOD	ARC RATING	STORAGE BAG
9150-54VULT	Jacket & Overpant	9100-524ULT & 9100-530ULT	Ultralight	9150-5236V	40 cal/cm ²	Carry Bag
9150-54VULTB	Jacket & Overpant	9100-524ULT & 9100-530ULT	Ultralight	9150-5236V	40 cal/cm ²	Back Pack
9150-540ULT	Jacket & Overpant	9100-524ULT & 9100-530ULT	Ultralight	9150-523ULT	40 cal/cm ²	Carry Bag
9150-540ULTB	Jacket & Overpant	9100-524ULT & 9100-530ULT	Ultralight	9150-523ULT	40 cal/cm ²	Back Pack
9150-52436	Jacket & Overall	9100-52412 & 9100-52422	2-Piece Set	9150-52850	40 cal/cm ²	Carry Bag
9150-52436B	Jacket & Overall	9100-52412 & 9100-52422	2-Piece Set	9150-52850	40 cal/cm ²	Back Pack
9150-75050	Jacket & Overall	9100-75000 & 9100-75001	2-Piece Set	9150-75002	75 cal/cm ²	Carry Bag
9150-75050B	Jacket & Overall	9100-75000 & 9100-75001	2-Piece Set	9150-75002	75 cal/cm ²	Back Pack
9150-52730	Jacket & Overall	9100-52750 & 9100-53750	2-Piece Set	9150-52689	100 cal/cm ²	Carry Bag
9150-52730B	Jacket & Overall	9100-52750 & 9100-53750	2-Piece Set	9150-52689	100 cal/cm ²	Back Pack

ARC FLASH PROTECTION KITS

40 CAL HYBRID FABRIC ARC KITS

40

CAL/CM²

LIGHTER IS BETTER 37% BETTER

ULTRALIGHT 40 CAL/CM² CLOTHING UTILIZES A HYBRID FABRIC TECHNOLOGY TO INCREASE GARMENT DURABILITY IN THE FIELD WHILE DECREASING ITS WEIGHT BY 37%. OUR ULTRALIGHT GARMENT USES A DUPONT® SHELL TO PROVIDE ITS SUPERIOR TENSILE STRENGTH, INDUSTRIAL WASH RESISTANCE, AND LONG-TERM DURABILITY. MEETS NFPA 70E, ASTM F1506, OSHA 29 CFR 1910.269.

- 40 CAL/CM² HYBRID FABRIC TECHNOLOGY
- SHELL: DUPONT® PROTERA® (FIBER BLEND: 33% NOMEX® AND KEVLAR®, 65% MODACRYLIC, 2% ANTISTATIC)
- INSIDE LAYER: WESTEX® ULTRASOFT® INTERLOCK KNIT (88% COTTON, 12% HIGH TENACITY NYLON)



HYBRID FABRIC TECHNOLOGY

VENTILATING UNIT

VENTILATING UNIT AND POWER PACK ARE PROTECTED BY A COMPACT AND DURABLE ABS CASE COVERED BY ULTRALIGHT FABRIC.

- UNIT WEIGHT: 1 LB (16 OZ.)
- AIRFLOW: 35 CFM

6+ USABLE HOURS OF BATTERY LIFE

40 CAL ULTRALIGHT HOODS, JACKETS & PANTS (NFPA 70E, ASTM F1506)

ITEM NUMBER	GARMENT	FEATURE	COLOR	ARC RATING	SIZE
9150-5236V	Hood	Ventilated with Battery Pack	<input type="checkbox"/> Navy	40 cal/cm ²	OSFM
9150-523ULT	Hood	Non-Ventilated	<input type="checkbox"/> Navy	40 cal/cm ²	OSFM
9100-524ULT	Jacket	Aramid High Tenacity Thread	<input type="checkbox"/> Navy	40 cal/cm ²	S - 5X
9100-530ULT	Overpant	Aramid High Tenacity Thread	<input type="checkbox"/> Navy	40 cal/cm ²	S - 5X

ARC FLASH HEAD GEAR

REPLACEMENT SHIELDS & ACCESSORIES



TRANSPARENT CHIN CUP



USES ACCESSORY SLOTS



UNIVERSAL FIT

ADAPTERS & STORAGE BAGS

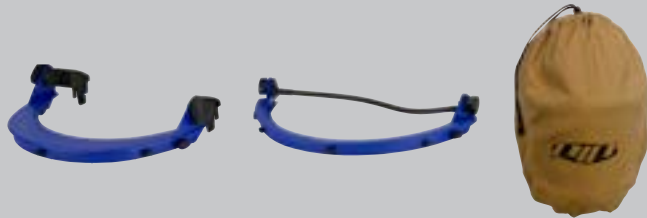

ARC PROTECTIVE SHIELDS (NFPA 70E, ASTM F2178, ANSI Z87+S, INCLUDES CHIN CUP)

ITEM NUMBER	ARC RATING	MATERIAL	FITS	CHIN CUP COLOR	INCLUDES
9400-53512	12 cal/cm ²	Polycarbonate	Full Brim	Transparent	Mounting Bracket
9400-53520	20 cal/cm ²	Polycarbonate	Full Brim	Transparent	Mounting Bracket
9400-53514	12 cal/cm ²	Polycarbonate	Cap Style	Transparent	Mounting Bracket
9400-53524	20 cal/cm ²	Polycarbonate	Cap Style	Transparent	Mounting Bracket
9400-53502	12 cal/cm ²	Polycarbonate	---	Transparent	Replacement Shield
9400-53504	20 cal/cm ²	Polycarbonate	---	Transparent	Replacement Shield
9400-52505	12 cal/cm ²	Polycarbonate	Cap Style	Blue	Clip Mount
9400-52511	20 cal/cm ²	Polycarbonate	Cap Style	Blue	Clip Mount
9400-52501	12 cal/cm ²	Polycarbonate	Universal	Blue	Elastomeric Hard Hat Attachment
9400-52507	20 cal/cm ²	Polycarbonate	Universal	Blue	Elastomeric Hard Hat Attachment
9400-52502	12 cal/cm ²	Polycarbonate	---	Blue	Replacement Shield
9400-52504	20 cal/cm ²	Polycarbonate	---	Blue	Replacement Shield

ARC PROTECTIVE ACCESSORIES (NFPA 70E, ASTM F2178, ANSI Z87+S)

ITEM NUMBER	MATERIAL	DESCRIPTION
9400-52503	Nylon	Cap Style Hard Hat Adapter
9400-52506	Nylon	Full Brim Hard Hat Adapter with Elastomeric Band
9400-80016	Nylon	Universal Hard Hat Adapter with Elastomeric Band
9400-52509	Cotton	Premium Arc Shield Storage Bag with Pull Cord Closure
9400-52508	Cotton	Arc Shield Storage Bag with Pull Cord Closure

Hard hat not included



ARC SHIELDS

ARC FLASH HEAD GEAR

ARC FLASH HOODS



INCORPORATES
UV AND IR ABSORBING
ARC SHIELD LENS
PROVIDING PROTECTION
UP TO 100 CAL/CM²



GREEN TINT WINDOW IS
COATED WITH A PERMANENT
ANTI-FOG INNER SURFACE

ELECTRICAL ARC HOODS (NFPA 70E, ASTM F1506)

ITEM NUMBER	WEIGHT	LAYERS	MATERIAL	PPE CAT.	ARC RATING	DESCRIPTION
9150-52548	9 oz.	1	Cotton / Nylon	2	12 cal/cm ²	Includes Arc Shield, Hard Hat, etc.
9150-52515	7 oz.	2	Cotton / Nylon	3	25 cal/cm ²	Includes Arc Shield, Hard Hat, etc.
9150-52685	9 oz.	2	Cotton / Nylon	3	33 cal/cm ²	Includes Arc Shield, Hard Hat, etc.
9150-5236V	8 oz. / 6 oz.	2	Protera [®] / Ultrasoft [®]	4	40 cal/cm ²	Includes Arc Shield, Hard Hat, etc.
9150-523ULT	8 oz. / 6 oz.	2	Protera [®] / Ultrasoft [®]	4	40 cal/cm ²	Includes Arc Shield, Hard Hat, etc.
9150-52850	9 oz. / 13 oz.	2	Cotton / Nylon	4	40 cal/cm ²	Includes Arc Shield, Hard Hat, etc.
9150-75002	13 oz. / 5.5 oz. 13 oz. / 5.5 oz.	4	Cotton / Nylon	4	75 cal/cm ²	Includes Arc Shield, Hard Hat, etc.
9150-52689	---	Multi	Ultrasoft [®] / High Tenacity Nylon	4	100 cal/cm ²	Includes Arc Shield, Hard Hat, etc.

ELECTRICAL ARC HOOD REPLACEMENT WINDOWS (NFPA 70E, ASTM F2178, ANSI Z87+S)

9400-52517	6.4 oz.	---	Polycarbonate	3	25 cal/cm ²	Arc Shield Replacement Window
9400-52686	8 oz.	---	Polycarbonate	4	40 cal/cm ²	Arc Shield Replacement Window
9400-52699	9.6 oz.	---	Polycarbonate	4	100 cal/cm ²	Arc Shield Replacement Window

ULTRALIGHT

ARC FLASH HOODS

Arc Rating (NFPA)
40 cal/cm²

ARC FLASH ACCESSORIES

HOODS / BAGS / EYEWEAR



◀ 385-FRBL-11-NV



◀ 9100-HDFR15



ARC RATED PROTECTION BALACLAVAS

ITEM NUMBER	COLOR	WEIGHT	LAYERS	MATERIAL	PPE CATEGORY	ARC RATING
385-FRBL-11-NV	■ Navy	6.5 oz.	Single	FR Cotton Knit	2	11.8 cal/cm ²
385-FRBL-11-OR	■ Orange					
9100-HDFR12	■ Navy	8.5 oz.	Single	Pro-C FR Westex® Ultrasoft®	2	12.1 cal/cm ²
9100-HDFR15	■ Navy	8.5 oz.	Single	FR Cotton Rib	2	15.1 cal/cm ²
385-HDFR13-NV	■ Navy	13 oz.	Double	FR Cotton / Nylon Knit	3	32.4 cal/cm ²
385-HDFR13-OR	■ Orange					



FOR USE UNDER ARC SHIELDS

BALACLAVAS



▼ 9400-52514



▼ 9400-52599

WATER RESISTANT SHELL

ESP KIT STORAGE BAGS

ITEM NUMBER	COLOR	STYLE	MATERIAL	FEATURE	CLOSURE	SIZE
9400-52514	■ Orange	Back Pack	600 D Polyester	Insulating Glove Pocket	Drawcord & Buckle	20"L x 8"W x 15"H
9400-52599	■ Orange	Carry Bag	600 D Polyester	Molded Rubber Bottom	Zipper	24"L x 10"W x 13"H



SAFETY GLASSES

REFER TO THE PAGE NUMBERS BELOW FOR MORE INFORMATION

bouton
OPTICAL



▲ TRANZMISSION
PAGE 195

▲ CAPTAIN
PAGE 187

▲ Q-VISION
PAGE 184

UNDERSTANDING RUBBER INSULATING GLOVES

AS ONE OF THE MOST IMPORTANT COMPONENTS OF PPE FOR ELECTRICAL WORKERS, RUBBER INSULATING GLOVES NEED TO BE STRONG, FLEXIBLE, DURABLE, AND, OF COURSE, DIELECTRIC.

STANDARDS & USE

The proper function of rubber insulating gloves is extremely critical, and there are strict requirements outlined by OSHA 29 CFR 1910.137 with regards to their use and in-service care. There are also different classes of gloves available depending on the level of voltage protection they provide (see the table on the following page for this information).

It is critical to inspect your rubber insulating gloves before each day's use and after any action that could be expected to cause damage to the glove. If the gloves show any evidence of damage, they should not be used.

LEATHER PROTECTORS

Leather protectors must be worn over the rubber insulating gloves when working with them. Leather protectors help provide cut, puncture, and abrasion protection for the rubber insulating gloves. The class of the leather protectors needs to match the class of the electrical gloves and leather protectors alone do **not** provide electrical protection.

GLOVE STORAGE BAGS

When they are not in use, rubber insulating gloves should be stored finger tips up in a glove bag and hung – **not laid** – flat. Leather protectors should be removed prior to storage and the rubber insulating gloves should never be folded. The bag should be stored in as dry and cool a place as possible (95°F maximum), away from sources of ozone and direct sunlight.

258 RUBBER INSULATING GLOVES & SLEEVES

260 LEATHER PROTECTORS

260 ACCESSORIES

RUBBER INSULATING GLOVES

RUBBER INSULATING GLOVES

NOVAX® STRAIGHT CUFF GLOVES

NOVAX® LABELING CHART

CLASS COLOR	NOVAX® GLOVE LABEL	TEST AC VOLTS	USE AC VOLTS	USE DC VOLTS
CLASS 00	10 NOVAX™ by G.B. INDUSTRIES ANSI / ASTM MADE IN D120 CLASS 00 TYPE I MAX USE VOLT 500V AC	2,500	500	750
CLASS 0	10 NOVAX™ by G.B. INDUSTRIES ANSI / ASTM MADE IN D120 CLASS 0 TYPE I MAX USE VOLT 1000V AC	5,000	1,000	1,500
CLASS 1	10 NOVAX™ by G.B. INDUSTRIES ANSI / ASTM MADE IN D120 CLASS 1 TYPE I MAX USE VOLT 7500V AC	10,000	7,500	11,250
CLASS 2	10 NOVAX™ by G.B. INDUSTRIES ANSI / ASTM MADE IN D120 CLASS 2 TYPE I MAX USE VOLT 17000V AC	20,000	17,000	25,500
CLASS 3	10 NOVAX™ by G.B. INDUSTRIES ANSI / ASTM MADE IN D120 CLASS 3 TYPE I MAX USE VOLT 26500V AC	30,000	25,500	39,750
CLASS 4	10 NOVAX™ by G.B. INDUSTRIES ANSI / ASTM MADE IN D120 CLASS 4 TYPE I MAX USE VOLT 36000V AC	40,000	36,000	54,000

NOVAX® STANDARDS SPECIFICATION REFERENCE

OSHA REGULATIONS	29CFR part 1910 Occupational Safety and Health Standards
ASTM STANDARDS	ASTM D120-14a Rubber Insulating Gloves ASTM F496-14a In-Services Care of Insulating Gloves and Sleeves ASTM F696-06 Leather Protectors for Rubber Insulating Gloves and Mittens ASTM F1236-16 Visual Inspection of Electrical Protective Rubber Products ASTM D1051-14a Rubber Insulating Sleeves
NFPA STANDARDS	National Electric Safety Code NFPA 70E Electrical Safety in the Workplace - General Workplaces

NOVAX
ELECTRICAL SAFETY



STRAIGHT CUFF STYLES

Novax® products exceed all requirements of ASTM D120 & D1051, ensuring compliance with OSHA regulations and satisfying NFPA 70E requirements for protection against electrical shock hazards. The natural rubber construction offers excellent dielectric properties combined with flexibility, strength, and durability. Other features include a contoured shape that reduces hand fatigue and a rolled cuff for increased durability during donning and doffing.

RUBBER INSULATING GLOVES

NOVAX® GLOVES & SLEEVES

NOVAX® RUBBER INSULATING GLOVES STRAIGHT CUFF STYLES

STYLE NUMBER	CLASS	COLOR	LENGTH	SIZES
150-00-11	00	Black	11"	7 - 12
147-00-11	00	Orange	11"	7 - 12
170-00-11	00	Yellow	11"	7 - 12
153-00-11	00	Red	11"	8 - 11
150-00-14	00	Black	14"	7 - 12
170-00-14	00	Yellow	14"	7 - 12
150-0-11	0	Black	11"	7 - 12
147-0-11	0	Orange	11"	7 - 12
155-0-11	0	Black / Orange	11"	7 - 12
170-0-11	0	Yellow	11"	7 - 12
153-0-11	0	Red	11"	8 - 11
150-0-14	0	Black	14"	7 - 12
170-0-14	0	Yellow	14"	7 - 12
150-1-14	1	Black	14"	7 - 12
147-1-14	1	Orange	14"	7 - 12
155-1-14	1	Black / Orange	14"	7 - 12
153-1-14	1	Red	14"	7 - 12
155-1-16*	1	Black / Orange	16"	7 - 12
147-2-14	1	Orange	14"	7 - 12
155-2-14	1	Black / Orange	14"	7 - 12
170-2-14	1	Yellow	14"	7 - 12
150-2-14	2	Black	14"	7 - 12
156-2-14	2	Black / Red	14"	9 - 12
152-2-16	2	Black / Yellow	16"	7 - 12
155-2-16	2	Black / Orange	16"	8 - 12
152-2-18**	2	Black / Yellow	18"	7 - 12
155-2-18	2	Black / Orange	18"	8 - 12
150-3-16*	3	Black	16"	9 - 12
155-3-16	3	Black / Orange	16"	9 - 12
150-3-18*	3	Black	18"	9 - 12
155-3-18	3	Black / Orange	18"	9 - 12
155-4-16	4	Black / Orange	16"	9 - 12
155-4-18	4	Black / Orange	18"	9 - 12



BELL CUFF STYLES

STYLE NUMBER	CLASS	COLOR	LENGTH	SIZES
154-2-16*	2	Black / Yellow	16"	8 - 12
159-2-16	2	Black / Orange	16"	8 - 12
161-2-16*	2	Black / Red	16"	8 - 12
154-2-18	2	Black / Yellow	18"	8 - 12
159-2-18	2	Black / Orange	18"	8 - 12
161-2-18	2	Black / Red	18"	8 - 12
159-3-16	3	Black / Orange	16"	9 - 12
159-3-18	3	Black / Orange	18"	9 - 12
159-4-16	4	Black / Orange	16"	9 - 12
159-4-18	4	Black / Orange	18"	9 - 12

CONTOUR CUFF STYLES

158-1-18	1	Black / Orange	18"	8 - 12
151-2-18*	2	Black / Yellow	18"	8 - 12
158-2-18	2	Black / Orange	18"	8 - 12
162-2-18	2	Black / Red	18"	8 - 12
151-3-18	3	Black / Yellow	18"	9 - 12
158-3-18	3	Black / Orange	18"	9 - 12
158-4-18	4	Black / Orange	18"	9 - 12



NOVAX® TYPE I RUBBER INSULATING SLEEVES

- Designed to provide extended protection for electrical workers whose arms can potentially come into contact with an energized part
- Meets all requirements of ASTM D1051, ensuring compliance with OSHA regulations
- Superior comfort and flexibility
- Curved shape delivers enhanced ergonomics
- Straps are included with each set

STYLE NUMBER	CLASS	COLOR	SIZES
190-2-REGULAR	2	Black	Regular
190-2-LARGE	2	Black	Large
190-2-XLARGE	2	Black	Extra Large
195-2-REGULAR	2	Black / Orange	Regular
195-2-LARGE	2	Black / Orange	Large
195-2-XLARGE	2	Black / Orange	Extra Large
197-2-REGULAR	2	Orange	Regular
197-2-LARGE	2	Orange	Large
197-2-XLARGE	2	Orange	Extra Large

*Special-order items

**Half sizes are available for this style (8.5, 9.5, 10.5, 11.5)

RUBBER INSULATING GLOVES

LEATHER PROTECTORS / STORAGE BAGS / INFLATOR / SAFETY KITS

LEATHER PROTECTOR GLOVE COVERS

STYLE NUMBER	CLASS	MATERIAL	CUFF	LENGTH	SIZES
148-1000	00-0	Goatskin	Driver	10"	7 - 12
148-2000	00-0	Goatskin	Gauntlet	13"	7 - 12
148-4000	1-2	Cowhide	Gauntlet	12"	8 - 12
148-5000	1-2	Goatskin	Gauntlet	12"	7 - 12
148-6000	1-4	Goatskin	Gauntlet	14"	8 - 12
148-7000	3-4	Goatskin	Gauntlet	12"	9 - 12



GLOVE STORAGE BAGS

STYLE NUMBER	COLOR	MATERIAL	LENGTH
148-2136	☐ Black	Nylon	11"
148-2142	☐ Black	Nylon	14"
148-6011	■ Natural	Canvas	11"
148-6014	■ Natural	Canvas	14"
148-6016	■ Natural	Canvas	16"
148-6018	■ Natural	Canvas	18"

**KEEP YOUR GLOVES
SAFE AND CLEAN!**

STORE THEM BETWEEN USES



GLOVE INFLATOR

- Used for quick and thorough inspection of insulated rubber gloves
- In compliance with OSHA 1910.137 requiring daily inspection of insulating equipment

ITEM NUMBER

9010-51200



WE MAKE IT EASY FOR YOU



**SAFETY KIT
INCLUDES:**

- 1** PAIR OF RUBBER INSULATING GLOVES
- 1** PAIR OF LEATHER PROTECTOR GLOVE COVERS
- 1** 11" STORAGE BAG FOR GLOVES

Just pick the class that your application requires, the color and size rubber glove that you want, and we do the rest by assembling a kit that works.

ELECTRICAL SAFETY KITS

STYLE NUMBER	CLASS	COLOR	LENGTH	SIZES
150-SK-00	00	☐ Black	11"	7 - 12
147-SK-00	00	■ Orange	11"	7 - 12
150-SK-0	0	☐ Black	11"	7 - 12
147-SK-0	0	■ Orange	11"	7 - 12
150-SK-1	1	☐ Black	14"	7 - 12
147-SK-1	1	■ Orange	14"	7 - 12
150-SK-2	2	☐ Black	14"	7 - 12
147-SK-2	2	■ Orange	14"	7 - 12
155-SK-2	2	■ Black / Orange	14"	7 - 12

WHY USE **ERGONOMICS**

WHEN THE WEAR AND TEAR OF THE JOB STARTS TO TAKE ITS TOLL, THERE IS SOMEWHERE TO TURN TO HELP RELIEVE SOME OF THE PRESSURE AND DISCOMFORT ONE ENDURES, ESPECIALLY WHEN PERFORMING REPETITIVE TASKS AND/OR WHEN LIFTING IS INVOLVED. ERGONOMIC PRODUCTS CAN LIMIT DISCOMFORT AND HELP REDUCE STRESS ON THE GIVEN BODY PART THE PRODUCT IS DESIGNED TO HELP.

SLEEVES & SUPPORTS

- **Wrist, elbow, and knee sleeves** can reduce stress, strain, and swelling.
- **Elbow and wrist supports** provide additional reinforcement for those areas.
- **Back supports** support the lumbar area and provide stability for the worker when lifting.

PREVENT & PROTECT

Ergonomics should not only be worn once discomfort or pain is incurred. Using Ergonomic products can proactively help reduce injuries and provide a more comfortable work experience.

By using Ergonomic products, one can continue working more comfortably and productively by significantly reducing the pains and strains incurred from day-to-day work.

262 WRIST & ELBOW SUPPORTS

263 KNEE PADS & SUPPORTS

264 BACK SUPPORTS

ERGONOMICS

REDUCE STRESS & PROVIDE STABILITY



WRIST WRAP



WRIST WRAP WITH THUMB LOOP



WRIST SUPPORT WITH STAYS



NEOPRENE WRIST WRAP



ELBOW SUPPORT WRAP



ELBOW SLEEVE

STYLE NUMBERS	290-9010BLK ■ Black - One Size	290-9011BLK ■ Black - One Size	290-9013S ■ Black - 5.375"-6.125"	290-9015 ■ Black - One Size	290-9000S ■ Black - 8.5"-10"	290-9001S ■ Black - 8.5"-10"
	290-9010BGE ■ Beige - One Size		290-9013M ■ Black - 6.125"-6.875"		290-9000M ■ Black - 10"-11"	290-9001M ■ Black - 10"-11"
			290-9013L ■ Black - 6.875"-7.625"		290-9000L ■ Black - 11"-12"	290-9001L ■ Black - 11"-12"
			290-9013XL ■ Black - 7.625"-8.375"		290-9000XL ■ Black - 12"-13.5"	290-9001XL ■ Black - 12"-13.5"
KEY FEATURE	Stretchable Elastic Fabric	Thumb Loop Holds Support in Place	Helps Maintain a Neutral Wrist Position	Light Neoprene Body Provides Soothing Warmth	Provides Relief from Stress and Pressure Caused by Repetitive Motion	Provides Therapeutic Warming to Relieve Stress and Comfort Muscles
APPLICATIONS	Office / Retail / Light Industrial	Office / Retail / Light Industrial	Office / Retail / Light Industrial	Office / Retail / Light Industrial	Office / Retail / Light Industrial	Office / Retail / Light Industrial
FABRIC	Nylon & Spandex	Polyester & Spandex	Neoprene & Nylon	Neoprene & Nylon	Neoprene & Nylon	Neoprene & Nylon
THUMB LOOP	No	Yes	Yes	Yes	---	---
CLOSURE	Hook & Loop	Hook & Loop	Hook & Loop	Hook & Loop	Hook & Loop	Sleeve
SUPPORT STAYS	No	No	Top & Bottom	No	---	---
FIT	Ambidextrous	Ambidextrous	Ambidextrous	Ambidextrous	Ambidextrous	Ambidextrous
COLOR	■ Black or ■ Beige	■ Black	■ Black	■ Black	■ Black	■ Black
SIZES	OSFM	OSFM	S - XL	OSFM	S - XL	S - XL
PACKAGING	1 per Poly Bag	1 per Poly Bag	1 per Poly Bag	1 per Poly Bag	1 per Poly Bag	1 per Poly Bag

ALL STYLES ON THIS PAGE ARE MACHINE WASHABLE



HARD PLASTIC CAP

NON-MARRING

CLEAR FLAT-CAP GEL

STYLE NUMBERS	291-100	291-110	291-130
KEY FEATURE	Economical with Abrasion Resistance & Great for Pivoting	PVC Cap Won't Mark, Scratch or Scuff Surfaces	Air-Injected Gel Pads are Ideal for Hard Surfaces
APPLICATIONS	Industrial / Construction	Industrial / Construction	Industrial / Construction
KNEE CAP	Polyethylene	Extended PVC	PVC with Flat Surface
ANTI-SLIP RIDGES	No	Yes	Yes
CLOSURE	Two Hook & Loop Closure Straps	Two Hook & Loop Closure Straps	One Wide Hook & Loop Closure Strap
COLOR	■ Gray Cap on ■ Black	□ White Cap on ■ Black	□ Clear Cap on ■ Black
SIZES	OSFM	OSFM	OSFM
PACKAGING	1 per Poly Bag	1 per Poly Bag	1 per Poly Bag

KNEE SLEEVES

Supports muscles and tissues after suffering minor strains, sprains, injuries and arthritis

- Terry-lined vented neoprene with nylon outer shell
- Additional neoprene panel surrounds patella
- Ambidextrous contour design

STYLE NUMBER	COLOR	DIMENSIONS
290-9020S	■ Black	13" - 14"
290-9020M	■ Black	14" - 15"
290-9020L	■ Black	15" - 17"
290-9020XL	■ Black	17" - 18"





BACK SUPPORTS



BLACK MESH

KEY FEATURE	Popular & Economic Design	
APPLICATIONS	Warehouse / Construction	
BELT Material	9" Wide Nylon Mesh	
BACK STAYS	5	
FASTENER	Hook & Loop Closure on Front Panels	
SUSPENDERS	Adjustable & Detachable	
PACKAGING	1 per Poly Bag	
STYLE NUMBER	COLOR	SIZE
290-440S	■ Black	32" - 36"
290-440M	■ Black	36" - 40"
290-440L	■ Black	40" - 44"
290-440XL	■ Black	44" - 48"
290-440XXL	■ Black	48" - 54"

HI-VIS LIME YELLOW SOLID

KEY FEATURE	Bright Hi-Vis Side Bands & Suspenders	
APPLICATIONS	Warehouse / Construction	
BELT Material	8" Wide Nylon Elastic	
BACK STAYS	5	
FASTENER	Hook & Loop Closure on Front Panels	
SUSPENDERS	Adjustable & Detachable	
PACKAGING	1 per Poly Bag	
STYLE NUMBER	COLOR	SIZE
290-550M	■ Hi-Vis Lime Yellow	36" - 40"
290-550L	■ Hi-Vis Lime Yellow	40" - 44"
290-550XL	■ Hi-Vis Lime Yellow	44" - 48"
290-550XXL	■ Hi-Vis Lime Yellow	48" - 54"

REDUCE THE CHANCE OF
COSTLY BACK INJURIES & LOST WORK DAYS

BREATHING HAZARDS



GASES

Substances similar to air in their ability to diffuse or spread freely throughout a container or area. Examples include oxygen, carbon monoxide, carbon dioxide, nitrogen and helium.



FUMES

Created when solid materials vaporize under high heat. Fumes come from operations such as welding, smelting and pouring of molten metal.



VAPORS

Formed when a solid or liquid evaporates. Common examples of vapors are gasoline, paint thinners and degreaser solvents.



PARTICULATES

Solid particles are produced by operations such as grinding, crushing, drilling, blasting, sanding and milling.

266 N95 RESPIRATORS

267 DISPOSABLE NUISANCE & DUST MASKS

268 PERSONAL & CONTRACTOR FIRST AID KITS

269 BLOODBORNE PATHOGENS FIRST AID KITS

270 BURN KIT

RESPIRATORY & FIRST AID

N95 RESPIRATORS

- N95 Masks provide 95% filtration efficiency against airborne particles (not resistant to oil)
- NO STAPLES - cone style features ultrasonic welding of straps on wings
- Adjustable outside aluminum nosepiece (with inside foam padding) provides a proper fit



N95 CONE



N95 CONE WITH EXHALATION VALVE



N95 FLAT FOLDED



N95 FLAT FOLDED WITH EXHALATION VALVE

STYLE NUMBERS	270-2000	270-2050	270-3000	270-3050
KEY FEATURE	Flanged Mask Edge For a Better Fit & Seal	Easier Breathing Especially in Hot & Humid Conditions	Fits Inside Pockets, Individually Poly Bagged	Easier Breathing Especially in Hot & Humid Conditions
APPLICATIONS	Manufacturing / Construction / Industrial	Manufacturing / Construction / Industrial	Manufacturing / Construction / Industrial	Manufacturing / Construction / Industrial
EXHALATION VALVE	No	Yes	No	Yes
NOSEPIECE	Adjustable Aluminum	Adjustable Aluminum	Adjustable Aluminum	Adjustable Aluminum
HEAD STRAP	Latex-Free Braided	Latex-Free Braided	Latex-Free Rubber	Latex-Free Rubber
STRAP ATTACHMENT	Ultrasonic Welded	Ultrasonic Welded	Single Looped Strap	Single Looped Strap
APPROVALS	NIOSH Certified	NIOSH Certified	NIOSH Certified	NIOSH Certified
PACKAGING	20 Masks per Box; 12 Boxes per Case	10 Masks per Box; 12 Boxes per Case	20 Poly Bagged Masks per Box; 12 Boxes per Case	10 Poly Bagged Masks per Box; 12 Boxes per Case

The PIP products in this section of the catalog must be used in accordance with OSHA regulations, user instructions, warnings and limitations accompanying each product.



DISPOSABLE



	NUISANCE DUST MASK	FACE MASK
STYLE NUMBERS	270-1000 - Standard 270-1101 - Economy	270-4000
KEY FEATURE	Low Profile Design Allows for Perfect Vision with Safety Glasses or Goggles	3-Ply Pleated Construction with 99% Bacterial Filter Efficiency (BFE)
APPLICATIONS	Manufacturing / General Maintenance / Critical Environment / Food Service	Manufacturing / General Maintenance / Critical Environment
NOSE CLIP	Adjustable Aluminum	Adjustable Aluminum
HEAD STRAP	Latex-Free Braided Head Strap	Latex-Free Ear Loops
STRAP ATTACHMENT	Ultrasonic Welded	Tied Ear Loops
PACKAGING	50 Masks per Box; 12 Boxes per Case	50 Masks per Box; 40 Boxes per Case

NUISANCE MASKS & FACE MASKS

FIRST AID KITS

PERSONAL & CONTRACTOR KITS



PERSONAL FIRST AID KIT

STYLE NUMBERS	299-13210 - 10 Person Kit 299-13225 - 25 Person Kit 299-13255 - 50 Person Kit
KEY FEATURE	Variety of Different Items to Treat Minor Injuries
APPLICATIONS	Job Site / Office / Vehicle
PACKAGING	Weatherproof Plastic Box
MOUNT	Wall Mountable via Slots in Carrying Handle

CONTRACTOR FIRST AID KIT

STYLE NUMBERS	299-13285 - 10 Person Kit 299-13290 - 25 Person Kit 299-13293 - 50 Person Kit
KEY FEATURE	Fewer Items in Bulk Quantities to Treat Minor Injuries
APPLICATIONS	Job Site / Office / Vehicle
PACKAGING	Weatherproof Plastic Box
MOUNT	Wall Mountable via Slots in Carrying Handle

First Aid instructions are shown in both English and Spanish

COMPACT KITS CONTAIN THE SUPPLIES YOU NEED TO TREAT MINOR INJURIES

STYLE	PERSONAL			CONTRACTOR		
	10	25	50	10	25	50
ABDOMINAL PAD (5" x 9")	1	1	1	1	1	1
ALCOHOL PREP PADS	-	6	20*	20*	20*	6
ANTISEPTIC TOWELETTES	12*	20*	20*	-	-	20*
HAND SANITIZER	1	1	2	-	-	-
COLD INSTANT PACK (4" x 5")	1	1	1	-	1	1
CONFORMING GAUZE ROLL (2")	-	1	1	-	1	2
COTTON TIP APPLICATORS (3")	-	-	12	-	-	-
CPR DEVICE (DISPOSABLE)	-	-	1	-	-	-
FLEXIBLE FABRIC STRIPS	6	12*	12*	-	-	6
OVAL EYE PADS	-	-	2	-	-	-
EYE WASH (1 OZ.)	-	1	1	1	1	1
FLEXIBLE FABRIC FINGERTIP	2	4	12*	-	-	2
FLEXIBLE FABRIC KNUCKLE	2	4	12*	-	-	2
FIRST AID & BURN CREAM	8*	8*	12*	8*	8*	8*
GAUZE PADS (3" x 3")	4	4	12	-	-	2
MICROBIAL TOWELETTES	1	1	3	-	-	-
MEDICAL EXAM GLOVES	2	2	4	1	1	2
CLEAR ADHESIVE STRIPS	16*	25*	25*	16*	100*	16*
ELASTIC BANDAGE (2")	1	1	1	-	-	1
ASSORTED SAFETY PINS	4	4	8	-	-	4
SCISSORS (4")	1	1	-	1	1	1
BANDAGE SCISSORS (5.5")	-	-	1	-	-	-
SPLINTER FORCEPS	1	1	1	1	1	1
SPLINTER OUT	-	2	-	-	-	-
STING RELIEF PADS	-	6	-	-	-	1
ADHESIVE TAPE (1/2")	1	1	1	1	1	1
TRIANGLE BANDAGE	1	1	1	1	1	1
CLEANSING TOWELETTES	6	6	12	-	-	-

* ITEMS ARE BOXED



BLOODBORNE PATHOGENS KIT

STYLE NUMBER	299-13215
KEY FEATURE	Biohazard Kit for Bodily Fluid Cleanup
APPLICATIONS	Job Site / Office / Vehicle
STANDARDS MET	OSHA 1910.103
PACKAGING	Weatherproof Plastic Box
MOUNT	Wall Mountable via Slots in Carrying Handle

SUPPLIES INCLUDED

FACE SHIELD & VISOR	1
ABSORBENT TOWELS	3
APRON	1
ANTI-MICROBIAL TOWELETTE	1
MEDICAL EXAM GLOVES	2
BIO SCOOP & SCRAPPER	1
BIOHAZARD WASTE BAGS	2
RED SUPER ABSORB FOAM (10G)	1
ANTISEPTIC TOWELETTES (XL)	2
INCIDENT REPORT	1 Exposure Control Report Form

FIRST AID & BLOODBORNE PATHOGENS KIT

STYLE NUMBER	299-17030
KEY FEATURE	A Combination of the First Aid and Bloodborne Pathogens Kit
APPLICATIONS	Job Site / Office / Vehicle
STANDARDS MET	OSHA 1910.103
PACKAGING	Weatherproof Plastic Box
MOUNT	Wall Mountable via Slots in Carrying Handle



SUPPLIES INCLUDED

ABDOMINAL PAD	1 (5" x 9" Sterile)
ALCOHOL PREP PADS	20
ANTISEPTIC TOWELETTES	10 Small
INSTANT COLD PACK	1
CONFORMING GAUZE ROLL	1 (2")
CPR DEVICE	1 Disposable
PLASTIC STRIPS	16 (1" X 3" Sterile)
EYE WASH	1 (1 oz.)
FIRST AID & BURN CREAM	8 (0.9 g packets)
GAUZE PADS	4 (3" x 3" Sterile)
MEDICAL EXAM GLOVES	2
BANDAGE SCISSORS	1 (5½")
TWEEZERS	1 Disposable
ADHESIVE TAPE	1 (½")
TRIANGULAR BANDAGE	1 with 2 Safety Pins
FIRST AID GUIDE	1 (English & Spanish)
BBP FLUID CLEANUP KIT	1
BBP PPE BIOHAZARD KIT	1

First Aid instructions are shown in both English and Spanish

FIRST AID KITS

BURN KIT

EXCELLENT FOR TREATING BURNS ON THE JOBSITE



BURN KIT

STYLE NUMBER	299-13295
KEY FEATURE	Basic Necessities for Burn Care
APPLICATIONS	Job Site / Office / Vehicle
PACKAGING	Weatherproof Plastic Box
MOUNT	Wall Mountable via Slots in Carrying Handle

SUPPLIES INCLUDED

STERILE BURN DRESSING	1 (4" x 4")
STERILE BURN DRESSING	2 (8" x 8")
CO-WRAP	1 (2" x 5 yds)
MEDICAL EXAM GLOVES	2
SCISSORS	1 (4")

First Aid instructions are shown in both English and Spanish

UNDERSTANDING SAFETY & EMERGENCY BEACONS

WARNING BEACONS ARE DESIGNED TO PROVIDE INSTANT VISIBILITY WHERE NEEDED, CALLING ATTENTION TO ANYONE IN THEIR VICINITY.

Their design and brightness combined with the different colors and accessory items make warning beacons infinitely versatile. They can be used to draw attention to road closures, obstructions, spills, or loading/unloading zones and help reduce potentially serious and otherwise avoidable injuries.

LIGHT BEAM PROFILE

Beacons are designed to deliver the most intense part of the light beam in a range of 0-5° above horizontal, with a peak near 3°. Due to this beam profile, these beacons will not dazzle or impede the vision of users at short range unless it's positioned at eye level.

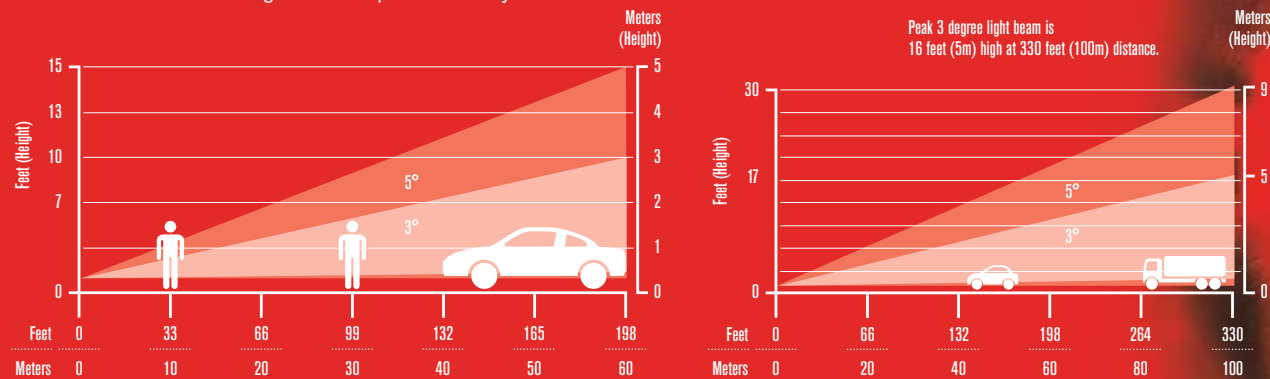

WHY USE WARNING BEACONS OVER CONVENTIONAL FLARES?

Conventional Flares are often pyrotechnic, which require an open flame to operate. This is inherently dangerous and limits areas where they can be used. Most flares also include mixtures that can create toxic fumes and residue.

Incandescent and Strobe Lights can cause night vision, point fixation, and distance judgment issues, especially with impaired or sleep-deprived drivers.

Warning Beacons featured in this section utilize LED technology to produce an intensely bright display and project at an angle that will not dazzle or impede the vision of drivers. Standalone units and units compatible with safety triangles are available.

SAFETY & EMERGENCY BEACONS

272 E-FLARE™ BEACONS

274 FLASH BATONS

SAFETY & EMERGENCY BEACONS

E-FLARE™

E-FLARE™ WARNING BEACONS

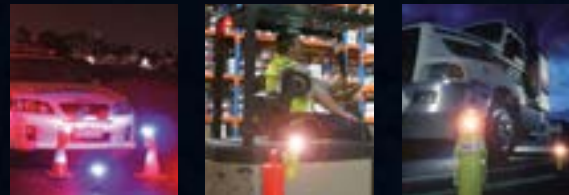

INTENSELY BRIGHT

Can be seen for up to 3/4 of a mile and features full 360° illumination. Angle and beam projection minimizes the risk of target fixation and distance judgment problems associated with strobe and incandescent lights.

LIGHTWEIGHT & EASY TO USE

Beacon weighs less than 10 ounces with four "AA" batteries installed. Improved activation enables a simple twist of the lens to the desired function.

SAFER & BETTER FOR THE ENVIRONMENT

Unlike pyrotechnic flares, there is no risk of fire or explosion, and no toxic fumes or residues.

DURABLE

E-Flare™ beacons can survive up to a 3-foot drop onto a concrete surface. They are also dust-proof and water resistant (up to a depth of 100 ft.).

INFINITELY VERSATILE

Body molded clips with added holes easily attach to belts and clothing. Base accessories are available for heavy-duty mounted applications

HAZMAT accredited for use in Class 1, Division 2 / Zone 2 hazardous areas.

Patented Fresnel lens and high-luminosity LEDs allow beam to be visible for 3/4 mile

Shatterproof polycarbonate lens

Colored pins indicate beacon light colors

Reflective strip and fluorescent body for maximum visibility

High-strength clips with added holes for versatility of attachment

Impact resistant ABS body

Compact and lightweight, weighs under 10 oz. with 4 "AA" batteries



IDEAL FOR POLICE, FIRE, UTILITIES, RAIL & PORT, WAREHOUSE & FACTORY

E-FLARE™ SAFETY & EMERGENCY BEACONS

STYLE NUMBER	BEACON COLOR	LIGHT INTENSITY	OPERATION	FLASH RATE	BATTERIES	HEIGHT	WEIGHT
939-AT290-R	Red	8 LED	Flash or Steady-On 1-Color	165-185 fpm	Four "AA" Alkaline	8"	9.6 oz. with Batteries
939-AT290-A	Amber	8 LED	Flash or Steady-On 1-Color	165-185 fpm	Four "AA" Alkaline	8"	9.6 oz. with Batteries
939-AT290-B	Blue	8 LED	Flash or Steady-On 1-Color	165-185 fpm	Four "AA" Alkaline	8"	9.6 oz. with Batteries
939-AT290-G	Green	8 LED	Flash or Steady-On 1-Color	165-185 fpm	Four "AA" Alkaline	8"	9.6 oz. with Batteries
939-AT290-W	White	8 LED	Flash or Steady-On 1-Color	165-185 fpm	Four "AA" Alkaline	8"	9.6 oz. with Batteries
939-AT293-R/B	Red & Blue	4 + 4 LED	Dual Flash 2-Color	165-185 fpm	Four "AA" Alkaline	8"	9.6 oz. with Batteries
939-AT293-A/W	Amber & White	4 + 4 LED	Dual Flash 2-Color	165-185 fpm	Four "AA" Alkaline	8"	9.6 oz. with Batteries
939-AT293-B/W	Blue & White	4 + 4 LED	Dual Flash 2-Color	165-185 fpm	Four "AA" Alkaline	8"	9.6 oz. with Batteries
939-AT293-R/A	Red & Amber	4 + 4 LED	Dual Flash 2-Color	165-185 fpm	Four "AA" Alkaline	8"	9.6 oz. with Batteries
939-AT293-R/W	Red & White	4 + 4 LED	Dual Flash 2-Color	165-185 fpm	Four "AA" Alkaline	8"	9.6 oz. with Batteries

Batteries not included

COMPACT E-FLARE™ ONLY 6" HIGH



▲ 939-AT280-A

▲ 939-EF350-R

E-FLARE™ COMPACT SAFETY & EMERGENCY BEACONS

STYLE NUMBER	BEACON COLOR	LIGHT INTENSITY	OPERATION	FLASH RATE	BATTERIES	HEIGHT	WEIGHT
939-AT280-R	Red	8 LED	Flash or Steady-On 1-Color	165-185 fpm	Four "AA" Alkaline	6"	6.4 oz. with Batteries
939-AT280-A	Amber	8 LED	Flash or Steady-On 1-Color	165-185 fpm	Four "AA" Alkaline	6"	6.4 oz. with Batteries
939-EF350-R	Red	4 LED	Flash 1-Color	165-185 fpm	Four "AA" Alkaline	6"	6.4 oz. with Batteries
939-EF350-A	Amber	4 LED	Flash 1-Color	165-185 fpm	Four "AA" Alkaline	6"	6.4 oz. with Batteries

Batteries not included



RUBBER BASE MOUNT 939-EFBASE

- General purpose base fits all E-Flare™ beacons



AVIATION RUBBER BASE MOUNT 939-EFAVBASE

- Secure base for special purposes that fits all beacons



MAGNETIC BASE MOUNT 939-EFMAGBASE

- Combined magnetic base and cap
- Rated to 50 MPH when securely mounted on vehicle
- Fits all E-Flare™ beacons



MAGNETIC MOUNTING CLIP 939-EFMAGCLIP

- For stationary objects (not for moving vehicles)
- Attaches to any E-Flare™ beacon



CONE MOUNTING CLIP 939-EFCLIP

- Enables vertical positioning on most types of cones
- Attaches to any E-Flare™ beacon



FLOTATION COLLAR 939-EFFCOL/L

- Provides reliable self-righting buoyancy for marine use
- Includes lanyard
- Attaches to 8" tall E-Flare™ beacons only



STORAGE BAG - SMALL 939-EFBAG-2

- Carry bag for 2 to 3 beacons plus accessories



STORAGE BAG - LARGE 939-EFBAG-4

- Carry bag for 4 to 6 beacons plus accessories



MAGNETIC CAP BASE

E-FLARE™ BEACON FOR RAILROAD SAFETY

- Blue flashing beacon
- 6" High and 0.6 lbs with 4 "AA" batteries
- Built-in magnetic cap base and flashlight
- Includes lanyard for easy transport

STYLE NUMBER	BEACON COLOR	LIGHT INTENSITY	OPERATION
939-TF250-B-ASY	Blue	4 LED	Flash 1-Color
	White	3 LED	Steady-On Flashlight

Batteries not included

e flare™ BE SEEN. BE SAFE.
safety in a flash



Orange triangle not included

E-FLARE™ BEACON FOR SAFETY TRIANGLE

- Maximize the safety of the road triangle
- Visible for over 1/2 mile at night
- Runs on a single "AA" battery for 20+ hours
- Mounts inside most road triangles at 4" in height

STYLE NUMBER	BEACON COLOR	LIGHT INTENSITY	OPERATION
939-TB10-R	Red	3 LED	Flash 1-Color

Batteries not included

BATONS

FLASH BATONS



▲ 935-004

▲ 935-006B

ECONOMICAL BATTERY OPERATED BATON

USES BRIGHT LED'S TO IDENTIFY HAZARDOUS CONDITIONS OR DANGEROUS AREAS

FLASH BATON

STYLE NUMBER	BATON COLOR	LIGHT INTENSITY	OPERATION	BATTERIES	LENGTH	DIAMETER	PACKAGING
935-004	Red	4 LED	Flash, Steady-On, Off	Two "C"	16"	1.25"	Individually Boxed

FLASH BATON WITH AUDIBLE SIGNAL

935-006B	Red	6 LED	Flash, Steady-On, Off Audible Alarm Button (approximately 110 dB)	Three "C"	22"	1.25"	Individually Boxed
----------	-----	-------	---	-----------	-----	-------	--------------------

Batteries not included
Note: All Batons include carrying strap & attachment clip

BATONS

IDEAL FOR POLICE, FIREFIGHTERS, AIRPORT WORKERS, TRAFFIC CONTROLLERS, PARKING VALETS, CONSTRUCTION WORKERS AND OTHER PUBLIC SAFETY PERSONNEL

HEAT STRESS IS 100% PREVENTABLE

EACH YEAR, MILLIONS OF WORKERS ARE EXPOSED TO POTENTIAL HEAT STRESS. INJURIES RELATED TO HEAT STRESS RANGE FROM DIZZINESS TO DEATH. WITH PROPER EDUCATION, TRAINING, AND COOLING PRODUCTS, HEAT STRESS RELATED INJURIES CAN BE AVOIDED.

COOLING TECHNOLOGIES



PHASE CHANGE

Cold temperature is absorbed by the **Phase Change** material, changing it from a clear liquid to an opaque solid as it is activated.

To use, place the activated phase change pack in the torso garment and wear it against body. The cold temperature begins to be transferred to the wearer as the latent heat is absorbed by the Phase Change material. The material begins to turn back to a clear liquid as it deactivates. Reactivate as needed.

ACTIVATION & USE

PIP's Heat Stress line ranges from premium products that will last your workers through multiple seasons to more economical solutions that are meant for single-use. The activation time is included with each product.



EVAPORATIVE

To activate **Evaporative** cooling products, water is first absorbed by the product's cooling fibers or polymers. Cooling occurs when the moisture within the unit evaporates, creating a cooling sensation for the wearer. When activating, you may use room temperature water. The products must be exposed to air movement to facilitate cooling, and are meant for use over other PPE garments.



ABSORPTIVE

Absorptive materials help to keep the sweat and the sting out of workers' eyes while trapping and moving sweat for a safer, more comfortable job with fewer distractions.



SUN PROTECTION

PIP's **Sun Protection** products include hats and visors with neck shades that will help to screen workers from the sun, to alleviate the toll it takes on productivity, skin and the ability to keep hydrated.

276 PHASE CHANGE

276 EVAPORATIVE

280 ABSORPTIVE

280 SUN PROTECTION

HEAT STRESS

HEAT STRESS

PHASE CHANGE & EVAPORATIVE



PHASE CHANGE
COOLING TECHNOLOGY

WEAR UNDER
OTHER PPE GARMENTS



▼ 390-EZSPC

▼ 390-EZFRPC

45
MINUTES

FR OUTER SHELL



▲ 390-PCVCP1

▲ 390-PCVKT1

REPLACEMENT PACKS

▲ 390-PC099



▼ 390-EZ150

MACHINE WASHABLE

1-2
MINUTES

WEAR OVER
OTHER PPE
GARMENTS



▲ 390-10



EVAPORATIVE
COOLING TECHNOLOGY

WEAR UNDER
OTHER PPE
GARMENTS



▼ 390-EZ202

▼ 390-EZ100

COOLING VESTS

STYLE NUMBER	COOLING TYPE	DESCRIPTION	ACTIVATION TIME	OUTER FABRIC	INNER FABRIC	WEIGHT	CLOSURE	COLOR	SIZE
390-EZSPC	Phase Change	Active Fit Vest with Rechargeable Cooling Packs & Insulated Cooler Bag	45 Minutes	100% Cotton	Nylon	6.0 lbs	Zipper with Side & Shoulder Adjustments	Blue	M/L 100-175 lbs, L/XL 175-250 lbs, 2X/3X 250-300 lbs
390-EZFRPC	Phase Change	Active Fit FR Vest with Rechargeable Cooling Packs & Insulated Cooler Bag	45 Minutes	Banwear FR Cotton	100% Cotton	6.0 lbs	Zipper with Side & Shoulder Adjustments	Navy	M/L 100-175 lbs, L/XL 175-250 lbs, 2X/3X 250-300 lbs
390-PC099	Phase Change	Reusable Phase Change Pack Set for Slim Fit Design	45 Minutes	PU	TechKewl™	5.0 lbs	---	Clear	---
390-PCVKT1	Phase Change	Vest with Rechargeable Cooling Packs that Fit Inside a Vest	45 Minutes	Polyester	Nylon	6.5 lbs	Pullover with Side & Shoulder Adjustments	Navy	One Size
390-PCVCP1	Phase Change	Reusable Phase Change Pack Set for Classic Design	45 Minutes	PU	Alkane Blend	5.5 lbs	---	Clear	---
390-EZ100	Evaporative	Lightweight Cooling Vest	1-2 Minutes	Polyester / Nylon	HyperKewl™	1.5 lbs	Zipper	Hi-Vis Lime Yellow	S - 3X
390-EZ150	Evaporative	Cooling Tank Top	1-2 Minutes	Spandex / Nylon	HyperKewl™ Plus	0.75 lbs	Zipper	Black with Blue Trim	S - 3X
390-EZ202	Evaporative	ANSI 107 Type R Class 2 Cooling Vest with 4 Pockets	1-2 Minutes	Polyester / Nylon	HyperKewl™	1.5 lbs	Hook & Loop	Hi-Vis Lime Yellow	S/M, L/XL, 2X/3X, 4X/5X
390-10	Evaporative	High Tech Cooling Vest, No Wetness-Body & Clothing Stay Dry	30 seconds	Polyester	Engineered Polyfleece	0.5 lbs	Hook & Loop	Navy	S - 3X

HEAT STRESS

EVAPORATIVE



EZ-COOL® COOLING NECK WRAP

COOLING TYPE	Evaporative
ACTIVATION TIME	30 Seconds
OUTER	PVA
SIZE	4" x 30"
STYLE NUMBER	COLOR
393-650-B	Blue
393-650-L	Hi-Vis Lime Yellow
393-650-P	Pink



UV PROTECTION

EZ-COOL® MAX COOLING TOWEL

COOLING TYPE	Evaporative
ACTIVATION TIME	30 Seconds
OUTER	Nylon Hollow Fiber / Polyester
SIZE	12" x 33"
STYLE NUMBER	COLOR
396-EZ900-NV	Blue
396-EZ900-LY	Hi-Vis Lime Yellow
396-EZ900-PK	Pink
396-EZ900-GC	Digital Camo



EVAPORATIVE COOLING TECHNOLOGY

SUPER ABSORBENT & SUPER COOL



EZ-COOL® COOLING TOWEL

COOLING TYPE	Evaporative
ACTIVATION TIME	30 Seconds
OUTER	PVA
SIZE	13" x 31"
STYLE NUMBER	COLOR
396-602-B	Blue
396-602-L	Hi-Vis Lime Yellow
396-602-P	Pink



393-EZ201-PAT



393-100-DGC

EZ-COOL® COOLING BANDANA

COOLING TYPE	Evaporative
ACTIVATION TIME	1-2 Minutes
OUTER	Polyester Mesh
INNER	HyperKewl™
CLOSURE	Tie / Breakaway Snap
STYLE NUMBER	COLOR
393-EZ201-NVY	Navy
393-EZ201-KHK	Khaki
393-EZ201-PAT	Patriotic Flag
393-EZ201-RTC	REALTREE® Max5® Camo

VALUE COOLING BANDANA

COOLING TYPE	Evaporative
ACTIVATION TIME	20-30 Minutes
OUTER	Poly Cotton
INNER	Cooling Crystals
CLOSURE	Tie
STYLE NUMBER	COLOR
393-100-BLU	Blue
393-100-CBL	Cowboy Blue
393-100-CRD	Cowboy Red
393-100-DGC	Digital Camo
393-100-KHK	Khaki
393-100-NAVY	Navy
393-100-PAT	Patriotic Flag

EXTENDED COOLING COMFORT



EZ-COOL® COOLING TIE HAT

COOLING TYPE	Evaporative	
ACTIVATION TIME	1-2 Minutes	
OUTER	Polyester Mesh	
INNER	HyperKewl™	
CLOSURE	Tie	
STYLE NUMBER	COLOR	
396-EZ205	<input type="checkbox"/> Blue	
396-EZ205-RTC	<input type="checkbox"/> REALTREE® Max5® Camo	



EZ-COOL® COOLING RANGER HAT WITH NECK SHADE

COOLING TYPE	Evaporative	
ACTIVATION TIME	1-2 Minutes	
OUTER	Cotton	
INNER	HyperKewl™	
CLOSURE	Drawstring	
STYLE NUMBER	COLOR	SIZE
396-EZ450-KHK	<input type="checkbox"/> Khaki	S/M, L/XL, 2X/3X
396-EZ450-RTC	<input type="checkbox"/> REALTREE® Max5® Camo	S/M, L/XL, 2X/3X
396-EZ450-LY	<input type="checkbox"/> Hi-Vis Lime Yellow	S/M, L/XL, 2X/3X



VALUE COOLING TIE HAT

COOLING TYPE	Evaporative	
ACTIVATION TIME	20-30 Minutes	
OUTER	Poly Cotton	
INNER	Cooling Crystals	
CLOSURE	Tie	
STYLE NUMBER	COLOR	
396-300-NAV	<input type="checkbox"/> Navy	
396-300-CBL	<input type="checkbox"/> Cowboy Blue	
396-300-PAT	<input type="checkbox"/> Patriotic Flag	



VALUE COOLING RANGER HAT WITH NECK SHADE

COOLING TYPE	Evaporative	
ACTIVATION TIME	20-30 Minutes	
OUTER	Poly Cotton	
INNER	Cooling Crystals	
CLOSURE	Hook & Loop	
STYLE NUMBER	COLOR	SIZE
396-425-KHK	<input type="checkbox"/> Khaki	M - XL

NOTE: RECOMMENDED TO SIZE UP - MAY RUN SMALL



EVAPORATIVE
COOLING TECHNOLOGY



EVAPORATIVE
COOLING TECHNOLOGY



**EZ-COOL® COOLING
HARD HAT NECK SHADE**

COOLING TYPE	Evaporative
ACTIVATION TIME	1-2 Minutes
OUTER	Polyester
INNER	HyperKewl™
CLOSURE	Hook & Loop
STYLE NUMBER	HI-VIS COLOR
396-EZ810	■ Lime Yellow



**EZ-COOL® COOLING FR
HARD HAT NECK SHADE**

COOLING TYPE	Evaporative
ACTIVATION TIME	1-2 Minutes
OUTER	FR Cotton Banox
INNER	HyperKewl™
CLOSURE	Hook & Loop
STYLE NUMBER	COLOR
396-EZ811FR	■ Navy



**VALUE COOLING
HARD HAT PAD WITH NECK SHADE**

COOLING TYPE	Evaporative
ACTIVATION TIME	20-30 Minutes
OUTER	Poly Cotton
INNER	Cooling Crystals
CLOSURE	Hook & Loop
STYLE NUMBER	COLOR
396-405	■ Blue



**VALUE COOLING
HARD HAT PAD**

COOLING TYPE	Evaporative
ACTIVATION TIME	20-30 Minutes
OUTER	Poly Cotton
INNER	Cooling Crystals
CLOSURE	Hook & Loop
STYLE NUMBER	COLOR
396-400-BLU	■ Blue

COOLING COMFORT UNDER HARD HATS

HEAT STRESS

ABSORPTIVE & SUN PROTECTION

KEEPING COOL: NO SWEAT



ABSORPTIVE COOLING TECHNOLOGY

HARD HAT TERRY SWEATBAND

COOLING TYPE	Absorptive
OUTER	Cotton Terry Cloth
CLOSURE	Snaps
STYLE NUMBER	COLOR
396-20870-NAV	■ Navy
396-20870-BGE	■ Beige



DISPOSABLE SWEATBANDS

STYLE NUMBER	COLOR	COOLING TYPE	OUTER	CLOSURE
396-500	■ Blue	Absorptive	100% Cellulose	Elastic
396-505	■ Teal	Absorptive	100% Polyester Non-Woven	Elastic



▲ 396-800-LY

▲ 396-801FR-LY

SOLID POLYESTER

MESH POLYESTER

HARD HAT VISOR WITH NECK SHADE

COOLING TYPE	Shading	
OUTER	ANSI Compliant Polyester Hi-Vis with Reflective Tape	
CLOSURE	Elastic	
STYLE NUMBER	HI-VIS COLOR	MATERIAL
396-800	■ Lime Yellow	Solid
396-801FR	■ Lime Yellow	Mesh



SUN PROTECTION COOLING TECHNOLOGY

BLOCK HARMFUL SUN RAYS



FR TREATED HI-VIS HARD HAT NECK SHADE

COOLING TYPE	Shading
OUTER	ANSI Compliant Polyester Hi-Vis with Reflective Tape
CLOSURE	Elastic
STYLE NUMBER	HI-VIS COLOR
396-700FR-LY	■ Lime Yellow
396-700FR-OR	■ Orange



HI VISIBILITY RANGER HAT

COOLING TYPE	Shading
OUTER	ANSI Compliant Polyester Hi-Vis with Reflective Tape
CLOSURE	Drawstring
STYLE NUMBER	HI-VIS COLOR
350-RANGER	■ Lime Yellow

ITEM NUMBER	PAGE NUMBER
07-K200	54
07-K259	54
07-K300	54
07-K320	54
07-K350	53
07-K390	49
07-KA700	51
07-KA710	51
07-KA720	49
07-KA730	49
07-KA740	51
07-KA744	53
08-K200PD	54
08-K200PDD	54
08-K252	54
08-K259PDD	54
08-K300PD	54
08-K300PDD	54
08-K300PS	54
08-K300XC	54
08-K312	54
08-K350PDD	53
08-K385	49
08-K412PDD	53
08-KA700PD	49
08-KA700PDD	49
08-KA720PD	49
08-KA720PDD	49
08-KA728PD	49
08-KA728PDD	49
08-KA740PD	51
08-KA740PDD	51
08-KA740RT	51
08-KA744PD	53
08-KA744PDD	53
08-KA750PD	51
08-KA750PDD	51
09-K1218	35
09-K1250	42
09-K1300	29
09-K1310	35
09-K1350	35, 120
09-K1400	42
09-K1450	28

ITEM NUMBER	PAGE NUMBER
09-K1444	35
09-K1450	42
09-K1600	29
09-K1618	35
09-K1630	29
09-K1640	29
09-K1660	42
09-K1700	29
09-K300LP	51
09-K3700	117
09-K3700	54
09-K3720	54, 117
09-K3750	54, 118
10-21ACPCB18TH	133
10-21HACPNY18-ET	133
10-21KVACPM18-ET	133
10-21KVACPMBK18-ET	133
10-21KVHACP18TH	133
10-4IK157	143
10-BKDS18	137
10-BKS18	137
10-K4622	145
10-K4626	145
10-K4722	143
10-K4726	143
10-K4826	143
10-KA18	135
10-KA18CL	135
10-KA18KL	135
10-KA18S	135
10-KA24SCTOT	135
10-KAM18	145
10-KAN018	135
10-KAN018CL	135
10-KAN018KL	135
10-KAN018S	135
10-KANP18	135
10-KANP18CL	135
10-KANP18KL	135
10-KANP18S	135
10-KANY18	135
10-KANY18CL	135
10-KANY18KL	135
10-KANY18S	135

ITEM NUMBER	PAGE NUMBER
10-KS18	137
10-KS18CL	137
10-KS18S	137
10-KSB18	143
10-KVS18DGH	143
10-KVS18RD	143
10-KVS18YBH	143
10-KVSDGH	29
10-KVSRD	29
10-KVSYBH	29
11-45153	145
11-45182	145
11-45183	145
14-ASP700	51
14-ASP700PDD	51
14-PK700	51
15-210	25
15-215	25
15-218BKL	140
15-218BKS	140
15-218NOL	140
15-218NOS	140
15-218NPL	140
15-218NPS	140
15-218NYL	140
15-218NYS	140
15-218WL	140
15-218WS	140
15-21KVBK18	133
15-21KVBK18TH	133
15-21PR18BBL	140
15-21PR18KVB	140
15-21PR18WL	140
15-21PR18WV	140
15-21PR18WV-ET	133
15-21PR18WV-ET	133
15-340	25
15-440	25
16-150	41
16-318V	41
16-323	39
16-330	39
16-334	39
16-340LG	34
16-3400R	34

ITEM NUMBER	PAGE NUMBER
16-343LG	39
16-3430R	39
16-350	34
16-355	39
16-520HY	34
16-530	41
16-560	27
16-747	34
16-813	39
16-815	34
16-820	34
16-D622	41
16-X310	23
16-X320	23
16-X540	23
16-X570	23
16-X575	23
17-D200	54
17-D300	54
17-D350	53
17-DA700	51
17-DA720	51
17-DL200	54
17-DL300	53
17-SD200	54
17-SD300	54
17-SD350	53
18-570	43
18-575	43
18-SD385	49
19-D310	33
19-D313	27
19-D315	27
19-D318	38
19-D320	33
19-D322	33
19-D324	38
19-D325	33
19-D326	33
19-D327	33
19-D330	27
19-D334	33
19-D340LG	27
19-D3400R	27

ITEM NUMBER	PAGE NUMBER
19-D350	38
19-D355	33
19-D360	33
19-D470	30
19-D475	30
19-D526B	27
19-D534B	27
19-D650	41
19-D655	41
20-21DACP18-ET	133
20-D18	139
20-DA18	139
20-DA18CL	139
20-DA18S	139
20-DA4210	139
20-DAPB22TOV	139
20-SD18	139
20-TG18	139
20-TG18S	139
22-600	49
22-600BK	49
22-601	49
22-615	49
22-650	49
22-720	49
22-730	51
22-750	49
22-751	49
22-760	49
22-760BB	49
22-760BG	49
22-760G	49
22-760GRN	49
22-760NP	49
22-760OR	49
22-770	49
22-900	49
23-44182	144
25-612	144
25-618	144
25-621	144
25-7612BB	144
25-7612BG	144
25-7612GRN	144

ITEM NUMBER	PAGE NUMBER
25-7612NP	144
30-6775B	144
30-6775W	144
30-6795B	144
30-6795W	144
31-48182	144
31-C-18	140
31-CDS18	140
31-CS18	140
33-115	64
33-125	64
33-325	64
33-425LY	64
33-425OR	64
33-825	64
33-B115	64
33-B125	64
33-G115	64
33-G125	64
33-GT125	64
34-1743	44
34-225	62
34-244	59
34-245	59
34-274	59
34-275	59
34-300	62
34-400	62
34-500	62
34-600	65
34-6743	44
34-800	60
34-8014	57
34-824	60
34-8264	60
34-844	58
34-8443	44
34-845	58
34-8453	44
34-846	58
34-874	57
34-8743	44
34-8743FY	44
34-8745	58

INDEX

BRINGING THE BEST OF THE WORLD TO YOU®

ITEM NUMBER	PAGE NUMBER
34-874FY	57
34-875	57
34-8753	44
34-876	57
34-900	60
34-9025	60
34-C229	62
34-C232	62
34-C234	62
35-C103	68
35-C104	68
35-C110	68
35-C115	68
35-C119	68
35-C2110	68
35-C2113	68
35-C410	68
35-C500	68
35-C510	68
35-CB110	68
35-CB604	68
35-G410	68
35-G510	68
36-110BB	67
36-110PC-BK	67
36-110PC-BL	67
36-110PD	67
36-110PDD	67
36-110PDD-WT	67
36-110VV	67
36-112PDD	67
36-C330PD	67
36-C330PDD	67
37-C110B	67
37-C110BB	67
37-C110PC-BK	67
37-C110PC-BL	67
37-C110PD	67
37-C110PDD	67
37-C110PDD-BL	67
37-C110PDD-WT	67
37-C112PDD	67
37-C119PD	67
37-C119PDD	67

ITEM NUMBER	PAGE NUMBER
37-C2110PC-BL	67
37-C2110PC-RT	67
37-C2110PD	67
37-C2110PDD	67
37-C2110PD-WT	67
37-C500BB-BL	67
37-C500PDD	67
37-C512PDD-BL	67
38-1410	62
38-1460	62
38-620	62
38-625	62
38-630	62
38-635	62
38-720	126
38-720	67
38-N2110PC	67
39-1310	63
39-3013	67
39-C120	63
39-C121	63
39-C122	63
39-C1300	63
39-C1305	63
39-C1375	63, 117
39-C1500	63
39-C1600	63
40-130	105
40-230	105
40-630	105
40-6410	105
40-6411	105
40-6415	105
40-6416	105
40-730	105
40-732	105
40-736	105
40-750	105
40-C125	105
40-C2130	105
40-C2210	105
41-001	121
41-001NB	121
41-001W	121

ITEM NUMBER	PAGE NUMBER
41-002	121
41-005	121
41-010	121
41-011	121
41-013	121
41-070	121
41-075	121
41-130	121
41-1400	119
41-1405	119
41-1415	62, 120
41-1420	120
41-1425	63, 120
41-1430	119
41-1475	119
42-215	125
42-329	125
42-811	125
42-853	125
42-857	125
42-C700	125
42-C713	125
42-C750	125
42-C753	125
42-C920	125
43-500	126
43-502	126
43-552	126
43-802	126
43-850	126
43-851	126
43-858	126
43-859	126
44-1745	36
44-3445	36
44-3455	36
44-3745	36
44-3755	36
44-6745	36
47-L161B	85
47-L161N	85
47-L170Y	85
47-L171B	85
47-L171N	85

ITEM NUMBER	PAGE NUMBER
47-L210T	85
47-L442	85
48-L140Y	85
48-L160Y	85
48-L162Y	85
48-L185B	85
48-L185P	85
48-L185T	85
48-L185Y	85
48-L187Y	85
48-L2125Y	85
48-L212Y	85
48-L300K	85
48-L302T	85
50-N092B	86
50-N110G	86
50-N115G	86
50-N140B	86
50-N140G	86
50-N150G	86
50-N160B	86
50-N160G	86
50-N2250G	86
50-N2272G	86
50-NKHT1	86
52-3665	87
52-3670	87
52-3671	87
52-3672	87
55-1600	63
55-1635	85
55-3243	69
55-3253	69
55-3271	69
55-3273	69
55-3274	69
55-AG315	63
55-AG316	63
55-AG317	63
56-3143	71
56-3145	71
56-3147	71
56-3151	71
56-3152	71

ITEM NUMBER	PAGE NUMBER
56-3153	71
56-3154	71
56-3170	71
56-3171	71
56-3175	71
56-3176	71
56-3180	71
56-3185	71
56-3186	71
56-3195	71
56-424	61
56-425	61
56-426	61
56-451	61
56-530	61
56-630	89
56-633	89
56-635	89
56-AG566	93
56-AG567	93
56-AG585	93
56-AG586	93
56-AG588	93
57-8615	93
57-8630	93
57-8630R	93
57-8640R	93
57-8643R	93
57-8645	93
57-8645R	93
57-8653R	93
57-8675	93
58-7303	92, 121
58-7304	92, 121
58-7305	92, 121
58-7313	92, 121
58-7315	92, 121
58-8015	91
58-8015DD	91
58-8015R	91
58-8020	91
58-8020DD	91
58-8020R	91
58-8025DD	91

ITEM NUMBER	PAGE NUMBER
58-8030	91
58-8030DD	91
58-8030R	91
58-8030Y	91
58-8035DD	91
58-8040	91
58-8040DD	91
58-8040R	91
58-8040Y	91
58-8060	91
58-8115DD	91
58-8120DD	91
58-8130DD	91
58-8140DD	91
58-8215DD	91
58-8230DD	91
58-8240DD	91
58-8362	91
58-8364	91
58-8414R	91
58-8431R	91
58-8650	92, 121
58-8651	92, 121
58-8655	92
58-8656	92
58-8657	92
58-8658DL	92
58-8658K	91
59-2115	72
59-2515	72
60-3105	72
60-3106	72
60-3107	72
60-3140	72
61-249L	72
61-249M	72
62-310	98
62-321PF	98
62-322	98
62-322PF	98
62-323	98
62-323PF	98
62-327	99
62-327PF	99

ITEM NUMBER	PAGE NUMBER
62-350	98
63-230PF	96
63-3314PF	96
63-331PF	96
63-332	96
63-332PF	96
63-336	96
63-336PF	96
63-338	96
63-338PF	96
63-510PF	96
63-532	96
63-532PF	96
63-550PF	96
63-632PF	96
63-732PF	96
64-346	100
64-346PF	100
64-433	100
64-436	100
64-V2000	100
64-V2000PF	100
64-V3000	100
64-V3000PF	100
64-V77B	100
64-V77BPF	100
65-543	100
65-544	100
65-545	100
65-553	100
67-246	97
67-306	97
67-308	97
68-101	77
68-101G	77
68-103	77
68-105	77
68-106	77
68-116	77
68-118	77
68-153	77
68-158	77
68-161SB	77
68-162	77

ITEM NUMBER	PAGE NUMBER
68-162SB	77
68-163	77
68-163HV	77
68-163SB	77
68-165	77
68-165HV	77
68-168	77
69-134	78
69-138	78
69-148	78
69-189	78
70-300	77
70-301	77
70-318	77
70-360	77
70-360SB	77
70-361	77
70-368	77
71-3600	77
71-3601	77
71-3618	77
73-1700	118
73-1703	117
73-2000	117
73-7007	123
73-7007LHO	123
73-7007RHO	123
73-7015	123
73-7015A	123
73-7018	123
73-7080	123
73-7085	123
73-7088	123
73-7150	123
73-7250	123
73-888	123
73-888A	123
73-888LHO	123
73-888RHO	123
73-K1800	29, 118
74-SC7104	124
75-2022	124
75-2026	124
75-320	124

ITEM NUMBER	PAGE NUMBER
75-320/LHO	124
75-320/RHO	124
75-4854	124
75-4904	124
77-208	122
77-218	122
77-238	122
77-265	122
77-268	122
77-269	122
77-289	122
77-289TL	122
77-298	122
77-418	122
77-468	122
77-469	122
78-3927	122
78-3927KW	122
78-7825	122
78-7863B	122
80-8800	81
80-8844	81
80-8846	81
80-8855	82
80-8866	82
80-8889	81
81-7563YB	81
82-5044	81
82-5066	81
82-7563	81
82-7563ID	82
82-7583	81
82-7663	81
82-7683D	81
82-7763	82
83-6033	81
83-6563	81
83-6563/LHO	81
83-6563/RHO	81
83-6663	81
83-6733	82
83-6763	82
84-6532	82
84-7532	82

ITEM NUMBER	PAGE NUMBER
84-7532A	82
84-7533	82
84-7533J	82
84-7632	82
84-7633	82
85-7500	82
85-7500P	82
85-7500S	82
85-7512	82
85-7512C	82
85-7512CS	82
85-7512J	82
85-7513P	82
85-7612S	82
85-DB7563	82
85-DB7563P	82
86-4104	82
86-4104C	82
86-4104P	82
86-4144	82
86-4244	81
86-6044	81
87-1563	79
87-1563P	79
87-1663	79
87-1944	79
87-2066	79
87-3501	79
87-3563	79
90-908	74
90-908/5KW	74
90-908BT	74
90-908BW	74
90-908C	74
90-908CI	74
90-908I	74
90-909I	74
90-910	74
90-910C	74
90-910G	74
90-910GA	74
90-910I	74
90-912	74
90-912I	74

ITEM NUMBER	PAGE NUMBER
91-908PD	73
91-908PDC	73
91-908PDI	73
91-910PD	73
91-910PDI	73
91-910PDL	73
91-910PDL-R	73
91-910PDO	73
92-918	74
92-918BT	74
92-918BTO	74
92-918G	74
92-918GO	74
92-918O	74
92-918PC	74
92-918PCG	74
92-918PCGB	74
92-918PCO	74
92-918PCY	74
93-548	75
93-568	75
93-578G	75
93-588	75
93-589	75
93-598	75
94-924	125
94-924G	125
94-924I	125
94-924R	125
94-928	125
94-928G	125
94-928I	125
94-930	125
94-932	125
94-932G	125
94-934	125
95-606	75
95-606B	75
95-606C	75
95-806	75
95-806C	75
95-808	75
95-809	75
95-809C	75

ITEM NUMBER	PAGE NUMBER
95-809PD	75
95-809PDC	75
95-864	75
95-890	75
97-500	106
97-500/10	106
97-500/12	106
97-500/14	106
97-500/14I	106
97-500/14NI	106
97-500H	106
97-500I	106
97-500J	106
97-501	106
97-501/10	106
97-501/12	106
97-501H	106
97-501I	106
97-510	106
97-511	106
97-520	106, 130
97-520/10	106
97-520/12	106
97-520/12R	106
97-520/14	106
97-520H	106, 130
97-520J	106
97-520R	106, 130
97-521	106, 130
97-521/10	106
97-521H	106
97-540	107
97-540/12	107
97-540H	107
97-540R	107
97-541	107
97-541/12	107
97-541H	107
98-700	107
98-701	107
98-702	107
98-702/12	107
98-702I	107
98-703	107

INDEX

BRINGING THE BEST OF THE WORLD TO YOU®

ITEM NUMBER	PAGE NUMBER
98-703/12	107
98-703I	107
98-712	107
98-713	107
98-740	107
98-741	107
99-126	105
100-2824	103
100-2830	103
100-3201PF	102
100-322400	103
100-323000	103
100-323010	103
100-332400	103
100-333000	103
100-333010	103
100-93-183638	108
100-93-184538	108
100-93-243638	108
100-93-264538	108
100-93-264564	108
100-93-363638	108
100-93-363664	108
100-93-364538	108
100-93-364564	108
100-93-366064	108
100-95-501	108
120-4000	110
120-4050	110
120-4070	110
120-4100	113
120-4150	113
120-4200	113
120-4300	114
120-4400	114
120-4500	114
120-4600	114
120-4700	112
120-4720	112
120-4800	117
120-4900	114
120-5130	46, 110
120-5150	46, 110
120-5200	111

ITEM NUMBER	PAGE NUMBER
120-5250	111
120-5275	111
120-5300	111
120-5900	112
120-MX2805	115
120-MX2820	115
120-MX2830	115
120-MX2840	115
122-169	116
122-AV14	116
122-AV20	116
122-AV40	116
122-AV70	116
122-AV71	116
125-348	77
125-368	77
125-7563	81
130-100GM	130
130-100WM	130
130-100WMNZ	107, 130
130-100WMPD	130
130-150WM	130
130-600WL	129
130-600WM	129
130-650BM	129
130-650WL	129
130-650WM	129
147-00-11	259
147-0-11	259
147-1-14	259
147-2-14	259
147-SK-0	260
147-SK-00	260
147-SK-1	260
147-SK-2	260
148-1000	260
148-2000	260
148-2136	260
148-2142	260
148-4000	260
148-5000	260
148-6000	260
148-6011	260
148-6014	260

ITEM NUMBER	PAGE NUMBER
148-6016	260
148-6018	260
148-7000	260
150-00-11	259
150-00-14	259
150-0-11	259
150-0-14	259
150-1-14	259
150-2-14	259
150-3-16	259
150-3-18	259
150-SK-0	260
150-SK-00	260
150-SK-1	260
150-SK-2	260
151-2-18	259
151-3-18	259
152-2-16	259
152-2-18	259
153-00-11	259
153-0-11	259
153-1-14	259
154-2-16	259
154-2-18	259
155-0-11	259
155-1-14	259
155-1-16	259
155-2-14	259
155-2-16	259
155-2-18	259
155-3-16	259
155-3-18	259
155-4-16	259
155-4-18	259
155-SK-2	260
156-2-14	259
158-1-18	259
158-2-18	259
158-3-18	259
158-4-18	259
159-2-16	259
159-2-18	259
159-3-16	259
159-3-18	259

ITEM NUMBER	PAGE NUMBER
159-4-16	259
159-4-18	259
161-2-16	259
161-2-18	259
162-2-18	259
170-00-11	259
170-00-14	259
170-0-11	259
170-0-14	259
170-2-14	259
190-2-LARGE	259
190-2-REGULAR	259
190-2-XLARGE	259
195-2-LARGE	259
195-2-REGULAR	259
195-2-XLARGE	259
197-2-LARGE	259
197-2-REGULAR	259
197-2-XLARGE	259
200-010	242
200-01001	242
200-01002	242
200-011	242
200-012	242
200-06001	242
200-06002	242
200-07501	242
200-08001	242
200-12501	242
200-20001	242
200-91018	242
200-BC18	242
200-BC21	242
200-BC24	242
200-BG01	242
201-100	240
201-250	240
201-300	240
201-320	240
201-322	240
201-340	240
201-350	240
201-350B	240
201-350J	240

ITEM NUMBER	PAGE NUMBER
201-350P	240
201-355	240
201-360	240
201-370	240
201-650B	237
201-650C	237
201-650J	237
202-100	166
202-101	166
202-1012	108
202-1015	108
202-1019	108
202-102	166
202-1027	108
202-110	166
202-112	166
202-130	166
202-132	166
202-2036	108
202-2042	108
202-2048	108
202-2054	108
205-300FR	240
205-320FR	240
205-322FR	240
205-370FR	240
205-375FR	238
205-420B	236
205-420CV	236
205-420JH	236
248-4400-300	211
248-4400-400	211
248-4401-300	211
248-4401-400	211
248-5090-300B	211
248-5090-400B	211
248-5190-300B	211
248-5190-400B	211
248-5290-300B	211
248-5290-400B	211
249-5907-207	200
249-5907-400	200
249-5907-401	200
250-00-0000	191

ITEM NUMBER	PAGE NUMBER
250-00-0001	191
250-00-0002	191
250-00-0020	191
250-00-0900	191
250-00-0920	191
250-01-0000	190
250-01-0001	190
250-01-0002	190
250-01-0004	190
250-01-0005	190
250-01-0020	190
250-01-0021	190
250-01-0080	190
250-01-0900	190
250-01-0902	190
250-01-0920	190
250-01-0980	190
250-01-5503	190
250-01-5504	190
250-01-5509	190
250-01-F020	205
250-01-F021	205
250-01-F022	205
250-03-0000	203
250-03-0001	203
250-03-0080	203
250-06-0000	191
250-06-0002	191
250-06-0005	191
250-06-0006	191
250-06-0020	191
250-06-0080	191
250-06-5501	191
250-06-5503	191
250-06-5504	191
250-06-5509	191
250-06-5521	191
250-08-0000	191
250-08-0001	191
250-08-0002	191
250-08-0005	191
250-08-0020	191
250-08-0021	191
250-08-5503	191

ITEM NUMBER	PAGE NUMBER
250-08-5509	191
250-09-0000	189
250-09-0001	189
250-09-0002	189
250-09-0020	189
250-09-0021	189
250-10-0900	192
250-10-0904	192
250-10-0920	192
250-10-5501	192
250-11-0900	192
250-11-0904	192
250-11-0920	192
250-11-5501	192
250-12-0100	192, 207
250-12-0125	192, 207
250-12-0150	192, 207
250-12-0175	192, 207
250-12-0200	192, 207
250-12-0225	192, 207
250-12-0250	192, 207
250-12-0275	192, 207
250-12-0300	192, 207
250-21-0100	198
250-21-0101	198
250-21-0102	198
250-21-0120	198
250-21-0400	198
250-21-0401	198
250-21-0402	198
250-21-0403	198
250-21-0409	198
250-21-0420	198
250-21-0421	198
250-24-0000	198
250-24-0001	198
250-24-0080	198
250-24-0300	198
250-24-0301	198
250-25-0010	207
250-25-0015	207
250-25-0020	207
250-25-0025	207
250-25-0030	207

ITEM NUMBER	PAGE NUMBER
250-25-0115	207
250-25-0120	207
250-25-0125	207
250-25-0130	207
250-25-1515	207
250-25-2020	207
250-25-2525	207
250-26-0010	206
250-26-0012	206
250-26-0015	206
250-26-0017	206
250-26-0020	206
250-26-0022	206
250-26-0025	206
250-26-0030	206
250-27-0010	206
250-27-0012	206
250-27-0015	206
250-27-0017	206
250-27-0020	206
250-27-0022	206
250-27-0025	206
250-27-0027	206
250-27-0030	206
250-27-0115	206
250-27-0120	206
250-27-0125	206
250-27-0130	206
250-28-0000	199
250-28-0001	199
250-28-0002	199
250-28-0003	199
250-28-0006	199
250-28-0009	199
250-28-0020	199
250-28-0021	199
250-31-0010	196
250-31-0020	196
250-31-0021	196
250-31-0023	196
250-31-0026	196
250-31-0029	196
250-31-0031	196
250-31-0226	196

ITEM NUMBER	PAGE NUMBER
250-32-0010	186
250-32-0020	186
250-32-0021	186
250-32-0031	186
250-32-0226	186
250-32-0520	186
250-32-0521	186
250-33-0010	181
250-33-0020	181
250-33-0021	181
250-33-0041	181
250-33-0226	181
250-33-1010	181
250-33-1020	181
250-33-1024	181
250-33-1042	181
250-33-1226	181
250-34-0010	197, 205
250-34-0020	197, 205
250-34-0021	197, 205
250-34-0031	197, 205
250-34-0226	197, 205
250-34-FOAM	197, 205
250-36-0010	184
250-36-0020	184
250-36-0021	184
250-36-0025	184
250-36-0226	184
250-36-1010	184
250-36-1020	184
250-36-1021	184
250-36-1226	184
250-37-0900	203
250-37-0980	203
250-45-0010	185
250-45-0020	185
250-45-0021	185
250-45-0226	185
250-45-1010	185
250-45-1020	185
250-45-1021	185
250-45-1226	185
250-46-0010	187
250-46-0020	187

ITEM NUMBER	PAGE NUMBER
250-46-0021	187
250-46-0226	187
250-46-0520	187
250-46-0521	187
250-47-0004	178
250-47-0005	178
250-47-0006	178
250-47-0007	178
250-47-0020	178
250-47-0021	178
250-47-0041	178
250-47-1008	178
250-47-1042	178
250-48-0006	198
250-48-0021	198
250-48-0226	198
250-49-0000	195
250-49-0020	195
250-49-0021	195
250-49-0022	195
250-50-0420	204
250-50-0421	204
250-50-0422	204
250-50-0425	204
250-50-0426	204
250-50-0429	204
250-50-0520	204
250-50-0521	204
250-51-0015	204, 207
250-51-0020	204, 207
250-51-0025	204, 207
250-51-0030	204, 207
250-53-0006	179
250-53-0020	179
250-53-0021	179
250-53-0022	179
250-53-1024	179
250-57-0004	180
250-57-0008	180
250-57-0020	180
250-57-0021	180
250-57-0226	180
250-60-0020	201
250-60-0620	201

ITEM NUMBER	PAGE NUMBER
250-60-0625	201
250-60-0626	201
250-60-0628	201
250-60-0630	201
250-71-0000	195
250-71-0001	195
250-71-0002	195
250-71-0005	195
250-71-0020	195
250-71-0021	195
250-92-0000	194
250-92-0001	194
250-92-0002	194
250-92-0005	194
250-92-0009	194
250-92-0020	194
250-92-0021	194
250-98-0000	203
250-98-0013	203
250-98-0020	203
250-98-0080	203
250-99-0900	202
250-99-0901	202
250-99-0980	202
250-AN-10110	183
250-AN-10111	183
250-AN-10112	183
250-AN-10113	183
250-AN-10114	183
250-AN-10115	183
250-AN-10116	183
250-AN-10117	183
250-AN-10118	183
250-AN-10119	183
250-AN-10120	183
250-AN-10121	183
250-AN-10122	183
250-AN-10123	183
250-AN-10124	183
250-AN-10125	183
250-AN-10126	183
250-AN-10127	183
250-AN-10128	183
250-AN-10130	183

ITEM NUMBER	PAGE NUMBER
250-AN-10131	183
250-CE-10090	205
250-CE-10091	205
250-CE-10092	205
250-CE-10093	205
250-CE-10095	205
250-EVS-0000	158
250-EVS-0001	158
250-EVS-0002	158
250-MT-10070	195
250-MT-10071	195
250-MT-10072	195
250-MT-10074	195
250-MT-10075	195
251-01-5200	213
251-01-5201	213
251-01-5211	213
251-01-5212	213
251-01-5225	213
251-01-5270	213
251-01-5271	213
251-01-5400	213
251-01-6201	159, 213
251-01-6211	159, 213
251-01-6225	159, 213
251-01-6230-JSP	213
251-01-7204	213
251-01-7206	213
251-01-7214	213
251-01-7301	213
251-01-7311	213
251-01-7312	213
251-01-7313	213
251-01-7315	213
251-01-7401	213
251-01-7701	213
251-5300-000	208
251-5300-400	208
251-5300-400-RHB	208
251-5300-402	208
251-60-000V	208
251-60-0020	208
251-65-0020	209
251-65-0020-RHB	209

INDEX

BRINGING THE BEST OF THE WORLD TO YOU®

ITEM NUMBER	PAGE NUMBER
251-65-0021-RHB	209
251-80-0020	208
251-80-0020-RHB	208
252-CDL-06	214
252-CDS-12	214
252-FB30	214
252-FX-0001	214
252-L401	214
252-L404	214
252-L407	214
252-LCS08	214
252-LCT100	214
262-AEJ030-50	172
262-AEK010HV	172
262-AEK020HV	172
263-11001	172
263-41001	168
263-41002	168
263-41003	168
263-42001	168
263-42002	168
263-42003	168
263-43001	168
263-43002	168
263-43003	168
263-99400	172
263-99401	172
264-45002	169
264-45102	169
264-46002	169
264-46102	169
264-47002	169
264-47102	169
264-99403	172
265-100C	170
265-200U	170
267-HPB200	171
267-HPB300	171
267-HPD100	172
267-HPF200	170
267-HPF200-1	170
267-HPF200-1	172
267-HPF200C	170
267-HPF200D	171

ITEM NUMBER	PAGE NUMBER
267-HPF300	170
267-HPF300-1	170, 172
267-HPF300C	170
267-HPF700	170
267-HPF700C	170
267-HPR200	171
267-HPR200C	171
267-HPR300	171
267-HPR300C	171
267-HPR300D	171
270-1000	267
270-1101	267
270-2000	266
270-2050	266
270-3000	266
270-3050	266
270-4000	267
280-AHS150-10	150
280-AHS150-20	150
280-AHS150-50	150
280-AHS150V-10	150
280-AHS240-10	150
280-AHS240-20	150
280-AHS240-50	150
280-AHS240V-10	150
280-AJS260-10	156
280-EV6121-10	154
280-EV6121-20	154
280-EV6121-30	154
280-EV6121-39	154
280-EV6121-40	154
280-EV6121-50	154
280-EV6121-60	154
280-EV6121-LY	154
280-EV6121-OR	154
280-EV6131-10	154
280-EV6131-20	154
280-EV6131-30	154
280-EV6131-50	154
280-EV6131-60	154
280-EV6131-LY	154
280-EV6131-OR	154
280-EV6131V-10	154
280-EV6131V-20	154

ITEM NUMBER	PAGE NUMBER
280-EV6141-10	154
280-EV6141-20	154
280-EV6141-30	154
280-EV6141-50	154
280-EV6141-60	154
280-EV6141-LY	154
280-EV6141-OR	154
280-EV6141V-10	154
280-EV6141V-20	154
280-EV6151-10	153
280-EV6151-11	153
280-EV6151-20	153
280-EV6151-30	153
280-EV6151-39	153
280-EV6151-40	153
280-EV6151-50	153
280-EV6151-60	153
280-EV6151-LY	153
280-EV6151M-10	156
280-EV6151M-20	156
280-EV6151M-30	156
280-EV6151M-50	156
280-EV6151M-60	156
280-EV6151MCR2-XX	156
280-EV6151M-LY	156
280-EV6151M-OR	156
280-EV6151-OR	153
280-EV6151S-10	153
280-EV6151S-20	153
280-EV6151SV-10	153
280-EV6151SV-20	153
280-EV6151SV-50	153
280-EV6151V-10	153
280-EV6151V-20	153
280-EV6151V-40	153
280-EV6151V-50	153
280-EV6151V-LY	153
280-EV6151V-OR	153
280-EV6161-10	152
280-EV6161-20	152
280-EV6161-30	152
280-EV6161-40	152
280-EV6161-50	152
280-EV6161-60	152

ITEM NUMBER	PAGE NUMBER
280-EV6161-LY	152
280-EV6161M-10	156
280-EV6161M-20	156
280-EV6161M-30	156
280-EV6161M-50	156
280-EV6161M-60	156
280-EV6161MCR2-XX	156
280-EV6161M-LY	156
280-EV6161M-OR	156
280-EV6161-OR	152
280-EV6161V-10	152
280-EV6161V-20	152
280-EV6161V-30	152
280-EV6161V-40	152
280-EV6161V-50	152
280-EV6161V-60	152
280-EV6161V-LY	152
280-EV6161V-OR	152
280-ML5151-10	153
280-ML5151-20	153
280-ML5151-30	153
280-ML5151-39	153
280-ML5151-50	153
280-ML5151-60	153
280-ML5151-80	153
281-CAP-LED	161
281-CL-SET	158
281-CR2-10	157
281-CR2-10-BL	157
281-CR2-10-GR	157
281-CR2-10-OR	157
281-CR2-10-RE	157
281-CR2-10-YE	157
281-CR2FB-10	157
281-CR2FB-10-BL	157
281-CR2FB-10-GR	157
281-CR2FB-10-OR	157
281-CR2FB-10-RE	157
281-CR2FB-10-YE	157
281-CR2SW-10	157
281-CS-2PT	159
281-CS-4PT	159
281-CSD-2PT	159
281-SB-CHN	159

ITEM NUMBER	PAGE NUMBER
281-SB-NBF	159
281-SB-NBF/CP	159
281-SSE-CAP	159
281-SSE-FB	159
282-ABM130-11	160
282-ABM130-12	160
282-ABM130-21	160
282-ABR170-11	160
282-ABR170-12	160
282-ABR170-18	160
282-ABR170-21	160
282-ABR170-52	160
282-ABR170-62	160
282-ABR170-CAMO	160
282-ABR170-LY	160
282-ABR170-OR	160
282-ABS150-11	160
282-ABS150-12	160
282-ABS150-18	160
282-ABS150-21	160
282-ABS150-62	160
282-AEM130-11	161
282-AEM130-21	161
282-AEP-10	161
282-AES150-11	161
282-AES150-21	161
282-AFB375-21	161
282-AFB375-LY	161
289-GTW-6121-L/XL	155
289-GTW-6121-M/L	155
289-GTW-6121-M/M-39	155
289-GTW-6121-XL/XXL	155
289-GTW-6141-L/XL	155
289-GTW-6141-M/L	155
289-GTW-6141-XL/XXL	155
290-440L	264
290-440M	264
290-440S	264
290-440XL	264
290-440XXL	264
290-550L	264
290-550M	264
290-550XL	264
290-550XXL	264

ITEM NUMBER	PAGE NUMBER
290-9000L	262
290-9000M	262
290-9000S	262
290-9000XL	262
290-9001L	262
290-9001M	262
290-9001S	262
290-9001XL	262
290-9010BGE	262
290-9010BLK	262
290-9011BLK	262
290-9013L	262
290-9013M	262
290-9013S	262
290-9013XL	262
290-9015	262
290-9020L	263
290-9020M	263
290-9020S	263
290-9020XL	263
291-100	263
291-110	263
291-130	263
299-13210	268
299-13215	269
299-13225	268
299-13255	268
299-13285	268
299-13290	268
299-13293	268
299-13295	270
299-17030	269
300-0800-LY	227
300-0800-OR	227
300-0900-LY	227
300-0900-OR	227
300-1000-BL	227
300-1000-RD	227
300-1502	226
300-1504	226
300-1505	226
300-1507	226
300-1508	226
300-1510	226

ITEM NUMBER	PAGE NUMBER
300-1511	226
300-1516	226
300-2501	226
300-2502	226
300-2503	226
300-2504	226
300-2505	226
300-2506	226
300-2507	226
300-2508	226
300-2509	226
300-2510	226
300-2511	226
300-2512	226
300-2513	226
300-2514	226
300-2515	226
300-EVOR-E-LY	227
300-EVOR-E-OR	227
300-EVOR-P-LY	227
300-EVOR-P-OR	227
301-0150-LY	227
301-0150-OR	227
302-0210-LY	221
302-0210-OR	221
302-0211-LY	221
302-0211-OR	221
302-0212-LY	221
302-0212-OR	221
302-0215-LY	224
302-0215-OR	224
302-0500M-LY	223
302-0500M-OR	223
302-0500-LY	223
302-0500S-LY	223
302-0500S-OR	223
302-0500-YEL	223
302-0590E-LY	221
302-0590E-OR	221
302-0600D-LY	224
302-0600D-OR	224
302-0650D-LY	223
302-0650D-OR	223
302-0700-LY	223

ITEM NUMBER	PAGE NUMBER
302-0700-OR	223
302-0702-LY	218
302-0702-OR	218
302-0702Z-LY	218
302-0702Z-OR	218
302-0750-LY	223
302-0750-OR	223
302-0800D-BK	223
302-0800D-LY	223
302-0800D-OR	223
302-0900-LY	223
302-0900-OR	223
302-5PMV-LY	221
302-5PMV-OR	221
302-5PV-LY	221
302-5PV-OR	221
302-MAP-LY	223
302-MAPM-LY	223
302-MAPM-OR	223
302-MAP-OR	223
302-MVAT-LY	224
302-MVAT-OR	224
302-MVG-LY	218
302-MVG-OR	218
302-MVGZ4P-LY	218
302-MVGZ4P-OR	218
302-MVGZ-LY	218
302-MVGZ-OR	218
302-MV-LY	224
302-MV-OR	224
302-MVZP-LY	224
302-MVZP-OR	224
302-MVZT-LY	224
302-MVZT-OR	224
302-P070-LY	226
302-PSV-BLK	226
302-PSV-BLK-NL	226
302-PSV-BLU	226
302-PSV-BLU-NL	226
302-PSV-GRN	226
302-PSV-RED	226
302-PSV-RED-NL	226
302-USV5-LY	221
302-USV5-OR	221

ITEM NUMBER	PAGE NUMBER
302-V100-LY	218
302-V100-OR	218
302-WCENG-LY	218
302-WCENG-OR	218
302-WCENGZ-LY	218
302-WCENGZ-OR	218
303-0500M-LY	223
303-0500M-OR	223
303-0500-OR	223
303-0500-YEL	223
303-0800D-LY	223
303-0800D-OR	223
303-5PMTT-LY	221
303-5PMTT-OR	221
303-HSVE-LY	218
303-HSVE-OR	218
303-MVGZ4P-LY	218
303-MVGZ4P-OR	218
305-2000	246
305-2100	246
305-3000	246
305-3100	246
305-5PVFR-LY	225
305-5PVFR-OR	225
305-HSSVFR-LY	225
305-HSSVFR-OR	225
305-HSVPFR-LY	225
305-HSVPFR-OR	225
305-MVFR-LY	225
305-MVFR-OR	225
305-USV5FR-LY	225
305-USV5FR-OR	225
305-WCENGFR-LY	225
305-WCENGFR-OR	225
310-1100-LY	229
310-1100-OR	229
310-1150B-LY	229
310-950B-LY	229
310-CNTSN-LY	229
310-CNTSN-OR	229
312-1200-LY	229
312-1200-OR	229
312-1250B-LY	229
312-1250B-OR	229

ITEM NUMBER	PAGE NUMBER
312-1350B-LY	229
312-1350B-OR	229
312-1360B-LY	229
312-1360B-OR	229
313-1300-LY	229
313-1300-OR	229
313-1375B-LY	229
313-1375B-OR	229
313-1400-LY	229
313-1400-OR	229
313-CNTSE-LY	229
313-CNTSELY*-PRI18W	141, 229
313-CNTSE-OR	229
313-CNTSP-LY	229
313-CNTSP-OR	229
315-1350FR	245
315-1350FR-LY	229
318-1757-LY	234
318-1757-OR	234
318-1771-LY	234
318-1771-OR	234
319-GT1	234
319-GT2	234
319-MTP-LY	234
323-1330B-LY	230
323-1330B-OR	230
323-1350B-LY	230
323-1350B-OR	230
323-1370B-LY	230
323-1370B-OR	230
323-CNSSE-LY	230
323-CNSSE-OR	230
323-HSSE-LY	230
323-HSSE-OR	230
323-HSSP-LY	230
333-1550-LY	233
333-1740-LY	233
333-1740-OR	233
333-1762-LY	233
333-1762-OR	233
333-1766-LY	233
333-1766-OR	233
333-1770-LY	233
333-1770-OR	233

ITEM NUMBER	PAGE NUMBER
333-WB-LY	233
333-WB-OR	233
343-1755-LY	233
343-1755-OR	233
343-1756-LY	233
343-1756-OR	233
350-RANGER	280
353-1000-LY	239
353-1000-OR	239
353-1048-LY	239
353-1048-OR	239
353-2000-OR	239
353-2000-YEL	239
353-2001-OR	239
353-2001-YEL	239
353-2002-OR	239
353-2002-YEL	239
355-2500AR-LY	239
355-2501AR-LY	239
355-2505AR-LY	239
360-1500FR-BK	165
360-BEANNIELY	165
360-BEANNIEOR	165
363-1ML2FB	165
363-1RL2B	165
363-1RL3QB	165
363-1SL2FB	165
364-1170	165
364-ML2FB	165
364-ML2FMP	165
364-ML2SB	165
364-RL2B	165
364-RL3QB	165
364-SL1FB	165
364-SL2FB	165
364-SL2SB	165
365-1502-BK	165
365-1505-BK	165
365-1510FR-BK	165
365-1520FR-BK	165
365-1620	165
365-1370FR	244
385-1370FR-LY	230
385-FRBL-11-NV	256

ITEM NUMBER	PAGE NUMBER
385-FRBL-11-OR	256
385-FRCJ	248
385-FRHN-LG	245
385-FRHN-NV	245
385-FRHN-OR	245
385-FRLS-LG	245
385-FRLS-NV	245
385-FRLS-OR	245
385-FRPH-NV	245
385-FRPH-OR	245
385-FRRJ	248
385-FRSC-KH	249
385-FRSC-NV	249
385-FRSC-LG	245
385-FRSC-NV	245
385-FRWS-KH	248
385-FRWS-NV	248
385-FRZH-NV	245
385-FRZH-OR	245
385-HDFR13-NV	256
385-HDFR13-OR	256
390-10	276
390-EZ100	276
390-EZ150	276
390-EZ202	276
390-EZFRPC	276
390-EZSPC	276
390-PC099	276
390-PCVCP1	276
390-PCVKT1	276
393-100-BLU	277
393-100-CBL	277
393-100-CRD	277
393-100-DGC	277
393-100-KHK	277
393-100-NAVY	277
393-100-PAT	277
393-650-B	277
393-650-L	277
393-650-P	277
393-EZ201-KHK	277
393-EZ201-NVY	277
393-EZ201-PAT	277
393-EZ201-RTC	277

INDEX

BRINGING THE BEST OF THE WORLD TO YOU®

ITEM NUMBER	PAGE NUMBER
396-20870-BGE	280
396-20870-NAV	280
396-300-CBL	278
396-300-NAV	278
396-300-PAT	278
396-400-BLU	279
396-405	279
396-425-KHK	278
396-500	280
396-505	280
396-602-B	277
396-602-L	277
396-602-P	277
396-700FR-LY	280
396-700FR-DR	280
396-800	280
396-801FR	280
396-EZ205	278
396-EZ205-RTC	278
396-EZ450-KHK	278
396-EZ450-LY	278
396-EZ450-RTC	278
396-EZ810	279
396-EZ811FR	279
396-EZ900-GC	277
396-EZ900-LY	277
396-EZ900-NV	277
396-EZ900-PK	277
399-HEATPACK	119
805-3455	162
805-3479	162
828-0378	163
828-0379	163
828-0380	163
828-0382	163
841-0398	163
841-0399	163
841-0400	163
841-0401	163
856-6323	162
856-6324	162
856-6325	162
856-6326	162
903-GB651	162

ITEM NUMBER	PAGE NUMBER
903-GB652	162
903-GB653	162
906-100NOM7	166
906-100NOM7B	166
906-100NOM7BLKB	166
906-2080NOL7	166
906-2080NOL7B	166
906-2080NOL7BLK	166
906-2080NOL7BLKB	166
906-8416CBX	166
906-8416CT	166
910-P735	127
910-P775	127
911-AX9	128
911-AX9P	128
935-004	274
935-006B	274
939-AT280-A	273
939-AT280-R	273
939-AT290-A	272
939-AT290-B	272
939-AT290-G	272
939-AT290-R	272
939-AT290-W	272
939-AT293-A/W	272
939-AT293-B/W	272
939-AT293-R/A	272
939-AT293-R/B	272
939-AT293-R/W	272
939-EF350-A	273
939-EF350-R	273
939-EFAVBASE	273
939-EFBAG-2	273
939-EFBAG-4	273
939-EFBASE	273
939-EFCLIP	273
939-EFFLCOL/L	273
939-EFMAGBASE	273
939-EFMAGCLIP	273
939-TB10-R	273
939-TF250-B-ASY	273
9010-51200	260
9100-2100D	249
9100-2110D	249

ITEM NUMBER	PAGE NUMBER
9100-2120D	249
9100-2160D	247, 249
9100-2170D	247, 249
9100-21721	247
9100-21731	247
9100-21782	247
9100-22070	247
9100-240ULT	247
9100-52412	247
9100-52422	247
9100-524UL	247, 253
9100-52564	247
9100-52680	247
9100-52750	247
9100-52758	247
9100-52772	247
9100-530ULT	247, 253
9100-53680	247
9100-53750	247
9100-75000	247
9100-75001	247
9100-HDFR12	256
9100-HDFR15	256
9150-21712	252
9150-5236V	253, 255
9150-523ULT	253, 255
9150-52436	252
9150-52436B	252
9150-52500	251
9150-52508	251
9150-52512	251
9150-52515	255
9150-52548	255
9150-52609	252
9150-52685	255
9150-52689	255
9150-52730	252
9150-52730B	252
9150-52804	251
9150-52810	251
9150-52815	252
9150-52821	252
9150-52850	255
9150-52917	252

ITEM NUMBER	PAGE NUMBER
9150-52946	252
9150-53003	252
9150-53018	252
9150-53871	251
9150-5388E	251
9150-5388EB	251
9150-540ULT	252
9150-540ULTB	252
9150-5488E	251
9150-5488EB	251
9150-54VULT	252
9150-54VULTB	252
9150-56510	251
9150-56511	251
9150-75002	255
9150-75050	252
9150-75050B	252
9400-52501	254
9400-52502	254
9400-52503	254
9400-52504	254
9400-52505	254
9400-52506	254
9400-52507	254
9400-52508	254
9400-52509	254
9400-52511	254
9400-52514	256
9400-52517	255
9400-52599	256
9400-52686	255
9400-52699	255
9400-53502	254
9400-53504	254
9400-53512	254
9400-53514	254
9400-53520	254
9400-53524	254
9400-80016	254

TRADEMARKS

3GX®, ACP™, Adversary™, Air Force™, Ambi-dex®, Ambi-Thix®, Anti-ReflectivePLUS™, ArmorFlex®, ArmorGrip®, ArmorLite®, ArmorLiteXT®, AmorTuff®, AmorTuff XT®, Assurance®, Assurance® Plus, AutoXT™, Black Pearl, Blue Bison™, Bouton™ Optical, Bringing the Best of the World to You®, Brahma Quality®, Cabaret™, ChemGrip™, CleanTeam™, Cut Risk Hazard Matrix™, Double V™, Duo-Pro™, E-Flare™, ESP™, Eva®, Excalibur®, EZ-COOL™, Falcon™, FingerNails®, FlashFire™, Fogless® 3Sixty™, Fuselage™, GP™, Great White®, Grippaz™, G-Tek®, Hi-Voltage AC™, Hi-Voltage ARC™, KEV™, K-Force™, Lady Eva®, Mag Readers™, Maximum Safety™, MirrorPLUS™, Neofoam™, PermFlex™, PolarizedXL5™, PolyKor™, Pritex™, ProCoat®, Red Viper™, SafetyGear by PIP®, Smart Fit™, Supreme™, The Scout™, U-Fit®, Xrystal™, XtraTuff™, Zenon Z11sm™, Zenon Z12™, Zenon Z12R™, Zenon Z13™, Zenon Z14sm™, Zenon Z28™, Zenon Z36™, and Zenon Z44™ are registered trademarks or trademarks pending registration of Protective Industrial Products, Inc.

Active™, AD-APT®, AIRtech®, Comfort™, Elite™, Endurance™, MaxiChem®, MaxiCut®, MaxiCut® Ultimate DT™, MaxiDry®, MaxiDry® Plus™, MaxiDry® Zero™, MaxiFlex® Ultimate™ and MaxiFoam™, are registered trademarks or trademarks pending registration of ATG®.

EverGrip™, Kut Gard® and Temp-Gard® are registered trademarks or trademarks pending registration of PR Industries.

Dare Bigger™, DuPont®, Kevlar®, Lycra®, Nomex® and Protera® are trademarks or registered trademarks of E.I. du Pont de Nemours and Company.

Velcro® is a registered trademark of Velcro Industries B.V.

3M™ and Thinsulate™ are trademarks of 3M™.

Dyneema® is a registered trademark of DSM.

HyperKewl™ is a trademark of TechNiche International.

REALTREE® is a registered trademark of Jordan Outdoor Enterprises, Ltd.

UltraSoft® is a registered trademark of Westex®.

Actifresh® is a registered trademark of British Sanitized Limited.

Aerolite™, Bushmaster™, Classic™ Extreme, Comfort Plus™, EasyJust®, EVOLite® Skyworker™, Evolution®, EVOSpec™, Hard Cap A1+™, Inter EXV™, Inter GPV™, J Muff™, MKB Evolution®, PowerCap®, Surefit™ and Top Cap™, are registered trademarks or trademarks pending registration of JSP®.

Secure™ is a trademark of Hellberg® Safety AB.

Novax® is a registered trademark of GB Industries.

ActivGrip™ Advance, ActivGrip™, MicroFinish®, N-Spector XRT and PowerGrab® are registered trademarks or trademarks pending registration of the TOWA Corporation.

LIMITED WARRANTY

Protective Industrial Products, Inc.® (PIP) warrants only that PIP products will be free from defects in materials and workmanship at the time of sale. Upon receipt of each shipment, the customer must examine the products for defect or shortage and notify PIP in writing within thirty (30) days after such receipt of any claims reasonably discernible within such thirty (30) day period. All claims not reasonably discernible within thirty (30) days must be made in writing within one (1) year after receipt of shipment. Any claim not timely made shall be waived. This limited warranty is exclusive and in lieu of all other warranties, express, implied or statutory. PIP's entire obligation and the exclusive remedy to any party for breach of this limited warranty shall be limited to replacement of the defective product or refund of the original purchase price of the product, at PIP's option. PIP's limited warranty shall not apply to PIP products that have been subject to misuse, accident, negligence, handling, storage, or use.

DISCLAIMER OF IMPLIED WARRANTIES

All implied warranties which may arise by implication of law or application, course of dealing, usage of trade, including, but not limited to, implied warranties of merchantability, fitness for a particular purpose title, and non-infringement are expressly excluded. The user is solely responsible for the suitability of the product selected for a particular application. This catalog is the exclusive property of Protective Industrial Products, Inc.® It may not be copied, duplicated or reproduced in whole or in part by any means without the written permission of Protective Industrial Products, Inc.®

TRIAL-ORDER PROGRAM

Trial orders are available to customers of Protective Industrial Products distributors on a satisfaction or no-pay basis. The program lets end-users evaluate PIP gloves, in their actual application and on-site condition, on a satisfaction-or-they-don't-pay basis to make sure they're the right gloves for the job. For more information about our "Satisfaction-or-No-Pay" guaranteed Trial Order Program, please contact your PIP Sales Representative.