

WHEEL TRIM | TOOLBOXES | LIGHTING | ACCESSORIES

Thank You For Choosing Phoenix USA, Inc.

Since 1985, Phoenix USA, Inc. has been providing dependable quality service to our customers and partners. We are located in middle Tennessee in the city of Cookeville, and our facility totals more than 145,000 square feet.

Our broad range of production abilities offers a unique solution to your company's needs. The added value of issuing one purchase order to one vendor offers our partners an advantage in increased productivity, decreased inventory costs, and an ability to concentrate on your core competencies.

Phoenix USA, Inc. is an ISO9001 certified company that continuously strives to meet the highest industry standards.

Phoenix USA, Inc. also offers an additional product line... The Tow-Rax® line of storage solutions for your garage, shop & trailer needs.

Contents

WHEEL SIMULATORS

Wheel Information	
Terms & Definitions	4
Finding Wheel Information	5
Wheel Simulator Descriptions	6-7
Air Inflation/Valve Extensions	8-9
Application Guide	10-18
Alcoa Aluminum Wheels & Accessories	19

WHEEL ACCESSORIES

QuickTrim®	
Medium Duty Truck Hub & Lugnut Covers	20-21
Medium & Heavy Duty Hub & Lugnut Covers	22-23
Lugnut Covers	23
Hub Covers/Trim Rings for Trailers	24-25
Golf Carts/Mowers	26

STORAGE PRODUCTS

Tool Boxes	27-31
3-Drawer Tool Boxes	31
Tool Box Insert	31
Underbody Mesh Baskets	32
Tool Box Mounting Brackets	33
Tool Box Accessories	34-36
Tool Box Replacement Parts	37

LIGHTING

Phoenix USA Light Bars	38-40
Work Lights	41
Lighting and Switch Panels	42

ELECTRICAL ACCESSORIES

Junction Boxes	42
Switch Panels	42

BODY ACCESSORIES

Handles/Grab Rails	43
Body Flares	44
Fenders	45
Spare Tire Storage	45

Tow-Rax®

Garage/Trailer Storage	46-47
----------------------------------	-------

Wheel Simulator Parts

Breakdown Index	48-67
---------------------------	-------





Glossary of Terms & Definitions

Baby Moon/Pop-In Usually associated with hub covers for the front aluminum wheel.

- **Smooth** A hub cover that is a one piece, with no logo indentation.
- **Emblem** A hub cover that is a one piece, with logo indentation.
- **Open** A hub cover that is a one piece, with an open center area.

Bolt Circle (BC) The measurement between the stud center to the opposite side stud circle center.

“Clocking” a wheel/liner The process of rotating a wheel or wheel liner in order to line up hand holes, valve stem, and to ensure proper fit, etc.

DOT-Liner® A Simulator that mechanically attaches to the wheel. Does not require the removal of the lugnuts for installation.

Dual Wheel Two wheels are attached to the hub of the vehicle.

Flotation Wheel/Duplex Wheel/Super-Single Wheel 22.5” wide base wheels that are over 9” wide and have a recessed center.

Hand hole (HH) The openings on a wheel or wheel liner.

• **Round**



• **Oval**



Hub cover A cover for only the center hub.

Hub piloted The wheel is “centered” or located into the proper location by the hub of the vehicle. The lugnuts on this type of application are usually black with a flat “swivel” washer on the bottom end.

Jamnut A hex head nut used to mechanically attach a DOTLiner.

Jamnut cover A cover that fits over the top of a jamnut for cosmetic purposes.

Liner/Wheel Simulator A cover for a wheel (normally a steel wheel) that gives the appearance of a chrome or polished aluminum wheel. Wheel simulators are usually made from stainless steel.

Lugnut A nut used to thread on a stud for attaching the wheel to the axle.

Pop-In Usually associated with hub covers for the front aluminum wheel. **(see also “Baby Moon”)**

Quick-Liner® A Simulator that attaches to the wheel using a friction fit and/or clips. Does not require the removal of the lugnuts or any tools for installation.

Quick-Cover® A Simulator that attaches to the wheel using a ring mount system and does not require the removal of the lugnuts for installation.

Single wheel A single (one) wheel is attached to the hub of the vehicle.

Stud A threaded bolt used to thread a lugnut.

Stud extender A tube that is threaded on the inside and outside used to “extend” the OEM stud length to be able to attach the DOTLiner® wheel simulator.

Stud hole The opening through which the stud will protrude thru the wheel.

Stud piloted The wheel is “centered” or located into the proper location by the lugnuts. The lugnuts are usually tapered on one end and flat on the opposite end. Sometimes referred to as a “Ball Seat Wheel.”

Tandem axle A pair of axles spaced close together.

Uni-Liner® A Simulator that mechanically attaches to the wheel and does require the removal of the lugnuts for a universal fit to wheel.

Wheel Simulator/Liner A cover for a wheel (normally a steel wheel) that gives the appearance of a chrome or polished aluminum wheel. Wheel simulators are usually made from stainless steel.

Information you will need to determine the right simulator:

1. Find the wheel # at the location shown on Figure 1 to the right. Wheel #'s are usually used for larger size wheels.
2. Find the wheel diameter at the location shown on Figure 1 to the right.
3. Count the number of lugnuts.
4. Note the shape of the lugnuts:

HUB PILOTED

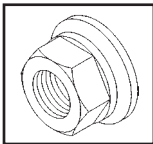

STUD PILOTED

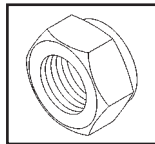

5. Note the type of wheel:

DUAL WHEEL

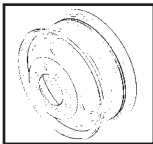

DUPLEX WHEEL

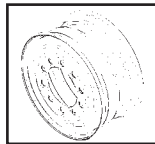

6. If you have dual wheels, count the number of hand holes on your wheel.

HAND HOLES

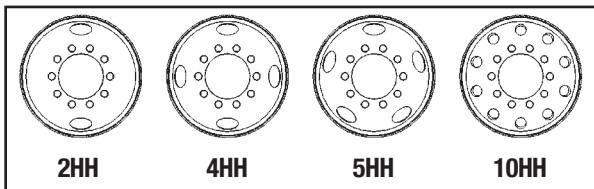

7. Note the hex size of the lugnuts.

Hub Pilot

30mm (1 3/16")
 32mm (1 1/4")
 33mm (1 5/16")
 38mm (1 1/2")

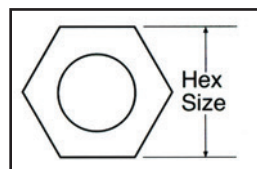

Stud Pilot

1.5"
 1.75"
 41mm (1 5/8")

8. Some mounting styles require at least 3 threads of the stud protruding through the top of the lugnut for stud extenders.

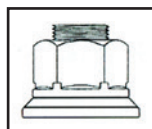
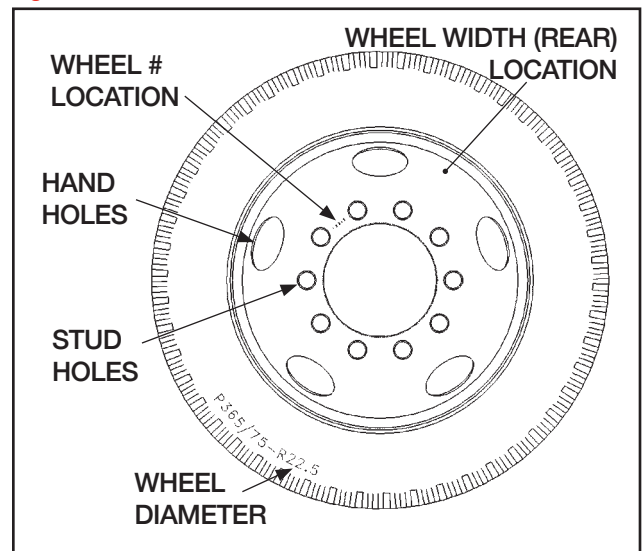

Figure 1





About Our Simulators:

Wheel simulators are often used to cover a less attractive OEM steel wheel and improve the overall appearance of the vehicle by giving it more style. All Phoenix[®] USA, Inc. wheel simulators have been designed to fit a specific manufacturer's wheel. Always select a wheel simulator designed to fit your particular vehicle.

Wheel simulators must be installed carefully. Phoenix[®] USA, Inc. offers a variety of mounting styles described below. Depending on your vehicle year and make along with specific OEM wheel designs, mounting styles will vary from simulator to simulator. All simulators should fit flush to the OEM steel wheel and have no excess overhang. If your simulator does not firmly seat all the way around, do not drive with it.

D.O.T.Liner[®]

Bolts on without removing the wheel lugnuts

- Does not violate chassis manufacturer's warranty
- Mirror polished stainless steel for lasting beauty and durability
- Pop-out centers for 4WD hubs
- Protective rolled edge for strength and handling safety
- Secure bolt-on installation

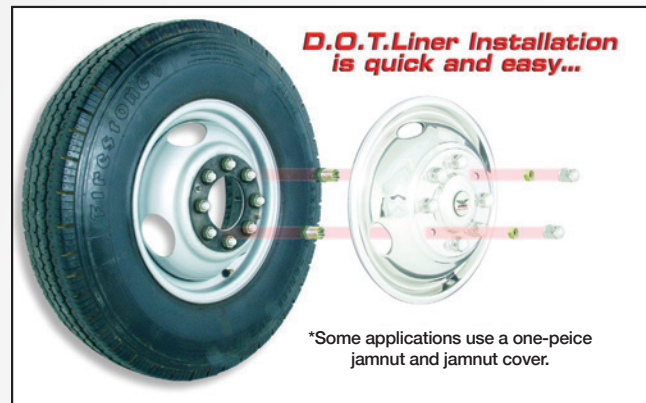

QuickLiner[®]

Secure snap-on mounting provides quick and easy installation

- No lugnut removal required.
- Mirror polished stainless steel for lasting beauty and durability
- Protective rolled edge for strength and handling safety



QuickCover®

Universal, no lug removal, ring mount

- For 17.5", 19.5" and 22.5" wheels.
- Rear valve extension included for easy air inflation and pressure checks.
- Made from highly polished, durable stainless steel
- Offers easy access to Stemco® oil seals (19.5" & 22.5").



UniLiner®

Universal under-lug mounting

- Fits most 16" and 16.5" dual wheel trucks
- Mirror polished stainless steel for lasting beauty and durability
- Protective rolled edge for strength and handling safety
- Secure bolt-on installation



CustomLiner®

Under-lug mounting with excellent fit

- Protective rolled edge for strength and handling safety
- Mirror polished stainless steel for lasting beauty and durability





Valve stem extenders take the hassle out of inflating and checking the air pressure of dual tires. Inflation kits let you easily check air pressure and inflate your vehicle's dually tires by relocating the inner tire's valve stem to the outer wheel and extends the valve stem on the outer tire. Kits are designed to be used with steel or aluminum wheels with wheel liners. All necessary hardware is included.

Outer Dual Valve Stem Extensions

AP3



Pair of outer valve stem extensions made of tough stainless steel for durability.



AirPlus®

Two Hose Inner Dual Valve Stem Extension & Stabilizer Kits

- Rugged braided stainless steel hoses
- One pair of extensions with stabilizers
- Quick and easy installation
- Makes checking and filling air easier
- Ideal for any brand of wheel simulators
- Live stem hoses

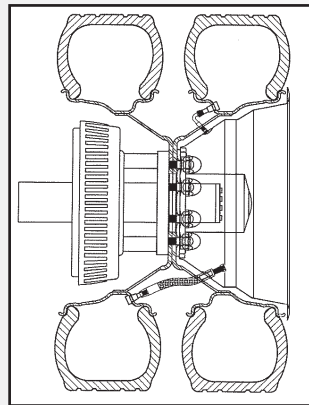

AP4



Kit fits all light duty wheels with oval hand holes.

AP6



Kit fits '99-C Ford F-450 and F-550, '08-C Ram 4500 & 5500.

AP5



Kit fits '92-'07 Ford E-350 and E-450 dual wheel with round hand holes.



Four Hose Valve Stem Extensions With Heavy Duty Brackets

- Braided stainless steel valve extensions for use with DOTLiner® dual wheel simulator kits
- Kits include four hoses and four brackets to provide easy air fill access to inner and outer tires.

NOTE: Use AMH1 with import D.O.T. applications (except N6695).

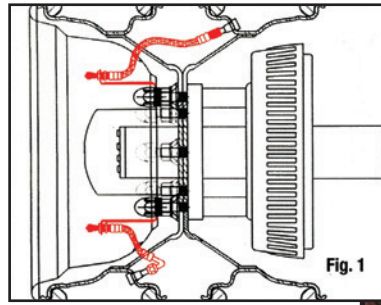

AML1

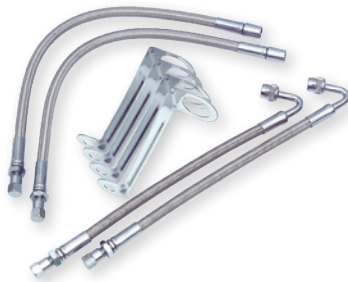

Four hose kit with brackets for most dual wheels with lugnut hex of 1 1/16" and smaller. Fits part #s NF10, NF12, NF98, GD816, GDG92, GDG01, GDF16, GDF17, ND20, NDT165, NFS156.

AMG1



Four hose kit with brackets for '03-'10 Chevy/GMC C4500 - C6500 with 19.5" 8Lug wheel.

AML2

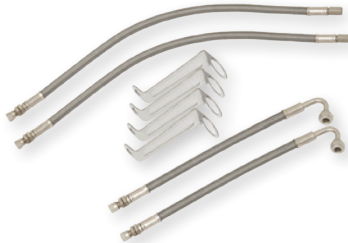

Four hose kit with brackets for part #s NF19, NF22, NF23, NF25, NG961, NG17, NG18, ND1912.

AMH1

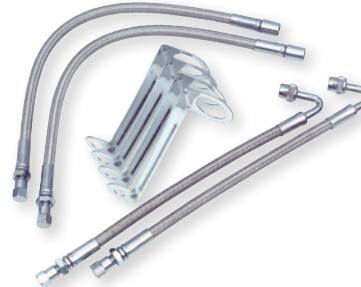

Four hose kit with brackets for most dual wheels with lugnut hex of 1 3/16" and larger. Fits part #s N252, N552, NH252, NH552, NH8495, NH5092, N6664, N6670.

AML3

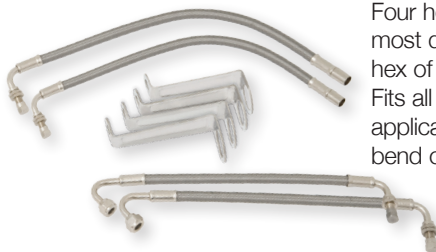

Four hose kit with brackets for most dual wheels with lugnut hex of 1 1/16" and smaller. Fits all AML1 and AML2 applications but adds a 90° bend on male end of extension.

AMM2



Four hose kit with brackets for N6695, N6664, N6559, N6670, N6681.

Replacement Hoses

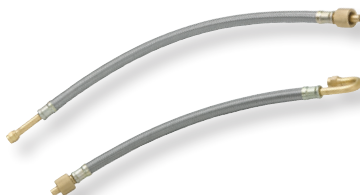

- 2500 PSI burst strength
- Fit most major constant air pressure systems
- 8 strand braided steel
- Reduced chance of trapped debris
- Double crimped
- Brass knurling and valves

VE1301SS

13" replacement hose

VE1601SS

16" replacement hose





Bering Truck

Year	MODEL/ Description	DOTLiner®	QuickLiner®	QuickCover®	Custom Liner®	Uni-Liner®	AirPlus®	AirMax®
99-00	19.5" x 6.75" 6 lug	N6695						AMM2

Chevrolet/GMC

Year	MODEL/ Description	DOTLiner®	QuickLiner®	QuickCover®	Custom Liner®	Uni-Liner®	AirPlus®	AirMax®
01-10	C/K2500/C/K3500 2WD/4WD 16" 8 lug single wheel	NSG03						
88-00	C/K2500 & C/K3500 2WD/4WD 16" 8 lug single wheel		GQST60	QC160A**				
73-87	C20/C30 2WD 16" 8 lug single wheel		GQST60	QC160A**				
73-87	K20/K30 4WD 16" 8 lug single wheel		GQST60					
92-06	C/K2500 2WD/4WD Suburban 16" 8 lug single wheel		GQST60	QC160A**				
73-91	C25 2WD Suburban 16" 8 single wheel		GQST60	QC160A**				
73-91	K25 4WD Suburban 16" 8 lug single wheel		GQST60					
11-C	C/K 3500 HD 17" 8 lug dual wheel	NG18	QL74					AML2*
08-10	C/K 3500 HD 17" 8 lug dual wheel	NG17	QL74					AML2*
01-07	C/K 3500 2WD/4WD 16" 8 lug dual wheel	GDG01			SLG116		AP3/AP4	AML1*
90-00	C/K 3500 2WD/4WD 16" 8 lug dual wheel	GDG92	GQ64	QC160A**		SLU168	AP3/AP4	AML1*
88-89	C/K 3500 2WD/4WD 16" 8 lug dual wheel		GQ64	QC160A**		SLU168	AP3/AP4	
73-91	C30 & C35 2WD 16" 8 lug dual wheel		GQ64	QC160A**		SLU168	AP3/AP4	
73-91	K30 & K35 4WD 16" 8 lug dual wheel		GQ64	QC160A**			AP3/AP4	
73-87	C30 2WD 16.5" 8 lug dual wheel					SLU168	AP3/AP4	
90-03	3500HD 19.5" 5 Lug Front/10 Lug Rear	NG961		QC1019			AP3/AP4	AML2*
03-10	C4500 19.5"x 6.00" 8 lug, wheel # 29717	NH4860		QC1019			AP3/AP4	AMG1*
90-10	C4500/C5500/C6500 19.5"x 6.75" 8 lug Kodiak/Topkick Wheel # 28680, 50180	NH8494		QC1019			AP3/AP4	AMG1*
19-C	C4500/C5500/C6500 19.5" x 6.75" 8 lug	NH8495		QC1019			AP3/AP4	AMH1

* AirMax® only fits DOTLiner® / ** Will not fit BUDD brand wheels

Wheel Simulator Application Guide

Chevrolet/GMC (cont.)

03-C	G2500/G3500 16" 8 lug single wheel van	NSG03		QC160A**				
85-02	G20/G30 & G2500/G3500 16" 8 lug single wheel van		GQST60	QC160A**				
03-C	G3500/G4500 16" 8 lug dual wheel van	GDG01			SLG116		AP3/AP4	AML1*
96-02	G3500 16" 8 lug dual wheel van	GDG92	GQ64	QC160A**		SLU168	AP3/AP4	AML1*
71-95	G30/P30 16" 8 lug dual wheel van		GQ64	QC160A**		SLU168	AP3/AP4	
75-03	P30 Van/motorhome 19.5" 5 Lug Front 10 lug Rear	NG961		QC1019			AP3/AP4	AML1*
85-C	16" 6 lug dual wheel 1 Piece Wheels Isuzu Cabover	N6664						AMM2
85-C	16" 6 lug dual wheel 2 Piece Wheels Isuzu Cabover	N6670						AMM2
84-C	17.5" 6 lug dual Isuzu Cabover	N6670						AMM2
99-C	19.5" 6 lug - Wheels Isuzu Cabover	N6681		QC1019 (will not fit gas with Accuride wheel)				AMM2*

Dodge/RAM

Year	MODEL	DOTLiner®	QuickLiner®	QuickCover®	Custom Liner®	Uni-Liner®	AirPlus®	AirMax®
94-02	2500 2WD/4WD 16" 8 lug single wheel		GQST60	QC160A**				
85-93	350 2WD 16" 8 lug single wheel		GQST60	QC160A**				
85-93	350 4WD 16" 8 lug single wheel		GQST60					
85-C	2500/3500 16" 8 lug single wheel van		GQST60	QC160A**				
03-C	3500 17" 8 lug dual wheel		QL74		SLD1703		AP3/AP4	
99-02	3500 2WD/4WD 16" 8 lug dual wheel	ND20	GQ64	QC160A**		SLU168	AP3/AP4	AML1*
94-98	3500 2WD/4WD 16" 8 lug dual wheel	GD816	GQ64	QC160A**		SLU168	AP3/AP4	AML1*
70-93	3500 2WD 16" 8 lug dual wheel	ND64	GQ64**	QC160A**		SLU168	AP3/AP4	AML1*
70-93	3500 4WD 16" 8 lug dual wheel Truck		GQ64				AP3/AP4	
67-90	3500 2WD 16.5" 8 lug dual wheel	ND64				SLU168	AP3/AP4	AML1*

* AirMax® only fits DOTLiner® / ** Will not fit BUDD brand wheels





Dodge/RAM (cont.)

Year	MODEL	DOTLiner®	QuickLiner®	QuickCover®	Custom Liner®	Uni-Liner®	AirPlus®	AirMax®
08-C	4500/5500 19.5" 10 lug 2WD/4WD Truck	ND1912					AP3/AP6	AML2*
08-10	Sterling Bullet Truck 19.5" 10 Lug	ND1912					AP3/AP6	AML2*
03-06	Sprinter 15" 6 lug dual wheel	NFS156						AML1*
06-C	Sprinter 16" 6 lug dual wheel		QS16					

Ford

Year	MODEL	DOTLiner®	QuickLiner®	QuickCover®	Uni-Liner®	AirPlus®	AirMax®
92-C	E250/E350 2WD 16" 8 lug single wheel van	NSF921		QC160A**			
85-91	E250/E350 2WD 16" 8 lug single wheel van			QC160A**			
07-C	E350/E450 17" 4WD dual wheel 8 lug Quigley conversion	NFQ17					
08-C	E350/E450 16" 8 lug dual wheel van 4 Oval Hand Hole	NF12	GQ64	QC160A**	SLU168	AP3/AP4	AML1*
92-07	E350/E450 16" 8 lug dual wheel van 8 Round Hand Hole	NF98	GQ62	QC160A**		AP3/AP5	AML1*
85-91	E350 16" 8 lug dual wheel van	GD816	GQ64	QC160A**	SLU168	AP3/AP4	AML1*
2003	E550 19.5" 8 lug van	NF22		QC1019		AP3/AP4	AML2*
2002	E550 19.5" 8 lug van	NF19		QC1019		AP3/AP4	AML2*
17-C	F150 17" 6 lug 8 Hand Hole		QLSF17				
03-04	F250/F350 2WD/4WD 16" 8 lug single wheel		GQST60	QC160A**			
99-02	F250/F350 2WD/4WD 16" 8 lug single wheel		GQST60	QC160A**			
92-98	F250/F350 2WD 16" 8 lug single wheel	NSF921		QC160A**			
92-98	F250/F350 4WD 16" 8 lug single wheel	NSF941					
05-C	F350 2WD/4WD 17" 8 lug dual wheel	NF23	QL74***				AML2*
03-04	F350 2WD/4WD 16" 8 lug dual wheel	GDF16	GQ64	QC160A**		AP3/AP4	AML1*
99-02	F350 2WD/4WD 16" 8 lug dual wheel	GDF17	GQ64	QC160A**		AP3/AP4	AML1*
85-98	F350 2WD 16" 8 lug dual wheel	GD816	GQ64	QC160A**	SLU168	AP3/AP4	AML1*
85-98	F350 4WD 16" 8 lug dual wheel	GD816	GQ64			AP3/AP4	AML1*
69-84	F350 2WD 16" 8 lug dual wheel		GQ64**	QC160A**	SLU168	AP3/AP4	
73-90	F350 2WD 16.5" 8 lug dual wheel				SLU168	AP3/AP4	
88-98	F-Super Duty 2WD 16" 10 lug dual wheel	NF10		QC160A**		AP3/AP4	AML1*
05-C	F450/F550 2WD/4WD 19.5" 10 lug Wheel # 29884	NF25				AP3/AP6	AML2*
03-04	F450/F550 2WD/4WD 19.5" 8 lug	NF22		QC1019		AP3/AP6	AML2*
99-02	F450/F550 2WD/4WD 19.5" 8 lug	NF19		QC1019		AP3/AP6	AML2*
99-C	F53 Motorhome chassis 19.5" x 6.75" 10 lug	NF20		QC1019		AP3/AP6	AML2*
04-C	F650 19.5" 10 Lug Wheel # 29195 Air brake	NH5092		QC1019		AP3/AP6	AMH1*
04-C	F650 19.5" 8 lug - Wheel #28680 & 50180 Hydraulic brake	NH8495		QC1019		AP3/AP6	AMH1*
99-03	F650 19.5" 8 lug Wheel #28680	NH8494		QC1019		AP3/AP6	AMH1*

* AirMax® only fits DOTLiner® / ** Will not fit BUDD brand wheels / *** Will not fit wheel #29837 w/square hand holes

Wheel Simulator Application Guide

Ford (cont.)

Year	MODEL	DOTLiner®	QuickLiner®	QuickCover®	Uni-Liner®	AirPlus®	AirMax®
90-98	F600/F700 19.5" 8 lug Wheel #28680	NH8494		QC1019		AP3/AP6	AMH1*
06-09	LCF Cabover 19.5" 10 lug	NF25				AP3/AP6	AML2*
15-C	Transit 16" 5 lug single rear wheel		QLST16				
15-C	Transit 2WD 16" 6 lug dual wheel	NF14					AML3

Freightliner

Year	MODEL	DOTLiner®	QuickCover®	AirPlus®	AirMax®
96-C	FL50/FL60/M2 19.5" 8 lug w/33mm hex lugnuts wheel #28680	NH8496	QC1019		AMH1*
92-96	FL50/FL60 19.5" 8 lug w/30mm hex lugnuts wheel #28680, 50180	NH8494	QC1019	AP3/AP4	AMH1*
94-C	FL60/FL70 19.5" 10 lug Wheel #29195	NH5092		AP3/AP4	AMH1*
02-C	Motorhome & M2 19.5" 6 lug, 2 Hand Hole		QC1019		
03-06	Sprinter 15" 6 lug dual wheel	NFS156			AML1*
06-C	Sprinter 16" 6 lug dual wheel		QS16		

Hino

Year	MODEL/ Description	DOTLiner®	QuickCover®	AirPlus®	AirMax®
90-10	16" 6 lug dual wheel, 1-Piece Wheel Cabover	N6664			AMM2
90-10	16" 6 lug dual wheel, 2-Piece Wheel Cabover	N6670			AMM2
90-03	17.5" 6 lug dual wheel Cabover	N6670			AMM2
04-10	165/185 19.5" 8 lug	NF19	QC1019	AP3/AP6	AML2*
04-C	258 19.5" 8 lug - Hydraulic brake Wheel #50180, 28680	NH8495	QC1019	AP3/AP4	AMH1*
04-C	258A 19.5" 10 lug - Wheel #29195 Air brake	NH5092	QC1019	AP3/AP4	AMH1*
90-12	19.5" 6 lug dual wheel Cabover	N6681	QC1019 (will not fit gas w/ Accuride wheel)		AMM2
13-C	19.5" 6 lug dual wheel Cabover	N6695			AMM2

International/Navistar

Year	MODEL	DOTLiner®	QuickCover®	AirPlus®	AirMax®
90-C	4300/4600/4700 19.5" 8 lug Wheel #28680, 50180	NH8495	QC1019	AP3/AP4	AMH1*
92-C	4300/4600/4700 19.5" 10 lug Wheel #29195	NH5092	QC1019	AP3/AP4	AMH1*
80-97	4600/4700 19.5" 6 lug		QC1019		
06-09	CF500/CF600 Cabover 19.5" 10 lug	NF25			AML2*
11-C	TerraStar 19.5" 10 lug Wheel #29884	NF25			AML2*

Isuzu

Year	MODEL/ Description	DOTLiner®	QuickCover®	AirPlus®	AirMax®
85-C	16" 6 lug dual wheel, 1-Piece Wheel Cabover	N6664			AMM2
85-C	16" 6 lug dual wheel, 2-Piece Wheel Cabover	N6670			AMM2
84-C	17.5" 6 lug dual wheel Cabover	N6670			AMM2
99-C	19.5" 6 lug Cabover	N6681	QC1019		AMM2*

* AirMax® only fits DOTLiner® / ** Will not fit BUDD brand wheels





Mitsubishi

Year	MODEL/ Description	DOTLiner®	QuickCover®	Custom Liner®	AirMax®
11-C	16" 5 lug dual wheel Cabover	N6559			AMM2
90-10	16" 6 lug dual wheel Cabover	N6664			AMM2
94-C	17.5" 6 lug dual wheel Cabover	N6670			AMM2
ALL	22.5" 8 or 10 lug dual wheel		QC1030		

UD/Nissan

Year	MODEL	DOTLiner®	QuickCover®	Custom Liner®	AirMax®
94-C	16" 6 lug dual wheel, 1-Piece Wheel Cabover	N6664			AMM2
90-C	16" 6 lug dual wheel, 2-Piece Wheel Cabover	N6670			AMM2
84-C	17.5" 6 lug dual wheel Cabover	N6670			AMM2
ALL	19.5" 6 lug 6 handhole Cabover	N6695			AMM2*

22.5" Wheels

Wheel #	Description	DOTLiner®	QuickCover®	AirPlus®	AirMax®
27403N	22.5" x 7.50" 10 lug Stud Pilot, 2 Hand Hole Front Axle	N252F	QC1025F		
	Rear Axle	N252R	QC1030R	AP3/AP4	AMH1*
	Full Set	N252	QC1030	AP3/AP4	AMH1*
27404N	22.5" x 8.25" 10 lug Stud Pilot, 2 Hand Hole Front Axle	N252F	QC1025F		
	Rear Axle	N252R	QC1030R	AP3/AP4	AMH1*
	Full Set	N252	QC1030	AP3/AP4	AMH1*
27685N	22.5" x 7.50" 10 lug Stud Pilot, 5 Hand Hole Front Axle	N552F	QC1025F		
	Rear Axle	N552R	QC1030R	AP3/AP4	AMH1*
	Full Set	N552	QC1030	AP3/AP4	AMH1*
27686NZ	22.5" x 8.25" 10 lug Stud Pilot, 5 Hand Hole Front Axle	N552F	QC1025F		
	Rear Axle	N552R	QC1030R	AP3/AP4	AMH1*
	Full Set	N552	QC1030	AP3/AP4	AMH1*
27833N	22.5" x 8.25" 10 lug Stud Pilot, 5 Hand Hole Front Axle	N552F	QC1025F		
	Rear Axle	N552R	QC1030R	AP3/AP4	AMH1*
	Full Set	N552	QC1030	AP3/AP4	AMH1*
27834N	22.5" x 8.25" 10 lug Hub Pilot, 5 Hand Hole Front Axle Set	NH552F	QC1025F		
	Rear Axle	NH552R	QC1030R	AP3/AP4	AMH1*
	Full Set	NH552	QC1030	AP3/AP4	AMH1*
27835N	22.5" x 8.25" 10 lug Hub Pilot, 2 Hand Hole Front Axle Set	NH252F	QC1025F		
	Rear Axle	NH252R	QC1030R	AP3/AP4	AMH1*
	Full Set	NH252	QC1030	AP3/AP4	AMH1*
28118	22.5" x 12.25" 10 lug, No Hand Hole 11.25" BC		QC1025F		
28120	22.5" x 12.25" 10 lug, No Hand Hole 11.25" BC		QC1025F		
28126	22.5" x 12.25" 10 lug, No Hand Hole 11.25" BC		QC1025F		
28128	22.5" x 13.00" 10 lug, No Hand Hole 11.25" BC		QC1025F		
28132	22.5" x 12.25" 10 lug, No Hand Hole 11.25" BC		QC1025F		
28157	22.5" x 6.75" 6 lug Stud Pilot, 6 Hand Hole		QC1030		

* AirMax® only fits DOTLiner® / ** Will not fit BUDD brand wheels

Wheel Simulator Application Guide

22.5" Wheels (cont.)

Wheel #	Description	DOTLiner®	QuickCover®	AirPlus®	AirMax®
28160	22.5" x 6.75" 10 lug Stud Pilot, 5 Hand Hole Front Axle		QC1025F		
	Rear Axle		QC1030R		
	Full Set		QC1030		
28165	22.5" x 12.25" 10 lug, No Hand Hole 11.25" BC		QC1025F		
28169	22.5" x 13.00" 10 lug, No Hand Hole 11.25" BC		QC1025F		
28192	22.5" x 9.00" 10 lug, No Hand Hole 11.25" BC		QC1025F		
28408	22.5" x 8.25" 10 lug Hub Pilot, 2 Hand Hole Front Axle Set	NH252F	QC1025F		
	Rear Axle	NH252R	QC1030R	AP3/AP4	AMH1*
	Full Set	NH252	QC1030	AP3/AP4	AMH1*
28415N	22.5" x 7.50" 8 lug, 4 Hand Hole Front Axle Set		QC1025F		
	Rear Axle		QC1030R		
	Full Set		QC1030		
28476	22.5" x 8.25" 10 lug Stud Pilot, 5 Hand Hole Front Axle	N552F	QC1025F		
	Rear Axle	N552R	QC1030R	AP3/AP4	AMH1*
	Full Set	N552	QC1030	AP3/AP4	AMH1*
28484	22.5" x 8.25" 8 lug, 4 Hand Hole Front Axle Set		QC1025F		
	Rear Axle		QC1030R		
	Full Set		QC1030		
28487	22.5" x 8.25" 10 lug Hub Pilot, 5 Hand Hole Front Axle Set	NH552F	QC1025F		
	Rear Axle	NH552R	QC1030R	AP3/AP4	AMH1*
	Full Set	NH552	QC1030	AP3/AP4	AMH1*
28510	22.5" x 9.00" 10 lug Stud Pilot, 2 Hand Hole Front Axle	N252F	QC1025F		
	Rear Axle	N259R	QC1030R		AMH1*
	Full Set	N259	QC1030		AMH1*
28542	22.5" x 9.00" 10 lug Hub Pilot, 2 Hand Hole Front Axle Set	NH252F	QC1025F		AMH1*
	Rear Axle	NH259R	QC1030R		AMH1*
	Full Set	NH259	QC1030R		AMH1*
28549	22.5" x 8.25" 10 lug Stud Pilot, 2 Hand Hole Front Axle	N252F	QC1025F		AMH1*
	Rear Axle	N252R	QC1030R	AP3/AP4	AMH1*
	Full Set	N252	QC1030	AP3/AP4	AMH1*
28624	22.5" x 12.25" 10 lug, 2 Hand Hole 285.75MM BC		QC1025F		
28624N	22.5" x 7.50" 10 lug Hub Pilot, 2 Hand Hole Front Axle Set	NH252F	QC1025F		
	Rear Axle	NH252R	QC1030R	AP3/AP4	AMH1*
	Full Set	NH252	QC1030	AP3/AP4	AMH1*
28684	22.5" x 13.00" 10 lug, No Hand Hole 11.25" BC		QC1025F		
28803	22.5" x 12.25" 10 lug, No Hand Hole 285.75MM BC		QC1025F		
28828	22.5" x 8.25" 10 lug Hub Pilot, 2 Hand Hole Front Axle Set	NH252F	QC1025F		
	Rear Axle	NH252R	QC1030R	AP3/AP4	AMH1*
	Full Set	NH252	QC1030	AP3/AP4	AMH1*

* AirMax® only fits DOTLiner® / ** Will not fit BUDD brand wheels





22.5" Wheels (cont.)

Wheel #	Description	DOTLiner®	QuickCover®	AirPlus®	AirMax®
28842	22.5" x 9.00" 10 lug Hub Pilot, 5 Hand Hole Front Axle Set	NH552F	QC1025F		
	Rear Axle	NH5259R	QC1030R		AMH1*
	Full Set	NH5259	QC1030		AMH1*
28869	22.5" x 6.75" 8 lug, 4 Hand Hole Front Axle Set		QC1025F		
	Rear Axle		QC1030R		
	Full Set		QC1030		
28889	22.5" x 12.25" 10 lug, No Hand Hole 11.25" BC		QC1025F		
29001	22.5" x 7.50" 10 lug Hub Pilot, 5 Hand Hole Front Axle Set	NH552F	QC1025F		
	Rear Axle	NH552R	QC1030R	AP3/AP4	AMH1*
	Full Set	NH552	QC1030	AP3/AP4	AMH1*
29028	22.5" x 7.50" 8 lug, 4 Hand Hole Front Axle Set		QC1025F		
	Rear Axle		QC1030R		
	Full Set		QC1030		
29039	22.5" x 9.00" 10 lug, 5 Hand Hole 285.75MM BC		QC1025F		
29054	22.5" x 12.25" 10 lug, No Hand Hole 285.75MM BC		QC1025F		
29056	22.5" x 12.25" 10 lug, 5 Hand Hole 285.75MM BC		QC1025F		
29057	22.5" x 13.00" 10 lug, No Hand Hole 285.75MM BC		QC1025F		
29058	22.5" x 13.00" 10 lug, 5 Hand Hole 285.75MM BC		QC1025F		
29146	22.5" x 13.00" 10 lug, 5 Hand Hole 285.75MM BC		QC1025F		
29147	22.5" x 12.25" 10 lug, 5 Hand Hole 285.75MM BC		QC1025F		
29174	22.5" x 13.00" 10 lug, 5 Hand Hole 285.75MM BC		QC1025F		
29183	22.5" x 12.25" 10 lug, 2 Hand Hole 11.25" BC		QC1025F		
29218	22.5" x 12.25" 10 lug, 2 Hand Hole 11.25" BC		QC1025F		
29220	22.5" x 12.25" 10 lug, 2 Hand Hole 11.25" BC		QC1025F		
29221	22.5" x 12.25" 10 lug 2 Hand Hole 11.25" BC		QC1025F		
29300	22.5" x 9.00" 10 lug Hub Pilot, 5 Hand Hole Front Axle Set	NH552F	QC1025F		
	Rear Axle	NH5259R	QC1030R		AMH1*
	Full Set	NH5259	QC1030		AMH1*
29301	22.5" x 13.00" 10 lug, 2 Hand Hole 11.25" BC		QC1025F		
29303	22.5" x 13.00" 10 lug, 5 Hand Hole 285.75MM BC		QC1025F		
50408	22.5" x 8.25" 10 lug Hub Pilot, 2 Hand Hole Front Axle Set	NH252F	QC1025F		
	Rear Axle	NH259R	QC1030R		AMH1*
	Full Set	NH259	QC1030		AMH1*
50487	22.5" x 8.25" 10 lug Hub Pilot, 5 Hand Hole Front Axle Set	NH552F	QC1025F		
	Rear Axle	NH5259R	QC1030R		AMH1*
	Full Set	NH5259	QC1030		AMH1*
87893E	22.5" x 7.50" 10 lug Stud Pilot, 2 Hand Hole Front Axle Set	N252F	QC1025F		
	Rear Axle	N252R	QC1030R	AP3/AP4	AMH1*
	Full Set	N252	QC1030	AP3/AP4	AMH1*

* AirMax® only fits DOTLiner® / ** Will not fit BUDD brand wheels

Wheel Simulator Application Guide

22.5" Wheels (cont.)

Wheel #	Description	DOTLiner®	QuickCover®	AirPlus®	AirMax®
87904E	22.5" x 8.25" 10 lug Stud Pilot, 5 Hand Hole Front Axle Set	N552F	QC1025F		
	Rear Axle	N552R	QC1030R	AP3/AP4	AMH1*
	Full Set	N552	QC1030	AP3/AP4	AMH1*
87905E	22.5" x 8.25" 10 lug Stud Pilot, 2 Hand Hole Front Axle Set	N252F	QC1025F		
	Rear Axle	N252R	QC1030R	AP3/AP4	AMH1*
	Full Set	N252	QC1030	AP3/AP4	AMH1*
87934E	22.5" x 8.25" 10 lug Stud Pilot, 5 Hand Hole Front Axle Set	N552F	QC1025F		
	Rear Axle	N552R	QC1030R	AP3/AP4	AMH1*
	Full Set	N552	QC1030	AP3/AP4	AMH1*
88884E	22.5" x 8.25" 8 lug, 4 Hand Hole Front Axle Set		QC1025F		
	Rear Axle		QC1030R		
	Full Set		QC1030		
89920E	22.5" x 8.25" 8 lug, 4 Hand Hole Front Axle Set		QC1025F		
	Rear Axle		QC1030R		
	Full Set		QC1030		
89921E	22.5" x 8.25" 10 lug Stud Pilot, 2 Hand Hole Front Axle Set	N252F	QC1025F		
	Rear Axle	N252R	QC1030R	AP3/AP4	AMH1*
	Full Set	N252	QC1030	AP3/AP4	AMH1*
90541E	22.5" x 8.25" 10 lug Hub Pilot, 2 Hand Hole Front Axle Set	NH252F	QC1025F		
	Rear Axle	NH252R	QC1030R	AP3/AP4	AMH1*
	Full Set	NH252	QC1030	AP3/AP4	AMH1*
90614E	22.5" x 7.50" 8 lug, 4 Hand Hole Front Axle Set		QC1025F		
	Rear Axle		QC1030R		
	Full Set		QC1030		
90631E	22.5" x 7.50" 10 lug Hub Pilot, 2 Hand Hole Front Axle Set	NH252F	QC1025F		
	Rear Axle	NH252R	QC1030R	AP3/AP4	AMH1*
	Full Set	NH252	QC1030	AP3/AP4	AMH1*
100-8901	22.5" x 8.25" 10 lug Stud Pilot, 2 Hand Hole Front Axle Set	N252F	QC1025F		
	Rear Axle	N252R	QC1030R	AP3/AP4	AMH1*
	Full Set	N252	QC1030	AP3/AP4	AMH1*
100-8910	22.5" x 8.25" 10 lug Hub Pilot, 2 Hand Hole Front Axle Set	NH252F	QC1025F		
	Rear Axle	NH252R	QC1030R	AP3/AP4	AMH1*
	Full Set	NH252	QC1030	AP3/AP4	AMH1*
100-9207	22.5" x 8.25" 10 lug Stud Pilot, 2 Hand Hole Front Axle Set	N252F	QC1025F		
	Rear Axle	N252R	QC1030R	AP3/AP4	AMH1*
	Full Set	N252	QC1030	AP3/AP4	AMH1*
R87460	22.5" x 8.25" 10 lug Stud Pilot, 2 Hand Hole Front Axle Set	N252F	QC1025F		
	Rear Axle	N252R	QC1030R	AP3/AP4	AMH1*
	Full Set	N252	QC1030	AP3/AP4	AMH1*

* AirMax® only fits DOTLiner® / ** Will not fit BUDD brand wheels





22.5" Wheels (cont.)

Wheel #	Description	DOTLiner®	QuickCover®	AirPlus®	AirMax®
R87540	22.5" x 7.50" 10 lug Stud Pilot, 2 Hand Hole Front Axle Set	N252F	QC1025F		
	Rear Axle	N252R	QC1030R	AP3/AP4	AMH1*
	Full Set	N252	QC1030	AP3/AP4	AMH1*
R93590	22.5" x 8.25" 10 lug Hub Pilot, 2 Hand Hole Front Axle Set	NH252F	QC1025F		
	Rear Axle	NH252R	QC1030R	AP3/AP4	AMH1*
	Full Set	NH252	QC1030	AP3/AP4	AMH1*
R93790	22.5" x 7.50" 10 lug Hub Pilot, 2 Hand Hole Front Axle Set	NH252F	QC1025F		
	Rear Axle	NH252R	QC1030R	AP3/AP4	AMH1*
	Full Set	NH252	QC1030	AP3/AP4	AMH1*

Trailer Simulators

MODEL	DOTLiner®	QuickLiner®	QuickCover®	AirPlus®	AirMax®
15" 5 lug or 6 lug single wheel	NST15	GQST50			
16" x 6" 8 lug single wheel w/ 1/2" & 9/16" studs	NST06	GQST60	QC160A**		
16.5" x 6.75" 8 lug single wheel w/ 1/2" & 9/16" studs	NST06				
16" 8 lug dual wheel w/ 5/8" studs	NDT165	GQT60**	QC160A**	AP3/AP4	AML1*
16.5" 8 lug dual wheel w/ 5/8" studs	NDT165			AP3/AP4	AML1*
17.5" x 6.75" single wheel w/ 5/8" studs	GDST175		QC175R / QCT175		
17.5" x 6.00" single wheel w/ 5/8" studs Armstrong wheels			QC175R / QCT175		
17.5" x 8.25" single wheel w/ 5/8" studs			QC175R / QCT175		
17.5" 6 lug dual wheel, 2 Hand Hole			QC175R / QCT175		
17.5" 8 lug dual wheel, 4 Hand Hole			QC175R / QCT175		
17.5" 10 lug dual wheel, 2 Hand Hole			QC175R / QCT175		

* AirMax® only fits DOTLiner® / ** Will not fit BUDD brand wheels





Ford

AFD16AL	'85-C E350 & E450 van dual wheel 16" 8 lug w/Alcoa access.
	'85-'98 F350 dual wheel 16" 8 lug w/Alcoa accessories
AFD9510ABS	'05-'16 F450-F550 19.5" 10 lug w/ABS chrome accessories
AFD17ABS	'17-C F450-F550 19.5" 10 lug w/ABS chrome accessories
AL195833SS	'04-C F650 19.5" 8 lug w/stainless QuickTrim® accessories
AL1958822	'04-C F650 19.5" 8 lug w/ABS chrome accessories
AL19510-33SS	'90-C F600 & F650 19.5" 10 lug w/ss QuickTrim® accessories
AL19510-33SSQ	'90-C F600 & F650 19.5" 10 lug w/ABS chrome accessories

Freightliner / International / Hino / Dodge

AL195833SS	19.5" 8 lug on 275mm B.C. w/stainless QuickTrim® accessories
AL1958822	19.5" 8 lug on 275mm B.C. w/ABS chrome accessories
AL19510-33SS	19.5" 10 lug on 285mm B.C. w/stainless QuickTrim® accessories
AL19510-33SSQ	19.5" 10 lug on 285mm B.C. w/ABS chrome accessories
AD08ABS	'08-'11 Dodge 4500/5500 19.5" 10 lug on 225mm B.C. w/ABS chrome accessories
AD12ABS	'12-C Dodge 4500/5500 19.5" 10 lug on 225mm B.C. w/ABS chrome accessories

Alcoa Hub Covers

3167	4.70" Push-thru cover used w/167041 wheel
3611	8" on 6.5" front dually cover w/medallion
3612	8" on 6.5" rear dually cover w/medallion

ALCOA Mounting Hardware



Two-Piece Flange Nuts for ALCOA Single & Dual Hub-Piloted Wheels

139987

1 1/16" hex - 9/16" x 18 RH threads
Mounts single and dual-piloted wheels.

39946

1 1/16" hex - 5/8" x 18 RH threads
Used with 661401 trailer wheels.

PH3324

22mm hex - 9/16" I.D. lugnut
Used with '08-'11 Dodge 4500/5500.

PH4327

22mm hex - 14mm I.D. lugnut
Used with '12-C Dodge 4500/5500.

ALCOA Chrome Plated ABS Lugnut Covers



78

Size: 7/8" / H=2.125"

79

Size: 7/8" / H=1.515"

190

Size: 1 1/16" / H=1.5"





QuickTrim®

Hub Covers for Aluminum Wheels

- No lugnut removal is required for installation.
- Our Ford hub covers offer a pop-out front for manual hubs.
- Our Lo-Pro hub covers offer pop-outs in front and rear for easy hub inspection.

See p.8-9 for available replacement air hoses.



Q820F



Lo-Pro with 30mm lugnuts
19.5" 8 lug on 275mm BC
(front)

Q820



Lo-Pro with 30mm lugnuts
19.5" 8 lug on 275mm BC
(rear)

Q822F



Lo-Pro with 33mm lugnuts
19.5" 8 lug on 275mm BC
(front)

Q822R



Lo-Pro with 33mm lugnuts
19.5" 8 lug on 275mm BC
(rear)

Q1102



'99-'04 F450 - F550 19.5"
8 lug Ford Super Duty (front)

Q1103



'99-'04 F450 - F550 19.5"
8 lug Ford Super Duty (rear)

QH1002F



'05-'16 F450 - F550 19.5"
10 lug Ford Super Duty (front)

QH1002R



'05-'16 F450 - F550 19.5"
10 lug Ford Super Duty (rear)

QuickTrim® Wheel Accessories

QH2001F



'17-C F450 - F550 19.5"
10 lug Ford Super Duty (front)

QH2001R



'17-C F450 - F550 19.5"
10 lug Ford Super Duty (rear)

QH1002DK



'08-'11 Dodge 4500/5500 19.5"
10 lug (full set)

QH1002DK12



'12-C Dodge 4500/5500 19.5"
10 lug (full set)

QH1200AS



Heavy duty 10 lug on 285mm
BC with 33mm lugnuts
front
(sold as a pair)

QH1300AS



Heavy duty 10 lug on 285mm
BC with 33mm lugnuts
rear
(sold as a pair)

*mount over ribbed jamnuts

QH1400F



22.5" 335mm BC
10 lug on 335mm BC
front
(sold as a pair)

*(must remove & reinstall
4 lugnuts)*

QH1401R



22.5" 335mm BC
10 lug on 335mm BC
rear
(sold as a pair)

*(must remove & reinstall
4 lugnuts)*

Q1022F

NEW!



Heavy duty 10 lug on 285mm
BC with 33mm lugnuts
(front single)

*(attaches via nut covers
screwing to excess lug stud.
Minimum of four threads
required for attachment.)*

Q1022R

NEW!



Heavy duty 10 lug on 285mm
BC with 33mm lugnuts
(rear single)

*(attaches via nut covers
screwing to excess lug stud.
Minimum of four threads
required for attachment.)*





QuickTrim®

Polished Stainless Steel Hub Covers for Steel and Aluminum Wheels

- No lugnut removal is required for installation (unless noted).
- Available in three styles.
- For use with all brands of aluminum wheels



Medium Duty Hub Covers

Medium Duty hub covers feature exclusive bolt-on mounting bracket.

Medium duty trucks - approx. 6.5" axle end cap diameter

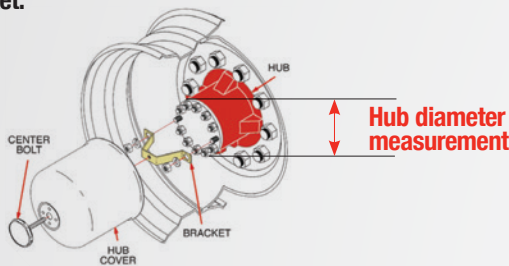

Heavy Duty Rear Hub Covers

Our patented QuickClips make installation quick, simple and secure.

Heavy duty trucks - approx. 8.5" axle end cap diameter; 3.5"-5" hub protrusion from wheel face required

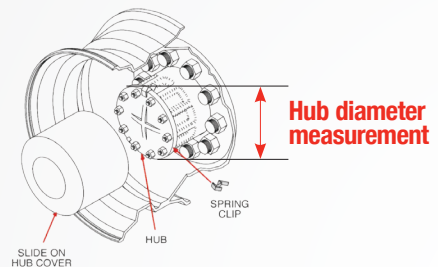

Front Under-lug



C023SS
8 lug on 275mm BC
(requires lugnut removal)

Rear Under-lug



C033SS
8 lug on 275mm BC
(requires lugnut removal)

Clip-Mount (Rear)



Q938
Heavy trucks w/ 8 lug Wheels
8.25" hub diameter

Q247
Heavy trucks w/ 10 lug Wheels
8.25" hub diameter
(3 spring clip attachment w/pop out)

Hex-bolt Center (Rear)



Q1009
Medium trucks w/ 8 lug Wheels
2.88" hex bolt length
6.25" hub diameter

Q1010
Medium trucks w/ 8 lug Wheels
3.5" hex bolt length
6.25" hub diameter

Q1020
Heavy trucks w/ 8 lug Wheels
2.88" hex bolt length
8.25" hub diameter

Q2010
Medium trucks w/ 10 lug Wheels
2.88" hex bolt length
6.25" hub diameter

Q2020
Heavy trucks w/ 10 lug Wheels
2.88" hex bolt length
8.25" hub diameter

Hex bolt tool



PH1763TOLK
For use with hexbolt center rear and baby moon front hub covers

Heavy Duty Front Hub Covers

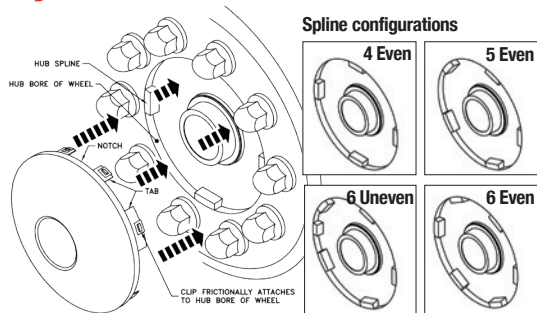

Smooth Pop-Out Hub Cover



Q1401B

4 spline front pop-out

Q1501B

5 spline front pop-out

Emblem Pop-Out Hub Cover



Q1402B

4 spline front pop-out

Q1502B

5 spline front pop-out

Q1602B

6 uneven spline front pop-out

CLPH275

2.75" Phoenix USA™ Logo emblem



Open Hub Cover



Q1400

4 spline front pop-out
2.75" open center

Q1403

4 spline front pop-out
5.3" open center

Q1500

5 spline front pop-out
2.75" open center

Q1503

5 spline front pop-out
5.3" open center

Q1703

6 even spline front pop-out
5.3" open center

Universal Lugnut Cover Pullers



901

For use with any brand of 1" or larger lugnut covers.

Polished Stainless Steel Lugnut Covers



SP27

30mm x 2 1/16"



SP35

30mm x 2 9/16" (Tall)



SP17

33mm x 2 1/16"



SP33

33mm x 2 9/16" (Tall)

Other sizes available.

Chrome ABS Lugnut Covers

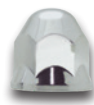

Q33

33mm hex x 2"



Q33T

33mm hex x 2.8"

Lugnut Rotation Indicator



Q33SNP

- Slips tightly over Phoenix USA brand SP17 & SP33 lugnut covers
- "Quick check" visual safety cue indicates possibility of dangerously loose lugnuts.

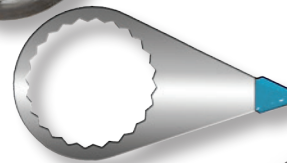

Indicating Safe

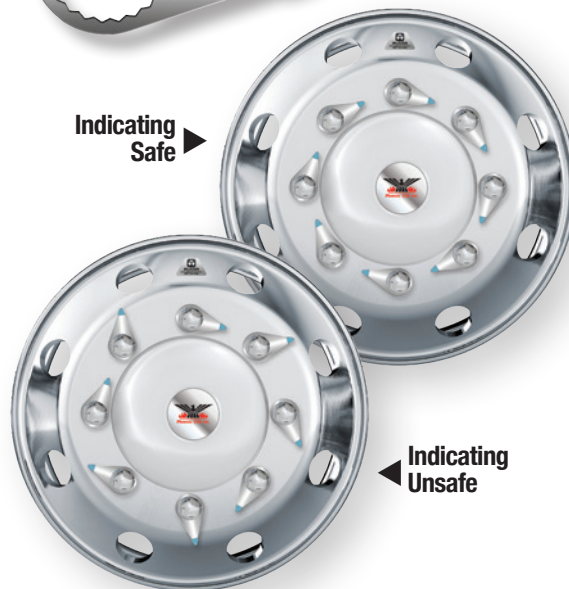

Indicating Unsafe





QuickTrim®

Hub Covers for Trailers

- ABS hub covers
- Made from temperature-stable plastic for years of durable service
- Available in 5-, 6-, and 8-lug applications in either white, black or chrome

White ABS Hub Covers



QT545WHS
5 lug on 4.5" BC
1 5/8" emblem indent

QT655WHN
6 lug on 5.5" BC
2.75" emblem indent

Black ABS Hub Covers



QT545BHS
5 lug on 4.5" BC
1 5/8" emblem indent

QT655BHN
6 lug on 5.5" BC
2.75" emblem indent

QT765BHN
8 lug on 6.5" BC
(7K axle) with 13/16" lugnut hex
2.75" emblem indent

Lugnut for Aluminum Wheel Applications



PQT50LNAD
1/2" trailer lugnut
Custom-made lugnut designed for aluminum wheel applications. External notches provide multiple hub cover mounting points.

Chrome ABS Hub Covers



QT545CHN
5 lug on 4.5" BC
2.75" emblem indent



QT545CHS
5 lug on 4.5" BC
1 5/8" emblem indent



QT545CH4
5 lug on 4.5" BC
2.75" emblem indent

QT550CH4
5 lug on 5" BC with
13/16" hex lugnuts
2.75" emblem indent



QT655CHN
6 lug on 5.5" BC
2.75" emblem indent



QT765CHN
8 lug on 6.5" BC
(7K axle) with 13/16" lugnut hex
2.75" emblem indent

QT865CHN
8 lug on 6.5" BC
(8K axle) with 7/8" lugnut hex
2.75" emblem indent

QT965CHN
8 lug on 6.5" BC
(9K-10K axle) with 1 1/16" lug stud diameter
pop-out center with 2.75" emblem indent
Includes three ribbed attachment nuts per hub cover

Chrome ABS Trim Rings



1403
14" trim rings
(set of 4)

1503
15" trim rings
(set of 4)

1603
16" trim rings
(set of 4)

QuickTrim® Wheel Accessories

Chrome ABS Wheel Covers



6-Lug Chrome ABS Hub Cover

Chrome ABS Wheel Cover

ABS wheel covers installed with QuickTrim® hub covers give the look of aluminum wheels while maintaining the strength of the factory steel wheel.

QT544CLO

14" chrome ABS
5 lug on 4.5" BC
(use with QT545CHS, QT545CHN & QT545CH4)

QT545CLO

15" chrome ABS
5 lug on 4.5" BC
(use with QT545CHS, QT545CHN & QT545CH4)

QT655CLO

15" chrome ABS
6 lug on 5.5" BC
5 lug on 5" BC
(use with QT655CHN & QT550CH4)

QT6556CLO

16" chrome ABS
6 lug on 5.5" BC
(use with QT655CHN)

QT865CLO

16" chrome ABS
8 lug on 6.5" BC
(use with QT765CHN, QT865CHN)

Stainless Steel Baby Moon



1307SS

Polished stainless steel
Applications include, but are not limited to:

- 5 on 4.5" bolt circle
- 6 on 6.5" bolt circle
- 13", 14" & 15" diameter conventional wheels

1309SS

Polished stainless steel
Applications include, but are not limited to:

- 6 on 5.5" bolt circle
- 8 on 6.5" bolt circle
- 16" diameter conventional wheels

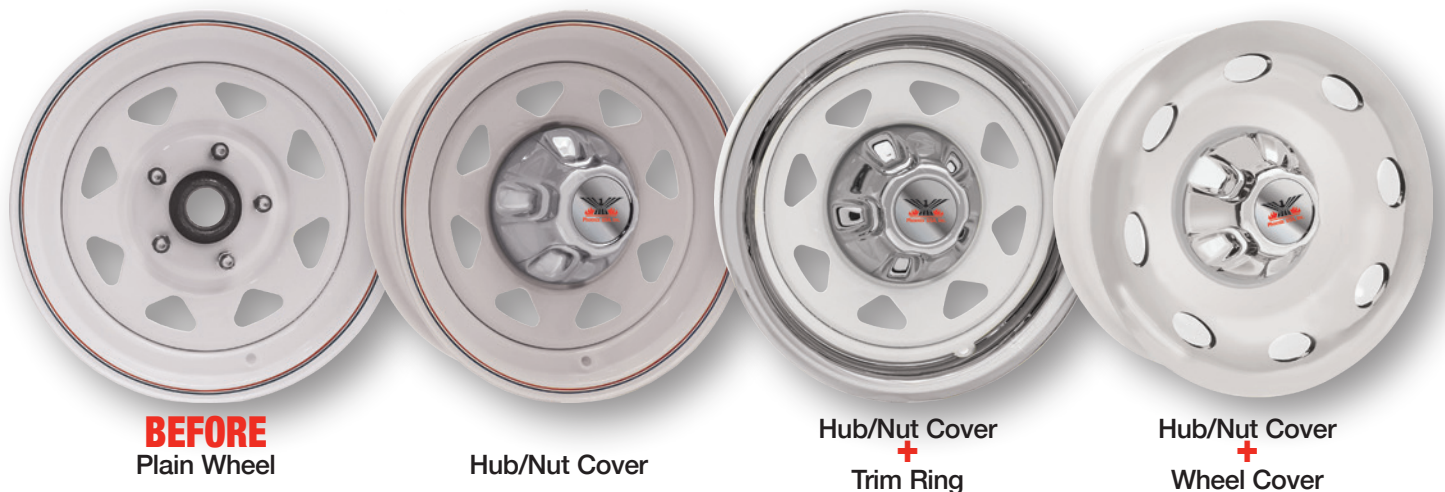

BEFORE
Plain Wheel

Hub/Nut Cover

Hub/Nut Cover
+
Trim Ring

Hub/Nut Cover
+
Wheel Cover





QuickTrim®

Wheel Covers for Golf Carts & Mowers

- Stainless steel and ABS covers
- All utilize easy, one-piece snap on design.
- Some designs also fit tow dolly wheels.

Stainless Steel Golf Cart/Mower Wheel Covers



R2512

8" stainless steel baby moon
Fits tow dolly wheels as well as many standard golf cart wheels.



5-spoke Mag Style ABS

QT8CHM

8", 5-spoke
Fits most standard mower rear wheels, spring clip retention.

QT6CHM

6", 5-spoke
Fits most standard mower rear wheels, spring clip retention.



Sawblade Style ABS

QT8CH

8"
Fits tow dolly wheels as well as many standard golf cart wheels.

Chrome ABS Golf Cart/Mower Wheel Covers



Beadlock Style ABS

QT12CHB

12", 8 hole
Fits most standard mower rear wheels, spring clip retention.

QT10CHB

10", 8 hole
Fits most standard mower rear wheels, spring clip retention.

QT8CHB

8", 8 hole
Fits most standard mower rear wheels, spring clip retention.



QT6CHBH

6", 8 hole
Open 60mm hub for front ZR caster wheels

Trimmer Storage & Security Rack

SPDDTR3

Installed: 42"W x 53"H x 4"D

- Prevents scratching, denting and rotation during transport.
 - Robust lockout & security plate prevents tampering.
- Bright green color increases visibility for safety.
- Powdercoat finish & stainless steel latches help resist elements.
 - Locking plate allows one lock to secure all three tools.
- Remove one tool from any of the three positions without releasing others.



(Trimmers not included)

Other products for the landscaping industry:



Tear-away Stuff Pack

SP10SP

Hook and loop fastener directly to your equipment or clip on with carabineer latch.

- 10" W x 6" H
- 2 zipper pockets
- carabineer latch
- adhesive hook and loop fastener back

STMD

Mounting brackets not included - see page 33.



Black Powder Coated Steel Toolbox

- 13 gauge steel construction
- Stainless steel hardware
- T-style, single-point latch
- Automotive bulb seal

STMD24

24" L x 18" D x 18" H
Door Opening: 19" L x 14" H
Weight: 66 lbs.

STMD48

48" L x 18" D x 18" H
Door Opening: 43" L x 14" H
Weight: 111 lbs.

STMD30

30" L x 18" D x 18" H
Door Opening: 25" L x 14" H
Weight: 76 lbs.

STMD60

60" L x 18" D x 18" H
Door Opening: 55" L x 14" H
Weight: 133 lbs.

STMD36

36" L x 18" D x 18" H
Door Opening: 31" L x 14" H
Weight: 88 lbs.

SSTSD

Mounting brackets not included - see page 33.



Stainless Steel Toolbox with Stainless Steel Door

- 13 gauge stainless steel construction
- Stainless steel hardware
- T-style, single-point latch (60" boxes = 3-point latch)
- Automotive bulb seal

Mirror Polished Stainless Steel Door

- Smooth, mirror-like finish
- Rolled top edge for increased rigidity
- No unsightly cross-breaks

SSTSD24

24" L x 18" D x 18" H
Door Opening: 19" L x 14" H
Weight: 66 lbs.

SSTSD36

36" L x 18" D x 18" H
Door Opening: 31" L x 14" H
Weight: 88 lbs.

SSTSD30

30" L x 18" D x 18" H
Door Opening: 25" L x 14" H
Weight: 77 lbs.

Part #s ending in "A": Hansen Compression Latch

- 1.5mm stainless steel body
- Ergonomic twist-latch grip
- Single-point latch (60" boxes = 3-point latch)
- Compression latch creates tight seal
- Mount with "L" style brackets

SSTSD48A

48" L x 18" D x 18" H
Door Opening: 43" L x 14" H
Weight: 111 lbs.

SSTSD60A

60" L x 18" D x 18" H
Door Opening: 55" L x 14" H
Weight: 136 lbs.





STSD

Mounting brackets not included - see page 33.



Black Powder Coated Steel Toolbox with Stainless Steel Door

- 13 gauge stainless steel construction
- Stainless steel hardware
- Automotive bulb seal

Mirror Polished Stainless Steel Door

- Smooth, mirror-like finish
- Rolled top edge for increased rigidity
- No unsightly cross-breaks

Hansen Compression Latch

- Stainless steel construction
- Ergonomic twist-latch grip
- Single-point latch (60" boxes = 3-point latch)
- Compression latch creates tight seal

STSD24A

24" L x 18" D x 18" H
Door Opening: 19" L x 14" H
Weight: 66 lbs.

STSD48A

48" L x 18" D x 18" H
Door Opening: 43" L x 14" H
Weight: 111 lbs.

STSD30A

30" L x 18" D x 18" H
Door Opening: 25" L x 14" H
Weight: 77 lbs.

STSD60A

60" L x 18" D x 18" H
Door Opening: 55" L x 14" H
Weight: 136 lbs.

STSD36A

36" L x 18" D x 18" H
Door Opening: 31" L x 14" H
Weight: 88 lbs.

SUSS

Mounting brackets not included - see page 33.



Slider Box

- Slide-away door helps keep operators at a safer distance from traffic
- 13 gauge steel construction
- High-gloss automotive powdercoat finish
- Stainless steel hardware
- Automotive bulb seal

Mirror Polished Stainless Steel Door

- Smooth, mirror-like finish
- Paddle-style latch
- No unsightly cross-breaks

SUSS48

48" L x 20" D x 21" H
Weight: 110 lbs.



STMRD/ST3MRD

Mounting brackets not included - see page 33.



Black Powder Coated Steel Toolbox

- 13 gauge steel construction
- High-gloss automotive powdercoat finish
- Stainless steel hardware
- T-style, single-point latch (≥30" boxes = 3-point latch)
- Automotive bulb seal
- Door has rolled top edge for increased rigidity
- No unsightly cross-breaks

STMRD24

24" L x 18" D x 18" H
Door Opening: 19" L x 14" H
Weight: 57 lbs.

ST3MRD48

48" L x 18" D x 18" H
Door Opening: 43" L x 14" H
Weight: 120 lbs.

ST3MRD30

30" L x 18" D x 18" H
Door Opening: 25" L x 14" H
Weight: 81 lbs.

ST3MRD60

60" L x 18" D x 18" H
Door Opening: 55" L x 14" H
Weight: 137 lbs.

ST3MRD36

36" L x 18" D x 18" H
Door Opening: 31" L x 14" H
Weight: 93 lbs.

78" Tow Box

Mounting brackets not included - see page 33.

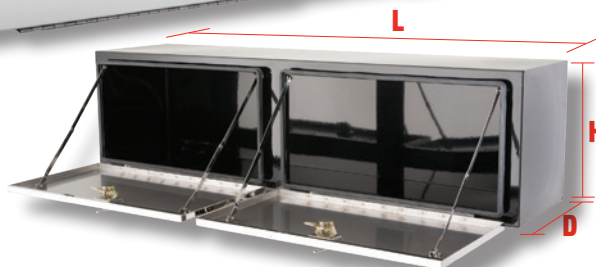

78" Toolbox with Two Stainless Steel Doors

- Can be top or underbody mounted
- 13 gauge steel construction
- High-gloss automotive powdercoat finish
- Stainless steel hardware
- Automotive bulb seal

Mirror Polished Stainless Steel Doors

- Smooth, mirror-like finish
- Integrated, quick-release gutter door design
- Polished stainless steel scissor straps that can be unhooked to drop doors 180°
- Hansen compression latch

STTB78A

78" L x 20" D x 21" H
Door Opening: 34" L x 17" H
Weight: 209 lbs.

Step Box

Mounting brackets not included - see page 33.



- Aluminum body
- 3-step (bottom to top: 5"D, 5"D, 12"D)
- Polished diamond plate door
- T-style, single-point latch/handle
- Stainless, hinged lock cover
- Serrated anti-slip channel on all three steps

ASBDD12

12" W x 25" H x 28" D

ASBDD30

30" W x 25" H x 28" D

ASBDD18

18" W x 25" H x 28" D

ASBDD36

36" W x 25" H x 28" D

ASBDD24

24" W x 25" H x 28" D





Toolbox Features

Our toolboxes have distinct features that are available according to model and/or size of toolbox. The chart below distinguishes these features and their availability per toolbox.



	SSTD/SST3SD (see page 27)	STSD/ST3SD (see page 28)	STMD (see page 27)	STMRD/ST3MRD (see page 29)
13-gauge steel construction	24", 30", 36"	24", 30", 36", 48", 60"	24", 30", 36", 48", 60"	24", 30", 36", 48", 60"
1.5mm steel construction	48", 60"			
Black, automotive grade, powder-coated body	-----	24", 30", 36", 48", 60"	24", 30", 36", 48", 60"	24", 30", 36", 48", 60"
Black, automotive grade, powder-coated door	-----	-----	24", 30", 36", 48", 60"	24", 30", 36", 48", 60"
Machine finish, stainless steel body	24", 30", 36", 48", 60"	-----	-----	-----
Mirror-polished, stainless steel door	24", 30", 36", 48", 60"	24", 30", 36", 48", 60"	-----	-----
Stainless steel hardware	24", 30", 36", 48", 60"	24", 30", 36", 48", 60"	24", 30", 36", 48", 60"	24", 30", 36", 48", 60"
 Patented rigid, rolled-edge door	24", 30", 36", 48", 60"	24", 30", 36", 48", 60"	-----	24", 30", 36", 48", 60"
 Piano-style door hinge	24", 30", 36", 48", 60"	24", 30", 36", 48", 60"	24", 30", 36", 48", 60"	24", 30", 36", 48", 60"
 t-handle latch (PH3199 has lock cover)	(PH3199) 24", 30", 36"	(PH3199) 24", 30", 36", 48", 60"	(PH1283) 24", 30", 36", 48", 60"	(PH3199) 24", 30", 36", 48", 60"
 Hansen latch	48", 60"	24", 30", 36", 48", 60"	-----	-----
 Single handle, 3-point latch	60" (SST3SD60)	60" (ST3SD60)	-----	30", 36", 48", 60"
Automotive-grade bulb seal	24", 30", 36", 48", 60"	24", 30", 36", 48", 60"	24", 30", 36", 48", 60"	24", 30", 36", 48", 60"
 Carabiner latch-style door support cables	24", 30", 36", 48", 60" (Black = as available via inventory replenishment)	24", 30", 36", 48", 60"	-----	24", 30", 36", 48", 60"
 Rear vent hole	24", 30", 36", 48", 60" (Black = as available via inventory replenishment)	24", 30", 36", 48", 60"	-----	24", 30", 36", 48", 60"
 Bottom drain hole with plug	24", 30", 36", 48", 60" (Black = as available via inventory replenishment)	24", 30", 36", 48", 60"	-----	24", 30", 36", 48", 60"
Top mountable	24", 30", 36", 48", 60"	24", 30", 36", 48", 60"	24", 30", 36", 48", 60"	24", 30", 36", 48", 60"

3-Drawer 24" Toolboxes

Mounting brackets not included - see page 33.

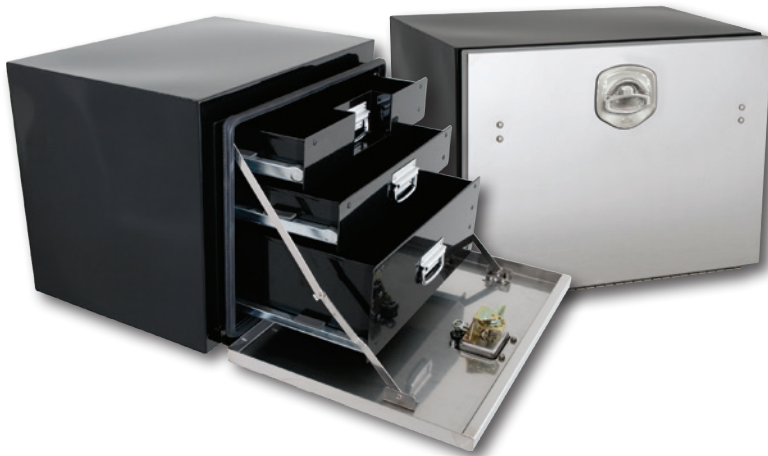

3-Drawer 24" Toolbox with Stainless Steel Door

- 13 gauge steel construction
- Polished Stainless Steel door
- Top or underbody mount
- Scissor straps
- Two 3" deep drawers, One 6" deep drawer

STSD24D3A

Outside Dimensions: 24" L x 18" D x 18" H
Weight: 98 lbs.



3-Drawer 24" Toolbox with Black Powdercoated Steel Door

- 13 gauge steel construction
- Top or underbody mount
- Scissor straps
- Two 3" deep drawers, One 6" deep drawer

STMRD24D3

Outside Dimensions: 24" L x 18" D x 18" H
Weight: 96 lbs.

2-Drawer Toolbox Insert



2-Drawer 24" Toolbox Insert

- Fits all Phoenix (and most competitor) boxes 36" or longer
- 13 gauge steel construction

(will NOT fit in 24" box)

TB2DK

Outside Dimensions: 24" L x 14" D x 13" H
Weight: 47 lbs.

*48" toolbox not included

Drawer Dividers

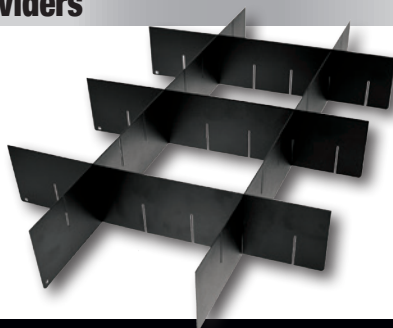

Adjustable Drawer Divider

- Add up to 12 compartments to a drawer
- 13 gauge steel construction
- Each panel = 19.5" x 12.82" x 3"
- Six interlocking notches per panel to adjust compartment sizes

TBP01DV





Heavy Duty Mesh Bottom Basket and Dress Plate

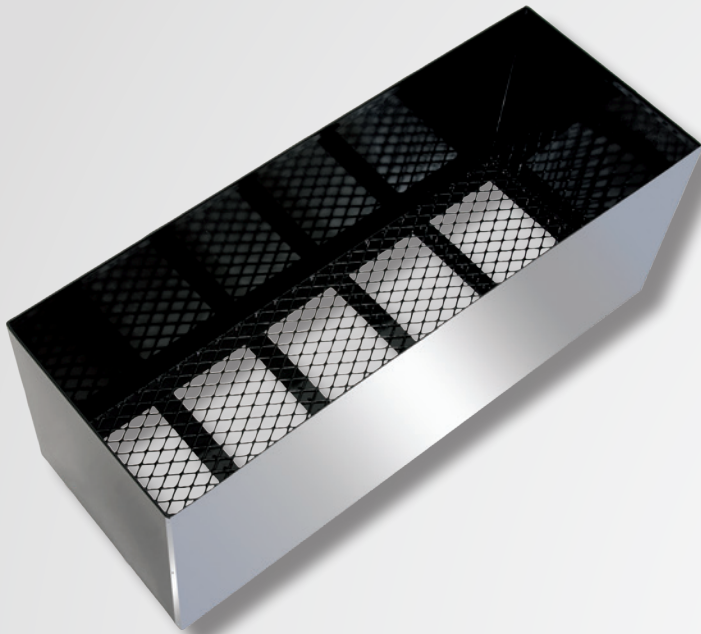

Mesh Bottom Basket

- Powdercoated
- Solid sides with mesh bottom only
- Solid metal construction

SUBMB36

Outside Dimensions:
36" L x 18" D x 18" H
Weight: 48 lbs.

SUBMB36DP

36" Mesh bottom basket
dress plate

SUBMB48

Outside Dimensions:
48" L x 18" D x 18" H
Weight: 58 lbs.

SUBMB48DP

48" Mesh bottom basket
dress plate

SUBMB60

Outside Dimensions:
60" L x 18" D x 18" H
Weight: 90 lbs.

SUBMB60DP

60" Mesh bottom basket
dress plate

Mesh Bottom Basket Dress Plate

- Mirror polished stainless steel
- Grooved top edge and predrilled side holes for easy mounting (mounting screws included)

Underbody Mesh Drawer



- Powdercoated, solid metal construction
- Auto-close latch
- Polished stainless fascia door
- Pull-out mesh basket
- 500 lb. working load limit
- Stainless rollers
- Holes on all sides of basket for easy strapping

SSUD30

Outside Dimensions: 30" L x 28.5" D x 18.5" H
Inner Drawer Dimensions: 27" x 25.5"
Weight: 105 lbs.

Fender Basket



- Galvanized steel
- Solid sides with mesh bottom
- Mirror polished stainless steel side plate

BF36QF21L

Left side
21" wide fender
Open top: 36"L x 18"W
Bottom: 26"L x 18"W

BF36QF21R

Right side
21" wide fender
Open top: 36"L x 18"W
Bottom: 26"L x 18"W

BF48QF21L

Left side
21" wide fender
Open top: 48"L x 18"W
Bottom: 38"L x 18"W

BF48QF21R

Right side
21" wide fender
Open top: 48"L x 18"W
Bottom: 38"L x 18"W

Toolbox Mounting Brackets

TBP002



- One pair of L-arm mounting brackets
- 24"-48" box application
 - 24" x 24"

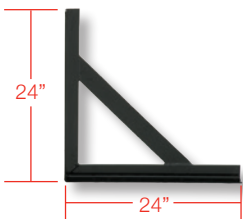

TBP007



- One pair of Super HeavDuty L-arm mounting brackets with mounting hardware
- 24"-78" box application
 - 33" x 19"

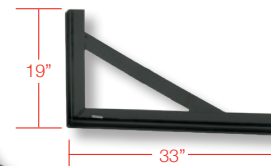

TBP003

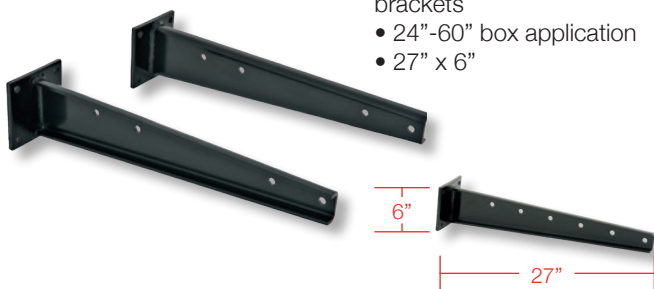

- One pair of side-mounting brackets
- 24"-60" box application
 - 27" x 6"



TBP008

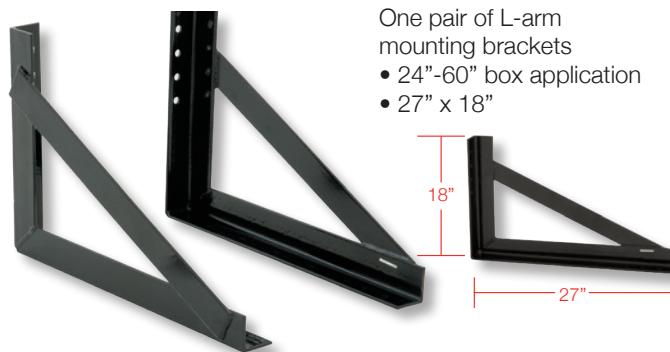

- One pair of L-arm mounting brackets
- 24"-60" box application
 - 27" x 18"

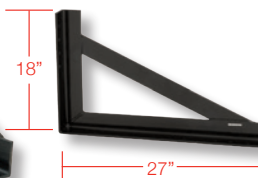

TBP004



- One pair of L-arm mounting brackets
- 24"-60" box application
 - 26" x 26"

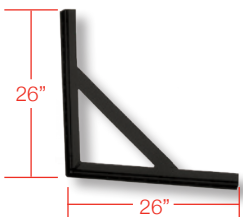

TBP013

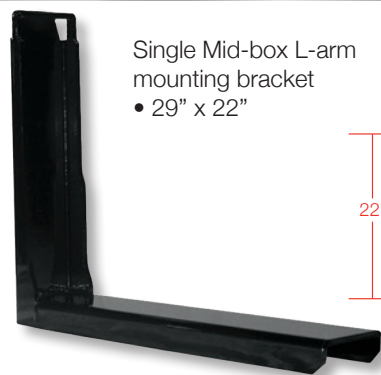

- Single Mid-box L-arm mounting bracket
- 29" x 22"

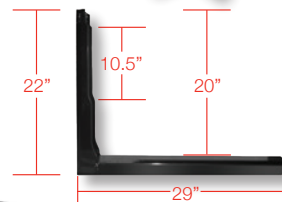

TBP006



(front view)

- Single sandwich bracket with mounting hardware
- 33" x 19"

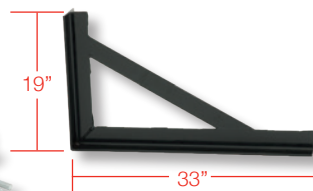

TBP014

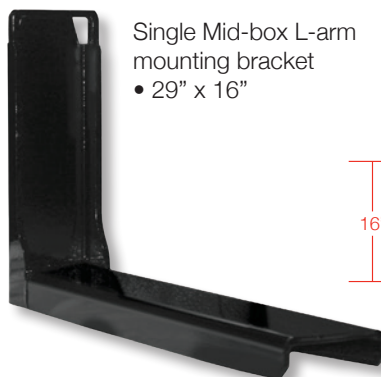

- Single Mid-box L-arm mounting bracket
- 29" x 16"

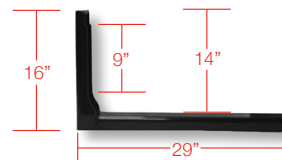



Top Mount Storage Tray

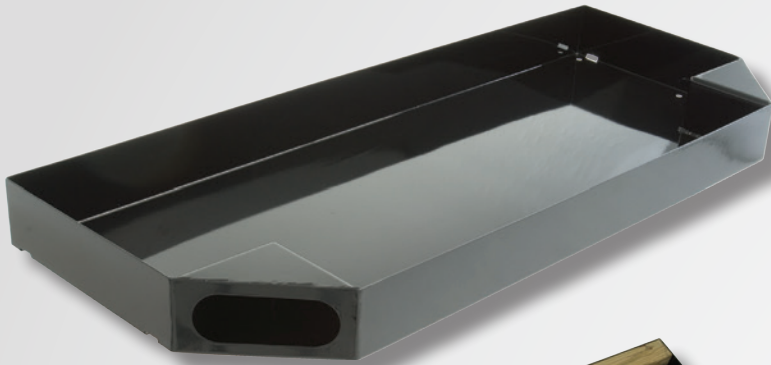

Black Powdercoated Top Mount Storage Tray

- 13 gauge steel construction
- High-gloss automotive powdercoat finish
- Drain holes to keep water out of tray
- Space prepared for two optional oval stop/turn/tail lights (see "Optional LED Lighting" below)
- Optional mounting clips (PH2967) allow secure storage while providing easy access.

Note: there is a 2" overhang on the back when used with any 18" D box.

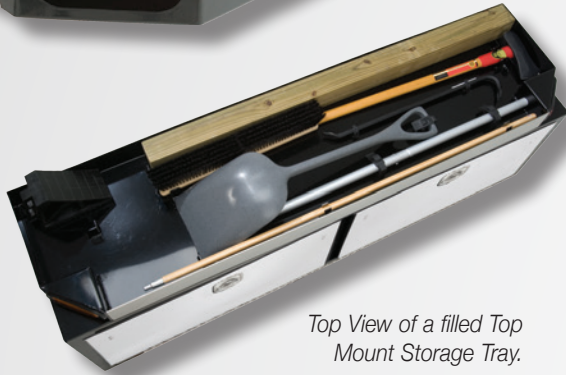

Top View of a filled Top Mount Storage Tray.

SUTB36ST

36" L x 20" H x 4" D

SUTB60ST

60" L x 20" H x 4" D

SUTB48ST

48" L x 20" H x 4" D

SUTB78ST

78" L x 20" H x 4" D

Optional LED Top Mount Storage Tray Lighting Kit

PL650VLALK

Amber

6.5" oval LED with grommet & pigtail

PL650VLRK

Red

6.5" oval LED with grommet & pigtail



Top Mount Storage Tray Dress Plate



Stainless Steel Dress Plate

- Smooth, mirror-polished finish
- Dress up your storage tray or add to match stainless steel box applications

SUTB36DP

36"

SUTB60DP

60"

SUTB48DP

48"

SUTB78DP

78"

Mounting Clip



PH2967

Use to secure anything from tools to hoses. Recommended for use with Top Mount Storage Trays to secure items while still providing easy access.

Rubber Mat Toolbox Liner



TBP2059

35" x 18" x 1/8"

TBP2060

47" x 18" x 1/8"

TBP2061

59" x 18" x 1/8"

TBP2062

77" x 18" x 1/8"

Adjustable Toolbox Shelf



- Galvanized steel
- Single shelf and two end brackets
- Adjustable to three different heights
- Fits virtually any 18" D x 18" H toolbox (order length that matches length of box).

SUSD24SK
24"

SUSD48SK
48"

SUSD36SK
36"

SUSD60SK
60"

LED Lighting



- High output LED lights
- Weather resistant
- Built in On/Off switch
- Includes two snap-fit mounting brackets

PLSL06
6" L x 3/8" H x 5/8" W

PLSL36
35.4" L x 3/8" H x 5/8" W

PLSL12
12" L x 3/8" H x 5/8" W

PLSL48
47.2" L x 3/8" H x 5/8" W

PLSL24
23.6" L x 3/8" H x 5/8" W

PLSLC
Replacement mounting brackets
3/4" L x 5/8" W x 3/8" H

Portable Air Compressor



- AC12V3**
- 12V
 - 3 gallon tank
 - 3/4 hp motor
 - 0-120 psi in just 90 seconds
 - Vibration dampening feet
 - Fits any 18" x 18" x 24" or larger toolbox

AC12V3PK
Air compressor Kit Includes:

- Air compressor
- Hose reel (HR3825)
- 50 amp breaker
- Compressor-to-reel hose

Retractable Hose Reel



- HR3825**
- 25' long 3.8" diameter hose
 - Spring-driven drum allows automatic rewind.
 - Locking ratchet holds desired length during use.
 - Fits inside any 18" D x 18" H or larger toolbox





Rotation Kit



Save time and money by stocking your tow necessities in one comprehensive kit that includes:

ROTATION

- Shovel - 40" square
- SAE Lug Wrench - 20"
- Metric Lug Wrench - 20"
- Bolt Cutters - 24"
- Scotch Block
- Air Tank - 5 gal.
- Maul Axe - 36", 6 lbs.
- First Aid Kit - 25 person
- Pry Bar - 36"
- Triangle Kit (PH3247)
- Jack - 2 1/2 ton
- Trash Can (x 2) (PH3819)
- Shop Broom - 60" L, 24" head
- Snatch Block - 4 ton

Trash Can



- Powdercoated steel
- 15"H x 15"L x 8"W
- 5.5 gal. capacity
- Hinged, latch-close lid

PH3819

Jerry Can



- Powdercoated steel
- 16"H x 13.3"L x 6.5"W
- 4.5 gal. capacity

PH3815

Not recommended for use with fuel or corrosives.

Booster Cable Assembly

JumpMax[®]



- Constructed from 4 gauge copper wire
- Removeable handle
- All necessary hardware and dust cap included in kit.

JM254
25' kit
4' harness

JM25-10
25' kit
10' harness

JM304
30' kit
4' harness



PJM30PC
Replacement plug



PJM30RC
Replacement clamp - pos
PJM30BC
Replacement clamp - neg



PJM30DC
Replacement dust cap

Toolbox Replacement Parts

Replacement Stainless Steel Door Assembly



PSTSD24DC

24" toolbox door
(for toolbox STSD24)

PSTSD30DC

30" toolbox door
(for toolbox STSD30)

PSTSD36DC

36" toolbox door
(for toolbox STSD36)

PSTSD48DC

48" toolbox door
(for toolbox STSD48)

PSTSD60DC

60" toolbox door
(for toolbox STSD60)

PST3SD60DC

60" 3-point-latch toolbox door
(for toolbox ST3SD60)

PSTTB78DC

78" toolbox door
(for toolbox STTB78)

Replacement doors include standard t-latch. Add "A" before "DC" in part number for door with Hansen Compression latch.

Replacement Black Powdercoated Single-point Latch Door Assembly



PSTMRD24DC

24" toolbox door
(for toolbox STMRD24)

PSTMRD30DC

30" toolbox door
(for toolbox STMRD30)

PSTMRD36DC

36" toolbox door
(for toolbox STMRD36)

PSTMRD48DC

48" toolbox door
(for toolbox STMRD48)

PSTMRD60DC

60" toolbox door
(for toolbox ST3MRD60)

All replacement doors include standard t-latch.

Replacement Cable Assembly

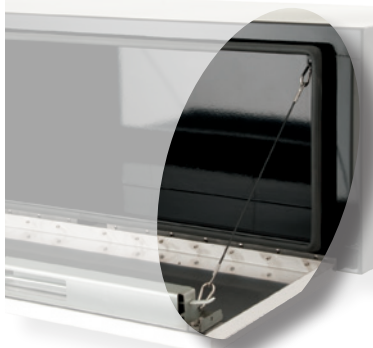

TBP2053

Cable

PH1940

Bracket

37018

Nylock Nut

TBP2052

Carabiner

Three-point Latch Assembly



Upgrade retrofit for STSD & STMRD boxes or replacement for ST3MRD boxes.

TB3PK30

30" 3-point latch assembly

TB3PK36

36" 3-point latch assembly

TB3PK48

48" 3-point latch assembly

TB3PK60

60" 3-point latch assembly

Toolbox Latch



T-Handle Latch

- All stainless steel
- Blind mount construction
- lock and cylinder w/key
- Dust/weather cover on lock

PH3199PK* (*final characters in part # indicate key/cylinder)



Classic T-Handle Latch

- All stainless steel
- includes key

PH1283



Hansen Compression Latch

- twist-latch grip
- compression seal

GC2501RXCRC01

Misc. Replacement Parts



TBP2051

Vent

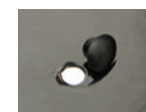

TBP2057

Bottom drain hole plug



PH3226

Plastic weather lock cover for PH3199 t-handle latch





S-Series Light Bar



(rear view)

59" Long, Low Profile LED Light Bar with LED Work Lights

- LED Work Lights
- 12 LED standard (upgradable to 20 light heads)
- 11 flash patterns and 5 head groupings - making a total of 55 flash sequences
- Stop/Tail/Turn
- Work lights with flash function
- Flash dimmer for safer operation in low visibility driving conditions
- Plug and play upgradeable
- Extruded aluminum top and bottom plates
- 5 year manufacturer's warranty
- Built-in 11-function arrow stick
- Clear lenses
- Pylon mounting brackets included (1.75" tall)
- Outside dimensions: 58.75" L x 12" W x 2.5" T
- LEDs per head:
 - Corner: 6
 - Middle: 3

Available Upgrades:

- LED Alley Lights
- Red

Part #	LED Heads	Alley Lights	Arrow Stick	Weight
PS5912AL	12	N	Y	41 lb
PS5912AAL	12	Y	Y	41 lb
PS5914AL	14	N	Y	41.5 lb
PS5916AL	16	N	Y	41.5 lb
PS5916AAL	16	Y	Y	41.5 lb
PS5916ARTL*	16	N	N	42 lb
PS5918AL	18	N	Y	42 lb
PS5918AAL	18	Y	Y	42 lb
PS5920AL	20	N	Y	42 lb
PS5920AAL	20	Y	Y	42 lb

* Texas moveover compliant

L-Series Light Bar



(rear view)

60" Long, Low Profile LED Light Bar with LED Work Lights

- LED Work Lights
- 4 corner LED standard (upgradable to 16 light heads)
- 11 flash patterns and 5 head groupings - making a total of 55 flash sequences
- Stop/Tail/Turn
- Work lights
- Flash dimmer for safer operation in low visibility driving conditions
- 5 year manufacturer's warranty
- Pylon mounting brackets included (1.75" tall)
- Outside dimensions: 60.5" L x 13" W x 2.5" T
- LEDs per head:
 - Corner: 6
 - Middle: 3

Available Upgrades:

- LED Alley Lights
- Red

Part #	LED Heads	Alley Lights	Arrow Stick	Weight
PL6004AL	4	N	N	37 lb
PL6008AL	8	N	N	37 lb
PL6010AL	10	N	N	37.5 lb
PL6012AL	12	N	N	37.5 lb
PL6014AL	14	N	N	38 lb
PL6016AL	16	N	N	38 lb

M-Series Mini Light Bar



magnetic mount

bolt mount (underside)



- 18"
- 10 LED heads (3 LEDs per head)
- 25 flash patterns

PM1810ABW

Amber
Bolt/Wired
14' cord

PM1810AMS

Amber
Magnet/Switch
9' cord





Mini LED Warning Light Bar



(side view)



(bottom view)

PB1106AMS

- 24 high-output LEDs
- 7 flash patterns
- heavy-duty magnetic mount
- high strength, impact resistant polycarbonate lens and base
- lower current draw
- includes 12ft power cord, 12v plug with double switch
- operational temperature range:
-30° C to 50° C (-22° F to +122° F)
- 11" x 6.5" x 2"

Square Mini Light Bar



- 12V DC plug
- 2.4 max amp draw
- 19 user-selectable flash patterns
- Clear lens
- Dual button (power/flash pattern)
- Magnetic mount
- 6 head with 3 diodes each
- SAE certified
- 16.75" x 6.5" x 2.9"
- 11' cord

PG1606AMS

Amber

PG1606RMS

Red

LED Hide-A-Way Surface Mount Strobe



- 12V DC
- 1.8 max amp draw
- 19 flash patterns
- Kit contains 2 lights with control unit
- Industry-standard 3-pin style connector can utilize existing cables in vehicle for a simple upgrade.
- No risk of melting head/tail light housings like old-style strobe tube systems
- Meets/exceeds SAE and CA-XIII
- Installs in head or tail lights or can be surface-mounted.
- Black bezel included

HAL06AB-YY

Amber

HAL06AB-WW

White

Bumper Lights



- Use as turn signal or parking light

836220
4300 International

731512
'05-'07 Ford F250-F550

728410
'99-'04 Ford F250-F550

848310
'04-C Ford F650-F750

842222
'03-C Freightliner M2
'90-'02 Freightliner FL Series

Mini Emergency Lighting



- 12 flash patterns
- 3.35" L x 1" W x 0.65" H

PELMS3W
3 LED
White



PELMS3R
3 LED
Red



PELMS3A
3 LED
Amber



PELMS6A
6 LED
Amber

ABS Chrome Screwless Grommet Mount Light Bezels



PH4871
2" round bezel

PH4872
2.5" round bezel

PH4873
4" round bezel



PH4874
6" oval bezel

Mountable Work Lights



500 Series Square Work Light

- PWLS500**
- 6 high-intensity LED diodes
 - 1900 lumen
 - 10-30v
 - 4.5" x 4.5" x 2.7"
 - Die cast housing



100 Series Round Work Light

- PWLR100**
- 6 high-intensity LED diodes
 - 750+ lumen
 - 18 watt
 - 10-30v
 - 4.6" x 4.6" x 1.7"
 - Die cast housing



500 Series Round Work Light

- PWLR500**
- 6 high-intensity LED diodes
 - 1900 lumen
 - 5" die cast housing
 - single bolt mount



Surface Mount Work Light

- PWLS10**
- 10 LED
 - 30° angled housing included





Junction Boxes



PH1053

7 pole junction box



PH3276

7 pole fused junction box



PH310

10 pole junction box

PH3320

12 pole junction box



PH3277

10 pole fused junction box



PH4450

18 pole junction box



PH4518

24 pole junction box

All boxes have:

- Weather and corrosion-resistant housing
- Wire entry point grommets for increased weather protection

Fused junction boxes:

- provide added protection from malfunctioning and overloaded circuits (fuses not included with fused junction boxes)

Phoenix USA stocks a wide variety of custom junction boxes and wiring harnesses for tow trucks, commercial vehicles and industrial uses.

Switch Panels



PSP9

- 5 lighted on/off rocker switches
- 2 lighted on/off/on rocker switches
- 2 on/off momentary switches
- Function labels included
- Will work all functions on the Phoenix USA, Inc. T- and S-series light bars plus a PTO switch.



PSP5

- 4 lighted on/off rocker switches
- 1 on/off momentary switch
- Function labels included
- Ideal for Phoenix USA, Inc. L-series light bar

Electrical Accessories/Body Accessories

Grab Rails



Stainless Steel Grab Rails

Tubing - 7/8"

SST12

7/8" x 12"

SST24

7/8" x 24"

SST36

7/8" x 36"

SST50

7/8" x 50"

SST55

7/8" x 55"

SST60

7/8" x 60"

SST72

7/8" x 72"

SST96

7/8" x 96"

7/8" Grab Rail Kits

GRSS12

7/8" x 12" kit

GRSS24

7/8" x 24" kit

GRSS36

7/8" x 36" kit

GRSS50

7/8" x 50" kit

GRSS55

7/8" x 55" kit

GRSS60

7/8" x 60" kit

GRSS72

7/8" x 72" kit

GRSS96

7/8" x 96" kit

Tubing - 1 1/4"

SSTB12

1.25" x 12"

SSTB24

1.25" x 24"

SSTB36

1.25" x 36"

SSTB48

1.25" x 48"

SSTB60

1.25" x 60"

SSTB72

1.25" x 72"

SSTB96

1.25" x 96"

1 1/4" Grab Rail Kits

GRSSB12

1.25" x 12" kit

GRSSB24

1.25" x 24" kit

GRSSB36

1.25" x 36" kit

GRSSB48

1.25" x 48" kit

GRSSB60

1.25" x 60" kit

GRSSB72

1.25" x 72" kit

GRSSB96

1.25" x 96" kit

Kits < 48" tube length include end stanchions. Kits ≥ 48" tube length include end and center stanchions.

Add a "K" to the end of any of the above Grab Rail Kit part #s to include mounting screws. Stanchion gaskets also included in 1 1/4" Grab Rail Kits.

Stanchions



1288B1

7/8" end stanchion



1290B1

7/8" center stanchion



4300E

1.25" end stanchion



4000C

1.25" center stanchion



Mounting Screws:

SS1032

7/8" stanchion

SS114

1.25" stanchion



Stanchion Gasket:

4000G

1.25" stanchion

Handles



PH1258

Folding hand holds
Polished, cast stainless steel



PH4003

Bright dipped aluminum handle
16.5" x 1.25"



PH3906

Chrome plated steel handle
8.25" x 2"





Rear Body Flares



Fiberglass Rear Body Flares for Light and Medium Wrecker Bodies

RBF-C

1 Pair
Century
3" wide

RBF-D

1 Pair
Dynamic
2" wide

RBF-C14S

1 Single
Century 2465
Vulcan V-24 single
3" wide

RBF-H

1 Pair
Holmes & 4700 series
Challenger
2.75" wide

RBF-O

1 Pair
Century
4" wide

RBF-HW

1 Pair
Holmes & 4700 series
Challenger
4" wide

RBF-M97

1 Pair
Chevron '97-C
2.5" wide

RBF-J93

1 Pair
Jerr-Dan (steel body)
2" wide

RBF-M97M

1 Pair
Chevron '97-C
3.5" wide

7415000003

1 Pair
Jerr-Dan (steel body) '93-C
4" wide

RBF-MW97

1 Pair
Chevron '97-C
4" wide

RBF-V98

1 Pair
Vulcan
2.5" wide

Rubber Flares



Universal Rubber Flexy Flares with Memory Wire

52-170

- 1 Pair
- blind mount
- 58" L x 2.25" W
- includes wire & bolts

52-188

- 1 Pair
- 61" L x 2" W
- includes wire & bolts

52-172

- heavy duty
- 4.5" wide
- 50' roll

52-190

- 2" wide
- 50' roll

52-172PF

- heavy duty
- 4.5" wide
- sold per foot

52-191

- 2" wide
- sold per foot

Quarter Fender



Heavy duty mounting clip equally distributes clamping force.

QF21

1 Pair, 21" W

Mirror polished stainless steel
Fits trucks with 19.5" x 6.75"
& 7.5" wide wheels

QF22

1 Pair, 21" W

Mirror polished stainless steel
Fits trucks with 16" - 19.5" x
6" wide wheels

QF21NF

1 Pair, 21" W

Mirror polished stainless steel
Fits trucks with 19.5" x 6.75"
& 7.5" wide wheels

QF24

1 Pair, 24" W

Mirror polished stainless steel
Fits trucks with 22.5" wheels

QF21 with stainless trim strip
instead of rubber flap for
lower deck height carriers.

Half Fender



HF23

1 Pair
21" W

Mirror polished stainless
steel
Fits trucks with 19.5" x
6.75" x 7.5" wide wheels

Wheel/Tire Storage Bag



Store off-season wheels
and tires with no need to
change the tire pressure
during storage.

TBK01

Fits 28" H tire & 10" W tire
Holds 1 wheel/tire per bag

TBK02

Fits 33" H tire & 12" W tire
Holds 1 wheel/tire per bag

Spare Tire Carrier

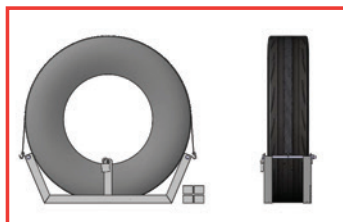

SPTCK1

Variable width
Mounts to back of cab





Phoenix USA, Inc. also offers an additional product line...
The Tow-Rax® line of storage solutions for your garage, shop & trailer needs.

For more products for use in your shop garage or trailer, check out our line of products specifically designed with the user in mind: Tow-Rax® storage solutions include cabinets, trays, racks and shelves to fit almost any description.



Junior Storage Cabinet



- Mill finish aluminum
- Two-level storage
- Paper towel holder
- Fold-down work tray
- Key hole button mounting kit

SPJCA
22" H x 13" W x 6" D

Light Bucket

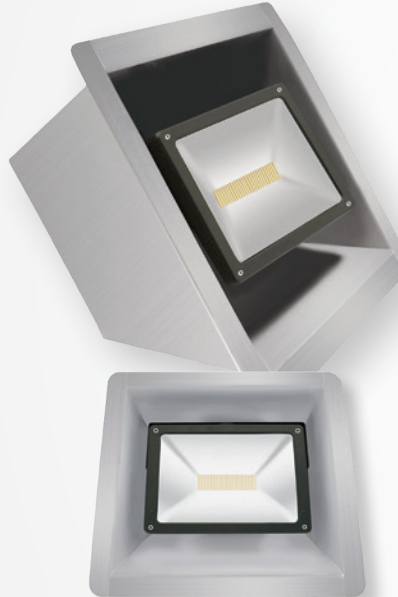

- 50w LED
- 110-130v
- 4,500 lumen
- Bridgelux chip
- 1 amp draw
- IP65
- 3500-4000 color
- 50,000 hr lifespan

12.625" W x 11.625" H x 5.625" D

SPRLB2L
Bucket with light

SPRLB2
Bucket only

PWLS110V50W
Light only

Flashlight Holder



- Mill finish aluminum
- Lightweight
- Convenient flashlight storage

SP135FLHOA
5.5" H x 3" W x 3" D

*Flashlight not included

Brackets

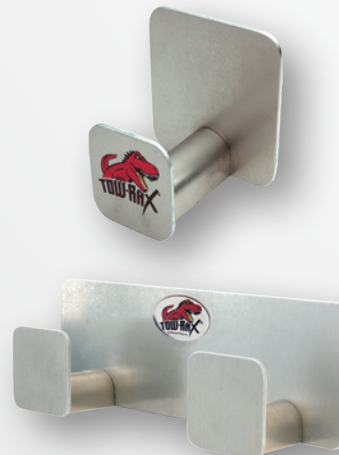

- Mill finish aluminum
- Convenient storage for tape, small cords, goggles, helmets, hoses, etc.

SP35SBA
Single bracket
4" H x 4" W x 2.5" D

SP1025DBA
Double bracket
3.5" H x 10.5" W x 2.5" D

Wall/Floor Track



L-Track
0.42" H x 1.2" W
Black Powder-coated Finish

SP6LTAB
6" Length

SP12LTAB
12" Length

SP18LTAB
18" Length

SPLTE
Protective End Cap

L-Series Domed Track
0.43" H x 2" W
Black Powder-coated Finish

SP6DTAB
6" Length

SP12DTAB
12" Length

SP18DTAB
18" Length

SPDE
Protective End Cap

Tapered
0.47" H x 2.5" W
Black Powder-coated Finish

SP6TAB
6" Length

SP12TAB
12" Length

SP18TAB
18" Length

SPPGF
Protective End Cap

Tapered
0.47" H x 2.5" W
Mill Finish

SP24TA
24" Length

SP72TA
72" Length

SPPGF
Protective End Cap

Strap Track

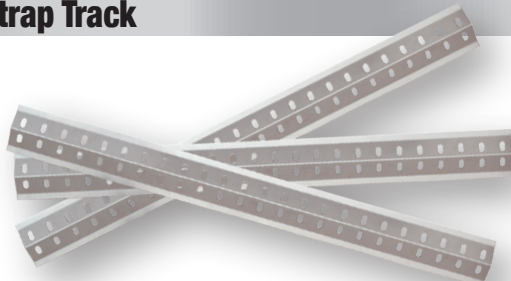

- Mill finish aluminum
- Use with bungee cord to store items vertically and save floor space

SP26AST
2" W x 26" L

Wheel Chock



SPWM
Black powder-coated steel with wood surface mounting kit

SPWC
Chromed steel with wood surface mounting kit

SPWC3BT
Chromed steel with multi-surface mounting kit

Helmet Shelf



SP1HS
1-helmet shelf
7"H x 14"W x 15"D

SP280HSA
2-helmet shelf
7"H x 28"W x 15"D





GD816



Simulator Set 16" 8Lug 4HH w/ 9/16" Stud Size

GD816F	Complete front axle set only
GD816R	Complete rear axle set only
PGD1684FWL	2 Front Wheel Liner 16" 8 Lug 4HH
PGD168RWL	2 Rear Wheel Liner 16" 8 Lug 4HH
PGD168LNT	8 Lugnut Cover/Jamnut
PGD168TSX	8 Stud Extender w/ 9/16" inner diameter threads
PGD168TOL	1 Installation Tool for Lugnut/Jamnut attachment
PGQ60POC	2 Pop Out Center
CLPH2	4 2" Phoenix Logo disc

GDF16



Simulator Set '03 -'04 Ford F350 16" 8Lug 4HH Dual Wheel

GDF16F	Complete front axle set only
GDF16R	Complete rear axle set only
PGDF17FWL	2 Front Wheel Liner 16" 8 Lug 4HH
PGDF17RWL	2 Rear Wheel Liner 16" 8 Lug 4HH
PNF22LNT	8 Lugnut Cover/Jamnut
PGD168TOL	1 Installation Tool for Lugnut/Jamnut attachment
PGQ60POC	2 Pop Out Center
CLPH2	4 2" Phoenix Logo disc

GDF17



Simulator Set '99 -'02 Ford F350 16" 8Lug 4HH Dual Wheel

GDF17F	Complete front axle set only
GDF17R	Complete rear axle set only
PGDF17FWL	2 Front Wheel Liner 16" 8 Lug 4HH
PGDF17RWL	2 Rear Wheel Liner 16" 8 Lug 4HH
PNF19LNT	8 Lugnut Cover/Jamnut
PGD168TOL	1 Installation Tool for Lugnut/Jamnut attachment
PGQ60POC	2 Pop Out Center
CLPH2	4 2" Phoenix Logo disc

GDG01



Simulator Set '01 -'07 Chevy/GMC C/K3500, '03-C G3500 16" 8Lug 4HH Dual Wheel

GDG01F	Complete front axle set only
GDG01R	Complete rear axle set only
PGDG01FWL	2 Front Wheel Liner 16" 8 Lug 4HH
PGD168RWL	2 Rear Wheel Liner 16" 8 Lug 4HH
PGDG01TSX	8 Stud Extender
PGDG01SPA	2 Spacer
PGD168LNT	8 Lugnut Cover/Jamnut
PGD168TOL	1 Installation Tool for Lugnut/Jamnut attachment
PGQ60POC	2 Pop Out Center
CLPH2	4 2" Phoenix Logo disc

Wheel Simulator Parts Breakdown List

GDG92



Simulator Set '90 -'00 GM C/K3500, '96 -'02 G3500 Dual 16" 8Lug 4HH

GDG92F	Complete front axle set only
GDG92R	Complete rear axle set only
PGD1684FWL	2 Front Wheel Liner 16" 8 Lug 4HH
PGD168RWL	2 Rear Wheel Liner 16" 8 Lug 4HH
PGDG92TSX	8 Stud Extender
PGD168LNT	8 Lugnut Cover/Jamnut
PGD168TOL	1 Installation Tool for Lugnut/Jamnut attachment
PGQ60POC	2 Pop Out Center
CLPH2	4 2" Phoenix Logo disc

GDST175



Simulator Set Single Wheel Trailer 17.5" 8Lug 7HH

GDST175AS	Complete axle set
PGDST1751SWL	4 Single Wheel Liner 17.5" 8 Lug 7HH
PGDST175HC	4 Hub Cover w/Popout
PN1463TSX	8 Stud Extender 1.4" tall w/ 5/8" thread
PN1863TSX	8 Stud Extender 1.8" tall w/ 5/8" thread
PGD168LNT	8 Lugnut Cover/Jamnut
PGD168TOL	1 Installation Tool for Lugnut/Jamnut attachment
PGDSF99POC	4 Pop Out Center
CLPH2	4 2" Phoenix Logo disc

GQ62



Simulator Set '92-'07 Ford E350/E450 16" 8Lug 8HH Dual Wheel

GQ62F	Complete front axle set only
GQ62R	Complete rear axle set only
PGQ62FWL	2 Front Wheel Liner 16" 8Lug 8HH
PGQ62RWL	2 Rear Wheel Liner 16" 8Lug 8HH
CLPH2	4 2" Phoenix Logo disc

GQ64



Simulator Set Chevy/GMC/Ford/Dodge 16" 8Lug 4HH Dual Wheel

GQ64F	Complete front axle set only
GQ64R	Complete rear axle set only
PGQ64FWL	2 Front Wheel Liner 16" 8Lug 4HH
PGQ60RWL	2 Rear Wheel Liner 16" 8Lug 4HH
PGQ60POC	2 Pop Out Center w/ 2" Logo indent
CLPH2	4 2" Phoenix Logo disc





GQST50



Simulator Set Single Wheel Trailer 15" 5/6Lug 8HH

GQST50AS	Complete axle set only
PGQST50SWL	4 Single Wheel Trailer 15" 6Lug 8HH
PGQ60POC	4 Pop Out Center w/ 2" Logo indent
CLPH2	4 2" Phoenix Logo disc

GQST60



Simulator Set Single Wheel Trailer 16" 6/8Lug 8HH

GQST60AS	Complete axle set only
PGQS64SWL	4 Single Wheel Trailer 16" 8Lug 8HH
PGQ60POC	4 Pop Out Center w/ 2" Logo indent
CLPH2	4 2" Phoenix Logo disc

GQT60



Simulator Set Tandem Trailer 16"x6" 8Lug 4HH

GQT60AS	Complete axle set
PGQT60RWL	4 Rear Wheel Liner 16" 8Lug 4HH
PGQ60POC	4 Pop Out Center w/ 2" Logo indent
CLPH2	4 2" Phoenix Logo disc

N252



Simulator Set 22.5" x 7.5"/8.25" 10Lug 2HH 11.25" BC Stud Pilot

N252F	Complete front axle set only
N252R	Complete rear axle set only
PN212FWL	2 Front Wheel Liner 22.5" 10Lug 2HH 11.25" BC
PN257RWL	2 Rear Wheel Liner 22.5" 10Lug 2HH 11.25" BC
PN252FHC	2 Front Hub Cover
PN252RHL	8 Rear Hub Cover
PN1418LTX	2 Left Hand Stud Extender 1 1/8" inside thread
PN1418RTX	2 Right Hand Stud Extender 1 1/8" inside thread
PN1475LTX	2 Left Hand Stud Extender 3/4" inside thread
PN1475RTX	2 Right Hand Stud Extender 3/4" inside thread
PN52080LTX	2 Left Hand Stud Extender 2" x 1 1/8" thread
PN52080RTX	2 Right Hand Stud Extender 2" x 1 1/8" thread
PN6256LJN	4 Left Hand Jamnut
PN6256RJN	4 Right Hand Jamnut
PN6256LNC	8 Lugnut Cover 1 5/8" Large SS
PN205TOL	1 Installation Tool for Lugnut/Jamnut attachment
SP425	4 Pop Out Center w/ 4.25" diameter and 2.75" Logo indent
CLPH275	4 2.75" Phoenix Logo disc

Wheel Simulator Parts Breakdown List

N252F



Simulator Front Set 22.5" x 7.5"/8.25" 10Lug 2HH 11.25" BC Stud Pilot

PN212FWL	2	Front Wheel Liner 22.5" 10Lug 2HH 11.25" BC
PN252FHC	2	Front Hub Cover
PN1418LTX	2	Left Hand Stud Extender 1 1/8" inside thread
PN1418RTX	2	Right Hand Stud Extender 1 1/8" inside thread
PN1475LTX	2	Left Hand Stud Extender 3/4" thread
PN1475RTX	2	Right Hand Stud Extender 3/4" thread
PN6256LJN	2	Left Hand Jamnut
PN6256RJN	2	Right Hand Jamnut
PN6256LNC	4	Lugnut Cover 1 5/8" Large SS
PN205TOL	1	Installation Tool for Lugnut/Jamnut attachment
SP425	2	Pop Out Center w/ 4.25" diameter and 2.75" Logo indent
CLPH275	2	2.75" Phoenix Logo disc

N252R



Simulator Rear Set 22.5" x 7.5"/8.25" 10Lug 2HH 11.25" BC Stud Pilot

PN257RWL	2	Rear Wheel Liner 22.5" 10Lug 2HH 11.25" BC
PN252RHL	2	Rear Hub Cover
PN52080LTX	2	Left Hand Stud Extender 2" x 1 1/8" thread
PN5280RTX	2	Right Hand Stud Extender 2" x 1 1/8" thread
PN6256LJN	2	Left Hand Jamnut
PN6256RJN	2	Right Hand Jamnut
PN6256LNC	4	Lugnut Cover 1 5/8" Large SS
PN205TOL	1	Installation Tool for Lugnut/Jamnut attachment
SP425	2	Pop Out Center w/ 4.25" diameter and 2.75" Logo indent
CLPH275	2	2.75" Phoenix Logo disc

N259



Simulator Set 22.5" x 9" 10Lug 2HH 11.25" BC Stud Pilot

PN212FWL	2	Front Wheel Liner 22.5" 10Lug 2HH 11.25" BC
PN257RWL	2	Rear Wheel Liner 22.5" 10Lug 2HH 11.25" BC
PN252FHC	2	Front Hub Cover
PN252RHL	2	Rear Hub Cover
PN1418LTX	2	Left Hand Stud Extender 1 1/8" inside thread
PN1418RTX	2	Right Hand Stud Extender 1 1/8" inside thread
PN1475LTX	2	Left Hand Stud Extender 3/4" inside thread
PN1475RTX	2	Right Hand Stud Extender 3/4" inside thread
PN205LTX	2	Left Hand Stud Extender 1 1/8" inside thread
PN205RTX	2	Right Hand Stud Extender 1 1/8" inside thread
PN6256LJN	4	Left Hand Jamnut
PN6256RJN	4	Right Hand Jamnut
PN6256LNC	8	Lugnut Cover 1 5/8" Large SS
PN205TOL	1	Installation Tool for Lugnut/Jamnut attachment
CLPH275	4	2.75" Phoenix Logo disc





N259R



Simulator Rear Set 22.5" x 9" 10Lug 2HH 11.25" BC Stud Pilot

PN257RWL	2	Rear Wheel Liner 22.5" 10Lug 2HH 11.25" BC
PN252RHL	2	Rear Hub Cover
PN205LTX	2	Left Hand Stud Extender 3.5" tall w/ 1 1/8" inside thread
PN205RTX	2	Right Hand Stud Extender 3.5" tall w/ 1 1/8" inside thread
PN6256LJN	2	Left Hand Jamnut
PN6256RJN	2	Right Hand Jamnut
PN6256LNC	4	Lugnut Cover 1 5/8" Large SS
PN205TOL	1	Installation Tool for Lugnut/Jamnut attachment
SP425	2	Pop Out Center w/ 4.25 diameter and 2.75" Logo indent
CLPH275	2	2.75" Phoenix Logo disc

N552



Simulator Set 22.5" x 7.5" /8.25" 10Lug 5HH 11.25" BC Stud Pilot

N552F		Complete front axle set only
N552R		Complete rear axle set only
PN512FWL	2	Front Wheel Liner 22.5" 10Lug 5HH 11.25" BC
PN5257RWL	2	Rear Wheel Liner 22.5" 10Lug 5HH 11.25" BC
PN252FHC	2	Front Hub Cover
PN252RHL	2	Rear Hub Cover
PN1418LTX	2	Left Hand Stud Extender 1 1/8" inside thread
PN1418RTX	2	Right Hand Stud Extender 1 1/8" inside thread
PN1475LTX	2	Left Hand Stud Extender 3/4" inside thread
PN1475RTX	2	Right Hand Stud Extender 3/4" inside thread
PN52080LTX	2	Left Hand Stud Extender 2" x 1 1/8" thread
PN52080RTX	2	Right Hand Stud Extender 2" x 1 1/8" thread
PN6256LJN	4	Left Hand Jamnut
PN6256RJN	4	Right Hand Jamnut
PN6256LNC	8	Lugnut Cover 1 5/8" Large SS
PN205TOL	1	Installation Tool for Lugnut/Jamnut attachment
SP425	4	Pop Out Center w/ 4.25" diameter and 2.75" Logo indent
CLPH275	4	2.75" Phoenix Logo disc

N552F



Simulator Front Set 22.5" x 7.5"/8.25" 10Lug 5HH 11.25" BC Stud Pilot

PN512FWL	2	Front Wheel Liner 22.5" 10Lug 5HH 11.25" BC
PN252FHC	2	Front Hub Cover
PN1418LTX	2	Left Hand Stud Extender 1 1/8" inside thread
PN1418RTX	2	Right Hand Stud Extender 1 1/8" inside thread
PN1475LTX	2	Left Hand Stud Extender 3/4" thread
PN1475RTX	2	Right Hand Stud Extender 3/4" thread
PN6256LJN	2	Left Hand Jamnut
PN6256RJN	2	Right Hand Jamnut
PN6256LNC	4	Lugnut Cover 1 5/8" Large SS
PN205TOL	1	Installation Tool for Lugnut/Jamnut attachment
SP425	2	Pop Out Center w/ 4.25" diameter and 2.75" Logo indent
CLPH275	2	2.75" Phoenix Logo disc

Wheel Simulator Parts Breakdown List

N552R



Simulator Rear Set 22.5" x 7.5"/8.25" 10Lug 5HH 11.25" BC Stud Pilot

PN5257RWL	2	Rear Wheel Liner 22.5" 10Lug 5HH 285mm BC
PN252RHL	2	Rear Hub Cover
PN52080LTX	2	Left Hand Stud Extender 2" x 1 1/8" inside thread
PN52080RTX	2	Right Hand Stud Extender 2" x 1 1/8" inside thread
PN6256LJN	2	Left Hand Jamnut
PN6256RJN	2	Right Hand Jamnut
PN6256LNC	4	Lugnut Cover 1 5/8" Large SS
PN205TOL	1	Installation Tool for Lugnut/Jamnut attachment
SP425	2	Pop Out Center w/ 4.25" diameter and 2.75" Logo indent
CLPH275	2	2.75" Phoenix Logo disc

N6559



Simulator Set Mitsubishi 16" 5Lug 5HH Dual Wheel

N6559F		Complete front axle set only
N6559R		Complete rear axle set only
PN5560FWL	2	Front Wheel Liner 16" 5Lug 6HH
PN6559RWL	2	Rear Wheel Liner 16" 5Lug 6HH
PN6558RHL	2	Rear Hub Cover
PN1430LTX	2	Left Hand Stud Extender 1.4" x 30mm
PN1430RTX	2	Right Hand Stud Extender 1.4" x 30mm
PN6559LBK	3	Left Hand Bracket
PN6559RBK	3	Right Hand Bracket
PN6256LJN	5	Left Hand Jamnut
PN6256RJN	5	Right Hand Jamnut
PN6256LNC	10	Lugnut Cover 1 5/8" Large SS
PN205TOL	1	Installation Tool for Lugnut/Jamnut attachment
SP425	2	Pop Out Center w/ 4.25" diameter and 2.75" Logo indent
CLPH275	4	2.75" Phoenix Logo disc

N6664



Simulator Set Isuzu/Hino/UD/Mitsubishi 16" 6Lug 6HH Dual Wheel

N6664F		Complete front axle set only
N6664R		Complete rear axle set only
PN6558FWL	2	Front Wheel Liner 16" 6Lug 6HH
PN6660RWL	2	Rear Wheel Liner 16" 6Lug 6HH
PN6660RHLL	2	Rear Hub Cover
PN6680LBK	2	Left Hand Bracket w/ 2" post
PN6680RBK	2	Right Hand Bracket w/ 2" post
PN1830LTX	2	Left Hand Stud Extender 1.8" x 30mm
PN1830RTX	2	Right Hand Stud Extender 1.8" x 30mm
PN6256LJN	4	Left Hand Jamnut
PN6256RJN	4	Right Hand Jamnut
PN6256LNC	8	Lugnut Cover 1 5/8" Large SS
PN205TOL	1	Installation Tool for Lugnut/Jamnut attachment
SP425	2	Pop Out Center w/ 4.25" diameter and 2.75" Logo indent
CLPH275	4	2.75" Phoenix Logo disc





N6670



Simulator Set Isuzu/Hino/UD/Mitsubishi 16" (2 piece Dual Wheel) & 17.5" 6Lug 6HH Dual Wheel

N6670F	Complete front axle set only
N6670R	Complete rear axle set only
PN6670FWL	2 Front Wheel Liner 17.5" 6Lug 6HH
PN6670RWL	2 Rear Wheel Liner 17.5" 6Lug 6HH
PN6660RHLL	2 Rear Hub Cover
PN6680LBK	2 Left Hand Bracket w/ 2" post
PN6680RBK	2 Right Hand Bracket w/ 2" post
PN1830LTX	2 Left Hand Stud Extender 1.8" x 30mm
PN1830RTX	2 Right Hand Stud Extender 1.8" x 30mm
PN6256LJN	4 Left Hand Jamnut
PN6256RJN	4 Right Hand Jamnut
PN6256LNC	8 Lugnut Cover 1 5/8" Large SS
PN205TOL	1 Installation Tool for Lugnut/Jamnut attachment
CLPH275	4 2.75" Phoenix Logo disc

N6681



Simulator Set Isuzu Import 19.5" 6Lug 6HH Dual Wheel

N6681F	Complete front axle set only
N6681R	Complete rear axle set only
PN6680FWL	2 Front Wheel Liner 19.5" 6Lug 6HH Import
PN6681RWL	2 Rear Wheel Liner 19.5" 6Lug 6HH Import
PN6680LBK	2 Left Hand Bracket w/ 2 posts
PN6680RBK	2 Right Hand Bracket w/ 2 posts
PN1830LTX	2 Left Hand Stud Extender 1.8" x 30mm
PN1830RTX	2 Right Hand Stud Extender 1.8" x 30mm
PN6256LJN	4 Left Hand Jamnut
PN6256RJN	4 Right Hand Jamnut
PN197LNC	8 Lugnut Cover 1 5/8" Large (Tall) SS
PN205TOL	1 Installation Tool for Lugnut/Jamnut attachment
CLPH275	4 2.75" Phoenix Logo disc

N6695



Simulator Set Hino 19.5" 6Lug 6HH Dual Wheel

N6695F	Complete front axle set only
N6695R	Complete rear axle set only
PN6695FWL	2 Front Wheel Liner 19.5" 6Lug 6HH Hino
PN6695RWL	2 Rear Wheel Liner 19.5" 6Lug 6HH Hino
PN6695FLBK	2 Left Hand Front Bracket
PN6695FRBK	2 Right Hand Front Bracket
PN6695RLBK2	2 Left Hand Rear Bracket
PN6695RRBK2	2 Right Hand Rear Bracket
PN6256LJN	4 Left Hand Jamnut
PN6256RJN	4 Right Hand Jamnut
PN197LNC	8 Lugnut Cover 1 5/8" Large (Tall) SS
PN6695SPA	4 Rear Spacer
PN205TOL	1 Installation Tool for Lugnut/Jamnut attachment
CLPH275	4 2.75" Phoenix Logo disc

Wheel Simulator Parts Breakdown List

ND1912



Simulator Set '08 - C Dodge 4500/5500 19.5" 10Lug 5HH

ND1912F	Complete front axle set only
ND1912R	Complete rear axle set only
PND1907FWL	2 Front Wheel Liner 19.5" 10Lug
PND1907RWL	2 Rear Wheel Liner 19.5" 10Lug
PGDSF03TSX	4 Stud Extender w/ M 14 x 1.5 inner diameter threads
PGD168TSX	4 Stud Extender w/ 9/16" inner diameter threads
PH3709	1 6mm Hex Key
PND1907BKT	4 Bracket
PGD168LNT	4 Lugnut Cover/Jamnut
PGD168TOL	1 Installation Tool for Lugnut/Jamnut attachment
CLPH275	4 2.75" Phoenix Logo disc

ND20



Simulator Set '99-'02 Dodge 3500 2WD/4WD 16" 8Lug 4HH

ND20F	Complete front axle set only
PGD1684FWL	2 Front Wheel Liner 16" 8Lug 4HH
PGD168RWL	2 Rear Wheel Liner 16" 8Lug 4HH
PGD168LNT	8 Lugnut Cover/Jamnut
PGD168TSX	8 Stud Extender w/ 9/16" inner diameter threads
PGDST87SPA	8 Spacer
139987	8 Lugnut 3/4" Tall w/ 9/16" threads w/ washer
PGD168TOL	1 Installation Tool for Lugnut/Jamnut attachment
PGQ60POC	2 Pop Out Center w/ 2" Logo indent
CLPH2	4 2" Phoenix Logo disc

ND64



Simulator Set '69-'93 Dodge D350 2WD 16" 8Lug 4HH Dual Wheel

PGD1684FWL	2 Front Wheel Liner 16" 8Lug 4HH
PGD168RWL	2 Rear Wheel Liner 16" 8Lug 4HH
PGD168LNT	8 Lugnut Cover/Jamnut
PN1463TSX	8 Stud Extender w/ 9/16" inner diameter threads
PGD168TOL	1 Installation Tool for Lugnut/Jamnut attachment
PGQ60POC	2 Pop Out Center w/ 2" Logo indent
CLPH2	4 2" Phoenix Logo disc

NDT165



Simulator Set Trailer 16"/16.5" 8Lug 4HH Dual Wheel

NDT165AS	Complete axle set
PNDT165RWL	4 Rear Wheel Liner 16"/16.5" 8Lug 4HH
PN1863TSX	8 Stud Extender 1.8" Tall w/ 5/8" thread
PNF98LNT	8 Lugnut Cover/Jamnut
PGD168TOL	1 Installation Tool for Lugnut/Jamnut attachment
PGDSF99POC	4 Pop Out Center w/ 2" Logo indent
CLPH2	4 2" Phoenix Logo disc





NF10



Simulator Set '88-'98 Ford SD 2WD 16" 10Lug 4HH

NF10F	Complete front axle set only
NF10R	Complete rear axle set only
PNF10FWL	2 Front Wheel Liner 16" 10Lug 4HH
PNF10RWL	2 Rear Wheel Liner 16" 10Lug 4HH
PNF10STX	8 Stud Extender w/ 9/16" inner diameter
PNF98LNT	8 Lugnut Cover/Jamnut
PGD168TOL	1 Installation Tool for Lugnut/Jamnut attachment
CLPH2	4 2" Phoenix Logo disc

NF12



Simulator Set '08-C Ford E350/E450 16" 8Lug 4HH Dual Wheel

NF12F	Complete front axle set only
NF12R	Complete rear axle set only
PGD1684FWL	2 Front Wheel Liner 16" 8Lug 4HH
PGD168RWL	2 Rear Wheel Liner 16" 8Lug 4HH
PNF12STX	8 Stud Extender 9/16" threads
PGD168LNT	8 Lugnut Cover/Jamnut
PGD168TOL	1 Installation Tool for Lugnut/Jamnut attachment
PGQ60POC	2 Pop Out Center w/ 2" Logo indent
CLPH2	4 2" Phoenix Logo disc

NF14



Simulator Set '15-C Ford Transit 2WD 16" 6Lug Dual Wheel

NF14F	Complete front axle set only
NF14R	Complete rear axle set only
PNF14FWL	2 Front Wheel Liner 16" 6Lug
PNF14RWL	2 Rear Wheel Liner 16" 6Lug
PNF14BKT	4 Bracket
PNF22LNT	4 Lugnut Cover/Jamnut 1 3/8" tall 14mm dia. w/ 1.5mm threads
PH3709	1 Allen Wrench
PGD168TOL	1 Installation Tool for Lugnut/Jamnut attachment
CLPH275	4 2.75" Phoenix Logo disc

NF19



Simulator Set '99-'02 Ford F450/F550 19.5" 8Lug 5HH

NF19F	Complete front axle set only
NF19R	Complete rear axle set only
PNF19FWL	2 Front Wheel Liner 19.5" 8Lug 5HH
PNF19RWL	2 Rear Wheel Liner 19.5" 8Lug 5HH
PNF19LNT	8 Lugnut Cover/Jamnut
PGD168TOL	1 Installation Tool for Lugnut/Jamnut attachment
SP425	2 Pop Out Center w/ 4.25" diameter and 2.75" Logo indent
CLPH275	4 2.75" Phoenix Logo disc

Wheel Simulator Parts Breakdown List

NF22



Simulator Set '03-'04 Ford F450/F550 19.5" 8Lug 5HH

NF22F	Complete front axle set only
NF22R	Complete rear axle set only
PNF19FWL	2 Front Wheel Liner 19.5" 8Lug 5HH
PNF22RWL	2 Rear Wheel Liner 19.5" 8Lug 5HH
PNF22LNT	8 Lugnut Cover/Jamnut
PGD168TOL	1 Installation Tool for Lugnut/Jamnut attachment
SP425	2 Pop Out Center w/ 4.25" diameter and 2.75" Logo indent
CLPH275	4 2.75" Phoenix Logo disc

NF23



Simulator Set '05-C Ford F350 17" 8Lug 4HH Dual Wheel

NF23F	Complete front axle set only
NF23R	Complete rear axle set only
PNF23FWL	2 Front Wheel Liner 17" 8Lug on 200mm BC
PNF23RWL	2 Rear Wheel Liner 17" 8Lug on 200mm BC
PNF22LNT	8 Lugnut Cover/Jamnut
PGD168TOL	1 Installation Tool for Lugnut/Jamnut attachment
SP425	2 Pop Out Center w/ 4.25" diameter and 2.75" Logo indent
CLPH275	4 2.75" Phoenix Logo disc

NF25



Simulator Set '05-C Ford F450/F550 19.5" 10Lug 5HH

NF25F	Complete front axle set only
NF25R	Complete rear axle set only
PNF25FWL	2 Front Wheel Liner 19.5" 10Lug 5HH
PNF25RWL	2 Rear Wheel Liner 19.5" 10Lug 5HH
PNF22LNT	8 Lugnut Cover/Jamnut
PGD168TOL	1 Installation Tool for Lugnut/Jamnut attachment
SP425	2 Pop Out Center w/ 4.25" diameter and 2.75" Logo indent
CLPH275	4 2.75" Phoenix Logo disc

NF98



Simulator Set '92-'07 Ford E350/E450 16" 8Lug 8HH Dual Wheel

NF98F	Complete front axle set only
NF98R	Complete rear axle set only
PNF98FWL	2 Front Wheel Liner 16" 8Lug 8HH
PNF98RWL	2 Rear Wheel Liner 16" 8Lug 8HH
PNF10STX	8 Stud Extender w/ 9/16" inner diameter
PNF98LNT	8 Lugnut Cover/Jamnut
PGD168TOL	1 Installation Tool for Lugnut/Jamnut attachment
CLPH2	4 2" Phoenix Logo disc





NFQ17



Simulator Set Quigley Conversion 17" 4WD 8Lug Dual Wheel

PNFQ17FWL	2	Front Wheel Liner 17" 8Lug
PNFQ17RWL	2	Rear Wheel Liner 17" 8Lug
PNF12STX	4	Stud Extender w/ 9/16" threads
PNF22LNT	4	Lugnut Cover/Jamnut
PNF98LNT	4	Lugnut Cover/Jamnut
PGD168TOL	1	Installation Tool for Lugnut/Jamnut attachment
SP425	2	Pop Out Center w/ 4.25" diameter and 2.75" Logo indent
CLPH275	4	2.75" Phoenix Logo disc

NFS156



Simulator Set Sprinter Chassis 15" 6Lug 6HH Dual Wheel

NFS156F		Complete front axle set only
NFS156R		Complete rear axle set only
PNFS156FWL	2	Front Wheel Liner 15" 6Lug 6HH
PNFS156RWL	2	Rear Wheel Liner 15" 6Lug 6HH
PNFS156LNT	8	Lugnut Cover/Jamnut
PGD168TOL	1	Installation Tool for Lugnut/Jamnut attachment
CLPH275	4	2.75" Phoenix Logo disc

NG17



Simulator Set '08-'10 Chevy/GMC C/K 3500 17" 8Lug 5HH Dual Wheel

NG17F		Complete front axle set only
NG17R		Complete rear axle set only
PNG17FWL	2	Front Wheel Liner 17" 8Lug 5HH
PNG17RWL	2	Rear Wheel Liner 17" 8Lug 5HH
PGDG92TSX	8	Stud Extender
PGD168LNT	8	Lugnut Cover/Jamnut
PGD168TOL	1	Installation Tool for Lugnut/Jamnut attachment
CLPH2	4	2" Phoenix Logo disc

NG18



Simulator Set '11-C Chevy/GMC C/K 3500 17" 8Lug 5HH Dual Wheel

NG18F		Complete front axle set only
NG18R		Complete rear axle set only
PNG18FWL	2	Front Wheel Liner 17" 8Lug 5HH
PNG18RWL	2	Rear Wheel Liner 17" 8Lug 5HH
PGDG92TSX	8	Stud Extender
PNF98LNT	8	Lugnut Cover/Jamnut
PGD168TOL	1	Installation Tool for Lugnut/Jamnut attachment
CLPH275	4	2.75" Phoenix Logo disc

Wheel Simulator Parts Breakdown List

NG961



Simulator Set '75-C GM p-30 19.5" 5Lug Front/10Lug Rear 5HH

NG961F	Complete front axle set only
NG961R	Complete rear axle set only
PNG960FWL	2 Front Wheel Liner 19.5" 5Lug 5HH
PNG961RWL	2 Rear Wheel Liner 19.5" 10Lug 5HH
PNG961FHC	2 Front Hub Cover
PN1463TSX	10 Stud Extender 1.4" Tall w/5/8" threads
PGD168LNT	10 Lugnut Cover/Jamnut
PGD168TOL	1 Installation Tool for Lugnut/Jamnut attachment
CLPH275	4 2.75" Phoenix Logo disc

NH252



Simulator Set 22.5" x 7.5"/8.25" 10Lug 2HH 285mm BC Hub Pilot

NH252F	Complete front axle set only
NH252R	Complete rear axle set only
PN212FWL	2 Front Wheel Liner 22.5" 10Lug 2HH 285mm BC
PN257RWL	2 Rear Wheel Liner 22.5" 10Lug 2HH 285mm BC
PN252FHC	2 Front Hub Cover
PN252RHL	2 Rear Hub Cover
PNH1422TSX	8 Stud Extender 1.4" Tall w/ 22mm threads
PN6256RJN	8 Right Hand Jamnut
PN6256LNC	8 Lugnut Cover 1 5/8" Large SS
PNH251SPA	4 Spacer
PN205TOL	1 Installation Tool for Lugnut/Jamnut attachment
SP425	4 Pop Out Center w/ 4.25" diameter and 2.75" Logo indent
CLPH275	4 2.75" Phoenix Logo disc

NH252F



Simulator Front Set 22.5" x 7.5"/8.25" 10Lug 2HH 285mm BC Hub Pilot

PN212FWL	2 Front Wheel Liner 22.5" 10Lug 2HH 285mm BC
PN252FHC	2 Front Hub Cover
PNH1422TSX	4 Stud Extender 1.4" Tall w/ 22mm threads
PN6256LNC	4 Lugnut Cover 1 5/8" Large SS
PN6256RJN	4 Right Hand Jamnut
PN205TOL	1 Installation Tool for Lugnut/Jamnut attachment
SP425	2 Pop Out Center w/ 4.25" diameter and 2.75" Logo indent
CLPH275	2 2.75" Phoenix Logo disc

NH252R



Simulator Rear Set 22.5" x 7.5"/8.25" 10Lug 2HH 285mm BC Hub Pilot

PN257RWL	2 Rear Wheel Liner 22.5" 10Lug 2HH 285mm BC
PN252RHL	2 Rear Hub Cover
PNH1422TSX	4 Stud Extender 1.4" Tall w/ 22mm threads
PN6256RJN	4 Right Hand Jamnut
PN6256LNC	4 Lugnut Cover 1 5/8" Large SS
PNH251SPA	4 Spacer
PN205TOL	1 Installation Tool for Lugnut/Jamnut attachment
SP425	2 Pop Out Center w/ 4.25" diameter and 2.75" Logo indent
CLPH275	2 2.75" Phoenix Logo disc





NH259



Simulator Set 22.5" x 9" 10Lug 2HH 285mm BC Hub Pilot

NH252F	Complete front axle set only
NH259R	Complete rear axle set only
PN212FWL	2 Front Wheel Liner 22.5" 10Lug 2HH 285mm BC
PN257RWL	2 Rear Wheel Liner 22.5" 10Lug 2HH 285mm BC
PN252FHC	2 Front Hub Cover
PN252RHL	2 Rear Hub Cover
PNH1422TSX	4 Stud Extender 1.4" Tall w/ 22mm threads
PNH2522TSX	4 Stud Extender 2.5" Tall w/ 22mm threads
PN6256RJN	8 Right Hand Jamnut
PN6256LNC	8 Lugnut Cover 1 5/8" Large SS
PNH251SPA	4 Spacer
PN205TOL	1 Installation Tool for Lugnut/Jamnut attachment
SP425	4 Pop Out Center w/ 4.25" diameter and 2.75" Logo indent
CLPH275	4 2.75" Phoenix Logo disc

NH259R



Simulator Rear Set 22.5" x 9" 10Lug 2HH 285mm BC Hub Pilot

PN257RWL	2 Rear Wheel Liner 22.5" 10Lug 2HH 285mm BC
PN252RHL	2 Rear Hub Cover
PN2522TSX	4 Stud Extender 2.5" Tall w/ 22mm threads
PN6256RJN	4 Right Hand Jamnut
PN6256LNC	4 Lugnut Cover 1 5/8" Large SS
PNH251SPA	4 Spacer
PN205TOL	1 Installation Tool for Lugnut/Jamnut attachment
SP425	2 Pop Out Center w/ 4.25" diameter and 2.75" Logo indent
CLPH275	2 2.75" Phoenix Logo disc

NH4860



Simulator Rear Set '03-'10 C4500 19.5" 8Lug 4HH Wheel #29717

NH4860F	2 Complete front axle set only
NH4860R	2 Complete rear axle set only
PNH4860FWL	2 Front Wheel Liner 19.5" 8Lug 4HH
PNH4860RWL	2 Rear Wheel Liner 19.5" 8Lug 4HH
PNH8490JNT	4 Jamnut 20mm Double Shouldered
PN6256LNC	4 Lugnut Cover 1 5/8" Large SS
PN205TOL	1 Installation Tool for Lugnut/Jamnut attachment
SP425	2 Pop Out Center w/ 4.25" diameter and 2.75" Logo indent
CLPH275	2 2.75" Phoenix Logo disc

Wheel Simulator Parts Breakdown List

NH5092



Simulator Set 19.5" 10Lug 5HH on 285mm BC Wheel #29195

NH5092F	Complete front axle set only
NH5092R	Complete rear axle set only
PNH5090FWL	2 Front Wheel Liner 19.5" 10Lug 5HH
PNH5090RWL	2 Rear Wheel Liner 19.5" 10Lug 5HH
PNH8495JNT	8 Jamnut 22mm Double Shouldered
PN6256LNC	8 Lugnut Cover 1 5/8" Large SS
PN205TOL	1 Installation Tool for Lugnut/Jamnut attachment
SP425	2 Pop Out Center w/ 4.25" diameter and 2.75" Logo indent
CLPH275	4 2.75" Phoenix Logo disc

NH5259



Simulator Set 22.5" x 9" 10Lug 5HH 285mm BC Hub Pilot

NH552F	Complete front axle set only
NH5259R	Complete rear axle set only
PN512FWL	2 Front Wheel Liner 22.5" 10Lug 5HH 285mm BC
PN5257RWL	2 Rear Wheel Liner 22.5" 10Lug 5HH 285mm BC
PN252FHC	2 Front Hub Cover
PN252RHL	2 Rear Hub Cover
PNH1422TSX	4 Stud Extender 1.4" Tall w/ 22mm threads
PNH2522TSX	4 Stud Extender 2.5" Tall w/ 22mm threads
PN6256RJN	8 Right Hand Jamnut
PN6256LNC	8 Lugnut Cover 1 5/8" Large SS
PNH251SPA	4 Spacer
PN205TOL	1 Installation Tool for Lugnut/Jamnut attachment
SP425	4 Pop Out Center w/ 4.25" diameter and 2.75" Logo indent
CLPH275	4 2.75" Phoenix Logo disc

NH552



Simulator Set 22.5" x 7.5"/8.25" 10Lug 5HH 285mm BC Hub Pilot

NH552F	Complete front axle set only
NH552R	Complete rear axle set only
PN512FWL	2 Front Wheel Liner 22.5" 10Lug 5HH 285mm BC
PN5257RWL	2 Rear Wheel Liner 22.5" 10Lug 5HH 285mm BC
PN252FHC	2 Front Hub Cover
PN252RHL	2 Rear Hub Cover
PN6256RJN	8 Right Hand Jamnut
PNH1422TSX	8 Stud Extender 1.4" Tall w/ 22mm threads
PN6256LNC	8 Lugnut Cover 1 5/8" Large SS
PNH251SPA	4 Spacer
PN205TOL	1 Installation Tool for Lugnut/Jamnut attachment
SP425	4 Pop Out Center w/ 4.25" diameter and 2.75" Logo indent
CLPH275	4 2.75" Phoenix Logo disc





NH552F



Simulator Front Set 22.5" x 7.5"/8.25" 10Lug 5HH 285mm BC Hub Pilot

PN512FWL	2	Front Wheel Liner 22.5" 10Lug 5HH 285mm BC
PN252FHC	2	Front Hub Cover
PNH1422TSX	4	Stud Extender 1.4" Tall w/ 22mm threads
PN6256RJN	4	Right Hand Jamnut
PN6256LNC	4	Lugnut Cover 1 5/8" Large SS
PN205TOL	1	Installation Tool for Lugnut/Jamnut attachment
SP425	2	Pop Out Center w/ 4.25" diameter and 2.75" Logo indent
CLPH275	4	2.75" Phoenix Logo disc

NH552R



Simulator Rear Set 22.5" x 7.5"/8.25" 10Lug 5HH 285mm BC Hub Pilot

PN5257RWL	2	Rear Wheel Liner 22.5" 10Lug 5HH 285mm BC
PN252RHL	2	Rear Hub Cover
PNH1422TSX	4	Stud Extender 1.4" Tall w/ 22mm threads
PN6256RJN	4	Right Hand Jamnut
PN6256LNC	4	Lugnut Cover 1 5/8" Large SS
PNH251SPA	4	Spacer
PN205TOL	1	Installation Tool for Lugnut/Jamnut attachment
SP425	2	Pop Out Center w/ 4.25" diameter and 2.75" Logo indent
CLPH275	2	2.75" Phoenix Logo disc

NH8494



Simulator Set 19.5" x 6.75" 8Lug 4HH w/ 20mm Studs

NH8494F		Complete front axle set only
NH8494R		Complete rear axle set only
PNH8490FWL	2	Front Wheel Liner 19.5" x 6.75" 8Lug 4HH
PNH8494RWL	2	Rear Wheel Liner 19.5" x 6.75" 8Lug 4HH
PNH8490JNT	8	Jamnut 20mm Double Shouldered
PN6256LNC	8	Lugnut Cover 1 5/8" Large SS
PN205TOL	1	Installation Tool for Lugnut/Jamnut attachment
SP425	2	Pop Out Center w/ 4.25" diameter and 2.75" Logo indent
CLPH275	4	2.75" Phoenix Logo disc

NH8495



Simulator Set 19.5" x 6.75" 8Lug 4HH w/ 22mm Studs

NH8495F		Complete front axle set only
NH8495R		Complete rear axle set only
PNH8490FWL	2	Front Wheel Liner 19.5" x 6.75" 8Lug 4HH
PNH8494RWL	2	Rear Wheel Liner 19.5" x 6.75" 8Lug 4HH
PNH8495JNT	8	Jamnut 22mm Double Shouldered
PN6256LNC	8	Lugnut Cover 1 5/8" Large SS
PN205TOL	1	Installation Tool for Lugnut/Jamnut attachment
SP425	2	Pop Out Center w/ 4.25" diameter and 2.75" Logo indent
CLPH275	4	2.75" Phoenix Logo disc

Wheel Simulator Parts Breakdown List

NH8496



Simulator Set 19.5" x 6.75" 8Lug 4HH w/ 22mm Studs

NH8496F	Complete front axle set only
NH8496R	Complete rear axle set only
PNH8490FWL	2 Front Wheel Liner 19.5" x 6.75" 8Lug 4HH
PNH8494RWL	2 Rear Wheel Liner 19.5" x 6.75" 8Lug 4HH
PNH8495JNT	8 Jamnut 22mm Double Shouldered
PN6256LNC	8 Lugnut Cover 1 5/8" Large SS
39874	8 Jamnut 33mm hex short black
PN205TOL	1 Installation Tool for Lugnut/Jamnut attachment
SP425	2 Pop Out Center w/ 4.25" diameter and 2.75" Logo indent
CLPH275	4 2.75" Phoenix Logo disc

NSF921



Simulator Set '92-C Ford E250/E350, '92-'98 F250/F350 16" 8Lug 2WD

NSF921F	Complete front axle set only
NSF921R	Complete rear axle set only
PNSF921SWL	4 Single Wheel Liner 16" 8Lug
PGDSF92MHC	2 Front Hub Cover
PGDSF92RHC	2 Rear Hub Cover
PGDSF92LNT	8 9/16" Lugnut Cover/Jamnut
PGD168TOL	1 Installation Tool for Lugnut/Jamnut attachment
CLPH2	4 2" Phoenix Logo disc

NSF941



Simulator Set '92-C Ford E250/E350, '92-'98 F250/F350 16" 8Lug 2WD

NSF941F	Complete front axle set only
NSF921R	Complete rear axle set only
PNSF921SWL	4 Single Wheel Liner 16" 8Lug
PGDSF99MH4	2 Front Hub Cover w/ Popout
PGDSF92RHC	2 Rear Hub Cover
PGDSF92LNT	8 9/16" Lugnut Cover/Jamnut
PGD168TOL	1 Installation Tool for Lugnut/Jamnut attachment
PGDSF99POC	2 Pop Out Center w/ 2" Logo indent for Single Wheel
CLPH2	4 2" Phoenix Logo disc

NSG03



Simulator Set '03-C GM Express Van 16" 8Lug Single Wheel

NSG03AS	Complete axle set
PNSG03SWL	4 Single Wheel Liner 16" 8Lug
PNSG03HC	4 Hub Cover
PNSG03LNT	8 Lugnut Cover/Jamnut
PGD168TOL	1 Installation Tool for Lugnut/Jamnut attachment
CLPH2	4 2" Phoenix Logo disc





NST06



Simulator Set Single Wheel Trailer 16" 8Lug 7HH (oval)

NST06AS	Complete axle set
PNST06SWL	4 Single Wheel Liner 16" 8Lug 7HH (oval)
PGDSF99MH4	4 Hub Cover
PN1850TSX	8 Stud Extender w/ 1/2" inner diameter
PN1856TSX	8 Stud Extender w/ 9/16" inner diameter
PGD168LNT	8 Lugnut Cover/Jamnut
PGDST87SPA	8 Spacer
PGD168TOL	1 Installation Tool for Lugnut/Jamnut attachment
PGDSF99POC	4 Pop Out Center w/ 2" Logo indent
CLPH2	4 2" Phoenix Logo disc

NST15



Simulator Set Single Wheel Trailer 15" 5/6Lug 7HH (oval)

NST15AS	Complete axle set
PNST15SWL	4 Single Wheel Liner 15" 5/6Lug 7HH (oval)
PNST15HC	4 Hub Cover
PNST15JNT	16 Jamnut
PNST15BKT	4 Bracket
PNST15SPA	8 Spacer
P790ASSS	8 Mounting Screw
40222	8 Flat Washer
QM25800	8 Pan Head SS Machine Screw M8.0 x 1.25 x 35
PNST15POC	4 Pop Out Center w/ 2" Logo
CLPH2	4 2" Phoenix Logo disc

QC1019



Simulator Set Universal 19.5" Ring Mount

QC1019F	Complete front axle set only
QC1019R	Complete rear axle set only
PQC1019FWL	2 Front Wheel Liner 19.5" Ring Mount
PQC1019RWL	2 Rear Wheel Liner 19.5" Ring Mount
PQC1019RNG	4 Universal 19.5" Mounting Ring
VE1500SS	2 Air Inflation 15" Outer Wheel Valve Extension
VE2400SS	2 Air Inflation 24" Outer Wheel Valve Extension
PQC225SSS	16 SS Liner Screws for Quick Cover sets
PQC225TOL	1 Quick Cover Installation Tool
CLPH275	4 2.75" Phoenix Logo disc

QC1025F



Simulator Front Set Universal 22.5" Ring Mount

PQC1025FWL	2 Front Wheel Liner 22.5" Ring Mount
PQC1025RNG	2 Mounting Ring 22.5"
PQC225SSS	10 SS Liner Screws for Quick Cover sets
PQC225TOL	1 Quick Cover Installation Tool
PQC1025POC	2 Pop Out Center w/ 2.75" Logo indent
CLPH275	2 2.75" Phoenix Logo disc

Wheel Simulator Parts Breakdown List

QC1030



Simulator Set Universal 22.5" Ring Mount

QC1025F	Complete front axle set only
QC1030R	Complete rear axle set only
PQC1025FWL	2 Front Wheel Liner 22.5" Ring Mount
PQC1030RWL	2 Rear Wheel Liner 22.5" Ring Mount
PQC1025RNG	4 Mounting Ring 22.5"
VE1500SS	2 Air Inflation 15" Outer Wheel Valve Extension
VE2400SS	2 Air Inflation 24" Outer Wheel Valve Extension
PQC225SSS	20 SS Liner Screws for Quick Cover sets
PQC225TOL	1 Quick Cover Installation Tool
PQC1025POC	2 Pop Out Center w/ 2.75" Logo indent
CLPH275	4 2.75" Phoenix Logo disc

QC1030R



Simulator Rear Set Universal 22.5" Ring Mount

PQC1030RWL	2 Rear Wheel Liner 22.5" Ring Mount
PQC1025RNG	2 Mounting Ring 22.5"
VE1500SS	2 Air Inflation 15" Outer Wheel Valve Extension
VE2400SS	2 Air Inflation 24" Outer Wheel Valve Extension
PQC225SSS	10 SS Liner Screws for Quick Cover sets
PQC225TOL	1 Quick Cover Installation Tool
CLPH275	2 2.75" Phoenix Logo disc

QC160A



Simulator Set 16" 8Lug 8HH Single/Dual Wheel

QC160AS	Complete axle set
PQC160ASWC	4 Quick Cover 16" 8Lug 8HH

QC175R



Simulator Rear Set Universal 17.5" Single/Dual Wheel for Trailers

PQC17RWC	2 Rear Wheel Set Cover 17.5" Ring Mount
PQC1025RNG	2 Mounting Ring 17.5"
PQC225SSS	8 SS Liner Screws for Quick Cover sets
PQC225TOL	1 Quick Cover Installation Tool





QCT175



Simulator Set 17.5" Tandem Axle Dual Wheel/Single Wheel Trailer

PQCT175SWL	4	Single Wheel Liner 17.5" Ring Mount
PQCT175RNG	4	Mounting Ring 17.5"
PQCT175SSS	12	Mounting Screw 19mm
CLPH275	4	2.75" Phoenix Logo disc

QL74



Simulator Set Chevy/GMC/Ford/Dodge 17" Dual Wheel

PQL74FWL	2	Front Wheel Liner 17" 8Lug 8HH
PQL74RWL	2	Rear Wheel Liner 17" 8Lug 8HH
CLPH275	4	2.75" Phoenix Logo disc

Note: will NOT fit wheel #29837 with square hand holes found on some '05-'06 Ford trucks.

Also Available in retail package.

QL74 snap-on liner is ready for the retail shelf in packaging with a pop-out front for easy display.



QLSF17



Simulator Set '17-C Ford F150 17" 6Lug 8HH

PQLSF17SWL	4	Single Wheel Liner 17" 6Lug
CLPH275	4	2.75" Phoenix Logo disc

QLST16



Simulator Set '15-C Ford Transit Van 16" 5Lug

QLST16AS		Complete axle set
PQLST16SWL	4	Single Wheel Liner 17" 6Lug
CLPH275	4	2.75" Phoenix Logo disc

Wheel Simulator Parts Breakdown List

QS16



Simulator Set '06-C Sprinter 16" 6Lug Dual Wheel

QS16F	Complete front axle set only
QS16R	Complete rear axle set only
PQS16FWL	2 Front Wheel Liner 16" 6Lug
PQS16RWL	2 Rear Wheel Liner 16" 6Lug
PQS16RHC	2 Rear Hub Cover
P790ASSS	4 Stainless Steel Screw
CLPH2	4 2" Phoenix Logo disc

SLD1703



Simulator Set '03-C Dodge 3500 17" 8Lug 5HH Dual Wheel

SLD1703F	Complete front axle set only
SLD1703R	Complete rear axle set only
PD1703FWL	2 Front Wheel Liner 17" 8Lug 5HH
PD1703RWL	2 Rear Wheel Liner 17" 8Lug 5HH
PD1703FHC	2 Front Hub Cover
PD1703RHC	2 Rear Hub Cover
P790ASSS	8 Mounting Screw
CLPH2	4 2" Phoenix Logo disc

SLG116



Simulator Set '01-'07 GM C/K3500, '01-C G3500 Van 16" 8Lug Dual Wheel

SLG116F	Complete front axle set only
SLG116R	Complete rear axle set only
PG116FWL	2 Front Wheel Liner 16" 8Lug 4HH
PG116RWL	2 Rear Wheel Liner 16" 8Lug 4HH
PG116PNC	32 Lugnut Cover

SLU168



Simulator Set 16"/16.5" 8Lug on 6.5" BC 4HH Dual Wheel

SLU168F	Complete front axle set only
SLU168R	Complete rear axle set only
SP28	2 Front Wheel Liner 16"/16.5" 8Lug on 6.5" BC
SP32	2 Rear Wheel Liner 16"/16.5" 8Lug on 6.5" BC
PU168FHC	2 Front Hub Cover
PU168RHC	2 Rear Hub Cover
PU168RNG	4 Ring Attachment
PU168TOL	1 Installation Tool



TRAILER PRODUCTS - ENGINEERED BY ENTHUSIASTS!

Tough + Durable + Functional.

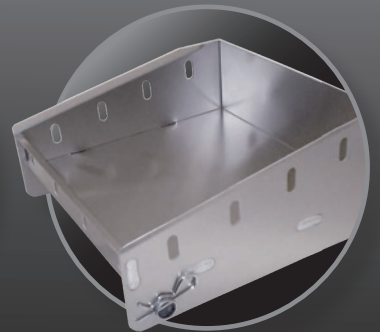
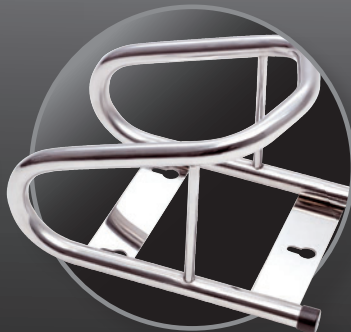



Tough + Durable + Functional.

A Storage Cabinet
with Folding Work Tray
SP30CSA - Mill Finish Aluminum
with mirror polished door
Dimensions: 30"H x 25.5"W x 9"D

Every shop and trailer needs additional, secure, organized storage, and this cabinet provides it. Space for oil, transmission fluid, cleaners, lubricants and even a spring loaded paper towel holder that prevents unrolling. A fold down tray that rides on nylon bushings for quiet, dependable service is perfect for cleaning and repairing small parts.

B Button Kit
SP25BK 2.5mm
SP30BK 3.0mm (used for SP45HFTA only)

Set of 4 mounting buttons and screws allow your Tow-Rax® product to be used in a variety of locations: garage to trailer and back again, as well as inside and outside your trailer. The location possibilities are endless.

C Key Punch Bracket Kit
SPKPB
Dimensions: 4"H x 2"W x 1"D

Make your favorite Tow-Rax® cabinet mobile by adding brackets to cabinets. Mount button kits in your preferred locations and you're ready to go.

D Junior Storage Cabinet
with Folding Work Tray
SPJCA
Dimensions: 22"H x 13"W x 6"D

Mill finish aluminum, button-mount Junior Storage Cabinet with folding work tray provides two levels of storage for one-quart oil and aerosol cans, a paper towel holder and a fold down work tray. Two key hole button mounting kits included for easy removal and multiple location use.

All Tow-Rax® cabinet doors include our latch which does not require a pull of the pin to close. Hands free, shut-and-go convenience from the engineers at Tow-Rax®!!!

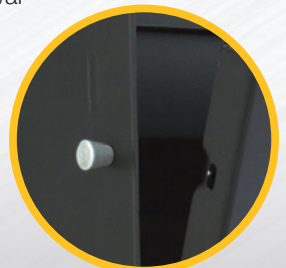

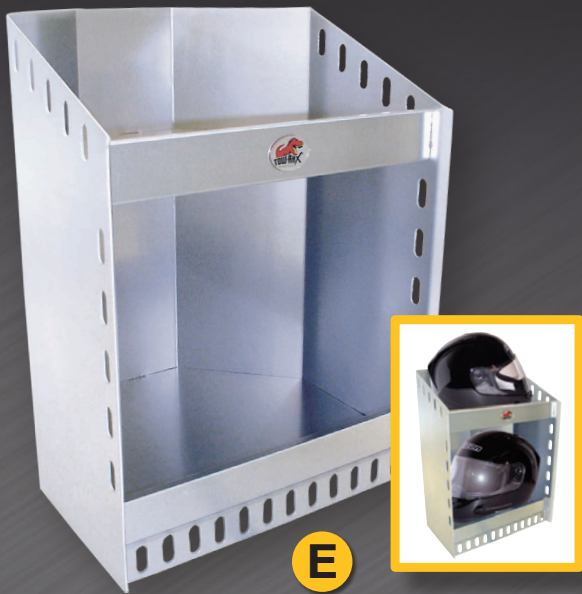

E



G



F



H



E Corner Helmet Shelf
SPCHH

Dimensions: 12"H x 14"W x 15.5"D

Mill finish aluminum shelf fits in a corner and offers the ability to store two helmets while utilizing as little wall space as possible. Secure helmets, gloves and hang clothing with convenience and ease.

F Tubular Gear Rack
SP48HR

Dimensions: 12.5"H 16.5"W 50"L

High polished stainless steel gear rack is designed to make helmets, duffle bags, packs and kits easier to stow. Hang items from the strong tubular bars as well. This 48" durable shelf gives you options for storing gear.

G 2-Helmet Shelf
SP280HSA

Dimensions: 7"H x 28"W x 15"D

Store and protect the things that protect you. Aluminum shelf designed to hold helmets, goggles, shoes, gloves and uniforms. Removable hanging bar aids organization. Mount it high to maximize storage capacity.

H Single Helmet Shelf
SP1HS

Dimensions: 7"H x 14"W x 15"D

A smaller version of the 2-helmet shelf, this aluminum single helmet shelf has the same features as its counterpart, but takes up less space. Removable hanging bar provides additional organizational options.



Tough + Durable + Functional.

A Wheel Chock
SPWM (includes SPWFKW - see B below)
 Black Powder-coated Steel with Wood Surface Mounting System

SPWC (includes SPWFKW - see B below)
 Chromed Steel with Wood Surface Mounting System

SPWC3BT (includes PH2770 - see B below)
 Chromed Steel with Multi-Surface Mounting System

Tubular construction makes this wheel chock the strongest around. Keyhole slots make removal and storage easy. Tapered design stabilizes up to 6.5" tires. Mounting hardware available for multiple surfaces (see B for mounting options).

B Three-point Mount System
 Three different sets available to suit your application needs.

(1) SPWFKW Wood Surface Mounting System
 Includes three screws and togglers ideal for wood mounting.

(2) PH2770 Multi-Surface Mounting System
 Combines wood floor insert with a 2" top disk secured with additional, included screws.

(3) SPWFKM Metal Surface Mounting System
 Includes three screws and togglers ideal for metal mounting.

C 4-Bottle Nitrous Rack
SPNR4
 Dimensions: 13"H x 29.5"W x 7.5"D

2-Bottle Nitrous Rack
SPNR2
 Dimensions: 13" H x 15"W x 7.5"D

Keep safe by preventing tanks from rolling around on the way to the track with a mill finish aluminum nitrous rack. Also useful for storing acetylene, nitrogen and scuba tanks. This rack can double as a useful storage bin when not used for tanks.

D Battery Box
SP12B / SP12BP
 12" Box Mill Finish / 12" Box Polished Finish

SP14B / SP14BP
 14" Box Mill Finish / 14" Box Polished Finish

Give your battery extra protection and reduce under hood clutter with this rugged aluminum battery box. Featuring a sealed design with external vent tube, box comes complete with mounting rods, mounting rod brackets and stainless steel lock nuts.

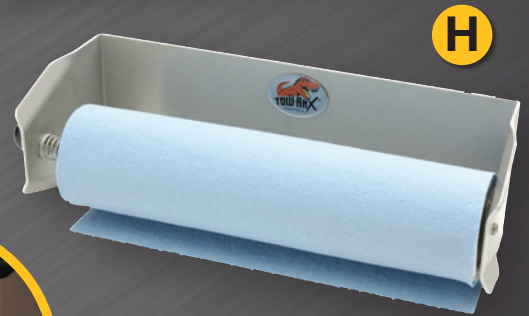
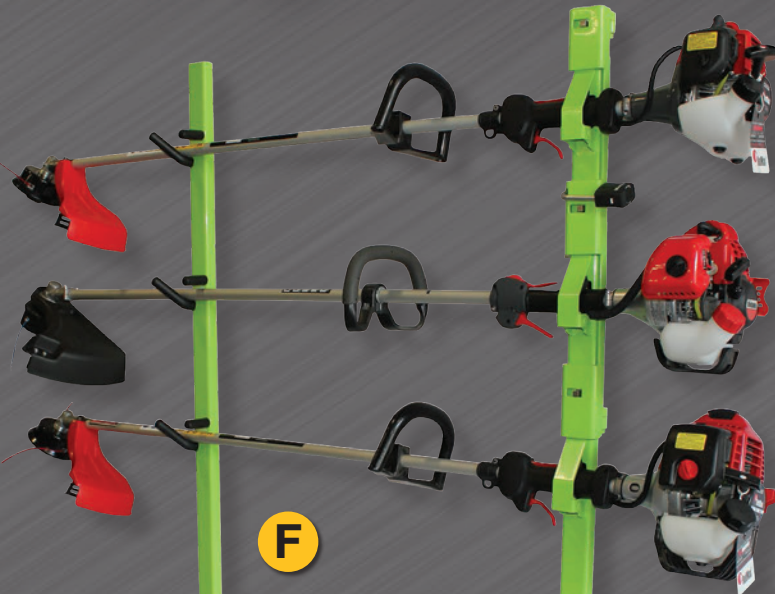

**E Tray with Tool Rack
SPOTS**

Dimensions: 6.5"H x 5.5"W x 33.5"D

Machined aluminum finish with precision cut and marked rack for wrenches and drivers with space for cleaning supplies, aerosol and oil cans.

**F Trimmer Storage & Security Rack
SPDDTR3**

Dimensions: 42"W x 53"H x 4"D

Solid steel construction provides stability and theft protection for up to three trimmers. Secure trimmers in place without denting, scratching or rotating during transport. You can secure all three tools with one pad or disc-style lock, yet release a single tool from any of its three positions without releasing the others. The unit's bright green color aims to increase visibility for safety, while the powder coated finish and stainless steel latches help resist the elements.

(1) SPTRWM Trimmer Rack Wall Mount Bracket

Used to mount rack in enclosed trailer or garage wall. Four brackets needed to mount one SPDDTR3 rack.

PSPDDTR3P Replacement Wear Pad Kit (Not Shown)

All pads needed to replace worn, cushioned resting locations on SPDDTR3 to prevent jostling and scratching of trimmers.

**G Tool Cabinet with Tray
SP30ATC**

Dimensions: 30"H x 26"W x 4"D

Secure and organize your tools. Tool cabinet provides storage for wrenches, sockets, screwdrivers, and a wide assortment of every-day use tools. The convenient work tray is ideal for cleaning and repairing small parts. All aluminum. (Use SP25BK for mounting. Predrilled holes)

**H Towel Holder
SPPTH**

Dimensions: 4"H x 13.25"W x 4.5"D

This mill finish aluminum holder keeps your paper towels neat, clean and easily accessible. Unit is equipped with a spring-loaded rod to help prevent unrolling during travel.

A**B****C****D****E**

Tough + Durable + Functional.

A Junior Oil Cabinet
SP180CSA

Dimensions: 17.5"H x 16"W x 5.5"D

Mill finish aluminum junior cabinet designed to hold and organize 2 rows of 6 one-quart bottles of oil. Most aerosol cans and spray bottles fit this cabinet as well.

B Combo Cabinet
SP36CCA

Dimensions: 35"H x 23"W x 9"D

Mill finish aluminum Combo Cabinet provides storage for all your fluids and lubricants. Top shelf designed for aerosol cans, middle shelf holds one-quart containers, and bottom shelf is perfect for gallon containers.

C Cup Holder
SP2CH

Dimensions: 5.25"H x 8"W x 4.25"D

Mill finish aluminum cup holder has two 3" openings for cans/cups.

D Aerosol Can Utility Tray
SP12AT

Dimensions: 4"H x 33.5"W x 4"D

Handy mill finish aluminum tray holds up to 12 standard aerosol cans as well as other items that are easily misplaced. Helps eliminate clutter.

E Air Tool Holder
SPATH

Dimensions: 1.75"H x 17.5"W x 5.5"D

Keep air tools handy with this powder coated steel rack that lets up to nine air tools hang out and stay organized.

F 6-Can Black Aerosol Holder
SP6AT

Dimensions: 5.5"H x 3.25"W x 21.5"D

Avoid piling aerosol cans where the nozzle can accidentally be pressed. Store up to six 3" diameter cans upright and out of the way.



G Single Point Tie Down
SP1DTAB

Dimensions: 1.65"D x .42"H

Round anchor point fits in tight spaces where there may not be enough room for tracks. Two pre-drilled holes make installation fast and easy.

H Single Stud Tie Down
SPSSTD

Load Capacity: 4,000 lbs. vertical
2,000 lbs. horizontal

Spring loaded track fitting for use with any of the Tow-Rax® wall/floor tracks or SP1DTAB.

I Double Stud Tie Down
SPSSTD225

Load Capacity: 6,000 lbs. vertical
2,000 lbs. horizontal

This double-stud mechanism locks into tow track holes for a secure fit in any of the Tow-Rax® wall/floor tracks. (Cannot be used with SP1DTAB.)

J Aluminum L-Series "L" Track

SP6LTAB	SP12LTAB	SP18LTAB
6" Length	12" Length	18" Length

Dimensions: 0.42"H x 1.2"W

SPLTE - Protective End Cap

K Aluminum O-Series Domed Track

SP6DTAB	SP12DTAB	SP18DTAB
6" Length	12" Length	18" Length

Dimensions: 0.43"H x 2"W

SPDE - Protective End Cap

L Aluminum Tapered Track - Black

SP6TAB	SP12TAB	SP18TAB
6" Length	12" Length	18" Length

Aluminum Tapered Track - Mill Finish

SP24TA	SP72TA
24" Length	72" Length

Dimensions: 0.47"H x 2.5"W

SPPGF - Protective End Cap

All tracks are made of sturdy aluminum and can be used for floor or wall installation. Counter-sunk holes are distributed across length for easy mounting. (Mounting screws not included.)



Tough + Durable + Functional.

A Cord Hanger SPSCBA

Dimensions: 4"H x 6"W x 4"D

Tow-Rax® mill finish aluminum cord hangers neatly store most types of cords, hoses and cables up to 100 ft. Mounts virtually anywhere.

B Air Gauge Holder SPSAGHA

Dimensions: 3.5"H x 4"W x 2.13"D

Store your air pressure gauge by slipping it into this convenient mill finish aluminum holder. Mount it to the wall of your trailer, shop or garage for easy access

C Flashlight Holder SP135FLHOA (Flashlight not included)

Dimensions: 5.5"H x 3"W x 3"D

Another perfect addition to the home, garage or trailer, our mill finish aluminum flashlight holder is lightweight and convenient. It can be installed virtually anywhere.

D Tear-away Stuff Pack SP10SP (Tools not included)

Dimensions: 10"W x 6"H

Finally, a convenient place to store your stuff while you work. Made of durable woven nylon, this pack features two zipper pockets to store tools, cell phones, etc. A 2" wide adhesive hook and loop closure and a carabineer latch mean this pack can be attached virtually anywhere.

E Strap Track SP26AST

Mill finish aluminum strap track securely stores long, unwieldy items such as brooms, ramps, tables, etc. These strap tracks allow vertical storage; saving precious floor space. Available in 26" lengths.

F**H****I****G**

F 12V Air Compressor AC12V3

Dimensions: 18"H x 20.5"W x 8.5"D
1.70 CFM @90 PSI / 2.55 CFM @ 60 PSI

Ready to work in 90 seconds, this 12 volt portable air compressor features a 3 gallon tank, 3/4 horse power motor and vibration dampening feet.

G Tire Storage Rack SPTSR

Outside: 28" H x 30"D (adjustable width from 34.5"-62.5")
Capacity Width: 52" / **Track:** 65" / **Wheel size:** up to 22"

Mount this adjustable, powder coated steel unit high on the wall as a space saving storage solution for your garage, shop or trailer. Telescoping rod expands and contracts to accommodate wide or narrow widths. Rated to hold up to 400 lbs. (requires additional mounting hardware for trailer mounting - not included)

H Hose Reel HR3825

Dimensions: 17.5"H x 14"W x 6.25"D

Industrial hose reel features a 25' long, 3/8" diameter hose with spring-driven drum allowing for automatic rewind. Locking ratchet also allows users to maintain any desired length during use.

Compressor/Reel Kit AC12V3PK

Kit includes everything you need to mount inside your trailer, garage or shop: air compressor, hose reel, 50 amp breaker and compressor-to-reel hose.

I Light Bucket SPRLB2 (Polished Outer Face Light Bucket for use with PWLS110V50W light)

SPRLB2L (Light Bucket Kit includes PWLS110V50W light)
Bucket Dimensions: 11.625" H x 12.625"W x 5.625"D

PWLS110V50W 50 watt, 110-130v LED light

Recessed light bucket offers a convenient lighting solution, while maintaining overall trailer width. Can be used with or without interior trim ring for that finished look. (mounting bezel included)



A

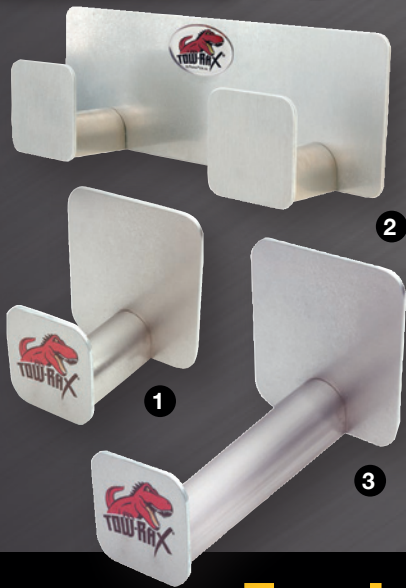

B



C

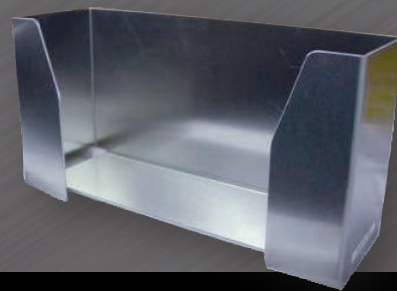

Tough + Durable + Functional.

A Brackets

(1) SP35SBA

Dimensions: 4" H x 4"W x 2.5"D

(2) SP1025DBA

Dimensions: 3.5"H x 10.5"W x 2.5"D

(3) SPHHA

Dimensions: 4"H x 4"W x 5"D

Brackets and hangers keep important items at your finger tips. Tape, small cords, goggles, helmets, hoses, etc., easily hang on these mill finish aluminum brackets offering organization and convenience.

B Strap Hanger

SP8SHA

Dimensions: 4"H x 3.5"W x 8"L

SP25SHA

Dimensions: 4"H x 3.5"W x 17"L

No more tangled or lost straps! Tow-Rax® strap hangers are the perfect solution to those frustrating, knotted bungee cords and straps. Mill finish aluminum units available in 8" and 17" sizes.

C Glove Dispenser

SPGD

Dimensions: 5.1"H x 10"W x 3.3"D

Keep disposable gloves handy. This aluminum finish dispenser holds 100-count box with 4.75" H x 9.5"W x 3"D dimensions.



D Folding Table
SP45HFTA

Dimensions: 13"H x 45.5"W x 18.5"D

Mill finish aluminum table folds to approximately 4" from the wall, yet provides almost 6 sq. ft. of workspace in its upright position. Has a working capacity of 100 lbs., securely locks in place while in use, yet can be easily removed. Addition of exterior mounting buttons allows use in multiple locations. Mounts on 32" centers.

(2 sets of buttons are included for multiple mounting # SP30BK only.)

E Jack Mounts
SPJSTAL

Dimensions: 2.5"H x 2"W x 16"D

Hydraulic floor jack rack stays secured while in transport. No worries about where your "little wrecking ball" (floor jack) will go while you travel from point A to B. Mill finish aluminum jack rack holds jack wheels up to 4" in diameter. Sold as a pair.

F Oil Rack/Utility Bin
SP31TB

Dimensions: 5"H x 5.5"W x 31"L

Store fluid bottles out of the way with this mill finish aluminum unit. Easily holds oil, transmission fluid, brake fluid, paint cans, cleaning supplies and much, much more.

G Propane/Fuel Jug Rack
SP2BRA (2 jug)

Dimensions: 12"H x 25.5"W x 12.5"D

SP4BRA (4 jug)

Dimensions: 12"H x 51"W x 12.5"D

Safely stores fuel jugs and/or propane bottles. Mill finish aluminum rack eliminates sliding and minimizes chance of dangerous spills. Screws to trailer wall for security.





Phoenix USA, Inc.

Trailer Simulators



GQST60



GQST50



NST06

NST15



GQT60



NDT165



GDST175



QC160A



QCT175

MODEL	DOTLiner®	QuickLiner®	QuickCover®	AirPlus®	AirMax®
15" 5 Lug or 6 Lug single wheel	NST15	GQST50			
16" X 6" single wheel w/ 1/2" & 9/16" studs	NST06	GQST60	QC160A**		
16.5" X 6.75" single wheel w/ 1/2" & 9/16" studs	NST06				
16" 8 lug dual wheel w/ 5/8" Studs	NDT165	GQT60**	QC160A**	AP3/AP4	AML1*
16.5" 8 lug dual wheel w/ 5/8" Studs	NDT165			AP3/AP4	AML1*
17.5" X 6.75" single wheel w/ 5/8" studs	GDST175		QC175R / QCT175		
17.5" X 6.00" single wheel w/ 5/8" studs Armstrong wheels			QC175R / QCT175		
17.5" X 8.25" single wheel w/ 5/8" studs			QC175R / QCT175		
17.5" 6 Lug dual wheel 2 Hand Hole			QC175R / QCT175	AP3/AP4	AMH1*
17.5" 8 Lug dual wheel 4 Hand Hole			QC175R / QCT175		
17.5" 10 Lug dual wheel 2 Hand Hole			QC175R / QCT175		

D.O.T. Liner® = Bolts on without removing the wheel lugnuts.

QuickLiner® = Secure snap-on with no lugnut removal required.

QuickCover® = universal no lugnut removal, ring-mount simulator.

* AirMax® only fits DOTLiner®

** Will not fit BUDD brand wheels

QuickTrim®

Hubcovers For Trailers

Manufactured from temperature-stable plastic for years of durable service, QuickTrim® hubcovers are the preferred alternative for providing the finished look on trailer wheels.

Chrome ABS Trim Rings

- 1403** 14" trim rings
- 1503** 15" trim rings
- 1603** 16" trim rings

*all sets of 4



CHROME ABS HUBCOVERS



QT545CHN
5 lug on 4.5" bolt circle hubcover (2.75" emblem indent)



QT545CHS
5 lug on 4.5" bolt circle hubcover (1 5/8" emblem indent)



QT545CH4
5 lug on 4.5" bolt circle hubcover (2.75" emblem indent) with 13/16" hex lugnuts



QT550CH4
5 lug on 5" bolt circle hubcover (2.75" emblem indent) with 13/16" hex lugnuts



QT655CHN
6 lug on 5.5" bolt circle hubcover (2.75" emblem indent)



QT765CHN
8 lug on 6.5" bolt circle hubcover (7K axle) with 13/16" lugnut hex

QT865CHN
8 lug on 6.5" bolt circle hubcover (8K axle) with 7/8" lugnut hex

QT965CHN
8 lug on 6.5" bolt circle hubcover (9K-10K axle) with 5/8" lug stud pop-out center (2.75" emblem indent)



BLACK ABS HUBCOVERS

- QT545BHS**
5 lug on 4.5" bolt circle hubcover
- QT655BHN**
6 lug on 5.5" bolt circle hubcover
- QT765BHN**
8 lug on 6.5" bolt circle hubcover (7K axle) with 13/16" lugnut hex

Lugnut for Aluminum Wheel QuickTrim® Applications

Custom-made lugnut designed for aluminum wheel applications. External notches provide multiple hubcover mounting points.



PQT50LNAD
1/2" trailer lugnut

Two per wheel recommended for proper QuickTrim® hubcover attachment

WHITE ABS HUBCOVERS

- QT545WHS**
5 lug on 4.5" bolt circle hubcover
- QT655WHN**
6 on 5.5" bolt circle hubcover



Chrome ABS Wheel Covers

ABS wheel cover installed with QuickTrim® hubcover gives the look of an aluminum wheel while maintaining the strength of the factory steel wheel.



QT544CLO 14" chrome ABS, 5 lug on 4.5" bolt circle (use with QT545CHS, QT545CHN & QT545CH4)

QT545CLO 15" chrome ABS, 5 lug on 4.5" bolt circle (use with QT545CHS, QT545CHN & QT545CH4)

QT655CLO 15" chrome ABS, 6 lug on 5.5" bolt circle (use with QT655CHN & QT550CH4)

QT6556CLO 16" chrome ABS, 6 lug on 5.5" bolt circle (use with QT655CHN & QT550CH4)

QT865CLO 16" chrome ABS, 8 lug on 6.5" bolt circle (use with QT765CHN & QT865CHN)



6-Lug Chrome ABS Hubcover

Chrome ABS Wheel Cover



Phoenix USA, Inc.

Chrome ABS Golf Cart, ATV/UTV and Zero Turn Mower Wheel Covers



After



QT6CHM*
6", 5-spoke
mag style



QT8CHM*
8"
5-spoke
mag style



Before



QT12CHB*
12", 8-hole
beadlock style

QT10CHB*
10", 8-hole
beadlock style

QT8CHB*
8", 8-hole
beadlock style



QT8CH
8"
sawblade style

QT6CHBH
6", 8-hole
beadlock
style



Before



After

* Fits most standard mower rear wheels, spring clip retention.

Mini LED Warning Light Bar



(side view)



(bottom view)

PB1106AMS

- 24 high-output LEDs
- 7 flash patterns
- heavy-duty magnetic mount
- high strength, impact resistant polycarbonate lens and base
- lower current draw
- includes 12ft power cord, 12v plug with double switch
- operational temperature range: -30° C to 50° C (-22° F to +122° F)
- 11" x 6.5" x 2"

Lighting Accessories



100 Series Round Work Light

PWL100

- 6 high intensity LED diodes
- 750+ lumen
- 18 watt
- 10-30v
- 4.6" x 4.6" x 1.7"

ABS Chrome Screwless Grommet Mount Light Bezels



PH4871

2" round bezel

PH4873

4" round bezel

PH4872

2.5" round bezel

PH4874

6" oval bezel

LED Light Strip



- High output LED lights
- weather resistant
- built in On/Off switch
- includes two snap-fit mounting brackets

PLSL06

6" L x 3/8" H x 5/8" W

PLSL12

12" L x 3/8" H x 5/8" W

PLSL24

23.6" L x 3/8" H x 5/8" W

PLSL36

35.4" L x 3/8" H x 5/8" W

PLSL48

47.2" L x 3/8" H x 5/8" W



PLSLC

Replacement mounting brackets
34" L x 5/8" W x 3/8" H



Mini Emergency Lighting

- 12 flash patterns
- 3.35" L x 1" W x 0.65" H



PELMS3W

3 LED, White



PELMS3A

3 LED, Amber



PELMS3R

3 LED, Red



PELMS6A

6 LED, Amber

Manufactured from high grade aluminum and stainless steel, the Tow-Rax® line of storage solution products includes cabinets, hangers, shelves and racks that are tough, light weight, durable and functional as well as designed to save valuable space in your garage, shop, toy hauler, RV or trailer. If your toys are important to you, Tow-Rax® is your space-saving storage solution.

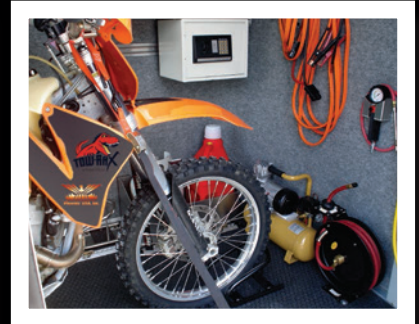
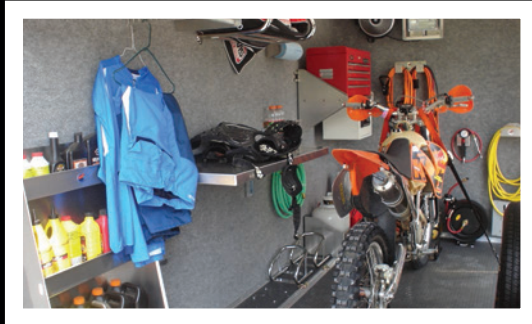

Look through our comprehensive collection of semi truck wheel covers right away.