

Heavy Duty Pistol Grip Grease Gun

Stock Number W54291

OWNER'S MANUAL

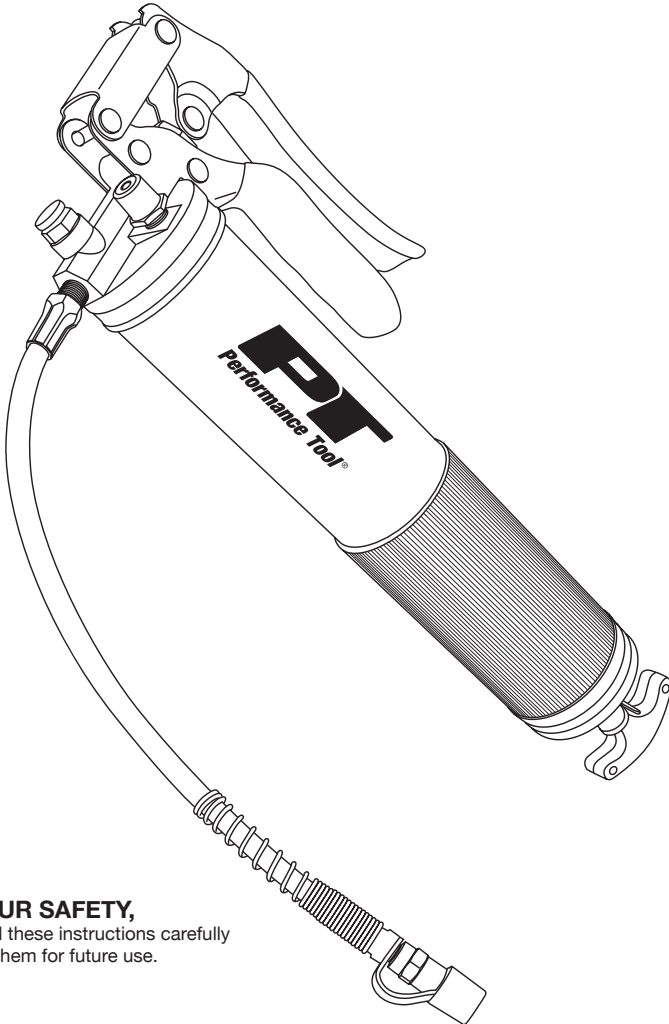

FOR YOUR SAFETY,
please read these instructions carefully
and retain them for future use.

GREASE CARTRIDGE LOADING

NOTE - This is a basic instruction manual which covers various models of grease guns. The illustrations below may not depict exactly your specific gun.

1. Rotating counter clockwise, unscrew Head Cap from gun Barrel. (Figure 1)

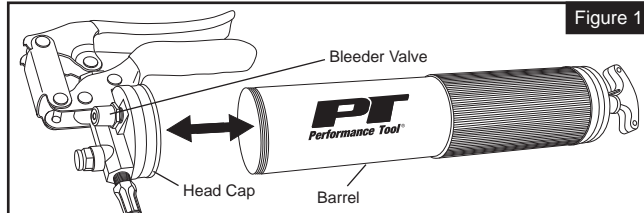

Figure 1

NOTE - Because they lack lubrication on the rubber plunger, new grease guns may be difficult to load with grease cartridges the first time. Apply a liberal coating of grease to plunger when using gun for the first time. **This grease gun requires a 14 oz. grease cartridge.**

2. Draw handle back fully so that the plunger rod catches and locks into place. (Figure 2)

CAUTION: Depressing the lock release when empty causes the handle to snap back quickly.

3. After removing the plastic cap from the grease cartridge, apply a small amount of grease to the inside edge of the cartridge. This will make insertion of the plunger easier. (Figure 3)

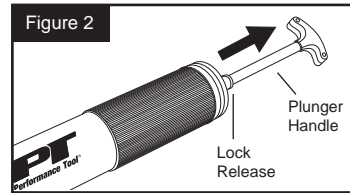

Figure 2

4. Push grease cartridge into gun barrel completely, until metal edge tightly seals on top of the grease gun barrel. Detach flip-top seal from cartridge. (Figure 4)

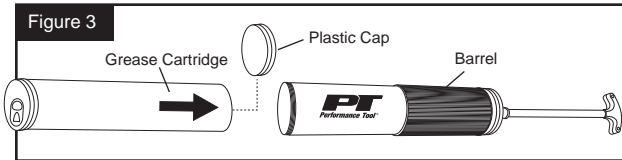

Figure 3

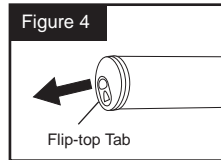

Figure 4

5. Screw on head cap approximately two turns, being sure not to tighten. Release plunger rod from its locked position and push in. Push on plunger rod handle to force plunger into cartridge. At the same time, pump the lever or handle to release trapped air. When grease comes through vents and the head of the gun, fully tighten the head cap to the barrel.

6. As soon as the gun is pumping grease, carefully depress the lock release and push plunger rod back into gun.

! WARNING!
DO NOT REFILL
USED CARTRIDGES

BULK LOADING WITH DISPENSER

NOTE - Used cartridges must be removed prior to bulk loading.

1. Make sure the valve is compatible with the adapter on the pump. (Figure 5)

2. Attach the filler valve to the adapter by pushing in and rotating slightly.

3. Operate the pump handle while holding the gun firmly to the pump. As the grease pumps into the grease gun barrel the plunger handle will extend. Loading is complete when the plunger rod is fully extended.

4. A slight twist of the gun will detach it from the pump. Depress lock release and push the plunger rod back into the gun.

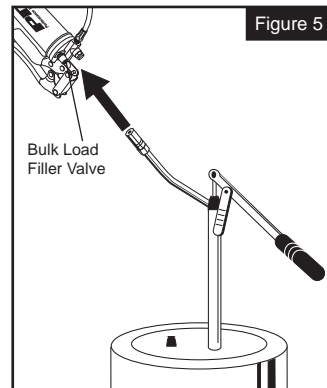

Figure 5

SUCTION FILLING

NOTE - Used cartridges must be removed prior to suction filling.

1. Remove the gun head cap from the barrel.

2. Submerge open end of the barrel into grease bucket. Be sure the plunger handle is depressed completely. Grasp the barrel firmly and pull back slowly on the plunger handle. Be sure the mouth of the barrel is always under the surface so that air is not transferred into the barrel. (Figure 6)

3. Loading is complete when plunger rod is fully extended.

4. Reattach the gun head cap to the barrel. Depress lock release and push the plunger rod back into the gun.

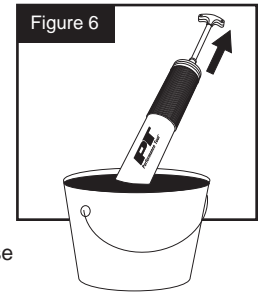

NOTE - Grease guns may lose their prime on occasion, because of air pockets in the grease. If this occurs, remove the trapped air by bleeding the head cap and resume pumping.

LIMITED WARRANTY

PERFORMANCE TOOL extends only the following warranties, and only to original retail purchasers. These warranties give specific legal rights. Except where prohibited by local law, the law of the State of Washington governs all warranties and all exclusions and limitations of warranties and remedies. There may be other rights which vary from state to state. PERFORMANCE TOOL warrants the product to be free from defects in materials and workmanship under normal use and service. A defective product may be returned for a free replacement within 90 days from the date of purchase, provided that product is returned to place of purchase immediately after discovery of defect. These warranties shall be valid only when a sales receipt showing the date of purchase accompanies the defective product being returned. These warranties exclude blades, bits, punches, dies, bulbs, fuses, hoses, and other consumables which must be replaced under normal use and service. These warranties shall not apply to any product or part which is used for a purpose for which it is not designed, or which has been repaired or altered in any way so as to affect adversely its performance or reliability, nor shall these warranties apply to any product or part which has been subject to misuse, neglect, accident or wear and tear incident to normal use and service. PERFORMANCE TOOL does not authorize any other person to make any warranty or to assume any liability in connection with its products. Except for warranties of title and the limited express warranties set forth above, PERFORMANCE TOOL makes no express or implied warranties of any kind with respect to its products. In particular, PERFORMANCE TOOL makes no implied warranty of merchantability and no implied warranty of fitness for any particular purpose, except that for goods purchased primarily for personal, family or household use and not for commercial or business use, PERFORMANCE TOOL makes an implied warranty of merchantability (and, if otherwise applicable, an implied warranty of fitness for a particular purpose), but only for the particular qualities or characteristics, and for the duration, expressly warranted above. The laws on limitation of implied warranties may differ from state to state, so the above limitations may not apply in all cases. PERFORMANCE TOOL shall not be liable for consequential, incidental or special damages resulting from or in any manner related to any product, or to the design, use, or any inability to use the product. The sole and exclusive remedy for a defective product or part shall be the repair, or replacement thereof as provided above. The laws on limitation of remedies or on consequential, incidental or special damages may vary from state to state, so the above limitations may not apply in all cases. Copyright © 2014 PERFORMANCE TOOL - All rights reserved