

1 YEAR LIMITED WARRANTY

PERFORMANCE TOOL® extends only the following warranties, and only to original retail purchasers. These warranties give specific legal rights. Except where prohibited by local law, the law of the State of Washington governs all warranties and all exclusions and limitations of warranties and remedies. There may be other rights which vary from state to state.

PERFORMANCE TOOL® warrants the product to be free from defects in materials and workmanship under normal use and service. A defective product may be returned for a free replacement within 90 days from the date of purchase, provided that product is returned to place of purchase immediately after discovery of defect. After 90 days and up to one year from date of purchase, PERFORMANCE TOOL® will replace at no charge any parts which our examination shall disclose to be defective and under warranty.

These warranties exclude blades, bits, punches, dies, bulbs, fuses, hoses, and other consumables which must be replaced under normal use and service. These warranties shall not apply to any product or part which is used for a purpose for which it is not designed, or which has been repaired or altered in any way so as to affect adversely its performance or reliability, nor shall these warranties apply to any product or part which has been subject to misuse, neglect, accident or wear and tear incident to normal use and service.

PERFORMANCE TOOL® does not authorize any other person to make any warranty or to assume any liability in connection with its products.

Except for warranties of title and the limited express warranties set forth above, PERFORMANCE TOOL® makes no express or implied warranties of any kind with respect to its products. In particular, PERFORMANCE TOOL® makes no implied warranty of merchantability and no implied warranty of fitness for any particular purpose, except that for goods purchased primarily for personal, family or household use and not for commercial or business use, PERFORMANCE TOOL® makes an implied warranty of merchantability (and, if otherwise applicable, an implied warranty of fitness for a particular purpose), but only for the particular qualities or characteristics, and for the duration, expressly warranted above. The laws on limitation of implied warranties may differ from state to state, so the above limitations may not apply in all cases.

PERFORMANCE TOOL® shall not be liable for consequential, incidental or special damages resulting from or in any manner related to any product, or to the design, use, or any inability to use the product. The sole and exclusive remedy for a defective product or part shall be the repair, or replacement thereof as provided above. The laws on limitation of remedies or on consequential, incidental or special damages may vary from state to state, so the above limitations may not apply in all cases.

7" VARIABLE SPEED POLISHER/SANDER

Item Number W50084

OWNER'S MANUAL



▲WARNING

It is the owner and/or operators' responsibility to study all WARNINGS, operating, and maintenance instructions contained on the product label and instruction manual prior to operation of this product. The owner/operator shall retain product instructions for future reference.

The owner and/or operator are responsible for maintenance, maintaining all decals or warning labels and while in use, maintaining the unit in good working order. If the owner and/or operator are not fluent in English, the product warnings and instructions shall be read and discussed with the operators' native language by the purchaser/owner or his designee. Make sure that the operator comprehends its contents. Safety information shall be emphasized and understood prior to usage. The product shall be inspected per the operating instructions.

Users of this product must fully understand these instructions. Each person operating this product must also be of sound mind and body and must not be under the influence of any substance that might impair their vision, dexterity or judgment.

Protect yourself and others by observing all safety information.

Failure to comply with instructions could result in personal injury and/or property damage!

SAFETY GUIDELINES / DEFINITIONS

This instruction manual is intended for your benefit. Please read and follow the safety, installation, maintenance and troubleshooting steps described within to ensure your safety and satisfaction. The contents of this instruction manual are based upon the latest product information available at the time of publication. The manufacturer reserves the right to make product changes at any time without notice.

⚠ WARNING: Read and understand this entire instruction manual before attempting to assemble, install, operate or maintain this product. Failure to comply with the instructions may result in serious personal injury and/or property damage!

The following signal words are used to emphasize safety warnings that must be followed when using this product:

⚠ DANGER Indicates an imminently hazardous situation that, if not avoided, WILL result in death or serious injury.

⚠ WARNING Indicates a potentially hazardous situation that, if not avoided, COULD result in death or serious injury.

⚠ CAUTION Indicates a potentially hazardous situation that, if not avoided, MAY result in minor or moderate injury.

⚠ NOTICE Indicates important information, which if not followed, MAY cause damage to equipment.

UNPACKING AND INSPECTION

After opening the carton, unpack your new product and related parts & accessories. Please inspect it carefully for any damage that may have occurred during transit. Please check it against the photograph on carton.

⚠ WARNING DO NOT operate this product if damaged during shipment, handling or misuse. Do not operate the product until the parts have been replaced or the fault rectified. Failure to do so may result in serious personal injury or property damage. All damaged parts must be repaired or replaced as needed prior to operating this product. Check to see that all nuts, bolts and fittings are secure before putting this product into service.

Please have the serial number, model number, and date of purchase available for reference when calling.

SPECIFICATIONS

No-load Speed: 800-3000 RPM

Amperage: 11A

Max Accessory Diameter:7" (178mm)

Spindle Thread: 5/8"-11

Motor: 120 V ~ 60hz

Specifications are subject to change without notice.

IMPORTANT SAFETY INFORMATION

⚠ WARNING
READ, UNDERSTAND AND FOLLOW ALL INSTRUCTIONS AND WARNINGS BEFORE OPERATING THIS PRODUCT. FAILURE TO DO SO MAY RESULT IN PERSONAL INJURY AND/OR PROPERTY DAMAGE AND WILL VOID WARRANTY.

1. Always use common sense and pay particular attention to all the DANGER, WARNING, CAUTION and NOTICE statements of this manual. The safety instructions provided are not intended to cover all possible conditions and practices that may occur when operating, maintaining and cleaning power tools.
2. Observe work area conditions. Do not use machines or power tools in damp or wet locations. Don't expose to rain. Keep work area well lighted. Do not use electrically powered tools in the presence of flammable gases or liquids. Do not bring combustible materials near the tools. Power tools create sparks, which may ignite the dust or fumes. Keep work area clean and well lit. Cluttered work areas invite accidents.
3. Wear personal protective equipment. Depending on application, use face shield, safety goggles or safety glasses. as appropriate, wear dust mask, hearing protectors, gloves and workshop apron capable of stopping small abrasive or workpiece fragments. the eye protection must be capable

- of stopping flying debris generated by various operations. The eye protection must be capable of stopping flying debris generated by various operations. The dust mask or respirator must be capable of filtering out particles generated by your operation. Prolonged exposure to high intensity noise may cause hearing loss.
4. Keep bystanders, children and visitors away while operating this product. Distractions can cause you to lose control. Anyone entering the work area must wear personal protective equipment. Fragments of workpiece or of a broken accessory may fly away and cause injury beyond immediate area of operation.
 5. Stay alert. Watch what you are doing, and use common sense when operating this product. Do not use this product while tired or under the influence of drugs, alcohol, or medication. A moment of inattention while operating this product may result in serious personal injury. Keep proper footing and balance

TROUBLESHOOTING

Problem	Possible Causes	Likely Solutions
Overheating.	<ol style="list-style-type: none"> 1. Forcing tool to work too fast. 2. Blocked motor housing vents. 3. Motor being strained by long or small diameter extension cord. 	<ol style="list-style-type: none"> 1. Allow tool to work at its own rate. 2. Wear ANSI-approved safety goggles and NIOSH-approved dust mask respirator while blowing dust out of motor using compressed air. 3. Eliminate use of extension cord. If an extension cord is needed, use one with the proper diameter for its length and load. See Extension Cords in GROUNDING section.
Tool does not sand or polish effectively.	<ol style="list-style-type: none"> 1. Disc accessory may be loose on Spindle. 2. Disc accessory may be damaged, worn or wrong type for the material. 3. Wax sprays off polishing pad. 	<ol style="list-style-type: none"> 1. Be sure disc accessory arbor is correct and Outer Flange/Arbor Nut is tight. 2. Check condition and type of disc accessory. Use only proper type of disc accessory in good condition. 3. Reduce RPM to minimum setting.
<p>⚠ WARNING Follow all safety precautions whenever diagnosing or servicing the tool. Disconnect power supply before service.</p>		

CARE & MAINTENANCE

- they will be reinstalled.
- c. If either carbon brush is worn down by more than 1/2, replace them both.
 - d. To clean old carbon brushes before reusing them, rub the contact areas with a pencil eraser.
 - e. Reinsert the old carbon brushes in the same orientation to reduce wear.
 - f. When installing, make sure the carbon portions of the brushes contact the motor armature, and that the springs

- face away from the motor. Also, make sure the springs operate freely.
- g. Replace the Carbon Brush Covers. Do not overtighten.

NOTE: New carbon brushes tend to spark when first used until they wear and conform to the motor's armature.

▲ WARNING If the supply cord of this power tool is damaged, it must be replaced only by a qualified service technician.

TROUBLESHOOTING

Problem	Possible Causes	Likely Solutions
Tool will not start.	<ol style="list-style-type: none"> 1. Cord not connected. 2. No power at outlet. 3. Internal damage or wear. (Carbon brushes or switch, for example.) 	<ol style="list-style-type: none"> 1. Check that cord is plugged in. 2. Check power at outlet. If outlet has no power, turn off tool and check circuit breaker. If breaker is tripped, make sure circuit is right capacity for tool and circuit has no other loads. 3. Replace Carbon Brushes and/ or have technician service tool.
Tool operates slowly.	<ol style="list-style-type: none"> 1. Excess pressure applied to workpiece. 2. Power being reduced by long or small diameter extension cord. 	<ol style="list-style-type: none"> 1. Decrease pressure, allow tool to do the work. 2. Eliminate use of extension cord. If an extension cord is needed, use one with the proper diameter for its length and load. See Extension Cords in GROUNDING section.
Performance decreases over time.	Carbon brushes worn or damaged.	Replace brushes.
Excessive noise or rattling.	Internal damage or wear. (Carbon brushes or bearings, for example.)	Have technician service tool.

IMPORTANT SAFETY INFORMATION

- at all times. Do not reach over or across running machines, hoses, cords, etc.
6. Dress properly. Do not wear loose clothing or jewelry. Keep your hair, clothing, and gloves away from moving parts. Loose clothes, jewelry or long hair can be caught in moving parts.
7. Work Safe. Operate tool a safe distance from yourself and others in the work area. Do not run the power tool while carrying it at your side. Accidental contact with the spinning accessory could snag your clothing, pulling the accessory into your body. Never lay the power tool down until the accessory has come to a complete stop. The spinning accessory may grab the surface and pull the power tool out of your control. Keep proper footing and balance at all times. Do not overreach, especially on ladders. Be certain ladders being used are sturdy, stable, on a firm surface and erected as safe working angles. Do not reach over or across running machines, hoses, cords, etc.
8. Inspect before every use; do not use if parts are loose or damaged.
9. Do not alter this product in any way.
10. Use the right tool for the job. Do not attempt to force a small tool or attachment to do the work of a larger industrial tool. Don't use a tool whose performance is not adequate for your work. Do not modify this tool and do not use this tool for a purpose for which it was not intended.
11. Power tool plugs must match the outlet. Never modify the plug in any way. Do not use any adapter plugs with earthed (grounded) power tools. Unmodified plugs and matching outlets will reduce risk of electric shock.
12. People with pacemakers should consult their physician(s) before use. Electromagnetic fields in close proximity to heart pacemaker could cause pacemaker interference or pacemaker failure. In addition, people with pacemakers should:
 - Avoid operating alone.
 - Do not use with power switch locked on.
 - Properly maintain and inspect to avoid electrical shock.
 - Any power cord must be properly grounded. Ground Fault Circuit Interrupter (GFCI) should also be implemented – it prevents sustained electrical shock.
13. Avoid body contact with earthed or grounded surfaces such as pipes, radiators, ranges and refrigerators. There is an increased risk of electric shock if your body is earthed or grounded.
14. Do not expose power tools to rain or wet conditions. Water entering a power tool will increase the risk of electric shock.
15. Do not abuse the cord. Never use the cord for carrying, pulling or unplugging the power tool. Position the cord clear of the spinning accessory. If you lose control, the cord may be cut or snagged and your hand or arm may be pulled into the spinning accessory. Keep cord away from heat, oil, sharp edges or moving parts. Damaged or entangled cords increase the risk of electric shock.
16. When operating a power tool outdoors, use an extension cord suitable for outdoor use. Use of a cord suitable for outdoor use reduces the risk of electric shock.
17. If operating a power tool in a damp location is unavoidable, use a ground fault circuit interrupter (GFCI) protected supply. Use of a GFCI reduces the risk of electric shock.
18. Use power tool ONLY on adequately rated circuits to avoid overheating of electrical systems.
19. Prevent accidental starting. Ensure switch is in the "OFF" position before connecting to power source and/or battery pack, picking up or carrying the tool. Carrying power tools with your finger on the switch or energizing power tools that have the switch "ON" invites accidents.
20. Do not use the power tool if the switch does not turn it on and off. Any power tool that cannot be controlled with the switch is dangerous and must be repaired.
21. Have your power tool serviced by a qualified repair person using only identical replacement parts. This will ensure that the safety of the power tool is maintained. Follow instructions in the Maintenance section of this manual. Use of unauthorized parts or failure to follow Maintenance Instructions may create a risk of shock or injury.
22. Maintain labels and nameplates on the tool. These carry important safety information. If unreadable or missing, contact Performance Tool® for a replacement.
23. Disconnect the plug from the power source before making any adjustments or changing accessories. Such preventive safety measures reduce the risk of starting the power tool accidentally.
24. Maintain power tools. Check for misalignment or binding of moving parts, breakage of parts and any other condition that may affect the power tool's operation. Regularly clean the power tool's air vents. The motor's fan will draw the dust inside the housing and excessive accumulation of powdered metal may cause electrical hazards. If damaged, have the power tool repaired before use. Many accidents are caused by poorly maintained power tools.
25. Use the power tool, accessories and tool bits etc. in accordance with these instructions, taking into account the working conditions and the work to be performed. Use of the power tool for operations different from those intended could result in a hazardous situation.
26. Store idle equipment. When not in use, tools must be stored in a dry location to inhibit rust. Always lock up tools and keep out of reach of children and other untrained persons. Switch off all unused electrical tools when stored. Disconnect battery from unit. Tools are dangerous in the hands of untrained users.
27. Operations such as grinding, wire brushing, or cutting-off are not recommended to be performed with this power tool. Operations for which the power tool was not designed may create a hazard and cause personal injury.
28. Do not use accessories which are not specifically designed and recommended by the tool manufacturer. Just because the accessory can be attached to your power tool, it does not assure safe operation.
29. The rated speed of the accessory must be at least equal to the maximum speed marked on the power tool. Accessories running faster than their RATED SPEED can break and fly apart.
30. The outside diameter and the thickness of your accessory must be within the capacity rating of your power tool. Incorrectly sized accessories cannot be adequately guarded or controlled.
31. The arbor size of wheels, flanges, backing pads or any other accessory must properly fit the spindle of the power tool. Accessories with arbor holes that do not match the mounting hardware of the power tool will run out of balance, vibrate excessively and may cause loss of control.
32. Do not use excessively oversized sanding disc paper. Follow manufacturer's recommendations when selecting sanding paper. Larger sanding paper extending beyond the sanding pad presents a laceration hazard and may cause snagging, tearing of the disc or kickback.
33. Do not allow any loose portion of the polishing bonnet or its attachment strings to spin freely, tuck away or trim any loose attachment strings. Loose and spinning attachment strings can entangle your fingers or snag on the workpiece.

IMPORTANT SAFETY INFORMATION

34. Do not use a damaged accessory. Before each use inspect the accessory such as abrasive wheels for chips and cracks, backing pad for cracks, tear or excess wear, wire brush for loose or cracked wires. If power tool or accessory is dropped, inspect for damage or install an undamaged accessory. After inspecting and installing an accessory, position yourself and bystanders away from the plane of the rotating accessory and run the power tool at maximum no-load speed for one minute. Damaged accessories will normally break apart during this test time.
35. Hold power tool by insulated gripping surfaces only, when performing an operation where the accessory may contact hidden wiring or its own cord. An accessory contacting a "live" wire may make exposed metal parts of the power tool "live" and shock the operator.
36. Do not use accessories that require liquid coolants. Using water or other liquid coolants may result in electrocution or shock.
37. Do not depress the spindle lock when starting or during operation.
38. Use clamps (not included) or other practical ways to secure and support the workpiece to a stable platform. Holding the work by hand or against your body is unstable and may lead to loss of control and personal injury.
39. **WARNING:** Some dust created by power sanding, sawing, grinding, drilling, and other construction activities, contains chemicals known [to the State of California] to cause cancer, birth defects or other reproductive harm. Some examples of these chemicals are:
 - Lead from lead-based paints.
 - Crystalline silica from bricks and cement or other masonry products.
 - Arsenic and chromium from chemically treated lumber.Your risk from these exposures varies, depending on how often you do this type of work. To reduce your exposure to these chemicals: work in a well ventilated area, and work with approved safety equipment, such as those dust masks that are specially designed to filter out microscopic particles. (California Health & Safety Code § 25249.5, et seq.)
40. **WARNING:** Handling the cord on this product will expose you to lead, a chemical known to the State of California to cause cancer, and birth defects or other reproductive harm. Wash hands after handling. (California Health & Safety Code § 25249.5, et seq.)
41. **KICKBACK WARNING:** Kickback is a sudden reaction to a pinched or snagged rotating wheel, backing pad, brush or any other accessory. Pinching or snagging causes rapid stalling of the rotating accessory which in turn causes the uncontrolled power tool to be forced in the direction opposite of the accessory's rotation at the point of the binding. For example, if an abrasive wheel is snagged or pinched by the workpiece, the edge of the wheel that is entering into the pinch point can dig into the surface of the material causing the wheel to climb out or kick out. The wheel may either jump toward or away from the operator, depending on direction of the wheel's movement at the point of pinching. Abrasive wheels may also break under these conditions. Kickback is the result of power tool misuse and/or incorrect operating procedures or conditions and can be avoided by taking proper precautions as given below.
 1. Maintain a firm grip on the power tool and position your body and arm to allow you to resist kickback forces. always use auxiliary handle, if provided, for maximum control over

kickback or torque reaction during start-up. The operator can control torque reactions or kickback forces, if proper precautions are taken.

2. Never place your hand near the rotating accessory. Accessory may kickback over your hand.
3. Do not position your body in the area where power tool will move if kickback occurs. Kickback will propel the tool in direction opposite to the wheel's movement at the point of snagging.
4. Use special care when working corners, sharp edges etc. avoid bouncing and snagging the accessory. Corners, sharp edges or bouncing have a tendency to snag the rotating accessory and cause loss of control or kickback.
5. Do not attach a saw chain woodcarving blade or toothed saw blade. Such blades create frequent kickback and loss of control.
42. **VIBRATION WARNING:** This tool vibrates during use. Repeated or long-term exposure to vibration may cause temporary or permanent physical injury, particularly to the hands, arms and shoulders. To reduce the risk of vibration-related injury:
 1. Anyone using vibrating tools regularly or for an extended period should first be examined by a doctor and then have regular medical check-ups to ensure medical problems are not being caused or worsened from use. Pregnant women or people who have impaired blood circulation to the hand, past hand injuries, nervous system disorders, diabetes, or Raynaud's Disease should not use this tool. If you feel any medical or physical symptoms related to vibration (such as tingling, numbness, and white or blue fingers), seek medical advice as soon as possible.
 2. Do not smoke during use. Nicotine reduces the blood supply to the hands and fingers, increasing the risk of vibration-related injury.
 3. Wear suitable gloves to reduce the vibration effects on the user.
 4. Use tools with the lowest vibration when there is a choice between different processes.
 5. Include vibration-free periods each day of work.
 6. Grip tool as lightly as possible (while still keeping safe control of it). Let the tool do the work.
 7. To reduce vibration, maintain the tool as explained in this manual. If any abnormal vibration occurs, stop use immediately.
43. The warnings, precautions, and instructions discussed in this instruction manual cannot cover all possible conditions and situations that may occur. It must be understood by the operator that common sense and caution are factors which cannot be built into this product, but must be supplied by the operator.

WARNING: Some dust created by power sanding, sawing, grinding, drilling and other construction activities contains chemicals known to the State of California to cause cancer, birth defects or other reproductive harm.

WARNING: This product and its packaging contain a chemical known to the State of California to cause cancer, birth defects, or other reproductive harm.

OPERATION

3. Rotate the Speed Dial to select the desired speed setting.
4. Plug the Power Cord of the Polisher/Sander into a grounded 120 volt, electrical outlet.
5. To start, grip the Polisher/Sander firmly with both hands and press the Trigger. Release the Trigger to stop. To use the Lock on button, while holding in the Trigger, press the Lock On Button, then release the Trigger. The Polisher/Sander will stay on. Press and release the Trigger to stop.
6. Wait until the Polisher/Sander has reached full speed, then gently contact the surface.
7. Keep heavy pressure off of the Polisher/

- Sander when operating. Allow the sanding disk to do the work.
8. Move the Polisher/Sander in a uniform pattern up and down or side to side as you sand to ensure even sanding.
9. Periodically, stop the Polisher/Sander and check for possible disc wear. Replace used or worn sanding discs when necessary.
10. When finished, turn off and unplug the Polisher/Sander.
11. Allow the tool to come to a complete stop before setting it down.
12. To prevent accidents, turn off the tool and disconnect its power supply after use. Clean, then store the tool indoors out of children's reach.

CARE & MAINTENANCE

▲ NOTICE Procedures not specifically explained in this manual must be performed only by a qualified technician.

▲ WARNING TO PREVENT SERIOUS INJURY FROM A ACCIDENTAL OPERATION: Release the trigger and unplug the tool from its electrical outlet before performing any inspection, maintenance, or cleaning procedures.

▲ WARNING TO PREVENT SERIOUS INJURY FROM TOOL FAILURE: Do not use damaged equipment. If abnormal noise or vibration occurs, have the problem corrected before further use.

1. **BEFORE EACH USE**, inspect the general condition of the tool. Check for:
 - loose hardware,
 - misalignment or binding of moving parts,
 - cracked or broken parts,
 - damaged electrical wiring, and
 - any other condition that may affect its safe operation.
2. **AFTER USE**, wipe external surfaces of the tool with clean cloth.
3. Periodically blow dust and grit out of the motor vents using dry compressed air. Wear ANSI-approved safety goggles and

- NIOSH-approved breathing protection while doing this.
4. Periodically recheck all nuts, bolts, and screws for tightness.
5. Remove Foam Pad from Backing Pad when Polisher/Sander is not in use. This will allow Backing Pad to dry and retain its original shape. Wash with mild soap and water before storing.
6. The Polishing Bonnet may be machine washed in cold water with mild detergent. Do not put in the dryer.
7. Use only a clean cloth and mild detergent to clean the body of the Polisher. Do not use solvents. Do not immerse any part of the tool in liquid.
8. **CARBON BRUSH MAINTENANCE.** The carbon brushes may require maintenance when the motor performance of the tool decreases or stops working completely. To maintain the brushes:
 - a. Remove the Carbon Brush Cover on each side of the motor housing.
 - b. Remove the carbon brushes from the housing. Keep track of which orientation the old carbon brushes were in to prevent needless wear if

OPERATION

5. Plug the Power Cord into an electrical extension cord (not included). Then, plug the extension cord into a grounded, GFCI-protected, 120 volt electrical outlet.

▲WARNING To prevent electric shock, keep cord connection off ground.

NOTE: Always start and stop the Polisher/Sander while it is held firmly against the surface of the vehicle. Failure to do so may result in the Foam Pad or Polishing Bonnet being thrown from the Polishing Pad.

6. To start, position the unit on the area to be polished, grip the Polisher/Sander firmly with both hands and press the Trigger. Release the Trigger to stop. To use the Lock on button, while holding in the Trigger, press the Lock On Button, then release the Trigger. The Polisher/Sander will stay on. Press and release the Trigger to stop.

7. Keep pressure off of the Polisher/Sander when operating. The Foam Pad should LIGHTLY contact the polishing surface.

▲CAUTION To prevent damage to the foam pad, polishing bonnet, and vehicle finish: Only apply the pad/bonnet flat against the surface, see below.

8. Begin using the Polisher/Sander to apply wax to the vehicle. Apply the wax to all flat surfaces with broad, sweeping strokes in a crisscross pattern. Apply the wax evenly over the surface of the vehicle.

9. Add additional wax to the Polishing Pad as needed. To add additional wax:

- A. Stop the tool and allow the Polisher/Sander to come to a complete stop.
- B. Add a small amount of wax evenly over the pad surface.
- C. Avoid using too much wax. For additional applications of wax to Foam Pad, reduce the amount of wax. The Foam Pad will not absorb as much wax in subsequent applications.
- D. Resume operation.

NOTE: The most common error when waxing/polishing a vehicle is applying too much

wax. If the Foam Pad becomes saturated with wax, applying wax will be more difficult and will take longer. Applying too much wax may also reduce the life of the Foam Pad. If the Foam Pad continually comes off the Backing Pad during use, too much wax may have been applied.

10. After the wax has been applied to the vehicle's surface, turn off the Polisher/Sander. Unplug the Power Cord from the electrical extension cord.
11. Remove the Foam Pad from the Backing Pad and with your hand and the Foam Pad, apply wax to any hard to reach areas of the vehicle such as around lights, door handles, under bumpers, etc.
12. Allow sufficient time for the wax to dry.
13. Place a clean Polishing Bonnet (sold separately) securely onto the Backing Pad.

NOTE: Tightly pull the string to secure the Polishing Bonnet. Secure the string and keep it out of the way by tying several knots.

NOTE: Start and stop the Polisher/Sander only while it is held firmly against the surface of the vehicle. Failure to do so may result in the Bonnet being thrown from the Backing Pad.

14. Start the Polisher/Sander and begin buffing off the dried wax.
15. When you have removed as much wax as you can with the Polisher/Sander, turn off and unplug the Polisher/Sander.
16. Remove the Polishing Bonnet from Backing Pad. Using the Polishing Bonnet, remove the wax from all hard to reach areas of the vehicle.

SANDING

1. Make sure that the surface to be sanded is wiped clean of all dirt and debris, especially that of previous coarser sanding sessions, which will scratch the surface of a finer grit sanding session.
2. Attach the desired grit Sanding Disk (sold separately) onto the Backing Pad.

GROUNDING

▲WARNING: TO PREVENT ELECTRIC SHOCK AND DEATH FROM INCORRECT GROUNDING WIRE CONNECTION. Check with a qualified electrician if you are in doubt as to whether the outlet is properly grounded. Do not modify the power cord plug provided with the tool. never remove the grounding prong from the plug. Do not use the tool if the power cord or plug is damaged. if damaged, have it repaired by a service facility before use. if the plug will not fit the outlet, have a proper outlet installed by a qualified electrician.

GROUNDED TOOLS: TOOLS WITH THREE PRONG PLUGS

1. Tools marked with "Grounding Required" have a three wire cord and three prong ground-ing plug. The plug must be connected to a properly grounded outlet. If the tool should electrically malfunction or break down, grounding provides a low resistance path to carry electricity away from the user, reducing the risk of electric shock. (See Figure A.)
2. The grounding prong in the plug is connected through the green wire inside the cord to the grounding system in the tool. The green wire in the cord must be the only wire connected to the tool's grounding system and must never be attached to an electrically "live" terminal. (See Figure A.)
3. Your tool must be plugged into an appropriate outlet, properly installed and

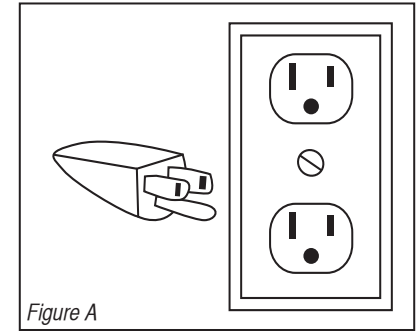

Figure A

grounded in accordance with all codes and ordinances. The plug and outlet should look like those in the following illustration. (See Figure A)

DOUBLE INSULATED TOOLS: TOOLS WITH TWO PRONG PLUGS

1. Tools marked "Double Insulated" do not require grounding. They have a special double insulation system which satisfies OSHA requirements and complies with the applicable standards of Underwriters Laboratories, Inc., the Canadian Standard Association, and the National Electrical Code. (See Figure B.)
2. Double insulated tools may be used in either of the 120 volt outlets shown in the following illustration. (See Figure B.)

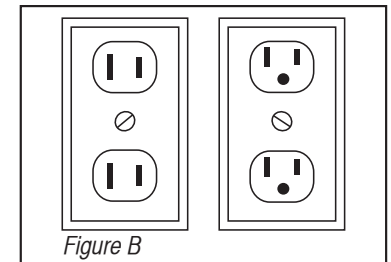

Figure B

EXTENSION CORDS

1. Grounded tools require a three wire extension cord. Double Insulated tools can use either a two or three wire extension cord.
2. As the distance from the supply outlet increases, you must use a heavier gauge extension cord. Using extension cords with inadequately sized wire causes a serious drop in voltage, resulting in loss of power and possible tool damage. (See table a.)
3. The smaller the gauge number of the wire, the greater the capacity of the cord. For example, a 14 gauge cord can carry a higher current than a 16 gauge cord. (See table a.)
4. When using more than one extension cord to make up the total length, make sure each cord contains at least the minimum wire size required. (See table a.)

RECOMMENDED MINIMUM WIRE GAUGE FOR EXTENSION CORDS* (120/240 VOLT)					
NAMEPLATE AMPERES (at full load)	EXTENSION CORD LENGTH				
	25'	50'	75'	100'	150'
0 – 2.0	18	18	18	18	16
2.1 – 3.4	18	18	18	16	14
3.5 – 5.0	18	18	16	14	12
5.1 – 7.0	18	16	14	12	12
7.1 – 12.0	18	14	12	10	-
12.1 – 16.0	14	12	10	-	-
16.1 – 20.0	12	10	-	-	-

* Based on limiting the line voltage drop to five volts at 150% of the rated amperes.





TABLE A

GROUNDING

- If you are using one extension cord for more than one tool, add the nameplate amperes and use the sum to determine the required minimum cord size. (See table a.)
- If you are using an extension cord outdoors, make sure it is marked with the suffix "W-A" ("W" in Canada) to indicate it is acceptable for outdoor use.
- Make sure the extension cord is properly wired and in good electrical condition. Always replace a damaged extension cord or have it repaired by a qualified electrician before using it.
- Protect the extension cords from sharp objects, excessive heat, and damp or wet areas.

SYMBOL DEFINITIONS

IMPORTANT: Some of the following symbols may be used on your tool. Please study them and learn their meaning. Proper interpretation of these symbols will allow you to operate the tool better and safer.

Symbol	Name	Explanation
V	Volts	Voltage (Potential)
A	Amperes	Current
Hz	Hertz	Frequency (Cycles per Second)
W	Watt	Power
Kg	Kilograms	Weight
	Alternating Current	Type of Current
	Direct Current	Type of Current
	Alternating or Direct Current	Type of Current
	Earthing Terminal	Grounding Terminal
	Class II Construction	Denotes Double Insulation
min	Minutes	Time
s	Seconds	Time
∅	Diameter	Size of Drill Bits, Grinding Wheels, etc.
n ₀	No load speed	No-load Rotational Speed
.../min	Revolutions per Minute	Revolutions, Surface Speed, Strokes, etc. per Minute
1,2,3,...	Ring Selector Settings	Speed, Torque or Position Settings

CONTROLS AND COMPONENTS

- Backing Pad
- Spindle Lock Cap
- "D" Grip Handle
- Speed Adjustment
- Lock-on Button
- Trigger Control
- Carbon Brush Holder Cover
- Spindle

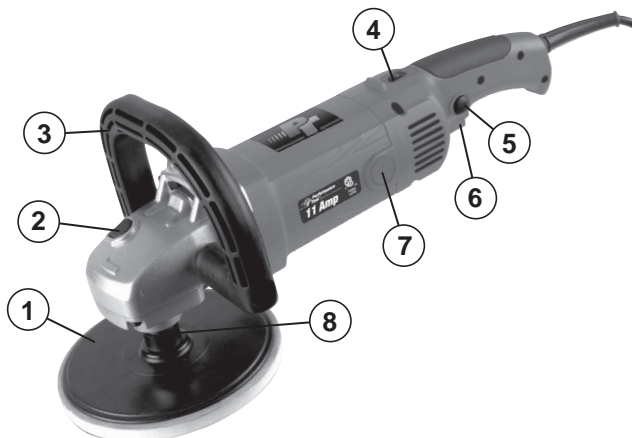

SETUP - BEFORE USE

▲WARNING Read the ENTIRE IMPORTANT SAFETY INFORMATION section at the beginning of this manual including all text under subheadings therein before set up or use of this product.

▲WARNING TO PREVENT SERIOUS INJURY FROM ACCIDENTAL OPERATION: Release the trigger and unplug the tool from its electrical outlet before assembling or making any adjustments to the tool.

NOTE For additional information regarding the parts listed in the following pages, refer to the Assembly Diagram near the end of this manual.

INSTALLING THE AUXILIARY HANDLES

▲WARNING TO PREVENT SERIOUS INJURY: Do not operate this tool without an auxiliary handle properly installed. The D-Handle (included) may be installed for either right-hand or left-hand use. Option 1: using with the D-handle Attach the D-Handle to the sides of the Front Cover, using the Hex Key and two Hex Head Bolts. Option 2: using with a Side handle (Side handle not included).

OPERATION

▲WARNING Read the ENTIRE IMPORTANT SAFETY INFORMATION section at the beginning of this manual including all text under subheadings therein before set up or use of this product.

INSTALLING THE BACKING PAD/FOAM PAD

- The accessory MUST be:
 - Rated to at least 3000 RPM.
 - No larger than 7" (178 mm) in diameter.
 - Fitted with a threaded opening of 5/8" x 11 TPI.
 - undamaged.
 - a backing pad.
- Press in and hold the Spindle Lock Button to prevent the Spindle from turning.
- Thread the Backing Pad onto the Spindle until firmly secured in place.

WORKPIECE AND WORK AREA SET UP

- Designate a work area that is clean and well-lit. The work area must not allow access by children or pets to prevent distraction and injury.
- Route the power cord along a safe route to reach the work area without creating a tripping hazard or exposing the power cord to possible damage. The power cord must reach the work area with enough extra length to allow free movement while working.

- Secure loose workpieces using a vise or clamps (not included) to prevent movement while working.
- There must not be hazardous objects, such as utility lines or foreign objects, nearby that will present a hazard while working.

POLISHING

- Make sure the surface to polish has been thoroughly washed, and is free of dust, dirt, oil, grease, etc.
- Place a clean Foam Pad (sold separately) securely onto the Backing Pad.
- Apply about two tablespoons of wax (not included) evenly on the clean Foam Pad.

▲CAUTION Do not apply the wax directly to the surface of the vehicle. The amount of wax needed will vary according to the size of the vehicle being waxed.

- Rotate the Speed Dial to select the desired speed between 1 and 4.

▲CAUTION Only use the slower speeds (1 through 4) for polishing. Otherwise, damage may occur to the paint being polished. Performance Tool® is not responsible for damage to the vehicle's finish due to improper use of this Polisher/Sander.