



2018



16

PAGES OF FEATURED ITEMS

OBDII MULTI-LINGUAL SCAN TOOL

- Supports English, Spanish, German, French, and Dutch
- Turns off check engine light (MIL)
- Erases trouble codes and resets the OBD2 system

W2976
Inner 10 Master 60



12V RECHARGEABLE 2-IN-1 DRILL DRIVER

- 12 Volt 1300 mAh Lithium ion battery with quick charger
- 2 Speed motor 0-400 and 0-1400 RPM
- 20 ft./lb. Max torque and 18+1 torque settings
- Includes 6 drill bits, 6 driver bits and magnetic bit holder

W50095 w/Case
Inner: 1 Master 5



W50094
Inner: 1 Master 8

- Drill/Driver and charger only

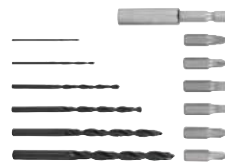

LED

3/8" Drill
chuck adapter

1/4" Quick connect
bit driver chuck

3/8"

1/4"

HIGH VISIBILITY LED BIT DRIVER

- Three bright white LEDs
- Includes #1, #2 Phillips bits, and 3/16" and 1/4" slotted bits

W9205
Inner 12 Master 48



TOOL CADDY PRO

- Oversized compartments so you can transport all your tools to the job site
- Large aluminum handle and oversized access will accommodate the largest of hands, even while wearing heavy winter gloves

W88995
Inner 1 Master 5



POCKET LED WORK LIGHT

- Compact work light with wide angle beam
- Magnetic base for directing light in any direction
- Pocket/belt clip and swivel hook
- 3 AAA Batteries included

W2422
Inner 6 Master 48

280
LUMENS

10
HOURS
RUN TIME



200 LUMEN COB WORK LIGHT

- Work light and emergency red flasher
- 180° Folding magnetic base and swivel hook for hands free use
- 3 AAA batteries included

339
Inner 8 Master 24

COB
COB (CHIP-ON-BOARD)
LONG LIFE
LOW HEAT

200
LUMENS

ATAK



1/2 IN. DR. IMPACT WRENCH

- 220 ft. lbs. Maximum torque
- Heavy duty carrying case
- Includes 11/16, 3/4, 13/16, and 7/8 in. impact sockets

1/2

W50080

Inner 1 Master 4



110 Volt



4-1/2 IN. ANGLE GRINDER

- Powerful 5 amp motor with 11,000 RPM no-load speed
- 5/8-11 Spindle with lock for quick wheel/blade changes
- Metal gear case and side handle

Bonus pack includes grinding wheel, 2 cut off wheels, 40, 80 and 120 grit flap discs

W50044

Inner 1 Master 10



7.3 AMP RECIPROCATING SAW

- Powerful 7.3 amp 120v/60Hz (900 Watt) motor for demanding applications
- Variable 0-29000 SPM and 3/4" stroke length
- Handle rotates 180° with five positively locking positions



Quick release blade chuck for fast blade changes

W50093

Inner 1 Master 6

12V PORTABLE VACUUM CLEANER

- High powered suction in a compact, portable and lightweight unit
- Replaceable and washable HEPA filter
- Connects to a 12V outlet in your vehicle
- Includes 5 attachments



W50012

Inner 4 Master 16



VARIABLE SPEED BLOWER

- Amazing blowing power in a compact, easy to handle size
- Two piece nozzle can extend 9" or 18"
- Comfortable handle with oversized lockable trigger
- 120V AC, 60Hz, 700 Watt, 17,000 max RPM, 90 MPH air speed, 100 CFM



W50069

Inner 1 Master 4



12 PC RECIPROCATING SAW BLADE SET

- Assortment of bi-metal blades

W721

Inner 6 Master 48



3 IN. PORTABLE BENCH GRINDER

- Mini bench grinder and buffer tool with variable speed control
- 31" Flexible shaft rotary tool
- 150W High-speed motor with speed control from 0 to 10,000 RPM
- Includes 3" x 3/4" - 80 grit grinder stone and fiber wheel with 10mm arbor

W50003

Inner 1 Master 4

10 pc Assorted 1/8" shaft grinding stones





AIR RATCHET

- 10-50 ft./lbs. Working torque
- Compact head for access in tight areas
- Fast, lightweight and easy to use
- Variable speed throttle

3/8

10-50 FT./LBS
WORKING TORQUE



M560DB
Inner 1 Master 10

AIR IMPACT WRENCH

- Rocking dog clutch provides 230 ft./lbs. of torque
- Soft touch finish for improved comfort and control
- Push button reverse
- Built-in air regulator



230 FT./LBS
WORKING TORQUE

1/2

M558DB
Inner 1 Master 10

DIGITAL TIRE INFLATOR

- Measure tire pressure from 0-150 psi,
- Change readout between psi, kpa, bar and kg/cm²
- Built-in bleed button for lowering pressure
- Includes 2 AAA batteries

M525
Inner 6 Master 24



41 PC AIR TOOL KIT

1/2

- 1/2" Impact wrench, 1/2" ratchet wrench, air hammer, 1/4" die grinder
- Includes 4 chisel bits, 10 impact sockets, air hammer spring, die grinder stones and more.

M670
Inner 1 Master 2



3-IN-1 AIR NAILER

- Drives brads, staples, and finish nails
- Light die-cast body for ease of use
- 360° Rotary exhaust
- Depth adjustment, trigger lock and quick release latch
- T nails: 3/4"-2", F nails: 3/8"-2", Staple: 1/2"-1-5/8"

M673
Inner 1 Master 10

PORTABLE AIR TANKS

- Industrial grade air hose with tire air chuck
- Safety pressure bypass valve w/ manual override
- On/off air adjustment dial
- 125 PSI maximum

W10005 5 Gallon
Inner 1 Master 1



W10011 11 Gallon
Inner 1 Master 1

50 FT. AIR HOSE REEL

- Steel reel with powder coated finish
- Holds up to 50' of 3/8" rubber air hose
- 3/8" Female NPT inlet fitting
- 300 PSI max

M635 Reel Only
Inner 1 Master 1



50 FT. AIR HOSE REEL W/ 3/8" HOSE

- Includes 3/8" x 50' rubber air hose rated to 300 PSI
- Quick-release wall mount plate
- Automatic hose lock and internal brake

M672
Inner 1 Master 1



65 FT. AUTO REWIND HOSE REEL

- Includes 3/8" x 65' rubber air hose with working pressure up to 300 PSI
- Non-sag rollers and reel lock
- Adjustable rubber stop

M655
Inner 1 Master 1

Mounts to wall, ceiling or floor



FEATURED DIAGNOSTIC TOOLS



LCD INSPECTION CAMERAS

- 180° Image rotation and mirroring
- Submersible 11/32 in. (9mm) diameter camera with 640 x 480 resolution
- Useful for inspecting engine compartment, valves, A/C vents, plumbing pipes, under or around furniture & appliances, home theater installations, cable routing, pest control & machinery

2.4" INSPECTION CAMERA

- 2.4" Color LCD monitor with 320 x 240 VGA resolution
- 4 white LEDs with 6 output levels
- 40 in. flexible neck
- TV/video output jack
- Includes mirror, hook clip, magnet and video cable
- Requires 4AA batteries (included)

W50045
Inner 1 Master 12



4.3" INSPECTION CAMERA

- Extra large 4.3" color LCD display monitor with 480 x 272 VGA resolution
- Dual screen image sizes and 2.0X zoom function
- Compact enough to fit in your pocket
- 4 white LEDs with 5 output levels
- On-screen battery indicator
- 35 in. flexible neck
- Includes mirror, hook clip, magnet and protective nylon storage/carrying case
- Requires 4AA batteries (included)



W50072
Inner 1 Master 10

CAN OBDII DIAGNOSTIC SCAN TOOL

- Both of our scan tools work with MOST 1996 and later American, European and Asian cars
- Support all OBD2 protocols including the newer (CAN) Controller Area Network
- Reads your (DTC) Diagnostic Trouble Codes for identification
- Turns off check engine light (MIL)
- Erases (DTC) trouble codes and resets the OBD2 system

W2977
Inner 10 Master 60



DIGITAL LASER TACHOMETER

- Accurately measure the RPM without touching the object, displays it on a LCD screen
- Class II laser measures from 2.5 - 99,999 RPM
- Includes storage case, 9v battery and manual

W89719
Inner 1 Master 50



DIGITAL 12V BATTERY ANALYZER

- Indicates the condition of your battery and charging system
- Tests 12V DC systems, guiding you through the testing process

W2998
Inner 8 Master 48



DELUXE INFRARED THERMOMETER

- Ranges from -58 to 1382° F and -50 to 750° C
- Measures surface temperature without making contact
- Stores up to 30 readings and variance calculations
- Laser pointer for accurate use
- Includes 9 volt battery

W89724
Inner 5 Master 10



DIGITAL ADVANCE TIMING LIGHT

- Xenon flash, and high Vis LED display
- Displays engine speed up to 9,000 RPM, and ignition spark advance from 0-90°
- 60" inductive pickup leads
- Works with 12V systems

W80587
Inner 1 Master 10



52 PC SOCKET SET

- 3/8" and 1/2" Dr. Ratchets, extension bar, adapter, 1/4" spinner handle
- 1/4, 3/8 and 1/2" Dr. sockets: 5/32 - 7/8" and 4 - 17mm
- Storage case

W1172

Inner 1 Master 5



75 PC SPECIALTY BIT DRIVER SET

W9027

Inner: 4 Master 24

- Includes socket adapters, bits and tamper resistant bits
- Pull out peg hook hanger for hanging
- Patented flip case with clear lids



28 PC TITANIUM COATED DRILL BIT & DRIVER SET

W9040

Inner: 4 Master 24

- 14 Titanium coated drill bits 1/16 to 5/16 in.
- 2 in. Slotted, Phillips, star, square bits and socket adapters
- Pull out peg hook hanger for hanging
- Patented flip case with clear lids



117 PC MICRO BIT SET

W9041

Inner: 4 Master 24

- Tools to open and repair electronic and small devices
- Pull out peg hook hanger for hanging
- Patented flip case with clear lids



10 PC 3/8 IN. DR. SPLINE SOCKET SET

- Tighter fit on proper size fasteners for better tightening
- Works on SAE/MET sizes, 6pt, 12pt, external star and square
- Chrome vanadium alloy steel construction for strength and durability
- Convenient storage rack
- Sizes: 7 (9/32), 8 (5/16), 9 (11/32), 10 (3/8), 11 (7/16), 13 (1/2), 14 (9/16), 16 (5/8), 17 (11/16), 18mm (23/32).

W38194

Inner 6 Master 24



32 PC SAE & METRIC WRENCH SET

- Combination box and open end
- Stubby SAE wrenches: 5/16, 3/8, 7/16, 1/2, 9/16 and 5/8 in., stubby Metric wrenches: 10, 11, 12, 13, 14 and 15 mm, SAE standard wrenches: 1/4, 5/16, 11/32, 3/8, 7/16, 1/2, 9/16, 5/8, 11/16 and 3/4 in., Metric standard wrenches: 6, 8, 10, 11, 12, 13, 14, 15, 17 and 18 mm

W1099

Inner 1 Master 5



85 PC SOCKET SET

- Drop forged chrome plated carbon steel
- SAE and Metric sockets in 3 drive sizes
- 1" Driver bits w/ holder, drive adaptor, hex keys
- Storage case.

W1183

Inner 1 Master 5



7 PC STUBBY RATCHETING WRENCH SETS

- 100 gear teeth for a precise 3.6 degree sweep
- Triple chrome plated to resist corrosion
- Low profile head for access in tight spaces
- Premium drop forged chrome vanadium steel
- Convenient storage/carrying rack

W30634 SAE

Inner 6 Master 24

- Sizes: 5/16, 3/8, 7/16, 1/2, 9/16, 5/8 and 3/4"



W30635 METRIC

Inner 6 Master 24

- Sizes: 8, 10, 12, 13, 14, 15 and 18mm



36 IN. HEAVY DUTY PRY BAR

- Chrome vanadium steel shaft
- Comfortable oversized injection molded handle
- 5/8" Diameter shank

W2034

Inner 5 Master 10



36 in.

40 IN. FLEX MAGNETIC CLAW RETRIEVER

- Retractable 4 claw pickup and magnetic tool

W83194

Inner 6 Master 24



61 PC SCREWDRIVER & BIT SET

- Storage/organizing rack with bit storage and removable magnetizer/demagnetizer
- Alloy steel blades with satin finish, magnetic tips and non-slip molded grips
- Most popular Phillips, slotted, star and square sizes plus straight pick, angled pick and bit driver

W1731

Inner 0 Master 4



6 PC PRECISION SCREWDRIVER SET

- Chrome vanadium blades
- #00, #0 Phillips, 1.0, 1.2, 1.8, 2.4mm slotted

W1732

Inner 20 Master 100



Color coded grips

13 PC STAR BIT SET TAMPER RESISTANT

- 2" Heat treated CrV bits for strength and durability
- 1/4" and 3/8" Drive bit holders
- Sizes: T8, T10, T15, T20, T25, T27, T30, T40, T45, T50 and T55
- Storage holder with magnetic base

W38973

Inner 4 Master 24



6 PC TAP WRENCH KITS

- Cuts and renews internal threads
- Dual holding jaws for large and small sized taps
- Movable T-handle provides additional leverage

W8651 SAE

Inner 6 Master 36

- Sizes: 1/4 in. NC20, 5/16 in. NC18, 3/8 in. NC16, 7/16 in. NC14, 1/2 in. NC13

W8652 METRIC

Inner 6 Master 36

- Sizes: M6x1, M7x1, M8x1.25, M10x1.5, M12x1.75

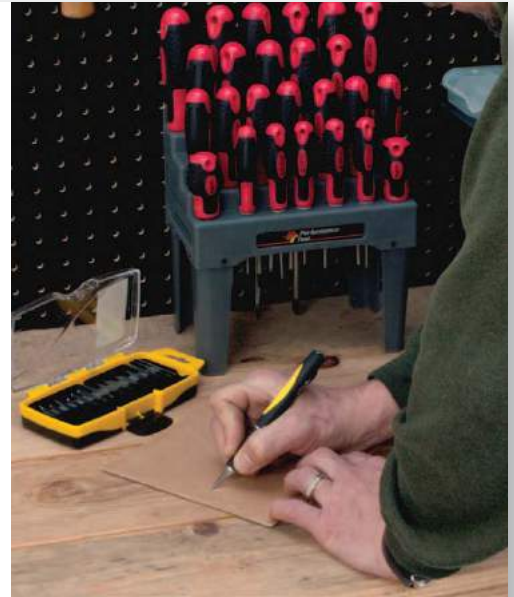

COMPOSITE 8 IN. DIGITAL CALIPER

- Measures outside and inside dimensions
- Large LCD display
- SAE to metric conversion
- Battery included

W80160

Inner 12 Master 48



16 PC HOLE SAW SET

- 12 Cutting blades sizes: 3/4, 7/8, 1-1/8, 1-1/4, 1-1/2, 1-3/4, 2, 2-1/2, 3, 3-1/2, 4 and 5" dia.
- Set includes 2 arbors, hex key, metal plate and case

W9071

Inner 1 Master 20



SPRING LOADED HACKSAW

- Pistol grip handle with spring loaded blade guide
- Includes high quality bi-metal 10" blade
- Accepts any 10" or 12" hacksaw blade.

W726

Inner 24 Master 72





VACUUM PUMP KIT

- Bleeds brakes, tests vacuum switches and removes fluids
- Durable steel construction
- Includes tubes, various adapters and containers

W89727

Inner 1 Master 10



A/C & FUEL LINE DISCONNECT SET

- Disconnects air conditioning lines and quick connect fuel lines in many Ford, Chrysler and GM automobiles
- Includes the following sizes: 5/16, 3/8, 1/2, 5/8, 3/4 and 7/8"

W83149

Inner 12 Master 72



FLEXIBLE HOSE CLAMP PLIERS

- Locking mechanism to hold clamp in the open position
- Heavy duty 24" flex cable
- Access flat-type hose clamps located in hard-to-reach areas

W80656

Inner 15 Master 30

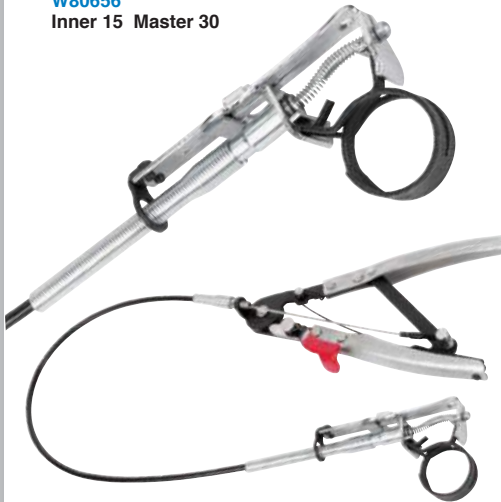

PROFESSIONAL TUBING BENDER

- Ideal for brass, copper, steel and aluminum
- Bends 3/16, 1/4, 5/16 and 3/8" O.D. tubing

W80674

Inner 6 Master 24



O2 SENSOR SOCKET

- Cutaway slot for sensor wire clearance
- Heavy duty alloy steel construction

W1267

Inner 6 Master 72



2-1/2 IN. BRAKE ROTOR HONE

- Use to score a cross hatch pattern on the surface of brake rotors and flywheels
- 2-1/2 in. diameter 120 grit flexible ball stones.

W80629

Inner 6 Master 48

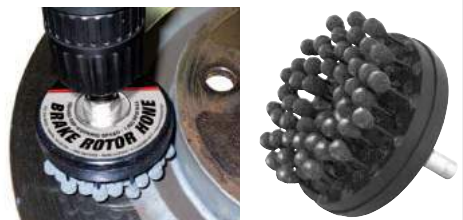

8 PC SCREW EXTRACTOR SET

- Use with T-handle or wrench to remove broken and stripped screws
- Tapered counter clockwise threads
- Spiral extractor sizes #1 - #8

W2968

Inner 12 Master 24



STUD EXTRACTOR

- Remove seized or broken studs and bolts
- Fits all studs 1/4" to 1/2" (6 to 12mm)
- Remove stripped, rusted, broken, or smooth studs
- Hex shaft can be used with a wrench, ratchet, or impact tool and socket

W83203

Inner 6 Master 36



DOOR UPHOLSTERY TOOL

- Heavy duty chrome plated shaft. Large easy grip handle. Removes panels without marring upholstery

W80645

Inner 6 Master 72



FEATURED TOOL STORAGE

18 PC DUAL POSITION BIN RACK

- New Dual Position Tilt Bin feature allows better access to your parts
- New Clear Bin feature lets you easily see what's inside each container
- Tri-Rack system can be used with the included base and frame as a floor standing bin rack, mounting to wall studs or peg board

W5170

Inner 1 Master 1

**DUAL
ANGLE
TILT BIN**



6" X 10" MAGNETIC PARTS TRAY

- Permanent magnet sticks to any ferrous metal surface
- Rubber coated magnets prevent scratching
- Even works sideways and upside down

W1285

Inner 12 Master 24



PORTABLE SAFE/LOCKBOX

- Securely store your small valuables at home or on the go
- Can be secured with the included mounting bracket or 3 foot security cable
- Heavy duty steel construction with black powder coat finish
- Soft, durable interior will not scratch stored articles
- Exterior dimensions: 8.2" x 5.9" x 2.2"

W53998

Inner 1 Master 10



PLASTIC AMMO BOX

- Heavy gauge polypropylene construction with reinforced water resistant tongue-and-groove lid
- Pre-drilled for padlock (lock sold separately)
- 11.5" wide, 5.25" deep and 7.2" Tall

W5994

Inner 1 Master 10



53 PC DUAL POSITION BIN RACK

- New Dual Position Tilt Bin feature allows better access to your parts
- New Clear Bin feature lets you easily see what's inside each container
- Tri-Rack system can be used with the included base and frame as a floor standing bin rack, mount to wall studs or peg board
- Includes 36 small, 12 medium and 5 large Clear Bins

W5171

Inner 1 Master 1

**DUAL
ANGLE
TILT BIN**



12 PC WALL MOUNT BIN SYSTEM

- Storage bin rack system for mounting to a wall or pegboard
- Bins stack together for free standing storage
- Mini bins are 3-3/4" wide x 3-1/2" deep x 1-3/4" high
- Small bins are 4" wide x 6-1/2" deep and 2-3/4" high

W530

Inner 1 Master 1



SOCKET STORAGE TRAYS **METRIC**

- Securely holds and organizes standard and deep sockets and accessories

W776

Inner: 6 Master 96

1/4

W778

Inner: 6 Master 48

3/8

W779

Inner: 6 Master 48

1/2



OVERSIZED X-FRAME CREEPER

- 5" Jumbo swivel poly casters and extra wide, pad with 2" thick padding
- Wide wheelbase and low profile design provides improved clearance
- Frame dimensions: 46" L x 25" W x 7" H
- 300 lbs. Capacity

W85014

Inner 1 Master 1

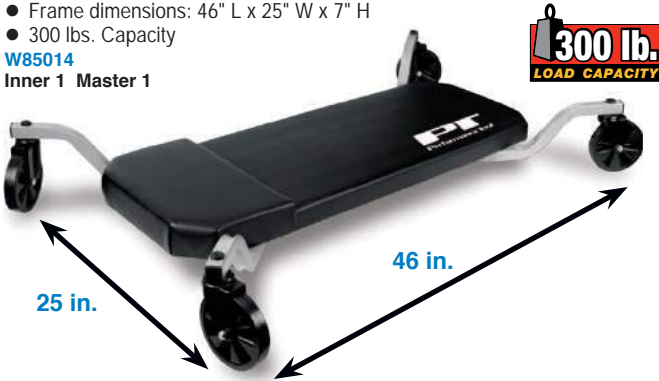

40 IN. PLASTIC CREEPER WITH 6 CASTERS

- Contoured shape for comfort and easy movement
- 360° swivel casters for easy movement
- Built-in storage tray and padded headrest
- 300 lb. Capacity

W85006

Inner 1 Master 1



2 PC SAW HORSE SET

- Lightweight 300 lb. capacity
- Compact and easy to store
- Rubber anti skid buttons
- SAE and Metric Markings

W54011

Inner 1 Master 5



40 FT. 12GA RETRACTABLE CORD REEL

- Polarized plug and 3 15 AMP outlets
- Wall mountable with included hardware
- Auto-rewind and no-snag rollers

W2278

Inner 1 Master 4



100 FT. 16GA EXTENSION CORD

- Suitable for indoor/outdoor use
- grounded three-prong plug
- 13 Amp max rating

W2277

Inner 2 Master 4



PNEUMATIC BAR STOOL WITH SWIVEL SEAT

- Seat adjusts from 26" to 32" quickly and easily
- 14" Diameter padded seat with 360° swivel
- Steel tubing frame with matte black powder coated finish

W85011

Inner 1 Master 1

DIGITAL MEASURING WHEEL

- Handle mounted backlit display
- Displays up to 10,000"/meters
- Stores up to 5 measurement
- Telescopic aluminum handle extends from 28" to 40"

W5704

Inner 1 Master 10



3 SHELF UTILITY CART WITH DRAWER

- Four swivel casters, plus two locking casters
- Organizer shelf with bins
- Two tool trays, foam drawer and tray liner

W54006

Inner 1 Master 1



CREEPER SEAT TOOL BOX

- 350 lb. Capacity
- Two folding tool trays with magnetic pads
- Padded seat cushion and full bearing casters
- Rear tray supports screwdrivers and pliers
- Seat Dimension: 19" x 9"

W85025

Inner 1 Master 1





2 TON LOW PROFILE JACK

- Great for Cars and Light Duty Trucks
- Extended side flange for strength and durability
- Rubber saddle pad
- Dual pistons for faster lift
- Lift range: 2-3/4 to 20" Load capacity: 4,000 lbs.

W1642
Inner 1 Master 1

2 Ton
LOAD CAPACITY



3-1/2 TON LOW PROFILE JACK

- 3-1/2" to 20-1/2" Lift range
- Double-pump mechanism for quick lifting
- Rubber saddle pad included

W1645
Inner 1 Master 1



2 TON COMPACT TROLLEY JACK

- Maximum height 13"
- Swivel casters for easy positioning

W1606
Inner 1 Master 1



2 Ton
LOAD CAPACITY

12V ELECTRIC SCISSOR JACK

- For emergency roadside tire changes
- Push button controller
- Plugs into 12 volt utility outlet
- Lifting range of 5 to 14 in.

W1609
Inner 1 Master 4

2 Ton
LOAD CAPACITY



TRANSMISSION JACK

- 2 stage telescoping transmission jack
- Fully adjustable saddle with corner brackets
- Foot operated pump and 360° guide wheel
- Meets ASME-PALD safety standards

W1608
Inner 1 Master 1



1000 lb.
LOAD CAPACITY

1/2 TON TRANSMISSION JACK

- Extra long jack handle and expandable saddle
- Steel swivel casters
- Minimum height of 7-1/4 inch and maximum height is 26"
- Meets ASME-PALD safety standards

W1607
Inner 1 Master 1



1000 lb.
LOAD CAPACITY

BREAKDOWN LUG WRENCHES

1/2

- Wrench breaks down into two parts for compact storage
- Two position center rod for applying added torque
- Free spinning handle with push button release

W5 **SAE**
Inner 2 Master 8

- Includes 11/16 + 3/4 and 13/16 + 15/16" double ended sockets



W6 **METRIC**
Inner 2 Master 8

- Includes 17 + 19mm and 21 + 23mm double ended sockets





14.4V CORDLESS GREASE GUN

- Planetary gearbox and reciprocating piston provide 7000psi, and 3 oz. of grease per minute
- 14.4 V Ni-CAD battery and 1 hour quick charger
- 30" Grease hose and heavy duty coupler

W50014

Inner 1 Master 3



MINI GREASE GUN WITH GREASE

- Vented zinc die cast head cap
- Positive lock for easy filling
- Air bleeder valve eliminates air lock
- Includes 3 oz. grease cartridge

W54205

Inner 4 Master 20



TOYOTA® CANISTER TYPE OIL FILTER WRENCH

- 14 Flute Filter canister wrench for use on Toyota, Lexus and Scion cars
- Heavy gauge steel construction
- Use a 1/2" drive ratchet or 21mm hex wrench

W54076

Inner 10 Master 50



ALUMINUM GREASE GUNS

- Lightweight aluminum anodized barrel
- Extra heavy t-handle and internal return spring
- 3-way loading, accepts standard 14oz cartridge
- 4 jaw coupler with protective PVC cap
- Textured rubber non-slip barrel grip



W54290 LEVER ACTION
Inner 1 Master 12



W54291 PISTOL GRIP
Inner 1 Master 12

PROFESSIONAL PISTOL GRIP GREASE GUN

- Professional quality for long service life
- Vented zinc die cast head cap
- Positive lock for easy filling
- Air bleeder valve eliminates air lock
- Accepts standard 14 oz cartridge or bulk

W54204

Inner 1 Master 12



LEVER ACTION GREASE GUN

- Heavy duty cast head with bulk load, and pressure release valves
- Zinc plated lever handle with a PVC grip for comfort
- Extra heavy t-handle and internal return spring

W54292

Inner 1 Master 12



QUICK RELEASE TRANSFER PUMP

- Quick change fittings for easy attach and release
- Ideal for changing oil, inflating beach balls, siphoning fluids and more

W1156

Inner 6 Master 24



QUART / GALLON FLUID PUMP

- Double threaded cap fits both quart and gallon size containers

W1139

Inner 6 Master 48





3-PK LED SAFETY ROAD FLARES

- 12 bright red LEDs last up to 50 hours
- Swivel hook and magnet on back for easy use
- Compact and lightweight

W2343

Inner 4 Master 32



JUMPER CABLES

- Tangle-free rubber coated cables
- Heavy duty copper jaw clamps

12 FT. 10 GA

W1670

Inner 6 Master 12

- Light duty for compact vehicles & motorcycles
- 150 AMP/250 Peak
- All weather use



20 FT. 4 GA

W1673

Inner 1 Master 6

- Heavy duty for full size trucks, vans and SUVs
- 500 AMP/600 Peak
- All weather use



EMERGENCY TRACTION MAT

- Emergency traction in snow, ice, mud or sand
- Best alternative for tire chains and easier to use
- Works on almost any car, van or pickup truck
- Lightweight, and folds to a compact size
- Set of 2 traction mats in safety yellow
- 38" long x 7" wide

W41003

Inner 1 Master 4



DELUXE ROADSIDE ASSISTANCE KIT

- Zippered case with integrated reflective triangle
- 8' 10GA jumper cables, 2 ton 14' tow rope
- Flashlight, pliers, 2 in 1 screwdriver, bungee cords, rain poncho, first aid kit, gloves and more

W1555

Inner 1 Master 6



TIRE INFLATOR WITH LED

- 100 PSI High pressure air compressor
- 3 Super bright LEDs for night time emergencies
- 15" high pressure hose with screw on chuck
- 10' Power cord with fused 12V power plug
- Inflates standard car tire in under 4 minutes
- nclude sports ball needle, raft and toy inflator nozzles and Presta valve adapter

60402

Inner 6 Master 12



12 VOLT COMPACT TIRE INFLATOR

- High output 250 PSI motor
- Plugs into 12V accessory outlet
- Includes nozzle adapters and sport needle
- 10' Power cord and 18" hose length with universal valve adapter

60399

Inner 1 Master 20



ICE SCRAPER/SQUEEGEE

- 3 in 1 tool for ice breaking, scraping and wiping

W9166

Inner 24 Master 96



LOCK DE-ICER

- Heating 'pick' that thaws locks in seconds
- Integrated LED for use in low light
- LED power indicator and keyring
- Includes 2 AAA batteries

W9195

Inner 6 Master 24



320 LUMEN PRO-FOCUS RECHARGEABLE FLASHLIGHT

- Black anodized flashlight with clip and holster
- Powered by 3.7V lithium ion rechargeable battery
- Uses a professional grade Cree lifetime LED
- Hi beam and low beam functions
- USB charge cable included

550

Inner 8 Master 24



ATAK

PRO-FOCUS Tactical Design™

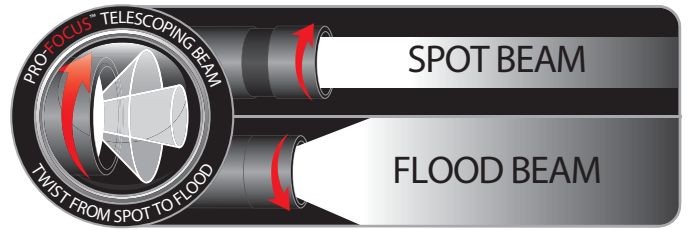

500 LUMEN PRO-FOCUS RECHARGEABLE FLASHLIGHT

- Powered by 3.7V lithium ion rechargeable battery
- Uses a professional grade Cree XPG3(R5) lifetime LED
- Hi beam, low beam and safe mode functions
- Charging port for smart phones or tablets
- USB charge cable included

551

Inner 6 Master 24



ATAK

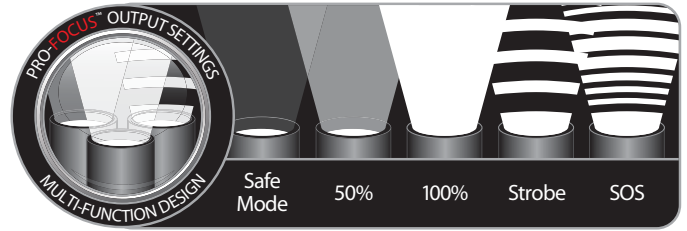

250 LUMEN WORK LIGHT FLASHLIGHT

- Strong magnetic base for hands free operation
- Professional grade lifetime LED
- 3 Flashlight functions: hi beam, low beam and strobe
- 3 Work light functions: hi beam, red beam and emergency red flasher
- 4-AAA batteries, included

615

Inner 6 Master 36



ATAK



1000 LUMEN PRO-FOCUS RECHARGE FLASHLIGHT

- Powered by two 3.7V lithium ion rechargeable batteries
- Uses a professional grade Cree XM-L2 (U3) lifetime LED
- Hi beam, low beam and safe mode functions
- Charging port for smart phones or tablets
- USB charge cable included

552

Inner 6 Master 24



ATAK



1000 LUMEN FLASHLIGHT WITH WORKLIGHT COLLAR

- Heavy duty aircraft grade aluminum construction
- Professional grade LEDs
- Hi, low and strobe functions
- Includes red safety flasher
- Uses 9-AA batteries, included

546

Inner 6 Master 24



ATAK



FIREPOINT 2.0 1AA FLASHLIGHT

- Anodized tactical aluminum flashlight
- Water and impact resistant
- Batteries included

W2650

Inner 6 Master 24



STORM COMPOSITE LED FLASHLIGHT

- Submersible to one meter
- 62 lumens, 4 hour run time

W2456

Inner 12 Master 48



FIREPOINT 75 LUMEN LED FLASHLIGHT

- Anodized tactical aluminum flashlight
- Water and impact resistant
- 75 lumens, 3.5 hour run time
- 3 AAA batteries included

W2474

Inner 6 Master 48



FEATURED WORK LIGHTS & PEN LIGHTS

12 +1 SMD LED SLIM WORK LIGHT

- High output area light and spotlight in one
- Comfortable lightweight housing with ergonomic grip
- Swivel hook and magnetic base for hands free use

W2419
Inner 1 Master 8

LED
540+
LUMENS

6-1/2 in.

LIGHT BAR
ADJUSTS
120°

MAGNETIC

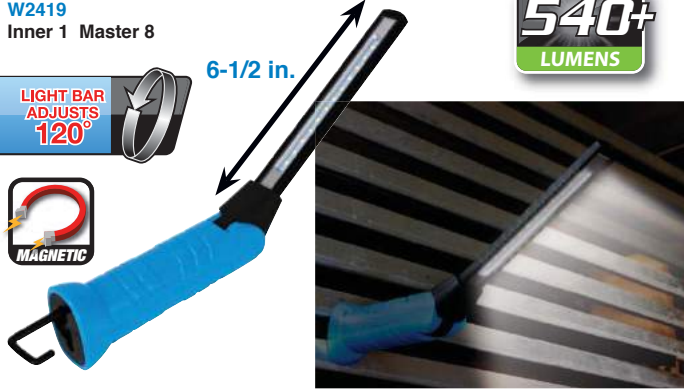

LI-ION 1000 LUMEN LED WORK LIGHT

- Unit stays cool enough to touch
- Wide angle LEDs distribute large flood beam of light
- Textured reflector distributes light evenly
- Rechargeable lithium ion battery with USB charging cable
- Dimensions: 9" high x 5-1/2" deep x 6-1/4" wide

W2406
Inner 6 Master 12

1000
LUMENS

RECHARGEABLE
Li-ion
BATTERY

1.5
HOUR
RUN TIME



WIDE ANGLE LED WORK LIGHT

- Unit stays cool enough to touch
- Wide angle LEDs distribute large flood beam of light
- Adjustable light angle and foam padded handle
- 6' 18GA power cable with insulated on/off switch
- Dimensions: 11-3/4" high x 7" deep x 9" wide

W2402
Inner 1 Master 8

120 Volt

2100+
LUMENS



LED WORK LIGHT

- Unit stays cool enough to touch
- Wide angle LEDs distribute large flood beam
- Adjustable light angle and foam padded handle
- 5' 18GA power cable with insulated on/off switch
- 12-1/2" high x 6-3/4" deep x 7-1/2" wide

W2230
Inner 1 Master 8

LED

1000+
LUMENS



120 Volt

3 +1 LED PENLIGHT

W2421 CARDED
Inner 6 Master 36

- Area light and spotlight in one tool
- Comfortable lightweight housing with rubberized grip
- Magnetic base and pocket clip for hands free use
- Includes 3AAA batteries

W2420 DISPLAY
Inner 12 Master 48

UP TO
16.0
HOUR
RUN TIME

136
LUMENS



MAGNETIC



FIREPOINT LED PENLIGHT

243
LUMENS

- Super Bright Nichia LED never needs replacing
- Anodized aluminum housing with pocket clip
- 3 AAA batteries included

W2330
Inner 12 Master 72



2.5
HOUR
RUN TIME

FIREPOINT POCKET LIGHT

- Super bright Nichia LEDs never need replacing
- Anodized aluminum housing with pocket clip
- High strength magnetic base
- 3 AA batteries included

W2331
Inner 6 Master 24

10.2
HOUR
RUN TIME

MAGNETIC



452
LUMENS

360° PENLIGHT/WORKLIGHT

- Uses licensed Chip On Board technology strip
- COB Worklight functions: Hi, low and red flasher
- Pocket clip and strong magnetic base
- Aluminum Alloy Steel housing
- 2 AA batteries included

606
Inner 6 Master 48

200
LUMENS

COB
CHIP ON BOARD
LONG LIFE
LOW HEAT

ATAK



PARACORD HANDLE FOLDING KNIFE

- Paracord handle for an emergency supply of rope
- 3-1/2" Stainless steel drop point blade
- 8-1/2" Overall open length, 4-3/4" folded length
- Thumb stud for easy one hand operation
- In-line blade lock/release mechanism
- Includes 30" of paracord

W9360

Inner 6 Master 48

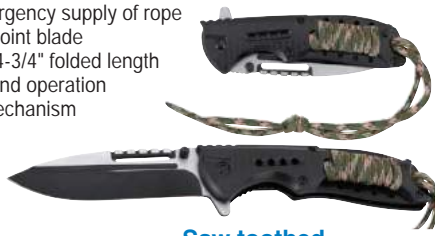

16 IN. MINI MACHETE

Saw toothed back edge

- Paracord wrapped handle provides emergency supply of rope
- 10" Long blade

W9359

Inner 12 Master 36



16" Overall length



LED RESCUE KNIFE

- LED light, glass breaker and carabiner clip
- 3" straight edge stainless steel Tanto blade
- Lithium ion rechargeable battery
- Includes micro USB charging cable

W9362

Inner 1 Master 8



7-7/8"

MASAKA FOLDING KNIFE

- 3-1/4" stainless steel non-reflective Tanto blade
- Thumb stud for easy one hand operation
- Inline blade lock/release mechanism

W9357

Inner 6 Master 48



8-1/4"

KYOTERA POCKET KNIFE

- Integrated seat belt cutter and glass breaker
- 3" Straight edge tanto blade with black finish
- Inline blade lock/release mechanism
- Thumb stud for easy one hand operation

W9356

Inner 6 Master 48

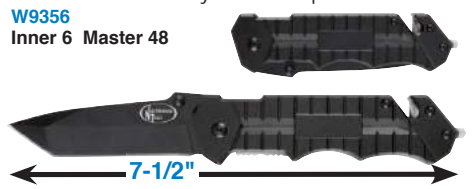

7-1/2"

315 LUMEN RECHARGEABLE LANTERN

UP TO 4.0 HOUR RUN TIME

- USB & Micro USB port for charging
- Can be used to charge devices including phones & tablets
- Hi, low, red flash and red SOS functions
- 2 Rechargeable li-ion batteries included

398

Inner 10 Master 20

RECHARGEABLE Li-ion BATTERY

315 LUMENS

C-O-B COB (CHIP-ON-BOARD) LONG LIFE LOW HEAT



1000 LUMEN RECHARGEABLE LANTERN

C-O-B COB (CHIP-ON-BOARD) LONG LIFE LOW HEAT

ATAK

- USB & Micro USB port for charging
- Can be used to charge devices including phones & tablets
- Hi and low functions
- 2 Rechargeable li-ion batteries included

403

Inner 1 Master 9

1000 LUMENS

RECHARGEABLE Li-ion BATTERY



Phone not included

300 LUMEN LANTERN

- Hi COB 17m beam distance and low COB 10m
- Red flasher on top of ABS and TPR housing
- Metal hanger on top
- 3 AA batteries included

397

Inner 10 Master 20

C-O-B COB (CHIP-ON-BOARD) LONG LIFE LOW HEAT

300 LUMENS

BATTERIES INCLUDED



WATER RESISTANT HEADLAMP

- 20m or 40m Beam distance
- 3 AAA batteries

395

Inner 8 Master 48

C-O-B COB (CHIP-ON-BOARD) LONG LIFE LOW HEAT

200 LUMENS



ATAK

500 LUMEN PRO-FOCUS RECHARGEABLE HEADLAMP

- Flexible head
- Hi, low and safe mode functions
- USB charge cable included
- Batteries included

560

Inner 6 Master 24

RECHARGEABLE Li-ion BATTERY

500 LUMENS

ATAK



FIREPOINT LED HEADLAMP

- DuoFocus beam goes from spot to flood
- High, low and flash functions
- Flip down head
- Includes 4AA batteries

W2492

Inner 6 Master 24

457 LUMENS



3 PC CAR SEAT CONVENIENCE SET

- Tablet holder, utility clip and headrest bracket
- Adjustable bracket fits headrests with openings from 4-1/4" to 5-1/2" wide, fits tablets from 5-1/2" up to 9-3/4" wide/high
- Utility hook for hanging clothes and more



W1284
Inner 6 Master 24



HIGH TORQUE MINI RATCHET DRIVE



- Comfortable L-shaped handle provides added leverage in a compact design
- Left/right lock switch function
- Magnetic insert to hold bits secure in drive end

W480
Inner 6 Master 48



High torque 20 tooth ratchet



4-PK LED MOON STICKS

- Safe alternative to chem
- On and blink functions
- Batteries included

W2349
Inner 6 Master 24



7 SECOND GLUE AND FILLER

- Adhesive and filler compound bonds almost anything
- Repair all types of holes, cracks, gaps
- Can be drilled, tapped and conducts electricity

W481
Inner 6 Master 48



CARABINER WITH MAGNETIC BASE

- Hold to any ferrous surface
- Use to hang tools, keys, cords, ropes and more
- 45 lb. pull

W482
Inner 8 Master 72



SCREWDRIVER GRIP BOTTLE OPENER

- Ergonomic non slip molded grip for improved comfort and control
- An essential in every tool box, garage, cabinet or junk drawer

W30975
Inner 6 Master 72



24 IN. FOLDING LEVEL

- Bends around corners, pipes, or on stairs
- 2 Horizontal, 1 vertical, and 1- 45° bubble
- Use as a straight edge around corners
- Folds for compact storage
- 23-1/2" x 2" x 3/4"

W5703
Inner 16 Master 64

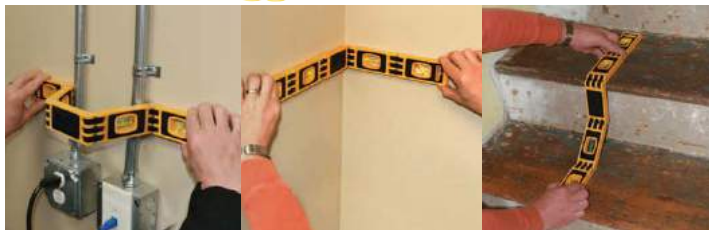

USB CHARGER & AUTO ESCAPE TOOL

- 2.1mAh USB charger with integrated 12v socket
- Includes seat belt cutter and spring-loaded steel tip window punch

W9206
Inner 8 Master 96



6 IN. USB MINI FAN

- Compact 4" aluminum blade and 6" frame
- Brushless axial motor for quiet operation
- Powered by 3' USB cable that can operate from any USB outlet

W1663
Inner 1 Master 45



Adhesives & Tapes 82	Drop Lights 40-41	Mats & Trays..... 69	Spot Lights..... 44-45
Appearance Accessories.. 77	Engine Lift..... 50-51	Mobile Accessories..... 81	Stands & Benches 58
Auto Accessories..... 79	Engravers 37	Outdoor Accessories 75	Storage Bin Racks..... 60-63
Bench Top Power Tools 27	Gloves 71	Parts Washers 31	Tarps & Straps..... 74
Blowers..... 30	Grinders & Polishers.... 25-26	Power Tools 20-37	Tool Boxes & Bags 66-67
Cable Ties..... 83	Hardware Kits 84-87	Roadside Accessories 78	Tow Ropes & Pullers 73
Cargo Control 72	Heat Guns 34	Rotary Tools..... 36	Transmission Jacks 52
Cleaning Brushes 76	Impact Wrenches..... 24	Safety Gear 70	Utility Carts 64-65
Cords & Reels 38-39	Inspection Camera 28-29	Saw Horses 57	Vises..... 59
Creepers & Seats 54-56	Lift Equipment..... 46-48	Shop Presses 53	Wheel Accessories 49
Drills & Accessories..... 20-23	Magnetic Storage 68	Soldering 35	Work Lights..... 42-43

Auto Body 98-99	Electrical Testers 106-107	Oilers & Dispensers..... 127
Barrel Pumps..... 126	Fluid Transfer Pumps 124-125	Specialty Filter Removal..... 121
Battery Accessories 102	Funnels & Spouts 123	Tire Inflators..... 110
Battery Cable 100	Grease Guns 114-117	Tire Pressure Gauges 111
Battery Jump Starters..... 104	Lug Nut Sockets 109	Tire Repair 112-113
Battery Jumper Cables 105	Lug Wrenches 108	Welding..... 99
Battery Terminals..... 101	Oil Drainage..... 122	
Battery Testers..... 103	Oil Filter Wrenches 118-120	

Axle Nut Sockets 134	Drum Brakes..... 130	Spark Plug Sockets 161
Belts & Hoses 144-145	Exhaust..... 157	Spark Plugs & Ignition 160
Body & Interior..... 142-143	Feeler Gauges..... 162	Spring Compressors..... 139
Brake Bleeding 131	Flaring Tools 132	Suspension..... 140-141
Camshaft & Crankshaft 152-153	Gear Pullers..... 149	Thread Chasers..... 163
Compression Tester..... 166-167	Lock Nut Sockets..... 135	Timing Lights 165
Cooling System 170-171	Piston Service..... 154-155	Tubing Benders & Cutters 133
Diagnostic..... 164	Pulley Pullers..... 148	Vacuum..... 166-167
Diesel & Fuel Injection..... 168-169	Quick Disconnect Tools 158-159	Valves & Valve Springs..... 150-151
Disc Brake 128-129	Seals & O-Rings..... 147	Water Pump & Fan Clutch..... 146
Drivetrain 138	Sensors & Switches..... 156	Wheel Bearings & Hubs 136-137

Adjustable Wrenches..... 210	Hex Key Sets..... 230-233	Pipe Wrenches 252	Socket Rails & Trays 197
Bit Sets 224-229	Hooks & Picks 267	Pliers..... 206-213	Sockets & Sets 172-179
Bolt Extractors 244-247	Impact Bit Sockets..... 183	Precision Measuring 270-271	Star Bit Sockets..... 182
Bolt Cutters..... 252	Impact Drive Accessories 187	Pry Bars..... 256-257	Star Key Sets..... 230-233
Breaker Bars 188-189	Impact Sockets & Sets .. 184-186	Ratchets 190-191	Thread Repair..... 242-243
Chisels & Punches 258-259	Inspection Mirrors 262	Rivet Guns & Rivets 248-251	Tool Sets 234-239
Drill Bit Sets 240-241	Knife Sets 280	Saws & Blades 273-274	Torque Wrenches 192-193
Drill Bits 242	Knives..... 278-281	Scrapers & Knives 275-277	Wire Strippers..... 260-261
Extensions..... 194	Magnifying Glasses 266	Screw Extractors 244-247	Wrench Sets 198-205
Files..... 272	Measuring & Leveling.... 268-269	Screwdriver Sets 214-220	
Hammers & Mallets 254-255	Multi-Bit Drivers 221-223	Sledge Hammers..... 253	
Hex Bit Sockets 180-181	Pickup Tools 263-265	Socket Accessories 195-196	

Cutting Tools..... 285	Impact Sockets..... 287	Spray Guns & Accessories..... 292-293
Die Grinder 286	Plugs & Connectors..... 294-295	Tanks & Accessories..... 298-299
Hammer & Saws..... 284	Ratchets & Drills..... 283	
Hoses & Reels..... 296-297	Sanders & Polishers..... 288-289	
Impact Wrenches..... 282	Specialty..... 290-291	

3/8 IN. KEYLESS CHUCK DRILL

- 3/8" Keyless chuck which will handle all small to medium bits.
- 400 watt motor will handle most household jobs.
- Variable speed and reversible for total control.
- ETL listed 5001662



Built-in belt clip for safety and portability.



Item #	IP	MP	PKG	Chuck	No Load		Amp	Length	AWG	Listing
					RPM					
W50086	1	10	CBX	3/8"	3,000		3.2A	6'	18/2	ETL

3/8 IN. CORDLESS DRILL

- The integrated Nichia LED puts light right where it is needed.
- 19.2 volt motor with forward / reverse switch.
- 3/8" chuck with 16+1 torque settings.
- Comfortable rubber secure grip handle.
- Includes bits, drill bits, 2-1/4" magnetic bit holder, 19.2V battery and 3-5 hour charger.
- ETL listed 4006774

Phillips	1"	#1, #2
Pozi	1"	#1, #2
Slotted	1"	5, 6
Drill Bit		1.5, 2.5,
		3, 4, 5, 6



Item #	IP	MP	PKG	Chuck	RPM	Rechargeable Battery		Charge Time	Charger			
									Output	Cord	Rated	
W50092	Drill Set	1	5	CBX								
W50092B	Battery	1	8	CLM	3/8"	550	19.2V	Ni-cd	3-5 Hr	23V 400mA	6'	ETL
W50092C	Charger	1	16	CBX								

1/4 IN. CORDLESS DRILL

- Automatic spindle lock.
- Blue LED area light.
- 180 RPM and reversible.
- Includes storage/carrying case, 3 to 5-hour charger and 24 power tool accessories.
- ETL listed 3062189, and Title 20 Certified

Phillips	1"	#1, #2, #3
	2"	#2
Pozi	1"	#1, #2, #3
	1"	3, 4, 5, 6
Slotted	1"	3, 4, 5, 6
	2"	5
Star	1"	T7, T10, T15, T20, T25, T30
	1"	S1, S2
Drill Bit		1.5, 2.5mm



Item #	IP	MP	PKG	Chuck	RPM	Rechargeable Battery		Charge Time	Output	Charger Cord	Rated
W50033	1	10	CLM	1/4" QR	180	3.6V	Li-Ion 1.3Ah	3-5 Hr	5V 0.3A	6'	ETL Title 20

45-PC POWER BIT SET

- 27 assorted chrome vanadium bits: Slotted, Phillips, Star, Pozi and Square, 1/4" hex adapter, 7 chrome vanadium 6 point nut drivers, magnetic Hex extension, 5 drill bits, 3 bit holders.

Phillips	2-1/2" 4-1/4"	#2, #3 double ended #2 (3) double ended	4"	#2
Pozi	2-1/2" 4"	#1, #2, #3 double ended #2		
Slotted	1" 1-3/4"	3/16, 1/4" 1/4"		
Star	2-1/2"	T10, T15, T20, T25, T30, T40		
Square	2-1/2"	S1, S2		
Hex	1"	1/8, 5/32, 3/16, 1/4"		
Nut Driver		7/32, 1/4, 9/32, 5/16, 3/8, 7/16, 1/2"		
Drill Bits		1/16, 3/32, 1/8, 5/32, 3/16"		

Item #	IP	MP	PKG
W1352	6	12	DBL



25-PC RAPID CHANGE BIT SET

- Contains: 1 quick change holder, 3 nut drivers, 12 assorted 2" length CRV bits: Phillips and slotted, 7 titanium coated drill bits with hex shank, handy storage case.

Phillips	2" 6"	#1, #2 (3), #3 #2
Slotted	2" 6"	6-8, 8-10 (2), 10-12 8-10
Square	2"	S1, S2, S3
Nut Setter	1-1/2"	1/4, 5/16, 3/8"
Drill Bits		1/16, 3/32, 1/8, 5/32, 3/16, 7/32, 1/4"

Item #	IP	MP	PKG
W1343	6	24	DBL



29-PC QUICK CHANGE DRIVER SET

- Chrome vanadium steel construction.
- Heat treated for longer life.
- 3-3/16" magnetic screw guide with retracting sleeve.

Phillips	1" 2"	#1, #2 (4), #3 #2
Pozi	1"	#2, #3
Slotted	1"	6-8, 8-10, 10-12
Star	1"	T10, T20, T30
Square	1" 2"	S1 (2), S2 (4), S3 (2) S2
Nut Setter	1"	1/4, 5/16"

Item #	IP	MP	PKG
W9024	6	24	DBL



14-PC BIT DRIVER ACCESSORY SET

- Telescoping screw guide helps drive screws with better accuracy.
- 1/4 and 3/8" socket adapters transform your power drill into a power nut driver
- Chrome vanadium steel construction
- 2-1/4" magnetic bit extension



Item #	IP	MP	PKG
W474	6	36	CRD Pg 318

Phillips	1"	#1, #2, #3
Slotted	1"	3/16", 1/4", 5/16"
Star	1"	T15, T20
Square	1"	S1, S2



DRILL ACCESSORIES

SHOP/GARAGE

90° IMPACT DRIVER ATTACHMENT

- Magnetic 1/4" hex adapter accepts standard drill and driver bits.
- Die-cast gear housing and 3 sets of ball bearings.
- Works in forward or reverse.

Item #	IP	MP	PKG	Shank	Length
W9029	15	60	CRD	1/4"	6"



Impact driver attachment lets you use 1/4" quick connect bits in tight spaces.

QUICK RELEASE BIT EXTENSION

- 1/4" hex fits standard drills, drivers and screwdrivers.
- Magnetic bit holder keeps bits in place.
- Auto-locking quick release chuck.

Item #	IP	MP	PKG	Shank	Length
W8603	6	72	TAB	1/4"	6"



Easy to hold rotating sleeve.

SCREWDRIVER BITS & HOLDER

- Heat treated for durability.

Item #	IP	MP	PKG	Shank	Length	Sizes
W8598	5	240	CRD	1/4"	2"	1/4", #2
W3219	50	600	Pg 315	1/4"	2"	#2
W3220	50	600	Pg 315	1/4"	2-1/4"	-



IMPACT BIT SET

- Impact grade chrome vanadium steel.
- Heat-treated to resist breakage.

Item #	IP	MP	PKG	Shank	Length	Sizes
W472	5	240	CRD Pg 318	1/4"	2"	2ea: #2, 1/4", S1, S2



3-PC MAGNETIC NUT SETTER

- Powerful magnet holds fasteners, freeing up your hands in tight spaces.
- Lobular drive prevents rounding
- 1/8" insert depth.

Item #	IP	MP	PKG	Shank	Length	Sizes
W9022	12	96	CRD	1/4"	2-1/2"	1/4, 3/8, 5/16"



14-PC NUT DRIVER BIT SET

- Compact bit holder with belt clip
- Hardened chrome vanadium with black phosphate finish

Item #	IP	MP	PKG	Shank	Length	Sizes
W473	10	40	CRD Pg 318	1/4"	2"	3/16, 1/4, 9/32, 5/16, 11/32, 3/8, 7/16" 5, 5.5, 6, 7, 8, 10, 12mm



3-PC POWER DRILL SOCKET ADAPTER SETS

- Transforms your power drill into a power nut/socket driver.
- Impact grade chrome vanadium steel.
- Ball bearing ensures sockets are securely seated.
- 1/4, 3/8 and 1/2" drive sizes.



Item #	IP	MP	PKG	Shank	Length	Sizes
W1390	12	96	CRD	1/4"	2"	
W9026	6	48	CRD	1/4"	6"	
W9030	6	48	TAB	1/4"	2"	30° Wobble



30° taper provides increased angle flexibility for hard to reach areas.

POLISHING KITS

- Designed for harder finishes like Aluminum, brass, and copper.
- Includes 4-oz black (first stage), brown (second stage) and white (final polish) emery polishing compounds.
- 1/4" round shaft for use with power drill.



W50091

Used for harder finishes like Chrome, Stainless steel and iron. Includes 4-oz blue (first stage), brown (second stage) and white (final polish) emery polishing compounds.



W50090

Item #		IP	MP	PKG	
W50090	Aluminum	1	20	CBX	Polishing wheels: 2", 3", 4"
W50091	Stainless Steel	1	20	CBX	Polishing pads include: 3" mushroom, 2-1/2" tapered cylinder Polishing felts: 3-1/5" bullet, 2-1/5" conical, 2-3/10" cone, 2-3/10" pear

STEEL WIRE CUP BRUSH

- Many utility cleaning uses at home and shop.
- Heavy duty construction.
- Use with any power drill.
- 1/4" Shank.

Item #	IP	MP	PKG	Diameter	
W1208C	6	72	CRD	2"	Coarse
W1214C	6	72	CRD	3"	Coarse
W1211	6	72	CLM	1-1/2"	Fine
W1212	6	72	CLM	2"	Fine
W1213	6	72	CLM	3"	Fine



STEEL WIRE WHEEL

- Many utility cleaning uses at home and shop.
- Heavy duty construction.
- Use with any power drill.
- 1/4" Shank.

Item #	IP	MP	PKG	Diameter	
W1209	6	72	CLM	3"	Coarse
W1215	6	72	CLM	4"	Coarse
W1222	6	72	CLM	2"	Fine
W1223	6	72	CLM	3"	Fine
W1224	12	72	CLM	4"	Fine



DRILL PUMP

- Fits standard garden hose.
- Use with any power drill.
- Self priming pump.

Item #	IP	MP	PKG	Shank
W1143	12	36	CRD	1/4"



IMPACT WRENCHES & SAWS

SHOP/GARAGE

1/2 IN. IMPACT WRENCH

- Variable speed for safety and control.
- Comfortable shock absorbing grip.
- Includes: Impact wrench, battery, 3-5 hour charger, and carrying case.
- cUL Listed E244495



Item #	IP	MP	PKG	Drive	Torque ft/lbs.	BPM	Rechargeable Battery	Charge Time
W50042	1	4	CBX	1/2"	240	4,000	24V Ni-cd	3-5 Hr

1/2 IN. IMPACT WRENCH

- Rocker trigger for quick change between forward and reverse.
- The 1/2" anvil with detent pin will securely hold your sockets when in use.
- Includes 11/16, 3/4, 13/16, 7/8" impact sockets and sturdy carrying case.
- CSA listed 216220



Item #	IP	MP	PKG	Drive	Torque ft/lbs.	BPM	Amp	Cord		
								Length	AWG	Listing
W50080	1	4	CBX	1/2"	220	2,700	7.5/110V	6'	18/2	CSA

RECIPROCATING SAW

- Versatile Handle Rotates 180° with five positively locking positions.
- Quick release blade chuck for fast blade changes.



Item #	IP	MP	PKG	SPM	Stoke		Amp	Cord	
					Length	Length		Length	AWG
W50093	1	6	CBX	2,500	3/4"	7.3A/110V	6'	18/2	

RECIPROCATING SAW BLADES

- Perfect for cutting metal, wood, PVC or just general demo work at the job site.
- The bi-metal construction allow the blades to be flexible yet continue to cut much longer than a standard blade.

Includes tough expandable case.



W721



Item #	IP	MP	PKG	Teeth per inch (TPI)				
				6	10	14	18	
W721	12-PC	6	48	DBL	6" (4), 9" (2)	9"	8" (2)	6" (3)
W8608	2-PC	5	240	CRD	-	6"	6"	-

4-1/2 IN. ANGLE GRINDER

- Metal gear case dissipates heat for longer life.
- 2 position side handle for right or left hand use.
- Spindle lock for quick wheel/blade changes.
- 5/8"-11 spindle for mounting the most popular 4 to 4-1/2" wheels.
- cETL listed 315240

Bonus pack includes: 4-1/2" grinding wheel, 2 - type 1 metal cut off wheels, 40, 80 and 120 grit flap discs, side handle. Also comes with replaceable motor brushes to extend tool life and spindle wrench.



Item #	IP	MP	PKG	Wheel Diameter	Arbor UNC	Flange Shoulder	No Load RPM	Amp	Cord		
									Length	AWG	Listing
W50044	1	10	CBX	4-1/2"	5/8"-11	7/8"	12,000	4.4A	6'	18/2	cETL
W8698	12	72	CRD	Replacement 5/8"-11 Flange Nut & 4-1/2" Wrench Set							

6 IN. RANDOM ORBIT POLISHER/SANDER

- Oscillating range of 3/8" for a swirl free finish.
- Dial controlled variable speed control and trigger lock for professional results.
- 2 position side handle for right or left hand use.
- ETL listed 5001662

6" hook and loop backing waffle pad, polishing bonnet, applicator pad, terry cloth cover.



Includes 6" hook and loop backing pad, 2 sanding discs, polishing bonnet, applicator pad, terry cloth cover, handle, wrench.

Item #	IP	MP	PKG	Pad Diameter	Spindle Tread	No Load RPM	Amp	Cord		
								Length	AWG	Listing
W50087	1	6	CBX	6"	5/8"-11	6,300	5.7A	6'	18/2	ETL
W50087A	6	36	BAG	3-pc replacement pad set						

7 IN VARIABLE SPEED SANDER/POLISHER

- 10 amp motor produces 0-4200 no-load RPM.
- Ball bearing motor and built in regulator for long life.
- Variable speed for use with multiple tasks.
- Ergonomic D-handle for left or right hand use.
- ETL listed 5001662

7" hook and loop backing waffle pad, polishing bonnet, applicator pad, terry cloth cover.



Includes - 7" hook and loop backing pad, 2 sanding discs, polishing bonnet, applicator pad, terry cloth cover, handle, spanner wrench.

Item #	IP	MP	PKG	Pad Diameter	Spindle Tread	No Load RPM	Amp	Cord		
								Length	AWG	Listing
W50084	1	6	CBX	7"	5/8"-11	4,200	10A	6'	18/2	ETL
W50084A	6	36	BAG	3-pc replacement pad set						

POLISERS & ACCESSORIES

SHOP/GARAGE

12V DETAIL POLISHER

- Use this 3" Detail Polisher to take care of tight spaces or spot polishing.
- Comes with foam backer pad, terry cloth and synthetic wool bonnets.



Item #	IP	MP	PKG	Pad Diameter	No Load RPM	Volt	Amp	Length	AWG
W50089	1	20	CBX	3"	1,200	12V	1.5A	12'	24
W50089A	20	80	BAG	3-pc replacement pad set					

6 IN. RANDOM ORBITAL BUFFER/POLISHER

- Random orbital action reduces risk of paint burn through and swirl free finish.
- Oval palm grip for better control.
- Lightweight compact design.
- cUL listed E187474



Includes one terry cloth bonnet and one synthetic wool bonnet.

Item #	IP	MP	PKG	Pad Diameter	No Load RPM	Amp	Length	AWG	Listing
W50053	1	6	CBX	6"	3,500	0.5A	17"	18/2	cUL
W50056	12	72	CLM	3-pc replacement pad set					

10 IN. RANDOM ORBITAL BUFFER/POLISHER

- Random orbital action reduces risk of paint burn through and swirl free finish.
- Large comfortable double handle for optimum control with less fatigue.
- Polish cars, boats, granite counter tops and more.
- cUL listed E242023



Includes one terry cloth bonnet and one synthetic wool bonnet.



Item #	IP	MP	PKG	Pad Diameter	No Load RPM	Amp	Length	AWG	Listing
W50054	1	6	CBX	10"	3,000	0.92A	6.5'	18/2	cUL
W50055	12	72	CLM	3-pc replacement pad set					

3 IN. BENCH GRINDER WITH ROTARY WAND

- Variable speed to 10,000 RPM.
- 31" flexible shaft rotary tool.
- 3" x 3/4" wide 80 grit grinding stone and fiber wheel.
- Includes 10 assorted 1/8" shaft grinding stones.
- cUL listed E237800

Includes 3" x 3/4"- 80 grit grinder stone and fiber wheel with 10mm arbor and 10 assorted 1/8" shaft grinding stones.



Item #	IP	MP	PKG	Wheel		Flexible Shaft		Arbor	No Load			Listing
				Dia.	Thick	Length	Collet		RPM	Amp	Length	
W50003	1	4	CBX	3"	3/4"	31"	1/8"	10mm	10,000	1.25A	5'	18/3 cUL

BENCH GRINDERS

- Wide, clear, easy to adjust eye shields.
- Ball bearings for durability.
- Adjustable tool rests.
- Cast iron housing.
- Includes 36 and 60 grit wheels
- cUL E237800

W1221



W50058

Equipped with work light.
W50001



Item #	IP	MP	PKG	Wheel		Max HP	No Load RPM	Cord		Listing
				Dia.	Thick			Length	AWG	
W50001	1	1	CBX	6"	3/4"	1/2	3,450	5'	18/3	cUL
W50058	1	1	CBX	8"	3/4"	3/4	3,450	5'	18/3	cUL
W1221	6	72	CLM	6" wire wheel						

5 SPEED DRILL PRESS

- 1/2" spring loaded chuck with protective guard and 2-1/2" vise.
- Fully adjustable machined table tilts 45 degrees left and right.
- Cast iron construction.
- CSA Approved.

Chuck	Spindle		Spindle to		
	Travel	Swing	Base	Table	Height
1/2"	2"	8"	11-3/8"	7-3/4"	22-1/2"

Item #	IP	MP	PKG	HP	RPM	Amp	Length	AWG	Listing
W50005	1	1	CBX	1/3	760 / 1,150, 1,630 / 2,180 / 3,070	2.4A	6'	18/3	CSA



DRILL PRESS VISE

- Durable powder coat finish and chrome plated handle.
- Replaceable hardened steel jaw faces.

Item #	IP	MP	PKG	Jaw Width	Jaw Opening	Throat Depth
W3939	1	12	CBX	2-1/2"	2-1/4"	3/4"
W3902	1	4	CBX	4"	4-1/2"	1-1/16"



W3902

INSPECTION CAMERA

SHOP/GARAGE

4.3 IN LCD INSPECTION CAMERA

- Useful for inspecting engine compartment, valves, A/C vents, plumbing pipes, under or around furniture & appliances, home theater installations, cable routing, pest control & machinery.
- Extra large 4.3" color LCD display monitor with dual screen image sizes, 2.0X digital zoom function and 180° image rotation and mirroring.
- Submersible 35" flexible camera with 4 white LEDs (5 output levels).
- Compact enough to fit in your pocket.
- On-screen battery indicator.
- Includes mirror, hook clip, magnet, batteries and protective nylon storage/carrying case.



Camera and probe assembly coils inside the case for storage.



Item #	IP	MP	PKG	LCD Monitor			Submersible Camera				Battery	
				Size	Resolution	Rotation	Dia.	Length	Resolution	LED	Qty.	Type
W50072	1	10	CBX	4.3"	480 x 272px	180°	11/32"	35"	640 x 480 VGA	4	4	AA

INSPECTION CAMERA 10' CABLE EXTENSION

- Provides greater reach and access for remote visual inspection of confined spaces
- For use with Performance Tool Inspection Camera models W50045 and W50046



To install: disconnect existing camera tube assembly from your inspection camera. Attach male threaded end of extension to camera. Then attach the camera tube assembly to the other end

Item #	IP	MP	PKG	Extension	
				Dia.	Length
W50045-2	1	32	WBX	11/32"	10'

2.7 IN. LCD INSPECTION CAMERA

- Great for inspecting engine compartment, valves, A/C vents, plumbing pipes, under or around furniture & appliances, home theater installations, cable routing, pest control & machinery.
- Full function camera with image camera and video playback/record.
- 32MB built-in memory, Micro SD card slot and TV/video output jack.
- 2.7" color LCD monitor with 180° image rotation and mirroring.
- Submersible 40" flexible camera with 4 white LEDs (6 output levels).
- Includes mirror, hook clip, magnet, USB cable, video cable and batteries.



Item #	IP	MP	PKG	LCD Monitor			Submersible Camera				Battery	
				Size	Resolution	Rotation	Dia.	Length	Resolution	LED	Qty.	Type
W50046	1	8	CBX	2.7"	320 x 240px	180°	11/32"	40"	640 x 480 VGA	4	4	AA

2.4 IN LCD INSPECTION CAMERA

- Great for inspecting engine compartment, valves, A/C vents, plumbing pipes, under or around furniture & appliances, home theater installations, cable routing, pest control & machinery.
- TV/video output jack
- 2.4" color LCD monitor with 180° image rotation and mirroring.
- Submersible 40" flexible camera with 4 white LEDs (6 output levels).
- Includes mirror, hook clip, magnet, video cable and batteries.



Item #	IP	MP	PKG	LCD Monitor			Submersible Camera				Battery	
				Size	Resolution	Rotation	Dia.	Length	Resolution	LED	Qty.	Type
W50045	1	12	CBX	2.4"	320 x 240px	180°	11/32"	40"	640 x 480 VGA	4	4	AA

ELECTRIC BLOWERS

- Great for drying carpet, floors, paint & other surfaces as well as ventilation or increasing air flow.
- Four different positions for concentrated air flow and fast drying.
- 2 Built-in 15 amp grounded outlets
- Durable ABS construction.
- Built-in carrying handle.
- Overload reset switch.
- CSA listed 255294



W50061

Variable rheostat switch allows precise speed control.

W50068

3-speed switch allows different levels of air speed.



Item #	IP	MP	PKG	CFM	RPM	Length	AWG	Amp	Listing
W50061	1	2	CBX	300	900 to 1500	8.4'	14/3	2.0	CSA
W50068	1	2	CBX	1,200	1400/1500/1600	8.4'	14/3	2.0	CSA

ELECTRIC BLOWER HEATER ELEMENT

- Converts our electric blower (W50061) into an efficient 1400 watt area heater.
- Easily attaches to front of blower. Plugs directly into receptacle on blower.
- Lighted power switch.
- CSA listed 277847

Item #	IP	MP	PKG	Watt	Cord Length	Listing
W50060	1	2	CBX	1400	12"	CSA

W50060



SHOP BLOWER/VACUUM

- Great electric broom for garage floor, sidewalks, clearing dust and saw dust from power tools, or a touch-less dry on your car.
- Large handle with lockable trigger.
- Includes vacuum bag.
- cETL listed 4008076



W50063

20 oz. vacuum bag



VARIABLE SPEED BLOWER

- Variable speed feature allows you to select just the right amount of power.
- Comfortable handle with oversized lockable trigger.



W50069

Two piece nozzle can be used at 9 or 18".

W50069A

Use to inflate air mattresses, boats, pool toys, beach toys and more.

Item #	IP	MP	PKG	Air Flow			Motor			Noise	Cord		Listing
				MPH	CFM	RPM	Watts	AMP	Length		AWG		
W50063	1	8	CBX	75	75	16,000	600	5	98 db (A)	9"	18/2	cETL	
W50069	1	4	CBX	90	100	17,000	700	5.8	98 db (A)	11"	18/2	cETL	
W50069A	12	48	BAG	3 inflator nozzle attachments in 1 adapter. Fits both W50063 and W50069.									

PARTS WASHERS

- A great tool for cleaning small parts.
- Flexible metal spigot.
- Recycles cleaning solvent.
- Heavy gauge steel construction.
- Durable powder coat finish.
- For use with water based solvents only.
- cUL listed E204083

Tank: 17-3/8" x 14-1/4" x 8-3/4".
Removable: 15-3/8" x 11-3/8" tray for quick drying and easy examination.



Item #	IP	MP	PKG	Tank	Output		Length	AWG	Listing
					GPH	Spigot			
W54040	1	1	CBX	20 Gal	50	24"	5-1/2'	18/3	cUL
W54041	1	1	CBX	3-1/2 Gal	264	13-1/4"	5-1/2'	18/3	cUL

BUCKET PARTS WASHER

- Lightweight and portable, designed to be used on a standard 5-gal bucket.
- Ribbed drainage channels and a filtered gate to catch waste material.
- Apply cleaning solution with the handy flow through 8" brush.
- For use with water based solvents only.
- cUL E204083



Item #	IP	MP	PKG	Diameter	Output		Hose	Amp	Length	AWG	Listing
					GPH						
W54043	1	5	CBX	13-3/4"	50		4'	0.6A	6'	18/3	cUL

Pump sets conveniently in the base of your 5 gallon bucket.

STEAM CLEANER

- Great multi-purpose handheld steam cleaner.
- Non-toxic - no dangerous chemicals, fumes or residues.
- Clean grease, grime, dirt, soap scum, wrinkles, stains, bacteria, insects, doors, windows, floors.
- Chemical-free solution for insects, bacteria and other household pests.
- cETL listed 362189

Includes 9 Accessories: flexible extension, round brush nozzle, 90° spray nozzle, long spray nozzle, wide nozzle, squeegee, fabric towel, funnel and measuring cup.



Use anywhere: car, garage, kitchen, bathroom, clothing, patio, pool and more.

Item #	IP	MP	PKG	Capacity	PSI	Heating		Watt	Length	AWG	Listing
						Time	Use				
W50079	1	4	CBX	10 oz	45	3 - 4 min	8 - 10 min	900	10"	16/2	cETL

CORDLESS GREASE GUNS

- A well balanced design helps make hard-to reach fittings easy to service, simplifying the lubrication process.
- The planetary gearbox and reciprocating piston provide 7,000 psi and approximately 3 oz. of grease per minute.
- Two way loading, 14 oz. grease cartridge or bulk.
- Knurled barrel for secure grip.
- Grease hose with heavy duty coupler, battery and 1 hour quick charger, heavy duty plastic storage case.



W50048

Includes two 18V batteries and a shoulder strap for easy portability.



W50014

Item #	IP	MP	PKG	PSI	Hose	Rechargeable Battery		Input	Charger Output	Cord	Rated	
W50014	5-PC	1	3	CBX	7,000	30"	14.4V	Ni-cd	120V 60Hz 70W	9.6-24V 1.5A	6'	cETL
W50048	6-PC	1	4	CBX	7,000	42"	18V	Ni-cd	120V 60Hz 45W	18.0V 1.3A	6'	cUL
W11046	Battery	1	12	CLM	-	-	18V	Ni-cd	-	-	-	-

120V AIR INFLATOR

- Inflate air mattresses, rafts, or float tubes at home or on the go.
- Quickly and easily inflates or deflates large volume inflatables.
- High quality and made to last.
- Includes 3 valve adapters.
- cETL listed 3135568

Inflates a twin mattress in about approx. 1-min.



Item #	IP	MP	PKG	Length	AWG	Listing
60397	1	24	CBX	5.6'	18/2	cETL

120V COMPACT TIRE INFLATOR

- Portable 120V direct drive tire inflator quickly inflates tires, rafts, and sports equipment.
- Rubber air hose, and power cord stores conveniently within the inflator.
- Built in tire pressure gauge and rubber stabilizing pads.
- Cooling fan gives extended unit life and reliability.
- Inflates standard car tires in under 4 minutes.

Additional inflators on page 110



Includes adapters and an inflation needle to fit balls and sports equipment.

Item #	IP	MP	PKG	PSI	Hose Length	Length	AWG	Listing
60398	1	6	CBX	100	30"	6'	18/3	cETL

12V PORTABLE VACUUM CLEANER

- High powered suction in a compact, portable and lightweight unit.
- Washable HEPA filter captures smaller particles.
- Operates directly from a 12V outlet in your vehicle.
- On/off switch and power indicator.
- Carrying case keeps everything together for easy storage in your vehicle.



Includes 5 attachments: crevice tool, bristled brush, dust brush, 11" hose, 10" extension.



Item #	IP	MP	PKG	Fuse	Vacuum	Noise	Length
W50012	4	16	CBX	10A	3000 Pa	80 dB	13.3'

12V HEATER/DEFROSTER

- Use to quickly defrost / warm windshields and surfaces.
- Separate switches for heater, fan and LED flashlight.
- 360° swivel base for dash mounting.
- Three position heat switch.
- 15 amp in-line blade fuse.



Swing-out handle lets you use the heater as a spot defroster.

Item #	IP	MP	PKG	Fuse	Length
W5009	1	12	CBX	15A	7'

12V OSCILLATING FAN

- Unique oscillating pattern covers both the high and low zones.
- Convenient 12 volt adapter plug with 6' cord.
- Comes with clamp and plate for permanent mounting.



Item #	IP	MP	PKG	Diameter	Fuse	Length
W1658	10	20	CLM	6"	5A	6'

12V DUAL OUTLET EXTENSION CORD

- Provides additional cord length to any automotive accessory.
- Dual outlets for powering multiple devices.
- Fits standard 12V auto outlets.



Item #	IP	MP	PKG	Length
W1279	6	48	CRD	10'

HEAT GUNS

SHOP/GARAGE

DIGITAL HEAT GUN

- LCD readout allows you to set the desired temperature and monitor exact outgoing air temperature.
- Digitally adjusted temp range from 160 - 1020 °F (50-550 °C).
- Adjustments are made in increments of 10 degrees.
- Dual air flow settings.
- cETL listed 4002205



Item #	IP	MP	PKG	CFM	Temp °F	Watt	Amp	Cord		
								Length	AWG	Listing
W50075	1	10	CBX	300 - 500	160 - 1,020	1,500	0.8 - 12A	6'	16/2	cETL

2 SPEED HEAT GUN

- Ideal way to strip paint and varnish, remove decals, shrink wire wraps, loosen fittings, thaw pipes and more.
- Powerful 2-speed 1500 watt motor easily adjust heat level from 572 - 932 °F (300 500 °C).
- Durable ABS body.
- cETL listed 50022889



Item #	IP	MP	PKG	CFM	Temp °F	Watt	Amp	Cord		
								Length	AWG	Listing
W50076	1	10	CBX		572 - 932	1,500	12.5	6'	16/2	cETL

VARIABLE TEMP HEAT GUN

- Manual variable heat settings for a wide variety of jobs.
- Superior coil design heats more quickly and maintains even temperature.
- Three-way switch for better control and functionality.
- Durable ABS body.
- Loop pistol grip for easy hanging.
- cETL listed 4002205.



Item #	IP	MP	PKG	CFM	Temp °F	Watt	Amp	Cord		
								Length	AWG	Listing
W50077	1	10	CBX		158 - 1,022	1,500	0.8-12A	6'	16/2	cETL

HEAVY DUTY HEAT GUN

- Heavy duty die cast housing with aluminum nozzle.
- Detachable, three-position non-slip steel base for hands-free operation.
- Cool blower feature with three-position switch.
- 1" Diameter air flow nozzle.
- ETL listed 4002205



Item #	IP	MP	PKG	SCFM	Temp °F	Watt	Amp	Cord		
								Length	AWG	Listing
W50078	1	4	CBX	6	1,000 - 1,100	1,600	13.5A	6'	14/3	ETL

4 -PC HEAT GUN NOZZLE KIT

- Expand the functionality of your heat gun with these universal adapters for heat guns with 1-3/8" nozzles.
- Used for controlling the flow of air and focusing heat to the desired area.

Includes air spreader, reducer, scraper and deflector adapters.

Fits models: W50075, W50076, W50077



Item #	IP	MP	PKG
W50076A	1	50	CRD

SOLDERING KITS

- Nickel plated tip gives longer life and more efficient soldering.
- Built in spotlight.
- Instant heat.
- cUL listed E231844



Item #	IP	MP	PKG	Watt	Amp	Temp °F	Length	AWG	Listing		
W2012	5-PC	6	24	DBL	60W	.8A	1,135	4.5'	18/2	cUL	Gun, wire, paste, two tips
W2019A	4-PC	6	24	CBX	85W	.7A		4.5'	18/2	cUL	Gun, wire, two tips
W2013	2-PC	6	48	CRD	30W			4.4'	18/2	UL	Pencil, tool rest
W2012-1	2-PC	12	72	CRD	Replacement tips for W2012						

CORDLESS SOLDERING IRON

- Heats up to working temperature in under 15 seconds and cools down instantly.
- Equivalent to an 8W soldering iron.
- LED power indicator.
- Continuous runtimes:
45 min on low, 30 min on high.



Item #	IP	MP	PKG	Power	Temp °F	Battery	
						Qty.	Type
W2000	6	24	DBL	8W*	572	3	AA
W2000-1	24	288	CRD	Replacement tip			

LEAD FREE SOLDER

- 0.031" Rosin core solder for any application.
- Lead free solder - 99.3% tin, 0.7% copper.
- 10' (3.0m) roll in storage tube.



Item #	IP	MP	PKG	Thick	Length
W3248	12	144	Pg 318	0.031"	10'

HELPING HANDS

- Adjustable ball joints position and hold work at any angle
- Two alligator clamps hold light materials steady
- 2X, 2-1/2" magnifying glass for precision work
- Heavy duty cast iron base

Item #	IP	MP	PKG
W2010	6	24	DBL

MINI FLAME THROWER

- Refillable with an adjustable flame.
- Melts solder, gold, small brazing rod, tin and much more.

Item #	IP	MP	PKG	Temp °F
W2002	6	24	DBL	2,500

ROTARY TOOL & ACCESSORIES

SHOP/GARAGE

40-PC ROTARY TOOL SET

- Variable speed dial lets you adjust from 8,000 to 30,000 RPM.
- Lightweight design for comfort and control.
- Replaceable motor brushes extend tool life.
- Drum sanders, polishing stones, cutting wheels, buffing, drill bits, dressing stone, wrench, 10 assorted aluminum oxide grinding stones and carrying case.
- cUL listed E2305109



	Sanding	8	13/16" 60 grit
Disc	Cut-off	3	15/16 x 0.031"
		3	15/16 x 0.015"
	Mandrel	1	1/8"
Polishing	Felt	1	1/2, 1"
Wheel	Mandrel	1	1/8"
Drum	Sander	4	1/2" 60 grit
Sleeves	Mandrel	1	1/8"
	Drill Bits	1	3/16", 1/8"
Addition	Collet	1	1/8, 3/32"
			2 Diamond wheel point 1/8"

Item #	IP	MP	PKG	No Load (RPM)	Amp	Collet	Cord Length	AWG	Listing	Overall Length
W50031	1	10	SLV	8,000 - 30,000	1A	1/8, 3/32"	6'	18/2	cUL	9-1/4"

80-PC MINI ROTARY TOOL SET

- Great for cutting, grinding, polishing, sharpening and drilling.
- Spindle lock with 4 collet sizes- 1mm, 2mm, 3/32 and 1/8".
- 79pc accessory set for cutting, polishing, grinding and engraving.
- cUL listed E251203



Item #	IP	MP	PKG	No Load (RPM)	Amp	Collet	Cord Length	AWG	Listing	Overall Length
W50083	3	12	DBL	16,000	7A	1/8, 3/32" 1mm, 2mm	3' & 3'	24/2	cUL	4-3/4"

146-PC ROTARY TOOL STONE ASSORTMENT

- Includes 19 drum sanding sleeves, large drum mandrel, small drum mandrel, 3 bristle brushes, 3 steel brushes, 5 assorted diamond grit polishing bits, 13 assorted grinding stones, 10 fiberglass cut-off wheels, buffing compound, 3 copper collets, 6 high speed cutters, screw tighten mandrel, thread screw mandrel, 36 regular cut-off wheels, 30 heavy-duty cut-off wheels, 6 polishing wheels, 2 polishing tips, 80 grit sanding wheel, 3 drill bits and 1 wet stone.



Item #	IP	MP	PKG
W50037	4	16	CAS

HEAVY DUTY ENGRAVER

- Ideal for decorative engraving or adding security by personalizing your valuables, engraves on metal, plastic, glass, ceramics, wood & even leather.
- 9 position depth adjustment dial for fine lines to deep grooves.
- Long lasting tungsten carbide tipped steel engraving bit.
- Comfortable non-slip grip.
- 5 Minutes on/5 minutes off operating cycle,
- cETL listed 4005094



Item #	IP	MP	PKG	Stroke (SPM)	Amp	Cord		Listing
						Length	AWG	
W50036	1	10	CLM	3,600	0.2A	6'	18/2	cETL

CORDLESS ENGRAVERS

- Fast and easy way to protect your valuables.
- Suitable for metal, plastic, wood, leather, stone and glass.
- Includes pointed and round burrs.
- Batteries included.

Item #	IP	MP	PKG	Battery	
				Qty.	Type
W50035	6	48	DBL	2	AA
20187	4	72	DBL	2	AA



RETRACTABLE CORD REELS

- Great for use in any garage, workshop or job site!
- Heavy duty retractable cord reel with impact resistant housing.
- Triple tap grounded outlet provide up to 15 amp of power.
- Automatic roller guide ensures smooth and even recoil.
- Spring loaded auto-rewind.
- Wall mount and hardware included.

Adjustable cord stopper

No-sag rollers reduce wear

W2273

50' 16 gauge cord with polarized plug and 3 grounded 10 AMP outlets



W2278

40' 12 gauge cord with polarized plug and 3 grounded 15 AMP outlets

Item #	IP	MP	PKG	Length	Type	Amp	Lead
W2273	1	4	CBX	50'	16/3 SJTW	10	4'
W2278	1	4	CBX	40'	12/3 SJTW	15	4'

25 FT. RETRACTABLE CORD REEL

- Retractable cord reel for extended range.
- Ideal for the professional or at home user.
- Durable steel housing.
- Spring loaded auto-rewind.
- Mounting brackets included.
- UL listed E234282.



Item #	IP	MP	PKG	Length	Plug	Amp	Listing	Lead
W2272	1	4	CBX	25'	16/3 SJTW	10	UL	3'

20 FT. RETRACTABLE CORD REEL

- Retractable cord reel for extended range.
- Ideal for a garage, shed, smaller size shop.
- Impact resistant housing.
- Spring loaded auto-rewind.
- Includes mounting hook.
- cETL listed 3090498.



Item #	IP	MP	PKG	Length	Plug	Amp	Listing	Lead
W2275	1	6	CBX	20'	18/3 SJTW	8	cETL	4'

20' cord with polarized plug and 3 grounded 8 amp outlets.

EXTENSION CORDS

- Vinyl covering protects against moisture, abrasion, and direct sunlight and is suitable indoor/outdoor use.
- Three-prong plug, grounded for safety.
- High visibility orange, with single outlet.
- 13 Amp max rating.
- cUL listed E218475.

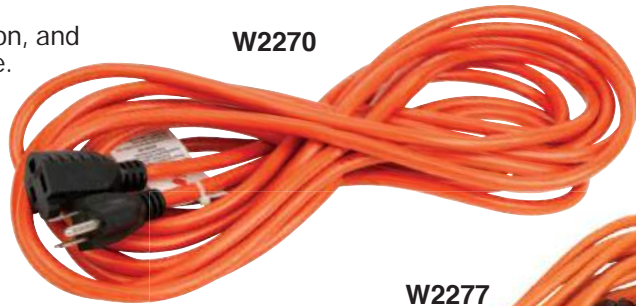

Item #	IP	MP	PKG	Length	Gauge	Amp	Listing
W2270	3	12	SLV	25'	16	13	cUL
W2271	3	12	SLV	50'	16	13	cUL
W2277	2	4	SLV	100'	16	13	cUL

CORD REEL

- 11" diameter cord storage reel.
- Heavy duty impact resistant housing.
- Holds up to 150 foot 16GA or 100 foot 12GA cord.



Item #	IP	MP	PKG
W2274	6	6	BLK

HOSE & CORD CARRY STRAP

- Holds extension cords, air hoses, water hoses or cables up to 3" in diameter.
- Adjustable to two different sizes.
- Easy to carry handle with built hang hole.
- Great for easy carrying or organizing.



Item #	IP	MP	PKG
W467	6	120	CRD Pg 318

JUMBO CARABINERS

- Hundreds of Uses.
- Lightweight Aluminum Construction.
- Ergonomic Soft Grip Handle.



Item #	IP	MP	PKG	Size
W461	8	48	CRD	5"
20197	5	30	Pg 321	5"
W463	6	48	CRD Pg 318	7"

DROP LIGHTS

SHOP/GARAGE

ALUMINUM CLAMP LIGHT

- Adjustable ball joint for easy positioning.
- Steel clamp with scratch resistant vinyl sleeve.
- Rated for up to a 100-watt incandescent bulb.
- On/Off switch.
- cUL listed E156161.



Incandescent bulb sold separately.

Item #	IP	MP	PKG	Length	AWG	Bulb	Listing	Diameter
W2263	3	12	SLV	6'	18/2	100W	cUL	8-1/2"

METAL FRAME DROP LIGHT

- Reflective galvanized metal lamp shield with hang hook.
- Impact resistant handle with durable push on/off switch.
- Uses up to 75 watt incandescent bulb.
- cUL listed E240972.



Item #	IP	MP	PKG	Length	AWG	Bulb	Listing
W2260	3	12	SLV	25'	18/2	75W	cUL

PLASTIC DROP LIGHT

- Non-metallic bulb guard with integrated swivel hook.
- Rated for up to a 75-watt Incandescent bulb.
- Impact resistant housing.
- cUL listed E240972.



Item #	IP	MP	PKG	Length	AWG	Bulb	Listing
W2261	3	12	SLV	6'	18/2	75W	cUL

DUAL 12V PLASTIC DROP LIGHT

- Non-metallic bulb guard with integrated swivel hook.
- Dual 12V power supply options: battery clamps and 12V outlet.
- Impact resistant housing.
- Includes heavy duty service bulb.
- cUL listed E240972.



Item #	IP	MP	PKG	Length	Bulb	Listing
W2262	6	24	SLV	20'	50W	cUL

13W CFL WORK LIGHT

- Cool running, 13-Watt bulb provides up to 10,000 hours of use.
- Impact, moisture and chemical resistant housing.
- Electronic ballast for no flicker cold starts.
- Dual hooks for hands-free lighting.
- Heavy duty switch.
- cUL listed E240972.



Powerful magnet for additional mounting options



4100k warm white, 8000 hour bulb.

Item #	IP	MP	PKG	Bulb CFL	Length	AWG	Listing	Overall Length
W2251	1	6	SLV	13W	6'	16/2	cUL	14-7/8"
W2252	1	6	SLV	13W	6'	18/2	cUL	11-5/8"
W2281	6	48	CRD	13W	Bulb		-	

30 LED WORK LIGHT

- 30 Bright white LEDs never need replacing.
- Impact, moisture and chemical resistant housing.
- Magnet and dual hooks for hands-free lighting.
- Heavy duty switch.
- cUL listed E240972.



Powerful magnet for additional mounting options



Built-in power outlet.

Item #	IP	MP	PKG	LED	Length	AWG	Listing	Overall Length
W2250	1	4	SLV	30	6'	18/2	cUL	14-7/8"

24 LED RECHARGEABLE WORK LIGHT

- Cordless or corded operation.
- 24 Super bright white LEDs.
- 360° swivel hanging hook and heavy duty magnet.
- 4-5 hour continuous run time.
- Includes 12V car charger, 120V wall charger, charging base and built-in Ni-Mh Battery pack.



Item #	IP	MP	PKG	LED	Battery	Charge Time	Listing	Overall Length
W2480	3	9	CLM	24	Ni-Mh	3-4 Hr	cUL	11-3/4"
W2480-BULK	1	12	WBX	24	Ni-Mh	3-4 Hr	cUL	11-3/4"



CORDED WORK LIGHTS

SHOP/GARAGE

L.E.D. WORK LIGHTS

- Ultra high output of more than 1,000 lumens.
- Wide angle LEDs distribute large flood beam of light.
- Foam covered handle and heat conductive body.
- SMD* LED technology means unit stays cool enough to touch.
- Insulated on/off switch.



Item #	IP	MP	PKG	LED		Beam Distance	Peak Intensity	Cord		Listing	Assembled		
				Count	Lumen			Length	AWG		W	D	H
W2401	6	12	CBX	12	1,030	65m	1,050cd	16"	18	-	6-1/4"	5-1/2"	9"
W2402	1	8	CBX	46	2,138			6'	18	cETL	9"	7"	11-3/4"
W2230	1	8	CBX	14	1,186	47.2m	556cd	5'	18	cETL	7-1/2"	6-3/4"	12-1/2"

PORTABLE 500W WORK LIGHT

- Tempered glass lens with metal safety cage.
- Durable powder coated finish.
- Foam covered S-handle.
- Weather proof On/Off switch.
- cUL listed E229796.



Replacement 500W halogen bulb. 120 Volt. For use with Performance Tool Work light model W2264.



Item #	IP	MP	PKG	Cord			Assembled		
				Length	AWG	Listing	W	D	H
W2264	1	8	CBX	12"	18/3	cUL	8-3/4"	9"	12-1/4"
W2280 2-PK	6	48	CRD	2-PK Bulbs					

RECHARGEABLE LI-ION L.E.D. WORK LIGHT

- Ultra high output of more than 1000 lumens.
- LED technology means unit stays cool enough to touch.
- Wide angle LEDs distribute large flood beam of light.
- Textured reflector distributes light more evenly.
- Rechargeable lithium ion battery with USB charging cable.

Battery			Assembled		
	W	D	H		
Li-Ion	3.6V	2.5A	6-1/4"	5-1/2"	9"

Item #	IP	MP	PKG	LED Count	Lumen	Beam Distance	Peak Intensity	Run time
W2406	6	12	CBX	12	1,020	61m	924cd	1.5 Hr



RECHARGEABLE LI-ION UNDERHOOD L.E.D. WORK LIGHT

- Wide angle LEDs provide over 500 lumens of flood light.
- Counterbalanced to always shine light downward where you need it.
- Padded hooks prevent scratching or denting.
- Magnets and hooks on back for added versatility.
- High and low beam settings.

Unique design spans up to a 78" wide hood, yet takes up less than 18" of space in your tool box.



Powered by 18650 Li-Ion battery, or direct plug in via USB cable (both included).



Retractable steel wires with end hooks to fit almost any size hood.

Item #	IP	MP	PKG	LED Count	Lumen	Beam Distance	Peak Intensity	Run time	Rechargeable Battery	Overall Length
W2404	4	24	CRD	8	513 H 256 L	60m	924cd	1.25 Hr.	Li-Ion 18650	18"



SPOT LIGHTS

SHOP/GARAGE

12V SPOTLIGHT

- Super bright 100 watt H3 quartz halogen bulb.
- Compact design with ergonomic grip.
- 6 ft. coiled cord with 12V fused power plug.
- Perfect for RV's, trucks, boats & ATV's.

Includes removable red lens



Item #	IP	MP	PKG	Reflector Diameter	Candle Power	Color	Halogen Bulb	Battery
W2426	1	12	CLM	5"	3.5 million	Black	H3 100W	6V 4Ah

LI-ION SPOTLIGHT

- High capacity Lithium Ion rechargeable battery.
- Powerful quartz halogen bulb.
- High impact ABS housing with protective lens bumper.
- Comfort pistol grip with trigger lock and wrist strap.
- Includes both a car charger and household charger.
- LED charge indicator light with auto shutoff.
- Integrated rechargeable battery - No batteries required.



Item #	IP	MP	PKG	Reflector Diameter	Candle Power	Color	Halogen Bulb	Battery	Run Time	Charge Time
W2435	1	4	DBL	4"	2 million	Grey	4V 25W	Li-Ion	1 Hr.	6-8 Hr

LEAF CAMO RECHARGEABLE SPOTLIGHT

- High power quartz halogen bulb.
- Durable ABS housing with camo finish.
- Non-skid rubber bezel protector.
- Red and amber lenses included.
- Locking trigger switch for hands free use.
- Convenient built-in hanger.
- Charging indicator light.



Item #	IP	MP	PKG	Reflector Diameter	Candle Power	Color	Halogen Bulb	Battery
W2425	4	8	CLM	4-1/4"	2 million	Leaf Camo	H3 55W	6V 4Ah

RECHARGEABLE SPOTLIGHTS

- Comfort grip with built-in hanging hook and tripod hole.
- High power quartz halogen bulb.
- Rechargeable sealed lead acid battery.
- Lockable trigger switch for hands free use.
- LED charge indicator light.
- Includes both a car charger and household charger.

Great for roadside emergencies, power failures, camping, boating, home, auto and more.



Item #	IP	MP	PKG	Reflector	Candle	Halogen		
				Diameter	Power	Color	Bulb	Battery
W2409	1	8	CBX	4-1/4"	1 million	Black	H3 55W	6V 4Ah
W2432	1	8	CBX	4-1/4"	1 million	Camo	H3 55W	6V 4Ah
W2433	1	8	CBX	4-1/4"	2 million	Black	H3 55W	6V 4Ah

5 LED MINI HEAD LAMP

- Adjustable elastic headband.
- Adjusts 90 degrees for use anywhere.
- Easy on and off, just twist.
- Spring loaded clip attaches to hats and other thin items.
- Batteries included



Item #	IP	MP	PKG	Battery	
				Qty.	Type
W2393	8	72	CLM	2	CR2032
W2427	8	32	DBL	2	CR2032



PEN LIGHT

- Super bright bulb.
- Convenient pocket clip
- Batteries included.



Item #	IP	MP	PKG	Battery	
				Qty.	Type
W2416	12	144	CRD	2	AAA



L.E.D. KEY CHAIN FLASHLIGHT

- Energy efficient Nichia LED never needs replacing!
- Rubber on/off push button. Water resistant.
- Batteries included.

Item #	IP	MP	PKG	Length	Battery		Colors
					Qty.	Type	
W2375	16	128	BLK	2-3/4"	3	AG13	Red, Blue, Black, Silver



2 TON FLOOR JACK & SETS

- 4,000 lbs. capacity jack, maximum height 13", swivel casters for easy positioning. Heavy duty steel lifting arm. Lightweight for fast positioning. Tough enamel finish.
- Ratcheting style 4,000 lbs. capacity jack stands.
- 40" cool weave folding creeper, 350 lbs. capacity.



W85028

See Seats and Creepers for more details.

Item #		IP	MP	PKG		Lift Range	Pumps (to max height)	Length	Width	Height
W1606	Jack Only	1	1	CBX	Jacks	5-1/4 to 13"	42	17"	8"	5-1/2"
W1605	Jack & Stands	1	1	CBX	Stands	10-3/4 to 16-3/8"	-	6-11/16"	6-15/16"	16-3/8"
W85030	Jack, Stands & Cool Weave Creeper	1	1	CBX	Folding Creeper	Open	-	40"	18"	4-3/4"
						Folded	-	19-7/8"	18"	6-1/2"

FLOOR JACKS

- Swivel casters for easy positioning.
- Durable flanged steel frame.
- Great for cars and light duty trucks.

Rapid lift feature allows you to quickly raise jack into position under the vehicle.



W1614
Carry handle included.



W1612



W1616



W1611
Carry handle included.

blow molded plastic case.



W1640
Carry handle included.



W1617

Item #	Capacity	IP	MP	PKG	Lift Range	Pumps (to max height)	Base	
							Length	Width
W1614	2 Ton	1	1	CBX	5-1/4 to 15-1/2"	45	17"	8"
W1611	Blow Case	1	1	CBX	5-1/4 to 15-1/2"	45	17"	8"
W1640	2-1/2 Ton	1	1	CBX	5 to 15-1/2"	42	21-5/8"	8"
W1612	2-1/2 Ton	1	1	CBX	5 to 19-1/4"	22	28-3/4"	14"
W1616	Rapid Lift	1	1	CBX	4-5/8 to 19-3/4"	21	27"	13-1/2"
W1617	3 Ton	1	1	CBX	5-1/2 to 21-1/4"	18	28-1/2"	13-5/8"

LOW PROFILE GARAGE JACKS

- Double-pump mechanism for quick lifting.
- Rubber saddle pad.
- Durable flanged steel frame.
- Swivel caster for easy maneuvering
- Great for cars and light trucks.
- Meets or exceeds ASME PALD-2005.



Dual Pistons

Item #	Capacity	IP	MP	PKG	Lift Range	Pumps	Base	
						(to max height)	Length	Width
W1642	2 Ton	1	1	CBX	2-3/4" to 20"	18	26-1/2"	13-1/2"
W1627	3-1/2 Ton	1	1	CBX	4 to 20-1/2"	19	28"	14-1/4"
W1645	3-1/2 Ton	1	1	CBX	3-1/2 to 20-1/2"	19	28-3/8"	15"

ALUMINUM FLOOR JACKS

- Rubber saddle prevents marring, rotates 360°
- Light weight aircraft aluminum.
- 1-1/2 ton capacity.



W1601
40" cushion grip handle.



4,000 lbs. capacity.



Low Profile Design



Dual Pistons



W1630
47-3/4" cushion grip handle.

Item #	Description	IP	MP	PKG	Lift Range	Pumps	Base	
						(to max height)	Length	Width
W1601	Jack & Stand Set	1	1	CBX	Jack	3-3/4 to 14-3/4"	19-3/4"	9-1/2"
					Stands	10-1/4 to 15-1/4"	7"	7"
W1630	Jack Only	1	1	CBX	Jack	3-5/8 to 17-1/2"	25"	11-1/2"

12V ELECTRIC SCISSOR JACK

- Ideal for emergency roadside tire changes.
- Designed for compact to medium size vehicles only.
- Push button controller with extra long 12' cord.
- Compact size for easy transport and storage.
- Included: Jack, carrying case, emergency hand crank, and three extra fuses.



Item #	IP	MP	PKG	Lift Range	Base Plate		Specs	Cord
					W	L		
W1609	1	4	CBX	5 to 14"	5"	7"	12V 11A 75W	12'

1-1/2 TON SCISSOR JACK

- Oversized base for added stability and support.
- Precision threaded shaft.
- Sturdy steel construction.

Item #	IP	MP	PKG	Lift Range	Base Plate	
					W	L
W1600	1	4	CBX	4 to 15"	4-7/8"	15"



Capacity	Capacity	
	W1600	W1609
14"	3,000	4,000
10"	1,800	2,400
8"	1,200	1,600
6"	900	1,200

LIFT EQUIPMENT

SHOP/GARAGE

BOTTLE JACKS

- Heat treated critical stress areas ensure long life performance.
- Steel lifting saddle cleated for load gripping power.
- Two piece pump handle.
- Ideal for auto, truck service, farm and shop use.

Folding handle.

W1643/
W1644

Patented Bypass device for safety. Meets or exceeds ASME PALD-2009.



Adjustable top screws.



W1621
through
W1633



W1636/
W1637
Folding handle.
Heavy duty base.

Item #	Capacity	IP	MP	PKG	Lift Range	Saddle Diameter	Base		Wt.
							Width	Depth	
W1621	2 Ton	1	6	CBX	7-1/8 to 13-1/2"	5-3/64"	3-15/32"	3-25/32"	5.95
W1623	4 Ton	1	6	CBX	7-5/8 to 14-5/8"	1-5/64"	3-5/8"	3-15/16"	7.7
W1625	6 Ton	1	4	CBX	8-1/2 to 16-1/4"	1-7/32"	3-55/64"	4-21/64"	9.9
W1628	8 Ton	1	4	CBX	9 to 18"	1-11/32"	4-3/32"	4-5/8"	13.2
W1632	12 Ton	1	4	CBX	9-1/4 " 18-1/2"	1-21/32"	4-5/8"	5-9/32"	17.15
W1633	20 Ton	1	2	CBX	9-1/2 to 17 3/4"	1-13/16"	5-45/64"	5-63/64"	24.2
W1636	30 Ton	1	2	CBX	11-1/4 to 18-1/4"	2-1/8"	5-7/64"	6-3/4"	39.6
W1637	50 Ton	1	1	CBX	11-3/4 to 18-7/8"	3-17/64"	6-7/8"	8-5/8"	72.6
W1643	12 Ton Shorty	1	2	CBX	6-5/8 to 13"	1-11/16"	5-5/16"	5-25/64"	14.1
W1644	20 Ton Shorty	1	2	CBX	7-1/2 to 13-1/8"	1-13/16"	6-1/8"	6-1/4"	20.9

JACK STANDS

- High-grade steel with for quality and durability.
- Large saddle surface area provides better contact.
- Ratchet style for easy adjustments.
- Tough enamel finish.

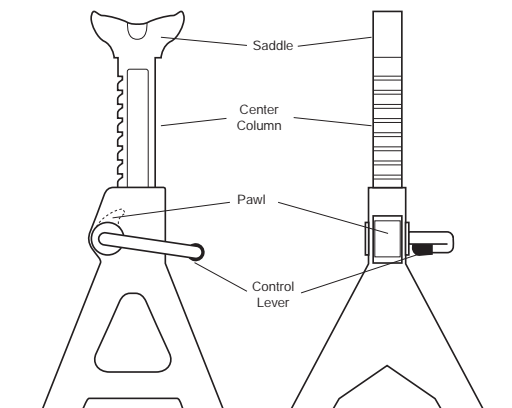

Item #	Capacity	IP	MP	PKG	Lift Range	Steps/ Locks	Base		Wt.
							Width	Depth	
W41021	2 Ton (Pair)	1	2	CBX	10-3/4 to 16-3/8"	10	6-11/16"	6-15/16"	11.1
W41022	3 Ton (Pair)	1	2	CBX	11-1/4 to 16-3/4"	10	6-7/8"	7-5/8"	14.0
W41023	6 Ton (Pair)	1	2	CBX	15-1/2 to 23-3/4"	10	9-5/8"	10-15/16"	29.0

RUBBER WHEEL CHOCK

- Ideal to keep your vehicle or trailer in place in any climate.
- All weather construction with rubber traction pad.
- Oil resistant non-slip surface provides superior traction.
- Weighs less than 5 pounds.
- 45° slope angle.

Item #	IP	MP	PKG		Width	Depth	Height
W41001	1	8	LAB	Wheel Contact	6-1/2"	6-7/8"	-
				Base	8-1/4"	6-7/8"	6"



2-PC PLASTIC WHEEL CHOCKS

- Safety device for use with ramps or other lifting devices.
- Keeps tires from rolling.
- Heavy duty ABS plastic.

Item #	IP	MP	PKG		Width	Depth	Height
W41000	1	48	WBX	Wheel Contact	7"	4-1/2"	-
				Base	8-1/8"	5-5/8"	4-1/2"



WHEEL DOLLY

- Move your car, riding mower, trailer and much more in any direction with just a push.
- Makes storage and service and restoration easier.
- 1,000 lbs. capacity per dolly.
- 3-1/2" cast iron swivel ball bearing casters.
- Accepts tires up to 14" wide.



Item #	IP	MP	PKG	Width	Depth	Height
W54013	1	1	CBX	23-1/2"	15-1/2"	5-1/2"

ADJUSTABLE WHEEL STEP

- Non-slip surface.
- Fits tires up to 13" wide.
- 300 lbs. rated capacity.

4 position height adjustments
 - 3-1/8"
 - 5-1/2"
 - 7-5/8"
 - 10-1/4"



Item #	IP	MP	PKG		Width	Depth	Height
W41039	1	1	CBX	Folded	21-1/2"	9"	3-7/8"
				Open	21-1/2"	20-1/2"	14-1/8"

ENGINE LIFT & SUPPORT

SHOP/GARAGE

2 TON FOLDING ENGINE CRANE

- 4,000 lbs. capacity.
- Adjustable boom with chain and hook.
- Legs fold up for easy storage.

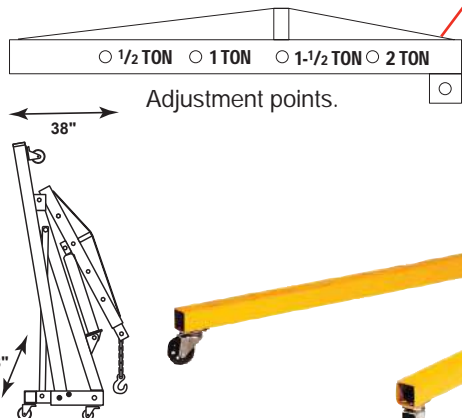
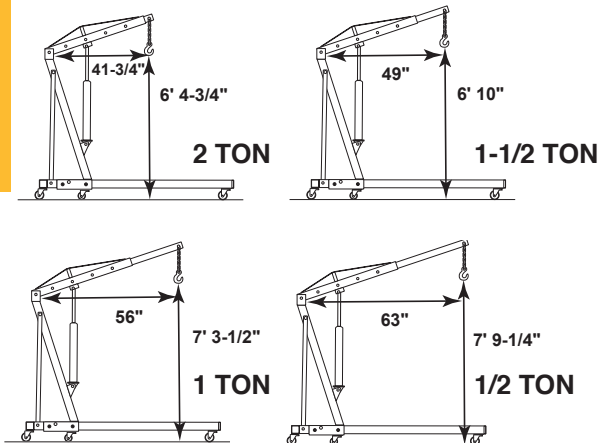

Item #	IP	MP	PKG	Range	Height	Boom	Dimension	Width	Depth	Height	Wt.	
W41029	1	1	CBX	@4,000 lbs.	75-1/4"	41-3/4"	Assembled	69"	36"	58-1/2"	230	
				@500 lbs.	90-3/4"	63"	Folded	25-1/2"	33-1/2"	63-1/4"		
W41027	1	2	LAB	8 Ton Replacement Ram							24"	30

3/4 TON ENGINE HOIST LEVELERS

- Drop forged steel construction.
- Crank handle for fast adjustments.
- Heat treated chain and hooks.
- Fully adjustable with threaded rod and 3 position chain mount holes.

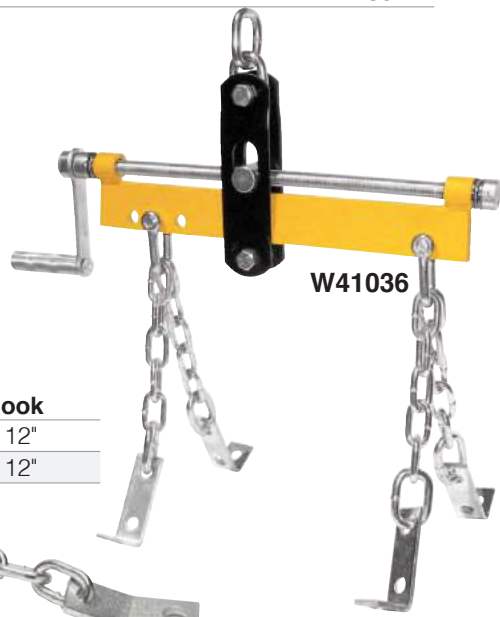
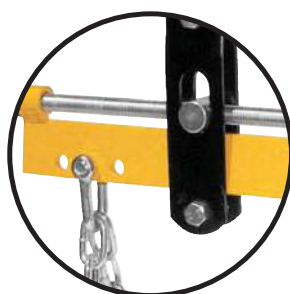

Item #	IP	MP	PKG	Width	Height	Chain & Hook
W41036	1	6	CBX	W/ Handle	20-3/4"	8" 4 12"
W41030	1	6	CBX	W/O Handle	18-1/4"	" 4 12"

ENGINE LIFT CHAIN

- Assists in lifting most engines & heavy components from chassis.
- Heat treated alloy steel.



Item #	IP	MP	PKG	Capacity	Chain	Overall
W41032	6	24	CLM	1,000 lbs.	24"	28"

ENGINE LIFT PLATE

- Universal design fits more than 90% of common applications including Dominator* manifolds.
- Makes removing or installing engines with or without the transmission easy.

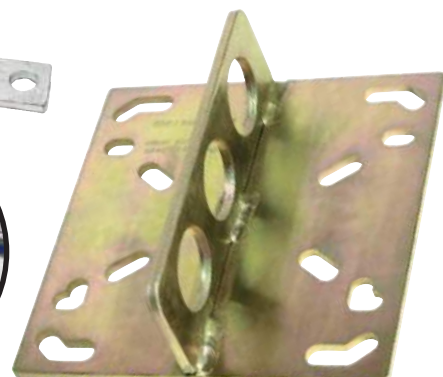

Item #	IP	MP	PKG	Capacity	Width	Depth
W41034	8	16	CLM	1,000 lbs.	6-5/8"	6-1/2"

*Dominator is a registered trademark of Holley Performance Products, Inc.

ADJUSTABLE ENGINE SUPPORT

- Works on front wheel drive vehicles when the engine needs to be suspended.
- Adjustable extension arms with protective feet straddle the inner fender wells.
- Adjustable width from 40 to 54".
- Center support screw has a travel of up to 12".



Item #	IP	MP	PKG	Capacity	Width	Depth	Height
W41018	1	1	LAB	700 lbs.	44-1/2"	2-3/8"	7-1/8"

ENGINE STANDS & MOVER

- Rugged heavy gauge tubular steel construction.
- Head rotates 360 degrees and locks in 6 positions.
- Securely holds most foreign and domestic engine blocks.
- Fully adjustable mounting head assembly.
- Stable 4 wheel design, 2 with swivel.



W41037

Adjustable width and depth for most engines. Includes cam buckle straps.



W41025



W41031

Sturdy metal parts tray.

Item #	IP	MP	PKG	Capacity	Width	Depth	Height	Wt.	
W41025	I-Shape	1	1	CBX	1,000 lbs.	30-5/8"	30-1/2"	33-7/16"	48
W41031	U-Shape with Tray	1	1	CBX	1,250 lbs.	34-1/4"	33-7/16"	35-5/8"	57
W41037	Mover	1	1	CBX	750 lbs.	20-5/16"	17-3/4"	13-5/32"	22

1 TON CHAIN HOIST

- Heavy duty construction.
- Heat treated bushings and bearings.
- 8' lift range.



Item #	IP	MP	PKG	Capacity
W4005DB	1	2	CBX	2,000 lbs.

TRANSMISSION JACKS

SHOP/GARAGE

TRANSMISSION ADAPTER

- Converts floor jacks into transmission jacks.
- Fits all jacks with 1-5/32" removable saddle shaft.
- Tilts forward and back and includes safety chain.

Item #	IP	MP	PKG	Capacity
W41044	1	1	CBX	300 lbs.

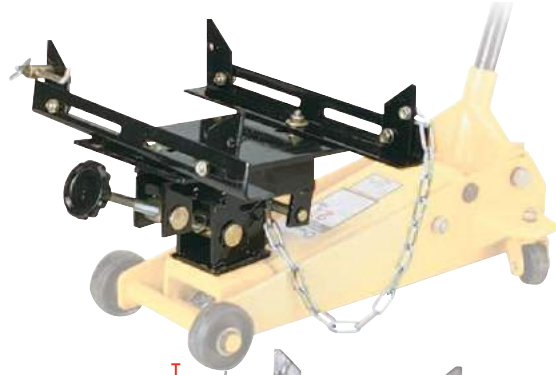

TRANSMISSION JACKS

- Fully adjustable saddle with corner brackets will fit most transmissions.
- Safety chains for securing the transmission on the saddle.
- Release valve automatically halts lowering when let go.
- Heavy duty steel construction for maximum durability.
- Meets ASME-PALD-2009 safety standards.



Extra long jack handle and an expandable saddle.

Low profile design helps you position, align and safely remove transmissions.

Adjust from 34" to 40"

Foot operated pump allows mechanics to use both hands to position and align transmissions.



Four 360° casters helps to maneuver the jack into position.

Item #	IP	MP	PKG	Capacity	Lift Range	Saddle Range		Width	Depth	Wt.	
						Width	Depth				
W1607	Low Profile	1	1	LAB	1/2 Ton	7-1/4 to 26"	6 to	6 to	30"	13"	97
W1608	Telescoping	1	1	LAB		34-1/4" to 74-1/4"	13-5/8"	10"	26"	31"	130

MULTI-PURPOSE JACK

- Versatile, compact unit for lifting motorcycles, lawn mowers, ATV's golf carts, jet skis and more.
- Leveling bolts ensure stability.
- Three position locking levers.
- Non-slip rubber foot pedal.
- Easy to roll steel swivel casters.



Four 6' cam buckle tie down set included



Easy lift foot pedal.

Item #	IP	MP	PKG	Capacity	Lift Range	Surface
W41035	1	1	CBX	3/4 Ton	4-3/4 to 16-1/2"	13-1/4 x 14-1/2"

SNOWMOBILE DOLLY

- Rubber covered top for secure moving.
- Heavy duty 2" casters.
- 1500 lbs. Capacity.



Item #	IP	MP	PKG	Capacity	Surface
W41061	1	1	CBX	1,500 lbs.	7-5/8 x 7-3/4"

SHOP PRESSES

- Great for straightening, stamping, bending and pressing any component that is hard to handle.
- Rugged heavy gauge tubular steel construction.
- Remote pressure cylinder with relief valve.
- Includes a 4" liquid-filled pressure gauge with dual metric/tons pressure readings.
- Up to 9 adjustable height positions
- Some assembly required.



Item #	IP	MP	PKG	Continous Force	Adjust Points	Bed Opening	Bed Depth	Working Range	Stroke Length	Dimensions			Wt.
										Width	Depth	Height	
W41062	1	1	WBX	12 Ton	7	20"	7"	35-3/4"	7"	27-1/2"	19-3/4"	65"	152
W41063	1	1	WBX	20 Ton	9	19-1/2"	7"	35-3/4"	7-1/2"	27-1/2"	19-3/4"	69"	220

ACCESSORY KIT

- Designed to be used with presses up to 50-ton.
- Set includes six common accessories used in a variety of press applications.
- Constructed from high quality material to ensure long lasting durable performance.



Item #	IP	MP	PKG	Steel Punches	Steel Plate(s)		
					Width	Depth	Height
W41065	1	1	CBX	1/2, 1 & 2"	14"	3"	1"

CREEPERS & SEATS

SHOP/GARAGE

COOL WEAVE FOLDING CREEPER

- Heavy duty cool weave fabric with a steel power coated frame.
- Weather-resistant, lightweight, and provides extra comfort.
- Folds for convenient transportation or storage.
- 350 lbs. weight capacity.

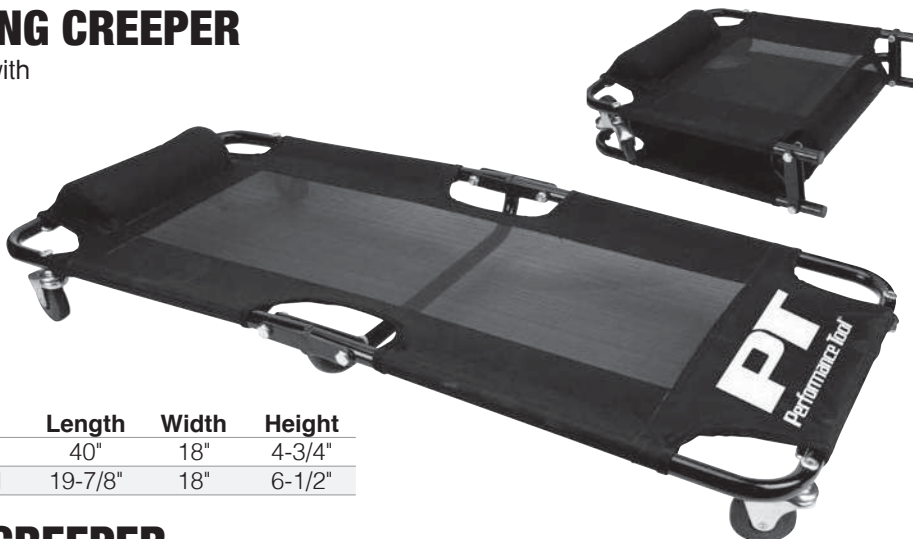

Item #	IP	MP	PKG		Length	Width	Height
W85028	1	1	WBX	Open	40"	18"	4-3/4"
				Folded	19-7/8"	18"	6-1/2"

OVERSIZED X-FRAME CREEPER

- 5" jumbo swivel poly casters allow for use even on cracked and uneven floors.
- Extra wide, contoured pad with 2" thick padding provides comfortable mobility.
- Low profile design provides improved clearance.
- 300 lbs. weight capacity.



Deck dimensions:
38" x 14" x 2"

Wide wheelbase allows you to lay closer to the ground for more room to work.

Item #	IP	MP	PKG	Length	Width	Height
W85014	1	1	LAB	46"	25"	7"

CREEPERS

- Powder coated heavy duty tubular steel frame. (W85004 & W85005)
- Blow molded base built-in storage tray (W85006)
- Shielded 2-1/2" swivel casters allow easy 360 degree movement.
- Fully padded deck with cushion headrest.

Contoured shape for comfort.

W85006



W85004



headrest adjusts to 3 positions.

W85005

Item #		IP	MP	PKG	Casters	Length	Width	Height
W85004	Metal	1	1	WBX	4	36"	17"	4"
W85005	Metal	1	1	WBX	6	40"	17"	4"
W85006	Plastic	1	1	WBX	6	40"	17"	4-1/2"

CREEPER SEAT TOOL BOX

- Reinforced seat supports up to 350 lbs.
- 3-drawer tool box with roller bearing slides.
- Vinyl padded seat cushion for maximum comfort and support.



Rear tray supports screwdrivers and pliers.



Two folding tool trays with magnetic pads.

Item #	IP	MP	PKG	Width	Depth	Height	
W85025	1	1	CBX	Overall	19"	9"	17"
				Drawers	13-1/2"	7-3/4"	2"

FOLDING C-FRAME CREEPER SEAT

- Heavy duty tubular steel design.
- 300 lbs. weight capacity.
- Convenient 12" x 13-1/4" tool tray.
- Shielded 2-1/2" casters allow easy 360 degree movement.
- Locking pins to seat closed while not in use.



Folded size: 16-1/4 x 16-1/4 x 6-1/4"

Item #	IP	MP	PKG	Width	Depth	Height
W85021	1	1	CBX	5-1/2"	14-1/2"	12-1/2"

C-FRAME CREEPER SEAT

- Heavy duty tubular steel design.
- 250 lbs. weight capacity.
- Convenient 11-1/2" x 12-1/2" tool tray.
- Shielded 2-1/2" casters allow easy 360 degree movement.
- Fully padded seat cushion.



2-1/2" replacement caster assembly Performance Tool Part # W85003.

Item #	IP	MP	PKG	Width	Depth	Height
W85007	1	5	CBX	14"	18-1/4"	14-1/8"

ROLLING WORK SEAT

- Great for working around wheels and brakes.
- Lightweight and durable composite seat with 4 swivel casters.
- Weight capacity 330 lbs.

Storage trays and built-in storage compartment.



Item #	IP	MP	PKG	Width	Depth	Height
W85026	1	10	LAB	18"	13-3/8"	12-3/8"

REPLACEMENT CASTERS

- For use as a general replacement part.

Item #	IP	MP	PKG	Size
W85017	6	36	BAG	3" PVC
W85029	6	36	BAG	3" Nylon
W85002	1	90	WBX	2"
W85003	1	90	WBX	2-1/2"
W85019	6	36	WBX	2-1/2"



W85003

2-Pack W85017/
upgrades W85029

SEATS & BAR STOOLS

SHOP/GARAGE

PNEUMATIC SHOP SEATS

- Pneumatic action adjusts from 15" to 20" height quickly and easily.
- Five Shielded 2-1/2" casters allow easy 360 degree movement.*
- Convenient 15" diameter tool tray.*



W85008
Fully padded
12" diameter
seat.



W85020
14-1/2" wide seat.
5-1/2" high seat back.



W85027
Foam padded
13" diameter
seat.

2-1/2" replacement caster assembly
Performance Tool Part # W85003.

Item #	IP	MP	PKG	Lift Range	Weight Capacity	Base Diameter	Height	
							Min	Max
W85008	1	4	CBX	15 to 20"	300 lbs.	15"	15"	20"
W85020	1	1	CBX	15 to 20"	300 lbs.	15"	15"	20"
W85027	1	4	CBX	19 to 24"	250 lbs.	12-1/2"	18"	24"

- Chrome plated frame and foot rest.
- Five hooded dual-caster wheels.

BAR STOOLS

- Durable & easy to clean
- 14" diameter seat.
- Ball bearing swivel top.
- 300 lbs. weight capacity.



W85023
Twin ring
frame.



W85010
Sturdy chrome
plated legs.



5-1/2" high seat back.



PNEUMATIC BAR STOOL

- Pneumatic action adjusts seat height from 26" to 32" quickly and easily.
- 14" diameter synthetic leather foam padded seat with 360° swivel.
- Heavy duty steel tubing frame with matte black powder coated finish.
- Wide foot stool base comes pre-assembled.
- 330 lbs. weight capacity.

Item #	IP	MP	PKG	Ring Diameter	Height
W85023	1	4	CBX	16-1/2"	28-1/2"

Item #	IP	MP	PKG	Width	Depth	Height
W85011	1	1	CBX	16"	16-3/4"	36"

PLASTIC FOLDING SAWHORSES

- Compact and easy to store.
- Rubber anti skid buttons.
- SAE and Metric Markings.
- Handy cord wrap and tool tray. (except on W54009)



W54011



W54036

V-groove top with easy height and width adjustment.



W54009

Cut away master box for instant floor display.



Item #	IP	MP	PKG	Capacity	Width	Depth	Height	
W54009	2-PK	1	4	SLV 900 lbs.	Close	22-1/4"	1-3/4"	32-1/2"
					Open	"	21-3/4"	30-3/8"
W54011	2-PK	1	5	SLV 300 lbs.	Close	22-3/8"	1-7/8"	31-1/4"
					Open	"	16-1/2"	30"
W54036	1-PC	1	4	SLV 660 lbs.	Close	28-1/4"	2"	33-1/8"
					Open	41-5/8"	18-1/2"	31-1/4"

METAL FOLDING SAWHORSE

- Durable powder coated steel construction.
- Padded top to protect work.
- Convenient steel carrying handle.

Folded: 2 1/2" x 4" x 39".



Item #	IP	MP	PKG	Capacity	Width	Depth	Height	
W54035	1	4	CBX	250 lbs.	Close	39"	4"	2-1/2"
					Open	39"	19-1/4"	30-3/4"

2-PK SAWHORSE BRACKETS

- Create your own sawhorse for supporting a variety of projects.
- Pre-drilled nail screw holes for easy assembly.
- Steel construction with rust resistant finish.
- Designed to hold standard 2 x 4 lumber.



Do not exceed 150 lbs. weight capacity.

Item #	IP	MP	PKG	Width	Depth	Height
W53994	6	24	SLV	3.7"	3.54"	5.75"

STANDS & BENCHES

SHOP/GARAGE

FOLDING SHOP STAND

- Thick foam padding protects painted parts and glass from being scratched.
- Portable, easy to adjust and stores flat.
- Heavy duty tubular steel.
- 500 lbs. capacity rating.

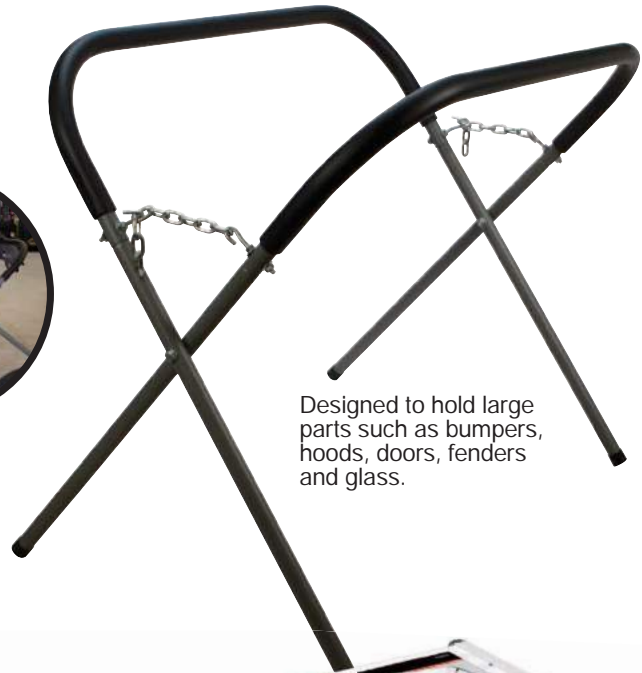

Designed to hold large parts such as bumpers, hoods, doors, fenders and glass.

Item #	IP	MP	PKG	Width	Depth	Height
W54024	1	1	CBX	40"	15 to 34"	33 to 44"

ALUMINUM WORK PLATFORM

- PVC ABS plastic non skid feet.
- Maximum weight capacity 225 lbs.
- Locking safety legs.



Item #	IP	MP	PKG	Width	Depth	Height
W54039	1	4	WBX	30"	15-1/4"	19-1/2"

MULTI-PURPOSE WORKBENCH

- Folding design for compact storage.
- Tabletop printed with grid, ruler and protractor for added convenience.
- Safe Working Load: 200 lbs.
- Jaw: 0 to 4-1/4"
- Vise: 7/8 to 10-1/2"

Closed: 23-7/8 x 9-7/16"
Open: 23-7/8 x 13-11/16"

Includes 4 bench dogs for odd shaped pieces



Includes tool storage rail
(Tools not included)

Item #	IP	MP	PKG	Width	Depth	Height
W54025	1	1	CBX	25"	23-7/8"	31"

MACHINIST VISES

- Heavy duty cast iron construction.
- Replaceable hardened steel jaws.
- Diamond serrated for a secure grip.
- Precision machined surface for flat shaping.
- Swivel base with 3 mounting holes and 2 lock downs.

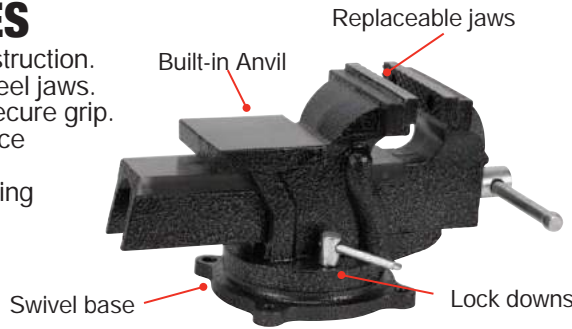

MV4
MV5
MV6
MV8

Item #	IP	MP	PKG	Jaw Width	Jaw Opening	Throat Depth	Built in Anvil	Swivel Base
MV4	1	1	CBX	4"	4"	2"	3-1/8 x 2-7/8"	360°
MV5	1	1	CBX	5"	5"	2-3/8"	3-5/8 x 3-1/2"	360°
MV6	1	1	CBX	6"	5-7/8"	3"	4-1/4 x 4"	360°
MV8	1	1	CBX	8"	7"	3"	4-1/4 x 4"	360°
MV10	1	1	CBX	5"	4-1/2"	2-1/4"	3-11/32 x 3-3/4"	360°

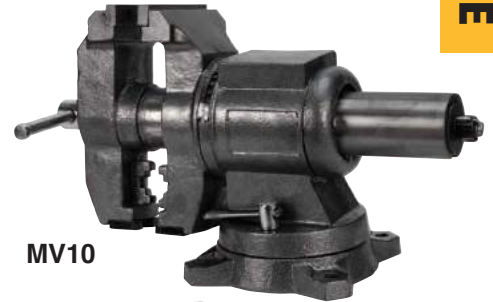

MV10

BENCH VISES

- Durable powder coat finish and chrome plated hardware.
- Swivel base with 3 mounting holes and 2 lock downs.

Item #	IP	MP	PKG	Jaw Width	Jaw Opening	Throat Depth	Built in Anvil	Swivel Base
W3903	1	1	CBX	6"	5-1/4"	2-3/8"	3-5/8 x 3-1/2"	360°
W3904	1	1	CBX	5"	7"	3"	2-11/64 x 1-7/8"	360°
W3905	1	1	CBX	3-1/2"	3"	2"	1-3/8 x 1-5/8"	180°

W3903
W3905

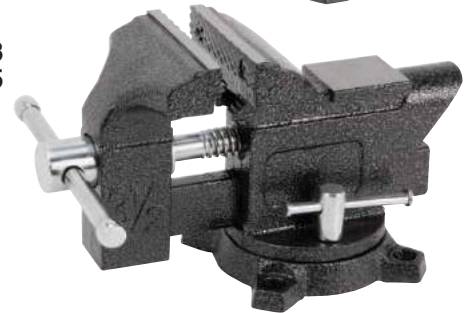

SOFT GRIP VISE JAWS

- Avoid marring softer objects like wood, plastic, or tubing.
- Strong magnets hold pads securely to your vise jaws.
- Fits vises from 3" to 6".

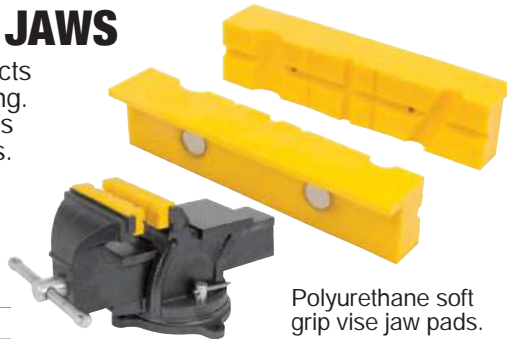

W3904
Quick release



Item #	IP	MP	PKG
MV1	6	24	CRD

Polyurethane soft grip vise jaw pads.

CLAMP ON VISE

- Portable design quickly clamps to any work surface up to 1-1/2 in. thick.
- Durable powder coat finish and chrome plated hardware.
- Twin steel guide bars and built-in pipe jaws.

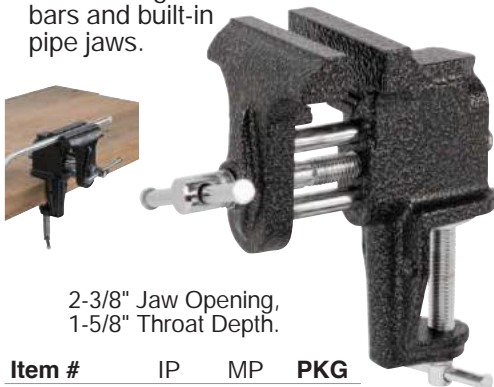

2-3/8" Jaw Opening,
1-5/8" Throat Depth.

Item #	IP	MP	PKG
W3900	1	10	CBX

WOODWORKER'S VISE

- Pre-drilled holes in jaws for attaching wood facings.
- Continuous screw and steel guide bars for smooth operation.
- Durable powder coat finish and chrome plated handle and spindle.

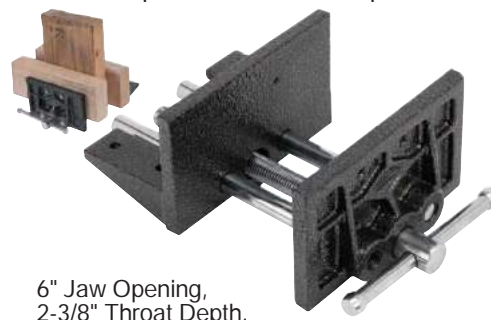

6" Jaw Opening,
2-3/8" Throat Depth.

Item #	IP	MP	PKG
W3901	1	6	CBX

DRILL PRESS VISE

- Specially designed for drill press applications.
- Durable powder coat finish and chrome plated handle. (see Power Tools section for more details)



W3939

Item #	Size	IP	MP	PKG
W3902	4"	1	4	CBX
W3939	2-1/2"	1	12	CBX

STORAGE BIN RACKS

SHOP/GARAGE

DUAL ANGLE TILT BIN STORAGE SYSTEM

- New Dual Angle feature allows better access to your part and let's you easily see what's inside each container.
- Convenient Tri-Rack system can be used with the included base and frame as a floor standing bin rack, use the pre-drilled 16" on center holes for mounting to wall studs or peg board.
- Light grey powder coated rack resists corrosion and fits into any work place.
- Steel rack assembles in minutes.
- Great for organizing home, office or workshop.



Bin contents not included

53 CLEAR BIN RACK

- Includes 36 small, 12 medium and 5 large clear bins.



Item #	IP	MP	PKG	Width	Depth	Height
W5171	1	1	CBX	41-3/4"	11-7/8"	49"

18 CLEAR BIN RACK

- Includes 18 small clear bins.



Item #	IP	MP	PKG	Width	Depth	Height
W5170	1	1	CBX	27-1/4"	11"	19-3/4"

2-PACK BIN RAIL SET

- Add on rails can be use with both Dual Position Tilt Bins and standard Performance bins to expand your storage system.
- Holes are predrilled at 16" intervals for mounting to wall studs or standard peg board holes.



Item #	IP	MP	PKG	Width	Depth	Height
W5169	1	8	SHK	31-3/4"	-	3-1/2"

DUAL ANGLE TILT BINS & DIVIDERS

- Clear Bin feature lets you easily see what's in each bin.
- When used with accessory rails the Dual Position Tilt Bin feature allows better access to your parts.
- 30% thicker walled than standard bins for strength and durability.
- Stack vertically without use of rack or align horizontally.
- Clear dividers available so you can maximize your storage options.

**W5172/
W5175**



**W5173/
W5178**



**W5174/
W5179**



Item #	IP	MP	PKG	Width	Depth	Height	Weight Capacity		
W5172	6-PC	Small	5	10	LAB	4-1/8"	7-1/2"	3-1/8"	4 lbs.
W5173	4-PC	Medium	4	8	LAB	5-3/4"	9-1/8"	4-7/8"	6 lbs.
W5174	3-PC	Large <i>NON-TILT</i>	1	4	LAB	7-1/8"	11"	6-1/4"	8 lbs.
Clear Dividers									
W5175	6-PC	Small	6	36	CRD	Used to divide bins in half to make the most of your storage options.			
W5178	4-PC	Medium	6	36	CRD				
W5179	3-PC	Large	6	36	CRD				

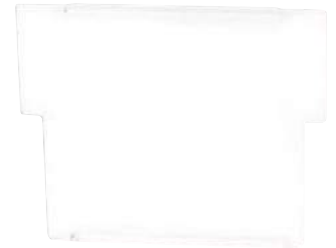

STORAGE BIN RAIL HOOKS

- Hooks mount easily onto our bin rail set W5169 or with any of the rails that come with the Dual Position Tilt Bin line.
- Small hooks provide flexible storage solutions to help organize your work area.
- Easily moved anywhere along your bin rail for maximum flexibility.

Item #	IP	MP	PKG	
W5161	J-Hook	12	72	BLK
W5163	L-Hook	12	72	BLK
W5165	Double Loop	12	72	BLK
W5167	12-PC Set	1	24	CBX



12-pc set contains 4 each of the J, L and double loop hooks.

STORAGE BIN RACKS

SHOP/GARAGE

WALL MOUNT STORAGE BIN RACK

- For garage, home, office or garden.
- Heavy duty metal bracket.
- Mountable directly to wall studs.
- Removable bins are convenient and easily accessible.
- Includes screw and wall anchors.
- Powder coated steel resists corrosion.



Includes 6 small bins and 4 large bins.



Item #	IP	MP	PKG	Width	Depth	Height
W5190	10 BIN	1	8 CBX	23-1/2"	-	9-1/2"

WALL MOUNT STORAGE BIN SYSTEM

- Complete 12-pc bin rack system for mounting to a wall or pegboard.
- Bins will stack together for free standing storage or for transporting your parts to where they are needed.
- Comes with 6 mini and 6 small bins.



Item #	IP	MP	PKG	Width	Depth	Height	Weight Capacity	
W530	1	1	CBX	Peg Board	12-1/2"	1/2"	14-7/8"	-
				Mini Bin	3-3/4"	3-1/2"	1-3/4"	2 lbs.
				Small Bin	4"	6-1/2"	2-3/4"	4 lbs.



TABLE TOP STORAGE BIN RACKS

- Compact design fits anywhere.
- Powder coated finish resists corrosion.
- Steel rack assembles in minutes.
- Easy to access removable bins.



W5186
Unique design provides plenty of storage below bins.

Item #	IP	MP	PKG	Width	Depth	Height
W5186	15 Bins	1	1 CBX	21-1/4"	6-1/2"	15-7/8"
W5182	24 Bins	1	1 CBX	34"	9-1/4"	25"



W5182
Holds 14 small storage bins and 10 large storage bins.

TABLE TOP STORAGE BIN RACK

- Magnetic tool holder keep tools close at hand.
- Easy to assemble steel rack.
- Heavy duty metal frame.
- 4 blue bins and 12 red bins.

Tools not included



Item #	IP	MP	PKG	Width	Depth	Height
W5185	16 Bins	1	1 CBX	25"	10"	25-1/2"



FREE STANDING STORAGE BIN RACK

- Black powder coated finish resists corrosion.
- Steel rack assembles in minutes.
- Easy to access removable bins.
- Holds 32 small red storage bins and 15 large blue bins
- Includes: metal rack and hardware for assembly.

Bolt-less post & cross beams

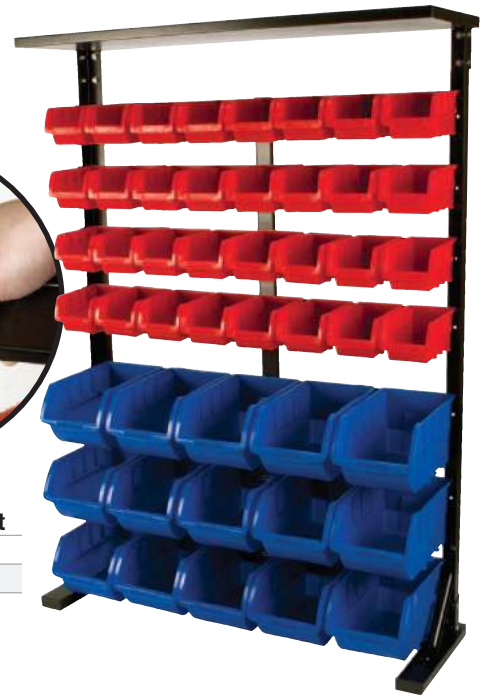

Item #	IP	MP	PKG	Width	Depth	Height		
W5193	47 Bins	1	1	CBX	Rack	37"	11"	45"
					Tray	33-3/4"	8-7/8"	-

ROLLING STORAGE BIN RACK

- Double sided rack provides more efficient storage space.
- Easy to access removable bins in two sizes: 36 small red, 16 large blue.
- Four heavy duty 3" casters and side handle for easy maneuvering.
- Heavy duty steel rack with corrosion resistant powder coated finish.
- Top & bottom trays for easy storage and access to small parts.

Bolt-less post & cross beams



Item #	IP	MP	PKG	Width	Depth	Height	
W5183	52 Bins	1	1	CBX	26"	20-1/2"	41"

STACKABLE BIN SETS

- Stack vertically or align horizontally.
- Interlocking mounting rails.
- Removable from rail.
- Great for organizing home, office or workshop.



Item #	IP	MP	PKG	Width	Depth	Height	Weight Capacity		
W5196	4-PC	Large	4	8	LAB	6"	9-1/4"	5"	8 lbs.
W5197	8-PC	Small	5	10	LAB	4"	6-1/2"	3"	5 lbs.
W5195	15-PC	Lg & Sm	1	4	LAB	(8 small & 6 large)		-	

UTILITY CARTS & MOVERS

SHOP/GARAGE

UTILITY CART WITH LOCKING DRAWER

- 2 Shelf cart with locking drawer.
- Load Capacity: 350 lbs.
- 2 swivel casters for easy maneuvering.

Item #	IP	MP	PKG	Width	Depth	Height	
W54004	1	1	CBX	Cart	31-1/4"	16"	35-1/4"
				Shelf	30"	16"	3-1/2"
				Drawer	27"	15"	3-3/4"



W54004



W54006

UTILITY CART WITH LOCKING DRAWER

- Four swivel casters (two locking).
- Organizer shelf with bins.
- Shelf with storage drawer.
- Foam drawer and tray liner.

Item #	IP	MP	PKG	Width	Depth	Height	
W54006	1	1	CBX	Cart	23-3/4"	16"	31-3/8"
				Shelf	23-1/2"	16"	2-5/8"
				Drawer	19"	14"	2-3/8"

COMPACT SHOP CART

- Heavy duty steel construction.
- Durable powder coated finish.
- 200 lbs. max capacity.
- 4 Swivel casters
- 2 with locks.
- Assembly required.



Tools sold separately.

COMPACT SHOP CART

- Two shelf compact cart constructed of blow molded plastic with metal frame.
- Complete with 2-1/2" casters.
- Some assembly required.



Handy slide out storage tray.

Tools sold separately.

Item #	IP	MP	PKG	Width	Depth	Height
W53995	1	1	CBX			

Item #	IP	MP	PKG	Width	Depth	Height
W54032	1	1	CBX	23-1/2"	16-1/2"	29"

INDUSTRIAL SHOP CART

- Easy rolling utility cart with upper and lower trays.
- 2 shelf utility cart holds up to 500 lbs. total but is light weight and maneuverable.
- Industrial duty polypropylene construction won't rust, dent or chip.
- 5" Diameter non marring casters, (two locked and two swivel).



Tool utility cart has tool storage and cup holder on the handle.



Item #	IP	MP	PKG	Width	Depth	Height
W53991	1	1	CBX	Cart	17"	39-3/4"
				Trays	16"	30"

3 WHEEL MOVERS DOLLY

- Soft cushions protect objects being moved.
- Depressed center for objects with legs.
- Holds up to 132 lbs. evenly distributed.
- 1-1/2" casters for easy maneuvering.



Item #	IP	MP	PKG
W54038	6	36	CBX

UNIVERSAL WELDING CART

- All steel construction with durable finish.
- 7-1/2" back wheels and 3" front swivel castors makes the welding cart very easy to move around.



Item #	IP	MP	PKG
W53992	1	1	LAB

STEEL HAND TRUCK

- Heavy duty design,
- 18 gauge 1" steel tube frame.
- Durable powder coated finish.
- 10" 4 ply pneumatic tires.
- Extra large 14 x 7-1/2" toe plate.
- 600 lbs. load capacity.



Item #	IP	MP	PKG	Width	Depth	Height
W41060	1	1	LAB	21"	17-1/2"	51-1/2"

TOOL BOXES & BAGS

SHOP/GARAGE

TOOL CADDY PRO

- Dual oversized compartments so you can transport all your tools to the job site.
- SAE and Metric measurements embossed onto side rails for quick measurements.
- Large aluminum handle and oversized access will accommodate the largest of hands, even while wearing heavy winter gloves.



Built-in channel will stabilize pipe, conduit and molding so you can make clean cuts.

Additional screwdriver and pliers holders

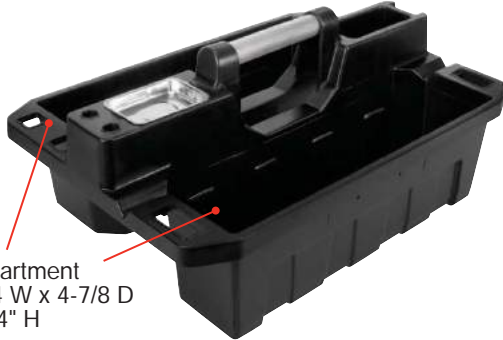

Compartment
15-3/4" W x 4-7/8" D
x 5-1/4" H



Built-in cell phone holder and Tape measure clip.



Integrated magnetic tray with hidden compartment underneath,

Item #	IP	MP	PKG	Width	Depth	Height
W88995	1	5	LAB	19-7/16"	14-5/8"	8-7/8"

PLASTIC TOOL BOXES

- Heavy-duty box with recessed ergonomic comfort handle.
- Removable tray.
- Lid organizers (excludes W54017)



W54012
W54016

W54019
Strong double latch with padlock eyehole.



Item #	IP	MP	PKG	Width	Depth	Height	
W54012	12-1/2"	1	16	LAB	12-1/2"	7"	5-3/8"
W54016	16"	1	8	LAB	15-7/8"	8-5/8"	6-1/2"
W54017	18"	1	8	LAB	17-5/8"	7"	7-1/2"
W54019	19"	1	6	LAB	19"	11"	9-1/2"



W54017

STEEL TOOL BOXES

- Heavy-duty box with recessed ergonomic comfort handle.
- Strong double latch with padlock eyehole.
- Removable inner tray.



Item #	IP	MP	PKG	W	D	H	
W54020	20"	1	6	SLV	19-1/2"	8"	8-1/2"
W54026	26"	1	4	SLV	26"	10"	8-1/2"

TOOL BOX DRAWER LINER

- Durable tear resistant material for rugged use and long life.
- Helps protect tools and tool boxes from rust, scratches, sliding, and permanent damage.
- Easy, cut-to-fit design.



Item #	IP	MP	PKG	W	L	H
W88996	12	24	SLV	16"	96"	1/16"

TOOL BAGS

- Reinforced bottom for durability.
- Heavy duty 2-way zipper.
- Double web handles.
- Anti-skid rubber feet.
- Water repellent.
- Great for automotive and motorcycle use.



W88990

Tools sold separately.



W88990



W88986

SHOP/GARAGE

Item #	IP	MP	PKG	# Pockets		Width	Depth	Height	
				Inner	Outer				
W88985	12"	6	24	SLV	-	3	12"	8-3/4"	8-1/2"
W88986	18"	1	6	SLV	11	25	18-1/2"	11-1/2"	12"
W88987	17"	1	6	SLV	6	20	17-1/8"	10-1/4"	11-5/8"
W88990	Pouch	6	48	SLV	12	-	13-3/4"	15-1/2"	-

PLASTIC AMMO BOX

- Heavy gauge polypropylene construction with reinforced lid.
- Corrosion resistant bail latch.
- Water resistant tongue and groove lid.
- Pre-drilled for padlock.



Item #	IP	MP	PKG		Width	Depth	Height
W5994	1	10	LAB	O.D.	11.5"	5.25"	7.2"
				I.D.	9.5"	4.25"	6"

PLASTIC PARTS ORGANIZER

- Durable injection molded plastic construction.
- Full height internal dividers to keep parts separated.
- Store flat or upright with built-in feet.



W5189



W5188
DOUBLE SIDED.
Color coded
latches identify
sides.

Item #	IP	MP	PKG	Width	Depth	Height
W5188	1	12	SHK	13"	10-3/4"	3-1/2"
W5189	1	36	SHK	9-1/2"	7"	1-7/8"

26 COMPARTMENT ORGANIZER

- Adjustable compartments for customizing.
- Clear cover for quick identification.
- Latch keeps compartments closed and secure.
- Heavy duty built in handle for portable use.



Item #	IP	MP	PKG	Width	Depth	Height
W54037	6	12	SHK	18"	12-5/8"	3-1/8"

TOOL BOX TOTE

- Top storage bin with durable, secure latch.
- 4 removable bins with 13 compartments each.
- Durable carry handle.
- Good for storing tools, nuts, bolts, screws & more.



Item #	IP	MP	PKG		Width	Depth	Height
W54042	1	12	SHK	Overall	11"	7"	10"
				Trays	9-1/4"	5"	1-1/4"



MAGNETIC STORAGE

SHOP/GARAGE

MAGNETIC TOOL ORGANIZER

- Perfect for garages, workshops, commercial service trucks, kitchens and much more.
- Steel construction for dependable and long service life.
- Easily mount to wall, work bench or any flat surface.
- Powerful full length magnet to hold tools and other ferrous objects in place.

Great for hammers, wrenches, screwdrivers, clamps, pliers, knives, and much more.



Item #	IP	MP	PKG	Sizes
W1287	12	24	DBL	12"
W1288	12	24	DBL	18"
W1289	12	24	DBL	24"
W1286	6	12	DBL	Set: 8, 12 & 18"

MAGNETIC PARTS TRAYS

- Sticks to almost any metal surface.
- Keeps small metal parts and tools from getting lost.
- Even works sideways or upside down.



W1264



High impact ABS construction.

W1285



W1280

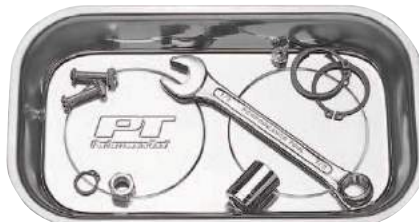

Item #	IP	MP	PKG	Sizes
W1264	1	24	CBX	5-1/2"
W1265	1	20	CBX	9-1/2 x 5-1/2"
W1280 2-PC	6	36	DBL	4" & 5-1/2"
W1285	12	24	CBX	6 x 10"

MAGNETIC TRAY & HOOK SETS

- Padded magnetic trays to protect surfaces.
- Keeps small metal parts and tools from getting lost.



W1256



W1260



Item #	IP	MP	PKG	Contents
W1256	6-PC	6	24	DBL 1-1/2" hook magnets (4), 2-1/2 x 3-3/4" trays (2)
W1260	4-PC	6	24	DBL 1-1/2" hook magnets (2), 2-1/2 x 8-7/8" tray, 2-1/2 x 3-3/4" tray

MAGNETIC WRIST BAND

- Perfect for home improvement projects.
- One-size-fits-all elastic band.
- Easy hook and loop closure.



Use to hold small metallic objects: nails, screws, nuts, bolts, pins, drill bits, and more.



Item #	IP	MP	PKG
W1275	12	96	DBL

FENDER COVER

- Heavy duty vinyl with foam backing.
- Convenient built in tool pockets.
- Fully sewn ribbed edge.



Item #	IP	MP	PKG	Size
W80583	1	12	BAG	33 x 24"

GRIP MATS

- Revolutionary multi-purpose non-slip mat.
- Grips and protects almost any surface.
- Grip mat will not shift or move once placed.
- Mold and mildew resistant.
- 18 x 48" fully washable mat.

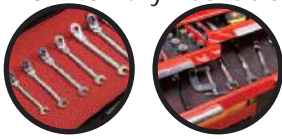

Item #	IP	MP	PKG	Colors
W88970	8	8	LAB	Black
W88971	8	8	LAB	Red
W88984	16	16	CBX	Black & Red

ANTI-FATIGUE MAT ROLLS

- Protects your floors from damage.
- Lightweight and easy to clean.
- Reduces noise and vibration.
- Cut to fit any size or shape.
- Shock absorbent.
- EVA Foam.
(Ethylene Vinyl Acetate)



Item #	IP	MP	PKG	Width	Length	Thick	
W88980	SM	1	6	SHK	24"	70"	9/32"
W88981	LG	1	6	SHK	46"	93"	9/32"

INTERLOCKING ANTI-FATIGUE MATS

- Add comfort and protection to any floor.
- 3/8" (12mm) thick interlocking mats.
- EVA (Ethylene Vinyl Acetate) Foam.
- Water resistant, easy to clean and light weight.



Connect multiple packs for extended floor coverage.



Item #	IP	MP	PKG	Width	Length	Thick	
W88988	12-PC	1	6	SHK	12"	12"	3/8"
W88989	6-PC	1	6	SHK	24"	24"	3/8"

Borders included.



PLASTIC BOOT TRAY

- Perfect for muddy and wet boots and shoes.
- Large enough to hold 3 pairs.
- Made of 100% recycled materials.



Item #	IP	MP	PKG	Size
W89018	12	12	LAB	26-1/2" x 13-1/2"

SAFETY GOGGLES

- Sealed Goggle Surround for Maximum Chemical and Particulate Protection.
- Adjustable Elastic Headband.
- Meets High Impact Requirements of ANSI Z87.1-2003.



Item #		IP	MP	PKG
W1024	Ventilated	12	120	BAG
W1036	Non-Vented	10	100	BAG

SAFETY GLASSES

- Meets High Impact Requirement of ANSI Z87.7-2003.



W1031



W1033

W1032



W1034



W1037

Item #		IP	MP	PKG	
W1031	Adjustable	16	128	CRD	Comfortable molded nose bridge. Adjustable temple length. UV resistant.
W1032	Flex Frame	16	128	CRD	Removable padded nose piece. Flexible frame for comfort. UV resistant.
W1033	Clear Frame	16	128	CRD	Padded temple tips. Comfortable molded nose piece.
W1034	Large Frame	16	128	CRD	Integral side shields. Fits over most prescription eyewear.
W1037	Tinted	16	128	CRD	Scratch-resistant polycarbonate lens. Flexible arms for a comfortable fit.

PROTECTIVE EAR MUFFS

- Folding design for easy storage.
- Lightweight for all day use.
- Foam-filled ear cups provide excellent noise reduction.
- Soft, wide ear cushions for comfortable fit.
- Noise reduction rating NRR: 25 db.



Item #	IP	MP	PKG
W50071	6	24	CLM

FOAM EAR PLUGS

- Cylindrical shape provides easy insertion and removal.
- Disposable foam ear plugs expand gradually for a secure, comfortable fit.
- Noise reduction rating NRR: 30 db.



W1501

Item #		IP	MP	PKG
W1501	50-PK	12	48	CAS
W3216	2-PK	30	360	BAG/Pg 315
W3239	8-PK	12	144	BAG/Pg 316

DUST MASK

- 5 pieces per card.
- Easy to breathe and speak through.
- Adjustable contour nose piece.



Item #	IP	MP	PKG
W1026	6	72	CRD

TECH GLOVES

- Designed and tested by mechanics for comfort and durability.
- Thick enough to protect, thin enough to handle small objects.
- Guards hands from cuts, scrapes & burns.
- Soft, breathable fabric is easy to clean.

Sizes fit a wide range of mechanics.



Item #	IP	MP	PKG
W88999	Medium	12	72 BAG
W89000	Large	12	72 BAG
W89001	X-Large	12	72 BAG

MECHANIC'S WORK GLOVES

- Comfortable, breathable, materials for maximum comfort.
- Polyurethane coated palm for improved grip.
- Reinforced saddle and thumb for high durability.
- 50% PU, 35% knit fabric, 10% spandex, 5% neoprene.

Item #	IP	MP	PKG
W89005	Medium	3	48 BAG
W89006	Large	3	48 BAG
W89007	X-Large	3	48 BAG



BLACK NITRILE GLOVES 20-PACK

- Provides a protective barrier against dirt, grime, oil, chemicals and solvents.
- Textured fingertips for better grip.
- Comfortable fit and feel.
- Powder/latex free.
- 5.5 mil.



Item #	IP	MP	PKG
W89016	Large	5	50 BAG
W89017	X-Large	5	50 BAG



100-PACK GLOVES

- 3.5 mil.

Item #	IP	MP	PKG
W89011	Medium	1	10 CBX
W89012	Large	1	10 CBX
W89013	X-Large	1	10 CBX



Adjustable straps secure and fit most every knee size.

PLASTIC KNEE PADS

- Water resistant for protection and easy clean up.
- Rubber anti slip surface for complete control.
- Flexible cover for extra comfort while walking.
- Contoured soft foam pad for maximum comfort.

Item #	IP	MP	PKG
W88982	1	20	BAG

BUNGEE CORDS

- Vinyl coated hooks with protective caps.

Item #	IP	MP	PKG	Length
W1400	12	180	BAG	13"
W1401	12	180	BAG	16"
W1402	12	180	BAG	20"
W1403	12	180	BAG	24"
W1405	12	144	BAG	30"
W1400-5	6	48	BAG	5-PC



W1400-5

Lengths included:
13, 16, 20, 24 & 30"



8-PC TIE DOWN & BUNGEE SET

- Complete cargo control kit in an easy to store case.
- Working load limit: 400 lbs.
- Break strength: 1,200 lbs. (for tie downs only).



Ratcheting tie downs with hooks

Item #	IP	MP	PKG	(2) EACH
W1417	1	4	SLV	1" x 10' tie downs 1" x 15' endless tie downs 15" & 24" flat bungee cords

CARGO NET

- High-quality latex core for strength and resilience.
- Ideal for securing items with odd, bulky shapes.
- Knotted design helps reduce scratched cargo.
- 12 Easy-to-pull hooks.

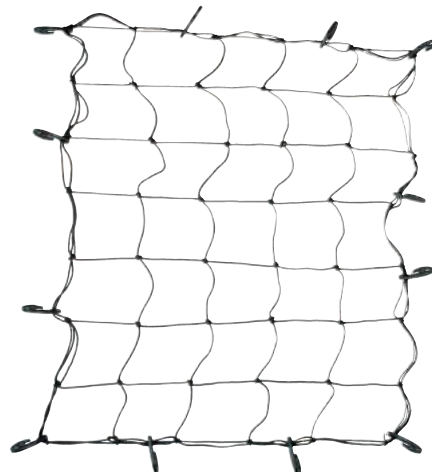

Item #	IP	MP	PKG	Size
W1429	4	24	DBL	36 x 48"

4-PC TIE DOWN SETS

- Heavy duty vinyl coated hooks.
- Easy push button release.
- Working weight limit: 400 lbs.
- Break strength: 1,200 lbs.



Woven nylon straps.
Push button release.

Item #		IP	MP	PKG	W	L
W1446	Auto Locking	6	12	DBL	1"	6'
W1440	Ratcheting	3	6	RAC	1"	15"

2-PC CAM BUCKLE TIE DOWN SET

- Die cast cam buckle.
- Steel vinyl coated "S" hooks.



Item #	IP	MP	PKG	W	L	Break	Safe
W1419	12	24	CLM	1"	6'	900	300

2-PC RATCHETING SETS

- 4' to 15' adjustable length.
- 1" wide synthetic webbing.



RATCHETING TIE DOWNS

- Tough wide webbing.
- 4' to 15' adjustable length.
- Over molded grip for added comfort and protection

2" double "J" hooks.



W1427

Item #	IP	MP	PKG	Break	Safe
20160	6	24	DBL	900 lbs.	300 lbs.
W1424	6	24	DBL	750 lbs.	250 lbs.

Item #	IP	MP	PKG	W	L	Break	Safe
W1425	6	12	CLM	1"	15'	1,500 lbs.	500 lbs.
W1426	5	10	CLM	1-1/2"	15'	1,650 lbs.	500 lbs.
W1427	6	12	CLM	2"	27'	10,000 lbs.	3,000 lbs.

LED TRAILER ALIGNMENT KIT

- 2-in-1 magnetic trailer alignment kit features bright yellow foam balls for day use, and red flashing LEDs for night.
- Dual telescoping rods magnetically attach to your hitch and coupler.
- Telescoping sections extend to 41" tall.
- Stainless steel sections collapse down to 7-1/4" for easy storage.
- Includes 3-AG3 button cell batteries.

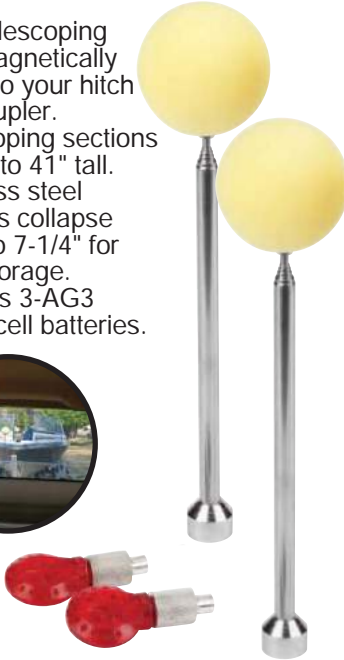

Item #	IP	MP	PKG
W1276	12	48	DBL

EMERGENCY TOW STRAPS

- 2" weather & cut resistant polyester webbing.
- Will not rot, rust or mildew.
- Heavy duty zinc plated forged hooks.



Item #	IP	MP	PKG	Size	Break	Safe
W1420	1	12	CLM	2" x 15'	8,500	2,833
W1422	1	12	CLM	2" x 20'	10,000	3,300
W1423	1	12	CLM	2" x 30'	10,000	3,300

Intended for vehicle recovery not for prolonged towing.

- Durable polypropylene rope resists wear and tear.
- Diamond braided to absorb shock.
- Lighter and stronger than chain.
- Zinc plated steel forged hooks.
- Heavy-Duty stitching.

W1435



W1436



W1437



Item #	IP	MP	PKG	Size	Break	Safe
W1435	1	6	CBX	5/8" x 14'	6,500	2,167
W1436	1	6	CBX	3/4" x 17'	8,500	2,833
W1437	1	6	CBX	7/8" x 20'	10,000	3,333

TOW ROPES

- Designed for use with cars, trucks, 4x4's and farm equipment.

TREE SAVER STRAP

- 8000 lbs. rating.
- Quality synthetic webbing.
- Protects trees and winch cables from damage.



Item #	IP	MP	PKG	Size
W1416	12	24	CLM	2" x 6'

COMPACT POWER PULLER

- Collapsible with carrying case for easy storage and portability.
- Alloy hooks with approved safety latches.
- Removable handle with comfort grip for extra leverage.

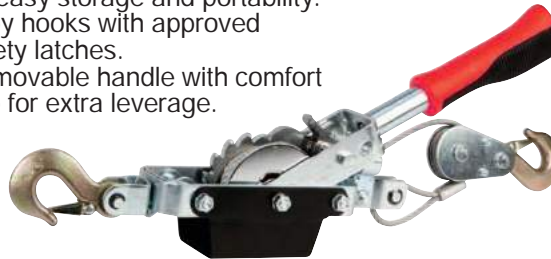

Item #	IP	MP	PKG	Rolling	Lifting	Cable
W4003	1	6	SLV	1 ton	1/2 ton	6' x 5mm

Use for stretching fences and wire, hoisting motors, shafts and gears, vehicle recovery, farm/ranch, construction and more.

POWER PULLER

- Drop forged steel safety hooks.
- High grade aircraft cable.
- Automatic notch-at-a-time release for maximum safety.

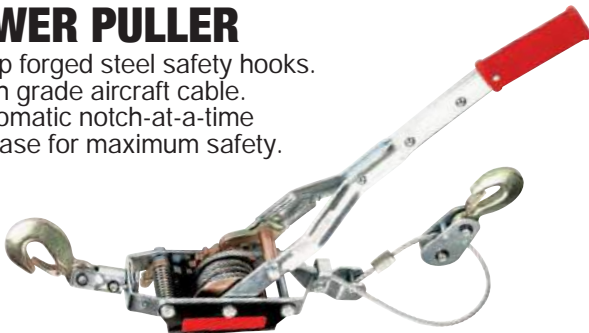

Item #	IP	MP	PKG	Rolling	Lifting	Cable
50-100	1	6	CBX	2 ton	1 ton	6' x 5mm
50-101	1	4	CBX	4 ton	2 ton	10' x 6mm

HAND POWER PULLER

- Drop forged steel safety hooks.
- High grade aircraft cable.
- Versatile hook design.
- Automatic notch at a time release for maximum safety.

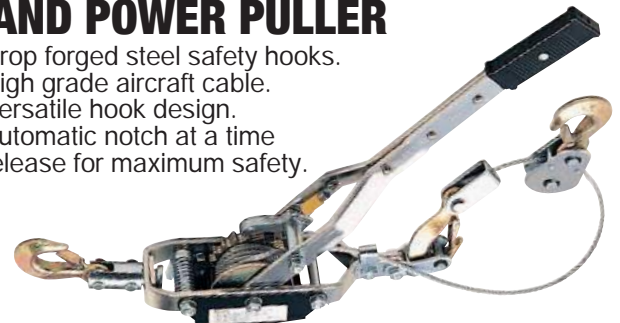

Item #	IP	MP	PKG	Rolling	Lifting	Cable
W4000DB	1	6	CBX	2 ton	1 ton	12' x 5mm
W4004DB	1	4	CBX	4 ton	2 ton	12' x 6mm

TARPS & STRAPS

SHOP/GARAGE

TARP STRAPS

- Heavy duty E.P.D.M. rubber construction.
- Steel "S" hooks at each end.

Item #	IP	MP	PKG	L
W1410	6	96	BAG	10"
W1411	6	96	BAG	15"
W1412	6	96	BAG	21"
W1413	6	96	BAG	31"
W1414	6	48	BAG	41"



BLUE TARPS

- Water, mildew, tear and UV resistant.
- Double water proof surfaces.
- Double reinforced corners.
- Rope sewn in along edges for added strength.

Item #	IP	MP	PKG	Cut Size	Finished	Mil
W6000	1	50	BAG	5 x 7'	4' 6" x 6' 6"	4
W6002	1	40	BAG	6 x 8'	5' 6" x 7' 6"	4
W6004	1	20	BAG	8 x 10'	7' 6" x 9' 6"	4
W6006	1	15	BAG	10 x 12'	9' 6" x 11' 6"	4
W6009	1	8	BAG	10 x 20'	9' 6" x 19' 6"	4
W6011	1	10	BAG	12 x 16'	11' 6" x 15' 6"	4
W6015	1	5	BAG	16 x 20'	15' 6" x 19' 6"	4
W6022	1	3	BAG	20 x 30'	19' 6" x 29' 6"	4
W6025	1	2	BAG	26 x 40'	25' 6" x 39' 6"	4
W6027	1	1	BAG	30 x 60'	29' 6" x 59' 6"	4



CAMO TARPS

Item #	IP	MP	PKG	Cut Size	Finished	Mil
W6005	1	20	BAG	8 x 10'	7' 6" x 9' 6"	4
W6007	1	20	BAG	10 x 12'	9' 6" x 11' 6"	4

SILVER TARPS

Item #	IP	MP	PKG	Cut Size	Finished	Mil
W7002	1	20	BAG	6 x 8'	5' 6" x 7' 6"	10
W7004	1	10	BAG	8 x 10'	7' 6" x 9' 6"	10
W7006	1	8	BAG	10 x 12'	9' 6" x 11' 6"	10



BOOT AND SHOE BRUSH

- Wood blocks with heavy duty steel frame.
- Easily screwed down to any surface using the integrated tabs.
- Heavy poly bristles for long life.

Item #	IP	MP	PKG
W9451	1	6	CBX



PLASTIC BOOT TRAY

- Perfect for muddy and wet boots and shoes.
- Large enough to hold 3 pairs.
- Made of 100% recycled materials.

Item #	IP	MP	PKG	Size
W89018	12	12	LAB	26-1/2 x 13-1/2"



STADIUM BINOCULARS

- High Quality glass lenses produce crisp, clear images.
- Ergonomic Rubberized Body for improved grip.
- Fold down rubber eye cups for use with glasses.
- Center wheel focus.
- Field of view 402 ft. at 1100 yards.



Item #	IP	MP	PKG	Magnification
W9460	10	20	CBX	7x50

COMPACT BINOCULARS

- 21mm objective ruby colored glass lenses produce crisp clear images.
- Ergonomic rubberized body for improved grip.
- Compact design so you can take them anywhere.
- Fold down rubber eye cups for use with glasses.
- Neck strap, carrying case and lens cleaning cloth included.
- Center wheel focus.
- Field of view 402 ft. at 1100 yards.



Item #	IP	MP	PKG	Magnification
W9461	12	48	CBX	8x21

SCREWDRIVER GRIP BOTTLE OPENER

- Ergonomic non slip molded grip for improved comfort and control.
- Alloy steel construction with corrosion resistant chrome finish.
- Works on foreign and domestic models.
- An essential in every tool box, tool chest, garage cabinet or junk drawer for both the professional and DIY.



Item #	IP	MP	PKG
W30975	6	72	TAB

CARABINERS

- Lightweight aluminum construction.
- Hundreds of uses.
- Not for Climbing.



W461
20197



Includes non-scratch liner. 45 lbs. pull.
W482

Locking cage prevents tampering or accidental opening. 45 lbs. limit.



300 lbs. rated polyester paracord cord material. Unravels to over 10' in length. (Approximately 9' coiled x 3/4" wide). 200 lbs. rated aluminum carabiner buckle.

Item #		IP	MP	PKG	Size
W461	Jr. Jumbo	8	48	CRD	5"
20197	Jr. Jumbo	5	30	Pg 321	5"
W463	Jumbo	6	48	CRD	7"
W3203	with Key Ring	20	240	Pg 315	3"
W969	with Key Ring	30	180	BLK	3"
W469	Locking	12	72	Pg 318	3"
20194	Locking	6	36	CRD	3"
W482	with Magnet	8	72	DBL/Pg 318	2"
W2558	w/ 10' Paracord	12	108	Pg 314	2"

CLEANING BRUSHES

SHOP/GARAGE

3-PC WIRE BRUSH SETS

- Useful for many utility cleaning purposes.
- Brass, stainless steel and nylon bristles.

W1149



W1148
20140



Item #	IP	MP	PKG	Steel	Brass	Nylon
W1148	6	144	CRD	7-1/8"	7-1/8"	7-1/8"
20140	4	24	Pg 321	6-7/8"	6-7/8"	6-7/8"
W1149	6	72	CRD	9-1/8"	8-3/4, 7-1/8"	-

UTILITY WIRE BRUSHES

- Tough, all purpose steel bristles.
- Comfortable curved handle.
- Cleans rust, paint, dirt, and much more, quickly and easily.



Item #	IP	MP	PKG	Handle Type
W1150	12	144	BLK	Plastic
W1152	12	144	CRD	Wood

FINGERNAIL BRUSHES

- Easy grip, plastic handle.
- Tough, long lasting nylon bristles.

W9163
Contoured handle for better grip.



Item #	IP	MP	PKG	
W3229	12	144	Pg 315	
W3300	18	144	Pg 317	
W985	30	180	BLK	
W990	15	90	BLK	
20127	12	72	Pg 320	
W9163	9	54	CRD Pg 312	W/Magnet

PAINT BRUSH SETS

- Durable plastic handles.
- For use with many paints.

20124



W232C



20195



Item #	IP	MP	PKG	
W232C	3-PC	12	288	CRD 1/2, 1, 2"
20124	2-PC	4	24	Pg 320 1, 2"
20195	5-PC	4	24	BAG 1, 1-1/2, 2, 2-1/2, 3"

PARTS CLEANING BRUSH

- Durable PVC bristles.
- Essential around the shop for keeping parts free of build-up.



Item #	IP	MP	PKG
W197B	12	144	BLK
W197C	6	144	CRD
20180	6	36	Pg 321

HOSE NOZZLES

- Attaches to any standard garden hose.
- Adjustable from light mist to powerful stream.
- Heavy duty rubber grips.
- Durable and built to last.

Blasts away dirt, grime, mud and more.

W11090



W11091
Rustproof zinc alloy stem.



W11092
Lever action flow control and shut off.



Item #	IP	MP	PKG	Jet Spray
W11090	Fire Nozzle	6	36	CRD/Pg 313 up to 40'
W11091	High Flow	6	36	LAB/Pg 313 up to 50'
W11092	Pistol	6	48	LAB/Pg 313 up to 30'

4-PC MICROFIBER CLOTH SET

- Nonabrasive for delicate surfaces.
- Machine wash and dry.
- 4 uses: green for washing, orange for dusting, yellow for polishing and blue for glass cleaning.



Item #	IP	MP	PKG	Size
W1474	6	48	CLM/Pg 312	12 x 16"

25 PACK SHOP TOWELS

- Picks up dirt, grease and liquids.
- Machine washable.
- Soft all-cotton weave.



Item #	IP	MP	PKG	Size
W1476	1	24	BAG	13-3/4 x 13"

STEEL DUSTPAN

- Double riveted tubular steel handle.
- Comfortable rubberized grip.
- Durable powder coated finish resists rust and corrosion.



Item #	IP	MP	PKG	Size
W29	1	6	LAB	16-1/2 x 9"

SQUEEGEES

- Tough, rubber blades.
- Wood handles.
- Zinc plated body.



W1460
• Quality flexible silicone blade.

Item #	IP	MP	PKG	Blade	Length
W1466	10	50	BLK	8" Rubber	W/20" Handle
W1468	10	50	BLK	8" Rubber	W/24" Handle
W1472	10	50	BLK	10" Rubber	W/20" Handle
W1460	8	16	BLK	8" Silicone	-

ICE SCRAPER/SQUEEGEE

- High impact ABS construction.



Item #	IP	MP	PKG
W465	12	96	Pg 318
W9166	24	96	Pg 312

3-IN-1 WAVE SCRAPER

- Durable polymer construction.

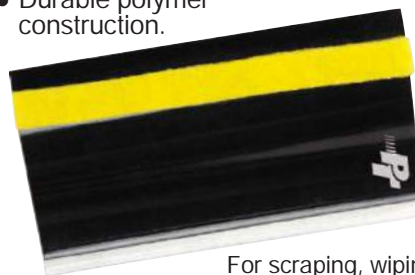

For scraping, wiping and cleaning

Item #	IP	MP	PKG
W9191	20	80	Pg 313

ICE SCRAPER

- Heavy-duty 4-1/4" scraping blade with ice ripping teeth.



Item #	IP	MP	PKG
W9197	12	48	Pg 313

ROADSIDE ACCESSORIES

SHOP/GARAGE

EMERGENCY ROADSIDE KITS



W1555
Zippered case with integrated reflective triangle.

60220
Essential tools for the occasional automotive emergency.

Useful automotive tools for a basic roadside repair.

Item #	IP	MP	PKG	Contents
W1555	1	6	SLV	8' jumper cables (10ga), 2 ton 14' tow rope (1,333 lbs. working load), Krypton flashlight with 2-AA batteries, slip joint pliers, 2-in-1 screwdriver, bungee cords, rain poncho, first aid kit, gloves, ice scraper, tire gauge, knife, cable ties and electrical tape.
W1556	1	10	SLV	8' jumper cables, flashlight with 2-AA batteries, tire gauge, knit gloves, whistle, 10-pc fuse and terminal kit, electrical tape, slip joint pliers, #2 Philips, 1/4" slotted screwdrivers. 1/4" dr sockets: 1/4, 5/16, 3/8, 7/16", 4, 6, 8, 10, 12mm, spinner handle.
60220	1	4	SLV	12V 250 PSI tire inflator, 8' jumper cables (10ga), free standing warning triangle, flashlight, slip joint pliers, bungee cords, screwdriver, gloves, snap blade knife, rain poncho, tire gauge, electrical tape and cable ties.

DOT WARNING TRIANGLES

- This D.O.T. approved warning triangle is ideal for unexpected roadside emergencies.
- Total weight of 2.9 pounds for stability in windy conditions.
- Measures 17-1/2" long / wide and 17-1/4" tall.



W1498
Convenient travel case keeps all three triangles together and clean until needed.

Item #	IP	MP	PKG
W1499	1	4	LAB
W1498	1	4	LAB 3-PACK

EMERGENCY TRACTION MAT

- Emergency traction when your vehicle is stuck in snow, ice, mud or sandy conditions.
- Flexible heavy duty plastic, strong metal hinges, and raised nubs for superior traction.
- Works on almost any car, van, pickup truck or small cargo truck.
- Lightweight, and folds to a compact size to store easily in your trunk.
- Comes as a set of 2 traction mats in safety yellow.



Best alternative for tire chains and easier to use, simply place it under your tires and drive up smoothly.

Item #	IP	MP	PKG	W	D	H	
W41003	1	4	SLV	Open	38"	7"	1/2"
				Closed	11-3/4"	7"	3"

PORTABLE SAFE/LOCKBOX

- Great for keeping your phone, wallet, documents, protection devices or other valuable articles secure. Ideal for use in cars, trucks, vans, boats, in the office, at home and more.
- Heavy duty steel construction with black powder coat finish.
- Soft, durable interior will not scratch stored articles.
- Includes bracket, mounting hardware, security cable and 2 keys.



Can be secured with the included mounting bracket and hardware or 3' security cable.

When box is locked it cannot be removed from the mounting bracket.

Item #	IP	MP	PKG		W	D	H
W53998	1	10	CBX	O.D.	8-1/4"	5-7/8"	2-1/4"
				I.D.	7"	5-1/4"	2"

MAGNETIC KEY HOLDER

- Accommodates large-head keys.
- Box has slide cover.
- Strong magnetic sticks to metal surfaces.



Item #	IP	MP	PKG
W1804C	24	288	CRD
W3221	10	120	Pg 315

EMERGENCY AUTO SAFETY TOOL

- Seat belt cutter to quickly exit vehicle.
- Bright LED flashlight and 9 flashing red LED lights to alert others.
- Glass breaker for emergency escapes.
- Magnetic base sticks to any steel surface.
- Powered by 2-AA batteries (not included).



Item #	IP	MP	PKG
W1553	6	48	DBL

BLIND SPOT MIRRORS

- Provides essential wide angle view.
- Aluminum housing.
- Self adhesive back sticks to side view mirror.



Item #	IP	MP	PKG	Size
W29C	12	288	CRD	3-3/4"
W30C	12	288	CRD	3"
W31C	12	288	CRD	2"
W3231	25	300	Pg 316	2"
W36C	12	144	CRD	4 x 5-1/4"

HANDYMAN FIRST AID KIT

- 1 Non-woven triangular bandage.
- 5 Fabric bandages - 3" x 1"
- 4 Fabric knuckle bandages.
- 4 Fabric Fingertip bandages.
- 1 Saline solution 0.5 oz.
- 2 Small dressing.
- 1 Finger dressing.
- 6 Safety pins.
- 2 Alcohol wipes.



Item #	IP	MP	PKG
W1554	6	24	SLV
20189	4	24	SLV

PROP ROD

- Extends from 16" to 40".
- Simple twist-lock action.



LICENSE PLATE SCREWS

- Set of four Nylon fasteners.
- All weather, will not corrode.



Item #	IP	MP	PKG
W26C	24	288	CRD

Item #	IP	MP	PKG
W1475	1	60	BAG

12V ACCESSORIES

SHOP/GARAGE

VACUUM CLEANER

- High powered suction in a compact, portable and lightweight unit.
- Includes 5 attachments: crevice tool, bristled brush, dust brush, 11" hose, 10" extension.



Item #	IP	MP	PKG	
W50012	4	16	CBX	See page 33 for more

6 IN OSCILLATING FAN

- Unique oscillating pattern covers both the high and low zones.
- Convenient 12 volt adapter plug with 6' cord.
- Comes with clamp but also comes with plate for permanent mounting.



Item #	IP	MP	PKG	
W1658	10	20	CLM	See page 33 for more

DETAIL POLISHER

- 12 volt 1.5 mp motor.
- No load speed of 1200 RPM.
- 12' fused power cord.
- Comes with foam backer pad, terry cloth and synthetic wool bonnets.



Item #	IP	MP	PKG	
W50089	1	20	CBX	See page 26 for more

USB ADAPTERS

- Keep your electronics running without swapping batteries.
- Compatible with most USB charging devices.
- Available in Silver and Black.



Item #	IP	MP	PKG	Input	Output
W2550	24	240	Pg 314	12-24V	5V/700mA
W2556	24	240	Pg 314	12-24V	5V/1000mA & 5V/2100mA

ELECTRIC JACK

- Ideal for emergency roadside tire changes.
- 2 ton capacity, lifting range of 5 to 14"
- Included: Jack, carrying case, emergency hand crank, and three extra fuses.



Item #	IP	MP	PKG	
W1609	1	4	CBX	See page 47 for more

HEATER/DEFROSTER

- Use to quickly defrost / warm windshields and surfaces.
- 360 degree swivel base for dash mounting.
- Three position heat switch.
- 15 amp in-line blade fuse.



Item #	IP	MP	PKG	
W5009	1	12	CBX	See page 33 for more

USB CHARGER & AUTO ESCAPE

- Easy to find, easy to use emergency escape tool so you are always prepared.
- 4-in-1 uses: Seat belt cutter, spring-loaded steel tip window punch, 2.1A USB charger with power-on light and 12 volt accessory socket.



Item #	IP	MP	PKG	
W9206	8	96	CRD/Pg 311	

DUAL OUTLET EXTENSION CORD

- Provides additional cord length to any automotive accessory.
- Dual outlets for powering multiple devices.
- Fits standard 12V auto outlets.



Item #	IP	MP	PKG	Length	AWG
W1279	6	48	CRD	10'	18

3-PC CAR SEAT CONVENIENCE SET

- Features tablet holder, utility clip and headrest bracket.
- Quick connect system with easy push button release.
- Foam padding reduce shock and vibration to your device.
- Adjustable depth clips allow you to keep your protective case on your tablet.
- Utility hook is great for hanging clothes, shopping bags, trash bags and more.
- Adjustable bracket fits headrests with openings from 4-1/4" to 5-1/2" wide.
- Fits tablets from 5-1/2" up to 9-3/4" wide/high.



Item #	IP	MP	PKG
W1284	1	24	CBX

6 IN. USB MINI FAN

- Compact 4" aluminum blade and 6" frame delivers a lot of cooling air flow without taking up a lot of space.
- Brushless axial motor allowing for whisper quiet operation.
- Sturdy metal stand with rubber feet is adjustable with 360 degrees of rotation.
- Powered by a 3' USB cable that can operate from a computer, laptop, power bank and other USB outlet.



Perfect fan for the office, home, dorm, study, library, game room or garage.

Item #	IP	MP	PKG	Watts	USB Cable
W1663	1	45	CBX	0.25	3'

BATTERY TESTERS

- Test standard and rechargeable batteries: 9V, AA, AAA, C, D, 1.5V Button Type.
- Easy-to-read with Good, Low and Poor indicators.

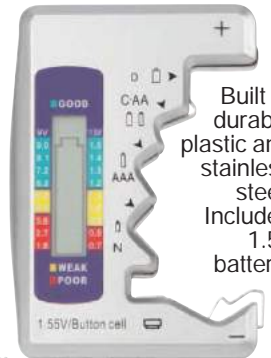

Built of durable plastic and stainless steel, Includes 1.5v battery.



Compact design, no batteries required.

Item #		IP	MP	PKG
W2986	Digital	16	96	CRD
W2987	Analog	16	96	CRD

SELF PORTRAIT MONOPOD

- Portable, compact, lightweight, sturdy and easy to use.
- Anti-swivel groove to stabilize and prevent camera/phone from turning.
- Adjustable thumb screw provides flexibility for multiple angle shooting and 180° rotation.
- Connection cable allows operation without batteries, timers or a separate remote.

W15034

Built-in 2200mAh li-ion battery charges your phone on the go!



Compatible with iOS 5.01+, and most Android 4.2.2+ operating systems.

Item #	IP	MP	PKG	Reach
W15034	8	48	Pg 313	LI-ION 12-1/2 to 27-1/2"
W15033	8	48	Pg 313	12" to 43"

44-PC BUTTON CELL BATTERY PACK

- Wide range of popular button cell batteries.
- Includes:
 - 12 of AG13 (LR44)
 - 6 of AG3 (LR41)
 - 12 of CR2032
 - 6 of CR2016
 - 4 of CR2025
 - 4 of CR1616

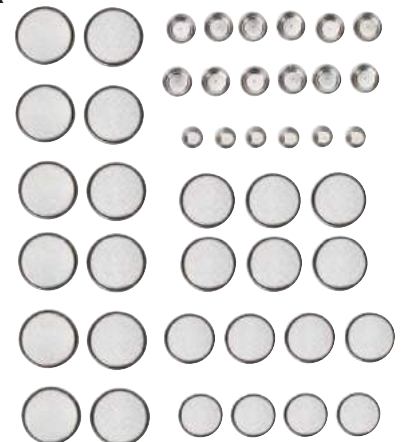

Item #	IP	MP	PKG
W483	8	48	CRD/Pg 318

ADHESIVES & TAPES

SHOP/GARAGE

7 SECOND GLUE AND FILLER

- Works on rubber, glass, copper, aluminum, steel and most plastics.
- Combine the welding compound with adhesive and it will be rock hard in 7 seconds.
- Ready to be drilled or sanded.
- Included application pack with sand paper, razor blade, masking tape, glove, paddle, pin, precision applicator tube.

Not engineered to work on polyethylene, polypropylene plastics, Teflon, or fiber based materials like paper and cloth.



Item #	IP	MP	PKG
W481	6	48	CRD/Pg 318

PTFE SEALING TAPES

- Perfect for fittings, pipes, valves, gauges and other threaded parts.

Item #	IP	MP	PKG	Size
M609C	24	288	CRD	1/2" x 21'
W1909	24	144	BLK	1/2" x 21'
W3245	12	144	Pg 316	1/2" x 21'
W3303	20	160	Pg 317	1/2" x 21'
20100	2-PK	6	36	Pg 320 1/2" x 33'
W974	40	240	BLK	1/2" x 33'



ELECTRICAL TAPES

- Flexible material conforms to sharp contours with firm gripping rubber resin adhesive.
- Suitable for use at no more than 600V and not more than 176°F (80°C).
- UL Listed.

Item #	IP	MP	PKG	Size
W501	10	500	SHK	3/4" x 30'
W502	10	200	SHK	3/4" x 60'
W3244	12	144	Pg 316	3/4" x 30'
W3309	15	120	Pg 317	3/4" x 30'
W501D	24	144	BLK	3/4" x 30'
20101	2-PK	6	36	Pg 320 3/4" x 30'



W549



5-PACK ROLLS SETS

W548	Black	12	72	BAG	3/4" x 30'
W549	Color	12	72	BAG	3/4" x 30'
20165	Color	4	24	Pg 321	3/4" x 30'

DUTY DUCT TAPES

- Heavy duty duct tape has thousands of uses around the home, garage or workshop.
- Strong polyethylene backed, rubber base adhesive for a strong hold. 17 mil thick.



Item #	IP	MP	PKG	Size
W503	Silver	1	24	LAB 2" x 150'
W504	Black	1	24	LAB 2" x 150'
20102		6	36	Pg 320 2-7/8" x 30'

SUPER GLUE

- Bonds metal, plastics, rubber, ceramic and porcelain.
- Works in seconds.
- Permanent repairs to most non-porous surfaces.



Item #	IP	MP	PKG
20135	12	72	Pg 320
W3236	20	240	Pg 316

RUBBER CEMENT

- For use with tire patches.
- Many uses around the house and garage.



Item #	IP	MP	PKG
60210	10	100	CRD

RATCHETING CAULK GUN

- Ratcheting action for easy material application.
- Built-in caulk tube nozzle tip cutter.



Item #	IP	MP	PKG
W54250	6	48	BLK

LENS REPAIR TAPE

- Use as a temporary fix on rear brake lights and turn signals.

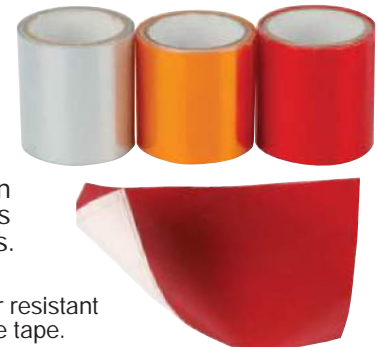

Red weather resistant self adhesive tape.

Item #	IP	MP	PKG	Size
W508	3-PK	12	48	CRD 2" x 40"
W506C	Sheet	60	1200	BAG 10" x 5"

ADJUSTABLE CABLE TIE GUN

- High impact nylon and fiberglass body.
- Adjustable bundling pressure.
- Flush cuts end of cable tie.



Item #	IP	MP	PKG	Capacity
W2919	6	48	CRD	3/32" to 3/16" wide, up to 1/16" thick. 2.4mm to 4.8mm

8-PC HOOK & LOOP TIES

- Durable self gripping straps.
- Weather resistant for indoor or outdoor use.



Item #	IP	MP	PKG	Size
W2911	12	144	BAG	12"

CABLE TIE SETS

- Resealable bag.
- Weather resistant.

Item #	Length	Color	IP	MP	PKG	Tensile Strength
W2904	100-PC 4"	Black	10	100	BAG	18 lbs.
W2905	100-PC 5-1/2"	Black	10	100	BAG	40 lbs.
W2910	100-PC 8"	Black	10	100	BAG	40 lbs.
W2912	100-PC 12"	Black	10	100	BAG	50 lbs.
W2915	100-PC 14"	Black	10	100	BAG	50 lbs.
W2924	50-PC 18"	Black	10	100	BAG	120 lbs.
W2906	100-PC 4"	White	10	100	BAG	18 lbs.
W2907	100-PC 5-1/2"	White	10	100	BAG	40 lbs.
W2908	100-PC 8"	White	10	100	BAG	40 lbs.
W2913	100-PC 12"	White	10	100	BAG	50 lbs.
W2917	100-PC 14"	White	10	100	BAG	50 lbs.
W2926	50-PC 18"	White	10	100	BAG	120 lbs.
W2903	50-PC 11"	B&W	20	80	BAG	40 lbs.
W2927	24-PC 25"	B&W	10	40	BAG	175 lbs.
W2928	24-PC 40"	B&W	10	40	BAG	250 lbs.

150-PC NEON CABLE TIE SET

- 50 pieces of each color. • Resealable Bag.

Item #	IP	MP	PKG	Contents
W2929	10	100	BAG	4" Yellow, 8" Pink, 12" Blue.



250-PC CABLE TIE ASSORTMENT

- Variety of lengths, color coded.
- Handy assortment for the home, office, or shop.
- Clear plastic tubes keep small pieces in one place, easy to find.

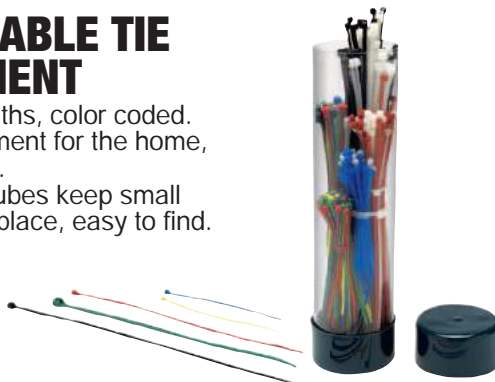

Item #	IP	MP	PKG	4"	6"	8"
W2918	1	12	LAB	50	50	150

1,000-PC CABLE TIE ASSORTMENT

- Four lengths, color coded.
- 500 4", 100 6", 300 8" and 100 12" cable ties.
- Great for home, shop, office, RV, boat and so much more.



Item #	IP	MP	PKG
W2925	6	12	LAB

HARDWARE KITS

SHOP/GARAGE

200-PC HEX WASHER SELF DRILLING SCREWS



Item #	IP	MP	PKG
W5220	6	24	CAS



X	X	X	X	X	X
		X	X		

347-PC SAE NUTS & BOLTS



Item #	IP	MP	PKG
W5221	6	24	CAS



#6 X 1/2 in. Sheet Metal Screw 32 pcs	#6 X 3/4 in. Sheet Metal Screw 26 pcs	#10 X 1 in. Sheet Metal Screw 13 pcs	#4 X 1/2 in. Wood Screw 43 pcs	#6 X 3/4 in. Wood Screw 32 pcs	#8 X 1 in. Wood Screw 10 pcs
#10 Flat Washer 59 pcs	1/4 in. Flat Washer 19 pcs	#10-24 X 1 in. Machine Screw 19 pcs	#10-20 X 3/4 in. Machine Screw 24 pcs & 1/4 in.-20 Hex Nut 11 pcs	1/4 in.-20 X 3/4 in. Machine Screw 10 pcs	#10-24 Hex Nut 49 pcs

347-PC METRIC NUTS & BOLTS



Item #	IP	MP	PKG
W5222	6	24	CAS



3.5 X 12mm Sheet Metal Screw 32 pcs	3.5 X 19mm Sheet Metal Screw 26 pcs	5 X 25mm Sheet Metal Screw 13 pcs	3 X 12mm Wood Screw 43 pcs	3.5 X 19mm Wood Screw 32 pcs	4 X 25mm Wood Screw 10 pcs
M5 Flat Washer 59 pcs	M6 Flat Washer 19 pcs	5 X 25mm Machine Screw 19 pcs	6 X 19mm Machine Screw 10 pcs & M6 Hex Nut 11 pcs	5 X 19mm Machine Screw 24 pcs	M5 Hex Nut 49 pcs

224-PC NUTS & BOLTS



Item #	IP	MP	PKG
W5358	6	24	CAS



#6-32 24 pcs	#10-24 12 pcs	6-32 x 1 in. 12 pcs	8-32 x 1/2 in. 16 pcs	8-32 x 1-1/2 in. 10 pcs	8-32 x 2 in. 6 pcs
#8-32 18 pcs	#6 26 pcs	#10 12 pcs	8-32 x 3/4 in. 14 pcs		
1/4 in. 16 pcs	1/4 in. 16 pcs	#8 18 pcs	10-24 x 1 in. 10 pcs	1/4 x 1 in. 8 pcs	1/4 x 1-1/2 in. 6 pcs

150-PC WING NUTS



Item #	IP	MP	PKG
W5219	6	24	CAS



3/16 in. - 24 30 pcs	3/16 in. - 32 30 pcs	1/4 in. - 20 25 pcs	1/4 in. - 28 25 pcs	5/16 in. - 18 20 pcs	5/16 in. - 24 20 pcs

240-PC NUTS & BOLTS



Item #	IP	MP	PKG
W5334	6	24	CAS

M5 x 25M Bolt 10 pcs	M5 x 16M Bolt 10 pcs	M6 x 20M Bolt 10 pcs	M10 x 16M Bolt 5 pcs	M6 x 30M Bolt 10 pcs	M10 x 40M Bolt 5 pcs
M5 Nut 20 pcs	M8 Nut 10 pcs	M10 Nut 10 pcs	M8 x 25M 5 pcs	M6 Washer 20 pcs	M10 Washer 10 pcs
M6 Nut 20 pcs	M4 x 20M Bolt 10 pcs	M4 x 12M Bolt 10 pcs	M8 x 40M 5 pcs	M8 Washer 10 pcs	
	M4 Nut 20 pcs	M4 Washer 20 pcs			

240-PC METRIC NUTS & BOLTS



Item #	IP	MP	PKG
W5331	6	24	CAS

M5 x 25M Bolt 10 pcs	M5 x 16M Bolt 10 pcs	M6 x 20M Bolt 10 pcs	M10 x 16M Bolt 5 pcs	M6 x 30M Bolt 10 pcs	M10 x 40M Bolt 5 pcs
M5 Nut 20 pcs	M8 Nut 10 pcs	M10 Nut 10 pcs	M8 x 25M 5 pcs	M6 Washer 20 pcs	M10 Washer 10 pcs
M6 Nut 20 pcs	M4 x 20M Bolt 10 pcs	M4 x 12M Bolt 10 pcs	M8 x 40M 5 pcs	M8 Washer 10 pcs	
	M4 Nut 20 pcs	M4 Washer 20 pcs			

106-PC ALLEN CAP SCREWS



Item #	IP	MP	PKG
W5342	6	24	CAS

10-24 x 1/2 in.	8-32 x 1/2 in.	10-24 x 1 in.	3/8-16 x 1-1/2 in.	1/4-20 x 1 in.	5/16-18 x 1-1/2 in.
			3/8-16 x 1 in.	1/4-20 x 1/2 in.	5/16-18 x 1 in.

200-PC SAE HEX SET SCREWS



Item #	IP	MP	PKG
W5237	6	24	CAS

5/32-32 X 3/16" 10 pcs	3/8-24 X 3/8" 10 pcs Fine Thread	5/16-24 X 3/8" 20 pcs Fine Thread	5/16-18 X 3/8" 30 pcs	3/8-16 X 3/8" 10 pcs	5/16-18 X 1/2" 20 pcs
1/8-40 X 3/16" 10 pcs	3/16-24 X 1/4" 10 pcs	1/4-28 X 1/4" 20 pcs Fine Thread	1/4-20 X 1/4" 30 pcs	3/8-16 X 1/2" 10 pcs	1/4-20 X 3/8" 20 pcs

200-PC METRIC HEX SET SCREWS



Item #	IP	MP	PKG
W5238	6	24	CAS

4mm X 5mm 10 pcs	10mm X 10mm 10 pcs Fine Thread	8mm X 10mm 20 pcs Fine Thread	8mm X 10mm 30 pcs	10mm X 10mm 10 pcs	8mm X 12mm 20 pcs
3mm X 5mm 10 pcs	5mm X 6mm 10 pcs	6mm X 6mm 20 pcs Fine Thread	6mm X 6mm 30 pcs	10mm X 12mm 10 pcs	6mm X 10mm 20 pcs

1,120-PC NUTS & BOLTS



Item #	IP	MP	PKG
W5355	1	12	SLV

6 X 3/4 in. 40 each	6 X 1 in. 35 each	8 X 3/4 in. 30 each	8 X 1 in. 25 each	8 X 1-1/2 in. 25 each	10 X 3/4 in. 20 each	10 X 1 in. 20 each	10 X 1-1/2 in. 15 each		
6 X 3/4 in. 40 each	6 X 1 in. 35 each	8 X 3/4 in. 30 each	8 X 1 in. 25 each	8 X 1-1/2 in. 25 each	10 X 3/4 in. 25 each	10 X 1 in. 20 each	10 X 1-1/2 in. 15 each		
6 X 1/2 in. 30 each	8 X 3/4 in. 25 each	8 X 1/2 in. 25 each	10 X 3/4 in. 20 each	10 X 1 in. 20 each	6 X 1 in. 30 each	1/4 in. Washer 30 each	#6 Washer 110 each	#8 Washer 80 each	#10 Washer 50 each
1/4 X 3/4 in. 10 each	1/4 in. Hex Nut 30 each	#6 Hex Nut 110 each	#8 Hex Nut 80 each	#10 Hex Nut 50 each					

1,200-PC NUT & BOLT

- 360 screws, 840 nuts, bolts and washers. Labeled for quick identification. Mountable rack with handle. Extra storage container included.



Item #	IP	MP	PKG
W5226	1	4	CBX

6 X 3/4 in. 40 each	6 X 1/2 in. 40 each	8 X 1/2 in. 30 each	8 X 5/8 in. 20 each	8 X 3/4 in. 30 each	10 X 1 in. 20 each
4 X 1/2 in. 40 each	6 X 1/2 in. 40 each	6 X 5/8 in. 30 each	6 X 3/4 in. 30 each	8 X 5/8 in. 20 each	8 X 1 in. 20 each
6 X 5/8 in. 20 each	1/4 X 3/4 in. 20 each	8 X 5/8 in. 20 each	8 X 1 in. 20 each	10 X 3/4 in. 30 each	10 X 1 in. 20 each
#6 Washer 25 each	1/4 in. Washer 25 each	#8 Washer 25 each	#8 Washer 25 each	#10 Washer 25 each	#10 Washer 25 each
#6 Hex Nut 25 each	1/4 in. Hex Nut 25 each	#8 Hex Nut 25 each	#8 Hex Nut 25 each	#10 Hex Nut 25 each	#10 Hex Nut 25 each
3 X 16 mm 20 each	4 X 16 mm 20 each	4 X 25 mm 20 each	5 X 20 mm 20 each	5 X 25 mm 20 each	6 X 20 mm 20 each
M3 Washer 25 each	M4 Washer 25 each	M4 Washer 25 each	M5 Washer 25 each	M5 Washer 25 each	M6 Washer 25 each
M3 Hex Nut 25 each	M4 Hex Nut 25 each	M4 Hex Nut 25 each	M5 Hex Nut 25 each	M5 Hex Nut 25 each	M6 Hex Nut 25 each

350-PC LOCK & FLAT WASHERS



Item #	IP	MP	PKG
W5216	6	24	CAS



#6 Flat Washer 50 pcs	#8 Flat Washer 40 pcs	#10 Flat Washer 30 pcs	1/4" Flat Washer 25 pcs	5/16" Flat Washer 15 pcs	3/8" Flat Washer 15 pcs
#6 Lock Washer 50 pcs	#8 Lock Washer 40 pcs	#10 Lock Washer 30 pcs	1/4" Lock Washer 25 pcs	5/16" Lock Washer 15 pcs	3/8" Lock Washer 15 pcs

350-PC LOCK & FLAT WASHERS



Item #	IP	MP	PKG
W5245	6	24	CAS

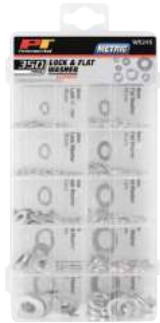

3mm Flat Washer 50 pcs	4mm Flat Washer 40 pcs	5mm Flat Washer 30 pcs	6mm Flat Washer 25 pcs	8mm Flat Washer 15 pcs	10mm Flat Washer 15 pcs
3mm Lock Washer 50 pcs	4mm Lock Washer 40 pcs	5mm Lock Washer 30 pcs	6mm Lock Washer 25 pcs	8mm Lock Washer 15 pcs	10mm Lock Washer 15 pcs

110-PC COPPER WASHERS



Item #	IP	MP	PKG
W5217	6	24	CAS

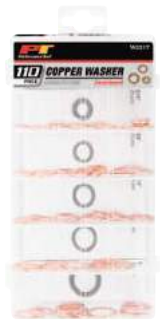

1/4" 30 pcs	5/16" 25 pcs	3/8" 20 pcs	7/16" 15 pcs	1/2" 10 pcs	5/8" 10 pcs
-------------	--------------	-------------	--------------	-------------	-------------

720-PC ASSORTED WASHERS



Item #	IP	MP	PKG
W5218	6	24	CAS



#6 Lock Washer 50 pcs	#8 Lock Washer 50 pcs	#10 Lock Washer 50 pcs	1/4" Lock Washer 40 pcs	5/16" Lock Washer 30 pcs	3/8" Lock Washer 20 pcs
#6 Washer 50 pcs	#8 Washer 50 pcs	#10 Washer 50 pcs	1/4" Washer 40 pcs	5/16" Washer 30 pcs	3/8" Washer 20 pcs
#6 Washer 50 pcs	#8 Washer 50 pcs	#10 Washer 50 pcs	1/4" Washer 40 pcs	5/16" Washer 30 pcs	3/8" Washer 20 pcs

200-PC ASSORTED SPRINGS



Item #	IP	MP	PKG
W5200	6	24	CAS



C : 10 pcs	C : 10 pcs	: 10 pcs	: 10 pcs	C : 10 pcs	C : 10 pcs
10 pcs	C : 10 pcs	: 10 pcs	: 10 pcs	10 pcs	C : 10 pcs
C : 10 pcs	: 10 pcs	: 10 pcs	: 10 pcs	10 pcs	C : 10 pcs
10 pcs	: 10 pcs	: 10 pcs	: 10 pcs	10 pcs	C : 10 pcs

HARDWARE KITS

SHOP/GARAGE

300-PC E-CLIPS



Item #	IP	MP	PKG
W5208	6	24	CAS



1/16 in. 30 pcs	1/8 in. 30 pcs	3/16 in. 40 pcs	5/8 in. 20 pcs	3/4 in. 20 pcs	7/8 in. 20 pcs
1/4 in. 50 pcs	3/8 in. 50 pcs	1/2 in. 40 pcs			

300-PC EXTERNAL SNAP RINGS



Item #	IP	MP	PKG
W5212	6	24	CAS



1/8 in. 20 pcs	5/32 in. 10 pcs	3/16 in. 15 pcs	1/4 in. 25 pcs	5/16 in. 15 pcs	3/8 in. 20 pcs
13/16 in. 15 pcs	7/8 in. 20 pcs	1 in. 15 pcs	1-1/16 in. 15 pcs	1-1/8 in. 10 pcs	1-1/4 in. 5 pcs
7/16 in. 15 pcs	15/32 in. 15 pcs	1/2 in. 25 pcs	9/16 in. 15 pcs	5/8 in. 20 pcs	3/4 in. 25 pcs

1,000-PC COTTER PINS



Item #	IP	MP	PKG
W5204	6	24	CAS



1/16 x 1 in. 380 pcs	3/32 x 1 in. 240 pcs	3/32 x 1-1/2 in. 140 pcs	1/8 x 1-1/4 in. 115 pcs	1/8 x 2 in. 75 pcs	5/32 x 2-1/2 in. 50 pcs

560-PC COTTER PINS



Item #	IP	MP	PKG
W5205	6	24	CAS



1/16 x 1 in. 150 pcs	3/32 x 1 in. 150 pcs	3/32 x 1-1/2 in. 100 pcs	1/8 x 1-1/4 in. 75 pcs	1/8 x 2 in. 55 pcs	5/32 x 2-1/2 in. 30 pcs

150-PC LARGE COTTER PINS



Item #	IP	MP	PKG
W5206	6	24	CAS



1/8" x 2" 50 pcs	5/32" x 2-1/2" 30 pcs	3/16" x 3" 20 pcs	1/4" x 2" 25 pcs	1/4" x 3" 15 pcs	5/16" x 2-1/2" 10 pcs

74-PC UNIVERSAL CLEVIS PINS



Item #	IP	MP	PKG
W5359	6	24	CAS

7/64 x 1-5/8 in. 20 pcs	7/64 x 2-5/16 in. 8 pcs	5/16 x 2 in. 18 pcs	7/16 x 2-1/2 in. 5 pcs	3/8 x 2 in. 5 pcs	1/2 x 2 in. 3 pcs
5/64 x 1-5/16 in. 8 pcs	9/64 x 1-3/4 in. 7 pcs				

150-PC HAIR PINS



Item #	IP	MP	PKG
W5210	6	24	CAS

3/32 x 1-3/16 in. 42 pcs	5/64 x 1-5/16 in. 30 pcs	5/64 x 1-9/16 in. 25 pcs	7/64 x 1-5/8 in. 25 pcs	9/64 x 1-3/4 in. 20 pcs	5/32 x 2-15/16 in. 8 pcs
-----------------------------	-----------------------------	-----------------------------	----------------------------	----------------------------	-----------------------------

120-PC ROLL PINS



Item #	IP	MP	PKG
W5340	6	24	CAS

5/32" x 5/8" 4 pcs/pzas	5/16" x 3/4" 4 pcs/pzas	1/16" x 3/16" 4 pcs/pzas	1/8" x 5/8" 5 pcs/pzas	7/32" x 1-1/4" 4 pcs/pzas
5/32" x 1" 4 pcs/pzas	5/16" x 1-1/2" 4 pcs/pzas	1/16" x 3/4" 4 pcs/pzas	1/8" x 1-3/4" 5 pcs/pzas	7/32" x 1-3/4" 4 pcs/pzas
5/32" x 1-1/2" 4 pcs/pzas	5/16" x 2" 4 pcs/pzas	1/16" x 5/16" 4 pcs/pzas	1/8" x 1-1/4" 5 pcs/pzas	7/32" x 5/8" 4 pcs/pzas
1/4" x 5/8" 4 pcs/pzas	5/64" x 1/4" 4 pcs/pzas	3/32" x 5/8" 4 pcs/pzas	3/8" x 3/4" 2 pcs/pzas	3/16" x 5/8" 5 pcs/pzas
1/4" x 1-1/4" 4 pcs/pzas	5/64" x 1/2" 4 pcs/pzas	3/32" x 1-3/4" 4 pcs/pzas	3/8" x 1-1/2" 2 pcs/pzas	3/16" x 1" 5 pcs/pzas
1/4" x 1-1/4" 4 pcs/pzas	5/64" x 1" 4 pcs/pzas	3/32" x 1-1/4" 4 pcs/pzas	3/8" x 2" 2 pcs/pzas	3/16" x 1-1/4" 5 pcs/pzas

80-PC METRIC WOODRUFF KEYS



Item #	IP	MP	PKG
W5341	6	24	CAS

4 x 7.5 x 19 mm 10 pcs	5 x 7.5 x 19 mm 10 pcs	3 x 6.5 x 16 mm 10 pcs	3 x 5 x 13 mm 10 pcs	5 x 9 x 22 mm 10 pcs	6 x 9 x 22 mm 10 pcs
		4 x 5 x 13 mm 10 pcs	4 x 6.5 x 16 mm 10 pcs		

80-PC SAE WOODRUFF KEYS



Item #	IP	MP	PKG
W5343	6	24	CAS

1/8 x 3/16 x 33/64 in. 10 pcs	1/8 x 1/4 x 41/64 in. 10 pcs	5/32 x 3/16 x 33/64 in. 10 pcs	5/32 x 1/4 x 41/64 in. 10 pcs	1/4 x 23/64 x 7/8 in. 10 pcs	3/16 x 19/64 x 49/64 in. 10 pcs
		5/32 x 19/64 x 49/64 in. 10 pcs	3/16 x 23/64 x 7/8 in. 10 pcs		

500-PC ALUMINUM RIVETS



Item #	IP	MP	PKG
W5228	6	24	CAS

1/8 in. x 1/4 in.
Rivets
120 pcs



1/8 in. x 5/16 in.
Rivets
120 pcs



1/8 in. x 3/8 in.
Rivets
120 pcs



3/16 in. x 5/16 in.
Rivets
120 pcs



3/16 in. x 3/8 in.
Rivets
120 pcs



80-PC POLY RIVETS

- Molded industrial strength Polyoxymethylene (POM) rivets
- Fasten plastic to plastic, metal, fiberglass and other materials.
- Assorted beveled round head blind rivets.



Item #	IP	MP	PKG
W5250	6	24	CAS

5mm x 15.8mm
20 pcs



5mm x 17.2mm
20 pcs



6.6mm x 17.2mm
20 pcs



6.3mm x 25.2mm
20 pcs



120-PC SAE THREADED RIVETS

- Sets threaded rivets into thin materials, including sheet metal, plastic and fiberglass.
- Easily install threaded nuts when only one side of the material is accessible.



Item #	IP	MP	PKG
W5251	6	24	CAS

6 - 32
30 pcs



8 - 32
30 pcs



10 - 24
30 pcs



1/4 - 20
30 pcs

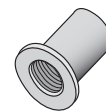

120-PC METRIC THREADED RIVETS

- Sets threaded rivets into thin materials, including sheet metal, plastic and fiberglass.
- Easily install threaded nuts when only one side of the material is accessible.



Item #	IP	MP	PKG
W5252	6	24	CAS

3mm
30 pcs



4mm
30 pcs



5mm
30 pcs



6mm
30 pcs

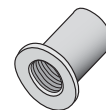

1000-PC STEEL HOG RINGS

- Many applications like: upholstery, fencing, craft, rope, bungee cords, bag closures, furniture and much more.

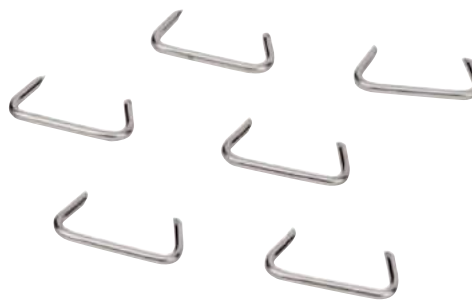

Item #	IP	MP	PKG
W5230	6	24	CAS

125-PC RUBBER GROMMETS



Item #	IP	MP	PKG
W5214	6	24	CAS

1/8 x 9/32 in. 15 pcs	3/16 x 5/16 in. 10 pcs	1/4 x 1/2 in. 7 pcs	5/16 x 17/32 in. 3 pcs	3/8 x 1/2 in. 6 pcs	3/8 x 9/16 in. 5 pcs
3/8 x 3/4 in. 3 pcs	7/16 x 3/4 in. 3 pcs	1/2 x 21/32 in. 4 pcs	5/8 x 1 in. 3 pcs	3/4 x 5/16 in. 2 pcs	5/16 in. 20 pcs
3/8 in. 20 pcs	1/2 in. 10 pcs	5/8 in. 5 pcs	3/4 in. 4 pcs	7/8 in. 3 pcs	1 in. 2 pcs

270-PC HNBR O-RINGS

- Use in applications requiring higher resistance to chemicals and higher Temperatures than NBR.
- Suitable for high dynamic loads and is abrasion resistant.



Hydrogenated Nitrile Butadiene Rubber.

Item #	IP	MP	PKG
W5201	6	24	CAS

7/32" x 1/16" (5.55 x 1.58) 20 pcs	1/4" x 1/16" (6.35 x 1.58) 20 pcs	6.8 x 1.9 20 pcs	5/16" x 1/16" (7.93 x 1.58) 20 pcs	7.8 x 1.9 20 pcs	8 x 2 20 pcs
8.8 x 1.9 20 pcs	7/16" x 1/16" (11.11 x 1.58) 15 pcs	7/16" x 3/32" (11.11 x 2.38) 15 pcs	11 x 2 15 pcs	12 x 2 15 pcs	13.9 x 1.8 10 pcs
9/16" x 3/32" (14.28 x 2.38) 10 pcs	14 x 2 10 pcs	15 x 2 10 pcs	17 x 2 10 pcs	11/16" x 1/16" (17.46 x 1.58) 10 pcs	11/16" x 1/8" (17.46 x 3.17) 10 pcs

180-PC VITON® O-RINGS

- Constructed of special Viton polymer which offers excellent high heat resistance up to 400° F.
- Compatibility with biodiesel, and ethanol; high resistance to permeation and chemical attack by alcohol, pure ethanol and blends of ethanol with hydrocarbon fuel.



Item #	IP	MP	PKG
W5239	6	24	CAS

13.95 x 2.62mm 5 pcs	15.54 x 2.62mm 5 pcs	17.12 x 2.62mm 5 pcs	18.72 x 2.62mm 5 pcs	18.64 x 3.53mm 5 pcs	20.22 x 3.53mm 5 pcs
7.65 x 1.78mm 15 pcs	9.25 x 1.78mm 10 pcs	15.6 x 1.78mm 10 pcs	9.19 x 2.62mm 10 pcs	10.77 x 2.62mm 10 pcs	12.37 x 2.62mm 10 pcs
2.57 x 1.78mm 10 pcs	2.90 x 1.78mm 15 pcs	3.69 x 1.78mm 15 pcs	4.47 x 1.78mm 15 pcs	5.25 x 1.78mm 15 pcs	6.07 x 1.78mm 15 pcs

407-PC SAE NBR O-RINGS

- Suitable for many hydrocarbons, fats, oils, gas, etc.
- Temp range of -50 °F to 220 °F.
- High tensile strength.

Not suitable for use with brake fluids.



Nitrile Butadiene Rubber.

Item #	IP	MP	PKG
W5202	6	24	CAS

Part Number	Nominal Size			Quantity In Kit	Part Number	Nominal Size			Quantity In Kit
	I/D	O/D	Section			I/D	O/D	Section	
R-01	1/8"	1/4"	1/16"	20	R-17	13/16"	1-1/16"	1/8"	10
R-02	3/16"	5/16"	1/16"	20	R-18	7/8"	1-1/8"	1/8"	10
R-03	1/4"	3/8"	1/16"	20	R-19	15/16"	1-3/16"	1/8"	10
R-04	5/16"	7/16"	1/16"	20	R-20	1"	1-1/4"	1/8"	10
R-05	3/8"	1/2"	1/16"	20	R-21	1-1/16"	1-5/16"	1/8"	10
R-06	1/2"	5/8"	1/16"	20	R-22	1-1/8"	1-3/8"	1/8"	10
R-07	3/8"	9/16"	3/32"	13	R-23	1-3/16"	1-7/16"	1/8"	10
R-08	7/16"	5/8"	3/32"	13	R-24	1-1/4"	1-1/2"	1/8"	10
R-09	1/2"	11/16"	3/32"	13	R-25	1-5/16"	1-9/16"	1/8"	10
R-10	9/16"	3/4"	3/32"	13	R-26	1-3/8"	1-5/8"	1/8"	10
R-11	5/8"	13/16"	3/32"	13	R-27	1-7/16"	1-11/16"	1/8"	10
R-12	11/16"	7/8"	3/32"	13	R-28	1-1/2"	1-3/4"	1/8"	10
R-13	3/4"	15/16"	3/32"	13	R-29	1-5/8"	1-7/8"	1/8"	10
R-14	13/16"	1"	3/32"	13	R-30	1-3/4"	2"	1/8"	10
R-15	7/8"	1-1/16"	3/32"	13	R-31	1-7/8"	2-1/8"	1/8"	10
R-16	3/4"	1"	1/8"	10	R-32	2"	2-1/4"	1/8"	10

419-PC METRIC NBR O-RINGS

- Suitable for many hydrocarbons, fats, oils, gas, etc.
- Temp range of -50 °F to 220 °F.
- High tensile strength.

Not suitable for use with brake fluids.



Nitrile Butadiene Rubber.

Item #	IP	MP	PKG
W5203	6	24	CAS

Part Number	Sizes		Quantity In Kit	Part Number	Sizes		Quantity In Kit
	I/D	Section			I/D	Section	
R-01	3	1.5mm	20	R-17	20	3.5mm	10
R-02	4	2.0mm	20	R-18	22	3.5mm	10
R-03	5	2.0mm	18	R-19	23.5	3.5mm	10
R-04	7	1.5mm	23	R-20	25	3.5mm	10
R-05	10	1.5mm	23	R-21	26.5	3.5mm	10
R-06	13	1.5mm	23	R-22	28	3.5mm	10
R-07	10	2.5mm	14	R-23	30	3.5mm	10
R-08	11	2.5mm	13	R-24	31	3.5mm	10
R-09	13	2.5mm	14	R-25	33	3.5mm	10
R-10	14	2.5mm	13	R-26	34.5	3.5mm	10
R-11	16	2.5mm	14	R-27	36	3.5mm	10
R-12	18	2.5mm	14	R-28	38	3.5mm	10
R-13	19	2.5mm	13	R-29	41	3.5mm	10
R-14	21	2.5mm	14	R-30	44	3.5mm	10
R-15	22	2.5mm	13	R-31	47	3.5mm	10
R-16	18	3.5mm	10	R-32	50	3.5mm	10

HARDWARE KITS

SHOP/GARAGE

350-PC GM TRIM CLIPS

- All the essential retainers, fasteners, and clip needed for the auto body panels on GM and Chevrolet vehicles.



Item #	IP	MP	PKG
W5240	1	20	CAS

415-PC FORD TRIM CLIPS

- Auto body retainer, fastener, and clip for Ford vehicles.
- Made of OEM quality nylon for OEM installation, fit, and finish.



Item #	IP	MP	PKG
W5241	1	20	CAS

215-PC CHRYSLER TRIM CLIPS

- Auto body retainer, fastener, and clip for Chrysler vehicles.
- Made of OEM quality nylon for OEM installation, fit, and finish.



Item #	IP	MP	PKG
W5242	1	20	CAS

340-PC TOYOTA TRIM CLIPS

- Auto body retainer, fastener, and clip for Toyota and Lexus vehicles.
- Made of OEM quality nylon for OEM installation, fit, and finish.



Item #	IP	MP	PKG
W5243	1	20	CAS

418-PC HONDA TRIM CLIPS

- Auto body retainer, fastener, and clip for Honda vehicles.
- Made of OEM quality nylon for OEM installation, fit, and finish.



Item #	IP	MP	PKG
W5244	1	20	CAS

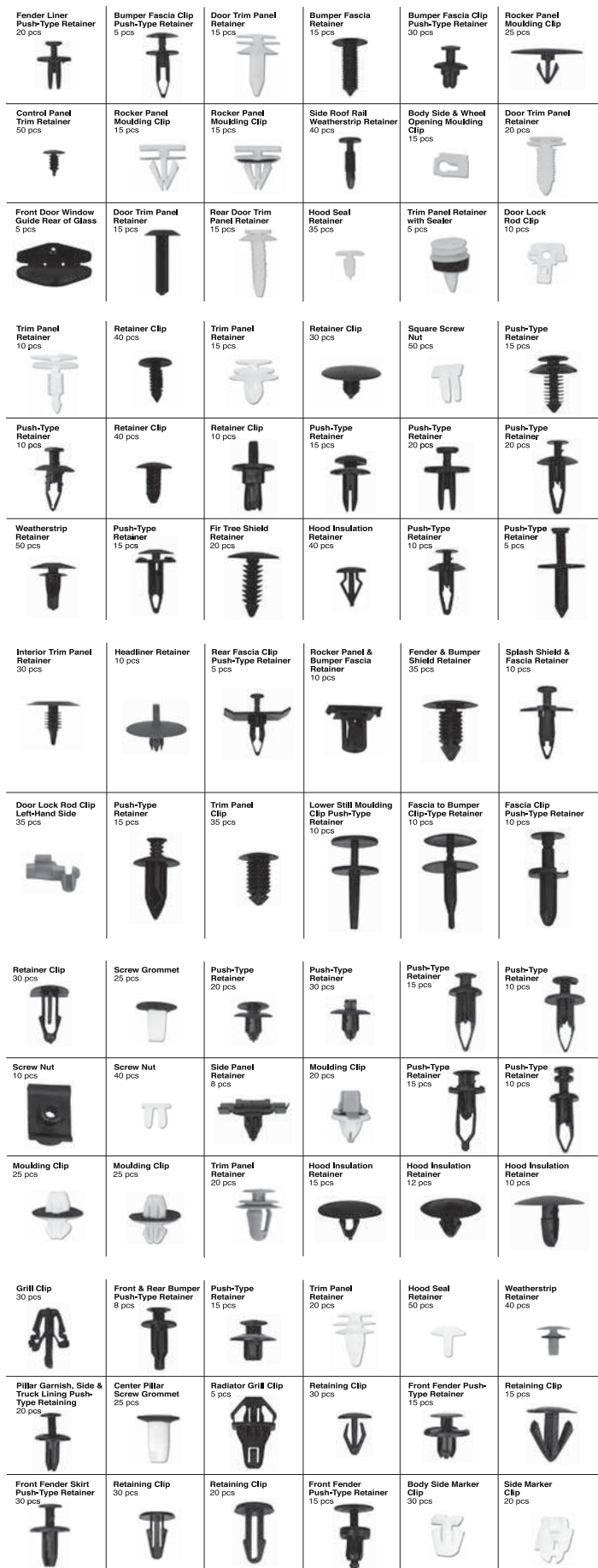

26-PC HOSE CLAMPS



Item #	IP	MP	PKG
W5348	6	24	CAS



1-1/2 in. 4 pcs	1-1/4 in. 2 pcs	1-1/16 in. 2 pcs	1 in. 4 pcs	7/8 in. 6 pcs	5/8 in. 8 pcs
--------------------	--------------------	---------------------	----------------	------------------	------------------

26-PC KEY TYPE HOSE CLAMPS

- Key type hose clamps, no tools needed.
- Large easy to turn keys tighten securely.

Item #	IP	MP	PKG
W5231	6	24	CAS



1/2 in. 10 pcs	5/8 in. 6 pcs	3/4 in. 6 pcs	7/8 in. 2 pcs	1 in. 2 pcs
-------------------	------------------	------------------	------------------	----------------

60-PC OIL DRAIN PLUG GASKETS

- General purpose oil drain plug gasket kit.
- Includes nylon and fiber gaskets.

Item #	IP	MP	PKG
W5234	5	25	CAS



Fiber 1/2 in. 10 pcs	Fiber 1/2 in. 10 pcs	Fiber 18 mm 5 pcs	Fiber 20 mm 5 pcs	Nylon 1/2 in. 10 pcs	Nylon 12 mm 10 pcs
Nylon 14 mm 5 pcs	Fiber 16 mm 5 pcs				

27-PC OVERSIZED OIL DRAIN PLUGS & GASKETS

Item #	IP	MP	PKG
W5235	5	25	CAS



Drain Plug DY-DP-1B 1/2 - 20 S.O. 2 pcs	Drain Plug DY-DP-2B 1/2 - 20 D.O. 2 pcs	Drain Plug DY-DP-3B 1/2 - 20 T.O. 2 pcs	Drain Plug DY-DP-4B 1/2 - 20 S.O. piggyback 2 pcs	Drain Plug DY-DP-5B 1/2 - 20 D.O. piggyback 2 pcs	Drain Plug DY-DP-28B 14 - 1.5 S.O. 2 pcs
Gasket DY-DG-45B M14 Fiber 5 pcs	Gasket DY-DG-52B 1/2 S.O. Fiber 5 pcs	Gasket DY-DG-53B 1/2 in. D.O Fiber 5 pcs			

40-PC OIL DRAIN PLUGS

- Contains the most popular drain plugs providing excellent coverage for most domestic and imported cars and light trucks.

Item #	IP	MP	PKG
W5236	2	10	CAS



Pilot Point w/Gasket 12 mm - 1.75 3 pcs	Pilot Point w/Gasket 14 mm - 1.50 3 pcs	Pilot Point w/Gasket 14 mm - 1.50 3 pcs	Pilot Point w/Gasket 12 mm - 1.75 3 pcs	Pilot Point w/Gasket 14 mm - 1.50 5 pcs	Standard Zinc 12 mm - 1.25 3 pcs
Pilot Point 12 mm - 1.75 3 pcs	Standard Zinc 14 mm - 1.50 3 pcs	Pilot Point w/Gasket 1/2 - 20 3 pcs	Standard Zinc 14 mm - 1.50 3 pcs	Pilot Point 14 mm - 1.50 5 pcs	Pilot Point w/Gasket 12 mm - 1.75 3 pcs

HARDWARE KITS

SHOP/GARAGE

80-PC VACUUM CAPS

- Nitrile Butadiene Rubber (NBR)
- Use them on carburetors, manifolds, etc., where various vacuum tube caps are needed for different sized vacuum ports.

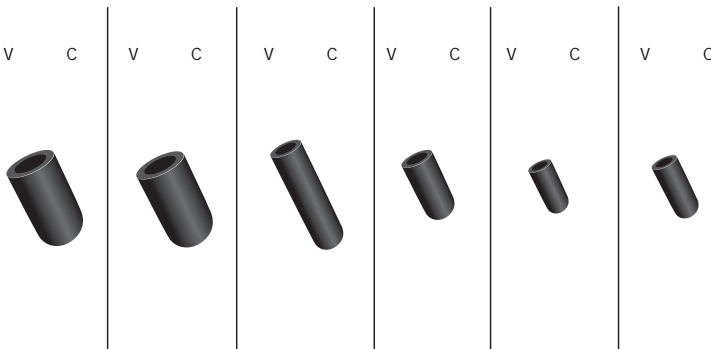

Item #	IP	MP	PKG
W5232	6	24	CAS

GREASE FITTINGS

- Corrosion resistant.
- Leak-proof fittings.

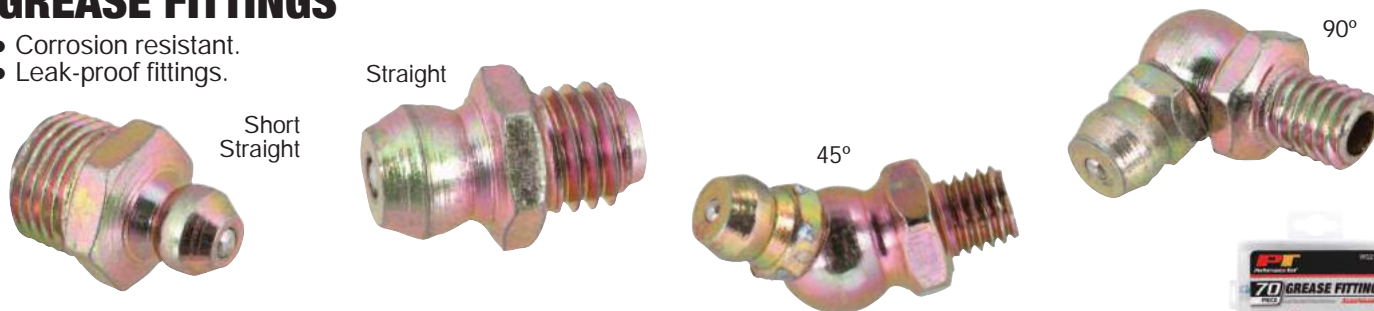

Item #	IP	MP	PKG	NPT (m)	Straight	Short	30°	45°	60°	90°	
W54251	100-PC	6	24	CAS	1/8"	30	-	2	5	5	3
					1/4-28"	40	-	-	10	-	5
W54253	100-PC	6	24	CAS	1/4-28"	-	100	-	-	-	-
W54254	100-PC	6	24	CAS	1/4-28"	-	-	-	100	-	-
W54255	50-PC	6	24	CAS	1/4-28"	-	-	-	-	-	50
W54256	100-PC	6	24	CAS	1/8"	-	100	-	-	-	-
W5215	70-PC	6	24	CAS	1/8, 1/4-28", 6, 8 & 10mm	See hardware kits for more					



FUSES

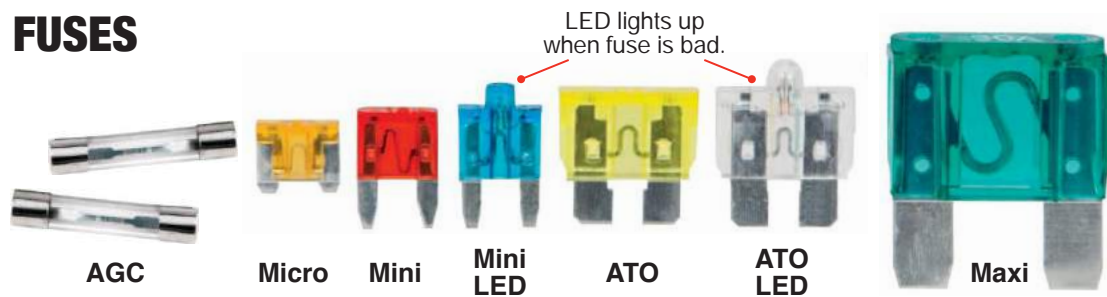

Item #	IP	MP	PKG	Type	5A	10A	15A	20A	25A	30A
W5368	120-PC	6	24	CAS	ATO	20	20	20	20	20
W5373	60-PC	6	36	CAS	ATO	10	10	10	10	10
W5378	30-PC	6	36	CAS	ATO W/LED	5	5	5	5	5
W5369	120-PC	6	24	CAS	Mini	20	20	20	20	20
W5371	30-PC	6	36	CAS	Mini	5	5	5	5	5
W5377	30-PC	6	36	CAS	Mini W/LED	5	5	5	5	5
W5370	33-PC	6	36	CAS	ATO	4	5	-	3	-
					Mini	4	5	-	3	-
					Maxi	1 ea: 40A, 50A, 60A				
W5376	15-PC	6	36	CAS	Micro	2	3	3	3	2
W5375	60-PC	6	36	CAS	AGC	10	10	10	10	10
W5374	16-PC	6	36	CAS	Maxi	2 ea: 20A, 30A, 40A, 50A, 60A, 70A, 80A, 100A				



160-PC WIRE TERMINALS



12-10ga Ring Terminal 55-5 4 pcs	12-10ga Male Connector 5 pcs	22-18ga Ring Terminal 1.25-4L 8 pcs	22-18ga Butt Connector 12 pcs	16-14ga Ring Terminal 2-5L 10 pcs	16-14ga Female Disconnect 10 pcs
12-10ga Ring Terminal 55-8 4 pcs	12-10ga Female Disconnect 5 pcs	22-18ga Quick Splice 4 pcs	18-14ga Quick Splice 4 pcs	16-14ga Ring Terminal 2-4L 10 pcs	16-14ga Spade Terminal 2-4M 10 pcs
12-10ga Ring Terminal 55-10 4 pcs	12-10ga Butt Connector 12 pcs	18-14ga Butt Connector 18 pcs	16-14ga Ring Terminal 2-6 10 pcs	16-14ga Bullet Male Connect & Female Disconnect 2 x 10 pcs	16-14ga Male Connector 10 pcs

Item #	IP	MP	PKG
W5213	6	24	CAS

24-PC ALLIGATOR CLIPS

- Make your own low-voltage jumper leads.
- Repair broken leads on test equipment and chargers.



Mini Alligator Clips 8 pcs	2 in. Alligator Clips 4 pcs	30 AMP Charging Clips 2 pcs	25 AMP Charging Clips 2 pcs	1-1/2 in. Alligator Clips 6 pcs	10 AMP Charging Clips 2 pcs
-------------------------------	--------------------------------	--------------------------------	--------------------------------	------------------------------------	--------------------------------

Item #	IP	MP	PKG
W5209	6	24	CAS

120-PC HEAT SHRINK TUBES

- Set color-codes; positive, negative and ground for easy identification.
- 100% polyolefin construction.
- Operating temp -60 °F to 275 °F
- UL listed.



5/32" 15 pcs	3/16" 15 pcs	5/32" 15 pcs	3/16" 15 pcs	9/32" 15 pcs	5/16" 15 pcs
9/32" 15 pcs	5/16" 15 pcs				

Item #	IP	MP	PKG
W5233	6	24	CAS

171-PC HEAT SHRINK TUBES

- Shrink ratio: 2:1.
- 100% polyolefin construction
- Operating temp -67 °F to 257 °F
- UL listed.



5/64 in. X 1-3/16 in. (2.0 X 30 mm) GREEN	5/32 in. X 2-3/8 in. (4.0 X 60 mm) BLUE	3/16 in. X 2-3/8 in. (4.5 X 60 mm) BLACK	13/64 in. X 2-3/8 in. (5.0 X 60 mm) RED	15/64 in. X 2-3/8 in. (6.0 X 60 mm) WHITE	5/64 in. X 1-3/16 in. (2.0 X 30 mm) RED
5/64 in. X 1-3/16 in. (2.0 X 30 mm) WHITE					5/64 in. X 1-3/16 in. (2.0 X 30 mm) BLACK
23/64 in. X 3-9/16 in. (9.0 X 90 mm) BLUE	5/16 in. X 3-9/16 in. (8.0 X 90 mm) WHITE	25/64 in. X 3-9/16 in. (10 X 11) BLACK	23/32 in. X 3-9/16 in. (18 X 90 mm) YELLOW	15/32 in. X 3-9/16 in. (12.7 X 90 mm) GREEN	

Item #	IP	MP	PKG
W540	10	40	CAS

106-PC WEATHERPROOF HEAT SHRINK TUBES

- Shrink Ratio: 3:1.
- Operating temp -49 °F to 257 °F
- UL listed.



5/16 in. X 2-61/64 in. (7.9 X 75 mm) BLACK	3/8 in. X 2-61/64 in. (9.5 X 75 mm) BLACK	1/2 in. X 2-61/64 in. (12.7 X 75 mm) BLACK			
1/8 in. X 1-25/32 in. (3.2 X 45 mm) RED/BLACK	3/16 in. X 1-25/32 in. (4.8 X 45 mm) RED/BLACK	1/4 in. X 1-25/32 in. (6.4 X 45 mm) RED/BLACK	5/16 in. X 1-25/32 in. (7.9 X 45 mm) RED	3/8 in. X 1-25/32 in. (9.5 X 45 mm) RED	1/2 in. X 1-25/32 in. (12.7 X 45 mm) RED

Item #	IP	MP	PKG
W541	10	40	CAS DUAL WALL

HARDWARE KITS

SHOP/GARAGE

1,000-PC FASTENER TOTE

- A compact collection of useful hardware and storage.
- Also includes two empty trays for your own organization.
- Great for hobby and craft materials, beads, buttons, fishing tackle, sewing notions and so much more.
- Carry handle and snap tight latch secures storage and portable use.

Wood Screws	112
Machine Screws	48
Washers	80
Push pins	40
Plastic Anchors	31
Sheet Metal Screws	125
Hex Nuts	61
Picture Hangers	10
Nails	487
Cup Hooks	6



Item #	IP	MP	PKG		W	D	H
W5199	1	6	SHK	Overall	7-1/2"	4-1/4"	8"
				Trays	7"	3-3/4"	1-1/8"

285-PC ELECTRICAL REPAIR KIT

- Great for use on automotive, marine, industrial and agricultural applications
- 2 part plastic case folds open 180° for easy access to both sides of kit



Wire Crimping Tool	1
6-12 Volt Tester	1
Phillips Screwdriver	1
Electrical Tape 3/4" x 30'	1
32" Test Leads	2
ATO Fuses	5
AGC Glass Fuses	5
Fuse Puller	1
48" Primary Wire Roll	1
1/8" Wire Clamps	10
1/4" Wire Clamps	3
Heat Shrink Tubes	10
4" Cable Ties	30
6" Cable Ties	10
7-1/2" Cable Ties	10
Rubber Grommets	6
Assorted Wire Nuts	26
Assorted Terminals	160
Plastic Organizer Case	

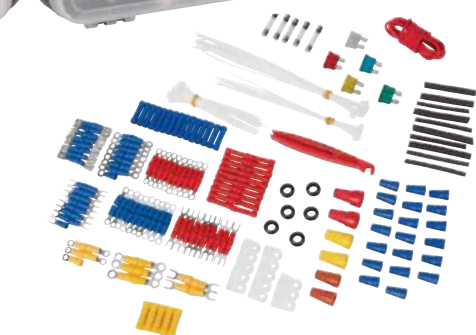

Item #	IP	MP	PKG
W5207	1	12	CBX

22-18ga Butt Connector 15 pcs	22-18ga Spade Terminal 1.25-4L 20 pcs	22-18ga Ring Terminal 1.25-4L 20 pcs	5/32" Heat Shrink 5 pcs	3/16" Heat Shrink 5 pcs
18-14ga Butt Connector 10 pcs	16-14ga Spade Terminal 2-4M 15 pcs	16-14ga Ring Terminal 2-4L 20 pcs	16-14ga Ring Terminal 2-5L 20 pcs	16-14ga Female Disconnect 10 pcs
12-10ga Butt Connector 5 pcs	12-10ga Spade Terminal 5-8 5 pcs	12-10ga Ring Terminal 55-5 5 pcs	12-10ga Ring Terminal 55-8 6 pcs	16-14ga Male Connector 10 pcs

1,000-PC O-RING, SPRING, COTTER PIN ASSORTMENT

Cotter Pins		SAE O-rings		Metric O-rings	
1/16 x 1"	60	3/32 x 15/64"	10	3 x 1.5mm	10
3/32 x 1"	40	7/32 x 11/32"	15	4.4 x 2mm	15
3/32 x 1-1/2"	35	5/8 x 3/4"	10	5 x 2mm	20
1/8 x 1-1/4"	35	9/16 x 3/4"	10	7 x 1.5mm	20
1/8 x 2"	16	3/4 x 1"	10	10 x 1.5mm	20
5/32 x 2-1/2"	14	1/8 x 1/4"	20	13 x 1.5mm	15
3/16 x 3"	5	1/4 x 3/8"	15	10 x 2.5mm	15
1/4 x 2"	5	3/8 x 9/16"	10	11 x 2.5mm	15
1/4 x 3"	5	5/8 x 3/16"	10	13 x 2.5mm	10
5/16 x 2-1/2"	5	13/16 x 1-1/16"	10	14 x 2.5mm	10
		5/32 x 9/32"	20	16 x 2.5mm	60
Compress Springs		5/16 x 7/16"	15	18 x 2.5mm	40
7/32 x 1-1/2"	20	7/16 x 5/8"	10	19 x 2.5mm	35
3/8 x 3/4"	20	11/16 x 7/8"	10	21 x 2.5mm	35
23/64 x 1-3/8"	20	7/8 x 1-1/8"	10	22 x 2.5mm	16
9/32 x 1/2"	20	3/16 x 5/16"	20	18 x 3.5mm	14
		3/8 x 1/2"	10	20 x 3.5mm	5
Extension Springs		1/2 x 11/16"	10	22 x 3.5mm	5
5/16 x 1-1/8"	20	3/4 x 15/16"	10	23.5 x 3.5mm	5
3/16 x 1-3/4"	20	15/16 x 1-3/16"	10	25 x 3.5mm	5



Item #	IP	MP	PKG
W5353	1	4	CBX

TOOL BOX TOTE

- Top storage bin with durable, secure latch.
- 4 removable bins w/13 compartments each.
- Durable carry handle.
- Good for storing tools, nuts, bolts, screws & more.



Item #	IP	MP	PKG	W	D	H	
W54042	1	12	SHK	Overall	11"	7"	10"
				Trays	9-1/4"	5"	1-1/4"

PLASTIC PARTS ORGANIZER

- Durable injection molded plastic construction.
- Full height internal dividers to keep parts separated.
- Store flat or upright with built in feet.



W5189



W5188
DOUBLE SIDED.
Color coded latches identify sides.

Item #	IP	MP	PKG	W	D	H
W5188	1	12	SHK	13"	10-3/4"	3-1/2"
W5189	1	36	SHK	9-1/2"	7"	1-7/8"

MULTI-POWER SETS

- Sets contain hydraulic hand pump, 6' jack hose, 4 /10 ton ram, spreader ram, extension tubes, male connector, flat base, 90 degrees V base, wedge head, spreader plunger toe, spreader ram toe, flex head and serrated saddle.



Item #	IP	MP	PKG	Capacity (lbs.) & w/Extensions		Ram Travel	Extension Pole (L)	Spreader Wedge	Extension Lengths	
W1650	4 Ton	1	1	CBX	8,000	4,000	5"	5' 10-1/2"	3-3/4" max	3-3/4, 5, 8-1/2, 16-1/2"
W1651	10 Ton	1	1	CBX	20,000	10,000	6"	5'	3-3/4" max	4-1/4, 10, 14-1/2, 20-1/2"

AUTO BODY REPAIR KITS

- For pounding auto sheet metal before finishing.
- Each set includes heavy shrinking hammer, pick and finish hammer, straight pein finishing hammer, heal dolly, utility dolly, double end dolly, and curved dolly.

Item #	IP	MP	PKG	
M7007	7-PC Fiberglass Set	1	4	CBX
W1007DB	7-PC Hickory Set	1	4	CBX
Hickory Handle Hammers				
W1010	Straight Pein	6	36	CLM
W1012	Shrinking	6	36	CLM
W1013	Pick	6	36	CLM
Steel Dollies				
W1014	Utility Dolly	6	24	DBL
W1016	Heel Dolly	6	18	DBL



Use on flat and curved surfaces.

M7007

W1007DB

9-PC DENT & SEAL PULLER SET

- Black oxide finish resists corrosion.
- Multiple attachments for various applications.
- All types of body repairs are made possible with assorted pulling attachments included.



Item #	IP	MP	PKG	Contents
W2029DB	1	4	CBX	Hammer, two panel pullers, attachment accessory holder, 2 puller hooks, 2 puller screws and screw holder.



SUCTION CUP DENT PULLERS

- Pulls out many shallow dents without drilling holes.
- Can also be used to lift plate glass.

W1028
Fingertip pressure release.



DENT PULLERS

- One piece shaft/handle for strength.
- Contains 3 screw tips.

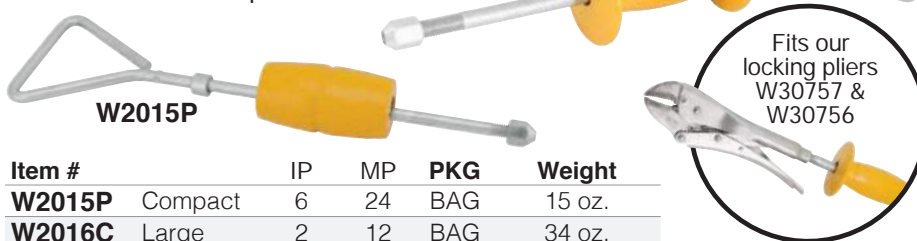

Item #	IP	MP	PKG	Weight	
W2015P	Compact	6	24	BAG	15 oz.
W2016C	Large	2	12	BAG	34 oz.



Fits our locking pliers W30757 & W30756



Item #	IP	MP	PKG	Diameter
W1028	6	72	CRD	6"
W1029	6	24	CBX	4-1/2"

Durable high-impact nylon body. Squeeze handle release.

3-PC PLASTIC SPREADERS

- 3 convenient sizes
- Useful for many filler or putty spreading jobs.
- Easy to clean, just bend applicator and dried filler will pop off.



Item #	IP	MP	PKG	
W1001	6	144	CRD	3-1/2 x 6-1/4", 3 x 5-1/4", 2-3/4 x 4"
W407C	24	360	CRD	3-3/4 x 5-1/8", 2-5/8 x 4", 3-3/4 x 2-5/8"

HAND SANDERS



- W1019**
- Flexible natural rubber block.
 - Distributes even pressure.

Item #		IP	MP	PKG	
W1019	Block	6	48	CRD	
W1021	Flexible	6	72	SLV	3 x 11" sheet of sandpaper included

- Flexible design allows sanding on flat or curved surfaces.



HALF ROUND SHAPER FILE

- Fits most 10" adjustable handles.
- Use on body filler putty or glaze.

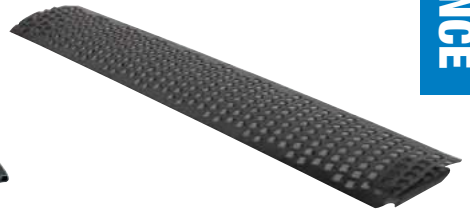

Item #	IP	MP	PKG	
W1023	6	240	CRD	10"

MAINTENANCE

AUTO-DARKENING WELDING HELMET

- Darkens in 1/20,000 of a second.
- Variable shade control from #9 to #13.
- High/low sensitivity adjustment.



Item #	IP	MP	PKG	
W50057	1	4	CBX	Helmet
W50057-1	1	30	WBX	Shield Replacement

UNIVERSAL WELDING CART

- All steel construction with durable finish.
- 7-1/2" back wheels and 3" front swivel castors makes the welding cart very easy to move around.



Item #	IP	MP	PKG	
W53992	1	1	LAB	

MAGNETIC SUPPORT JIGS

- Heavy duty magnets hold up to 75 lbs.
- Designed to hold material at 45°, 90° and 135° angles for maximum versatility.

Item #	IP	MP	PKG	Capacity
W41291	10	60	DBL	25 lbs.
W41292	6	24	DBL	50 lbs.
W41293	4	16	DBL	75 lbs.
W41294	4-PC	8	DBL	9 lbs.



BATTERY CABLES & ACCESSORIES

SWITCH TO STARTER CABLES

- 4 gauge cable with steel plated connectors transfers power from starter solenoid to starter.
- For 6 and 12-volt battery systems.
- Full gauge stranded copper extends entire length of flattened lug, insures complete conductivity.
- PVC insulation with heat-shrunk ends.

Item #	IP	MP	PKG	Length	Gauge	Stud Hole
W16850	10	60	CLM	10"	4	3/8"
W16851	10	60	CLM	24"	4	3/8"
W16852	10	60	CLM	32"	4	3/8"



W16853

CABLE EYELET LUGS

- Ideal for ground connections, battery cables and general wiring purposes.
- Made from seamless copper tubing with electro-tin plating.
- Corrosion resistance.

Item #	IP	MP	PKG	Gauge	Stud Hole
W16853	10	200	CLM	4	3/8"
W16854	10	200	CLM	6	3/8"



W16854

BATTERY POST CLEANERS

- Scrapes stubborn corrosion from battery posts and terminals.



W152C

- All metal construction.
- Cleans both battery post and terminals.



Item #		IP	MP	PKG
W152C	4-Way Cleaner	12	48	CRD
W147C	2-IN-1 Brush	12	288	CRD
W147FB	2-IN-1 Brush	20	120	BLK
W3235	2-IN-1 Brush	6	72	Pg 316
W3302	2-IN-1 Brush	10	80	Pg 317
20134	2-IN-1 Brush	8	48	Pg 320

BATTERY TERMINAL PULLER

- Removes the battery cable clamp or windshield wiper arm from the post without damage.
- Spring-loaded sharp jaws get under the clamp for a secure grip.
- Progressive screw action with simple spring loaded release.

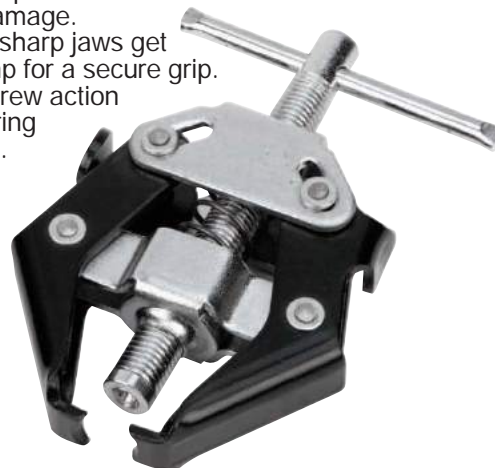

Item #	IP	MP	PKG	Reach	Spread
W87120	6	24	CRD	25mm	33mm

BATTERY TERMINAL PROTECTORS

- Designed to provide a barrier against acid fumes that seep through improperly sealed batteries.
- Will not dry out or evaporate.

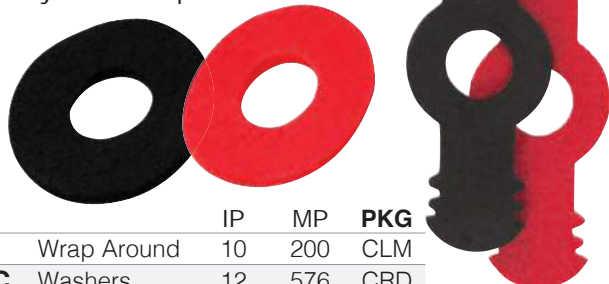

Item #		IP	MP	PKG
W1652	Wrap Around	10	200	CLM
W1658C	Washers	12	576	CRD

SIDE TERMINAL BATTERY WRENCH

- Reversible ratchet action.
- Narrow design for confined areas.
- Easily removes and replaces 5/16" side terminal battery bolts.



Item #	IP	MP	PKG
W1674	6	72	CRD

BATTERY TERMINALS

- Good corrosion resistance, electrical conductivity, convenient wiring.
- Fits over the positive or negative posts on top terminal batteries.
- Universal fit for 6v and 12v battery posts.



Item #		IP	MP	PKG
W1686B	Standard Top Post	50	200	BLK
W1686C	Standard Top Post	6	144	CRD
W1683	Heavy Duty Top Post	10	60	CLM
W1680C	Replacement Bolts	12	288	CRD

W1688	Marine	10	80	CLM
W1688-2C	2-PK Marine	6	72	CRD
W1685C	Side Post	6	144	CRD
W1679C	Replacement Bolts	12	288	CRD



OEM BATTERY TERMINAL SET

- Heavy Duty Zinc Plated, works for 6 and 8 gauge cable.
- 5/16" stud allows for the easy connection of power accessories.

Item #		IP	MP	PKG
W1687	2-PK	10	100	CLM

W1687
OEM Style

QUICK CONNECT BATTERY TERMINAL

- Installs on most top post batteries making connecting and disconnecting power quick and effortless.
- Made of brass-plated alloy and fits on either posts.
- Compatible with 12-or-24v vehicle dynamic control systems.

Item #	IP	MP	PKG
W1684	10	60	CLM

Turn the green knob counter-clockwise to disconnect power or clockwise to connect power.



BATTERY CABLE ADAPTER KIT

- Converts side terminal battery cables for use with top post battery.
- Contains 2 terminals and ground cable extension lead.

Item #	IP	MP	PKG
W1681C	6	48	CRD

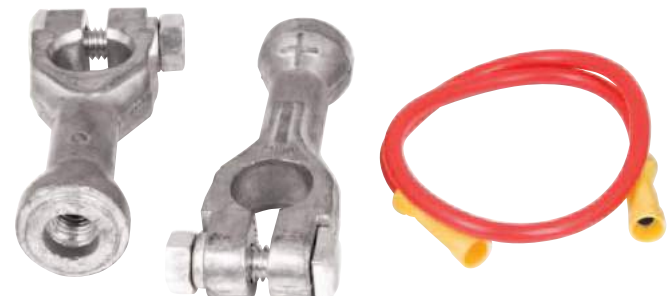

BATTERY CHARGING POST

- Polarity specific for correct hookup.
- 3/8"-16 threaded steel insert and 3/8" hex base.

Provide connection for quick & easy charging and or jump starts on side terminal batteries.

Item #		IP	MP	PKG
W1646	2-PK Female	10	60	CLM
W1682C	2-PK Male	6	48	CRD



BATTERY ACCESSORIES

BATTERY HOLD DOWN BOLTS

- Heavy gauge steel.
- Plated to resist corrosion.

Item #	IP	MP	PKG	Type
W1694C	6	72	CRD	8" J
W1695C	6	72	CRD	10" J
W1696C	6	72	CRD	12" J
W1697C	6	72	CRD	10" L



MAINTENANCE

CROSSBAR BATTERY HOLD DOWN SET

- Vinyl coated for corrosion resistance.

Item #	IP	MP	PKG
W1691C	6	72	CRD



UNIVERSAL BATTERY HOLD DOWN

- Solid rubber construction.
- Nylon inserts for strength.
- Fits most batteries.

Item #	IP	MP	PKG
W1699C	6	48	CRD



PLASTIC BATTERY TRAY

- Easy to install, acid resistant trays to fit standard size batteries.

Item #	IP	MP	PKG
W1692PC	6	24	LAB



BATTERY FILLER

- 2 quart capacity.
- Spring loaded filler valve.
- Durable injection molded plastic.

Item #	IP	MP	PKG
W54274	1	10	LAB



W54274

BATTERY FILLER

- Acid resistant
- 6 oz. bulb
- 6" spout.

Item #	IP	MP	PKG
W1641	12	96	CRD



W1641

DIGITAL 12V BATTERY ANALYZER

- Portable, fast, and very simple to use battery starting and charging system analyzer.
- Digital display indicates the condition of your battery and charging system.
- Tests 12VDC systems, guiding you through the testing process.
- Clear and easy to understand results to indicate systems condition.

Item #	IP	MP	PKG	Battery CCA	Battery Types	Voltage	Standards
W2998	8	48	CRD	200-1,200	LA, AGM & VRLA	7-15VDC	SAE, DIN, EN, IEC, CA

BATTERY LOAD TESTER

- Accurately test the condition of your battery and charging systems.
- Performs both a voltage test and 15-second battery-load test.
- Reliable and highly accurate, works on both 6- and 12-volt batteries.
- Extra heavy leads with strain relief and color coded, insulated, copper plated steel clamps.

Item #	IP	MP	PKG	Capacity
W2988	1	10	CBX	100 Amp

BATTERY/ALTERNATOR TESTER

- For all 12 volt systems.
- Easy to read L.E.D. lights.
- Determines battery state of charge and level of alternator output.

Item #	IP	MP	PKG
W2980	6	72	CRD

BATTERY/ALTERNATOR TESTER

- Compact size, a handy item for your glove box so you know right away if the problem you have is related to the battery or alternator, simply plug into the 12v utility plug.
- 3 LED indicators to show the battery condition: weak, normal or strong.
- 3 LED indicators to check the status of the alternator voltage: low, normal or high.

Item #	IP	MP	PKG
W2989	8	48	DBL

BATTERY TESTERS

- Test 6V, 12V and 24V batteries.
- ACID resistant



W1667C
Instant reading warm or cold.



W1666C
Color coded balls for easy readings.

W1653C
Precision calibrated. Color coded indicator float.

Item #		IP	MP	PKG
W1657C	Dial	6	72	CRD
W1666C	Mini Tube	24	288	CRD
W1653C	Tube	6	72	CRD

MAINTENANCE

BATTERY JUMP STARTERS

JUMP STARTER POWER BANKS

- Jump starts most passenger cars, trucks, vans and SUVs.
- Each model includes Smart Clamp Technology.
- Three mode LED light: on, strobe, S.O.S.
- Lithium battery provides longer shelf life.
- 5V USB port(s) charge various model smart phones.
- 12V output for vehicle jump and other 12V devices.
- 19V output to recharge laptop computers (*W1677 only*)
- Operating temperature: -4 to 140F (-20 to 60C)
- Storage temperature: 50 to 77F (10 to 25C)

MAINTENANCE



W16751
Includes smart clamps, 12V/120V chargers, zipper storage case.



W1677
Includes home and car chargers, smart clamps and adapters for most popular cell phone and laptops.



W16750
Includes smart clamp and micro USB charging cable.

Item #	IP	MP	PKG	Peak AMP	Starting AMP	Input 15V	5V	Output 12V	19V	Capacity (mAh)	Charging Time
W1677	1	10	CBX	400	200	1A	1.8A	6A-10A	2A-2.5A	11,000	4 hr
W16750	1	10	CBX	350	200	2A	2A	6A-10A	-	6,900	5.5 hr
W16751	1	10	CBX	600	300	1A	2.1A, 1A	2.1A, 1A	-	11,000	6 hr

SMART CLAMP

- Automatic shut-off prevents sparking, reverse polarity overload or battery damage
- LED indicator detects if clamps are connected correctly - green means go, red means check and reconnect.
- Non-sparking technology provides an additional level of safety.



Item #	IP	MP	PKG
W1677-1	1	50	BAG

PORTABLE JUMP STARTER/AIR COMPRESSOR

- Reverse polarity warning light and beep signal help prevent damaging unit or battery.
- Three LED Battery Level Indicator lets you know how much power you have left at all times.
- Features 7 Blue LED Work Light.
- Two 12V power adapter outlets.
- Automatic shut-off prevents over charging.
- ON/OFF safety switch for jumper cables.
- 12 Volt, 12AH sealed lead acid battery.
- UL Certified 120V/12V charging adapter.
- 300 psi air compressor with 24" air hose.



300 psi Air Compressor/Inflator for pumping up tires and inflating rafts, balls, air mattresses & other misc items.

Item #	IP	MP	PKG	Peak AMP	Starting AMP
W1665	1	2	CBX	900	400

BATTERY JUMPER CABLES

- Red/black PVC-coated clamps for easy identification.
- Tangle-free rubber coated cables.
- Heavy duty copper jaw clamps.
- All weather use.



W1671



W1672



W1667

100% Copper core



Item #	IP	MP	PKG	Length	Gauge	Peak AMP	Starting AMP	Clamp Style	Application
W1670	6	12	SLV	12'	10	250	150	Standard	Light duty cars & motorcycles
W1671	6	12	SLV	12'	8	300	250	Standard+	Medium duty cars & light trucks
W1672	1	6	CBX	16'	6	500	400	Standard+	Standard duty mid-size cars & trucks
W1673	1	6	CBX	20'	4	600	500	Standard+	Heavy duty trucks, vans & SUV
W1667 copper	1	6	CBX	20'	4	600	500	Parrot	Heavy duty trucks, vans & SUV
W1669	1	4	CBX	20'	2	800	600	Parrot	Commercial duty tractors, buses & semis

- 450 amp replacement jumper cable clamps.
- Heavy duty coil spring action for firm reliable contact.
- Vinyl insulated grips.

Item #	IP	MP	PKG
W1661	10	40	CLM Replacement Clamps



SOLAR PANEL BATTERY MAINTAINER

- 2.5 watt solar panel for all your off the grid 12 volt battery charging and maintaining needs.
- Amorphous solar panels operate in all daylight conditions, even cloudy days.
- Durable ABS plastic housing with mounting holes.
- Includes 4 suction cups for easy mounting to the windshield, 1' from connector to adapter plug and 8' from adapter plug to solar panel, 12V DC plug and alligator battery clamps.



Item #	IP	MP	PKG	Output	W	D	H
W2997	1	12	CLM	12/24 VAC / 1.5W	13-3/4"	4-3/4"	1/2"

12V BATTERY FLOAT CHARGERS

- Used for maintaining wet or gel cell batteries that are stored or used periodically in boats, cars, snowmobiles, ATV's and tractors.
- This unit is for use on 12 volt DC batteries only.

W2996



W2985



Item #	IP	MP	PKG	Output		Cable Length			Listing
				Volts	Amps	Clamp	Charger	Overall	
W2985	1	20	DBL	12V	0.6A	44"	78"	10'	cUL E241069
W2996 2-PK	2	12	CBX	12V	1.2A	24"	55"	6-1/2'	cUL E361658

ELECTRICAL TESTERS

DIGITAL CIRCUIT TESTERS

- Ideally used to detect power, voltage, ground, and circuit integrity.
- Large LCD display provides a 'no guess' voltage value of the circuit tested.
- Surge protected circuitry displays DC Voltage from 3 to 48v.
- Backlit LED glows red for power and green for ground.
- Computer safe <10mA circuit draw for confident testing.
- Recoil lead wire stretches safely from 3 to 7 feet.
- LED indicates red for "power" or green for "ground".



Durable storage case for tool protection.

Do not use on airbags

W2990

Item #	IP	MP	PKG	Range DC	Resolution	Accuracy	Operating Temp	Cord Length	Probe Length	
W2990	Pro with case	6	24	CRD	3 to 48v	0.1v	± 0.3v	0 to 120°F	12' Recoil	3-1/2"
W2992	Standard	6	24	CRD	3 to 48v	0.1v	± 0.3v	0 to 120°F	12' Recoil	3-1/2"

COMPUTER SAFE LOGISTIC PROBE

- Drawing less than 7 milliamps.
- Quickly tests high and low voltages on all vehicle circuits, including computerized engine and body controls.
- Tests power and ground voltages.
- Heavy gauge color coded battery clips.

Gives the professional the ability to test fuel injectors, solenoids, tach reference signals.



Test the output on MAS, Cam, Crank, VSR sensors and much more.

Item #	IP	MP	PKG	Range	Cord Length	Probe Length
W2991	6	24	CRD	6/12/24v	10' Recoil	3-1/2"

CORDLESS TESTER

- No ground wire or clip required.
- Includes 2 "N" type batteries.
- Safe with ECM's, sensors, transducers, etc.



5-5/8" overall length

Item #	IP	MP	PKG	Range
W2979	10	100	CRD	3 to 28v
20192	6	60	CRD	3 to 28v

CIRCUIT TESTERS



W2978
Automatic voltage identification with blue LED (12v) and red LED (42v).



W2982
Self powered by AA battery (not included).



W2983
Green Body
18/24/36 volt tester.



Clear Body
High/low 6/12 volt tester.



Red Body
Continuity tester.



W2981
Reinforcing spring prevents damage to test lead at base of handle.

Item #	IP	MP	PKG	Range DC	Cord Length	Probe Length
W2973C	Economy Circuit	12	288	CRD	6/12v	30"
W2975C	Deluxe Circuit	12	144	CRD	12v	46"
W2982	Continuity	6	72	CRD		46"
W2983	High/Low				6/12v	44"
W2983	Circuit	6	24	DBL	18/24/36v	44"
W2983	3-PC Continuity				-	44"
W2981	Heavy Duty Circuit	6	72	CRD	6/12/24v	60'
W2978	Hybrid Circuit	5	60	CRD	12/42v	12' Recoil



Insulated probe for 6 volt and 12 volt systems. Test lead with alligator clip.

W2973C

DIGITAL MULTI-METERS

- Designed to safely and accurately troubleshoot a variety of automotive, household and shop electrical circuits.
- Features AC & DC voltage, DC current, resistance measurements, Ohms and diode test.
- Includes large digital LED display, leads and probes, automatic zero adjust and 9V battery*



W2974



W1714

Includes 7" diagonal wire cutting pliers, 7" wire stripper/cutter for 10-20 AWG wire, and digital multi-meter.



W2979C
Includes 1-AA battery.



W2970



W2971

AUTO RANGING

RAN Range button. HOLD Data hold button. SEL Select button. Automatic ranging eliminate the need to dial in the correct range when making electronic or electrical measurements. Includes 2-AAA batteries.

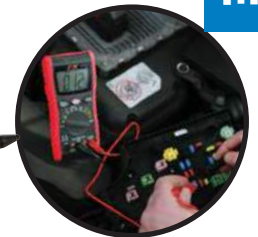

MAINTENANCE

Item #		IP	MP	PKG	DCV	ACV	DCA	Ohm	Battery
W2979C	Analog	6	48	CRD	10-500V	10-500V	.05-250mA		
W2970	Digital	6	36	CRD	200mV 500V	200V 500V	200mA 200µA	200Ω 2000kΩ	
W2974	Digital	6	36	CRD	200mV 500V	200V 500V	200mA 200µA	200Ω 2000kΩ	1.5V, 9V
W2971	Digital Auto Ranging	6	36	DBL	200mV 600V	2V 600V	200µA 10A	200Ω 20MΩ	1.5, 9, 12V
W1714	Digital 3-PC	6	24	DBL	200mV 600V	200V 600V	200µA- 10A	200Ω 2MΩ	

INFRARED THERMOMETERS

- Measures surface temperature without making contact.
- Easy to read large digital display with backlight.
- Includes a 9V battery (except W89721 2-AAA batteries).

Item #	IP	MP	PKG	Temperature Range		Distance Spot Ratio	Accuracy
				°F	°C		
W89720	5	20	CLM	0 to 960	-18 to 520	8:1	±1.5%
W89721	10	20	CLM	-58 to 716	-50 to 380	12:1	±1.5%
W89722	10	60	CLM	-58 to 626	-50 to 330	12:1	±1.5%
W89724	5	10	CLM	-58 to 1382	-50 to 750	12:1	±2%



W89722

DIGITAL THERMOMETER

- Displays digital temperature quickly and accurately.
- Large easy-to-read display window.
- Auto shut-off after 3 minutes.
- Stainless steel probe resists rust and corrosion.

Item #	IP	MP	PKG	Temperature Range °F
W89723	6	72	CRD	-40 to 390



W89723

LUG WRENCHES

4 WAY LUG WRENCHES

- Drop forged steel.
- SAE and metric sizes.



W7
Chrome plated to resist corrosion. Folds down for compact storage.



W2



W1

Item #	Size	IP	MP	PKG	SAE	Metric
W2	14"	1	12	BLK	11/16, 3/4, 13/16 & 7/8"	17, 19, 21 & 23 mm
W1	20"	1	12	BLK	3/4, 13/16, & 7/8"	19 mm
W11	25"	1	6	BLK	7/8, 15/16, 1 & 1-1/16"	-
W7	Folding	1	12	BAG	11/16, 3/4, 13/16 & 7/8"	17, 19, 21 & 23 mm

LUG WRENCHES/ SPADE TIP

- Heavy duty drop forged steel.
- Spade tip for hub cap removal.

Item #	Size	IP	MP	PKG	SAE	Metric
W9	14"	1	12	BLK	3/4, 13/16 & 7/8"	19, 21 & 23 mm
W9A	20"	1	12	BLK	3/4, 13/16, & 7/8"	19, 21 & 23 mm



**W9
W9A**

BREAKDOWN LUG WRENCHES

- Full size lug wrench breaks down into two parts for compact storage.
- Two position center rod allows for applying added torque to those really tight lug nuts.
- Heavy duty heat treated steel with rust resistant chrome plated finish.
- Free spinning handle with push button release.
- Includes two 1/2" drive double ended sockets and a nylon storage pouch to keep everything together.

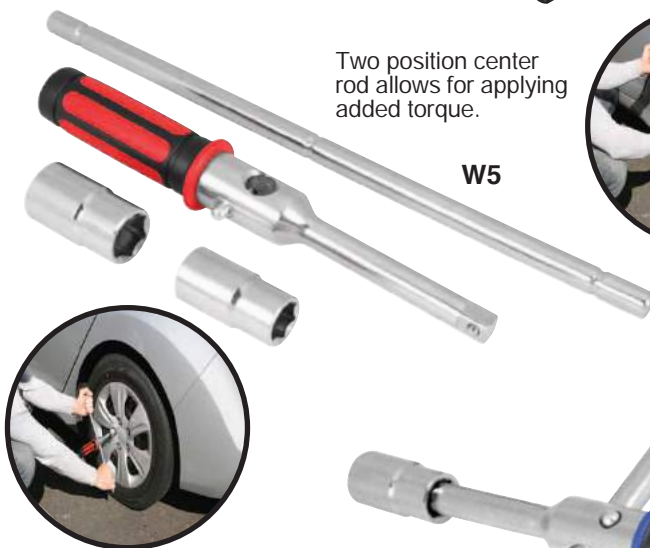

Two position center rod allows for applying added torque.

W5



W6

Item #	IP	MP	PKG	Socket 1	Socket 2
W5 SAE	2	8	CLM	11/16 & 3/4"	13/16 & 15/16"
W6 Metric	2	8	CLM	17 & 19 mm	21 & 23 mm

DOT WARNING TRIANGLES

- This D.O.T. approved warning triangle is ideal for unexpected roadside emergencies.



Roadside kits on page 78

Item #	IP	MP	PKG
W1499	1	4	LAB
W1498	1	4	LAB 3-PACK

SAFETY ROAD FLARES

- Make others aware of your vehicle even if the vehicle battery is dead.
- Tough plastic construction is compact and lightweight.



Item #	IP	MP	PKG
W2368	6	36	CRD
W2343	4	32	CRD 3-PACK

1/2 IN. DR. THIN WALL SOCKETS

- Protective sleeves and plastic insert prevent scratching of wheels and lug nuts.
- Hollow design allows room for removing longer bolts.
- Color coded for easy identification.
- Heavy duty chrome molybdenum.

Item #	IP	MP	PKG	Size	O.D. w/Sleeve
W32921	Purple	4	24	TAB 13/16"	1.232" (31.3mm)
W32922	Green	4	24	TAB 7/8"	1.307" (33.2mm)
W32923	Blue	4	24	TAB 17mm	1.087" (27.6mm)
W32924	Yellow	4	24	TAB 19mm	1.157" (29.4mm)
W32925	Red	4	24	TAB 21mm	1.228" (31.2mm)
W32926	Turquoise	4	24	TAB 22mm	
W32902	5-PC Set	1	12	CAS 17, 19 (3/4"), 21mm, 13/16, 7/8"	



W32902



MAINTENANCE

1/2 IN. DR. LUG NUT REMOVER SOCKETS

- Use to remove lug nuts and locking lug nuts, if the lug nut key is misplaced, lost or lug nuts are worn, stripped or damaged.
- Oil resistant black phosphate finish (except M980).
- Heavy duty impact-grade chrome-moly steel will not split or crack.
- Sizes fit most lug nuts/bolts on most vehicles.



M982



M981



M983



M980



Item #	IP	MP	PKG	Size
M980	2-PC	6	72	CLM 13/16, 1"
M981	6	120	TAB	3/4" (19mm)
M982	6	120	TAB	13/16" (21mm)
M983	6	120	TAB	1" (25mm)
M984	6	96	TAB	1-1/8" (28/29mm)

CORDED IMPACT WRENCH

- Rocker trigger for quick change between forward and reverse.
- CSA listed 216220

Includes 11/16, 3/4, 13/16, 7/8" impact sockets and sturdy carrying case.

Item #	IP	MP	PKG	Drive	Torque ft/lbs.	Listing
W50080	1	4	CBX	1/2"	220	CSA

See page 24 for additional info



AIR IMPACT WRENCHES

- Comfortable composite housing is compact and lightweight.
- Balanced design for low vibration.

Item #	IP	MP	PKG	Drive	Max Torque (ft/lbs)	Working Torque (ft/lbs)	Avg CFM	RPM	Inlet (NPT)
M624	1	10	CBX	1/2"	230	50 - 200	7	7,800	1/4"
M558DB	1	10	CBX	1/2"	230	50 - 200	4.5	7,500	1/4"
M625	1	8	CBX	1/2"	550	25 - 250	8	7,000	1/4"

See page 282 for additional info



TIRE PUMPS & INFLATORS

TIRE INFLATORS

MAINTENANCE



60398

Built in tire pressure gauge and rubber stabilizing pads. Cooling fan gives extended unit life and reliability.



60399

Handy on/off switch. Easy to read pressure gauge.

3 Super bright LEDs for night time emergencies.



60400

Compact size for easy storage with convenient storage compartment. Built in dial pressure gauge.



60401

Rechargeable tire inflator with pressure control.



60402



60404

Canvas bag for storage. Bright LEDs for night time emergencies.

Item #	IP	MP	PKG	Source	Cord	PSI	Hose	Inflate time	Accessories included
60398	1	6	CBX	120V	6'	100	27"	4 min.	Sports ball needle and 6 raft/mattress inflator nozzles
60399	1	20	CBX	12V	10'	250	18"	7 min.	Two nozzle adapters and sport ball needle
60400	6	12	CBX	12V	9'	100	17-1/2"	8 min.	Sports ball needle, raft/toy inflator nozzles and Presta valve adapter
60401	1	12	CLM	12V/120V	9'	120	22-1/2"	7 min.	Sports ball needle and 3 nozzle adapters. Includes AC and 12V auto charger.
60402	6	12	CBX	12V	10'	100	15"	4 min.	Sports ball needle, raft/toy inflator nozzles and Presta valve adapter
60404	1	8	CBX	12V	9-1/2"	150	40"	3 min.	Sports ball needle and raft/toy inflator nozzle
60397	1	24	CBX	120V	5-1/2"		NA	NA	3 valve adapters

TIRE FOOT PUMP

- Steel construction.
- Braided hose with quick release thumb lock.

Easy to read pressure gauge.



W1638DB

Includes sports ball needle and raft/toy inflator nozzle.

Item #	IP	MP	PKG	Type	PSI	Hose
W1638DB	1	16	CBX	Foot	100	23"
60405	1	16	CBX	Foot	100	23"
W1635	1	6	BAG	Hand	60	17"
60406	1	6	BAG	Hand	60	17"
W1636PB	1	6	BAG	Hand w/Tank	100	24"



W1635



W1636PB

AIR INFLATOR

- Inflate air mattresses, rafts, or float tubes at home or on the go.
- Inflates a twin mattress in about approx. 1-min.



60397

DIAL TIRE GAUGE

- Maintaining proper tire pressure optimizes fuel economy, tire performance and safety

Item #	IP	MP	PKG	Diameter	Face	PSI
60305	12	144	CRD	2"	White	5 to 60
W1450	6	72	CRD	2"	White	1 to 100
W9106	6	24	Pg 309	2"	White	1 to 100
W1915	21	126	Pg 312	1"	Black	1 to 60
W9105	12	48	Pg 308	1"	White	1 to 60



TIRE PRESSURE GAUGE

- Maintaining proper tire pressure optimizes fuel economy, tire performance and safety.
- Heavy duty 2 color square plastic stem.
- Chrome plated to resist rust.



Item #	IP	MP	PKG	PSI	Length	Application
60302	Standard	12	144	CRD	10 to 50	5-5/8" Cars & Trucks
W191C	Standard	6	120	CRD	10 to 50	5-5/8" Cars & Trucks
W1925	Standard	25	300	Pg 312	10 to 50	5-5/8" Cars & Trucks
W9104	Standard	12	72	Pg 308	10 to 50	5-5/8" Cars & Trucks
W3238	Mini	25	300	Pg 316	10 to 50	3-1/8" Cars & Trucks
60300	Tractor	12	144	CRD	5 to 45	5-5/8" Air and liquid filled tires
60301	Low Pressure	12	144	CRD	1 to 20	5-5/8" ATVs, golf carts & lawn mowers
60303	High Pressure	12	144	CRD	20 to 150	6" Bicycles, semis & motorcycles
60304	Dual Foot	12	144	CRD	10 to 120	6" Trucks & Vans
W192C	Dual Foot	6	144	CRD	10 to 120	6" Cars, Trucks & Vans
60306	Dual Foot	6	72	CRD	10 to 150	11-3/8" Trucks & Semis
60307	Straight	6	72	CRD	10 to 150	12" Trucks & Semis



MAINTENANCE

DIGITAL DUAL HEAD TIRE PRESSURE GAUGE

- Professional quality for extended service life.
- Dual head air chuck, back light display with a LED spot for seeing valves at night.
- Gauges are accurate to ± 1 psi.
- Measures in PSI, BAR, KPA.



Item #	IP	MP	PKG	PSI	Length	Application
60309	3	24	DBL	5 to 99	12"	Auto, trucks and RVs
60311	3	24	DBL	5 to 150	12"	Larger truck and trailer rigs



DIGITAL TIRE PRESSURE GAUGE

- Triple function display shows PSI, BAR & kPa
- Lighted nozzle and backlit display
- Auto-off feature shuts off in 90 seconds when not in use
- Accurate to ±1 PSI.



Double injection molded handle for extra grip. US Patent D685,660.

Item #	IP	MP	PKG	PSI
60308	4	24	DBL	1 to 150
W9107	4	24	Pg 309	1 to 150

TIRE REPAIR

TIRE VALVES

- For use with automotive rims.



Item #	IP	MP	PKG	Length	Rim Hole	Finish
60100	12	144	CRD	1-1/4"	.453	Chrome
60101	12	144	CRD	1"	.453/.625	Chrome
60102	12	144	CRD	2"	.625	Rubber
60103	12	144	CRD	2"	.453	Rubber
60104	12	144	CRD	1-1/4"	.453	Rubber
60105	12	144	CRD	1-1/2"	.453	Rubber



MAINTENANCE

TIRE VALVE CAPS SETS

- Fits standard tire valves.



Item #	IP	MP	PKG
60110	12	144	CRD 4-PK PLASTIC
60111	12	144	CRD 4-PK HIGH HEAT DOME
60112	12	144	CRD 4-PK CHROME HEX
60113	12	144	CRD 4-PK SLOT HEAD



VALVE EXTENSIONS

- For hard to reach stems
- Fits all tires.
- Easy to use.



Item #	IP	MP	PKG	Length	Finish
60106	12	144	CRD	1-1/4"	Plastic
60107	12	144	CRD	3/4"	Plastic
60108	12	144	CRD	1-1/4"	Chrome
60109	12	144	CRD	3/4"	Chrome



VALVE CORE TOOLS

Compatible for all vehicle valves as well as air conditioning units.



Avoid damaging the TPMS sensor caused by over tightening.



Item #	IP	MP	PKG
60501	Fishing	12	144 CRD Deflator. Core remover. Valve stem puller.
60502	2 Way	12	144 CRD Removes valve cores. Cleans cap threads.
60503	4 Way	12	144 CRD Removes valve cores. Cleans cap threads. Aids in re-taping threads. Reams inside the valve.
60500		12	144 CRD Removes valve cores on both tire and air conditioning systems.
60508	Torque	12	72 CRD TPMS safe. Removes valve cores on both tire and air conditioning systems.
60114	4-PC	12	144 CRD High temp. Easy to install valve cores.

TREAD DEPTH GAUGES

- Designed to facilitate quick and easy reading of tire tread depth.
- Metric/Inch system interchangeable.



Large LCD display for easy reading.

Zero setting at any position.

Item #		IP	MP	PKG	Range		Resolution	
					in.	mm	in.	mm
60310	Digital	25	100	CRD	0 to 1"	0 to 25.4	0.0005"	0.01
60504	Analog	12	144	CRD	0 to 1"	0 to 25	1/32"	1

TIRE MARKING CRAYON

- Use to mark tires for repair.

Item #		IP	MP	PKG
60506	Yellow	10	100	CRD
60507	White	10	100	CRD



Clean up white walls.

TIRE PATCH KITS

- For all tubeless, radial and/or bias ply tires.
- Each kit contains patches, rubber cement and metal scuffer.

Item #		IP	MP	PKG
60206	Tubeless Radial	10	100	CRD
60207	Bias & Radial	10	100	CRD
60210	Rubber Cement	10	100	CRD



TIRE REPAIR KITS

- For all tubeless radial and bias ply tires.
- 4" long tire plugs

Item #		IP	MP	PKG	Contents
60200	7-PC	5	50	CRD	Deluxe T-handle Plugger, Reamer & 5 Plugs
60201	6-PC	10	50	CRD	Plugger & 5 Plugs
60202	7-PC	5	50	CRD	Plugger, Reamer & 5 Plugs
60208	30-PK	10	50	CRD	30 Plugs
60209	5-PK	10	100	CRD	5 Plugs



60208



60206



60201



60202



60200

TIRE REPAIR & MAINTENANCE KITS

- A must have for maintenance or emergency tire service.
- Kits includes valves, caps, valve cores, valve core remover, pressure gauge, rubber cement, scuffer, tubeless plugs, patches, plugger and reamer



60204



60203

Item #		IP	MP	PKG	Chrome Caps	Plastic Caps	Valve Cores	Tubeless Plugs	Round Patches	Additional content
60203	82-PC	5	30	CAS	8	8	8	20	15 small 2 large	Dual foot tire gauge, 2 long & 2 short tire valves, 8 valve extensions, tire chuck & 2 rectangular patches
60204	35-PC	6	36	CAS	4	4	4	3	10 small	Pencil tire gauge & 4 way valve tool

MAINTENANCE

GREASE GUNS & ACCESSORIES

PISTOL GRIP GREASE GUNS

- Vented zinc die cast head cap.
- Comfort pistol grip handle.
- Positive lock for easy filling.
- 3-way loading, bulk, suction or 14 oz (3 oz on mini) cartridges.

Item #		IP	MP	PKG	Extension		PSI
					Rigid	Hose	
W54204	Professional	1	12	CBX	-	12"	3,000
W54291	Aluminum	1	12	CBX	5-1/2"	12"	4,500
W54200	Mini	4	20	CLM	4"	-	-
W54205	Mini w/Grease	4	20	CLM	4"	-	-

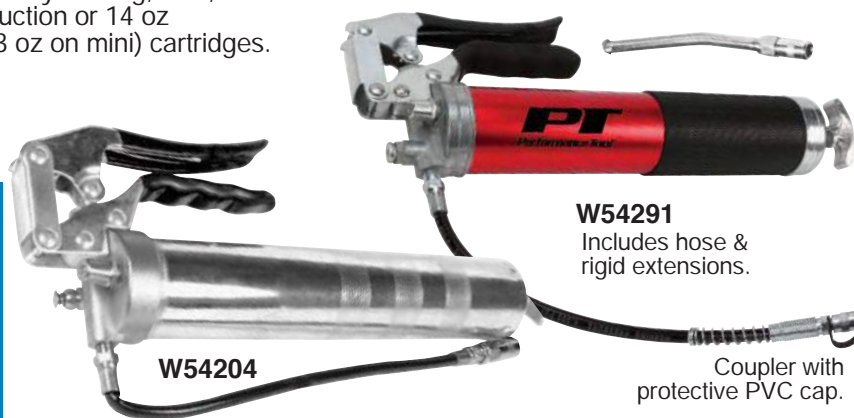

W54204

W54291
Includes hose & rigid extensions.

Coupler with protective PVC cap.

W54200



Heavy duty construction. Uses 3 oz. grease cartridge

W54205

MAINTENANCE

Features	Barrel	Head Cap	Handle/Trigger	Loading
Professional	Knurled thick wall, chrome plated finish	Zinc die cast with bulk load and release valve	Zinc plated with rubber grip	3 Way
Aluminum	Textured rubber sleeve, red anodized aluminum	Zinc die cast with bulk load and release valve	Zinc plated with PVC grip	3 Way
Economy/Mini	Knurled thick wall, blue	Vented zinc die cast	Zinc plated	2 Way
Industrial	Knurled thick wall, maroon rust proof paint	Heavy duty cast with bulk load and release valve	Zinc plated with PVC grip	3 Way
Commercial	Textured rubber sleeve, blue rust proof paint	Heavy duty cast with release valve	Zinc plated with rubber grip	2 Way



LEVER ACTION GREASE GUNS

- Short stroke "lever action" for easy use in tight spaces.
- Vented zinc die cast head cap.
- Positive lock for easy filling.
- 3-way loading, bulk, suction or 14 oz cartridge.

Item #		IP	MP	PKG	Extension		PSI
					Rigid	Hose	
W54202	Professional	1	12	CBX	5-1/2"	-	-
W54290	Aluminum	1	12	CBX	5-1/2"	12"	4,500
W54201	Economy	1	12	CBX	5-1/2"	-	-
W54203	Economy	1	12	CBX	5-1/2"	-	-
W54207	Commercial	1	12	CBX	6"	-	6,000
W54292	Industrial	1	12	CBX	6"	18"	6,900
W54220*	Economy	1	20	CBX	-	12"	NA

*See Fluid Transfer for more details



W54202

W54290

W54207

6000 PSI working pressure.

Includes hose & rigid extensions.

Extra heavy t-handle and internal return spring.

W54201

W54203

W54292

Includes hose & rigid extensions.

CORDLESS GREASE GUNS

- A well balanced design helps make hard-to reach fittings easy to service, simplifying the lubrication process.
- Two way loading, 14 oz. grease cartridge or bulk.
- Knurled barrel for secure grip.
- The planetary gearbox and reciprocating piston provide 7,000 psi and approximately 3 oz. of grease per minute.
- Grease hose with heavy duty coupler, battery and 1 hour quick charger, heavy duty plastic storage case.



W50014



W50048

Includes two 18V batteries and a shoulder strap for easy portability.

W11046

Item #	IP	MP	PKG	PSI	Hose	Rechargeable Battery	Input	Output	Cord	Rated	
W50014	5-PC	1	3	CBX	7,000	30"	14.4V Ni-cd	90-132V 60Hz 70W	9.6-24V 1.5A	6'	cETL
W50048	6-PC	1	4	CBX	7,000	42"	18V Ni-cd	120V 60Hz 45W	18.0V 1.3A	6'	cUL
W11046	Battery	1	12	CLM	-	-	18V Ni-cd	-	-	-	-

GREASE GUN ACCESSORY KIT

- For all types of grease lubrication applications.
- Accessories included (left to right)
 1. 90 degree angle tip
 2. Straight extension tip
 3. Slide on 90 degree coupler
 4. Rubber tipped nozzle
 5. Needle nozzle
 6. 360 degree coupler
 7. 12" hose extension



Item #	IP	MP	PKG
W50049	1	12	SLV

WALL-MOUNT GREASE GUN HOLDER

- Center latch locks.
- Corrosion resistant finish.
- Holds Grease or Suction guns with 2-1/4" OD barrel.



Item #	IP	MP	PKG
W54271	6	24	CRD

MULTI-PURPOSE LITHIUM GREASE

- Multi purpose lithium based grease is designed for light duty applications which require extended lubrication.
- For light duty automotive, industrial, agricultural or commercial equipment.
- Smooth consistency, water resistant and extremely stable.



Item #	IP	MP	PKG	Size
W54206	2-PK	1	12	CLM 3 oz.
W54208	1	24	LAB	14 oz.

MAINTENANCE

GREASE GUN ACCESSORIES

LOCK ON GREASE GUN COUPLER

- Allows you to lock on the fitting with just a slight push, releases with the same minimal effort.
- Positive seal prevents leakage while pumping grease.
- Once locked on both hands can be used to operate the grease gun.
- The small design allows you into tighter areas than other lock on couplers.



Item #	IP	MP	PKG	NPT (F)	Working PSI
W54228	10	100	CRD	1/8"	10,000

MAINTENANCE

GREASE GUN COUPLERS

- Fits most hand operated grease guns.

W54212



W54227



W54234



Narrow body fits into the tightest applications.



W54225

W54226/
W54215
(2-PC Kit)



W54214/
W54215
(2-PC Kit)

Item #	IP	MP	PKG	NPT (f)	Working PSI	Burst PSI	
W54212	Standard	6	240	CLM	1/8"	3,000	6,000
W54224	Heavy Duty	12	144	CLM	1/8"	4,000	8,000
W54225	90° Swivel	6	144	CLM	1/8"	4,500	8,000
W54226	360° Swivel	4	72	CLM	1/8"	3,000	7,000
W54227	Right Angle	12	144	CLM	1/8"	1,000	-
W54234	Narrow Body	24	144	CLM	1/8"	3,000	6,000
W54215	360° Swivel & Seal-off	4	72	CLM	1/8"	-	-
W54214	Seal-off	24	144	CLM	1/8"	-	-

Includes large and small sleeves to fit standard couplers.

W54216



NEEDLE NOSE ADAPTERS

- Dispenses a fine line of grease to confined areas.
- Fits most hand operated grease guns.
- Great for 4WD (CV) universal joints.

Item #	IP	MP	PKG	Length	PSI
W54219	4	72	CLM		3,000
W54216	24	120	CLM	4"	3,000

W54219



GREASE GUN FLEX HOSES

- Use hoses for hard to reach areas.
- For use with hand and air powered grease guns.



W54252 Double steel braided.

W54210/
W54211



W54223



W54221/
W54222

Item #	IP	MP	PKG	NPT (M)	Working PSI	Burst PSI		
W54210	12"	W/Coupler	4	72	CRD	1/8"	4,500	12,000
W54211	18"	W/Coupler	12	144	CRD	1/8"	4,500	10,000
W54221	12"	Standard	12	144	CRD	1/8"	3,000	10,000
W54222	18"	Standard	12	144	CRD	1/8"	3,000	10,000
W54223	12"	W/Spring	12	144	CRD	1/8"	3,500	10,500
W54252	12"	Heavy Duty	12	144	CRD	1/8"	8,000	16,000

GREASE FITTINGS

- Corrosion resistant.
- Leak-proof fittings.

Item #	IP	MP	PKG	NPT (m)	Straight	Short	30°	45°	60°	90°
W54241	10-PK	12	144	CLM	1/8"	10	-	-	-	-
W54242	10-PK	12	144	CLM	1/8"	-	-	10	-	-
W54243	10-PK	12	144	CLM	1/8"	-	-	-	-	10
W54217	8-PK	24	144	CLM	1/4-28"	4	-	2	-	2
W54240	10-PK	12	144	CLM	1/4-28"	10	-	-	-	-
W54258	10-PK	12	144	CLM	1/4-28"	-	10	-	-	-
W54244	10-PK	12	144	CLM	1/4-28"	-	-	-	-	10
W54245	10-PK	12	144	CLM	1/4-28"	-	-	10	-	-
W54249	10-PK	12	144	CLM	1/4-28"	-	-	5	-	5
W54218	8-PK	24	144	CLM	6mm	4	-	2	-	2
W54246	10-PK	12	144	CLM	6mm	10	-	-	-	-
W54247	10-PK	12	144	CLM	6mm	-	-	10	-	-
W54248	10-PK	12	144	CLM	6mm	-	-	-	-	10
W54259	10-PK	12	144	CLM	8mm	10	-	-	-	-
W54260	10-PK	12	144	CLM	8mm	-	-	10	-	-
W54261	10-PK	12	144	CLM	10mm	-	10	-	-	-
W54251	100-PC	6	24	CAS	1/8"	30	-	2	5	5
					1/4-28"	40	-	10	-	5
W54253	100-PC	6	24	CAS	1/4-28"	-	100	-	-	-
W54254	100-PC	6	24	CAS	1/4-28"	-	-	100	-	-
W54255	50-PC	6	24	CAS	1/4-28"	-	-	-	-	50
W54256	100-PC	6	24	CAS	1/8"	-	100	-	-	-
W5215	70-PC	6	24	CAS	1/8, 1/4-28", 6, 8 & 10mm	See Hardware Kits for more				

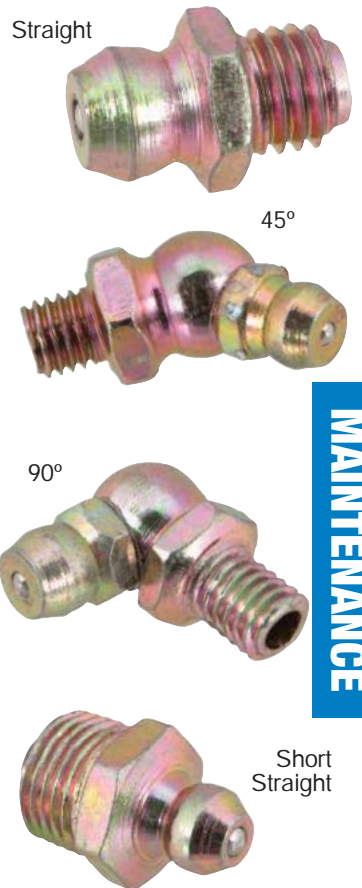

MAINTENANCE

ALL-IN-ONE GREASE FITTING TOOLS

- All-in-one fitting tool used to install and remove.
- For tapping and thread chasing fitting holes.
- Has broken fitting spiral removal tool.
- Installs 30/45/65/90 degree grease fittings.

Item #	IP	MP	PKG	Thread	For Fittings
W54229	24	144	CRD	1/8 NPT	1/8 & 7/16"
W54231	24	144	CRD	1/4-28 NPT	1/4, 5/16 & 3/8

W54229



W54231



UNIVERSAL BEARING PACKERS

- Quickly and thoroughly packs bearings with new grease while forcing out old grease all in one easy operation.
- Accommodates most roller and ball bearings.

Item #	IP	MP	PKG
W1218	6	36	CRD
W1225	6	36	CLM



GREASE FITTING CLEANING TOOL

- Fits both angled and straight grease fittings.
- Clears grease fittings of hardened matter.
- Simply draw oil or grease into the tool, place on fitting and strike with a hammer.



Item #	IP	MP	PKG
W54209	10	50	CRD

GREASE INJECTOR NEEDLE

- Tempered stainless steel.
- Can be easily inserted under or through bearing seals.
- Includes protective cover.
- For use with hand grease guns only.



Item #	IP	MP	PKG	Gauge	PSI
W54213	24	144	CLM	18	3,000

OIL FILTER WRENCHES

BAND WRENCHES

- Vinyl grip handle.
- Studded band for better grip.
- Removes most spin-on type filters.

Item #	IP	MP	PKG	Range
W186C	6	36	CRD	2-1/2 to 3-7/8"
W54050	6	36	CRD	3 to 3-3/4"
W54051	6	36	CRD	4 to 4-3/8"

Automatic clamping action.



MAINTENANCE

BAND WRENCHES

- Removes most spin-on type filters.
- Wide steel band for extra strength.
- Studded band for better grip.
- Vinyl grip handle.

Item #	IP	MP	PKG	Range
W54052	6	36	CRD	2-1/4 to 2-3/4"
W54053	6	36	CRD	2-7/8 to 3-1/8"



SWIVEL BAND WRENCHES

- Smaller narrow band fits oil and fuel filters in tight access applications.
- Swivel handle, vinyl grip.
- Narrow studded band for better grip.

Item #	IP	MP	PKG	Range
W54044	8	48	CRD	2-3/8 to 2-5/8"
W54045	6	36	CRD	2-7/8 to 3-1/4"
W54046	6	36	CRD	2-15/16 to 3-3/4"
W54047	6	36	CRD	3-1/2 to 3-7/8"
W54048	6	36	CRD	4 to 4-3/8"
W54049	6	36	CRD	4-3/4 to 5-3/4"



HEAVY DUTY BAND WRENCHES

- Studded band for better grip.
- Corrosion resistant construction.
- For use with 1/2" drive tool.

Item #	IP	MP	PKG	Range
W54054	6	24	CRD	4-1/8 to 4-21/32"
W54055	6	24	CRD	4-21/32 to 5-5/32"
W54056	6	24	CRD	5-5/32 to 5-11/16"



ADJUSTABLE WRENCH

- Fits most U.S. and imported cars.
- Vinyl grip handle.

Item #	IP	MP	PKG	Range
W189C	6	36	CRD	2-3/4 to 3-3/4"



ADJUSTABLE PLIERS

- Slip joint design fits multiple size filters.
- Durable gripping teeth.
- Textured grip.



Item #		IP	MP	PKG	Range
W54057	Offset Jaw	6	36	CRD	1-3/4 to 4"
W54058	Offset Jaw	6	36	CRD	2 to 5-1/2"
W54310	Straight Jaw	6	36	CRD	2-1/4 to 3-1/2"
W54311	Straight Jaw	6	48	CRD	3-1/4 to 4-1/2"

JAW GRIP WRENCH

- Serrated jaws for maximum grip.
- Adjustable to fit most filters.

Item #	IP	MP	PKG	Range
W157	12	72	CRD	2-3/4 to 4-1/4"



STRAP WRENCHES

- Durable non-slip rubber strap for industrial strength and added grip.
- Flexible strap fits any shape and works easily in confined areas.
- Versatile usage on automobiles, tractors, home applications and more.

2 Tone color handle with PVC coating for extra control.



W54059

Chrome plated steel bar. Turn with 1/2" ratchet.



W173C

Item #		IP	MP	PKG	Range
W54059	2-PC Rubber	6	24	CRD	3/8 to 6-1/2"
W173C	Nylon	6	72	CRD	up to 6"

CHAIN WRENCHES

- Steel chain for superior grip.
- Versatile usage on automobiles, tractors, home applications and more.

Durable aluminum handle.



W54060

W54061

Vinyl grip handle. Studded band.

Item #	IP	MP	PKG	Range
W54060	6	36	CRD	2-3/4 to 4-1/2"
W54061	6	36	CRD	3/8 to 4-1/4"

CLAMP WRENCH

- Clamping action fits many filters.
- Positive grip.
- Chrome plated.



Item #	IP	MP	PKG	Range
W171C	6	72	CRD	2-3/4 to 3"

3-JAW WRENCH

- Heat treated carbon steel construction.
- Tough black oxide finish.
- Use with 3/8" drive ratchet.



Item #	IP	MP	PKG	Range
W270	6	72	CRD	2-1/2 to 3-7/8"

OIL FILTER WRENCHES

TOYOTA CANISTER WRENCH

- Heavy gauge steel construction.
- Six cut outs to engage the tabs on the filter canisters.
- Use a 1/2" drive ratchet or 21 mm hex wrench.

Canister wrench for use on Toyota, Lexus and Scion cars.

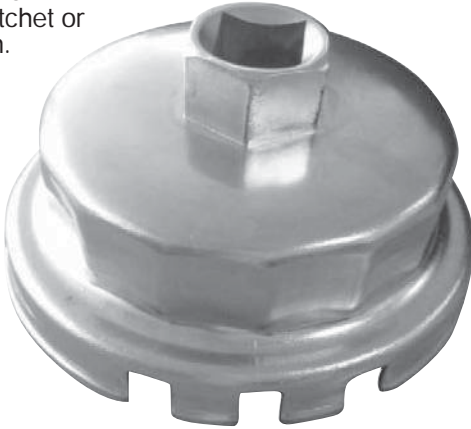

MAZDA CAP WRENCH

- Heavy gauge steel construction.
- Designed to fit 75.6mm 14 flute filters.
- Use a 1/2" drive ratchet or 21 mm hex wrench.



2.3L 4-cylinder engines. Mazda 3, Mazda 5, and Mazda 6 / Ford Fusion / Mercury Milan.

Item #	IP	MP	PKG
W54076	10	50	CRD 64MM 14 Flute
W54120	12	72	BLK 64MM 14 Flute

Item #	IP	MP	PKG
W54077	10	50	CRD 75.6MM 14 Flute

MAINTENANCE

CAP WRENCHES

- Steel construction for strength.
- Use with 3/8" drive tool.
- Fits multiple brands of oil filters.

Cap Size	Flute	IP	MP	CRD	BLK	Application
65mm	14	12	72	W54074	W54117	
65/67mm	14	12	72	W54066	W54109	
68mm	14	12	72	W54067	W54110	
73mm	14	12	72	W54065	W54108	
74mm	14	12	72	W54078	W54121	
74mm	15	12	72	W54069	W54112	
74/76mm	15	12	72	W54062	W54105	
75.6mm	14	12	72	-	W54104	2.3L 4-cylinder engines. Mazda 3, Mazda 5, and Mazda 6 / Ford Fusion / Mercury Milan.
75mm	15	12	72	W54073	W54116	
76mm	14	12	72	W54063	W54106	
80mm	15	12	72	W54068	W54111	
80/82mm	15	12	72	W54071	W54114	
90mm	15	12	72	W54070	W54113	
93mm	15	12	72	W54064	W54107	
93mm	36	12	72	W54072	W54115	
Toyota	14	12	72	W54075	W54118	Selected Toyota, Scion (2007-on)



OIL/FUEL FILTER SOCKET

- Chrome vanadium construction for strength and durability.
- Low profile socket are specially designed for operating clearance.
Not for impact use.



W54085

Item #	IP	MP	PKG	Application
W54085	7-PC	1	20 SLV	Set includes 24, 27, 29, 30, 32, 36 and 38 mm sockets.
W80683	24 mm	12	72 DBL	Cadillac, BMW, Dodge, and Saturn.
W80684	27 mm	12	72 DBL	Mercedes, Volkswagen, Hyundai, Kia, Mini's, and Smart Car.
W80676	29 mm	12	72 DBL	Dodge Cummins 5.9L fuel filter.
W80678	32 mm	12	72 DBL	GM Ecotec 2.2L oil filter.
W54119	32 mm	12	72 BLK	Bulk version W80678
W80677	36 mm	12	72 DBL	Ford diesel pickups 6.0L filters.

W80676



W80678

VW DRAIN PLUG SOCKET

- For transmission drain and fill plugs on Volkswagen and other German vehicles.
- Heat treated and zinc plated alloy steel.
Not for impact use.

Item #	IP	MP	PKG
W80681	12	144	CRD 17mm hex
W80682	12	288	CRD Tamper Proof

W80682



W80681

15-PC DRAIN PLUG SOCKET SET

- Chrome vanadium construction.
- Includes socket rail.



Item #	IP	MP	PKG	Application	
W54287	10	20	CRD	Hex	8 mm (BMW, Ford), GM, 9 mm (GM), 10 mm (Ford), 12 mm (Fiat, Lancia, Peugeot), 14 mm (Lancia, Mercedes) and 17 mm (Audi, Austin, BMW, VW)
				Square	7 mm (BMW, Ford, Toyota, Renault), 8 mm (Citroen, Peugeot, Renault, Talbot, Volvo), 11 mm (Ford), 13 mm (Nissan, Subaru), 3/8" (Honda, Mazda, Renault, Saab, Volvo) and 5/16" (Domestic Models Oil Galley Plugs)
				Other	10 mm Female (gear boxes and differentials. BMW, Ford, Toyota and Renault) Triangle: 10 mm (Renault). Triple Square Tamper Resistant: 16 mm (Audi, Boxster, Cayman, VW, Porsche Detroit Diesel Flywheel, Crank Pulley and Head Bolts)

OIL DRAIN PLUGS & GASKETS

- Contains the most popular drain plugs & gaskets providing excellent coverage for most domestic and imported cars and light trucks.

W5235

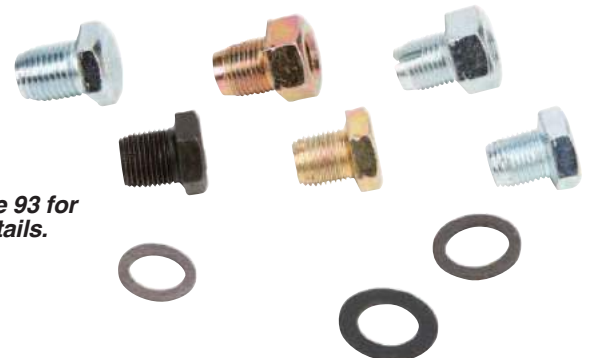

See page 93 for more details.

Item #	IP	MP	PKG
W5234	60-PC Gasket Kit	5	25 CAS
W5235	27-PC Oversized Kit	5	25 CAS
W5236	40-PC Drain Plug Kit	2	10 CAS

OIL DRAINAGE

MAINTENANCE

OIL LIFT DRAIN

- Telescopic tube adjusts to desired height.
- Range 40-1/2" to 60" with 13-1/2" diameter funnel.
- Comes complete with heavy duty 5 gallon container.
- Telescopic tube and sturdy funnel.



Item #	IP	MP	PKG	Tank	
				Diameter	Height
W54282	1	1	LAB	13-1/4"	11-1/2"

GALVANIZED DRAIN PAN

- Durable galvanized steel.
- 3-1/2 gallon capacity.



Item #	IP	MP	PKG	Diameter	H
W54280	1	12	BLK	16"	4"

TRANSMISSION PAN

- Heavy duty, high density polyethylene.
- Small diameter drain holes in bottom of pan prevent loss of pan bolts.



Item #	IP	MP	PKG	Diameter
W54281	1	5	BLK	24"

ROLLING BASE

- Heavy duty steel construction.
- Baked enamel finish.
- Ball bearing type casters.



Item #	IP	MP	PKG
W54283	1	4	LAB



PLASTIC DRAIN PAN

- Molded handles and pour spout.
- Chemical and solvent resistant, won't rust or corrode.
- 7 quart capacity.



Item #	IP	MP	PKG	W	D	H
W4070	1	12	LAB	13-1/2"	11"	4"

ALL PURPOSE

- Great for dispensing petroleum based fluids and much more.
- Easy to use.

Item #	IP	MP	PKG	Capacity	Diameter
W4007	1	72	LAB	1/2 pt.	3-3/4"
W4015	1	72	LAB	1 pt.	5-1/2"
W4064	1	12	LAB	1 qt.	7-1/2"
W54275	1	24	LAB	48 oz.	8"



EXTENDED REACH

- Great for dispensing petroleum based fluids and much more.
- Extra long neck prevents spills.

Item #	IP	MP	PKG	Spout	Diameter
W4034	1	12	LAB	18"	6"
W219	1	24	BLK	12"	5"



2-PC FUNNEL SETS

- Great for dispensing petroleum based fluids and much more.
- Extra long neck prevents spills.

Item #	IP	MP	PKG	Flex Spout	Diameter
W220	1	50	BLK	18"	5-5/8"
W227	1	24	LAB	18"	5-5/8"



HIGH CAPACITY FUNNELS

Item #	IP	MP	PKG	Capacity	Diameter
W54276	1	10	LAB	2 qt.	6-3/4"
W54272	1	12	LAB	8 qt.	9-1/2"



EASY FUNNELS

- Clips onto most common bottle necks.
- Easy one handed pouring.
- Compact and easy to store.
- Durable polypropylene construction.



Item #	IP	MP	PKG
W464	6	48	CRD/Pg 318
W9167	12	144	Pg 312

MAINTENANCE

FLUID TRANSFER PUMPS

QUART & GALLON FLUID PUMPS

- Patented double threaded cap fits both the quart and gallon size lubricants.
- Convenient and versatile for hard to reach places.



Dispenses 1 oz. of fluid.
W1141



2 adapters fit most marine lower unit drain holes



Fits both Quart and Gallon bottles

MAINTENANCE

Item #	IP	MP	PKG		
W1139*	4-PC	6	48	DBL	Pump, 24" dispenser tube, 4-1/2" & 5-1/2" intake tubes.
W54150*	6-PC	12	48	DBL	Same as W1139, plus 3/8" (W54151) & 8 mm (W54152) marine adapters.
W54151	3/8"	12	144	CLM	Fits: OMC, Mercruiser, Evinrude, Johnson, Volvo, Force, Honda (70hp and up), and Mercury US origin.
W54152	8MM	12	144	CLM	Fits: Yamaha, Nissan, Tohatsu, small Honda's, and Mercury Japanese origin.
W1141**	5-PC	1	6	DBL	Pump, 24" dispenser tube, "Quick Fit" nozzle, 3 & 5" intake tubes

**US Patent 7,857,172 **Fits standard gallon bottles only*

MULTI USE TRANSFER PUMPS

- Quickly transfers low-viscosity fluids, such as water and oils. Also works as an air pump.
- Ideal for changing oil, inflating beach balls, siphoning fluids and more.

Clear view barrel & hoses allows visual inspection.



W1156

Unique couplers offer far more holding power - no more messes from hoses coming loose. Quick change fittings for easy attach and release.



W1145

Not for use with caustic or flammable liquids

Item #	IP	MP	PKG	Contents
W1145	6	24	CLM	Transfer pump, Two 48" x 1/2" Plus 48" x 1/64" hose & inflatable kit.
W1156	Grip Clip™	6	24	CLM hoses, 15' air pressure hose Plus snap-shut valve & inflation needle.

LIQUID TRANSFER SHAKER SIPHON

- Shaker Siphon helps you transfer fluids with ease.
- Simply shake the hose up and down to start the transfer.
- Moves up to 7 gallons a minute (GPM), through a 6' anti-static tube.



W54155

Safely transfer fuels, gasoline, diesel, water and many other liquids.

SIPHON PUMPS

- All purpose.
- Oil and gas resistant.

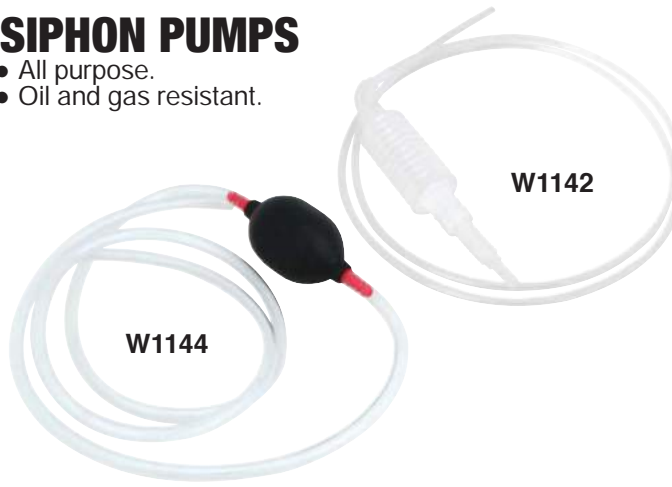

W1142

W1144

Item #	IP	MP	PKG	Diameter	Length	GPM	Item #	IP	MP	PKG	Hose Length	
W54154	6	24	CRD	1/2"	6'	3.5	W1142	Standard	24	BAG	6'	
W54155	12	24	TAB	3/4"	6'	7	W1144	Deluxe	12	96	CRD	2' & 4'

OIL EXTRACTION PUMP

- Conveniently remove oil or other liquids with no mess from spills or inconveniently accessed drain plugs.
- Evacuates fluids including engine oil, transmission fluid, gear oil, coolant, and power steering fluid.
- 8 Liters (2.11 Gal) Polyethylene constructed reservoir, large enough for most jobs.



Perfect for small equipment including: lawn mower, tillers, generators, ATV's, motorcycles, or other 4-cycle engines. Larger equipment including: cars, trucks, boats, farm, construction and much more.



Item #	IP	MP	PKG	
W54171	1	4	CBX	Two 48" pvc hoses needed to fit dip stick holes, or fill ports.

SUCTION GUN

- Professional quality heavy duty construction and rust resistant paint for long service life.
- Knurled thick wall barrel for secure grip.
- Zinc head cap.
- No priming necessary.



Perfect for transmissions, differentials, gear cases, lower units, cranks, etc.

Item #	IP	MP	PKG	Hose	Capacity
W54220	1	20	CBX	12"	1 pint

DRILL PUMP

- Fits standard garden hose.
- Use with any power drill.
- Self priming pump.



Item #	IP	MP	PKG	Shank
W1143	12	36	CRD	1/4"

MAINTENANCE

CORDLESS FLUID TRANSFER PUMP

- This highly versatile 2-D battery operated (not included) pump is capable of 2.6 gallons per minute.
- Works well with kerosene for heaters or stoves also.
- Chemical fluids, cleaners, water (not for use with drinking water), light oil, etc.

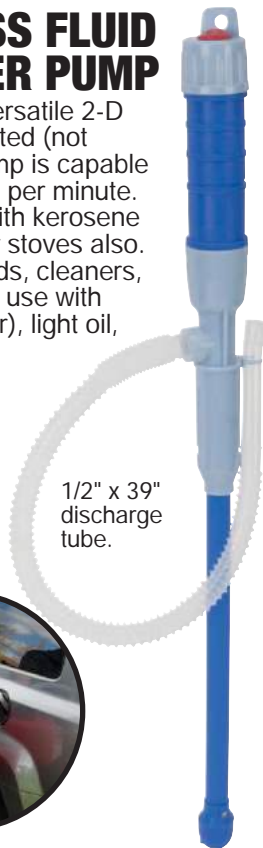

1/2" x 39" discharge tube.



Item #	IP	MP	PKG	GPM
W54172	6	24	CBX	2.6

PROFESSIONAL VACUUM PUMP

- Vacuum tool can test and diagnose a wide variety of parts and common systems on any vehicle.
- Complete kit includes accessories for both brake bleeding and automotive diagnosis.
- Vacuum gauge scales in inches of Mercury (Hg).



Item #	IP	MP	PKG
W87030	1	10	DBL

OIL EXTRACTION PUMP

- Our pump is portable, compact, lightweight and easy to use.
- Efficiently removes up to 1 gallon per minute (GPM).
- Easily removes oil from cars, motorcycles, RV's, boats and so much more.



Includes: Pump, hose clamps and 47 x 5/32" inlet hose and 59 x 15/32" outlet hose.

Item #	IP	MP	PKG	Motor	DC	Draw	RPM	Diesel	Oil
W54170	1	10	CBX	12V	5A	1,400	1.1	0.8	

BARREL PUMPS

BARREL PUMPS

- Lever style barrel pump with non-drip spout.
- Self adjusting telescopic suction tube.
- Designed to pump all lubrication based fluids, antifreeze, agricultural and industrial non-corrosive fluids.

W54267

Equipped with brass rings and a floating piston design.



W54268/ W54269

Polypropylene (PP) pumps with steel rods.

W54266

Features die cast head with garden hose threads. 18 gauge steel cylinder.



MAINTENANCE

Item #	IP	MP	PKG	Type	Body	Flow Rate /Stoke	Max Reach	Fits Container	Applications
W54267	1	10	CBX	Lever	Steel	12 oz.	36"		Lubrication based fluids, antifreeze, agricultural, industrial non-corrosive fluids
W54268	1	12	CBX	Lever	Blue PP	9 oz.	36"	5 to 55 gallon drums	Water, alcohol, gasoline, diesel, kerosene petroleum-based products
W54269	1	12	CBX	Lever	Yellow PP	9 oz.	36"		Water, alcohol, gasoline, diesel, kerosene petroleum-based products, mild acid and mild alkali solutions
W54266	1	12	CBX	Pump	Steel		36"		Kerosene, solvents, aggressive chemicals

ROTARY PUMPS



W54270

For industrial, commercial, automotive and agricultural applications. Single direction 2 vane pump with rugged cast iron housing.



Polypropylene body with PTFE vanes aids in resistance to harsh chemicals. One way check valve to aid in the prevention of product contamination.



W54285

Item #	IP	MP	PKG	Type	Body	Flow Rate /100 Turns	Max Reach	Fits Container	Applications
W54270	1	6	CBX	Rotary	Cast Iron	8 gal.	42"	5 to 55 gallon drums	non-corrosive petroleum based fluids of light to medium viscosity
W54285	1	6	CBX	Rotary	White PP	7 gal.	40"		DEF (Diesel Exhaust Fluid), also resistant to gasoline, diesel, machine oil, alcohol, acidic fluids and much more.

BUCKET PUMP

- Manual operation for quick, clean transferring of heavier lubricating oils including transmission and differential oils.
- Self-priming for ease of use.
- Rubber grip for comfort and control.

W54232

48" PVC hose pipe with nozzle.



Item #	IP	MP	PKG	Type	Body	Flow Rate /Stoke	Max Reach	Fits Container
W54232	1	6	CBX	Lever	Steel	2 oz.	18"	25 to 50 lbs. buckets

OILERS

- Drawn steel body.
- Durable epoxy finish.
- Brass tips.



Item #	IP	MP	PKG	Type	Capacity	Spout
W241	6	60	LAB	Hand	4 oz.	5" Flex
W242	6	36	LAB	Hand	12 oz.	5" Flex
W54263	1	24	LAB	Hand	16 oz.	5" Flex
W54264	6	24	LAB	Pistol	6 oz.	5" Rigid
W54265	6	24	LAB	Pistol	6 oz.	6-1/2" Flex
W243	12	96	CRD	Precision	-	-



Smooth, push-button actuator provides greater control and placement of lubricant. Lightweight and durable machined aluminum construction.

MAINTENANCE

MEASURING DISPENSERS

- Tapered 1/2" OD tip swings into the necessary angle for hard to reach jobs.
- Recessed bottoms drain fully and guard against puncture.
- Rolled edge top helps prevent oil spillage.
- Designed for one hand operation.

Thumb operated valve controls flow, flip action locks valve open.



Item #	IP	MP	PKG	Capacity	Spout
W54278	1	6	LAB	4 qt.	7-1/2"
W54279	1	4	LAB	5 qt.	14"

RECHARGEABLE LIQUID SPRAYER

- Eco friendly uses no aerosol propellants.
- Pressurize with your compressor and your ready to spray.
- Not for use with flammable material, or paint.



Item #	IP	MP	PKG	PSI	Capacity
M715	1	10	CBX	80-150	32 oz.

DISC BRAKES

DISC BRAKE CALIPER SERVICE KIT

- Great for installing new disc brake pads on many popular import and domestic 4 wheel disc brake vehicles.
- Winds back pistons in rear calipers with integral parking brake assemblies.

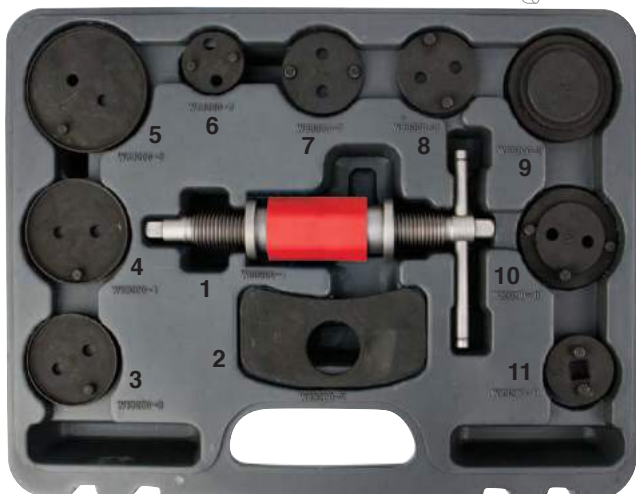
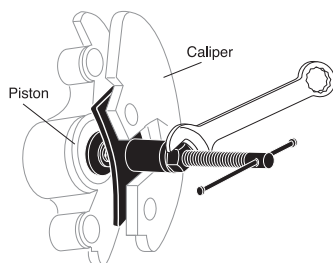

Includes ¹ Center screw assembly and ² Forcing plate

SPECIALTY

Item #	IP	MP	PKG	Single Pin			Dual Pin			Triple Pin	Step Bore	
				3	4	5	6	7	8	11	10	9
W89200	1	5	CBX	1-3/4"	1-15/16"	2-3/8"	1-1/4"	1-5/8"	1-5/8" (Shallow)	1-3/8" (3/8" dr)	1-15/16"	2-1/8"

DISC BRAKE PISTON TOOLS

- Realigns piston slots to back of brake pad.
- Use in with a 3/8" drive ratchet and extension.
- Not for use with air or impact tools.

W83165
Size: 1-7/8" and 2-1/8".

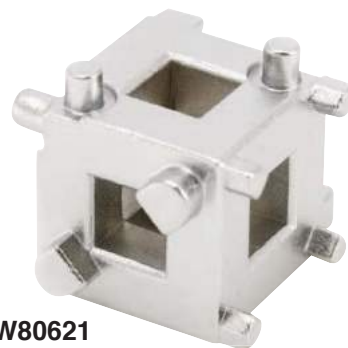

Item #	IP	MP	PKG	Application	
W80621	5-IN-1	6	72	CRD	Chrysler, Ford and GM vehicles with 4 wheel disc brakes
W83165	2-IN-1	12	96	CRD	Ford and GM vehicles equipped with rear wheel disc brakes

DISC BRAKE CALIPER SPREADER

- For installing pads on domestic and import cars and trucks that have the wind back pistons calipers.
- Wind back pistons on both left hand and right hand threaded piston calipers.

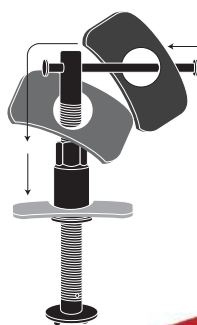

To place forcing plate onto center screw assembly, push T-handle to one side and thread forcing plate over handle and slide down to rest on retaining lip.



Item #	IP	MP	PKG
W89201	6	24	CRD

DISC BRAKE PAD SPREADER

- Used to compress pistons back into calipers when installing new brake pads.
- Durable, heavy duty construction.

Item #	IP	MP	PKG
W209	6	24	CRD

X-TYPE PAD SPREADER

- Used to spread pads in calipers apart for reinstallation of calipers onto car.
- Quality alloy steel construction.

Item #		IP	MP	PKG
W80112	X-Type	6	72	CLM

BRAKE CALIPER HANGER

- Hold brake calipers out of the way, reducing the possibility of damage to calipers, brake hoses and other parts.
- Made from 1/4" heavy-duty steel.



Item #	IP	MP	PKG
W80624	20	100	CRD

4-PC BRAKE CALIPER HEX BIT SETS

- Heat treated alloy steel.
- Professional sand finish.

Item #	IP	MP	PKG	Drive	Length	Sizes
W86021	6	36	CRD	3/8"	4"	1/4, 3/8, 5/16, 7/32"
W86022	6	36	CRD	3/8"	4"	6, 7, 8, 10mm
W86020	6	36	CRD	3/8"	4"	T40, T45, T47, T50

Additional Hex bits on Pg 180



Perfect for a variety of automotive work, including tasks related to brakes, wheel bearings, axle shafts and suspension servicing.

SPECIALTY

BRAKE FLUID TESTER

- Used to examine the quality of brake fluid by indicating the percentage of water in the fluid.
- 5 LED readout indicates percentage of moisture.
- Includes 1-AAA battery.

Item #	IP	MP	PKG	Suitable for
W181	10	100	CRD	DOT 3, DOT 4
W182	10	100	CRD	DOT 3, DOT 4, DOT 5



5-PC BRAKE SERVICE KIT

- Contains all the tools necessary for common disc and drum pad and shoe replacement.
- Includes disc brake pad spreader, disc brake piston tool, brake spoon, brake spring pliers and brake bleeder kit.



Item #	IP	MP	PKG
W180	1	12	CBX

DRUM BRAKES



BRAKE SPOONS

- Adjusts star-adjuster and screw-adjuster type brakes quickly and easily.
- Drop forged steel.
- Chrome plated to resist corrosion.

Angled blades for confined areas.

W80630



**W178C/
W179C**



Item #	IP	MP	PKG	
W178C	7"	12	144	CRD
W179C	9"	6	72	CRD
W80630	7"	6	72	CRD Offset design

BRAKE SPRING HOOK

- Removes and installs headlight adjusting and brake springs.
- Easy access to hard to reach areas.
- Heat treated alloy construction.



Item #	IP	MP	PKG
W86557	12	144	CRD

BRAKE SPRING PLIERS

- Used to remove and install shoe return springs on most drum brakes.
- Cutaway portion on tool allows better visual alignment of pin and washer.
- Chrome plated to resist rust and provides easy clean up.

Socket end removes spring from anchor stud.

W175



Notched end installs spring on anchor.

W159C



Item #	IP	MP	PKG
W175	6	48	CRD
W159C	12	96	CRD

BRAKE SPRING WASHER TOOLS

- For removal and replacement of backing plate springs, cups and pins.
- Cutaway portion on tool allows better visual alignment of pin and washer.

W158C



W80622



W82004

Patented handle for improved grip.
US Patent D693201S1



Item #	IP	MP	PKG	Sizes
W158C	6	96	CRD	11/16 to 7/8"
W82004	Pro	12	108	CRD 5/8 to 11/16"
W80622	2-in-1	6	72	CRD 9/16 to 5/8 & 11/16 to 3/4"

BRAKE CYLINDER HONES

- Flexible self-aligning shaft permits use without removing cylinder.
- For use with any electric drill.
- Adjustable honing tension.
- Quality construction.

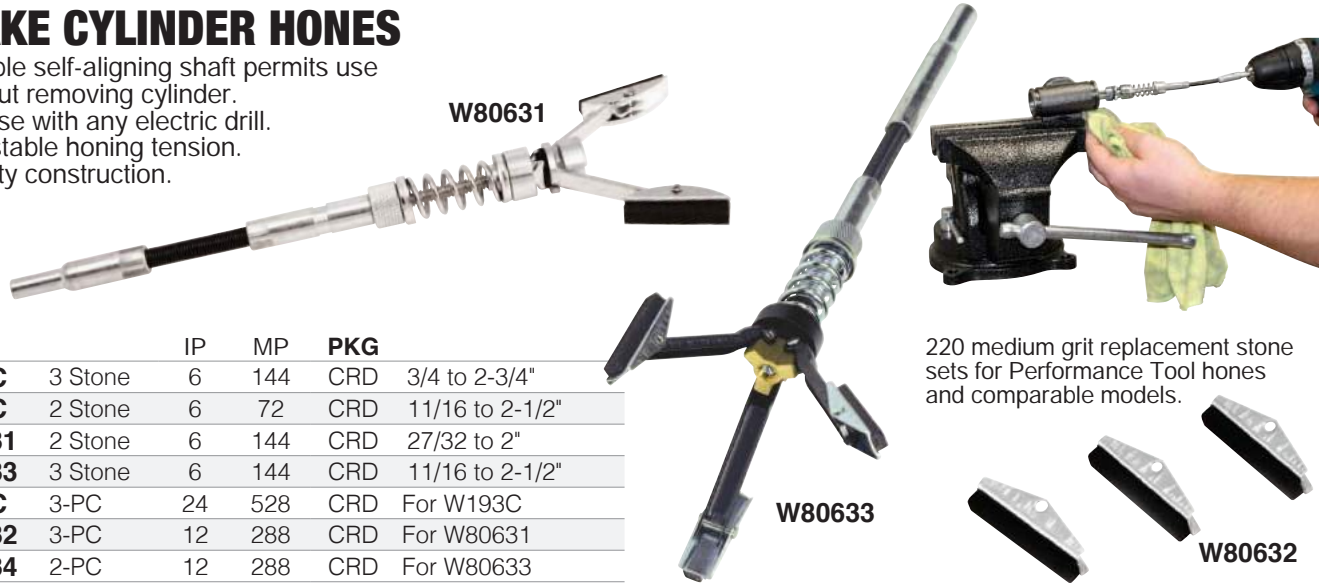

Item #	IP	MP	PKG	
W193C	3 Stone	6	144	CRD 3/4 to 2-3/4"
W196C	2 Stone	6	72	CRD 11/16 to 2-1/2"
W80631	2 Stone	6	144	CRD 27/32 to 2"
W80633	3 Stone	6	144	CRD 11/16 to 2-1/2"
W199C	3-PC	24	528	CRD For W193C
W80632	3-PC	12	288	CRD For W80631
W80634	2-PC	12	288	CRD For W80633

220 medium grit replacement stone sets for Performance Tool hones and comparable models.

BRAKE ROTOR HONE

- Use to score a cross hatch pattern on the surface of brake rotors.
- Works on automotive and motorcycle brake rotors, and flywheels.
- Gain lower harmonic vibration, and a quieter braking system.
- 120 grit flexible ball stones.

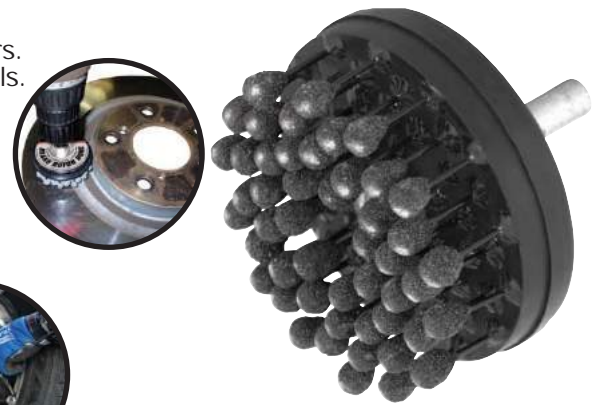

Item #	Diameter	IP	MP	PKG	Grit
W80629	2-1/2"	6	48	CRD	120

BRAKE BLEEDER WRENCHES

- Offset design for confined areas
- Fully polished chrome plated finish
- Chrome vanadium steel construction

Item #	IP	MP	PKG	Sizes
W80616	6	48	CRD	1/4, 3/8"
W80617	6	48	CRD	5/16, 3/8"
W80619	6	48	CRD	7, 9 mm
W80620	6	48	CRD	8, 10 mm



BRAKE BLEEDER KITS

- Allows one person to quickly and easily bleed air from brake lines.
- Fits most cars and light trucks.

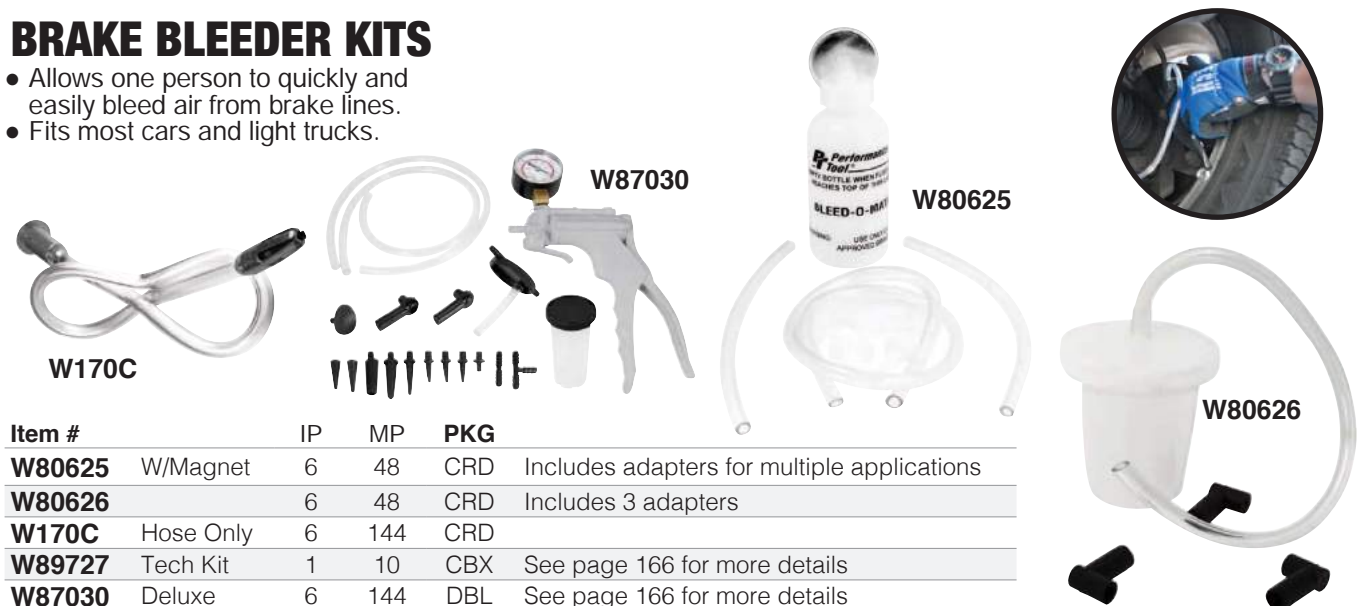

Item #	IP	MP	PKG	
W80625	W/Magnet	6	48	CRD Includes adapters for multiple applications
W80626		6	48	CRD Includes 3 adapters
W170C	Hose Only	6	144	CRD
W89727	Tech Kit	1	10	CBX See page 166 for more details
W87030	Deluxe	6	144	DBL See page 166 for more details

SPECIALTY

FLARING TOOLS

DOUBLE FLARE TOOL SET

- Easy to use level lock flaring bar.
- Floating cone for accurate alignment.
- Fits tubing sizes: 3/16, 1/4, 5/16, 3/8 and 1/2" O.D.



Item #	IP	MP	PKG	Contents
W80670	6	24	CRD	Includes flaring bar, yoke, and 5 double flare dies.
W80679	1	120	CRD	3/16, 1/4, 5/16, 3/8, 1/2"



37 DEGREE FLARING TOOL SET

- Creates the proper angle for AN and JIC fittings.
- Floating cone for accurate alignment.
- Fits tubing sizes: 3/16, 1/4, 5/16, 3/8 and 1/2" O.D.

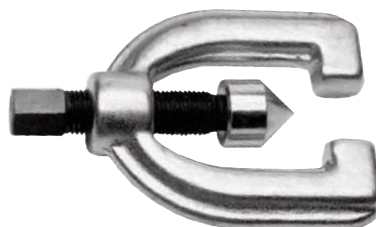

For high performance applications only.

Item #	IP	MP	PKG	Contents
W80671	6	24	CRD	Set includes flaring bar and yoke with center screw.

ISO BUBBLE FLARING TOOL SET

- Multiple die sizes for variety of jobs.
- Crack free flares in automotive brake system tubing.
- Fits tubing sizes: 4.75, 6, 8 and 10 mm.



Item #	IP	MP	PKG	Contents
W80672	6	24	CRD	Set includes flaring bar, yoke, dies and wrench.

SINGLE FLARING TOOL

- Single flares copper, brass, aluminum and mild steel tubing.
- Easy to use lever lock flaring bar.
- Floating cone for accurate alignment.
- Fits tubing sizes: 3/16, 1/4, 5/16, 3/8, 1/2 and 5/8" O.D.



Item #	IP	MP	PKG	Contents
W701C	6	24	CRD	Set includes flaring bar and yoke with center screw.

TUBING BENDER

- Heavy duty construction.
- Four grooves designed to fit popular tubing sizes.

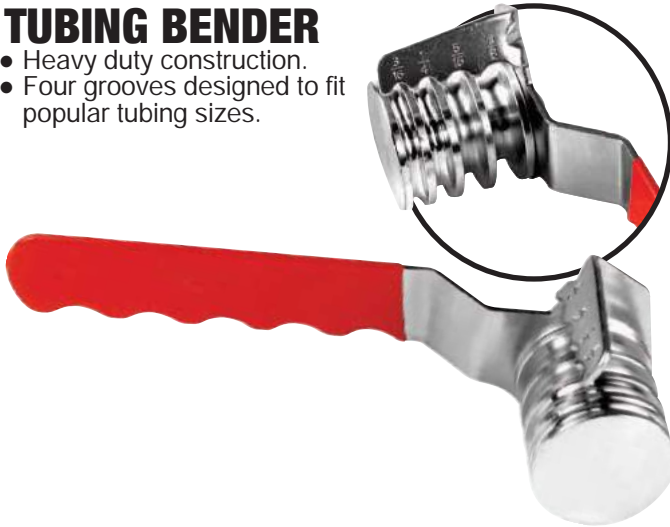

Item #	IP	MP	PKG	Range
W86013	6	48	CRD	3/16, 1/4, 5/16, 3/8" O.D.

TUBING BENDERS

- For copper and brass tubing, brake lines and Bundy welding tubes.
- Durable die cast construction.

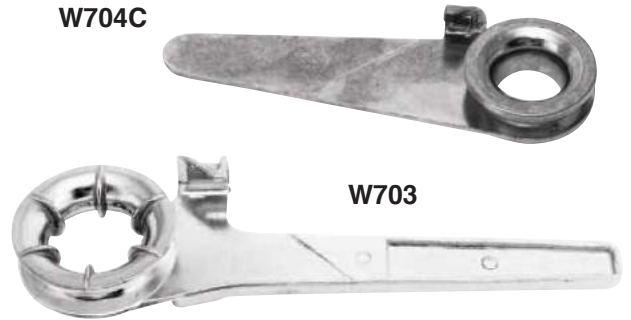

Item #	IP	MP	PKG	Bends up to
W703	Large	6	48	CRD 1/2" (13 mm) O.D.
W704C	Small	6	48	CRD 5/16" (8 mm) O.D.

PROFESSIONAL TUBING BENDER

- Pliers action tube bender makes tight bends without collapsing tubing
- Roller adapters included for each size and are locked into place with locating pin
- Quality alloy steel construction



Item #	IP	MP	PKG	Range
W80674	6	24	CRD	3/16, 1/4, 5/16, 3/8" O.D.

PRECISION TUBING BENDER

- Accurately bends tubing to angles up to 90 degrees.
- Markings for precise bend angle and measurements from left or right end of tubing.

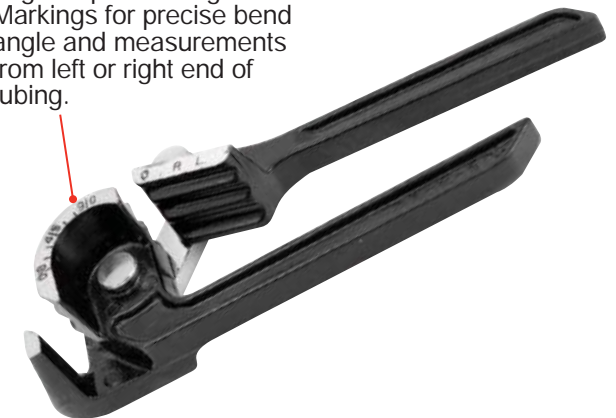

Item #	IP	MP	PKG	Range
W80675	6	24	CRD	1/4, 5/16, 3/8" O.D.

TUBING CUTTERS

- Carbide steel wheel cuts to within 1/4" from end of tube.
- For use on hard and soft copper, aluminum, brass, thin wall steel and stainless steel lines.
- Wide rollers prevent spiral cut.

W700C
Handy in confined areas



W82003
Highly polished, chrome plated for corrosion resistance.



Tapered bur remover
W702C



Self tensioning
W82005

Item #	IP	MP	PKG	Cuts O.D.
W82003	Professional	6	48	CRD 1/8 to 1-1/8" (3 to 28 mm)
W702C	Standard	6	72	CRD 1/8 to 1-1/8" (3 to 27 mm)
W700C	Mini	6	96	CRD 1/8 to 5/8" (3 to 16 mm)
W82005	Self Tensioning	6	36	CRD 1/8 to 3/4" (3 to 19 mm)

Also cuts plastic and PVC tubing. Super strong internal spring keep constant cutting pressure. Retractable reamer blade for debarring.

SPECIALTY

AXLE NUT SOCKETS

12 POINT FWD SOCKETS

- Designed for removal or installation of axle nuts on front wheel drive vehicles.
- Heavy duty chrome moly alloy steel.
- Use with 1/2" drive tool.

Item #	12 pt.	IP	MP	PKG
W83177	32mm	10	60	TAB
W83179	34mm	10	60	TAB
W83180	36mm	12	48	TAB
W158	39mm	6	24	TAB
W89316	5-PC	1	8	CBX
	30, 32, 34, 36, 39mm			



6 POINT FWD SOCKETS

Item #	6 pt.	IP	MP	PKG
W80548	29mm	6	24	TAB
W153	30mm	6	24	TAB
W80546	31mm	6	24	TAB
W155	32mm	6	24	TAB
W80553	33mm	6	24	TAB
W156	34mm	6	24	TAB
W80549	35mm	6	24	TAB
W154	36mm	6	24	TAB
W80550	38mm	6	24	TAB
W83178	30mm	10	60	TAB
W89318	9-PC	1	4	CBX
	29, 30, 31, 32, 33, 34, 35, 36, 38mm			



6 POINT CHROME

- Heat treated alloy steel.
- Polished chrome plated finish.
- Use with 1/2" drive tool.

Item #	6 pt.	IP	MP	PKG
W1296	30mm	6	24	TAB
W1297	32mm	6	36	TAB
W1298	34mm	6	24	TAB
W1299	36mm	6	36	TAB



SPECIALTY

BUDD WHEEL SOCKETS

- Heavy duty chrome moly construction.
- Use with 1" drive tool.

Item #		IP	MP	PKG
W83030	1-1/2"	1	20	TAB
W83033	33mm	1	20	TAB
W83035	35mm	1	20	TAB
W83038	38mm	1	20	TAB
W83041	41mm	1	10	TAB
W89315	5-PC	1	4	CBX



33, 35, 38, 41mm, 1-1/2"



LOCK NUT SOCKETS

- Heavy duty chrome moly construction.
- Use with 1/2" drive tool.



Round Type



Hex Type



Item #		IP	MP	PKG	Years	Application
W83243	2-1/2" Hex	6	24	TAB		
W83244	2-1/2" Round	6	24	TAB	1995-96	Ford F-series 1/2 ton trucks and full-size Bronco with automatic hubs.
W83240	2-3/8" Hex	6	24	TAB	1984-92 1993-97	Ford Ranger and Bronco II with automatic hubs; Ford Ranger, Bronco II and Explorer with automatic hubs.
W83241	2-3/8" Round	6	24	TAB	1990-newer	Ford Ranger, Bronco II and Explorer with automatic hubs.
W83246	2-3/4" Round	6	24	TAB	1995-98	Ford F-series 3/4 and 1 ton trucks with automatic hubs.
W83245	2-9/16" Hex	6	24	TAB	1990-93	Dodge truck with Dana 60 manual hubs.
W83255	55mm Hex	6	24	TAB		Toyota FJ, LN and RN models.
W89314	7-PC	1	4	CBX		Tech Kit Hex: 2-3/8, 2-1/2", 55 mm. Round: 2-1/2, 2-3/4, 2-9/16, 2-3/8"

4 X 4 SPINDLE NUT WRENCHES

- For many 2 wheel and 4 wheel drive light truck applications.
- Chrome vanadium steel construction.
- Use with 1/2" drive tool.



Item #	IP	MP	PKG	Years	Application
W1269	4 Slot 2-1/4"	6	24	TAB	1993-newer 1995-96 1995-newer 1959-85 1960-90 1969-89 1969-72 Ford Ranger, Bronco II and Explorer with manual hubs Ford F-series 1/2 ton truck and full-size Bronco with manual hubs; Ford F-series 3/4 ton and 1 ton trucks with manual hubs; Ford F-series 1/2 and 3/4 ton trucks and full-size Bronco; GM 1/2-ton truck and full-size Blazer/Jimmy; Dodge 1/2 ton truck with manual hubs; International 1/2 ton truck.
W1270	6 Slot 2-5/8"	6	24	TAB	1978-84 1973-81 Ford F-series H.D. 3/4 and 1 ton 4WD trucks; GM 3/4 and 1 ton 4WD trucks.
W1271	4 Slot 2-3/8"	6	24	TAB	1984-92 1986-95 1990-93 Ford Ranger and Bronco II with manual hubs; Ford F-series 1/2 ton truck; full size Bronco with Dana 44 front axle; Dodge trucks with Dana 44 automatic hubs.
W1272	4 Slot 2-5/8"	6	24	TAB	1995-2002 1996-2002 Tacoma T100 and 4Runner. Similar to Toyota No. 09318-12010-01.
W1273	4 Slot 2-1/2"	5	25	TAB	1985½ - 95 1982-90 1994-newer Ford F-series H.D. 3/4 and 1 ton Dana 50 IFS of Dana 60 front axle; GM H.D. 3/4 and 1 ton trucks, Dodge Dana 60 with Cummins.
W83005	8 Slot	6	12	TAB	2007-14 2008-14 Toyota 4Runner and Tundra Sequoia
W83006	9 Slot 2-3/4"	4	16	TAB	2011-newer Heavy duty GM C/K2500 and C/K3500 trucks with 10.5 and 11.5 full floating rear axles.
W83008	4 Slot 2-3/4"	2	12	TAB	1985-newer Ford F-series 3/4 and 1 ton trucks with Dana 80 rear axle.
W83010	4 Slot 2-5/8"	6	24	TAB	1982-1990 1985-newer GM 3/4 and 1 ton heavy duty trucks Ford F-series and full size Bronco with Dana 28 front axle, F-250 series pickup, F-350 series 4x4 pickup, Dana 50 IFS and Model 60 mono beam outer adjusting nut
W80490	1-11/16"	6	24	TAB	1994-newer Dodge 1/2 ton 4x4 pickups with Dana 44 front axle and Dana 60 axle with vacuum disconnect from front axle.
W89319	6-PC	1	3	CBX	Tech Kit: W1269, W1270, W1271, W1272, W83008 and W83009

SPECIALTY

WHEEL BEARINGS & HUBS

SLIDE HAMMER PULLER SET

- Contains slide hammer with multiple attachments including 2/3 jaw, internal and external pullers, rear axle puller, locking pliers adapter, puller hook and dent puller.



Item #	IP	MP	PKG
W89725	1	2	CBX

HUB REMOVER & INSTALLERS

- To remove and install most front wheel drive hubs for servicing of wheel bearings, CV joints or transaxle.

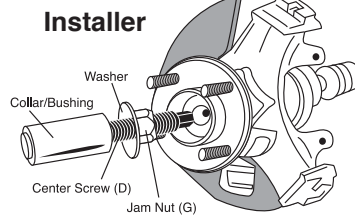
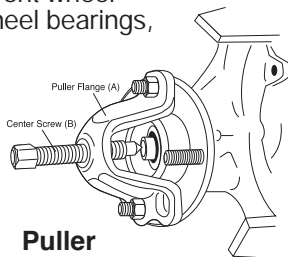

Item #	IP	MP	PKG	Contents
W89324	1	5	CBX	Puller Flange, Center Screw for Puller, Locknut for Puller, Center Screws for Installer (large & small), Installer Collar/Bushings (large & small), Washer, Jam Nut.

UNIVERSAL HUB & DRUM PULLER

- Puller frees frozen hubs, axle shafts, and other tough pulling applications.
- Adjustable sliding legs can be positioned anywhere on the center hub ring.
- Maximum bolt pattern 7-1/2" (190.2mm), also removes press-fit rear brake drums.
- Designed to be used on most model cars.



Item #	IP	MP	PKG	Contents
W89325	1	2	CBX	striking wrench and puller screw and three jaws.

REAR AXLE BEARING PULLER SET

- The specially designed pullers allow for the removal of semi-floating rear axle bearings by firmly seizing and evenly extracting the bearing.
- Use with 5/8" - 18 UNF thread slide hammer.

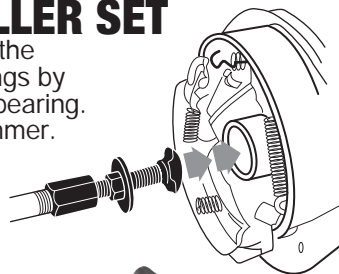

Item #	IP	MP	PKG	Bearing Tube I.D.	
				Min	Max
W89326	1	12	CBX	1"	1-7/8"
				1-5/16"	2-3/8"
				1-3/8"	2-7/8"



SPECIALTY

BEARING SPLITTERS

- Separates and removes press-on style bearings.
- Knife-like edges allow for a secure grip.
- Forged steel construction.

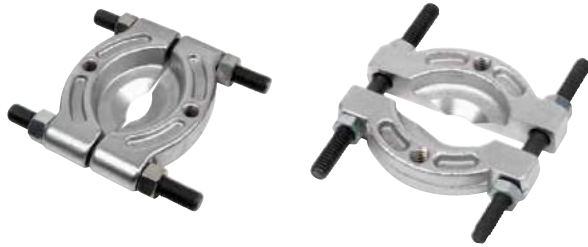

W87128



Item #	IP	MP	PKG	Range
W84550	1	50	CBX	3/8 to 1-1/4"
W84551	1	20	CBX	1-1/4 to 2-1/4"
W84552	1	12	CBX	2-1/4 to 3-1/2"
W84553	1	10	CBX	3 to 4-1/2"
W87128	1	4	CBX	2-1/4 to 3-1/2" 3 to 4-1/2"

Includes 2" and 3" bearing splitters and four sets of hex push puller legs, 5" puller cross-bar with 6-1/4" forcing screw can be used independently

WHEEL BEARING RACE & SEAL INSTALLER SETS

- Inserts tapered wheel bearing race and seals without damage to the component or axle housing.
- Includes driver handle with bolt.
- Fits most standard wheel bearings.

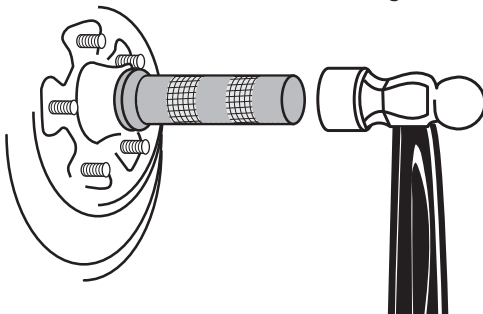

SPECIALTY

Item #	IP	MP	PKG	Sizes
W83020	7-PC	6	CLM	1.565, 1.75, 1.965, 2.325, 2.47, 2.555"
W89715	10-PC	1	CBX	1.565, 1.75, 1.965, 2.325, 2.47, 2.555, 2.83, 2.995, 3.180"

SHOP PRESSES

- Great for straightening, stamping, bending and pressing any component that is hard to handle.
- Rugged heavy gauge tubular steel construction.
- Remote pressure cylinder with relief valve.
- Includes a 4" liquid-filled pressure gauge with dual metric/tons pressure readings.
- Up to 9 adjustable height positions
- Some assembly required.



See page 53 for more details

Item #	IP	MP	PKG
W41062	12 Ton	1	WBX
W41063	20 Ton	1	WBX
W41065	Accessory	1	CBX

Set includes six common accessories used in a variety of press applications.

PILOT BEARING PULLER SET

- For removal of pilot bearings or any other items requiring an internal puller.

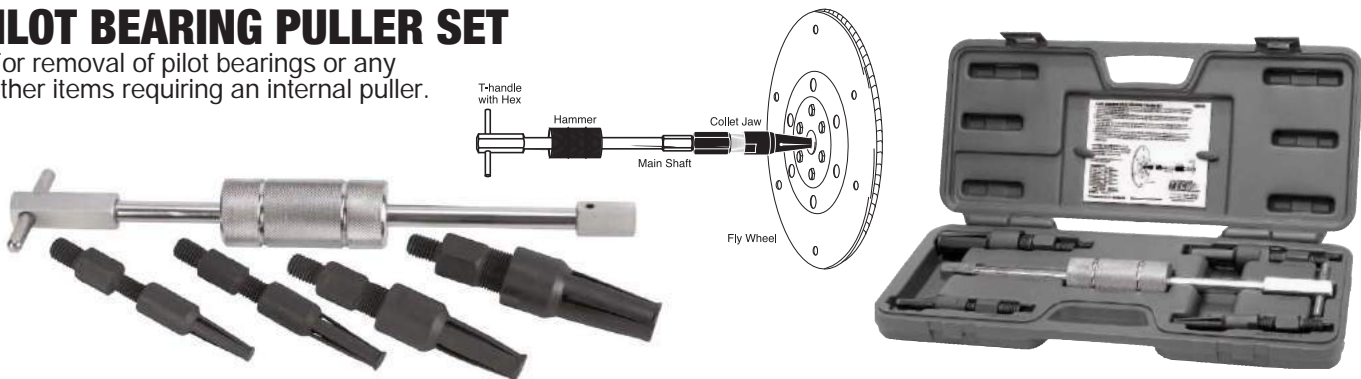

Item #	IP	MP	PKG	Contents
W89742	1	5	CBX	Includes four separate adapters for multiple applications.

CLUTCH ALIGNMENT TOOLS

- Plated aligning cone with graduated diameters for "automatic" fit to most clutch plates.
- Tapered cone for all others.



Item #	IP	MP	PKG	Sizes
W1157P	SAE	6	36	CRD .590, .612, .624, .668, .749, .786, .808 and .904"
W1158P	Metric	6	36	CRD 12, 12.6, 14, 15, 15.8, 16, 17, 18, 19 and 20 mm

SPECIALTY

CV JOINT BOOT CLAMP BAND TOOL

- For installing Band-It and Band-It Jr. and open end clamps on CV joint boots.
- Tightens band and holds it securely in place until clamped.
- All steel construction with professional style PVC handle

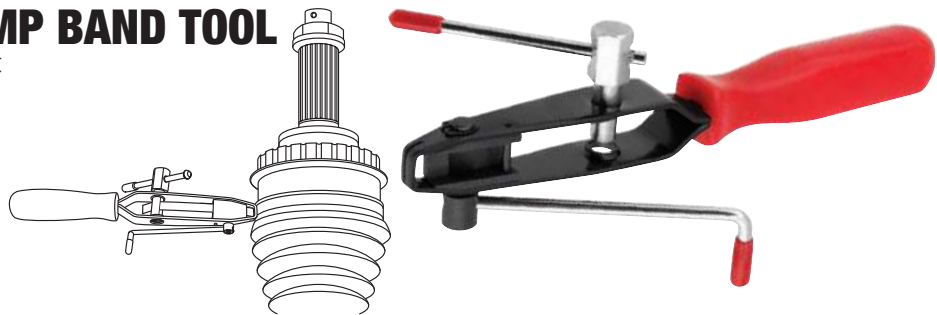

Item #	IP	MP	PKG
W83011	6	48	CRD

CV JOINT BOOT CLAMP PLIERS

- Crimps and flattens clamps on ear type CV joint boot clamps.
- All steel construction with vinyl grips



Item #	IP	MP	PKG
W83013	6	48	CRD

CLUTCH LINE DISCONNECTS

- For removing hydraulic clutch lines from clutch slave cylinders.
- All steel construction.



W83150
4" length with 5/8" opening

W83151
5" long with 5/8" opening and 1-1/2" offset

Item #	IP	MP	PKG	Application
W83150	Ford	6	144	CRD Ford light-duty trucks, Bronco II, Ranger, and Explorer. 1989 to current Thunderbird and Cougar. 1993 to current Pontiac Grand Prix, Firebird Oldsmobile Cutlass Supreme, Buick Regal. 1993-94 Chevy Lumina. 1995 to current Chevrolet Monte Carlo. 2002-05 Dodge Neon
W83151	GM	6	24	CRD The bent end intended for NVG3500 and NV4500 manual transmissions works on 1996 to 2004 fullsize 2WD and 4WD trucks Chevrolet S-10 Blazer and pickups The straight end is for 1993 to 1994 Chevrolet Lumina sedan 1995 to 2000 Chevrolet Monte Carlo 1993 to 1999 Buick Regal 1998 to 2002 Olds Intrigue 1993 to 1997 Olds Cutlass Supreme and Pontiac Grand Prix

STRUT SPRING COMPRESSOR

- Safely and easily compresses coil springs not accessible from the center of the coil.
- Works with springs up to 6" outside diameter and wire diameter of a maximum of 5/8".

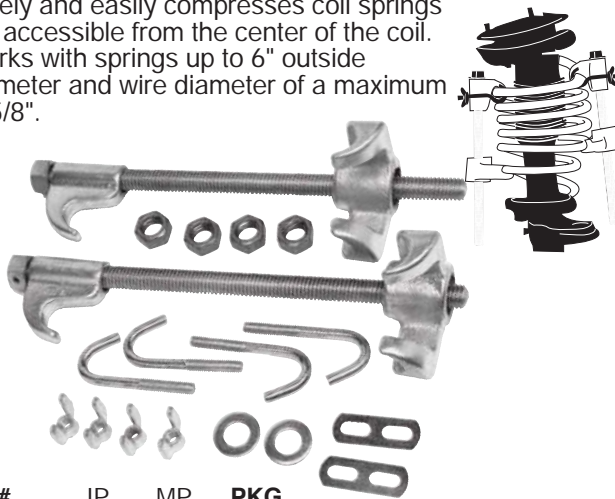

Item #	IP	MP	PKG
W80556	2	6	CLM Macpherson

STRUT SPRING COMPRESSOR

- Compresses springs for strut service or replacement.
- U-bolts securely attach tool to spring during operation for maximum safety.



Item #	IP	MP	PKG
W80555	3	6	CLM Macpherson

STRUT SPRING COMPRESSOR

- For most automotive and light truck applications.
- Includes locking pins for additional safety.
- Drop forged steel constructed.



Item #	IP	MP	PKG
W89322	1	5	CBX Macpherson

STRUT SPRING COMPRESSOR

- Compresses strut and coil springs.
- Suitable for passenger cars and light duty trucks.
- Drop forged steel jaws.



Item #	IP	MP	PKG
W80559	1	10	CBX Macpherson

COIL SPRING COMPRESSOR

- Safely and easily compresses coil springs accessible from the center of the coil.
- 2" rod with 8-1/4" - 14" jaw opening range.
- Tempered chrome moly steel jaws.



Item #	IP	MP	PKG
W80554	2	12	CLM Single Action
W89311	1	5	CBX Single Action

UNIVERSAL SHOCK NUT TOOL SET

Easily removes and installs shock nuts on most vehicles. Includes shock nut socket and 2 stem tools accommodating 3 sizes of stems.



Item #	IP	MP	PKG
W80551	6	72	CRD 3-PC

UNIVERSAL STRUT NUT REMOVER

Removes top nut on most MacPherson Struts. Contains: 3/4" adapter, 6.5 mm hex and "Double D", 7.5 mm hex and "Double D", T-50 star, 10 mm internal hex and "Double D".



Item #	IP	MP	PKG
W83015	6	24	CRD 6-PC

SPECIALTY

SUSPENSION

FRONT END SERVICE TOOLS

- For removal of most types of pitman arms, tie rods and ball joints found on automotive and light truck applications.
- Heavy duty drop forged steel.

Removes and installs various gears, pulleys and bearings.
7" center screw.

W83021



W80557



Opening 1-1/16" (27 mm).
Pull travel 2-1/8" (54 mm).
Use with 3/8" drive ratchet.

W89303



W142

Opening 1-5/16" (33 mm).
Pull travel 2-1/2" (63 mm).
Use with 3/8" drive ratchet.

Adjustable for different size ball joints. Use with 3/8" drive ratchet.



W83022



2" inside clearance

W83025

SPECIALTY

Item #	IP	MP	PKG	Item #	IP	MP	PKG	Opening	Depth
				W142			CRD	1-5/16"	2-1/2"
				W83021			CRD		7"
W89303	5-PC Set	1	3 CBX	W83022			CRD	-	2"
				W83025			CRD	3/4"	1-7/8"
				W80557			DBL	1-1/16"	2-1/8"

PICKLE FORKS

- For separating most types of pitman arms, tie rods and ball joints found on a automotive and light truck applications.
- Drop forged steel.

W1205

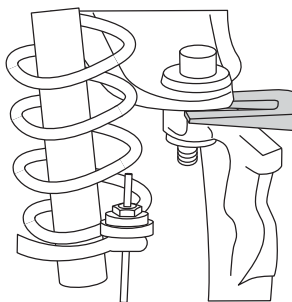

W1206P



W89310

Item #	IP	MP	PKG	Item #	IP	MP	PKG	Opening	Depth
				-			-	1-1/16"	2-3/8"
				W1204P			CLM	21/32"	2-3/4"
W89310	5-PC Set	1	3 CBX	W1205			CLM	1-3/8"	2-7/8"
				W1206P			CLM	15/16"	3"
				-			-	1-5/8"	3-1/8"

BALL JOINT SERVICE KITS

- Includes the necessary tools to service press fit type ball joints without removing the control arm.
- Service most car and light truck U-joints either on or off the vehicle
- 4 x 4 Adapters allow removal and installation of upper & lower ball joints on 1967 to current 4WD vehicles with Dana 44 axles
- Also removes and installs brake anchor pins

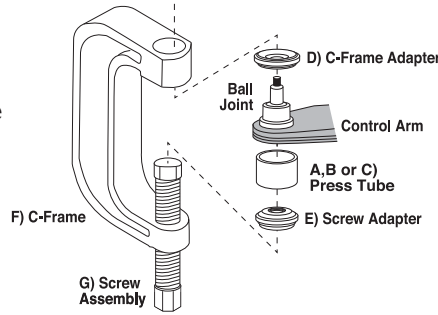

Item #	IP	MP	PKG	Pressing Tubes
W89304	1	3	CBX	1-3/4 x 2", 1-3/4 x 2-1/2", 2-1/4 x 3"

BALL JOINT SERVICE KITS

- Includes all receiving tubes removing and installing adapters needed to work on most GM, Ford and Dodge two and four wheel drive pickups, vans and SUVs through 1997.
- Works on press fit upper and lower ball joints.

	O.D.	I.D.	Length	O.D.	I.D.	Length	
Receiving Tubes	3"	2-3/4"	2-1/4"	Installing Tubes	2"	1-3/4"	3"
	2-3/4"	2-7/16"	2-1/4"	Receiving Cups	2-1/4"	1-7/8"	7/16"
	2-1/2"	2-1/4"	2-3/4"		2-1/8"	1-3/4"	1/2"
	2-7/8"	2-5/8"	2-7/8"	Installer Plug	1-7/16"	3/4"	1"
	2-7/16"	2-3/16"	3-3/16"		7/8"	-	-
	2-1/2"	2-1/4"	3/4"				
	2-1/4"	2"	2"				
	2-1/2"	2-1/4"	1-1/2"				



Item #	IP	MP	PKG
W89305	1	3	CBX

This set expands the service capabilities of the W89304 Ball Joint Service Set.



SPECIALTY

GM TORSION BAR UNLOADING TOOL

- Premium tool is designed to hold the torsion bar while making adjustments, or replacing keys.
- Heavy duty forged steel with a larger 7/8" diameter threaded screw.
- Designed to handle GM's K-3500 series trucks with heavy-duty chassis and a larger torsion bars.
- Features a larger C-frame opening to accommodate beefier torsion bars.



Item #	IP	MP	PKG
W83026	1	6	CBX

BODY & INTERIOR

10-IN-1 TRIM TOOL

- All steel construction.
- Comfortable grip handle.
- 9-3/4" overall length.

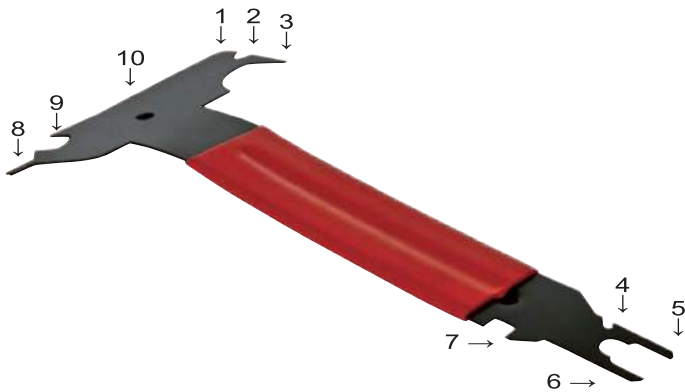

1. Serrated edge for panel seam cleanup
2. Door clip remover (plastic clips)
3. Windshield molding clip release tool
4. Headlight spring tool
5. Door handle clip remover
6. Trim pad removing tool
7. Door weather strip clip & headlight screw remover
8. Metal door trim clip installer
9. Windshield wiper wrench 1/2" (13 mm)
10. Beveled edge for removing molding

Item #	IP	MP	PKG
W83201	24	144	CRD

DOOR PANEL REMOVER

- Removes panels without marring upholstery.
- Heavy duty chrome plated shaft.
- 8-3/4" length.



Item #	IP	MP	PKG
W80645	6	72	CRD

DOOR/WINDOW HANDLE CLIP TOOL

- Removes and installs door handle and window crank retainer clips on many popular vehicles.



Item #	IP	MP	PKG
W80646	6	72	CRD

COMPOSITE TRIM REMOVAL TOOL SET

- Set contains five unique tools for removing internal and external trim and molding fasteners.
- Anti-marring design prevents damage to vehicle paint, upholstery, chrome or finish.

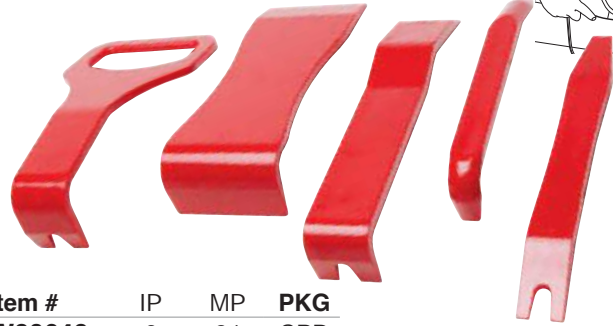
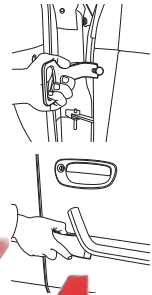

Item #	IP	MP	PKG
W80648	6	24	CRD

PLASTIC CHISEL SET

- High impact plastic handle withstands hammer blows and includes hand guard.



Plastic blade can be re-sharpened.

Item #	IP	MP	PKG	Blade
W83199	6	24	CRD	1 & 2"

CLIP REMOVAL PLIERS

- Removes door upholstery and other trim anchors.
- 2 step tip for easy access.
- Spring loaded handle for greater leverage.

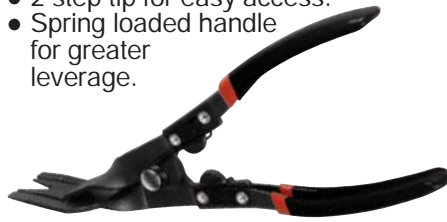

Item #	IP	MP	PKG
W86556	6	36	CRD

PUSH PIN PLIERS

- Designed to remove push pins with center locking pin.
- Quickly and easily removes plastic anchors without damage.



Item #	IP	MP	PKG
W86561	6	36	CRD

DOOR SPRING TOOL

- Removes and installs door springs on most GM cars and trucks.
- Alloy steel construction.
- Use with 1/2" wrench or socket.



Item #	IP	MP	PKG	
W84603	GM	12	72	CRD

LOCK OUT TOOL

- For emergency access when keys are locked inside.
- 1-1/4" x 24" with push and pull ends.

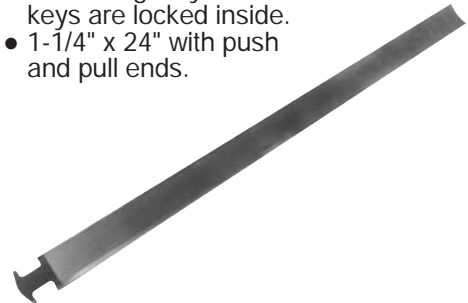

Item #	IP	MP	PKG
W1147C	24	144	CRD

SPECIALTY

STEERING WHEEL LOCK PLATE TOOLS

- Compatible with many domestic steering wheels including tilt and telescoping models.
- For easy removal and installation of lock ring.
- Heavy duty construction.

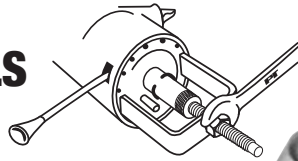

Designed for air bag equipped vehicles.

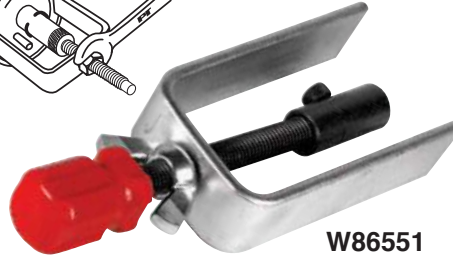

W86551



W80649

Item #	IP	MP	PKG	
W80649	6	48	CRD	Includes 2 puller yokes 1-7/8 & 3". SAE and Metric adapters.
W80650	6	48	CRD	Includes 3" puller yoke, SAE and Metric adapters.
W86551	6	24	CRD	9/16" x 18mm, M14 x 1.5mm adapters.

STEERING WHEEL PULLERS

- All heavy duty components.
- Fits vehicles with 4" hubs.
- Complete with SAE and Metric threaded bolts, T-bar, 4-1/2" center bolt, screw pad and washer

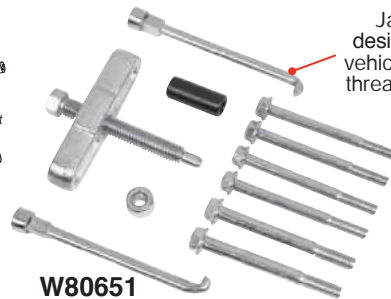
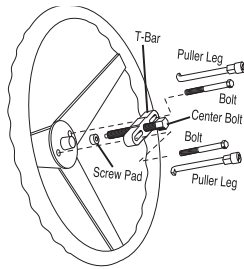

W80651

Jaws are designed to fit vehicles without threaded holes.



W89704

Item #	IP	MP	PKG	Bolts	Additional Content
W150	6	48	DBL	5/16" NF	-
W80651	6	24	DBL	3" 3/8" NC M8 x 1.25	4-3/4" GM legs, 1-1/2" adapter
W89704	1	5	CBX	4" 5/16" NC	4-3/4" GM legs, 1-1/2" adapter, pivot pin remover, lock plate remover, clamp nut, forcing screws M14 x 15 & 9/16"-18

STEERING PIVOT PIN REMOVER

- 1969 and newer GM, Chrysler and Ford cars and trucks with tilt or telescoping Saginaw type steering columns.



Item #	IP	MP	PKG
W80652	6	60	CRD

FORD HEADLIGHT ADJUSTER

- For aerodynamic style headlight adjuster bolts on late model Ford, Lincoln and Mercury vehicles.



Item #	IP	MP	PKG
W80665	6	72	CRD 4mm

HEADLIGHT SCREWDRIVER SET

- Star driver tips for headlights and tail lights, interior and exterior body trim.
- Includes T15 and T20 drivers



Item #	IP	MP	PKG
W902C	6	144	CRD

RADIO REMOVAL TOOL

- Disengages retaining clips on Ford and most imports for easy, damage free removal.

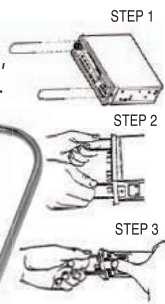

Item #	IP	MP	PKG
W80230	Ford	6	24 CRD

WINDSHIELD REMOVAL TOOL

- Steel cable pull handle for necessary leverage.
- Cuts sealant with specialty designed and tempered steel blade.

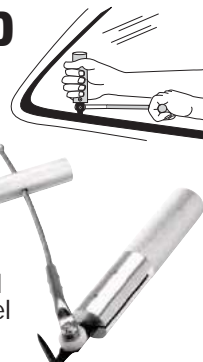

Item #	IP	MP	PKG
W80641	6	48	CRD

WIPER ARM REMOVAL TOOL

- Easily removes wiper arms without damaging wiper arm and hood cowling.
- Heat treated alloy steel.



Item #	IP	MP	PKG
W86555	6	72	CRD

SPECIALTY

BELTS & HOSES

ANODIZED ALUMINUM STRETCH BELT TOOLS

- These tools are required to properly install stretch belts on vehicles that use stretch fit belt technology.
- Anodized aluminum construction.

2001-2015 Ford: Escape, Edge, Fusion, Flex, Taurus
 2006-2015 Lincoln: Zephyr, MKX, MKZ, MKT, MKS
 2002-2015 Mazda: 3, 5, 6, Tribute, CX, MX-5 Miata
 2005-2011 Mercury: Mariner, Milan, Sable
 2009-2015 Chevrolet: Avalanche, Colorado, Express, Silverado, Suburban, Tahoe, Camaro
 2009-2015 GMC: Canyon, Savana, Sierra, Yukon
 2009-2015 Cadillac: Escalade
 2008-2010 Hummer: H2, H3, H3T
 2007-2010 Chrysler: Sebring
 2007-2010 Dodge: Avenger, Nitro
 2008-2015 Subaru: Forester, Impreza

Item #		IP	MP	PKG
W84013	Low Profile	10	100	CRD
W84014	Universal	10	100	CRD
W84015	Large Pulleys	10	100	CRD

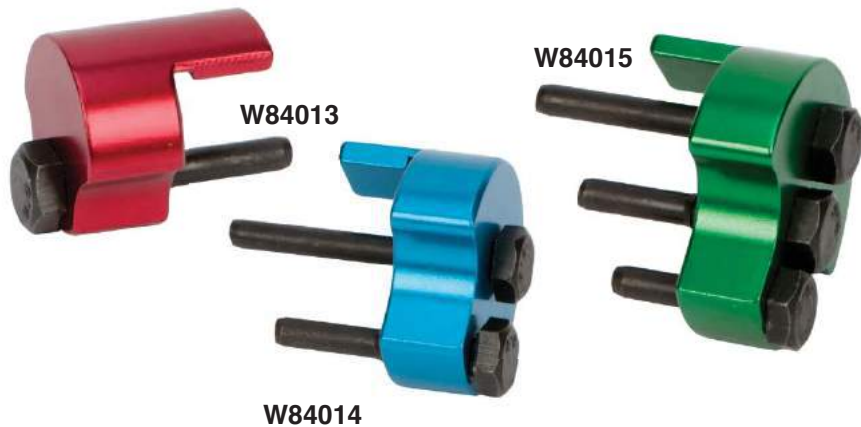

SERPENTINE BELT TOOL

- Remove and install belts on serpentine systems using spring loaded idler pulleys.



SPECIALTY

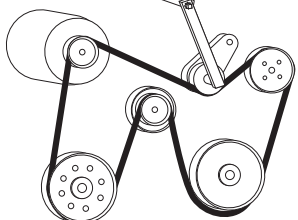

Item #	IP	MP	PKG	Hex Sockets	Crowfoot Wrenches	Arm Bars		Adapters	Screw
						Length	End		
W84010	1	6	DBL	15, 16, 18mm	13, 14, 15mm	23"	3/8" dr.	-	-
						10"	1/2" dr.		
						23"	13mm x 12pt		
W89716	1	6	CBX	13, 14, 15, 16, 18mm	13, 14, 15mm	10"	16mm x 6pt	3/8, 1/2"	3/8"-16 UNC
						6"			
						6"	5/8" GM		
						6"			

UNIVERSAL BELT HOOK TOOL

- Long reach tool aids in removal and installation of serpentine, timing and V belts.
- Hook allows pushing, pulling and twisting belts into place in confined, hard to reach areas.
- Black oxide shaft resists corrosion.



Item #	IP	MP	PKG	Length
W84012	6	48	TAB	29"

FLEXIBLE HOSE CLAMP PLIERS

- Pliers has locking mechanism to hold clamp in the open position, making removal and installation of clamp easier.



Item #	IP	MP	PKG
W80656	15	30	CRD

24" flexible cable to access the flat-type hose clamps located in hard-to-reach areas

FLAT BAND HOSE CLAMP PLIERS

- Used to compress spring type hose clamps in tight areas.
- Locking ratchet action holds clamp open for removal and installation.

Item #	IP	MP	PKG
W80654	12	72	CRD



FLEXIBLE HOSE CLAMP DRIVER

- Flex shaft with a formed ergonomic handle.
- 1/4" drive.
- US Patent D693201S1

Item #	IP	MP	PKG
W80657	6	48	CRD



Includes 1/4 and 5/16" sockets

3-PC LINE CLAMP SET

- Heat resistant reinforced nylon construction.
- Built in locking mechanism.

Item #	IP	MP	PKG	Range	
				Sm	1/8 to 5/16"
W83205	6	24	CRD	Med	1/2 to 3/4"
				Lg	3/4 to 2 1/2"



MINI HOSE CUTTER

- For cutting flexible or semi-rigid PVC, rubber, silicone, PU, PE, nylon and other plastic tubing.
- Stainless steel blade.

Item #	IP	MP	PKG	Cutting Capacity
W82006	24	240	CRD	1/8" to 1/2"



Overall length 4-1/2"

SPECIALTY

WATER PUMP & FAN CLUTCH

FAN CLUTCH WRENCHES

- Allows for easy removal of fan clutches when repairing or replacing water pumps, timing chains or fan clutch.
- Also useful when installing or removing engines, and for a variety of other engine service projects.

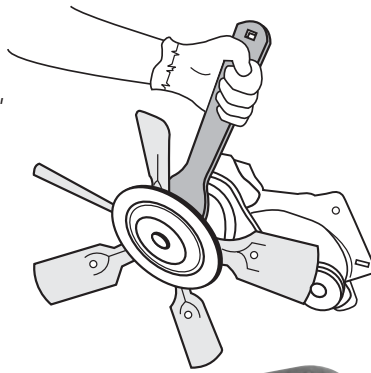

W80585



W80498

Work with both 10 mm and 13 mm pulley bolts.



SPECIALTY

Fan Clutch

Item #	IP	MP	PKG	Fan Pulley	Fan Clutch	Holder	Bolt	Nut	Hub
W80498	GM	6	24	CRD	-	-	10, 13mm	-	-
W80585	Ford	6	24	CLM	2-1/4"	1-7/16"	-	-	-
W89400	10-PC	1	3	CBX	2-1/4, 3-1/4"	1-7/16"	2-1/8, 3"	2-3/8"	1-7/16, 1-9/16, 1-7/8" LH, 2-13/16"

GM WATER PUMP SOCKET

- Specially designed for use on 1993 to current Northstar 4.6 Liter, 1997 to current Aurora 4.0 Liter.
- Chrome molybdenum.
- 1/2" drive size.



Item #	IP	MP	PKG	Application
W89399	GM	6	24	DBL 1996 and later GM trucks and vans

FROST PLUG INSTALLER

- Remove and install frost plugs found in liquid-cooled, gas and diesel engines in automobiles, trucks, SUVs, agricultural, and construction equipment.
- Simple to use, just hammer the driver with the appropriate matching installation disc.
- Install frost plugs ranging from 1 to 2-3/8" diameter.
- Forged high carbon steel and plated to resist corrosion.



Item #	IP	MP	PKG	Contents
W89737	1	4	CBX	18" Installer Handle, Frost Plug Remover, 7 Frost Plug Discs (1 to 2-3/8") and retaining nut

SEAL PULLERS

- For removal of grease and oil seals.
- Two tip sizes accommodate many applications.
- Large easy grip handle with heavy duty chrome plated shaft.

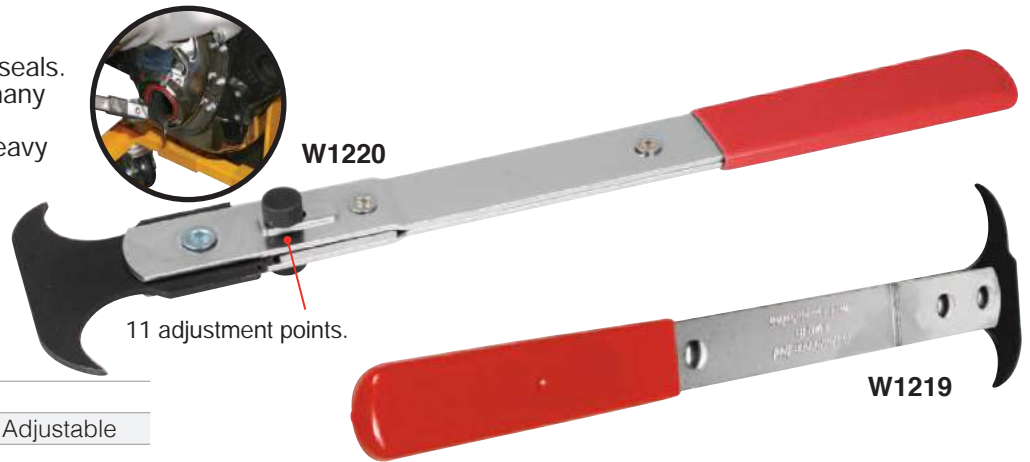

Item #	IP	MP	PKG
W1219	6	48	CRD
W1220	6	36	CRD Adjustable

UPPER REAR MAIN SEAL REMOVER

- Removes and installs upper rear main seals without removing engine or crankshaft.
- Contains corkscrew removal tool, T-handle and wire with clip for pulling new seals into place.

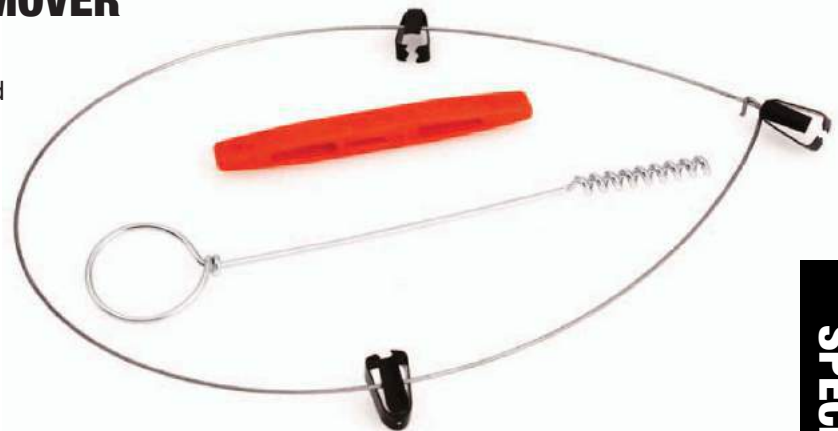

Item #	IP	MP	PKG
W84019	6	72	CRD 2 extra clips

4-PC SEAL & O-RING REMOVER

- Insures you have no damage to seals or the surrounding surface.
- Easily cups O-rings and seals making them simpler to remove.
- Cushion grip handles reduce fatigue and add comfort.
- US Patent D693201S1



Item #	IP	MP	PKG
W80751	6	48	CRD

9-PC INSPECTION SET

- Versatile utility kit for automotive access, inspection, removal and retrieval
- 3 LED anodized aluminum flashlight features 1/4" hex holder.
- Mirror and pickup tool extend to nearly 20"
- Batteries included.



Item #	IP	MP	PKG	Mirror Diameter	Lift Capacity	Telescoping Min	Telescoping Max	Battery Qty.	Battery Type	Picks	Drivers
W949	6	36	DBL	1-1/8"	3 lbs.	5-3/4"	20"	4	LR44	Straight, 90°, hook, double angle	#0, 1/8"

SPECIALTY

PULLEY PULLERS

ALTERNATOR PULLEY SERVICE KIT

- Service late model vehicles with either OWC or OAD alternator pulleys.
- Remove the One Way Clutch or Decoupler pulleys found on 1997 to current vehicles.



Item #	IP	MP	PKG
W87024	1	5	CBX

PULLEY PULLER

- Pulls pressed on 1 and 2 groove pulleys on alternators and power steering pumps.
- Adjustable jaw tension.
- Heat treated alloy steel.

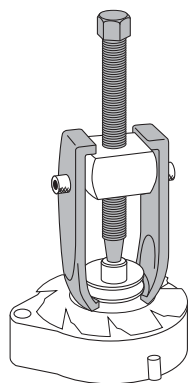

Also removes some alternator bearings.



Item #	IP	MP	PKG
W80653	6	24	CRD

SPECIALTY

POWER STEERING PUMP PULLERS & INSTALLERS

- Removes and installs power steering pump pulleys.
- Exerts force only through the shaft to prevent damage to pump and pulley.
- Alloy steel construction.

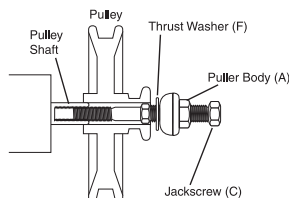

W87022

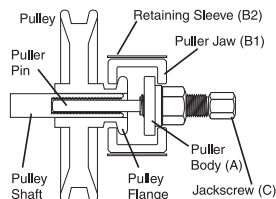

W87021

Use W87021 to reinstall pulleys on Ford vehicles.



W87020

Item #	IP	MP	PKG	Application
W87020	Domestic	6	24	DBL Chrysler, Ford, GM, and VW with hub size of 1-1/8, 1-1/4, 1-5/16, 1-3/8"
W87021	Ford	6	24	DBL Fits most pumps with 3/8"-16 threaded internal
W87022	GM	6	24	DBL 1990-Current GM pumps
W89708	14-PC Set	1	10	CBX For most alternator and power steering pulleys. Includes power steering line disconnect tool.

PULLEY HOLDING TOOL

- Adjustable jaw opening from 1/4 to 7/8".
- Long handle for extra leverage.

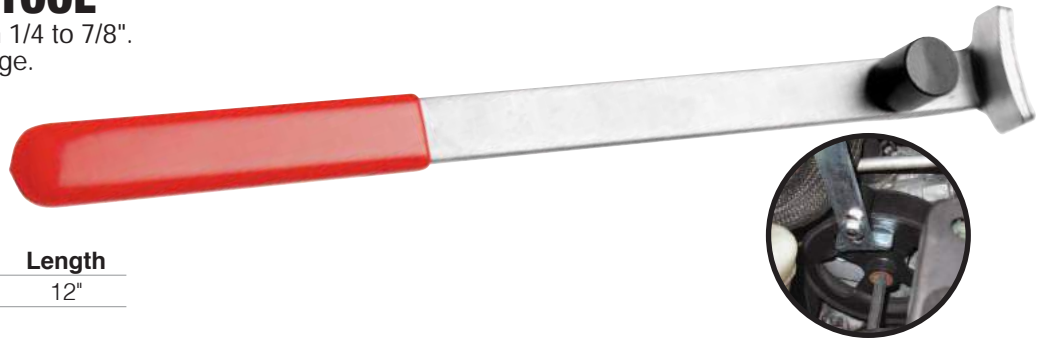

Item #	IP	MP	PKG	Length
W87023	6	48	CRD	12"

GEAR PULLERS

- Heat treated alloy steel.
- Drop forged for strength.
- Chrome plated finish.



Item #	Jaws	IP	MP	PKG	Spread	Reach
W139	2	6	24	CRD	8"	8"
W140	2	6	48	CRD	3-1/2"	3"
W141	2	6	48	CRD	6"	6"

2/3 JAW GEAR PULLERS

- Heat treated alloy steel.
- Drop forged for strength.
- Chrome plated finish.

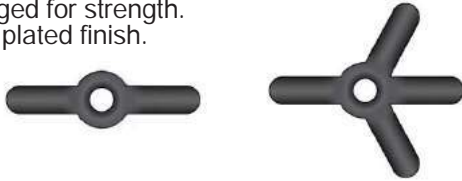

Item #	Jaws	IP	MP	PKG	Spread	Reach
W135P	2/3	6	48	CRD	3"	2-3/4"
W136P	2/3	6	36	CRD	4"	3-1/2"
W137P	2/3	1	12	CBX	6-1/4"	5-1/2"
W138P	2/3	1	6	CBX	8-1/4"	7"
W134DB	2/3	1	4	CBX	Includes 1 each	

PROFESSIONAL GEAR PULLERS

- Heavy duty chrome vanadium steel construction.
- Fine thread center bolt for smooth operation.
- Plated to resist corrosion.
- Heat treated jaws.

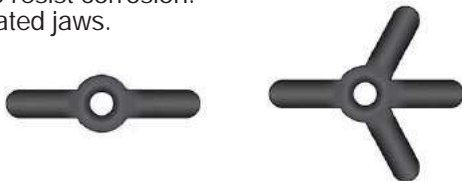

Item #	Jaws	IP	MP	PKG	Spread	Reach
W84500	2	6	24	CLM	4"	3-1/2"
W84501	2	6	12	CLM	6"	5-1/2"
W87122	2	6	24	CLM	4"	3-1/4"
W87123	2/3	6	24	CLM	4-3/4"	3-1/4"
W87124	2	6	36	CLM	6"	3-1/4"
W87125	2	6	18	CLM	6"	5-1/2"
W87126	2/3	6	12	CLM	7"	3-1/4"
W87127	2/3	6	12	CLM	7"	5-1/2"

SPECIALTY

VALVES & VALVE SPRINGS

OVERHEAD VALVE SPRING COMPRESSORS

- Conveniently removes valve springs on most cars and light trucks without removing cylinder head.
- Offset jaws easily grip and compress valve springs.
- Requires flexible air valve holder (PT W84003) and air hold fittings (PT W84005) to keep valves from dropping into cylinders when keepers are removed.



In confined areas, remove lever and turn with a socket.

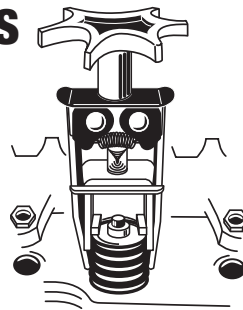

W84001



W84005



W84003

Item #		IP	MP	PKG
W80567	Lever Action	6	24	CRD
W84001		6	24	CRD
W84003	Flexible Holder	6	48	CRD
W84005	2-PC Holder Set	6	72	CRD

VALVE SPRING COMPRESSOR

- Compresses valve springs without removing head.
- Allows access for service to most engines with stud type rocker arms.

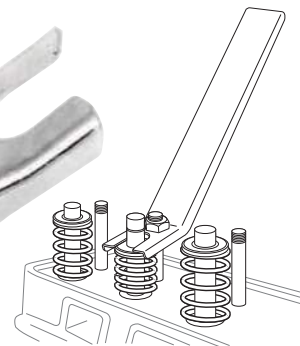

Item #	IP	MP	PKG	Length
W84002	6	48	CRD	12-1/2"

SPECIALTY

HEAVY DUTY VALVE SPRING COMPRESSOR

- For servicing overhead valve engine with cylinder head removed.
- Includes small and large jaws for multiple applications.

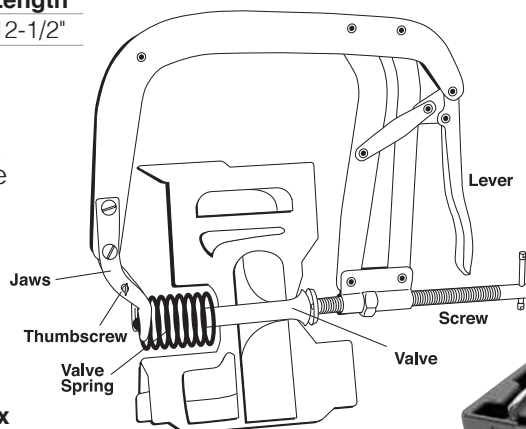

Viewed from end of cylinder head

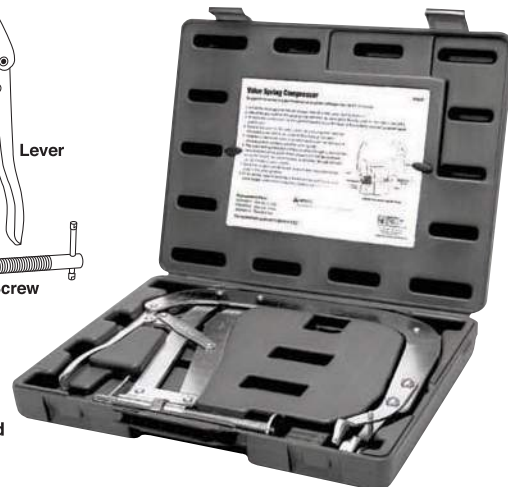

Item #	IP	MP	PKG	Max Opening
W89409	1	5	CBX	10"

VALVE LAPPERS

- Heavy duty rubber suction cups.
- Hardwood handle.



Item #		IP	MP	PKG	
W80570	Small	6	72	CRD	5/8, 13/16"
W80571	Large	6	72	CRD	1-1/8, 1-3/8"
W86552	2-PC	12	72	CRD	5/8, 13/16" & 1-1/8, 1-3/16"

Use with lapping compound to lap valves to match valve seats

HYDRAULIC VALVE LIFTER REMOVER

- Specially designed slide hammer easily frees tight or stuck lifters.
- Knurled handle for secure grip high quality steel construction.
- High quality steel construction.

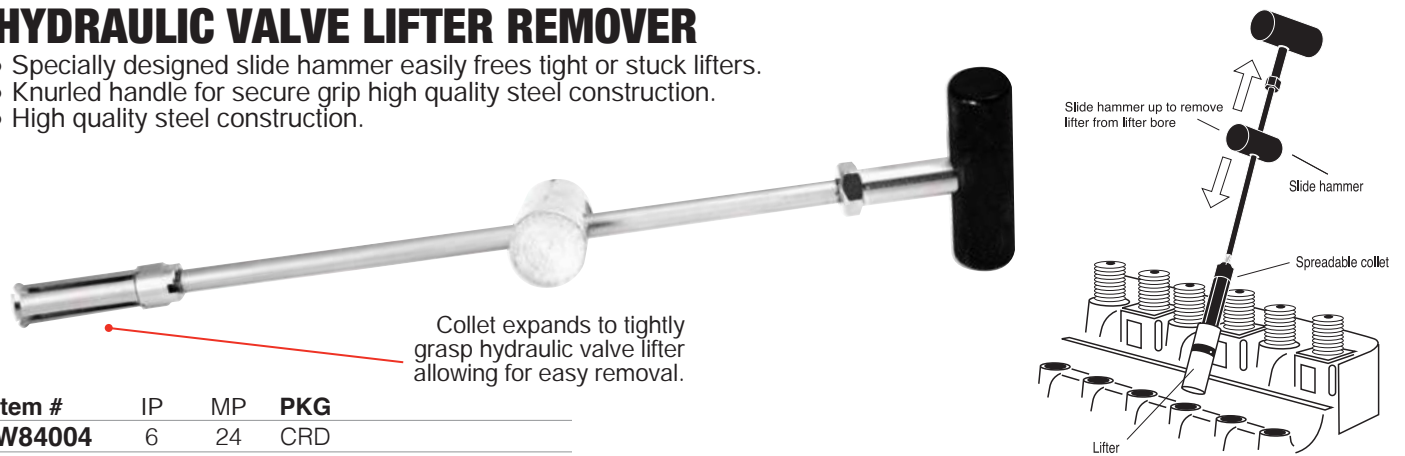

Item #	IP	MP	PKG
W84004	6	24	CRD

GO-NO GO GAUGE

- 22 hardened and tempered high quality steel two step ground blades.



TAPPET/IGNITION FEELER GAUGE

- Features 18 hardened and tempered high quality steel blades.



TAPPET GAUGE

- 12 hardened and tempered high quality offset tip steel blades.



Item #	IP	MP	PKG
W80524	12	192	CRD
W84602	12	144	CRD
W130C	6	192	CRD

.004/.006 (.102/.152mm), .005/.007 (.127/.178mm), .006/.008 (.152/.203mm), .007/.009 (.178/.229mm), .008/.010 (.203/.254mm), .009/.011 (.229/.279mm), .010/.012 (.254/.305mm), .011/.013 (.279/.330mm), .012/.014 (.305/.356mm), .013/.015 (.330/.381mm), .014/.016 (.356/.406mm), .015/.017 (.381/.432mm), .016/.018 (.406/.457mm), .017/.019 (.432/.483mm), .018/.020 (.457/.508mm), .019/.021 (.483/.533mm), .020/.022 (.508/.559mm), .021/.023 (.533/.584mm), .022/.024 (.559/.610mm), .023/.025 (.584/.635mm), .024/.026 (.610/.660mm), .025/.027" (.635/.686mm)

Tappet Blade SAE: .004, .005, .006, .007, .008, .009, .010, .012, .013 and .015".
Metric: .102, .127, .152, .178, .203, .229, .254, .305, .330, .381 mm.

Ignition Blade SAE: .012, .015, .018, .020, .022, .025, .030, .040".
Metric: .305, .381, .457, .508, .559, .635, .762 and 1.02 mm

SAE: .008, .010, .012, .013, .014, .015, .016, .018, .019, .020, .025, .026".
Metric: .203, .254, .305, .330, .356, .381, .406, .457, .483, .508, .635, .660mm

SPECIALTY

SERRATED WRENCHES

- Heat treated alloy steel.
- 1/2" hex drive shaft.

Item #	IP	MP	PKG
W1395	6	48	CRD 6, 8, 10, 12mm
W1397	6	144	CRD 8 mm
W1398	6	144	CRD 10 mm
W1399	6	144	CRD 12 mm

12 point triple square.



HEAD BOLT SOCKET BIT

- Fits 1998 and later VW/Audi head bolts.
- Chrome vanadium.

Item #	IP	MP	PKG	Drive	Length
W83182	12	48	CRD	1/2"	4-29/32"

Not for impact use.

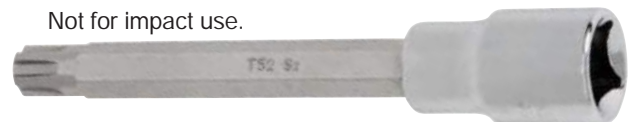

CAMSHAFT & CRANKSHAFT

UNIVERSAL CAMSHAFT BEARING KIT

- Removes and installs camshaft bearings in nearly all automobile engines, from compacts to heavy duty trucks.



Includes: Expander sleeves, five split driving plates, driving collars, nylon centering cone, driving shaft and extension.



Item #	IP	MP	PKG	Bearing I.D.	Use Driver	Washer
W89220	1	2	CBX	1.125 to 1.475	Expander	1-1/4"
				1.475 to 1.700	No. 1	1-1/4"
				1.700 to 1.925	No. 2	1-3/4"
				1.925 to 2.150	No. 3	1-3/4"
				2.150 to 2.375	No. 4	1-3/4"
				2.375 to 2.690	No. 5	1-3/4"

CAMSHAFT PULLEY HOLDER

- For holding camshaft gears stationary on OHC engines.
- Also works on injection pump and other gears and pulleys.
- Works on many Toyota, Nissan, Mazda, and other makes.



W89208

Fits most Honda and Acura engines.

Item #	IP	MP	PKG
W89208	1	18	CRD

HONDA CRANK PULLEY TOOL

- For removal and installation of crankshaft pulley bolt.
- Hex shape fits hole in center of crankshaft pulley.
- Prevents engine from turning when held with breaker bar.



W83168

Not for impact use.

Item #	IP	MP	PKG	Drive
W83168	6	36	CRD	1/2"

FLY WHEEL TURNER

- Great for working on clutches, transmissions, installing rings or other jobs that require the crankshaft to be in a certain position.
- Easily turn engine from underneath the vehicle.
- Spring tension holds tool onto flywheel, allowing free use of both hands.



Item #	IP	MP	PKG
W80510	6	36	CRD

TIMING GEAR PULLERS

- Removes timing gears and other gears with tapped holes.
- Drop forged yoke is plated to resist corrosion.
- Heat treated center screw.
- Includes two 5/16" x 4" bolts.



W87010

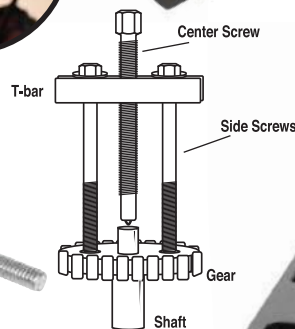

W89705

Item #	IP	MP	PKG
W87010	6	24	CLM
W89705	1	10	CBX

COMPACT HARMONIC BALANCER PULLER KIT

- Designed for removing damper pulleys in tight engine compartments, without removing the radiator.
- Jaw design provides greater strength, clevis pins allow jaws to be quickly removed and installed.
- Works on virtually all Chrysler, Mitsubishi and Dodge vehicles 1990 and later, GM and Cadillac 1988 and later, Ford 1995 and later with 3 spoke pressed on dampers.



Item #	IP	MP	PKG
W89712	1	5	CBX

HARMONIC BALANCER PULLER

- Helps stop damage to pulley and shaft.
- Easily removes harmonic balancer.
- Drop forged alloy steel.

14 Assorted bolts:
 3 - 5/16"-18 x 3"
 2 - 3/8"-16 x 3"
 3 - 3/8"-24 x 3"
 3 - 8mm-1.25 x 80mm
 3 - 10mm-1.5 x 75mm



Item #	IP	MP	PKG
W151P	6	24	CLM

HARMONIC BALANCER PULLERS & INSTALLERS

- For removal and installation of harmonic balancers on most automotive and light truck applications.
- Master set includes necessary bolts and adapters for most applications.

Services harmonic balancers as well as under drive pulleys and recessed crank threads on Dodge Hemi, GM Gen III/IV, and Ford 4.6 and 5.4 modular engines.

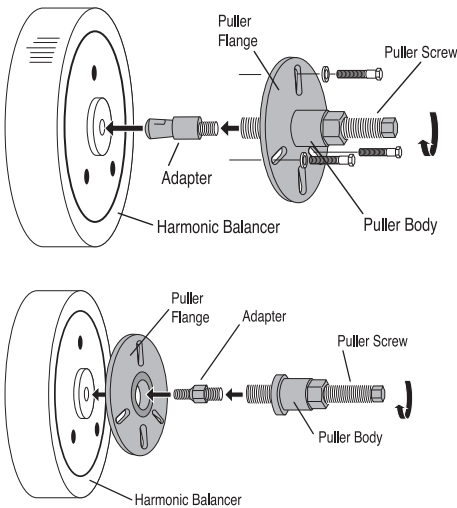

W89710

Works on most European vehicles including BMW and VW as well as Toyota, Honda, Kia and Hyundai.

Item #	IP	MP	PKG
W89711	1	5	CBX
W89710	1	6	CBX Expansion Kit



W89711

SPECIALTY

PISTON SERVICE

PISTON RING COMPRESSOR KIT

- Includes six sizes of bands for multiple applications.

- 2-7/8 to 3-1/8" (73 to 79mm)
- 3-1/8 to 3-3/8" (79 to 86mm)
- 3-3/8 to 3-5/8" (86 to 92mm)
- 3-5/8 to 3-7/8" (92 to 98mm)
- 3-7/8 to 4-1/8" (98 to 105mm)
- 4-1/8 to 4-3/8" (105 to 111mm)



Item #	IP	MP	PKG
W89410	1	5	CBX

PISTON RING INSTALLER

- Installs and removes piston rings 3/64 through 1/4".
- Comfortable vinyl grip handles.



Item #	IP	MP	PKG	Range
W80575	6	72	CRD	3/64 to 1/4"

PISTON RING COMPRESSORS

- Use to install pistons on most passenger cars.
- Positive compression and adjustable friction brake.
- Includes ratchet key.

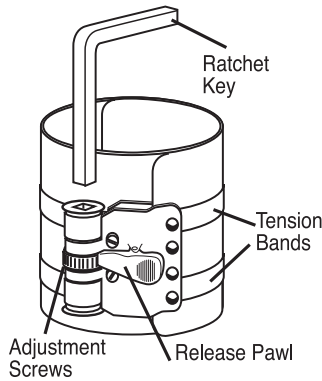

Item #	IP	MP	PKG	Range
W80572	6	24	CLM	2-1/8 to 5"
W80573	6	24	CLM	3-1/2 to 7"

WRINKLE BAND RING COMPRESSOR

- Low friction wrinkle band.
- Adjust only once for all pistons.

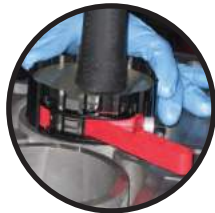

Item #	IP	MP	PKG	Range
W80574	6	48	CRD	3 to 5"

PISTON RING GROOVE CLEANER

- Cleans carbon and deposits from ring grooves.
- Includes two 5 cutter wheels for a total of 10 groove cleaning sizes.

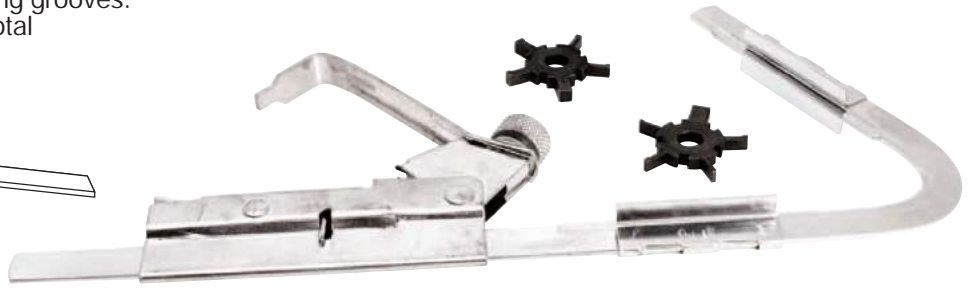
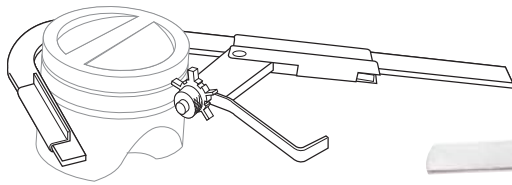

Item #	IP	MP	PKG
W80576	6	24	CRD 1/16, 5/64, 3/32, 1/8, 5/32, 3/16, 1/4", 1.5, 1.75, 2mm

PISTON CYLINDER HONE

- De-glaze creating a surface finish that allows the rings to seat quickly with minimal wear.
- Adjustable honing tension
- Two settings 2" through 4" and 4" though 7" settings.

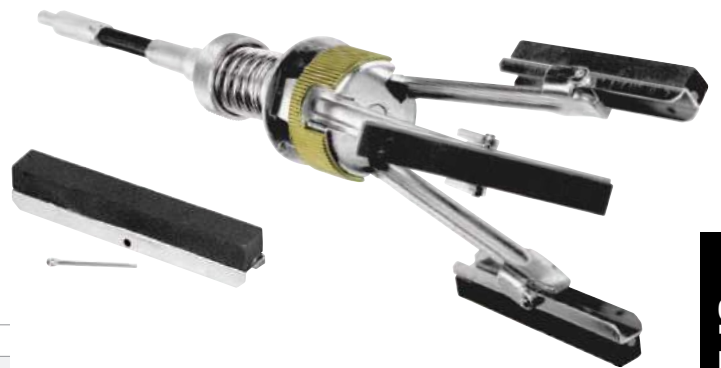

Item #	IP	MP	PKG	Stone Length	Grit
W80560	6	36	CRD	3"	220
W80561	12	144	CRD	3-PC Replacement Stones	

ENGINE BRUSH KIT

- Ergonomic non-slip molded grip for improved comfort and control.
- Used to clean small tubes, pipes and other hard to clean areas.
- Nylon, brass and stainless steel brushes for various surfaces.
- 1/4" quick change shanks.
- US Patent D693201S1



Item #	IP	MP	PKG	Sizes
W1231	6	24	DBL	1/4", 3/8", 1/2", 5/8", 3/4", 1"

FORD FUEL PUMP RETAINER TOOL

- For proper removal or secure lock down of the fuel pump retaining ring.
- Reduces the chance of damaging fuel tank, fuel pump or retaining ring.
- Offset coated handle for sure grip and easy use.

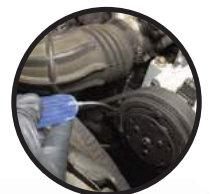

Item #	IP	MP	PKG
W80669	6	36	CRD

FLEX SHAFT CARBURETOR ADJUSTER

- Tips store in handle or plastic boot.
- 11-1/2" flexible shaft reaches into confined areas.



Item #	IP	MP	PKG
W1187	6	72	CRD Hex bit size: 3/32" Hex socket: 4.5 mm, 1/4" and Double D

SPECIALTY

SENSORS & SWITCHES

7-PC SPECIALTY SWITCH SOCKET KIT

- Removes and installs sensors on computerized engine control vehicles.
- Heavy duty alloy steel construction.

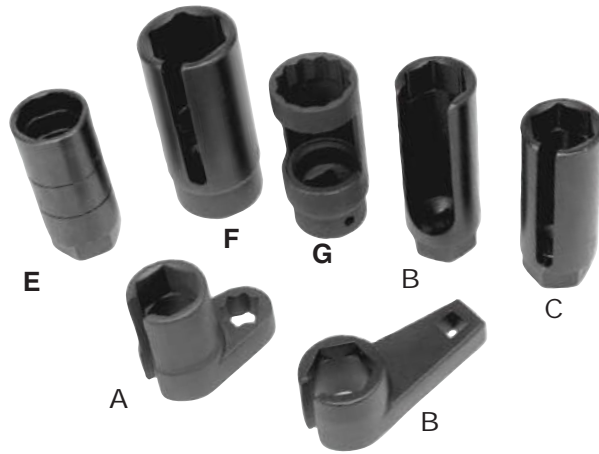

Item #	IP	MP	PKG
W89333	1	12	CBX

Socket Type	Size	Drive	Item #	IP	MP	PKG
A O2 Offset Extended	7/8"	1/2"	W80491	12	72	CRD
B O2 Offset Compact	7/8"	3/8"	W84008	6	12	CRD
C O2 Socket	7/8"	3/8"	W1267	6	72	CRD
D Vacuum Switch	7/8"	3/8"	W1266	6	72	CRD
E Oil Switch	1-1/16"	3/8"	W80590	6	48	CRD
F Oil Sender Switch	1-3/16"	1/2"	W80591	6	24	CRD
G GM Thermo Sensor	1-1/16"	1/2"	-	-	-	-

SPECIALTY

OIL PRESSURE SWITCH SOCKET

- Removes and installs sensors on computerized engine control vehicles.
- Heavy duty alloy steel construction.

Item #	IP	MP	PKG
W1130	6	72	CRD

Use with 3/8" Dr. ratchet or 1-1/8" wrench.



OXYGEN SENSOR WRENCH

- Designed for all oxygen sensors with 7/8" (22mm) hex.
- Curved handle allows user to easily work around exhaust.
- Chrome vanadium steel.

Item #	IP	MP	PKG	Overall Length
W84007	10	40	TAB	10-1/4"



TERMINAL RELEASE KIT

- Contains terminal release tools for most domestic, European and Japanese cars and trucks.

1 BMW, Mercedes, Opel, VW/Audi	2 BMW, Jaguar, Mercedes, Porsche, Saab, Skoda	3 BMW, Mercedes, Opel, Porsche, VW/Audi	4 Ford	5 BMW, Ford, Mercedes, Opel, Porsche, Seat, Skoda, VW/Audi	6 BMW, Ford, Jaguar, Mercedes, Opel, Porsche, Saab, Seat, Skoda, VW/Audi	7 Mercedes	8 Ford, Jaguar, Mercedes, Opel, Porsche, VW/Audi
9 Ford, Mercedes	10 Mercedes	11 BMW, Ford, Jaguar, Mercedes, Opel, Porsche, Saab, Seat, Skoda, VW/Audi	12 BMW, Jaguar, Mercedes, Opel, Renault, Skoda, VW/Audi	13 Ford, Mercedes	14 Ford, Jaguar, Porsche	15 BMW, Ford, Mercedes, Opel, Seat, Skoda, VW/Audi	16 BMW, Ford, Jaguar, Mercedes, Opel, Porsche, VW/Audi
17 BMW	18 Mercedes	19 Citroen, Chrysler, Fiat, Ford, Honda, Mazda, Mercedes, Mitsubishi, Opel, Porsche, Renault, Seat, Toyota, VW/Audi	20 Ford	21 BMW, Ford, Jaguar, Mercedes, Opel, Porsche, Saab, Seat, Skoda, VW/Audi	22 Honda, Opel, Toyota, VW/Audi	23 Opel, VW/Audi	

Item #	IP	MP	PKG
W89732	1	12	SHK 23-PC



TAIL PIPE EXPANDERS

- Rounds out pipe ends and removes clamp grooves.

W80662

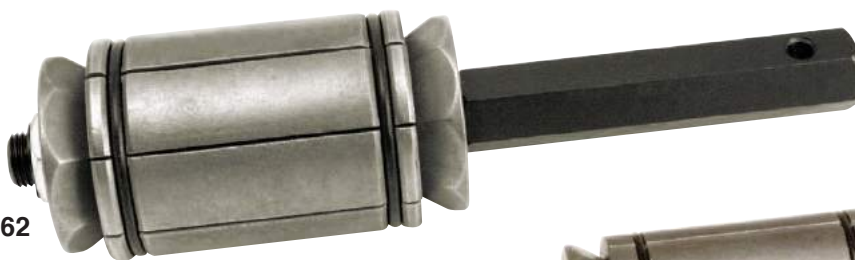

W80661



Item #	IP	MP	PKG	Capacity
W80661	6	24	CRD	1-1/2 to 2-7/16"
W80662	6	12	CRD	2-1/8 to 3-7/16"

TAIL PIPE CUTTER

- Easily cuts tailpipe and exhaust components.
- Adjustable 12" cutter chain allows for cutting action on pipe diameters from 3/4 to 3 1/2".



Item #	IP	MP	PKG	Capacity
W80664	6	24	CRD	3/4 to 3-12"

EXHAUST MANIFOLD SPREADER

- Helps prevent cross-threading of manifold bolts
- Designed for use on GM small-block V8s, but can also be used on many applications that need just the slightest spreading
- Corrosion resistant zinc plating
- Alloy steel construction
- Adjust spreader width using 3/4" or 19 mm open-end wrench.

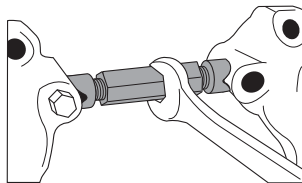

Item #	IP	MP	PKG
W80663	6	48	CRD

CHAIN BREAKER

- Use this heavy duty chain breaker to repair your motorcycle or bicycle chains with strength and ease.
- Drop forged and heat treated for long life and dependable service.
- This kit will break, press, and rivet most #25 - #35 and #428 - #630 standard and O-ring roller chains.
- Includes 3 pin sizes to fit a variety of chains.



The hardened steel body has a removable handle for compact storage.



Item #	IP	MP	PKG
W89100	1	10	CBX

SPECIALTY

QUICK DISCONNECT TOOLS

FUEL LINE COUPLING

- Separates fuel line from pressure regulator on applications with quick disconnect style couplings.



Item #		IP	MP	PKG
W80542	Ford	6	288	CRD

FUEL, TRANS & A/C

- Separates spring lock in A/C, fuel and transmission line connectors.
- Spring loaded closed clamp deflects spray when disconnecting lines.



Item #		IP	MP	PKG
W83118	3/8"	6	72	CRD
W83119	1/2"	6	72	CRD

FUEL, TRANS & A/C

- Separates quick disconnect style fittings on EFI fuel lines with hair pin connectors and transmission cooler lines.



Item #		IP	MP	PKG
W83102		6	72	CRD

FUEL FILTER/LINE

- Anodized aluminum construction.
- Fits most 5/16" fuel and transmission oil cooler lines.



Item #		IP	MP	PKG
W83130		6	72	CRD

FUEL & A/C LINE

- Easily separates spring coupling fitting on fuel lines and air conditioning systems.

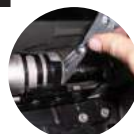

5/8 & 3/4"



Item #		IP	MP	PKG
W83113	4-IN-1	6	72	CRD

FUEL LINE

- Easily separates quick disconnect style fittings on 5/16 and 3/8" fuel lines.



Item #		IP	MP	PKG
W83114	2-IN-1	6	72	CRD

SPECIALTY

OIL COOLER LINE

- Separates automatic transmission oil cooler lines on Ford Taurus and Escort with AXOD and ATX transmissions.



Item #		IP	MP	PKG
W83133		6	72	CRD

CLUTCH LINE

- For removing hydraulic clutch lines from clutch slave cylinders on some manual transmissions.



Item #		IP	MP	PKG
W83150	Ford	6	144	CRD

CLUTCH LINE

- 2-in-1 disconnect tool for removing clutch lines from slave cylinders.



Item #		IP	MP	PKG
W83151	GM	6	24	CRD

TRANS COOLER

- Disconnects transmission to radiator cooler line quick connect fittings.

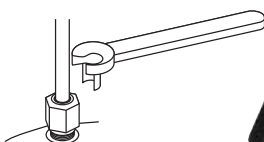

Item #		IP	MP	PKG
W83111	Ford	6	72	CRD

HEATER HOSE DISCONNECT

- Disconnects 5/8 and 3/4" heater hose quick connect fittings from heater core without damaging coupling retainer or hose.
- Extended handle for easier access.



Item #		IP	MP	PKG
W83108	Ford/Chrysler	6	24	CRD

MASTER DISCONNECT SET

- Includes disconnect tools for air conditioning, fuel, heater, transmission, and power steering lines.
- Tool identification number included.
- Tools color coded for easy identification.



Item #	IP	MP	PKG
W89331	21-PC	1	5 CBX

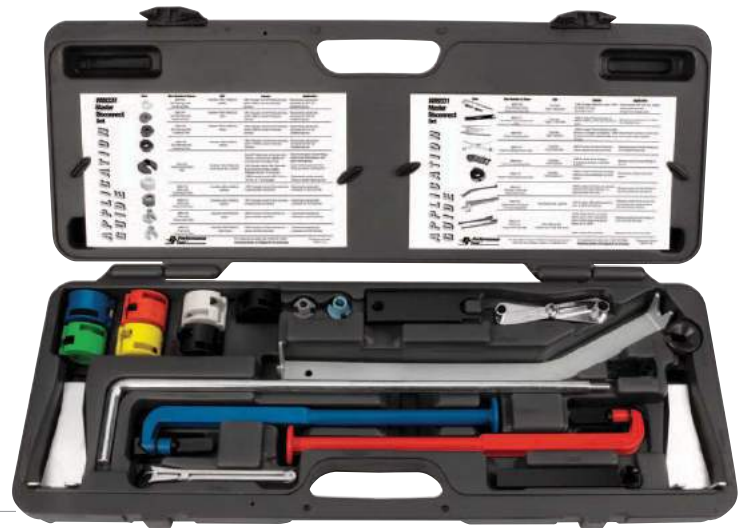

7-PC FUEL & TRANS LINE SET

- Anodized aluminum construction.

W831305/16" Fuel Line
W83131 3/8" Fuel Line
W83132 1/4" Fuel Line
W83133 Oil Cooler Line
W83111 Oil Cooler Line
W80542 Fuel Line Coupling Tool
W83102 Quick Disconnect Coupler

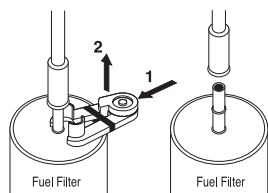

Item #	IP	MP	PKG
W89330	7-PC	1	12 CBX

6-PC A/C & FUEL LINE SET

- Easily disconnects air conditioning lines and quick connect fuel lines.
- Set contains six release tools that disengages the spring lock coupling on Ford and Chrysler air conditioning lines.

Includes: 5/16, 3/8, 1/2, 5/8, 3/4 and 7/8"

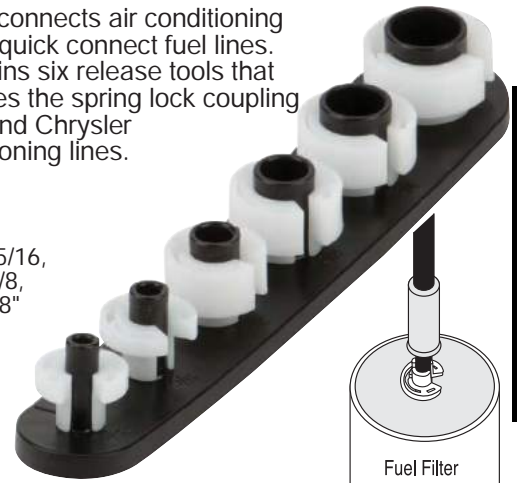

SPECIALTY

Item #	IP	MP	PKG
W83149	6-PC	12	72 CRD

9-PC SPRING LOCK SET

- Separates spring lock in air conditioning, fuel and transmission line connectors.
- Spring loaded closed clamp deflects spray when disconnecting lines.



A/C lines: Red 3/8", Blue 1/2", Black 5/8" and White 3/4"
Fuel lines: Yellow 3/8", Green 1/2", Gray 5/16" and Blue 3/8"

Item #	IP	MP	PKG
W86550	9-PC	6	72 CRD

6-PC FUEL & TRANS SET

- For separating quick disconnect fittings on fuel and cooler lines.
- Color coded, compact size for quick selection & easy storage
- Injection molded plastic

Fuel lines: Grey 5/16" and Light Blue 3/8"
A/C lines: Dark Red 1/2", Dark Blue 5/8", Black 3/4" and White 7/8"

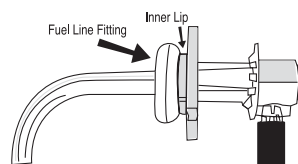

Item #	IP	MP	PKG
W83148	6-PC	12	120 CRD

SPARK PLUGS & IGNITION

SPARK PLUG GAUGE & GAP TOOLS

Item #	IP	MP	PKG	Sizes
W80535	12	288	CRD	SAE .020 to .100". Metric 0.5 to 2.5mm.
W80540	25	200	BLK	Bulk
W162C	24	720	CRD	SAE .020, .025, .028, .030, .032, .035 and .040". Metric: .50, .63, .71, .76, .81, .89, and 1.00 mm
W163C H.E.I.	24	720	CRD	SAE .025, .030, .035, .040, .044, .054, .060 and .080". Metric: .635, .762, .889, 1.01, 1.11, 1.37, 1.52 and 2.03 mm



W162C/
W163C

electrode tool included

W80535/
W80540



Tapered hole adjusts electrode.

IGNITION POINT FILE

- High grade steel construction.
- Precise double cut file pattern.
- Quickly cleans ignition points.

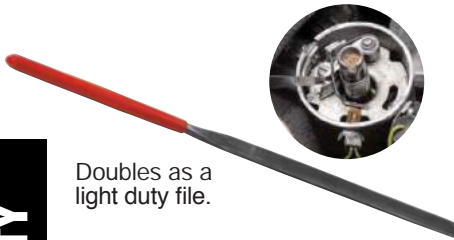

Doubles as a light duty file.

Item #	IP	MP	PKG
W123C	12	240	CRD

FORD IGNITION MODULE TOOL

- Knurled aluminum knob.
- Heat treated carbon steel shank.



7/32" hex or T20 star retaining bolt on Ford ignition.

Item #	IP	MP	PKG
W1216	6	72	CRD

DISTRIBUTOR CLAMP WRENCHES

- Drop forged steel.
- Chrome plated.



Item #	IP	MP	PKG	Sizes
W1186	12	48	CRD	13, 15mm
W1189C	12	48	CRD	1/2, 9/16"

SPECIALTY

IGNITION SPARK TESTERS

- Troubleshoot dirty spark plug connections, defective points, bad cables or connections, and more.
- Easily checks if there is sufficient energy for spark plug to ignite.

Item #	IP	MP	PKG
W86554	Inline	24	48 CRD
W84600	H.E.I.	6	72 CRD
W86553		12	96 CRD



W84600



W86553



W86554

Easily connects between the spark plug and spark plug wire. 5" spark plug connector, 8-1/2" overall length.

INSULATED SPARK PLUG BOOT PULLER

- Nylon insulating tips.
- Comfortable vinyl grip handles.

Angled nose for easier access.



Item #	IP	MP	PKG
W80532	6	72	CRD

SPARK PLUG WIRE PULLER

- Heavy duty plastic construction.
- Grips boot to prevent wire damage.



Item #	IP	MP	PKG
W80531	6	144	CRD

SPARK PLUG WIRE TESTER

- Tester flashes in sync with spark plug firing until it runs across a break in wire.



50" cable.

Item #	IP	MP	PKG
W80530	6	72	CRD

4-PC IGNITION TUNE-UP KIT

- For spark plug replacement in most foreign and domestic autos and light trucks.
- Heat treated alloy steel.
- 3/8" dr. ratchet, 6" extension, 5/8" and 13/16" spark plug sockets.



Item #	IP	MP	PKG
W1131C	6	24	CRD

5-PC SOCKET SET

- Chrome vanadium alloy steel.
- Polished nickel chrome plated finish.
- SAE: 5/8, 3/4 and 13/16"
- Metric: 14 and 18 mm.



Item #	IP	MP	PKG
W30936	6	24	RAC

SPARK PLUG WRENCH

- Simple compact tools for easy spark plug removal.
- Fits both 5/8" and 13/16" plugs.

Includes handle for leverage.

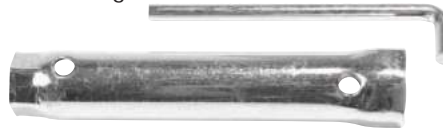

Item #	Length	IP	MP	PKG
W165	3-1/2"	12	144	CRD
W166	5"	6	144	CRD

3/8 IN DR. SPARK PLUG SOCKETS

- Chrome vanadium alloy steel construction for strength and durability.
- Socket openings are designed to reduce fastener rounding.
- Polished nickel chrome plated finish resists corrosion.
- Rubber insert holds and protects plugs.
- Recessed edges.



- Drop forged steel construction.
- Chrome plated and heat treated.

Item #	Sizes	IP	MP	PKG
W1128C	5/8"	12	120	CRD
W1126C	13/16"	12	72	CRD

MAGNETIC SOCKETS

- Internal magnet aids in retrieval and replacement of spark plugs.



Item #	Sizes	IP	MP	PKG
W38172	5/8"	6	48	TAB
W38173	13/16"	6	48	TAB

UNIVERSAL SPARK PLUG TOOLS

- Drop forged steel construction.
- Chrome plated to resist corrosion.
- Swivel action for confined areas.
- Neoprene insert to grip and protect plugs.



Item #	Sizes	IP	MP	PKG
W1125C	13/16"	6	72	CRD
W1129C	5/8"	6	72	CRD

SOCKETS WITH U-JOINTS

- Swivel action for confined areas.



Item #	Sizes	IP	MP	PKG
W38161	5/8"	6	48	TAB
W38165	13/16"	6	48	TAB

LONG REACH SOCKETS

- Knurled design offers better grip when hand turning.



5" overall length.

Item #	Sizes	IP	MP	PKG
W80533	5/8"	6	72	CRD
W38162	5/8"	6	48	TAB

SPECIALTY

1/2 Drive Sockets				
W32160	5/8"	6	48	TAB
W32163	13/16"	6	48	TAB

FEELER GAUGES

THICKNESS GAUGES

- Hardened and tempered high quality steel thickness blades.

W129C



electrode adjuster



W131C 3" steel rule.

STANDARD FEELER GAUGES

- Check for accurate clearance on ignition points, valve lash, etc.
- SAE and Metric sizes.

**W80527/
W80528**



W80526



non magnetic brass blades.

W80541

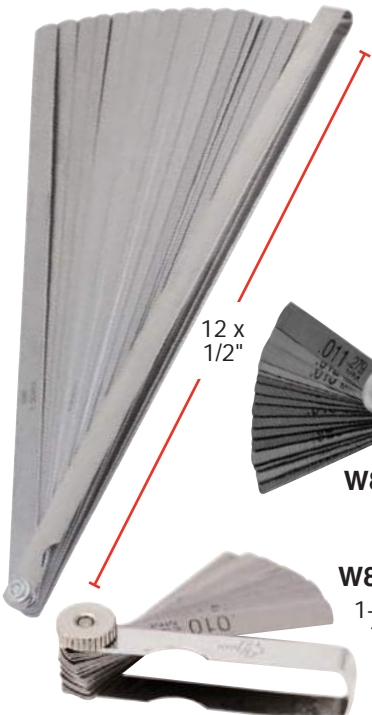

12 x 1/2"

W80526

W80525

1-1/2 x 1/4"

Item #	IP	MP	PKG	Sizes
W125C 32 Blades	6	192	CRD	Features a .010" brass blade for transistorized ignitions. SAE: .0015, .002, .0025, .003, .004, .005, .006, .007, .008, .009, .010, .011, .012, .013, .014, .015, .016, .017, .018, .019, .020, .021, .022, .023, .024, .025, .026, .028, .030, .032, .035". Metric: .04, .05, .06, .08, .10, .13, .15, .18, .20, .23, .25, .28, .30, .33, .35, .38, .40, .43, .45, .48, .50, .53, .55, .58, .60, .63, .65, .70, .75, .80, .88 mm.
W129C 15 Blades	6	192	CRD	Features 9 straight 2" thickness blades, 6 flat 1" spark plug blades, 2" steel rule and electrode adjuster. Straight Blade SAE: .002, .003, .004, .006, .008, .010, .015, .017, .018, .019, .020 and .025". Metric: .05, .08, .10, .15, .20, .25, .38, .432, .457, .483, .50 and .63 mm. Flat Blade SAE: .020, .025, .028, .030, .035 and .040". Metric: .50, .64, .70, .75, .88 and 1.02 mm
W131C 15 Blades	6	192	CRD	SAE: .002, .003, .004, .005, .006, .008, .011, .012, .013, .014, .016, .018, .020, .022 and .025". Metric: .05, .08, .10, .13, .15, .20, .28, .30, .33, .35, .40, .45, .50, .55 and .63 mm.
W80527 25 Blades	12	192	CRD	Metric: .04, .05, .06, .07, .08, .09, .10, .15, .20, .25, .30, .35, .40, .45, .50, .55, .60, .65, .70, .75, .80, .85, .90, .95 and 1.00 mm
W80528 26 Blades	12	192	CRD	SAE: .0015, .002, .0025, .003, .004, .005, .006, .007, .008, .009, .010, .011, .012, .013, .014, .015, .016, .017, .018, .019, .020, .021, .022, .023, .024 and .025". Metric: .038, .051, .064, .076, .102, .127, .152, .178, .203, .229, .254, .279, .305, .330, .356, .381, .406, .432, .457, .483, .508, .533, .559, .584, .610 and .635 mm
W80526 6 Blades	12	192	CRD	SAE: .006, .008, .010, .012, .014 and .016". Metric: .152, .203, .254, .305, .356 and .406 mm
W80525 17 Blades	12	192	CRD	SAE: .010, .012, .013, .015, .016, .017, .018, .019, .020, .022, .024, .025, .026, .028, .030, .032 and .035"
W84601 16 Blades	12	192	CRD	SAE: .011, .012, .013, .014, .015, .016, .017, .018, .019, .020, .022, .024, .025, .028, .030 and .032". Metric: .279, .305, .330, .356, .381, .408, .432, .457, .483, .508, .559, .610, .635, .711, .762 and .813 mm
W80541 20 Blades	6	36	CRD	SAE: .002, .004, .006, .008, .010, .012, .014, .016, .018, .020, .022, .024, .026, .028, .030, .032, .034, .036, .038, .040"

See Engine section for tappet gauges

COMBINATION TUNE-UP GAUGE

- Features 12 straight steel blades, 6 straight brass blades, 6 wire test loops, and electrode adjuster.



W80529

Item #	IP	MP	PKG	Sizes
W80529 18 Blades 6 Loops	12	192	CRD	Steel Blade SAE: .010, .012, .015, .016, .017, .018, .019, .020, .022, .024, .025 and .026". Metric: .254, .305, .381, .406, .432, .457, .483, .508, .559, .610, .635 and .660 mm. Magnetic Blade SAE: .006, .008, .010, .012, .014 and .016". Metric: .152, .203, .254, .305, .356 and .406 mm. Wire Test Loop SAE: .025, .030, .034, .035, .040 and .045"

SPARK PLUG RETHREAD KIT

- Used to repair damaged threads of spark plug holes.
- Heat treated alloy steel construction.
- Turn with a 5/8" wrench or socket.



W83164
Includes 3/8, 7/16, 1/2 and 3/4" reach inserts.

Item #	IP	MP	PKG	Thread	Inserts
W83164	12	96	CRD	M14 x 1.25	3/8, 7/16, 1/2, 3/4"
W80537	6	72	CRD	M14 x 1.25	

SPARK PLUG HOLE CHASER LIMITED ACCESS

- The narrow profile and long length allows access to spark plug holes in confined spaces.
- Use with 3/8" drive ratchet and extension.
- Not to be used as a tap.



W83193

Item #	IP	MP	PKG	Thread
W83193	12	96	CRD	M14 x 1.25 Limited Access

SPARK PLUG HOLE CHASER

- Quickly and easily cleans dirt, carbon and metal particles from spark plug hole.
- Not to be used as a tap.



W83163

Item #	IP	MP	PKG	Thread
W80539	6	72	CRD	M14 x 1.25 & M18 x 1.5
W83163	12	96	CRD	M10 x 1.0 & M14 x 1.25

OXYGEN SENSOR THREAD CHASER

- Cleans threads in oxygen sensor holes.
- Size M18 x 1.5 also works on M18 x 1.5 spark plug threads.
- Not to be used as a tap.
- Not for impact use.

Use with 3/4" hex socket or 3/8" square drive.



Item #	IP	MP	PKG	Thread
W84006	12	144	CRD	M18 X 1.5

SPECIALTY

CAN OBDII DIAGNOSTIC SCAN TOOL

- Works with MOST 1996 and later include American, European and Asian cars.
- Supports all OBD2 protocols including the newer (CAN) Controller Area Network.
- Reads and displays your (DTC) Diagnostic Trouble Codes on an easy to read screen.
- Erases (DTC) trouble codes and resets the OBD2 system.
- Turns off check engine light (MIL).
- No batteries needed (powered via cable).
- Includes a user manual with the most current trouble codes.

Displays code number and description.



Supports five languages including; English, Spanish, German, French, and Dutch.

Item #	IP	MP	PKG
W2976	10	60	DBL Multilingual
W2977	10	60	DBL

W2976



W2977



SPECIALTY

DIGITAL LASER TACHOMETER

- Use to accurately measure the RPM without touching the object, displays it on a LCD screen.
- Measures the rotational speed with a visible red LED beam.
- High intensity class II laser measures from 2.5 - 99,999 RPM.
- Auto zero adjustment, stores last, minimum and maximum readings.
- Includes a handy storage case, 9v battery, 24" of reflective tape to aid measurements and operating manual.



Item #	IP	MP	PKG	Testing Range (RPM)	Resolving Power (RPM)	Accuracy	Sampling Time	Battery	
								Qty.	Type
W89719	1	50	DBL	2.5 to 99,999	0.1 (2.5 to 999.9)	±0.05%	0.8s	1	9V



INFRARED THERMOMETERS

- Measures surface temperature without making contact.
- Easy to read large digital display with backlight.
- Laser pointer for accurate use.
- Fahrenheit or Celsius readings.
- Battery included.



W89722



W89724

Advanced features including emissivity settings, high/low alarm, min/max, storage of up to 30 readings and variance calculation.

Item #	IP	MP	PKG	Temperature Range		Distance Spot Ratio	Accuracy	Battery	
				°F	°C			Qty.	Type
W89720	5	20	CLM	0 to 960	-18 to 520	8:1	±1.5%	1	9V
W89721	10	20	CLM	-58 to 716	-50 to 380	12:1	±1.5%	2	AAA
W89722	10	60	CLM	-58 to 626	-50 to 330	12:1	±1.5%	1	9V
W89724	5	10	CLM	-58 to 1382	-50 to 750	12:1	±2%	1	9V

DIGITAL ADVANCE TIMING LIGHT

- Professional set initial and advance timing to obtain total timing and peak performance.
- Super bright xenon flash, and LED display.
- Designed for precise tuning and diagnostic work.
- Display engine speed up to 9,000 RPM, and ignition spark advance from 0-90°.
- Push button control to adjust advance and switch between 4 and 2 cycle engines.
- Tough ABS shell, 60" inductive pickup leads and works with 12 volt systems.



Item #	IP	MP	PKG
W80587	1	10	CLM

SELF-POWERED TIMING LIGHT

- Detachable inductive pick up can be easily hooked up.
- Designed for all gas engines, outdoor power equipment, motorcycle, snow mobile, mowers and tractors.
- Works with magnetos.



Item #	IP	MP	PKG	Battery	
				Qty.	Type
W80578	6	24	CRD	2	D

REMOTE STARTER SWITCH

- Allows one person to start and crank the engine from either side of the vehicle.
- A high current push button switch provides long life and reliable operation.
- A red light glows when starter switch is connected to a hot circuit.
- High current clips with protective boots.

Features above apply to W80586 model only

W80581

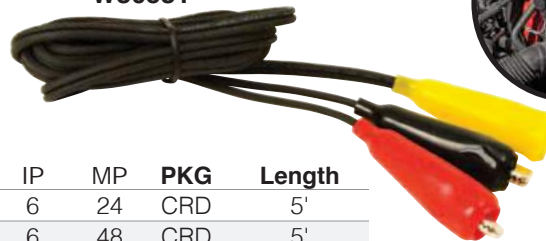

12-gauge oil and grease resistant wire.

W80586

Item #		IP	MP	PKG	Length
W80586	Heavy Duty	6	24	CRD	5'
W80581	Standard	6	48	CRD	5'

COMPUTER MEMORY KEEPER

- For maintaining voltage continuity to engine computer, clock, and radio memory when vehicle battery is disconnected.
- Retains radio presets, ECM codes, and learned procedures up to four hours.
- Plugs into vehicle's cigarette lighter outlet.
- Uses 9 volt battery (not included).



Item #	IP	MP	PKG
W89203	12	144	CRD

SPECIALTY

COMPRESSION & VACUUM

DELUXE COMPRESSION TESTER KIT

- Deluxe compression tester for gas engines. 2-1/2" gauge with quick disconnect ends.
- 5 threaded adapters to cover most gas engines.
- Includes the hard to find 16mm x 1-1/2" adapter.

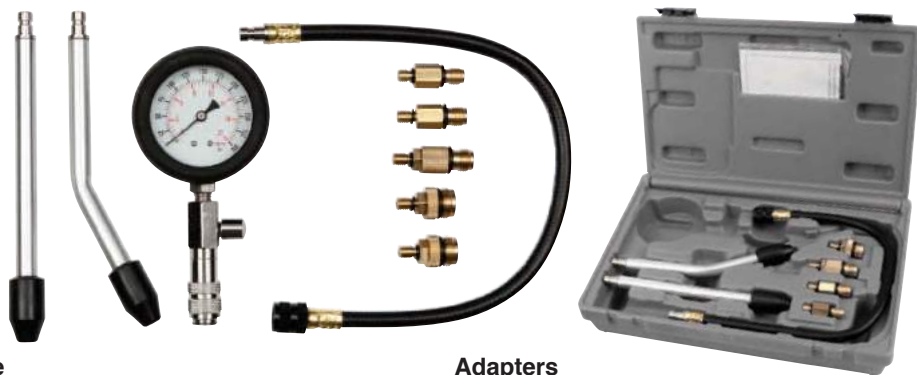

Item #	IP	MP	PKG	Gauge		Hoses	Tube	Adapters		
				Size	PSI			1.0	1.25	1.5
W80584	1	12	CBX	2-1/2"	300	17"	Straight, Offset	10mm	12, 14mm	16, 18mm

LEAK DOWN TEST KIT

- Helps identify causes of low cylinder compression.
- Adjustable pressure regulator.



Item #	IP	MP	PKG	Gauges			Hoses		Adapter	
				Sizes	PSI	Bar	Adapter	Extension	1.25	1.5
W89729	1	5	CBX	2-1/2"	100	7			12mm	14mm

VACUUM PUMP KIT

- Bleeds brakes, tests vacuum switches and removes fluids.
- Durable steel construction.
- Includes tubes, various adapters and containers.

Also includes 6 tapered hose adapters, "T" hose connector, straight hose connector, 2 brake bleeder valve adapters, universal cup adapter, vacuum hose adapter, 2 plugs and 2 jar lids.



Item #	IP	MP	PKG	Gauge	Vacuum		Clear Hose		Reservoir
					in/Hg	cm/Hg	Lengths	I.D.	
W89727	1	10	CBX	2"	30	76	23" (2), 3" (2)	1/4"	4 oz.

PROFESSIONAL VACUUM PUMP

- Vacuum tool can test and diagnose a wide variety of parts and common systems on any vehicle.
- Complete kit includes accessories for both brake bleeding and automotive diagnosis.
- Test Ignition timing, chokes, mechanical fuel pumps, and other vacuum actuated accessories.
- Vacuum gauge scales is in inches of Mercury (Hg).

Also includes 6 tapered hose adapters, "T" hose connector, straight hose connector, 2 brake bleeder valve adapters, universal cup adapter, vacuum hose adapter, 2 plugs and 2 jar lids.



Item #	IP	MP	PKG	Gauge	Vacuum		Clear Hose		Reservoir
					in/Hg	cm/Hg	Lengths	I.D.	
W87030	1	10	DBL	2"	30	76	23" (2), 3" (2), 2"	1/4"	4 oz.

BLK: Bulk | CAS: Storage Case | CBX: Color Box | CRD: Carded | CLM: Clamshell | DBL: Double Blister
 LAB: Color Label | RAC: Storage Rack | SHK: Shrink Wrap | SLV: Sleeve | TAB: Hang Tab | WBX: White Box

COMPRESSION TESTERS

- Checks cylinder compression on snowmobiles, motorcycles, outboards, lawn equipment and most gas engines.

Large easy to read gauge.



W80580

Tapered rubber tip fits all common spark plug holes.



Item #	IP	MP	PKG	PSI	kg/cm2
W80579 Flex Drive	12	48	CRD	300	21
W80580	6	48	CRD	300	21

Fits 14mm & 18mm spark plug threads.



Equipped with air-hold valve and gauge reset button.

W80579
12" flexible rubber hose.

COMPRESSION TESTER SPARK PLUG ADAPTER SET

- Kit contains the necessary sizes to test compression most gas engines.
- Snowmobiles, motorcycles, outboards, lawn equipment and much more.
- Rubber o-rings insure a positive seal and accurate readings.
- Fits our compression tester W80579 and others with a 14mm x 1.25 male thread.

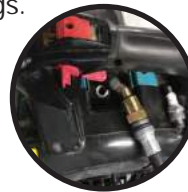

Item #	IP	MP	PKG	Sizes
W80577	12	72	CRD	10mm x 1.0, 12mm x 1.25, 18mm x 1.5 and the special 16mm x 1.5 Ford adapter

AIR VALVE HOLDERS

- Fits 14mm & 18mm spark plug holes, and 1/4-NPT air hose.
- Allows service of overhead valve components without removing head from engine block.
- Use in conjunction with Valve Spring Compressor (Performance Tool # W84001 or W84002).

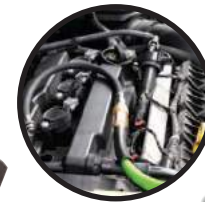

W84005



W84003
14" flexible hose reaches confined areas.

Item #	IP	MP	PKG
W84003	6	48	CRD 14" Flexible
W84005	6	72	CRD 2-PC Set

VACUUM & FUEL PUMP TESTER

- Checks for sticking valves, valve timing and burnt valves or insufficient valve tappet clearance.
- Detect weak valve springs, worn valve stem guides or leaking head gasket.
- Check fuel pump suction or pressure.
- Tests settings of the carburetor.
- Quick, accurate testing for a variety of applications.



Item #	IP	MP	PKG	Gauge	Vacuum		Hose	
					in/Hg	mm/Hg	Length	I.D.
W80594	12	48	CRD	2-1/4"	30	761	24"	1/4"

SPECIALTY

DIESEL & FUEL INJECTION

DIESEL COMPRESSION TEST KIT

- Tests compression through both glow plug and injector holes.
- Includes adapters for popular Asian, European and Domestic cars and trucks.

		Qty
Quick Couplers	7/16"-20 (F)	3
	ZG 1/8" (M)	1
Adapters	M12 x 1.25 (M)-7/16"-20 (M)	3
	M12 x 1.25 (F)-M18 x 1.5 (M)	2
	M10 x 1 (M)	1
	M10 x 1.25 Short	1
	M10 x 1.25 Long	1
	ZG 1/8" (F)-M24 x 2 (M)	1
	ZG 1/8" (M)-M24 x 1.5 (M)	1
Connector	Adapter Sleeve	1
	7/16"-20 (M)-7/16" x 20 (F) 90°	1
Additional	Quick Connect with Ball Tip	1
	1/2"-19 Lock Nut	1
	Copper Washers	2



Item #	IP	MP	PKG	Gauge			Hose w/Coupler			
				Dia.	PSI	kPa	±	Length	I.D.	NPT
W89731	1	5	CBX		1,000	7,000	2%	16"	15/64"	1/8"

SPECIALTY

DIESEL COMPRESSION TESTER KIT

- Diesel compression Tester set includes all the necessary components to test diesel compression on most diesel trucks, cars and tractors.
- Constructed of durable carbon steel with a chrome plated gauge for accurate measurements in harsh environments.
- Swivel end coupler allows quick and easy change-out of adapters.
- Includes adapters for most diesel engines including farm equipment.



Item #	IP	MP	PKG	Gauge			Hose w/Coupler			
				Dia.	PSI	Bar	±	Length	I.D.	NPT
W89735	1	3	CAS		1,000	70	2%	14-1/2"		

PROFESSIONAL DEF TESTER

- Professional disc type DEF, Diesel Exhaust Fluid tester.
- For most diesel power cars, light duty and semi-trucks from 2010 to current.
- Design to test the urea purity to maintained 32.5 percent.
- Floating discs will accurately display urea levels.
- Tests accurately hot or cold, temperature compensating.



Item #	IP	MP	PKG
W16500	6	24	CRD

MASTER FUEL INJECTION TEST KIT

- Quickly and accurately diagnose fuel injection problems.
- Adapters for most foreign and domestic fuel systems.
- Includes universal inline adapter for unique systems.

#	Adapters	#	Adapters
1	Gauge w/Boot & Hang-Up Hook	17	8mm - 1.00 (M) with O-Ring
2	GM 2.5L & 5.7L Fuel Injection Pressure Test	18	8mm - 1.00 (M) (Long)
3	GM 2.2L Fuel Injection Pressure Test Adapter	19	10mm - 1.00 (F)
4	Hose Clamps & Hoses	20	10mm - 1.00 (M)
5	GM TBI Fuel Pressure	21	12mm-1.50 (F) Swivel
6	Seals, Tank Valve & Gasket	22	14mm-1.50 (M) & (F) Swivel
7	Double End Barbed Hose	23	1/4" BSPT (M) & (F) Swivel
8	Single End Barbed Hose	24	16mm-1.50 (M) & (F) Swivel
9	6mm-1.00 Honda & Acura Multi-Port (PGM-FI)	25	Pressure Testing & Bleed-Off Assy.
10	8mm - 1.00 Banjo Bolt	26	Schrader Valve for Ford
11	10mm - 1.00 Banjo Bolt	27	Schrader Valve for GM & Chrysler
12	12mm - 1.25 Banjo Bolt	28	5/16" Hair Pin for Ford CFI
13	12mm - 1.50 Banjo Bolt	29	3/8" Hair Pin for GM & Chrysler
14	14mm - 1.50 Banjo Bolt	30	Spring Lock for Ford EFI
15	8mm - 1.00 (Long)	31	CIS Testing Assy. w/Ball Valve
16	8mm - 1.00 (F)		

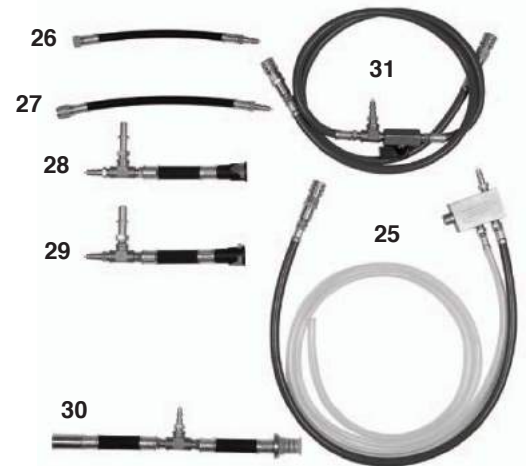
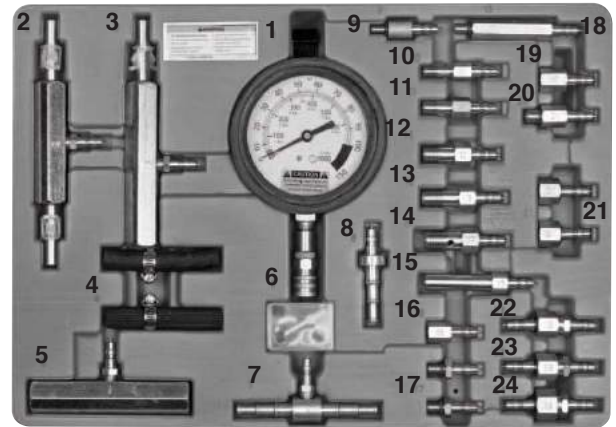

Item #	IP	MP	PKG	Gauge		
				Dia.	PSI	Bar
W89726	1	4	CBX		100	7

NOID & IAC LIGHT SETS

- Tests electronic fuel injection systems on GM TBI, Bosch PFI, Ford TBI, GM PFI, Geo TBI, GM SCPI, Bosch 2 and GM MULTEC2 equipped vehicles.
- Straight IAC Signal Tester for use on 1987 to current GM No. 700 TBI and PFI Fuel Injection Systems with flat 4 pin connectors.
- 90° IAC Signal Tester for use on 1982 to current GM TBI and PFI Fuel Injection System with square 4 pin connectors.

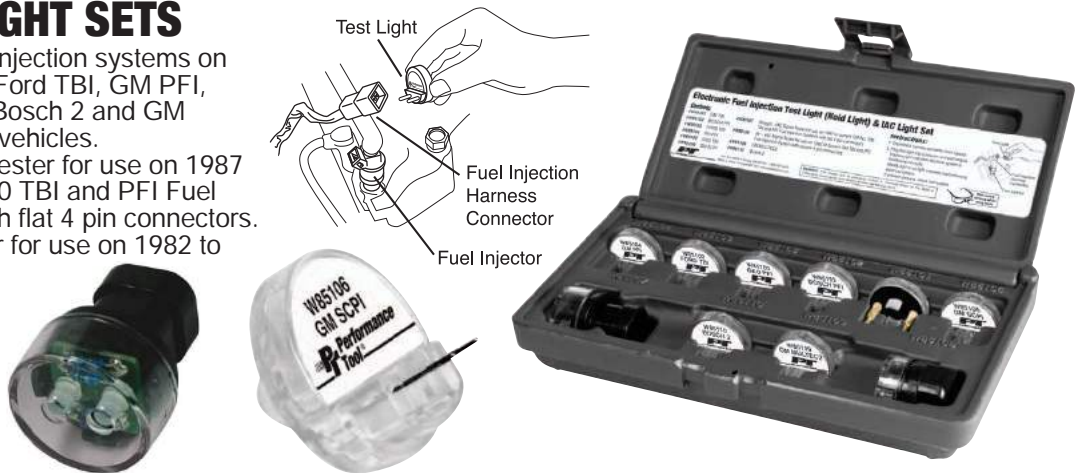

Item #	IP	MP	PKG	GM	TBI			PFI		SCPI	MULTEC2	IAC	
					Ford	Geo	GM	GM	Bosch	GM	GM	Bosch 2	Straight
W89500	6	24	CBX 6-PC	x	x	x	x	x	x	x	-	-	-
W89501	6	36	CBX 10-PC	x	x	x	x	x	x	x	x	x	x

AUTOMOTIVE STETHOSCOPE

- Helps identify noises in automotive assemblies including engine, transmission, rear axle, transfer case, valve train, etc.
- Super sensitive.



Item #	IP	MP	PKG
W80582	6	48	CRD 11" probe tip

SPECIALTY

COOLING SYSTEM

COOLING SYSTEM PRESSURE TESTER

- Allows quick and easy testing for leakage in radiator system and quick change of coolant.
- Color coded radiator test caps make it easy to choose the suitable test cap for the job.
- Adapters for use with most cars and trucks, import and domestic.
- Allows testing of the radiator caps checking the original pressure release.
- Includes a cooling system purge & refill kit for quick change of coolant.



Item #	IP	MP	PKG	Gauge			Hose
				Dia.	PSI	Bar	Length
W89736	1	2	CBX	3"	35	2.5	18, 21"

COOLING SYSTEM PRESSURE TESTER

- Quickly reveals external cooling system leaks.
- Detects internal engine leaks caused by blown head gaskets and/or cracked block or heads.
- Includes high quality hand pump and 12 adapters to fit the most popular domestic/import cars & light trucks.



Item #	IP	MP	PKG	Gauge			Hose
				Dia.	PSI	Bar	Length
W89733	1	5	CBX	3"	35	2.5"	21"

UNIVERSAL AIRVAC COOLANT REFILLER

- Refill your entire cooling system with no air pockets.
- Eliminate overheating due to trapped air in your cooling system.
- Quick and easy to use, requires shop air.
- Universal adapter for use on most car & light truck radiators.



Item #	IP	MP	PKG	Gauge			Hose
				Dia.	PSI	Bar	Length
W89734	1	5	CBX	2-1/4"	14.5	1	18"

SPECIALTY

ANTIFREEZE TESTERS

W1655C

Color coded balls for easy readings.



W1656C

Freezing to boiling points for anti-freeze, calibrated in °C and °F.



W1660C

Easy to use, precise color coded glass float indicates anti-freeze content.



W1654C

Color coded indicator float.



Item #		IP	MP	PKG
W1656C	Dial	6	72	CRD
W1655C	Mini Tube	24	288	CRD
W1654C	Tube	6	72	CRD
W1660C	Temperature Compensation	6	72	CRD

MULTIFUNCTION REFRACTOMETER

- Refractometers measure refraction index to calculate the composition of various materials.
- Measurements are on the Brix scale in varying ranges depending on what's tested.
- Measures DEF, Ethylene Glycol, Propylene Glycol, Battery Fluid, and Cleaning Fluids. ATC (Automatic Temperature Compensation).
- Heavy duty lightweight aluminum construction, includes a protective storage case.



Item #	IP	MP	PKG
W80158	1	20	CLM

PLASTIC RADIATOR FILLER

- Tough polyethylene won't damage automotive finishes.
- Impervious to oil, gasoline and antifreeze.



Item #	IP	MP	PKG	Capacity
W54273	1	4	LAB	2.5 Gallons

A/C MANIFOLD TEST KIT

- 50" hose length.
- High quality brass fittings.
- 0-120 psi low side,
- 0-500 psi high side.

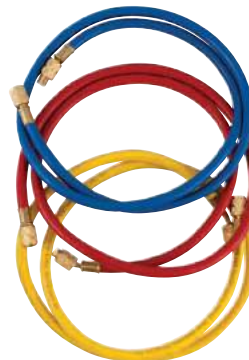

Item #	IP	MP	PKG
W89730	1	5	CBX

SPECIALTY

SOCKET & RATCHET SETS

240-PC MASTER MECHANIC'S TOOL SET

- Complete starter kit for the weekend warrior or aspiring professional.
- Includes everything you need!
128 standard and deep wall sockets,
18 drive tools and accessories,
35 combination and flare wrenches,
59 general tools and enough socket
rails for all 128 sockets.

Item #	IP	MP	PKG
W30500	1	1	CBX



Some tools not pictured.

	1/4"	3/8"	1/2"
SOCKETS			
Standard Sockets	6pt: 5/32, 3/16, 7/32, 1/4, 9/32, 5/16, 11/32, 3/8, 7/16, 1/2"	12pt: 1/4, 5/16, 3/8, 7/16, 1/2, 9/16, 5/8, 11/16, 3/4, 13/16, 7/8, 15/16"	12pt: 1/2, 9/16, 5/8, 11/16, 3/4, 13/16, 7/8, 15/16, 1, 1-1/16, 1-1/8, 1-1/4"
	6pt: 4, 5, 6, 7, 8, 9, 10, 11, 12, 13mm	12pt: 7, 8, 9, 10, 11, 12, 13, 14, 15, 16, 17, 18, 19mm	12pt: 12, 13, 14, 15, 17, 18, 19, 21, 22, 24mm
Deep Sockets	6pt: 7/32, 1/4, 5/16, 3/8, 7/16, 1/2"	12pt: 5/16, 3/8, 7/16, 1/2, 9/16, 5/8, 3/4, 13/16, 7/8, 15/16"	12pt: 9/16, 5/8, 3/4, 13/16, 7/8, 15/16"
	6pt: 4, 6, 7, 8, 10, 12mm	12pt: 8, 10, 12, 13, 14, 15, 16, 17, 18, 19mm	12pt: 14, 15, 17, 18, 19, 21mm
Bit Type	T10, T15, T20, T25, T27, T30	T40, T45, T47, T50, T55	T60
Spark plug	-	9/16, 5/8, 13/16" sockets	5/8, 13/16" sockets
DRIVE ACCESSORIES			
Pro Ratchet	5-1/2"	7-5/8"	9-1/2"
Flex Handle	-	-	15"
Spinner Handle	4"	-	-
Extensions	3, 6"	3, 6, 10"	5"
Adapters	1/4 (F) x 3/8" (M)	3/8 (F) x 1/2" (M) 3/8 (F) x 1/4" (M)	1/2 (F) x 3/8" (M)
Universal joints	1/4"	3/8"	1/2"
Socket Rails	2-pcs	3-pcs	3-pcs
WRENCHES			
Combination	1/4, 5/16, 3/8, 7/16, 1/2, 9/16, 5/8, 3/4, 7/8, 15/16, 1, 1-1/16, 1-1/8, 1-1/4" 7, 8, 10, 11, 12, 13, 14, 15, 16, 17, 18, 19, 22mm		
Flare Nut	3/8 x 7/16, 1/2 x 9/16, 5/8 x 11/16, 3/4 x 7/8" 10 x 12, 16 x 18, 13 x 14, 9 x 11mm		
Pliers	6" Diagonal, 7 Curve jaw lock grip, 8" Slip joint, 8" Long nose, 8" Adjustable, 10" Groove joint, 11" Long handle nose		
Screwdrivers	#0 x 2-1/2, #1 x 3, #2 x 4, #2 x 1-1/2, #3 x 6" T15, T20, T25		
Hex Keys	1/16, 5/64, 3/32, 7/64, 1/8, 9/64, 5/32, 3/16, 7/32, 1/4, 5/16, 3/8" 1.27, 1.5, 2, 2.5, 3, 4, 4.5, 5, 5.5, 6, 7, 8, 10mm		
Additional	12 oz. ball pein hammer, 8, 12, 17-3/4" pry bars, spark plug gapper		

HAND TOOLS

36-PC 1/4 IN DR. MECHANIC'S SET

- Socket openings are designed to reduce fastener rounding.
- Chrome vanadium alloy steel construction for strength and durability.
- Polished nickel chrome plated finish resists corrosion.
- Features high torque quick release ratchet.
- 72 gear teeth for 5 degree sweep.
- Smaller head for tight areas.



Item #	IP	MP	PKG	6pt. Sockets	6pt. Deep Sockets	Additional Contents
W36905	1	10	SLV	5/32, 3/16, 7/32, 1/4, 9/32, 5/16, 11/32, 3/8, 7/16, 1/2"	7/32, 1/4, 5/16, 3/8, 7/16, 1/2"	1/4" dr. quick release ratchet 1/4" dr. spinner handle 1/4" dr. universal joint 3" extension bar
				4, 5, 6, 7, 8, 9, 10, 11, 12, 13mm	4, 6, 7, 8, 10, 12mm	

51-PC 3/8 IN DR. MECHANIC'S SET



Item #	IP	MP	PKG	12pt. Sockets	12pt. Deep Sockets	Additional Contents
W38905	1	5	SLV	1/4, 5/16, 3/8, 7/16, 1/2, 9/16, 5/8, 11/16, 3/4, 13/16, 7/8, 15/16"	5/16, 3/8, 7/16, 1/2, 9/16, 5/8, 3/4, 13/16, 7/8, 15/16"	3/8" dr. quick release ratchet 3/8" dr. universal joint, 3 and 6" extensions, 5/8 and 13/16" spark plug sockets.
				7, 8, 9, 10, 11, 12, 13, 14, 15, 16, 17, 18, 19mm	8, 10, 12, 13, 14, 15, 16, 17, 18, 19mm	

40-PC 1/2 IN DR. MECHANIC'S SET



Item #	IP	MP	PKG	12pt. Sockets	12pt. Deep Sockets	Additional Contents
W32905	1	3	SLV	1/2, 9/16, 5/8, 11/16, 3/4, 13/16, 7/8, 15/16 1, 1-1/16, 1-1/8, 1-1/4"	9/16, 5/8, 3/4, 13/16, 7/8, 15/16"	1/2" dr. Quick release ratchet, 15" flex handle, 1/2" dr. universal joint, 3 and 6" extensions, 5/8 and 13/16" spark plug sockets.
				12, 13, 14, 15, 17, 18, 19, 21, 22, 24mm	14, 15, 17, 18, 19, 21mm	

HAND TOOLS

SOCKET & RATCHET SETS

1/4 IN DR. 6 POINT SOCKET SETS

- Recessed edges, socket openings are designed to reduce fastener rounding.
- Chrome vanadium alloy steel construction for strength and durability.
- Polished nickel chrome plated finish resists corrosion.
- Features high torque quick release ratchet.
- 108 gear teeth.



Item #	IP	MP	PKG	Standard	Deep	Additional Contents
W36901	1	10	SLV	5/32, 3/16, 7/32, 1/4, 9/32, 5/16, 11/32, 3/8, 7/16, 1/2"	7/32, 1/4, 9/32, 5/16, 11/32, 3/8, 7/16, 1/2"	Quick release ratchet, universal joint,
W36904	1	10	SLV	4, 5, 6, 7, 8, 9, 10, 11, 12, 13mm	6, 7, 8, 9, 10, 11, 12, 13mm.	2 and 6" extensions

3/8 IN DR. 6 POINT SOCKET SETS



Item #	IP	MP	PKG	Standard	Deep	Spark Plug	Additional Contents
W38911	1	5	SLV	3/8, 7/16, 1/2, 9/16, 5/8, 11/16, 3/4"	3/8, 7/16, 1/2, 9/16, 5/8, 11/16, 3/4"	5/8, 13/16"	Quick release ratchet universal joint,
W38914	1	5	SLV	10, 11, 13, 14, 15, 16, 17, 19mm	10, 11, 12, 13, 14, 15, 16, 17, 19mm	16, 21mm	3 and 6" extensions

1/2 IN DR. 6 POINT SOCKET SETS



Item #	IP	MP	PKG	Standard	Deep	Spark Plug	Additional Contents
W32901	1	5	SLV	3/8, 7/16, 1/2, 9/16, 5/8, 11/16, 3/4, 13/16, 7/8, 15/16, 1"	1/2, 9/16, 5/8, 11/16, 3/4, 13/16, 7/8, 15/16"	5/8, 13/16"	Quick release ratchet 10" flex handle universal joint,
W32904	1	5	SLV	12, 13, 14, 16, 17, 19, 21, 22, 23, 24, 27mm	13, 14, 15, 16, 17, 18, 19, 21mm	16, 21mm	3 and 5" extensions

BLK: Bulk | CAS: Storage Case | CBX: Color Box | CRD: Carded | CLM: Clamshell | DBL: Double Blister
 LAB: Color Label | RAC: Storage Rack | SHK: Shrink Wrap | SLV: Sleeve | TAB: Hang Tab | WBX: White Box

3/4 IN DR. PROFESSIONAL SOCKET SETS

- Socket openings feature recessed corners to reduce fastener rounding.
- Chrome vanadium alloy steel construction for added strength and durability.
- Polished nickel chrome plated finish resists corrosion.
- Durable storage case included.



W34906



W34904

Item #	IP	MP	PKG	12pt. Sockets	Additional Contents
W34904	21-PC	1	2	CBX 7/8, 15/16, 1, 1-1/16, 1-1/8, 1-3/16, 1-1/4, 1-5/16, 1-3/8, 1-7/16, 1-1/2, 1-5/8, 1-3/4, 1-13/16, 1-7/8, 2"	24 gear teeth 19-1/2" ratchet, 18" sliding T-handle 4, 8 and 16" extensions
W34906	16-PC	1	3	CBX 22, 23, 24, 26, 27, 29, 30, 32, 33, 35, 36, 38, 40, 41, 46, 50mm	

3/4 IN DR. SOCKET SETS

- Drop forged chrome plates steel.
- Includes heavy duty metal storage/carrying cases.



W1179



Item #	IP	MP	PKG	12pt. Sockets	Additional Contents
W1180	21-PC	1	2	SLV 3/4, 7/8, 15/16, 1, 1-1/16, 1-1/8, 1-3/16, 1-1/4, 1-5/16, 1-3/8, 1-7/16, 1-1/2, 1-5/8, 1-3/4, 1-7/8, 2"	43 gear teeth 20" ratchet, 18" flex handle, 4 and 8" extensions
W1179	9-PC	1	3	CBX 2 1/16, 2 1/8, 2 3/16, 2 1/4, 2 5/16, 2 3/8, 2 7/16, 2 1/2"	

SOCKET & RATCHET SETS

- Recessed edges, socket openings are designed to reduce fastener rounding.
- Chrome vanadium alloy steel construction for strength and durability. Polished nickel chrome plated finish resists corrosion.

Laser etched, double plated black sockets



Item #	IP	MP	PKG	Drive	Gear	6pt. Sockets
W38304	21-PC	6	24	RAC	1/4"	43 5/32, 7/32, 1/4, 9/32, 4, 5, 6, 7, 8, 5/16, 11/32, 3/8, 9, 10, 11, 12, 7/16, 15/32, 1/2" 13mm
W38301	19-PC	6	24	RAC	3/8"	45 3/8, 7/16, 15/32, 1/2, 9, 10, 11, 12, 9/16, 5/8, 11/16, 3/4, 13, 14, 15, 13/16" 17, 19mm
W38337 Black	19-PC	6	24	RAC	3/8"	72 5/16, 3/8, 7/16, 1/2, 9, 10, 11, 12, 9/16, 5/8, 11/16, 3/4, 13, 14, 15, 13/16" 17, 19mm
W38302	17-PC	6	12	RAC	1/2"	45 3/8, 7/16, 1/2, 9/16, 10, 11, 12, 5/8, 11/16, 3/4, 13, 14, 15, 13/16" 17, 19mm



HAND TOOLS

SOCKETS & SETS

PROFESSIONAL SOCKETS

- Socket openings are designed to reduce fastener rounding.
- Chrome vanadium alloy steel construction for strength and durability.
- Polished nickel chrome plated finish resists corrosion.
- Large stamping for quick identification.
- Recessed edges.
- Storage rack.



	1/4" Dr. 6 point		3/8" Dr. 6 point		1/2" Dr. 6 point	
	Deep		Deep		Deep	
	W36002	W36300	W38002	W38300	W32002	W32300
	IP: 6 MP:24	IP: 6 MP:24	IP: 6 MP:24	IP: 6 MP:12	IP: 6 MP:12	IP: 6 MP:12
5/32"	X	X	-	-	-	-
3/16"	X	X	-	-	-	-
7/32"	X	X	-	-	-	-
1/4"	X	X	X	-	-	-
9/32"	X	X	-	-	-	-
5/16"	X	X	X	-	-	-
11/32"	X	X	-	-	-	-
3/8"	X	X	X	X	-	-
7/16"	X	X	X	X	-	-
1/2"	X	X	X	X	X	X
9/16"	-	-	X	X	X	X
5/8"	-	-	X	X	X	X
11/16"	-	-	X	X	X	X
3/4"	-	-	X	X	X	X
13/16"	-	-	X	X	X	X
7/8"	-	-	-	X	X	X
15/16"	-	-	-	X	X	X
1"	-	-	-	-	X	-

	3/8" Dr. 12 point		1/2" Dr. 12 point
	Deep		Deep
	W38500	W38600	W32600
	IP: 6 MP:24	IP: 6 MP:12	IP: 6 MP:12
	-	-	-
	-	-	-
	-	-	-
	X	-	-
	-	-	-
	X	-	-
	-	-	-
	X	X	-
	X	X	-
	X	X	X
	X	X	X
	X	X	X
	X	X	X
	X	X	X
	-	X	X
	-	X	X
	-	-	-

OPEN STOCK

HAND TOOLS

	1/4" Dr. 6 point		3/8" Dr. 6 point		1/2" Dr. 6 point	
	Deep		Deep		Deep	
	W36005	W36305				
5/32"	W36005	W36305	-	-	-	-
3/16"	W36006	W36306	-	-	-	-
7/32"	W36007	W36307	-	-	-	-
1/4"	W36008	W36308	W38008	W38308	-	-
9/32"	W36009	W36309	-	-	-	-
5/16"	W36010	W36310	W38010	W38310	-	-
11/32"	W36011	W36311	-	-	-	-
3/8"	W36012	W36312	W38012	W38312	W32012	
7/16"	W36014	W36314	W38014	W38314	W32014	
1/2"	W36016	W36316	W38016	W38316	W32016	W32316
9/16"	-	-	W38018	W38318	W32018	W32318
5/8"	-	-	W38020	W38320	W32020	W32320
11/16"	-	-	W38022	W38322	W32022	W32322
3/4"	-	-	W38024	W38324	W32024	W32324
13/16"	-	-	W38026	W38326	W32026	W32326
7/8"	-	-	W38028	W38328	W32028	W32328
15/16"	-	-	W38030	W38330	W32030	W32330
1"	-	-	W38032	W38332	-	W32332
1-1/16"	-	-	-	-	W32034	W32334
1-1/8"	-	-	-	-	-	W32336
1-3/16"	-	-	-	-	W32038	-
1-1/4"	-	-	-	-	W32040	W32340

	3/8" Dr. 12 point		1/2" Dr. 12 point
	Deep		Deep
	IP	MP	PKG
	6	48	TAB
	-	-	-
	-	-	-
	-	-	-
	-	-	-
	-	-	-
	-	-	-
	W38510	-	-
	-	-	-
	W38512	W38612	W32512
	W38514	W38614	W32514
	W38516	W38616	W32516
	W38518	W38618	W32518
	W38520	W38620	W32520
	W38522	W38622	W32522
	W38524	W38624	W32524
	W38526	W38626	W32526
	W38528	W38628	W32528
		W38630	W32530
	-	-	W32532
	-	-	W32534
	-	-	W32536
	-	-	W32538
	-	-	W32540



	1/4" Dr. 6 point		3/8" Dr. 6 point		1/2" Dr. 6 point		3/8" Dr. 12 point		1/2" Dr. 12 point
	Deep		Deep		Deep		Deep		Deep
	W36202	W36400	W38202*	W38402*	W32202	W32400	W38800	W38700	W32700
	IP: 6 MP:24	IP: 6 MP:24	IP: 6 MP:24	IP: 6 MP:12	IP: 6 MP:24	IP: 6 MP:12	IP: 6 MP:12	IP: 6 MP:12	IP: 6 MP:12
4mm	x	x	-	-	-	-	-	-	-
5mm	x	x	-	-	-	-	-	-	-
6mm	x	x	-	-	-	-	-	-	-
7mm	x	x	-	-	-	-	-	-	-
8mm	x	x	-	-	-	-	-	-	-
9mm	x	x	-	-	-	-	-	-	-
10mm	x	x	x	x	-	-	x	x	-
11mm	x	x	x	x	-	-	x	x	-
12mm	x	x	x	x	x	x	x	x	x
13mm	x	x	x	x	x	x	x	x	x
14mm	-	-	x	x	x	x	x	x	x
15mm	-	-	x	x	x	x	x	x	x
16mm	-	-	x	x	x	x	x	x	x
17mm	-	-	x	x	x	x	x	x	x
18mm	-	-	x	x	x	x	x	x	x
19mm	-	-	x	x	x	x	x	x	x
21mm	-	-	-	-	x	-	-	-	-

* Available in black laser etched socket set W38201 and deep socket set W38401.

OPEN STOCK

	1/4" Dr. 6 point		3/8" Dr. 6 point		1/2" Dr. 6 point		3/8" Dr. 12 point		1/2" Dr. 12 point		IP 6	MP 48	PKG TAB
	Deep		Deep		Deep		Deep		Deep				
	W36204	W36404	-	-	-	-	-	-	-	-			
4mm	W36204	W36404	-	-	-	-	-	-	-	-	-	-	-
5mm	W36205	W36405	-	-	-	-	-	-	-	-	-	-	-
6mm	W36206	W36406	W38206	-	-	-	-	-	-	-	-	-	-
7mm	W36207	W36407	W38207	W38407	-	-	W38807	-	-	-	-	-	-
8mm	W36208	W36408	W38208	W38408	-	-	W38808	W38708	-	-	-	-	-
9mm	W36209	W36409	W38209	W38409	-	-	W38809	W38709	-	-	-	-	-
10mm	W36210	W36410	W38210	W38410	W32210	W32410	W38810	W38710	W32810	-	-	-	-
11mm	W36211	W36411	W38211	W38411	W32211	W32411	W38811	W38711	W32811	-	-	-	-
12mm	W36212	W36412	W38212	W38412	W32212	W32412	W38812	W38712	W32812	-	-	-	-
13mm	W36213	W36413	W38213	W38413	W32213	W32413	W38813	W38713	W32813	-	-	-	-
14mm	-	-	W38214	W38414	W32214	W32414	W38814	W38714	W32814	-	-	-	-
15mm	-	-	W38215	W38415	W32215	W32415	W38815	W38715	W32815	-	-	-	-
16mm	-	-	W38216	W38416	W32216	W32416	W38816	W38716	W32816	-	-	-	-
17mm	-	-	W38217	W38417	W32217	W32417	W38817	W38717	W32817	-	-	-	-
18mm	-	-	W38218	W38418	W32218	W32418	W38818	W38718	W32818	-	-	-	-
19mm	-	-	W38219	W38419	W32219	W32419	W38819	W38719	W32819	-	-	-	-
20mm	-	-	W38220	-	W32220	W32420	W38820	-	W32820	-	-	-	-
21mm	-	-	W38221	W38421	W32221	W32421	W38821	-	W32821	-	-	-	-
22mm	-	-	W38222	W38422	W32222	W32422	W38822	-	W32822	-	-	-	-
23mm	-	-	-	-	W32223	W32423	-	-	W32823	-	-	-	-
24mm	-	-	-	-	W32224	W32424	-	-	W32824	-	-	-	-
25mm	-	-	-	-	W32225	-	-	-	W32825	-	-	-	-
26mm	-	-	-	-	W32226	-	-	-	W32826	-	-	-	-
27mm	-	-	-	-	W32227	W32427	-	-	W32827	-	-	-	-
28mm	-	-	-	-	W32228	-	-	-	W32828	-	-	-	-
30mm	-	-	-	-	W32230	-	-	-	W32830	-	-	-	-
32mm	-	-	-	-	W32232	-	-	-	W32832	-	-	-	-

HAND TOOLS

SOCKETS & SETS

3/4 IN. DR. 12 POINT SOCKETS

- Chrome vanadium alloy steel construction.
- Polished nickel chrome plated finish resists corrosion.



Item #	IP	MP	PKG	
W34906	16-PC MM	1	3	CBX See Ratchets & Sockets for additional sets
W1179	9-PC SAE	1	3	CBX

OPEN STOCK

IP	MP	PKG
3	12	TAB

Size	Item #	W34906
22mm	W34822	x
23mm	W34823	x
24mm	W34824	x
25mm	W34825	-
26mm	W34826	x
27mm	W34827	x
28mm	W34828	-
29mm	W34829	x
30mm	W34830	x
32mm	W34832	x
33mm	W34833	x
35mm	W34835	x
36mm	W34836	x
38mm	W34838	x
40mm	W34840	x
41mm	W34841	x
42mm	W34842	-
46mm	W34846	x
50mm	W34850	x
55mm	W34855	-

Size	Item #	W1179
3/4"	W34524	-
7/8"	W34528	-
15/16"	W34530	-
1"	W34532	-
1-1/16"	W34534	-
1-1/8"	W34536	-
1-3/16"	W34538	-
1-1/4"	W34540	-
1-5/16"	W34542	-
1-3/8"	W34544	-
1-7/16"	W34546	-
1-1/2"	W34548	-
1-9/16"	W34550	-
1-5/8"	W34552	-
1-11/16"	W34554	-
1-3/4"	W34556	-
1-13/16"	W34558	-
1-7/8"	W34560	-
2"	W34564	-
2-1/16"	W34566	x
2-1/8"	W34568	x
2-3/16"	W34570	x
2-1/4"	W34572	x
2-3/8"	W34574	x

3/8 IN DR. SPARK PLUG SOCKETS

- Chrome vanadium alloy steel construction for strength and durability.
- Socket openings are designed to reduce fastener rounding.
- Polished nickel chrome plated finish resists corrosion.
- Rubber insert holds and protects plugs.
- Recessed edges.

Item #	Size	IP	MP	PKG
W38160	5/8"	6	48	TAB
W38164	13/16"	6	48	TAB
W38170	9/16"	6	48	TAB
W38163	3/4"	6	48	TAB
W38166	14mm	6	48	TAB
W38171	14mm 12pt	6	48	TAB
W38167	16mm	6	48	TAB
W38168	18mm	6	48	TAB
W38169	21mm	6	48	TAB

Standard

W1128C	5/8"	12	120	CRD
W1126C	13/16"	12	72	CRD

with U-Joint

W38161	5/8"	6	48	TAB
W38165	13/16"	6	48	TAB

Long Reach

W80533	5/8"	6	72	CRD
W38162	5/8"	6	48	TAB

Magnetic

W38172	5/8"	6	48	TAB
W38173	13/16"	6	48	TAB

1/2 Drive Sockets

W32160	5/8"	6	48	TAB
W32163	13/16"	6	48	TAB



W38172
W38173

Internal magnet aids in retrieval and replacement of spark plugs



W38161
W38165

Swivel action for confined areas



W80533
W38162

Knurled design offers better grip when hand turning



5" overall length

HAND TOOLS

FLEX JOINT SOCKET SETS

- Socket openings are designed to reduce fastener rounding.
- Polished nickel chrome plated finish resists corrosion.
- Chrome vanadium alloy steel construction.
- Large stamping for quick identification.
- Includes metal clip socket rail.



Item #	IP	MP	PKG	Drive
W36980	6-PC	6	48	CRD 1/4" 1/4, 5/16, 3/8, 7/16, 1/2, 9/16"
W38980	7-PC	20	40	CRD 3/8" 3/8, 7/16, 1/2, 9/16, 5/8, 11/16, 3/4"
W36981	9-PC	6	48	CRD 1/4" 6, 7, 8, 9, 10, 11, 12, 13, 14mm
W38981	10-PC	12	24	CRD 3/8" 10, 11, 12, 13, 14, 15, 16, 17, 18, 19mm

10-PC 3/8 IN DR. SPLINE SOCKET SET

- Universal spine design offers a tighter fit on proper size fasteners for better tightening.
- Also works on SAE/MET sizes, 6pt, 12pt, external star, square.
- Black phosphate finish with polished edges make sizes easy to read.
- Chrome vanadium alloy steel construction for strength and durability.
- Convenient storage rack.



Note: due to varying tolerances, check fastener to ensure proper fit before use.

Item #	IP	MP	PKG	Sizes
W38194	6	24	TAB	9/32" 5/16" 11/32" 3/8" 7/16" 1/2" 9/16" 5/8" 11/16" 23/32" 7mm 8mm 9mm 10mm 11mm 13mm 14mm 16mm 17mm 18mm

1/2 IN. DR. THIN WALL SOCKETS

- Protective sleeves and plastic inserts prevent scratching of wheels and lug nuts.
- Hollow design allows room for removing longer bolts.
- Color coded for easy identification.
- Heavy duty chrome molybdenum.



Item #	IP	MP	PKG	Size	O.D. w/Sleeve
W32921	Purple	4	24	TAB 13/16"	1.232" (31.3mm)
W32922	Green	4	24	TAB 7/8"	1.307" (33.2mm)
W32923	Blue	4	24	TAB 17mm	1.087" (27.6mm)
W32924	Yellow	4	24	TAB 19mm	1.157" (29.4mm)
W32925	Red	4	24	TAB 21mm	1.228" (31.2mm)
W32926	Turquoise	4	24	TAB 22mm	
W32902	5-PC	1	12	CAS 17, 19 (3/4"), 21mm, 13/16 & 7/8"	

HAND TOOLS

HEX BIT SOCKETS

8-PC HEX BIT SOCKET SETS

- Polished nickel chrome plated finish resists corrosion.
- Chrome vanadium alloy steel construction.
- Heat treated for strength.
- Recessed edges.



Item #	IP	MP	PKG	Sizes
W38870	6	24	RAC	1/8, 9/64, 5/32, 3/16, 7/32, 1/4, 5/16, 3/8".

8-PC HEX BIT SOCKET SETS

- Polished nickel chrome plated finish resists corrosion.
- Chrome vanadium alloy steel construction.
- Heat treated for strength.
- Recessed edges.



Item #	IP	MP	PKG	Sizes
W38890	6	24	RAC	3, 4, 5, 6, 7, 8, 9, 10mm

6-PC 1/2 IN DR. HEX BIT SOCKET SETS

- Chrome vanadium alloy steel construction for strength and durability.
- Polished nickel chrome plated finish resists corrosion.
- Heat treated for strength.
- Recessed edges.
- Bonus storage rail included.



Item #	IP	MP	PKG	Sizes
W38886	6	24	CRD	3/8, 1/2, 9/16", 12, 14, 17mm

OPEN STOCK

Drive	Size	Item #	IP	MP	PKG
1/4" Dr.	5/64"	W36801	12	144	TAB
	3/32"	W36802	12	144	TAB
	7/64"	W36803	12	144	TAB
3/8" Dr.	1/8"	W38874	6	48	TAB
	9/64"	W38875	6	48	TAB
	5/32"	W38876	6	48	TAB
	3/16"	W38877	6	48	TAB
	7/32"	W38878	6	48	TAB
	1/4"	W38879	6	48	TAB
	5/16"	W38880	6	48	TAB
	3/8"	W38881	6	48	TAB
	7/16"	W32880	6	48	TAB
	1/2"	W32881	6	48	TAB
1/2" Dr.	9/16"	W32882	6	48	TAB
	5/8"	W32883	6	48	TAB
	11/16"	W32884	6	48	TAB
	3/4"	W32885	6	48	TAB
	13/16"	W32886	6	48	TAB
	7/8"	W32887	6	48	TAB
	15/16"	W32888	6	48	TAB
	1"	W32889	6	48	TAB

Drive	Size	Item #	IP	MP	PKG
1/4" Dr.	2mm	W36902	12	144	TAB
	2.5mm	W36903	12	144	TAB
3/8" Dr.	3mm	W38893	6	48	TAB
	4mm	W38894	6	48	TAB
	5.5mm	W38892	12	144	TAB
	5mm	W38895	6	48	TAB
	6mm	W38896	6	48	TAB
	7mm	W38897	6	48	TAB
	8mm	W38898	6	48	TAB
	9mm	W38899	6	48	TAB
	10mm	W38900	6	48	TAB
	11mm	W32981	6	48	TAB
	12mm	W32982	6	48	TAB
	13mm	W32983	6	48	TAB
	14mm	W32984	6	48	TAB
1/2" Dr.	15mm	W32985	6	48	TAB
	16mm	W32986	6	48	TAB
	17mm	W32987	6	48	TAB
	18mm	W32988	6	48	TAB
	19mm	W32989	6	48	TAB
	20mm	W32990	6	48	TAB
	21mm	W32991	6	48	TAB
	22mm	W32992	6	48	TAB

HAND TOOLS

EXTENDED BIT SOCKET SETS

- Chrome vanadium steel sockets with S2 bits for strength and durability.
- Polished nickel chrome plated finish resists corrosion.
- Extended length bits for hard to reach fasteners.
- Includes plastic storage and organizing tray.



Item #	IP	MP	PKG	Drive	Sizes
W38750	7-PC	6	24	CRD	3/8" 1/8, 5/32, 3/16, 7/32, 1/4, 5/16, 3/8
W38751	7-PC	6	24	CRD	3/8" 3, 4, 5, 6, 7, 8, 10mm
W38752	10-PC	6	24	CRD	3/8" T10, T15, T20, T25, T27, T30, T40, T45, T50, T55

BIT SOCKET SETS

- Chrome vanadium alloy steel construction for strength and durability.
- Heat treated for strength with professional sand finish.
- Includes storage rail.

Item #	IP	MP	PKG	Drive	Sizes
W1336	3-PC	6	72	CRD	3/8" 1/4, 3/8, 5/16"
W1339	4-PC	6	72	CRD	3/8" 1/4, 3/8, 5/16, 7/32"
W1387	10-PC	6	24	CRD	3/8" 3/32, 7/64, 1/8, 9/64, 5/32, 3/16, 7/32, 1/4, 5/16, 3/8"
W1341	3-PC	6	72	CRD	3/8" 7, 8, 10mm
W86023	3-PC	12	48	CRD	1/2" 12, 14, 17mm
W1388	10-PC	6	24	CRD	3/8" 2, 3, 4, 5, 5.5, 6, 7, 8, 9, 10mm



STAR					
W1337	3-PC	6	72	CRD	3/8" T40, T45, T50
W1178	9-PC	6	48	CRD	3/8" T10, T15, T20, T25, T27, T30, T40, T45, T50
W1335	12-PC	6	36	CRD	1/4" T10, T15, T20, T25, T27, T30
					3/8" T40, T45, T47, T50, T55
					1/2" T60
W1313	15-PC	6	24	CRD	1/4" T10, T15, T20, T25, T27, T30
					3/8" T40, T45, T47, T50, T55, T60

STAR TAMPER RESISTANT

W1385	9-PC	6	36	CRD	1/4" T10, T15, T20, T25, T27, T30
					3/8" T40, T45, T50

EXTERNAL STAR SOCKETS

- Heat treated alloy steel.
- Polish chrome plated finish.
- Bonus storage rail and 3/8" (F) to 1/4" (M) adapter included.



Item #	IP	MP	PKG	Drive	Sizes
W1338	6	36	CRD	1/4"	E5, E6, E7, E8
				3/8"	E10, E12, E14, E16



HAND TOOLS

OPEN STOCK

Drive	Size	Item #	IP	MP	PKG
1/4" Dr.	E6	W81006	6	288	CRD
	E7	W81007	6	288	CRD
	E8	W81008	6	288	CRD
3/8" Dr.	E10	W81010	6	288	CRD
	E12	W81012	6	288	CRD
	E14	W81014	6	288	CRD
	E16	W81016	6	288	CRD
	E18	W81018	6	288	CRD

STAR BIT SOCKETS

12-PC STAR BIT SOCKET SET

- Chrome vanadium alloy steel construction for strength and durability.
- Polished nickel chrome plated finish resists corrosion.



Item #	IP	MP	PKG	Drive	Sizes
W38802	6	24	RAC	1/4"	T10, T15, T20, T25, T27, T30
				3/8"	T40, T45, T47, T50, T55
				1/2"	T60

OPEN STOCK

Drive	Size	Item #	IP	MP	PKG
1/4" Dr.	T10	W36810	6	48	TAB
	T15	W36815	6	48	TAB
	T20	W36820	6	48	TAB
	T25	W36825	6	48	TAB
	T27	W36827	6	48	TAB
	T30	W36830	6	48	TAB
3/8" Dr.	T40	W38840	6	48	TAB
	T45	W38845	6	48	TAB
	T47	W38847	6	48	TAB
	T50	W38850	6	48	TAB
	T55	W38855	6	48	TAB
	1/2" Dr.	T60	W32860	6	48
	T70	W32870	6	48	TAB

TAMPER RESISTANT			IP	MP	PKG
1/4" Dr.	T10	W36910	12	144	TAB
	T15	W36915	12	144	TAB
	T20	W36920	12	144	TAB
	T25	W36925	12	144	TAB
	T27	W36927	12	144	TAB
	T30	W36930	12	144	TAB
3/8" Dr.	T40	W38940	12	144	TAB
	T45	W38945	12	144	TAB
	T47	W38947	12	144	TAB
	T50	W38950	12	144	TAB
	T55	W38955	12	144	TAB
	1/2" Dr.	T60	W32960	12	144

10-PC 5 LOBE SOCKET SET

- Chrome vanadium steel construction.
- Equivalent to IPR (Internal Tamper Resistant Pentalobe) sizes.
- Bonus storage rail included.



W80564

Item #	IP	MP	PKG	Drive	Sizes
W80564	6	24	CRD	3/8"	10, 15, 20, 25, 27, 30, 40, 45, 50, 55

5-PC MORTORQ BIT SOCKET SET

- Used to remove and replace new fasteners found on many GM, Chrysler, BMW, Nissan, Honda, and Fiat.
- Special designed driver provides full contact resulting in higher torque capability.
- Sockets are made of heat-treated alloy steel.
- Bits are S2 steel with a zinc phosphate finish.



Item #	IP	MP	PKG	Drive	Sizes
W13500	6	72	CRD	3/8"	MTS-0, MTS-1, MTS-2, MTS-3, MTS-4

BLK: Bulk | CAS: Storage Case | CBX: Color Box | CRD: Carded | CLM: Clamshell | DBL: Double Blister
LAB: Color Label | RAC: Storage Rack | SHK: Shrink Wrap | SLV: Sleeve | TAB: Hang Tab | WBX: White Box

IMPACT HEX BIT SOCKET SETS

- Impact grade with oil resistant finish.
- Large size laser etching for easy identification.
- Includes socket storage rail.

W32090



Item #	IP	MP	PKG	Type	Drive	Sizes
W32090	8-PC	4	16	CLM	1/2"	1/4, 5/16, 3/8, 7/16, 1/2, 9/16, 5/8, 3/4"
W38963	9-PC	6	24	CLM	Stubby	1/4" 1/4, 5/16, 3/8" 3/8" 7/16, 1/2, 9/16, 5/8, 11/16, 3/4"
W38964	9-PC	6	24	CLM	Stubby	1/4" 6, 7, 8, 10mm 3/8" 12, 14, 17, 18, 19mm

W38963



W38964



IMPACT STAR BIT SOCKET SETS

- Impact grade with oil resistant finish.
- Large size laser etching for easy identification.
- Includes socket storage rail.

W32092



Item #	IP	MP	PKG	Type	Drive	Sizes
W32092	8-PC	4	16	CLM	1/2"	T30, T40, T45, T47, T50, T55, T60, T70
W38961	10-PC	6	24	CLM	Stubby	1/4" T10, T15, T20, T25, T27, T30 3/8" T40, T45, T47, T50 1/4" T10, T15, T20, T25, T27, T30
W38803	15-PC	6	36	CRD	3/8"	T40, T45, T47, T50, T55, T60 also 3/8 to 1/4" (M) adapter

W38803



W38961



IMPACT TAMPER RESISTANT STAR BIT SOCKET SET

Item #	IP	MP	PKG	Type	Drive	Sizes
W38962	10-PC	6	24	CLM	Stubby	1/4" T10, T15, T20, T25, T27, T30 3/8" T40, T45, T47, T50

W38962



IMPACT TRIPLE SQUARE SOCKET SET

Item #	IP	MP	PKG	Type	Drive	Sizes
W38965	9-PC	6	24	CLM	Stubby	1/4" M4, M5, M6, M8 3/8" M10, M12, MT14 1/2" MT16, MT18 Tamper Resistant

W38965



HAND TOOLS

IMPACT SOCKETS & SETS

IMPACT SOCKET SETS

- Drop forged chrome vanadium steel for strength and durability.
- Rounded corners for a tighter grip.
- Large size laser etching for easy identification.

	3/8" Dr. 6 point		1/2" Dr. 6 point	
	Deep		Deep	
	M588DB	M594DB	M592DB	M590DB
	IP:10 MP:40	IP:5 MP:20	IP:4 MP:16	IP:5 MP:10
5/16"	x	-	-	-
11/32"	-	-	-	-
3/8"	x	x	-	x
7/16"	x	x	x	x
1/2"	x	x	x	x
9/16"	x	x	x	x
5/8"	x	x	x	x
11/16"	x	x	x	x
3/4"	x	x	x	x
13/16"	-	x	x	x
7/8"	-	-	x	x
15/16"	-	-	x	x
1"	-	-	x	x



OPEN STOCK

	3/8" Dr. 6 point						1/2" Dr. 6 point					
	IP	MP	Deep	IP	MP		IP	MP	Deep	IP	MP	
5/16"	M891	6	144	M931	6	144	-	-	-	-	-	-
3/8"	M892	6	144	M932	6	144	M800	6	144	M839	6	72
7/16"	M893	6	144	M933	6	144	M801	6	144	M840	6	72
1/2"	M894	6	144	M934	6	144	M802	6	144	M841	6	72
9/16"	M895	6	144	M935	6	72	M803	6	144	M842	6	72
5/8"	M896	6	144	M936	6	72	M804	6	144	M843	6	72
11/16"	M897	6	144	M937	6	72	M805	6	144	M844	6	72
3/4"	M898	6	144	M938	6	72	M806	6	144	M845	6	72
13/16"	M899	6	144	M939	6	72	M807	6	72	M846	6	72
7/8"	M900	6	144	M940	6	72	M808	6	72	M847	6	72
15/16"	-	-	-	-	-	-	M809	6	72	M848	6	36
1"	-	-	-	-	-	-	M810	6	72	M849	6	36
1-1/16"	-	-	-	-	-	-	M811	6	36	M850	6	36
1-1/8"	-	-	-	-	-	-	M812	6	36	M851	6	36
1-3/16"	-	-	-	-	-	-	M813	6	36	M852	6	36
1-1/4"	-	-	-	-	-	-	M814	6	36	M853	6	36
1-5/16"	-	-	-	-	-	-	M818	6	72	-	-	-
1-3/8"	-	-	-	-	-	-	M817	6	72	-	-	-

	3/4" Dr. point						1" Dr. 6 point					
	IP	MP	Deep	IP	MP		IP	MP	Deep	IP	MP	
3/4"	M740-24	5	25	-	-	-	-	-	-	-	-	-
13/16"	M740-26	5	25	-	-	-	-	-	-	-	-	-
7/8"	M740-28	5	25	-	-	-	M745-12	5	25	-	-	-
15/16"	M740-30	5	25	-	-	-	M745-14	5	25	-	-	-
1"	M740-32	5	25	-	-	-	M745-16	5	25	-	-	-
1-1/16"	M740-34	5	25	-	-	-	-	-	-	-	-	-
1-1/8"	M740-36	5	25	M742-36	5	25	-	-	-	-	-	-
1-3/16"	M740-38	5	25	-	-	-	M745-22	5	25	-	-	-
1-1/4"	M740-40	5	25	M742-40	5	25	-	-	-	M747-20	5	10
1-5/16"	M740-42	5	25	M742-42	5	10	-	-	-	-	-	-
1-3/8"	M740-44	5	25	M742-44	5	10	-	-	-	-	-	-
1-7/16"	M740-46	5	25	M742-46	5	10	-	-	-	-	-	-
1-1/2"	M740-48	5	25	M742-48	5	10	M745-32	5	25	M747-30	5	10
1-7/8"	M1263	3	18	-	-	-	-	-	-	-	-	-
33mm	-	-	-	-	-	-	-	-	-	M743-33	5	25

HAND TOOLS

	3/8" Dr. 6 point		1/2" Dr. 6 point	
	Deep		Deep	
	M589DB IP:10 MP:40	M595DB IP: 5 MP:20	M593DB IP:4 MP:16	M591DB IP:5 MP:10
8mm	x	-	-	-
9mm	-	-	-	-
10mm	x	x	x	x
11mm	x	x	-	-
12mm	x	x	-	x
13mm	x	x	x	x
14mm	x	x	x	x
15mm	-	-	x	x
16mm	-	x	x	x
17mm	x	x	x	x
18mm	-	-	x	x
19mm	x	x	x	x
21mm	-	-	x	x
22mm	-	-	x	x



OPEN STOCK

	3/8" Dr. 6 point					1/2" Dr. 6 point						
	IP	MP	Deep	IP	MP	IP	MP	Deep	IP	MP		
9mm	M909	6	144	M949	6	144	-	-	-	-	-	
10mm	M910	6	144	M950	6	144	M820	6	144	M860	6	72
11mm	M911	6	144	M951	6	144	M821	6	144	M861	6	72
12mm	M912	6	144	M952	6	144	M822	6	144	M862	6	72
13mm	M913	6	144	M953	6	144	M823	6	144	M863	6	72
14mm	M914	6	144	M954	6	72	M824	6	144	M864	6	72
15mm	M915	6	144	M955	6	72	M825	6	144	M865	6	72
16mm	M916	6	144	M956	6	72	M826	6	144	M866	6	72
17mm	M917	6	144	M957	6	72	M827	6	144	M867	6	72
18mm	M918	6	144	M958	6	72	M828	6	144	M868	6	72
19mm	M919	6	144	M959	6	72	M829	6	144	M869	6	72
20mm	-	-	-	-	-	-	M830	6	144	M870	6	72
21mm	-	-	-	-	-	-	M831	6	72	M871	6	72
22mm	-	-	-	-	-	-	M832	6	72	M872	6	36
24mm	-	-	-	-	-	-	M834	6	72	M873	6	36
26mm	-	-	-	-	-	-	M836	6	72	M874	6	36
27mm	-	-	-	-	-	-	M837	6	72	M876	6	36
23mm	-	-	-	-	-	-	-	-	-	M877	6	36
30mm	-	-	-	-	-	-	-	-	-	M880	6	36
32mm	-	-	-	-	-	-	-	-	-	M882	6	36

IMPACT SQUARE BUDD SOCKETS

- Optimum wall thickness for strength and access on fasteners with restrictions.
- Drop forged chrome molybdenum steel for strength and durability.
- Plated and black oxide coated for protection from rusting.

Item #	IP	MP	PKG	Drive	Sizes
M745-10	5	25	TAB	1"	13/16"
M740-27	5	25	TAB	3/4"	13/16"
M782	5	10	TAB	3/4"	1-1/2 x 13/16"
M783	5	10	TAB	1"	1-1/2 x 13/16"



HAND TOOLS

FLIP IMPACT SOCKETS

- Drop forged chrome molybdenum steel for strength and durability.
- Thinner walls provide better access in tight areas.
- Rounded corners for a tighter grip.

Item #	IP	MP	PKG	Drive	Side A	Side B
M587C	6	72	TAB	1/2"	13/16"	3/4"
M771	6	72	TAB	1/2"	17mm	19mm
M772	6	72	TAB	1/2"	7/8"	21mm

IMPACT SOCKET SETS

38-PC IMPACT SOCKET SET

- Drop forged chrome vanadium steel for strength and durability.
- Large size laser etching for easy identification.
- Rounded corners for a tighter grip.
- Includes SAE & Metric, deep and standard sizes and 1/2" (F) to 3/8" (M) adapter.
- Storage / Carrying Case.



Item #	IP	MP	PKG	Drive	Sizes
M796	1	5	LAB	3/8"	5/16, 3/8, 7/16, 1/2, 9/16, 5/8, 11/16, 3/4",
				Deep	8, 10, 11, 12, 13, 14, 17, 18mm
				1/2"	7/16, 1/2, 9/16, 5/8, 11/16, 3/4, 13/16, 7/8, 15/16, 1", 11, 12, 13, 14, 16, 17, 18, 21, 22, 24mm

3/4 IN DR. IMPACT SOCKET SETS

- Corrosion and oil resistant black phosphate finish.
- High quality chrome molybdenum alloy steel.
- Heavy duty storage/carrying case.



Item #	IP	MP	PKG	Square Budd	6 point
W34902	21-PC	1	1	SLV	13/16"
					7/8, 15/16 (24mm), 1, 1-1/16 (27mm), 1-1/8, 1-3/16, 1-1/4, 1-5/16, 1-3/8 (35mm), 1-7/16, 1-1/2 (38mm), 1-5/8 (41mm), 1-3/4, 1-13/16 (46mm), 1-7/8, 2".
M792	11-PC	1	4	SLV	13/16"
					3/4, 13/16, 7/8, 15/16, 1, 1-1/16, 1-1/8, 1-3/16, 1-1/4, 1-1/2"

8-PC IMPACT ADAPTER SET

- Chrome molybdenum steel for strength and durability.
- Impact grade with oil resistant finish.

Item #	IP	MP	PKG	1/4" (M)	3/8" (M)	1/2" (M)	3/4" (M)	1" (M)	
M795	1	12	SLV	1/4" (F)	-	x	-	-	
				3/8" (F)	x	-	x	-	
				1/2" (F)	-	x	-	x	
				3/4" (F)	-	-	x	-	x
				1" (F)	-	-	-	x	-



Also includes a 19-3/4" quick release ratchet, 18" sliding T-Bar, 5 and 10" extensions.

5-PC TORQUE LIMITING EXTENSION SET

- Helps apply torque to the correct tolerances and prevent over tightening.
- Color coded for easy identification.
- Heavy duty chrome molybdenum.
- Includes storage/carrying case.



Item #	IP	MP	PKG	Length	Torque Range
W32903	1	12	CAS	7-5/8"	75 ft./lbs. Black
					80 ft./lbs. Yellow
					90 ft./lbs. Red
					100 ft./lbs. Blue
					110 ft./lbs. Orange



HAND TOOLS

IMPACT EXTENSIONS

- Drop forged chrome molybdenum steel for strength and durability.
- Large size laser etching for easy identification.



Drive	Length	Item #	IP	MP	PKG
3/8"	3"	M972	6	144	TAB
	6"	M973	6	72	TAB
1/2"	3"	M969	6	72	TAB
	5"	M970	6	72	TAB
	10"	M971	6	36	TAB
3/4"	7"	M786	6	24	TAB
	7"	M787	6	18	TAB

IMPACT ADAPTERS

- Drop forged chrome molybdenum steel for strength and durability.
- Large size laser etching for easy identification.



Item #	IP	MP	PKG	(F)	3/8" (M)	1/2" (M)	3/4" (M)	1" (M)
M962	6	144	TAB	3/8"	-	X	-	-
M963	6	144	TAB	1/2"	X	-	-	-
M966 Wobble	6	144	TAB	1/2"	X	-	-	-
M974 36"	6	12	TAB	1/2"	X	-	-	-
M975 30"	6	18	TAB	1/2"	X	-	-	-
M964	6	72	TAB	1/2"	-	-	X	-
M765	5	100	TAB	3/4"	-	X	-	-
M780	5	25	TAB	3/4"	-	-	-	X
M785	5	25	TAB	1"	-	-	X	-



IMPACT STUBBY ADAPTER SET

- Chrome molybdenum steel for strength and durability.
- Impact grade with oil resistant finish.

Item #	IP	MP	PKG	Drive	1/4" (M)	3/8" (M)	1/2" (M)	
M793	3-PC	12	96	TAB	3/8" (F)	X	-	
				TAB	1/2" (F)	-	X	-
				TAB	3/4" (F)	-	-	X



IMPACT U-JOINTS

- Drop forged chrome molybdenum steel for strength and durability.
- Large size laser etching for easy identification.

Item #	Drive	IP	MP	PKG
M967	3/8"	6	144	TAB
M968	1/2"	6	72	TAB



7-PC U-JOINT & ADAPTER SET

- Drop forged chrome molybdenum steel for strength and durability.
- Contains 3 U-joint sizes and 4 adapter sizes.

Item #	IP	MP	PKG	Drive	1/4" (M)	3/8" (M)	1/2" (M)	U-Joint
W30937	6	24	RAC	1/4" (F)	-	X	-	1/4"
				3/8" (F)	X	-	X	3/8"
				1/2" (F)	-	X	-	1/2"



RETAINER PIN & O-RING

- For use with impact sockets and accessories.

Item #	Drive	IP	MP	PKG	Pin Length	O-Ring OD	O-Ring ID
M976	3/4"	12	96	BAG	4mm	1-3/4"	1-1/2"
M977	1"	12	96	BAG	5mm	2-3/4"	1-3/4"



HAND TOOLS

BREAKER BARS & ACCESSORIES

FLEX HANDLES

- Chrome vanadium alloy steel construction for strength and durability.
- Polished nickel chrome plated finish resists corrosion.
- Knurled handle for better grip.

Item #	IP	MP	PKG	Drive	Length
W36118	6	48	TAB	1/4"	6"
W38118	6	48	TAB	3/8"	10"
W32118	6	48	TAB	1/2"	10"
W32119	6	24	TAB	1/2"	15"
W32120	6	24	TAB	1/2"	18"
W32121	6	24	TAB	1/2"	24"
M3008B	1	10	BLK	3/4"	8"
W34120	1	6	TAB	3/4"	19"
W31110	2	4	BLK	1"	40"
W32127	2	8	TAB	1/2"	18"

with pry bar



HEAVY DUTY BREAKER BARS

- Heavy duty chrome vanadium steel handles up to 1000 ft./lbs.
- Corrosion resistant chrome plated and black oxide finish.
- 180° swivel head.

Item #	IP	MP	PKG	Drive	Length
W38121	6	12	TAB	3/8"	18"
W32126	6	12	BLK	1/2"	30"
W34122	2	6	TAB	3/4"	40"



RATCHETING BREAKER BAR

- Heavy duty chrome vanadium steel construction.
- 3 way ratcheting action: right hand, left hand or locked.

Item #	IP	MP	PKG	Drive	Length
W32124	6	12	TAB	1/2"	18"



SLIDING T-HANDLE

- Chrome vanadium alloy steel construction for strength and durability.
- Polished nickel chrome plated finish resists corrosion.

Item #	IP	MP	PKG	Drive	Length
W38120	6	48	TAB	3/8"	7"
W32129	6	48	TAB	1/2"	12"
W34121	1	6	TAB	3/4"	18"



SPEEDER HANDLES

- Ergonomic handle for comfort and control.
- Chrome vanadium alloy steel construction.
- Polished nickel chrome plated finish resists corrosion.
- Diamond knurled grip for positive grip.

Item #	IP	MP	PKG	Drive	Length
W38128	1	20	TAB	3/8"	17"
W32128	1	20	TAB	1/2"	17-3/4"



RATCHETING ADAPTERS

- Converts any breaker bar or sliding T-handle into a ratchet.
- Hex bolster for use with an open end or adjustable wrench.
- Works independently as a thumb wheel ratchet.
- Heavy duty chrome vanadium construction.
- Oil resistant black phosphate finish.



Item #	IP	MP	PKG	Drive	Finish
W38137	24	96	TAB	3/8"	Red
W32137	12	96	TAB	1/2"	Blue

RATCHETING ADAPTER

- Convert your breaker bar, flex handle or t-handle into a ratchet.
- Also works as a palm ratchet.
- Chrome vanadium construction.



Item #	IP	MP	PKG	Drive
W32114	8	48	CRD	1/2"

THUMB WHEEL RATCHETS

- Black oxide coated drive surfaces for long life.
- High torque non-slip grips.
- Quick release.



Item #	Color	IP	MP	PKG	Drive	Teeth	Sweep
W36125	Green	6	144	TAB	1/4"	43	8.4°
W38125	Red	6	96	TAB	3/8"	72	5°
W32125	Blue	6	96	TAB	1/2"	72	5°
W1716	3-PC Set	6	36	CLM		43, 72	8.4, 5.0

SPINNER HANDLE

- Chrome vanadium alloy steel construction for strength and durability.
- Polished nickel chrome plated finish resists corrosion.
- Ergonomic handle for comfort and control.



Item #	IP	MP	PKG	Drive
W36124	6	48	TAB	1/4"

HAND TOOLS

RATCHETS

PT HANDLE TEARDROP RATCHETS

- Chrome vanadium alloy steel construction for strength and durability.
- 108 gear teeth provide a precise 3.3 degree sweep.
- Quick release feature for quick and easy socket changes.
- Black phosphate finish resists oil and corrosion.
- Double-injection molded handle.
- US Patent D693201S1



Item #	Quick Release	IP	MP	PKG	Drive	Gear Teeth	Sweep	Length
W38100	x	6	24	TAB	3/8"	108	3.3°	8-11/16"
W32100	x	3	12	TAB	1/2"	108	3.3°	10-3/4"

LONG HANDLE TEARDROP RATCHETS

- Chrome vanadium alloy steel construction for strength and durability.
- Polished nickel chrome plated finish resists corrosion.
- 108 gear teeth provide a precise 3.3 degree sweep.
- Double-injection molded handle.
- US Patent D693201S1
- Available in fixed or flex head.



Fixed Head	Flex Head	IP	MP	PKG	Drive	Teeth	Sweep	Length
W36180	W36181	6	36	TAB	1/4"	108	3.3°	12"
W38180	W38181	6	24	TAB	3/8"	108	3.3°	18"
W32180	W32181	6	12	TAB	1/2"	108	3.3°	24"

TEARDROP RATCHETS

- Quick release feature for quick and easy socket changes.
- Chrome vanadium alloy steel construction for strength and durability.
- Polished nickel chrome plated finish resists corrosion.
- Larger gear teeth for higher torque and added gear strength.



Item #	Quick Release	IP	MP	PKG	Drive	Teeth	Sweep	Length
W36101	x	6	48	TAB	1/4"	72	5°	5-1/2"
W38101	x	6	24	TAB	3/8"	72	5°	7-5/8"
W32101	x	6	24	TAB	1/2"	72	5°	9-1/2"

BLK: Bulk | CAS: Storage Case | CBX: Color Box | CRD: Carded | CLM: Clamshell | DBL: Double Blister
LAB: Color Label | RAC: Storage Rack | SHK: Shrink Wrap | SLV: Sleeve | TAB: Hang Tab | WBX: White Box

TEARDROP RATCHETS

- Quick Release feature for quick and easy socket changes.
- Chrome vanadium alloy steel construction for strength and durability.
- Polished nickel chrome plated finish resists corrosion.
- Extended length for extra leverage.



Item #	Quick Release	IP	MP	PKG	Drive	Teeth	Sweep	Length
W38122	x	6	12	TAB	3/8"	24	15°	15"
W32122	x	6	12	TAB	1/2"	24	15°	15"
W34100	x	1	6	TAB	3/4"	24	15°	19-1/2"

FLEX HEAD TEARDROP RATCHETS

- Flex head for hard-to-reach spots.

Item #	Quick Release	IP	MP	PKG	Drive	Teeth	Sweep	Length
W36102	x	6	48	TAB	1/4"	72	5°	5-1/2"
W38102	x	6	24	TAB	3/8"	72	5°	5-1/2"
W32102	x	6	24	TAB	1/2"	24	15°	11-1/2"



ROUND HEAD RATCHETS

- Chrome vanadium alloy steel construction for strength and durability.
- Polished nickel chrome plated finish resists corrosion.
- Quick Release feature on for quick and easy socket changes on some models.



Item #	Quick Release	IP	MP	PKG	Drive	Teeth	Sweep	Length
W36113	-	6	48	TAB	1/4"	45	8°	3-3/4"
W36106	-	6	48	TAB	1/4"	45	8°	5-1/2"
W38112	-	6	48	TAB	3/8"	41	8.8°	3-15/16"
W38113	x	6	48	TAB	3/8"	41	8.8°	3-15/16"
W38106	-	6	24	TAB	3/8"	41	8.8°	7-7/8"
W38107	x	6	48	TAB	3/8"	41	8.8°	7-7/8"
W32106	-	6	24	TAB	1/2"	45	8°	9-1/2"
W34101	-	1	6	TAB	3/4"	43	8.4°	19-1/2"



ROUND FLEX HEAD RATCHETS

- Flex head for hard-to-reach spots.

Item #	Quick Release	IP	MP	PKG	Drive	Teeth	Sweep	Length
W36114	-	6	48	TAB	1/4"	45	8°	4-1/2"
W38114	-	6	48	TAB	3/8"	41	8.8°	5"
W38115	x	6	48	TAB	3/8"	41	8.8°	5"
W38108	-	6	24	TAB	3/8"	41	8.8°	11"



ROUND HEAD RATCHETS

- Drop forged steel construction.
- Chrome plated to resist corrosion.
- Comfortable rubber grip handle.

Item #	IP	MP	PKG	Drive	Teeth	Sweep	Length
W17C	6	36	CRD	3/8"	39	9.2°	5"
20104	6	36	Pg 320				



TORQUE WRENCHES

3/4 IN. DR. TORQUE WRENCHES

- Professional grade 3/4" dr. reversible clicker type torque wrench.
- Locking mechanism prevents accidental adjustment during operations.
- Wrench clicks when you reached your desire torque setting.
- High impact ABS storage case included.



Accuracy +/- 4% meets standards for torque wrenches



24 gear teeth for precision torque control



Engraved with ft.-pound and newton-meters.

Item #	IP	MP	PKG	Drive	Torque Range	Accuracy	Length
M203	1	4	CAS	3/4"	50-100 ft/lbs.	±4%	32-1/8"
M204	1	2	CAS	3/4"	100-600 ft/lbs	±4%	40"

LOCKING TORQUE WRENCHES

- Clockwise & counterclockwise operation.
- High grade spring steel torque mechanism.
- Wrench clicks when you reached your desire torque setting.
- Heavy duty case



41 gear teeth for precision torque control



Patented torque adjusting lock/unlock collar



Non-slip cushion grip handle

Item #	IP	MP	PKG	Drive	Torque Range	Accuracy	Length
M196	1	6	CLM	1/4"	25-250 in/lbs.	±4%	12"
M197	1	6	CLM	3/8"	25-250 in/lbs.	±4%	12-1/2"
M198	1	6	CLM	3/8"	10-100 ft/lbs.	±4%	17-1/2"
M199	1	6	CLM	1/2"	25-250 ft/lbs.	±4%	22"

CLICK TORQUE WRENCHES

- Professional style.
- Chrome plated alloy steel.
- Ratchet style with engraved scale.
- Nickel chrome plated alloy steel.



Compact size for tight spots.

Item #	IP	MP	PKG	Drive	Torque Range	Accuracy	Length
M201	1	12	CLM	1/4"	20-200 in/lbs.	±4%	10-1/2"
M202-P	6	24	CLM	3/8"	120-960 in/lbs.	±4%	10-1/4"
M200DB	1	12	CLM	1/2"	10-150 ft/lbs.	±4%	17-1/2"

BLK: Bulk | CAS: Storage Case | CBX: Color Box | CRD: Carded | CLM: Clamshell | DBL: Double Blister
LAB: Color Label | RAC: Storage Rack | SHK: Shrink Wrap | SLV: Sleeve | TAB: Hang Tab | WBX: White Box

BEAM STYLE TORQUE WRENCHES

- Clockwise or counterclockwise measurement.
- Deflection beam wrenches do not wear or fatigue over the lifetime of the tool, insuring better accuracy.
- Directly measure a variety of torque values when tightening fasteners.

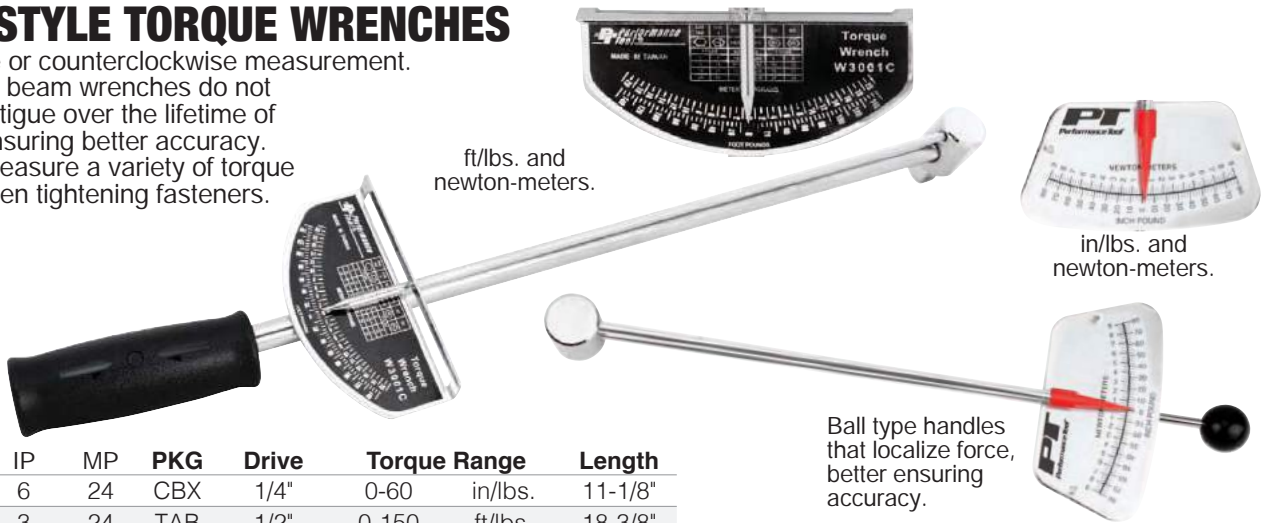

ft/lbs. and newton-meters.

in/lbs. and newton-meters.

Ball type handles that localize force, better ensuring accuracy.

Item #	IP	MP	PKG	Drive	Torque Range	Length
M195	6	24	CBX	1/4"	0-60 in/lbs.	11-1/8"
W3001C	3	24	TAB	1/2"	0-150 ft/lbs.	18-3/8"

MICRO TORQUE SCREWDRIVER

- Great for the electronics, instruments, TPMS valve cores, firearms and more.
- Universal 1/4" hex bit holder with 1/4" drive socket adapter.
- Easy to adjust torque collar holds desired setting when released.
- Comfortable rubberized grip.
- Permanently lubricated internal mechanism, never needs oil.



Eliminate over torquing and reduce risk of damage to sensitive equipment or components.



Item #	IP	MP	PKG	Drive	Torque Range	Accuracy	Length
M194	12	48	CRD	1/4"	3-15 in/lbs.	±5%	6"

1/2 IN DR. TORQUE ANGLE GAUGE

- 360° angle scale in 2 degree increments.
- Adjustable arm has 2 different lengths for flexibility of use.
- For use with 1/2" drive tools.



Item #	IP	MP	PKG	Diameter
M205	12	48	CRD	3"

DIGITAL TORQUE ADAPTER

- Rotatable adapter is rotatable for ease of use.
- Audible and LED torque limit indicator.
- Automatic sleep mode after 3 minutes of non-activity.
- 1/2" drive (includes adapters for 3/8" and 1/4" drive).
- Blow molded storage case.



Item #	IP	MP	PKG	Drive	Torque Range	Accuracy	Battery
M206	6	48	CLM	1/2"	30 - 150 ft/lbs. also kg/cm kg/m in/lbs. N/m	±2%	CR2032

HAND TOOLS

EXTENSIONS

EXTENSIONS

- Chrome vanadium alloy steel construction for strength and durability.
- Polished nickel chrome plated finish resists corrosion.



W38154
Push button quick release.

Drive	Length	Item #	IP	MP	PKG
1/4"	2"	W36142	6	48	TAB
	3"	W36143	6	48	TAB
	6"	W36146	6	48	TAB
3/8"	1-3/4"	W38140	6	48	TAB
	3"	W38143	6	48	TAB
	6"	W38146	6	48	TAB
	8"	W38148	6	48	TAB
	10"	W38150	6	48	TAB
	18"	W38156	6	48	TAB
1/2"	3"	W32143	6	48	TAB
	5"	W32145	6	48	TAB
	10"	W32150	6	48	TAB
3/4"	20"	W32153	6	24	TAB
	4"	W34144	6	24	TAB
	8"	W34148	6	24	TAB
	16"	W34151	6	12	TAB

Item #		IP	MP	PKG	Drive	1-3/4"	2"	3"	5"	6"	8"	10"
W36940	3-PC	6	48	TAB	1/4"	-	X	X	-	X	-	-
W38152	4-PC	6	48	TAB	3/8"	X	-	X	-	X	X	-
W38155	3-PC	6	24	TAB	3/8"	X	-	X	-	-	X	-
W38154	3-PC LOCKING	6	36	TAB	3/8"	-	-	X	-	X	-	X
W32140	3-PC	6	24	TAB	1/2"	-	-	X	X	-	-	X

WOBBLE EXTENSIONS

- Increased angle flexibility.
- Chrome vanadium alloy steel construction for strength and durability.
- Polished nickel chrome plated finish resists corrosion.



Drive	Length	Item #	IP	MP	PKG
3/8"	1-3/4"	W38141	6	48	TAB
	3"	W38144	6	48	TAB
	6"	W38147	6	48	TAB
	8"	W38149	6	48	TAB
	10"	W38151	6	48	TAB

Item #		IP	MP	PKG	Drive	1-3/4"	2"	3"	5"	8"	10"
W30957	3-PC	6	48	TAB	1/4"	-	X	-	-	-	-
					3/8"	X	-	-	-	-	-
					1/2"	-	X	-	-	-	-
W38157	3-PC	6	24	TAB	3/8"	-	-	X	X	-	X
W32141	3-PC	6	24	TAB	1/2"	X	-	X	-	X	-

LONG EXTENSION SETS

- Extended length long for hard to reach nuts & bolts.
- Chrome vanadium steel for strength and durability.
- Chrome plated finish with knurled grip.



Item #		IP	MP	PKG	Drive	12"	15"	18"	24"	30"
W36139	3-PC	6	24	TAB	1/4"	X	X	X	-	-
W38139	3-PC	6	12	TAB	3/8"	-	-	X	X	X
W32139	3-PC	1	6	TAB	1/2"	-	-	X	X	X

HAND TOOLS

DRIVE ADAPTERS

- Chrome vanadium alloy steel construction for strength and durability.
- Polished nickel chrome plated finish resists corrosion.

Item #	IP	MP	PKG	Size	1/4" (M)	3/8" (M)	1/2" (M)	3/4" (M)	1" (M)
W36157	6	48	TAB	1/4" (F)	-	x	-	-	-
W38159	6	48	TAB	3/8" (F)	x	-	-	-	-
W38158	6	48	TAB		-	-	x	-	-
W32157	6	48	TAB	-	x	-	-	-	
W1136C	12	120	CRD	1/2" (F)	-	x	-	-	-
W32158	6	48	TAB	-	-	-	x	-	
W34157	6	24	TAB	3/4" (F)	-	-	x	-	-
W34158	6	24	TAB		-	-	-	-	x

Item #	IP	MP	PKG	Size	1/4" (M)	3/8" (M)	1/2" (M)
W30934 4-PC	6	48	TAB	1/4" (F)	-	x	-
				3/8" (F)	x	-	x
				1/2" (F)	-	x	-



W30934



W30939

6-PC DRIVE ADAPTER SET

- Chrome vanadium alloy steel construction for strength and durability.
- Polished nickel chrome plated finish resists corrosion.
- Storage / carrying case.

Item #	IP	MP	PKG	Size	1/4" (M)	3/8" (M)	1/2" (M)	3/4" (M)	1" (M)
W30939	6	24	CLM	1/4" (F)	-	x	-	-	-
				3/8" (F)	x	-	x	-	-
				1/2" (F)	-	x	-	x	-
				3/4" (F)	-	-	x	-	-

U-JOINTS

- Chrome vanadium alloy steel construction for strength and durability.
- Polished nickel chrome plated finish resists corrosion.

Item #	IP	MP	PKG	Item #	Drive	IP	MP	PKG
W30933 3-PC Set	6	48	TAB	W36130	1/4"	6	48	TAB
				W38130	3/8"	6	48	TAB
				W32130	1/2"	6	48	TAB
				W34130	3/4"	6	24	TAB

W30933



HAND TOOLS

FLEX UNIVERSAL JOINT

- Spring loaded for smooth operation.
- Unique space saving ball and pin design.
- High polish chrome vanadium steel.

Item #	Drive	IP	MP	PKG
W36136	1/4"	6	96	TAB
W38136	3/8"	6	96	TAB
W32136	1/2"	6	96	TAB



ADAPTERS & U-JOINTS

DRIVE ACCESSORY SETS

- Chrome vanadium alloy steel construction for strength and durability.
- Polished nickel chrome plated finish resists corrosion.

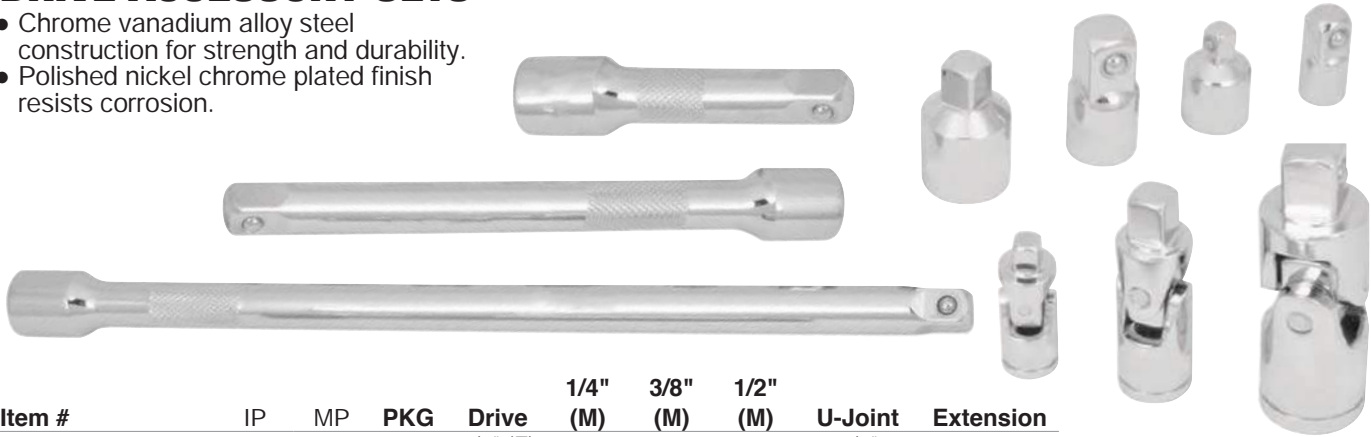

Item #	IP	MP	PKG	Drive	1/4" (M)	3/8" (M)	1/2" (M)	U-Joint	Extension	
W30938	10-PC	4	16	CLM	1/4" (F)	-	x	-	1/4"	
					3/8" (F)	x	-	x	3/8"	3, 6, 10"
					1/2" (F)	-	x	-	1/2"	-
W30935	7-PC	6	24	RAC	1/4" (F)	-	x	-	1/4"	
					3/8" (F)	x	-	x	3/8"	-
					1/2" (F)	-	x	-	1/2"	-

3-PC MAGNETIC EXTENSION SET

- Strong magnetic tips protrude through socket to help prevent dropped fasteners.
- Chrome vanadium alloy steel construction for strength and durability.
- Polished nickel chrome plated finish resists corrosion.
- Designed for use with standard shallow wall sockets.



Item #	IP	MP	PKG	1/4"	3/8"	1/2"
W30932	6	48	TAB	1-1/4"	1-7/8"	2-1/2"

2-PC FLEXIBLE EXTENSION SET

- Flexible shafts allow improved access in tight spaces without sacrificing torque.
- Chrome vanadium alloy steel construction.
- Polished nickel chrome plated finish.

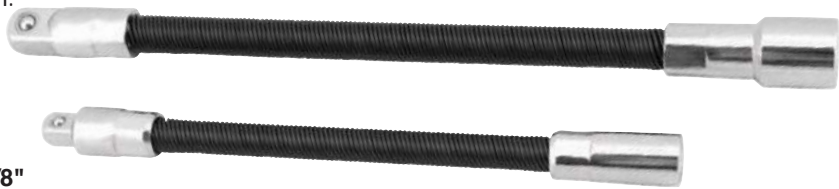

Item #	IP	MP	PKG	1/4"	3/8"
W30931	10	100	TAB	6"	8"

SOCKET RAILS

- Convenient way to organize sockets.
- Rail contains 16 socket clips.
- Easily mounts to wall or tool box.

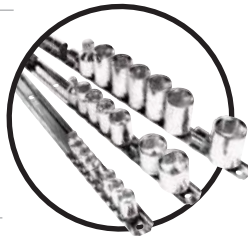

Item #	IP	MP	PKG	Capacity
W14-SKH	12	48	CRD	1/4" 16 sockets
W38-SKH	12	48	TAB	3/8" 16 sockets
W12-SKH	12	48	CRD	1/2" 16 sockets
W3-SKH	6	48	CRD	3-PC
WITH HANDLES				
W36000	6	36	TAB	1/4" 14 sockets
W38000	6	36	TAB	3/8" 14 sockets
W32000	6	36	TAB	1/2" 14 sockets



HAND TOOLS

ALUMINUM DUAL SIDED SOCKET RAILS

- Clips feature spring loaded ball bearings for easy on/off.
- Double sided for efficient use of space.



Item #	IP	MP	PKG	Capacity
W36001	6	72	TAB Green	1/4" 18 sockets
W38004	6	72	TAB Red	3/8" 16 sockets
W32004	6	72	TAB Blue	1/2" 14 sockets

MAGNETIC SOCKET RAILS

- Heavy duty rare earth magnets hold to any ferrous surface.
- Clips feature spring loaded ball bearings for easy on/off.
- EVA foam backing won't scratch delicate finishes.

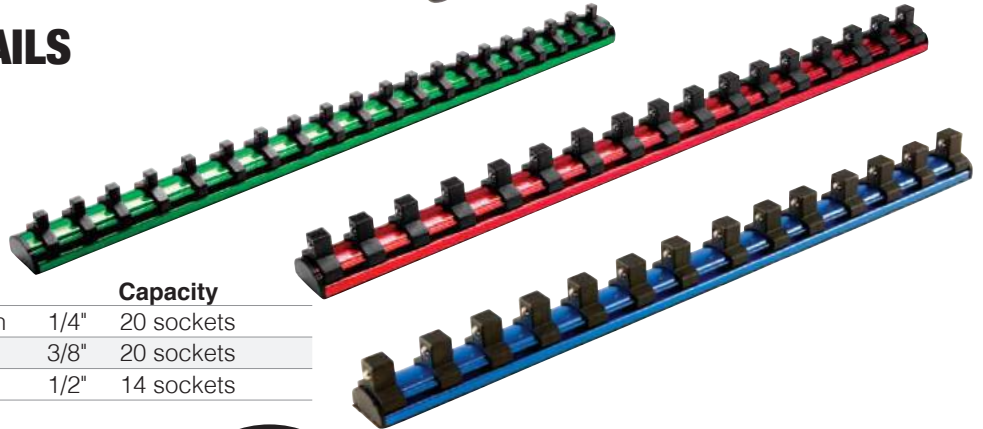

Item #	IP	MP	PKG	Capacity
W36003	6	36	CLM Green	1/4" 20 sockets
W38003	6	36	CLM Red	3/8" 20 sockets
W32003	6	36	CLM Blue	1/2" 14 sockets

MAGNETIC SOCKET RAILS WITH TWIST LOCK

- Heavy duty magnet holds to any ferrous surface.
- Sliding clips allow for a variety of socket sizes.
- Unique twist lock feature - place socket on clip, rotate 90° to lock on, turn again to remove.



Unique twist lock feature



NOTE: use only sockets with detents in the drive end.

Item #	IP	MP	PKG	Capacity
W36190	6	24	CRD Green	1/4" 14 sockets
W38190	6	24	CRD Red	3/8" 14 sockets
W32190	6	24	CRD Blue	1/2" 10 sockets

SOCKET HOLDER TRAYS

- Securely holds and organizes standard and deep sockets and accessories.
- Pre-marked with appropriate standard size markings for quick and easy viewing.
- Designed for standard and deep wall sockets and/or accessories.

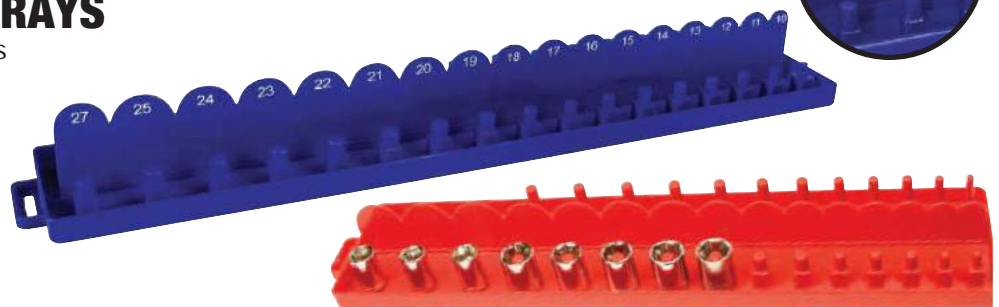

Item #	IP	MP	PKG	Holds	Drive & Markings
W773	6	96	SHK	22	1/4" 3/16, 7/32, 1/4, 9/32, 5/16, 11/32, 3/8, 7/16, 1/2, 9/16, 5/8"
W776	6	96	SHK	28	1/4" 4, 4.5, 5, 5.5, 6, 7, 8, 9, 10, 11, 12, 13, 14, 15mm
W774	6	48	SHK	26	3/8" 1/4, 5/16, 3/8, 7/16, 1/2, 9/16, 5/8, 11/16, 3/4, 13/16, 7/8, 15/16, 1", 3/8"
W778	6	48	SHK	30	3/8" 6, 7, 8, 9, 10, 11, 12, 13, 14, 15, 16, 17, 18, 19, 20mm
W775	6	48	SHK	28	1/2" 3/8, 7/16, 1/2, 9/16, 5/8, 11/16, 3/4, 13/16, 7/8, 15/16, 1, 1-1/16, 1-1/8, 1-1/4"
W779	6	48	SHK	34	1/2" 10, 11, 12, 13, 14, 15, 16, 17, 18, 19, 20, 21, 22, 23, 24, 25, 27mm

PROFESSIONAL WRENCHES

7-PC PRO COMBINATION WRENCH SETS

- Premium quality drop forged and hardened chrome alloy steel.
- Nickel chrome plated to resist corrosion and fully polished for easy cleanup.
- Box end features rounded corners for increased torque.



Item #	IP	MP	PKG	Sizes
W30001	6	24	RAC	10, 12, 13, 14, 15, 16, 18mm
W30200	6	24	RAC	5/16, 3/8, 7/16, 1/2, 9/16, 5/8, 3/4"

10-PC PRO COMBINATION WRENCH SETS

- Premium quality drop forged and hardened chrome alloy steel.
- Nickel chrome plated to resist corrosion and fully polished for easy cleanup.
- Box end features rounded corners for increased torque.



Item #	IP	MP	PKG	Sizes
W30002	3	12	CAS	10, 11, 12, 13, 14, 15, 16, 17, 18, 19mm
W30202	3	12	CAS	1/4, 5/16, 3/8, 7/16, 1/2, 9/16, 5/8, 11/16, 3/4, 13/16"

OPEN STOCK

Size	Item #	IP	MP	PKG
1/4"	W30208	6	72	TAB
5/16"	W30210	6	72	TAB
11/32"	W30211	6	72	TAB
3/8"	W30212	6	72	TAB
7/16"	W30214	6	72	TAB
1/2"	W30216	6	72	TAB
9/16"	W30218	6	72	TAB
5/8"	W30220	6	72	TAB
11/16"	W30222	6	72	TAB
3/4"	W30224	6	72	TAB
13/16"	W30226	6	72	TAB
7/8"	W30228	6	72	TAB
15/16"	W30230	6	48	TAB
1"	W30232	6	36	TAB
	W30332			
1-1/16"	W30234	6	36	TAB
1-1/8"	W30236	6	24	TAB
1-3/16"	W30238	6	24	TAB
1-1/4"	W30240	6	24	TAB



Size	Item #	IP	MP	PKG
6mm	W30006	6	72	TAB
7mm	W30007	6	72	TAB
8mm	W30008	6	72	TAB
9mm	W30009	6	72	TAB
10mm	W30010	6	72	TAB
11mm	W30011	6	72	TAB
12mm	W30012	6	72	TAB
13mm	W30013	6	72	TAB
14mm	W30014	6	72	TAB
15mm	W30015	6	72	TAB
16mm	W30016	6	72	TAB
17mm	W30017	6	72	TAB
18mm	W30018	6	72	TAB
19mm	W30019	6	72	TAB
20mm	W30020	6	72	TAB
21mm	W30021	6	72	TAB
22mm	W30022	6	72	TAB
23mm	W30023	6	48	TAB
24mm	W30024	6	36	TAB
25mm	W30025	6	36	TAB
26mm	W30026	6	36	TAB
27mm	W30027	6	36	TAB
28mm	W30028	6	36	TAB
29mm	W30029	6	24	TAB
30mm	W30030	6	24	TAB
32mm	W30032	6	24	TAB



HAND TOOLS

7-PC STUBBY WRENCH SETS

- Premium quality drop forged and hardened chrome alloy steel.
- Nickel chrome plated to resist corrosion
- Stubby length for easy access to tight areas.



Item #	IP	MP	PKG	Sizes
W30507	6	24	RAC	3/8, 7/16, 1/2, 9/16, 5/8, 11/16, 3/4"
W30607	6	24	RAC	10, 12, 13, 14, 15, 18, 19mm

OPEN STOCK

Size	Item #	IP	MP	PKG
3/8"	W30512	6	96	TAB
7/16"	W30514	6	96	TAB
1/2"	W30516	6	96	TAB
9/16"	W30518	6	96	TAB
5/8"	W30520	6	96	TAB
11/16"	W30522	6	96	TAB
3/4"	W30524	6	96	TAB
10mm	W30610	6	96	TAB
11mm	W30611	6	96	TAB
12mm	W30612	6	96	TAB
13mm	W30613	6	96	TAB
14mm	W30614	6	96	TAB
15mm	W30615	6	96	TAB
16mm	W30616	6	96	TAB
17mm	W30617	6	96	TAB
18mm	W30618	6	96	TAB
19mm	W30619	6	96	TAB



4-PC FLARE NUT WRENCH SETS

- Premium quality drop forged and hardened chrome alloy steel.
- Nickel chrome plated to resist corrosion and fully polished for easy cleanup.
- 15 degree offset.



Item #	IP	MP	PKG	Sizes			
				A	B	C	D
W30430	6	24	RAC	1/4"	3/8"	1/2"	5/8"
				5/16"	7/16"	9/16"	11/16"
W30431	6	24	RAC	9mm	10mm	13mm	16mm
				11mm	12mm	14mm	18mm

OPEN STOCK

Item #	Sizes		IP	MP	PKG
W30402	3/8"	7/16"	6	48	TAB
W30403	1/2"	9/16"	6	48	TAB
W30404	5/8"	11/16"	6	48	TAB
W30405	3/4"	7/8"	6	48	TAB
W30409	9mm	11mm	6	48	TAB
W30410	10mm	12mm	6	48	TAB
W30413	13mm	14mm	6	48	TAB
W30415	15mm	17mm	6	48	TAB
W30416	16mm	18mm	6	48	TAB
W30419	19mm	21mm	6	48	TAB



10-PC IGNITION WRENCH SETS

- Mini wrench set includes popular metric sizes perfect for use in tight spaces.
- Fully polished chrome plated finish.
- Vinyl pouch for easy storage.



Item #	IP	MP	PKG	Sizes
W30681	6	48	BAG	5/32, 3/16, 13/64, 7/32, 15/64, 1/4, 9/32, 5/16, 3/8, 7/16"
W30682	6	48	BAG	4, 4.5, 5, 5.5, 6, 7, 8, 9, 10, 11mm



HAND TOOLS

PROFESSIONAL RATCHETING WRENCHES

12-PC RATCHETING WRENCH SETS

- Premium quality drop forged chrome vanadium steel.
- Triple chrome plated to resist corrosion and fully polished for easy cleanup.
- Low profile head for access in tight spaces.
- 100 gear teeth for a precise 3.6° sweep.



Item #	IP	MP	PKG	Sizes
W30641	3	6	RAC	1/4, 5/16, 3/8, 7/16, 1/2, 9/16, 5/8, 11/16, 3/4, 13/16, 7/8, 1"
W30642	3	6	RAC	8, 9, 10, 11, 12, 13, 14, 15, 16, 17, 18, 19mm

OPEN STOCK

Size	Item #	IP	MP	PKG
1/4"	W30250	10	100	TAB
5/16"	W30251	10	100	TAB
3/8"	W30252	10	100	TAB
7/16"	W30253	10	100	TAB
1/2"	W30254	10	100	TAB
9/16"	W30255	10	100	TAB
5/8"	W30256	10	100	TAB
11/16"	W30257	10	100	TAB
3/4"	W30258	10	100	TAB
13/16"	W30259	10	50	TAB
7/8"	W30260	10	50	TAB
15/16"	W30261	10	50	TAB
1"	W30262	10	50	TAB
8mm	W30348	10	100	TAB
9mm	W30349	10	100	TAB
10mm	W30350	10	100	TAB
11mm	W30351	10	100	TAB
12mm	W30352	10	100	TAB
13mm	W30353	10	100	TAB
14mm	W30354	10	100	TAB
15mm	W30355	10	100	TAB
16mm	W30356	10	100	TAB
17mm	W30357	10	100	TAB
18mm	W30358	10	100	TAB
19mm	W30359	10	100	TAB
21mm	W30361	10	50	TAB
22mm	W30362	10	50	TAB



7-PC RATCHETING WRENCH SETS

- Premium quality drop forged chrome vanadium steel.
- Triple chrome plated to resist corrosion and fully polished for easy cleanup.
- Low profile head for access in tight spaces.
- 100 gear teeth for a precise 3.6° sweep.



Item #	IP	MP	PKG	Sizes
W30630	3	12	RAC	5/16, 3/8, 7/16, 1/2, 9/16, 5/8, 3/4"
W30631	3	12	RAC	8, 10, 12, 13, 14, 15, 18mm



HAND TOOLS

7-PC STUBBY RATCHETING WRENCH SETS

- 100 gear teeth for a precise 3.6° sweep.
- Triple chrome plated to resist corrosion and fully polished for easy cleanup.
- Low profile head for access in tight spaces.
- Premium quality drop forged chrome vanadium steel.



Item #	IP	MP	PKG	Sizes
W30634	6	24	RAC	5/16, 3/8, 7/16, 1/2, 9/16, 5/8, 3/4"
W30635	6	24	RAC	8, 10, 12, 13, 14, 15, 18mm



4-PC JUMBO RATCHETING WRENCH SET

- Premium quality drop forged chrome vanadium steel.
- Triple chrome plated to resist corrosion and fully polished for easy cleanup.
- Low profile head for access in tight spaces.
- 72 gear teeth for a precise 5° sweep.



Item #	IP	MP	PKG	Sizes
W30632	1	6	RAC	13/16, 7/8, 15/16, 1"
W30633	1	6	RAC	21, 22, 24, 25mm



8-PC MAGNETIC HEAD RATCHETING WRENCH SETS

- Exclusive magnetic stop ring holds fastener to wrench.
- Drop forged chrome vanadium.
- Triple chrome plated finish.
- 72 Gear teeth for 5° sweep.



Item #	IP	MP	PKG	Sizes
W30643	3	18	RAC	5/16, 3/8, 7/16, 1/2, 9/16, 5/8, 11/16, 3/4"
W30644	3	18	RAC	8, 10, 12, 13, 14, 15, 17, 18mm



8-PC MAGNETIC FLEX HEAD RATCHETING WRENCH SETS

- Exclusive magnetic stop ring holds fastener to wrench.
- Drop forged chrome vanadium.
- Triple chrome plated finish.
- 72 Gear teeth for 5° sweep.



Item #	IP	MP	PKG	Sizes
W30645	3	18	RAC	5/16, 3/8, 7/16, 1/2, 9/16, 5/8, 11/16, 3/4"
W30646	3	18	RAC	8, 10, 12, 13, 14, 15, 17, 18mm



RATCHETING WRENCH SETS

7-PC RATCHETING WRENCH SETS

- 72 Gear teeth for 5° sweep.
- Drop forged chrome vanadium.
- Mirror polish finish.
- Reusable storage rack.



Item #	IP	MP	PKG	Sizes
W1091	-	5	RAC	5/16, 3/8, 7/16, 1/2, 9/16, 5/8, 3/4"
W1092	-	5	RAC	8, 10, 12, 13, 14, 15, 18mm



6-PC BLACK RATCHET WRENCH SETS

- Oil and corrosion resistant black finish.
- 72 Gear teeth for 5° sweep.
- Drop forged alloy steel.
- Reusable storage rack.



Item #	IP	MP	PKG	Sizes
W1166	5	20	RAC	5/16, 3/8, 7/16, 1/2, 9/16, 5/8"
W1167	5	20	RAC	8, 10, 12, 13, 14, 17mm



5-PC RATCHETING WRENCH SET

- Reversible for easy on and off application.
- 12 point heat treated box ends*.
- Reusable storage rack.

*1/4" is 6 point



Item #	IP	MP	PKG	Sizes				
				A	B	C	D	E
W709	6	24	RAC	1/4"	3/8"	1/2"	5/8"	11/16"
				5/16"	7/16"	9/16"	11/16"	7/8"



RATCHETING WRENCH ADAPTER SET

- Convert your ratcheting wrench into a ratchet or bit driver.
- Fits 3/8, 1/2 and 3/4" size ratcheting wrenches.
- 1/4, 3/8 and 1/2" drive, and 1/4" hex.
- Chrome vanadium construction.



Item #	IP	MP	PKG
W30602	10	100	CRD

BLK: Bulk | CAS: Storage Case | CBX: Color Box | CRD: Carded | CLM: Clamshell | DBL: Double Blister
LAB: Color Label | RAC: Storage Rack | SHK: Shrink Wrap | SLV: Sleeve | TAB: Hang Tab | WBX: White Box

22-PC COMBINATION WRENCH SET

- Polished chrome vanadium steel construction.
- Handy storage rack.



Item #	IP	MP	PKG	Sizes
W1069	2	8	RAC	1/4, 5/16, 3/8, 7/16, 1/2, 9/16, 5/8, 11/16, 3/4, 13/16, 7/8" 9, 10, 11, 12, 13, 14, 15, 16, 17, 18, 19mm



22-PC COMBINATION WRENCH SET

- Chrome vanadium steel construction.
- Full pattern raised panel design.
- Chrome plated finish.
- Handy storage rack.



Item #	IP	MP	PKG	Sizes
W1084	1	6	RAC	1/4, 5/16, 3/8, 7/16, 1/2, 9/16, 5/8, 11/16, 3/4, 13/16, 7/8" 6, 7, 8, 9, 10, 11, 12, 13, 14, 17, 19mm



32-PC COMBINATION WRENCH SET

- Mirror polished chrome vanadium steel.
- Improved box end design grips sides of fasteners for more torque.



Item #	IP	MP	PKG	Sizes
W1099	1	5	RAC	Standard 1/4, 5/16, 11/32, 3/8, 7/16, 1/2, 9/16, 5/8, 11/16, 3/4"
				Stubby 1/4, 3/8, 7/16, 1/2, 9/16, 5/8"
				Standard 6, 7, 8, 9, 10, 12, 13, 15, 17, 18mm
				Stubby 10, 11, 12, 13, 14, 15mm



14-PC COMBINATION WRENCH SETS

- Heat treated alloy steel.
- Raised panel design.
- Roll pouch for storage.



Item #	IP	MP	PKG	Sizes
W1114	1	6	WBX	3/8, 7/16, 1/2, 9/16, 5/8, 11/16, 3/4, 13/16, 7/8, 15/16, 1, 1-1/16, 1-1/8, 1-1/4"
W1114M	6	12	WBX	6, 7, 8, 9, 10, 11, 12, 13, 14, 15, 17, 19, 21, 22mm



HAND TOOLS

WRENCH SETS

11-PC WRENCH SETS

- Chrome vanadium steel construction.
- Fully polished finish.
- Handy storage rack.



Item #	IP	MP	PKG	Sizes
W1061	2	8	RAC	1/4, 5/16, 3/8, 7/16, 1/2, 9/16, 5/8, 11/16, 3/4, 13/16, 7/8"
W1062	2	8	RAC	9, 10, 11, 12, 13, 14, 15, 16, 17, 18, 19mm

12-PC STUBBY WRENCH SETS

- Fully polished chrome vanadium steel construction.
- Handy storage rack.

Mechanics
Products



Item #	IP	MP	PKG	Sizes
W1157	6	24	RAC	5/16, 3/8, 10, 11, 12, 7/16, 1/2, 13, 14, 15mm, 9/16, 5/8"

5-PC WRENCH SETS

- Heat treated alloy steel.
- Raised panel design.



Item #	IP	MP	PKG	Sizes
W15P	6	48	CRD	3/8, 7/16, 1/2, 9/16, 5/8"
W15MP	6	48	CRD	8, 10, 12, 14, 17mm

OPEN STOCK

Size	Item #	IP	MP	PKG
1/4"	W320C	12	72	TAB
5/16"	W321C	12	72	TAB
3/8"	W322C	12	72	TAB
7/16"	W323C	12	72	TAB
1/2"	W324C	12	72	TAB
9/16"	W325C	12	72	TAB
5/8"	W326C	6	36	TAB
11/16"	W327C	6	36	TAB
3/4"	W328C	6	36	TAB
13/16"	W329C	6	36	TAB
7/8"	W330C	3	36	TAB
15/16"	W331C	12	36	TAB
1"	W332C	12	36	TAB
1-1/16"	W333C	12	36	TAB
1-1/8"	W334C	3	36	TAB
1-1/4"	W340C	3	36	TAB
1-5/16"	W376B	3	12	BLK
1-3/8"	W343B	3	12	BLK
1-7/16"	W377B	3	12	BLK
1-1/2"	W344B	3	12	BLK
1-5/8"	W345B	3	12	BLK
1-11/16"	W378B	3	12	BLK
1-3/4"	W346B	3	12	BLK
1-13/16"	W379B	3	12	BLK
1-7/8"	W347B	3	12	BLK
2"	W348B	3	12	BLK
2-1/8"	W353B	3	6	BLK
2-1/4"	W354B	3	6	BLK
2-3/8"	W355B	3	6	BLK
2-1/2"	W356B	3	6	BLK

Size	Item #	IP	MP	PKG
6mm	W308C	12	72	TAB
7mm	W309C	6	72	TAB
8mm	W310C	12	72	TAB
9mm	W311C	12	72	TAB
10mm	W312C	12	72	TAB
11mm	W313C	6	72	TAB
12mm	W314C	12	72	TAB
13mm	W315C	12	72	TAB
14mm	W316C	12	72	TAB
15mm	W317C	12	72	TAB
16mm	W307C	6	72	TAB
17mm	W318C	6	48	TAB
18mm	W349C	12	36	TAB
19mm	W319C	6	36	TAB
21mm	W341C	3	36	TAB
22mm	W342C	3	36	TAB
24mm	W368C	3	36	TAB



HAND TOOLS

JUMBO COMBINATION WRENCH SETS

- Drop forged alloy steel construction.
- Fully polished for easy cleanup.
- Nickel plated to resist corrosion.



Item #	IP	MP	PKG	Sizes
W1104M	13-PC	1	4	CBX 20, 21, 22, 23, 24, 25, 26, 27, 28, 29, 30, 31, 32mm
W1104S	6-PC	1	8	CBX 7/8, 15/16, 1, 1-1/16, 1-1/8, 1-1/4"

SUPER JUMBO WRENCH SETS

- Heat treated alloy steel.
- Full pattern raised panel design.



Item #	IP	MP	PKG	Sizes
S/4	4-PC	1	2	CBX 2-1/8, 2-1/4, 2-3/8, 2-1/2"
S/6	6-PC	1	2	CBX 1-3/8, 1-1/2, 1-5/8, 1-3/4, 1-7/8, 2"

3-PC FLARE NUT WRENCH SETS

- Heat treated alloy steel.
- Drop forged for strength.
- Polished chrome plated finish.



Item #	IP	MP	PKG	Sizes		
				A	B	C
W350	6	96	CRD	3/8"	1/2"	5/8"
				7/16"	9/16"	11/16"
W350M	6	96	CRD	10mm	13mm	16mm
				12mm	14mm	18mm

CROWFOOT WRENCH SETS

- Heat treated alloy steel.
- Drop forged for strength.
- Polished chrome plated finish.
- Ideal for hard to reach fasteners.
- Bonus storage rail.



Item #	IP	MP	PKG	Drive	Sizes
W351	8-PC	6	36	CRD	3/8" 3/8, 7/16, 1/2, 9/16, 5/8, 11/16, 3/4, 7/8"
W352	8-PC	6	36	CRD	3/8" 10, 11, 13, 14, 15, 17, 18, 22mm
W452	10-PC	6	36	DBL	3/8" 10, 12, 13, 14, 15, 16, 17, 18, 19, 21mm
W453	10-PC	6	36	DBL	3/8" 3/8, 7/16, 1/2, 9/16, 5/8, 11/16, 3/4, 13/16, 7/8, 1"

EMPTY WRENCH SET RACKS

- Durable impact resistant construction.
- Comfortable molded handle.



Item #	IP	MP	PKG	Markings
W30600	3	6	SHK	1/4, 5/16, 3/8, 7/16, 1/2, 9/16, 5/8, 11/16, 3/4, 13/16, 7/8, 15/16, 1"
W30601	3	6	SHK	6, 8, 10, 12, 13, 14, 15, 17, 18, 19, 21, 22, 24mm

PROFESSIONAL PLIERS

PROFESSIONAL GRIP

- Ergonomic non slip molded grips for improved comfort and control.
- Premium quality drop forged and hardened chrome vanadium steel.
- US Patent D704523S1

SLIP JOINT PLIERS

- Precision machined jaws for maximum gripping power.

Item #	IP	MP	PKG	Length
W30720	6	36	CRD	6"
W30721	6	36	CRD	8"
W30722	6	36	CRD	10"

LINESMAN PLIERS

- Induction hardened and precision sharpened cutting edges.

Item #	IP	MP	PKG	Length
W30728	6	36	CRD	8"

LONG NOSE PLIERS

- Induction hardened and precision sharpened cutting edges.

Item #	IP	MP	PKG	Length	Angle
W30736	12	144	CRD	5"	-
W30731	6	36	CRD	6"	-
W30732	6	36	CRD	6"	45°
W30733	6	36	CRD	8"	-

CUTTING PLIERS

- Induction hardened and precision sharpened cutting edges.

Item #	IP	MP	PKG	Length
W30737	12	144	CRD	5"
W30725	6	36	CRD	6"
W30726	6	36	CRD	8"

4-PC PROFESSIONAL GRIP PLIERS SET

- Drop forged chrome vanadium steel.
- Induction hardened cutting edges.
- Precision machined jaws.



Item #	IP	MP	PKG	Slip Joint	Diagonal Cutter	Long Nose	Linesman
W30765	6	12	CRD	6"	6"	6"	7"

BLK: Bulk | CAS: Storage Case | CBX: Color Box | CRD: Carded | CLM: Clamshell | DBL: Double Blister
 LAB: Color Label | RAC: Storage Rack | SHK: Shrink Wrap | SLV: Sleeve | TAB: Hang Tab | WBX: White Box

LONG REACH PLIERS

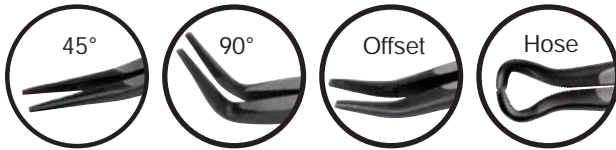

Item #	IP	MP	PKG	Length	Angle
W30771	6	48	CRD	11"	-
W30772	6	48	CRD	11"	45°
W30773	6	48	CRD	11"	90°
W30774	6	48	CRD	11"	Offset
W30775	6	48	CRD	11"	1/2" Hose

GROOVE JOINT PLIERS

Item #	IP	MP	PKG	Length	Capacity
W30762	6	36	CRD	8"	7/8"
W30741	6	36	CRD	10"	1-3/8"
W30743	6	36	CRD	12"	1-5/8"
W30745	6	12	CRD	16"	3-1/4"

WATER PUMP PLIERS

- Unique design quickly adjusts and maintains position.
- Double guide box design for added stability.
- 7-position adjustment.
- US Patent D704523S1

Item #	IP	MP	PKG	Length	Capacity
W30740	6	36	CRD	10"	1/4 to 1-1/4"

CABLE CUTTERS

- Precision sharpened cutting edges.
- Cuts up to: 2/0 (1/2") soft aluminum, 4/0 (3/8") soft copper, and 7/8" coaxial cable.
- US Patent D704523S1

Item #	IP	MP	PKG	Length
W30729	6	36	CRD	10"

CRIMPING PLIERS

- Slim nose shape for tight places.
- Designed for crimping of both insulated and non-insulated solderless connections and terminals.
- US Patent D704523S1

Item #	IP	MP	PKG	Length	Capacity
W30764	6	24	CRD	9-1/2"	10-22 AWG

ANGLED FLUSH CUTTER

- Offset at 30° to produce closer and more precise flush cuts.
- For use on copper and soft wire up to 16 gauge (1.3mm).
- Spring loaded jaws.
- US Patent D704523S1

Item #	IP	MP	PKG	Length	Capacity
W30763	12	144	CRD	5"	16 AWG



HAND TOOLS

The flush cutter is perfect for detailed flush cutting such as wire, mono and braid knots and zip-tie ends.

STANDARD PLIERS

SLIP JOINT PLIERS

- Ergonomic cushion grip handles for comfort and control.
- Heat treated cutting edges for added hardness.
- Drop forged alloy steel construction.
- Machine ground and polished jaws.

Item #	IP	MP	PKG	Length
W1120PC	6	60	CRD	6"
W1121PC	6	72	CRD	8"

LINESMAN PLIERS

Item #	IP	MP	PKG	Length
W1118	6	72	CRD	7"

LONG NOSE PLIERS

Item #	IP	MP	PKG	Length
W1117C	6	72	CRD	6"
W1102	6	48	CRD	8"

DIAGONAL PLIERS

Item #	IP	MP	PKG	Length
W1122C	6	72	CRD	6"
W1103	6	48	CRD	7"

LONG REACH PLIERS

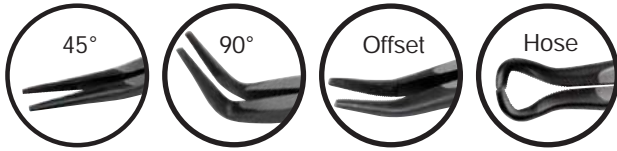

Item #	IP	MP	PKG	Length	Angle
W1044	6	48	CRD	11"	-
W1045	6	48	CRD	11"	45°
W1046	6	48	CRD	11"	90°
W1047	6	48	CRD	11"	Offset
W1048	6	48	CRD	11"	1/2" Hose

GROOVE JOINT PLIERS

Item #	IP	MP	PKG	Length	Capacity
W1119C	6	48	CRD	9-1/2"	1-1/4"
W1101	6	24	CRD	12"	1-5/8"

FENCE PLIERS

- Drop forged alloy steel construction.
- Machine ground and polished jaws.
- Hammer head, pick end and wire cutters.

Item #	IP	MP	PKG	Length
W1500	6	36	CRD	10"



10-PC PLIERS SET

- Soft cushion grips with ergonomic shape for safe, easy use.
- Machine polish finish and drop forged for long life.
- Sturdy blow mold case for storage.



Item #	IP	MP	PKG	Slip Joint	Diagonal	Long Nose			Needle Nose	Bent Nose	End Nipper
						Straight	45°	Linesman			
W30715	6	12	DBL	6"	4-1/2" & 6"	4-1/2" & 6"	6"	7"	4-1/2"	4-1/2"	4-1/2"

7-PC PLIERS SET

- Cutting pliers feature induction harden cutting edges for durability.
- Comfort grips with ergonomic shape for safe, easy use.
- Machined jaws for maximum gripping strength.
- Drop forged alloy steel construction.



Item #	IP	MP	PKG	Slip Joint	Diagonal	Long Nose	Groove Joint	Bent Nose	End Nipper
W30759	6	12	CLM	8"	4-1/2" & 7-1/2"	8"	10"	4-1/2"	4-1/2"

5-PC PLIERS SET

- Cutting pliers feature induction harden cutting edges for durability.
- Non slip molded grips for comfort and control.
- Machined jaws for maximum gripping strength.
- Durable alloy steel construction.



Item #	IP	MP	PKG	Slip Joint	Diagonal	Long Nose	Linesman	Groove Joint
W1717	6	12	DBL	6"	7"	8"	8"	10"

4-PC LONG NOSE PLIERS SET

- Ergonomic cushion grip handles with safety rests to keep hands from slipping on to pliers.
- Drop forged, hardened and tempered construction.



Item #	IP	MP	PKG	Needle Nose	Straight	45°	90°
W30714	6	12	DBL	7"	11"	11"	11"

8-PC PLIER & WRENCH SET

- Cutting pliers feature induction hardened cutting edges for durability.
- Ergonomic cushion grip handles for comfort and control.
- Machined jaws for maximum gripping strength.
- Chrome vanadium steel construction.



Item #	IP	MP	PKG	Slip Joint	Diagonal	Long Nose	Linesman	Groove Joint	Adjustable Wrench
W1704	6	12	DBL	8"	4-1/2" & 6"	4-1/2" & 6"	8"	10"	8"

ADJUSTABLE WRENCHES

PROFESSIONAL GRADE ADJUSTABLE WRENCHES

- Wide I-Beam handle design for increased comfort and torque.
- SAE and Metric graduations for accurate sizing.
- Premium quality drop forged and hardened chrome alloy steel.



Length	Jaw Capacity		Pro Series	IP	MP	PKG	Standard	IP	MP	PKG
	Length	Capacity								
4"	9/16"		W30704	6	48	CRD	-	-	-	-
6"	3/4"		W30706	6	48	CRD	W6C	6	120	CRD
8"	1"		W30708	6	48	CRD	W8C	5	100	CRD
10"	1-1/4"		W30710	6	48	CRD	W10C	6	60	CRD
12"	1-1/2"		W30712	6	24	CRD	W12C	6	48	CRD
15"	1-3/4"		-	-	-	BLK	W415C	2	12	BLK
18"	2"		-	-	-	BLK	W418P	2	12	BLK
24"	2-1/8"		-	-	-	BLK	W424P	1	6	BLK

STANDARD

- Precision crafted for smooth operation.
- Heat treated alloy steel.
- Polished heads.



CONSTRUCTION WRENCH

- Corrosion resistant industrial black finish.
- SAE and Metric graduations.
- Drop forged alloy steel.



Tapered handle for aligning bolt holes.

Item #	IP	MP	PKG	Length	Jaw Capacity
W30766	4	24	CRD	16"	1-5/8"

3-PC ADJUSTABLE WRENCH SET

- Soft cushion grips with ergonomic shape for safe easy use.
- Machine polished finish and drop forged for long life.
- Precision SAE and Metric rule on wrench heads for accuracy.



Box ends in handles

HAND TOOLS

Item #	IP	MP	PKG	Wrench 1			Wrench 2			Wrench 3		
				Length	Capacity	Box	Length	Capacity	Box	Length	Capacity	Box
W30703	6	12	CLM	6"	3/4"	3/8"	8"	1"	9/16"	12"	1-1/2"	3/4"

FACE SPANNER WRENCH

- Corrosion and oil resistant black phosphate finish
- High quality chrome vanadium alloy steel

Item #	IP	MP	PKG	Range
W30781	6	48	CRD	6"

W30781

HOOK WRENCHES

- Corrosion and oil resistant black phosphate finish
- High quality chrome vanadium alloy steel
- Use for service collars and lock nut rings

Item #	IP	MP	PKG	Range
W30783	6	36	CRD	1-1/4 to 3"
W30784	6	36	CRD	2 to 4-3/4"
W30782	6	36	CRD	3/4 to 2"
W30785	6	36	CRD	4-1/2 to 6-1/4"



W30783

LOCK GRIP PLIERS

- Premium quality drop forged and hardened chrome vanadium steel.
- Precision machined jaws with integrated wire cutter.
- Triple riveted and welded center point for added strength.
- Knurled adjustment screw for quick loosening and tightening.

Item #		Length	IP	MP	PKG
W30758	Long Nose	6-1/2"	6	48	CRD
W30760		9"	6	48	CRD
W30752	Curved Jaw	5"	6	48	CRD
W30754		7"	6	48	CRD
W30756		10"	6	48	CRD
W30757	Straight Jaw	10"	6	48	CRD

LOCK GRIP PLIERS

- Drop forged steel construction.
- Hardened and tempered milled teeth.

Item #		Length	IP	MP	PKG
W1039	Curved Jaw	7"	6	48	CRD
W1116C	Curved Jaw	10"	6	48	CRD

LOCKING C-CLAMP

- Heavy duty construction.
- Quickly adjusts to right size before use.
- Locks to work with squeeze of one hand.
- Unlocks easily by squeezing release lever.

Item #	IP	MP	PKG	Length	Capacity
W5100	6	48	SLV	6"	2"
W5101	6	48	SLV	8"	2-3/8"
W5102	6	24	SLV	11"	3-1/2"

3-PC LOCKING PLIERS SET

- Machine polish finish and drop forged for long life
- Indispensable tool set for the home or shop
- Ergonomic cushion grip handles

Item #	IP	MP	PKG	Contents
W30713	6	12	DBL	6-1/2" long nose, 7" curved jaw, 10" curved jaw pliers

3-PC LOCKING PLIERS SET

- Drop forged steel construction.
- Hardened and tempered milled teeth.
- Wire cutters and quick release levers.

Item #	IP	MP	PKG	Contents
W1107DB	6	24	CRD	5, 7, 10" curved jaw pliers



HAND TOOLS

SNAP RING PLIERS

ADJUSTABLE SNAP RING PLIERS

- Professional quality construction.
- Adjustable tips for 0°, 45° or 90° use.
- Tips are tapered for better hold.
- Vinyl grip handles.

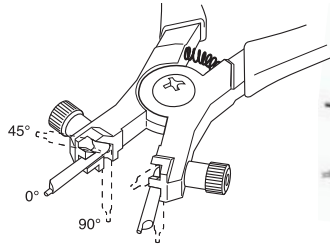

Item #	IP	MP	PKG		Capacity		Tapered Tips		
					Min	Max	0°	45°	90°
W88010	6	72	CRD	Internal	3/8"	1-1/4"	1mm	1.5mm	2mm
W88011	6	72	CRD	External	3/8"	1-1/4"	1mm	1.5mm	2mm

5-PC COMBINATION SNAP RING PLIER SET

- Two straight, one 45° and one 90°.
- One spring retainer assembly.
- Vinyl grip handles.
- For internal or external snap rings.



Item #	IP	MP	PKG	Capacity		Tips			
				Min	Max	0°	45°	90°	
W1159	6	60	CRD	1/8"	2"	1mm	1.4mm	1.4mm	1.4mm

REVERSIBLE SNAP RING PLIERS

- Unique design switches easily from internal/external operation.
- Comfortable cushion grips feature storage for spare tips.
- Change tips easily with included hex key.

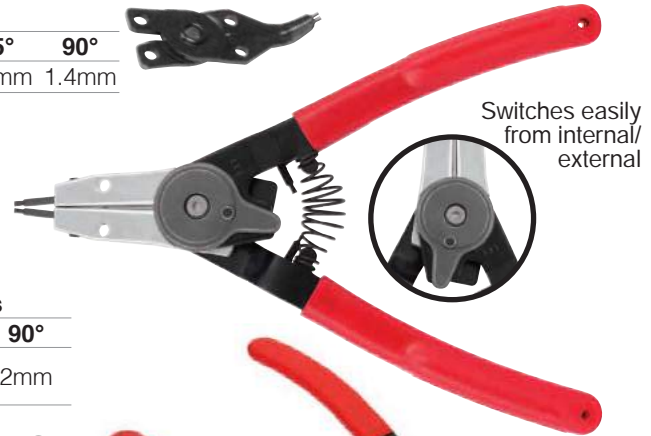

Item #	IP	MP	PKG	Capacity		Tips	
				Min	Max	0°	90°
				Internal	External		
W88013	6	48	CRD	7/8"	1-7/8"	1.8mm	2mm
				5/16"	1-7/8"		

INTERNAL / EXTERNAL SNAP RING PLIERS

- Push button lever arm converts pliers for internal or external snap rings.
- Includes 4 sets of tips in handy storage case.
- Two straight, one 45° and one 90°.



Item #	IP	MP	PKG	Capacity		Tapered Tips			
				Min	Max	0°	45°	90°	
				1/8"	1"	1mm	1.4mm	1.4mm	1.4mm
W1151	6	72	CRD	1/8"	2"				
				1/8"					

SNAP RING PLIER SET

- Internal and external pliers.
- Includes straight, 90° and 45° tips.

Item #	IP	MP	PKG	Capacity		Tapered Tips		
				Min	Max	0°	45°	90°
				1/8"	7/8"	1mm	1.4mm	1.4mm
W1150S	6	48	CRD	1/8"	1-3/4"			
				1/8"				



4-PCS MINI SNAP RING PLIER SET

- Spring loaded for precise movement and control in tight working areas.
- Chrome molybdenum steel with vinyl coated handles.



Item #	IP	MP	PKG	Contents
W88012	12	48	CRD	Internal straight pliers, internal 45° pliers, External straight and external 45° pliers.

HAND TOOLS

LOCK RING PLIERS

- Knurled outer tips hold rings securely.
- Spring loaded jaws.
- Vinyl grip handles.

Item #	IP	MP	PKG
W88001	6	72	CRD



HOG RING PLIERS

- Many applications like: upholstery, fencing, craft, rope, bungee cords, bag closures, furniture and much more.
- Specially designed head to roll the hog ring closed.
- Spring loaded to aid in holding the hog ring.
- Heavy duty steel construction.

Item #	IP	MP	PKG
W88002	Straight	12	48 CRD
W88003	Angled	12	48 CRD



Angled head for easy access.

AVIATION TIN SNIPS

- Forged, heat treated steel blades.
- Spring-loaded for self-opening action.
- Non-slip serrated jaws.
- Ergonomic grip.

Item #	IP	MP	PKG	Snips
W2040	3-PK	6	12 DBL	Left cut, Right cut, Center cut
W2043		6	24 DBL	Center cut



MULTI-FUNCTION SHEARS

- High quality stainless steel blades separate for individual use as knives.
- Ergonomic non-slip molded grips for improved comfort and control.
- Ideal for cutting, slicing, trimming, peeling and more.



W9353



W9354

Great for working in the kitchen, home office, camping, hunting, fishing and more.

Item #	IP	MP	PKG	Functions	Additional
W9354	12	36	CRD	6-IN-1 Shears, chef knife, scraping blade,	-
W9353	6	36	CRD	9-IN-1 scaler, paring blade, bottle opener	nut cracker, peeler, lid lifter

RATCHETING SLIDE WRENCH

- Pivoting flex head locks into position for 180° of flexibility.
- Ratchets for quick removing and tightening.
- Knurled thumb wheel adjusts sizes easily.
- Heavy duty chrome molybdenum construction.
- Low profile head for tight spaces.
- Meets or exceed ANSI for torque.

Item #	IP	MP	PKG	Length	Range
W30709	6	48	TAB	9"	5/16 to 1"



PROFESSIONAL SCREWDRIVERS & SETS

TRILOBULAR HANDLES

- Ergonomic non-slip molded grips for improved comfort and control.
- Chrome vanadium steel shafts with corrosion resistant satin finish.
- Magnetic tips for added convenience.
- US Patent D693201S1

OPEN STOCK PHILLIPS

Item #	Size	Length	IP	MP	PKG
W30960	#0	2-1/2"	12	120	TAB
W30961	#1	3"	12	120	TAB
W30962	#1	6"	12	120	TAB
W30967	#2	1-1/2"	12	120	TAB
W30963	#2	4"	12	120	TAB
W30964	#2	6"	12	120	TAB
W30965	#2	8"	6	60	TAB
W30968	#3	6"	6	60	TAB
W30969	#4	8"	6	60	TAB

OPEN STOCK SLOTTED

Item #	Size	Length	IP	MP	PKG
W30970	1/8"	3"	12	120	TAB
W30986	3/16"	3"	12	120	TAB
W30987	3/16"	6"	12	120	TAB
W30994	1/4"	1-1/2"	12	120	TAB
W30988	1/4"	4"	12	120	TAB
W30989	1/4"	6"	12	120	TAB
W30990	1/4"	8"	6	60	TAB
W30991	5/16"	6"	6	60	TAB
W30995	5/16"	8"	6	60	TAB
W30992	3/8"	8"	6	60	TAB
W30993	3/8"	10"	6	60	TAB
W30983	3/8"	12"	6	60	TAB



HAND TOOLS

6-PC SCREWDRIVER SET

- Ergonomic non-slip molded grips for improved comfort and control.
- US Patent D693201S1

Item #	IP	MP	PKG	Phillips			Slotted		
				#0	#1	#2	1/8"	3/16"	1/4"
W30896	6	12	CRD	2-1/2"	3"	4"	3"	3"	4"

6-PC JUMBO SCREWDRIVER SET

- Ergonomic non-slip molded grips for improved comfort and control.
- US Patent D693201S1



Item #	IP	MP	PKG	Phillips		Slotted	
				#2	#3	1/4"	5/16"
W30989	6	12	CRD	10, 12"	24"	10, 12"	24"

PROFESSIONAL STAR DRIVERS

- Comfortable non-slip molded grips.
- Chrome vanadium steel shafts with magnetic tips.
- US Patent D693201S1

Item #	Size	Length	IP	MP	PKG
W30810	T10	4"	12	120	TAB
W30815	T15	4"	12	120	TAB
W30820	T20	4"	12	120	TAB
W30825	T25	4"	12	120	TAB
W30827	T27	4"	12	120	TAB
W30830	T30	4"	12	120	TAB



5-PC STAR DRIVER SET

Item #	IP	MP	PKG	Star				
				T10	T15	T20	T25	T27
W30899	6	12	CRD	4"	4"	4"	4"	4"

W30899

PROFESSIONAL NUT DRIVERS

- Ergonomic non-slip molded grips for improved comfort and control.
- Chrome vanadium steel construction with corrosion resistant chrome plating.
- Color coded for easy size identification.
- Hollow shafts.

Item #	Size	Length	IP	MP	PKG
W30920	3/16"	3"	6	48	TAB
W30921	7/32"	3"	6	48	TAB
W30922	1/4"	3"	6	48	TAB
W30923	5/16"	3"	6	48	TAB
W30924	11/32"	3"	6	48	TAB
W30925	3/8"	3"	6	48	TAB
W30926	7/16"	3"	6	48	TAB
W30927	1/2"	3"	6	48	TAB
W30905	5mm	3"	6	48	TAB
W30906	6mm	3"	6	48	TAB
W30907	7mm	3"	6	48	TAB
W30908	8mm	3"	6	48	TAB
W30909	9mm	3"	6	48	TAB
W30910	10mm	3"	6	48	TAB
W30911	11mm	3"	6	48	TAB
W30912	12mm	3"	6	48	TAB



W30900

HAND TOOLS

8-PC NUT DRIVER SETS

- US Patent D693201S1

Item #	IP	MP	PKG
W30900	SAE	6	24 CLM 3/16, 7/32, 1/4, 5/16, 11/32, 3/8, 7/16, 1/2"
W30901	METRIC	6	24 CLM 5, 6, 7, 8, 9, 10, 11, 12mm



W30901

SCREWDRIVERS SETS



61-PC DRIVER & BIT SET

- Heat treated alloy steel blades with satin finish, magnetic tips and non-slip molded grips.
- Most popular Phillips, slotted, star and square sizes.



Features removable magnetizer/demagnetizer.

Item #	IP	MP	PKG
W1731	1	4	DBL



	Phillips	Slotted	Star	Square	
Screwdrivers	1-1/2"	#2	1/4"	-	-
	3"	#00, #0	1/8"	-	-
	4"	#1	3/16"	T15, T20, T25, T27, T30	S1, S2, S3
	6"	#2	5/16" & 1/4"	T40 (5")	-
	8"	#3	5/16"	-	-
Bits	SAE	Metric	Star		
	Hex/Star	5/56, 3/32, 7/64, 1/8,	2, 2.5, 3,	T7, T8, T9, T10, T15, T20,	-
	Tamper Proof	9/64, 5/32, 3/16"	4, 5, 6mm	T25, T27, T30, T35, T40	-
	Nut driver	3/16, 1/4, 5/16, 3/8, 7/16	6, 7, 8, 9, 10mm	-	-

Straight pick, angled pick, bit driver, de/magnetizer & rack.



39-PC DRIVER & BIT SET

- Organizing rack features built-in bit holders and magnetizer/demagnetizer.
- Chrome vanadium blades and power bits.
- Comfortable non-slip molded grips.
- Satin finish with magnetic tips.



Features removable magnetizer/demagnetizer.

Item #	IP	MP	PKG
W1727	1	6	DBL



	Phillips	Slotted	Star	Hex	
Screwdrivers	1-1/2"	#2	1/4"	-	-
	2"	#00, #0	2, 2.5, 3mm	T6, T8, T10	-
	3"	#1	5/32"	-	-
	4"	#2	1/4"	-	-
	6"	#2	6"	-	-
Bits	Phillips	Slotted	Star	Hex	
	1/4"	#0, #1 PZ: #1, #2	5/32, 3/16, 1/4"	T20, T25, T30	2, 3, 4, 5, 6mm
	Nut	6, 7, 8, 9, 10mm			

Magnetic bit driver, de/magnetizer & rack.

HAND TOOLS



26-PC DRIVER SET W/RACK

- Removable feet to hang on pegboard.
- Chrome vanadium blades with satin finish and magnetic tips.
- Non-slip molded grips.

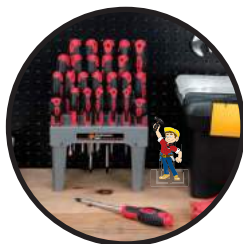

Item #	IP	MP	PKG
W1726	1	4	DBL



	Phillips	Slotted	Star	Pozi	
Screwdrivers	1-1/2"	#2	1/4"	-	-
	2"	-	1/8"	-	-
	3"	#00, #0	1/8"	-	#0, #1
	4"	#1, #2	3/16", 1/4"	T15, T20, T25, T27, T30	#2
	5"	#3	1/4", 5/16"	T40	#3
	8"	#3	5/16"	-	-

100-PC SCREWDRIVER SET

- Comfortable non-slip molded grips.
- Chrome vanadium blades and power bits.
- Satin finish with magnetic tips.
- Organizing zippered carrying case.

	Phillips	Slotted	Star	Square	
Screwdrivers	3"	#0, #1	1/8, 3/16"	T8, T10, T15, T20	S0, S1
	4"	#1, #2	5/32, 3/16, 1/4"	T25, T30	S1, S2
	6"	#1, #2	3/16, 1/4"	-	S3
	8"	-	5/16"	-	-
	10"	-	5/16"	-	-
	Precision				
	2"	#00, #0	1/16, 3/32"	T6, T7, T8, T9	-
	Phillips	Slotted	Star	Square	
Bits	2ea: #0, #1	1/8, 9/64, 5/32,	T8, T15,		
	3ea: #2, #3	11/64, 3/16,	T20, T25,	S1, S2,	
	(Pozi sizes/	7/32, 1/4, 17/64,	T27, T30,	S3	
	quantities)	9/32, 5/16"	T40		
		SAE		Metric	
	Hex	5/32, 3/16, 1/4, 5/16, 3/8"	4, 5, 5.5, 6 and 7mm		
	Nut	3/16, 7/32, 5/16, 3/8, 7/16, 1/2"	4, 6, 7, 8, 10, 12mm		

Offset sizes: 1/4 x #2 and 3/16" x #1.



Item #	IP	MP	PKG
W1721	1	4	DBL

30-PC DRIVER & BIT SET

- Comfortable non-slip molded grips.
- Chrome vanadium blades and power bits with magnetic tips and satin finish.
- Compact storage rack keeps all tools organized.

	Phillips	Slotted	Star	
Screwdrivers	1-1/2"	#1	1/4"	-
	3"	#1	3/16"	-
	4"	#2	1/4"	-
	6"	-	5/16"	-
		Precision		
	2"	#00, #0	1/16, 3/32, 1/8"	T6, T8
	Phillips	Slotted	Star	
Bits	#1, #2, #3	5/32,	T6, T7,	
	(Pozi sizes)	3/16, 1/4"	T10	
	Hex	3/16, 1/4"		



Item #	IP	MP	PKG
W1718	4	8	RAC

18-PC DRIVER SET

- Soft handle screwdriver and precision screwdriver set.
- Chrome vanadium blades with satin finish and magnetic tips.
- Organizing rack stands or mounts on wall.

	Phillips	Slotted	Star	
Screwdrivers	1-1/2"	#2	1/4"	-
	3"	#1	3/16"	-
	4"	#2	1/4"	-
	6"	#3	5/16"	-
		Precision		
	1-1/2"	#00, #0	3/32, 1/8"	T5, T6, T7, T8, T9, T10

Item #	IP	MP	PKG
W1710	6	12	DBL



HAND TOOLS

SCREWDRIVERS SETS

22-PC SCREWDRIVER SET

- Heavy duty easy grip color coded handles.
- Chrome vanadium steel shafts with magnetic tips.
- Hex bolster on larger sizes

Phillips (Yellow), Slotted (Red), Star (Blue), Nut drivers (Green) and Tack puller (Blue).

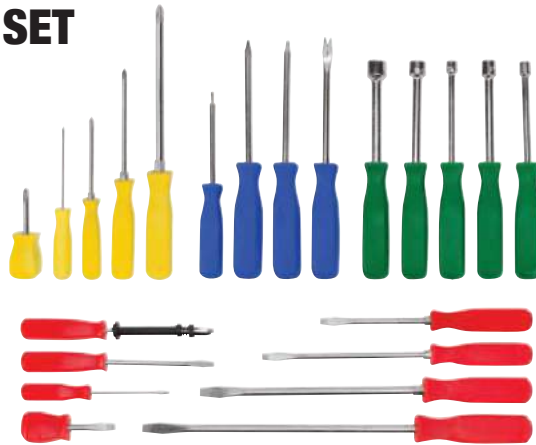

Screwdrivers	Phillips		Slotted	
	1-1/2"	#2	1/4"	1/4"
	3"	#0, #1	1/8"	
	4"	#2	3/16, 1/4, 5/32"	
	6"	#3	1/4"	
	8"	-	5/16"	
	10"	-	3/8"	
Star	4"	T10, T15, T20		
Hex	4"	3/16, 1/4, 5/16, 3/8, 7/16"		

Item #	IP	MP	PKG
W80022	6	12	LAB

SCREWDRIVER SETS

- Chrome vanadium heat treated shafts with magnetic tips.
- Professional style heat resistant handles.



Item #	IP	MP	PKG	Phillips		Slotted				Star						
				#1	#2	3/16"	1/4"	5/16"	3/8"	T15	T20	T25	T27	T30		
W901S	8-PC	Black	6	24	DBL	3"	1-1/2, 4"	3"	1-1/2, 4"	6"	8"	-	-	-	-	-
W904	8-PC	Orange	6	24	DBL	3"	1-1/2, 4"	3"	1-1/2, 4"	6"	8"	-	-	-	-	-
W904GN	8-PC	Green	6	24	DBL	3"	1-1/2, 4"	3"	1-1/2, 4"	6"	8"	-	-	-	-	-
W900S	5-PC	Black	6	48	DBL	-	-	-	-	-	-	4"	4"	4"	4"	4"

NUT DRIVER SETS

- Chrome plated drop forged steel shafts.
- Pro style polypropylene handles.
- Hollow shanks.



Item #	IP	MP	PKG
W950	SAE	6	24 DBL
W951	Metric	6	24 DBL



W80006 Includes wall mount.



W80015

SCREWDRIVER SETS

- Oversized fluted handles deliver comfort and maximum grip.
- Chrome vanadium steel construction with corrosion resistant chrome plating.
- Magnetic tips.



Item #	IP	MP	PKG	Phillips				Slotted					Star							
				#0	#1	#2	#3	1/8"	3/16"	1/4"	5/16"	3/8"	T10	T15	T20	T25	T27	T30		
W80006	6-PC	6	24	DBL	-	-	-	-	-	-	-	-	-	-	4"	4"	4"	4"	4"	4"
W80007	7-PC	6	24	DBL	3"			4"	4"	4"	8"	-	-	-	-	-	-	-	-	-
W80008	8-PC	6	24	DBL	-	3"	1-1/2 & 4"	-	-	3"	1-1/2 & 4"	-	-	-	4"	4"	-	-	-	-
W80015	15-PC	6	12	DBL	2-1/2"	3"	1-1/2 & 4"	6"	2-1/2"	3"	1-1/2 & 4"	6"	-	-	4"	4"	-	-	-	-

W80015 also includes 4" Square (R2) driver, scratch awl and dual offset driver 3/16" & #1

HAND TOOLS

15-PC SCREWDRIVER SET

- Drop forged, heat-treated chrome vanadium steel shafts.
- Comfortable fluted handles for maximum grip.
- Magnetic tips.



Item #	IP	MP	PKG	Phillips				Slotted					Precision		
				#0	#1	#2	#3	1/8"	5/32"	3/16"	1/4"	5/16"	3/8"	#00	3/32"
W80005	6	24	DBL	3"	3"	1-1/2", 4"	6"	2"	4"	4, 6"	1-1/2", 5"	8", 10"	8"	1-1/2"	1-1/2"

6-PC STRIKE CAP SCREWDRIVER SET

- Go-through solid shafts with hex drive strike end caps.
- Professional style heat resistant handles.
- Heat treated shafts with magnetic tips.



Item #	IP	MP	PKG	Phillips			Slotted		
				#1	#2	#3	3/16"	1/4"	5/16"
W1729	6	24	DBL	6"	7-1/2"	10"	6"	7-1/2"	10"

6-PC SCREWDRIVER SET

- Oversized comfort grips for more turning power.
- Heat treated alloy steel blades for durability.
- Plated shafts for corrosion resistance.



Item #	IP	MP	PKG	Phillips			Slotted		
				#1	#2	#3	3/16"	1/4"	5/16"
W1703	6	24	DBL	3"	4"	6"	3"	4"	6"

7-PC ELECTRICIAN DRIVER SET

- Insulated blades for applications up to 1000V AC and 1500V DC.
- Comfortable non-slip molded grips.
- Tested according to IEC 60900 : 2012.



Item #	IP	MP	PKG	Phillips			Slotted			
				#0	#1	#2	3/32"	5/32"	7/32"	1/4"
W30897	6	24	CRD	3"	4"	4"	3"	4"	5"	6"

3-PC LONG SHAFT SCREWDRIVER SET

- Extended length for hard to reach areas.
- Hi-visibility pro style handles.
- Chrome plated steel shafts with magnetic tips.

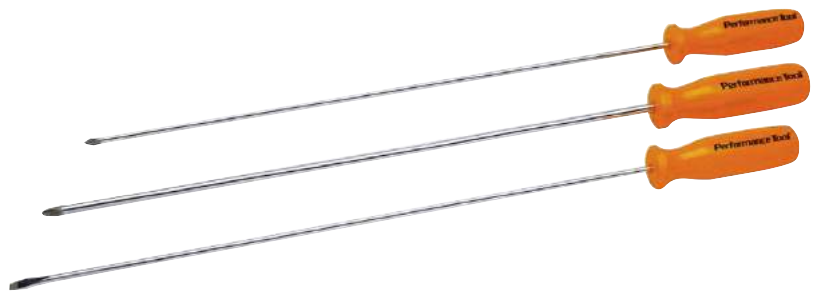

Item #	IP	MP	PKG	Phillips		Slotted
				#2	#3	3/32"
W924	6	48	DBL	22-1/2"	22-1/2"	22-1/2"

HAND TOOLS

SCREWDRIVER SETS

6-PC PRECISION SCREWDRIVER SET

- Hardened and tempered steel blades.
- Handles are chrome plated to resist corrosion.
- Convenient carry case keeps tools organized.

Item #	IP	MP	PKG	Phillips	Slotted
W944S	6	72	CRD	#0, #1	1.4, 2.0, 2.4, 3mm



6-PC CHROMATIC SCREWDRIVER SET

- Color coded grips allow for more torque and quick size identification.
- Precision milled brass handles with color coded rubber grips.
- Superior quality top grade chrome vanadium blades.
- Reusable storage case.

Item #	IP	MP	PKG	Phillips	Slotted
W1732	20	100	CRD	#00, #0	1.0, 1.2, 1.8, 2.4mm



2-PC OFFSET DRIVER SETS

- Heat-treated carbon steel construction.
- Corrosion-resistant chrome plated finish.
- Non-slip knurled handles.
- For hard to reach fasteners.



Item #	IP	MP	PKG	Driver 1	Driver 2
W30980	12	144	CRD	#1 3/16"	#2 1/4"
W1316	6	72	CRD	T10 T15	T20 T30

2-PC POCKET CLIP SCREWDRIVER

- Yellow and black line color handles with handy pocket clip.
- Polished chrome plated alloy steel shafts.
- Magnetic tips.



Item #	IP	MP	PKG	Phillips	Slotted
W907	12	288	CRD	#0	1/8"

4-PC MINI STUBBY SCREWDRIVER SET

- Great for confined or hard to reach places.
- Chrome vanadium steel shafts.



Item #	IP	MP	PKG	Phillips	Slotted
W80004	12	288	CRD	#1, #2	3/16, 1/4"

HAND TOOLS

10-IN-1 GEARLESS BIT DRIVER

- Auto-loading bit chamber makes changing bits quick and easy.
- Gearless ratchet mechanism for precise tightening.
- On-board bit storage - 6 pre-loaded in the chamber, 4 additional bits in the handle.
- Great for computer repairs, electronics, home projects, or hobbies.



Operation: to change bits, pull clear portion of handle back, rotate red bit chamber to desired size, and close handle. To change bits, remove unwanted bit from tip, pull handle back, replace desired bit from handle with removed bit.

Item #	IP	MP	PKG	Phillips	Slotted	Star
W9146	4	24	CRD/Pg 310	#00, #0, #1	1.5, 2.0 3.0mm	T5, T6, T8, T10

PRECISION LED BIT DRIVER

- Push button operated LED never needs replacing
- Durable aluminum construction
- On-board bit storage and pocket clip
- Batteries included.



Item #	IP	MP	PKG	Phillips	Slotted	Battery	
						Qty.	Type
W9194	4	24	LAB/Pg 311	#00, #0,	1.5, 2.0	4	LR41
W479	6	24	CRD/Pg 318	#1	3.0mm		

*W479 Only available in blue

PRECISION POCKET SCREWDRIVER

- Convenient bit storage in handle and handy pocket clip.
- Anodized aluminum alloy handle is knurled for a secure grip.
- Magnetic tip.

W9169



Item #	IP	MP	PKG	Phillips	Slotted
W9147	Red	6	DBL/Pg 310	#000, #00, #0, #1	1/16, 5/64, 3/32, 1/8"
W9148	Green	6	DBL/Pg 310	T3, T4, T5, T6, T7, T8, T9, T10	
W9157	2-PC	6	48 DBL	<i>contains one of each</i>	
W9169	2-PC	4	24 CAS/Pg 310	<i>contains one of each</i>	

4-IN-1 PRECISION SCREWDRIVERS

- Chrome vanadium bits.
- Non slip molded grip.
- Convenient pocket clip.



HAND TOOLS

Item #	IP	MP	PKG	Bit 1	Bit 2
W80036	12	144	CRD	#0 5/32"	#1 1/8"
W9174	16	96	Pg 310		

7-IN-1 STUBBY PRECISION SCREWDRIVER

- Compact design stores easily
- On-board storage keeps bits organized

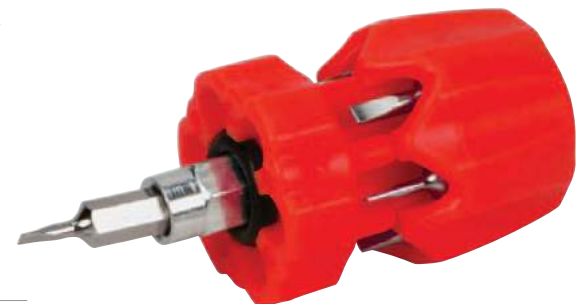

Item #	IP	MP	PKG	Phillips	Slotted	Star
W476	12	48	CRD/Pg 318	#0, #1	5/32, 1/8"	T4, T5, T6

MULTI-BIT DRIVERS

HI-VIZ LED BIT DRIVER

- Three bright white LEDs illuminate your work area
- Ergonomic non-slip molded handle.
- On-board bit storage.
- US Patent D693201S1



Item #	IP	MP	PKG	Phillips	Slotted	Battery	
						Qty.	Type
W9205	12	48	LAB Pg 313	#1, #2	13/16, 1/4"	3	AAA

LED BIT DRIVER

- Three bright white LEDs illuminate your work area
- Ergonomic non-slip molded handle.
- On-board bit storage.
- US Patent D693201S1



Item #	IP	MP	PKG	Phillips	Slotted	Battery	
						Qty.	Type
W9193	6	24	LAB/Pg 311	#1, #2	13/16, 1/4"	3	AAA
20171	4	24	LAB/Pg 321				

6-IN-1 SCREWDRIVERS

- Includes handle, reversible shaft, and 2 double sided bits.
- Chrome vanadium steel bits.

Ergonomic trilobular comfort grip handle



20116



20152



W975



Item #	IP	MP	PKG	Phillips	Slotted	Nut Driver
20152	4	24	Pg 321	#1, #2	3/16, 1/4"	1/4, 5/16"
20116	6	36	Pg 320			
W975	12	48	Pg 312			

HAND TOOLS

3/8 IN. IMPACT DRIVER SET

- Ideal for loosening firmly tightened or rusted screws or bolts.
- Removable hex adapter allows use with 3/8" drive sockets and accessories.
- Heavy duty blow molded storage case.



W2500-36mm replacement bits.

Item #	IP	MP	PKG	Bit Length	Phillips	Slotted
W2500P	4	24	CRD	36mm	#2, #3	5/16, 3/8"
W2500-36MM	24	288	CRD			

1/4 IN. IMPACT DRIVER & EXTRACTOR SET

- Ideal for loosening or removing firmly tightened or rusted screws or bolts.
- Convenient 1/4" receiver allows use of any 1/4" bit tip or hex nut driver.



W2503-50mm replacement bits.



Item #	IP	MP	PKG	Bit			Extractor	
				Length	Phillips	Slotted	#1	#2
W2503	12	24	CRD	50mm	#1, #2	3/16	#1	1/8 to 15/16"
W2503-50MM	12	72	CRD				#2	15/16 to 5/16"
							#3	5/16 to 7/16"

Spiral:
 #1 3/32- 5/32", 2.5mm-4mm. No.3- No.5.
 #2 5/32- 7/32", 4mm-6mm. No.6- No.12.
 #3 7/32- 9/32", 6mm-8mm. No.14.

12-PC BIT DRIVER SET

- Oversized handle for improved torque.
- Comfortable non-slip molded grip.
- Built-in storage inside handle.
- Includes 6-1/2" flexible bit extension and 1/4" socket adapter.



Item #	IP	MP	PKG	Phillips	Slotted	Star
W1728	12	24	CRD	#1, #2, #3	5/32, 3/16, 1/4"	T10, T15, T20



BIT SETS

148-PC MASTER BIT SET

- Huge assortment of popular and hard-to-find bits for a wide range of applications.

Phillips	1"	#00 (3), #0 (3), #1 (3), #2 (5), #3 (3), #4 (3)
	2"	#1, #2, #3
Pozi	1"	#0, #1, #2 (3), #3, #4
	2"	#2, #3
Slotted	1"	1/8 (2), 9/64, 5/32 (2), 11/64, 3/16 (4), 7/32, 1/4 (4), 17/64, 9/32, 5/16"
	2"	-
Star	1"	T5, T6, T7, T8, T9, T10, T15, T20, T25, T27, T30, T40, T45 (also as Tamper Resistant)
	2"	T10, T15, T20, T25, T27, T30, T40
Square	1"	S1, S2 (2), S3
	2"	S2
Hex	1"	1/16 (2), 5/64 (2), 3/32 (2), 7/64 (2), 1/8, 9/64, 5/32, 3/16, 7/32, 1/4"
	2"	3/16, 7/32, 1/4"
	1"	1.5 (2), 2 (2), 2.5 (2), 3 (2), 4, 5, 5.5, 6, 8mm
Spline		M5, M6, M8
Spanner		#4, #6, #8, #10
Tri Wing	1"	#1, #2, #3, #4
Four Wing		#6, #8, #10
Clutch		C1, C2, C3

Item #	IP	MP	PKG
W1725	6	12	DBL



101-PC RATCHETING BIT DRIVER SET

- Hi-torque ergonomic cushion grip ratcheting screwdriver.
- High quality S2 alloy steel bits for superior strength & durability. Includes 1/4" drive socket adapter (1" and 2"), 1" wing nut driver, 2-1/4" magnetic bit holder, 1" coupler.

Phillips	1"	#0 (2), #1 (2), #2 (3), #3 (2)
Pozi	1"	#0, #1 (2), #2 (3), #3 (2)
Slotted	1"	3, 4, 5, 6mm
Star	1"	T8, T10 (2), T15 (2), T20 (2), T25 (2), T27, T30, T40, T45
		T8, T10, T15, T20, T25, T27, T30, T40, T45
Square	1"	S0, S1, S2, S3
Hex	1"	1/16, 5/64, 3/32, 7/64, 1/8, 9/64, 5/32, 3/16, 7/32, 1/4"
		1.5, 2, 2.5, 3, 4, 4.5, 5, 5.5, 6mm
Tamper Resistant	1"	5/64, 3/32, 7/64, 1/8, 9/64, 5/32"
		2, 2.5, 3, 4, 5, 6mm
Spline		M5, M6, M8
Spanner		#4, #6, #8, #10
Tri Wing	1"	#1, #2, #3, #4
Four Wing		#6, #8, #10
Clutch		C1, C2, C3

Item #	IP	MP	PKG
W1719	6	12	DBL



HAND TOOLS

29-PC QUICK CHANGE DRIVER SET

- Chrome vanadium steel construction.
- Heat treated for longer life.
- 3-3/16" magnetic screw guide with retracting sleeve.

Phillips	1"	#1, #2 (4), #3
	2"	#2
Pozi	1"	#2, #3
Slotted	1"	6-8, 8-10, 10-12
Star	1"	T10, T20, T30
Square	1"	S1 (2), S2 (4), S3 (2)
	2"	S2
Nut Setter	1"	1/4, 5/16"

Item #	IP	MP	PKG
W9024	6	24	DBL



100-PC BIT SET

- Use with screwdrivers, electric drills or socket wrenches.
- Includes 1 and 2" bit adapters, 2-3/8" magnetic bit holder, "Y" style bits, couplers, Phillips, pozi, square, slotted, spanner, star, torque, tamper resistant star, hex triwing, clutch head and spline bits.

Phillips	1"	#0, #1, #2 (5), #3
Pozi	1"	#0, #1, #2 (5), #3
Slotted	1"	3, 4, 4.5, 5, 5.5, 6, 6.5, 7, 8mm
Star	1"	T8, T10, T15, T20, T25, T27, T30, T40, T45 (also as Tamper Resistant)
Square	1"	S0, S1, S2, S3
Hex	1"	1/16, 5/64, 3/32, 7/64, 1/8, 9/64, 5/32,
		3/16, 7/32, 1/4"
Tamper Resistant	1"	1.5, 2, 2.5, 3, 4, 5, 5.5, 6, 8mm
		5/32, 9/64, 1/8, 7/64, 3/32, 5/64"
Spline		M5, M6, M8
Spanner		#0, #1, #2, #3
Tri Wing	1"	#1, #2, #3, #4
Four Wing		#6, #8, #10
Clutch		#1, #2, #3

Item #	IP	MP	PKG
W1389	6	12	DBL

45-PC POWER BIT SET

- 27 assorted chrome vanadium bits: Slotted, Phillips, Star, Pozi and Square.
- 1/4" hex adapter.
- 7 chrome vanadium 6 point nut drivers.
- Magnetic Hex extension.
- 5 drill bits, 3 bit holders.

Phillips	2-1/2"	#2, #3 double ended		
	4-1/4"	#2 (3) double ended	4"	#2
Pozi	2-1/2"	#1, #2, #3 double ended		
	4"	#2		
Slotted	1"	3/16, 1/4"		
	1-3/4"	1/4"		
Star	2-1/2"	T10, T15, T20, T25, T30, T40		
Square	2-1/2"	S1, S2		
Hex	1"	1/8, 5/32, 3/16, 1/4"		
Nut Driver		7/32, 1/4, 9/32, 5/16, 3/8, 7/16, 1/2"		
Drill Bits		1/16, 3/32, 1/8, 5/32, 3/16"		

Item #	IP	MP	PKG
W1352	6	12	DBL

25-PC RAPID CHANGE DRILL BIT SET

- Contains: 1 quick change holder, 3 nut drivers, 12 assorted 2" length CRV bits: Phillips and slotted, 7 titanium coated drill bits with hex shank, handy storage case.

Phillips	2"	#1, #2 (3), #3
	6"	#2
Slotted	2"	6-8, 8-10 (2), 10-12
	6"	8-10
Square	2"	S1, S2, S3
Nut Setter	1-1/2"	1/4, 5/16, 3/8"
Drill Bits		1/16, 3/32, 1/8, 5/32,
		3/16, 7/32, 1/4"

Item #	IP	MP	PKG
W1343	6	24	DBL



BIT SETS

75-PC SPECIALTY BIT DRIVER SET

- 75 Specialty bit driver set with the most popular fastener styles so you should be ready to tackle most common jobs.
- Includes 2-1/2" magnetic bit holder, 1/4" and 3/8" socket adapters.

Phillips	1"	#0, (2) #1, #2 (4), #3
	2"	#1, #2 (3), #3
Pozi	1"	#2 (2), #3
Slotted	1"	1/8, 13/64, 7/32, 15/64, 5/16"
	2"	13/64, 15/64"
Star	1"	T8, T9, T10, T15, T20, T15, T20, T25, T27, T30, T35, T40
	2"	T25
TR	1"	T10, T15, T20, T25, T27, T30, T35
Square	1"	S0, S1, S2, S3, S4
	2"	S2, S4 (2)
Hex	1"	1.5, 2, 2.5, 3, 3.5, 4, 4.5, 5, 5.5, 6, 7, 8mm
TR	1"	2, 2.5, 3, 4, 5, 6, 7mm
Spanner	1"	#4, #6, #8, #10

Item #	IP	MP	PKG
W9027	4	24	CAS



Peg hook hanger tab can be pulled out for hanging or pushed flush into the case for compact storage.



2 sided flip case with crystal clear lids so you can easily find the needed bit.

28-PC DRILL BIT & DRIVER SET

- 1/4" driver and titanium drill bit set is well equipped to tackle most common jobs.,
- Includes 1/4" and 3/8" socket adapters .

Phillips	2"	#1, #2 (3), #3
Slotted	2"	13/64, 15/64"
Star	2"	T25
Square	2"	S2
Drill Bits	-	1/16, 1/8, 9/64, 5/32, 11/64, 3/16, 13/64, 7/32, 15/64, 1/4, 9/32, 5/16"

Item #	IP	MP	PKG
W9040	4	24	CAS



117-PC MICRO BIT SET

- Micro screwdriver repair kit is the perfect choice for the electronics enthusiast.
- Additional tools included magnetizer, suction cup, narrow and wide pry bars, triangle prying tool, tweezers, aluminum screwdriver handle with 6cm straight and 13cm flexible extender.

Every bit you might need to open and repair you electronic and small devices.

Phillips	1"	#000 (2), #00 (2), #0 (2), #1 (2), #2 (2)
Pozi	1"	#00 (2), #0 (2), #1 (2), #2 (2), 2.0mm, 3.0mm
Slotted	1"	1.0mm (2), 1.5mm (2), 2.0mm (2), 2.5mm (2), 3.0mm (2), 3.5mm (2), 4.0mm (2), 1/16 (2), 5/64 (2), 3/32 (2), 7/64, 1/8 9/64, 5/32"
		0.8 (2), 1.2mm (2), 1.5mm (2), 2.0mm (2), T3, T4 (2), T5 (2), T6 (2), T7 (2), T8 (2), T9 (2), T10 (2), T15 (2), T20 (2)
Hex	1"	0.7, 0.9, 1.3 (2), 1.5 (2), 2.0 (2), 2.5 (2), 3.0 (2), 3.5, 4.0 (2), 1/16, 5/64, 3/32, 7/64, 1/8, 9/64, 5/32"
Nut Driver	1"	2.5, 3.0, 3.5, 4.0, 4.5, 5.0, 5.5mm
Tri Wing	1"	#2.0, #2.3, #2.7, #3.0
Spanner	1"	#2.6

Item #	IP	MP	PKG
W9041	4	24	CAS

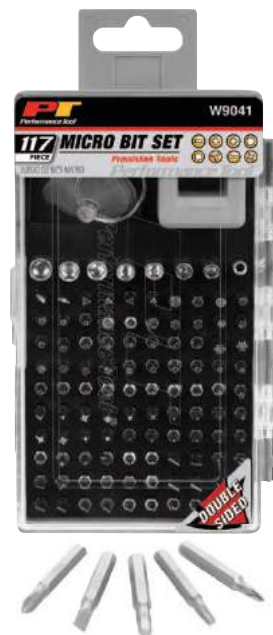

HAND TOOLS

13-PC IMPACT DRIVER BIT SET

- Impact grade S2 steel with black phosphate finish.
- Color coded bits for easy identification.
- Includes quick change bit holder and 3/8" dr. socket adapter.



Phillips	2"	#1, #2
Star	2"	T15, T30
Square	2"	S1, S2
Magnetic Nut Setter	2"	1/4, 5/16, 3/8, 7/16, 1/2"

Item #	IP	MP	PKG
W9025	4	24	CAS
W9179	4	24	CAS/Pg 311



38-PC RATCHETING DRIVER & BIT SET

- Includes 36 popular bits and 1 driver.
- Features forward, reverse and lock positions.
- Compact, stubby design for those hard to reach areas.
- Rubber, cushion grip handle.



Phillips	1"	#0, #1, #2 (2), #3
Pozi	1"	#0, #1, #2 (2), #3
Slotted	1"	3, 4, 5, 6, 7mm
Star	1"	T10, T15, T20, T25, T27, T30, T35, T40
Square	1"	S0, S1, S2, S3
Hex	1"	1/8, 5/32, 3/16, 7/32, 1/4" 2, 3, 4, 5, 6mm

Item #	IP	MP	PKG
W9159	4	24	CAS/Pg 310
20151	3	18	CAS/Pg 321



67-PC BIT SET

- Chrome vanadium construction.
- 1/4" magnetic bit holder.

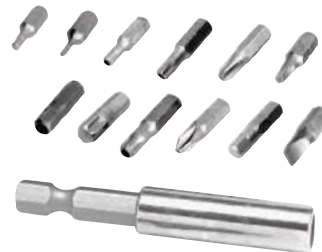

Phillips	1"	#0 (2), #1 (2), #2 (2), #3 (3)
Pozi	1"	#0 (3), #1 (3), #2 (6), #3 (3)
Slotted	1"	3, 4, 4.5, 5, 5.5, 6, 6.5, 7mm
Star	1"	T8, T9, T10, T15, T20, T25, T27, T30, T35, T40
Square	1"	S0, S1, S2, S3
Hex	1"	1/16, 5/64, 3/32, 7/64, 1/8, 9/64, 5/32, 3/16, 7/32, 1/4" 1.5, 2, 2.5, 3, 3.5, 4, 4.5, 5, 5.5, 6mm

Item #	IP	MP	PKG
W9172	4	24	CAS/Pg 310
20145	3	18	CAS/Pg 321



23-PC BIT & SOCKET SET

- Compact stubby design for those hard to reach areas
- Includes 8 sockets, 12 bits, 1/4" dr. rubber cushion grip handle stubby ratchet, 1/4" dr. coupler and 2" extension.



Phillips	1"	#1, #2, #3
Slotted	1"	5/32, 3/16, 1/4"
Star	1"	T15, T20, T25
Hex	1"	5/32, 3/16, 1/4"
Socket	1/4" dr.	3/16, 1/4, 9/32, 5/16, 11/32, 3/8, 7/16, 1/2"

Item #	IP	MP	PKG
20156	3	18	CAS/Pg 321



33-PC PRECISION BIT SET

- Includes bits for various projects, precision screwdriver handle, 1" magnifier and 8" flexible extension shaft.



Phillips	1"	#000, #00, #0, #1
Pozi	1"	#0, #1
Slotted	1"	1.0, 1.5, 2.0, 2.5, 3.0, 3.5, 4.0mm
Star	1"	T4, T5, T6, T7, T8, T9, T10, T15, T20
Hex	1"	0.7, 0.9, 1.3, 1.5, 2.0, 2.5, 3.0, 4.0mm

Item #	IP	MP	PKG
W9178	4	24	CAS/Pg 311
20154	3	18	CAS/Pg 321



HAND TOOLS

BIT SETS

32-PC SECURITY BIT SET

- 3" bits fit most power drills, screw guns and magnetic drivers.
- Set includes the most common tamper proof sizes, including, tri-wing bits, torque bits, spanner bits and hex bits.

Phillips	3"	#1, #2
Pozi	3"	#1, #2, #3
Slotted	3"	1/4"
Star TR	3"	T8, T10, T15, T20, T25, T27, T30, T35, T40
Hex TR	3"	2, 2.5, 3, 4, 5, 6mm
Spanner	3"	#4, #6, #8, #10
Tri Wing	3"	#1, #2, #3, #4
Four Wing	3"	#6, #8, #10

Item #	IP	MP	PKG
W8659	12	24	CRD



33-PC SECURITY BIT SET

- Fits most popular sizes of tamper proof fasteners.
- Top and bottom bit boots.
- Includes 2-1/2" magnetic bit holder.

Star TR	1"	T8, T10, T15, T20, T25, T27, T30, T35, T40
Hex TR	1"	5/56, 3/32, 7/64, 1/8, 9/64, 5/32", 2, 2.5, 3, 4, 5, 6mm
Spanner	1"	#4, #6, #8, #10
Tri Wing	1"	#1, #2, #3, #4
Four Wing	1"	#6, #8, #10

Item #	IP	MP	PKG
W1384	12	72	CRD

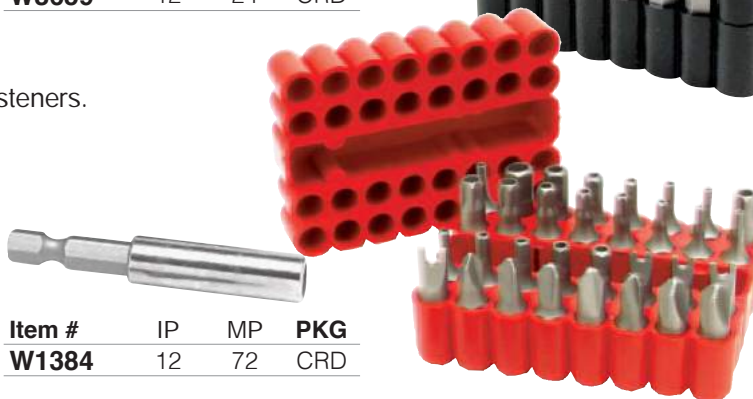

18-PC IMPACT BIT SET

- Interchangeable bit socket system.
- High strength S2 bits with corrosion resistant black nickel finish.
- 3/8" drive adapter.

Phillips	1-1/8"	#2, #3, #4
Slotted	1-1/8"	1/4, 5/16, 3/8"
Star	1-1/8"	T40, T45, T50, T55, T60
Hex	1-1/8"	1/4, 3/8, 5/16, 8, 10, 12mm

Item #	IP	MP	PKG
W38887	12	48	CRD



8-PC STAR BIT SET

- 1/4" hex to 1/4" square drive adapter.
- Heat treated alloy steel.
- Includes storage boot.

Item #	IP	MP	PKG
W1386	6	144	CRD

T10, T15, T20, T25, T27, T30, T40



14-PC BIT DRIVER ACCESSORY SET

- Telescoping screw guide helps drive screws with better accuracy.
- 1/4 and 3/8" socket adapters transform your power drill into a power nut driver
- Chrome vanadium steel construction
- 2-1/4" magnetic bit extension

Phillips	1"	#1, #2, #3
Slotted	1"	3/16", 1/4", 5/16"
Star	1"	T15, T20
Square	1"	S1, S2

Item #	IP	MP	PKG
W474	6	36	CRD/Pg 318

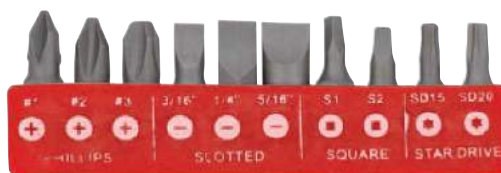
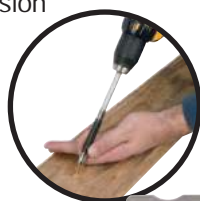

HAND TOOLS

13-PC TAMPER RESISTANT 1 IN. BIT SETS

- Impact grade chrome vanadium bits for strength and durability.
- 1/4 and 3/8" drive bit holders.
- Convenient storage holder with magnetic base.



I	IP	MP	PK	S
W	Blue	8	48	DBL 1.5, 2, 2.5, 3, 4, 5, 5.5, 6, 7, 8, 10mm
W	Red	8	48	DBL 1/16, 3/32, 1/8, 9/64, 5/32, 3/16, 7/32, 1/4, 5/16, 3/8, 7/16"
W	Green	8	48	DBL T8, T10, T15, T20, T25, T27, T30, T40, T45, T50, T55

13-PC TAMPER RESISTANT 2 IN. STAR BIT SET

- Impact grade chrome vanadium bits for strength and durability.
- 1/4 and 3/8" drive bit holders.
- Convenient storage holder with magnetic base.

I	IP	MP	PK	S
W	Green	4	24	DBL T8, T10, T15, T20, T25, T27, T30, T40, T45, T50, T55

17-PC IMPACT STAR BIT SET

- Impact grade chrome vanadium steel
- Heat-treated to resist breakage
- 1/4" bit coupler

I	IP	MP	PK	S
W	4	24	CRD Pg 318	1" T5, T5.5, T6, T7, T8, T9, T10, T15, T20, T25, T27, T30, T40 2" T45, T50, T55



10-PC IMPACT BIT SETS

- Impact grade chrome vanadium steel.
- Heat-treated to resist breakage.

I	IP	MP	PK	S
W	12	144	Pg 316	Phillips #1, #2, #3 Slotted 3/16, 1/4, 9/32" Square S1, S2, S3
W	12	144	Pg 316	Star T8, T10, T15, T20, T25, T27, T30, T40, T45, T50



HAND TOOLS

HEX & STAR KEYS

HEX KEY SETS W/HOLDER

- Black oxide finish resists corrosion.
- Heat treated alloy steel.
- Includes handy organizer.

Item #	IP	MP	PKG
W80280 22-PC SAE/Metric Ball End	6	24	CRD
W80281 25-PC SAE/Metric	6	24	CRD
W1391 12-PC SAE	6	48	CRD
W86102 11-PC SAE	6	72	CRD
W1392 9-PC Metric	6	48	CRD
W86100 10-PC Metric	6	72	CRD

Extended Reach

W1393 12-PC SAE	6	48	CRD
W86101 12-PC SAE	6	48	CRD
W1394 9-PC Metric	6	48	CRD
W86103 9-PC Metric	6	48	CRD

W80281
Plastic holder folds open or separates for versatile storage.



W86102

	Ball End W80280	Standard W80281	Standard W1391	Standard W86101	Long Reach W1393	Long Reach W86102	Key Ring W1109C	Key Ring W1110C
.050"	x	-	x	x	x	x	-	-
1/16"	x	x	x	x	x	x	x	-
5/64"	x	x	x	x	x	x	x	x
3/32"	x	x	x	x	x	x	x	x
7/64"	x	x	x	-	x	-	-	-
1/8"	x	x	x	x	x	x	x	x
9/64"	x	x	x	-	x	-	-	-
5/32"	x	x	x	x	x	x	x	x
3/16"	x	x	x	x	x	x	x	x
7/32"	x	x	x	x	x	x	x	-
1/4"	x	x	x	x	x	x	x	x
5/16"	x	x	x	x	x	x	-	x
3/8"	x	x	-	x	-	x	-	x
-	-	-	W1392	W86100	W1394	W86103	W1108C	W1113C
1.27mm	-	x	-	x	-	-	-	-
1.5mm	x	x	x	x	x	x	x	-
2mm	x	x	x	x	x	x	x	x
2.5mm	x	-	x	x	x	x	x	x
3mm	x	-	x	x	x	x	x	x
4mm	x	x	x	x	x	x	x	x
4.5mm	-	x	-	-	-	-	-	-
5mm	x	x	x	x	x	x	x	x
5.5mm	-	x	-	-	-	-	x	-
6mm	x	x	x	x	x	x	x	x
7mm	-	x	-	-	-	-	-	-
8mm	x	x	x	x	x	x	-	x
10mm	x	x	x	x	x	x	-	x

HAND TOOLS



W86103

Long shank for access to confined areas.

KEY RING HEX KEY SETS

- Tough, chrome plated steel.
- Complete with handy "key ring" style holder to keep wrenches organized.

Item #	IP	MP	PKG
W1109C 8-PC	6	120	CRD
W1110C 8-PC	6	72	CRD
W1108C 8-PC	6	120	CRD
W1113C 8-PC	6	72	CRD
W1315 8-PC	6	60	CRD



Star: T9, T10, T15, T20, T25, T27, T30, T40

10-PC T-HANDLE HEX KEY SET

- Heat treated alloy steel shafts.
- Plastic grips add comfort and turning power.
- Bonus storage tray mounts on wall or bench.



Item #	IP	MP	PKG	Sizes
W80274	1	10	CBX	3/32, 7/64, 1/8, 9/64, 5/32, 3/16, 7/32, 1/4, 5/16, 3/8"



10-PC T-HANDLE HEX KEY SET

- Heat treated alloy steel shafts.
- Plastic grips add comfort and turning power.
- Bonus storage tray mounts on wall or bench.



Item #	IP	MP	PKG	Sizes
W80275	1	10	CBX	2, 2.5, 3, 4, 4.5, 5, 5.5, 6, 8, 10mm



10-PC T-HANDLE STAR KEY SET

- Heat treated alloy steel shafts.
- Plastic grips add comfort and turning power.
- Bonus storage tray mounts on wall or bench.



Item #	IP	MP	PKG	Sizes
W80276	1	10	CBX	T7, T8, T9, T10, T15, T20, T25, T27, T30, T40



10-PC T-HANDLE HEX KEY SET

- Heat treated alloy steel shafts.
- High visibility PVC T-handles for added comfort, identification and torque.
- Red SAE Wrenches and Blue Metric wrenches.
- Bonus storage tray mounts on wall or bench.



Item #	IP	MP	PKG	Red Handle	Blue Handle
W80277	1	10	CBX	1/8, 5/32, 3/16, 5/16, 3/8"	3, 4, 5, 6, 8mm



HAND TOOLS

HEX & STAR KEYS

6-PC JUMBO HEX KEY SETS

- Alloy steel wrenches are heat treated and black-oxide finished.
- Precisely-sized, chamfered ends insert smoothly into fastener head, reducing wear.
- Long arm wrenches provide extra reach and greater torque.



Easy-to-read sizes marked on case for fast wrench selection.



Item #	IP	MP	PKG	Sizes
W1938	Metric	2	8	DBL 8, 10, 12, 14, 17, 19mm
W1939	SAE	2	8	DBL 3/8, 7/16, 1/2, 9/16, 5/8, 3/4"

7-PC T-HANDLE HEX & STAR DRIVER SETS

- Comfortable non-slip molded grips.
- Single piece construction runs through handle for greater strength.
- Chrome plated shafts.



Two drive ends: long end for hard to reach areas, short end for extra torque.



Item #	IP	MP	PKG	Color	Sizes
W1711	6	24	DBL	Red	3/32, 1/8, 5/32, 3/16, 1/4, 5/16, 3/8"
W1712	6	24	DBL	Blue	2.5, 3, 4, 5, 6, 8, 10mm
W1713	6	24	DBL	Green	T10, T15, T20, T25, T27, T30, T40

L-TYPE STAR KEY SET

- Chrome vanadium steel construction.



Item #	IP	MP	PKG	Sizes
W75933	9-PC	6	72	CRD T10, T15, T20, T25, T27, T30, T40, T45, T50
W1319	6-PC	6	24	CRD T40, T45, T47, T50, T55, T60

30-PC HEX KEY SET

- Long and short shank hex keys.
- Alloy steel construction.
- Includes handy organizer.

Item #	IP	MP	PKG	Sizes
W80288	6	12	DBL	.028, .035, .050, .7, .9, 1.3, 1/16, 5/64, 3/32, 1.5, 2, 2.5, 7/64, 1/8, 9/64, 3, 4, 4.5, 5, 5/32, 3/16, 7/32, 5.5, 6, 7, 8, 1/4, 5/16, 3/8" 10 mm



HAND TOOLS

FOLDING HEX/STAR KEYS

- Chrome vanadium steel construction.
- Fold out drivers for compact and convenient uses.
- Color coded for easy identification.



Item #	IP	MP	PKG	Color	Sizes
W80282	6	24	TAB	Red	1/16, 5/64, 3/32, 1/8, 5/32, 3/16, 1/4, 5/16"
W80283	6	24	TAB	Blue	1.5, 2, 2.5, 3, 4, 5, 6, 8mm
W80284	6	24	TAB	Green	T9, T10, T15, T20, T25, T27, T30, T40
W80287	6	24	TAB	3-PC Set	Includes one of each.

3-PC FOLDING BALL/STAR KEY SET

- Lightweight anodized aluminum body and chrome vanadium steel construction for strength and durability.
- Ball end on hex keys allow use at angles up to 25° for obstructed areas.
- Keys conveniently fold for compact easy storage.



Star keys work on regular and tamper proof star fasteners.

Item #	IP	MP	PKG	Color	Sizes
W80291 3-PC	6	24	CLM	Red	1/16, 5/64, 3/32, 1/8, 9/64, 5/32, 3/16, 1/4"
				Blue	1.5, 2, 2.5, 3, 4, 5, 6, 8mm
				Green	T9, T10, T15, T20, T25, T27, T30, T40

8-PC FOLDING STAR BIT SET

- Heat treated alloy steel construction.
- Rust resistant black oxide finish.

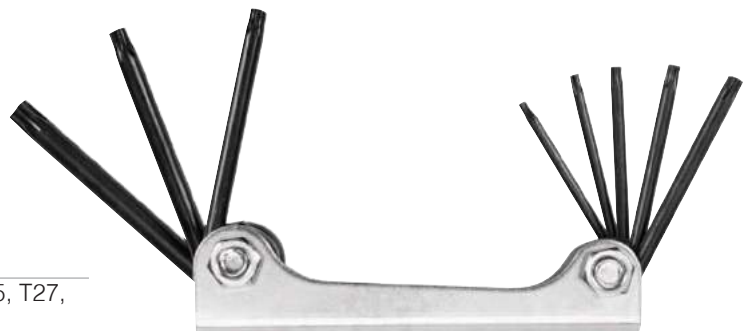

Item #	IP	MP	PKG	Sizes
W1317	6	60	CRD	T9, T10, T15, T20, T25, T27, T30, T40

TOOL SETS

40-PC SOCKET SET

- Ratchet, extension bar, 1/4" spinner handle, spin disc, spark plug socket, adapter and more.
- Sturdy blow molded case.



Item #	IP	MP	PKG
W1173	1	10	SLV
W1541	5	10	SLV

Drive	Sockets	Additional Contents
1/4" 6pt	5/32, 3/16, 7/32, 1/4, 9/32, 5/16, 11/32, 3/8, 13/32, 7/16, 15/32". 4, 4.5, 5, 5.5, 6, 7, 8, 9, 10, 11, 12, 13mm	3/8" Dr. 3" extension, 3/8" (F) to 1/4" (M) adapter
3/8" 6pt	1/2, 9/16, 5/8, 3/4". 14, 16, 17mm	3/8" Dr. 39 gear teeth 6" ratchet,
3/8" 12pt	1/4, 5/16, 3/8"	3/8" Dr. 5/8" spark plug socket

52-PC SOCKET SET

- Ratchet, extension bar, 1/4" spinner handle, spin disc, spark plug socket, adapter and more.
- Sturdy blow molded case.



Item #	IP	MP	PKG
W1172	1	5	SLV

Drive	Sockets	Additional Contents
1/4" 6pt	5/32, 3/16, 7/32, 1/4, 9/32, 5/16, 11/32, 3/8, 13/32, 7/16, 15/32, 1/2" 4, 4.5, 5, 5.5, 6, 7, 8, 9, 10, 11, 12, 13mm	3/8" Dr. 3" extension, 3/8" (F) to 1/4" (M) adapter
1/4" 12pt	1/4, 5/16, 3/8"	3/8" & 1/2" Dr. 39 gear teeth
3/8" 6pt	9/16, 11/16, 3/4". 14, 16, 17mm	6" ratchets, 3/8" Dr. 5/8" & 13/16" spark plug socket
1/2" 6pt	3/8, 7/16, 1/2, 9/16, 5/8, 11/16, 3/4, 25/32, 13/16, 7/8"	

60-PC SOCKET & BIT SET

- 1/4" drive spinner handle, 1/4" drive bit coupler, 1/4" square drive adapter.
- Sturdy blow molded case.

Item #	IP	MP	PKG
W1168	6	12	SLV



Drive	Sockets	Additional Contents
1/4" 6pt	5/32, 3/16, 7/32, 1/4, 9/32, 5/16, 11/32, 3/8, 13/32, 7/16, 15/32", 4, 5, 5.5, 6, 7, 8, 9, 10, 11, 12, 13, 14 mm	3/8" Dr. 3" extension, 3/8" (F) to 1/4" (M) adapter, 3/8" Dr. 39 gear teeth 6" ratchet
3/8" 6pt	1/2, 9/16", 15, 16 mm	
1" Bits	Phillips: #0, #1, #2, #3	Pozi: #1, #2, #3
	Slotted: 3/16, 1/4 & 9/32"	Square: S1, S2, S3
	Star: T10, T15, T20, T25, T30, T40	Hex: 1/8, 5/32, 3/16, 7/32, 4, 5, 6mm

HAND TOOLS

100-PC SOCKET & BIT SET

- Magnetic bit driver and 22 1" bits with holders, 16 hex keys on rings
- Storage / carrying case.

Item #	IP	MP	PKG
W1198	1	5	CBX

Drive	Sockets	
1/4"	6pt	5/32, 3/16, 7/32, 1/4, 9/32, 5/16, 11/32, 3/8", 4, 4.5, 5, 5.5, 6, 6.5, 7, 8, 9, 10mm
3/8"	6pt	3/8, 7/16, 1/2, 9/16, 5/8, 11/16, 3/4", 10, 11, 12, 13, 14, 15, 17 18mm
	Deep	3/8, 7/16, 1/2, 9/16", 10, 11, 12, 13mm
1/2"	6pt	15/8, 11/16, 3/4, 13/16, 7/8", 14, 15, 17, 18, 19mm
1" Bits		Phillips: #1, #2, #3
		Slotted: 5/32, 3/16, 1/4, 7/32, 9/32, 5/16"
		Pozi: #1, #2, #3
Hex Keys		Star: T15, T20, T25, T27, T30, T40
		Hex: 5/32, 3/16, 7/32, 1/4"
		Hex: 1/16, 5/64, 3/32, 1/8, 5/32, 3/16, 7/32, 1/4", 1.5, 2, 2.5, 3, 4, 5, 5.5, 6mm



MECHANICS
Products

85-PC SOCKET SET

- Drop forged chrome plated carbon steel.
- Wide range of SAE and Metric sockets in 3 drive sizes.
- Ratchet, extension bar, 1/4" spinner handle, spin disc, spark plug socket, adapter and hex keys.
- Sturdy blow molded case.

Item #	IP	MP	PKG
W1183	1	5	SLV

Drive	Sockets	
1/4"	6pt	5/32, 3/16, 7/32, 1/4, 9/32, 5/16, 11/32, 3/8, 13/32, 7/16, 15/32, 1/2, 17/32, 9/16", 4, 4.5, 5, 5.5, 6, 6.5, 7, 8, 9, 10, 11, 12, 13, 14mm
	8pt	1/4, 5/16, 3/8"
3/8"	6pt	7/16, 15/32, 1/2, 9/16, 5/8, 11/16", 11, 12, 13, 14, 15, 17mm
1/2"	6pt	11/16, 3/4, 13/16, 7/8
1" Bits		Phillips: #0, #1, #2
		Slotted: 5/32, 3/16, 1/4"
		Star: T15, T20, T30
Hex Keys		3/8" Dr. 3" extension,
		3/8" (F) to 1/4" (M) adapter
		3/8" Dr. 39 gear teeth 6" ratchet,
	3/8" Dr. 5/8" spark plug socket	
	1/2" Dr. 39 gear teeth 8" ratchet	
	Hex Keys	1/16, 5/64, 3/32, 1/8, 5/32, 3/16, 1/4, 5/16, 3/8", 1.5, 2, 2.5, 3, 4, 5, 6, 8, 10mm



MECHANICS
Products

HAND TOOLS

TOOL SETS

119-PC TOOL SET

- Set includes 8" wire crimper, 12V circuit tester, 44 wire terminals set, 3/4" x 30' electrical tape, brass detail brush, break-away utility knife, magnetic bit driver, and durable blow molded storage case

Drive	Sockets	Additional Contents
1/4"	6pt 1/4, 9/32, 5/16, 11/32", 7, 8, 9, 10mm	3/8" dr. accessories: ratchet, 3" extension, u-joint, 3/8 (F) to 1/4" (M) adapter, spark plug sockets 5/8", 13/16"
3/8"	6pt 3/8, 7/16, 1/2, 9/16, 5/8, 11/16, 3/4", 11, 12, 13, 14, 15, 16, 17, 18, 19mm	
Wrenches	3/8, 7/16, 1/2, 9/16, 5/8"	10, 12, 13, 14, 15mm
Pliers	6" adjustable wrench, 6" diagonal, 5" long nose	
Screwdrivers	#1 x 3", #2 x 4", 3/16 x 4"	
1" Bits	Phillips: #1, #2, #3	Slotted: 3/16, 1/4, 9/32"
	Star: T10, T15, T20	Square: S1, S2, S3
	Hex: 1/8, 5/32, 3/16, 7/32" 4, 5, 6mm. 1/4" hex adapter	

Item #	IP	MP	PKG
W1193	1	5	CBX

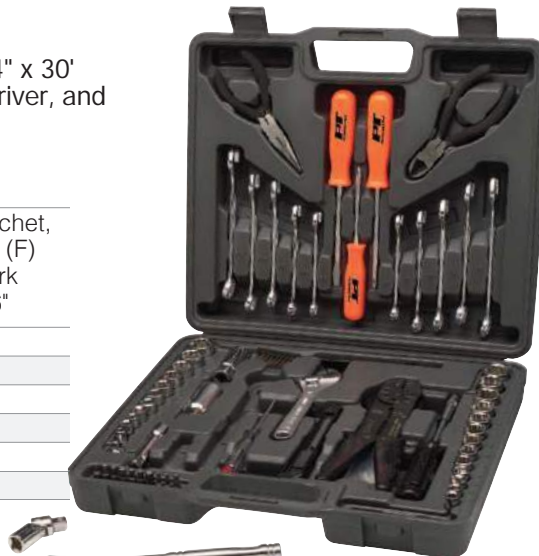

38-PC COMPACT AUTO TOOL KIT

- Set includes breakaway utility knife, brass detail brush, compact flashlight, tire gauge, 12 volt tester, 3/4" x 30' electrical tape and handy zipper case.

Drive	Sockets
1/4"	6pt 3/16, 7/32, 1/4, 9/32, 5/16, 11/32, 3/8, 7/16, 1/2", 5, 6, 7, 8, 9, 10, 11, 12, 13mm
1" Bits	Phillips #1, #2, Slotted 4, 5.5, 7mm
	Star T10, T15, T20, T25 1/4" hex adapter
Pliers	6" slip joint, 6" adjustable wrench
Driver	1/4" dr spinner handle, 1/4" dr. coupler

Item #	IP	MP	PKG
W1197	6	24	SLV



45-PC STUBBY SET

- Dual drive ratchet: 1/4" and 3/8" drives in one ratchet.
- Ratcheting screwdriver: clockwise, counter clockwise and locking positions.
- Stubby adjustable wrench has 1" rule on head for precision adjustments.
- Alloy steel construction for strength and durability.
- Comfortable cushion grip handles.
- Adapters and extension.

Drive	Sockets	Additional Contents
1/4"	6pt 5/32, 3/16, 7/32, 1/4, 9/32, 5/16, 11/32, 3/8, 7/16, 1/2", 4, 4.5, 5, 6, 7, 8, 9, 10, 11, 12mm	3/8" dr. accessories: ratchet, 3" extension, 3/8" (F) to 1/4" (M) adapter
3/8"	6pt 9/16, 5/8, 3/4", 13, 14, 15, 17mm	
Wrench	8" stubby adjustable wrench	
1" Bits	Phillips: #1 (2), #2 (2), #3	Slotted: #1 (2), #2 (2), #3
	Star T10, T15	Hex: 1/8, 1/4"



Item #	IP	MP	PKG
W39000	6	12	RAC

HAND TOOLS

94-PC MECHANICS PRODUCT TOOL SET

- 3/8" drive reversible ratchet, SAE and metric sockets and accessories. pliers, adjustable wrench, screwdrivers, magnetic bit driver, assorted hex bits and hex key wrenches and heavy duty case for organized storage.

Drive	Sockets	Additional Contents
1/4" 6pt	5/32, 3/16, 7/32, 1/4, 9/32, 5/16, 11/32, 3/8, 13/32, 7/16, 15/32, 17/32, 1/2, 9/16", 4, 4.5, 5, 5.5, 6, 6.5, 7, 8, 9, 10, 11, 12, 13, 14mm	3/8" dr. accessories: ratchet, 3" extension, 3/8 (F) to 1/4" (M) adapter, 5/8" spark plug socket
3/8" 6pt	3/8, 7/16, 15/32, 1/2, 9/16, 5/8", 11, 12, 13, 14, 15, 16mm	
Pliers	6" long nose, 6" adjustable wrench	
Screwdriver	#2 x 3", 1/4 x 4"	
1" Bits	Phillips: #1, #2, #3	Slotted: 3/16, 1/4, 9/32
	Star: T10, T20	Square: S1, S2
	Hex: 3/32, 1/8, 5/32, 3/16, 1/4"	Hex: 2.5, 3, 4, 5, 6mm
Hex Keys	.05, 1/16, 5/64, 3/32, 1/8, 9/64, 5/32, 3/16, 7/32, 1/4"	
	1.27, 1.5, 2, 2.5, 3, 3.5, 4, 4.5, 5, 5.5, 6mm	

Item #	IP	MP	PKG
W1538	1	4	LAB



107-PC HOME & AUTO TOOL SET

- 3/8" drive reversible ratchet. SAE and metric sockets and accessories, pliers, wrenches, bit driver hammer, tape measure, knife, adjustable wrench, precision screwdrivers, hex key wrenches, 50 piece fastener assortment and heavy duty case for organized storage.

Drive	Sockets	Additional Contents
1/4" 6pt	5/32, 3/16, 7/32, 1/4, 9/32, 5/16, 11/32, 3/8, 13/32, 7/16, 15/32, 17/32, 1/2", 4, 4.5, 5, 5.5, 6, 7, 8, 9, 10, 11, 12, 13mm	3/8" dr. accessories: ratchet, 3" extension, 3/8 (F) to 1/4" (M) adapter
12pt	1/4, 5/16, 3/8"	
3/8" 6pt	9/16, 5/8", 14, 16mm	
Pliers	6" long nose, 6" adjustable wrench	
Wrenches	1/4, 5/16, 3/8, 7/16, 1/2"	
Screwdriver	#0, #1, #2, #3, 1.4, 2.0, 2.4, 3.0mm	
1" Bits	Phillips: #0, #1, #2, #3	Pozi: #1, #2, #3
	Slotted: 5/32, 3/16, 1/4, 9/32"	Square: S1, S2, S3
	Star: T10, T15, T20, T25, T27, T30, T40	
Hex Keys	3/32, 1/8, 5/32, 3/16, 7/32, 1/4"	
	0.05, 1/16, 5/64, 3/32, 7/64, 1/8, 9/64, 5/32, 3/16, 7/32, 1/4"	
	1.27, 1.5, 2, 2.5, 3, 3.5, 4, 4.5, 5, 5.5, 6mm	

Item #	IP	MP	PKG
W1532	1	4	CBX



75-PC HOMEOWNERS TOOL SET

- 8 oz. steel hammer with rubber grip. 2 screwdrivers, 6 precision screwdrivers, 12" tape measure, snap-blade Knife, torpedo level, assorted fastener kit and storage/carrying case.



Item #	IP	MP	PKG	Screwdrivers	Precision
W1543	1	10	SLV	#2 X 4" 1/4 x 4"	#0, #00, #000 1/16, 3/32, 1/8"

HAND TOOLS



125-PC SOCKET & WRENCH TOOL SET

- Extremely versatile set for repairs around your home, auto, garage, workshop, R.V. or boat.
- Set features: ratchets, SAE and metric sockets with accessories, screwdrivers, wrenches, pliers, hex key sets, bit driver with bits and much more.

Item #	IP	MP	PKG
W1525	1	4	CBX

Drive		Sockets	
1/4"	6pt	5/32, 3/16, 7/32, 1/4, 9/32, 5/16, 11/32, 3/8", 4, 4.5, 5, 5.5, 6, 6.5, 7, 8, 9, 10mm	1/2" dr. & 3/8" dr. ratchet, 3" extension, 3/8 (F) to 1/4" (M), 1/2 (F) to 3/8" (M) adapters, spark plug sockets 5/8", 13/16"
3/8"	6pt	3/8, 7/16, 1/2, 9/16, 5/8, 11/16, 3/4"	
	Deep	3/8, 7/16, 1/2, 9/16", 10, 11, 12, 13mm	
1/2"	Deep	5/8, 11/16, 3/4, 13/16, 7/8" 14, 15, 17, 18, 19mm	
Wrenches		1/4, 5/16, 3/8, 7/16, 1/2, 9/16, 5/8, 11/16, 3/4" 9, 10, 11, 12, 13, 14, 15, 16, 17mm	
1" Bits		Phillips: #1, #2, #3	Pozi: #1, #2, #3
		Slotted: 5/32, 3/16, 1/4, 7/32, 5/16"	
		Star: T15, T20, T25, T27, T30, T40	
Hex Keys		.05, 1/16, 5/64, 3/32, 7/64, 1/8, 9/64, 5/32, 3/16, 7/32, 1/4"	
		1.27, 1.5, 2, 2.5, 3, 3.5, 4, 4.5, 5, 5.5, 6 mm	

123-PC MECHANIC'S TOOL SET

- Comprehensive selection of tools including sockets, wrenches, pliers, screwdrivers, hex keys, 1/4" square drive adapter, bit storage boots, ratcheting bit driver, 4-in-1 screwdriver with 2 bits and blow molded storage/carrying case.

HAND TOOLS



Drive		Sockets	
1/4"	6pt	5/32, 3/16, 7/32, 1/4, 9/32, 5/16, 11/32, 3/8, 7/16", 4.5, 5, 6, 7, 8, 9, 10, 11, 12mm	3/8" dr. ratchet, 3" extension, 3/8 (F) to 1/4" (M) adapter
3/8"	12pt	3/8, 7/16, 1/2, 9/16, 5/8, 3/4", 10, 12, 13, 14, 17, 19mm	
Pliers		6" long nose, 6" diagonal, 8" adjustable	
Wrenches		3/8, 7/16, 1/2, 9/16, 5/8" 10, 12, 13, 14, 15mm	
Screwdriver		#1 x 3", #2 x 4", 3/16 x 3", 1/4 x 4"	
Precision		#00, #0, #1, 1.6mm, 2.4mm x 2"	
1" Bits		Phillips: #0, #1, #2, #3	Slotted: 1/8, 5/32, 3/16, 1/4"
		Star: T15, T20, T25, T27, T30, T40	Square: S1, S2, S3
Hex Keys		Hex: 3/32, 1/8, 5/32", 3, 4, 5, 6, 7mm 1/16, 5/64, 3/32, 1/8, 5/32, 3/16, 7/32, 1/4", 1.5, 2, 2.5, 3, 4, 5, 5.5, 6mm	

Item #	IP	MP	PKG
W1801	1	3	CBX



265-PC TOOL SET

- Fully polished 3/8" drive pro style ratchet. Magnetic bit driver with 20 pc bit set with holders. Stainless steel scissors. Wire crimper with 44 assorted terminals in storage box. Detail brush, break-away knife, electrical tape, 10 ft. tape measure.

Item #	IP	MP	PKG
W1519	1	5	CBX

Drive	Sockets
1/4" 6pt	1/4, 9/32, 5/16, 11/32", 7, 8, 9, 10mm
3/8" 6pt	3/8, 7/16, 1/2, 9/16, 5/8, 11/16, 3/4", 11, 12, 13, 14, 15, 16, 17, 18, 19mm
Pliers	6" long nose, 6" diagonal, 6" adjustable wrench
Wrenches	7/16, 1/2, 9/16, 5/8", 10, 12, 13, 14, 15mm
1" Bits	Phillips: #1, #2, #3 Star: T10, T15, T20 Hex: 1/8, 5/32, 3/16, 7/32", .4, 5, 6mm
	3/8" dr. ratchet, 3" extension, 3/8 (F) to 1/4" (M) adapter, spark plug sockets 5/8", 13/16"
	Slotted: 3/16, 1/4, 9/32"
	Square: S1, S2, S3

157-PC HOMEOWNER'S

- Set contains 13 oz. claw hammer with fiberglass handle, 3 vial aluminum level, 2 lbs. magnetic pickup tool, magnetic bit driver with 3" shaft, 2-3/8" magnetic bit extension, 1/4" square drive socket adapter and blow molded storage case.

Drive	Sockets
1/4" 6pt	5/32, 3/16, 7/32, 13/32, 7/16, 15/32, 1/2, 17/32, 9/16", 4, 4.5, 5, 5.5, 6, 6.5, 7, 8, 9, 10, 11, 12, 13, 14mm
3/8" 12pt	1/4, 5/16, 3/8"
Pliers	6" long nose, 6" linesman, 8" adjustable
Wrenches	3/8, 7/16, 1/2, 9/16, 5/8" 10, 12, 13, 14, 15mm
Screwdriver Precision	#1 x 3", #2 x 4", 1/4 x 3", 3/16 x 4", 1/4 x 4" 1.0, 1.2, 1.6, 2.0mm x 2"
1" Bits	Phillips: #0, #1, #2, #3 Star: T10, T15, T20, T25 Hex: 3/32, 1/8, 5/32, 3/16, 7/32" 2, 3, 4, 5, 6mm
Hex Keys	1/16, 5/64, 3/32, 1/8, 5/32, 3/16, 7/32, 1/4" 1.5, 2, 2.5, 3, 4, 5, 5.5, 6mm
Nut Setter	3/16, 7/32, 1/4, 9/32, 5/16, 3/8, 7/16" 5, 6, 7, 8, 9, 10, 11mm
Drill Bits	1/16, 5/64, 3/32, 7/64, 1/8, 9/64, 5/32, 11/64, 3/16, 13/64, 7/32, 15/34, 1/4"

Item #	IP	MP	PKG	Gauge ruler
W1802	1	3	CBX	0.51, 0.61, 0.71, 0.81, 0.91, 1.02mm



HAND TOOLS

DRILL BIT SETS

204-PC DRILL BIT SET

- Unique four panel case folds three ways. use with power drill, press or bit drivers.
- Set features: Drill bits, titanium coated drill bits, pilot drill bits, wood boring drill bits, flat wood bits, masonry drill bits.
- Also contains nut drivers, drill stoppers, cupped nail setters, center punch, counter sink, screw finders, steel drill gauge, bit holder and hex key.



HSS BITS	Twist	3/64, 1/16, 5/64, 3/32, 7/64, 1/8, 9/64, 5/32 (4), 3/16, 13/64, 7/32, 15/64, 1/4, 17/64, 9/32, 5/16, 11/32, 3/8"
	Black	
	Twist Titanium	3/64, 1/16, 5/64, 3/32, 1/8, 9/64 (5), 7/64, 5/32 (6), 13/64 (2), 11/64, 7/32, 15/64, 1/4, 17/64, 9/32, 5/16"
SPECIALTY BITS	Pilot	5/64, 7/64, 5/32"
	Wood Boring	5/32 (2), 3/16, 1/4, 9/32, 5/16, 11/32, 3/8"
	Flat Wood	3/8, 1/2, 5/8, 3/4, 7/8, 1-1/4"
	12" Flat Wood	5/16, 3/8, 1/2, 9/16"
	Masonry	1/8, 5/32, 11/64, 3/16, 7/32, 15/64, 1/4, 17/64, 5/16, 11/32, 3/8"
	12" Masonry	5/16, 3/8, 1/2"
1" & 2" Bits	Hole Saw	1-1/4, 1-1/2, 1-3/4, 2-1/8"
	Phillips	#0, #1, #2, #3. 2" Bits: #0, #1, #2 (2), #3
	Pozi:	#1, #2, #3
	Slotted	1/8, 3/16, 1/4, 5/16" 2" Bits: 1/8, 5/32, 3/16, 7/32, 1/4, 9/32, 5/16
	Star	T10, 15, 20, 25, 27, 30 2" Bits: T10, 15, 20, 25, 27, 30, 40, 45
	Square	S1, S2
Other	Hex	3/16, 1/4, 5/16, 3/8", 6, 7, 8, 10mm
	Nut Driver	5/32, 3/16, 7/32, 1/4, 9/32, 5/16, 11/32, 3/8, 7/16, 1/2"
	Drill Stopper	7/64, 13/64, 5/16"
	Nail Setter	1/16, 3/32, 1/8"
	Punch	1/32"

Item #	IP	MP	PKG
W1368	1	4	CBX

T-HANDLE DRILL & BIT SET

- For wood, metal and masonry.
- Includes T-handle, 2-3/8" magnetic bit holder and mini-bubble level.

Drill Bits	5/64, 1/8, 5/32, 3/16, 15/64, 5/16"
Masonry	3/16, 1/4, 1/4, 5/16, 5/16, 3/8"
Brad Point	5/32, 3/16, 15/64, 5/16, 3/8"
Phillips	1" #0, #1, #2 (2), #3
Pozi	1" #1, #2, #3
Slotted	1" 1/8, 5/32, 3/16, 1/4, 9/32"
Star	1" T10, T15, T20, T25, T27, T30, T35, T40
Square	1" S1, S2, S3
Hex	1" 3, 4, 5 (2), 6mm (2)

Item #	IP	MP	PKG
W125	6	24	CAS



6-PC SPADE BIT SET

- Hardened steel with precision machined cutting edges.
- Hex shanks help reduce slipping in drill chuck.

Item #	IP	MP	PKG	Sizes
W8694	6	36	CRD	3/8, 1/2, 5/8, 3/4, 7/8, 1"



21-PC TITANIUM DRILL BIT SETS

- Assorted bit sizes from 1/16" to 3/8".
- Great for drilling plastic, wood and metal.
- Handy storage case.

Item #	IP	MP	PKG	Coating	Sizes	
W9016	21-PC	6	24	CAS	Titanium	
W9018	21-PC	4	24	CAS		
W9019	21-PC	4	24	CAS	Black	1/16, 5/64, 3/32, 7/64, 1/8, 9/64, 5/32, 11/64, 3/16, 13/64, 7/32, 15/64, 1/4, 17/64, 9/32, 19/64, 5/16, 21/64, 11/32, 23/64, 3/8"
W9014	13-PC HSS	12	48	CAS	Black	1/16, 5/64, 3/32, 7/64, 1/8, 9/64, 5/32, 11/64, 3/16, 13/64, 7/32, 15/64, 1/4"



29-PC TITANIUM COATED DRILL BIT SET

- Durable titanium nitride coated high speed steel.
- Sizes: 1/16" through 1/2" in 64th increments.
- Handy steel storage box included.

Item #	IP	MP	PKG	Sizes
W9017	1	12	CBX	1/16, 5/64, 3/32, 7/64, 1/8, 9/64, 5/32, 11/64, 3/16, 13/64, 7/32, 15/64, 1/4, 17/64, 9/32, 19/64, 5/16, 21/64, 11/32, 23/64, 3/8, 25/64, 13/32, 27/64, 7/16, 29/64, 15/32, 31/64, 1/2"



6-PC HEX SHANK DRILL BIT SET

- 1/4" hex shanks prevent slippage in drill chuck.
- High speed steel with 135° angle tips.
- Use for metal, wood, or plastic.

Item #	IP	MP	PKG	Sizes
W8692	6	72	CRD	1/16, 3/32, 7/64, 1/8, 5/32, 1/4"



STEP DRILL SET

- Titanium nitride coated high speed steel.
- For use with metal, wood and plastic.
- Starts on contact, no center punch needed.
- Automatically deburrs holes as you drill.
- 1/4" hex shank.

Item #	IP	MP	PKG	Steps	Sizes	
W9003	3-PC	10	80	CLM	6	3/16, 1/4, 5/16, 3/8, 7/16, 1/2"
					9	1/4, 5/16, 3/8, 7/16, 1/2, 9/16, 5/8, 11/16, 3/4"
					12	1/8, 5/32, 3/16, 7/32, 1/4, 9/32, 5/16, 11/32, 3/8, 13/32, 7/16, 15/32, 1/2"
W9004	2-PC	12	48	CLM	11	1/4, 25/64, 35/64, 11/16, 13/16, 7/8, 1, 1-1/8, 1-7/32, 1-1/4, 1-3/8"
					12	3/16, 1/4, 5/16, 3/8, 7/16, 1/2, 9/16, 5/8, 11/16, 3/4, 13/16, 7/8"



HAND TOOLS

DRILL BITS & THREAD REPAIR

TITANIUM DRILL BITS

- Durable titanium nitride coated high speed steel.
- Great for drilling plastic, wood and metal.

Drill Bit	Item #	IP	MP	PKG	Tap & Drill Bit		Extractor & Drill Bit		
					IP: 5	MP: 240	IP: 5	MP: 120	
1/16"	W8561	2-PK	5	240	CRD	-	-	-	-
5/64"	W8562	2-PK	5	240	CRD	-	-	W8663	#1
3/32"	W8563	2-PK	5	240	CRD	-	-	-	-
7/64"	W8564	2-PK	5	240	CRD	-	-	W8664	#2
1/8"	W8565	2-PK	5	240	CRD	-	-	-	-
9/64"	W8566		5	240	CRD	-	-	-	-
5/32"	W8567		24	240	CRD	-	-	W8665	#3
3/16"	W8569		5	240	CRD	-	-	-	-
13/64"	W8570		5	240	CRD	W8630	1/4"-20 NC	-	-
7/32"	W8571		5	240	CRD	-	-	-	-
1/4"	W8573		5	240	CRD	-	-	-	-
17/64"	W8574		5	240	CRD	W8632	5/16"-18 NC	-	-
9/32"	W8575		5	240	CRD	W8633	5/16"-24 NF	-	-
19/64"	-	-	-	-	-	-	-	W8667	#5
5/16"	W8577		24	240	CRD	-	-	-	-
21/64"	W8578		5	240	CRD	-	-	-	-
11/32"	W8579		5	240	CRD	-	-	-	-
3/8"	W8581		5	240	CRD	W8636	7/16"-14 NC	-	-
25/64"	W8582		5	240	CRD	W8637	7/16"-20 NF	-	-
13/32"	W8583		5	240	CRD	-	-	W8668	#6
7/16"	W8585		5	240	CRD	-	-	-	-
29/64"	-	-	-	-	-	W8639	1/26"-20 NF	-	-
1/2"	W8589		5	240	CRD	-	-	-	-
5.0mm	-	-	-	-	-	W8615	6mm X 1	-	-
6.8mm	-	-	-	-	-	W8617	8mm X 1.25	-	-
8.8mm	-	-	-	-	-	W8618	10mm X 1.25	-	-
12mm	-	-	-	-	-	W8662	12mm X 1.25	-	-



10-PC SCREW EXTRACTOR SET

- Reverse threaded drill bits for tapping broken or stripped screws.
- Multi-fluted, machined alloy extractors for screw removal.
- Includes durable metal storage box.

Item #	IP	MP	PKG	Reverse Bits	Extractors
W8697	6	36	CRD	5/64, 7/64, 5/32, 1/4, 19/64"	#1, #2, #3, #4, #5

13-PC LEFT HANDED DRILL BIT SET

- 135 degree split point design for drilling of most metals.
- High speed M2 steel with Titanium Nitride coating for long lasting quick drilling.
- Useful for extracting broken screws and studs.
- Comes with metal storage case.

Item #	IP	MP	PKG	Sizes
W9011	10	60	CRD	1/16", 5/64", 3/32", 7/64", 1/8", 9/64", 5/32", 11/64", 3/16", 13/64"



HAND TOOLS

40-PC TAP & DIE SETS

- High quality carbon steel for precision cutting and durability.
- Sets Include: 17 taps and 17 dies, tap wrench, T-handle tap wrench, die stock, screwdriver and screw pitch gauge.
- Blow molded plastic storage case.



NC = National Coarse
NF = National Fine
NPT = National Pipe Thread

Item #	IP	MP	PKG	Sizes
W4001DB	1	10	SLV	4-40 NC, 6-32 NC, 8-32 NC, 10-24 NC, 10-31 NF, 12-24 NC, 1/4"-20 NC, 1/4"-28 NF, 5/16"-18 NC, 5/16"-24 NF, 3/8"-16 NC, 3/8"-24 NF, 7/16"-14 NC, 7/16"-20 NF, 1/2"-13 NC, 1/2"-20 NF, 1/8"-27 NPT
W4002DB	1	10	SLV	M3 x 0.5, M3 X 0.6, M4 x 0.7, M5 x 0.8, M5 x 0.9, M6 x 0.75, M6 x 1.0, M7 x 0.75, M7 x 1.0, M8 x 1.0, M8 x 1.25, M10 x 1.25, M10 x 1.5, M12 x 1.5, M12 x 1.75, 1/8" NPT

6-PC TAP WRENCH KITS

- Cuts and renews internal threads for standard pipe sizes.
- Wrench features dual holding jaws for large and small sized taps.
- Movable t-handle provides additional leverage.
- Tungsten steel for strength and durability.
- Great for thread maintenance, repair work, and re-threading.
- T-handle with positive grip chuck.

Item #	IP	MP	PKG	Sizes
W8651	6	36	CRD	1/4"-20 NC, 5/16"-18 NC, 3/8"-16 NC, 7/16"-14 NC, 1/2"-13 NC
W8652	6	36	CRD	M6 x 1, M7 x 1, M8 x 1.25, M10 x 1.5, M12 x 1.75



T-HANDLE TAP WRENCHES

Item #	IP	MP	PKG	Range
W8654	5	120	CRD	
W8669	5	120	CRD	1/4 to 1/2"

5-PC TAPERED EXTRACTOR SET

- Removes broken studs, screws, bolts, pipes and pipe fittings.
- Chrome vanadium steel.
- Features flutes for more positive grip.

Item #	IP	MP	PKG	Sizes
W80562	12	120	CRD	1/8, 3/16, 15/64, 5/16, 3/8"
W8605	5	120	CRD	#1, #2, #3, #4, #5



BOLT & SCREW EXTRACTORS

8-PC SCREW EXTRACTOR SET

- Use with T-handle or wrench to remove broken and stripped screws.
- Drop forged, heat treated carbon steel for long life.
- Tapered counter clockwise threads.
- Comes with blow mold storage case.

	Pre-Drill Size	Square Drive	Overall Length	Screw or bolt size to be removed		
				SAE	Metric	Pipe
#1	5/64"	1/8"	2"	3/32 - 5/32"	2.5 - 4mm	No. 6
#2	7/64"	5/32"	2-1/4"	5/32 - 7/32"	4 - 6mm	No. 12
#3	5/32"	7/32"	2-1/2"	7/32 - 9/32"	6 - 8mm	No. 14
#4	1/4"	1/4"	2-15/16"	9/32 - 3/8"	8 - 10mm	1/8" NPT
#5	19/64"	11/32"	3-1/8"	3/8 - 5/8"	10 - 16mm	1/4" NPT
#6	13/32"	15/32"	3-1/2"	5/8 - 7/8"	16 - 22mm	3/8" NPT
#7	17/32"	9/16"	3-3/4"	7/8 - 1-1/8"	22 - 27 mm	1/2" NPT
#8	13/16"	3/4"	4"	1-1/8 - 1-3/8"	27 - 36mm	3/4" NPT



Item #	IP	MP	PKG
W2968	12	24	CRD

5-PC SCREW EXTRACTOR SET

- Removes damaged screws, broken studs, set screws and pipe fittings.
- Hardened alloy steel construction.
- Includes storage case.

	Pre-Drill Size	Square Drive	Overall Length	Screw or bolt size to be removed		
				SAE	Metric	Pipe
#1	5/64"	1/8"	2"	3/32 - 5/32"	2.5 - 4mm	No. 6
#2	7/64"	5/32"	2-1/4"	5/32 - 7/32"	4 - 6mm	No. 12
#3	5/32"	7/32"	2-1/2"	7/32 - 9/32"	6 - 8mm	No. 14
#4	1/4"	1/4"	2-15/16"	9/32 - 3/8"	8 - 10mm	1/8" NPT
#5	*17/64" 19/64"	11/32"	3-1/8"	3/8 - 5/8"	10 - 16mm	1/4" NPT

* 17/64 available in W2965 only

Item #	IP	MP	PKG
W2965	6	120	CRD
W2966	12	24	CRD Chrome Moly



W2965



W2966

5-PC BOLT EXTRACTOR SET

- Heat treated high strength steel.
- Removes bolts without wedging or binding.
- Works on left or right threaded bolts.

	Screw Size	Drill Size	Square Drive	Overall Length
#1	1/4"	1/8"	1/4"	1-1/2"
#2	5/16"	11/64"	1/4"	1-1/2"
#3	3/8"	15/64"	19/64"	1-1/2"
#4	7/16"	9/32"	5/16"	1-1/2"
#5	1/2"	3/8"	3/8"	1-1/2"



Item #	IP	MP	PKG
W80635	6	72	CRD

BLK: Bulk | CAS: Storage Case | CBX: Color Box | CRD: Carded | CLM: Clamshell | DBL: Double Blister
LAB: Color Label | RAC: Storage Rack | SHK: Shrink Wrap | SLV: Sleeve | TAB: Hang Tab | WBX: White Box

5-PC DEEP BOLT EXTRACTOR SET

- Patented gripping edges remove old, stripped, rusted or painted nuts and bolts.
- Deep wall sockets for hard to reach fasteners, exposed studs and recessed nuts/bolts.
- Chrome molybdenum steel for strength and durability.
- Storage/carrying case.
- Use with a 3/8" drive tool.



Item #	IP	MP	PKG	Sizes
W38920	6	24	CLM	3/8" (10mm), 7/16" (11mm), 1/2" (13mm), 9/16" (14mm), 5/8" (16mm)

5-PC BOLT EXTRACTOR SETS

- Chrome molybdenum steel for strength and durability.
- Use with a 3/8" drive tool.



W38919
Features additional storage for 5-pc add-on set W38918.



Item #	IP	MP	PKG	Sizes
W38918	6	48	CLM	5/16" (8mm), 3/8" (10mm), 1/2" (13mm), 11/16", 3/4" (19mm)
W38919	6	24	CLM	7/16" (11mm), 12mm, 9/16" (14mm), 15mm, 5/8" (16mm)

9-PC BOLT EXTRACTOR SETS

- Chrome molybdenum steel for strength and durability.
- Storage/carrying case.
- Use with a 3/8" drive tool.



Item #	IP	MP	PKG	Sizes
W38916	6	24	CRD	1/4, 5/16, 3/8, 7/16, 1/2, 9/16, 3/4, 11/16, 5/8"
W38917	6	24	CRD	8, 10, 11, 12, 13, 14, 16, 17, 19mm

HAND TOOLS

EXTRACTORS

4-PC STUD PULLER SET

- Quickly and easily removes right or left threaded studs with no damage to threads.
- Turn with 3/8" or 1/2" square drive tool or 13/16" wrench.
- Chrome vanadium steel construction.
- For hand use only.



Item #	IP	MP	PKG	3/8" Dr.	1/2" Dr.
W89413	6	24	CRD	1/4", 5/16"	3/8", 7/16"
W89414	6	24	CRD	6, 8mm	10, 12mm

STUD EXTRACTOR

- Stud Extractor is used to remove seized or broken studs and bolts.
- Designed to fit into small areas, where studs may be hard to reach.
- Use on a low setting with your 3/8" impact gun.
- Remove stripped, rusted, broken, or smooth studs.
- Hex shaft can be used with a wrench, ratchet, or impact tool and socket.



Item #	IP	MP	PKG	Capacity
W83203	6	36	DBL	1/4 to 1/2" (6 to 12mm)

STUD EXTRACTOR

- For removing broken or seized studs, bolts, etc from 1/4" to 3/4" diameter.
- Knurled roller uses cam action to grasp stud firmly while minimizing damage.
- Use 1/2" drive ratchet.



Item #	IP	MP	PKG	Capacity
W83202	6	24	CRD	1/4 to 3/4"

HEAVY DUTY NUT SPLITTER

- Removes rusted, stripped and stubborn nuts.
- Self centering wobble tip.
- Offset design for easier operation.
- Drop forged steel construction.
- Plated to resist corrosion.
- Heat treated chisel.



Item #	IP	MP	PKG	Capacity
W88030	12	72	CRD	7/16 to 3/4"

3-PC INTERNAL PIPE EXTRACTOR

- Internal Pipe Wrenches are designed to easily remove broken pipe threads, plugs and fittings.
- Multiple uses including broken heater hose fittings, household plumbing, to HVAC connections.
- Machined heat-treated cams mounted on alloy steel hex shafts.
- Use with a standard socket and ratchet or your open-box end wrench.

Item #	IP	MP	PKG	Sizes
W83204	6	24	CRD	3/8, 1/2, 3/4"



2-PC TAPERED REAMER SET

- Tapered Reamers will help align holes, remove burrs from cut pipe, tubing, and conduit, and enlarge and countersink holes in sheet metal, plastic, and other materials.
- Heat treated #45 High Carbon steel for longer service life.
- T-handle design for easy turning and sure handling.

Item #	IP	MP	PKG	Capacity
W2967	1	72	CRD	1/8 to 1/2" (3 to 13mm) 5/32 to 7/8" (4 to 22mm)



3/8 IN. IMPACT DRIVER SET

- Ideal for loosening firmly tightened or rusted screws or bolts.
- Removable hex adapter allows use with 3/8" drive sockets and accessories.
- Heavy duty blow molded storage case.



Item #	IP	MP	PKG	Bit		
				Length	Phillips	Slotted
W2500P	4	24	CRD	36mm	#2, #3	5/16,
W2500-36MM	24	288	CRD			3/8"



W2500-36MM replacement bits.

1/4 IN. IMPACT DRIVER & EXTRACTOR

- Ideal for loosening or removing firmly tightened or rusted screws or bolts.
- Convenient 1/4" receiver allows use of any 1/4" bit tip or hex nut driver.



W2503-50MM replacement bits.



Item #	IP	MP	PKG	Bit			Screw or bolt size to be removed				
				Length	Phillips	Slotted	Extractor	SAE	Metric	Pipe	
W2503	12	24	CRD	50mm	#1, #2	3/16	#1	1/8 to 15/16"	3/32 - 5/32"	2.5 - 4mm	No. 6
W2503-50MM	12	72	CRD				#2	15/16 to 5/16"	5/32 - 7/32"	4 - 6mm	No. 12
							#3	5/16 to 7/16"	7/32 - 9/32"	6 - 8mm	No. 14

HAND TOOLS

RIVET GUNS & RIVETS

67-PC HAND RIVETER KIT

- Heavy duty hand rivet gun with four nose pieces.
- Nose pieces and wrench store conveniently in handle.
- Vinyl grip handles provide more comfort and better grip.
- Tough black finish resists corrosion.
- Includes storage case

Item #	IP	MP	PKG	Rivets Included
W2017C	5	20	CAS	15 ea. 3/32, 1/8, 5/32 & 3/16"



PROFESSIONAL HAND RIVETER

- Precision die cast aluminum alloy body.
- Handles 1/8" through 1/4" aluminum and steel rivets and 1/8" and 5/32" stainless steel rivets
- Drop forged carbon steel upper handle and thick cushion-molded vinyl grips.
- Four mounted nosepieces: 3/32, 1/8, 5/32, and 3/16".

Item #	IP	MP	PKG
W2009	5	30	CBX



HEAVY DUTY HAND RIVETER

- Heavy duty steel construction.
- Handles 1/8" through 1/4" aluminum and steel rivets.
- Cushion grip handles with nosepiece storage.
- Double compound action to maximize leverage.
- Handy collection bottle for easy disposal.

Item #	IP	MP	PKG
W2008	1	20	CBX



AIR RIVETER

- Air hydraulic riveter is ideal for setting blind rivets in aluminum, steel and stainless with professional results the first time.
- Air relief valve prevents overloading.

Includes four nose pieces: 3/32", 1/8", 5/32" and 3/16", spanner, spanner gauge, safety cap, and replacement O-rings.

Item #	IP	MP	PKG	PSI	Avg. CFM	Pull (lbs)	Max Capacity	Compressor
M680	1	10	CBX	90	4	1,584	3/16"	20 Gal



RIVET REFILL KITS

- Contains the most popular rivets sizes.
- For Performance Tool rivet guns and air riveter.

Item #	IP	MP	PKG	Diameter Length	3/32"		1/8"			5/32"	3/16"		
					7/32"	5/16"	1/4"	5/16"	3/8"	7/32"	5/16"	3/8"	
W2018	Steel	6	72	CRD	100-PC	25	-	-	25	-	25	25	-
W2011	Aluminum	6	72	CRD	100-PC	25	25	25	25	-	-	-	-
W5228	Aluminum	6	24	CAS	500-PC	-	-	120	120	120	-	120	120

BLK: Bulk | CAS: Storage Case | CBX: Color Box | CRD: Carded | CLM: Clamshell | DBL: Double Blister
LAB: Color Label | RAC: Storage Rack | SHK: Shrink Wrap | SLV: Sleeve | TAB: Hang Tab | WBX: White Box

POLY RIVET KIT & REFILLS

- Ergonomically designed for one-handed operation.
- Self-adjusting jaws help set rivets perfectly in a single stroke without re-gripping or prematurely breaking the stem.
- Provides easy access to confined areas with the long forward nose.
- Will not cause damage to painted or delicate surfaces.
- Perfect for fastening door panels and various automotive trims.
- Additional rivets sold separately (W5250).



Set all sizes of poly rivets perfectly in a single stroke without changing the nosepiece.



Item #	IP	MP	PKG		Diameter	5mm	6.6mm	6.3mm	
W2005	41-PC	6	24	CRD	10 ea.	15.8mm	17.2mm	17.2mm	25.2mm
W5250	80-PC	6	24	CAS	20 ea.				

W2005
Includes 40 industrial strength Polyoxymethylene (POM) rivets.

THREADED INSERT RIVET KIT & REFILLS

- Used to Insert threaded rivet style fasteners into thin metal, plastic or fiberglass.
- Each set includes 4 threaded mandrels and nosepieces.
- Comes with 10 of each size aluminum threaded rivet-nuts.
- Formed blow molded case to keep the inserts organized.
- Additional inserts sold separately (W5251 & W5252).



Long handle with comfort grips.



Item #	IP	MP	PKG		
W2006	45-PC Kit	6	12	CBX	10 ea. 6-32, 8-32, 10-24, 1/4-20
W5251	120-PC Refill	6	24	CAS	30 ea. See Hardware Kits for more details
W2007	45-PC Kit	6	12	CBX	10 ea. 3mm, 4mm, 5mm, 6mm
W5252	120-PC Refill	6	24	CAS	30 ea. See Hardware Kits for more details

W2007

3-IN-1 STAPLE GUN & REFILLS

- Easy slide open staple loading feature.
- Comfort grip handle for extended use.
- Easy smooth squeeze.
- Handy storage case.



HAND TOOLS

Item #	IP	MP	PKG	Staples	U-Shaped	Brad Nails
W2050	Kit	6	24	CAS	300	300
W2051	Refill	4	24	CRD	300	300

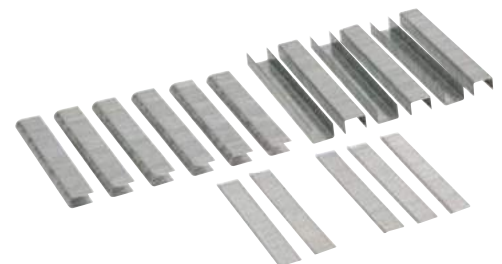

CLAMPS

RATCHETING BAR CLAMPS

- Nylon clamps with durable carbon steel bar.
- Pistol action, rubberized comfort grip handle.
- Quickly converts from a clamp to a spreader without the use of tools.
- Removable jaw pads protect surfaces from marring and damage.

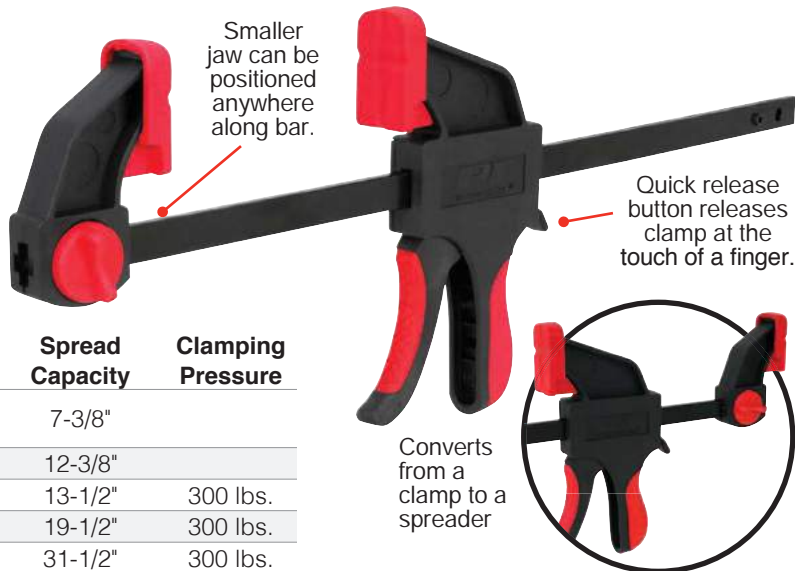

Item #	IP	MP	PKG	Bar Length	Throat Depth	Spread Capacity	Clamping Pressure
W3943 2-PC	6	48	CRD	4"	1-3/8"	7-3/8"	
W3944	12	48	LAB	6"	2-1/2"	12-3/8"	
W3945	6	24	TAB	6"	2-3/4"	13-1/2"	300 lbs.
W3946	6	24	TAB	12"	2-3/4"	19-1/2"	300 lbs.
W3948	6	24	TAB	24"	2-3/4"	31-1/2"	300 lbs.

F-STYLE BAR CLAMPS

- Ideal for gluing, hold down work, and general purpose clamping.
- F-Style clutch bar clamps come with cast heads with powder-coated finish to resist corrosion and chipping.
- Zinc finished rail with a two piece clutch plate system for instant adjustment, secure hold, and easy release.
- Rubber comfort grip handle for more torque and less user fatigue.

Item #	IP	MP	PKG	Bar Length	Throat Depth	Clamping Pressure
W3952	5	30	TAB	12"	2-1/2"	600 lbs.
W3954	5	20	TAB	24"	2-1/2"	600 lbs.



C-CLAMPS

- Ductile Iron construction for superior strength and corrosion resistance.
- Larger swivel pad head for better contact on angled surfaces.
- Precision crafted chrome plated screw and spindle for smooth operation.



W3970

Item #	IP	MP	PKG	Opening	Throat Depth
W3970	12	72	TAB	1"	
W221	12	72	LAB	2"	1"
W206C	6	48	LAB	3"	1-1/2"
W207C	6	36	LAB	4"	2"
W213C	4	24	LAB	5"	2-1/4"
W214C	4	12	LAB	6"	2-1/2"
W215C	2	12	LAB	8"	2-3/4"
W86012	5	20	LAB	1, 2, 3"	-

Tough enamel finish for years of service.



Industrial grade cast iron body

DEEP C-CLAMPS

- Heavy cast Iron construction with a powder-coat finish for rust resistance and long life.
- Built with heavy sliding t-handle and extra-large swivel base for easy and quick tightening.

Item #	IP	MP	PKG	Opening	Throat Depth
W3980	10	40	TAB	2-3/4"	3-1/2"
W3981	15	30	TAB	2-3/4"	5"
W3982	10	20	TAB	3"	8"



Ideal for projects where extra deep clamping is needed.

HAND TOOLS

RATCHETING CLAMPS

- High strength rubber grip nylon handle.
- Quick release trigger allows for fast and easy operation.
- Pivoting soft jaws with V-groove for round applications.

Item #	IP	MP	PKG	Length	Opening	Throat Depth	Clamping Pressure
W5090	12	120	TAB	5"	1-1/2"	1-3/4"	17 lbs.
W5091	12	120	TAB	6-1/4"	2"	2-1/4"	33 lbs.
W5092	12	96	TAB	9"	3"	3-3/4"	55 lbs.



METAL SPRING CLAMPS

- Heavy duty spring for extra gripping power.
- Corrosion resistant nickel plating.
- Non-marring rubber tips.

Item #	IP	MP	PKG	Length	Opening	Clamping Pressure
W5081	18	108	BLK	1"	1"	3.5 lbs.
W5082	12	72	BLK	6"	2"	4.5 lbs.
W5083	8	32	BLK	9"	3"	6.5 lbs.
W5080 4-PC	12	48	CRD	2"	1/2"	2.5 lbs.



NYLON SPRING CLAMPS

- Heavy duty fiberglass reinforced nylon body.
- Non-marring swivel pads at the ends to adjust to irregular shapes.
- Inner gripping teeth for larger clamping applications.

Item #	IP	MP	PKG	Length	Throat Depth	Opening	Clamping Pressure
W5088	50	400	TAB	2"	3/4"	1/2"	1.5 lbs.
W5087	50	400	TAB	3"	1"	1"	2 lbs.
W5089	6	72	BLK	3"	1"	1"	2lbs.



PIPE CLAMPS

- The quick release four plate clutch produces up to 1,950 pounds of clamping pressure.
- Cast steel construction provide durability for years of service.



Item #	IP	MP	PKG	Pipe (NPT)	Throat Depth	Clamping Pressure
W3960	6	24	CLM	1/2"	3/4"	1,250 lbs.
W3961	6	24	CLM	3/4"	3/4"	1,950 lbs.

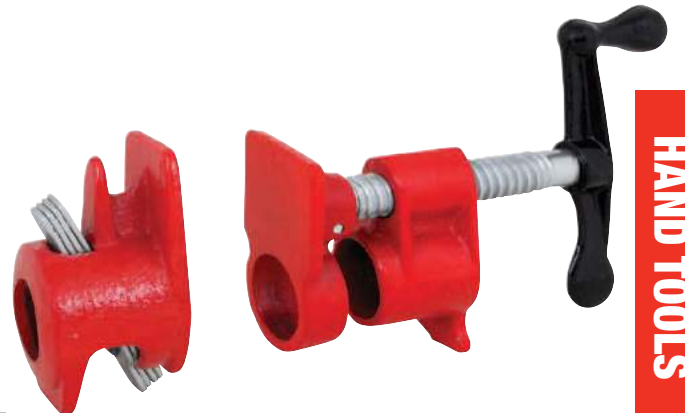

HAND TOOLS

LOCKING C-CLAMP

- Heavy duty construction.
- Quickly adjusts to right size before use.
- Locks to work with squeeze of one hand.
- Unlocks easily by squeezing release lever.

Item #	IP	MP	PKG	Length	Capacity
W5100	6	48	SLV	6"	2"
W5101	6	48	SLV	8"	2-3/8"
W5102	6	24	SLV	11"	3-1/2"



BOLT CUTTERS & PIPE WRENCHES

BOLT CUTTERS

- Drop forged heat treated alloy steel construction handles.
- Precision milled and drop forged steel jaws.
- Rubber hand grips for comfort and control.
- Durable protective enamel paint.



BC-8

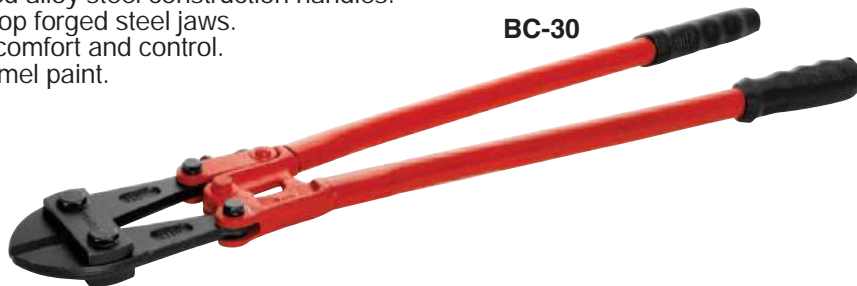

BC-30

Item #	IP	MP	PKG	Length	Max Capacity	Replacement		IP	MP	PKG
						Head				
BC-8	10	60	CRD	8"	-	-	-	-	-	-
BC-14	1	12	BLK	14"	1/4" (6mm)	-	-	-	-	-
BC-18	1	20	BLK	18"	5/16" (8mm)	BC-18-1	12	24	WBX	
BC-24	1	10	BLK	24"	3/8" (10mm)	BC-24-1	12	24	WBX	
BC-30	1	5	BLK	30"	15/32" (12mm)	BC-30-1	12	24	WBX	
BC-36	1	5	BLK	36"	9/16" (14mm)	BC-36-1	12	24	WBX	



BC-36-1

CAST IRON PIPE WRENCHES

- Precision milled and drop forged steel jaws.
- Durable protective enamel paint.
- Heavy duty finish.

Item #	IP	MP	PKG	Length	Capacity
W1133-8B	6	36	BLK	8"	
W1133-10B	6	24	BLK	10"	1-1/2"
W1133-12B	6	12	BLK	12"	2"
W1133-14B	6	12	BLK	14"	2"
W1133-18B	6	12	BLK	18"	2-1/8"
W1133-24B	2	6	BLK	24"	2-7/8"
W1133-36B	1	1	BLK	36"	3"
W1136 4-PC	1	4	CBX	8", 10, 14, 24"	-



ALUMINUM PIPE WRENCHES

- Precision milled and drop forged steel jaws.
- Strong and lightweight aluminum handles.

Item #	IP	MP	PKG	Length	Capacity
W2110	6	12	BLK	10"	1-1/2"
W2114	6	12	BLK	14"	2-1/2"
W2118	1	6	BLK	18"	3"
W2124	1	6	BLK	24"	3-1/2"
W2136	1	1	BLK	36"	4"
W2148	1	1	BLK	48"	4-1/2"



ADJUSTABLE PIPE WRENCH

- Easy one handed operation.
- Size adjusts quickly to your application.
- Serrated jaw teeth for a secure grip.
- Lighter than standard 14" cast iron pipe wrench.



Item #	IP	MP	PKG	Length	Capacity
W2149	5	20	DBL	14"	2-1/4"

BLK: Bulk | CAS: Storage Case | CBX: Color Box | CRD: Carded | CLM: Clamshell | DBL: Double Blister
LAB: Color Label | RAC: Storage Rack | SHK: Shrink Wrap | SLV: Sleeve | TAB: Hang Tab | WBX: White Box

SLEDGE HAMMERS

- Heavy duty fiberglass handles for strength and durability.
- Anti-shock, rubber cushion grips.
- Black matte finished head.
- Mirror polish heads.

Item #	IP	MP	PKG	Head			Overall Length
				Weight	Length	Diameter	
M7101	1	4	LAB	4 lbs.	5"	1-1/2"	14-7/8"
M7102	2	4	LAB	6 lbs.	5-7/8"	2"	33-1/2"
M7103	1	4	LAB	8 lbs.	6-1/2"	2-1/8"	33-5/8"
M7114	2	4	LAB	10 lbs.	6-5/8"	2-1/4"	33-3/4"
M7115	2	4	LAB	12 lbs.	7"	2-5/8"	34"
M7116	1	2	LAB	16 lbs.	7-3/4"	2-3/4"	34-1/4"

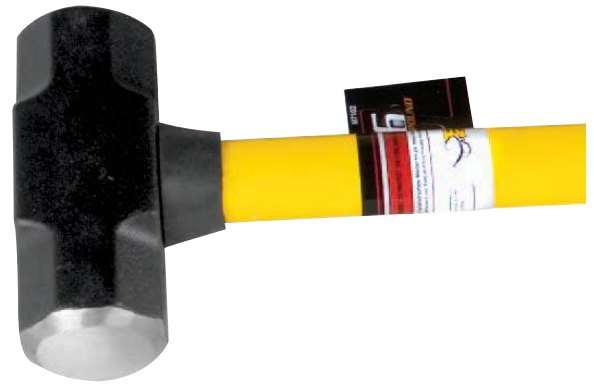

SPLITTING MAULS

- Heavy duty fiberglass handles for strength and durability.
- Anti-shock, rubber cushion grips.
- Black matte finished head.
- Mirror polish heads.

Item #	IP	MP	PKG	Head			Overall Length
				Weight	Length	Blade	
M7113	1	4	LAB	6 lbs.	8-1/4"	3-1/2"	33"
M7111	1	4	LAB	8 lbs.	9"	4"	35"



AXES

- Heavy duty fiberglass handles for strength and durability.
- Anti-shock, rubber cushion grips.
- Black matte finished head.
- Mirror polish heads.



Item #	IP	MP	PKG	Head			Overall Length
				Weight	Length	Blade	
M7109	1	6	LAB	3.5 lbs.	7-5/8"	4-7/8"	33-7/8"
M7112	1	6	LAB	1.25 lbs.	5-3/8"	3"	4"

SLEDGE & CROSS PEIN HAMMERS

- Heavy duty fiberglass handles.
- Drop forged high carbon steel construction.
- Mirror polish heads.
- Anti-shock cushion grips.



Item #	IP	MP	PKG	Head			Overall Length
				Weight	Length	Diameter	
M7100	4	8	LAB	3 lbs.	4-5/8"	1-5/8"	14"
M7104	1	4	LAB	3 lbs.	5"	1/5/8"	14"
M7040B	2	4	SLV	2-PC Combo Set			

HAND TOOLS

HAMMERS & MALLETS

DEAD BLOW HAMMERS

- Steel shot filled canister, maximizes force, reduces rebound, and absorbs the shock of impact.
- The non-sparking, chemical resistant molded urethane covering is bright orange for high visibility and safety.



Item #	IP	MP	PKG	Weight	Head		Overall
					Length	Diameter	Length
M7008B	6	24	TAB	8 oz.	3-1/4"	1-3/8"	10-1/2"
M7216	6	12	TAB	16 oz.	3-7/8"	1-5/8"	11-5/8"
M7224	6	12	TAB	24 oz.	3-7/8"	1-5/8"	12-1/2"
M7232	6	12	TAB	32 oz.	3-7/8"	1-7/8"	13"
M7248	6	12	TAB	48 oz.	4-5/8"	2-1/4"	13-3/4"
M7264	6	12	TAB	64 oz.	5-1/4"	2-1/2"	14-1/8"



3-PC DEAD BLOW HAMMER SET

- 12 oz. brass plated cap hammer can be used for non-sparking applications.
- 16 oz. hammer's steel face and pein allows for conventional use in striking punches and chisels as well as shaping and straightening unhardened metals.
- 8 oz. urethane coated hammer is used for non-marring/non-sparking applications.



Item #	IP	MP	PKG	Weight	Head		Overall
					Length	Diameter	Length
M7234	6	12	CLM	8 oz.	3-1/4"	2"	10-1/2"
				12 oz.	3"	1"	8-1/2"
				16 oz.	4"	1-1/4"	10-1/2"

RUBBER MALLETS

- Non-marring rubber head.
- Rubber cushion grip*.
- Many uses around home and shop.

Item #	IP	MP	PKG	Weight	Head		Overall
					Length	Diameter	Length
W1154	6	36	CLM	8 oz.	2-7/8"	1-1/2"	10-1/4"
W1153	6	36	CLM	16 oz.	3-1/2"	2-1/4"	12"
Tubular chrome plated handles.							
M7132	6	24	LAB	32 oz.	5"	2-1/2"	14"
Heavy duty fiberglass handle.							
W1146	6	24	BLK	32 oz.	4-1/4"	2"	13"
Hardwood handle. *No rubber grip							



4-IN-1 QUICK CHANGE HAMMER

- Plastic heads won't mark or spark, preventing surface damage and protecting both product and user.
- Shock absorbing fiberglass handle reduces vibration.
- Non-slip rubber grip for comfort and durability.
- Convex striking surfaces minimize bounce.
- Includes soft, medium, hard plastic heads and a high grade carbon steel head.

Item #	IP	MP	PKG	Head		Overall
				Length	Diameter	Length
M7215	6	12	CRD	4"	1-1/2"	11-3/4"



HAND TOOLS

BALL PEIN HAMMERS

- Drop forged high carbon steel head.
- Heavy duty fiberglass handle*.
- Rubber cushion grip.



Item #	IP	MP	PKG	Weight	Head		Overall Length
					Length	Diameter	
M7030B	6	48	TAB	12 oz.	3-1/2"	1"	12"
M7032B	6	36	TAB	16 oz.	3-5/8"	1"	11-5/8"
W1134-16 <i>*Wood Handle</i>	6	24	TAB	16 oz.	4"	1-1/8"	12-7/8"
M7034B	6	24	TAB	24 oz.	4-1/2"	1-1/4"	13-3/8"
M7036B	6	24	TAB	32 oz.	4-7/8"	1-3/8"	13-7/8"
M7134	1	4	CBX	8, 12, 16, 24, 32 oz.			



M7030B



M7032B



W1134-16



W1137

SOLID BRASS HAMMER

- Brass is used for non-magnetic, non-sparking applications and generally less damaging to harder metal surfaces.
- High visibility fiberglass handle with comfort rubber grip handle.



Item #	IP	MP	PKG	Weight	Head		Overall Length
					Length	Diameter	
W1137	4	24	LAB	16 oz.	3"	1-1/8"	11"



M7020B

CLAW HAMMERS

- Drop forged high carbon steel head.
- Heavy duty fiberglass handle.
- Rubber cushion grip.



Item #	IP	MP	PKG	Weight	Head		Overall Length
					Length	Diameter	
M7020B	6	24	TAB	16 oz.	5-1/4"	1-1/8"	12-1/2"
W1076	6	24	BLK	16 oz.	5-1/4"	1-1/8"	13"



W1076

AUTO BODY HAMMERS

- High carbon drop forged steel head
- Genuine hickory handle

More Auto Body tools on page 98



W1012

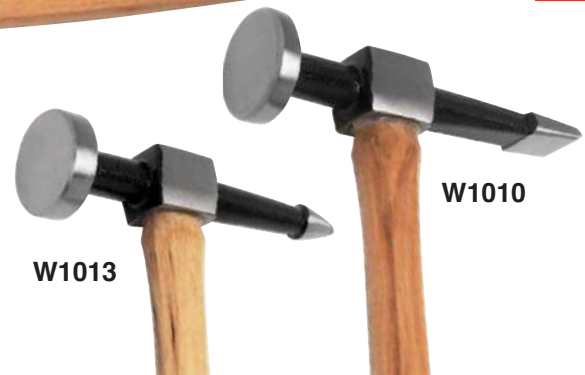

W1010

W1013

Item #		IP	MP	PKG	Head		Overall Length
					Length	Diameter	
W1010	Straight Pein	6	36	CLM	5-1/4"	1-1/2"	12-3/8"
W1012	Shrinking	6	36	CLM	4-1/4"	1-7/8"	12-5/8"
W1013	Pick	6	36	CLM	5-1/2"	1-1/2"	12-1/2"

HAND TOOLS

PRY BARS

4-PC PROFESSIONAL PRY BAR SET

- Chrome vanadium steel shafts.
- Injection molded handle.
- Black oxide finish resists corrosion.
- Includes handy storage tray.



Item #	IP	MP	PKG	Size
W2030	1	6	DBL	8, 12, 18, 24"

36 IN. HEAVY DUTY PRY BAR

- Chrome vanadium steel shaft.
- Comfortable injection molded handle.
- Black oxide finish resists corrosion.
- Use this additional size to complement our pro set W2030.



Item #	IP	MP	PKG	Overall	Blade	Shank
W2034	5	10	TAB	40"	27-1/4"	5/8"

FLAT UTILITY PRY BAR

- Drop forged steel.
- Tough painted finish.
- Wide, flat design for many pulling, prying and scraping jobs.



Item #	IP	MP	PKG	Size
W2022	6	36	LAB	15"

INDEXING PRY BAR

- Indexing head locks at 15 different angles.
- Quick release thumb lever.
- Chrome vanadium steel.
- Perfect for prying seals, manifolds, bearings, oil pans and much more.



Item #	IP	MP	PKG	Size
W2032	6	24	TAB	12"

ALIGNMENT/PRY BAR

- Forged alloy steel.
- Heat-treated to resist bending or breaking.
- Alignment point on one end, bent chisel end on the other.



Item #	IP	MP	PKG	Overall	Diameter
W2033	1	450	BLK	30"	7/8"

HAND TOOLS

3-PC PRY BAR SET

- Curved blade design provides extra leverage.
- Capped ends allow user to strike with a hammer without damaging the head.
- Blade protection for added safety.



Item #	IP	MP	PKG	Size
W3033	6	24	TAB	8, 12, 17-3/4"

4-PC PRY BAR SET

- Heat treated drop forged steel.
- Black oxide finish to resist corrosion.
- Durable high visibility orange PVC handles.

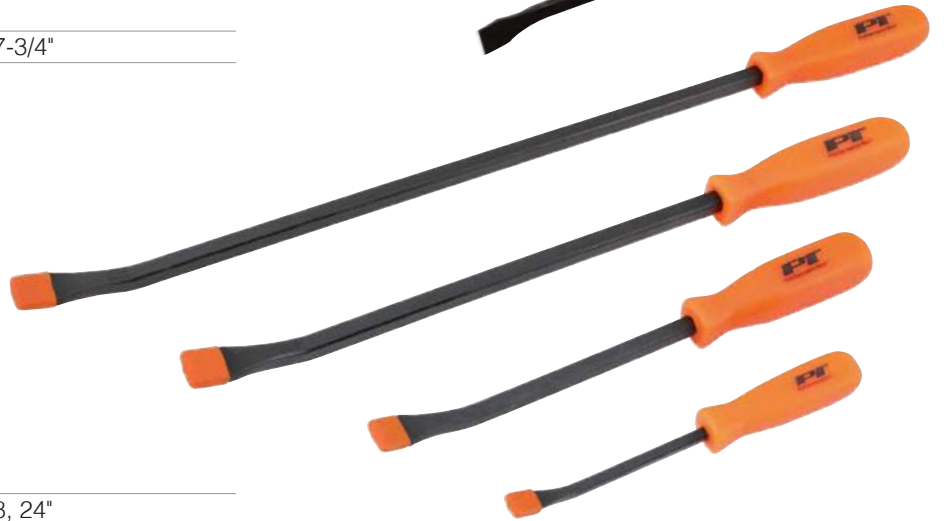

Item #	IP	MP	PKG	Size
W2020	1	6	DBL	8, 12, 18, 24"

5-PC PRY BAR SET

- Heat treated drop forged steel.
- Black oxide finish to resist corrosion.
- Durable PVC handles on mechanic's pry bars.



Item #	IP	MP	PKG	Pry Bars	Roll Bar
W2025	1	6	DBL	8, 12, 18, 24"	16"

4-PC ROLL TYPE PRY BAR SET

- Drop forged steel.
- Tapered shaft design.



Item #	IP	MP	PKG	Size
W2021	1	6	CBX	6, 12, 16, 20"

CHISELS & PUNCHES

- Hardened and tempered high carbon steel construction.
- Vinyl covered shank absorbs shock and reduces vibration.



W751



W752

		Item #	IP	MP	PKG	W750	W751	W752	W753
COLD CHISEL	3/8" 6"	-	-	-	-	X	-	-	-
	3/8" 7"	W5434	12	72	CRD	-	-	-	X
	1/2" 6"	-	-	-	-	X	X	-	-
	1/2" 7"	W5432	12	72	CRD	-	-	-	-
	5/8" 6"	-	-	-	-	X	-	-	-
	5/8" 7"	-	-	-	-	-	X	-	-
	3/4" 7"	W5436	12	72	CRD	-	-	-	-
	3/4" 7-1/2"	-	-	-	-	-	X	-	-
	7/8" 8"	-	-	-	-	-	X	-	
PIN PUNCH	1/16" 4"	W5414	12	72	CRD	-	-	-	-
	1/8" 6"	W5417	12	72	CRD	-	-	X	X
	5/32" 6"	-	-	-	-	-	X	X	-
	3/16" 6"	-	-	-	-	X	-	X	-
	1/4" 6"	W5420	12	72	CRD	-	X	X	-
TAPER PUNCH	1/8" 8"	W5427	12	72	CRD	X	-	-	-
	5/32" 8"	-	-	-	-	-	-	-	X
	3/16" 6"	-	-	-	-	X	X	-	-
	3/16" 10"	-	-	-	-	-	X	-	-
	1/4" 6"	-	-	-	-	X	-	-	
CENTER PUNCH	1/4" 4-1/2"	W5424	12	72	CRD	-	-	-	X
	3/8" 6"	-	-	-	-	X	X	-	-



Item #	IP	MP	PKG
W750	7-PC	6	24 DBL
W751	12-PC	6	12 DBL
<i>Plus 3/16 x 6" cape punch, 1/2 x 6" concrete chisel</i>			
W752	4-PC	6	60 CRD
W753	4-PC	6	60 CRD

HAND TOOLS

28-PC PUNCH & CHISEL SET

- Contains 16 chrome vanadium (CrV) and 12 high carbon steel (CS) punches, chisels and pins.
- Complete with roll-up vinyl storage pouch.



Item #	IP	MP	PKG	Cold Chisel		Pin Punch		Taper	
				CrV	CS	CrV	CS	CrV	
W754	1	6	CBX	3/32"	-	-	4-1/4"	-	5-1/4"
				1/8"	-	-	4-3/4"	6"	5-3/4"
				5/32"	-	-	5"	-	6"
				3/16"	-	-	5-1/4"	10-1/8"	6-1/4"
				1/4"	-	-	5-1/4"	-	6-3/4"
				3/8"	5-1/2"	-	-	8", 10"	-
				1/2"	6"	6-3/4"	-	-	-
				5/8"	6-1/2"	7"	-	-	-
				3/4"	-	8"	-	-	-
				13/16"	-	8"	-	-	-
7/8"	-	10"	-	-	-				
1"	-	10"	-	-	-				

Also includes chisel punch gauge, 1/8" X 5", 3/16" X 6" (CrV), 1/8" x 5-3/4", 3/16" x 7-7/8" (CS) center punches.



9-PC ROLL PIN PUNCH SET

- Drop forged, heat treated & knurled steel for maximum durability, grip, workability.
- Reverse taper tip for easy alignment and end of pin punch won't stick in pin hole.
- Comes with fitted nylon roll-up storage/carry pouch.



Item #	IP	MP	PKG	Sizes
W7559	6	36	DBL	1/16 x 2-3/4", 5/64 x 3-1/4", 3/32 x 3-1/2", 1/8 x 4-7/8", 5/32 x 4-1/2", 3/16 x 4-3/4", 7/32 x 5", 1/4 x 5-3/8", 5/16 x 6-1/4"

5-PC 8 IN. LONG PIN PUNCH SETS

- 8" Long to reach deeply set pins in obstructed areas.
- Carbon steel construction with hardened tips for long life.
- Knurled steel handles for sure grip in every application.



Item #	IP	MP	PKG	Sizes
W758	Carbon	5	30	CRD
W759	Brass	5	30	CRD

1/8, 3/16, 1/4, 5/16, 3/8"

3-PC NAIL PUNCH SET

- Drop forged, heat treated steel with knurled body.
- Large, square striking surface and precision point.

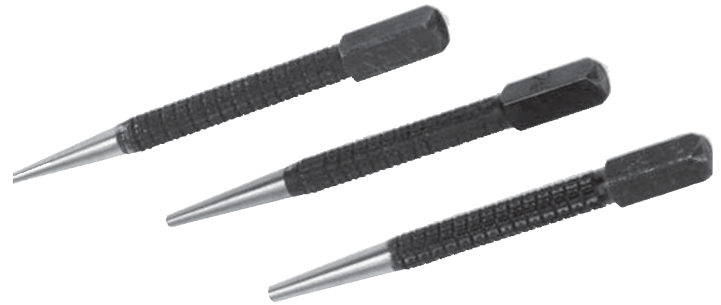

Item #	IP	MP	PKG	Sizes
W757	12	72	CRD	1/32, 1/16, 3/32"

3-PC WOOD CHISEL SET

- Comfortable non-slip molded handles.
- Drop forged heat treated blades.
- Full length shaft.



Item #	IP	MP	PKG	Sizes
W5372	4	24	DBL	1/2, 3/4, 1"

LETTER/NUMBER STEEL STAMP SETS

- Stamp a number or letter combination onto most items for identification.
- 26 letters A-Z and the "&" sign.
- 9 numbers 0-8 (uses the 6 upside down for 9).
- Handy storage box.



Item #	IP	MP	PKG	Shank Size
W5421	6	36	CBX	1/8"
W5422	6	12	CBX	1/4"

WIRE STRIPPERS & CRIMPERS

DEUTSCH RATCHETING CRIMPER SET

- Includes 6 dies for most popular automotive applications.
- Quick change dies, no tools required.
- Adjustable crimp tension.
- Double-injection molded handles for better grip.



Item #	IP	MP	PKG	Crimping Dies AWG					
W186	1	10	SLV	14-12	10-12 & 5-6mm ²	18-16-14	16-14-12	20-16-14	20-18-16

151-PC RATCHETING CRIMPER SET

- Crimps wires and cables with a professional and secure connection.
- Designed for 10 to 22 gauge wire.
- Includes 150 piece assortment of 10-22 gauge connectors.



Item #	IP	MP	PKG	Crimps AWG		
W185	1	20	CAS	10-12	16-14	18-22

OPEN BARREL CRIMPING TOOL

- For use with open barrel terminals, weatherpack, and Deutsch crimps.



Item #	IP	MP	PKG	Crimps AWG
W86502	12	24	CRD	24-14

2-IN-1 WIRE STRIPPER/CRIMPER

- Two tools in one - One end features a professional grade stripper, flip the handles around and you have a full range crimper.
- Precision machined and hardened jaws.
- Three position safety lock: open to switch, lock to hold on position, closed to prevent operation.
- Comfortable non-slip grips.



Crimper



Wire Stripper

Item #	IP	MP	PKG	Crimps AWG	Strips AWG
W202	6	36	CRD	310/311/410/411 22-18, 16-10	10, 12, 14, 16, 18, 20

AUTOMATIC WIRE STRIPPERS

- Cuts and removes insulation from wire with a single squeeze of the handle.
- Heavy duty construction with vinyl hand grips



Item #	IP	MP	PKG	Strips AWG
W200	12	24	CRD	18, 14, 12, 10, 8

WIRE CRIMPING TOOL

- Contains wire cutter, bolt cutter, crimper and stripper.
- Includes assorted terminals.

Item #	IP	MP	PKG	Crimps AWG	Strips AWG	Bolt Cutter
W190C	6	36	CRD	22-18, 16-14, 12-10	10, 12, 14, 16, 18, 20-22	8-32, 10-24, 10-32, 6-32, 4-40



7-WAY WIRE CRIMPING TOOL

- Wire cutter, terminal crimper & wire stripper in one handy tool.
- Black anodized finish with insulated grips.
- Crimp slot on end of tool secures most ignition terminals including "W" type, right angle and "High Tower" terminals.

Item #	IP	MP	PKG	Crimps	Strips AWG
W86500	6	48	CRD	10-22 AWG, 7-8.5mm ignition wire	10, 12, 14, 16, 18, 20-22

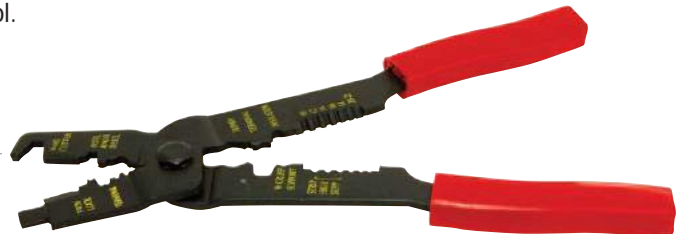

CRIMPING PLIERS

- Slim nose shape for tight places.
- Designed for crimping of both insulated and non-insulated solderless connections and terminals, as well as cutting 10-22 AWG wire.
- US Patent D704523S1

Item #	IP	MP	PKG	Strips AWG
W30764	6	24	CRD	10-22



Ergonomic non-slip molded grips for improved comfort and control.

ANGLED FLUSH CUTTER

- Offset at 30° to produce closer and more precise flush cuts.
- For use on copper and soft wire up to 16 gauge (1.3mm).
- The flush cutter is perfect for detailed flush cutting such as wire, mono and braid knots and zip-tie ends, or anywhere a flush cleaner look is needed.
- US Patent D704523S1

Item #	IP	MP	PKG	Cutting Capacity
W30763	12	144	CRD	16 AWG

Premium quality drop forged and hardened chrome vanadium steel.



CABLE CUTTERS

- Comfortable non-slip molded grips.
- Precision sharpened cutting edges.
- Drop forged and heat treated alloy steel.
- US Patent D704523S1

Item #	IP	MP	PKG	Cutting Capacity
W30729	6	36	CRD	Soft Aluminum 2/0 (1/2")
				Soft Copper 4/0 (3/8")
				Coaxial Cable 7/8"



WIRE INSERTION TOOL

- Stainless steel tube and hollow handle aids in installing wires for radios, alarms and electronic equipment.
- Feed wires safely through the firewall grommet, allowing them to be accessed from the opposite side.
- US Patent D693201S1

Item #	IP	MP	PKG
W2935	6	48	CRD



HAND TOOLS

INSPECTION MIRRORS

TELESCOPING MIRRORS

- Multi swivel feature for confined areas.
- Telescopes to a lengths up to 28" for hard to reach areas.
- Includes a convenient pocket clip.
- Chrome plated corrosion resistant shaft.

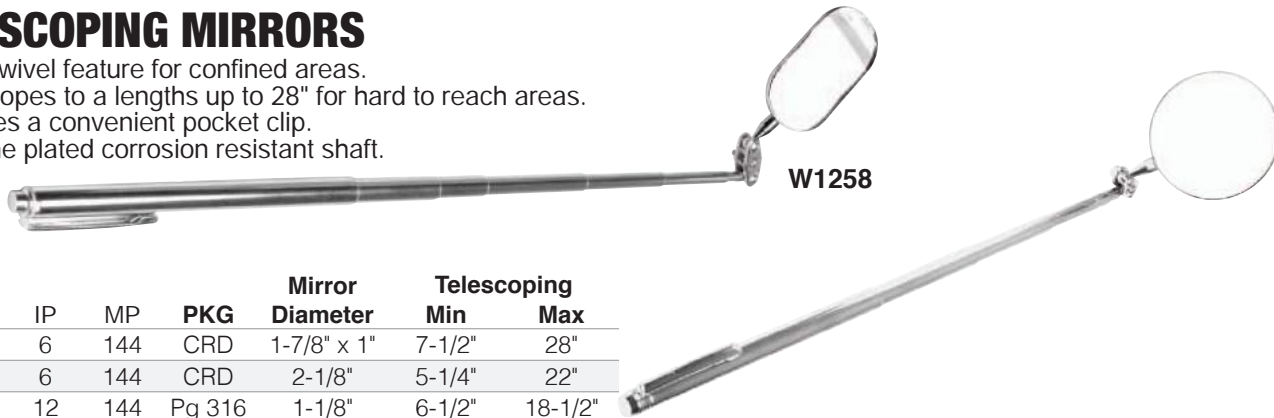

W1258

Item #	IP	MP	PKG	Mirror Diameter	Telescoping	
					Min	Max
W1258	6	144	CRD	1-7/8" x 1"	7-1/2"	28"
W1259	6	144	CRD	2-1/8"	5-1/4"	22"
W3230	12	144	Pg 316	1-1/8"	6-1/2"	18-1/2"
W3304	20	160	Pg 317	1-1/8"	6-1/2"	20"
W9103	12	72	Pg 308	1-1/8"	6-1/2"	18-1/2"
20128	12	72	Pg 320	1-1/8"	6-1/2"	18-1/2"

JUMBO INSPECTION MIRRORS

- Comfortable injection molded grip.
- Double ball joint swivel.
- Indispensable for visual access in confined areas.



Item #	IP	MP	PKG	Mirror Diameter	Telescoping	
					Min	Max
W9124	8	48	Pg 309	2"	9-3/4"	36"
W9141	4	24	Pg 309	3-1/2"	11-3/8"	30"

TELESCOPING MIRROR WITH VINYL GRIPS

- Multi direction swivel for visual access to confined areas.
- Chrome plated corrosion resistant shaft.



W86011

Item #	IP	MP	PKG	Mirror Size	Telescoping	
					Min	Max
W1262C	12	120	CRD	2"	11-1/2"	18"
W86011	12	96	CRD		12-3/4"	19-1/4"

2-IN-1 INSPECTION TOOL

- Chrome plated corrosion resistant shaft.
- Magnetic tip retrieves up to 3 lbs.
- Handy pocket clip.

Item #	IP	MP	PKG	Mirror Diameter	Telescoping		Lift Capacity
					Min	Max	
W9109	12	72	Pg 309	1-1/8"	6-1/2"	15"	3 lbs.
20170	8	48	Pg 321				

LED INSPECTION MIRROR PICKUP TOOL

- 2 lighted tools in 1 - inspection mirror and pickup tool.
- Mirrors snaps on/off for access into confined areas.
- Moveable LED provides light where needed.
- Batteries included.



Item #	IP	MP	PKG	Mirror Size	Telescoping		Battery	
					Min	Max	Qty.	Type
W9145	12	48	Pg 312	2-5/8 x 1-5/8"	10-3/8"	34"	2	CR2032

HAND TOOLS

TELESCOPIC MAGNETIC PICKUP TOOLS

- Telescoping handle extends magnet up to 25".
- Compact size with pocket clip.
- Easily retrieves small parts from confined or hard to reach areas.

Item #	IP	MP	PKG	Lift Capacity	Telescoping	
					Min	Max
W1261	6	144	CRD	3 lbs.	4-5/8"	18-1/2"
W1904	30	180	BLK	3 lbs.	5"	25"
W3234	12	144	Pg 316	3 lbs.	4-3/4"	18-1/2"
W3301	20	160	Pg 317	3 lbs.	4-3/4"	18-1/2"
W1908	25	300	Pg 312	3 lbs.	5"	25"
W9100	15	90	Pg 308	3 lbs.	5"	25"
20126	12	72	Pg 320	3 lbs.	4-3/4"	18-1/2"



TELESCOPIC MAGNETIC PICKUP TOOLS

- Heavy duty magnetic tip.
- Handy pocket clip.

Item #	IP	MP	PKG	Lift Capacity	Telescoping	
					Min	Max
W1254	12	48	CRD	3.5 lbs.	5"	24-3/4"
W86010	12	144	CRD	3.5 lbs.	5"	25-1/2"



W1254



W86010

TELESCOPIC MAGNETIC PICKUP TOOL

- Telescoping handle extends magnet to 24".
- Ball joint allows head to swivel 90 degrees.
- Easily retrieves small parts from confined or hard to reach areas.

Item #	IP	MP	PKG	Lift Capacity	Telescoping	
					Min	Max
W1200C	12	144	CRD	8 lbs.	14"	24"

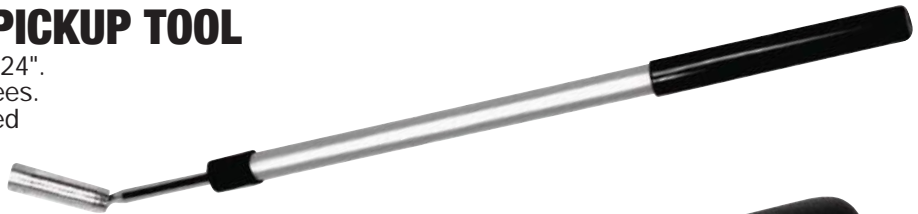

W9115

HEAVY DUTY TELESCOPIC MAGNETIC PICKUP TOOLS

- Heavy duty magnetic tip retrieves up to 16 lbs.
- Cushion grip handle.
- Handy pocket clip.

Item #	IP	MP	PKG	Lift Capacity	Telescoping	
					Min	Max
W9101	12	72	Pg 308	8 lbs.	6-1/2"	24"
20129	12	72	Pg 320			
W9115	12	72	Pg 309	16 lbs.	7"	30"



W9101



BACK SCRATCHER PICKUP TOOL

- Pickup tool and back scratcher in one
- Claw hand features integrated bottle opener.

Item #	IP	MP	PKG	Lift Capacity	Telescoping	
					Min	Max
W9144	9	54	Pg 310	2 lbs.	8-1/2"	20"
20193	6	36	BLK			
W9204	9	54	Pg 311	2 lbs.	8-1/2"	27-1/2"



W9144
Straight claw hand

W9204
Angled claw hand

HAND TOOLS

LIGHTED MAGNETIC PICKUP TOOLS

LIGHTED MAGNETIC PICKUP TOOL

- Bright LED light helps you retrieve lost tools and parts.
- Easily retrieves objects from confined areas.
- Cushion grip handle.
- Batteries included

Item #	IP	MP	PKG	Lift Capacity	Telescoping Min	Telescoping Max	Battery Qty.	Battery Type
W1933	6	48	DBL					
W9102	12	72	Pg 308	8 lbs.	6-1/2"	27-1/2"	3	AG13
20150	8	48	Pg 321					



3-PC LIGHTED PICKUP TOOL KIT

- Includes lighted magnetic pickup tool, large and small attachable mirrors.

Item #	IP	MP	PKG	Mirror Diameter	Telescoping Min	Telescoping Max
W1935	8	48	CRD	1-1/4" 2-1/8"	6-1/2"	33"



2-PC LIGHTED TOOL SET

- Includes lighted magnetic pickup tool and 2" round telescoping mirror.

Item #	IP	MP	PKG	Mirror Diameter	Telescoping Min	Telescoping Max
W1934	6	48	DBL	2"	6-1/2"	19"



3-PC LIGHTED TOOL SET

- Includes lighted magnetic pickup tool, 2" round telescoping mirror and magnetic parts tray.

Item #	IP	MP	PKG	Tray Diameter
W1932	6	36	DBL	4-1/4"



LIGHTED MAGNETIC PICKUP TOOLS

- Bright LED light helps you find lost tools and parts.
- Easily retrieves objects from confined areas.
- Comfortable injection molded grip.
- Double ball joint swivel.
- Batteries included.
- US Patent D693201S1



Item #	IP	MP	PKG	Lift Capacity	Telescoping Min	Telescoping Max	Battery Qty.	Battery Type
W1927	Telescoping	12	72	CRD	8 lbs.	28-1/2"	3	AG13
W25934	Flexible	6	36	CRD	8 lbs.	23-1/2"	3	AG13



HAND TOOLS

LIGHTED FLEXIBLE MAGNETIC CLAW RETRIEVER

- Lighted retractable 4 claw pickup and magnetic tool.
- Durable anodized aluminum head and handle.

Item #	IP	MP	PKG	Length	Lift	Battery	
					Capacity	Qty	Type
W83196	6	72	CRD	24"	2 lbs.	3	AG13

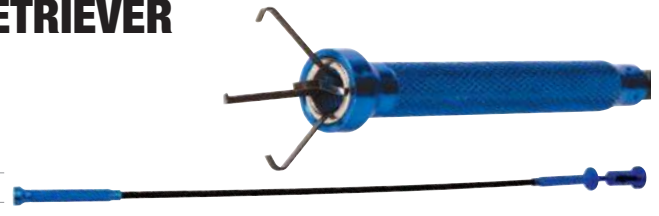

FLEXIBLE MAGNETIC CLAW RETRIEVER

- Retractable 4 claw pickup and magnetic tool all in one.
- Durable anodized aluminum head and handle.

Item #	IP	MP	PKG	Length
W83198	6	24	TAB	28"

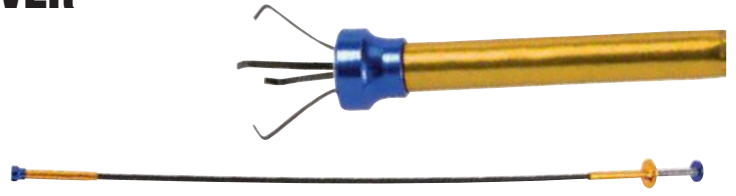

FLEX MAGNETIC CLAW RETRIEVER

- Retractable 4 claw pickup and magnetic tool all in one.
- Durable anodized aluminum head and handle.

Item #	IP	MP	PKG	Length
W83194	6	24	LAB	40"

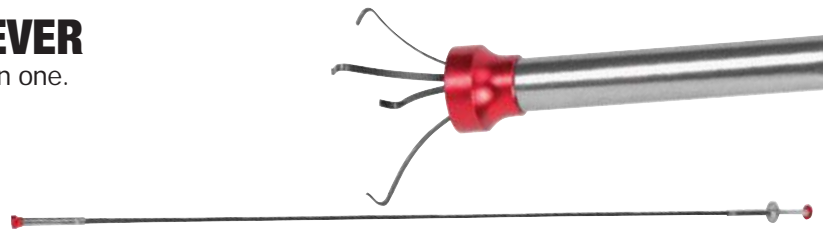

FLEXIBLE CLAW RETRIEVER

- Flexible shaft reaches confined areas.
- Powerful 4 claw design.

Item #	IP	MP	PKG	Length
W1184C	12	144	CRD	24"

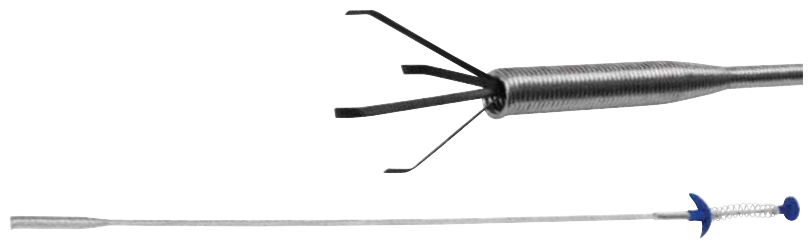

FLEXIBLE MAGNETIC PICKUP TOOL

- Flexible shaft reaches confined areas.
- Strong durable magnets and powerful claws for easy retrieval.

Item #	IP	MP	PKG	Length	Capacity
W1182C	12	144	CRD	24"	2 lbs.



FLEXIBLE MAGNETIC PICKUP TOOL

- For retrieving lost parts, tools, nuts, and bolts.

Item #	IP	MP	PKG	Length	Capacity
W83197	12	48	CRD	24"	4 lbs.



FLEXIBLE MAGNETIC PICKUP TOOL

- Rigid flexible pickup tool bends to any position and stays there.
- Great for small parts in blind spots and other hard to reach places.
- Brass neck with aluminum handle.

Item #	IP	MP	PKG	Length	Capacity
W9117	12	72	Pg 309	24"	1.5 lbs.



HAND TOOLS

MAGNIFYING GLASSES

TELESCOPING MAGNETIC SWEEPER

- Lightweight aluminum housing and durable steel handle.
- Telescoping handle extends from 27 to 40".
- 14-1/2" sweeping width.
- 3" solid rubber wheels.



Item #	IP	MP	PKG	Telescoping	
				Min	Max
W2071	1	6	CBX	27"	40"

EXTENDABLE MAGNETIC PICKUP

- Super strong magnet lifts up to 50 lbs.
- Comfortable rubber handle.
- Extends from 24" to 38".
- 3" magnetic head.



Item #	IP	MP	PKG	Length	Capacity
W2070	6	24	LAB	24 to 38"	50 lbs.

4X MAGNIFYING GLASS

- 4x Power non-distorting optical grade glass lens.
- Comfortable rubber grip handle.
- Over molded frame for extra protection.



Item #	IP	MP	PKG	Lens	Length	Color(s)
W15029	8	48	Pg 313	2-7/8"	7-1/4"	Red, Blue, Green, Orange
W15038	12	72	CRD	2-7/8"	7-1/4"	Red
20169	4	24	Pg 321	2-7/8"	7-1/4"	Red, Blue

3X JUMBO MAGNIFYING GLASS

- 3X Power non-distorting optical grade glass lens.
- Comfortable rubber grip handle.
- Over molded frame for extra protection.



Item #	IP	MP	PKG	Lens	Length	Color(s)
W15032	5	40	Pg 313	4-1/2"	10"	Red

4X LIGHTED MAGNIFYING GLASS

- Wide angle LED lights up work area.
- 4X Power non-distorting optical grade glass lens.
- Comfortable rubber grip handle.
- Over molded frame for extra protection.
- Batteries included.



Item #	IP	MP	PKG	Lens	Length	Battery		
						Qty.	Type	Color(s)
W15028	6	48	CRD	2-7/8"	7-1/4"	3	AG13	Yellow
W15036	8	48	Pg 313	2-7/8"	7-1/4"	3	AG13	Red, Blue, Green, Orange

5X-7X LIGHTED MAGNIFYING LENS

- Adjusts from 5x-7x magnification by simply rotating the outer ring.
- Features 3 LEDs for better illumination.
- Optical grade glass and impact resistant housing.
- Dual mode operation: on/off, and touch mode
- touch the outer ring to activate the LEDs.
- Batteries included.



Item #	IP	MP	PKG	Lens	Diameter	Battery	
						Qty.	Type
W15035	12	48	CRD	2-5/8"	3-1/2"	2	CR2016

HAND TOOLS

9-PC HOOK & PICK SET

- Drop forged, heat-treated chrome vanadium steel shafts.
- Comfortable non-slip molded grips.
- Includes 1" scraper.
- US Patent D693201S1



Item #	IP	MP	PKG	Length	Contents
W948	1	6	CRD	10"	Straight, full hook, 45, 90, hook, scraper
				6-1/2"	Straight, full hook, 45, 90, hook

6-PC HOOK & PICK SET

- Includes straight, angled and combination picks.
- Durable double injection molded handles.
- Handy storage tray included.



Item #	IP	MP	PKG	Length	Contents
W942	6	48	CRD	9-3/8"	Straight, 90°, hook, double angle, complex, combination pick.

8-PC SPECIALTY PICK/DRIVER SET

- Chrome vanadium steel shafts with magnetic tips.
- High visibility PVC handles.



Item #	IP	MP	PKG	Length	Picks	Drivers
W941	6	24	CRD	5-1/4"	Straight, 45°, 90°, hook	#0, 1/8", T15, T20

2-PC SPECIALTY PICK SET

- Hardened tips.
- Knurled center grips.
- O-ring and seal pick for removing and installing o-rings and seals.



Item #	IP	MP	PKG	Length	Contents
W80750	24	144	CRD	9"	Straight, 90°, hook, double angle

9-PC INSPECTION SET

- Versatile utility kit for automotive access, inspection, removal and retrieval
- 3 LED anodized aluminum flashlight features 1/4" hex holder.
- Mirror and pickup tool extend to nearly 20"
- Batteries included.



Item #	IP	MP	PKG	Mirror	Lift	Telescoping		Battery		Picks	Drivers
				Diameter	Capacity	Min	Max	Qty.	Type		
W949	6	36	DBL	1-1/8"	3 lbs.	5-3/4"	20"	4	LR44	Straight, 90°, hook, double angle	#0, 1/8"

HAND TOOLS

MEASURING & LEVELING

DIGITAL MEASURING WHEEL

- 6-1/4" digital measuring wheel handle mounted backlit display that is easy to read from a standing position.
- Displays measurements up to 10,000'/meters with an accuracy of 1" per 100'.
- Memory stores up to 5 measurement values that can be quickly recalled.
- Comes in a convenient carrying case with shoulder strap.

Integrated kickstand.

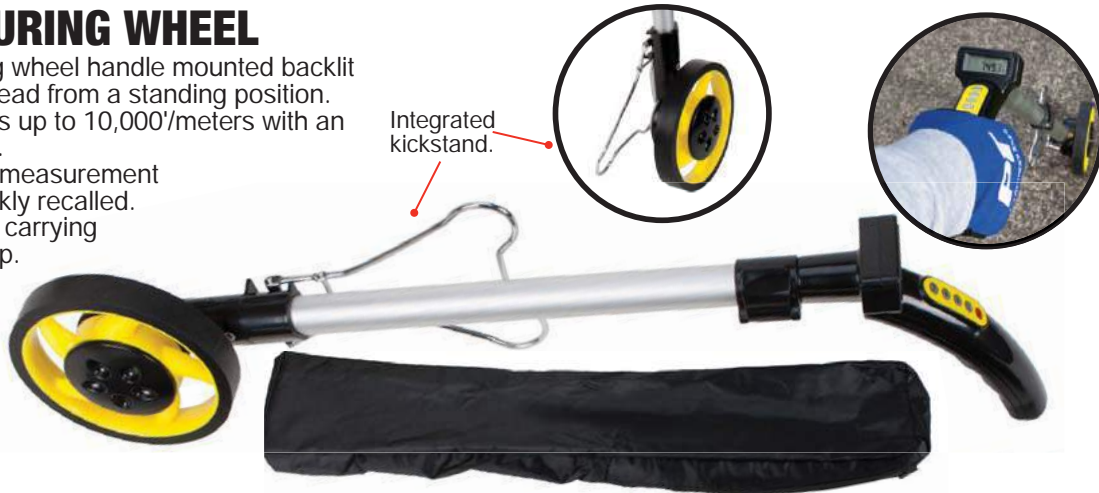

Telescopic aluminum handle allows for height adjustment and quick, easy storage.

Item #	IP	MP	PKG	Range	Accuracy	Telescoping		Battery	
						Min	Max	Qty.	Type
W5704	1	10	CBX	0 to 10,000'	±.3%	28"	40"	2	AAA

TAPE MEASURES

- Convenient and quick fractional readout every 1/8".
- Durable casing stands up to rough treatment.



W5025BP readout (other may vary)

Item #	IP	MP	PKG	Length	Width	
W5006	12	48	DBL	6'	1/4"	Key ring
W5020	6	36	CRD	12'	5/8"	-
W5022	6	36	CRD	16'	3/4"	-
W5024	6	36	CRD	25'	1"	-
W5035	4	16	CRD	35'	1"	Magnetic
W5025BP	6	12	CRD	12' 25'	5/8" 1"	-



HAND TOOLS

TAPE MEASURE SAE/METRIC

- Convenient and quick fractional readout every 1/8".
- Both SAE and Metric markings on tape measure blade.
- Durable casing stands up to rough treatment.



Item #	IP	MP	PKG	Length	Width
W5124	6	36	DBL	25'	1"
W5124BP	6	12	DBL	12' 25'	5/8" 1"



CLEAR TAPE MEASURE

- Clear polycarbonate housing.
- Double sided hook for easy measuring.
- Convenient belt hook and wrist strap.



Item #	IP	MP	PKG	Length	Width
W5040	6	48	BLK	25'	1"
W5041	8	48	TAB	25'	1"



Printing on both sides of tape, with both horizontal and vertical incremental measurements.

FOLDING LEVEL

- This versatile hinged level measures precisely and quickly, even around corners, pipes, or on stairs.
- Also can be used as a reliable straight edge around corners and obstructions.

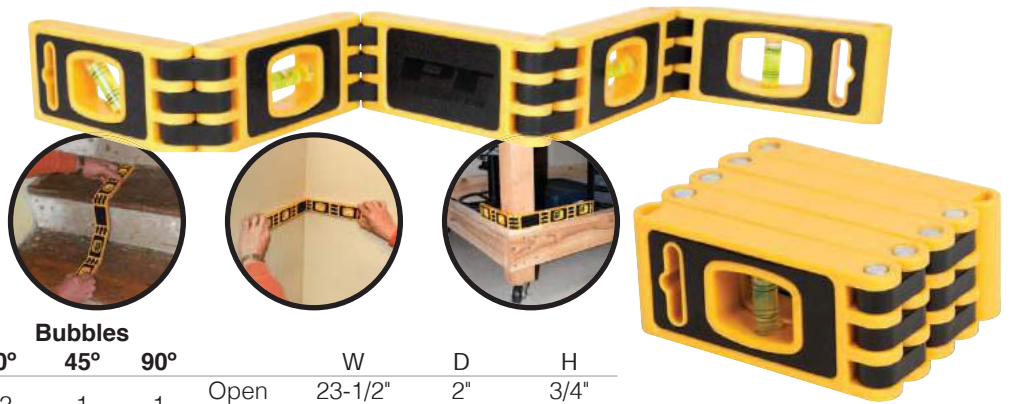

Item #	IP	MP	PKG	Bubbles			W	D	H	
				0°	45°	90°				
W5703	16	64	SLV	2	1	1	Open	23-1/2"	2"	3/4"
							Folded	4-3/4"	3-19/32"	3-3/4"

HIGH IMPACT ABS LEVEL

- High impact plastic construction.
- Three easy to read bubble vials



Item #	IP	MP	PKG	Length	Bubbles		
					0°	45°	90°
W5701	4	24	LAB	24"	1	1	1

ALUMINUM RAFTER SQUARE

- Aluminum alloy body with protective powder coat finish.
- Permanent cast graduations on both sides.
- Works as saw guide for 45 and 90° angles.

Item #	IP	MP	PKG	Size
W5052	6	36	CRD	7"

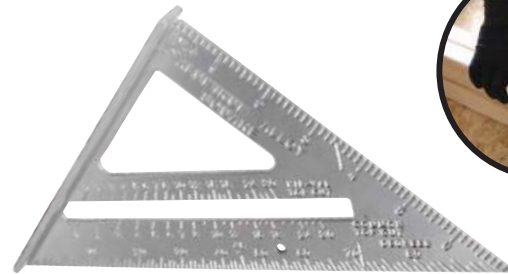

STRAIGHT EDGE

- SAE and Metric markings.
- 36" long x 1" wide.

Item #	IP	MP	PKG
W5702	50	200	LAB



STUD FINDER

- Detects metal and wood studs and AC wire up to 1-1/4" deep.
- Accurate within 1/8" of stud.
- Audible and LED indicators.
- Battery not included.



Item #	IP	MP	PKG	Battery	
				Qty.	Type
W5763	6	48	DBL	1	9V

3-PC CHALK LINE SET

- 100' chalk reel with durable zinc alloy housing.
- Reel can be used as a plumb bob for vertical marking.
- Line level for horizontal marking.
- 4 oz. red chalk.



Item #	IP	MP	PKG	Line Length
W5512	6	24	CRD	100'

HAND TOOLS

PRECISION MEASURING

DIGITAL CALIPER

- SAE to metric conversion with a push of a button.
- Zero setting at any position within measuring range.
- Thumb wheel with lock.
- Battery and storage case included.

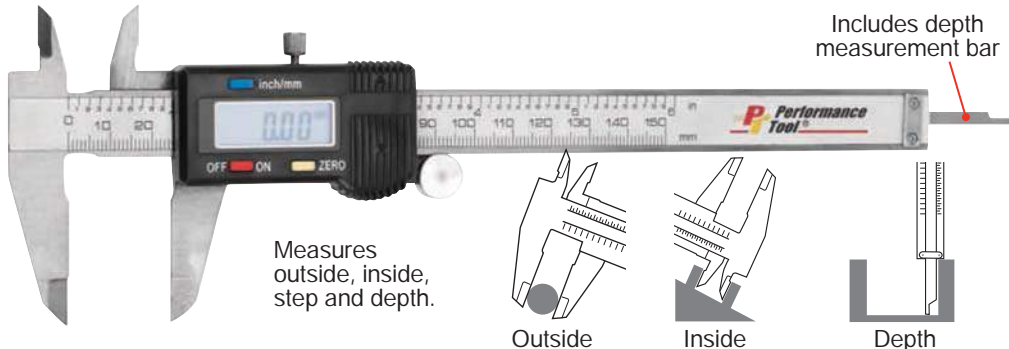

Measures outside, inside, step and depth.

Outside

Inside

Depth

Item #	IP	MP	PKG	Max Range		Resolution		Accuracy ±		Throat Depth		Overall Length	Battery	
				inch	mm	inch	mm	inch	mm	O.D.	I.D.		Qty.	Type
W80152	12	48	CRD	6	150	0.0005	0.01	0.001	0.03	1-9/16"	13/16"	9-3/8"	1	LR44

COMPOSITE DIGITAL CALIPERS

- Lightweight and durable carbon fiber construction.
- Measures outside and inside dimensions.
- Large easy to read LCD display.
- Zero setting at any position within measuring range.



Great tool for gathering accurate measurements on just about anything from projects around the home or office, to automotive repairs, carpentry or laboratory applications.

Item #	IP	MP	PKG	Max Range		Resolution		Accuracy ±		Throat Depth		Overall Length	Battery	
				inch	mm	inch	mm	inch	mm	O.D.	I.D.		Qty.	Type
W80157	12	72	CRD	4	100	0.01	0.1	0.01	0.2	1-1/8"	11/16"	7"	1	LR44
W80155	25	100	CRD	6	150	0.01	0.1	0.01	0.2	1-9/16"	13/16"	9-1/2"	1	SR44
W80160	12	48	CRD	8	200	0.01	0.1	0.01	0.2	2-29/32"	13/16"	11-1/8"	1	LR44

HAND TOOLS

DIAL CALIPER

- Measures outside, inside, step and depth.
- Stainless steel construction.



Item #	IP	MP	PKG	Max Range		Graduations		Revolutions		Throat Depth		Overall Length
				inch	mm	inch	mm	inch	mm	O.D.	I.D.	
W80151	12	48	CRD	6	150	0.001	0.02	0.01	0.2	1-9/16"	13/16"	9-1/4"

PLASTIC CALIPER

- 4 way measurements for outside, inside, step and depth.

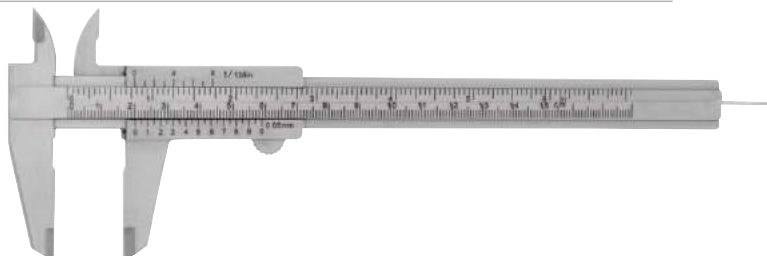

Item #	IP	MP	PKG	Max Range		Throat Depth		Overall Length
				inch	mm	O.D.	I.D.	
W80150	24	240	CRD	6	150	1-1/2"	13/16"	9"

DIGITAL MICROMETER

- Reads both SAE and Metric dimensions to an accuracy of 1/10,000th of an inch, and 0.0025mm.
- C2 carbide ground anvil and spindle for added durability and accuracy.
- Measures up to 1" (25mm) in an easy to read LCD screen.
- Includes rolling measurement adapter, battery and storage/carrying case.



Item #	IP	MP	PKG	Max Range		Resolution		Accuracy ±		Overall Length	Battery	
				inch	mm	inch	mm	inch	mm		Qty.	Type
W80156	5	50	SLV	1	25	0.00005	0.001	0.0001	0.0025	6-1/8"	1	SR44

DIGITAL SCALES

- Digital LCD screen clearly shows weight in pounds, kilograms or *stones.
- Provides accurate readings up to 660 lbs. (300Kg).



Strong and comfortable handle.

W1478
Strong steel S-hook and O-ring to connect to hoist or gambrel

Item #	IP	MP	PKG	Units	Capacity	Accuracy	Battery	
							Qty.	Type
W1477	6	24	CRD	lbs, Kg	100 lbs.	-	1	CR2032
W1478	6	24	CBX	lbs, Kg, St	660 lbs.	±0.2 lbs.	2	CR2032

INFRARED THERMOMETERS

- Measures surface temperature without making contact.
- Easy to read large digital display with backlight.
- Laser pointer for accurate use.
- Fahrenheit or Celsius readings.
- Includes a 9V battery.
(except W89721 2-AAA batteries)



Item #	IP	MP	PKG	Temperature Range		Distance Spot Ratio	Accuracy
				°F	°C		
W89720	5	20	CLM	0 to 960	-18 to 520	8:1	±1.5%
W89721	10	20	CLM	-58 to 716	-50 to 380	12:1	±1.5%
W89722	10	60	CLM	-58 to 626	-50 to 330	12:1	±1.5%
W89724	5	10	CLM	-58 to 1382	-50 to 750	12:1	±2%

DIGITAL LASER TACHOMETER

- Use to accurately measure the RPM without touching the object, displays it on a LCD screen.
- Measures the rotational speed with a visible red LED beam.
- High intensity class II laser measures from 2.5 - 99,999 RPM.
- Auto zero adjustment, stores last, minimum and maximum readings.
- Includes a handy storage case, 9v battery, 24" of reflective tape to aid measurements and operating manual.

Item #	IP	MP	PKG	Testing Range (RPM)	Resolving Power (RPM)	Accuracy	Sampling Time	Battery	
								Qty.	Type
W89719	1	50	DBL	2.5 to 99,999	0.1 (2.5 to 999.9)	±0.05%	0.8s	1	9V

HAND TOOLS

FILES & SETS

6-PC FILE SET

- Two durable black rubber handles with plastic inserts for comfort and convenience.
- Heat treated carbon steel files.
- Contents: 6" mill file, 8" mill file, 6" round file and 8" half round file.



Item #	IP	MP	PKG
W5390	6	36	DBL

FILES WITH HANDLE

- Durable black rubber handles with plastic inserts for comfort and convenience.
- Heat treated carbon steel files.

	Item #	IP	MP	PKG
Round	6" W5400	6	72	TAB
	8" W5399	6	72	TAB
Half Round	6" W5403	6	72	TAB
	8" W5398	6	72	TAB
Mill	6" W5406	6	72	TAB
	8" W5394	6	72	TAB
	10" W5393	6	72	TAB



Round

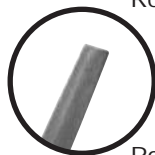

Half Round

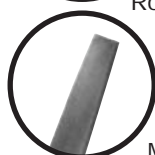

Mill



13-PC MICRO FILE SET

- Diamond and carbon surfaces for quick removal.
- Precision sizes for fine detail work.
- Nylon storage case keeps everything organized.
- Comfortable non-slip molded handle with quick change 1/4" hex chuck.
- US Patent D693201S1



HAND TOOLS



Item #	IP	MP	PKG
W5391	6	24	CBX

HALF ROUND SHAPER FILE

- Fits most 10" adjustable handles.
- Use on body filler putty or glaze.



Item #	IP	MP	PKG	Size
W1023	6	240	CRD	10"

ADJUSTABLE HACKSAW

- Adjustable for 10 or 12" blades.
- Comfortable handle.

Item #	IP	MP	PKG	Blade Length	Overall Length
W730	6	36	SLV	10, 12"	17-1/4"
W731	6	36	SLV	10, 12"	18-5/8"

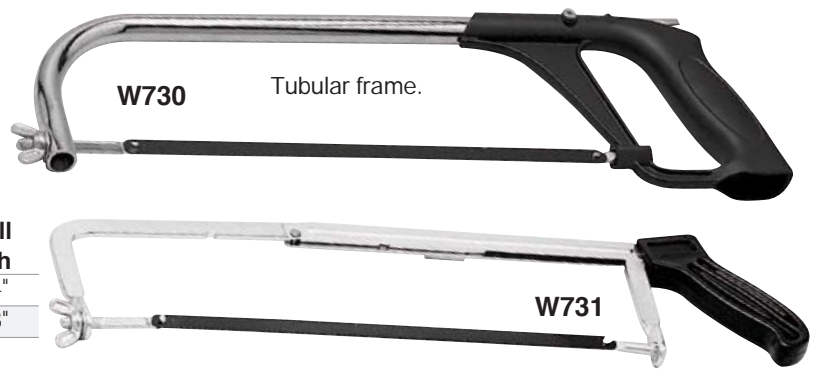

PROFESSIONAL HACKSAW

- Comfortable die cast aluminum handle.
- 45 and 90° blade positioning.
- Extra blades store in top bar.
- Works as a keyhole saw.

Item #	IP	MP	PKG	Blade Length	Overall Length
W732	6	36	SLV	12"	15-1/4"



MINI HACKSAW

- Sturdy I-Beam cast aluminum construction with protective powder coat finish.
- 6 blade angle settings.
- Uses standard coping saw blades.

Item #	IP	MP	PKG	Blade Length	Overall Length
W725	12	96	SLV	5-3/4"	10"



UTILITY HACKSAW

- Comfort grip handle.
- Compact design for confined work areas.
- Works with several blade sizes.

Item #	IP	MP	PKG	Blade Length	Overall Length
W733	12	48	CRD	8"	12-1/2"



SPRING LOADED HACKSAW

- Pistol grip handle with spring loaded blade guide.
- Rubber foot on end adds stability to ensure straight cuts.
- Comfortable molded handle with rubberized grip.
- Includes high quality bi-metal 10" blade.

Item #	IP	MP	PKG	Blade Length	Overall Length
W726	6	72	CRD	10, 12"	10-1/2"



4-PC HACKSAW BLADE SETS

- High carbon steel.
- Each set contains two 18 and 24 teeth per inch blades.

Item #	IP	MP	PKG	Blade Length
W739	12	72	CRD	12"
W740C	12	144	CRD	10"
W741C	12	144	CRD	12"



HAND TOOLS

SAWS & BLADES

WOOD HANDLE TOOL BOX SAW

- Aggressive tri-bevel tooth design cuts 50% faster than conventional hand saws.
- Back of saw can be used to mark 45 & 90° angles.
- Smooth hardwood handle for comfort and control.
- Teeth can be sharpened.



Item #	IP	MP	PKG	Blade Length
W696	4	24	SLV	15"

JAB SAW

- Sharp blade tip for easy wallboard penetration.
- Aggressive crosscut tooth pattern.
- Comfortable injection molded grip.
- Includes storage pouch.



Item #	IP	MP	PKG	Blade Length
W5150	12	48	DBL	15"

36-PC HOBBY KNIFE SET

- Useful for numerous hobbies and crafts projects.
- Excellent for detail work on sculptures, carvings and model work.
- Easy carrying storage case and deluxe knife handles with SK5 blades.
- Set contains:
 - 28 pcs. SK5 hobby knife blades,
 - 2 pcs. TPR cushion knife handles,
 - 2 pcs. needles,
 - 1 pc. tweezers,
 - 1 pc. 2mm slotted screwdriver.
 - 1 pc. 3" vernier caliper.



Item #	IP	MP	PKG
W1709	6	12	DBL

7-PC HOBBY KNIFE SET

- 6 assorted knife blades for multiple applications.
- Includes flat chisels style and most popular scalpel style blades.

Item #	IP	MP	PKG
W748	12	144	CRD



KNIFE SETS

- Includes blades for various projects.
- Comfortable contoured handle.
- 14 precision hobby blades.
- Storage case.



Item #	IP	MP	PKG
W9170	15-PC Hobby Knife	4	24 CAS/Pg 310
W9171	21-PC Utility Knife	4	24 CAS/Pg 310

BLK: Bulk | CAS: Storage Case | CBX: Color Box | CRD: Carded | CLM: Clamshell | DBL: Double Blister
LAB: Color Label | RAC: Storage Rack | SHK: Shrink Wrap | SLV: Sleeve | TAB: Hang Tab | WBX: White Box

PRO GRIP SCRAPERS

- Rigid stainless steel blade with sharp chisel tip.
- Ergonomic grip w/broad hilt for greater comfort and control.

W9183

6-in-1 painter's tool: scraper, spreader, gouger, putty remover painter roller cleaner, nail & tack puller.



Item #		IP	MP	PKG	Length	
					Blade	Overall
W5489	Offset	8	48	CRD	1-1/4"	10"
W9181	Straight	6	36	Pg 311	1-1/4"	9-1/2"
W9183	Painter's	6	36	Pg 311	3"	9-3/4"

W5489

Offset design for hard to reach areas.

WALL SCRAPER

- Tempered and ground steel blade.
- High impact plastic handle with hang hole.
- Rigid blade.

Item #	IP	MP	PKG	Length	
				Blade	Overall
W5486	12	144	TAB	1-1/4"	7-3/8"



PUTTY KNIFE & SCRAPER SET

- Tough natural wood handles.
- Includes 3" wall scraper and 1-1/4" putty knife.

Item #	IP	MP	PKG	Length	
				Blade	Overall
W3013	6	60	CRD	1-1/4"	7-1/8"
				3"	7-7/8"



CARBON & GASKET SCRAPER

- Alloy steel construction.
- Plated to resist corrosion.

Item #	IP	MP	PKG	Length	
				Blade	Overall
W234C	6	72	CRD	1"	10-7/8"



5-PC SCRAPER & REMOVER SET

- Durable alloy steel shafts.
- Tough plastic handles.



Item #	IP	MP	PKG	Scraper		Hose Remover	Scratch Awl	Cotter Pin Puller
				Blade	Overall			
W235	6	24	CRD	1"	8"	7"	9"	9"
				1"	11"			

HAND TOOLS

SCRAPERS & KNIVES

BX5 RAZOR SCRAPERS

- BX5 blades last up to 5 times longer than standard blades.
- Ergonomic non-slip molded grip for greater comfort and control.
- Compact size for confined or hard to reach places.
- Includes 1 BX5 scraper blade.



W5750



W7508



W7502

Item #		IP	MP	PKG	Length
W5750	Mini	6	48	DBL	4-1/2"
W7502	Stubby	12	72	CRD	5"
W7508	Extended	6	24	CRD	9-1/2"

EXTENDED SCRAPER

- Reaches confined areas.
- Extra blades storage in handle.
- Includes 3 razor blades and 3 plastic blades.



Item #	IP	MP	PKG	Length
W233	6	72	CRD	12"

RETRACTABLE SAFETY SCRAPER

- Zinc plated for corrosion resistance.
- Blade retracts for safety when not in use.
- Includes box with 5 replacement blades.



Item #	IP	MP	PKG	Length
W743	6	144	CRD	4"

3 POSITION RAZOR SCRAPER

- Folds out and locks in 3 positions.
- Blade retracts and locks into handle for compact storage and safety.



Item #	IP	MP	PKG	Length
W749	6	36	CRD	8-1/4"

BX5 RAZOR BLADES

- High quality SK2 steel lasts up to 5X longer than standard steel blades.
- Fits standard razor scrapers.

Item #		IP	MP	PKG	
W7506	5-PK	40	200	CRD	BX5
W7507	50-PK	8	32	CRD	BX5
W742	12-PK	24	240	CRD	-
W747	100-PK	6	36	CRD	-



W7506



PLASTIC RAZOR BLADES

- High quality polycarbonate plastic.

Item #		IP	MP	PKG
W7504	20-PK	24	144	CRD



W7504



W7507

HAND TOOLS

AUTO-LOADING UTILITY KNIFE

- Auto-loading blade chamber.
- Quick change blade mechanism.
- Heavy duty compact design.
- Single-handed operation.
- On-board blade store for up to 7 spare blades.
- Includes 8 heavy duty utility blades.

Item #	IP	MP	PKG	Length
W694	12	72	CRD	5-1/2"



QUICK CHANGE UTILITY KNIFE

- High grade steel blade.
- Push button auto open and easy lock.
- Durable rubber grip handle.
- Extra blade in internal storage compartment for easy access.

Item #	IP	MP	PKG	Length
W746	12	48	CRD	7"



UTILITY KNIFE

- 3 position retractable blade.
- Extra blade included stores in handle.
- Indispensable around the home, shop & office.

Item #	IP	MP	PKG	Length
W745C	6	144	CRD	5-3/4"



52-PC FOLDING UTILITY KNIFE SET

- Combines the strength of a fixed blade with convenience of pocket knife.
- Compact design folds down to 3-9/16" for easy storage & portability.
- Change blades with the push of a button.
- Blade locks in open position for safety.
- Includes 50 standard utility knife blades.

Item #		IP	MP	PKG	
W1720	52-PC	6	24	DBL	Red, blue knife, 50 blades with storage
W2600	6-PC	6	48	DBL	Red knife, 5 blades
W2601	6-PC	6	48	DBL	Blue knife, 5 blades
W12113	6-PC	6	48	CRD	Silver knife, 5 blades



BX5 UTILITY KNIFE BLADES

- High quality SK2 steel lasts up to 5X longer than standard steel blades.
- Heavy duty blades precision honed to razor edge.

Item #		IP	MP	PKG	
W7503	5-PK	24	144	CRD	BX5
W7505	50-PK	4	24	CRD	BX5
W744	5-PK	24	240	CRD	-
W7500	10-PK	20	240	CRD	-
W7501	100-PK	4	24	CRD	-



HOOK BLADES

- Fits standard utility knives.

Item #		IP	MP	PKG	
W756	5-PK	20	240	CRD	



HAND TOOLS

POCKET KNIVES

STAINLESS STEEL KNIFE

- Stainless steel straight back blade.
- In handle locking safety mechanism.
- Nylon case for storage.

Item #	IP	MP	PKG	Blade	Closed	Open
W458	6	72	DBL	4"	4-1/2"	7-3/4"



THE SOROTI CAMO POCKET KNIFE

- Stainless steel straight back blade.
- Thumb stud for easy one hand operation.
- Inline blade lock/release mechanism.

Item #	IP	MP	PKG	Blade	Closed	Open
W9350	6	48	DBL	3-1/4"	4-1/4"	8"



Special edition dual tone camo pattern.

THE KAMPALA CAMO POCKET KNIFE

- Stainless steel partially serrated blade.
- Thumb stud for easy one hand operation.
- Inline blade lock/release mechanism.

Item #	IP	MP	PKG	Blade	Closed	Open
W9351	6	48	DBL	3-1/4"	4-1/4"	8"



Special edition dual tone camo pattern.

TRACTION KNIFE

- Titanium coated stainless steel blade.
- All other components are stainless steel for durability.
- Wire loop pocket clip.

Item #	IP	MP	PKG	Blade	Closed	Open
W9352	6	48	CRD	3-3/8"	4-13/16"	8-1/2"



G10 tactical engraved handle.

RESCUE KNIFE

- Stainless steel partially serrated blade
- Dual thumb studs for easy opening.
- Liner lock with pocket clip.

Item #	IP	MP	PKG	Blade	Closed	Open
W9341	6	48	DBL	3-1/2"	5"	8-1/2"



Black tactical finish.



Aluminum handle.

Tempered glass breaker.

THE KYOTERA KNIFE

- Straight edge Tanto blade with black finish.
- Thumb stud for easy one hand operation.
- In-line blade lock/release mechanism with pocket clip.

Item #	IP	MP	PKG	Blade	Closed	Open
W9356	6	48	DBL	3"	4-1/2"	7-1/2"



Black tactical finish.



Black anodized finish.

Tempered glass breaker.

MASAKA FOLDING KNIFE

- Stainless steel non-reflective black Tanto blade.
- Thumb stud for easy one hand operation.
- In-line blade lock/release mechanism with pocket clip.

Item #	IP	MP	PKG	Blade	Closed	Open
W9357	6	48	DBL	3-1/4"	4-1/2"	8-1/4"



PARACORD HANDLE KNIFE

- Stainless steel drop point blade with polished face.
- Thumb stud for easy one hand operation.
- In-line blade lock/release mechanism with pocket clip.

Item #	IP	MP	PKG	Blade	Closed	Open
W9360	6	48	DBL	3-1/2"	4-3/4"	8-1/2"



Includes 30" of paracord.

HAND TOOLS

LI-ION LED RESCUE KNIFE

- Features LED light, glass breaker and carabiner clip
- Straight edge stainless steel Tanto blade.
- Includes micro USB recharging cable.

Item #	IP	MP	PKG	Blade	Closed	Open	Battery
W9362	1	8	DBL	3"	4-5/8"	7-5/8"	Li-Ion



LEAF CAMO KNIFE

- Stainless steel blade with tactical black finish.
- Thumb stud for easy one hand operation.
- Blade lock/release mechanism and pocket clip.

Item #	IP	MP	PKG	Blade	Closed	Open
W9333	6	48	DBL	3-1/4"	4-1/2"	7-3/4"



DIGITAL CAMO KNIFE

- Stainless steel blade with tactical black finish.
- Dual thumb studs for easy opening.
- Liner lock and pocket clip.

Item #	IP	MP	PKG	Blade	Closed	Open
W9339	6	48	DBL	3-1/2"	4-9/16"	8"



Aluminum handle with digital camo finish

POLISHED STEEL KNIFE

- Stainless steel partially serrated blade.
- Thumb stud for easy one hand operation.
- Blade lock/release mechanism and pocket clip.

Item #	IP	MP	PKG	Blade	Closed	Open
W9328	6	48	DBL	3-1/2"	4-1/2"	8"



POCKET KNIFE

- Stainless steel partially serrated blade.
- Thumb stud for easy one hand operation.
- Blade lock/release mechanism and pocket clip.

Item #	IP	MP	PKG	Blade	Closed	Open
W9332	6	48	DBL	2-3/4"	3-3/4"	6-1/2"



LOCK BACK KNIFE

- Stainless steel partially serrated blade.
- Thumb stud for easy one hand operation.
- Blade lock/release mechanism and pocket clip.

Item #	IP	MP	PKG	Blade	Closed	Open
W9316	6	48	DBL	3"	4"	6-3/4"



Aluminum handle with rubberized ABS inlay

CLASSIC LOCK BACK KNIFE

- Stainless steel clip point blade.
- Lock back blade release mechanism.
- Thumb groove.

Item #	IP	MP	PKG	Blade	Closed	Open
W9313	6	48	DBL	3-1/2"	5"	8-1/2"



Polished hardwood handle. Solid brass linings and bolsters

MEDIUM STOCKMAN KNIFE

- Stainless steel clip point 2-1/4" blade.
- 1-3/4" sheep foot & 1-1/2" spey blade.
- Thumb grooves.

Item #	IP	MP	PKG	Blade	Closed	Open
W9317	6	48	DBL	2-1/4"	3-3/8"	5-3/4"



Polished hardwood handle. Solid brass linings and bolsters.

POCKET KNIFE SETS

2-PC MINI MULTI TOOL SET

- Stainless steel blade.
- Includes one hand opening knife with belt clip and 12-in-1 multi purpose tool.

Item #	IP	MP	PKG	Blade	Closed	Open
W9320	6	48	DBL	2-1/8"	3"	5"
				-	4-3/8"	



See next page for function details.

TACTICAL KNIFE & SETS

- Stainless steel blade with black finish.
- Thumb stud for easy one hand operation.
- Blade lock/release mechanism and pocket clip.

Item #		IP	MP	PKG	Blade	Closed	Open
W9340	Knife Only	6	48	DBL	3-3/8"	4-1/2"	7-7/8"
W9345	w/Sharpener	12	72	DBL	See W2554		
W2491	w/Flashlight	8	32	DBL	See W2456		



2-PC POCKET KNIFE SET

- Stainless steel blades.
- Built in bottle openers.
- Thumb stud for easy one hand operation.

Item #	IP	MP	PKG	Blade	Closed	Open
W9309	6	48	DBL	1-1/4"	2-1/2"	3-1/8"

Built in bottle openers.



2-PC CAMO KNIFE GIFT SET

- Stainless steel blades.
- Thumb stud for easy one hand operation.
- Blade lock/release mechanism and pocket clip.

Item #	IP	MP	PKG	Blade	Closed	Open
W9323	6	48	DBL	2-1/2"	3-3/4"	6-1/4"
				3"	4-1/2"	7-1/2"



High impact resistant ABS handles

HAND TOOLS 2-PC TACTICAL KNIFE SET

- Stainless steel partially serrated blade.
- Thumb stud for easy one hand operation.
- Blade lock/release mechanism and pocket clip.

Includes pocket size sharpening stone.

Item #	IP	MP	PKG	Blade	Closed	Open
W9344	8	32	DBL	3-3/8"	4-1/2"	7-1/2"
				3-1/4"	4-3/8"	7-3/4"



Knurled black aluminum handle with pocket clip

Polished steel handle with pocket clip

3-PC ALUMINUM CAMO KNIFE SET

- Stainless steel blades.
- Aluminum handles with camo finish.
- Includes fixed blade knife, folding knife with belt clip, 2 blade stockman knife and lithographed collector's tin.

Item #	IP	MP	PKG	Blade	Closed	Open
W9335	8	32	DBL	3-1/2"	-	8"
				2-5/8"	3-3/4"	6-1/2"
				2"	3"	5"
				1-5/8"	4-5/8"	



6-5/8" overall length

MULTI-FUNCTION TOOLS

- Lightweight and durable anodized aluminum handles.
- Spring loaded jaws.



1. Sm Slotted Drivers
 2. Bottle Cap Opener
 3. Saw Blade
 4. Knife Blade
 5. Long Nose Pliers
 6. Curved Jaw Pliers
 7. Wire Cutters
 8. Fine File
 9. Coarse File
 10. Lg Slotted Driver
 11. Can Opener
 12. Phillips Driver
- example only, may vary from model to model.*

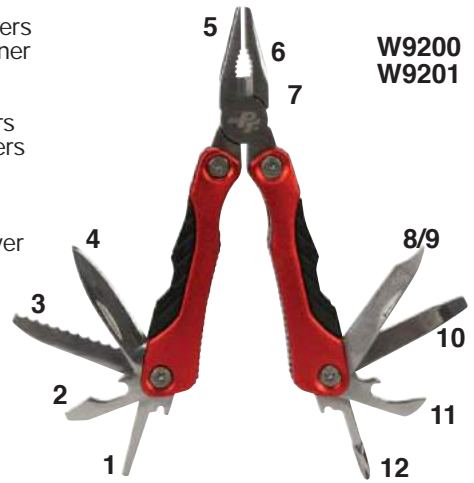

Item #	IP	MP	PKG	#	1	2	3	4	5	6	7	8	9	10	11	12	Other function(s)
W9305	Tactical	5	30	CRD/Pg 311	12	x	x	x	x	x	x	x	-	x	x	x	mini blade
W9200	Mini	8	32	Pg 313	13	x	x	x	x	x	x	x	x	x	x	x	med slotted
W9201		6	24	Pg 313	16	x	x	x	x	x	x	x	x	x	x	x	med slotted, ruler, fish scaler, hook remover
W9198	Mini	6	36	CRD/Pg 311	12												
W9176	Mini	6	36	CRD	12	x	x	x	x	x	x	x	x	x	-	x	mini blade
W459	Mini	6	48	CRD/Pg 318	12												
W9320	2-PC	6	48	DBL	12	x	x	x	x	x	x	x	x	x	-	x	awl

16 IN. MINI MACHETE

- Reinforced nylon sheath with strap for safe storage and carrying.
- 10" blade with rust resistant black oxide finish.
- Saw toothed back edge for heavier cutting/sawing.
- Compact size is easy to store and carry.



Paracord wrapped handle provides added comfort as well as an emergency supply of rope.

Item #	IP	MP	PKG	Blade	Cutting Edge	Saw Tooth	Paracord
W9359	12	36	DBL	16"	10"	7-1/4"	11'

KNIFE SHARPENERS

- Super hard tungsten carbide sharpening tools.

Polymer material protects knife edge from damage

Safety handle provides positive easy grip while sharpening your knives. Includes one extra set of sharpening edges



Lever activates suction base securely. Sharpening angle preset at 20° for a perfect edge every time

W9400

Item #	IP	MP	PKG
W9400	Suction Cup	6	48 CLM
W9402	Safety Grip	12	72 DBL



KNIFE SHARPENER W/ BOTTLE OPENER

- Dual edges for precision sharpening.
- Super hard tungsten carbide for new edges.
- Smooth ceramic edge for final polishing.

Item #	IP	MP	PKG
W2554	24	216	Pg 314
W3243	9	108	Pg 316

HAND TOOLS

AIR IMPACT WRENCHES

3/8 IN. IMPACT WRENCHES

- Ideal for changing tires, shock/spring work, and other automotive jobs.
- Push button direction change for quick and easy operation.
- Built-in air regulator for precise speed control.
- Lightweight cast aluminum housing.

Built-in 9 setting regulator.
Air inlet swivels 360 degrees.

M562DB



M622

Contoured handle for comfort and control.



M621

Push button direction for quick and easy operation



Item #		IP	MP	PKG	Max Torque (ft/lbs)	Working Torque (ft/lbs)	Avg CFM	RPM	Inlet (NPT)	Wt (lbs)	Recommended Compressor
M562DB	Butterfly	1	20	CBX		20 - 75	3	11,000	1/4"	2.0	5 Gallon
M622	Single Hammer Clutch	1	16	CBX	180	50 - 100	4	10,000	1/4"	2.9	20 Gallon
M621	Rocking Dog Clutch	1	16	CBX	120	20 - 100	4	11,000	1/4"	2.6	20 Gallon

1/2 IN. IMPACT WRENCHES

- Ideal for changing tires, shock/spring work, and other automotive jobs.
- Comfortable composite housing is compact and lightweight.
- Balanced design for low vibration.

M624

Variable speed with two forward speeds, one reverse.



M558DB

Push button direction for quick and easy operation



M625

Built-in air regulator has 6 torque settings for precise speed control.



Item #		IP	MP	PKG	Max Torque (ft/lbs)	Working Torque (ft/lbs)	Avg CFM	RPM	Inlet (NPT)	Wt (lbs)	Recommended Compressor
M624	Composite Housing	1	10	CBX	230	50 - 200	7	7,800	1/4"	3.0	60 Gallon
M558DB	Rocking Dog Clutch	1	10	CBX	230	50 - 200	4.5	7,500	1/4"	4.4	20 Gallon
M625	Twin Hammer	1	8	CBX	550	25 - 250	8	7,000	1/4"	5.7	60 Gallon

HEAVY DUTY IMPACT WRENCHES

- Built-in air regulator for precise speed control.
- Pin lock hole for oversized sockets.
- Ring socket retainer allows for rapid socket changes.

M634

Heavy duty blow molded case for carrying and storage.



M627

Lever select direction change for quick and easy operation.



Item #		IP	MP	PKG	Max Torque (ft/lbs)	Working Torque (ft/lbs)	Avg CFM	RPM	Inlet (NPT)	Wt (lbs)
M627	3/4" Dr. Heavy Duty	1	4	CBX	950	75 - 450	7	4,600	3/8"	10.7
M634	1" Dr. Extended Anvil	1	1	CBX	1623	200 - 1200	12	3,900	1/2"	23.1

BLK: Bulk | CAS: Storage Case | CBX: Color Box | CRD: Carded | CLM: Clamshell | DBL: Double Blister
LAB: Color Label | RAC: Storage Rack | SHK: Shrink Wrap | SLV: Sleeve | TAB: Hang Tab | WBX: White Box

AIR RATCHETS

- Quality construction triple planetary gear design.
- Ball type retainer for positive socket retention.
- Compact head for easy access in tight areas.
- Level throttle variable speed for precise control.
- Fast, lightweight and easy to use.



Contents: 3/8" Dr. air ratchet, 3" Impact Ext, 3 Impact Bits and 3" Bit Ext, Impact u-joint, 7 SAE Impact Sockets: 3/8", 7/16", 1/2", 9/16", 5/8", 11/16" & 3/4", Storage case

Item #	Drive	IP	MP	PKG	Working Torque (ft/lbs)	Avg CFM	RPM	Inlet (NPT)	Wt (lbs)	Recommended Compressor
M637	1/4"	1	20	CBX	5 - 12	4	250	1/4"	1.2	20 Gallon
M560DB	3/8"	1	10	CBX	10 - 50	4	150	1/4"	2.65	20 Gallon
M561	1/2"	1	20	CBX	10 - 50	4	150	1/4"	2.65	20 Gallon
M639	1/2" HD	1	10	CBX	90	5.3	150	1/4"	4.4	20 Gallon
M564DB	3/8"	1	5	SLV	10 - 50	4	150	1/4"	2.65	20 Gallon

REVERSIBLE AIR DRILLS

M651

- Quality construction triple planetary gear design.
- Side handle for better grip and control.
- Non-slip grip provides added comfort.
- Variable speed throttle.



M648

- Keyless 3/8 in chuck for fast and easy bit changes.
- Convenient fingertip reverse for replacing screws or when binding occurs.
- Long lasting multiple planetary gears with ball bearings.



Item #	Chuck Size	IP	MP	PKG	Chuck Capacity	Avg CFM	RPM	Inlet (NPT)	Wt (lbs)	Recommended Compressor
M648	3/8"	1	10	CBX	3/64"- 3/8"	4	1800	1/4"	2.5	20 Gallon
M651	1/2"	1	10	CBX	1/16"- 1/2"	4	600	1/4"	3.6	20 Gallon

ANGLE AIR DRILL

- Balanced and easy to use for pinpoint accuracy and less fatiguing.
- Lightweight aluminum alloy housing with compact design.
- 90 degree angle head for drilling in confined areas.
- Planetary gear drive for longer life.



M649

Item #	Chuck Size	IP	MP	PKG	Chuck Capacity	Avg CFM	RPM	Inlet (NPT)	Wt (lbs)	Recommended Compressor
M649	3/8"	1	20	CBX	3/64"- 3/8"	4	1900	1/4"	2.4	20 Gallon

AIR HAMMER & SAWS

AIR HAMMERS

- Ideal for general repairs, panel cutting, hole punching, removing rivets and exhaust work.
- Built-in regulator for precise speed control.
- Single piece assembly for longer tool life.
- Quick change coil spring retainer.
- Use replacement chisel set M620

Item #	Accessories	IP	MP	PKG
M669	Needle Scale	1	20	CRD
M696	Retainer Springs	12	36	CRD
M620	4-PC Chisels	6	36	CRD



M669 Used with air hammer to remove rust and scale.



M696 Replacement retainer springs for air hammers.

Weld buster, cold chisel, tapered punch and round nose panel cutter.

M620



M668 Includes 5 chisels: flat, round, spot weld breaker, tapered punch, rivet cutter.



M550DB Includes 4 chisels: flat, spot weld breaker, tapered punch, rivet cutter.

Item #		IP	MP	PKG	Bore Size	Stroke Length	Avg CFM	BPM	Inlet (NPT)	Wt (lbs)	Recommended Compressor
M668	w/5 Chisels	1	10	CBX	3/4"	2.6"	4.8	3,500	1/4"	3.1	20 Gallon
M550DB	w/4 Chisels	1	10	CBX	3/4"	1.7"	4	4,500	1/4"	2.2	20 Gallon

RECIPROCATING AIR BODY SAW

- Cuts a wide range of materials, trims and shapes light plate steel, sheet metal and plastics.
- Adjustable blade guard for controlling depth of cuts.
- Lightweight slim design for access to tight spaces.
- Handles up to 16 gauge sheet metal.
- Rugged die cast aluminum body with rubber grip.



M660

Item #	IP	MP	PKG	Cutting Capacity	Avg CFM	SPM	Inlet (NPT)	Wt (lbs)	Recommended Compressor
M660	1	20	CBX	16GA	6	9,000	1/4"	1.4	60 Gallon
M555-24	12	96	BAG	24 TPI Blades	-	-	-	-	-
M555-32	12	96	BAG	32 TPI Blades	-	-	-	-	-



3-IN-1 AIR NAILER

- This patented tool can drive Brads, Staples, and Finish nails.
- 30% lighter die-cast body for ease of use.
- 360° rotary exhaust to vent away from debris.
- Tool-fire fastener depth adjustment.
- Trigger lock for safety.
- Quick release latch for easy jamming clearing.

18 Ga 1/4" (5.7mm)	16 Ga 0.118" (3mm)	18 Ga 0.079" (2mm)
1/2" 13mm	3/4" 19mm	3/8" 10mm
5/8" 16mm	1" 25mm	5/8" 15mm
3/4" 19mm	1-1/4" 32mm	3/4" 20mm
1" 25mm	1-3/8" 35mm	1" 25mm
1-1/4" 32mm	1-1/2" 38mm	1-3/16" 30mm
1-1/2" 38mm	1-5/8" 40mm	1-1/4" 32mm
1-5/8" 40mm	2" 50mm	1-3/8" 35mm
		1-1/2" 38mm
		1-5/8" 40mm
		1-3/4" 45mm
		2" 50mm



	Gauge	Length	Capacity
Brad	18	3/8 to 2"	80
Finish	16	3/4 to 2"	100
Staple	18	1/2 to 1-5/8"	100

Item #	IP	MP	PKG	Avg CFM	Inlet (NPT)	Wt (lbs)	Recommended Compressor
M673	1	10	CBX	1	1/4"	2.9	5 Gallon

BLK: Bulk | CAS: Storage Case | CBX: Color Box | CRD: Carded | CLM: Clamshell | DBL: Double Blister
LAB: Color Label | RAC: Storage Rack | SHK: Shrink Wrap | SLV: Sleeve | TAB: Hang Tab | WBX: White Box

AIR UTILITY CUTOFF TOOL

- Metal blade guard for maximum protection.
- Built-in air regulator for precise speed control.
- Safety throttle prevents accidental start up.
- Lightweight and durable aluminum housing.
- Rear exhaust directs air away from work area.
- High speed for cutting through sheet metal, fiberglass, bolts, muffler clamps and more.

M563DB



Item #	IP	MP	PKG	Max Diameter	Arbor Hole Size	Cutting Capacity	Avg CFM	RPM	Inlet (NPT)	Wt (lbs)	Recommended Compressor
M563DB	1	20	CBX	3"	3/8"	1"	4	22,000	1/4"	2.0	20 Gallon

3 IN. CUT-OFF WHEELS

- Designed to cut through sheet metal, muffler clamps, hose clamps, rusted bolts, etc.
- For Performance Tool item M563DB.

M575

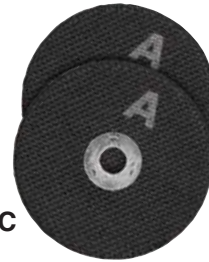

M579C



M580C

Includes aluminum oxide (A), silicon carbide (C), green silicon carbide (GC) and white aluminum oxide disks.

Item #		IP	MP	PKG
M575	Bulk Aluminum Oxide	100	1000	BLK
579C	2-PC Aluminum Oxide	50	500	CRD
580C	4 Assorted Disks	25	200	CRD

AIR NIBBLER

- Adjustable die guide for left, right or straight cutting.
- Cuts up to 16 gauge and leaves no burrs or bent edges.
- Cuts intricate patterns more precisely than shears.
- Lightweight and durable aluminum housing.
- Use on aluminum, tin, plastic, steel & other metals.

M552DB



M554C

M553C	Punch	36	144	CRD
M554C	Die	36	144	CRD

M553C

Item #	IP	MP	PKG	Air Pressure	Hose Size	Avg CFM	SPM	Inlet (NPT)	Wt (lbs)	Recommended Compressor
M552DB	1	10	CBX	90 PSI	3/8"	4	3,500	1/4"	2.0	20 Gallon

AIR METAL SHEARS

- Make smooth, clean cuts through sheet metal, mild steel, tin, aluminum and plastic.
- Adjustable cutting head for radial and contoured cuts.
- Aluminum body with rubber grip for comfort and durability.
- 360 degree swivel head.

M662



Item #	IP	MP	PKG	Cutting Capacity	Air Pressure	Hose Size	Avg CFM	SPM	Inlet (NPT)	Wt (lbs)	Recommended Compressor
M662	1	10	CBX	18 GA	90 PSI	3/8"	6	2,500	1/4"	2.6	20 Gallon
M597DB	30	60	BLK	18 GA	Replacement heads						

HEAVY DUTY PUNCH/FLANGE TOOL

- 360 degree swivel head for effortless operation.
- Lever throttle for precise control.
- Heavy-duty aluminum body with hardened head.
- Punches, crimps, and flanges up to 14-gauge material.
- Quickly prepares sheet metal for riveting, brazing and welding.



Item #	Cutting Capacity	IP	MP	PKG	Air Pressure	Hose Size	Avg CFM	Punch Diameter	Inlet (NPT)	Wt (lbs)	Recommended Compressor
M661	14 Gauge	1	10	CBX	90 PSI	3/8"	4	3/16"	1/4"	3.0	20 Gallon

AIR DIE GRINDERS

1/4 IN. DIE GRINDERS

- Compact design allows for easy use in tight spaces.
- Built-in air regulator for precise speed control.
- Variable speed safety throttle.
- Lightweight and durable aluminum housing.
- Rear exhaust directs air away from work area.



M567DB
Die Grinder, (5) 1/4" shank mounted stones, (5) 1/8" shank mounted stones, 1/4" and 1/8" collets, 2 collet wrenches, storage case

M656
90 degree angle head design allows use in confined areas.



M566DB
Includes 5 of the popular grinding stones.

Item #		IP	MP	PKG	Collet Sizes	Avg CFM	RPM	Inlet (NPT)	Wt (lbs)	Recommended Compressor
M656	Angle Head	1	20	CBX	1/8 & 1/4"	4	20,000	1/4"	1.3	20 Gallon
M566DB	Straight Head	1	20	CBX	1/8 & 1/4"	4	22,000	1/4"	1.3	20 Gallon
M567DB	14-PC Kit	1	20	SLV	1/8 & 1/4"	4	22,000	1/4"	2.2	20 Gallon

DIE GRINDERS ACCESSORIES

- For use with drills and die grinders.

W5313
Rust resistant zinc plated. 25,000 maximum RPM. Fits 1/4 and 3/8" arbors.



M565C
Includes five 1/8" shank and five 1/4" shank mounted stones in assorted sizes.

M535

Includes: 6 roll lock sanding pads, 1 surface conditioning roll lock pad, 1 backing pad with mandrel.



Item #		IP	MP	PKG	Collet Sizes
W5313	Cut-Off Wheel Mandrel	1	20	CBX	1/8 & 1/4"
M565C	10-PC Mounted Stone Set	1	20	CBX	1/8 & 1/4"
M535	8-PC Surface PrepKit	1	20	SLV	1/8 & 1/4"

1/8 IN. MICRO DIE GRINDER

- Lightweight and powerful micro design.
- Slim and comfortable design is ideal for detail work.
- Variable speed with infinitely adjustable throttle.
- Vibration-free ball bearing construction.
- Compact and durable aluminum body.
- Easy twist on/off switch.
- 10pc precision mounted stone kit stores in blow case.
- 42" x 3/16" air hose with 13-1/2" protective sleeve.
- Includes inline oiler, tool oil, female plug, and wrenches.



Item #	IP	MP	PKG	Collet Size	Avg CFM	RPM	Inlet (NPT)	Wt (lbs)	Recommended Compressor
M547	1	10	SLV	1/8"	2	54,000	1/4"	1.8	5 Gallon

BLK: Bulk | CAS: Storage Case | CBX: Color Box | CRD: Carded | CLM: Clamshell | DBL: Double Blister
LAB: Color Label | RAC: Storage Rack | SHK: Shrink Wrap | SLV: Sleeve | TAB: Hang Tab | WBX: White Box

IMPACT SOCKET SETS

- Drop forged chrome vanadium steel for strength and durability.
- Rounded corners for a tighter grip.
- Large size laser etching for easy identification.

	3/8" Dr. 6 point		1/2" Dr. 6 point	
	Deep		Deep	
	M588DB	M594DB	M592DB	M590DB
	IP:10 MP:40	IP:5 MP:20	IP:4 MP:16	IP:5 MP:10
5/16"	x	-	-	-
11/32"	-	-	-	-
3/8"	x	x	-	x
7/16"	x	x	x	x
1/2"	x	x	x	x
9/16"	x	x	x	x
5/8"	x	x	x	x
11/16"	x	x	x	x
3/4"	x	x	x	x
13/16"	-	x	x	x
7/8"	-	-	x	x
15/16"	-	-	x	x
1"	-	-	x	x

	M589DB	M595DB	M593DB	M591DB
	IP:10 MP:40	IP:5 MP:20	IP:4 MP:16	IP:5 MP:10
8mm	x	-	-	-
9mm	-	-	-	-
10mm	x	x	x	x
11mm	x	x	-	-
12mm	x	x	-	x
13mm	x	x	x	x
14mm	x	x	x	x
15mm	-	-	x	x
16mm	-	x	x	x
17mm	x	x	x	x
18mm	-	-	x	x
19mm	x	x	x	x
21mm	-	-	x	x
22mm	-	-	x	x



Additional impact sockets and accessories on page 185

8-PC IMPACT ADAPTER SET

- Chrome moly steel for strength and durability.
- Impact grade with oil resistant finish.

Item #	IP	MP	PKG	Size	1/4"	3/8"	1/2"	3/4"	1"
					(M)	(M)	(M)	(M)	(M)
M795	1	12	SLV	1/4" (F)	-	x	-	-	-
				3/8" (F)	x	-	x	-	-
				1/2" (F)	-	x	-	x	-
				3/4" (F)	-	-	x	-	x
				1" (F)	-	-	-	x	-



5-PC TORQUE LIMITING EXTENSION SET

- Helps apply torque to the correct tolerances and prevent over tightening.
- Color coded for easy identification.
- Heavy duty chrome molybdenum.
- Includes storage/carrying case.

Item #	IP	MP	PKG	Length	Torque Range	
W32903	1	12	CAS	7-5/8"	75 ft./lbs.	Black
					80 ft./lbs.	Yellow
					90 ft./lbs.	Red
					100 ft./lbs.	Blue
					110 ft./lbs.	Orange



AIR SANDERS & POLISHERS

5 IN. SANDERS

- Use for sanding, feather edging, scuffing, finishing and blending metals, plastics, fiberglass and body filler.
- Built-in air regulator for precise speed control.
- Specially balanced design for less vibration.
- Compact design allows maximum control.

M573DB

Compact but powerful 1/2 HP ball bearing motor. Lightweight and durable aluminum housing. Includes three resin fiber backing pads: 3", 4.5", 5.5".



M548

Rotary and orbital action produces swirl-free finishes. Hardened steel cylinders extend the life of the tool. Hook and loop backing pad.

Item #		IP	MP	PKG	Pad Diameter	Avg CFM	RPM	Inlet (NPT)	Wt (lbs)	Recommended Compressor
M548	Random Orbital	1	10	CBX	5"	6	10,000	1/4"	2.4	60 Gallon
M573DB	High Speed	1	10	CBX	5"	4.2	18,000	1/4"	2.2	20 Gallon

6 IN. SANDERS

- Rotary and orbital motion produces swirl-free finishes.
- Cast iron cylinder with larger shaft for better balance.
- Built-in air regulator for precise speed control.
- Specially balanced design for less vibration.
- Insulated grip provides added comfort.
- Heavy duty ball bearing construction.
- Great for body work and paint preparation.
- Works with stick-on adhesive backed sand paper.



M689

5/16" - 24 size threads.



M697

Item #		IP	MP	PKG
M689	5" Pad Replacement	6	36	BAG
M697	6" Pad Replacement	6	36	CRD

M641



M568DB



Item #		IP	MP	PKG	Pad Diameter	Avg CFM	RPM	Inlet (NPT)	Wt (lbs)	Recommended Compressor
M568DB	Dual Action	1	10	CBX	6"	5	10,000	1/4"	3.3	60 Gallon
M641	HD Dual Action	1	10	CBX	6"	5	10,000	1/4"	3.3	60 Gallon

JITTERBUG AIR SANDER

- Orbital sanding action provides a smooth, fine finish.
- Balanced ball bearing design for low vibration and longer-life.
- Contoured palm grip with rubber over-molding.
- Built-in air regulator for precise speed control.
- Useful for general sanding, paint preparation, smooth and rough wood surfaces and more.
- Uses standard 3-3/4" x 9" sandpaper.



Item #	IP	MP	PKG	Pad Diameter	Avg CFM	SPM	Inlet (NPT)	Wt (lbs)	Recommended Compressor
M569DB	1	10	CBX	3.5 x 6.75"	6	7,000	1/4"	4.2	60 Gallon

BLK: Bulk | CAS: Storage Case | CBX: Color Box | CRD: Carded | CLM: Clamshell | DBL: Double Blister
LAB: Color Label | RAC: Storage Rack | SHK: Shrink Wrap | SLV: Sleeve | TAB: Hang Tab | WBX: White Box

AIR ANGLE GRINDERS

- Hardened bevel gears provide extended life.
- Built-in air regulator for precise speed control.
- Handle mounts on either side for right or left hand operation.
- Contoured throttle control for easy handling.

M658



M647



Includes 7" grinding wheel and metal blade guard.

Item #	IP	MP	PKG	Pad Diameter	PSI	Avg CFM	RPM	Inlet (NPT)	Wt (lbs)	Recommended Compressor
M658	1	10	CBX	4"	90	6	11,000	1/4"	3.7	60 Gallon
M647	1	5	CBX	7"	90	12	2,500	3/8"	4.2	60 Gallon

AIR ANGLE SANDER/POLISHER

- Hardened bevel gears provide extended life.
- Built-in air regulator for precise speed control.
- Handle mounts on either side for right or left hand operation.
- Contoured throttle control for easy handling.



Includes 6-3/4" sanding backing pad.

Item #	IP	MP	PKG	Pad Diameter	PSI	Avg CFM	RPM	Inlet (NPT)	Wt (lbs)	Recommended Compressor
M643	1	10	CBX	4"	90	12	4,500	3/8"	4.2	60 Gallon

STRAIGHT LINE AIR SANDER

- Twin piston design provides ample power and prevents stalling.
- 2.75" x 16.75" sanding pad for smooth sanding of large flat surfaces.
- Ideal for flat sanding of body filler, shaping, leveling and finishing.
- Place on firm surface, and pull back on handles to realign pistons.
- Two handle design for comfortable operation.
- Quick action paper clamps.
- NOTE: Sander may need realigning during normal use.



Item #	IP	MP	PKG	Pad Diameter	Avg CFM	SPM	Inlet (NPT)	Wt (lbs)	Recommended Compressor
M574DB	1	10	CBX	2.75 x 16.75"	5	2,500	1/4"	5.6	60 Gallon

SPECIALTY AIR TOOLS

MULTIFUNCTION AIR TOOL

- Spindle & blade arbor design provide 7 forward positions for added versatility.
- Incredibly versatile air tool perfect for cutting, scraping and sanding.
- Comfortable soft touch finish for improved comfort and control.
- Level trigger for variable speed control.

Includes: 3" triangular sanding pad w/ 6 sheets of sandpaper, 1-5/16" straight plunge blade, 3-1/2" round flush cutting blade, 2" rounded flush scraping blade, & 2-5/8" round flush grinding blade.



Item #	IP	MP	PKG	Avg. CFM	PSI	OPM	Oscillation Angle	Inlet (NPT)	Compressor
M546	1	20	CBX	6	90	18,000	2°	1/4"	20 Gallon

METAL CAULK GUN

- Dispenses caulks, adhesives and sealants from standard 11 oz. cartridges.
- Variable speed trigger for maximum flow control.
- Responsive trigger shut-off valve stops material flowing when the trigger is released.
- All metal construction with one piece metal body for longer life.

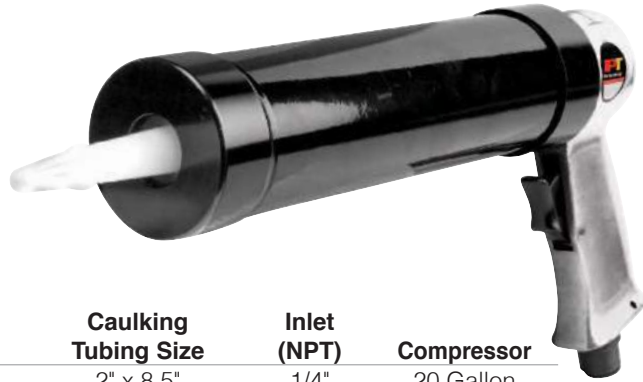

Item #	IP	MP	PKG	Capacity	PSI	Avg. CFM	Caulking Tubing Size	Inlet (NPT)	Compressor
M682	1	10	CBX	11oz	30-60	4	2" x 8.5"	1/4"	20 Gallon

WINDSHIELD REMOVAL TOOL

- Ideal for windshield removal, cutting rubber sealants and molding.
- Flexible blade mounts in 12 different positions.
- Built-in air regulator for precise speed control.
- 18" lead hose with exhaust cover.
- Variable speed safety throttle.
- Lightweight and durable aluminum housing.
- Use replacement blade Performance Tool model M664-08

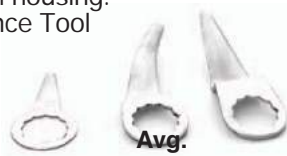

Item #	IP	MP	PKG	PSI	Avg. CFM	SPM	Oscillation Angle	Inlet (NPT)	Compressor
M664	1	10	CBX	90	7	20,000	3°	1/4"	60 Gallon

AIR GREASE GUN

- Use either standard 14 oz. grease cartridge, bulk or dispenser filling.
- Delivers 4,500 PSI to 6,000 PSI at the tip.
- Knurled thick wall barrel for secure grip.
- Use either the included 9" flex tube or 5.5" ridged tube with positive lock for easy filling.

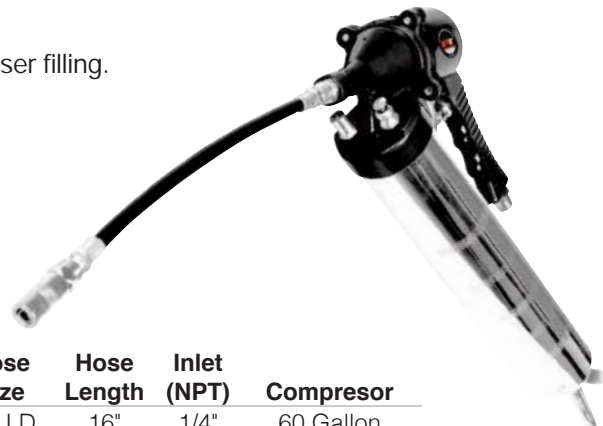

Item #	IP	MP	PKG	Capacity	PSI	Avg. CFM	Hose Size	Hose Length	Inlet (NPT)	Compressor
M582DB	1	10	CBX	14oz	30-150	6	3/8" I.D.	16"	1/4"	60 Gallon

BLK: Bulk | CAS: Storage Case | CBX: Color Box | CRD: Carded | CLM: Clamshell | DBL: Double Blister
LAB: Color Label | RAC: Storage Rack | SHK: Shrink Wrap | SLV: Sleeve | TAB: Hang Tab | WBX: White Box

AIR RIVETER

- Air hydraulic riveter is ideal for setting blind rivets in aluminum, steel and stainless with professional results the first time.
- Air relief valve prevents overloading.



Includes four nose pieces: 3/32", 1/8", 5/32" and 3/16", spanner, spanner gauge, safety cap, and replacement O-rings.



Item #	IP	MP	PKG	PSI	Avg. CFM	Pull (lbs)	Max Capacity
M680	1	10	CBX	90	4	1,584	3/16"

RECHARGEABLE LIQUID SPRAYER

- Eco friendly uses no aerosol propellants.
- Reusable and refillable.
- Pressurize with your compressor and your ready to spray.
- Not for use with flammable material, or paint



Item #	IP	MP	PKG	PSI	Capacity
M715	1	10	CBX	80-150	32 oz.

SANDBLASTER KIT

- Designed to remove rust, scale and paint as well as etch glass and weather wood.

Positive action trigger gun, 10 ft. rubber hose, pick-up tool, hex key wrench and 1 extra air jet and 3 nozzles.



Item #	IP	MP	PKG	PSI	Avg. CFM	Hose Size	Inlet (NPT)
M570C	1	10	CBX	90	8	3/8" I.D.	1/4"
M571C	30	120	CRD	Replacement ceramic nozzle			

PORTABLE ABRASIVE BLASTER

- Remove rust, paint, graffiti, corrosion and scale.
- Heavy duty 50lb capacity hopper, aluminum blast gun and 15' material hose.
- Compatible with any abrasive: silica, sand, glass beads, and pecan shells.



Item #	IP	MP	PKG	PSI	Avg. CFM	Hose Size	Inlet (NPT)
M549	1	2	CBX	90	3.5	3/8" I.D.	1/4"

AIR ENGINE CLEANER

- High quality construction alloy body with brass tip and fittings.
- Pistol grip handle with pressure trigger for maximum efficiency.
- Adjustable siphon system with 6' hose and screen.

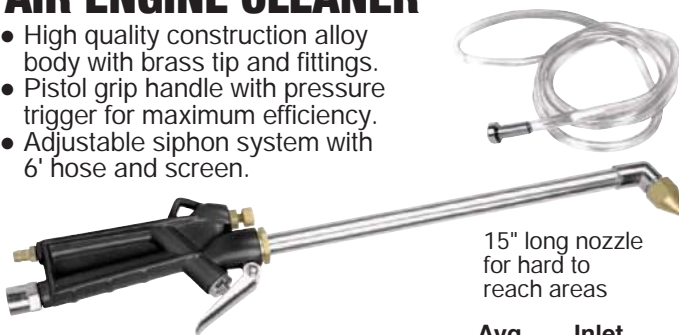

15" long nozzle for hard to reach areas

Item #	IP	MP	PKG	PSI	Avg. CFM	Inlet (NPT)
M584DB	1	40	CBX	90	4	1/4"

SPRAY GUNS & ACCESSORIES

H.V.L.P. GRAVITY FEED SPRAY GUN SETS

- Integrated fine adjustment knob on each gun for precise air flow control and results.
- Fully adjustable spray pattern of 3-7".
- Each kit includes HVLP spray guns, regulator with gauge, connectors, socket, filter, multi-wrench and cleaning brush.

Locking air pressure regulator for precise air flow control.



Item #	Nozzle	IP	MP	PKG	Paint Cup	Spray Pattern	Avg CFM	Inlet (NPT)	Compressor
M706 2-PC	1.3 & 1.5mm	1	5	CBX	1000cc	3-7"	7-9	1/4"	60 Gallon
M707 3-PC	1.3, 1.5 & 1.7mm	1	5	CBX	1000cc	3-7"	7-9	1/4"	60 Gallon
M503 2-PC	1.2 & 1.5mm	1	6	CBX	200cc & 600cc	3-7"	7-9	1/4"	60 Gallon

H.V.L.P. GRAVITY FEED SPRAY GUNS

- All-purpose gun sprays primers, base coats & clear coats.
- Fully adjustable spray pattern of 6-8".
- Locking pressure regulator with pressure gauge.
- Each Include wall mount hanger, multi-wrench, cleaning brush, socket and fluid filter.



M4710
Hose size: 3/8" ID.
Performance Tool repair kit: M710K

Item #	Nozzle	IP	MP	PKG	Paint Cup	Spray Pattern	Avg CFM	Inlet (NPT)	Compressor
M708	1.3mm	1	5	CBX	700cc	6-8"	7-9	1/4"	60 Gallon
M4710	1.4mm	5	10	CBX	600cc	6-8"	7-9	1/4"	60 Gallon
M710	1.5mm	1	5	CBX	700cc	6-8"	7-9	1/4"	60 Gallon
M711	1.8mm	1	5	CBX	700cc	6-8"	7-9	1/4"	60 Gallon

H.V.L.P. GRAVITY FEED TOUCH UP GUN

- All-purpose gun sprays primers, base coats & clear coats.
- Fully adjustable spray pattern.
- Locking pressure regulator with pressure gauge.
- Includes multi-wrench, cleaning brush, socket and fluid filter.



Item #	Nozzle	IP	MP	PKG	Paint Cup	Spray Pattern	Avg CFM	Inlet (NPT)	Compressor
M705	1.2mm	1	10	CBX	2000cc	3-4"	3.1	1/4"	5 Gallon

H.V.L.P. GRAVITY FEED SPRAY GUN ACCESSORIES

M710K
Rebuild kit for Performance Tool Spray Guns



M731
For Performance Tool items M503, M708, M710 and M711.

Item #	IP	MP	PKG
M710K	1	20	BAG
M731	1	20	WBX

BLK: Bulk | CAS: Storage Case | CBX: Color Box | CRD: Carded | CLM: Clamshell | DBL: Double Blister
LAB: Color Label | RAC: Storage Rack | SHK: Shrink Wrap | SLV: Sleeve | TAB: Hang Tab | WBX: White Box

H.V.L.P. SIPHON FEED SPRAY GUNS

- All-purpose gun sprays primers, base coats & clear coats.
- Comfortable and easy to use pistol grip handle.
- Built-in regulator with gauge for easy adjusting.

M576DB

Fully adjustable spray pattern of 6-8".



M701

Fully adjustable spray pattern of 6.5".



M702

Separate spray head and reservoir feed hoses.



M577B

1,000 cc replacement paint cup for siphon feed spray guns.

Item #	Nozzle	IP	MP	PKG	Paint Cup	Spray Pattern	Avg CFM	Inlet (NPT)	Compressor
M576DB	1.8mm	1	10	CBX	1000cc	8-10"	8.5-12	1/4"	60 Gallon
M577B	Replacement Cup	1	20	WBX	1000cc	-	-	-	-
M701	1.2mm	1	10	CBX	800cc	6.5"	2	1/4"	5 Gallon
M702	1.2mm	1	6	CBX	2000cc	10-12"	3.5-11	1/4"	20 Gallon

H.V.L.P. SIPHON FEED TOUCH UP GUN

- For detail and touch-up painting applications.
- Fully adjustable spray pattern.
- Fluid regulator adjusts the volume of paint sprayed.
- Precision machined brass construction.



Item #	Nozzle	IP	MP	PKG	Paint Cup	Spray Pattern	Avg CFM	Inlet (NPT)	Compressor
M578DB	1.6mm	1	10	CBX	200cc	5-6"	4	1/4"	20 Gallon

DUAL ACTION AIR BRUSH KIT

- Dual-action air/paint trigger for maximum control.
- Built-in fluid regulator for adjusting paint volume.
- Stainless steel construction with brass fittings and glass jars.



Airbrush, cap, 3/4oz color jar, 1/4oz color cup, 6ft air hose, air regulator, 2oz mixing jar w/ cap, wrench for brush head.



Item #	IP	MP	PKG	CFM	PSI	Spray	Air Inlet	Nozzle
M676	1	20	CBX	1	10 - 35	1/16-1-1/4"	1/4" NPS	.35mm

AIR TOOLS

PLUGS & CONNECTORS

AIR ACCESSORY SET

- Includes Blow gun, 4" blow gun nozzle, rubber blow gun nozzle, blow gun adapter, dual head chuck, tire gauge, ball chuck, tapered inflation needle, two pin inflation needles, safety nozzle and thread tape.
- 1/4" by 25' PE coil hose
- (2) 1/4" (F) couplers
- (2) 1/4" (F) NPT plugs
- (3) 1/4" (M) NPT plugs
- 1/4" NPT (M) connector
- 1/4" NPT (F) connector



Item #	IP	MP	PKG
M523	22-PC	6	12 DBL

AIR ACCESSORY SET

- Includes blow gun with 4 nozzles, inflation needle, 120 PSI air gauge, power wire brush, dual tire chuck,
- (2) 1/4" (F) couplers
- (2) 1/4" NPT (F) plugs
- (2) 1/4" NPT (M) plugs
- (2) 1/4" NPT (M) connectors



Item #	IP	MP	PKG
M611	17-PC	10	20 CRD

PTFE TAPE

- Prevents leaks in plumbing and air lines.
- 1/2" x 22'.



See page 82 for more options

Item #	IP	MP	PKG
M609C	24	288	CRD

FEMALE BRASS COUPLERS

- Fits industrial (Milton), automotive (Truflate) and aro type fittings.
- One touch design for quick engage and release.
- Brass construction.



Item #	IP	MP	PKG	Size
M461	6	144	CRD	1/4" NPT (F)
M462	6	144	CRD	3/8" NPT (F)

ONE TOUCH BRASS COUPLERS

- One touch design for quick engage and release.
- Brass construction.

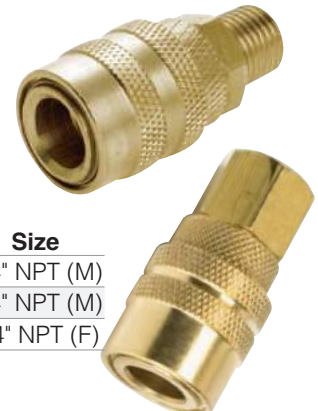

Item #	IP	MP	PKG	Size
M504C	10	200	CRD	1/4" NPT (M)
M507C	24	240	CRD	1/4" NPT (M)
60613	24	240	CRD	1/4" NPT (F)

2-PC BRASS PLUG SETS

- M-Type.
- Brass construction.

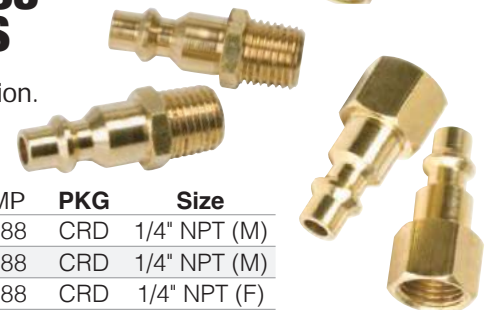

Item #	IP	MP	PKG	Size
M505C	24	288	CRD	1/4" NPT (M)
60611	24	288	CRD	1/4" NPT (M)
60612	24	288	CRD	1/4" NPT (F)

HOSE COUPLERS

- Fits industrial (Milton), automotive (Truflate) and aro type fittings.
- One touch design for quick engage and release.



Item #	IP	MP	PKG	Size
M464	6	144	CRD	1/4" I.D.
M465	6	144	CRD	3/8" I.D.

STEEL COUPLER SETS

- Set includes a NPT (F) coupler, NPT (F) plug and three NPT (M) plugs.
- Steel construction.



Item #	IP	MP	PKG	Size
M604C	5-PC	12	72	CRD 1/4" NPT
M466	2-PC	6	144	CRD 1/4" NPT (M) plugs only

3-IN-1 AIR CONTROL UNIT

- Air filter, regulator with gauge and lubricator.



Item #	IP	MP	PKG
M598DB	1	6	CBX

AIR REGULATOR WITH GAUGE

- Inline 1/4" locking pressure regulator with gauge.
- Attaches to all conventional and HVLP spray guns.
- 0-180 PSI.



- Pressure gauge reads up to 160 PSI.
- Brass construction.

Item #	IP	MP	PKG	Size
M688	Locking	10	100	CRD 1/4 (M) x 1/4 (F) NPT
M693		10	100	CRD 1/4 (M) x 1/4 (F) NPT

OIL & WATER SEPARATOR

- Eliminates moisture for maximum air tool efficiency.
- Removes oil for a clean air spray job.
- 90 PSI maximum.



Item #	IP	MP	PKG	Size
M695	10	100	CRD	1/4" NPT

AIR REGULATOR

- Use at the tool end of the air line for precise regulation.
- Brass construction.



Item #	IP	MP	PKG	Size
M694	10	100	CRD	1/4 (M) x 1/4 (F) NPT

BALL VALVE

- Change tools without depressurizing systems.
- High capacity airflow design.
- Brass body with plated steel ball.



Item #	IP	MP	PKG	Size
M486	6	144	CRD	1/4" NPT (F) X (M)

ADAPTERS & CONNECTORS

- Brass construction.

M482
Converts 3/8" NPT (M) to 1/4" NPT (M). Brass construction.



M483
Converts 1/4" NPT (M) to 3/8" NPT (M).



M487
Converts 3/8" NPT (M) to 1/2" NPT (M).



M481
Connects 1/4" NPT (F) to 1/4" NPT (F).



M484
Supplies two air tools from one source. 1/4" NPT (F) x 1/4" NPT (M) x 1/4" NPT (F).



Item #		IP	MP	PKG	Size
M482	Reducing Adapter	6	144	CRD	3/8 (F) X 1/4" NPT (M)
M483	Increasing Adapter	6	144	CRD	3/8 (M) X 1/4" NPT (F)
M487	Increasing Adapter	6	144	CRD	1/2 (M) X 3/8" NPT (F)
M481	2- Pack Connectors	6	144	CRD	1/4 (F) X 1/4" NPT (F)
M484	T-Type Connector	6	144	CRD	1/4" NPT (FMF)

AIR HOSES & REELS

AIR HOSE REELS

- Heavy gauge steel construction for years of reliable service in the toughest conditions.
- Mounting holes allow for direct mounting to bench top, ceiling or wall.

All brass
1/4" NPT 360°
swivel valve.

Quick - release
wall - mount plate
makes it easy to
remove reel for
remote use.

3/8" (F)
NPT swivel
inlet fitting.

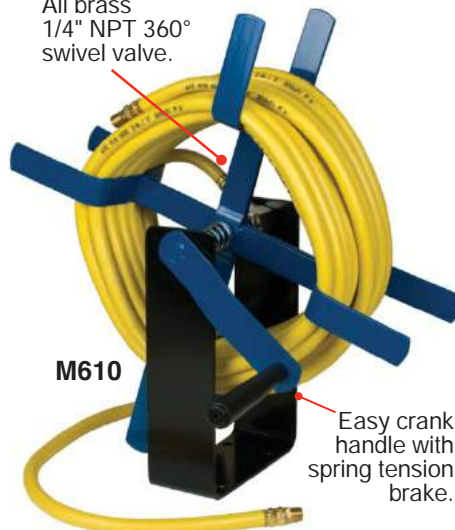

M610

Easy crank
handle with
spring tension
brake.



Flexible
hose lead for
extended life.



M672

Brass inlet.



M635

Item #	IP	MP	PKG	Reel Capacity	Inlet NPT	Outlet NPT	Hose ID	Hose Length	PSI	W	D	H
M610	1	1	CBX	100'	1/4" (M)	1/4" (M)	3/8"	50'	250	9-3/8"	10-3/8"	11-1/8"
M672	1	1	CBX	50'	1/4" (F)	1/4" (M)	3/8"	50'	300	8-1/8"	8-1/4"	13"
M635	1	1	CBX	50'	3/8" (F)	1/4" (F)		<i>Reel only</i>				

AUTO REWIND HOSE REEL

- Popular with both commercial markets and do-it-yourselfers, extends hose life eliminates storage problems.
- Heavy duty steel construction with corrosion resistant powder coated finish.
- Four-way roller guides, adjustable guide arm and rubber stop.
- Permanently lubricated all brass main shaft.
- Mounts to floor, wall, ceiling or truck bed

Solid brass
NPT swivel.

M619

M655

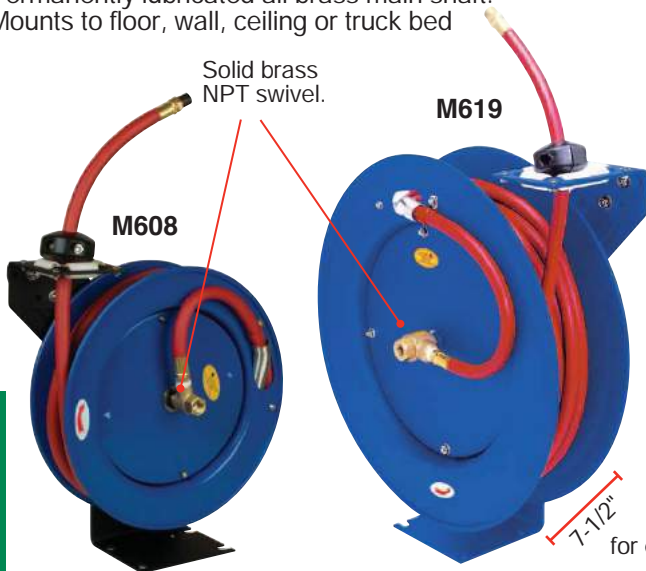

M608

Narrow width
for easy storage.



Item #	IP	MP	PKG	Inlet NPT	Outlet NPT	Hose ID	Hose Length	PSI Work	W	D	H
M608	1	1	CBX	3/8" (F)	3/8" (M)	3/8"	25'	300	14"	10-5/8"	12-11/16"
M619	1	1	CBX	3/8" (F)	3/8" (M)	3/8"	50'	300	16-3/4"	7-1/2"	17-3/4"
M655	1	1	CBX	1/4" (F)	1/4" (M)	3/8"	65'	300	16-1/2"	6-1/2"	18-3/4"

BLK: Bulk | CAS: Storage Case | CBX: Color Box | CRD: Carded | CLM: Clamshell | DBL: Double Blister
LAB: Color Label | RAC: Storage Rack | SHK: Shrink Wrap | SLV: Sleeve | TAB: Hang Tab | WBX: White Box

AUTO REWIND HOSE REEL WITH HYBRID HOSE

- Retractable reel with fully enclosed case.
- Automatic roller guide ensures smooth and even recoil.
- Extremely flexible blend of rubber and PVC.
- Adjustable rubber stop.



1/4" NPT brass male fittings.



Bend restrictors at each end for long life.

Item #		IP	MP	PKG	Inlet NPT	Outlet NPT	Hose		PSI	
							ID	Length	Work	Burst
M613	Reel	1	2	CBX	1/4"	1/4"	3/8"	25'	300	600
M628	25' Hose	1	10	CLB	1/4" (M)	1/4" (M)	3/8"	25'	300	600
M617	50' Hose	1	3	CBX			3/8"	50'	300	600

RUBBER AIR HOSES

- Lightweight and flexible rubber construction.
- Kink, abrasion, ozone and weather resistant.
- Oil resistant cover.

Item #	IP	MP	PKG	Inlet NPT	Outlet NPT	Hose		PSI	
						ID	Length	Work	Burst
M601P	1	8	SHK	1/4" (M)	3/8"	25'	300	600	
M603P	1	5	SHK	1/4" (M)	3/8"	50'	300	600	



RECOIL AIR HOSE

- 1/4" NPT (m), with spring guards.
- 200 PSI working pressure.

Item #	IP	MP	PKG	Inlet NPT	Outlet NPT	PSI

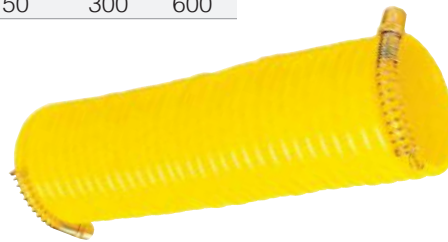

HOSE REPAIR KITS

- Brass construction.
- 1/4" NPT (M).

Item #	IP	MP	PKG	Inlet NPT	Outlet NPT	PSI
M479	6	144	CRD	3/8" I.D.		

M479
3/8" I.D.



Kits include 1 hose splicer, 2 hose ends and 4 hose clamps.

HOSE MENDERS

- Brass construction.

Item #	IP	MP	PKG	Inlet NPT	Outlet NPT	PSI
M477	6	144	CRD	3/8" I.D.		

M476
1/4" I.D.



GRIP CLIP SHOP AIR LINE KITS

- Allows drop down air lines on 1 or 2 walls, keeping your shop organized.
- Installs quick, and easy to modify if changes are desired.
- Designed to operate with a maximum air pressure of 150 PSI.

aitIGHT

60750
Includes 100' of 1/2" high grade nylon tubing.

60700

Item #	IP	MP	PKG	Sizes
60700	1	6	CBX	3/8" x 60'
60750	1	4	CBX	1/2" x 100'

Contents	60700	60750
Shut-Off Valve	1	1
90 Degree Elbow	6	4
T-Connector	3	-
Union	4	-
Check Valve	1	-
Brass Fitting	-	2
Brass Fitting	-	2
Connector (M)	3	6
Connector (F)	3	-
Industrial Coupler (F)	3	-
Industrial Plug (F)	1	3
Reducer	2	-
Tubing Clamps	16	-
Wall-Mounted Outlet	3	2
Manifold	-	1
Tubing Cutter	1	1
Nylon Tubing	1	1

AIR TANKS & ACCESSORIES

PORTABLE AIR TANKS

- Lightweight, portable with handle for easy transport.
- Safety pressure bypass valve with manual override.
- On/off air adjustment dial.
- Industrial grade air hose with standard tire air chuck.
- 125 PSI maximum.

Item #	IP	MP	PKG	Capacity
W10005	1	1	CBX	5 Gal
W10011	1	1	CBX	11 Gal

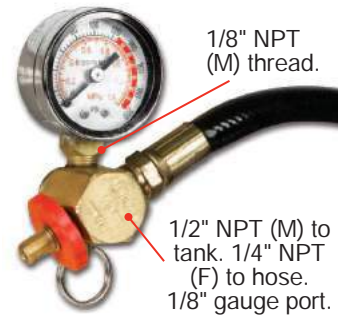

3-PC REPAIR KIT

- Air tank gauge (W10055) easy to read two color gauge. 0 to 200 PSI.
- Air tank manifold (W10056) made of brass construction.
- 4' Air hose (W10057) with tire chuck with 1/4" (F) NPT tire chuck.

Item #	IP	MP	PKG	Item #	IP	MP	PKG		
W10058	3-PC Repair Kit	12	48	CRD	W10055	Gauge	12	72	CRD
					W10056	Manifold	12	72	CRD
					W10057	4' Hose	12	72	CRD



AIR BLOW GUNS

- Rubber tip prevents scratching or sparking.
- 1/4" female NPT air inlet.



Item #	IP	MP	PKG	Contents	
M524	7-PC	6	48	CRD	Includes safety nozzle, 4" nozzle, rubber tip, tapered nozzle, inflation needle and adapter
M586C	2-PC	12	36	CRD	Includes safety tip and rubber nozzle
M518	Extended	6	48	DBL	Includes 24" telescoping nozzle



BLOW GUN TIP

- Rubber tip prevents scratching and sparking.
- Built in shutoff.
- Bend tip to operate.
- 1/4" female NPT air inlet.



Item #	IP	MP	PKG
M519	6	144	CRD

POCKET BLOW GUN

- Adjustable air pressure knob.
- Non-slip knurled grip.
- Convenient pocket clip.



Item #	IP	MP	PKG
M522	6	144	CRD

INLINE BLOW GUN

- Fits permanently between hose and coupler.
- Natural angle, compact and durable.
- No need to disconnect.



Item #	IP	MP	PKG
M685	12	144	BLK

3-PC ANGLED AIR BLOW GUN

- Comfort grip handle.
- 3" extension nozzle, comfort grip handle, quick connect coupler.



Item #	IP	MP	PKG
M686	6	24	CRD

4 IN. ANGLED AIR BLOW GUN

- Insulated fiberglass reinforced nylon grip.
- Contoured handle for better control.
- 4" long barrel angled at 15 degrees.
- Brass air flow valve.

Item #	IP	MP	PKG
M687	6	36	CRD



PT BLASTER TIRE BEAD SEATER

- Perfect for cars, trucks, 4x4, ATV, tractors and lawn equipment.
- Portable, no need for larger stationary equipment.
- Heavy duty ball valve on both air inlet and exhaust port.
- Designed to seat tires on the bead simply, safe, and fast.
- Works on wheel sizes up to 24.5".



Item #	IP	MP	PKG	Capacity
W10012	1	1	CBX	5 Gallon

TIRE INFLATORS WITH GAUGES



- M521**
- Back-lit blue LCD display.
 - Includes 2-AAA batteries.
 - Accurate within 0.5 psi.
 - Change digital readout between psi, kpa, bar and kg/cm2 with a push of a button.
 - Built-in bleed button for lowering pressure.



- M585DB**
- Protective sleeve over dial tube.
 - Heavy chrome plated casting.

Item #	Gauge Type	IP	MP	PKG	PSI Gauge	Inlet (NPT)	Hose Length
M521	Dial	6	48	CRD	10-170 PSI	1/4"	14"
M525	Digital	6	24	CRD	0-150 PSI	1/4"	
M585DB	Bar	1	40	CRD	10-120 PSI	1/4"	12"

- M525**
- Large gauge with rubber ring.
 - Push button air release valve.
 - 14" hose with clip on chuck.

DUAL HEAD TIRE CHUCKS

- 1/4" female NPT.
- Extended chuck for hard to reach valves.
- Angled head can inflate either side.



Item #	IP	MP	PKG
M517	12	72	CRD
60605	12	72	CRD

BALL FOOT AIR CHUCKS

- Locking clip design.
- Built-in shut off valve.
- 1/4" female NPT air inlet.



Item #	IP	MP	PKG
M520	6	144	CRD

BALL FOOT AIR CHUCKS

- 1/4" female NPT air inlet.
- Brass construction.



Item #	IP	MP	PKG
M516C	20	200	CRD
60606	20	200	CRD

TANK VALVE

- Use with compressed air tanks.
- Do not exceed maximum PSI.



Item #	IP	MP	PKG
60505	12	144	CRD

TOOL TABLE - YELLOW

- Fast selling items
- Color coded packaging.
- Two small footprint merchandisers available.



PROJECT PRO™

2-PC STUBBY DRIVERS



1100
IP MP
4 48

6-PC PRECISION DRIVERS



1101
IP MP
4 24

4-PC HOOK & PICKS



1103
IP MP
4 24

LONG NOSE PLIERS



1105
IP MP
4 24

SLIP JOINT PLIERS



1106
IP MP
4 24

FLEXIBLE PUTTY KNIFE



1107
IP MP
4 48

PUTTY KNIFE



1108
IP MP
4 48

RETRACTABLE SAFETY SCRAPER



1109
IP MP
4 48

RETRACTABLE UTILITY KNIFE



1110
IP MP
4 24

6-PC SNAP-OFF KNIFE SET



1111
IP MP
4 24

MINI HACKSAW



1112
IP MP
4 24

2-PC FILE SET



1114
IP MP
4 24

12-PK DUST MASKS



1115
IP MP
4 24

PARTS CLEANING BRUSH



1116
IP MP
4 24

12-PC ACID BRUSHES



1117
IP MP
4 48

2-PC PAINT BRUSH SET



1119
IP MP
4 24

10-PC ARTIST BRUSH SET



1120
IP MP
4 48

3-PC WIRE BRUSH SET



1121
IP MP
4 24

50 FT. POLYPROPYLENE ROPE



1122
IP MP
4 24

3-PC STRETCH CORDS



1123
IP MP
4 24

MAGNETIC PICKUP TOOL



1124
IP MP
4 48

TELESCOPING INSPECTION MIRROR



1125
IP MP
4 48

3-PC MAGNIFYING GLASS SET



1126
IP MP
4 24

SAFETY GLASSES



Item #	IP	MP
1127	4	24

CLAW HAMMER



1128
IP MP
4 24

RUBBER MALLET



1129
IP MP
4 24

TAPE MEASURE



1131
IP MP
4 24

5-PC ELECTRICAL TAPE



1135
IP MP
4 48

3-PC ELECTRICAL TAPE



1136
IP MP
4 48

2-PC PTFE TAPE



1137
IP MP
4 48

WOOD SCREWS

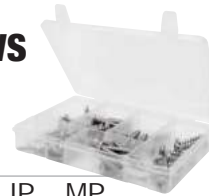

Item #	IP	MP
1139	4	48

SHEET METAL SCREWS



Item #	IP	MP
1140	4	48

6-PC PLASTIC SPRING CLAMPS



1141
IP MP
4 24

C-CLAMP



1142
IP MP
4 24

4-PC PLASTIC FUNNELS



1144
IP MP
4 24

DIAL TYPE TIRE PRESSURE GAUGE



1145
IP MP
4 48

2-PC BLIND SPOT MIRROR



1146
IP MP
4 48

MINI SUCTION CUP



1147
IP MP
4 48

3-PC MAGNETIC KEY HOLDERS



Item #	IP	MP
1148	4	24

3-PC CARABINER SET



1149
IP MP
4 48

20-PC AUTO FUSES



1150
IP MP
4 48

4-PC PICK SET



1153
IP MP
4 24

2-PC PLASTIC CALIPER SET



Item #	IP	MP
1155	4	48

TOOL TABLE - RED

9-PC SAE HEX KEYS



1400
IP MP
4 24

9-PC MM HEX KEYS



1401
IP MP
4 24

9-PC SAE FOLDING HEX KEYS



1402
IP MP
4 24

ADJUSTABLE WRENCH



1404
IP MP
4 24

5-PC SAE WRENCH SET



1405
IP MP
4 24

5-PC MET WRENCH SET



1406
IP MP
4 24

3/8 IN DR. RATCHET



1407
IP MP
4 24

3-PC 3/8 IN DR. EXTENSION SET



1408
IP MP
4 24

7-PC 1/4 IN DR. SOCKET SET



1409
IP MP
4 24

3-PC 3/8 IN DR. SPARK PLUG SOCKET SET



1410
IP MP
4 24

8-PC 3/8 IN DR. MET SOCKET SET



Item #	IP	MP
1412	4	24

25-PC T-BAR DRIVER SET

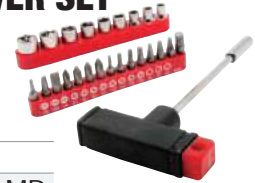

1413
IP MP
4 24

10-PC POWER BIT SET



1414
IP MP
4 24

33-PC BIT SET



1415
IP MP
4 24

16-PC STAR BIT SET



1416
IP MP
4 24

2-WAY RATCHET BIT DRIVER



1417
IP MP
4 24

RATCHETING BIT SCREWDRIVER



1418
IP MP
4 24

6-PC SCREWDRIVER SET



1419
IP MP
4 24

6-PC MINI STUBBY SCREWDRIVER SET



1420
IP MP
4 48

6-PC PRECISION SCREWDRIVER SET



1421
IP MP
4 24

16-PC PRECISION SCREWDRIVER SET



Item #	IP	MP
1422	4	24

6-PC PRECISION SCREWDRIVER SET



1423
IP MP
4 24

6-1/2 IN LONG NOSE LOCKING PLIERS



1424
IP MP
4 24

10 IN CURVED JAW LOCKING PLIERS



1426
IP MP
4 24

8 IN LONG NOSE PLIERS



1428
IP MP
4 24

7 IN CUTTING PLIERS



1429
IP MP
4 24

8 IN LINESMAN PLIERS



1430
IP MP
4 24

11 IN LONG REACH PLIERS



1432
IP MP
4 24

11 IN LONG REACH PLIERS - BENT TIP



1433
IP MP
4 24

2-PC 6 IN PLIER SET



1434
IP MP
4 24

5-PC SNAP RING PLIER SET



1435
IP MP
4 24

REVOLVING LEATHER PUNCH



1436
IP MP
4 24

AVIATION TIN SNIP - STRAIGHT CUT



1437
IP MP
4 24

MINI MULTI-FUNCTION TOOL



1438
IP MP
4 48

50-PC UTILITY KNIFE BLADES



1439
IP MP
4 24

13-PC HOBBY KNIFE SET



1440
IP MP
4 24

TUBULAR FRAME HACKSAW



Item #	IP	MP
1441	4	24

CLOSE QUARTERS HACKSAW



Item #	IP	MP
1442	4	24

12-PC HACKSAW BLADE SET



1443
IP MP
4 48

16 IN HAND SAW



Item #	IP	MP
1445	4	24

6-PC FILE SET



Item #	IP	MP
1446	4	24

2-PC SCISSORS SET



1448
IP MP
4 48

3-PC 9 IN BRUSH SET



1449
IP MP
4 24

2-PC WOOD HANDLE WIRE BRUSH



1450
IP MP
4 24

12-PC LONG HANDLE ARTIST BRUSH



Item #	IP	MP
1451	4	24

5-PC POLYESTER PAINT BRUSH SET



1452
IP MP
4 24

RATCHETING TIE DOWN



Item #	IP	MP
1453	4	24

10-PC STRETCH CORD SET



1455
IP MP
4 24

TOOL TABLE - RED

DRILL PUMP



1456
IP MP
4 24

13-PC HSS DRILL BIT SET

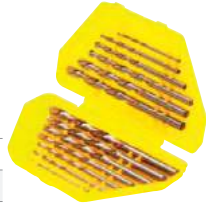

1459
IP MP
4 24

5-PC HOLE SAW SET



1460
IP MP
4 24

10-PC MOUNTED STONE SET



1461
IP MP
4 24

3-PC ROTARY WIRE BRUSH SET



1462
IP MP
4 24

WIRE WHEEL SET

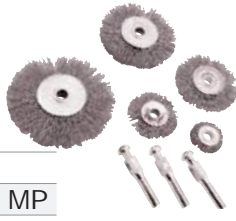

1463
IP MP
4 24

16 OZ. CLAW HAMMER



1464
IP MP
4 24

16 OZ. BALL PEIN HAMMER



1465
IP MP
4 24

32 OZ. RUBBER MALLET



1466
IP MP
4 16

NON-SLIP TOOL BOX DRAWER LINER



Item #	IP	MP
1468	4	24

31 IN CABLE LOCK



1470
IP MP
4 24

13 IN TOOL BAG

Tools sold separately



1472
IP MP
4 24

LATEX COATED GLOVES



1473
IP MP
4 24

25 FT. TAPE MEASURE



1474
IP MP
4 24

300 FT. CAUTION TAPE



Item #	IP	MP
1475	4	24

2-PC SQUARE SET



1477
IP MP
4 24

MIRROR & MAGNETIC PICKUP TOOL SET



1478
IP MP
4 48

2-PC PICKUP TOOL SET



1479
IP MP
4 48

TIRE REPAIR KIT



1480
IP MP
4 24

4-PC COUPLER SET



1481
IP MP
4 48

150-PC CABLE TIES



1482
IP MP
4 24

60-PC ELECTRICAL CRIMPER SET



1483
IP MP
4 48

60-PC TERMINAL SET



1484
IP MP
4 48

SOLDERING IRON



1485
IP MP
4 24

12V CIRCUIT TESTER



1486
IP MP
4 24

4-PC ELECTRICAL TEST KIT



1487
IP MP
4 24

25-PC AUTO FUSE KIT



1488
IP MP
4 48

30-PC MINI FUSE SET



1489
IP MP
4 48

80-PC O-RING ASSORTMENT



1490
IP MP
4 24

3-PC C-CLAMP SET



1491
IP MP
4 24

4-PC BLOW GUN



1493
IP MP
4 24

CAR DUSTER



1495
IP MP
4 24

15-PC PAINT BRUSH SET



1496
IP MP
4 24

12-PC UTILITY KNIFE SET



1498
IP MP
4 24

7-PC TWEEZERS SET



1499
IP MP
4 24

SAFETY GLASSES & EARPLUG COMBO



1500
IP MP
4 24

5-PC BRUSH SET



1502
IP MP
4 24

3-PC POWER DRIVE ADAPTERS



1503
IP MP
4 24

8-PC STORAGE HOOKS

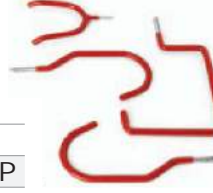

1507
IP MP
4 24

20 IN SLOTTED SCREWDRIVER



Item #	IP	MP
1508	4	24

20 IN PHILLIPS SCREWDRIVER



Item #	IP	MP
1509	4	24

2-PC JUMBO WIRE TIES



1511
IP MP
12 72

2-PC SCRAPER SET



1512
IP MP
12 48



TOOL TABLE - BLUE

13-PC BALL END SAE HEX KEY SET



1900
IP MP
4 24

13-PC BALL END MET HEX KEY SET



1901
IP MP
4 24

2-PC STRAP WRENCH SET



1903
IP MP
4 24

1/2 IN DR. RATCHET



Item #	IP	MP
1904	4	24

10-PC 1/2 IN DR. MET SOCKET SET



Item #	IP	MP
1906	4	24

22-PC 1/4 IN DR. SOCKET SET



Item #	IP	MP
1907	4	24

21-PC OFFSET RATCHETING DRIVER SET



1908
IP MP
4 24

10-PC SCREW DRIVER SET



1909
IP MP
4 24

7-PC SAE NUT DRIVER SET



1910
IP MP
4 24

3-PC PRY BAR SET



Item #	IP	MP
1911	4	24

5-PC SCRAPER & AWL SET



1912
IP MP
4 24

11 IN LOCKING C-CLAMP PLIERS



1913
IP MP
4 24

2-PC LOCKING PLIER SET



1914
IP MP
4 24

3-PC PLIER SET



1916
IP MP
4 24

4-PC MINI PLIER SET



1917
IP MP
4 24

12 IN BOLT CUTTER



1919
IP MP
4 24

5-PC SCISSORS SET



1922
IP MP
4 24

4-PC FILE SET



1923
IP MP
4 24

4-PC WOOD CHISEL SET



1924
IP MP
4 24

HEAVY DUTY HACKSAW



Item #	IP	MP
1925	4	24

2-PC CAMBUCKLE TIEDOWN SET



Item #	IP	MP
1927	4	24

2-PC RATCHET TIEDOWN SET



Item #	IP	MP
1928	4	16

10-PC STRETCH CORD SET



Item #	IP	MP
1929	4	16

14 FT. EMERGENCY TOW ROPE



Item #	IP	MP
1930	4	24

20-PC DRUM SANDING SET



1932
IP MP
4 24

134-PC ROTARY TOOL ACCESSORY SET



1933
IP MP
4 24

20 OZ. FRAMING HAMMER



1934
IP MP
4 24

2 LBS SLEDGE HAMMER



1935
IP MP
4 12

1 LBS. DEAD BLOW HAMMER



1936		
IP	MP	
4	24	

7-PC PUNCH & CHISEL SET



1937		
IP	MP	
4	24	

KNEE PADS



1938		
IP	MP	
4	8	

15 IN WIDE-MOUTH TOOL BAG



1939		
IP	MP	
4	24	

BUCKET ORGANIZER



Item #	IP	MP
1940	4	24

2-PC TAPE MEASURE SET



1941		
IP	MP	
4	24	

150 FT OPEN REEL TAPE MEASURE



1942		
IP	MP	
4	24	

1,000-PC CABLE TIES



Item #	IP	MP
1943	4	16

RIVET GUN WITH 40 RIVETS



Item #	IP	MP
1944	4	24

3-WAY STAPLE GUN



1945		
IP	MP	
4	24	

MIRROR & MAGNETIC PICKUP TOOL SET



1946		
IP	MP	
4	24	

13-PC HARMONIC BALANCER PULLER



1947		
IP	MP	
4	24	

BATTERY JUMPER CABLES



1948		
IP	MP	
4	24	

6 OUTLET POWER STRIP



1949		
IP	MP	
4	24	

40-PC SOCKET SET



1950		
IP	MP	
1	6	

44-PC SCREWDRIVER SET



1951		
IP	MP	
4	24	

84-PC RATCHETING DRIVER SET



1952		
IP	MP	
1	6	

300-PC ANCHOR SET



1954		
IP	MP	
4	24	

9-PC STAR BIT SOCKET SET



Item #	IP	MP
1955	4	24

4-PC TUNE-UP SET



1957		
IP	MP	
4	24	

6-PC INSPECTION TOOL SET



Item #	IP	MP
1958	4	24

3-PACK MAGNETIC TRAYS



Item #	IP	MP
1959	4	24

2-PC POCKET KNIFE SET



1960		
IP	MP	
4	24	

MULTICOLOR D-CLIP SET



1961		
IP	MP	
4	24	

LIGHTED TWEEZERS



1962		
IP	MP	
4	24	

16-IN-1 BICYCLE MULTI-TOOL



1963		
IP	MP	
24	72	

3-PC DETAIL BRUSH SET



1965		
IP	MP	
12	48	

12 IN STEEL DUST PAN



1967		
IP	MP	
1	24	

SOLDIER PACK DISPLAYS

SOLDIER PACKS

- Angled informational panel.
- Bulk and pegable items.
- Lower quantities- higher inventory turns.
- Two compact sizes available.



Large footprint
10 x 6-1/2"



Small footprint
6-5/8 x 6-1/2"

MAGNETIC PICKUP TOOL



3 lbs.

Item #	IP	MP	PKG
W9100	15	90	BLK

MAGNETIC PICKUP TOOL



8 lbs.

Item #	IP	MP	PKG
W9101	12	72	BLK

LIGHTED MAGNETIC PICKUP



Item #	IP	MP	PKG
W9102	12	72	BLK

INSPECTION MIRROR



Item #	IP	MP	PKG
W9103	12	72	BLK

TIRE PRESSURE GAUGE



10 to 50 PSI range

Item #	IP	MP	PKG
W9104	12	72	BLK

TIRE PRESSURE GAUGE



1 to 60 PSI range

Item #	IP	MP	PKG
W9105	12	48	BLK

TIRE PRESSURE GAUGE



1 to 100 PSI range

Item #	IP	MP	PKG
W9106	6	24	BLK

TIRE PRESSURE GAUGE



Item #	IP	MP	PKG
W9107	4	24	CRD

ADJUSTABLE WRENCH



8 lbs.

Item #	IP	MP	PKG
W9108	6	36	BLK

2-IN-1 MAGNETIC PICKUP/MIRROR



3 lbs.

Item #	IP	MP	PKG
W9109	12	72	BLK

DUAL DRIVE RATCHET



1/4" and 3/8" drive

Item #	IP	MP	PKG
W9111	6	36	BLK

DUAL DRIVE RATCHET



3/8" and 1/2" drive

Item #	IP	MP	PKG
W9112	6	36	BLK

DUAL DRIVE RATCHET



1/4" and 3/8" drive

Item #	IP	MP	PKG
W9113	6	36	BLK

MAGNETIC PICKUP TOOL



16 lbs.

Item #	IP	MP	PKG
W9115	12	72	BLK

DUAL DRIVE FLEX HEAD RATCHET



1/4" and 3/8" drive

Item #	IP	MP	PKG
W9116	6	36	BLK

FLEXIBLE MAGNETIC RETRIEVER



1.5 lbs.

Item #	IP	MP	PKG
W9117	12	72	BLK

OFFSET RATCHET



3/8" drive

Item #	IP	MP	PKG
W9118	6	36	BLK

2 IN. JR. JUMBO INSPECTION MIRROR



Item #	IP	MP	PKG
W9124	8	48	BLK

EXTENDABLE RATCHET



3/8" drive

Item #	IP	MP	PKG
W9125	6	36	BLK

RATCHETNG BIT DRIVER



Item #	IP	MP	PKG
W9128	6	36	BLK

17-PC BIT & HOLDER SET

16 assorted slotted, Phillips, star, hex and pozi bits.



Item #	IP	MP	PKG
W9130	6	24	CAS

9-PC SAE HEX KEY SET



Item #	IP	MP	PKG
W9132	6	36	CRD

10-PC STAR KEY SET

Tamper resistant



Item #	IP	MP	PKG
W9134	6	36	CRD

9-PC SAE HEX KEY SET



Item #	IP	MP	PKG
W9135	4	24	DBL

9-PC METRIC HEX KEY SET



Item #	IP	MP	PKG
W9136	4	24	DBL

9-PC STAR KEY SET

Tamper resistant



Item #	IP	MP	PKG
W9137	4	24	DBL

3.5 IN JUMBO INSPECTION MIRROR



Item #	IP	MP	PKG
W9141	4	24	BLK

SOLDIER PACK DISPLAYS

BACK SCRATCHER PICKUP TOOL



Item #	IP	MP	PKG
W9144	9	54	BLK

9-PC PRECISION BIT DRIVER



Item #	IP	MP	PKG
W9148	6	36	DBL

38-PC RATCHET SCREWDRIVER SET

Includes 36 popular bits.



Item #	IP	MP	PKG
W9159	4	24	CAS

18-PC PRECISION BIT DRIVER

Phillips, slotted, star, hex and pozi bits.



Item #	IP	MP	PKG
W9169	4	24	CAS

67-PC BIT SET

Phillips, pozi, square, slotted, star, Metric and SAE hex.



Item #	IP	MP	PKG
W9172	4	24	CAS

33-PC PRECISION SCREWDRIVER SET

Includes slotted phillips, pozi, star & hex bits.



Item #	IP	MP	PKG
W9178	4	24	CAS

GEARLESS BIT DRIVER



Includes 10 bits

Item #	IP	MP	PKG
W9146	4	24	CRD

MAGNETIC TRAY

4-1/4" diameter



Item #	IP	MP	PKG
W9155	5	30	BLK

LED SCREWDRIVER



Bits: #1, #2, 3/16, 1/4"

Item #	IP	MP	PKG
W9161	12	72	BLK

15-PC HOBBY KNIFE SET



Item #	IP	MP	PKG
W9170	4	24	CAS

23-PC TOOL SET

Includes 12 popular bits & 8 popular 1/4" dr sockets.



Item #	IP	MP	PKG
W9173	4	24	CAS

13-PC IMPACT DRIVER BIT SET

Impact grade S2 steel with black phosphate finish.



Item #	IP	MP	PKG
W9179	4	24	CAS

9-PC PRECISION BIT DRIVER

Phillips and slotted bits



Item #	IP	MP	PKG
W9147	6	36	DBL

MINI RAZOR SCRAPER



Item #	IP	MP	PKG
W9158	8	48	BLK

3-IN-1 LASER POINTER PEN



Item #	IP	MP	PKG
W9168	15	90	BLK

21-PC UTILITY KNIFE SET



Item #	IP	MP	PKG
W9171	4	24	CAS

4-IN-1 PRECISION SCREWDRIVER



Phillips #0 and #1, slotted 5/32" and 1/8".

Item #	IP	MP	PKG
W9174	16	96	BLK

RIGID SCRAPER



Item #	IP	MP	PKG
W9181	6	36	BLK

6-IN-1 PAINTER SCRAPER



Item #	IP	MP	PKG
W9183	6	36	BLK

17-PC SAE HEX KEY SET



Item #	IP	MP	PKG
W9184	6	48	CRD

17-PC METRIC HEX KEY SET



Item #	IP	MP	PKG
W9185	6	48	CRD

16-PC STAR KEY SET



Item #	IP	MP	PKG
W9186	6	48	CRD

18-PC BIT DRIVER SET



Item #	IP	MP	PKG
W9187	6	36	CAS

SNAP BLADE KNIFE



Includes five 7-point blades

Item #	IP	MP	PKG
W9188	5	30	CRD

LED BIT DRIVER

Includes #1, #2 Phillips bits, and 3/16" and 1/4" slotted bits.



Item #	IP	MP	PKG
W9193	6	24	BLK

PRECISION LED BIT DRIVER

Includes 6 bits: 1.5, 2 & 3mm slotted, #1, #0 & #00 Phillips.



Item #	IP	MP	PKG
W9194	6	24	CRD

DOOR LOCK DE-ICER

Integrated LED for use in low light.



Item #	IP	MP	PKG
W9195	6	24	CRD

12-IN-1 MINI MULTIFUNCTION TOOL



Item #	IP	MP	PKG
W9198	6	36	CRD

3 LED HEADLAMP



Item #	IP	MP	PKG
W9199	18	72	CRD

2-PC BIT DRIVER SET



8 bit sizes in 2 compact

Item #	IP	MP	PKG
W9203	6	48	DBL

BACK SCRATCHER PICKUP TOOL



Item #	IP	MP	PKG
W9204	9	54	BLK

USB CHARGER & ESCAPE TOOL

4-in-1 uses seat belt cutter, window punch, 2.1A USB charger and 12v accessory socket



Item #	IP	MP	PKG
W9206	8	96	CRD

MULTIFUNCTION TOOL



Item #	IP	MP	PKG
W9305	5	30	CRD

COUNTER TOPS

COUNTER TOPS

- Bulk and pegable items.
- Lower quantities- higher inventory turns.
- Eye catching displays



4-PC MICROFIBER CLOTH SET



Item #	IP	MP	PKG
W1474	6	48	CLM

TIRE PRESSURE GAUGE



10 to 50 PSI range

Item #	IP	MP	PKG
W1925	25	300	BLK

FLEXIBLE LED LIGHT WITH LASER



Flexible head

Item #	IP	MP	PKG
W2380	16	64	CLM

SQUEEGEE/ ICE SCRAPER



3 in 1 tool for ice breaking, scraping and wiping

Item #	IP	MP	PKG
W9166	24	96	BLK



6-IN-1 SCREWDRIVER

Phillips, slotted, nut drivers



Item #	IP	MP	PKG
W975	12	48	BLK

MAGNETIC PICKUP TOOL



3 lbs.

Item #	IP	MP	PKG
W1908	25	300	BLK

LED KEY CHAIN WITH CLIP

Features swivel ball joint clip. Energy Efficient LED.



Item #	IP	MP	PKG
W2369	16	128	BLK

MAGNETIC PICKUP/ MIRROR



2 lighted tools in 1

Item #	IP	MP	PKG
W9145	12	48	BLK

EASY FUNNEL



US Patent 7,677,276B2

Item #	IP	MP	PKG
W9167	12	144	BLK

STUBBY CLAW HAMMER



8 oz.

Item #	IP	MP	PKG
M7019B	6	24	BLK

17-PC BIT & HOLDER SET

16 assorted slotted, Phillips, star, hex and pozi bits



Item #	IP	MP	PKG
W1309	12	48	CAS

TIRE PRESSURE GAUGE

1 to 60 PSI range



Item #	IP	MP	PKG
W1915	21	126	BLK

3 LED DYNAMO LIGHT



Built-in rechargeable battery

Item #	IP	MP	PKG
W2372	12	96	BLK

2-IN-1 FINGERNAIL BRUSH



with magnet

Item #	IP	MP	PKG
W9163	9	54	CRD

LIGHTED TWEEZERS



Item #	IP	MP	PKG
W9189	8	64	DBL

EYEGLOSS REPAIR KIT



Item #	IP	MP	PKG
W9190	8	96	CRD

WAVE SCRAPER

3-in-1 tool for scraping, wiping and cleaning.



Item #	IP	MP	PKG
W9191	20	80	BLK

ICE SCRAPER



Item #	IP	MP	PKG
W9197	12	48	BLK

13-IN-1 MINI MULTIFUNCTION TOOL



Item #	IP	MP	PKG
W9200	8	32	BLK

16-IN-1 MULTIFUNCTION TOOL



Item #	IP	MP	PKG
W9201	6	24	BLK

TELESCOPING CLOTH DUSTER



Item #	IP	MP	PKG
W9202	12	96	BLK

HI-VIZ LED BIT DRIVER

Includes #1, #2 Phillips bits, and 3/16" and 1/4" slotted bits.



Item #	IP	MP	PKG
W9205	12	48	BLK

MAGNIFYING GLASS

4x Power non-distorting optical grade glass lens



Item #	IP	MP	PKG
W15029	8	48	BLK

JUMBO MAGNIFYING GLASS

3X Power non-distorting optical grade glass lens



Item #	IP	MP	PKG
W15032	5	40	BLK

SELF PORTRAIT MONOPOD



Item #	IP	MP	PKG
W15033	8	48	BLK

LI-ION SELF PORTRAIT MONOPOD

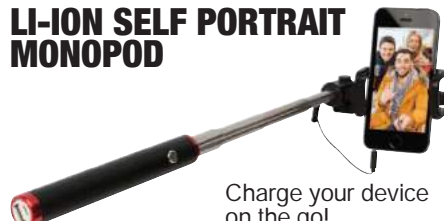

Charge your device on the go!

Item #	IP	MP	PKG
W15034	8	48	BLK

LED MAGNIFYING GLASS

4X Power non-distorting optical grade glass lens



Item #	IP	MP	PKG
W15036	8	48	BLK

FIRE HOSE NOZZLE

Up to 40' jet spray



Item #	IP	MP	PKG
W11090	6	36	CRD

HIGH FLOW HOSE NOZZLE

Up to 50' jet spray



Item #	IP	MP	PKG
W11091	6	36	BLK

PISTOL GRIP HOSE NOZZLE

Up to 30' jet spray



Item #	IP	MP	PKG
W11092	6	48	BLK

RATCHET-DUAL HEAD



3/8" & 1/2" drive

Item #	IP	MP	PKG
W32110	6	36	BLK

RATCHETNG BIT DRIVER

6 bits stored in handle



Item #	IP	MP	PKG
W38927	12	72	BLK

HIGH TORQUE RATCHETNG BIT DRIVER



Item #	IP	MP	PKG
W38937	12	48	BLK

DISPENSERS

PLASTIC DISPENSERS

- Hang or display on counter.
- Small 3" x 4" footprint.



3 LED KEY CHAIN FLASHLIGHT

W2479		
IP	MP	
36	360	



12V USB ADAPTER

W2550		
IP	MP	
24	240	



USB RECHARGEABLE LED KEY CHAIN LIGHT

W2551		
IP	MP	
24	216	



2 IN FOLDING KNIFE

W2552		
IP	MP	
24	240	



KNIFE SHARPENER W/BOTTLE OPENER

W2554		
IP	MP	
24	216	



DUAL 12V USB ADAPTER

W2556		
IP	MP	
24	240	



10 FT PARACORD BRACELET

W2558		
IP	MP	
12	108	



MAGNESIUM FIRE STARTER

W2559		
IP	MP	
24	240	



BOTTLE CAP CARABINER KEY CHAIN

Item #	IP	MP
W2560	24	240



FISHBOWLS

- Fast moving items.
- Two compact sizes.



SMALL
4" x 5"



LARGE
4" x 7"

6 FISHBOWL COUNTER RACK

- Rack can be used as a freestanding counter display unit, or mounted on pegboard using built-in hang hooks.
- Holds six (6) fishbowl displays: six (6) small, or three (3) small and three (3) large fishbowls.
- Compact 12" x 8" footprint.
- Heavy duty steel construction.
- Durable powder coated finish.

Item #	IP	MP	PKG
W59278	1	4	BLK

Note: Large fishbowls must be displayed on bottom tier of display rack

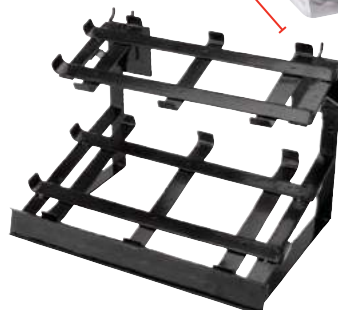

**MINI RAZOR
SCRAPER**

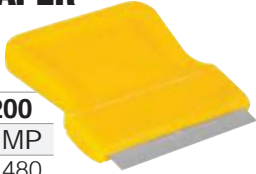

W3200
IP MP
40 480

**BOTTLE OPENER
SCREWDRIVER**



W3201
IP MP
20 240

**PERMANENT
MARKER**



W3202
IP MP
32 384

CARABINER

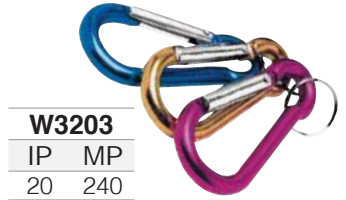

W3203
IP MP
20 240

**SPARK PLUG GAP
GAUGE**



W3204
IP MP
50 600

FINGERNAIL CLIPPER

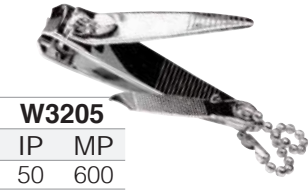

W3205
IP MP
50 600

4-IN-1 SCREWDRIVER



W3207
IP MP
15 180

#0, #1,
1/8, 3/16"

**PULL APART KEY
CHAIN**



W3208
IP MP
40 480

MINI POCKET KNIFE

Wood
handle



W3209
IP MP
20 240

**CARABINER
POCKET
KNIFE**

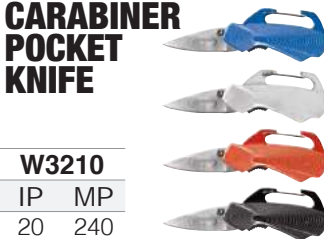

W3210
IP MP
20 240

WHISTLE



W3211
IP MP
40 480

**CARABINER
POCKET
KNIFE**



W3212
IP MP
20 240

**MAGNIFYING
GLASS
TWEEZERS**



W3213
IP MP
25 300

**EYEGLASS
REPAIR KIT**



W3214
IP MP
25 300

MINI SCREWDRIVERS



W3215
IP MP
20 240

#2 blue,
1/4" red

2-PC EAR PLUGS



W3216
IP MP
30 360

SMALL PILL FOB



W3217
IP MP
20 240

LARGE PILL FOB



W3218
IP MP
20 240

**POWER BIT
REPLACEMENT**

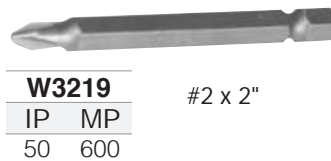

W3219
IP MP
50 600

#2 x 2"

BIT HOLDER

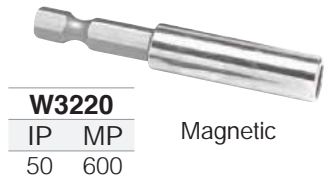

W3220
IP MP
50 600

Magnetic

**MAGNETIC
KEY
HOLDER**



W3221
IP MP
10 120

**LED KEY
CHAIN
LIGHT**



W3222
IP MP
25 300

LED CARABINER

w/bottle
opener

W3223
IP MP
24 288



BRASS COUPLER



W3225
IP MP
15 180

1/4" NPT (F)

BRASS COUPLER

1/4" NPT (M)

W3226
IP MP
15 180



BRASS PLUG

1/4" NPT (F)

W3227
IP MP
25 300



BRASS PLUG

1/4" NPT (M)

W3228
IP MP
25 300



FINGERNAIL BRUSH

Also Large
Fishbowl
W3300

W3229
IP MP
12 144



SMALL FISHBOWLS

INSPECTION MIRROR



W3230
IP MP
12 144

BLIND SPOT MIRROR

2"
diameter



W3231
IP MP
25 300

MINI POCKET KNIFE

Rubber
grip



W3232
IP MP
20 240

FOLDING SCISSORS



W3233
IP MP
20 240

MAGNETIC PICKUP TOOL



W3234
IP MP
12 144

BATTERY TERMINAL CLEANER



W3235
IP MP
6 72

SUPER GLUE



W3236
IP MP
20 240

TAPE MEASURE



W3237
IP MP
15 180

3' tape

TIRE PRESSURE GAUGE



W3238
IP MP
25 300

8-PK EAR PLUGS

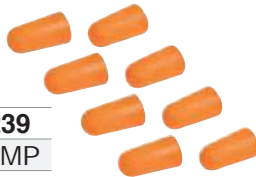

W3239
IP MP
12 144

LED FINGER LIGHT



W3240
IP MP
30 360

LED KEY CHAIN LIGHT



W3241
IP MP
12 144

LED SCREWDRIVER



W3242
IP MP #0, #00,
12 144 2.5, 3.0mm

KNIFE SHARPENER



W3243
IP MP
9 108

ELECTRICAL TAPE

3/4" x 30'



W3244
IP MP
12 144

PTFE SEALING TAPE

1/2" x 20"



W3245
IP MP
12 144

10-PC IMPACT HEX BIT SET

1" bits



W3246
IP MP
12 144

10-PC IMPACT STAR BIT SET

1" bits



W3247
IP MP
12 144

LEAD FREE SOLDER



W3248
IP MP rosin core
12 144 0.031" x 10'

LED WORK LIGHT

32 lumen



W3249
IP MP
15 180

1 IN. C-CLAMP



W3250
IP MP
12 144

1 IN. PADLOCK

1"



W3251
IP MP
12 144

MAGNIFYING GLASS

5x and 10x
magnification



W3252
IP MP
12 144

3-PC QUICK LINK SET



W3253
IP MP
12 144

3/16"

MAGNETIC HOOK

2-1/2"



W3254
IP MP
6 72

KEY TAGS



W3255
IP MP
12 144

LOCKING CARABINER

3"



W3256
IP MP
12 144

SINGLE BLADE SCRAPER



W3257
IP MP
12 144

FINGERNAIL BRUSH



W3300
IP MP
18 144

MAGNETIC PICKUP TOOL



W3301
IP MP
20 160

BATTERY TERMINAL CLEANER



W3302
IP MP
10 80

PTFE SEALING TAPE

1/2" x 33'



W3303
IP MP
20 160

INSPECTION MIRROR



W3304
IP MP
20 160

SNAP BLADE KNIFE



W3305	13 points
IP MP	
20 160	

MINI PLIERS



W3306	Long nose, bent nose, diagonal cutter
IP MP	
15 120	

3 LED HEADLAMP



W3307
IP MP
12 96

ELECTRICAL TAPE

3/4" x 30'



W3309
IP MP
15 120

MULTIFUNCTION TOOL



W3311
IP MP
15 120

SPRING CLAMPS



W3312
IP MP
30 240

MECHANIC'S WIRE

25' Roll



W3313
IP MP
30 240

RETRACTABLE KEY RING

48"



W3314
IP MP
15 120

LUGGAGE LOCK

TSA Approved



W3315
IP MP
15 120

4-PK VALVE CAPS



W3316
IP MP
16 128

STYLUS



W3317
IP MP
18 144

MICRO USB CABLE

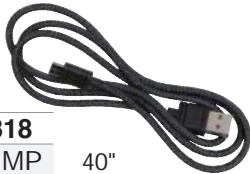

W3318	40"
IP MP	
16 128	

USB WALL CHARGER



W3319
IP MP
12 96

COUNTERFEIT PEN



W3321
IP MP
18 144

4-IN-1 SCREWDRIVER

#1, #2,
3/16, 1/4"



W3322
IP MP
15 120

UTILITY KNIFE



W3323	2-1/2" length
IP MP	
25 200	

SINGLE FISHBOWL RACKS

- Heavy duty steel construction.
- Durable powder coated finish.

Item #		IP	MP	PKG
W59276	Small	1	8	BLK
W59277	Large	6	36	BLK

W59276



W59277



3 FISHBOWL RACKS

- Heavy duty steel construction.
- Durable powder coated finish.

Item #		IP	MP	PKG
W59281	Small	1	8	BLK
W59282	Large	6	36	BLK

W59282



W59281



MERCHANDISING STRIPS

MERCHANDISING STRIPS

- Hangs nearly anywhere.
- Pinched style assures that product stays on strip
- Fast moving items



MINI MULTI TOOL

W459		
IP	MP	
6	48	



JUMBO CARABINER

W463		
IP	MP	
6	48	



EASY FUNNEL

W464		
IP	MP	
6	48	



ICE SCRAPER/SQUEEGEE

W465		
IP	MP	
12	96	



HOSE & CORD CARRY STRAP

W467		
IP	MP	
6	120	



COMBO LOCK CARABINER

W469		
IP	MP	
12	72	



MAGNETIZER & DEMAGNETIZER

W471		
IP	MP	
8	96	



10-PC IMPACT BIT SET

W472		
IP	MP	
12	144	



14-PC NUTDRIVER BIT SET

W473		
IP	MP	
10	40	



14-PC BIT DRIVER ACCESSORY SET

W474		
IP	MP	
6	36	



MINI RATCHET W/BITS

W475		
IP	MP	
6	48	



7-PC STUBBY PRECISION DRIVER

W476		
IP	MP	
12	48	

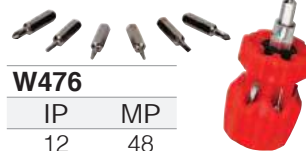

4-PK MINI PERMANENT MARKERS

W477		
IP	MP	
8	48	



17-PC IMPACT STAR BIT SET

W478		
IP	MP	
4	24	



PRECISION LED BIT DRIVER

W479		
IP	MP	
6	24	



MINI RATCHET DRIVER

W480		
IP	MP	
6	48	



7 SECOND GLUE AND FILLER

W481		
IP	MP	
6	48	



CARABINER WITH MAGNETIC BASE

W482		
IP	MP	
8	72	



44-PC BUTTON CELL BATTERY PACK

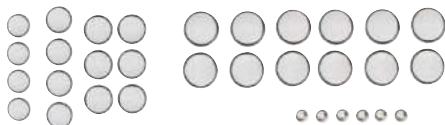

Item #	IP	MP
W483	8	48





MERCHANDISING SOLUTIONS THAT INFLUENCE SALES!

- The NEW Interlocking display Bin System showcases impulse merchandise with a captivating and uniform look
- Durable and refillable plastic bins
- Interlocking bins are designed for use on flat or tilted shelving without the use of fencing-fronts
- Bin dimensions are 4" wide x 9.75" deep
- Nine bins fill a 3' shelf and 12 bins on a 4' shelf. Note: For matching bin precede item # with "-B" (example 20106-B)

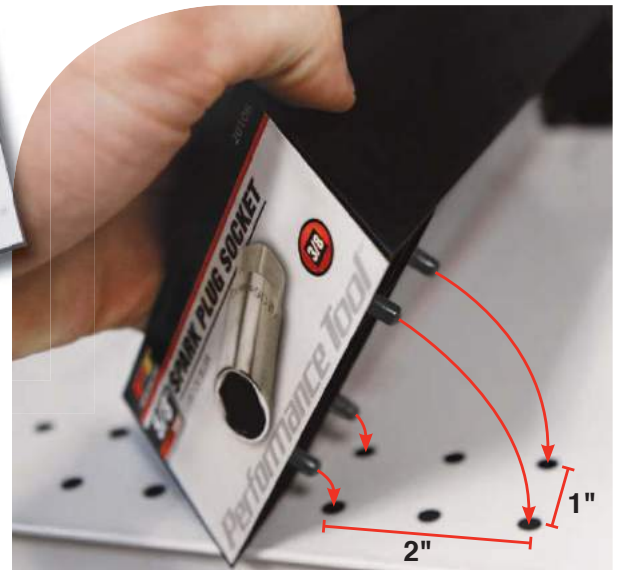

IMPULSE PRODUCTS

- Over 60 impulse products to choose from: unique innovations to basic tools and supplies to get the job done

MINI LED BAT LIGHT



Item #	IP	MP
20202	12	72

MINI LED BAT LIGHT



Item #	IP	MP
20203	12	72

PINK FIREPOINT LED FLASHLIGHT



Item #	IP	MP
20204	12	72

MINI UTILITY KNIFE



Lock back.

Item #	IP	MP
20205	6	72

7-PC QUICK RELEASE BIT SET



Item #	IP	MP
20206	12	72

MINI RAZOR SCRAPER



Item #	IP	MP
20207	40	480

MINI FOLDING POCKET KNIFE



Item #	IP	MP
20208	20	240

IMPULSE BULK TOOLS

2-PK PTFE TAPE



1/2" x 33'

Item #	IP	MP
20100	6	36

2-PK ELECTRICAL TAPE



3/4" x 30'

Item #	IP	MP
20101	6	36

DUCT TAPE



2-7/8" x 30'

Item #	IP	MP
20102	6	36

6 IN. EXTENSION BAR

3/8" dr.



Item #	IP	MP
20103	6	36

3/8" DR. RATCHET



39 gear teeth.

Item #	IP	MP
20104	6	36

UNIVERSAL JOINT



3/8" dr.

Item #	IP	MP
20105	10	60

SPARK PLUG SOCKET 5/8 IN.



3/8" dr.

Item #	IP	MP
20106	8	48

SPARK PLUG SOCKET 13/16 IN.



3/8" dr.

Item #	IP	MP
20107	8	48

6 IN. SLIP JOINT PLIERS



Item #	IP	MP
20108	6	36

7 IN. CURVE JAW LOCKING PLIERS



Item #	IP	MP
20109	6	36

6 IN. LONG NOSE PLIERS



Item #	IP	MP
20110	6	36

8 IN. ADJUSTABLE WRENCH



Item #	IP	MP
20111	6	36

SCREWDRIVER 6-IN-1



Item #	IP	MP
20116	6	36

SCREWDRIVER PHILLIPS



#2 x 4"

Item #	IP	MP
20117	6	36

SCREWDRIVER SLOTTED

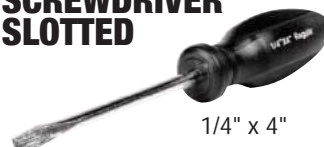

1/4" x 4"

Item #	IP	MP
20118	6	36

SNAP BLADE KNIFE



8 point

Item #	IP	MP
20119	10	60

3 IN. C-CLAMP



Item #	IP	MP
20120	4	24

TAPE MEASURE



5/8" x 12'

Item #	IP	MP
20122	4	24

2-PC PAINT BRUSH SET



Item #	IP	MP
20124	4	24

MAGNETIC PICKUP TOOL



3 lbs.

Item #	IP	MP
20126	12	72

FINGERNAIL BRUSH



Item #	IP	MP
20127	12	72

INSPECTION MIRROR



Item #	IP	MP
20128	12	72

HD MAGNETIC PICKUP TOOL



8 lbs.

Item #	IP	MP
20129	12	72

SINGLE BLADE SCRAPER



Item #	IP	MP
20130	12	72

25-PC SAE/MET HEX KEY SET



Item #	IP	MP
20133	4	24

BATTERY TERMINAL BRUSH



Item #	IP	MP
20134	8	48

SUPER GLUE



Item #	IP	MP
20135	12	72

3-PC CLEANING BRUSHES



Item #	IP	MP
20140	4	24

5-PC METRIC WRENCH SET



Item #	IP	MP
20142	5	30

5-PC SAE WRENCH SET



Item #	IP	MP
20143	5	30

67-PC BIT SET



Item #	IP	MP
20145	3	18

9-PC SAE HEX KEY SET



Item #	IP	MP
20146	4	24

10-PC STAR KEY SET



Item #	IP	MP
20147	4	24

7-PC METRIC HEX KEY SET



Item #	IP	MP
20148	4	24

RATCHETING SCREWDRIVER



Item #	IP	MP
20149	4	24

LIGHTED MAGNETIC PICKUP TOOL



Item #	IP	MP
20150	8	48

38-PC RATCHETING DRIVER SET



Item #	IP	MP
20151	3	18

SCREWDRIVER 6-IN-1



Item #	IP	MP
20152	4	24

DUAL DRIVE RATCHET



Item #	IP	MP
20153	4	24

3/8 & 1/4" dr.

33-PC PRECISION DRIVER SET



Item #	IP	MP
20154	3	18

STUBBY ADJUSTABLE WRENCH



Item #	IP	MP
20155	4	24

8"

23-PC BIT & SOCKET SET

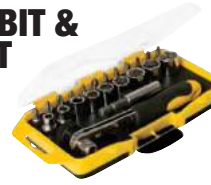

Item #	IP	MP
20156	3	18

MAGNETIC PARTS TRAY



Item #	IP	MP
20157	4	24

4-1/4" diameter

EXTENDED REACH RAZOR SCRAPER



Item #	IP	MP
20158	4	24

6 IN. DIAGONAL PLIERS



Item #	IP	MP
20162	6	36

5-PK COLORED ELECTRICAL TAPE



Item #	IP	MP
20165	4	24

4X MAGNIFYING GLASS



Item #	IP	MP
20169	4	24

2-IN-1 INSPECTION TOOL



Item #	IP	MP
20170	8	48

LED BIT DRIVER



Item #	IP	MP
20171	4	24

WRENCH



Item #	IP	MP
20177	15	90

1/2"

PARTS CLEANING BRUSH



Item #	IP	MP
20180	6	36

STUBBY CLAW HAMMER



8 oz.

Item #	IP	MP
20181	4	24

MULTI-PURPOSE SCISSORS



Item #	IP	MP
20183	8	48

JUNIOR JUMBO CARABINER



Item #	IP	MP
20197	5	30

5"

BENT NOSE PLIERS



Item #	IP	MP
20200	6	36

4-1/2"

ATAK LIGHTING

PRO-FOCUS™ FLASHLIGHTS

- Adjustable beam goes from spot to flood.
- Aluminum housing.
- Water and impact resistant.



541



549



ATAK

Item #	IP	MP	PKG	Display	Lumen	Run Time	Beam Distance	Battery		Length	Head Diameter	
								Qty.	Type			
538	Dual Pack	4	16	DBL	Y	500	3.5	172m	3	C	8.625"	1.75"
541		6	24	DBL	Y	1000	6	203m	9	AA	9"	2"
549	XL	6	24	DBL	Y	1500	5	201m	9	AA	12.5"	2"

FLASHLIGHTS WITH COB TECH

- Includes new chip on board (COB) technology that provides a higher lumen output and longer life.
- Durable aluminum housing.
- Water and impact resistant.

ATAK

615 3 lbs. strong magnetic base for hands free operation



606

Includes red safety flasher



546



Item #	IP	MP	PKG	Lumen	Run Time	Beam Distance	Battery		Length	Head Diameter	
							Qty.	Type			
546		6	24	DBL	1000	6	201m	9	AA	11.375"	2"
615		6	36	DBL	250	3	188m	4	AAA	7.625"	1.5"
606		6	48	CRD	200	1.5	100	2	AA	6.75"	1"

LED TIRE THUMPER

- Adjustable beam goes from spot to flood.
- Anodized aluminum housing.
- Water and impact resistant.



ATAK

Item #	IP	MP	PKG	Lumen	Run Time	Beam Distance	Battery		Length	Head Diameter
							Qty.	Type		
204	6	24	DBL	200	17	220m	4	AA	16"	1.25"

RECHARGEABLE FLASHLIGHTS

- Adjustable Pro-Focus beam goes from spot to flood.
- Powered by 3.7V lithium ion rechargeable battery.
- High grade aircraft aluminum housing.
- Includes micro USB charging cable.

RECHARGEABLE



Charging port for smart phones or tablets (flashlights only)

Includes micro USB charging cable and carrying pouch

Item #		IP	MP	PKG	Lumen	Run Time	Beam Distance	Battery		Head Diameter	
								Qty.	Type		
550	Flashlight	8	24	DBL	320	1.5	220m	1	18650 Li-ion	6"	1.5"
551	Flashlight	6	24	DBL	500	1	178m	1	18650 Li-ion	7.625"	2.75"
552	Flashlight	6	24	DBL	1000	1.5	188m	2	18650 Li-ion	10.25"	2"
560	Head Lamp	6	24	DBL	560	2	150m	2	18650 Li-ion	1.25"	

HEAD LAMPS

- Adjustable head band for maximum comfort



Functions: Ultra high, high, low, strobe, and red/white/green COB

3 Output Settings 50% 100% Strobe

Adjustable Pro-Focus beam goes from spot to flood

Item #		IP	MP	PKG	Lumen	Run Time	Beam Distance	Battery		Head Diameter
								Qty.	Type	
365	Pro-Focus	8	48	DBL	120	8	199m	3	AAA	1"
372	COB	8	32	DBL	300	1.5	60m	3	AAA	2.5"
								1	CR2032	
373	COB w/ Hi-Viz Housing	8	32	DBL	300	5	60m	3	AAA	2.5"
								1	CR2032	
395	Water Resistant	6	48	DBL	200	5	20m	3	AAA	2.25"

ATAK LIGHTING

COB MULTI-FUNCTION LANTERNS

- Uses licensed COB technology strips.
- ABS and TPR housing.

ATAK™

USB & Micro USB port for charging, cord included. Can also be used to charge smart devices includes phones, tablets, etc

397

- 3 functions: high COB, low COB, red flash.
- Metal hanger on top.

- 4 functions: high, low, red flash and red SOS.
- Metal hanger on top.



403



- 3 functions: high, med and low COB



Item #		IP	MP	PKG	Lumen	Run Time	Beam Distance	Battery		Width	Depth	Height
								Qty.	Type			
397	COB Multi-function	10	20	CBX	300	2	5m	3	AA	3"	3"	6.25"
398	COB Rechargeable	10	20	CBX	315	2	20m	2	18650 li-ion	3.75"	3.75"	7.5"
403	COB Rechargeable	1	9	CBX	1000	3	20m	2	18650 li-ion	5"	5.375"	9.75"

MULTI-FUNCTION LANTERNS

- Great for camping, fishing, boating, tailgating, power outages and more.

422

Collapses to 4-3/8"



418



Glow in the dark strap & button

420



ATAK™

424

- 3 functions: high, low and strobe
- 3-watt wireless Bluetooth speaker.



Works with most digital devices such as Smart Phones, Tablets, Laptops etc.

Item #		IP	MP	PKG	Display	Lumen	Run Time	Beam Distance	Battery		Width	Depth	Height
									Qty.	Type			
418	Mini	6	48	SLV	Y	83	10	11m	4	AA	2.75"	2"	6"
420	Triangle	4	8	LAB	Y	143	50	20m	4	D	4.75"	4.5"	8.5"
422	Collapsible	6	36	SLV	Y	100	20	11m	4	A	2.75"	1.875"	5.875"
424	W/ Speaker	6	18	CRD	N	120	64	12m	4	C	4"	2.5"	7"

SPECIALTY LANTERNS

- Great for camping, fishing, boating, tailgating, power outages and more.



410
• 3 functions: 50%, 100% and strobe



• Flashlight and lantern all-in-one features bonus amber LED

405



• 3 functions: 33%, 100%, strobe.
• Locking swivel handle.
• Non-slip rubber shell.

375

Batteries not included



Item #		IP	MP	PKG	Lumen	Run Time	Beam Distance	Battery			Width	Depth	Height
								Qty.	Type				
375	Spot Light	6	24	CBX	250	2	304m	3	AA		7"	4"	5.5"
405	Flashlight/Lantern	6	48	LAB	21	25	50m	3	AA		2.25"	2.75"	8"
410	Multi-function	1	9	CBX	610	25	22m	6	D		4.375"	4.75"	9.875"

WORK LIGHTS

- Great for camping, fishing, boating, tailgating, power outages and more.

- Heavy duty ABS housing with TPR soft grip rubber.
- Built in stand to help angle light towards work area.



357



• 3 functions: High, medium and strobe



Includes 360 degree hook and hands free magnet

339

- Heavy duty ABS plastic housing.
- Emergency red flasher.

180 degree folding magnetic base for hands free use



364

Item #		IP	MP	PKG	Lumen	Run Time	Beam Distance	Battery			Width	Depth	Height
								Qty.	Type				
364	Work Light	6	36	BLK	100	20	20m	3	AA		1.875"	2"	8"
339	COB Work Light	6	24	CRD	200	2.5	20m	3	AAA		2.5"	1"	5"
357	COB Work Light	6	24	CRD	200	6.5	-	3	AAA		-	2.25"	-
	COB Head Lamp				160	10	26m	3	AAA	2.5"	1.5"	3.75"	

PT POWER FLASHLIGHTS

FIREPOINT DUOFOCUS FLASHLIGHT

- Adjustable DuoFocus beam goes from spot to flood.
- Anodized tactical aluminum housing.
- Water and impact resistant.

LED FIREPOINT
TACTICAL



Item #	IP	MP	PKG	Display	Lumen	Run Time	Beam Distance	Battery		Length	Head Diameter	
								Qty.	Type			
W2405	Pewter	6	24	CRD	N	2,369	1.5	135m	9	AA	11.5"	2"
W2499	Black	2	12	CRD	N	1,068	13	346m	9	AA	9.25"	2"
W2493	Black	6	24	CRD	N	408	9.5	250m	3	C	8"	1.625"
W2482	Black	8	48	CRD	N	294	4	129m	3	AAA	5.25"	1.325"

FIREPOINT LED FLASHLIGHTS

- Aircraft grade aluminum flashlight.
- Water and impact resistant.
- Anodized tactical aluminum housing.

LED FIREPOINT
TACTICAL



Item #	IP	MP	PKG	Display	Lumen	Run Time	Beam Distance	Battery		Length	Head Diameter	
								Qty.	Type			
W2478	Pewter	8	48	CRD	N	419	5.5	250m	4	AAA	5.25"	1.625"
W2458	Gun Metal	8	32	BLK	Y	271	2.5	105m	3	AAA	5"	1.325"
W2470	HD Black	6	24	CRD	N	267	30	227m	3	D	12.5"	1.5"
W2476	2-PK Black	4	16	CRD	N	265	2.5	150m	3	AAA	5"	1.325"
W2481	Gun Metal	8	48	CRD	Y	103	2	121m	3	AAA	4.375"	1.325"
W2474	Gun Metal	6	48	BLK	Y	75	3.5	100m	3	AAA	4.75"	1.325"
W2490	Mini Black	12	48	BLK	Y	33	7	58m	1	AA	3.875"	1.025"

FIREPOINT SLIM LED FLASHLIGHTS

- Super Bright Nichia® LED never needs replacing.
- Aircraft grade aluminum flashlight.

LED FIREPOINT
TACTICAL



Item #	IP	MP	PKG	Display	Lumen	Run Time	Beam Distance	Battery		Length	Head Diameter	
								Qty.	Type			
W2471	Pink Camo	8	32	CRD	Y	169	6	76m	2	AA	5.875"	1.035"
W2473	Arctic Camo	8	32	CRD	Y	169	6	76m	2	AA	5.875"	1.035"
W2488	Black	12	48	CRD	N	169	6	76m	2	AA	5.875"	1.035"

FIREPOINT LED/LASER FLASHLIGHTS

- Features high output flashlight, laser pointer and *UV light.
- Anodized tactical aluminum housing.

LED FIREPOINT
TACTICAL



Item #	IP	MP	PKG	Display	Lumen	Run Time	Beam Distance	Battery		Length	Head Diameter	
								Qty.	Type			
W2444	UV/Laser	12	48	CRD	N	43	7.5	41m	3	AAA	5.25"	1.325"
W2468	UV/Laser	12	48	CRD	N	43	7.5	41m	3	AAA	5.25"	1.325"
W2472	Laser	8	48	CRD	Y	119	3	79m	3	AAA	4.75"	1.325"

FIREPOINT RECHARGEABLE LED FLASHLIGHT SET

- Rechargeable Li-ion battery.
- Includes 12V & 120V Chargers.
- Red preserves night vision,
- Green good for night hunting/fishing,
- Blue for leak detection.
- Aircraft grade aluminum flashlight.
- Padded nylon belt pouch.

LED FIREPOINT
TACTICAL



Item #		IP	MP	PKG	Display	Lumen	Run Time	Beam Distance	Battery	Length	Head Diameter
W2475	Arctic Camo	1	8	CBX	N	330	2.5	200m	Li-Ion	6.05"	1.325"

FIREPOINT SPOTLIGHT

- High output spotlight in a compact and comfortable design.
- Adjustable DuoFocus beam goes from spot to flood.
- Comfort pistol grip with trigger lock.
- Spring loaded battery chamber.

LED FIREPOINT
TACTICAL



Item #		IP	MP	PKG	Display	Lumen	Run Time	Beam Distance	Battery Qty.	Battery Type	Length	Head Diameter
W2436	Atomic Orange	6	12	CRD	N	230	1.5	110m	3	AAA	7.5"	2"
W2438	Electric Green	6	12	CRD	N	230	1.5	110m	3	AAA	7.5"	2"
W2439	Candy Apple Red	6	12	CRD	N	230	1.5	110m	3	AAA	7.5"	2"
W2440	Sapphire Blue	6	12	CRD	N	230	1.5	110m	3	AAA	7.5"	2"

PT POWER FLASHLIGHTS

STORM COMPOSITE FLASHLIGHTS

- Super Bright Nichia LEDs never need replacing.
- Flashlight submersible to one meter.
- US Patent D659870.



Item #	IP	MP	PKG	Display	Lumen	Run Time	Beam		Battery		Length	Head Diameter
							Distance	Qty.	Type			
W2456	Black	12	48	BLK	Y	65	6.5	76m	3	AAA	3.75"	1.25"
W2477	Black	12	144	CRD	N	65	6.5	76m	3	AAA	3.75"	1.25"
W2455	Camo	12	48	BLK	Y	65	6.5	76m	3	AAA	3.75"	1.25"
W2483	Camo	12	48	CRD	N	65	6.5	76m	3	AAA	3.75"	1.25"
W2489	Pink	12	144	BLK	Y	65	6.5	76m	3	AAA	3.75"	1.25"
W2495	3-PK Color	6	24	CRD	Y	65	6.5	76m	3	AAA	3.75"	1.25"
W2491	W/Knife	8	32	DBL	Y	65	6.5	76m	3	AAA	3.75"	1.25"
W2453	2-Pack	8	32	CRD	Y	65	6.5	76m	3	AAA	3.75"	1.25"
W2449	2-Pack	6	48	CRD	N	108	7.5	142m	2	D	3.75	1.25
						65	6.5	76m	3	AAA	7.125	2.1
W2497	Magnetic	12	48	CRD	N	65	6.5	76m	3	AAA	3.75"	1.25"
W2498	Magnetic	12	48	CRD	Y	65	6.5	76m	3	AAA	3.75"	1.25"

3-PC LED FLASHLIGHT & LANTERN

- Multi-Pack set great for outdoors.
- Compact Product Design for easy transport.



Item #	IP	MP	PKG	Display	Lumen	Run Time	Beam		Battery		Length	Head Diameter
							Distance	Qty.	Type			
W2341	3	12	CRD	N	1	65	6.5	76m	3	AAA	3.75"	1.25"
					2	60	-	-	2	AA	-	7.75
					3	50	-	-	4	AA	6"	2.125

ESSENTIAL LED FLASHLIGHTS

- Super Bright Nichia LED never needs replacing.
- Anodized aluminum flashlight.



Item #	IP	MP	PKG	Display	Lumen	Run Time	Beam		Battery		Length	Head Diameter
							Distance	Qty.	Type			
W2450	Black	16	64	CRD	Y	85	9.5	100m	3	AAA	3.625"	1.05"
W2451	Multi-Color	16	64	BLK	Y	85	9.5	100m	3	AAA	3.625"	1.05"
W2452	Camo	16	64	BLK	Y	85	9.5	100m	3	AAA	3.625"	1.05"
W2459	2-Pack	10	40	CRD	Y	85	9.5	100m	3	AAA	3.625"	1.05"
W2460	3-Pack	6	24	CRD	Y	85	9.5	100m	3	AAA	3.625"	1.05"

LED HEAD LAMPS

- Adjustable head band for maximum comfort

W2485



4 bright white, wide angle LEDs create a large flood of light.

W2374



W2333



Adjustable DuoFocus beam goes from spot to flood.

W2492

Flip down head for precise illumination. Rear battery pack for optimal balance.



Comfortable and lightweight design.

Adjustable DuoFocus beam goes from spot to flood.



Simple clip design attached to the brim of most hats.



W2463

Flip down head for precise illumination. Rear battery pack for optimal balance.

Item #	IP	MP	PKG	Display	Lumen	Run Time	Beam Distance	Battery		Length	Head Diameter	
								Qty.	Type			
W2492	FirePoint	6	24	CRD	N	457	5.5	187m	4	AA	2.75"	1.375
W2463	FirePoint	4	24	CRD	N	193	1.25	87m	3	AAA	2.875"	2"
W2374	4 LED	6	36	CRD	Y	199	5	28.2m	3	AAA	2.75"	1.75"
W2333	4 LED	6	36	CRD	Y	180	5	28.2m	3	AAA	2.75"	1.75"
W2485	6 LED	12	72	CRD	N	38	6.5	28.5m	3	AAA	2.75"	1.575"
W2342	Brim Clip	8	48	CRD	N	106	3.5	58m	3	AAA	4"	2.125"

POCKET & PEN LIGHTS



W2359



W2353
W2354



W2420
W2421



W2352
W2356



W2330



W2366



Anodized aluminum housing with pocket clip. High strength magnetic base.

W2331

Item #	IP	MP	PKG	Display	Lumen	Run Time	Beam Distance	Battery		Length	Head Diameter	
								Qty.	Type			
W2331	6 LED	6	24	CRD	N	452	10.25	34m	3	AA	7.5"	0.75"
W2353	6 + 1 LED	12	48	CRD	N	106	5.5	23m	3	AAA	6.75"	0.725"
W2354	6 + 1 LED	12	48	BLK	Y	106	5.5	23m	3	AAA	6.75"	0.725"
W2420	3 + 1 LED	12	48	BLK	Y	136	16	24m	3	AAA	6.375"	0.75"
W2421	3 + 1 LED	6	36	CRD	N	136	16	24m	3	AAA	6.375"	0.75"
W2330	FirePoint	12	72	BLK	Y	243	2.5	72m	3	AAA	6.625"	0.75"
W2352	Essential	12	72	CRD	N	72	4.5	73m	3	AAA	6.625"	0.665"
W2356	Essential	12	72	BLK	Y	72	4.5	73m	3	AAA	6.625"	0.665"
W2366	Swivel	12	72	CRD	Y	7.5	11	21m	2	AA	6.25"	0.655"
W2359	Pickup Tool	8	32	CRD	Y	56	2	35m	3	AAA	6.25"	1"

SPECIALTY LIGHTING

HAND HELD LED WORK LIGHTS

W2348
W2358

Area light and spotlight in one tool. Moveable magnetic base for directing light in any direction.



Thin, low profile light bar body for access in confined areas. Light bar adjusts 120° for precise illumination. Swivel hook and magnetic base for hands free use.

W2419



Strong magnet attaches to almost any metal surface. Swivel hook adjusts to multiple angles and stores away easily.

W2424



W2422

Movable magnetic base for directing light in any direction. Pocket/belt clip and swivel hook for added versatility.

Item #	IP	MP	PKG	Display	Lumen	Run Time	Beam Distance	Battery		Length	Width	
								Qty.	Type			
W2419	12+1 Slim	1	12	CBX	N	542	4.25	43m	3	AA	13.5"	1.5"
W2422	8 LED	6	48	CRD	N	280	1	28m	3	AAA	4.625"	2.125"
W2424	3 LED	12	24	CLM	N	248	11	27	3	AA	8"	2.5"
W2348	3 +1 LED	3	24	BLK	Y	154	6.5	4.6m	3	AA	8.5"	2.25"
W2358	3 +1 LED	6	48	CRD	N	154	6.5	4.6m	3	AA	8.5"	2.25"

SPECIALTY LED WORK LIGHTS



Carabiner clip provides easy way to hang or carry light almost anywhere.

W2345



Carabiner clip on top for easy carrying or hanging. Magnetic back for hands free use.



W2350

Lantern lens slides up for use as a lantern mode and back down for use as a flashlight.

W2447



Collapsible hook and magnetic base for added utility.

W2351



Adjustable clamping base for mounting to a table or workbench.

Spring loaded clamp and magnetic back for hands free use. Articulating design provides lights where needed.

W2381



Item #	IP	MP	PKG	Display	Lumen	Run Time	Beam Distance	Battery		Length	Head Diameter	
								Qty.	Type			
W2345	Carabiner	8	32	BLK	Y	200	5.25	23m	3	AAA	5.875"	1.9"
W2381	Clamp	6	24	CRD	N	196	2	40m	3	AAA	1.525"	7.875"
W2351	Coil	6	24	BLK	Y	128	5	82m	3	AAA	7.75-16.25"	1.875"
W2447	Slide Light	6	24	BLK	Y	248	2.5	20m	3	AAA	4.675"	2.125"
W2350	Dome Light	6	36	CRD	N	170	8.5	22m	3	AA	2.125"	3.25"

LED WORK LIGHTS

- Wide angle high output white LED.
- Rare earth magnet on back for hands free work.



Compact size provides light anywhere.
W2484



Unique hook & loop strap system for maximum versatility. Built-in stand for angling light towards work space.



W2469



360° swivel hook for added versatility.



W2404

See Power Tool Section for more details.

Item #	IP	MP	PKG	Display	Lumen	Run Time	Beam Distance	Battery		Length	Head Diameter	
								Qty.	Type			
W2362	Silver	6	48	BLK	N	123	2	33m	3	AAA	2.875"	1.875"
W2363	Silver	8	48	CRD	N	123	2	33m	3	AAA	2.875"	1.875"
W2367	Silver	8	48	BLK	Y	123	2	33m	3	AAA	2.875"	1.875"
W2464	Silver	3	48	BLK	N	123	2	13m	3	AAA	2.875"	1.875"
W2364	Multi-Color	8	32	BLK	Y	123	2	13m	3	AAA	2.875"	1.875"
W2462	Camo	8	48	CRD	Y	123	2	13m	3	AAA	2.875"	1.875"
W2469	w/Strap	8	48	CRD	Y	290	2.5	59m	3	AAA	8"	1.5"
W2484	2-Pack Mini	8	48	CRD	Y	32	4	13m	2	CR2032	2"	1.2"
W2404	Underhood	4	24	CRD	N	513	1.25	60m	-	Li-Ion	16"	2.5"

LED SAFETY FLARES

- Tough plastic construction is compact and lightweight.
- 12 bright red LEDs last up to 50 hours.
- 5 light patterns: 3 LED area light, rotate, blink, flash, 12 LED light.
- Swivel hook and magnet on back for hands free use.



Item #	IP	MP	PKG	Display	Lumen	Run Time	Beam Distance	Battery		Length	Head Diameter	
								Qty.	Type			
W2343	3-PK	4	32	CRD	N	-	50+	N/A	3	AAA	1.375"	3.785"
W2368		6	36	CRD	N	-	50+	N/A	3	AAA	1.375"	3.785"

LED MOONSTICKS

- Make yourself visible at night.
- Safe alternative to chemical glowsticks.
- LED never needs replacing.
- On and blink functions.
- Wrist lanyard.



Item #	IP	MP	PKG	Display	Lumen	Run Time	Beam Distance	Battery		Length	Head Diameter	
								Qty.	Type			
W2349	4-PK	6	24	CRD	Y	-	12	N/A	3	AG13	8.5"	0.1"
W2357		12	72	BLK	Y	-	12	N/A	3	AG13	8.5"	0.1"

INDEX

Item #	Page	Item #	Page	Item #	Page	Item #	Page	Item #	Page	Item #	Page
204.....	322	1410.....	302	1511.....	305	20169.....	266, 321	60306.....	111	M521.....	299
339.....	325	1412.....	302	1512.....	305	20170.....	262, 321	60307.....	111	M522.....	298
357.....	325	1413.....	302	1900.....	306	20171.....	222, 321	60308.....	111	M523.....	294
364.....	325	1414.....	302	1901.....	306	20180.....	76, 321	60309.....	111	M524.....	298
365.....	323	1415.....	302	1903.....	306	20187.....	37	60310.....	113	M525.....	299
372.....	323	1416.....	302	1904.....	306	20189.....	79	60311.....	111	M535.....	286
373.....	323	1417.....	302	1906.....	306	20192.....	106	60397.....	32, 110	M546.....	290
375.....	325	1418.....	302	1907.....	306	20193.....	263	60398.....	32, 110	M547.....	286
395.....	323	1419.....	302	1908.....	306	20194.....	75	60399.....	110	M548.....	288
397.....	324	1420.....	302	1909.....	306	20195.....	76	60400.....	110	M549.....	291
398.....	324	1421.....	302	1910.....	306	20197.....	39, 75, 321	60401.....	110	M550DB.....	284
403.....	324	1422.....	302	1911.....	306	20103.....	320	60402.....	110	M552DB.....	285
405.....	325	1423.....	302	1912.....	306	20105.....	320	60404.....	110	M553C.....	285
410.....	325	1424.....	302	1913.....	306	20106.....	320	60405.....	110	M554C.....	285
418.....	324	1426.....	302	1914.....	306	20107.....	320	60406.....	110	M555-24.....	284
420.....	324	1428.....	303	1916.....	306	20108.....	320	60500.....	112	M555-32.....	284
422.....	324	1429.....	303	1917.....	306	20109.....	320	60501.....	112	M558DB.....	109, 282
424.....	324	1430.....	303	1919.....	306	20110.....	320	60502.....	112	M560DB.....	283
538.....	322	1432.....	303	1922.....	306	20111.....	320	60503.....	112	M561.....	283
541.....	322	1433.....	303	1923.....	306	20117.....	320	60504.....	113	M562DB.....	282
546.....	322	1434.....	303	1924.....	306	20118.....	320	60505.....	299	M563DB.....	285
549.....	322	1435.....	303	1925.....	306	20119.....	320	60506.....	113	M564DB.....	283
550.....	323	1436.....	303	1927.....	306	20120.....	320	60507.....	113	M565C.....	286
551.....	323	1437.....	303	1928.....	306	20122.....	320	60508.....	112	M566DB.....	286
552.....	323	1438.....	303	1929.....	306	20130.....	320	60605.....	299	M567DB.....	286
560.....	323	1439.....	303	1930.....	306	20133.....	320	60606.....	299	M568DB.....	288
606.....	322	1440.....	303	1932.....	306	20142.....	321	60611.....	294	M569DB.....	288
615.....	322	1441.....	303	1933.....	306	20143.....	321	60612.....	294	M570C.....	291
1100.....	300	1442.....	303	1934.....	306	20146.....	321	60613.....	294	M571C.....	291
1101.....	300	1443.....	303	1935.....	306	20147.....	321	60700.....	297	M573DB.....	288
1103.....	300	1445.....	303	1936.....	307	20148.....	321	60750.....	297	M574DB.....	289
1105.....	300	1446.....	303	1937.....	307	20149.....	321	50-100.....	73	M575.....	285
1106.....	300	1448.....	303	1938.....	307	20153.....	321	50-101.....	73	M576DB.....	293
1107.....	300	1449.....	303	1939.....	307	20155.....	321	BC-8.....	252	M577B.....	293
1108.....	300	1450.....	303	1940.....	307	20157.....	321	BC-14.....	252	M578DB.....	293
1109.....	300	1451.....	303	1941.....	307	20158.....	321	BC-18.....	252	M579C.....	285
1110.....	300	1452.....	303	1942.....	307	20162.....	321	BC-18-1.....	252	M580C.....	285
1111.....	300	1453.....	303	1943.....	307	20177.....	321	BC-24.....	252	M582DB.....	290
1112.....	300	1455.....	303	1944.....	307	20181.....	321	BC-24-1.....	252	M584DB.....	291
1114.....	300	1456.....	304	1945.....	307	20183.....	321	BC-30.....	252	M585DB.....	299
1115.....	300	1459.....	304	1946.....	307	20200.....	321	BC-30-1.....	252	M586C.....	298
1116.....	300	1460.....	304	1947.....	307	20202.....	319	BC-36.....	252	M587C.....	185
1117.....	300	1461.....	304	1948.....	307	20203.....	319	BC-36-1.....	252	M588DB.....	184, 287
1119.....	300	1462.....	304	1949.....	307	20204.....	319	M194.....	193	M589DB.....	185, 287
1120.....	301	1463.....	304	1950.....	307	20205.....	319	M195.....	193	M590DB.....	184, 287
1121.....	301	1464.....	304	1951.....	307	20206.....	319	M196.....	192	M591DB.....	185, 287
1122.....	301	1465.....	304	1952.....	307	20207.....	319	M197.....	192	M592DB.....	184, 287
1123.....	301	1466.....	304	1954.....	307	20208.....	319	M198.....	192	M593DB.....	185, 287
1124.....	301	1468.....	304	1955.....	307	60100.....	112	M199.....	192	M594DB.....	184, 287
1125.....	301	1470.....	304	1957.....	307	60101.....	112	M200DB.....	192	M595DB.....	185, 287
1126.....	301	1472.....	304	1958.....	307	60102.....	112	M201.....	192	M597DB.....	285
1127.....	301	1473.....	304	1959.....	307	60103.....	112	M202-P.....	192	M598DB.....	295
1128.....	301	1474.....	304	1960.....	307	60104.....	112	M203.....	192	M601P.....	297
1129.....	301	1475.....	304	1961.....	307	60105.....	112	M204.....	192	M602P.....	297
1131.....	301	1477.....	304	1962.....	307	60106.....	112	M205.....	193	M603P.....	297
1135.....	301	1478.....	304	1963.....	307	60107.....	112	M206.....	193	M604C.....	294
1136.....	301	1479.....	304	1965.....	307	60108.....	112	M461.....	294	M608.....	296
1137.....	301	1480.....	304	1967.....	307	60109.....	112	M462.....	294	M609C.....	82, 294
1139.....	301	1481.....	304	20100.....	82, 320	60110.....	112	M464.....	294	M610.....	296
1140.....	301	1482.....	304	20101.....	82, 320	60111.....	112	M465.....	294	M611.....	294
1141.....	301	1483.....	304	20102.....	82, 320	60112.....	112	M466.....	294	M613.....	297
1142.....	301	1484.....	304	20104.....	191, 320	60113.....	112	M476.....	297	M617.....	297
1144.....	301	1485.....	304	20112.....	221	60114.....	112	M477.....	297	M619.....	296
1145.....	301	1486.....	305	20116.....	222, 320	60200.....	113	M478.....	297	M620.....	284
1146.....	301	1487.....	305	20124.....	76, 320	60201.....	113	M479.....	297	M621.....	282
1147.....	301	1488.....	305	20126.....	263, 320	60202.....	113	M481.....	295	M622.....	282
1148.....	301	1489.....	305	20127.....	76, 320	60203.....	113	M482.....	295	M624.....	109, 282
1149.....	301	1490.....	305	20128.....	262, 320	60204.....	113	M483.....	295	M625.....	109, 282
1150.....	301	1491.....	305	20129.....	263, 320	60206.....	113	M484.....	295	M627.....	282
1153.....	301	1493.....	305	20134.....	100, 320	60207.....	113	M486.....	295	M628.....	297
1155.....	301	1495.....	305	20135.....	82, 320	60208.....	113	M487.....	295	M634.....	282
1400.....	302	1496.....	305	20140.....	76, 321	60209.....	113	M503.....	292	M635.....	296
1401.....	302	1498.....	305	20145.....	227, 321	60210.....	82, 113	M504C.....	294	M637.....	283
1402.....	302	1499.....	305	20150.....	264, 321	60220.....	78	M505C.....	294	M639.....	283
1404.....	302	1500.....	305	20151.....	227, 321	60300.....	111	M507C.....	294	M641.....	288
1405.....	302	1502.....	305	20152.....	222, 321	60301.....	111	M516C.....	299	M643.....	289
1406.....	302	1503.....	305	20154.....	227, 321	60302.....	111	M517.....	299	M647.....	289
1407.....	302	1507.....	305	20156.....	227, 321	60303.....	111	M518.....	298	M648.....	283
1408.....	302	1508.....	305	20160.....	72	60304.....	111	M519.....	298	M649.....	283
1409.....	302	1509.....	305	20165.....	82, 321	60305.....	111	M520.....	299	M651.....	283

Item #	Page	Item #	Page	Item #	Page	Item #	Page	Item #	Page	Item #	Page
M655	296	M801	184	M913	185	M7264	254	W190C	261	W415C	210
M656	286	M802	184	M914	185	MV1	59	W191C	111	W418P	210
M658	289	M803	184	M915	185	MV4	59	W192C	111	W424P	210
M660	284	M804	184	M916	185	MV5	59	W193C	131	W452	205
M661	285	M805	184	M917	185	MV6	59	W196C	131	W453	205
M662	285	M806	184	M918	185	MV8	59	W197B	76	W458	278
M664	290	M807	184	M919	185	MV10	59	W197C	76	W459	281, 318
M668	284	M808	184	M931	184	S/4	205	W199C	131	W461	39, 75
M669	284	M809	184	M932	184	S/6	205	W200	260	W463	39, 75, 318
M672	296	M810	184	M933	184	W1	108	W202	260	W464	123, 318
M673	284	M811	184	M934	184	W2	108	W206C	250	W465	77, 318
M676	293	M812	184	M935	184	W3-SKH	196	W207C	250	W467	39, 318
M680	248, 291	M813	184	M936	184	W5	108	W209	129	W469	75, 318
M682	290	M814	184	M937	184	W6	108	W213C	250	W471	318
M685	298	M817	184	M938	184	W6C	210	W214C	250	W472	22, 318
M686	298	M818	184	M939	184	W7	108	W215C	250	W473	22, 318
M687	298	M820	185	M940	184	W8C	210	W219	123	W474	21, 228, 318
M688	295	M821	185	M949	185	W9	108	W220	123	W475	318
M689	288	M822	185	M950	185	W9A	108	W221	250	W476	221, 318
M693	295	M823	185	M951	185	W10C	210	W227	123	W477	318
M694	295	M824	185	M952	185	W11	108	W232C	76	W478	229, 318
M695	295	M825	185	M953	185	W12C	210	W233	276	W479	221, 318
M696	284	M826	185	M954	185	W12-SKH	196	W234C	275	W480	318
M697	288	M827	185	M955	185	W14-SKH	196	W235	275	W481	82, 318
M701	293	M828	185	M956	185	W15MP	204	W241	127	W482	75, 318
M702	293	M829	185	M957	185	W15P	204	W242	127	W483	81, 318
M705	292	M830	185	M958	185	W17C	191	W243	127	W501	82
M706	292	M831	185	M959	185	W26C	79	W270	119	W501D	82
M707	292	M832	185	M962	187	W29	77	W307C	204	W502	82
M708	292	M834	185	M963	187	W29C	79	W308C	204	W503	82
M710	292	M836	185	M964	187	W30C	79	W309C	204	W504	82
M710K	292	M837	185	M966	187	W31C	79	W310C	204	W506C	82
M711	292	M839	184	M967	187	W36C	79	W311C	204	W508	82
M715	127, 291	M840	184	M968	187	W38-SKH	196	W312C	204	W530	62
M731	292	M841	184	M969	187	W116	99	W313C	204	W540	95
M740-24	184	M842	184	M970	187	W123C	160	W314C	204	W541	95
M740-26	184	M843	184	M971	187	W125	240	W315C	204	W548	82
M740-27	185	M844	184	M972	187	W125C	162	W316C	204	W549	82
M740-28	184	M845	184	M973	187	W129C	162	W317C	204	W694	277
M740-30	184	M846	184	M974	187	W130C	151	W318C	204	W696	274
M740-32	184	M847	184	M975	187	W131C	162	W319C	204	W700C	133
M740-34	184	M848	184	M976	187	W134DB	149	W320C	204	W701C	132
M740-36	184	M849	184	M977	187	W135P	149	W321C	204	W702C	133
M740-38	184	M850	184	M980	109	W136P	149	W322C	204	W703	133
M740-40	184	M851	184	M981	109	W137P	149	W323C	204	W704C	133
M740-42	184	M852	184	M982	109	W138P	149	W324C	204	W709	202
M740-44	184	M853	184	M983	109	W139	149	W325C	204	W721	24
M740-46	184	M860	185	M984	109	W140	149	W326C	204	W725	273
M740-48	184	M861	185	M1263	184	W141	149	W327C	204	W726	273
M742-32	184	M862	185	M3008B	188	W142	140	W328C	204	W730	273
M742-34	184	M863	185	M4710	292	W147C	100	W329C	204	W731	273
M742-36	184	M864	185	M7007	98	W147FB	100	W330C	204	W732	273
M742-40	184	M865	185	M7008B	254	W150	143	W331C	204	W733	273
M742-42	184	M866	185	M7019B	312	W151P	153	W332C	204	W739	273
M742-44	184	M867	185	M7020B	255	W152C	100	W333C	204	W740C	273
M742-46	184	M868	185	M7030B	255	W153	134	W334C	204	W741C	273
M742-48	184	M869	185	M7032B	255	W154	134	W340C	204	W742	276
M743-33	184	M870	185	M7034B	255	W155	134	W341C	204	W743	276
M745-10	185	M871	185	M7036B	255	W156	134	W342C	204	W744	277
M745-12	184	M872	185	M7040B	253	W157	119	W343B	204	W745C	277
M745-14	184	M873	185	M7100	253	W158	134	W344B	204	W746	277
M745-16	184	M874	185	M7101	253	W158C	130	W345B	204	W747	276
M745-22	184	M876	185	M7102	253	W159C	130	W346B	204	W748	274
M745-32	184	M877	185	M7103	253	W162C	160	W347B	204	W749	276
M747-20	184	M880	185	M7104	253	W163C	160	W348B	204	W750	258
M747-30	184	M882	185	M7109	253	W165	161	W349C	204	W751	258
M765	187	M891	184	M7111	253	W166	161	W350	205	W752	258
M771	185	M892	184	M7112	253	W170C	131	W350M	205	W753	258
M772	185	M893	184	M7113	253	W171C	119	W351	205	W754	258
M780	187	M894	184	M7114	253	W173C	119	W352	205	W756	277
M782	185	M895	184	M7115	253	W175	130	W353B	204	W757	259
M783	185	M896	184	M7116	253	W178C	130	W354B	204	W758	259
M785	187	M897	184	M7132	254	W179C	130	W355B	204	W759	259
M786	187	M898	184	M7134	255	W180	129	W356B	204	W773	197
M787	187	M899	184	M7215	254	W181	129	W368C	204	W774	197
M792	186	M900	184	M7216	254	W182	129	W376B	204	W775	197
M793	187	M909	185	M7224	254	W185	260	W377B	204	W776	197
M795	186, 287	M910	185	M7232	254	W186	260	W378B	204	W778	197
M796	186	M911	185	M7234	254	W186C	118	W379B	204	W779	197
M800	184	M912	185	M7248	254	W189C	118	W407C	99	W900S	218

INDEX

Item #	Page	Item #	Page	Item #	Page	Item #	Page	Item #	Page	Item #	Page
W901S	218	W1133-18B	252	W1271	135	W1475	79	W1685C	101	W2070	266
W902C	143	W1133-24B	252	W1272	135	W1476	77	W1686B	101	W2071	266
W904	218	W1133-36B	252	W1273	135	W1477	271	W1686C	101	W2110	252
W904GN	219	W1133-8B	252	W1275	68	W1478	271	W1687	101	W2114	252
W907	220	W1134-16	255	W1276	73	W1498	78, 108	W1688	101	W2118	252
W924	219	W1136	252	W1279	33, 80	W1499	78, 108	W1688-2C	101	W2124	252
W941	267	W1136C	195	W1280	68	W1500	208	W1691C	102	W2136	252
W942	267	W1137	255	W1284	81	W1501	70	W1692PC	102	W2148	252
W944S	220	W1139	124	W1285	68	W1519	239	W1694C	102	W2149	252
W948	267	W1141	124	W1286	68	W1525	238	W1695C	102	W2230	42
W949	147, 267	W1142	124	W1287	68	W1532	237	W1696C	102	W2250	41
W950	218	W1143	23, 125	W1288	68	W1538	237	W1697C	102	W2251	41
W951	218	W1144	124	W1289	68	W1541	234	W1699C	102	W2252	41
W969	75	W1145	124	W1296	134	W1543	237	W1703	219	W2260	40
W974	82	W1146	254	W1297	134	W1553	79	W1704	209	W2261	40
W975	222, 312	W1147C	142	W1298	134	W1554	79	W1709	274	W2262	40
W985	76	W1148	76	W1299	134	W1555	78	W1710	217	W2263	40
W990	76	W1149	76	W1309	312	W1556	78	W1711	232	W2264	42
W1001	99	W1150	76	W1313	181	W1600	47	W1712	232	W2270	39
W1007DB	98	W1150S	212	W1315	230	W1601	47	W1713	232	W2271	39
W1010	98, 255	W1151	212	W1316	220	W1605	46	W1714	107	W2272	38
W1012	98, 255	W1152	76	W1317	233	W1606	46	W1716	189	W2273	38
W1013	98, 255	W1153	254	W1319	232	W1607	52	W1717	209	W2274	39
W1014	98	W1154	254	W1335	181	W1608	52	W1718	217	W2275	38
W1016	98	W1156	124	W1336	181	W1609	47, 80	W1719	224	W2277	39
W1019	99	W1157	204	W1337	181	W1611	46	W1720	277	W2278	38
W1021	99	W1157P	138	W1338	181	W1612	46	W1721	217	W2280	42
W1023	99, 272	W1158P	138	W1339	181	W1614	46	W1725	224	W2281	41
W1024	70	W1159	212	W1341	181	W1616	46	W1726	216	W2330	329
W1026	70	W1166	202	W1343	21, 225	W1617	46	W1727	216	W2331	329
W1028	98	W1167	202	W1352	21, 225	W1621	48	W1728	223	W2333	329
W1029	98	W1168	234	W1368	240	W1623	48	W1729	219	W2341	328
W1031	70	W1172	234	W1384	228	W1625	48	W1731	216	W2342	329
W1032	70	W1173	234	W1385	181	W1627	47	W1732	220	W2343	108, 331
W1033	70	W1178	181	W1386	228	W1628	48	W1801	238	W2345	330
W1034	70	W1179	175, 178	W1387	181	W1630	47	W1802	239	W2348	330
W1036	70	W1180	175	W1388	181	W1632	48	W1804C	79	W2349	331
W1037	70	W1182C	265	W1389	225	W1633	48	W1904	263	W2350	330
W1039	211	W1183	235	W1390	22	W1635	110	W1908	263, 312	W2351	330
W1044	208	W1184C	265	W1391	230	W1636	48	W1909	82	W2352	329
W1045	208	W1186	160	W1392	230	W1636PB	110	W1915	111, 312	W2353	329
W1046	208	W1187	155	W1393	230	W1637	48	W1925	111, 312	W2354	329
W1047	208	W1189C	160	W1394	230	W1638DB	110	W1927	264	W2356	329
W1048	208	W1193	236	W1395	151	W1640	46	W1932	264	W2357	331
W1061	204	W1197	236	W1397	151	W1641	102	W1933	264	W2358	330
W1062	204	W1198	235	W1398	151	W1642	47	W1934	264	W2359	329
W1069	203	W1200C	263	W1399	151	W1643	48	W1935	264	W2362	331
W1076	255	W1204P	140	W1400	72	W1644	48	W1938	232	W2363	331
W1084	203	W1205	140	W1400-5	72	W1645	47	W1939	232	W2364	331
W1091	202	W1206P	140	W1401	72	W1646	101	W2000	35	W2366	329
W1092	202	W1208C	23	W1402	72	W1650	98	W2000-1	35	W2367	331
W1099	203	W1209	23	W1403	72	W1651	98	W2002	35	W2368	108, 331
W1101	208	W1211	23	W1405	72	W1652	100	W2005	249	W2369	312
W1102	208	W1212	23	W1410	74	W1653C	103	W2006	249	W2372	312
W1103	208	W1213	23	W1411	74	W1654C	171	W2007	249	W2374	329
W1104M	205	W1214C	23	W1412	74	W1655C	171	W2008	248	W2375	45
W1104S	205	W1215	23	W1413	74	W1656C	171	W2009	248	W2380	312
W1107DB	211	W1216	160	W1414	74	W1657C	103	W2010	35	W2381	330
W1108C	230	W1218	117	W1416	73	W1658	33, 80	W2011	248	W2393	45
W1109C	230	W1219	147	W1417	72	W1658C	100	W2012	35	W2401	42
W1110C	230	W1220	147	W1419	72	W1660C	171	W2012-1	35	W2402	43
W1113C	230	W1221	27	W1420	73	W1661	105	W2013	35	W2404	43, 331
W1114	203	W1222	23	W1422	73	W1663	81	W2015P	98	W2405	326
W1114M	203	W1223	23	W1423	73	W1665	104	W2016C	98	W2406	42
W1116C	211	W1224	23	W1424	72	W1666C	103	W2017C	248	W2409	45
W1117C	208	W1225	117	W1425	72	W1667	105	W2018	248	W2416	45
W1118	208	W1231	155	W1426	72	W1669	105	W2019A	35	W2419	330
W1119C	208	W1254	263	W1427	72	W1670	105	W2020	257	W2420	329
W1120PC	208	W1256	68	W1429	72	W1671	105	W2021	257	W2421	329
W1121PC	208	W1258	262	W1435	73	W1672	105	W2022	256	W2422	330
W1122C	208	W1259	262	W1436	73	W1673	105	W2025	257	W2424	330
W1125C	161	W1260	68	W1437	73	W1674	100	W2029DB	98	W2425	44
W1126C	161, 178	W1261	263	W1440	72	W1677	104	W2030	256	W2426	44
W1128C	161, 178	W1262C	262	W1446	72	W1677-1	104	W2032	256	W2427	45
W1129C	161	W1264	68	W1450	111	W1679C	101	W2033	256	W2432	45
W1130	156	W1265	68	W1460	77	W1680C	101	W2034	256	W2433	45
W1131C	161	W1266	156	W1466	77	W1681C	101	W2040	213	W2435	44
W1133-10B	252	W1267	156	W1468	77	W1682C	101	W2043	213	W2436	327
W1133-12B	252	W1269	135	W1472	77	W1683	101	W2050	249	W2438	327
W1133-14B	252	W1270	135	W1474	77, 312	W1684	101	W2051	249	W2439	327

Item #	Page	Item #	Page	Item #	Page	Item #	Page	Item #	Page	Item #	Page
W2440	327	W2935	261	W3249	316	W5092	251	W5342	85	W8570	242
W2444	326	W2965	244	W3250	316	W5100	211, 251	W5343	89	W8571	242
W2447	330	W2966	244	W3251	316	W5101	211, 251	W5348	93	W8573	242
W2449	328	W2967	247	W3252	316	W5102	211, 251	W5353	97	W8574	242
W2450	328	W2968	244	W3253	316	W5124	268	W5355	86	W8575	242
W2451	328	W2970	107	W3254	316	W5124BP	268	W5358	84	W8577	242
W2452	328	W2971	107	W3255	316	W5150	274	W5359	89	W8578	242
W2453	328	W2973C	106	W3256	316	W5161	61	W5368	94	W8579	242
W2455	328	W2974	107	W3257	316	W5163	61	W5369	94	W8581	242
W2456	328	W2975C	106	W3300	76, 317	W5165	61	W5370	94	W8582	242
W2458	326	W2976	164	W3301	263, 317	W5167	61	W5371	94	W8583	242
W2459	328	W2977	164	W3302	100, 317	W5169	60	W5372	259	W8585	242
W2460	328	W2978	106	W3303	82, 317	W5170	60	W5373	94	W8589	242
W2462	331	W2979	106	W3304	262, 317	W5171	60	W5374	94	W8598	22
W2463	329	W2979C	107	W3305	317	W5172	61	W5375	94	W8603	22
W2464	331	W2980	103	W3306	317	W5173	61	W5376	94	W8605	243
W2468	326	W2981	106	W3307	317	W5174	61	W5377	94	W8608	24
W2469	331	W2982	106	W3309	82, 317	W5175	61	W5378	94	W8615	242
W2470	326	W2983	106	W3311	317	W5178	61	W5390	272	W8617	242
W2471	326	W2985	105	W3312	317	W5179	61	W5391	272	W8618	242
W2472	326	W2986	81	W3313	317	W5182	62	W5393	272	W8630	242
W2473	326	W2987	81	W3314	317	W5183	63	W5394	272	W8632	242
W2474	326	W2988	103	W3315	317	W5185	62	W5398	272	W8633	242
W2475	327	W2989	103	W3316	317	W5186	62	W5399	272	W8636	242
W2476	326	W2990	106	W3317	317	W5188	67	W5400	272	W8637	242
W2477	328	W2991	106	W3318	317	W5189	67	W5403	272	W8639	242
W2478	326	W2992	106	W3319	317	W5190	62	W5406	272	W8651	243
W2479	314	W2996	105	W3321	317	W5193	63	W5414	258	W8652	243
W2480	41	W2997	105	W3322	317	W5195	63	W5417	258	W8654	243
W2480-BULK	41	W2998	103	W3323	317	W5196	63	W5420	258	W8659	228
W2481	326	W3001C	193	W3900	59	W5197	63	W5421	259	W8662	242
W2482	326	W3013	275	W3901	59	W5199	96	W5422	259	W8663	242
W2483	328	W3033	257	W3902	27, 59	W5200	87	W5424	258	W8664	242
W2484	331	W3200	315	W3903	59	W5201	91	W5427	258	W8665	242
W2485	329	W3201	315	W3904	59	W5202	91	W5432	258	W8667	242
W2488	326	W3202	315	W3905	59	W5203	91	W5434	258	W8668	242
W2489	328	W3203	75, 315	W3939	27, 59	W5204	88	W5436	258	W8669	243
W2490	326	W3204	315	W3943	250	W5205	88	W5486	275	W8692	241
W2491	280, 328	W3205	315	W3944	250	W5206	88	W5489	275	W8694	240
W2492	329	W3207	315	W3945	250	W5207	96	W5512	269	W8697	242
W2493	326	W3208	315	W3946	250	W5208	88	W5701	269	W8698	25
W2495	328	W3209	315	W3948	250	W5209	95	W5702	269	W9003	241
W2497	328	W3210	315	W3952	250	W5210	89	W5703	269	W9004	241
W2498	328	W3211	315	W3954	250	W5212	88	W5704	268	W9011	242
W2499	326	W3212	315	W3960	251	W5213	95	W5750	276	W9014	241
W2500-36MM		W3213	315	W3961	251	W5214	91	W5763	269	W9016	241
	223, 247	W3214	315	W3970	250	W5215	94, 117	W5994	67	W9017	241
W2500P	223, 247	W3215	315	W3980	250	W5216	87	W6000	74	W9018	241
W2503	223, 247	W3216	70, 315	W3981	250	W5217	87	W6002	74	W9019	241
W2503-50MM		W3217	315	W3982	250	W5218	87	W6004	74	W9022	22
	223, 247	W3218	315	W4000DB	73	W5219	84	W6005	74	W9024	21, 224,
W2550	80, 314	W3219	22, 315	W4001DB	243	W5220	84	W6006	74	W9025	227
W2551	314	W3220	22, 315	W4002DB	243	W5221	84	W6007	74	W9026	22
W2552	314	W3221	79, 315	W4003	73	W5222	84	W6009	74	W9027	226
W2554	281, 314	W3222	315	W4004DB	73	W5226	86	W6011	74	W9029	22
W2556	80, 314	W3223	315	W4005DB	51	W5228	90, 248	W6015	74	W9030	22
W2558	75, 314	W3225	315	W4007	123	W5230	90	W6022	74	W9040	226
W2559	314	W3226	315	W4015	123	W5231	93	W6025	74	W9041	226
W2600	277	W3227	315	W4034	123	W5232	94	W6027	74	W9100	263, 308
W2601	277	W3228	315	W4064	123	W5233	95	W7002	74	W9101	263, 308
W2903	83	W3229	76, 315	W4070	122	W5234	93, 121	W7004	74	W9102	264, 308
W2904	83	W3230	262, 316	W5006	268	W5235	93, 121	W7006	74	W9103	262, 308
W2905	83	W3231	79, 316	W5009	33, 80	W5236	93, 121	W7500	277	W9104	111, 308
W2906	83	W3232	316	W5020	268	W5237	85	W7501	277	W9105	111, 308
W2907	83	W3233	316	W5022	268	W5238	85	W7502	276	W9106	111, 309
W2908	83	W3234	263, 316	W5024	268	W5239	91	W7503	277	W9107	111, 309
W2910	83	W3235	100, 316	W5025BP	268	W5240	92	W7504	276	W9108	309
W2911	83	W3236	82, 316	W5035	268	W5241	92	W7505	277	W9109	262, 309
W2912	83	W3237	316	W5040	268	W5242	92	W7506	276	W9111	309
W2913	83	W3238	111, 316	W5041	268	W5243	92	W7507	276	W9112	309
W2915	83	W3239	70, 316	W5052	269	W5244	92	W7508	276	W9113	309
W2917	83	W3240	316	W5080	251	W5245	87	W7559	259	W9115	263, 309
W2918	83	W3241	316	W5081	251	W5250	90, 249	W8561	242	W9116	309
W2919	83	W3242	316	W5082	251	W5251	90, 249	W8562	242	W9117	265, 309
W2924	83	W3243	281, 316	W5083	251	W5252	90, 249	W8563	242	W9118	309
W2925	83	W3244	82, 316	W5087	251	W5313	286	W8564	242	W9124	262, 309
W2926	83	W3245	82, 316	W5088	251	W5331	85	W8565	242	W9125	309
W2927	83	W3246	229, 316	W5089	251	W5334	85	W8566	242	W9128	309
W2928	83	W3247	229, 316	W5090	251	W5340	89	W8567	242	W9130	309
W2929	83	W3248	35, 316	W5091	251	W5341	89	W8569	242	W9132	309

INDEX

Item #	Page	Item #	Page	Item #	Page	Item #	Page	Item #	Page	Item #	Page
W9134	309	W9460	75	W30250	200	W30708	210	W30938	196	W32181	190
W9135	309	W9461	75	W30251	200	W30709	213	W30939	195	W32190	197
W9136	310	W10005	298	W30252	200	W30710	210	W30957	194	W32202	177
W9137	310	W10011	298	W30253	200	W30712	210	W30960	214	W32210	177
W9141	262, 310	W10012	299	W30254	200	W30713	211	W30961	214	W32211	177
W9144	263, 310	W10055	298	W30255	200	W30714	209	W30962	214	W32212	177
W9145	262, 312	W10056	298	W30256	200	W30715	209	W30963	214	W32213	177
W9146	221, 310	W10057	298	W30257	200	W30720	206	W30964	214	W32214	177
W9147	221, 310	W10058	298	W30258	200	W30721	206	W30965	214	W32215	177
W9148	221, 310	W11046	32, 115	W30259	200	W30722	206	W30967	214	W32216	177
W9155	310	W11090	77, 313	W30260	200	W30725	206	W30968	214	W32217	177
W9157	221	W11091	77, 313	W30261	200	W30726	206	W30969	214	W32218	177
W9158	310	W11092	77, 313	W30262	200	W30728	206	W30970	214	W32219	177
W9159	227, 310	W12113	277	W30332	198	W30729	207, 261	W30975	75	W32220	177
W9161	310	W13500	182	W30348	200	W30731	206	W30980	220	W32221	177
W9163	76, 312	W15028	266	W30349	200	W30732	206	W30983	214	W32222	177
W9166	77, 312	W15029	266, 313	W30350	200	W30733	206	W30986	214	W32223	177
W9167	123, 312	W15032	266, 313	W30351	200	W30736	206	W30987	214	W32224	177
W9168	310	W15033	81, 313	W30352	200	W30737	206	W30988	214	W32225	177
W9169	221, 310	W15034	81, 313	W30353	200	W30740	207	W30989	214	W32226	177
W9170	274, 310	W15035	266	W30354	200	W30741	207	W30990	214	W32227	177
W9171	274, 310	W15036	266, 313	W30355	200	W30743	207	W30991	214	W32228	177
W9172	227, 310	W15038	266	W30356	200	W30745	207	W30992	214	W32230	177
W9173	310	W16500	168	W30357	200	W30752	211	W30993	214	W32232	177
W9174	221, 310	W16750	104	W30358	200	W30754	211	W30994	214	W32300	176
W9176	281	W16751	104	W30359	200	W30756	211	W30995	214	W32316	176
W9178	227, 311	W16850	100	W30361	200	W30757	211	W31110	188	W32318	176
W9179	227, 311	W16851	100	W30362	200	W30758	211	W32000	196	W32320	176
W9181	275, 311	W16852	100	W30402	199	W30759	209	W32002	176	W32322	176
W9183	275, 311	W16853	100	W30403	199	W30760	211	W32003	197	W32324	176
W9184	311	W16854	100	W30404	199	W30762	207	W32004	197	W32326	176
W9185	311	W25934	264	W30405	199	W30763	207, 261	W32012	176	W32328	176
W9186	311	W30001	198	W30409	199	W30764	207, 261	W32014	176	W32330	176
W9187	311	W30002	198	W30410	199	W30765	206	W32016	176	W32332	176
W9188	311	W30006	198	W30413	199	W30766	210	W32018	176	W32334	176
W9189	312	W30007	198	W30415	199	W30771	207	W32020	176	W32336	176
W9190	313	W30008	198	W30416	199	W30772	207	W32022	176	W32340	176
W9191	77, 313	W30009	198	W30419	199	W30773	207	W32024	176	W32400	177
W9193	222, 311	W30010	198	W30430	199	W30774	207	W32026	176	W32410	177
W9194	221, 311	W30011	198	W30431	199	W30775	207	W32028	176	W32411	177
W9195	313	W30012	198	W30500	172	W30781	210	W32030	176	W32412	177
W9197	77, 313	W30013	198	W30507	199	W30782	210	W32032	176	W32413	177
W9198	281, 311	W30014	198	W30512	199	W30783	210	W32034	176	W32414	177
W9199	311	W30015	198	W30514	199	W30784	210	W32036	176	W32415	177
W9200	281, 313	W30016	198	W30516	199	W30785	210	W32038	176	W32416	177
W9201	281, 313	W30017	198	W30518	199	W30810	215	W32040	176	W32417	177
W9202	313	W30018	198	W30520	199	W30815	215	W32090	183	W32418	177
W9203	311	W30019	198	W30522	199	W30820	215	W32092	183	W32419	177
W9204	263, 311	W30020	198	W30524	199	W30825	215	W32100	190	W32420	177
W9205	222, 313	W30021	198	W30600	205	W30827	215	W32101	190	W32421	177
W9206	80, 311	W30022	198	W30601	205	W30830	215	W32102	191	W32422	177
W9305	281, 311	W30023	198	W30602	202	W30896	214	W32106	191	W32423	177
W9309	280	W30024	198	W30607	199	W30897	219	W32110	313	W32424	177
W9313	279	W30025	198	W30610	199	W30898	214	W32114	189	W32427	177
W9316	279	W30026	198	W30611	199	W30899	215	W32118	188	W32512	176
W9317	279	W30027	198	W30612	199	W30900	215	W32119	188	W32514	176
W9320	280	W30028	198	W30613	199	W30901	215	W32120	188	W32516	176
W9323	280	W30029	198	W30614	199	W30905	215	W32121	188	W32518	176
W9328	279	W30030	198	W30615	199	W30906	215	W32122	191	W32520	176
W9332	279	W30032	198	W30616	199	W30907	215	W32124	188	W32522	176
W9333	279	W30200	198	W30617	199	W30908	215	W32125	189	W32524	176
W9335	280	W30202	198	W30618	199	W30909	215	W32126	188	W32526	176
W9339	279	W30208	198	W30619	199	W30910	215	W32127	188	W32528	176
W9340	280	W30210	198	W30630	200	W30911	215	W32128	188	W32530	176
W9341	278	W30211	198	W30631	200	W30912	215	W32129	188	W32532	176
W9344	280	W30212	198	W30632	201	W30920	215	W32130	195	W32534	176
W9345	280	W30214	198	W30633	201	W30921	215	W32136	195	W32536	176
W9350	278	W30216	198	W30634	201	W30922	215	W32137	189	W32538	176
W9351	278	W30218	198	W30635	201	W30923	215	W32139	194	W32540	176
W9352	278	W30220	198	W30641	200	W30924	215	W32140	194	W32600	176
W9353	213	W30222	198	W30642	200	W30925	215	W32141	194	W32616	176
W9354	213	W30224	198	W30643	201	W30926	215	W32143	194	W32618	176
W9356	278	W30226	198	W30644	201	W30927	215	W32145	194	W32620	176
W9357	278	W30228	198	W30645	201	W30931	196	W32150	194	W32622	176
W9359	281	W30230	198	W30646	201	W30932	196	W32153	194	W32624	176
W9360	278	W30232	198	W30681	199	W30933	195	W32157	195	W32626	176
W9362	279	W30234	198	W30682	199	W30934	195	W32158	195	W32628	176
W9400	281	W30236	198	W30703	210	W30935	196	W32160	161, 178	W32630	176
W9402	281	W30238	198	W30704	210	W30936	161	W32163	161, 178	W32636	176
W9451	74	W30240	198	W30706	210	W30937	187	W32180	190	W32700	177

I	P	I	P	I	P	I	P	I	P	I	P
W32810	177	W34550	178	W36306	176	W38140	194	W38413	177	W38886	180
W32811	177	W34552	178	W36307	176	W38141	194	W38414	177	W38887	228
W32812	177	W34554	178	W36308	176	W38143	194	W38415	177	W38890	180
W32813	177	W34556	178	W36309	176	W38144	194	W38416	177	W38892	180
W32814	177	W34558	178	W36310	176	W38146	194	W38417	177	W38893	180
W32815	177	W34560	178	W36311	176	W38147	194	W38418	177	W38894	180
W32816	177	W34564	178	W36312	176	W38148	194	W38419	177	W38895	180
W32817	177	W34566	178	W36314	176	W38149	194	W38421	177	W38896	180
W32818	177	W34568	178	W36316	176	W38150	194	W38422	177	W38897	180
W32819	177	W34570	178	W36400	177	W38151	194	W38500	176	W38898	180
W32820	177	W34572	178	W36404	177	W38152	194	W38510	176	W38899	180
W32821	177	W34574	178	W36405	177	W38154	194	W38512	176	W38900	180
W32822	177	W34822	178	W36406	177	W38155	194	W38514	176	W38905	173
W32823	177	W34823	178	W36407	177	W38156	194	W38516	176	W38911	174
W32824	177	W34824	178	W36408	177	W38157	194	W38518	176	W38914	174
W32825	177	W34825	178	W36409	177	W38158	195	W38520	176	W38916	245
W32826	177	W34826	178	W36410	177	W38159	195	W38522	176	W38917	245
W32827	177	W34827	178	W36411	177	W38160	161, 178	W38524	176	W38918	245
W32828	177	W34828	178	W36412	177	W38161	161, 178	W38526	176	W38919	245
W32830	177	W34829	178	W36413	177	W38162	161, 178	W38528	176	W38920	245
W32832	177	W34830	178	W36801	180	W38163	161, 178	W38600	176	W38927	313
W32860	182	W34832	178	W36802	180	W38164	161, 178	W38612	176	W38937	313
W32870	182	W34833	178	W36803	180	W38165	161, 178	W38614	176	W38940	182
W32880	180	W34835	178	W36810	182	W38166	161, 178	W38616	176	W38945	182
W32881	180	W34836	178	W36815	182	W38167	161, 178	W38618	176	W38947	182
W32882	180	W34838	178	W36820	182	W38168	161, 178	W38620	176	W38950	182
W32883	180	W34840	178	W36825	182	W38169	161, 178	W38622	176	W38955	182
W32884	180	W34841	178	W36827	182	W38170	161, 178	W38624	176	W38961	183
W32885	180	W34842	178	W36830	182	W38171	161, 178	W38626	176	W38962	183
W32886	180	W34846	178	W36901	174	W38172	161, 178	W38628	176	W38963	183
W32887	180	W34850	178	W36902	180	W38173	161, 178	W38630	176	W38964	183
W32888	180	W34855	178	W36903	180	W38180	190	W38700	177	W38965	183
W32889	180	W34902	186	W36904	174	W38181	190	W38708	177	W38970	229
W32901	174	W34904	175	W36905	173	W38190	197	W38709	177	W38971	229
W32902	109, 179	W34906	175, 178	W36910	182	W38194	179	W38710	177	W38972	229
W32903	186, 287	W36000	196	W36915	182	W38201	177	W38711	177	W38973	229
W32904	174	W36001	197	W36920	182	W38202	177	W38712	177	W38980	179
W32905	173	W36002	176	W36925	182	W38206	177	W38713	177	W38981	179
W32921	109, 179	W36003	197	W36927	182	W38207	177	W38714	177	W39000	236
W32922	109, 179	W36005	176	W36930	182	W38208	177	W38715	177	W41000	49
W32923	109, 179	W36006	176	W36940	194	W38209	177	W38716	177	W41001	49
W32924	109, 179	W36007	176	W36980	179	W38210	177	W38717	177	W41003	78
W32925	109, 179	W36008	176	W36981	179	W38211	177	W38718	177	W41018	51
W32926	109, 179	W36009	176	W38000	196	W38212	177	W38719	177	W41021	48
W32960	182	W36010	176	W38002	176	W38213	177	W38750	181	W41022	48
W32981	180	W36011	176	W38003	197	W38214	177	W38751	181	W41023	48
W32982	180	W36012	176	W38004	197	W38215	177	W38752	181	W41025	51
W32983	180	W36014	176	W38008	176	W38216	177	W38800	177	W41027	50
W32984	180	W36016	176	W38010	176	W38217	177	W38802	182	W41029	50
W32985	180	W36101	190	W38012	176	W38218	177	W38803	183	W41030	50
W32986	180	W36102	191	W38014	176	W38219	177	W38807	177	W41031	51
W32987	180	W36106	191	W38016	176	W38220	177	W38808	177	W41032	50
W32988	180	W36113	191	W38018	176	W38221	177	W38809	177	W41034	50
W32989	180	W36114	191	W38020	176	W38222	177	W38810	177	W41035	52
W32990	180	W36118	188	W38022	176	W38300	176	W38811	177	W41036	50
W32991	180	W36124	189	W38024	176	W38301	175	W38812	177	W41037	51
W32992	180	W36125	189	W38026	176	W38302	175	W38813	177	W41039	49
W34100	191	W36130	195	W38028	176	W38304	175	W38814	177	W41044	52
W34101	191	W36136	195	W38030	176	W38308	176	W38815	177	W41060	65
W34120	188	W36139	194	W38032	176	W38310	176	W38816	177	W41061	52
W34121	188	W36142	194	W38100	190	W38312	176	W38817	177	W41062	53, 137
W34122	188	W36143	194	W38101	190	W38314	176	W38818	177	W41063	53, 137
W34130	195	W36146	194	W38102	191	W38316	176	W38819	177	W41065	53, 137
W34144	194	W36157	195	W38106	191	W38318	176	W38820	177	W41291	99
W34148	194	W36180	190	W38107	191	W38320	176	W38821	177	W41292	99
W34151	194	W36181	190	W38108	191	W38322	176	W38822	177	W41293	99
W34157	195	W36190	197	W38112	191	W38324	176	W38840	182	W41294	99
W34158	195	W36202	177	W38113	191	W38326	176	W38845	182	W50001	27
W34524	178	W36204	177	W38114	191	W38328	176	W38847	182	W50003	27
W34528	178	W36205	177	W38115	191	W38330	176	W38850	182	W50005	27
W34530	178	W36206	177	W38118	188	W38332	176	W38855	182	W50012	33, 80
W34532	178	W36207	177	W38120	188	W38337	175	W38870	180	W50014	32, 115
W34534	178	W36208	177	W38121	188	W38401	177	W38874	180	W50031	36
W34536	178	W36209	177	W38122	191	W38402	177	W38875	180	W50033	20
W34538	178	W36210	177	W38125	189	W38407	177	W38876	180	W50035	37
W34540	178	W36211	177	W38128	188	W38408	177	W38877	180	W50036	37
W34542	178	W36212	177	W38130	195	W38409	177	W38878	180	W50037	36
W34544	178	W36213	177	W38136	195	W38410	177	W38879	180	W50042	24
W34546	178	W36300	176	W38137	189	W38411	177	W38880	180	W50044	25
W34548	178	W36305	176	W38139	194	W38412	177	W38881	180	W50045	29

INDEX

Item #	Page	Item #	Page	Item #	Page	Item #	Page	Item #	Page	Item #	Page
W50044	25	W54054	118	W54228	116	W80277	231	W80634	131	W83177	134
W50045	29	W54055	118	W54229	117	W80280	230	W80635	244	W83178	134
W50045-2	28	W54056	118	W54231	117	W80281	230	W80641	143	W83179	134
W50046	29	W54057	119	W54232	126	W80282	233	W80645	142	W83180	134
W50048	32, 115	W54058	119	W54234	116	W80283	233	W80646	142	W83182	151
W50049	115	W54059	119	W54240	117	W80284	233	W80648	142	W83193	163
W50053	26	W54060	119	W54241	117	W80287	233	W80649	143	W83194	265
W50054	26	W54061	119	W54242	117	W80288	232	W80650	143	W83196	265
W50055	26	W54062	120	W54243	117	W80291	233	W80651	143	W83197	265
W50056	26	W54063	120	W54244	117	W80490	135	W80652	143	W83198	265
W50057	99	W54064	120	W54245	117	W80491	156	W80653	148	W83199	142
W50057-1	99	W54065	120	W54246	117	W80498	146	W80654	145	W83201	142
W50058	27	W54066	120	W54247	117	W80510	152	W80656	145	W83202	246
W50060	30	W54067	120	W54248	117	W80524	151	W80657	145	W83203	246
W50061	30	W54068	120	W54249	117	W80525	162	W80661	157	W83204	247
W50063	30	W54069	120	W54250	82	W80526	162	W80662	157	W83205	145
W50068	30	W54070	120	W54251	94, 117	W80527	162	W80663	157	W83240	134
W50069	30	W54071	120	W54252	116	W80528	162	W80664	157	W83241	134
W50069A	30	W54072	120	W54253	94, 117	W80529	162	W80665	143	W83243	134
W50071	70	W54073	120	W54254	94, 117	W80530	160	W80669	155	W83244	134
W50072	28	W54074	120	W54255	94, 117	W80531	160	W80670	132	W83245	134
W50075	34	W54075	120	W54256	94, 117	W80532	160	W80671	132	W83246	134
W50076	34	W54076	120	W54258	117	W80533	161, 178	W80672	132	W83255	134
W50076A	34	W54077	120	W54259	117	W80535	160	W80674	133	W84001	150
W50077	34	W54078	120	W54260	117	W80537	163	W80675	133	W84002	150
W50078	34	W54085	121	W54261	117	W80539	163	W80676	121	W84003	150, 167
W50079	31	W54104	120	W54263	127	W80540	160	W80677	121	W84004	151
W50080	24, 109	W54105	120	W54264	127	W80541	162	W80678	121	W84005	150, 167
W50083	36	W54106	120	W54265	127	W80542	158	W80679	132	W84006	163
W50084	25	W54107	120	W54266	126	W80546	134	W80681	121	W84007	156
W50084A	25	W54108	120	W54267	126	W80548	134	W80682	121	W84008	156
W50086	20	W54109	120	W54268	126	W80549	134	W80683	121	W84010	144
W50087	25	W54110	120	W54269	126	W80550	134	W80684	121	W84012	144
W50087A	25	W54111	120	W54270	126	W80551	139	W80750	267	W84013	144
W50089	26, 80	W54112	120	W54271	115	W80553	134	W80751	147	W84014	144
W50089A	26	W54113	120	W54272	123	W80554	139	W81006	181	W84015	144
W50090	23	W54114	120	W54273	171	W80555	139	W81007	181	W84019	147
W50091	23	W54115	120	W54274	102	W80556	139	W81008	181	W84500	149
W50092	20	W54116	120	W54275	123	W80557	140	W81010	181	W84501	149
W50092B	20	W54117	120	W54276	123	W80559	139	W81012	181	W84550	137
W50092C	20	W54118	120	W54278	127	W80560	155	W81014	181	W84551	137
W50093	24	W54119	121	W54279	127	W80561	155	W81016	181	W84552	137
W53991	65	W54120	120	W54280	122	W80562	243	W81018	181	W84553	137
W53992	65, 99	W54121	120	W54281	122	W80564	182	W82003	133	W84600	160
W53994	57	W54150	124	W54282	122	W80567	150	W82004	130	W84601	162
W53995	64	W54151	124	W54283	122	W80570	150	W82005	133	W84602	151
W53998	79	W54152	124	W54285	126	W80571	150	W82006	145	W84603	142
W54004	64	W54154	124	W54287	121	W80572	154	W83005	135	W85002	55
W54006	64	W54155	124	W54290	114	W80573	154	W83006	135	W85003	55
W54009	57	W54170	125	W54291	114	W80574	154	W83008	135	W85004	54
W54011	57	W54171	125	W54292	114	W80575	154	W83010	135	W85005	54
W54012	66	W54172	125	W54310	119	W80576	155	W83011	138	W85006	54
W54013	49	W54200	114	W54311	119	W80577	167	W83013	138	W85007	55
W54016	66	W54201	114	W59276	317	W80578	165	W83015	139	W85008	56
W54017	66	W54202	114	W59277	317	W80579	167	W83020	137	W85010	56
W54019	66	W54203	114	W59278	314	W80580	167	W83021	140	W85011	56
W54020	66	W54204	114	W59281	317	W80581	165	W83022	140	W85014	54
W54024	58	W54205	114	W59282	317	W80582	169	W83025	140	W85017	55
W54025	58	W54206	115	W75933	232	W80583	68	W83026	141	W85019	55
W54026	66	W54207	114	W80004	220	W80584	166	W83030	134	W85020	56
W54032	64	W54208	115	W80005	219	W80585	146	W83033	134	W85021	55
W54035	57	W54209	117	W80006	218	W80586	165	W83035	134	W85023	56
W54036	57	W54210	116	W80007	218	W80587	165	W83038	134	W85025	55
W54037	67	W54211	116	W80008	218	W80590	156	W83041	134	W85026	55
W54038	65	W54212	116	W80015	218	W80591	156	W83102	158	W85027	56
W54039	58	W54213	117	W80022	218	W80594	167	W83108	158	W85028	54
W54040	31	W54214	116	W80036	221	W80616	131	W83113	158	W85029	55
W54041	31	W54215	116	W80112	129	W80617	131	W83114	158	W85030	46
W54042	67	W54216	116	W80150	270	W80619	131	W83118	158	W86010	263
W54043	31	W54217	117	W80151	270	W80620	131	W83119	158	W86011	262
W54044	118	W54218	117	W80152	270	W80621	128	W83130	158	W86012	250
W54045	118	W54219	116	W80155	270	W80622	130	W83133	158	W86013	133
W54046	118	W54220	114, 125	W80156	271	W80624	129	W83148	159	W86020	129
W54047	118	W54221	116	W80157	270	W80625	131	W83149	159	W86021	129
W54048	118	W54222	116	W80158	171	W80626	131	W83150	138	W86022	129
W54049	118	W54223	116	W80160	270	W80629	131	W83151	138	W86023	181
W54050	118	W54224	116	W80230	143	W80630	130	W83163	163	W86100	230
W54051	118	W54225	116	W80274	231	W80631	131	W83164	163	W86101	230
W54052	118	W54226	116	W80275	231	W80632	131	W83165	128	W86102	230
W54053	118	W54227	116	W80276	231	W80633	131	W83168	152	W86103	230

Item #	Page	Item #	Page	Item #	Page	Item #	Page	Item #	Page	Item #	Page
W86500	261	W87123	149	W88985	67	W89100	157	W89330	159	W89720	164, 271
W86502	260	W87124	149	W88986	67	W89200	128	W89331	159	W89721	164, 271
W86550	159	W87125	149	W88987	67	W89201	128	W89333	156	W89722	164, 271
W86551	143	W87126	149	W88988	69	W89203	165	W89399	146	W89723	107
W86552	150	W87127	149	W88989	69	W89208	152	W89400	146	W89724	164, 271
W86553	160	W87128	137	W88990	67	W89220	152	W89409	150	W89725	136
W86554	160	W88001	213	W88995	66	W89303	140	W89410	154	W89726	169
W86555	143	W88002	213	W88996	66	W89304	141	W89413	246	W89727	131, 166
W86556	142	W88003	213	W88999	71	W89305	141	W89414	246	W89729	166
W86557	130	W88010	212	W89000	71	W89310	140	W89500	169	W89730	171
W86561	142	W88011	212	W89001	71	W89311	139	W89501	169	W89731	168
W87010	152	W88012	212	W89005	71	W89314	134	W89704	143	W89732	156
W87020	148	W88013	212	W89006	71	W89315	134	W89705	152	W89733	170
W87021	148	W88030	246	W89007	71	W89316	134	W89708	148	W89734	170
W87022	148	W88970	69	W89011	71	W89318	134	W89710	153	W89735	168
W87023	149	W88971	69	W89012	71	W89319	135	W89711	153	W89736	170
W87024	148	W88980	69	W89013	71	W89322	139	W89712	153	W89737	146
W87030	131, 166	W88981	69	W89016	71	W89324	136	W89715	137	W89742	138
W87120	100	W88982	71	W89017	71	W89325	136	W89716	144		
W87122	149	W88984	69	W89018	69	W89326	136	W89719	164, 271		



© Copyright 2017 Wilmar Corporation. This material is being furnished for the exclusive use of Wilmar Corporation customers and may only be used in connection with the sale of Wilmar®, aiRTIGHT®, Northwest Trail®, Performance Tool®, Project Pro®, Performance Tech® and Mechanics Products® brand merchandise. Any other use is strictly prohibited. Illustrations and photographs are intended for reference only. Actual products may vary. On occasion, after printing of our catalogs, flyers or other sales aids is completed, the manufacturers may make changes and/or modifications to merchandise which will not be reflected in this literature. Accordingly, when ordering, please inquire of our sales representative as to any such changes or modifications which have been made following publication. Wilmar is not responsible for typographical errors.

WARRANTIES: PERFORMANCE TOOL extends only the following warranties, and only to original retail purchasers. These warranties give specific legal rights. Except where prohibited by local law, the law of the State of Washington governs all warranties and all exclusions and limitations of warranties and remedies. There may be other rights which vary from state to state.

Hand Tools:

Lifetime Replacement Warranty: If any tool ever fails to give complete satisfaction, it may be returned, along with original sales receipt, for a free replacement of like grade and quality, postage prepaid to PERFORMANCE

Hydraulic Jacks & Heavy Duty Equipment:

PERFORMANCE TOOL warrants the product to be free from defects in materials and workmanship under normal use and service. A defective product may be returned for a free replacement within 90 days from the date of purchase, provided that product is returned to place of purchase immediately after discovery of defect. After 90 days and up to 1 year from date of purchase, PERFORMANCE TOOL will replace at no charge any parts which our examination shall disclose to be defective and under warranty. These warranties shall be valid only when a sales receipt showing the date of purchase accompanies the defective product or defective part(s) being returned.

Torque Wrenches:

PERFORMANCE TOOL warrants torque wrenches that are calibrated and serviced regularly to be free from defects in materials and workmanship under normal use and service for a period of 90 days from date of purchase, during which time a defective product may be returned for a free replacement when accompanied by the original sales receipt. Calibration and servicing must be done regularly and are the owner's responsibility.

Air Tools, Drill Press & Grinders:

MECHANICS PRODUCTS / PERFORMANCE TOOL warrants these products when serviced regularly to be free from defects in materials and workmanship under normal use and service for a period of 1 year from date of purchase, during which time a defective product may be returned for a free replacement when accompanied by the original sales receipt. Servicing must be done regularly and are the owner's responsibility.

Exclusions:

These warranties exclude blades, bits, punches, dies, bulbs, fuses, grinding wheels, belts and other consumable which must be replaced under normal use and service. These warranties shall not apply to any product or part which is used for a purpose for which it is not designed, or which has been repaired or altered in any way so as to affect adversely its performance or reliability, nor shall these warranties apply to any product or part which has been subject to misuse, neglect, accident or wear and tear incident to normal use & service.

PERFORMANCE TOOL does not authorize any other person to make any warranty or to assume any liability in connection with its products. Except for warranties of title and the limited express warranties set forth above, PERFORMANCE TOOL makes no express or implied warranties of any kind with respect to its products. In particular, PERFORMANCE TOOL makes no implied warranty of merchantability and no implied warranty of fitness for any particular purpose, except that for goods purchased primarily for personal, family or household use and not for commercial or business use, PERFORMANCE TOOL makes an implied warranty of merchantability (and, if otherwise applicable, an implied warranty of fitness for a particular purpose), but only for the particular qualities or characteristics, and for the duration, expressly warranted above. The laws on limitation of implied warranties may differ from state to state, so the above limitations may not apply in all cases.

PERFORMANCE TOOL shall not be liable for consequential, incidental or special damages resulting from or in any manner related to any product, or to the design, use, or any inability to use the product. The sole and exclusive remedy for a defective product or part shall be the repair, or replacement thereof as provided above. The laws on limitation of remedies or on consequential, incidental or special damages may vary from state to state, so the above limitations may not apply in all cases.