



2016 PRODUCT CATALOG



THE AUTOMOTIVE LIGHTING BENCHMARK



WE REDEFINE THE AUTOMOTIVE AFTERMARKET FOR
HIGH INTENSITY LIGHTING

TABLE OF CONTENTS

COMPANY HISTORY
(6)

HID PROJECTORS
(8)

HID BALLASTS
(20)

HID BULBS
(24)

WIRE HARNESSES
(30)

SHROUDS
(34)

LED LIGHTING
(38)

FOG & FULL HEADLIGHTS
(52)

OFF-ROAD LIGHTING
(60)

ES

COMPANY HISTORY



We redefine the automotive aftermarket for high intensity lighting. Taking the poorly lit back roads has never been more exciting with Morimoto-powered headlamps.

Morimoto lighting was established in 2008 to fill the gap in the aftermarket for truly high quality automotive lighting products. Without the budget of a major automaker to back R&D and production, individual consumers could either salvage original equipment components, or be forced to settle for inferior aftermarket parts. If you are an enthusiast, a fabricator, or a distributor and have found yourself unimpressed with the 'dime-a-dozen' HID kits and accessories from other manufactures, then we urge you to take a closer look at what we have to offer. Search the web for an alternative name in lighting that comes more widely recommended by end-users for performance, reliability, and the way it looks and if you can find it, then buy it. Morimoto is the automotive lighting benchmark.

The relationship that Morimoto has with over seven hundred Authorized Distributors worldwide is mutually beneficial. By working hand-in-hand with them to develop products according to local market demands, we can ensure that our product line for every consumer and climate. Further, through an open and honest line of communication with our distributors, we can continually monitor, improve, and adjust our product offerings according to their feedback and feedback from their customer bases. The company is structured to realize long-term gains, and nearly all profit is reinvested back into our product development and infrastructure to improve the deliverable. We have worked hard to develop an honorable reputation and refuse to compromise quality in the name of increased margins.

HID PROJECTORS

WORD ON THE STREET

"My friend built me a sealed beam projector H4 Housing, using the Mini D2S 3.0 Projectors and the new Morimoto XB35 5500k HID kit, for my 1989 Toyota Supra. The difference from stock to H4 housings with HIDs to a proper Projector retrofit is amazing. Love how quickly the XB35 kit warms up. The high beam on these projectors is awesome too. Cannot even literally blind someone on the road. This retrofit, driving down an unlit road/highway, overpowers pretty much everything on the road even a good quality OEM projector setup in terms of light output. Well worth the money!"

– Mihir

"I have been running the FX-R kit for about 2 months now and every time I turn them on I am always amazed! Everything from the light output to the build quality are awesome. This was my first retrofit which I was a little scared to attempt but I did anyways. These went into a 04 Toyota matrix and man, did it not only transform my light output but also the looks of the front end as well. These lights project the light very wide with an awesome cut off. The FX-R over-power all of my friends cars with factory projectors and hid's."

– Anthony

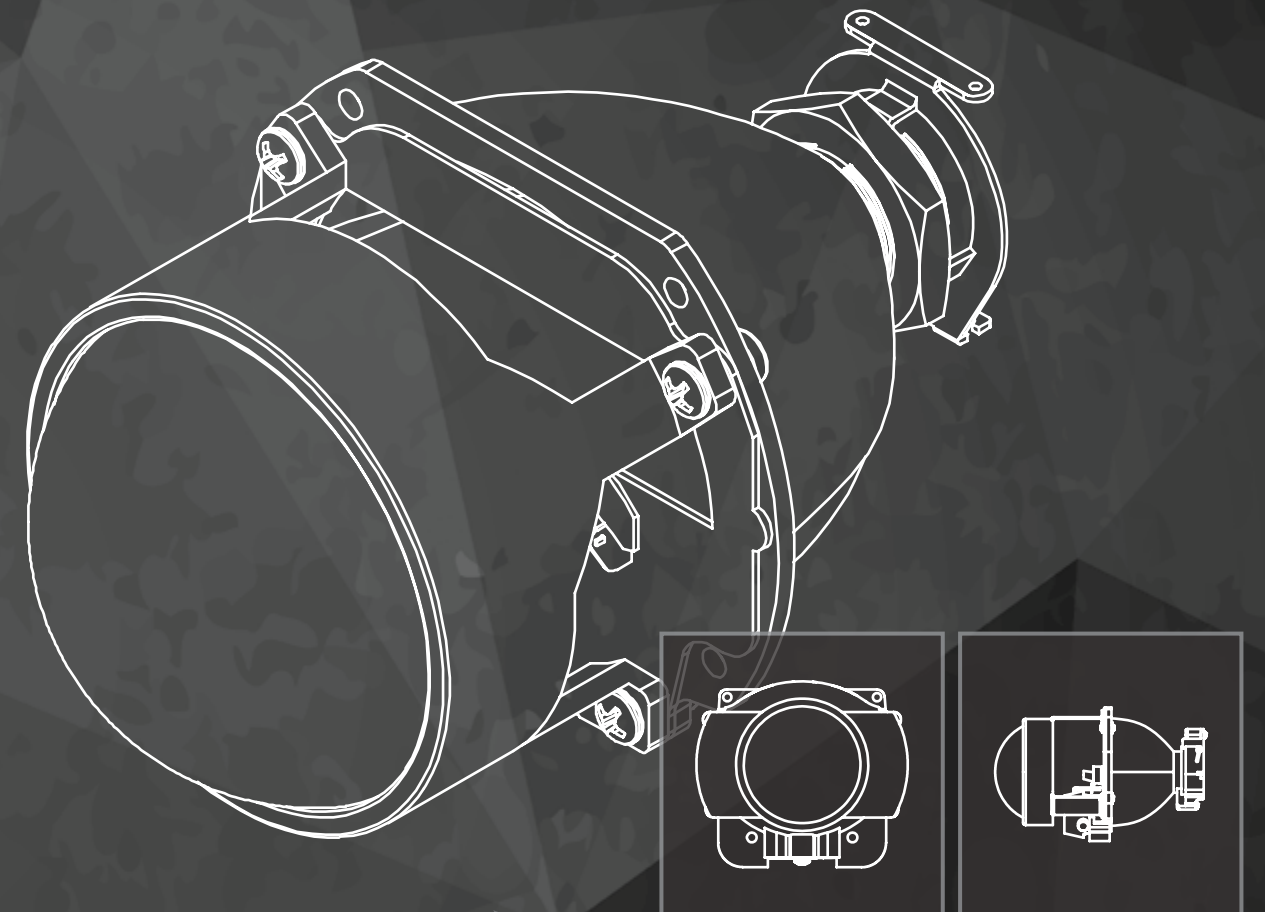

MINI H1 6.0

DESCRIPTION

Morimoto sets the stage with the the 6.0's overhauled optics. With an all-new wider and multifaceted reflector bowl pumping out the light; the ultra popular Morimoto Mini H1 projector is better than ever.

Optics: The re-designed reflector concentrates the hot spot directly underneath the step for distribution of light that is technically correct in aiding distance vision. With a proper gradient of light towards the bottom of the beam pattern, there's no need for foreground limiters as a "patch fix" anymore, and brought back the Mini's appeal to both sedan and SUV owners. The beam is wider. The distribution of light more proper. Your ability to see is better.

Easy Install: Amazing ease of installation relative to the amount of performance they produce makes them one of our most popular projectors. No other projector performs quite like the real Morimoto Mini and takes less work to install.

In Comparison: With a pre-installed clear lens and curved cutoff shield that's been tuned in-house, the H1 6.0's will literally perform on-par with many other popular full size aftermarket and OEM HID projectors. Their wide, uniformly lit beam stays intense all the way to the outer limits. The bi-xenon high beam provides plenty of additional light.

Pre-Tuned: Each Morimoto projector is individually tested and hand-tuned to perfection to ensure nothing but the best output. Spend a few bucks less with other sellers on eBay and get the units we turned down.

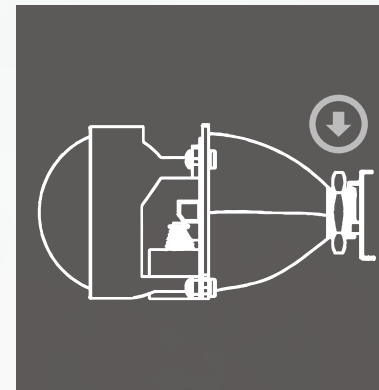

EASY-INSTALL THREADED SHAFT

AVAILABLE STYLES

LHD Traffic Pattern:
(North America-Spec)
Part # 00020



RHD Traffic Pattern:
(UK/AU-Spec)
Part # 00021



TECHNICAL INFO

- Dimensions: 136mm deep, 87mm wide, 70mm tall
- Lens: 2.5" optically-clear
- Mounting Shaft: 20mm diameter
- Mounting Depth: 107mm minimum
- Traffic Patterns: LHD (North America-Spec) or RHD
- Bulb Type: H1 HID only

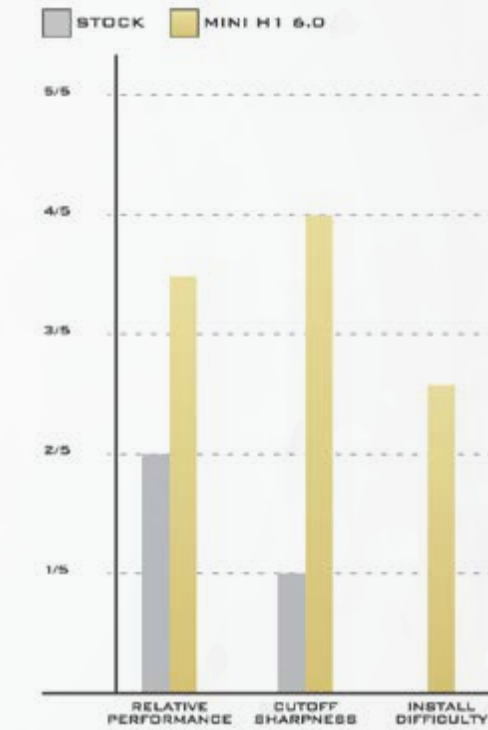

MINI D2S 3.0

DESCRIPTION

As the big brother to the popular Mini H1, the D2S 3.0 has improved optics increased precision in the castings, and superior materials used for the bi-xenon mechanism. This truly is OEM quality in an aftermarket setting.

Optics: The wider re-designed reflector concentrates the hot spot directly under the step for intense performance, but also mind blowing width. The cutoff line is crisp, clean, and full of brilliant color flicker. Competition struggles to compete with the Mini D2S 3.0, and even its larger and more mature brother, the FX-R, only slightly surpasses it in overall performance.

Easy Install: Like its little brother, the Mini H1, the Mini D2S 3.0 shares the same threaded shaft design at the rear of the reflector bowl to ease installation, improve versatility, and simplify your life from the need of having to cut and glue the projector in place like "traditional" retrofits. This little guy just bolts on to your reflector bowls and away you go to blast the streets at night.

Lens Options: The optional "X" Lens, with its modern square shape is for those looking for something extra unique without compromising any light output. Though shroud options are more limited for the X-Lens, the projectors are also available with a traditional 3" round ("O" Lens) that works with all shrouds. Both lenses are 100% optically clear, so no need for any upgrades here.

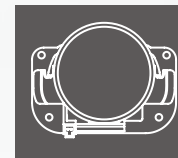

ROUND LENS

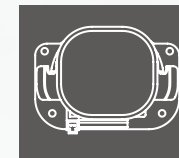

SQUARE LENS

AVAILABLE STYLES

LHD Traffic Pattern:
(North America-Spec)

Round Lens: 47735
Square Lens: 48286



RHD Traffic Pattern:
(UK/AU-Spec)

Round Lens: 47736
Square Lens: 48287



TECHNICAL INFO

Dimensions: 145mm deep, 100mm wide, 95mm tall

Lens: 3" round or 2.25" x 2.5" square optically-clear

Mounting Shaft: 35mm diameter

Mounting Depth: 117mm minimum

Traffic Patterns: LHD (North America-Spec) or RHD

Bulb Type: D2S or D2H only

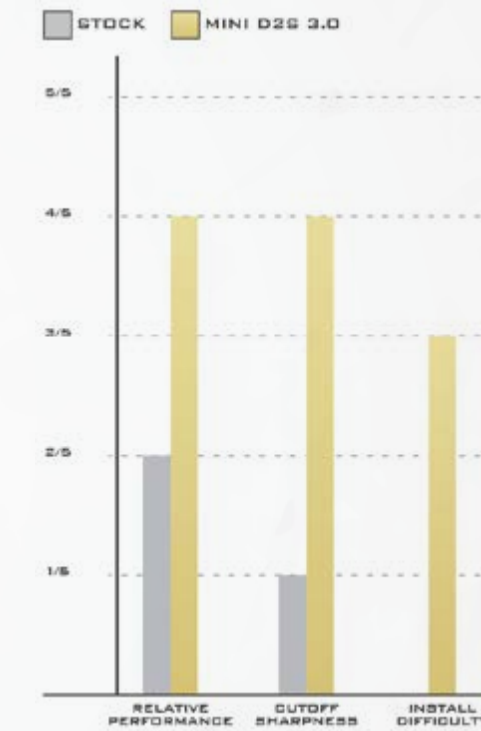

HID PROJECTORS
FX-R 3.0

DESCRIPTION

The FX-R 3.0 is a retrofitter's delight with its high precision castings, advanced optics, and available 2.5 and 3" clear lens. It all adds up to put the Morimoto FX-R 3.0 near the top of the lighting totem poll. If you've got the courage to cut up your headlights in order to retrofit them, you won't be let down.

Well-Rounded: When you consider a full size projector on the basis of light output, out of the box readiness, fitment in most applications, and value, the FX-R easily takes the cake.

Tuned: Each Morimoto FX-R 3.0 projector is hand-tuned to ensure optimal output, and crisp cutoff guaranteeing the best performance right out of the box.

Performance: More light! With a pre-installed clear lens and DOT stepped cutoff shield that's been tuned in-house, the FX-R 3.0 is a stand out. Their advanced internal optics create a wide beam pattern with a uniform distribution of light that cuts through darkness like a laser. They have one of the straightest, sharpest, and most vibrantly colored cutoff lines of any projector in existence and a high beam that will penetrate for hundreds of yards.

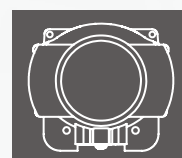

2.5" LENS

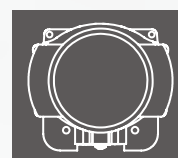

3.0" LENS

AVAILABLE STYLES

LHD Traffic Pattern:
 (North America-Spec)
 2.5" Lens: 47822
 3.0" Lens: 47825



RHD Traffic Pattern:
 (UK/AU-Spec)
 2.5" Lens Part: 47823
 3.0" Lens Part: 47824



TECHNICAL INFO

Dimensions: 140mm deep (2.5" lens), 155mm deep (3" lens), 112mm wide, 95mm tall
Lens: 2.5" or 3" optically-clear
Mounting Depth: 117mm minimum
Traffic Patterns: LHD (North America-Spec) or RHD
Bulb Type: D2S or D2H only

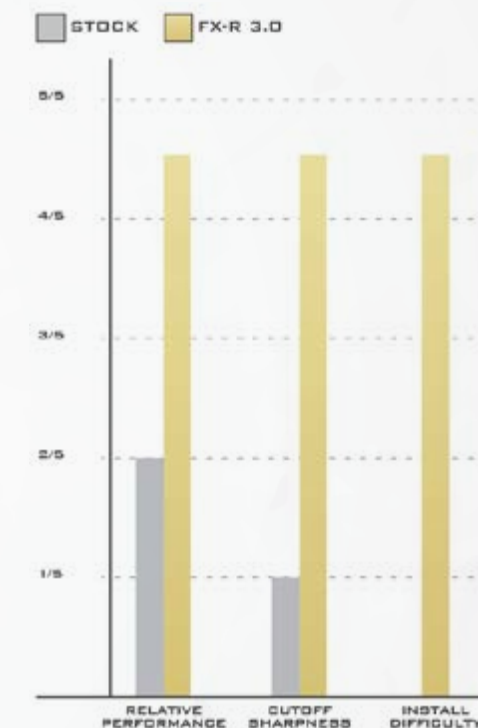

DESCRIPTION

The Morimoto Matchbox bi-xenon projector is the worlds smallest projector that has both low and high beam capabilities. With the threaded mounted shaft and extremely compact size, these go where no projector has gone before! Literally.

Marvelous: Easily the smallest bi-xenon capable projector on the planet, it's a technical marvel something like this can be retrofitted into a foglight!

Performance: With a pre-installed clear lens and their LHD cutoff shields, their light output is on par with any other dedicated fog light projector that's this small. Plenty of foreground light and a bonus high beam function make them an excellent addition to any existing retrofit in the main headlights.

Installation: With their threaded shaft at the rear, these little projectors install just as easily as their larger brothers, the Mini H1s. If depth is limited, these can be epoxied into a reflector bowl once trimmed at which point they require only 45mm of depth.

Covered: Coming standard with MicroGatling shrouds to keep things compact and easy to assemble, you'll be able to finish things up nice and clean with these.

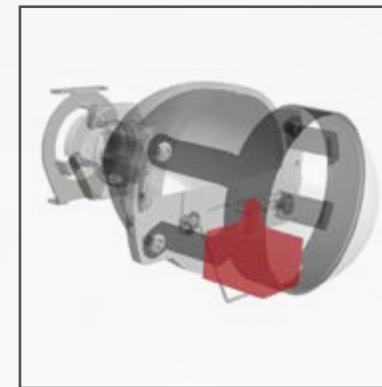

BI-XENON CAPABILITY

BLUEPRINT

LHD Traffic Pattern (ONLY):
North America-Spec: 47375

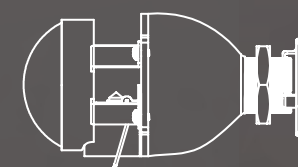
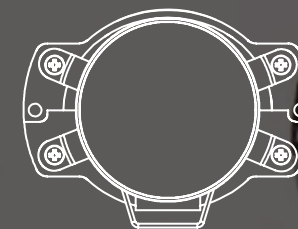
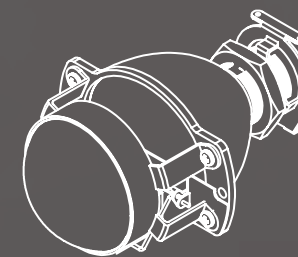
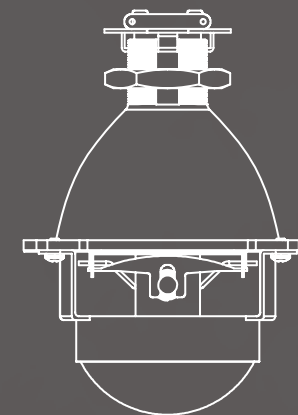

TECHNICAL INFO

Dimensions: 110mm deep, 75mm wide, 55mm tall

Lens: 1.8" optically-clear

Mounting Depth: 45mm minimum

Traffic Patterns: LHD (North America-Spec)

Bulb Type: H1 HID only

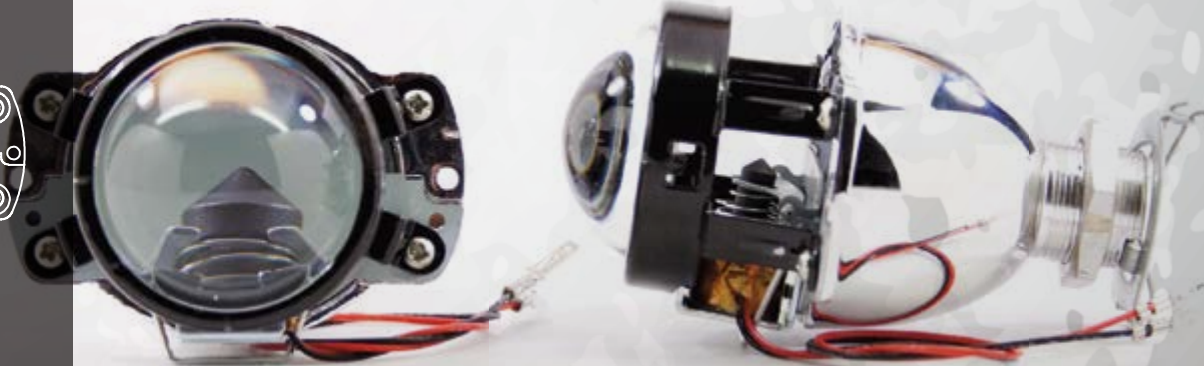
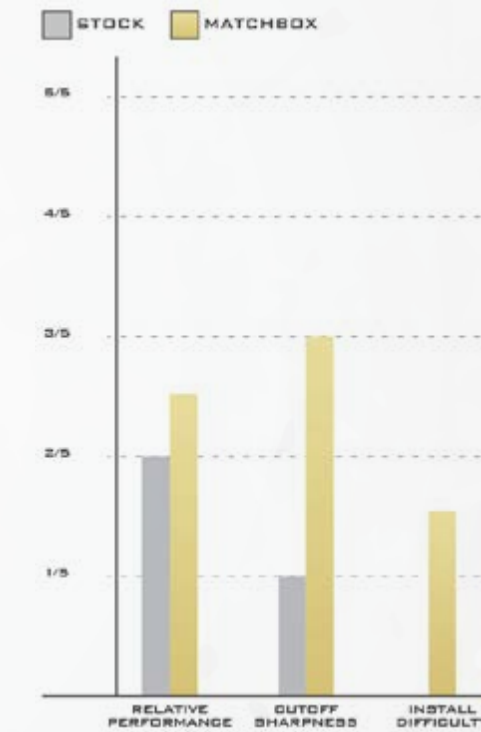

DESCRIPTION

The original Hella "E55" design is the most widely used original equipment projector in the world. So what? It's a good design, but the EvoX-R is better in every way. So whether it's a new retrofit or a direct swap out for the old, the EvoX-R is a winner.

All-Rounder: The EvoX-R is derived from the Mitsubishi Lancer Evo X Original Equipment design. It's the best option for upgrading cars that came with older 3" Hella HID or Halogen projectors, and it's also ideally shaped for a traditional retrofit too.

Performance: Coming standard with a 3" clear lens and a mirror finish reflector bowl, the EvoX-R manages to make plenty of light. With a proper gradient of intensity from the cutoff line downwards in its low beam, and amazing table-top pattern high beam, you'll easily be blowing away Beemers and Benz's at night with these.

Cross-Compatible: Their bolt pattern is identical to older Hella 3" halogen, xenon, and bi-xenon projectors - so can be used as a direct bolt on upgrade in many OEM or aftermarket housings that use these designs.

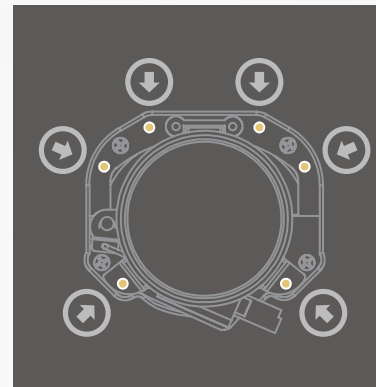
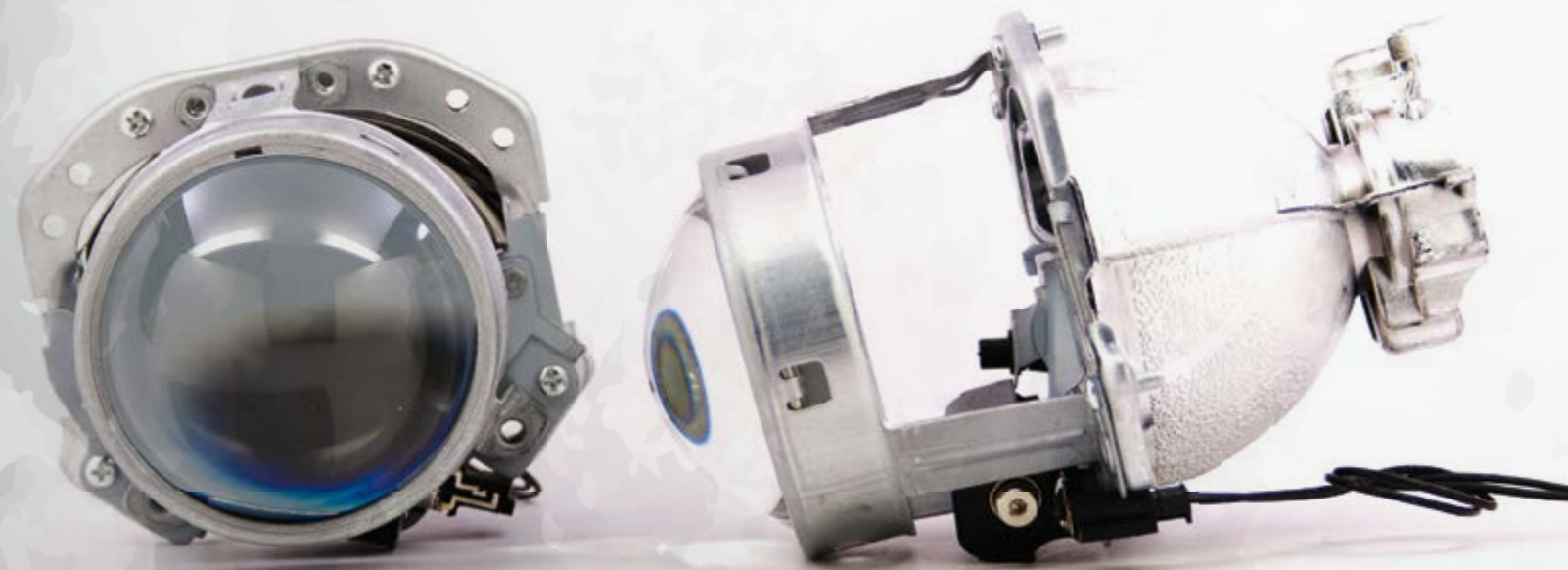

HELLA "E55" DROP-IN REPLACEMENT

BLUEPRINT

LHD Traffic Pattern (ONLY):
North America-Spec: 47264

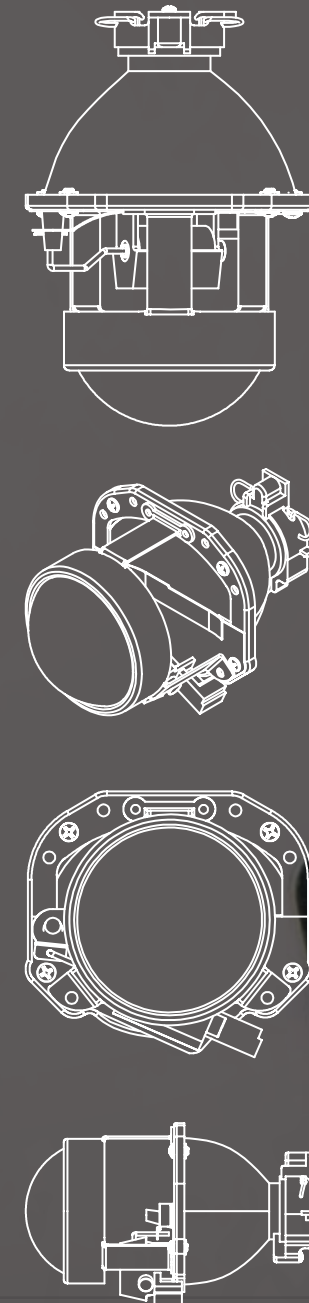

TECHNICAL INFO

Dimensions: 147mm deep, 107mm wide, 96mm tall

Lens: 3.0" optically-clear

Traffic Patterns: LHD (North America-Spec)

Bulb Type: D2S or D2H only

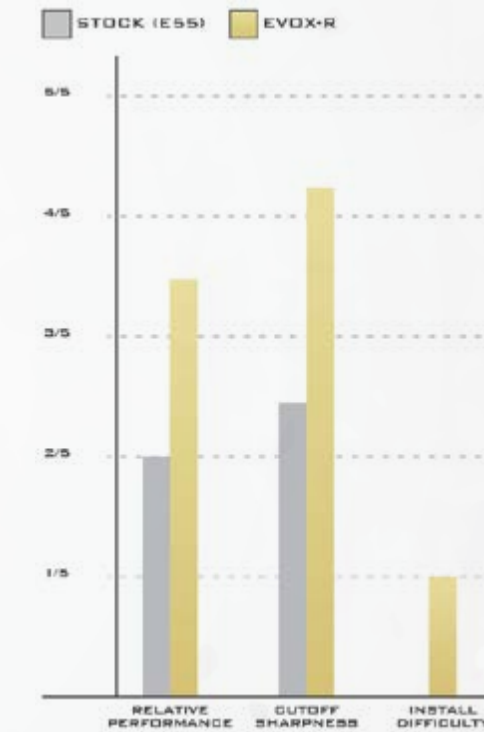

HID BALLASTS

WORD ON THE STREET

“Swapping out my OEM 35watt HID ballast to Morimoto 50watt ballast with the XB HID bulbs, the difference is day and night. Here is the few things about the unit: ballasts are slim, feel very solid, the wiring are top of the line well made and my favorite parts of the unit is the new orange mounted bracket. Overall all this the very best aftermarket HID you can buy, period.”

– Hung

“I’ve used many HID conversion kits over the years and NO ONE can match the quality of the kits that Morimoto sells. Ill never shop anywhere else for my HID needs.”

– Thomas

“The moment you open the box you just know that you purchased a quality product. The ballast looks and feels like it could take a bullet. The wires, connectors and bulbs are just quality. It exceeded my expectation and was very surprised with how far the throw is. Did I mention that they’re bright, mad bright. Very happy customer here and upgrading my fogs with 3000k with

35 ballast soon.”

– Raymond

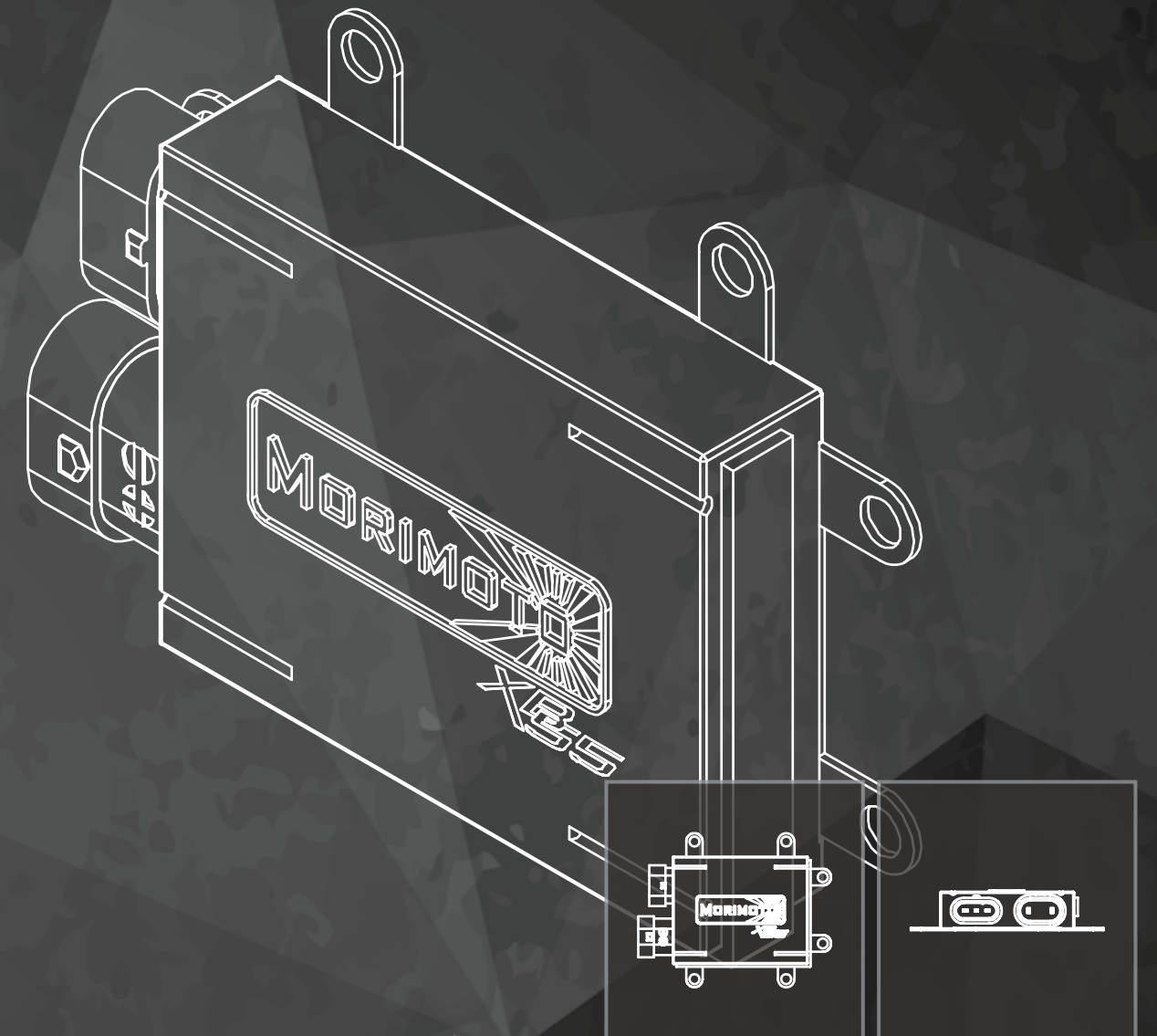

XB HID BALLASTS

DESCRIPTION

With distribution exceeding 150,000 units over the last four years, more enthusiasts chose Morimoto over any other aftermarket ballast. Easily filling the shoes of the 3Five units that they replace, the brand new XB35 and XB55 ballasts excel in every way.

Protected: Their die-cast aluminum shell houses a 100% potted circuit board, eliminating any chance of moisture damage. The AMP SuperSeal three-pin connector from TE Connectivity between the igniter and the ballast ensures the safety of this crucial output.

Versatile: Since the igniter cord can be unplugged from the ballast, you can easily change from AMP to D2S or vice-versa (without the use of unreliable adapters, that is). Likewise, if an igniter does happen to go bad, it can easily be replaced.

Fast, Friendly, & Efficient: Power hungry ballasts never work well with tricky CanBus systems, but the new XB35 ballast consume < 5A on ignition without compromising their reasonably quick warm up speed. That's much less than Denso, Mitsubishi, FastBright, and the old Morimoto too, which makes their ability to reach full intensity a more efficient process.

Modern: Like all modern OEM D1 and D2 ballasts: the XB has relocated igniters far closer to the HID bulb. The lack of high voltage transmitted through wiring drastically reduces EMI/RFI (radio interference). Total system reliability is also improved by shielding the main circuit board from the static produced by these high voltage bursts on start up.

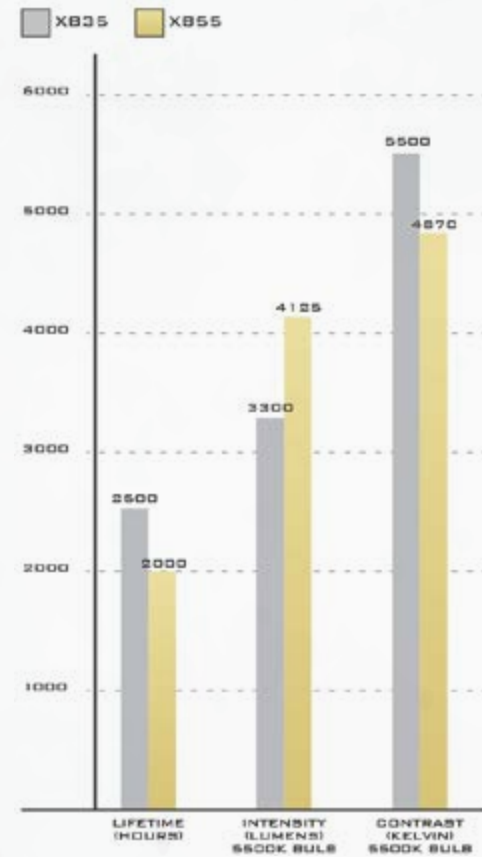

TECHNICAL INFO

- Input: 9-32VDC via industry-standard "9006" plug
- Output: 35w or 50w via AMP or D2S/D2R (P32D)
- Ignition Voltage: 23kV
- Input Current: <5A
- Open or Short Circuit: Protected (< 1s)
- Climate Range: -40C to +85C
- Dimensions: 82mm x 68mm x 17mm
- Output Length: 35cm

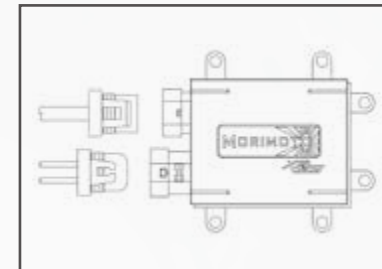

MODULAR DESIGN

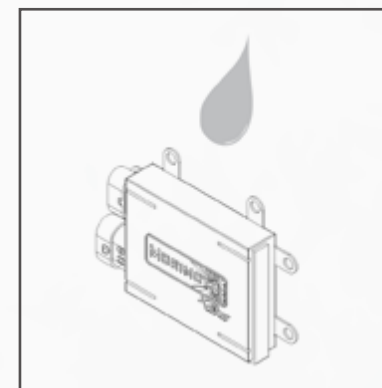

WATERPROOF

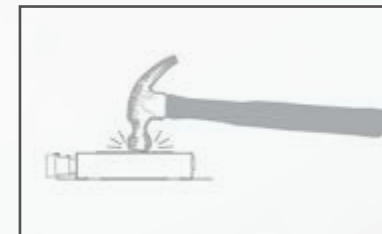

DURABLE

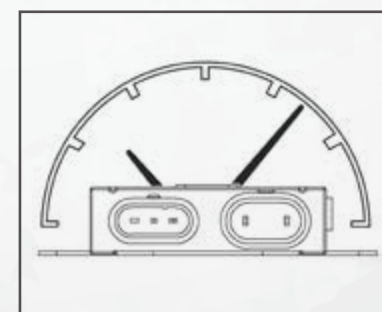

RELIABLE



XB35 Ballast Computers:
Part # 49455



XB35 Ballast Computers:
Part # 49456



AMP Igniters:
Part # 49457



D2S Igniters:
Part # 49458



HID BULBS

WORD ON THE STREET

“Purchased these for my ‘09 G37s Coupe in the 65K color. Awesome bulbs and have no on/off/flicker issues whatsoever. Went from the 6yr old stock bulb to this and night and day difference. Light is white with a hint of blue. If you’re debating whether these are a good aftermarket bulb then don’t wait, purchase yours today. You won’t be disappointed.”

– Byron

“These XB bulbs are amazing, so I far I bought 2 sets of bulbs for both my cars, and it’s pure white. I had originally some Phillips 85122 bulbs, but these are brighter and whiter. Morimoto has the best stuff and I probably will spend my whole tax return on some more parts.”

– Sharad

“I bought these bulbs for my 2014 Infiniti Q60 coupe. I have done some research and if you have a 2012 G37/Q60 or up you may have trouble with aftermarket HID bulbs which I did. The headlight lighting system do not work well with many aftermarket/cheap bulbs, they will flicker and shut off. These look great I am happy with the purchase, great price too.”

– Jason

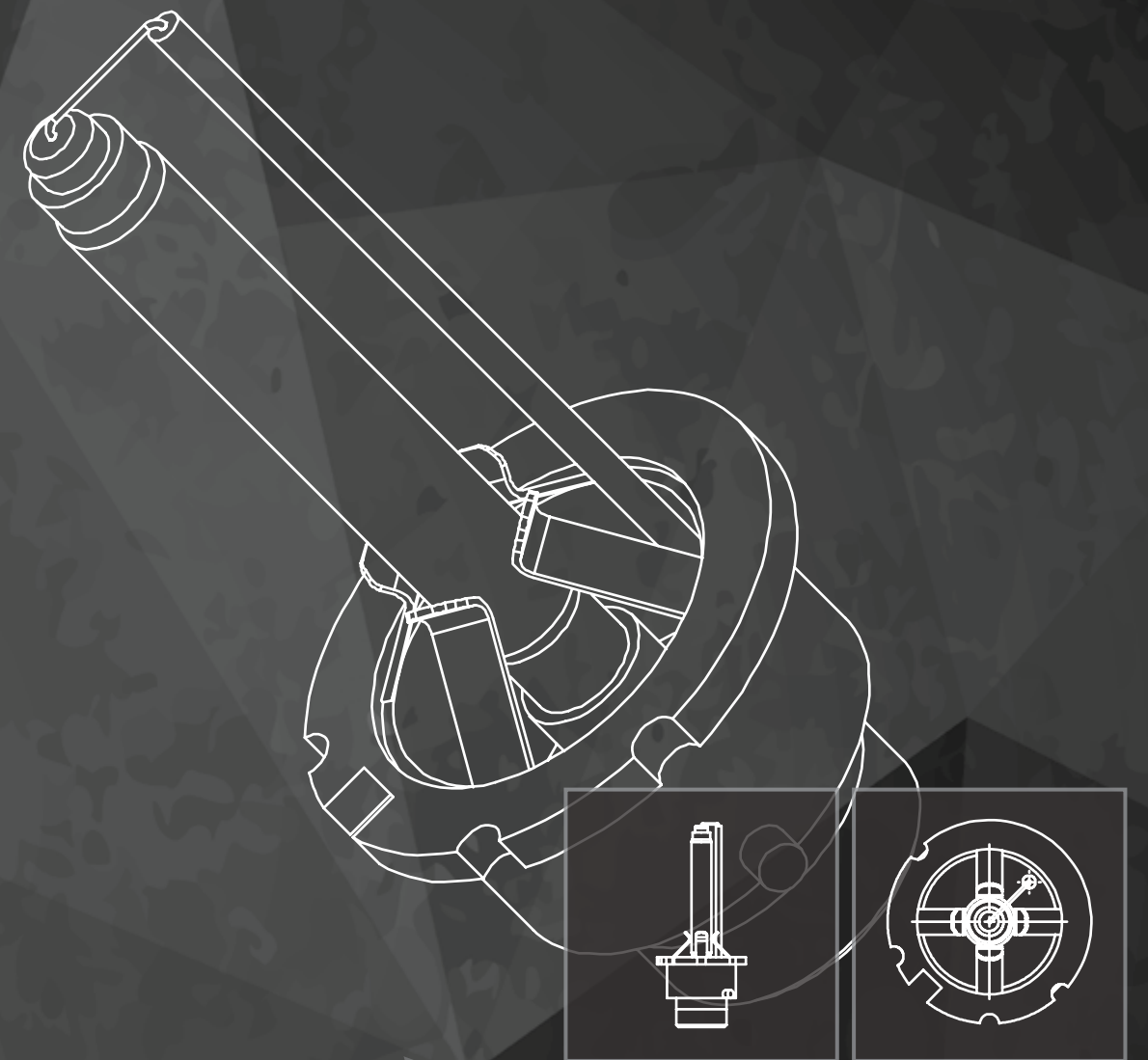

XB HID BULBS [D SERIES]

DESCRIPTION

The XB HID bulbs will deliver the absolute best. Compared to the alternatives; they produce more lumens, last longer, project farther, and look better doing it.

Luminosity: High precision Philips Quartz glass paired with APL-USA capsule and Messer halide salts from Germany combine to provide nearly the same luminosity (intensity) as the industry-best bulbs from Osram at 5500K.

Long Life: The Austrian-sourced Plansee electrodes help keep the bulbs running brighter for longer. Compared to a Philips lamps which lose 14% of their luminosity after 200 hours of use, the XB's will lose just 17%. Unheard of for a non-OE part.

Reliability: Fire it up 100 times in a row or even run it underwater for days at a time and the difference between the XB line and any so called "competition" will be clear. Hot-restrikes are no match for Morimoto HID bulbs.

Value: When it comes to aftermarket HID bulbs, the saying "you pay for what you get" has never been more appropriate, but in comparison to expensive OE parts, the bang for the buck here is absolutely unbeatable.

Compatibility: The XB bulbs sacrifice nothing, making them a perfect match for any OEM replacement headlamps or projector retrofits that use D2S bulbs.

PART NUMBERS

49468:	D2S 4500K
49469:	D2S 5500K
49470:	D2S 6500K
49471:	D4S 4500K
49472:	D4S 5500K
49473:	D4S 6500K
49477:	D1S 4500K
49478:	D1S 5500K
49479:	D1S 6500K
49498:	D2R 4500K
49499:	D2R 5500K
49500:	D2R 6500K
49891:	D3S 4500K
49892:	D3S 5500K
49893:	D3S 6500K

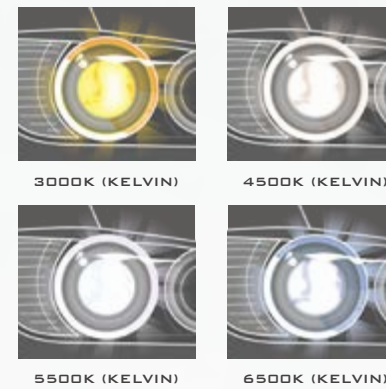

AVAILABLE FITMENTS

- D1S:**
 Osram: 66144 / 66140
 Philips: 9285148294
 BMW: 63217162862
 63217160807
 Audi: N10445701
 Mercedes-Benz: 91013900000
 N000000004248
- D2S:**
 Osram: 66040 / 66240
 Philips: 85122 / 85122+
 BMW: 63217160806
 Audi: N10445701
 Lexus: 909812002
 Mercedes-Benz: 910139000001
- D2R:**
 Osram: 66050 / 66250
 Philips: 85126 / 85126+
 GE: 53510 / 090626-00492
 Hella: 78404 / 8GS 007 001-121
 Nissan: 262979B90A
- D3S:**
 Osram: 66340
 Philips: 42302, 9285335244
 Audi: 0903110500
 Ford: 7L7Z13N021A
- D4S:**
 Osram: 66440
 Philips: 42402
 Toyota / Lexus: 9098120024

TECHNICAL INFO

- Warranty: 3 years
 Available Sizes: D1S, D2S, D2R, D3S, D4S
 Rated Lifespan: 2000 hours
 Rated Wattage: 35W
 Kelvins and Lumens: • 3000K Range: Golden Yellow (~3000lm)
 • 4500K Range: Warm White (~3200lm)
 • 5500K Range: Pure White (~3300lm)
 • 6500K: Cool White (~3200lm)

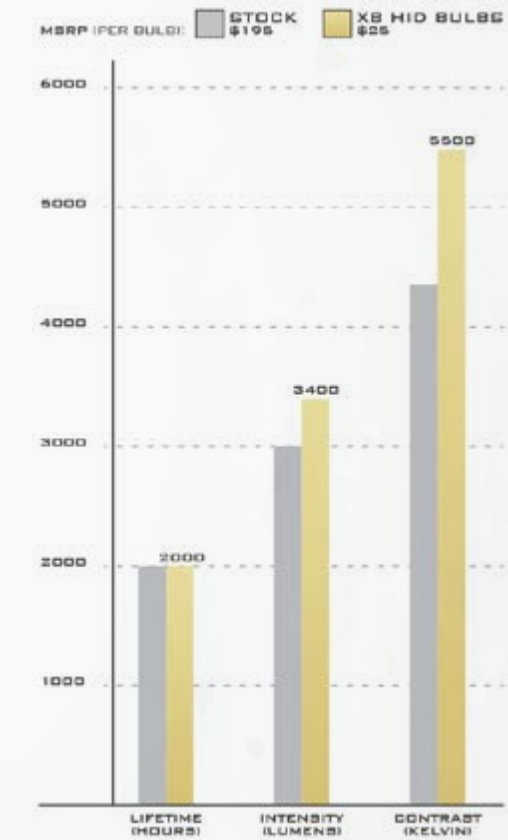

XB HID BULBS [H SERIES]

DESCRIPTION

The XB HID bulbs will deliver the absolute best. Compared to the alternatives; they produce more lumens, last longer, project farther, and look better doing it.

Luminosity: High precision Philips Quartz glass paired with APL-USA capsule and Messer halide salts from Germany combine to provide nearly the same luminosity (intensity) as the industry-best bulbs from Osram at 5500K.

Long Life: The Austrian-sourced Plansee electrodes help keep the bulbs running brighter for longer. Compared to a Philips lamps which lose 14% of their luminosity after 200 hours of use, the XB's will lose just 17%. Unheard of for a non-OE part.

Reliability: Fire it up 100 times in a row or even run it underwater for days at a time and the difference between the XB line and any so called "competition" will be clear. Hot-restrikes are no match for Morimoto HID bulbs.

Value: When it comes to aftermarket HID bulbs, the saying "you pay for what you get" has never been more appropriate, but in comparison to expensive OE parts, the bang for the buck here is absolutely unbeatable.

Compatibility: The XB bulbs are a perfect match for the Morimoto ballasts, but they can also be used to make the most of an existing HID system if you've already got one too.

AVAILABLE FITMENTS

D2H:
4500K: 49495, 5500K: 49496,
6500K: 49497

H1:
3000K: 49504, 4500K: 49462,
5500K: 49463, 6500K: 49464

H3C:
3000K: 49517, 4500K: 49518,
5500K: 49519, 6500K: 49520

H7:
4500K: 49474, 5500K: 49475,
6500K: 49476

H8:
3000K: 49524, 4500K: 49525,
5500K: 49526, 6500K: 49527

H9:
3000K: 49528, 4500K: 49529,
5500K: 49530, 6500K: 49531

H10/9145:
3000K: 49506, 4500K: 49507,
5500K: 49508, 6500K: 49509

H11A:
3000K: 50317, 4500K: 50315,
5500K: 50316, 6500K: 49505

H11B:
4500K: 49459, 5500K: 49460,
6500K: 49461

5202/2504:
3000K: 49513, 4500K: 49514,
5500K: 49515, 6500K: 49516

880:
3000K: 49480, 4500K: 49481,
5500K: 49482, 6500K: 49483

9005:
4500K: 49484, 5500K: 49485,
6500K: 49486

9006:
3000K: 49487, 4500K: 49465,
5500K: 49466, 6500K: 49467

9012:
4500K: 49492, 5500K: 49493,
6500K: 49494

H13/9008:
4300K: 47590, 5000K: 47591,
6000K: 47592

TECHNICAL INFO

Warranty: 3 years

Rated Lifespan: 2000 hours

Rated Wattage: 35W

Kelvins and Lumens:

- 3000K Range: Golden Yellow (~3000lm)
- 4500K Range: Warm White (~3200lm)
- 5500K Range: Pure White (~3300lm)
- 6500K: Cool White (~3200lm)

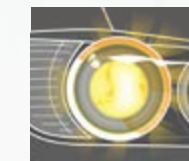

3000K (KELVIN)

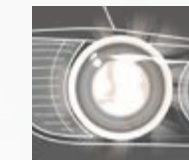

4500K (KELVIN)

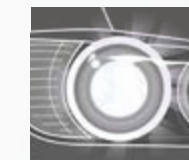

5500K (KELVIN)

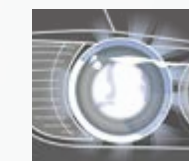

6500K (KELVIN)

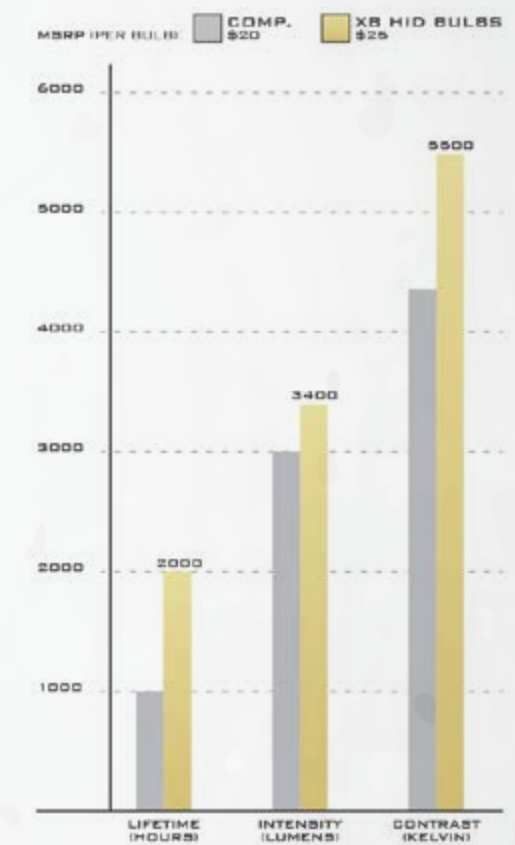

WIRE HARNESSES

WORD ON THE STREET

“Install was a breeze and the quality of connectors and wire used is incredible. I’ve purchased a couple of these and I am about to order a third.”

– Eric

“Simply beautiful. I bought this harness to replace a cube harness I installed 5 years ago. Install was simple and easy and the looks are stunning. I would highly recommend this if you are using an old cube relay harness as the cubes tend to go out after so much time. This is probably the most sexy harness I have seen and it takes all the guess work out with a bi-xenon setup. For this price this is one amazing harness.”

– Thayne

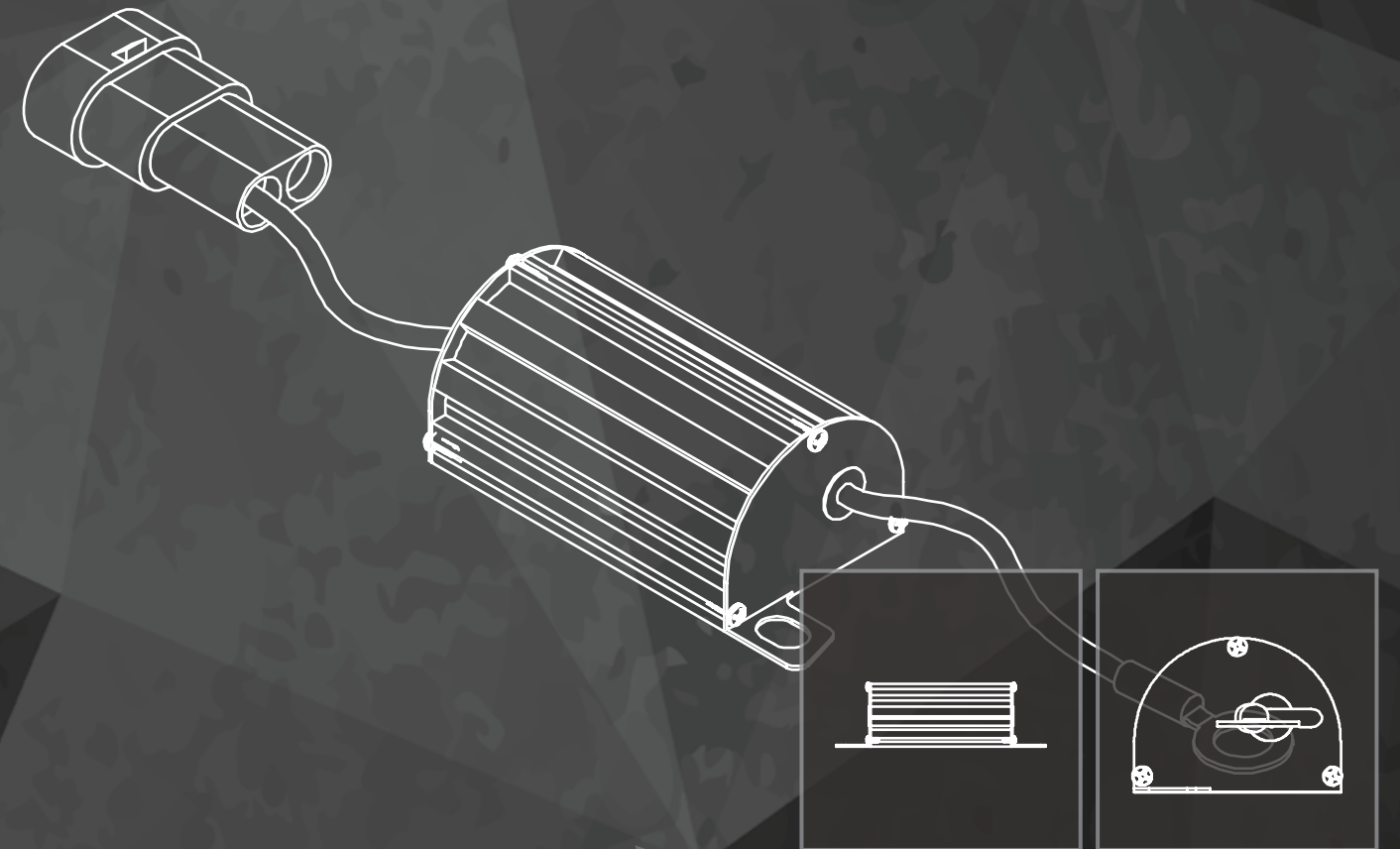

“I have a 2014 Dodge Dart. I’ve tried a few different Can-Bus systems and had real trouble locating one that actually worked. Can-Bus ballasts would function without throwing a code, but their output was typically reduced, and they would still run a risk of frying my ECM starting up.

This harness solved all of that. I’m using 55W AC ballasts and not only was the install fast and simple, but I have been completely error-free while running it. With the high quality in the wiring and connections, I also expect that it will last much longer than the harness it was replacing.”

– Joseph

DESCRIPTION

Morimoto wire harnesses ensure HID components have no kickback from the vehicle they're installed on, are more durable, and look better than any other aftermarket HID wiring harness available. Multiple types available ensure even the pickiest factory wiring is no match!

HD Relay: The Morimoto HD Relay ensures ample power delivery from the battery or sufficient 12V+ power source directly via beefy 14-gauge wire and 100% sealed WeatherPack dual relays. Unlike inferior harnesses with a single cheap relay, if one relay fails here, you're not left in the dark--the other will stay running strong.

MotoControl: This unique Bi-Xenon harness offers the ability to work with both positive- and ground-switched vehicles with ease. Proprietary circuitry inside also boasts a capacitor that ensures even if you do have a delay in switching from high to low or low to high that you'll never see it in the HID setup. OEM-like in function, and fully sealed connectors ensure a one-two punch with your install.

MotoCycle: Unlike all other Morimoto harnesses, the MotoCycle harness was specially designed for motorcycle applications. It's not only made with specific lengths to ensure everything lines up and reaches the battery often under the seat of your bike, but the H7 and H11 models even feature a 10-second delay upon startup, ensuring your bike is idling smoothly before your HID's kick on.

Standalone Canbus: Have a European vehicle that has a pesky "bulb out" error? Look no further! Made especially to combat this annoying light on your dash, the Standalone Canbus harnesses plug in-between the stock connector and the ballast to give the necessary feedback to the car's computer and soothe it from having a panic attack. Chunky extruded and anodized aluminum casing that's fully sealed--this thing's not going anywhere.

Mopar-Spec: Chrysler, Jeep, and Dodge marques are notorious for hating aftermarket lighting, especially headlight components. After realizing the Standalone Canbus harness can't work with these vehicles properly, we went back to the drawing board and created what we consider is the most versatile harness for these vehicles. The result: no flickering, no "bulb out" error, no loss of factory function. Rock on into the night!

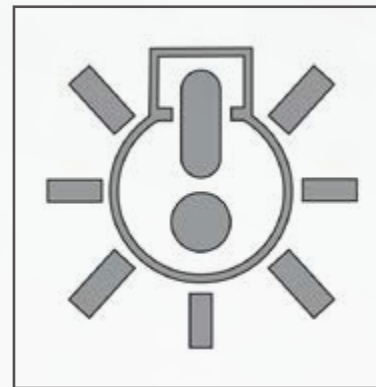

NO "BULB OUT" ERRORS!

AVAILABLE VERSIONS

HD Relay (Single Xenon):

9012:	48318
5202/5204:	47741
880/881:	47392
H10/9145:	47380
9006:	47338
H7:	47335
9005:	47329
H8/H9/H11:	47309
H1/H3:	47308

MotoControl (Bi-Xenon):

H4/9003:	47390
H13/9008:	47385
9007/9004:	47310

MotoCycle:

H7 Single Output:	47395
H7 Dual Output:	47277
H11 Single Output:	48498
H11 Dual Output:	48495
H4 Single Output:	48015
H4 Dual Output:	47704

Standalone Canbus:

9012:	48319
5202/5204:	47743
880/881:	47748
9006:	47696
H7:	47697
9005:	47754
H8/H9/H11:	47698
H1/H3:	47699
H4/9003:	47693
H13/9008:	47695
9007/9004:	47694

Mopar-Spec:

H13/9008:	48735
9007/9004:	48734
Low Beam:	48733

Wiring Accessories:

Cap Link:	48753
Single Resistor:	47951
Dual Resistor:	47952



MotoControl



HD Relay



MotoCycle



Mopar-Spec



Standalone Canbus



HD Load Resistors

SHROUDS

WORD ON THE STREET

“Gatling Gun Shroud A+. I used this shroud for my retrofit on a Morimoto Mini H1 6.0 projector and it turned out great. What really looks good was the 100mm LED halo behind the vents really set the headlight apart from the others! Great quality and looks amazing!”

– Travis

“Beautiful. Pretty simple really, these shrouds are perfect, ordered multiple pairs and they fit the same each and every time. Great product, whether you’re using the XB LED ring behind it or individual LEDs like Porsche does, it looks stunning. Great way to fill a large headlight as well!”

– Michael

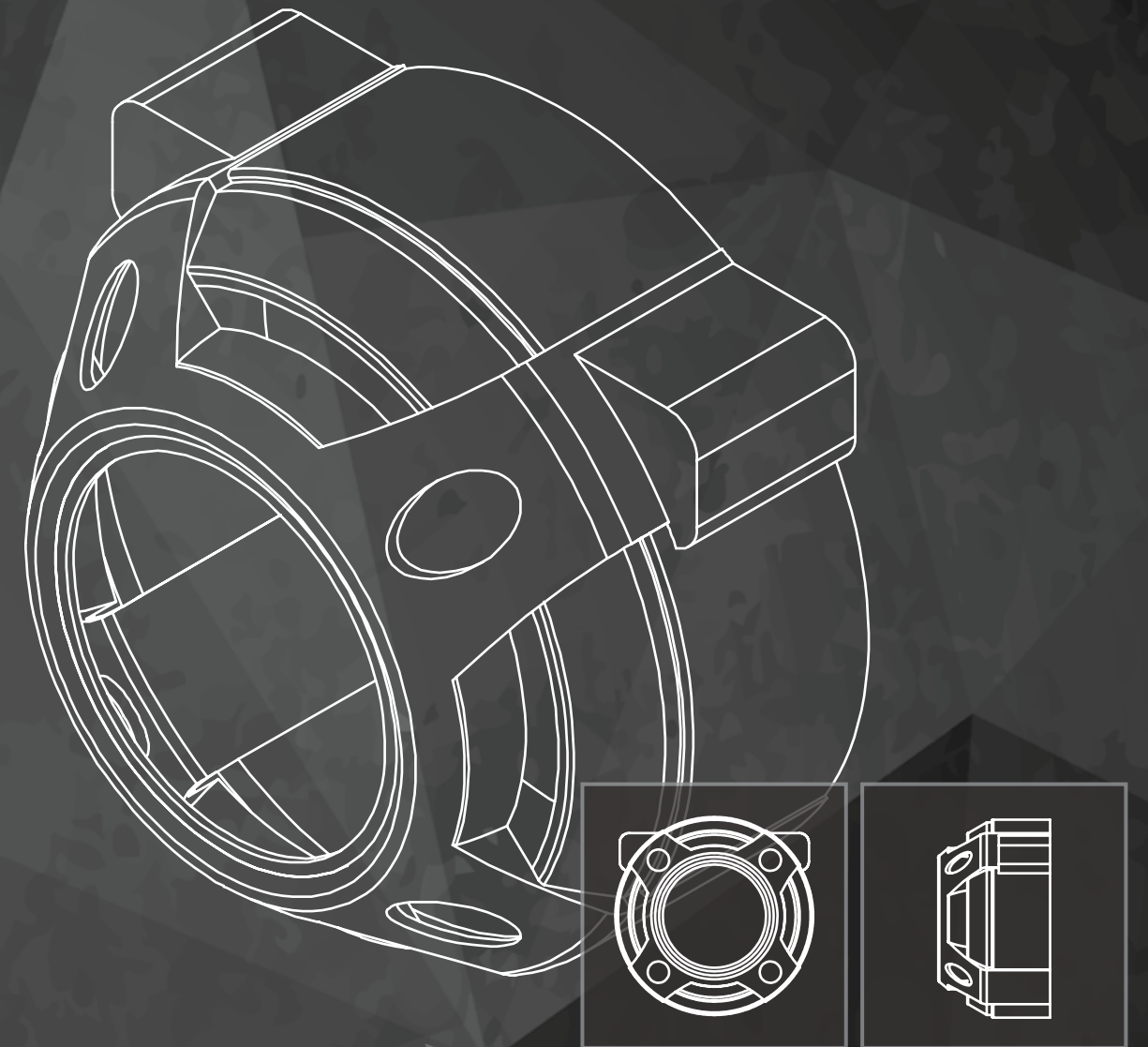

“Although these shrouds are very large, they cover a lot of space which was perfect for my TL projectors. I also mounted the 100mm XBA inside and the 90mm for the turn turn signal on the exterior for a truly unique look. Personally I think that there is enough room to fit the 110mm XBA, because the 100mm has a lot of room. A bigger halo would fit better I think. Overall these things are awesome! No one better than Morimoto!”

– Keith

SHROUDS
ALL STYLES

DESCRIPTION

Morimoto's extensive line of projector shrouds ensures your install not only looks the part, but can be customized to match your build. In true Morimoto fashion, every shroud is built to the best standards possible.

Variety: Some styles are modeled from OEM projector shrouds, some are unique to the retrofitting realm. One thing's consistent across the board: choose your flavor!

In Comparison: Even though less-expensive options may be available elsewhere, our shrouds are made from the highest quality plastic and have by far the most durable metalized chrome finishes. The cheaper shrouds out there are flimsy enough to deform from the heat of just a 35w HID bulb and their chrome finish easily flakes off.

Mounting: Centric Rings are not included by default, but are highly recommended to improve ease of installation on many 2.5" projectors. Centric rings are a simple reducers that clip into the shroud to reduce inside diameter, making them more of a "press fit" onto the lens holder of the projector. For projectors with square or 3" lens sizes, centric rings are not used.

Trimming: Please note that trimming shrouds is a common task when retrofitting. Whether required to clear part of the projector or fit within the geometry of your headlights, it's normal. Luckily, they're made out of plastic, making that easily possible. We recommend using small rotary cutting wheels to make the job easy.



HEAT RESISTANT

PAINTABLE

DURABLE FINISH

UNIVERSAL SIZE

AVAILABLE VERSIONS

Micro Gatling:	49839
Mini Gatling:	47372
Mini Graphite:	47373
Apollo 1.0:	47691
Apollo 1.0 Square:	49216
Apollo 2.0 Flat-Side:	47803
Apollo 2.0 Full Circle:	47801
Apollo 2.0 Square:	48840
Apollo 3.0:	47806
Bullet:	47668
E46-R:	47689
E46-R Extended:	47679
E55-R:	47687
G37-R:	47666
G37C-R:	49061
Gatling Gun 1.0:	47685
Gatling Gun 2.0:	47677
Gatling Gun 2.0 Square:	48296
GTI-R:	47683
Iris:	47670
MC-R:	47675
Ocular:	47681
Ocular Square:	48295
Orbit:	47673
Panamera:	47671
PanaSquare:	49190

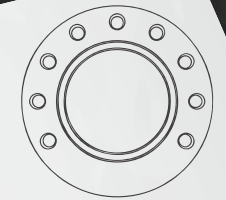

Round:
MC-R

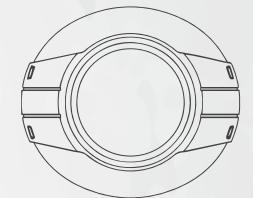

Oval:
Ocular

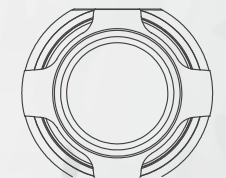

Flat-Sided:
Apollo 2.0

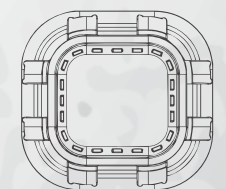

Square:
Apollo 1.0

LED LIGHTING

WORD ON THE STREET

"I have installed halos in the past, but they were the Morimoto in standard white so I was curious to see how much the difficulty would rise in this installation...particularly with the addition of the RGB capability. It was EASIER! These guys installed seamlessly with a few connectors and very easy plug and play components that come with the kit. You know when the directions specifically state NOT to cut or splice the wiring that this will be an easy installation for you...

and it was!"

- Harold

"The bulbs are amazing, I am very impressed by these. Ive always wanted the light output and color as seen on OEM LEDs. Like on BMW, Mercedes, and Lexus. They have a very white light and not that cheap looking purple color of the other LED bulbs I have purchased in the past. I was so excited with the bulbs that I couldn't wait to see them how they looked at night. They are worth every penny, I will purchase some more for my other cars. Thanks to Morimoto for a well

made product!!"

- Angel

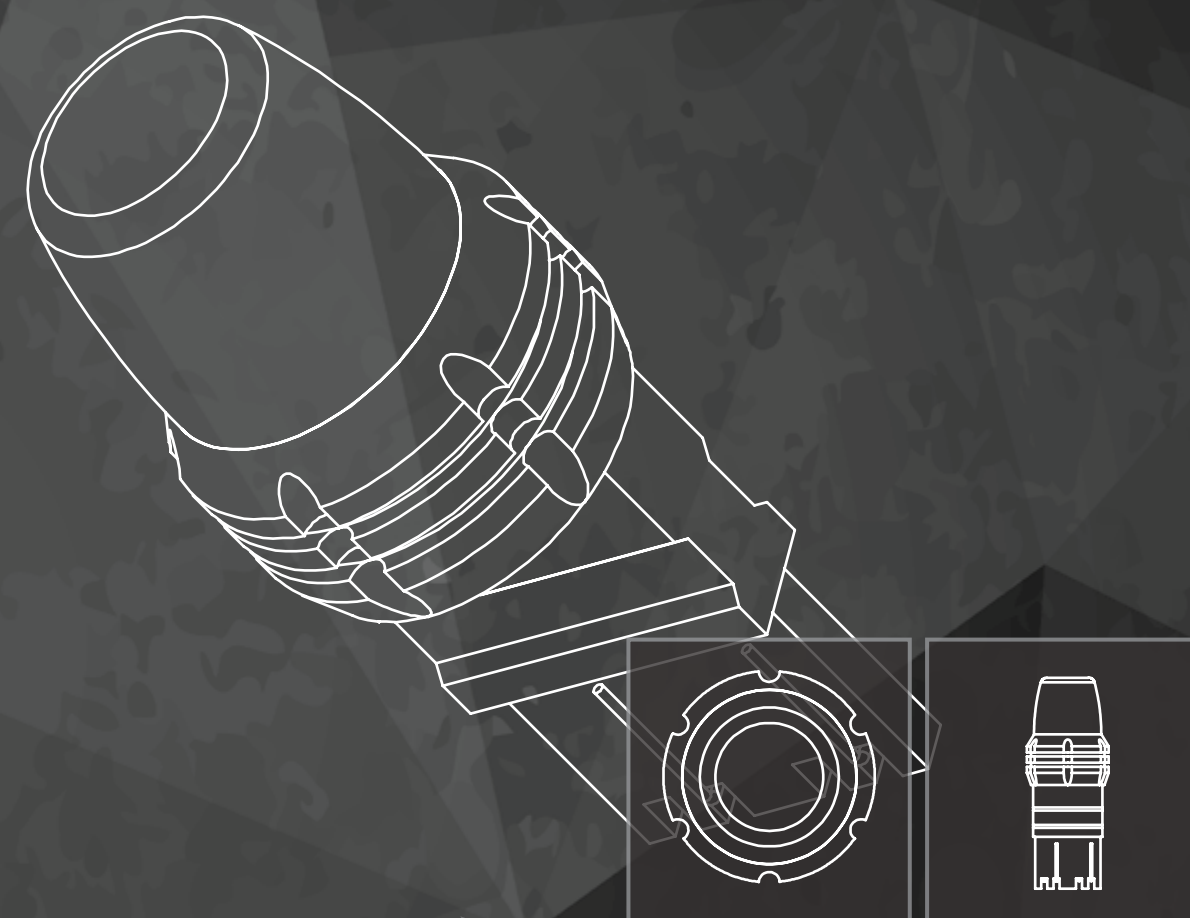

RGB

XB LED BULBS

DESCRIPTION

Beautiful, bright light. Nearly infinite lifespan. Great for signal, marker, brake, or tail lights. The XB LED bulbs are an instant upgrade in the looks and performance for the lighting on your car from bumper-to-bumper.

T10/194: The bulb is constructed with a white fiberglass PCB sandwiched between two very unique white-faced COB LED panels. The positive/ground contacts are perforated and dipped in gold copper to improve contact across both sides of the base. The T10 bulb is the most common automotive bulb, so chances are you can use these!

Festoon: With a huge COB panel on one side, these aim-able Festoon-Style LED bulbs can be fitted into many dome light applications and provide ample pure white light. At the rear, a thick aluminum anodized heat sink directly from the Morimoto logo can be seen, as well as gorgeous X-Shape gold-copper contacts on the ends.

Lenses: As with our projectors and other housings that are focused on optics, the 1156, 1157, 3156, 3157, 3157CK, 7440, and 7443 bulbs all utilize a unique polycarbonate optical lens to help radiate the light outward from the bulb. With perfect clarity that distributes the light from its six LEDs in a 360 degree pattern, these bulbs will radiate light in all directions without any dark spots.

LED Tech: Under these polycarbonate lenses, the XB LED signal bulbs use just six LED chips to produce peak output, the XB LED bulbs generate less heat compared to other bulbs that sometimes use up to 48 chips. The CREE XB-D LEDs are mounted inside the lens, which sits atop a ribbed aluminum heat sink. Inside, an integrated thermal resistor reduces output as a secondary level of protection.

Switchback: In 1157, 3157, 3157CK, and 7443 sizes, a switchback option is offered. In standard "parking light" mode, these bulbs offer a brilliant pure white light. When the turn signal is activated, the white LEDs turn off and the amber LEDs blink. Once deactivated, the white LEDs return. Two functions, two colors, one bulb.

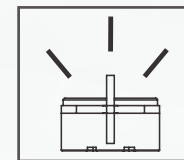

INTENSE LIGHT OUTPUT

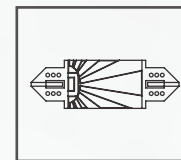

PROPRIETARY DESIGNS

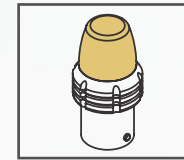

CLEAR DOME LENS

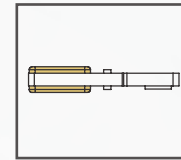

CHIP-ON-BOARD TECHNOLOGY

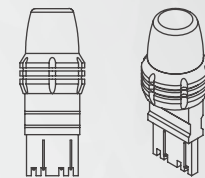

XB LED Bulbs:
3156 / 3157

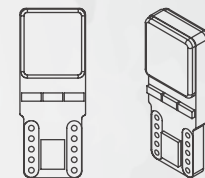

XB LED Bulbs:
T10

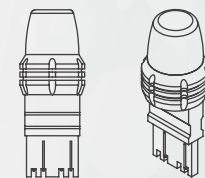

XB LED Bulbs:
7440 / 7443

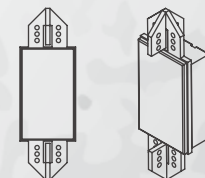

XB LED Bulbs:
Festoon

AVAILABLE STYLES

T10 / 194 / 168:

T10/194: 49218

Festoon Style:

31mm: 49822

36mm: 49821

39mm: 49823

42mm: 49824

44mm: 49864

1156 Style:

1156 White: 49807

1156 Amber: 49808

1157 Style:

1157 White: 49809

1157 Amber: 49810

1157 Switchback: 49811

3156 Style:

3156 White: 49812

3156 Amber: 49813

3157 Style:

3157 White: 49814

3157 Amber: 49815

3157 Switchback: 49816

3157 "CK" Style:

3157CK White: 50206

3157CK Amber: 50205

3157CK Switchback: 50204

7440 Style:

7440 White: 49817

7440 Amber: 49818

7443 Style:

7443 White: 49819

7443 Amber: 49820

7443 Switchback: 49896

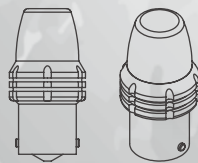

XB LED Bulbs:
1156 / 1157



XB LED BULBS [H SERIES]

DESCRIPTION

Expanding on the success of other automotive lighting products from Morimoto we're proud to finally introduce the XB LED Headlight bulbs. Unlike anything else and especially the generic LED-based replacements you can buy for a dime a dozen, these are easily the best LED-based headlight bulbs to hit the market yet.

Easy Install: It takes just a few minutes to lock the bulbs in, and the wiring is completely plug-n-play. No ballasts to mount, no relay harness to run. the XB LED's are a suitable alternative for illuminating auxiliary light sources.

Focused: With two monster sized CREE 15W chips, the XB LED bulbs are capable of producing up to 1500 lumens. By mounting the chips in an opposed fashion on a purposely thin (yet rigid) thermal stem, the focus attempts to mimic that of a halogen or HID bulb - which means the distribution of light will be as good as it gets (for an LED-based system, that is).

Cool: As heat management is a requirement for longevity of LEDs, these utilize a copper heat-pipe to extract as much heat as possible from the LED chips and transfer it down to a stacked aluminum radiator in the base. No need for cheap ball-bearing fans here--the heat management is all passive.

Fitment: With an externalized LED driver and weather-resistant inputs and outputs, the XB LED bulbs offer easier serviceability and much smaller bases. This allows the bulbs to fit in most automotive headlights without conflict.

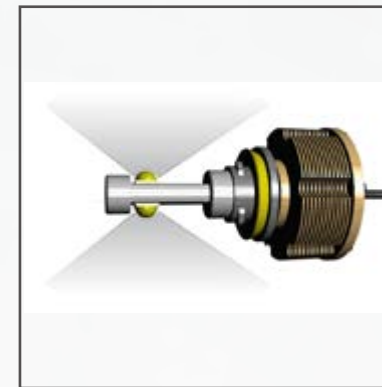

DUAL-EMITTER DESIGN

AVAILABLE VERSIONS

H7:

Part # 49798

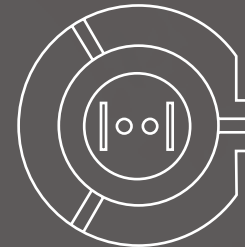

H11:

Part # 49801

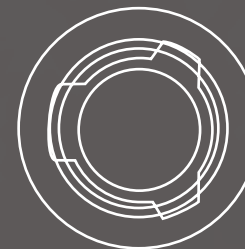

9005 / HB3:

Part # 49803

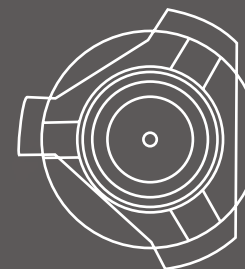

9006 / HB4:

Part # 49804



TECHNICAL INFO

- Rated Color: 5000K (Kelvin; Pure White)
- Rated Luminosity: 1500lm per bulb
- Input Voltage: 12-24VDC
- Input Current: 1.5A per bulb
- Light Source: CREE Emitters
- Functions: DRL, High Beam, or Fog Light (no low beam use)

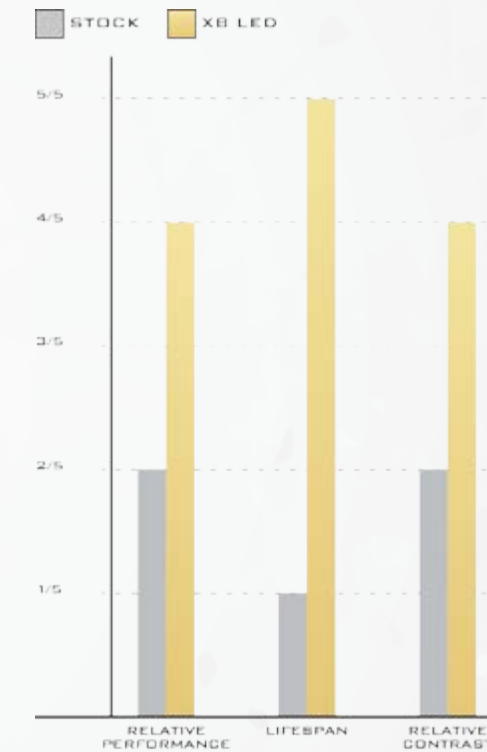

XC LED [RGB]

DESCRIPTION

Although the XC LED System certainly isn't the first entry to the market for color-changing LED lights, it's the most thought-out and refined, making it the most advanced. Flexibility. Reliability. Intensity. Uniformity. Simplicity. Functionality. Last but not least: affordability. Nothing has been sacrificed.

Best of Both Worlds: The innovative Hybrid-LED color-changing technology delivers up to 50,000 hours of lifespan--that's almost six years straight! The matured SMD technology has been revised in a smaller scale, so not only are the LEDs more reliable than ever, but the light pattern is as consistent as a COB style ring. The best of both!

XC LED Family: With their proprietary 5-wire setup, each ColorControl receiver is capable of controlling up to three sets of XC Rings, XC Strips, XC Demon Eyes, or a combination of the three. It will allow users to change between 12 preset colors, and also has strobe and fade programs. Best of all: When re-started, the setup will default to it's last setting, not some random rave-mode that'll get you pulled over instantly.

Plug 'n' Play: Unlike competing systems that can require cutting and splicing, the Morimoto XC LED system requires none of that. Proprietary 5-pin plugs abound. All components are weather-resistant and the receiver is RF based. No IR "eye" here!

High Class: In traditional Morimoto style, all wiring in the XC components is insulated rubber tubing and wrapped in a black and gold mesh for an OEM-like appearance, abrasion resistance, and durability. The control gear is housed in a machined and piano black-anodized case which is then laser engraved. Make sure your setup looks good inside and out!

Flexibility: Unique to Morimoto: flexible "Micro SMD" RGB strips that maintain an unbroken appearance. Don't cheap out on your install and go with strips that you can fit a small hatchback between each LED, these look like COB or CCFL while still being able to conform to your headlight's nooks and crannies.

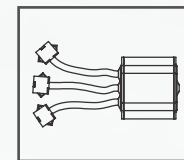

MODULAR DESIGN



FLEXIBLE (STRIPS)

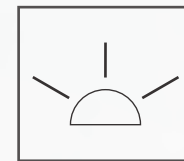

UNBROKEN LIGHT PATTERN

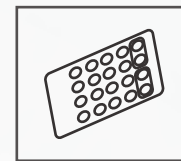

REMOTE CONTROLLED

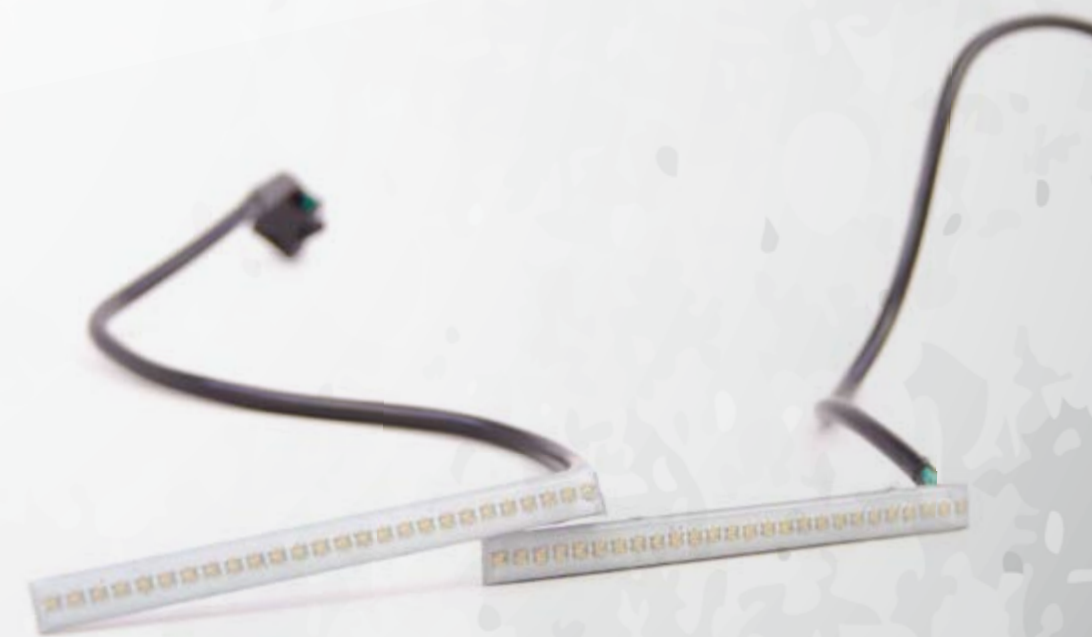
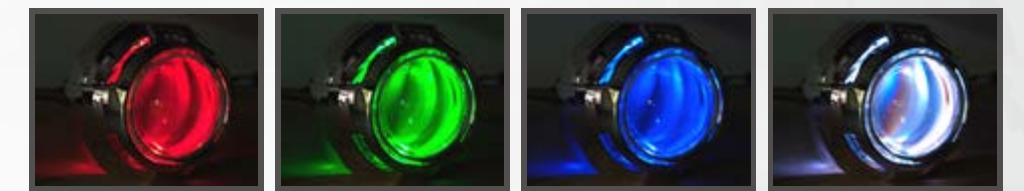

AVAILABLE VERSIONS

XC LED Strips:

3" Flexible:	49394
6" Flexible:	49393
18" Flexible:	49392
24" Flexible:	50196



XC LED Halos:

60mm Round:	49390
70mm Round:	49389
80mm Round:	49388
90mm Round:	49387
100mm Round:	49391
110mm Round:	49383
120mm Round:	49382
140mm Round:	49381

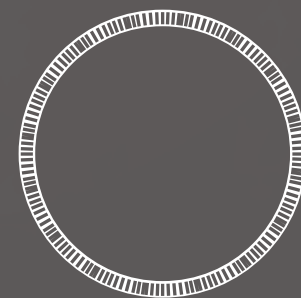

Demon Eyes:

With Brackets:	50186
----------------	-------



ColorControl Module:

With Remote:	49545
--------------	-------

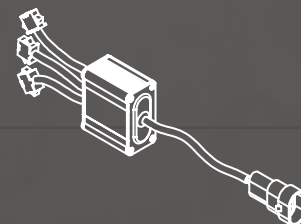

LED LIGHTING
XSB LED

DESCRIPTION

Taking every lesson learned from previous Morimoto designs and all others on the market, the XSB is the culmination of years of halo designs. Utilizing the same technology as the XC LED rings ("Hybrid LED"), the XSB switchback halos and strips offer not only an intense white light for DRL or running light mode, but a secondary amber switchable mode for turn signal use.

Usability: There are three micro-mounts integrated into their backing, making the XSB's the easiest and cleanest rings on the market to install. Now you can forget about failing glue or wires wrapped around the face of your halos forever. Don't be "that guy" with dripping glue or picture hanging wire visible inside your headlights.

Best of Both Worlds: The innovative Hybrid-LED color-changing technology delivers up to 50,000 hours of lifespan--that's almost six years straight! The matured SMD technology has been revised in a smaller scale, so not only are the LEDs more reliable than ever, but the light pattern is as consistent as a COB style ring. The best of both!

Intensity & Uniformity: A special blend of silicone and phosphor covers the face of each ring. This proprietary coating is responsible for the neutral "white when off" look of the XSB's and their amazing, uniform intensity - which is unlike anything else on the market.

Switchback or DRL: Wiring is easy with a variant of the XChange Module integrated into the LED driver that powers each ring. The white wire receives a constant 12V+. The black wire is grounded, and the yellow wire is tapped into the turn signal circuit. Though they come out of the box ready to run as a switchback system, the XSB halos and strips can also be wired as a Daytime Running Light that turns off when your low beam headlights turn on.

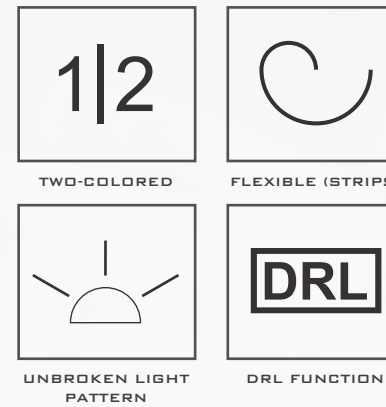

AVAILABLE VERSIONS

XSB LED Strips:

3" Flexible:	50182
6" Flexible:	50183
18" Flexible:	50071
24" Flexible:	50072



XSB LED Halos:

60mm Round:	50172
70mm Round:	50173
80mm Round:	50174
90mm Round:	50175
100mm Round:	50178
110mm Round:	50179
120mm Round:	50180
140mm Round:	50181
83mm x 90mm Square:	50198

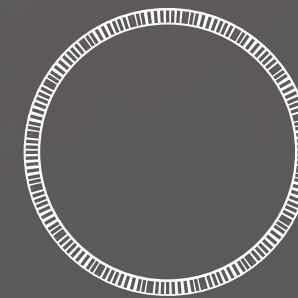

Controller:

XChange:	50207
----------	-------

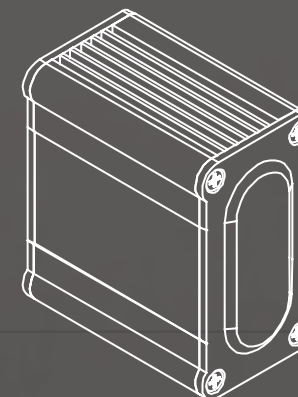

TECHNICAL INFO

Dimensions: 4mm wide, 3mm thick. Diameter/length varies
Rated Lifespan: 50,000 hours
Input Length: 89cm
Kelvin Rating: 5500K (white mode)



X.DRL1 & X.DRL5

DESCRIPTION

After the Audi LED DRL craze hit the automotive aftermarket, plenty of low quality DRL products came about. None of them can match the looks and quality of Morimoto's X.DRL system.

Hard-Bodied: Both the X.DRL1 and X.DRL5 utilize machined aluminum bodies that are powder coated black to not only provide a stealth look but resist the worst of environments. The internal circuitry is nearly bomb-proof, with all electrics encased in a thick layer of hard acrylic potting compound. Damage from moisture, dust, or dirt is no threat.

X.DRL1: This little guy packs a punch brighter than some headlights! One single flat-faced 10w Chip-On-Board (COB) LED projects through an optically-clear glass projector lens to create a very unique circle pattern--perfect for DRL use. A neutral pure white color ensures you'll be seen!

X.DRL5: The X.DRL5 packs a similar design as the X.DRL, but utilizes five (5) 1w COB LEDs each of which projects through its own little glass lens. The pattern is a very visible and pure white light, perfect for an OEM-style fitment in the grille of your project vehicle. These use a swiveling bracket for mounting in a variety of ways.

Easy Setup: With a simple power and ground for each terminated with a standard 9006 male plug, wiring the X.DRL will be easy. You can trigger them with your parking lights, low beams, or any other 12V source that comes on along with the vehicles ignition for a true DRL style circuit.

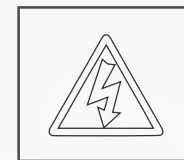

LOW POWER DRAW

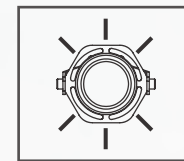

INTENSE LIGHT OUTPUT

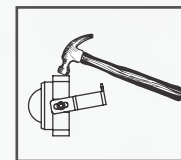

DURABLE

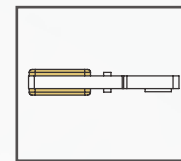

CHIP-ON-BOARD TECHNOLOGY

AVAILABLE VERSIONS

X.DRL1:

Pure White Color
1x 10w COB LED
Width - 83mm
Height - 63mm
Depth - 45mm

X.DRL5:

Pure White Color
5x 1w COB LED
Width - 160mm
Height - 28mm
Depth - 26mm

TECHNICAL INFO

Casing Material: Powdercoated 6061 CNC Aluminum
Potting Compound: Hard black acrylic
Input Type: 1x 12V+, 1x Ground w/ 9006 Male connector
Input Voltage: 9-14.8VDC



X.DRL1:
Part # 49722

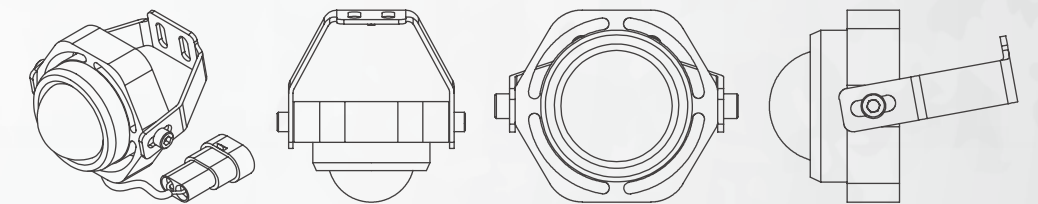

X.DRL5:
Part # 48216

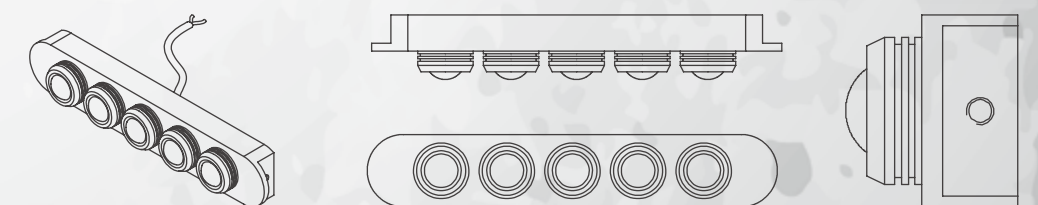

X.CHANGE DRIVER

DESCRIPTION

Forget about 5-pin relays and complicated custom wiring! Morimoto makes it easy with the new XChange drivers that allow users to easily achieve “daytime running light” or “switchback” functionality for any accessories operating on 12V.

Daytime Running Lights: Simply connect the [9006 female] DRL-output to your Angel Eyes, LED DRLs, (or whatever else you want). Then feed a constant 12V into the white/black wires and tap into your low beam circuit with the yellow input wire. When the car turns on, so will your DRL's. When you turn the headlights on, the DRL's will automatically shut off.

Switchback Function: Connect the white/black output to your white angel eyes. Connect the yellow/black output to your amber angel eyes. Connect the white/black input a 12V constant, and the yellow/black input to your blinker circuit. With the car running, the white angel eyes will be on. When the blinker starts, the white angel eyes turn off and the amber will start blinking. When the blinker stops, the white angel eyes will automatically turn back on.

Universal: Despite the examples above, these have a wide variety of uses, from angel eyes, to LED strips, to daytime running lights, to fog lights. Anything that runs on a 12V input can conceivably be used with the XChange drivers.

Quality: Housed inside of an attractive black extruded aluminum housing; the circuit board is covered in conformal coating to protect from moisture damage. Each output is setup with a sealed 9006 Female connector to keep the connections from corroding.



BLUEPRINT

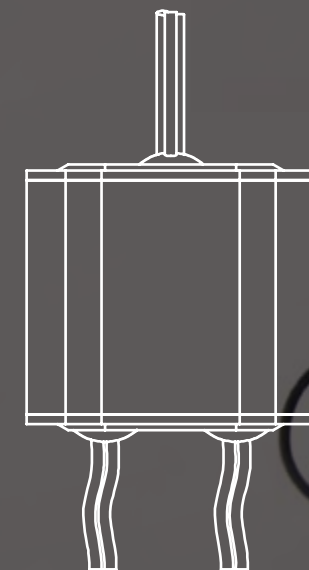
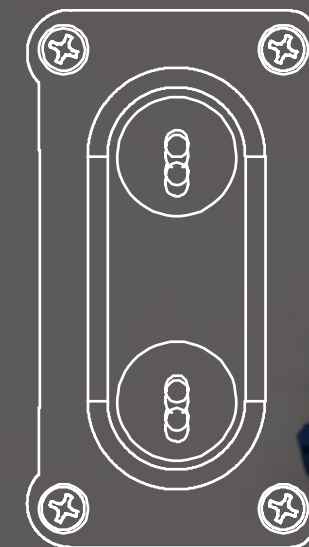
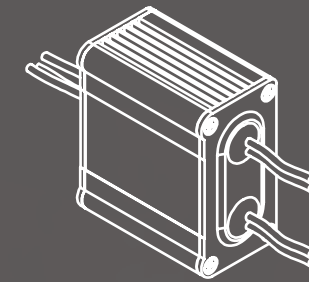

TECHNICAL INFO

- Trigger One: T-Tap
- Trigger Two: T-Tap
- Ground: T-Tap
- Output One: 9006 Female
- Output Two: 9006 Female

COMPATIBILITY

- Ballasts: 35w
- HID Systems: With relay harness
- Running Lights: 12V LED
- LED Halos: All Brands
- LED Strips: All Brands

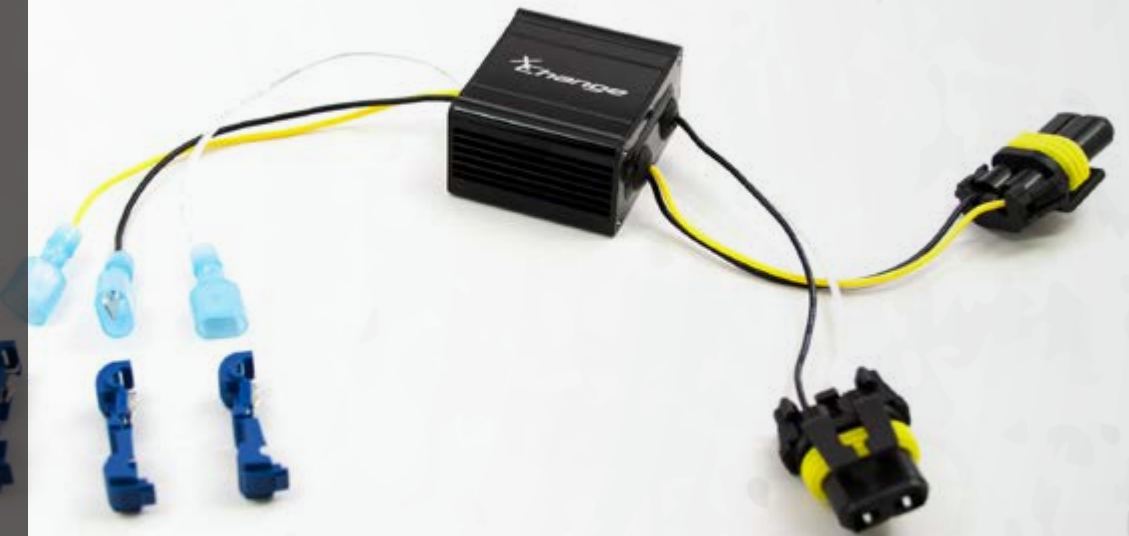

FOG & FULL HEADLIGHTS

WORD ON THE STREET

“AMAZING!!!! What else can I say about these lights besides amazing!! They come ready to go right out of the box with the supplied H11 connectors so install is a breeze...unbolt the old fogs and bolt these on! Although you are doing more than bolting on a new set of fog lights...you are basically adding a 2nd set of headlights. These LEDs are BRIGHT!! They put off a huge amount of light but it is perfectly focused as a fog light. Buy these now...trust me you wont regret it! I

would rate higher than 5 stars if I could”

– Kevin

“I have these installed on my 2004 Jeep LJ Rubicon. Jeep Wrangler headlights have always been pretty pathetic. These headlights are nothing short of incredible. From the aggressive looks, to the outstanding performance, these headlights are worth every penny. Very easy install, great instructions, and amazing customer support. My Jeep has a 6 inch lift with 37” tires. It’s very nice to have such a controlled light output. You won’t blind people anymore with the sealed 7’s or attract attention from the police unless they just like your ride. The light output of these lights compared to the led headlights on the market is (from personal experience) much better. The Sealed 7’s throw light further and do not have any dark spots. Just clean, bright, and even lighting. Thank you Morimoto for developing such an incredible product.”

– David

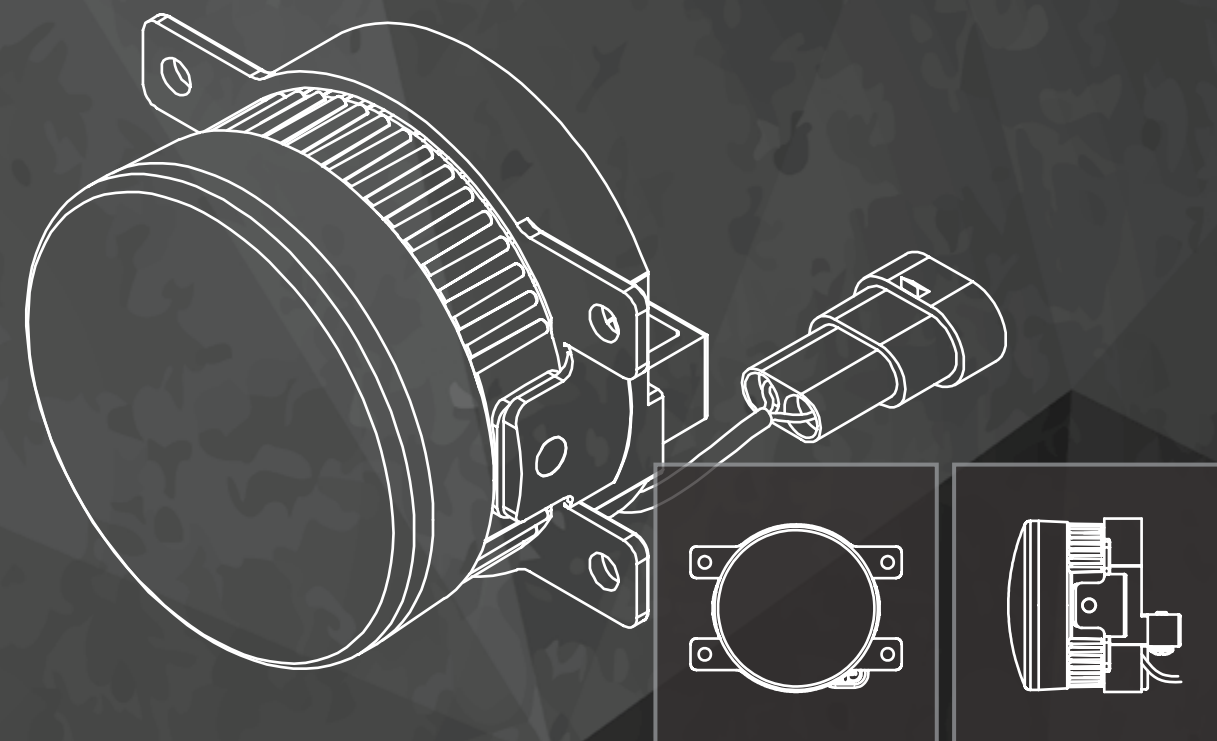

SEALED7

DESCRIPTION

Whether you're driving a muddy Jeep or a classic Muscle car, we know you can't see a damn thing while driving at night with those stock 7" rounds! With the Sealed7 headlights, you may actually re-think taking the family beater to dinner next time.

World's First: The Sealed7 is the world first high-performance, fully modular bi-xenon replacement for all industry-standard 7" Round Headlights. Nothing comes close to offering the same quality of light, the ability to customize the look, or the ease of assembly.

Customizable: Several shroud options. Add on XSB or XC halos, paint-match the internal parts or leave em chrome! Virtually infinite combinations to improve the light output on your vehicle and modernize the look at the same time!

Design: Replacing all "universal" 7" round headlights, the Sealed7 offers full low and high beam functionality in a housing that should mount right up to the stock mounting brackets.

Lasting: The slightly convex front lenses are made of impact resistant plastic that have been coated with a UV resistant film that wont chip or fade over time. They seat into a 360 degree channel on the rear shell and a perfect seal is made with the optional RetroRubber butyl sealant.

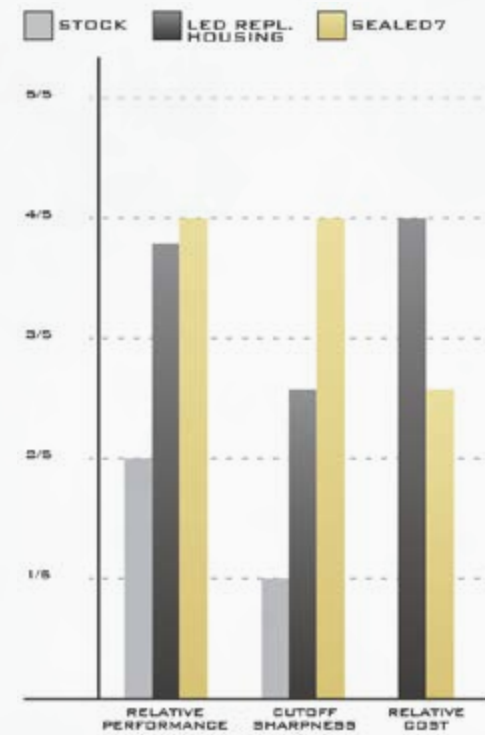

TECHNICAL INFO

Dimensions: 175mm diameter, 175mm deep (assembled)

Lens: 3.0" optically-clear

Housing Material: High temp-resistant ABS plastic

Lens Material: UV-resistant polycarbonate

Bulb Type: D2S only

KIT OPTIONS

Standard Kit: 45000
 Housings
 Projectors
 XB35 Ballast Computers
 AMP Igniters
 XB 5500K D2S Bulbs
 AMP to D2S 90-Degree Adapters
 Apollo 1.0 Shrouds

Optional:
 H4 Harness: 47390
 H13 Mopar-Spec Harness: 48735
 Apollo 2.0 Full Circle: 47801
 Apollo 3.0: 47806
 MC-R: 47675
 Orbit: 47673
 Panamera: 47671

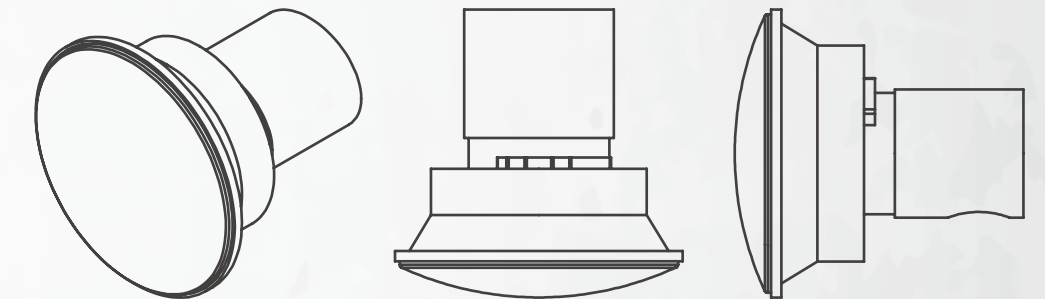

555

XB LED FOGS

DESCRIPTION

The new Morimoto XB LED projector fog lights blow away your stock fogs – they look great, are well-built, perform like champs, have a virtually infinite life span, and an unbeatable warranty. Best of all, you won't need to sell your soul to afford them.

Designed: Utilizes original mounting points. Integrated aiming adjuster makes fine tuning easy.

Powered: The projector based optics inside concentrate a total of 2400 lumens of pure white light into a beam that's super wide and perfectly distributed.

Well-Built: The powder-coated cast aluminum housing is lightweight and much stronger than comparable plastic alternatives. Internals are well protected from the elements, and the UV-resistant polycarbonate lens resists hazing.

Plug 'n' Play: Designed to work without any special wiring. Includes all necessary connectors, rubber seals, and pigtailed for a plug n play install.

Warranty: 10 years.

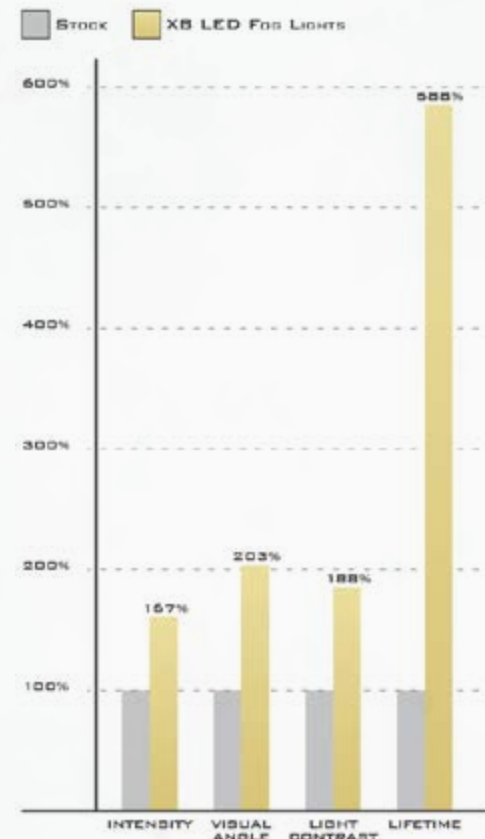

TECHNICAL INFO

- Light Source: 3x Philips Luxeon-T (3W)
- Lens Material: High Impact Polycarb (UV resistant)
- Shell Material: Cast Aluminum
- Luminosity: 1200 per lamp
- Kelvin Rating: 5000K
- Input Range: 12-24V
- Input Socket: H11 Male
- Weather Rated: IP67 Water-tight



XB LED Fog Light (Type Z):
Part # 50372

[TYPE Z] APPLICATIONS:

Mazda:
2009+ Mazda2, 2004-2006 Mazda3, 2014+ Mazda3, 2006-2010 Mazda5, 2004-2010 MPV, 2006-2008 Mazda6, 2006-2008 Mazdaspeed6, 2011+ Mazda6, 2013+ CX-5, 2007-2009 CX-7, 2013+ CX-9, 2006-2015 MX-5 Miata

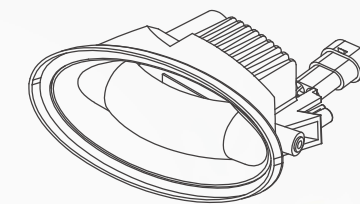

XB LED Fog Light (Type H):
Part # 50055

[TYPE H] APPLICATIONS:

Acura:
RSX 2002-2006, TSX 2004-2005

Honda:
Accord Sedan 2002-2007, Accord Coupe 2002-2007, Civic Coupe/Sedan 2008-2012, Civic Hybrid 2006-2008, Fit(base only) 2009-2013, Insight 2010-2012



XB LED Fog Light (Type F2):
Part # 50373

[TYPE F2] APPLICATIONS:

Ford:
F-150 Truck 2015+

XB LED Fog Light (Type M):
Part # 50053

[TYPE M] APPLICATIONS:

Chrysler:
300 2005-2010, PT Cruiser 2006-2009

Dodge:
Charger 2011-2015, Journey 2009-2015, Magnum 2005-2008

Jeep:
Wrangler 2007-2015, Cherokee 2014-2015, Grand Cherokee 2011-2013

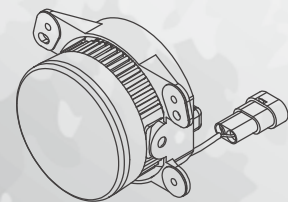

XB LED FOGS CONTINUED...



XB LED Fog Light (Type GM):
Part # 50374

[TYPE GM] APPLICATIONS:

GM:
2007-2011 Avalanche, 2007-2011 Tahoe (w/o Off-Road Pkg), 2007-2010 Silverado, 2010-2013 Camaro (w/o RS Pkg), 2007-2013 Yukon (w/o Denali Pkg.), 2007-2011 Acadia, 2008-2009 Pontiac G8, 2010 Pontiac G6, 2014+ Sierra, 2014+ Silverado

Ford:
2007-2011 Mustang GT500, 2007-2009 Escape (w/ Round Fog)

XB LED Fog Light (Type T):
Part # 49075

[TYPE T] APPLICATIONS:

Lexus:
ES350 2013-2015, GS350 & GS450H 2013-2015, HS250 2010-2012, IS250 & IS350 2011-2014, IS-F 2008-2013, LX570 2008-2015, RX350 & RX450H 2010-2015

Toyota:
4Runner 2010-2015, Avalon 2007-2015, Camry (+Hybrid) 2007-2014, Corolla 2009-2015, Highlander 2008-2014, Matrix 2009-2013, Prius 2010-2015, Prius C 2012-2015, Prius V 2012-2015, Rav 4 2006-2012, Sienna 2010-2015, Solara 2006-2008, Tacoma 2012-2015, Tundra 2014-2015, Venza 2009-2014, Yaris 2007-2014, Subaru Legacy 2015+

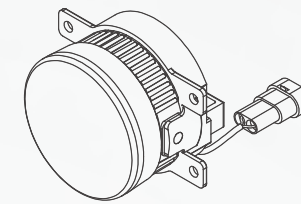
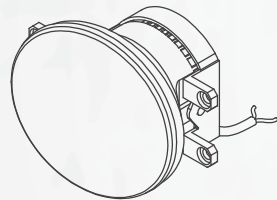

XB LED Fog Light (Type S):
Part # 49074

[TYPE S] APPLICATIONS:

Acura:
TLX 2013-2015, RDX 2010-2014, TL 2012-2014, TSX 2011-2013

Ford:
Explorer 2012-2015, Focus 2009-2015, Focus ST 2013-2015, Fusion 2013-2015, Ranger 2005-2007, Taurus X 2008-2009, C-Max Hybrid 2013-2015, Mustang 2006-2015 (varies), Transit Van 2006-2015

Honda:
Accord Coupe 2013-2014, Civic Si Sedan 2013-2015, Crosstour 2013-2015, CR-V 2012-2014, CR-Z 2013-2014, Insight 2009-2014, Pilot 2012-2014

Nissan:
Xterra 2005-2013, Frontier 2009-2013, Sentra (black bezels only) 2007-2012

Subaru:
*XV Crosstrek 2012-2014, *BRZ 2013-14, *Forester 2014-2015 (*Requires fitment mod), Legacy 2010-2012, Outback 2010-2012, Impreza 2012-2013, WRX/Sti 2015



XB LED Fog Light (Type X):
Part # 50447

[TYPE X] APPLICATIONS:

Subaru:
WRX 2011-2014, WRX STI 2011-2014, Legacy 2008-2009

XB LED Fog Light (Type N):
Part # 50054

[TYPE N] APPLICATIONS:

Infiniti:
G37 2010, JX 2013-2015, QX 2014-2015, M 2006-2010

Nissan:
Altima 2007-2015, Maxima 2007-2015, Pathfinder (non-hybrid) 2013-2015, Rogue 2008-2015, Sentra 2004-2015, Versa Sedan 2012-2015

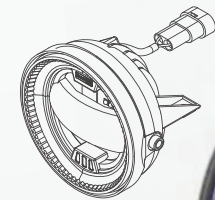

XB LED Fog Light (Type F):
Part # 50052

[TYPE F] APPLICATIONS:

Ford:
F-150 Truck 2011-2014 (07-10 Req. New Mounting Bracket), Ranger 2008-2011, Expedition 2007+

OFF-ROAD LIGHTING

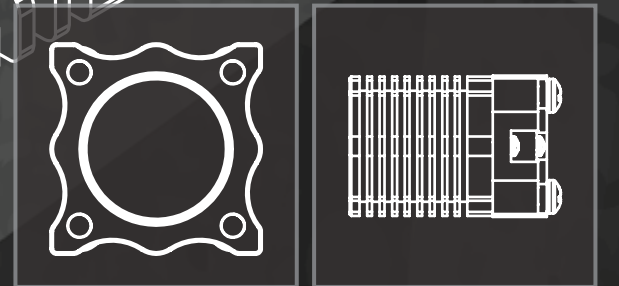
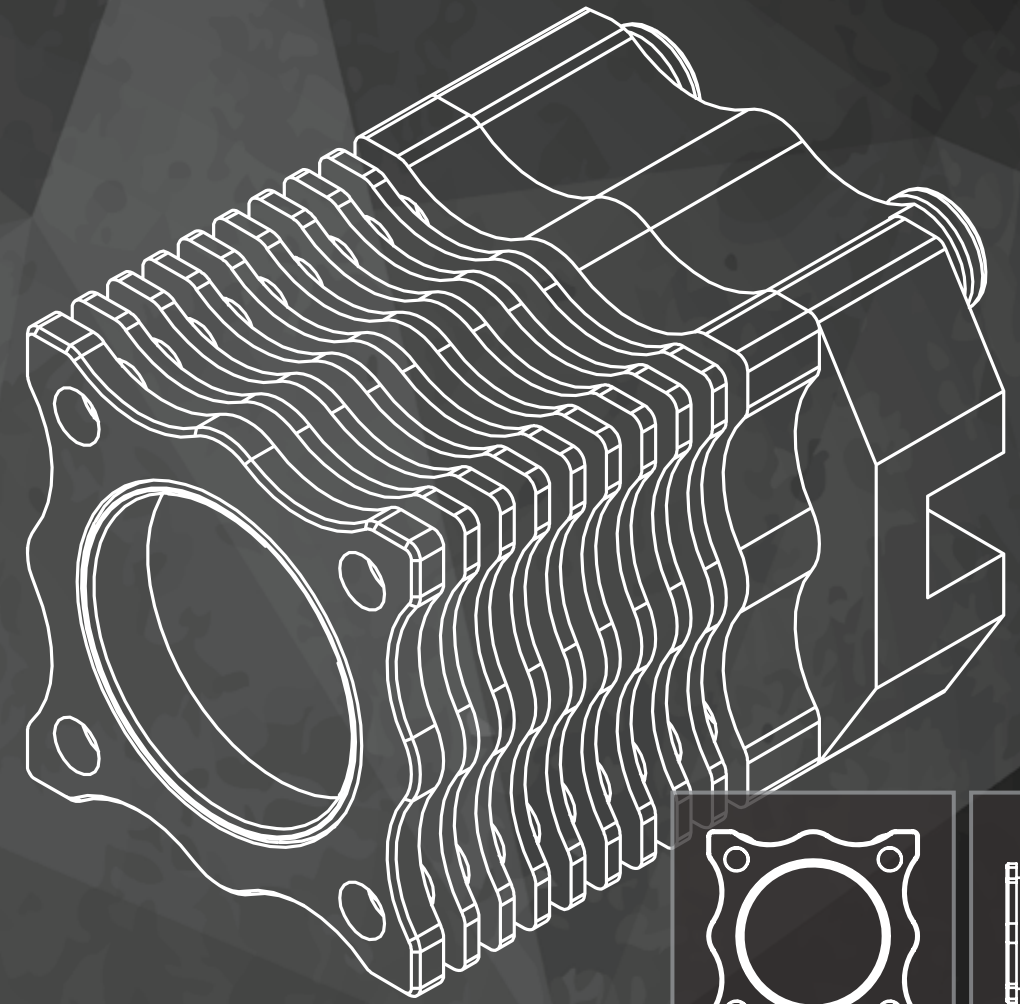

S1

XTORCH & 4BANGER

DESCRIPTION

No matter the time of day. Turn the sun back on with Morimoto's XTorch 24" Light Bar that produces 9600 lumens of mosquito-melting forward intensity!

Identity: Distinct design separates itself (and your truck) from the pack with it's low profile geometry, blacked out bash guard, and Morimoto rising sun side caps. Make no mistake, this is from Morimoto; the Benchmark in Automotive Lighting.

Bright AF: Using the latest CREE X-Lamp XTE 5W LED's and a combination of spot and flood optics, you will be rewarded with mind blowing light output to blast through the night.

Reliable: The XTorch is designed to run in the rough, and they've been put through the paces for a whole year pre-release on two Toyota trucks and a 24HR Racecar. IP67 waterproof, die-cast aluminum shell keeps the shit well-protected and the moisture out. Thermally optimized heat sink design radiates plenty of heat and keeps the system cool. It will take care of itself, you just keep moving.

Weather Tech: Ready to roll out in a storm? Just un-screw the bash guards from the front of the bar and swap in the included foul-weather 3000K lenses. The resulting yellow light output can penetrate through particles in the air such as fog, rain, snow much more effectively compared to reflective white light. Science.

TECHNICAL INFO

Input: 9-32V
Power: 120W
LED: CREE XLamp XT-E 5W
Kelvin: 5000K
Lumens: 9600
Weather Rated: IP67
Body Material: Die-Cast Aluminum
Body Finish: Black Powdercoat
Lens Material: 99% Clarity Polycarb

XTorch

XTORCH VERSIONS:

24":	51096
Power: 120W	
Lumens: 9600LM output	
36":	51097
Power: 160W	
Lumens: 12800LM output	
42":	51098
Power: 180W	
Lumens: 14500LM output	
52":	51170
Power: 220W	
Lumens: 17600LM output	



4Banger:
Part # 51090

DESCRIPTION

The Morimoto 4Banger spot lights are bound to change the game. You will be rewarded with mind blowing intensity from a product that is 100% MADE IN THE USA.

4Banger Construction: A body that's completely machined from 6061 aircraft aluminum, shot peened and anodized with a piano black finish. Back-bone: machined and anodized. Brackets: machined and anodized. Bash-guard Bezel machined and anodized a beautiful dark bronze. You won't find any cheap extruded housings, boring black powder coat paint, chromed plastic reflectors or stamped steel mounting brackets here.

4Banger Performance: A model of efficiency; The 2x2 4Banger uses 4 LED's to produce 4400 Lumens while consuming only 40W of power. Some of the most popular bars on the market use more LED's to produce less lumens while consuming even more power!

4Banger Tech: Completely unique, patented free form optics. CREE XT-E LED's with proprietary voltage regulators that are surrounded by light weight thermally optimized heat sinks. Gold plated contacts offer perfect conductivity and will never corrode.

4Banger Looks: Priceless. (but if you compare head to head with our competitors, we're confident you'll still find our actual price worthwhile) - and they can be customized too! The lens guard can be unbolted, painted or re-anodized, and then reassembled. Boner-time beware!

TECHNICAL INFO

Input: 9-36V
LED Light Source: CREE XT-E 5W
Weather Rated: IP68 Waterproof
Body Material: 6061 CNC Aluminum
Lens Material: 99.9% Clarity Polycarbonate

