



MOELLER[®]
marine products

ACCESSORY LINE



Why Should You Choose Moeller Marine?

- Our brand has been in existence for over 40 years.
- We assure that all our fuel tanks are EPA, CARB, ABYC, and NMMA compliant
- Our fuel lines are 80" in length when combined with connectors.
- All US fuel lines are EPA and CARB compliant
- Our horns are EPA compliant
- We offer new product introductions
- Moeller's warranty is 1 year on accessories, 2 years on fuel tanks, and 3 years on bilge pumps from date of purchase.



Table of Contents

Portable Fuel Tanks	2, 29
Fuel Accessories	4
Plumbing	8
Lighting.....	12
Electrical	14
Hardware.....	19
General Boating Supplies.....	22
Fishing and Accessories	23
Steering, Anchoring & Docking	25
Boat Cover & Bimini Accessories	27
Water Sports	28
Trailerling	30

Moeller Marine made every effort to ensure the information in this catalog is correct. In the event that we have made any mistakes, we reserve the right to correct any error.

*Revised 1.2019





Portable Fuel Tanks

Anatomy of a Portable Tank

Defined by the EPA as tanks with a capacity of 12 gallons or less, **Portable Tanks** are used to convey fuel directly to the engine. Portable Tanks are not intended for permanent installation. Our Portable Tanks feature the same attention to detailed engineering and robust construction which set all our Moeller fuel tanks apart. Our tanks prevent the escape of hydrocarbons at the molecular level which makes them compliant with EPA emissions and permeation requirements. Constructed from seamless, thick-walled plastic, they are up to **30% tougher** than other brands.

Other features:

- ✓ ABYC/NMMA/EPA/CARB Compliant
- ✓ Rotating fuel withdrawal
- ✓ Fuel reserve
- ✓ Sight gauge
- ✓ Cap tether
- ✓ Audible click on closure of cap
- ✓ EPA-compliant cap
- ✓ Two-year warranty

Reliable

Portable tanks feature two-year warranty.

Safe

Two-way vented cap safely releases system pressure.



Durable

Seamless, thick-walled plastic is tougher than other brands.



This logo indicates that the tank meets or exceeds EPA regulations for marine fuel systems emissions.

Portable Fuel Tanks



620003LP

3 Gal/ 11L Ultra 3
16.60" L x 8.50 W x 9.60" H
422 mm L x 216 mm W x 244 mm H



620049LP

6.5 Gal/ 23L Ultra 6
21.50" L x 13.18" W x 10.10" H
546 mm L x 334.8 mm W x 257 mm H



630009LP

9 Gal/ 34L
23.06" L x 14.25" W x 11.57" H
586 mm L x 362 mm W x 294 mm H



630012LP

12 Gal/ 45L Moeller 12 Tall
22.75" L x 14.00" W x 13.95" H
578 mm L x 356 mm W x 354 mm H



630013LP

12 Gal/ 45L Moeller 12 Low Profile
24.51" L x 17.76" W x 10.82" H
623 mm L x 451 mm W x 275 mm H



Fuel Accessories



The fuel line assembly connects your outboard to your Moeller fuel tank.

Fuel line assemblies must comply with both USCG safety regulations and EPA evaporative emissions requirements. Hose and primer bulbs are also required to meet low permeation standards. Below deck fuel line assemblies must conform to ABYC H-24, and outboard fuel assemblies must be installed in accordance with ABYC H-25. Hoses which are exposed to sunlight—this includes nearly all hoses used in outboards—must also be UV resistant.

Moeller hose and primer bulb assemblies are EPA and CARB-approved and UV resistant. Bulbs feature dual internal check valves for rapid priming and fuel flow back prevention.



When to Replace Outboard Fuel Line Assemblies

Manufacturers generally use ten years as the lifespan for gasoline hoses, but it's important to inspect the fuel lines every year. Remember, the inner lining of older hose is susceptible to deterioration from E-10 fuel. If there's any doubt, replace them with a new Moeller hose and clamps. Hose should be inspected for cracks, stiffening, mushiness, and leaks around the fittings/connectors. Examine primer bulb which may also be damaged by alcohol-blended fuel. If they feel squishy to the touch and the engine can "suck" the bulb flat, replace them. If the bulb is deteriorating, the check valves may fail and leave you stranded! While your tank fitting is not part of the fuel assembly, you will want to check it when you evaluate the rest of the fuel system.

Fuel Line Assembly Installation Tips

- Be sure to have the engine manufacturer's instructions handy.
- Remember to de-pressurize the system before you begin. Most fuel leaks occur at fittings, so careful installation of all components is critically important. Moeller uses O-ring construction on all fittings for tight, leak-free connections.



034390-10LPA UNIVERSAL FUEL ASSEMBLY

3/8" ID Hose, B1-15, 80" length
when used with connectors

- Gasoline & solvent-resistant
- Stainless steel clamps
- Dual internal check valves



PRIMER BULBS













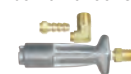

034590-10LP

3/8" Hose Barbs

034690-10LP

5/16" Hose Barbs

Fuel Assemblies

	Engine Connector	Hose	Fuel Line Connector	Tank Connector
 <p>*034385-10LPA EPA</p>	<p>033482-10 1998 & Newer Style Engines</p>  <p>1997 & Older: Use 033481-10 (Yamaha)</p> <p>033485-10 Nylon Female Bayonet Style</p> 	<p>3/8 in. ID</p> 	<p>033486-10 1998 & Newer Style Engines</p>  <p>033421-10</p> 	<p>033477-10 1998 & Newer Style Engines</p>  <p>033418-10 Combo kit with 90° elbow</p> 
 <p>*034391-10LPA EPA</p>	<p>033480-10</p> 	<p>3/8 in. ID</p> 	<p>033480-10</p> 	<p>033400-10</p> 
 <p>*034394-10LPA EPA</p>	<p>033481-10</p> 	<p>3/8 in. ID</p> 	<p>033481-10</p> 	<p>033470-10</p> 





033323-10

LONG FILTER REPLACEMENT FOR UNIVERSAL & MERCURY

- 10 micron filtration
- 11/16" thread opening
- 4.35" tall

 Not recommended for use with diesel engines



099076-00

UNIVERSAL ROUND CUP MOTOR FLUSHER

- No tools required
- Easy to use

For use on all lower units with side water inlets



099077-00

UNIVERSAL RECTANGULAR CUP MOTOR FLUSHER

- Ideal in low-pressure conditions often found in marinas
- For use on all lower units with side water inlets, including Volvo SX

Improved water flow with rectangular cups virtually eliminates water leakage during higher-pressure flushing



099082-00

RECTANGULAR DUAL WATER FEED

- A customer favorite for all engines over 50 hp
- For use on all lower units with side water inlets, including Volvo

Improved water flow with rectangular cups virtually eliminates water leakage for higher-pressure flushing



Dash Mounted Gauge



035725-10

SWINGARM ELECTRICAL

- 4-28 in. 102-685 mm
- Manufactured from corrosion-resistant materials
- Float rotates for tank wall & baffle clearance
- Purchase electrical sending units based on range of tank depth; adjust to correct length
- 1/4 in. ground spade terminal

Swingarm Electrical Sending Units gather fuel level information from a float which is read on dash-mounted.

Item #	Voltage	CFM Open Flow	Amp Draw	Fuse Size
053710-10	12V	120	1.5	3 Amp
053715-10	12V	230	1.5	5 Amp



053710-10
3" In-Line Blower



053715-10
4" In-Line Blower

12V In-Line Blowers

USCG 183,410 COMPLIANT

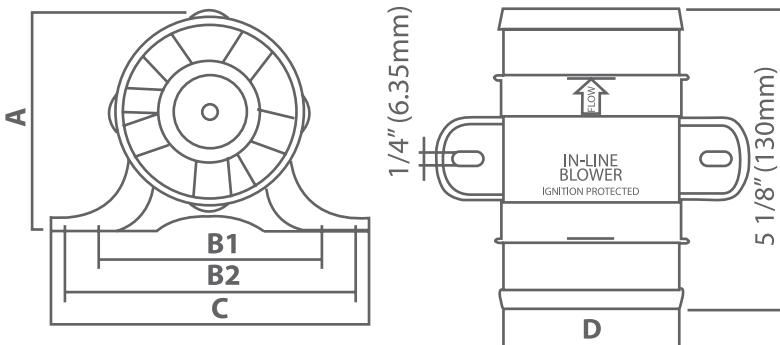

Item #	A	B1
053710-10	3 9/16"	3 21/32"
053715-10	4 19/32"	4 21/32"

Item #	B2	C	D
053710-10	4 3/4"	4 3/4"	6 3/16"
053715-10	5 3/4"	5 3/4"	6 3/16"

ISO8846 • ISO9097 • ABYC H-2
NMMA TYPE ACCEPTED 



Plumbing

Now you can get our most popular plugs in a convenient PDQ display!

This unique design allows your display box to sit on a shelf or be hung on peg hooks.

Each box contains 24 individually UPC labeled plugs.

Sold by the each in multiples of 24.





Twist Turn Drain Plug

Tightens in place with a clockwise rotation of the "T" handle. 1" diameter. Made of corrosion resistant brass.

053061-10

1" BRASS PLUG

053064-24

24 TURN PLUGS (PDQ)

1" BRASS PLUG



Snap Down Drain Plug

Simply snaps in the drain tube for a secure fit. Corrosion resistant, brass model available in 2 popular sizes.

053056-10

1" BRASS PLUG

053060-10

1 1/4" BRASS PLUG

053062-24

24 SNAP PLUGS (PDQ)

1" BRASS PLUG



Baitwell / Bailer Plugs

Brass Livewell/Baitwell drain plugs snap shut to form a secure seal. Brass construction.

053065-10

1/2" PAIR

053070-10

5/8" PAIR

053075-10

3/4" PAIR



020305-10

BRASS TRANSOM DRAIN PLUG KIT

- Cast brass flange with brass plug
- 1/2" NPT Thread
- Flange OD 2" Depth 5/8"

020307-10

BRASS REPLACEMENT DRAIN PLUG 1/2"



053040-10

BILGE PUMP INSTALLATION KIT

Kit Contains:

- 6 ft. corrugated hose
- (2) stainless steel hose clamps
- 3/4" white thru-hull



053725-10

UNIVERSAL LOWER UNIT LUBE PUMP

- Fits all quart bottles
- Extra threaded adapter for 1 1/2" neck quart and gallon bottles
- Includes 3 engine adapters for most outboards of stern drives.
 - 3/8" adapter fits Outboards J/E, Mercury/Mariner, Stern drives OMC, Cobra, OMC SX Cobra, Mercruiser, Speedmaster and Volvo Penta SX.
 - M10 adapter fits Suzuki 4 stroke
 - M8 adapter fits Yamaha, Honda, Mercury 4 stroke, Nissan and Tohatsu
- Not for transfer of fuel or gasoline



THRU-HULL CONNECTOR WITH BROAD FLANGE

Molded plastic with wide flange.
Not recommended for use below the waterline.

Item #	Hose	Flange OD	Max Hull Thickness
053050-10	3/4"	1 3/4"	1 1/4"
053055-10	1 1/8"	1 7/8"	1 1/4"

Pumps and Switches



053045-10 3 WAY BILGE PUMP SWITCH

Pump switch made of corrosion proof aluminum back plate. The fuse access is located on the front of the switch panel. Comes standard with a red indicator light which lets you know when the bilge is turned on and off. 3-way switch with auto-off-momentary.

- Plate measures 3.5" x 2" x .04"
- Easy to Mount
- Requires 2 1/2" x 1 3/8" cut-out



053001-10 AUTOMATIC FLOAT SWITCH

This automatic switch has a time-proven micro switch without mercury. When water exceeds the acceptable level, the pump is turned on by a rolling steel ball, which changes the pressure on micro switch.

- Full automatic bilge pumping operation, connect the automatic switch to your bilge pump
- The 053001-10 attaches to any Moeller or Johnson Pump bilge pump through the clip on "T-slot" and can be used with 6, 12, 24 or 32V systems.



CARTRIDGE - SUBMERSIBLE BILGE PUMP

Our cartridge bilge pumps incorporate some of the most advanced features in the industry. For 500 GPH and 750 GPH, we have improved the design with easy-to-install Dura-Port discharge ports to eliminate stress cracking caused by over-tightened hose clamps. The pumps are delivered including both a straight and 90° smooth elbow Dura-Port as well as a removable check valve. Dualport fittings.

Item #	Description	Capacity 3ft head (13.6V)	Capacity straight (13.6V/ 27.2)	Amp	Fuse size	Connection
053005-10	500 GPH 12V	33 l/min - 525 GPH	40 l/min - 630 GPH	2.5A	5A	3/4"
053015-10	750 GPH 12V	44 l/min - 700 GPH	50 l/min - 800 GPH	3A	5A	3/4"



REPLACEMENT CARTRIDGES FOR BILGE PUMP AND AERATORS

Replacement cartridge for Moeller and Johnson Pump and aerators.

- 500 GPH, 3/4" hose, 12V, 2.5A, 5A fuse

Item #	GPH	Hose	Volts	Amp	Fuse
053010-10	500	3/4"	12	2.5	5A
053020-10	750	3/4"	12	3	5A

Pumps and Switches



CARTRIDGE - AERATOR PUMP

Livewell pumps in 500 GPH capacity with 2 different intake configurations, straight and 90°. Smaller profiles to fit in more confined spaces. Easy to change motor cartridge. The pumps are delivered including both a straight and 90° smooth elbow Dura-port.

Item #	Description
053030-10	Cartridge Bilge Pump 500 GPH 12V - Straight
053035-10	Cartridge Bilge Pump 500 GPH 12V - 90°



053025-10

CARTRIDGE BILGE PUMP & FLOAT SWITCH COMBO

This great value, easy to clean pump has a water cooled motor. Packed with a rolling ball float switch that activates your pump. Prewired for automatic operation with manual override.

- 500 GPH, 3/4" hose, 12V, 2.5A, 5A fuse





Lighting



054200-10

BOW LIGHT WITH RED/GREEN LENSES

- Mounts on decks or gunwales with external screws
- 12 V DC - 6 CP - 7.5W - Lamp with 90GE bulb included
- Predrilled with 2 countersunk holes to accommodate #8 screws
- Housing is die-cast zamak
- 2 1/4" L x 1 3/8" H x 2 1/2" base width

054215-10

LED BOW LIGHT WITH RED/GREEN LENSES

- 1 mile visibility for boats under 39'
- Predrilled with 2 countersunk holes to accommodate #8 screws
- Housing is die-cast zamak to be mounted horizontally
- Meets USCG regulations
- 2 1/4" L x 1 3/8" H x 2 1/2" base width



054205-10

LARGE BOW LIGHT WITH RED/GREEN LENSES

- 12 V DC - 8 CP - 7.5W
- Predrilled with 2 countersunk holes to accommodate #8 screws
- Housing is chrome plated Zamak with a black plastic base
- 4" L x 3 1/8" H x 1 3/8" base width

054225-10

LED LARGE BOW LIGHT WITH RED/GREEN LENSES

- 2 mile visibility for boats under 39'
- Predrilled with 2 countersunk holes to accommodate #8 screws
- Housing is chrome plated zinc with a low profile black plastic base
- Meets USCG regulations
- 4" L x 1 3/4" H x 3 1/8" base width

MOELLER[®]
marine products



054210-10
BOW LIGHT WITH RED/GREEN LENSES

- Supplied with prewired brass socket and bulb.
- Polished Stainless Steel
- Size: Round 3" Diameter



054220-10
LED RED/GREEN COMBINATION BOW LIGHT

- Meets ABYC-A16/USCG 2NM visibility
- 1.1W power consumption
- 12v DC
- Housing is white PC. Also, comes with a Stainless steel cover for an optional decorative look



054230-10
TRANSOM LIGHT

- Case is made of 304 polished stainless steel with clear plastic lens
- Supplied with rubber mounting gasket
- 3" diameter, 1 3/4" deep
- Uses #8 screws



LED CLAMP-ON PORTABLE BATTERY OPERATED LIGHT

Each light requires 3 AAA batteries (not included)

054235-10

- Bow Light: Red/Green portable bow light with adjustable clamp for horizontal or vertical surfaces

054240-10

- Stern Light: 24" pole light with adjustable clamp for horizontal or vertical surfaces
- High visibility
- Water resistant
- Compact size and quick release



054255-10
LED FLUORESCENT LIGHT

- Single bulb, LED 12 PC
- Size: 15" L x 3" W, 1" H
- Volts: 12-24V
- Surface mount with On-Off rocker switch



054250-10
LED FIXED RECESSED UTILITY LIGHT

- Molded black plastic
- Comes with 3 white LED's
- Size: 2 1/4" x 2 1/4" x 13/16"
- Installed in 1 3/4" diameter opening



054260-10
LED STRIP LIGHT

- Water Resistant
- 12/24V DC
- Predrilled to accommodate
- #8 screws included

***Not for underwater applications**



054245-10
ALL-ROUND WHITE LIGHT

- 2-mile visibility for boats 66'
- 24" Stainless steel pole with white translucent globe
- 12V DC, 15 CP lamp
- Chrome plated zinc, plug in base
- Drilled to accommodate 3 #8 screws

Meets IMO COLREG 72, USCG, ABYC A-16 and NMMA Type accepted



Electrical



053300-10
WATER TIGHT DECK CONNECTOR

- 1 1/2" diameter, chrome plated brass flange with waterproof plastic snap-on cover
- 2 pin double contact socket and plug with a plastic boot



053310-10
2 ROUND POLARIZED ROUND CONNECTOR

- Constructed of rugged plastic with molded-in terminals
- Soft, pliable rubber caps at the rear of each connector
- Sold only in mating pairs



053315-10
HEAVY-DUTY MARINE BATTERY TERMINALS

- Made of lead with steel wing nuts.
- Allow the use of automotive style batteries.
- Convert the post style battery to the wing nut style for easy marine connections to battery.
- Negative 5/16" | Positive 3/8"
- Sold by the pair

Trolling Motor Plugs



054400-10
MALE MOTOR SIDE TROLLING MOTOR PLUG

- 12V, 3 plugs
- 10" - 10 gauge w/butt connectors
- Use with 054410-10



054410-10
FEMALE BOAT SIDE TROLLING MOTOR SOCKET

- 12V, 3 slots
- 10" - 10 gauge w/butt connectors
- Use with 054400-10



054405-10
FEMALE MOTOR SIDE TROLLING MOTOR SOCKET

- 12V
- 6" - 8 gauge w/butt connectors



099078-10

BATTERY TERMINAL COVER SET

- Includes 1 black and 1 red cover Flexible PVC
- Accepts up to 1/2" OD cable



053330-10

PUSH BUTTON SWITCH Heavy Duty

- Momentary On-Off SPST
- 7/16" L x 5/8" mounting stem
- Boss screw terminals
- 30A @ 12V DC



053340-10

IGNITION STARTER SWITCH Heavy Duty

- 3 position: Off-Ignition-Start
- 3 terminals
- 15A @ 12V DC
- Chrome plated brass face nut and brass back-up nut
- Stainless steel springs
- Panel thickness to 1"



053345-10

IGNITION STARTER SWITCH Push to Choke

- 3 position: Off-Ignition-Start
- 6 terminals
- 20A @ 12V DC
- Supplied with 2 keys



053335-10

PUSH BUTTON SWITCH

- Solid brass construction
- For starter, horn or other functions
- Momentary On-Off SPST
- 1 1/4" L x 5/8" mounting stem
- 2 screw terminals
- 25A @ 6V DC



053320-10

BATTERY CLIPS

- 30A
- Copper plated
- Jaw opening: 1" long

Heavy Duty Marine Push Pull Switches



053350-10

- Off-On SPST | Pull for ON
- Chrome plated plastic knob
- Solid brass construction
- 3/8" mounting bushing
- For panels up to 1" thick
- 2 screw terminals
- 15A @ 12V DC



053355-10

- Off-On(1)-On(1&2) SPDT
- 1st pull energizes #1, 2nd pull energizes both circuits
- Chrome finish plastic knob
- Solid brass construction
- 3/8" mounting bushing
- For panels up to 1" thick
- 3 screw terminals
- 15A @ 12V DC

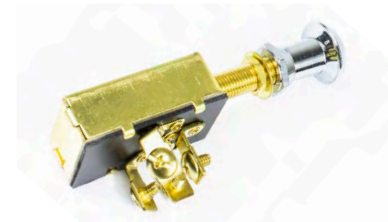

053360-10

- Off-On(1)-On(2&3) SPDT
- 1st pull energizes #1, 2nd pull energizes 2 separate circuits
- For anchor/running lights or similar function
- Chrome finish plastic knob
- Solid brass construction
- 3/8" mounting bushing
- For panels up to 1" thick
- 4 screw terminals
- 15A @ 12V DC

Switches

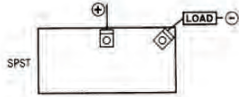

053370-10

- On-Off SPST

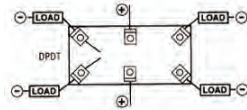

053375-10

- On-Off-On DPDT

STANDARD TOGGLE SWITCHES

- Non-corrosive plastic construction
- Brass blade terminals, silver contacts
- 15/32" L x 15/32" -32 mounting stem
- 10A @ 12V DC



053380-10

- On-Off SPST

HEAVY DUTY 25A TOGGLE SWITCH

- Nickel plated brass mounting stem and hardware
- Handle 11/16" long
- Mounting stem 15/32" -32 thread, 15/32" long
- Fits panels up to 1/4" thick
- 25A @ 12V DC



053385-10

- On-Off-On SPDT

WEATHER RESISTANT TOGGLE SWITCH

- Heavy Duty
- Chrome plated brass bat handle
- 3/8" L x 15/32" -32 mounting stem
- 3 screw terminals
- 20A @ 125V AC



053905-10

- On-Off SPST

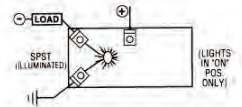

ILLUMINATED ROCKER SWITCH

- Dependent pilot light
- Illuminated in "on" position
- Non-corrosive plastic construction
- Silver contacts
- Brass blade terminals
- 15A @ 12V DC



053395-10

WEATHER PROOF BOOT NUT (BLACK)

- For standard toggles w/ 15/32" mounting stem
- Completely covers toggle handle
- Seals out moisture and dirt



053435-10

ACCESSORY PLUG & SOCKET

- Nylon and nickel plated
- Numerous applications and uses
- Includes: Weather resistant-seal flap and O-ring gasket
- Supplied with #8 x 3/4" stainless steel screws



053440-10

CHART LIGHTER SOCKET/ CIGARETTE LIGHTER

- Includes stainless steel spring and plate
- Push on wires | 12V
- Lighter handle contains on-off switch for chart light
- Requires 2 1/4" behind dash
- Extends 1" from dash

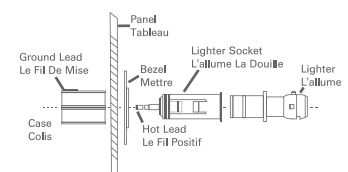

Blocks



053430-10

BARRIER TYPE JUNCTION BLOCK

- 8 gang block • 16 10-32 screw terminals
- Overall size: 5.33" L x 1.312" W x .812" H
- 3/8" mounting bushing
- Nickel plated • 30A @ 12V DC
- Each screw pair is 1 isolated circuit
- Closed back insulates power from mounting circuit



053425-10

HOT FEED/COMMON GROUND FUSE BLOCK

- 6 gang • Tin plated brass fuse clips
- Use with SFE, AGC, or MGL fuses up to 20A
- Common bus bar connects hot side of fuses for power feed
- Separate bus bar for ground or unfused common hot feed
- Heavy duty black molded base
- 8-32 terminal screws and stud terminals for power/ground connection

Fuse Holders



053305-10

PANEL MOUNT GLASS TUBE STYLE FUSE HOLDER

- Weather resistant gasket sealed
- For AGC, MDL fuses
- For panels up to 5/16" thick
- Fuse not included



053400-10

IN-LINE GLASS TUBE STYLE FUSE HOLDER

- White plastic twist lock case
- 16 gauge wire loop
- Includes 10A fuse



WATERTIGHT IN-LINE FUSE HOLDER

053410-10

- 10 GA 8" wire loop w/ 2- 30A fuses

053405-10

- 16 GA 8" wire loop w/ 2- 10A fuses



053420-10

ATO/ATC IN-LINE FUSE HOLDER

- Sealed case
- Up to 30A
- 10 gauge, 3" wire
- Includes 10A fuse

Switches



053445-10

UNIVERSAL KILL SWITCH AND LANYARD

- 50" coil type tether
- Black nylon casting
- 5A @ 12V



053455-10

UNIVERSAL 7 KEY KILL SWITCH

- Keys to fit: Johnson, Evinrude, Mercury, Yamaha, Honda, Tohatsu, Suzuki, and Nissan kill switches
- 70" coil type tether



053450-10

RED MAIN BATTERY SWITCH Off/1/All/2

- 6 - 32V DC
- Continuous Rating: 210 A
- Intermittent Rating: 315 A/ 5 sec.



042229-10

TWO BATTERY SWITCH ON-ON-OFF

- 2.72 in. L x 2.72 in. W x 2.87 in. H
- 12-50 Volts DC
- 200 A DC
- 1000 A DC
- Designed to work with two battery systems
- Includes any 4-direction battery cable

Battery Accessories



042213

BATTERY BOX

Holds 24 Series Batteries

13.43 in. L x 9.09 in. W x 10.34 in. H
341 mm L x 231 mm W x 263 mm H

Fits Batteries to:
10.50 in. L x 7.00 in. W x 8.37 in. H
Complete with hold-down strap and mounting hardware



042214

BATTERY BOX

Holds 27, 30 & 31 Series Batteries

16.63 in. L x 9.56 in. W x 10.75 in. H
422 mm L x 243 mm W x 273 mm H

Fits Batteries to:
12.75 in. L x 7.00 in. W x 9.00 in. H
Complete with hold-down strap and mounting hardware



042233

BATTERY TRAY

Holds 24 Series Batteries

11.31 in. L x 7.25 in. W x 1.31 in. H
287 mm L x 184 mm W x 33 mm H
Heavy Duty battery tray includes tray, quick release buckle and strap

Holds Batteries up to:
10.25 in. L x 6.75 in. W x 8.12 in. H
14.5 in. strap length



042234

BATTERY TRAY

Holds 27 Series Batteries

12.94 in. L x 7.25 in. W x 1.31 in. H
329 mm L x 184 mm W x 33 mm H
Heavy Duty battery tray includes tray, quick release buckle and strap

Holds Batteries up to:
11.75 in. L x 6.75 in. W x 7.75 in. H
14.5 in. strap length

Electronics



042217-10

REPLACEMENT

39" BATTERY STRAP

- Includes footman loops & stainless steel screws



053500-10

ANTENNA BASE

- White base, full fold down, all position lock
- Stainless steel hardware
- Fits most VHF antennas
- 1" - 14 threads. Base: 2.5" x 3.6"



053485-10

PITOT TUBE

- Universal replacement for most popular brands.
- 80 MPH maximum
 - Fits existing mounting holes

Hardware

SNAP AND HOOK APPLICATION GUIDE

Item #	Max Work Load/ lbs	Item #	Max Work Load/ lbs	Item #	Max Work Load/ lbs
053225-10	2000	054090-10	550	054080-10	600
053230-10	3000	054095-10	1000	054070-10	300
053245-10	2000	054100-10	200	054130-10	1750
053240-10	1000	054105-10	200	054135-10	500
053235-10	600	054110-10	200	054125-10	500
054020-10	6000	054115-10	250	-	-
054025-10	12000	054120-10	150	054505-10	1250
054085-10	350	054075-10	700	-	-

Cleats

CHROME PLATED ZAMAK CLEAT

Hollow base cleat with chrome plating for corrosion resistance.
Use #8 fastener



054000-10

- 4 1/2" Zamak Cleat, **Pair**
- 4/1/2" x 3/4" height

054005-10

- 6" Zamak Cleat, **Pair**
- 6" x 7/8" height

054015-10

6" BLACK NYLON CLEAT

- Durable high impact, open base cleats.
- UV resistant.
- Perfect for docks
- Display pack



Clamps



184008-10

STAINLESS STEEL HOSE CLAMPS (2)

0.25 in. x 0.88 in.
6 mm x 22 mm

Straps

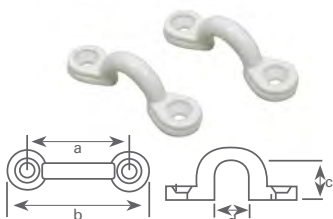

054035-10

PLASTIC EYE STRAPS

- White molded plastic eye straps with inset holes for a flush mount
- 4 pack

A: 1 7/8" B: 1 7/8" C: 5/16" D: 1/2"

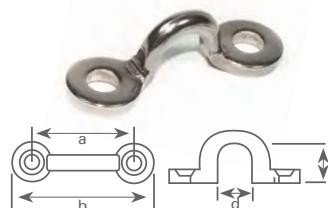

054040-10

STAINLESS STEEL EYE STRAPS

- Pre drilled stainless steel eye straps with inset holes for a flush
- 4 pack

A: 1 5/6" B: 1 13/16" C: 5/16" D: 1/2"

Bow Eyes



BOW EYE
304 Stainless Steel
Not for lifting

054020-10 *

- Max Safe Load: 6,000 lbs.
- Size: 3/8" Thread: 3 1/2"

054025-10 *

- Max Safe Load: 12,000 lbs.
- Size: 1/2" Thread: 3 1/2"



054030-10 *

BOW EYE

- Die cast ZAMAK eye with chrome finish.
- Cadmium plated, single shank
- Shank length: 3" x 3/8"

Not for lifting

Hooks



SAFETY SPRING HOOK
Zinc Plated Steel

Spring loaded, interlocking safety snap. Not recommended for towing or lifting.

054070-10 *

- Size: 1/4" x 2 1/2"
- Max Safe Load: 300 lbs.

054080-10 *

- Size: 3/8" x 4"
- Max Safe Load: 200 lbs.

054075-10 *

- Size: 5/16" x 3 1/4"
- Max Safe Load: 700 lbs.



SAFETY SPRING HOOK
316 Stainless Steel

Spring loaded, interlocking safety snap. Not recommended for towing or lifting.

054085-10 *

- Size: 1/4" x 2 1/2"
- Max Safe Load: 350 lbs.

054090-10 *

- Size: 5/16" x 3 1/4"
- Max Safe Load: 550 lbs.

054095-10 *

- Size: 3/8" x 4"
- Max Safe Load: 1,000 lbs.



054100-10 *
SWIVEL EYE SNAP HOOK
Chrome Plated Brass

Spring loaded closure, for a variety of uses

- Throat: 1/2" Length: 3"
- Eye Diameter: 5/8"
- Max Safe Load: 200 lbs.



SWIVEL EYE SNAP HOOK
Polished Cast Brass

054105-10 *

- Size: #1
- Length: 3 1/4"
- Eye ID: 5/8"
- Snap ID: 3/8"
- Max Safe Load: 200 lbs.

054110-10 *

- Size: #2
- Length: 3 3/4"
- Eye ID: 3/4"
- Snap ID: 1/2"
- Max Safe Load: 200 lbs.



054115-10 *
SWIVEL EYE BOLT SNAP
Stainless Steel

- Length: 3"
- Throat: 3/8"
- Max Safe Load: 250 lbs.



054120-10 *
SWIVEL EYE BOLT SNAP
Polished Cast Brass

- Length: 3"
- Throat: 1/2"
- Max Safe Load: 150 lbs.



054130-10 *
WINCH HOOK
Forged Steel, Zinc Plated

- Closure is spring loaded
- Heavy Duty
- Size: 5/8" x 4 1/4"
- Max Safe Load: 1,750 lbs.
- Throat: 5/8"



054135-10 *

SNAP HOOK
Zinc Plated

Rugged hook with spring loaded closure

- Heavy Duty
- Length: 3 1/2"
- Max Safe Load: 500 lbs.
- Eye: 5/8" Snap ID: 9/16"



054125-10 *
UNIVERSAL SNAP HOOK
Wire Formed Zinc Plated Steel

- Size: 4"
- Max Safe Load: 500 lbs.

*** If personal safety, life and limb are at risk, DO NOT USE. SEE CHART ON PAGE 19 FOR MAX SAFE LOAD INSTRUCTIONS.**

Hinges



BUTT HINGES

054140-10
**Polished 304 Stamped
 Stainless Steel**

- Size: 1 5/16" x 1 1/2"
- #8 Fastener
- Pair



054150-10
316 Stainless Steel

- Size: 2" x 2"
- #8 Fastener
- Pair



054160-10

CAM LOCK
Chrome Plated Steel
 Comes with complete set of
 installation hardware

- Size: 1 1/8" L
- Includes 2 keys



054145-10

UTILITY HINGES
**Polished 304 Stamped
 Stainless Steel**

- Size: 2 7/8" x 1 1/2"
- #8 Fastener
- Pair



054155-10

STRAP HINGES
304 Stainless Steel
 Drilled and countersunk

- Size: 4" x 1"
- #10 Fastener
- Pair



054045-10

FRICTION CATCH
Chrome Plated Brass

- Size: 1 15/16" x 3/8"
- #6 Fastener



054050-10

HATCH HOLDER
304 Stainless Steel
 Recommended for hatches
 up to 10 lbs.

- Size: 8"



054060-10

90° ANGLE BRACKET
Stainless Steel

- Size: 2 3/8" x 1/2"
- #8 Fastener
- Pair



054065-10

SWIVEL EYE SAFETY HASP
304 Polished Stainless Steel

- Size: 1" x 2 3/4"
- #8 Fastener



054055-10

FLUSH RING PULL
Chrome Plated Cast Brass

- Size: 1 7/8" x 2 1/2"
- #8 Fastener



054165-10

BARREL BOLT
Chrome Plated Cast Brass
 Friction pad included to
 eliminate rattle

- Size: 2 1/2" x 1/4"
- Length: 2 1/2"
- #6 Fastener



053705-10

DECK PLATE KEY AND TOOL
Non-magnetic Stainless Steel

- Universal key has many appli-
 cations including bottle opener
 and screwdriver.
- Overall length: 3 7/8"



General Boating Supplies



053820-10

**DRINK HOLDER
Folding & Adjustable**

Made of reinforced nylon, with stainless springs. Pop-up, adjustable arms hold cans, glasses, insulated drink holders and bottles.

- Expands from 2 1/4" to 3 1/2"
- Color: Black



053815-10

**DRINK HOLDER
Chrome Plated Brass**

Foam thermal insulator and 2 mounting brackets. Swings freely to prevent spills and is easily detachable.

- Supplied with #8 screws



053800-10

3" BLACK LETTER KIT

- Contains 4 of each 3" letter & number, as well as 16 dashes
- Waterproof
- Peel and stick
- Meets USCG regulations



053810-10

KEY FLOAT

Key float with chamber used to store small items such as registration, money, etc.

- Color top snaps apart.



053805-10

UNITED STATES FLAG

Reinforced printed nylon body with brass grommets.

- 12" x 18"
- MADE IN THE USA



Fishing & Accessories

053610-10

BOAT HOOK HOLDER

Polished Stainless Steel
Holds poles up to 1 1/2" diameter

- Size: 3 1/2"
- #6 Fasteners



053615-10

POLE STORAGE CLIPS

Soft rubber holds light pole snugly without scratching or denting.

- Easy mount on flat surfaces
- Fits 3/4" tubing
- #6 Fasteners



053620-10

SPRING CLAMPS

Polished Stainless Steel

- Size: 5/8" - 1 1/4"
- #6 Fasteners



053605-10

ROD HOLDER

Excellent anywhere a flush mount holder can be installed

- PP tube and metal clamps
- Size: 12" L x 1 3/4" W



054300-10

AIR HORN KIT 8 OZ.

Push button, 8 oz. signal horn kit. Complete with trumpet made of a high impact plastic.

- 120 decibels at over 3 feet
- UPS-able

054301-10

AIR HORN REFILL 8 OZ.

**Great for boats,
sports, safety,
and construction!**



8oz. Air Horn Kit

**USCG COMPLIANT
& OZONE SAFE**



Steering, Anchoring & Docking

Steering

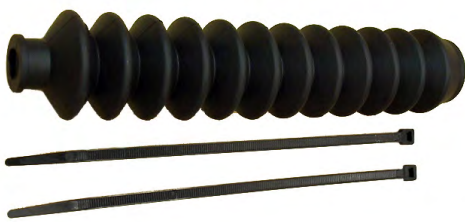

054415-10

RUBBER CABLE PROTECTOR

Rubber boot to fit over output end of steering cable for complete protection from elements.

- Fits all standard steering cables including SeaStar, Detmar, etc.
- Heavy Duty

Links



CHAIN LINKS

053225-10 *

- 1/4" Stainless Steel Quick Link
- Max Safe Load: 2,000 lbs.

053230-10 *

- 5/16" Stainless Steel Quick Link
- Max Safe Load: 3,000 lbs.

053235-10 *

- 3/16" Zinc Plated Steel Quick Link
- Max Safe Load: 600 lbs.

053240-10 *

- 7/32" Zinc Plated Steel Quick Link
- Max Safe Load: 1,000 lbs.

053245-10 *

- 5/16" Zinc Plated Steel Quick Link
- Max Safe Load: 2,000 lbs.

*** If personal safety, life and limb are at risk, DO NOT USE.
SEE CHART ON PAGE 19 FOR MAX SAFE LOAD INSTRUCTIONS.**

Anchoring



053200-10

LOCKING ANCHOR CONTROL

Zinc Plated Steel

The locking anchor control pulley allows for easy and safe setting of mushroom or river anchor, typically from a small freshwater fishing boat. Easy operation allows the operator to set and retrieve the anchor from a sitting position.

- Holds up to a 20 lb. anchor
- 1/4" to 7/16" rope



053210-10

ANCHOR SHACKLE

Forged Stainless Steel

- One per card
- Size: 5/16"
- Max Safe Load: 1,000 lbs.
- Compatible with 053215 anchor



053220-10

ANCHOR CHAIN WITH SHACKLE

Galvanized

Hot dipped galvanized proof coil anchor lead chain supplied with 2, 5/16" hot dipped galvanized shackles.

- Size: 1/4" x 4"
- For boat size: 16' - 28'



053215

MUSHROOM ANCHOR

Vinyl Coated

Cast iron with a heavy duty PE black coating for scratch protection.

- Weight: 8 lbs.

MOELLER[®]
marine products

Fueling
the Fun





Boat Cover & Bimini Accessories



053105-10

EXTERNAL EYE END

Stainless Steel

Replacement external eye end fitting made of marine grade 316 stainless steel.

- Size: 7/8"



053110-10

DECK HINGE

Stainless Steel

Made of marine grade

- 316 stainless steel
- Offers superior performance
- 7/8" x 2"



053100-10

REPLACEMENT BIMINI STRAP

Adjustable Bimini top straps

- 1" nylon webbing
- Ring snap and buckle are corrosion resistant
- Color: Black
- Pair



2 Person Tow Rope

054705-10

2 PERSON TOW-ABLE ROPE

Designed for towing 1 or 2 persons in an inflatable tube.

- 2375 lb. Break strength
- 60 feet long
- Minimal stretch for safe tubing
- Rope caddy and foam float included

054700-10

DELUXE WATER SKI ROPE

- 16 strand poly rope
- Floating aluminum handle.
- 75 feet long

Deluxe Ski Rope

Ultra 6

All-in-1 Fuel Tank Combo Package

053701-10

Industry first All-in-1, Fuel Tank Combo Package

- EPA/CARB approved
- Applications with 2 prong barb engine fitting:
 - 1998 and newer Mercury
 - Most Evinrude/Johnson
 - Most Yamaha outboard engines

Includes:

- 1- 6 gallon fuel tank
- 1- Universal fuel line
- 1- Quick disconnect to tank fuel connector
- 3- fuel line connectors
(*Evinrude/Johnson, Mercury, Yamaha*)
- 1- Tank connector with sealant
- 1- Hose clamp





Trailering



054500-10

WINCH CABLE

Galvanized aircraft cable

- Length: 25'
- Size: 3/16"
- Tensile Strength: 4,000 lbs.

Not to be used for lifting or bodily harm may occur.



054505-10

TRAILER SAFETY CHAIN

Zinc Plated, Welded Link Chain

- Size: 1/4" x 42"
- Receiver: Class III
- 2 heavy duty hooks
- Max Load: 900 lbs



054510-10

UNIVERSAL LOCKING PIN

Zinc Plated Steel

Keeps coupler release handle from accidentally disengaging while in travel.

- Fits: 2" and 3"
- Pin: 5/16"

Rollers



054515-00

BOW ROLLER

Non-marking black rubber

- Length: 3"
- Hole: 1/2" ID
- Includes holder



054525-00

KEEL ROLLER

Non-marking black rubber with 5/8" nylon inserts.

- Length: 8"
- Includes holder



054520-00

ROLLER SPOOL

Non-marking black rubber with plastic sleeve.

- Length: 5"
- Hole: 5/8" ID
- Includes holder

Bearings



Each kit includes:

- 2 bearings with races
- 1 grease seal
- 1 cotter pin



054590-10

**BEARING PROTECTORS
W/ COVER**

Stainless Steel

Provides proper lubrication and inhibits corrosion by preventing intrusion of water and dirt.

- Fits: trailers with a 1.98" hub diameter
- All stainless steel internal parts
- Spring loaded for proper operation pressure
- Pair

Item #	Size	Bearing	Cup/Race
054575-10	1"	L44643	L44610
054580-10	1 1/16"	L44649	L44610
054585-10	1 3/8" x 1 1/16"	L68149 / L44649	L68111 / L44610

U-Bolts

Solid, mechanical, galvanized steel U-Bolts with nuts and lock washers.

- Covers most U-Bolt applications.
- One per card

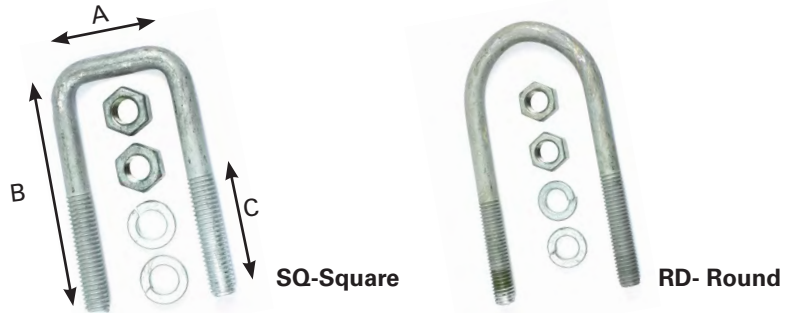

Item #	Thread	A	B	C	Type	For
054530-10	7/16"-14	1 9/16"	3 9/16"	1 3/4"	SQ	Axle U-Bolt Plates
054535-10	7/16"-14	3 1/16"	4 5/16"	1 3/4"	SQ	-
054540-10	7/16"-14	4 1/16"	2 13/16"	1 3/4"	SQ	Bolster Brackets for 4" Frames
054545-10	1/2"-13	2 1/16"	4 13/16"	2"	SQ	Axle U-Bolt Plates
054550-10	1/2"-13	2 3/8"	5 3/8"	2"	RD	Axle U-Bolt Plates
054555-10	1/2"-13	3 1/16"	6 5/16"	2"	SQ	-



054560-10

BUNK CARPETING

Protects boat hull from mars and scratches. Made of charcoal colored marine grade carpet with durable backing.

- Size: 8" x 12'
- Color: Black