



## OPERATOR'S MANUAL

**Cat. No.**  
**No de cat.**  
**5615-20 5616-20**  
**5619-20 5625-20**  
**48-10-5600**



## HEAVY-DUTY ROUTERS

**TO REDUCE THE RISK OF INJURY, USER MUST READ AND UNDERSTAND OPERATOR'S MANUAL.**

## GENERAL POWER TOOL SAFETY WARNINGS

 **WARNING READ ALL SAFETY WARNINGS AND ALL INSTRUCTIONS.** Failure to follow the warnings and instructions may result in electric shock, fire and/or serious injury. **Save all warnings and instructions for future reference.** The term “power tool” in the warnings refers to your mains-operated (corded) power tool or battery-operated (cordless) power tool.

### WORK AREA SAFETY

- **Keep work area clean and well lit.** Cluttered or dark areas invite accidents.
- **Do not operate power tools in explosive atmospheres, such as in the presence of flammable liquids, gases or dust.** Power tools create sparks which may ignite the dust or fumes.
- **Keep children and bystanders away while operating a power tool.** Distractions can cause you to lose control.

### ELECTRICAL SAFETY

- **Power tool plugs must match the outlet. Never modify the plug in any way. Do not use any adapter plugs with earthed (grounded) power tools.** Unmodified plugs and matching outlets will reduce risk of electric shock.
- **Avoid body contact with earthed or grounded surfaces such as pipes, radiators, ranges and refrigerators.** There is an increased risk of electric shock if your body is earthed or grounded.
- **Do not expose power tools to rain or wet conditions.** Water entering a power tool will increase the risk of electric shock.
- **Do not abuse the cord. Never use the cord for carrying, pulling or unplugging the power tool. Keep cord away from heat, oil, sharp edges or moving parts.** Damaged or entangled cords increase the risk of electric shock.
- **When operating a power tool outdoors, use an extension cord suitable for outdoor use.** Use of a cord suitable for outdoor use reduces the risk of electric shock.
- **If operating a power tool in a damp location is unavoidable, use a ground fault circuit interrupter (GFCI) protected supply.** Use of an GFCI reduces the risk of electric shock.

### PERSONAL SAFETY

- **Stay alert, watch what you are doing and use common sense when operating a power tool. Do not use a power tool while you are tired or under the influence of drugs, alcohol or medication.** A moment of inattention while operating power tools may result in serious personal injury.
- **Use personal protective equipment. Always wear eye protection.** Protective equipment such as dust mask, non-skid safety shoes, hard hat, or hearing protection used for appropriate conditions will reduce personal injuries.
- **Prevent unintentional starting. Ensure the switch is in the off-position before connecting to power source and/or battery pack, picking up or carrying the tool.** Carrying power tools with your finger on the switch or energising power tools that have the switch on invites accidents.

- **Remove any adjusting key or wrench before turning the power tool on.** A wrench or a key left attached to a rotating part of the power tool may result in personal injury.
- **Do not overreach. Keep proper footing and balance at all times.** This enables better control of the power tool in unexpected situations.
- **Dress properly. Do not wear loose clothing or jewellery. Keep your hair, clothing and gloves away from moving parts.** Loose clothes, jewellery or long hair can be caught in moving parts.
- **If devices are provided for the connection of dust extraction and collection facilities, ensure these are connected and properly used.** Use of dust collection can reduce dust-related hazards.

### POWER TOOL USE AND CARE

- **Do not force the power tool. Use the correct power tool for your application.** The correct power tool will do the job better and safer at the rate for which it was designed.
- **Do not use the power tool if the switch does not turn it on and off.** Any power tool that cannot be controlled with the switch is dangerous and must be repaired.
- **Disconnect the plug from the power source and/or the battery pack from the power tool before making any adjustments, changing accessories, or storing power tools.** Such preventive safety measures reduce the risk of starting the power tool accidentally.
- **Store idle power tools out of the reach of children and do not allow persons unfamiliar with the power tool or these instructions to operate the power tool.** Power tools are dangerous in the hands of untrained users.
- **Maintain power tools. Check for misalignment or binding of moving parts, breakage of parts and any other condition that may affect the power tool's operation. If damaged, have the power tool repaired before use.** Many accidents are caused by poorly maintained power tools.
- **Keep cutting tools sharp and clean.** Properly maintained cutting tools with sharp cutting edges are less likely to bind and are easier to control.
- **Use the power tool, accessories and tool bits etc. in accordance with these instructions, taking into account the working conditions and the work to be performed.** Use of the power tool for operations different from those intended could result in a hazardous situation.

### SERVICE

- **Have your power tool serviced by a qualified repair person using only identical replacement parts.** This will ensure that the safety of the power tool is maintained.

## SPECIFIC SAFETY RULES

- **Hold power tool by insulated gripping surfaces, because the cutter may contact its own cord.** Cutting a "live" wire may make exposed metal parts of the power tool "live" and shock the operator.
- **Use clamps or another practical way to secure and support the workpiece to a stable platform.** Holding the work by your hand or against the body leaves it unstable and may lead to loss of control.
- **Always wear safety goggles and dust mask. Use only in a well ventilated area.** Using personal safety devices and in a safe environment reduce the risk for injury.
- **Some woods contain preservatives that can be toxic.** Take extra care to prevent inhalation and skin contact when working with these materials. Request, and follow, any safety information available from your material supplier.
- **Always make sure the workpiece is free from nails, screws and other foreign objects. Keep the working edge away from the clamping surface.** Cutting these objects can cause loss of control of the tool and damage to the bit.
- **Never hold the workpiece in one hand and the tool in the other hand when using the tool. Never place hands near or below cutting surface.** Clamping the material and guiding the tool with both hands is safer.
- **Never use dull or damaged bits. Sharp bits must be handled with care.** Damaged bits can break during use. Dull bits require more force to push the tool, which could cause the bit to break. Damaged bits can throw carbide pieces and burn the workpiece.
- **After changing the bit or making any adjustments, make sure the collet nut and any other adjustment devices are securely tightened.** Loose adjustment devices can unexpectedly shift, causing loss of control. Loose rotating components will be violently thrown. Watch for vibration or wobbling that could indicate an improperly installed bit.
- **Maintain firm grip on router when starting motor to resist starting torque.**
- **Always keep the power supply cord away from moving parts on the tool.** Keep the cord away from the direction of the cut.
- **Never start the tool when the bit is in contact with the material.** The bit cutting edge may grab the material causing loss of control of the tool.
- **Never lay the tool down until the bit has come to a complete stop.** The spinning bit can grab the surface and pull the tool out of your control.
- **Never touch the bit during or immediately after use.** After use the bit may be hot enough to burn bare skin.
- **Never clamp the workpiece to a hard surface, such as concrete or stone.** Contact with the bit could cause the tool to jump and loss of control.
- **Only operate the routers when held.** Do not clamp or secure the router to a surface and hold the workpiece by hand.

- **Never use bits larger than the smallest of the openings in the base, sub-base, or dust collection port.**
- **Do not loosen or remove the plunge base caps.** Internal springs are under pressure. If loosened or removed, the plunge base caps and internal springs will become projectiles, which could cause injury.
- **Maintain labels and nameplates.** These carry important information. If unreadable or missing, contact a *MILWAUKEE* service facility for a free replacement.

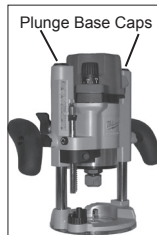

- **WARNING:** Some dust created by power sanding, sawing, grinding, drilling, and other construction activities contains chemicals known to cause cancer, birth defects or other reproductive harm. Some examples of these chemicals are:
  - lead from lead-based paint
  - crystalline silica from bricks and cement and other masonry products, and
  - arsenic and chromium from chemically-treated lumber.

Your risk from these exposures varies, depending on how often you do this type of work. To reduce your exposure to these chemicals: work in a well ventilated area, and work with approved safety equipment, such as those dust masks that are specifically designed to filter out microscopic particles.

### SYMBOLGY

	Double Insulated
	Volts
	Alternating Current
	Amps
$n_0 \text{ XXXXmin.}^{-1}$	No Load Revolutions per Minute (RPM)
	Underwriters Laboratories, Inc. United States and Canada

### SPECIFICATIONS

Cat. No.	Volts AC	Amps	No Load RPM	Max HP
5615-20* Bodygrip®	120	11	24,000	1-3/4
5616-20* Bodygrip®	120	13	10,000-24,000	2-1/4
5619-20 D-Handle	120	11	24,000	1-3/4
5625-20 Production	120	15	10,000-22,000	3-1/2

\* Also compatible with plunge base 48-10-5600, available separately and in kits.

## FUNCTIONAL DESCRIPTION

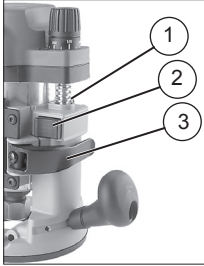

- Bodygrip® models**
1. Depth adjustment screw
  2. Motor release button
  3. Locking lever
  4. Scale
  5. Depth adjustment knob
  6. Variable speed dial  
(For Cat. No. 5616-20 only)
  7. On/Off switch
  8. Motor
  9. Cord

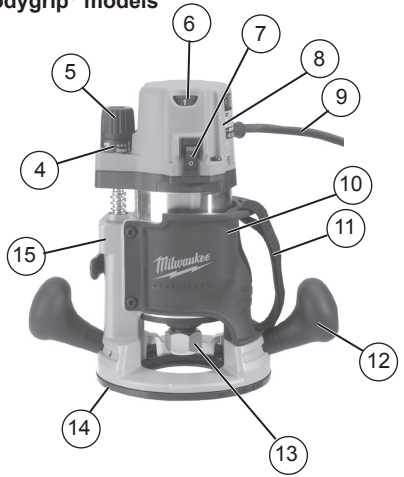

10. Body grip
11. Strap
12. Ball handle
13. Collet assembly
14. Sub-Base
15. Base

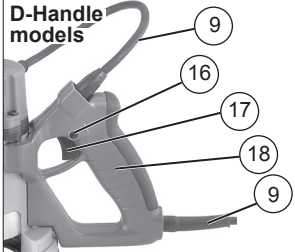

**D-Handle models**

16. Lock button
17. Trigger
18. D-handle

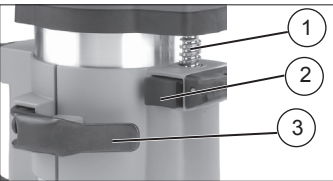

- Production model**
1. Depth adjustment screw
  2. Motor release button
  3. Locking lever
  4. Scale
  5. Depth adjustment knob
  6. Variable speed dial
  7. On/Off switch
  8. Cord
  9. Motor
  10. Handle
  11. Collet assembly

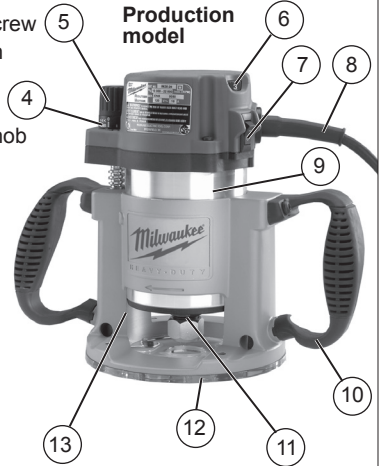

**Plunge base models**

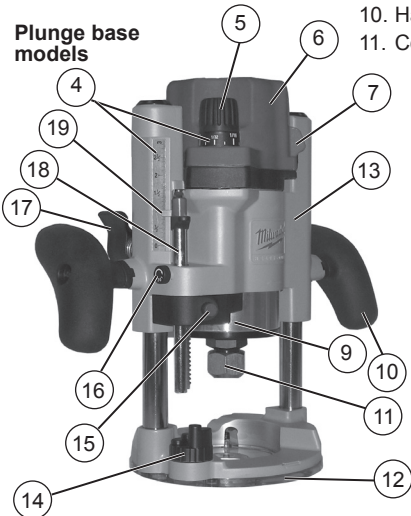

12. Sub-base
13. Base
14. Turret
15. Depth stop rod release button
16. Depth stop rod locking screw
17. Plunge release lever
18. Depth stop rod
19. Depth stop rod adjustable pointer

## GROUNDING

**⚠️ WARNING** Improperly connecting the grounding wire can result in the risk of electric shock. Check with a qualified electrician if you are in doubt as to whether the outlet is properly grounded. Do not modify the plug provided with the tool. Never remove the grounding prong from the plug. Do not use the tool if the cord or plug is damaged. If damaged, have it repaired by a **MILWAUKEE** service facility before use. If the plug will not fit the outlet, have a proper outlet installed by a qualified electrician.

### Grounded Tools: Tools with Three Prong Plugs

Tools marked "Grounding Required" have a three wire cord and three prong grounding plug. The plug must be connected to a properly grounded outlet (See Figure A). If the tool should electrically malfunction or break down, grounding provides a low resistance path to carry electricity away from the user, reducing the risk of electric shock.

The grounding prong in the plug is connected through the green wire inside the cord to the grounding system in the tool. The green wire in the cord must be the only wire connected to the tool's grounding system and must never be attached to an electrically "live" terminal.

Your tool must be plugged into an appropriate outlet, properly installed and grounded in accordance with all codes and ordinances. The plug and outlet should look like those in Figure A.

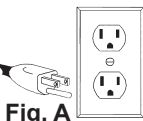
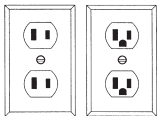

**Fig. A**

### Double Insulated Tools:

#### Tools with Two Prong Plugs

Tools marked "Double Insulated" do not require grounding. They have a special double insulation system which satisfies OSHA requirements and complies with the applicable standards of Underwriters Laboratories, Inc., the Canadian Standard Association and the National Electrical Code. Double Insulated tools may be used in either of the 120 volt outlets shown in Figures B and C.



**Fig. B Fig. C**

## EXTENSION CORDS

Grounded tools require a three wire extension cord. Double insulated tools can use either a two or three wire extension cord. As the distance from the supply outlet increases, you must use a heavier gauge extension cord. Using extension cords with inadequately sized wire causes a serious drop in voltage, resulting in loss of power and possible tool damage. Refer to the table shown to determine the required minimum wire size.

The smaller the gauge number of the wire, the greater the capacity of the cord. For example, a 14 gauge cord can carry a higher current than a 16 gauge cord. When using more than one extension cord to make up the total length, be sure each cord contains at least the minimum wire size required. If you are using one extension cord for more than one tool, add the nameplate amperes and use the sum to determine the required minimum wire size.

### Guidelines for Using Extension Cords

- If you are using an extension cord outdoors, be sure it is marked with the suffix "W-A" ("W" in Canada) to indicate that it is acceptable for outdoor use.
- Be sure your extension cord is properly wired and in good electrical condition. Always replace a damaged extension cord or have it repaired by a qualified person before using it.
- Protect your extension cords from sharp objects, excessive heat and damp or wet areas.

### Recommended Minimum Wire Gauge For Extension Cords\*

Nameplate Amps	Extension Cord Length				
	25'	50'	75'	100'	150'
0 - 2.0	18	18	18	18	16
2.1 - 3.4	18	18	18	16	14
3.5 - 5.0	18	18	16	14	12
5.1 - 7.0	18	16	14	12	12
7.1 - 12.0	16	14	12	10	--
12.1 - 16.0	14	12	10	--	--
16.1 - 20.0	12	10	--	--	--

\* Based on limiting the line voltage drop to five volts at 150% of the rated amperes.

**READ AND SAVE ALL INSTRUCTIONS FOR FUTURE USE.**

## ASSEMBLY

**⚠ WARNING** To reduce the risk of injury, always unplug tool before changing or removing accessories. Only use accessories specifically recommended for this tool. Others may be hazardous.

### Collets

The collet must be attached to the collet nut before it is put into the collet shaft. Be sure that the size of the collet matches the size of the bit shank being used. If the wrong size bit shank is used, the collet may break. For attaching or detaching the collet nut to the collet, follow the illustrated instructions on this page.

### Attaching Collet to Collet Nut

To assemble, place the narrow end of the collet on an even surface. Take the nut and place it over the collet.

Fig. 1

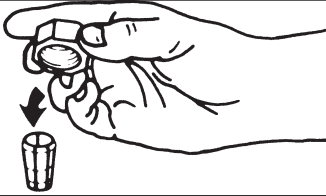

Position nut squarely over collet with the smaller opening of the nut facing up.

Fig. 2



Snap nut and collet together by firmly applying downward pressure into assembly with palm of hand.

Fig. 3

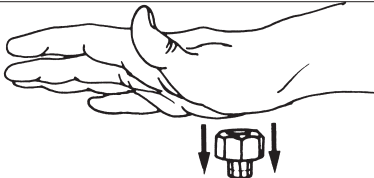

To remove collet from nut, hold nut firmly with one hand and press the collet to one side with the other hand.

Fig. 4

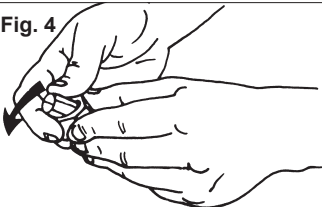

**⚠ WARNING** Pressing the motor release button will cause the motor housing to drop down, which may cause personal injury or damage to the tool or workpiece. Make sure your hand is firmly on the motor when pressing the button.

### Installing/Removing the Motor

Fig. 5



1. Unplug the tool. Make sure the locking lever is fully open.
2. Align the depth adjustment screw on the motor with the hole on the base.
3. Press and hold the motor release button and lower the motor into the base to the desired depth.  
**NOTE:** The plunge base does not have a motor release button. Release the locking lever and pull out the motor.
4. Release the motor release button and push in the locking lever to the fully closed position.
5. To remove the motor, fully open the locking lever, grasp the motor, press and hold the motor release button, and pull out the motor.

**⚠ WARNING** To reduce the risk of injury, **DO NOT** use the router if the locking lever does not hold the motor securely in the base. If the locking lever becomes loose, contact a **MILWAUKEE** service facility for repairs.

### Installing/Removing Edge Guide

To install an edge guide, loosen the two rod screws. Insert the edge guide rods into the rod holes and tighten the rod screws.

Fig. 6

Rod screws  
Cat. Nos.  
5615-20,  
5616-20 and  
5619-20

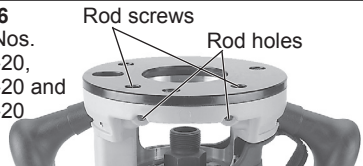

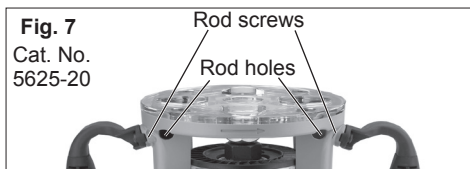

### Installing/Removing Sub-bases

#### Fixed sub-bases (black):

To remove the sub-base, remove the sub-base screws. To install the sub-base, secure it with the sub-base screws.

#### Adjustable sub-bases (clear):

To ensure the sub-base is centered, use the centering cone and pin whenever tightening, adjusting, or changing the adjustable sub-base.

1. Unplug the tool.
2. Install the sub-base and screws, but do not tighten them.
3. Lower the motor until the collet is about 1" above the base.
4. With the router upside down, insert the pin into the cone, then into the collet (see Fig. 8 for correct orientation). Tighten the collet.

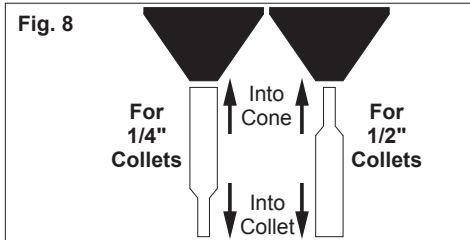

5. Push the cone down firmly. The sub-base will center.
6. While pressing down on the cone, tighten the sub-base screws.
7. Remove the centering pin from the collet. Save the pin and cone for future use.
8. To remove the sub-base, remove the sub-base screws.

**WARNING** To reduce the risk of injury, do not use the dust collection port when plunge cutting if the bit is larger than the port opening (1-3/8"). If a rotating router bit contacts the dust collection port, the port will break and flying debris may cause injury.

### Installing the Dust Collection Port (not available on Cat. No. 5625-20)

1. If an edge guide has been installed, it must be removed temporarily to install the dust collection port.
2. Loosen the rod screws.
3. Place the router upright and set the circle into the base (Fig. 9).

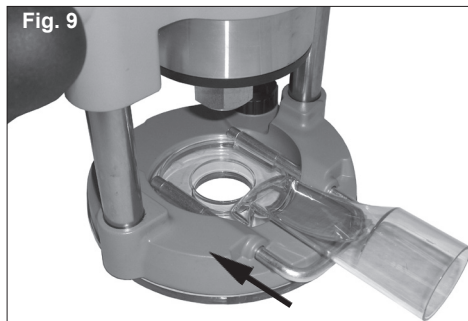

4. Slide the rods through the base rod holes and into the port rod holes.

**NOTE:** Use either the rods supplied with the dust collection port or rods from a MILWAUKEE edge guide.

5. Tighten the rod screws.
6. Twist a vacuum hose into the end of the port.

### Templet Guides

A 1-3/16" center hole sub-base is needed to use a templet guide.

To install a templet guide, insert the guide into the center hole of a 1-3/16" router base and secure according to the templet guide instructions.

**WARNING** To reduce the risk of injury, wear safety goggles or glasses with side shields.

Always unplug the tool before attaching or removing accessories or making adjustments. Use only specifically recommended accessories. Others may be hazardous.

Never use bits larger than the smallest of the openings in the base, sub-base, or dust collection port.

### Installing the Bit

It is not necessary to remove the motor from the base to install a collet assembly or a bit. If removal of the base is desired, see previous section. Always remove wood chips, dust or other foreign materials from the collet shaft and collet assembly before assembling.

Insert the collet assembly into the collet shaft. Insert the bit shank into the collet as follows:

1. Unplug the tool.
2. Insert the bit shank into the collet as far as it will go.
3. Back the bit shank out slightly to avoid bottoming out.
4. Be sure there is a minimum of 1/16" between the bottom of the collet assembly and the radius to the cutting portion of the bit (Fig. 10).

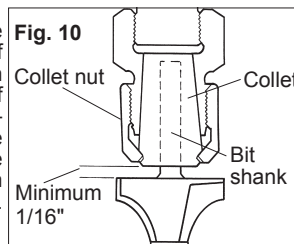

5. Be sure that the collet is not clamped to a fluted section on the bit shank. The collet should be clamped to a solid part on the bit shank to ensure a tight grip.

To tighten the bit in the collet assembly, use two wrenches.

**NOTE:** Never tighten a collet assembly without inserting a bit shank of the proper size. This may damage the collet.

Fig. 11

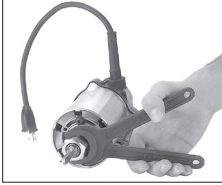

## Removing the Bit

1. Unplug the tool.
2. Loosen the collet nut from the collet shaft using two wrenches.
3. Once loose, unscrew the collet nut by hand until it feels tight again.
4. Use the wrenches again until the bit shank can be pulled out.

## OPERATION

**WARNING** To reduce the risk of injury, wear safety goggles or glasses with side shields.

Unplug the tool before changing accessories or making adjustments.

Never make adjustments while the router is running.

DO NOT use the router if the locking lever does not hold the motor securely in the base.

NEVER use the Plunge Base Router models in a router table.

### Adjusting the Depth of Cut

#### Bodygrip®, D-Handle and Production bases:

The tool depth can be adjusted by using the depth adjustment knob or a 3/8" socket wrench with an extension, or the Above-the-table Depth Wrench (Cat. No. 49-96-0370).

When using the depth adjustment knob, fully open the locking lever and rotate knob to the desired depth of cut. One revolution of the depth adjustment knob is equal to 0.2". For fine adjustments less than 5/32", use the independent scale on the depth adjustment knob.

For deeper cuts:

1. Align the "0" on the scale with the arrow on the tool.
2. Rotate depth adjustment knob clockwise to desired depth measurement.

For shallower cuts:

1. Align the desired depth measurement with the arrow on the tool.
2. Rotate depth adjustment knob counterclockwise to "0."

Push in locking lever to fully closed position when finished adjusting.

When using a socket wrench, place the router upside down on a flat surface and fully open the locking lever. Insert a 3/8" socket wrench into the hole on the base and turn to desired depth. Push in locking lever to fully closed position.

Fig. 12

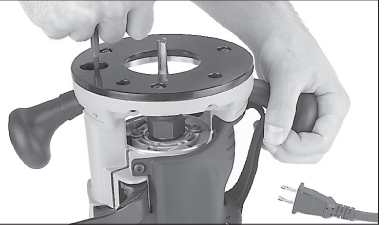

### Plunge base:

1. Unplug the tool.
2. Install the bit.
3. Press the plunge release lever and push down on the handles until the bit touches the workpiece.
4. Loosen the depth stop rod locking screw.
5. Turn the turret so the full depth position is directly below the rod
6. Press the depth stop rod release button to lower the rod. It should rest on the full depth position of the turret.
7. Place the adjustable pointer on "0".
8. Press in the depth stop rod release button Move the rod up to the desired depth of cut.
9. Use the depth adjustment knob to finely tune the depth of cut.
10. Tighten the depth stop rod locking screw.
11. To obtain the cut making multiple passes, rotate the turret to a higher step. Each step is 1/8"

**NOTE:** A fine finish can be made using the turret and multiple passes.

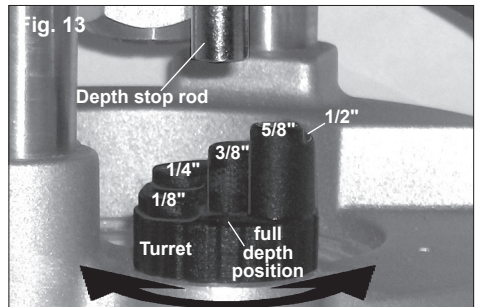



## Holding the Tool

These tools should be held using both hands at all times for maximum control.

### For Bodygrip® bases:

You can hold this tool using the body grip and ball handle or both ball handles. The body grip features an adjustable strap, which can be attached in two different positions for maximum control and comfort.

One handle on these bases may be adjusted to three different positions for maximum control and comfort.



### For D-Handle base:

Grip the D-handle with one hand and place the other on the ball handle.

One handle on these bases may be adjusted to three different positions for maximum control and comfort.

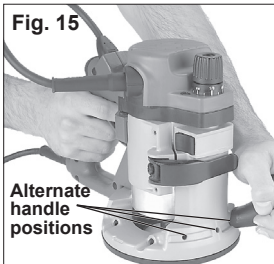

### For Plunge and Production bases:

**WARNING** To reduce the risk of injury, NEVER use the Plunge Base Router in a router table.

**WARNING** To reduce the risk of injury, wear safety goggles or glasses with side shields.

To reduce the risk of injury, keep hands, body and cord away from the bit and all moving parts.

Before plugging the tool into a power outlet, make sure the on/off switch is in the "O" position.

### Starting and Stopping Router Motor

For Cat. No. 5615-20, 5616-20 and 5625-20:

1. To start the motor, place the router so the bit is away from you and not in contact with the workpiece. Grasp the tool firmly and push the On/Off switch to the "I" position.

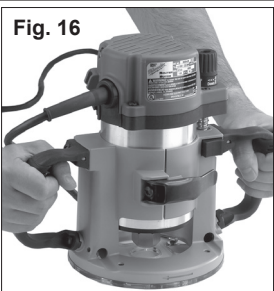

2. To stop the motor, place the router so the bit is away from you and push the On/Off switch to the "O" position. Hold the tool until the bit stops turning.

For Cat. No. 5619-20:

1. Push the On/Off switch to the "I" position.
2. To start the motor, place the router so the bit is away from you and not in contact with the workpiece. Grasp the tool firmly and pull the trigger.
3. To stop the motor, release the trigger.

### Locking the D-handle Base Trigger

The lock button holds the trigger in the ON position for continuous use.

1. To **lock** the trigger, hold in the lock button while pulling the trigger. Release the trigger.
2. To **unlock** the trigger, pull the trigger and release. The lock button will pop out.

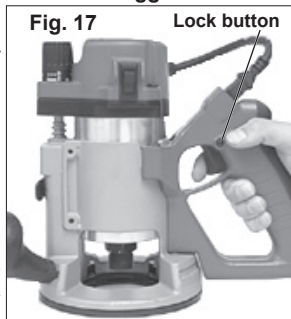

**NOTE:** D-handle base does not fit Cat.No.5625-20.

### Electronic Overload Protection (For Cat. No. 5616-20 and 5625-20 only)

These tools are equipped with an electronic overload protection feature.

If the motor shuts off during use, remove the bit from the workpiece and push the On/Off switch to the "O" position for three (3) seconds. This will reset the electronics in the tool. The tool can then be restarted.

### Using the Variable Speed Dial (For Cat. No. 5616-20 and 5625-20 only)

The variable speed dial allows the user to adjust the rotating speed (RPM) of the tool.

Variable speed dial settings range from numbers (7) seven through (1) one. Higher numbers correspond to higher speeds and lower number correspond to lower speeds.

To change the speed, set the variable speed control dial to the desired number.

### Soft Start (For Cat. No. 5616-20 and 5625-20 only)

The Soft-Start feature reduces the amount of torque reaction to the tool and the user. This feature gradually increases the motor speed up from zero to the speed set by the variable speed dial.

### Feedback Control

### (For Cat. No. 5616-20 and 5625-20 only)

The electronic speed control system allows the tool to maintain constant speed between no-load and load conditions.

**⚠ WARNING** To reduce the risk of injury, always wear eye protection. To reduce the risk of explosion, electric shock and property damage, always check the work area for hidden pipes and wires before routing.

### Making the Cut

Before cutting, check that all adjustments are tight and the locking lever is fully closed and secure. The speed and depth of cut will depend largely on the type of material being worked. Keep the cutting pressure constant but do not use excessive force on the router so the motor speed slows excessively. It may be necessary on exceptionally hard woods or problem materials to make more than one pass to get the desired depth of cut.

Before beginning the cut on the actual workpiece, make a sample cut on a scrap piece of lumber. This will show you exactly how the cut will look as well as enable you to check dimensions. Always be sure the workpiece is secure before routing. When routing edges, the router should be held firmly down and against the work using handles.

Since the cutter rotates clockwise, more efficient cutting will be obtained if the router is moved from left to right as you stand facing the work. The arrows on the base of the tool indicate the direction of bit rotation. When working on the outside of an edge, move router in a counterclockwise direction.

**⚠ WARNING** To reduce the risk of injury, avoid "climb cutting." Climb cutting increases the potential for loss of control of the tool and damage to the workpiece. If climb cutting can not be avoided, use extreme caution.

**⚠ WARNING** To reduce the risk of injury, do not use a plunge base router if the motor does not rise automatically when the plunge release lever is pressed.

### Plunge Cutting

1. Set the depth of cut.
2. Securely clamp the workpiece.
3. Press the plunge release lever and raise the bit so it does not contact the workpiece.
4. Hold the handles securely and turn on the motor. Wait for the motor to reach full speed (or the speed indicated by the variable speed dial).
5. Press the plunge release lever and slowly lower the bit into the workpiece until the depth stop rod contacts the turret. Release the plunge release lever.
6. Begin moving the router, keeping the sub-base flat on the workpiece. Keep the cord and dust collection hose out of the path of the router.
7. When finished, press the plunge release lever and raise the bit out of the workpiece. Turn the motor off and wait for the bit to stop turning.

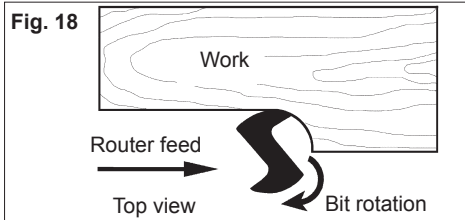

When working on an inside edge, move the router in a clockwise direction.

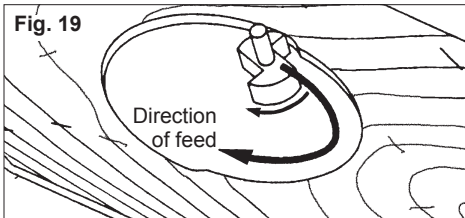

Moving the router in the opposite direction is known as "climb cutting."

## MAINTENANCE

 **WARNING** To reduce the risk of injury, always unplug your tool before performing any maintenance. Never disassemble the tool or try to do any rewiring on the tool's electrical system. Contact a *MILWAUKEE* service facility for ALL repairs.

### Maintaining Tools

Keep your tool in good repair by adopting a regular maintenance program. Before use, examine the general condition of your tool. Inspect guards, switches, tool cord set and extension cord for damage. Check for loose screws, misalignment, binding of moving parts, improper mounting, broken parts and any other condition that may affect its safe operation. If abnormal noise or vibration occurs, turn the tool off immediately and have the problem corrected before further use. Do not use a damaged tool. Tag damaged tools "DO NOT USE" until repaired (see "Repairs").

Under normal conditions, relubrication is not necessary until the motor brushes need to be replaced. After six months to one year, depending on use, return your tool to the nearest *MILWAUKEE* service facility for the following:

- Lubrication
- Brush inspection and replacement
- Mechanical inspection and cleaning (gears, spindles, bearings, housing, etc.)
- Electrical inspection (switch, cord, armature, etc.)
- Testing to assure proper mechanical and electrical operation

 **WARNING** To reduce the risk of injury, electric shock and damage to the tool, never immerse your tool in liquid or allow a liquid to flow inside the tool.

### Cleaning

Clean dust and debris from vents. Keep the tool handles clean, dry and free of oil or grease. Use only mild soap and a damp cloth to clean your tool since certain cleaning agents and solvents are harmful to plastics and other insulated parts. Some of these include: gasoline, turpentine, lacquer thinner, paint thinner, chlorinated cleaning solvents, ammonia and household detergents containing ammonia. Never use flammable or combustible solvents around tools.

### Repairs

If your tool is damaged, return the entire tool to the nearest service center.

## ACCESSORIES

 **WARNING** To reduce the risk of injury, always unplug the tool before attaching or removing accessories. Use only specifically recommended accessories. Others may be hazardous.