



OPERATOR'S MANUAL

Cat. No.

5381-20

5387-20



1/2" HAMMER-DRILL

TO REDUCE THE RISK OF INJURY, USER MUST READ AND UNDERSTAND OPERATOR'S MANUAL.

GENERAL POWER TOOL SAFETY WARNINGS

WARNING READ ALL SAFETY WARNINGS AND ALL INSTRUCTIONS. Failure to follow the warnings and instructions may result in electric shock, fire and/or serious injury. Save all warnings and instructions for future reference. The term "power tool" in the warnings refers to your mains-operated (corded) power tool or battery-operated (cordless) power tool.

WORK AREA SAFETY

- Keep work area clean and well lit. Cluttered or dark areas invite accidents.
- Do not operate power tools in explosive atmospheres, such as in the presence of flammable liquids, gases or dust. Power tools create sparks which may ignite the dust or fumes.
- Keep children and bystanders away while operating a power tool. Distractions can cause you to lose control.

ELECTRICAL SAFETY

- Power tool plugs must match the outlet. Never modify the plug in any way. Do not use any adapter plugs with earthed (grounded) power tools. Unmodified plugs and matching outlets will reduce risk of electric shock.
- Avoid body contact with earthed or grounded surfaces such as pipes, radiators, ranges and refrigerators. There is an increased risk of electric shock if your body is earthed or grounded.
- Do not expose power tools to rain or wet conditions. Water entering a power tool will increase the risk of electric shock.
- Do not abuse the cord. Never use the cord for carrying, pulling or unplugging the power tool. Keep cord away from heat, oil, sharp edges or moving parts. Damaged or entangled cords increase the risk of electric shock.
- When operating a power tool outdoors, use an extension cord suitable for outdoor use. Use of a cord suitable for outdoor use reduces the risk of electric shock.
- If operating a power tool in a damp location is unavoidable, use a ground fault circuit interrupter (GFCI) protected supply. Use of an GFCI reduces the risk of electric shock.

PERSONAL SAFETY

- Stay alert, watch what you are doing and use common sense when operating a power tool. Do not use a power tool while you are tired or under the influence of drugs, alcohol or medication. A moment of inattention while operating power tools may result in serious personal injury.
- Use personal protective equipment. Always wear eye protection. Protective equipment such as dust mask, non-skid safety shoes, hard hat, or hearing protection used for appropriate conditions will reduce personal injuries.
- Prevent unintentional starting. Ensure the switch is in the off-position before connecting to power source and/or battery pack, picking up or carrying the tool. Carrying power tools with your finger on the switch or energising power tools that have the switch on invites accidents.
- Remove any adjusting key or wrench before turning the power tool on. A wrench or a key left attached to a rotating part of the power tool may result in personal injury.

- Do not overreach. Keep proper footing and balance at all times. This enables better control of the power tool in unexpected situations.
- Dress properly. Do not wear loose clothing or jewellery. Keep your hair, clothing and gloves away from moving parts. Loose clothes, jewellery or long hair can be caught in moving parts.
- If devices are provided for the connection of dust extraction and collection facilities, ensure these are connected and properly used. Use of dust collection can reduce dust-related hazards.
- Do not force the power tool. Use the correct power tool for your application. The correct

POWER TOOL USE AND CARE

- power tool will do the job better and safer at the rate for which it was designed.
- Do not use the power tool if the switch does not turn it on and off. Any power tool that cannot be controlled with the switch is dangerous and must be repaired.
 - Disconnect the plug from the power source and/or the battery pack from the power tool before making any adjustments, changing accessories, or storing power tools. Such preventive safety measures reduce the risk of starting the power tool accidentally.
 - Store idle power tools out of the reach of children and do not allow persons unfamiliar with the power tool or these instructions to operate the power tool. Power tools are dangerous in the hands of untrained users.
 - Maintain power tools. Check for misalignment or binding of moving parts, breakage of parts and any other condition that may affect the power tool's operation. If damaged, have the power tool repaired before use. Many accidents are caused by poorly maintained power tools.
 - Keep cutting tools sharp and clean. Properly maintained cutting tools with sharp cutting edges are less likely to bind and are easier to control.
 - Use the power tool, accessories and tool bits etc. in accordance with these instructions, taking into account the working conditions and the work to be performed. Use of the power tool for operations different from those intended could result in a hazardous situation.

SERVICE







- Have your power tool serviced by a qualified repair person using only identical replacement parts. This will ensure that the safety of the power tool is maintained.

SPECIFIC SAFETY RULES

- Wear ear protectors when impact drilling. Exposure to noise can cause hearing loss.
- Use auxiliary handle(s), if supplied with the tool. Loss of control can cause personal injury.

- Hold power tool by insulated gripping surfaces, when performing an operation where the cutting accessory may contact hidden wiring or its own cord. Cutting accessory contacting a "live" wire may make exposed metal parts of the power tool "live" and could give the operator an electric shock.
- Maintain labels and nameplates. These carry important information. If unreadable or missing, contact a MILWAUKEE service facility for a free replacement.
- WARNING Some dust created by power sanding, sawing, grinding, drilling, and other construction activities contains chemicals known to cause cancer, birth defects or other reproductive harm. Some examples of these chemicals are:
 - lead from lead-based paint
 - crystalline silica from bricks and cement and other masonry products, and
 - arsenic and chromium from chemically-treated lumber.
 Your risk from these exposures varies, depending on how often you do this type of work. To reduce your exposure to these chemicals: work in a well ventilated area, and work with approved safety equipment, such as those dust masks that are specially designed to filter out microscopic particles.

SYMBOLOLOGY

	Double Insulated
	Amperes
	Volts
	Alternating Current
$n_0 \text{ XXXX min.}^{-1}$	No Load Revolutions per Minute (RPM)
BPM	Blows per Minute (BPM)
	Underwriters Laboratories, Inc. United States and Canada
	Mexican Approvals Marking

FUNCTIONAL DESCRIPTION

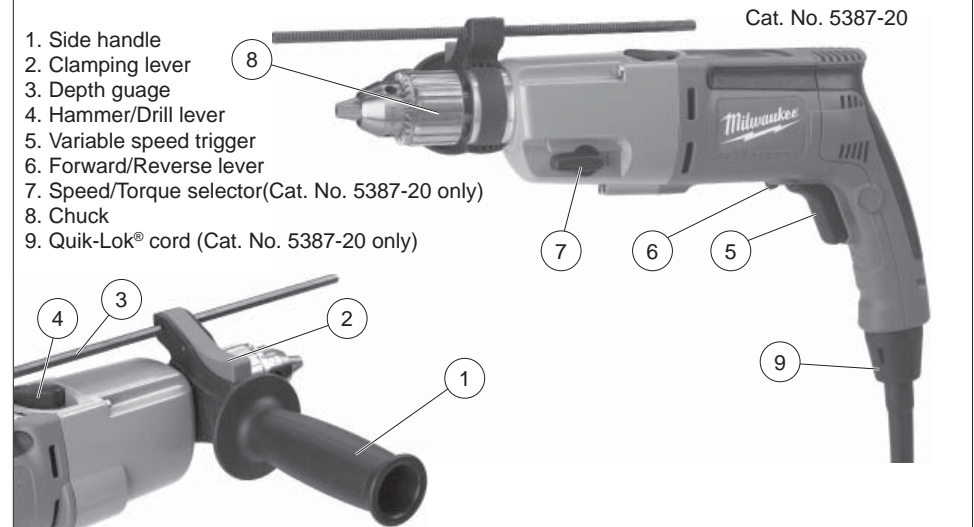

SPECIFICATIONS

Cat. No.	Volts AC	Amps	Tool	Capacities		
				No Load RPM	No Load Blows per Minute	Drill Only (steel/wood) Twist Drill Bit
5387-20	120	8.5	Low 0 - 1000 High 0 - 2500	16,000 40,000	1/2" / 1"	3/4"
5381-20	120	8.5	0 - 1800	28,000	3/8" / 3/4"	5/8"

GROUNDING

⚠ WARNING Improperly connecting the grounding wire can result in the risk of electric shock. Check with a qualified electrician if you are in doubt as to whether the outlet is properly grounded. Do not modify the plug provided with the tool. Never remove the grounding prong from the plug. Do not use the tool if the cord or plug is damaged. If damaged, have it repaired by a MILWAUKEE service facility before use. If the plug will not fit the outlet, have a proper outlet installed by a qualified electrician.

Grounded Tools: Tools with Three Prong Plugs
Tools marked "Grounding Required" have a three wire cord and three prong grounding plug. The plug must be connected to a properly grounded outlet (See Figure A). If the tool should electrically malfunction or break down, grounding provides a low resistance path to carry electricity away from the user, reducing the risk of electric shock. The grounding prong in the plug is connected through the green wire inside the cord to the grounding system in the tool. The green wire in the cord must be the only wire connected to the tool's grounding system and must never be attached to an electrically "live" terminal.

Your tool must be plugged into an appropriate outlet, properly installed and grounded in accordance with all codes and ordinances. The plug and outlet should look like those in Figure A.

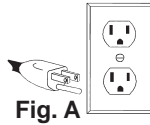

Fig. A

Double Insulated Tools:

Tools with Two Prong Plugs

Tools marked "Double Insulated" do not require grounding. They have a special double insulation system which satisfies OSHA requirements and complies with the applicable standards of Underwriters Laboratories, Inc., the Canadian Standard Association and the National Electrical Code. Double Insulated tools may be used in either of the 120 volt outlets shown in Figures B and C.

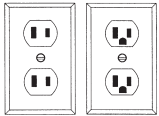

Fig. B Fig. C

ASSEMBLY

⚠ WARNING To reduce the risk of injury, always unplug tool before attaching or removing accessories or making adjustments. Use only specifically recommended accessories. Others may be hazardous.

Removing and Replacing Quik-Lok® Cords (Cat. No. 5387-20)

MILWAUKEE's exclusive Quik-Lok® Cords provide instant field replacement or substitution.

EXTENSION CORDS

Grounded tools require a three wire extension cord. Double insulated tools can use either a two or three wire extension cord. As the distance from the supply outlet increases, you must use a heavier gauge extension cord. Using extension cords with inadequately sized wire causes a serious drop in voltage, resulting in loss of power and possible tool damage. Refer to the table shown to determine the required minimum wire size.

The smaller the gauge number of the wire, the greater the capacity of the cord. For example, a 14 gauge cord can carry a higher current than a 16 gauge cord. When using more than one extension cord to make up the total length, be sure each cord contains at least the minimum wire size required. If you are using one extension cord for more than one tool, add the nameplate amperes and use the sum to determine the required minimum wire size.

Guidelines for Using Extension Cords

- If you are using an extension cord outdoors, be sure it is marked with the suffix "W-A" ("W" in Canada) to indicate that it is acceptable for outdoor use.
- Be sure your extension cord is properly wired and in good electrical condition. Always replace a damaged extension cord or have it repaired by a qualified person before using it.
- Protect your extension cords from sharp objects, excessive heat and damp or wet areas.

Nameplate Amperes	Extension Cord Length				
	25'	50'	75'	100'	150'
0 - 2.0	18	18	18	18	16
2.1 - 3.4	18	18	18	16	14
3.5 - 5.0	18	18	16	14	12
5.1 - 7.0	18	16	14	12	12
7.1 - 12.0	16	14	12	10	--
12.1 - 16.0	14	12	10	--	--
16.1 - 20.0	12	10	--	--	--

* Based on limiting the line voltage drop to five volts at 150% of the rated amperes.

READ AND SAVE ALL INSTRUCTIONS FOR FUTURE USE.

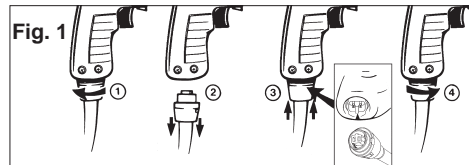

1. To remove the Quik-Lok® Cord, turn the cord nut 1/4 turn to the left and pull it out.
2. To replace the Quik-Lok® Cord, align the connector keyways and push the connector in as far as it will go. Turn the cord nut 1/4 turn to the right to lock.

⚠ WARNING To prevent personal injury, always remove the chuck key from the chuck after each use.

Installing Bits into Keyed Chucks

Be sure that the shank of the bit and the chuck jaws are clean. Dirt particles may cause the bit to line up improperly. Do not use bits larger than the maximum recommended capacity of the drill because gear damage or motor overloading may result. For best performance, be sure that the bits are properly sharpened before use.

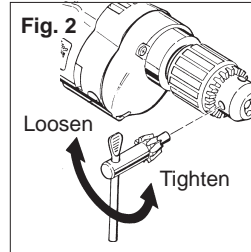

1. Unplug the tool.
2. Open the chuck jaws wide enough to insert a bit. Allow the bit to strike the bottom of the chuck. Center the bit in the chuck jaws and tighten the jaws by hand to align the bit.
3. Place the chuck key into each of the three holes in the chuck, turning it clockwise to tighten the chuck securely.
NOTE: Never use a wrench or means other than a chuck key to tighten or loosen the chuck.
4. To remove the bit, insert the chuck key into one of the holes in the chuck and turn it counterclockwise.

⚠ WARNING To reduce the risk of injury, always use a side handle when using this tool. Always brace or hold securely.

Adjusting the Side Handle Position

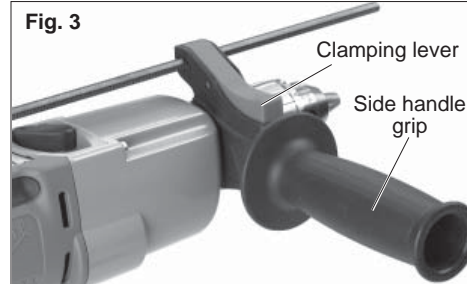

1. Loosen the side handle by unscrewing the side handle grip until the side handle rotates freely.
2. Rotate the side handle to the desired position.
3. Tighten the side handle grip securely.

Setting the Depth Gauge

1. Press in the clamping lever (Fig. 3).

Fig. 4

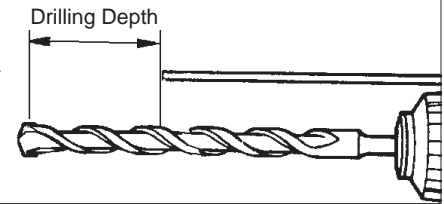

2. Slide the depth gauge rod backward or forward until it is set for the desired depth (Fig. 4).
NOTE: The drilling depth is the distance between the tip of the bit and the tip of the depth gauge rod.
3. Release the clamping lever.

⚠ WARNING To reduce the risk of injury, always wear eye protection.

Chuck Removal

This tool is equipped with a threaded spindle to hold the chuck. Before removing the chuck, unplug the tool and open the chuck jaws. A left-handed thread screw is located inside the chuck to prevent the chuck from loosening when the tool is operated in reverse direction. Remove the screw by turning it clockwise. To remove the chuck, hold the tool so that only the side of the chuck rests firmly and squarely on a solid workbench. Insert the chuck key or a chuck remover bar in one of the keyholes. Turn the chuck so the key is at about a 30° angle to the bench top and strike the key sharply with a hammer so the chuck turns in a counterclockwise direction (looking from the front of the tool). This should loosen the chuck from the spindle which has a right hand thread making it easy to remove the chuck by hand.

NOTE: When replacing the chuck, always replace the left hand thread screw in the chuck.

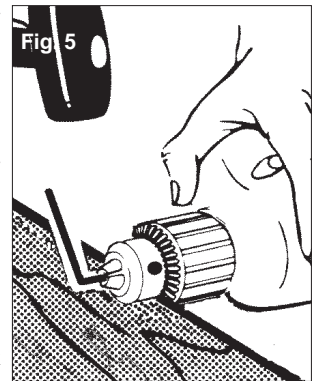



OPERATION

⚠ WARNING To reduce the risk of injury, wear safety goggles or glasses with side shields. Unplug the tool before changing accessories or making adjustments.

Selecting Action

MILWAUKEE Hammer-Drills have two settings: drilling and hammer-drilling.

1. For **drilling**, turn the hammer-drill lever to the drill symbol. 
2. For **hammer-drilling**, turn the hammer-drill lever to the hammer symbol. 

NOTE: To engage the hammering mechanism, maintain pressure on the bit. When pressure on the bit is released, the hammering action will stop.

Using Forward/Reverse Lever

The forward/reverse lever can only be adjusted when the trigger is not pressed. Always allow the motor to come to a complete stop before using the forward/reverse lever.

1. For **forward** (clockwise) rotation, push the forward/reverse lever to the left (when viewed from the back of the tool) as shown.
 2. For **reverse** (counterclockwise) rotation, push the forward/reverse lever to the right (when viewed from the back of the tool) as shown. Allow the motor to come to a full stop before reversing.
- NOTE:** When hammer-drilling, use the tool in forward rotation (clockwise) only.

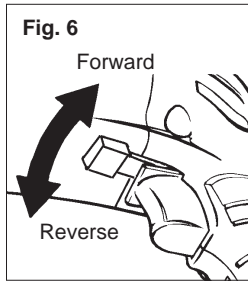

Selecting Speed (Cat. No. 5387-20 only)

The speed can only be changed when the tool is at a complete stop.

1. For **high torque/low speed** (up to 1000 rpm), turn the speed selector to position 1.
2. For **low torque/high speed** (up to 2500 rpm), turn the speed selector to position 2.

Starting, Stopping & Controlling Speed

1. To **start** the tool, pull trigger.
2. To **stop** the tool, release trigger.
3. To **vary** the speed, increase or decrease pressure to trigger. The further the trigger is pulled, the greater the speed.

Operating

Position the tool, grasp the handles firmly and pull the trigger. Always hold or brace the tool securely using both handles and maintain control. This tool has been designed to achieve top performance with only moderate pressure. Let the tool do the work. If the speed begins to drop off when drilling deep holes, pull the bit partially out of the hole while the tool is running to help clear dust. Do not use water to settle the dust since it will clog the bit flutes and tend to make the bit bind in the hole.

APPLICATIONS

⚠ WARNING To reduce the risk of electric shock, check work area for hidden pipes and wires before drilling.

Drilling in Wood, Composition Materials and Plastic

When drilling in wood, composition materials and plastic, select the drill operating mode. Start the drill slowly, gradually increasing speed as you drill. Select low speeds for plastics with a low melting point.

Drilling in Metal

When drilling in metal, select the drill operating mode. Use high speed steel twist drills or hole saws. Use a center punch to start the hole. Lubricate drill bits with cutting oil when drilling in iron or steel. Use a coolant when drilling in nonferrous metals such as copper, brass or aluminum. Back the material to prevent binding and distortion on breakthrough.

Drilling in Masonry

When drilling in masonry, select the hammer-drill operating mode. Use high speed carbide-tipped bits. Drilling soft masonry materials such as cinder block requires little pressure. Hard materials like concrete require more pressure. A smooth, even flow of dust indicates the proper drilling rate. Do not let the bit spin in the hole without cutting. Do not use water to settle dust or to cool bit. Do not attempt to drill through steel reinforcing rods. Both actions will damage the carbide.

ACCESSORIES

⚠ WARNING To reduce the risk of injury, always unplug the tool before attaching or removing accessories. Use only specifically recommended accessories. Others may be hazardous.

MAINTENANCE

⚠ WARNING To reduce the risk of injury, always unplug your tool before performing any maintenance. Never disassemble the tool or try to do any rewiring on the tool's electrical system. Contact a **MILWAUKEE** service facility for ALL repairs.

Maintaining Tools

Keep your tool in good repair by adopting a regular maintenance program. Before use, examine the general condition of your tool. Inspect guards, switches, tool cord set and extension cord for damage. Check for loose screws, misalignment, binding of moving parts, improper mounting, broken parts and any other condition that may affect its safe operation. If abnormal noise or vibration occurs, turn the tool off immediately and have the problem corrected before further use. Do not use a damaged tool. Tag damaged tools "DO NOT USE" until repaired (see "Repairs").

Under normal conditions, relubrication is not necessary until the motor brushes need to be replaced. After six months to one year, depending on use, return your tool to the nearest **MILWAUKEE** service facility for the following:

- Lubrication
- Brush inspection and replacement
- Mechanical inspection and cleaning (gears, spindles, bearings, housing, etc.)
- Electrical inspection (switch, cord, armature, etc.)
- Testing to assure proper mechanical and electrical operation

⚠ WARNING To reduce the risk of injury, electric shock and damage to the tool, never immerse your tool in liquid or allow a liquid to flow inside the tool.

Cleaning

Clean dust and debris from vents. Keep the tool handles clean, dry and free of oil or grease. Use only mild soap and a damp cloth to clean your tool since certain cleaning agents and solvents are harmful to plastics and other insulated parts. Some of these include: gasoline, turpentine, lacquer thinner, paint thinner, chlorinated cleaning solvents, ammonia and household detergents containing ammonia. Never use flammable or combustible solvents around tools.

Repairs

If your tool is damaged, return the entire tool to the nearest service center.