

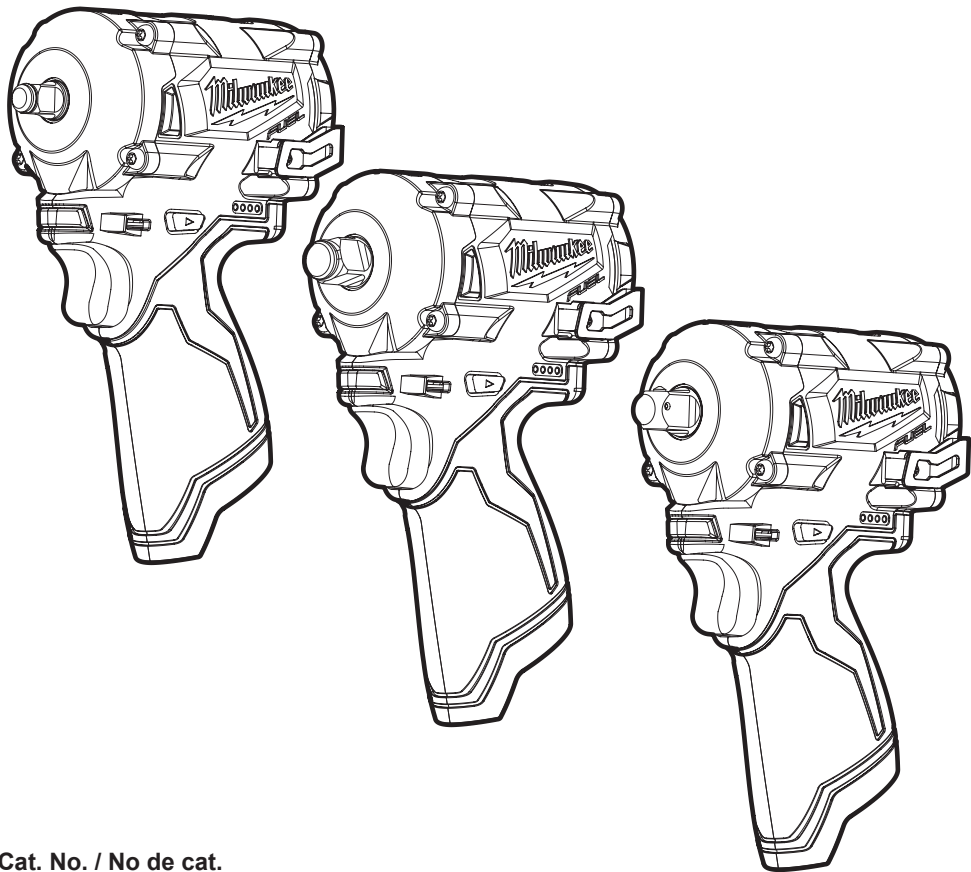

## OPERATOR'S MANUAL



Cat. No. / No de cat.  
2554-20, 2555-20, 2555P-20

### M12 FUEL™ IMPACT WRENCHES



**WARNING** To reduce the risk of injury, user must read and understand operator's manual.

## GENERAL POWER TOOL SAFETY WARNINGS

**⚠WARNING** Read all safety warnings, instructions, illustrations and specifications provided with this power tool. Failure to follow all instructions listed below may result in electric shock, fire and/or serious injury. **Save all warnings and instructions for future reference.** The term "power tool" in the warnings refers to your mains-operated (corded) power tool or battery-operated (cordless) power tool.

### WORK AREA SAFETY

- **Keep work area clean and well lit.** Cluttered or dark areas invite accidents.
- **Do not operate power tools in explosive atmospheres, such as in the presence of flammable liquids, gases or dust.** Power tools create sparks which may ignite the dust or fumes.
- **Keep children and bystanders away while operating a power tool.** Distractions can cause you to lose control.

### ELECTRICAL SAFETY

- **Power tool plugs must match the outlet. Never modify the plug in any way. Do not use any adapter plugs with earthed (grounded) power tools.** Unmodified plugs and matching outlets will reduce risk of electric shock.
- **Avoid body contact with earthed or grounded surfaces, such as pipes, radiators, ranges and refrigerators.** There is an increased risk of electric shock if your body is earthed or grounded.
- **Do not expose power tools to rain or wet conditions.** Water entering a power tool will increase the risk of electric shock.
- **Do not abuse the cord. Never use the cord for carrying, pulling or unplugging the power tool. Keep cord away from heat, oil, sharp edges or moving parts.** Damaged or entangled cords increase the risk of electric shock.
- **When operating a power tool outdoors, use an extension cord suitable for outdoor use.** Use of a cord suitable for outdoor use reduces the risk of electric shock.
- **If operating a power tool in a damp location is unavoidable, use a ground fault circuit interrupter (GFCI) protected supply.** Use of an GFCI reduces the risk of electric shock.

### PERSONAL SAFETY

- **Stay alert, watch what you are doing and use common sense when operating a power tool. Do not use a power tool while you are tired or under the influence of drugs, alcohol or medication.** A moment of inattention while operating power tools may result in serious personal injury.
- **Use personal protective equipment. Always wear eye protection.** Protective equipment such as a dust mask, non-skid safety shoes, hard hat or hearing protection used for appropriate conditions will reduce personal injuries.
- **Prevent unintentional starting. Ensure the switch is in the off-position before connecting to power source and/or battery pack, picking up or carrying the tool.** Carrying power tools with your finger on the switch or energizing power tools that have the switch on invites accidents.

- **Remove any adjusting key or wrench before turning the power tool on.** A wrench or a key left attached to a rotating part of the power tool may result in personal injury.
- **Do not overreach. Keep proper footing and balance at all times.** This enables better control of the power tool in unexpected situations.
- **Dress properly. Do not wear loose clothing or jewelry. Keep your hair and clothing away from moving parts.** Loose clothes, jewelry or long hair can be caught in moving parts.
- **If devices are provided for the connection of dust extraction and collection facilities, ensure these are connected and properly used.** Use of dust collection can reduce dust-related hazards.
- **Do not let familiarity gained from frequent use of tools allow you to become complacent and ignore tool safety principles.** A careless action can cause severe injury within a fraction of a second.

### POWER TOOL USE AND CARE

- **Do not force the power tool. Use the correct power tool for your application.** The correct power tool will do the job better and safer at the rate for which it was designed.
  - **Do not use the power tool if the switch does not turn it on and off.** Any power tool that cannot be controlled with the switch is dangerous and must be repaired.
  - **Disconnect the plug from the power source and/ or remove the battery pack, if detachable, from the power tool before making any adjustments, changing accessories, or storing power tools.** Such preventive safety measures reduce the risk of starting the power tool accidentally.
  - **Store idle power tools out of the reach of children and do not allow persons unfamiliar with the power tool or these instructions to operate the power tool.** Power tools are dangerous in the hands of untrained users.
  - **Maintain power tools and accessories. Check for misalignment or binding of moving parts, breakage of parts and any other condition that may affect the power tool's operation. If damaged, have the power tool repaired before use.** Many accidents are caused by poorly maintained power tools.
  - **Keep cutting tools sharp and clean.** Properly maintained cutting tools with sharp cutting edges are less likely to bind and are easier to control.
  - **Use the power tool, accessories and tool bits etc. in accordance with these instructions, taking into account the working conditions and the work to be performed.** Use of the power tool for operations different from those intended could result in a hazardous situation.
  - **Keep handles and grasping surfaces dry, clean and free from oil and grease.** Slippery handles and grasping surfaces do not allow for safe handling and control of the tool in unexpected situations.
- ### BATTERY TOOL USE AND CARE
- **Recharge only with the charger specified by the manufacturer.** A charger that is suitable for one type of battery pack may create a risk of fire when used with another battery pack.
  - **Use power tools only with specifically designated battery packs.** Use of any other battery packs may create a risk of injury and fire.

•When battery pack is not in use, keep it away from other metal objects, like paper clips, coins, keys, nails, screws or other small metal objects, that can make a connection from one terminal to another. Shorting the battery terminals together may cause burns or a fire.

•Under abusive conditions, liquid may be ejected from the battery; avoid contact. If contact accidentally occurs, flush with water. If liquid contacts eyes, additionally seek medical help. Liquid ejected from the battery may cause irritation or burns.

•Do not use a battery pack or tool that is damaged or modified. Damaged or modified batteries may exhibit unpredictable behavior resulting in fire, explosion or risk of injury.

•Do not expose a battery pack or tool to fire or excessive temperature. Exposure to fire or temperature above 265°F (130°C) may cause explosion.

•Follow all charging instructions and do not charge the battery pack or tool outside the temperature range specified in the instructions. Charging improperly or at temperatures outside the specified range may damage the battery and increase the risk of fire.

### SERVICE

•Have your power tool serviced by a qualified repair person using only identical replacement parts. This will ensure that the safety of the power tool is maintained.

•Never service damaged battery packs. Service of battery packs should only be performed by the manufacturer or authorized service providers.

### SPECIFIC SAFETY RULES FOR IMPACT WRENCH

•Hold power tool by insulated gripping surfaces, when performing an operation where the fastener may contact hidden wiring. Fasteners contacting a "live" wire may make exposed metal parts of the power tool "live" and could give the operator an electric shock.

•Wear ear protectors when impact drilling. Exposure to noise can cause hearing loss.

•Use only sockets and other accessories specifically designed for use on impact wrenches and drivers. Other sockets and accessories might shatter or break causing injury.

•Always use common sense and be cautious when using tools. It is not possible to anticipate every situation that could result in a dangerous outcome. Do not use this tool if you do not understand these operating instructions or you feel the work is beyond your capability; contact Milwaukee Tool or a trained professional for additional information or training.

•Maintain labels and nameplates. These carry important information. If unreadable or missing, contact a MILWAUKEE service facility for a free replacement.

**⚠WARNING** Some dust created by power sanding, sawing, grinding, drilling, and other construction activities contains chemicals known to cause cancer, birth defects or other reproductive harm. Some examples of these chemicals are:

- lead from lead-based paint
- crystalline silica from bricks and cement and other masonry products, and
- arsenic and chromium from chemically-treated lumber.

Your risk from these exposures varies, depending on how often you do this type of work. To reduce your exposure to these chemicals: work in a well ventilated area, and work with approved safety equipment, such as those dust masks that are specially designed to filter out microscopic particles.

### FUNCTIONAL DESCRIPTION

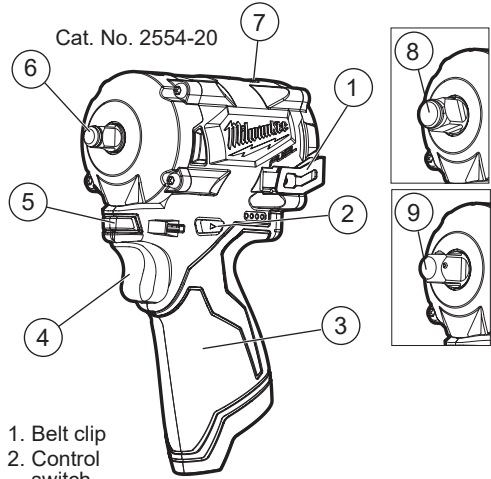

- 1. Belt clip
- 2. Control switch
- 3. Handle
- 4. Trigger
- 5. LED
- 6. 3/8" Friction ring (Cat. No. 2554-20)
- 7. 4-Mode drive control
- 8. 1/2" Friction ring (Cat. No. 2555-20)
- 9. 1/2" Square drive with pin detent (Cat. No. 2555P-20)

### SYMBOLGY

- V** Volts
- Direct Current

$n_0$  XXXX min<sup>-1</sup> No Load Revolutions per Minute (RPM)

$n$  XXXX min<sup>-1</sup> Impacts per Minute Under Load (IPM)

**UL** US UL Listing for Canada and U.S.

### SPECIFICATIONS

Cat. No. ....	2554-20, 2555-20, 2555P-20
RPM .....	0 - 2700
IPM .....	0 - 3200
Volts .....	12 DC
Battery Type .....	M12™
Charger Type .....	M12™
Recommended Ambient Operating Temperature .....	0°F to 125°F

## ASSEMBLY

**⚠WARNING** Recharge only with the charger specified for the battery. For specific charging instructions, read the operator's manual supplied with your charger and battery.

### Removing/Inserting the Battery

To remove the battery, push in the release buttons and pull the battery pack away from the tool.

**⚠WARNING** Always remove battery pack before changing or removing accessories.

To insert the battery, slide the pack into the body of the tool. Make sure it latches securely into place.

**⚠WARNING** Only use accessories specifically recommended for this tool. Others may be hazardous.

Use only sockets and other accessories specifically designed for use on impact wrenches and drivers. Other sockets and accessories might shatter or break causing injury.

### Attaching and Removing Accessories

#### 3/8" and 1/2" Friction Ring

(Cat. No. 2554-20 and 2555-20)

1. Use only the appropriate size Square Drive Sockets.
2. To attach a socket, align the accessory with the anvil and push it firmly over the retaining ring.
3. To remove the accessory, pull the accessory off the anvil.

#### 1/2" Pin Detent

(Cat. No. 2555P-20)

1. Use only the appropriate size Square Drive Sockets.
2. To attach a socket, align the hole in the accessory with the detent pin on the anvil. Hold the detent pin in while pushing the socket onto the anvil. The detent pin will snap into place in the hole to secure the socket.
3. To remove the socket, insert a nail or other thin object into the hole in the accessory and press in the detent pin. Pull the accessory off the anvil.

## OPERATION

**⚠WARNING** To reduce the risk of injury, always wear proper eye protection marked to comply with ANSI Z87.1.

Always remove battery pack before changing or removing accessories. Only use accessories specifically recommended for this tool. Others may be hazardous.

### Fuel Gauge

To determine the amount of charge left in the battery, turn the tool ON. The Fuel Gauge will light up for 2-3 seconds. When less than 10% of charge is left, 1 light on the fuel gauge will flash 4 times.

To signal the end of charge, 1 light on the fuel gauge will flash 8 times and the tool will not run. Charge the battery pack.

If the battery becomes too hot, the fuel gauge lights will flash in an alternating pattern and the tool will not run. Allow the battery to cool down.

## Using the Drive Control

The drive control button is used to adjust the rotation speed (RPM) for the application.

To select the drive control mode:

1. Pull and release the trigger to turn on the tool. The current indicator is lit.
2. Press the drive control button  to cycle through the 4 modes. When the desired mode indicator is lit, begin work.

\*In auto shut off mode , the tool will drive forward at a reduced RPM until the torque is achieved. In reverse the tool will operate at full RPM to remove fasteners at full torque.

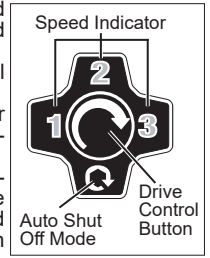

Mode	RPM	IPM
1	0-1200	0-1100
2	0-1800	0-2100
3	0-2700	0-3200
	0-2700*	-

### Using the Control Switch

The control switch may be set to three positions: forward, reverse and lock. Due to a lockout mechanism, the control switch can only be adjusted when the ON/OFF switch is not pressed. Always allow the motor to come to a complete stop before using the control switch.

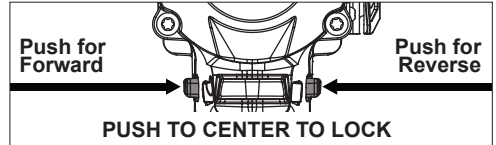

1. For **forward** (clockwise) rotation, push the control switch in the direction shown. Check the direction of rotation before use.
2. For **reverse** (counterclockwise) rotation, push the control switch in the direction shown. Check the direction of rotation before use.
3. To **lock** the trigger, push the control switch to the center position. The trigger will not work when the control switch is in the locked position. Always remove the battery pack before performing maintenance, changing accessories, storing the tool and any time the tool is not in use.

### Starting, Stopping and Controlling Speed

These tools may be operated at any speed from 0 to full speed.

1. To **start** the tool, pull the trigger.  
**NOTE:** An LED is turned on when the trigger is pulled.
2. To **vary** the driving speed, simply increase or decrease pressure on the trigger. The further the trigger is pulled, the greater the speed.
3. To **stop** the tool, release the trigger and the electric brake stops the tool instantly.

## Impacting Techniques

The longer a bolt, screw, or nut is impacted, the tighter it will become. To help prevent damaging the fasteners or workpieces, avoid excessive impacting. Be particularly careful when impacting smaller fasteners because they require less impacting to reach optimum torque.

Practice with various fasteners, noting the length of time required to reach the desired torque. Check the tightness with a hand-torque wrench. If the fasteners are too tight, reduce the impacting time. If they are not tight enough, increase the impacting time.

Oil, dirt, rust or other matter on the threads or under the head of the fastener affects the degree of tightness.

The torque required to loosen a fastener averages 75% to 80% of the tightening torque, depending on the condition of the contacting surfaces.

On light gasket jobs, run each fastener down to a relatively light torque and use a hand torque wrench for final tightening.

## MAINTENANCE

**⚠WARNING** To reduce the risk of injury, always unplug the charger and remove the battery pack from the charger or tool before performing any maintenance. Never disassemble the tool, battery pack or charger. Contact a MILWAUKEE service facility for ALL repairs.

### Maintaining Tool

Keep your tool, battery pack and charger in good repair by adopting a regular maintenance program. Inspect your tool for issues such as undue noise, misalignment or binding of moving parts, breakage of parts, or any other condition that may affect the tool operation. Return the tool, battery pack, and charger to a MILWAUKEE service facility for repair. After six months to one year, depending on use, return the tool, battery pack and charger to a MILWAUKEE service facility for inspection.

If the tool does not start or operate at full power with a fully charged battery pack, clean the contacts on the battery pack. If the tool still does not work properly, return the tool, charger and battery pack, to a MILWAUKEE service facility for repairs.

**⚠WARNING** To reduce the risk of personal injury and damage, never immerse your tool, battery pack or charger in liquid or allow a liquid to flow inside them.

### Cleaning

Clean dust and debris from vents. Keep handles clean, dry and free of oil or grease. Use only mild soap and a damp cloth to clean, since certain cleaning agents and solvents are harmful to plastics and other insulated parts. Some of these include gasoline, turpentine, lacquer thinner, paint thinner, chlorinated cleaning solvents, ammonia and household detergents containing ammonia. Never use flammable or combustible solvents around tools.

### Repairs

For repairs, return the tool, battery pack and charger to the nearest authorized service center.

## ACCESSORIES

**⚠WARNING** Use only recommended accesso-

Discover other impact wrenches on our website.