

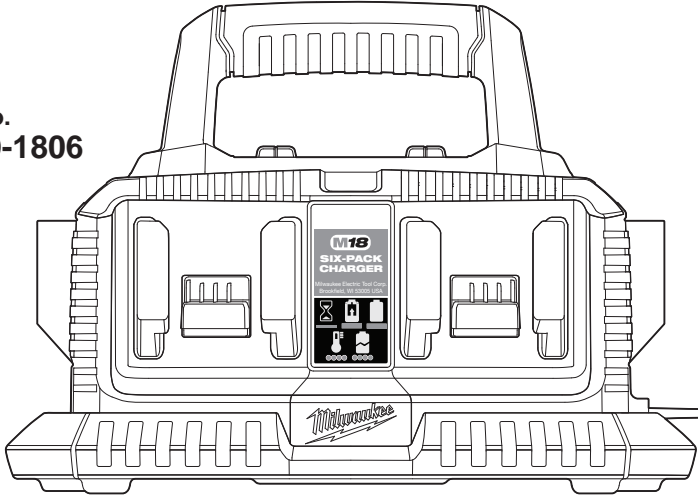

OPERATOR'S MANUAL

Cat. No.
48-59-1806



Cat. No.
48-11-1815
48-11-1820

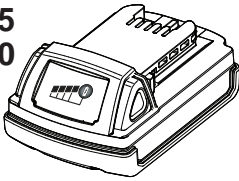

Cat. No.
48-11-1828
48-11-1840
48-11-1850
48-11-1860
48-11-1890

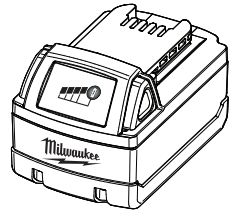

M18™ SIX-PACK CHARGER M18™ LITHIUM-ION BATTERY PACKS

New batteries must be charged before first use.



WARNING To reduce the risk of injury, user must read and understand operator's manual.

IMPORTANT SAFETY INSTRUCTIONS

WARNING READ AND UNDERSTAND ALL INSTRUCTIONS. Failure to follow all instructions listed below, may result in electric shock, fire and/or serious personal injury.

SAVE THESE INSTRUCTIONS

- 1. SAVE THESE INSTRUCTIONS - THIS OPERATOR'S MANUAL CONTAINS IMPORTANT SAFETY AND OPERATING INSTRUCTIONS FOR MILWAUKEE LI-ION BATTERY PACKS AND THE MILWAUKEE LI-ION CHARGER.**
- 2. BEFORE USING THE BATTERY PACK AND CHARGER, READ THIS OPERATOR'S MANUAL, YOUR TOOL OPERATOR'S MANUAL, AND ALL LABELS ON THE BATTERY PACK, CHARGER AND TOOL.**
- 3. CAUTION TO REDUCE THE RISK OF INJURY, CHARGE MILWAUKEE M18™ LI-ION RECHARGEABLE PACKS ONLY IN THEIR MILWAUKEE LI-ION M18™ CHARGER.** Other types of chargers may cause personal injury or damage. Battery pack and charger are not compatible with V™-technology or NiCd systems. Do not wire a battery pack to a power supply plug or car cigarette lighter. Battery packs will be permanently disabled or damaged.
- 4. USE MILWAUKEE LI-ION PACKS ONLY ON COMPATIBLE MILWAUKEE LI-ION TOOLS.** Battery pack and charger are not compatible with V™-technology or NiCd systems. Use with other tools may result in a risk of fire, electric shock or personal injury.
- 5. AVOID DANGEROUS ENVIRONMENTS.** Do not charge battery pack in rain, snow, damp or wet locations. Do not use battery pack or charger in the presence of explosive atmospheres (gaseous fumes, dust or flammable materials) because sparks may be generated when inserting or removing battery pack, possibly causing fire
- 6. CHARGE IN A WELL VENTILATED AREA.** Do not block charger vents. Keep them clear to allow proper ventilation. Do not allow smoking or open flames near a charging battery pack. Vented gases may explode.
- 7. MAINTAIN CHARGER CORD.** When unplugging charger, pull plug rather than cord to reduce the risk of damage to the electrical plug and cord. Never carry charger by its cord. Keep cord from heat, oil and sharp edges. Make sure cord will not be stepped on, tripped over or subjected to damage or stress. Do not use charger with damaged cord or plug. Have a damaged charger replaced immediately.
- 8. DO NOT USE AN EXTENSION CORD UNLESS IT IS ABSOLUTELY NECESSARY.** Using the wrong, damaged or improperly wired extension cord could result in the risk of fire and electrical shock. If an extension cord must be used, plug the charger into a properly wired 16 gauge or larger extension cord with pins that are the same number, size and shape as the pins on the charger. Make sure that the extension cord is in good electrical condition.
- 9. CHARGER IS RATED FOR 120 VOLT AC ONLY.** Charger must be plugged into an appropriate receptacle.
- 10. USE ONLY RECOMMENDED ATTACHMENTS.** Use of an attachment not recommended or sold by the battery charger or battery pack manufacturer may result in a risk of fire, electric shock or personal injury.
- 11. UNPLUG CHARGER** when not in use. Remove battery packs from unplugged chargers.
- 12. TO REDUCE THE RISK OF ELECTRIC SHOCK,** always unplug charger before cleaning or maintenance. Do not allow water to flow into AC/DC plug. Use a Ground Fault Circuit Interrupter (GFCI) to reduce shock hazards.
- 13. DO NOT BURN OR INCINERATE BATTERY PACKS.** Battery packs may explode, causing personal injury or damage. Toxic fumes and materials are created when battery packs are burned.
- 14. DO NOT CRUSH, DROP, OR DAMAGE** battery pack. Do not use a battery pack or charger that has received a sharp blow, been dropped, run over, or damaged in any way (e.g., pierced with a nail, hit with a hammer, stepped on).
- 15. DO NOT DISASSEMBLE.** Incorrect reassembly may result in the risk of electric shock, fire or exposure to battery chemicals. If it is damaged, take it to a MILWAUKEE service facility.
- 16. BATTERY CHEMICALS CAUSE SERIOUS BURNS.** Never allow contact with skin, eyes, or mouth. If a damaged battery pack leaks battery chemicals, use rubber or neoprene gloves to dispose of it. If skin is exposed to battery fluids, wash with soap and water and rinse with vinegar. If eyes are exposed to battery chemicals, immediately flush with water for 20 minutes and seek medical attention. Remove and dispose of contaminated clothing.
- 17. DO NOT SHORT CIRCUIT.** A battery pack will short circuit if a metal object makes a connection between the positive and negative contacts on the battery pack. Do not place a battery pack near anything that may cause a short circuit, such as coins, keys or nails in your pocket. Do not allow fluids to flow into battery pack. Corrosive or conductive fluids, such as seawater, certain industrial chemicals, and bleach or bleach containing products, etc., can cause a short circuit. A short circuited battery pack may cause fire, personal injury, and product damage.
- 18. STORE YOUR BATTERY PACK AND CHARGER** in a cool, dry place. Do not store battery pack where temperatures may exceed 120°F (50°C) such as in direct sunlight, a vehicle or metal building during the summer.



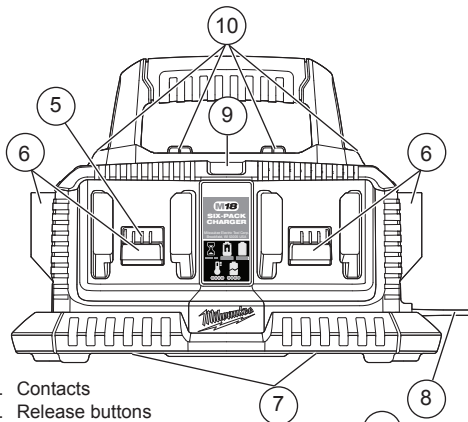

READ AND SAVE ALL INSTRUCTIONS FOR FUTURE REFERENCE.

FUNCTIONAL DESCRIPTION

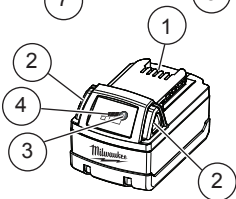

1. Contacts
2. Release buttons
3. Fuel Gauge button
4. Fuel Gauge
5. Electrical contacts
6. Bays
7. Vents
8. Cord
9. Skip button
10. Light indicators:











-  Continuous red: Charging
-  Continuous green light: Charging is complete
-  Fast flashing red: Battery is too hot/cold - Charging will begin when battery reaches correct charging temperature
-  Slow flashing red: Battery charge is pending - Charging will begin when the first pack is fully charged
-  Flashing red/green: Damaged or faulty battery pack

SPECIFICATIONS

Cat. No.	48-59-1806
Input Volts.....	120 AC
Input Amps.....	2.1 AC
Output Volts.....	18 DC
Output Amps.....	3.5 DC
Recommended Ambient Charging Temperature.....	40°F to 105°F
Battery Cat. No.....	48-11-1815
Volts.....	18 DC
Battery Cat. No.....	48-11-1820
Volts.....	18 DC
Battery Cat. No.....	48-11-1828
Volts.....	18 DC
Battery Cat. No.....	48-11-1840
Volts.....	18 DC
Battery Cat. No.....	48-11-1850
Volts.....	18 DC
Battery Cat. No.....	48-11-1860
Volts.....	18 DC
Battery Cat. No.....	48-11-1890
Volts.....	18 DC

SYMBOLOLOGY

-  Volts
-  Direct Current
-  Alternating Current
-  Double Insulated
-  Properly Recycle Batteries
-  Hertz
-  Amps
-  UL Listing for Canada and U.S.

MILWAUKEE M18™ LI-ION BATTERY PACKS

Fuel Gauge

Use the Fuel Gauge to determine the battery pack's remaining run time. Press the Fuel Gauge button to display the lights. The Fuel Gauge will light up for 2-3 seconds. When less than 10% of charge is left, 1 light on the fuel gauge will flash slow.

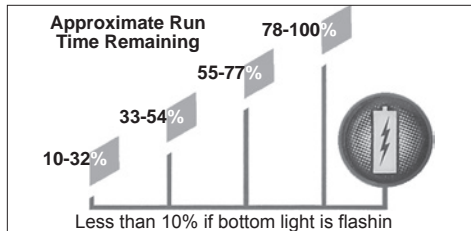

NOTE: If the Fuel Gauge doesn't appear to be working, place the battery pack on the charger and charge as needed.

Compared to NiCd battery pack types, MILWAUKEE Li-Ion battery packs deliver fade-free power for their entire run time. The tool will not experience a slow, gradual loss of power as you work. To signal the end of discharge, 1 light on the fuel gauge will flash quickly for 2-3 seconds and the tool will not run. Charge the battery pack.

NOTE: Immediately after using the battery pack, the Fuel Gauge may display a lower charge than it will if checked a few minutes later. The battery cells "recover" some of their charge after resting.

Battery Pack Protection

To protect itself from damage and extend its life, the battery pack's intelligent circuit monitors current draw and temperature. In extremely high torque, binding, stalling, and short circuit situations, the battery pack will turn OFF the tool if the current draw becomes too high. All the fuel gauge lights will flash. Release the trigger and restart.

Under extreme circumstances, the internal temperature of the battery could become too high. If this happens, the fuel gauge lights will flash in an alternating pattern and the tool will not run. Allow the battery to cool down.

Fuel Gauge Lights	Diagnosis	Solution
Lights 1 - 4 Solid	Remaining run time	Continue working
1 Light, flashin slowly	Less than 10% run time left	Prepare to charge pack
1 Light, flashin quickly	End of discharge	Charge pack
Lights 1-4, flashin quickly	Current draw too high	Release trigger and restart, reduce pressure
Lights 1&3 / 2&4, flashing alternating	Battery temperature too high	Release trigger and allow battery to cool

Cold Weather Operation

MILWAUKEE Li-Ion battery packs are designed to operate in temperatures below freezing. When the battery pack is too cold, it may need to warm up before normal use. Put the battery on a tool and use the tool in a light application. It may "buzz" for a short time until it warms up. When the buzzing stops, use the tool normally.

WARNING To reduce the risk of fire, personal injury, and product damage due to a short circuit, never immerse your tool, battery pack or charger in fluid or allow a fluid to flow inside them. Corrosive or conductive fluids, such as seawater, certain industrial chemicals, and bleach or bleach containing products, etc., can cause a short circuit.

Maintenance and Storage

Do not expose your battery pack or cordless tools to water or rain, or allow them to get wet. This could damage the tool and battery pack. Do not use oil or solvents to clean or lubricate your battery pack. The plastic casing will become brittle and crack, causing a risk of injury.

Store battery packs at room temperature away from moisture. Do not store in damp locations where corrosion of terminals may occur. As with other battery pack types, permanent capacity loss can result if the pack is stored for long periods of time at high temperatures (over 120° F). MILWAUKEE Li-Ion battery packs maintain their charge during storage longer than other battery pack types. After about a year of storage, charge the pack as normal.

Transport

Personal transport of Li-Ion battery packs is allowed when done in accordance with these warnings and instructions. The proper classification, packaging, labeling, marking, and documentation requirements for shipping Li-Ion batteries is dependent upon whether the particular batteries are rated greater than or less than 100 Wh. Generally, Li-Ion batteries rated 100 Wh or less are "excepted" from certain Class 9 DG requirements. Always check compliance of Li-Ion battery consignments against the current regulations governing the chosen mode of transport. When in doubt, contact the carrier or other trained Dangerous Goods professional to confirm acceptability. Li-Ion packs are shipped under classification UN 3480 (battery only) or UN 3481 (batteries contained in or packed with equipment).

WARNING To reduce the risk of injury or explosion, never burn or incinerate a battery pack even if it is damaged, dead or completely discharged. When burned, toxic fumes and materials are created.

Disposing of MILWAUKEE Li-Ion Battery Packs

MILWAUKEE Li-Ion battery packs are more environmentally friendly than some other types of power tool battery packs (e.g., nickel-cadmium). Always dispose of your battery pack according to federal, state and local regulations. Contact a recycling agency in your area for recycling locations.

Even discharged battery packs contain some energy. Before disposing, use electrical tape to cover the terminals to prevent the battery pack from shorting, which could cause a fire or explosion.

RBRC Battery Recycling Seals

The RBRC™ Battery Recycling Seals (see "Symbology") on your tool battery packs indicate that MILWAUKEE has arranged for the recycling of that battery pack with the Rechargeable Battery Recycling Corporation (RBRC). At the end of your battery pack's useful life, return the battery pack to a MILWAUKEE Branch Office/Service Center or the participating retailer nearest you.

MILWAUKEE M18™ SIX-PACK CHARGER

WARNING Charge only MILWAUKEE M18™ Li-Ion batteries in this MILWAUKEE Li-Ion charger. Other types of batteries may cause personal injury and damage.

When to Charge the Battery Pack with this MILWAUKEE Charger

Remove the battery pack from the tool for charging when convenient for you and your job. MILWAUKEE batteries do not develop a "memory" when charged after only a partial discharge. It is not necessary to run down the battery pack before placing it on the charger.

- Use the Fuel Gauge to determine when to charge your MILWAUKEE Li-Ion battery pack.
- You can "Top-Off" your battery pack's charge before starting a big job or long day of use.
- The only time it is necessary to charge the MILWAUKEE Li-Ion battery pack is when the battery pack has reached the end of its charge. To signal the end of charge, power to the tool will drop quickly, allowing you just enough power to finish making a cut, drilling a hole, or driving a fastener. Charge the battery pack as needed.

How to Charge the Battery Pack

Align the battery pack with the bay and slide the battery pack into the charger as far as possible. The red light will come on, either flashing quickly (battery pack is too hot or cold), flashing slowly (battery pack is waiting for another pack to finish charging) or continuous (pack is charging).

- The 48-59-1806 charges six batteries in sequence in a counter-clockwise rotation.
- The next pack inserted in the charger will begin charging when the previous pack is fully charged. To skip a pack and move to the next pack, press the skip button ►.
- A fully discharged battery pack with an internal temperature in the normal range will charge in 30 to 185 minutes, depending on the battery pack.
- Heavily cycled batteries may take longer to charge completely.
- The Fuel Gauge lights on 18V battery packs are displayed as the pack is being charged, indicating how fully charged the pack is. The fuel gauge will turn off when charging is complete.
- After charging is complete, the continuous green light will come on.
- The charger will keep the battery pack fully charged if it is left on the charger.
- If the light indicator flashes red and green, check that the battery pack is fully seated into the bay. Remove the battery pack and reinsert. If the light continues to flash red and green, remove pack(s) and unplug charger for at least 2 minutes. After 2 minutes, plug charger back in and insert pack. If the problem persists, contact a MILWAUKEE service facility.

• If the light indicator does not come on, check that the battery pack is fully seated into the bay. Remove the battery pack and reinsert. If the light indicator still does not come on, remove pack(s) and unplug charger for at least 2 minutes. After 2 minutes, plug charger back in and insert pack. If after these attempts the light indicator still does not come on, contact a MILWAUKEE service facility.

Charging a Hot or Cold Battery Pack

The Red Flashing Indicator light on the charger indicates that the battery pack temperature is outside the charging range. Once the battery pack is within the acceptable range, normal charging will take place and the red light will be continuous. Hot or cold batteries may take longer to charge.

Li-Ion Charging Status

Battery Pack Temperature	Red Charger Indicator Light	Charging Status
Too Hot	Fast Flashing	Not charging
Normal Range	Continuous	Normal charging
Too Cold	Fast Flashing	Not charging

Powering the Charger with an Inverter or Generator

The charger will operate with most generators and inverters rated at 300 Watts or higher.

Maintenance and Storage

Store your charger in a cool, dry place. As a general practice, it is best to unplug battery chargers and remove batteries when not in use. No battery pack damage will occur, however, if the charger and battery pack are left plugged in.

WARNING To reduce the risk of injury, always unplug the charger and remove the battery from the charger before performing any maintenance. Never disassemble the battery or charger. Contact a MILWAUKEE service facility for ALL repairs.

To reduce the risk of injury and damage, never immerse your battery or charger in liquid or allow a liquid to flow inside them.

Cleaning

Clean out dust and debris from charger vents and electrical contacts by blowing with compressed air. Use only mild soap and a damp cloth to clean the battery pack and charger, keeping away from all electrical contacts. Certain cleaning agents and solvents are harmful to plastics and other insulated parts. Some of these include gasoline, turpentine, lacquer thinner, paint thinner, chlorinated cleaning solvents, ammonia and household detergents containing ammonia. Never use flammable or combustible solvents around batteries, charger, or tools.

Repairs

The charger has no serviceable parts.