



OPERATOR'S MANUAL

Cat. No.
4253-1
4262-1
4292-1
4297-1

Cat. No.
4204-1
4206-1
4208-1
4210-1

Cat. No.
4202
4203



**HEAVY-DUTY DRILL MOTORS, ELECTROMAGNETIC DRILL STANDS,
ELECTROMAGNETIC DRILL PRESSES**

**TO REDUCE THE RISK OF INJURY, USER MUST READ AND UNDERSTAND OPERATOR'S
MANUAL.**

GENERAL POWER TOOL SAFETY WARNINGS



WARNING READ ALL SAFETY WARNINGS AND ALL INSTRUCTIONS. Failure to follow the warnings and instructions may result in electric shock, fire and/or serious injury. **Save all warnings and instructions for future reference.** The term "power tool" in the warnings refers to your mains-operated (corded) power tool or battery-operated (cordless) power tool.

WORK AREA SAFETY

- **Keep work area clean and well lit.** Cluttered or dark areas invite accidents.
- **Do not operate power tools in explosive atmospheres, such as in the presence of flammable liquids, gases or dust.** Power tools create sparks which may ignite the dust or fumes.
- **Keep children and bystanders away while operating a power tool.** Distractions can cause you to lose control.

ELECTRICAL SAFETY

- **Power tool plugs must match the outlet. Never modify the plug in any way. Do not use any adapter plugs with earthed (grounded) power tools.** Unmodified plugs and matching outlets will reduce risk of electric shock.
- **Avoid body contact with earthed or grounded surfaces such as pipes, radiators, ranges and refrigerators.** There is an increased risk of electric shock if your body is earthed or grounded.
- **Do not expose power tools to rain or wet conditions.** Water entering a power tool will increase the risk of electric shock.
- **Do not abuse the cord. Never use the cord for carrying, pulling or unplugging the power tool. Keep cord away from heat, oil, sharp edges or moving parts.** Damaged or entangled cords increase the risk of electric shock.
- **When operating a power tool outdoors, use an extension cord suitable for outdoor use.** Use of a cord suitable for outdoor use reduces the risk of electric shock.
- **If operating a power tool in a damp location is unavoidable, use a residual current device (RCD) protected supply.** Use of an RCD reduces the risk of electric shock.

PERSONAL SAFETY

- **Stay alert, watch what you are doing and use common sense when operating a power tool. Do not use a power tool while you are tired or under the influence of drugs, alcohol or medication.** A moment of inattention while operating power tools may result in serious personal injury.
- **Use personal protective equipment. Always wear eye protection.** Protective equipment such as dust mask, non-skid safety shoes, hard hat, or hearing protection used for appropriate conditions will reduce personal injuries.
- **Prevent unintentional starting. Ensure the switch is in the off-position before connecting to power source and/or battery pack, picking up or carrying the tool.** Carrying power tools with your finger on the switch or energising power tools that have the switch on invites accidents.
- **Remove any adjusting key or wrench before turning the power tool on.** A wrench or a key left attached to a rotating part of the power tool may result in personal injury.

- **Do not overreach. Keep proper footing and balance at all times.** This enables better control of the power tool in unexpected situations.
- **Dress properly. Do not wear loose clothing or jewellery. Keep your hair, clothing and gloves away from moving parts.** Loose clothes, jewellery or long hair can be caught in moving parts.
- **If devices are provided for the connection of dust extraction and collection facilities, ensure these are connected and properly used.** Use of dust collection can reduce dust-related hazards.

POWER TOOL USE AND CARE

- **Do not force the power tool. Use the correct power tool for your application.** The correct power tool will do the job better and safer at the rate for which it was designed.
- **Do not use the power tool if the switch does not turn it on and off.** Any power tool that cannot be controlled with the switch is dangerous and must be repaired.
- **Disconnect the plug from the power source and/or the battery pack from the power tool before making any adjustments, changing accessories, or storing power tools.** Such preventive safety measures reduce the risk of starting the power tool accidentally.
- **Store idle power tools out of the reach of children and do not allow persons unfamiliar with the power tool or these instructions to operate the power tool.** Power tools are dangerous in the hands of untrained users.
- **Maintain power tools. Check for misalignment or binding of moving parts, breakage of parts and any other condition that may affect the power tool's operation. If damaged, have the power tool repaired before use.** Many accidents are caused by poorly maintained power tools.
- **Keep cutting tools sharp and clean.** Properly maintained cutting tools with sharp cutting edges are less likely to bind and are easier to control.
- **Use the power tool, accessories and tool bits etc., in accordance with these instructions, taking into account the working conditions and the work to be performed.** Use of the power tool for operations different from those intended could result in a hazardous situation.

SERVICE

- **Have your power tool serviced by a qualified repair person using only identical replacement parts.** This will ensure that the safety of the power tool is maintained.

SPECIFIC SAFETY RULES

- When working overhead or on a vertical surface, always use safety chain. Mounting can release. (See "Safety Chain" under "Operation")
- Clean the surface before attaching the drill stand to the work surface. Paint, rust, scale, or uneven surfaces decrease the holding strength of the magnet. Chips, burrs, dirt and other foreign matter on the surface of the magnetic base will also decrease holding power.
- Do not attach magnetic base to nonmagnetic grades of stainless steel. The magnetic base will not hold. The electro magnetic drill press attaches magnetically to any ferrous metal. It is designed for use on 1/2 inch or thicker ferrous stock. Holding power will decrease on thinner stock. A back up plate must be used (See "Backing Plate" under "Operation").
- Wet connections are shock hazards. Prevent cutting fluid from traveling along the cord and contacting the outlet, extension cord connections or tool plug.
- If the plug or connections get wet, turn power off to the outlet before unplugging the tool.
- Use clamps or other practical way to secure and support the workpiece to a stable platform. Holding the work by hand or against your body is unstable and may lead to loss of control.

- Use only accessories that are recommended by the manufacturer for your model. Accessories that may be suitable for one tool, may become hazardous when used on another tool.
- Maintain labels and nameplates. These carry important information. If unreadable or missing, contact a MILWAUKEE service facility for a free replacement.
- WARNING: Some dust created by power sanding, sawing, grinding, drilling, and other construction activities contains chemicals known to cause cancer, birth defects or other reproductive harm. Some examples of these chemicals are:
 - lead from lead-based paint
 - crystalline silica from bricks and cement and other masonry products, and
 - arsenic and chromium from chemically-treated lumber.
 Your risk from these exposures varies, depending on how often you do this type of work. To reduce your exposure to these chemicals: work in a well ventilated area, and work with approved safety equipment, such as those dust masks that are specially designed to filter out microscopic particles.

SPECIFICATIONS

							Maximum Recommended Capacity			
Drill Motor Cat. No.	Speed	Volts AC	Amps	No Load RPM	Chuck or Taper	Drill	Fine Thread Tap	Coarse Thread Tap	Steel Hawg™ Cutters	
4253-1	• --	120	6.2	600	1/2" Chuck	5/8"	5/8" - 18	3/8" - 16	-	
4262-1	--	120	11.5	350	3/4" Chuck	1-3/8"	1" - 14	7/8" - 9	4" **	
4292-1	HIGH	120	11.5	750	No. 3 M.T.	3/4"	-	-	2" *	
-	LOW	-	-	375	-	1-1/4"	1" - 14	7/8" - 9	4" *	
4297-1	HIGH	120	11.5	500	No. 3 M.T.	1-1/8"	-	-	3" *	
-	LOW	-	-	250	-	1-1/2"	1" - 14	1" - 8	5" *	

M.T. - Internal Morse Taper Socket

• - 5/8" -11 or 1/2" -13 taps not recommended

** - Requires use of 3/4" shank arbor, Cat. No. 49-57-0030

* - Requires use of #3 MT Arbor, Cat. No. 49-57-0010 or 49-57-0014

FUNCTIONAL DESCRIPTION

- | | |
|---|---|
| <ol style="list-style-type: none"> 1. Rack 2. Slide 3. Slide locking wing screw 4. Drill motor 5. Grease fitting 6. Gib adjusting screws 7. Chuck 8. Housing 9. Magnet 10. Adjusting handle | <ol style="list-style-type: none"> 11. Cord 12. Control panel 13. Control panel socket 14. Wing screw assembly 15. Feed handle 16. Feed handle grip |
|---|---|

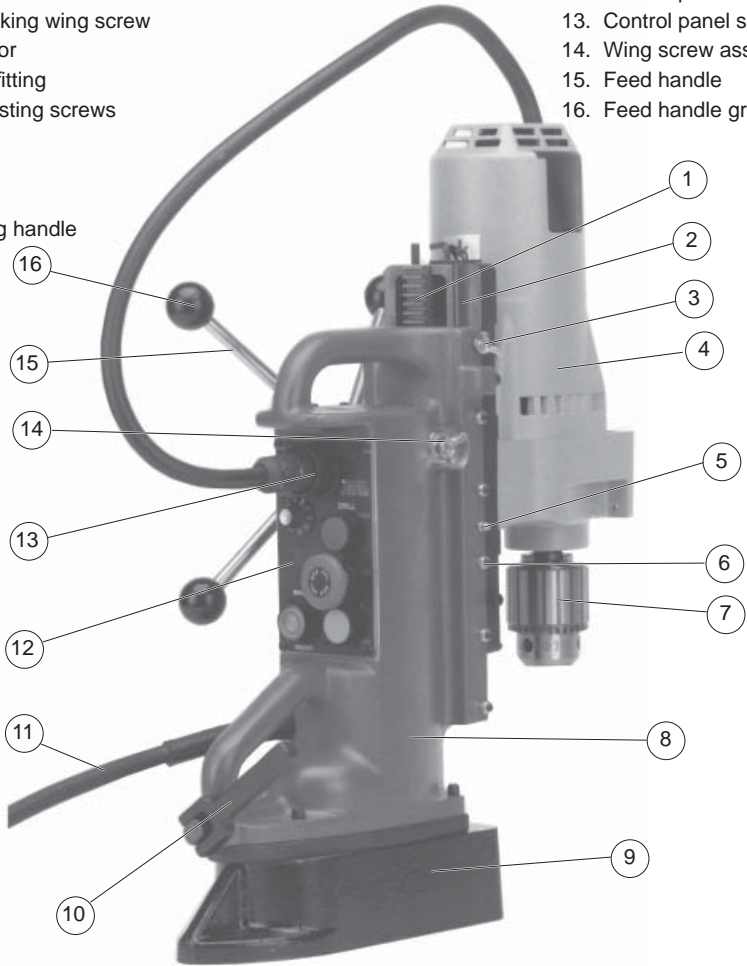

SYMBOLOLOGY

	Double Insulated		DANGER! To reduce the risk of injury, always keep hands, rags, clothing, etc. away from moving parts and chips. Do not try to remove chips while the cutter is rotating. Chips are sharp and can pull objects into moving parts.
$V \sim$	Volts Alternating Current		
A	Amps		
$n_0 \text{ xxx } \text{min.}^{-1}$	No Load Revolutions per Minute (RPM)		
Hz	Hertz		Underwriters Laboratories, Inc. United States and Canada

GROUNDING

⚠ WARNING Improperly connecting the grounding wire can result in the risk of electric shock. Check with a qualified electrician if you are in doubt as to whether the outlet is properly grounded. Do not modify the plug provided with the tool. Never remove the grounding prong from the plug. Do not use the tool if the cord or plug is damaged. If damaged, have it repaired by a **MILWAUKEE** service facility before use. If the plug will not fit the outlet, have a proper outlet installed by a qualified electrician.

Grounded Tools: Tools with Three Prong Plugs

Tools marked "Grounding Required" have a three wire cord and three prong grounding plug. The plug must be connected to a properly grounded outlet (See Figure A). If the tool should electrically malfunction or break down, grounding provides a low resistance path to carry electricity away from the user, reducing the risk of electric shock.

The grounding prong in the plug is connected through the green wire inside the cord to the grounding system in the tool. The green wire in the cord must be the only wire connected to the tool's grounding system and must never be attached to an electrically "live" terminal.

Your tool must be plugged into an appropriate outlet, properly installed and grounded in accordance with all codes and ordinances. The plug and outlet should look like those in Figure A.

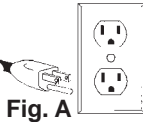

Fig. A

Double Insulated Tools:

Tools with Two Prong Plugs

Tools marked "Double Insulated" do not require grounding. They have a special double insulation system which satisfies OSHA requirements and complies with the applicable standards of Underwriters Laboratories, Inc., the Canadian Standard Association and the National Electrical Code. Double Insulated tools may be used in either of the 120 volt outlets shown in Figures B and C.

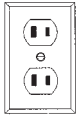

Fig. B

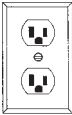

Fig. C

EXTENSION CORDS

Grounded tools require a three wire extension cord. Double insulated tools can use either a two or three wire extension cord. As the distance from the supply outlet increases, you must use a heavier gauge extension cord. Using extension cords with inadequately sized wire causes a serious drop in voltage, resulting in loss of power and possible tool damage. Refer to the table shown to determine the required minimum wire size.

The smaller the gauge number of the wire, the greater the capacity of the cord. For example, a 14 gauge cord can carry a higher current than a 16 gauge cord. When using more than one extension cord to make up the total length, be sure each cord contains at least the minimum wire size required. If you are using one extension cord for more than one tool, add the nameplate amperes and use the sum to determine the required minimum wire size.

Guidelines for Using Extension Cords

- If you are using an extension cord outdoors, be sure it is marked with the suffix "W-A" ("W" in Canada) to indicate that it is acceptable for outdoor use.
- Be sure your extension cord is properly wired and in good electrical condition. Always replace a damaged extension cord or have it repaired by a qualified person before using it.
- Protect your extension cords from sharp objects, excessive heat and damp or wet areas.

Recommended Minimum Wire Gauge for Extension Cords*

Nameplate Amperes	Extension Cord Length				
	25'	50'	75'	100'	150'
0 - 2.0	18	18	18	18	16
2.1 - 3.4	18	18	18	16	14
3.5 - 5.0	18	18	16	14	12
5.1 - 7.0	18	16	14	12	12
7.1 - 12.0	16	14	12	10	
12.1 - 16.0	14	12	10		
16.1 - 20.0	12	10			

* Based on limiting the line voltage drop to five volts at 150% of the rated amperes.

READ AND SAVE ALL INSTRUCTIONS FOR FUTURE USE.

ASSEMBLY

WARNING To reduce the risk of injury, always unplug tool before changing or removing accessories. Only use accessories specifically recommended for this tool. Others may be hazardous.

Attaching Feed Handles and Grips

1. Assemble the feed handles and grips to the feed handle hub. Tighten securely.
2. To mount the feed handle to the opposite side, remove the wing screw assembly that secures the hub/pinion assembly. Pull out the hub/pinion assembly and insert on the other side of the housing. Replace and tighten the wing screw assembly.

Mounting the Drill on Slide

To provide maximum holding power, mount the motor with the spindle closest to the stand. All drills (except 4253-1) can also be mounted in a reverse position to permit drilling close to walls and corners. When the spindle is furthest from the stand, the maximum drill point pressure is reduced.

1. Select the mounting area that best suits your application.
2. Line up the mounting holes.
3. Slip the lock washers over the mounting screw and insert them through the back of the slide and into the motor mounting pad. Tighten securely.

Fig. 1

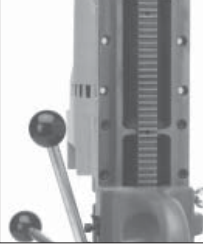

Adjusting the Gib Assembly

To adjust the gib, loosen or tighten the gib adjustment set screws on the side of the support housing accordingly with the 3/32" hex key provided. Tightening the set screws increases friction on the slide. The gib should be set tight enough to support the weight of the drill in any position. All adjusting screws should be set to provide smooth and even travel over the entire length of slide movement.

The set screws contain a nylon patch that prevents them from moving freely. Additional adjustment of the gib may be required from time to time with extended use of the tool.

Connecting the Power Cord Control Panel Socket

Insert the drill plug into the control panel socket and screw it on tightly. Plug the drill press into the nearest power source. This drill press is rated for 120 volts AC, 60 Hz.

Fig. 2



OPERATION

Line Lockout

The line lockout prevents the drill motor from starting when line power is first applied to the system or after a momentary power loss.

Motor/Magnet Interlock

The motor/magnet interlock is a feature that prevents power from being applied to the drill motor if the magnet is not energized. The motor magnet interlock also prevents the magnet from being de-energized while the motor is running.

Diagnostic Light

Low current reduces the magnet's holding power. When current is low, the detection light will flash and the drill motor will stop. When the magnet light flashes, check for the following:

- Low voltage at the plug
 - Loose motor connection
 - Mag panel buttons are jammed or stuck
- If the detection light continues to flash, take the entire unit to an authorized service center.

Auto Base/Chip De-Mag (Motor must be OFF)

The metal chips formed while drilling have a tendency to retain some residual magnetism and stick to the base once the electromagnet is de-energized. In order to prevent this, a base/chip de-mag is accomplished after the motor has stopped by pushing the magnet button. The indicator light will turn off and the base will automatically de-mag.

Electronic Switching

The drill motor may be switched from forward to reverse without first having to bring the motor to a full stop. Ideal for tapping.

Soft-Start

Soft-start is incorporated into the system to help increase drill motor life and decrease stress on the overall system. This feature increases the drill motor speed up from zero to the maximum speed set by the dial in less than one (1) second.

Feedback/Speed Control

The electronic speed control system allows the user to obtain repeatable speed selections, at a given speed dial setting, without the constant change seen with standard speed controls.

Magnetic Holding Force

The electromagnetic drill press attaches magnetically to any ferrous metal. It is designed for use on 1/2" or thicker ferrous stock. Holding power will decrease on thinner stock, a backup plate must be used. The magnetic base WILL NOT hold on non-magnetic grades of stainless steel.

Backing Plate

A backing plate must be used when the workpiece is less than 1/2" thick because the electromagnet cannot provide sufficient holding force on thickness' less than 1/2". The backing plate must bring the combined thickness of the workpiece and backing plate to at least 1/2". Make sure the backing plate is larger than the magnet footprint. Clamp the backing plate underneath the workpiece, directly below the magnet, before turning the magnet on.

The workpiece must be able to support the mag

stand's weight without bending. A bent workpiece reduces the magnet's contact area which can result in the magnet coming loose.

Surface Preparation

Paint, rust, scale or uneven surfaces decrease the holding strength of the magnet. Chips, burrs, dirt and other foreign materials on the surface of the magnetic base will also decrease holding power. Use a smooth, flat file to keep the magnet clean and free of nicks. Clean the surface before attaching the drill stand to the material.

Rack and Pinion

These units have a 10:1 feed ratio: i.e. for every pound applied to the handle, you create ten pounds on the drill point, thereby eliminating operator fatigue. Even large bits only require a small amount of pressure on the handle. Example: 20 Pounds on the handle creates 200 Pounds on the drill point.

Safety Chain

WARNING To reduce the risk of injury, always use a safety chain when drilling overhead or on a vertical surface.

A safety chain is standard equipment with every unit. Should a power loss occur, the mounting could come loose.

When mounting the tool to a vertical surface, the safety chain must be used to secure the tool to the surface.

1. To mount the tool to a vertical surface, place the magnetic drill press on the prepared surface. Push the magnet button on to activate the magnet.
2. Route the safety chain through the lower carrying handle and wrap it tightly around a solid, rigid structure as shown.



3. Eliminate any slack in the chain. Hook the safety chain together using the snaphook provided.
4. Secure the safety chain with a c-clamp or similar device. This will hold the chain in place and prevent the tool from sliding down the vertical surface.

WARNING To reduce the risk of injury, wear safety goggles or glasses with side shields. Unplug the tool before changing accessories or making adjustments.

Control Panel

Fig. 4

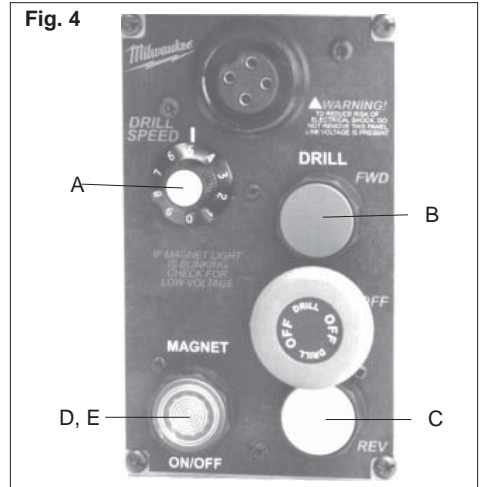

A - Drill Rotation Speed - Fast/Slow

Adjusting the dial changes the drill rotation speed electronically. The higher numbers on the dial produce faster rotation.

B - Forward Drill Button

C - Reverse Drill Button

The drill may be set to two positions: forward and reverse.

1. For **forward** (clockwise) rotation, push the green forward button. Check the direction of rotation before use.
2. For **reverse** (counterclockwise) rotation, push the yellow reverse button. Check direction of rotation before use.

D - Magnet Button - On/Off

The magnet button must be activated before the drill will run.

1. To turn the magnet **on**, push the "Magnet" button. The red indicator light will turn on.
2. To turn the magnet **off**, push the "Magnet" button. The red indicator light will turn off.

E - Drill and Magnet Interlock

The drill will not operate unless the magnet button is pushed and the red indicator light is on. If the operator attempts to start the drill before turning on the magnet, the drill buttons will not function.

To start the drill:

1. Push the magnet button to activate the magnet.
2. Make sure the red indicator light is on. If the light is flashing, check for the following:
 - Low voltage at plug
 - Loose motor connection
 - Mag panel buttons are jammed or stuck
 If flashing light still occurs, take entire unit to an authorized service center.
3. Push a drill button for forward or reverse.
 - If a loss of line voltage occurs while the drill is running, the drill will stop.

Gear Shift Lever



Cat. Nos. 4292-1 and 4297-1 operate in either high or low speed. Use low speed for large diameter bits and high speed for small diameter bits (see "Specifications" chart).

To change speeds, turn the drill off and rotate the lever up or down while the drill is coasting to a stop.

NOTE: To avoid damage to the gearbox, do not shift at full speed, when the tool is under load, or when the tool has stopped.

The gear shift on the motor is labeled:

(L) - for low speed

(H) - for high speed

Typical Operation

1. Insert the bit into the chuck or socket (see "Keyed Chuck" or "Morse Taper Socket" and "Using Twist Drills" and "Using MILWAUKEE STEEL HAWG™ Cutters").
2. Place the magnetic drill press on a prepared surface.
3. Position the unit so that the tip of the drill bit is directly over the center of the hole to be drilled.
4. Push the magnet button. The red indicator light will turn on.
5. Attach the safety chain if drilling overhead or on a vertical surface.
6. Check the gear speed setting and change if required.
7. Push the forward or reverse button as required.
8. Drill hole (see "Using Twist Drills" and "Using MILWAUKEE STEEL HAWG™ Cutters").
9. Push the "Drill Off" button.
10. Remove the chain (if drilling overhead or on a vertical surface).
11. Push the magnet button. The red indicator light will turn off.

Using the Adjustable Base (4203 only)



1. Turn the drill motor off.
2. Position the magnetic base so that the drill bit is near the desired hole location and push the magnet button. The red indicator light will turn on.
3. Loosen the adjusting handle located at the back of the housing base. Move the housing to position the drill bit over the center of the hole. Tighten the adjusting handle securely.

Keyed Chuck (Select Models)

1. Open the chuck jaws wide enough to insert the bit. Be sure the shank and the chuck jaws are clean. Dirt particles may prevent the bit from lining up properly.
2. When using drill bits, insert the bit into the chuck. Center the bit in the chuck jaws and lift it about 1/32" off of the bottom. Tighten the chuck jaws by hand to align the bit.
3. Place the chuck key in each of the three holes in the chuck, turning it clockwise as shown below. Tighten securely.
4. To remove the bit, insert the chuck key into one of the three holes in the chuck and turn it counterclockwise.

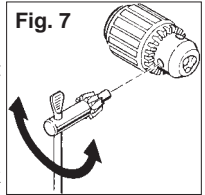

 - Clockwise (Tighten)

 - Counterclockwise (Loosen)

Morse Taper Socket (Select Models)

These drills are supplied with a No. 3 Morse Taper Socket.

To insert a bit or adapter into the socket:

1. Make sure the taper is clean and lightly oiled. Foreign material can cause misalignment.
2. Insert the taper into the socket and rotate the taper until the bit tang slides into the slot at the top of the socket.
3. Press the taper firmly into the socket, or use the feed handle to press the bit against a piece of wood. To remove a bit or adapter from the socket:

1. Unscrew the knurled collar and remove the entire Morse Taper Socket.
2. Strike the bit tang firmly with a soft metal mallet or strike the bit tang firmly on a wood or soft metal surface.
3. Replace the Morse Taper Socket by aligning the notches with tabs on the drill.
4. Replace the knurled collar and tighten.

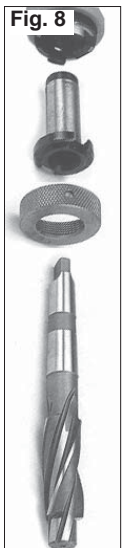

APPLICATIONS

⚠ DANGER To reduce the risk of injury, always keep hands, rags, clothing, etc. away from moving parts and chips. Do not try to remove chips while the cutter is rotating. Chips are sharp and can pull objects into moving parts.



Drilling

When preparing to drill, align the bit with the spot to be drilled. When proper alignment is established, energize the magnet and start the drill motor. A pilot hole is recommended for drilling holes larger than 1/2" in diameter. When drilling, apply only enough force to produce a curled chip. Applying too little force will result in small broken chips and increased drilling time. Applying too much force will cause overheating of the bit resulting in short bit life. Overheating of the bit can be noticed when drill bit and chips turn brown or blue. Excessive force can cause the drill to slow down to a point where drilling time will increase. The use of cutting lubricants will reduce drilling heat and increase drill bit life.

Tapping

Select the proper tap and drill combination. Refer to the "Maximum Recommended Capacity" chart. On two-speed drill motors, use the low speed shift setting. Drill the hole as described above. If possible, tap the hole before moving the base to another position. This eliminates the need to align the tap with the hole. Always use a quality tapping wax or oil for smooth cutting and avoid damage to the tap or workpiece. Pipe taps are not recommended.

1. Insert the tap into the chuck. **TIGHTEN THE CHUCK SO THAT THE CHUCK JAWS GRIP THE ROUND PORTION OF THE SHANK AND NOT THE FLATS OF THE TAP.**
2. For tapping existing holes, align the tap so it is centered with the hole and reenergize the base.
3. Lubricate the tap and hole and lower the tap onto the work surface. Turn the drill speed control to the slowest setting and push the "Drill Fwd" button ("Drill Rev" for the left hand threads) to start the drill motor. Adjust the speed control knob so the tap turns slowly and smoothly into the hole.
4. When using smaller taps, reverse the motor as soon as the tap breaks through the hole. With large taps, reverse the motor as soon as the first full thread is exposed, the motor does not have to be stopped before changing directions.
5. Reverse the motor to slowly withdraw the tap from the hole. Maintain light pressure on the handle to compensate for the weight of the drill motor on the tap. As soon as the tap comes out of the hole, raise the motor and tap clear of the workpiece.

NOTE: Only the low speed shift setting on the 2-speed drill is recommended for tapping.

Using Twist Drills

When preparing to drill, align the bit with the area to be drilled. When proper alignment is established, energize the magnet and start the drill motor. A pilot hole is recommended for drilling holes larger than

1/2" in diameter.

When drilling, apply only enough force to produce a curled chip. Applying too little force will result in small broken chips and increased drilling time. Applying too much force will cause overheating of the bit resulting in short bit life. Overheating of the bit can be noticed when drill bit and chips turn brown or blue. Excessive force can cause the drill to slow down to a point where drilling time will increase. The use of cutting lubricants will reduce drilling heat and increase drill bit life.

Using MILWAUKEE STEEL HAWG™ CUTTERS

MILWAUKEE STEEL HAWG™ CUTTERS cut an annular ring around the edge of the hole leaving the center "slug" intact. This greatly reduces the time, power and drilling force required. The carbide teeth also leave a finished hole that does not require reaming. These cutters are designed for use with an electromagnetic or industrial drill press.

- Do not use these cutters in hand held tools.
- Center pin is spring loaded. Provide protection from ejected slug for people and property below drilling area.
- Do not remove cutter from arbor unless slug is removed. Slug may be ejected unexpectedly.
- Keep pump bottle and hose away from moving parts.
- Use pliers to remove chips from bit and arbor only after motor has stopped.
- Avoid contact with the carbide tips.
- Periodically inspect the carbide tips for loose or cracked tips. **DO NOT USE carbide tips with cracked or loose tips.**

⚠ WARNING

• These bits require the use of HAWG WASH™ cutting fluid for extended life. Do not use cutting fluid in an overhead or any other position that allows cutting fluid to enter motor or switch enclosure.

• Wet connections are shock hazards. Prevent cutting fluid from traveling along cord and contacting the outlet, extension cord connections or tool plug. Each time tool is plugged in, elevate extension cord or gang box connections and arrange a drip loop. If plug or connections get wet, turn power off to outlet before unplugging tool.

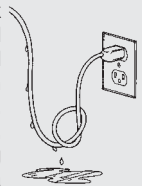

⚠ **WARNING** Always use well maintained equipment with minimum spindle run out.

Attaching MILWAUKEE STEEL HAWG™ CUTTERS

See the information supplied with your arbor.

Cutting Procedure

1. Refer to the chart supplied with the arbor to determine the proper drill rotating speed for the type of material and cutter diameter. When using this chart, use the upper end of the range for softer

materials and the lower end for harder materials. Set the drill rotating speed to the recommended speed.

- Position the workpiece or tool so that the center pin is directly over the desired drilling location.
- The use of HAWG WASH™ cutting fluid is required for long life of these cutters (see "Lubrication"). Attach the hose to the oil fitting on the side of the arbor and to your lubricant reservoir.
- Swing the arbor arm in the direction of the spindle rotation until it comes in contact with the side of the drill motor or drill press.
- Start the drill motor.
- Cutting fluid will not flow freely until the center pin is depressed slightly. Move the cutter towards the material until the center pin is depressed slightly and begin pumping cutting fluid.
- When feeding the cutter into the material, use only enough pressure to produce efficient cutting without overloading the tool or cutter. Because STEEL HAWG™ CUTTERS have multiple cutting edges, they require considerably less downward pressure than ordinary twist drills. STEEL HAWG™ CUTTERS work best at their recommended drill rotating speed and with moderate pressure. Excessive pressure will only slow the operation and damage the cutter. Use less feed pressure when slotting or notching because there is less support for the cutting edges in these situations.
- Avoid raising the cutter before the cut is complete. Keep constant pressure throughout the entire operation to prevent chips and cuttings from falling under the cutting edges. A loose cutting under the cutter can make cutting difficult or impossible.
- When the cut is completed, stop pumping cutting fluid, and withdraw the cutter while the drill motor is still rotating.
- Turn the drill motor off.
- When the drill has stopped, use a pliers to remove cuttings from the bit and arbor. Use care to avoid damaging the carbide teeth.
- The center pin is spring loaded and should eject the slug when the cut is completed. Provide protection from falling slugs for people or property below.

Lubrication

A continuous flow of lubricant is required with these cutters. MILWAUKEE HAWG WASH™ (cutting fluid) is recommended for most applications. It is available in a case of twelve 16 oz. bottles of concentrate, Cat. No. 49-32-0081, which will make 1 gal. of lubricant per bottle. Failure to use the lubricant properly will cause cutter damage. When cutting with STEEL HAWG™ CUTTERS, supply a continuous flow of cutting fluid to the arbor. When notching or slotting, the lubricant system may not supply enough lubricant to the cutting area. In these situations, the cutting fluid should be applied directly to the area being cut. Alternative lubricants introduce different cooling and lubricating reactions. The operator is responsible for the application of lubricants other than HAWG WASH™ cutting fluid.

MAINTENANCE



WARNING To reduce the risk of injury, always unplug your tool before performing any maintenance. Never disassemble the tool or try to do any rewiring on the tool's electrical system. Contact a MILWAUKEE service facility for ALL repairs.

Maintaining Tools

Keep your tool in good repair by adopting a regular maintenance program. Before use, examine the general condition of your tool. Inspect guards, switches, tool cord set and extension cord for damage. Check for loose screws, misalignment, binding of moving parts, improper mounting, broken parts and any other condition that may affect its safe operation. If abnormal noise or vibration occurs, turn the tool off immediately and have the problem corrected before further use. Do not use a damaged tool. Tag damaged tools "DO NOT USE" until repaired (see "Repairs"). Under normal conditions, relubrication is not necessary until the motor brushes need to be replaced. After six months to one year, depending on use, return your tool to the nearest MILWAUKEE service facility for the following:

- Lubrication
- Brush inspection and replacement
- Mechanical inspection and cleaning (gears, spindles, bearings, housing, etc.)
- Electrical inspection (switch, cord, armature, etc.)
- Testing to assure proper mechanical and electrical operation



WARNING To reduce the risk of injury, electric shock and damage to the tool, never immerse your tool in liquid or allow a liquid to flow inside the tool.

Cleaning

Clean dust and debris from vents. Keep the tool handles clean, dry and free of oil or grease. Use only mild soap and a damp cloth to clean your tool since certain cleaning agents and solvents are harmful to plastics and other insulated parts. Some of these include: gasoline, turpentine, lacquer thinner, paint thinner, chlorinated cleaning solvents, ammonia and household detergents containing ammonia. Never use flammable or combustible solvents around tools.

Repairs

If your tool is damaged, return the entire tool to the nearest service center.

ACCESSORIES



WARNING To reduce the risk of injury, always unplug the tool before attaching or removing accessories. Use only specifically recommended accessories. Others may be hazardous.