

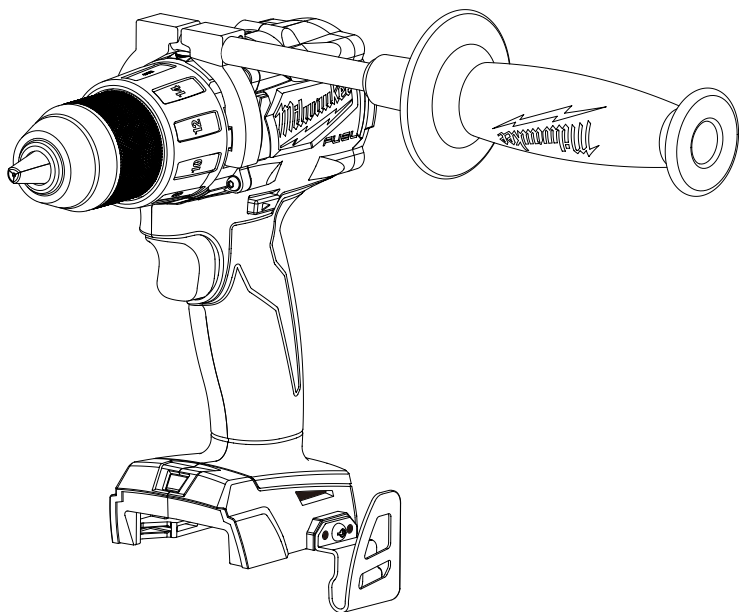

OPERATOR'S MANUAL



Cat. No.
2803-20, 2804-20

M18™ FUEL™ 1/2" DRILL/DRIVER AND HAMMER DRILL/DRIVER



WARNING To reduce the risk of injury, user must read and understand operator's manual.

GENERAL POWER TOOL SAFETY WARNINGS

⚠WARNING Read all safety warnings, instructions, illustrations and specifications provided with this power tool. Failure to follow all instructions listed below may result in electric shock, fire and/or serious injury. **Save all warnings and instructions for future reference.** The term "power tool" in the warnings refers to your mains-operated (corded) power tool or battery-operated (cordless) power tool.

WORK AREA SAFETY

- **Keep work area clean and well lit.** Cluttered or dark areas invite accidents.
- **Do not operate power tools in explosive atmospheres, such as in the presence of flammable liquids, gases or dust.** Power tools create sparks which may ignite the dust or fumes.
- **Keep children and bystanders away while operating a power tool.** Distractions can cause you to lose control.

ELECTRICAL SAFETY

- **Power tool plugs must match the outlet.** Never modify the plug in any way. Do not use any adapter plugs with earthed (grounded) power tools. Unmodified plugs and matching outlets will reduce risk of electric shock.
- **Avoid body contact with earthed or grounded surfaces, such as pipes, radiators, ranges and refrigerators.** There is an increased risk of electric shock if your body is earthed or grounded.
- **Do not expose power tools to rain or wet conditions.** Water entering a power tool will increase the risk of electric shock.
- **Do not abuse the cord.** Never use the cord for carrying, pulling or unplugging the power tool. Keep cord away from heat, oil, sharp edges or moving parts. Damaged or entangled cords increase the risk of electric shock.
- **When operating a power tool outdoors, use an extension cord suitable for outdoor use.** Use of a cord suitable for outdoor use reduces the risk of electric shock.
- **If operating a power tool in a damp location is unavoidable, use a ground fault circuit interrupter (GFCI) protected supply.** Use of an GFCI reduces the risk of electric shock.

PERSONAL SAFETY

- **Stay alert, watch what you are doing and use common sense when operating a power tool. Do not use a power tool while you are tired or under the influence of drugs, alcohol or medication.** A moment of inattention while operating power tools may result in serious personal injury.
- **Use personal protective equipment. Always wear eye protection.** Protective equipment such as a dust mask, non-skid safety shoes, hard hat or hearing protection used for appropriate conditions will reduce personal injuries.
- **Prevent unintentional starting.** Ensure the switch is in the off-position before connecting to power source and/or battery pack, picking up or carrying the tool. Carrying power tools with your finger on the switch or energizing power tools that have the switch on invites accidents.

- **Remove any adjusting key or wrench before turning the power tool on.** A wrench or a key left attached to a rotating part of the power tool may result in personal injury.
- **Do not overreach. Keep proper footing and balance at all times.** This enables better control of the power tool in unexpected situations.
- **Dress properly. Do not wear loose clothing or jewelry. Keep your hair and clothing away from moving parts.** Loose clothes, jewelry or long hair can be caught in moving parts.
- **If devices are provided for the connection of dust extraction and collection facilities, ensure these are connected and properly used.** Use of dust collection can reduce dust-related hazards.
- **Do not let familiarity gained from frequent use of tools allow you to become complacent and ignore tool safety principles.** A careless action can cause severe injury within a fraction of a second.

POWER TOOL USE AND CARE

- **Do not force the power tool. Use the correct power tool for your application.** The correct power tool will do the job better and safer at the rate for which it was designed.
 - **Do not use the power tool if the switch does not turn it on and off.** Any power tool that cannot be controlled with the switch is dangerous and must be repaired.
 - **Disconnect the plug from the power source and/or remove the battery pack, if detachable, from the power tool before making any adjustments, changing accessories, or storing power tools.** Such preventive safety measures reduce the risk of starting the power tool accidentally.
 - **Store idle power tools out of the reach of children and do not allow persons unfamiliar with the power tool or these instructions to operate the power tool.** Power tools are dangerous in the hands of untrained users.
 - **Maintain power tools and accessories. Check for misalignment or binding of moving parts, breakage of parts and any other condition that may affect the power tool's operation. If damaged, have the power tool repaired before use.** Many accidents are caused by poorly maintained power tools.
 - **Keep cutting tools sharp and clean.** Properly maintained cutting tools with sharp cutting edges are less likely to bind and are easier to control.
 - **Use the power tool, accessories and tool bits etc. in accordance with these instructions, taking into account the working conditions and the work to be performed.** Use of the power tool for operations different from those intended could result in a hazardous situation.
 - **Keep handles and grasping surfaces dry, clean and free from oil and grease.** Slippery handles and grasping surfaces do not allow for safe handling and control of the tool in unexpected situations.
- ### BATTERY TOOL USE AND CARE
- **Recharge only with the charger specified by the manufacturer.** A charger that is suitable for one type of battery pack may create a risk of fire when used with another battery pack.
 - **Use power tools only with specifically designated battery packs.** Use of any other battery packs may create a risk of injury and fire.

- When battery pack is not in use, keep it away from other metal objects, like paper clips, coins, keys, nails, screws or other small metal objects, that can make a connection from one terminal to another. Shorting the battery terminals together may cause burns or a fire.
- Under abusive conditions, liquid may be ejected from the battery; avoid contact. If contact accidentally occurs, flush with water. If liquid contacts eyes, additionally seek medical help. Liquid ejected from the battery may cause irritation or burns.
- Do not use a battery pack or tool that is damaged or modified. Damaged or modified batteries may exhibit unpredictable behavior resulting in fire, explosion or risk of injury.
- Do not expose a battery pack or tool to fire or excessive temperature. Exposure to fire or temperature above 265°F (130°C) may cause explosion.
- Follow all charging instructions and do not charge the battery pack or tool outside the temperature range specified in the instructions. Charging improperly or at temperatures outside the specified range may damage the battery and increase the risk of fire.

SERVICE

- Have your power tool serviced by a qualified repair person using only identical replacement parts. This will ensure that the safety of the power tool is maintained.
- Never service damaged battery packs. Service of battery packs should only be performed by the manufacturer or authorized service providers.

SPECIFIC SAFETY RULES FOR DRILL / DRIVERS

Safety instructions for all operations

- Wear ear protectors when impact drilling. Exposure to noise can cause hearing loss.
- Use the auxiliary handle(s). Loss of control can cause personal injury.
- Hold the power tool by insulated gripping surfaces, when performing an operation where the cutting accessory or fasteners may contact hidden wiring. Cutting accessory or fasteners contacting a "live" wire may make exposed metal parts of the power tool "live" and could give the operator an electric shock.

Safety instructions when using long drill bits

- Never operate at higher speed than the maximum speed rating of the drill bit. At higher speeds, the bit is likely to bend if allowed to rotate freely without contacting the workpiece, resulting in personal injury.
- Always start drilling at low speed and with the bit tip in contact with the workpiece. At higher speeds, the bit is likely to bend if allowed to rotate freely without contacting the workpiece, resulting in personal injury.
- Apply pressure only in direct line with the bit and do not apply excessive pressure. Bits can bend causing breakage or loss of control, resulting in personal injury.

AWARNING To reduce the risk of injury in applications that produce a considerable amount of dust, use an OSHA compliant dust extraction solution in accordance with the solution's operating instructions.

- Always use common sense and be cautious when using tools. It is not possible to anticipate every situation that could result in a dangerous outcome. Do not use this tool if you do not understand these operating instructions or you feel the work is beyond your capability; contact Milwaukee Tool or a trained professional for additional information or training.
- Maintain labels and nameplates. These carry important information. If unreadable or missing, contact a MILWAUKEE service facility for a free replacement.

- AWARNING** Some dust created by power sanding, sawing, grinding, drilling, and other construction activities contains chemicals known to cause cancer, birth defects or other reproductive harm. Some examples of these chemicals are:
 - lead from lead-based paint
 - crystalline silica from bricks and cement and other masonry products, and
 - arsenic and chromium from chemically-treated lumber.

Your risk from these exposures varies, depending on how often you do this type of work. To reduce your exposure to these chemicals: work in a well ventilated area, and work with approved safety equipment, such as those dust masks that are specially designed to filter out microscopic particles.

SYMBOLOLOGY



Volts



Direct Current

n₀ XXXX min⁻¹ No Load Revolutions per Minute (RPM)

n XXXX min⁻¹ Blows per Minute Under Load (BPM)



UL Listing for Canada and U.S.

SPECIFICATIONS

Volts.....	18 DC
Battery Type	M18™
Charger Type.....	M18™
Recommended Ambient Operating Temperature.....	0°F to 125°F
Cat. No.	2803-20
No Load RPM.....	Low 0 - 550 High 0 -2000
Steel	1/2"
Wood Flat Bit	1-1/2"
Auger Bit	1-1/2"
Hole Saw	3-1/2"
Screws (dia.).....	5/8"
Self Feed Bits	2-9/16"
Cat. No.	2804-20
No Load RPM.....	Low 0 - 550 High 0 -2000
BPM.....	High 0 - 32,000
Steel	1/2"
Wood Flat Bit	1-1/2"
Auger Bit	1-1/2"
Hole Saw	3-1/2"
Screws (dia.).....	5/8"
Self Feed Bits	2-9/16"
Masonry.....	5/8"

FUNCTIONAL DESCRIPTION

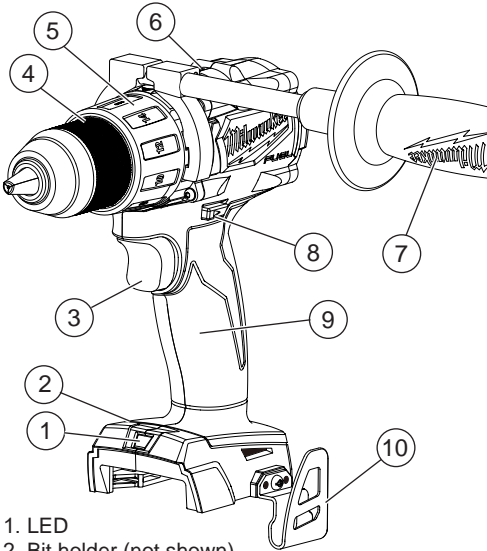

1. LED
2. Bit holder (not shown)
3. Trigger
4. Keyless chuck
5. Torque selector collar
6. Speed selector
7. Side handle
8. Control switch
9. Handle
10. Belt hook

ASSEMBLY

WARNING Recharge only with the charger specified for the battery. For specific charging instructions, read the operator's manual supplied with your charger and battery.

Removing/Inserting the Battery

To remove the battery, push in the release buttons and pull the battery pack away from the tool.

WARNING Always remove battery pack before changing or removing accessories.

To insert the battery, slide the pack into the body of the tool. Make sure it latches securely into place.

WARNING To reduce the risk of injury, always use a side handle when using this tool. Always brace or hold securely. Ensure side handle is tightened securely before each use.

Installing the Side Handle

1. To install the side handle, loosen the side handle grip until the hooks are far enough apart to fit into the slots on the gear case ring. Position the side handle on the top, pointing to the left or right. Tighten the side handle grip until it is secure.

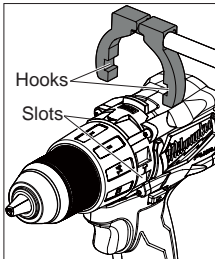

2. To remove the side handle, loosen the side handle grip until the side handle can be removed. Reposition and tighten securely.

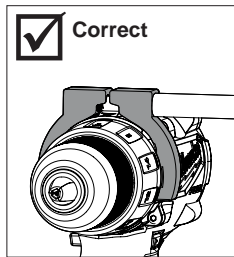

Correct

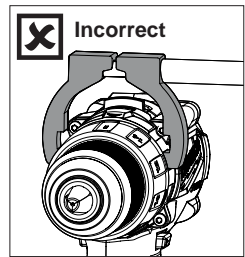

Incorrect

WARNING Always remove battery pack before changing or removing accessories. Only use accessories specifically recommended for this tool. Others may be hazardous.

Installing Bits

Always remove the battery before inserting or removing bits. Select the proper style and size bit for the job. This tool is equipped with a spindle lock. The chuck can be tightened with one hand, creating higher grip strengths on the bit.

1. To open the chuck jaws, turn the sleeve in the counterclockwise direction. When using drill bits, allow the bit to strike the bottom of the chuck. Center the bit in the chuck jaws and lift it about 1/16" off of the bottom. When using screwdriver bits, insert the bit far enough for the chuck jaws to grip the hex of the bit.
2. To close the chuck jaws, turn the sleeve in the clockwise direction. The bit is secure when the chuck makes a ratcheting sound and the sleeve can not be rotated any further.
3. To remove the bit, turn the sleeve in the counterclockwise direction.

NOTE: A ratcheting sound may be heard when the chuck is opened or closed. This noise is part of the locking feature, and does not indicate a problem with the chuck's operation.

OPERATION

WARNING To reduce the risk of injury, always wear safety goggles or glasses with side shields.

Selecting Drill or Drive Action

(Cat. No. 2803-20)

1. To use the drilling mode, rotate the torque selector collar until the drill symbol  appears in line with the arrow.
2. To use the driving mode rotate the torque selector collar until the desired clutch setting appears in line with the arrow. The adjustable clutch, when properly adjusted, will slip at a preset torque to prevent driving the screw too deep into different materials and to prevent damage to the screw or tool.

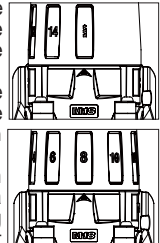

Selecting Hammer, Drill or Drive Action

(Cat. No. 2804-20)

1. To use the **hammer-drilling mode**, rotate the torque selector collar until the hammer symbol  appears in line with the arrow. Apply pressure to the bit to engage the hammering mechanism.

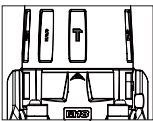

NOTE: When using carbide bits, do not use water to settle dust. Do not attempt to drill through steel reinforcing rods. This will damage the carbide bits.

2. To use the **drilling only mode**, rotate the torque selector collar until the drill symbol  appears in line with the arrow.

NOTE: The number selected on the torque selector collar has no effect on operation of the drill in drilling mode.

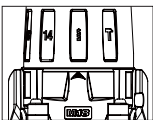

3. To use the **driving screws mode** rotate the torque selector collar until the desired clutch setting appears in line with the arrow.

The adjustable clutch, when properly adjusted, will slip at a preset torque to prevent driving the screw too deep into different materials and to prevent damage to the screw or tool.

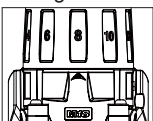

The torque specifications shown here are approximate values obtained with a fully charged battery pack.

TORQUE SPECIFICATIONS

Clutch Setting	in. lbs	Applications
1-4 5-8	25-40 45-60	Small screws in softwood.
9-11 12-14	65-75 80-90	Medium screws in softwood or small screws in hardwood.

NOTE: Because the settings shown in the table are only a guide, use a piece of scrap material to test the different clutch settings before driving screws into the workpiece.

Selecting Speed

The speed selector is on top of the motor housing. Allow the tool to come to a complete stop before changing speeds. See "Applications" for recommended speeds under various conditions.

1. For **Low** speed, push the speed selector to display "1".
2. For **High** speed, push the speed selector to display "2".

Using the Control Switch

The control switch may be set to three positions: forward, reverse and lock. Due to a lockout mechanism, the control switch can only be adjusted when the ON/OFF switch is not pressed. Always allow the motor to come to a complete stop before using the control switch.

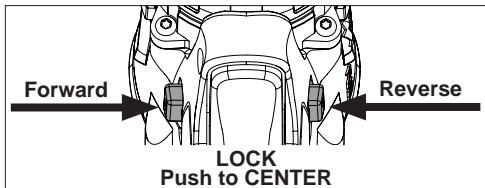

For **forward** (clockwise) rotation, push in the control switch from the right side of the tool. **Check the direction of rotation before use.**

For **reverse** (counterclockwise) rotation, push in the control switch from the left side of the tool. **Check direction of rotation before use.**

To **lock** the trigger, push the control switch to the center position. The trigger will not work while the control switch is in the center locked position. Always lock the trigger or remove the battery pack before performing maintenance, changing accessories, storing the tool and any time the tool is not in use.

WARNING To reduce the risk of injury, always hold or brace securely.

Starting, Stopping and Controlling Speed

1. To **start** the tool, grasp the handles firmly and pull the trigger.

NOTE: An LED is turned on when the trigger is pulled.

2. To **vary** the speed, increase or decrease the pressure on the trigger. The further the trigger is pulled, the greater the speed.
3. To **stop** the tool, release the trigger. Make sure the bit comes to a complete stop before laying the tool down.

Drilling

Place the bit on the work surface and apply firm pressure before starting. Too much pressure will slow the bit and reduce drilling efficiency. Too little pressure will cause the bit to slide over the work area and dull the point of the bit.

If the tool begins to stall, reduce pressure slightly to allow the bit to regain speed. If the bit binds, reverse the motor to free the bit from the workpiece.

APPLICATIONS

WARNING To reduce the risk of electric shock, check work area for hidden pipes and wires before drilling or driving screws.

To reduce the risk of injury in applications that produce a considerable amount of dust, use an OSHA compliant dust extraction solution in accordance with the solution's operating instructions.

Drilling in Wood, Composition Materials and Plastic

When drilling in wood, composition materials and plastic, select the  drill-only operating mode. Start the drill slowly, gradually increasing speed as you drill. When drilling into wood, use wood augers or twist drill bits. Always use sharp bits. When using twist drill bits, pull the bit out of the hole frequently to clear chips from the bit flutes. To reduce the chance of splintering, back work with a piece of scrap wood. Select low speeds for plastics with a low melting point.

Drilling in Metal

When drilling in metal, select the  drill-only operating mode. Use high speed steel twist drills or hole saws. Use a center punch to start the hole. Lubricate drill bits with cutting oil when drilling in iron or steel. Use a coolant when drilling in nonferrous metals such as copper, brass or aluminum. Back the material to prevent binding and distortion on breakthrough.

Drilling in Masonry

When drilling in masonry, select the  hammer drill operating mode. Use high speed carbide-tipped bits. Drilling soft masonry materials such as cinder block requires little pressure. Hard materials like concrete require more pressure. A smooth, even flow of dust indicates the proper drilling rate. Do not let the bit spin in the hole without cutting. Do not use water to settle dust or to cool bit. Both actions will damage the carbide.

Driving Screws and Nut Running

Drill a pilot hole when driving screws into thick or hard materials. Set the torque selector collar to the proper position and set the speed to low. Use the proper style and size screwdriver bit for the type of screw you are using. With the screwdriver bit in the screw, place the tip of the screw on the workpiece and apply firm pressure before pulling the trigger. Screws can be removed by reversing the motor.

Overloading

Continuous overloading may cause permanent damage to tool or battery pack.

MAINTENANCE

⚠WARNING To reduce the risk of injury, always unplug the charger and remove the battery pack from the charger or tool before performing any maintenance. Never disassemble the tool, battery pack or charger. Contact a MILWAUKEE service facility for ALL repairs.

Maintaining Tool

Keep your tool, battery pack and charger in good repair by adopting a regular maintenance program. Inspect your tool for issues such as undue noise, misalignment or binding of moving parts, breakage of parts, or any other condition that may affect the tool operation. Return the tool, battery pack, and charger to a MILWAUKEE service facility for repair. After six months to one year, depending on use, return the tool, battery pack and charger to a MILWAUKEE service facility for inspection.

If the tool does not start or operate at full power with a fully charged battery pack, clean the contacts on the battery pack. If the tool still does not work properly, return the tool, charger and battery pack, to a MILWAUKEE service facility for repairs.

⚠WARNING To reduce the risk of personal injury and damage, never immerse your tool, battery pack or charger in liquid or allow a liquid to flow inside them.

Cleaning

Clean dust and debris from vents. Keep handles clean, dry and free of oil or grease. Use only mild soap and a damp cloth to clean, since certain cleaning agents and solvents are harmful to plastics and other insulated parts. Some of these include gasoline, turpentine, lacquer thinner, paint thinner, chlorinated cleaning solvents, ammonia and household detergents containing ammonia. Never use flammable or combustible solvents around tools.

Repairs

For repairs, return the tool, battery pack and charger to the nearest service center.