



SERVICE PARTS LIST

BULLETIN NO.
54-38-2780

SPECIFY CATALOG NO. AND SERIAL NO. WHEN ORDERING PARTS		REVISED BULLETIN	DATE
M18 FUEL™ 7"/9" Large Angle Grinder			Aug. 2018
CATALOG NO.	2785-20	STARTING SERIAL NO.	J59A
		WIRING INSTRUCTION SEE PAGE 2	

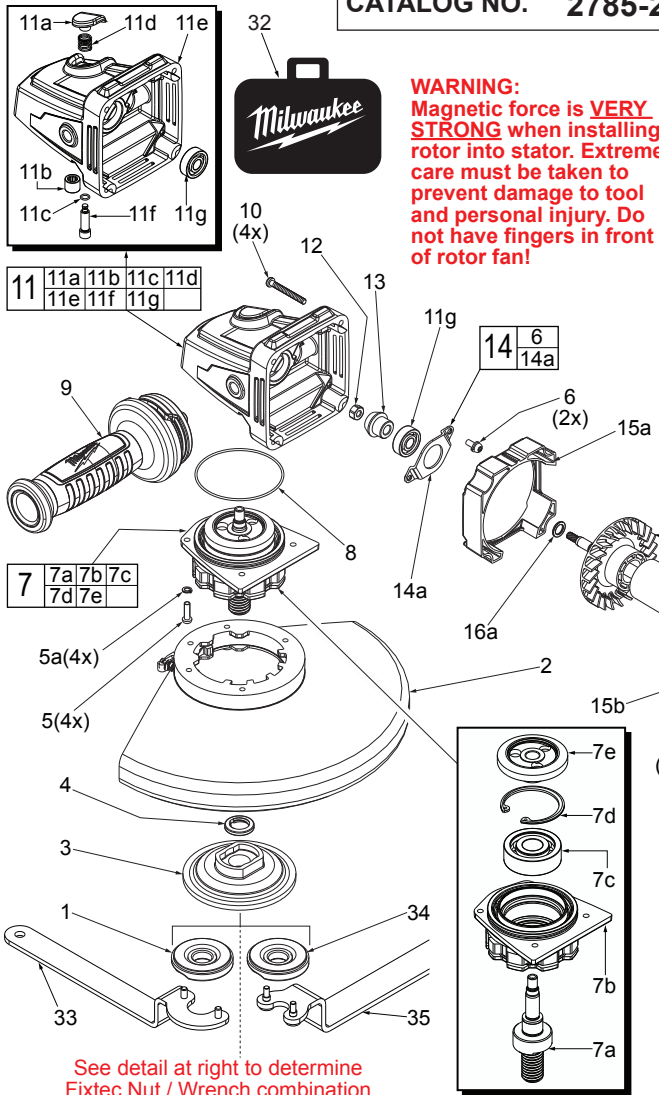

FIG.	PART NO.	DESCRIPTION OF PART	NO. REQ.
16	16-01-2785	Rotor Assembly	(1)
16a	45-88-0406	Washer	(1)
17	05-88-0082	K45 x 49mm Pan Hd. T-20 PT Screw	(3)
18	45-88-0010	Washer	(3)
20	14-20-2800	Grounding Assembly	(1)
22	12-20-0123	Service Nameplate	(1)
23	14-20-2785	Electronics Assembly	(1)
23b	23-66-2785	On-Off Switch Assembly with Screws	(1)
25	06-82-0126	M2.3 x 5mm PWH Tapt. T-6 Screw	(1)
26	22-56-0150	Closed End Terminal	(1)
27	14-34-2785	Rear Handle/Housing Kit	(1)
27a	-----	Left Handle/Housing Halve - Support	(1)
27b	-----	Right Handle/Housing Halve - Cover	(1)
27c	05-81-1195	M3 x 8mm Pan Hd. ST T-10 Screw	(4)
27d	06-82-0011	M4 x 20mm Pan Hd. ST T-20 Screw	(5)
27e	05-88-0780	M3 x 18mm Pan Hd. ST T-10 Screw	(2)
28	31-15-0072	Vent Clip Assembly	(1)
32	48-55-3565	M18 FUEL Large Contractor Bag	(1)
33	49-96-0002	Spanner Wrench	(1)
34	05-59-0016	5/8"-11 Fixtec Nut	(1)
35	49-96-0004	Spanner Wrench	(1)

See detail at right to determine Fixtec Nut / Wrench combination

FIG.	PART NO.	DESCRIPTION OF PART	NO. REQ.
1	05-59-0015	5/8"-11 Fixtec Nut	(1)
2	49-12-0010	7" Type 27 Wheel Guard Assy. (Not Shown)	(1)
2	49-12-0020	9" Type 27 Wheel Guard Assembly	(1)
2	49-12-0230	7" Type 1 Wheel Guard Assy. (Not Shown)	(1)
2	49-12-0240	9" Type 1 Wheel Guard Assy. (Not Shown)	(1)
3	43-34-0825	Type 27 Backing Flange	(1)
3	43-35-0925	Type 1 Backing Flange (Not Shown)	(1)
4	45-88-8466	5/8"-11 Spindle Washer	(1)
5	05-88-1210	M4 x 14mm Pan Hd. T-20 Mach. Scr.	(4)
5a	05-90-0225	Lock Washer	(4)
6	06-81-0003	M4 x 10mm Pan Hd. Sems T-20 Mach. Scr.	(2)
7	14-73-0005	Spindle Hub Assembly	(1)
7a	-----	5/8"-11 Spindle	(1)
7b	-----	Spindle Hub	(1)
7c	-----	Ball Bearing	(1)
7d	-----	Retaining Ring	(1)
7e	-----	Bevel Gear	(1)
8	34-40-0262	O-Ring	(1)
9	42-62-0125	AVS Side Handle	(1)
10	06-81-5376	M4 x 34mm Pan Hd. ST T-20 Screw	(4)
11	14-30-2785	Gearcase Assembly	(1)
11a	42-42-0525	Spindle Lock Button	(1)
11b	02-50-0025	Needle Bearing	(1)
11c	34-40-0450	O-Ring	(1)
11d	40-50-1330	Spindle Lock Spring	(1)
11e	-----	Gearcase	(1)
11f	42-60-0003	Spindle Lock Pin	(1)
11g	02-04-0620	Ball Bearing	(1)
12	05-55-0620	M5 Hex Nut	(1)
13	32-60-0165	Bevel Pinion	(1)
14	44-86-0192	Bearing Retainer Kit	(1)
14a	-----	Bearing Retainer	(1)
15	42-14-0037	Baffle Assembly	(1)
15a	-----	Baffle Scroll	(1)
15b	-----	Baffle Foot	(1)

05-59-0015

It is important to note that there are two different Fixtec Nut designs that can be used on the 2785-20 M18 FUEL Grinder. Each Fixtec Nut utilizes a spanner wrench that is unique to the nut.

05-59-0016

Fixtec Nut 05-59-0015 (1) must be used with Spanner Wrench 49-96-0002 (33). Fixtec Nut 05-59-0016 (34) must be used with Spanner Wrench 49-96-0004 (35).

Use this diagram to determine the nut and wrench design and order service parts accordingly.

When servicing, remove 90-95% of the existing grease prior to installing Type 'Y'. Original grease may be similar in color but not compatible with 'Y'. Clean gear assemblies with a clean, dry cloth.

LUBRICATION
Type 'Y' Grease, No. 49-08-5275 (14oz. tub)
 Apply a liberal amount of grease, approximately 5 grams/.17oz. to the Bevel Gear (7e) and Bevel Pinion (13). Be sure that all gear teeth are coated.

Place approximately 25 grams/.88oz. of grease in the gear cavity of gearcase assembly (11).