

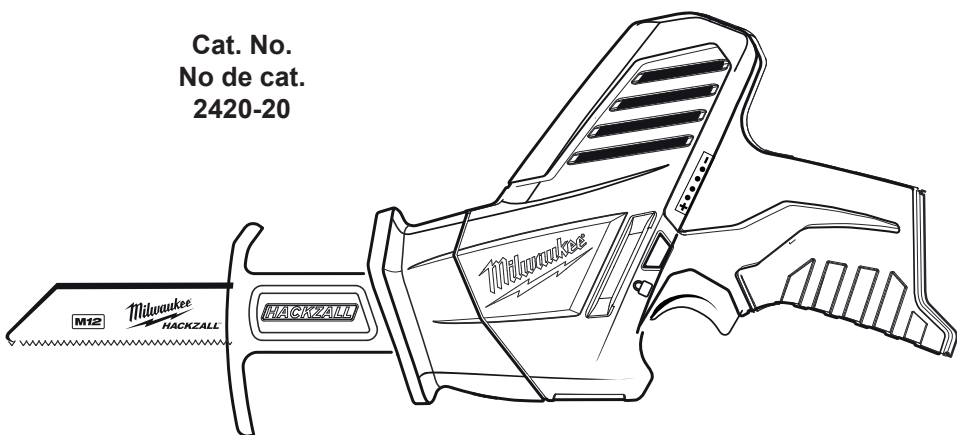

## OPERATOR'S MANUAL

Cat. No.  
No de cat.  
2420-20



### M12™ CORDLESS HACKZALL® RECIPROCATING SAW

TO REDUCE THE RISK OF INJURY, USER MUST READ AND UNDERSTAND OPERATOR'S MANUAL.

#### GENERAL POWER TOOL SAFETY WARNINGS

**⚠ WARNING READ ALL SAFETY WARNINGS AND ALL INSTRUCTIONS.** Failure to follow the warnings and instructions may result in electric shock, fire and/or serious injury. **Save all warnings and instructions for future reference.** The term "power tool" in the warnings refers to your mains-operated (corded) power tool or battery-operated (cordless) power tool.

#### WORK AREA SAFETY

- Keep work area clean and well lit. Cluttered or dark areas invite accidents.
- Do not operate power tools in explosive atmospheres, such as in the presence of flammable liquids, gases or dust. Power tools create sparks which may ignite the dust or fumes.
- Keep children and bystanders away while operating a power tool. Distractions can cause you to lose control.

#### ELECTRICAL SAFETY

- Power tool plugs must match the outlet. Never modify the plug in any way. Do not use any adapter plugs with earthed (grounded) power tools. Unmodified plugs and matching outlets will reduce risk of electric shock.
- Avoid body contact with earthed or grounded surfaces such as pipes, radiators, ranges and refrigerators. There is an increased risk of electric shock if your body is earthed or grounded.
- Do not expose power tools to rain or wet conditions. Water entering a power tool will increase the risk of electric shock.
- Do not abuse the cord. Never use the cord for carrying, pulling or unplugging the power tool. Keep cord away from heat, oil, sharp edges or moving parts. Damaged or entangled cords increase the risk of electric shock.
- When operating a power tool outdoors, use an extension cord suitable for outdoor use. Use of a cord suitable for outdoor use reduces the risk of electric shock.
- If operating a power tool in a damp location is unavoidable, use a residual current device (RCD) protected supply. Use of an RCD reduces the risk of electric shock.

#### PERSONAL SAFETY

- Stay alert, watch what you are doing and use common sense when operating a power tool. Do not use a power tool while you are tired or under the influence of drugs, alcohol or medication. A moment of inattention while operating power tools may result in serious personal injury.
- Use personal protective equipment. Always wear eye protection. Protective equipment such as dust mask, non-skid safety shoes, hard hat, or hearing protection used for appropriate conditions will reduce personal injuries.
- Prevent unintentional starting. Ensure the switch is in the off-position before connecting to power source and/or battery pack, picking up or carrying the tool. Carrying power tools with your finger on the switch or energising power tools that have the switch on invites accidents.
- Remove any adjusting key or wrench before turning the power tool on. A wrench or a key left attached to a rotating part of the power tool may

result in personal injury.

- Do not overreach. Keep proper footing and balance at all times. This enables better control of the power tool in unexpected situations.
- Dress properly. Do not wear loose clothing or jewellery. Keep your hair, clothing and gloves away from moving parts. Loose clothes, jewellery or long hair can be caught in moving parts.
- If devices are provided for the connection of dust extraction and collection facilities, ensure these are connected and properly used. Use of dust collection can reduce dust-related hazards.
- Do not force the power tool. Use the correct

#### POWER TOOL USE AND CARE

- power tool for your application. The correct power tool will do the job better and safer at the rate for which it was designed.
- Do not use the power tool if the switch does not turn it on and off. Any power tool that cannot be controlled with the switch is dangerous and must be repaired.
- Disconnect the plug from the power source and/or the battery pack from the power tool before making any adjustments, changing accessories, or storing power tools. Such preventive safety measures reduce the risk of starting the power tool accidentally.
- Store idle power tools out of the reach of children and do not allow persons unfamiliar with the power tool or these instructions to operate the power tool. Power tools are dangerous in the hands of untrained users.
- Maintain power tools. Check for misalignment or binding of moving parts, breakage of parts and any other condition that may affect the power tool's operation. If damaged, have the power tool repaired before use. Many accidents are caused by poorly maintained power tools.
- Keep cutting tools sharp and clean. Properly maintained cutting tools with sharp cutting edges are less likely to bind and are easier to control.
- Use the power tool, accessories and tool bits etc., in accordance with these instructions, taking into account the working conditions and the work to be performed. Use of the power tool for operations different from those intended could result in a hazardous situation.

#### BATTERY TOOL USE AND CARE

- Recharge only with the charger specified by the manufacturer. A charger that is suitable for one type of battery pack may create a risk of fire when used with another battery pack.
- Use power tools only with specifically designated battery packs. Use of any other battery packs may create a risk of injury and fire.
- When battery pack is not in use, keep it away from other metal objects like paper clips,

coins, keys, nails, screws, or other small metal objects that can make a connection from one terminal to another. Shorting the battery terminals together may cause burns or a fire.

•Under abusive conditions, liquid may be ejected from the battery; avoid contact. If contact accidentally occurs, flush with water. If liquid contacts eyes, additionally seek medical help. Liquid ejected from the battery may cause irritation or burns.

### SERVICE

•Have your power tool serviced by a qualified repair person using only identical replacement parts. This will ensure that the safety of the power tool is maintained.

### SPECIFIC SAFETY RULES

•Hold power tool by insulated gripping surfaces, when performing an operation where the cutting accessory may contact hidden wiring. Cutting accessory contacting a "live" wire may make exposed metal parts of the power tool "live" and could give the operator an electric shock.

•Use clamps or another practical way to secure and support the workpiece to a stable platform. Holding the work by hand or against your body leaves it unstable and may lead to loss of control.

•Maintain labels and nameplates. These carry important information. If unreadable or missing, contact a MILWAUKEE service facility for a free replacement.

•**WARNING** Some dust created by power sanding, sawing, grinding, drilling, and other construction activities contains chemicals known to cause cancer, birth defects or other reproductive harm. Some examples of these chemicals are:

- lead from lead-based paint
- crystalline silica from bricks and cement and other masonry products, and
- arsenic and chromium from chemically-treated lumber.

Your risk from these exposures varies, depending on how often you do this type of work. To reduce your exposure to these chemicals: work in a well ventilated area, and work with approved safety equipment, such as those dust masks that are specially designed to filter out microscopic particles.

### FUNCTIONAL DESCRIPTION

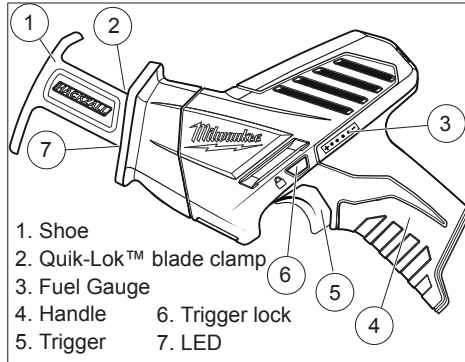

1. Shoe
2. Quik-Lok™ blade clamp
3. Fuel Gauge
4. Handle
5. Trigger
6. Trigger lock
7. LED

### ASSEMBLY

**WARNING** Recharge only with the charger specified for the battery. For specific charging instructions, read the operator's manual supplied with your charger and battery.

#### Inserting/Removing the Battery

To remove the battery, push in the release buttons and pull the battery pack away from the tool. To insert the battery, slide the pack into the body of the tool. Make sure it latches securely into place.

**WARNING** Always remove battery pack before changing or removing accessories. Only use accessories specifically recommended for this tool. Others may be hazardous.

#### Selecting a Blade

The Quik-Lok® Blade Clamp can be used with all 1/2" shank universal Hackzall®, and Sawzall® blades. Use MILWAUKEE blades for best performance. When selecting a blade, choose the right type and length. Many types of blades are available for a variety of applications: cutting metal, wood, nail-embedded wood, scroll cutting, roughing-in, and contours.

Many lengths are also available. Choose a length long enough to extend beyond the shoe and your work throughout the stroke. **Do not use blades less than 3-1/2" long since they won't extend beyond the shoe throughout the stroke.**

#### Installing and Removing Blades from the Quik-Lok® Blade Clamp

Remove battery pack before changing blades. Make sure the spindle and blade clamp areas are clean. Metal chips and sawdust may prevent the Quik-Lok® Blade Clamp from clamping securely.

1. Depending on the job, the blade may be inserted with the teeth facing up or down. To install a blade, twist collar in the direction of the arrow while inserting the blade into the clamp until the tang butts against the collar.

Fig. 1

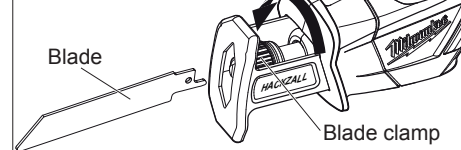

2. Release collar and the spring loaded mechanism will clamp the blade firmly in place.
3. Twist collar in the opposite direction of the arrow to ensure that the blade is locked into the clamp.
4. Tug on blade to make sure it is securely locked in place.
5. To remove a blade, twist collar in the direction of the arrow while pulling on the blade. Be careful when handling hot blades.

#### Quik-Lok® Blade Clamp Maintenance

- Periodically clean dust and debris from the Quik-Lok® Blade Clamp with dry compressed air.
- If the collar resists twisting, twist the collar back and forth to shake debris loose.
- Periodically lubricate Quik-Lok® Blade Clamp with a dry lubricant such as graphite.

#### Removing broken blades from the Quik-Lok® Blade Clamp

- Broken blades can be removed by the following:
- Remove battery pack before removing blades.
  - Point the tool downward, twist the collar, and shake the tool up and down (**DO NOT** turn the tool on while your fingers are holding the blade clamp open). The shank of the broken blade should drop out of the clamp.
  - If shaking the tool doesn't work - In most cases, a corner of the broken blade will extend beyond the blade clamp. Twist the collar and pull the broken blade out of the clamp by this corner.
  - If the broken stub doesn't extend far enough to be grabbed by its corner, use a thin blade with small teeth (such as a metal cutting blade) to hook the blade that is jammed in the clamp while twisting the collar and pull it out.

**WARNING** To reduce the risk of injury, be sure the blade always extends beyond the shoe and workpiece throughout the stroke. Blades may shatter if they impact the workpiece or shoe (Fig. 2).

Fig. 2

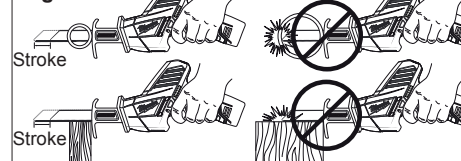



### OPERATION

**WARNING** Always remove battery pack before changing or removing accessories. Only use accessories specifically recommended for this tool. Others may be hazardous.

**WARNING** To reduce the risk of injury, wear safety goggles or glasses with side shields.

#### Trigger Lock

To lock  the trigger, push the trigger lock as shown. The trigger will not work while the switch is in the locked position. Always lock the trigger and remove the battery pack before performing maintenance and changing accessories. Lock the trigger when storing the tool and when the tool is not in use. To unlock  the trigger, push the trigger lock as shown.

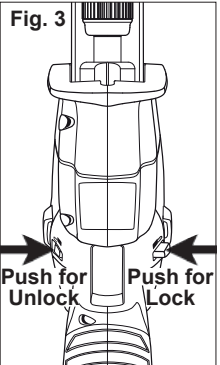

#### Fuel Gauge

To determine the amount of charge left in the battery, pull the trigger. The Fuel Gauge will light up for 2-3 seconds. To signal the end of charge, 1 light on the fuel gauge will flash for 2-3 seconds.

**WARNING** Do not touch blade immediately after use. Blade will be hot.

#### Starting, Stopping and Controlling Speed

To start the tool, grasp the handle firmly and pull the trigger. An LED is turned on when the trigger is pulled.

To vary the speed, increase or decrease the pressure on the trigger. The further the trigger is pulled, the greater the speed.

To stop the tool, release the trigger. Make sure the blade comes to a complete stop before removing the blade from a partial cut or laying the tool down.



#### General Cutting

For straight or contour cutting from an edge, line the blade up with your cutting line. Before the blade contacts the workpiece, grasp the handle firmly and pull the trigger. Then guide the tool along your cutting line. Always hold the shoe flat against the workpiece to avoid excessive vibration.

#### Cutting Metals

Begin cutting at a slow speed, gradually increasing speed as you cut. When cutting into metals or hard materials that can not be cut from an edge, drill a starting hole larger than the widest part of the blade.

### SYMBOLOLOGY

	Volts
	Direct Current
$n_0$ XXXXmin. <sup>-1</sup>	No Load Strokes per Minute (SPM)
	Underwriters Laboratories, Inc. United States and Canada

### SPECIFICATIONS

Cat. No.	Volts DC	No Load Strokes Per Minute	Length of Stroke
2420-20	12	0 - 3000	1/2"

**⚠ WARNING** To reduce the risk of explosion, electric shock and property damage, always check the work area for hidden gas pipes, electrical wires or water pipes when making blind or plunge cuts.

#### Plunge Cutting

Your *MILWAUKEE* Hackzall® is ideal for plunge cutting directly into surfaces that can not be cut from an edge, such as walls or floors. Do not plunge cut into metal surfaces (see "Cutting Metals").

1. Insert the blade into the tool with the teeth facing down. Hold the tool as shown, resting the edge of the shoe on the workpiece.
2. With the blade just above the workpiece, pull the trigger. Using the edge of the shoe as a pivot, lower the blade into the workpiece as shown.
3. As the blade starts cutting, raise the handle of the tool slowly until the shoe rests firmly on the workpiece. Then guide the tool along your cutting line to acquire the desired cut.

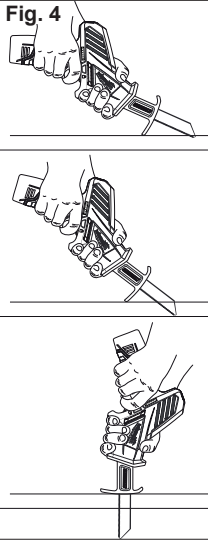

## MAINTENANCE

**⚠ WARNING** To reduce the risk of injury, always unplug the charger and remove the battery pack from the charger or tool before performing any maintenance. Never disassemble the tool, battery pack or charger. Contact a *MILWAUKEE* service facility for ALL repairs.

#### Maintaining Tool

Keep your tool, battery pack and charger in good repair by adopting a regular maintenance program. After six months to one year, depending on use, return the tool, battery pack and charger to A *MILWAUKEE* service facility for:

- Lubrication
- Mechanical inspection and cleaning (gears, spindles, bearings, housing, etc.)
- Electrical inspection (battery pack, charger, motor)
- Testing to assure proper mechanical and electrical operation

If the tool does not start or operate at full power with a fully charged battery pack, clean the contacts on the battery pack. If the tool still does not work properly, return the tool, charger and battery pack, to a *MILWAUKEE* service facility for repairs.

**⚠ WARNING** To reduce the risk of personal injury and damage, never immerse your tool, battery pack or charger in liquid or allow a liquid to flow inside them.

#### Cleaning

Clean dust and debris from charger and tool vents. Keep tool handles clean, dry and free of oil or grease. Use only mild soap and a damp cloth to clean the tool, battery pack and charger since certain cleaning agents and solvents are harmful to plastics and other insulated parts. Some of these include gasoline, turpentine, lacquer thinner, paint thinner, chlorinated cleaning solvents, ammonia and household detergents containing ammonia. Never use flammable or combustible solvents around tools.

#### Repairs

For repairs, return the tool, battery pack and charger to the nearest service center.