



## OPERATOR'S MANUAL



Cat. No.  
0100-20, 0101-20, 0200-20, 0201-20,  
0202-20, 0299-20, 0300-20, 0302-20

### DRILLS



**WARNING** To reduce the risk of injury, user must read and understand operator's manual.

## GENERAL POWER TOOL SAFETY WARNINGS

**⚠WARNING** Read all safety warnings, instructions, illustrations and specifications provided with this power tool. Failure to follow all instructions listed below may result in electric shock, fire and/or serious injury. **Save all warnings and instructions for future reference.** The term "power tool" in the warnings refers to your mains-operated (corded) power tool or battery-operated (cordless) power tool.

### WORK AREA SAFETY

- **Keep work area clean and well lit.** Cluttered or dark areas invite accidents.
- **Do not operate power tools in explosive atmospheres, such as in the presence of flammable liquids, gases or dust.** Power tools create sparks which may ignite the dust or fumes.
- **Keep children and bystanders away while operating a power tool.** Distractions can cause you to lose control.

### ELECTRICAL SAFETY

- **Power tool plugs must match the outlet. Never modify the plug in any way. Do not use any adapter plugs with earthed (grounded) power tools.** Unmodified plugs and matching outlets will reduce risk of electric shock.
- **Avoid body contact with earthed or grounded surfaces, such as pipes, radiators, ranges and refrigerators.** There is an increased risk of electric shock if your body is earthed or grounded.
- **Do not expose power tools to rain or wet conditions.** Water entering a power tool will increase the risk of electric shock.
- **Do not abuse the cord. Never use the cord for carrying, pulling or unplugging the power tool. Keep cord away from heat, oil, sharp edges or moving parts.** Damaged or entangled cords increase the risk of electric shock.
- **When operating a power tool outdoors, use an extension cord suitable for outdoor use.** Use of a cord suitable for outdoor use reduces the risk of electric shock.
- **If operating a power tool in a damp location is unavoidable, use a ground fault circuit interrupter (GFCI) protected supply.** Use of an GFCI reduces the risk of electric shock.

### PERSONAL SAFETY

- **Stay alert, watch what you are doing and use common sense when operating a power tool. Do not use a power tool while you are tired or under the influence of drugs, alcohol or medication.** A moment of inattention while operating power tools may result in serious personal injury.
- **Use personal protective equipment. Always wear eye protection.** Protective equipment such as a dust mask, non-skid safety shoes, hard hat or hearing protection used for appropriate conditions will reduce personal injuries.
- **Prevent unintentional starting. Ensure the switch is in the off-position before connecting to power source and/or battery pack, picking up or carrying the tool.** Carrying power tools with your finger on the switch or energizing power tools that have the switch on invites accidents.

- **Remove any adjusting key or wrench before turning the power tool on.** A wrench or a key left attached to a rotating part of the power tool may result in personal injury.
- **Do not overreach. Keep proper footing and balance at all times.** This enables better control of the power tool in unexpected situations.
- **Dress properly. Do not wear loose clothing or jewelry. Keep your hair and clothing away from moving parts.** Loose clothes, jewelry or long hair can be caught in moving parts.
- **If devices are provided for the connection of dust extraction and collection facilities, ensure these are connected and properly used.** Use of dust collection can reduce dust-related hazards.
- **Do not let familiarity gained from frequent use of tools allow you to become complacent and ignore tool safety principles.** A careless action can cause severe injury within a fraction of a second.

### POWER TOOL USE AND CARE

- **Do not force the power tool. Use the correct power tool for your application.** The correct power tool will do the job better and safer at the rate for which it was designed.
- **Do not use the power tool if the switch does not turn it on and off.** Any power tool that cannot be controlled with the switch is dangerous and must be repaired.
- **Disconnect the plug from the power source and/ or remove the battery pack, if detachable, from the power tool before making any adjustments, changing accessories, or storing power tools.** Such preventive safety measures reduce the risk of starting the power tool accidentally.
- **Store idle power tools out of the reach of children and do not allow persons unfamiliar with the power tool or these instructions to operate the power tool.** Power tools are dangerous in the hands of untrained users.
- **Maintain power tools and accessories. Check for misalignment or binding of moving parts, breakage of parts and any other condition that may affect the power tool's operation. If damaged, have the power tool repaired before use.** Many accidents are caused by poorly maintained power tools.
- **Keep cutting tools sharp and clean.** Properly maintained cutting tools with sharp cutting edges are less likely to bind and are easier to control.
- **Use the power tool, accessories and tool bits etc. in accordance with these instructions, taking into account the working conditions and the work to be performed.** Use of the power tool for operations different from those intended could result in a hazardous situation.
- **Keep handles and grasping surfaces dry, clean and free from oil and grease.** Slippery handles and grasping surfaces do not allow for safe handling and control of the tool in unexpected situations.

### SERVICE

- **Have your power tool serviced by a qualified repair person using only identical replacement parts.** This will ensure that the safety of the power tool is maintained.

### SPECIFIC SAFETY RULES FOR DRILLS

- **Use auxiliary handle(s), if supplied with the tool.** Loss of control can cause personal injury.

## GROUNDING

**WARNING** Improperly connecting the grounding wire can result in the risk of electric shock. Check with a qualified electrician if you are in doubt as to whether the outlet is properly grounded. Do not modify the plug provided with the tool. Never remove the grounding prong from the plug. Do not use the tool if the cord or plug is damaged. If damaged, have it repaired by a MILWAUKEE service facility before use. If the plug will not fit the outlet, have a proper outlet installed by a qualified electrician.

### Grounded Tools (Three-Prong Plugs)

Tools marked "Grounding Required" have a three wire cord and three prong grounding plug. The plug must be connected to a properly grounded outlet (See Figure A). If the tool should electrically malfunction or break down, grounding provides a low resistance path to carry electricity away from the user, reducing the risk of electric shock.

The grounding prong in the plug is connected through the green wire inside the cord to the grounding system in the tool. The green wire in the cord must be the only wire connected to the tool's grounding system and must never be attached to an electrically "live" terminal.

Your tool must be plugged into an appropriate outlet, properly installed and grounded in accordance with all codes and ordinances. The plug and outlet should look like those in Figure A.

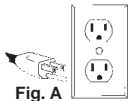

Fig. A

### Double Insulated Tools (Two-Prong Plugs)

Tools marked "Double Insulated" do not require grounding. They have a special double insulation system which satisfies OSHA requirements and complies with the applicable standards of Underwriters Laboratories, Inc., the Canadian Standard Association and the National Electrical Code. Double Insulated tools may be used in either of the 120 volt outlets shown in Figures B and C.

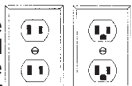

Fig. B



Fig. C

## SYMBOLY



Double Insulated



Volts



Alternating Current



Amps

$n_0$  XXXX min<sup>-1</sup> No Load Revolutions per Minute (RPM)



c UL US UL Listing for Canada and U.S.



Approval Mark for Mexico

• **Hold power tool by insulated gripping surfaces, when performing an operation where the cutting accessory may contact hidden wiring or its own cord.** Cutting accessory contacting a "live" wire may make exposed metal parts of the power tool "live" and could give the operator an electric shock.

• **Maintain labels and nameplates.** These carry important information. If unreadable or missing, contact a MILWAUKEE service facility for a free replacement.

• **WARNING** Some dust created by power sanding, sawing, grinding, drilling, and other construction activities contains chemicals known to cause cancer, birth defects or other reproductive harm. Some examples of these chemicals are:

- lead from lead-based paint
- crystalline silica from bricks and cement and other masonry products, and
- arsenic and chromium from chemically-treated lumber.

Your risk from these exposures varies, depending on how often you do this type of work. To reduce your exposure to these chemicals: work in a well ventilated area, and work with approved safety equipment, such as those dust masks that are specially designed to filter out microscopic particles.

## EXTENSION CORDS

Grounded tools require a three wire extension cord. Double insulated tools can use either a two or three wire extension cord. As the distance from the supply outlet increases, you must use a heavier gauge extension cord. Using extension cords with inadequately sized wire causes a serious drop in voltage, resulting in loss of power and possible tool damage. Refer to the table shown to determine the required minimum wire size.

The smaller the gauge number of the wire, the greater the capacity of the cord. For example, a 14 gauge cord can carry a higher current than a 16 gauge cord. When using more than one extension cord to make up the total length, be sure each cord contains at least the minimum wire size required. If you are using one extension cord for more than one tool, add the nameplate amperes and use the sum to determine the required minimum wire size.

Guidelines for Using Extension Cords

- If you are using an extension cord outdoors, be sure it is marked with the suffix "W-A" ("W" in Canada) to indicate that it is acceptable for outdoor use.
- Be sure your extension cord is properly wired and in good electrical condition. Always replace a damaged extension cord or have it repaired by a qualified person before using it.
- Protect your extension cords from sharp objects, excessive heat and damp or wet areas.

Recommended Minimum Wire Gauge For Extension Cords*					
Nameplate Amps	Extension Cord Length				
	25'	50'	75'	100'	150'
0 - 2.0	18	18	18	18	16
2.1 - 3.4	18	18	18	16	14
3.5 - 5.0	18	18	16	14	12
5.1 - 7.0	18	16	14	12	12
7.1 - 12.0	16	14	12	10	--
12.1 - 16.0	14	12	10	--	--
16.1 - 20.0	12	10	--	--	--

\* Based on limiting the line voltage drop to five volts at 150% of the rated amperes.

## SPECIFICATIONS

<b>Cat. No.</b> .....	<b>0100-20</b>
Volts.....	120 AC
Amps.....	.7
No Load RPM.....	0 - 2500
<b>Cat. No.</b> .....	<b>0101-20</b>
Volts.....	120 AC
Amps.....	.7
No Load RPM.....	0 - 4300
<b>Cat. No.</b> .....	<b>0200-20</b>
Volts.....	120 AC
Amps.....	.7
No Load RPM.....	0 - 1200
<b>Cat. No.</b> .....	<b>0201-20</b>
Volts.....	120 AC
Amps.....	.7
No Load RPM.....	0 - 2500
<b>Cat. No.</b> .....	<b>0202-20</b>
Volts.....	120 AC
Amps.....	.7
No Load RPM.....	0 - 1200
<b>Cat. No.</b> .....	<b>0299-20</b>
Volts.....	120 AC
Amps.....	.8
No Load RPM.....	0 - 850
<b>Cat. No.</b> .....	<b>0300-20</b>
Volts.....	120 AC
Amps.....	.8
No Load RPM.....	0 - 850
<b>Cat. No.</b> .....	<b>0302-20</b>
Volts.....	120 AC
Amps.....	.8
No Load RPM.....	0 - 850

## FUNCTIONAL DESCRIPTION

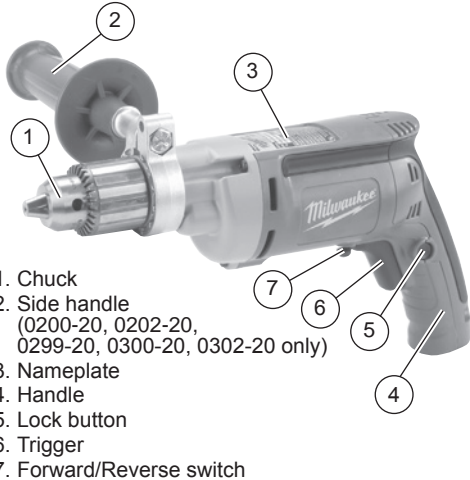

1. Chuck
2. Side handle  
(0200-20, 0202-20,  
0299-20, 0300-20, 0302-20 only)
3. Nameplate
4. Handle
5. Lock button
6. Trigger
7. Forward/Reverse switch

## ASSEMBLY

**WARNING** To reduce the risk of injury, always unplug tool before changing or removing accessories. Only use accessories specifically recommended for this tool. Others may be hazardous.

**Removing and Replacing Quik-Lok® Cords**  
(Cat. No. 0100-20, 0101-20, 0202-20, 0302-20)  
MILWAUKEE's exclusive Quik-Lok® Cords provide instant field replacement or substitution.

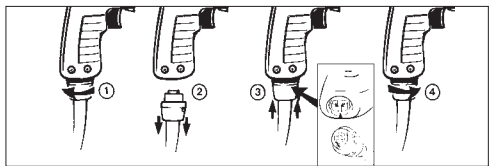

1. To remove the Quik-Lok® Cord, turn the cord nut 1/4 turn to the left and pull it out.
2. To replace the Quik-Lok® Cord, align the connector keyways and push the connector in as far as it will go. Turn the cord nut 1/4 turn to the right to lock.

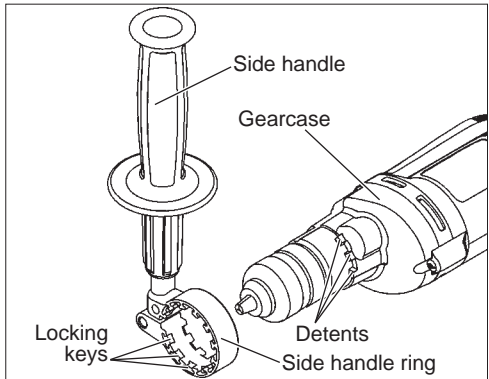

**WARNING** To reduce the risk of injury, always use a side handle when using this tool. Always brace and hold securely.

**Adjusting the Side Handle**  
(Cat. No. 0200-20, 0202-20, 0299-20,  
0300-20, 0302-20)



1. Turn the side handle counterclockwise to loosen.
2. Slide the side handle assembly forward over the chuck and rotate to the desired angle.
3. Slide the side handle back to the gearcase and position the locking keys into the detents. The locking keys help prevent the handle from slipping. **NOTE:** The side handle ring must clear the chuck.
4. Turn the side handle clockwise to tighten. **NOTE:** Always use the side handle for best control.

## Chuck Identification

	Chuck Type	Drill Cat. No.
	Keyed	0100-20 0101-20 0200-20
	Double sleeve Keyless	0201-20
	Single sleeve Keyless	0202-20 0302-20

## Installing and Removing Bits

**WARNING** To reduce the risk of injury, always remove the chuck key from the chuck after each use.



## Keyed Chuck

These tools are equipped with a chuck tightened using a key. Always unplug the tool before installing or removing bits.

1. To open the chuck jaws, place the chuck key in one (1) of the three (3) holes located on the chuck. Turn the key counterclockwise.

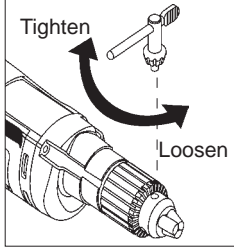

Be sure the bit shank and chuck jaws are clean. Dirt particles may prevent the bit from lining up properly.

2. When using drill bits, insert the bit into the chuck. Center the bit in the chuck jaws and lift it about 1/16" off of the bottom. Tighten the chuck jaws by hand to align the bit.

When using screwdriver bits, insert the bit far enough for the chuck jaws to grip the bit shank. Tighten the chuck jaws by hand to align the bit.

3. To close the chuck jaws, place the chuck key in each of the three holes in the chuck. Turn the chuck key clockwise. Tighten securely.

4. To remove the bit, insert the chuck key into one of the holes in the chuck. Turn the chuck key counterclockwise. Be sure the bit shank and chuck jaws are clean. Dirt particles may prevent the bit from lining up properly.

**⚠WARNING** To reduce the risk of injury, do not grasp the bit while the chuck is rotating or while the bit is falling from the chuck.



## Double Sleeve Keyless Chuck

These tools are equipped with a hand tightening keyless chuck. Always unplug the tool before installing or removing bits.

1. To open the chuck jaws, hold the collar and turn the sleeve counterclockwise.

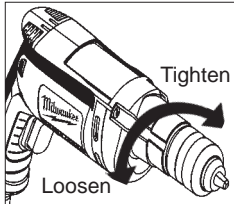

Be sure the bit shank and chuck jaws are clean. Dirt particles may prevent the bit from lining up properly.

2. When using drill bits, insert the bit into the chuck. Center the bit in the chuck jaws and lift it about 1/16" off of the bottom. Tighten the chuck jaws by hand to align the bit.

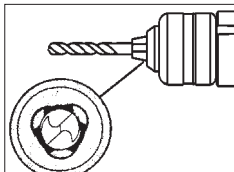

When using screwdriver bits, insert the bit far enough for the chuck jaws to grip the bit shank. Tighten the chuck jaws by hand to align the bit.

3. To close the chuck jaws, hold the collar and turn the sleeve clockwise. Tighten securely.

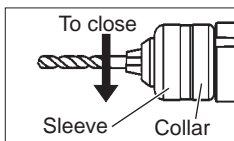

4. To remove the bit, hold the chuck collar and turn the sleeve counterclockwise to release the bit from the chuck jaws.



## Single Sleeve Keyless Chuck

These tools are equipped with a spindle-lock mechanism and a single-sleeve keyless chuck. Always unplug the tool before inserting or removing bits.

1. To open the chuck jaws, turn the chuck sleeve counterclockwise.

Be sure the bit shank and chuck jaws are clean. Dirt particles may prevent the bit from lining up properly.

2. When using drill bits, insert the bit into the chuck. Center the bit in the chuck jaws and lift it about 1/16" off of the bottom. Tighten the chuck jaws by hand to align the bit.

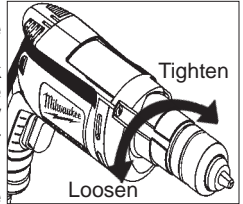

When using screwdriver bits, insert the bit far enough for the chuck jaws to grip the bit shank. Tighten the chuck jaws by hand to align the bit.

3. To close the chuck jaws, turn the chuck sleeve clockwise. Tighten securely. Several detents will be felt as the chuck sleeve is turned.

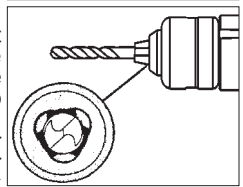

**NOTE:** If the spindle rotates when opening or closing the chuck jaws, grasp the chuck and slightly rotate back and forth to engage the spindle-lock mechanism.

The spindle will remain locked until the tool is turned on. The spindle-lock mechanism will automatically disengage when the tool is turned on.

4. To remove the bit, turn the chuck sleeve counterclockwise to release the bit from the chuck jaws.

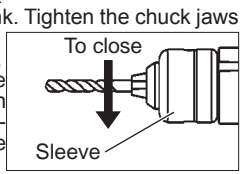

**⚠WARNING** To reduce the risk of injury, always wear eye protection.

### Chuck Removal

This tool is equipped with a threaded spindle to hold the chuck. Before removing the chuck, unplug the tool and open the chuck jaws. A left-handed thread screw is located inside the chuck to prevent the chuck from loosening when the tool is operated in reverse direction. Remove the screw by turning it clockwise. To remove the chuck, hold the tool so that only the side of the chuck rests firmly and squarely on a solid workbench. Insert the chuck key or a chuck remover bar in one of the keyholes. Turn the chuck so the key is at about a 30° angle to the bench top and strike the key sharply with a hammer so the chuck turns in a counterclockwise direction (looking from the front of the tool). This should loosen the chuck from the spindle which has a right hand thread making it easy to remove the chuck by hand.

**NOTE:** When replacing the chuck, always replace the left hand thread screw in the chuck.

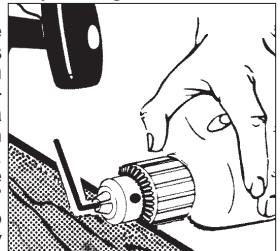

## OPERATION

**WARNING** To reduce the risk of injury, always wear safety goggles or glasses with side shields.

### Using Forward/Reverse Switch

1. For **forward** (clockwise) rotation, push the forward/reverse switch to the left position as shown.
2. For **reverse** (counterclockwise) rotation, push the forward/reverse switch to the right position as shown. Although an interlock prevents reversing the tool while the motor is running, allow it to come to a full stop before reversing.

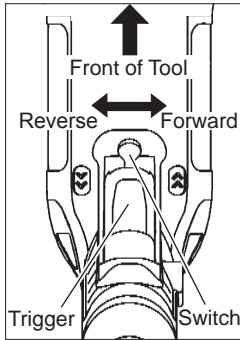

**WARNING** To reduce the risk of injury, keep hands and cord away from the bit and all moving parts.

### Starting, Stopping and Controlling Speed

1. To **start** the tool, pull the trigger.
2. To **stop** the tool, release the trigger.
3. To **vary** the drilling speed, simply increase or decrease pressure on the trigger. The further the trigger is pulled, the greater the speed.

### Locking Trigger

The lock button holds the trigger in the ON position for continuous full speed use.

1. To **lock** the trigger, hold the lock button in while pulling the trigger. Release the trigger.
2. To **unlock** the trigger, pull the trigger and release. The lock button will pop out.

## APPLICATIONS

Cat. No.	No Load RPM	Wood					Wood/Steel	Steel
		Flat Boring Bits	Auger Bits	Hole Saws	Self-feed Bits	Pathfinder™ Bits	Twist Bits	Hole Saws
<b>0100-20</b>	0 - 2500	1-1/2"	NR	NR	NR	NR	1/4"	NR
<b>0101-20</b>	0 - 4300	1-1/4"	NR	NR	NR	NR	1/4"	NR
<b>0200-20</b>	0 - 1200	1-1/2"	1"	3-1/4"	NR	1-1/4"	1/2"	1-5/8"
<b>0201-20</b>	0 - 2500	1-1/2"	7/8"	2-1/4"	NR	1-1/4"	1/2"	NR
<b>0202-20</b>	0 - 1200	1-1/2"	1"	3-1/4"	NR	1-1/4"	1/2"	1-5/8"
<b>0299-20</b>	0 - 850	1-1/2"	1-1/2"	3-5/8"	2-9/16"	1-1/4"	3/4"	2"
<b>0300-20</b>	0 - 850	1-1/2"	1-1/2"	3-5/8"	2-9/16"	1-1/4"	3/4"	2"
<b>0302-20</b>	0 - 850	1-1/2"	1-1/2"	3-5/8"	2-9/16"	1-1/4"	3/4"	2"

NR = Not recommended

**WARNING** To reduce the risk of explosion, electric shock and property damage, always check the work area for hidden pipes and wires before drilling.

### Selecting Bits

When selecting a bit, use the right type for your job. For best performance, always use sharp bits.

### Drilling

1. Before drilling, be sure the workpiece is clamped securely. Use backing material to prevent damage to the workpiece during breakthrough.
2. When starting a hole, place the drill bit on the work surface and apply firm pressure. Begin drilling at a slow speed, gradually increasing the speed as you drill.
3. Always apply pressure in line with the bit. Use enough pressure to keep the drill biting, but do not push hard enough to stall the motor.
4. Reduce pressure and ease the bit through the last part of the hole. While the tool is still running, pull the bit out of the hole to prevent jamming.

### Drilling in Wood, Composition Materials and Plastic

When drilling in wood, composition materials and plastic, start the drill slowly, gradually increasing speed as you drill. When using twist drill bits, pull the bit out of the hole frequently to clear chips from the bit flutes. Use low speeds for plastics with a low melting point.

### Drilling in Masonry

When drilling in masonry, use high speed carbide-tipped bits. Drilling soft masonry materials such as cinder block requires little pressure. Hard materials like concrete require more pressure. A smooth, even flow of dust indicates the proper drilling rate. Do not let the bit spin in the hole without cutting. Do not use water to settle dust or to cool bit. Both actions will damage the carbide.

### Drilling in Metal

When drilling in metal, use high speed steel twist drills or hole saws. Use slow speeds for hard metals and high speeds for softer metals. Lubricate drill bits with cutting oil when drilling in iron or steel. Use a coolant when drilling in nonferrous metals such as copper, brass or aluminum. Back the material to prevent binding and distortion on breakthrough.

### Driving Screws

When driving screws, use the proper screwdriver bit for your job. After drilling pilot and shank holes, start the screw slowly and increase the speed as driving progresses. Set the screw by slowing to a stop. Do not run screws down at excessive speeds. To remove screws, reverse the motor.

## Stalling

If the tool seems as if it is about to stall, maintain a firm grip and reduce pressure slightly to allow the bit to regain speed. If the tool does stall, release the trigger immediately. Reverse the motor, remove the bit from the work and start again. Do not pull the trigger on and off in an attempt to start a stalled drill. This can damage the drill.

**⚠WARNING** High rotational force. To reduce the risk of injury, always hold or brace securely. Always use side handle on tools rated 1200 rpm or less.

## Bit Binding

A high rotational force occurs when a bit binds. If the bit binds, the tool will be forced in the opposite direction of the bit rotation. Bits may bind if they are misaligned or when they are breaking through a hole. Wood boring bits can also bind if they run into nails or knots. Be prepared for bit binding situations. To reduce the chance of bit binding:

- Use sharp bits. Sharp bits are less likely to bind when drilling.
- Use the proper bit for the job. There are bits that are designed for specific purposes.
- Use caution when drilling pitchy, knotty, wet or warped material or when drilling in material that may contain nails.

## Typical Bracing Methods

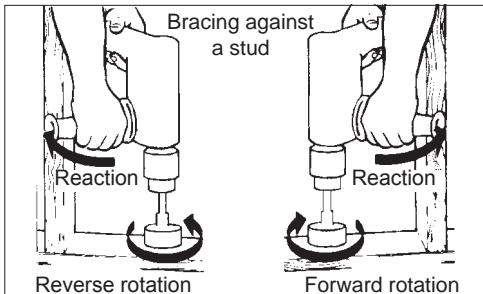
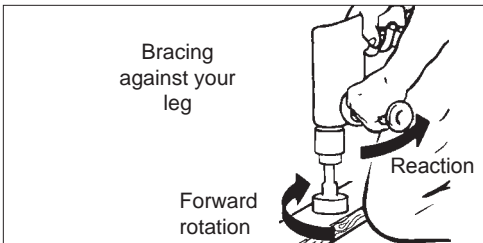
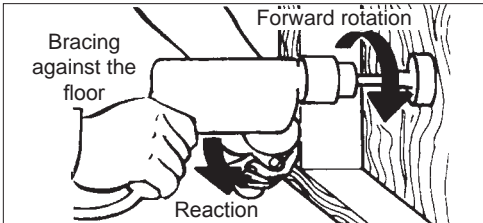

## MAINTENANCE

**⚠WARNING** To reduce the risk of injury, always unplug the tool before performing any maintenance. Never disassemble the tool. Contact a MILWAUKEE service facility for ALL repairs.

## Maintaining Tools

Keep your tool in good repair by adopting a regular maintenance program. Inspect your tool for issues such as undue noise, misalignment or binding of moving parts, breakage of parts, or any other condition that may affect the tool operation. Return the tool to a MILWAUKEE service facility for repair. After six months to one year, depending on use, return the tool to a MILWAUKEE service facility for inspection.

**⚠WARNING** To reduce the risk of personal injury, electric shock and damage, never immerse your tool in liquid or allow a liquid to flow inside it.

## Cleaning

Clean dust and debris from vents. Keep handles clean, dry and free of oil or grease. Use only mild soap and a damp cloth to clean, since certain cleaning agents and solvents are harmful to plastics and other insulated parts. Some of these include gasoline, turpentine, lacquer thinner, paint thinner, chlorinated cleaning solvents, ammonia and household detergents containing ammonia. Never use flammable or combustible solvents around tools.

## Repairs

For repairs, return the tool to the nearest service center.



# OPERATOR'S MANUAL

- Cat. No.  
 0100-20 0202-20  
 0101-20 0299-20  
 0200-20 0300-20  
 0201-20 0302-20



## HEAVY-DUTY DRILLS

TO REDUCE THE RISK OF INJURY, USER MUST READ AND UNDERSTAND OPERATOR'S MANUAL.

### GENERAL POWER TOOL SAFETY WARNINGS

**WARNING** READ ALL SAFETY WARNINGS AND ALL INSTRUCTIONS. Failure to follow the warnings and instructions may result in electric shock, fire and/or serious injury. Save all warnings and instructions for future reference. The term "power tool" in the warnings refers to your mains-operated (corded) power tool or battery-operated (cordless) power tool.

#### WORK AREA SAFETY

- Keep work area clean and well lit. Cluttered or dark areas invite accidents.
- Do not operate power tools in explosive atmospheres, such as in the presence of flammable liquids, gases or dust. Power tools create sparks which may ignite the dust or fumes.
- Keep children and bystanders away while operating a power tool. Distractions can cause you to lose control.

#### ELECTRICAL SAFETY

- Power tool plugs must match the outlet. Never modify the plug in any way. Do not use any adapter plugs with earthed (grounded) power tools. Unmodified plugs and matching outlets will reduce risk of electric shock.
- Avoid body contact with earthed or grounded surfaces such as pipes, radiators, ranges and refrigerators. There is an increased risk of electric shock if your body is earthed or grounded.
- Do not expose power tools to rain or wet conditions. Water entering a power tool will increase the risk of electric shock.
- Do not abuse the cord. Never use the cord for carrying, pulling or unplugging the power tool. Keep cord away from heat, oil, sharp edges or moving parts. Damaged or entangled cords increase the risk of electric shock.
- When operating a power tool outdoors, use an extension cord suitable for outdoor use. Use of a cord suitable for outdoor use reduces the risk of electric shock.
- If operating a power tool in a damp location is unavoidable, use a ground fault circuit interrupter (GFCI) protected supply. Use of an GFCI reduces the risk of electric shock.

#### PERSONAL SAFETY

- Stay alert, watch what you are doing and use common sense when operating a power tool. Do not use a power tool while you are tired or under the influence of drugs, alcohol or medication. A moment of inattention while operating power tools may result in serious personal injury.
- Use personal protective equipment. Always wear eye protection. Protective equipment such as dust mask, non-skid safety shoes, hard hat, or hearing protection used for appropriate conditions will reduce personal injuries.
- Prevent unintentional starting. Ensure the switch is in the off-position before connecting to power source and/or battery pack, picking up or carrying the tool. Carrying power tools with your finger on the switch or energising power tools that have the switch on invites accidents.

- Remove any adjusting key or wrench before turning the power tool on. A wrench or a key left attached to a rotating part of the power tool may result in personal injury.
- Do not overreach. Keep proper footing and balance at all times. This enables better control of the power tool in unexpected situations.
- Dress properly. Do not wear loose clothing or jewellery. Keep your hair, clothing and gloves away from moving parts. Loose clothes, jewellery or long hair can be caught in moving parts.
- If devices are provided for the connection of dust extraction and collection facilities, ensure these are connected and properly used. Use of dust collection can reduce dust-related hazards.

#### POWER TOOL USE AND CARE

- Do not force the power tool. Use the correct power tool for your application. The correct power tool will do the job better and safer at the rate for which it was designed.
- Do not use the power tool if the switch does not turn it on and off. Any power tool that cannot be controlled with the switch is dangerous and must be repaired.
- Disconnect the plug from the power source and/or the battery pack from the power tool before making any adjustments, changing accessories, or storing power tools. Such preventive safety measures reduce the risk of starting the power tool accidentally.
- Store idle power tools out of the reach of children and do not allow persons unfamiliar with the power tool or these instructions to operate the power tool. Power tools are dangerous in the hands of untrained users.
- Maintain power tools. Check for misalignment or binding of moving parts, breakage of parts and any other condition that may affect the power tool's operation. If damaged, have the power tool repaired before use. Many accidents are caused by poorly maintained power tools.
- Keep cutting tools sharp and clean. Properly maintained cutting tools with sharp cutting edges are less likely to bind and are easier to control.
- Use the power tool, accessories and tool bits etc. in accordance with these instructions, taking into account the working conditions and the work to be performed. Use of the power tool for operations different from those intended could result in a hazardous situation.

#### SERVICE

- Have your power tool serviced by a qualified repair person using only identical replacement parts. This will ensure that the safety of the power tool is maintained.



## SPECIFIC SAFETY RULES

•Use auxiliary handle(s), if supplied with the tool. Loss of control can cause personal injury.  
 •Hold power tool by insulated gripping surfaces, when performing an operation where the cutting accessory may contact hidden wiring or its own cord. Cutting accessory contacting a “live” wire may make exposed metal parts of the power tool “live” and could give the operator an electric shock.

•Maintain labels and nameplates. These carry important information. If unreadable or missing, contact a MILWAUKEE service facility for a free replacement.

•**WARNING** Some dust created by power sanding, sawing, grinding, drilling, and other construction activities contains chemicals known to cause cancer, birth defects or other reproductive harm. Some examples of these chemicals are:

- lead from lead-based paint
- crystalline silica from bricks and cement and other masonry products, and
- arsenic and chromium from chemically-treated lumber.

Your risk from these exposures varies, depending on how often you do this type of work. To reduce your exposure to these chemicals: work in a well ventilated area, and work with approved safety equipment, such as those dust masks that are specially designed to filter out microscopic particles.

## SPECIFICATIONS

Cat. No.	Volts AC	Amps	No Load RPM
0100-20	120	7	0 - 2500
0101-20	120	7	0 - 4000
0200-20	120	7	0 - 1200
0201-20	120	7	0 - 2500
0202-20	120	7	0 - 1200
0299-20	120	8	0 - 850
0300-20	120	8	0 - 850
0302-20	120	8	0 - 850

## FUNCTIONAL DESCRIPTION

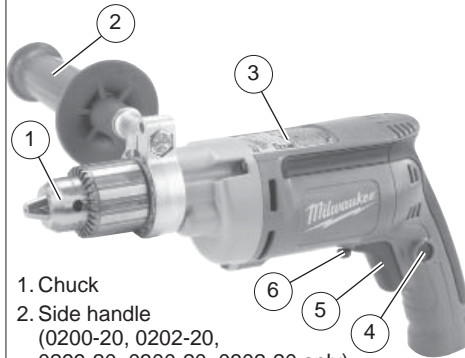

1. Chuck
2. Side handle  
(0200-20, 0202-20, 0299-20, 0300-20, 0302-20 only)
3. Nameplate
4. Lock button
5. Trigger
6. Forward/Reverse switch

## SYMBOLOLOGY

	Double Insulated
	Amps
	Volts
	Alternating Current Only
$n_0$ XXXXmin. <sup>-1</sup>	No Load Revolutions per Minute (RPM)
	Underwriters Laboratories, Inc. United States and Canada
	Mexican Approvals Marking

## GROUNDING

**WARNING** Improperly connecting the grounding wire can result in the risk of electric shock. Check with a qualified electrician if you are in doubt as to whether the outlet is properly grounded. Do not modify the plug provided with the tool. Never remove the grounding prong from the plug. Do not use the tool if the cord or plug is damaged. If damaged, have it repaired by a MILWAUKEE service facility before use. If the plug will not fit the outlet, have a proper outlet installed by a qualified electrician.

### Grounded Tools: Tools with Three Prong Plugs

Tools marked “Grounding Required” have a three wire cord and three prong grounding plug. The plug must be connected to a properly grounded outlet (See Figure A). If the tool should electrically malfunction or break down, grounding provides a low resistance path to carry electricity away from the user, reducing the risk of electric shock.

The grounding prong in the plug is connected through the green wire inside the cord to the grounding system in the tool. The green wire in the cord must be the only wire connected to the tool's grounding system and must never be attached to an electrically “live” terminal.

Your tool must be plugged into an appropriate outlet, properly installed and grounded in accordance with all codes and ordinances. The plug and outlet should look like those in Figure A.

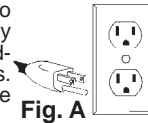

Fig. A

### Double Insulated Tools:

#### Tools with Two Prong Plugs

Tools marked “Double Insulated” do not require grounding. They have a special double insulation system which satisfies OSHA requirements and complies with the applicable standards of Underwriters Laboratories, Inc., the Canadian Standard Association and the National Electrical Code. Double Insulated tools may be used in either of the 120 volt outlets shown in Figures B and C.

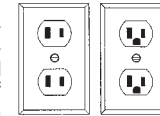

Fig. B Fig. C

## EXTENSION CORDS

Grounded tools require a three wire extension cord. Double insulated tools can use either a two or three wire extension cord. As the distance from the supply outlet increases, you must use a heavier gauge extension cord. Using extension cords with inadequately sized wire causes a serious drop in voltage, resulting in loss of power and possible tool damage. Refer to the table shown to determine the required minimum wire size.

The smaller the gauge number of the wire, the greater the capacity of the cord. For example, a 14 gauge cord can carry a higher current than a 16 gauge cord. When using more than one extension cord to make up the total length, be sure each cord contains at least the minimum wire size required. If you are using one extension cord for more than one tool, add the nameplate amperes and use the sum to determine the required minimum wire size.

### Guidelines for Using Extension Cords

- If you are using an extension cord outdoors, be sure it is marked with the suffix “W-A” (“W” in Canada) to indicate that it is acceptable for outdoor use.
- Be sure your extension cord is properly wired and in good electrical condition. Always replace a damaged extension cord or have it repaired by a qualified person before using it.
- Protect your extension cords from sharp objects, excessive heat and damp or wet areas.

### Recommended Minimum Wire Gauge For Extension Cords\*

Nameplate Amperes	Extension Cord Length				
	25'	50'	75'	100'	150'
0 - 2.0	18	18	18	18	16
2.1 - 3.4	18	18	18	16	14
3.5 - 5.0	18	18	16	14	12
5.1 - 7.0	18	16	14	12	12
7.1 - 12.0	16	14	12	10	
12.1 - 16.0	14	12	10		
16.1 - 20.0	12	10			

\* Based on limiting the line voltage drop to five volts at 150% of the rated amperes.

**READ AND SAVE ALL INSTRUCTIONS FOR FUTURE USE.**

## ASSEMBLY

**WARNING** To reduce the risk of injury, always unplug tool before changing or removing accessories. Only use accessories specifically recommended for this tool. Others may be hazardous.

**Removing and Replacing Quik-Lok® Cords** (Cat. No. 0100-20, 0101-20, 0202-20, 0302-20)  
MILWAUKEE's exclusive Quik-Lok® Cords provide instant field replacement or substitution.

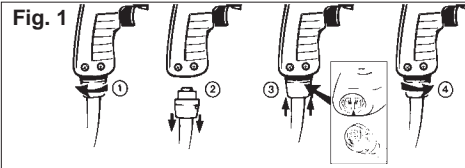

1. To remove the Quik-Lok® Cord, turn the cord nut 1/4 turn to the left and pull it out.
2. To replace the Quik-Lok® Cord, align the connector keyways and push the connector in as far as it will go. Turn the cord nut 1/4 turn to the right to lock.

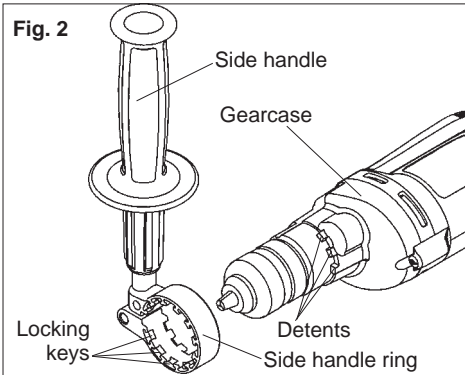

**WARNING** To reduce the risk of injury, always use a side handle when using this tool. Always brace and hold securely.

**Adjusting the Side Handle** (Cat. No. 0200-20, 0202-20, 0299-20, 0300-20, 0302-20)



1. Turn the side handle counterclockwise to loosen.
2. Slide the side handle assembly forward over the chuck and rotate to the desired angle.
3. Slide the side handle back to the gearcase and position the locking keys into the detents. The locking keys help prevent the handle from slipping.  
**NOTE:** The side handle ring must clear the chuck.
4. Turn the side handle clockwise to tighten.  
**NOTE:** Always use the side handle for best control.

### Chuck Identification

	Chuck Type	Drill Cat. No.
	Keyed	0100-20 0101-20 0200-20
	Double sleeve Keyless	0201-20
	Single sleeve Keyless	0202-20 0302-20

### Installing and Removing Bits

**WARNING** To reduce the risk of injury, always remove the chuck key from the chuck after each use.

#### Keyed Chuck

These tools are equipped with a chuck tightened using a key. Always unplug the tool before installing or removing bits.

1. To open the chuck jaws, place the chuck key in one (1) of the three (3) holes located on the chuck. Turn the key counterclockwise. Be sure the bit shank and chuck jaws are clean. Dirt particles may prevent the bit from lining up properly.

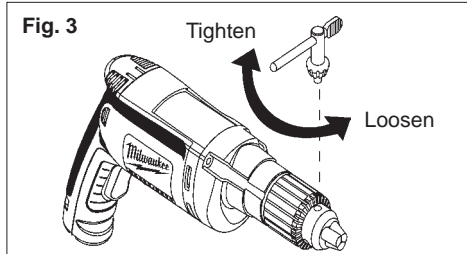

2. When using drill bits, insert the bit into the chuck. Center the bit in the chuck jaws and lift it about 1/16" off of the bottom. Tighten the chuck jaws by hand to align the bit.  
When using screwdriver bits, insert the bit far enough for the chuck jaws to grip the bit shank. Tighten the chuck jaws by hand to align the bit.
3. To close the chuck jaws, place the chuck key in each of the three holes in the chuck. Turn the chuck key clockwise. Tighten securely.
4. To remove the bit, insert the chuck key into one of the holes in the chuck. Turn the chuck key counterclockwise. Be sure the bit shank and chuck jaws are clean. Dirt particles may prevent the bit from lining up properly.

**WARNING** To reduce the risk of injury, do not grasp the bit while the chuck is rotating or while the bit is falling from the chuck.

#### Double Sleeve Keyless Chuck

These tools are equipped with a hand tightening keyless chuck. Always unplug the tool before installing or removing bits.

1. To open the chuck jaws, hold the collar and turn the sleeve counterclockwise.

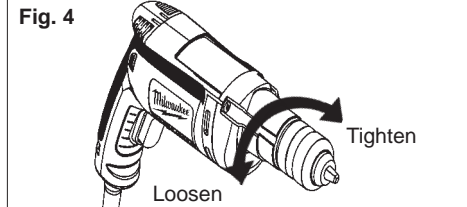

- Be sure the bit shank and chuck jaws are clean. Dirt particles may prevent the bit from lining up properly.
2. When using drill bits, insert the bit into the chuck. Center the bit in the chuck jaws and lift it about 1/16" off of the bottom. Tighten the chuck jaws by hand to align the bit.

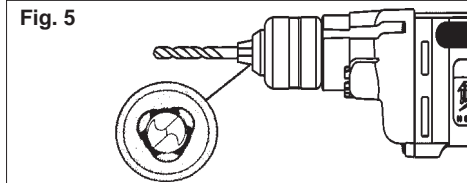

- When using screwdriver bits, insert the bit far enough for the chuck jaws to grip the bit shank. Tighten the chuck jaws by hand to align the bit.
3. To close the chuck jaws, hold the collar and turn the sleeve clockwise. Tighten securely.

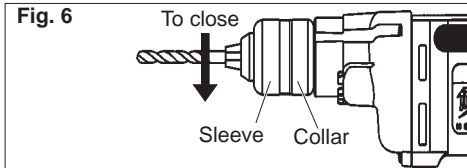

4. To remove the bit, hold the chuck collar and turn the sleeve counterclockwise to release the bit from the chuck jaws.

#### Single Sleeve Keyless Chuck

These tools are equipped with a spindle-lock mechanism and a single-sleeve keyless chuck. Always unplug the tool before inserting or removing bits.

1. To open the chuck jaws, turn the chuck sleeve counterclockwise.

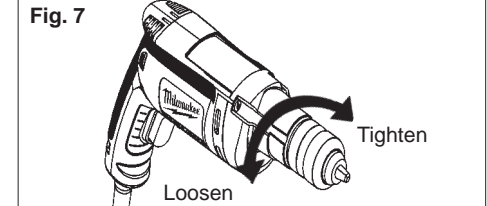

- Be sure the bit shank and chuck jaws are clean. Dirt particles may prevent the bit from lining up properly.
2. When using drill bits, insert the bit into the chuck. Center the bit in the chuck jaws and lift it about 1/16" off of the bottom. Tighten the chuck jaws by hand to align the bit.

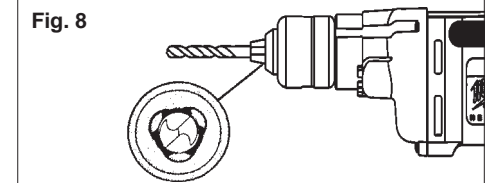

- When using screwdriver bits, insert the bit far enough for the chuck jaws to grip the bit shank. Tighten the chuck jaws by hand to align the bit.
3. To close the chuck jaws, turn the chuck sleeve clockwise. Tighten securely. Several detents will be felt as the chuck sleeve is turned.

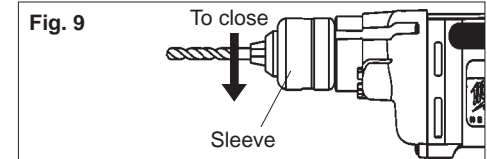

**NOTE:** If the spindle rotates when opening or closing the chuck jaws, grasp the chuck and slightly rotate back and forth to engage the spindle-lock mechanism.

- The spindle will remain locked until the tool is turned on. The spindle-lock mechanism will automatically disengage when the tool is turned on.
4. To remove the bit, turn the chuck sleeve counterclockwise to release the bit from the chuck jaws.

**WARNING** To reduce the risk of injury, always wear eye protection.

### Chuck Removal

This tool is equipped with a threaded spindle to hold the chuck. Before removing the chuck, unplug the tool and open the chuck jaws. A left-handed thread screw is located inside the chuck to prevent the chuck from loosening when the tool is operated in reverse direction. Remove the screw by turning it clockwise. To remove the chuck, hold the tool so that only the side of the chuck rests firmly and squarely on a solid workbench. Insert the chuck key or a chuck remover bar in one of the keyholes. Turn the chuck so the key is at about a 30° angle to the bench top

and strike the key sharply with a hammer so the chuck turns in a counterclockwise direction (looking from the front of the tool). This should loosen the chuck from the spindle which has a right hand thread making it easy to remove the chuck by hand.

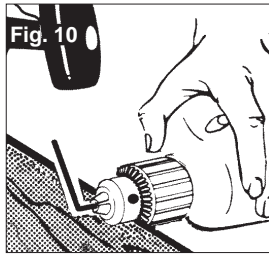

**NOTE:** When replacing the chuck, always replace the left hand thread screw in the chuck.

## OPERATION

**WARNING** To reduce the risk of injury, always unplug tool before attaching or removing accessories or making adjustments. Use only specifically recommended accessories. Others may be hazardous.

**WARNING** To reduce the risk of injury, wear safety goggles or glasses with side shields.

### Using Forward/Reverse Switch

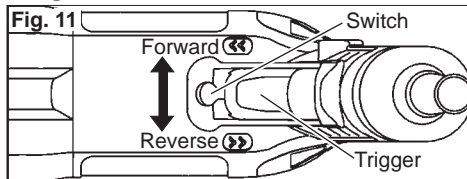

1. For forward (clockwise) rotation, push the forward/reverse switch to the left position as shown.

2. For reverse (counterclockwise) rotation, push the forward/reverse switch to the right position as shown. Although an interlock prevents reversing the tool while the motor is running, allow it to come to a full stop before reversing.

**WARNING** To reduce the risk of injury, keep hands and cord away from the bit and all moving parts.

### Starting, Stopping and Controlling Speed

1. To start the tool, pull the trigger.
2. To stop the tool, release the trigger.
3. To vary the drilling speed, simply increase or decrease pressure on the trigger. The further the trigger is pulled, the greater the speed.

### Locking Trigger

The lock button holds the trigger in the ON position for continuous full speed use.

1. To lock the trigger, hold the lock button in while pulling the trigger. Release the trigger.
2. To unlock the trigger, pull the trigger and release. The lock button will pop out.

## APPLICATIONS

Cat. No.	No Load RPM	Wood					Wood/Steel	Steel
		Flat Boring Bits	Auger Bits	Hole Saws	Self-feed Bits	Pathfinder™ Bits	Twist Bits	Hole Saws
0100-20	0 - 2500	1-1/2"	NR	NR	NR	NR	1/4"	NR
0101-20	0 - 4000	1-1/4"	NR	NR	NR	NR	1/4"	NR
0200-20	0 - 1200	1-1/2"	1"	3-1/4"	NR	1-1/4"	1/2"	1-5/8"
0201-20	0 - 2500	1-1/2"	7/8"	2-1/4"	NR	1-1/4"	1/2"	NR
0202-20	0 - 1200	1-1/2"	1"	3-1/4"	NR	1-1/4"	1/2"	1-5/8"
0299-20	0 - 850	1-1/2"	1-1/2"	3-5/8"	2-9/16"	1-1/4"	3/4"	2"
0300-20	0 - 850	1-1/2"	1-1/2"	3-5/8"	2-9/16"	1-1/4"	3/4"	2"
0302-20	0 - 850	1-1/2"	1-1/2"	3-5/8"	2-9/16"	1-1/4"	3/4"	2"

NR = Not recommended

**WARNING** To reduce the risk of explosion, electric shock and property damage, always check the work area for hidden pipes and wires before drilling.

### Selecting Bits

When selecting a bit, use the right type for your job. For best performance, always use sharp bits.

### Drilling

1. Before drilling, be sure the workpiece is clamped securely. Use backing material to prevent damage to the workpiece during breakthrough.

2. When starting a hole, place the drill bit on the work surface and apply firm pressure. Begin drilling at a slow speed, gradually increasing the speed as you drill.
3. Always apply pressure in line with the bit. Use enough pressure to keep the drill biting, but do not push hard enough to stall the motor.
4. Reduce pressure and ease the bit through the last part of the hole. While the tool is still running, pull the bit out of the hole to prevent jamming.

### Drilling in Wood, Composition Materials and Plastic

When drilling in wood, composition materials and plastic, start the drill slowly, gradually increasing speed as you drill. When using twist drill bits, pull the bit out of the hole frequently to clear chips from the bit flutes. Use low speeds for plastics with a low melting point.

### Drilling in Masonry

When drilling in masonry, use high speed carbide-tipped bits. Drilling soft masonry materials such as cinder block requires little pressure. Hard materials like concrete require more pressure. A smooth, even flow of dust indicates the proper drilling rate. Do not let the bit spin in the hole without cutting. Do not use water to settle dust or to cool bit. Both actions will damage the carbide.

### Drilling in Metal

When drilling in metal, use high speed steel twist drills or hole saws. Use slow speeds for hard metals and high speeds for softer metals. Lubricate drill bits with cutting oil when drilling in iron or steel. Use a coolant when drilling in nonferrous metals such as copper, brass or aluminum. Back the material to prevent binding and distortion on breakthrough.

### Driving Screws

When driving screws, use the proper screwdriver bit for your job. After drilling pilot and shank holes, start the screw slowly and increase the speed as driving progresses. Set the screw by slowing to a stop. Do not run screws down at excessive speeds. To remove screws, reverse the motor.

### Stalling

If the tool seems as if it is about to stall, maintain a firm grip and reduce pressure slightly to allow the bit to regain speed. If the tool does stall, release the trigger immediately. Reverse the motor, remove the bit from the work and start again. Do not pull the trigger on and off in an attempt to start a stalled drill. This can damage the drill.

**WARNING** High rotational force. To reduce the risk of injury, always hold or brace securely. Always use side handle on tools rated 1200 rpm or less.

### Bit Binding

A high rotational force occurs when a bit binds. If the bit binds, the tool will be forced in the opposite direction of the bit rotation (See Fig. 12-14). Bits may bind if they are misaligned or when they are breaking through a hole. Wood boring bits can also

bind if they run into nails or knots. Be prepared for bit binding situations.

To reduce the chance of bit binding:

- Use sharp bits. Sharp bits are less likely to bind when drilling.
- Use the proper bit for the job. There are bits that are designed for specific purposes.
- Use caution when drilling pitchy, knotty, wet or warped material or when drilling in material that may contain nails.

## Typical Bracing Methods

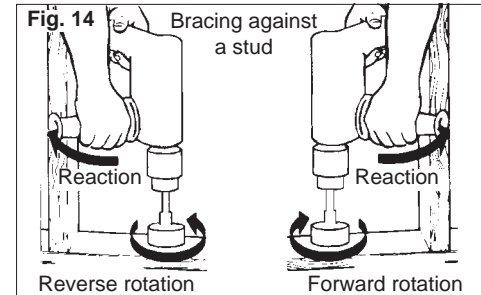
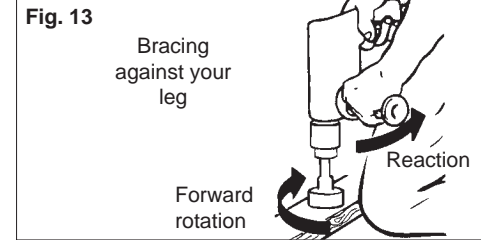
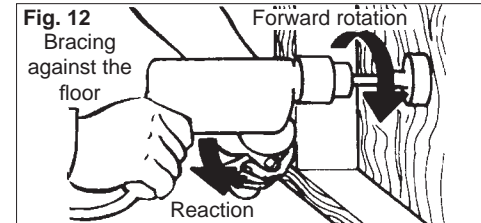

## ACCESSORIES

 **WARNING** To reduce the risk of injury, always unplug the tool before attaching or removing accessories. Use only specifically recommended accessories. Others may be hazardous.

## MAINTENANCE

 **WARNING** To reduce the risk of injury, always unplug your tool before performing any maintenance. Never disassemble the tool or try to do any rewiring on the tool's electrical system. Contact a *MILWAUKEE* service facility for ALL repairs.

### Maintaining Tools

Keep your tool in good repair by adopting a regular maintenance program. Before use, examine the general condition of your tool. Inspect guards, switches, tool cord set and extension cord for damage. Check for loose screws, misalignment, binding of moving parts, improper mounting, broken parts and any other condition that may affect its safe operation. If abnormal noise or vibration occurs, turn the tool off immediately and have the problem corrected before further use. Do not use a damaged tool. Tag damaged tools "DO NOT USE" until repaired (see "Repairs").

Under normal conditions, relubrication is not necessary until the motor brushes need to be replaced. After six months to one year, depending on use, return your tool to the nearest *MILWAUKEE* service facility for the following:

- Lubrication
- Brush inspection and replacement
- Mechanical inspection and cleaning (gears, spindles, bearings, housing, etc.)
- Electrical inspection (switch, cord, armature, etc.)
- Testing to assure proper mechanical and electrical operation

 **WARNING** To reduce the risk of injury, electric shock and damage to the tool, never immerse your tool in liquid or allow a liquid to flow inside the tool.

### Cleaning

Clean dust and debris from vents. Keep the tool handles clean, dry and free of oil or grease. Use only mild soap and a damp cloth to clean your tool since certain cleaning agents and solvents are harmful to plastics and other insulated parts. Some of these include: gasoline, turpentine, lacquer thinner, paint thinner, chlorinated cleaning solvents, ammonia and household detergents containing ammonia. Never use flammable or combustible solvents around tools.

### Repairs

If your tool is damaged, return the entire tool to the nearest service center.