



FITTINGS • VALVES • HOSE • CLAMPS & ACCESSORIES



2021



MIDLANDINDUSTRIES.COM | FIND US ON: f i n

ACCOUNT MANAGER

FULL CONTROL AT YOUR FINGER TIPS!

MUCH MORE THAN JUST PLACING ORDERS!

LOG INTO

ACCOUNT MANAGER FOR:

- Get Account Information
- New Customer Profile
- Check Your Order History
- Access Your Invoices
- Download Current Pricing
- Print Bin Labels
- Check Backorders
- Print Invoices
- Pick A Preferred Warehouse
- Save Orders
- Manage Part Numbers
- Quick Order
- Upload Your Order
- And More...



Login or Open an Account

SEARCH



> HOME > ABOUT US > OUR SERVICES > CONTACT US > BLOG



Speed Order (add items to your cart)

Part # QTY

Survey

What industries do you serve? (Hold Shift to select multiple)
Beverage
Car Wash
Compressor
Farm and Ag

Any Other Industries Served?

Check Price and Availability

Product Search

Account Links

Orders [Place an Order \(?\)](#) Account [Manage Part Numbers \(?\)](#)

Overview

	Open	Total
Orders (?)	0	\$0
Invoices (?)	0	\$0

Your Preferred Warehouse

Account Details

Account # 100
Company Name ABC Supply
Sales Rep INDUSTRIAL ACCOUNT
Multiplier
Saved Orders Request an Appointment

LOG IN TO MIDLANDINDUSTRIES.COM

VISIT WWW.MIDLANDINDUSTRIES.COM AND LOGIN TO YOUR ACCOUNT USING YOUR CUSTOMER ID AND PASSWORD.

- View your price and available stock.
- View open orders and tracking information on all shipments.
- Download pricing files.
- Update your Customer Profile and Contacts
- For Purchasing, Accounts Payable, Sales, and Marketing.
- Check your message center to see the latest updates and specials.

CUSTOMER ID # : _____

PASSWORD : _____

MULTIPLIER : _____

Fax 1-800-877-5391



sales@midlandindustries.com

FIND WHAT YOU NEED

TABLE OF CONTENTS	INTRO 4-6
PICTORIAL	PAGES 21-49
NUMERICAL INDEX	PAGES 635-702
GENERAL INFORMATION	PAGES 703-705
KNOWLEDGE BANK	PAGE 706
THREAD INFORMATION	PAGE 711
THREAD PROFILES	PAGE 712

CUSTOMER TOOLS

MARKETING SOLUTIONS	INTRO 9-15
LOCATIONS / TRANSIT MAPS	INTRO 19-20
ACCOUNT MANAGER	INSIDE FRONT COVER

PRODUCTS AND SERVICES



CUSTOM CATALOGS SEE INTRO PAGE **10**



PRIVATE LABELING SEE INTRO PAGE **12**



CUSTOM BIN LABELS SEE INTRO PAGE **13**



MOBILE APP SEE INTRO PAGE **14**



BRASSCATALOG.COM WEBSITE SEE INTRO PAGE **15**

MIDLANDINDUSTRIES.COM

NEW PRODUCTS INTRO PGS 7-8

PICTORIAL INDEX PGS 21-49

BRASS PGS 1-210

LEAD FREE PGS 211-245

LF VALVES & PLUMBING PGS 246-264

VALVES PGS 265-317

NIPPLES & FITTINGS PGS 318-407

PLASTIC PGS 408-422

HOSE ACCESSORIES PGS 423-481

HOSE PGS 452-494

CLAMPS PGS 495-515

TUBING PGS 516-522

PRESSURE WASHER 523-528

PNEUMATICS PGS 529-551

TRUCK & TRAILER PGS 552-573

HYDRAULICS PGS 574-618

STAINLESS STEEL ADAPTERS 619-634

NUMERICAL INDEX 635-702



THE BUILT TO SERVE ADVANTAGE

As a new family of companies working together we're building the most powerful platform our industry has ever seen.

Founded upon a legacy of customer service, our mission is to give you a distinct competitive advantage. As a leader in globally sourced and domestically manufactured products we're providing needed innovations to distributor supply chains with a variety of marketing and data driven initiatives.

Save time and money with the industry knowledge that comes from decades of experience and hard work. Building advantage means you gain access to our growing network of distribution centers across North America. Come see what the Midland Advantage can do for your business.

THE PERFECT FIT

For decades the Midland family has been the chosen manufacturer and supplier of fittings, valves, hose and accessories to distributors across North America. Today's Midland Industries and our family of companies are committed to helping our customer serve their customers better Experience simple, worry-free products and innovations that make doing business easier.



Midland Metal

A MIDLAND INDUSTRIES COMPANY



Anderson Metals

A MIDLAND INDUSTRIES COMPANY



STAINLESS
ADAPTERS INC.

A MIDLAND INDUSTRIES COMPANY



CHAMPION BRASS
FITTINGS • CONNECTORS • VALVES

A MIDLAND INDUSTRIES COMPANY



MID-AMERICA
FITTINGS, LLC.

A MIDLAND INDUSTRIES COMPANY



BUCHANAN
RUBBER LTD

A MIDLAND INDUSTRIES COMPANY



AMIFLEX INC.

A MIDLAND INDUSTRIES COMPANY

www.MidlandIndustries.com | 800-821-5725

Connect with us



TABLE OF CONTENTS



INTRODUCTION

Account Manager	1
Find What You Need	2
About Midland Industries	3
Table Of Contents	4
New Products	7
Suite Of Marketing Tools	9
Custom Catalog	10
Shop Brass Catalog	11
Private Label Shipping	12
Bin Labels	13
Midland App	14
Brasscatalog.com	15
Customer Profile	16
Oem Solutions	17
Domestic Manufacturing	18
Distribution Locations	19



LEAD FREE

Lead Free Fittings	211
Lead Free Pipe	212
Lead Free Hose Barb	220
Lead Free Garden Hose	223
Lead Free Flare	226
Lead Free Compression	232
Lead Free Valves	244
Lead Free Ball Valves	247
Lead Free Press Ball Valves	250
C/E Pex & Pex Ball Valves Lead Free	251
Lead Free Push-Fit Ball Valve	252
Lead Free Gate, Check etc	253
Lead Free Frost Free Sillcock	254
Lead Free Hose Bibb, Boiler Drain, Sillcock	255
Lead Free Supply Stops	258
Lead Free SS Supply Connectors	260
Transition, Water Meter	262
Rubber Couplings	264



BRASS FITTINGS

Pipe Fittings	1
Hose Barb Fittings	23
Push On Barb Fittings	48
Garden Hose Fittings	57
Sae 45° Flare	69
Inverted Flare Fittings	95
Compression Fittings	105
Flareless Fittings	124
Push-In/ Push-To-Connect Fittings	130
Brass Push-In Fittings	131
Nickel Plated Push-In Fittings	137
N/P w/ N/P Collet	146
SS Push-In	150
Composite Body Push-In Fittings	154
D.O.T. Push-In Tube Fittings	163
Composite Body Dot Airbrake Fittings	170
D.O.T. Air Brake - Nylon Tubing	176
D.O.T. Air Brake Reusable Hose/Fittings	185
Adapters For Grease Fittings	192
Specialty Valves And Cocks	193



VALVES

Forged Brass Ball Valve	266
Locking Handle Ball Valve	267
Butterfly Handle Ball Valve	267
Nickel Plated Ball Valve	268
N/P Ball Valve W/Ss Trim	269
Italian Ball Valve	270
Male X Female Brass Ball Valve	271
Italian Male X Female Ball Valve	272
Tee Handle Ball Valve - Male X Female	273
Locking Handle Ball Valves - Female X Male	274
Gas Ball Valves	277
Side Outlet 3-Way Ball Valve	282
Brass Gate Valve	284
Bronze Ips Gate Valve	285
Ductile Iron Valves	307
And Accessories	307

TABLE OF CONTENTS (CONTINUED)



NIPPLES & FITTINGS

Brass Nipples	319
Bronze Fittings	328
Lead Free Brass Fittings	328
Stainless Steel Fittings	352
Black And Galvanized Steel Nipples	360
Hammer Unions	379
Merchant Couplings	380
Api Line Couplings	381
Malleable Fittings	382
Steel Fittings	392
300# Malleable	394
Bull Plugs And Swages	396
Carbon Steel Flanges	398
Copper Fittings	402



PLASTIC FITTINGS

Schedule 80 Pvc Nipples	409
Pipe-Nylon Poly	411
Hose Barb	413
Garden Hose	417
Compression	418
Plastic Push-In Tube Fittings	419



HOSE ACCESSORIES

Cam And Groove	424
Crimlok Cam & Groove	436
Combination Nipples	441
Combination Nipples	442
Hose Barb X Male Pipe	442
Victaulic Grooved	442
Combination Nipples	442
Hose Menders	446
Universal Coupling	447
Ground Joint Coupling	448
Fire Hose Fittings	451



BUCHANAN HOSE

Air & General Purpose	452
Material Handling	459
Petroleum & Chemical	463
Water Suction & Discharge	466
Ferrules	474
Sleeves	482
	488



HOSE CLAMPS

Worm Gear Clamps	496
Quick Release	500
T-Bolt Clamps	501
Mega Clamps	502
Constant Torque Hose Clamps	505
Muffler Clamps	508
Exhaust Clamps	509
Carbon Steel 1-Ear Clamps	510
Ear Clamps	511
Hammerlock Clamps	511
Clamp Tools	512
Lined Band Clamps	513
Hose Ferrules	515



TUBING

Polyurethane Nsf 51®	517
Polyethylene	518
Nylon 12 Tubing	520
Pvc Polyvinylchloride Tubing - Nsf61	521
Tube Cutters	521
Aluminum Tubing - Easy Bend	522
Copper Tubing - Refrigeration Tubing	522



HIGH PRESSURE SPRAYERS

Nozzles	524
Swivels	525
Sprayers	526
Quick Disconnects	527



PNEUMATICS

Industrial Interchange	530
Universal Series Couplers	532
Aro 210 Interchange	533
Automotive/Parker Interchange (Tru-Flate)	534
Lincoln Interchange	535
Straight Through	536
Mini/ Mold	536
Vents, Mufflers, Filters	537
Manifolds	539
Safety Valves	540
Tank Valves	541
Blow Guns	542
Tire Gauges	543
Foot Chucks	544
Gauges	548
Teflon Tape	551



TRUCK AND TRAILER

Air Coils	552
Hose Support	553
Gladhands	556
Air Cylinder	560
Coiled Cable	564
Accessories	570
Nylon Dot Air Brake Tubing	572
Fuel Line And Air Brake Hose	573



HYDRAULIC ADAPTERS & ACCESSORIES

Technical Information	575
Profile Size Chart	581
JIC	585
Pipe	591
O-Ring	596
BSP/Metric	606
Flange	615
QDs	610
Flow Control	613



STAINLESS STEEL ADAPTERS

JIC	619
Pipe	623
SAE O-Ring	627
Hose Crimp	631
	634

NEW PRODUCTS

STAINLESS STEEL SUPPLY CONNECTOR

BALLCOCK CONNECTOR NOW
WITH N/P BRASS NUT

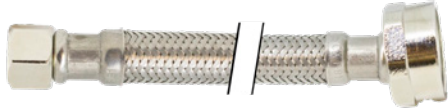

PAGE: 260

LEAD FREE, FULL PORT BRASS BALL VALVES PUSH-FITTING END



PAGE: 252

LF BRASS FROST FREE SILLCOCK VALVES/ ANTI SIPHON



PAGE: 254

LOW PRESSURE LF BRASS VALVES



PAGE: 255-257

NOW CARRYING FULL LINE OF



 A MIDLAND INDUSTRIES COMPANY



 A MIDLAND INDUSTRIES COMPANY

**NICKEL PLATED
PUSH-IN FITTINGS
WITH NICKEL
PLATED COLLET**



PAGE: 146

**BRONZE IPS
GATE VALVE**



PAGE: 285

SS PUSH-IN FITTINGS

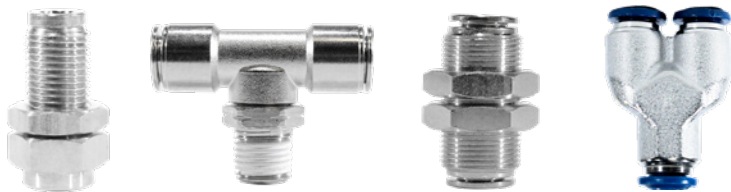

PAGE: 150

BLIND FLANGES

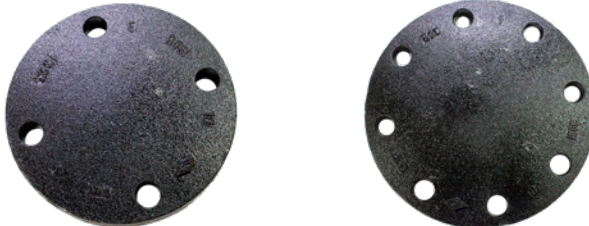

PAGE: 400

**SCH 40 SINGLE RUN
NIPPLE BLACK**



PAGE: 368



BUILDING ADVANTAGE STARTS WITH VISIBILITY.

YOUR BRAND IS OUR BRAND. At Midland we keep our name off of everything so your customers only see yours. Our dedication to being a silent partner helps you build your brand while gaining critical exposure your market.

Our customized suite of **MARKETING TOOLS** helps you grow and expand your business. We make it simple to sell and ship with greater ease and accuracy.

TO SCHEDULE A DEMO CONTACT; SALES@MIDLANDINDUSTRIES.COM. LET'S START BUILDING TOGETHER!

MARKETING



CUSTOM CATALOG

Print custom catalogs with your brand, your pricing and your contact information.



FREE E-COMMERCE SITE

We will provide you with a free, fully functional, custom branded e-commerce site, pre-loaded with all of Midland's 20,000 items.

ORDER GATHERING



BIN LABELS

Create & print personalized bin labels with your brand to affix to bin boxes. Helps with reorders and managing your warehouse.



MIDLAND APP

Use the app to scan bin labels on location to quickly reorder, check stock and pricing. Save orders to submit later.

SHIPPING



PRIVATE LABEL

Private label shipments with your logo on boxes, packing slips and product labels...shipped how you want it, today!



ABC SUPPLY
 1234 Main Ave, Supply, NY - 10001
 WWW.ABCSUPPLYZ.COM - 1-888-555-5555

WWW.ABCSUPPLYZ.COM - 1-888-555-5555
 1234 Main Ave, Supply, NY - 10001
 ABC SUPPLY

OPTION A (FREE): CUSTOM DIGITAL

Our designers will work with you to create a cover that incorporates your logo, colors and photos.

OPTION B: CUSTOM COVER

CONTACT YOUR SALES REP FOR PRICING

List price, net price or anywhere in between. You set the pricing that is right for you.

OPTION C: CUSTOMIZED CATALOG

CONTACT YOUR SALES REP FOR PRICING

Your company logo and contact information will print on the footer of each page. Minimum of 25

GET STARTED TODAY

MidlandIndustries.com/marketing

CUSTOM CATALOG

Print custom catalogs with your brand, your pricing and your contact information.

A UNIQUE CATALOG AT A REASONABLE PRICE

Using Midland's newest catalog as a template, we can completely customize the look, contact information, and pricing to fit your company's needs. The process is simple and takes about a month to complete (times may vary due to the printer's schedule). Work with our designer to customize a catalog that is unique and properly represents your company.

Custom Catalogs have list prices so your sales team can use to sell to your customers.

UNION TEE

Part #	Thread size NPTF	A	B	C	Approx. Wt. Lbs.	List Price
28-024	1/8"	0.55	0.55	0.56	0.08	8024
28-025	1/4"	0.78	0.78	0.68	0.17	8025
28-026	3/8"	0.84	0.84	0.81	0.22	8026
28-027	1/2"	1.09	1.09	1.00	0.43	8027
28-028	3/4"	1.16	1.16	1.25	0.64	8028

UNION FORGED TEE

Part #	Thread size NPTF	A & B	Body Width	Approx. Wt. Lbs.	List Price
28-032	1/8"	0.56	0.50	0.06	8032
28-033	1/4"	0.71	0.68	0.13	8033
28-034	3/8"	0.81	0.81	0.16	8034
28-035	1/2"	1.00	1.00	0.27	8035
28-036	3/4"	1.16	1.25	0.53	8036
28-023	1"	1.42	1.50	.924	8023

www.abcsupplyz.com

Toll Free Phone 1-800-555-5555



ABC SUPPLY

search items...



Log In | Register

CATEGORIES

- Accessories
- Brass
- Clamps
- High Pressure
- Sprayer
- Hydraulics
- Lead Free
- Nipples & Fittings
- Pneumatics
- Truck And Trailer
- Tubing
- Valves



SPECIAL DEAL!

SHOP.BRASSCATALOG

Midland Industires will provide you with a fully functional branded E-commerce site, preloaded with every one of Midland's 40,000 items.

HOW IS IT USED?

Shop Brass Catalog (SBC) is an e-commerce platform we have developed for our customers to sell our products to their customers. Our customers can choose to have Midland fulfill the order or they can fulfill the order themselves.

SBC can be used as a Point of Sale system for showroom floor sales. Simply enter the order on the website while the customer is at the counter, get P.O. number from the customer and enter the order. Then simply use the site to log orders and bill them.

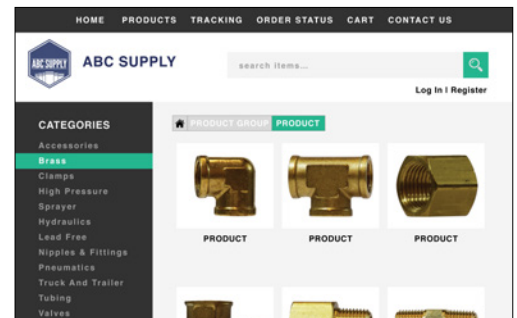

Product	Part Number	Quantity	Unit Price	Total
ITEM 1	ABC123456	<input type="text" value="100"/>	\$3.53	\$353.00
ITEM 2	ABC78901	<input type="text" value="100"/>	\$9.49	\$949.00
ORDER SUBTOTAL				\$1,302.00
ESTIMATED SHIPPING				\$22.73
TOTAL				\$1324.73

ADDITIONALFEATURES

- Easy Sign-Up
- Free Marketing Materials
- Custom Items
- Cart and Checkout
- Admin Page



IDENTIFICATION TAGS
 Tags and packing slips are printed with your company information.

PERSONALIZED
 Tags for each product ordered, including your part number if provided.

SHIPPING
 Shipped in a blank box, with no reference to Midland anywhere.

GET STARTED TODAY
MidlandIndustries.com/marketing

PRIVATE LABELING

Private label shipments with your logo on boxes, packing slips and product labels.

SHIPPED HOW YOU WANT IT, TODAY!

Last year, Midland Industries shipped over 17,000 private labeled packages for our customers. Our customers trust Midland with their customers! Private-labeled packages are shipped in generic boxes with your return shipping information on the pack list and a generic UPS label; Midland isn't referenced anywhere on the shipment. Using this program you have access to an additional 40,000 items without investing in additional inventory. Drive up your profits-not your inventory costs-by using Midland Industries' Private Label Shipping.



PERSONALIZED

Print labels with pictures and barcodes.

SCAN

Using the Midland Metal mobile app you can scan the labels to check stock and place orders.

CUSTOMER SERVICE

Put your custom labels on your customer's bins.

GET STARTED TODAY

MidlandIndustries.com/marketing

BIN LABELS ON DEMAND

Now you can create and print personalized Bin Labels on demand for any product that Midland carries. Labels can be customized with your logo or name. Multiple sizes available.

BIN LABELS FOR MIDLAND PRODUCTS

Looking for a way to keep your foot in the door with your customers? Try labeling their bins. Using easy-to-follow steps, you're able print labels with pictures and barcodes. Then, using the Midland app, scan the labels on the bins to place orders. Not only will you save time with stock replenishment, you will improve your relationship with your customers as well.

4" x 2"



3.5" x 2"



2.625" x 1"



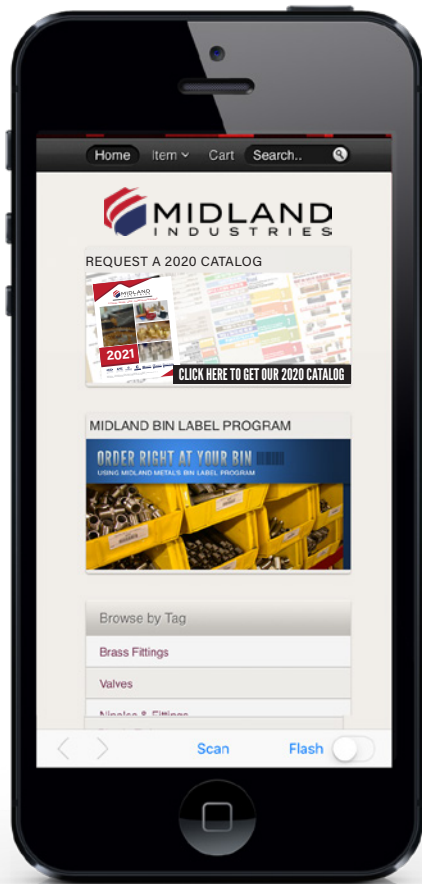

CHECK STOCK/PRICING

The mobile app gives you quick access to stock and pricing on your displayed items.

SEARCH

Search for products by part number or keyword. Browse by category or type.

CUSTOMER SERVICE

Manage your customer's inventory by using your custom bin labels. Scan for quick reordering.

GET STARTED TODAY

MidlandIndustries.com/marketing

MOBILE APP

Use the app to scan bin labels on location to quickly re-order, check stock or pricing. Save orders to submit later.

SCAN BIN LABELS FOR EASY ACCESS

You can affix these bin labels on your bins and/or your customer's bins. Use the app on your smartphone to quickly scan labels for re-order or to save orders to place at the end of the day.

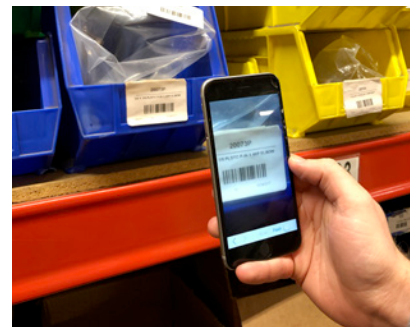



PDF CATALOG

Full color or black/white PDF catalog online.

PRINT

Print by product category or page. Available in color or black/white.

GET STARTED TODAY

MidlandIndustries.com/marketing

BRASSCATALOG.COM

Brasscatalog.com is an unbranded sales and marketing tool. Use it to provide your customers with specifications, pictures and pricing. With no reference to Midland. Your customers can access over 40,000 products by product category.

Online, download or print a generic line card, pictorial index and product category pages with no reference to Midland Industries.

Access catalog pages with list prices so your sales team can use to sell to your customers.

Fax 1-800-877-5391



sales@midlandindustries.com

CUSTOMER PROFILE

To better serve you, Midland has added a customer profile page to the account manager tab on midlandindustries.com. We want to ensure that we are sending the right information to the right people. Please take a minute to make sure your information is up to date. Thank You!

Purchasing: New product information, Order acknowledgement, Updated pricing, Specials

Sales and Marketing: Suite of marketing tools, Library of sales resources

Accounting: Invoices, Payment information

What is your website address?

What Industries do you serve?
Please check all that apply

HELP US HELP YOU!

- Beverage
- Compressor
- Fastener
- Fluid Power
- Hardware/Retail
- Hydraulics
- Irrigation
- MRO
- OEM
- PVF
- Pneumatics
- Pressure Washer
- Refrigeration and Appliance
- Truck and Auto
- Water Filtration
- Waterwell
- Car Wash
- Farm and Ag
- Fire Protection
- HVAC
- Hose and Fitting
- Industrial Supply
- LP Gas
- Marine
- Oil and Gas
- Plumbing
- Power Transmission
- RV and Mobile Home
- Swimming Pool
- Utility
- Water Works

Any Other Industries Served?

What Buying Groups do you belong to?
Please check all that apply

- AD
- IDC
- DPA
- Equity
- WIT
- VIPAR
- IDCO
- Net Plus Alliance
- IBC
- Omni
- HDA
- Embassy

Any Other Buying Groups?

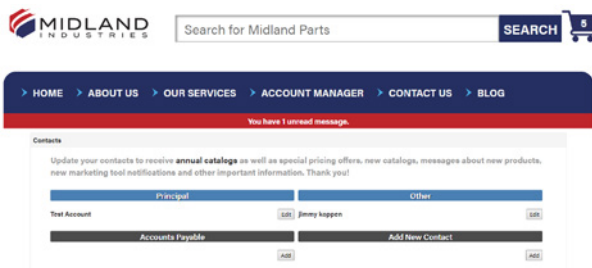

**UPLOAD YOUR LOGO IN
ACCOUNT MANAGER TO
UTILIZE ALL OF OUR
CUSTOMIZABLE
MARKETING TOOLS!**

To access your customer profile, log in to your account manager and select the profile tab along the top menu.



MIDLAND OEM SOLUTIONS

In an ever changing global business environment, all applications are not created equal. As an OEM partner, Midland can help the distributor work with Original Equipment Manufacturers and specify solutions in order to make informed purchasing decisions around technology, applications and relevant specification requirements.

Certain OEM applications require specific fittings, hoses, clamps and valves. For example, your application may require easier installation, a globally available product, or extended life among other critical features. No matter what the application, Midland is prepared to meet the demands of your end user business with our OEM solutions and equipment.

When you work with Midland, you are getting a Midland designed product made worldwide in our factories in the US, Asia and Europe, assembled by dedicated employees. Therefore, as an OEM wholesale partner, Midland Industries can promise premier customer service, high quality manufacturing standards, on-time delivery and a philosophy of continuous improvement. This allows the distributor to remain competitive in the marketplace and achieve growth objectives on new and existing projects.

As part of the Midland OEM program, you can expect increased co-marketing opportunities, better market planning with our sales force, and improved customer engagement with co-managed objectives.

INNOVATIVE THINKING. INNOVATIVE SOLUTIONS. PARTNERING FOR YOUR SUCCESS!

Ask about our OEM Solutions – contact specials@midlandindustries.com to get started today.

DD	8-8-72	Mid-America Fittings, Inc. 7604 Wedd Street Overland Park, KS 66204
CHT	8-9-72	
CHT	8-9-72	
DATE		PART DESCRIPTION: CONNECTOR- 5/16 INV. X 1/4 S
REDRAWN ON 10-31-2013 BY CAD/CAM		

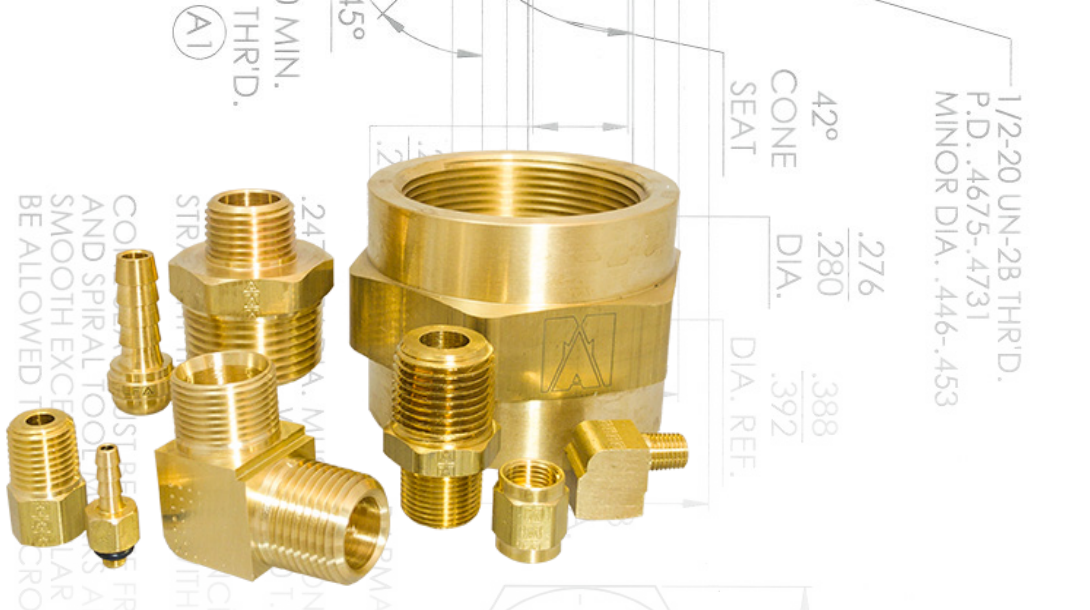

DOMESTIC MANUFACTURING

Midland Industries is a leading manufacturer of our MAF™ brand of industrial fitting products for use by OEM's and wholesale distributors.

Midland Industries Engineering and Design team works closely with OEM's in the automotive, trucking, HVAC, industrial, consumer and commercial electronics and appliances and fluid industries. We take original design concepts, sometimes drawn on nothing more than a lid of a pizza box over lunch and move them seamlessly from CAD drawing phase, prototype phase, sample production phase and final production in a matter of weeks instead of months. This is done by using a variety of CNC machine tools and our facilities at our disposal. This includes "Miltronics Vertical Machining Center", "Okuma Turning Centers" and Miyano Machining Centers complete with "Live Tooling" on both long and short beds to create specialty custom parts. At the same time, we achieve maximum quality, efficiency and cost savings for the customer.

**COMMITTED TO BEING AN INDUSTRY LEADER
IN ENVIRONMENTAL "BEST PRACTICES" AND WILL APPLY IT
TO ALL ASPECTS OF OUR BUSINESS.**

In addition to our MAF™ brand brass fittings, Midland Industries is a major supplier of **chrome-plated** and **nickel-plated brass fittings** as well as **black and galvanized malleable iron pipe fittings, stainless steel pipe fittings, cast bronze fittings and red brass pipe nipples** along with a wide variety of plumbing installation and repair specialty products.

**TO FIND OUT MORE OR TO HAVE YOUR SPECIALTY PARTS QUOTED VISIT:
MIDLANDINDUSTRIES.COM/MANUFACTURING**



MIDLAND INDUSTRIES DISTRIBUTION

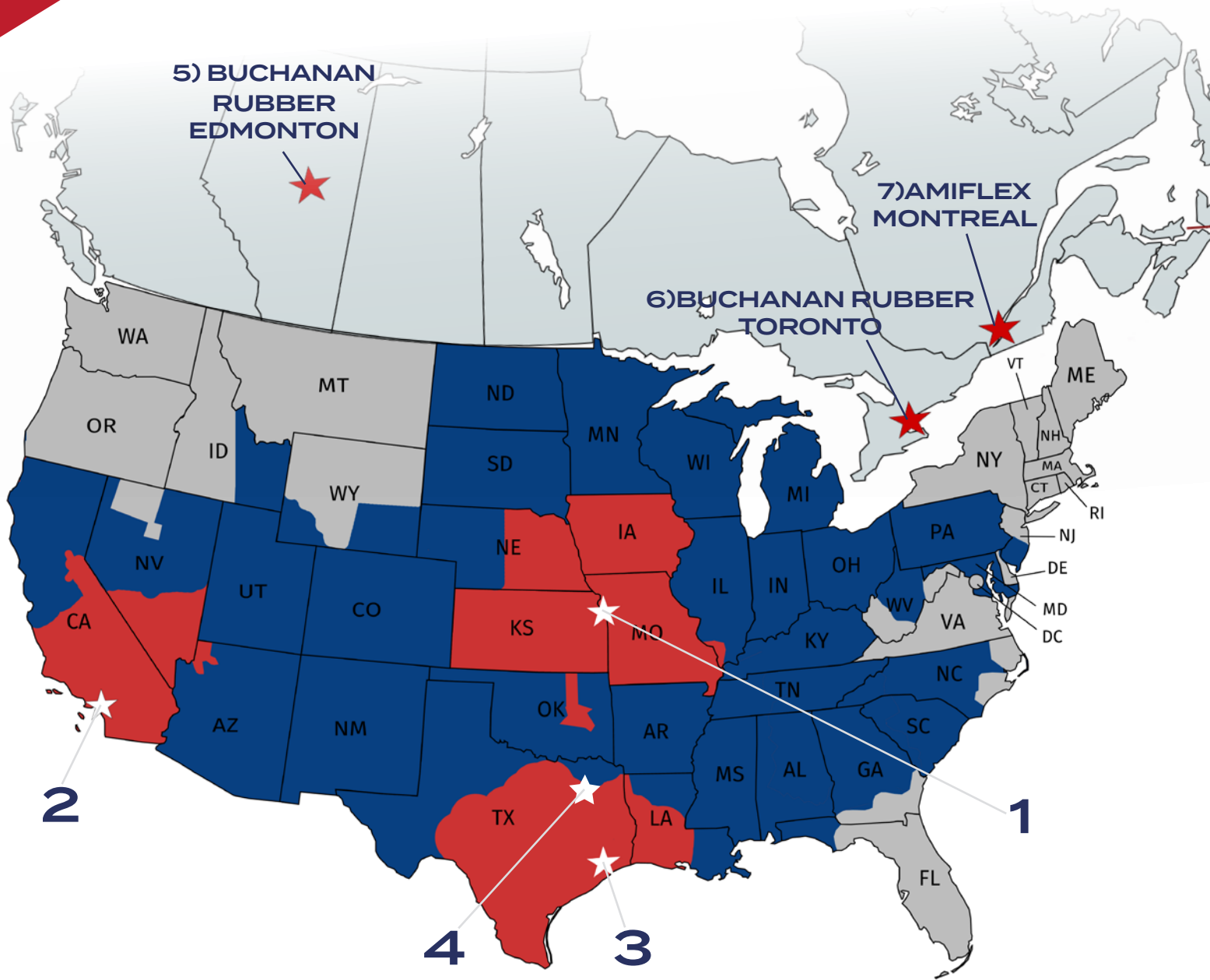

UPS GROUND TIME IN TRANSIT

- NEXT DAY DELIVERY
- 2 DAY DELIVERY
- 3 DAY DELIVERY

*2 Day Delivery is determined by warehouse location and inventory at specified location.

* For detailed UPS Ground time in transit maps please visit www.UPS.com/maps

DISTRIBUTION LOCATIONS

1) MIDWEST DISTRIBUTION

Full Stocking Location

3145 Oak Street
Kansas Ciy, MO 64111

2) WEST COAST DISTRIBUTION

Full Stocking Location

659 E Ball Rd
Anahiem, CA 92805

3) TEXAS DISTRIBUTION

Full Stocking Location

5544 Armour Drive,
Houston, TX 77020

4) TEXAS DISTRIBUTION

Full Stocking Location

600 E. Centre Park
DeSoto, TX 75115

MIDLAND INDUSTRIES CUSTOMER SERVICE

Phone: 800-821-5725

Fax: 800-877-5391

Email: Sales@MidlandIndustries.com

www.MidlandIndustries.com

You can easily check stock and availability for products at these locations online using Account Manager. All accounting will be handled in Kansas City.

CANADIAN DISTRIBUTION

5) BUCHANAN RUBBER-EDMONTON

9547-12 Ave SW,
Edmonton, AB T6X-0C3
Phone: 1-888-775-4673
Fax: 1-888-990-4673
Sales@BuchananRubber.com

6) BUCHANAN RUBBER-TORONTO

50 Fasken Drive
(units 11-21),
Etobicoke, ON M9W-1K5
Phone: 1-888-775-4673
Fax: 1-888-990-4673
Sales@BuchananRubber.com

7) AMIFLEX-MONTREAL

9555 Henri Bourassa Ouest,
Montreal, QC H4S-1S7
Phone: 1-888-775-4673
Fax: 1-888-990-4673
Sales@BuchananRubber.com

Canadian operations serviced through our Edmonton, Toronto & Montreal distribution centers. For more information call customer service at 1-800-775-HOSE (4673)



















































BRASS

PICTORIAL INDEX

BRASS FITTINGS PGS 1-210		PIPE PGS 1		90° ELBOW  PG 2	90° FORGED EL  PG 2	45° ELBOW  PG 2	UNION TEE  PG 3	FGD TEE  PG 3	RED FRG TEE  PG 3	CROSS  PG 3
FORGED  PG 4	COUPLING  PG 4	RED COUPLING  PG 5	UNION  PG 5	CAP  PG 6	90° ST EL  PG 6	90° ST EL  PG 6	FORGE 90°  PG 6	FORGE RED  PG 7		
HEX BUSHING  PG 8	FACE BUSHING  PG 7	BREAKAWAY  PG 7	SQ HEAD PLUG  PG 9	COUNTERSUNK  PG 9	SLOTTED HEAD  PG 9	CORED HEX  PG 10	SOLID HEX  PG 10	LOCKNUT  PG 10		
CLOSE NIPPLE  PG 11	LONG NIPPLE  PG 11	HEX NIPPLE  PG 12	RED HEX NIPPLE  PG 13	45° ST EL  PG 14	45° FORGE ST EL  PG 14	STREET TEE  PG 15	FORGED ST TEE  PG 15	TAPPED ST TEE  PG 15		
EXTENDER  PG 16	FPT X MPT SWIVEL  PG 13	MPT X FPT SWIVEL  PG 13	90° MALE ELBOW  PG 17	BARSTOCK ELBOW  PG 17	90° RED ELBOW  PG 17	MALE BRANCH T  PG 17	FGD BRANCH TEE  PG 18	ALL MALE T  PG 18		
LONG ST EL  PG 18	LONG EX ADAPT  PG 18	FIP X MIP WYE  PG 14	MALE WYE N/P  PG 14	ALL FIP N/P WYE  PG 14	BULKHEAD FITTINGS PGS 19-21		BULKHEAD FXF  PG 19	BULKHEAD FXM  PG 19	BULKHEAD FXM  PG 20	
BULKHEAD FXM  PG 20	BULK TUBE X F  PG 20	FPXCLAMP-STUD  PG 20	MARINE BULK-HEAD  PG 20	STEEL BULK-HEAD  PG 19	STEEL BULK-HEAD  PG 21	STEEL BULK-HEAD  PG 21	STEEL BULK-HEAD  PG 21	STEEL BULK-HEAD  PG 21	STEEL BULK-HEAD  PG 20	
STAINLESS BULKHEAD  PG 21	STAINLESS BULKHEAD  PG 21	HOSE BARB PGS 23		MALE ADAPTER  PG 24	BSPT ADAPTER  PG 26	SWL MALE ADPT  PG 26	SWL MALE ADPT  PG 26	MENDER/SPLICER  PG 27	FEMALE ADAPT  PG 28	

BRASS

PICTORIAL INDEX

FEMALE  PG 28	MALE SWIVEL  PG 27	MALE SWIVEL  PG 27	GASKET  PG 29	HB 90° ELBOW  PG 29	BS 90° ELBOW  PG 30	TEE  PG 30	90° HB ELBOW  PG 31	FEMALE HB EL  PG 30	
45° ELBOW  PG 31	CROSS  PG 31	BALL END  PG 32	BALLSEAT  PG 32	BALLSEAT  PG 32	45° FLARE  PG 33	BARB X COMP  PG 33	DUAL FLARE  PG 34	DUAL FLARE  PG 34	
FEM FLARE SWL  PG 34	FEM FLARE SWL  PG 34	JIC FLARE SWL  PG 35	BARB X SWT  PG 35	REUSABLE FITTINGS PGS 35		REUSABLE MALE  PG 35	REUSABLE STEMS  PG 36	REUSABLE SWIVELS  PG 36	REUSABLE FERRULES  PG 36
REUSABLE STEMS  PG 36	FUEL HOSE PGS 37		FUEL HOSE  PG 37	BUBBLE BARB  PG 37	INV FLARE CONN  PG 38	90° MALE ELBOW  PG 38	BUBBLE BARB  PG 38	SWL MALE ELBOW  PG 38	OXY ASSBLY  PG 39
ACTL ASSBLY  PG 39	WELD CON-NECTOR  PG 40	WELD HOSE NUT  PG 40	HOSE CON-NECT  PG 40	TUBE BARB PGS 41		UNION SINGLE BARB  PG 41	MALE ADAPTER 1 BARB  PG 41	FEMALE ADAPTER  PG 41	BULKHEAD UNION  PG 41
UNION ELBOW  PG 42	MALE 90° ELBOW  PG 42	FEMALE 90° EL  42	1 BARB TEE  PG 42	MALE BRANCH T  PG 43	FEMALE BRANCH T  PG 43	MALE RUN TEE  PG 43	PLUGS  PG 43	TWO BARB  PG 43	
2 BARB TEE  PG 43	90° ELBOW 2 BARB  PG 43	DB X MIP ELL  PG 44	SS. HOSE BARB PGS 45		SS ADAPTER  PG 45	SS SPLICER  PG 45	SS BARB ELBOW  PG 45	#304 SS HOSE  PG 45	#304 RED NIPPLE  PG 45
#316 SS HOSE NIPPLE  PG 45	BEVERAGE BARB PGS 46		PIPE ADAPTER  PG 46	HOSE SPLICER  PG 46	BRASS SPLIC-ERS  PG 46	FLARE ADAPTER  PG 46	THINWALL SPLICERS  PG 46	TAILPIECE  PG 46	SWIVEL SETS  PG 46

BRASS

PICTORIAL INDEX

<p>PLUG</p>  <p>PG 46</p>	<p>TAILPIECE</p>  <p>PG 46</p>	<p>SWIVEL BARB</p>  <p>PG 46</p>	<p>COMPRESSION</p>  <p>PG 46</p>	<p>90° ELBOW</p>  <p>PG 46</p>	<p>SWIVEL ELBOW</p>  <p>PG 47</p>	<p>U-BEND</p>  <p>PG 47</p>	<p>HOSE TEES</p>  <p>PG 47</p>	<p>SWIVEL ELBOW</p>  <p>PG 47</p>	
<p>U-BEND</p>  <p>PG 47</p>	<p>THINWALL</p>  <p>PG 47</p>	<p>MALE ELBOWS</p>  <p>PG 47</p>	<p>CROSS</p>  <p>PG 47</p>	<p>BARB SPLICER</p>  <p>PG 47</p>	<p>PUSH-ON BARB PGS 48</p>		<p>MALE ADAPTER</p>  <p>PG 49</p>	<p>MALE SWIVEL</p>  <p>PG 50</p>	<p>FEMALE</p>  <p>PG 50</p>
<p>HOSE SPLICER</p>  <p>PG 50</p>	<p>FEMALE ADAPTER</p>  <p>PG 51</p>	<p>MALE ELBOW</p>  <p>PG 49</p>	<p>TUBE ADAPTER</p>  <p>PG 52</p>	<p>SAE FLARE ADPT</p>  <p>PG 51</p>	<p>37° JIC FLARE</p>  <p>PG 52</p>	<p>DUAL SEAL</p>  <p>PG 52</p>	<p>45° SAE FL SWL</p>  <p>PG 53</p>	<p>37° JIC FL SWL</p>  <p>PG 53</p>	
<p>INV FLARE SWL</p>  <p>PG 53</p>	<p>FEMALE ADAPTER</p>  <p>PG 54</p>	<p>BALLSEAT SWIVEL</p>  <p>PG 54</p>	<p>FEMALE SWIVEL</p>  <p>PG 55</p>	<p>45 FE ST SW</p>  <p>PG 55</p>	<p>316 MALE ADPT</p>  <p>PG 56</p>	<p>FEMALE SWIVEL</p>  <p>PG 56</p>	<p>37° JIC FL SWL</p>  <p>PG 56</p>	<p>GARDEN HOSE PGS 57</p>	
<p>SWL MGH X FGH</p>  <p>PG 58</p>	<p>SWL FGH X FGH</p>  <p>PG 58</p>	<p>FGH X FGH</p>  <p>PG 58</p>	<p>SWL FGH X FPIPE</p>  <p>PG 58</p>	<p>COOLER FITTINGS</p>  <p>PG 58</p>	<p>COOLER FITTINGS</p>  <p>PG 58</p>	<p>COOLER FITTINGS</p>  <p>PG 58</p>	<p>RGD FGH X FPIPE</p>  <p>PG 58</p>	<p>RGD FGH X FPIPE</p>  <p>PG 59</p>	
<p>SWL FGH X MPIPE</p>  <p>PG 59</p>	<p>DSHWSHR ELBOW</p>  <p>PG 59</p>	<p>SWL FGH X MPIPE</p>  <p>PG 59</p>	<p>SWL FGH X MPIPE</p>  <p>PG 59</p>	<p>RGD FGH X MPIPE</p>  <p>PG 59</p>	<p>RGD FEMALE PIPE</p>  <p>PG 60</p>	<p>RGD FEMALE PIPE</p>  <p>PG 60</p>	<p>RGD MALE PIPE</p>  <p>PG 60</p>	<p>RGD MGH X MGH</p>  <p>PG 60</p>	
<p>GH NUT</p>  <p>PG 60</p>	<p>GH NUT</p>  <p>PG 60</p>	<p>GH WASHER</p>  <p>PG 61</p>	<p>GH WASHER</p>  <p>PG 61</p>	<p>GH FILTER WSHR</p>  <p>PG 61</p>	<p>GH CAP</p>  <p>PG 61</p>	<p>GH CAP W/ CHAIN</p>  <p>PG 61</p>	<p>GH PLUG</p>  <p>PG 61</p>	<p>MENDER</p>  <p>PG 62</p>	
<p>QCK DISCON GH</p>  <p>PG 62</p>	<p>QCK DISCON GH</p>  <p>PG 62</p>	<p>MALE FL X FGH RGD</p>  <p>PG 62</p>	<p>MALE FL SWIVEL</p>  <p>PG 62</p>	<p>COMP X FGH</p>  <p>PG 62</p>	<p>COMP X MGH</p>  <p>62PG 31</p>	<p>FEMALE SWIVEL</p>  <p>PG 63</p>	<p>SS FEMALE SWL</p>  <p>PG 63</p>	<p>MALE END</p>  <p>PG 63</p>	















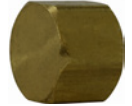





































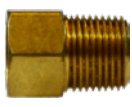











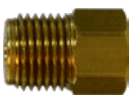

BRASS

PICTORIAL INDEX

SS MALE END  PG 63	GH COUPLING  PG 63	GH COUPLING  PG 63	FEMALE END  PG 64	MALE END  PG 64	GH COUPLING  PG 64	FEMALE SWL 2"  PG 64	MALE END 2"  PG 64	GH COUPLING  PG 64	
FE. SHRT SHNK  PG 65	MALE SHRT  PG 65	SHRT SHNK  PG 65	FE. LONG SHNK  PG 65	M. LONG  PG 65	LONG SHNK  PG 65	BRASS BALL  PG 66	HOSE SHUT-  PG 66	PL. GH VALVE  PG 66	
ZINC Y  PG 67	CAST WYE  PG 67	2-WAY SHUT- OFF  PG 67	"Y" CONNec- TOR  PG 67	SWL HOSE CONN  PG 67	"Y" CONNec- TOR  PG 67	BRASS NOZZLE  PG 68	CROSS PTTN NOZ  PG 68	CROSS PTTN NOZ  PG 68	
SPRAY NOZZLE  PG 68	SPRAY NOZZLE  PG 68	SPRAY NOZZLE  PG 68	PL. SPRAY NOZZ  PG 68	FLARE PGS 69		SHORT ROD NUT  PG 70	RED. SHRT ROD  PG 70	LONG ROD NUT  PG 71	LONG FRG. NUT  PG 71
SHORT FRG. NUT  PG 71	HVY. SHRT NUT  PG 72	FLARED PLUG  PG 72	FLARED CAP  PG 73	FNGR TIGHT. CAP  PG 73	COPPER GASKET  PG 73	COPPER BON- NET  PG 73	M BALL CHK CON  PG 74	UNION  PG 74	
REDUCING UNION  PG 75	UNION TEE  PG 75	REDUCING TEE  PG 76	M. BRANCH TEE  PG 76	FE. ADAPTER  PG 77	MALE ADAPTER  PG 78	MALE ELBOW  PG 80	TAPPED ELL  PG 81	FEMALE ELBOW  PG 81	
MALE RUN TEE  PG 82	FLARE CROSS  PG 82	FE RUN TEE  PG 82	ADAPTER TEE  PG 83	FE BRANCH TEE  PG 83	FLARE ELBOW  PG 83	45° ELBOW  PG 84	UNION  PG 84	FE. FL ADAPTER  PG 85	
FL REDUCER  PG 85	FORGED SWIVEL  PG 86	SWIVEL ELBOW  PG 86	DRUM ADAP  PG 86	FL X SWT  PG 87	FLXSWT 90  PG 87	SPACE HEATER PG 87		SPACE NUT  PG 87	HEATER MALE  PG 88

































BRASS

PICTORIAL INDEX

SPACE FEMALE  PG 87	HEATER UNION  PG 88	GAS RANGE PG 88	GAS MALE  PG 88	RANGE FEMALE  PG 88	RANGE CAP  PG 88	POL PGS 89	POL TEE  PG 89	TAILPIECE  PG 89
TAIL AND NUT  PG 89	POL CAP  PG 89	PLUG AND  PG 90	ADAPTER  PG 90	MALE ADAPTER  PG 90	TAILPIECE  PG 91	POL ADAPTER  PG 91	TAILPIECE  PG 91	POL ADAPTER  PG 91
HEX HEAD  PG 91	POL ADAPTER  PG 91	SOFT NOSE  PG 91	POL ADAPTER  PG 91	PROPANE ADAPTER  PG 92	DUST PLUG  PG 92	POL X MIP  PG 92	APPLIANCE TEE  PG 92	FPT X POL  PG 92
APPLIANCE TEE  PG 92	APPLIANCE TEE  PG 92	O-RING  PG 92	DUAL APPLIANCE  PG 92	37 FLARE PGS 93	JIC UNION  PG 93	JIC FE ADPT  PG 93	MALE ADAPTER  PG 93	JIC SWIVEL  PG 93
90° ELBOW  PG 94	FE ELBOW  PG 94	45° ELBOW  PG 94	INVERTED FLARE PGS 95	CHROMATE NUT  PG 96	LONG STEEL NUT  PG 96	INVERTED FL NUT  PG 96	METRIC TUBE NUT  PG 97	UNION INTERNAL  PG 97
FE. ADAPTER  PG 98	MALE ADAPTER  PG 98	MALE UNION  PG 99	ELBOW  PG 99	45° ELBOW  PG 100	UNION TEE  PG 100	STEEL PLUG  PG 100	BRASS PLUG  PG 100	M. BRANCH TEE  PG 101
FEMALE ELBOW  100	MALE RUN TEE  PG 101	FE. BRANCH TEE  PG 101	TRAIL BRAKE TEE  PG 102	CYLINDER ADAPT  PG 102	CYLINDER ADAPT  PG 103	CARBURETOR  PG 103	RESTRICT. ADAPT  PG 103	SAE FL X INVERT  PG 104
METRIC ADAPTER  PG 104	ADAPT STANDARD  PG 104	METRIC UNION  PG 104	COMPRESSION PG 105	BRASS SLEEVE  PG 106	BRASS NUT  PG 106	UNION  PG 107	REDUCING UNION  PG 107	TEE  PG 108





























































BRASS

PICTORIAL INDEX

REDUCING TEE  PG 108	UNION ELBOW  PG 108	REDUCING  PG 109	FE. ADAPTER  PG 109	MALE ADAPTER  PG 110	MALE ELBOW  PG 111	MALE ELBOW  PG 111	MALE RUN TEE  PG 113	M. BRANCH TEE  PG 114
M. BRANCH TEE  PG 114	FE. ELBOW  112	FORGED TEE  PG 114	ADAPTER TEE  PG 114	FE. BRANCH  PG 115	45° ELBOW  PG 115	CAP  PG 115	COMPRESS  PG 115	BULKHEAD  PG 116
CHECK VALVE  PG 116	TANK ADAPTER  PG 117	DOUBLE COMP PG 118	DOUBLE COM- PRESSION  PG 118	MALE ADAPTER  PG 118	90° ELBOW  PG 118	BREAK-AWAY NUT  PG 118	SPLIT SLEEVE PG 119	SPLIT SLEEVE  PG 119
NUT  PG 119	DBL. END UNION  PG 119	CONNECTOR TRANSMISSION  PG 119	ELBOW  PG 119	COMP ASSEMBLIES PG 120	DELIRIN SLEEVE  PG 120	BRASS INSERT  PG 120	LONG NUT COMP  PG 120	SELF-ALIGN SLEEVE  PG 120
CAPTIVE SLEEVE PG 121	CAP SLEEVE NUT  PG 121	UNION  PG 121	TEE  PG 121	FE ADAP  PG 121	MALE ADAPTER  PG 122	MALE ELBOW  PG 122	M. BRANCH TEE  PG 123	ANG. NEED. VALV  PG 123
SLE. NEED. VALV  PG 123	FLARELESS PGS 124	NUT PLS. SLEEVE  PG 125	BLACK SL NUT  PG 125	UNION  PG 125	BULKHEAD UNION  PG 125	UNION TUBE  PG 125	BULKHEAD UNION  PG 126	UNION TEE  PG 126
FE. CONNec- TOR  PG 126	M. CONNECTOR  PG 127	MALE ELBOW  PG 127	FEMALE ELBOW  PG 127	MALE RUN TEE  PG 128	M. BRANCH TEE  PG 128	FE. BRANCH TEE  PG 128	UNI NUT SLEEVE  PG 128	NUT  PG 128
PLASTIC SLEEVE  PG 129	BLACK SLEEVE  PG 129	BRASS SLEEVE  PG 129	CAP  PG 129	PUSH-IN FITTINGS PGS 130	BRASS PUSH-IN PGS 131	UNION CON- NECT  PG 132	UNION TEE  PG 132	UNION ELBOW  PG 132

BRASS

PICTORIAL INDEX

FE. CONNec-  PG 132	M. CONNECTOR  PG 133	SWVL. M.  PG 133	FIXED M.  PG 134	FE. SWVL  PG 134	FEMALE  PG 134	SWVL M. RUN T  PG 135	FIXED M. RUN T  PG 135	SWVL M.  PG 135
FIX M. BRANCH  PG 135	UNION "Y"  PG 136	BULKHEAD  PG 136	FE. BLKHD  PG 136	CROSS  PG 136	REDUCER  PG 136	PLASTIC PLUG  PG 136	N/P PUSH-IN FITTINGS PGS 137	UNION CON-  PG 138
UNION TEE  PG 138	UNION ELBOW  PG 138	FE. CONNec- TOR  PG 138	FIXED M. ELBOW  PG 139	MALE W/INT HEX  PG 139	M. CONNECTOR  PG 139	SWVL. M. ELBOW  PG 140		FE. SWVL ELBOW  PG 140
REDUCER  PG 141	UNION "Y"  PG 141	SWVL M. BRANCH  PG 141	BULKHEAD UNION  PG 141	N/P VALVES PG 142	PUSH-IN VALVE  PG 142	TUBE X MIP MINI  PG 142	FIP MINI BALL  PG 142	MXF MINI BALL  PG 142
FIP ANGLE BALL  PG 142	3-WAY MINI  PG 142	3 WAY MINI  PG 142	METRIC N/P BRASS PGS 143		BULKHEAD UNION  PG 143	UNION TEE  PG 143	UNION ELBOW  PG 143	UNION "Y"  PG 143
NC ELBOWMET- RIC TUBE M.  PG 144	INTERNAL HEX  PG 144	METRIC TUBE ELB  PG 144		METRIC SWVL TEE  PG 145	METRIC SWVL TEE  PG 145	BULKHEAD  PG 145	N/P WITH NICKEL COLLET PGS 146	NC UNION  PG 146
NC ELBOW  PG 146	NC FE ADAP  PG 146	NC MALE ADAP  PG 147	NC MALE ELL  PG 147	MALE RUN TEE  PG 148	MALE BRANCH T  PG 148	BULKHEAD  PG 148		METRIC N/P PG 148
METRIC TEE  PG 148	METRIC ELL  PG 149	FE ADAP  PG 149	MALE ADAP  PG 149	SW MALE ELL  PG 149	BULKHEAD  PG 149	SS Push-In PG 150	SS UNION  PG 150	

BRASS

PICTORIAL INDEX





























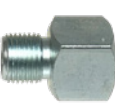





















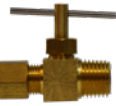







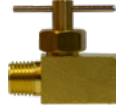





<p>SS ELL</p>  <p>PG 150</p>	<p>FE ADAP</p>  <p>PG 150</p>	<p>MALE ADAP</p>  <p>PG 151</p>	<p>SW MALE ELL</p>  <p>PG 151</p>	<p>MALE RUN TEE</p>  <p>PG 152</p>	<p>MALE BRANCH</p>  <p>PG 152</p>	<p>FE BULKHEAD</p>  <p>PG 153</p>	<p>UNION BULK</p>  <p>PG 136</p>	<p>Y UNION</p>  <p>PG 153</p>
<p>COMPOSITE BODY PUSH-IN PGS 154</p>	<p>UNION</p>  <p>PG 155</p>	<p>UNION TEE</p>  <p>PG 155</p>	<p>FE. CONNEX-</p>  <p>PG 156</p>	<p>90° UNION ELB.</p>  <p>PG 155</p>	<p>UNION "Y"</p>  <p>PG 155</p>	<p>M. CONNECTOR</p>  <p>PG 156</p>	<p>SW MALE</p>  <p>PG 157</p>	<p>LONG PTTN</p>  <p>PG 157</p>
<p>FE. SWVL ELBOW</p>  <p>PG 157</p>	<p>45 SWIVEL ELL</p>  <p>PG 158</p>	<p>SWVL M. RUN T</p>  <p>PG 158</p>	<p>SWVL M. BRANCH</p>  <p>PG 158</p>	<p>BULKHEAD FE.</p>  <p>PG 159</p>	<p>BULKHEAD UNION</p>  <p>PG 158</p>	<p>SWIVEL "Y" CON</p>  <p>PG 159</p>	<p>NEEDLE VALVE</p>  <p>PG 159</p>	<p>FLOW CON-TROL</p>  <p>PG 159</p>
<p>FLOW CON-TROL</p>  <p>PG 159</p>	<p>METRIC COMP PUSH-IN PGS 160</p>	<p>METRIC MALE</p>  <p>PG 161</p>	<p>METRIC ELBOW</p>  <p>PG 160</p>	<p>FEMALE ADAP</p>  <p>PG 160</p>	<p>METRIC TEE</p>  <p>PG 160</p>	<p>METRIC UNION</p>  <p>PG 160</p>	<p>METRIC TEE</p>  <p>PG 162</p>	<p>METRIC TEE</p>  <p>PG 161</p>
<p>METRIC SW ELBOW</p>  <p>PG 161</p>	<p>METRIC WYE</p>  <p>PG 162</p>	<p>METRIC SW WYE</p>  <p>PG 162</p>	<p>CAP</p>  <p>PG 162</p>	<p>DOT PUSH-IN PGS 163</p>	<p>PLUG</p>  <p>PG 164</p>	<p>UNION</p>  <p>PG 164</p>	<p>UNION TEE</p>  <p>PG 164</p>	<p>UNION ELBOW</p>  <p>PG 164</p>
<p>FEMALE CONN</p>  <p>PG 165</p>	<p>MALE CONNEX-TOR</p>  <p>PG 165</p>	<p>MALE ELBOW</p>  <p>PG 166</p>	<p>MALE SWL ELBOW</p>  <p>PG 166</p>	<p>FEMALE ELBOW</p>  <p>PG 167</p>	<p>FEMALE SWL EL</p>  <p>PG 167</p>	<p>MALE RUN TEE</p>  <p>PG 167</p>	<p>MALE SWL RUN T</p>  <p>PG 167</p>	<p>MALE 45° ELBOW</p>  <p>PG 168</p>
<p>45° SWL ELBOW</p>  <p>PG 168</p>	<p>MALE BRANCH T</p>  <p>PG 168</p>	<p>SWL BRANCH TEE</p>  <p>PG 169</p>	<p>FEM BRANCH T</p>  <p>PG 169</p>	<p>BULK CONNECT</p>  <p>PG 169</p>	<p>BULKHEAD UNION</p>  <p>PG 169</p>	<p>FEM BULK UNION</p>  <p>PG 169</p>	<p>COMP D.O.T PUSH-IN PG 170</p>	<p>STRAIGHT UNION</p>  <p>PG 171</p>
<p>UNION TEE</p>  <p>PG 171</p>	<p>UNION 90° EL</p>  <p>PG 171</p>	<p>FEM CONNEX-TOR</p>  <p>PG 171</p>	<p>MALE CONNEX-TOR</p>  <p>PG 172</p>	<p>90° MALE ELBOW</p>  <p>PG 172</p>	<p>90° FEMALE EL</p>  <p>PG 173</p>	<p>MALE RUN TEE</p>  <p>PG 173</p>	<p>MALE BRANCH T</p>  <p>PG 174</p>	<p>FEM BRANCH T</p>  <p>PG 174</p>

BRASS

PICTORIAL INDEX

























































45° MALE  PG 174	UNION "Y"  PG 175	MALE BRANCH  PG 175	BULKHEAD  PG 175	FEM BULK  PG 175	DOT AIR BRAKE NYLON PGS 176	SLEEVE  PG 177	NUT  PG 177	UNION  PG 177
BULKHEAD  PG 177	SS INSERT  PG 177	BRASS INSERT  PG 177	TEE  PG 178	RED BRANCH  PG 178	ELBOW  PG 178	FEMALE  PG 178	MALE ADAPTER  PG 179	SWL MALE  PG 179
MALE ELBOW  PG 179	SWL MALE ELBOW  PG 180	FEMALE ELBOW  PG 180	MALE RUN TEE  PG 180	MALE BRANCH T  PG 180	FEM BRANCH T  PG 181	45° ELBOW  PG 181	SWL 45° ELBOW  PG 181	DOT AIR BRAKE COPPER PGS 182
SLEEVE  PG 182	NUT  PG 182	UNION  PG 182	TEE  PG 182	UNION ELBOW  PG 182	FE ADAP  PG 183	MALE ADAPTER  PG 183	90° MALE ELBOW  PG 183	FE ELBOW  PG 184
MALE RUN TEE  PG 184	MALE BRANCH T  PG 184	45 ELBOW  PG 184	DOT FOR HOSE PGS 185	SLEEVE  PG 185	NUT  PG 185	NUT-USE SPRING  PG 185	SPRING  PG 186	NUT/SPRING  PG 186
UNION  PG 186	CONNECTOR HOSE  PG 186	MALE CONNecTOR  PG 186	ADAPTER FOR SWL  PG 187	MALE ADAPTER  PG 187	ADAPTER BODY  PG 187	MALE ADAPTER  PG 187	AIR BRAKE HOSE  PG 187	GREASE FITTINGS PGS 188
1/8 STR.  PG 188	BALL CHECK 1/8 LONG  PG 188	1/8" 30  PG 188	1/8" 45  PG 188	65° 1/8"  PG 188	90° 1/8"  PG 188	1/4 STR  PG 188	65° BALL CHECK  PG 189	SHORT 1/4-28  PG 189
LONG 1/4-28  PG 189	EXTRA LONG 1/4-28  PG 189	SHORT 45° BC 1/4-28  PG 189	SHORT 45° BC 1/4-28  PG 189	LONG 45° BC 1/4-28  PG 189	90° BALL CHECK 1/4-28  PG 189	DRIVE TYPE  PG 190	DRIVE TYPE  PG 190	6MM  PG 190

LEAD FREE PICTORIAL INDEX

 PG 190	 PG 190	 PG 190	 PG 190	 PG 190	 PG 191	 PG 191	 PG 191	 PG 191		
 PG 191	 PG 191	 PG 191	 PG 192	 PG 192	 PG 192	 PG 192	 PG 192	 PG 192		
 PG 192	DRAIN COCKS PG 194		 PG 194	 PG 194	 PG 194	 PG 194	 PG 194	 PG 194	 PG 195	
 PG 195	 PG 195	 PG 195	 PG 195	 PG 195	 PG 195	SHUT OFF COCKS PGS 196		 PG 196	 PG 196	
 PG 196	 PG 196	 PG 196	 PG 197	 PG 197	 PG 197	NEEDLE VALVES PG 198		 PG 198	 PG 198	
 PG 198	 PG 198	 PG 199	 PG 199	 PG 199	 PG 199	 PG 199	 PG 199	SPECIALTY VALVES PG 200		
 PG 200	 PG 200	 PG 200	 PG 200	 PG 200	 PG 201	 PG 201	 PG 201	 PG 201		
 PG 202	SOLID BOTTOM VALVES PGS 202		 PG 202	 PG 202	 PG 203	 PG 203	 PG 203	 PG 203	SHUT OFF COCK VALVES PG 204	

BRASS/LEAD FREE

PICTORIAL INDEX

3-WAY (SIDE)  PG 204	3-WAY (BOT-)  PG 205	4-WAY  PG 205	MARINE FITTINGS PG 210	ANTI-SIPHON  PG 210	ANTI-SIPHON  PG 210	ALUM ANTI-  PG 210	MXF ANTI-  PG 210	ALUM MXF  PG 210
ALUM BARB  PG 210	FL X MIP  PG 210	6-PORT  PG 210	MINATURE BALL VALVES PG 206	MINI BALL  PG 206	MALE X MALE  PG 206	PIPE X BARB  PG 206	F X F  PG 206	F X F  PG 206
F X F  PG 206	FNPT X FNPT  PG 207	MNPT X FNPT  PG 207	PANEL MOUNT PG 207	PANAL MOUNT  PG 207	F X F  PG 207	F X F  PG 207	4-WAY FIP  PG 207	CHECK VALVES PGS 208
FIFXFIP BUNA-N  PG 208	M X F BUNA-N  PG 208	MNPT X MNPT  PG 209	MNPT X FNPT  PG 209	FNPT X FNPT  PG 209	NPT X NPSM  PG 208	F X F  PG 209	F X M  PG 209	M X F  PG 209
M X M CHECK  PG 209	L/F PIPE PGS 212	FGD ELL  PG 212	FGD TEE  PG 213	BS TEE  PG 213	BS 45  PG 212	BS ELL  PG 212	FACE BUSH  PG 215	SQ. HEAD  PG 214
CAP  PG 214	CROSS  PG 213	COUPLING  PG 213	BUSHING  PG 215	HEX PLUG  PG 215	CS PLUG  PG 214	UNION  PG 214	ST. ELL  PG 217	BS ST ELL  PG 218
FGD ST ELL  PG 218	45 ST ELBOW  PG 218	HEX NIPPLE  PG 216	CL. NIPPLE  PG 216	ADAPTER  PG 217	NIPPLE  PG 216	ALL MALE  PG 219	BS ELL  PG 219	MALE BRANCH  PG 219
MALE RUN  PG 218	L/F PUSH ON PG 219	DUAL SEAT  PG 219	MALE ADAPTER  PG 219	L/F HOSE BARB PG. 220	RIGID MALE ADAPTER  PG 220	FORGED HOSE BARB  PG 222	MENDER/SPLICER  PG 222	RIGID FEMALE  PG 221















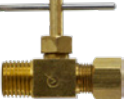







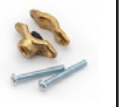















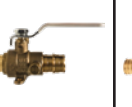

























VALVES

PICTORIAL INDEX

<p>BARB TEE</p>  <p>PG 222</p>	<p>FEMALE</p>  <p>PG 222</p>	<p>LF MINI BALL</p>  <p>PG 223</p>	<p>L/F GARDEN HOSE PGS 225</p>	<p>MGH X MALE</p>  <p>PG 225</p>	<p>GARDEN HOSE</p>  <p>PG 223</p>	<p>FGH X MALE</p>  <p>PG 224</p>	<p>MGH X MGH</p>  <p>PG 224</p>	<p>BRASS CON-</p>  <p>PG 225</p>
<p>SWIVEL</p>  <p>PG 224</p>	<p>MALE END</p>  <p>PG 223</p>	<p>FEMALE</p>  <p>PG 223</p>	<p>CAP</p>  <p>PG 225</p>	<p>GARDEN HOSE</p>  <p>PG 225</p>	<p>RIGID</p>  <p>PG 224</p>	<p>SWIVEL</p>  <p>PG 223</p>	<p>FGH X MALE</p>  <p>PG 224</p>	<p>MGH X FEMALE</p>  <p>PG 224</p>
<p>EVAP CLR FTGS</p>  <p>PG 225</p>	<p>L/F FLARE PGS 226</p>	<p>SHORT ROD NUT</p>  <p>PG 226</p>	<p>SHORT FORGE NUT</p>  <p>PG 226</p>	<p>UNION</p>  <p>PG 227</p>	<p>FLARED CAP</p>  <p>PG 227</p>	<p>TEE</p>  <p>PG 227</p>	<p>PLUG</p>  <p>PG 228</p>	<p>FEMALE ADAPTER</p>  <p>PG 228</p>
<p>MALE BRANCH TEE</p>  <p>PG 228</p>	<p>FORGED SWIVEL</p>  <p>PG 229</p>	<p>MALE ADAPTER</p>  <p>PG 229</p>	<p>UNION ELBOW</p>  <p>PG 230</p>	<p>FIP BRANCH TEE</p>  <p>PG 230</p>	<p>90° MALE ELBOW</p>  <p>PG 230</p>	<p>FEMALE ELBOW</p>  <p>PG 231</p>	<p>MALE RUN TEE</p>  <p>PG 231</p>	<p>L/F COMPRESSION PGS 232</p>
<p>BRASS SLEEVE</p>  <p>PG 232</p>	<p>NUT</p>  <p>PG 233</p>	<p>BRASS INSERT</p>  <p>PG 233</p>	<p>CAPTIVE SLEEVE NUT</p>  <p>PG 233</p>	<p>CAP</p>  <p>PG 233</p>	<p>UNION</p>  <p>PG 234</p>	<p>TANK UNION</p>  <p>PG 234</p>	<p>TEE</p>  <p>PG 234</p>	<p>UNION ELBOW</p>  <p>PG 235</p>
<p>FEMALE ADAPTER</p>  <p>PG 236</p>	<p>COMP X SWEAT</p>  <p>PG 236</p>	<p>MALE ADAPTER</p>  <p>PG 237</p>	<p>MALE ELBOW</p>  <p>PG 238</p>	<p>TANK CONNECTOR</p>  <p>PG 238</p>	<p>FEMALE ELBOW</p>  <p>PG 239</p>	<p>45 ELBOW</p>  <p>PG 239</p>	<p>MALE RUN TEE</p>  <p>PG 239</p>	<p>MALE BRANCH TEE</p>  <p>PG 240</p>
<p>COMPX FIP X MIP</p>  <p>PG 240</p>	<p>FIPXMIPXCOMP</p>  <p>PG 240</p>	<p>COMPX FIP TEE</p>  <p>PG 240</p>	<p>COMP X FE FL</p>  <p>PG 240</p>	<p>COMP X MALE FLARE</p>  <p>PG 240</p>	<p>COMP X FE COMP</p>  <p>PG 241</p>	<p>COMP X FE FLARE</p>  <p>PG 241</p>	<p>COMP X FE GDN HOSE</p>  <p>PG 241</p>	<p>COMP X FE 90</p>  <p>PG 241</p>
<p>ADD-A-TEE</p>  <p>PG 241</p>	<p>N/P COMPRESSION PGS 242</p>	<p>NUT</p>  <p>PG 242</p>	<p>UNION</p>  <p>PG 242</p>	<p>RED UNION</p>  <p>PG 242</p>	<p>TEE</p>  <p>PG 242</p>	<p>UNION ELBOW</p>  <p>PG 242</p>	<p>FEMALE COUPLING</p>  <p>PG 242</p>	<p>COMP X SWT</p>  <p>PG 243</p>

VALVES

PICTORIAL INDEX

 MALE ADAPTER PG 243	 MALE ELBOW PG 243	 FEMALE PG 243	 ICE MAKER KIT PG 243	L/F NEEDLE VALVES PG 244-245	 COMP NEEDLE PG 244	 COMP X MIP PG 244	 COMP X M PG 244	 FL X FL NEEDLE 244
 FL X MIP PG 244	 FIP X FIP PG 244	 M X F PIPE PG 244	 MIP X MIP PG 245	 VALVE WITH PG 245	 VALVE W/ PG 245	 SADDLE ONLY PG 245	 SADDLE VALVE PG 245	L/F & PLBG PG 246
L/F BRASS BALL VALVES PG 247	 LF BALL VALVE PG 247	 SWT X SWT PG 247	 FIP X FIP LF PG 248	 SWT X SWT LF PG 248	 LF ITALIAN PG 249	 SWT X SWT LF PG 249	L/F GATE & CHECK VALVES PG 253	 LF GATE VALVE PG 253
 GATE VALVE CXC PG 253	 LF BRASS CHECK PG 253	 SWING CHECK PG 253	 CXC SWING CHK PG 253	 Y-STRAINER PG 253	 LF COPPER PRESS VALVE PG 250	 C/E PEX UNION BALL PG 251	 C/E PEX W/ DRAIN & DROP PG 251	 PEX BALL VALVE PG 251
 MIP X PROPEX PG 251	 PEX DRAIN VALVE PG 251	 PUSH FIT VALVE PG 252	 FROST FREE PG 254	 MALE HOSE BIBB PG 255	 FIP HOSE BIBB PG 255	 SWT HOSE BIBB PG 255	 FIP BOILER DRN PG 256	 MIP BOILER PG 256
 ANGLE MALE PG 256	 ANGLE FIP PG 256	 PEX SILLCOCK PG 257	 CE PEX SILLCOCK PG 257	 VACUUM BREAK PG 257	SUPPLY STOPS & CONNECTORS PG 258	 ANGLE STOPS PG 258	 CONTRACTOR PG 258	 COMP X FIP PG 258
 COMP X SWT PG 258	 X C/E PEX PG 258	 X PEX PG 258	 1/4 COMP PG 206	 PRESS FIT PG 258	 3-WAY SUPPLY STOPS PG 258	 STRAIGHT STOPS PG 259	 X FIP PG 259	 X SWT PG 259
 X C/E PEX PG 259	 X PEX PG 259	 1/4 COMP PG 259	 XCPVC PG 259	 PRESS FIT PG 259	 3/8 X FIP LAV CONNECTOR PG 260	 3/8 X 3/8 LAV CNCTR PG 260	 PVC BALLCOCK CNCTR PG 260	 PVC LAV CON-NECTOR PG 260

NIPPLES AND FITTINGS

PICTORIAL INDEX

 PG 260	 PG 260	 PG 261	 PG 261	 PG 261	 PG 261	 PG 261	TRANSITION FITTINGS PG. 262	 PG 262
 PG 262	 PG 262	 PG 262	 PG 262	 PG 262	 PG 263	 PG 263	 PG 263	 PG 264
 PG 264	 PG 264	 PG 264	VALVES PG. 265	 PG 266	 PG 267	 PG 267	 PG 268	 PG 269
 PG 270	 PG 271	 PG 272	 PG 273	 PG 274	 PG 275	 PG 275	 PG 276	 PG 276
GAS VALVES PG. 277	 PG 277	 PG 277	 PG 277	 PG 277	 PG 277	MINI BALL VALVES PG. 278	 PG 278	 PG 278
 PG 278	 PG 279	 PG 279	 PG 279	 PG 280	 PG 280	 PG 280	 PG 281	 PG 281
 PG 281	 PG 281	 PG 281	 PG 281	3 WAY BALL VALVE PG. 282	 PG 282	 PG 282	 PG 283	 PG 283
 PG 283	 PG 283	 PG 283	 PG 283	 PG 284	 PG 285	 PG 286	 PG 287	BRASS SWING CHECK PG. 288

NIPPLES AND FITTINGS

PICTORIAL INDEX

SWING CHECK  PG 288	Y-SWING  PG 288	CHECK VALVE  PG 289	IN LINE CHECK  PG 289	IN LINE CHECK  PG 290	SS FULL PORT VALVES PG. 291			2000#  PG 291	316 SS 1-PC  PG 292	316 SS 2-PC  PG 293		
SS MINI  PG 294	SS M X F  PG 294	FXF BUTTER-  PG 295	MXF BUT-  PG 295	MXM BUT-  PG 295	SS CHECK VALVES PG. 296			304 CHECK  PG 296	SS IN LINE  PG 297	FXF SPRING  PG 298		
MXF SPRING CHK  PG 298	Y-SPRING CHECK  PG 299	2PC BARREL  PG 299	Y STRAINER  PG 300	SS SWING CHK  PG 300	SS GLOBE VALVE  PG 300	SS GATE VALVE  PG 300	CARBON STEEL BALL VALVES PG. 301		STANDARD PORT  PG 301			
2PC FULL PORT  PG 302	2 WAY  PG 303	3 WAY  PG 303	CHECK VALVES  PG 304	PVC VALVES PG. 305		PVC THREAD  PG 305	SLIP X SLIP  PG 305	FIP X FIP  PG 305	SLIP X SLIP  PG 305			
IN-LINE CHECK  PG 306	FIP PVC CHECK  PG 306	DRUM FAUCET  PG 306	DRUM & BAR- REL  PG 306	DUCTILE IRON VALVES PG. 308		BUTTERFLY VALVE LEVER  PG 308	BUTTERFLY VALVE GEAR  PG 308	GEAR RE- PLACEMENT  PG 310	WHEEL  PG 310			
EXTENSIONS  PG 310	ROLL PIN  PG 310	WAFER CHECK  PG 311	CHECK VALVE UL  PG 312	CHECK  PG 312	CHECK  PG 313	GATE VALVE NO TAP  PG 314	GATE VALVE NRS RES.  PG 314	GATE VALVE DI  PG 314				
GATE VALVE FL X MJ  PG 314	NIPPLES & FITTINGS PG. 318		BRASS NIPPLES PG. 319		SEAMLESS SCH 40  PG 320	CHROME PLATED  PG 326	BRONZE FITTINGS PG. 329		L/F BRONZE FITTINGS PG. 329		90° ELBOW  PG 329	90° REDUCE ELB  PG 329
90° STREET ELLS  PG 330	45° ELBOW  PG 330	45 ST ELBOW  PG 331	CROSS  PG 331	TEE  PG 332	REDUCING TEE  PG 333	COUPLING  PG 334	REDUCE COUP  PG 335	CAP  PG 336				

NIPPLES AND FITTINGS

PICTORIAL INDEX

UNION  PG 336	HEX LOCKNUT  PG 338	HEX BUSHING  PG 337	HEX BUSHING  PG 337	CNTRSUNK  PG 338	CORED PLUG  PG 338	SOLID PLUG  PG 339	HEX NIPPLE  PG 339	REDUCE HEX  PG 339
LF COMPANION  PG 340	LF SWT COMP  PG 340	LF FLOOR  PG 340	C/P BRONZE FITTINGS PG. 341	C/P TEE  PG 341	C/P CROSS  PG 341	C/P ST ELL  PG 341	C/P 45 ST ELL  PG 341	C/P COUPLING  PG 341
C/P ELL  PG 341	C/P 45 ELL  PG 342	C/P UNION  PG 342	C/P CAP  PG 342	C/P BUSHING  PG 342	C/P PLUG  PG 342	CLEAN OUT PLUGS PG. 343	CLEANOUT PLUG  PG 343	CS C/O PLUG  PG 343
C/O PLUG W/ TAP  PG 343	DROP EAR ELBOWS PG. 343	BRONZE D/E  PG 343	SWT X SWT  PG 343	PEX X FIP  PG 343	BRONZE INSERT FITTINGS PG. 344	BARB FOR PL PIPE  PG 344	BRONZE TEE BARB  PG 344	90 BRONZE BARB  PG 344
UNION 90  PG 344	STEEL INSERT FITTINGS PG. 344	STEEL INSERT  PG 344	REDUCER  PG 344	UNION  PG 344	SS INSERT FITTINGS PG. 345	SS MALE ADAPTER  PG 345	SS 90 ELBOW  PG 345	L/F INSERT FITTINGS PG. 345
LF UNION  PG 345	LF MALE BRANCH  PG 345	LF UNION ELBOW  PG 345	SS COUPLINGS PG. 345	SS DROP WELL  PG 345	SS HEAVY CPLG  PG 345	SS MERCHANT  PG 345	SS NIPPLES PG. 347	304 SCH 40 WELDED  PG 347
316 SCH 40 WELDED  PG 347	SS FITTINGS PG. 353	90° ELBOW  PG 353	90° STREET ELB.  PG 353	45° ELBOW  PG 353	TEE  PG 354	CROSS  PG 354	HEX NIPPLE  PG 354	REDUCE HEX NIP  PG 354
COUPLING  PG 355	REDUCE COUP  PG 355	MACHINED COUP  PG 355	HALF COUPLING  PG 356	UNION  PG 356	CAP-CAST  PG 356	HEX CAP-BRSTCK  PG 356	HEX BUSHING  PG 357	HEX LOCKNUT  PG 358

NIPPLES AND FITTINGS

PICTORIAL INDEX

































 HEX SOCKET PG 359	 CORED PLUG PG 358	 SOLID PLUG PG 359	 SOLID HEX PG 359	 CORED HEX PG 358	 HOSE NIPPLE PG 358	 REDUCING PG 359	STEEL NIPPLES PG. 361	 SCH 40 GALVA- PG 361361
 SCH 40 BLACK PG 361	 SINGLE NIP PG 368	 ASSORTMENTS PG 369	 TOTE TRAYS PG 369	 SCH 80 SEAM- PG 370	 XXS SEAMLESS PG 376	GROOVE NIPPLES PG. 377	 THREAD X PG 377	 GROOVE X PG 378
HAMMER UNIONS PG 379	 FIG 100 PG 379	 FIG 200/ 206 PG 379	 CRIMPLOK HAMMER UNIONS PG 379	MERCHANT COUPLINGS PG. 380	 MERCHANT COUP PG 380	 MERCHANT COUP PG 380	 HALF MERCHANT C PG 380	 API LINE COUP PG 381
MALLEABLE FITTINGS PG. 383	 90° ELBOW GALV PG 383	 90° ELB. BLACK PG 383	 REDUCE ELBOW PG 383	 REDUCE ELBOW PG 383	 GALV ST. ELBOW PG 383	 BLK. ST. ELBOW PG 383	 45° GALV ELBOW PG 384	 45° BLK. ELBOW PG 384
 45° GALV ST. ELB PG 384	 45° BLK. ST. ELB PG 384	 GALV CROSS PG 384	 BLACK CROSS PG 384	 GALV TEE PG 385	 BLACK TEE PG 385	 GALV REDUCE T PG 385	 BLK. REDUCE T PG 385	 BULLHEAD TEE PG 385
 BLK. BLKHD TEE PG 385	 REDUCING TEE PG 386	 MALL SERVICE T PG 386	 MALL SERVICE T PG 386	 GALV OUT TEE PG 386	 BLK. OUT TEE PG 386	 GALV COU- PLING PG 387	 BLK. COUPLING PG 387	 GALV RED COUP PG 387
 BLK. RED COUP PG 387	 INSIDE HEX PG 388	 BLK. HEX BUSH PG 388	 GALV HEX BUSH PG 388	 GALV UNION PG 389	 BLACK UNION PG 389	 GALV SQR PLUG PG 389	 BLK SQR PLUG PG 389	 GALV CAP PG 389
 BLACK CAP PG 389	 LATERAL Y PG 390	 LOCKNUTS PG 390	 COUPLING PG 390	 OUTLET ELBOW PG 390	 GALV FLR FLANGE PG 391	 BLK FLR FLANGE PG 391	 EXTENSION PG 391	 SHROOM CAP PG 391

PLASTIC
PICTORIAL INDEX

STEEL FITTINGS PG. 392	GALV HEX  PG 392	BLK HEX BUSH  PG 392	GALV CAP  PG 392	BLK CAP  PG 392	GALV FACE  PG 392	BLK FACE  PG 392	GALV SQR  PG 393	BLK SQR PLUG  PG 393
	GALV HEX  PG 393	BLK HEX PLUG  PG 393	GALV CS PLUG  PG 393	BLK CS PLUG  PG 393	CS HEX  PG 393	BLK CS PLUG  PG 393	300# MALLEABLE PG. 394	90° ELBOW  PG 394
90° ST ELBOW  PG 394	TEE  PG 394	COUPLING  PG 394	REDUCE COUP  PG 395	CAP  PG 395	UNION  PG 395	MAG DRAIN PLUG  PG 395		SWAGES BULLPLUGS PG. 396
XH BULL PLUG  PG 396	SCH 40 SWAGE  PG 396	HEX SWAGE  PG 397	SCH 80 SWAGE  PG 397	XXH SWAGE  PG 397	CARBON STEEL FLANGES PG. 398	SLIP-ON  PG 398	THREADED  PG 398	
BLIND FLNG  PG 399	DUCTILE IRON FLANGES PG. 400	COMP FLANGE THREAD  PG 400	COMPANION FLANGE  PG 400	BLIND FLANGE  PG 401		COPPER FITTINGS PG. 403	90° EL CXC  PG 403	90° ST EL FTG X C  PG 403
90° LONG TURN ST  PG 403		45° EL CXC  PG 403	45° ST FTG X C  PG 404	COUPLING  PG 404	COUPLING  PG 404		COUPLING  PG 404	REDUCER W/ STOP  PG 405
FTGXM ADAPTER  PG 406	FEMALE ADAPTER  PG 406	FTG X F ADAPTER  PG 406	CAP  PG 406	UNION C X C  PG 407	U-TYPE STRAP  PG 407	TEE  PG 407	PLASTIC FITTINGS PG. 408	PLASTIC NIPPLES PG. 409
PIPE NYLON POLY PG. 411	ELBOW  PG 411	TEE  PG 411	STREET ELBOW  PG 411	STREET ELBOW  PG 411	HEX HEAD PLUG  PG 411	HEX HEAD PLUG  PG 411		

HOSE ACCESSORIES

PICTORIAL INDEX

<p>HEX NIPPLE</p>  <p>PG 412</p>	<p>HEX NIPPLE</p>  <p>PG 412</p>	<p>RED NIPPLE</p>  <p>PG 412</p>	<p>RED NIPPLE</p>  <p>PG 412</p>	<p>COUPLING</p>  <p>PG 413</p>	<p>COUPLING</p>  <p>PG 413</p>	<p>PIPE CAP</p>  <p>PG 413</p>	<p>PLASTIC BULK-</p>  <p>PG 413</p>	<p>PIPE/HOSE BARB PG. 413</p>
<p>MALE ADAPTER</p>  <p>PG 413</p>	<p>MALE ADAPTER</p>  <p>PG 414</p>	<p>HOSE X MALE</p>  <p>PG 414</p>	<p>HOSE X MALE</p>  <p>PG 414</p>	<p>UNION ELBOW</p>  <p>PG 415</p>	<p>SPLICER</p>  <p>PG 415</p>	<p>SPLICER</p>  <p>PG 415</p>	<p>RED SPLICER</p>  <p>PG 415</p>	<p>RED SPLICER</p>  <p>PG 415</p>
<p>BARBED TEE</p>  <p>PG 416</p>	<p>BARBED TEE</p>  <p>PG 416</p>	<p>BARBED Y</p>  <p>PG 416</p>	<p>BARBED Y</p>  <p>PG 416</p>	<p>REDUCING TEE</p>  <p>PG 416</p>	<p>REDUCING TEE</p>  <p>PG 416</p>	<p>M BRANCH TEE</p>  <p>PG 416</p>	<p>PLASTIC GARDEN HOSE PG. 417</p>	<p>GH CAP</p>  <p>PG 417</p>
<p>GH NUT</p>  <p>PG 417</p>	<p>GH ADPT INSERT</p>  <p>PG 417</p>	<p>GH THREAD ADPT</p>  <p>PG 417</p>	<p>MGH X F</p>  <p>PG 417</p>	<p>FGH X M</p>  <p>PG 417</p>	<p>FGH X F</p>  <p>PG 417</p>	<p>MGH X M</p>  <p>PG 417</p>	<p>PLASTIC COMPRESSION PG. 418</p>	<p>UNION CON- NECTOR</p>  <p>PG 418</p>
<p>PLASTIC CONNECTORS PG. 418</p>	<p>UNION TEE</p>  <p>PG 418</p>	<p>UNION ELBOW</p>  <p>PG 418</p>	<p>FEMALE CON- NECT</p>  <p>PG 418</p>	<p>MALE CONNEC- TOR</p>  <p>418</p>	<p>MALE ELBOW</p>  <p>PG 418</p>	<p>NSF PUSH-IN PG. 419</p>	<p>UNION CON- NECT</p>  <p>PG 419</p>	<p>BULKHEAD UNION</p>  <p>PG 419</p>
<p>UNION TEE</p>  <p>PG 419</p>	<p>UNION ELBOW</p>  <p>PG 419</p>	<p>REDUCING ELBOW</p>  <p>PG 419</p>	<p>FEMALE CON- NECT</p>  <p>PG 420</p>	<p>MALE CONNEC- TOR</p>  <p>PG 420</p>	<p>STEM ADAPTER</p>  <p>PG 420</p>	<p>REDUCER</p>  <p>PG 420</p>	<p>FIXED ELBOW</p>  <p>PG 421</p>	<p>PLUG-IN ELBOW</p>  <p>PG 421</p>
<p>2-WAY DIVIDER</p>  <p>PG 421</p>	<p>PLUG</p>  <p>PG 421</p>	<p>BSP ADAPTER</p>  <p>PG 421</p>	<p>PLXPL</p>  <p>PG 421</p>	<p>PL X MIP VALVE</p>  <p>PG 421</p>	<p>CHECK VALVE</p>  <p>PG 422</p>	<p>STOP VALVE</p>  <p>PG 422</p>	<p>LOCKING CLIP</p>  <p>PG 422</p>	<p>FLOW BEND CLIP</p>  <p>PG 422</p>
<p>SPANNER</p>  <p>PG 422</p>	<p>STOP VALVE ADAPTER</p>  <p>PG 422</p>	<p>SLIP TEE VALVE</p>  <p>PG 422</p>	<p>HOSE ACCESSORIES PG. 423</p>	<p>CAM AND GROOVE PG. 424</p>	<p>ALUMINUM SPOOL & PART A PG. 426</p>	<p>M ADPT X F NPT A</p>  <p>PG 424</p>	<p>FEMALE COU- PLER B</p>  <p>PG 424</p>	<p>HOSE SHANK C</p>  <p>PG 424</p>





































































HOSE ACCESSORIES

PICTORIAL INDEX

FEMALE COU-  PG 424	HOSE SHANK E  PG 425	MALE ADAPER  PG 425	DUST CAP DC  PG 425	DUST CAP DP  PG 425	SPOOL  PG 426	MALE ADAPTER  PG 426	SWIVEL A  PG 426	FEMALE COU-  PG 426
ELBOW C  PG 426	REDUCER C  PG 426	REDUCER D  PG 427	FEMALE COU-  PG 427	FEMALE COU-  PG 427	SWIVEL D  PG 427	MALE ADAPTER  PG 427	POLY CAM & GROOVE PG. 428	MALE ADAPTER  PG 428
FEMALE COU- PLER B  PG 428	HOSE SHANK C  PG 428	FEMALE COU- PLER D  PG 428	M X HOSE SHANK E  PG 429	MALE ADAPTER F  PG 429	DUST CAP DC  PG 429	DUST PLUG DP  PG 429		SS CAM & GROOVE PG. 430
FEMALE COU- PLER B  PG 430	HOSE SHANK C  PG 430	FEMALE COU- PLER D  PG 430	HOSE SHANK E  PG 431	MALE ADAPTER F  PG 431	DUST CAP DC  PG 431	DUST PLUG DP  PG 431	SS ADAPTER  PG 432	
SS DA  PG 432	ELBOW D SS  PG 432	BRASS CAM & GROOVE PG. 433	MALE ADAPTER A  PG 433	FEMALE COU- PLER B  PG 433	HOSE SHANK C  PG 433	FEMALE COU- PLER D  PG 433	HOSE SHANK E  PG 434	MALE ADAPTER F  PG 434
DUST CAP DC  PG 434	DUST CAP DP  PG 434		CRIMPLOK PG. 436	ALUM DC  PG 436	ALUM B  PG 436	ALUM D  PG 436	ALUM C  PG 436	SS B  PG 437
SS DC  PG 437	SS C  PG 437	ALUM C  PG 438		ALUM C AND E  PG 438	SS CRIMPLOK  PG 438	CRIMP CAMS  PG 438	SS HANDLE  PG 439	BRASS HANDLE  PG 439
SAFETY CLIP  PG 439	SILICONE GASKET  PG 440	VITON GASKET  PG 440	KING NIPPLES PG. 441	HOSE NIPPLE STEEL  PG 441	ZINC PLATED  PG 441	REDUCER/EX- PANDER  PG 441	316 SS  PG 441	BRASS  PG 442













































HOSE CLAMPS

PICTORIAL INDEX

ALUMINUM  PG 442	STEEL VIC-  PG 442	PLATED  PG 442	CRIMP KING  PG 444	CRIMP KING  PG 444	CRIMP COMBO  PG 444	CRIMP KING  PG 444	SQUARE CUT  PG 445	SS FLANGE  PG 445
VICTAULIC  PG 445	HOSE MENDER  PG 446	PLATED STEEL  PG 446	316 HOSE  PG 446	BRASS  PG 446	UNIVERSAL COUPLINGS PG. 447	UNIVERSAL  PG 447	WASHER  PG 447	FEMALE NPT  PG 447
HOSE END  PG 447	TRIPLE CON- NECT  PG 447	GROUND JOINT  PG 448	HOSE STEM ONLY  PG 448	WING NUT ONLY  PG448	F SPUT ONLY  PG 449	M NPT STEM  PG 449	BOLT CLAMP  PG 449	STEEL HOSE BARB  PG 449
ALUMINUM BARBS  PG 449	STRAINERS & NOZZLES PG. 450	SAFETY CHECK  PG 450	FOOT VALVE  PG 450	ROUND STRAINER  PG 450	LONG STRAINER  PG 450	BOTTOM STRAINER  PG 450	BOTTOM HOLE  PG 450	FOG NOZZLE  PG 450
FIRE HOSE FITTINGS PG. 451	FIRE HOSE  PG 451	FXM HEX ADPT  PG 451	DBL M HEX NIP  PG 451	M SWL ADAPTER  PG 451	BRASS CAP  PG 451	NOZZLE  PG 451	BUCHANAN HOSE PG. 459	CLEAR BRAID  PG 459
JACK HAMMER  PG 460	JACK HAMMER  PG 460	HOT AIR BLOWER  PG 460	JACK HAMMER  PG 460	GENERAL PURPOSE  PG 461	GENERAL PURPOSE  PG 461	MARINE EX- HAUST  PG 462	PUSH-ON  PG 462	FUEL LINE  PG 463
ARI SUCTION  PG 463	IND VACUUM  PG 464	BULKMASTER SOFTWALL  PG 464	EPDM SUCTION  PG 465	SANDBLAST  PG 465	FLEXLITE  PG 466	FLEXCHEM  PG 466	TANK TRUCK  PG 467	FLEXLITE  PG 467
TANK TRUCK  PG 468	OIL VACUUM  PG 468	TANK TRUCK 300  PG 469	OIL VACUUM  PG 469	FRACLINE 400  PG 470	PETRO DIS- CHARGE  PG 470	HOT TAR  PG 471	PETRO DIS- CHARGE  PG 471	PETRO DIS- CHARGE  PG 472

PRESSURE WASHER/ PNEUMATICS

PICTORIAL INDEX

STEAM 250 BLACK  PG 472	STEAM 250  PG 473	BLUE LAYFLAT  PG 474	BLUE ASSEMBLY  PG 474	BROWN LAYFLAT  PG 475	DURAFLEX  PG 476	DURAFLEX  PG 476	HIGH PRESSURE  PG 477	HIGH PRESSURE  PG 477
SATURN OLIVE  PG 478	SATURN GREEN  PG 478	SATW  PG 479	SAT  PG 479	WATER SUCTION  PG 480	SUPERFLEX  PG 480	CRIMPLOK FERRULES  PG 482	CRIMPLOK SLEEVES  PG 488	HOSE CLAMPS PG. 495
WORM GEAR PG. 496	MINI WORM GEAR  PG 496	WORM GEAR CLAMP  PG 496	QUICK RELEASE  PG 500	T-BOLT CLAMPS  PG 501	M6 MAXI  PG 502	MKL MEGAK-LAMP  PG 502	M8 MAXI  PG 503	M10 MAXI HEAVY  PG 503
M8S STD MAXI  PG 503	T-BOLT SPRING LDD  PG 504	V-BAND  PG 505	CONSTANT TORQUE  PG 505	HEAVY DUTY  PG 506	DOUBLE BOLT  PG 506	SC SPIRAL  PG 507	M10DC MAXI  PG 507	GUILLOTINE  PG 508
SADDLE  PG 508	FLAT  PG 508	LAP  PG 509	BUTT  PG 509	EXHAUST  PG 509	EASY FORM  PG 509	1-EAR  PG 510	HAMMERLOCK  PG 511	2-EAR  PG 511
GAPLESS  PG 511	SIDE JAW  PG 512	PINCERS  PG 512	CRIMPER  PG 512	LOKING TOOL  PG 512	LOKING TOOL  PG 512	MARINE EMBOSSED  PG 513	MINI CLAMPS SS  PG 513	MINI ALUZINC  PG 513
LINED CLAMPS  PG 513	VINYL COATED  PG 514	RUBBER LINED  PG 514	HOSE FERRULE-SS  PG 515	TUBING PG. 516	POLYURETHANE  PG 517	BLACK  PG 517	BLUE  PG 517	RED  PG 517
POLYETHYLENE  PG 518	BLACK POLY  PG 519	GREEN POLY  PG 519	BLUE POLY  PG 519	RED POLY  PG 519	NYLON 12  PG 520	PVC  PG 521	MINITUBING CUT  PG 521	TUBING CUTTER  PG 521

PNEUMATICS

PICTORIAL INDEX

 PLASTIC TUBE PG 521	 MOUNTING PG 521	 ALUMINUM PG522	 COPPER TUBE PG 522	 SOFT COPPER PG 522	PRESSURE SPRAYERS PG. 524	 QD NOZZLE PG 524	 MEG NOZZLE PG 524	 RUBBER TIP PG 525		
 SS LIVE SWIVEL PG 525	 THERMAL PG 525	 BOOM SWIVEL PG 526	 WAND PG 526	 SPRAY GUN PG 526	 GUN W/EXT PG 526	 MALE STEEL PG 527	 FE. STEEL PG 527	 MOLDED GRIP PG 528		
 MOLDED GRIP FE PG 528	PNUMATICS PG. 529		INDUSTRIAL QUICK DISCONNECTS PG. 530		 INDUSTRIAL INTERCHANGE PG 530	 BRASS M. COUPL PG 530	 STEEL FE. COUPL PG 530	 STEEL M. COUPL PG 530	 BR. HOSE COUPL PG 530	 STL. HOSE COUPL PG 530
 BR. PUSH-ON PG 531	 STL PUSH-ON PG 531	 STEEL M. PLUG PG 531	 STEEL FE. PLUG PG 531	 BRASS M. PLUG PG 531	 STL HOSE PLUG PG 531	 PUSH-ON PLUG PG 531	 STL SWL M. PLUG PG 531	UNIVERSAL PG. 532		
 UNIVERSAL SERIES PG 532	 BRASS FE. COUPL PG 532	 BR. HOSE COUPL PG 532	 SS M. COUPLER PG 532	 SS FE. COUPLER PG 532	 SS MALE PLUG PG 532	 SS FE. PLUG PG 532	ARO 210 INTERCHANGE PG. 533		 ARO 210 PG 533	
 FEMALE COUPLER PG 533	 HOSE ID COUPL PG 533	 MALE PLUG PG 533	 FEMALE PLUG PG 533	 HOSE ID PLUG PG 533	AUTO INTERCHANGE PG. 534		 AUTO INTERCHANGE PG 534	 BR. FE. COUPLER PG 534	 STL. M. COUPLER PG 534	
 STL. FE. COUPLER PG 534	 BR. MALE PLUG PG 534	 BR. FE. PLUG PG 534	 STEEL MALE PLUG PG 534	 STEEL FE. PLUG PG 535	 HOSE ID COUPL PG 535	 PUSH-ON COUPL PG 535	 HOSE ID PLUG PG 535	 PUSH-ON PLUG PG 535		
LINCOLN INTERCHANGE PG. 535		 LINCOLN PG 535	 FEMALE COUPLER PG 535	 STEEL MALE PLUG PG 535	 STEEL FE. PLUG PG 535	MISC COUPLERS PG. 536		 HIGH FLOW PG 536	 FEMALE COUPLER PG 536	 MALE PLUG PG 536
 FEMALE PLUG PG 536	 MOLD COOLANT PG 536	 FEMALE PLUG PG 536	 MINI QD PG 535536	 FE PLUG PG 535536	MUFFLERS VENTS PG. 537		 HIGH FLOW BR. MUFFLER PG 537	 STAINLESS MUFFLER PG 537	 BR. BREATH VENT PG 537	

HYDRAULICS

PICTORIAL INDEX

<p>STLS BREATH VEN</p>  <p>PG 537</p>	<p>PSI SNUBBER</p>  <p>PG 537</p>	<p>SPEED VALVE</p>  <p>PG 538</p>	<p>SPEED VALVE</p>  <p>PG 538</p>	<p>MUFF W/ FLOW</p>  <p>PG 538</p>	<p>HI FLOW MUFF</p>  <p>PG 538</p>	<p>HI FLOW MUFF</p>  <p>PG 538</p>	<p>HI FLOW MUFF</p>  <p>PG 538</p>	<p>HI FLOW MUFF</p>  <p>PG 538</p>		
<p>NIP INLINE FILTER</p>  <p>PG 538</p>	<p>RPR AIR/OIL FILTER</p>  <p>PG 538</p>	<p>AIR REGULATOR</p>  <p>PG 539</p>	<p>MANIFOLD</p>  <p>PG 539</p>	<p>AIR MANIFOLD</p>  <p>PG 539</p>	<p>SAFETY VALVES PG. 540</p>		<p>SAFETY VALVES</p>  <p>PG 540</p>	<p>SAFETY VALVES</p>  <p>PG 540</p>	<p>CHECK VALVE</p>  <p>PG 540</p>	
<p>CHECK VALVE</p>  <p>PG 540</p>	<p>TANK VALVES PG. 541</p>		<p>BIKE PUMP FITT</p>  <p>PG 541</p>	<p>INFLATOR</p>  <p>PG 541</p>	<p>SLIDE VALVE</p>  <p>PG 541</p>	<p>SPRING CORE</p>  <p>PG 541</p>	<p>SPRING CORE</p>  <p>PG 541</p>	<p>SPRING CORE</p>  <p>PG 541</p>	<p>BLK PLASTIC CAP</p>  <p>PG 541</p>	
<p>DOME CAP</p>  <p>PG 541</p>	<p>BLOW GUNS PG. 542</p>		<p>CPCT BLOW GUN</p>  <p>PG 542</p>	<p>SAFE BLOW GUN</p>  <p>PG 542</p>	<p>SAFE BLOW GUN</p>  <p>PG 542</p>	<p>CPCT BLOW GUN</p>  <p>PG 542</p>	<p>PISTOL BLOW GUN</p>  <p>PG 542</p>	<p>PISTOL BLOW GUN</p>  <p>PG 542</p>	<p>MISC GAUGES PG. 542</p>	
<p>RUB TIP NOZZLE</p>  <p>PG 542</p>	<p>HI FLOW NOZZLE</p>  <p>PG 543</p>	<p>M-TIRE GAUGE</p>  <p>PG 543</p>	<p>STANDARD NOZZ</p>  <p>PG 543</p>	<p>VOL REGULATOR</p>  <p>PG 543</p>	<p>EXTENSION</p>  <p>PG 543</p>	<p>GUN ADAPTER</p>  <p>PG 543</p>	<p>COIL AIR HOSE</p>  <p>PG 543</p>	<p>COIL AIR HOSE</p>  <p>PG 544</p>		
<p>HEX BALL CHUCK</p>  <p>PG 544</p>	<p>M. BALL CHUCK</p>  <p>PG 544</p>	<p>BALL CHCK BARB</p>  <p>PG 544</p>	<p>DUAL AIR CHUCK</p>  <p>PG 544</p>	<p>DUAL STRT AIR</p>  <p>PG 544</p>	<p>INFLATOR/ GAUGE</p>  <p>PG 544</p>	<p>INFLATOR/ GAUGE</p>  <p>PG 544</p>	<p>GAUGES PG. 548</p>		<p>DRY GAUGE</p>  <p>PG 548</p>	
<p>CENTER BACK MOUNT</p>  <p>PG 548</p>	<p>LIQUID FILLED</p>  <p>PG 549</p>	<p>WATER TEST</p>  <p>PG 550</p>	<p>GAS TEST</p>  <p>PG 550</p>	<p>TAPES & SEALANT PG. 551</p>		<p>THREAD SEAL</p>  <p>PG 551</p>	<p>BLUE SEAL TAPE</p>  <p>PG 551</p>	<p>YEL GAS TAPE</p>  <p>PG 551</p>	<p>GRE OXY TAPE</p>  <p>PG 551</p>	
<p>GREY SS TAPE</p>  <p>PG 551</p>	<p>TRUCK & TRAILER PG. 552</p>		<p>AIR COIL</p>  <p>PG 552</p>	<p>SLIDER COIL</p>  <p>PG 552</p>	<p>AIRLINE CABLE</p>  <p>PG 553</p>	<p>AIRBRAKE REPAIR</p>  <p>PG 553</p>	<p>POGO STICK</p>  <p>PG 553</p>	<p>HOSE HOLDER</p>  <p>PG 553</p>	<p>HOSE HOLDER</p>  <p>PG 553</p>	

HYDRAULICS

PICTORIAL INDEX

 HOSE SEPARA- PG 553	 CLIP CARA- PG 554	 HANGER PG 554	 YOKE PG 554	 FRAME CLIP PG 554	 AIRHOSE CLIP PG 554	 TENDER KIT PG 555	 SPRING PG 555	 SLIDER BAR PG 555	
 GLADHANDS PG 556	 BRACKET PG 556	 KNOB STYLE PG 557	 LEVER STYLE PG 557	 GLADHAND PG 558	 AL GLADHAND PG 558	 GLADHAND PG 558	 GLADHAND PG 558	 GH COUPLING PG 558	
 NYLON GH HOLDER PG 558	 GH HOLDER KIT PG 559	 GLADHAND LOCK PG 559	 KING PIN LOCK PG 560	 AIR CYLINDER PG 560	 HIGH LIFT CYLINDER PG 561	 TAILGATE CYLINDER PG 561	 TAILGATE AIR CYLINDER PG 561	 FIFTH WHEEL CYLINDER PG 562	
 AIR TANK CHECK PG 562	 D2 AIR GOVERNOR PG 562	 QCK RELEASE VALVE PG 562	 R12 RELAY VALVE PG 563	 R14 RELAY VALVE PG 563	 3 WAY SOLENOID PG 563	 UNI SOLENOID PG 563	 AIR SOLENOID PG 563	 7 WAY CABLE PG 564	
 6 WAY ELEC CABLE PG 565	 4 WAY ELEC CABLE PG 565	 DUEL POLE PG 565	 SINGLE POLE PG 565	 PLUG PG 566	 PLUG PG 566	 SOCKET PG 566	 7W DBLE GRIP PG 566	 ADAPTER PG 566	
 RV 7WAY PLUG PG 566	 RV 7WAY SOCK PG 567	 4WAY PLUG PG 567	 GROUND KIT PG 567	 PROTECTOR BOOT PG 567	 CIRCUIT BREAKER PG 568	 NOSE BOX-DEEP PG 569	 BATT GRND STRAP PG 569	 SS BATTERY NUT PG 569	
 DEER WHISTLE PG 570	 CONSP TAPE PG 571	 TARP STRAP PG 571	 DOT TUBING PG 572	 FUEL LINE PG 573	 AIR BRAKE HOSE PG 573	HYDRAULICS PG. 574		STEEL PIPE SWIVEL PG. 583	
 FE. SWL ADAPTER PG 583	 M. ELB ADAPTER PG 583	 FE. UNION ELB. PG 583	 M. 45° ELBOW PG 584	 FE. 45° UNION PG 584	 M. SWL TEE PG 584	 FE. SWL TEE PG 584	 FE. SWL TEE PG 584	JIC FLARE PG. 585	

HYDRAULICS

PICTORIAL INDEX

LONG JIC NUT  PG 585	JIC CAP  PG 585	JIC TUBE NUT  PG 585	JIC TUBE SLEEVE  PG 585	JIC TUBE UNION  PG 585	JIC M. CONN  PG 586	JIC FE. CONN  PG 586	JIC RED/EXP  PG 587	PLUG  PG 587
JIC UNION ELB.  PG 587	JIC M. ELBOW  PG 588	JIC M. ELBOW  PG 588	MALE 45° ELBOW  PG 588	M. BRANCH TEE  PG 589	JIC FE. TEE  PG 589	JIC UNION TEE  PG 589	LOCKNUT  589	JIC BULK UNION  PG 589
BULK UNION ELB  PG 590	45° UNION ELB  PG 590	BULK BRANCH T  PG 590	BULK RUN TEE  PG 590	JIC TO FEMALE  PG 590	JIC TO MALE  PG 590	STEEL PIPE FITTINGS PG. 591	PIPE COUPLING  PG 591	HEX PIPE NIPPLE  PG 591
EXP/ PIPE ADAP  PG 591	HEX RED/ BUSH  PG 592	HEX HEAD PLUG  PG 592	HOLLOW HEX PLG  PG 592	FLUSH HLW PLUG  PG 592	SQR HEAD PLUG  PG 592	PIPE CAP  PG 593	MALE ELBOW  PG 593	45° M. ELBOW  PG 594
90° ST ELBOW  PG 594	45° ST ELBOW  PG 594	FE. ELBOW  PG 594	45° FE. ELBOW  PG 594	MALE PIPE TEE  PG 595	FE. PIPE TEE  PG 595	ST PIPE TEE  PG 595	FE. RUN PIPE T  PG 595	MALE PIPE TEE  PG 595
FE. PIPE TEE  PG 595	STEEL O-RING ADAPTERS PG. 596	JIC TO O-RING  PG 596	O-RING TO PIPE  PG 596	O-RING TO 37°  PG 596	O-RING UNION  PG 596	FE. O-RING  PG 597	O-RING TO FE.  PG 597	O-RING PLUG  PG 597
O-RING HLW PLG  PG 597	O-RING PORT  PG 598	JIC SWIVEL PG. 598	JIC SWL ELBOW  PG 598	JIC SW X MIP  PG 598	JIC SWL 45°  PG 598	JIC SWL TO F 90°  PG 598	JIC SWL CONN  PG 599	JIC SWL TO M  PG 599
JIC SWL TOF ADP  PG 599	JIC SWL BRANCH T  PG 599	JIC SWL RUN T  PG 599	JIC O-RING PG. 599	JIC RUN TEE  PG 599	JIC TO ORING 90°  PG 600	JIC TO ORING 45°  PG 600	JIC BRANCH TEE  PG 600	ORING TO F 90°  PG 600

STAINLESS STEEL

PICTORIAL INDEX

 PG 601	 PG 601	 PG 601	 PG 601	 PG 602	 PG 602	 PG 602	 PG 602	 PG 602
 PG 603	 PG 603	 PG 603	 PG 603	 PG 603	 PG 603	 PG 604	 PG 604	 PG 604
 PG 604	 PG 604	 PG 605	 PG 604	 PG 605	 PG 605	 PG 605	 PG 605	 PG 606
STEEL BSPT ADAPTERS PG. 606	 PG 606	 PG 606	 PG 606	 PG 606	 PG 606	 PG 607	 PG 607	 PG 607
 PG 607	 PG 607	 PG 607	 PG 608	 PG 608	 PG 608	 PG 608	METRIC PG. 608	 PG 608
 PG 609	 PG 609	 PG 609	 PG 609	 PG 609	ISO A & B INTERCHANGE PG. 610	 PG 610	 PG 610	 PG 610
 PG 610	 PG 610	 PG 610	 PG 611	 PG 611	 PG 611	 PG 611	 PG 612	 PG 612
FLOW CONTROL PG. 613	 PG 613	 PG 613	 PG 614	 PG 616	 PG 616	 PG 616	 PG 617	 PG 617

STAINLESS STEEL

PICTORIAL INDEX

 SPLIT FLANGE PG 617	 FLANGE PLUG PG 617	 FLANGE HALF PG 618	 FLANGE PAD PG 618	 FLANGE HALF PG 618	STAINLESS STEEL ADAPTERS PG. 622	 PIPE SWIVEL PG 622	 PIPE SWIVEL PG 622	 TUBE SLEEVE PG 623
 TUBE NUT PG 623	 CAP PG 623	 MALE ADAPTER PG 624	 UNION PG 624	 FEMALE PG 625	 PLUG PG 625	 MJIC X FJIC PG 625	 BULKHEAD NUT PG 626	 FEMALE BULK- PG 626
 BULKHEAD MALE PG 626	 BULKHEAD COUPLING PG 626	 PIPE NIPPLE PG 627	 HEX PIPE NIPPLE PG 627	 COUPLING PG 627	 ADAPTER PG 628	 PLUG PG 628	 BUSHING PG 628	 CAP PG 629
 STREET ELBOW PG 629	 MALE ELBOW PG 629	 ALL MALE TEE PG 630	 ELBOW PG 630	 TEE PG 630	 MORB X FIP PG 631	 BOSS X JIC SW PG 631	 MJIC X MORB PG 631	 PLUG PG 632
 PLUG PG 632	 FIP X FJIC SWIVEL PG 633	 MIP X FJIC SWIVEL PG 633	 MALE API PG 634	 JIC 90 SWIVEL PG 634	 MALE CRIMP PG 634	 FEMALE CRIMP PG 634	PG	PG
PG	PG	PG	PG	PG	PG	PG	PG	PG
PG	PG	PG	PG	PG	PG	PG	PG	PG
PG	PG	PG	PG	PG	PG	PG	PG	PG



MIDLAND INDUSTRIES

A NEW FAMILY OF COMPANIES WORKING TOGETHER

The new Midland Industries is a family of brands recognizable industry wide. With our history of outstanding customer service and innovation, Midland Industries is the perfect fit of customer driven solutions, smart technology and deep product selection - built on strong family values and traditions.

WE OFFER ALL THE RESOURCES



BRASS FITTINGS



VALVES



NIPPLES & FITTINGS



PLASTIC FITTINGS



CLAMPS



TUBING



PNEUMATICS



ACCESSORIES



HYDRAULICS



STAINLESS STEEL
HYDRAULIC ADAPTERS



HIGH PRESSURE
SPRAYER



HOSE

SCHEDULE A SALES MEETING WITH MIDLAND INDUSTRIES!

SHOP OUR AMAZING BRANDS



For More Info Or To Schedule A Sales Meeting Visit Us At MidlandIndustries.com

PIPE FITTINGS



Pipe Size	1/16	1/8	1/4	3/8	1/2	3/4	1
Thread Size	1/16-27	1/8-27	1/4-18	3/8-18	1/2-14	3/4-14	1-11 ¹ / ₂
Working Pressure	1200	1200	1200	1200	1200	1000	1000
Thread OD	1/4	3/8	1/2	5/8	3/4	1	1-1/4

Typical Application: Grease, Fuels, LP and Natural Gas (available on special order), Refrigeration, Instrumentation and Hydraulic Systems.

Pressure: Operating pressure up to 1200 PSI.

Vibration: Fair resistance.

Temperature Range:

-65°F to +250°F (-53°C to +121°C).

Used With: Brass, Bronze, Copper, Steel, Aluminum And Iron Pipe.

Tolerance : +/- .02 on all dimensions. Dimension Data can change without notice. Please call us when dimensions are critical.

Conformance: Meets specifications and standards of ASA, ASME and SAE

• Not lead free

• **Assembly Instructions**

1 - Tighten approximately 2 turns past hand tight.

2 - Fittings with thread sealant tighten two turns past hand tight. Brittle materials require special cautions.

MIDLAND	MIDLAND INDUSTRIES PRODUCT NUMBER
AMC	ANDERSON METALS CORPORATION CROSSOVER NUMBERS
CHAMPION	CHAMPION CROSSOVER NUMBERS
MAF	MID-AMERICA FITTINGS PART NUMBERS

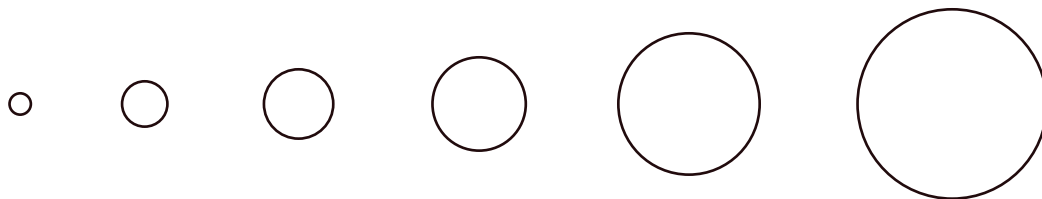

Actual outside diameters of pipe threads



Actual Male Thread Profiles

PIPE**BRASS FITTINGS****90° FEMALE ELBOW**

SAE# 130238

06100
100

MIDLAND	AMC	CHAMPION	LIST	THREAD SIZE NPTF	MAF #	MAF PRICE
				1/16"	23500X1	...
28001	06100-02	100A-A	----	1/8"	23500X2	...
28002	06100-04	100A-B	----	1/4"	23500X4	...
28003	06100-06	100A-C	----	3/8"	23500X6	...
28004	06100-08	100A-D	----	1/2"	23500X8	...
28005	06100-12	100A-E	----	3/4"	23500X12	...
				1/8 x 1/16	23502X1	...
				1/4 x 1/8	23504X2	...
				3/8 x 1/8	23506X2	...
28015B			----	3/8" x 1/4"	23506X4	...
28053B			----	1/2" x 1/4"	23508X4	...
28016B			----	1/2" x 3/8"	23508X6	...
				3/4 x 1/4	23512X4	...
				3/4" x 3/8"	23512X6	...
				3/4 x 1/2	23512X8	...

100 2200P 3500 302 200

90° FORGED FEMALE ELBOW06200
100F

MIDLAND	AMC	CHAMPION	LIST	THREAD SIZE NPTF	MAF #	MAF PRICE
28009	06200-02	100AF-A	----	1/8"	100F-2	...
28010	06200-04	100AF-B	----	1/4"	100F-4	...
28011	06200-06	100AF-C	----	3/8"	100F-6	...
28012	06200-08	100AF-D	----	1/2"	100F-8	...
28013	06200-12	100AF-E	----	3/4"	100F-12	...
28014	06205-0402	100AF-BA	----	1/4" x 1/8"	100FR-42	...
28015	06205-0604	100AF-CB	----	3/8" x 1/4"	100FR-64	...
28016	06205-0806	100A-DC	----	1/2" x 3/8"	100FR-86	...
28017			----	1"		

1200P E7 100AF 100B

45° FEMALE ELBOW06107
10045

MIDLAND	AMC	CHAMPION	LIST	THREAD SIZE NPTF	MAF #	MAF PRICE
28018	06107-02	100-45A-A	----	1/8"	10045-2	...
28019	06107-04	100-45A-B	----	1/4"	10045-4	...
28020			----	3/8"	10045-6	...
28021B		100X-45-D	----	1/2"	10045-8	...

129 2201P 205 23355 45EZ 105 100-45A

DIMENSION DATA CAN CHANGE WITHOUT NOTICE. PLEASE CALL WHEN DIMENSIONS ARE CRITICAL.

PIPE
BRASS FITTINGS

UNION TEE

SAE# 130438



06101
101

MIDLAND	AMC	CHAMPION	LIST	THREAD SIZE NPTF	MAF #	MAF PRICE
28022			----	1/16"	23700X1	...
28024	06101-02	101A-A	----	1/8"	23700X2	...
28025	06101-04	101A-B	----	1/4"	23700X4	...
28026	06101-06	101A-C	----	3/8"	23700X6	...
28027	06101-08	101A-D	----	1/2"	23700X8	...
28028	06101-12	101A-E	----	3/4"	23700X12	...
				1/8 x 1/16	23700X2X1	...
				1/4 x 1/8	23700X4X2	...
				3/8 x 1/4	23700X6X4	...
				1/2 x 3/8	23700X8X6	...
				3/4 x 1/2	23700X12X8	...

311 101A 322 2203P 3700 203

UNION FORGED TEE



06201
101F

MIDLAND	AMC	CHAMPION	LIST	THREAD SIZE NPTF	MAF #	MAF PRICE
28032	06201-02	101AF-A	----	1/8"	101F-2	...
28033	06201-04	101AF-B	----	1/4"	101F-4	...
28034	06201-06	101AF-C	----	3/8"	101F-6	...
28035	06201-08	101AF-D	----	1/2"	101F-8	...
28036	06201-12	101AF-E	----	3/4"	101F-12	...
28023		101AF-F	----	1"		

1203P LT7 101AF 101B

REDUCING FORGED TEES



06206
101FR

MI	AMC	LIST	1 NPT	2 NPT	3 NPT	BODY WIDTH	MAF #	MAF PRICE
28029	06206-020204	----	1/8"	1/8"	1/4"	0.69	101FR-224	...
28030	06206-040402	----	1/4"	1/4"	1/8"	0.69	101FR-442	...
28031		----	1/4"	1/4"	3/8"	0.81	101FR-446	...
28038		----	3/8"	1/4"	3/8"	0.81	101FR-646	...
28039	06206-060604	----	3/8"	3/8"	1/4"	0.81	101FR-664	...
28046	06206-080806	----	1/2"	1/2"	3/8"	1.00	101FR-886	...
28047		----	3/4"	1/2"	3/4"	1.25	101FR-12812	...
28048	06206-121208	----	3/4"	3/4"	1/2"	1.25	101FR-12128	...

CROSS



06102
102

MIDLAND	AMC	CHAMPION	LIST	THREAD SIZE NPTF	MAF #	MAF PRICE
				1/16"	23950X1	22.94
28041	06102-02	102A-A	----	1/8"	23950X2	...
28042	06102-04	102A-B	----	1/4"	23950X4	...
28043	06102-06	102A-C	----	3/8"	23950X6	...
28044	06102-08	102A-D	----	1/2"	23950X8	...
28045	06102-12	102A-E	----	3/4"	23950X12	...

2205P 3950 228 102A 102BE

WARNING: This product can expose you to chemicals, including lead, which are known to the State of California to cause cancer and birth defects or other reproductive harm. For more information, visit www.P65Warnings.ca.gov

PIPE**BRASS FITTINGS****FORGED CROSS**06202
102F

MIDLAND	AMC	CHAMPION	LIST	THREAD SIZE NPTF	MAF #	MAF PRICE
28049	06202-02	102AF-A	----	1/8"	102F-2	...
28050	06202-04	102AF-B	----	1/4"	102F-4	...
28051	06202-06	102AF-C	----	3/8"	102F-6	...
28052	06202-08	102AF-D	----	1/2"	102F-8	...

C7 105 102AF 102

COUPLING

SAE# 130138



23300 = SAE Pattern

06103
103

MIDLAND	AMC	CHAMPION	LIST	THREAD SIZE NPTF	MAF #	MAF PRICE
28057			----	1/16"	23300X1	...
28058L	06103-02	103A-A	----	1/8"	103-2	...
28058	06303-02	103AH-A	----	1/8"	23300X2	...
28059L	06103-04	103A-B	----	1/4"	103-4	...
28059	06303-04	103AH-B	----	1/4"	23300X4	...
28060L	06103-06	103A-C	----	3/8"	103-6	...
28060	06303-06	103AH-C	----	3/8"	23300X6	...
28061L	06103-08	103A-D	----	1/2"	103-8	...
28061	06303-08	103AH-D	----	1/2"	23300X8	...
28062L	06103-12	103A-E	----	3/4"	103-12	...
28062	06303-12	103AH-E	----	3/4"	23300X12	...
				1"	103-16	...
28063		103AH-F	----	1"	23300X16	...
				2"	23300X32	...

207P 371 3300 103AH 103

WARNING: This product can expose you to chemicals, including lead, which are known to the State of California to cause cancer and birth defects or other reproductive harm. For more information, visit www.P65Warnings.ca.gov



PIPE

BRASS FITTINGS

REDUCING COUPLING

SAE# 130138



06119
119

MIDLAND	AMC	CHAMPION	LIST	THREAD SIZE NPTF	MAF #	MAF PRICE
				1/8" x 1/16"	23302X1	...
28181L	06119-0402	119A-BA	----	1/4" x 1/8"	119-42	...
28181		119AH-BA	----	1/4" x 1/8"	23304X2	...
				3/8" x 1/8"	119-62	...
28182	06119-0602		----	3/8" x 1/8"	23306X2	...
28183L	06119-0604	119A-CB	----	3/8" x 1/4"	119-64	...
28183		119AH-CB	----	3/8" x 1/4"	23306X4	...
28180	06119-0802	119A-DA	----	1/2" x 1/8"	119-82	...
28184L	06119-0804	119A-DB	----	1/2" x 1/4"	119-84	...
28184		119AH-DB	----	1/2" x 1/4"	23308X4	...
28185L	06119-0806	119A-DC	----	1/2" x 3/8"	119-86	...
28185		119AH-DC	----	1/2" x 3/8"	23308X6	...
28187	06119-1204		----	3/4" x 1/4"	119-124	...
				3/4" x 1/4"	23312X4	...
28188*	706119-1206	119A-EC	----	3/4" x 3/8"	119-126	...
				3/4" x 3/8"	23312X6	...
28189*	706119-1208	119A-ED	----	3/4" x 1/2"	119-128	...
				3/4" x 1/2"	23312X8	...
				1 x 1/4"	119-164	...
				1 x 3/8"	119-166	...
28178	06119-1608		----	1" x 1/2"	119-168	...
28179	06119-1612		----	1" x 3/4"	119-1612	...
				2 x 1"	23332X16	...

10 377 3300 208P 108 119B 119AH

UNION



06104
104

MIDLAND	AMC	CHAMPION	LIST	THREAD SIZE NPTF	MAF #	MAF PRICE
28067	06104-02	104A-A	----	1/8"	104-2	...
28068	06104-04	104A-B	----	1/4"	104-4	...
28069	06104-06	104A-C	----	3/8"	104-6	...
28070	06104-08	104A-D	----	1/2"	104-8	...
28071	06104-12		----	3/4"	104-12	...

3250 212P 104A 104B

PIPE**BRASS FITTINGS****CAP**

06108
108

MIDLAND	AMC	CHAMPION	LIST	THREAD SIZE NPTF	MAF #	MAF PRICE
28075	06108-02	108A-A	----	1/8"	108-2	...
28076	06108-04	108A-B	----	1/4"	108-4	...
28077	06108-06	108A-C	----	3/8"	108-6	...
28078	06108-08	108A-D	----	1/2"	108-8	...
28079	06108-12	108A-E	----	3/4"	108-12	...
28080	06108-16	108A-F	----	1"	108-16	...
				1-1/4"	108-20	...
				1-1/2"	108-24	...
				2"	108-32	...

3129 213P 23129 108A 108B

90° STREET ELBOW

SAE# 130239

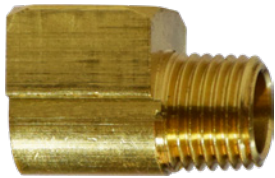

SHORT 06116
116
LONG 06118

MIDLAND	AMC	CHAMPION	LIST	THREAD SIZE NPTF	MAF #	MAF PRICE
28161			----	1/16"	23400X1	...
28156	06118-02	116A-A	----	1/8"	23400X2	...
28156S	06116-02		----	1/8" short	23401X2	...
28157	06118-04	116A-B	----	1/4"	23400X4	...
28157S	06116-04	116A-AMB	----	1/4" short	23401X4	...
28158	06118-06	116AH-C	----	3/8"	23400X6	...
		116A-C		3/8" short	23401X6	...
28159	06116-08	116AH-D	----	1/2"	23400X8	...
28160	06116-12	116A-E	----	3/4"	23400X12	...
				1/8 x 1/16"	23402X1	...
				1/8 x 1/4"	23402X4	...
				1/4 x 1/8"	23404X2	...
				3/8 x 1/8"	23406X2	...
				3/8 x 1/4"	23406X4	...
				1/2 x 1/4"	23408X4	...
				1/2 x 3/8"	23408X6	...
				1/2 x 3/4"	23400X8X12	...

2202P 304 115 202 3400 116A

FORGED 90° STREET ELBOW

116F

MIDLAND	AMC	CHAMPION	LIST	THREAD SIZE NPTF	MAF #	MAF PRICE
28165	06216-02	116AF-A	----	1/8"	116F-2	...
28166	06216-04	116AF-B	----	1/4"	116F-4	...
28167	06216-06	116AF-C	----	3/8"	116F-6	...
28168	06216-08	116AF-D	----	1/2"	116F-8	...
28169	06216-12	116AF-E	----	3/4"	116F-12	...

5E8 1202P 116AF 116B

WARNING: This product can expose you to chemicals, including lead, which are known to the State of California to cause cancer and birth defects or other reproductive harm. For more information, visit www.P65Warnings.ca.gov

PIPE

BRASS FITTINGS

REDUCING 90° STREET ELBOW

Barstock & Forged



128

*Barstock (B)

MIDLAND	AMC	CHAMPION	LIST	THREAD SIZE NPTF FXM	MAF #	MAF PRICE
28259*			----	1/8" x 1/16"	23402X1*	...
28260	06228-0204		----	1/8" x 1/4"	23402X4*	...
28261B	06228-0402	128A-BA	----	1/4" x 1/8"	23404X2*	...
28261			----	1/4" x 1/8"	128F-42	...
				1/4 x 3/8"	23404X6*	...
28262	06228-0406		----	1/4" x 3/8"	128F-46	...
				3/8" x 1/4"	23406X4*	...
28263	06228-0604	128A-CB	----	3/8" x 1/4"	128F-64	...
				3/8" x 1/2"	23406X8*	...
28264	06228-0608		----	3/8" x 1/2"	128F-68	...
28265	06228-0806		----	1/2" x 3/8"	128F-86	...
				1/2" X 1/4"	23408X4*	...
28265B*			----	1/2" x 3/8"	23408X6*	...

FACE BUSHING



06140
110F

MIDLAND	AMC	CHAMPION	LIST	THREAD SIZE NPTF MXF	MAF #	MAF PRICE
28121	06140-0402		----	1/4" x 1/8"	110F-42	...
28122	06140-0602		----	3/8" x 1/8"	110F-62	...
28116	06140-0604	110FB-CB	----	3/8" x 1/4"	110F-64	...
28090			----	1/2" x 1/8"	110F-82	...
28128			----	1/2" x 1/4"	110F-84	...
28117	06140-0806	110FB-DC	----	1/2" x 3/8"	110F-86	...
28129			----	3/4" x 1/4"	110F-124	...
28130			----	3/4" x 3/8"	110F-126	...
28118	06140-1208	110FB-ED	----	3/4" x 1/2"	110F-128	...
28120	06140-1608		----	1" x 1/2"	110F-168	...
28119	06140-1612		----	1" x 3/4"	110F-1612	...

120AH-BW HEAVY ADAPTER BREAKAWAY



116F

MIDLAND	AMC	CHAMPION	LIST	THREAD SIZE NPTF	MAF #	MAF PRICE
		120AH-BB-BW		1/4"		
		120AH-CC-BW		3/8"		

SE8 1202P 116AF 116B

WARNING: This product can expose you to chemicals, including lead, which are known to the State of California to cause cancer and birth defects or other reproductive harm. For more information, visit www.P65Warnings.ca.gov

BRASS

PIPE**BRASS FITTINGS****HEX BUSHING**

SAE# 130140



232 = SAE Pattern

06110
110

MIDLAND	AMC	CHAMPION	LIST	THREAD SIZE NPTF MXF	MAF #	MAF PRICE
28101	06110-0201		----	1/8" x 1/16"	110-21	...
28102L	06110-0402	110A-BA	----	1/4" x 1/8"	110-42	...
28102		110AH-BA	----	1/4" x 1/8"	23224X2	...
				3/8 x 1/8	110-62	...
28103	06110-0602	110A-CA	----	3/8" x 1/8"	23226X2	...
28104L	06110-0604	110A-CB	----	3/8" x 1/4"	110-64	...
28104		110AH-CB	----	3/8" x 1/4"	23226X4	...
28105L	06110-0802	110A-DA	----	1/2" x 1/8"	110-82	...
28105		110AH-DA	----	1/2" x 1/8"	23228X2	...
28106L	06110-0804	110A-DB	----	1/2" x 1/4"	110-84	...
28106		110AH-DB	----	1/2" x 1/4"	23228X4	...
28107L	06110-0806	110A-DC	----	1/2" x 3/8"	110-86	...
28107		110AH-DC	----	1/2" x 3/8"	23228X6	...
				3/4 x 1/8	110-122	...
28108	06110-1202	110A-EA	----	3/4" x 1/8"	23232X2	...
28109L	06110-1204	110A-EB	----	3/4" x 1/4"	110-124	...
				3/4 x 1/4	23232X4	...
28110L	06110-1206	110A-EC	----	3/4" x 3/8"	110-126	...
				3/4 x 3/8	23232X6	...
28111L	06110-1208	110A-ED	----	3/4" x 1/2"	110-128	...
28111		110AH-ED	----	3/4" x 1/2"	23232X8	...
28091	06110-1602		----	1" x 1/8"	110-162	...
28112	06110-1604	110A-FB	----	1" x 1/4"	110-164	...
28113	06110-1606	110A-FC	----	1" x 3/8"	110-166	...
				1 x 1/2	110-168	...
28114	06110-1608	110A-FD	----	1" x 1/2"	23236X8	...
				1 x 3/4	110-1612	...
28115	06110-1612	110A-FE	----	1" x 3/4"	23236X12	...
				2 x 1/2	110-328	...
				2 x 3/4	110-3212	...
				2 x 1	110-3216	...
				2 X 1-1/4	110-3220	...
				2 x 1-1/2	110-3224	...

PRB 373 3220 209P 110A 110B

WARNING: This product can expose you to chemicals, including lead, which are known to the State of California to cause cancer and birth defects or other reproductive harm. For more information, visit www.P65Warnings.ca.gov



PIPE

BRASS FITTINGS

SQUARE HEAD CORED PLUG



06109
109

MIDLAND	AMC	CHAMPION	LIST	THREAD SIZE NPTF	MAF #	MAF PRICE
				1/8"	109-2	...
				1/4"	109-4	...
				3/8"	109-6	...
		109A-D		1/2"	109-8	...
28088	06109-12	109A-E	----	3/4"	109-12	...
28089	06109-16	109A-F	----	1"	109-16	...

3151 211P 109A 109B

SQUARE HEAD SOLID PLUG



06114

MIDLAND	AMC	CHAMPION	LIST	THREAD SIZE NPTF	MAF #	MAF PRICE
28084	06114-02	109A-A	----	1/8"	109SD-2	...
28085	06114-04	109A-B	----	1/4"	109SD-4	...
28086	06114-06	109A-C	----	3/8"	109SD-6	...
28087	06114-08	109AS-D	----	1/2"	109SD-8	...
		109AS-E		3/4"	109SD-12	...
				1"	109SD-16	...

COUNTERSUNK HEX PLUG

3/4" taper thread



06115
109AL

MIDLAND	AMC	CHAMPION	LIST	THREAD SIZE NPTF	MAF #	MAF PRICE
28092			----	1/16"	109AL-1	...
28093	06115-02	109CS-A	----	1/8"	109AL-2	...
28094	06115-04	109CS-B	----	1/4"	109AL-4	...
28095	06115-06	109CS-C	----	3/8"	109AL-6	...
28096	06115-08	109CS-D	----	1/2"	109AL-8	...
28097			----	3/4"	109AL-12	...
				1"	109AL-16	...

3153 219P 109CS 118

SLOTTED-HEAD PLUG



06117
117

MIDLAND	AMC	CHAMPION	LIST	THREAD SIZE NPTF	MAF #	MAF PRICE
28174	06117-02	117A-A	----	1/8"	117-2	...
28175	06117-04	117A-B	----	1/4"	117-4	...
28176	06117-06	117A-C	----	3/8"	117-6	...
				1/2"	117-8	...

220P 3150 117A 117B

WARNING: This product can expose you to chemicals, including lead, which are known to the State of California to cause cancer and birth defects or other reproductive harm. For more information, visit www.P65Warnings.ca.gov

BRASS

PIPE**BRASS FITTINGS****CORED HEX PLUGS**

23152 = SAE Pattern

06121
121

MIDLAND	AMC	CHAMPION	LIST	THREAD SIZE NPTF	MAF #	MAF PRICE
28200			----	1/16"	121-1	...
28201	06121-02	121A-A	----	1/8"	121-2	...
				1/8"	23152X2	...
28202	06121-04	121A-B	----	1/4"	121-4	...
				1/4"	23152X4	...
28203	06121-06	121A-C	----	3/8"	121-6	...
				3/8"	23152X6	...
28204	06121-08	121A-D	----	1/2"	121-8	...
				1/2"	23152X8	...
28205	06121-12	121A-E	----	3/4"	121-12	...
				3/4"	23152X12	...
28206			----	1"	121-16	...
				1-1/4"	121-20	...
				1-1/2"	121-24	...
				2"	121-32	...

218P 3152 121A 103 121B PPH 218P

SOLID HEX HEAD PLUGS06125
121S

MIDLAND	AMC	CHAMPION	LIST	THREAD SIZE NPTF	MAF #	MAF PRICE
28201S	06125-02	121AS-A	----	1/8"	121S-2	...
28202S	06125-04	121AS-B	----	1/4"	121S-4	...
28203S	06125-06	121AS-C	----	3/8"	121S-6	...
28204S	06125-08	121AS-D	----	1/2"	121S-8	...
28205S	06125-12	121AS-E	----	3/4"	121S-12	...
28206S			----	1"	121S-16	...

121AS

LOCKNUT

- Jam Nuts
- Straight pipe thread

06111
111

MIDLAND	AMC	CHAMPION	LIST	THREAD SIZE NPTF	MAF #	MAF PRICE
28123	06111-02	111A-A	----	1/8"	111-2	...
28124	06111-04	111A-B	----	1/4"	111-4	...
28125	06111-06	111A-C	----	3/8"	111-6	...
28126	06111-08	111A-D	----	1/2"	111-8	...
28127	06111-12		----	3/4"	111-12	...

210P 21102 111A 111B

WARNING: This product can expose you to chemicals, including lead, which are known to the State of California to cause cancer and birth defects or other reproductive harm. For more information, visit www.P65Warnings.ca.gov

PIPE

BRASS FITTINGS

CLOSE NIPPLE



06112
112

MIDLAND	AMC	CHAMPION	LIST	THREAD SIZE NPTF	MAF #	MAF PRICE
28131	06112-02	112A-A	----	1/8"	112-2	...
28132	06112-04	112A-B	----	1/4"	112-4	...
28133	06112-06	112A-C	----	3/8"	112-6	...
28134	06112-08	112A-D	----	1/2"	112-8	...
28135	06112-12	112A-E	----	3/4"	112-12	...

165 215PN 3326 112A 112B

LONG NIPPLE



06113
113

MIDLAND	AMC	CHAMPION	LIST	THREAD SIZE NPTF	LENGTH	MAF #	MAF PRICE
28140	06113-0224	113A-A15	----	1/8"	1.5	113-224	...
28141	06113-0232	113A-A2	----	1/8"	2.0	113-232	...
28142	06113-0240	113A-A25	----	1/8"	2.5	113-240	...
28143	06113-0248	113A-A3	----	1/8"	3	113-248	...
28475			----	1/8"	3.5	113-256	...
28144	06113-0424	113A-B15	----	1/4"	1.5	113-424	...
28145	06113-0432	113A-B2	----	1/4"	2	113-432	...
28146	06113-0440	113A-B25	----	1/4"	2.5	113-440	...
28147	06113-0448	113A-B3	----	1/4"	3	113-448	...
28481			----	1/4"	3.5	113-456	...
28148	06113-0624	113A-C15	----	3/8"	1.5	113-624	...
28149	06113-0632	113A-C2	----	3/8"	2	113-632	...
28150	06113-0640		----	3/8"	2.5	113-640	...
28151	06113-0648	113A-C3	----	3/8"	3	113-648	...
28487			----	3/8"	3.5	113-656	...
28152	06113-0824	113A-D15	----	1/2"	1.5	113-824	...
28153	06113-0832	113A-D2	----	1/2"	2	113-832	...
28154	06113-0840	113A-D25	----	1/2"	2.5	113-840	...
28155	06113-0848		----	1/2"	3	113-848	...
28493			----	1/2"	3.5	113-856	...
28136	06113-1224	113A-E15	----	3/4"	1.5	113-1224	...
28497		113A-E2	----	3/4"	2	113-1232	...
28498			----	3/4"	2.5	113-1240	...
28499			----	3/4"	3	113-1248	...

113B 113A 166 3327, 3328, 3329, 3330 3331 215PNL

WARNING: This product can expose you to chemicals, including lead, which are known to the State of California to cause cancer and birth defects or other reproductive harm. For more information, visit www.P65Warnings.ca.gov

BRASS

PIPE**BRASS FITTINGS****HEX NIPPLE**

SAE# 130137



06122
06322 (LONG)
122

MIDLAND	AMC	CHAMPION	LIST	THREAD SIZE NPTF	MAF #	MAF PRICE
28210			----	1/16"	23325X1	...
28211L	06122-02	122A-A	----	1/8"	122-2	...
28211		122AH-A	----	1/8"	23325X2	...
28212L	06122-04	122A-B	----	1/4"	122-4	...
28212	06322-04	122AH-B	----	1/4"	23325X4	...
				1/4" BSPT	122-4BSPT	...
28213L	06122-06	122A-C	----	3/8"	122-6	...
28213		122AH-C	----	3/8"	23325X6	...
28214L	06122-08	122A-D	----	1/2"	122-8	...
28214		122AH-D	----	1/2"	23325X8	...
28215L	06122-12	122A-E	----	3/4"	122-12	...
28215		122AH-E	----	3/4"	23325X12	...
				3/4 3800 PSI	HPHN-12	...
28216L	06122-16		----	1"	122-16	...
28-216				1"	23325X16	...
				1-1/4	122-20	...
				1-1/2	122-24	...
				2"	122-32	...

PHN 216P 3325 379 122AH 122B

WARNING: This product can expose you to chemicals, including lead, which are known to the State of California to cause cancer and birth defects or other reproductive harm. For more information, visit www.P65Warnings.ca.gov



PIPE

BRASS FITTINGS

REDUCING HEX NIPPLE

SAE# 130137



23325 = SAE Pattern

06123
123

MIDLAND	AMC	CHAMPION	LIST	THREAD SIZE NPTF	MAF #	MAF PRICE
28218			----	1/8" x 1/16"	23325X2X1	...
28220L	06123-0402	123A-BA	----	1/4" x 1/8"	123-42	...
28220		123AH-BA	----	1/4" x 1/8"	23325X4X2	...
28221L	06123-0602	123A-CA	----	3/8" x 1/8"	123-62	...
28221		123AH-CA	----	3/8" x 1/8"	23325X6X2	...
28222L	06123-0604	123A-CB	----	3/8" x 1/4"	123-64	...
28222		123AH-CB	----	3/8" x 1/4"	23325X6X4	...
				1/2" x 1/8"	123-82	...
28223L	06123-0804	123A-DB	----	1/2" x 1/4"	123-84	...
28223		123AH-DB	----	1/2" x 1/4"	23325X8X4	...
28224L	06123-0806	123A-DC	----	1/2" x 3/8"	123-86	...
28224		123AH-DC	----	1/2" x 3/8"	23325X8X6	...
				1/2" x 3/8"	23325X8X6TP*	...
				3/4" x 1/8"	123-122	...
				3/4" x 1/4"	123-124	...
				3/4" x 3/8"	123-126	...
28225L	06123-1208		----	3/4" x 1/2"	123-128	...
28225		123AH-ED	----	3/4" x 1/2"	23325X12X8	...
				1" x 1/4"	123-164	...
				1" x 3/8"	123-166	...
				1" x 1/2"	123-168	...
28227	06123-1612		----	1" x 3/4"	123-1612	...
				1" x 3/4"	23325X16X12	...
				2" x 1/2"	123-328	...
				2" x 3/4"	123-3212	...
				2" x 1"	123-3216	...
				2" x 1-1/4"	123-3220	...
				2" x 1-1/2"	123-3224	...

*Tapped 3/8 NPTF on 1/2 NPTF

PHN 216P 3325 379 122AH 122B

PIPE SWIVEL ADAPTER

*300 PSI all sizes

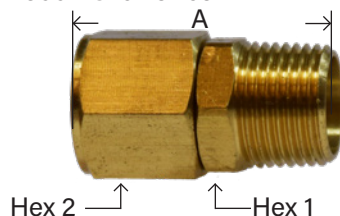

MIDLAND	THREAD SIZE NPTF FXM	A	HEX 1	HEX 2	APPROX. WT. LBS.	
28424	1/8"	1.10	0.43	0.50	0.05	----
28425	1/4"	1.34	0.56	0.62	0.06	----
28426	3/8"	1.36	0.68	0.75	0.08	----
28427	1/2"	1.87	0.87	0.95	0.10	----

MALE NPT X FEMALE NPT

- 360° Turning
- Swivels



MIDLAND	SIZE	
320061	1/4	----

344R 3183

WARNING: This product can expose you to chemicals, including lead, which are known to the State of California to cause cancer and birth defects or other reproductive harm. For more information, visit www.P65Warnings.ca.gov

PIPE**BRASS FITTINGS****45° STREET ELBOW**

SAE# 130339

06124
124

MIDLAND	AMC	CHAMPION	LIST	1 X 2 THREAD SIZE NPTF	MAF #	MAF PRICE
				1/16"	23350X1	...
28230	06124-02	124A-A	----	1/8"	23350X2	...
28231	06124-04	124A-B	----	1/4"	23350X4	...
28232	06124-06	124A-C	----	3/8"	23350X6	...
28233	06124-08	124A-D	----	1/2"	23350X8	...
28234	06124-12	124A-E	----	3/4"	23350X12	...
				1/8" x 1/16"	23350X2X1	...
				1/4" x 1/16"	23350X4X1	...
				1/4" x 1/8"	23350X4X2	...
				1/4" x 3/8"	23350X4X6	...
				3/8" x 1/8"	23350X6X2	...
				3/8" x 1/4"	23350X6X4	...
				3/8" x 1/2"	23350X6X8	...
				1/2" x 1/8"	23350X8X2	...
				1/2" x 1/4"	23350X8X4	...
				1/2" x 3/8"	23350X8X6	...
				3/4" x 3/8"	23350X12X6	...
				3/4" x 1/2"	23350X12X8	...

306 3350 2214P 224

45° FORGED STREET ELBOW06224
124F

MIDLAND	AMC	CHAMPION	LIST	THREAD SIZE NPTF	MAF #	MAF PRICE
28238	06224-02		----	1/8"	124F-2	...
28239	06224-04		----	1/4"	124F-4	...
28240	06224-06	124AF-C	----	3/8"	124F-6	...

45E8 124B

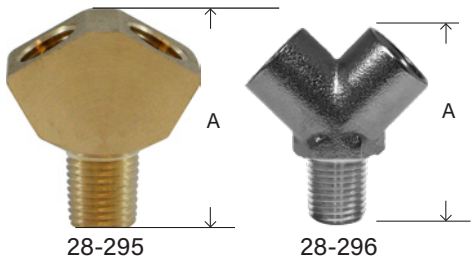
PIPE WYE FIP X MIP

28-295

28-296

MIDLAND	LIST	THREAD SIZE NPT	A	APPROX. WT. LBS.	MAF #	MAF PRICE
28295	----	1/4"	1.56	.15	137yb-4fm	
28296	----	1/4 N/P	1.4	.12		

PIPE WYE FIP X FIP - NICKEL PLATED

MIDLAND	THREAD SIZE NPT	A	APPROX. WT. LBS.	MAF PRICE
28298	1/4	1.4	.12	----

SEE OUR WEBSITE FOR BSPT, BSPP & BSP FITTINGS

PIPE

BRASS FITTINGS

STREET TEE/ SERVICE TEE/ MALE RUN TEE

SAE# 130424



06127
127

MIDLAND	AMC	CHAMPION	LIST	1 X 2 X 3 THREAD SIZE NPTF	MAF #	MAF PRICE
28245	06127-02	127A-A	----	1/8"	23750X2	...
				1/8"	127-2	...
28246	06127-04	127A-B	----	1/4"	23750X4	...
				1/4"	127-4	...
28247	06127-06	127A-C	----	3/8"	23750X6	...
				3/8"	127-6	...
28248	06127-08	127A-D	----	1/2"	23750X8	...
				1/2"	127-8	...
28249	06127-12	127A-E	----	3/4"	23750X12	...
				3/4"	127-12	...
				1/8 X 1/16 X 1/8"	127R-212	...
				1/4 X 1/8 X 1/4"	127R-424	...
				3/8 X 1/4 X 3/8"	127R-646	...
				1/2 X 3/8 X 1/2"	127R-868	...
				1/2 x 1/2 x 1/4"	127R-884	...

225 2225P 3750 326 225 127A

FORGED STREET TEE



06227
127F

MIDLAND	AMC	CHAMPION	LIST	THREAD SIZE NPTF	MAF #	MAF PRICE
28253	06227-02	127AF-A	----	1/8"	127F-2	...
28254	06227-04		----	1/4"	127F-4	...
28255	06227-06	127AF-C	----	3/8"	127F-6	...
28256	06227-08		----	1/2"	127F-8	...
28257	06227-12			3/4"	127F-12	...

107 T8 127B

127A TAP TAPPED STREET TEE

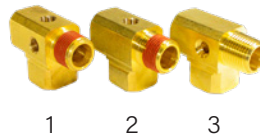

PICTURE NO.	PART NO.	EPT	MPT	TAP	TAP LOCATION	THREAD SEALANT	LIST
1	CVS127A-D-1/8TAPX2*	1/2	1/2	1/8	TOP & SIDE	YES	
2	CVS127A-D-1/8TAPX1*	1/2	1/2	1/8	TOP	YES	
3	NE-127A-B-1/8TAP	1/4	1/4	1/8	SIDE	NO	
3	NE-127A-C-1/8TAP	3/8	3/8	1/8	SIDE	NO	
3	NE-127A-D-1/8TAP	1/2	1/2	1/8	SIDE	NO	

WARNING: This product can expose you to chemicals, including lead, which are known to the State of California to cause cancer and birth defects or other reproductive harm. For more information, visit www.P65Warnings.ca.gov

BRASS

PIPE**BRASS FITTINGS****EXTENDER ADAPTER**

SAE# 130139

06120
120

MIDLAND	AMC	CHAMPION	LIST	THREAD SIZE NPTF FXM	MAF #	MAF PRICE
				1/8 x 1/6	23200X2X1	...
				1/8" x 10/32"	120-20	...
28190L	06120-0202	120A-AA	----	1/8" x 1/8"	120-22	...
28190		120AH-AA	----	1/8" x 1/8"	23200X2	...
				1/4" x 1/16"	120-41	...
28191L	06120-0402	120A-BA	----	1/4" x 1/8"	120-42	...
28191		120AH-BA	----	1/4" x 1/8"	23404X2	...
28192L	06120-0404	120A-BB	----	1/4" x 1/4"	120-44	...
28192		120AH-BB	----	1/4" x 1/4"	23200X4	...
				1/4 X 1/2	120-48	...
28198	06120-0602	120A-CA	----	3/8" x 1/8"	120-62	...
				3/8" x 1/8"	23206X2	...
28193L	06120-0604	120A-CB	----	3/8" x 1/4"	120-64	...
28193		120AH-CB	----	3/8" x 1/4"	23206X4	...
28194L	06120-0606	120A-CC	----	3/8" x 3/8"	120-66	...
28194		120AH-CC	----	3/8" x 3/8"	23200X6	...
				3/8 X 1/2	120-68	...
28197	06120-0802		----	1/2" x 1/8"	120-82	...
				1/2 x 1/4	120-84	...
28199	06120-0804	120A-DB	----	1/2" x 1/4"	23208X4	...
28195L	06120-0806	120A-DC	----	1/2" x 3/8"	120-86	...
28195		120AH-DC	----	1/2" x 3/8"	23208X6	...
28196L	06120-0808	120A-DD	----	1/2" x 1/2"	120-88	...
28196		120AH-DD	----	1/2" x 1/2"	23200X8	...
				3/4 x 1/4	120-124	...
				3/4 x 3/8	120-126	...
28207			----	3/4" x 3/8"	23212X6	...
28208		120A-ED	----	3/4" x 1/2"	23212X8	...
28208L			----	3/4" x 1/2"	120-128	...
28209	06120-1212		----	3/4" x 3/4"	23200X12	...
				1" x 1/4"	120-164	...
				1" x 3/8"	120-166	...
				1" x 1/2"	120-168	...
				1" x 3/4"	120-1612	...
				1" x 1"	120-1616	...
				2" X 1/2"	120-328	...
				2" x 3/4"	120-3212	...
				2" x 1-1/2"	120-3224	...
				2" X 2"	120-3232	...

375 222P 3200 R1 120AH 120B

WARNING: This product can expose you to chemicals, including lead, which are known to the State of California to cause cancer and birth defects or other reproductive harm. For more information, visit www.P65Warnings.ca.gov



PIPE

BRASS FITTINGS

FORGED 90° MALE ELBOW



06230
130

MIDLAND	AMC	CHAMPION	LIST	THREAD SIZE NPTF	MAF #	MAF PRICE
28266	06230-02	116AM-A	----	1/8"	130F-2	...
28267	06230-04	116AM-B	----	1/4"	130F-4	...
28268	06230-06	116AM-C	----	3/8"	130F-6	...
28269	06230-08	116AM-D	----	1/2"	130F-8	...

1204P LE5 3455 116AMF

BARSTOCK 90° MALE ELBOW



06130
130R

MIDLAND	AMC	CHAMPION	LIST	THREAD SIZE NPTF	MAF #	MAF PRICE
28266B	06130-02		----	1/8"	23455X2	...
28267B	06130-04		----	1/4"	23455X4	...
				1/4 MPT X BSPT	23455X4X4B-SPT	...
28268B	06130-06		----	3/8"	23455X6	...
28269B	06130-08		----	1/2"	23455X8	...
28270B			----	3/4"	23455X12	...
28276B			----	1/2" x 3/8"	23455X8X6	...

FORGED 90° MALE REDUCING ELBOW



06235
130F

MIDLAND	AMC	CHAMPION	LIST	THREAD SIZE NPTF	MAF #	MAF PRICE
28274	06235-0402	116AM-BA	----	1/4" x 1/8"	130FR-42	...
				3/8" x 1/8"	130FR-62	...
28275	06235-0604	116AM-CB	----	3/8" x 1/4"	130FR-64	...
28276	06235-0806	116AM-DC	----	1/2" x 3/8"	130FR-86	...

SAE# 130425

MALE BRANCH TEE



06131
131

MIDLAND	AMC	CHAMPION	LIST	THREAD SIZE NPTF	MAF #	MAF PRICE
28281	06131-02	T9-222	----	1/8"	23600X2	...
				1/8"	131-2	...
28282	06131-04	T9-444	----	1/4"	23600X4	...
				1/4"	131-4	...
28283	06131-06	T9-666	----	3/8"	23600X6	...
				3/8"	131-6	...
28284	06131-08	T9-888	----	1/2"	23600X8	...
				1/2"	131-8	...
28285	06131-12	T9-121212	----	3/4"	23600X12	...
				3/4"	131-12	...
				1/8 X 1/16	131R-21	...
				1/4 X 1/8	131R-42	...
				3/8 X 1/4	131R-64	...
				1/2 X 3/8	131R-86	...
				3/4 X 1/2	131R-128	...

				(1"x2") x 3"		
--	--	--	--	--------------	--	--

WARNING: This product can expose you to chemicals, including lead, which are known to the State of California to cause cancer and birth defects or other reproductive harm. For more information, visit www.P65Warnings.ca.gov



PIPE**BRASS FITTINGS****FORGED MALE BRANCH TEE**06231
131F

MIDLAND	AMC	CHAMPION	LIST	THREAD SIZE NPTF	MAF #	MAF PRICE
28281F			----	1/8"	131F-2	...
28282F			----	1/4"	131F-4	...
				3/8"	131F-6	...
				1/2"	131F-8	...

T9

FORGED ALL MALE TEE06232
132F

MIDLAND	AMC	CHAMPION	LIST	THREAD SIZE NPTF	MAF #	MAF PRICE
28290	06232-02		----	1/8"	132F-2	...
28291	06232-04		----	1/4"	132F-4	...
28292	06232-06		----	3/8"	132F-6	...
28293	06232-08		----	1/2"	132F-8	...
28294	06232-12		----	3/4"	132F-12	...

T12 M101

LONG STREET ELLS

D.O.T. Approved



MIDLAND	AMC	CHAMPION	LIST	THREAD SIZE NPTF	LENGTH	MAF #	MAF PRICE
28440			----	1/8"	1"-3/16"	116XL-219	...
28441			----	1/8"	1"-7/16"	116XL-223	...
28442			----	1/8"	1"-11/16"	116XL-227	...
28443			----	1/8"	1"-7/8"	116XL-230	...
28328			----	1/4"	1"-3/16"	116XL-419	...
28329			----	1/4"	1"-7/16"	116XL-423	...
28330			----	1/4"	1"-11/16"	116XL-427	...
28331			----	1/4"	1"-7/8"	116XL-430	...
28332			----	1/4"	2"-1/4"	116XL-436	...
28333			----	3/8"	1"-3/4"	116XL-628	...

LONG EXTENSION ADAPTERS

D.O.T. Approved



MIDLAND	AMC	CHAMPION	LIST	THREAD SIZE NPTF	LENGTH	MAF #	MAF PRICE
28335			----	1/8"	1"-1/4"	120XL-220	...
28336			----	1/8"	1"-3/4"	120XL-228	...
28337			----	1/8"	3"	120XL-248	...
28338			----	1/4"	1"-9/16"	120XL-425	...
28339			----	1/4"	1"-13/16"	120XL-429	...
28340			----	1/4"	2"-1/16"	120XL-433	...

WARNING: This product can expose you to chemicals, including lead, which are known to the State of California to cause cancer and birth defects or other reproductive harm. For more information, visit www.P65Warnings.ca.gov



BULKHEAD FITTINGS

BRASS FITTINGS

BULKHEAD SUFFIX DESCRIPTIONS:

129FC-#	All Brass Fitting
129C-#-SN	Brass Fitting with Steel Nut
129FC-#-STL	All Steel Fitting
129FC-#-STL-XL	All Steel Fitting, Long Body

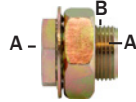
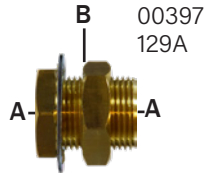

BULKHEAD / ANCHOR / FRAME COUPLINGS FEMALE PIPE X FEMALE PIPE

MIDLAND	CHAMPION	LIST	FEMALE NPTF	STRAIGHT THREAD	HOLE SIZE	LENGTH (IN.)	MAF #	MAF PRICE
28299	129AS-A	----	1/8	5/8-18 UNS	5/8	0.96	207ACBH-2S	...
28300	129A-A	----	1/8	5/8-18 UNS	5/8	1-1/2	207ACBH-2	...
28301	129AS-B	----	1/4	3/4-16 UNS	3/4	15/16	207ACBH-45	
28301SN	129AS-B-SN		Brass body/Steel Nut					
28306	129AS-B-STL		All Steel					
28302	129A-B	----	1/4	3/4-16 UNS	3/4	1-1/2	207ACBH-4	...
28302SN	129A-B-SN		Brass Body/Steel Nut					
28307	129A-B-STL		All Steel					
28315		----	with Large Mounting Nut				207ACBHLH-4	...
28303	129A-C	----	3/8	1-14 UNS	1	1-5/16	207ACBH-6	...
28303SN	129A-C-SN		Brass Body/Steel Nut					
28308	129A-C-STL		All Steel					
28304	129A-D	----	1/2	1-1/8-14 UNS	1-1/8	1-1/2	207ACBH-8	...
28311	129A-E	----	3/4	1-5/16-12	1-5/16	1-1/2	207ACBH-12	...
28316**	129A-F	----	1	1-5/8-14	1-5/8	1.68	207ACBH-16	...

**Without washer

344R 3183

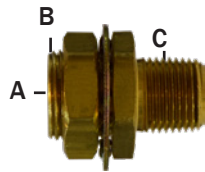

FEMALE PIPE X MALE PIPE

MIDLAND	CHAMPION	LIST	FEMALE NPTF	STRAIGHT THREAD	C	LENGTH (IN.)	MAF #	MAF PRICE
28317	129FC-1	----	1/4	1-14 UNS	1/2-14 NPTF	2-1/8	MA1317	...
28317SN	129FC-1-SN		Brass Body/Steel Nut					
28318	129FC-4	----	3/8	1-14 UNS	1/2-14 NPTF	1-11/16	MA1318	...
28318SN	129FC-4-SN		Brass Body/Steel Nut					
28318STL	129FC-4-STL		All Steel					
28319	129FC-4-XL	----	3/8	1-14 UNS	1/2-14 NPTF	1-29/32	MA1319	...
28319SNXL	129FC-4-SN-XL		Long Brass Body/Steel Nut					
28319STLXL	129FC-4-STL-XL		All Steel					

WARNING: This product can expose you to chemicals, including lead, which are known to the State of California to cause cancer and birth defects or other reproductive harm. For more information, visit www.P65Warnings.ca.gov

BRASS

BULKHEAD FITTINGS

BRASS FITTINGS



FEMALE PIPE X MALE PIPE

MIDLAND	CHAMPION	LIST	FEMALE NPTF	STRAIGHT THREAD	MALE PIPE	LENGTH (IN.)	MAF #	MAF PRICE
28313	129FC-3-SN	----	1/4	1-14 UNS	1/2-14 NPTF	2.88	MA1342	...
28313BN	129FC-3		Brass Body/Brass Nut			2.88		
28312	129FC-3-STL		All Steel			2.94		
28320	129FC-3-STL-XL		All Steel			3.94		

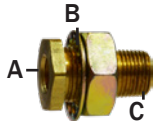

FEMALE PIPE X MALE PIPE

MIDLAND	CHAMPION	LIST	FEMALE NPTF	STRAIGHT THREAD	MALE PIPE	LENGTH (IN.)	MAF #	MAF PRICE
28346	129FC-7-SN	----	3/8	1-14 UNS	1/2	1-7/8	207BH-6FML	...
28346BN	129FC-7		Brass Body/Brass Nut					
28347	129FC-8	----	1/2	1-14 UNS	1/2	2-3/8	207BH-8FML	...
28347SN	129FC-8-SN		Brass Body/Brass Nut					

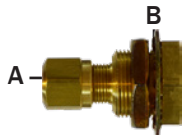

NYLON AIR BRAKE X FEMALE PIPE

MIDLAND	CHAMPION	LIST	OD TUBE	STRAIGHT THREAD	FIP	LENGTH (IN.)	MAF #	MAF PRICE
28321		----	1/2	7/8-20 UNCF	3/8	1-5/16	NT207BH-8	...
28322		----	3/8	7/8-20 UNCF	3/8	1-3/8	NT207BH-6	...

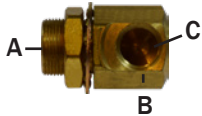

FEMALE PIPE X CLAMPING STUD ELBOW

MIDLAND	CHAMPION	LIST	OD TUBE	STRAIGHT THREAD	FIP	LENGTH (IN.)	MAF #	MAF PRICE
28348	129FC-6	----	3/8	7/8-20 UNEF	3/8-18 NPTF	2-5/16	MA1348	...



BRASS MARINE BULKHEAD

MIDLAND	CHAMPION	LIST	OD TUBE	STRAIGHT THREAD	FIP	LENGTH (IN.)	MAF #	MAF PRICE
46540		----	5/16 Hose ID	----	----	2.37	29SBBHS-5	...
46541		----	3/8 Hose ID	----	----	2.37	29SBBHS-6	...

WARNING: This product can expose you to chemicals, including lead, which are known to the State of California to cause cancer and birth defects or other reproductive harm. For more information, visit www.P65Warnings.ca.gov



BULKHEAD FITTINGS

BRASS FITTINGS

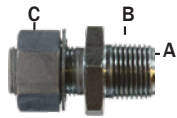

FEMALE PIPE X MALE PIPE - ALL STEEL

MIDLAND	CHAMPION	LIST	FEMALE	STRAIGHT THREAD	MIP	LENGTH (IN.)	MAF #	MAF PRICE
28345	129FC-2	----	1/4-18 NPTF	3/4 - 16 UNS	1/2-14 NPTF	2.16	MA1345	
28309	129FC-2-STL		28345 w/ Large				MA1309	

28310		----	Long Pattern			2.53	MA1310	

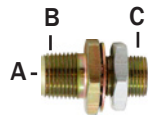

FEMALE PIPE X MALE PIPE - ALL STEEL

MIDLAND	CHAMPION	LIST	FEMALE NPTF	STRAIGHT THREAD	MALE PIPE	LENGTH (IN.)	MAF #	MAF PRICE
28325	129FC-5-STL	----	1/4	3/4 - 16 UNS	1/2-14 NPTF	1-11/16	MA1325	

STAINLESS STEEL BULKHEAD FITTINGS

- Temperature range: -20F° - 360F°
- Working pressure: 1450 - 2175PSI
- Washers are PA6 (Nylon)

BULKHEAD FITTINGS - STAINLESS STEEL 316L NPT (1/8-1/2")



MIDLAND	LIST	SIZE	HOLE SIZE	HEX	LENGTH
28300SS	----	1/8"	0.701	0.866	0.748
28301SS	----	1/4"	0.858	1.063	0.748
28303SS	----	3/8"	1.055	1.260	1.102
28304SS	----	1/2"	1.173	1.417	1.378

BULKHEAD FITTINGS - STAINLESS STEEL 316 NPT (3/4-2")



63214	----	3/4"	1-5/8"	2-15/32"	1-13/16"
63215	----	1"	2-1/4"	3-1/16"	2-7/8"
63216	----	1-1/4"	2-1/4"	3-1/16"	2-3/8"
63217	----	1-1/2"	3"	4-1/4"	2-5/8"
63218	----	2"	3"	4-1/4"	2-5/8"

WARNING: This product can expose you to chemicals, including lead, which are known to the State of California to cause cancer and birth defects or other reproductive harm. For more information, visit www.P65Warnings.ca.gov

BRASS

BULKHEAD FITTINGS

BRASS FITTINGS

INDUSTRY CROSSOVERS

CHAMPION BRASS PART NO.	CHAMPION	INDUSTRY	MIDLAND	MID-AMERICA
129A-A	129A-A	55207	28300	207ACBH-2
129A-B	129A-B	55661-BN	28302	207ACBH-4
129A-B-SN		55661	28302SN	
129A-B-STL	129A-55661STL	55661STL	28307	
129A-C	129A-C	55607-BN	28303	207ACBH-6
129A-C-SN		55607	28303SN	
129A-C-STL	129ASTL-C	55607STL	28308	
129A-D	129A-D	55807	28304	207ACBH-8
129A-E	129A-E		28311	207ACBH-12
129A-F	129A-F		28316	207ACBH-16
129AS-A			28299	207ACBH-25
129AS-B	129AS-B	55611	28301	207ACBH-45
129AS-B-SN		55611-SN	28301SN	
129AS-B-STL	129A-55611STL	55611STL	28306	
129FC-1		55615-BN	28317	MA1317
129FC-1-SN	129A-391FC1	55615	28317SN	
129FC-2	129A-391FC2		28345	MA1345
129FC-2-STL	129A-391FC2STL	55689STL	28309	MA1309
129FC-3	129A-391FC3-BN	55600-BN	28313	MA1342
129FC-3-SN	129A-391FC3	55600	28313SN	
129FC-3-STL	129A-55600STL	55600STL	28312	
129FC-3-STL-XL	129A-55664	55664	28320	
129FC-4	129A-391FC4	55620	28318	MA1318
129FC-4-SN		55620-SN6	28318SN	
129FC-4-STL		55620STL	28318STL	
129FC-4-XL	129A-55646	55646-BN	28319	MA1319
129FC-4-SN-XL		55646	28319SN	
129FC-4-STL-XL	129A-55646STL	55646STL	28319STLXL	
129FC-5-STL		55612STL	28325	MA1325
129FC-6	129A-55616	55616	28348	MA1348
129FC-7		55613-BN	28346BN	
129FC-7-SN	129A-55613	55613	28346	207BH-6FML
129FC-8	129A-55629-BN	55629-BN	28347	207BH-8FML
129FC-8-SN	129A-55629	55629	28347SN	
			28321	NT207BH-8
			28322	NT207BH-6
			46540	29BBHS-5
			46541	29BBHS-6
			28310	MA1310

WARNING: This product can expose you to chemicals, including lead, which are known to the State of California to cause cancer and birth defects or other reproductive harm. For more information, visit www.P65Warnings.ca.gov

HOSE BARB FITTINGS



Temperature and Working Pressure Ranges

From -40°F to + 160°F at 150 PSI maximum.

Tolerance

+/- .02 on all dimensions. Dimension Data can change without notice. Please call us when dimensions are critical.

Note: These fittings are intended for use with hose clamp, similar type clamp or a crimped ferrule.

Assembly Instructions

- 1- Cut hose cleanly and squarely to length.
- 2- Slide clamp on hose.
- 3- Lubricate hose. Push hose on fitting until hose bottoms against stop ring or hex.
- 4- Position hose clamp as shown and secure with a screwdriver or wrench. Maintain "A" dimension noted below for proper clamp positioning. (Diagram/Reference is to the right)

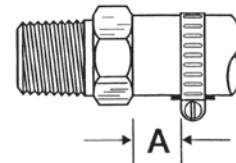

HOSE SIZE	A
3/16"	1/4"
1/4"	1/4"
5/16"	1/4"
3/8"	1/8"
1/2"	1/8"
5/8"	1/8"
3/4"	1/8"

Actual Profile of Hose Barbs

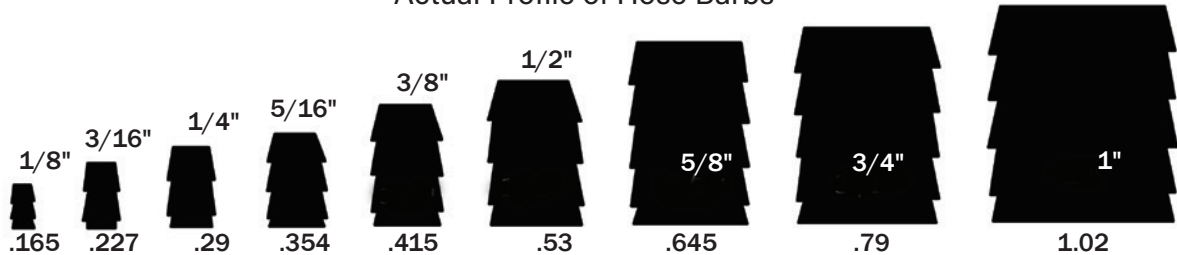

WARNING: This product can expose you to chemicals, including lead, which are known to the State of California to cause cancer and birth defects or other reproductive harm. For more information, visit www.P65Warnings.ca.gov

BRASS

HOSE BARB

BRASS FITTINGS

RIGID MALE ADAPTER

- These are not Lead Free



PGH = SAE Pattern

07001
29
129

MIDLAND	AMC	CHAMPION	LIST	HOSE I.D. X MALE NPTF	MAF #	MAF PRICE
32950			----	1/16" x 10/32"	29-10	...
32951			----	1/16" x 1/16"	29-11	...
32912			----	1/8" x 10/32"	29-20	...
32300			----	1/8" x 1/16"	29-21	...
32001	07001-0202	201A-2A	----	1/8" x 1/8"	29-22	...
32027	07001-0204	201A-2B	----	1/8" x 1/4"	29-24	...
32952			----	3/16" x 1/16"	29-31	...
32002	07001-0302	201A-3A	----	3/16" x 1/8"	29-32	...
32003	07001-0304	201A-3B	----	3/16" x 1/4"	29-34	...
32953			----	3/16" x 3/8"	29-36	...
32301		201A-4X	----	1/4" x 1/16"	29-41	...
32004	07001-0402	201A-4A	----	1/4" x 1/8"	29-42	...
				1/4" x 1/8"	PGH4X2	...
32005	07001-0404	201A-4B	----	1/4" x 1/4"	29-44	...
				1/4" x 1/4"	PGH4X4	...
32006	07001-0406	201A-4C	----	1/4" x 3/8"	29-46	...
32007	07001-0408	201A-4D	----	1/4" x 1/2"	29-48	...
32954			----	1/4" x 3/4"	29-412	...
32008	07001-0502	201A-5A	----	5/16" x 1/8"	29-52	...
32009	07001-0504	201A-5B	----	5/16" x 1/4"	29-54	...
				5/16" x 1/4"	PGH5X4	...
32010	07001-0506	201A-5C	----	5/16" x 3/8"	29-56	...
		201A-5D		5/16" x 1/2"	29-58	...
				5/16" x 3/4"	29-512	...
32011	07001-0602	201A-6A	----	3/8" x 1/8"	29-62	...
	07001-0604	201A-6B	----	3/8" x 1/4"	29-64	...
32012				3/8" x 1/4"	PGH6X4	...
32013	07001-0606	201A-6C	----	3/8" x 3/8"	29-66	...
				3/8" x 3/8"	PGH6X6	...
32014	07001-0608	201A-6D	----	3/8" x 1/2"	29-68	...
				3/8" x 1/2"	PGH6X8	...
32026	07001-0612	201A-6E	----	3/8" x 3/4"	29-612	...
32956	07001-0704	201A-7B	----	7/16" x 1/4"	29-74	...
32957	07001-0706		----	7/16" x 3/8"	29-76	...
32958			----	7/16" x 1/2"	29-78	...
32302		201A-8A	----	1/2" x 1/8"	29-82	...

CONTINUED ON NEXT PAGE

WARNING: This product can expose you to chemicals, including lead, which are known to the State of California to cause cancer and birth defects or other reproductive harm. For more information, visit www.P65Warnings.ca.gov

HOSE BARB

BRASS FITTINGS

RIGID MALE ADAPTER - CONTINUED

• These are not Lead Free



PGH = SAE Pattern

07001
29
129

MIDLAND	AMC	CHAMPION	LIST	HOSE I.D. X MALE NPTF	MAF #	MAF PRICE
32015	07001-0804	201A-8B	----	1/2" x 1/4"	29-84	...
				1/2" x 1/4"	PGH8X4	...
32016	07001-0806	201A-8C	----	1/2" x 3/8"	29-86	...
				1/2" x 3/8"	PGH8X6	...
32017	07001-0808	201A-8D	----	1/2" x 1/2"	29-88	...
				1/2" x 1/2"	PGH8X8	...
32018	07001-0812	201A-8E	----	1/2" x 3/4"	29-812	...
32303			----	1/2" x 1"	29-816	...
32304			----	5/8" x 1/4"	29-104	...
32019	07001-1006	201A-10C	----	5/8" x 3/8"	29-106	...
				5/8" x 3/8"	PGH10X6	...
32020	07001-1008	201A-10D	----	5/8" x 1/2"	29-108	...
				5/8" x 1/2"	PGH10X8	...
32021	07001-1012	201A-10E	----	5/8" x 3/4"	29-1012	...
				5/8" x 3/4"	PGH10X12	...
32305			----	5/8" x 1"	29-1016	...
32915			----	3/4" x 1/4"	29-124	...
32306	07001-1206	201A-12C	----	3/4" x 3/8"	29-126	...
32022	07001-1208	201A-12D	----	3/4" x 1/2"	29-128	...
				3/4" x 1/2"	PGH12X8	...
32023	07001-1212	201A-12E	----	3/4" x 3/4"	29-1212	...
				3/4" x 3/4"	PGH12X12	...
32316	07001-1216	201A-12F	----	3/4" x 1"	29-1216	...
				1" x 3/8"	29-166	...
32307		201A-16D	----	1" x 1/2"	29-168	...
32024	07001-1612	201A-16E	----	1" x 3/4"	29-1612	...
32025	07001-1616	201A-16F	----	1" x 1"	29-1616	...
				1" x 1-1/4"	29-1620	...
32029		201A-20E	----	1-1/4" x 3/4"	29-2012	...
32028	07001-2016	201A-20F	----	1-1/4" x 1"	29-2016	...
				1-1/4" x 1-1/4"	29-2020	...

4244 PGH 101 102 201A 125HBL 105B-1 KF-PS MPB

WARNING: This product can expose you to chemicals, including lead, which are known to the State of California to cause cancer and birth defects or other reproductive harm. For more information, visit www.P65Warnings.ca.gov



HOSE BARB

BRASS FITTINGS

BRASS RIGID MALE BSPT BARB ADAPTER

29SWV
29MS

MIDLAND	AMC	CHAMPION	LIST	HOSE I.D. X MALE BSPT	MAF #	MAF PRICE
32450			----	1/4" x 1/8"	29BSPT-42	...
32451			----	1/4" x 1/4"	29BSPT-44	...
32452			----	3/8" x 1/4"	29BSPT-64	...
32453			----	3/8" x 3/8"	29BSPT-66	...
32454			----	3/8" x 1/2"	29BSPT-68	...
32455			----	1/2" x 3/8"	29BSPT-86	...
32456			----	1/2" x 1/2"	29BSPT-88	...
32457			----	3/4" x 3/4"	29BSPT-1212	...
32458			----	1" x 1"	29BSPT-1616	...

SWIVEL MALE ADAPTER

Rotation 360°

07003

MIDLAND	AMC	CHAMPION	LIST	HOSE I.D. X MALE NPTF	MAF #	MAF PRICE
32329		201AS-3A	----	3/16" x 1/8"	29MS-32	...
32331		201AS-3B	----	3/16" x 1/4"	29MS-34	...
32332		201AS-4A	----	1/4" x 1/8"	29MS-42	...
32349		201AS-4B	----	1/4" x 1/4"	29MS-44	...
				1/4" x 3/8"	29MS-46	...
32351	07003-0602		----	3/8" x 1/8"	29MS-62	...
32201	07003-0604	201AS-6B	----	3/8" x 1/4"	29MS-64	...
32360		201AS-6C	----	3/8" x 3/8"	29MS-66	...
				3/8" x 1/2"	29MS-68	...
32355	07003-0806	201AS-8C	----	1/2" x 3/8"	29MS-86	...
32356	07003-0808	201AS-8D	----	1/2" x 1/2"	29MS-88	...
32357	07003-1212	201AS-12E	----	3/4" x 3/4"	29MS-1212	...
32386		201AS-16F	----	1" x 1"	29MS-1616	...

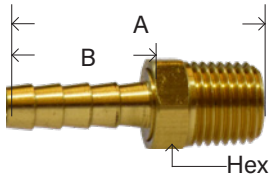
SWIVEL MALE ADAPTER

MIDLAND	AMC	CHAMPION	LIST	HOSE I.D. X MALE NPTF	MAF #	MAF PRICE
32200	07003-0404		----	1/4" x 1/4"		
32202	07003-0606		----	3/8" x 3/8"		

WARNING: This product can expose you to chemicals, including lead, which are known to the State of California to cause cancer and birth defects or other reproductive harm. For more information, visit www.P65Warnings.ca.gov



HOSE BARB

BRASS FITTINGS

MENDER/ SPLICER



07014
29S
129S

MIDLAND	AMC	CHAMPION	LIST	HOSE I.D. X HOSE I.D.	MAF #	MAF PRICE
32091	07014-02	HM-2	----	1/8"	29S-2	...
32092	07014-03	HM-3	----	3/16"	29S-3	...
32093	07014-04	HM-4	----	1/4"	29S-4	...
32079		HM-42	----	1/4" x 1/8"	29SR-42	...
32094	07014-05	HM-5	----	5/16"	29S-5	...
32090		HM-54	----	5/16" x 1/4"	29SR-54	...
32095	07014-06	HM-6	----	3/8"	29S-6	...
32960			----	3/8 x 1/8	29SR-62	...
32961			----	3/8 x 3/16	29SR-63	...
32080		HM-64	----	3/8" x 1/4"	29SR-64	...
32375		HM-65	----	3/8" x 5/16"	29SR-65	...
32096	07014-08	HM-8	----	1/2"	29S-8	...
				1/2" x 1/4"	29SR-84	...
32087		HM-86	----	1/2" x 3/8"	29SR-86	...
32097	07014-10	HM-10	----	5/8"	29S-10	...
				5/8" x 1/4"	29SR-104	...
32088		HM-106	----	5/8" x 3/8"	29SR-106	...
32376		HM-108	----	5/8" x 1/2"	29SR-108	...
32098	07014-12	HM-12	----	3/4"	29S-12	...
				3/4" x 3/8"	29SR-126	...
32089		HM-128	----	3/4" x 1/2"	29SR-128	...
32379		HM-1210	----	3/4" x 5/8"	29SR-1210	...
				1" x 1/2"	29SR-168	...
				1" x 5/8"	29SR-1610	...
32380		HM-1612	----	1" x 3/4"	29SR-1612	...
32099	07014-16	HM-16	----	1"	29S-16	...
				1-1/4"	29S-20	...

HIGH VOLUME MALE SWIVEL

- 300 PSI
- Nitrile Buna (NBR) O-Ring



29MS-64HF



29HPS

MIDLAND	AMC	CHAMPION	LIST	HOSE I.D. X MALE NPTF	MAF #	MAF PRICE
32781			----	3/8" x 1/4"	29MS-64HF	...
28415			----	1/4" x 1/4"	29HPS-44	...
28417				3/8" x 1/4"	29HPS-64	...

WARNING: This product can expose you to chemicals, including lead, which are known to the State of California to cause cancer and birth defects or other reproductive harm. For more information, visit www.P65Warnings.ca.gov

BRASS

HOSE BARB

BRASS FITTINGS

RIGID FEMALE ADAPTER

07002
29F
129F

MIDLAND	AMC	CHAMPION	LIST	HOSE I.D. X FEMALE NPTF	MAF #	MAF PRICE
32050	07002-0202	209A-2A	----	1/8" x 1/8"	29F-22	...
32317	07002-0204	209A-2B	----	1/8" x 1/4"	29F-24	...
32051	07002-0302	209A-3A	----	3/16" x 1/8"	29F-32	...
32062	07002-0304	209A-3B	----	3/16" x 1/4"	29F-34	...
32052	07002-0402	209A-4A	----	1/4" x 1/8"	29F-42	...
32053	07002-0404	209A-4B	----	1/4" x 1/4"	29F-44	...
32054	07002-0406	209A-4C	----	1/4" x 3/8"	29F-46	...
32441	07002-0408	209A-4D	----	1/4" x 1/2"	29F-48	...
32055	07002-0502	209A-5A	----	5/16" x 1/8"	29F-52	...
32056	07002-0504	209A-5B	----	5/16" x 1/4"	29F-54	...
32318	07002-0506	209A-5C	----	5/16" x 3/8"	29F-56	...
32320			----	5/16" x 1/2"	29F-58	...
32057	07002-0602	209A-6A	----	3/8" x 1/8"	29F-62	...
32058	07002-0604	209A-6B	----	3/8" x 1/4"	29F-64	...
32059	07002-0606	209A-6C	----	3/8" x 3/8"	29F-66	...
32063	07002-0608	209A-6D	----	3/8" x 1/2"	29F-68	...
		209A-6E		3/8" X 3/4"	29F-612	
32449				1/2" x 1/8"	29F-82	...
32064	07002-0804	209A-8B		1/2" x 1/4"	29F-84	...
32060	07002-0806	209A-8C		1/2" x 3/8"	29F-86	...
32061	07002-0808	209A-8D		1/2" x 1/2"	29F-88	...
32443		209A-8E		1/2" x 3/4"	29F-812	...
32444		209A-10C		5/8" x 3/8"	29F-106	...
32445		209A-10D		5/8" x 1/2"	29F-108	...
32446		209A-10E		5/8" x 3/4"	29F-1012	...
32447		209A-12D		3/4" x 1/2"	29F-128	...
32065	07002-1212	209A-12E		3/4" x 3/4"	29F-1212	...
32049	07002-1612	209A-16E		1" x 3/4"	29F-1612	...
32321	07002-1616	209A-16F		1" x 1"	29F-1616	...
32448				1-1/4" x 1"	29F-2016	...

209A 128 29A 29F 126HB 126 FPB 105B-2 KF-RS 104 144

SWIVEL FEMALE ADAPTER NPTF

MIDLAND	AMC	CHAMPION	LIST	HOSE I.D. X FEMALE NPTF	MAF #	MAF PRICE
32470		209AF-4B	----	1/4" x 1/4"		
32472		209AF-6B	----	3/8" x 1/4"		
32473		209AF-6C	----	3/8" x 3/8"		
32475		209AF-8C	----	1/2" x 3/8"		
32476		209AF-8D	----	1/2" x 1/2"		

WARNING: This product can expose you to chemicals, including lead, which are known to the State of California to cause cancer and birth defects or other reproductive harm. For more information, visit www.P65Warnings.ca.gov



HOSE BARB

BRASS FITTINGS

SWIVEL FEMALE ADAPTER - WITH GASKET

National Pipe Straight Gasket Seal Swivel

- NPSM Thread



07009
29UFS
129UFS

- Not recommend for water due to fiber gasket - for air service only.

MIDLAND	AMC	CHAMPION	LIST	HOSE I.D. X FEMALE NPSM	MAF #	MAF PRICE
32131	07009-0202	209AFSG-2A		1/8" x 1/8"	29UFS-22	...
32132	07009-0302	209AFSG-3A		3/16" x 1/8"	29UFS-32	...
32133	07009-0304	209AFSG-3B		3/16" x 1/4"	29UFS-34	...
32120	07009-0402	209AFSG-4A		1/4" x 1/8"	29UFS-42	...
32121	07009-0404	209AFSG-4B		1/4" x 1/4"	29UFS-44	...
32129	07009-0406	209AFSG-4C		1/4" x 3/8"	29UFS-46	...
32130	07009-0504	209AFSG-5B		5/16" x 1/4"	29UFS-54	...
32122	07009-0604	209AFSG-6B		3/8" x 1/4"	29UFS-64	...
32123	07009-0606	209AFSG-6C		3/8" x 3/8"	29UFS-66	...
32354	07009-0608	209AFSG-6D		3/8" x 1/2"	29UFS-68	...
32124	07009-0806	209AFSG-8C		1/2" x 3/8"	29UFS-86	...
32125	07009-0808	209AFSG-8D		1/2" x 1/2"	29UFS-88	...
32117		209AFSG-8E		1/2" x 3/4"	29UFS-812	...
32118		209AFSG-10E		5/8" x 3/4"	29UFS-1012	...
32119		209AFSG-12E		3/4" x 3/4"	29UFS-1212	...

130 126 29FSG KF-RN NPSM Gasket Seal

FORGED HOSE BARB 90° ELBOW



07020
29E
129E

MIDLAND	AMC	CHAMPION	LIST	HOSE I.D. X MALE NPTF	MAF #	MAF PRICE
32308	07020-0302	HE1-3A		3/16" x 1/8"		
32391		HE1-3B		3/16" x 1/4"		
32038	07020-0402	HE1-4A		1/4" x 1/8"	29E-42	...
32039	07020-0404	HE1-4B		1/4" x 1/4"	29E-44	...
32309		HE1-4C		1/4" x 3/8"	29E-46	...
32036	07020-0502	HE1-5A		5/16" x 1/8"	29E-52	...
32040	07020-0504	HE1-5B		5/16" x 1/4"	29E-54	...
32310	07020-0506	HE1-5C		5/16" x 3/8"	29E-56	...
32046	07020-0602	HE1-6A		3/8" x 1/8"	29E-62	...
32041	07020-0604	HE1-6B		3/8" x 1/4"	29E-64	...
32042	07020-0606	HE1-6C		3/8" x 3/8"	29E-66	...
32047	07020-0608	HE1-6D		3/8" x 1/2"	29E-68	...
32048	07020-0804	HE1-8B		1/2" x 1/4"	29E-84	...
32043	07020-0806	HE1-8C		1/2" x 3/8"	29E-86	...
32311	07020-0808	HE1-8D		1/2" x 1/2"	29E-88	...
32044	07020-1006	HE1-10C		5/8" x 3/8"	29E-106	...
32045	07020-1008	HE1-10D		5/8" x 1/2"	29E-108	...
32312		HE1-10E		5/8" x 3/4"		
32313		HE1-12D		3/4" x 1/2"		
32314 *		HE1F-12E		3/4" x 3/4"		
32330 **				3/4" x 1"		
32315		HE1-16E		1" x 3/4"		
32319		HE1-16F		1" x 1"		

DIMENSION DATA CAN CHANGE WITHOUT NOTICE. PLEASE CALL WHEN DIMENSIONS ARE CRITICAL.

WARNING: This product can expose you to chemicals, including lead, which are known to the State of California to cause cancer and birth defects or other reproductive harm. For more information, visit www.P65Warnings.ca.gov



129 HBEI KF-PS90 HE-1 29E 146

HOSE BARB

BRASS FITTINGS

BARSTOCK HOSE BARB 90° ELBOW

29EBS

MIDLAND	AMC	CHAMPION	LIST	HOSE I.D. X MALE NPTF	MAF #	MAF PRICE
32038B				1/4" X 1/8"	29E-42BS	...
32039B				1/4" X 1/4"	29E-44BS	...
32309B				1/4" X 3/8"	29E-46BS	...
32036B				5/16" X 1/8"	29E-52BS	...
32040B				5/16" X 1/4"	29E-54BS	...
32310B				5/16" X 3/8"	29E-56BS	...
32046B				3/8" X 1/8"	29E-62BS	...
32041B				3/8" X 1/4"	29E-64BS	...
32042B				3/8" X 3/8"	29E-66BS	...
32047B				3/8" X 1/2"	29E-68BS	...
32048B				1/2" X 1/4"	29E-84BS	...
32043B				1/2" X 3/8"	29E-86BS	...
32311B				1/2" X 1/2"	29E-88BS	...
32314B				3/4" X 3/4"	29E-1212BS	...

HOSE BARB TEES

07024

* Barstock

MIDLAND	AMC	CHAMPION	LIST	HOSE BARB SIZE (1 & 2) X 3	MAF #	MAF PRICE
32367 *		HBT2-2		1/8"		
32368		HBT2-3		3/16"		
32365 **	07024-04	HBT2-4		1/4"	29T-4	...
32350 *		HBT2-442		(1/4") x 1/8"		
32366	07024-05	HBT2-5		5/16"	29T-5	...
32126 **	07024-06	HBT2-6		3/8"	29T-6	...
		HBT2-664		3/8" x 1/4"		
32400 *		HBT2-8		1/2"		
32352 *		HBT2-886		(1/2") x 3/8"		
32361		HBT2-10		5/8"		
32363		HBT2-12		3/4"		
32353		HBT2-12128		(3/4") x 1/2"		
32128 *		HBT2-6B		3/8"HB x 1/4" MIP	29TRM-664	...

90° FEMALE HOSE BARB ELBOW

129HB

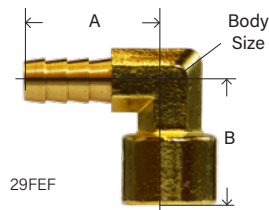

29FEF

MIDLAND	AMC	CHAMPION	LIST	HOSE I.D. X FEMALE NPTF	MAF #	MAF PRICE
32401		HE3-4A	----	1/4" x 1/8"		
32402		HE3-4B	----	1/4" x 1/4"		
32403		HE3-6A	----	3/8" x 1/8"		
32404		HE3-6B	----	3/8" x 1/4"		
32405		HE3-6C	----	3/8" x 3/8"		
32406			----	3/8" x 1/2"		
32407		HE3-8B	----	1/2" x 1/4"		
32410		HE3-8C	----	1/2" x 3/8"		
32411		HE3-8D	----	1/2" x 1/2"		
32409		HE3-12E	----	3/4" x 3/4"		

WARNING: This product can expose you to chemicals, including lead, which are known to the State of California to cause cancer and birth defects or other reproductive harm. For more information, visit www.P65Warnings.ca.gov

BRASS FITTINGS

90° HOSE BARB ELBOW

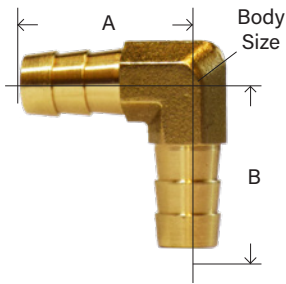

MIDLAND	AMC	CHAMPION	LIST	HOSE I.D. X HOSE I.D.	MAF #	MAF PRICE
32429		HM-90-2	----	1/8" x 1/8"		
32433		HM-90-3	----	3/16" x 3/16"		
32412			----	1/4" x 1/8"		
32413 *		HM-90-4	----	1/4" x 1/4"		
32425		HM-90-5	----	5/16" x 5/16"		
32414			----	3/8" x 1/8"		
32415			----	3/8" x 1/4"		
32416 *		HM-90-6	----	3/8" x 3/8"		
32417			----	3/8" x 1/2"		
32418			----	1/2" x 1/4"		
32419			----	1/2" x 3/8"		
32420 *		HM-90-8	----	1/2" x 1/2"		
32434		HM-90-10	----	5/8" x 5/8"		
32435			----	3/4" x 1/2"		
32436		HM-90-12	----	3/4" x 3/4"		

45° ELBOW



07045
294S
1294S

* Barstock

MIDLAND	AMC	CHAMPION	LIST	HOSE I.D. X MALE NPTF	MAF #	MAF PRICE
32110	07045-0402	HE1-45-4A		1/4" x 1/8"	2945F-42	...
				1/4" x 1/8"	2945-42BS*	...
32109*	07045-0404	HE1-45-4B		1/4" x 1/4"	2945-44BS*	...
	07045-0002	HE1-45-5A		5/16" x 1/8"	2945F-52	
	07045-0504	HE1-45-5B		5/16" x 1/4"	2945F-54	...
32111	07045-0602	HE1-45-6A		3/8" x 1/8"	2945F-62	...
32112	07045-0604	HE1-45-6B		3/8" x 1/4"	2945F-64	...
32113	07045-0606	HE1-45-6C		3/8" x 3/8"	2945F-66	...
32346	07045-0804	HE1-45-8B		1/2" x 1/4"	2945F-84	...
32114	07045-0806	HE1-45-8C		1/2" x 3/8"	2945F-86	...
32116		HE1-45-8D		1/2" x 1/2"	2945F-88	...
32115	07045-1006	HE1-45-10C		5/8" x 3/8"	2945F-106	...
32345		HE1-45-12D		3/4" x 1/2"		

140 HE145 139HB KF-PS45 13945

CROSSES



MIDLAND	AMC	CHAMPION	LIST	HOSE ID	MAF #	MAF PRICE
32608			----	1/4"		
32609			----	5/16"		
32610			----	3/8"		

Hose Wyes available with extended lead time.

DIMENSION DATA CAN CHANGE WITHOUT NOTICE. PLEASE CALL WHEN DIMENSIONS ARE CRITICAL.

HOSE BARB

BRASS FITTINGS

BALL END SWIVEL

NPSM - Ball seat type

07008
29FS
129FS

MIDLAND	AMC	CHAMPION	LIST	HOSE I.D. X NPSM	MAF #	MAF PRICE
32066	07008-0202	209AS-2A		1/8" x 1/8"	29FS-22	...
32067	07008-0302	209AS-3A		3/16" x 1/8"	29FS-32	...
32068	07008-0304	209AS-3B		3/16" x 1/4"	29FS-34	...
32962				3/16" x 3/8"	29FS-36	...
32069	07008-0402	209AS-4A		1/4" x 1/8"	29FS-42	...
32070	07008-0404	209AS-4B		1/4" x 1/4"	29FS-44	...
32078	07008-0406	209AS-4C		1/4" x 3/8"	29FS-46	...
32071	07008-0504	209AS-5B		5/16" x 1/4"	29FS-54	...
32389		209AS-5C		5/16" x 3/8"	29FS-56	...
32072	07008-0604	209AS-6B		3/8" x 1/4"	29FS-64	...
32073	07008-0606	209AS-6C		3/8" x 3/8"	29FS-66	...
32074	07008-0608	209AS-6D		3/8" x 1/2"	29FS-68	...
32075	07008-0806	209AS-8C		1/2" x 3/8"	29FS-86	...
32076	07008-0808	209AS-8D		1/2" x 1/2"	29FS-88	...
32077	07008-1212	209AS-12E		3/4" x 3/4"	29FS-1212	...

128HBLSV 29FS 209AS 124 131

BALLSEAT MALE ADAPTER

Beveled Seat



07654

MIDLAND	AMC	CHAMPION	LIST	NPSM X MALE NPTF	MAF #	MAF PRICE
32359	07654-0202	122AS-2A		1/8" x 1/8"	WH48-22	...
32034	07654-0402	122AS-4A		1/4" x 1/8"	WH48-42	...
32030	07654-0404	122AS-4B		1/4" x 1/4"	WH48-44	...
32362	07654-0604	122AS-6B		3/8" x 1/4"	WH48-64	...
32031	07654-0606	122AS-6C		3/8" x 3/8"	WH48-66	...
32392		122AS-6D		3/8" x 1/2"	WH48-68	...
32364	07654-0806	122AS-8C		1/2" x 3/8"	WH48-86	...
32032	07654-0808	122AS-8D		1/2" x 1/2"	WH48-88	...
32033	07654-1212	122AS-12E		3/4" x 3/4"	WH48-1212	...

172 134 127HB 122AS

BALLSEAT UNION30° Seat
07656

MIDLAND	AMC	CHAMPION	LIST	NPSM X NPSM	MAF #	MAF PRICE
32460		122AS-22UN		1/8"	WH42-2	...
32461	07656-0404	122AS-44UN		1/4"	WH42-4	...
32462				3/8"	WH42-6	...
32463	07656-0808			1/2"	WH42-8	...

WARNING: This product can expose you to chemicals, including lead, which are known to the State of California to cause cancer and birth defects or other reproductive harm. For more information, visit www.P65Warnings.ca.gov



HOSE BARB

BRASS FITTINGS

45° FLARE ADAPTER



07004
29SAE
129SAE

MIDLAND	AMC	CHAMPION	LIST	HOSE I.D. X 45° FLARE	MAF #	MAF PRICE
32322	07004-0304	201BF-34		3/16" x 1/4"	29MSAE-34	...
32081	07004-0404	201BF-44		1/4" x 1/4"	29MSAE-44	...
32082	07004-0406	201BF-46		1/4" x 3/8"	29MSAE-46	...
32083	07004-0505	201BF-55		5/16" x 5/16"	29MSAE-55	...
32084	07004-0606	201BF-66		3/8" x 3/8"	29MSAE-66	...
32085	07004-0608	201BF-68		3/8" x 1/2"	29MSAE-68	...
32086	07004-0808	201BF-88		1/2" x 1/2"	29MSAE-88	...

142 201BF KF-MS KDS

COMPRESSION ADAPTER - BARB X MALE COMPRESSION THREAD



MIDLAND	AMC	CHAMPION	LIST	SIZE	MAF #	MAF PRICE
				1/8" x 1/4"	29CT-24	...
				3/16" x 3/16"	29CT-33	...
				3/16" x 1/4"	29CT-34	...
				1/4" x 3/16"	29CT-43	...
				1/4" x 1/4"	29CT-44	...
				1/4" x 5/16"	29CT-45	...
				1/4" x 3/8"	29CT-46	...
				5/16" x 1/4"	29CT-54	...
				5/16" x 5/16"	29CT-55	...
				3/8" x 3/16"	29CT-63	...
				3/8" x 1/4"	29CT-64	...
				3/8" x 3/8"	29CT-66	...
				1/2" x 1/2"	29CT-88	...

WARNING: This product can expose you to chemicals, including lead, which are known to the State of California to cause cancer and birth defects or other reproductive harm. For more information, visit www.P65Warnings.ca.gov

BRASS

HOSE BARB

BRASS FITTINGS

DUAL 45°/ 37° FLARE SWIVEL

MIDLAND	AMC	CHAMPION	LIST	HOSE ID X DUAL SEAT	MAF #	MAF PRICE
32107	07010-0304			3/16" x 1/4"	29DS-34	...
32107C**				3/16 X 1/4		
32337				1/4" x 1/4"	29DS-44	...
32337C**				1/4" X 1/4"	29CSAE-44	
32102	07010-0405			1/4" x 5/16"	29DS-45	...
32339				5/16" x 5/16"	29DS-55	...
32340				3/8" x 1/2"	29DS-68	...
				3/8" x 3/8"	29CSAE-66	
32341				1/2" x 1/2"	29DS-88	...
32341C**				1/2" X 1/2"	29CSAE-88	
32342	07010-0810			1/2" x 5/8"	29DS-810	...
32394**				5/8" x 5/8"		
				5/8" x 5/8"	29CSAE-1010	
				3/4" x 3/4"	29CSAE-122	

** Swivel crimp style

KDS

FEMALE 45° FLARE SWIVEL07010
29SAE
129SAE* CRIMP STYLE
29CSAE

MIDLAND	AMC	CHAMPION	LIST	HOSE I.D. X FEMALE 45° FLARE	MAF #	MAF PRICE
32326	07010-0303	209ASF-33		3/16" x 3/16"	29SAE-33	...
	07010-0304			3/16" x 1/4"	29SAE-34	...
				3/16" x 1/4"	29CSAE-34	...
				3/16" x 3/8"	29SAE-36	...
30295	07215-0310			3/16" x 3/8"	29CSAE-36	...
32101	07010-0404	209ASF-44		1/4" x 1/4"	29SAE-44	...
				1/4" x 1/4"	29CSAE-44	...
	07010-0405			1/4" x 5/16"	29SAE-45	...
32103	07010-0406	209ASF-46		1/4" x 3/8"	29SAE-46	...
32104	07010-0505	209ASF-55		5/16" x 5/16"	29SAE-55	...
32327	07010-0506	209ASF-56		5/16" x 3/8"	29SAE-56	...
32105	07010-0606	209ASF-66		3/8" x 3/8"	29SAE-66	...
32105C				3/8" x 3/8"	29CSAE-66	...
32106	07010-0608	209ASF-68		3/8" x 1/2"	29SAE-68	...
32100	07010-0808	209ASF-88		1/2" x 1/2"	29SAE-88	...
32341C				1/2" x 1/2"	29CSAE-88	...
32394				5/8" x 5/8"	29SAE-1010	...
32328	07010-1212	209ASF-1212		3/4" x 3/4"	29CSAE-1212	...

29SAE 209ASF 146HBLFSV KF-NS 128 FSS 146 144

WARNING: This product can expose you to chemicals, including lead, which are known to the State of California to cause cancer and birth defects or other reproductive harm. For more information, visit www.P65Warnings.ca.gov



HOSE BARB

BRASS FITTINGS

FEMALE 37° J.I.C. FLARE SWIVEL



* CRIMP STYLE
**STAINLESS

MIDLAND	AMC	CHAMPION	LIST	HOSE ID X FEMALE 37° FLARE	MAF #	MAF PRICE
32334		209ASJ-46		1/4" x 3/8"	29JIC-46	...
32335		209ASJ-56		5/16" x 3/8"	29JIC-56	...
				3/8" x 3/8"	29CJIC-66	
32336C				3/8" X 3/8"	29CJIC-66*	...
32338		209ASJ-1212		3/4" x 3/4"	29JIC-1212	
32338C				3/4" x 3/4"	29CJIC-1212*	
32338SS**				3/4" x 3/4"		

KJS

* swivel crimp style - (100 piece minimum)

BARB X SWT

MIDLAND	AMC	CHAMPION	LIST	HOSE ID	MAF #	MAF PRICE
				1/2" x 1/2"	29SWT-88	...
				3/4" x 1/2"	29SWT-128	...
				3/4" x 5/8"	29SWT-1210	...
				3/4" x 7/8"	29SWT-1214	...
				1" x 1"	29SWT-1616	...

REUSABLE MALE FITTINGS



07216
29RU17

MIDLAND	AMC	LIST	HOSE ID	HOSE OD	MALE NPTF	MAF #	MAF PRICE
32727	07217-040804		1/4"	1/2"	1/4"	29RU17-484	...
32728	07217-040904		1/4"	9/16"	1/4"	29RU17-494	...
32726	07217-041004		1/4"	5/8"	1/4"	29RU17-4104	...
32741			5/16"	5/8"	1/4"	29RU17-5104	...
32742	07217-061004		3/8"	5/8"	1/4"	29RU17-6104	...
32744	07217-061104		3/8"	11/16"	1/4"	29RU17-6114	...
32725	07217-061204		3/8"	3/4"	1/4"	29RU17-6124	...
32747	07217-061006		3/8"	5/8"	3/8"	29RU17-6106	...
32750	07217-061106		3/8"	11/16"	3/8"	29RU17-6116	...
32746	07217-081408		1/2"	7/8"	1/2"	29RU17-8148	...

WARNING: This product can expose you to chemicals, including lead, which are known to the State of California to cause cancer and birth defects or other reproductive harm. For more information, visit www.P65Warnings.ca.gov

BRASS

HOSE BARB

BRASS FITTINGS

REUSABLE FEMALE SWIVEL STEMS



MIDLAND	AMC	CHAMPION	LIST	HOSE ID	FEMALE NPSM
32770			----	1/4"	1/4"-18
32771			----	3/8"	3/8"-18

REUSABLE FEMALE SWIVELS



29RU16

MIDLAND	AMC	CHAMPION	LIST	HOSE ID	HOSE OD	FEMALE NPSM
32772			----	1/4"	1/2"	1/4"
32773			----	3/8"	5/8"	3/8"
32774			----	3/8"	11/16"	3/8"
32775			----	1/2"	7/8"	1/2"

REUSABLE FERRULES

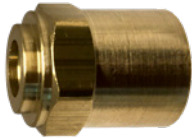

MIDLAND	AMC	CHAMPION	LIST	HOSE ID	HOSE OD
32749			----	1/4"	1/2"
32751			----	1/4"	9/16"
32752			----	1/4"	5/8"
32753			----	3/8"	5/8"
32754			----	3/8"	11/16"
32755			----	3/8"	3/4"
32756			----	1/2"	7/8"

REUSABLE MALE STEMS

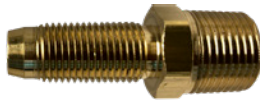

MIDLAND	AMC	CHAMPION	LIST	HOSE ID	MALE NPT THREAD
32758			----	1/4"	1/4"
32759			----	3/8"	1/4"
32760			----	3/8"	3/8"
32761			----	1/2"	1/2"

WARNING: This product can expose you to chemicals, including lead, which are known to the State of California to cause cancer and birth defects or other reproductive harm. For more information, visit www.P65Warnings.ca.gov



HOSE BARB

BRASS FITTINGS

BRASS FUEL HOSE BARBS

Typical Application: Low pressure air, fuel and oil applications. Generally used for automotive, light truck, and small engine fuel lines. Use with fuel hose SAE 30R7 & SAE 30R9.

Advantages: Easy to assemble, just push the fitting into the hose & clamp. Good selection of configurations at reasonable cost.

BEADED BARB X MALE PIPE



08701
159
29SB

MIDLAND	AMC	CHAMPION	LIST	HOSE ID	MAF #	MAF PRICE
38800	08701-0302	201AB-3A		3/16" x 1/8"	29SB-32	...
38802	08701-0402	201AB-4A		1/4" x 1/8"	29SB-42	...
32377	08701-0404	201AB-4B		1/4" x 1/4"	29SB-44	...
38806	08701-0502	201AB-5A		5/16" x 1/8"	29SB-52	...
38808	08701-0504	201AB-5B		5/16" x 1/4"	29SB-54	...
38810	08701-0602	201AB-6A		3/8" x 1/8"	29SB-62	...
32381	08701-0604	201AB-6B		3/8" x 1/4"	29SB-64	...
32382	08701-0606	201AB-6C		3/8" x 3/8"	29SB-66	...
		201AB-8B		1/2" x 1/4"	29SB-84	...
32383	08701-0806	201AB-8C		1/2" x 3/8"	29SB-86	...
32384	08701-0808	201AB-8D		1/2" x 1/2"	29SB-88	...
				1/2" x 3/4"	29SB-812	...
	08701-1006	201AB-10C		5/8" x 3/8"	29SB-106	...
32385	08701-1008	201AB-10D		5/8" x 1/2"	29SB-108	...
	08701-1012			5/8" x 3/4"	29SB-1012	...
32387	08701-1208	201AB-12D		3/4" x 1/2"	29SB-128	...
32388	08701-1212	201AB-12E		3/4" x 3/4"	29SB-1212	...
				1" x 1/2"	29SB-168	...
		201AB-16E		1" x 3/4"	29SB-1612	...
				1" x 1"	29SB-1616	...
				1"-1/8" x 1"	29SB-1816	...

68HB

BUBBLE BARB MALE ADAPTER

BUBBLE X MIP

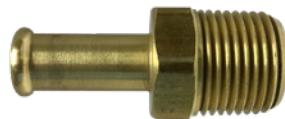

MIDLAND	AMC	CHAMPION	LIST	BUBBLE X MIP	MAF #	MAF PRICE
32176				3/8" x 3/8"		
32177				1/2" x 1/4"	29BB-84	...
32178				1/2" x 3/8"	29BB-86	...
32179				1/2" x 1/2"	29BB-88	...
32182				5/8" x 3/8"	29BB-106	...
32183				5/8" x 1/2"	29BB-108	...
32184				3/4" x 1/2"	29BB-128	...
32180				3/4" x 3/4"	29BB-1212	...
32185				1" x 3/4"	29BB-1612	...
32181				1" x 1"	29SB-1616	...

WARNING: This product can expose you to chemicals, including lead, which are known to the State of California to cause cancer and birth defects or other reproductive harm. For more information, visit www.P65Warnings.ca.gov

BRASS

HOSE BARB

BRASS FITTINGS

INVERTED FLARE MALE CONNECTOR

BEADED BARB X INVERTED FLARE

08706
159IN
29IFSB

MIDLAND	AMC	CHAMPION	LIST	HOSE ID	MAF #	MAF PRICE
	08706-0404			1/4" x 1/4"	29IFSB-44	...
	08706-0405			1/4" x 5/16"	29IFSB-45	...
38828	08706-0504	205AB-54		5/16" x 1/4"	29IFSB-54	...
38830	08706-0505	205AB-55		5/16" x 5/16"	29IFSB-55	...
38832	08706-0506	205AB-56		5/16" x 3/8"	29IFSB-56	...
38834	08706-0605			3/8" x 5/16"	29IFSB-65	...
38836	08706-0606	205AB-66		3/8" x 3/8"	29IFSB-66	...

90° MALE ELBOW

BEADED BARB X MALE PIPE

08720
29ESB

MIDLAND	AMC	CHAMPION	LIST	HOSE ID	MAF #	MAF PRICE
38860	08720-0402	HE1B-4A		1/4" x 1/8"	29ESB-42	...
38862	08720-0502	HE1B-5A		5/16" x 1/8"	29ESB-52	...
38864	08720-0504	HE1B-5B		5/16" x 1/4"	29ESB-54	...
38866	08720-0602	HE1B-6A		3/8" x 1/8"	29ESB-62	...
38868	08720-0604	HE1B-6B		3/8" x 1/4"	29ESB-64	...

269HB

BUBBLE BARB

159E

MIDLAND	AMC	CHAMPION	LIST	HOSE ID	MAF #	MAF PRICE
32186	08720-0606	HE1B-6C		3/8" x 3/8"	29ESB-66	...
32194		HE1B-8B		1/2" x 1/4"		
32187	08720-0806	HE1B-8C		1/2" x 3/8"	29ESB-86	...
32191	08720-0808			1/2" x 1/2"	29ESB-88	...
32195		HE1B-10B		5/8" x 1/4"		
32188	08720-1006	HE1B-10C		5/8" x 3/8"	29ESB-106	...
32189	08720-1008	HE1B-10D		5/8" x 1/2"	29ESB-108	...
32190	08720-1208	HE1B-12D		3/4" x 1/2"	29ESB-128	...
32192		HE1B-12E		3/4" x 3/4"	29ESB-1212	...
				1" x 3/4"	29ESB-1612	...

INVERTED FLARE MALE SWIVEL 90° ELBOW

BEADED BARB X TUBE O.D.

08722
159ELS
29IMES

MIDLAND	AMC	CHAMPION	LIST	HOSE ID	MAF #	MAF PRICE
38861	08722-0404	205AB-90-44		1/4" x 1/4"	29IMES-44	...
	08722-0405	205AB-90-45		1/4" x 5/16"	29IMES-45	...
38873	08722-0505	205AB-90-55		5/16" x 5/16"	29IMES-55	...
38869	08722-0605			3/8" x 5/16"	29IMES-65	...
38874	08722-0606	205AB-90-66		3/8" x 3/8"	29IMES-66	...

WARNING: This product can expose you to chemicals, including lead, which are known to the State of California to cause cancer and birth defects or other reproductive harm. For more information, visit www.P65Warnings.ca.gov



WELD HOSE FITTINGS

BRASS FITTINGS

WELDING HOSE ASSEMBLIES

OXYGEN LINE HOSE BARB X RIGHT HAND THREAD (9-16-18) ASSEMBLIES



MIDLAND	AMC	CHAMPION	LIST	WELDING HOSE	MAF #	MAF PRICE
30408	07629-0309	209RWA-3		3/16"	29FWE3-9	
30409	07629-0409	209RWA-4		1/4"	29FWE4-9	
	07629-0509	209RWA-5		5/16"	29FWE5-6	
30415	07629-0609	209RWA-6		3/8"	29FWE6-9	
30407	07629-0306			3/16"	29FWE3-6	

ACETYLENE LINE HOSE BARB X LEFT HAND THREAD (9/16-18) ASSEMBLY



MIDLAND	AMC	CHAMPION	LIST	HOSE SIZE	MAF #	MAF PRICE
30417	07639-0309	209LWA-3		3/16"	29FWL3-9	
30431	07639-0409	209LWA-4		1/4"	29FWL4-9	
	07639-0509	209LWA-5		5/16"	29FWL5-9	
30433	07639-0609	209LWA-6		3/8"	29FWL6-9	
	07639-0306*			3/16"	29FWL3-6	

* 3/8-24 thread

WARNING: This product can expose you to chemicals, including lead, which are known to the State of California to cause cancer and birth defects or other reproductive harm. For more information, visit www.P65Warnings.ca.gov

BRASS

WELD HOSE FITTINGS

BRASS FITTINGS

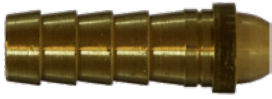
WELDING HOSE FITTINGS**STEM ONLY - WELDING HOSE CONNECTOR**

MIDLAND	AMC	CHAMPION	LIST	HOSE ID	MAF #	MAF PRICE
30410		209WA-3		3/16"	29FW-3	...
30411		209WA-4		1/4"	29FW-4	...
		209WA-5		5/16"	29FW-5	...
30413		209WA-6		3/8"	29FW-6	...

Assemble with nuts below.

201RWA WRS WLS

RIGHT HAND 9/16 - 18 FOR OXYGEN LINE - WELDING HOSE NUT07629
(WITH STEM)

MIDLAND	AMC	CHAMPION	LIST	SIZE	MAF #	MAF PRICE
30420		209RWA-NUT		R.H. Nut only	29FWN-9R	...

Assemble with stem above.

201RWA WRS KF-PE 152

LEFT HAND 9/16 - 18 FOR ACETYLENE LINE - WELDING HOSE NUT07639
(WITH STEM)

MIDLAND	AMC	CHAMPION	LIST	SIZE	MAF #	MAF PRICE
30421		209LWA-NUT		L.H. Nut only	29FWN-9L	...

Assemble with stem above.

209LWA WLS 154 KF-RE

RIGHT HAND 9/16 - 18 #122RWA - WELDING HOSE CONNECTOR07651
651
WH42R

MIDLAND	AMC	CHAMPION	LIST	SIZE	MAF #	MAF PRICE
		122RWA-A		1/8"-27		
30401	07651-0904	122RWA-B		1/4"-18	122RWA-92	...
32437	07651-0906	122RWA-C		3/8"-18	122RWA-96	...
32438*	07651-0909	122RWA-UNION		9/16"-18	122RWA-99	...

* Right UNF thread

156

LEFT HAND 9/16 - 18 #122LWA - WELDING HOSE CONNECTOR07652
652
WH42L

MIDLAND	AMC	CHAMPION	LIST	SIZE	MAF #	MAF PRICE
30406	07652-0904	122LWA-B		1/4"-18	122LWA-94	...
32439	07652-0906	122LWA-C		3/8"-18	122LWA-96	...
32440*	07652-0909			9/16"-18	122LWA-99	...

* Left UNF thread

158

WARNING: This product can expose you to chemicals, including lead, which are known to the State of California to cause cancer and birth defects or other reproductive harm. For more information, visit www.P65Warnings.ca.gov

BARBED FOR PLASTIC TUBING

BRASS FITTINGS

UNION

07062
29MBS



TUBE O.D. (TUBE I.D.) X TUBE O.D. (TUBE I.D.)

MIDLAND	AMC	LIST	SIZE	MAF #	MAF PRICE
21003	07062-02		1/4(1/8) x 1/4(1/8)	29MBS-2	...
			1/4(1/8) Long	29MBS-2L	...
			1/4(1/8) x 10/32(5/32)	29MBS-250	...
21007			3/8(1/4) x 1/4(1/8)	29MBS-42	...
			3/8(1/4) x 5/16(3/16)	29MBS-43	...
21009	07062-04		3/8(1/4) x 3/8(1/4)	29MBS-4	...
			1/2(3/8) x 1/4(1/8)	29MBS-62	...
			1/2(3/8) x 3/8(1/4)	29MBS-64	...
21084	07062-06		1/2(3/8) x 1/2(3/8)	29MBS-6	...

1062 962

MALE ADAPTER

07068



TUBE O.D. (TUBE I.D.) X MALE PIPE

MIDLAND	AMC	CHAMPION	LIST	SIZE	MAF #	MAF PRICE
				1/8(1/16) x 1/8	29MB-12	...
21021				1/4(1/8) x 1/16	29MB-21	...
21023	07068-0202			1/4(1/8) x 1/8	29MB-22	...
21025	07068-0204			1/4(1/8) x 1/4	29MB-24	...
21027	07068-0402	68MB-4A		3/8(1/4) x 1/8	29MB-42	...
20128	02082-06	68MB-4B		3/8(1/4) x 1/4	29MB-44	...
				3/8(1/4) x 1/2	29MB-48	...
21033	07068-0806			1/2(3/8) x 3/8	29MB-66	...
				1/2(3/8) x 1/2	29MB-68	...

1068 968 688

FEMALE ADAPTER



TUBE O.D. (TUBE I.D.) X FEMALE PIPE

MIDLAND	AMC	CHAMPION	LIST	SIZE	MAF #	MAF PRICE
21043				1/4(1/8) x 1/8	29FMB-22	...
21044				1/4(1/8) x 1/4	29FMB-24	...
21046				3/8(1/4) x 1/4	29FMB-44	...
21049				3/8(1/4) x 3/8	29FMB-46	...
				1/2(3/8) x 3/8	29FMB-66	...

1066 966 26 668

BULKHEAD UNION

29MBHS



MIDLAND	AMC	CHAMPION	LIST	SIZE	MAF #	MAF PRICE
21082				1/4(1/8)	29MBHS-2	...
21083		62MBH-4		3/8(1/4)	29MBHS-4	...
21084				1/2(3/8)	29MBHS-6	...

WARNING: This product can expose you to chemicals, including lead, which are known to the State of California to cause cancer and birth defects or other reproductive harm. For more information, visit www.P65Warnings.ca.gov



BARBED FOR PLASTIC TUBING

BRASS FITTINGS

MINI BARB ELBOW

1065
965
07065

MIDLAND	AMC	CHAMPION	LIST	SIZE	MAF #	MAF PRICE
21095	07065-02			1/4(1/8)	29BEMB-2	...
21097	07065-04			3/8(1/4)	29BEMB-4	...
21099	07065-06			1/2(3/8)	29BEMB-6	...

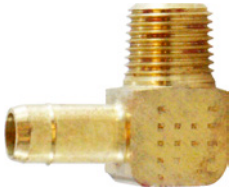
MALE 90° ELBOW

07069

MIDLAND	AMC	CHAMPION	LIST	SIZE	MAF #	MAF PRICE
21111				1/4(1/8) x 1/16	29MBE-21	...
21113	07069-0202			1/4(1/8) x 1/8	29MBE-22	...
21115	07069-0204			1/4(1/8) x 1/4	29MBE-24	...
21117	07069-0402			3/8(1/4) x 1/8	29MBE-42	...
21119	07069-0404			3/8(1/4) x 1/4	29MBE-44	...
21121	07069-0606			1/2(3/8) x 3/8	29MBE-66	...

1069 969 229

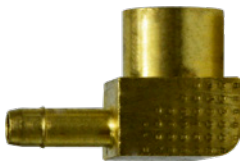
FEMALE 90° ELBOW

MIDLAND	AMC	CHAMPION	LIST	SIZE	MAF #	MAF PRICE
21133				1/4(1/8) x 1/8	29MBFE-22	...
21134				3/8(1/4) x 1/4	29MBFE-44	...

1070 970 230

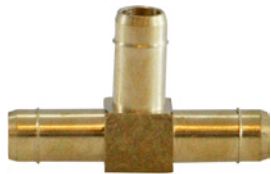
UNION TEE

07064

MIDLAND	AMC	LIST	1 X 2 X 3 SIZE	MAF #	MAF PRICE
21151	07064-02		1/4(1/8)	29MBT-2	...
21153			3/8(1/4)X 3/8(1/4)X1/4(1/8)	29MBTR-442	...
			3/8(1/4) x 1/2(3/8) x 3/8(1/4)	29MBTR-464	...
21155	07064-04		3/8(1/4)	29MBT-4	...
			1/2(3/8) x 1/2(3/8) x 1/4(1/8)	29MBTR-662	...
21159			1/2(3/8)X1/2(3/8)X3/8(1/4)	29MBTR-664	...
21161	07064-06		1/2(3/8)	29MBT-6	...

1064 964 224

WARNING: This product can expose you to chemicals, including lead, which are known to the State of California to cause cancer and birth defects or other reproductive harm. For more information, visit www.P65Warnings.ca.gov



BARBED FOR PLASTIC TUBING

BRASS FITTINGS

MALE BRANCH TEE



29MRMT
07072

MIDLAND	AMC	LIST	SIZE	MAF #	MAF PRICE
21193	07072-0202		1/4(1/8) x 1/4(1/8) x 1/8	29MBMT-22	...
21195			3/8(1/4) x 3/8(1/4) x 1/8	29MBMT-42	...
			3/8(1/4) x 3/8(1/4) x 1/4	29MBMT-44	...

1072 972 232

FEMALE BRANCH TEE



29MBPT

MIDLAND	AMC	LIST	SIZE	MAF #	MAF PRICE
21207			1/4(1/8) x 1/4(1/8) x 1/8	29MBFT-22	...

1077 978

MALE RUN TEE



07071

MIDLAND	AMC	CHAMPION	LIST	SIZE	MAF #	MAF PRICE
				1/4(1/8) x 1/8	29MBMRT-22	...
				3/8 (1/4) x 1/8	29MBMRT-42	...

PLUGS



MIDLAND	AMC	CHAMPION	LIST	SIZE	MAF #	MAF PRICE
				1/4(1/8)	29MBP-2	...
				3/8(1/4)	29MBP-4	...
				1/2(3/8)	29MBP-6	...

DOUBLE BARB ADAPTERS



MIDLAND	AMC	CHAMPION	LIST	SIZE	MAF #	MAF PRICE
				1/4(1/8) x 10/32	29DB-20	...
32150				1/4(1/8) x 1/8	29MDB-22	...
32151				1/4(1/8) x 1/4	29MDB-24	...
32153				3/8(1/4) x 1/4	29MDB-44	...

UNION TEE



MIDLAND	AMC	CHAMPION	LIST	SIZE	MAF #	MAF PRICE
32159				1/4(1/8)	29DBT-2	...
32160				3/8(1/4)	29DBT-4	...

WARNING: This product can expose you to chemicals, including lead, which are known to the State of California to cause cancer and birth defects or other reproductive harm. For more information, visit www.P65Warnings.ca.gov

BRASS

BARBED FOR PLASTIC TUBING

BRASS FITTINGS

90° ELBOW

MIDLAND	AMC	CHAMPION	LIST	SIZE	MAF #	MAF PRICE
32170				1/4(1/8 ID)	29DBBE-2	...
32171				3/8(1/4 ID)	29DBBE-4	...
				10/32 (5/32 ID)	29DBBE-532	...

DB X MIP ELBOW

MIDLAND	AMC	CHAMPION	LIST	SIZE	MAF #	MAF PRICE
				1/4 (1/8) x 1/8	29DBE-22	...
				1/4 (1/8) x 1/4	29DBE-24	...
				3/8(1/4) x 1/8	29DBE-42	...
				3/8(1/4) x 1/4	29DBE-44	...

REDUCING DB SPLICER

MIDLAND	AMC	CHAMPION	LIST	SIZE	MAF #	MAF PRICE
				1/2(3/8) x 1/8	29SDB-62	...

WARNING: This product can expose you to chemicals, including lead, which are known to the State of California to cause cancer and birth defects or other reproductive harm. For more information, visit www.P65Warnings.ca.gov

BARSTOCK/ CAST SS HOSE BARB

BRASS FITTINGS

316 STAINLESS STEEL MACHINED RIGID MALE ADAPTER



PART #	HOSE I.D. X NPT	
32001SS	1/8" x 1/8"	----
32002SS	3/16" x 1/8"	----
32003SS	3/16" x 1/4"	----
32004SS	1/4" x 1/8"	----
32005SS	1/4" x 1/4"	----
32006SS	1/4" x 3/8"	----
32008SS	5/16" x 1/8"	----
32009SS	5/16" x 1/4"	----
32010SS	5/16" x 3/8"	----
32011SS	3/8" x 1/8"	----
32012SS	3/8" x 1/4"	----
32013SS	3/8" x 3/8"	----
32014SS	3/8" x 1/2"	----
32015SS	1/2" x 1/4"	----
32016SS	1/2" x 3/8"	----
32017SS	1/2" x 1/2"	----
32018SS	1/2" x 3/4"	----
32019SS	5/8" x 3/8"	----
32020SS	5/8" x 1/2"	----
32021SS	5/8" x 3/4"	----
32022SS	3/4" x 1/2"	----
32023SS	3/4" x 3/4"	----
32024SS	1" x 3/4"	----

316 STAINLESS STEEL SPLICER

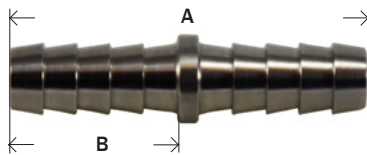

PART #	HOSE I.D. X HOSE I.D.	A	B	
32091SS	1/8"			----
32093SS	1/4"	2.03	0.97	----
32094SS	5/16"			----
32095SS	3/8"	2.06	0.97	----
32096SS	1/2"	2.06	0.97	----
32098SS	3/4"	2.50	1.19	----

316 STAINLESS STEEL BARB ELBOW



PART #	HOSE I.D. X NPT	
32038SS	1/4" x 1/8"	----
32039SS	1/4" x 1/4"	----
32041SS	3/8" x 1/4"	----
32042SS	3/8" x 3/8"	----
32043SS	1/2" x 3/8"	----
32311SS	1/2" x 1/2"	----
32314SS	3/4" x 3/4"	----

304 STAINLESS STEEL HOSE NIPPLES



• Cast

PART #	HOSE I.D. X MALE PIPE	
73951	1/4"	----
73952	3/8"	----
73953	1/2"	----
73954	3/4"	----
73955	1"	----
73956	1-1/4"	----
73957	1-1/2"	----
73958	2"	----
73959	2-1/2"	----
73960	3"	----

304 STAINLESS STEEL REDUCING HOSE NIPPLES



• Cast

PART #	HOSE I.D. X MALE PIPE	
73970	1/4" X 1/8"	----
73971	3/8" X 1/4"	----
73972	1/2" X 3/8"	----
73973	1/2" X 1/4"	----
73974	3/4" X 1/2"	----
73975	1" X 3/4"	----
73976	1" X 1/2"	----
73977	1-1/4" X 1"	----
73979	1-1/2" X 1-1/4"	----
73980	1-1/2" X 1"	----
73981	2" X 1-1/2"	----
73982	2" X 1-1/4"	----

316 STAINLESS STEEL HOSE NIPPLES



• Cast

PART #	HOSE I.D. X MALE PIPE	
973951	1/4"	----
973952	3/8"	----
973953	1/2"	----
973954	3/4"	----
973955	1"	----
973956	1-1/4"	----
973957	1-1/2"	----
973958	2"	----
973959	2-1/2"	----
973990	3"	----
973991	4"	----

• See King nipples on page 359

WARNING: This product can expose you to chemicals, including lead, which are known to the State of California to cause cancer and birth defects or other reproductive harm. For more information, visit www.P65Warnings.ca.gov

BRASS

BEVERAGE FITTINGS

BRASS FITTINGS

BARB TO MALE PIPE ADAPTERSTAINLESS
STEEL

PART #	SIZE	
34587	1/4" x 1/8"	----
34588	1/4" x 1/4"	----
34589	1/4" x 3/8"	----
34590	3/8" x 1/8"	----
34591	3/8" x 1/4"	----
34592	3/8" x 3/8"	----
34595	3/8" x 1/2"	----
34597	1/2" x 3/4"	----

BARB TO MALE FLARE ADAPTERSTAINLESS
STEEL**HOSE ID X 45° FLARE**

PART #	SIZE	
34579	1/4" x 1/4"	----
34586	1/4" x 5/16"	----
34584	1/4" x 3/8"	----
34580	1/4" x 1/2-16"	----
34583	3/8" x 1/4"	----
34585	3/8" x 3/8"	----
34581	3/8" x 1/2-16"	----

FEMALE FLARE SWIVEL SETSSTAINLESS
STEEL

BARB X FEMALE FLARE - TWO PIECE

PART #	SIZE	
34501	1/4" x 1/4"	----
34502	5/16" x 1/4"	----
34504	3/8" x 3/8"	----

ONE PIECE SWIVEL BARB X FE.STAINLESS
STEEL

BARB X FE-FLARE

PART #	SIZE	
34510	3/8" x 1/4"	----

HOSE SPLICER (STRAIGHT)STAINLESS
STEEL**ID HOSE**

PART #	SIZE	
34532	3/16"	----
34533	1/4"	----
34534	1/4" x 3/16"	----
34536	5/16"	----
34537	5/16" x 1/4"	----
34535	3/8"	----
34538	3/8" x 3/16"	----
34543	3/8" x 1/4"	----
34539	3/8" x 5/16"	----
34540	1/2" x 3/8"	----

THINWALL SPLICERSSTAINLESS
STEEL

PART #	SIZE	
34533T	1/4"	----
34535T	3/8"	----
34541T	1/2"	----
34540T	1/2" x 3/8"	----
34543T	3/8" x 1/4"	----

PLUGSTAINLESS
STEEL

PART #	SIZE	
34572	1/4"	----
34574	3/8"	----

THINWALL

PART #	SIZE	
34572T	1/4"	----
34574T	3/8"	----

BARB X COMPRESSIONSTAINLESS
STEEL

PART #	SIZE	
34624	1/4" x 1/4"	----
34625	1/4" x 3/8"	----
34626	3/8" x 3/8"	----

PLATED BRASS SPLICERS

ID SIZES

VINYL TUBE ID/ PL. TUBE ID



PART #	SIZE	
34725	3/16"/1/4"	----
34726	1/4" x 3/16"	----
	5/16" x 1/4"	----
34728	5/16"/3/8"	----
34727	5/16" x 3/16"	----
	3/8"/1/4"	----

TAILPIECES**SS BARB X SWIVEL SHANK**

PART #	SIZE	
34711	-/ 3/16"	----
34713	3/16"/ 1/4"	----
34715	1/4"/ 5/16"	----
34717	3/8"/-	----
34719	1/2"/ 3/8"	----

**N/P BRASS**

PART #	SIZE	
34710	3/16"/1/4"	----
34712	1/4"/5/16"	----
34714	5/16"/3/8"	----
34716	3/8"/-	----
34718	1/2"/-	----

**#304 SS 90° ELBOW**

PART #	SIZE	
34720	3/16"/-	----
34721	1/4"/1/4"	----
34722	5/16"/5/16"	----
34723	3/8"/3/8"	----
34724	1/2"/1/2"	----

WARNING: This product can expose you to chemicals, including lead, which are known to the State of California to cause cancer and birth defects or other reproductive harm. For more information, visit www.P65Warnings.ca.gov

BEVERAGE FITTINGS

BRASS FITTINGS

90° SWIVEL ELBOW



HOSE ID X FEMALE 45°

PART #	SIZE	
34525	1/4" x 1/4"	----
34526	3/8" x 1/4"	----
34529	3/8" x 3/8"	----
34531	1/2" x 1/2"	----

BARB TO SWIVEL ELBOW

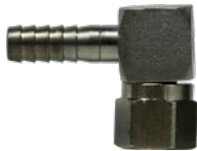

HOSE ID X FEMALE 45° FLARE

PART #	SIZE	
34600	1/4" x 1/4"	----
34601	3/8" x 1/4"	----

MALE ELBOWS



HOSE ID X MALE NPTF

PART #	SIZE	
34610	1/4" x 1/8"	----
34611	3/8" x 1/4"	----
34612	3/8" x 3/8"	----
34613	1/2" x 1/2"	----

FEMALE ADAPTERS



BARB X FEMALE PIPE

PART #	SIZE	
34661	1/4"	----
34658	1/2"	----

U-BEND

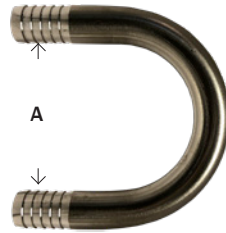

PART #	SIZE	A	
34633	3/8"	2	----

THINWALL U-BEND

Part #	Size	A	
34633T	3/8"	1-1/2	----

U-BEND W/MANIFOLD



THINWALL

PART #	SIZE	
34621T	1/4"	----
34622T	3/8"	----

CROSS



PART #	SIZE	
34635T	1/4"	----
34638T	3/8"	----

Y TEES

T= LIGHT PATTERN

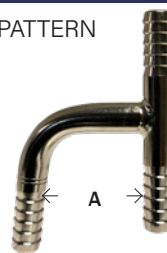

PART #	SIZE	A	
34826	1/4"		
34650T	1/4"	1-1/8	----
34652T	3/8"	1-1/4	----
34854	3/8"		

BARB HOSE TEES



ID HOSE

PART #	SIZE	
34561	1/8"	----
34562	1/4"	----
34565	5/16"	----
34563	3/8"	----

REDUCING TEES

PART #	1&2	3	
34567	1/4"	3/8"	----
34568	3/8"	1/4"	----

THINWALL TEES



PART #	SIZE	
34562T	1/4"	----
34565T	5/16"	----
34563T	3/8"	----
34564T	1/2"	----

REDUCING THINWALL TEES

PART #	1&2	3	
34567T	1/4"	3/8"	----
34568T	3/8"	1/4"	----

90° BARB SPLICER



ID HOSE

PART #	SIZE	
34551	1/4"	----
34550	5/16"	----
34552	3/8"	----

THINWALL 90° BARB SPLICERS



PART #	SIZE	
34551T	1/4"	----
34552T	3/8"	----
34553T	1/2"	----

PUSH ON HOSE BARB

BRASS FITTINGS

PUSH ON BARB FITTINGS

Typical Application: Low Pressure Air, Fuel, Lube, and Oil Lines

• Pressure determined by tube material and hardness. Midland Parts have been tested to max 150 PSI.

Advantages: Easy assembly. No clamps needed!!

• **Assembly Instructions**

- 1- Lubricate insert.
- 2- Hold hose at angle to insert over first barb.
- 3- Continue to push straight on until hose is seated under protective plastic cap. Keep hands back from hose end area so that hose can expand.

• **Disassembling Instructions**

- 1- Split hose. Do not cut completely through hose. Sealing edge of barb could be damaged.
- 2- Bend hose and remove with a quick pull.

See lead free section for lead free push-on barb fittings. **Stainless steel available at the end of this section.**

Actual Profile of Push On Barbs



USE OUR APP WITH YOUR FREE BIN LABELS TO MANAGE YOUR CUSTOMERS INVENTORY MORE EFFICIENTLY

WARNING: This product can expose you to chemicals, including lead, which are known to the State of California to cause cancer and birth defects or other reproductive harm. For more information, visit www.P65Warnings.ca.gov

PUSH-ON FITTINGS

BRASS FITTINGS

MALE ADAPTERS

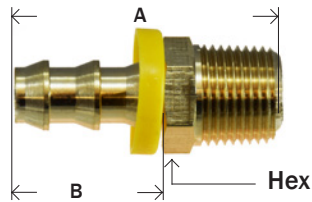

07201
29PO1
129PO1

MIDLAND	AMC	CHAMPION	LIST	HOSE I.D. X MALE NPTF	MAF #	MAF PRICE
30200	07201-0402	301-42		1/4" x 1/8"	29PO1-42	
30201	07201-0404	301-44		1/4" x 1/4"	29PO1-44	
30211	07201-0406	301-46		1/4" x 3/8"	29PO1-46	
30208				1/4" x 1/2"	29PO1-48	
30212	07201-0502	301-52		5/16" x 1/8"	29PO1-52	
30213	07201-0504	301-54		5/16" x 1/4"	29PO1-54	
30202	07201-0602	301-62		3/8" x 1/8"	29PO1-62	
30203	07201-0604	301-64		3/8" x 1/4"	29PO1-64	
30204	07201-0606	301-66		3/8" x 3/8"	29PO1-66	
30205	07201-0608	301-68		3/8" x 1/2"	29PO1-68	
30392	07201-0612	301-612		3/8" x 3/4"	29PO1-612	
30216	07201-0804	301-84		1/2" x 1/4"	29PO1-84	
30206	07201-0806	301-86		1/2" x 3/8"	29PO1-86	
30207	07201-0808	301-88		1/2" x 1/2"	29PO1-88	
30217	07201-0812	301-812		1/2" x 3/4"	29PO1-812	
30218				1/2" x 1"	29PO1-816	
30219	07201-1006	301-106		5/8" x 3/8"	29PO1-106	
30209	07201-1008	301-108		5/8" x 1/2"	29PO1-108	
30214	07201-1012	301-1012		5/8" x 3/4"	29PO1-1012	
30215	07201-1208	301-128		3/4" x 1/2"	29PO1-128	
30210	07201-1212	301-1212		3/4" x 3/4"	29PO1-1212	
				3/4" x 1"	29PO1-1216	
30238	07201-1612	301-1612		1" x 3/4"	29PO1-1612	
30239	07201-1616	301-1616		1" x 1"	29PO1-1616	

301 P990A HLM 100B-1 KA-MB 272 29PO 725 625 BPN 941 30182

MALE ELBOW

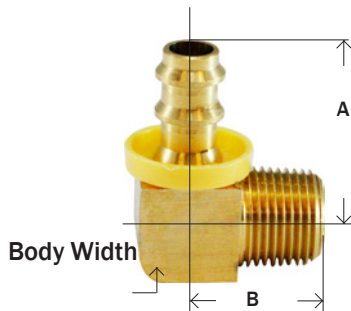

29POE
129PO20

MIDLAND	AMC	CHAMPION	LIST	HOSE I.D. X MALE NPTF	MAF #	MAF PRICE
30372	07220-0402	311-42	----	1/4" x 1/8"		
30373	07220-0404	311-44	----	1/4" x 1/4"		
30374	07220-0502	311-52	----	5/16" x 1/8"		
30375	07220-0504	311-54	----	5/16" x 1/4"		
30370	07220-0602	311-62	----	3/8" x 1/8"		
30371	07220-0604	311-64	----	3/8" x 1/4"		
30376	07220-0606	311-66	----	3/8" x 3/8"		
30377	07220-0608	311-68	----	3/8" x 1/2"		
30382	07220-0806	311-86	----	1/2" x 3/8"		
30378	07220-0808	311-88	----	1/2" x 1/2"		
30379	07220-1008	311-108	----	5/8" x 1/2"		
30383	07220-1208	311-128	----	3/4" x 1/2"		
30381	07220-1212	311-1212	----	3/4" x 3/4"		

WARNING: This product can expose you to chemicals, including lead, which are known to the State of California to cause cancer and birth defects or other reproductive harm. For more information, visit www.P65Warnings.ca.gov



100-C 29EPO 273

PUSH-ON FITTINGS

BRASS FITTINGS

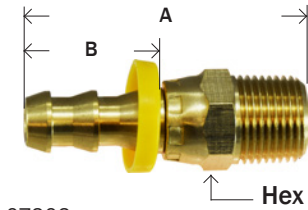
MALE SWIVEL

07202
29PO9
129PO2

MIDLAND	AMC	CHAMPION	LIST	HOSE I.D. X MALE NPTF	MAF #	MAF PRICE
30422		301S-42		1/4" x 1/8"	29PO9-42	
30385	07202-0404	301S-44		1/4" x 1/4"	29PO9-44	
30423				3/8" x 1/8"	29PO9-62	
30386	07202-0604	301S-64		3/8" x 1/4"	29PO9-64	
30387	07202-0606	301S-66		3/8" x 3/8"	29PO9-66	
30388	07202-0806	301S-86		1/2" x 3/8"	29PO9-86	
30389	07202-0808	301S-88		1/2" x 1/2"	29PO9-88	
30424		301S-108		5/8" x 1/2"	29PO9-108	
30390	07202-1212	301S-1212		3/4" x 3/4"	29PO9-1212	

921 HMS 285 31382

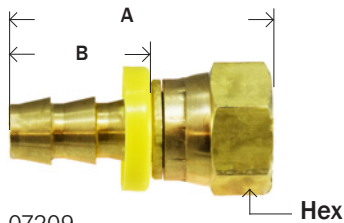
FEMALE GASKET SEAL SWIVEL - NPSM

07209
129PO9

MIDLAND	AMC	CHAMPION	LIST	HOSE I.D. X MALE NPTF	MAF #	MAF PRICE
30359	07209-0402	312-42		1/4" x 1/8"	29PO12-42	
30358	07209-0404	312-44		1/4" x 1/4"	29PO12-44	
	07209-0406			1/4" x 3/8"		
30360	07209-0604	312-64		3/8" x 1/4"	29PO12-64	
30361	07209-0606	312-66		3/8" x 3/8"	29PO12-66	
30362	07209-0608	312-68		3/8" x 1/2"	29PO12-68	
30363	07209-0808	312-88		1/2" x 1/2"	29PO12-88	
	07209-0812	312-108		1/2" x 3/4"		
	07209-1012			5/8" x 3/4"	29PO12-1012	
30366	07209-1212	312-1212		3/4" x 3/4"	29PO12-1212	

280

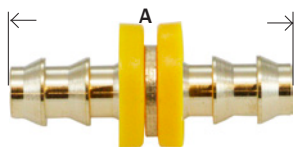
HOSE SPLICER

07214
29P08
129PO14

MIDLAND	AMC	CHAMPION	LIST	HOSE I.D.	MAF #	MAF PRICE
30300	07214-04	304-44		1/4"	29PO8-4	
30305	07214-05	304-55		5/16"	29PO8-5	
30301	07214-06	304-66		3/8"	29PO8-6	
30302	07214-08	304-88		1/2"	29PO8-8	
30303	07214-10	304-1010		5/8"	29PO8-10	
30304	07214-12	304-1212		3/4"	29PO8-12	

BPM 696 29SPO 296 915 729 100B-Y KA-RM MHL 296 38282

WARNING: This product can expose you to chemicals, including lead, which are known to the State of California to cause cancer and birth defects or other reproductive harm. For more information, visit www.P65Warnings.ca.gov



PUSH ON HOSE BARB

BRASS FITTINGS

RIGID FEMALE ADAPTER

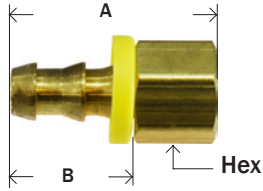

07207
29PO2
129PO7

MIDLAND	AMC	CHAMPION	LIST	HOSE I.D. X FEMALE NPTF	MAF #	MAF PRICE
30220	07207-0402	3099-42		1/4" x 1/8"	29PO2-42	
30221	07207-0404	3099-44		1/4" x 1/4"	29PO2-44	
30384	07207-0406	3099-46		1/4" x 3/8"	29PO2-46	
30391	07207-0502	3099-52		5/16" x 1/8"	29PO2-52	
30222	07207-0504	3099-54		5/16" x 1/4"	29PO2-54	
30393	07207-0602	3099-62		3/8" x 1/8"	29PO2-62	
30224	07207-0604	3099-64		3/8" x 1/4"	29PO2-64	
30225	07207-0606	3099-66		3/8" x 3/8"	29PO2-66	
30394	07207-0608	3099-68		3/8" x 1/2"	29PO2-68	
30397	07207-0612			3/8" x 3/4"	29PO2-612	
30223	07207-0804	3099-84		1/2" x 1/4"	29PO2-84	
30226	07207-0806	3099-86		1/2" x 3/8"	29PO2-86	
30227	07207-0808	3099-88		1/2" x 1/2"	29PO2-88	
30396	07207-0812	3099-812		1/2" x 3/4"	29PO2-812	
30398	07207-1006			5/8" x 3/8"	29PO2-106	
30229	07207-1008	3099-108		5/8" x 1/2"	29PO2-108	
30403	07207-1012			5/8" x 3/4"	29PO2-1012	
30399	07207-1208	3099-128		3/4" x 1/2"	29PO2-128	
30395	07207-1212	3099-1212		3/4" x 3/4"	29PO2-1212	
30400	07207-1612			1" x 3/4"	29PO2-1612	
30402	07207-1616	3099-1616		1" x 1"	29PO2-1616	

30282 29FPO HLF 626 274 726 940

45° MALE SAE FLARE ADAPTER

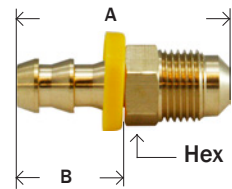

07204
29PO3
129PO4

MIDLAND	AMC	CHAMPION	LIST	HOSE I.D. X 45° MALE FLARE	MAF #	MAF PRICE
30240	07204-0404	302-44		1/4" x 1/4"	29PO3-44	
30241	07204-0405	302-45		1/4" x 5/16"	29PO3-45	
	07204-0406			1/4" x 3/8"	29PO3-46	
30249	07204-0505	302-55		5/16" x 5/16"	29PO3-55	
	07204-0604			3/8" x 1/4"	29PO3-64	
30271	07204-0605	302-65		3/8" x 5/16"	29PO3-65	
30243	07204-0606	302-66		3/8" x 3/8"	29PO3-66	
	07204-0608			3/8" x 1/2"	29PO3-68	
30245	07204-0808	302-88		1/2" x 1/2"	29PO3-88	
	07204-0810			1/2" x 5/8"	29PO3-810	
				5/8" x 3/8"	29PO3-106	
	07204-1008			5/8" x 1/2"	29PO3-108	
30246	07204-1010	302-1010		5/8" x 5/8"	29PO3-1010	
	07204-1210			3/4" x 5/8"	29PO3-1210	
30247	07204-1212	302-1212		3/4" x 3/4"	29PO3-1212	

100B-3 KA-MS 727 945 682 302 282

PUSH ON HOSE BARB

BRASS FITTINGS

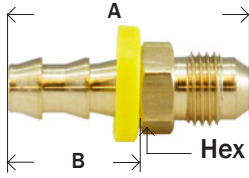
37° MALE JIC FLARE ADAPTER

07205
29PO11
129PO5

MIDLAND	AMC	CHAMPION	LIST	HOSE I.D. X MALE JIC	MAF #	MAF PRICE
32900	07205-0404	310-44		1/4" x 1/4"	29PO11-44	
32901	07205-0405			1/4" x 5/16"	29PO11-45	
32906	07205-0406	310-46		1/4" x 3/8"	29PO11-46	
	07205-0604			3/8" x 1/4"	29PO11-64	
	07205-0605			3/8" x 5/16"	29PO11-65	
32902	07205-0606	310-66		3/8" x 3/8"	29PO11-66	
	07205-0608			3/8" x 1/2"	29PO11-68	
32903	07205-0808	310-88		1/2" x 1/2"	29PO11-88	
	07205-0810			1/2" x 5/8"	29PO11-810	
	07205-1008			5/8" x 1/2"	29PO11-108	
32907	07205-1010	310-1010		5/8" x 5/8"	29PO11-1010	
	07205-1210			3/4" x 5/8"	29PO11-1210	
32905	07205-1212	310-1212		3/4" x 3/4"	29PO11-1212	
				1" x 3/4"	29PO11-1612	
				1" x 1"	29PO11-1616	

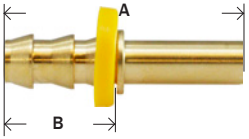
RIGID TUBE ADAPTER

07215
29PO10
129PO15

MIDLAND	AMC	CHAMPION	LIST	HOSE I.D. X O.D TUBE	MAF #	MAF PRICE
30290	07215-0403	303-43		1/4" x 3/16"	29PO10-43	
30291	07215-0404	303-44		1/4" x 1/4"	29PO10-44	
30292	07215-0405	303-45		1/4" x 5/16"	20PO10-45	
30293	07215-0505	303-55		5/16" x 5/16"	29PO10-55	
30294	07215-0606	303-66		3/8" x 3/8"	29PO10-66	
30426		303-68		3/8" x 1/2"	29PO10-68	
30297	07215-0808	303-88		1/2" x 1/2"	29PO10-88	
30298	07215-1010	303-1010		5/8" x 5/8"	29PO10-1010	
30299	07215-1212	303-1212		3/4" x 3/4"	29PO10-1212	

294 100B-X KA-RL 303 732 694

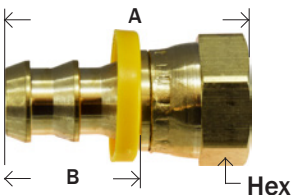
SAE/JIC DUAL 45°/37° FEMALE SWIVEL

07210
29PO5
129PO10

MIDLAND	AMC	CHAMPION	LIST	HOSE I.D. X DUAL SEAT	MAF #	MAF PRICE
30230	07210-0404	309-44		1/4" x 1/4"	29PO5-44	
30231	07210-0405	309-45		1/4" x 5/16"	29PO5-45	
30232	07210-0505	309-55		5/16" x 5/16"	29PO5-55	
30427		309-65		3/8" x 5/16"	29PO5-65	
30233	07210-0608	309-68		3/8" x 1/2"	29PO5-68	
30234	07210-0808	309-88		1/2" x 1/2"	29PO5-88	
30235	07210-0810	309-810		1/2" x 5/8"	29PO5-810	
30236	07210-1008	309-108		5/8" x 1/2"	29PO5-108	
30237	07210-1010	309-1010		5/8" x 5/8"	29PO5-1010	
30428	07210-1210			3/4" x 5/8"	29PO5-1210	

DIMENSION DATA CAN
CHANGE WITHOUT NOTICE.
PLEASE CALL WHEN
DIMENSIONS ARE CRITICAL.

29FDS 287 HDF 309 735 690 P990-K 305 935/934

PUSH ON HOSE BARB

BRASS FITTINGS

45° SAE FLARE FEMALE SWIVEL

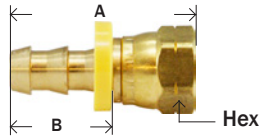

07211
29P06
129PO14

MIDLAND	AMC	CHAMPION	LIST	HOSE I.D. X 45° FEMALE FLARE	MAF #	MAF PRICE
30250	07211-0404			1/4" x 1/4"	29PO6-44	
30251	07211-0405			1/4" x 5/16"	29PO6-45	
30253	07211-0406	307-46		1/4" x 3/8"	29PO6-46	
30254	07211-0505			5/16" x 5/16"	29PO6-55	
30260	07211-0506	307-56		5/16" x 3/8"	29PO6-56	
				3/8" x 5/16"	29PO6-65	
30252	07211-0606	307-66		3/8" x 3/8"	29PO6-66	
30257	07204-0608			3/8" x 1/2"	29PO6-68	
30261	07211-0806	307-86		1/2" x 3/8"	29PO6-86	
30255	07211-0808			1/2" x 1/2"	29PO6-88	
30258	07211-1010			5/8" x 5/8"	29PO6-1010	
30259	07211-1212	307-1212		3/4" x 3/4"	29PO6-1212	...

30882 728 P990-H 29AEPO 307 284 100S-4 KA-NS HSF 684 934

FEMALE 37° JIC FLARE SWIVEL

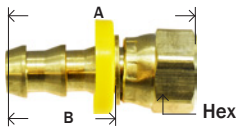

07212
29P07
129PO12

MIDLAND	AMC	CHAMPION	LIST	HOSE I.D. X FEMALE JIC	MAF #	MAF PRICE
30265	07212-0404			1/4" x 1/4"	29PO7-44	
30264	07212-0406	308-46		1/4" x 3/8"	29PO7-46	
30270	07212-0506	308-56		5/16" x 3/8"	29PO7-56	
30266	07212-0606	308-66		3/8" x 3/8"	29PO7-66	
		308-86		1/2" x 3/8"	29PO7-86	
30267	07212-0808	308-88		1/2" x 1/2"	29PO7-88	
30268	07212-1010			5/8" x 5/8"	29PO7-1010	
30269	07212-1212	308-1212		3/4" x 3/4"	29PO7-1212	
30429		308-1616		1" x 1"	29PO7-1616	...

JF 944/934 29J1CPO HJF 688 738 288 100B-6 308 P990-F 30682 KA-NJ

INVERTED FLARE MALE SWIVEL

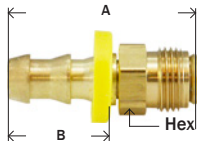

07206
29P016
129PO6

MIDLAND	AMC	CHAMPION	LIST	HOSE I.D. X MALE INV FLARE	MAF #	MAF PRICE
30275	07206-0403	305-43		1/4" x 3/16"	29PO16-43	
30276	07206-0404	305-44		1/4" x 1/4"	29PO16-44	
30277	07206-0405	305-45		1/4" x 5/16"	29PO16-45	
	07206-0504			5/16" x 1/4"	29PO16-54	
30280	07206-0505	305-55		5/16" x 5/16"	29PO16-55	
30283	07206-0506	305-56		5/16" x 3/8"	29PO16-56	
30284	07206-0605	305-65		3/8" x 5/16"	29PO16-65	
30279	07206-0606	305-66		3/8" x 3/8"	29PO16-66	...
	07206-0608			3/8" x 1/2"	29PO16-68	
	07206-0806			1/2" x 3/8"	29PO16-86	
30282	07206-0808	305-88		1/2" x 1/2"	29PO16-88	
30286	07206-1010	305-1010		5/8" x 5/8"	29PO16-1010	...

290 100B-B KA-MF 1MS 947

PUSH ON HOSE BARB

BRASS FITTINGS

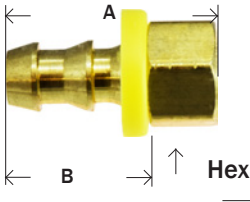
INVERTED FLARE FEMALE ADAPTER-RIGID

07213
29P013
129P013

MIDLAND	AMC	CHAMPION	LIST	HOSE I.D. X FEMALE INV FLARE	MAF #	MAF PRICE
30310	07213-0403	306-43		1/4" x 3/16"	29PO13-43	
30311	07213-0404	306-44		1/4" x 1/4"	29PO13-44	
30312	07213-0405	306-45		1/4" x 5/16"	29PO13-45	
30316	07213-0505	306-55		5/16" x 5/16"	29PO13-55	
30313	07213-0605	306-65		3/8" x 5/16"	29PO13-65	
30314	07213-0606	306-66		3/8" x 3/8"	29PO13-66	
30315	07213-0808	306-88		1/2" x 1/2"	29PO13-88	...

306 100B-A KA-NG 292 P990-J 736 692 946

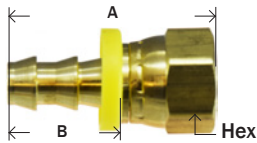
FEMALE BALLSEAT SWIVEL

07208
29P04
129P08

MIDLAND	AMC	CHAMPION	LIST	HOSE I.D. X FEMALE NPSM	MAF #	MAF PRICE
30340	07208-0402	3099S-42		1/4" X 1/8"	29PO4-42	
30341	07208-0404	3099S-44		1/4" X 1/4"	29PO4-44	
30342	07208-0406	3099S-46		1/4" x 3/8"	29PO4-46	
30343	07208-0604	3099S-64		3/8" X 1/4"	29PO4-64	
30344	07208-0606	3099S-66		3/8" X 3/8"	29PO4-66	
30430	07208-0608	3099S-68		3/8" x 1/2"	29PO4-68	
30346	07208-0808	3099S-88		1/2" X 1/2"	29PO4-88	
30345	07208-0812	3099S-812		1/2" x 3/4"	29PO4-812	
				5/8" x 1/2"	29PO4-108	
	07208-1012			5/8" x 3/4"	29PO4-1012	
30349	07208-1212	3099S-1212		3/4" X 3/4"	29PO4-1212	...

628 278 29SPO 731 NPSM

PUSH ON MALE BRANCH TEE

MIDLAND	AMC	CHAMPION	LIST	BRB X BRB X MPT	MAF #	MAF PRICE
				1/4HID X 1/4HID X 1/8MPT	29PO19-442	
				1/4HID X 1/4HID X 1/4MPT	29PO19-444	
				3/8HID X 3/8HID X 1/4MPT	29PO19-664	
				3/8HID X 3/8HID X 3/8MPT	29PO19-666	...

WARNING: This product can expose you to chemicals, including lead, which are known to the State of California to cause cancer and birth defects or other reproductive harm. For more information, visit www.P65Warnings.ca.gov

PUSH ON HOSE BARB

BRASS FITTINGS

SAE/ JIC 37°/ 45° FEMALE SWIVEL 90° ZINC PLATED STEEL

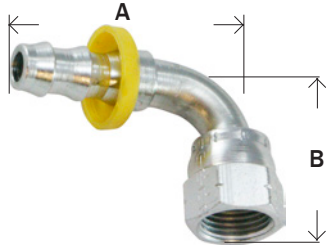

MIDLAND	AMC	CHAMPION	LIST	HOSE I.D. X FEMALE 37°/45°	MAF #	MAF PRICE
30480		318S-44		1/4"		
30482		318S-66		3/8"		
30483*				3/8"		
30484		318S-88		1/2"		
30486		318S-1212	----	3/4"		

* SAE

317S 45° FEMALE SAE SWIVEL STEEL FITTING



MIDLAND	AMC	CHAMPION	LIST	HOSE I.D.	MAF #	MAF PRICE
		317S-44	----	1/4"		
		317S-66	----	3/8"		

WARNING: This product can expose you to chemicals, including lead, which are known to the State of California to cause cancer and birth defects or other reproductive harm. For more information, visit www.P65Warnings.ca.gov

BRASS

STAINLESS STEEL PUSH ON 316 HOSE BARB

BRASS FITTINGS

316 STAINLESS STEEL MALE ADAPTERS

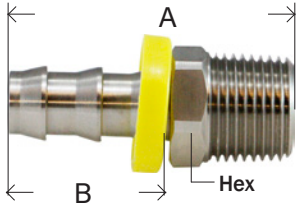

MIDLAND	AMC	CHAMPION	LIST	HOSE I.D. X NPT	MAF #	MAF PRICE
30200SS				1/4" x 1/8"		
30201SS				1/4" x 1/4"		
30203SS				3/8" x 1/4"		
30204SS				3/8" x 3/8"		
30206SS				1/2" x 3/8"		
30207SS				1/2" x 1/2"		
30215SS				3/4" x 1/2"		
30210SS				3/4" x 3/4"		

316 STAINLESS STEEL SAE/ JIC 45°/ 37° FEMALE SWIVEL

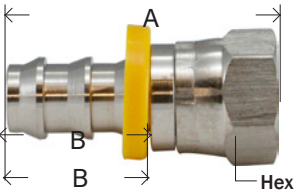

MIDLAND	AMC	CHAMPION	LIST	HOSE I.D. X FEMALE 45°/37°	MAF #	MAF PRICE
30230SS				1/4" x 1/4"		
30234SS				1/2" x 1/2"		

316 STAINLESS STEEL FEMALE 37° JIC FLARE SWIVEL

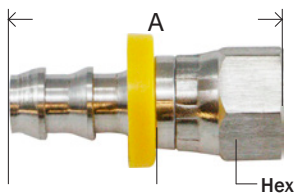

MIDLAND	AMC	CHAMPION	LIST	HOSE I.D. X FEMALE 37°	MAF #	MAF PRICE
30266SS				3/8" x 3/8"		
30269SS				3/4" x 3/4"		

WARNING: This product can expose you to chemicals, including lead, which are known to the State of California to cause cancer and birth defects or other reproductive harm. For more information, visit www.P65Warnings.ca.gov

GARDEN HOSE FITTINGS



• **Temperature and Working Pressure Ranges**

From +35°F to +100°F at 75 PSI maximum or the recommended working pressure of the garden hose. (Not to exceed 150 PSI.)

Note: All female connector ends should have a rubber washer inserted prior to usage.

FGH = Female Garden Hose threads

MGH = Male Garden Hose threads

Male garden hose threads are all 3/4" with an outside diameter of 1.0625 and 11-1/2" threads per inch.



Male Garden Hose Profile



See Plastic section for Plastic Garden Hose Fittings



See Lead Free Section for lead free Garden Hose

Washers included are #30150B black rubber washers.

Actual Profile of Garden Hose Barbs

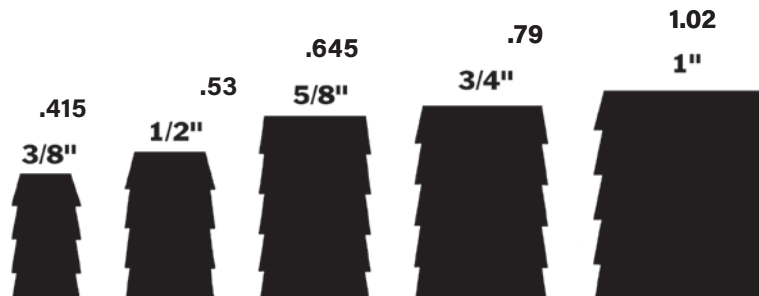

WARNING: This product can expose you to chemicals, including lead, which are known to the State of California to cause cancer and birth defects or other reproductive harm. For more information, visit www.P65Warnings.ca.gov

BRASS

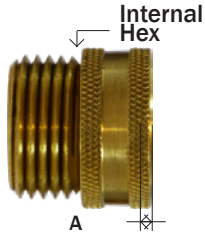
GARDEN HOSE**BRASS FITTINGS****SWIVEL - MGH X FGH****•WASHER INCLUDED****•NOT A LIVE SWIVEL**

MIDLAND	AMC	CHAMPION	LIST	MGH X FGH	MAF #	MAF PRICE
30000**		24AS-12		3/4" x 3/4"	106GH	
				1" x 3/4"	16GH	
				1" x 3/4"	16KNGH*	

** available in swivel crimp style | * Knurled Nut

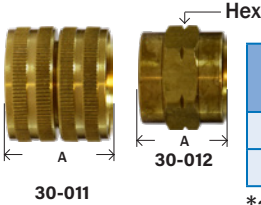
SWIVEL - FGH X FGH**•WASHER INCLUDED**

MIDLAND	AMC	CHAMPION	LIST	FGH X FGH	MAF #	MAF PRICE
30011	07403-12	22AS-12E		3/4" x 3/4"	S3*	
30012	07402-12	22A-12		No Swivel	13GH	

*add w for washer

HUS 91 203W GSU 101GHSV 22AS 506 FS66

SWIVEL - FGH X FEMALE PIPE

PART #	AMC	CHAMPION	LIST	FGH X FEMALE NPTF	MAF #	MAF PRICE
30001	07401-1208	5AS-12D		3/4" x 1/2"	S1*	
30006	07401-1212	5AS-12E		3/4" x 3/4"	S2*	
				1" x 1"	S5	

*add w for washer

S1 HSU11 91Z 197S 98GHSV 5AS 21517 502 FS65

EVAPORATIVE COOLER FITTINGS

MIDLAND	AMC	CHAMPION	LIST	SIZE	MAF #	MAF PRICE
50016	07487-1208			MGH x 1/2" FIP	ECD-12*	
30013	07492-0808			1/2 MIP x 1/2 FIP x 1/8	ECF8	
30019	07492-1212			3/4 MIP x 3/4 FIP x 1/8	ECF12	
30020	07493-1212			MGH x FGH x 1/8	ECF12H	

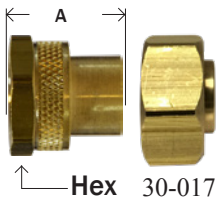
RIGID - FGH X FEMALE PIPE

MIDLAND	AMC	CHAMPION	LIST	FGH X FEMALE NPTF	MAF #	MAF PRICE
30016	07411-1202	5A-12A		3/4" x 1/8"	73GH	
30017	07411-1204	5A-12B		3/4" x 1/4"	74GH	
30018		5A-12C		3/4" x 3/8"	75GH	

95GH 501



SEE WEBSITE TO DOWNLOAD YOUR MOST UPDATED PRICING

WARNING: This product can expose you to chemicals, including lead, which are known to the State of California to cause cancer and birth defects or other reproductive harm. For more information, visit www.P65Warnings.ca.gov



GARDEN HOSE

BRASS FITTINGS

RIGID - FGH X FEMALE PIPE

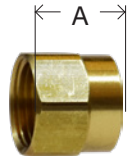

Hex

MIDLAND	AMC	CHAMPION	LIST	FGH X FEMALE NPTF	MAF #	MAF PRICE
30078	07482-1208	5A-12D		3/4" x 1/2"	82GH	
30083	07482-1212	5A-12E		3/4" x 3/4"	83GH	

FS67 198 HU11 21507 501 99GH 5A H15PP

SWIVEL - FGH X MALE PIPE

• WASHER INCLUDED

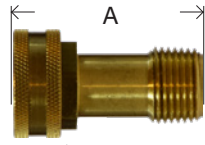

Hex

MIDLAND	AMC	CHAMPION	LIST	FGH X MALE NPTF	MAF #	MAF PRICE
30047	07420-1204			3/4" x 1/4"	102GH-LNG	
30048	07420-1206	W1-CX		3/4" x 3/8"	103GH-LNG	
30049	07420-1208			3/4" x 1/2"	104GH-LNG	

504 89GH W1 62H4 88GH W1

3/8" COMP 3/4" FGH DISHWASHER 90° ELBOW

• WASHER INCLUDED

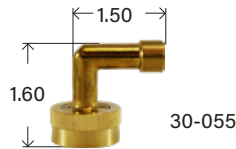
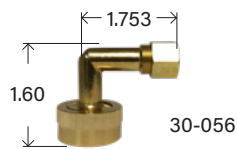

MIDLAND	LIST	3/4 FEMALE GARDEN HOSE THREAD X 3/8 COMPRESSION
30055		3/4" x 3/8" Body Only
30056		3/4" x 3/8" w/ nut & sleeve

SWIVEL - FGH X MALE PIPE

• WASHER INCLUDED

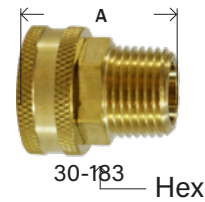

* Crimp style

MIDLAND	AMC	CHAMPION	LIST	FGH X MALE NPTF	MAF #	MAF PRICE
30181*		W1-B	----	3/4" x 1/4"	102GH	
30184*	07420-1206	W1-C	----	3/4" x 3/8"	103GH	
30183		W1-D	----	3/4" x 1/2"	104GH	
30182*		W1-E	----	3/4" x 3/4"	105GHXD	
				3/4" x 1/2"	104GHHN	
				3/4" x 3/4"	105GH	

RIGID - FGH X MALE PIPE

• WASHER INCLUDED

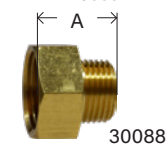

Hex



MIDLAND	AMC	CHAMPION	LIST	FGH X MALE NPTF	MAF #	MAF PRICE
30087		20A-12C	----	3/4" x 3/8"	84GH-126	
30088	07484-1208	20A-12D	----	3/4" x 1/2"	84GH	
30088S				3/4" x 1/2"(1/2"SWT)	84GHS	
30093	07484-1212	20A-12E	----	3/4" x 3/4"	85GH	
30094	07484-121208	20A-12ED	----	3/4" x 3/4"(1/2" FIP)	85GHT	
30093L*			----	3/4" x 3/4"	85GHL	

* Long pattern | ** 1/2 Swt = 5/8 O.D.

21505 503 83GH 20A HU21 199 H7

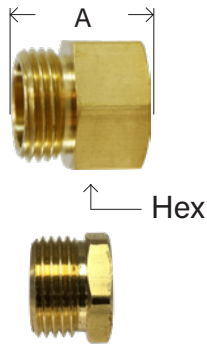
GARDEN HOSE**BRASS FITTINGS****RIGID - MGH X FEMALE PIPE**

MIDLAND	AMC	CHAMPION	LIST	MGH X FEMALE NPTF	MAF #	MAF PRICE
30066	07480-1204	18A-12B	----	3/4" x 1/4"	110GH-124	
30067	07480-1206	18A-12C	----	3/4" x 3/8"	110GH-126	
30068	07480-1208	18A-12D	----	3/4" x 1/2"	80GH	
30073	07480-1212	18A-12E	----	3/4" x 3/4"	81GH	
30074				3/4" x 1"	66GH-1216	
30075				1" x 1"	66GH-1616	

197 18R HU12 H11PP 18A 507 18H 81GH 21503 MF67

30-068

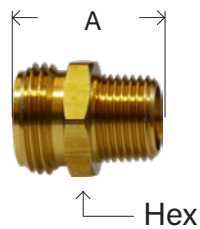
RIGID - MGH X MALE PIPE

MIDLAND	AMC	CHAMPION	LIST	MGH X MALE NPTF	MAF #	MAF PRICE
30054				3/4" x 1/4"	76GH	
30053	07478-1206	19A-12C	----	3/4" x 3/8"	77GH	
30058	07478-1208	19A-12D	----	3/4" x 1/2"	78GH	
30058S*	07478-1208			3/4" x 1/2" SWT	78GHS	
30063**	07478-121208	19AF-12DE	----	3/4" x 3/4" x 1/2"	79GHT	
30063BE***			----	3/4" x 3/4"	79GHTS	
30063S		19AF-12E	----	3/4" x 3/4" Short	79GH	
30064		19A-12F	----	3/4" x 1"	68GH-1216	
30065				1" x 1"	68GH-1616	

19R 196 H530 21501 508 HU22 514 71GH 19A

No Tap

* (1/2 Swt = 5/8 O.D.)

** (Tapped 1/2 FIP)

*** (Tapped 1/2 FIP

Both ends)

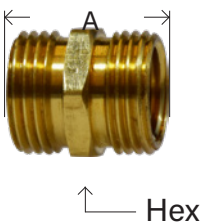
RIGID - MGH X MGH

* 1-11/2

MIDLAND	AMC	CHAMPION	LIST	MGH X MGH	MAF #	MAF PRICE
30098	07486-121208		----	3/4" x 3/4" (1/2" FIP)	86GHT	
30099	07486-1212	23A-12	----	3/4" x 3/4"	86GH	
30100*		23A-16	----	1" x 3/4"	86GH-1612H	
30101				1" x 1"	86GH-16H	

21500 509 75GH 23A H8 19R

GARDEN HOSE NUT

30-022

30-021

MIDLAND	AMC	CHAMPION	LIST	SIZE	MAF #	MAF PRICE
30021	07407-12	GHN1	----	Knurled	GHNK	
30022	07406-12	GHN1-HC	----	Cut Hex Nut	GHNH	
		GHN1-H		Hex Nut		

94GH GHN1 HNR 21514

Dimension data can change without notice. Please see our website when dimensions are critical.

WARNING: This product can expose you to chemicals, including lead, which are known to the State of California to cause cancer and birth defects or other reproductive harm. For more information, visit www.P65Warnings.ca.gov



GARDEN HOSE

BRASS FITTINGS

GARDEN HOSE WASHERS

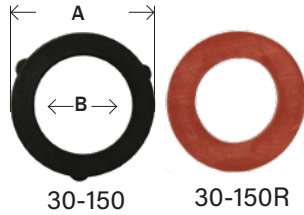

MIDLAND	AMC	CHAMPION	LIST	SIZE	MAF #	MAF PRICE
30150	07405-12	GH-W	----	black*	GHW	
30150R		GH-W-RED	----	red	GHW-12R	
				white	GHW-12-PE	
30151			----	1"	GHW-16	

* plasticized rubber

GHW 901GH

GARDEN HOSE FILTER WASHER

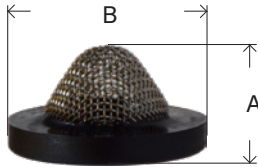

MIDLAND	AMC	CHAMPION	LIST	SIZE	MAF #	MAF PRICE
30180		GH-W-SCREEN	----	30 Mesh	GHFW	
30180F			----	60 Mesh	GHFW-60	

▪ 300 Series Stainless Steel Screen

LA662

GARDEN HOSE CAP

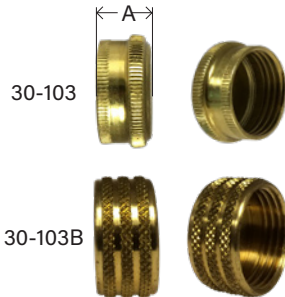

MIDLAND	AMC	CHAMPION	LIST	SIZE	MAF #	MAF PRICE
30103	07408-12	GHN5-DC	----	3/4" Die Cast		
30103B		GHN5	----	3/4" Barstock	HC-12BS	
				w/ washer	HC12BSW	

▪ Garden hose washers sold separately

513 96GH GHN5 HC1 LA215 21518 200-W

GARDEN HOSE CAP WITH CHAIN

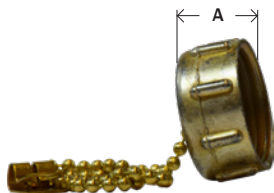

MIDLAND	AMC	CHAMPION	LIST	SIZE	MAF #	MAF PRICE
30142		GHN5-CHAIN	----	3/4" w/ 12" Chain	HC-12WC	

* Zinc die cast

GARDEN HOSE PLUG

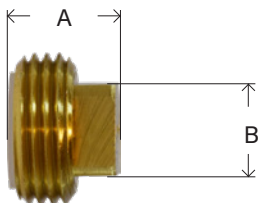

MIDLAND	AMC	CHAMPION	LIST	SIZE	MAF #	MAF PRICE
30026	07412-12	GHP1	----	3/4" Square	GHP	
				3/4 Hex	GHPH	

WARNING: This product can expose you to chemicals, including lead, which are known to the State of California to cause cancer and birth defects or other reproductive harm. For more information, visit www.P65Warnings.ca.gov

BRASS

GARDEN HOSE

BRASS FITTINGS

HOSE MENDERS - SOLID BARB X BARB

MIDLAND	AMC	CHAMPION	LIST	HOSE I.D. X HOSE I.D.	MAF #	MAF PRICE
32096			----	1/2"	29S-8	
32097	07014-10	HM-10	----	5/8"	29S-10	
32098	07014-12	HM-12	----	3/4"	29S-12	
32099			----	1"	29S-16	

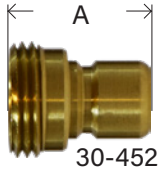
QUICK DISCONNECT GARDEN HOSE COUPLERS**.WASHER INCLUDED**

30-452

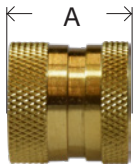

30-451

MIDLAND	AMC	CHAMPION	LIST	SIZE	MAF #	MAF PRICE
30450			----	Complete		
30451			----	Female end		
30452			----	Male end		
30149				Recessed Washer		

- Unvalved construction allows maximum Flow
- 150 PSI
- NBR Seals

LA73C

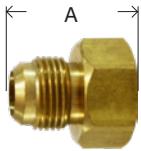
MALE FLARE X FGH RIGID

Hex

MIDLAND	AMC	CHAMPION	LIST	MALE FLARE X FGH	MAF #	MAF PRICE
30123	07495-0612	46WH-612	----	3/8" x 3/4"	94GH	
30128	07495-0812		----	1/2" x 3/4"	95GH	
30133	07495-1012		----	5/8" x 3/4"	96GH	

190 46WH HFU21

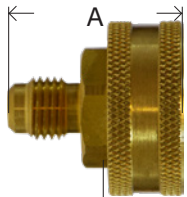
MALE FLARE X FGH SWIVEL**.WASHER INCLUDED**

Hex

MIDLAND	AMC	CHAMPION	LIST	MALE FLARE X FGH	MAF #	MAF PRICE
30052			----	1/4" x 3/4"	98GH	
30138	07499-0612	W1-6	----	3/8" x 3/4"	99GH	
30139	07499-0812		----	1/2" x 3/4"	100GH	

* Internal Hex

50GHSV 51GHSV W1 68H 191

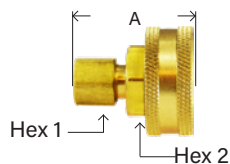
COMPRESSION X FGH**.WASHER INCLUDED**

Hex 1

Hex 2

MIDLAND	AMC	CHAMPION	LIST	SWIVEL COMPRESSION X FGH	MAF #	MAF PRICE
30050			----	1/4" x 3/4"	124GH-412	
30051			----	3/8" x 3/4"	125GH-612	
				1/2" x 3/4"	129GH-812	



MIDLAND	AMC	CHAMPION	LIST	NO SWIVEL COMPRESSION X MGH	MAF #	MAF PRICE
30135			----	1/4" x 3/4"	126GH	
30136			----	3/8" x 3/4"	127GH	
30137			----	1/2" x 3/4"	128GH	

Male Flare X Garden Hose Available

WARNING: This product can expose you to chemicals, including lead, which are known to the State of California to cause cancer and birth defects or other reproductive harm. For more information, visit www.P65Warnings.ca.gov

GARDEN HOSE

BRASS FITTINGS

BARSTOCK BRASS GARDEN HOSE COUPLINGS

FEMALE SWIVEL ONLY

•WASHER INCLUDED

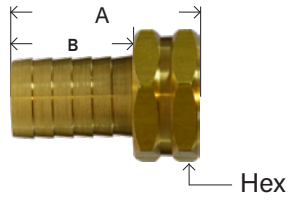

29FGH
329F



BRASS					
MIDLAND	CHAMPION	LIST	HOSE BARB X FGH	MAF #	MAF PRICE
30031	209GHS-6EH	----	3/8" x 3/4"	29FGH-612H	
30032	209GHS-8EH	----	1/2" x 3/4"	29FGH-812H	
30033	209GHS-10EH	----	5/8" x 3/4"	29FGH1012H	
30034	209GHS-12EH	----	3/4" x 3/4"	29FGH-1212H	
30044	209GHS-16EH	----	1" x 3/4"	29FGH-1612H	
30035	209GHS-16FH	----	1" x 1"	29FGH-1616H	

STAINLESS STEEL 316					
30032SS		----	1/2" x 3/4"		
30033SS		----	5/8" x 3/4"		
30034SS		----	3/4" x 3/4"		

MALE END ONLY

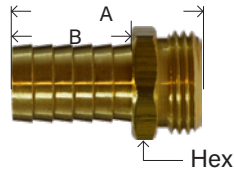

29MGH
329M



BRASS					
MIDLAND	CHAMPION	LIST	HOSE BARB X MGH	MAF #	MAF PRICE
30039	201GH-6EX	----	3/8" x 3/4"	29MGH-612	
30040	201GH-8EX	----	1/2" x 3/4"	29MGH-812	
30041	201GH-10EX	----	5/8" x 3/4"	29MGH-1012	
30042	201GH-12EX	----	3/4" x 3/4"	29MGH-1212	
30045	201GH-16EX	----	1" x 3/4"	29MGH-1612	
30043	201GH-16FX	----	1" x 1"	29MGH-1616	

STAINLESS STEEL 316					
30040SS		----	1/2" x 3/4"		
30041SS		----	5/8" x 3/4"		
30042SS		----	3/4" x 3/4"		

GARDEN HOSE COUPLING



BRASS					
MIDLAND	CHAMPION	LIST	HOSE BARB	MAF #	MAF PRICE
30025	202GHSH-66	----	3/8"	29GHS-65H	
30027	202GHSH-88	----	1/2"	29GHS-8H	
30028	202GHSH-1010	----	5/8"	29GHS-10H	
30029	202GHSH-1212	----	3/4"	29GHS-12H	
30046		----	1"(3/4" threads)	29GHS-16H	
30030	202GHSH-1616	----	1"		

STAINLESS STEEL 316					
30027SS		----	1/2"		
30028SS		----	5/8"		
30029SS		----	3/4"		

WARNING: This product can expose you to chemicals, including lead, which are known to the State of California to cause cancer and birth defects or other reproductive harm. For more information, visit www.P65Warnings.ca.gov

BRASS

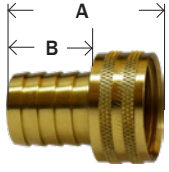
GARDEN HOSE**BRASS FITTINGS****FEMALE SWIVEL ONLY - SHORT SHANK KNURLED NUT**

MIDLAND	AMC	CHAMPION	LIST	HOSE BARB X FGH	MAF #	MAF PRICE
30464		209GHS-4E		1/4" x 3/4"	29FGH-412	
		209GHS-6E		3/8" x 3/4"	29FGH-0612	
30466	07046-0812	209GHS-8E	----	1/2" x 3/4"	29FGH-812	
30467	07046-1012	209GHS-10E	----	5/8" x 3/4"	209GHS-1012	
30468	07046-1212	209GHS-12E	----	3/4" x 3/4"	209GHS-1212	

FEMALE END ONLY - SHORT SHANK W/ HEX

MIDLAND	AMC	CHAMPION	LIST	HOSE X FGH	MAF #	MAF PRICE
30453			----	1/2" x 3/4"	29FGH-812MHK	
30454			----	5/8" x 3/4"	29FGH-1012MHK	
30455			----	3/4" x 3/4"	29FGH-1212MHK	

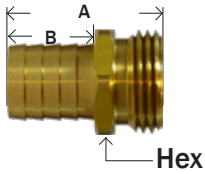
MALE END ONLY - SHORT SHANK

MIDLAND	AMC	CHAMPION	LIST	HOSE BARB X MGH	MAF #	MAF PRICE
30469				1/4" x 3/4"	29MGH-412	
	07048-0612	201GH-6E			29MGH-0612	
30471	07048-0812	201GH-8E	----	1/2" x 3/4"	29MGH-812	
30472	07048-1012	201GH-10E	----	5/8" x 3/4"	29MGH-1012	
30473	07048-1212	201GH-12E	----	3/4" x 3/4"	29MGH-1212	

GARDEN HOSE COUPLING SETS - SHORT SHANK W/ HEX NUT

MIDLAND	AMC	CHAMPION	LIST	HOSE BARB	MAF #	MAF PRICE
30457	07042-08	202GHS-88	----	1/2"	29GHS-8MHK	
30458	07042-10	202GHS-1010	----	5/8"	29GHS-10MHK	
30459	07042-12	202GHS-1212	----	3/4"	29GHS-12MHK	

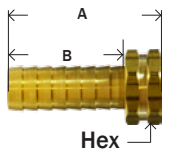
FEMALE SWIVEL ONLY - 2" SHANK**•WASHER INCLUDED**

GHFL 594

MIDLAND	AMC	CHAMPION	LIST	HOSE BARB X FGH	MAF #	MAF PRICE
30505		209GHS-8EHXL	----	1/2" x 3/4"	29FGH-8LGH	
30506		209GHS-10EHXL	----	5/8" x 3/4"	29FGH-10LGH	
30507		209GHS-12EHXL	----	3/4" x 3/4"	29FGH-12LGH	
30508		209GHS-16FHXL	----	1" x 1"	29FGH-16LGH	

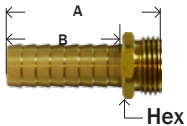
MALE END ONLY - 2" SHANK

MIDLAND	AMC	CHAMPION	LIST	HOSE BARB X MGH	MAF #	MAF PRICE
30510		201GH-8EXL	----	1/2" x 3/4"	29MGH-8LG	
30511		201GH-10EXL	----	5/8" x 3/4"	29MGH-10LG	
30512		201GH-12EXL	----	3/4" x 3/4"	29MGH-12LG	
30513		201GH-16FXL	----	1" x 1"	29MGH-16LG	

GARDEN HOSE COUPLING SETS - 2" SHANK

GHML 593

MIDLAND	AMC	CHAMPION	LIST	HOSE X FGH	MAF #	MAF PRICE
30516		202GHSH-8XL	----	1/2"	29GHS-8LGH	
30517		202GHSH-10XL	----	5/8"	29GHS-10LGH	
30518		202GHSH-12XL	----	3/4"	29GHS-12LGH	

WARNING: This product can expose you to chemicals, including lead, which are known to the State of California to cause cancer and birth defects or other reproductive harm. For more information, visit www.P65Warnings.ca.gov

NPSM GARDEN HOSE

BRASS FITTINGS

NPSM FEMALE SHORT SHANK

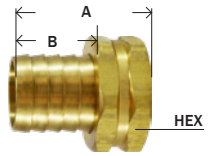

329NPSM

MIDLAND	AMC	CHAMPION	HOSE ID	LIST
30545	07040-812	209NPSM-8EH	1/2	----
30546	07040-1012		5/8	----
30547	07040-1212	209NPSM-12EH	3/4	----
30548			1	----

NPSM MALE SHORT SHANK

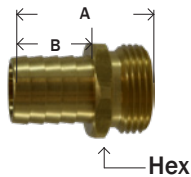

MIDLAND	AMC	CHAMPION	HOSE ID	LIST
30550			1/2	----
30551			5/8	----
30552			3/4	----
30553			1	----

NPSM SHORT SHANK SETS



MIDLAND	AMC	CHAMPION	SIZE	LIST
30540			1/2"	----
30541			5/8"	----
30542			3/4"	----
30543			1"	----

NPSM FEMALE LONG SHANK

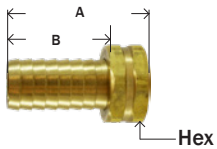

MIDLAND	AMC	CHAMPION	HOSE ID	LIST
30565			1/2	----
30566			5/8	----
30567			3/4	----
30568			1	----

NPSM MALE LONG SHANK

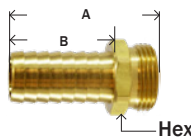

MIDLAND	AMC	CHAMPION	HOSE ID	LIST
30570			1/2	----
30571			5/8	----
30572			3/4	----
30573			1	----

NPSM LONG SHANK SETS



MIDLAND	AMC	CHAMPION	SIZE	LIST
30560			1/2"	----
30561			5/8"	----
30562			3/4"	----
30563			1"	----

WARNING: This product can expose you to chemicals, including lead, which are known to the State of California to cause cancer and birth defects or other reproductive harm. For more information, visit www.P65Warnings.ca.gov

BRASS

GARDEN HOSE VALVES/ FITTINGS

BRASS FITTINGS

GARDEN HOSE VALVES**ONE WAY BRASS BALL VALVE - FGH X MGH**

• 500 PSI • 180°F

• WASHER INCLUDED

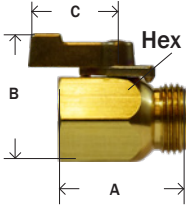

MIDLAND	AMC	CHAMPION	LIST	FGH X MGH	MAF #	MAF PRICE
30161		24AV-12	----	3/4" x 3/4"		

ONE WAY BRASS BALL VALVE - FEMALE PIPE X MGH

• 500 PSI • 180°F

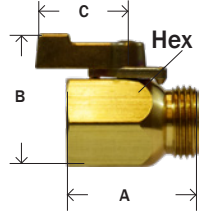

MIDLAND	AMC	CHAMPION	LIST	FEMALE NPTF X MGH	MAF #	MAF PRICE
30162		18AV-12E	----	3/4" x 3/4"		

ZINC ALLOY HOSE SHUT-OFF W/ ONE LEVER

• WASHER INCLUDED

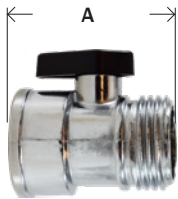

MIDLAND	AMC	CHAMPION	LIST	FGH X MGH	MAF #	MAF PRICE
30631			----	3/4" x 3/4"		

PLASTIC GARDEN HOSE VALVE • CYCOLAC BODY & BALL

• WASHER INCLUDED

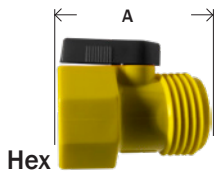

MIDLAND	AMC	CHAMPION	LIST	FGH X MGH	MAF #	MAF PRICE
30163			----	3/4" x 3/4"		

LA450C



VIEW PRICING AND AVAILABLE STOCK ONLINE

WARNING: This product can expose you to chemicals, including lead, which are known to the State of California to cause cancer and birth defects or other reproductive harm. For more information, visit www.P65Warnings.ca.gov



GARDEN HOSE VALVES

BRASS FITTINGS

ZINC ALLOY HOSE - "Y" CONNECTOR

• WASHER INCLUDED

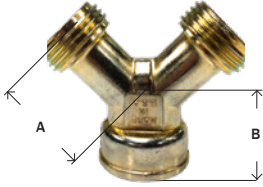

MIDLAND	AMC	CHAMPION	LIST	SIZE FGH X MGH(2)	MAF #	MAF PRICE
30141	07460-12			3/4"		

86Y 21A

CAST BRASS HOSE - "Y" CONNECTOR

• WASHER INCLUDED

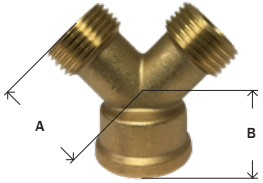

MIDLAND	AMC	CHAMPION	LIST	SIZE FGH X MGH(2)	MAF #	MAF PRICE
30140	07461-12		----	3/4"		

86Y 21A

86YRB
HY12

PLASTIC, NON-CORROSIVE, 2-WAY HOSE SHUT-OFF "Y"

• WASHER INCLUDED

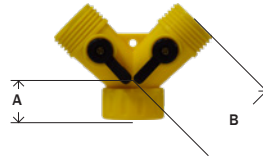

No Swivel ✓

MIDLAND	AMC	CHAMPION	LIST	SIZE FGH X MGH(2)	MAF #	MAF PRICE
30160			----	3/4"		

"Y" SHAPE ZINC ALLOY CONNECTOR W/ TWO LEVERS

• WASHER INCLUDED

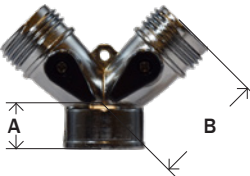

No Swivel

MIDLAND	AMC	CHAMPION	LIST	SIZE FGH X MGH(2)	MAF #	MAF PRICE
30626		21AVNI-12	----	3/4"		

"Y" SHAPE BRASS CONNECTOR W/ 2-WAY SHUT OFF

• WASHER INCLUDED



• Brass Levers

MIDLAND	AMC	CHAMPION	LIST	SIZE	MAF #	MAF PRICE
30627		21AV-12	----	3/4"		

ZINC ALLOY SWIVEL HOSE CONNECTOR

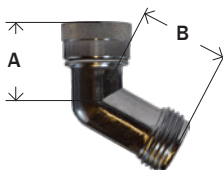

MIDLAND	AMC	CHAMPION	LIST	SIZE FGH X MGH	MAF #	MAF PRICE
30629			----	3/4"		

WARNING: This product can expose you to chemicals, including lead, which are known to the State of California to cause cancer and birth defects or other reproductive harm. For more information, visit www.P65Warnings.ca.gov



GARDEN HOSE NOZZLES

BRASS FITTINGS

2-1/2" BRASS NOZZLE

• WASHER INCLUDED

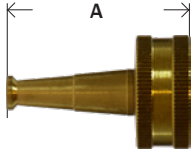

MIDLAND	AMC	CHAMPION	LIST	SIZE	MAF #	MAF PRICE
30637		PSN76	----	3/4"		

3" CROSSED PATTERN BRASS NOZZLE

• WASHER INCLUDED

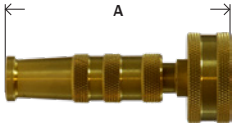

MIDLAND	AMC	CHAMPION	LIST	SIZE	MAF #	MAF PRICE
30640		500AM4-3	----	3/4"		

4" CROSSED PATTERN BRASS NOZZLE

• WASHER INCLUDED

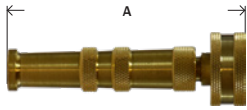

MIDLAND	AMC	CHAMPION	LIST	SIZE	MAF #	MAF PRICE
30638			----	3/4"		

ADJUSTABLE SPRAY

• WASHER INCLUDED



MIDLAND	AMC	CHAMPION	LIST	SIZE	MAF #	MAF PRICE
30600			----	5-1/2"		

Zinc Alloy spray nozzle with insulated handle soft grip and front thread protector

LEAD FREE

• WASHER INCLUDED



MIDLAND	AMC	CHAMPION	LIST	SIZE	MAF #	MAF PRICE
30620			----	4-1/4"		

Zinc Alloy spray nozzle

ADJUSTABLE SPRAY - LEAD FREE

• WASHER INCLUDED



MIDLAND	AMC	CHAMPION	LIST	SIZE	MAF #	MAF PRICE
30609			----	5-1/4"		

Zinc Alloy spray nozzle with easily adjustable brass head and plastic grip

PLASTIC SPRAY NOZZLE

• WASHER INCLUDED

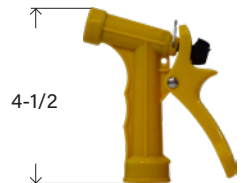

MIDLAND	AMC	CHAMPION	LIST	SIZE	MAF #	MAF PRICE
30630			----	4-1/2"		

Plastic spray nozzle

WARNING: This product can expose you to chemicals, including lead, which are known to the State of California to cause cancer and birth defects or other reproductive harm. For more information, visit www.P65Warnings.ca.gov



SAE 45° FLARE

BRASS FITTINGS

SAE 45° FLARE



Tube O.D.	1/8	3/16	1/4	5/16	3/8	7/16	1/2	5/8	3/4
Thread Size-B	5/16-24	3/8-24	7/16-20	1/2-20	5/8-18	11/16-16	3/4-16	7/8-14	1-1/16-14

•Typical Application

LP and natural gas, flammable liquids, instrumentation, refrigeration, power steering, hydraulic and pneumatic systems.

•Working Pressure Ranges

Temperature and type of tubing used are important factors. However, the following table is a good guide for proper selection. Temperature 73°F with copper tubing:

PSI	Tube O.D. (in.)	Tube Wall (in.)
2800	1/8	.030
1900	3/16	.030
1400	1/4	.030
1200	5/16	.032
1000	3/8	.032
750	1/2	.032
650	5/8	.035
550	3/4	.035
450	7/8	.035

•Vibration

Good resistance - use long nut when greater vibration resistance is required.

•Temperature Range

-65°F to +250°F (-53°C to +121°C) range at maximum operating pressures.

•Used With

Copper, brass, aluminum and steel hydraulic tubing that can be flared.

Actual O.D. of Flare Fittings

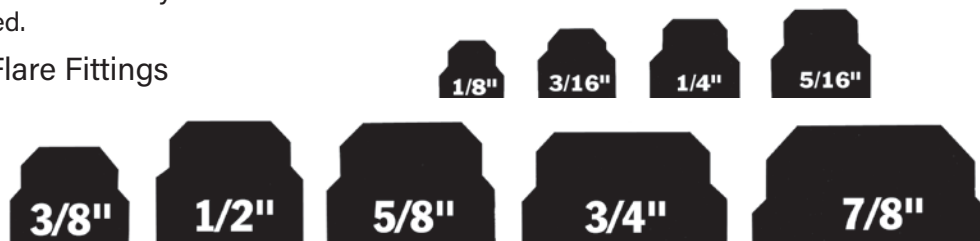

• Tolerance

+/- .03 on all dimensions. Dimension data can change without notice. Please call us when dimensions are critical.

•Conformance

Meets specifications and standards of ASA, ASME, SAE and MS (Military standards).

Assembly Instructions

- 1- Cut tubing to desired length. Make sure all burrs are removed and ends are cut square.
- 2- Slide nut on tube. Threaded end "A" of nut must face out.
- 3- Flare end of tube with a 45° flaring tool.
 - a- Measure flare diameter.
 - b- Examine flare for excessive thin out.
- 4- Lubricate threads and assemble to fitting body. Nut should be turned hand tight.
- 5- Tighten assembly with wrench until a solid feeling is encountered. From that point, apply a one-sixth turn.

Note: Do not over-torque as it may damage the fitting or split the tubing at the flare.

PRICING FILE AVAILABLE ONLINE

WARNING: This product can expose you to chemicals, including lead, which are known to the State of California to cause cancer and birth defects or other reproductive harm. For more information, visit www.P65Warnings.ca.gov

BRASS

SAE 45° FLARE

BRASS FITTINGS

SAE# 010110

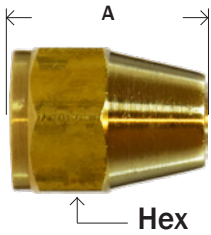
SHORT ROD NUT

41S
411S
04014

MIDLAND	AMC	CHAMPION	LIST	THREAD SIZE UNF	MAF #	MAF PRICE
10013	04014-02	N1-2		1/8"	21110X2	...
				1/8"	41S-2	...
10014	04014-03	N1-3		3/16"	21110X3	...
				3/16"	41S-3	...
10015				1/4"	21110X4	...
10015L	04014-04	N1-4		1/4"	41S-4	...
				1/4"	21010X4	...
10016	04014-05	N1-5		5/16"	21110X5	...
				5/16"	41S-5	...
10017L	04014-06	N1-6		3/8"	41S-6	...
				3/8"	21010X6	...
10017		41AS-6		3/8"	21110X6	...
10018	04014-07	N1-7		7/16"	21110X7	...
				7/16"	41S-7	...
10019L	04014-08	N1-8		1/2"	41S-8	...
10019		41AS-8		1/2"	21110X8	...
10020L	04014-10	N1-10		5/8"	41S-10	...
10020		41AS-10		5/8"	21110X10	...
10021	04014-12	N1-12		3/4"	41S-12	...
				3/4"	21110X12	...
10022	04014-14	N1-14		7/8"	41S-14	...
				7/8"	21110X14	...
10026	04014-16	N1-16		1"	41S-16	...

20910 41FS 1110 N1 41FX 441S 'L'

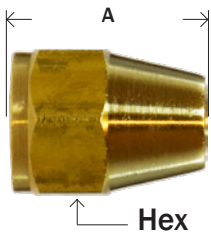
REDUCING SHORT ROD NUT

MIDLAND	AMC	CHAMPION	LIST	THREAD SIZE UNF	MAF #	MAF PRICE
10023		N1-64		3/8" x 1/4"	41SR-64	...
10024		N1-86		1/2" x 3/8"	41SR-86	...
10025		N1-108		5/8" x 1/2"	41SR-108	...

WARNING: This product can expose you to chemicals, including lead, which are known to the State of California to cause cancer and birth defects or other reproductive harm. For more information, visit www.P65Warnings.ca.gov

SAE 45° FLARE

BRASS FITTINGS

LONG ROD NUT

SAE# 010111

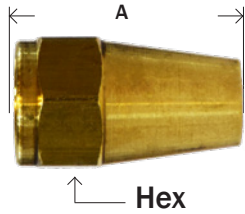

41L
04041

MIDLAND	AMC	CHAMPION	LIST	THREAD SIZE UNF	MAF #	MAF PRICE
10001	04041-02	N2-2		1/8"	41L-2	...
10002	04041-03	N2-3		3/16"	41L-3	...
10003	04041-04	N2-4		1/4"	41L-4	...
10004	04041-05	N2-5		5/16"	41L-5	...
10005	04041-06	N2-6		3/8"	41L-6	...
10006	04041-08	N2-8		1/2"	41L-8	...
10007	04041-10	N2-10		5/8"	41L-10	...
10008	04041-12	N2-12		3/4"	41L-12	...

41FL N2 241 441 41

LONG FORGED NUT

SAE# 010167

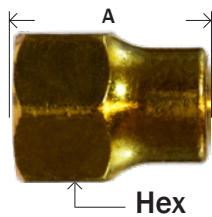

640L
641L
04016

MIDLAND	AMC	CHAMPION	LIST	THREAD SIZE UNF	MAF #	MAF PRICE
10028	04016-04	N4-4		1/4"	641L-4	...
	04016-05	N4-5		5/16"	641L-5	...
10030	04016-06	N4-6		3/8"	641L-6	...
10031	04016-08	N4-8		1/2"	641L-8	...
10032	04016-10	N4-10		5/8"	641L-10	...
10033	04016-12	N4-12		3/4"	641L-12	...

41FF 39 N4 14FL 641

SHORT FORGED NUT

SAE# 010166

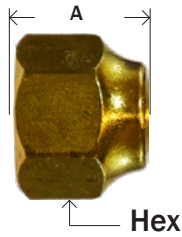

641S
6401S
04018

MIDLAND	AMC	CHAMPION	LIST	THREAD SIZE UNF	MAF #	MAF PRICE
10038	04018-03	NS4-3		3/16"	641S-3	...
10039	04018-04	NS4-4		1/4"	641S-4	...
10040	04018-05	NS4-5		5/16"	641S-5	...
10041	04018-06	NS4-6		3/8"	641S-6	...
10042	04018-08	NS4-8		1/2"	641S-8	...
10043	04018-10	NS4-10		5/8"	641S-10	...
10044	04018-12	NS4-12		3/4"	641S-12	...
10045	04018-14	NS4-14		7/8"	641S-14	...

14FS 41FFS 40 641-S 1116 NS4

FROST PROOF

MIDLAND	AMC	CHAMPION	LIST	THREAD SIZE UNF	MAF #	MAF PRICE
				1/4"	641SFP-4	...
				3/8"	641SFP-6	...
				1/2"	641SFP-8	...
				5/8"	641SFP-10	...

WARNING: This product can expose you to chemicals, including lead, which are known to the State of California to cause cancer and birth defects or other reproductive harm. For more information, visit www.P65Warnings.ca.gov

BRASS

SAE 45° FLARE

BRASS FITTINGS

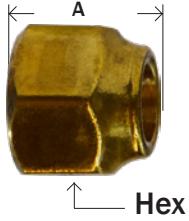
EXTRA HEAVY SHORT FORGED NUT

641SH
6401SXH
04019

MIDLAND	AMC	CHAMPION	LIST	THREAD SIZE UNF	MAF #	MAF PRICE
10046	04019-04			1/4"	641SH-4	...
				5/16"	641SH-5	...
10047	04019-06			3/8"	641SH-6	...
10048	04019-08			1/2"	641SH-8	...
10049	04019-10			5/8"	641SH-10	...
				3/4"	641SH-12	...
				7/8"	641SH-14	...

NSA

FORGED REDUCING NUT

660
662S
04020

MIDLAND	AMC	CHAMPION	LIST	FEMALE FLARE X OD	MAF #	MAF PRICE
10051	04020-0504	NSR4-54		5/16" x 1/4"	662S-54	...
10052	04020-0604	NSR4-64		3/8" x 1/4"	662S-64	...
10053	04020-0605	NSR4-65		3/8" x 5/16"	662S-65	...
10054	04020-0806	NSR4-86		1/2" x 3/8"	662S-86	...
10055	04020-1006	NSR4-106		5/8" x 3/8"	662S-106	...
10056	04020-1008	NSR4-108		5/8" x 1/2"	662S-108	...
	04020-1208	NSR4-128		3/4" x 1/2"	662S-128	...
10058	04020-1210	NSR4-1210		3/4" x 5/8"	662S-1210	...

NSR4 14FS 41FRS 40R 662-S

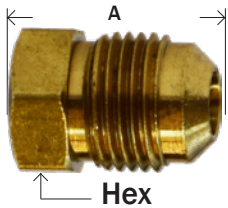
FLARED PLUG

39
439
04039

MIDLAND	AMC	CHAMPION	LIST	THREAD SIZE UNF	MAF #	MAF PRICE
10062	04039-02			1/8"	39-2	...
10063	04039-03	P2-3		3/16"	39-3	...
10064	04039-04	P2-4		1/4"	39-4	...
10065	04039-05	P2-5		5/16"	39-5	...
10066	04039-06	P2-6		3/8"	39-6	...
10067	04039-08	P2-8		1/2"	39-8	...
10068	04039-10	P2-10		5/8"	39-10	...
10069	04039-12	P2-12		3/4"	39-12	...
				7/8"	39-14	...

58 639F PF 57 P2 2229 439

WARNING: This product can expose you to chemicals, including lead, which are known to the State of California to cause cancer and birth defects or other reproductive harm. For more information, visit www.P65Warnings.ca.gov



SAE 45° FLARE

BRASS FITTINGS

FLARED CAP

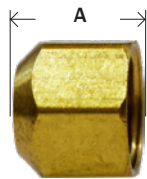

Hex

40
440
04040

MIDLAND	AMC	CHAMPION	LIST	THREAD SIZE UNF	MAF #	MAF PRICE
10073	04040-02			1/8"	40-2	...
10074	04040-03	N5-3		3/16"	40-3	...
10075 *	04040-04	N5-4		1/4"	40-4	...
10075EH				1/4"	2139X4	...
10076	04040-05	N5-5		5/16"	40-5	...
10077 *	04040-06	N5-6		3/8"	40-6	...
10078	04040-08	N5-8		1/2"	40-8	...
10079	04040-10	N5-10		5/8"	40-10	...
10080	04040-12	N5-12		3/4"	40-12	...
				7/8"	40-14	...

640F 41FC 56 N5 2129 54 440

FINGER TIGHTENING CAP



NFTS
FTC5
04099

MIDLAND	AMC	CHAMPION	LIST	THREAD SIZE UNF	MAF #	MAF PRICE
10081	04099-04			1/4"	FTC5-4	...
10082	04099-06			3/8"	FTC5-6	...

• Neoprene | • O-Ring Included

NFT5

COPPER GASKET

SAE# 010113



463
04063

MIDLAND	AMC	CHAMPION	LIST	SIZE	MAF #	MAF PRICE
10084	04063-03			3/16"	463-3	...
10085	04063-04	B2-4		1/4"	463-4	...
10086	04063-05	B2-5		5/16"	463-5	...
10087	04063-06	B2-6		3/8"	463-6	...
10088	04063-08	B2-8		1/2"	463-8	...
10089	04063-10	B2-10		5/8"	463-10	...
10090	04063-12	B2-12		3/4"	463-12	...

B2 2GF 6251 FG 157 59 46

COPPER BONNET

SAE# 010114

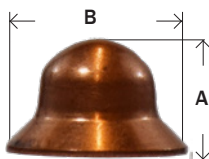

464
04064

MIDLAND	AMC	CHAMPION	LIST	SIZE	MAF #	MAF PRICE
10094	04064-03			3/16"	464-3	...
10095	04064-04	B1-4		1/4"	464-4	...
	04064-05			5/16"	464-5	...
10097	04064-06	B1-6		3/8"	464-6	...
10098	04064-08	B1-8		1/2"	464-8	...
10099	04064-10	B1-10		5/8"	464-10	...
10100	04064-12			3/4"	464-12	...

B1 3GF 64C 57 156 FB 695 464

WARNING: This product can expose you to chemicals, including lead, which are known to the State of California to cause cancer and birth defects or other reproductive harm. For more information, visit www.P65Warnings.ca.gov

BRASS

SAE 45° FLARE

BRASS FITTINGS

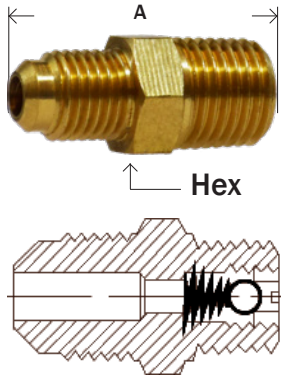
MALE BALL CHECK CONNECTOR

MIDLAND	AMC	CHAMPION	LIST	MALE FLARE X MALE NPTF	MAF #	LIST
10131*	04043-0402			1/4" x 1/8"	43-42	...
10256WC				1/4" x 1/4"	43-44	...
10132				5/16" x 1/8"	43-52	...
10133*	04043-0604			3/8" x 1/4"	43-64	...

43A

43
403
04043

* Note: Ball & Spring position may be reversed to change flow/check position. Min working pressure 3 PSI.

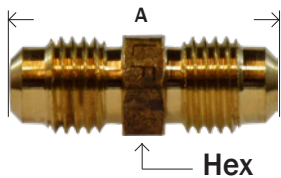
UNION**SAE# 010101**

42 - LIGHT
242 - SAE
04042

MIDLAND	AMC	CHAMPION	LIST	THREAD SIZE UNF	MAF #	MAF PRICE
10104	04042-02	U2-2		1/8"	242X2	...
				1/8"	42-2	...
10105	04042-03	U2-3		3/16"	242X3	...
				3/16"	42-3	...
10106L	04042-04	U2-4		1/4"	42-4	...
10106				1/4"	242X4	...
10106EH				1/4"	R42XH-4	...
10107	04042-05	U2-5		5/16"	242X5	...
				5/16"	42-5	...
10108L	04042-06			3/8"	42-6	...
10108		U2-6		3/8"	242X6	...
				7/16"	242X7	...
10109L	04042-08	U2-8		1/2"	42-8	...
10109				1/2"	242X8	...
10110L	04042-10			5/8"	42-10	...
10110		U2-10		5/8"	242X10	...
				3/4"	42-12	...
10111	04042-12	U2-12		3/4"	242X12	...
10112	04042-14	U2-14		7/8"	42-14	...

42F U2

WARNING: This product can expose you to chemicals, including lead, which are known to the State of California to cause cancer and birth defects or other reproductive harm. For more information, visit www.P65Warnings.ca.gov

SAE 45° FLARE

BRASS FITTINGS

REDUCING UNION



42R
506
04056

MIDLAND	AMC	CHAMPION	LIST	THREAD SIZE UNF	MAF #	MAF PRICE
10115	04056-0402			1/4" x 1/8"	42R-42	...
10116	04056-0403			1/4" x 3/16"	42R-43	...
10117	04056-0504	UR2-54		5/16" x 1/4"	42R-54	...
10118	04056-0604	UR2-64		3/8" x 1/4"	42R-64	...
				3/8" x 1/4"	242RX6X4	...
10119	04056-0605	UR2-65		3/8" x 5/16"	42R-65	...
10120	04056-0804	UR2-84		1/2" x 1/4"	42R-84	...
				1/2" x 1/4"	242RX8X4	...
10121	04056-0806	UR2-86		1/2" x 3/8"	42R-86	...
				1/2" x 3/8"	242RX8X6	...
10122	04056-1006	UR2-106		5/8" x 3/8"	42R-106	...
				5/8" x 3/8"	242RX10X6	...
10123	04056-1008	UR2-108		5/8" x 1/2"	42R-108	...
				5/8" x 1/2"	242RX10X8	...
10126	04056-1208	UR2-128		3/4" x 1/2"	42R-128	...
10127	04056-1210	UR2-1210		3/4" x 5/8"	42R-1210	...

656F UR2 42-R

BULKHEAD UNION

MIDLAND	AMC	CHAMPION	LIST	THREAD SIZE UNF	MAF #	MAF PRICE
				1/4"	42BH-4	...
				3/8"	42BH-6	...
				1/2"	42BH-8	...
				5/8"	42BH-10	...
				3/4"	42BH-12	...
				3/8" x 1/2"	42RBH-68	...
				1/2" x 3/8"	42RBH-86	...

LOCKNUT ONLY

				1/4"	41LN-4	...
				3/8"	41LN-6	...
				1/2"	41LN-8	...

244F T2 144F

UNION TEE



44F - FORGED
404
244 - BARSTOCK
04044

MIDLAND	AMC	CHAMPION	LIST	THREAD SIZE UNF	MAF #	MAF PRICE
10157	04044-02	T2-2		1/8"	44F-2	...
10158	04044-03	T2-3		3/16"	44F-3	...
10159	04044-04	T2F-4		1/4"	44F-4	...
		T2-4		1/4"	244X4	...
10160	04044-05	T2-5		5/16"	44F-5	...
				5/16"	244X5	...
10161	04044-06	T2-6		3/8"	44F-6	...
				3/8"	244X6	...
10162	04044-08	T2-8		1/2"	44F-8	...
				1/2"	244X8	...
10163	04044-10	T2-10		5/8"	44F-10	...
				5/8"	244X10	...
10164	04044-12	T2-12		3/4"	44F-12	...
10165	04044-14			7/8"	44F-14	...

244F T2 144F

WARNING: This product can expose you to chemicals, including lead, which are known to the State of California to cause cancer and birth defects or other reproductive harm. For more information, visit www.P65Warnings.ca.gov

SAE 45° FLARE

BRASS FITTINGS

REDUCING TEE 1 X 2 X 3

144F TR2 659F 684F 44R

44FR
509
04059

MIDLAND	AMC	CHAMPION	LIST	THREAD SIZE UNF 1X2X3	MAF #	MAF PRICE
10170	04059-040406	TR2-446		1/4" x 1/4" x 3/8"	44FR-446	...
10171	04059-050504			5/16" x 5/16" x 1/4"	44FR-554	...
10172	04059-060404			3/8" x 1/4" x 1/4"	44FR-644	...
10173	04059-060406			3/8" x 1/4" x 3/8"	44FR-646	...
10174	04059-060604	TR2-664		3/8" x 3/8" x 1/4"	44FR-664	...
10175	04059-060608	TR2-668		3/8" x 3/8" x 1/2"	44FR-668	...
10176	04059-060610	TR2-6610		3/8" x 3/8" x 5/8"	44FR-6610	...
	04059-080408			1/2" x 1/4" x 1/2"	44FR-848	...
10178	04059-080606	TR2-686		1/2" x 3/8" x 3/8"	44FR-866	...
10179	04059-080608	TR2-868		1/2" x 3/8" x 1/2"	44FR-868	...
10180	04059-080804	TR2-884		1/2" x 1/2" x 1/4"	44FR-884	...
10181	04059-080806	TR2-886		1/2" x 1/2" x 3/8"	44FR-886	...
10182	04059-080810	TR2-8810		1/2" x 1/2" x 5/8"	44FR-8810	...
	04059-080812	TR2-8812		1/2" x 1/2" x 3/4"		
	04059-100608	TR2-1068		5/8" x 3/8" x 1/2"		
	04059-100610	TR2-10610		5/8" x 3/8" 5/8"		
	04059-100808	TR2-1088		5/8" x 1/2" x 1/2"		
	04059-100606			5/8" x 3/8" x 3/8"	44FR-1066	...
10187	04059-100810	TR2-10810		5/8" x 1/2" x 5/8"	44FR-10810	...
	04059-101006	TR2-10106		5/8" x 5/8" x 1/4"	44FR-10104	...
10188	04059-101008	TR2-10108		5/8" x 5/8" x 3/8"	44FR-10106	...
10189	04059-121210			5/8" x 5/8" x 1/2"	44FR-10108	...
				3/4" x 5/8" x 3/4"	44FR-121012	...
				3/4" x 3/4" x 5/8"	44FR-121210	...

**MALE BRANCH
TEE**

SAE# 010425

45R
245
405

MIDLAND	AMC	CHAMPION	LIST	MALE FLARE X MALE NPT (1&2)X3	MAF #	MAF PRICE
	04045-0202	T1-2A		1/8" x 1/8"		
10203	04045-0302	T1-3A		3/16" x 1/8"		
10204	04045-0402	T1F-4A		1/4" x 1/8"		
10205	04045-0404	T1-4B		1/4" x 1/4"		
10206	04045-0406			1/4" x 3/8"		
	04045-0408	T1-4D		1/4" x 1/2"		
10207	04045-0502	T1-5A		5/16" x 1/8"		
10208	04045-0504	T1-5B		5/16" x 1/4"		
10209	04045-0602	T1-6A		3/8" x 1/8"		
10210	04045-0604	T1-6B		3/8" x 1/4"		
10211	04045-0606	T1-6C		3/8" x 3/8"		
10212	04045-0608	T1-6D		3/8" x 1/2"		
10213	04045-0804	T1-8B		1/2" x 1/4"		
10214	04045-0806	T1-8C		1/2" x 3/8"		
10215	04045-0808	T1-8D		1/2" x 1/2"		
10216	04045-0812	T1-8E		1/2" x 3/4"		
10217	04045-1006	T1-10C		5/8" x 3/8"		
10218	04045-1008	T1-10D		5/8" x 1/2"		
10219	04045-1012	T1-10E		5/8" x 3/4"		
10220	04045-1208	T1-12D		3/4" x 1/2"		
	04045-1212	T1-12E		3/4" x 3/4"		

WARNING: This product can expose you to chemicals, including lead, which are known to the State of California to cause cancer and birth defects or other reproductive harm. For more information, visit www.P65Warnings.ca.gov

SAE 45° FLARE

BRASS FITTINGS

FEMALE ADAPTER

SAE# 010103



46 - LIGHT
246 - SAE
406
04046

MIDLAND	AMC	CHAMPION	LIST	MALE FLARE X FEMALE NPTF	MAF #	MAF PRICE
	04046-0202	u3-2a		1/8" x 1/8"	46-22	...
10227	04046-0302	U3-3A		3/16" x 1/8"	246X3	...
				3/16" x 1/8"	46-32	...
10228L	04046-0402	U3-4A		1/4" x 1/8"	46-42	...
10228		RU3-4A		1/4" x 1/8"	246X4	...
10229L	04046-0404	U3-4B		1/4" x 1/4"	46-44	...
10229				1/4" x 1/4"	246X4X4	...
10230	04046-0406	U3-4C		1/4" x 3/8"	46-46	...
				1/4" x 3/8"	246X4X6	...
10231	04046-0408	U3-4D		1/4" x 1/2"	46-48	...
10232	04046-0502	U3-5A		5/16" x 1/8"	246X5	...
				5/16" x 1/8"	46-52	...
				5/16" x 1/4"	246X5X4	...
10233	04046-0504	U3-5B		5/16" x 1/4"	46-54	...
	04046-0506	u3-5c		5/16" x 3/8"		
				3/8" x 1/8"	246X6X2	...
10234	04046-0602	U3-6A		3/8" x 1/8"	46-62	...
10235L	04046-0604	U3-6B		3/8" x 1/4"	46-64	...
10235		RU3-6B		3/8" x 1/4"	246X6	...
10236L	04046-0606			3/8" x 3/8"	46-66	...
10236		U3-6C		3/8" x 3/8"	246X6X6	...
10237L	04046-0608	U3-6D		3/8" x 1/2"	46-68	...
10237		RU3-6D		3/8" x 1/2"	246X6X8	...
10238	04046-0612	U3-6E		3/8" x 3/4"	46-612	...
10239	04046-0804	U3-8B		1/2" x 1/4"	46-84	...
10240L	04046-0806	U3-8C		1/2" x 3/8"	46-86	...
10240		RU3-8C		1/2" x 3/8"	246x8	...
10241L	04046-0808			1/2" x 1/2"	46-88	...
10241		RU3-8D		1/2" x 1/2"	246x8x8	...
10242L	04046-0812	U3-8E		1/2" x 3/4"	46-812	...
10242				1/2" x 3/4"	246X8X12	...
10243	04046-1006	U3-10C		5/8" x 3/8"	46-106	...
10244L	04046-1008	U3-10D		5/8" x 1/2"	46-108	...
10244				5/8" x 1/2"	246X10	...
10245	04046-1012	U3-10E		5/8" x 3/4"	46-1012	...
10246	04046-1208	U3-12D		3/4" x 1/2"	46-128	...
10247	04046-1212	U3-12E		3/4" x 3/4"	46-1212	...
				7/8" x 1/2"	46-148	...
10248	04046-1412	U3-14E		7/8" x 3/4"	46-1412	...

46 U3

WARNING: This product can expose you to chemicals, including lead, which are known to the State of California to cause cancer and birth defects or other reproductive harm. For more information, visit www.P65Warnings.ca.gov

BRASS

SAE 45° FLARE

BRASS FITTINGS

MALE ADAPTER

SAE# 010102



48
248 - LIGHT
408 - SAE
04048

MIDLAND	AMC	CHAMPION	LIST	MALE FLARE X MALE NPTF	MAF #	MAF PRICE
10253	04048-0202	U1-2A		1/8" x 1/8"	248X2	...
				1/8" x 1/8"	48-22	...
10254	04048-0302	U1-3A		3/16" x 1/8"	248X3	...
				3/16" x 1/8"	48-32	...
	04048-0302	U1-3B		3/16" x 1/4"	48-34	...
10255L	04048-0402	U1-4A		1/4" x 1/8"	48-42	...
10255		RU1-4A		1/4" x 1/8"	248X4	...
10255EH				1/4" x 1/8"	R48XH-42	...
				1/4" x 1/4"	AV48-44	...
10256L	04048-0404	U1-4B		1/4" x 1/4"	48-44	...
10256	04448-0404	RU1-4B		1/4" x 1/4"	248X4X4	...
10257	04048-0406	U1-4C		1/4" x 3/8"	48-46	...
				1/4" x 3/8"	248X4X6	...
10258	04048-0408	U1-4D		1/4" x 1/2"	48-48	...
				1/4" x 1/2"	248X4X8	...
10259L	04048-0502	U1-5A		5/16" x 1/8"	48-52	...
10259				5/16" x 1/8"	248X5	...
10260L	04048-0504	U1-5B		5/16" x 1/4"	48-54	...
10260		RU1-5B		5/16" x 1/4"	248X5X4	...
10261	04048-0506	U1-5C		5/16" x 3/8"	48-56	...
				5/16" x 1/2"	48-58	...
10262	04048-0602	U1-6A		3/8" x 1/8"	248X6X2	...
				3/8" x 1/8"	48-62	...
10263L	04048-0604	U1-6B		3/8" x 1/4"	48-64	...
10263		RU1-6B		3/8" x 1/4"	248X6	...
10264L	04048-0606	U1-6C		3/8" x 3/8"	48-66	...
10264	04448-0606	RU1-6C		3/8" x 3/8"	248X6X6	...
10265L		U1-6D		3/8" x 1/2"	48-68	...
10265	04048-0608	RU1-6D		3/8" x 1/2"	248X6X8	...
10266	04448-0612	RU1-6E		3/8" x 3/4"	248X6X12	...
				7/16" x 1/4"	248X7	...
				1/2" x 1/8"	248X8X2	...
10267	04048-0804	U1-8B		1/2" x 1/4"	48-84	...
				1/2" x 1/4"	248X8X4	...
10268L	04048-0806	U1-8C		1/2" x 3/8"	48-86	...
10268	04448-0806	RU1-8C		1/2" x 3/8"	248X8	...
10269L		U1-8D		1/2" x 1/2"	48-88	...
10269	04048-0808	RU1-8D		1/2" x 1/2"	248X8X8	...
10270	04048-0812	U1-8E		1/2" x 3/4"	248X8X12	...
				1/2" x 3/4"	48-812	...
10271	04048-1004	U1-10B		5/8" x 1/4"	48-104	...
				5/8" x 1/4"	248X10X4	...

CONTINUED ON NEXT PAGE

U1 48

WARNING: This product can expose you to chemicals, including lead, which are known to the State of California to cause cancer and birth defects or other reproductive harm. For more information, visit www.P65Warnings.ca.gov



SAE 45° FLARE

BRASS FITTINGS

MALE ADAPTER - CONTINUED

MIDLAND	AMC	CHAMPION	LIST	MALE FLARE X MALE NPTF	MAF #	MAF PRICE
10272L	04048-1006	U1-10C		5/8" x 3/8"	48-106	...
10272		RU1-10C		5/8" x 3/8"	248X10X6	...
10273L		U1-10D		5/8" x 1/2"	48-108	...
10273	04048-1008	RU1-10D		5/8" x 1/2"	248X10	...
10274	04448-1012	RU1-10E		5/8" x 3/4"	248X10X12	...
				5/8" x 3/4"	48-1012	...
10275	04048-1208	U1-12D		3/4" x 1/2"	248X12	...
				3/4" x 1/2"	48-128	...
10276	04048-1212	U1-12E		3/4" x 3/4"	248X12X12	...
				3/4" x 3/4"	48-1212	...
10277	04048-1408	U1-14D		7/8" x 1/2"	48-148	...
10278	04048-1412	U1-14E		7/8" x 3/4"	48-1412	...
				1" x 1/2"	48-168	...
10279	04048-1612	U1-16E		1" x 3/4"	48-1612	...
10280	04048-1616	U1-16F		1" x 1"	48-1616	...

WARNING: This product can expose you to chemicals, including lead, which are known to the State of California to cause cancer and birth defects or other reproductive harm. For more information, visit www.P65Warnings.ca.gov

BRASS

SAE 45° FLARE

BRASS FITTINGS

**90° MALE ELBOW
SAE# 010202**

Forged Elbow

249
E1

Barstock Elbow

*Barstock
**Available in
stainless steel add
SS to part #

Dimension data
can change without
notice. Please call
when dimensions
are critical.

MIDLAND	AMC	CHAMPION	LIST	MALE FLARE X MALE NPTF	MAF #	MAF PRICE
10283	04049-0202	E1-2A		1/8" x 1/8"	49F-22	...
10283B*				1/8" x 1/8"	249X2	...
10284	04049-0302	E1F-3A		3/16" x 1/8"	49F-32	...
10284B*		E1-3A		3/16" x 1/8"	249X3	...
10285	04049-0304	E1-3B		3/16" x 1/4"	49F-34	...
10286	04049-0402	E1F-4A		1/4" x 1/8"	49F-42	...
10286B*		E1-4A		1/4" x 1/8"	249X4	...
10287	04049-0404	E1F-4B		1/4" x 1/4"	49F-44	...
10287B*		E1-4B		1/4" x 1/4"	249X4X4	...
10288 **	04049-0406	E1-4C		1/4" x 3/8"	49F-46	...
				1/4" x 3/8"	249X4X6	...
10289	04049-0408	E1-4D		1/4" x 1/2"	49F-48	...
10290	04049-0502	E1F-5A		5/16" x 1/8"	49F-52	...
10290B*		E1-5A		5/16" x 1/8"	249X5	...
10291	04049-0504	E1-5B		5/16" x 1/4"	49F-54	...
10291B*				5/16" x 1/4"	249X5X4	...
10292	04049-0506	E1-5C		5/16" x 3/8"	49F-56	...
	04049-0508	E1-5D		5/16" x 1/2"		
10293	04049-0602	E1F-6A		3/8" x 1/8"	49F-62	...
10293B*		E1-6A		3/8" x 1/8"	249X6X2	...
10294	04049-0604	E1-6B		3/8" x 1/4"	49F-64	...
10294B*	04049-0604B	E1F-6B		3/8" x 1/4"	249X6	...
10295 **	04049-0606	E1F-6C		3/8" x 3/8"	49F-66	...
10295B*		E1-6C		3/8" x 3/8"	R49F-66	...
10295L				3/8" x 3/8"	249X6X6	...
10296 **	04049-0608	E1-6D		3/8" x 1/2"	249X6X8	...
				3/8" x 1/2"	49F-68	...
10297	04049-0612	E1-6E		3/8" x 3/4"	249X6X12	...
				3/8" x 3/4"	49F-612	...
				7/16" x 1/4"	249X7	...
	04049-0802	E1-8A		1/2" x 1/8"		
10298	04049-0804	E1F-8B		1/2" x 1/4"	49F-84	...
10298B*		E1-8B		1/2" x 1/4"	249X8X4	...
10299	04049-0806	E1F-8C		1/2" x 3/8"	49F-86	...
10299B*	04049-0806B	E1-8C		1/2" x 3/8"	249X8	...
10300	04049-0808	E1F-8D		1/2" x 1/2"	49F-88	...
10300B*	04049-0808B	E1-8D		1/2" x 1/2"	249X8X8	...
				1/2" x 1/2"	R49F-88	...
				1/2" x 1/2"	R49F-88L	...
10301	04049-0812	E1-8E		1/2" x 3/4"	49F-812	...
				1/2" x 3/4"	249X8X12	...
10311	04049-1004	E1-10B		5/8" x 1/4"	49F-104	...
10302	04049-1006	E1-10C		5/8" x 3/8"	49F-106	...
10302B*				5/8" x 3/8"	249X10X6	...
10303	04049-1008	E1-10D		5/8" x 1/2"	249X10	----

CONTINUED ON NEXT PAGE

249F 49 E1 149F

WARNING: This product can expose you to chemicals, including lead, which are known to the State of California to cause cancer and birth defects or other reproductive harm. For more information, visit www.P65Warnings.ca.gov

SAE 45° FLARE

BRASS FITTINGS

90° MALE ELBOW - CONTINUED



*1/8 TAP.
MIP Threads have
threaded sealant

MIDLAND	AMC	CHAMPION	LIST	MALE FLARE X MALE NPTF	MAF #	MAF PRICE
10303B*				5/8" x 1/2"	249X10	...
10304	04049-1012	E1-10E		5/8" x 3/4"	49F-1012	...
				5/8" x 3/4"	249X10X12	...
	04049-1206	E1-12C		3/4" x 3/8"	49F-126	...
10305	04049-1208	E1-12D		3/4" x 1/2"	49F-128	...
				3/4" x 1/2"	249X12	...
		CVSE1F-12D-1/8TAP*		3/4" x 1/2" x 1/8"		
10306	04049-1212	E1-12E		3/4" x 3/4"	49F-1212	...
10306B*				3/4" x 3/4"	249X12X12	...
	04049-1216	E1-12F		3/4" x 1		
10307	04049-1412	E1-14E		7/8" x 3/4"	49F-1412	...
10308	04049-1612	E1-16E		1" x 3/4"	49F-1612	...
10309	04049-1616			1" x 1"	49F-1616	...

90° FEMALE ELBOW

SAE# 010203



Forged Elbow

50F



Barstock Elbow

50F
250
500
04050

* Barstock

MIDLAND	AMC	CHAMPION	LIST	MALE FLARE X FEMALE NPTF	MAF #	MAF PRICE
10312	04050-0302	E3-3A		3/16" x 1/8"	50F-32	...
10313	04050-0402	E3-4A		1/4" x 1/8"	50F-42	...
10313B*				1/4" x 1/8"	250X4	...
10314	04050-0404	E3-4B		1/4" x 1/4"	50F-44	...
10314B*				1/4" x 1/4"	250X4X4	...
10315	04050-0406	E3-4C		1/4" x 3/8"	50F-46	...
10333	04050-0408			1/4" x 1/2"	50F-48	...
10316	04050-0502	E3-5A		5/16" x 1/8"	50F-52	...
10316B*				5/16" x 1/8"	250X5	...
10317	04050-0504	E3-5B		5/16" x 1/4"	50F-54	...
10318	04050-0602	E3-6A		3/8" x 1/8"	50F-62	...
10319	04050-0604	E3-6B		3/8" x 1/4"	50F-64	...
10319B*				3/8" x 1/4"	250X6	...
10320	04050-0606	E3F-6C		3/8" x 3/8"	50F-66	...
10320B*		E3-6C		3/8" x 3/8"	250X6X6	...
10321		E3-6D		3/8" x 1/2"	50F-68	...
				3/8" x 1/2"	250X6X8	...
10321L	04050-0608			3/8" x 1/2"		...
10322	04050-0612	E3-6E		3/8" x 3/4"	50F-612	...
10323	04050-0804	E3-8B		1/2" x 1/4"	50F-84	...
10324	04050-0806	E3-8C		1/2" x 3/8"	50F-86	...
10324B*				1/2" x 3/8"	250X8	...
10325		E3-8D		1/2" x 1/2"	50F-88	...
10325L	04050-0808			1/2" x 1/2"		...
10326	04050-0812	E3-8E		1/2" x 3/4"	50F-812	...
10327	04050-1006	E3-10C		1/2" x 3/4"	50F-106	...
10328	04050-1008	E3-10D		5/8" x 3/8"	50F-108	...
				5/8" x 1/2"	250X10	...
10329	04050-1012	E3-10E		5/8" x 3/4"	50F-1012	...
10-330	04050-1208	E3-12D		3/4" x 1/2"	50F-128	...
10-331	04050-1212	E3-12E		3/4" x 3/4"	50F-1212	...
	04050-1412	E3-14E		7/8" x 3/4"	50F-1412	...

E3 50 150F

SAE 45° FLARE

BRASS FITTINGS

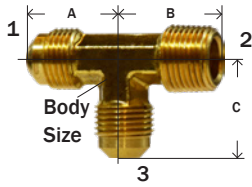
FORGED MALE RUN TEE

51F
501
04051

MIDLAND	AMC	CHAMPION	LIST	MALE FLARE X MALE NPTF (1&3) X 2	MAF #	MAF PRICE
10343	04051-0302	T3-3A		3/16" x 1/8"	51F-32	...
10344	04051-0402	T3-4A		1/4" x 1/8"	51F-42	...
10344B				1/4" x 1/8"	251X4	...
10345	04051-0404	T3-4B		1/4" x 1/4"	51F-44	...
	04051-0406	T3-4C		1/4" x 3/8"	51F-46	...
10347	04051-0502	T3-5A		5/16" x 1/8"	51F-52	...
10348	04051-0504	T3-5B		5/16" x 1/4"	51F-54	...
	04051-0602	T3-6A		3/8" x 1/8"	51F-62	...
10350	04051-0604	T3-6B		3/8" x 1/4"	51F-64	...
10351	04051-0606	T3-6C		3/8" x 3/8"	51F-66	...
10340				3/8" x 1/2" x 3/8"	51F-668	...
10352	04051-0608	T3-6D		3/8" x 1/2"	51F-68	...
10353				1/2" x 3/8" x 1/2"	51F-886	...
	04051-0804			1/2" x 1/4"	51F-84	...
10354	04051-0806	T3-8C		1/2" x 3/8"	51F-86	...
10355	04051-0808	T3-8D		1/2" x 1/2"	51F-88	...
	04051-0806	T3-10C		5/8" x 3/8"	51F-106	...
10357	04051-1008	T3-10D		5/8" x 1/2"	51F-108	...
10359	04051-1208	T3-12D		3/4" x 1/2"	51F-128	...
10360	04051-1212	T3-12E		3/4" x 3/4"	51F-1212	...

FORGED FLARE CROSS

SAE# 010501

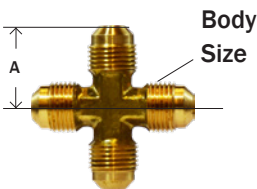

52
502
04052

MIDLAND	AMC	CHAMPION	LIST	THREAD SIZE UNF	MAF #	MAF PRICE
10373	04052-04	C1-4444		1/4"	52F-4	...
10374	04052-05	C1-5555		5/16"	52F-5	...
10375	04052-06	C1-6666		3/8"	52F-6	...
10376	04052-08	C1-8888		1/2"	52F-8	...
	04052-10	C1-101010		5/8"	52F-10	...

455 C1 147F 52

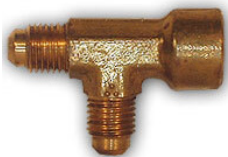
FEMALE RUN TEE

04091

MIDLAND	AMC	CHAMPION	LIST	THREAD SIZE UNF	MAF #	MAF PRICE
	04091-040404			1/4" x 1/4"	51FP-44	...
	04091-060606			3/8" x 3/8"	51FP-66	...
	04091-060608			3/8" x 1/2"	51FP-68	...
	04091-060808					
	04091-080806					

Dimension data can change without notice. Please call when dimensions are critical.

T3 151F 51

SAE 45° FLARE

BRASS FITTINGS

FORGED ADAPTER TEE / SERVICE TEE

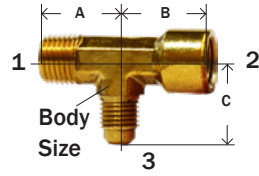

04053
53
503

MIDLAND	AMC	CHAMPION	LIST	SIZE 1 X 2 X 3	MAF #	MAF PRICE
				1/8"x1/8"x3/16"	253X3	...
10382	04053-020204	T4-4A		1/8"x1/8"x1/4"	53F-42	...
	04053-040404	T4-4B		1/4"x1/4"x1/4"	53F-44	...
				3/8"x3/8"x1/4"	53F-64	...
	04053-040406	T4-6B				

T17 53

MIP X MIP X FL

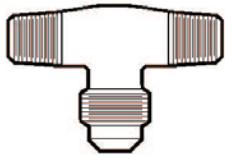

MIDLAND	AMC	CHAMPION	LIST	MIP X MIP ON RUN X MALE FLARE	MAF #	MAF PRICE
		T13-4A		1/8" x 1/4"	53FM-224	...
		T13-4B		1/4" x 1/4"	53FM-444	...
				3/8" x 3/8"	53FM-666	...

FL X FL X FIP FEMALE TEE



040

MIDLAND	AMC	CHAMPION	LIST	FLARE X FLARE X FIP	MAF #	MAF PRICE
	04058-040402			1/4" x 1/8"	58FP-42	...
	04058-040404			1/4" x 1/4"	58FP-44	...
	04058-060604			3/8" x 1/4"	58FP-64	...
	04058-060606			3/8" x 3/8"	58FP-66	...
	04058-080806			1/2" x 3/8"	58FP-86	...
	04058-080808			1/2" x 1/2"	58FP-88	...
	04093-06060608			3/8" x 1/2"	53FP-6668*	...
	04096-040404			1/4"x 1/4"	T6-444**	...

* Flare x flare x flare x FIP cross ** fe. flare on branch

UNION ELBOW

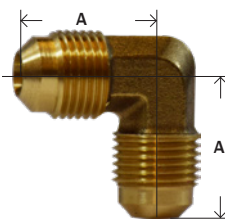

55F Forged
505
255 Barstock

* Barstock

MIDLAND	AMC	CHAMPION	LIST	THREAD SIZE UNF	MAF #	MAF PRICE
10404	04055-02	E2-2		1/8"	55F-2	...
10405	04055-03	E2-3		3/16"	55F-3	...
10406	04055-04	E2-4		1/4"	55F-4	...
10406B*				1/4"	255X4*	...
10407	04055-05	E2-5		5/16"	55F-5	...
				5/16"	255X5*	...
10408	04055-06	E2F-6		3/8"	55F-6	...
				3/8"	255X6*	...
10409	04055-08	E2-8		1/2"	55F-8	...
10409B*				1/2"	255X8*	...
10410	04055-10	E2-10		5/8"	55F-10	...
				5/8"	255X10*	...
10411	04055-12	E2-12		3/4"	55F-12	...
10412	04055-14	E2-14		7/8"	55F-14	...

E2 155F

SAE 45° FLARE

BRASS FITTINGS

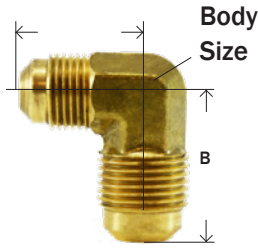
FORGED REDUCING ELBOW

55R
507
04057

MIDLAND	AMC	CHAMPION	LIST	MALE FLARE X MALE FLARE	MAF #	MAF PRICE
10416	04057-0604	ER2-64		3/8" x 1/4"	55FR-64	...
	04057-0804	ER2-84		1/2" x 1/4"	55FR-84	...
10419	04057-0806	ER2-86		1/2" x 3/8"	55FR-86	...
	04057-1006	ER2-106		5/8" x 3/8"	55FR-106	...
10421	04057-1008	ER2-108		5/8" x 1/2"	55FR-108	...
	04057-1208			3/4" x 1/2"	55FR-128	...
	04057-1210	ER2-1210		3/4" x 5/8"	55FR-1210	...

ER2 657F 55R

45° ELBOW

SAE# 010302



10151
254

54
4945
40945
04095

MIDLAND	AMC	CHAMPION	LIST	MALE FLARE X MALE NPTF	MAF #	MAF PRICE
	04095-0302	E1-4S-3A		3/16" x 1/8"	4945F-32	...
10448	04095-0402			1/4" x 1/8"	4945F-42	...
10448B*		E1-45-4A		1/4" x 1/8"	254X4*	...
10449	04095-0404	E1-45-4B		1/4" x 1/4"	4945F-44	...
				1/4" x 1/4"	254X4X4	...
10450	04095-0502	E1-45-5A		5/16" x 1/8"	4945F-52	...
				5/16" x 1/8"	254X5*	...
10451	04095-0504	E1-45-5B		5/16" x 1/4"	4945F-54	...
10452	04095-0604	E1F-45-6B		3/8" x 1/4"	4945F-64	...
10452B*		E1-45-6B		3/8" x 1/4"	254X6*	...
10453	04095-0606	E1-45-6C		3/8" x 3/8"	4945F-66	...
				3/8" x 3/8"	254X6X6*	...
10454	04095-0608	E1-45-6D		3/8" x 1/2"	4945F-68	...
				1/2" x 1/4"	4945F-84	...
10455	04095-0806	E1-45-8C		1/2" x 3/8"	4945F-86	...
10455B*				1/2" x 3/8"	254X8*	...
10456	04095-0808	E1-45-8D		1/2" x 1/2"	4945F-88	...
				1/2" x 1/2"	254X8X8*	...
10460	04095-1006	E1-45-10C		5/8" x 3/8"	4945F-106	...
				5/8" x 3/8"	254X10X6*	...
10457	04095-1008	E1-45-10D		5/8" x 1/2"	4945F-108	...
				5/8" x 1/2"	254X10*	...
10458	04095-1208	E1-45-12D		3/4" x 1/2"	4945F-128	...

* Barstock

E145 54 159F 654F 59FF 254 47 4945

FEMALE 45° FLARE FITTINGS**UNION**

SAE# 010107

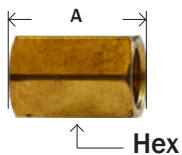

600
600F
04060

MIDLAND	AMC	CHAMPION	LIST	FEMALE FLARE X FEMALE FLARE	MAF #	MAF PRICE
10135	04060-04	U4-4		1/4"	600F-4	...
10136	04060-06	U4-6		3/8"	600F-6	...
10137	04060-08	U4-8		1/2"	600F-8	...
10138	04060-10			5/8"	600F-10	...
10139	04060-12			3/4"	600F-12	...

• Use with Copper Gasket

2310 U4 660HD 32

WARNING: This product can expose you to chemicals, including lead, which are known to the State of California to cause cancer and birth defects or other reproductive harm. For more information, visit www.P65Warnings.ca.gov

SAE 45° FLARE

BRASS FITTINGS

FEMALE FLARE X MALE PIPE

SAE# 010106

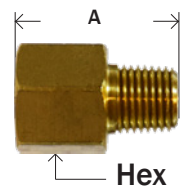

664
04066

* Swivel

MIDLAND	AMC	CHAMPION	LIST	FEMALE FLARE X MALE NPTF	MAF #	MAF PRICE
10440	04066-0402	U5-4A		1/4" x 1/8"	664-42	...
10441	04066-0404	U5-4B		1/4" x 1/4"	664-44	...
10442	04066-0604	U5-6B		3/8" x 1/4"	664-64	...
				3/8" x 1/4"	664S-64*	...
10438				3/8" x 1/2"	664-68	...
10443	04066-0806	U5-8C		1/2" x 3/8"	664-86	...
10444	04066-0808	U5-8D		1/2" x 1/2"	664-88	...

U5 664FHD 33 48-FF

FEMALE FLARE X MALE FLARE

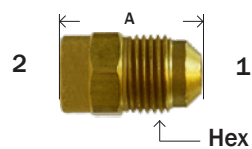

601
04061

WG=WITH GASKET

MIDLAND	AMC	CHAMPION	LIST	FEMALE FLARE X MALE FLARE	MAF #	MAF PRICE
				3/16" x 1/4"	601-34	...
	04061-0403			1/4" x 3/16"	601-43	...
				1/4" x 5/16"	601-45	...
	04061-0406			1/4" x 3/8"	601WG-46	...
10463	04061-0406	UR3-46		1/4" x 3/8"	601-46	...
	04061-0408			1/4" x 1/2"	601-48	...
				1/4" x 3/4"	601-412	...
				5/16" x 1/4"	601WG-54	...
				5/16" x 1/4"	601-54	...
				5/16" x 3/8"	601-56	...
10462	04061-0604	UR3-64		3/8" x 1/4"	601-64	...
				3/8" x 1/4"	601WG-64	...
10467	04061-0608	UR3-68		3/8" x 1/2"	601-68	...
				3/8" x 1/2"	601WG-68	...
	04061-0610	UR3-610		3/8" x 5/8"	601-610	...
				3/8" x 3/4"	601-612	...
10461	04061-0804	UR3-84		1/2" x 1/4"	601-84	...
10464	04061-0806	UR3-86		1/2" x 3/8"	601-86	...
				1/2" x 3/8"	601WG-86	...
				1/2" x 5/8"	601WG-810	...
10469	04061-0810	UR3-810		1/2" x 5/8"	601-810	...
				1/2" x 3/4"	601-812	...
				5/8" x 1/4"	601-104	...
10473	04061-1006	UR3-106		5/8" x 3/8"	601-106	...
				5/8" x 1/2"	601WG-108	...
10468	04061-1008	UR3-108		5/8" x 1/2"	601-108	...
				5/8" x 3/4"	601-1012	...
				5/8" x 3/4"	601WG-1012	...
				5/8" x 15/16"	601RG-1015	...
				3/4" x 3/8"	601-126	...
10471	04061-1012	UR3-1012		3/4" x 1/2"	601-128	...
10470	04061-1210	UR3-1210		3/4" x 5/8"	601-1210	...

UR3 661FHD 227 46-FF

WARNING: This product can expose you to chemicals, including lead, which are known to the State of California to cause cancer and birth defects or other reproductive harm. For more information, visit www.P65Warnings.ca.gov

BRASS

SAE 45° FLARE

BRASS FITTINGS

BRASS FLARE SWIVEL FITTINGS

FORGED SWIVEL

SAE# 010108

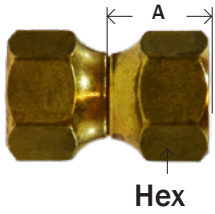
700
04070

MIDLAND	AMC	CHAMPION	LIST	FEMALE FLARE UNF	MAF #	MAF PRICE
10481	04070-04	US4-4		1/4"	700-4	...
10482	04070-05	US4-5		5/16"	700-5	...
10483		US4-6		3/8"	700-6	...
10483L	04070-06			3/8"	700SH-6	...
10484		US4-8		1/2"	700-8	...
10484L	04070-08			1/2"	700SH-8	...
10485	04070-10	US4-10		5/8"	700-10	...
				5/8"	700SH-10	...
10486	04070-12	US4-12		3/4"	700-12	...

1350 US4 14FSV 34

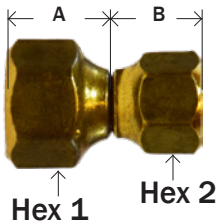
REDUCING SWIVELS700R
04075

MIDLAND	AMC	CHAMPION	LIST	FEMALE FLARE UNF	MAF #	MAF PRICE
10487	04075-0604	US4-64		3/8" x 1/4"	700R-64	...
10488	04075-0806	US4-86		1/2" x 3/8"	700R-86	...
10489	04075-1008	US4-108		5/8" x 1/2"	700R-108	...

FORGED SWIVEL ELBOWS701
04071

MIDLAND	AMC	CHAMPION	LIST	MALE FLARE X FEMALE FLARE	MAF #	MAF PRICE
10493	04071-0404	ES4-44		1/4"	ES4-44	...
10494	04071-0606	ES4-66		3/8"	ES4-66	...
				3/8" x 1/2"	ES4-68	...
10495	04071-0808	ES4-88		1/2"	ES4-88	...
10496	04071-1010	ES4-1010		5/8"	ES4-1010	...
10497	04071-1212	ES4-1212		3/4"	ES4-1212	...

ES4

DRUM ADAPTERS

SAE# 010165

K1
04030

MIDLAND	AMC	CHAMPION	LIST	MALE FLARE X FIP	MAF #	MAF PRICE
50011	04030-0804	K1-8		1/4" x 1/2"	K1-48	...
50001	04030-1204			1/4" x 3/4"	K1-412	...
	04030-1206			3/8" x 3/4"	K1-612	...
	04030-1208			1/2" x 3/4"	K1-812	...
GASKET						
	04032-08			1/2"	KG-8	...
	04032-12			3/4"	KG-12	...

• Straight Thread

WARNING: This product can expose you to chemicals, including lead, which are known to the State of California to cause cancer and birth defects or other reproductive harm. For more information, visit www.P65Warnings.ca.gov



45° FLARE

BRASS FITTINGS

FLARE SWEAT FITTINGS-SOLDER CONNECTORS



04082

MIDLAND	AMC	CHAMPION	LIST	FLARE X SWEAT	MAF #	MAF PRICE
10600	04082-0404	US3-44		1/4" x 1/4"	48S-44	...
10602	04082-0406	US3-46		1/4" x 3/8"	48S-46	...
10620				3/8" x 1/4"	48S-64	...
10612	04082-0606	US3-66		3/8" x 3/8"	48S-66	...
10613	04082-0608			3/8" x 1/2"	48S-68	...
10621	04082-0808			1/2" x 1/2"	48S-88	...
10611				1/2" x 5/8"	48S-810	...
10614	04082-1010	US3-1010		5/8" x 5/8"	48S-1010	...
10622				5/8" x 7/8"	48S-1014	...
10615	04082-1212	US3-1212		3/4" x 3/4"	48S-1212	...
10616				3/4" x 7/8"	48S-1214	...
10617				7/8" x 7/8"	48S-1414	...
10618				1" x 1-1/8"	48S-1618	...
10619				1-1/8" x 1-1/8"	48S-1818	...

FL X SWT ELBOW



04089

MIDLAND	AMC	CHAMPION	LIST	FLARE X SOLDER OD FEMALE FLARE UNF	MAF #	MAF PRICE
				1/4" x 1/4"	49S-44	...
				3/8" x 3/8"	49S-66	...
				1/2" x 1/2"	49S-88	...

SPACE HEATER FITTINGS

9/16-24 FINE THREAD FLARE NUT/CAP



#M-82SH
04800
04840
41FT
800

MIDLAND	AMC	CHAMPION	LIST	SIZE	MAF #	MAF PRICE
14001	04800-06			3/8	41FT-6	...
				3/8 CAP	40FT-6	...

FEMALE ADAPTER



#M-80SH
04806
46FT
805

MIDLAND	AMC	CHAMPION	LIST	SIZE	MAF #	MAF PRICE
14018	04806-0606			3/8 x 3/8	46FT-66	...
14025	04806-0608			3/8 x 1/2	46FT-68	...
	04806-0612			3/8 x 3/4	46FT-612	...

WARNING: This product can expose you to chemicals, including lead, which are known to the State of California to cause cancer and birth defects or other reproductive harm. For more information, visit www.P65Warnings.ca.gov

BRASS

SPACE HEATER/ GAS RANGE FITTINGS**BRASS FITTINGS****SPACE HEATER UNION/TEE**

MIDLAND	AMC	CHAMPION	LIST	SIZE	MAF #	MAF PRICE
14011	04802-06			3/8	42FT-6	...
	04844-06			3/8 TEE	44FT-6	...

04802

SPACE HEATER MALE ADAPTER/ ELBOWS

MIDLAND	AMC	CHAMPION	LIST	SIZE	MAF #	MAF PRICE
14016	04808-0606			3/8 x 3/8	48FT-66	...
14017	04808-0608			3/8 x 1/2	48FT-68	...
	04809-0608			3/8 x 1/2 *	49FT-68	...
	04850-0608			3/8 x 1/2**	50FT-68	...

#M-83SH

*MALE ELBOW || ** FEMALE ELBOW

BRASS GAS RANGE FITTINGS**BRASS MALE ADAPTERS - 15/16-16 FLARE THREAD**45RG
408RC
04748

MIDLAND	AMC	CHAMPION	LIST	MALE FLARE X MALE NPTF	MAF #	MAF PRICE
35130				3/8" x 3/8"(1/8 TAP)	48WT-662	...
35133				3/8" x 3/8"(1/4 TAP)	48WT-664	...
35131				3/8" x 1/2"(3/8 TAP)	48WT-66-820	...
35132	04088-080806			1/2" x 1/2" (3/8" FIP TAP)	48WT-686	...
35134	04748-1508			15/16" x 1/2"	48WT-886	...
35135		U1GA- 10DE		15/16" x 1/2" (3/8" FIP TAP)	48RGT-158	...
	04748-151208			15/16" x 3/4" (1/2" FIP TAP)	48RGT-1512	...

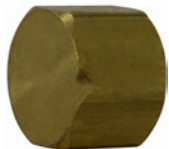
CAP & NUT

04741

MIDLAND	AMC	CHAMPION	LIST	SIZE	MAF #	MAF PRICE
35186				15/16"	40RG-15	...
	04741-15			15/16-16"*	41SRG	...

*NUT

BRASS FEMALE ADAPTERS

MIDLAND	AMC	CHAMPION	LIST	SIZE	MAF #	MAF PRICE
35136	04746-1508			15/16" x 1/2"	46RG-158	...
35142	04746-1512			15/16" x 3/4"	46RG-1512	...

WARNING: This product can expose you to chemicals, including lead, which are known to the State of California to cause cancer and birth defects or other reproductive harm. For more information, visit www.P65Warnings.ca.gov



POL FITTINGS

BRASS FITTINGS

TEE CONNECTION



2000
05200

MIDLAND	AMC	CHAMPION	LIST	PIPE SIZE	MAF #	MAF PRICE
34001	05200	POL-T1		1/4" Inverted flare x 1/4" MPT	2000	...
				2000 + 200IAB	2001	...

41-1-390-0014 2000

TAILPIECE WITH FLATS



2001A
05220

1/4 NPT

MIDLAND	AMC	CHAMPION	LIST	PIPE SIZE	MAF #	MAF PRICE
34011	05220	POL-LTP		2.34 w/ wrench Flats	2001A	...
34012		POL-LTPH		2.13 w/ Hex	2001AHN	...

1001AUL 21605 M-2001-A 2002A 2001AHN

STANDARD NUT



2001B
05221

MIDLAND	AMC	CHAMPION	LIST	PIPE SIZE	MAF #	MAF PRICE
34016	05221	POL-N		.880-14 LH	2001B	...
				Large hex	2001BLH	...

7/8" Hex

2001B

TAILPIECE & NUT ASSEMBLY



MANIFOLD
BLOCK TEE
ASSEMBLY

2002AB
05225

MIDLAND	AMC	CHAMPION	LIST	PIPE SIZE	MAF #	MAF PRICE
34022	05225	POL-NLTP		1/4	2001AB	...
					2001AHB	...
					200IS	...

2002AB

POL CAP



2004
05204

MIDLAND	AMC	CHAMPION	LIST	PIPE SIZE	MAF #	MAF PRICE
34031	05204	POL-N5		.880-14LH	2004	...

ME1699 POL2004 1004A M-2004

WARNING: This product can expose you to chemicals, including lead, which are known to the State of California to cause cancer and birth defects or other reproductive harm. For more information, visit www.P65Warnings.ca.gov

BRASS

POL FITTINGS

BRASS FITTINGS

POL PLUG WITH CHAIN

2014
2014

MIDLAND	AMC	CHAMPION	LIST	DESCRIPTION	MAF #	MAF PRICE
34141				POL PLUG WITH CHAIN	2014	...

ME1691-1

SINGLE PIECE POL ADAPTER

2008
05208

MIDLAND	AMC	CHAMPION	LIST	DESCRIPTION	MAF #	MAF PRICE
34130	05208			MALE POL X 1/4 FPT	2008	...
34131				MALE POL X 1/2 FPT	2009	

ME351 ME357

ADAPTERS

35792
35810
05205

MIDLAND	AMC	CHAMPION	LIST	PIPE SIZE	MAF #	MAF PRICE
34041	05205	POL-U2-6		3/8 Flare x .880-14LH	2005	...
34046	05206	POL-U2-8		1/2 Flare x .880-14LH	2006	...
34051	05207	POL-U2-10		5/8 Flare x .880-14LH	2007	...

ME3510 2906E 2007

WARNING: This product can expose you to chemicals, including lead, which are known to the State of California to cause cancer and birth defects or other reproductive harm. For more information, visit www.P65Warnings.ca.gov



POL FITTINGS

BRASS FITTINGS

TAILPIECE ASSEMBLY W/HEX HEAD NUT & STEM

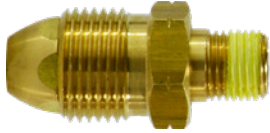

PART #	LENGTH	
34080	1/4 NPT X POL 2 LONG HARD NOSE 2 OAL	----
34082	MALE POL X 3/8 NPT	----

2906D ME352



PART #	LENGTH	
34088	MPOL HARD NOSE 9/16- 18 FE LH THREAD	----

ME1650



PART #	LENGTH	
34084	MPOL X 1/4 HOSE BARB 7/8 HEX	----

ME5930 970JR

SOFT NOSE TAILPIECE ASSEMBLY



PART #	LENGTH	
34060	1/4 NPT X POL 2.1 LONG #60 ORIFICE	----
34061	1/4 MPT X POL SOFT NOSE 2-1/2	----
34062	1/4 NPT POL SOFT NOSE #60 ORIFICE 2.3 LONG	----
34063	POL X 9/16-18 LH TAIL- PIECE SOFT NOSE	----
34064	1/4 NPT X POL SOFT NOSE 2 3/8 LONG	----

ME1638 2003-T-GH-60 2002 2018-L 2003-T 970S

HAND WHEEL POL ADAPTERS

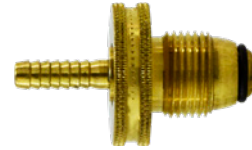

PART #	LENGTH	
34065	MPOL SOFT NOSE X 1/4 HOSE BARB BR.WHEEL	----

ME1656AR



PART #	LENGTH	
34072	1/4 MPT POL SOFT NOSE W/PLASTIC WHEEL	----

ME1654



PART #	LENGTH	
34073	1/4 MPT POL SOFT NOSE WITH BRASS WHEEL	----

ME1654AR



PART #	LENGTH	
34074	MPOL SOFT NOSE X 1/4 HB W/PLASTIC WHEEL	----

ME1656

VISIT MIDLANDINDUSTRIES.COM/LPGAS TO SEE OUR COMPLETE OFFERING OF LP GAS PRODUCTS

WARNING: This product can expose you to chemicals, including lead, which are known to the State of California to cause cancer and birth defects or other reproductive harm. For more information, visit www.P65Warnings.ca.gov

BRASS

POL FITTINGS

BRASS FITTINGS

PROPANE MOTOR FUEL FILL ADAPTER

- Allows a standard POL fitting to be adapted to fill an engine fuel tank.

PART #	LENGTH	
34079	FE POL X 1 3/4 ACME FUEL FILL ADPT	----

ME458 2017

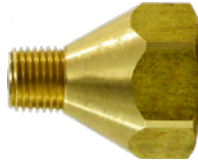
FEMALE POL X MIP ADAPTER

PART #	LENGTH	
34111	1/4 MPT X FE POL ADAPTER	----
34112	3/8 MPT X FE POL ADAPTER	----
34113	1/2 MPT X FE POL ADAPTER	----
34114	3/4 MPT X FE POL ADAPTER	----

2011-B ME285 2011-D 2011-E

FEMALE FPT X FEMALE POL ADAPTER

PART #	LENGTH	
34120	1/4 FPT X FE POL	----
34121	3/8 FPT X FE POL	----
34122	1/2 FPT X FE POL	----
34123	3/4 FPT X FE POL	----

2016-B ME302 2016-D ME304

POL O-RING ONLY

PART #	LENGTH	
34143	POL O-RING ONLY	----

C5-OR-POL 568-110-01

POL PLASTIC DUST PLUG

PART #	LENGTH	
34160	POL PLASTIC DUST PLUG	----

ME970P

APPLIANCE TEE

- Tap & Add

PART #	LENGTH	
34170	M.POLXF.POL W/1-20M CYL AND 1/4 INV FLAR	----

2090

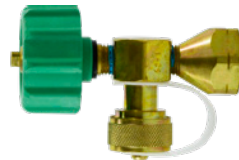

- With QCC1 connection

PART #	LENGTH	
34174	QCC1 X F. POL W/1-20 MALE CYLINDER THD	----

2013

DUAL APPLIANCE TEE

PART #	LENGTH	
34176	M.POL X (2) OF 1-20 MALE CYLINDER THREAD	----

2099

WARNING: This product can expose you to chemicals, including lead, which are known to the State of California to cause cancer and birth defects or other reproductive harm. For more information, visit www.P65Warnings.ca.gov



JIC 37° FLARE STRAIGHTS

BRASS FITTINGS

STRAIGHT TUBE UNION



PART #	TUBE OD	TUBE THREAD	L	HEX	WORKING PRESSURE	
28966	1/4	7/16-20	1.35	0.49	3250 psi	----
28969	3/8	9/16-18	1.41	0.63	3250 psi	----
28970	1/2	3/4-16	1.62	0.81	3250 psi	----
28971	3/4	1-1/16-12	2.14	1.13	3250 psi	----
28972	1"	1-5/16-12	2.25	1.38	2600 psi	----

SBC 132403 HTXB

FEMALE STRAIGHT ADAPTER

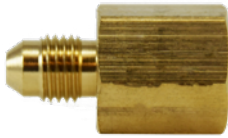

PART #	TUBE OD	PIPE	TUBE THREAD	L	HEX	WORKING PRESSURE	
28957	1/4	1/8-27	7/16-20	1.19	0.56	3250 psi	----
28958	1/4	1/4-18	7/16-20	1.40	0.75	3250 psi	----
28959	3/8	1/4-18	9/16-18	1.40	0.75	3250 psi	----
28960	3/8	3/8-18	9/16-18	1.40	0.88	3250 psi	----
28961	1/2	3/8-18	3/4-16	1.56	0.88	3250 psi	----
28962	1/2	1/2-14	3/4-16	1.79	1.13	3250 psi	----
28963	5/8	1/2-14	7/8-14	1.87	1.13	3250 psi	----
28964	3/4	3/4-1/4	1-1/16-12	2.06	1.38	2600 psi	----

STRAIGHT



PART #	TUBE OD	A NPTF	TUBE THREAD	L	HEX	WORKING PRESSURE	
28701	1/4	1/8-27	7/16-20	1.22	0.45	3250 psi	----
28702	1/4	1/4-18	7/16-20	1.37	0.56	3250 psi	----
28703	1/4	3/8-18	7/16-20	1.42	0.75	3250 psi	----
28704	5/16	1/8-27	1/2-20	1.41	0.56	3250 psi	----
28705	5/16	1/4-18	1/2-20	1.42	0.56	3250 psi	----
28706	3/8	1/8-27	9/16-18	1.24	0.63	3250 psi	----
28707	3/8	1/4-18	9/16-18	1.43	0.63	3250 psi	----
28708	3/8	3/8-18	9/16-18	1.38	0.75	3250 psi	----
28709	3/8	1/2-14	9/16-18	1.69	0.88	3250 psi	----
28710	1/2	1/4-18	3/4-16	1.53	0.81	3250 psi	----
28711	1/2	3/8-18	3/4-16	1.53	0.81	3250 psi	----
28712	1/2	1/2-14	3/4-16	1.79	0.88	3250 psi	----
28713	1/2	3/4-14	3/4-16	1.85	1.13	2600 psi	----
28714	5/8	3/8	7/8-14	1.84	0.94	3250 psi	----
28715	5/8	1/2-14	7/8-14	1.89	0.94	3250 psi	----
28716	5/8	3/4-14	7/8-14	1.95	1.13	2600 psi	----
28748	3/4	1/2-14	1 1/16-12	2.06	1.13	2925 psi	----
28717	3/4	3/4-14	1 1/16-12	2.06	1.13	2600 psi	----
28749	3/4	1-11 1/2	1 1/16-12	2.25	1.38	1950 psi	----
28719	1	3/4-14	1 5/16-12	2.06	1.13	2275 psi	----
28718	1	1-11 1/2	1 5/16-12	2.3	1.38	1950 psi	----

B2404 SB FTXB

STRAIGHT SWIVEL ADAPTER



PART #	TUBE OD	A NPTF	TUBE THREAD	L	HEX	WORKING PRESSURE	
28752	1/4	1/4-18	7/16-20	1.389	.563	3250 psi	----
28753	3/8	1/4-18	9/16-18	1.6	.563	3250 psi	----
28754	3/8	3/8-18	9/16-18	1.574	.690	2925 psi	----
28756	1/2	1/2-14	3/4-16	1.706	.875	2600 psi	----

B6505 SJS

JIC 37° SHAPES

BRASS FITTINGS

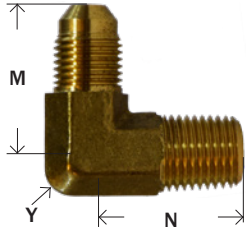
90° FORGED ELBOW

• Swivel available

PART #	TUBE OD	TUBE THREAD	A NPTF	M	N	Y	WORKING PRESSURE	
28760F	1/4	7/16-20	1/8-27	0.89	0.78	0.5	2160 psi	----
28762F	1/4	7/16-20	1/4-18	1.05	1.03	0.53	1846 psi	----
28766F	5/16	1/2-20	1/4-18	1.10	1.10	0.55	3905 psi	----
28768F	3/8	9/16-18	1/8-27	1.06	1.00	0.56	3128 psi	----
28770F	3/8	9/16-18	1/4-18	1.06	1.09	0.54	1564 psi	----
28772F	3/8	9/16-18	3/8-18	1.15	1.22	0.74	1464 psi	----
28773F	3/8	9/16-18	1/2-14	1.22	1.47	0.90	1265 psi	----
28774F	1/2	3/4-16	3/8-18	1.25	1.22	0.81	1467 psi	----
28777F	1/2	3/4-16	1/2-14	1.31	1.47	0.90	1265 psi	----
28778F	1/2	3/4-16	3/4-14	1.4	1.59	0.89	2061 psi	----
28780F	5/8	7/8-14	1/2-14	1.45	1.47	0.88	1265 psi	----
28781F	3/4	1 1/16-12	1/2-14	1.66	1.56	1.08	1265 psi	----
28783F	3/4	1 1/16-12	3/4-14	1.66	1.59	1.06	1084 psi	----
28784F	1	1 5/16-12	3/4-14	1.88	1.77	1.32	1802 psi	----
28786F	1	1 5/16-12	1-11 1/2	1.81	1.97	1.3	2361 psi	----

DL3B2 3F69CL GGL6A1 F23L2 EE48D3 EE46B2 FF45A2 F48C3 FF22C3 D49B1 D25B1 3F47C1

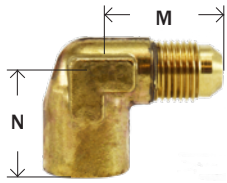
FEMALE ELBOW FORGED BODY

PART #	TUBE OD	TUBE THREAD	A NPTF	M	N	WORKING PRESSURE	
28973	1/4	7/16-20	1/8-27	1.08	0.66	2797 psi	----
28974	1/4	7/16-20	1/4-18	1.25	0.55	3066 psi	----
28975	3/8	9/16-18	1/4-18	1.23	0.88	2842 psi	----

B2502 EBF DTXB

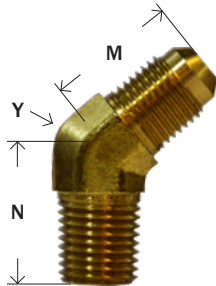
45° FORGED ELBOW

• Swivel available

PART #	TUBE OD	TUBE THREAD	A NPTF	M	N	Y	WORKING PRESSURE	
28722F	1/4	7/16-20	1/8-27	0.72	0.64	0.5	4367 psi	----
28724F	1/4	7/16-20	1/4-18	0.81	0.84	0.53	3750 psi	----
28728F	5/16	1/2-20	1/4-18	0.88	0.86	0.54		
28729F	3/8	9/16-18	1/8-27	0.83	0.65	0.63	3128 psi	----
28731F	3/8	9/16-18	1/4-18	0.83	0.86	0.63	3128 psi	----
28733F	3/8	9/16-18	3/8-18	0.91	0.95	0.81	3100 psi	----
28734F	3/8	9/16-18	1/2-14	1.03	1.17	0.94	2826 psi	----
28736F	1/2	3/4-16	3/8-18	0.98	0.95	0.75	2938 psi	----
28738F	1/2	3/4-16	1/2-14	1.13	1.17	0.86	2826 psi	----
28740F	5/8	7/8-14	1/2-14	1.13	1.08	0.88		
28742F	3/4	1 1/16-12	3/4-14	1.28	1.2	1.13	2442 psi	----

B2503 FBC-F VTXB

THREAD CHART

SIZE	JIC THREAD
1/8	5/16-24
3/16	3/8-24
1/4	7/16-20
5/16	1/2-20
3/8	9/16-18
1/2	3/4-16
5/8	7/8-14
3/4	1-1/16-12
1	1-5/16-12

WARNING: This product can expose you to chemicals, including lead, which are known to the State of California to cause cancer and birth defects or other reproductive harm. For more information, visit www.P65Warnings.ca.gov

INVERTED FLARE

BRASS FITTINGS

INVERTED FLARE FITTINGS



Tube O.D.	1/8	3/16	1/4	5/16	3/8	7/16	1/2	5/8	3/4	7/8	1
Thread O.D. threads per inch	5/16-28	3/8-24	7/16-24	1/2-20	5/8-18	11/16-18	3/4-18	7/8-18	1-1/16-16	1-3/16-16	1-5/16-16

•Typical Application

Hydraulic brake, power steering, fuel lines and transmission cooler lines, LP and natural gas.

•Working Pressure Ranges

Temperature and type of tubing used are important factors. However, the following table is a

PSI	Tube O.D. (in.)	Tube Wall (in.)
2800	1/8	.030
1900	3/16	.030
1400	1/4	.030
1200	5/16	.032
1000	3/8	.032
750	1/2	.032
650	5/8	.035
550	3/4	.035

good guide for proper selection. Temperature 73°F with copper tubing:

•Vibration

Excellent resistance.

•Temperature Range

-65°F to +250°F (-53°C to +121°C) range at maximum operating pressures.

•Used With

Copper, brass, aluminum and steel hydraulic tubing that can be flared.

•Advantages

Very low cost and reusable. Seats and threads are internal and protected. Compact, excellent vibration life. Short nut affords very close tube bends. Steel or brass

tube nut.

•Tolerance

+/- .03 on all dimensions.

•Conformance

Meets specifications and standards of ASA, ASME, SAE and MS (Military Standards).

•Assembly Instructions

- 1-Cut tubing to desired length. Make sure all burrs are removed and the ends are cut square.
- 2- Slide nut on tube. Threaded end "A" of nut must face out.
- 3- Flare end of tube with a 45° flaring tool.
 - a- Measure flare diameter.
 - b- Examine flare for excessive thin out.
 - c- On thin wall, welded or brazed tubing, use double flare to prevent pinch-off and cracked flares.
- 4- Lubricate threads and assemble to fitting body. Nut should be turned hand tight.

STANDARD METRIC THREADS

Description Tube Size	Thread O.D.	Crest (Pitch)	Thread Description
Japanese 3/16"	10mm	1.0mm	M10 x 1.0
European 3/16"	10mm	1.0mm	M10 x 1.0
GM 6mm	12mm	1.0mm	M12 x 1.0
Fuel 5/16"	14mm	1.5mm	M14 x 1.5
Fuel 3/8"	16mm	1.5mm	M16 x 1.5

Measuring Metric Threads: Measure the O.D. of the threads and the crest to crest distance (pitch) in millimeters between threads.

Actual O.D. of male inverted flare threads

5/16"-28 2800 PSI 3/8"-24 1900 PSI 7/16"-24 1400 PSI 1/2"-20 1200 PSI 5/8"-18 1000 PSI

3/4"-18 750 PSI

7/8"-18 650 PSI

1-1/16"-16 550 PSI

1/8"

3/16"

1/4"

5/16"

3/8"

1/2"

5/8"

3/4"

WARNING: This product can expose you to chemicals, including lead, which are known to the State of California to cause cancer and birth defects or other reproductive harm. For more information, visit www.P65Warnings.ca.gov

BRASS

INVERTED FLARE

BRASS FITTINGS

ZINC CHROMATE STEEL NUT

SAE# 040110

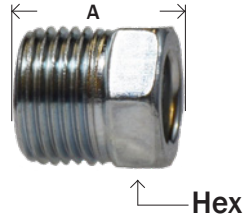

41IFS
41INS
04340

MIDLAND	AMC	CHAMPION	LIST	SIZE	MAF #	MAF PRICE
12001	04340-02	41IS-2		1/8"	41IFS-2	...
12002	04340-03	41IS-3		3/16"	41IFS-3	...
12018	04335-0304			3/16"	MA105X3X4	...
12003	04340-04	41IS-4		1/4"	41IFS-4	...
12004	04340-05	41IS-5		5/16"	41IFS-5	...
12005	04340-06	41IS-6		3/8"	41IFS-6	...
12000		41IS-7		7/16"	41IFS-7	...
12011		41IS-67		3/8"	MA105X6X7	...
12006	04340-08	41IS-8		1/2"	41IFS-8	...
12007	04340-10	41IS-10		5/8"	41IFS-10	...
12008	04340-12	41IS-12		3/4"	41IFS-12	...
12083				7/8"	41IFS-14	...
12084				1"	41IFS-16	...

121XXX 2105 411FS 105 41W

LONG STEEL NUT

FOR DOMESTIC LINES

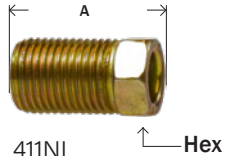

411NL
04330

MIDLAND	AMC	CHAMPION	LIST	SIZE	MAF #	MAF PRICE
12009	04330-03	41ISL-3		3/16"	41IFS-3L	...
12010	04330-04	41ISL-4		1/4"	41IFS-4L	...

7896

INVERTED FLARE BRASS NUT

SAE# 040110

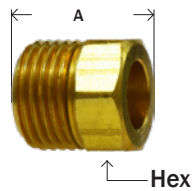

411FB
41INB
04341

MIDLAND	AMC	CHAMPION	LIST	SIZE	MAF #	MAF PRICE
12012	04341-02	41IB-2		1/8"	41IFB-2	
12013	04341-03	41IB-3		3/16"	41IFB-3	...
12014	04341-04	41IB-4		1/4"	41IFB-4	...
12015	04341-05	41IB-5		5/16"	41IFB-5	...
12016	04341-06	41IB-6		3/8"	41IFB-6	...
12017	04341-08	41IB-8		1/2"	41IFB-8	...
12019	04341-10	41IB-10		5/8"	41IFB-10	...
				3/4"	41IFB-12	...
				1"	41IFB-16	...

WARNING: This product can expose you to chemicals, including lead, which are known to the State of California to cause cancer and birth defects or other reproductive harm. For more information, visit www.P65Warnings.ca.gov



INVERTED FLARE

BRASS FITTINGS

ZINC STEEL METRIC TUBE NUTS - SEE OUR WEBSITE FOR BRAKE LINES AND TUBING



PART #	TUBESIZE	THREAD	REF#	
12260	3/16 British	3/8-24 Bubble	---	----
12261	3/16 European	M10 x 1.0 Bubble	276110	----
12262	3/16 Japanese	M10 x 1.0 Inv.	121050	----
12263	3/16 Domestic	1/2 x 20 Inv.	---	----
12264	3/16 Domestic	9/16 - 18 Inv.	121039	----
12266	3/16 Imported	M12 x 1.0 Bubble	276012	----
12268	1/4 Domestic	9/16 x 18 Inv.	121049	----
12269	1/4 Domestic	1/2 x 20 Inv.	121045	----
12270	6mm Imported	M12 x 1.0 Bubble		----
12274	5/16 Domestic	M14 x 1.5 Surface Seal	121069	----
12275	3/8 Domestic	M16 x 1.5 Surface Seal	121070	----

2100 411F 100 411B

UNION INTERNAL

SAE# 040101

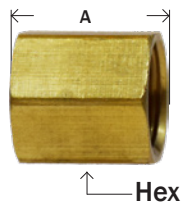

421F
421N
04342

MIDLAND	AMC	CHAMPION	LIST	INV. FLARE X INV. FLARE	MAF #	MAF PRICE
12022	04342-02	421-2		1/8"	2302X2	
				1/8"	421F-2	
12023	04342-03	421-3		3/16"	2302X3	...
				3/16"	421F-3	...
12024	04342-04	421-4		1/4"	2302X4	...
				1/4"	421F-4	...
12025	04342-05	421-5		5/16"	2302X5	...
				5/16"	421F-5	...
12026	04342-06	421-6		3/8"	2302X6	...
				3/8"	421F-6	...
12027	04342-08	421-8		1/2"	2302X8	...
				1/2"	421F-8	...
12028				5/8"	2302X10	...
				3/16" X 1/8"	421FR-32	...
				1/4" X 3/16"	421FR-43	...
				5/16" X 3/16"	421FR-53	...
				5/16" X 1/4"	421FR-54	...
				3/8" X 1/4"	421FR-64	...
				3/8" X 5/16"	421FR-65	...

302 2300 421FHD

WARNING: This product can expose you to chemicals, including lead, which are known to the State of California to cause cancer and birth defects or other reproductive harm. For more information, visit www.P65Warnings.ca.gov

BRASS

INVERTED FLARE

BRASS FITTINGS

FEMALE ADAPTER

SAE# 040103

46IFHD 252 46W

46IN
46IN
04346

MIDLAND	AMC	CHAMPION	LIST	INV. FLARE X FEMALE NPTF	MAF #	MAF PRICE
12029				1/8" x 1/8"	46IF-22	...
12032	04346-0302	46I-3A		3/16" x 1/8"	46IF-32	...
12033	04346-0402	46I-4A		1/4" x 1/8"	46IF-42	...
12030	04346-0404			1/4" x 1/4"	46IF-44	...
12034	04346-0502	46I-5A		5/16" x 1/8"	46IF-52	...
12035	04346-0604	46I-6B		3/8" x 1/4"	46IF-64	...
				3/8" x 3/8"	46IF-66	...
12031	04346-0704			7/16" x 1/4"	46IF-74	...
12037				1/2" x 1/4"	46IF-84	...
12036	04346-0806	46I-8C		1/2" x 3/8"	46IF-86	...
12039	04346-1008			5/8" x 1/2"	46IF-108	...
12099	04346-1212			3/4" x 3/4"	46IF-1212	...

MALE ADAPTER

SAE# 040102

48IN
48IF
04348

MIDLAND	AMC	CHAMPION	LIST	INV. FLARE X MALE NPTF	MAF #	MAF PRICE
12041	04348-0202	48I-2A		1/8" x 1/8"	48IF-22	
12042	04348-0302	48I-3A		3/16" x 1/8"	48IF-32	...
12053	04348-0304			3/16" x 1/4"	48IF-34	...
12043	04348-0402	48I-4A		1/4" x 1/8"	2202X4	...
				1/4" x 1/8"	48IF-42	...
12044	04348-0404	48I-4B		1/4" x 1/4"	2234X4	...
				1/4" x 1/4"	48IF-44	...
				1/4" x 3/8"	48IF-46	...
12045	04348-0502	48I-5A		5/16" x 1/8"	2200X5	...
				5/16" x 1/8"	2202X5	...
				5/16" x 1/8"	48IF-52	...
12046	04348-0504	48I-5B		5/16" x 1/4"	48IF-54	...
12055	04348-0506			5/16" x 3/8"	48IF-56	...
12047	04348-0602	48I-6A		3/8" x 1/8"	48IF-62	...
12048	04348-0604	48I-6B		3/8" x 1/4"	2202X6	...
				3/8" x 1/4"	48IF-64	...
12049	04348-0606	48I-6C		3/8" x 3/8"	2236X6	...
				3/8" x 3/8"	48IF-66	...
12104	04348-0704			7/16" x 1/4"	48IF-74	...
12038	04348-0804	48I-8B		1/2" x 1/4"	48IF-84	...
12050	04348-0806	48I-8C		1/2" x 3/8"	2202X8	...
				1/2" x 3/8"	48IF-86	...
				1/2" x 1/2"	2202X8X8	...
12051	04348-0808	48I-8D		1/2" x 1/2"	48IF-88	...
12052	04348-1008	48I-10D		5/8" x 1/2"	48IF-108	...
				5/8" x 3/4"	48IF-1012	...
12105	04348-1208			3/4" x 1/2"	48IF-128	...
12040	04348-1212	48I-12E		3/4" x 3/4"	48IF-1212	...
12107	04348-1608			7/8" x 3/4"	48IF-1412	...
12108	04348-1616			1" x 3/4"	48IF-1612	...
				1" x 1"	48IF-1616	...

Dimension data can change without notice. Please call when dimensions are critical.

2200 48IFHD 202 48W 200

INVERTED FLARE

BRASS FITTINGS

MALE INVERTED FLARE UNIONS



MIDLAND	AMC	CHAMPION	LIST	SIZE	MAF #	MAF PRICE
				1/4" x 3/16"	22IFS-43	
				5/16" x 3/16"	22IFS-53	...
				5/16" x 1/4"	22IFS-54	...
				3/8" x 1/4"	22IFS-64	...
				3/8" x 5/16"	22IFS-65	...

ELBOW

SAE# 040202



491N
491F
04349

MIDLAND	AMC	CHAMPION	LIST	INV. FLARE X MALE NPTF	MAF #	MAF PRICE
12057	04349-0202	49I-2A		1/8" x 1/8"	49IF-22	
12058	04349-0302	49I-3A		3/16" x 1/8"	49IF-32	...
12059	04349-0402	49I-4A		1/4" x 1/8"	2402X4	...
				1/4" x 1/8"	49IF-42	...
12054*				1/4" x 1/8"	49IFRH-42	...
12060	04349-0404	49I-4B		1/4" x 1/4"	49IF-44	...
12061	04349-0502	49I-5A		5/16" x 1/8"	49IF-52	...
12062	04349-0504	49I-5B		5/16" x 1/4"	49IF-54	...
12082	04394-0506			5/16" x 3/8"	49IF-56	...
12063	04349-0602	49I-6A		3/8" x 1/8"	49IF-62	...
12064	04349-0604	49I-6B		3/8" x 1/4"	2402X6	...
				3/8" x 1/4"	49IF-64	...
12065	04349-0606	49I-6C		3/8" x 3/8"	49IF-66	...
12114	04349-0804	49I-8B		1/2" x 1/4"	49IF-84	...
12066	04349-0806	49I-8C		1/2" x 3/8"	49IF-86	...
12067	04349-0808	49I-8D		1/2" x 1/2"	49IF-88	...
12056	04349-1006	49I-10C		5/8" x 3/8"	49IF-106	...
12068	04349-1008	49I-10D		5/8" x 1/2"	49IF-108	...
12069	04349-1208			3/4" x 1/2"	49IF-128	...
				3/4" x 3/4"	49IF-1212	...
12080	04394-1412			7/8" x 3/4"	49IF-1412	...
12081	04394-1616			1" x 1"	49IF-1616	...

*Restricted pipe end .062

400 2400 2491FHD 402 2491F 49W

WARNING: This product can expose you to chemicals, including lead, which are known to the State of California to cause cancer and birth defects or other reproductive harm. For more information, visit www.P65Warnings.ca.gov

BRASS

INVERTED FLARE

BRASS FITTINGS

45° ELBOW

SAE# 040302

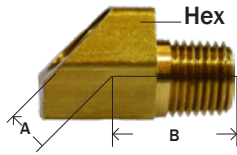

591F
941N
04394

MIDLAND	AMC	CHAMPION	LIST	INV. FLARE X MALE NPTF	MAF #	MAF PRICE
12070	04394-0202			1/8" x 1/8"	591F-22	...
12072	04394-0302	94I-3A		3/16" x 1/8"	591F-32	...
12073	04394-0402	94I-4A		1/4" x 1/8"	591F-42	...
12074	04394-0502	94I-5A		5/16" x 1/8"	591F-52	...
12075	04394-0504	94I-5B		5/16" x 1/4"	591F-54	...
12115	04394-0602			3/8" x 1/8"	591F-62	...
12076	04394-0604	94I-6B		3/8" x 1/4"	591F-64	...
12077	04394-0806	94I-8C		1/2" x 3/8"	591F-86	...
12079	04394-1008	94I-10D		5/8" x 1/2"	591F-108	...

154 2352 2591FHD 352 94W

UNION TEE

SAE# 040401



441F
441N
04344

MIDLAND	AMC	CHAMPION	LIST	SIZE	MAF #	MAF PRICE
12085	04344-02			1/8"	441F-2	
12086	04344-03	44I-3		3/16"	441F-3	...
12087	04344-04	44I-4		1/4"	441F-4	...
12088	04344-05	44I-5		5/16"	441F-5	...
12089	04344-06	44I-6		3/8"	441F-6	...
12090	04344-08	44I-8		1/2"	441F-8	...
				7/8"	441F-14	...

2441FHD 702 44I

STEEL PLUG

SAE# 040109

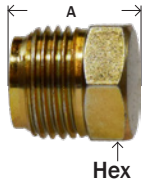

391N
391F
04399



STEEL						
MIDLAND	AMC	CHAMPION	LIST	SIZE	MAF #	MAF PRICE
12091	04339-03	41IP-3		3/16"	391F-3	...
12092	04339-04	41IP-4		1/4"	391F-4	...
12093	04339-05	41IP-5		5/16"	391F-5	...
12094	04339-06	41IP-6		3/8"	391F-6	...
BRASS						
12095				3/8"	391FB-6	...
12096				1/2"	391FB-8	...
12097				5/8"	391FB-10	...
12098				3/4"	391FB-12	...

▪ cored

106 41IP 131 2131

FEMALE ELBOW

SAE# 040203

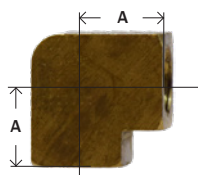

501F
501N
04350

MIDLAND	AMC	CHAMPION	LIST	INV. FLARE X FEMALE NPTF	MAF #	MAF PRICE
	04350-0320	50I-3A		3/16" x 1/8"	501F-32	
12110	04350-0402	50I-4A		1/4" x 1/8"	501F-42	
12111	04350-0502	50I-5A		5/16" x 1/8"	501F-52	...
12112	04350-0604	50I-6B		3/8" x 1/4"	501F-64	...
				1/2" x 3/8"	501F-86	...

450

WARNING: This product can expose you to chemicals, including lead, which are known to the State of California to cause cancer and birth defects or other reproductive harm. For more information, visit www.P65Warnings.ca.gov

INVERTED FLARE

BRASS FITTINGS

UNION ELBOW INV. FL X INV. FL

SAE# 040203

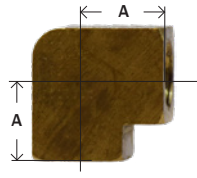

MIDLAND	AMC	CHAMPION	LIST	INV. FLARE X FEMALE NPTF	MAF #	MAF PRICE
12415	04355-04			1/4	55IF-4	
				5/16	55IF-5	
	04355-06			3/8	55IF-6	
				1/2	55IF-8	

MALE BRANCH TEE

SAE# 040425

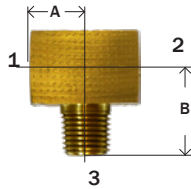

451F
451N
04345

MIDLAND	AMC	CHAMPION	LIST	INV. FLARE X MALE NPTF (1&2)X3	MAF #	MAF PRICE
12100	04345-0302	54I-3A		3/16" x 1/8"	451F-32	...
12101	04345-0402	54I-4A		1/4" x 1/8"	451F-42	...
12102	04345-0502	54I-5A		5/16" x 1/8"	451F-52	...
12103	04345-0604	54I-6B		3/8" x 1/4"	451F-64	...

145 245IFHD 602 2600 600

MALE RUN TEE

SAE# 040424

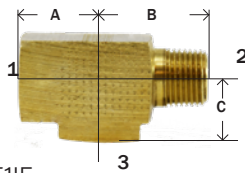

511F
511N
04351

MIDLAND	AMC	CHAMPION	LIST	INV. FLARE X MALE NPTF (1&3)X2	MAF #	MAF PRICE
12118	04351-0302	51I-3A		3/16" x 1/8"	511F-32	...
12119	04351-0402	51I-4A		1/4" x 1/8"	511F-42	...
12120	04351-0502	51I-5A		5/16" x 1/8"	511F-52	...
12121	04351-0604	51I-6B		3/8" x 1/4"	511F-64	...
				1/2" x 3/8"	511F-86	...

251IFHD 752 550 151

FEMALE BRANCH TEE

SAE# 040427

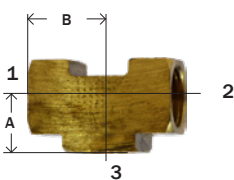

521F
521N
04352

MIDLAND	AMC	CHAMPION	LIST	INV. FLARE X FEMALE NPTF (1&2)X3	MAF #	MAF PRICE
12127		52I-3A		3/16" x 1/8"	521F-32	
12128				1/4" x 1/8"	521F-42	
12129	04352-0502			5/16" x 1/8"	521F-52	...
12130	04352-0604			3/8" x 1/4"	521F-64	...
				1/2" x 3/8"	521F-86	...
				1/2" x 1/2"	521F-88	...

252IFHD 652 136

FIPXMIPXINV FL TEE

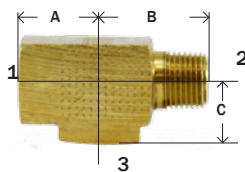

MIDLAND	AMC	CHAMPION	LIST	FIP X MIP X INV FL. SIZE	MAF #	MAF PRICE
				1/8" x 1/8" x 3/16"	53IF-32	
				1/8" x 1/8" x 1/4"	53IF-42	

WARNING: This product can expose you to chemicals, including lead, which are known to the State of California to cause cancer and birth defects or other reproductive harm. For more information, visit www.P65Warnings.ca.gov



INVERTED FLARE

BRASS FITTINGS

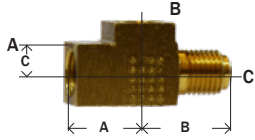
TOWED TRAILER BRAKE TEE

127BT

MIDLAND	AMC	CHAMPION	REF #	LIST	INVERTED SEAT	INV SEAT	MALE THREAD	MAF #	MAF PRICE
12147	08603	127BT-3	7900		3/16" 0.57	3/16" 0.76	3/16" 0.42	MA7900	...
12145	08608		7906		3/16" (1/2-20) 0.68	3/16" (3/8-24) 0.94	3/16" (1/2-20) 0.47	MA7906	...
12148	08605		7933		3/16" (9/16-18)	3/16" (3/8-24)	3/16" (9/16/18)	MA7933	...
12144	08607		7905		3/16" (9/16-20) 0.82	3/16" (3/8-24) 0.94	3/16" (9/16-20) 0.47	MA7905	...
12146	08609		7914		3/16" (7/16-24) 0.54	3/16" (3/8-24) 0.78	1/4" (7/16-24) 0.42	MA7914	...
12150	08604	127BT-4	7901		1/4" 0.56	3/16" 0.77	1/4" 0.43	MA7901	...
12149	08606		7904		1/4" (9/16-18) 0.81	3/16" (3/8-24) 0.93	1/4" (9/16-18) 0.50	MA7904	...
12151	08601	127BT-1	7898		1/4" 0.56	1/4" 0.77	1/4" 0.43	MA7898	...

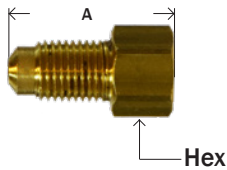
INVERTED FLARE AUTO FITTINGS**DUAL MASTER CYLINDER ADAPTER**

MIDLAND	AMC	CHAMPION	LIST	MALE FLARE X FEMALE INV.	MAF #	MAF PRICE
12200				3/16" x 3/16"	MA1441	...
12202				5/16" x 3/16"	MA7897	...

WARNING: This product can expose you to chemicals, including lead, which are known to the State of California to cause cancer and birth defects or other reproductive harm. For more information, visit www.P65Warnings.ca.gov



INVERTED FLARE

BRASS FITTINGS

DUAL MASTER CYLINDER ADAPTER

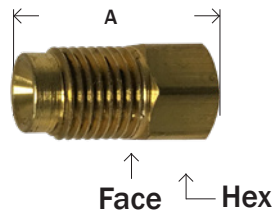

48STA
6641N
6011N

* Seals on hex face

MIDLAND	AMC	CHAMPION	REF#	LIST	MALE INVERTED THREAD	FEMALE INVERTED THREAD	MAF #	MAF PRICE
12206	08664-090918		7911		3/16(9/16-18)	3/16	MA7911	...
12209	08664-0809		7913		3/16(9/16-18)	3/16(1/2-20)	MA7913	...
12207	08664-030920		7910		3/16(9/16-20)	3/16	MA7910	...
12210	08661-0403	47I-43	7828		3/16	1/4	MA7828	...
12212	08661-0304	47I-34	7818		1/4	3/16	MA7818	...
12214*	08683	47I-47-HEX	7732		7/16-20	1/4	MA7732	...
12211	08664-0409		7908		1/4(9/16-18)	1/4	MA7908	...
12215	08661-0504		7917		1/4	5/16	MA7917	...
12213*	08681		7817		5/16	3/16	MA7817	...
12216	08661-0305	47I-35	7909		5/16	3/16	MA7909	...
12208	08664-0908	7912	7912		5/16	3/16(9/16-18)	MA7912	...
12218*	08684	47I-45-HEX	7727		5/16	1/4	MA7727	...
12220	08661-0405	47I-45	7829		5/16	1/4	MA7829	...
12222*	08685	47I-55-HEX	1074		5/16	5/16	MA1074	...
12221	08661-0506	47I-65	7915		5/16	3/8	MA7915	...
12224			7771		3/8" NPTF	5/16	MA7771	...
12217	08661-0605	47I-56	7916		3/8	5/16	MA7916	...

47W

CARBURETOR TO FUEL LINE ADAPTER - FORD

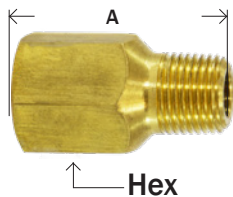

MIDLAND	AMC	CHAMPION	LIST	FEMALE TUBE OD X MALE NPTF	MAF #	MAF PRICE
12230				1/4"(1/2-20) x 1/8"	MA1513	

RESTRICTION PIPE ADAPTER (.0625 ORIFICE)

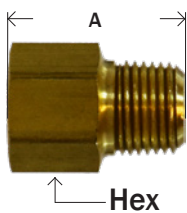

MIDLAND	AMC	CHAMPION	REF#	LIST	SIZE FIP X MIP	MAF #	MAF PRICE
12310			1512		1/8"	MA1512	

Dimension data can change without notice. Please call when dimensions are critical.

INVERTED FLARE

BRASS FITTINGS

SAE FLARE X INVERTED FLARE

4205

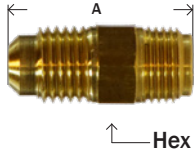

MIDLAND	AMC	CHAMPION	REF #	LIST	SAE FLARE X INV. FLARE	MAF #	MAF PRICE
12250		04MF-04MI	1518		1/4" x 3/16"	MA1518	----
12252			1522		1/4" x 1/4"	MA1522	----
12254		06MF-06MI	1553		3/8" x 5/16"	MA1553	----
12256			1563		3/8" x 3/8"	MA1563	----
12257			1554		3/8" x 7/16"	MA1554	----

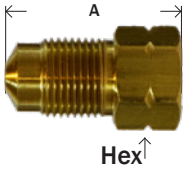
METRIC HYDRAULIC BRAKE FITTINGS**METRIC ADAPTER**

MIDLAND	AMC	CHAMPION	REF #	LIST	TUBE O.D./ FEMALE THREAD	MAF #	MAF PRICE
12335			1442		3/16"(3/8-24)	MA1442	...
12326			7935		3/16"(M10x1.0)	MA7935	...
12327			7936		3/16"(M10x1.0)	MA7936	...
12328			7937		3/16"(M10x1.0)	MA7937	...

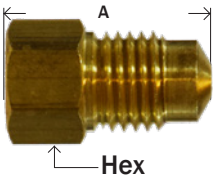
ADAPTER STANDARD TO METRIC BUBBLE

MIDLAND	AMC	CHAMPION	REF #	LIST	FEMALE INV. FLARE SEAT	MALE METRIC BUBBLE FLARE	MAF #	MAF PRICE
12336			7973		3/16" (3/8-24)	11x1.5	MA7973	...
12337			7970		3/16" (3/8-24)	(3/16") (10x1.25)	MA7970	...
12339			7972		3/16" (3/8-24)	13x1.5	MA7972	...
12341			7974		3/16" (3/8-24)	12x1.0	MA7974	...

FEMALE X MALE ADAPTERS

MIDLAND	LIST	FEMALE STANDARD FLARE SEAT	MALE BUBBLE FLARE	MAF #	MAF PRICE
12330		3/8-24 (3/16)	7/16-20	MA1330	...



MIDLAND	REF #	LIST	TUBE OD/ FEMALE THREAD	INVERTED MALE THREAD	MAF #	MAF PRICE
12205	1443		3/16 (3/8-24)	M10 x 1.0	MA1443	

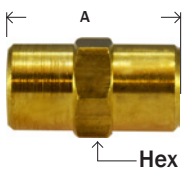

MIDLAND	LIST	FEMALE STANDARD FLARE	INVERTED MALE THREAD	MAF #	MAF PRICE
12329		3/8-24 (3/16)	M9 x 1.0	MA1329	

METRIC UNION

MIDLAND	REF #	LIST	SIZE	MAF #	LIST
12342	1594		British Brake Lines 3/16 (3/8-24 Bubble)	MA1594	
12343	7975		European Brake Lines 3/16"(10.0MM)	MA7975	...
12344	7934A		Japanese Brake Lines 3/16 (M10 x 1.0) Inverted	MA7934A	...
12345			GM Brake Lines 6mm M12 x 1.0 Bubble	MA2345	...

WARNING: This product can expose you to chemicals, including lead, which are known to the State of California to cause cancer and birth defects or other reproductive harm. For more information, visit www.P65Warnings.ca.gov

COMPRESSION

BRASS FITTINGS

COMPRESSION FITTINGS



These are NOT Lead Free
See Lead Free section for Lead Free products

Tube O.D.	1/8	3/16	1/4	5/16	3/8	7/16	1/2	5/8	3/4	7/8
Thread Size-B	5/16-24	3/8-24	7/16-24	1/2-24	9/16-24	5/8-24	11/16-20	13/16-18	1-18	1-1/8-18
Working Pressure	400	400	300	300	200	200	200	150	100	75

• Typical Application

Use with copper, aluminum and thermoplastic tubing. Not recommended for steel tubing. Manufactured for low and medium pressure tubing connection work where excessive vibration or tube movement is not involved. Not recommended for application using gaseous media.

• Pressure

See table above for working pressures at 73°F.

• Vibration

Fair resistance - use long nut when greater vibration resistance is needed.

• Temperature Range

-65°F to +250°F (-53°C to +121°C) range at maximum operating pressures. (Refer to tubing temperature range.)

• Used With

Aluminum, copper, brass and plastic tubing. Plastic tubing requires insert. Not recommended for steel tubing.

• Tolerance

+/- .02 on all dimensions. Dimension data can change without notice. Please call us when dimensions are critical.

• Conformance

Meets specifications and standards of ASA, ASME and SAE.

• Assembly Instructions

- 1- Cut tubing to desired length.
- 2- Slide nut and then sleeve on tube. Threaded end "A" of nut must face toward fitting.
- 3- Insert tubing into fitting body. Be sure tubing is bottomed on fitting shoulder.
- 4- Lubricate threads and assemble nut to fitting body.
- 5- Tighten nut hand tight. From that point, tighten with a wrench the number of turns indicated in the chart below.

Tube Size	Additional Turns from Hand Tight
1/8" thru 1/4"	1-1/4"
5/16"	1-3/4"
3/8" thru 1"	2-1/4"

• "L" at the end of a Part# means Light Pattern

-These fittings are completely interchangeable with full pattern fittings, but have been modified in some way. This modification is usually in the length of the pipe threads. Used in plumbing and light industrial applications.

Actual Profile of Compression Threads



WARNING: This product can expose you to chemicals, including lead, which are known to the State of California to cause cancer and birth defects or other reproductive harm. For more information, visit www.P65Warnings.ca.gov

COMPRESSION**BRASS FITTINGS****BRASS SLEEVE**

• FERRULES
SAE# 060115

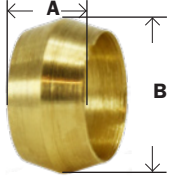

60
00060

MIDLAND	AMC	CHAMPION	LIST	SIZE	MAF #	MAF PRICE
18001	00060-02	60A-2	----	1/8"	60-2	----
				1/8"	260X2	----
18002	00060-03	60A-3	----	3/16"	60-3	----
				3/16"	260X3	----
18003	00060-04	60A-4	----	1/4"	60-4	----
				1/4"	260X4	----
18004	00060-05	60A-5	----	5/16"	60-5	----
				5/16"	260X5	----
18005	00060-06	60A-6	----	3/8"	60-6	----
				3/8"	260X6	----
18006	00060-07	60A-7	----	7/16"	60-7	----
				7/16"	260X7	----
18007	00060-08	60A-8	----	1/2"	60-8	----
				1/2"	260X8	----
18008	00060-10	60A-10	----	5/8"	60-10	----
				5/8"	260X10	----
18009	00060-12	60A-12	----	3/4"	60-12	----
				3/4"	260X12	----
18010	00060-14	60A-14	----	7/8"	60-14	----
18011			----	1"	260X16	----
					260X16	

60 260

BRASS NUT

SAE# 060110

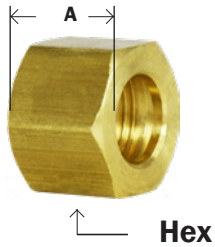

61
00061

MIDLAND	AMC	CHAMPION	LIST	SIZE	MAF #	MAF PRICE
				1/8"	61-2	----
18033	00061-02	61A-2	----	1/8"	261X2	----
				3/16"	61X3	----
18034	00061-03	61A-3	----	3/16"	261X3	----
18035L			----	1/4"	61-4	----
18035	00061-04	61A-4	----	1/4"	261X4	----
				5/16"	61-5	----
18036	00061-05	61A-5	----	5/16"	261X5	----
18037L	00061-06		----	3/8"	61-6	----
18037		61A-6	----	3/8"	261X6	----
				7/16"	61-7	----
18038	00061-07	61A-7	----	7/16"	261X7	----
18039L	00061-08		----	1/2"	61-8	----
18039		61AH-8	----	1/2"	261X8	----
18040L	00061-10		----	5/8"	61-10	----
18040		61AH-10	----	5/8"	261X10	----
				3/4"	61-12	----
18041	00061-12	61A-12	----	3/4"	261X12	----
				7/8"	61-14	----
18042	00061-14	61A-14	----	7/8"	261X14	----
18043			----	1"	261X16	----

61 261

WARNING: This product can expose you to chemicals, including lead, which are known to the State of California to cause cancer and birth defects or other reproductive harm. For more information, visit www.P65Warnings.ca.gov

COMPRESSION

BRASS FITTINGS

UNION

SAE# 060101BA

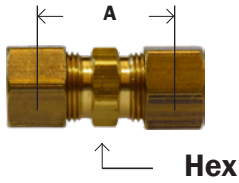

62
262
00062

MIDLAND	AMC	CHAMPION	LIST	SIZE	MAF #	MAF PRICE
				1/8"	62-2	----
18062	00062-02	62A-22	----	1/8"	262X2	----
				3/16"	62-3	----
18063	00062-03	62A-33	----	3/16"	262X3	----
18064L	00062-04		----	1/4"	62-4	----
18064		62A-44	----	1/4"	262X4	----
				5/16"	62-5	----
18065	00062-05	62A-55	----	5/16"	262X5	----
18066L	00062-06		----	3/8"	62-6	----
18066		62A-66	----	3/8"	262X6	----
				3/8"	62FC-6	----
18067	00062-07	62A-77	----	7/16"	62-7	----
18068L	00062-08		----	1/2"	62-8	----
18068		62A-88	----	1/2"	262X8	----
18069L	00062-10		----	5/8"	62-10	----
18069		62A-1010	----	5/8"	262X10	----
18070	00062-12	62A-1212	----	3/4"	262X12	----
18071L	00062-14		----	7/8"	62-14	----
18071		62A-1414	----	7/8"	262X14	----
18072	00062-16		----	1"	262X16	----

M-62

REDUCING UNION

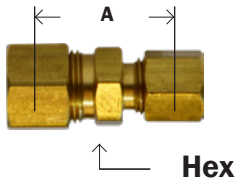

62R
00082

MIDLAND	AMC	CHAMPION	LIST	SIZE	MAF #	MAF PRICE
				3/16" x 1/8"	62R-32	----
18076	00082-0402	62A-42	----	1/4" x 1/8"	62R-42	----
18077	00082-0403	62A-43	----	1/4" x 3/16"	62R-43	----
18078	00082-0504	62A-54	----	5/16" x 1/4"	62R-54	----
18079	00082-0604	62A-64	----	3/8" x 1/4"	62R-64	----
				3/8" x 1/4"	262RX6X4	----
18080	00082-0605	62A-65	----	3/8" x 5/16"	62R-65	----
				1/2" x 1/4"	262RX8X4	----
18081	00082-0806	62A-86	----	1/2" x 3/8"	262RX8X6	----
18082	00082-1006	62A-106	----	5/8" x 3/8"	62R-106	----
18083	00082-1008	62A-108	----	5/8" x 1/2"	62R-108	----
				5/8" x 1/2"	262RX10X8	----
18085	00082-1406		----	7/8" x 3/8"	62R-146	----
18086	00082-1408		----	7/8" x 1/2"	262RX14X8	----
18084	00082-1410		----	7/8" x 5/8"	262RX14X10	----
				7/8" x 3/4"	262RX14X12	----

62-R

DRILLED THRU TANK UNION

00092

MIDLAND	AMC	CHAMPION	LIST	SIZE	MAF #	MAF PRICE
				1/8"	62T-2	----
				1/4"	62T-4	----
				3/8"	62T-6	----
				1/2"	62T-8	----
				5/8"	62T-10	----
				7/8"	62T-14	----

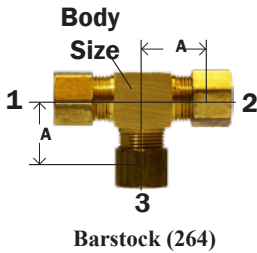
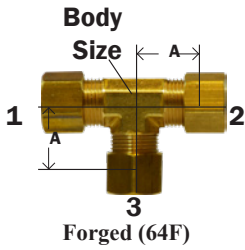
COMPRESSION**BRASS FITTINGS****TEE**
SAE# 06040164
00064

MIDLAND	AMC	CHAMPION	LIST	SIZE	MAF #	MAF PRICE
18101	00064-02		----	1/8"	64F-2	----
18101B		64A-22	----	1/8"	264X2	----
18102	00064-03		----	3/16"	64F-3	----
18102B		64A-33	----	3/16"	264X3	----
18103	00064-04	64AF-44	----	1/4"	64F-4	----
18103B		64A-44	----	1/4"	264X4	----
18104	00064-05	64A-55	----	5/16"	64F-5	----
18104B			----	5/16"	264X5	----
18105		64AF-66	----	3/8"	64F-6	----
18105B	00064-06	64A-66	----	3/8"	264X6	----
	00064-07	64A-77		7/16"	64F-7	----
				7/16"	264X7	----
18106	00064-08	64A-88	----	1/2"	64F-8	----
				1/2"	264X8	----
18107	00064-10		----	5/8"	64F-10	----
				5/8"	264X10	----
18108	00064-12	64A-1212	----	3/4"	64F-12	----
				3/4"	264X12	----
18109	00064-14	64A-1414	----	7/8"	64F-14	----
				7/8"	264X14	----
				1"	264X16	----

64 264C

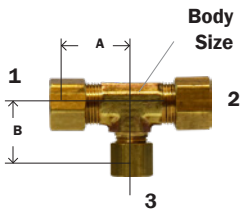
FORGED REDUCING TEE64R
00084

MIDLAND	AMC	CHAMPION	LIST	SIZE 1 X 2 X 3	MAF #	MAF PRICE
18114	00084-040402	64A-442	----	1/4" x 1/4" x 1/8"	64FR-442	----
18110	00084-040406	64A-446	----	1/4" x 1/4" x 3/8"	64FR-446	----
	00084-050504	64A-554		5/16" x 5/16" x 1/4"	64FR-554	----
18111	00084-060404	64A-644	----	3/8" x 1/4" x 1/4"	64FR-644	----
18115	00084-060604	64A-664	----	3/8" x 3/8" x 1/4"	64FR-664	----
18116	00084-080804	64A-884	----	1/2" x 1/2" x 1/4"	64FR-884	----
18117	00084-080806	64A-886	----	1/2" x 1/2" x 3/8"	64FR-886	----
18118	00084-101006	64A-10106	----	5/8" x 5/8" x 3/8"	64FR-10106	----
18119	00084-101008	64A-10108	----	5/8" x 5/8" x 1/2"	64FR-10108	----

64-R

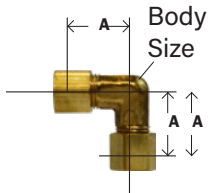
UNION ELBOW SAE# 06020165
00065

MIDLAND	AMC	CHAMPION	LIST	SIZE	MAF #	MAF PRICE
18122B	00065-02	65A-22	----	1/8"	265X2	----
18123	00065-03	65A-33	----	3/16"	265X3	----
18124	00065-04	65AF-44	----	1/4"	265X4	----
18125	00065-05	65A-55	----	5/16"	265X5	----
18126	00065-06	65A-66	----	3/8"	265X6	----
18127	00065-08	65A-88	----	1/2"	265X8	----
18128	00065-10	65A-1010	----	5/8"	65F-10	----
18129	00065-12	65A-1212	----	3/4"	65F-12	----
18130	00065-14	65A-1414	----	7/8"	65F-14	----

65 BSE2 165C 265C

COMPRESSION

BRASS FITTINGS

REDUCING ELBOW - FORGED

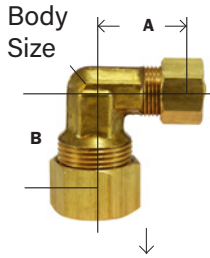

00085
65R

MIDLAND	AMC	CHAMPION	LIST		MAF #	MAF PRICE
18135	00085-0604	65A-64	----	3/8" x 1/4"	65FR-64	----
18136	00085-0806	65A-86	----	1/2" x 3/8"	65FR-86	----
18137	00085-1006	65A-106	----	5/8" x 3/8"	65R-106	----
	00085-1008	65A-108		5/8" x 1/2"	65R-108	

65-R

FEMALE ADAPTER

SAE# 060103

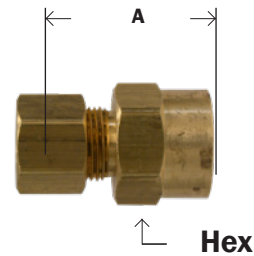

66

MIDLAND	AMC	CHAMPION	LIST	COMP. X FEMALE NPTF	MAF #	MAF PRICE
18142	00066-0202	66A-2A	----	1/8" x 1/8"	66-22	----
18143	00066-0302	66A-3A	----	3/16" x 1/8"	66-32	----
18144	00066-0304	66A-3B	----	3/16" x 1/4"	66-34	----
18145L	00066-0402		----	1/4" x 1/8"	66-42	----
18145		66A-4A	----	1/4" x 1/8"	266X4	----
18146L	00066-0404		----	1/4" x 1/4"	66-44	----
18146		66A-4B	----	1/4" x 1/4"	266X4X4	----
	00066-0406	66A-4C		1/4" x 3/8"	66-46	----
18148	00066-0408	66A-4D	----	1/4" x 1/2"	66-48	----
				1/4" x 5/8"	66S-410*	----
18149	00066-0502	66A-5A	----	5/16" x 1/8"	66-52	----
18150	00066-0504	66A-5B	----	5/16" x 1/4"	66-54	----
	00066-0506	66A-5C		5/16" x 3/8"	66-56	----
18152	00066-0602	66A-6A	----	3/8" x 1/8"	66-62	----
18153L	00066-0604		----	3/8" x 1/4"	66-64	----
18153		66A-6B	----	3/8" x 1/4"	266X6	----
18154L	00066-0606		----	3/8" x 3/8"	66-66	----
18154		66A-6C	----	3/8" x 3/8"	266X6X6	----
18155	00066-0608	66A-6D	----	3/8" x 1/2"	66-68	----
	00086-0610	66AS-610		3/8" x 5/8"	66S-610*	----
18156	00066-0612	66A-6E	----	3/8" x 3/4"	66-612	----
18157	00066-0804	66A-8B	----	1/2" x 1/4"	66-84	----
18158L	00066-0806		----	1/2" x 3/8"	66-86	----
18158		66A-8C	----	1/2" x 3/8"	266X8	----
18159L	00066-0808		----	1/2" x 1/2"	66-88	----
18159		66A-8D	----	1/2" x 1/2"	266X8X8	----
	00096-0808			1/2"	66T-88**	----
				1/2" x 5/8"	66S-810*	----
18160	00066-0812	66A-8E	----	1/2" x 3/4"	66-812	----
	00096-1006	66A-10C		5/8" x 3/8"	66-106	----
18162L	00066-1008		----	5/8" x 1/2"	66-108	----
18162		66A-10D	----	5/8" x 1/2"	266X10	----
18163	00066-1012	66A-10E	----	5/8" x 3/4"	66-1012	----
18164	00066-1208	66A-12D	----	3/4" x 1/2"	66-128	----
18165	00066-1212	66A-12E	----	3/4" x 3/4"	66-1212	----
18167	00066-1408		----	7/8" x 1/2"	66-148	----
18166	00066-1412	66A-14E	----	7/8" x 3/4"	66-1412	----

** Drilled thru

* Comp x SWT

• More sizes available online

WARNING: This product can expose you to chemicals, including lead, which are known to the State of California to cause cancer and birth defects or other reproductive harm. For more information, visit www.P65Warnings.ca.gov

BRASS

COMPRESSION

BRASS FITTINGS

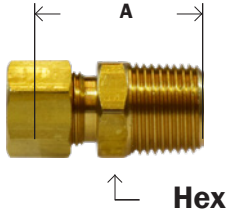
MALE ADAPTER
SAE# 06010268
00068

MIDLAND	AMC	CHAMPION	LIST	COMP. X MALE NPTF	MAF #	MAF PRICE
18175		68A-2X	----	1/8" x 1/16"	68-21	----
18176	00068-0202	68A-2A	----	1/8" x 1/8"	268X2	----
				3/16" x 1/8"	68-32	----
18177	00068-0302	68A-3A	----	3/16" x 1/8"	268X3	----
18178	00068-0304	68A-3B	----	3/16" x 1/4"	68-34	----
18179L			----	1/4" x 1/8"	68-42	----
18179	00068-0402	68A-4A	----	1/4" x 1/8"	268X4	----
18180L	00068-0404		----	1/4" x 1/4"	68-44	----
18180		68A-4B	----	1/4" x 1/4"	268X4X4	----
18181	00068-0406	68A-4C	----	1/4" x 3/8"	268X4X6	----
18182	00068-0408	68A-4D	----	1/4" x 1/2"	268X4X8	----
	00068-0502			5/16" x 1/8"	68-52	----
18183		68A-5A	----	5/16" x 1/8"	268X5	----
18184L	00068-0504		----	5/16" x 1/4"	68-54	----
18184		68A-5B	----	5/16" x 1/4"	268X5X4	----
18185	00068-0506	68A-5C	----	5/16" x 3/8"	68-56	----
18186	00068-0508	68A-5D	----	5/16" x 1/2"	68-58	----
18187L	00068-0602		----	3/8" x 1/8"	68-62	----
18187		68A-6A	----	3/8" x 1/8"	268X6X2	----
18188L	00068-0604		----	3/8" x 1/4"	68-64	----
18188		68A-6B	----	3/8" x 1/4"	268X6X4	----
18189L	00068-0606		----	3/8" x 3/8"	68-66	----
18189		68A-6C	----	3/8" x 3/8"	268X6X6	----
18190L	00068-0608		----	3/8" x 1/2"	68-68	----
18190		68A-6D	----	3/8" x 1/2"	268X6X8	----
				3/8" x 1/2"	68LP-68	----
18191	00068-0612	68A-6E	----	3/8" x 3/4"	68-612	----
18192	00068-0704	68A-7B	----	7/16" x 1/4"	268X7	----
18204	00068-0706	68A-7C	----	7/16" x 3/8"	68-76	----
18193L	00068-0804		----	1/2" x 1/4"	68-84	----
18193		68A-8B	----	1/2" x 1/4"	268X8X4	----
18194L	00068-0806		----	1/2" x 3/8"	68-86	----
18194		68A-8C	----	1/2" x 3/8"	268X8	----
18195L	00068-0808		----	1/2" x 1/2"	68-88	----
18195		68A-8D	----	1/2" x 1/2"	268X8X8	----
18196	00068-0812	68A-8E	----	1/2" x 3/4"	68-812	----
18216	00068-1004		----	5/8" x 1/4"	68-104	----
18197	00068-1006	68A-10C	----	5/8" x 3/8"	268X10X6	----
18198	00068-1008	68A-10D	----	5/8" x 1/2"	68-108	----
				5/8" x 1/2"	268X10	----
18199	00068-1012	68A-10E	----	5/8" x 3/4"	68-1012	----
18200	00068-1208	68A-12D	----	3/4" x 1/2"	68-128	----
18201	00068-1212	68A-12E	----	3/4" x 3/4"	68-1212	----
18202	00068-1408	68A-14D	----	7/8" x 1/2"	68-148	----
18203	00068-1412	68A-14E	----	7/8" x 3/4"	68-1412	----
18205	00068-1416		----	7/8" x 1"	68-1416	----
18206	00068-1612		----	1" x 3/4"	68-1612	----
18207	00068-1616		----	1" x 1"	68-1616	----

68

WARNING: This product can expose you to chemicals, including lead, which are known to the State of California to cause cancer and birth defects or other reproductive harm. For more information, visit www.P65Warnings.ca.gov

COMPRESSION

BRASS FITTINGS

MALE ELBOW SAE# 060202

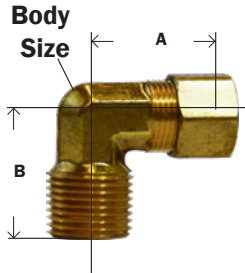

Forged (69F)

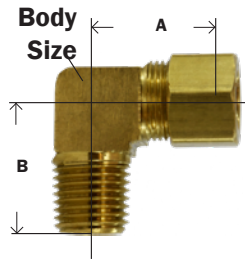

Barstock (269)

69
00069

* Barstock

** Compression x SWT

MIDLAND	AMC	CHAMPION	LIST	COMP. X MALE NPTF	MAF #	MAF PRICE
18219		69A-2X	----	1/8" x 1/16"	269X2X1	----
18220	00069-0202		----	1/8" x 1/8"	69F-22	----
18220B*		69A-2A	----	1/8" x 1/8"	269X2	----
18221	00069-0302		----	3/16" x 1/8"	69F-32	----
18221B*		69AF-3A	----	3/16" x 1/8"	269X3	----
18223	00069-0304	69A-3B	----	3/16" x 1/4"	69F-34	----
18223B*			----	3/16" x 1/4"	269X3X4	----
18224	00069-0402		----	1/4" x 1/8"	69F-42	----
				1/4" x 1/8"	69-42	----
18224B*	00069-0402B	69AF-4A	----	1/4" x 1/8"	269X4	----
18225	00069-0404	69AF-4B	----	1/4" x 1/4"	69F-44	----
18225B*		69A-4B	----	1/4" x 1/4"	269X4X4	----
18226	00069-0406	69A-4C	----	1/4" x 3/8"	69F-46	----
18226B			----	1/4" x 3/8"	269X4X6	----
18227	00069-0408	69A-4D	----	1/4" x 1/2"	69F-48	----
18228	00069-0502	69AF-5A	----	5/16" x 1/8"	69F-52	----
18228B*		69A-5A	----	5/16" x 1/8"	269X5	----
18229	00069-0504	69AF-5B	----	5/16" x 1/4"	69F-54	----
18229B*		69A-5B	----	5/16" x 1/4"	269X5X4	----
18230	00069-0506	69A-5C	----	5/16" x 3/8"	69F-56	----
18231	00069-0508		----	5/16" x 1/2"	69F-58	----
18232	00069-0602		----	3/8" x 1/8"	69F-62	----
18232B*		69A-6A	----	3/8" x 1/8"	269X6X2	----
18233	00069-0604	69AF-6B	----	3/8" x 1/4"	69F-64	----
18233B*		69A-6B	----	3/8" x 1/4"	269X6	----
18234	00069-0606	69AF-6C	----	3/8" x 3/8"	69-66	----
18234B*	00069-0606B	69A-6C	----	3/8" x 3/8"	269X6X6	----
18235	00069-0608	69A-6D	----	3/8" x 1/2"	69F-68	----
18235B*			----	3/8" x 1/2"	269X6X8	----
	00089-0610			3/8" x 5/8"	69S-610**	----
18248	00069-0612		----	3/8" x 3/4"	69F-612	----
18248B*		69A-6E	----	3/8" x 3/4"	269X6X12	----
18247	00069-0704	69A-7B	----	7/16" x 1/4"	69F-74	----
	00069-0706			7/16" x 3/8"	69F-76	----
18236	00069-0804	69A-8B	----	1/2" x 1/4"	69F-84	----
18236B*			----	1/2" x 1/4"	269X8X4	----
18237	00069-0806		----	1/2" x 3/8"	69F-86	----
18237B*		69A-8C	----	1/2" x 3/8"	269X8	----
18238	00069-0808		----	1/2" x 1/2"	69F-88	----
18238B*		69A-8D	----	1/2" x 1/2"	269X8X8	----
18239	00069-0812	69A-8E	----	1/2" x 3/4"	69F-812	----
18240	00069-1006	69A-10C	----	5/8" x 3/8"	69F-106	----
				5/8" x 3/8"	269X10X6	----

(Continued On Next Page)

69 269C BSE1 169C

WARNING: This product can expose you to chemicals, including lead, which are known to the State of California to cause cancer and birth defects or other reproductive harm. For more information, visit www.P65Warnings.ca.gov

BRASS

COMPRESSION

BRASS FITTINGS

MALE ELBOW-CONTINUED

SAE# 060202

MIDLAND	AMC	CHAMPION	LIST	COMP. X MALE NPTF	MAF #	MAF PRICE
18241	00069-1008		----	5/8" x 1/2"	69F-108	----
18241B*		69A-10D	----	5/8" x 1/2"	269X10	----
18242	00069-1012	69A-10E	----	5/8" x 3/4"	69F-1012	----
18243	00069-1208	69A-12D	----	3/4" x 1/2"	69F-128	----
18245	00069-1212	69A-12E	----	3/4" x 3/4"	69F-1212	----
	00069-1408			7/8" x 1/2"	69F-148	----
18246	00069-1412	69A-14E	----	7/8" x 3/4"	69F-1412	----

FEMALE ELBOW

SAE# 060203

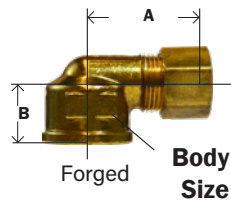

Barstock

70

* Barstock

** Drop ear elbow

MIDLAND	AMC	CHAMPION	LIST	COMP. X FEMALE NPTF	MAF #	MAF PRICE
18251	00070-0202		----	1/8" x 1/8"	70F-22	----
18251B*		70A-2A	----	1/8" x 1/8"	270X2*	----
18252	00070-0302		----	3/16" x 1/8"	70F-32	----
18252B*		70A-3A	----	3/16" x 1/8"	270X3*	----
18253	00070-0402	70A-4A	----	1/4" x 1/8"	70F-42	----
18253B*			----	1/4" x 1/8"	270X4*	----
18254	00070-0404	70A-4B	----	1/4" x 1/4"	70F-44	----
18254B*			----	1/4" x 1/4"	270X4X4*	----
18267	00070-0406	70A-4C	----	1/4" x 3/8"	70F-46	----
18268	00070-0408		----	1/4" x 1/2"	70F-48	----
18255	00070-0502	70A-5A	----	5/16" x 1/8"	70F-52	----
18256	00070-0504		----	5/16" x 1/4"	70F-54	----
18257	00070-0602	70A-6A	----	3/8" x 1/8"	70F-62	----
18258	00070-0604	70A-6B	----	3/8" x 1/4"	70F-64	----
				3/8" x 1/4"	270X6*	----
18259	00070-0606	70A-6C	----	3/8" x 3/8"	70F-66	----
18260	00070-0608	70A-6D	----	3/8" x 1/2"	70F-68	----
18250	00070-0612		----	3/8" x 3/4"	70F-612	----
18261	00070-0804	70A-8B	----	1/2" x 1/4"	70F-84	----
18262	00070-0806	70A-8C	----	1/2" x 3/8"	70F-86	----
18262B				1/2" x 3/8"	270X8*	----
18263	00070-0808	70A-8D	----	1/2" x 1/2"	70F-88	----
18270	00070-0812	70A-8E	----	1/2" x 3/4"	70F-812	----
18269	00070-1006	70A-10C	----	5/8" x 3/8"	70F-106	----
18264	00070-1008	70A-10D	----	5/8" x 1/2"	70F-108	----
				5/8" x 1/2"	270X10	----
				5/8" x 1/2"	70DE-108**	----
18265	00070-1012	70A-10E	----	5/8" x 3/4"	70F-1012	----
18266	00070-1208	70A-12D	----	3/4" x 1/2"	70F-128	----
		70A-12E		3/4" x 3/4"		

70 270C BSE3 170C

COMPRESSION

BRASS FITTINGS

FORGED MALE RUN TEE

SAE# 060424BA

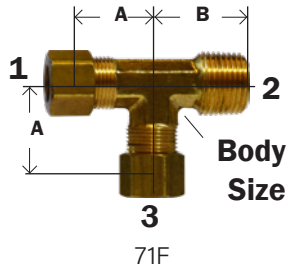

71
00071

* Barstock

MIDLAND	AMC	CHAMPION	LIST	COMP. X MALE NPTF (1&3) X 2	MAF #	MAF PRICE
18272	00071-0202	71A-2A	----	1/8" x 1/8"	71F-22	----
				1/8" x 1/8"	271X2*	----
18273	00071-0302		----	3/16" x 1/8"	71F-32	----
18273B*		71A-3A	----	3/16" x 1/8"	271X3*	----
18274	00071-0402	71A-4A	----	1/4" x 1/8"	71F-42	----
18274B*			----	1/4" x 1/8"	271X4*	----
18275	00071-0404	71A-4B	----	1/4" x 1/4"	71F-44	----
18276	00071-0502	71A-5A	----	5/16" x 1/8"	71F-52	----
				5/16" x 1/8"	271X5*	----
18277	00071-0504	71A-5B	----	5/16" x 1/4"	71F-54	----
18278	00071-0602	71A-6A	----	3/8" x 1/8"	71F-62	----
18279	00071-0604	71A-6B	----	3/8" x 1/4"	71F-64*	----
18279B				3/8" x 1/4"	271X6*	----
18280	00071-0606	71A-6C	----	3/8" x 3/8"	71F-66	----
18281	00071-0806	71A-8C	----	1/2" x 3/8"	71F-86	----
18282	00071-0808	71A-10D	----	1/2" x 1/2"	71F-88	----
18283	00071-1008	71A-10D	----	5/8" x 1/2"	71F-108	----
18284	00071-1208	71A-12D	----	3/4" x 1/2"	71F-128	----
	00071-1212			3/4" x 3/4"	71F-1212	----

71 171C BST3

WARNING: This product can expose you to chemicals, including lead, which are known to the State of California to cause cancer and birth defects or other reproductive harm. For more information, visit www.P65Warnings.ca.gov

BRASS

COMPRESSION

BRASS FITTINGS

MALE BRANCH TEE

SAE# 060425

72
00072

MIDLAND	AMC	CHAMPION	LIST	COMP. X MALE NPTF (1&2) X 3	MAF #	MAF PRICE
18289	00072-0202	72A-22	----	1/8" x 1/8"	72F-22	----
18289B				1/8" x 1/8"	272X2*	----
18290	00072-0302	72A-3A	----	3/16" x 1/8"	272X3	----
18291	00072-0402	72A-4A	----	1/4" x 1/8"	72F-42	----
18291B*			----	1/4" x 1/8"	272X4*	----
18292	00072-0404		----	1/4" x 1/4"	72F-44	----
18292B		72A-4B		1/4" x 1/4"	272X4X4*	----
18293	00072-0502	72A-5A	----	5/16" x 1/8"	72F-52	----
18294	00072-0504	72A-5B	----	5/16" x 1/4"	72F-54	----
18294B				5/16" x 1/4"	272X5*	----
18295	00072-0602	72A-6A	----	3/8" x 1/8"	72F-62	----
18296	00072-0604	72A-6B	----	3/8" x 1/4"	72F-64	----
18296B				3/8" x 1/4"	272X6*	----
18297	00072-0606	72A-6C	----	3/8" x 3/8"	72F-66	----
18298	00072-0608		----	3/8" x 1/2"	72F-68	----
18304	00072-0804		----	1/2" x 1/4"	72F-84	----
18299B*			----	1/2" x 3/8"	272X8*	----
18299	00072-0806	72A-8C	----	1/2" x 3/8"	72F-86	----
18300	00072-0808	72A-8D	----	1/2" x 1/2"	72F-88	----
18301	00072-1008	72A-10D	----	5/8" x 1/2"	72F-108	----
18302	00072-1208	72A-12D	----	3/4" x 1/2"	72F-128	----
18303	00072-1212	72A-12E	----	3/4" x 3/4"	72F-1212	----

* Barstock

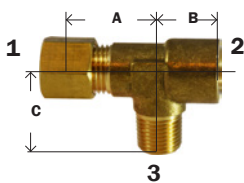
72 **BST1** 172C**TEE - COMP X FIP X MIP**

* Barstock

MIDLAND	AMC	CHAMPION	LIST	COMP. X FEMALE NPTF X MALE NPTF 1X(2&3)	MAF #	MAF PRICE
				1/4" x 1/8"	273X4*	----
				3/8" x 1/4"	273X6*	----
18307	00075-040202		----	1/4" x 1/8"	75F-42	----

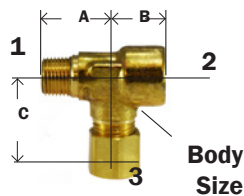
75
273 BARSTOCK
00075**BST3****ADAPTER TEE & GAUGE TEE*** Barstock
** Gauge tee

MIDLAND	AMC	CHAMPION	LIST	MALE NPTF X FEMALE NPTF X COMP. 3 X (1&2)	MAF #	MAF PRICE
	00076-0202			1/8" x 1/8"	276X2*	----
	00076-0302			3/16" x 1/8"	276X3*	----
18314	00076-0402	76A-4A	----	1/4" x 1/8"	76F-42	----
		76A-4B		1/4" x 1/8"	276X4*	----
				5/16" x 1/4"	2905X4**	----
18316	00076-0604	76A-6B	----	3/8" x 1/4"	76F-64	----

76
0007676 **176C**

COMPRESSION

BRASS FITTINGS

FEMALE BRANCH FORGED TEE

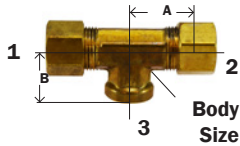

78
00078

MIDLAND	AMC	CHAMPION	LIST	COMP. X FEMALE NPTF (1&2)X3	MAF #	MAF PRICE
18321	00078-0402	77A-4A	----	1/4" x 1/8"	78-42	----
18328	00078-0404		----	1/4" x 1/4"	78-44	----
18325	00078-0602		----	3/8" x 1/8"	78-62	----
18322	00078-0604		----	3/8" x 1/4"	78-64	----
18323	00078-0606		----	3/8" x 3/8"	78-66	----
18326	00078-0802		----	1/2" x 1/8"	78-82	----
18324	00078-0806		----	1/2" x 3/8"	78-86	----
18327	00078-1002		----	5/8" x 1/8"	78-102	----

78 **BST4 77 177C 2908**

45° ELBOW

SAE# 060302

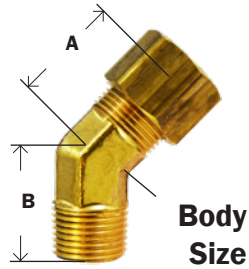

6945
00095

* Barstock

MIDLAND	AMC	CHAMPION	LIST	COMP. X MALE NPTF	MAF #	MAF PRICE
18329	00095-0302	6945A-3A	----	3/16" x 1/8"	6945F-32	----
18330	00095-0402	6945A-4A	----	1/4" x 1/8"	6945F-42	----
18330B				1/4" x 1/8"	273X4*	----
18336	00095-0404	6945A-4B	----	1/4" x 1/4"	6945F-44	----
18331	00095-0502	6945A-5A	----	5/16" x 1/8"	6945F-52	----
18332	00095-0504	6945A-5B	----	5/16" x 1/4"	6945F-54	----
18333	00095-0604	6945A-6B	----	3/8" x 1/4"	6945F-64	----
18333B				3/8" x 1/4"	273X6*	----
18338	00095-0606	6945A-6C	----	3/8" x 3/8"	6945F-66	----
18334	00095-0806	6945A-8C	----	1/2" x 3/8"	6945F-86	----
18339	00095-0808	6945A-8D	----	1/2" x 1/2"	6945F-88	----
18335	00095-1008	6945A-10D	----	5/8" x 1/2"	6945F-108	----

6945 **45BSE1 74 179C 273 77**

COMPRESSION PLUG

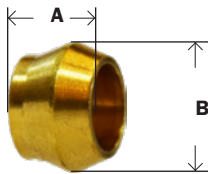

60CP
60CSP
00039

MIDLAND	AMC	CHAMPION	LIST	SIZE	MAF #	MAF PRICE
18028	00039-04		----	1/4"	60CSP-4	----
18029	00039-06		----	3/8"	60CSP-6	----
18032			----	5/16"	60CSP-5	----
18030	00039-08		----	1/2"	60CSP-8	----
18031	00039-10		----	5/8"	60CSP-10	----

CSP

CAP

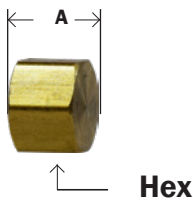

61CC
61CX
00081

MIDLAND	AMC	CHAMPION	LIST	SIZE	MAF #	MAF PRICE
				1/8"	61CC-2	----
				3/16"	61CC-3	----
18047	00081-04	N5CT-4	----	1/4"	61CC-4	----
18048	00081-06	N5CT-6	----	3/8"	61CC-6	----
18049	00081-08	N5CT-8	----	1/2"	61CC-8	----
18050	00081-10	N5CT-10	----	5/8"	61CC-10	----
				3/4"	61CC-12	----

61-CC **N5CT**

WARNING: This product can expose you to chemicals, including lead, which are known to the State of California to cause cancer and birth defects or other reproductive harm. For more information, visit www.P65Warnings.ca.gov

BRASS

COMPRESSION

BRASS FITTINGS

BULKHEAD UNIONS

SAE# 060101

62BH
00083

MIDLAND	AMC	CHAMPION	LIST	SIZE	MAF #	MAF PRICE
				3/16"	62BH-3	----
18088	00083-04	62BH-4	----	1/4"	62BH-4	----
				5/16"	62BH-5	----
18090	00083-06	62BH-6	----	3/8"	62BH-6	----
18093	00083-10		----	1/2"	62BH-8	----
				5/8"	62BH-10	----

62BH 75 274

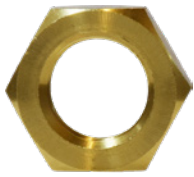
BULKHEAD LOCKNUT

MIDLAND	AMC	CHAMPION	LIST	SIZE	MAF #	MAF PRICE
				1/8"	61LN-2	----
				3/16"	61LN-3	----
				1/4"	61LN-4	----
				5/16"	61LN-5	----
				3/8"	61LN-6	----
				1/2"	61LN-8	----
				5/8"	61LN-10	----

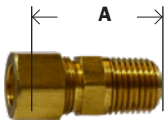
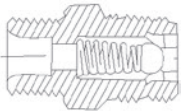
BALL CHECK VALVE - MIN. WORKING PRESSURE 3 PSI.

Hex

63
00063

MIDLAND	AMC	CHAMPION	LIST	TUBE OD X MALE NPTF	MAF #	MAF PRICE
18092	00063-0202	63A-2A	----	1/8" x 1/8"	63-22	----
18093	00063-0302		----	3/16" x 1/8"	63-32	----
18094	00063-0402	63A-4A	----	1/4" x 1/8"	63-42	----
18095	00063-0502			5/16" x 1/8"	63-52	----
18096	00063-0604	63A-6B	----	3/8" x 1/4"	63-64	----

63 263 63A

WARNING: This product can expose you to chemicals, including lead, which are known to the State of California to cause cancer and birth defects or other reproductive harm. For more information, visit www.P65Warnings.ca.gov

COMPRESSION

BRASS FITTINGS

TANK ADAPTER DRILLED THRU (NO STOP)

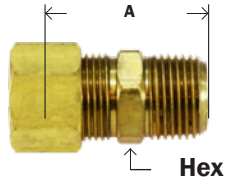

68T
00088

MIDLAND	AMC	CHAMPION	LIST	COMP. X MALE NPTF	MAF #	MAF PRICE
				1/8" x 1/8"	68T-22	----
	00088-0302			3/16" x 1/8"	68T-32	----
				3/16" x 1/4"	68T-34	----
18208	00088-0402	68ATS-4A	----	1/4" x 1/8"	68T-42	----
18209	00088-0404	68ATS-4B	----	1/4" x 1/4"	68T-44	----
				1/4" x 3/8"	68T-46	----
				1/4" x 1/2"	68T-48	----
				5/16" x 1/4"	68T-54	----
				5/16" x 3/8"	68T-56	----
18210	00088-0604	68ATS-6B	----	3/8" x 1/4"	68T-64	----
18211	00088-0606	68ATS-6C	----	3/8" x 3/8"	68T-66	----
18212	00088-0608		----	3/8" x 1/2"	68T-68	----
				7/16" x 3/8"	68T-76	----
18213	00088-0806	68ATS-8C	----	1/2" x 3/8"	68T-86	----
18214	00088-0808	68ATS-8D	----	1/2" x 1/2"	68T-88	----
18215	00088-1008		----	5/8" x 1/2"	68T-108	----
	00088-1012			5/8" x 3/4"	68T-1012	----
				3/4" x 3/4"	68T-1212	----
				7/8" x 1"	68T-1416	----

68-T 682C 80F

COMP X FLARE

MIDLAND	AMC	CHAMPION	LIST	COMP X FLARE	MAF #	MAF PRICE
				1/4" x 1/4"	6242CF-44	----
				1/4" x 3/8"	6242CF-46	----
				3/8" x 3/8"	6242CF-66	----
				3/8" x 1/2"	6242CF-68	----
				1/2" x 1/2"	6242CF-88	----

WARNING: This product can expose you to chemicals, including lead, which are known to the State of California to cause cancer and birth defects or other reproductive harm. For more information, visit www.P65Warnings.ca.gov

BRASS

DOUBLE COMPRESSION

BRASS FITTINGS

DOUBLE COMPRESSION THREADED SLEEVE FITTINGS

- Use with aluminum and copper tubing or plastic tubing with internal tube support. Not recommended for steel tubing.
- Easy to assemble, no flaring, two piece construction.
- For use on oil, air, water and grease lubrication systems.
- When design makes a dimension critical, contact us for information.

Tube OD	1/8	3/16	1/4	5/16	3/8
Thread	5/16-24	3/8-24	7/16-24	1/2-20	9/16-20
Working Pressure	500	500	500	250	250

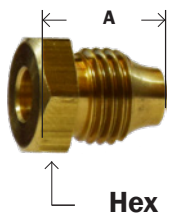
NUT

181

MIDLAND	AMC	CHAMPION	LIST	SIZE	MAF #	MAF PRICE
16001	00881-02	181A-2	----	1/8"	26100X2	----
16002	00881-03	181A-3	----	3/16"	26100X3	----
16003	00881-04	181A-4	----	1/4"	26100X4	----
16004	00881-05	181A-5	----	5/16"	26100X5	----
16005	00881-06		----	3/8"	26100X6	----
16006	00881-08		----	1/2"	26100X8	----
16007	00881-10		----	5/8"	26100X10	----

181 6100 11

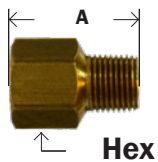
MALE ADAPTER

188

26200

* 1/4 - 28 Male Thread Tapered.

MIDLAND	AMC	CHAMPION	LIST	THRD SLEEVE X MALE NPTF	MAF #	MAF PRICE
16117			----	1/8" x *	26200X2X21	----
16118	00888-0202	188A-2A	----	1/8" x 1/8"	26200X2	----
16119	00888-0302	188A-3A	----	3/16" x 1/8"	26200X3	----
16121	00888-0402	188A-4A	----	1/4" x 1/8"	26200X4	----
16120	00888-0404		----	1/4" x 1/4"	26200X4X4	----
16122	00888-0502	188A-5A	----	5/16" x 1/8"	26200X5	----
16125	00888-0504		----	5/16" x 1/4"	26200X5X4	----
16123	00888-0604		----	3/8" x 1/4"	26200X6	----

188 6200 12

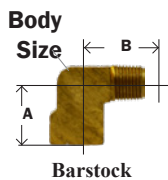
90° ELBOW

189

26400

* 1/4 - 28 Male Thread Tapered

MIDLAND	AMC	CHAMPION	LIST	THRD SLEEVE X MALE NPTF	MAF #	MAF PRICE
16127			----	1/8" x *	26400X2X21	----
16128	00889-0202	189A-2A	----	1/8" x 1/8"	26400X2	----
16129	00889-0302	189A-3A	----	3/16" x 1/8"	26400X3	----
16130	00889-0402	189A-4A	----	1/4" x 1/8"	26400X4	----
16131	00889-0502		----	5/16" x 1/8"	26400X5	----
16133	00889-0604		----	3/8" x 1/4"	26400X6	----

189 6400 15

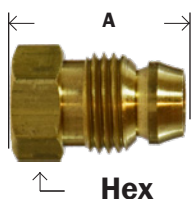
BREAK-AWAY NUT181SP
21604

MIDLAND	AMC	CHAMPION	LIST	SIZE	MAF #	MAF PRICE
16009	00880-02		----	1/8"	26104X2	----
16090	00880-03		----	3/16"	26104X3	----
16010	00880-04	81LB-4	----	1/4"	26104X4	----
16011			----	5/16"	26104X5	----
16012	00880-06		----	3/8"	26104X6	----

181-BA 21604 99LB 81LB

SPLIT SLEEVE FITTINGS

BRASS FITTINGS

BRASS SPLIT SLEEVE D.O.T. FITTINGS (5/32 O.D.)

TRANSMISSION BRASS FITTINGS

APPLICATIONS: Used with SAE J844 Type A nylon tube in pressure protected air transmission applications.
 TECHNICAL DATA: Maximum working pressure up to 150 PSI. Fittings will withstand variations from -40°F to +220°F (-40°C to + 104°C)

Ideally suited for use in passive protected air transmission applications. A specially designed slotted sleeve helps eliminate notch stress related to over torque. **25 prefix parts do not have a stake, use 38 part # with white sealant only.**

COLLET



MIDLAND	AMC	CHAMPION	LIST	TUBE O.D.	MAF #	MAF PRICE
38711	00840-53	60TF-2.5	----	5/32"	280X50	----
25001		60TF-2	----	1/8"	280X2	----
25002		60TF-3	----	3/16"	280X3	----
25003			----	1/4"	280X4	----

1460 90791 280 90946

NUT



MIDLAND	AMC	CHAMPION	LIST	TUBE O.D.	MAF #	MAF PRICE
38732		61TF-2.5	----	5/32"	281X50	----
25033		61TF-2	----	1/8"	281X2	----
					281X3	----
					281X4	----

1461 90790 281 90885

DOUBLE END UNION



MIDLAND	AMC	CHAMPION	LIST	TUBE O.D.	MAF #	MAF PRICE
38761		62TF-2.5	----	5/32"	283X50S	----
25062		62TF-2	----	1/8"	283X2	----
25064				1/4"	283X4	----

1462 90792 283 90891

CONNECTOR WITH NUT AND SLEEVE



MIDLAND	AMC	CHAMPION	LIST	TUBE O.D.	MAF #	MAF PRICE
38769		68TF-2.5X	----	5/32" x 1/6"	282X51S	----
38770	00848-5302	68TF-2.5A	----	5/32" x 1/8"	282X52S	----
25175		68TF-2X	----	1/8" x 1/16"	282X2X1N	----
25176		68TF-2A	----	1/8" x 1/8"	282X2N	----
25177				3/16" x 1/8"	282X3	----
25179				1/4" x 1/8"	282X4	----

• Shipped with nut and split sleeve, picture shows insert

1468 90794 282 90985

ELBOW



MIDLAND	AMC	CHAMPION	LIST	TUBE O.D.	MAF #	MAF PRICE
38715		69TF-2X	----	5/32"	284X51SN	----
38718	00849-5302	69TF-2.5A	----	5/32"	284X52S	----
25219	00849-0202	69TF-2A	----	1/8"	284X2	----
25220			----	1/8"	284X2X1N	----
25221			----	3/16"	284X3	----
25224			----	1/4"	284X4	----

284

WARNING: This product can expose you to chemicals, including lead, which are known to the State of California to cause cancer and birth defects or other reproductive harm. For more information, visit www.P65Warnings.ca.gov

BRASS

SPECIAL COMPRESSION ASSEMBLIES**BRASS FITTINGS**

To purchase special compression assemblies, delete the 18 prefix on part# and add the prefix of the type of special assembly you desire. Pricing and availability upon request.

22 - Plastic sleeve (inserts should be ordered separately) | 24 - Long nut compression | 26 - Captive sleeve (parts listed on following pages) | 27 - Self align sleeve

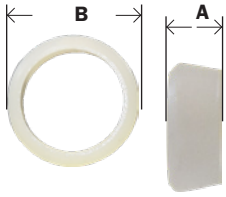
DELTRIN SLEEVE

MIDLAND	AMC	CHAMPION	LIST	SIZE	MAF #	MAF PRICE
18015	00560-04	60AP-4	----	1/4"	60P-4	----
18016	00560-05	60AP-5	----	5/16"	60P-5	----
18017	00560-06	60AP-6	----	3/8"	60P-6	----
18018	00560-08	60AP-8	----	1/2"	60P-8	----
18019	00560-10	60AP-10	----	5/8"	60P-10	----

60P

60-P

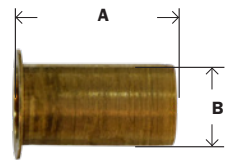
BRASS INSERT**• SLEEVE**61P
63P

MIDLAND	AMC	CHAMPION	LIST	SIZE	MAF #	MAF PRICE
22008	00561-02	60AE-2	----	1/8"	63P-2	----
22008A			----	1/8"	295X2	----
22009	00561-03	60AE-3	----	3/16"	63P-3	----
22009A			----	3/16"	295X3	----
22010	00561-04	60AE-4	----	1/4"	63P-4	----
22010A			----	1/4"		
22010B			----	1/4"		
22011A			----	5/16"	295X5	----
22011	00561-05	60AE-5	----	5/16"	63P-5	----
22012	00561-06	60AE-6	----	3/8"	63P-6	----
22013	00561-08	60AE-8	----	1/2"	63P-8	----
22014	00561-10	60AE-10	----	5/8"	63P-10	----
22015	00561-12	60AE-12	----	3/4"	63P-12	----

63-BI 60AE 2030 63PT

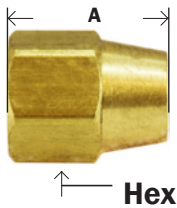
LONG NUT COMPRESSION - CAN BE ASSEMBLED ON ANY COMPRESSION FITTING

161

MIDLAND	AMC	CHAMPION	LIST	SIZE	MAF #	MAF PRICE
10013	04014-02	N1-2	----	1/8"	21110X2	----
24002	00161-03	161A-3	----	3/16"		
24003	00161-04	161A-4	----	1/4"	21611-4	----
24004	00161-05	161A-5	----	5/16"	21611X5	----
24005	00161-06	161A-6	----	3/8"	21611X6	----
24006	00161-08	161A-8	----	1/2"	21611X8	----
24007	00161-10	161A-10	----	5/8"	21611X10	----
24008	00161-12	161A-12	----	3/4"	21611X12	----

161

SELF-ALIGN SLEEVES

MIDLAND	AMC	CHAMPION	LIST	SIZE	MAF #	MAF PRICE
27001	00260-02	60SA-2	----	1/8"	260-2M	----
27002	00260-03	60SA-3	----	3/16"	260-3M	----
27003	00260-04	60SA-4	----	1/4"	260-4M	----
27005	00260-06	60SA-6	----	3/8"	260X6M	----
27006	00260-08	60SA-8	----	1/2"	260-8M	----

• More sizes available online

860 601

WARNING: This product can expose you to chemicals, including lead, which are known to the State of California to cause cancer and birth defects or other reproductive harm. For more information, visit www.P65Warnings.ca.gov

CAPTIVE SLEEVE COMPRESSION

BRASS FITTINGS

CAPTIVE SLEEVE NUT



61SA
61CS

MIDLAND	AMC	CHAMPION	LIST	SIZE	MAF #	MAF PRICE
26001	00261-02	961A-2	----	1/8"	261CAX2	----
26002	00261-03	961A-3	----	3/16"	261CAX3	----
26003	00261-04	961A-4	----	1/4"	261CAX4	----
26004	00261-05	961A-5	----	5/16"	261CAX5	----
26005	00261-06	961A-6	----	3/8"	261CAX6	----
26007	00261-08	961A-8	----	1/2"	261CAX8	----
26008	00261-10	961A-10	----	5/8"	261CAX10	----
	00261-12	961A-12		3/4"		
	00261-14	961A-14		7/8"		

CS61 61CA

UNION



62SA

MIDLAND	AMC	CHAMPION	LIST	SIZE	MAF #	MAF PRICE
26062	00262-02	962A-22	----	1/8"	62CS-2	----
26063	00262-03	962A-33	----	3/16"	62CS-3	----
26064	00262-04	962A-44	----	1/4"	62CS-4	----
26065	00262-05	962A-55	----	5/16"	62CS-5	----
26066	00262-06	962A-66	----	3/8"	62CS-6	----
26079	00282-0604	962A-64	----	3/8" x 1/4"	62CS-64	----
26068	00262-08	962A-88	----	1/2"	62CS-8	----
26069	00262-10	962A-1010	----	5/8"	62CS-10	----

CS62 62CA

TEE

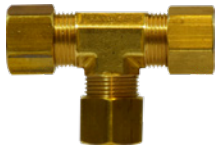

64SA

MIDLAND	AMC	CHAMPION	LIST	SIZE	MAF #	MAF PRICE
	00264-02	964A-22				
26102	00264-03	964A-33	----	3/16"	64FCS-3	----
26103	00264-04	964A-44	----	1/4"	64FCS-4	----
26105	00264-06	964A-66	----	3/8"	64FCS-6	----
	00264-08	964A-88				

CS64 164CA

FEMALE ADAPTER



66SA

MIDLAND	AMC	CHAMPION	LIST	COMP. X FEMALE NPTF	MAF #	MAF PRICE
26142	00266-0202	966A-2A	----	1/8" x 1/8"		
26145	00266-0402	966A-4A	----	1/4" x 1/8"		
26146	00266-0404	966A-4B	----	1/4" x 1/4"		
26153	00266-0604	966A-6B	----	3/8" x 1/4"		
	00266-0606	966A-6C		3/8" x 3/8"		
	00266-0608	966A-6D		3/8" x 1/2"		
	00266-0806	966A-8C		1/2" x 3/8"		
	00266-0808	966A-8D		1/2" x 1/2"		
	00266-1008	966A-10D		5/8" x 1/2"		

CS66 66CA

Any compression fitting can be used for captive sleeve by simply changing out the nuts.



WARNING: This product can expose you to chemicals, including lead, which are known to the State of California to cause cancer and birth defects or other reproductive harm. For more information, visit www.P65Warnings.ca.gov

BRASS

CAPTIVE SLEEVE COMPRESSION

BRASS FITTINGS

MALE ADAPTER

68SA

MIDLAND	AMC	CHAMPION	LIST	COMP. X MALE NPTF	MAF #	MAF PRICE
26175		968A-2X	----	1/8" x 1/16"	68CS-21	----
26176	00268-0202	968A-2A	----	1/8" x 1/8"	68CS-22	----
26177	00268-0302	968A-3A	----	3/16" x 1/8"	68CS-32	----
26178	00268-0304	968A-3B	----	3/16" x 1/4"	68CS-34	----
26179	00268-0402	968A-4A	----	1/4" x 1/8"	68CS-42	----
26180		968A-4B	----	1/4" x 1/4"	268CS-44	----
26180L	00268-0404		----	1/4" x 1/4"	68CS-44	----
26181	00268-0406	968A-4C	----	1/4" x 3/8"	68CS-46	----
26182	00268-0408	968A-4D	----	1/4" x 1/2"	68CS-48	----
26183	00268-0502	968A-5A	----	5/16" x 1/8"	68CS-52	----
26184	00268-0504	968A-5B	----	5/16" x 1/4"	68CS-54	----
26188	00268-0604	968A-6B	----	3/8" x 1/4"	68CS-64	----
26189	00268-0606	968A-6C	----	3/8" x 3/8"	68CS-66	----
26190	00268-0608	968A-6D	----	3/8" x 1/2"	68CS-68	----
26193	00268-0804	968A-8B	----	1/2" x 1/4"	68CS-84	----
26194	00268-0806	968A-8C	----	1/2" x 3/8"	68CS-86	----
26195	00268-0808	968A-8D	----	1/2" x 1/2"	68CS-88	----
26198	00268-1008	968A-10D	----	5/8" x 1/2"	68CS-108	----
	00268-1212	968A-12E		3/4" x 3/4"		
	00268-1412	968A-14E		7/8" x 3/4"		

CS68 68CA

MALE ELBOW

69SA

MIDLAND	AMC	CHAMPION	LIST	COMP. X MALE NPTF	MAF #	MAF PRICE
26220	00269-0202	969A-2A	----	1/8" x 1/8"	69FCS-22	----
26220B			----	1/8" x 1/8"	269CS-22	----
26221B			----	3/16" x 1/8"	269CS-32	----
26221	00269-0302	969A-3A	----	3/16" x 1/8"	69FCS-32	----
26223	00269-0304		----	3/16" x 1/4"	69FCS-34	----
26224B			----	1/4" x 1/8"	269CS-42	----
26224	00269-0402	969A-4A	----	1/4" x 1/8"	69FCS-42	----
26225	00269-0404	969A-4B	----	1/4" x 1/4"	69FCS-44	----
26225B			----	1/4" x 1/4"	269CS-44	----
26226	00269-0406		----	1/4" x 3/8"	69FCS-46	----
26228	00269-0502	969A-5A	----	5/16" x 1/8"	69FCS-52	----
26229	00269-0504	969A-5B	----	5/16" x 1/4"	69FCS-54	----
26232	00269-0602	969A-6A	----	3/8" x 1/8"	69FCS-62	----
26233	00269-0604	969A-6B	----	3/8" x 1/4"	69FCS-64	----
26233B			----	3/8" x 1/4"	269CS-64	----
26234	00269-0606	969A-6C	----	3/8" x 3/8"	69FCS-66	----
26235	00269-0608		----	3/8" x 1/2"	69FCS-68	----
26237	00269-0806	969A-8C	----	1/2" x 3/8"	69FCS-86	----
26238	00269-0808	969A-8D	----	1/2" x 1/2"	69FCS-88	----
	00269-1008	969A-10D		5/8" x 1/2"		
	00269-1212	969A-12E		3/4" x 3/4"		

CS69 169CA

WARNING: This product can expose you to chemicals, including lead, which are known to the State of California to cause cancer and birth defects or other reproductive harm. For more information, visit www.P65Warnings.ca.gov



CAPTIVE SLEEVE COMPRESSION

BRASS FITTINGS

MALE BRANCH TEE



72SA

MIDLAND	AMC	CHAMPION	LIST	COMP. X MALE NPTF (1&2) X 3	MAF #	MAF PRICE
26291	00272-0402	972A-4A	----	1/4" x 1/8"	72FCS-42	----
26292	00272-0404	972A-4B	----	1/4" x 1/4"	72FCS-44	----
26293	00272-0502		----	5/16" x 1/8"	72FCS-52	----
26296	00272-0604	972A-6B	----	3/8" x 1/4"	72FCS-64	----

CS72 172CA

CAPTIVE SLEEVE X MALE PIPE ANGLE NEEDLE VALVE



MIDLAND	AMC	CHAMPION	LIST	COMP X MALE PIPE	MAF #	MAF PRICE
26011	09603-0402		----	1/4" x 1/8"	103CCS	----
26014	09603-0504		----	5/16" x 1/4"	1102CCS	----

CAPTIVE SLEEVE X CAPTIVE SLEEVE NEEDLE VALVE

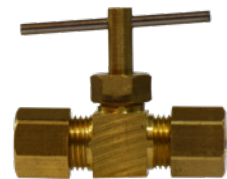

MIDLAND	AMC	CHAMPION	LIST	COMP X COMP	MAF #	MAF PRICE
26021	09606-04		----	1/4"	106CCS	----
26023	09606-06		----	3/8"	113CCS	----

Interchangeable with compress-align fittings.

These are NOT Lead Free

- More sizes available
- Lead Free - add LF to part #

Lead Free products
available upon request

WARNING: This product can expose you to chemicals, including lead, which are known to the State of California to cause cancer and birth defects or other reproductive harm. For more information, visit www.P65Warnings.ca.gov

BRASS

FLARELESS BRASS FITTINGS

Flareless FITTINGS

Flareless Brass Tube Fittings are Interchangeable with Poly-Flo®, Poly-Tite® and Poly-Line® and Poly-Fit®



Built-in SS
Tube Support

Tube O.D.	1/8	3/16	1/4	5/16	3/8	1/2
Thread Size-B	5/16-24	3/8-24	3/8-24	7/16-24	1/2-24	1 1/16-20

•Typical Application

Pneumatic instrumentation circuits, lubricant and cooling lines.

•Working Pressure and Temperature Ranges

Up to 150 PSI from 0°F to + 150°F with thermoplastic tubing. Up to 300 PSI from 0°F to + 175°F with soft metal tubing.

•Maximum allowable metal tube wall thickness for use with Poly-Tite fittings:

1/8", 3/16" O.D. --no limitation,
1/4" O.D.--.035 5/16", 3/8", 1/2" O.D.--.049

•Vibration

Excellent Resistance.

•Temperature Range

Depends on tubing used. -65°F to +250°F (-53°C to +121°C) with brass sleeve, -40°F to +150°F (-40°C to +66°C) with plastic sleeve. (Refer to tubing temperature range.)

•Used With

Aluminum & copper tubing. Hard plastic tubing requires brass sleeve. Not recommended for steel tubing.

• Tolerance

+/- .02 on all dimensions. Dimension data can change without notice. Please call us when dimen-

sions are critical.

•Advantages

No flaring of tubing required. Easy installation, captive sleeve, pre-assembled for installation and can be reassembled. Nuts rotate around the sleeve during tightening, preventing twisting of tubing.

•Assembly Instructions

- 1- Cut tubing to desired length.
- 2- Slide nut/sleeve assembly on tube. Threaded end "A" of nut must face toward fitting.
- 3- Bottom tubing into fitting.
- 4- Plastic sleeve - Tighten nut hand tight.
Brass Sleeve - Tighten nut hand tight, then an additional 3/4 turn.

* Note: 1/8 and 3/16 sizes have brass sleeves

WARNING: This product can expose you to chemicals, including lead, which are known to the State of California to cause cancer and birth defects or other reproductive harm. For more information, visit www.P65Warnings.ca.gov

FLARELESS

BRASS FITTINGS

NUT AND PLASTIC SLEEVE ASSEMBLY - WHITE SLEEVE



MIDLAND	AMC	CHAMPION	LIST	TUBE O.D.	MAF #	MAF PRICE
20211	022661-04	261PF-4	----	1/4"	MP61P-4	----
20212	022661-05	261PF-5	----	5/16"	MP61P-5	----
20213	022661-06	261PF-6	----	3/8"	MP61P-6	----

261PF 1261 61PN

MP61P
261PF

NUT AND PLASTIC SLEEVE ASSEMBLY - BLACK SLEEVE



MIDLAND	AMC	CHAMPION	LIST	TUBE O.D.	MAF #	MAF PRICE
				1/4"	MP61P-4BLK	----
				5/16"	MP61P-5BLK	----
				3/8"	MP61P-6BLK	----
				1/2"	MP61P-8BLK	----

NUT/BLACK SLEEVE ASSEMBLY

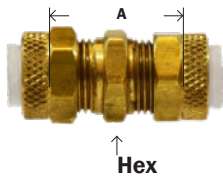

MIDLAND	AMC	CHAMPION	LIST	TUBE O.D.	MAF #	MAF PRICE
20240	02662-02	262PF-2	----	1/8"	MP62-2	----
20241	02662-03	262PF-3	----	3/16"	MP62-3	----
20242	02662-04	262PF-4	----	1/4"	MP62-4	----
20243	02662-05	262PF-5	----	5/16"	MP62-5	----
20244	02662-06	262PF-6	----	3/8"	MP62-6	----
20200	02656-0604	256PF-64	----	3/8" x 1/4"	MP56-64	----
20245	02662-08	262PF-8	----	1/2"	MP62-8	----
				1/2" x 3/8"	MP56-86	----

262PF 1262 62P 262P

MP62
262PF

BULKHEAD UNION

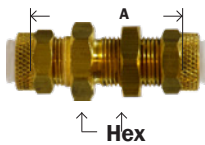

MIDLAND	AMC	CHAMPION	LIST	TUBE O.D.	MAF #	MAF PRICE
20337	02682-04	282PF-4	----	1/4"	MP82-4	----
20338	02682-05	282PF-5	----	5/16"	MP82-5	----
20339	02682-06	282PF-6	----	3/8"	MP82-6	----
	02682-08	282PF-8		1/2"	MP82-8	----

62PBH 329P 282P

MP82
282PF

UNION TUBE #M62C - FLARELESS X STANDARD COMPRESSION

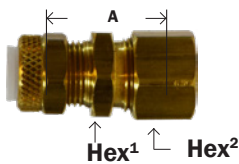

MIDLAND	AMC	CHAMPION	LIST	TUBE O.D.	MAF #	MAF PRICE
20235	02642-04		----	1/4"	MP62C-4	----
				5/16"	MP62C-5	----
20237	02642-06		----	3/8"	MP62C-6	----

MP62C
262PFC

262S 62PCA 262PC

WARNING: This product can expose you to chemicals, including lead, which are known to the State of California to cause cancer and birth defects or other reproductive harm. For more information, visit www.P65Warnings.ca.gov

BRASS

FLARELESS

BRASS FITTINGS

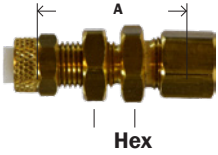
BULKHEAD UNION - FLARELESS X COMPRESSION

MP827
282PFC

MIDLAND	AMC	CHAMPION	LIST	TUBE O.D.	MAF #	MAF PRICE
20333	02648-04			1/4"	MP82C-4	----
20334	02648-06			3/8"	MP82C-6	----

1274

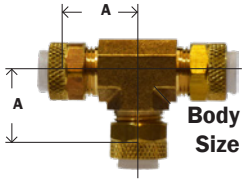
UNION TEE

* Reducing Branch

MP6A
264PF

MIDLAND	AMC	CHAMPION	LIST	TUBE O.D.	MAF #	MAF PRICE
20248	02664-02	264PF-2		1/8"	MP64-2	----
20249				3/16"	MP64-3	----
20250	02664-04	264PF-4		1/4"	MP64-4	----
20251	02664-05	264PF-5		5/16"	MP64-5	----
20252	02664-06	264PF-6		3/8"	MP64-6	----
20330*	02679-0604	264PF-664		3/8" x 1/4"	MP79-64	----
20253	02664-08	264PF-8		1/2"	MP64-8	----

1264 164P 264P

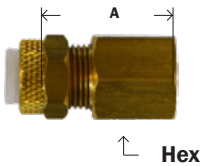
FEMALE CONNECTOR

MP66
266PF

MIDLAND	AMC	CHAMPION	LIST	TUBE O.D. X FEMALE NPTF	MAF #	MAF PRICE
20256	02666-0202	266PF-2A		1/8" x 1/8"	MP66-22	----
20257	02666-0302			3/16" x 1/8"	MP66-32	----
				3/16" x 1/4"	MP66-34	----
20259	02666-0402	266PF-4A		1/4" x 1/8"	MP66-42	----
20260	02666-0404	266PF-4B		1/4" x 1/4"	MP66-44	----
20261	02666-0502	266PF-5A		5/16" x 1/8"	MP66-52	----
				5/16" x 1/4"	MP66-54	----
20265	02666-0602			3/8" x 1/8"	MP66-62	----
20262	02666-0604	266PF-6B		3/8" x 1/4"	MP66-64	----
20263	02666-0806	266PF-8C		1/2" x 3/8"	MP66-86	----
				1/2" x 1/2"	MP66-88	----

1266 66P 266P

WARNING: This product can expose you to chemicals, including lead, which are known to the State of California to cause cancer and birth defects or other reproductive harm. For more information, visit www.P65Warnings.ca.gov

FLARELESS

BRASS FITTINGS

MALE CONNECTOR

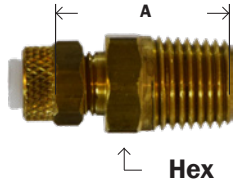

MP68
268PF

MIDLAND	AMC	CHAMPION	LIST	TUBE O.D. X MALE NPTF	MAF #	MAF PRICE
		268PF-2X1032		1/8" x 10/32"	MP68-20	----
				1/8" x 1/16"	MP68-21	----
20268	02668-0202	268PF-2A		1/8" x 1/8"	MP68-22	----
20269	02668-0302	268PF-3A		3/16" x 1/8"	MP68-32	----
20270	02668-0400	268PF-4X1032		1/4" x 10/32"	MP68-40	----
	02668-0401			1/4" x 1/16"	MP68-41	----
20271	02668-0402	268PF-4A		1/4" x 1/8"	MP68-42	----
20272	02668-0404	268PF-4B		1/4" x 1/4"	MP68-44	----
20273	02668-0406	268PF-4C		1/4" x 3/8"	MP68-46	----
				1/4" x 1/2"	MP68-48	----
20274	02668-0502	268PF-5A		5/16" x 1/8"	MP68-52	----
20275	02668-0504	268PF-5B		5/16" x 1/4"	MP68-54	----
20276	02668-0602	268PF-6A		3/8" x 1/8"	MP68-62	----
20277	02668-0604	268PF-6B		3/8" x 1/4"	MP68-64	----
20278	02668-0606	268PF-6C		3/8" x 3/8"	MP68-66	----
				3/8" x 1/2"	MP68-68	----
	02668-0804	268PF-8B		1/2" x 1/4"	MP68-84	----
20279	02668-0806	268PF-8C		1/2" x 3/8"	MP68-86	----
20282	02668-0808	268PF-8D		1/2" x 1/2"	MP68-88	----

1268 68P 268P

MALE ELBOW

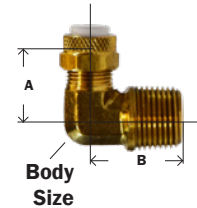

* Barstock

MP69
269PF

MIDLAND	AMC	CHAMPION	LIST	TUBE O.D. X MALE NPTF	MAF #	MAF PRICE
				1/8" x 1/16"	MP69-21	----
20287	02669-0202	269PF-2A		1/8" x 1/8"	MP69-22	----
20288	02669-0302	269PF-3A		3/16" x 1/8"	MP69-32	----
20289*	02669-0402	269PF-4A		1/4" x 1/8"	MP69-42	----
20290	02669-0404	269PF-4B		1/4" x 1/4"	MP69-44	----
20291	02669-0406	269PF-4C		1/4" x 3/8"	MP69-46	----
20292	02669-0502	269PF-5A		5/16" x 1/8"	MP69-52	----
20293	02669-0602	269PF-6A		3/8" x 1/8"	MP69-62	----
20294	02669-0604	269PF-6B		3/8" x 1/4"	MP69-64	----
20295	02669-0606	269PF-6C		3/8" x 3/8"	MP69-66	----
20296	02669-0806	269PF-8C		1/2" x 3/8"	MP69-86	----
	02669-0808	269PF-8D		1/2" x 1/2"	MP69-88	----

1269 169P 269P

FEMALE ELBOW

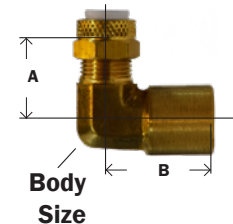

MP70
270PF

MIDLAND	AMC	CHAMPION	LIST	TUBE O.D. X FEMALE NPTF	MAF #	MAF PRICE
20300	02670-0202			1/8" x 1/8"	MP70-22	----
20301	02670-0302			3/16" x 1/8"	MP70-32	----
20302	02670-0402	270PF-4A		1/4" x 1/8"	MP70-42	----
20303	02670-0404	270PF-4B		1/4" x 1/4"	MP70-44	----
20304	02670-0604	270PF-6B		3/8" x 1/4"	MP70-64	----
20305	02670-0806	270PF-8C		1/2" x 3/8"	MP70-86	----

1270 170P

FLARELESS

BRASS FITTINGS

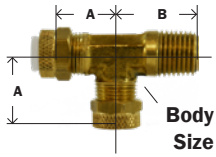
MALE RUN TEEMP71
271PF

MIDLAND	AMC	CHAMPION	LIST	TUBE O.D. X MALE NPTF	MAF #	MAF PRICE
20308	02671-0202			1/8" x 1/8"	MP71-22	----
20309	02671-0302			3/16" x 1/8"	MP71-32	----
20310	02671-0402	271PF-4A		1/4" x 1/8"	MP71-42	----
20311	02671-0404	271PF-4B		1/4" x 1/4"	MP71-44	----
20312	02671-0502			5/16" x 1/8"	MP71-52	----
20313	02671-0604	271PF-6B		3/8" x 1/4"	MP71-64	----
20314	02671-0806	271PF-8C		1/2" x 3/8"	MP71-86	----

1271 171P

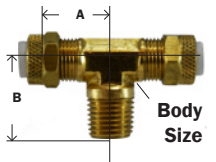
MALE BRANCH TEEMP72
272PF

MIDLAND	AMC	CHAMPION	LIST	TUBE O.D. X MALE NPTF	MAF #	MAF PRICE
20317	02672-0202	272PF-2A		1/8" x 1/8"	MP72-22	----
20318	02672-0302			3/16" x 1/8"	MP72-32	----
20319	02672-0402	272PF-4A		1/4" x 1/8"	MP72-42	----
20320	02672-0404	272PF-4B		1/4" x 1/4"	MP72-44	----
20321	02672-0502	272PF-5A		5/16" x 1/8"	MP72-52	----
20322	02672-0602	272PF-6A		3/8" x 1/8"	MP72-62	----
20323	02672-0604	272PF-6B		3/8" x 1/4"	MP72-64	----
20324	02672-0806	272PF-8C		1/2" x 3/8"	MP72-86	----

1272 172P 272P

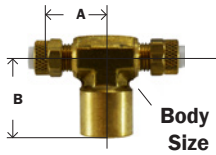
FEMALE BRANCH TEEMP77
277PF

MIDLAND	AMC	CHAMPION	LIST	TUBE O.D. X FEMALE NPTF	MAF #	MAF PRICE
20327	02677-0402			1/4" x 1/8"	MP77-42	----
20328	02677-0404	277PF-4B		1/4" x 1/4"	MP77-44	----
	02677-0406	277PF-4C		1/4" x 3/8"	MP77-46	----

1277 177P 277P

UNIVERSAL NUT AND BRASS SLEEVE ASSEMBLYMP61B
261PFB

MIDLAND	AMC	CHAMPION	LIST	TUBE O.D.	MAF #	MAF PRICE
20227	02761-02	261PFB-2		1/8"	MP61B-2	----
20228	02761-03	261PFB-3		3/16"	MP61B-3	----
20229	02761-04	261PFB-4		1/4"	MP61B-4	----
20230	02761-05	261PFB-5		5/16"	MP61B-5	----
20231	02761-06	261PFB-6		3/8"	MP61B-6	----
20232	02761-08	261PFB-8		1/2"	MP61B-8	----

261PFB 1261B 61PB 261UB

C/P NUT PLASTIC SLEEVE ASSEMBLY

MIDLAND	AMC	CHAMPION	LIST	TUBE O.D.	MAF #	MAF PRICE
		02621-04		1/4"	MP61PCP-4	----
		02621-06		3/8"	MP61PCP-6	----

WARNING: This product can expose you to chemicals, including lead, which are known to the State of California to cause cancer and birth defects or other reproductive harm. For more information, visit www.P65Warnings.ca.gov



FLARELESS

BRASS FITTINGS

NUT



MP61
261PFN

MIDLAND	AMC	CHAMPION	LIST	TUBE O.D.	MAF #	MAF PRICE
20218	02961-02	261PFN-2		1/8"	MP61-2	----
20219				3/16"	MP61-3	----
20220	02961-04	261PFN-4		1/4"	MP61-4	----
20221	02961-05	261PFN-5		5/16"	MP61-5	----
20222	02961-06	261PFN-6		3/8"	MP61-6	----
20223	02961-08	261PFN-8		1/2"	MP61-8	----

61PN 1261 261FPN

PLASTIC SLEEVE

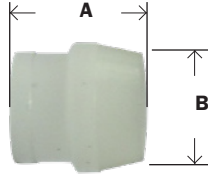

MP60
260PF

MIDLAND	AMC	CHAMPION	LIST	TUBE O.D.	MAF #	MAF PRICE
20205	02660-04	260PF-4		1/4"	MP60-4W	----
20206	02660-05	260PF-5		5/16"	MP60-5	----
20207	02660-06	260PF-6		3/8"	MP60-6W	----
20208	02660-08	260PF-8		1/2"	MP60-8	----

260FF 1260 60P 260P

BLACK PLASTIC SLEEVE



MIDLAND	AMC	CHAMPION	LIST	TUBE O.D.	MAF #	MAF PRICE
				1/4"	MP60-4BLK	----
				3/8"	MP60-6BLK	----

BRASS SLEEVE ONLY



MIDLAND	AMC	CHAMPION	LIST	TUBE O.D.	MAF #	MAF PRICE
	02760-02	260PFB-2		1/8"	MP60B-2	----
		260PFB-3		3/16"	MP60B-3	----
	02760-04	260PFB-4		1/4"	MP60B-4	----
	02760-06	260PFB-6		3/8"	MP60B-6	----

PLASTIC CAP

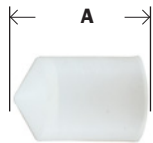

MP59
269PF

MIDLAND	AMC	CHAMPION	LIST	TUBE O.D.	MAF #	MAF PRICE
20201	02659-04			1/4"	MP59-4	----
20203	02659-06			3/8"	MP59-6	----
20204	02659-08			1/2"	MP59-8	----

1229 59P 259P

WARNING: This product can expose you to chemicals, including lead, which are known to the State of California to cause cancer and birth defects or other reproductive harm. For more information, visit www.P65Warnings.ca.gov

BRASS

BRASS PUSH-IN FITTINGS

BRASS FITTINGS

PUSH-IN/ PUSH-TO-CONNECT FITTINGS

BRASS PUSH-IN



NICKEL PLATED BRASS PUSH-IN



BALL VALVES FOR N/P PUSH-IN



METRIC N/P BRASS PUSH-IN



COMPOSITE BODY PUSH-IN



COMPOSITE BODY METRIC PUSH-IN



FDA PLASTIC PUSH-IN



DOT BRASS PUSH-IN



DOT COMPOSITE PUSH-IN



WARNING: This product can expose you to chemicals, including lead, which are known to the State of California to cause cancer and birth defects or other reproductive harm. For more information, visit www.P65Warnings.ca.gov

BRASS PUSH-IN FITTINGS

BRASS FITTINGS

BRASS PUSH-IN FITTINGS



ENGINEERING AND DESIGN

- **QUICK CONNECT**, simply push tubing in, no tools. Saves up to 75% of assembly time of standard compression fittings.
- **QUICK DISCONNECT**, hold two fingers on insert and pull tubing out, no tools required.
- **REUSEABLE**, connect and disconnect numerous times.
- **FULL FLOW DESIGN**, provides up to 60% more flow area than conventional fittings with internal tube supports.
- **POSITIVE SEAL**, no leaks. After tubing is inserted, seal is made.
- **VERSATILE**, BunaN "O" rings standard. Other materials of "O" rings available.
- **SECURE TUBE RETENTION**, pulling on tubing only serves to tighten the connection.
- **SELF CONTAINED ASSEMBLY**, no loose parts, brass body and insert.
- **BRASS CONSTRUCTION**, elbows and tees are forged brass.
- **CHOICE** of convenient swivel or economical stationary elbows and tees.
- **STRAIGHT CONNECTORS** have interior hex for Allen key tightening where space is limited...no need to use a wrench.
- **PRE-APPLIED POLYTETRAFLUOROETHYLENE**® based pipe sealant on all male pipe threads, saving customer additional labor.
- **METRIC SIZES AVAILABLE**: Metric tube sizes from 2mm through 12mm in both standard NPT and metric pipe sizes are available on a special order basis.
- **WORKING TEMPERATURE**:
-10°F to 200°F (other ranges available on request).
- **PIPE THREAD**: NPTF with Polytetrafluoroethylene® based sealant pre-applied.

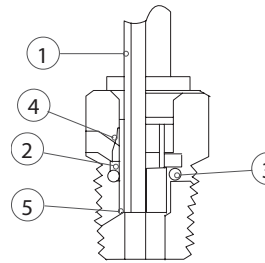

When tubing (1) is inserted into the fitting, it first passes through the gripping teeth (2). Just beyond the gripping teeth is the o-ring (3) which provides the leak proof seal against the OD of the tube. The gripping teeth grab the tube, which

expands the insert. Pulling back on the tube only tightens the grip as the insert moves onto the camming surface (4). Pressure through the tube also serves to tighten the grip. The tube bottoms against a positive tube stop (5) in a cavity providing tube support to prevent leakage.

• Tolerance

+/- .02 on all dimensions. Dimension data can change without notice. Please call us when dimensions are critical

WARNING: This product can expose you to chemicals, including lead, which are known to the State of California to cause cancer and birth defects or other reproductive harm. For more information, visit www.P65Warnings.ca.gov

BRASS

BRASS PUSH-IN FITTINGS

BRASS FITTINGS

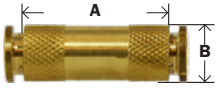
UNION CONNECTOR

MIDLAND	AMC	CHAMPION	LIST	TUBE O.D.	MAF #	MAF PRICE
20017	02062-02	262PP-2		1/8"	MQ62-2	----
20018	02062-53	262PP-2.5		5/32"	MQ62-532	----
20019	02062-04	262PP-4		1/4"	MQ62-4	----
20022		262PP-64		3/8" x 1/4"	MQ62-64	----
20020	02062-06	262PP-6		3/8"	MQ62-6	----
20021	02062-08	262PP-8		1/2"	MQ62-8	----

AQ62P
MQ62

AQ62 6580 3106 62PL KQH 12-020 50-562 262-OF 1162 262PP

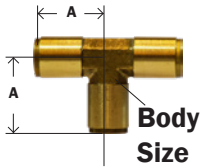
UNION TEE

MIDLAND	AMC	CHAMPION	LIST	TUBE O.D.	MAF #	MAF PRICE
20025	02064-02	264PP-2		1/8"	MQ64-2	----
20026	02064-53	264PP-2.5		5/32"	MQ64-532	----
20027	02064-03	264PP-3		3/16"	MQ64-3	----
20028	02064-04	264PP-4		1/4"	MQ64-4	----
20031*		264PPNIC-5		5/16"	MQ64-5	----
20029	02064-06	264PP-6		3/8"	MQ64-6	----
20030	02064-08	264PP-8		1/2"	MQ64-8	----

AQ64P
MQ64

* Nickel Plated

KQT 12-060 50-564 264OF 264PP 1164 AQ64 6540 3140 164PL

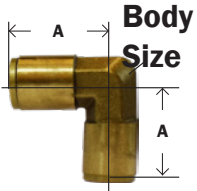
UNION ELBOW

MIDLAND	AMC	CHAMPION	LIST	TUBE O.D.	MAF #	MAF PRICE
20150	02065-02	265PP-2		1/8"	MQ65-2	----
20151	02065-53	265PP-2.5		5/32"	MQ65-532	----
20152	02065-04	265PP-4		1/4"	MQ65-4	----
20155				5/16"	MQ65-5	----
20153	02065-06	265PP-6		3/8"	MQ65-6	----
20154	02065-08	265PP-8		1/2"	MQ65-8	----

AQ65P
MQ65

AQ65 6550 3102 165PL KQL 12-040 50-565 265-OF

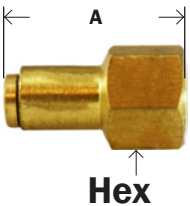
FEMALE CONNECTOR

MIDLAND	AMC	CHAMPION	LIST	TUBE O.D. X FEMALE NPTF	MAF #	MAF PRICE
20032	02066-0202	266PP-2A		1/8" x 1/8"	MQ66-22	----
20038				1/8" x 1/4"	MQ66-24	----
20012	02066-5302	266PP25A		5/32" x 1/8"	MQ66-5322	----
20034	02066-0402	266PP-4A		1/4" x 1/8"	MQ66-42	----
20035	02066-0404	266PP-4B		1/4" x 1/4"	MQ66-44	----
20036	02066-0604	266PP-6B		3/8" x 1/4"	MQ66-64	----
20037	02066-0606	266PP-6C		3/8" x 3/8"	MQ66-66	----

AQ66P

266PP AQ66 6463 3114 66PL 12-426 50-566 266-OF 1166

WARNING: This product can expose you to chemicals, including lead, which are known to the State of California to cause cancer and birth defects or other reproductive harm. For more information, visit www.P65Warnings.ca.gov



BRASS PUSH-IN FITTINGS

BRASS FITTINGS

MALE CONNECTOR

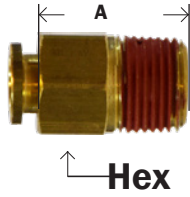

AQ68P
MQ68

MIDLAND	AMC	CHAMPION	LIST	TUBE O.D. X MALE NPTF	MAF #	MAF PRICE
20047*	02068-0200	268PP-2X1032		1/8" x 10-32"*	MQ68-20	----
20045	02068-0201	268PP-2X		1/8" x 1/16"	MQ68-21	----
20048	02068-0202	268PP-2A		1/8" x 1/8"	MQ68-22	----
20023	02068-0204	268PP-2B		1/8" x 1/4"	MQ68-24	----
20049*	02068-5300	268PP-2.5X1032		5/32" x 10-32"*	MQ68-5320	----
20050	02068-5302	268PP-2.5A		5/32" x 1/8"	MQ68-5322	----
20046	02068-5304	268PP-2.5B		5/32" x 1/4"	MQ68-5324	----
20051*	02068-0300	268PP-3X1032		3/16" x 10-32"*	MQ68-30	----
20052	02068-0302	268PP-3A		3/16" x 1/8"	MQ68-32	----
20053*	02068-0400	268PP-4X1032		1/4" x 10-32"*	MQ68-40	----
20039		268PP-4X		1/4" x 1/16"		----
20054	02068-0402	268PP-4A		1/4" x 1/8"	MQ68-42	----
20055	02068-0404	268PP-4B		1/4" x 1/4"	MQ68-44	----
20056	02068-0406	268PP-4C		1/4" x 3/8"	MQ68-46	----
20530	02068-0502			5/16" x 1/8"	MQ68-52	----
20531	02068-0504			5/16" x 1/4"	MQ68-54	----
20532				5/16" x 3/8"	MQ68-56	----
20057	02068-0602	268PP-6A		3/8" x 1/8"	MQ68-62	----
20058	02068-0604	268PP-6B		3/8" x 1/4"	MQ68-64	----
20059	02068-0606	268PP-6C		3/8" x 3/8"	MQ68-66	----
20062	02068-0608	268PP-6D		3/8" x 1/2"	MQ68-68	----
20060	02068-0804	268PP-8B		1/2" x 1/4"	MQ68-84	----
20061	02068-0806	268PP-8C		1/2" x 3/8"	MQ68-86	----
20063	02068-0808	268PP-8D		1/2" x 1/2"	MQ68-88	----

* Furnished with gaskets

268PP AQ68 6510 3115 68PL KQH 12-425 50-568 268-OF 1168

SWIVEL MALE ELBOW

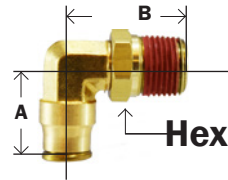

AQ69PS
MQ69S

MIDLAND	AMC	CHAMPION	LIST	TUBE O.D. X MALE NPTF	MAF #	MAF PRICE
20079	02169-0202	269PPS-2A		1/8" x 1/8"	MQ69S-22	----
20535*				1/8" x 1/4"	MQ69S-24	----
20076**	02169-5300	269PPS-2.5X1032		5/32" x 10-32"	MQ69S-5320	----
20080	02169-5302	269PPS-2.5A		5/32" x 1/8"	MQ69S-5322	----
20077	02169-5304	269PPS-2.5B		5/32" x 1/4"	MQ69S-5324	----
20078**	02169-0400	269PPS-4X1032		1/4" x 10-32"	MQ69S-40	----
20081	02169-0402	269PPS-4A		1/4" x 1/8"	MQ69S-42	----
20082	02169-0404	269PPS-4B		1/4" x 1/4"	MQ69S-44	----
20086	02169-0406	269PPS-4C		1/4" x 3/8"	MQ69S-46	----
20538*				5/16" x 1/4"	MQ69S-54	----
20539*				5/16" x 3/8"	MQ69S-56	----
20087	02169-0602	269PPS-6A		3/8" x 1/8"	MQ69S-62	----
20083	02169-0604	269PPS-6B		3/8" x 1/4"	MQ69S-64	----
20084	02169-0606	269PPS-6C		3/8" x 3/8"	MQ69S-66	----
20088	02169-0608	269PPS-6D		3/8" x 1/2"	MQ69S-68	----
20085	02169-0806	269PPS-8C		1/2" x 3/8"	MQ69S-86	----
20092	02169-0808	269PPS-8D		1/2" x 1/2"	MQ69S-88	----

* Nickel Plated

** Furnished with gaskets

aq69-ps 56520 3109 169pl kql 12-447 50-579 269-OF 11695

BRASS PUSH-IN FITTINGS

BRASS FITTINGS

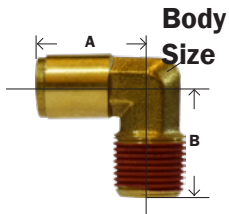
FIXED MALE ELBOWAQ69P
MQ69

MIDLAND	AMC	CHAMPION	LIST	TUBE O.D. X MALE NPTF	MAF #	MAF PRICE
20065	02069-0202	269PP-2A		1/8" x 1/8"	MQ69-22	----
20066	02069-5302	269PP-2.5A		5/32" x 1/8"	MQ69-5322	----
20067	02069-0302	269PP-3A		3/16" x 1/8"	MQ69-32	----
20068	02069-0402	269PP-4A		1/4" x 1/8"	MQ69-42	----
20069	02069-0404	269PP-4B		1/4" x 1/4"	MQ69-44	----
20070	02069-0406	269PP-4C		1/4" x 3/8"	MQ69-46	----
20071	02069-0602	269PP-6A		3/8" x 1/8"	MQ69-62	----
20072	02069-0604	269PP-6B		3/8" x 1/4"	MQ69-64	----
20073	02069-0606	269PP-6C		3/8" x 3/8"	MQ69-66	----
20074	02069-0804	269PP-8B		1/2" x 1/4"	MQ69-84	----
20075	02069-0806	269PP-8C		1/2" x 3/8"	MQ69-86	----
20064	02069-0808	269PP-8D		1/2" x 1/2"	MQ69-88	----

269PP AQ69-P 6500 169PLNS 12-445 1169

Dimension data can change without notice. Please see our website when dimensions are critical.

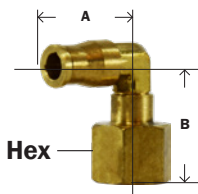
FEMALE SWIVEL ELBOWAQ70PS
MQ70S

MIDLAND	AMC	CHAMPION	LIST	TUBE O.D. X FEMALE NPTF	MAF #	MAF PRICE
20094S		270PPS-25A		5/32" x 1/8"	MQ70S-5322	----
20089S	02170-0402	270PPS-4A		1/4" x 1/8"	MQ70S-42	----
20090S	02170-0404	270PPS-4B		1/4" x 1/4"	MQ70S-44	----
20091S	02170-0604	270PPS-6B		3/8" x 1/4"	MQ70S-64	----
	02170-0606			3/8" x 3/8"	MQ70S-66	
	02170-0806	270PPS-8C		1/2" x 3/8"	MQ70S-86	

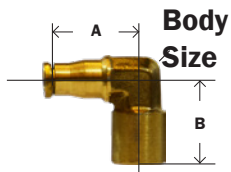
FEMALE ELBOWAQ70P
MQ70

MIDLAND	AMC	CHAMPION	LIST	TUBE O.D. X FEMALE NPTF	MAF #	MAF PRICE
20192	02070-0202	270PP-2A		1/8" x 1/8"	MQ70-22	----
20094	02070-5302	270PP-2.5A		5/32" x 1/8"	MQ70-5322	----
20089	02070-0402	270PP-4A		1/4" x 1/8"	MQ70-42	----
20090	02070-0404	270PP-4B		1/4" x 1/4"	MQ70-44	----
20091	02070-0604	270PP-6B		3/8" x 1/4"	MQ70-64	----

AQ70-P 3009

WARNING: This product can expose you to chemicals, including lead, which are known to the State of California to cause cancer and birth defects or other reproductive harm. For more information, visit www.P65Warnings.ca.gov

BRASS PUSH-IN FITTINGS

BRASS FITTINGS

SWIVEL MALE RUN TEE

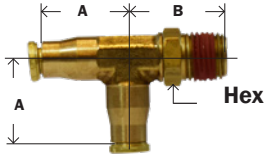

AQ71PS
MQ71S

MIDLAND	AMC	CHAMPION	LIST	TUBE O.D. X MALE NPTF	MAF #	MAF PRICE
20160	02171-0202	271PPS-2A		1/8" x 1/8"	MQ71S-22	----
20161	02171-5302	271PPS-2.5A		5/32" x 1/8"	MQ71S-5322	----
20162	02171-0402	271PPS-4A		1/4" x 1/8"	MQ71S-42	----
20163	02171-0404	271PPS-4B		1/4" x 1/4"	MQ71S-44	----
20164	02171-0604	271PPS-6B		3/8" x 1/4"	MQ71S-64	----
20165	02171-0606	271PPS-6C		3/8" x 3/8"	MQ71S-66	----
20174				1/2" x 1/4"		
20166	02171-0806	271PPS-8C		1/2" x 3/8"	MQ71S-86	----
20167	02171-0808	271PPS-8D		1/2" x 1/2"	MQ71S-88	----

AQ71-PS 56440 3103 171PL KQY 12-468 50-571 271-OFS 11715

FIXED MALE RUN TEE

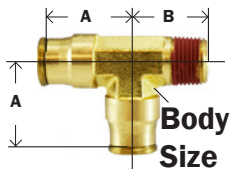

AQ71P
MQ71

MIDLAND	AMC	CHAMPION	LIST	TUBE O.D. X MALE NPTF	MAF #	MAF PRICE
20095	02071-0202	271PP-2A		1/8" x 1/8"	MQ71-22	----
20097	02071-0302			3/16" x 1/8"		
20098	02071-0402	271PP-4A		1/4" x 1/8"	MQ71-42	----
20093	02071-0404	271PP-4B		1/4" x 1/4"	MQ71-44	----
20099	02071-0602			3/8" x 1/8"		
20100	02071-0604	271PP-6B		3/8" x 1/4"	MQ71-64	----
20101	02071-0606	271PP-6C		3/8" x 3/8"	MQ71-66	----
20102	02071-0806			1/2" x 3/8"	MQ71-86	----

AQ71-P

SWIVEL MALE BRANCH TEE

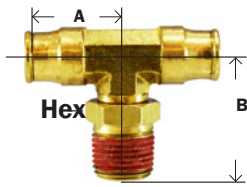

AQ72PS
MQ72S

* Furnished with gaskets

MIDLAND	AMC	CHAMPION	LIST	TUBE O.D. X MALE NPTF	MAF #	MAF PRICE
20103	02172-0202	272PPS-2A		1/8" x 1/8"	MQ72S-22	----
20104*	02172-5300	272PPS-2.5A x 10.32		5/32" x 10-32"	MQ72S-5320	----
20109	02172-5302	272PPS-2.5A		5/32" x 1/8"	MQ72S-5322	----
20105	02172-0402	272PPS-4A		1/4" x 1/8"	MQ72S-42	----
20106	02172-0404	272PPS-4B		1/4" x 1/4"	MQ72S-44	----
20107	02172-0604	272PPS-6B		3/8" x 1/4"	MQ72S-64	----
20108	02172-0606	272PPS-6C		3/8" x 3/8"	MQ72S-64	----
20110	02172-0806	272PPS-8C		1/2" x 3/8"	MQ72S-86	----
20111	02172-0808	272PPS-8D		1/2" x 1/2"	MQ72S-88	----

FIXED MALE BRANCH TEE

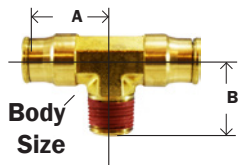

AQ72P
MQ72

MIDLAND	AMC	CHAMPION	LIST	TUBE O.D. X MALE NPTF	MAF #	MAF PRICE
20112	02072-0202			1/8" x 1/8"	MQ72-22	----
20113	02072-5302	272PP-2.5A		5/32" x 1/8"	MQ72-532	----
20115	02072-0402	272PP-4A		1/4" x 1/8"	MQ72-42	----
20116	02072-0404	272PP-4B		1/4" x 1/4"	MQ72-44	----
20117	02072-0602	272PP-6A		3/8" x 1/8"	MQ72-62	----
20118	02072-0604	272PP-6B		3/8" x 1/4"	MQ72-64	----
20119	02072-0606	272PP-6C		3/8" x 3/8"	MQ72-66	----
20120	02072-0806	272PP-8C		1/2" x 3/8"	MQ72-86	----

AQ72-P

BRASS PUSH-IN FITTINGS

BRASS FITTINGS

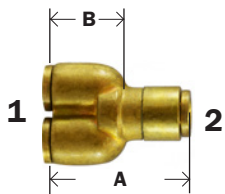
UNION "Y"

AQ89P

MIDLAND	AMC	CHAMPION	LIST	TUBE O.D. 1 X 2	MAF #	MAF PRICE
20551	02089-5353	289PP-2.5		5/32" x 5/32"	MQ89-532	----
20552	02089-0402			1/4" x 1/8"	MQ89-42	----
20553	02089-0404	289PP-4		1/4" x 1/4"	MQ89-44	----

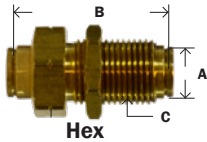
BULKHEAD UNIONAQ82P
MQ82

MIDLAND	AMC	CHAMPION	LIST	TUBE O.D. A	MAF #	MAF PRICE
20124	02082-02	283PP-2		1/8"	MQ82-2	----
20125	02082-53	283PP-2.5		5/32"	MQ82-532	----
20126	02082-03			3/16"	MQ82-3	----
20127	02082-04	283PP-4		1/4"	MQ82-4	----
20128	02082-06	283PP-6		3/8"	MQ82-6	----
20129	02082-08	283PP-8		1/2"	MQ82-8	----

AQ82-P 6590 62PLBH KQE 12-029 50-582 282-OF 1174

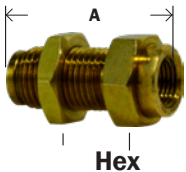
FEMALE BULKHEAD UNIONAQ86P
MQ86

MIDLAND	AMC	CHAMPION	LIST	TUBE O.D. X FEMALE NPTF	MAF #	MAF PRICE
20170	02086-0402	287PP-4A		1/4" x 1/8"	MQ86-42	----
20171	02086-0404	287PP-4B		1/4" x 1/4"	MQ86-44	----
20172	02086-0604	287PP-6B		3/8" x 1/4"	MQ86-64	----

AQ86-P 1166BH

Dimension data can change without notice. Please call us when dimensions are critical.

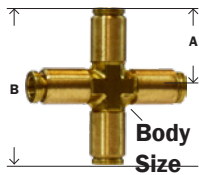
CROSS

MIDLAND	AMC	CHAMPION	LIST	SIZE	MAF #	MAF PRICE
20142		252PP-4		1/4"	MQ52-4	----
20143		252PP-6		3/8"	MQ52-6	----

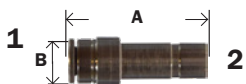
REDUCER - NICKEL PLATED - TUBE OD X STUD

MQ97

MIDLAND	AMC	CHAMPION	LIST	TUBE O.D. 1 X 2	MAF #	MAF PRICE
20510		286PP-42		1/8" x 1/4"	MQ97-24	----
20511		286PP-42.5		5/32" x 1/4"	MQ97-5324	----
20512		286PP-64		1/4" x 3/8"	MQ97-46	----

67PPL 286PP

PLASTIC PLUGAQ59P
MQ59

MIDLAND	AMC	CHAMPION	LIST	TUBE O.D.	MAF #	MAF PRICE
20009	02059-53	284PP-2.5		5/32"	MQ59-532	----
20010	02059-04	284PP-4		1/4"	MQ59-4	----
20011	02059-06	284PP-6		3/8"	MQ59-6	----
20013	02059-08	284PP-8		1/2"	MQ59-8	----

• Cored

284PP AQ59 209-OF 1129 6900 639PL 12-004 50-526

NICKEL PLATED PUSH-IN FITTINGS

BRASS FITTINGS

NICKEL PLATED PUSH-IN FITTINGS WITH GLOBAL THREAD

• NPTF • BSPP • BSPT • ISO 7 • ISO 228 • G THREAD • J THREAD



- Saves time and money
- No stripped threads
- No stripped parts
- Reduce inventory

- Completely reusable
- Quick installation
- No pitch identification

Component Parts and Materials	
Body	Brass - Nickel Plated
Thrust Ring	Acetalic Resin/ Glass filled Nylon
Sleeve	Brass - Nickel Plated
Gripper Collet	Stainless Steel
Safety Ring	PA66
Lip Seal (1/8 O-Ring Seal)	NBR 70
Thread Seal	NBR 70

Max Operating Pressure: Vacuum to 290PSI.
Min Temperature: -4°F
Max Temperature: 176°F
Tubing: Nylon, Polyethylene, Polyurethane.
- For best results use 95 Durometer
Media: Compressed air, water, vacuum

• Tolerance

+/- .02 on all dimensions. Dimension data can change without notice. Please call us when dimensions are critical.

GLOBAL THREAD

WORKS WITH INCH OR METRIC THREADS



“Global Thread” fittings can be assembled with female threads produced to the following standards:

Tapered NPTF
Parallel (BSPP, BSP, ISO 7)
Tapered (BSPT, PT, ISO 7, ISO 228)

WARNING: This product can expose you to chemicals, including lead, which are known to the State of California to cause cancer and birth defects or other reproductive harm. For more information, visit www.P65Warnings.ca.gov

BRASS

NICKEL PLATED PUSH-IN FITTINGS

BRASS FITTINGS

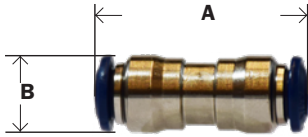
UNION CONNECTOR

*w/ plastic collet

MIDLAND	CHAMPION	TUBE O.D.	LIST
20017N	262PPNI-2	1/8"	
20018N*	262PPNI-2.5	5/32"	
20016N	262PPNI-42.5	5/32" x 1/4"	
20019N*	262PPNI-4	1/4"	
20015N*	262PPNI-5	5/16"	
20020N*	262PPNI-6	3/8"	
20022N	262PPNI-64	3/8" x 1/4"	
20021N*	262PPNI-8	1/2"	
20024N	262PPNI-86	1/2" x 3/8"	

62PL 88040

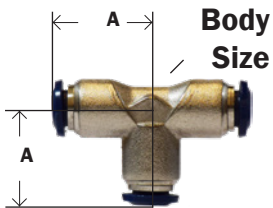
UNION TEE

MIDLAND	CHAMPION	TUBE O.D.	LIST
20025N	264PPNI-2	1/8"	
20026N*	264PPNI-2.5	5/32"	
20028N*	264PPNI-4	1/4"	
20031N*	264PPNI-5	5/16"	
20029N*	264PPNI-6	3/8"	
20030N*	264PPNI-8	1/2"	

164PL 88230

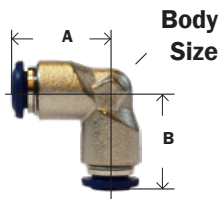
UNION ELBOW

MIDLAND	CHAMPION	TUBE O.D.	LIST
20150N	265PPNI-2	1/8"	
20151N*	265PPNI-2.5	5/32"	
20152N*	265PPNI-4	1/4"	
20155N*	265PPNI-5	5/16"	
20153N*	265PPNI-6	3/8"	
20154N*	265PPNI-8	1/2"	

165PL 88130

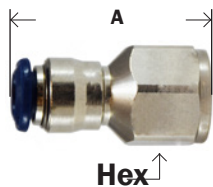
FEMALE CONNECTOR

MIDLAND	CHAMPION	TUBE O.D. X FEMALE NPTF	LIST
20032N	266PPNI-2A	1/8" x 1/8"	
20038N	266PPNI-2B	1/8" x 1/4"	
20034N	266PPNI-4A	1/4" x 1/8"	
20035N	266PPNI-4B	1/4" x 1/4"	
20036N	266PPNI-6B	3/8" x 1/4"	
20037N	266PPNI-6C	3/8" x 3/8"	

66PL 88030

WARNING: This product can expose you to chemicals, including lead, which are known to the State of California to cause cancer and birth defects or other reproductive harm. For more information, visit www.P65Warnings.ca.gov



NICKEL PLATED PUSH-IN FITTINGS

BRASS FITTINGS

MALE CONNECTOR

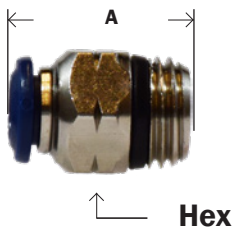

• Can be purchased with NPTF threads upon request

* Available in stainless steel

MIDLAND	CHAMPION	TUBE O.D. X MALE GLOBAL THREAD	LIST
20047N	268PPNI-2X1032	1/8" x 10-32"	
20048N	268PPNI-2A	1/8" x 1/8"	
20023N	268PPNI-2B	1/8" x 1/4"	
20049N*	268PPNI-2.5X1032	5/32" x 10-32"	
20050N*	268PPNI-2.5A	5/32" x 1/8"	
20046N*	268PPNI-2.5B	5/32" x 1/4"	
20053N*	268PPNI-4X1032	1/4" x 10-32"	
20054N*	268PPNI-4A	1/4" x 1/8"	
20055N*	268PPNI-4B	1/4" x 1/4"	
20056N	268PPNI-4C	1/4" x 3/8"	
20530N*	268PPNI-5A	5/16" x 1/8"	
20531N*	268PPNI-5B	5/16" x 1/4"	
20532N	268PPNI-5C	5/16" x 3/8"	
20057N	268PPNI-6A	3/8" x 1/8"	
20058N*	268PPNI-6B	3/8" x 1/4"	
20059N*	268PPNI-6C	3/8" x 3/8"	
20062N	268PPNI-6D	3/8" x 1/2"	
20841N		1/2" x 1/8"	
20060N	268PPNI-8B	1/2" x 1/4"	
20061N*	268PPNI-8C	1/2" x 3/8"	
20063N*	268PPNI-8D	1/2" x 1/2"	

MALE CONNECTOR WITH INTERNAL HEX

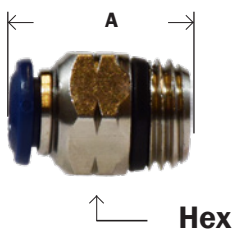

MIDLAND	CHAMPION	TUBE O.D. X MALE GLOBAL THREAD	LIST
20842N		1/8" x 10-32" UNF	
20847N		5/32" x 10-32 UNF	
20846N		5/32" x 1/8"	
20845N		1/4" x 10-32" UNF	
20843N		1/4" x 1/8"	
20844N		1/4" x 1/4"	

68PL 87000

FIXED MALE ELBOW

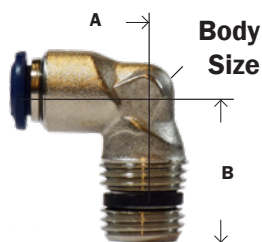

MIDLAND	CHAMPION	TUBE O.D. X MALE NPTF	LIST
20068N	269PPNI-4A	1/4" x 1/8"	
20069N	269PPNI-4B	1/4" x 1/4"	
20072N	269PPNI-6B	3/8" x 1/4"	
20073N	269PPNI-6C	3/8" x 3/8"	

W169PLNS 8100

WARNING: This product can expose you to chemicals, including lead, which are known to the State of California to cause cancer and birth defects or other reproductive harm. For more information, visit www.P65Warnings.ca.gov

BRASS

NICKEL PLATED PUSH-IN FITTINGS

BRASS FITTINGS

SWIVEL MALE ELBOW

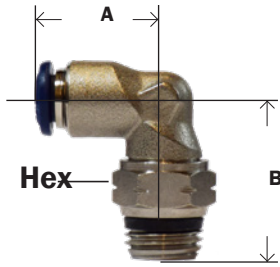

• Can be purchased with NPTF threads upon request

* Available in stainless steel

MIDLAND	CHAMPION	TUBE O.D. X MALE GLOBAL THREAD	LIST
20079N	269PPSNI-2A	1/8" x 1/8"	
20535N	269PPSNI-2B	1/8" x 1/4"	
20076N*	269PPSNI-2.5X1032	5/32" x 10-32"	
20080N*	269PPSNI-2.5A	5/32" x 1/8"	
20848N*	269PPSNI-2.5B	5/32" x 1/4"	
20081N*	269PPSNI-4A	1/4" x 1/8"	
20082N*	269PPSNI-4B	1/4" x 1/4"	
20086N	269PPSNI-4C	1/4" x 3/8"	
20537N*	269PPSNI-5A	5/16" x 1/8"	
20538N*	269PPSNI-5B	5/16" x 1/4"	
20539N	269PPSNI-5C	5/16" x 3/8"	
20087N	269PPSNI-6A	3/8" x 1/8"	
20083N*	269PPSNI-6B	3/8" x 1/4"	
20084N*	269PPSNI-6C	3/8" x 3/8"	
20088N*	269PPSNI-6D	3/8" x 1/2"	
20184N	269PPSNI-8B	1/2" x 1/4"	
20085N*	269PPSNI-8C	1/2" x 3/8"	
20092N*	269PPSNI-8D	1/2" x 1/2"	

W169PL 87110

FEMALE SWIVEL ELBOW

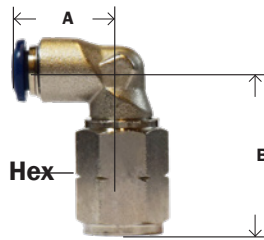

MIDLAND	CHAMPION	TUBE O.D. X FEMALE NPTF	LIST
20094N	270PPSNI-2.5A	5/32" x 1/8"	
20089N	270PPSNI-4A	1/4" x 1/8"	
20090N	270PPSNI-4B	1/4" x 1/4"	
20762N	270PPSNI-6A	3/8" x 1/8"	
20091N	270PPSNI-6B	3/8" x 1/4"	

SWIVEL MALE RUN TEE

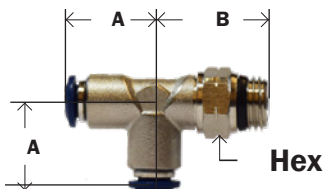

• Can be purchased with NPTF threads upon request

MIDLAND	CHAMPION	TUBE O.D. X MALE GLOBAL THREAD	LIST
20095N	271PPSNI-2A	1/8" x 1/8"	
20851N	271PPSNI-2B	1/8" x 1/4"	
20852N	271PPSNI-2.5A	5/32" x 1/8"	
20853N	271PPSNI-2.5B	5/32" x 1/4"	
20162N	271PPSNI-4A	1/4" x 1/8"	
20163N	271PPSNI-4B	1/4" x 1/4"	
20164N		1/4" x 3/8"	
20159N		3/8" x 1/8"	
20168N	271PPSNI-6B	3/8" x 1/4"	
20165N	271PPSNI-6C	3/8" x 3/8"	
20181N	271PPSNI-6D	3/8" x 1/2"	
20174N	271PPSNI-8B	1/2" x 1/4"	
20166N	271PPSNI-8C	1/2" x 3/8"	
20167N	271PPSNI-8D	1/2" x 1/2"	

W171PL 87222

NICKEL PLATED PUSH-IN FITTINGS

BRASS FITTINGS

SWIVEL MALE BRANCH TEE

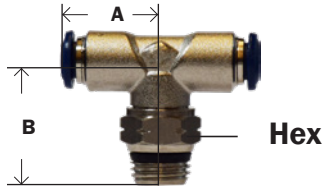

• Can be purchased with NPTF threads upon request

* with plastic collet

MIDLAND	CHAMPION	TUBE O.D. X MALE GLOBAL THREAD	LIST
20103N	272PPSNI-2A	1/8" x 1/8"	
20104N		5/32" x 10-32"	
20109N	272PPSNI-2.5A	5/32" x 1/8"	
20850N	272PPSNI-2.5B	5/32" x 1/4"	
20105N	272PPSNI-4A	1/4" x 1/8"	
20106N	272PPSNI-4B	1/4" x 1/4"	
20156N	272PPSNI-4C	1/4" x 3/8"	
20157N		3/8" x 1/8"	
20107N	272PPSNI-6B	3/8" x 1/4"	
20108N	272PPSNI-6C	3/8" x 3/8"	
20158N	272PPSNI-6D	3/8" x 1/2"	
20112N	272PPSNI-8B	1/2" x 1/4"	
20110N	272PPSNI-8C	1/2" x 3/8"	
20111N	272PPSNI-8D	1/2" x 1/2"	

W172PL 87210

BULKHEAD UNION

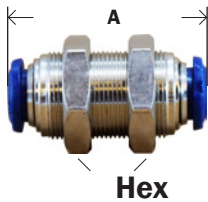

MIDLAND	CHAMPION	TUBE O.D.	LIST
20124N	283PPNI-2	1/8"	
20125N*	283PPNI-2.5	5/32"	
20127N*	283PPNI-4	1/4"	
20123N*	283PPNI-5	5/16"	
20128N*	283PPNI-6	3/8"	
20129N*	283PPNI-8	1/2"	

62PLBH 88050

UNION "Y"

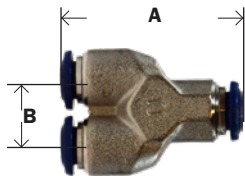

MIDLAND	CHAMPION	TUBE O.D.	LIST
20553N	289PPNI-4	1/4" x 1/4"	

662PL 88310

REDUCER



MIDLAND	CHAMPION	TUBE O.D. 2	LIST
20510N	286PPNI-42	1/4"	
20511N	286PPNI-42.5	1/4"	
20512N	286PPNI-64	3/8"	
20513N	286PPNI-84	1/2"	
20514N	286PPNI-86	1/2"	

67PPL 88700

Also available:

- Nylon plug
- Single banjo
- Double banjo
- Push fit cartridges and tools

NICKEL PLATED PUSH-IN FITTINGS

BRASS FITTINGS

CHROME PLATED BRASS MINI BALL VALVES

- Compact Design
- Max Working Pressure 250 psi

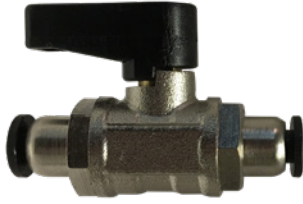
**PUSH-IN X PUSH-IN**

PART #	SIZE	BOX/CASE	WGT.	
28400	1/8	30/300	.07	----
28401	1/4	30/300	.10	----
28402	3/8	20/200	.21	----

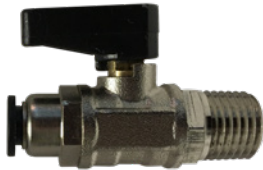
**PUSH-IN X MALE PIPE**

PART #	SIZE TUBE X MIP	BOX/ CASE	WGT.	
28403	5/32 x 1/8	30/300	.08	----
28407	1/4 x 1/8	30/300	.08	----
28404	1/4 x 1/4	30/300	.10	----
28405	3/8 x 3/8	20/200	.17	----

**FIP X FIP**

PART #	SIZE	BOX/CASE	WGT.	
46650	1/8	30/300	.11	----
46651	1/4	30/300	.10	----
46652	3/8	20/200	.14	----
46653	1/2	15/150	.25	----

**MIP X FIP**

PART #	SIZE	BOX/CASE	WGT.	
46660	1/8	30/300	.11	----
46661	1/4	30/300	.10	----
46662	3/8	20/200	.14	----
46663	1/2	15/150	.25	----

- Optional colors of handle plate for identification

PANEL MOUNT DESIGN**FIP X FIP ANGLE**

PART #	SIZE	BOX/CASE	WGT.	
46670	1/8	20/200	.19	----
46671	1/4	20/200	.20	----
46672	3/8	25/250	.11	----

**3-WAY FIP - OPEN CENTER**

PART #	SIZE	BOX/CASE	WGT.	
466900	1/8	25/250	.13	----
466901	1/4	20/200	.21	----
466902	3/8	20/200	.21	----

**3-WAY FIP - CLOSED CENTER**

PART #	SIZE	BOX/CASE	WGT.	
46680	1/8	25/250	.13	----
46681	1/4	20/200	.21	----
46682	3/8	20/200	.21	----

WARNING: This product can expose you to chemicals, including lead, which are known to the State of California to cause cancer and birth defects or other reproductive harm. For more information, visit www.P65Warnings.ca.gov

NICKEL PLATED METRIC PUSH-IN FITTINGS

BRASS FITTINGS

UNION

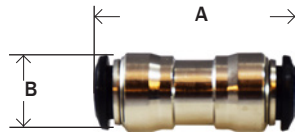

* Available in SS

MIDLAND	CHAMPION	TUBE O.D. (MM)	LIST
20723N	262PPNI-3MM	3	
20600N*	262PPNI-4MM	4	
20724N	262PPNI-5MM	5	
20725N	262PPNI-6MMX4MM	6 x 4	
20601N*	262PPNI-6MM	6	
20726N	262PPNI-8MMX6MM	8 x 6	
20727N*	262PPNI-8MM	8	
20728N	262PPNI-10MMX8MM	10 x 8	
20603N*	262PPNI-10MM	10	
20729N	262PPNI-12MMX10MM	12 x 10	
20604N*	262PPNI-12MM	12	
20730N	262PPNI-14MM	14	

UNION TEE

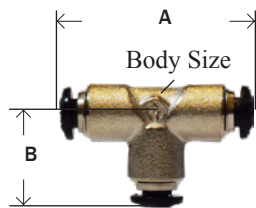

* Available in SS

MIDLAND	CHAMPION	TUBE O.D. (MM)	LIST
20741N	264PPNI-3MM	3	
20610N*	264PPNI-4MM	4	
20742N	264PPNI-5MM	5	
20611N*	264PPNI-6MM	6	
20612N*	264PPNI-8MM	8	
20613N*	264PPNI-10MM	10	
20614N*	264PPNI-12MM	12	
20743N	264PPNI-14MM	14	

UNION ELBOW

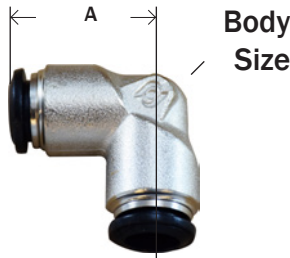

* Available in SS

MIDLAND	CHAMPION	TUBE O.D. (MM)	LIST
20738N	265PPNI-3MM	3	
20206N*	265PPNI-4MM	4	
20739N	265PPNI-5MM	5	
20660N*	265PPNI-6MM	6	
20661N*	265PPNI-8MM	8	
20807N*	265PPNI-10MM	10	
20808N*	265PPNI-12MM	12	
20740N	265PPNI-14MM	14	

UNION Y

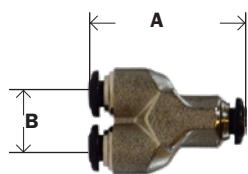

MIDLAND	CHAMPION	TUBE O.D. (MM)	LIST
20744N		3	
20813N		4	
20745N		5	
20814N	289PPNI-6MM	6	
20815N		8	
20746N		10	

PLUG

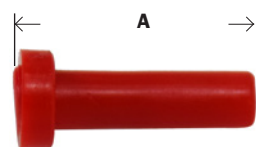

MIDLAND	CHAMPION	TUBE O.D. (MM)	LIST
20748N		4	
20749N		5	
20750N		6	
20751N		8	
20752N		10	
20753N		12	

NICKEL PLATED METRIC PUSH-IN FITTINGS

BRASS FITTINGS

METRIC TUBE STRAIGHT MALE

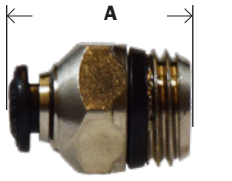

Hex



• Can be purchased with
BSPP or BSPT Threads

* Available in SS

MIDLAND	CHAMPION	TUBE O.D. (MM) X GLOBAL THREAD	LIST
20630N*	268PPNI-4MMX1/8	4 x 1/8	
20631N*	268PPNI-4MMX1/4	4 x 1/4	
20700N	268PPNI-5MMX1/8	5 x 1/8	
20701N	268PPNI-5MMX1/4	5 x 1/4	
20632N*	268PPNI-6MMX1/8	6 x 1/8	
20633N*	268PPNI-6MMX1/4	6 x 1/4	
20628N	268PPNI-6MMX3/8	6 x 3/8	
20629N	268PPNI-6MMX1/2	6 x 1/2	
20702N*	268PPNI-8MMX1/8	8 x 1/8	
20634N*	268PPNI-8MMX1/4	8 x 1/4	
20635N	268PPNI-8MMX3/8	8 x 3/8	
20703N	268PPNI-8MMX1/2	8 x 1/2	
20636N*	268PPNI-10MMX1/4	10 x 1/4	
20637N*	268PPNI-10MMX3/8	10 x 3/8	
20704N*	268PPNI-10MMX1/2	10 x 1/2	
20801N	268PPNI-12MMX1/4	12 x 1/4	
20638N*	268PPNI-12MMX3/8	12 x 3/8	
20705N*	268PPNI-12MMX1/2	12 x 1/2	
20706N	268PPNI-14MMX3/8	14 x 3/8	
20707N	268PPNI-14MMX1/2	14 x 1/2	

METRIC TUBE INTERNAL HEX

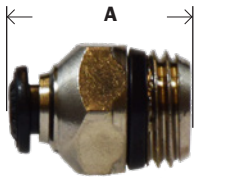

Hex

MIDLAND	CHAMPION	TUBE O.D. (MM) X GLOBAL THREAD	LIST
20619N		3 x M5	
20620N		4 x 1/8	
20621N*		4 x M5	
20622N		4 x M7 x 1	
20623N		6 x 1/4	
20624N		6 x 1/8	
20625N*		6 x M5	
20626N		8 x 1/4	
20627N		8 x 1/8	

METRIC TUBE SWIVEL MALE ELBOW

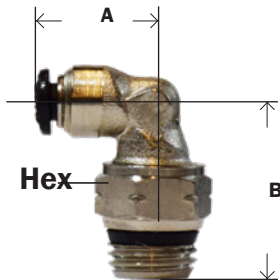

Hex



• Can be purchased with
BSPP or BSPT Threads

* Available in SS w BSPP or
BSPT Threads

MIDLAND	CHAMPION	TUBE O.D. (MM) X GLOBAL THREAD	LIST
20708N*	269PPSNI-4MMX1/8	4 x 1/8	
20709N*	269PPSNI-4MMX1/4	4 x 1/4	
20710N	269PPSNI-5MMX1/8	5 x 1/8	
20642N*	269PPSNI-6MMX1/8	6 x 1/8	
20803N*	269PPSNI-6MMX1/4	6 x 1/4	
20711N*	269PPSNI-8MMX1/8	8 x 1/8	
20805N*	269PPSNI-8MMX1/4	8 x 1/4	
20655N	269PPSNI-8MMX3/8	8 x 3/8	
20712N	269PPSNI-8MMX1/2	8 x 1/2	
20656N*	269PPSNI-10MMX1/4	10 x 1/4	
20657N*	269PPSNI-10MMX3/8	10 x 3/8	
20713N*	269PPSNI-10MMX1/2	10 x 1/2	
20658N*	269PPSNI-12MMX3/8	12 x 3/8	
20659N*	269PPSNI-12MMX1/2	12 x 1/2	
20714N	269PPSNI-14MMX3/8	14 x 3/8	
20715N	269PPSNI-14MMX1/2	14 x 1/2	

WARNING: This product can expose you to chemicals, including lead, which are known to the State of California to cause cancer and birth defects or other reproductive harm. For more information, visit www.P65Warnings.ca.gov

NICKEL PLATED METRIC PUSH-IN FITTINGS

BRASS FITTINGS

METRIC TUBE SWIVEL MALE BRANCH TEE

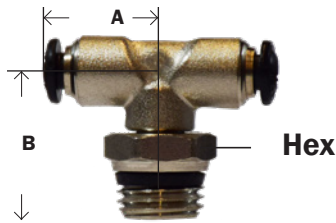

• Can be purchased with BSPP or BSPT threads

* Available in SS w/BSPP or BSPT threads

MIDLAND	CHAMPION	TUBE O.D. (MM) X GLOBAL THREAD	LIST
20680N*	272PPSNI-4MMX1/8	4 x 1/8	
20716N*	272PPSNI-4MMX1/4	4 x 1/4	
20717N	272PPSNI-5MMX1/8	5 x 1/8	
20682N*	272PPSNI-6MMX1/8	6 x 1/8	
20683N*	272PPSNI-6MMX1/4	6 x 1/4	
20809N*	272PPSNI-8MMX1/8	8 x 1/8	
20684N*	272PPSNI-8MMX1/4	8 x 1/4	
20690N	272PPSNI-8MMX3/8	8 x 3/8	
20691N	272PPSNI-8MMX1/2	8 x 1/2	
20686N*	272PPSNI-10MMX1/4	10 x 1/4	
20687N*	272PPSNI-10MMX3/8	10 x 3/8	
20810N*	272PPSNI-10MMX1/2	10 x 1/2	
20688N*	272PPSNI-12MMX3/8	12 x 3/8	
20689N*	272PPSNI-12MMX1/2	12 x 1/2	
20718N	272PPSNI-14MMX3/8	14 x 3/8	
20719N	272PPSNI-14MMX1/2	14 x 1/2	

METRIC TUBE SWIVEL MALE RUN TEE

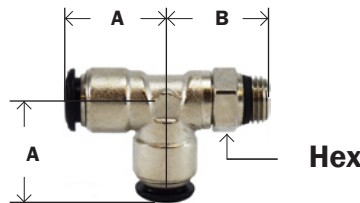

• Can be purchased with BSPP threads

* Available in SS w/BSPP or BSPT threads

MIDLAND	CHAMPION	TUBE O.D. (MM) X GLOBAL THREAD	LIST
20670N	271PPSNI-4MMX1/8	4 x 1/8	
20720N	271PPSNI-4MMX1/4	4 x 1/4	
20721N	271PPSNI-5MMX1/8	5 x 1/8	
20672N	271PPSNI-6MMX1/8	6 x 1/8	
20673N	271PPSNI-6MMX1/4	6 x 1/4	
20811N	271PPSNI-8MMX1/8	8 x 1/8	
20674N	271PPSNI-8MMX1/4	8 x 1/4	
20668N	271PPSNI-8MMX3/8	8 x 3/8	
20669N	271PPSNI-8MMX1/2	8 x 1/2	
20676N	271PPSNI-10MMX1/4	10 x 1/4	
20677N	271PPSNI-10MMX3/8	10 x 3/8	
20722N	271PPSNI-10MMX1/2	10 x 1/2	
20678N	271PPSNI-12MMX3/8	12 x 3/8	
20679N	271PPSNI-12MMX1/2	12 x 1/2	

BULKHEAD

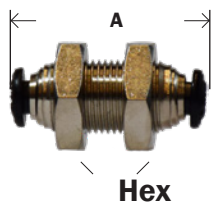

MIDLAND	CHAMPION	TUBE O.D. (MM)	LIST
20731N	283PPNI-3MM	3	
20732N*	283PPNI-4MM	4	
20733N	283PPNI-5MM	5	
20734N*	283PPNI-6MM	6	
20735N*	283PPNI-8MM	8	
20736N*	283PPNI-10MM	10	
20737N*	283PPNI-12MM	12	

* Available in SS

NICKEL PLATED WITH NICKEL COLLET

BRASS FITTINGS

UNION W/ NICKEL COLLET



CHAMPION	LIST	PTC	MAF #	MAF PRICE
262PPNIC-2		1/8	MQ62-2	----
262PPNIC-2.5		5/32	MQ62-532	
262PPNIC-4		1/4	MQ62-4	----
262PPNIC-5		5/16		
262PPNIC-6		3/8	MQ62-6	----
262PPNIC-8		1/2	MQ62-8	----

UNION TEE W/ NICKEL COLLET



CHAMPION	LIST	PTC X FPT	MAF #	MAF PRICE
264PPNIC-2		1/8	MQ64-2	----
264PPNIC-2.5		5/32	MQ64-532	
264PPNIC-4		1/4	MQ64-4	----
264PPNIC-5		5/16		
264PPNIC-6		3/8	MQ64-6	----
264PPNIC-8		1/2	MQ64-8	----

90° UNION ELBOW W/ NICKEL COLLET



CHAMPION	LIST	PTC	MAF #	MAF PRICE
265PPNIC-2		1/8	MQ65-2	----
265PPNIC-2.5		5/32	MQ65-532	
265PPNIC-4		1/4	MQ65-4	----
265PPNIC-5		5/16	MQ65-5	
265PPNIC-6		3/8	MQ65-6	----
265PPNIC-8		1/2	MQ65-8	----

FEMALE ADAPTER W/ NICKEL COLLET



CHAMPION	LIST	PTC X FPT	MAF #	MAF PRICE
266PPNIC-2X1032		1/8 x 10-32		
266PPNIC-2A		1/8 x 1/8	MQ66-22	----
266PPNIC-2.5X1032		5/32 x 10-32		
266PPNIC-2.5A		5/32 x 1/8	MQ65-5322	
266PPNIC-4A		1/4 x 1/8	MQ65-42	
266PPNIC-4B		1/4 x 1/4	MQ65-44	
266PPNIC-4C		1/4 x 3/8		
266PPNIC-5B		5/16 x 1/4		
266PPNIC-5C		5/16 x 3/8		
266PPNIC-6B		3/8 x 1/4	MQ65-64	
266PPNIC-6C		3/8 x 3/8	MQ65-66	
266PPNIC-6D		3/8 x 1/2		
266PPNIC-8C		1/2 x 3/8		
266PPNIC-8D		1/2 x 1/2		

WARNING: This product can expose you to chemicals, including lead, which are known to the State of California to cause cancer and birth defects or other reproductive harm. For more information, visit www.P65Warnings.ca.gov



NICKEL PLATED WITH NICKEL COLLET

BRASS FITTINGS

MALE ADAPTER W/ NICKEL COLLET



CHAMPION	LIST	PTC X MPT	MAF #	MAF PRICE
268PPNIC-2X1032		1/8 x 10-32	MQ68-20	
268PPNIC-2A		1/8 x 1/8	MQ6-22	
268PPNIC-2B		1/8 x 1/4	MQ6-24	
268PPNIC-2.5X1032		5/32 x 10-32	MQ6-5320	
268PPNIC-2.5A		5/32 x 1/8	MQ6-5322	
268PPNIC-2.5B		5/32 x 1/4	MQ6-5324	
268PPNIC-4X1032		1/4 x 10-32	MQ6-40	
268PPNIC-4A		1/4 x 1/8	MQ6-42	
268PPNIC-4B		1/4 x 1/4	MQ6-44	
268PPNIC-4C		1/4 x 3/8	MQ6-46	
268PPNIC-5A		5/16 x 1/8	MQ6-52	
268PPNIC-5B		5/16 x 1/4	MQ6-54	
268PPNIC-5C		5/16 x 3/8	MQ6-56	
268PPNIC-6A		3/8 x 1/8	MQ6-62	
268PPNIC-6B		3/8 x 1/4	MQ6-64	
268PPNIC-6C		3/8 x 3/8	MQ6-66	
268PPNIC-6D		3/8 x 1/2	MQ6-68	
268PPNIC-8B		1/2 x 1/4	MQ6-84	
268PPNIC-8C		1/2 x 3/8	MQ6-86	
268PPNIC-8D		1/2 x 1/2	MQ6-88	

90° MALE ELBOW SWIVEL W/ NICKEL COLLET



CHAMPION	LIST	PTC X MPT	MAF #	MAF PRICE
269PPSNIC-2X1032		1/8 x 10-32		
269PPSNIC-2A		1/8 x 1/8	MQ69S-22	----
269PPSNIC-2B		1/8 x 1/4	MQ69S-24	----
269PPSNIC-2.5X1032		5/32 x 10-32	MQ69S-5320	----
269PPSNIC-2.5A		5/32 x 1/8	MQ69S-5322	
269PPSNIC-4A		1/4 x 1/8	MQ69S-42	----
269PPSNIC-4B		1/4 x 1/4	MQ69S-44	----
269PPSNIC-4C		1/4 x 3/8	MQ69S-46	----
269PPSNIC-5B		5/16 x 1/4	MQ69S-54	
269PPSNIC-5C		5/16 x 3/8	MQ69S-56	
269PPSNIC-6A		3/8 x 1/8	MQ69S-62	----
269PPSNIC-6B		3/8 x 1/4	MQ69S-64	----
269PPSNIC-6C		3/8 x 3/8	MQ69S-66	----
269PPSNIC-6D		3/8 x 1/2	MQ69S-68	----
269PPSNIC-8B		1/2 x 1/4	MQ69S-84	
269PPSNIC-8C		1/2 x 3/8	MQ69S-86	----
269PPSNIC-8D		1/2 x 1/2	MQ69S-88	----

WARNING: This product can expose you to chemicals, including lead, which are known to the State of California to cause cancer and birth defects or other reproductive harm. For more information, visit www.P65Warnings.ca.gov

BRASS

NICKEL PLATED WITH NICKEL COLLET

BRASS FITTINGS

MALE RUN TEE SWIVEL W/ NICKEL COLLET

CHAMPION	LIST	PTC X MPT	MAF #	MAF PRICE
271PPSNIC-2X1032		1/8 x 10-32		
271PPSNIC-2A		1/8 x 1/8		
271PPSNIC-4A		1/4 x 1/8		
271PPSNIC-4B		1/4 x 1/4		
271PPSNIC-4C		1/4 x 3/8		
271PPSNIC-6B		3/8 x 1/4		
271PPSNIC-6C		3/8 x 3/8		
271PPSNIC-6D		3/8 x 1/2		
271PPSNIC-8C		1/2 x 3/8		
271PPSNIC-8D		1/2 x 1/2		

MALE BRANCH TEE SWIVEL W/ NICKEL COLLET

CHAMPION	LIST	PTC X MPT	MAF #	MAF PRICE
272PPSNIC-2X1032		1/8 x 10-32	MQ72-20	
272PPSNIC-2A		1/8 x 1/8	MQ72-22	----
272PPSNIC-4A		1/4 x 1/8	MQ72-42	----
272PPSNIC-4B		1/4 x 1/4	MQ72-44	----
272PPSNIC-4C		1/4 x 3/8		
272PPSNIC-5A		5/16 x 1/8		
272PPSNIC-5B		5/16 x 1/4		
272PPSNIC-5C		5/16 x 3/8		
272PPSNIC-6B		3/8 x 1/4	MQ72-64	----
272PPSNIC-6C		3/8 x 3/8	MQ72-66	----
272PPSNIC-6D		3/8 x 1/2	MQ72-68	
272PPSNIC-8B		1/2 x 1/4	MQ72-84	
272PPSNIC-8C		1/2 x 3/8	MQ72-86	----
272PPSNIC-8D		1/2 x 1/2	MQ72-88	

BULKHEAD UNION W/ NICKEL COLLET

CHAMPION	LIST	PTC	MAF #	MAF PRICE
283PPNIC-2.5		5/32	MQ82-532	
283PPNIC-4		1/4	MQ82-4	----
283PPNIC-5		5/16	MQ82-5	
283PPNIC-6		3/8	MQ82-6	----
283PPNIC-8		1/2	MQ82-8	----

METRIC UNION W/ NICKEL COLLET

CHAMPION	LIST	PTC	MAF #	MAF PRICE
262PPNIC-4MM		4MM		
262PPNIC-6MM		6MM		
262PPNIC-8MM		8MM		
262PPNIC-10MM		10MM		
262PPNIC-12MM		12MM		

METRIC UNION TEE W/ NICKEL COLLET

CHAMPION	LIST	PTC	MAF #	MAF PRICE
264PPNIC-4MM		4MM		
264PPNIC-6MM		6MM		
264PPNIC-8MM		8MM		
264PPNIC-10MM		10MM		
264PPNIC-12MM		12MM		

WARNING: This product can expose you to chemicals, including lead, which are known to the State of California to cause cancer and birth defects or other reproductive harm. For more information, visit www.P65Warnings.ca.gov

NICKEL PLATED WITH NICKEL COLLET

BRASS FITTINGS

METRIC 90° UNION ELBOW W/ NICKEL COLLET



CHAMPION	LIST	PTC	MAF #	MAF PRICE
265PPNIC-4MM		4MM		
265PPNIC-6MM		6MM		
265PPNIC-8MM		8MM		

METRIC FEMALE ADAPTER W/ NICKEL COLLET



CHAMPION	LIST	PTC X FEMALE BSPP	MAF #	MAF PRICE
266PPNIC-4MMX1/8		4MM x 1/8		
266PPNIC-6MMX1/8		6MM x 1/8		
266PPNIC-6MMX1/4		6MM x 1/4		
266PPNIC-8MMX1/8		8MM x 1/8		
266PPNIC-8MMX1/4		8MM x 1/4		
266PPNIC-10MMX1/4		10MM x 1/4		
266PPNIC-10MMX3/8		10MM x 3/8		

METRIC MALE CONNECTOR W/ NICKEL COLLET



CHAMPION	LIST	PTC X MALE BSPT	MAF #	MAF PRICE
268PPNIC-4MMX1/8		4MM x 1/8		
268PPNIC-4MMX1/4		4MM x 1/4		
268PPNIC-6MMX1/8		6MM x 1/8		
268PPNIC-6MMX1/4		6MM x 1/4		
268PPNIC-8MMX1/8		8MM x 1/8		
268PPNIC-8MMX1/4		8MM x 1/4		
268PPNIC-8MMX3/8		8MM x 3/8		
268PPNIC-10MMX1/4		10MM x 1/4		
268PPNIC-10MMX3/8		10MM x 3/8		
268PPNIC-12MMX1/4		12MM x 1/4		

METRIC 90° MALE ELBOW SWIVEL W/ NICKEL COLLET



CHAMPION	LIST	PTC X MALE BSPT	MAF #	MAF PRICE
269PPSNIC-4MMX1/8		4MM x 1/8		
269PPSNIC-4MMX1/4		4MM x 1/4		
269PPSNIC-6MMXM5		6MM x M5		
269PPSNIC-6MMX1/8		6MM x 1/8		
269PPSNIC-6MMX1/4		6MM x 1/4		
269PPSNIC-8MMX1/8		8MM x 1/8		
269PPSNIC-8MMX1/4		8MM x 1/4		
269PPSNIC-8MMX3/8		8MM x 3/8		
269PPSNIC-10MMX1/4		10MM x 1/4		
269PPSNIC-10MMX3/8		10MM x 3/8		

METRIC BULKHEAD UNION W/ NICKEL COLLET



CHAMPION	LIST	PTC	MAF #	MAF PRICE
283PPNIC-4MM		4MM		
283PPNIC-8MM		8MM		

WARNING: This product can expose you to chemicals, including lead, which are known to the State of California to cause cancer and birth defects or other reproductive harm. For more information, visit www.P65Warnings.ca.gov



STAINLESS STEEL PUSH IN FITTINGS

BRASS FITTINGS

UNION STAINLESS STEEL

CHAMPION	PTC	LIST
262PP-SS-2.5	5/32	
262PP-SS-3	3/16	
262PP-SS-4	1/4	
262PP-SS-5	5/16	
262PP-SS-6	3/8	
262PP-SS-8	1/2	

UNION TEE STAINLESS STEEL

CHAMPION	PTC	LIST
264PP-SS-2.5	5/32	
264PP-SS-4	1/4	
264PP-SS-5	5/16	
264PP-SS-6	3/8	
264PP-SS-8	1/2	

90° UNION ELBOW STAINLESS STEEL

CHAMPION	PTC	LIST
265PP-SS-2.5	5/32	
265PP-SS-4	1/4	
265PP-SS-5	5/16	
265PP-SS-6	3/8	
265PP-SS-8	1/2	

FEMALE ADAPTER STAINLESS STEEL

CHAMPION	PTC X FPT	LIST
266PP-SS-2.5X1032	5/32 x 10-32	
266PP-SS-2.5A	5/32 x 1/8	
266PP-SS-2.5B	5/32 x 1/4	
266PP-SS-4X1032	1/4 x 10-32	
266PP-SS-4A	1/4 x 1/8	
266PP-SS-4B	1/4 x 1/4	
266PP-SS-4C	1/4 x 3/8	
266PP-SS-4D	1/4 x 1/2	
266PP-SS-5A	5/16 x 1/8	
266PP-SS-5B	5/16 x 1/4	
266PP-SS-5C	5/16 x 3/8	
266PP-SS-5D	5/16 x 1/2	
266PP-SS-6B	3/8 x 1/4	
266PP-SS-6C	3/8 x 3/8	
266PP-SS-6D	3/8 x 1/2	
266PP-SS-8B	1/2 x 1/4	
266PP-SS-8C	1/2 x 3/8	
266PP-SS-8D	1/2 x 1/2	

WARNING: This product can expose you to chemicals, including lead, which are known to the State of California to cause cancer and birth defects or other reproductive harm. For more information, visit www.P65Warnings.ca.gov



STAINLESS STEEL PUSH IN FITTINGS

BRASS FITTINGS

MALE CONNECTOR STAINLESS STEEL



CHAMPION	PTC X MPT	LIST
268PP-SS-2X1032	1/8 x 10-32	
268PP-SS-2.5X1032	5/32 x 10-32	
268PP-SS-2.5A	5/32 x 1/8	
268PP-SS-2.5B	5/32 x 1/4	
268PP-SS-4X1032	1/4 x 10-32	
268PP-SS-4A	1/4 x 1/8	
268PP-SS-4B	1/4 x 1/4	
268PP-SS-4C	1/4 x 3/8	
268PP-SS-4D	1/4 x 1/2	
268PP-SS-5A	5/16 x 1/8	
268PP-SS-5B	5/16 x 1/4	
268PP-SS-5C	5/16 x 3/8	
268PP-SS-5D	5/16 x 1/2	
268PP-SS-6B	3/8 x 1/4	
268PP-SS-6C	3/8 x 3/8	
268PP-SS-6D	3/8 x 1/2	
268PP-SS-8B	1/2 x 1/4	
268PP-SS-8C	1/2 x 3/8	
268PP-SS-8D	1/2 x 1/2	

90° MALE ELBOW SWIVEL STAINLESS STEEL



CHAMPION	PTC X MPT	LIST
269PPS-SS-2.5X1032	5/32 x 10-32	
269PPS-SS-2.5A	5/32 x 1/8	
269PPS-SS-2.5B	5/32 x 1/4	
269PPS-SS-4X1032	1/4 x 10-32	
269PPS-SS-4A	1/4 x 1/8	
269PPS-SS-4B	1/4 x 1/4	
269PPS-SS-4C	1/4 x 3/8	
269PPS-SS-4D	1/4 x 1/2	
269PPS-SS-5A	5/16 x 1/8	
269PPS-SS-5B	5/16 x 1/4	
269PPS-SS-5C	5/16 x 3/8	
269PPS-SS-5D	5/16 x 1/2	
269PPS-SS-6A	3/8 x 1/8	
269PPS-SS-6B	3/8 x 1/4	
269PPS-SS-6C	3/8 x 3/8	
269PPS-SS-6D	3/8 x 1/2	
269PPS-SS-8B	1/2 x 1/4	
269PPS-SS-8C	1/2 x 3/8	
269PPS-SS-8D	1/2 x 1/2	

WARNING: This product can expose you to chemicals, including lead, which are known to the State of California to cause cancer and birth defects or other reproductive harm. For more information, visit www.P65Warnings.ca.gov

BRASS

STAINLESS STEEL PUSH IN FITTINGS

BRASS FITTINGS

MALE RUN TEE SWIVEL STAINLESS STEEL

CHAMPION	PTC X MPT	LIST
271PPS-SS-2.5X1032	5/32 x 10-32	
271PPS-SS-2.5A	5/32 x 1/8	
271PPS-SS-2.5B	5/32 x 1/4	
271PPS-SS-4X1032	1/4 x 10-32	
271PPS-SS-4A	1/4 x 1/8	
271PPS-SS-4B	1/4 x 1/4	
271PPS-SS-4C	1/4 x 3/8	
271PPS-SS-4D	1/4 x 1/2	
271PPS-SS-5A	5/16 x 1/8	
271PPS-SS-5B	5/16 x 1/4	
271PPS-SS-5C	5/16 x 3/8	
271PPS-SS-5D	5/16 x 1/2	
271PPS-SS-6B	3/8 x 1/4	
271PPS-SS-6C	3/8 x 3/8	
271PPS-SS-6D	3/8 x 1/2	
271PPS-SS-8B	1/2 x 1/4	
271PPS-SS-8C	1/2 x 3/8	
271PPS-SS-8D	1/2 x 1/2	

MALE BRANCH TEE SWIVEL STAINLESS STEEL

CHAMPION	PTC X MPT	LIST
272PPS-SS-2.5X1032	5/32 x 10-32	
272PPS-SS-2.5A	5/32 x 1/8	
272PPS-SS-2.5B	5/32 x 1/4	
272PPS-SS-4X1032	1/4 x 10-32	
272PPS-SS-4A	1/4 x 1/8	
272PPS-SS-4B	1/4 x 1/4	
272PPS-SS-4C	1/4 x 3/8	
272PPS-SS-4D	1/4 x 1/2	
272PPS-SS-5A	5/16 x 1/8	
272PPS-SS-5B	5/16 x 1/4	
272PPS-SS-5C	5/16 x 3/8	
272PPS-SS-5D	5/16 x 1/2	
272PPS-SS-6A	3/8 x 1/8	
272PPS-SS-6B	3/8 x 1/4	
272PPS-SS-6C	3/8 x 3/8	
272PPS-SS-6D	3/8 x 1/2	
272PPS-SS-8B	1/2 x 1/4	
272PPS-SS-8C	1/2 x 3/8	
272PPS-SS-8D	1/2 x 1/2	

WARNING: This product can expose you to chemicals, including lead, which are known to the State of California to cause cancer and birth defects or other reproductive harm. For more information, visit www.P65Warnings.ca.gov

STAINLESS STEEL PUSH IN FITTINGS

BRASS FITTINGS

FEMALE BULKHEAD ADAPTER STAINLESS STEEL



CHAMPION	PTC X FPT	LIST
287PP-SS-2.5X1032	5/32 x 10.32	
287PP-SS-2.5A	5/32 x 1/8	
287PP-SS-2.5B	5/32 x 1/4	
287PP-SS-4X1032	1/4 x 10.32	
287PP-SS-4A	1/4 x 1/8	
287PP-SS-4B	1/4 x 1/4	
287PP-SS-4C	1/4 x 3/8	
287PP-SS-4D	1/4 x 1/2	
287PP-SS-5A	5/16 x 1/8	
287PP-SS-5B	5/16 x 1/4	
287PP-SS-5C	5/16 x 3/8	
287PP-SS-5D	5/16 x 1/2	
287PP-SS-6B	3/8 x 1/4	
287PP-SS-6C	3/8 x 3/8	
287PP-SS-6D	3/8 x 1/2	
287PP-SS-8B	1/2 x 1/4	
287PP-SS-8C	1/2 x 3/8	
287PP-SS-8D	1/2 x 1/2	

BULKHEAD UNION STAINLESS STEEL

CHAMPION	PTC	LIST
262BHPP-SS-6	3/8	

BULKHEAD UNION STAINLESS STEEL



CHAMPION	PTC	LIST
283PP-SS-2.5	5/32	
283PP-SS-4	1/4	
283PP-SS-5	5/16	
283PP-SS-6	3/8	
283PP-SS-8	1/2	

Y-CONNECTOR UNION STAINLESS STEEL



CHAMPION	PTC	LIST
289PP-SS-2.5	5/32	
289PP-SS-4	1/4	
289PP-SS-5	5/16	
289PP-SS-6	3/8	
289PP-SS-8	1/2	

WARNING: This product can expose you to chemicals, including lead, which are known to the State of California to cause cancer and birth defects or other reproductive harm. For more information, visit www.P65Warnings.ca.gov

BRASS

COMPOSITE BODY PUSH-IN FITTINGS

BRASS FITTINGS

Composite Body Push-In Fittings

- For Food Grade, see page 340-343

Specifications

Fluid admitted	Air
Working pressure range	0-150 PSI (10BAR)
Min. Burst pressure	340PSI (23BAR)
Working Temperature range	0°F ~160°F

Materials of Construction:

1	Body	Composite Polyacetal (hemopolymer, copolymer)
2	Body	Brass
3	Tube Release	Acetal Resin
4	Retainer	Brass
5	Gripper Ring	Stainless Steel
6	Spacer	Brass
7	O-Ring	NBR 70
8	Threads	Brass w/ white sealant

The latest generation of composite material is used in the body construction in addition to brass on threaded components and stainless steel on the tube gripper.

• Tolerance

+/- .02 on all dimensions. Dimension data can change without notice. Please call us when dimensions are critical.

May you live all the
days of your life.

- Jonathan Swift



GO ONLINE TO VIEW OPEN ORDERS, ORDER HISTORY, AND TRACKING INFORMATION ON ALL SHIPMENTS

WARNING: This product can expose you to chemicals, including lead, which are known to the State of California to cause cancer and birth defects or other reproductive harm. For more information, visit www.P65Warnings.ca.gov



COMPOSITE BODY PUSH-IN FITTINGS

BRASS FITTINGS

UNION

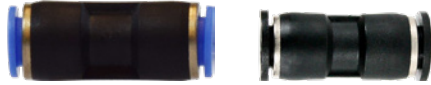

MIDLAND	CHAMPION	TUBE O.D.	LIST
20017C	262PPC-2	1/8"	
20018C	262PPC-2.5	5/32"	
20001C	262PPC-3	3/16"	
20019C	262PPC-4	1/4"	
20015C	262PPC-5	5/16"	
20020C	262PPC-6	3/8"	
20021C	262PPC-8	1/2"	
	262PPC-42	1/4" x 1/8"	
20016C	262PPC-42.5	1/4" x 5/32"	
20515C	262PPC-54	5/16" x 1/4"	
20022C	262PPC-64	3/8" x 1/4"	
20516C	262PPC-65	3/8" x 5/16"	
20024C	262PPC-86	1/2" x 3/8"	

PQ62P

UNION TEE

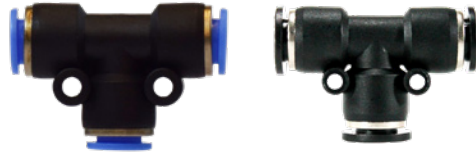

MIDLAND	CHAMPION	TUBE O.D.	LIST
20025C	264PPC-2	1/8"	
20026C	264PPC-2.5	5/32"	
20027C	264PPC-3	3/16"	
20028C	264PPC-4	1/4"	
20031C	264PPC-5	5/16"	
20029C	264PPC-6	3/8"	
20030C	264PPC-8	1/2"	
	264PPC-2.54	5/32" x 1/4"	
	264PPC-42.5	1/4" x 5/32"	
	264PPC-46	1/4" x 3/8"	
	264PPC-54	5/16" x 1/4"	
	264PPC-64	3/8" x 1/4"	
	264PPC-65	3/8" x 5/16"	
	264PPC-86	1/2" x 3/8"	

PQ64P

90° UNION ELBOW



MIDLAND	CHAMPION	TUBE O.D.	LIST
20150C	265PPC-2	1/8"	
20151C	265PPC-2.5	5/32"	
20149C	265PPC-3	3/16"	
20152C	265PPC-4	1/4"	
20155C	265PPC-5	5/16"	
20153C	265PPC-6	3/8"	
20154C	265PPC-8	1/2"	

PQ65P

UNION "Y" CONNECTOR



MIDLAND	CHAMPION	TUBE O.D.	LIST
	289PPC-2	1/8"	
20551C	289PPC-2.5	5/32"	
20553C	289PPC-4	1/4"	
20182C	289PPC-5	5/16"	
20555C	289PPC-6	3/8"	
20185C	289PPC-8	1/2"	
	289PPC-46	1/4" x 3/8"	
	289PPC-64	3/8" x 1/4"	

PQ89P

WARNING: This product can expose you to chemicals, including lead, which are known to the State of California to cause cancer and birth defects or other reproductive harm. For more information, visit www.P65Warnings.ca.gov

BRASS

COMPOSITE BODY PUSH-IN FITTINGS

BRASS FITTINGS

FEMALE CONNECTOR

• Brass

MIDLAND	CHAMPION	TUBE O.D. X FEMALE NPT	LIST
	266PPC-2X1032	1/8" x 10-32	
	266PPC-2A	1/8" x 1/8"	
	266PPC-2.5A	5/32" x 1/8"	
	266PPC-2.5B	5/32" x 1/4"	
	266PPC-3A	3/16" x 1/8"	
20034C	266PPC-4A	1/4" x 1/8"	
20035C	266PPC-4B	1/4" x 1/4"	
	266PPC-5A	5/16" x 1/8"	
	266PPC-5B	5/16" x 1/4"	
	266PPC-5C	5/16" x 3/8"	
	266PPC-6A	3/8" x 1/8"	
20036C	266PPC-6B	3/8" x 1/4"	
20037C	266PPC-6C	3/8" x 3/8"	
	266PPC-6D	3/8" x 1/2"	
	266PPC-8B	1/2" x 1/4"	
	266PPC-8C	1/2" x 3/8"	

PQ66P

MALE CONNECTOR

• Nickel Plated

MIDLAND	CHAMPION	TUBE O.D. X MALE NPT	LIST
	268PPC-2X1032	1/8" x 10-32	
	268PPC-2X	1/8" x 1/16"	
	268PPC-2A	1/8" x 1/8"	
	268PPC-2B	1/8" x 1/4"	
	268PPC-2.5X1032	5/32" x 10-32	
20050C	268PPC-2.5A	5/32" x 1/8"	
	268PPC-2.5B	5/32" x 1/4"	
	268PPC-3A	3/16" x 1/8"	
	268PPC-3B	3/16" x 1/4"	
20053C	268PPC-4X1032	1/4" x 10-32"	
20054C	268PPC-4A	1/4" x 1/8"	
20055C	268PPC-4B	1/4" x 1/4"	
20056C	268PPC-4C	1/4" x 3/8"	
	268PPC-4D	1/4" x 1/2"	
20530C	268PPC-5A	5/16" x 1/8"	
20531C	268PPC-5B	5/16" x 1/4"	
	268PPC-5C	5/16" x 3/8"	
20057C	268PPC-6A	3/8" x 1/8"	
20058C	268PPC-6B	3/8" x 1/4"	
20059C	268PPC-6C	3/8" x 3/8"	
20062C	268PPC-6D	3/8" x 1/2"	
20060C	268PPC-8B	1/2" x 1/4"	
20061C	268PPC-8C	1/2" x 3/8"	
20063C	268PPC-8D	1/2" x 1/2"	

PQ68P

WARNING: This product can expose you to chemicals, including lead, which are known to the State of California to cause cancer and birth defects or other reproductive harm. For more information, visit www.P65Warnings.ca.gov

COMPOSITE BODY PUSH-IN FITTINGS

BRASS FITTINGS

SWIVEL MALE ELBOW



- Swivels for installation only.
- Not a live swivel
- * Global Thread

MIDLAND	CHAMPION	TUBE O.D. X MALE NPT	LIST
	269PPSC-2X1032	1/8" x 10-32	
	269PPSC-2X	1/8" x 1/16"	
20079C	269PPSC-2A	1/8" x 1/8"	
20535C*	269PPSC-2B	1/8" x 1/4"	
20049C*	269PPSC-2.5X1032	5/32" x 10/32	
20080C*	269PPSC-2.5A	5/32" x 1/8"	
20077C*	269PPSC-2.5B	5/32" x 1/4"	
	269PPSC-3A	3/16" x 1/8"	
20517C*		3/16" x 1/4"	
20078C	269PPSC-4X1032	1/4" x 10-32	
20081C	269PPSC-4A	1/4" x 1/8"	
20082C	269PPSC-4B	1/4" x 1/4"	
20086C	269PPSC-4C	1/4" x 3/8"	
20518C*	269PPSC-4D	1/4" x 1/2"	
20537C	269PPSC-5A	5/16" x 1/8"	
20538C	269PPSC-5B	5/16" x 1/4"	
20539C*	269PPSC-5C	5/16" x 3/8"	
20087C	269PPSC-6A	3/8" x 1/8"	
20083C	269PPSC-6B	3/8" x 1/4"	
20084C	269PPSC-6C	3/8" x 3/8"	
20088C	269PPSC-6D	3/8" x 1/2"	
20184C	269PPSC-8B	1/2" x 1/4"	
20085C	269PPSC-8C	1/2" x 3/8"	
20092C*	269PPSC-8D	1/2" x 1/2"	

PQ69PS

LONG PATTERN MALE ELBOWS



MIDLAND	CHAMPION	TUBE O.D. X THREAD	LIST
20572C	269EXTPPSC-4A	1/4" x 1/8"	
20573C	269EXTPPSC-4B	1/4" x 1/4"	
20574C	269EXTPPSC-4C	1/4" x 3/8"	
20579C	269EXTPPSC-6B	3/8" x 1/4"	
20580C	269EXTPPSC-6C	3/8" x 3/8"	
20581C	269EXTPPSC-6D	3/8" x 1/2"	
20582C	269EXTPPSC-8B	1/2" x 1/4"	
20583C	269EXTPPSC-8C	1/2" x 3/8"	
20584C	269EXTPPSC-8D	1/2" x 1/2"	

FEMALE SWIVEL ELBOWS



MIDLAND	CHAMPION	TUBE O.D. X FEMALE NPT	LIST
	270PPSC-2A	1/8" x 1/8"	
	270PPSC-2.5A	5/32" x 1/8"	
	270PPSC-2.5B	5/32" x 1/4"	
	270PPSC-4X1032	1/4" x 10-32	
20089C	270PPSC-4A	1/4" x 1/8"	
20090C	270PPSC-4B	1/4" x 1/4"	
20591C	270PPSC-4C	1/4" x 3/8"	
	270PPSC-5A	5/16" x 1/8"	
	270PPSC-6A	3/8" x 1/8"	
20091C	270PPSC-6B	3/8" x 1/4"	
20595C	270PPSC-6C	3/8" x 3/8"	
20596C		3/8" x 1/2"	
20597C	270PPSC-8C	1/2" x 3/8"	
20598C		1/2" x 1/2"	

WARNING: This product can expose you to chemicals, including lead, which are known to the State of California to cause cancer and birth defects or other reproductive harm. For more information, visit www.P65Warnings.ca.gov

BRASS

COMPOSITE BODY PUSH-IN FITTINGS

BRASS FITTINGS

45° SWIVELS



MIDLAND	CHAMPION	TUBE O.D. X MALE NPT	LIST
20139C	279PPSC-4A	1/4" x 1/8"	
20140C	279PPSC-4B	1/4" x 1/4"	

SWIVEL MALE RUN TEE



- Swivels for installation only.
- Not a live swivel
- * Global Thread

MIDLAND	CHAMPION	TUBE O.D. X MALE NPT	LIST
	271PPSC-2X1032	1/8" x 10-32	
20160C*	271PPSC-2A	1/8" x 1/8"	
20833C*		1/8" x 1/4"	
20835C*	271PPSC-2.5X1032	5/32" x 10-32	
	271PPSC-2.5A	5/32" x 1/8"	
	271PPSC-2.5B	5/32" x 1/4"	
20834C*	271PPSC-4X1032	1/4" x 10-32	
20162C	271PPSC-4A	1/4" x 1/8"	
20163C	271PPSC-4B	1/4" x 1/4"	
	271PPSC-4C	1/4" x 3/8"	
	271PPSC-5A	5/16" x 1/8"	
	271PPSC-5B	5/16" x 1/4"	
	271PPSC-5C	5/16" x 3/8"	
20099C	271PPSC-6A	3/8" x 1/8"	
20100C	271PPSC-6B	3/8" x 1/4"	
20165C	271PPSC-6C	3/8" x 3/8"	
20181C	271PPSC-6D	3/8" x 1/2"	
20174C	271PPSC-8B	1/2" x 1/4"	
20166C	271PPSC-8C	1/2" x 3/8"	
20167C	271PPSC-8D	1/2" x 1/2"	

PQ71PS

SWIVEL MALE BRANCH TEE



- Swivels for installation only.
- Not a live swivel
- * Global Thread

MIDLAND	CHAMPION	TUBE O.D. X MALE NPT	LIST
	272PPSC-2X1032	1/8" x 10-32	
	272PPSC-2X	1/8" x 1/16"	
20103C*	272PPSC-2A	1/8" x 1/8"	
20519C*	272PPSC-2B	1/8" x 1/4"	
20104C*	272PPSC-2.5X1032	5/32" x 10-32	
20109C*	272PPSC-2.5A	5/32" x 1/8"	
20135C*	272PPSC-2.5B	5/32" x 1/4"	
20830C*		3/16" x 1/8"	
20831C*	272PPSC-4X1032	1/4" x 10-32	
20105C	272PPSC-4A	1/4" x 1/8"	
20106C	272PPSC-4B	1/4" x 1/4"	
20121C	272PPSC-4C	1/4" x 3/8"	
20136C*	272PPSC-5A	5/16" x 1/8"	
20137C*	272PPSC-5B	5/16" x 1/4"	
20832C*	272PPSC-5C	5/16" x 3/8"	
	272PPSC-6A	3/8" x 1/8"	
20107C	272PPSC-6B	3/8" x 1/4"	
20108C	272PPSC-6C	3/8" x 3/8"	
20158C*	272PPSC-6D	3/8" x 1/2"	
20138C*	272PPSC-8B	1/2" x 1/4"	
20110C	272PPSC-8C	1/2" x 3/8"	
20111C	272PPSC-8D	1/2" x 1/2"	

PQ72PS

BULKHEAD UNION



MIDLAND	CHAMPION	TUBE O.D.	LIST
	283PPC-2	1/8"	
	283PPC-2.5	5/32"	
20127C	283PPC-4	1/4"	
	283PPC-5	5/16"	
20128C	283PPC-6	3/8"	
20129C	283PPC-8	1/2"	

PQ82P

WARNING: This product can expose you to chemicals, including lead, which are known to the State of California to cause cancer and birth defects or other reproductive harm. For more information, visit www.P65Warnings.ca.gov



COMPOSITE BODY PUSH-IN FITTINGS

BRASS FITTINGS

BULKHEAD FEMALES



MIDLAND	CHAMPION	TUBE O.D. X THREAD	LIST
20170C	287PPC-4A	1/4" x 1/8"	
20171C	287PPC-4B	1/4" x 1/4"	
20172C	287PPC-6B	3/8" x 1/4"	
20173C	287PPC-6C	3/8" x 3/8"	
20175C		1/2" x 1/4"	
20176C		1/2" x 3/8"	
20179C		1/2" x 1/2"	

SWIVEL "Y" CONNECTOR



- Swivels for installation only.
- Not a live swivel

MIDLAND	CHAMPION	TUBE O.D. X MALE NPT	LIST
20187C	288PPSC-4A	1/4" x 1/8"	
20557C	288PPSC-4B	1/4" x 1/4"	
20188C	288PPSC-6B	3/8" x 1/4"	
20189C	288PPSC-6C	3/8" x 3/8"	
20193C	288PPSC-6D	3/8" x 1/2"	
20194C	288PPSC-8C	1/2" x 3/8"	
20195C	288PPSC-8D	1/2" x 1/2"	

PQ88PS

IN-LINE NEEDLE VALVE



MIDLAND	CHAMPION	TUBE O.D.	LIST
	959PPC-2	1/8"	
	959PPC-2.5	5/32"	
20487C	959PPC-4	1/4"	
20488C	959PPC-5	5/16"	
20489C	959PPC-6	3/8"	
	959PPC-8	1/2"	

PQ310C

RIGHT ANGLE FLOW CONTROL METER IN



- Marked w/V
- Free flow out

← Metered

→ Free Flow

MIDLAND	CHAMPION	TUBE O.D. X MALE NPT	LIST
20727C		1/4" x 1/8"	
20728C		1/4" x 1/4"	
20780C		3/8" x 1/4"	
20781C		3/8" x 3/8"	
20782C		1/2" x 1/2"	

JPQ

RIGHT ANGLE FLOW CONTROL METER OUT



- Marked w/C
- Free flow in

→ Metered

← Free Flow



MIDLAND	CHAMPION	TUBE O.D. X MALE NPT	LIST
20785C	958PPC-4A	1/4" x 1/8"	
20786C	958PPC-4B	1/4" x 1/4"	
20787C		3/8" x 1/4"	
20788C	958PPC-6C	3/8" x 3/8"	
20789C	958PPC-8D	1/2" x 1/2"	

WARNING: This product can expose you to chemicals, including lead, which are known to the State of California to cause cancer and birth defects or other reproductive harm. For more information, visit www.P65Warnings.ca.gov

BRASS

METRIC COMPOSITE BODY PUSH-IN FITTINGS

BRASS FITTINGS

Technical Characteristics

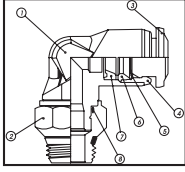

PART 1	BODY	COMPOSITE
PART 2	BODY	NICKEL PLATED BRASS
PART 3	TUBE RELEASE	ACETAL RESIN
PART 4	RETAINER	NICKEL PLATED BRASS
PART 5	GRIPPER RING	STAINLESS STEEL
PART 6	SPACER	COMPOSITE
PART 7	THREAD PACKING	NBR 70
PART 8	O-RING	NBR 70
PART 9	THREAD SEAL	NBR70

Operating Range

Pressure: 0 to 220 PSI (15 bar)

Vacuum: 0 to 29hg (-.99 bar)

Temperature

-5° F to + 175° F (-20° C to + 80° C)

Media

Compressed air.

Non-toxic fluids (water)

Materials

The latest generation of composite material is used in the body construction in addition to nickel-plated brass on threaded components and stainless steel on the tube gripper.

UNION



MIDLAND	CHAMPION	TUBE O.D. (MM)	LIST
20600	262PPC-4MM	4	
20601	262PPC-6MM	6	
20602	262PPC-8MM	8	
20603	262PPC-10MM	10	
20604	262PPC-12MM	12	
	262PPC-14MM	14	
	262PPC-16MM	16	
	262PPC-6MMX4MM	6 x 4	
	262PPC-8MMX6MM	8 x 6	
	262PPC-10MMX8MM	10 x 8	
	262PPC-12MMX10MM	12 x 10	

UNION ELBOW



MIDLAND	CHAMPION	TUBE O.D. (MM)	LIST
20806	265PPC-4MM	4	
20660	265PPC-6MM	6	
20661	265PPC-8MM	8	
20807	265PPC-10MM	10	
20808	265PPC-12MM	12	
20740	265PPC-14MM	14	
	265PPC-16MM	16	

3102

UNION TEE



MIDLAND	CHAMPION	TUBE O.D. (MM)	LIST
20610	264PPC-4MM	4	
20862		5	
20611	264PPC-6MM	6	
20612	264PPC-8MM	8	
20613	264PPC-10MM	10	
20614	264PPC-12MM	12	
20861	264PPC-14MM	14	
	264PPC-16MM	16	

3104

FEMALE ADAPTER



MIDLAND	CHAMPION	TUBE O.D. (MM) X FEMALE BSPT	LIST
	266PPC-4MMX1/8	4 x 1/8	
	266PPC-4MMX1/4	4 x 1/4	
	266PPC-6MMX1/8	6 x 1/8	
	266PPC-6MMX1/4	6 x 1/4	
	266PPC-8MMX1/8	8 x 1/8	
	266PPC-8MMX1/4	8 x 1/4	
	266PPC-10MMX3/8	10 x 3/8	
	266PPC-12MMX3/8	12 x 3/8	
	266PPC-12MMX1/2	12 x 1/2	

WARNING: This product can expose you to chemicals, including lead, which are known to the State of California to cause cancer and birth defects or other reproductive harm. For more information, visit www.P65Warnings.ca.gov

METRIC COMPOSITE BODY PUSH-IN FITTINGS

BRASS FITTINGS

MALE ADAPTER



MIDLAND	CHAMPION	TUBE OD (MM) X MALE BSPT	LIST
	268PPC-4MMXM5	4 x M5	
20630	268PPC-4MMX1/8	4 x 1/8	
20631	268PPC-4MMX1/4	4 x 1/4	
	268PPC-6MMXM5	6 x M5	
20632	268PPC-6MMX1/8	6 x 1/8	
20633	268PPC-6MMX1/4	6 x 1/4	
	268PPC-6MMX3/8	6 x 3/8	
	268PPC-6MMX1/2	6 x 1/2	
	268PPC-8MMX1/8	8 x 1/8	
20634	268PPC-8MMX1/4	8 x 1/4	
20635	268PPC-8MMX3/8	8 x 3/8	
	268PPC-8MMX1/2	8 x 1/2	
	268PPC-10MMX1/8	10 x 1/8	
20636	268PPC-10MMX1/4	10 x 1/4	
20637	268PPC-10MMX3/8	10 x 3/8	
	268PPC-10MMX1/2	10 x 1/2	
20801	268PPC-12MMX1/4	12 x 1/4	
20638	268PPC-12MMX3/8	12 x 3/8	
	268PPC-12MMX1/2	12 x 1/2	
	268PPC-14MMX3/8	14 x 3/8	
	268PPC-14MMX1/2	14 x 1/2	

3175

SWIVEL RUN TEE



MIDLAND	CHAMPION	TUBE OD (MM) X BSPT	LIST
20670		4 x 1/8	
20720*	271PPSNI-4MMX1/4	4 x 1/4	
20721*	271PPSNI-5MMX1/8	5 x 1/8	
20672		6 x 1/8	
20673		6 x 1/4	
20811		8 x 1/8	
20674		8 x 1/4	
20675		8 x 3/8	
20676		10 x 1/4	
20677		10 x 3/8	
20678		12 x 3/8	
20679		12 x 1/2	

- * Global Thread
- BSPP Available

SWIVEL ELBOW



MIDLAND	CHAMPION	TUBE OD (MM) X MALE BSPT	LIST
20690*		4 x M5	
20856*	269PPSC-4MMX1/8	4 x 1/8	
20855*	269PPSC-4MMX1/4	4 x 1/4	
20692*		5 x M5	
20857*		5 x 1/8	
20859*		6 x M5	
20642	269PPSC-6MMX1/8	6 x 1/8	
20803	269PPSC-6MMX1/4	6 x 1/4	
20698*	269PPSC-6MMX3/8	6 x 3/8	
20699*	269PPSC-6MMX1/2	6 x 1/2	
20711*	269PPSC-8MMX1/8	8 x 1/8	
20805	269PPSC-8MMX1/4	8 x 1/4	
20655	269PPSC-8MMX3/8	8 x 3/8	
20712*	269PPSC-8MMX1/2	8 x 1/2	
	269PPSC-10MMX1/8	10 x 1/8	
20656	269PPSC-10MMX1/4	10 x 1/4	
20657	269PPSC-10MMX3/8	10 x 3/8	
20713*	269PPSC-10MMX1/2	10 x 1/2	
20790	269PPSC-12MMX1/4	12 x 1/4	
20658	269PPSC-12MMX3/8	12 x 3/8	
20659	269PPSC-12MMX1/2	12 x 1/2	
20714*	269PPSC-14MMX3/8	14 x 3/8	
20854*	269PPSC-14MMX1/2	14 x 1/2	

- BSPP Available
- * Global Thread

WARNING: This product can expose you to chemicals, including lead, which are known to the State of California to cause cancer and birth defects or other reproductive harm. For more information, visit www.P65Warnings.ca.gov

BRASS

METRIC COMPOSITE BODY PUSH-IN FITTINGS

BRASS FITTINGS

SWIVEL BRANCH TEE

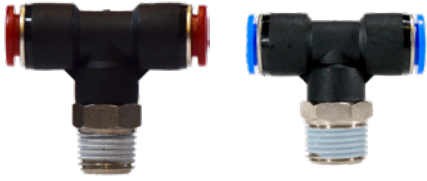

- BSPP Available
- * Global Thread

MIDLAND	CHAMPION	TUBE OD (MM) X MALE BSPT	LIST
20680*	272PPSC-4MMX1/8	4 x 1/8	
20860*	272 PPSC-4MMX1/4	4 x 1/4	
20717*		5 x 1/8	
20682	272PPSC-6MMX1/8	6 x 1/8	
20683	272PPSC-6MMX1/4	6 x 1/4	
20809	272PPSC-8MMX1/8	8 x 1/8	
20684	272PPSC-8MMX1/4	8 x 1/4	
20685	272PPSC-8MMX3/8	8 x 3/8	
20686	272PPSC-10MMX1/4	10 x 1/4	
20687	272PPSC-10MMX3/8	10 x 3/8	
20810	272PPSC-10MMX1/2	10 x 1/2	
	272PPSC-12MMX1/4	12 x 1/4	
20688	272PPSC-12MMX3/8	12 x 3/8	
20689	272PPSC-12MMX1/2	12 x 1/2	
20718*	272PPSC-14MMX3/8	14 x 3/8	

CAP



MIDLAND	CHAMPION	TUBE O.D. (MM)	LIST
20610	285PPC-4MM	4	
20862	285PPC-6MM	6	
20611	285PPC-8MM	8	
20612	285PPC-10MM	10	
20613	285PPC-12MM	12	

UNION WYE



MIDLAND	CHAMPION	TUBE OD (MM)	LIST
20813	289PPC-4MM	4	
20814	289PPC-6MM	6	
20815	289PPC-8MM	8	
20746	289PPC-10MM	10	
20802	289PPC-12MM	12	
	289PPC-4MMX6MM	4 x 6	
	289PPC-6MMX8MM	6 x 8	
	289PPC-8MMX10MM	8 x 10	

SWIVEL MALE WYE



- * Global Thread
- BSPP Available

MIDLAND	CHAMPION	TUBE OD (MM)	LIST
20816		4	
20821*		4	
20817*		6	
20818		6	
20819*		8	
20820*		8	
20822*		8	
20823*		10	
20824*		10	
20825*		10	
20826*		12	
20827*		12	

Also available:

- 45° elbow swivel
- 4 position Y
- Manifolds
- Extended swivel elbows
- Bulkhead union
- Plug-in elbows and tees

WARNING: This product can expose you to chemicals, including lead, which are known to the State of California to cause cancer and birth defects or other reproductive harm. For more information, visit www.P65Warnings.ca.gov



D.O.T. PUSH-IN TUBE FITTINGS



Meets D.O.T. FMVSS 571.106 SAE J1131 Air Brake System Require-

Benefits for Cost Savings & Engineering Project

- **Fast assembly:** No tools required. Simply push tubing in. Saves up to 75% of assembly time compared to standard air compression fittings. No loose parts to handle.
- **Fast disconnect:** Hold the collet collar with two fingers and pull out tube. No tools required.
- **Reusable:** Can be connected and disconnected several times.
- **Reliable sealing:** Using recommended tubing, full sealing is guaranteed.
- **Versatility:** Buna N O'ring standard. Fluoroelastomer and others available per request. Secure tube retention. Pulling on tubing only serves to tighten the connection.
- **Pre-Applied Polytetrafluoroethylene®** based pipe sealant on all male pipe threads, saving customer additional labor.
- **Full Flow Design,** provides more flow area than conventional fittings with internal tube supports even in the swivels.

DOT Fittings are constructed with an all brass captive eyelet which allows for maximum flow. The brass captive eyelet with extended length is floating and has a machined top end radius for easy installation of tubing. All male threads have a pre-applied Polytetrafluoroethylene® based pipe sealant to provide for easy assembly and leak proof seal.

▪ Materials:

Brass

"O" Ring: Buna - Nitrile (90 Durometer)

EP (Ethylene Propylene)

▪ Working Pressures & Temperature Ranges

Vacuum to 150 PSI

-40°F to 200° F (-40°C to +93°C)

PRICING FILE AVAILABLE ONLINE

Dimension data can change without notice. Please see our website when dimensions are critical.

D.O.T. PUSH-IN

BRASS FITTINGS

PLUG

AQ59DOT

MIDLAND	AMC	CHAMPION	TUBE O.D.	LIST
595320	02459-53		5/32"	
590400	02459-04		1/4"	
590600	02459-06		3/8"	
590800	02459-08		1/2"	

1829 **DQ59DOT** 639PMT**UNION**AQ62DOT
DQ62

MIDLAND	AMC	CHAMPION	TUBE O.D.	LIST
		262PPDOT-2	1/8"	
620532	02462-53	262PPDOT-2.5	5/32"	
620300		262PPDOT-3	3/16"	
620400	02462-04	262PPDOT-4	1/4"	
		262PPDOT-5	5/16"	
620600	02462-06	262PPDOT-6	3/8"	
620604			3/8" x 1/4"	
620800	02462-08	262PPDOT-8	1/2"	
621000	02462-10	262PPDOT-10	5/8"	
621200	02462-12	262PPDOT-12	3/4"	

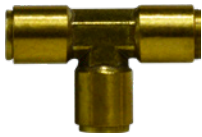
AQ62DOT **62PMT** 1862 **DQ62DOT****UNION TEE**AQ64DOT
DQ64

MIDLAND	AMC	CHAMPION	TUBE O.D.	LIST
		264PPDOT-2.5	5/32"	
640400	02464-04	264PPDOT-4	1/4"	
640600	02464-06	264PPDOT-6	3/8"	
640800	02464-08	264PPDOT-8	1/2"	
641000		264PPDOT-10	5/8"	
641200	02464-12	264PPDOT-12	3/4"	
640604		264PPDOT-664	3/8" x 1/4"	
640804		264PPDOT-884	1/2" x 1/4"	

AQ64DOT **164 PMT** 1864 **DQ64DOT****UNION ELBOW**AQ65DOT
DQ65

MIDLAND	AMC	CHAMPION	TUBE O.D.	LIST
655320	02465-53		5/32"	
		265PPDOT-3	3/16"	
650400	02465-04	265PPDOT-4	1/4"	
650600	02465-06	265PPDOT-6	3/8"	
650800	02465-08	265PPDOT-8	1/2"	

WARNING: This product can expose you to chemicals, including lead, which are known to the State of California to cause cancer and birth defects or other reproductive harm. For more information, visit www.P65Warnings.ca.gov



D.O.T. PUSH-IN

BRASS FITTINGS

FEMALE CONNECTOR



AQ66DOT
DQ66

MIDLAND	AMC	CHAMPION	TUBE O.D. X FEMALE NPTF	LIST
		266PPDOT-2.5A	5/32" x 1/8"	
660402	02466-0402	266PPDOT-4A	1/4" x 1/8"	
660404	02466-0404	266PPDOT-4B	1/4" x 1/4"	
660602		266PPDOT-6A	3/8" x 1/8"	
660604	02466-0604	266PPDOT-6B	3/8" x 1/4"	
660606	02466-0606	266PPDOT-6C	3/8" x 3/8"	
660804	02466-0804	266PPDOT-8B	1/2" x 1/4"	
660806	02466-0806	266PPDOT-8C	1/2" x 3/8"	
660808	02466-0808	266PPDOT-8D	1/2" x 1/2"	

AQ66DOT 66PMT 1866 DQ66DOT

MALE CONNECTOR



AQ68DOT
DQ68

MIDLAND	AMC	CHAMPION	TUBE O.D. X MALE NPTF	LIST
			1/8" x 1/8"	
685320	02468-5300		5/32" x 10/32"	
685321	02468-5301	268PPDOT-2.5X	5/32" x 1/16"	
685322	02468-5302	268PPDOT-2.5A	5/32" x 1/8"	
		268PPDOT-3 x 10/32	3/16" x 10-32"	
680302		268PPDOT-3A	3/16" x 1/8"	
		268PPDOT-3B	3/16" x 1/4"	
		268PPDOT-3X	3/16" x 1/16"	
680421		268PPDOT-4X	1/4" x 1/16"	
680402	02468-0402	268PPDOT-4A	1/4" x 1/8"	
680404	02468-0404	268PPDOT-4B	1/4" x 1/4"	
680406	02468-0406	268PPDOT-4C	1/4" x 3/8"	
680602	02468-0602	268PPDOT-6A	3/8" x 1/8"	
680604	02468-0604	268PPDOT-6B	3/8" x 1/4"	
680606	02468-0606	268PPDOT-6C	3/8" x 3/8"	
680608	02468-0608	268PPDOT-6D	3/8" x 1/2"	
680804	02468-0804	268PPDOT-8B	1/2" x 1/4"	
680806	02468-0806	268PPDOT-8C	1/2" x 3/8"	
680808	02468-0808	268PPDOT-8D	1/2" x 1/2"	
		268PPDOT-8E	1/2" x 3/4"	
681006	02468-1006	268PPDOT-10C	5/8" x 3/8"	
681008	02468-1008	268PPDOT-10D	5/8" x 1/2"	
		268PPDOT-10E	5/8" x 3/4"	
681208	02468-1208	268PPDOT-12D	3/4" x 1/2"	
681212	02468-1212	268PPDOT-12E	3/4" x 3/4"	

AQ68DOT 68PM 1868 DQ68DOT 68PMT

Dimension data can change without notice.
Please see our website when dimensions are critical.

D.O.T. PUSH-IN

BRASS FITTINGS

MALE ELBOW

Forged

AQ69DOT
DQ69

MIDLAND	AMC	CHAMPION	TUBE O.D. X MALE NPTF	LIST
695302		269PPDOT-2.5X	5/32" x 1/16"	
695322	02469-5302	269PPDOT-2.5A	5/32" x 1/8"	
690302		269PPDOT-3A	3/16" x 1/8"	
690402	02469-0402	269PPDOT-4A	1/4" x 1/8"	
690404	02469-0404	269PPDOT-4B	1/4" x 1/4"	
690406	02469-0406	269PPDOT-4C	1/4" x 3/8"	
690602	02469-0602	269PPDOT-6A	3/8" x 1/8"	
690604	02469-0604	269PPDOT-6B	3/8" x 1/4"	
690606	02469-0606	269PPDOT-6C	3/8" x 3/8"	
690608	02469-0608	269PPDOT-6D	3/8" x 1/2"	
690804	02469-0804	269PPDOT-8B	1/2" x 1/4"	
690806	02469-0806	269PPDOT-8C	1/2" x 3/8"	
690808	02469-0808	269PPDOT-8D	1/2" x 1/2"	
691006	02469-1006	269PPDOT-10C	5/8" x 3/8"	
691008	02469-1008	269PPDOT-10D	5/8" x 1/2"	
691208	02469-1208	269PPDOT-12D	3/4" x 1/2"	
691212	02469-1212	269PPDOT-12E	3/4" x 3/4"	

AQ69DOT 169PMTNS 1869 DQ69DOT

MALE SWIVEL ELBOW

Forged

AQ62DOTS
DQ69S

MIDLAND	AMC	CHAMPION	TUBE O.D. X MALE NPTF	LIST
695322S	02569-5302	269PPSDOT-2.5A	5/32" x 1/8"	
		269PPSDOT-2.5B	5/32" x 1/4"	
690402S	02569-0402	269PPSDOT-4A	1/4" x 1/8"	
690404S	02569-0404	269PPSDOT-4B	1/4" x 1/4"	
690406S	02569-0406	269PPSDOT-4C	1/4" x 3/8"	
690602S	02569-0602	269PPSDOT-6A	3/8" x 1/8"	
690604S	02569-0604	269PPSDOT-6B	3/8" x 1/4"	
690606S	02569-0606	269PPSDOT-6C	3/8" x 3/8"	
690608S	02569-0608	269PPSDOT-6D	3/8" x 1/2"	
		269PPSDOT-6E	3/8" x 3/4"	
690804S	02569-0804	269PPSDOT-8B	1/2" x 1/4"	
690806S	02569-0806	269PPSDOT-8C	1/2" x 3/8"	
690808S	02569-0808	269PPSDOT-8D	1/2" x 1/2"	
691006S	02569-1006	269PPSDOT-10C	5/8" x 3/8"	
691008S	02569-1008	269PPSDOT-10D	5/8" x 1/2"	
		269PPSDOT-10E	5/8" x 3/4"	
		269PPSDOT-12C	3/4" x 3/8"	
691208S	02569-1208	269PPSDOT-12D	3/4" x 1/2"	
691212S	02569-1212	269PPSDOT-12E	3/4" x 3/4"	

AQ69DOTS 169PMT 1869 DQ69DOTS

WARNING: This product can expose you to chemicals, including lead, which are known to the State of California to cause cancer and birth defects or other reproductive harm. For more information, visit www.P65Warnings.ca.gov

D.O.T. PUSH-IN

BRASS FITTINGS

FEMALE ELBOW



Forged

AQ70DOTS
DQ70

MIDLAND	AMC	CHAMPION	TUBE O.D. X FEMALE NPTF	LIST
700402	02470-0402	270PPDOT-4A	1/4" x 1/8"	
700404	02470-0404	270PPDOT-4B	1/4" x 1/4"	
700406	02470-0406	270PPDOT-4C	1/4" x 3/8"	
700602			3/8" x 1/8"	
700604	02470-0604	270PPDOT-6B	3/8" x 1/4"	
700606	02470-0606	270PPDOT-6C	3/8" x 3/8"	
700806		270PPDOT-8C	1/2" x 3/8"	
700808	02470-0808	270PPDOT-8D	1/2" x 1/2"	

AQ70DOTS 1870 DQ70DOTS 170PMTNS

FEMALE SWIVEL ELBOW



AQ70DOTS

MIDLAND	AMC	CHAMPION	TUBE O.D. X FEMALE NPTF	LIST
	02570-0402	270PPSDOT-4A	1/4" x 1/8"	
700404S	02570-0404	270PPSDOT-4B	1/4" x 1/4"	
		270PPSDOT-6B	3/8" x 1/4"	

MALE RUN TEE

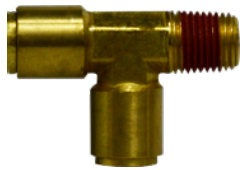

Forged

AQ71DOT
DQ71

MIDLAND	AMC	CHAMPION	TUBE O.D. X MALE NPTF (1 X 3) X 2	LIST
710402	02471-0402	271PPDOT-4A	1/4" x 1/8"	
			(1/4" x 3/8") x 1/4"	
710404	02471-0404	271PPDOT-4B	1/4" x 1/4"	
710604	02471-0604	271PPDOT-6B	3/8" x 1/4"	
71060404		271PPDOT-64B	(3/8" x 1/4") x 1/4"	
710606	02471-0606	271PPDOT-6C	3/8" x 3/8"	
71060406		271PPDOT-64C	(3/8" x 1/4") x 3/8"	
710608			3/8" x 1/2"	
710806	02471-0806	271PPDOT-8C	1/2" x 3/8"	

AQ71DOT 171PMTNS 1871 DQ71DOT

MALE SWIVEL RUN TEE

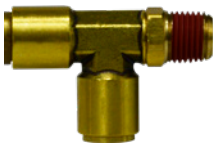

Forged

AQ71DOTS
DQ71S

MIDLAND	AMC	CHAMPION	TUBE O.D. X MALE NPTF	LIST
710402S	02571-0402	271PPSDOT-4A	1/4" x 1/8"	
710404S	02571-0404	271PPSDOT-4B	1/4" x 1/4"	
710604S	02571-0604	271PPSDOT-6B	3/8" x 1/4"	
710606S	02571-0606	271PPSDOT-6C	3/8" x 3/8"	
710804S		271PPSDOT-8B	1/2" x 1/4"	
710806S	02571-0806	271PPSDOT-8C	1/2" x 3/8"	
710808S	02571-0808	271PPSDOT-8D	1/2" x 1/2"	

AQ71DOTS 171PMT 1871 DQ71DOTS

WARNING: This product can expose you to chemicals, including lead, which are known to the State of California to cause cancer and birth defects or other reproductive harm. For more information, visit www.P65Warnings.ca.gov

BRASS

D.O.T. PUSH-IN

BRASS FITTINGS

MALE 45° ELBOW

Forged
AQ54DOT
DQ54

MIDLAND	AMC	CHAMPION	TUBE O.D. X MALE NPTF	LIST
540402	02454-0402	279PPDOT-4A	1/4" x 1/8"	
540404	02454-0404	279PPDOT-4B	1/4" x 1/4"	
540602	02454-0602	279PPDOT-6A	3/8" x 1/8"	
540604	02454-0604	279PPDOT-6B	3/8" x 1/4"	
540606	02454-0606	279PPDOT-6C	3/8" x 3/8"	
540608	02454-0608	279PPDOT-6D	3/8" x 1/2"	
540804	02454-0804	279PPDOT-8B	1/2" x 1/4"	
540806	02454-0806	279PPDOT-8C	1/2" x 3/8"	
540808		279PPDOT-8D	1/2" x 1/2"	
541006		279PPDOT-10C	5/8" x 3/8"	
541008	02454-1008	279PPDOT-10D	5/8" x 1/2"	
541208		279PPDOT-12D	3/4" x 1/2"	
541212		279PPDOT-12E	3/4" x 3/4"	

AQ54DOT 179MTNS 1880 DQ54DOT

MALE 45° SWIVEL ELBOW

AQ54DOTS
DQ54S

MIDLAND	AMC	CHAMPION	TUBE O.D. X MALE NPTF	LIST
540402S	02554-0402	279PPSDOT-4A	1/4" x 1/8"	
540404S	02554-0404	279PPSDOT-4B	1/4" x 1/4"	
540602S	02554-0602	279PPSDOT-6A	3/8" x 1/8"	
540604S	02554-0604	279PPSDOT-6B	3/8" x 1/4"	
540606S	02554-0606	279PPSDOT-6C	3/8" x 3/8"	
		279PPSDOT-6D	3/8" x 1/2"	
540804S	02554-0804	279PPSDOT-8B	1/2" x 1/4"	
540806S	02554-0806	279PPSDOT-8C	1/2" x 3/8"	
540808S	02554-0808	279PPSDOT-8D	1/2" x 1/2"	
		279PPSDOT-10C	5/8" x 3/8"	
541008S	02554-1008	279PPSDOT-10D	5/8" x 1/2"	
		279PPSDOT-12E	3/4" x 3/4"	

AQ54DOTS 179PMT 1880 DQ54DOTS

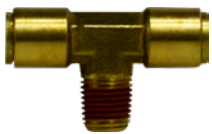
MALE BRANCH TEE

Forged
AQ72DOT
DQ72

MIDLAND	AMC	CHAMPION	TUBE O.D. X MALE NPTF (1 X 2) X 3	LIST
		272PPDOT-2.5A	5/32" x 1/8"	
720302			3/16" x 1/8"	
720402	02472-0402	272PPDOT-4A	1/4" x 1/8"	
720404	02472-0404	272PPDOT-4B	1/4" x 1/4"	
720604	02472-0604	272PPDOT-6B	3/8" x 1/4"	
72060404			(3/8" x 1/4") x 1/4"	
720606	02472-0606	272PPDOT-6C	3/8" x 3/8"	
		272PPDOT-6D	3/8" x 1/2"	
720804	02472-0804		1/2" x 1/4"	
720806	02472-0806	272PPDOT-8C	1/2" x 3/8"	
720808			1/2" x 1/2"	

AQ72DOT 172PMTNS 1872 DQ72DOT

WARNING: This product can expose you to chemicals, including lead, which are known to the State of California to cause cancer and birth defects or other reproductive harm. For more information, visit www.P65Warnings.ca.gov



D.O.T. PUSH-IN

BRASS FITTINGS

MALE SWIVEL BRANCH TEE



AQ72DOTS
DQ72S

MIDLAND	AMC	CHAMPION	TUBE O.D. X MALE NPTF	LIST
720402S	02572-0402	272PPSDOT-4A	1/4" x 1/8"	
720404S	02572-0404	272PPSDOT-4B	1/4" x 1/4"	
720602S		272PPSDOT-6A	3/8" x 1/8"	
720604S	02572-0604	272PPSDOT-6B	3/8" x 1/4"	
720606S	02572-0606	272PPSDOT-6C	3/8" x 3/8"	
		272PPSDOT-6D	3/8" x 1/2"	
720804S	02572-0804	272PPSDOT-8B	1/2" x 1/4"	
720806S	02572-0806	272PPSDOT-8C	1/2" x 3/8"	
720808S	02572-0808	272PPSDOT-8D	1/2" x 1/2"	

AQ72DOTS 172PMT 1872 DQ72DOTS

FEMALE BRANCH TEE

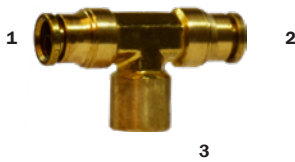

AQ77DOT
DQ77

(RUN) BRANCH				
MIDLAND	AMC	CHAMPION	(1 & 2) X 3	LIST
770402	02477-0402	277PPDOT-4A	1/4" x 1/8"	
770404		277PPDOT-4B	1/4" x 1/4"	
770604		277PPDOT-6B	3/8" x 1/4"	
		277PPDOT-6C	3/8" x 3/8"	

GLADHAND BULKHEAD CONNECTOR

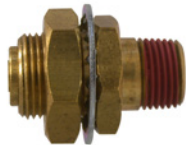

TUBE OD X MALE NPTF				
MIDLAND	AMC	CHAMPION	SIZE	LIST
830808			1/2" x 1/2"	

BULKHEAD UNION

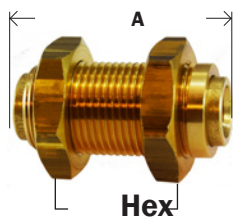

AQ82DOT
DQ82

MIDLAND	AMC	CHAMPION	TUBE O.D.	LIST
820400	02482-04	262BHPPDOT-4	1/4"	
820600	02482-06	262BHPPDOT-6	3/8"	
820800	02482-08	262BHPPDOT-8	1/2"	
821000	02482-10	262BHPPDOT-10	5/8"	

AQ82DOT 62PMTBH 1874 DQ82DOTS

FEMALE BULKHEAD UNION



AQ86DOT
DQ86

• Jam nuts not available separately

MIDLAND	AMC	CHAMPION	TUBE O.D. X FEMALE NPTF	LIST
860402	02486-0402	266BHPPDOT-4A	1/4" x 1/8"	
860404	02486-0404	266BHPPDOT-4B	1/4" x 1/4"	
860604	02486-0604	266BHPPDOT-6B	3/8" x 1/4"	
860606		266BHPPDOT-6C	3/8" x 3/8"	
		266BHPPDOT-8C	1/2" x 3/8"	
860808			1/2" x 1/2"	

AQ86DOT 1873 DQ86DOT 66PMTBH

COMPOSITE BODY D.O.T. PUSH-IN

BRASS FITTINGS

COMPOSITE BODY DOT AIRBRAKE FITTINGS

WARNING

- Composite DOT push-to-connect fittings are designed only for use in applications where air is utilized as an operating fluid.
 - Fittings must be used in accordance with manufacturer and industry specifications.
 - They are not intended for use in environments exceeding 145psi or 140 degrees F.
 - The Department of Transportation FMVSS 49CFR571-106 prohibits use of this type of fitting for connections between towed and towing vehicles or between a driveshaft and chassis.
 - Using Composite DOT fittings in a manner inconsistent with manufacturer specifications may result in serious injury or property damage.
 - Under no circumstances shall the supplier be liable to buyer for any consequential or incidental damages of any nature whatsoever arising from nonconformity of goods, defective goods, or delay in shipment or any other breach by seller.
- Please feel free to email warning@compdotfitting.com with any questions or concerns.



- One touch connection reduces installation time and cost.
- Rugged ultraviolet and vibration resistant composite body.
- Various shapes and configurations to meet vehicle applications and make installations easier.

SPECIFICATIONS FOR FMVSS (D.O.T.) AND SAE COMPLIANT FITTINGS

PRICING FILE AVAILABLE ONLINE

Operating Fluid		Air					
Max. Operating Pressure		145psi (1.0MPa)					
Proof Pressure	Size	5/32"	1/4"	3/8"	1/2"	5/8"	3/4"
	At 75°F (24°C)	1200psi	1200psi	1400psi	950psi	900psi	800psi
	At 200 °F (93°C)	450psi (3.1MPa)					
Recommended Fluid and Ambient Temperature*		-40°F to 140°F (-40°C to 60°C)					
Leak Rate at -40°F (-40°C)		7 Ncm ³ /min. or less					
Thread	Thread Portion	ANSI/ASME B1.20.1, 1983 R1992					
	Nut	JIS B 0208 (Unified fine thread) ISO 263					
Thread Sealant		Fluorine/ Acrylic					
Applicable Standards		D.O.T. FMVSS 49 CFR 571.106, SAE J2494-3					
Applicable Tubing		Tubing conforming to both SAE J844 and D.O.T. FMVSS 49 CFR 571.106. Material: Nylon12					
Tube O.D.		5/32", 1/4", 3/8", 1/2", 5/8", 3/4"					

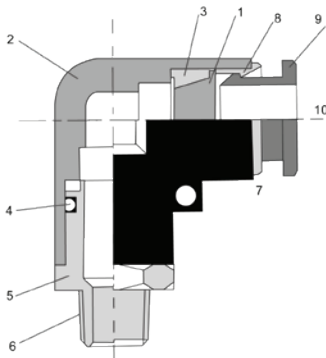

1. Chuck	Stainless steel or Brass
2. Body	Polybutylene Terephthalate (PBT), Brass
3/4. Tube seal, O-Ring	Buna-N, Nitrile Rubber
5. Stud	Brass
6. Sealant	Flourine/ Acrylic
7. Guide	Stainless Steel or Polyacetal (Acetal)
8. Stabilization Ring	Stainless Steel
9. Release Button	Polyacetal, POM (Acetal)
10. Tube support	Stainless Steel/ Brass

WARNING: This product can expose you to chemicals, including lead, which are known to the State of California to cause cancer and birth defects or other reproductive harm. For more information, visit www.P65Warnings.ca.gov



COMPOSITE BODY D.O.T. PUSH-IN

BRASS FITTINGS

STRAIGHT UNION



MIDLAND	CHAMPION	TUBE OD (INCH)	LIST
620532C	262PPCDOT-2.5	5/32	
620300C	262PPCDOT-3	3/16	
620400C	262PPCDOT-4	1/4	
620600C	262PPCDOT-6	3/8	
620800C	262PPCDOT-8	1/2	
621000C	262PPCDOT-10	5/8	
621200C	262PPCDOT-12	3/4	
620453C	262PPCDOT-42.5	1/4 x 5/32	
640604C	262PPCDOT-64	3/8 x 1/4	
620806CC	262PPCDOT-86	1/2 x 3/8	

UNION TEE



MIDLAND	CHAMPION	TUBE OD (INCH)	LIST
645320C	264PPCDOT-2.5	5/32	
640300C	264PPCDOT-3	3/16	
640400C	264PPCDOT-4	1/4	
640600C	264PPCDOT-6	3/8	
640800C	264PPCDOT-8	1/2	
641000C	264PPCDOT-10	5/8	
640406C	264PPCDOT-446	1/4 x 3/8	
64060604C	264PPCDOT-664	3/8 x 1/4	
640806C	264PPCDOT-886	1/2 x 3/8	

UNION 90° ELBOW



MIDLAND	CHAMPION	TUBE OD (INCH)	LIST
655320C	265PPCDOT-2.5	5/32	
650400C	265PPCDOT-4	1/4	
650600C	265PPCDOT-6	3/8	
650800C	265PPCDOT-8	1/2	
651000C	265PPCDOT-10	5/8	

FEMALE CONNECTOR



MIDLAND	CHAMPION	TUBE OD (INCH)	LIST
665302C	266PPCDOT-2.5A	5/32 x 1/8	
665304C	266PPCDOT-2.5B	5/32 x 1/4	
660302C	266PPCDOT-3	3/16 x 1/8	
660402C	266PPCDOT-4A	1/4 x 1/8	
660404C	266PPCDOT-4B	1/4 x 1/4	
660406C	266PPCDOT-4C	1/4 x 3/8	
660602C	266PPCDOT-6A	3/8 x 1/8	
660604C	266PPCDOT-6B	3/8 x 1/4	
660606C	266PPCDOT-6C	3/8 x 3/8	
660608C	266PPCDOT-6D	3/8 x 1/2	
660802C	266PPCDOT-8A	1/2 x 1/8	
660804C	266PPCDOT-8B	1/2 x 1/4	
660806C	266PPCDOT-8C	1/2 x 3/8	
660808C	266PPCDOT-8D	1/2 x 1/2	
661008C	266PPCDOT-10D	5/8 x 1/2	

COMPOSITE BODY D.O.T. PUSH-IN

BRASS FITTINGS

STRAIGHT MALE CONNECTOR

MIDLAND	CHAMPION	APP. TUBE OD (INCH)	LIST
685301C	268PPCDOT-2.5X	5/32 x 1/16	
685302C	268PPCDOT-2.5A	5/32 x 1/8	
685304C	268PPCDOT-2.5B	5/32 x 1/4	
680302C	268PPCDOT-3A	3/16 x 1/8	
680304C	268PPCDOT-3B	3/16 x 1/4	
680402C	268PPCDOT-4A	1/4 x 1/8	
680404C	268PPCDOT-4B	1/4 x 1/4	
680406C	268PPCDOT-4C	1/4 x 3/8	
680408C	268PPCDOT-4D	1/4 x 1/2	
680602C	268PPCDOT-6A	3/8 x 1/8	
680604C	268PPCDOT-6B	3/8 x 1/4	
680606C	268PPCDOT-6C	3/8 x 3/8	
680608C	268PPCDOT-6D	3/8 x 1/2	
680804C	268PPCDOT-8B	1/2 x 1/4	
680806C	268PPCDOT-8C	1/2 x 3/8	
680808C	268PPCDOT-8D	1/2 x 1/2	
681006C	268PPCDOT-10C	5/8 x 3/8	
681008C	268PPCDOT-10D	5/8 x 1/2	
681012C	268PPCDOT-10E	5/8 x 3/4	
681206C	268PPCDOT-12C	3/4 x 3/8	
681208C	268PPCDOT-12D	3/4 x 1/2	
681212C	268PPCDOT-12E	3/4 x 3/4	

90° MALE ELBOW

• Positional Swivel

MIDLAND	CHAMPION	TUBE OD (INCH)	LIST
695322SC	269PPSCDOT-2.5A	5/32 x 1/8	
695304SC	269PPSCDOT-2.5B	5/32 x 1/4	
690302SC	269PPSCDOT-3A	3/16 x 1/8	
690402SC	269PPSCDOT-4A	1/4 x 1/8	
690404SC	269PPSCDOT-4B	1/4 x 1/4	
690406SC	269PPSCDOT-4C	1/4 x 3/8	
690408SC	269PPSCDOT-4D	1/4 x 1/2	
690602SC	269PPSCDOT-6A	3/8 x 1/8	
690604SC	269PPSCDOT-6B	3/8 x 1/4	
690606SC	269PPSCDOT-6C	3/8 x 3/8	
690608SC	269PPSCDOT-6D	3/8 x 1/2	
690804SC	269PPSCDOT-8B	1/2 x 1/4	
690806SC	269PPSCDOT-8C	1/2 x 3/8	
690808SC	269PPSCDOT-8D	1/2 x 1/2	
690812SC	269PPSCDOT-8E	1/2 x 3/4	
691006SC	269PPSCDOT-10C	5/8 x 3/8	
691008SC	269PPSCDOT-10D	5/8 x 1/2	
691012SC	269PPSCDOT-10E	5/8 x 3/4	
691208SC	269PPSCDOT-12D	3/4 x 1/2	
691212SC	269PPSCDOT-12E	3/4 x 3/4	

WARNING: This product can expose you to chemicals, including lead, which are known to the State of California to cause cancer and birth defects or other reproductive harm. For more information, visit www.P65Warnings.ca.gov

COMPOSITE BODY D.O.T. PUSH-IN

BRASS FITTINGS

90° FEMALE ELBOW



• Positional Swivel

MIDLAND	CHAMPION	TUBE OD (INCH)	LIST
705302C	270PPSCDOT-2.5A	5/32 x 1/8	
705304C	270PPSCDOT-2.5B	5/32 x 1/4	
700402SC	270PPSCDOT-4A	1/4 x 1/8	
700404SC	270PPSCDOT-4B	1/4 x 1/4	
700406SC	270PPSCDOT-4C	1/4 x 3/8	
700602C	270PPSCDOT-6A	3/8 x 1/8	
700604SC	270PPSCDOT-6B	3/8 x 1/4	
700606SC	270PPSCDOT-6C	3/8 x 3/8	
700608SC	270PPSCDOT-6D	3/8 x 1/2	
700804C	270PPSCDOT-8B	1/2 x 1/4	
700806SC	270PPSCDOT-8C	1/2 x 3/8	
700808SC	270PPSCDOT-8D	1/2 x 1/2	

MALE RUN TEE



• Positional Swivel

MIDLAND	CHAMPION	TUBE OD (INCH)	LIST
715301C	271PPSCDOT-2.5X	5/32 x 1/16	
715302C	271PPSCDOT-2.5A	5/32 x 1/8	
715304C	271PPSCDOT-2.5B	5/32 x 1/4	
710402SC	271PPSCDOT-4A	1/4 x 1/8	
710404SC	271PPSCDOT-4B	1/4 x 1/4	
710604SC	271PPSCDOT-6B	3/8 x 1/4	
710606SC	271PPSCDOT-6C	3/8 x 3/8	
710608SC	271PPSCDOT-6D	3/8 x 1/2	
710804C	271PPSCDOT-8B	1/2 x 1/4	
710806SC	271PPSCDOT-8C	1/2 x 3/8	
710808C	271PPSCDOT-8D	1/2 x 1/2	
711008C	271PPSCDOT-10D	5/8 x 1/2	

REDUCING MALE RUN TEE

MIDLAND	CHAMPION	TUBE OD (INCH) 1 X 2 X 3	LIST
71060404C	271PPSCDOT-64B	3/8 x 1/4 x 1/4	
71060406C	271PPSCDOT-64C	3/8 x 1/4 x 3/8	
71080408C	271PPSCDOT-84D	1/2 x 1/4 x 1/2	
71080608C	271PPSCDOT-86D	1/2 x 3/8 x 1/2	

WARNING: This product can expose you to chemicals, including lead, which are known to the State of California to cause cancer and birth defects or other reproductive harm. For more information, visit www.P65Warnings.ca.gov

BRASS

COMPOSITE BODY D.O.T. PUSH-IN

BRASS FITTINGS

MALE BRANCH TEE

- Positional Swivel

MIDLAND	CHAMPION	TUBE OD (INCH)	LIST
725301C	272PPSCDOT-2.5X	5/32 x 1/16	
725302C	272PPSCDOT-2.5A	5/32 x 1/8	
725304C	272PPSCDOT-2.5B	5/32 x 1/4	
720402SC	272PPSCDOT-4A	1/4 x 1/8	
720404SC	272PPSCDOT-4B	1/4 x 1/4	
720406SC	272PPSCDOT-4C	1/4 x 3/8	
720602SC	272PPSCDOT-6A	3/8 x 1/8	
720604SC	272PPSCDOT-6B	3/8 x 1/4	
720606SC	272PPSCDOT-6C	3/8 x 3/8	
720608C	272PPSCDOT-6D	3/8 x 1/2	
720804C	272PPSCDOT-8B	1/2 x 1/4	
720806SC	272PPSCDOT-8C	1/2 x 3/8	
720808SC	272PPSCDOT-8D	1/2 x 1/2	
721006C	272PPSCDOT-10C	5/8 x 3/8	
721008C	272PPSCDOT-10D	5/8 x 1/2	

FEMALE BRANCH TEE

- Positional Swivel

MIDLAND	CHAMPION	TUBE OD (INCH)	LIST
770402C	277PPSCDOT-4A	1/4 x 1/8	
770404C	277PPSCDOT-4B	1/4 x 1/4	
770604C	277PPSCDOT-6B	3/8 x 1/4	
770806C	277PPSCDOT-8C	1/2 x 3/8	
771004C	277PPSCDOT-10B	5/8 x 1/4	

45° MALE ELBOW

- Positional Swivel

MIDLAND	CHAMPION	TUBE OD (INCH)	LIST
545302C	279PPSCDOT-2.5A	5/32 x 1/8	
540402SC	279PPSCDOT-4A	1/4 x 1/8	
540404SC	279PPSCDOT-4B	1/4 x 1/4	
540406SC	279PPSCDOT-4C	1/4 x 3/8	
540602SC	279PPSCDOT-6A	3/8 x 1/8	
540604SC	279PPSCDOT-6B	3/8 x 1/4	
540606SC	279PPSCDOT-6C	3/8 x 3/8	
540608SC	279PPSCDOT-6D	3/8 x 1/2	
540802C	279PPSCDOT-8A	1/2 x 1/8	
540804SC	279PPSCDOT-8B	1/2 x 1/4	
540806SC	279PPSCDOT-8C	1/2 x 3/8	
540808SC	279PPSCDOT-8D	1/2 x 1/2	
541006SC	279PPSCDOT-10C	5/8 x 3/8	
541008SC	279PPSCDOT-10D	5/8 x 1/2	
541206C	279PPSCDOT-12C	3/4 x 3/8	
541208SC	279PPSCDOT-12D	3/4 x 1/2	

WARNING: This product can expose you to chemicals, including lead, which are known to the State of California to cause cancer and birth defects or other reproductive harm. For more information, visit www.P65Warnings.ca.gov

Dimension data can change without notice. Please see our website when dimensions are critical.

COMPOSITE BODY D.O.T. PUSH-IN

BRASS FITTINGS

UNION "Y"



MIDLAND	CHAMPION	A&B TUBE OD (INCH)	LIST
620553C	289PPCDOT-4	1/4	
620409C	289PPCDOT-46	1/4 x 3/8	
620555C	289PPCDOT-6	3/8	
620559C	289PPCDOT-64	3/8 x 1/4	
620557C	289PPCDOT-8	1/2	
620558C	289PPCDOT-10	5/8	

MALE BRANCH "Y"



• Positional Swivel

MIDLAND	CHAMPION	TUBE OD (INCH) X MIP	LIST
880402C	288PPSCDOT-4A	1/4 x 1/8	
880404C	288PPSCDOT-4B	1/4 x 1/4	
880406C	288PPSCDOT-4C	1/4 x 3/8	
620604C	288PPSCDOT-6B	3/8 x 1/4	
620606C	288PPSCDOT-6C	3/8 x 3/8	
620806C	288PPSCDOT-8C	1/2 x 3/8	
620808C	288PPSCDOT-8D	1/2 x 1/2	

BULKHEAD UNION



MIDLAND	CHAMPION	TUBE OD (INCH)	LIST
825320C	262BHPPCDOT-2.5	5/32	
820400C	262BHPPCDOT-4	1/4	
820600C	262BHPPCDOT-6	3/8	
820800C	262BHPPCDOT-8	1/2	
821000C	262BHPPCDOT-10	5/8	

FEMALE BULKHEAD CONNECTOR



MIDLAND	CHAMPION	TUBE OD (INCH) X FIP	LIST
865304C	266BHPPCDOT-2.5B	5/32 x 1/4	
860402C	266BHPPCDOT-4A	1/4 x 1/8	
860404C	266BHPPCDOT-4B	1/4 x 1/4	
860604C	266BHPPCDOT-6B	3/8 x 1/4	
860606C	266BHPPCDOT-6C	3/8 x 3/8	
860806C	266BHPPCDOT-8C	1/2 x 3/8	
860808C	266BHPPCDOT-8D	1/2 x 1/2	

Available on
MidlandIndustries.com



WARNING: This product can expose you to chemicals, including lead, which are known to the State of California to cause cancer and birth defects or other reproductive harm. For more information, visit www.P65Warnings.ca.gov

BRASS

D.O.T. AIR BRAKE - NYLON TUBING

BRASS FITTINGS

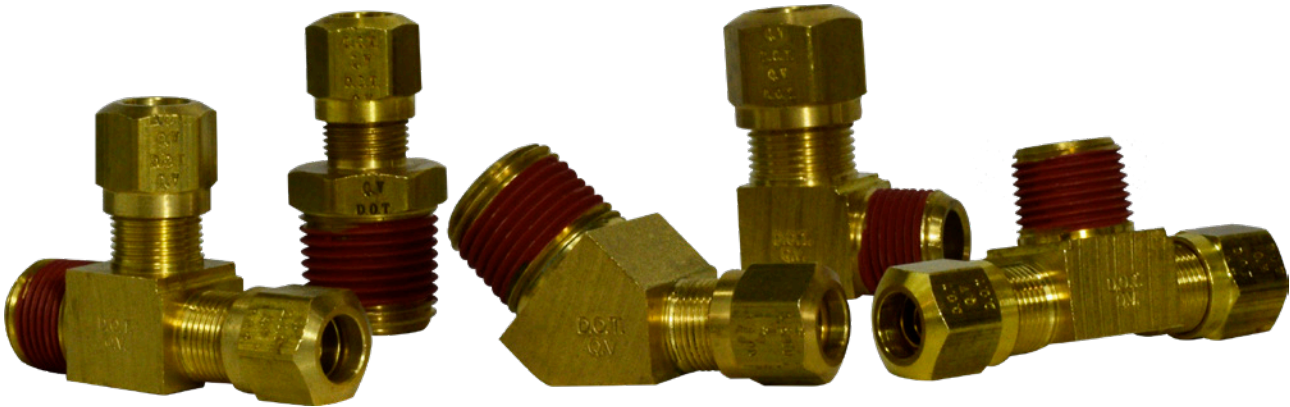
D.O.T. AIR BRAKE - NYLON TUBING

Tube O.D	1/4	3/8	1/2	5/8	3/4
Thread Size-B	7/16-24	17/32-24	11/16-20	13/16-18	1-18

-Typical Application

Air brake systems except where temperatures exceed +200°F or where battery acid can drip on tubing.

-Pressure

Maximum operating pressure of 150 PSI.

-Vibration

Fair resistance.

-Temperature Range

-40°F to +200°F (-40°C to +93°C).

-Material

Brass

-Used With

NT Nylon Tubing - SAE J844 Type A and B.

- Tolerance

+/- .02 on all dimensions. Dimension data can change without notice. Please call us when dimensions are critical

-Advantages

Easy to assemble (no tube preparation or flaring required.) Built in tube support. Fittings utilize a ribbed sleeve for compression and positive grip. May be used with copper tubing by replacing nut, sleeve and insert with long nut and spherical sleeve. Insert should be removed for copper tubing use.

-Conformance

Meets specifications and standards of SAE and DOT FMVSS 571,106.

-Assembly Instructions

- 1- Cut tubing to desired length.
- 2-Slide nut and then sleeve on tubing. Threaded end of nut "A" must face toward fitting body.
- 3-Insert tubing into the preassembled fitting. Be sure tubing is bottomed in fitting.
- 4- Tighten nut to required torque as indicated on chart.

Disassembling: Remove nut and pull tubing out of fitting body. Insert will remain in tubing.

Reassembly: Push tubing and insert into fitting body until it bottoms. Thread nut onto fitting body

Tube Size	Additional Number of Turns from Hand-Tight
1/4	3
3/8, 1/2	4
5/8, 3/4	3-1/2

WARNING: This product can expose you to chemicals, including lead, which are known to the State of California to cause cancer and birth defects or other reproductive harm. For more information, visit www.P65Warnings.ca.gov

D.O.T. AIR BRAKE - NYLON TUBING

BRASS FITTINGS

SLEEVE



SAE# 100115
60NA
NT60

MIDLAND	AMC	CHAMPION	LIST	TUBE O.D.	MAF #	MAF PRICE
38000		60NAB-3		3/16"	NT60-3	----
38001	00460-04	60NAB-4		1/4"	NT60-4	----
38002	00460-06	60NAB-6		3/8"	NT60-6	----
38003	00460-08	60NAB-8		1/2"	NT60-8	----
38004	00460-10	60NAB-10		5/8"	NT60-10	----
38005	00460-12	60NAB-12		3/4"	NT60-12	----

60NAB 60NTA 1460

NUT



SAE# 100110
62NA
NT61

MIDLAND	AMC	CHAMPION	LIST	TUBE O.D.	MAF #	MAF PRICE
38009	00461-03	61NAB-3		3/16"	NT61-3	----
38010	00461-04	61NAB-4		1/4"	NT61-4	----
38011	00461-06	61NAB-6		3/8"	NT61-6	----
38012	00461-08	61NAB-8		1/2"	NT61-8	----
38013	00461-10	61NAB-10		5/8"	NT61-10	----
38014	00461-12	61NAB-12		3/4"	NT61-12	----

61NAB 61NTA 1461

UNION



SAE# 100101BA
62NA
NT62

MIDLAND	AMC	CHAMPION	LIST	TUBE O.D.	MAF #	MAF PRICE
38018	00462-03			3/16"	NT62-3	----
38019	00462-04	62NAB-4		1/4"	NT62-4	----
38020	00462-06	62NAB-6		3/8"	NT62-6	----
38021	00462-08	62NAB-8		1/2"	NT62-8	----
38022	00462-10	62NAB-10		5/8"	NT62-10	----
38023	00462-12	62NAB-12		3/4"	NT62-12	----

62NAB 62NTA 1462

BULKHEAD UNION



62NABH
NT62BH

MIDLAND	AMC	CHAMPION	LIST	TUBE O.D.	MAF #	MAF PRICE
		62NABH-3		3/16"	NT62BH-3	----
38028	00483-04	62NABH-4		1/4"	NT62BH-4	----
38029	00483-06	62NABH-6		3/8"	NT62BH-6	----
38030	00483-08	62NABH-8		1/2"	NT62BH-8	----
	00483-10	62NABH-10		5/8"	NT62BH-10	----

62NBH 1474 47

STAINLESS STEEL INSERT



• 300 SERIES
STAINLESS
• For SAE# J844
TUBING
AQ71DOTS
DQ71S

MIDLAND	AMC	CHAMPION	LIST	TUBE O.D.	MAF #	MAF PRICE
					NT63SS1-3	
38035	00463-04	63NAB-4		1/4"	NT63SS1-4	
38036	00463-06	63NAB-6		3/8"	NT63SS1-6	
38037	00463-08	59A-8		1/2"	NT63SS1-8	
38038	00463-10	59A-10		5/8"	NT63SS1-10	
38039	00463-12	59A-12		3/4"	NT63SS1-12	

* STEEL INSERTS AVAILABLE FROM MAF

59A 63NTA

BRASS INSERT



AQ71DOTS
DQ71S

MIDLAND	AMC	CHAMPION	LIST	TUBE O.D.	MAF #	MAF PRICE
38040	00473-04	1484X4		1/4"	NT63B-4	----
38041	00473-06	1484X6		3/8"	NT63B-6	----
38042	00473-08	1484X8		1/2"	NT63B-8	----
38043	00473-10	1484X10		5/8"	NT63B-10	----
38048	00473-12	1484X12		3/4"	NT63B-12	----

D.O.T. AIR BRAKE - NYLON TUBING**BRASS FITTINGS****TEE**

MIDLAND	AMC	CHAMPION	LIST	TUBE O.D.	MAF #	MAF PRICE
38044	00464-04	64NAB-4		1/4"	NT464-4	
38045	00464-06	64NAB-6		3/8"	NT264X6	----
38046	00464-08	64NAB-8		1/2"	NT64-8	----
38047	00464-10	64NAB-10		5/8"	NT64-10	----
				3/4"	NT64-12	----

SAE# 100401BA

64NA

NT64

64NAB 264NTA 1464

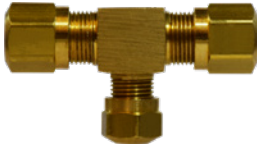
REDUCING BRANCH TEE

MIDLAND	AMC	CHAMPION	LIST	TUBE O.D. (1&2) X 3	MAF #	MAF PRICE
				(3/8" x 1/4") x 3/8"	NT64R-466	----
38049		64NAB-664		3/8" x 1/4"	NT64FR-664	----
				(1/2" X 3/8") X 1/2	NT64R-868	----
38057		64NAB-886		1/2" x 3/8"		
				3/8" X 1/2"	NT64R-668	----

ELBOW

MIDLAND	AMC	CHAMPION	LIST	TUBE O.D.	MAF #	MAF PRICE
38052	00465-04	65NAB-4		1/4"	NT65-4	----
38053	00465-06	65NAB-6		3/8"	NT265X6	----
38054	00465-08	65NAB-8		1/2"	NT65-8	----
38055	00465-10	65NAB-10		5/8"	NT65-10	----

SAE# 100201BA

65NA

NT65

65NAB 265NTA 1465

FEMALE ADAPTER

SAE# 100103BA

66NA

NT66

MIDLAND	AMC	CHAMPION	LIST	TUBE O.D. X FEMALE NPT	MAF #	MAF PRICE
38060	00466-0402	66NAB-4A		1/4" x 1/8"	NT66-42	----
38061	00466-0404	66NAB-4B		1/4" x 1/4"	NT66-44	----
38062	00466-0602	66NAB-6A		3/8" x 1/8"	NT66-62	----
38063	00466-0604	66NAB-6B		3/8" x 1/4"	NT66-64	----
38064	00466-0606	66NAB-6C		3/8" x 3/8"	NT66-66	----
38065	00466-0806	66NAB-8C		1/2" x 3/8"	NT66-86	----
38066	00466-0808	66NAB-8D		1/2" x 1/2"	NT66-88	----
38067	00466-1006	66NAB-10C		5/8" x 3/8"	NT66-106	----
38068	00466-1008	66NAB-10D		5/8" x 1/2"	NT66-108	----
38059	00466-1208			3/4" x 1/2"	NT66-128	----
				1/2" X 3/4"	NT66-812	----

66NAB 66NTA 1466 66NBH

Dimension data can change without notice. Please see our website when dimensions are critical.

D.O.T. AIR BRAKE - NYLON TUBING

BRASS FITTINGS

MALE ADAPTER



SAE# 100102BA
68NA
NT68VS

• More sizes
available online

MIDLAND	AMC	CHAMPION	LIST	TUBE O.D. X MALE NPTF	MAF #	MAF PRICE
38069		68NAB-3X		3/16" X 1/16"	NT68-31VS	----
38070		68NAB-3A		3/16" X 1/8"	NT68-32VS	----
		68NAB-3B		5/16 X 1/4		
38072		68NAB-4X		1/4" x 1/16"	NT68-41VS	----
38073	00468-0402	68NAB-4A		1/4" x 1/8"	NT68-42VS	----
38074	00468-0404	68NAB-4B		1/4" x 1/4"	NT68-44VS	----
38075	00468-0406	68NAB-4C		1/4" x 3/8"	NT68-46VS	----
38076	00468-0602	68NAB-6A		3/8" x 1/8"	NT68-62VS	----
38077	00468-0604	68NAB-6B		3/8" x 1/4"	NT68-64VS	----
38078	00468-0606	68NAB-6C		3/8" x 3/8"	NT68-66VS	----
38079	00468-0608	68NAB-6D		3/8" x 1/2"	NT68-68VS	----
38080	00468-0804	68NAB-8B		1/2" x 1/4"	NT68-84VS	----
38081	00468-0806	68NAB-8C		1/2" x 3/8"	NT68-86VS	----
38082	00468-0808	68NAB-8D		1/2" x 1/2"	NT68-88VS	----
38087	00468-0812	68NAB-8E		1/2" x 3/4"	NT68-812VS	----
38083	00468-1006	68NAB-10C		5/8" x 3/8"	NT68-106VS	----
38084	00468-1008	68NAB-10D		5/8" x 1/2"	NT68-108VS	----
38088	00468-1012	68NAB-10E		5/8" x 3/4"	NT68-1012VS	----
		68NAB-12C		5/8" x 3/8"	NT68-126VS	----
38085	00468-1208	68NAB-12D		3/4" x 1/2"	NT68-1218VS	
38086	00468-1212	68NAB-12E		3/4" x 3/4"	NT68-1212VS	----

68NAB 68NTA 1468

SWIVEL MALE ADAPTER



MIDLAND	AMC	CHAMPION	LIST	TUBE O.D. X MALE NPTF	MAF #	MAF PRICE
38078S				3/8" x 3/8"	NT68SWW-66VS	
38081S				1/2" x 3/8"	NT68SWW-86VS	

MALE ELBOW



SAE# 100202BA
69NA
NT69VS

• More sizes
available online

MIDLAND	AMC	CHAMPION	LIST	TUBE O.D. X MALE NPTF	MAF #	MAF PRICE
		69NAB-3A		3/16" X 1/8"	NT69-32VS	----
		69NAB-3B		3/16" X 1/4"	NT69-34VS	----
38091	00469-0402	69NAB-4A		1/4" x 1/8"	NT69-42VS	----
38092	00469-0404	69NAB-4B		1/4" x 1/4"	NT69-44VS	----
38093	00469-0406	69NAB-4C		1/4" x 3/8"	NT69-46VS	----
38094	00469-0602	69NAB-6A		3/8" x 1/8"	NT69-62VS	----
38095	00469-0604	69NAB-6B		3/8" x 1/4"	NT69-64VS	----
38090				3/8" x 1/4" LONG	NT69L-64VS	----
38101	00469-0606	69NAB-6C		3/8" x 3/8"	NT69-66VS	----
38102	00469-0608	69NAB-6D		3/8" x 1/2"	NT69-68VS	----
38103	00469-0804	69NAB-8B		1/2" x 1/4"	NT69-84VS	----
38104	00469-0806	69NAB-8C		1/2" x 3/8"	NT69-86VS	----
38109				1/2" x 3/8" LONG	NT69L-86VS	----
38105	00469-0808	69NAB-8D		1/2" x 1/2"	NT69-88VS	----
38106	00469-1006	69NAB-10C		5/8" x 3/8"	NT69-106VS	----
38107	00469-1008	69NAB-10D		5/8" x 1/2"	NT69-108VS	----
38110	00469-1012	69NAB-10E		5/8" x 3/4"	NT69-1012VS	----
				3/4" X 3/8"	NT69-126VS	----
38108	00469-1208	69NAB-12D		3/4" x 1/2"	NT69-128VS	----
38111	00469-1212	69NAB-12E		3/4" x 3/4"	NT69-1212VS	----

D.O.T. AIR BRAKE - NYLON TUBING

BRASS FITTINGS

SWIVEL MALE ELBOW

MIDLAND	AMC	CHAMPION	LIST	TUBE O.D. X MALE NPTF	MAF #	MAF PRICE
38101S				3/8" x 3/8"	NT69SWV-66VS	----
38104S				1/2" x 3/8"	NT69SWV-86VS	----

FEMALE ELBOW

SAE# 100203BA

70NA
NT70

MIDLAND	AMC	CHAMPION	LIST	TUBE O.D. X FEMALE NPTF	MAF #	MAF PRICE
		70NAB-3A		3/16" X 1/8"	nt270x3	----
38113	00470-0402	70NAB-4A		1/4" x 1/8"	NT70-42	----
38114	00470-0404	70NAB-4B		1/4" x 1/4"	NT70-44	----
38115	00470-0602	70NAB-6A		3/8" x 1/8"	NT70F-62	----
38116	00470-0604	70NAB-6B		3/8" x 1/4"	NT70F-64	----
38117	00470-0606	70NAB-6C		3/8" x 3/8"	NT70F-66	----
38118	00470-0806	70NAB-8C		1/2" x 3/8"	NT70F-86	----
38119	00470-0808	70NAB-8D		1/2" x 1/2"	NT70F-88	----
38120	00470-1008	70NAB-10D		5/8" x 1/2"	NT70F-108	----

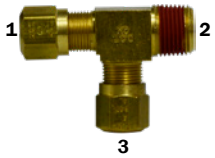
MALE RUN TEE

SAE# 100424BA

71NA
NT71VS

MIDLAND	AMC	CHAMPION	LIST	TUBE O.D. X MALE NPTF X TUBE O.D. 1X2X3	MAF #	MAF PRICE
38125	00471-0402	71NAB-4A		1/4" x 1/8" x 1/4"	NT71-42VS	----
38126	00471-0404	71NAB-4B		1/4" x 1/4" x 1/4"	NT71-44VS	----
38124		71NAB-64B		3/8" x 1/4" x 1/4"	NT71-644VS	----
38127	00471-0604	71NAB-6B		3/8" x 1/4" x 3/8"	NT71-646VS	----
38128	00471-0606	71NAB-6C		3/8" x 3/8" x 3/8"	NT271X6X6VS	----
38129	00471-0806	71NAB-8C		1/2" x 3/8" x 1/2"	NT71-86VS	----
		71NAB-8D		1/2" x 1/2" x 1/2"	NT71-88VS	----
		71NAB-10D		5/8" x 1/2" x 5/8"	NT71-108VS	----

71NAB 271NTA 1471

MALE BRANCH TEE

SAE# 100425BA

72NA
NT72VS

MIDLAND	AMC	CHAMPION	LIST	TUBE O.D. X TUBE O.D. X MALE NPTF 1X2X3	MAF #	MAF PRICE
		72nab-3a		3/16" x 3/16" x 1/8"		
38136	00472-0402	72NAB-4A		1/4" x 1/4" x 1/8"	NT72-42VS	----
38137	00472-0404	72NAB-4B		1/4" x 1/4" x 1/4"	NT72-44VS	----
38138	00472-0602	72NAB-6A		3/8" x 3/8" x 1/8"	NT72-62VS	----
38132		72NAB-64B		3/8" x 1/4" x 1/4"	NT72-644VS	----
38139	00472-0604	72NAB-6B		3/8" x 3/8" x 1/4"	NT272X6VS	----
38140	00472-0606	72NAB-6C		3/8" x 3/8" x 3/8"	NT272X6X6VS	----
38134	00472-080606	72NAB-86C		1/2" x 3/8" x 3/8"	NT72-866VS	----
38133		72NAB-8B		1/2" x 1/2" x 1/4"	NT7272X8X4VS	----
38141	00472-0806	72NAB-8C		1/2" x 1/2" x 3/8"	NT72-86VS	----
38142	00472-0808	72NAB-8D		1/2" x 1/2" x 1/2"	NT72-88VS	----
38143	00472-1008	72NAB-10D		5/8" x 5/8" x 1/2"	NT72-108VS	----

72NAB 272NTA 1472

WARNING: This product can expose you to chemicals, including lead, which are known to the State of California to cause cancer and birth defects or other reproductive harm. For more information, visit www.P65Warnings.ca.gov



D.O.T. AIR BRAKE - NYLON TUBING

BRASS FITTINGS

FEMALE BRANCH TEE

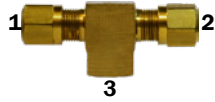

MIDLAND	AMC	CHAMPION	LIST	TUBE O.D. X TUBE O.D. X FEMALE NPTF 1X2X3	MAF #	MAF PRICE
38144				3/8" x 3/8" x 1/4"	NT-78-64	
				1/2" x 1/2" x 1/4"	NT-78-104	
38146				5/8" x 5/8" x 1/4"	NT-78-84	

45° ELBOW



SAE# 100302BA
6945NA
NT6945VS

MIDLAND	AMC	CHAMPION	LIST	TUBE O.D. X MALE NPTF	MAF #	MAF PRICE
38148	00495-0402	79NAB-4A		1/4" x 1/8"	NT6945-42VS	----
38149	00495-0404	79NAB-4B		1/4" x 1/4"	NT6945-44VS	----
38150	00495-0602	79NAB-6A		3/8" x 1/8"	NT6945-62VS	----
38151	00495-0604	79NAB-6B		3/8" x 1/4"	NT6945-64VS	----
38152	00495-0606	79NAB-6C		3/8" x 3/8"	NT6945-66VS	----
38153	00495-0608	79NAB-6D		3/8" x 1/2"	NT6945-68VS	----
38157	00495-0804	79NAB-8B		1/2" x 1/4"	NT6945-84VS	----
38154	00495-0806	79NAB-8C		1/2" x 3/8"	NT6945-86VS	----
38155	00495-0808	79NAB-8D		1/2" x 1/2"	NT6945-88VS	----
		79NAB-10C		5/8" x 3/8"	NT6945-106VS	----
38156	00495-1008	79NAB-10D		5/8" x 1/2"	NT6945-108VS	----
38158	00495-1208	79NAB-12D		3/4" x 1/2"	NT6945-128VS	----

6945NAB 279NTA 1480

SWIVEL 45° ELBOW



MIDLAND	AMC	CHAMPION	LIST	TUBE O.D. X MALE NPTF	MAF #	MAF PRICE
38152S				3/8" x 3/8"	NT6945SWV-66VS	----
38154S				1/2" x 3/8"	NT6945SWV-86VS	----

WARNING: This product can expose you to chemicals, including lead, which are known to the State of California to cause cancer and birth defects or other reproductive harm. For more information, visit www.P65Warnings.ca.gov

BRASS

D.O.T. AIR BRAKE - COPPER TUBING

BRASS FITTINGS

SLEEVE

SAE# 120115BA

60AB
AB60

MIDLAND	AMC	CHAMPION	LIST	TUBE O.D.	MAF #	MAF PRICE
38161	00360-04	260A-4		1/4"	AB60-4	----
				5/16"	AB60-5	----
38162	00360-06	260A-6		3/8"	AB60-6	----
38163	00360-08	260A-8		1/2"	AB60-8	----
38164	00360-10	260A-10		5/8"	AB60-10	----
38165	00360-12	260A-12		3/4"	AB60-12	----
				1"	AB60-16	----

60AB 1360

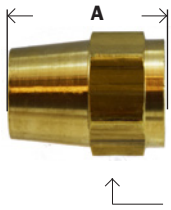
NUT

Hex

SAE# 120111BA

61AB
AB61

MIDLAND	AMC	CHAMPION	LIST	TUBE O.D.	MAF #	MAF PRICE
38170	00361-04	261A-4		1/4"	AB61-4	----
				5/16"	AB61-5	----
38171	00361-06	261A-6		3/8"	AB61-6	----
38172	00361-08	261A-8		1/2"	AB61-8	----
38173	00361-10	261A-10		5/8"	AB61-10	----
38174	00361-12	261A-12		3/4"	AB61-12	----

20961 61AB 1361

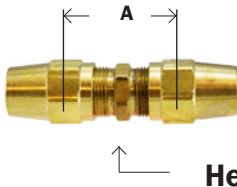
UNION

Hex

SAE# 120101BA

62AB
AB62

MIDLAND	AMC	CHAMPION	LIST	TUBE O.D.	MAF #	MAF PRICE
38179	00362-04	262A-4		1/4"	AB62-4	----
38180	00362-06	262A-6		3/8"	AB62-6	----
38181	00362-08	262A-8		1/2"	AB62-8	----
38182	00362-10	262A-10		5/8"	AB62-10	----
38183	00362-12	262A-12		3/4"	AB62-12	----

BULKHEAD UNIONS AVAILABLE UPON REQUEST

62AB 1362

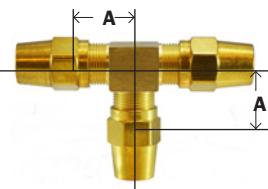
TEE

SAE# 120401BA

64AB
AB64

MIDLAND	AMC	CHAMPION	LIST	TUBE O.D.	MAF #	MAF PRICE
38188	00364-04	264A-44		1/4"	AB64-4	----
38189	00364-06	264A-66		3/8"	AB64-6	----
38190	00364-08	264A-88		1/2"	AB64-8	----
38191	00364-10	264A-1010		5/8"	AB64-10	----

264AB 1364

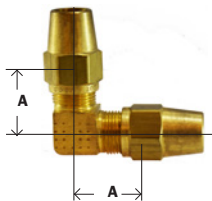
ELBOW

SAE# 120201BA

65AB
A65

MIDLAND	AMC	CHAMPION	LIST	TUBE O.D.	MAF #	MAF PRICE
38196	00365-04	265A-44		1/4"	AB65-4	----
38197	00365-06			3/8"	AB65-6	----
38198	00365-08			1/2"	AB65-8	----
38199	00365-10			5/8"	AB65-10	----

265AB 1365

WARNING: This product can expose you to chemicals, including lead, which are known to the State of California to cause cancer and birth defects or other reproductive harm. For more information, visit www.P65Warnings.ca.gov



D.O.T. AIR BRAKE - COPPER TUBING

BRASS FITTINGS

FEMALE ADAPTER

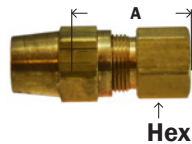

SAE# 120103BA
66AB
AB66

MIDLAND	AMC	CHAMPION	LIST	TUBE O.D. X FEMALE NPTF	MAF #	MAF PRICE
38204	00366-0402	266A-4A		1/4" x 1/8"	AB66-42	----
38205	00366-0404	266A-4B		1/4" x 1/4"	AB66-44	----
38206	00366-0602	266A-6A		3/8" x 1/8"	AB66-62	----
38207	00366-0604	266A-6B		3/8" x 1/4"	AB66-64	----
38208	00366-0606	266A-6C		3/8" x 3/8"	AB66-66	----
38209	00366-0806	266A-8C		1/2" x 3/8"	AB66-86	----
38210	00366-0808	266A-8D		1/2" x 1/2"	AB66-88	----
38211	00366-1006			5/8" x 3/8"	AB66-106	----
38212	00366-1008	266A-10D		5/8" x 1/2"	AB66-108	----
38213	00366-1208			3/4" x 1/2"	NT66-128	----

66AB 1366

MALE ADAPTER

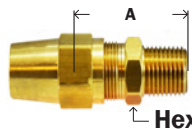

SAE# 120102BA
68AB
AB68

MIDLAND	AMC	CHAMPION	LIST	TUBE O.D. X MALE NPTF	MAF #	MAF PRICE
38217	00368-0402	268A-4A		1/4" x 1/8"	AB68-42	----
38218	00368-0404	268A-4B		1/4" x 1/4"	AB68-44	----
		268A-4C		1/4" x 3/8"		
		268A-6A		3/8" x 1/8"	AB68-62	----
38221	00368-0604	268A-6B		3/8" x 1/4"	AB68-64	----
38222	00368-0606	268A-6C		3/8" x 3/8"	AB68-66	----
38223	00368-0608	268A-6D		3/8" x 1/2"	AB68-68	----
38224	00368-0804	268A-8B		1/2" x 1/4"	AB68-84	----
38225	00368-0806	268A-8C		1/2" x 3/8"	AB68-86	----
38226	00368-0808	268A-8D		1/2" x 1/2"	AB68-88	----
38227	00368-1006	268A-10C		5/8" x 3/8"	AB68-106	----
38228	00368-1008	268A-10D		5/8" x 1/2"	AB68-108	----
38229	00368-1208	268A-12D		3/4" x 1/2"	AB68-128	----
		268A-12E		3/4" x 3/4"		

68AB 368

90° MALE ELBOW

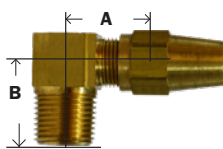

SAE# 120202BA
69AB
AB69

MIDLAND	AMC	CHAMPION	LIST	TUBE O.D. X MALE NPTF	MAF #	MAF PRICE
38235	00369-0402	269A-4A		1/4" x 1/8"	AB69-42	----
38236	00369-0404	269A-4B		1/4" x 1/4"	AB69-44	----
38237	00369-0406	269A-4C		1/4" x 3/8"	AB69-46	----
		269A-6A		3/8" x 1/8"		
38239	00369-0604	269A-6B		3/8" x 1/4"	AB69-64	----
38240	00369-0606	269A-6C		3/8" x 3/8"	AB69-66	----
38241	00369-0608	269A-6D		3/8" x 1/2"	AB69-68	----
		269A-8B		1/2" x 1/4"		
38243	00369-0806	269A-8C		1/2" x 3/8"	AB69-86	----
38244	00369-0808	269A-8D		1/2" x 1/2"	AB69-88	----
	00369-1006			5/8" x 3/8"	AB69-106	----
38246	00369-1008	269A-10D		5/8" x 1/2"	AB69-108	----
38247	00369-1208	269A-12D		3/4" x 1/2"	AB69-128	----

269AB 1369

D.O.T. AIR BRAKE - COPPER TUBING

BRASS FITTINGS

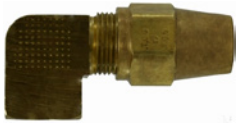
90 DEGREE FEMALE ELBOW

MIDLAND	AMC	CHAMPION	LIST	TUBE O.D. X MALE NPTF (1&2)X3	MAF #	MAF PRICE
38252	00370-0402	270A-4A		1/4 X 1/8	AB70-42	
38253	00370-0404	270A-4B		1/4 X 1/4	AB70-44	
	00370-0602	270A-6A		3/8 x 1/8	AB70-62	
38255	00370-0604	270A-6B		3/8 X 1/4	AB70-64	
38256	00370-0606	270A-6C		3/8 X 3/8	AB70-66	
38257	00370-0806	270A-8C		1/2 X 3/8	AB70-86	
38259	00370-1008	270A-10D		5/8 x 1/2	AB70-108	

MALE RUN TEE

MIDLAND	AMC	CHAMPION	LIST	TUBE O.D. X MALE NPTF (1&2)X3	MAF #	MAF PRICE
38264	00371-0402	271A-4A		1/4" x 1/8"	AB71-42	----
38265	00371-0404	271A-4B		1/4" x 1/4"	AB71-44	----
				3/8" x 1/4"	AB271X6	----
38266	00371-0604	271A-6B		3/8" x 1/4"	AB71F-64	----
38267	00371-0606	271A-6C		3/8" x 3/8"	AB71-66	----
	00371-0806			1/2" x 3/8"	AB71-86	----
38269	00371-0808			1/2" x 1/2"	AB71-88	----
	00371-1008			5/8" x 1/2"	AB71-108	----

271AB 1371

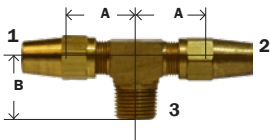
MALE BRANCH TEE

SAE# 120425BA

72AB

AB72

MIDLAND	AMC	CHAMPION	LIST	TUBE O.D. X MALE NPTF (1&2)X3	MAF #	MAF PRICE
	00372-0402			1/4" x 1/8"	AB72-42	----
	00372-0404			1/4" x 1/4"	AB72-44	----
38278	00372-0604			3/8" x 1/4"	AB72-64	----
38279	00372-0606			3/8" x 3/8"	AB72-66	----
				1/2" x 1/4"	AB72-84	----
38280	00372-0806			1/2" x 3/8"	AB72-86	----
38281	00372-0808			1/2" x 1/2"	AB72-88	----
	00372-1008			5/8" x 1/2"	AB72-108	----

272AB 1372

45° ELBOW

MIDLAND	AMC	CHAMPION	LIST	TUBE O.D. X MALE NPTF (1&2)X3	MAF #	MAF PRICE
38287	00395-0402			1/4" x 1/8"	AB6945-42	----
38288	00395-0404			1/4" x 1/4"	AB6945-44	----
	00395-0602			3/8" x 1/8"	AB6945-62	----
38290	00395-0604			3/8" x 1/4"	AB6945-64	----
38291	00395-0606			3/8" x 3/8"	AB6945-66	----
38292	00395-0608			3/8" x 1/2"	AB6945-68	----
				1/2" x 1/4"	AB6945-84	----
	00395-0806					
38294	00395-0808			1/2" x 1/2"	AB6945-88	----
				5/8" x 3/8"	AB6945-106	----
	00395-1008			5/8" x 1/2"	AB6945-108	----

279AB 1380

D.O.T. AIR BRAKE - HOSE/ ENDS

BRASS FITTINGS

D.O.T. AIR BRAKE REUSABLE HOSE/ FITTINGS

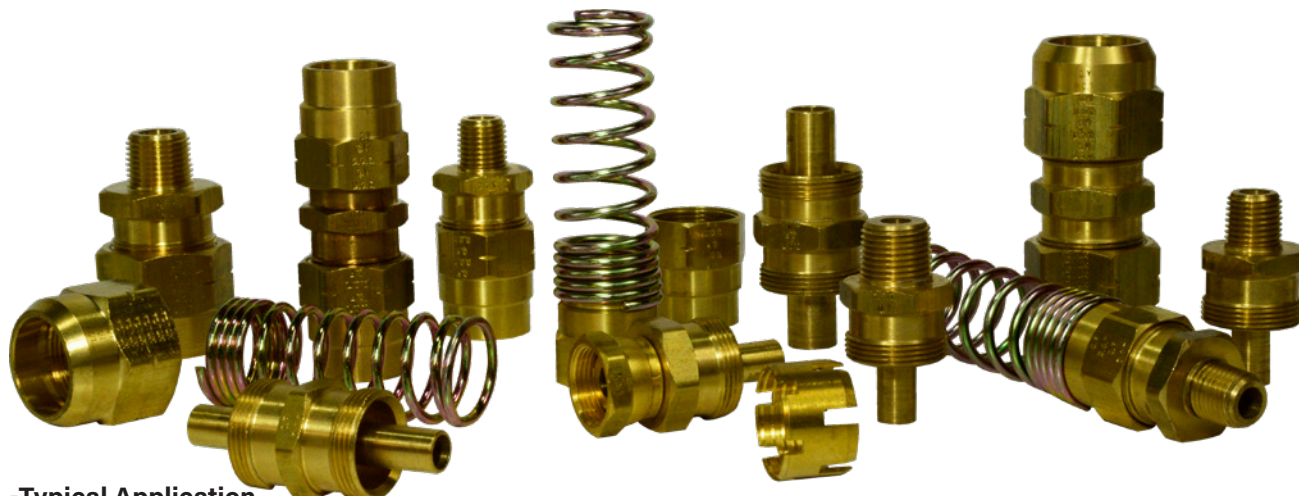

•Typical Application

Air Brake hose connections.
Meets SAE & DOT specifications
(FMVCS 10 GAL)

•Pressure

Determined by maximum working pressure for hose size. Up to 125 psi

Temperature: -40°F to + 120° F (-40°C to +48°C)

•Advantages

Can be used for nearly any brake line. Easy to assemble with a good selection of hose end configurations. Brass material offers excellent resistance against corrosion.

• Tolerance

+/- .02 on all dimensions. Dimension data can change without notice. Please call us when dimensions are critical.

•Assembly Instructions

- 1- Slide nut and sleeve onto hose. Make sure bevel edge of sleeve faces out toward fitting.
- 2- Push hose into fitting until it bottoms.
- 3- Screw nut until contact is made with body hex.

NOTE: When reassembling fitting, body and nut should be inspected. Only reuse if in proper condition. Sleeves should never be reused.

SLEEVE

FERRULE

60HE
HE60



MIDLAND	AMC	CHAMPION	LIST	HOSE I.D. SIZE	MAF #	MAF PRICE
38300	08060-06	360A-6		3/8"	HE60-6	----
38301	08060-08	360A-8		1/2"	HE60-8	----

#60HC 3380-A 0903610 367 60RB

NUT

61HE
HE61



MIDLAND	AMC	CHAMPION	LIST	HOSE I.D. SIZE	MAF #	MAF PRICE
38306	08061-06	361A-6		3/8"	HE61-6	----
38307	08061-08	361A-8		1/2"	HE61-8	----

61RB #61HC 369 3380-B 0903624

NUT FOR USE WITH SPRING



61HES
HE61N

MIDLAND	AMC	CHAMPION	LIST	HOSE I.D. SIZE	MAF #	MAF PRICE
38312	08071-06	361A-6G		3/8"	HE61N-6	----
38313	08071-08	361A-8G		1/2"	HE61N-8	----

WARNING: This product can expose you to chemicals, including lead, which are known to the State of California to cause cancer and birth defects or other reproductive harm. For more information, visit www.P65Warnings.ca.gov

BRASS

D.O.T. AIR BRAKE - HOSE/ ENDS

BRASS FITTINGS

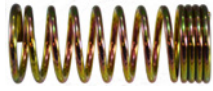
SPRING61HSG
HE61G

MIDLAND	AMC	CHAMPION	LIST	HOSE I.D.	MAF #	MAF PRICE
38351	08070-06	371AS-6		3/8"	HE61G-6	----
38352	08070-08	371AS-8		1/2"	HE61G-8	----

#60SG 0901045 3380-C 377

NUT & SPRING ASSEMBLY

HE61NG

MIDLAND	AMC	CHAMPION	LIST	HOSE I.D. SIZE	MAF #	MAF PRICE
38015		371A-6		3/8"	HE61NG-6	----
38016		371A-8		1/2"	HE61NG-8	----

379 67RBSG 0999999

UNION62HE
HE62

MIDLAND	AMC	CHAMPION	LIST	HOSE I.D.	MAF #	MAF PRICE
38318	08062-06	362A-6		3/8"	HE62-6	----
38319	08062-08	362A-8		1/2"	HE62-8	----

#62HC 3380B-Y0 362

**BODY ONLY**

MIDLAND	AMC	CHAMPION	LIST	HOSE I.D.	MAF #	MAF PRICE
39318		B362A-6		3/8"	HE62B-6	----
39319		B362A-8		1/2"	HE62B-8	----

FEMALE CONNECTOR HOSE

66HEA

MIDLAND	AMC	CHAMPION	LIST	HOSE I.D. X FEMALE ABS	MAF #	MAF PRICE
38357	08066-0612	366A-6		3/8" x 3/4-20	HE68SB-6	----
38358	08066-0814	366A-8		1/2" x 7/8-20	HE68SB-8	----

#66ABS 66RBSV 3380B-Y7 386

**BODY ONLY**

MIDLAND	AMC	CHAMPION	LIST	HOSE I.D. X FEMALE ABS	MAF #	MAF PRICE
39357				3/8" x 3/4-20	HE685B-6B0	
39358				1/2" x 7/8-20	HE685B-8B0	

MALE CONNECTOR68HEA
HE68S

MIDLAND	AMC	CHAMPION	LIST	HOSE I.D. X MALE PIPE	MAF #	MAF PRICE
38363	08086-0604	389A-6B		3/8" x 1/4"	HE68S-64	----
	08086-0606	389A-6C		3/8" X 3/8"	HE68S-66	----
		389A-6D		3/8" X 1/2"	HE68S-68	----
38364	08086-0806	389A-8C		1/2" x 3/8"	HE68S-86	----
		389A-8D		1/2" x 1/2"	HE68S-88	----

#68ABS 09155 3380B-Y8 387

WARNING: This product can expose you to chemicals, including lead, which are known to the State of California to cause cancer and birth defects or other reproductive harm. For more information, visit www.P65Warnings.ca.gov



D.O.T. AIR BRAKE - HOSE/ENDS

BRASS FITTINGS

ADAPTER FOR SWIVEL TYPE REUSABLE AND CRIMPED ON



68HEAB
1390

MIDLAND	AMC	CHAMPION	LIST	MALE ABS X MALE PIPE	MAF #	MAF PRICE
38369	08088-0604	388A-12B		3/8" x 1/4"	1390-64	----
38368	08088-0606	388A-12C		3/8" x 3/8"	1390-66	----
38372		388A-12D		3/8" x 1/2"	1390-68	----
38370	08088-0806	388A-14C		1/2" x 3/8"	1390-86	----
38371	08088-0808	388A-14D		1/2" x 1/2"	1390-88	----

#68ABS 1390 76RB 388

MALE ADAPTER



68HE
HE68

MIDLAND	AMC	CHAMPION	LIST	HOSE I.D. X MALE PIPE	MAF #	MAF PRICE
38333	08068-0604	368A-6B		3/8" x 1/4"	HE68-64	----
38334	08068-0606	368A-6C		3/8" x 3/8"	HE68-66	----
38335	08068-0608	368A-6D		3/8" x 1/2"	HE68-68	----
38336	08068-0806	368A-8C		1/2" x 3/8"	HE68-86	----
38337	08068-0808	368A-8D		1/2" x 1/2"	HE68-88	----

#68HC 368 3380B-Y2 68RB

ADAPTER BODY



68HEB
HE68B

MIDLAND	AMC	CHAMPION	LIST	HOSE I.D. X MALE PIPE	MAF #	MAF PRICE
38324	08098-0604	B368A-6B		3/8" x 1/4"	HE68B-64	----
38325	08098-0606	B368A-6C		3/8" x 3/8"	HE68B-66	----
38326	08098-0608	B368A-6D		3/8" x 1/2"	HE68B-68	----
38327	08098-0806	B368A-8C		1/2" x 3/8"	HE68B-86	----
38328	08098-0808	B368A-8D		1/2" x 1/2"	HE68B-88	----

#68B W1391Z

MALE ADAPTER



68HES
HE68G

MIDLAND	AMC	CHAMPION	LIST	HOSE I.D. X MALE PIPE	MAF #	MAF PRICE
38342	08078-0604	378A-6B		3/8" x 1/4"	HE68G-64	----
38343	08078-0606	378A-6C		3/8" x 3/8"	HE68G-66	----
38344	08078-0608	378A-6D		3/8" x 1/2"	HE68G-68	----
38345	08078-0806	378A-8C		1/2" x 3/8"	HE68G-86	----
38346	08078-0808	378A-8D		1/2" x 1/2"	HE68G-88	----

#68HCS 3380B-Y3 68RBSG 378

BLACK RUBBER AIR BRAKE HOSE



MIDLAND	AMC	CHAMPION	LIST	HOSE O.D. X HOSE I.D.	MAF #	MAF PRICE
38910		RAB6-50		3/4 x 3/8		
		RAB6-250		3/4 x 3/8		
38915		RAB8-50		7/8 x 1/2		
		RAB8-250		7/8 x 1/2		

WARNING: This product can expose you to chemicals, including lead, which are known to the State of California to cause cancer and birth defects or other reproductive harm. For more information, visit www.P65Warnings.ca.gov

BRASS

STEEL GREASE FITTINGS

BRASS FITTINGS

- 8000 PSI MAX. PRESSURE
- EXCEEDS 12HR SALT SPRAY
- ASSORTMENTS ALSO AVAILABLE
- Meets SAE #J-534C
- SEE WEBSITE FOR GREASE ACCESSORIES

BALL CHECK - 1/8"-27 NPTF

Many types available on special order.

PIPE THREAD

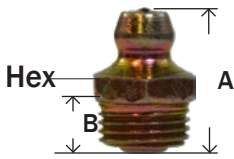

MIDLAND	AMC	CHAMPION	LIST	SIZE	MAF #	MAF PRICE
36110	08310			1/8" -27 NPTF	610	
36110SS				303 SS		
36111				Thread Forming		

#610 1610 2800 1720 5000

PIPE THREAD

BALL CHECK

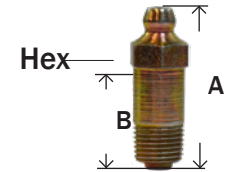

MIDLAND	AMC	CHAMPION	LIST	SIZE	MAF #	MAF PRICE
36112	08311			1/8" -27 NPTF	607	
36113				1/8" -27 NPTF		

#607 1607 2800 1669 5003

PIPE THREAD

30° ANGLE BALL CHECK

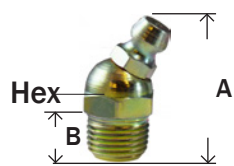

MIDLAND	AMC	CHAMPION	LIST	SIZE	MAF #	MAF PRICE
36114	08313			1/8" -27 NPTF	611	

#611 1611 2830 5100

PIPE THREAD

45° ANGLE BALL CHECK

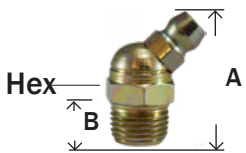

MIDLAND	AMC	CHAMPION	LIST	SIZE	MAF #	MAF PRICE
36116	08314			1/8" -27 NPTF	688	
36116SS				303 SS		

#688 1688 2845 5200

PIPE THREAD

65° ANGLE BALL CHECK

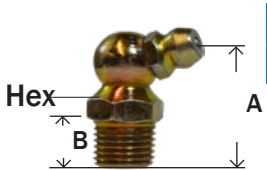

MIDLAND	AMC	CHAMPION	LIST	SIZE	MAF #	MAF PRICE
36118	08315			1/8" -27 NPTF	612	

#612 1612 2865 5300

PIPE THREAD

90° ANGLE BALL CHECK

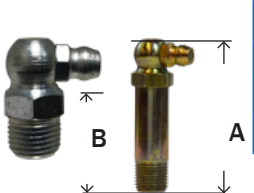

MIDLAND	AMC	CHAMPION	LIST	SIZE	MAF #	MAF PRICE
36120	08316			1/8" -27 NPTF	613	
36120SS				303 SS		
36121				1/8" -27 NPTF		

#613 1613 2890 5400 5407

PIPE THREAD

BALL CHECK - 1/4"-18 NPTF

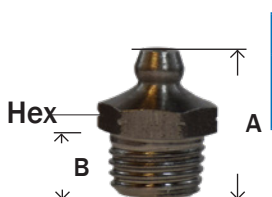

MIDLAND	AMC	CHAMPION	LIST	SIZE	MAF #	MAF PRICE
36130	08321			1/4" -18 NPTF	627	
36130SS				303 SS		

#627 1627 2900K 5050

WARNING: This product can expose you to chemicals, including lead, which are known to the State of California to cause cancer and birth defects or other reproductive harm. For more information, visit www.P65Warnings.ca.gov



STEEL GREASE FITTINGS

BRASS FITTINGS

PIPE THREAD 65° ANGLE BALL CHECK

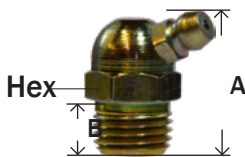

MIDLAND	AMC	CHAMPION	LIST	SIZE	MAF #	MAF PRICE
36132	08324			1/4"-18 NPTF	629	

#629 1629 2965 5350

1/4-28 TAPER THREAD SHORT BALL CHECK - 1/4-28 NPTF

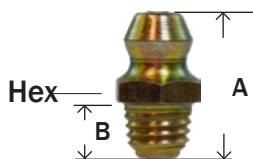

MIDLAND	AMC	CHAMPION	LIST	SIZE	MAF #	MAF PRICE
36140	08341			1/4"-28 NPTF	641	
36140SS				303 SS		
36141				Thread Forming		

#641 1641 2400 3038 5010

1/4-28 TAPER THREAD LONG BALL CHECK

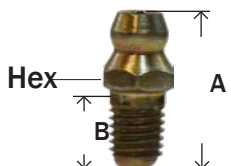

MIDLAND	AMC	CHAMPION	LIST	SIZE	MAF #	MAF PRICE
36142	08342			1/4"-28 Taper Thread	652	0.34

#652 1652 2400 5013

1/4-28 TAPER THREAD EXTRA LONG BALL CHECK

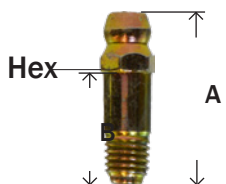

MIDLAND	AMC	CHAMPION	LIST	SIZE	MAF #	MAF PRICE
36144	08343			1/4"-28 Taper Thread	680	

#680 1680 2400 5014

1/4-28 TAPER THREAD SHORT 45° BALL CHECK

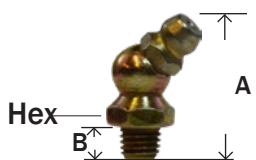

MIDLAND	AMC	CHAMPION	LIST	SIZE	MAF #	MAF PRICE
36146	08346			1/4"-28 Taper Thread	637	
36146SS				303 SS		
36147				1/4"-28 Taper Thread		

#637 1637 2445 1665 2465 3010 5210

1/4-28 TAPER THREAD LONG 45° BALL CHECK

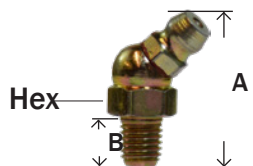

MIDLAND	AMC	CHAMPION	LIST	SIZE	MAF #	MAF PRICE
36148	08347			1/4"-28 Taper Thread	636	

#636 1630 2445

1/4-28 TAPER THREAD 90° ANGLE BALL CHECK

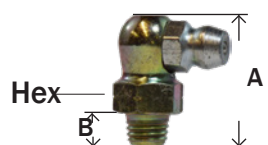

MIDLAND	AMC	CHAMPION	LIST	SIZE	MAF #	MAF PRICE
36150	08349			1/4"-28 Taper Thread	911	
36150SS				303 SS		
36152				Thread Forming		

SAE# A515002

#911 1911 2490 3054 5410

WARNING: This product can expose you to chemicals, including lead, which are known to the State of California to cause cancer and birth defects or other reproductive harm. For more information, visit www.P65Warnings.ca.gov

BRASS

STEEL GREASE FITTINGS

BRASS FITTINGS

DRIVE TYPE BALL CHECK Drive Type

MIDLAND	AMC	CHAMPION	LIST	SIZE	MAF #	MAF PRICE
36160	08375			5/16"	608	

#608 1608 5021

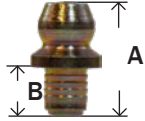
DRIVE TYPE BALL CHECK

MIDLAND	AMC	CHAMPION	LIST	SIZE	MAF #	MAF PRICE
36164	08373			3/16"	728	
36164SS				303 SS		

#728 1728 2316 5033

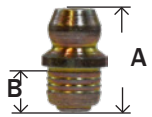
DRIVE TYPE BALL CHECK

MIDLAND	AMC	CHAMPION	LIST	SIZE	MAF #	MAF PRICE
36166	08374			1/4"	743	
36166SS				303 SS		

#743 1743 214 5029

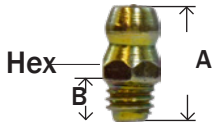
METRIC

MIDLAND	AMC	CHAMPION	LIST	SIZE	MAF #	MAF PRICE
36168	08391			6MM x 1	710	

(Diameter x Pitch)

#711 6000 2106 2M6 5175

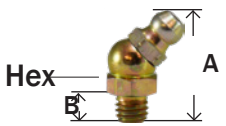
METRIC 45° ANGLE

MIDLAND	AMC	CHAMPION	LIST	SIZE	MAF #	MAF PRICE
36170	08392			6MM x 1	712	

#712 6045 2107 5176

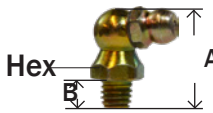
METRIC 90° ANGLE

MIDLAND	AMC	CHAMPION	LIST	SIZE	MAF #	MAF PRICE
36172	08393			6MM x 1	713	

#713 6090 2108 ZM906 5177

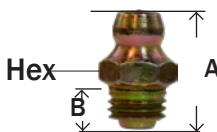
METRIC

MIDLAND	AMC	CHAMPION	LIST	SIZE	MAF #	MAF PRICE
36174	08394			8MM x 1	810	

#811 8000 2103 ZM58 5178

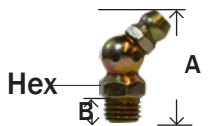
METRIC 45° ANGLE

MIDLAND	AMC	CHAMPION	LIST	SIZE	MAF #	MAF PRICE
36176	08395			8MM x 1	812	

#812 8045 2104 ZM458 5179

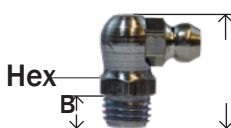
METRIC 90° ANGLE

MIDLAND	AMC	CHAMPION	LIST	SIZE	MAF #	MAF PRICE
36178	08396			8MM x 1	813	

#813 8090 2105 ZM908 5180

WARNING: This product can expose you to chemicals, including lead, which are known to the State of California to cause cancer and birth defects or other reproductive harm. For more information, visit www.P65Warnings.ca.gov



STEEL GREASE FITTINGS

BRASS FITTINGS

METRIC

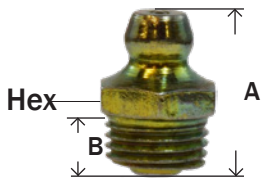

MIDLAND	AMC	CHAMPION	LIST	SIZE	MAF #	MAF PRICE
36180	08397			10MM x 1	910	

• DIAMETER X PITCH (EXTRA FINE)

#911 9000 2109 ZM510 5181

METRIC

45° ANGLE

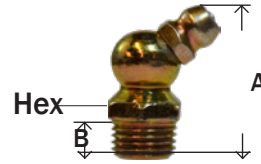

MIDLAND	AMC	CHAMPION	LIST	SIZE	MAF #	MAF PRICE
36182	08398			10MM x 1	912	

#912 9045 2110 ZM4510 5182

METRIC

90° ANGLE

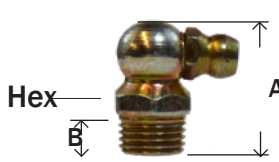

MIDLAND	AMC	CHAMPION	LIST	SIZE	MAF #	MAF PRICE
36184	08399			10MM x 1	913	

#913 9090 2111 ZM9010 5183

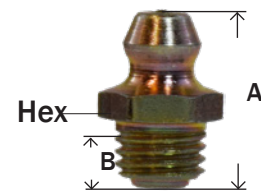

MIDLAND	AMC	CHAMPION	LIST	SIZE	MAF #	MAF PRICE
36186	08351			5/16"-24		

#711-B 1711 2500

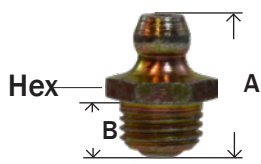

MIDLAND	AMC	CHAMPION	LIST	SIZE	MAF #	MAF PRICE
36188	08352			3/8"-24		

#710-B 1710 2600

BUTTON HEAD

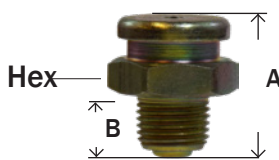

MIDLAND	AMC	CHAMPION	LIST	SIZE	MAF #	MAF PRICE
36200	08302			1/8"-27 PTF		
36205	08304			1/4"-18 NPT		

1184 1186

WHIP HOSE - EXCEEDS SAE 100R1-AT - USE WITH HAND GREASE GUNS ONLY

10,000 PSI BURST PRESSURE RUBBER

3,000 PSI WORKING PRESSURE

3/16" ID

1/8" NPT SOLID BASE



MIDLAND	AMC	CHAMPION	LIST	LENGTH	MAF #	MAF PRICE
36210				12" RUBBER		
36212				18" RUBBER		
36214				24" RUBBER		
36216				36" RUBBER		

4 JAW GREASE GUN COUPLER

PROVIDES QUICK, POSITIVE, LEAKPROOF CONNECTION W/ GREASE

1/8" NPTF

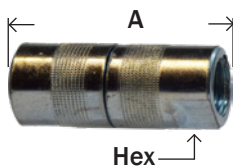

MIDLAND	AMC	CHAMPION	LIST	LENGTH	MAF #	MAF PRICE
36220				1.50		

STEEL GREASE FITTINGS

BRASS FITTINGS

Adapters for Grease Fittings

ADAPTERS

• CARBON STEEL, ZINC COATED



MIDLAND	AMC	CHAMPION	LIST	FEMALE	MALE	MAF #	MAF PRICE
36300				1/8"-27 NPTF	1/4"-28" SAE-LT		
36301				1/8"-27 NPTF	1/4"-28" SAE-LT		



MIDLAND	AMC	CHAMPION	LIST	FEMALE ENGLISH TO MALE ENGLISH		MAF #	MAF PRICE
36304				1/4"-28 UNF	M6 x 1.0		
36305				1/4"-28 UNF	M8 x 1.0		
36306				1/4"-28 UNF	M10 x 1.0		

EXTENSIONS

MIDLAND	AMC	CHAMPION	LIST	FEMALE ENGLISH TO MALE ENGLISH		MAF #	MAF PRICE
36307				1/4"-28 UNF	1/4"-28 SAE-LT		
36308				1/8"-27 NPTF	1/8"-27 NPTF		
36309*				1/8"-27 NPTF	1/8"-27 NPTF		
36310				1/8"-27 NPTF	1/8"-27 NPTF		
36311				1/8"-27 NPTF	1/8"-27 NPTF		

*BRASS PLATED

45° ANGLE ELBOWS

MIDLAND	AMC	CHAMPION	LIST	FEMALE	MALE	MAF #	MAF PRICE
36360				1/8"-27 NPTF	1/4"-28 SAE-LT		
36362				1/8"-27 NPTF	1/8"-27 PTF SAE Short		

90° ANGLE ELBOWS

MIDLAND	AMC	CHAMPION	LIST	FEMALE	MALE	MAF #	MAF PRICE
36370				1/8"-27 NPTF	1/4"-28 SAE-LT		
36371				1/8"-27 NPTF	1/4"-28 SAE-LT		
36372				1/8"-27 NPTF	1/4"-18 PTF SAE Short		
36374				1/8"-27 NPTF	1/8"-27 PTF SAE Short		
36375				1/8"-27 NPTF	1/8"-27 NPTF		
36377				1/4"-18 NPTF	1/4"-18 NPTF		
36376				1/8"-27 NPTF	1/8"-27 NPTF		
36373				1/8"-27 PTF SPL Extra Short	1/8"-27 PTF SPL Extra Short		

COUPLING

MIDLAND	AMC	CHAMPION	LIST	FEMALE	FEMALE	MAF #	MAF PRICE
36340				1/4"-28 UNF	1/8"-27 NPTF		

BULKHEAD CONNECTOR

MIDLAND	AMC	CHAMPION	LIST	FEMALE	MALE (FEMALE)	MAF #	MAF PRICE
36350				1/8"-27 NPTF	1/8"-27 NPSM (1/4"-28 UNF)		

WARNING: This product can expose you to chemicals, including lead, which are known to the State of California to cause cancer and birth defects or other reproductive harm. For more information, visit www.P65Warnings.ca.gov

SPECIALTY VALVES AND COCKS

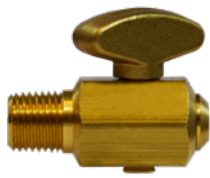

DRAIN COCKS



AIR VALVES



3, 4 AND 6 WAY

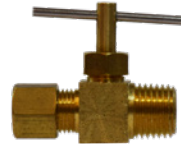

NEEDLE



MARINE & ANTI-SIPHON



PANEL MOUNT BALL VALVES



TRUCK



MINI BALL



SOLID BOTTOM SHUT-OFF



CHECK



SPRING BOTTOM SHUT-OFF

MORE VALVES ON OUR WEBSITE
See our valve section for much, much more!

WARNING: This product can expose you to chemicals, including lead, which are known to the State of California to cause cancer and birth defects or other reproductive harm. For more information, visit www.P65Warnings.ca.gov

DRAIN COCKS

BRASS FITTINGS

DRAIN COCKS

- For use with low pressure air, water and fluids.
- Designed for a working pressure of 150 psi @ 250°.
- Hand-tightening provides a metal-to-metal seal.
- Not intended for natural gas, LPG, nuclear or aircraft applications.

Install on your tank for easy draining

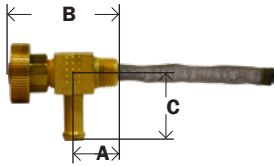
GASOLINE SHUT OFF W/ SCREEN FILTER

MIDLAND	AMC	CHAMPION	LIST	BARB X MALE PIPE	MAF #	MAF PRICE
46064				1/4" x 1/8"	MA6600	----

827

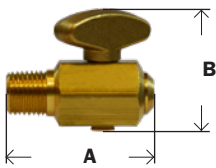
DRAIN COCK 150 PSI - TRUNK AIR TANK

MIDLAND	AMC	CHAMPION	LIST	MALE PIPE	MAF #	MAF PRICE
46066		40D		1/4"	PRC601-4	

DCR601-4

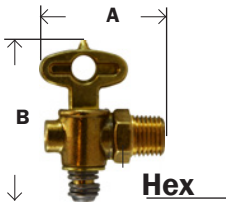
TRUCK DRAIN - 125 P.S.I.G

MIDLAND	AMC	CHAMPION	LIST	MALE PIPE	MAF #	MAF PRICE
46067	09403-02	37D		1/8"	H37P	----
46-068	09403-04	38D		1/4"	H38P	

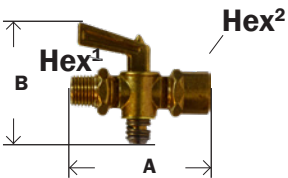
SHUT OFF - 150 P.S.I MAX.

MIDLAND	AMC	CHAMPION	LIST	MALE PIPE X FEMALE PIPE	INDUSTRY NUMBER	MAF #	MAF PRICE
46069		H130C-L		1/4"	W20332	H49P	----

#60HC 3380-A 0903610 367

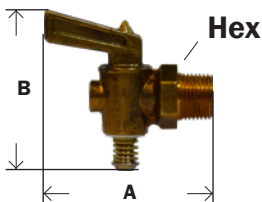
LEVER HANDLE

MIDLAND	AMC	CHAMPION	LIST	MALE PIPE	INDUSTRY NUMBER	MAF #	MAF PRICE
46070	09404-02	41D		1/8"	41P		
46071	09404-04	42D		1/4"	42P		
46072	09404-06	43D		3/8"	43P		
46073	09404-08	44D		1/2"	44P		

- 30 psi

840 41D DC601

*Valve is closed when handle is in the position of the picture

AIR TANK DRAIN PULL VALVE - 1/4 MALE

MIDLAND	AMC	CHAMPION	LIST	LENGTH OF CABLE	MAF #	MAF PRICE
39595		327-5		5'	MA595-60	----
39596		327-4		4'	MA595-68	
39597				3'	MA595-36	----
39600				AIR VALVE	MA595	----

DRAIN COCKS

BRASS FITTINGS

INTERNAL SEAT

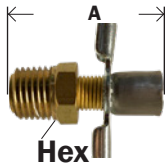

MIDLAND	AMC	CHAMPION	LIST	MALE PIPE	MAF #	MAF PRICE
46079				1/8"	MA6783	----

DC602 808 400A 1800A

INTERNAL SEAT - WING NUT HANDLE



MIDLAND	AMC	CHAMPION	LIST	MALE PIPE	MAF #	MAF PRICE
46074	09440-02	300D		1/8"	MA130	
46075	09440-04	301D		1/4"	MA140	
46077		302D		3/8"	MA230	

HB - 5/16 803 305A

LONG INTERNAL SEAT

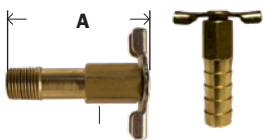

MIDLAND	AMC	CHAMPION	LIST	SIZE	MAF #	MAF PRICE
46078				1/8 MIP	MA185	----
46076				3/8" Hose I.D.		

46-078

46-076

809

PIN HANDLE - INTERNAL SEAT



MIDLAND	AMC	CHAMPION	LIST	MALE PIPE	MAF #	MAF PRICE
46080	09420-02	200D		1/8"	200P	----
46081	09420-04	201D		1/4"	201P	----
46082	09420-06	202D		3/8"	202P	----

DC603 802

EXTERNAL SEAT W/ SPOUT

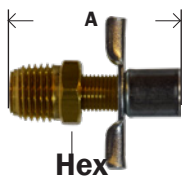

MIDLAND	AMC	CHAMPION	LIST	MALE PIPE	INDUSTRY NUMBER	MAF #	MAF PRICE
	09442-02	420D		1/8"		420P	
46084*	09442-04	421D		1/4"	6788	421P	

* Replaces GM # 511771 & Chrysler #836015

200A 239 DC606 807

BIBB VALVE



MIDLAND	AMC	CHAMPION	LIST	MALE PIPE	INDUSTRY NUMBER	MAF #	MAF PRICE
46088	09430-02	200DH		1/8"	150	302P	----
46089	09430-04	201DH		1/4"	120	303P	----
46089A				1/4"	6660	MA6660	----

* With valve closed

804 DC607 2019 201DH

RADIATOR TYPE - EXTERNAL SEAT

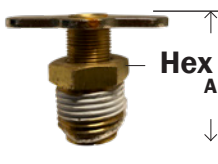

MIDLAND	AMC	CHAMPION	LIST	MALE PIPE	IND #	MAF #	MAF PRICE
46085	09432-02	320D		1/8"	135	320P	
46086	09432-04	321D		1/4"	145	321P	
46087	09432-06	322D		3/8"	270	322P	
46083	09432-08	323D		1/2"	108	323P	

320D 240 DC604 801

SHUT-OFF COCKS

BRASS FITTINGS

- Designed for working pressure of 30 PSI.
- Forged brass bodies and brass handles.
- Instantaneous off-on operation with 360° rotation.
- Not good for gasoline.

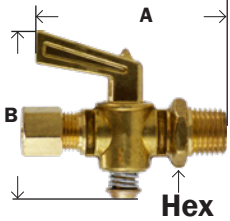
COMPRESSION X MALE PIPE

MIDLAND	AMC	CHAMPION	LIST	COMP X MALE PIPE	MAF #	MAF PRICE
46130	09201-0402	27CC		1/4" x 1/8"	27C	----
46131	09201-0404	227CC		1/4" x 1/4"	227C	----
46132	09201-0502	133C-5J		5/16" x 1/8"	29C	
	09201-0504			5/16" x 1/4"	229C	----
46134	09201-0604	57CC		3/8" x 1/4"	57C	----
46-135	09201-0606			3/8" x 3/8"	557C	----

868 V304C 2068 133C VC206

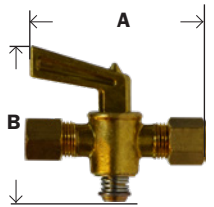
COMPRESSION X COMPRESSION

MIDLAND	AMC	CHAMPION	LIST	COMP X COMP	MAF #	MAF PRICE
46140	09206-04	28CC		1/4"	28C	----
46141	09206-05	30CC		5/16"	30C	----
46142	09206-06	58CC		3/8"	58C	----
46143	09206-08	68CC		1/2"	68C	

V3030F 2062 134C

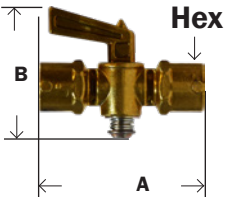
FEMALE X FEMALE PIPE

MIDLAND	AMC	CHAMPION	LIST	FEMALE PIPE X FEMALE PIPE	MAF #	MAF PRICE
46151	09234-02	31PC		1/8"	31P	
46152	09234-04	32PC		1/4"	32P	
46152T*				1/4"	H32P	----
46153	09234-06	40PC		3/8"	40P	

* 150 PSI

V403P 132C 875

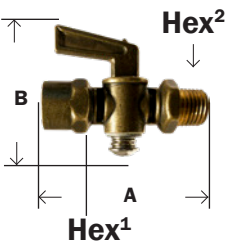
MALE PIPE X FEMALE

MIDLAND	AMC	CHAMPION	LIST	MALE PIPE X FEMALE PIPE	MAF #	MAF PRICE
46160	09235-02	48PC		1/8"	48P	
46161	09235-04	49PC		1/4"	49P	
46161T*				1/4"	H49P	----
46162	09235-06	50PC		3/8"	50P	

* 150 PSI

880 V402P 130C

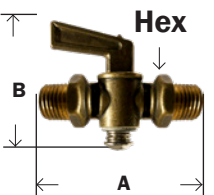
MALE PIPE X MALE PIPE

MIDLAND	AMC	CHAMPION	LIST	MALE PIPE X MALE PIPE	IND. #	MAF #	MAF PRICE
46165	09208-02	76PC		1/8"	76-P	76P	
46166	09208-04	77PC		1/4"	77-P	77P	
46166T*				1/4"		H77P	----
46167	09208-06	78PC		3/8"	78-P	78P	

* 150 PSI

1V401P 890

SHUT-OFF COCKS

BRASS FITTINGS

MALE FLARE X MALE PIPE



MIDLAND	AMC	CHAMPION	LIST	MALE FLARE X MALE PIPE	MAF #	MAF PRICE
46100	09204-0402	27SAE		1/4" x 1/8"	27SAE	----
46101	09204-0404	227SAE		1/4" x 1/4"	227SAE	----
46102	09204-0502			5/16" x 1/8"	295SAE	
46103	09204-0504			5/16" x 1/4"	229SAE	----
46104	09204-0604	57SAE		3/8" x 1/4"	57SAE	----
	09204-0606			3/8" x 3/8"		
	09204-0608			3/8" x 1/2"	577SAE	
46107	09204-0806	67SAE		1/2" x 3/8"	67SAE	----
	09204-0808			1/2" x 1/2"	77SAE	----

MALE FLARE X MALE FLARE

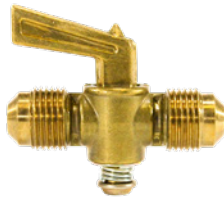

MIDLAND	AMC	CHAMPION	LIST	MALE FLARE	IND. #	MAF #	MAF PRICE
46115	09210-04	28SAE		1/4"		28SAE	----
	09210-05			5/16"		30SAE	----
46117	09210-06	58SAE		3/8"		58SAE	----
46118	09210-08	68SAE		1/2"		68SAE	----
	09210-10			5/8"		1010SAE	----

MALE FLARE X FEMALE PIPE



MIDLAND	AMC	CHAMPION	LIST	MALE FLARE X FEMALE PIPE	IND. #	MAF #	MAF PRICE
46125	09205-0608	161SAE		3/8" x 1/2"		161SAE	----
46127	09205-0606	163SAE		3/8" x 3/8"		163SAE	----
46128	09205-0808	164SAE		1/2" x 1/2"		164SAE	----
46126				3/8" x 9/16-24		161SAE	----
	09205-1012			5/8" x 3/4"		167SAE	----

WARNING: This product can expose you to chemicals, including lead, which are known to the State of California to cause cancer and birth defects or other reproductive harm. For more information, visit www.P65Warnings.ca.gov

BRASS

NEEDLE VALVES

BRASS FITTINGS

NEEDLE VALVES

THESE ARE NOT LEAD FREE SEE PAGES 169 FOR LEAD FREE PRODUCTS

Made with either pin handle or pressed on handle.

Please specify if you have a preference.

metal

- Used on instrumentation, hydraulic, and pneumatic systems.
- Designed for a maximum working pressure of 150 PSI. or

- Provided with steel handles and metal-to-seats with fine-thread screwdown.
- Not designed for natural gas, LPG, nuclear aircraft applications.
- Always install with pressure against the seat.

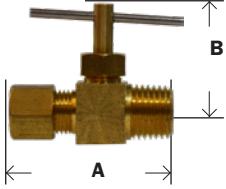
COMP X MALE PIPE

MIDLAND	AMC	CHAMPION	LIST	COMP X MALE PIPE	MAF #	MAF PRICE
46001	09101-0302			3/16" x 1/8"	133C	----
46002	09101-0402	101CP		1/4" x 1/8"	101C	----
46003	09101-0404	101CP-4		1/4" x 1/4"	1101C	----
46004	09101-0502	102-C		5/16" x 1/8"	102C	----
46005	09101-0604	143CP		3/8" x 1/4"	143C	----

NV106C 2205 820 3068

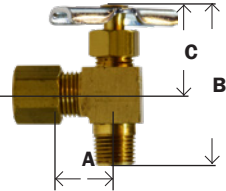
COMP X MALE PIPE-ANGLE

MIDLAND	AMC	CHAMPION	LIST	COMP X MALE PIPE	MAF #	MAF PRICE
46011	09103-0402	103CC		1/4" x 1/8"	103C	----
46011X				Heavy Pattern		
46012	09103-0404	103-4CC		1/4" x 1/4"	104C	----
46013	09103-0502	203CC		5/16" x 1/8"	203C	----
	09103-0602	303ACC		3/8" x 1/8"	302C	
46016	09103-0604	303CC		3/8" x 1/4"	303C	----

NV104C 2203 821 3069

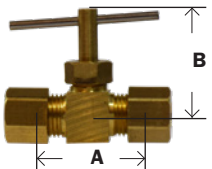
COMP X COMP

MIDLAND	AMC	CHAMPION	LIST	COMP X COMP	MAF #	MAF PRICE
46020				3/16"	105C	----
46021	09106-04	106CC		1/4"	106C	----
46022	09106-05	107CC		5/16"	107C	----
46023	09106-06	113CC		3/8"	113C	----

NV105C 3062 2201 822

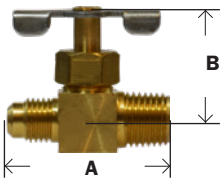
FLARE X MALE PIPE

MIDLAND	AMC	CHAMPION	LIST	MALE FLARE X MALE PIPE	MAF #	MAF PRICE
46028	09104-0402	104SAE		1/4" x 1/8"	104SAE	----
46029	09104-0404	105SAE		1/4" x 1/4"	1104SAE	----
	09104-0502			5/16" x 1/8"	106SAE	----
46031	09104-0604	108SAE		3/8" x 1/4"	108SAE	----

NV103F 2405 823 3048

WARNING: This product can expose you to chemicals, including lead, which are known to the State of California to cause cancer and birth defects or other reproductive harm. For more information, visit www.P65Warnings.ca.gov

NEEDLE VALVES

BRASS FITTINGS

FLARE X MALE PIPE

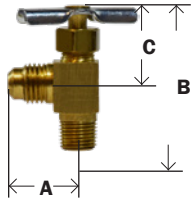

MIDLAND	AMC	CHAMPION	LIST	MALE FLARE X MALE PIPE	MAF #	MAF PRICE
46036	09102-0402	103SAE		1/4" x 1/8"	103SAE	----
46038		203SAE		5/16" x 1/8"	203SAE	----
46039		204SAE		5/16" x 1/4"	204SAE	----
46040	09102-0604	303SAE		3/8" x 1/4"	303SAE	----

NV101F 2403 824 3049

FLARE X FLARE

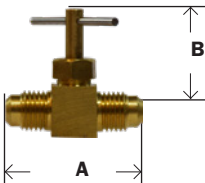

MIDLAND	AMC	CHAMPION	LIST	MALE FLARE X MALE FLARE	MAF #	MAF PRICE
46045	09110-04	110SAE		1/4"	110SAE	----
46046	09110-06	115SAE		3/8"	115SAE	----

NV102F 3042 825 2401

MULTI-PURPOSE AIR VENT

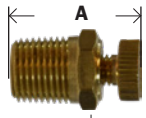

Hex

MIDLAND	AMC	CHAMPION	LIST	MALE PIPE	MAF #	MAF PRICE
46048		340AV		1/8"	AV-2S	----
46048S*				1/8"		

* #303 Stainless Steel

705

MALE PIPE TO MALE PIPE

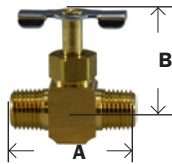

MIDLAND	AMC	CHAMPION	LIST	MALE PIPE X MALE PIPE	MAF #	MAF PRICE
46050	09108-02	108MP		1/8"	108P	----
46051	09108-04	110MP		1/4"	110P	----
				3/8"	202P	----

NV107P 2301 826 3122

FEMALE PIPE X FEMALE PIPE

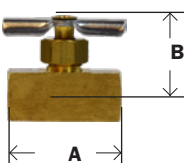

MIDLAND	AMC	CHAMPION	LIST	FEMALE PIPE X FEMALE PIPE	MAF #	MAF PRICE
46055*	09134-02	31NV		1/8"	304P	----
46056	09134-04	32NV		1/4"		
46056P*				1/4" Heavy	3044PFH	----

* Pressed on handle

6800 NV109P 2304 817 3103

MALE X FEMALE PIPE NBR seals -30°C to 120°C

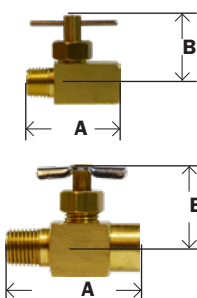

MIDLAND	AMC	CHAMPION	LIST	MALE PIPE X FEMALE PIPE	MAF #	MAF PRICE
46060	09135-02	48NV		1/8"	305P	----
46061	09135-04	49NV		1/4"	3055P	----
46061L				1/4" Light Pattern	3055PFH	----

NV108P 2305 818 3120

WARNING: This product can expose you to chemicals, including lead, which are known to the State of California to cause cancer and birth defects or other reproductive harm. For more information, visit www.P65Warnings.ca.gov

BRASS

SPECIALTY VALVES**BRASS FITTINGS****BRASS TRUCK VALVES**

- Used in heavy duty truck, trailer and mobile markets.
- Used on water, oil and coolant lines.
- Forged brass construction with steel handle.
- Temperature range -40° - 250°
- Max pressure 250 psi
- Metal to metal seats for high heat/fluid compatibility
- Fine thread screw down to afford flow control ability and a positive seal.
- Not intended for natural gas, LPG, Nuclear or aircraft applications

BARB TO MALE PIPE

MIDLAND	AMC	CHAMPION	LIST	SIZE	MAF #	MAF PRICE
46450	08944-0606	HV1-6C		3/8 x 3/8	TV44-66	----
	08944-0806	HV1-8C		1/2 x 3/8	TV44-86	----
46451	08944-1006	HV1-10C		5/8 x 3/8	TV44-106	----
46455	08944-1008	HV1-10D		5/8 x 1/2	TV44-108	----
46457	08944-1206	HV1-12C		3/4 x 3/8	TV44-126	----
46456	08944-1208	HV1-12D		3/4 x 1/2	TV44-128	----

404V

BARB TO MALE PIPE SPECIAL- PIN HANDLE

MIDLAND	AMC	CHAMPION	LIST	SIZE	MAF #	MAF PRICE
	08947-0606			3/8 x 3/8	TV44PH-66	----
	08947-1006	HV1-PH-10C		5/8 x 3/8	TV44PH-106	----



WITH ROUND SILVER HANDLE						
MIDLAND	AMC	CHAMPION	LIST	SIZE	MAF #	MAF PRICE
		97V-10P		5/8 x 1/2		

FEMALE TO MALE PIPE

MIDLAND	AMC	CHAMPION	LIST	SIZE	MAF #	MAF PRICE
46465	08945-0606	1W-66		3/8 x 3/8	TV45-66	----
46466	08945-0608	1W-86		3/8 x 1/2	TV45-68	----
46467	08945-0808	1W-88		1/2 x 1/2	TV45-88	----

405V

HOSE BARB TO MALE PIPE - ROUND HANDLE

MIDLAND	AMC	CHAMPION	LIST	SIZE	MAF #	MAF PRICE
		HBV-6C		3/8 x 3/8		

WARNING: This product can expose you to chemicals, including lead, which are known to the State of California to cause cancer and birth defects or other reproductive harm. For more information, visit www.P65Warnings.ca.gov

SPECIALTY VALVES

BRASS FITTINGS

BRASS TRUCK VALVES

- Used in heavy duty truck, trailer and mobile markets.
- Used on water, oil and coolant lines.
- Forged brass construction with steel handle.
- Temperature range -40° - 250°
- Max pressure 250 psi
- Metal to metal seats for high heat/fluid compatibility
- Fine thread screw down to afford flow control ability and a positive seal.
- Not intended for natural gas, LPG, Nuclear or aircraft applications

FLARE TO MALE PIPE



TV49

MIDLAND	AMC	CHAMPION	LIST	SIZE	MAF #	MAF PRICE
	08949-0604			3/8 x 1/4	TV49-64	----
	08949-0606			3/8 x 3/8	TV49-66	----
	08949-0608			3/8 x 1/2	TV49-68	----
	08949-0806			1/2 x 3/8	TV49-86	----
46475	08949-0808	7814X8X8X90		1/2 x 1/2	TV49-88	----
46476	08949-1008	7814X8X90		5/8 x 1/2	TV49-108	----

409V

MIP X FLARE



TV412

MIDLAND	AMC	CHAMPION	LIST	SIZE	MAF #	MAF PRICE
46485	08942-1008	7814X8X90X1		1/2 x 5/8	TV412-108	

KANTLEAK 90° BALL VALVE - PIN HANDLE



MIDLAND	AMC	CHAMPION	LIST	SIZE	MAF #	MAF PRICE
		ABV1-B		1/4 x 1/4	190BV-4	
		ABV1-C		3/8 x 3/8	190BV-6	----
		ABV1-D		1/2 x 1/2	190BV-8	----

OIL DRUM AND TANK VALVES

FLARE TUBE O.D. TO MALE PIPE 45° ELBOW

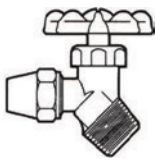

MIDLAND	AMC	CHAMPION	LIST	SIZE	MAF #	MAF PRICE
	09540-0606			3/8 x 3/8		
	09540-0608	5818X8		3/8 x 1/2	60V	
	09540-0612	5818X12		3/8 x 3/4	70V	
	09540-0808			1/2 x 1/2		
	09540-0812			1/2 x 3/4		

PLASTIC DRUM FAUCETS

- Pipe threads to ANSI B1.20.1
- Hose threads to ANSI B

The FLO-RITE faucet has been engineered to meet the demand for greater chemical resistance, using linear polyethylene for the stem.



"FLO-RITE" DRUM FAUCET

PART #	SIZE	MAF PRICE
46277	3/4"	----

WARNING: This product can expose you to chemicals, including lead, which are known to the State of California to cause cancer and birth defects or other reproductive harm. For more information, visit www.P65Warnings.ca.gov

BRASS

SPECIALTY VALVES

BRASS FITTINGS

DRUM & BARREL FAUCET VALVE

- Die cast body w/ nylon seat and steel spring.
- For use with all petroleum products except trichlorethylene.



G261N

Not suitable for potable water

SELF-CLOSING DRUM & BARREL FAUCET

PART #	SIZE	
46270	3/4"	----

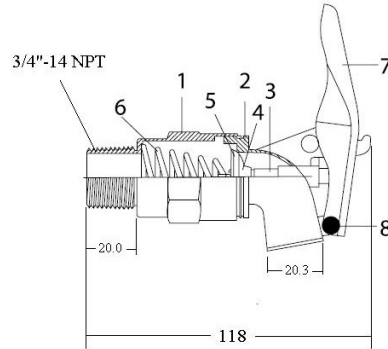

Part #	Part Name	Material
1	Body	Zinc
2	Bonnet	Zinc
3	Stem	Steel
4	Disc	Plastic
5	Seal	Rubber
6	Spring	Zinc plated steel
7	Handle	Aluminum
8	Rivet	Aluminum

SOLID BOTTOM VALVES

- Designed for instantaneous on-off operation.
- 360° rotation standard.
- 30 PSI
- Packed with grease.

O-RING SEALED MIP X FIP

MIDLAND	AMC	CHAMPION	LIST	SIZE	MAF #	MAF PRICE
46400		103SD-2		1/8	170C-2	----
46401		103SD-4		1/4	170C-4	----
46402		103SD-6		3/8	170C-6	----

- Good for Propane

1035D M-70-SBV

#M-72-SBV FIP X FIP

MIDLAND	AMC	CHAMPION	LIST	SIZE	MAF #	MAF PRICE
46411		32SD		1/4	172C-4	----

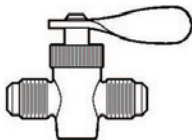
MALE FLARE X MALE FLARE

MIDLAND	AMC	CHAMPION	LIST	SIZE	MAF #	MAF PRICE
		58SD		3/8	176C-6	----

WARNING: This product can expose you to chemicals, including lead, which are known to the State of California to cause cancer and birth defects or other reproductive harm. For more information, visit www.P65Warnings.ca.gov



SPECIALTY VALVES

BRASS FITTINGS

SOLID BOTTOM FUEL VALVES

- Approved for use on Motorcraft fuel lines.
- Pointer lever.
- 90° turn stop mechanism to assure positive location of the on and off positions.
- Corrosion proofed internal construction assures maximum salt atmosphere protection.
- Port hole is 1/4 (.250) diameter.
- UL listed for use in fuel oils no. 1 & no. 2, LP gas and utility gas.

MALE PIPE X FEMALE PIPE



MIDLAND	AMC	CHAMPION	LIST	SIZE	MAF #	MAF PRICE
46400M	09500-02	670C-J		1/8 x 1/8	M670C-2	----
46401M	09500-04	670C-L		1/4 x 1/4	M670C-4	----
46402M	09500-06	670C-N		3/8 x 3/8	M670C-6	----

8980

MALE PIPE X MALE PIPE



MIDLAND	AMC	CHAMPION	LIST	SIZE	MAF #	MAF PRICE
46406M	09501-04	77SD		1/4 x 1/4	M671C-4	----

- Good for Propane

8990

FEMALE PIPE X FEMALE PIPE



MIDLAND	AMC	CHAMPION	LIST	SIZE	MAF #	MAF PRICE
46411M	09502-04	672C-L		1/4 x 1/4	M672C-4	----

8975

MALE FLARE X MALE PIPE



MIDLAND	AMC	CHAMPION	LIST	SIZE	MAF #	MAF PRICE
	09505-0402			1/4 x 1/8	M675C-42	
	09505-0404			1/4 x 1/4	M675C-44	
46429M	09505-0604	675C-6L		3/8 x 1/4	M675C-64	----
46430M	09505-0606	675C-6N		3/8 x 3/8	M675C-66	----
	09505-0608			3/8 x 1/2		
	09505-0806			1/2 x 3/8		

8948

WARNING: This product can expose you to chemicals, including lead, which are known to the State of California to cause cancer and birth defects or other reproductive harm. For more information, visit www.P65Warnings.ca.gov

BRASS

SPECIALTY VALVES

BRASS FITTINGS

GROUND PLUG SHUT-OFF COCKS

NON-LUBRICATED PLUG VALVES are designed to operate in systems where INSTANTANEOUS PORT SELECTION is desired. Since LUBRICANTS ARE NOT USED, relubrication is not required. There is no lubricant to freeze and lock the valve or to contaminate fine fluids. The O-RING SEALED CAP and STEM eliminate leakage to atmosphere. The mating BRASS BODY and CELCON PLUG produce a fine seal that WILL NOT SEIZE OR GALL.

Designed for PANEL or BRACKET MOUNTING. They are generally recommended for operation in GASOLINE, OIL, AIR, WATER and DETERGENT systems from minus 40° to 180°F, at a maximum operating pressure of 30 p.s.i.g. The fluid port size is 9/32 (.281) diameter for 1/8 and 1/4 sizes, 5/16 (.312) diameter for the 3/8 size. **(Consult factory for applications requiring a higher pressure).**

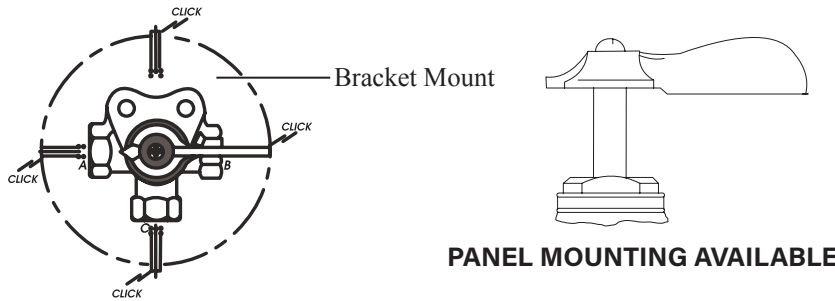

Type 1 (Standard)

A pronounced "click" may be felt at each position.
Handle travel is not restricted.

THREE-WAY VALVES (Side Outlet)

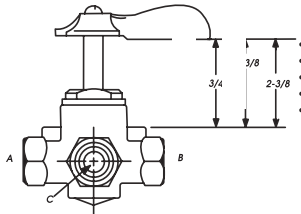

- 1-3/8" Stem
- Side Outlet
- Bracket Mounting
- O-Ring Sealed
- 4-way celcon roter standard

LESS CLICK

MIDLAND	AMC	CHAMPION	LIST	A-B-C FEMALE PIPE THREAD	LENGTH OF STEM	MAF #	MAF PRICE
46247		110C-J		1/4	1-3/8"		
46248		110C-N		3/8	1-3/8"		

M-108-MID WITH CLICK 360°

MIDLAND	AMC	CHAMPION	LIST	A-B-C FEMALE PIPE THREAD	LENGTH OF STEM	MAF #	MAF PRICE
46250	09508-02	108SD-2		1/8	1-3/8"	210C-2	----
46251	09508-04	108SD-4		1/4	1-3/8"	210C-4	----
46252	09508-06	108SD-6		3/8	1-3/8"	210C-6	----

V406P 6749

Openings:

Handle Pointer over A.....Valve Open A-C

Handle Pointer over C.....Valve Open B-C

Handle Pointer over B.....Valve "OFF"

Handle Pointer over Bracket.....Valve "OFF"

WARNING: This product can expose you to chemicals, including lead, which are known to the State of California to cause cancer and birth defects or other reproductive harm. For more information, visit www.P65Warnings.ca.gov



SPECIALTY VALVES

BRASS FITTINGS

GROUND PLUG SHUT-OFF COCKS

THREE-WAY VALVES (Bottom Outlet)

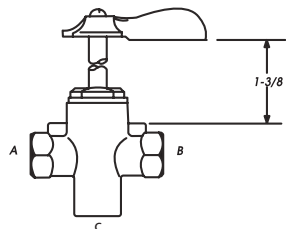

- 1-3/8" Stem
- Side Outlet
- Bracket Mounting
- O-Ring Sealed
- 4-way celcon roter standard

Openings:

Handle *Pointer* over A.....Valve Open A-C
 Handle *Pointer* over B.....Valve Open B-C
 Handle *Pointer* over Bracket.....Valve "OFF"

LESS CLICK

MIDLAND	AMC	CHAMPION	LIST	A-B-C FEMALE PIPE THREAD	LENGTH OF STEM	MAF #	MAF PRICE
46241		120C-L		1/4	1-3/8"	120C-4	----

WITH CLICK 360°

MIDLAND	AMC	CHAMPION	LIST	A-B-C FEMALE PIPE THREAD	LENGTH OF STEM	MAF #	MAF PRICE
46243		220C-J		1/8	1-3/8"	220C-2	----
46244		220C-L		1/4	1-3/8"	220C-4	----

FOUR-WAY VALVES

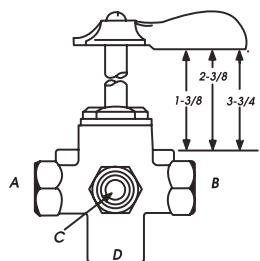

- Side Outlet
- Bracket Mounting
- O-Ring Sealed
- 4-way celcon roter standard

Openings:

Handle *Pointer* over A.....Valve Open A-D
 Handle *Pointer* over C.....Valve Open C-D
 Handle *Pointer* over B.....Valve Open B-D
 Handle *Pointer* over Bracket.....Valve "OFF"

LESS CLICK

MIDLAND	AMC	CHAMPION	LIST	A-B-C-D FEMALE PIPE THREAD	LENGTH OF STEM	MAF #	MAF PRICE
46257		100C-L		1/4	1-3/8"	220C-4LC	----

M-114-MID WITH CLICK (360°)

MIDLAND	AMC	CHAMPION	LIST	A-B-C-D FEMALE PIPE THREAD	LENGTH OF STEM	MAF #	MAF PRICE
46255	09514-04	114SD		1/4	1-3/8"	200C-4	----
46256	09514-06	200C-N		3/8	1-3/8"	200C-6	----

WITH 2-3/8" LONG STEM M-115-MID

MIDLAND	AMC	CHAMPION	LIST	A-B-C-D FEMALE PIPE THREAD	LENGTH OF STEM	MAF #	MAF PRICE
46260	09515-04	105C-L		1/4	2-3/8"	215C-4	----
	09515-06			3/8		215C-6	----

WARNING: This product can expose you to chemicals, including lead, which are known to the State of California to cause cancer and birth defects or other reproductive harm. For more information, visit www.P65Warnings.ca.gov

BRASS

V407P

MINIATURE BALL VALVES

BRASS FITTINGS

BRASS MINIATURE BALL VALVES

- Working Pressure up to 1000 P.S.I.G.
- ASTM B-16 Corrosion Resistant Brass Body.
- Non-Adjusting Fluoroelastomer O-Ring Stem Seal Design Never Needs Tightening.
- Highly Inert Polytetrafluoroethylene Seats.
- Long Life Nickel Plated Brass Ball.
- Blow-Out Proof Stem for Safety.
- Temperature: -40°F to 300°F
- 1/4 Turn Instantaneous On-Off Operation.
- Quarter Turn Handle Design.
- Water, Oil, and Air Pressure Systems.
- Ideal for tight, confined areas, or when routing aesthetics are desired. Applications include instrumentation, gas sampling systems, high pressure gauges, test stands, hydraulic and pneumatic service lines on capital equipment.
- Not good for steam.
- Good for propane, gas and diesel.

MALE X FEMALE

MIDLAND	AMC	CHAMPION	LIST	SIZE	MAF #	MAF PRICE
46900		350BV-J		1/8 x 1/8	350BV-22	----
46903		350BV-L		1/4 x 1/4	350BV-44	----

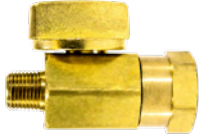
MALE X FEMALE

MIDLAND	AMC	CHAMPION	LIST	SIZE	MAF #	MAF PRICE
		350BVR-J		1/8 x 1/8		
		350BVR-L		1/4 x 1/4		

MALE X MALE

MIDLAND	AMC	CHAMPION	LIST	SIZE	MAF #	MAF PRICE
46910		351BV-J		1/8 x 1/8	351BV-22	----
46912		351BV-L		1/4 x 1/4	351BV-44	----

HOSE BARB X MALE PIPE

MIDLAND	AMC	CHAMPION	LIST	SIZE	MAF #	MAF PRICE
47042		357BV-4J		1/4 X 1/8	357BV-42	----
46980		357BV-4L		1/4 x 1/4	357BV-44	----
				5/16 X 1/4	357BV-54	----
46981		357BV-6L		3/8 X 1/4	357BV-64	----
				3/8 X 3/8	357BV-66	----
				1/2 X 1/2	357BV-88	----

FEMALE X FEMALE

MIDLAND	AMC	CHAMPION	LIST	SIZE	MAF #	MAF PRICE
46920		352BV-J		1/8 x 1/8	352BV-22	----
46921		352BV-JXL		1/8 x 1/4	352BV-24	----
46922		352BV-L		1/4 x 1/4	352BV-44	



MIDLAND	AMC	CHAMPION	LIST	SIZE	MAF #	MAF PRICE
46922A				1/4 x 1/4		
46923				3/8 x 3/8		



MIDLAND	AMC	CHAMPION	LIST	SIZE	MAF #	MAF PRICE
46924				1/2 x 1/2		
46925				3/4 x 3/4		

WARNING: This product can expose you to chemicals, including lead, which are known to the State of California to cause cancer and birth defects or other reproductive harm. For more information, visit www.P65Warnings.ca.gov

MINIATURE BALL VALVES

BRASS FITTINGS

U.L. TWO WAY VALVES

- Buna-N Seal, Polytetrafluoroethylene Seat Plated metal handle, plated brass ball.
- 250 PSI Working Pressure

U.L. TWO WAY VALVES FNPT X FNPT



MIDLAND	AMC	CHAMPION	LIST	SIZE	MAF #	MAF PRICE
46440				1/4 x 1/4		

U.L. TWO WAY VALVES MNPT X FNPT



MIDLAND	AMC	CHAMPION	LIST	SIZE	MAF #	MAF PRICE
46443				1/4 x 1/4		

PANEL MOUNT BRASS BALL VALVES

- Working pressure: 1500 psi wog for 1/8" to 1/4", 1000 psi wog for 3/8" to 1/2"
- Vacuum rating: 29.92" Hg
- Working temp: -40°F to +300°F
- Panel mount hole is 9/16" Dia.
- Brass body cap, PTFE ball seats, Fluoro-elastomer stem sealing, Brass chrome plated ball

FEMALE X FEMALE



MIDLAND	AMC	CHAMPION	LIST	SIZE	MAF #	MAF PRICE
46830		362BV-J		1/8 x 1/8	352BV-22	----
46832		362BV-L		1/4 x 1/4	352BV-44	
46833		362BV-N		3/8 x 3/8	352BV-66	
46834		362BV-P		1/2 x 1/2	352BV-88	



MIDLAND	AMC	CHAMPION	LIST	SIZE	MAF #	MAF PRICE
46875		392BV-JXJ		1/8 x 1/8	392BV-22	----
46878				1/4 x 1/4	392BV-44	----

FEMALE X FEMALE X FEMALE



MIDLAND	AMC	CHAMPION	LIST	SIZE	MAF #	MAF PRICE
46951		3222BV-JJXJ		1/8 FPT		
46956		3222BV-LLXL		1/4 FPT		

FEMALE X FEMALE X FEMALE X FEMALE



MIDLAND	AMC	CHAMPION	LIST	SIZE	MAF #	MAF PRICE
		4122BV-LL		1/4 FPT		

WARNING: This product can expose you to chemicals, including lead, which are known to the State of California to cause cancer and birth defects or other reproductive harm. For more information, visit www.P65Warnings.ca.gov

BRASS

CHECK VALVES

BRASS FITTINGS

BRASS CHECK VALVES

• 500 PSI • 1 PSI Cracking Pressure • Buna-N Seal for water, air & inert gas • **Fluoroelastomer Seal for oil, gas & diesel fuel**

FIP X FIP BUNA-N

• 180° temp rating

MIDLAND	AMC	CHAMPION	LIST	SIZE	MAF #	MAF PRICE
46560				1/8"		
46561				1/4"		
46562				3/8"		
46563				1/2"		
46564				3/4"		

FIP X FIP FLUOROELASTOMER

• 180° temp rating

MIDLAND	AMC	CHAMPION	LIST	SIZE	MAF #	MAF PRICE
46560V				1/8"		
46561V				1/4"		
46562V				3/8"		
46563V				1/2"		
46564V				3/4"		

FEMALE X MALE BUNA-N

MIDLAND	AMC	CHAMPION	LIST	SIZE	MAF #	MAF PRICE
46565				1/8"		
46566				1/4"		
46567		750CV2-NXN		3/8"		
46568				1/2"		
46569				3/4"		

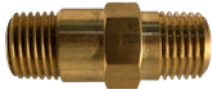
MALE X MALE

MIDLAND	AMC	CHAMPION	LIST	SIZE	MAF #	MAF PRICE
46570				1/8"		
46571				1/4"		
46572				3/8"		
46573				1/2"		

MALE X FEMALE

MIDLAND	AMC	CHAMPION	LIST	SIZE	MAF #	MAF PRICE
46575				1/8"		
46576				1/4"		
46577				3/8"		
46578				1/2"		

PNEUMATIC CHECK VALVES

• Max Operating Pressure: 220 psi • Working Pressure: 14.5-145 psi • Cracking Pressure: 2.8 psi
 • Maximum Temperatures: 140° F

Body	Chrome plated Brass
Spring	Steel
O-Ring	NBR Rubber

NPT- Inlet NPSM - Outlet



MIDLAND	AMC	CHAMPION	LIST	SIZE	MAF #	MAF PRICE
46200				1/4"		
46201				3/8"		
46202				1/2"		

CHECK VALVES

BRASS FITTINGS

HIGH PRESSURE CHECK VALVES

MNPT X MNPT MAX. 2500 PSI Cracking Pressure 1 PSI



MIDLAND	AMC	CHAMPION	LIST	SIZE	MAF #	MAF PRICE
46500				1/4 x 1/4		

•SS ball and spring • Opening diameter .187 • 180° max operating temp. CV = 0.4

MNPT X FNPT MAX. 2500 PSI



MIDLAND	AMC	CHAMPION	LIST	SIZE	MAF #	MAF PRICE
46505				1/4 x 1/4		

•SS ball and spring • Flo direction -> • Opening diameter .187 • 180° max operating temp. • Buna Seal

FNPT X FNPT MAX. 1200 PSI



MIDLAND	AMC	CHAMPION	LIST	SIZE	MAF #	MAF PRICE
46510				1/4 x 1/4		
46511		650-6F6F-B		3/8 x 3/8		
46512		850-8F8F-B		1/2 x 1/2		

• O-Ring poppet seal Bubble tight operation • 180°F max operating temp.

HIGH PRESSURE CHECK VALVES

- Operates in any position, and is available in mixed or matched end combinations.
- Standard cracking pressure 1 p.s.i. with a maximum operating pressure of 3000 p.s.i. and a maximum operating temperature of 180°F using Buna-N seals.
- Buna-N seals standard, other seals available.
- Guided 316 stainless steel ball + spring.
- Fixed ringed seat prevents extrusion of seal.
- Opening diameter .28
- Approximate CV 1.2
- Water G.P.M. @ 10 p.s.i. is 4.0
- Good for air

FEMALE X FEMALE



MIDLAND	AMC	CHAMPION	LIST	SIZE	MAF #	MAF PRICE
46513				1/4		
46517				3/8		

FEMALE X MALE

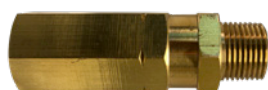

MIDLAND	AMC	CHAMPION	LIST	SIZE	MAF #	MAF PRICE
46514				1/4		
46518				3/8		

MALE X FEMALE



MIDLAND	AMC	CHAMPION	LIST	SIZE	MAF #	MAF PRICE
46516				1/4		
46539				3/8		

MALE X MALE



MIDLAND	AMC	CHAMPION	LIST	SIZE	MAF #	MAF PRICE
46515				1/4		
46519				3/8		

WARNING: This product can expose you to chemicals, including lead, which are known to the State of California to cause cancer and birth defects or other reproductive harm. For more information, visit www.P65Warnings.ca.gov

BRASS

MARINE FITTINGS

BRASS FITTINGS

MARINE FITTINGS

• Calibrated to support 30" column of gasoline.

• Flo direction <-



BRASS ANTI-SIPHON VALVES

PART #	SIZE
46520	1/4 x 1/4
46521	3/8 x 3/8
46522	1/2 x 1/2



**BRASS ANTI-SIPHON VALVES
BARB X NPT**

PART #	SIZE
46529	1/4 x 1/4
46530	5/16 x 1/4
46531	3/8 x 1/4
46532	3/8 x 3/8
46533	1/2 x 3/8

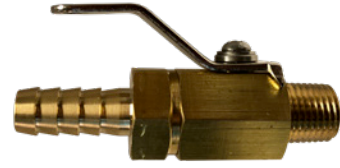

**MINI BALL VALVE - BRASS
W/ SS HANDLE AND NUT**

PART #	BARB X MIP
46986	5/6 x 1/4
46987	3/8 x 1/4
46988	3/8 x 3/8
46989	1/2 x 1/2



ALUMINUM

PART #	SIZE
46520A	1/4 x 1/4
46521A	3/8 x 3/8



ALUMINUM

PART #	SIZE
46530A	5/16 x 1/4
46531A	3/8 x 1/4
46532A	3/8 x 3/8
46533A	1/2 x 3/8

- NBR O-Ring
- Working temp 180°F
- 3,000 PSI
- Brass or Aluminum
- #316 Ball & Spring



MALE MIP X FEMALE FIP BRASS

PART #	SIZE
46523	1/4
46524	3/8



ALUMINUM

PART #	SIZE
46523A	1/4
46524A	3/8



FLARE X MIP - BRASS

PART #	SIZE	----
46526	3/8 x 1/4	

SIX-WAY VALVES

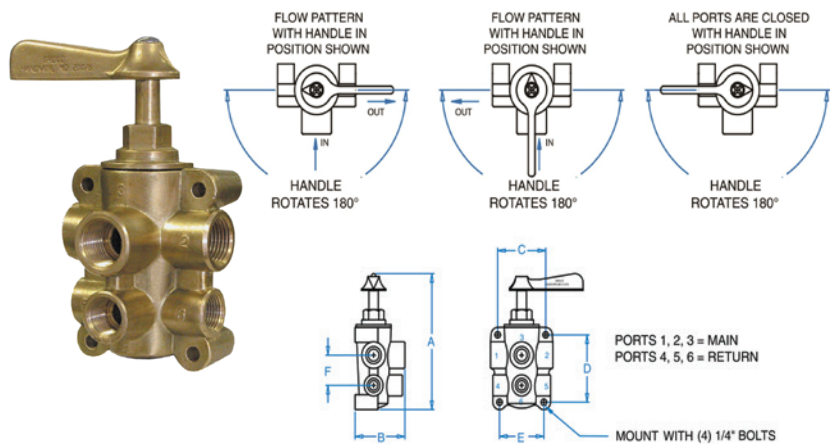

MIDLAND	CHAMPION	LIST	FEMALE PIPE THREAD OF 1-2-3 4-5-6	STEM	IND. #
46237	SP2483-CM		1/2 x 3/8	13/16	SK-1036

Six port fuel valves are used where 2 tanks supply a single engine, and a return to each supply tank is required.

ABYC H33.9.2 states that fuel system valves must have an independent means of support, so in-line valves are not suitable for fuel system applications.

WARNING: This product can expose you to chemicals, including lead, which are known to the State of California to cause cancer and birth defects or other reproductive harm. For more information, visit www.P65Warnings.ca.gov



LEAD FREE

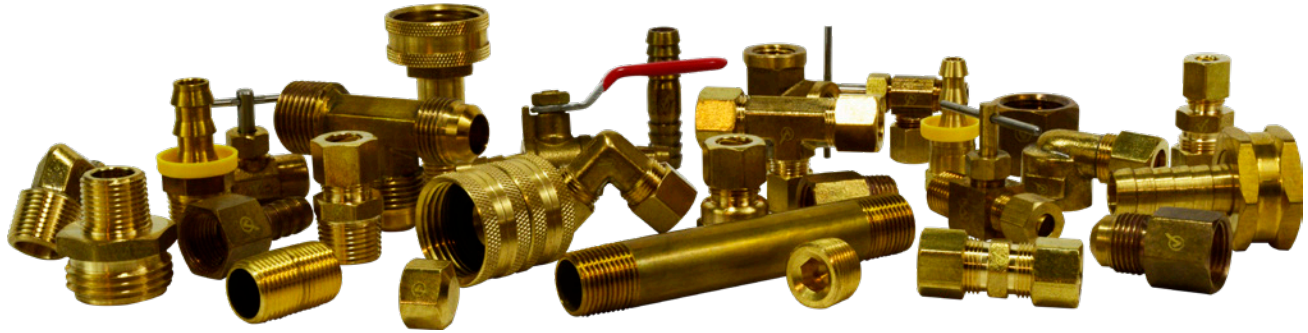

What is the new lead-free requirement?

In 2011, the Reduction of Lead in Drinking Water Act was signed into law. The Act has reduced the lead content allowed in drinking water system and plumbing materials by changing the definition of "lead-free" in Section 1417 of the Safe Drinking Water Act.

The term "lead-free" has been updated from not more than 8% lead content to mean "not more than a weighted average of 0.25% lead when used with respect to the wetted surfaces of pipes, pipe fittings, plumbing fittings and fixtures."

How do I know which products must meet the new lead-free requirement?

The prohibitions on use and introduction into commerce apply to all pipe, pipe fittings, plumbing fittings, and fixtures (henceforth referred to as "products"), including stocked inventories that have not been installed. This includes coated or uncoated brass or bronze materials. By using the flow-chart below as a guide, you can determine if a product must meet the new lead-free requirement:

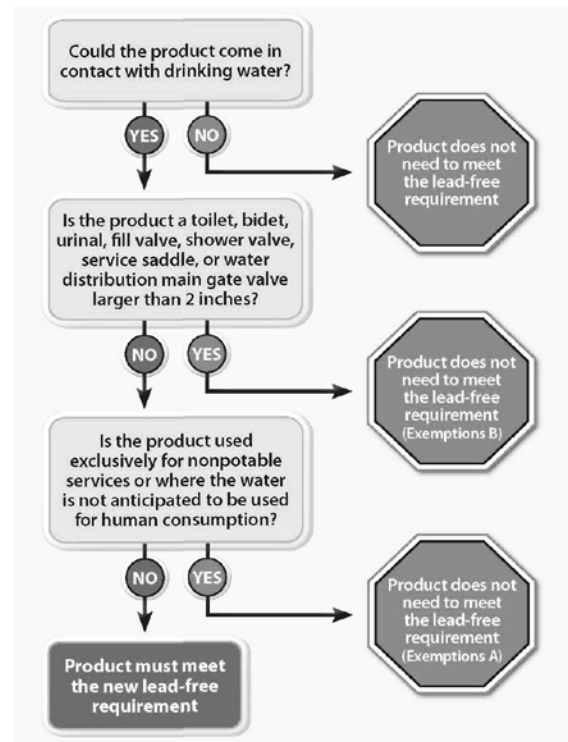

Lead-Free Requirement Exemptions

(A) The new requirement does not apply to pipes, pipe fittings, plumbing fittings, or fixtures, including backflow preventers, that are used exclusively for nonpotable service such as manufacturing, industrial processing, irrigation, outdoor watering or any other uses where the water is not anticipated to be used for human consumption.

(B) The new requirement does not apply to toilets, bidets, urinals, fill valves, flushometer valves, tub fillers, shower valves, service saddles or water distribution main gate valves 2 inches in diameter or larger.

LEAD FREE PIPE
LEAD FREE BRASS FITTINGS

BRASS PIPE FITTINGS LEAD FREE

- One piece construction, available in barstock or forgings
- Used with brass or steel pipe
- All pipe threads are "American Standard Taper Pipe Threads"
- Fair vibration resistance
- Used in low to medium pressure applications
- Teflon tape or pipe sealant is recommended
- Pipe threads should be tightened 2 1/2 turns past finger tight

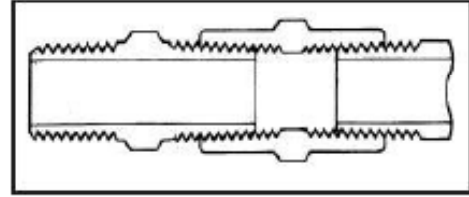

Nominal Pipe Size	1/8	1/4	3/8	1/2	3/4	1
Thread size	1/8-27	1/4-18	3/8-18	1/2-14	3/4-14	1-11 1/2
Approx. Diameter in inches	3/8"	1/2"	5/8"	3/4"	1"	1-3/8"

BRASS PIPE FITTINGS

ELBOW 90° BARSTOCK



LF100

AMC	MIDLAND	LIST	SIZE	MAF #	MAF PRICE
706100-02	28001LF		1/8"	LF100-2	
706100-04	28002LF		1/4"	LF100-4	
706100-06	28003LF		3/8"	LF100-6	
706100-08	28004LF		1/2"	LF100-8	
706100-12	28005LF		3/4"	LF100-12	

ELBOW 90° FORGED



AMC	MIDLAND	LIST	SIZE	MAF #	MAF PRICE
706200-02	28009LF		1/8"		
706200-04	28010LF		1/4"		
706200-06	28011LF		3/8"		
706200-08	28012LF		1/2"		
706200-12	28013LF		3/4"		

REDUCING ELBOW FORGED



AMC	MIDLAND	LIST	SIZE	MAF #	MAF PRICE
706205-0604	28015LF		3/8" x 1/4"	LF100R-64	

ELBOW 45°



LF10045

AMC	MIDLAND	LIST	SIZE	MAF #	MAF PRICE
706107-02	28018LF		1/8"		
706107-04	28019LF		1/4"		

TEE BARSTOCK



AMC	MIDLAND	LIST	SIZE	MAF #	MAF PRICE
706101-02	28024LF		1/8"	LF101-2	
706101-04	28025LF		1/4"	LF101-4	
706101-06	28026LF		3/8"	LF101-6	
706101-08	28027LF		1/2"	LF101-8	
706101-12	28028LF		3/4"	LF101-12	

TEE FORGED



AMC	MIDLAND	LIST	SIZE	MAF #	MAF PRICE
706201-02	28032LF		1/8"		
706201-04	28033LF		1/4"		
706201-06	28034LF		3/8"		
706201-08	28035LF		1/2"		
706201-12	28036LF		3/4"		

REDUCING TEE FORGED



AMC	MIDLAND	LIST	SIZE	MAF #	MAF PRICE
706206-060604	28039LF		3/8"x3/8"x1/4"		

CROSS BARSTOCK



AMC	MIDLAND	LIST	SIZE	MAF #	MAF PRICE
706102-02	28041LF		1/8"	LF102-2	
706102-04	28042LF		1/4"	LF102-4	
706102-06	28043LF		3/8"	LF102-6	
706102-08	28044LF		1/2"	LF102-8	
706102-12	28045LF		3/4"	LF102-12	

COUPLING



AMC	MIDLAND	LIST	SIZE	MAF #	MAF PRICE
706103-02	28058LF		1/8"	LF103-2	
706103-04	28059LF		1/4"	LF103-4	
706103-06	28060LF		3/8"	LF103-6	
706103-08	28061LF		1/2"	LF103-8	
706103-12	28062LF		3/4"	LF103-12	

X-HEAVY COUPLING



AMC	MIDLAND	LIST	SIZE	MAF #	MAF PRICE
			1/8"	LF23300X2	
706303-04	28059EHLF		1/4"	LF23300X4	
			3/8"	LF23300X6	
			1/2"	LF23300X8	

LEAD FREE PIPE

LEAD FREE BRASS FITTINGS

UNION



LF104

AMC	MIDLAND	LIST	SIZE	MAF #	MAF PRICE
706104-02	28067LF		1/8"	LF104-2	
706104-04	28068LF		1/4"	LF104-4	
706104-06	28069LF		3/8"	LF104-6	
706104-08	28070LF		1/2"	LF104-8	
706104-12	28071LF		3/4"	LF104-12	

CAP



LF108

AMC	MIDLAND	LIST	SIZE	MAF #	MAF PRICE
706108-02	28075LF		1/8"	LF108-2	
706108-04	28076LF		1/4"	LF108-4	
706108-06	28077LF		3/8"	LF108-6	
706108-08	28078LF		1/2"	LF108-8	
706108-12	28079LF		3/4"	LF108-12	

PLUG CORED SQUARE HEAD



LF

AMC	MIDLAND	LIST	SIZE	MAF #	MAF PRICE
706109-02	28084LF		1/8"	LF109-2	
706109-04	28085LF		1/4"	LF109-4	
706109-06	28086LF		3/8"	LF109-6	
706109-08	28087LF		1/2"	LF109-8	
706109-12	28088LF		3/4"	LF109-12	
			1"	LF109-16	

PLUG SOLID SQUARE HEAD



LF109SD

AMC	MIDLAND	LIST	SIZE	MAF #	MAF PRICE
706114-02	28084SLF		1/8"	LF109SD-2	
706114-04	28085SLF		1/4"	LF109SD-4	
706114-06	28086SLF		3/8"	LF109SD-6	
706114-08	28087SLF		1/2"	LF109SD-8	
706114-12	28088SLF		3/4"	LF109SD-12	
			1"	LF109SD-16	
			1 1/4"	LF109SD-20	
			1 1/2"	LF109SD-24	
			2"	LF109SD-32	

COUNTERSUNK PLUG HEX



LF109AL

AMC	MIDLAND	LIST	SIZE	MAF #	MAF PRICE
706115-02	28093LF		1/8"	LF109AL-2	
706115-04	28094LF		1/4"	LF109AL-4	
706115-06	28095LF		3/8"	LF109AL-6	
706115-08	28096LF		1/2"	LF109AL-8	
706115-12	28097LF		3/4"	LF109AL-12	

LEAD FREE PIPE
LEAD FREE BRASS FITTINGS

FACE BUSHING



LF110F

AMC	MIDLAND	LIST	SIZE	MAF #	MAF PRICE
706140-0402	28121LF		1/4" x 1/8"	LF110F-42	
			3/8" x 1/8"	LF110F-62	
706140-0604	28116LF		3/8" x 1/4"	LF110F-64	
			1/2" x 1/4"	LF110F-84	
706140-0806	28117LF		1/2" x 3/8"	LF110F-86	
			3/4" x 1/4"	LF110F-124	
			3/4" x 3/8"	LF110F-126	
706140-1208	28118LF		3/4" x 1/2"	LF110F-128	
			1" x 3/4"	LF110F-1612	

PLUG CORED HEX HEAD



LF121

AMC	MIDLAND	LIST	SIZE	MAF #	MAF PRICE
706121-02	28201LF		1/8"	LF121-2	
706121-04	28202LF		1/4"	LF121-4	
706121-06	28203LF		3/8"	LF121-6	
706121-08	28204LF		1/2"	LF121-8	
706121-12	28205LF		3/4"	LF121-12	
			1"	LF121-16	

PLUG SOLID HEX HEAD



AMC	MIDLAND	LIST	SIZE	MAF #	MAF PRICE
706125-02	28201SLF		1/8"	LF121S-2	
706125-04	28202SLF		1/4"	LF121S-4	
706125-06	28203SLF		3/8"	LF121S-6	
706125-08	28204SLF		1/2"	LF121S-8	
			3/4"	LF121S-12	
			1"	LF121S-16	

HEX BUSHING



LF110

AMC	MIDLAND	LIST	SIZE	MAF #	MAF PRICE
706110-0402	28102LF		1/4" x 1/8"	LF110-42	
706110-0602	28103LF		3/8" x 1/8"	LF110-62	
706110-0604	28104LF		3/8" x 1/4"	LF110-64	
706110-0802	28105LF		1/2" x 1/8"	LF110-82	
706110-0804	28106LF		1/2" x 1/4"	LF110-84	
706110-0806	28107LF		1/2" x 3/8"	LF110-86	
706110-1202	28108LF		3/4" x 1/8"	LF110-122	
706110-1204	28109LF		3/4" x 1/4"	LF110-124	
706110-1206	28110LF		3/4" x 3/8"	LF110-126	
706110-1208	28111LF		3/4" x 1/2"	LF110-128	
			1" x 1/8"	LF110-162	
706110-1604	28112LF		1" x 1/4"	LF110-164	
706110-1606	28113LF		1" x 3/8"	LF110-166	
706110-1608	28114LF		1" x 1/2"	LF110-168	
706110-1612	28115LF		1" x 3/4"	LF110-1612	

LEAD FREE PIPE

LEAD FREE BRASS FITTINGS

CLOSE NIPPLE



LF112

AMC	MIDLAND	LIST	SIZE	MAF #	MAF PRICE
706112-02	28131LF		1/8"	LF112-2	
706112-04	28132LF		1/4"	LF112-4	
706112-06	28133LF		3/8"	LF112-6	
706112-08	28134LF		1/2"	LF112-8	
706112-12	28135LF		3/4"	LF-112-12	

LONG NIPPLE



LF113

AMC	MIDLAND	LIST	SIZE	MAF #	MAF PRICE
706113-0224	28140LF		1/8" x 1-1/2"	LF113-224	
706113-0232	28141LF		1/8" x 2"	LF113-232	
706113-0240	28142LF		1/8" x 2-1/2"	LF113-240	
706113-0248	28143LF		1/8" x 3"	LF113-248	
706113-0424	28144LF		1/4" x 1-1/2"	LF113-424	
706113-0432	28145LF		1/4" x 2"	LF113-432	
706113-0440	28146LF		1/4" x 2-1/2"	LF113-440	
706113-0448	28147LF		1/4" x 3"	LF113-448	
706113-0624	28148LF		3/8" x 1-1/2"	LF113-624	
706113-0632	28149LF		3/8" x 2"	LF113-632	
	28150LF		3/8" x 2-1/2"	LF113-640	
			3/8" x 3"	LF113-648	
			1/2" x 1-1/2"	LF113-824	
			1/2" x 2"	LF113-832	
			1/2" x 2-1/2"	LF113-840	
			1/2" x 3"	LF113-848	

HEX NIPPLE



LF23325X
LF122

AMC	MIDLAND	LIST	SIZE	MAF #	MAF PRICE
706122-02	28211LF		1/8"	LF122-2	
706122-04	28212LF		1/4"	LF122-4	
706122-06	28213LF		3/8"	LF122-6	
706122-08	28214LF		1/2"	LF122-8	
706122-12	28215LF		3/4"	LF122-12	
706122-16	28216LF		1"	LF122-16	
			1-1/4"	LF122-20	
			1-1/2"	LF122-24	
			2"	LF122-32	

LONG HEX NIPPLE



AMC	MIDLAND	LIST	SIZE	MAF #	MAF PRICE
			1/8"	LF23325X2	
28212EHLF			1/4"	LF23325X4	
			3/8"	LF23325X6	
			1/2"	LF23325X8	

LEAD FREE PIPE
LEAD FREE BRASS FITTINGS

REDUCING HEX NIPPLE



LF123

AMC	MIDLAND	LIST	SIZE	MAF #	MAF PRICE
706123-0402	28220LF		1/4" x 1/8"	LF123-42	
706123-0602	28221LF		3/8" x 1/8"	LF123-62	
706123-0604	28222LF		3/8" x 1/4"	LF123-64	
706123-0804	28223LF		1/2" x 1/4"	LF123-84	
706123-0806	28224LF		1/2" x 3/8"	LF123-86	
706123-1208	28225LF		3/4" x 1/2"	LF123-128	

REDUCING COUPLING



LF119

AMC	MIDLAND	LIST	SIZE	MAF #	MAF PRICE
706119-0402	28181LF		1/4" x 1/8"	LF119-42	
706119-0602	28182LF		3/8" x 1/8"	LF119-62	
706119-0604	28183LF		3/8" x 1/4"	LF119-64	
706119-0802	28180LF		1/2" x 1/8"	LF119-82	
706119-0804	28184LF		1/2" x 1/4"	LF119-84	
706119-0806	28185LF		1/2" x 3/8"	LF119-86	
			3/4" x 3/8"	LF119-126	
706119-1208	28189LF		3/4" x 1/2"	LF119-128	

ADAPTER



LF120

AMC	MIDLAND	LIST	SIZE	MAF #	MAF PRICE
706120-0202	28190LF		1/8" x 1/8"	LF120-22	
706120-0402	28191LF		1/4" x 1/8"	LF120-42	
706120-0404	28192LF		1/4" x 1/4"	LF120-44	
706120-0602	28198LF		3/8" x 1/8"	LF120-62	
706120-0604	28193LF		3/8" x 1/4"	LF120-64	
706120-0606	28194LF		3/8" x 3/8"	LF120-66	
			1/2" x 1/8"	LF120-82	
706120-0804	28199LF		1/2" x 1/4"	LF120-84	
706120-0806	28195LF		1/2" x 3/8"	LF120-86	
706120-0808	28196LF		1/2" x 1/2"	LF120-88	
			3/4" x 3/8"	LF120-126	
706120-1208	28208LF		3/4" x 1/2"	LF120-128	
706120-1212	28209LF		3/4" x 3/4"	LF120-1212	
			1" x 3/4"	LF120-1612	

SHORT BARSTOCK* STREET ELBOW 90°



AMC	MIDLAND	LIST	SIZE	MAF #	MAF PRICE
706116-02	28156SLF		1/8"		
706116-04	28157SLF		1/4"		
706116-06	28158SLF		3/8"		
706116-08	28159SLF		1/2"		
706116-12	28160SLF		3/4"		

LEAD FREE PIPE

LEAD FREE BRASS FITTINGS

BARSTOCK* ST ELBOW



LF116

AMC	MIDLAND	LIST	SIZE	MAF #	MAF PRICE
706118-02	28156LF		1/8"	LF116-2	
706118-04	28157LF		1/4"	LF116-4	
706118-06	28158LF		3/8"	LF116-6	
	28159LF		1/2"	LF116-8	
	28160LF		3/4"		

FORGED* STREET ELBOW 90°



AMC	MIDLAND	LIST	SIZE	MAF #	MAF PRICE
706216-02	28165LF		1/8"		
706216-04	28166LF		1/4"		
706216-06	28167LF		3/8"		
706216-08	28168LF		1/2"	LF116F-8	
706216-12	28169LF		3/4"	LF116F-12	

FORGED* REDUCING STREET ELBOW



AMC	MIDLAND	LIST	SIZE	MAF #	MAF PRICE
706228-0402	28261LF		1/4" x 1/8"	LF128-42	
706228-0406	28262LF		1/4" x 3/8"		
706228-0608	28264LF		3/8" x 1/2"	LF128-68	
706228-0806	28265LF		1/2" x 3/8"	LF128-86	

* Forged and Barstock shapes may be substituted for one another in Lead Free.

STREET ELBOW 45°



LF124

AMC	MIDLAND	LIST	SIZE	MAF #	MAF PRICE
706124-02	28230LF		1/8"	LF124-2	
706124-04	28231LF		1/4"	LF124-4	
706124-06	28232LF		3/8"	LF124-6	
706124-08	28233LF		1/2"	LF124-8	
706124-12	28234LF		3/4"		

STREET TEE BARSTOCK



LF127

AMC	MIDLAND	LIST	SIZE	MAF #	MAF PRICE
706127-02	28245LF		1/8"	LF127-2	
706127-04	28246LF		1/4"	LF127-4	
706127-06	28247LF		3/8"	LF127-6	
706127-08	28248LF		1/2"	LF127-8	
706127-12	28249LF		3/4"	LF127-12	

STREET TEE FORGED



AMC	MIDLAND	LIST	SIZE	MAF #	MAF PRICE
706227-02	28253LF		1/8"		
706227-04	28254LF		1/4"		
706227-06	28255LF		3/8"		

LEAD FREE PIPE/LEAD FREE PUSH-ON

LEAD FREE BRASS FITTINGS

ELBOW BARSTOCK



AMC	MIDLAND	LIST	SIZE	MAF #	MAF PRICE
706130-02	28266BLF		1/8"	LF23455X2	
706130-04	28267BLF		1/4"	LF23455X4	
706230-06	28268LF		3/8"		

ELBOW FORGED



AMC	MIDLAND	LIST	SIZE	MAF #	MAF PRICE
706230-02	28266LF		1/8"		
706230-04	28267LF		1/4"		
706230-06	28268LF		3/8"		
706230-08	28269LF		1/2"		

REDUCING ELBOW



AMC	MIDLAND	LIST	SIZE	MAF #	MAF PRICE
706235-0402	28273LF		1/4" x 1/8"		
706235-0602	28272LF		3/8" x 1/8"		
706235-0604	28275LF		3/8" x 1/4"		
706235-0806	28276LF		1/2" x 3/8"		

TEE BARSTOCK



LF131

AMC	MIDLAND	LIST	SIZE	MAF #	MAF PRICE
706131-02	28281LF		1/8"	LF131-2	
706131-04	28282LF		1/4"	LF131-4	
706131-06	28283LF		3/8"	LF131-6	
706131-08	28284LF		1/2"	LF131-8	

TEE FORGED



AMC	MIDLAND	LIST	SIZE	MAF #	MAF PRICE
706232-02	28290LF		1/8"		
706232-04	28291LF		1/4"		
706232-06	28292LF		3/8"		

PUSH-ON

MALE ADAPTER



AMC	MIDLAND	LIST	HOSE I.D. X MALE NPTF	MAF #	MAF PRICE
707201-0402	30200LF		1/4" x 1/8"		
707201-0404	30201LF		1/4" x 1/4"		
707201-0604	30203LF		3/8" x 1/4"		
707201-0606	30204LF		3/8" x 3/8"		
707201-0608	30206LF		1/2" x 3/8"		
707201-0808	30207LF		1/2" x 1/2"		

SAE/JIC DUAL 45°/37° FEMALE SWIVEL



AMC	MIDLAND	LIST	HOSE I.D. X FEMALE 45°/37°	MAF #	MAF PRICE
707210-0404	30230LF		1/4" x 1/4"		

LEAD FREE PIPE HOSE BARBS

LEAD FREE BRASS FITTINGS

BRASS HOSE BARBS LEAD FREE

- One piece, except swivels (nut and stem)
- Used with plastic tubing or rubber hose
- -40° to 200° F. temperature range
- Intended for use with hose clamp or crimp type ferrule

- Barbed edges provide positive connection
- Excellent vibration resistance
- Barb size is hose I.D.

RIGID MALE ADAPTER



LF29

AMC	MIDLAND	LIST	HOSE I.D. X MALE NPTF	MAF	MAF PRICE
707001-0202	32001LF	----	1/8" x 1/8"	LF29-22	
707001-0204	32027LF	----	1/8" x 1/4"	LF29-24	
707001-0302	32002LF	----	3/16" x 1/8"	LF29-32	
707001-0304	32003LF	----	3/16" x 1/4"	LF29-34	
707001-0402	32004LF	----	1/4" x 1/8"	LF29-42	
707001-0404	32005LF	----	1/4" x 1/4"	LF29-44	
707001-0406	32006LF	----	1/4" x 3/8"	LF29-46	
707001-0408	32007LF	----	1/4" x 1/2"	LF29-48	
	32954LF	----	1/4" x 3/4"	LF29-42	
707001-0502	32008LF	----	5/16" x 1/8"	LF29-52	
707001-0504	32009LF	----	5/16" x 1/4"	LF29-54	
707001-0506	32010LF	----	5/16" x 3/8"	LF29-56	
707001-0602	32011LF	----	3/8" x 1/8"	LF29-62	
707001-0604	32012LF	----	3/8" x 1/4"	LF29-64	
707001-0606	32013LF	----	3/8" x 3/8"	LF29-66	
707001-0608	32014LF	----	3/8" x 1/2"	LF29-68	
707001-0612	32026LF	----	3/8" x 3/4"	LF29-612	
707001-0804	32015LF	----	1/2" x 1/4"	LF29-84	
707001-0806	32016LF	----	1/2" x 3/8"	LF29-86	
707001-0808	32017LF	----	1/2" x 1/2"	LF29-88	
707001-0812	32018LF	----	1/2" x 3/4"	LF29-812	
707001-1006	32019LF	----	5/8" x 3/8"	LF29-106	
707001-1008	32020LF	----	5/8" x 1/2"	LF29-108	
707001-1012	32021LF	----	5/8" x 3/4"	LF29-1012	
707001-1206	32306LF	----	3/4" x 3/8"	LF29-126	
707001-1208	32022LF	----	3/4" x 1/2"	LF29-128	
707001-1212	32023LF	----	3/4" x 3/4"	LF29-1212	
707001-1612	32024LF	----	1" x 3/4"	LF29-1612	
707001-1616	32025LF	----	1" x 1"	LF29-1616	

LEAD FREE HOSE BARBS

LEAD FREE BRASS FITTINGS

RIGID FEMALE ADAPTER



LF29F

AMC	MIDLAND	LIST	HOSE I.D. X FEMALE NPTF	MAF	MAF PRICE
707002-0202	32050LF	----	1/8" x 1/8"	LF29F-22	
707002-0204	32317LF	----	1/8" x 1/4"	LF29F-24	
707002-0302	32051LF	----	3/16" x 1/8"	LF29F-32	
707002-0304	32062LF	----	3/16" x 1/4"	LF29F-34	
707002-0402	32052LF	----	1/4" x 1/8"	LF29F-42	
707002-0404	32053LF	----	1/4" x 1/4"	LF29F-44	
707002-0406	32054LF	----	1/4" x 3/8"	LF29F-46	
	32441LF	----	1/4" x 1/2"	LF29F-48	
707002-0502	32055LF	----	5/16" x 1/8"	LF29F-52	
707002-0504	32056LF	----	5/16" x 1/4"	LF29F-54	
707002-0506	32318LF	----	5/16" x 3/8"	LF29F-56	
	32057LF	----	3/8" x 1/8"	LF29F-62	
707002-0604	32058LF	----	3/8" x 1/4"	LF29F-64	
707002-0606	32059LF	----	3/8" x 3/8"	LF29F-66	
707002-0608	32063LF	----	3/8" x 1/2"	LF29F-68	
707002-0804	32064LF	----	1/2" x 1/4"	LF29F-84	
707002-0806	32060LF	----	1/2" x 3/8"	LF29F-86	
707002-0808	32061LF	----	1/2" x 1/2"	LF29F-88	
			5/8" x 3/8"	LF29F-106	
			5/8" x 1/2"	LF29F-108	
707002-1212	32065LF	----	3/4" x 3/4"	LF29F-1212	

LEAD FREE HOSE BARBS

LEAD FREE BRASS FITTINGS

FORGED HOSE BARB 90° ELBOW



LF29EBS

AMC	MIDLAND	LIST	HOSE I.D. X MALE NPTF	MAF	MAF PRICE
707020-0402	32038LF	----	1/4" x 1/8"		
707020-0404	32039LF	----	1/4" x 1/4"	LF29E-44BS	
	32309LF	----	1/4" x 3/8"		
707020-0502	32036LF	----	5/16" x 1/8"		
707020-0504	32040LF	----	5/16" x 1/4"		
707020-0602	32046LF	----	3/8" x 1/8"		
707020-0604	32041LF	----	3/8" x 1/4"	LF29E-64BS	
707020-0606	32042LF	----	3/8" x 3/8"	LF29E-66BS	
707020-0608	32047LF	----	3/8" x 1/2"		
707020-0804	32048LF	----	1/2" x 1/4"		
707020-0806	32043LF	----	1/2" x 3/8"		
707020-0808	32311LF	----	1/2" x 1/2"		
	32313LF	----	3/4" x 1/2"		

HOSE BARB TEES



AMC	MIDLAND	LIST	HOSE BARB SIZE	MAF	MAF PRICE
707024-04	32365LF	----	1/4"		
707024-05	32366LF	----	5/16"		
707024-06	32126LF	----	3/8"		

MENDER/ SPLICER



AMC	MIDLAND	LIST	HOSE I.D. X HOSE I.D.	MAF	MAF PRICE
	32091LF	----	1/8"	LF29S-2	
707014-03	32092LF	----	3/16"	LF29S-3	
707014-04	32093LF	----	1/4"	LF29S-4	
707014-05	32094LF	----	5/16"	LF29S-5	
707014-06	32095LF	----	3/8"	LF29S-6	
707014-08	32096LF	----	1/2"	LF29S-8	
707014-10	32097LF	----	5/8"	LF29S-10	
707014-12	32098LF	----	3/4"	LF29S-12	

FEMALE 45° FLARE SWIVEL



AMC	MIDLAND	LIST		MAF	MAF PRICE
707010-0606	32105LF	----	3/8" x 3/8"		
707010-0808	32100LF	----	1/2" x 1/2"		

LEAD FREE GARDEN HOSE

LEAD FREE BRASS FITTINGS

LEAD FREE MINI BALL VALVES BARB X BARB



AMC	MIDLAND	LIST	H.B. X H.B.	MAF	MAF PRICE
	944142LF	----	1/4"		
	944134LF	----	3/8"		

BARSTOCK BRASS GARDEN HOSE COUPLINGS

FEMALE SWIVEL ONLY

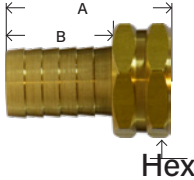

LF29FGH
• WASHER INCLUDED

AMC	MIDLAND	LIST	HOSE BARB X FGH	MAF	MAF PRICE
			1/4" x 3/4"	LF29FGH-412	
707046-0612	30031LF		3/8" x 3/4"	LF29FGH-612	
707046-0812	30032LF		1/2" x 3/4"	LF29FGH-812	
707046-1012	30033LF		5/8" x 3/4"	LF29FGH-1012	
707046-1212	30034LF		3/4" x 3/4"	LF29FGH-1212	

MALE END ONLY

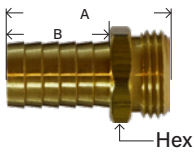

LF29MGH

AMC	MIDLAND	LIST	HOSE BARB X MGH	MAF	MAF PRICE
			1/4" x 3/4"	LF29MGH-412H	
707048-0612	30039LF	----	3/8" x 3/4"	LF29MGH-612H	
707048-0812	30040LF	----	1/2" x 3/4"	LF29MGH-812H	
707048-1012	30041LF	----	5/8" x 3/4"	LF29MGH-1012H	
707048-1212	30042LF	----	3/4" x 3/4"	LF29MGH-1212H	

GARDEN HOSE COUPLING



• WASHER INCLUDED

AMC	MIDLAND	LIST	HOSE BARB	MAF	MAF PRICE
			1/4"	LF29GHS-4H	
707042-06	30025LF	----	3/8"	LF29GHS-6H	
707042-08	30027LF	----	1/2"	LF29GHS-8H	
707042-10	30028LF	----	5/8"	LF29GHS-10H	
707042-12	30029LF	----	3/4"	LF29GHS-12H	

SWIVEL - FGH X FGH



LF53
• WASHER INCLUDED

AMC	MIDLAND	LIST	FGH X FGH	MAF	MAF PRICE
707403-12	30011LF	----	3/4" x 3/4"	LF53	
707402-12	30012LF	----	no swivel	LF13GH	

LEAD FREE GARDEN HOSE

LEAD FREE BRASS FITTINGS

SWIVEL - FGH X FEMALE PIPE



LFS1
LFS2

• WASHER INCLUDED

AMC	MIDLAND	LIST	FGH X FEMALE NPTF	MAF	MAF PRICE
707401-1208	30001LF	----	3/4" x 1/2"	LFS1	
707401-1212	30006LF	----	3/4" x 3/4"	LFS2	

RIGID - FGH X FEMALE PIPE



• WASHER INCLUDED

AMC	MIDLAND	LIST	FGH X FEMALE NPTF	MAF	MAF PRICE
707411-1202	30016LF	----	3/4" x 1/8"	LF73GH	
707482-1208	30078LF	----	3/4" x 1/2"	LF82GH	
707482-1212	30083LF	----	3/4" x 3/4"	LF83GH	

SWIVEL - FGH X MALE PIPE



• WASHER INCLUDED

AMC	MIDLAND	LIST	FGH X MALE NPTF	MAF	MAF PRICE
707420-1204	30047LF	----	3/4" x 1/4"	LF102GH	
707420-1206	30048LF	----	3/4" x 3/8"	LF103GH	
707420-1208	30049LF	----	3/4" x 1/2"	LF104GH	
			3/4" x 3/4"	LF105GH	

RIGID - FGH X MALE PIPE



• WASHER INCLUDED

AMC	MIDLAND	LIST	FGH X FEMALE NPTF	MAF	MAF PRICE
	30088LF	----	3/4" x 1/2" (1/2" SWT)	LF84GHS	
707484-121208	30094LF		3/4" x 3/4" (1/2" FIP)	LF85GHT	

RIGID - MGH X MGH



LF85GHT

AMC	MIDLAND	LIST	MGH X MGH	MAF	MAF PRICE
707486-121208	30098LF	----	3/4" x 3/4" (1/2" FIP)	LF86GHT	
707486-1212	30099LF		3/4" x 3/4"		

RIGID - MGH X FEMALE PIPE



LF110GH-124

AMC	MIDLAND	LIST	MGH X FEMALE NPTF	MAF	MAF PRICE
707480-1204	30066LF	----	3/4" x 1/4"	LF74GH	
			3/4" x 1/4"	LF110GH-124	
707480-1206	30067LF	----	3/4" x 3/8"	LF80GH-126	
707480-1208	30068LF	----	3/4" x 1/2"	LF80GH	
707480-1212	30073LF	----	3/4" x 3/4"	LF81GH	

LEAD FREE GARDEN HOSE

LEAD FREE BRASS FITTINGS

RIGID - MGH X MALE PIPE



LF68GH1216

AMC	MIDLAND	LIST	MGH X MALE NPTF	MAF	MAF PRICE
		----	3/4" x 1/4"	LF76GH	
707478-1206	30053LF	----	3/4" x 3/8"	LF77GH	
707478-1208	30058LF	----	3/4" x 1/2"	LF78GH	
707478-120808	30058SLF	----	3/4" x 1/2" (1/2" SWT)	LF78GHS	
707478-121208	30063LF	----	3/4" x 3/4" x 1/2"	LF79GHT	
			3/4" x 3/4"	LF79GH	
			3/4" x 1"	LF68GH-1216	

CAST BRASS HOSE - "Y" CONNECTOR

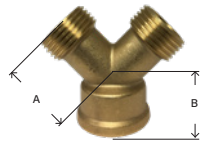

LFHY12

AMC	MIDLAND	LIST	SIZE FGH X MGH(2)	MAF	MAF PRICE
707461-12	30140LF	----	3/4"		

GARDEN HOSE CAP



LFHC-12W

AMC	MIDLAND	LIST	SIZE	MAF	MAF PRICE
707404-12	30103LF	----	3/4" Die Cast	LFHC-12W	

GARDEN HOSE NUT



30-021LF



30-022LF

AMC	MIDLAND	LIST	SIZE	MAF	MAF PRICE
707407-12	30021LF	----	Knurled	LFGHNK	
707406-12	30022LF	----	Hex Nut	LFGHNH	

EVAPORATING COOLER ADAPTERS



LFECF12H

* Pipe Threads
** Garden
Hose Threads

AMC	MIDLAND	LIST	SIZE	MAF #	MAF PRICE
	30019LF		3/4" x 3/4"	LFECF12*	22.99
	30020LF		3/4" x 3/4"	LFECF12H**	19.63
	30013LF		1/2" x 1/2"	LFECF8*	15.70

LEAD FREE FLARE
LEAD FREE BRASS FITTINGS

SAE 45° brass flare fittings

- Two pieces construction – nut and body
- Use with copper, brass, aluminum, or steel tubing
- -40° to +250° F. temperature range
- Resists mechanical pullout
- Easy to disassemble and can be reassembled many times, with no effect on the seal
- Primary uses: fuel equipment, plumbing, gases, refrigeration, and vacuum lines
- Meet functional requirements for SAE, ASME and ASA codes for pressure piping



TO ASSEMBLE:

- 1 Cut smooth, square end on tubing
- 2 Slide nut onto tube - threads facing end
- 3 Flare end of tube
- 4 Thread nut to body until snug, then

Tube O.D.	1/8	3/16	1/4	5/16	3/8	7/16	1/2	5/8	3/4	7/8	1
Thread Size	5/16-24	3/8-24	7/16-20	1/2-20	5/8-18	11/16-16	3/4-16	7/8-14	11/16-14	1-1/4-12	1 3/8-12

SHORT ROD NUT



LF41S
LF41XS

AMC	MIDLAND	LIST	THREAD SIZE UNF	MAF	MAF PRICE
704014-02	10013LF	----	1/8"	LF41S-2	
704014-03	10014LF	----	3/16"	LF41S-3	
704014-04	10015LF	----	1/4"	LF41S-4	
704014-05	10016LF	----	5/16"	LF41S-5	
704014-06	10017LF	----	3/8"	LF41S-6	
	10018LF	----	7/16"	LF41S-7	
704014-08	10019LF	----	1/2"	LF41S-8	
704014-10	10020LF	----	5/8"	LF41S-10	
704014-12	10021LF	----	3/4"	LF41S-12	

SHORT FORGED NUT



AMC	MIDLAND	LIST	THREAD SIZE UNF	MAF	MAF PRICE
704018-04	10039LF	----	1/4"	LF41XS-4	
704018-06	10041LF	----	3/8"	LF41XS-6	
704020-0604	10052LF	----	3/8" x 1/4"	LF41XSR-64	
704018-08	10042LF	----	1/2"	LF41XS-8	
704020-0806	10054LF	----	1/2" x 3/8"	LF41XSR-86	
704018-10	10043LF	----	5/8"	LF641S-10	
704020-1008	10056LF	----	5/8" x 1/2"		
704018-12	10044LF	----	3/4"		

LEAD FREE FLARE
LEAD FREE BRASS FITTINGS

UNION



LF242

AMC	MIDLAND	LIST	THREAD SIZE UNF	MAF	MAF PRICE
704042-02	10104LF	----	1/8"	LF242X2	
704042-03	10105LF	----	3/16"	LF242X3	
704042-04	10106LF	----	1/4"	LF242X4	
704042-05	10107LF	----	5/16"	LF262X5	
704042-06	10108LF	----	3/8"	LF242X6	
704056-0604	10118LF	----	3/8" x 1/4"	LF242X6x4	
704042-08	10109LF	----	1/2"	LF242X8	
704056-0804	10120LF	----	1/2" x 1/4"	LF242X8x4	
704056-0806	10121LF	----	1/2" x 3/8"	LF242X8X6	
704042-10	10110LF	----	5/8"	LF242X10	
704056-1006	10122LF	----	5/8" x 3/8"	LF242X10x6	
704056-1008	10123LF	----	5/8" x 1/2"	LF242X10X8	
704042-12	10111LF	----	3/4"	LF242X12	

CAP



LF40

AMC	MIDLAND	LIST	THREAD SIZE UNF	MAF	MAF PRICE
704040-04	10075LF	----	1/4"	LF40-4	
704040-05	10076LF	----	5/16"	LF40-5	
704040-06	10077LF	----	3/8"	LF40-6	
704040-08	10078LF	----	1/2"	LF40-8	
704040-10	10079LF	----	5/8"	LF40-10	
	10080LF	----	3/4"	LF40-12	

UNION TEE



AMC	MIDLAND	LIST	SIZE (1 X 2 X 3)	MAF	MAF PRICE
704044-02	10157LF	----	1/8"		
704044-03	10158LF	----	3/16"		
704044-04	10159LF	----	1/4"		
704044-05	10160LF	----	5/16"		
704044-06	10161LF	----	3/8"		
704044-08	10162LF	----	1/2"		
704044-10	10163LF	----	5/8"		

REDUCING UNION TEE

AMC	MIDLAND	LIST	SIZE (1 X 2 X 3)	MAF	MAF PRICE
704059-060604	10174LF	----	3/8" x 3/8" x 1/4"		
704059-060608	10175LF	----	3/8" x 3/8" x 1/2"		
704059-080806	10181LF	----	1/2" x 1/2" x 3/8"		
704059-080810	10182LF	----	1/2" x 1/2" x 5/8"		
704059-101008	10189LF	----	5/8" x 5/8" x 1/2"		

LEAD FREE FLARE
LEAD FREE BRASS FITTINGS

PLUG



LF39

AMC	MIDLAND	LIST	THREAD SIZE UNF	MAF	MAF PRICE
704039-04	10064LF	----	1/4"	LF39-4	
704039-06	10066LF	----	3/8"	LF39-6	
704039-08	10067LF	----	1/2"	LF39-8	
704039-10	10068LF	----	5/8"	LF39-10	

FEMALE ADAPTER



LF46

AMC	MIDLAND	LIST	MALE FLARE X FEMALE NPTF	MAF	MAF PRICE
704046-0302	10227LF	----	3/16" x 1/8"		
704046-0402	10228LF	----	1/4" x 1/8"	LF46-42	
704046-0404	10229LF	----	1/4" x 1/4"	LF46-44	
704046-0406	10230LF	----	1/4" x 3/8"	LF46-46	
704046-0408	10231LF	----	1/4" x 1/2"		
704046-0502	10232LF	----	5/16" x 1/8"		
704046-0504	10233LF	----	5/16" x 1/4"		
704046-0602	10234LF	----	3/8" x 1/8"		
704046-0604	10235LF	----	3/8" x 1/4"	LF46-64	
704046-0606	10236LF	----	3/8" x 3/8"	LF46-66	
704046-0608	10237LF	----	3/8" x 1/2"	LF46-68	
704046-0612	10238LF	----	3/8" x 3/4"	LF46-612	
704046-0804	10239LF	----	1/2" x 1/4"	LF46-84	
704046-0806	10240LF	----	1/2" x 3/8"	LF46-86	
704046-0808	10241LF	----	1/2" x 1/2"	LF46-88	
704046-0812	10242LF	----	1/2" x 3/4"	LF46-812	
704046-1006	10243LF	----	5/8" x 3/8"		
704046-1008	10244LF	----	5/8" x 1/2"	LF46-108	
704046-1012	10245LF	----	5/8" x 3/4"	LF46-1012	
704046-1212	10247LF	----	3/4" x 3/4"	LF46-1212	

MALE BRANCH TEE



AMC	MIDLAND	LIST	SIZE	MAF	MAF PRICE
704045-0402	10204LF	----	1/4" x 1/8"		
704045-0404	10205LF	----	1/4" x 1/4"		
704045-0406	10206LF	----	1/4" x 3/8"		
704045-0604	10210LF	----	3/8" x 1/4"		
704045-0606	10211LF	----	3/8" x 3/8"		
704045-0608	10212LF	----	3/8" x 1/2"		
704045-0806	10214LF	----	1/2" x 3/8"		
704045-0808	10215LF	----	1/2" x 1/2"		
704045-1008	10218LF	----	5/8" x 1/2"		

FORGED SWIVEL



LF700

AMC	MIDLAND	LIST	FEMALE FLARE UNF	MAF	MAF PRICE
704070-04	10481LF	----	1/4"	LF700-4	
704070-05	10482LF	----	5/16"		
704070-06	10483LF	----	3/8"	LF700-6	
704070-08	10484LF	----	1/2"	LF700-8	
704070-10	10485LF	----	5/8"	LF700-10	
704075-0604	10487LF	----	3/8" x 1/4"	LF700R-64	
704075-0806	10488LF	----	1/2" x 3/8"	LF700R-86	

MALE ADAPTER



LF48
LF248

AMC	MIDLAND	LIST	MALE FLARE X MALE NPTF	MAF	MAF PRICE
704048-0202	10253LF	----	1/8" x 1/8"	LF48-22	
704048-0302	10254LF	----	3/16" x 1/8"	LF48-32	
704048-0304	10252LF	----	3/16" x 1/4"	LF48-34	
704048-0402	10255LF	----	1/4" x 1/8"	LF48-42	
704048-0404	10256LF	----	1/4" x 1/4"	LF48-44	
704448-0404	10256EHLF	----	1/4" x 1/4"	LF48-248X4X4	
704048-0406	10257LF	----	1/4" x 3/8"	LF48-46	
704048-0408	10258LF	----	1/4" x 1/2"	LF48-48	
704048-0502	10259LF	----	5/16" x 1/8"		
704048-0504	10260LF	----	5/16" x 1/4"		
704048-0506	10261LF	----	5/16" x 3/8"		
704048-0508	10251LF	----	5/16" x 1/2"		
704048-0602	10262LF	----	3/8" x 1/8"	LF48-62	
704048-0604	10263LF	----	3/8" x 1/4"	LF48-64	
			3/8" x 1/4"	LF248X6	
704048-0606	10264LF	----	3/8" x 3/8"	LF48-66	
704048-0608	10265LF	----	3/8" x 1/2"	LF48-68	
704048-0612	10266LF	----	3/8" x 3/4"	LF48-612	
704048-0804	10267LF	----	1/2" x 1/4"	LF48-84	
704048-0806	10268LF	----	1/2" x 3/8"	LF48-86	
704048-0808	10269LF	----	1/2" x 1/2"	LF48-88	
704048-0812	10270LF	----	1/2" x 3/4"	LF48-812	
704048-1006	10272LF	----	5/8" x 3/8"	LF48-106	
704048-1008	10273LF	----	5/8" x 1/2"	LF48-108	
704048-1012	10274LF	----	5/8" x 3/4"	LF48-1012	
704048-1208	10275LF	----	3/4" x 1/2"	LF48-128	
704048-1212	10276LF	----	3/4" x 3/4"	LF48-1212	
704048-1412	10278LF	----	7/8" x 3/4"	LF48-1412	

LEAD FREE FLARE
LEAD FREE BRASS FITTINGS

UNION ELBOW



BS
LF255B

AMC	MIDLAND	LIST	FLARE X FLARE	MAF	MAF PRICE
704055-04	10406LF	----	1/4"	LF255X4	
704055-05	10407LF	----	3/8"	LF55F-6	
704055-08	10409LF	----	1/2"		
704057-0806	10419LF	----	1/2" x 3/8"		
704055-10	10410LF		5/8"		

FLARE X FIP TEE



AMC	MIDLAND	LIST	FLARE X FLARE X FE PIPE	MAF	MAF PRICE
704058-080808	10434LF	----	1/2" x 1/2" x 1/2"		

90° MALE ELBOW



LF249B
BS

AMC	MIDLAND	LIST	FLARE X MALE PIPE	MAF	MAF PRICE
704049-0302	10284LF	----	3/16" x 1/8"		
704049-0402	10286LF	----	1/4" x 1/8"	LF249X4X2	
704049-0404	10287LF	----	1/4" x 1/4"	LF249X4X4	
704049-0406	10288LF	----	1/4" x 3/8"	LF249X4X6	
704049-0408	10289LF	----	1/4" x 1/2"		
704049-0502	10290LF	----	5/16" x 1/8"	LF249X5	
704049-0504	10291LF	----	5/16" x 1/4"	LF249X5X4	
704049-0602	10293LF	----	3/8" x 1/8"	LF249X6X2	
704049-0604	10294LF	----	3/8" x 1/4"	LF249X6X4	
704049-0606	10295LF	----	3/8" x 3/8"	LF249X6X6	
704049-0608	10296LF	----	3/8" x 1/2"	LF249X6X8	
704049-0612	10297LF	----	3/8" x 3/4"	LF249X6X12	
704049-0804	10298LF	----	1/2" x 1/4"	LF249X8X4	
704049-0806	10299LF	----	1/2" x 3/8"	LF249X8X6	
704049-0808	10300LF	----	1/2" x 1/2"	LF249X8X8	
704049-0812	10301LF	----	1/2" x 3/4"	LF249X8X12	
704049-1006	10302LF	----	5/8" x 3/8"		
704049-1008	10303LF	----	5/8" x 1/2"	LF249X10	
704049-1012	10304LF	----	5/8" x 3/4"		
704049-1208	10305LF	----	3/4" x 1/2"	LF249X12	
704049-1212	10306LF	----	3/4" x 3/4"	LF249X12X12	



LEAD FREE FLARE

LEAD FREE BRASS FITTINGS

FEMALE ELBOW



AMC	MIDLAND	LIST	FLARE X FEMALE PIPE	MAF	MAF PRICE
704050-0402	10313LF	----	1/4" x 1/8"		
704050-0404	10314LF	----	1/4" x 1/4"		
704050-0604	10319LF	----	3/8" x 1/4"		
704050-0606	10320LF	----	3/8" x 3/8"		
704050-0608	10321LF	----	3/8" x 1/2"		
704050-0612	10322LF	----	3/8" x 3/4"		
704050-0806	10324LF	----	1/2" x 3/8"		
704050-0808	10325LF	----	1/2" x 1/2"		
704050-0812	10326LF	----	1/2" x 3/4"		
704050-1008	10328LF	----	5/8" x 1/2"		
704050-1012	10329LF	----	5/8" x 3/4"		
704050-1212	10331LF	----	3/4" x 3/4"		

LEAD FREE COMPRESSION

LEAD FREE BRASS FITTINGS

BRASS COMPRESSION FITTINGS - LEAD FREE

- Three piece construction- nut, sleeve (or ferrule) and body
- Use with copper, aluminum, or plastic tubing (plastic requires 60P sleeve and 61P insert)
- -40° to +250° F. temperature range
- Easy to disassemble, no flaring tool required
- Primary uses: water, gasoline, oil, and vacuum lines

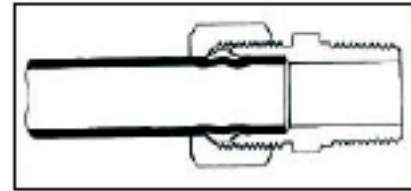

TO ASSEMBLE:

- 1 Cut smooth, square end on tubing
- 2 Slide nut, then sleeve onto tube. Threads must face end
- 3 Insert tube into fitting
- 4 Thread nut onto fitting until snug, then as follows:

Tube O.D.	1/8	3/16	1/4	5/16	3/8	7/16	1/2	5/8	3/4	7/8
Thread Size	5/16-24	3/8-24	7/16-24	1/2-24	9/16-24	5/8-24	11/16-20	13/16-18	1-18	1-1/8-18

BRASS COMPRESSION FITTINGS

BRASS SLEEVE



LF260
• FERRULES

AMC	MIDLAND	LIST	SIZE	MAF	MAF PRICE
700060-02	18001LF	----	1/8"	LF260X2	
700060-03	18002LF	----	3/16"	LF260X3	
700060-04	18003LF	----	1/4"	LF260X4	
700060-05	18004LF	----	5/16"	LF260X5	
700060-06	18005LF	----	3/8"	LF260X6	
700060-07	18006LF	----	7/16"	LF260X7	
700060-08	18007LF	----	1/2"	LF260X8	
700060-10	18008LF	----	5/8"	LF260X10	
700060-12	18009LF	----	3/4"	LF260X12	
700060-14	18010LF	----	7/8"	LF260X14	

60 260

DELTRIN SLEEVE



AMC	MIDLAND	LIST	SIZE	MAF	MAF PRICE
00560-04	18015	----	1/4"	60P-4	
00560-05	18016	----	5/16"	60P-5	
00560-06	18017	----	3/8"	60P-6	
00560-08	18018	----	1/2"	60P-8	
00560-10	18019	----	5/8"	60P-10	

60-P

BRASS NUT



LF261

AMC	MIDLAND	LIST	SIZE	MAF	MAF PRICE
700061-02	18033LF	----	1/8"	LF261X2	
700061-03	18034LF	----	3/16"	LF261X3	
700061-04	18035LF	----	1/4"	LF261X4	
700061-05	18036LF	----	5/16"	LF261X5	
700061-06	18037LF	----	3/8"	LF261X6	
700061-07	18038LF	----	7/16"	LF261X7	
700061-08	18039LF	----	1/2"	LF261X8LP	
700061-10	18040LF	----	5/8"	LF261X10	
700061-12	18041LF	----	3/4"	LF261X12	
700061-14	18042LF	----	7/8"	LF261X14	

BRASS INSERT



· SLEEVE

AMC	MIDLAND	LIST	SIZE	MAF	MAF PRICE
700561-02	22008LF	----	1/8"	63P-2	
700561-03	22009LF	----	3/16"	63P-3	
700561-04	22010LF	----	1/4"	63P-4	
700561-05	22011LF	----	5/16"	63P-5	
700561-06	22012LF	----	3/8"	63P-6	
700561-08	22013LF	----	1/2"	63P-8	
700561-10	22014LF		5/8"		

BRASS NUT W/ CAPTIVE SLEEVE



LF611X6

AMC	MIDLAND	LIST	SIZE	MAF	MAF PRICE
700261-02	26001LF	----	1/8"		
700261-03	26002LF	----	3/16"		
700261-04	26003LF	----	1/4"	LF261CAX4	
700261-05	26004LF	----	5/16"		
700261-06	26005LF	----	3/8"	LF261CAX6	
700261-08	26007LF	----	1/2"	LF261CAX8	
700261-10	26008LF	----	5/8"		
700261-12	26015LF	----	3/4"		
700261-14	26016LF	----	7/8"		

CAP



AMC	MIDLAND	LIST	SIZE	MAF	MAF PRICE
700081-04	18047LF	----	1/4"	LF61CC-4	
700081-05	18046LF	----	5/16"	LF61CC-5	
700081-06	18048LF	----	3/8"	LF61CC-6	
700081-08	18049LF	----	1/2"	LF61CC-8	
700081-10	18050LF	----	5/8"	LF61CC-10	

LEAD FREE COMPRESSION

LEAD FREE BRASS FITTINGS

UNION

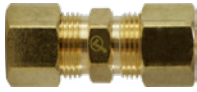

LF262

AMC	MIDLAND	LIST	SIZE	MAF	MAF PRICE
700062-02	18062LF	----	1/8"	LF262X2	
700062-03	18063LF	----	3/16"	LF262X3	
700062-04	18064LF	----	1/4"	LF262X4	
700062-05	18065LF	----	5/16"	LF262X5	
700062-06	18066LF	----	3/8"	LF262X6	
700062-07	18067LF	----	7/16"		
700062-08	18068LF	----	1/2"	LF262X8	
700062-10	18069LF	----	5/8"	LF62-10	
700062-12	18070LF	----	3/4"	LF62-12	
700062-14	18071LF	----	7/8"	LF62-14	

M-62

REDUCING UNION



LF62R

AMC	MIDLAND	LIST	SIZE	MAF	MAF PRICE
700082-0402	18076LF	----	1/4" x 1/8"	LF62R-42	
700082-0403	18077LF	----	1/4" x 3/16"	LF62R-43	
700082-0504	18078LF	----	5/16" x 1/4"	LF62R-54	
700082-0604	18079LF	----	3/8" x 1/4"	LF62R-64	
700082-0605	18080LF	----	3/8" x 5/16"	LF62R-65	
700082-0806	18081LF	----	1/2" x 3/8"	LF62R-86	
700082-1006	18082LF	----	5/8" x 3/8"	LF62R-106	
700082-1008	18083LF	----	5/8" x 1/2"	LF62R-108	

62-R

TANK UNION



LF62T

• DRILLED THROUGH

AMC	MIDLAND	LIST	SIZE	MAF	MAF PRICE
700092-06	18066DLF	----	3/8"	LF62T-6	
700092-08	18068DLF	----	1/2"	LF62T-8	
700092-10	18069DLF	----	5/8"	LF62T-10	
700092-14	18071DLF	----	7/8"	LF62T-14	

TEE



LF264B

AMC	MIDLAND	LIST	SIZE	MAF	MAF PRICE
700064-02	18101LF	----	1/8"		
700064-03	18102LF	----	3/16"	LF264X3	
700064-04	18103LF	----	1/4"	LF264X4	
700064-05	18104LF	----	5/16"	LF264X5	
700064-06	18105LF	----	3/8"	LF264X6	
700064-08	18106LF	----	1/2"	LF264X8	
700064-10	18107LF	----	5/8"	LF264X10	
700064-14	18109LF	----	7/8"	LF64-14	

LEAD FREE COMPRESSION

LEAD FREE BRASS FITTINGS

REDUCING TEE



AMC	MIDLAND	LIST	SIZE (1 X 2 X 3)	MAF	MAF PRICE
700084-040402	18114LF	----	1/4" x 1/4" x 1/8"		
700084-040406	18110LF	----	1/4" x 1/4" x 3/8"		
700084-060604	18115LF		3/8" x 3/8" x 1/4"	LF264X6X6X4	
700084-080804	18116LF		1/2" x 1/2" x 1/4"		
700084-080806	18117LF		1/2" x 1/2" x 3/8"	LF264X8X8X6	
700084-101006	18118LF		5/8" x 5/8" x 3/8"	LF264X10X10X6	

64-R

ELBOW



AMC	MIDLAND	LIST	SIZE	MAF	MAF PRICE
700065-02	18122LF	----	1/8"		
700065-03	18123LF	----	3/16"		
700065-04	18124LF	----	1/4"	LF265X4	
700065-05	18125LF	----	5/16"		
700065-06	18126LF	----	3/8"	LF265X6	
700065-08	18127LF	----	1/2"	LF265X8	
700065-10	18128LF	----	5/8"	LF265X10	
700065-12	18129LF	----	3/4"		
700065-14	18130LF	----	7/8"		
700085-0604	18135LF	----	3/8" x 1/4"		
700085-0806	18136LF	----	1/2" x 3/8"		
700085-1006	18137LF	----	5/8" x 3/8"		
700085-1008	18138LF		5/8" x 1/2"		

65 BSE2 165C 265C

LEAD FREE COMPRESSION

LEAD FREE BRASS FITTINGS

FEMALE COUPLING



LF66
LF266

AMC	MIDLAND	LIST	COMP. X FEMALE NPT	MAF	MAF PRICE
700066-0202	18142LF		1/8" x 1/8"	LF66-22	----
700066-0302	18143LF		3/16" x 1/8"	LF66-32	----
700066-0304	18144LF		3/16" x 1/4"		----
700066-0402	18145LF		1/4" x 1/8"	LF66-42	----
700066-0404	18146LF		1/4" x 1/4"	LF66-44	----
700066-0406	18147LF		1/4" x 3/8"	LF66-46	----
700066-0408	18148LF		1/4" x 1/2"	LF66-48	----
700066-0502	18149LF		5/16" x 1/8"		----
700066-0504	18150LF		5/16" x 1/4"		----
700066-0506	18151LF		5/16" x 3/8"	LF66-56	----
700066-0602	18152LF		3/8" x 1/8"	LF66-62	----
700066-0604	18153LF		3/8" x 1/4"	LF66-64	----
700066-0606	18154LF		3/8" x 3/8"	LF66-66	----
700066-0608	18155LF		3/8" x 1/2"	LF66-68	----
700066-0612	18156LF		3/8" x 3/4"	LF66-612	----
700066-0804	18157LF		1/2" x 1/4"		----
700066-0806	18158LF		1/2" x 3/8"	LF66-86	----
700066-0808	18159LF		1/2" x 1/2"	LF66-88	----
700066-0812	18160LF		1/2" x 3/4"	LF66-812	----
700066-1006	18161LF		5/8" x 3/8"	LF66-106	----
700066-1008	18162LF		5/8" x 1/2"	LF66-108	----
700066-1012	18163LF		5/8" x 3/4"	LF66-1012	----
700066-1208	18164LF		3/4" x 1/2"	LF66-128	----
700066-1212	18165LF		3/4" x 3/4"	LF66-1212	----
700066-1408	18167LF		7/8" x 1/2"	LF66-148	----
700066-1412	18166LF		7/8" x 3/4"	LF66-1412	----

66

COMP X SWEAT ADAPTER



AMC	MIDLAND	LIST	SIZE	MAF	MAF PRICE
700086-0610	18171LF		3/8" x 1/2" nom.swt.		----

LEAD FREE COMPRESSION

LEAD FREE BRASS FITTINGS

MALE ADAPTER COMP X MIP



LF68

AMC	MIDLAND	LIST	SIZE	MAF	MAF PRICE
700068-0202	18176LF	----	1/8" x 1/8"	LF68-22	
700068-0302	18177LF	----	3/16" x 1/8"	LF68-32	
700068-0304	18178LF	----	3/16" x 1/4"	LF68-34	
700068-0402	18179LF	----	1/4" x 1/8"	LF68-42	
700068-0404	18180LF	----	1/4" x 1/4"	LF68-44	
700068-0406	18181LF	----	1/4" x 3/8"	LF68-46	
700068-0408	18182LF	----	1/4" x 1/2"	LF68-48	
700068-0502	18183LF	----	5/16" x 1/8"	LF68-52	
700068-0504	18184LF	----	5/16" x 1/4"	LF68-54	
700068-0506	18185LF	----	5/16" x 3/8"		
700068-0508	18186LF	----	5/16" x 1/2"		
700068-0602	18187LF	----	3/8" x 1/8"	LF68-62	
700068-0604	18188LF	----	3/8" x 1/4"	LF68-64	
700068-0606	18189LF	----	3/8" x 3/8"	LF-68-66	
700068-0608	18190LF	----	3/8" x 1/2"	LF68-68	
700068-0612	18191LF	----	3/8" x 3/4"	LF68-612	
700068-0704	18192LF	----	7/16" x 1/4"		
700068-0706	18204LF	----	7/16" x 3/8"		
700068-0804	18193LF	----	1/2" x 1/4"	LF68-84	
700068-0806	18194LF	----	1/2" x 3/8"	LF68-86	
700068-0808	18195LF	----	1/2" x 1/2"	LF68-88	
700068-0812	18196LF	----	1/2" x 3/4"	LF68-812	
700068-1006	18197LF	----	5/8" x 3/8"	LF68-106	
700068-1008	18198LF	----	5/8" x 1/2"	LF68-108	
700068-1012	18199LF	----	5/8" x 3/4"	LF68-1012	
700068-1208	18200LF	----	3/4" x 1/2"	LF68-128	
700068-1212	18201LF	----	3/4" x 3/4"	LF68-1212	
700068-1408	18202LF	----	7/8" x 1/2"	LF68-148	
700068-1412	18203LF	----	7/8" x 3/4"	LF68-1412	
700068-1416	18205LF	----	7/8" x 1"	LF68-1416	

LEAD FREE COMPRESSION

LEAD FREE BRASS FITTINGS

LEAD FREE

ELBOW COMP X MIP



LF269B
LF69F

AMC	MIDLAND	LIST	SIZE	MAF	MAF PRICE
700069-0202	18220LF	----	1/8" x 1/8"		
700069-0302	18221LF	----	3/16" x 1/8"		
700069-0304	18223LF	----	3/16" x 1/4"		
700069-0402	18224LF	----	1/4" x 1/8"	LF269X4	
700069-0404	18225LF	----	1/4" x 1/4"	LF269X4X4	
700069-0406	18226LF	----	1/4" X 3/8"	LF269X4X6	
700069-0408	18227LF	----	1/4" x 1/2"		
700069-0502	18228LF	----	5/16" x 1/8"		
700069-0504	18229LF	----	5/16" x 1/4"		
700069-0506	18230LF	----	5/16" x 3/8"		
700069-0602	18232LF	----	3/8" x 1/8"	LF269X6X2	
700069-0604	18233LF	----	3/8" x 1/4"	LF269X6	
700069-0606	18234LF	----	3/8" x 3/8"	LF269X6X6	
700069-0608	18235LF	----	3/8" x 1/2"	LF269X6X8	
700069-0612	18248LF	----	3/8" x 3/4"		
700069-0704	18247LF	----	7/16" x 1/4"		
700069-0804	18236LF	----	1/2" x 1/4"		
700069-0806	18237LF	----	1/2" x 3/8"	LF69F-86	
700069-0808	18238LF	----	1/2" x 1/2"	LF69F-88	
700069-0812	18239LF	----	1/2" x 3/4"		
700069-1006	18240LF	----	5/8" x 3/8"	LF269X10X6	
700069-1008	18241LF	----	5/8" x 1/2"	LF69F-108	
700069-1012	18242LF	----	5/8" x 3/4"	LF269X10X12	
700069-1208	18243LF	----	3/4" x 1/2"		
700069-1212	18245LF	----	3/4" x 3/4"		
700069-1412	18246LF	----	7/8" x 3/4"	LF69F-1412	

TANK CONNECTOR COMP X MIP



LF68T
• DRILLED THROUGH

AMC	MIDLAND	LIST	SIZE	MAF	MAF PRICE
700088-0302	18177TLF	----	3/16" x 1/8"	LF68T-32	
700088-0402	18208LF	----	1/4" x 1/8"	LF68T-42	
700088-0404	18209LF	----	1/4" x 1/4"	LF68T-44	
700088-0604	18210LF	----	3/8" x 1/4"	LF68T-64	
700088-0606	18211LF	----	3/8" x 3/8"	LF68T-66	
700088-0608	18212LF	----	3/8" x 1/2"	LF68T-68	
700088-0806	18213LF	----	1/2" x 3/8"	LF68T-86	
700088-0808	18214LF	----	1/2" x 1/2"	LF68T-88	
700088-1008	18215LF	----	5/8" x 1/2"		

69 269C BSE1 169C

LEAD FREE COMPRESSION

LEAD FREE BRASS FITTINGS

FEMALE ELBOW COMP X FIP



AMC	MIDLAND	LIST	SIZE	MAF	MAF PRICE
700070-0202	18251LF	----	1/8" x 1/8"		
700070-0302	18252LF	----	3/16" x 1/8"		
700070-0402	18253LF	----	1/4" x 1/8"		
700070-0404	18254LF	----	1/4" x 1/4"		
700070-0406	18267LF	----	1/4" x 3/8"		
700070-0408	18268LF	----	1/4" x 1/2"		
700070-0502	18255LF	----	5/16" x 1/8"		
700070-0504	18256LF	----	5/16" x 1/4"		
700070-0602	18257LF	----	3/8" x 1/8"		
700070-0604	18258LF	----	3/8" x 1/4"	LF70F-64	
700070-0606	18259LF	----	3/8" x 3/8"	LF270X6X6	
700070-0608	18260LF	----	3/8" x 1/2"		
700070-0612	18250LF	----	3/8" x 3/4"		
700070-0806	18262LF	----	1/2" x 3/8"	LF270X8	
700070-0808	18263LF	----	1/2" x 1/2"	LF270X8X8	
700070-1006	18269LF	----	5/8" x 3/8"		
700070-1008	18264LF	----	5/8" x 1/2"	LF270X10	
700070-1012	18265LF	----	5/8" x 3/4"		

45° ELBOW COMP X MIP



AMC	MIDLAND	LIST	SIZE	MAF	MAF PRICE
700095-0402	18330LF	----	1/4" x 1/8"		
700095-0404	18336LF	----	1/4" x 1/4"		
700095-0604	18333LF	----	3/8" x 1/4"		
700095-0606	18338LF	----	3/8" x 3/8"		
700095-0806	18334LF	----	1/2" x 3/8"		
700095-0808	18339LF	----	1/2" x 1/2"		
700095-1008	18335LF	----	5/8" x 1/2"		

MALE RUN TEE COMPRESSION X MIP



LF272

AMC	MIDLAND	LIST	SIZE	MAF	MAF PRICE
700071-0302	18273LF	----	3/16" x 1/8"		
700071-0402	18274LF	----	1/4" x 1/8"		
700071-0404	18275LF	----	1/4" x 1/4"		
700071-0502	18276LF	----	5/16" x 1/8"		
700071-0504	18277LF	----	5/16" x 1/4"		
700071-0604	18279LF	----	3/8" x 1/4"		
700071-0606	18280LF	----	3/8" x 3/8"		
700071-0806	18281LF	----	1/2" x 3/8"		

LEAD FREE COMPRESSION

LEAD FREE BRASS FITTINGS

LEAD FREE

MALE BRANCH TEE COMP X MIP



AMC	MIDLAND	LIST	SIZE	MAF	MAF PRICE
700072-0202	18289LF	----	1/8" x 1/8"		
700072-0302	18290LF	----	3/16" x 1/8"		
700072-0402	18291LF	----	1/4" x 1/8"	LF272X4	
700072-0404	18292LF	----	1/4" x 1/4"		
700072-0502	18293LF	----	5/16" x 1/8"		
700072-0504	18294LF	----	5/16" x 1/4"		
700072-0602	18295LF	----	3/8" x 1/8"		
700072-0604	18296LF	----	3/8" x 1/4"		
700072-0606	18297LF	----	3/8" x 3/8"		
700072-0806	18299LF	----	1/2" x 3/8"		
700072-0808	18300LF	----	1/2" x 1/2"		
700072-1008	18301LF	----	5/8" x 1/2"		
700072-1212	18303LF	----	3/4" x 3/4"		

TEE COMP X FIP X MIP



AMC	MIDLAND	LIST	SIZE	MAF	MAF PRICE
700075-040202	18307LF		1/4" x 1/8 x 1/8"		----

TEE FIP X MIP X COMP



AMC	MIDLAND	LIST	SIZE	MAF	MAF PRICE
700076-0404	18315LF	----	1/4" x 1/4" x 1/4"		

FEMALE BRANCH TEE COMP X FIP



AMC	MIDLAND	LIST	SIZE	MAF	MAF PRICE
700078-0602	18325LF	----	3/8" x 1/8"		
700078-0604	18322LF	----	3/8" x 1/4"		
700078-0606	18323LF	----	3/8" x 3/8"		
700078-1002	18327LF	----	5/8" x 1/8"		

FEMALE ADAPTER COMPRESSION X FEMALE FLARE



AMC	MIDLAND	LIST	SIZE	MAF	MAF PRICE
700093-0404	18502LF	----	1/4" x 1/4"		

MALE ADAPTER COMPRESSION X MALE FLARE



AMC	MIDLAND	LIST	SIZE	MAF	MAF PRICE
700094-0404	18503LF	----	1/4" x 1/4"	LF6242CF-44	
			1/4" x 3/8"	LF6242CF-46	

LEAD FREE COMPRESSION

LEAD FREE BRASS FITTINGS

FEMALE ADAPTER (GASKET) FEMALE COMPRESSION X COMPRESSION



AMC	MIDLAND	LIST	SIZE	MAF	MAF PRICE
730097-0604	18500LF	----	3/8" x 1/4"		
700097-0806	18501LF	----	1/2" x 3/8"		

FEMALE ADAPTER (GASKET) FEMALE FLARE X COMPRESSION



AMC	MIDLAND	LIST	SIZE	MAF	MAF PRICE
734822-0606	18510LF	----	9/16-24 x 3/8		

FEMALE ADAPTER (GASKET) FE GARDEN HOSE X COMPRESSION



AMC	MIDLAND	LIST	SIZE	MAF	MAF PRICE
737422-1204	30050LF	----	3/4" x 1/4"		
737422-1206	30051LF	----	3/4" x 3/8"		

LF124GH
LF125GH

SWIVEL ELBOW COMP X FE GARDEN HOSE SWIVEL



AMC	MIDLAND	LIST	SIZE	MAF	MAF PRICE
737469-0612	30055LF	----	3/8" x 3/4"		

LF69GHS-162
• NO NUT & SLEEVE

LEAD FREE ADD-A-TEE COMP X COMP X SWIVEL FE COMPRESSION

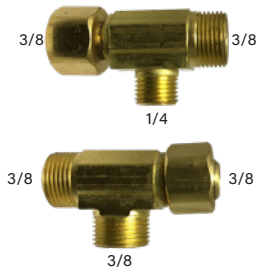

AMC	MIDLAND	LIST	MALE & FEM. COMPRESSION X MALE COMP	MAF	MAF PRICE
700073-060604	935044LF	----	3/8 x 1/4		
700073-060606	935045LF	----	3/8 x 3/8		

- For adding a water line
- Ice makers, Coffee makers and instant hot water systems
- NSF Approved

N/P COMPRESSION/ ICE MAKER KITS/ LEAD FREE BRASS FITTINGS

LEAD FREE BRASS FITTINGS



LEAD FREE

NICKEL PLATED COMPRESSION FITTINGS

NUT



AMC	MIDLAND	LIST	SIZE	MAF	MAF PRICE
700661-04	18054LF		1/4"		----
700661-06	18055LF		3/8"		----
700661-08	18056LF		1/2"		----
700661-10	18057LF		5/8"		----

UNION



AMC	MIDLAND	LIST	SIZE	MAF	MAF PRICE
700662-06	31066LF	----	3/8"		
700662-08	31068LF	----	1/2"		

REDUCING UNION



AMC	MIDLAND	LIST	SIZE	MAF	MAF PRICE
700682-0604	31079LF	----	3/8" x 1/4"		
700682-0806	31081LF	----	1/2" x 3/8"		
700682-1006	31082LF	----	5/8" x 3/8"		
700682-1008	31083LF	----	5/8" x 1/2"		

TEE



AMC	MIDLAND	LIST	SIZE	MAF	MAF PRICE
700664-06	31105LF	----	3/8"		
700664-08	31106LF	----	1/2"		

ELBOW



AMC	MIDLAND	LIST	SIZE	MAF	MAF PRICE
700665-06	31126LF		3/8"		
700665-08	31127LF		1/2"		

REDUCING ELBOW

AMC	MIDLAND	LIST	SIZE	MAF	MAF PRICE
700685-1006	31137LF		5/8" x 3/8"		

FEMALE COUPLING



AMC	MIDLAND	LIST	SIZE	MAF	MAF PRICE
700666-0606	31154LF	----	3/8" x 3/8"		
700666-0608	31155LF	----	3/8" x 1/2"		
700666-0806	31158LF	----	1/2" x 3/8"		
700666-0808	31159LF	----	1/2" x 1/2"		

COMP X SWEAT ADAPTER



AMC	MIDLAND	LIST	SIZE	MAF	MAF PRICE
700686-0610	31171LF	----	3/8" x 5/8" O.D (1/2 Nom. Sweat)		

CONNECTOR



AMC	MIDLAND	LIST	SIZE	MAF	MAF PRICE
700668-0604	31188LF	----	3/8" x 1/4"		
700668-0606	31189LF	----	3/8" x 3/8"		
700668-0608	31190LF	----	3/8" x 1/2"		
700668-0806	31194LF	----	1/2" x 3/8"		
700668-0808	31195LF	----	1/2" x 1/2"		
00668-1008	31198LF	----	5/8" x 1/2"		

ELBOW



AMC	MIDLAND	LIST	SIZE	MAF	MAF PRICE
700669-0604	31233LF	----	3/8" x 1/4"		
700669-0606	31234LF	----	3/8" x 3/8"		
700669-0608	31235LF	----	3/8" x 1/2"		
700669-0806	31237LF	----	1/2" x 3/8"		
700669-0808	31238LF	----	1/2" x 1/2"		

ELBOW



AMC	MIDLAND	LIST	SIZE	MAF	MAF PRICE
700670-0608	31260LF		3/8" x 1/2"		----

ICE MAKER KITS

ICE MAKER WATER SUPPLY KIT WITH POLY TUBING

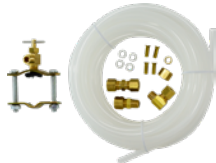

AMC	MIDLAND	LIST	DESCRIPTION	MAF	MAF PRICE
760001	43265LF	----	Kit		

- Lead free fittings
- Bag with Header Card
- 25' 1/4" O.D. Polyethylene
- Self Piercing Saddle Valve
- 1/4" O.D. Compression x 1/8" MIP Elbow & Adapter
- 1/4" O.D. Compression Union
- 1/4" Inserts & Sleeves

ICE-MAKER WATER SUPPLY KIT



AMC	MIDLAND	LIST	MAF	MAF PRICE
760008	43266LF	----		

- Economy
- 25' Polyethylene Tubing
- Self Piercing Saddle Valve
- 1/4" Compression Union
- 1/4" Inserts & Sleeves

LEAD FREE NEEDLE VALVES

LEAD FREE BRASS FITTINGS

COMP X COMP

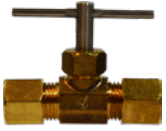

AMC	MIDLAND	LIST	COMP X COMP	MAF	MAF PRICE
709106-04	46021LF	----	1/4"		
709106-05	46022LF	----	5/16"		
709106-06	46023LF	----	3/8"		

COMP X MALE PIPE

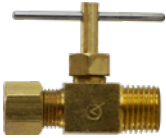

AMC	MIDLAND	LIST	COMP X MALE PIPE	MAF	MAF PRICE
709101-0402	46002LF	----	1/4" x 1/8"		
709101-0404	46003LF	----	1/4" x 1/4"		
709101-0604	46005LF	----	3/8" x 1/4"		

COMP X MALE PIPE-ANGLE



AMC	MIDLAND	LIST	COMP X MALE PIPE	MAF	MAF PRICE
709103-0402	46011LF	----	1/4" x 1/8"		
709103-0404	46012LF	----	1/4" x 1/4"		
709103-0502	46013LF	----	5/16" x 1/8"		
709103-0602	46015LF	----	3/8" x 1/8"		
709103-0604	46016LF	----	3/8" x 1/4"		

FLARE X FLARE



AMC	MIDLAND	LIST	FLARE X FLARE	MAF	MAF PRICE
709110-04	46045LF	----	1/4"		
709110-06	46046LF	----	3/8"		

FLARE X MALE PIPE

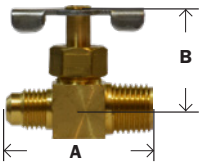

AMC	MIDLAND	LIST	MALE FLARE X MALE PIPE	MAF	MAF PRICE
709104-0404	46029LF	----	1/4" x 1/4"		

FEMALE PIPE X FEMALE PIPE



AMC	MIDLAND	LIST	FEMALE X FEMALE	MAF	MAF PRICE
709134-02	46055LF	----	1/8" x 1/8"		
709134-04	46056LF	----	1/4" x 1/4"		

MALE X FEMALE PIPE



AMC	MIDLAND	LIST	FEMALE X MALE	MAF	MAF PRICE
709135-02	46060LF	----	1/8" x 1/8"		
709135-04	46061LF	----	1/4" x 1/4"		

LEAD FREE NEEDLE VALVES

LEAD FREE BRASS FITTINGS

MALE PIPE TO MALE PIPE

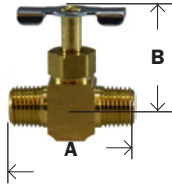

AMC	MIDLAND	LIST	MALE PIPE X MALE PIPE	MAF	MAF PRICE
709108-04	46051LF	----	1/4"		

VALVE WITH TEE



AMC	MIDLAND	LIST	SIZE	MAF	MAF PRICE
709178-0406	46175LF	----	1/4" x 3/8"		
709178-0410	46177LF	----	1/4" x 5/8"		
709178-0606	46174LF	----	3/8" x 3/8"		

VALVE WITH SADDLE FITS UP TO 3/4" PIPE



AMC	MIDLAND	LIST	SIZE	MAF	MAF PRICE
709195-04	46091LF	----	1/4"		
709195-05		----	5/16"		
709195-06	46093LF	----	3/8"		

BRASS SADDLE



AMC	MIDLAND	LIST	SIZE	MAF	MAF PRICE
709190	46099LF	----	1/8"		

SELF PIERCING SADDLE VALVES



AMC	MIDLAND	LIST		MAF	MAF PRICE
709199-04	46090ALF	----	Solid Pin		
	46090HLF	----	Hollow Pin		

- 1/4 Tube O.D.

SELF PIERCING NEEDLE VALVE KIT #M-104-VSP

- INDIVIDUALLY BAGGED WITH NEEDLE VALVE
 - SADDLE CLAMP
 - 2 NUTS
 - 2 BOLTS & WASHERS
- Has brass sleeve for copper tube installation & delrin

sleeve & brass insert for plastic tube installation.



LEAD FREE VALVES & PLBG

LEAD FREE VALVES & PLUMBING ACCESSORIES!

LEAD FREE BALL VALVES

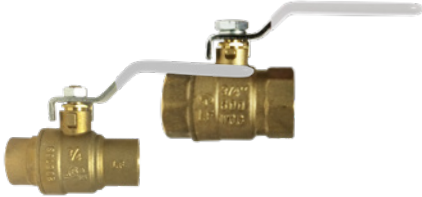

PRESS VALVES



PEX VALVES



PUSH FIT VALVES



SILCOCK



GATE VALVES



CHECK



BOILER DRAIN



SUPPLY CONNECTORS



RUBBER COUPLINGS



VACUUM BREAKER



SUPPLY STOPS

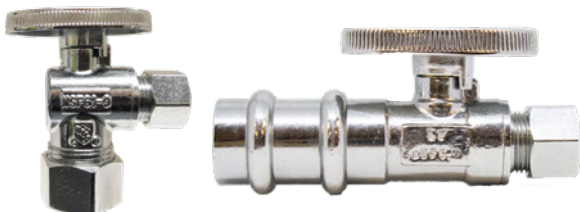

WATER METER FLANGES



WARNING: This product can expose you to chemicals, including lead, which are known to the State of California to cause cancer and birth defects or other reproductive harm. For more information, visit www.P65Warnings.ca.gov

LEAD FREE BALL VALVES

LF VALVES & PLBG FITTINGS



LEAD FREE BALL VALVE



IAMPO IGC 157 - 2004b

PRICING FILE AVAILABLE ONLINE

Lead Free Brass Ball Valve NPT,Female*Female
 Lead Free and dezincification resistant (DZR) material
 IAPMO listed to NSF/ANSI-61, NSF/ANSI-372 ,IGC-157
 CSA listed to NSF/ANSI-61, NSF/ANSI-372 ,IGC-157
 Vacuum Services 29.92 inches Hg
 600 psi (WOG) 150 psi (WSP) Service
 Thread conform ANSI B1.201
 Temperature Range : -40° F to 365° F
 Construction:Forging Brass Body
 PTFE Ball Seats
 Blow Out Proof Brass Stem
 Stainless Steel Ball
 Steel Handle w/Vinyl Grip
 Made in China

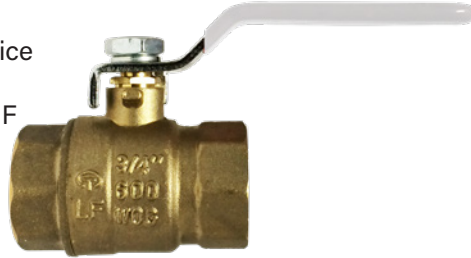

FIP X FIP LEAD FREE BALL VALVE

PART #	SIZE	DN	A	B	C	E	F	G	H	WEIGHT	BOX/CASE	
941151LF	1/4"	0.394	1.73	1.69	3.35	0.453	0.945	2.154	4.331	0.32	10/120	----
941152LF	3/8"	0.394	1.73	1.69	3.35	0.473	0.945	2.154	4.331	0.32	10/120	----
941153LF	1/2"	0.524	1.89	1.73	3.35	0.472	1.083	2.276	4.291	0.36	10/100	----
941154LF	3/4"	0.748	2.28	1.89	3.35	0.563	1.378	2.579	4.488	0.57	10/80	----
941155LF	1"	0.984	2.80	2.14	4.29	0.650	1.772	3.031	5.689	0.94	8/48	----
941156LF	1-1/4"	1.240	3.15	2.32	4.29	0.669	2.165	3.398	5.866	1.30	4/36	----
941157LF	1-1/2"	1.476	3.44	2.66	5.53	0.701	2.50	3.909	7.343	1.92	2/24	----
941158LF	2"	1.949	4.06	3.01	5.53	0.708	3.244	4.638	7.638	3.12	2/12	----
941159LF	2-1/2"	2.52	5.53	4.25	7.76					7.42	2/12	----
941160LF	3"	2.89	6.14	4.58	8.19					11.01	1/6	----
941161LF	4"	3.84	7.79	5.49	9.25					12.10	1/2	----

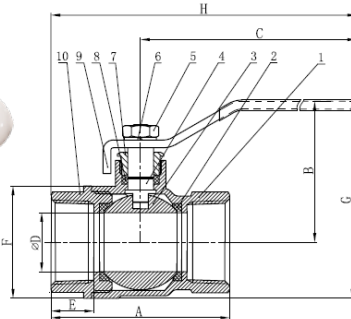

No	Item	Qty	Material
1	Body	1	Lead Free Brass
2	Seat	2	PTFE
3	Ball	1	Stainless Steel
4	Stem	1	Brass
5	Handle Nut	1	Plated Steel
6	Lock Washer	1	Plated Steel
7	Packing Nut	1	Brass
8	Packing	1	PTFE
9	Handle	1	Plated Steel
10	Cap	1	Lead Free Brass

SWT X SWT LEAD FREE BALL VALVE

PART #	SIZE	DN	A	B	C	E	G	H	WEIGHT	WTG	BOX/CASE	
941163LF	1/2"	0.524	1.945	1.73	3.35	0.504	1.083	2.276	4.319	0.38	10/100	----
941164LF	3/4"	0.748	2.654	1.89	3.35	0.748	1.378	2.579	4.665	0.65	10/80	----
941165LF	1"	0.984	3.315	2.14	4.29	0.909	1.772	3.031	5.949	0.93	8/48	----
941166LF	1-1/4"	1.240	3.741	2.32	4.29	0.968	2.165	3.398	6.165	1.35	4/36	----
941167LF	1-1/2"	1.476	4.252	2.66	5.53	1.091	2.50	3.909	7.756	1.88	2/24	----
941168LF	2"	1.949	5.38	3.01	5.53	1.343	3.244	4.638	8.268	3.62	2/12	----
941169LF	2 1/2"	2.52	5.53	4.25	7.76							----
941170LF	3"	2.89	6.14	4.58	8.19							----
941171LF	4"	3.84	7.79	5.49	9.25							----

WARNING: This product can expose you to chemicals, including lead, which are known to the State of California to cause cancer and birth defects or other reproductive harm. For more information, visit www.P65Warnings.ca.gov

LEAD FREE VALVES AND PLUMBING

LEAD FREE BALL VALVES

LF VALVES & PLBG FITTINGS

1/2" - 2" Sizes Gas Approved



LEAD FREE BALL VALVE

• BRASS • 600PSI • FULL PORT W/APPROVALS
 CSA, UL, FM(1/4"-2"), cUPC, NSF/ ANSI 61 & 372

FEATURES

- Leadfree Brass Ball valve NPT, Female * Female
- Lead free and dezincification resistant (DZR) material
- 1/4"-1" Lead Free Brass Ball
- Size 1-1/4" thru 4" with Stainless steel ball
- IAMPO listed to cUPC, NSF/ ANSI 61 & 372, IGC 157
- CSA - 1/4" thru 2": ANSI Z21.15/ CSA 9.1 for 1/2 psig valves ASME B16.44, CGA CR91-002 for 2 & 5 psig valves; CAN/ CGA-3.16, ASME B16.33 (1/2"-2") for 125 psig valves
- UL 125, UL 1477, UL 842 - for size 1/4" thru 4", 250 psig
- UL 258 - for size 1/4" thru 2", 175 psig
- FM - for size 1/4" thru 2"
- ISO 9002 Manufacture
- Suitable for full range of liquids and gases
- Minimal pressure drop due to large full size ports
- Bottom loaded, pressure retaining stem
- Pressure rated for 1/4"-2" at 600psi (42 bars) and 2-1/2"-4" at 400 psi WOG (non-shock) and 150 WSP (10.34 bars) saturated steam. Virgin PTFE stem packing seal, thrust washer and seats
- White vinyl insulator on heavy duty plated carbon steel handles
- Fast 1/4 turn open or close operation

- Low operating torque
- **Adjustable stem packing gland**
- Maximum operating temperature: 302°F (150° C)
- Minimum operating temperature: -22°F (-30°C)
- Each valve individually tested
- Forged Brass - for more strength
- Threaded ends to ANSI B1.20.1
- Hard chromium plated solid ball
- Bottom entry, blow-out proof stem

POS	Components	Materials
1	Body	Lead Free Brass
2	End Cap	Lead Free Brass
3	Ball Seat	PTFE
4	Ball	1/4-1:Lead Free Brass 1 1/4-4:SS316 Hollowball
5	Stem	Brass
6	Stem Padding	PTFE
7	Padding Nut	Brass
8	Lever Handle	Nickel plating steel
9	Stem Nut	Brass plating steel
10	Seal	PTFE

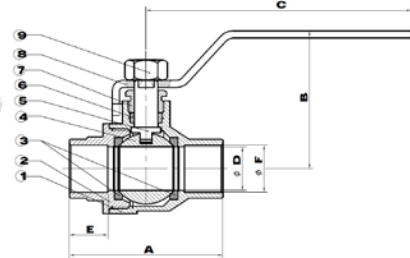

PART#	SIZE	DIMENSIONS								WEIGHT	BOX/ CASE	
		A	B	C	D	E	F	G	H			
940171LF	1/4"	1.756	1.732	3.543	0.394	0.457	1.012	2.238	4.421	0.34	70/140	----
940172LF	3/8"	1.756	1.732	3.543	0.394	0.457	1.012	2.238	4.421	0.34	70/140	----
940173LF	1/2"	2.047	2.040	3.543	0.583	0.520	1.240	2.559	4.567	0.45	50/100	----
940174LF	3/4"	2.362	2.260	3.780	0.748	0.563	1.492	2.854	4.961	0.69	30/60	----
940175LF	1"	2.756	2.579	4.528	0.945	0.630	1.791	3.476	5.906	1.11	20/40	----
940176LF	1-1/4"	3.307	3.050	4.528	1.260	0.709	2.343	4.134	6.181	1.85	12/24	----
940177LF	1-1/2"	3.661	3.366	5.420	1.575	0.717	2.835	4.783	7.343	2.60	9/18	----
940178LF	2"	4.181	3.701	5.42	1.969	0.748	3.425	5.413	7.602	3.62	6/12	----
940179LF	2-1/2"	4.181	4.650	8.870	2.520	1.024	4.331	6.969	11.350	7.93	3/6	----
940180LF	3"	6.039	4.970	8.870	2.913	1.102	4.921	7.579	11.681	10.40	1/4	----
940181LF	4"	7.386	6.130	10.85	3.898	1.220	6.430	9.055	13.299	20.99	1/2	----

SWT X SWT LEAD FREE BALL VALVE

FM, cUPC, NSF/ ANSI 61 & 372

PART #	SWT	A	B	C	D	E	F	WEIGHT	BOX/CASE	
943612LF	1/2"	2.047	1.839	3.543	0.583	0.512	0.630	0.45	50/100	----
943613LF	3/4"	2.748	2.14	3.780	0.748	0.748	0.878	0.68	30/60	----
943614LF	1"	3.228	2.449	4.528	0.945	0.906	1.130	1.08	20/40	----
943615LF	1-1/4"	3.819	3.04	4.36	1.260	0.972	1.378	1.80	12/24	----
943616LF	1-1/2"	4.425	3.169	5.39	1.575	1.088	1.630	2.51	9/18	----
943617LF	2"	5.377	3.488	6.307	1.989	1.346	2.130	3.57	6/12	----

WARNING: This product can expose you to chemicals, including lead, which are known to the State of California to cause cancer and birth defects or other reproductive harm. For more information, visit www.P65Warnings.ca.gov

ITALIAN LEAD FREE BRASS BALL VALVE



CSA AGA 3.88 5 PSIG



UL842, UL258, UL125,FM

ISO 9002 Manufacturer FEATURES

600 PSI non-shock cold water, gas, oil - 150 PSI saturated steam

IAMPO IGC 157 - 2004b

- **SOLID CHROME PLATED BRASS BALL**
- Suitable for full range of liquids and gases
- Minimal pressure drop due to large full size ports
- Bottom loaded, pressure retaining stem
- Pressure rated at 600psi (42 bars) WOG (non-shock) and 150 WSP (10.34 bars) saturated steam. Virgin TFE stem packing seal, thrust washer and seats.
- Blue vinyl insulator on heavy duty plated carbon steel handles.
- Fast 1/4 turn open or close operation
- Low operating torque
- Flow can go both directions

- Adjustable stem packing gland
- Maximum operating temperature: 248°F (120° C) at 600 PSI
- Minimum operating temperature: -20°F (-40°C)
- Each valve individually tested
- Forged Brass - for more strength
- Threaded ends to ANSI B1.20.1
- Hard chromium plated solid ball
- Bottom entry, blow-out proof stem
- Deeper threads - for better connections

MADE IN ITALY

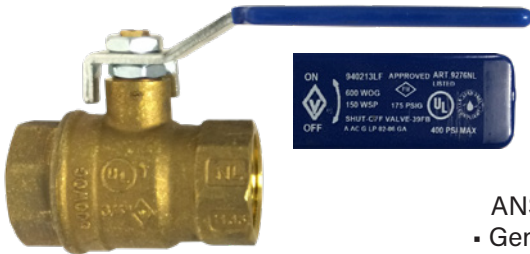

FIP X FIP

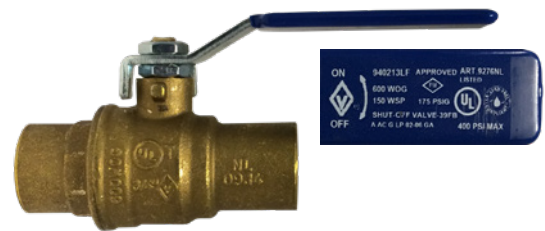

SWT X SWT

ANSI/INSE 61-8
• Generic Handles

FIP X FIP LEAD FREE FORGED BRASS BALL VALVE

PART #	NPT	DN	A	B	C	D	CH	WEIGHT (LBS)	BOX/CASE	
943233LF	1/2"	0.57	2.09	1.57	3.35	0.46	0.98	0.39	20/80	----
943234LF	3/4"	0.75	2.28	1.77	3.80	0.49	1.22	0.56	14/56	----
943235LF	1"	0.94	3.04	2.03	3.80	0.59	1.50	0.89	6/24	----
943236LF	1-1/4"	1.24	3.23	2.32	4.72	0.62	1.85	1.44	4/16	----
943237LF	1-1/2"	1.49	3.70	2.60	4.72	0.64	2.13	2.19	2/8	----

SWT X SWT LEAD FREE FORGED BRASS BALL VALVE

PART #	SWT	Ø	DN	A	B	C	D	CH	WEIGHT (LBS)	BOX/CASE	
940212LF	1/2"	0.63	0.57	2.40	1.57	3.35	0.42	0.79	0.35	20/80	----
940213LF	3/4"	0.866	0.75	3.26	1.77	3.80	0.61	1.06	0.55	10/40	----
940214LF	1"	1.102	0.94	3.68	2.03	3.80	0.73	1.34	0.87	6/24	----
940215LF	1-1/4"	1.377	1.24	4.23	2.32	4.72	0.91	1.61	1.41	6/24	----
940216LF	1-1/2"	1.61	1.49	4.96	2.60	4.72	1.06	1.89	2.08	2/8	----
940217LF	2"	2.125	1.96	5.86	3.27	6.38	1.26	2.40	3.62	1/4	----

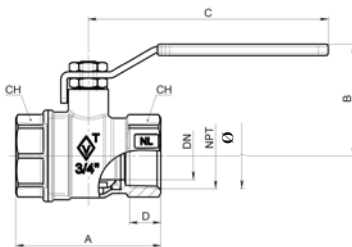

POS	Components	Materials
1	Body	CW510L
2	End Connection	CW510L
3	Ball Seal	PTFE
4	Seal	CW510L
5	Stem	CW614N
6	Lower Stem	PTFE
7	O-Ring	NBR70sh
8	Upper Seal	PTFE
9	Brass Ring	CW614N
10	Nut	Steel
11	Handle	Steel P10

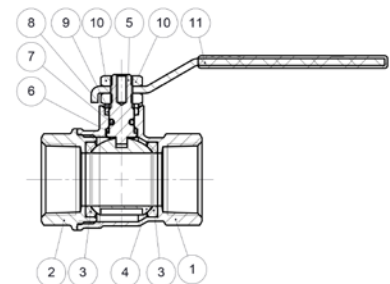

PRESS BALL VALVE

LF VALVES & PLBG FITTINGS

LEAD FREE COPPER PRESS BALL VALVE

Midland Series "9404LF" 2-Piece, Full Port, Lead Free, Copper, Press Ball Valves are designed for use in flameless, copper press piping systems. Midland Copper Press Ball Valves feature a lead free brass body, adjustable packing gland and blowout proof stem with stem a single O-ring seal. Our press ball valves come with integral ASTM-B88 compliant press end connections that can be used with type K, L, M, hard copper tubing 1/2 in. - 4 in. Utilizing industry standard tools.

Midland Press Ball Valve Features

- Lead Free construction.
- Available Sizes: 1/2 in. - 4 in.
- Integral press end connections designed for hard and soft copper tubing
- ISO-9001
- 250 WOG - 250 CWP (2-1/2" - 4")
- Full Port Stainless Steel ball
- One O-Ring design
- Blow Out Proof Stem
- UPC & NSF-61 Compliant
- AB1953 & NSF-372 Compliant



Midland Copper Press Ball Valves are a heat-free method for joining copper tubes. Our press valve allows installers the confidence to know the joint is secure due to our leak-detection o-ring. During low pressure testing, if the joint is not pressed properly, the specialized o-ring will leak. This allows the installer to correct the press before the system is operational at higher pressures.

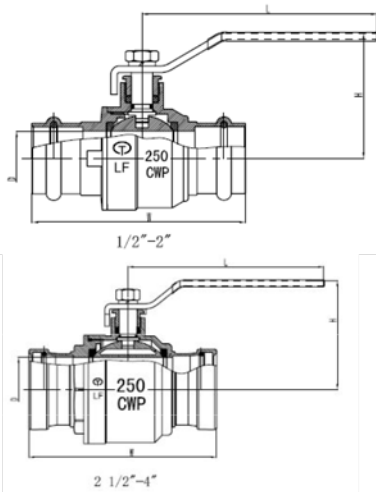

Part Name	Material
Body	Lead Free Brass
Seat	PTFE
Ball	Stainless Steel
Stem O-Ring	NBR
Packing Nut	Brass
Stem	Brass (1/2"-2")
	Stainless Steel(2-1/2"-4")
Lock Nut	Ferrum /Zinc Plated
Lock Washer	Ferrum /Zinc Plated
Packing	PTFE
Handle	Ferrum /Chrome Plated
Cap	Lead Free Brass
Body O-Ring	NBR
Press O-Ring	EPDM

PART	SIZE	D	L	H	W	CV	
940403LF	1/2"	0.591	3.46	1.81	3.15	18.55	----
940404LF	3/4"	0.748	4.29	2.09	3.60	29.76	----
940405LF	1"	0.984	4.29	2.25	3.92	51.55	----
940406LF	1-1/4"	1.259	5.63	2.52	4.41	84.42	----
940407LF	1 1/2"	1.574	5.63	2.74	5.35	131.93	----
940408LF	2 "	1.941	5.63	3.03	6.79	200.35	----
940409LF	2 1/2"	2.520	7.76	4.25	7.46	338.43	----
940410LF	3 "	2.874	8.19	4.58	8.17	445.44	----
940411LF	4"	3.839	9.25	5.49	9.88	783.88	----

WARNING: This product can expose you to chemicals, including lead, which are known to the State of California to cause cancer and birth defects or other reproductive harm. For more information, visit www.P65Warnings.ca.gov

PEX BALL VALVES - LEAD FREE

LF VALVES & PLBG FITTINGS

C/E PEX & PEX BALL VALVES LEAD FREE



CUPC, AB 1953, NSF/ANSI 61, NSF/ANSI 372 (ANNEX G) NSF-14

- 400 WOG
- FORGED LEAD FREE BRASS BODY
- SS BALL

UNION PEX VALVE
C/E PEX X C/E PEX



- Cold Expansion
- Conforms to ASTM F1960

PART	SIZE	
945611LF	1/2"	----
945612LF	3/4"	----
945613LF	1"	----
945614LF	1-1/4"	----
945615LF	1 1/2"	----
945616LF	2"	----

PEX VALVE WITH DROP EAR AND DRAIN
C/E PEX X C/E PEX

WITH DRAIN AND DROP EAR



- Cold Expansion
- Conforms to ASTM F1960

PART	SIZE	
945621LF	1/2"	----
945622LF	3/4"	----
945623LF	1"	----

MALE ADAPTER PEX VALVE
MALE PIPE X C/E PEX

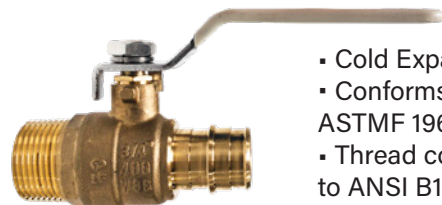

- Cold Expansion
- Conforms to ASTM F1960
- Thread conforms to ANSI B1.20.1

PART	SIZE	
945631LF	1/2"	----
945632LF	3/4"	----
945633LF	1"	----

- Dezincification resistant (D2B) Lead Free Brass material
- Cold expansion pex ends conform to ASTM F1960
- Blow out proof stem design

PEX X PEX

PEX ENDS CONFORM TO ASTM F1807

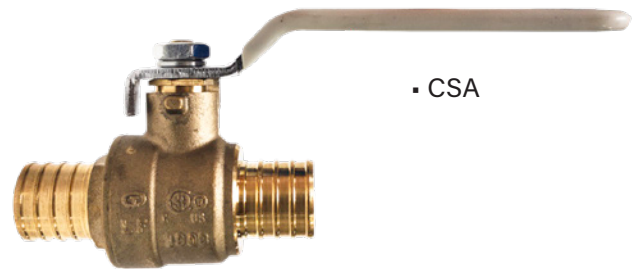

- CSA

PART	SIZE	
945601LF	1/2"	----
945602LF	3/4"	----
945603LF	1"	----
945604LF	1-1/4"	----
945605LF	1-1/2"	----
945606LF	2"	----

W/TEE HANDLE

PART	SIZE	
945640LF	3/4"	----

PEX DRAIN VALVE



- Conforms to ASTM F1807

PART	SIZE	
945650LF	1/2"	----
945651LF	3/4"	----
945652LF	1"	----

WARNING: This product can expose you to chemicals, including lead, which are known to the State of California to cause cancer and birth defects or other reproductive harm. For more information, visit www.P65Warnings.ca.gov

LEAD FREE VALVES AND PLUMBING

LEAD FREE VALVES
LF VALVES & PLBG FITTINGS

LEAD FREE, FULL PORT BRASS BALL VALVES PUSH-FITTING END

FEATURES

- dezincification resistant (DZR) Lead Free Brass Material
- Push-fitting conform ASSE 1061
- Forged Brass Body
- BLow Out Proof Stem Design
- Packing Nut & Packing On the Stem Seal
- Stainless Steel Ball
- Handle with Vinyl Grip

PERFORMANCE RATING

- 200 psi (CWP) 150 psi (WSP) Service
- Temperature Range: -20° F to 300° F



PUSH FIT VALVES

PART NO.	SIZE	DN	L	L1	L2	H	CV	WT(LBS.)	LIST
943750LF	1/2"	0.524	3.15	0.91	3.46	1.73	14.56		
943751LF	3/4"	0.748	3.55	1.10	3.46	1.89	29.76		
943752LF	1"	0.984	4.14	1.32	4.29	2.14	51.55		

PART NAME	MATERIAL
Body	Lead Free Brass
Seat	PTFE
Ball	Stainless Steel
Packing Nut	Brass
Stem	Brass
Lock Nut	Ferrum/Zinc Plated
Lock Washer	Ferrum/Zinc Plated
Packing	PTFE
Handle	Ferrum/Chrome Plated
Cap	Lead Free Brass
O-Ring	EPDM
Seat Ring	POM
Gripper Ring	Stainless Steel
Push Ring	POM
Lock Ring	POM
Liner	PSF

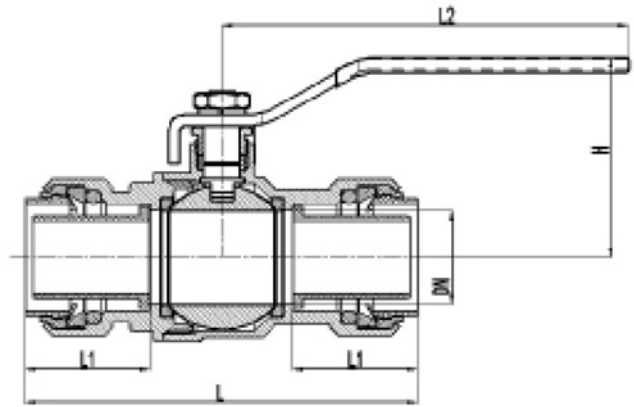

WARNING: This product can expose you to chemicals, including lead, which are known to the State of California to cause cancer and birth defects or other reproductive harm. For more information, visit www.P65Warnings.ca.gov

LEAD FREE GATE/ CHECK/ Y VALVES

LF VALVES & PLBG FITTINGS

BRASS GATE VALVE IPS

- 200 WOG (Cold water, oil, gas)
- 125 WSP (Saturated Steam)
- Brass Forged body/bonList- stronger than sand castings.
- Superior quality and finish.
- Each valve individually tested.
- Threaded ends to ANSI B1.20.1, Solder ends to ANSI B16.18
- Non rising stem.
- Cast iron handle.
- NSF Approved



BRASS GATE VALVE IPS

PART#	SIZE	
940130LF	1/4	----
940131LF	3/8	----
940132LF	1/2	----
940133LF	3/4	----
940134LF	1	----
940135LF	1-1/4	----
940136LF	1-1/2	----
940137LF	2	----

BRASS GATE VALVE C X C



PART#	SIZE	
940142LF	1/2"	----
940143LF	3/4"	----
940144LF	1"	----
940145LF	1-1/4"	----
940146LF	1-1/2"	----
940147LF	2"	----

BRASS CHECK VALVE

NO	Part	Material
1	Cap	C37700
2	Gasket	NBR
3	Spring	Stainless Steel
4	Positioning Seat	BRASS
5	Screw	BRASS
6	Body	C37700

- NSF Approved
- ANSI 61-4



LEAD-FREE

PART #	SIZE	
944430LF	1/2	----
944431LF	3/4	----
944432LF	1	----
944433LF	1-1/4	----
944434LF	1-1/2	----
944435LF	2	----
944436LF	2½	----
944437LF	3	----
944438LF	4	----

CAST BRASS SWING CHECK VALVE IPS SCREWED ENDS

- Working pressure non-shock: 200 psi W.O.G. (cold water, oil, gas) 125 psi WSP (saturated steam)
- Swing type disc.
- Screwed Cap.
- Hard Seat.
- 90° Straight Pattern.
- Used to prevent reverse flow in commercial and industrial applications.
- Threaded ends to ANSI B1.20.1. Solder ends ANSI 61-8
- Integral seat.
- NSF Approved



PART #	SIZE	
940352LF	1/2"	----
940353LF	3/4"	----
940354LF	1"	----
940355LF	1-1/4"	----
940356LF	1-1/2"	----
940357LF	2"	----
940358LF	2½"	----
940359LF	3"	----
940360LF	4"	----

C X C SWING CHECK VALVE



PART #	SIZE	
940362LF	1/2	----
940363LF	3/4	----
940364LF	1	----
940365LF	1-1/4	----
940366LF	1-1/2	----
940367LF	2	----

CLASS 150 BRASS Y-PATTERN STRAINER



LEAD-FREE

PART#	SIZE	
940523LF	1/2"	----

WARNING: This product can expose you to chemicals, including lead, which are known to the State of California to cause cancer and birth defects or other reproductive harm. For more information, visit www.P65Warnings.ca.gov



LOW PRESSURE LF BRASS VALVES

LF VALVES & PLBG FITTINGS

LF BRASS FROST FREE SILLCOCK VALVES/ ANTI SIPHON



PART#	SIZE	D	H	L	
	1/2" MIP & 1/2" SWEAT X 3/4" MHT X				
942150LF	6"	2.20	8.64	3.07	
942151LF	8"	2.20	12.66	3.07	
942152LF	12"	2.20	16.71	3.07	

NO	PARTS	MATERIALS	QTY	WATER CONTACT
1	Bolt	Forged Brass	1	N
2	Name Plate	Aluminium	1	N
3	Handle	Aluminium	1	N
4	Bonnet	Brass Rod	1	N
5	Washer	Stainless Steel	1	N
6	Packing	Rubber (NBR)	1	Y
7	Washer	Stainless Steel	1	Y
8	Pipe	Brass (Copper)	1	Y
9	Stem	Brass Rod	1	Y
10	Spring	Stainless Steel	1	Y
11	O-Ring	Rubber (NBR)	1	Y
12	Spring Seat	Brass Rod	1	Y
13	Flapper	Rubber (NBR)	1	Y
14	Seat	Forged Brass	1	Y
15	Seat Packing	Rubber (NBR)	1	Y
16	Screw	Forged Brass	1	Y
17	Body	Cast Brass	1	Y
18	Pipe	Brass (Copper)	1	Y
19	Nipple	Brass Rod	1	Y
20	Packing	Pom M90	1	N
21	Floating	Pom M90	1	Y
22	Floating Pk	Rubber (NBR)	1	Y
23	O-Ring	Rubber (NBR)	1	Y
24	Packing	Pom M90	1	Y
25	Cap	Brass Rod	1	Y

WARNING: This product can expose you to chemicals, including lead, which are known to the State of California to cause cancer and birth defects or other reproductive harm. For more information, visit www.P65Warnings.ca.gov





LOW PRESSURE LF BRASS VALVES

LF VALVES & PLBG FITTINGS

BRASS HOSE BIBB NO KINK VALVES HEAVY DUTY



NO	PARTS	MATERIALS	QTY	WATER CONTACT
1	Bolt	Hot Rolled	1	N
2	Handle	Zinc	1	N
3	Packing Nut	Brass Rod	1	N
4	Packing	Teflon Polyflon	1	Y
5	Bonnet	Brass Rod	1	Y
6	Packing	Nylon	1	Y
7	Stem	Brass Rod	1	Y
8	Seat Packing	Rubber (NBR)	1	Y
9	Screw	Forged Brass	1	Y
10	Body	Cast Brass	1	Y

PART#	NOMINAL SIZE	D	H	L	MIP	LIST
942110LF	1/2" MIP & 1/2" Sweat x 3/4" MHT	2.12	1.97	2.87	1/2"-14NPT	
942111LF	3/4" MIP x 3/4" MHT	2.12	1.97	2.97	3/4"-14NPT	



BRASS HOSE BIBB NO KINK VALVES HEAVY DUTY



NO	PARTS	MATERIALS	QTY	WATER CONTACT
1	Bolt	Hot Rolled	1	N
2	Handle	Zinc	1	N
3	Packing Nut	Brass Rod	1	N
4	Packing	Teflon Polyflon	1	Y
5	Bonnet	Brass Rod	1	Y
6	Packing	Nylon	1	Y
7	Stem	Brass Rod	1	Y
8	Seat Packing	Rubber (NBR)	1	Y
9	Screw	Forged Brass	1	Y
10	Body	Cast Brass	1	Y

PART#	NOMINAL SIZE	D	H	L	MIP
942112LF	1/2" FIP x 3/4" MHT	2.12	1.97	2.87	1/2"-14NPT
942113LF	3/4" FIP x 3/4" MHT	2.12	1.97	2.97	3/4"-14NPT

BRASS HOSE BIBB NO KINK VALVES HEAVY DUTY



NO	PARTS	MATERIALS	QTY	WATER CONTACT
1	Bolt	Hot Rolled	1	N
2	Handle	Zinc	1	N
3	Packing Nut	Brass Rod	1	N
4	Packing	Teflon Polyflon	1	Y
5	Bonnet	Brass Rod	1	Y
6	Packing	Nylon	1	Y
7	Stem	Brass Rod	1	Y
8	Seat Packing	Rubber (NBR)	1	Y
9	Screw	Forged Brass	1	Y
10	Body	Cast Brass	1	Y

PART#	NOMINAL SIZE	D	H	L
942123LF	3/4" FTG & 1/2" SWEAT x 3/4" MHT	2.12	1.97	2.87

WARNING: This product can expose you to chemicals, including lead, which are known to the State of California to cause cancer and birth defects or other reproductive harm. For more information, visit www.P65Warnings.ca.gov



LOW PRESSURE LF BRASS VALVES

LF VALVES & PLBG FITTINGS

LF BRASS BOILER DRAIN



PART#	NOMINAL SIZE	D	H	L	FIP
942132LF	1/2" FIP x 3/4" MHT	2.08	3.35	1.46	1/2"-14NPT
942133LF	3/4" FIP x 3/4" MHT	2.08	3.35	1.46	3/4"-14NPT

NO	PARTS	MATERIALS	QTY	WATER CONTACT
1	Bolt	Hot Rolled	1	N
2	Name Plate	Aluminium	1	N
3	Handle	Zinc	1	N
4	Packing Nut	Brass Rod	1	N
5	Packing	Teflon Polyflon	1	Y
6	Bonnet	Brass Rod	1	Y
7	Packing	Nylon	1	Y
8	Stem	Brass Rod	1	Y
9	Seat Packing	Rubber (NBR)	1	Y
10	Screw	Forged Brass	1	Y
11	Body	Cast Brass	1	Y

LF BOILER DRAIN



PART#	NOMINAL SIZE	D	H	L	MIP
942134LF	1/2"MIP & 1/2" SWEAT X 3/4" MHT	2.08	3.50	1.46	1/2"-14NPT
942135LF	3/4" FIP x 3/4" MHT	2.08	3.58	1.46	3/4"-14NPT

NO	PARTS	MATERIALS	QTY	WATER CONTACT
1	Nut	Hot Rolled	1	N
2	Name Plate	Aluminium	1	N
3	Handle	Cast Iron	1	N
4	Packing Nut	Brass Rod	1	N
5	Packing	Rubber (NBR)	1	Y
6	Bonnet	Cast Brass	1	Y
7	Stem	Cast Brass	1	Y
8	Seat Packing	Rubber (NBR)	1	Y
9	Screw	Forged Brass	1	Y
10	Body	Cast Brass	1	Y

LF BRASS BOILER DRAIN ANGLE SPOUT



PART#	NOMINAL SIZE	D	H	L	MIP
942162LF	1/2" MIP & 1/2" Sweat x 3/4" MHT	2.12	2.16	1.14	1/2"-14NPT
942163LF	3/4" MIP x 3/4" MHT	2.12	2.16	1.14	3/4"-14NPT

NO	PARTS	MATERIALS	QTY	WATER CONTACT
1	Nut	Hot Rolled	1	N
2	Name Plate	Aluminium	1	N
3	Handle	Cast Iron	1	N
4	Packing Nut	Brass Rod	1	N
5	Packing	Rubber (NBR)	1	Y
6	Bonnet	Cast Brass	1	Y
7	Stem	Cast Brass	1	Y
8	Seat Packing	Rubber (NBR)	1	Y
9	Screw	Forged Brass	1	Y
10	Body	Cast Brass	1	Y

LF BRASS BOILER DRAIN ANGLE SPOUT



PART#	NOMINAL SIZE	D	H	L	FIP
942164LF	1/2" FIP X 3/4" MHT	2.12	2.16	1.14	1/2"-14NPT
942165LF	3/4" FIPT X 3/4" MHT	2.12	2.16	1.14	3/4"-14NPT

NO	PARTS	MATERIALS	QTY	WATER CONTACT
1	Bolt	Hot Rolled	1	N
2	Name Plate	Aluminium	1	N
3	Handle	Zinc	1	N
4	Packing Nut	Brass Rod	1	N
5	Packing	Teflon Polyflon	1	Y
6	Bonnet	Brass Rod	1	Y
7	Packing	Nylon	1	Y
8	Stem	Brass Rod	1	Y
9	Seat Packing	Rubber (NBR)	1	Y
10	Screw	Forged Brass	1	Y
11	Body	Cast Brass	1	Y

WARNING: This product can expose you to chemicals, including lead, which are known to the State of California to cause cancer and birth defects or other reproductive harm. For more information, visit www.P65Warnings.ca.gov



LOW PRESSURE LF BRASS VALVES

LF VALVES & PLBG FITTINGS

LF SILLCOCK VALVE WITH PEX CONNECTIONS



NO	PARTS	MATERIALS	QTY	WATER CONTACT
1	Nut	Hot Rolled	1	N
2	Name Plate	Aluminium	1	N
3	Handle	Cast Iron	1	N
4	Packing Nut	Brass Rod	1	N
5	Packing	Rubber (NBR)	1	Y
6	Bonnet	Cast Brass	1	Y
7	Stem	Cast Brass	1	Y
8	Seat Packing	Rubber (NBR)	1	Y
9	Screw	Forged Brass	1	Y
10	Body	Cast Brass	1	Y

PART#	NOMINAL SIZE	B	C	D	H	L
942142LF	1/2" PEX F1807 x 3/4" MHT	2.58	0.22	2.09	2.40	2.34
942143LF	3/4" PEX F1807 x 3/4" MHT	2.58	0.22	2.09	2.40	2.40

LF SILLCOCK VALVE WITH PEX CONNECTIONS (COLD EXPANSION)



NO	PARTS	MATERIALS	QTY	WATER CONTACT
1	Nut	Hot Rolled	1	N
2	Name Plate	Aluminium	1	N
3	Handle	Cast Iron	1	N
4	Packing Nut	Brass Rod	1	N
5	Packing	Rubber (NBR)	1	Y
6	Bonnet	Cast Brass	1	Y
7	Stem	Cast Brass	1	Y
8	Seat Packing	Rubber (NBR)	1	Y
9	Screw	Forged Brass	1	Y
10	Body	Cast Brass	1	Y

PART#	NOMINAL SIZE	B	C	D	H	L
942144LF	1/2" PEX F1960 x 3/4" MHT	2.58	0.22	2.08	2.40	2.34
942145LF	3/4" PEX F1960 x 3/4" MHT	2.58	0.22	2.08	2.40	2.40

VACUUM BREAKER



- Male hose and female hose threads can be broken off for permanent attachment
- Set screw
- Vandal proof
- Rough brass construction
- Prevents back-siphonage on hoses to prevent potable water from getting contaminated
- Certified under ASSE Std. 1011
- UPC
- CSA

PART #	SIZE	
947055	3/4" x 3/4"	----
947055LF	3/4" x 3/4"	----

WARNING: This product can expose you to chemicals, including lead, which are known to the State of California to cause cancer and birth defects or other reproductive harm. For more information, visit www.P65Warnings.ca.gov

LEAD FREE VALVES AND PLUMBING

SUPPLY STOPS/ SS SUPPLY CONNECTORS

LF VALVES & PLBG FITTINGS

SUPPLY STOPS - 1/4 TURN

- 100% Pressure Leak Tested
- High Performance Teflon Seats
- Individually Boxed
- Conventional Oval Handle Design
- Meets or Exceeds ASME A112.18.1



ANGLE STOPS

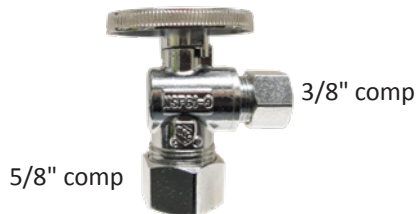

PART #	X 3/8 COMPRESSION	
746456	5/8 Compression	----



PART #	X 3/8 COMPRESSION	
746457	5/8 Compression Contractor Pack bagged less 3/8" Nut & Ferrule 10/Box	----

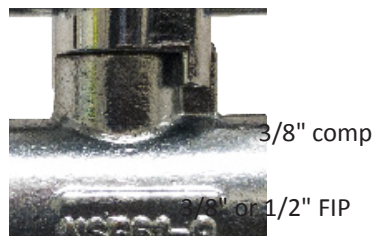

PART #	X 3/8 COMPRESSION	
746436	3/8 Female Iron Pipe	----
746446	1/2 Female Iron Pipe	----



PART #	X 3/8 COMPRESSION	
746466	LF 1/2 Nominal Sweat	----

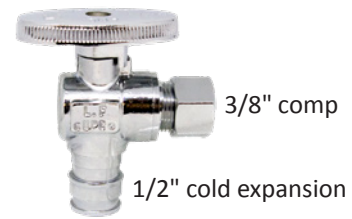

PART #	X 3/8 COMPRESSION	
746435	1/2 C/E Pex	----



PART #	X 3/8 COMPRESSION	
746438	1/2 Nominal Pex	----

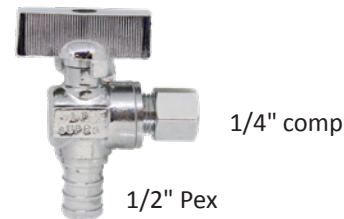

PART #	X 1/4 COMPRESSION	
746437	1/2 Nominal Pex	----

PRESS FIT



PART #	X 3/8 COMPRESSION	
746470	1/2 Press	----

3 WAY STOPS

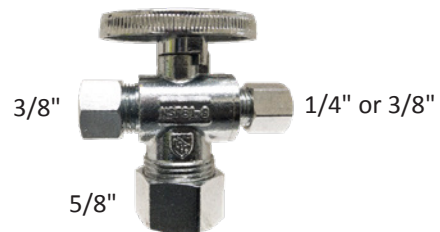

PART #	DESCRIPTION	
746439	LF 5/8 Compression x 3/8 Compression x 1/4 Compression	----
746440	LF 5/8 Compression x 3/8 Compression x 3/8 Compression	----

WARNING: This product can expose you to chemicals, including lead, which are known to the State of California to cause cancer and birth defects or other reproductive harm. For more information, visit www.P65Warnings.ca.gov

SUPPLY STOPS/ SS SUPPLY CONNECTORS

LF VALVES & PLBG FITTINGS

STRAIGHT STOPS



PART #	X 3/8 COMPRESSION	
746506	3/8 Compression	----
746556	5/8 Compression	----

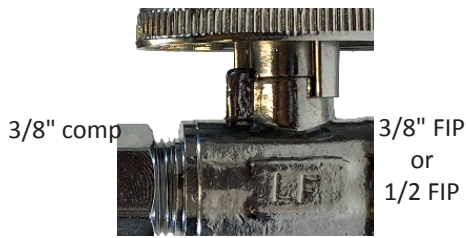

PART #	X 3/8 COMPRESSION	
746536	3/8 Female Iron Pipe	----
746546	1/2 Female Iron Pipe	----



PART #	X 3/8 COMPRESSION	
746566	1/2 Nominal Sweat	----



PART #	X 3/8 COMPRESSION	
746535	1/2 C/E Pex	----

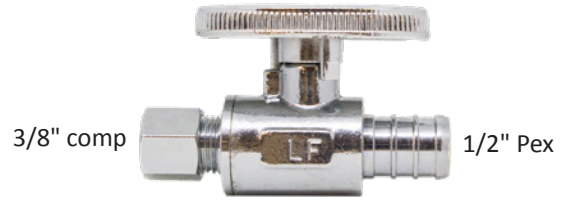

PART #	X 3/8 COMPRESSION	
746538	1/2 Nominal Pex	----



PART #	X 1/4 COMPRESSION	
746537	1/2 Nominal Pex	----



PART #	X 3/8 COMPRESSION	
746567	1/2 Socket CPVC	----

PRESS FIT STOPS



PART #	X 3/8 COMPRESSION	
746570	1/2" Press	----

WARNING: This product can expose you to chemicals, including lead, which are known to the State of California to cause cancer and birth defects or other reproductive harm. For more information, visit www.P65Warnings.ca.gov

LEAD FREE VALVES AND PLUMBING

SS SUPPLY CONNECTORS

LF VALVES & PLBG FITTINGS

LEAD FREE

AB1953/S.152
COMPLIANT

Meets S.3874/ Public Law No. 111-380
Reduction of Lead in Drinking Water Act

CONNECTORS

- Marine Grade Stainless Steel Braid
- Precision 12 Point Crimp
- Heavy duty Brass Inserts
- Chloramine/ Chlorine Resistant Inner Liner

LAVATORY

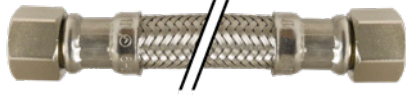

3/8 COMPRESSION X 3/8 COMPRESSION

PART #	LENGTH	
922012	12"	----
922016	16"	----
922020	20"	----
922030	30"	----
922036	36"	----

NEW WITH BRASS NUT

BALLCOCK

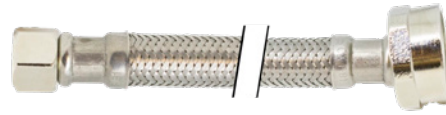

3/8 COMPRESSION X 7/8 BALLCOCK

923409	9"	----
923412	12"	----
923416	16"	----
923420	20"	----

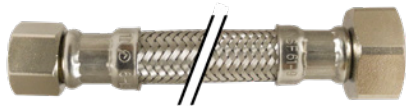

3/8 COMPRESSION X 1/2 FEMALE IRON PIPE

922112	12"	----
922116	16"	----
922120	20"	----
922130	30"	----
922136	36"	----

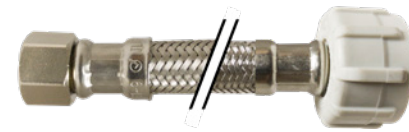

3/8 COMPRESSION X 7/8 BALLCOCK

923209	9"	----
923212	12"	----
923216	16"	----
923220	20"	----



1/2 FEMALE IRON PIPE X 1/2 FEMALE IRON PIPE

922412	12"	----
922416	16"	----
922420	20"	----
922430	30"	----
922436	36"	----



1/2 FEMALE IRON PIPE X 7/8 BALLCOCK

923509	9"	----
923512	16"	----
923520	20"	----

WARNING: This product can expose you to chemicals, including lead, which are known to the State of California to cause cancer and birth defects or other reproductive harm. For more information, visit www.P65Warnings.ca.gov

SS SUPPLY CONNECTORS

LF VALVES & PLBG FITTINGS

- Marine Grade Stainless Steel Braid
- Precision 12 Point Crimp
- Heavy duty Brass Inserts
- Chloramine/ Chlorine Resistant Inner Liner

LEAD FREE

AB1953/S.152

Compliant

Meets S.3874/ Public Law No. 111-380
Reduction of Lead in Drinking Water

Act

ICE MAKER

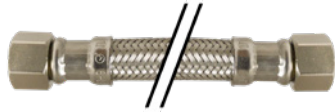

1/4 COMPRESSION X 1/4 COMPRESSION

PART #	LENGTH	
923112	12"	----
923124	24"	----
923136	36"	
923148	48"	
923161	60"	
923196	96"	----

DISHWASHER

3/8 COMPRESSION X 3/8 COMPRESSION

922009	9"	
922012	12"	
922024	24"	
922030	30"	
922036	36"	
922048	48"	----
922060	60"	----
922072	72"	----
922096	96"	----

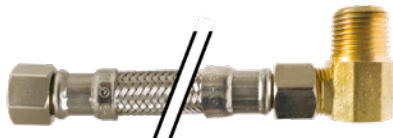

3/8 COMPRESSION X 3/8 MALE IRON PIPE ELBOW

PART #	L	
923648	48"	----
923660	60"	----
923672	72"	----
923684	84"	----

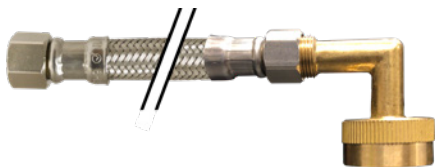

3/8 COMPRESSION X 3/4 FEMALE GARDEN HOSE ELBOW

924248	48"	----
924260	60"	----
924272	72"	----
924284	84"	----
924297	120"	----

WASHING MACHINE

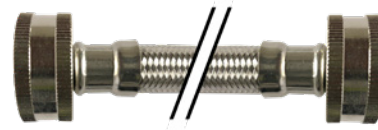

3/4 FEMALE GARDEN HOSE X 3/4 FEMALE GARDEN HOSE

923936	36"	----
923948	48"	----
923960	60"	----
923972	72"	----

WATER HEATER

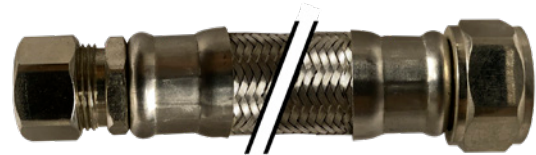

5/8 COMPRESSION X 3/4 FEMALE IRON PIPE

PART #	L	
922712	12"	----
922718	18"	----
922724	24"	----



7/8 COMPRESSION X 3/4 FEMALE IRON PIPE

922812	12"	----
922818	18"	----
922824	24"	----

3/4 MALE IRON PIPE X 3/4 FEMALE IRON PIPE

922912	12"	----
922918	18"	----
922924	24"	----

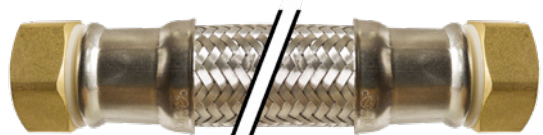

3/4 FEMALE IRON PIPE X 3/4 FEMALE IRON PIPE

924115	12"	----
924118	18"	----
924124	24"	----

WARNING: This product can expose you to chemicals, including lead, which are known to the State of California to cause cancer and birth defects or other reproductive harm. For more information, visit www.P65Warnings.ca.gov

LEAD FREE VALVES AND PLUMBING

TRANSITION FITTINGS

LF VALVES & PLBG FITTINGS

BRASS CPVC MALE ADAPTER



PART#	SIZE
35413LF	1/2"
35414LF	3/4"
35415LF	1"
35416LF	1-1/4"
35417LF	1-1/2"
35418LF	2

STAINLESS STEEL CPVC MALE ADAPTER



PART#	SIZE
35413SS	1/2"
35414SS	3/4"
35415SS	1"
35416SS	1-1/4"
35417SS	1-1/2"
35418SS	2

BRASS CPVC FEMALE ADAPTER



PART#	SIZE
35403LF	1/2"
35404LF	3/4"
35405LF	1"
35406LF	1-1/4"
35407LF	1-1/2"
35408LF	2

STAINLESS STEEL CPVC FEMALE ADAPTER



PART#	SIZE
35403SS	1/2"
35404SS	3/4"
35405SS	1"
35406SS	1-1/4"
35407SS	1-1/2"
35408SS	2

LEAD FREE CPVC DROP EAR ELBOW



PART#	SIZE
35420LF	1/2"

STAINLESS STEEL CPVC DROP EAR ELBOW



PART#	SIZE
35420SS	1/2"

WARNING: This product can expose you to chemicals, including lead, which are known to the State of California to cause cancer and birth defects or other reproductive harm. For more information, visit www.P65Warnings.ca.gov

WATER METER FLANGES

LF VALVES & PLBG FITTINGS

LEAD FREE OVAL WATER METER FLANGE OVAL



PART#	SIZE	CASE	
970207	1-1/2"	32	----
970208	2"	48	----

LEAD FREE OVAL WATER METER KIT

W/ BOLT & NUT STAINLESS STEEL



NO	PART	MATERIALS	QTY	WATER CONTACT
1	BOLT	SS 304	4	N
2	FLANGE	BRASS LEAD FREE	2	Y
3	PACKING	RUBBER	2	Y

PART#	SIZE	CASE	
970227	1-1/2"	32	----
970228	2"	48	----

LEAD FREE OVAL METER FLANGE KIT

W/ BOLT & NUT STAINLESS STEEL (NO LEAD)



NO	PART	MATERIALS	QTY	WATER CONTACT
1	BOLT	SS 304	2	N
2	FLANGE	BRASS LEAD FREE	1	Y
3	PACKING	RUBBER	1	Y
4	NUT	SS 304	2	N

PART#	SIZE	CASE	
970217	1-1/2"	12	----
970218	2"	10	----

LEAD FREE BRASS METER COUPLING



PART#	SIZE	CASE	
970253	1/2"	100	----
970254	3/4"	100	----
970255	1"	80	----
970257	1-1/2"	24	----
970258	2"	24	----

WARNING: This product can expose you to chemicals, including lead, which are known to the State of California to cause cancer and birth defects or other reproductive harm. For more information, visit www.P65Warnings.ca.gov

LEAD FREE VALVES AND PLUMBING

FLEXIBLE RUBBER COUPLINGS

LF VALVES & PLBG FITTINGS

FLEXIBLE RUBBER COUPLINGS / REDUCED COUPLINGS

Midland's stainless steel banded flexible rubber couplings are the perfect fit for Schedule 40 pipe applications.

Tech Specs:

- Installation torque: 60 inch lbs.
- Maximum test pressure: 4.3 PSI
- Maximum operating temperature: 140° F non-consistent
- Minimum operating temperature: -30° F

- Corrosion-resistant & rustproof stainless steel bands
- Durable Rubber for all Sch. 40 Pipe Applications
- Positive seal against infiltration and exfiltration
- Conforms to ASTM C 1173 and CSA B602
- Sizes 1-1/4" - 6" regular & reducing
- UPC Approved

COUPLING



REDUCING COUPLING



PART #	SIZE	LIST
195456	1-1/4"	
195470	1-1/2" x 1-1/4"	
195457	1-1/2"	
195471	2" x 1/2"	
195458	2"	
195472	3" x 1-1/2"	
195473	3" x 2"	
195459	3"	
195474	4" x 1-1/2"	
195475	4" x 2"	
195476	4" x 3"	
195460	4"	
195461	5"	
195481	6" x 4"	
195462	6"	

TEST CAPS



DRAIN & TRAP CONNECTORS



PART #	SIZE	LIST
195502	1-1/2"	
195510	2"	
195511	3"	
195512	4"	

PART #	SIZE	LIST
195520	1-1/2" x 1-1/4"	
195521	2" x 1-1/4"	

WARNING: This product can expose you to chemicals, including lead, which are known to the State of California to cause cancer and birth defects or other reproductive harm. For more information, visit www.P65Warnings.ca.gov



VALVES



VALVES

Forged Brass

- Full Port Ball
- Locking Handle
- Butterfly Handle
- N/P Ball Valve
- Italian Ball Valve
- M X F Ball Valve
- Spring Handle Ball Valve
- Right Angle Ball valve
- Wye, 3-Way Ball Valve
- Safety Exhaust Ball Valve
- Gas Valves
- Mini Ball Valves
- 3-Way Valves
- MISC
- Gate Valves
- Y Strainer
- Check Valves

Stainless Steel Valves

- Ball Valves
- SS Mini Ball Valve
- Check Valves
- Y-strainer, Globe, Gate

Carbon Steel Valves

- Ball Valves
- Check Valves

PVC Valves

Ductile Iron

- Butterfly
- Check
- Gate



BALL VALVE PRIVATE LABEL PROGRAM

Midland will put your company name and logo on our ball valve handle for FREE. Simply place a minimum blanket order of 10 cases per size and Midland will stock them under a special part # for your access only. Please allow 90-120 days for delivery on the first shipment only: Then have them delivered as you need them!

FORGED BRASS BALL VALVE

VALVES

FORGED BRASS BALL VALVE

• BRASS • 600WOG • FULL PORT

**ISO 9002 Manufacturer FEATURES**

Made in China

1/4"-2" 600 PSI non-shock cold water,
gas, oil - 150 PSI saturated steam
2-1/2"- 4" 400 PSI non-shock cold water,
gas, oil

- Suitable for full range of liquids and gases
- Minimal pressure drop due to large full size ports
- Bottom loaded, pressure retaining stem
- Pressure rated for 1/4"-2" at 600psi (42 bars) and 2-1/2"-4" at 400 psi WOG (non-shock) and 150 WSP (10.34 bars) saturated steam. Virgin PTFE stem packing seal, thrust washer and seats
- Yellow vinyl insulator on heavy duty plated carbon steel handles
- Fast 1/4 turn open or close operation
- Not Lead Free
- Good for gasoline and diesel

- Low operating torque
- Adjustable stem packing gland
- Maximum operating temperature: 302°F (150°C)
- Minimum operating temperature: -22°F (-30°C)
- Each valve individually tested
- Forged Brass - for more strength
- Threaded ends to ANSI B1.20.1
- Hard chromium plated solid ball
- Bottom entry, blow-out proof stem
- Deeper threads - for better connections

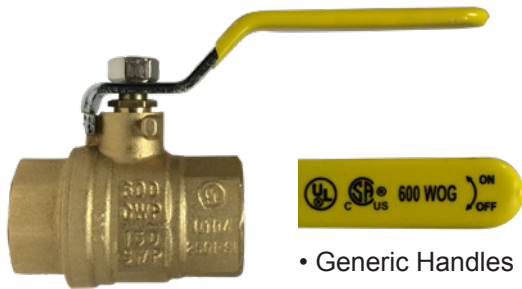

• Generic Handles

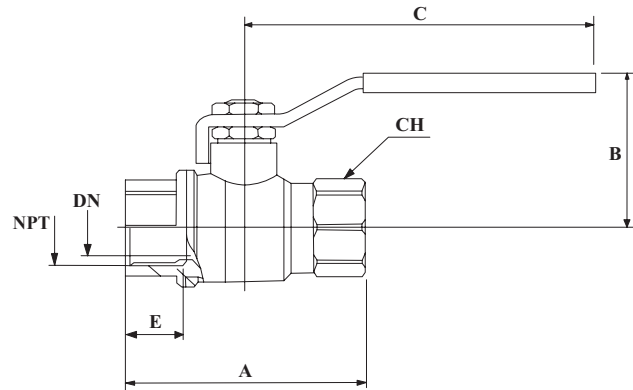

PART#	SIZE		DIMENSION INCHES					WEIGHT	BOX/CASE	
	NPT	DN	A	B	C	E	CH			
940171	1/4"	0.39	1.75	1.92	3.54	0.46	0.78	0.34	70/140	----
940172	3/8"	0.41	1.75	1.92	3.54	0.46	0.78	0.30	70/140	----
940173	1/2"	0.58	2.05	2.08	3.54	0.52	0.98	0.44	50/100	----
940174	3/4"	0.75	2.36	2.30	3.78	0.56	1.20	0.67	30/60	----
940175	1"	0.94	2.75	2.68	4.52	0.66	1.50	1.05	20/40	----
940176	1-1/4"	1.26	3.30	3.14	4.52	0.70	1.82	1.50	12/24	----
940177	1-1/2"	1.57	3.66	3.61	5.51	0.72	2.09	2.30	9/18	----
940178	2"	1.97	4.18	3.68	5.51	0.74	2.62	3.38	6/12	----
940179*	2-1/2"	2.52	5.38	4.76	8.66	1.01	3.36	7.61	3/6	----
940180*	3"	2.95	6.04	5.08	8.66	1.11	3.86	11.10	2/4	----
940181*	4"	3.89	7.38	5.86	9.00	1.22	4.89	12.12	1/2	----

* 400 PSI

* Add 'H' to part # to order handles *

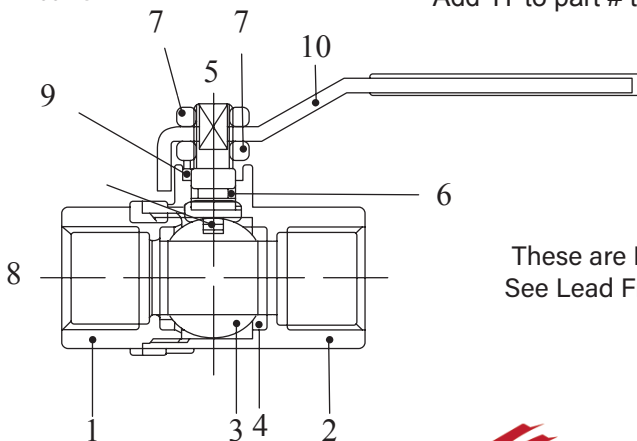

These are NOT Lead Free
See Lead Free SWT Valves

POS	Components	Materials	N
1	Body	Forged Brass	1
2	End Connection	Forged Brass	1
3	Ball	CP Brass	1
4	Ball Seat	P.T.F.E.	2
5	Stem	Brass	1
6	Gland	Brass	1
7	Nut	Steel	1
8	Spring Inseat	Steel	1
9	Stem Seal	P.T.F.E.	1
10	Handle	Steel	1

• Not Lead Free AB1953 Compliant

BUTTERFLY HANDLE BALL VALVE

VALVES

LOCKING HANDLE BALL VALVE

▪ BRASS ▪ 600WOG ▪ FULL PORT

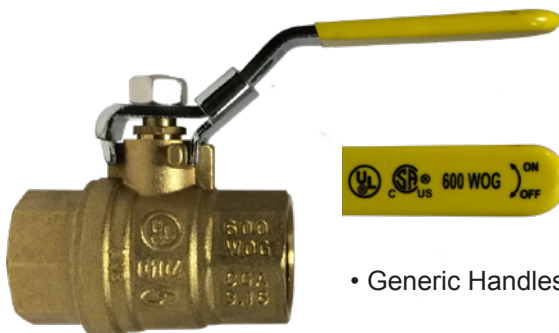

See specs on previous page

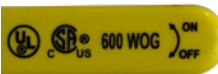

• Generic Handles

PART#	SIZE	DIMENSION INCHES						WEIGHT	BOX/CASE	
	NPT	DN	A	B	C	E	CH			
940171L	1/4"	0.31	1.73	1.84	3.15	0.49	0.71	0.39	70/140	----
940172L	3/8"	0.39	1.81	1.88	3.86	0.49	0.79	0.35	70/140	----
940173L	1/2"	0.58	2.23	2.09	3.43	0.61	0.98	0.49	50/100	----
940174L	3/4"	0.75	2.48	2.24	3.62	0.62	1.20	0.78	30/60	----
940175L	1"	0.94	2.95	2.67	4.42	0.73	1.50	1.18	20/40	----
940176L	1-1/4"	1.26	3.42	3.05	4.73	0.77	1.81	1.76	12/24	----
940177L	1-1/2"	1.57	3.78	3.51	5.18	0.78	2.09	2.53	9/18	----
940178L	2"	1.97	4.18	3.84	5.24	0.75	2.60	3.53	6/12	----

BUTTERFLY HANDLE BALL VALVE

▪ BRASS ▪ 600WOG ▪ FULL PORT



See specs on previous page

PART#	SIZE						WEIGHT	BOX/CASE	
	NPT	A	B	C	D	E			
940171T	1/4"	1.75	1.488	1.831	0.315	0.457	0.342	70/140	----
940172T	3/8"	1.756	1.488	1.831	0.394	0.457	0.31	70/140	----
940173T	1/2"	2.047	1.756	2.394	0.583	0.520	0.44	50/100	----
940174T	3/4"	2.362	1.921	2.394	0.748	0.563	0.68	30/60	----

• Not Lead Free AB1953 Compliant

WARNING: This product can expose you to chemicals, including lead, which are known to the State of California to cause cancer and birth defects or other reproductive harm. For more information, visit www.P65Warnings.ca.gov

VALVES

NICKEL PLATED BALL VALVE

VALVES

NICKEL PLATED BALL VALVE

• BRASS • 600WOG • FULL PORT • NO APPROVALS

Vacuum service to 29 inches Hg

600 psi (WOG) 150 psi (WSP) Service

Thread conform ANSI B1.20.1

Temperature Range : -40° F to 365° F

Construction: Forging Brass Body, Nickel plated

PTFE Ball Seats

Blow Out Proof Brass Stem

Steel Handle w/Vinyl Grip

Made in China

• Not Lead Free

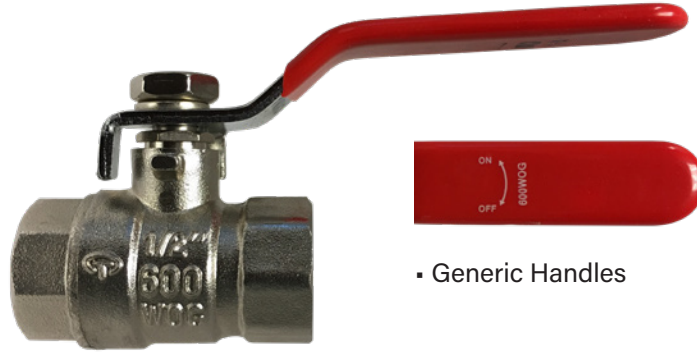

• Generic Handles

FIP X FIP NICKEL PLATED BALL VALVE

PART #	SIZE	OD	A	B	C	E	F	G	H	WEIGHT	BOX/CASE	
941151NP	1/4"	0.394	1.73	1.69	3.35	0.453	0.945	2.154	4.331	0.32	10/120	----
941152NP	3/8"	0.394	1.73	1.69	3.35	0.473	0.945	2.154	4.331	0.32	10/120	----
941153NP	1/2"	0.524	1.89	1.73	3.35	0.472	1.083	2.276	4.291	0.36	10/100	----
941154NP	3/4"	0.748	2.28	1.89	3.35	0.563	1.378	2.579	4.488	0.57	10/80	----
941155NP	1"	0.984	2.80	2.14	4.29	0.650	1.772	3.031	5.689	0.65	8/48	----
941156NP	1-1/4"	1.240	3.15	2.32	4.29	0.669	2.165	3.398	5.866	1.75	4/36	----
941157NP	1-1/2"	1.476	3.44	2.66	5.63	0.701	2.50	3.909	7.343	2.10	2/24	----
941158NP	2"	1.949	4.06	3.01	5.63	0.708	3.244	4.638	7.638	3.35	2/12	----

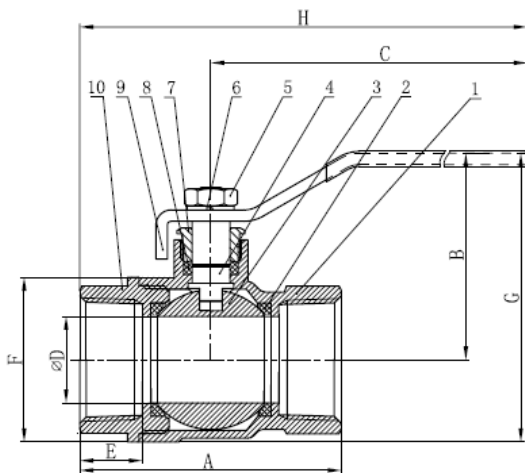

No	Item	Qty	Material
1	Body	1	NP Brass
2	Seat	2	PTFE
3	Ball	1	Brass CP
4	Stem	1	Brass/ NP
5	Handle Nut	1	Plated Steel
6	Lock Washer	1	Plated Steel
7	Packing Nut	1	Brass/ NP
8	Packing	1	PTFE



USE OUR TEXT LINE [855-609-3729](tel:855-609-3729) TO COMMUNICATE
WITH MIDLAND MORE CONVENIENTLY

WARNING: This product can expose you to chemicals, including Nickel, which are known to the State of California to cause cancer.
For more information, visit www.P65Warnings.ca.gov



N/P BALL VALVE W/SS TRIM VALVES

Gas Approved



UL842, UL258, UL125,FM

CSA AGA 3.88 5 PSIG

N/P BALL VALVE W/SS TRIM

- NICKEL PLATED
- SS BALL, HANDLE, NUT & STEM
- LOCKING HANDLE
- W/APPROVALS

Features

- Vacuum service to 29 inches Hg
- Thread Conform ANSI B1.20.1
- Forged Brass Body
- Blow Out Proof Stem Design
- Packing Nut, O-RING & Packing On The Stem Seal
- Stainless Steel Ball, Handle, Nut&Stem
- Handle With Vinyl Grip

Performance rating

- 600 PSI (WOG) 150 PSI (WSP) Service
- Temperature range: -20° F to 300° F
- Made in China
- Not lead free
- No more rusty handles



• Generic Handles

PART#	SIZE	D	L	H	W	CV	WT.(LBS.)	BOX/CASE	
941121NP	1/4	0.394	3.22	1.84	1.73	8.23	0.326	10/120	----
941122NP	3/8	0.394	3.22	1.84	1.73	8.23	0.320	10/120	----
941123NP	1/2	0.591	3.22	2.02	2.24	18.55	0.474	10/100	----
941124NP	3/4	0.748	4.04	2.40	2.52	29.76	0.785	10/80	----
941125NP	1	0.984	4.08	2.20	2.97	51.55	1.155	8/48	----
941126NP	1-1/4	1.259	5.20	3.05	3.44	84.42	1.797	4/36	----
941127NP	1 1/2	1.574	5.20	3.18	3.88	131.93	2.447	2/24	----
941128NP	2	1.941	5.20	3.48	4.33	200.35	3.477	2/12	----

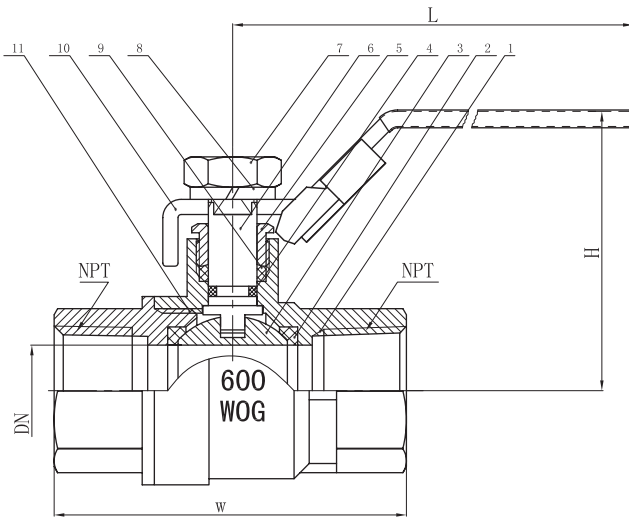

Part Name	Material
Body	Brass/ Nickel Plated
Seat	PTFE
Ball	Stainless Steel
O-ring	Fluoroelastomer
Packing Nut	Brass/ Nickel Plated
Stem	Stainless Steel
Handle Nut	Stainless Steel
Lock Washer	Stainless Steel
Packing	PTFE
Handle	Stainless Steel
Cap	Brass/ Nickel Plated



GO ONLINE TO UPLOAD YOUR LOGO TO UTILIZE ALL OF OUR CUSTOMIZABLE TOOLS!

WARNING: This product can expose you to chemicals, including chromium, which are known to the State of California to cause cancer and birth defects or other reproductive harm. For more information, visit www.P65Warnings.ca.gov

VALVES

ITALIAN BALL VALVE

VALVES

ITALIAN BALL VALVE

• BRASS • 600WOG • FULL PORT

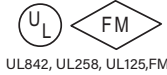

ISO 9002 Manufacturer
FEATURES

CSA AGA 3.88 5 PSIG

IAMPO IGC 157 - 2004b

- **SOLID CHROME PLATED BRASS BALL**
- Suitable for full range of liquids and gases
- Minimal pressure drop due to large full size ports
- Bottom loaded, pressure retaining stem
- Pressure rated at 600psi (42 bars) WOG (non-shock) and 150 WSP (10.34 bars) saturated steam. Virgin TFE stem packing seal, thrust washer and seats.
- Yellow vinyl insulator on heavy duty plated carbon steel handles.
- Fast 1/4 turn open or close operation
- Low operating torque
- Flow can go both directions
- Generic Handles

- **Adjustable stem packing gland**
- Maximum operating temperature: 248°F (120° C) at 600 PSI
- Minimum operating temperature: -20°F (-40°C)
- Each valve individually tested
- Forged Brass - for more strength
- Threaded ends to ANSI B1.20.1
- Hard chromium plated solid ball
- Bottom entry, blow-out proof stem
- Deeper threads - for better connections

• **REVERSIBLE HANDLES**

MADE IN ITALY

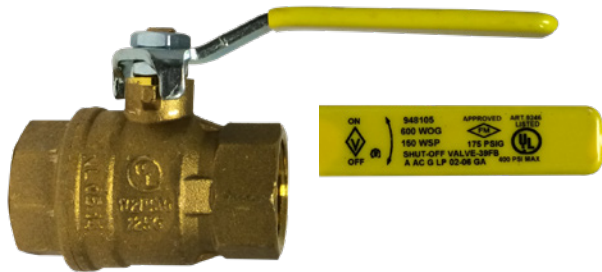

Female x Female

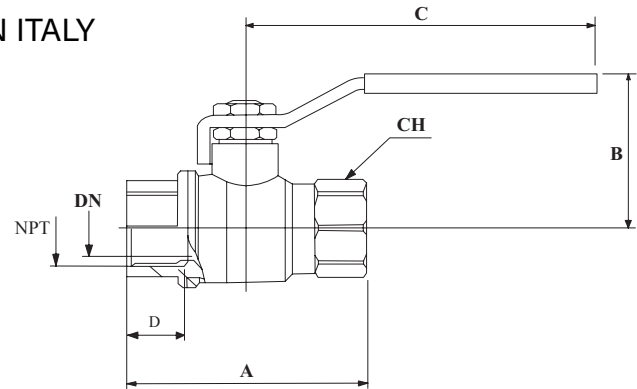

PART#	SIZE		DIMENSION INCHES					WEIGHT	BOX/CASE	
	NPT	DN	A	B	C	D	CH			
943200	1/4"	.39	1.96	1.53	3.31	.43	.75	0.36	24/96	----
943201	3/8"	.39	1.96	1.53	3.31	.43	.86	0.40	24/96	----
943202	1/2"	.57	2.09	1.57	3.25	.46	.98	0.44	20/80	----
943203	3/4"	.75	2.28	1.77	3.80	.49	1.22	0.57	14/56	----
943204	1"	.94	2.80	2.03	3.80	.59	1.50	0.89	6/24	----
943205	1-1/4"	1.24	3.50	2.32	4.72	0.72	1.85	1.64	4/16	----
943206	1-1/2"	1.49	3.90	3.02	6.38	0.85	2.13	2.78	2/8	----
943207	2"	1.96	4.07	3.27	6.38	.65	2.64	3.21	2/8	----
942208	2-1/2"	2.48	5.80	4.98	7.54	1.06	3.31	6.97	5	----
942209	3"	2.99	6.85	5.63	8.86	1.14	3.89	10.34	3	----
942210	4"	3.54	7.67	6.04	8.86	1.22	4.80	18.77	1	----

HANDLE OPTIONS

TEE HANDLES

PART #	VALVE SIZE	LIST PRICE
43200T	1/4" - 3/4"	----

LOCKING HANDLES

PART #	VALVE SIZE	LIST PRICE
43200L	1/4" - 3/4"	----
43204L	1"	----
43206L	1-1/4" - 1-1/2"	----

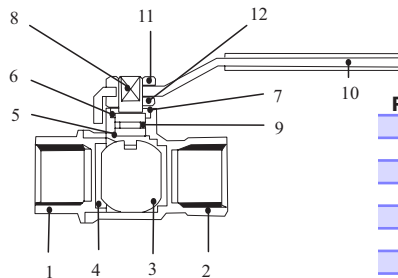

POS	Components	Materials	N
1	Body	Forged Brass	1
2	End Connection	Forged Brass	1
3	Ball	CP Brass	1
4	Ball Stems	P.T.F.E.	2
5	Stem Antif. Seat	P.T.F.E.	1
6	Stem Seat	P.T.F.E.	1
7	Brass Ring	Brass	1
8	Stem	Brass	1
9	O-Ring	NBR 80	1
10	Handle	Steel	1
11	Nut	Steel	1
12	Nut	Brass	1

WARNING: This product can expose you to chemicals, including lead, which are known to the State of California to cause cancer and birth defects or other reproductive harm. For more information, visit www.P65Warnings.ca.gov

• Not Lead Free AB1953 Compliant

www.midlandindustries.com



Toll Free Phone 1-800-821-5725

MALE X FEMALE BRASS BALL VALVE

VALVES

MALE X FEMALE BRASS BALL VALVE

• 600WOG • FULL PORT



UL842, UL258

- Solid chrome plated brass ball
- Suitable for full range of liquids and gases.
- Minimal pressure drop due to large full size ports.
- Bottom loaded, pressure retaining stem.
- Pressure rated at 600psi (42 bars) WOG (non-shock) and 150psi (10.34 bars) saturated steam. Virgin TFE stem packing seal, thrust washer and seats.
- Yellow vinyl insulator on heavy duty plated carbon steel handles.
- Fast 1/4 turn open or close operation.
- Flow both directions.
- Low operating torque.

- Adjustable stem packing gland.
- Generic Handles
- Maximum operating temperature: 248°F (120°C)
- Minimum operating temperature: -20°F (-40°C)
- Each valve individually tested.
- Forged Brass - for more strength.
- Threaded ends to ANSI B1.201
- Hard chromium plated solid ball

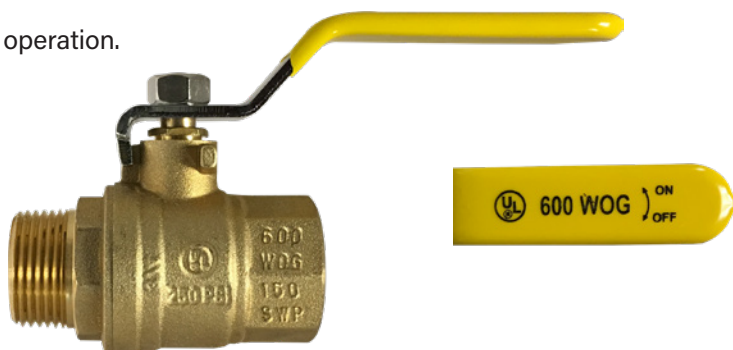

• Not Lead Free

PART#	SIZE	NPT	A	B	C	D	E	WEIGHT	BOX/CASE	
948170	1/4"	1/4 - 18	2.016	1.689	2.756	0.315	0.457	0.29	70/140	----
948171	3/8"	3/8 - 18	2.094	1.89	3.543	0.394	0.457	0.33	70/140	----
948172	1/2"	1/2 - 14	2.343	2.05	3.543	0.583	0.520	0.47	50/100	----
948173	3/4"	3/4 - 14	2.618	2.20	3.780	0.748	0.563	0.68	30/60	----
948174	1"	1 - 11.5	3.000	2.579	4.528	0.945	0.630	1.11	20/40	----
948175	1-1/4"	1-1/4 - 11.5	3.563	2.953	4.528	1.260	0.709	1.70	12/24	----
948176	1-1/2"	1-1/2 - 11.5	3.965	3.346	5.512	1.575	0.717	2.50	9/18	----
948177	2"	2 - 11.5	4.496	3.681	5.512	1.969	0.748	3.57	6/12	----

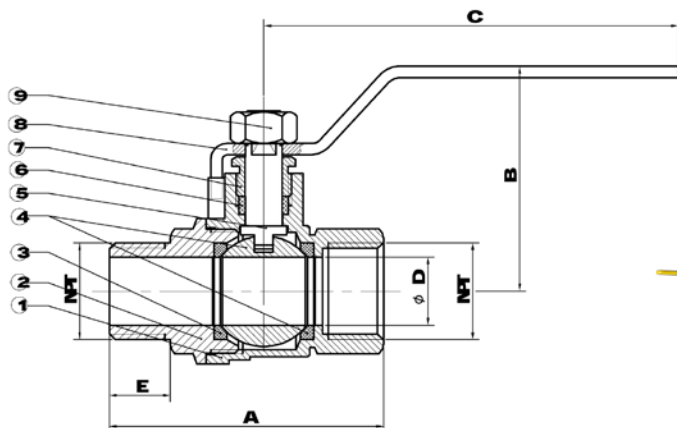

POS	Components	Materials
1	Body	C37700
2	End Cap	CS7700
3	Ball Seat	PTFE
4	Ball	CS7700
5	Stem	CS7700
6	Stem Reducing	PTFE
7	Reducing Nut	CS7700
8	Lever Handle	1008



Locking Handle option



Tee handle option

WARNING: This product can expose you to chemicals, including lead, which are known to the State of California to cause cancer and birth defects or other reproductive harm. For more information, visit www.P65Warnings.ca.gov

ITALIAN MALE X FEMALE BALL VALVE

VALVES

ITALIAN MALE X FEMALE BALL VALVE

• BRASS • 600WOG • FULL PORT

Gas Approved



CSA AGA 3.88 5 PSIG

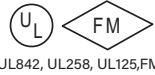

UL842, UL258, UL125, FM

Made in Italy

ISO 9002 Manufacturer
FEATURES

- Solid chrome plated brass ball
- Suitable for full range of liquids and gases.
- Minimal pressure drop due to large full size ports.
- Bottom loaded, pressure retaining stem.
- Pressure rated at 600psi (42 bars) WOG (non-shock) and 150psi (10.34 bars) saturated steam. Virgin TFE stem packing seal, thrust washer and seats.
- Yellow vinyl insulator on heavy duty plated carbon steel handles.
- Fast 1/4 turn open or close operation.
- Generic Handles
- Flow both directions.

- Low operating torque.
- Adjustable stem packing gland.
- Maximum operating temperature: 248°F (120°C) at 600 p.s.i
- Minimum operating temperature: -20°F (-40°C)
- KV: Pressure drop m^3/h .
- Each valve individually tested.
- Forged Brass - for more strength.
- Threaded ends to ANSI B1.20.1
- Hard chromium plated solid ball
- Bottom entry, blow-out proof stem.
- Deeper threads - for better connections.

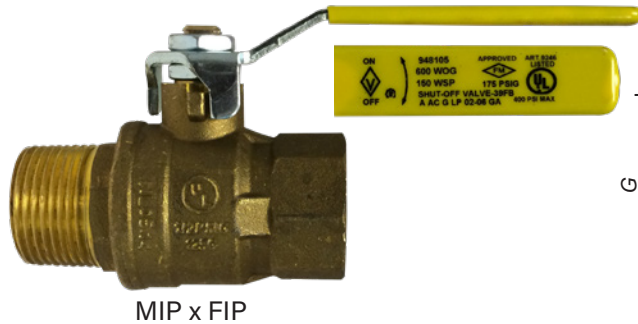

MIP x FIP

MADE IN ITALY

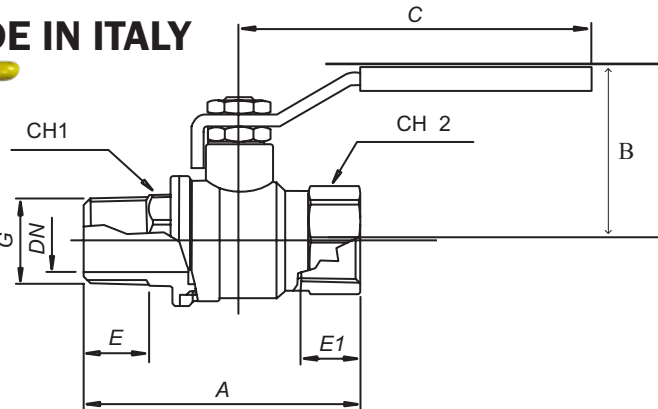

PART#	SIZE	DN	A	B	C	E	E1	CH1	CH2	WEIGHT	BOX/CASE	
948101	1/4"	.39	2.18	1.53	3.28	.39	.43	.55	.75	0.35	24/96	----
948102	3/8"	.39	2.20	1.53	3.28	.43	.43	.71	.86	0.35	24/96	----
948103	1/2"	.57	2.54	1.57	3.28	.62	.46	.87	.98	0.42	14/56	----
948104	3/4"	.75	2.75	1.77	3.80	.55	.49	1.12	1.22	0.68	12/48	----
948105	1"	.94	3.23	2.03	3.80	.69	.59	1.34	1.50	0.95	6 /24	----
948106	1-1/4"	1.24	3.86	2.32	4.63	.81	.79	1.69	1.90	1.66	4/16	----
948107	1-1/2"	1.49	4.20	2.98	6.28	.85	.64	2.15	2.13	2.83	2/8	----
948108	2"	1.96	4.90	3.27	6.38	.90	.75	2.40	2.64	4.22	1/4	----

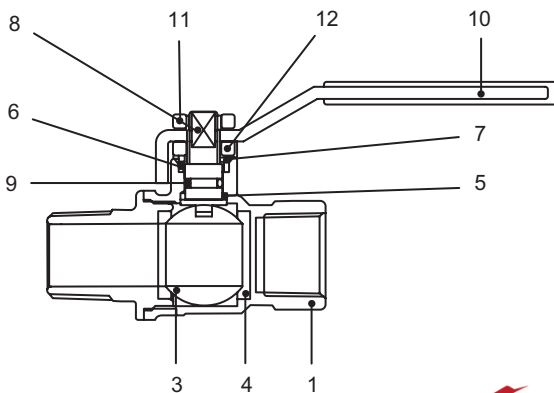

POS	Components	Materials	N
1	Body	CW617N Forged Brass	1
2	End Connection	CW617N Forged Brass	1
3	Ball	CW617N CP Brass	1
4	Ball Stems	P.T.F.E.	2
5	Stem Antif. Seat	P.T.F.E.	1
6	Stem Seat	P.T.F.E.	1
7	Brass Ring	CW617N Brass	1
8	Stem	CW617N Brass	1
9	O-Ring	NBR 80	1
10	Handle	UNI EN 10025 Steel	1
11	Nut	EN 5771 Steel	1
12	Nut	CW617N Brass	1

WARNING: This product can expose you to chemicals, including lead, which are known to the State of California to cause cancer and birth defects or other reproductive harm. For more information, visit www.P65Warnings.ca.gov



TEE HANDLE BALL VALVE - MXF

VALVES

TEE HANDLE BALL VALVE - MALE X FEMALE



UL842, UL258

Features

- Thread conform ANSI B1.20.1
- Forged brass body
- Blow out proof stem design
- Packing nut, O-Ring and packing on the stem seal
- Chrome Plated Brass Ball
- Handle with vinyl grip

Performance rating

- 600 PSI (WOG) 150 PSI (WSP) Service
- Temperature range: -20° F to 300° F
- Made in China
- Not lead free



PART#	SIZE NPT	DIMENSION INCHES					Weight	Box/Case	
		A	B	C	D	E			
948170T	1/4"	2.016	1.27	2.67	0.315	0.457	0.26	70/140	----
948171T	3/8"	2.094	1.213	2.67	0.394	0.457	0.33	70/140	----
948172T	1/2"	2.343	1.61	3.12	0.583	0.520	0.49	50/100	----
948173T	3/4"	2.618	1.26	3.12	0.748	0.563	0.66	30/60	----
948174T	1"	3.000	1.921	3.701	0.945	0.630	1.06	20/40	----
948176T	1-1/2"	3.965	2.717	4.331	1.575	0.717	2.46	9/18	----

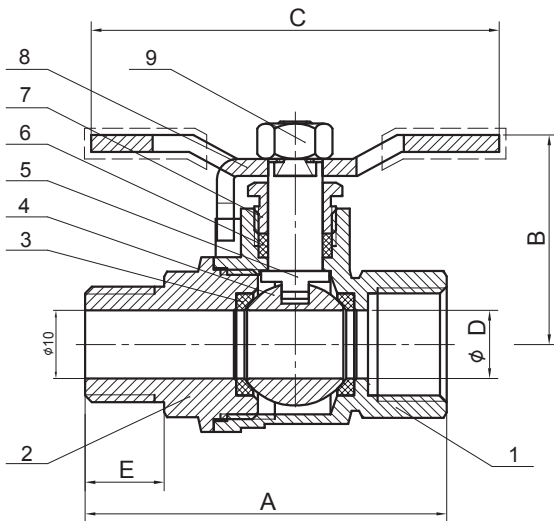

Item	Part	Materials
1	Body	Brass
2	End Cap	Brass
3	Ball Seat	PTFE
4	Ball	C/P Brass
5	Stem	Brass
6	Stem Packing	PTFE
7	Packing Nut	Brass
8	T-Handle	Nickel plating steel
9	Stem Nut	Brass plating steel



HELP US HELP YOU! GO ONLINE TO UPDATE YOUR CUSTOMER PROFILE SO THAT WE CAN UPDATE ALL THE APPROPRIATE DEPARTMENTS AND PERSONNEL AT YOUR COMPANY ON NEW CATALOGS, PRICING UPDATES, NEW MARKETING TOOLS, AND OTHER IMPORTANT INFORMATION. THANK YOU!

WARNING: This product can expose you to chemicals, including lead, which are known to the State of California to cause cancer and birth defects or other reproductive harm. For more information, visit www.P65Warnings.ca.gov

VALVES

LOCKING HANDLE BALL VALVES - FEMALE X MALE VALVES

LOCKING HANDLE BALL VALVES - FEMALE X MALE



UL842, UL258

Features

- Thread conform ANSI B1.20.1
- Forged brass body
- Blow out proof stem design
- Packing nut, O-Ring and packing on the stem seal
- Chrome Plated Brass ball
- Handle with vinyl grip

Performance rating

- 600 PSI (WOG) 150 PSI (WSP) Service
- Temperature range: -20° F to 300° F
- Made in China
- Not lead free



PART#	SIZE	DIMENSION INCHES					Weight	Box/Case	
	NPT	A	B	C	D	E			
948170L	1/4"	2.016	1.732	3.543	0.315	0.457	0.32	70/140	----
948171L	3/8"	2.094	1.732	3.543	0.394	0.457	0.37	70/140	----
948172L	1/2"	2.343	1.941	3.543	0.583	0.520	0.50	50/100	----
948173L	3/4"	2.618	2.106	3.78	0.748	0.563	0.77	30/60	----
948174L	1"	3.000	2.579	4.528	0.945	0.630	1.21	20/40	----
948175L	1-1/4"	3.563	2.961	4.528	1.260	0.709	1.74	12/24	----
948176L	1-1/2"	3.965	3.366	5.36	1.575	0.717	2.58	9/18	----
948177L	2"	4.496	3.701	5.36	1.969	0.748	3.73	6/12	----

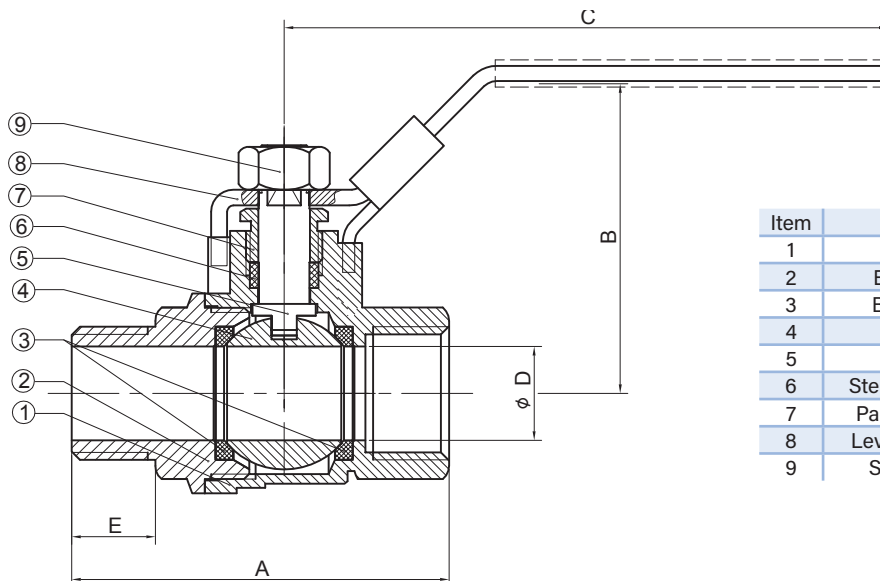

Item	Part	Materials
1	Body	Brass
2	End Cap	Brass
3	Ball Seat	PTFE
4	Ball	C/P Brass
5	Stem	Brass
6	Stem Packing	PTFE
7	Packing Nut	Brass
8	Lever Handle	Nickel plating steel
9	Stem Nut	Brass plating steel

WARNING: This product can expose you to chemicals, including lead, which are known to the State of California to cause cancer and birth defects or other reproductive harm. For more information, visit www.P65Warnings.ca.gov

SPRING HANDLE/ RIGHT ANGLE VALVES

VALVES

BRASS SPRING HANDLE BALL VALVE

Working pressure:600 PSI for brass
 Temperature Range:-40°F to 365°F(-40°C to +185°C)
 Material:Brass
 Spring Lever Handle w/Vinyl Grip
 Made in China
 Not lead free

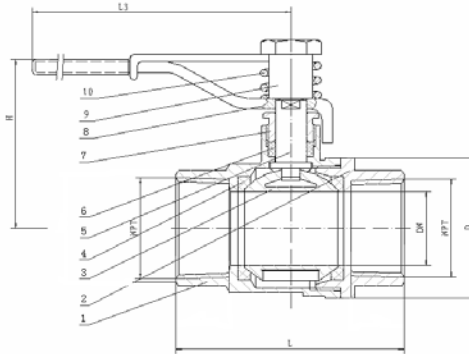

Part #	Part Name	Material
1	Body	Brass
2	Bonnet	Brass
3	Ball	Brass
4	Sealing Seat	PTFE
5	Stem	Stainless Steel
6	Packing Ring	PTFE
7	Gland	Brass
8	Handle	Stainless Steel
9	Bolt	Brass
10	Spring	Stainless Steel

PART#	SIZE	L	D	DN	H	L3	WTG	BOX/ CASE	
947103	1/2"	2.19	1.24	0.59	1.83	4.24	0.54	10/80	----
947104	3/4"	2.38	1.5	0.75	2.19	4.24	0.72	5/40	----
947105	1"	3.23	1.91	0.98	2.49	4.71	1.32	5/30	----

RIGHT ANGLE BRASS BALL VALVE

Working pressure: 250PSI
 Temperature Range -40° to 400°F(-40 °C to +205 °C)
 With lever Handle Polytetrafluoroethylene seats 2-pc,full port Heavy Duty forged Body Steel
 Handle w/Vinyl GripMade in China
 Not lead free

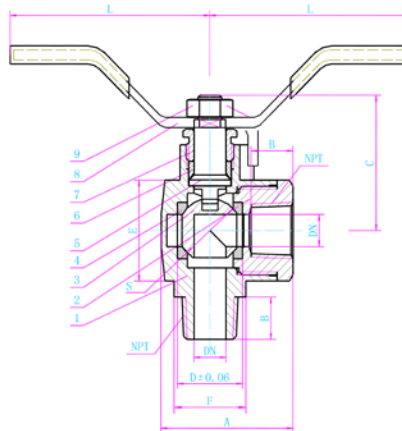
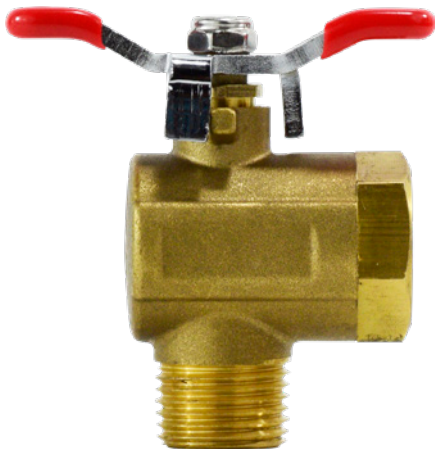

Part #	Part Name	Material
1	Body	Brass
2	Cap	Brass
3	Ball	Brass
4	Seat	PTFE
5	Stem	Brass
6	Stuffing	PTFE

PART #	SIZE	A	B	C	D	S	DN	L	E	F	WTG	BOX/ CASE	
947111	1/4	1.59	0.41	1.40	0.64	0.63	0.32	2.60	0.98	0.65	0.34	12/120	----
947112	3/8	1.59	0.41	1.40	0.73	0.71	0.39	2.60	0.98	0.65	0.36	12/120	----
947113	1/2	1.73	0.55	1.40	0.79	0.87	0.55	2.60	1.08	0.83	0.47	10/80	----

WARNING: This product can expose you to chemicals, including lead, which are known to the State of California to cause cancer and birth defects or other reproductive harm. For more information, visit www.P65Warnings.ca.gov

3 WAY AND SAFETY EXHAUST BALL VALVES

VALVES

3-WAY WYE BRASS BALL VALVE, VENTED AND UNVENTED

- Max. pressure: W.O.G. (water, oil, inert gas)
Unvented Valve: 600psi@70°F
Vented Valve: 250psi@70°F
W.S.P. (working steam pressure)
Unvented Valve: 150psi@365°F
Vented Valve: Not related
- Vacuum Rating: 29"Hg
- Temperature Range: -40° to 365°F
- Ports: Full

Part#	Part Name	Material
1	Body	Brass Nickel Plated
2	Seat	PTFE
3	Ball	Brass, Cr. Plated
4	Cap	Brass Nickel Plated
5	Stem	Brass
6	O-Ring	Fluoroelastomer

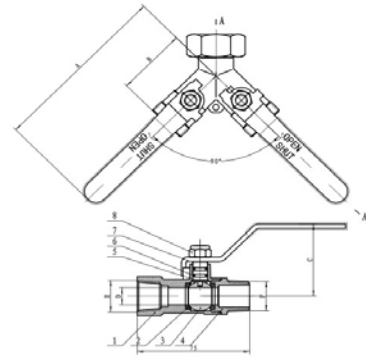

Designed for the portable air compressor industry, these valves control the flow of water, oil, and inert gases in two directions and are great for mixing and diverting. They have a single female inlet and two male outlets with two ball valves. Valves are Brass Nickel Plated and have chrome-plated brass balls, brass blow-out proof stems, PTFE seats and seals, and steel lever handles with vinyl grips. Vented valves have a drilled hole on the two valve balls and body that vents compressed air in the line when the valve is closed. Connections: 1" NPT female inlet and 3/4" NPT male outlet. • Made in China • Not lead free

Connections: 1" NPT female inlet and 3/4" NPT male outlet. • Made in China • Not lead free



NON-VENTED



VENTED

NOW WITH STAINLESS STEEL HANDLES

PART #	BALL	E	F	A	B	C	D	G	WTG	BOX/CASE	
947125	Non-vented	1" Female	3/4" Male	5.18"	2.5"	2.05"	0.59"	90°	1.43	2/24	----
947126	Vented								1.48	2/24	----

EXHAUST VALVES

AUTOMATIC DRAIN & LATCH LOCK HANDLE

Full port hot forged brass ball valve, blow-out proof stem, downstream automatic vent with lockable handle in compliance with OSHA requirements.

- Maximum working pressure: 200 PSI (CWP).
- Temperature rating: +15°F through +210°F.
- Made in Italy
- Not lead free

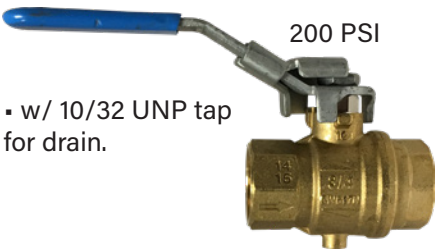

• w/ 10/32 UNP tap for drain.

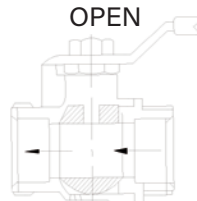

Valve - open position. Drain vent shut off.

CLOSED

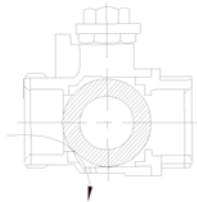

PART#	SIZE	
948131	1/4"	----
948132	3/8"	----
948133	1/2"	----
948134	3/4"	----
948135	1"	----

Valve - closed and draining occurs. Upstream seat prevents air flow. Downstream system is vented to atmosphere.

SAFETY EXHAUST BALL VALVE

- Threaded - Two Piece Body - Full Port
- Blow-out Proof Stem - PTFE Seats
- To Exhaust and Downstream Air in the Closed Position w/ locking lever handle.
- Made in China
- Vented
- 400 PSI WOG
- Not lead free
- 150 SWP



PART #	SIZE	A	B	D	E	
948141	1/4"	1.756	1.88	0.394	0.457	----
948142	3/8"	1.756	1.88	0.394	0.457	----
948143	1/2"	2.047	2.13	0.583	0.520	----
948144	3/4"	2.362	2.28	0.748	0.563	----

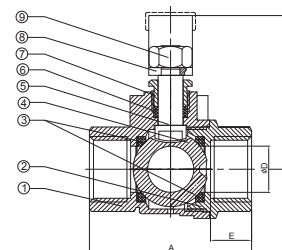

MATERIAL LIST

Item	Part	Material
1	Body	Brass
2	End Cap	Brass
3	Ball Seat	PTFE
4	Ball	Brass
5	Stem	Brass
6	Stem Packing	PTFE
7	Packing Nut	Brass
8	Lever Handle	Nickel plating steel
9	Stem Nut	Nickel plating steel

WARNING: This product can expose you to chemicals, including lead, which are known to the State of California to cause cancer and birth defects or other reproductive harm. For more information, visit www.P65Warnings.ca.gov

GAS BALL VALVES

VALVES



CSA AGA 3.88 5 PSIG

- Material: C37700
- Forged brass, Regular port, Thread*Flare Thread
- Thread ends in ANSI B1.20.1
- Working temperature: 0-65°(32-149°)
- Pressure :1/2PSI;5PSI;

GAS BALL VALVES

ISO 9002 MANUFACTURER
FEATURES

- ASME B16.44/CR91; ANSI Z21.15/CSA9.1
- UL 125 For LP-Gas 125psig
- Made in China



GAS BALL VALVE (2-PIECE)
FEMALE X FEMALE

PART#	SIZE	WTG	BOX/CASE
943311	3/8"	0.35	10/100
943312	1/2"	0.44	10/100
943313	3/4"	0.62	10/100
943314	1"		

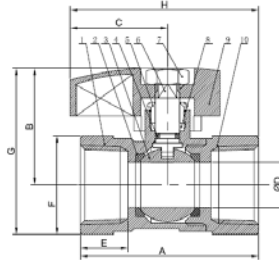

NO.	ITEM	TOTAL	MATERIAL
10	BALL VALVE CAP	1	BRASS
9	HANDLE	1	AL-alloy
8	PACKING	1	PTFE
7	HANDLE NUT	1	PLATED STEEL
6	STEM	1	BRASS
5	PACKING NUT	1	BRASS
4	O-RING	1	NBR
3	BALL	1	BRASS
2	SEALING WASHER	2	PTFE
1	BALL VALVE BODY	1	BRASS

SIZE	∅D	A	B	C	E	F	G	H
3/8"	0.394	1.752	1.437	1.28	0.472	0.945	1.909	2.146
1/2"	0.394	2.204	1.437	1.28	0.606	1.043	1.961	2.461
3/4"	0.591	2.362	1.535	1.28	0.626	1.299	2.815	2.476



FLARE X FLARE

PART#	SIZE
943342	3/8
943343	1/2
943345	5/8
943344	15/16

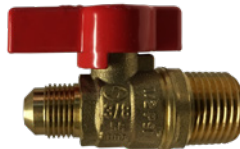

FLARE X MIP

PART#	SIZE
943347	3/8 x 1/2
943348	1/2 x 1/2



FLARE X FIP

PART#	SIZE
943331	3/8 x 1/2
943332	1/2 x 1/2
943351	5/8 x 3/4
943350	15/16 x 3/4

- For use with natural, manufactured, mixed liquified, petroleum and LP gas-air mixtures.
- Deeper thread connections. Smooth quarter-turn.
- Manufactured to ANSI Z21.15, C.G.A. 9.1-M81, 9.2-M88, 1/2 psig. 372 also to A.G.A.3-8, C.G.A. CR91-002, 2 psig.
- Solid chrome plated brass ball
- Bottom entry
- Blow out proof design.
- Double Fluoroelastomer o-rings stem seals
- Polytetrafluoroethylene seats for durability.
- Forged construction for greater strength.
- Larger ports for increased flow capacity.
- Red Reversible handle.
- May be used with water 400 WOG.

MADE IN ITALY

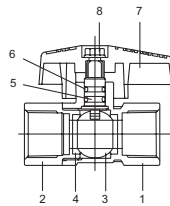

Components	Materials
1 Body	Forged Brass
2 End Connection	Forged Brass
3 Ball	Forged Brass
4 Ball Seats	P.T.F.E.
5 Stem	Brass
6 O-Ring	NBR
7 Butterfly	Steel
8 Screw	UNI 5771 Steel



CSA AGA 3.88 5 PSIG



Manual Valve LISTED Threaded NPT UL 842, UL 258, UL 125

GAS BALL VALVES FEMALE X FEMALE

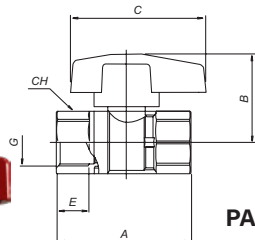
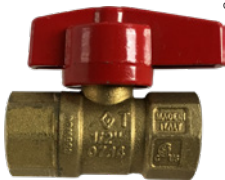

PART#	SIZE	DIMENSION INCHES								
		G	DN	A	B	C	E	CH	PN in psi	WTG
943212	1/2"	.47	2.26	1.45	2.28	.55	.98	600	0.33	20/80
943213	3/4"	.59	2.48	1.57	2.28	.57	1.22	600	0.45	14/56

WARNING: This product can expose you to chemicals, including lead, which are known to the State of California to cause cancer and birth defects or other reproductive harm. For more information, visit www.P65Warnings.ca.gov

CHROME PLATED BRASS MINI BALL VALVES

VALVES

ITALIAN CHROME PLATED BRASS MINI BALL VALVE

ISO 9002 Manufacturer

- FEATURES**
- Solid chrome plated brass ball
 - Max working pressure 235 psi will handle 300psi@75° F
 - Longer body style for longer, deeper thread connections
 - One piece drawn sand blasted chrome plated body.
 - Each valve is seal tested for maximum safety.
 - Double seal system allows valve to be operated in both directions making installation easier.
 - Blowout-proof brass stem.
 - NPT taper ANSI B1.20.1 threads.
 - 32°F to +176°F temperature.
 - 1/4 Turn Aluminium handle with mechanical stop.
 - NSF Approved valves available upon request.
 - Not lead free

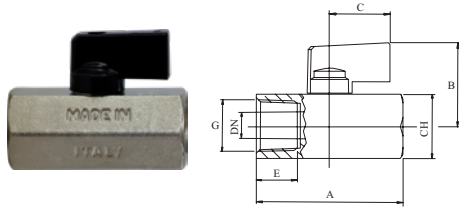

Made in Italy

Female x Female

PART#	SIZE		DIMENSION INCHES							BOX/ CASE
	G	DN	A	B	C	E	CH	WTG		
46922I	1/4"	0.31	1.81	1.17	0.9	0.51	0.83	0.24	50/200	----
46923I	3/8"	0.31	1.85	1.17	0.9	0.51	0.83	0.22	50/200	----
46924I	1/2"	0.39	2.18	1.26	0.9	0.61	0.98	0.32	30/120	----

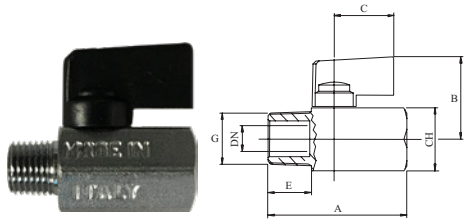
**Male x Female**

PART#	SIZE		DIMENSION INCHES							BOX/ CASE
	G	DN	A	B	C	E	CH	WTG		
46903I	1/4"	0.31	1.75	1.17	0.9	.40	0.83	0.20	50/200	----
46904I	3/8"	0.31	1.81	1.17	0.9	.41	0.83	0.20	50/200	----
46905I	1/2"	0.39	2.14	1.26	0.9	.52	0.98	0.30	40/160	----

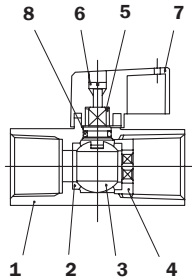

POS	Components	Materials	N
1	Body	CW517N Forged Brass	1
2	Ball Seats	P.T.F.E	2
3	Ball	CW517N CP Brass	1
4	Ring Unit	CW614N Brass	1
5	Stem	CW614N Brass	1
6	Screw	UNI 5771 Steel	1
7	Handle	Aluminum	1
8	O-Ring	NBR 80	1

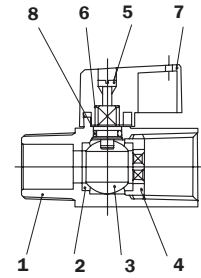

WARNING: This product can expose you to chemicals, including lead, which are known to the State of California to cause cancer and birth defects or other reproductive harm. For more information, visit www.P65Warnings.ca.gov

MINI BALL VALVES

VALVES

MINI BALL VALVES

- Chrome plated forged brass body
- Chrome plated brass ball
- NPT taper ANSI B1.20.1 threads*
- 450 PSI working pressure
- At 212°F - 355 PSI

- At 356°F - 142 PSI
- 1/4 Turn Alumzinc handle
- Not lead free
- Made in China

See page 107 for C/P Push-In mini ball valves



FEMALE X FEMALE - FLAG HANDLE

PART #	SIZE	DIMENSIONS (IN)				WT LBS	BOX/CASE	
		A	D(FLOW)	F	G			
46934	1/8	1.57	0.24	0.93	1.46	0.21	20/300	----
46935	1/4	1.57	0.31	0.93	1.46	0.20	20/300	----
46936	3/8	1.57	0.28	0.93	1.46	0.22	20/300	----
46937	1/2	1.77	0.35	0.93	1.56	0.24	20/200	----

MINI BALL VALVES W/FLUOROELASTOMER SEALS

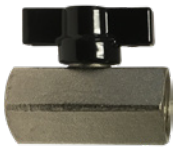

FEMALE X FEMALE - TEE HANDLE

PART #	SIZE	DIMENSIONS (IN)				WT LBS	BOX/CASE	
		A	D(FLOW)	HANDLE	G			
46934LT	1/8	1.60	0.24	1.34	1.43	0.21	20/300	----
46935LT	1/4	1.57	0.31	1.34	1.43	0.20	20/300	----
46936LT	3/8	1.60	0.28	1.34	1.43	0.22	20/300	----



FEMALE X FEMALE - SCREWDRIVER

PART #	SIZE	DIMENSIONS (IN)		WT LBS	BOX/CASE	
		A	D(FLOW)			
46934LS	1/8	1.57	0.24	0.21	20/300	----
46935LS	1/4	1.57	0.31	0.20	20/300	----
46936LS	3/8	1.57	0.28	0.22	20/300	----
46937LS	1/2	1.77	0.35	0.24	20/200	----

- Not lead free

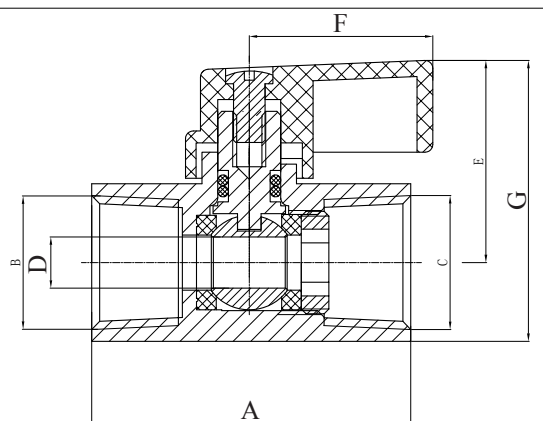

Pos	Components	Materials	N
1	Body	CP Forged Brass	1
2	Ball Seats	P.T.F.E.	2
3	Ball	CP Brass	1
4	Ring Unit	Brass	1
5	Stem	Brass	1
6	O-Ring - flag handle	NBR 80	1
6	O-Ring - all others	Fluoroelastomer	1

WARNING: This product can expose you to chemicals, including lead, which are known to the State of California to cause cancer and birth defects or other reproductive harm. For more information, visit www.P65Warnings.ca.gov

MINI BALL VALVES

VALVES

MINI BALL VALVES

- Chrome plated forged brass body
- Chrome plated brass ball
- NPT taper ANSI B1.20.1 threads*
- 450 PSI working pressure
- At 212°F - 355 PSI
- At 356°F - 142 PSI
- 1/4 Turn Alumzinc handle
- Not lead free
- Made in China

**MALE X FEMALE - FLAG HANDLE**

PART #	SIZE	DIMENSIONS (IN)				WT LBS	BOX/ CASE	
		A	D(FLOW)	F	G			
46930	1/8	1.57	0.24	0.93	1.46	0.17	20/300	----
46931	1/4	1.57	0.31	0.93	1.46	0.15	20/300	----
46932	3/8	1.57	0.28	0.93	1.46	0.21	20/300	----
46933	1/2	1.77	0.35	0.93	1.56	0.24	20/200	----

MINI BALL VALVES W/FLUOROELASTOMER SEALS**MALE X FEMALE - TEE HANDLE**

PART #	SIZE	DIMENSIONS (IN)				WT LBS	BOX/ CASE	
		A	D(FLOW)	HANDLE	G			
46930T	1/8	1.57	0.24	1.34	1.46	0.17	20/300	----
46931T	1/4	1.57	0.31	1.34	1.46	0.15	20/300	----
46932T	3/8	1.57	0.28	1.34	1.40	0.21	20/300	----
46933T	1/2	1.77	0.35	1.34	1.56	0.24	20/200	----

MALE X FEMALE - SCREWDRIVER

PART #	SIZE	DIMENSIONS (IN)		WT LBS	BOX/ CASE	
		A	D(FLOW)			
46930S	1/8	1.57	0.24	0.17	20/300	----
46931S	1/4	1.57	0.31	0.15	20/300	----
46932S	3/8	1.57	0.28	0.21	20/300	----
46933S	1/2	1.77	0.35	0.24	20/200	----

- Not lead free

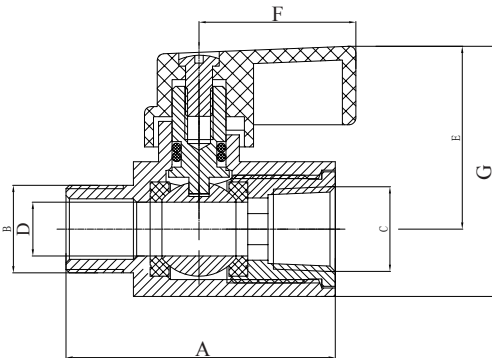

Pos	Components	Materials	N
1	Body	CP Forged Brass	1
2	Ball Seats	P.T.F.E.	2
3	Ball	CP Brass	1
4	Ring Unit	Brass	1
5	Stern	Brass	1
6	O-Ring - flag handle	NBR 80	1

WARNING: This product can expose you to chemicals, including lead, which are known to the State of California to cause cancer and birth defects or other reproductive harm. For more information, visit www.P65Warnings.ca.gov



FORGED BRASS MINI BALL VALVES

VALVES

FORGED BRASS MINI-BALL VALVES

- 180° operational handle, blow out proof stem. Stem with double "O" Rings
- 200 WOG
- Temp rating -20°F - 250°F
- Generic Handles
- Not lead free

See page 107 for C/P mini ball valves

NO	Part Name	Material	QTY
1	Nut	Steel	1
2	Handle	Steel	1
3	Cover	PVC	1
4	O-Ring	NBR	2
5	Stem	Brass	1
6	Body	Brass	1
7	Seat	Polyte	2
8	Ball Disc	Brass	1
9	End Plug	Brass	1

*Polyte Abbreviation for Polytetrafluoroethylene

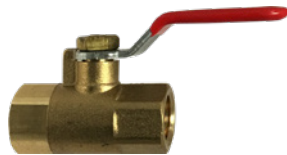
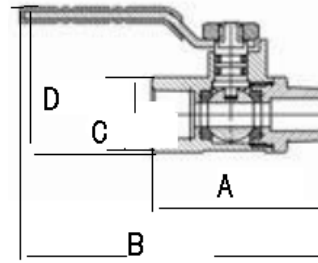

FEMALE X FEMALE

PART #	SIZE	A	B	C	D	
944113	1/8	1.53	2.80	0.73	1.42	----
944116	1/4	1.53	2.80	0.73	1.42	----
944117	3/8	1.73	2.90	0.87	1.50	----
944140	1/2	2.20	3.08	0.98	1.45	----

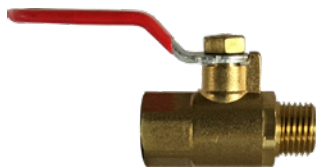

FEMALE X MALE

PART #	SIZE	A	B	C	D	
944106	1/8	1.69	3.02	0.73	1.46	----
944100	1/4X1/8	1.28	2.90	0.66	1.32	----
944101	1/4	1.70	3.00	0.73	1.46	----
944102	3/8X1/4	1.78	2.50	0.89	1.50	----



MALE X MALE

PART #	SIZE	A	B	C	D	
944107	1/8	1.70	2.94	0.65	1.42	----
944109	1/4	1.25	2.66	0.65	1.42	----
944110	3/8	1.90	2.98	0.73	1.42	----
944112	1/2	2.56	4.93	1.02	2.21	----



HOSE BARB X MALE

PART #	SIZE	A	B	C	D	
944132	1/4X1/8	2.05	2.91	0.73	1.51	----
944138	1/4X1/4	2.08	2.98	0.73	1.51	----
944128	3/8X1/4	2.08	3.04	0.73	1.51	----
944130	3/8X3/8	2.12	3.06	0.73	1.51	----
944139	1/2X1/2	2.15	3.19	0.73	1.51	----

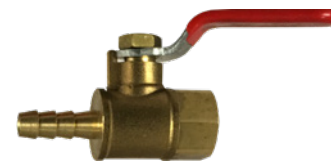

HOSE BARB X FEMALE

PART #	SIZE	A	B	C	D	
944136	1/4X1/4	1.97	2.87	0.73	1.55	----

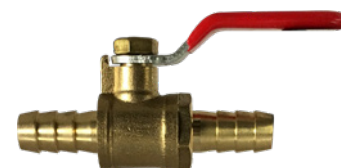

HOSE BARB X HOSE BARB

PART #	SIZE	A	B	C	D	
944142	1/4X1/4	2.47	3.19	0.73	1.55	----
944134	3/8X3/8	2.47	3.18	0.73	1.55	----

LEAD FREE

PART #	SIZE	A	B	C	D	
944142LF	1/4	2.49	3.19	0.73	1.55	----
944134LF	3/8	2.47	3.18	0.73	1.55	----

WARNING: This product can expose you to chemicals, including lead, which are known to the State of California to cause cancer and birth defects or other reproductive harm. For more information, visit www.P65Warnings.ca.gov

VALVES

3 WAY BALL VALVE
VALVES

SIDE OUTLET 3-WAY BALL VALVE

- BRASS • 600WOG • FULL PORT



- Forged Brass
- 600 WOG
- Temp Rating 0-230°F
- 150 SWP

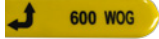

• Side outlet

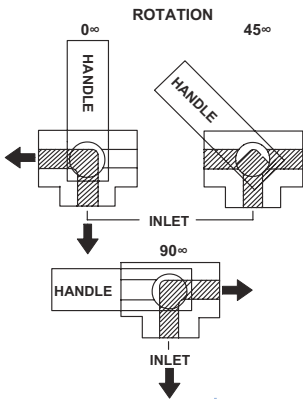
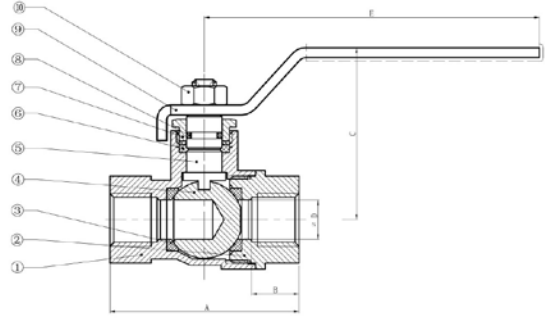

- Full Port
- Blow-out proof stem
- double o-ring stem packing
- PTFE Seal
- Made in China
- Not lead free

Nomenclature & Materials

NO	Part Name	Material	Qty
1	Body	Brass	1
2	End Cap	Brass	1
3	Ball Seat	PTFE	1
4	Ball	Brass	1
5	Stem	Brass	2
6	Seal	PTFE	1
7	Impacted Nut	Brass	1
8	O-Ring	NBR	2
9	Lever Handle	Steel	1
10	Stem Nut	Steel	1

PART#	SIZE	I	H	D	L	A	WTG	BOX/CASE	
940464	1/4"	1.89	1.73	0.39	3.58	0.47	0.51	50/100	----
940465	3/8"	1.89	1.73	0.39	3.35	0.47	0.57	50/100	----
940461	1/2"	2.11	1.80	0.50	3.58	0.51	0.65	30/60	----
940462	3/4"	2.56	2.16	0.74	4.31	0.55	0.99	20/40	----

BOTTOM OUTLET 3 WAY BALL VALVE

- Forged Brass
- Bottom Port is inlet 400 psi
- Side Ports are inlet 100 psi

- Polytetrafluoroethylene ball seats
- Double O-Ring Stem Seals - primary seal is Fluoroelastomer secondary seal is Aflas
- Blow out proof stem
- Made in USA
- Threaded ports
- Good for propane
- Not lead free
- Great for diesel fuel

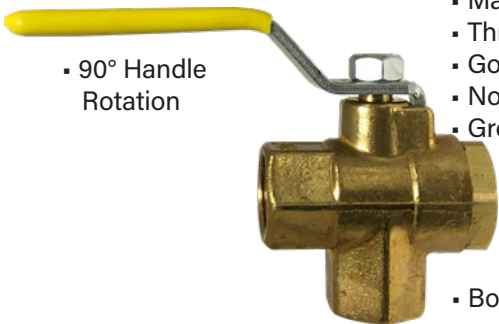

• 90° Handle Rotation

• Bottom outlet

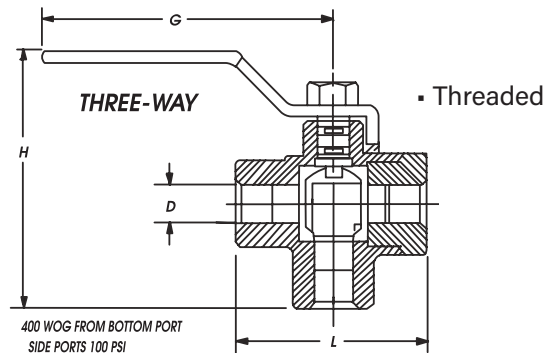

PART#	SIZE	D	G	H	L	CV	WTG	
940121	1/4"	.44	3.50	3.12	2.25	5.2	0.76	----
940122	3/8"	.50	3.50	3.12	2.25	5.5	0.69	----
940123	1/2"	.50	3.50	3.12	2.25	5.5	1.00	----

WARNING: This product can expose you to chemicals, including lead, which are known to the State of California to cause cancer and birth defects or other reproductive harm. For more information, visit www.P65Warnings.ca.gov

MISCELLANEOUS VALVES

VALVES

BRASS BALL VALVE WITH STRAINER

All-in-One design for economical ,compact and convenient .With stamped stainless Steel Screen . 600PSI WOG Forged brass body,Crome plated ball ,PTFE ball seats and cap seal , and rubber o-ring stem seals. Not lead free



Part #	Part Name	Material
1	Body	Brass
2	Caps	Brass
3	Ball	Brass,Cr.Plated
4	Seat	PTFE
5	Filter	SS
6	Gasket	PTFE
7	Caps	Brass
8	Stem	Brass
9	O-Ring	Fluoroelastomer
10	Handle	Zinc
11	Spring Washer	S.S

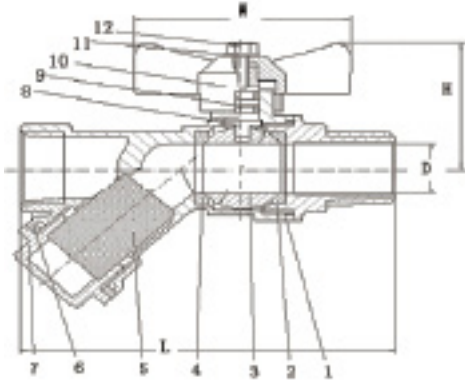

PART #	SIZE	L	D	W	H	WTG	BOX/CASE	
947133	1/2"x1/2"(MxF)	3.77"	0.59"	2.00"	1.50"	0.60	8/64	----
947134	3/4"x3/4"(MxF)	4.32"	0.75"	2.40"	1.85"	1.00	8/64	----

RADIATOR AIR VALVE COIN SLOT OR LOSSE KEY



PART #	SIZE	
943284	1/8" MIP	----
943287	Key only	----

ANGLE SILLCOCKS 3/4" HOSE THREAD OUTLET

- Notched flange for convenient installation.
- Heavy brass construction.
- Cast Iron handle.
- Not lead free



PART #	FEMALE IPS		
	SIZE	BOX	
942142	1/2	12	----

HOSE BIBBS 3/4" HOSE THREAD OUTLET



PART #	SIZE	WTG	IPS	
			BOX/CASE	
942170	1/2 (1/2"C)	0.33	10/100	----
942171	3/4	0.35	10/100	----

BENT NOSE GARDEN VALVES

- Heavy brass construction
- Cast iron handle
- Stuffing box
- Neoprene seal disc

PART #	SIZE	BOX	CASE	
942100	1/2"	12	72	----
942101	3/4"	12	72	----
942102	1"	12	72	----



WARNING: This product can expose you to chemicals, including lead, which are known to the State of California to cause cancer and birth defects or other reproductive harm. For more information, visit www.P65Warnings.ca.gov

BRASS GATE VALVE

VALVES

BRASS GATE VALVE

• BRASS • 200WOG • FULL PORT

- 200 WOG (cold water, oil, gas).
- Full-port design for a better water flow.
- Screw-in Bonnet - Non-Rising Stem - Solid Wedge
- NPT Threaded ends to ANSI B1.20.1
- Cast iron handle.
- Each valve individually air tested under water.
- Good for diesel fuel.
- Made in Indonesia
- Not lead free
- Temp. 32°-320°F

**BRASS GATE VALVES IPS**

PART#	SIZE	L	H	D1	D	T	S1	WEIGHT	BOX/CASE	
940130	1/4	1.64	2.91	2.09	0.44	1/4-18 NPT	.85	0.60	10/120	----
940131	3/8	1.71	2.91	2.09	0.48	3/8-18 NPT	.85	0.59	10/120	----
940132	1/2	1.71	2.91	2.09	0.50	1/2-14 NPT	1.03	0.75	10/120	----
940133	3/4	1.71	3.06	2.13	0.74	3/4-14 NPT	1.26	0.83	10/80	----
940134	1	2.13	3.60	2.48	0.97	1-11.5 NPT	1.51	1.24	5/60	----
940135	1-1/4	2.24	4.50	2.66	1.22	1-1/4-11.5 NPT	1.89	1.69	5/40	----
940136	1-1/2	2.44	5.08	3.15	1.45	1-1/2-11.5 NPT	2.17	2.17	5/30	----
940137	2	2.70	5.94	3.52	1.85	2-11.5 NPT	2.60	3.30	2/12	----
940138	2-1/2	3.70	7.87	3.98	2.48	2-1/2-8 NPT	3.27	6.26	1/10	----
940139	3	4.02	8.82	4.37	2.80	3-8 NPT	3.86	8.26	1/4	----
940140	4	4.53	9.88	4.74	3.60	4-8 NPT	4.88	13.09	1/4	----

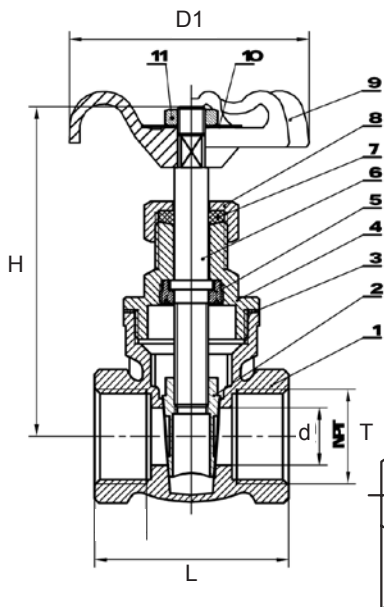

	Description	Material
1	Body	C85700
2	Disk	C85700
3	Seat	PTFE
4	Cap	C85700
5	Packing	C85700
6	Stem	C85700
7	Rubber Seat	NBR
8	Packing Nut	C85700
9	Handle	Cast Iron
10	Nameplate	AL

Crown handle

1/2-1/4

**X handle**

1/2-1/4



Add "C" to part# for Crown handle,
"X" for X handle.

Also Available SS Gate
Valve



See Lead Free for lead free Gate
Valves.



WARNING: This product can expose you to chemicals, including lead, which are known to the State of California to cause cancer and birth defects or other reproductive harm. For more information, visit www.P65Warnings.ca.gov

BRONZE IPS GATE VALVE

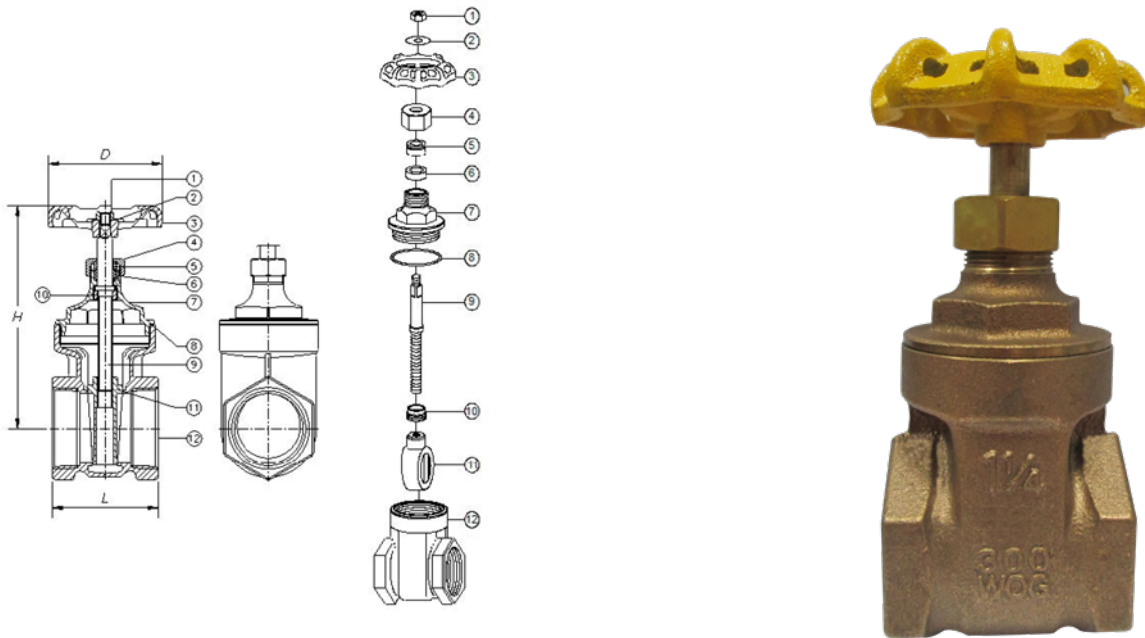

BRONZE GATE VALVE

NUMBER	PART	MATERIALS	NOTE
1	NUT	HOT ROLLED (SAE 1010R)	
2	NAME PLATE	ALUMINUM	
3	HANDLE	CAST IRON (JIS Z22202)	
4	PACKING NUT	BRASS ROD (C37700)	
5	GLAND RING	BRASS ROD (C37700)	Size 1-1/4" ~ 4"
6	PACKING	GRAPHITE (LK 33 NAFG)	
7	BONNET	CAST BRONZE (C83600)	
8	PACKING	FIBRE	Size 2" ~ 4"
9	STEM	BRASS ROD (C37700)	Size 1/4" ~ 2"
		CAST BRONZE (C83600)	Size 2-1/2" ~ 4"
10	LOCKNUT	BRASS ROD (C37700)	
11	DISC	CAST BRONZE (C83600)	
12	BODY	CAST BRONZE (C83600)	

PART#	SIZE	DIMENSION (MM)		
		D	H	L
	1/4" FIP	53	74	43.5
	3/8" FIP	53	74	43.5
939132	1/2" FIP	53	74	43.5
939133	3/4" FIP	54	84	46
939134	1" FIP	63	99	54
939135	1-1/4" FIP	69	117	57
939136	1-1/2" FIP	80	129	62
939137	2" FIP	89.5	152	68.5
939138	2-1/2" FIP	101	200	94
939139	3" FIP	111	224	102
939140	4" FIP	127	251	115

QUICK OPENING GATE VALVE

VALVES

GATE VALVE QUICK OPENING

Features: Bronze Material, Threaded Ends, 200 WOG

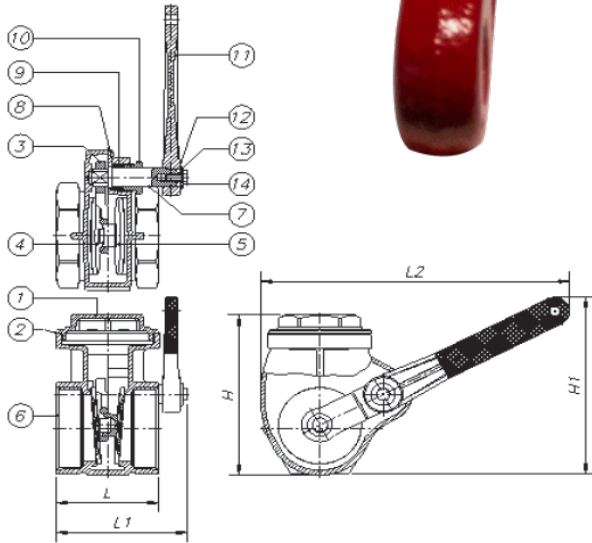
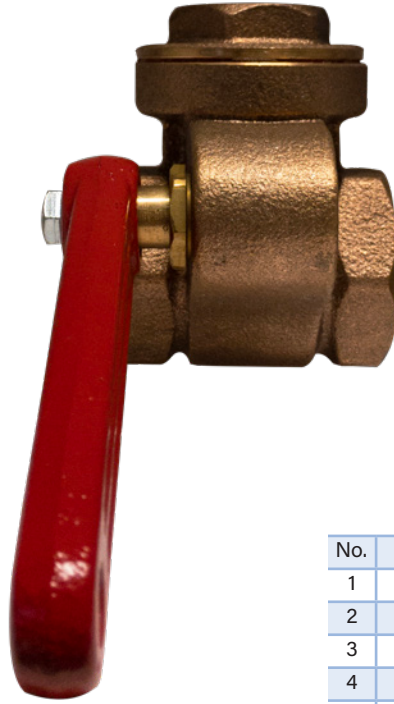
**MATERIAL SPECIFICATION**

No.	Part	Bronze
1	BONNET	BRASS (C85700)
2	PACKING	FIBRE
3	ARM	BRASS (C85700)
4	DISC MALE	BRASS (C85700)
5	DISC FEMALE	BRASS (C85700)
6	BODY	BRASS (C85700)
7	STEM	BRASS (C37700)
8	WASHER	BRASS (C37700)
9	PACKING	Polytetrafluoroethylene POLYFLON(PTFE M-392)
10	PACKING NUT	BRASS (C37700)
11	HANDLE	CAST IRON (JIS ZZ2202) RUBBER COATING BRASS (C85700)
12	NAME PLATE	ALUMINIUM (A1100)
13	WASHER	HOT ROLLED (SAE 1010R)
14	HANDLE BOLT	HOT ROLLED (SAE 1010R)

PART #	SIZE	L	L1	L2	H	H1	BOX	CASE	
941133	1/2"	45.6	60.6	119	56.8	52.8	10	50	----
941134	3/4"	51	62	126.3	68	87.5	10	50	----
941135	1"	58.3	72.3	155	78.7	90.2	10	30	----
941136	1-1/4"	30.1	78	180.2	89.5	104	5	25	----
941137	1-1/2"	66.7	85.3	196.6	99.2	131	6	18	----
941138	2"	76.4	90.3	250.6	119.3	143.7	2	10	----
941140	3"	101	129.2	305.6	172.2	191.3	2	6	----
941141	4"	114.5	150.7	378.2	213.5	248.6	1	2	----

Ignorance, the root and stem of all evil. - Plato

Y-PATTERN STRAINER

VALVES

CLASS 150 BRASS Y-PATTERN STRAINER

- Forged Brass body, size 1/4"-3".
- Pressure rating: 250 WOG (water, oil, gas)/PN25
125 WSP (Saturated Stem)
- NPT Threaded ends to ANSI B1.20.1
- Protects regulators, pumps, meters and other controls from damage due to sediment scale, metal chips or other foreign materials.
- Screwed cap is threaded & gasketed.
- Tapped drain plug opening in cap.
- 304 stainless steel screen #20 mesh.
- Self cleaning.
- Self cleaning can be accomplished by opening the valve or plug connected to the blow-off outlet.
- Made in Indonesia
- NOT LEAD FREE
- w/20 Mesh Screen
- Temp 180°F

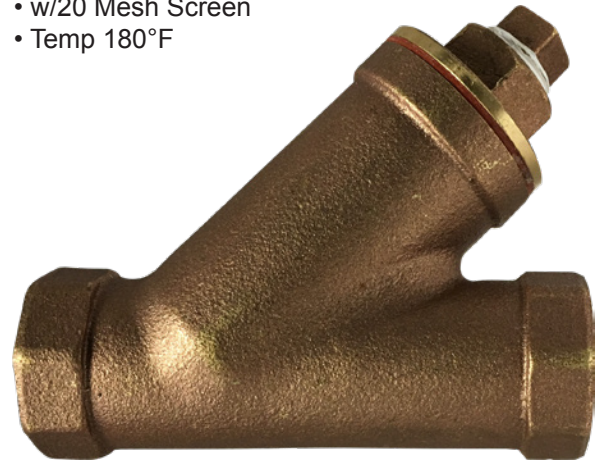

PART#	SIZE	L	H	C (PLUG)	WEIGHT	BOX/CASE	
940521	1/4"	2.57	1.95	NPT 3/8	.53	10/100	----
940522	3/8"	3.23	2.44	NPT 3/8	.71	12/48	----
940523	1/2"	3.23	2.44	NPT 3/8	.66	12/48	----
940524	3/4"	3.94	2.78	NPT 3/8	1.10	8/32	----
940525	1"	4.53	3.19	NPT 1/2	1.71	8/32	----
940526	1-1/4"	5.33	3.66	NPT 1/2	2.49	6/24	----
940527	1-1/2"	6.20	3.82	NPT 1/2	3.24	2/16	----
940528	2"	7.44	4.65	NPT 1/2	5.39	2/8	----
940529	2-1/2"	9.50	5.39	NPT 3/4	9.56	1/6	----
940530	3"	9.4	5.67	NPT 3/4	13.49	1/4	----

Add 'S' to part # for replacement screens

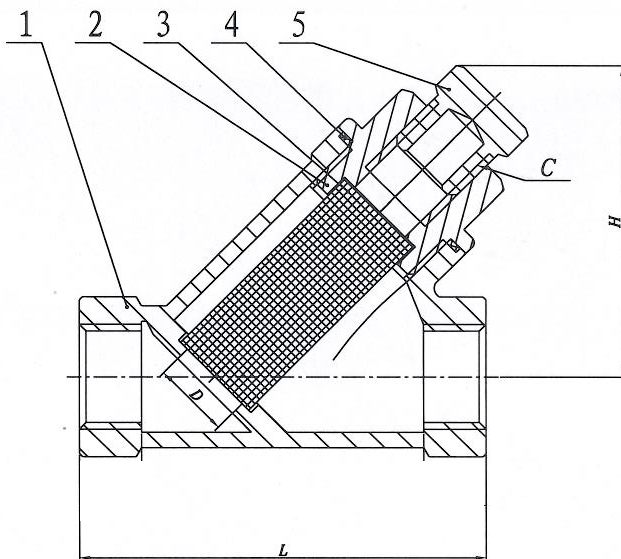

See Lead Free for 1/2" Lead Free



See Lead Free for SS Y Strainer

NO	Name	Material
1	BODY	C85700
2	BONNET	C85700
3	STRAINER	304 S.S.
4	SPRING SEAL	PTFE

WARNING: This product can expose you to chemicals, including lead, which are known to the State of California to cause cancer and birth defects or other reproductive harm. For more information, visit www.P65Warnings.ca.gov

VALVES

BRASS SWING CHECK VALVES

VALVES

BRASS SWING CHECK VALVES

- Working pressure non-shock: 200 psi W.O.G. (cold water, oil, gas) 125 psi WSP (saturated steam)
- Swing type disc.
- Screwed Cap.
- Hard Seat.
- 90° Straight Pattern.
- Used to prevent reverse flow in commercial and industrial applications.
- Threaded ends to ANSI B1.20.1

- Integral seat.
- Temp range -5° - 150F°
- NOT LEAD FREE
- Cracking pressure 3-5 psi

- Made in Indonesia

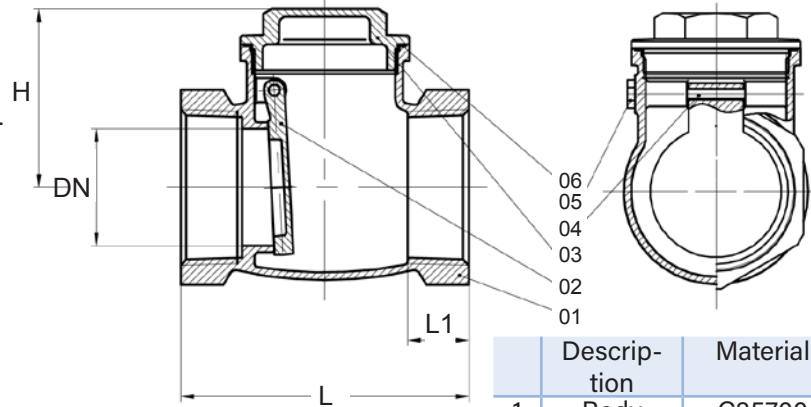

	Description	Material
1	Body	C85700
2	Disc	C85700
3	Cap	C85700

CAST BRASS SWING CHECK VALVES IPS SCREWED ENDS

PART #	SIZE	L	H	L1	DN	WEIGHT	BOX/CASE	
940352	1/2	2.09	1.42	0.531	0.512	.41	10/100	----
940353	3/4	2.36	1.56	0.579	0.728	.56	10/80	----
940354	1	2.62	1.77	0.748	0.925	.80	8/40	----
940355	1-1/4	3.19	2.07	0.748	1.201	1.36	5/40	----
940356	1-1/2	3.54	2.16	0.846	1.417	1.56	5/20	----
940357	2	4.21	2.74	0.886	1.772	2.61	2/16	----
940358	2-1/2	5.14	3.09	1.063	2.224	4.55	1/8	----
940359	3	5.77	3.80	1.102	2.579	6.53	1/6	----
940360	4	6.84	4.25	1.102	3.602	10.18	1/4	----



See Lead Free Brass Swing Check Valves



See SS Swing Check Valves

WARNING: This product can expose you to chemicals, including lead, which are known to the State of California to cause cancer and birth defects or other reproductive harm. For more information, visit www.P65Warnings.ca.gov

BRASS CHECK VALVES

VALVES

BRASS CHECK VALVES

S.S. SPRING LOADED BRONZE POPPET - For positive sealing & self-cleaning. Insures against leakage.

- Inline Lift Type - Resilient Discs - Spring Actuated - Threaded.
- Pressure rating: 200 WOG (water, oil, gas) / 125 WSP (Saturated Steam)
- Spring in stainless steel AISI 304. • Resilient washer hold/ disc in brass. • Forged Brass Body for 1/2"-2"
- Corrosion resistant material. • Can be used vertically or horizontally. • Opens & Closes with flow of media.
- No cracking pressure. • NOT LEAD FREE • Made in Indonesia

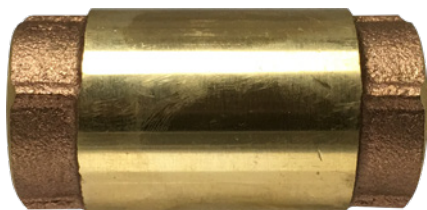

1/4 Made in Taiwan

Temp Range
-10°C - 110°C
14°F - 248°F

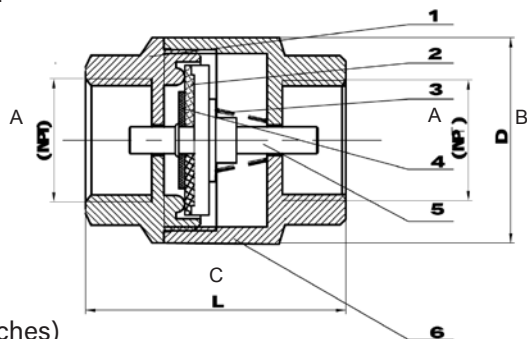

Brass Check Valve (Inches)

Part#	Size	Enters Pipe Size	A NPT	B	C	Weight	Box/Case	
944428	1/4"	-	1/4"	1.00	2.29	.24	24/192	----
944429	3/8"	-	3/8"	1.00	2.07	.23	10/100	----
944430	1/2"	1-1/4"	1/2"	1.26	2.40	.42	10/100	----
944431	3/4"	1-1/4"	3/4"	1.45	2.74	.53	10/80	----
944432	1"	2"	1"	1.77	3.23	.85	6/48	----
944433	1-1/4"	2-1/2"	1-1/4"	2.13	3.62	1.18	4/40	----
944434	1-1/2"	3"	1-1/2"	2.29	4.04	1.40	5/30	----



• See Lead Free Brass Check Valves



• See SS Check Valves

IN LINE CHECK VALVES VERTICAL OR HORIZONTAL

- Working Pressure: 250 PSI • Temperature Range: -40° to 450°F (-40° to 230°C)
- Cracking Pressure: 3 PSI • Made in China • Not lead free
- Applications: Air Compressor Discharge Lines, may also used on water or oil lines
- Construction: Cast Bronze Body, Corrosion Resistant Stainless Steel Spring to Ensure Long Life, 15% Glass Filled • Polytetrafluoroethylene Poppet, C360 Machined Brass Cap, 1/8 NPT Unloader Port is Standard • Repairable

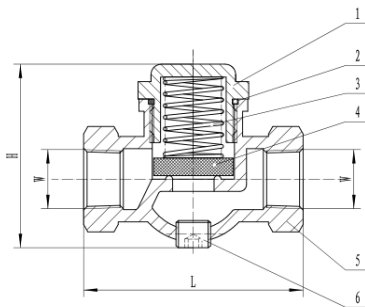

Part#	Part Name	Material
6	Plug	Brass
5	Body	Bronze
4	Gasket	PTPF
3	Spring	S.Steel
2	O-ring	HNBR
1	Cap	Brass

PART #	SIZE	W	L	H	WTG	BOX/CASE	
947140	1/8"	1/8	1.75	1.34	0.28	20/100	----
947141	1/4"	1/4	1.75	1.37	0.29	20/100	----
947142	3/8"	3/8	2.50	2.18	0.62	10/50	----
947143	1/2"	1/2	2.50	2.13	0.54	10/50	----
947144	3/4"	3/4	2.88	2.64	1.17	8/40	----
947145	1"	1	3.61	3.30	1.98	2/20	----

BRASS IN-LINE CHECK VALVES

VALVES

BRASS IN-LINE CHECK VALVES**High Capacity, Size 1/4"-2" 400 WOG, 2 1/2"-4" 175 WOG**

- Soft Seat for Bubble Tight Shutoff, Spring Loaded for Fast Seating Action.
- Compact design.
- Low Cracking Pressure 1/2 psi.
- Flow Profile Designed to Minimize Head Loss.
- Perfect Seating both at High and Low Pressure, Wide Temperature Range: +10° to 210°F.
- Polyetherimide Disc to ensure the Best Resistance For Corrosion and Abrasion.
- Patented Disc Guide to Prevent Any Side Loading.
- Connection: FNPT x FNPT.
- Made in Italy ▪ Not lead free

NBR for water, oils and general purpose.

With Fluoroelastomer® Seal for fuels and hydrocarbons. Max working TEMPERATURE 325°F/125 psi steam

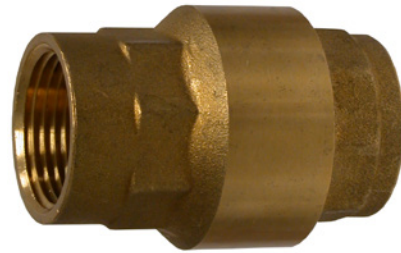
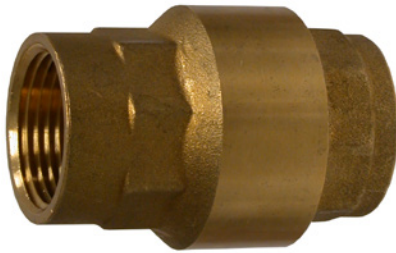
Add V to part# for Fluoroelastomer**BRASS IN-LINE CHECK**

PART#		SIZE	I	PSI	LBS	CASE	FLUOR PART#	
944401	----	1/4"	0.39	400	0.22	144		
944402	----	3/8"	0.40	400	0.18	144	944402V	----
944403	----	1/2"	0.60	400	0.32	144	944403V	----
944404	----	3/4"	0.65	400	0.49	90	944404V	----
944405	----	1"	0.66	400	0.71	90	944405V	----
944406	----	1-1/4"	0.68	400	1.13	30	944406V	----
944407	----	1-1/2"	0.68	400	1.53	30	944407V	----
944408	----	2"	0.69	400	2.28	12	944408V	----
944409	----	2-1/2"	0.93	175	4.83	4	944409V	----
944410	----	3"	1.01	175	6.70	4	944410V	----
944411	----	4"	1.09	175	12.43	2	944411V	----

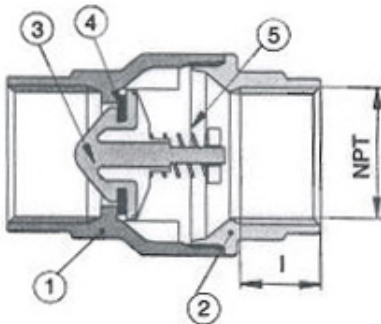

NO	Part	Material	PCS
1	BODY	BRASS	1
2	END CONNECTION	BRASS	1
3	DISC	POLYETHERIMIDE	1
4	SEAT	100002 NBR	1
		100003 Fluoroelastomer	1
5	SPRING	STAINLESS STEEL	1

WARNING: This product can expose you to chemicals, including lead, which are known to the State of California to cause cancer and birth defects or other reproductive harm. For more information, visit www.P65Warnings.ca.gov

316 SS FULL PORT VALVES

316 SS 2-PC BALL VALVE, FULL PORT, THREADED END, 2000 PSI

- Investment Castings for body and cap.
- Internal Entry blow-out proof stem.
- Pressure rating: 2000PSI.
- Threaded Ends: ANSI B2,1
- Material: CF8M (316SS)
- Pressure test: API 598
- Generic Handles

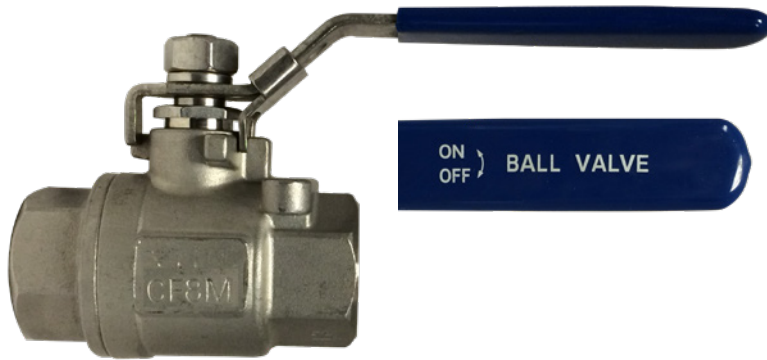

LOCKING HANDLE

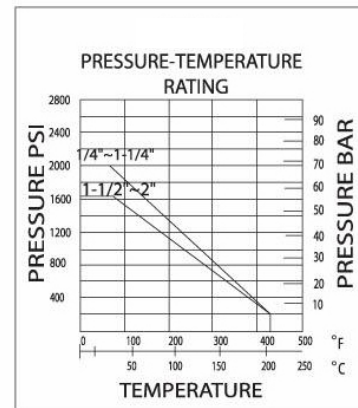

PART#	SIZE	D	L	H	W	N.M	LBS/ PC	CASE	
949171	1/4"	0.36	2.13	2.13	4.33	.157	0.64	80	----
949172	3/8"	0.50	2.13	2.16	4.33	.157	0.58	80	----
949173	1/2"	0.59	2.24	2.28	4.53	.197	0.71	70	----
949174	3/4"	0.79	2.76	2.40	4.53	.315	1.18	50	----
949175	1"	0.98	3.50	3.03	6.04	.394	2.33	30	----
949176	1-1/4"	1.25	4.12	3.19	6.04	.551	3.48	20	----
949177	1-1/2"	1.50	4.05	3.54	6.10	.709	4.03	14	----
949178	2"	1.96	4.90	4.25	6.10	.984	7.50	7	----

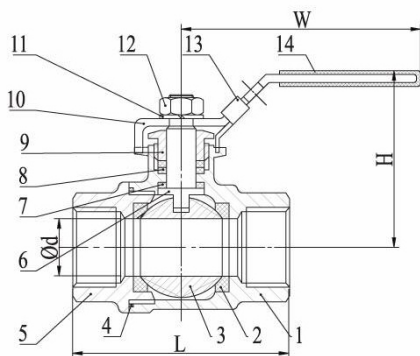

NO	Part	Material	QTY
1	BODY	316SS	1
2	BALL SEAT	PTFE	2
3	BALL	316SS	1
4	BODY SEAL	PTFE	1
5	CAP	316SS	1
6	STEM	SS316	1
7	THRUST WASHER	PTFE	1
8	PACKING	PTFE	1
9	GLAND NUT	SS304	1
10	HANDLE	SS304	1
11	WASHER	SS304	1
12	NUT	SS304	1
13	LOCK DEVICE	SS304	1
14	HANDLE COVER	PLASTIC	1

WARNING: This product can expose you to chemicals, including Chromium, which are known to the State of California to cause cancer and birth defects or other reproductive harm. For more information, visit www.P65Warnings.ca.gov

316 SS STANDARD PORT VALVES

VALVES

ONE PIECE STANDARD PORT BALL VALVE

316 Stainless Steel

1000 PSI

- Manufactured for harsh environments with female NPT threads.
- Locking handle for greater security.
- Standard port has restricted flow.
- Made with corrosion resistant stainless steel materials.
- PTFE seat and seals.
- Investment Castings for Body and Cap.
- Internal Entry Blow-out proof stem.
- Pressure rating: 1000PSI (PN63)
- Threaded Ends: ANSI B2.1
- Material: CF8M
- Pressure Test: API 598
- Generic handles

**LOCKING HANDLE**

Valves will accept a pad-lock on the handle.

PART#	SIZE	D	L	H	W	dimensions (inches)		
						WEIGHT	CASE	
949101	1/4"	0.20	1.53	1.53	3.03	0.19	150	----
949102	3/8"	0.27	1.74	1.53	3.03	0.23	150	----
949103	1/2"	0.36	2.24	1.73	3.46	0.41	100	----
949104	3/4"	0.50	2.32	1.89	3.46	0.63	70	----
949105	1"	0.59	2.80	2.24	4.29	0.86	50	----
949106	1-1/4"	0.79	3.07	2.32	4.29	1.34	30	----
949107	1-1/2"	0.98	3.26	2.76	5.14	2.00	25	----
949108	2"	1.25	3.94	2.24	6.50	2.88	15	----

Larger sizes available on special order basis

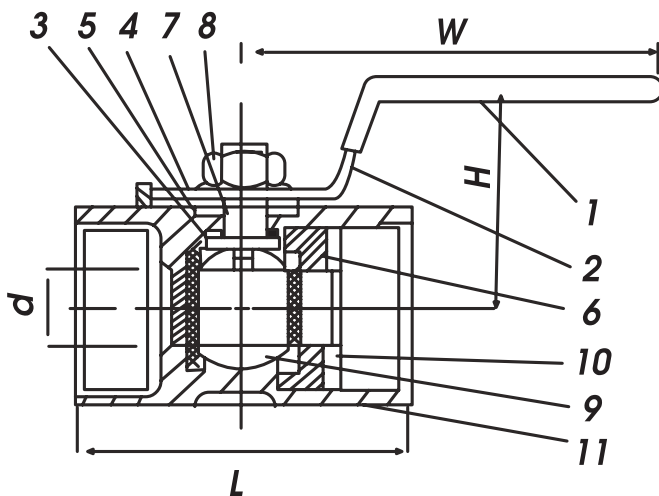

Item	Parts	Material
1	Plastic Cover	Plastic
2	Handle	AISI 304 SS
3	Thrust Washer	PTFE
4	Packing Ring	AISI 304 SS
5	Stem Packing	PTFE
6	Seat	PTFE
7	Seat	AISI 316 SS
8	Stem Nut	AISI 304 SS
9	Ball	316SS ASTM-A351 CF8M
10	Cap	316SS ASTM-A351 CF8M
11	Body	316SS ASTM-A351 CF8M

SS = Stainless Steel

WARNING: This product can expose you to chemicals, including Chromium, which are known to the State of California to cause cancer and birth defects or other reproductive harm. For more information, visit www.P65Warnings.ca.gov



316 SS TWO PIECE FULL PORT VALVES

VALVES

TWO PIECE FULL PORT BALL VALVE

316 Stainless Steel

1000 PSI

Materials: CFM8M (SS316)

Features:

- Quality manufactured for harsh environments.
- Corrosion resistant.
- Investment Casting body
- Working pressure 1000 psi for W.O.G.
- Adjustable stem packing
- Pure Polytetrafluoroethylene seals and seats
- Temperature range: -60 to 450°F
- Blow-out proof stem and safe pressure-reducing hole
- 100% leakage tested at 100 psi air under water
- Hydrostatic test pressure: 1500 psi
- Locking handle w/ blue generic sleeve
- 125 Steam rated
- Generic Handles



Valves will accept a pad-lock on the handle.

dimensions (inches)

PART#	SIZE	D	L	H	W	WEIGHT	CASE	
949161	1/4"	0.36	2.13	2.13	4.33	0.51	80	----
949162	3/8"	0.50	2.13	2.16	4.33	0.49	80	----
949163	1/2"	0.59	2.24	2.28	4.17	0.69	70	----
949164	3/4"	0.79	2.68	2.40	4.17	1.03	50	----
949165	1"	0.98	3.15	2.50	4.88	1.40	30	----
949166	1-1/4"	1.26	3.58	3.19	5.04	2.17	20	----
949167	1-1/2"	1.49	4.05	3.54	6.10	3.33	12	----
949168	2"	1.97	4.88	4.25	6.13	6.02	7	----
949170	3"	3.15	7.28	5.71	9.06	21.01	2	----
949180	4"	3.94	8.84	7.28	11.10	36.18	1	----

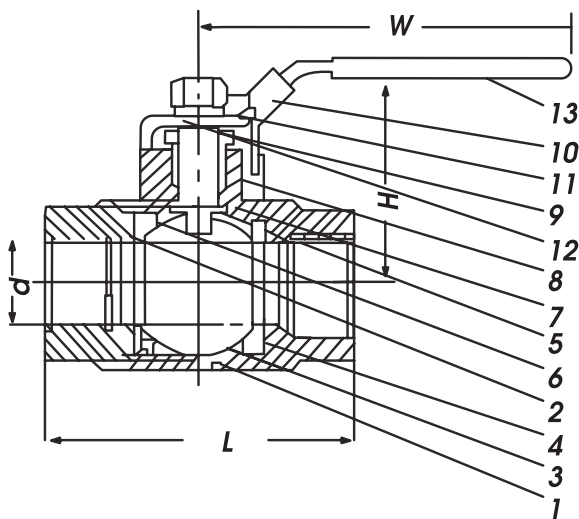

Dimensions may change without notice. Please see our website if they are critical.

Item	Parts	Material
1	Body	316SS ASTM-A351 CF8M
2	Body Cap	316SS ASTM-A351 CF8M
3	Ball	316SS ASTM-A351 CF8M
4	Seat	Reinforced PTFE
5	Stem	AISI 316 SS
6	Seal	Reinforced PTFE
7	Thrust Washer	Reinforced PTFE
8	Packing	Reinforced PTFE
9	Gland Nut	AISI 304SS
10/11	Nut & Washer	AISI 304SS
12	Handle	AISI 304SS
13	Plastic Cover	Plastic

SS = Stainless Steel

316 SS MINI BALL VALVES

VALVES

STAINLESS STEEL MIN BALL VALVES

- 316 Stainless Steel
- Working pressure 400PSI
- Working Temperature -10°C to 150°C

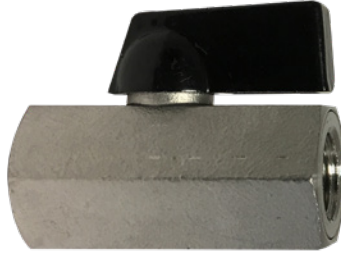
**FEMALE PIPE x FEMALE PIPE**

PART#	SIZE	W	D	H	L	WEIGHT	CASE	
46934SS	1/8"	.898	.197	.985	1.693	.18	150	----
46935SS	1/4"	.898	.276	.984	1.693	.21	150	----
46936SS	3/8"	.898	.276	.984	1.693	.19	150	----
46937SS	1/2"	.898	.362	1.114	1.811	.26	100	----

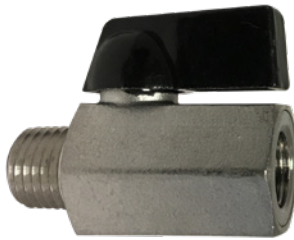
**MALE PIPE x FEMALE PIPE**

PART#	SIZE	W	D	H	L	WEIGHT	CASE	
46930SS	1/8"	.898	.197	.985	1.693	.18	150	----
46931SS	1/4"	.898	.276	.984	1.693	.18	150	----
46932SS	3/8"	.898	.276	.984	1.693	.19	150	----
46933SS	1/2"	.898	.362	1.114	1.811	.26	100	----

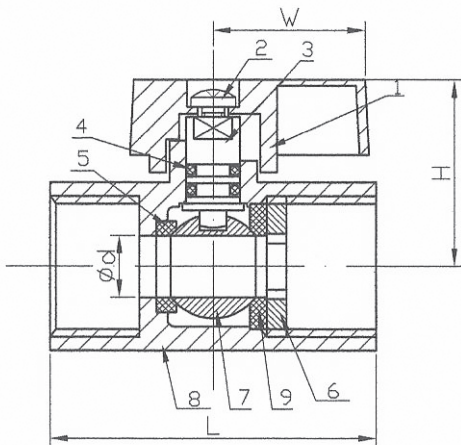

NO	Part	Material	QTY
1	LEVER	ALUMINIUM ALLOY	1
	HANDLES	PLASTIC	
2	BOLT	304	1
3	STEM	304/ 316	1
4	"O" RING	NBR	1~2
5	BALL SEAT (A)	PTFE	1
6	CAP	CF8/ CF8M	1
7	BALL	CF8/ CF8M	1
8	BODY	CF8/ CF8M	1
9	BALL SEAT (B)	PTFE	1

WARNING: This product can expose you to chemicals, including Chromium, which are known to the State of California to cause cancer and birth defects or other reproductive harm. For more information, visit www.P65Warnings.ca.gov



316 SS MINI BALL VALVES

VALVES

MINI STAINLESS STEEL BALL VALVE ,WITH BUTTERFLY HANDLE

1000PSI WOG , 150PSI WSP

Temperature Range: -36°F to + 368°F

Full Port for 1/4" , Standard port for 3/8" and 1/2"

316 Stainless Steel body and Ball

Polytetrafluoroethylene seats and sealing

• Fluoroelastomer O-Ring

• #316 Stainless Steel

• Made in China



FEMALE PIPE X FEMALE PIPE

PART #	SIZE FIP X FIP	DIMENSIONS IN						
		D	L	B (HEX)	H	WTG	BOX	
46922SS	1/4"×1/4"	0.314"	2.34"	22.1/0.87"	1.5"	0.33	36	----
46923SS	3/8"×3/8"	0.314"	2.39"	22.1/0.87"	1.5"	0.39	36	----
46924SS	1/2"×1/2"	0.314"	2.81"	24.9/0.98"	1.5"	0.43	36	----



MALE PIPE X FEMALE PIPE

PART #	SIZE MIP X FIP	DIMENSIONS IN						
		D	L	B (HEX)	H	WTG	BOX	
46903SS	1/4"×1/4"	0.314"	2.45"	0.87"	1.5"	0.39	36	----
46904SS	3/8"×3/8"	0.314"	2.45"	0.87"	1.5"	0.36	36	----
46905SS	1/2"×1/2"	0.314"	2.81"	0.98"	1.5"	0.41	36	----



MALE PIPE X MALE PIPE

PART #	SIZE MIP X MIP	DIMENSIONS IN						
		D	L	B (HEX)	H	WTG	BOX	
46912SS	1/4"×1/4"	0.314"	2.59"	0.87"	1.5"	0.33	36	----
46913SS	3/8"×3/8"	0.314"	2.65"	0.87"	1.5"	0.34	36	----
46914SS	1/2"×1/2"	0.314"	2.47"	0.98"	1.5"	0.63	36	----

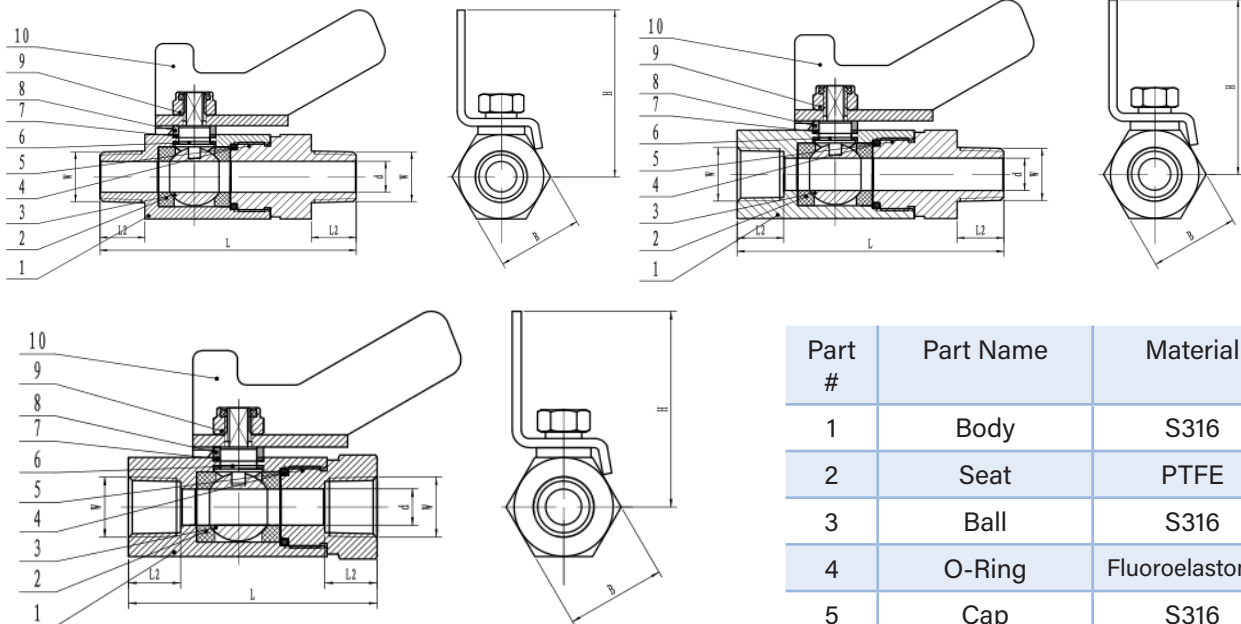

Part #	Part Name	Material
1	Body	S316
2	Seat	PTFE
3	Ball	S316
4	O-Ring	Fluoroelastomer
5	Cap	S316
6	Stem	S316
7	Stem Bottom Seal	PTFE
8	Stem Up Seal	PTFE

304 SS CHECK VALVES

VALVES

#304 STAINLESS STEEL**CHECK VALVE**

- No Lead.
- Water wells need a check valve installed above the pumps between lengths of drop pipes.
- Opens & Closes with flow of media.
- No cracking pressure.
- Working pressure unavailable.
- Made in Taiwan

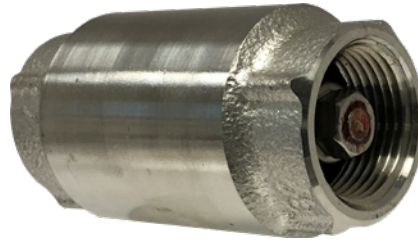
**DIMENSIONS (INCHES)**

PART#	SIZE	A NPT	B	C	BOX/CASE	
949430	1/2"	1/2"	1.26	2.43	10/100	----
949431	3/4"	3/4"	1.50	2.72	10/80	----
949432	1"	1"	1.77	3.23	10/60	----

More sizes available on a special order basis.

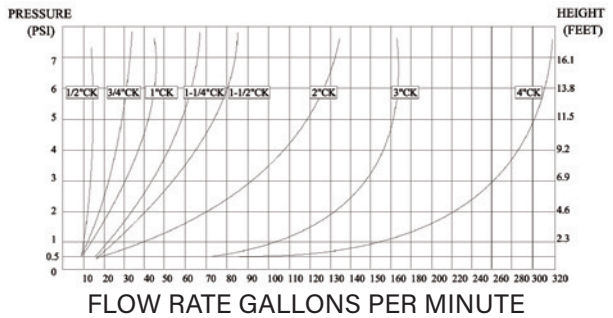
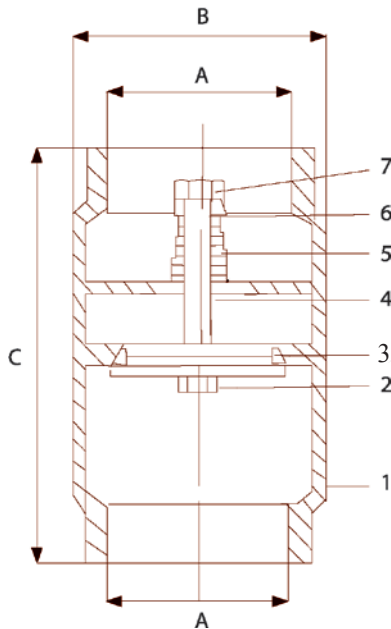

NO	Part	Material
1	Body	S.S 304
2	Stopper	S.S 304
3	O-Ring	Fluor
4	Washer	PE
5	Spring	S.S 304
6	Cap	S.S 304
7	Nut	S.S 304

FLUOR* ABBREVIATION FOR FLUOROELASTOMER

WARNING: This product can expose you to chemicals, including Chromium, which are known to the State of California to cause cancer and birth defects or other reproductive harm. For more information, visit www.P65Warnings.ca.gov



SS IN-LINE CHECK VALVES

VALVES

STAINLESS STEEL IN-LINE CHECK VALVE

High Capacity, Size 1/4"-2" 800 WOG

- Soft PTFE Seat for Bubble Tight Shutoff, Spring Loaded for Fast Seating Action
- Low Cracking Pressure 1/2 psi.
- Flow Profile Designed to Minimize Head Loss.
- Perfect Seating both at High and Low Pressure, Wide Temperature Range: +10° to 450°F.
- Corrosion Resistant-Excellent for use on Chemicals.
- ASTM A351-CF8M Investment Casting.
- Connection: FNPT x FNPT.
- 125WSP Saturated Steam.
- ANSI B1.20.1 Threads.
- Dual Guided Stem & Disc.
- Made in Italy



STAINLESS STEEL IN-LINE CHECK

PART#	SIZE	D	L	PSI	LBS	
949401	1/4"	1.15	2.25	800	0.36	----
949402	3/8"	1.16	2.25	800	0.34	----
949403	1/2"	1.35	2.31	800	0.40	----
949404	3/4"	1.81	2.87	800	0.85	----
949405	1"	2.13	3.50	800	1.30	----
949406	1-1/4"	2.46	4.18	800	2.50	----
949407	1-1/2"	2.88	4.93	800	3.40	----
949408	2"	3.56	6.00	800	6.0	----

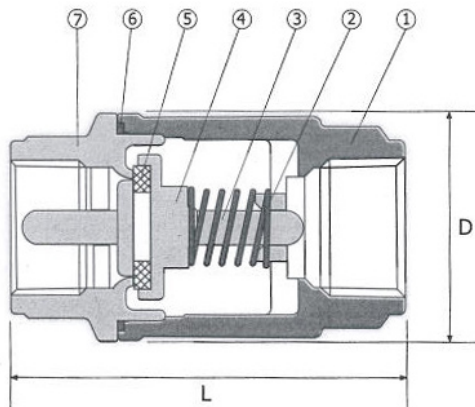

NO	Part	Material	PCS
1	BODY	ASTM A351-CF8M	1
2	SPRING	SS316	1
3	CENTER GUIDE	ASTM A351-CF8M	1
4	DISC	ASTM A351-CF8M	1
5	SEAT	PTFE	1
6	GASKET	PTFE	1
7	END CAP	ASTM A351-CF8M	1

WARNING: This product can expose you to chemicals, including Chromium, which are known to the State of California to cause cancer and birth defects or other reproductive harm. For more information, visit www.P65Warnings.ca.gov

VALVES

316 SS SPRING CHECK VALVES

VALVES

SPRING CHECK VALVE

- Working Pressure: 1500PSI (PN100)
- Working Temperature: -10 -150°C
- Opening Pressure: 2~3PSI
- Suitable Medium: W.O.G.
- Threaded End: NPT
- Made in China

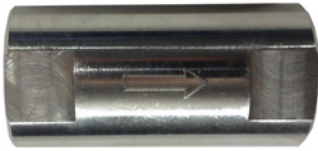
FEMALE PIPE x FEMALE PIPE

PART#	SIZE	L	C	D	B	E	LBS/PC	CASE	
949451	1/4"	2.165	.217	.748	.699	.394	.19	200	----
949452	3/8"	2.165	.295	.866	.787	.394	.21	160	----
949453	1/2"	2.165	.413	1.063	.945	.472	.31	100	----
949454	3/4"	2.677	.591	1.417	1.26	.472	.71	60	----
949455	1"	3.268	.787	1.693	1.496	.591	1.14	36	----

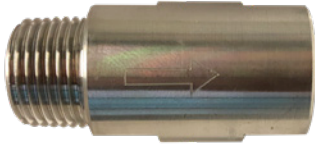
MALE PIPE x FEMALE PIPE

PART#	SIZE	L	C	D	B	E	LBS/PC	CASE	
949471	1/4"	2.165	.217	.748	.699	.394	.176	200	----
949472	3/8"	2.165	.295	.866	.787	.394	.22	160	----
949473	1/2"	2.165	.413	1.063	.945	.472	.27	100	----
949474	3/4"	2.677	.591	1.417	1.26	.472	.62	65	----
949475	1"	3.268	.787	1.693	1.496	.591	1.05	40	----

FLOWS MALE -> FEMALE

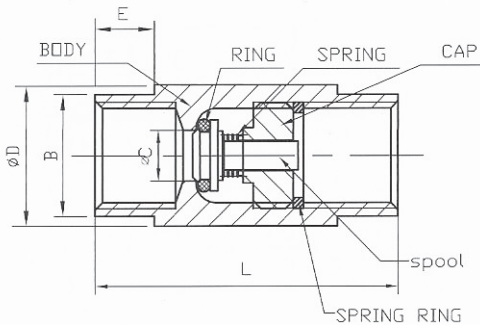

NO	Part	Material	QTY
1	BODY	316	1
2	RING	Rubber	1
3	SPRING	304	1
4	CAP	CF8M	1
5	SPOOL	304/316	1
6	SPRING RING	304	1



SEE WEBSITE TO DOWNLOAD YOUR MOST UPDATED PRICING

WARNING: This product can expose you to chemicals, including Chromium, which are known to the State of California to cause cancer and birth defects or other reproductive harm. For more information, visit www.P65Warnings.ca.gov

SS Y-SPRING/ BARREL CHECK VALVES

VALVES

Y-SPRING CHECK VALVE

- Working Pressure: 800PSI (PN55)
- Working Temperature: -10 -150°C
- Opening Pressure: 1.5PSI
- Suitable Medium: W.O.G.
- Made in China

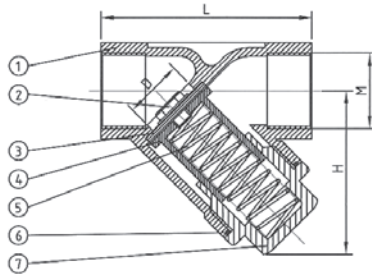
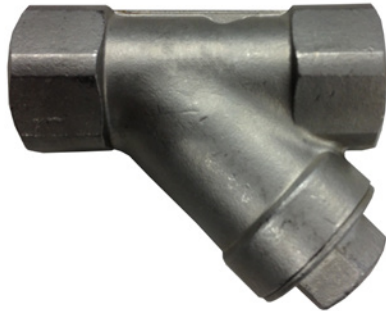

PART#	SIZE	L	H	D	LBS/ PC	CASE	
949481	1/4"	2.559	1.661	.472	.44	70	----
949482	3/8"	2.559	1.661	.472	.51	70	----
949483	1/2"	2.559	1.634	.591	.51	100	----
949484	3/4"	3.15	2.067	.787	.93	80	----
949485	1"	3.543	2.657	.984	1.25	40	----
949486	1-1/4"	4.134	2.795	1.26	2.20	30	----
949487	1-1/2"	4.724	3.169	1.575	3.24	24	----
949488	2"	5.512	3.74	1.969	5.21	10	----

NO	Part	Material	QTY
1	BODY	CF8M/ CF8	1
2	BOLT	304	1
3	SEAT	Polytetrafluoroethylene	1
4	DISC	304	1
5	SPRING	304	1
6	GASKET	Polytetrafluoroethylene	1
7	CAP	CF8M/ CF8	1

2PC BARREL TYPE SPRING CHECK VALVE

- Working Pressure: 300PSI (PN20)
- Working Temperature: -10 -120°C
- Opening Pressure: 2PSI
- Suitable Medium: W.O.G.
- Threaded end: NPT
- Made in China

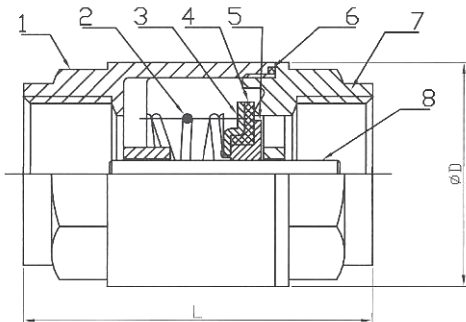

PART#	SIZE	L	D	LBS/ PC	CASE	
949441	1/4"	2.00	1.142	.27	100	----
949442	3/8"	2.00	1.142	.24	100	----
949443	1/2"	2.24	1.28	.36	100	----
949444	3/4"	2.44	1.594	.54	60	----
949445	1"	2.95	1.89	.88	30	----
949446	1-1/4"	3.23	2.362	1.39	18	----
949447	1-1/2"	3.46	2.756	1.81	25	----
949448	2"	3.94	3.425	2.86	14	----

NO	Part	Material	QTY
1	BODY	CF8M/ CF8	1
2	BOLT	304	1
3	SEAT	NBR	1
4	DISC	304	1
5	SPRING	316/ 304	1
6	GASKET	PTFE	1
7	CAP	CF8M/ CF8	1

316 SS MISCELLANEOUS VALVES**VALVES****#316 SS Y STRAINER**

- Investment Castings for Body
- Pressure Rating: 800PSI (PN40)
- Threaded Ends: ANSI B2.1
- Material: CF8M (#316 SS)
- Pressure Test: API 598
- Made in China

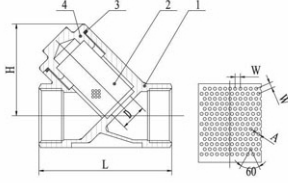

- 40 Mesh screen

Part	Material	QTY
1 BODY	CF8M	1
2 SCREEN	SS316	1
3 JOINT GASKET	PTFE	1
4 BONNET	CF8M	1

PART #	SIZE	D	L	H	W	ØA	LBS
949521	1/4"	.38"	2.53	51	1.69	1	0.44
949522	3/8"	.48"	2.53	51	1.69	1	0.38
949523	1/2"	.59"	2.53	51	1.76	1	0.46
949524	3/4"	.79"	3.12	60	2.07	1	0.69
949525	1"	.98"	3.57	72	2.67	1	1.27
949526	1-1/4"	1.26"	4.17	77	2.9	1	1.74
949527	1-1/2"	1.57"	4.71	87	3.23	1	2.38
949528	2"	1.96"	5.49	102	3.88	1	3.57

316 SS SWING CHECK VALVE

- 200PSI(PN16)
- Threaded Ends: ANSI B2.1
- Material: CF8M (#316 SS)
- Pressure Test: API 598
- Made in China



Part	Material	QTY
1 BODY	CF8M	1
2 DISC	CF8M	1
3 PIPE PLUG	CF8	1
4 SCREW	CF8	1
5 SCREW GAS-KET	PTFE	1
6 CAP	CF8M	1
7 CAP GASKET	PTFE	1

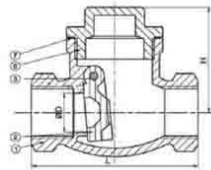

PART #	SIZE	D	L	W	LBS
949353	1/2"	.59"	2.45	1.66	0.53
949354	3/4"	.79"	2.92	1.82	0.73
949355	1"	.98"	3.41	2.06	1.2
949356	1-1/4"	1.26"	3.93	2.32	1.79
949357	1-1/2"	1.57"	4.54	2.54	2.18
949358	2"	1.96"	5.3	2.78	3.03

CF8 = 304SS

316 SS GLOBE VALVES

- 200PSI(PN16)
- Threaded Ends: ANSI B2.1
- Material: CF8M (#316 SS)
- Pressure Test: API 598
- Made in China



Part	Material	QTY
1 BODY	CF8M	1
2 DISC	CF8M	1
3 STEM	304SS	1
4 CAP	CF8M	1
5 SEAL	PTFE	1
6 GASKET	304SS	1
7 PACKING	PTFE	1
8 GASKET	CF8	1
9 GLAND	304SS	1
10 NUT	304SS	1
11 SPRING WASHER	CF8	1
12 HANDLE WHEEL	Steel	1

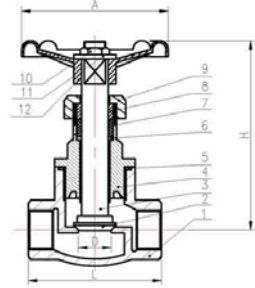

PART #	SIZE	L	LBS
949303	1/2	2.64	0.89
949304	3/4	3.19	1.3
949305	1	3.46	1.72
949306	1-1/4	3.81	2.33
949307	1-1/2	4.25	3.11
949308	2	5.1	4.38

316 SS GATE VALVES

- 200PSI(PN16)
- Threaded Ends: ANSI B2.1
- Material: CF8M (#316 SS)
- Pressure Test: API 598
- Made in China



Part	Material	QTY
1 BODY	CF8M	1
2 DISC	CF8M	1
3 SEAL	CF8M	1
4 CAP	CF8M	1
5 SEAL	PTFE	1
6 STEM	304SS	1
7 SEAL	PTFE	1
8 GLAND	304SS	1
9 NUT	304SS	1
HANDLE WHEEL	Steel	1

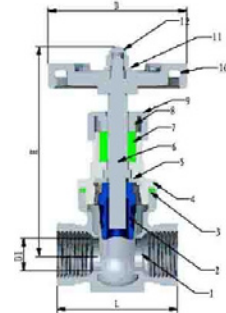

PART #	SIZE	L	D	D1	H	LBS
949253	1/2	2.07	2.54	0.55	3.37	0.78
949254	3/4	2.28	2.89	0.74	4.03	0.99
949255	1	2.42	2.89	0.95	4.46	1.25
949256	1-1/4	2.79	3.06	1.18	4.86	1.76
949257	1-1/2	2.92	3.79	1.49	5.53	2.59
949258	2	3.3	4.17	1.85	6.12	3.54

WARNING: This product can expose you to chemicals, including Chromium, which are known to the State of California to cause cancer and birth defects or other reproductive harm. For more information, visit www.P65Warnings.ca.gov

CARBON STEEL BALL VALVES

VALVES

STANDARD PORT CARBON STEEL BALL VALVE

- For chemical and industrial applications.
- Blow-out proof stem design.
- 100% air tested under water, at 100 psi, open and closed positions.
- Made in China
- Generic handles

SPECIFICATIONS

- Working Pressure: 1/4" ~ 1" 2000 psi WOG, 1-1/4" ~ 2" 1500 psi WOG,
- Temperature Range: -60° to 450°F
- End types: Threaded
- 1 piece ball valve
- Reinforced PTFE seat

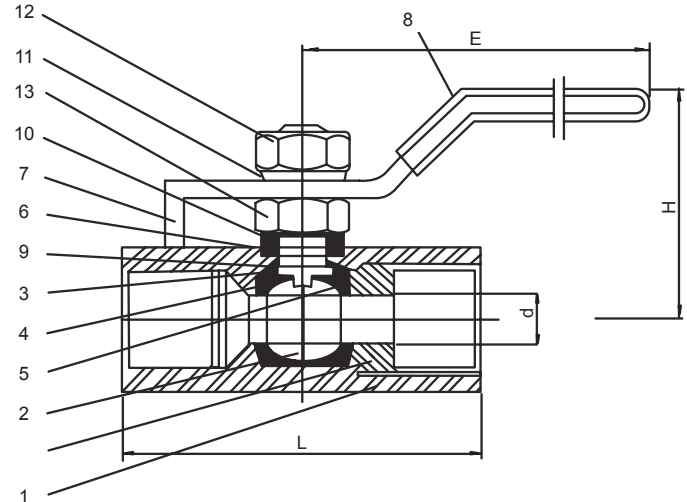
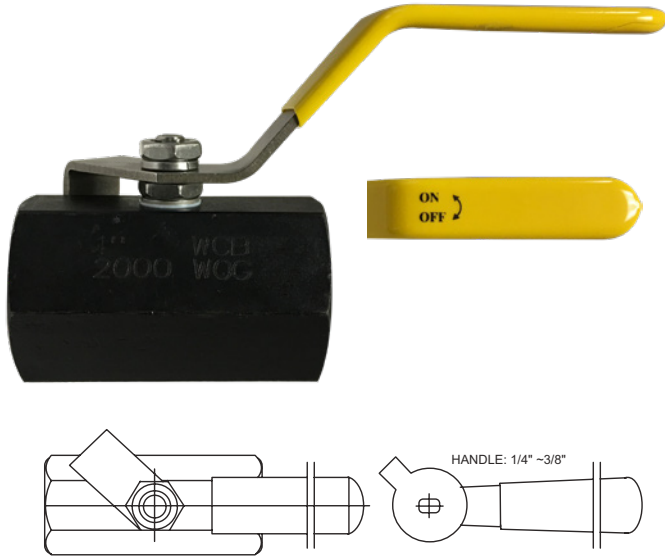

2000 PSI STANDARD PORT

PART #	SIZE	D	H	E	L	WTG	BOX/ CASE	
949121	1/4	.20	1.38	2.95	1.71	0.25	24/96	----
949122	3/8	.28	1.30	3.27	1.87	0.32	100/200	----
949123	1/2	.36	2.36	4.53	2.20	0.67	50/100	----
949124	3/4	.49	2.72	4.53	2.58	1.06	50/100	----
949125	1	.59	2.95	5.00	3.19	1.17	25/50	----
949126	1-1/4	.78	3.07	5.29	3.94	3.15	15/30	----
949127	1-1/2	0.98	3.39	5.29	3.94	2.15	15/30	----
949128	2	1.26	3.86	5.29	4.49	6.21	10/20	----

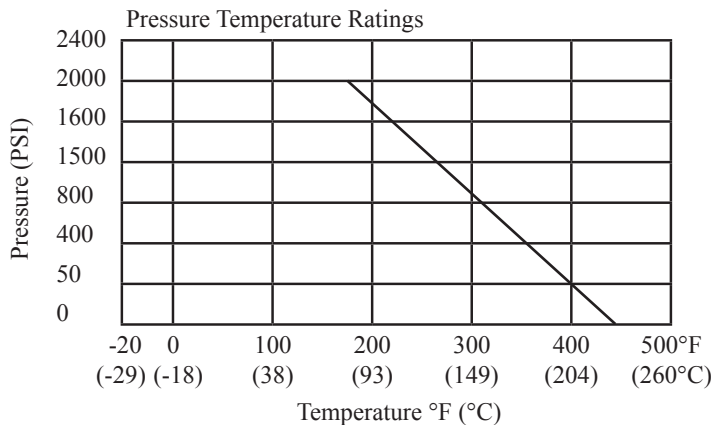

Item	Parts	Material
1	Body	ASTM A216 WCB
2	Ball	ASTM A351 CF8
3	Stem	304
4	Ball Seat	PTFE
5	Cap Seal	PTFE
6	Packing	PTFE
7	Handle	SS304
8	Handle Sleeve	Vinyl Grip
9	Thrust Washer	PTFE
10	Gland	SS304
11	Washer	SS304
12	Handle Nut	SS304
13	Stem Nut	SS304

WARNING: This product can expose you to chemicals, including Cobalt, which are known to the State of California to cause cancer. For more information, visit www.P65Warnings.ca.gov

VALVES

CARBON STEEL FULL PORT BALL VALVES

VALVES

2000 PSI CARBON STEEL 2PC FULL PORT BALL VALVE

• 2 PIECE

SPECIFICATIONS

- Working Pressure: 2000 PSI (138 Bar)
- Temperature Range: -10° C-150° C
- Suitable medium: WOG
- Threaded End conforms to ANSI B1.20.1
- Made in China
- Generic handle

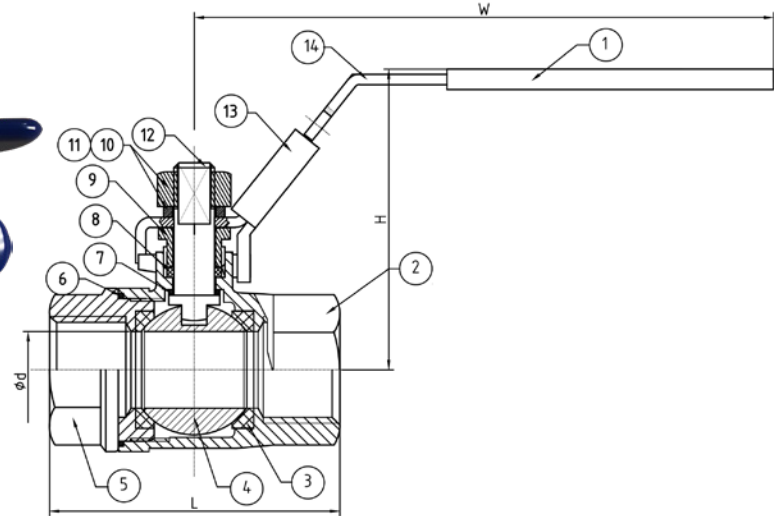
**2000 PSI FULL PORT**

PART #	SIZE	D	L	H	W	WTG	BOX/ CASE	
949111	1/4	0.36	2.13	2.13	4.33	0.59	70	----
949112	3/8	0.50	2.13	2.17	4.33	0.59	70	----
949113	1/2	0.59	2.24	2.28	4.33	0.75	60	----
949114	3/4	0.79	2.76	2.40	4.33	1.17	50	----
949115	1	0.98	3.25	3.03	5.04	1.88	30	----
949116	1-1/4	1.26	3.58	3.19	5.04	2.45	20	----
949117	1-1/2	1.50	4.06	3.54	6.10	4.06	20	----
949118	2	1.97	4.90	4.25	6.10	2.43	7	----

PRESSURE-TEMPERATURE RATING

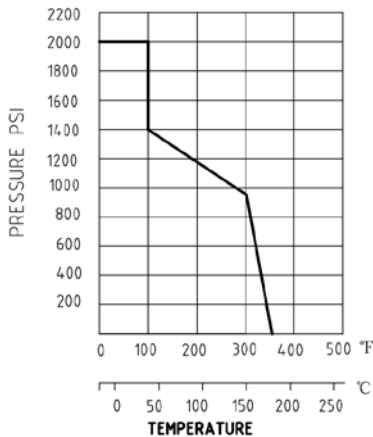

Item	Parts	Material
1	Handle cover	Plastic
2	Body	CF8M
3	Ball seat	PTFE
4	Ball	CF8M
5	Cap	CF8M
6	Joint gasket	PTFE
7	Thrust washer	PTFE
8	Stem packing	PTFE
9	Gland nut	304
10	Spring washer	304
11	Stem nut	304
12	Stem	316
13	Lock device	304
14	Handle	304

WARNING: This product can expose you to chemicals, including Cobalt, which are known to the State of California to cause cancer. For more information, visit www.P65Warnings.ca.gov



HIGH PRESSURE FULL PORT 2-WAY VALVES

VALVES

FULL PORT Two-Way



BKH

PART #	THREAD	WORKING PRESSURE	
GE214NPT	1/4" NPT	7250 PSI	----
GE238NPT	3/8" NPT	7250 PSI	----
GE212NPT	1/2" NPT	7250 PSI	----
GE234NPT	3/4" NPT	5800 PSI	----
GE21NPT	1" NPT	5075 PSI	----
GE2114TNPT*	1-1/4" NPT	5000 PSI	----
GE2112TNPT*	1-1/2" NPT	5000 PSI	----

PART #	THREAD	WORKING PRESSURE	
GE204SAE	7/16-20 UNF	7250 PSI	----
GE206SAE	9/16-18 UNF	7250 PSI	----
GE208SAE	3/4-16 UNF	7250 PSI	----
GE212SAE	1-1/16-12 UNF	5800 PSI	----
GE216SAE	1-5/16-12 UNF	5000 PSI	----

* Reduced Port
 + 'L' flow pattern
 Temp Rating = -22° - 212°F

Construction: Steel Body, Ball, Stem
 Zinc Chromate Plate
 Buna "O" Rings (Fluoroelastomer on request)
 Delrin Ball Seats

FULL PORT Three-Way



BK3

PART #	THREAD	WORKING PRESSURE	
GE3L14NPT	1/4" NPT	5880 PSI	----
GE3L38NPT	3/8" NPT	5880 PSI	----
GE3L12NPT	1/2" NPT	5145 PSI	----
GE3L34NPT	3/4" NPT	5145 PSI	----
GE3L1NPT	1" NPT	5145 PSI	----
GE3L114TNPT	1 1/4" NPT	4500 PSI	----
GE3L112TNPT	1 1/2" NPT	4500 PSI	----

PART #	THREAD	WORKING PRESSURE	
GE3L04SAE	7/16-20 UNF	5880 PSI	----
GE3L06SAE	9/16-18 UNF	5880 PSI	----
GE3L08SAE	3/4-16 UNF	5145 PSI	----
GE3L12SAE	1-1/16-12 UNF	5145 PSI	----
GE3L16SAE	1-5/16-12 UNF	5145 PSI	----

+ 'L' flow pattern
 Temp Rating = -22° - 212°F

Construction: Steel Body, Ball, Stem
 Zinc Chromate Plate
 Buna "O" Rings (Fluoroelastomer on request)
 Delrin Ball Seats

WARNING: This product can expose you to chemicals, including Cobalt, which are known to the State of California to cause cancer. For more information, visit www.P65Warnings.ca.gov

HIGH PRESSURE CHECK VALVES

VALVES

CHECK VALVES - HARD SEAT CARBON STEEL CONSTRUCTION - 5lb Cracking Pressure

- w/ NPT threads

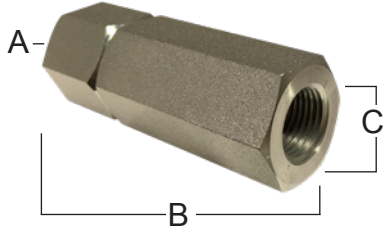

A (NPT Female both ends)

PART #	A SIZE	B INCHES	C INCHES	RATED FLOW GPM	PSI	
100025	1/4 NPT	2.44	.87	6	5,000	----
100035	3/8 NPT	2.87	.95	10	5,000	----
100045	1/2 NPT	3.76	1.26	18	5,000	----
100065	3/4 NPT	4.30	1.50	30	5,000	----
100085	1 NPT	4.74	1.83	36	5,000	----
1000105	1-1/4 NPT	5.56	2.40	50	3,000	----
1000125	1-1/2 NPT	5.56	2.56	60	3,000	----

CHECK VALVES - HARD SEAT CARBON STEEL CONSTRUCTION - 65lb Cracking Pressure

PART #	A SIZE	B INCHES	C INCHES	RATED FLOW GPM	PSI	
1000265	1/4NPT	2.45	.87	6	5,000	----
1000365	3/8NPT	2.91	.94	10	5,000	----
1000465	1/2NPT	3.74	1.18	18	5,000	----
1000665	3/4NPT	4.29	1.26	30	5,000	----
1000865	1NPT	5.00	1.81	36	5,000	----
10001065	1-1/4NPT	5.20	2.41	50	3,000	----
10001265	1-1/2NPT	5.20	2.56	60	3,000	----

CHECK VALVES - 5lb Cracking Pressure

- w/ SAE threads

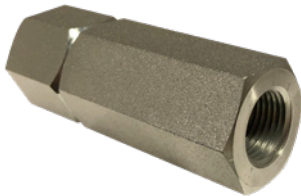

PART #	A SIZE	B INCHES	C INCHES	RATED FLOW GPM	PSI	
100145	7/16-20 SAE	2.56	.87	6	5,000	----
100165	9/16-18 SAE	2.91	.94	10	5,000	----
100185	3/4-16 SAE	3.74	1.18	18	5,000	----
1001125	1-1/6-12 SAE	4.29	1.50	30	3,000	----
1001165	1-5/16-12 SAE	5.00	1.81	36	3,000	----
1001205	1-5/8-12 SAE	5.20	2.41	50	3,000	----
1001245	1-7/8-12 SAE	5.20	2.56	60	3,000	----

CHECK VALVES - 65lb Cracking Pressure

- w/ SAE threads

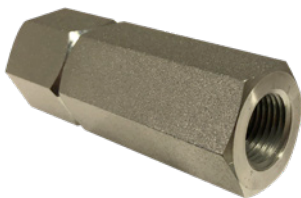

PART #	A SIZE	B INCHES	C INCHES	RATED FLOW GPM	PSI	
1001465	7/16-20 SAE	2.56	.87	6	5,000	----
1001665	9/16-18 SAE	2.91	.94	10	5,000	----
1001865	3/4-16 SAE	3.74	1.18	18	5,000	----
10011265	1-1/6-12 SAE	4.29	1.50	30	3,000	----
10011665	1-5/16-12 SAE	5.00	1.81	36	3,000	----
10012065	1-5/8-12 SAE	5.20	2.41	50	3,000	----
10012465	1-7/8-12 SAE	5.20	2.56	60	3,000	----

Rated Pressure: Sizes 2 thru 8 - 5000 psi / Sizes 10 thru 24 - 3000 psi

- Soft Seat available by special quote



USE OUR APP WITH YOUR FREE BIN LABELS TO MANAGE YOUR CUSTOMERS INVENTORY MORE EFFICIENTLY

WARNING: This product can expose you to chemicals, including Cobalt, which are known to the State of California to cause cancer. For more information, visit www.P65Warnings.ca.gov



PVC VALVES

VALVES

- Quarter turn **WHITE PVC BALL VALVES**
- Solvent ends comply with ASTM D2466
- Designed for use in residential, commercial & industrial system as well as waste water, chemical, agricultural applications, marine, food processing, swimming pools.
- Corrosion resistant
- EPDM seal
- FULL PORT
- EPDM O-ring
- Fits both Sch. 40 & 80 pipe
- Rated for 150 PSI at 73°F
- Threaded ends comply with ANSI B1.20.1



MOLDED IN PLACE - WHITE PIPE THREADS

PART#	SIZE	CASE	
940284	1/2"	100	----
940285	3/4"	100	----
940286	1"	100	----
940287	1-1/4"	100	----
940288	1-1/2"	48	----
940289	2"	24	----
940291	3"	12	----
940292	4"	6	----



WHITE SOCKET - SLIP X SLIP

PART #	SIZE	CASE	
940294	1/2"	100	----
940295	3/4"	100	----
940296	1"	100	----
940297	1-1/4"	100	----
940298	1-1/2"	48	----
940299	2"	24	----
940300	2-1/2"	12	----
940301	3"	12	----
940302	4"	6	----

I CAN'T CHANGE THE DIRECTION OF THE WIND, BUT I CAN ADJUST MY SAILS TO ALWAYS REACH MY DESTINATION.

- JIMMY DEAN

GREY PVC BALL VALVES

FEATURES

- Sizes range from 1/2" to 4"
- Excellent flow characteristics
- Leak-tight shut-off
- EPPM O-Ring
- SCH 80
- Test pressure: 225 psi @ 73°F
- Working Pressure: 150 psi @ 73°F



FIP X FIP THREADED BALL VALVE

PART #	SIZE	CASE	
899000	1/2"	100	----
899001	3/4"	100	----
899002	1"	100	----
899003	1-1/4"	100	----
899004	1-1/2"	48	----
899005	2"	24	----



SLIP X SLIP BALL VALVE

PART #	SIZE	CASE	
899050	1/2"	100	----
899051	3/4"	100	----
899052	1"	100	----
899053	1-1/4"	100	----
899054	1-1/2"	48	----
899055	2"	24	----



CPVC BALL VALVE

PART #	SIZE	
940281	1/2"	----
940282	3/4"	----

WARNING: This product can expose you to chemicals, including Chloroethane, which are known to the State of California to cause cancer. For more information, visit www.P65Warnings.ca.gov

PLASTIC VALVES

VALVES

INLINE PLASTIC SPRING CHECK VALVE

Socket x Socket

- 200 PSI working pressure @ 77°F .5 PSI to open.



PART#	SIZE	
940325	1/2"	----
940326	3/4"	----
940327	1"	----
940328	1-1/4"	----
940329	1-1/2"	----
940330	2"	----

INLINE PLASTIC SPRING CHECK VALVE FEMALE THREADED ENDS

- 200 PSI working pressure @ 77°F .5 PSI to open.



PART#	SIZE	
940331	1/2"	----
940332	3/4"	----
940333	1"	----
940334	1-1/4"	----
940335	1-1/2"	----
940336	2"	----

PLASTIC DRUM FAUCETS

- Pipe threads to ANSI B1.20.1
- Hose threads to ANSI B

The FLO-RITE faucet has been engineered to meet the demand for greater chemical resistance, using linear polyethylene for the stem.



"FLO-RITE" DRUM FAUCET

PART #	SIZE	
46277	3/4"	----

DRUM & BARREL FAUCET VALVE

- Die cast body w/ nylon seat and steel spring.
- For use with all petroleum products except trichlorethylene.



G261N

Not suitable for potable water

SELF-CLOSING DRUM & BARREL FAUCET

PART #	SIZE	
46270	3/4"	----

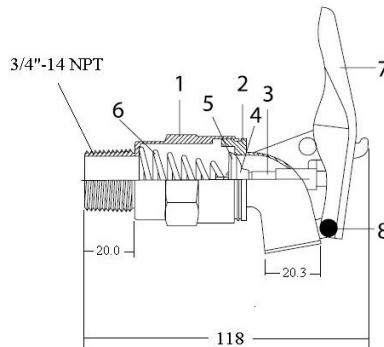

Part #	Part Name	Material
1	Body	Zinc
2	Bonnet	Zinc
3	Stem	Steel
4	Disc	Plastic
5	Seal	Rubber
6	Spring	Zinc plated steel
7	Handle	Aluminum
8	Rivet	Aluminum

WARNING: This product can expose you to chemicals, including Chloroethane, which are known to the State of California to cause cancer. For more information, visit www.P65Warnings.ca.gov



DUCTILE IRON VALVES AND ACCESSORIES

WAFER STYLE - LEVER OPERATED



NICKLE PLATED DUCTILE IRON DISC & SS DISC

WAFER STYLE GEAR OPERATED



NICKLE PLATED DUCTILE IRON DISC & SS DISC

BUTTERFLY ACCESSORIES



WAFER STYLE DOUBLE DOOR CHECK VALVE



AWWA C508 OUTSIDE LEVER



AND WEIGHT CHECK VALVES

UL/FM FLANGED SWING CHECK VALVE



SWING CHECK FLANGED

AWWA C515-15 GATE VALVES

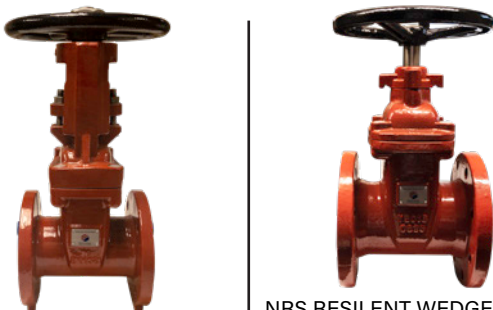

FLANGED OS & Y RESILIENT WEDGE GATE VALVE

NRS RESILIENT WEDGE GATE VALVES, FLANGED, MECHANICAL JOINT & FLANGE BY MECHANICAL JOINT

DUCTILE IRON THREADED FLAT FACED COMPANION FLANGES



LF WATER METER FLANGES, FLANGE KITS AND LF METER COUPLINGS



BUTTERFLY VALVES - WAFER

VALVES

LEVER - WAFER

Small in size and light in weight, easy to install. It can be mounted wherever needed, quick 90° on-off operation. Disc has two-way bearing, perfect seal without leakage under the pressure test. Flow curve tending to straight-line. Strong wash and brush resistance and can fit to bad working condition. Center plate structure, small torque of open and close. Disc & stem are fastened by pin, more stable.



STANDARD:

- 1.DESIGN CODE :AP1609 Class A
- 2.FACE TO FACE : AP1609
- 3.END STANDARD:ANSI B16.5 125LB/150LB
- 4.INSPECTION & TEST:API 598

TOP FLANGE DIMENSIONS

SIZE	4- d2
1.5"-3"	4-0.276
4"-6"	4-0.39
8"-14"	4-0.47

PART#	DUCTILE IRON DISC/ BUNA SEAT/ LEVER	CASE	WEIGHT	
9650L2	2"	200	7.3	----
9650L2.5	2-1/2"	190	8.4	----
9650L3	3"	180	9.8	----
9650L4	4"	150	12.1	----
9650L5	5"	110	16.5	----
9650L6	6"	90	16.9	----
9650L8	8"	50	30.3	----
9650L10	10"	35	44.5	----
9650L12	12"	24	51.6	----

SS DISC/ EPDM SEAT/
LEVER

PART#	SIZE	
9650L2SE	2"	----
9650L3SE	3"	----
9650L4SE	4"	----
9650L5SE	5"	----
9650L6SE	6"	----
9650L8SE	8"	----
9650L10SE	10"	----
9650L12SE	12"	----

GEAR - WAFER

STANDARD:

- 1.DESIGN CODE :AP1609 Class A
- 2.FACE TO FACE : AP1609
- 3.END STANDARD:ANSI B16.5 125LB/150LB
- 4.INSPECTION & TEST:API 598



TOP FLANGE DIMENSIONS

SIZE	ISO5211	K	E	4- D2
1.5"-3"	F05	2.56	1.97	4-0.276
4"-6"	F07	3.54	2.76	4-0.39
8"-14"	F10	4.92	4.02	4-0.47

PART#	WAFER/ DUCTILE IRON DISC/ BUNA SEAT/ GEAR	CASE	WEIGHT	
9650G2	2"	200	7.3	----
9650G2.5	2-1/2"	190	8.4	----
9650G3	3"	180	9.8	----
9650G4	4"	150	12.1	----
9650G6	6"	90	16.9	----
9650G8	8"	50	30.3	----
9650G10	10"	35	44.5	----
9650G12	12"	24	51.6	----

WAFER/ SS DISC/ EPDM
SEAT/ GEAR

PART#	SIZE	
9650G2SE	2"	----
9650G2.5SE	2-1/2"	----
9650G3SE	3"	----
9650G4SE	4"	----
9650G6SE	6"	----
9650G8SE	8"	----
9650G10SE	10"	----
9650G12SE	12"	----

BUTTERFLY VALVES - LUG

VALVES

LEVER - LUG

Small in size and light in weight, easy to install, can be mounted wherever needed. Lug type butterfly valve can be used at the end of the pipeline. Lug type butterfly valve has threaded metal inserts installed in the valve's bolt holes. Inserts are threaded on both ends, which allows this lug style valve to be installed into a system using two sets of bolts and no nuts for each hole. Valve is installed between two flanges using a separate set of bolts for each side of the flange. This setup permits either side of the piping system to be disconnected without disturbing the other side.



PART#	DUCTILE IRON DISC/ BUNA SEAT/ LEVER	CASE	WEIGHT	
9660L2	2"	200	7.3	----
9660L2.5	2-1/2"	190	8.4	----
9660L3	3"	180	9.8	----
9660L4	4"	150	12.1	----
9660L5	5"	110	16.5	----
9660L6	6"	90	16.9	----
9660L8	8"	50	30.3	----
9660L10	10"	35	44.5	----
9660L12	12"	24	51.6	----

SS DISC/ EPDM SEAT/ LEVER

PART#	SIZE	
9660L2SE	2"	----
9660L3SE	3"	----
9660L4SE	4"	----
9660L5SE	5"	----
9660L6SE	6"	----
9660L8SE	8"	----
9660L10SE	10"	----
9660L12SE	12"	----

GEAR - LUG



PART#	DUCTILE IRON DISC/ BUNA SEAT/ GEAR	CASE	WEIGHT	
9660G2	2"	200	7.3	----
9660G2.5	2-1/2"	190	8.4	----
9660G3	3"	180	9.8	----
9660G4	4"	150	12.1	----
9660G6	6"	90	16.9	----
9660G8	8"	50	30.3	----
9660G10	10"	35	44.5	----
9660G12	12"	24	51.6	----

SS DISC/ EPDM SEAT/ GEAR

PART#	SIZE	
9660G2SE	2"	----
9660G2.5SE	2-1/2"	----
9660G3SE	3"	----
9660G4SE	4"	----
9660G6SE	6"	----
9660G8SE	8"	----
9660G10SE	10"	----
9660G12SE	12"	----

BUTTERFLY ACCESSORIES

VALVES

STEM EXTENSIONS

- FOR BOLTS AND NUTS
- BLACK COLOR

PART#	FOR VALVE SIZES ""	LENGTH	
9650EX2324	2-3	24 LONG	----
9650EX2336	2-3	36 LONG	----
9650EX2348	2-3	48 LONG	----
9650EX2360	2-3	60 LONG	----
9650EX2372	2-3	72 LONG	----
9650EX4624	4-6	24 LONG	----
9650EX4636	4-6	36 LONG	----
9650EX4648	4-6	48 LONG	----
9650EX4660	4-6	60 LONG	----
9650EX4672	4-6	72 LONG	----
9650EX1224	8-12	24 LONG	----
9650EX1236	8-12	36 LONG	----
9650EX1248	8-12	48 LONG	----
9650EX1260	8-12	60 LONG	----
9650EX1272	8-12	72 LONG	----

LEVER REPLACEMENT

PART#	REPLACEMENT LEVER HANDLE FOR	
9650L23	2-3 9650BFV	----
9650L46	4-6 9650 BFV	----
9650L812	8-10 9650 B	----
9650L120	12 9650 BFV	----

GEAR WHEEL HANDLE

PART#	REPLACEMENT WHEEL HANDLE FOR	
9650WH23	2-3" 9650 BFV	----
9650WH46	4-6" 9650 BFV	----
9650WH812	8-12" BFV	----

ROLL PIN

PART#	REPLACEMENT ROLL PIN FOR	
9650RP23	2-3 9650 BFV	----
9650RP46	4-6 9650 BFV	----
9650RP12	8-12 9650 BFV	----

INDEX PLATE

PART#	REPLACEMENT INDEX PLATE	
9650IP23	2-3" 9650BFV	----
9650IP46	4-6" 9650BFV	----
9650IP812	8-12" 9650 B	----

GEAR REPLACEMENT

PART#	REPLACEMENT GEAR OPERATOR	
9650G23	2-3 9650 BFV	----
9650G46	4-6 9650 BFV	----
9650G812	8-10 9650BFV	----
9650G120	12 - 9650BFV	----

DUCTILE IRON CHECK VALVES

VALVES

DOUBLE DOOR WAFER CHECK VALVE

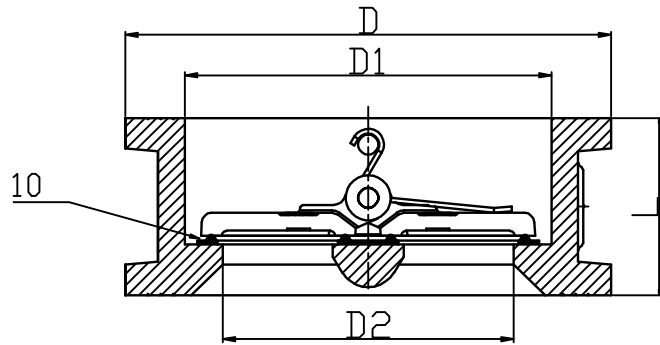
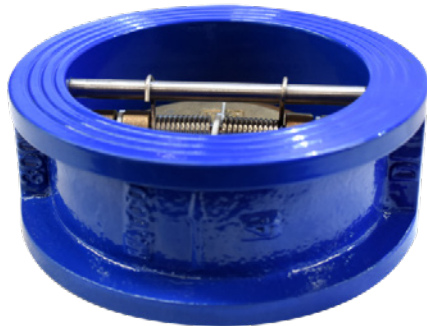

Part	Part	MATERIAL
1	Countersunk Hex Head Screws	Carbon Steel ASTM A325
2	Stal Ring	EPDM
3	Gasket	PTFE
4	Shaft	Stainless Steel SS420
5	Disc	Aluminum Brance C954
6	Spring	Stainless Steel SS304
7	Body	Ductile Iron ASTM 65-45-12

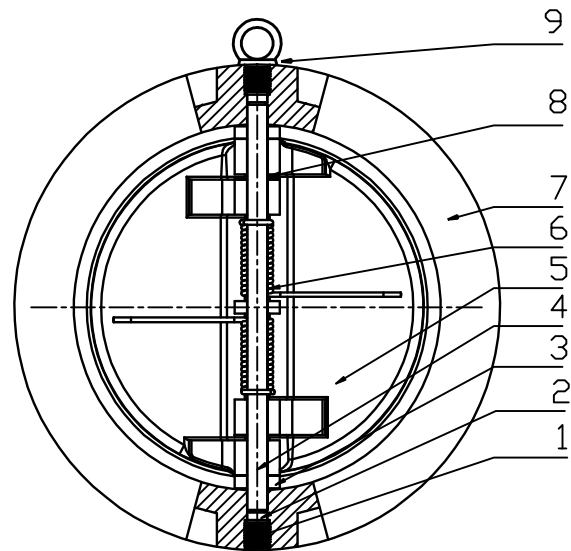

MAIN DIMENSIONS

DN		Dimensions (mm)			
inch	mm	L	D	D1	D2
2	50	54	102	64	46
2 1/2'	65	54	121	78	60
3	80	57	134	94	70
4	100	64	162	117	84
5	125	70	192	145	115
6	150	76	218	170	134
8	200	95	273	224	184
10	250	108	335	265	220
12	300	143	407	310	260
14	350	184	442	360	302
16	400	191	511	410	350

PART#	SIZE	CASE	WEIGHT	
963002	2	50	4	----
963025	2-1/2	40	5	----
963003	3	20	8	----
963004	4	20	13	----
963005	5	20	16	----
963006	6	10	20	----
963008	8	10	38	----
963010	10	10	38	----
963012	12	5	92	----
963014	14	4	121	----
963016	16	4	165	----



VIEW PRICING AND AVAILABLE STOCK ONLINE

DUCTILE IRON CHECK VALVES

VALVES

CHECK VALVE W/OUTSIDE L/W

AWWA C508 CHECK VALVE W/OUTSIDE L/W

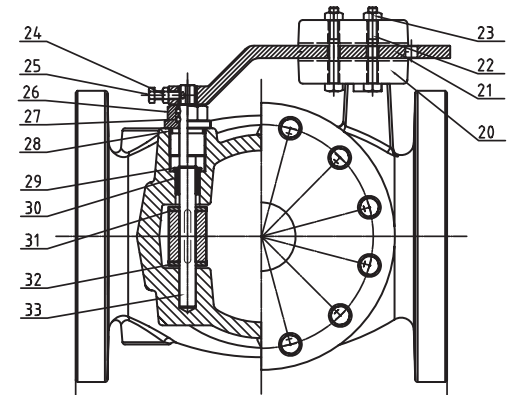
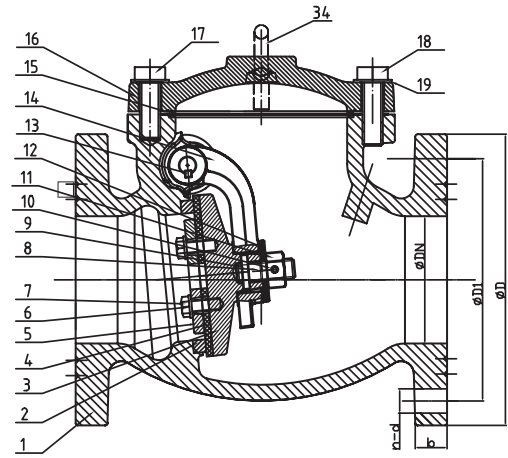

Part	Part	MATERIAL
1	Valve Body	Ductile iron 65-45-12
2	Seat	ASTM B62 C83600
3	Disc	Ductile iron 65-45-12
4	Disc Seat Ring	NBR
5	Retainer Washer	Ductile iron 65-45-12
6	Washer	AISI 304
7	Bolt	AISI 304
8	Stud	ASTM B62 C83600
9	Roll Pin	AISI 304
10	Roll Pin	AISI 304
11	Nut	ASTM B62 C83600
12	Washer	ASTM B62 C83600
13	Flat Key	AISI 304
14	Clapper Arm	Ductile iron 65-45-12
15	O-Ring	NBR
16	Bonnet	Ductile iron 65-45-12
17	Bolt	AISI 316
18	Bolt	AISI 316
19	Washer	AISI 316
20	Weight	Ductite iron,65-45-12
21	Arm	Cast steel WCB
22	Bolt	AISI 316
23	Nut	AISI 316
24	Nut	AISI 316
25	Bolt	AISI 316
26	Seat Nut	ASTM B62 C83600
27	O-Ring	NBR
28	Gasket	PTFE
29	Circlip	Carbon steel
30	Shaft sleeve gland	ASTM B62 CB3600

MAIN DIMENSIONS (mm)

inch	DN	L	D	D1	b	n-d	H
3"	80	241	200	152.5	19	4-19.1	173
4"	100	292	229	190.5	24	8-19.1	175.5
6"	150	356	285	241.5	25.5	8-22.2	237.5
8"	200	495	343	298.5	28.5	8-22.2	272.5
10"	250	622	406	362	30.5	12-25.4	326
12"	300	698	483	432	32	12-25.4	358

**UL/FM FLANGED SWING CHECK VALVE**

PART#	SIZE	CASE	WEIGHT	
96203LW	3	16	57	----
96204LW	4	12	84	----
96206LW	6	6	156	----
96208LW	8	4	294	----
962010LW	10	2	466	----
962012LW	12	2	627	----

PART#	SIZE	CASE	WEIGHT	
96203UL	3	36	50	----
96204UL	4	36	77	----
96206UL	6	14	140	----
96208UL	8	4	266	----
962010UL	10	1	398	----
962012UL	12	1	533	----

DUCTILE IRON CHECK VALVES

VALVES

AWWA C508 SWING CHECK VALVE FLANGED

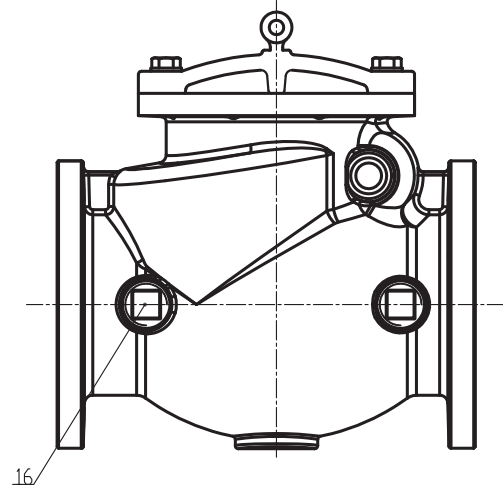
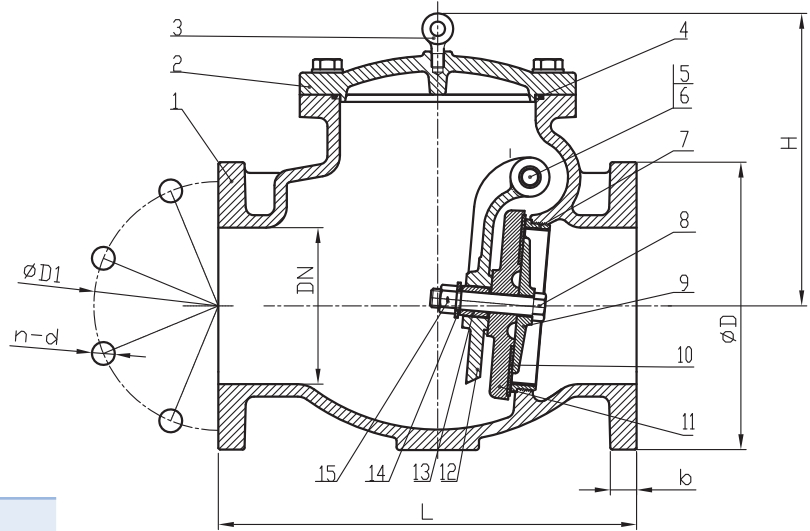

Part	Part	MATERIAL
1	Valve Body	Ductile Iron 65-45-12
2	Bonnet	Ductile Iron 65-45-12
3	Sling Ring	Carbon Steel Zinc Plated
4	O Ring	NBR
5	Hinge Pin	Stainless Steel 304
6	Hinge bushing	Brass ASTM B36
7	Seat Ring	Bronze ASTM B62
8	Disc Seat Bolts	Stainless Steel 304
9	Retainer Washer	Bronze ASTM B62
10	Disc Seat Ring	EPDM
11	Disc	Ductile Iron 65-45-12
12	Ctapper Arm	Ductile Iron 65-45-12
13	Stud Bushing	Bronze ASTM B36
14	O Ring	NBR
15	Nuts	Stainless Steel 304
16	Plug	Tin bronze

MAIN DIMENSIONS

DN		PSI	Dimensions (mm)					
inch	mm		L	D	D1	b	n-d	H
3"	80	300	278	191	152.5	19	4-19.1	160
4"	100	300	330	229	190.5	24	8-19.1	218
6"	150	300	406	279	241.5	25.5	8-22.2	290
8"	200	300	495	343	298.5	28.5	8-22.2	330
10"	250	300	622	406	362	30.5	12-25.4	350
12"	300	300	660	483	432	32	12-25.4	376

PART#	SIZE	CASE	WEIGHT	
962003	3	16	57	----
962004	4	12	84	----
962006	6	6	156	----
962008	8	4	294	----
962010	10	2	466	----
962012	12	2	627	----



GO ONLINE TO VIEW OPEN ORDERS, ORDER HISTORY, AND TRACKING INFORMATION ON ALL SHIPMENTS

DUCTILE IRON GATE VALVES

VALVES

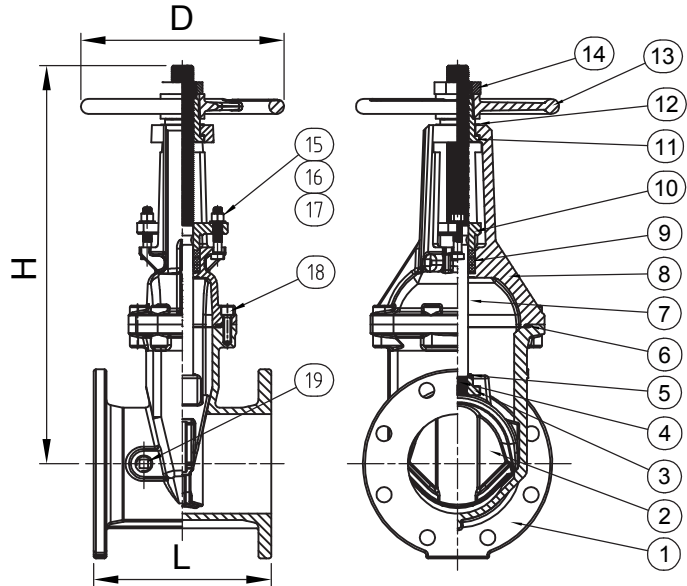
**OS&Y RESILIENT SEATED GATE VALVE
FLANGE ENDS, 300PSI**

PART#	SIZE	CASE	WEIGHT	
9610F25	2-1/2"	25	46.2	----
9610F3	3"	16	62.7	----
9610F4	4"	16	74.8	----
9610F6	6"	9	103.9	----
9610F8	8"	6	190.9	----
9610F10	10"	2	291.8	----
9610F12	12"	2	409.8	----

NO TAP

PART#	SIZE	CASE	WEIGHT	
9610NYCF25	2-1/2"	25	46.2	----
9610NYCF3	3"	32	62.7	----
9610NYCF4	4"	64	74.8	----
9610NYCF6	6"	54	103.9	----
9610NYCF8	8"	36	190.9	----
9610NYCF10	10"	12	291.8	----
9610NYCF12	12"	12	409.8	----

COMPLIES WITH NEW YORK AND CHICAGO REQUIREMENTS.

	DESCRIPTION	MATERIAL	ASTM SPEC.
1	Body	Ductile Iron	A536 65-45-12
2	Wedge	Ductile Iron, EPDM Encapsulated	A536 65-45-12
3	Wedge Nut	Stainless Steel	A276 Type 304SS
4	Pin	Stainless Steel	A276 Type 420SS
5	O-Ring	Rubber	D2000 NBR
6	Gasket	Rubber	D2000 NBR
7	Stem	Stainless Steel	A276 Type 304SS
8	Bonnet	Ductile Iron	A536 65-45-12
9	Packing	Graphite	
10	Gland	Ductile Iron	A536 65-45-12
11	Yoke Nut	Bronze	B148 C95200
12	Washer	Brass	
13	Handwheel	Ductile Iron	A536 65-45-12
14	Handwheel Nut	Ductile Iron	A536 65-45-12
15	Bolts	Stainless Steel	A276 Type 304SS
16	Nuts	Stainless Steel	A276 Type 316SS
17	Washers	Stainless Steel	A276 Type 304SS

MAIN DIMENSIONS

Size	2.5"	3"	4"	6"	8"	10"	12"
L	7-1/2"	8"	9"	10-1/2"	11-1/2"	13"	14"
H (Open)	16-5/8"	18-7/8"	21-5/8"	29-1/8"	36-5/8"	44-1/2"	52"
H (Close)	13-3/4"	15-3/4"	17-3/4"	23-1/4"	28-3/4"	34-3/4"	40-1/6"
D	7-1/4"	10"	10"	12"	14"	17-1/2"	17-1/2"

DUCTILE IRON GATE VALVES

VALVES

NRS RESILIENT SEATED GATE VALVE FLANGE ENDS, 300PSI

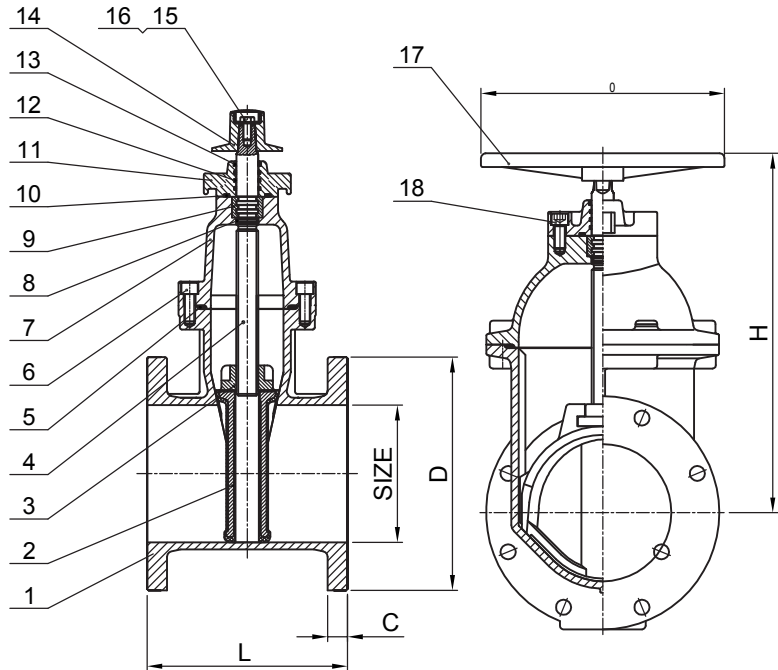

PART#	SIZE	CASE	WEIGHT	
9600FL25	2-1/2"	25	37.6	----
9600FL3	3"	16	54.2	----
9600FL4	4"	16	65.5	----
9600FL6	6"	9	107.5	----
9600FL8	8"	6	181.9	----
9600FL10	10"	2	297.4	----
9600FL12	12"	2	431.4	----

Item	Descript.	Material	ASTM Spec.
1	Body	Ductile Iron	A536 65-45-12
2	Wedge	Ductile Iron, EPDM Encapsulated	A536 65-45-12
3	Wedge Nut	Bronze	B148 C95200
4	Stem	Stainless Steel	A276 Type 304SS
5	Gasket	Rubber	D2000 NBR
6	Bolts	Stainless Steel	A276 Type 304SS
7	Bonnet	Ductile Iron	A536 65-45-12
8	O-Ring	Rubber	D2000 NBR
9	Thrust Collar	Bronze	B148 C95200
10	O-Ring	Rubber	D2000 NBR
11	Gland	Ductile Iron	A536 65-45-12
12	O-Ring	Rubber	D2000 NBR
13	Dust Ring	Rubber	D2000 NBR

CHANGE YOUR THOUGHTS AND YOU
CHANGE YOUR WORLD.

- NORMAN VINCENT PEALE

MAIN DIMENSIONS

Size	2.5"	3"	4"	6"	8"	10"	12"
L	7-1/2"	8.0"	9.0"	10-1/2"	11-1/2"	13.0"	14.0"

DUCTILE IRON GATE VALVES

VALVES

AWWA C515-15 NRS RESILIENT SEATED GATE VALVE MJ × MJ ENDS, 300PSI

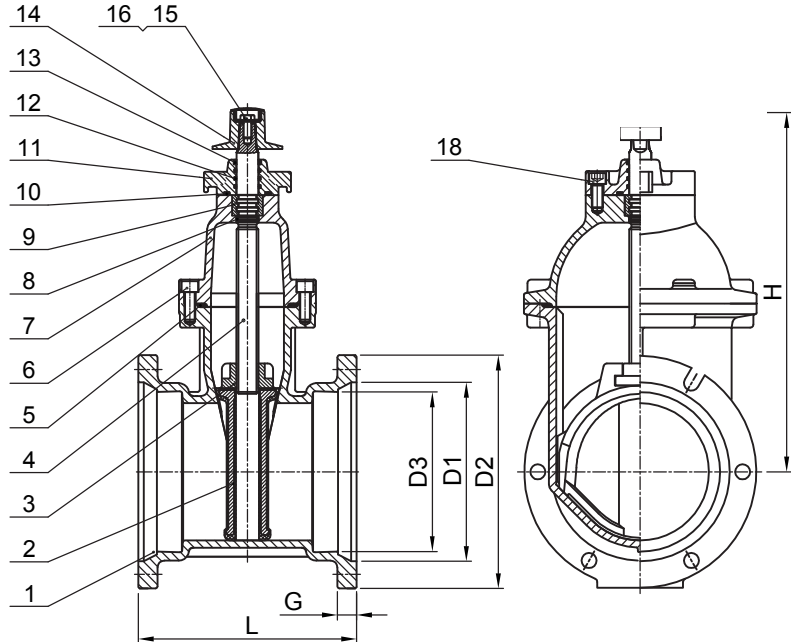

PART#	SIZE	WEIGHT	CASE
9600MJ3	3"	54.2	16
9600MJ4	4"	65.5	16
9600MJ6	6"	107.5	9
9600MJ8	8"	181.9	6
9600MJ10	10"	297.4	2
9600MJ12	12"	431.4	2

*STANDARD CONFIG IS OP NUT ONLY

Item	Descrip.	Material	ASTM Spec.
1	Body	Ductile Iron	A536 65-45-12
2	Wedge	Ductile Iron, EPDM Encapsulated	A536 65-45-12
3	Wedge Nut	Bronze	B148 C95200
4	Stem	Stainless Steel	A276 Type 304SS
5	Gasket	Rubber	D2000 NBR
6	Bolts	Stainless Steel	A276 Type 304SS
7	Bonnet	Ductile Iron	A536 65-45-12
8	O-Ring	Rubber	D2000 NBR
9	Thrust Collar	Bronze	B148 C95200
10	O-Ring	Rubber	D2000 NBR
11	Gland	Ductile Iron	A536 65-45-12
12	O-Ring	Rubber	D2000 NBR
13	Dust Ring	Rubber	D2000 NBR

If you always put limit on everything you do, physical or anything else. It will spread into your work and into your life. There are no limits. There are only plateaus, and you must not stay there, you must go beyond them.

- Bruce Lee

MAIN DIMENSIONS						
Size	3"	4"	6"	8"	10"	12"
L	11.5"	12.5"	14.8"	15.0"	13.0"	14.0"
H	16.4"	20.7"	24.5"	28.0"	24.5"	28.0"

DUCTILE IRON GATE VALVES

VALVES

NRS RESILIENT SEATED GATE VALVE

FL × MJ ENDS, 300PSI

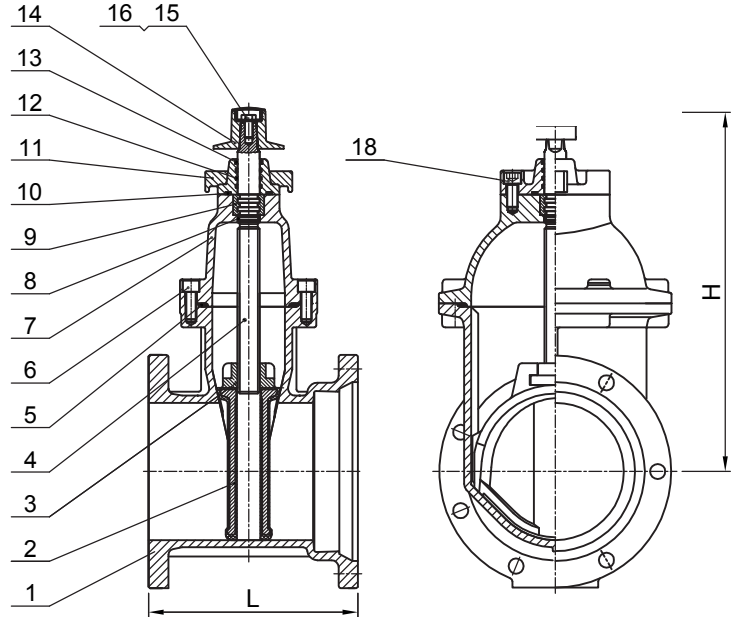
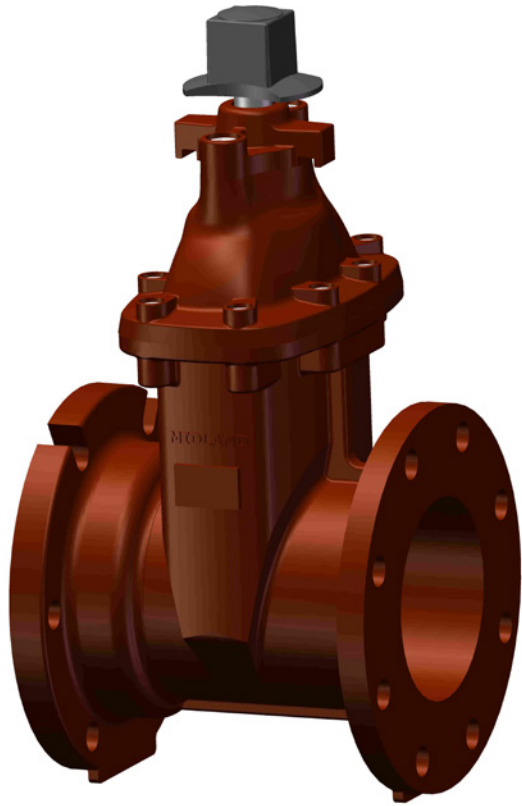

PART#	SIZE	WEIGHT	CASE	
9600FJ3	3"	54.3	16	----
9600FJ4	4"	65.5	16	----
9600FJ6	6"	107.5	9	----
9600FJ8	8"	181.9	6	----
9600FJ10	10"	297.4	2	----
9600FJ12	12"	431.4	2	----

*STANDARD CONFIG IS OP NUT ONLY

Item	Description	Material	ASTM Spec.
1	Body	Ductile Iron	A536 65-45-12
2	Wedge	Ductile Iron, EPDM Encapsulated	A536 65-45-12
3	Wedge Nut	Bronze	B148 C95200
4	Stem	Stainless Steel	A276 Type 304SS
5	Gasket	Rubber	D2000 NBR
6	Bolts	Stainless Steel	A276 Type 304SS
7	Bonnet	Ductile Iron	A536 65-45-12
8	O-Ring	Rubber	D2000 NBR
9	Thrust Collar	Bronze	B148 C95200
10	O-Ring	Rubber	D2000 NBR
11	Gland	Ductile Iron	A536 65-45-12
12	O-Ring	Rubber	D2000 NBR
13	Dust Ring	Rubber	D2000 NBR

MAIN DIMENSIONS

Size	3"	4"	6"	8"	10"	12"	10"	12"
L	8.8"	9.5"	11.0"	12.0"	14.0"	14.5"	13"	14"
H	11.0"	11.8"	16.4"	20.7"	24.5"	28.0"	44-1/2"	52"
D	10.0"	10.0"	12.0"	14.0"	16.0"	16.0"	34-3/4"	40-1/6"

NIPPLES

NIPPLES AND FITTINGS

NIPPLES & FITTINGS



BRASS & BRONZE

Brass Nipples - Sch 40
EH Sch 80
C/P Brass Nipples
Bronze Fittings
Lead Free Bronze Fittings
C/P Fittings
Bronze Cleanout Plugs
Bronze Drop Ear Elbows
Bronze Barbs for PL. Pipe
Steel Barbs for PL. Pipe
Lead Free Bronze Barbs for PL. Pipe
Stainless Steel Barbs for PL. Pipe
Stainless Steel Well Couplings
Stainless Steel Merchant Couplings

Single Run
Nipple Assortments

STAINLESS STEEL

Stainless Nipples
Sch 80 SS Nipples
150# Cast SS Fittings

BLACK & GALVANIZED

Sch. 40 Welded Steel Nipples
Sch. 80 Seamless Steel nipple
Sch. XXS Seamless Steel Nipple
Groove Nipples
Merchant Couplings
API Line Couplings
Malleable Fittings
Steel Fittings
300# Malleable
Bull Plugs and Swages
Forged Steel Fanges
Companion Flanges
Blind Flanges
Copper Fittings

If you don't see what you're looking for, visit www.midlandindustries.com

- Many malleable fittings not listed in the catalog
- Aluminum nipples and fittings
- Tank accessories - duplex tank bushings, double tapped bushings and vent caps
- Sch 40 seamless steel nipples
- Many odd sizes of nipples and fittings not listed in catalog

WARNING: This product can expose you to chemicals, including Nickel, which are known to the State of California to cause cancer.
For more information, visit www.P65Warnings.ca.gov



BRASS NIPPLES



We hereby certify that to the best of our knowledge and belief the CDA 230 alloy seamless Red Brass Pipe from which our nipples are produced meet the requirements of ASTM Specifications B43 and is free of mercury contamination. The chemical analysis is 85% copper, 15% Zinc and conforms to federal Specifications WWN-351. Our brass nipples meet ANSI/ASTM B687-96 and MS51846 for standard brass nipples, and MS51872 for extra heavy brass nipples.

Threads: Nipples are threaded with American Standard taper pipe threads (NPT) in accordance with screw-thread standard for Federal Services Handbook H-58. ANSI B1.20.1

This product is certified by NSF to NSF/ANSI 61 for use in drinking water supplies of pH 6.5 and above.

PRICING FILE AVAILABLE ONLINE

- ASTM B43
- ANSI B1.20.1, WW-N-351
- ANSI/ ASTM B687-96
- NSF-61 Approved
- MS51846 STD Brass Nipples
- RoHS compliant

SEE OUR WEBSITE FOR SCH 80 BRASS NIPPLES - EXTRA HEAVY

STANDARD RED BRASS 85% PIPE WITH THREADED ENDS SPECIFICATIONS:

Pipe Size in Inches	Dimension in Inches		
	O.D.	I.D.	Wall Thickness
1/8"	.405	.281	.062
1/4"	.540	.376	.082
3/8"	.675	.495	.090
1/2"	.840	.626	.107
3/4"	1.050	.822	.114
1"	1.315	1.063	.126
1-1/4"	1.660	1.368	.146
1-1/2"	1.900	1.600	.150
2"	2.375	2.063	.156
2-1/2"	2.875	2.501	.187
3"	3.500	3.062	.219
3-1/2"	4.000	3.500	.250
4"	4.500	4.000	.250
4-1/2"	5.000	4.500	.250
5"	5.563	5.063	.250
6"	6.625	6.125	.250

Standard Size (Inches)	Allowable Pressure POUNDS PER SQUARE INCH			
	@ 100° F	@ 200° F	@ 300° F	@ 400° F
1/8"	370	370	320	140
1/4"	870	870	760	330
3/8"	890	890	780	340
1/2"	900	900	790	340
3/4"	810	810	710	310
1"	630	630	560	240
1-1/4"	690	690	610	260
1-1/2"	630	630	560	240
2"	540	540	480	210
2-1/2"	450	450	390	170
3"	510	510	450	190
3-1/2"	570	570	500	220
4"	510	510	440	190
5"	410	410	360	160
6"	340	340	300	130

No-Lead 125LB seamless Threaded Red Brass Nipples - 2200

LEAD FREE



WARNING: This product can expose you to chemicals, including Nickel, which are known to the State of California to cause cancer. For more information, visit www.P65Warnings.ca.gov

SCH 40 SEAMLESS

NIPPLES AND FITTINGS

113RB



1/8" - 27



1/8" DIAMETER SCH 40 SEAMLESS

MIDLAND	AMC	CHAMPION	LENGTH	BOX/CASE	APPROX. WT. LBS.	LIST
40001	80300-02	112RB-A	Close (3/4")	25/400	0.02	
40002	80300-0215	113RB-A15	x 1-1/2"	25/400	0.03	
40003	80300-0220	113RB-A2	x 2"	25/400	0.04	
40004	80300-0225	113RB-A25	x 2-1/2"	25/400	0.05	
40005	80300-0230	113RB-A3	x 3"	25/400	0.06	
40006	80300-0235	113RB-A35	x 3-1/2"	25/400	0.07	
40007	80300-0240	113RB-A4	x 4"	25/400	0.08	
40008	80300-0245	113RB-A45	x 4-1/2"	25/400	0.10	
40009	80300-0250	113RB-A5	x 5"	25/400	0.11	
40010	80300-0255	113RB-A55	x 5-1/2"	25/400	0.12	
40011	80300-0260	113RB-A6	x 6"	25/400	0.13	
40012	80300-0270	113RB-A7	x 7"	25/400	0.15	
40013	80300-0280	113RB-A8	x 8"	25/400	0.17	
40014	80300-0290	113RB-A9	x 9"	25/400	0.19	
40015	80300-0292	113RB-A10	x 10"	25/400	0.21	
40016	80300-0294	113RB-A11	x 11"			
40017	80300-0296	113RB-A12	x 12"	25/400	0.25	
40018			x 14"	1/1	0.29	
40019			x 16"	1/1	0.34	



1/4" - 18



1/4" DIAMETER SCH 40 SEAMLESS

MIDLAND	AMC	CHAMPION	LENGTH	BOX/CASE	APPROX. WT. LBS.	LIST
40020	80300-04	112RB-B	Close (7/8")	25/400	0.03	
40021	80300-0415	113RB-B15	x 1-1/2"	25/400	0.05	
40022	80300-0420	113RB-B2	x 2"	25/400	0.07	
40023	80300-0425	113RB-B25	x 2-1/2"	25/400	0.09	
40024	80300-0430	113RB-B3	x 3"	25/400	0.11	
40025	80300-0435	113RB-B35	x 3-1/2"	25/400	0.13	
40026	80300-0440	113RB-B4	x 4"	25/400	0.14	
40027	80300-0445	113RB-B45	x 4-1/2"	25/400	0.16	
40028	80300-0450	113RB-B5	x 5"	25/400	0.18	
40029	80300-0455	113RB-B55	x 5-1/2"	25/400	0.20	
40030	80300-0460	113RB-B6	x 6"	25/400	0.22	
40031	80300-0470	113RB-B7	x 7"	25/200	0.25	
40032	80300-0480	113RB-B8	x 8"	25/200	0.29	
40033	80300-0490	113RB-B9	x 9"	25/200	0.33	
40034	80300-0492	113RB-B10	x 10"	25/200	0.36	
40035	80300-0494	113RB-B11	x 11"	25/200	0.40	
40036	80300-0496	113RB-B12	x 12"	25/200	0.43	

See page pipe fittings for Yellow Brass Nipples

WARNING: This product can expose you to chemicals, including Nickel, which are known to the State of California to cause cancer. For more information, visit www.P65Warnings.ca.gov

SCH 40 SEAMLESS

NIPPLES AND FITTINGS



3/8"-18

3/8" DIAMETER SCH 40 SEAMLESS

MIDLAND	AMC	CHAMPION	LENGTH	BOX/CASE	APPROX. WT. LBS.	LIST
40040	80300-06	112RB-C	Close (1")	25/400	0.05	
40041	80300-0615	113RB-C15	x 1-1/2"	25/400	0.08	
40042	80300-0620	113RB-C2	x 2"	25/400	0.10	
40043	80300-0625	113RB-C25	x 2-1/2"	25/400	0.13	
40044	80300-0630	113RB-C3	x 3"	25/400	0.16	
40045	80300-0635	113RB-C35	x 3-1/2"	25/400	0.18	
40046	80300-0640	113RB-C4	x 4"	25/400	0.21	
40047	80300-0645	113RB-C45	x 4-1/2"	25/300	0.23	
40048	80300-0650	113RB-C5	x 5"	25/300	0.26	
40049	80300-0655	113RB-C55	x 5-1/2"	25/300	0.29	
40050	80300-0660	113RB-C6	x 6"	25/300	0.31	
40051	80300-0670	113RB-C7	x 7"	25/200	0.36	
40052	80300-0680	113RB-C8	x 8"	25/150	0.42	
40053	80300-0690	113RB-C9	x 9"	25/150	0.47	
40054	80300-0692	113RB-C10	x 10"	25/100	0.52	
40055	80300-0694	113RB-C11	x 11"	25/100	0.57	
40056	80300-0696	113RB-C12	x 12"	25/100	0.62	

113RB



1/2" - 14

1/2" DIAMETER SCH 40 SEAMLESS

MIDLAND	AMC	CHAMPION	LENGTH	BOX/CASE	APPROX. WT. LBS.	LIST
40060	80300-08	112RB-D	Close (1-1/8")	25/400	0.09	
40061	80300-0815	113RB-D15	x 1-1/2"	25/400	0.12	
40062	80300-0820	113RB-D2	x 2"	25/400	0.16	
40063	80300-0825	113RB-D25	x 2-1/2"	25/300	0.20	
40064	80300-0830	113RB-D3	x 3"	25/300	0.23	
40065	80300-0835	113RB-D35	x 3-1/2"	25/300	0.27	
40066	80300-0840	113RB-D4	x 4"	25/200	0.31	
40067	80300-0845	113RB-D45	x 4-1/2"	25/200	0.35	
40068	80300-0850	113RB-D5	x 5"	25/200	0.39	
40069	80300-0855	113RB-D55	x 5-1/2"	25/200	0.43	
40070	80300-0860	113RB-D6	x 6"	25/200	0.47	
40071	80300-0870	113RB-D7	x 7"	25/100	0.55	
40072	80300-0880	113RB-D8	x 8"	25/100	0.62	
40073	80300-0890	113RB-D9	x 9"	25/100	0.70	
40074	80300-0892	113RB-D10	x 10"	25/75	0.78	
40075	80300-0894	113RB-D11	x 11"	25/75	0.86	
40076	80300-0896	113RB-D12	x 12"	25/75	0.94	
40079			x 24"			
40245			x 36"			

WARNING: This product can expose you to chemicals, including Nickel, which are known to the State of California to cause cancer. For more information, visit www.P65Warnings.ca.gov



SCH 40 SEAMLESS

NIPPLES AND FITTINGS

NIPPLES & FITTINGS



LEAD FREE

3/4" - 14

3/4" DIAMETER SCH 40 SEAMLESS

MIDLAND	AMC	CHAMPION	LENGTH	BOX/CASE	APPROX. WT. LBS.	LIST
40080	80300-12	112RB-E	Close (1- 3/8")	25/400	0.15	
40081	80300-1215	113RB-E15	x 1-1/2"	25/400	0.16	
40082	80300-1220	113RB-E2	x 2"	25/300	0.21	
40083	80300-1225	113RB-E25	x 2-1/2"	25/300	0.27	
40084	80300-1230	113RB-E3	x 3"	25/200	0.32	
40085	80300-1235	113RB-E35	x 3-1/2"	25/200	0.37	
40086	80300-1240	113RB-E4	x 4"	25/150	0.43	
40087	80300-1245	113RB-E45	x 4-1/2"	25/150	0.48	
40088	80300-1250	113RB-E5	x 5"	25/100	0.53	
40089	80300-1255	113RB-E55	x 5-1/2"	25/100	0.59	
40090	80300-1260	113RB-E6	x 6"	25/100	0.64	
40091	80300-1270	113RB-E7	x 7"	25/75	0.75	
40092	80300-1280	113RB-E8	x 8"	25/75	0.85	
40093	80300-1290	113RB-E9	x 9"	25/75	0.96	
40094	80300-1292	113RB-E10	x 10"	25/50	1.06	
40095	80300-1294	113RB-E11	x 11"	25/50	1.17	
40096	80300-1296	113RB-E12	x 12"	25/50	1.28	
40097	80300-129918		x 18"	1/1	1.92	
40098	80300-129924		x 24"	1/1	2.56	

113RB

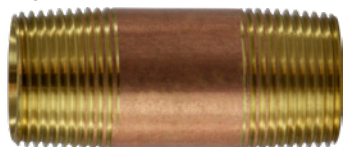

LEAD FREE

1" - 11 1/2

1" DIAMETER SCH 40 SEAMLESS

MIDLAND	AMC	LENGTH	BOX/CASE	APPROX. WT. LBS.	LIST
40100	80300-16	Close (1-1/2")	25/200	0.23	
40101	80300-1620	x 2"	25/200	0.30	
40102	80300-1625	x 2-1/2"	25/150	0.38	
40103	80300-1630	x 3"	25/150	0.45	
40104	80300-1635	x 3-1/2"	25/100	0.53	
40105	80300-1640	x 4"	25/100	0.60	
40106	80300-1645	x 4-1/2"	25/100	0.68	
40107	80300-1650	x 5"	25/75	0.75	
40108	80300-1655	x 5-1/2"	25/75	0.83	
40109	80300-1660	x 6"	25/50	0.94	
40110	80300-1670	x 7"	25/50	1.05	
40111	80300-1680	x 8"	25/50	1.20	
40112	80300-1690	x 9"	25/50	1.35	
40113	80300-1692	x 10"	25/50	1.50	
40114	80300-1694	x 11"	25/50	1.65	
40115	80300-1696	x 12"	20/40	1.80	
40118		x 18"			
40119		x 24"			

WARNING: This product can expose you to chemicals, including Nickel, which are known to the State of California to cause cancer. For more information, visit www.P65Warnings.ca.gov

SCH 40 SEAMLESS

NIPPLES AND FITTINGS



**LEAD
FREE**

1 1/4" - 11 1/2"

1-1/4" DIAMETER SCH 40 SEAMLESS

MIDLAND	AMC	LENGTH	BOX/CASE	APPROX. WT. LBS.	LIST
40120	80300-20	Close (1-5/8")	25/100	0.36	
40121	80300-2020	x 2"	25/100	0.44	
40122	80300-2025	x 2-1/2"	25/100	0.56	
40123	80300-2030	x 3"	25/100	0.67	
40124	80300-2035	x 3-1/2"	25/100	0.78	
40125	80300-2040	x 4"	25/50	0.89	
40126	80300-2045	x 4-1/2"	25/50	1.00	
40127	80300-2050	x 5"	25/50	1.11	
40128	80300-2055	x 5-1/2"	25/50	1.22	
40129	80300-2060	x 6"	25/50	1.33	
40130	80300-2070	x 7"	25/50	1.56	
40131	80300-2080	x 8"	25/50	1.78	
40132	80300-2090	x 9"	25/50	2.00	
40133	80300-2092	x 10"	25/50	2.22	
40134	80300-2094	x 11"	25/50	2.45	
40135	80300-2096	x 12"	25/50	2.67	
40136	80300-209918	x 18"	1/1	4.00	

113RB

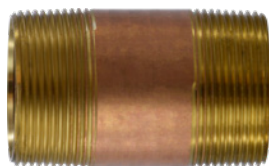

**LEAD
FREE**

1-1/2" - 11 1/2"

1-1/2" DIAMETER SCH 40 SEAMLESS

MIDLAND	AMC	LENGTH	BOX/CASE	APPROX. WT. LBS.	LIST
40140	80300-24	Close (1-3/4")	25/100	0.46	
40141	80300-2420	x 2"	25/100	0.53	
40142	80300-2425	x 2-1/2"	25/50	0.66	
40143	80300-2430	x 3"	25/50	0.79	
40144	80300-2435	x 3-1/2"	25/50	0.93	
40145	80300-2440	x 4"	25/50	1.06	
40146	80300-2445	x 4-1/2"	25/50	1.19	
40147	80300-2450	x 5"	20/40	1.32	
40148	80300-2455	x 5-1/2"	20/40	1.46	
40149	80300-2460	x 6"	20/40	1.59	
40150	80300-2470	x 7"	20/40	1.85	
40151	80300-2480	x 8"	20/40	2.12	
40152	80300-2490	x 9"	20/40	2.38	
40153	80300-2492	x 10"	20/40	2.65	
40154	80300-2494	x 11"	1/40	2.91	
40155	80300-2496	x 12"	1/15	3.18	
40156	80300-249918	x 18"	1/1	4.77	

WARNING: This product can expose you to chemicals, including Nickel, which are known to the State of California to cause cancer. For more information, visit www.P65Warnings.ca.gov



SCH 40 SEAMLESS

NIPPLES AND FITTINGS

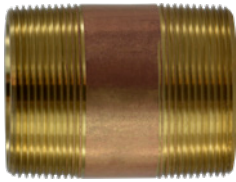

**LEAD
FREE**

2" - 11 1/2

2" DIAMETER SCH 40 SEAMLESS

MIDLAND	AMC	LENGTH	BOX/CASE	APPROX. WT. LBS.	LIST
40160	80300-32	Close (2")	25/50	0.69	
40161	80300-3225	x 2-1/2"	25/50	0.86	
40162	80300-3230	x 3"	25/50	1.03	
40163	80300-3235	x 3-1/2"	25/50	1.20	
40164	80300-3240	x 4"	1/25	1.37	
40165	80300-3245	x 4-1/2"	1/25	1.54	
40166	80300-3250	x 5"	1/25	1.72	
40167	80300-3255	x 5-1/2"	1/25	1.89	
40168	80300-3260	x 6"	1/25	2.06	
40169	80300-3270	x 7"	1/20	2.40	
40170	80300-3280	x 8"	1/18	2.74	
40171	80300-3290	x 9"	1/18	3.09	
40172	80300-3292	x 10"	1/18	3.43	
40173	80300-3294	x 11"	1/18	3.77	
40174	80300-3296	x 12"	1/14	4.12	
40175	80300-329918	x 18"	1/1	6.18	
40176	80300-329924	x 24"	1/1	8.24	
40178	80300-329936	x 36"	1/1	12.36	
40179	80300-329948	x 48"	1/1	16.48	

113RB



**LEAD
FREE**

2 1/2" - 8

2-1/2" DIAMETER SCH 40 SEAMLESS

MIDLAND	AMC	LENGTH	BOX/CASE	APPROX. WT. LBS.	LIST
40180	80300-40	Close (2-1/2")	1/36	1.26	
40181	80300-4030	x 3"	1/36	1.51	
40182	80300-4035	x 3-1/2"	1/30	1.76	
40183	80300-4040	x 4"	1/30	2.02	
40184	80300-4045	x 4-1/2"	1/30	2.27	
40185	80300-4050	x 5"	1/20	2.52	
40186	80300-4055	x 5-1/2"	1/20	2.77	
40187	80300-4060	x 6"	1/20	3.03	
40193		x 12"			

See our Valve section for 2-1/2, 3 and 4" Valves

WARNING: This product can expose you to chemicals, including Nickel, which are known to the State of California to cause cancer. For more information, visit www.P65Warnings.ca.gov

SCH 40 SEAMLESS

NIPPLES AND FITTINGS



**LEAD
FREE**

3" DIAMETER SCH 40 SEAMLESS

MIDLAND	AMC	LENGTH	BOX/CASE	APPROX. WT. LBS.	LIST
40200	80300-48	Close (2-5/8")	1/24	1.89	
40201	80300-4830	x 3"	1/20	2.16	
40202	80300-4835	x 3-1/2"	1/18	2.52	
40203	80300-4840	x 4"	1/18	2.88	
40204	80300-4845	x 4-1/2"	1/18	3.24	
40205	80300-4850	x 5"	1/18	3.60	
40206	80300-4855	x 5-1/2"	1/18	3.96	
40207	80300-4860	x 6"	1/12	4.32	
40209	80300-4880	x 8"	1/1	5.76	
40213	80300-4896	x 12"	1/1		

113RB



**LEAD
FREE**

4" DIAMETER SCH 40 SEAMLESS

MIDLAND	AMC	LENGTH	BOX/CASE	APPROX. WT. LBS.	LIST
40220	80300-64	Close (2-7/8)	1/20	2.40	
40221	80300-6430	x 3"	1/10	2.72	
40222	80300-6435	x 3-1/2"	1/10	3.18	
40223	80300-6440	x 4"	1/10	3.71	
40224	80300-6445	x 4-1/2"	1/5	4.24	
40225	80300-6450	x 5"	1/5	4.77	
40226	80300-6455	x 5-1/2"	1/5	5.30	
40234	80300-6460	x 6"	1/5	6.36	



**LEAD
FREE**

6" DIAMETER SCH 40 SEAMLESS

MIDLAND	AMC	LENGTH	BOX/CASE	APPROX. WT. LBS.	LIST
40254		Close	1/1	4.94	
40256		x 4"	1/1	6.54	
40259		x 4-1/2"	1/1	7.12	
40260		x 5"	1/1	7.91	
40261		x 6"	1/1	9.49	

WARNING: This product can expose you to chemicals, including Nickel, which are known to the State of California to cause cancer. For more information, visit www.P65Warnings.ca.gov



CHROME PLATED

NIPPLES AND FITTINGS

113CP



3/8" DIAMETER CHROME PLATED

MIDLAND	AMC	LENGTH	BOX/CASE	APPROX. WT. LBS.	LIST
41040	81300-06	X Close	5/25	0.05	
41041	81300-0615	x 1-1/2"	5/25	0.08	
41042	81300-0620	x 2"	5/25	0.10	
41043	81300-0625	x 2-1/2"	5/25	0.13	
41044	81300-0630	x 3"	5/25	0.16	
41045	81300-0635	x 3-1/2"	5/25	0.18	
41046	81300-0640	x 4"	5/25	0.21	
41047	81300-0645	x 4-1/2"	5/25	0.23	
41048	81300-0650	x 5"	5/25	0.26	
41049	81300-0655	x 5-1/2"	5/25	0.29	
41050	81300-0660	x 6"	5/25	0.31	
41054	81300-0692	x 10"	1/1	0.52	
41056	81300-0696	x 12"	1/1	0.62	



1/2" DIAMETER CHROME PLATED

MIDLAND	AMC	LENGTH	BOX/CASE	APPROX. WT. LBS.	LIST
41060	81300-08	X Close	5/25	0.09	
41061	81300-0815	x 1-1/2"	5/25	0.12	
41062	81300-0820	x 2"	5/25	0.16	
41063	81300-0825	x 2-1/2"	5/25	0.20	
41064	81300-0830	x 3"	5/25	0.23	
41065	81300-0835	x 3-1/2"	5/25	0.27	
41066	81300-0840	x 4"	5/25	0.31	
41067	81300-0845	x 4-1/2"	5/25	0.35	
41068	81300-0850	x 5"	5/25	0.39	
41069	81300-0855	x 5-1/2"	5/25	0.43	
41070	81300-0860	x 6"	5/25	0.47	
41074	81300-0892	x 10"	1/1	0.78	
41075		x 11"	1/1	0.86	
41076	81300-0896	x 12"	1/1	0.94	
41077		x 18"	1/1	1.41	
41079		x 24"	1/1	1.88	
41244		x 36"	1/1	2.82	
41245		x 48"	1/1	3.76	

 **WARNING:** This product can expose you to chemicals, including Nickel, which are known to the State of California to cause cancer. For more information, visit www.P65Warnings.ca.gov

CHROME PLATED

NIPPLES AND FITTINGS



81300-12

3/4" DIAMETER CHROME PLATED

MIDLAND	AMC	LENGTH	BOX/CASE	APPROX. WT. LBS.	LIST
41080	81300-12	Close (1- 3/8")	25/400	0.15	
41081	81300-1215	x 1-1/2"	25/400	0.16	
41082	81300-1220	x 2"	25/300	0.21	
41083	81300-1225	x 2-1/2"	25/300	0.27	
41084	81300-1230	x 3"	25/200	0.32	
41085	81300-1235	x 3-1/2"	25/200	0.37	
41086	81300-1240	x 4"	25/150	0.43	
41087	81300-1245	x 4-1/2"	25/150	0.48	
41088	81300-1250	x 5"	25/100	0.53	
41089	81300-1255	x 5-1/2"	25/100	0.59	
41090	81300-1260	x 6"	25/100	0.64	



81300-16

1" DIAMETER CHROME PLATED

MIDLAND	AMC	LENGTH	BOX/CASE	APPROX. WT. LBS.	LIST
41100	81300-16	Close (1-1/2")	25/200	0.23	
41101	81300-1620	x 2"	25/200	0.30	
41102	81300-1625	x 2-1/2"	25/150	0.38	
41103	81300-1630	x 3"	25/150	0.45	
41104	81300-1635	x 3-1/2"	25/100	0.53	
41105	81300-1640	x 4"	25/100	0.60	
41106	81300-1645	x 4-1/2"	25/100	0.68	
41107	81300-1650	x 5"	25/75	0.75	
41108	81300-1655	x 5-1/2"	25/75	0.83	
41109	81300-1660	x 6"	25/50	0.94	

 **WARNING:** This product can expose you to chemicals, including Nickel, which are known to the State of California to cause cancer. For more information, visit www.P65Warnings.ca.gov

BRONZE FITTINGS

NIPPLES AND FITTINGS

BRONZE FITTINGS

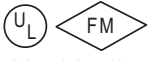

UL842, UL258, UL125, FM

Class 125 (150) For steam, water, gas, oil and air service

Standard specifications

Materials - ASTM B62-93 (85,5,5,5) C83600

Dimensions - ANSI B 16.15

Threads - ANSI B2.1 or BA 21 and Fed. WW-P-460C, MSS-SP-106, ANSI/ASME B1.20.1

PRICING FILE AVAILABLE ONLINE

- UL/ FM Approved
- ISO 9001:2000
- Not Lead Free
- RoHS Compliant

Bronze threaded fittings are manufactured from smooth-cored castings, designed to provide full flow with minimum restriction. All threads are accurately machined and gauged to ensure a perfect fit with the pipe. All fittings are individually tested under water to ensure quality. Bronze provides a tighter seal and is easier to install than other metals. Can be used for water, plumbing, heating, pneumatic and marine applications, able to resist the harmful effects of corrosion when coming into contact with salt water or fresh water polluted with mineral acids or peaty soils.

LEAD FREE BRASS FITTINGS

LEAD FREE



- Approved to ANSI/NSF 61-4 California AB 1953
- Meets Federal State Drinking Water Act, Lead Free Requirement
- Brass fittings conform to AWWA C800
- Brass castings conform to ASTM B584, UNS Alloy C8933

- Brass fittings dimensions conform to ASME B16.15
- NPT threads on all fittings conform to ASME B1.20.1
- Brass unions conform to specification A-A-59617
- Manufacturing facilities are ISO 9001:2008

PRICING FILE AVAILABLE ONLINE

WARNING: This product can expose you to chemicals, including Nickel, which are known to the State of California to cause cancer. For more information, visit www.P65Warnings.ca.gov

BRONZE/ LEAD FREE BRONZE

NIPPLES AND FITTINGS

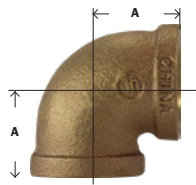

100RB

738100



90° ELBOWS

MIDLAND	AMC	LIST	BOX/CASE	SIZE	MIDLAND	AMC	LIST
44100	38100-02		50/600	1/8"	44100LF	738100-02	
44101	38100-04		35/420	1/4"	44101LF	738100-04	
44102	38100-06		90/360	3/8"	44102LF	738100-06	
44103	38100-08		50/200	1/2"	44103LF	738100-08	
44104	38100-12		35/105	3/4"	44104LF	738100-12	
44105	38100-16		20/60	1"	44105LF	738100-16	
44106	38100-20		20/40	1-1/4"	44106LF	738100-20	
44107	38100-24		15/30	1-1/2"	44107LF	738100-24	
44108	38100-32		8/16	2"	44108LF	738100-32	
44109	38100-40		1/12	2-1/2"	44109LF	738100-40	
44110	38100-48		1/4	3"	44110LF	738100-48	
44112	38100-64		1/2	4"	44112LF	738100-64	

• Other sizes available online

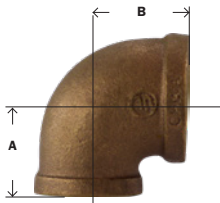

100RRB

738105



90° REDUCING ELBOWS

MIDLAND	AMC	LIST	BOX/CASE	SIZE	MIDLAND	AMC	LIST
44120	38105-0402			1/4 x 1/8	44120LF	738105-0402	
				3/8 x 1/8	44121LF	738105-0602	
44122	38105-0604			3/8 x 1/4	44122LF	738105-0604	
44123	38105-0804		60/240	1/2 x 1/4	44123LF	738105-0804	
44124	38105-0806		60/240	1/2 x 3/8	44124LF	738105-0806	
44125	38105-1204		40/160	3/4 x 1/4	44125LF	738105-1204	
				3/4 x 3/8	44126LF	738105-1206	
44127	38105-1208			3/4 x 1/2	44127LF	738105-1208	
				1 x 1/4	44128LF	738105-1604	
				1 x 3/8	44129LF		
				1 x 1/2	44130LF	738105-1608	
44131	38105-1612		50/100	1 x 3/4	44131LF	738105-1612	
				1 1/4 x 1/2	44132LF		
				1 1/4 x 3/4	44133LF	738105-2012	
44134	38105-2016		25/50	1 1/4 x 1	44134LF	738105-2016	
				1 1/2 x 1/2	44135LF	738105-2408	
				1 1/2 x 3/4	44136LF	738105-2412	
44137	38105-2416		10/40	1 1/2 x 1	44137LF	738105-2416	
				1 1/2 x 1 1/4	44138LF	738105-2420	
44140	38105-3216			2 x 1	44140LF	738105-3216	
				2 x 1 1/4	44141LF	738105-3220	
				2 x 1 1/2	44142LF	738105-3224	
				2 1/2 x 2	44146LF	738105-4032	
				3 x 2	44150LF	738105-4832	

WARNING: This product can expose you to chemicals, including Nickel, which are known to the State of California to cause cancer. For more information, visit www.P65Warnings.ca.gov

BRONZE/ LEAD FREE BRONZE

NIPPLES AND FITTINGS

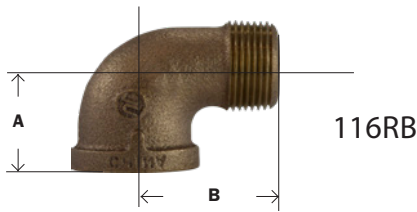

738116



90° STREET ELLS

MIDLAND	AMC	LIST	BOX/CASE	SIZE	MIDLAND	AMC	LIST
44160	38116-02		60/720	1/8"	44160LF	738116-02	
44161	38116-04		35/420	1/4"	44161LF	738116-04	
44162	38116-06		60/240	3/8"	44162LF	738116-06	
44163	38116-08		60/180	1/2"	44163LF	738116-08	
44164	38116-12		35/105	3/4"	44164LF	738116-12	
44165	38116-16		45/90	1"	44165LF	738116-16	
44166	38116-20		25/50	1-1/4"	44166LF	738116-20	
44167	38116-24		9/27	1-1/2"	44167LF	738116-24	
44168	38116-32		8/16	2"	44168LF	738116-32	
44169	38116-40		5/10	2-1/2"	44169LF	738116-40	
44170	38116-48		1/8	3"	44170LF	738116-48	



738107



45° ELBOWS

MIDLAND	AMC	LIST	BOX/CASE	SIZE	MIDLAND	AMC	LIST
44180	38107-02		50/600	1/8"	44180LF	738107-02	
44181	38107-04		30/360	1/4"	44181LF	738107-04	
44182	38107-06		75/300	3/8"	44182LF	738107-06	
44183	38107-08		50/200	1/2"	44183LF	738107-08	
44184	38107-12		40/120	3/4"	44184LF	738107-12	
44185	38107-16		20/60	1"	44185LF	738107-16	
44186	38107-20		20/40	1-1/4"	44186LF	738107-20	
44187	38107-24		10/30	1-1/2"	44187LF	738107-24	
44188	38107-32		12/24	2"	44188LF	738107-32	
44189	38107-40		1/12	2-1/2"	44189LF	738107-40	
44190	38107-48		1/10	3"	44190LF	738107-48	
				4"	44191LF	738107-64	

WARNING: This product can expose you to chemicals, including Nickel, which are known to the State of California to cause cancer. For more information, visit www.P65Warnings.ca.gov

BRONZE/ LEAD FREE BRONZE

NIPPLES AND FITTINGS

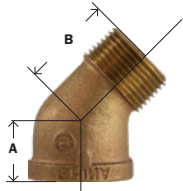

124RB

738124



45° STREET ELBOWS

MIDLAND	AMC	LIST	BOX/CASE	SIZE	MIDLAND	AMC	LIST
44200	38124-02		70/840	1/8"			
44201	38124-04		100/400	1/4"	44201LF	738124-04	
44202	38124-06		100/400	3/8"	44202LF	738124-06	
44203	38124-08		75/225	1/2"	44203LF	738124-08	
44204	38124-12		40/120	3/4"	44204LF	738124-12	
44205	38124-16		25/75	1"	44205LF	738124-16	
44206	38124-20		10/40	1-1/4"	44206LF	738124-20	
44207	38124-24		10/30	1-1/2"	44207LF	738124-24	
44208	38124-32		12/24	2"	44208LF	738124-32	

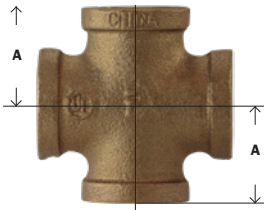

102RB

738102



CROSSES

MIDLAND	AMC	LIST	BOX/CASE	SIZE	MIDLAND	AMC	LIST
44391	38102-04		60/240	1/4"	44391LF	738102-04	
44392	38102-06		50/150	3/8"	44392LF	738102-06	
44393	38102-08		30/90	1/2"	44393LF	738102-08	
44394	38102-12		20/60	3/4"	44394LF	738102-12	
44395	38102-16		15/30	1"	44395LF	738102-16	
44396	38102-20		10/20	1-1/4"	44396LF	738102-20	
44397	38102-24		8/16	1-1/2"	44397LF	738102-24	
44398			5/10	2"	44398LF	738102-32	

WARNING: This product can expose you to chemicals, including Nickel, which are known to the State of California to cause cancer. For more information, visit www.P65Warnings.ca.gov

BRONZE/ LEAD FREE BRONZE

NIPPLES AND FITTINGS

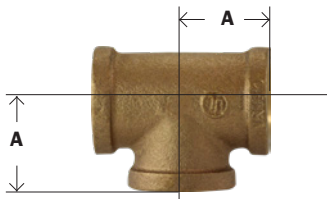

101RB

**LEAD
FREE**



TEES

MIDLAND	AMC	LIST	BOX/CASE	SIZE	MIDLAND	AMC	LIST
44250	38101-02		120/480	1/8"	44250LF	738101-02	
44251	38101-04		75/300	1/4"	44251LF	738101-04	
44252	38101-06		45/180	3/8"	44252LF	738101-06	
44253	38101-08		40/120	1/2"	44253LF	738101-08	
44254	38101-12		35/70	3/4"	44254LF	738101-12	
44255	38101-16		20/40	1"	44255LF	738101-16	
44256	38101-20		14/28	1-1/4"	44256LF	738101-20	
44257	38101-24		12/24	1-1/2"	44257LF	738101-24	
44258	38101-32		8/16	2"	44258LF	738101-32	
44259	38101-40		1/6	2-1/2"	44259LF	738101-40	
44260	38101-48		1/6	3"	44260LF	738101-48	
				4"	44261LF	738101-64	



USE OUR APP WITH YOUR FREE BIN LABELS TO MANAGE YOUR CUSTOMERS INVENTORY MORE EFFICIENTLY

WARNING: This product can expose you to chemicals, including Nickel, which are known to the State of California to cause cancer. For more information, visit www.P65Warnings.ca.gov

BRONZE/ LEAD FREE BRONZE

NIPPLES AND FITTINGS

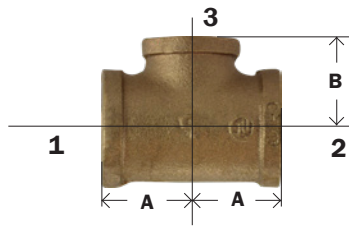

101RRB

738106

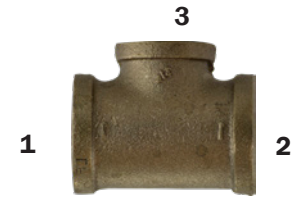

REDUCING TEES REDUCING ON THE BRANCH

MIDLAND	AMC	LIST	BOX/CASE	SIZE 1 X 2 X 3	MIDLAND	AMC	LIST
				1/4 x 1/4 x 1/8	44270LF	738106-040402	
				3/8 x 3/8 x 1/4	44273LF	738106-060604	
44276	38106-080804		40/160	1/2 x 1/2 x 1/4	44276LF	738106-080804	
				1/2 x 1/2 x 3/8	44279LF	738106-080806	
44280	38106-080812		40/160	1/2 x 1/2 x 3/4	44280LF	738106-080812	
44287	38106-120808			3/4 x 1/2 x 1/2	44287LF	738106-120808	
				3/4 x 1/2 x 3/4	44288LF	738106-120812	
44282	38106-121204		25/100	3/4 x 3/4 x 1/4	44282LF	738106-121204	
44283	38106-121206		25/100	3/4 x 3/4 x 3/8	44283LF	738106-121206	
44286	38106-121208		20/80	3/4 x 3/4 x 1/2	44286LF	738106-121208	
				1 x 1/2 x 1/2	44292LF	738106-160808	
				1 x 1/2 x 3/4	44293LF	738106-160812	
44296	38106-161212			1 x 3/4 x 3/4	44296LF		
				1 x 1 x 1/4	44268LF	738106-161604	
				1 x 1 x 3/8	44290LF	738106-161606	
44291			15/60	1 x 1 x 1/2	44291LF	738106-161608	
44298	38106-161612		12/48	1 x 1 x 3/4	44298LF	738106-161612	
				1 1/4 x 1/2 x 1 1/4	44314LF		
44301	38106-202008		20/40	1 1/4 x 1 1/4 x 1/2	44301LF	738106-202008	
44303	38106-202012		20/40	1 1/4 x 1 1/4 x 3/4	44303LF	738106-202012	
44306	38106-202016		20/40	1 1/4 x 1 1/4 x 1	44306LF	738106-202016	
				1 1/2 x 1 1/2 x 1/2	44315LF		
				1 1/2 x 1 1/2 x 3/4	44316LF	738106-241212	
				1 1/2 x 1 1/2 x 1	44318LF		
				1 1/2 x 1 1/2 x 1 1/4	44322LF		
				2 x 2 x 1/2	44327LF	738106-323208	
				2 x 2 x 3/4	44328LF		
				2 x 2 x 1	44330LF	738106-323216	
				2 x 2 x 1 1/4	44334LF		
				2 x 2 x 1 1/2	44336LF	738106-323224	
				2 1/2 x 2 1/2 x 2	44344LF		
				3 x 3 x 2	44351LF	738106-484832	



VIEW PRICING AND AVAILABLE STOCK ONLINE

WARNING: This product can expose you to chemicals, including Nickel, which are known to the State of California to cause cancer. For more information, visit www.P65Warnings.ca.gov

BRONZE/ LEAD FREE BRONZE

NIPPLES AND FITTINGS



103RB

738103



COUPLINGS

MIDLAND	AMC	LIST	BOX/CASE	SIZE	MIDLAND	AMC	LIST
44410	38103-02		70/840	1/8"	44410LF	738103-02	
44411	38103-04		40/480	1/4"	44411LF	738103-04	
44412	38103-06		40/480	3/8"	44412LF	738103-06	
44413	38103-08		60/240	1/2"	44413LF	738103-08	
44414	38103-12		50/150	3/4"	44414LF	738103-12	
44415	38103-16		25/100	1"	44415LF	738103-16	
44416	38103-20		16/64	1-1/4"	44416LF	738103-20	
44417	38103-24		18/36	1-1/2"	44417LF	738103-24	
44418	38103-32		12/24	2"	44418LF	738103-32	
44419	38103-40		1	2-1/2"	44419LF	738103-40	
44420	38103-48		1	3"	44420LF	738103-48	
				4"	44421LF	738103-64	

WARNING: This product can expose you to chemicals, including Nickel, which are known to the State of California to cause cancer. For more information, visit www.P65Warnings.ca.gov

BRONZE/ LEAD FREE BRONZE

NIPPLES AND FITTINGS



119RB

738119



REDUCING COUPLINGS

MIDLAND	AMC	LIST	BOX/CASE	SIZE	MIDLAND	AMC	LIST
44430	38119-0402		70/840	1/4" x 1/8"	44430LF	738119-0402	
44431	38119-0602		35/420	3/8" x 1/8"	44431LF	738119-0602	
44432	38119-0604		30/360	3/8" x 1/4"	44432LF	738119-0604	
44433	38119-0802		75/300	1/2" x 1/8"	44433LF		
44434	38119-0804		75/300	1/2" x 1/4"	44434LF	738119-0804	
44435	38119-0806		60/240	1/2" x 3/8"	44435LF	738119-0806	
44436	38119-1204		45/180	3/4" x 1/4"	44436LF	738119-1204	
44437	38119-1206		45/180	3/4" x 3/8"	44437LF	738119-1206	
44438	38119-1208		60/180	3/4" x 1/2"	44438LF	738119-1208	
44440	38119-1606		30/120	1" x 3/8"	44440LF		
44441	38119-1608		30/120	1" x 1/2"	44441LF	738119-1608	
44442	38119-1612		25/100	1" x 3/4"	44442LF	738119-1612	
44444	38119-2008		25/75	1-1/4" x 1/2"	44444LF	738119-2008	
44445	38119-2012		25/75	1-1/4" x 3/4"	44445LF	738119-2012	
44446	38119-2016		15/60	1-1/4" x 1"	44446LF	738119-2016	
44447	38119-2408		20/60	1-1/2" x 1/2"	44447LF	738119-2408	
44448	38119-2412		15/60	1-1/2" x 3/4"	44448LF	738119-2412	
44449	38119-2416		25/50	1-1/2" x 1"	44449LF	738119-2416	
44450	38119-2420		12/48	1-1/2" x 1-1/4"	44450LF	738119-2420	
44458	38119-3208		12/36	2" x 1/2"	44458LF		
44451	38119-3212		12/36	2" x 3/4"	44451LF	738119-3212	
44452	38119-3216		12/36	2" x 1"	44452LF	738119-3216	
44453	38119-3220		9/27	2" x 1-1/4"	44453LF	738119-3220	
44454	38119-3224		9/27	2" x 1-1/2"	44454LF	738119-3224	
44461	38119-4024		1	2-1/2" x 1-1/2"	44461LF		
44462	38119-4032		1	2-1/2" x 2"	44462LF	738119-4032	
44456	38119-4832		1	3" x 2"	44456LF		
44463	38119-4840		1	3" x 2-1/2"	44463LF		

WARNING: This product can expose you to chemicals, including Nickel, which are known to the State of California to cause cancer. For more information, visit www.P65Warnings.ca.gov

NIPPLES & FITTINGS

BRONZE/ LEAD FREE BRONZE

NIPPLES AND FITTINGS



108RB

738108



CAPS

MIDLAND	AMC	LIST	BOX/CASE	SIZE	MIDLAND	AMC	LIST
44470	38108-02		80/160	1/8"	44470LF	738108-02	
44471	38108-04		80/960	1/4"	44471LF	738108-04	
44472	38108-06		60/720	3/8"	44472LF	738108-06	
44473	38108-08		75/300	1/2"	44473LF	738108-08	
44474	38108-12		40/160	3/4"	44474LF	738108-12	
44475	38108-16		25/100	1"	44475LF	738108-16	
44476	38108-20		20/80	1-1/4"	44476LF	738108-20	
44477	38108-24		18/54	1-1/2"	44477LF	738108-24	
44478	38108-32		12/36	2"	44478LF	738108-32	
44479	38108-40			2-1/2"	44479LF	738108-40	
44480	38108-48		1	3"	44480LF	738108-48	
				4"	44481LF	738108-64	



104RB

738104



UNIONS

MIDLAND	AMC	LIST	BOX/CASE	SIZE	MIDLAND	AMC	LIST
44600	38104-02		40/160	1/8"	44600LF	738104-02	
44601	38104-04		40/160	1/4"	44601LF	738104-04	
44602	38104-06		40/160	3/8"	44602LF	738104-06	
44603	38104-08		50/100	1/2"	44603LF	738104-08	
44604	38104-12		35/70	3/4"	44604LF	738104-12	
44605	38104-16		20/40	1"	44605LF	738104-16	
44606	38104-20		15/30	1-1/4"	44606LF	738104-20	
44607	38104-24		10/20	1-1/2"	44607LF	738104-24	
44608	38104-32		6/12	2"	44608LF	738104-32	
44609	38104-40		4/8	2-1/2"	44609LF	738104-40	
44610	38104-48		4/8	3"	44610LF	738104-48	
				4"	44611LF	738104-64	

WARNING: This product can expose you to chemicals, including Nickel, which are known to the State of California to cause cancer. For more information, visit www.P65Warnings.ca.gov

BRONZE/ LEAD FREE BRONZE

NIPPLES AND FITTINGS



738110



HEX BUSHINGS

MIDLAND	AMC	LIST	BOX/CASE	SIZE	MIDLAND	AMC	LIST
44500	38110-0402		120/1440	1/4" x 1/8"	44500LF	738110-0402	
44501	38110-0602		75/900	3/8" x 1/8"	44501LF	738110-0602	
44502	38110-0604		75/900	3/8" x 1/4"	44502LF	738110-0604	
44503	38110-0802		150/600	1/2" x 1/8"	44503LF	738110-0802	
44504	38110-0804		150/600	1/2" x 1/4"	44504LF	738110-0804	
44505	38110-0806		150/600	1/2" x 3/8"	44505LF	738110-0806	
44506	38110-1202		75/300	3/4" x 1/8"	44506LF	738110-1202	
44507	38110-1204		75/300	3/4" x 1/4"	44507LF	738110-1204	
44508	38110-1206		75/300	3/4" x 3/8"	44508LF	738110-1206	
44509	38110-1208		75/300	3/4" x 1/2"	44509LF	738110-1208	
44557	38110-1602		50/200	1" x 1/8"			
44510*	38110-1604		50/200	1" x 1/4"	44510LF*	738110-1604	
44511*	38110-1606		50/200	1" x 3/8"	44511LF	738110-1606	
44512	38110-1608		50/200	1" x 1/2"	44512LF	738110-1608	
44513	38110-1612		50/200	1" x 3/4"	44513LF	738110-1612	
44514	38110-2004		30/120	1-1/4" x 1/4"	44514LF	738110-2004	
44515	38110-2006		30/120	1-1/4" x 3/8"	44515LF	738110-2006	
44516*	38110-2008		30/120	1-1/4" x 1/2"	44516LF*	738110-2008	
44517	38110-2012		30/120	1-1/4" x 3/4"	44517LF	738110-2012	
44518	38110-2016		30/120	1-1/4" x 1"	44518LF	738110-2016	
44519*	38110-2404		25/75	1-1/2" x 1/4"	44519LF	738110-2404	
44520*	38110-2406		25/75	1-1/2" x 3/8"	44520LF	738110-2406	
44521*	38110-2408		25/75	1-1/2" x 1/2"	44521LF*	738110-2408	
44522*	38110-2412		25/75	1-1/2" x 3/4"	44522LF*	738110-2412	
44523	38110-2416		25/75	1-1/2" x 1"	44523LF	738110-2416	
44524	38110-2420		25/75	1-1/2" x 1-1/4"	44524LF	738110-2420	
44527*	38110-3208		20/60	2" x 1/2"	44527LF	738110-3208	
44528*	38110-3212		20/60	2" x 3/4"	44528LF	738110-3212	
44529*	38110-3216		20/60	2" x 1"	44529LF*	738110-3216	
44530	38110-3220		20/60	2" x 1-1/4"	44530LF	738110-3220	
44531	38110-3224		20/60	2" x 1-1/2"	44531LF	738110-3224	
44532	38110-4016		15/30	2-1/2" x 1"	44532LF	738110-4016	
			15/30	2-1/2" x 1-1/4"	44533LF	738110-4020	
44534	38110-4024		15/30	2-1/2" x 1-1/2"	44534LF	738110-4024	
44535	38110-4032		15/30	2-1/2" x 2"	44535LF	738110-4032	
44537	38110-4824		12/24	3" x 1-1/2"	44537LF	738110-4824	
44538	38110-4832		12/24	3" x 2"	44538LF	738110-4832	
44539	38110-4840		12/24	3" x 2-1/2"	44539LF	738110-4840	
44541	38110-6432		5/10	4" x 2"	44541LF	738110-6432	
			5/10	4" x 2-1/2"	44542LF	738110-6440	
44543	38110-6448		12/24	4" x 3"	44543LF	738110-6448	

* INSIDE HEX



WARNING: This product can expose you to chemicals, including Nickel, which are known to the State of California to cause cancer. For more information, visit www.P65Warnings.ca.gov

NIPPLES & FITTINGS

BRONZE/ LEAD FREE BRONZE

NIPPLES AND FITTINGS

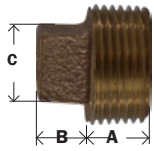

109RB

738109

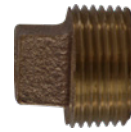

CORED SQUARE HEAD PLUGS

MIDLAND	AMC	LIST	BOX/CASE	SIZE	MIDLAND	AMC	LIST
44650*	38109-02		300/3600	1/8"	44650LF	738109-02	
44651*	38109-04		150/1800	1/4"	44651LF	738109-04	
44652*	38109-06		100/1200	3/8"	44652LF	738109-06	
44653	38109-08		50/600	1/2"	44653LF	738109-08	
44654	38109-12		30/360	3/4"	44654LF	738109-12	
44655	38109-16		20/240	1"	44655LF	738109-16	
44656	38109-20		40/120	1-1/4"	44656LF	738109-20	
44657	38109-24		30/90	1-1/2"	44657LF	738109-24	
44658	38109-32		20/60	2"	44658LF	738109-32	
44659	38109-40		16/32	2-1/2"	44659LF	738109-40	
44660	38109-48		16/32	3"	44660LF	738109-48	
44662	38109-64		6/12	4"	44662LF	738109-64	

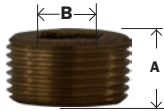

109ALRB

SQUARE DRIVE BRONZE COUNTERSUNK PLUGS

738115



MIDLAND	AMC	LIST	SIZE	BOX/CASE	MIDLAND	AMC	LIST
			1/8"		44630LF		
			1/4"		44631LF		
			3/8"		44632LF		
44633	38115-08		1/2"	120/1440	44633LF		
44634	38115-12		3/4"	70/840	44634LF		
44635	38115-16		1"	20/240	44635LF		
44636	38115-20		1-1/4"	40/120	44636LF		
44637	38115-24		1-1/2"	30/90	44637LF		
44638	38115-32		2"	20/60	44638LF		
44639	38115-40		2-1/2"	1/1	44639LF		
44640	38115-48		3"	1/1	44640LF		
44641	83115-64		4"	1/1	44641LF		



• Straight Thread

111RB

HEX LOCKNUTS

738111

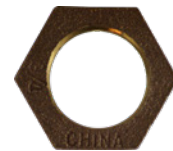

MIDLAND	AMC	LIST	BOX/CASE	SIZE	MIDLAND	AMC	LIST
44700	38111-02		180/720	1/8"	44700LF	780111-02	
44701	38111-04		90/540	1/4"	44701LF	738111-04	
44702	38111-06		90/540	3/8"	44702LF	738111-06	
44703	38111-08		90/360	1/2"	44703LF	738111-08	
44704	38111-12		90/360	3/4"	44704LF	738111-12	
44705	38111-16		50/150	1"	44705LF	738111-16	
44706	38111-20		45/180	1-1/4"	44706LF	738111-20	
44707	38111-24		45/135	1-1/2"	44707LF	738111-24	
44708	38111-32		25/75	2"	44708LF	738111-32	

WARNING: This product can expose you to chemicals, including Nickel, which are known to the State of California to cause cancer. For more information, visit www.P65Warnings.ca.gov

BRONZE/ LEAD FREE BRONZE

NIPPLES AND FITTINGS

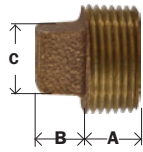

109SRB

738114

SOLID SQUARE HEAD PLUGS



MIDLAND	AMC	LIST	SIZE	BOX/CASE	MIDLAND	AMC	LIST
44670	38114-02		1/8"	400/4800	44670LF	738114-02	
44671	38114-04		1/4"	150/1800	44671LF	738114-04	
44672	38114-06		3/8"	120/1440	44672LF	738114-06	
44673	38114-08		1/2"	50/600	44673LF	738114-08	
44674	38114-12		3/4"	35/420	44674LF	738114-12	
44675	38114-16		1"	20/240	44675LF	738114-16	
44676	38114-20		1-1/4"	30/120	44676LF	738114-20	
44677	38114-24		1-1/2"	30/90	44677LF	738114-24	
44678	38114-32		2"	10/60	44678LF	738114-32	
			2-1/2"		44679LF	780114-40	
			3"		44680LF	780114-48	

HEX NIPPLES

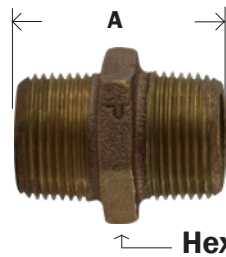

MIDLAND	AMC	LIST	SIZE	BOX/CASE
44720			1/8"	400/4800
44721			1/4"	150/1800
44722			3/8"	120/1440
44723			1/2"	240/480
44724			3/4"	80/320
44725			1"	50/150
44726			1-1/4"	50/100
44727			1-1/2"	35/70
44728			2"	20/40
44729			2-1/2"	1
44730M			3"	4/8

REDUCING HEX NIPPLES

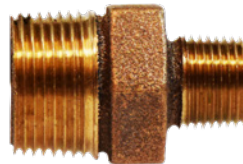

MIDLAND	AMC	LIST	SIZE	BOX/CASE
44740			1/4" x 1/8"	1/1
44742			1/2" x 3/8"	1/1
44753			1-1/2" x 1-1/4"	1/1

WARNING: This product can expose you to chemicals, including Nickel, which are known to the State of California to cause cancer. For more information, visit www.P65Warnings.ca.gov

BRONZE/ LEAD FREE BRONZE

NIPPLES AND FITTINGS

FLANGE THREADED COMPANION LEAD-FREE



MIDLAND	AMC	LIST	SIZE	STD. PACK.	WT. PER 100
44790LF	738150-08		1/2" x 3-1/2"	1	95
44791LF	780150-12		3/4" x 3-7/8"	1	124
44792LF	738150-16		1" x 4-1/4"	1	168
44793LF	738150-20		1-1/4" x 4-5/8"	1	224
44794LF	738150-24		1-1/2" x 5"	1	251
44795LF	738150-32		2" x 6"	1	454
44796LF	738150-40		2-1/2" x 7"	1	673
44797LF	738150-48		3" x 7-1/2"	1	864
44798LF	738150-64		4" x 9"	1	1227
44799LF	780150-80		5" x 10"	1	1495
44800LF			6" x 11"	1	1801

FLANGE SWEAT COMPANION LEAD FREE



MIDLAND	AMC	LIST	SIZE	STD. PACK.	WT. PER 100
44827LF			1-1/2" x 5"	1	176
44828LF			2" x 6"	1	291
44829LF			2-1/2" x 7"	1	405
44830LF			3" x 7-1/2"	1	520
44831LF			4" x 9"	1	798

FLANGE FLOOR LEAD FREE



MIDLAND	AMC	LIST	SIZE	STD. PACK.	WT. PER 100
44780LF	738151-08		1/2"	1	35
44781LF	738151-12		3/4"	1	44
44782LF	738151-16		1"	1	59
44783LF	780151-20		1-1/4"	1	87
44784LF	738151-24		1-1/2"	1	105
44785LF	738151-32		2"	1	150

WARNING: This product can expose you to chemicals, including Nickel, which are known to the State of California to cause cancer. For more information, visit www.P65Warnings.ca.gov



CHROME PLATED BRONZE FITTINGS

NIPPLES AND FITTINGS

90° ELBOW



LEAD FREE

781100

MIDLAND	AMC	SIZE	LIST
45102LF	781100-06	3/8"	
45103LF	781100-08	1/2"	
45104LF	781100-12	3/4"	
45105LF	781100-16	1"	

COUPLING



LEAD FREE

781103

MIDLAND	AMC	SIZE	LIST
45412LF	781103-06	3/8"	
45413LF	781103-08	1/2"	

90° ELBOW



81100

MIDLAND	AMC	SIZE	LIST
45100	81100-02	1/8"	
45101		1/4"	
45102	81100-06	3/8"	
45103	81100-08	1/2"	
45104	81100-12	3/4"	
45105	81100-16	1"	
45124	81105-0806	1/2" x 3/8"	
45127	81105-1208	3/4" x 1/2"	

90° STREET ELLS



81116

MIDLAND	AMC	SIZE	LIST
45160	81100-02	1/8"	
45161		1/4"	
45162	781116-06	3/8"	
45163	81116-08	1/2"	
45164	781116-12	3/4"	
45165	81116-15	1"	

90° STREET ELBOW



LEAD FREE

781116

MIDLAND	AMC	SIZE	LIST
45163LF	781116-08	1/2"	

TEE



LEAD FREE

781101

MIDLAND	AMC	SIZE	LIST
45252LF		3/8"	
45253LF		1/2"	

45° ELBOW



81124

MIDLAND	AMC	SIZE	LIST
45200	81124-02	1/8"	
45201	81124-04	1/4"	
45202	81124-06	3/8"	
45203	81124-08	1/2"	
45204	81124-12	3/4"	

CROSSES



81102

MIDLAND	AMC	SIZE	LIST
45393	81102-08	1/2"	
45394	81102-12	3/4"	

WARNING: This product can expose you to chemicals, including Nickel, which are known to the State of California to cause cancer. For more information, visit www.P65Warnings.ca.gov

CHROME PLATED BRONZE FITTINGS

NIPPLES AND FITTINGS

45° ELBOWS



81107

MIDLAND	AMC	SIZE	LIST
45180	81107-02	1/8"	
45181	780124-04	1/4"	
45182	81107-06	3/8"	
45183	781107-08	1/2"	
45184	81107-12	3/4"	
45185	81107-16	1"	

TEES



81101

MIDLAND	AMC	SIZE	LIST
45250	81101-02	1/8"	
45251	81101-04	1/4"	
45252	81101-06	3/8"	
45253	81101-08	1/2"	
45254	81101-12	3/4"	
45255	81101-16	1"	

COUPLINGS



81103

MIDLAND	AMC	SIZE	LIST
45410	81103-02	1/8"	
45411	81103-04	1/4"	
45412	81103-06	3/8"	
45413	81103-08	1/2"	
45414	81103-12	3/4"	
45415	81103-16	1"	
45432		3/8" x 1/4"	
45435	81119-0806	1/2" x 3/8"	
45438	81119-1208	3/4" x 1/2"	
45439	81119-1612	1" x 3/4"	

CAPS



81108

MIDLAND	AMC	SIZE	LIST
45470	81108-02	1/8"	
45471	81108-04	1/4"	
45472	81108-06	3/8"	
45473	81108-08	1/2"	
45474	81108-12	3/4"	
45475	81108-16	1"	

UNIONS



81104

MIDLAND	AMC	SIZE	LIST
45600	81104-02	1/8"	
45601	81104-04	1/4"	
45602		3/8"	
45603	781104-08	1/2"	
45604	81104-12	3/4"	
45605	81104-16	1"	
45606	81104-20	1-1/4"	

HEX BUSHINGS



81110

MIDLAND	AMC	SIZE	LIST
45502	781110-0604	3/8" x 1/4"	
45504	81110-0804	1/2" x 1/4"	
45505	781110-0806	1/2" x 3/8"	
45509	781110-1208	3/4" x 1/2"	
45513	81110-1612	1" x 3/4"	

PLUGS



MIDLAND	AMC	SIZE	LIST
45652	81109-06	3/8"	
45653	81109-08	1/2"	
45654	781109-12	3/4"	
45655	81109-16	1"	
45657		1-1/2"	

WARNING: This product can expose you to chemicals, including Nickel, which are known to the State of California to cause cancer. For more information, visit www.P65Warnings.ca.gov



CLEANOUT PLUGS/ DROP EAR ELBOWS

NIPPLES AND FITTINGS



- Southern Code

CAST BRASS SQUARE HEAD CLEANOUT PLUG

PART #	SIZE	BOX/CASE	
970300	1-1/2"	100/200	----
970301	2"	100/200	----
970302	2-1/2"	50/200	----
970303	3"	20/160	----
970304	3-1/2"	20/120	----
970305	4"	10/80	----
970330	5"	10/60	----
970331	6"	10/40	----
970332	8"	5/20	----
970333	10"	1/1	----

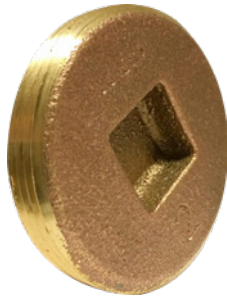

- Southern Code

CAST BRASS COUNTERSUNK HEAD CLEANOUT PLUG

PART #	SIZE	BOX/CASE	
970306	1-1/2"	100/200	----
970307	2"	100/200	----
970308	2-1/2"	100/200	----
970309	3"	50/200	----
970310	3-1/2"	20/160	----
970311	4"	20/120	----
970312	5"	10/60	----
970313	6"	10/40	----
970314	8"	5/20	----



CAST BRASS COUNTERSUNK CLEANOUT W 1/4-20 TAP

PART #	SIZE	BOX/CASE	
970700	1-1/2"	1/1	----
970701	2"	1/1	----
970702	2-1/2"	1/1	----
970703	3"	1/1	----
970704	3-1/2"	1/1	----
970705	4"	1/1	----
970706	5"	1/1	----
970707	6"	1/1	----

DROP EAR ELBOWS

- Lead Free Brass



- Lead Free Bronze



PART #	SWT X FIP	
44840LF	1/2 x 1/2 Bronze	----
44841LF	1/2 x 1/2 Brass	----
44842LF	3/4 x 1/2 Brass	----
44843LF	3/4 x 3/4 Brass	----



- Lead Free Brass

PART #	SWT X SWT	
44844LF	1/2 x 1/2	----

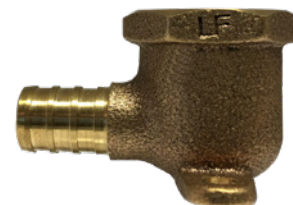

- Lead Free Bronze

PART #	PEX X FIP	
44845LF	1/2 x 1/2	----

WARNING: This product can expose you to chemicals, including Nickel, which are known to the State of California to cause cancer. For more information, visit www.P65Warnings.ca.gov

NIPPLES & FITTINGS

BRONZE/ STEEL INSERT FITTINGS

NIPPLES AND FITTINGS

BRONZE INSERT FITTINGS

150 PSI Genuine red brass - for plastic pipe

- Not Lead Free

HEX MALE ADAPTERS



(Barb x Male Pipe)

PART #	BARB X MALE	
973925	3/4" x 3/4"	----
973927	1" x 1"	----
973930	1" x 1-1/4"	----
973929	1-1/4" x 1"	----
973928	1-1/4" x 1-1/4"	----
973948	1-1/2" x 1-1/2"	----
973949	2" x 2"	----

BRONZE TEES ALL BARB



PART #	SIZE	
973965	3/4"	----
973966	1"	----
973967	1-1/4"	----

ELBOWS



(Barb x Male Pipe)

PART #	SIZE	
973980	3/4" x 3/4"	----
973981	1" x 3/4"	----
973982	1" x 1"	----

ELBOWS



(Barb x Barb)

PART #	HOSE SIZE	
973975	3/4"	----
973976	1"	----
973977	1-1/4" x 1"	----
973978	1-1/4"	----
973979	1-1/2"	----

STEEL INSERT FITTINGS FOR PLASTIC PIPE

MALE ADAPTER

- Galvanized

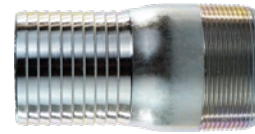

(Barb x Male Pipe)

PART #	SIZE	BOX/CASE	
973906	1/2"	25/100	----
973907	3/4"	25/10	----
973908	1"	16/48	----
973909	1-1/4"	12/36	----
973910	1-1/2"	6/36	----
973911	2"	5/25	----
973912	2-1/2"	1/3	----
973913	3"	1/3	----
973914	4"	1/3	----



(Insert x NPT)

PART #	SIZE	
974264	3/4 x 1/2	----
974265	1 x 3/4	----
974266	1-1/4 x 1	----
974267	1-1/2 x 1-1/4	----

COUPLINGS



PART #	SIZE	BOX/CASE	
973900	1/2	30/120	----
973901	3/4	20/100	----
973902	1	20/100	----
973903	1-1/4	16/64	----
973904	1-1/2	12/48	----
973905	2	5/25	----

WARNING: This product can expose you to chemicals, including Nickel, which are known to the State of California to cause cancer. For more information, visit www.P65Warnings.ca.gov

SS AND LEAD FREE BRONZE INSERT

NIPPLES AND FITTINGS

STAINLESS STEEL #304



#304 INSERT X MALE PIPE

- For coiled plastic pipe to submersible pump

PART #	SIZE	
973947SS	1/2 x 1/2	----
973925SS	3/4 x 3/4	----
973926SS	1 x 3/4	----
973927SS	1 x 1	----
973930SS	1 x 1-1/4	----
973928SS	1-1/4 x 1-1/4	----
973948SS	1-1/2 x 1-1/2	----
973949SS	2 x 2	----



#304 INSERT X MIP ELBOW

- Hydrant elbow

PART #	SIZE	
973980SS	3/4 x 3/4	----
973982SS	1 x 1	----
973985SS	1-1/4 x 1-1/4	----

LEAD FREE BRONZE INSERT FITTINGS

- NSF Approved
- ANSI 61-8



INSERT X INSERT

PART #	SIZE	
973960LF	1/2	----
973961LF	3/4	----
973962LF	1	----
973963LF	1-1/4	----

- NSF Approved
- ANSI 61-8



INSERT TEE

PART #	SIZE	
973965LF	3/4	----
973966LF	1	----
973967LF	1-1/4	----

- NSF Approved
- ANSI 61-8



INSERT X MALE BRANCH TEE

PART #	SIZE	
973969LF	3/4	----
973970LF	1 x 3/4	----
973971LF	1	----

- NSF Approved
- ANSI 61-8



INSERT X INSERT ELBOW

PART #	SIZE	
973975LF	3/4	----
973976LF	1	----

WELL COUPLINGS



304 SS DROP WELL COUPLINGS STANDARD

PART #	SIZE	
62415DC	1	----
62416DC	1-1/4	----
62417DC	1-1/2	----
62418DC	2	----



HEAVY WALLED SS 304 DROP WELL COUPLINGS

PART #	SIZE	
62415HDDC	1	----
62416HDDC	1-1/4	----
62417HDDC	1-1/2	----
62418HDDC	2	----



#304 STAINLESS STEEL MERCHANT COUPLINGS

PART #	SIZE	
61775	1	----
61776	1-1/4	----
61777	1-1/2	----
61778	2	----

WARNING: This product can expose you to chemicals, including Nickel, which are known to the State of California to cause cancer. For more information, visit www.P65Warnings.ca.gov

SCH 40 STAINLESS STEEL NIPPLES

NIPPLES AND FITTINGS

STAINLESS STEEL NIPPLES**SCHEDULE 40 WELDED**

Stainless steel pipe nipples are manufactured from stainless steel pipe that conforms to specification ASTM A312/SA312.

All stainless steel nipples conform to specification ASTM A733. Threads conform to the requirements of ANSI B1.20.1.

SEE MIDLANDINDUSTRIES.COM FOR SCHEDULE 80 NIPPLES

304

The basic alloy. Type 304 (18-8) is an austenitic steel possessing a minimum of 18% chromium and 8% nickel, combined with a maximum of 0.08% carbon. It is a nonmagnetic steel which cannot be hardened by heat treatment, but instead, must be cold worked to obtain higher tensile strengths.

Because of its ability to withstand the corrosive action of various acids found in fruits, meats, milk, and vegetables,

Type 304 is especially suited for all types of dairy equipment piping and valves, the brewing industry, the citrus and fruit juice industry, and in food processing applications. Also used for the dye tanks, pipelines buckets, dippers, etc. that come in contact with the lormic, acetic, and other organic acids used in the dyeing industry.

In the marine environment, because of its slightly higher strength and wear resistance than type 316 it is also used for nuts, bolts, screws, and other fasteners. It is also used for springs, cogs, and other components where both wear and corrosion resistance is needed.

SCHEDULE 80 SEAMLESS

- SEAMLESS FOR UNRESTRICTED FLOW
- USE WITH AIR, WATER, OIL, NATURAL GAS, STEAM
- FITTINGS: USE THREADED CLASS 3000 HIGH-PRESSURE STAINLESS STEEL.

- ASTM A733 • ASTM A312 • ANSI/ ASME B1.20.1
- PSI 3000

316

For severe environments. Of course, there are many industrial processes that require a higher level of resistance to corrosion than Type 304 can offer. For these applications, Type 316 is the answer.

In type 316, the nickel content is increased slightly. What distinguishes Type 316 from Type 304 is the addition of molybdenum up to a maximum of 3%.

Molybdenum increases the corrosion resistance of this chromium-nickel alloy to withstand attack by many industrial chemicals and solvents, and, in particular, inhibits pitting caused by chlorides. As such, molybdenum is one of the single most useful alloying additives in the fight against corrosion.

Type 316 can withstand corrosive attack by sodium and calcium brines, hypochlorite solutions, phosphoric acid; and the sulfite liquors and sulfurous acids used in the paper pulp industry. This alloy, therefore, is specified for industrial equipment that handles the corrosive process chemicals used to produce inks, rayons, photographic chemicals, paper, textiles, bleaches, and rubber. Type 316 is also used extensively for surgical implants within the hostile environment of the body.

Type 316 is the main stainless used in the marine environment, with the exception of fasteners and other items where strength and wear resistance are

WARNING: This product can expose you to chemicals, including Nickel, which are known to the State of California to cause cancer. For more information, visit www.P65Warnings.ca.gov



SCH 40 STAINLESS STEEL NIPPLES

NIPPLES AND FITTINGS

#304

1/8" - 27

#316



**1/8" DIAMETER
SCH 40 WELDED**



PART # 304 S.S.	LENGTH	BOX	APPROX. WT. LBS.	PART # 316 S.S.
48001	X Close (3/4")	25	0.01	49001
48002	x 1-1/2"	25	0.03	49002
48003	x 2"	25	0.04	49003
48004	x 2-1/2"	25	0.05	49004
48005	x 3"	25	0.06	49005
48006	x 3-1/2"	25	0.07	49006
48007	x 4"	25	0.07	49007
48008	x 4-1/2"	25	0.09	49008
48009	x 5"	25	0.10	49009
48010	x 5-1/2"	25	0.11	49010
48011	x 6"	25	0.12	49011
	x 8"			49013
48015	x 10"	1	0.19	
	x 12"	1	0.24	49017

1/4" - 18

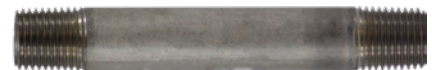

**1/4" DIAMETER
SCH 40 WELDED**



PART # 304 S.S.	LENGTH	BOX	APPROX. WT. LBS.	PART # 316 S.S.
48020	X Close (7/8")	25	0.02	49020
48021	x 1-1/2"	25	0.04	49021
48022	x 2"	25	0.06	49022
48023	x 2-1/2"	25	0.07	49023
48024	x 3"	25	0.09	49024
48025	x 3-1/2"	25	0.11	49025
48026	x 4"	25	0.13	49026
48027	x 4-1/2"	25	0.14	49027
48028	x 5"	25	0.16	49028
48029	x 5-1/2"	25	0.18	49029
48030	x 6"	25	0.19	49030
48031	x 7"	1	0.22	49031
48032	x 8"	1	0.25	49032
	x 9"	1	0.31	49033
48034	x 10"	1	0.35	49034
	x 11"	1	0.40	49035
48036	x 12"	1	0.44	49036
	x 14"	1	0.46	49037
	x 16"	1	0.47	49038



GO ONLINE TO VIEW OPEN ORDERS, ORDER HISTORY, AND TRACKING INFORMATION ON ALL SHIPMENTS

WARNING: This product can expose you to chemicals, including Nickel, which are known to the State of California to cause cancer. For more information, visit www.P65Warnings.ca.gov

NIPPLES & FITTINGS

SCH 40 STAINLESS STEEL NIPPLES

NIPPLES AND FITTINGS

#304

3/8"-18

#316



**3/8" DIAMETER
SCH 40 WELDED**



PART # 304 S.S.	LENGTH	BOX	APPROX. WT. LBS.	PART # 316 S.S.
48040	X Close (1")	25	0.03	49040
48041	x 1-1/2"	25	0.06	49041
48042	x 2"	25	0.07	49042
48043	x 2-1/2"	25	0.10	49043
48044	x 3"	25	0.12	49044
48045	x 3-1/2"	25	0.15	49045
48046	x 4"	25	0.17	49046
48047	x 4-1/2"	25	0.19	49047
48048	x 5"	25	0.22	49048
48049	x 5-1/2"	25	0.23	49049
48050	x 6"	25	0.26	49050
48052	x 8"	1	0.34	49052
48053	x 9"	1		
48054	x 10"	1	0.43	49054
48056	x 12"	1		



1/2" - 14

**1/2" DIAMETER
SCH 40 WELDED**



PART # 304 S.S.	LENGTH	BOX	APPROX. WT. LBS.	PART # 316 S.S.
48060	X Close 1-1/8"	25	0.05	49060
48061	x 1-1/2"	25	0.07	49061
48062	x 2"	25	0.10	49062
48063	x 2-1/2"	25	0.14	49063
48064	x 3"	25	0.18	49064
48065	x 3-1/2"	25	0.20	49065
48066	x 4"	25	0.25	49066
48067	x 4-1/2"	25	0.28	49067
48068	x 5"	25	0.31	49068
48069	x 5-1/2"	25	0.34	49069
48070	x 6"	25	0.39	49070
48071	x 7"	1	0.41	
48072	x 8"	1	0.52	49072
48073	x 9"	1	0.54	
48074	10"	1	0.58	49074
48075	x 11"	1	0.64	
48076	x 12"	1	0.69	49076



USE OUR TEXT LINE [855-609-3729](tel:855-609-3729) TO COMMUNICATE WITH MIDLAND MORE CONVENIENTLY

WARNING: This product can expose you to chemicals, including Nickel, which are known to the State of California to cause cancer. For more information, visit www.P65Warnings.ca.gov



SCH 40 STAINLESS STEEL NIPPLES

NIPPLES AND FITTINGS

#304



3/4" - 14

3/4" DIAMETER
SCH 40 WELDED

#316



PART # 304 S.S.	LENGTH	BOX	APPROX. WT. LBS.	PART # 316 S.S.
48080	X Close (1-3/8")	25	0.08	49080
48081	x 1-1/2"	25	0.13	49081
48082	x 2"	25	0.14	49082
48083	x 2-1/2"	25	0.17	49083
48084	x 3"	25	0.22	49084
48085	x 3-1/2"	25	0.27	49085
48086	x 4"	25	0.32	49086
48087	x 4-1/2"	25	0.38	49087
48088	x 5"	25	0.40	49088
48089	x 5-1/2"	25	0.42	49089
48090	x 6"	25	0.48	49090
48091	x 7"	1	0.45	49091
48092	x 8"	1	0.67	49092
48094	x 10"	1	0.94	49094
48096	x 12"	1	1.03	49096

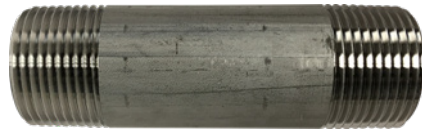

1" - 11 1/2

1" DIAMETER
SCH 40 WELDED



PART # 304 S.S.	LENGTH	BOX	APPROX. WT. LBS.	PART # 316 S.S.
48100	X Close (1-1/2")	25	0.13	49100
48101	x 2"	25	0.20	49101
48102	x 2-1/2"	25	0.25	49102
48103	x 3"	25	0.33	49103
48104	x 3-1/2"	25	0.40	49104
48105	x 4"	25	0.47	49105
48106	x 4-1/2"	25	0.53	49106
48107	x 5"	25	0.55	49107
48108	x 5-1/2"	25	0.60	49108
48109	x 6"	25	0.71	49109
48110	x 7"	1	0.57	49110
48111	x 8"	1	1.02	49111
48113	x 10"	1	1.16	49113
48115	x 12"	1	1.31	49115



HELP US HELP YOU! GO ONLINE TO UPDATE YOUR CUSTOMER PROFILE SO THAT WE CAN UPDATE ALL THE APPROPRIATE DEPARTMENTS AND PERSONNEL AT YOUR COMPANY ON NEW CATALOGS, PRICING UPDATES, NEW MARKETING TOOLS, AND OTHER IMPORTANT INFORMATION. THANK YOU!

WARNING: This product can expose you to chemicals, including Nickel, which are known to the State of California to cause cancer. For more information, visit www.P65Warnings.ca.gov

NIPPLES & FITTINGS

SCH 40 STAINLESS STEEL NIPPLES

NIPPLES AND FITTINGS



1 1/4" - 11 1/2"



1-1/4" DIAMETER SCH 40 WELDED

PART # 304 S.S.	LENGTH	BOX	APPROX. WT. LBS.	PART # 316 S.S.
48120	X Close (1-5/8")	10	0.17	49120
48121	x 2"	10	0.23	49121
48122	x 2-1/2"	10	0.35	49122
48123	x 3"	10	0.46	49123
48124	x 3-1/2"	10	0.52	49124
48125	x 4"	10	0.65	49125
48126	x 4-1/2"	10	0.53	49126
48127	x 5"	10	0.60	49127
48128	x 5-1/2"	10	0.61	49128
48129	x 6"	10	0.71	49129
48131	x 8"	1	1.34	
48135	x 12"	1	1.54	



1-1/2" - 11 1/2"

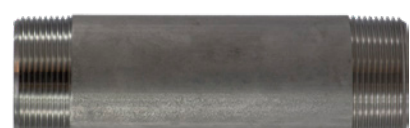

1-1/2" DIAMETER SCH 40 WELDED

PART # 304 S.S.	LENGTH	BOX	APPROX. WT. LBS.	PART # 316 S.S.
48140	X Close x 1-3/4"	10	0.25	49140
48141	x 2"	10	0.32	49141
48142	x 2-1/2"	10	0.41	49142
48143	x 3"	10	0.52	49143
48144	x 3-1/2"	10	0.62	49144
48145	x 4"	10	0.73	49145
48146	x 4-1/2"	10	0.86	49146
48147	x 5"	10	0.95	49147
48148	x 5-1/2"	10	1.01	49148
48149	x 6"	10	1.19	49149
48151	x 8"	1	1.63	49151
48152	x 9"	1	1.88	
48153	x 10"	1	2.28	49153
48155	x 12"	1	2.43	

• See our website for threaded one end (TOE) nipples

See our website for Sch. 80 # 304 and #316 Stainless Steel Seamless Nipples.



SEE WEBSITE TO DOWNLOAD YOUR MOST UPDATED PRICING

WARNING: This product can expose you to chemicals, including Nickel, which are known to the State of California to cause cancer. For more information, visit www.P65Warnings.ca.gov

SCH 40 STAINLESS STEEL NIPPLES

NIPPLES AND FITTINGS



2" DIAMETER SCH 40 WELDED



PART # 304 S.S.	LENGTH	BOX	APPROX. WT. LBS.	PART # 316 S.S.
48160	X Close (2")	10	0.37	49160
48161	x 2-1/2"	10	0.54	49161
48162	x 3"	10	0.65	49162
48163	x 3-1/2"	10	0.88	49163
48164	x 4"	10	1.02	49164
48165	x 4-1/2"	10	1.16	49165
48166	x 5"	10	1.29	49166
48167	x 5-1/2"	10	1.46	49167
48168	x 6"	10	1.57	49168
48169	x 7"	1	1.92	49169
48170	x 8"	1	2.01	49170
48171	x 9"	1	2.55	
48172	x 10"	1	2.69	
48174	x 12"	1	2.89	

2-1/2" DIAMETER SCH 40 WELDED

PART # 304 S.S.	LENGTH	BOX	APPROX. WT. LBS.
48180	X Close (2-1/2")	10	0.64
48181	x 3"		
48187	x 6"	1	2.37
48193	x 12"	1	4.85



3" DIAMETER SCH 40 WELDED

PART # 304 S.S.	LENGTH	BOX	APPROX. WT. LBS.	PART # 316 S.S.
48200	X Close (2-5/8")	10	0.95	49200
48201	x 3"	10	1.32	49201
48203	x 4"	10	1.66	49203
48205	x 5"	5	1.72	49205
48207	x 6"	5	1.88	49207
48209	x 8"	1	1.91	49209
48213	x 12"	1	2.12	49213



4" DIAMETER SCH 40 WELDED

PART # 304 S.S.	LIST PRICE	LENGTH	BOX	APPROX. WT. LBS.	PART # 316 S.S.	LIST PRICE
48220	----	X Close (2-7/8")	8	1.15	49220	----
		x 4"	1	2.98	49223	----
48227	----	x 6"	1	4.10	49234	----
		x 8"	1	5.95	49236	----
		x 12"	1	9.25	49240	----

WARNING: This product can expose you to chemicals, including Nickel, which are known to the State of California to cause cancer.
 For more information, visit www.P65Warnings.ca.gov



304 AND 316 150# SS FITTINGS

NIPPLES AND FITTINGS

STAINLESS STEEL FITTINGS



150# 304 & 316 Stainless Steel Fittings

Our high quality standard pattern 150lb rated stainless steel threaded fittings are manufactured to the highest standards. All stainless steel fittings are monitored by our quality control personnel for strict compliance with applicable standards and specifications.

These stainless steel pipe fittings are excellent for uses that involve chemicals or liquids that may be corrosive. Along with fighting corrosion, a stainless steel pipe fitting will prevent contamination making it useful to many professionals.

- Use with air, water, oil, natural gas, steam
- NPT and FNPT threads conform to ASME B1.20.1
- Maximum Pressure: 300 psi @ 72 F; 150 psi @ 366 F for steam
- Maximum Steam Pressure: 150 psi
- Material Conforms to ASTM A-351. Class 150 Pressure Ratings
- Manufacturing facility is ISO 9001:2008
- 304 Stainless Steel is economically priced, chromium-nickel material that offers very good corrosion resistance. 316 Stainless Steel has higher nickel content and contains molybdenum for even better corrosion resistance.

WARNING: This product can expose you to chemicals, including Nickel, which are known to the State of California to cause cancer. For more information, visit www.P65Warnings.ca.gov

304 AND 316 150# SS FITTINGS

NIPPLES AND FITTINGS

90° ELBOW 304 & 316 150#



PART # 304 S.S.		SIZE	BOX	APPROX. WT. LBS.	PART # 316 S.S.	
62100	----	1/8"	25	0.06	63100	----
62101	----	1/4"	25	0.06	63101	----
62102	----	3/8"	25	0.11	63102	----
62103	----	1/2"	25	0.13	63103	----
62104	----	3/4"	25	0.20	63104	----
62105	----	1"	10	0.33	63105	----
62106	----	1-1/4"	10	0.55	63106	----
62107	----	1-1/2"	5	0.77	63107	----
62108	----	2"	5	1.10	63108	----
62109	----	2-1/2"	1	2.09	63109	----
62110	----	3"	1	2.84	63110	----
62112	----	4"	1	5.00	63112	----

90° STREET ELBOW 304 & 316 150#



PART # 304 S.S.		SIZE	BOX	APPROX. WT. LBS.	PART # 316 S.S.	
62160	----	1/8"	25	0.04	63160	----
62161	----	1/4"	25	0.07	63161	----
62162	----	3/8"	25	0.09	63162	----
62163	----	1/2"	25	0.15	63163	----
62164	----	3/4"	25	0.24	63164	----
62165	----	1"	10	0.31	63165	----
62166	----	1-1/4"	10	0.51	63166	----
62167	----	1-1/2"	5	0.84	63167	----
62168	----	2"	5	1.26	63168	----
62169	----	3"	1	4.16	63170	----
		4"	1	7.61	63171	----

45° ELBOW 304 & 316 150#



PART # 304 S.S.	LIST PRICE	SIZE	BOX	APPROX. WT. LBS.	PART # 316 S.S.	
62180	----	1/8"	25	0.04	63180	----
62181	----	1/4"	25	0.07	63181	----
62182	----	3/8"	25	0.09	63182	----
62183	----	1/2"	25	0.13	63183	----
62184	----	3/4"	25	0.20	63184	----
62185	----	1"	10	0.33	63185	----
62186	----	1-1/4"	10	0.49	63186	----
62187	----	1-1/2"	5	0.66	63187	----
62188	----	2"	5	1.14	63188	----
62189	----	2-1/2"	1	2.82		
62190	----	3"	1	2.91	63190	----
62191	----	4"	1	5.05	63192	----

SEE OUR WEBSITE FOR STAINLESS STEEL FITTING DIMENSIONS

WARNING: This product can expose you to chemicals, including Nickel, which are known to the State of California to cause cancer.
 For more information, visit www.P65Warnings.ca.gov

NIPPLES & FITTINGS

304 AND 316 150# SS FITTINGS

NIPPLES AND FITTINGS

TEE 304 & 316 150#



PART # 304 S.S.		SIZE	BOX	APPROX. WT. LBS.	PART # 316 S.S.	
62250	----	1/8"	25	0.07	63250	----
62251	----	1/4"	25	0.07	63251	----
62252	----	3/8"	25	0.11	63252	----
62253	----	1/2"	25	0.20	63253	----
62254	----	3/4"	25	0.29	63254	----
62255	----	1"	10	0.42	63255	----
62256	----	1-1/4"	5	0.66	63256	----
62257	----	1-1/2"	5	0.99	63257	----
62258	----	2"	3	1.43	63258	----
62259	----	2-1/2"	1	1.43		
62260	----	3"	1	3.66	63260	----
		4"	1	7.19	63261	----

CROSS 304 & 316 150#



PART # 304 S.S.		SIZE	BOX	APPROX. WT. LBS.	PART # 316 S.S.	
		1/8"	25	0.06	63390	----
62391	----	1/4"	25	0.09	63391	----
62392	----	3/8"	25	0.13	63392	----
62393	----	1/2"	25	0.29	63393	----
62394	----	3/4"	10	0.44	63394	----
62395	----	1"	10	0.74	63395	----
62396	----	1-1/4"	5	1.25	63396	----
62397	----	1-1/2"	5	1.53	63397	----
62398	----	2"	1	2.28	63398	----
		3"	1	5.46	63400	----
		4"	1	9.41	63401	----

HEX NIPPLE 304 & 316 150#



PART # 304 S.S.	LIST PRICE	SIZE	BOX	APPROX. WT. LBS.	PART # 316 S.S.	LIST PRICE
62720	----	1/8"	1	0.02	63720	----
62721	----	1/4"	1	0.04	63721	----
62722	----	3/8"	1	0.07	63722	----
62723	----	1/2"	1	0.11	63723	----
62724	----	3/4"	1	0.18	63724	----
62725	----	1"	1	0.22	63725	----
62726	----	1-1/4"	1	0.37	63726	----
62727	----	1-1/2"	1	0.46	63727	----
62728	----	2"	1	0.61	63728	----

REDUCING HEX NIPPLE 304 & 316 150#



PART # 304 S.S.	LIST PRICE	SIZE	BOX	APPROX. WT. LBS.	PART # 316 S.S.	
62740	----	1/4" x 1/8"	1	0.04	63740	----
62741	----	3/8" x 1/8"	1	0.07	63741	----
62742	----	3/8" x 1/4"	1	0.07	63742	----
62744	----	1/2" x 1/4"	1	0.09	63744	----
62745	----	1/2" x 3/8"	1	0.11	63745	----
62747	----	3/4" x 1/4"	1	0.15	63747	----
62748	----	3/4" x 3/8"	1	0.15	63748	----
62749	----	3/4" x 1/2"	1	0.15	63749	----

WARNING: This product can expose you to chemicals, including Nickel, which are known to the State of California to cause cancer. For more information, visit www.P65Warnings.ca.gov



304 AND 316 150# SS FITTINGS

NIPPLES AND FITTINGS

COUPLING 304 & 316 150#



PART # 304 S.S.		SIZE*	BOX	APPROX. WT. LBS.	PART # 316 S.S.	
62410	----	1/8"	25	0.03	63410	----
62411	----	1/4"	25	0.06	63411	----
62412	----	3/8"	25	0.07	63412	----
62413	----	1/2"	25	0.13	63413	----
62414	----	3/4"	25	0.18	63414	----
62415	----	1"	25	0.24	63415	----
62416	----	1-1/4"	10	0.44	63416	----
62417	----	1-1/2"	10	0.51	63417	----
62418	----	2"	5	0.79	63418	----
62419	----	2-1/2"	1	1.28	63419	----
62420	----	3"	1	1.87	63420	----
62421	----	4"	1	2.80	63421	----

REDUCING COUPLING 304 & 316 150#



PART # 304 S.S.		SIZE	BOX	APPROX. WT. LBS.	PART # 316 S.S.	
62430	----	1/4" x 1/8"	25	0.04	63430	----
62431	----	3/8" x 1/8"	25	0.04	63431	----
62432	----	3/8" x 1/4"	25	0.04	63432	----
62433	----	1/2" x 1/8"	25	0.09	63433	----
62434	----	1/2" x 1/4"	25	0.09	63434	----
62435	----	1/2" x 3/8"	25	0.09	63435	----
62455	----	3/4" x 1/8"	25	0.13	63455	----
62436	----	3/4" x 1/4"	25	0.11	63436	----
62437	----	3/4" x 3/8"	25	0.13	63437	----
62438	----	3/4" x 1/2"	25	0.15	63438	----
		1" x 1/4"	25	0.25	63459	----
62440	----	1" x 3/8"	25	0.22	63440	----
62441	----	1" x 1/2"	25	0.24	63441	----
62442	----	1" x 3/4"	25	0.24	63442	----
62445	----	1-1/4" x 3/4"	10	0.33	63445	----
62446	----	1-1/4" x 1"	10	0.35	63446	----
62447	----	1-1/2" x 1/2"	10	0.40	63447	----
62448	----	1-1/2" x 3/4"	10	0.42	63448	----
62449	----	1-1/2" x 1"	10	0.44	63449	----
62450	----	1-1/2" x 1-1/4"	10	0.46	63450	----
62459		2" x 1/2"				
62451	----	2" x 3/4"				
62452	----	2" x 1"	5	0.57	63452	----
62453	----	2" x 1-1/4"	5	0.62	63453	----
62454	----	2" x 1-1/2"	5	0.62	63454	----
62462		2-1/2" x 2"				
62428	----	3" x 1"	1	1.82		
62456	----	3" x 2"	1	2.25		
62457		4" x 3"				

OD MACHINED COUPLING 304 & 316 150#

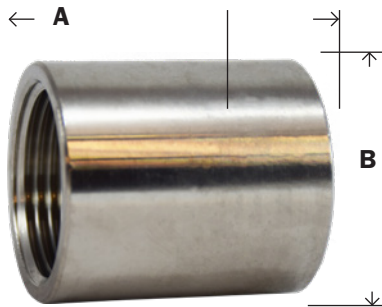

PART # 304 S.S.	LIST PRICE	SIZE	A	B	BOX	APPROX. WT. LBS.	PART # 316 S.S.	
62410B	----	1/8"	0.76	0.56	25	0.04	63410B	----
62411B	----	1/4"	0.94	0.71	25	0.04	63411B	----
62412B	----	3/8"	0.98	0.84	25	0.07	63412B	----
62413B	----	1/2"	1.33	1.01	25	0.09	63413B	----
62414B	----	3/4"	1.41	1.27	25	0.16	63414B	----
62415B	----	1"	1.69	1.54	10	0.21	63415B	----
62416B	----	1-1/4"	1.93	1.90	10	0.31	63416B	----
62417B	----	1-1/2"	1.93	2.16	5	0.41	63417B	----
62418B	----	2"	1.96	2.66	5	0.68	63418B	----
62420B	----	3"	3.23	3.76	1			

WARNING: This product can expose you to chemicals, including Nickel, which are known to the State of California to cause cancer. For more information, visit www.P65Warnings.ca.gov

304 AND 316 150# SS FITTINGS

NIPPLES AND FITTINGS

HALF COUPLING 304 & 316 150#

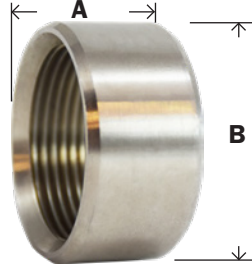

PART # 304 S.S.	LIST	SIZE	A	B	BOX	APPROX. WT. LBS.	PART # 316 S.S.
62770		1/8"					
62771	----	1/4"	0.39	0.70	25	0.02	63771
62772	----	3/8"	0.45	0.82	25	0.02	63772
62773	----	1/2"	0.57	1.02	25	0.09	63773
62774	----	3/4"	0.67	1.22	25	0.11	63774
62775	----	1"	0.79	1.47	25	0.13	63775
62776	----	1-1/4"	0.86	1.88	10	0.24	63776
62777	----	1-1/2"	0.94	2.10	10	0.26	63777
62778	----	2"	1.06	2.60	5	0.44	63778
62779		3"					

UNION 304 & 316 150#

• Stainless Steel Seat



PART # 304 S.S.	LIST PRICE	SIZE	BOX	APPROX. WT. LBS.	PART # 316 S.S.	LIST PRICE
62600	----	1/8"	25	0.09	63600	----
62601	----	1/4"	25	0.13	63601	----
62602	----	3/8"	25	0.22	63602	----
62603	----	1/2"	25	0.26	63603	----
62604	----	3/4"	25	0.46	63604	----
62605	----	1"	10	0.60	63605	----
62606	----	1-1/4"	5	0.90	63606	----
62607	----	1-1/2"	5	1.10	63607	----
62608	----	2"	1	1.81	63608	----
62609		2-1/2"				
62610	----	3"	1	3.40	63610	----

CAP - CAST 304 & 316 150#



PART # 304 S.S.		SIZE	BOX	APPROX. WT. LBS.	PART # 316 S.S.
62470	----	1/8"	25	0.02	63470
62471	----	1/4"	25	0.02	63471
62472	----	3/8"	25	0.04	63472
62473	----	1/2"	25	0.07	63473
62474	----	3/4"	25	0.11	63474
62475	----	1"	10	0.18	63475
62476	----	1-1/4"	10	0.29	63476
62477	----	1-1/2"	10	0.40	63477
62478	----	2"	10	0.60	63478
62480	----	3"	1	1.28	63480
62481	----	4"	1	1.54	

HEX CAP - BARSTOCK 304 & 316 150#



PART # 304 S.S.		SIZE	BOX	APPROX. WT. LBS.	PART # 316 S.S.
62075	----	1/8"	25	0.04	63075
62076	----	1/4"	25	0.09	63076
62077	----	3/8"	25	0.11	63077
62078	----	1/2"	25	0.13	63078
62079	----	3/4"	25	0.22	63079
62080	----	1"	10	0.22	63080
62081	----	1-1/4"	10	0.29	63081
62082	----	1-1/2"	5	0.40	63082
62083	----	2"	5	0.49	63083

WARNING: This product can expose you to chemicals, including Nickel, which are known to the State of California to cause cancer. For more information, visit www.P65Warnings.ca.gov

304 AND 316 150# SS FITTINGS

NIPPLES AND FITTINGS

HEX BUSHING 304 & 316 150#



PART # 304 S.S.		SIZE M X F	BOX	APPROX. WT. LBS.	PART # 316 S.S.	
62500	----	1/4" x 1/8"	25	0.04	63500	----
62501	----	3/8" x 1/8"	25	0.04	63501	----
62502	----	3/8" x 1/4"	25	0.04	63502	----
62503	----	1/2" x 1/8"	25	0.09		
62504	----	1/2" x 1/4"	25	0.09	63504	----
62505	----	1/2" x 3/8"	25	0.11	63505	----
62506	----	3/4" x 1/8"	25	0.13	63506	----
62507	----	3/4" x 1/4"	25	0.15	63507	----
62508	----	3/4" x 3/8"	25	0.15	63508	----
62509	----	3/4" x 1/2"	25	0.15	63509	----
62557	----	1" x 1/8"	25	0.27		
62510	----	1" x 1/4"	25	0.22	63510	----
62511	----	1" x 3/8"	25	0.24	63511	----
62512	----	1" x 1/2"	25	0.24	63512	----
62513	----	1" x 3/4"	25	0.24	63513	----
62515	----	1-1/4" x 3/8"	25	0.37		
62516	----	1-1/4" x 1/2"	25	0.37	63516	----
62517	----	1-1/4" x 3/4"	25	0.37	63517	----
62518	----	1-1/4" x 1"	25	0.37	63518	----
62521	----	1-1/2" x 1/2"	25	0.44	63521	----
62522	----	1-1/2" x 3/4"	25	0.46	63522	----
62532	----	1-1/2" x 1"	25	0.49	63523	----
62524	----	1-1/2" x 1-1/4"	25	0.46	63524	----
62559	----	2" x 1/4"	10	0.95	63526	
62527	----	2" x 1/2"	10	0.66	63527	----
62528	----	2" x 3/4"	10	0.66	63528	----
62529	----	2" x 1"	10	0.66	63529	----
62530	----	2" x 1-1/4"	10	0.68	63530	----
62531	----	2" x 1-1/2"	10	0.68	63531	----
62547		2-1/2" 3/4"				
62536	----	2-1/2" x 1"	5	1.70		
62534	----	2-1/2" x 1-1/2"	5	1.23	63534	----
62535	----	2-1/2" x 2"	5	1.21	63535	----
		3" x 1"	5	2.20	63550	----
62537	----	3" x 1-1/2"	5	1.97	63537	----
62538	----	3" x 2"	5	1.72	63538	----
62539	----	3" x 2-1/2"	5	1.81	63539	
		4" x 1-1/2"	5	3.92	63540	----
		4" x 2"	1	3.72	63541	----
62543	----	4" x 3"	1	2.43	63543	----

• STAINLESS STEEL BULKHEAD FITTINGS IN BULKHEAD SECTION

STAINLESS STEEL:

- BARBED FOR PLASTIC PIPE
- WELL COUPLINGS
- MERCHANT COUPLINGS
- SEE END OF BRONZE FITTING SECTION



GO ONLINE TO VIEW OPEN ORDERS, ORDER HISTORY, AND TRACKING INFORMATION ON ALL SHIPMENTS

WARNING: This product can expose you to chemicals, including Nickel, which are known to the State of California to cause cancer. For more information, visit www.P65Warnings.ca.gov

304 AND 316 150# SS FITTINGS

NIPPLES AND FITTINGS

HEX LOCKNUT

304 & 316 150#

• Straight Thread



PART # 304 S.S.		SIZE	BOX	APPROX. WT. LBS.	PART # 316 S.S.	
62700	----	1/8"	25	0.02		
62701	----	1/4"	25	0.05	63701	----
62702	----	3/8"	25	0.06	63702	----
62703	----	1/2"	25	0.07	63703	----
62704	----	3/4"	25	0.11	63704	----
62705	----	1"	25	0.15	63705	----
62706	----	1-1/4"	25	0.22	63706	----
62707	----	1-1/2"	25	0.29	63707	----
62708	----	2"	10	0.35	63708	----

CORED SQUARE HEAD PLUG

304 & 316 150#



PART # 304 S.S.		SIZE	BOX	APPROX. WT. LBS.	PART # 316 S.S.	
62670	----	1/8"	25	0.02	63670	----
62671	----	1/4"	25	0.03	63671	----
62672	----	3/8"	25	0.04	63672	----
62653	----	1/2"	25	0.06	63653	----
62654	----	3/4"	25	0.13	63654	----
62655	----	1"	25	0.20	63655	----
62656	----	1-1/4"	25	0.32	63656	----
62657	----	1-1/2"	10	0.41	63657	----
62658	----	2"	10	0.65	63658	----
62659	----	2-1/2"	1	1.04		
62660	----	3"	1	0.88		

CORED HEX HEAD PLUG

304 & 316 150#



PART # 304 S.S.		SIZE	BOX	APPROX. WT. LBS.	PART # 316 S.S.	
62630	----	1/8"	25	0.02	63630	----
62631	----	1/4"	25	0.02	63631	----
62632	----	3/8"	25	0.04	63632	----
62633	----	1/2"	25	0.07	63633	----
62634	----	3/4"	25	0.11	63634	----
62635	----	1"	25	0.20	63635	----
62636	----	1-1/4"	25	0.31	63636	----
62637	----	1-1/2"	10	0.44	63637	----
62638	----	2"	10	0.65	63638	----
62640		3"				
		4"	1	2.77	63641	----

HOSE NIPPLE

304 & 316 150#



HOSE BARB X MALE PIPE

PART # 304 S.S.		HOSE I.D. X MALE PIPE	BOX	APPROX. WT. LBS.	PART # 316 S.S.	
73951	----	1/4"	1	0.04	973951	----
73952	----	3/8"	1	0.07	973952	----
73953	----	1/2"	1	0.13	973953	----
73954	----	3/4"	1	0.20	973954	----
73955	----	1"	1	0.33	973955	----
73956	----	1-1/4"	1	0.47	973956	----
73957	----	1-1/2"	1	0.67	973957	----
73958	----	2"	1	0.88	973958	----
73959	----	2-1/2"	1	1.45	973959	----
73960	----	3"	1	1.94	973990	----
73961	----	4"	1	3.57	973991	----

WARNING: This product can expose you to chemicals, including Nickel, which are known to the State of California to cause cancer. For more information, visit www.P65Warnings.ca.gov

304 AND 316 150# SS FITTINGS

NIPPLES AND FITTINGS

REDUCING HOSE NIPPLE

304 150#



HOSE BARB X MALE PIPE

PART # 304 S.S	HOSE I.D. X MALE PIPE	BOX	APPROX. WT. LBS.	
73970	1/4" x 1/8"	1	0.04	----
73971	3/8" x 1/4"	1	0.07	----
73972	1/2" x 3/8"	1	0.13	----
73973	1/2" x 1/4"	1	0.13	----
73974	3/4" x 1/2"	1	0.20	----
73975	1" x 3/4"	1	0.33	----
73976	1" x 1/2"	1	0.33	----
73977	1-1/4" x 1"	1	0.46	----
73979	1-1/2" x 1-1/4"	1	0.66	----
73980	1-1/2" x 1"	1	0.66	----
73981	2" x 1-1/2"	1	0.88	----
73982	2" x 1-1/4"	1	0.88	----

SOLID HEX HEAD PLUG

316 150#



PART # 316 S.S	SIZE	BOX	APPROX. WT. LBS.	
63660	1/8"	25	0.04	----
63661	1/4"	25	0.06	----
63662	3/8"	25	0.08	----
63663	1/2"	25	0.12	----
63664	3/4"	25	0.15	----
63665	1"	25	0.24	----

HEX SOCKET PLUG - BARSTOCK

316 150#



PART # 316 S.S	SIZE	BOX	APPROX. WT. LBS.	
63759	1/16"	1	0.03	----
63760	1/8 "	1	0.05	----
63761	1/4 "	1	0.07	----
63762	3/8 "	1	0.10	----
63763	1/2 "	1	0.14	----
63764	3/4 "	1	0.21	----
63765	1"	1	0.24	----

SOLID SQUARE HEAD PLUG

316 150#



PART # 316 S.S	SIZE	BOX	APPROX. WT. LBS.	
63680	1/8"	25	0.04	----
63681	1/4"	25	0.04	----
63682	3/8"	25	0.05	----
63683	1/2"	25	0.06	----
63684	3/4"	25	0.12	----

WARNING: This product can expose you to chemicals, including Nickel, which are known to the State of California to cause cancer.
 For more information, visit www.P65Warnings.ca.gov

NIPPLES & FITTINGS

BLACK AND GALVANIZED SCH 40

NIPPLES AND FITTINGS



BLACK AND GALVANIZED STEEL NIPPLES

Product Specifications

Welded steel pipe nipples both galvanized and black in diameters ranging from 1/8" up to 4" in lengths from close to 12" and cut-pipe up to 120" -200°-150° Temp Rating.

Technical Specifications

Standards: Product complies with ASTM A-53, A-733 and ANSI B1.20.1 for threading, dimensions and pipe specifications.

Pipe: Complies with ASTM A-53 mill tested schedule 40 and 80 for both Welded & Seamless Meets ANSI B36.1. All pipe is hydrostatic tested. For pressure ratings, see the knowledge bank on our website.

Galvanized: Zinc coating applied by hot dipped. Galvanized complying with ASTM A-123, NSF approved, RoHS compliant.

Black: Protected against oxidation with varnish coating.

Cutting Procedure: All pipe is roller cut. A visual inspection of seams, excessive galvanizing, mid-welds, poor galvanizing, bends, roundness, under and over weight of the pipe is made at the time it is cut. This is done for every length of pipe. Pipe lengths are cut to a tolerance of + or - 1/16" of the actual length.

Threading Procedure:

All pipe is chaser thread cut to American Standard Tapered Pipe Thread standards. This is 3/4" taper per foot. Pipe is visually inspected for roundness of threads and other visual faults as it is removed from the threading machine.

SCHEDULE 80 XXS SEAMLESS



- ASTM A106 Grade B Seamless Pipe
- ASTM A 53
- WVN 351
- Standard NPT Tapered Pipe Threads as per ANSI B 1.20.1 Specification

XXS SEAMLESS



WARNING: This product can expose you to chemicals, including Nickel, which are known to the State of California to cause cancer. For more information, visit www.P65Warnings.ca.gov

PRICING FILE AVAILABLE ONLINE

BLACK AND GALVANIZED SCH 40

NIPPLES AND FITTINGS

1/8" - 27

Wall Thickness 0.068 - Grade B - Test Pressure
700 PSI - Thread Length 0.39



**1/8" DIAMETER
SCH 40 WELDED**



PART # GALV		LENGTH	BOX/CASE	APPROX. WT. LBS.	PART # BLACK	
56001	----	X Close (3/4")	50/600	0.02	57001	----
56002	----	x 1-1/2"	50/600	0.03	57002	----
56003	----	x 2"	50/500	0.04	57003	----
56004	----	x 2-1/2"	100/400	0.06	57004	----
56005	----	x 3"	50/300	0.07	57005	----
56006	----	x 3-1/2"	50/300	0.08	57006	----
56007	----	x 4"	50/300	0.09	57007	----
56008	----	x 4-1/2"	50/300	0.10	57008	----
56009	----	x 5"	50/300	0.11	57009	----
56010	----	x 5-1/2"	50/300	0.12	57010	----
56011	----	x 6"	50/300	0.13	57011	----
56012	----	x 7"	50/300	0.15	57012	----
56013	----	x 8"	50/300	0.18	57013	----
56014	----	x 9"	50/300	0.21	57014	----
56015	----	x 10"	50/300	0.25	57015	----
56017	----	x 12"	50/300	0.29	57017	----

1/4"-18

Wall Thickness 0.068 - Grade B - Test Pressure
700 PSI - Thread Length 0.39



**1/4" DIAMETER
SCH 40 WELDED**



PART # GALV		LENGTH	BOX/CASE	APPROX. WT. LBS.	PART # BLACK	
56020	----	X Close (7/8")	50/600	0.04	57020	----
56021	----	x 1-1/2"	125/500	0.06	57021	----
56022	----	x 2"	125/500	0.06	57022	----
56023	----	x 2-1/2"	100/400	0.08	57023	----
56024	----	x 3"	50/300	0.10	57024	----
56025	----	x 3-1/2"	50/300	0.12	57025	----
56026	----	x 4"	50/300	0.14	57026	----
56027	----	x 4-1/2"	50/300	0.17	57027	----
56028	----	x 5"	50/300	0.19	57028	----
56029	----	x 5-1/2"	50/300	0.21	57029	----
56030	----	x 6"	50/300	0.23	57030	----
56031	----	x 7"	50/100	0.27	57031	----
56032	----	x 8"	50/100	0.31	57032	----
56033	----	x 9"	50/100	0.35	57033	----
56034	----	x 10"	50/100	0.40	57034	----
56035	----	x 11"	50/100	0.44	57035	----
56036	----	x 12"	50/100	0.48	57036	----
56038	----	x 18"	50/100	0.54		

WARNING: This product can expose you to chemicals, including Nickel, which are known to the State of California to cause cancer.
 For more information, visit www.P65Warnings.ca.gov

NIPPLES & FITTINGS

BLACK AND GALVANIZED SCH 40

NIPPLES AND FITTINGS



3/8" DIAMETER SCH 40 WELDED

Wall Thickness 0.091 - Grade B
- Test Pressure 700 PSI - Thread



PART # GALV	LENGTH	BOX/CASE Length 0.6	APPROX. WT. LBS.	PART # BLACK
56040	X Close (1")	50/600	0.05	57040
56041	x 1-1/2"	125/500	0.07	57041
56042	x 2"	125/500	0.08	57042
56043	x 2-1/2"	100/400	0.11	57043
56044	x 3"	50/300	0.13	57044
56045	x 3-1/2"	50/300	0.16	57045
56046	x 4"	50/300	0.19	57046
56047	x 4-1/2"	50/200	0.21	57047
56048	x 5"	50/150	0.24	57048
56049	x 5-1/2"	50/150	0.27	57049
56050	x 6"	50/100	0.29	57050
56051	x 7"	50/100	0.35	57051
56052	x 8"	50/100	0.40	57052
56053	x 9"	50/100	0.45	57053
56054	x 10"	50/100	0.51	57054
56055	x 11"	50/100	0.56	57055
56056	x 12"	50/100	0.62	57056
56430	x 18"	5/10	0.71	57430
	x 24"	1/1	1.02	57431



1/2" DIAMETER SCH 40 WELDED

Wall Thickness 0.109 -
Grade B - Test Pressure 700
PSI - Thread Length 0.78



PART # GALV	LENGTH	BOX/CASE	APPROX. WT. LBS.	PART # BLACK
56060	X Close (1-1/8")	50/600	0.08	57060
56061	x 1-1/2"	125/500	0.08	57061
56062	x 2"	125/500	0.12	57062
56063	x 2-1/2"	100/400	0.15	57063
56064	x 3"	50/300	0.19	57064
56065	x 3-1/2"	50/300	0.23	57065
56066	x 4"	50/300	0.27	57066
56067	x 4-1/2"	50/200	0.30	57067
56068	x 5"	50/150	0.34	57068
56069	x 5-1/2"	50/150	0.38	57069
56070	x 6"	50/100	0.42	57070
56071	x 7"	50/100	0.49	57071
56072	x 8"	50/100	0.57	57072
56073	x 9"	50/100	0.65	57073
56074	x 10"	50/100	0.72	57074
56075	x 11"	50/100	0.80	57075
56076	x 12"	40/80	0.87	57076
56240	x 18"	1/3	1.29	57240
56241	x 24"	1/3	1.74	57241
56242	x 30"	1/3	2.16	57242
56243	x 36"	1/3	2.61	57243
56244	x 42"	1/3	3.03	57244
56245	x 48"	1/3	3.48	57245
56246	x 60"	1/3	4.35	57246
56247	x 72"	1/3	5.22	57247

WARNING: This product can expose you to chemicals, including Nickel, which are known to the State of California to cause cancer.
 For more information, visit www.P65Warnings.ca.gov



BLACK AND GALVANIZED SCH 40

NIPPLES AND FITTINGS

3/4" DIAMETER SCH 40 WELDED



Wall Thickness 0.113 -
Grade B - Test Pressure
700 PSI - Thread Length
0.79



Part # Galv		Length	Box/Case	Approx. Wt. Lbs.	Part # Black	
56080	----	X Close (1-3/8")	50/300	0.13	57080	----
56081	----	x 1-1/2"	125/250	0.10	57081	----
56082	----	x 2"	125/250	0.15	57082	----
56083	----	x 2-1/2"	50/250	0.20	57083	----
56084	----	x 3"	50/200	0.24	57084	----
56085	----	x 3-1/2"	50/150	0.29	57085	----
56086	----	x 4"	50/150	0.34	57086	----
56087	----	x 4-1/2"	50/150	0.39	57087	----
56088	----	x 5"	50/150	0.43	57088	----
56089	----	x 5-1/2"	60/120	0.48	57089	----
56090	----	x 6"	50/100	0.53	57090	----
56091	----	x 7"	50/100	0.63	57091	----
56092	----	x 8"	50/100	0.72	57092	----
56093	----	x 9"	40/80	0.82	57093	----
56094	----	x 10"	40/80	0.91	57094	----
56095	----	x 11"	30/60	1.01	57095	----
56096	----	x 12"	30/60	1.10	57096	----
56250	----	x 18"	1/3	1.63	57250	----
56251	----	x 24"	1/3	2.20	57251	----
56252	----	x 30"	1/3	2.73	57252	----
56253	----	x 36"	1/3	3.30	57253	----
56254	----	x 42"	1/3	3.83	57254	----
56255	----	x 48"	1/3	4.40	57255	----
56256	----	x 60"	1/3	5.50	57256	----
56257	----	x 72"	1/3	6.60	57257	----

WARNING: This product can expose you to chemicals, including Nickel, which are known to the State of California to cause cancer. For more information, visit www.P65Warnings.ca.gov

NIPPLES & FITTINGS

BLACK AND GALVANIZED SCH 40

NIPPLES AND FITTINGS



1" DIAMETER SCH 40 WELDED

Wall Thickness 0.133 - Grade
B - Test Pressure 700 PSI -
Thread Length 0.98



PART # GALV		LENGTH	BOX/CASE	APPROX. WT. LBS.	PART # BLACK	
56100	----	X Close (1-1/2")	50/200	0.16	57100	----
56101	----	x 2"	50/150	0.23	57101	----
56102	----	x 2-1/2"	50/150	0.29	57102	----
56103	----	x 3"	50/100	0.36	57103	----
56104	----	x 3-1/2"	50/100	0.43	57104	----
56105	----	x 4"	50/100	0.50	57105	----
56106	----	x 4-1/2"	50/100	0.56	57106	----
56107	----	x 5"	50/100	0.63	57107	----
56108	----	x 5-1/2"	50/100	0.70	57108	----
56109	----	x 6"	40/80	0.77	57109	----
56110	----	x 7"	25/50	0.90	57110	----
56111	----	x 8"	25/50	1.03	57111	----
56112	----	x 9"	15/30	1.17	57112	----
56113	----	x 10"	15/30	1.30	57113	----
56114	----	x 11"	15/30	1.44	57114	----
56115	----	x 12"	15/30	1.57	57115	----
56260	----	x 18"	1/3	2.34	57260	----
56261	----	x 24"	1/3	3.14	57261	----
56262	----	x 30"	1/3	3.91	57262	----
56263	----	x 36"	1/3	4.71	57263	----
56264	----	x 42"	1/3	5.48	57264	----
56265	----	x 48"	1/3	6.28	57265	----
56266	----	x 60"	1/3	7.85	57266	----
56267	----	x 72"	1/3	9.42	57267	----

WARNING: This product can expose you to chemicals, including Nickel, which are known to the State of California to cause cancer. For more information, visit www.P65Warnings.ca.gov



BLACK AND GALVANIZED SCH 40

NIPPLES AND FITTINGS



1-1/4" DIAMETER SCH 40 WELDED

Wall Thickness 0.14 - Grade
B - Test Pressure 1300 PSI -
Thread Length 1.01



PART # GALV	LENGTH	BOX/CASE	APPROX. WT. LBS.	PART # BLACK
56120	X Close (1-5/8")	50/100	0.25	57120
56121	x 2"	50/100	0.32	57121
56122	x 2-1/2"	50/100	0.41	57122
56123	x 3"	50/100	0.50	57123
56124	x 3-1/2"	30/60	0.60	57124
56125	x 4"	30/60	0.69	57125
56126	x 4-1/2"	30/60	0.78	57126
56127	x 5"	25/50	0.87	57127
56128	x 5-1/2"	25/50	0.96	57128
56129	x 6"	25/50	1.06	57129
56130	x 7"	15/30	1.24	57130
56131	x 8"	15/30	1.42	57131
56132	x 9"	15/30	1.61	57132
56133	x 10"	15/30	1.79	57133
56134	x 11"	10/20	1.97	57134
56135	x 12"	10/20	2.16	57135
56270	x 18"	1/3	3.22	57270
56271	x 24"	1/3	4.32	57271
56272	x 30"	1/3	3.22	57272
56273	x 36"	1/3	6.48	57273
56275	x 48"			57275
	x 48"	1/3	8.64	57275
56276	x 60"	1/3	10.80	57276



1-1/2" DIAMETER SCH 40 WELDED

Wall Thickness 0.145 - Grade
B - Test Pressure 1300 PSI -
Thread Length 1.03



PART # GALV	LENGTH	BOX/CASE	APPROX. WT. LBS.	PART # BLACK
56140	X Close (1-3/4")	50/100	0.31	57140
56141	x 2"	40/80	0.37	57141
56142	x 2-1/2"	40/80	0.47	57142
56143	x 3"	40/80	0.58	57143
56144	x 3-1/2"	25/50	0.68	57144
56145	x 4"	25/50	0.78	57145
56146	x 4-1/2"	25/50	0.89	57146
56147	x 5"	25/50	1.10	57147
56148	x 5-1/2"	20/40	1.10	57148
56149	x 6"	15/30	1.20	57149
56150	x 7"	15/30	1.41	57150
56151	x 8"	15/30	1.62	57151
56152	x 9"	15/30	1.83	57152
56153	x 10"	1/20	2.04	57153
56154	x 11"	1/20	2.25	57154
56155	x 12"	1/20	2.46	57155
56280	x 18"	1/3	3.66	57280
56281	x 24"	1/3	4.92	57281
56282	x 30"	1/3	6.12	57282
56283	x 36"	1/3	7.38	57283
56285	x 48"	1/3	9.84	57285
56286	x 60"			57286

WARNING: This product can expose you to chemicals, including Nickel, which are known to the State of California to cause cancer.
 For more information, visit www.P65Warnings.ca.gov

NIPPLES & FITTINGS

BLACK AND GALVANIZED SCH 40

NIPPLES AND FITTINGS



2" DIAMETER SCH 40 WELDED

Wall Thickness 0.154 - Grade
B - Test Pressure 2500 PSI -
Thread Length 1.06



PART # GALV		LENGTH	BOX/CASE	APPROX. WT. LBS.	PART # BLACK	
56160	----	X Close (2")	40/80	0.55	57160	----
56161	----	x 2-1/2"	25/50	0.70	57161	----
56162	----	x 3"	25/50	0.86	57162	----
56163	----	x 3-1/2"	1/30	1.01	57163	----
56164	----	x 4"	1/30	1.16	57164	----
56165	----	x 4-1/2"	1/25	1.31	57165	----
56166	----	x 5"	1/30	1.47	57166	----
56167	----	x 5-1/2"	1/30	1.62	57167	----
56168	----	x 6"	1/20	1.77	57168	----
56169	----	x 7"	1/20	2.08	57169	----
56170	----	x 8"	1/20	2.39	57170	----
56171	----	x 9"	1/10	2.70	57171	----
56172	----	x 10"	1/10	3.00	57172	----
56173	----	x 11"	1/10	3.31	57173	----
56174	----	x 12"	1/10	3.62	57174	----
56290	----	x 18"	1/3	5.39	57290	----
56291	----	x 24"	1/3	5.26	57291	----
56292	----	x 30"	1/3	7.03	57292	----
56293	----	x 36"	1/3	10.86	57293	----
56294	----	x 42"	1/3	12.63	57294	----
56295	----	x 48"	1/3	14.48	57295	----
56296	----	x 60"	1/3	18.10	57296	----
56297	----	x 72"	1/3	18.10	57297	----

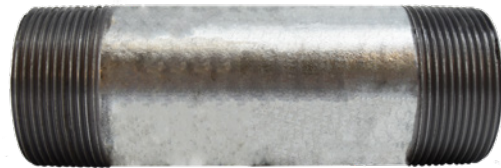

2-1/2" DIAMETER SCH 40 WELDED

Wall Thickness 0.203 - Grade
B - Test Pressure 2500 PSI -
Thread Length 1.57



PART # GALV		LENGTH	BOX/CASE	APPROX. WT. LBS.	PART # BLACK	
56180	----	X Close (2-1/2")	1/20	1.09	57180	----
56181	----	x 3"	1/20	1.33	57181	----
56182	----	x 3-1/2"	1/20	1.57	57182	----
56183	----	x 4"	1/20	1.82	57183	----
56184	----	x 4-1/2"	1/20	2.06	57184	----
56185	----	x 5"	1/20	2.30	57185	----
56186	----	x 5-1/2"	1/10	2.54	57186	----
56187	----	x 6"	1/10	2.78	57187	----
56188	----	x 7"	1/10	3.27	57188	----
56189	----	x 8"	1/10	3.75	57189	----
56190	----	x 9"	1/10	4.24	57190	----
56191	----	x 10"	1/8	4.72	57191	----
56192	----	x 11"	1/8	5.21	57192	----
56193	----	x 12"	1/8	5.69	57193	----

WARNING: This product can expose you to chemicals, including Nickel, which are known to the State of California to cause cancer.
 For more information, visit www.P65Warnings.ca.gov



BLACK AND GALVANIZED SCH 40

NIPPLES AND FITTINGS



3" DIAMETER SCH 40 WELDED

Wall Thickness 0.216 - Grade
B - Test Pressure 2500 PSI -
Thread Length 1.64



PART # GALV		LENGTH	BOX/CASE	APPROX. WT. LBS.	PART # BLACK	
56200	----	X Close (2-5/8")	1/20	1.52	57200	----
56201	----	x 3"	1/20	1.76	57201	----
56202	----	x 3-1/2"	1/10	2.08	57202	----
56203	----	x 4"	1/10	2.39	57203	----
56204	----	x 4-1/2"	1/10	2.71	57204	----
56205	----	x 5"	1/10	3.03	57205	----
56206	----	x 5-1/2"	1/10	3.35	57206	----
56207	----	x 6"	1/10	3.66	57207	----
56208	----	x 7"	1/8	4.30	57208	----
56209	----	x 8"	1/8	4.93	57209	----
56210	----	x 9"	1/8	5.57	57210	----
56211	----	x 10"	1/5	6.20	57211	----
56212	----	x 11"	1/5	7.20	57212	----
56213	----	x 12"	1/5	7.47	57213	----
		x 24"	1	14.94	57311	----



4" DIAMETER SCH 40 WELDED

Wall Thickness 0.237 - Grade
B - Test Pressure 2210 PSI -
Thread Length 1.74



PART # GALV		LENGTH	BOX/CASE	APPROX. WT. LBS.	PART # BLACK	
56220	----	X Close (2-7/8")	1/10	2.00	57220	----
56221	----	3-1/2"	1/8	2.21		
56223	----	x 4"	1/8	3.41	57223	----
56224	----	x 4-1/2"	1/6	3.86	57224	----
56225	----	x 5"	1/6	4.31	57225	----
56226	----	x 5-1/2"	1/6	4.76	57226	----
56227	----	x 6"	1/6	5.21	57227	----
56330	----	x 7"	1/5	6.48	57330	----
56229	----	x 8"	1/5	7.01	57229	----
56331	----	x 9"	1/5	7.54	57331	----
56332	----	x 10"	1/5	8.14	57332	----
56228	----	x 12"	1/4	8.54	57228	----



VIEW PRICING AND AVAILABLE STOCK ONLINE

WARNING: This product can expose you to chemicals, including Nickel, which are known to the State of California to cause cancer.
 For more information, visit www.P65Warnings.ca.gov

NIPPLES & FITTINGS

NIPPLES AND ASSORTMENTS

NIPPLES AND FITTINGS



6" DIAMETER SCH 40 WELDED

Wall Thickness 0.154 - Grade
B - Test Pressure 2500 PSI -
Thread Length 1.06



PART # GALV		LENGTH	BOX/CASE	APPROX. WT. LBS.	PART # BLACK	
56300	----	X Close (3-1/8")	1/1	3.80	57300	----
		x 4"	1/1	5.30	57304	----
		x 6"	1/1	8.30	57301	----
		x 8"	1/1	11.30	57305	----
		x 10"			57306	----
		x 12"	1/1	17.20	57308	----



8" DIAMETER SCH 40 WELDED

Wall Thickness 0.154 - Grade
B - Test Pressure 2500 PSI -
Thread Length 1.06

PART #	LENGTH	BOX/CASE	APPROX. WT. LBS.	
57320	X Close (3-1/8")	1/1	5.80	----
57322	x 6"	1/1	6.50	----
57324	x 8"	1/1	11.30	----
57326	x 10"	1/1	19.00	----
57328	x 12"	1/1	28.55	----



SCH 40 SINGLE RUN NIPPLE BLACK

PART	DESCRIPTION	CLOSE	1-1/2	2	2-1/2	3	3-1/2	4	4-1/2	5	5 1/2	6	TOTAL PCS	LIST
973570	1/2"	1	1	1	1	1	1	1	1	1	1	1	11	
973571	3/4"	1	1	1	1	1	1	1	1	1	1	1	11	
973572	1"	1		1	1	1	1	1	1	1	1	1	10	
973573	1-1/4"	1		1	1	1	1	1	1	1	1	1	10	
973574	1-1/2"	1		1	1	1	1	1	1	1	1	1	10	
973575	2"	1			1	1	1	1	1	1	1	1	9	

SCH 40 SINGLE RUN NIPPLE GALVANIZED

PART	DESCRIPTION	CLOSE	1-1/2	2	2-1/2	3	3-1/2	4	4-1/2	5	5 1/2	6	TOTAL PCS	LIST
973670	1/2"	1	1	1	1	1	1	1	1	1	1	1	11	
973671	3/4"	1	1	1	1	1	1	1	1	1	1	1	11	
973672	1"	1		1	1	1	1	1	1	1	1	1	10	
973673	1-1/4"	1		1	1	1	1	1	1	1	1	1	10	
973674	1-1/2"	1		1	1	1	1	1	1	1	1	1	10	
973675	2"	1			1	1	1	1	1	1	1	1	9	

WARNING: This product can expose you to chemicals, including Nickel, which are known to the State of California to cause cancer.
 For more information, visit www.P65Warnings.ca.gov

NIPPLES AND ASSORTMENTS

NIPPLES AND FITTINGS

STEEL NIPPLE ASSORTMENTS

B "6" ASSORTMENTS



BLACK		LENGTH											WT. LBS.	TOTAL PIECES		
		CLOSE	1-1/2"	2"	2-1/2"	3"	3-1/2"	4"	4-1/2"	5"	5-1/2"	6"				
973567	1/2"	6	6	6	6	6	6	6	6	6	6	6	6	20	66	----
973568	3/4"	6	6	6	6	6	6	6	6	6	6	6	6	27	66	----
973569	1"	6		6	6	6	6	6	6	6	6	6	6	34	60	----

GALV.		LENGTH											WT. LBS.	TOTAL PIECES		
		CLOSE	1-1/2"	2"	2-1/2"	3"	3-1/2"	4"	4-1/2"	5"	5-1/2"	6"				
973667	1/2"	6	6	6	6	6	6	6	6	6	6	6	6	20	66	----
973668	3/4"	6	6	6	6	6	6	6	6	6	6	6	6	27	66	----
973669	1"	6		6	6	6	6	6	6	6	6	6	6	34	60	----

STEEL TOTE TRAYS



PART #	SIZE	CAPACITY	
990781	1/2"	77pcs	----
990782	3/4"	66pcs	----
990783	1"	50pcs	----
990786	1-1/4"	40pcs	----
990784	1-1/2"	30pcs	----
990785	2"	27pcs	----

WARNING: This product can expose you to chemicals, including Nickel, which are known to the State of California to cause cancer. For more information, visit www.P65Warnings.ca.gov

NIPPLES & FITTINGS

BLACK SCH 80 SEAMLESS

NIPPLES AND FITTINGS

EXTRA HEAVY SEAMLESS STEEL PIPE NIPPLES

1/8" - 27



1/8" DIAMETER SCHEDULE 80 SEAMLESS

Wall Thickness 0.094 - Grade B - Test Pressure 850 PSI - Thread Length 0.39

PART #	LENGTH	BOX/CASE	APPROX. WT. LBS.	
59001SMLS	x Close	40/480	0.02	----
59002SMLS	x 1-1/2"	40/480	0.03	----
59003SMLS	x 2"	100/400	0.05	----
59004SMLS	2-1/2"	100/400	0.06	----
59005SMLS	x 3"	40/240	0.08	----
59006SMLS	x 3-1/2"	40/240	0.09	----
59007SMLS	x 4"	40/240	0.11	----
59009SMLS	x 5"	40/120	0.12	----
59010SMLS	x 5-1/2"	40/120	0.13	----
59011SMLS	x 6"	40/80	0.16	----

1/4" - 18



1/4" DIAMETER SCHEDULE 80 SEAMLESS

Wall Thickness 0.119 - Grade B - Test Pressure 850 PSI - Thread Length 0.59

PART #	LENGTH	BOX/CASE	APPROX. WT. LBS.	
59020SMLS	x Close (7/8")	40 / 480	0.03	----
59021SMLS	x 1-1/2"	100 / 400	0.06	----
59022SMLS	x 2"	100 / 400	0.08	----
59023SMLS	x 2-1/2"	80 / 320	0.10	----
59024SMLS	x 3"	40 / 240	0.12	----
59025SMLS	x 3-1/2"	40 / 240	0.15	----
59026SMLS	x 4"	40 / 240	0.17	----
59027SMLS	x 4-1/2"	40 / 120	0.19	----
59028SMLS	x 5"	40 / 120	0.21	----
59029SMLS	x 5-1/2"	40 / 80	0.24	----
59030SMLS	x 6"	40 / 80	0.26	----
59031SMLS	x 7"	40 / 80	0.30	----
59032SMLS	x 8"	40 / 80	0.35	----
59033SMLS	x 9"	40 / 80	0.39	----
59034SMLS	x 10"	40 / 80	0.44	----
59036SMLS	x 12"	40 / 80	0.53	----

WARNING: This product can expose you to chemicals, including Nickel, which are known to the State of California to cause cancer. For more information, visit www.P65Warnings.ca.gov



BLACK SCH 80 SEAMLESS

NIPPLES AND FITTINGS

3/8" - 18



3/8" DIAMETER SCHEDULE 80 SEAMLESS

Wall Thickness 0.126 - Grade B - Test Pressure 850 PSI - Thread Length 0.6

PART #	LENGTH	BOX/CASE	APPROX. WT. LBS.	
59040SMLS	X Close (3/8")	40 / 480	0.05	----
59041SMLS	x 1-1/2"	100 / 400	0.08	----
59042SMLS	x 2"	100 / 400	0.11	----
59043SMLS	x 2-1/2"	80 / 320	0.14	----
59044SMLS	x 3"	40 / 240	0.17	----
59045SMLS	x 3-1/2"	40 / 240	0.20	----
59046SMLS	x 4"	40 / 240	0.23	----
59047SMLS	x 4-1/2"	40 / 160	0.26	----
59048SMLS	x 5"	40 / 120	0.29	----
59049SMLS	x 5-1/2"	40 / 120	0.32	----
59050SMLS	x 6"	40 / 80	0.35	----
59052SMLS	x 8"	40/80	0.47	----
59054SMLS	x 10"	40/80	0.53	----
59056SMLS	x 12"	40/80	0.65	----

1/2" - 14



1/2" DIAMETER SCHEDULE 80 SEAMLESS

Wall Thickness 0.147 - Grade B - Test Pressure 850 PSI - Thread Length 0.78

PART #	LENGTH	BOX/CASE	APPROX. WT. LBS.	
59060SMLS	X Close (1-1/8")	40 / 480	0.07	----
59061SMLS	x 1-1/2"	100 / 400	0.11	----
59062SMLS	x 2"	100 / 400	0.15	----
59063SMLS	x 2-1/2"	80 / 320	0.20	----
59064SMLS	x 3"	40 / 240	0.24	----
59065SMLS	x 3-1/2"	40 / 240	0.29	----
59066SMLS	x 4"	40 / 240	0.33	----
59067SMLS	x 4-1/2"	40 / 160	0.38	----
59068SMLS	x 5"	40 / 120	0.42	----
59069SMLS	x 5-1/2"	40 / 120	0.47	----
59070SMLS	x 6"	40 / 80	0.51	----
59071SMLS	x 7"	40 / 80	0.60	----
59072SMLS	x 8"	40 / 80	0.69	----
59073SMLS	x 9"	40/80	0.73	----
59074SMLS	x 10"	40 / 80	0.88	----
59075SMLS	x 11"	32/64	0.96	----
59076SMLS	x 12"	32 / 64	1.06	----

See our website for Schedule 80 Welded Black and Galvanized Steel Nipples

BLACK SCH 80 SEAMLESS

NIPPLES AND FITTINGS

NIPPLES & FITTINGS



3/4" - 14

3/4" DIAMETER SCHEDULE 80 SEAMLESS

Wall Thickness 0.154 - Grade B - Test Pressure 850 PSI - Thread Length 0.79

PART #	LENGTH	BOX/CASE	APPROX. WT. LBS.	
59080SMLS	X Close (1-3/8")	40/240	0.13	----
59081SMLS	x 1-1/2"	100/200	0.15	----
59082SMLS	x 2"	100/200	0.21	----
59083SMLS	x 2-1/2"	40/160	0.27	----
59084SMLS	x 3"	40/160	0.33	----
59085SMLS	x 3-1/2"	40/120	0.39	----
59086SMLS	x 4"	40/120	0.45	----
59087SMLS	x 4-1/2"	40/120	0.51	----
59088SMLS	x 5"	40/120	0.57	----
59089SMLS	x 5-1/2"	48/96	0.64	----
59090SMLS	x 6"	40/80	0.69	----
59091SMLS	x 7"	40/80	0.82	----
59092SMLS	x 8"	40/80	0.94	----
59094SMLS	x 10"	32/64	1.19	----
59096SMLS	x 12"	24/48	1.44	----



1" - 11 1/2

1" DIAMETER SCHEDULE 80 SEAMLESS

Wall Thickness 0.179 - Grade B - Test Pressure 850 PSI - Thread Length 0.98

PART #	LENGTH	BOX/CASE	APPROX. WT. LBS.	
59100SMLS	X Close (1-1/2")	40 / 160	0.21	----
59101SMLS	x 2"	40 / 120	0.30	----
59102SMLS	x 2-1/2"	40 / 120	0.37	----
59103SMLS	x 3"	40 / 80	0.47	----
59104SMLS	x 3-1/2"	40 / 80	0.56	----
59105SMLS	x 4"	40 / 80	0.65	----
59106SMLS	x 4-1/2"	40 / 80	0.74	----
59107SMLS	x 5"	40 / 80	0.83	----
59108SMLS	x 5-1/2"	40 / 80	0.92	----
59109SMLS	x 6"	32 / 64	1.01	----
59110SMLS	x 7"	20 / 40	1.19	----
59111SMLS	x 8"	20 / 40	1.37	----
59112SMLS	x 9"	20 / 40	1.55	----
59113SMLS	x 10"	12 / 24	1.74	----
59114SMLS	x 11"	12 / 24	1.92	----
59115SMLS	x 12"	12 / 24	2.10	----

WARNING: This product can expose you to chemicals, including Nickel, which are known to the State of California to cause cancer. For more information, visit www.P65Warnings.ca.gov



BLACK SCH 80 SEAMLESS

NIPPLES AND FITTINGS



1-1/4" DIAMETER SCHEDULE 80 SEAMLESS

Wall Thickness 0.191 - Grade B - Test Pressure 1900 PSI - Thread Length 1.01

PART #	LENGTH	BOX/CASE	APPROX. WT. LBS.	
59120SMLS	X Close (1-5/8")	40 / 80	0.31	----
59121SMLS	x 2"	40 / 80	0.42	----
59122SMLS	x 2-1/2"	40 / 80	0.52	----
59123SMLS	x 3"	40 / 80	0.64	----
59124SMLS	x 3-1/2"	24 / 48	0.77	----
59125SMLS	x 4"	24 / 48	0.90	----
59126SMLS	x 4-1/2"	24 / 48	1.02	----
59127SMLS	x 5"	20 / 40	1.15	----
59128SMLS	x 5-1/2"	20 / 40	1.27	----
59129SMLS	x 6"	20 / 40	1.40	----
59130SMLS	x 7"	20 / 40	1.65	----
59131SMLS	x 8"	12 / 24	1.90	----
59132SMLS	x 9"	12 / 24	2.15	----
59133SMLS	x 10"	12 / 24	2.40	----
59134SMLS	x 11"	8 / 16	2.65	----
59135SMLS	x 12"	8 / 16	2.90	----



1-1/2" DIAMETER SCHEDULE 80 SEAMLESS

Wall Thickness 0.2 - Grade B - Test Pressure 1900 PSI - Thread Length 1.03

PART #	LENGTH	BOX/CASE	APPROX. WT. LBS.	
59140SMLS	X Close (1-3/4")	40 / 80	0.41	----
59141SMLS	x 2"	32 / 64	0.51	----
59142SMLS	x 2-1/2"	32 / 64	0.64	----
59143SMLS	x 3"	32 / 64	0.78	----
59144SMLS	x 3-1/2"	20 / 40	0.94	----
59145SMLS	x 4"	20 / 40	1.09	----
59146SMLS	x 4-1/2"	20 / 40	1.23	----
59147SMLS	x 5"	20 / 40	1.39	----
59148SMLS	x 5-1/2"	16 / 32	1.54	----
59149SMLS	x 6"	12 / 24	1.69	----
59150SMLS	x 7"	12 / 24	2.00	----
59151SMLS	x 8"	12 / 24	2.30	----
59152SMLS	x 9"	12 / 24	2.61	----
59153SMLS	x 10"	8 / 16	2.90	----
59154SMLS	x 11"	8 / 16	3.20	----
59155SMLS	x 12"	8 / 16	3.51	----

WARNING: This product can expose you to chemicals, including Nickel, which are known to the State of California to cause cancer. For more information, visit www.P65Warnings.ca.gov

BLACK SCH 80 SEAMLESS

NIPPLES AND FITTINGS



2" DIAMETER SCHEDULE 80 SEAMLESS

Wall Thickness 0.218 - Grade B - Test Pressure 2500 PSI - Thread Length 1.06

PART #	LENGTH	BOX/CASE	APPROX. WT. LBS.	
59160SMLS	X Close (2")	32/64	0.30	----
59161SMLS	x 2-1/2"	20 / 40	0.80	----
59162SMLS	x 3"	20 / 40	1.10	----
59163SMLS	x 3-1/2"	12 / 24	1.31	----
59164SMLS	x 4"	12 / 24	1.52	----
59165SMLS	x 4-1/2"	12 / 24	1.72	----
59166SMLS	x 5"	12 / 24	1.94	----
59167SMLS	x 5-1/2"	12 / 24	2.15	----
59168SMLS	x 6"	8 / 16	2.35	----
59169SMLS	x 7"	8 / 16	2.78	----
59170SMLS	x 8"	8 / 16	3.19	----
59171SMLS	x 9"	1 / 8	3.62	----
59172SMLS	x 10"	1 / 8	4.03	----
59173SMLS	x 11"	1 / 8	4.44	----
59174SMLS	x 12"	1 / 8	4.87	----
59196SMLS	x 18"	1/1	7.22	----
59197SMLS	x 24"	1/1	9.74	----
59198SMLS	x 36"	1/1	14.61	----
59199SMLS	x 48"	1/1	19.48	----



2-1/2" DIAMETER SCHEDULE 80 SEAMLESS

Wall Thickness 0.276 - Grade B - Test Pressure 2500 PSI - Thread Length 1.57

PART #	LENGTH	BOX/CASE	APPROX. WT. LBS.	
59180SMLS	x Close (2-1/2")	1 / 16	1.25	----
59181SMLS	x 3"	1 / 16	1.57	----
59182SMLS	x 3-1/2"	1 / 16	1.82	----
59183SMLS	x 4"	1 / 16	2.15	----
59184SMLS	x 4-1/2"	1 / 16	1.75	----
59185SMLS	x 5"	1 / 16	2.78	----
59186SMLS	x 5-1/2"	1 / 8	2.25	----
59187SMLS	x 6"	1 / 8	3.41	----
59188SMLS	x 7"	1 / 8	3.89	----
59189SMLS	x 8"	1 / 8	4.69	----
59190SMLS	x 9"	1 / 8	5.34	----
59191SMLS	x 10"	1 / 6	5.97	----
59192SMLS	x 11"	1 / 6	4.89	----
59193SMLS	x 12"	1 / 5	7.26	----

WARNING: This product can expose you to chemicals, including Nickel, which are known to the State of California to cause cancer. For more information, visit www.P65Warnings.ca.gov



BLACK SCH 80 SEAMLESS

NIPPLES AND FITTINGS



3" DIAMETER SCHEDULE 80 SEAMLESS

Wall Thickness 0.3 - Grade B - Test Pressure 2500 PSI - Thread Length 1.64

Part #	Length	Box/Case	Approx. Wt. Lbs.	
59-200SMLS	X Close (2-5/8")	1 / 16	1.79	----
59-201SMLS	x 3"	1 / 16	2.11	----
59-202SMLS	x 3-1/2"	1 / 16	2.55	----
59-203SMLS	x 4"	1 / 8	2.89	----
59-204SMLS	x 4-1/2"	1 / 8	3.30	----
59-205SMLS	x 5"	1 / 8	3.73	----
59-206SMLS	x 5-1/2"	1 / 8	4.17	----
59-207SMLS	x 6"	1 / 8	4.57	----
59-208SMLS	x 7"	1 / 6	5.45	----
59-209SMLS	x 8"	1 / 6	6.29	----
59-210SMLS	x 9"	1 / 6	7.17	----
59-211SMLS	x 10"	1 / 4	8.01	----
59-212SMLS	x 11"	1 / 4	8.85	----
59-213SMLS	x 12"	1 / 4	9.72	----



4" DIAMETER SCHEDULE 80 SEAMLESS

Wall Thickness 0.337 - Grade B - Test Pressure 2800 PSI - Thread Length 1.74

PART #	LENGTH	BOX/CASE	APPROX. WT. LBS.	
59220SMLS	X Close (2-7/8")	1 / 8	2.91	----
59221SMLS	x 4"	1 / 6	4.26	----
59223SMLS	x 5"	1 / 5	5.49	----
59224SMLS	x 5-1/2"			
59225SMLS	x 6"	1 / 5	6.72	----
59226SMLS	x 7"	1/3	7.33	----
59227SMLS	x 8"	1 / 3	9.23	----
59228SMLS	9"			
59229SMLS	x 10"	1 / 3	11.73	----
59231SMLS	x 12"	1 / 3	14.24	----



6" DIAMETER

SCHEDULE 80 SEAMLESS



8" DIAMETER

PART #		LENGTH	BOX/CASE	APPROX. WT. LBS.		PART #	
				6"	8"		
59300SMLS	----	X Close	2	3.57	4.62	59-320SMLS	----
59301SMLS	----	x 6"	2	14.29	16.91	59-322SMLS	----
59305SMLS	----	x 8"	2	19.05	22.54	59-324SMLS	----
59306SMLS	----	x 10"	2	23.81	27.47	59-326SMLS	----
59308SMLS	----	x 12"	2	28.57	34.18	59-328SMLS	----

WARNING: This product can expose you to chemicals, including Nickel, which are known to the State of California to cause cancer. For more information, visit www.P65Warnings.ca.gov

NIPPLES & FITTINGS

BLACK EXTRA HEAVY XXS SEAMLESS

NIPPLES AND FITTINGS



1/2" DIAMETER BLACK EXTRA HEAVY XXS SEAMLESS

Wall Thickness 0.294 - Grade B - Test Pressure 1000 PSI - Thread Length 0.79

PART #	LENGTH	BOX/CASE	APPROX. WT. LBS.	
59060SMLSXX	x Close	100 / 200	0.31	----
59062SMLSXX	x 2"	100 / 200	0.58	----
59064SMLSXX	x 3"	50 / 100	0.62	----
59066SMLSXX	x 4"	50 / 100	0.66	----
59070SMLSXX	x 6"	25 / 50	0.75	----



3/4" DIAMETER DIAMETER BLACK EXTRA HEAVY XXS SEAMLESS

Wall Thickness 0.308 - Grade B - Test Pressure 1000 PSI - Thread Length 0.79

PART #	LENGTH	BOX/CASE	APPROX. WT. LBS.	
59080SMLSXX	x Close	40/240	0.55	----
59082SMLSXX	x 2"	50 / 100	0.62	----
59086SMLSXX	x 4"	25 / 50	0.68	----
59090SMLSXX	x 6"	25 / 50	0.71	----



1" DIAMETER DIAMETER BLACK EXTRA HEAVY XXS SEAMLESS

Wall Thickness 0.358 - Grade B - Test Pressure 1000 PSI - Thread Length 0.98

PART #	LENGTH	BOX/CASE	APPROX. WT. LBS.	
59100SMLSXX	x close	50 / 100	0.88	----
59101SMLSXX	x 2"	50 / 100	1.07	----
59103SMLSXX	x 3"	20/40	1.10	----
59105SMLSXX	x 4"	20 / 40	1.14	----
59109SMLSXX	x 6"	20 / 40	1.75	----
59111SMLSXX	x 8"	1 / 25	1.88	----
59115SMLSXX	x 12"	1 / 15	2.15	----



2" DIAMETER DIAMETER BLACK EXTRA HEAVY XXS SEAMLESS

Wall Thickness 0.436 - Grade B - Test Pressure 2500 PSI - Thread Length 1.06

PART #	LENGTH	BOX/CASE	APPROX. WT. LBS.	
59160SMLSXX	x close	1 / 25	1.36	----
59161SMLSXX	x 2-1/2"	1 / 20	1.67	----
59162SMLSXX	x 3"	1 / 20	2.09	----
59163SMLSXX	x 3-1/2"	1 / 12	2.51	----
59164SMLSXX	x 4"	1 / 12	2.86	----
59166SMLSXX	x 5"	1/12	3.04	----
59168SMLSXX	x 6"	1 / 11	3.20	----
59169SMLSXX	x 7"	1 / 8	4.35	----
59170SMLSXX	x 8"	1 / 8	5.86	----
59171SMLSXX	x 9"	1 / 8	6.58	----
59172SMLSXX	x 10"	1 / 8	7.31	----
59174SMLSXX	x 12"	1 / 8	9.34	----
59179SMLSXX	x 24"	1 / 1	14.77	----

WARNING: This product can expose you to chemicals, including Nickel, which are known to the State of California to cause cancer. For more information, visit www.P65Warnings.ca.gov



SCH 40 AND SCH 80 GROOVE NIPPLES

NIPPLES AND FITTINGS

THREAD X GROOVE

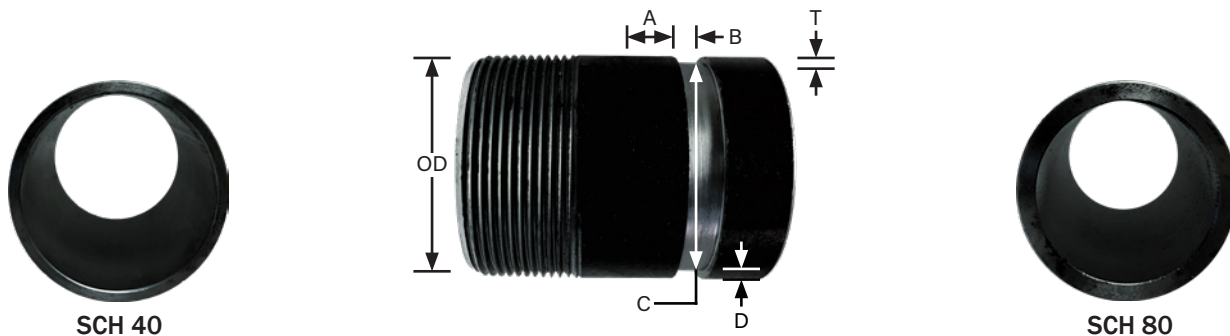

2" DIAMETER							
PART #	LIST PRICE	BOX	WTG	LENGTH	WTG	BOX	PART #
57162TV	----	50	0.70	x 3	1.03	40	59162TV
57164TV	----	30	0.97	x 4	1.40	24	59164TV
57168TV	----	20	1.64	x 6	2.41	16	59168TV
57170TV	----	20	2.15	x 8	3.20	16	59170TV
57172TV	----	10	2.80	x 10	3.65	8	59172TV
57174TV	----	10	3.45	x 12	4.01	8	59174TV

3" DIAMETER							
PART #	LIST PRICE	BOX	WTG	LENGTH	WTG	BOX	PART #
57201TV	----	20	1.26	x 3	2.01	16	59201TV
57203TV	----	10	1.80	x 4	3.01	8	59203TV
57207TV	----	10	3.17	x 6	4.87	8	59207TV
57209TV	----	8	4.13	x 8	5.86	6	59209TV
57211TV	----	5	5.48	x 10	6.19	4	59211TV
57213TV	----	5	6.24	x 12	6.37	4	59213TV

4" DIAMETER							
PART #	LIST PRICE	BOX	WTG	LENGTH	WTG	BOX	PART #
57222TV	----	8	2.40	x 3	4.11	6	59222TV
57223TV	----	8	2.52	x 4	4.15	6	59221TV
57227TV	----	6	4.30	x 6	6.52	5	59225TV
57229TV	----	4	5.63	x 8	7.18	3	59229TV
57332TV	----	4	7.90	x 10	11.74	3	59231TV
57228TV	----	4	8.25	x 12	14.24	3	59227TV

NOMINAL IPS PIPE SIZE	O.D. ACTUAL	GASKET SEAT "A"	GROOVE WIDTH "B"	GROOVE DIAMETER "C"	ACTUAL GROOVE DEPTH "D"
2	2.375	0.625	0.312	2.250	0.062
3	3.500	0.625	0.312	3.344	0.078
4	4.500	0.625	0.375	4.334	0.083



GO ONLINE TO VIEW OPEN ORDERS, ORDER HISTORY, AND TRACKING INFORMATION ON ALL SHIPMENTS

WARNING: This product can expose you to chemicals, including Nickel, which are known to the State of California to cause cancer. For more information, visit www.P65Warnings.ca.gov



BLACK SCH 40 AND SCH 80 SEAMLESS GROOVE NIPPLES

NIPPLES AND FITTINGS

GROOVE X GROOVE



SCH 40

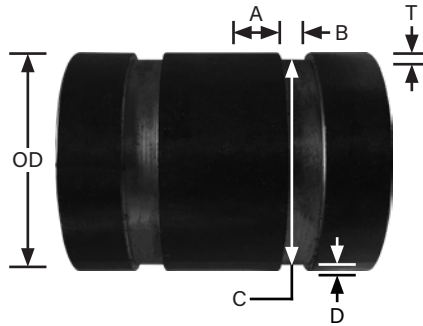

SCH 80

2" DIAMETER

PART #	BOX	WTG	LENGTH	WTG	BOX	PART #
57162V	50	0.70	x 3	1.03	40	59162V
57164V	30	0.97	x 4	1.40	24	59164V
57168V	20	1.64	x 6	2.41	16	59168V
57170V	20	2.15	x 8	3.20	16	59170V
57172V	10	2.80	x 10	3.65	8	59172V
57174V	10	3.45	x 12	4.01	8	59174V

3" DIAMETER

PART #	BOX	WTG	LENGTH	WTG	BOX	PART #
57201V	20	1.26	x 3	2.01	16	59201V
57203V	10	1.80	x 4	3.01	8	59203V
57207V	10	3.17	x 6	4.87	8	59207V
57209V	8	4.13	x 8	5.86	6	59209V
57211V	5	5.48	x 10	6.19	4	59211V
57213V	5	6.24	x 12	6.37	4	59213V

4" DIAMETER

PART #	BOX	WTG	LENGTH	WTG	BOX	PART #
57223V	8	2.52	x 4	4.15	6	59221V
57227V	6	4.35	x 6	6.52	5	59225V
57229V	4	5.63	x 8	7.18	3	59227V
57332V	4	7.90	x 10	11.74	3	59229V
57228V	4	8.25	x 12	14.24	3	59231V

SEAMLESS SCH 40 GROOVE X BEVEL NIPPLES



PART #	DIA. X LENGTH
57162GBS	2 x 3
57201GBS	3 x 3
57222GBS	4 x 3
57400GBS	8 x 3
57500GBS	10 x 3
57600GBS	12 x 3

WARNING: This product can expose you to chemicals, including Nickel, which are known to the State of California to cause cancer. For more information, visit www.P65Warnings.ca.gov



HAMMER UNIONS

NIPPLES AND FITTINGS

HAMMER UNIONS

FIG 100

Economical and for use in water, oil and gas low pressure applications up to 1,000 PSI CWP. Color coded with Yellow subs and Black nut.

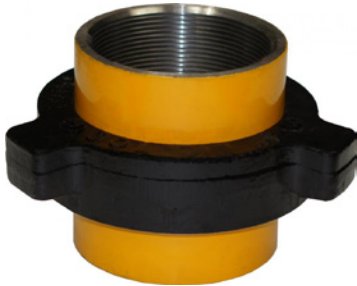

PART#	SIZE	
HAM100-200-SET	2"	----
HAM100-300-SET	3"	----
HAM100-400-SET	4"	----
HAM100-600-SET	6"	----
HAM100-800-SET	8"	----
HAM100-1000-SET	10"	----

FIG 200/ 206

Medium pressure for use in water, oil and gas applications up to 2,000 PSI CWP. Color coded with Grey subs and Blue Nut. The O-Ring in the Male Sub of the FIG206 spec provides greater sealing and protects metal-to-metal seal against corrosion.



PART# FIG 200	SIZE	
HAM200-100-SET	1"	----
HAM200-200-SET	2"	----
HAM200-300-SET	3"	----
HAM200-400-SET	4"	----
HAM200-500-SET	5"	----
Part# fig 206		
HAM206-200-SET	2"	----
HAM206-300-SET	3"	----
HAM206-400-SET	4"	----
HAM206-500-SET	5"	----
HAM206-600-SET	6"	----
HAM206-800-SET	8"	----

CRIMPLOK HAMMER UNIONS

HAMMER UNION

Our hose barb union is constructed of high quality forged steel. The integral hose shank is featured on both the male and female subs. Both time and money is saved by combining the unions with the integral shanks. No more welding hammer unions to combination nipples. Fig100 (black nut) configurations for dewatering applications and fig 200/206 (blue nut) configurations for Frac and Steam applications where a gasket seal is preferred. The union end connection is interchangeable with all major hammer union manufacturers products



PART#	SIZE	
HAM206-400CR-SET	4"	----



PART#	SIZE	
HAM100-400CR-SET	4"	----
HAM100-600CR-SET	6"	----

WARNING: This product can expose you to chemicals, including Nickel, which are known to the State of California to cause cancer. For more information, visit www.P65Warnings.ca.gov



MERCHANT COUPLINGS

NIPPLES AND FITTINGS

MERCHANT COUPLINGS

Product Specifications

Welded steel couplings both galvanized and black in diameters from 1/8" up to 4".

Technical Specifications

Standards: Product complies with ASTM A865 and ANSI B1.20.1 for threading, dimensions and pipe specifications. Federal Spec WW-P-404

Pipe: Complies with ASTM A-53 milltested schedule 40 and 80. Meets ANSI B36.1. All pipe is hydrostatic tested.

Galvanized: Zinc coating applied by hot dipping. Galvanized complying with ASTM-A-123.

MERCHANT COUPLINGS

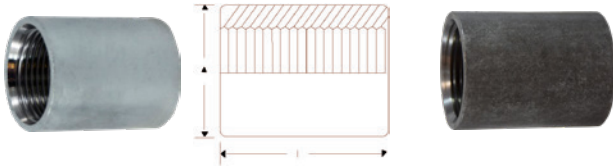

• Straight threads thru 2"

PART # GALV		SIZE	PART # BLACK	
64770	----	1/8"	65770	----
64771	----	1/4"	65771	----
64772	----	3/8"	65772	----
64773	----	1/2"	65773	----
64774	----	3/4"	65774	----
64775	----	1"	65775	----
64776	----	1-1/4"	65776	----
64777	----	1-1/2"	65777	----
64778	----	2"	65778	----
64779	----	2-1/2"	65779	----
64780	----	3"	65780	----
64781	----	4"	65781	----
		5"	65782	----
		6"	65783	----

HALF MERCHANT COUPLINGS



• Straight threads thru 2"

PART # GALV		SIZE	PART # BLACK	
		1/8"	65770H	
		1/4"	65771H	----
		3/8"	65772H	----
64773H	----	1/2"	65773H	----
64774H	----	3/4"	65774H	----
64775H	----	1"	65775H	----
64776H	----	1-1/4"	65776H	----
64777H	----	1-1/2"	65777H	----
64778H	----	2"	65778H	----
		2-1/2"	65779H	----
64780H	----	3"	65780H	----
64781H	----	4"	65781H	----



#304 STAINLESS STEEL MERCHANT COUPLINGS

PART #	SIZE	
61775	1	----
61776	1-1/4	----
61777	1-1/2	----
61778	2	----

Also available:
Extra Heavy Merchant Couplings

MERCHANT COUPLINGS SPECIFICATIONS

SIZE	OUTSIDE DIAM.	LENGTH INCHES	WEIGHT 100 PCS APPROX.		QUANTITY PER BOX	THREADS PER INCH	THREADS TYPE
				POUNDS			
1/8"	.59"	.78		3.5	1000	27	Straight
1/4"	.73"	1.18		7.5	500	18	Straight
3/8"	.86"	1.18"		9	600	18	Straight
1/2"	1.063"	1-9/16"		13.0	100	14	Straight
3/4"	1.313"	1-5/8"		28.3	50	14	Straight
1"	1.576"	2"		40.1	30	11-1/2	Straight
1-1/4"	1.900"	2-1/16"		49.5	25	11-1/2	Straight
1-1/2"	2.17"	2-3/64"		71.48	25	11-1/2	Straight
2"	2.750"	2-1/8"		112.0	20	11-1/2	Straight
2-1/2"	3.250"	3-1/8"		231.2	8	8	Taper Tapped
3"	4.000"	3-1/4"		353.8	5	8	Taper Tapped
4"	5.000"	3-1/2"		471.8	4	8	Taper Tapped
6"	7.32	4"		1000.05	4	8	Taper Tapped

WARNING: This product can expose you to chemicals, including Nickel, which are known to the State of California to cause cancer. For more information, visit www.P65Warnings.ca.gov

API LINE COUPLINGS

A105 BLACK STEEL TAPER TAPPED COUPLINGS

Product Specifications

These couplings are manufactured in accordance with American Petroleum Institute specifications 5L & 5B.

All couplings are phosphated.

All sizes are taper tapped 3/4" per foot on the diameter.

*Certified by the American Petroleum Institute



A105

- Black Steel
- API line API SL

- Each end has a short, unthreaded recess before the threads start.
- Use with sch 80 & sch. 160 nipples & pipe.
- Max. pressure: 3000PSI

API LINE PIPE COUPLINGS

PART #	NPT SIZE	THREADS PER INCH	OUTSIDE DIAMETER	LENGTH	UNIT WEIGHT	
65770API	1/8"	27	0.563	1-1/16	0.04	----
65771API	1/4"	18	0.719	1-5/8	0.10	----
65772API	3/8"	18	0.875	1-5/8	0.13	----
65773API	1/2"	14	1.063	2-1/8	0.24	----
65774API	3/4"	14	1.313	2-1/8	0.35	----
65775API	1"	11.5	1.576	2-5/8	0.52	----
65776API	1-1/4"	11.5	2.054	2-3/4	1.00	----
65777API	1-1/2"	11.5	2.200	2-3/4	0.88	----
65778API	2"	11.5	2.875	2-7/8	1.83	----
65779API	2-1/2"	8	3.375	4-1/8	3.28	----
65780API	3"	8	4.000	4-1/4	4.09	----
65781API	4"	8	5.200	4-1/2	7.59	----
65783API	6"	8	7.390	4-5/8	12.92	----
65784API	8"	8	9.625	5-3/4	23.18	----

I'm sorry, if you were right, I'd agree with you.

- Robin Williams



GO ONLINE TO UPLOAD YOUR LOGO TO UTILIZE ALL OF OUR CUSTOMIZABLE TOOLS!

WARNING: This product can expose you to chemicals, including Nickel, which are known to the State of California to cause cancer. For more information, visit www.P65Warnings.ca.gov



MALLEABLE FITTINGS

NIPPLES AND FITTINGS

MALLEABLE FITTINGS



- Saturated steam pressure 150 PSI @ 350°F
- Max pressure 300 PSI @ 150°F
- Temp range -20°F to 350°F

ISO 9002 - CERTIFICATE OF QUALITY - UL/FM LISTED

Our quality fittings are made with care and attention to detail. With better molds we can reduce parting lines and rough edges resulting in better fluid flow. By using a low temperature galvanizing process the coating is more durable which means a longer lasting fitting. All Fittings are 100% Pressure Tested to 300# Class.

(Every fitting is subjected to an underwater fitness test to ensure the highest quality)

SPECIFICATIONS

- MATERIAL: ASTM A 197 - Cuppla Malleable Iron, ASTM A 153 - Hot dipped galvanizing • Coating ASTM A164 LS
- DIMENSIONS: ANSI B 16.3 - Malleable Iron threaded fittings, ANSI B 16.14 - Ferrous Pipe Plugs, Bushings etc..., ANSI B 16.39 - Malleable Iron threaded pipe unions.
- THREADS: ANSI B 2.1 or BS 21 ASME B1.20.1 • RoHS Compliant • Tapered Threads
- Pressure - Saturated steam 150 PSI @350°F: Max pressure 300 PSI - 150°F
- Temperature range -20 - 350°F

MALLEABLE IRON - ANSI B

F°	16.3			
	Class	Sizes	Sizes	Sizes
	150 PSIG	1/4-1 300#	1 1/4-2 300#	2 1/4-3 300#
-200-	300	2000	1500	1000
150				
200	265	1785	1350	910
250	225	1575	1200	825
300	185	1360	1050	735
366*	150	1150	900	650

*Permissible for service temperature up to 366°F, reflecting the temperature of saturated steam at 150 psig.

SEE MIDLANDINDUSTRIES.COM FOR MORE SIZES AND CONFIGURATIONS

STEEL FITTINGS



- 1010 Carbon Steel, 3/4 taper threads (see hydraulic section for 7/8 taper threads.)
- Finish or coating • Black Dipped in rust resistant
- Galvanized, Zinc Plated (Inside and Out)

300lb MALLEABLE FITTINGS



Max. pressure: 300 psi WOG @ 72°F; 150 psi WOG saturated steam

- Meet ANSI/ ASME B1.20.1 standards
- Black meet ASTM 197 standards

BULL PLUGS AND SWAGES



FLANGES



WARNING: This product can expose you to chemicals, including Nickel, which are known to the State of California to cause cancer. For more information, visit www.P65Warnings.ca.gov

BLACK AND GALVANIZED IRON #150

NIPPLES AND FITTINGS

ELBOWS 90°

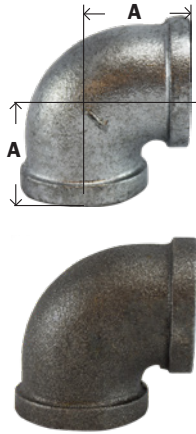

Part # Galvanized		Size	A	Box/Case	Approx. Wt. Lbs.	Part # Black	
64100	----	1/8"	0.69	50/600	0.07	65100	----
64101	----	1/4"	0.81	35/420	0.10	65101	----
64102	----	3/8"	0.95	90/360	0.16	65102	----
64103	----	1/2"	1.12	50/200	0.23	65103	----
64104	----	3/4"	1.31	35/105	0.35	65104	----
64105	----	1"	1.50	20/60	0.57	65105	----
64106	----	1-1/4"	1.75	20/40	0.86	65106	----
64107	----	1-1/2"	1.94	15/30	1.31	65107	----
64108	----	2"	2.25	8/16	1.79	65108	----
64109	----	2-1/2"	2.70	6/12	3.35	65109	----
64110	----	3"	3.08	4/8	5	65110	----
64112	----	4"	3.79	1/2	9.02	65112	----
64114	----	6"	5.13	1/1	23.68	65114	----
		8"			41.1	65115	----

REDUCING ELBOWS 90°

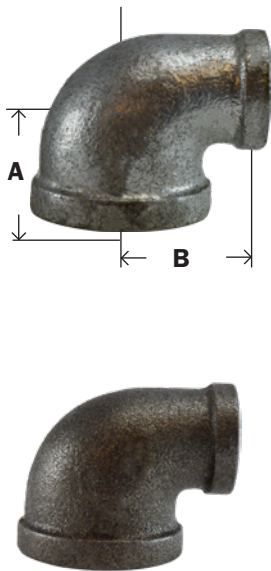

PART # GALVANIZED		SIZE	A	B	BOX/CASE	AP-PROX. WT. LBS.	PART # BLACK	
64122	----	3/8" x 1/4"	0.88	0.90	90/360	0.16	65122	----
64123	----	1/2" x 1/4"	0.97	0.98	60/240	0.21	65123	----
64124	----	1/2" x 3/8"	1.04	1.03	60/240	0.24	65124	----
64126	----	3/4" x 3/8"	1.12	1.13	40/160	0.31	65126	----
64127	----	3/4" x 1/2"	1.20	1.22	40/160	0.44	65127	----
64130	----	1" x 1/2"	1.26	1.40	25/100	0.52	65130	----
64131	----	1" x 3/4"	1.37	1.45	50/100	0.58	65131	----
64133	----	1-1/4" x 3/4"	1.45	1.62	15/120	0.79	65133	----
64134	----	1-1/4" x 1"	1.58	1.67	10/40	0.80	65134	----
64136	----	1-1/2" x 3/4"	1.52	1.75	10/40	0.88	65136	----
64137	----	1-1/2" x 1"	1.65	1.80	10/40	1.07	65137	----
64138	----	1-1/2" x 1-1/4"	1.82	1.88	15/30	1.12	65138	----
		2" x 3/4"					65139	----
64140	----	2" x 1"	1.73	2.02	14/28	1.41	65140	----
64141	----	2" x 1-1/4"	1.90	2.10	10/20	1.53	65141	----
64142	----	2" x 1-1/2"	2.02	2.16	10/20	1.65	65142	----
64145	----	2-1/2" x 1-1/2"	2.16	2.51	6/12	2.97	65145	----
64146	----	2-1/2" x 2"	2.39	2.60	6/12	3.18	65146	----
64148	----	3" x 1-1/2"	2.28	2.83	6/18	4.54	65148	----

90° STREET ELBOWS

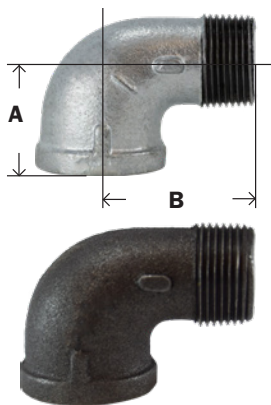

PART # GALVANIZED		SIZE	A	B	BOX/CASE	APPROX. WT. LBS.	PART # BLACK	
64160	----	1/8"	0.69	1.00	60/720	.06	65160	----
64161	----	1/4"	0.80	1.17	35/420	.10	65161	----
64162	----	3/8"	0.95	1.48	40/240	.15	65162	----
64163	----	1/2"	1.10	1.59	60/180	.22	65163	----
64164	----	3/4"	1.28	1.85	35/105	.39	65164	----
64165	----	1"	1.47	2.10	35/105	.60	65165	----
64166	----	1-1/4"	1.75	2.57	25/50	.95	65166	----
64167	----	1-1/2"	1.90	2.63	9/27	1.37	65167	----
64168	----	2"	2.21	3.19	8/16	2.25	65168	----
64169	----	2-1/2"	2.65	3.78	5/10	3.32	65169	----
64170	----	3"	3.02	4.42	4/8	5.27	65170	----
64171	----	4"	3.72	5.57	2/4	8.94	65171	----

WARNING: This product can expose you to chemicals, including Nickel, which are known to the State of California to cause cancer. For more information, visit www.P65Warnings.ca.gov

BLACK AND GALVANIZED IRON #150

NIPPLES AND FITTINGS

ELBOWS 45°

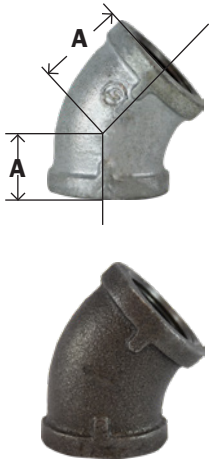

PART # GALVANIZED		SIZE	A	BOX/ CASE	APPROX. WT. LBS.	PART # BLACK	
64180	----	1/8"	0.63	50/600	.07	65180	----
64181	----	1/4"	0.73	30/360	.10	65181	----
64182	----	3/8"	0.80	75/300	.14	65182	----
64183	----	1/2"	0.88	50/200	.21	65183	----
64184	----	3/4"	0.98	40/120	.33	65184	----
64185	----	1"	1.12	20/60	.50	65185	----
64186	----	1-1/4"	1.29	20/40	.74	65186	----
64187	----	1-1/2"	1.43	10/30	1.01	65187	----
64188	----	2"	1.68	12/24	1.53	65188	----
64189	----	2-1/2"	1.95	9/18	2.78	65189	----
64190	----	3"	2.17	1/10	4.49	65190	----
64191	----	4"	2.61	2/4	7.44	65191	----
64192	----	6"	3.46	1/1	18.63	65192	----
		8"			26.40	65194	----

45° STREET ELBOWS

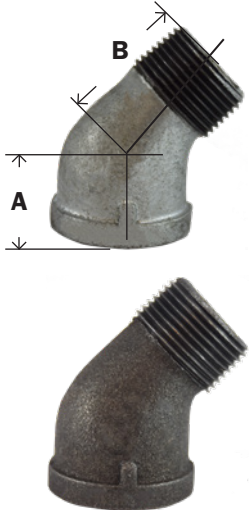

PART # GALVANIZED		SIZE	A	B	BOX/ CASE	APPROX. WT. LBS.	PART # BLACK	
64200	----	1/8"	0.63	0.83	70/840	.05	65200	----
64201	----	1/4"	0.73	0.94	40/480	.09	65201	----
64202	----	3/8"	0.80	1.03	100/400	.14	65202	----
64203	----	1/2"	0.86	1.30	75/225	.19	65203	----
64204	----	3/4"	0.96	1.48	40/120	.28	65204	----
64205	----	1"	1.10	1.69	25/75	.48	65205	----
64206	----	1-1/4"	1.26	1.87	10/40	.71	65206	----
64207	----	1-1/2"	1.40	2.05	10/30	1.02	65207	----
64208	----	2"	1.65	2.38	12/24	1.68	65208	----
64209	----	2-1/2"	1.95	2.72	6/12	2.69	65209	----
64210	----	3"	2.17	3.16	3/6	4.61	65210	----
64211	----	4"	2.61	3.90	2/4	7.74	65211	----

CROSSES

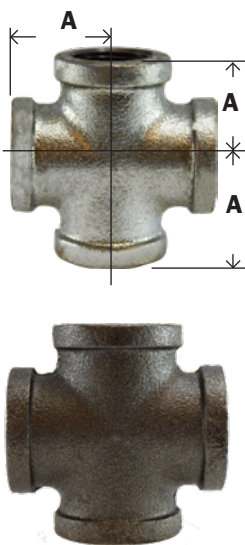

PART # GALVANIZED		SIZE	A	BOX/ CASE	APPROX. WT. LBS.	PART # BLACK	
64390	----	1/8"	0.65	50/600	.14	65390	----
64391	----	1/4"	0.80	60/240	.17	65391	----
64392	----	3/8"	0.95	50/150	.26	65392	----
64393	----	1/2"	1.12	30/90	.42	65393	----
64394	----	3/4"	1.31	20/60	.64	65394	----
64395	----	1"	1.50	15/30	.98	65395	----
64396	----	1-1/4"	1.75	10/20	1.45	65396	----
64397	----	1-1/2"	1.94	8/16	1.90	65397	----
64398	----	2"	2.25	5/10	2.96	65398	----
64399	----	2-1/2"	2.71	4/8	5.49	65399	----
64400	----	3"	3.06	2/4	7.71	65400	----
		4"		1/1	14.77	65401	----

WARNING: This product can expose you to chemicals, including Nickel, which are known to the State of California to cause cancer. For more information, visit www.P65Warnings.ca.gov



BLACK AND GALVANIZED IRON #150

NIPPLES AND FITTINGS

TEES

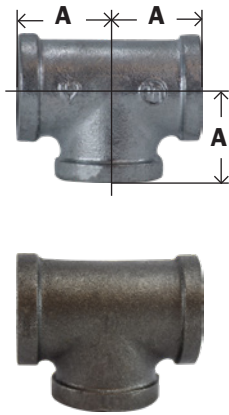

PART # GALVANIZED		SIZE	A	BOX/CASE	APPROX. WT. LBS.	PART # BLACK	
64250	----	1/8"	0.69	120/480	.11	65250	----
64251	----	1/4"	0.81	75/300	.15	65251	----
64252	----	3/8"	0.95	45/180	.22	65252	----
64253	----	1/2"	1.12	40/120	.36	65253	----
64254	----	3/4"	1.31	35/70	.48	65254	----
64255	----	1"	1.50	20/40	.83	65255	----
64256	----	1-1/4"	1.75	14/28	1.29	65256	----
64257	----	1-1/2"	1.94	12/24	1.66	65257	----
64258	----	2"	2.26	8/16	2.50	65258	----
64259	----	2-1/2"	2.70	4/8	4.45	65259	----
64260	----	3"	3.08	1/6	6.72	65260	----
64261	----	4"	3.79	1/2	11.31	65261	----
64262	----	6"	5.13	1/1	30.75	65262	----
		8"			37.85	65264	----

REDUCING TEES (SAME SIZE ON RUN, REDUCING ON BRANCH)

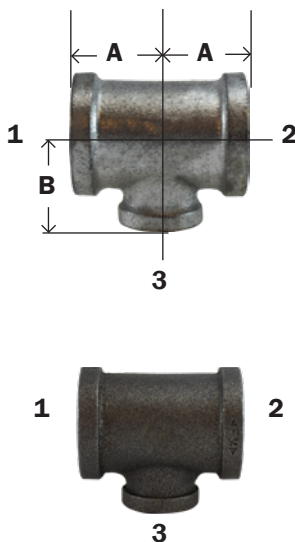

PART # GALVANIZED		SIZE (1&2) X 3	A	B	BOX/CASE	APPROX. WT. LBS.	PART # BLACK	
64273	----	3/8" x 1/4"	0.81	0.90	25/300	.18	65273	----
64276	----	1/2" x 1/4"	0.97	0.98	40/160	.24	65276	----
64279	----	1/2" x 3/8"	1.04	1.03	40/160	.35	65279	----
64282	----	3/4" x 1/4"	1.05	1.08	25/100	.43	65282	----
64283	----	3/4" x 3/8"	1.12	1.13	25/100	.39	65283	----
64286	----	3/4" x 1/2"	1.20	1.18	20/80	.49	65286	----
64268	----	1" x 1/4"	1.11	1.22	20/80	.51	65268	----
64269	----	1" x 3/8"	1.18	1.27	15/60	.55	65269	----
64291	----	1" x 1/2"	1.26	1.40	15/60	.63	65291	----
64298	----	1" x 3/4"	1.37	1.45	12/48	.71	65298	----
64301	----	1-1/4" x 1/2"	1.34	1.45	20/40	.91	65301	----
64303	----	1-1/4" x 3/4"	1.45	1.62	20/40	.99	65303	----
64306	----	1-1/4" x 1"	1.58	1.66	20/40	1.07	65306	----
64721	----	1-1/2" x 1/2"				1.12	65721	----
64316	----	1-1/2" x 3/4"	1.41	1.75	15/30	1.23	65316	----
64318	----	1-1/2" x 1"	1.65	1.88	10/30	1.33	65318	----
64322	----	1-1/2" x 1-1/4"	1.65	1.88	12/24	1.52	65322	----
64327	----	2" x 1/2"	1.49	1.88	10/20	1.64	65327	----
64328	----	2" x 3/4"	1.60	1.97	10/20	1.71	65328	----
64330	----	2" x 1"	1.73	2.02	10/20	1.88	65330	----
64334	----	2" x 1-1/4"	1.86	2.06	8/16	2.03	65334	----
64336	----	2" x 1-1/2"	1.98	2.12	8/16	2.22	65336	----
		2-1/2" x 1"				2.85	65342	----
64343	----	2-1/2" x 1-1/2"	2.16	2.51	5/10	2.97	65343	----
64729	----	3" x 1"	2.00	2.00	3/6	4.15		
		3" x 1-1/2"				5.19	65359	----
64351	----	3" x 2"	2.52	2.89	3/6	5.35	65351	----

BULLHEAD TEES

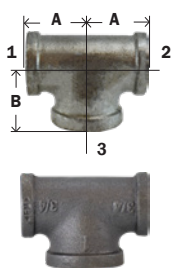

PART # GALVANIZED		SIZE (1&2) X 3	A	B	BOX/CASE	APPROX. WT. LBS.	PART # BLACK	
64280	----	1/2" x 3/4"	1.22	1.20	30/120	.4	65280	----
64733	----	1/2" x 1"	1.36	1.26	25/100	.50	65733	----
64289	----	3/4" x 1"	1.45	1.37	20/120	.60	65289	----
64299	----	1" x 1-1/4"	1.67	1.58	15/30	.96	65299	----
64300	----	1" x 1-1/2"	1.80	1.65	9/36	1.11	65300	----
64317	----	1-1/4" x 1-1/2"	1.88	1.82	12/24	1.07	65317	----
64319	----	1-1/2" x 2"	2.12	1.98	8/32	2.10	65-319	----
65335		2" x 1 1/4" x 2"						

BLACK AND GALVANIZED IRON #150

NIPPLES AND FITTINGS

NIPPLES & FITTINGS

REDUCING TEES REDUCING ON RUN

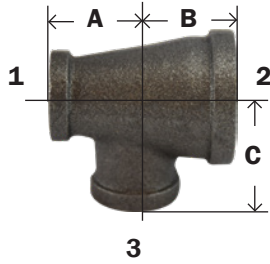

PART #	SIZE 1 X 2 X 3	A	B	C	BOX/ CASE	APPROX. WT. LBS.		PART # BLACK
64287	3/4" x 1/2" x 1/2"	1.18	1.18	1.20	25/100	0.39	----	65287
64288	3/4" x 1/2" x 3/4"	1.28	1.20	1.28	20/80	0.49	----	65288
	1" x 1/2" x 1/2"	1.31	1.22	1.31	20/80	0.51	----	65292
	1" x 1/2" x 3/4"	1.22	1.37	1.45	20/80	0.53	----	65293
64294	1" x 1/2" x 1"	1.40	1.50	1.50	15/60	0.54	----	65294
	1" x 3/4" x 1/2"	1.20	1.26	1.40	20/80	0.58	----	65295
64296	1" x 3/4" x 3/4"	1.34	1.28	1.42	15/60	0.63	----	65296
64297	1" x 3/4" x 1"	1.45	1.50	1.50	15/60	0.62	----	65297
	1-1/4" x 1/2" x 1/2"							65304
	1-1/4" x 1/2" x 1"							65311
	1-1/4" x 1/2" x 1 1/4"							65314
	1-1/4" x 3/4" x 3/4"	1.31	1.45	1.64	10/40	0.66	----	65347
	1-1/4" x 3/4" x 1"							65348
	1-1/4" x 3/4" x 1-1/4"	1.62	1.75	1.75	10/40	1.14	----	65305
64309	1-1/4" x 1" x 1"	1.55	1.47	1.63	20/40	1.00	----	65309
	1-1/4" x 3/4" x 1/2"	1.31	1.45	1.64	20/40	1.05	----	65346
	1-1/4" x 1" x 1/2"	1.26	1.34	1.53	20/40	1.10	----	65349
	1-1/4" x 1" x 3/4"						----	65350
	1-1/4" x 1" x 1-1/4"	1.30	1.36	1.44	15/30	1.21	----	65310
	1-1/2" x 3/4" x 1-1/2"							65281
64372	1-1/2" x 1" x 1"	1.50	1.65	1.78	15/30	1.28	----	65372
	1-1/2" x 1" x 1-1/2"							65323
	1-1/2" x 1-1/4" x 3/4"	1.43	1.52	1.25	15/30	1.30	----	65375
	1-1/2" x 1 1/4" x 1"							65325
	1-1/2" x 1-1/4" x 1-1/4"	1.75	1.82	1.88	15/30	1.35	----	65377
	2" x 3/4" x 2"						----	65267
	2" x 1" x 2"							65332
	2" x 1-1/4" x 1 1/4"							65302
	2" x 1-1/4" x 2"							65335
	2" x 1-1/2" x 1-1/4"	1.82	1.90	2.10	10/30	1.21	----	65312
	2" x 1-1/2" x 1-1/2"	1.94	2.02	2.16	10/30	1.79	----	65313

• SEE MIDLANDINDUSTRIES.COM FOR GALVANIZED REDUCING TEE & MORE BLACK SIZES

MALLEABLE SERVICE TEE (STREET TEE)

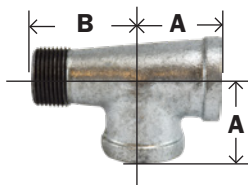

PART # GALVANIZED		SIZE	A	B	BOX/ CASE	APPROX. WT. LBS.	PART # BLACK	
64363	----	1/2"	1.12	1.62	40/12	0.31	65363	----
64364	----	3/4"	1.31	1.89	25/75	0.49	65364	----

SIDE OUTLET TEES

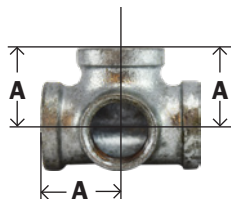

PART # GALVANIZED		SIZE	A	BOX/ CASE	APPROX. WT. LBS.	PART # BLACK	
64383	----	1/2"	1.12	25/100	.39	65383	----
64384	----	3/4"	1.31	15/60	.58	65384	----
64385	----	1"	1.50	20/40	.88	65385	----
64386	----	1-1/4"	1.75	12/24	1.32	65386	----
		1-1/2"	1.97	1/1	1.56	65387	----
		2"	2.29	1/1	1.81	65388	----

WARNING: This product can expose you to chemicals, including Nickel, which are known to the State of California to cause cancer. For more information, visit www.P65Warnings.ca.gov

BLACK AND GALVANIZED IRON #150

NIPPLES AND FITTINGS

COUPLINGS

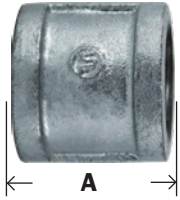

PART # GALVANIZED		SIZE	A	BOX/ CASE	APPROX. WT. LBS.	PART # BLACK	
64410	----	1/8"	0.96	70/840	.07	65410	----
64411	----	1/4"	1.06	40/480	.09	65411	----
64412	----	3/8"	1.16	40/480	.13	65412	----
64413	----	1/2"	1.34	60/240	.19	65413	----
64414	----	3/4"	1.52	50/150	.28	65414	----
64415	----	1"	1.67	25/100	.45	65415	----
64416	----	1-1/4"	1.93	16/64	.66	65416	----
64417	----	1-1/2"	2.15	18/36	.84	65417	----
64418	----	2"	2.54	12/24	1.39	65418	----
64419	----	2-1/2"	2.88	8/16	2.42	65419	----
64420	----	3"	3.18	1/12	3.49	65420	----
64421	----	4"	3.69	3/6	5.81	65421	----
64422	----	6"	4.23	1/2	28.62	65422	----

REDUCING COUPLINGS



SEE MIDLANDINDUSTRIES.COM
FOR MORE SIZES

PART # GALVANIZED		SIZE	A	BOX/ CASE	APPROX. WT. LBS.	PART # BLACK	
64430	----	1/4" x 1/8"	1.00	50/600	.07	65430	----
64431	----	3/8" x 1/8"	1.13	35/420	.09	65431	----
64432	----	3/8" x 1/4"	1.13	30/360	.11	65432	----
64433	----	1/2" x 1/8"	1.25	75/300	.13	65433	----
64434	----	1/2" x 1/4"	1.25	75/300	.11	65434	----
64435	----	1/2" x 3/8"	1.25	60/240	.15	65435	----
64439	----	3/4" x 1/8"	1.44	60/240	.18	65439	----
64436	----	3/4" x 1/4"	1.44	45/18	.19	65436	----
64437	----	3/4" x 3/8"	1.44	45/18	.21	65437	----
64438	----	3/4" x 1/2"	1.44	60/180	.25	65438	----
64459	----	1" x 1/4"	1.69	45/135	.34	65459	----
64440	----	1" x 3/8"	1.69	30/120	.35	65440	----
64441	----	1" x 1/2"	1.69	30/120	.36	65441	----
64442	----	1" x 3/4"	1.69	25/100	.39	65442	----
64460	----	1-1/4" x 3/8"	2.06	25/75	.55	65460	----
64444	----	1-1/4" x 1/2"	2.06	25/75	.53	65444	----
64445	----	1-1/4" x 3/4"	2.06	25/75	.57	65445	----
64446	----	1-1/4" x 1"	2.06	15/60	.61	65446	----
64443	----	1-1/2" x 3/8"	2.31	20/60	.71	65443	----
64447	----	1-1/2" x 1/2"	2.31	20/60	.69	65447	----
64448	----	1-1/2" x 3/4"	2.31	15/60	.71	65448	----
64449	----	1-1/2" x 1"	2.31	25/50	.78	65449	----
64450	----	1-1/2" x 1-1/4"	2.31	12/48	.87	65450	----
64458	----	2" x 1/2"	2.81	12/36	1.14	65458	----
64451	----	2" x 3/4"	2.81	12/36	1.14	65451	----
64452	----	2" x 1"	2.81	12/36	1.21	65452	----
64453	----	2" x 1-1/4"	2.81	9/27	1.19	65453	----
64454	----	2" x 1-1/2"	2.81	9/27	1.38	65454	----
		2 1/2" x 1"				65455	
		2 1/2" x 1 1/4"				65429	
64461	----	2-1/2" x 1-1/2"	3.25	20/40	2.07	65461	----
64462	----	2-1/2" x 2"	3.25	7/14	2.23	65462	----
		3" x 1"				65466	
		3" x 1-1/4"				65467	
64486	----	3" x 1-1/2"	3.69	6/12	3.23	65486	----
64456	----	3" x 2"	3.69	6/12	3.30	65456	----
64463	----	3" x 2-1/2"	3.69	5/10	3.55	65463	----
		4" x 1 1/2"				65468	
64464	----	4" x 2"	4.38	3/6	5.55	65464	----
64465	----	4" x 2-1/2"	4.38	3/6	5.90	65465	----
64457	----	4" x 3"	4.38	3/6	6.05	65457	----
		6" x 4"	4.24	1/2	10.86	65491	----

WARNING: This product can expose you to chemicals, including Nickel, which are known to the State of California to cause cancer. For more information, visit www.P65Warnings.ca.gov

BLACK AND GALVANIZED IRON #150

NIPPLES AND FITTINGS

HEX BUSHING



Hex



SEE MIDLANDINDUSTRIES.COM
FOR MORE SIZES



* INSIDE HEX

NOTE: ADD DT TO THE
PART# FOR A DOUBLE-
TAPPED BUSHING

PART #		SIZE	A	HEX	BOX/ CASE	APPROX. WT. LBS.	PART #	
GALVANIZED		M X F					BLACK	
64500	----	*1/4" x 1/8"	0.79	0.67	1/25	.03	65500	----
64501	----	*3/8" x 1/8"	0.79	0.75	1/25	.06	65501	----
64502	----	*3/8" x 1/4"	0.79	0.75	1/25	.05	65502	----
64503	----	1/2" x 1/8"	0.84	1.03	150/600	.09	65503	----
64504	----	1/2" x 1/4"				.08	65504	----
64505	----	1/2" x 3/8"	0.75	1.03	150/600	.07	65505	----
64506	----	3/4" x 1/8"	0.85	1.15	75/300	.14	65506	----
64507	----	3/4" x 1/4"	0.85	1.15	75/300	.13	65507	----
64508	----	3/4" x 3/8"	0.85	1.15	75/300	.12	65508	----
64509	----	3/4" x 1/2"	0.93	1.15	75/300	.10	65509	----
		1" x 1/8"					65557	
64510*	----	1" x 1/4"	1.13	1.12	50/200	.20	65510*	----
64511*	----	1" x 3/8"	1.13	1.12	50/200	.18	65511*	----
64512	----	1" x 1/2"	1.10	1.42	50/200	.21	65512	----
64513	----	1" x 3/4"	1.10	1.42	50/200	.17	65513	----
64514*	----	1-1/4" x 1/4"	1.24	1.12	30/120	.29	65514*	----
64515*	----	1-1/4" x 3/8"	1.24	1.12	30/120	.29	65515*	----
64516*	----	1-1/4" x 1/2"	1.24	1.24	30/120	.31	65516*	----
64517	----	1-1/4" x 3/4"	1.08	1.76	30/120	.35	65517	----
64518	----	1-1/4" x 1"	1.08	1.76	30/120	.29	65518	----
64519*	----	1-1/2" x 1/4"	1.30	1.12	25/75	.40	65519*	----
64520*	----	1-1/2" x 3/8"	1.30	1.12	25/75	.38	65520*	----
64521*	----	1-1/2" x 1/2"	1.30	1.34	25/75	.38	65521*	----
64522*	----	1-1/2" x 3/4"	1.30	1.44	25/75	.40	65522*	----
64523	----	1-1/2" x 1"	1.23	2.00	25/75	.45	65523	----
64524	----	1-1/2" x 1-1/4"	1.23	2.00	25/75	.34	65524	----
64526	----	2" x 1/4"	1.29	1.12	20/60	.57	65526	----
64525*	----	2" x 3/8"	1.28	1.12	20/60	.57	65525*	----
64527*	----	2" x 1/2"	1.39	1.34	20/60	.57	65527*	----
64528*	----	2" x 3/4"	1.39	1.63	20/60	.63	65528*	----
64529*	----	2" x 1"	1.39	1.77	20/60	.66	65529*	----
64530	----	2" x 1-1/4"	1.50	2.48	20/60	.74	65530	----
64531	----	2" x 1-1/2"	1.50	2.48	20/60	.61	65531	----
64546*	----	2-1/2" x 1/2"	1.51	1.34	15/30	.97	65546*	----
64547*	----	2-1/2" x 3/4"	1.51	1.63	15/30	.91	65547*	----
64532*	----	2-1/2" x 1"	1.51	1.95	15/30	.97	65532*	----
64533*	----	2-1/2" x 1-1/4"	1.51	2.39	15/30	1.03	65533*	----
64534	----	2-1/2" x 1-1/2"	1.51	2.98	15/30	1.16	65534	----
64535	----	2-1/2" x 2"	1.54	2.98	15/30	1.01	65535	----
64550	----	3" x 1"	1.61	1.95	12/24	1.41	65550	----
64549*	----	3" x 1-1/4"	1.61	2.39	12/24	1.42	65549*	----
64537*	----	3" x 1-1/2"	1.61	2.68	12/24	1.51	65537*	----
64538	----	3" x 2"	1.61	3.86	12/24	1.71	65538	----
64539	----	3" x 2-1/2"	1.61	3.86	12/24	1.68	65539	----
		3-1/2" x 3"	1.86	4.20	5/10	2.17	65555	----
64551	----	4" x 3/4"	2.15	4.90	5/10	3.88	65551	----
64553*	----	4" x 1"	2.00	4.75	5/10	3.79	65553*	----
64552	----	4" x 1-1/4"	1.82	2.39	5/10	2.39	65552	----
64540	----	4" x 1-1/2"	1.82	2.68	5/10	2.39	65540	----
64541*	----	4" x 2"	1.82	3.31	5/10	2.52	65541*	----
64542*	----	4" x 2-1/2"	2.06	3.87	5/10	2.87	65542*	----
64543	----	4" x 3"	2.17	4.96	5/10	2.95	65543	----
		5" x 4"	2.16	5.34	2/4	6.80	65544	----
64544		6" x 2"					65558	
64549		6" x 3"					65559	
64545*	----	6" x 4"	2.33	5.79	2/4	7.11	65545*	----
		6" x 5"			2/4		65560	

WARNING: This product can expose you to chemicals, including Nickel, which are known to the State of California to cause cancer.
 For more information, visit www.P65Warnings.ca.gov



BLACK AND GALVANIZED IRON #150

NIPPLES AND FITTINGS

UNIONS

• Brass Seat



PART # GALVANIZED		SIZE	A	BOX/ CASE	APPROX. WT. LBS.	PART # BLACK	
64600	----	1/8"	1.26	60/240	.17	65600	----
64601	----	1/4"	1.44	20/240	.25	65601	----
64602	----	3/8"	1.61	40/160	.37	65602	----
64603	----	1/2"	1.72	50/100	.52	65603	----
64604	----	3/4"	1.94	35/70	.78	65604	----
64605	----	1"	2.06	20/40	1.18	65605	----
64606	----	1-1/4"	2.26	15/30	1.64	65606	----
64607	----	1-1/2"	2.41	10/20	2.08	65607	----
64608	----	2"	2.75	6/12	3.24	65608	----
64609	----	2-1/2"	3.22	4/8	5.31	65609	----
64610	----	3"	3.50	4/8	6.94	65610	----
64611	----	4"	3.85	2/4	12.02	65611	----

SQUARE HEAD PLUGS • Cored

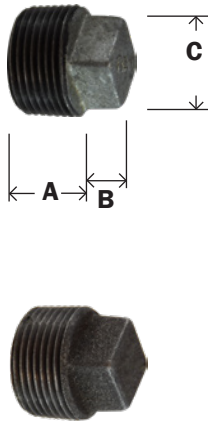

PART # GALVANIZED		SIZE	A	B	C	BOX/ CASE	APPROX. WT. LBS.	PART # BLACK	
		*1/8"	0.41	0.23	0.30	1/25	.02	65650	----
64651	----	*1/4"	0.48	0.28	0.38	1/25	.03	65651	----
64652	----	*3/8"	0.53	0.31	0.43	1/25	.04	65652	----
64653	----	1/2"	0.58	0.38	0.56	50/600	.08	65653	----
64654	----	3/4"	0.65	0.44	0.63	30/360	.13	65654	----
64655	----	1"	0.75	0.50	0.82	20/240	.22	65655	----
64656	----	1-1/4"	0.82	0.56	0.94	40/120	.33	65656	----
64657	----	1-1/2"	0.85	0.62	1.13	30/90	.41	65657	----
64658	----	2"	0.91	0.68	1.31	20/60	.68	65658	----
64659	----	2-1/2"	1.26	0.74	1.50	16/64	.89	65659	----
64660	----	3"	1.16	0.80	1.69	16/32	1.68	65660	----
64661	----	4"	1.22	1.00	2.28	6/12	3.02	65661	----
		6"	1.85	1.13	5.97	5/10	11.41	65662	----
		8"				1/1		65664	----

CAPS



PART # GALVANIZED		SIZE	A	BOX/ CASE	APPROX. WT. LBS.	PART # BLACK	
64470	----	1/8"	0.55	1/25	.03	65470	----
64471	----	1/4"	0.62	80/960	.07	65471	----
64472	----	3/8"	0.74	60/720	.08	65472	----
64473	----	1/2"	0.87	75/300	.13	65473	----
64474	----	3/4"	0.97	40/160	.18	65474	----
64475	----	1"	1.16	25/100	.30	65475	----
64476	----	1-1/4"	1.28	20/80	.47	65476	----
64477	----	1-1/2"	1.33	18/54	.66	65477	----
64478	----	2"	1.45	12/36	.99	65478	----
64479	----	2-1/2"	1.70	20/40	1.58	65479	----
64480	----	3"	1.80	12/24	2.51	65480	----
64481	----	4"	2.08	6/12	4.09	65481	----
64482	----	6"	2.55	2/4	5.18	65482	----

* Use steel fittings for smaller sizes. See Steel Fittings for Galvanized and Black Steel Fittings.

WARNING: This product can expose you to chemicals, including Nickel, which are known to the State of California to cause cancer. For more information, visit www.P65Warnings.ca.gov

NIPPLES & FITTINGS

BLACK AND GALVANIZED IRON #150

NIPPLES AND FITTINGS

LATERAL Ys

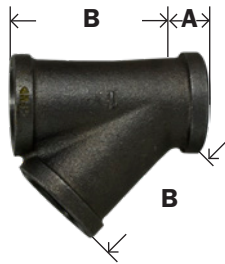

PART #	SIZE	A	B	CASE	WEIGHT		PART #
64963	1/2	2.32	1.71	120	.35	----	65963
64964	3/4	2.77	2.05	60	.58	----	65964
	1	3.28	2.42	40	.97	----	65965
	1-1/4	3.94	2.92	24	1.44	----	65966
	1-1/2	4.38	3.28	16	1.93	----	65967
64968	2	5.41	3.98	8	3.12	----	65968
	2-1/2	6.25	4.73	4	5.61	----	65969
	3	7.26	5.55	2	8.36	----	65970
	4	8.98	6.97	2	14.88	----	65971

LOCKNUTS

*Straight Thread

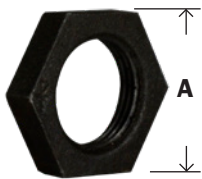

PART #		SIZE	A	THICK- NESS	BOX/ CASE	WEIGHT	PART #	
GALV			HEX				BLACK	
64703	----	1/2		0.31	150/600	0.08	65703	----
64704	----	3/4		0.34	90/360	0.13	65704	----
64705	----	1		0.38	60/240	0.19	65705	----
64706	----	1-1/4		0.42	45/180	0.27	65706	----
64707	----	1-1/2		0.47	45/135	0.47	65707	----
64708	----	2		0.53	25/75	0.56	65708	----

RIGHT & LEFT COUPLINGS

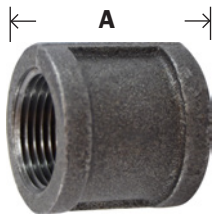

PART #		SIZE	A	CASE	WEIGHT	PART #	
GALV						BLACK	
64573	----	1/2	1.34	240	0.19	65573	----
64574	----	3/4	1.52	150	0.28	65574	----
64575	----	1	1.67	100	0.45	65575	----
64576	----	1-1/4	1.93	64	0.66	65576	----
64577	----	1-1/2	2.15	36	0.84	65577	----
64578	----	2	2.53	24	1.39	65578	----

SIDE OUTLET ELBOW

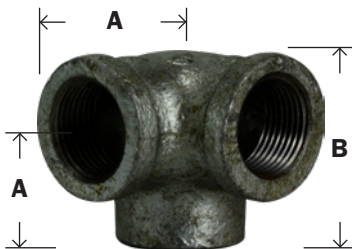

PART #		SIZE	A	B	CASE	PART #	
GALV						BLACK	
64583	----	1/2	1.10		135	65583	----
64584	----	3/4	1.30		80	65584	----
64585	----	1	1.50		40	65585	----
64586	----	1-1/4	1.77		30	65586	----
64587	----	1-1/2	1.97		24	65587	----
64588	----	2	2.29		10	65588	----



HELP US HELP YOU! GO ONLINE TO UPDATE YOUR CUSTOMER PROFILE SO THAT WE CAN UPDATE ALL THE APPROPRIATE DEPARTMENTS AND PERSONNEL AT YOUR COMPANY ON NEW CATALOGS, PRICING UPDATES, NEW MARKETING TOOLS, AND OTHER IMPORTANT INFORMATION. THANK YOU!

WARNING: This product can expose you to chemicals, including Nickel, which are known to the State of California to cause cancer. For more information, visit www.P65Warnings.ca.gov



BLACK AND GALVANIZED IRON #150

NIPPLES AND FITTINGS

FLOOR FLANGES

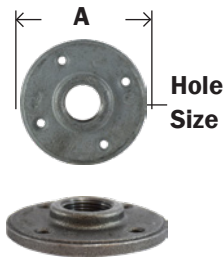

PART #	GALVANIZED	SIZE	A	THICKNESS	HOLE SIZE	BOX/CASE	APPROX. WT. LBS.	PART # BLACK
		1/4"						65691
		3/8"						65690
64692	----	1/2"	3.50	0.50	0.25	25/100	.63	65692 ----
64693	----	3/4"	3.50	0.63	0.25	15/45	.73	65693 ----
64694	----	1"	4.00	0.69	0.25	15/45	1.02	65694 ----
64695	----	1-1/4"	4.00	0.75	0.25	15/30	1.00	65695 ----
64696	----	1-1/2"	4.50	0.87	0.31	8/24	1.37	65696 ----

EXTENSION FIP X MIP



PART #	SIZE	APPROX. WT. LBS.	BOX/CASE
65621	1/2"	0.12	75 / 300
65622	3/4"	0.23	40 / 160

MUSHROOM VENT CAP



PART #	SIZE
21174	3/4"
21175	1"
21176	1-1/2"
21177	1-1/2"
21178	2"
21179	3"
21180	4"

More sizes available - see website

Cast Iron Galvanized Threaded Cap. 30 Mesh screen. Protects against driving rain, snow, sleet and insects.

DOUBLE TAPPED BUSHINGS



PART #	SIZE
65518DT	1-1/4" x 1"
65522DT	1-1/2" x 3/4"
65523DT	1-1/2" x 1"
65527DT	2" x 1/2"
65528DT	2" x 3/4"
65529DT	2" x 1"
65530DT	2" x 1 1/4"
65531DT	2" x 1-1/2"
65541DT	4" x 2"

SEE MIDLANDINDUSTRIES.COM FOR:



DUPLEX TANK BUSHINGS



WASTE NUT

WARNING: This product can expose you to chemicals, including Nickel, which are known to the State of California to cause cancer. For more information, visit www.P65Warnings.ca.gov

NIPPLES & FITTINGS

STEEL FITTINGS

NIPPLES AND FITTINGS

STEEL FITTINGS

This will certify that the material was manufactured in accordance with ASME B16.14 - 1991 Standards. All Threads are Dryseal (NPTF) - 3/4 inch taper per foot and are made of Carbon Steel 12L14. Pressure rating: 150/300 PSI

- Clear Zinc plating specifications ASTM B633-07
- Federal Specification QQ-Z-325 (Zinc Plate)
- Type III with supplemental clear Trivalent chromate
- .00015" Zinc (Minimum)
- ROHS Compliant
- Lead Free

HEX BUSHINGS



PART # ZINC		SIZE M X F	A	HEX	APPROX. WT. LBS.	PART # BLACK	
66500	----	1/4" x 1/8"	0.63	0.62	0.02	67500	----
66501	----	3/8" x 1/8"	0.66	0.68	0.04	67501	----
66502	----	3/8" x 1/4"	0.66	0.68	0.02	67502	----
66503	----	1/2" x 1/8"	0.80	0.87	0.10	67503	----
66504	----	1/2" x 1/4"	0.80	0.87	0.08	67504	----
66505	----	1/2" x 3/8"	0.80	0.87	0.06	67505	----
66506	----	3/4" x 1/8"	0.94	1.06	0.18	67506	----
66507	----	3/4" x 1/4"	0.94	1.06	0.14	67507	----
66508	----	3/4" x 3/8"	0.94	1.06	0.14	67508	----
66509	----	3/4" x 1/2"	0.94	1.06	0.10	67509	----
66510	----	1" x 1/4"	1.00	1.31	0.16	67510	----
66511	----	1" x 3/8"	1.00	1.31	0.26	67511	----
66512	----	1" x 1/2"	1.00	1.31	0.22	67512	----
66513	----	1" x 3/4"	1.00	1.31	0.14	67513	----

FACE BUSHING

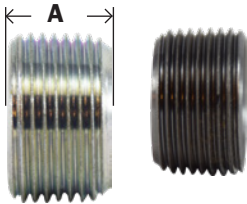

PART # ZINC		SIZE M X F	A	APPROX. WT. LBS.	PART # BLACK	
	----	1/4" x 1/8"	0.44	0.01	67700	----
	----	3/8" x 1/4"	0.48	0.02	67702	----
	----	1/2" x 1/4"	0.56	0.04	67704	----
66705	----	1/2" x 3/8"	0.56	0.04	67705	----
	----	3/4" x 3/8"	0.62	0.10	67708	----
66709	----	3/4" x 1/2"	0.62	0.10	67709	----
	----	1" x 3/4"	0.75	0.16	67713	----

CAPS

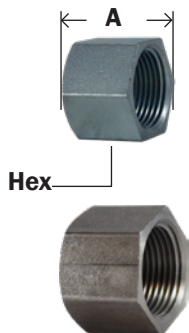

PART # ZINC		SIZE NPTF	A	HEX	APPROX. WT. LBS.	PART # BLACK	
66470	----	1/8"	0.53	0.56	0.02	67470	----
66471	----	1/4"	0.63	0.62	0.04	67471	----
66472	----	3/8"	0.69	0.81	0.06	67472	----
66473	----	1/2"	0.87	1.00	0.12	67473	----
66474	----	3/4"	0.97	1.18	0.16	67474	----
66475	----	1"	1.16	1.50	0.30	67475	----
	----	1-1/4"	1.28	2.00	0.68	67476	----
	----	1-1/2"	1.35	2.25	0.83	67477	----

WARNING: This product can expose you to chemicals, including Nickel, which are known to the State of California to cause cancer.
 For more information, visit www.P65Warnings.ca.gov

STEEL FITTINGS

NIPPLES AND FITTINGS

This will certify that the plugs are dimensional per SAE J531 MAY 95 Standards. All threads are Dryseal (NPTF) - 3/4" Taper per foot and are made of SAE J403 Low Carbon Steel 1010 Cold headed.

SQUARE HEAD PLUGS

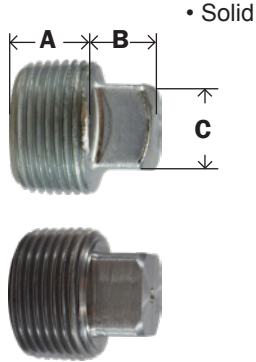

PART #		SIZE	A	B	C	APPROX.	PART #
ZINC		NPTF				WT. LBS.	BLACK
66670	----	1/8"	0.33	0.24	0.28	0.01	67670
66671	----	1/4"	0.45	0.28	0.37	0.02	67671
66672	----	3/8"	0.50	0.31	0.43	0.04	67672
66653	----	1/2"	0.59	0.38	0.55	0.12	67653
66654	----	3/4"	0.63	0.44	0.62	0.18	67654
66655	----	1"	0.75	0.5	0.81	0.34	67655
66656	----	1-1/4"	0.80	0.56	0.93	0.62	67656
66657	----	1-1/2"	0.83	0.62	1.12	0.82	67657
66658	----	2"	0.88	0.68	1.31	1.36	67658

HEX HEAD PLUGS



PART #		SIZE	A	HEX	APPROX.	PART #
ZINC		NPTF			WT. LBS.	BLACK
66770	----	1/8"	0.55	0.43	0.01	67770
66771	----	1/4"	0.74	0.56	0.04	67771
66772	----	3/8"	0.67	0.68	0.06	67772
66773	----	1/2"	0.80	0.70	0.12	67773
66774	----	3/4"	0.94	1.06	0.18	67774
66775	----	1"	1.00	1.31	0.22	67775
66776	----	1-1/4"	1.17	1.75	0.7	67776
66777	----	1-1/2"	1.51	2.00	1.2	67777
66778	----	2"	1.65	2.50	2.06	67778

COUNTERSUNK PLUG - Square Socket



PART #		SIZE	A	SOCKET	APPROX.	PART #
ZINC		NPTF		SIZE	WT. LBS.	BLACK
66630	----	1/8"	0.29	0.19	0.01	67630
66631	----	1/4"	0.45	0.25	0.02	67631
66632	----	3/8"	0.45	0.31	0.04	67632
66633	----	1/2"	0.59	0.38	0.08	67633
66634	----	3/4"	0.60	0.50	0.12	67634
66635	----	1"	0.75	0.50	0.16	67635
66636	----	1-1/4"	0.80	0.75	0.32	67636
66637	----	1-1/2"	0.83	0.75	0.45	67637
66638	----	2"	0.88	0.875	2.06	67638

COUNTERSUNK PLUG - Hex Socket



PART #		SIZE	A	SOCKET	APPROX.	PART #
ZINC		NPTF		SIZE	WT. LBS.	BLACK
66760	----	1/16"	0.29	0.15	0.01	67760
66761	----	1/8"	0.29	0.18	0.01	67761
66762	----	1/4"	0.44	0.25	0.02	67762
66763	----	3/8"	0.44	0.31	0.04	67763
66764	----	1/2"	0.59	0.37	0.08	67764
66765	----	3/4"	0.60	0.56	0.14	67765
66766	----	1"	0.75	0.625	0.22	67766
66767	----	1-1/4"	0.80	0.75	0.37	67767
66768	----	1-1/2"	0.83	1.0	0.45	67768
66769	----	2"	0.88	1.0	0.86	67769

• Slotted and Flush plugs available upon request

WARNING: This product can expose you to chemicals, including Nickel, which are known to the State of California to cause cancer. For more information, visit www.P65Warnings.ca.gov

BLACK EXTRA HEAVY 300# IRON

NIPPLES AND FITTINGS

300# MALLEABLE

90° ELBOW



PART #	SIZE	
69101	1/4"	----
69102	3/8"	----
69103	1/2"	----
69104	3/4"	----
69105	1"	----
69106	1-1/4"	----
69107	1-1/2"	----
69108	2"	----

45° ELBOW



PART #	SIZE	
69181	1/4"	----
69182	3/8"	----
69183	1/2"	----
69184	3/4"	----
69185	1"	----
69186	1-1/4"	----
69187	1-1/2"	----
69188	2"	----

90° STREET ELBOW



PART #	SIZE	
69161	1/4"	----
69162	3/8"	----
69163	1/2"	----
69164	3/4"	----
69165	1"	----
69166	1-1/4"	----
69167	1-1/2"	----
69168	2"	----

TEE



PART #	SIZE	
69252	3/8"	----
69253	1/2"	----
69254	3/4"	----
69255	1"	----
69256	1-1/4"	----
69257	1-1/2"	----
69258	2"	----

COUPLING



PART #	SIZE	
69411	1/4"	----
69412	3/8"	----
69413	1/2"	----
69414	3/4"	----
69415	1"	----
69416	1-1/4"	----
69417	1-1/2"	----
69418	2"	----

SEE MIDLANDINDUSTRIES.COM FOR MORE SIZES AND GALVANIZED



SEE WEBSITE TO DOWNLOAD YOUR MOST UPDATED PRICING

WARNING: This product can expose you to chemicals, including Nickel, which are known to the State of California to cause cancer. For more information, visit www.P65Warnings.ca.gov

BLACK EXTRA 300# IRON

NIPPLES AND FITTINGS

REDUCING COUPLING



PART #	SIZE	
69432	3/8 x 1/4"	----
69434	1/2 x 1/4"	----
69435	1/2 x 3/8"	----
69438	3/4 x 1/2"	----
69441	1 x 1/2"	----
69442	1 x 3/4"	----

CAP



PART #	SIZE	
69471	1/4"	----
69472	3/8"	----
69473	1/2"	----
69474	3/4"	----
69475	1"	----
69476	1-1/4"	----
69477	1-1/2"	----
69478	2"	----

UNION

- Brass Seat



PART #	SIZE	
69600	1/8"	----
69601	1/4"	----
69602	3/8"	----
69603	1/2"	----
69604	3/4"	----
69605	1"	----
69606	1-1/4"	----
69607	1-1/2"	----
69608	2"	----

STEEL MAGNETIC PLUGS

Steel Magnetic Drain Plugs - NPT Threaded

Magnetic Drain Plugs are similar to standard pipe or straight thread drain plugs with one important difference - a permanent magnet is fastened to the plug body. This magnet attracts and holds abrasive, ferrous metal particles preventing their circulation through the lubrication or hydraulic system.

These abrasive, ferrous metal particles appear in lubricating or hydraulic systems as a result of the following conditions:

- The constant flaking effect of normal wear of moving parts.
- Particles not removed by flushing operations after boring or machining.
- Chipping due to sub-surface casting flaws.
- Minute component breakdown caused by stress usage.

Magnetic Drain Plugs prevent excessive wear to the system's components.

Magnetic Plugs are used by numerous manufacturers of gear boxes, transmissions, engines, and hydraulic systems for the automotive, aircraft, agricultural and machinery industries.

Typical applications include:

- Outboard Engines
- Earthmoving Equipment
- Combines
- Balers
- Crawler Tractors
- Lift Trucks
- Mining Equipment
- Military Vehicles
- Turbine Engines
- Truck Axles
- Heavy-Duty Transmissions

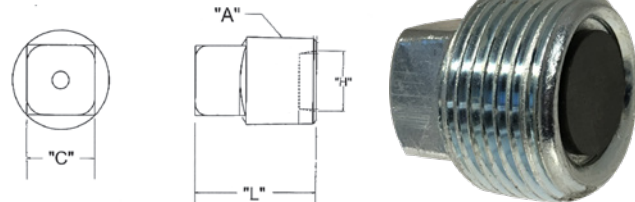

PART	SIZE "A"	HEAD WIDTH "C"	RECESS DIA. "H"	O/L LENGTH "L"	
28996	3/8 - 18	.428 - .440	.435 - .445	.805 - .860	----
28997	1/2 - 14	.553 - .565	.560 - .570	.970 - 1.04	----
28998	3/4 - 14	.615 - .627	.725 - .735	1.120 - 1.170	----
28999	1-11 1/2	.803 - .815	.895 - .905	1.25 - 1.33	----

WARNING: This product can expose you to chemicals, including Nickel, which are known to the State of California to cause cancer. For more information, visit www.P65Warnings.ca.gov

BULL PLUGS AND SWAGS

NIPPLES AND FITTINGS

BULL PLUGS AND SWAGES

STANDARD BULL PLUG

- Sch 40 150#
- Zinc plated



PART #	DESCRIPTION	
91008	2"	----
	2" w/ 1/2" TAP	----
	2-1/2"	----
	3"	----
	4"	----

XH BULL PLUG

- Made from sch. 80 pipe.
- Zinc plated
- Hollow



PART #	DESCRIPTION	
	1/4"	----
90002	3/8"	----
90003	1/2"	----
90004	3/4"	----
90005	1"	----
	1-1/4"	----
	1-1/2"	----
90008	2"	----
93001*	2"	----
90213	2" w/ 1/4" TAP	----
90212	2" w/ 1/2" TAP	----
93212*	2"XXH w/1/2" TAP	----
	2-1/2"	----
	3"	----
	3" w/ 1/2" TAP	----
90011	4"	----

* XXH

STANDARD SCH. 40 SWAGE

MIP X MIP

- Zinc plated



PART #	DESCRIPTION	
93113	1-1/4" x 1"	----
93121	2" x 1"	----
93122	2" x 1-1/4"	----
93123	2" x 1-1/2"	----
	2-1/2" x 2"	----
	3" x 1"	----
93127	3" x 1-1/2"	----
93128	3" x 2"	----
	3" x 2-1/2"	----
93130	4" x 2"	----
93131	4" x 3"	----
93139	6" x 3"	----

Pressure Ratings: Due to the wide variation in service conditions, temperature, vibrations, etc...Midland Industries can make no recommendations as to allowable working pressure of swage nipples and bull plugs. There are a number of working pressure formulas from which the end user may choose to determine the required wall thickness of the piping system. It is our responsibility only to furnish a fitting with end dimensions equal to those of the pipe size and schedule ordered.

WARNING: This product can expose you to chemicals, including Nickel, which are known to the State of California to cause cancer. For more information, visit www.P65Warnings.ca.gov

SWAGES

NIPPLES AND FITTINGS

SCH 80 XH SWAGES MIP X MIP



* Hex Style



XXH SWAGE



PART #	DESCRIPTION	
	1/4" x 1/8"	----
	1/2" x 1/4"	----
90103*	1/2" x 3/8"	----
90104*	3/8" x 1/4"	----
90105*	3/4" x 1/4"	----
90106*	3/4" x 3/8"	----
90107*	3/4" x 1/2"	----
	1" x 1/4"	----
	1" x 3/8"	----
90110*	1" x 1/2"	----
90111*	1" x 3/4"	----
90140	1-1/4" x 3/4"	----
90141	1-1/4" x 1"	----
90114	1-1/2" x 1/2"	----
90115	1-1/2" x 3/4"	----
90116	1-1/2" x 1"	----
90117	1-1/2" x 1-1/4"	----
	2" x 1/4"	----
90119	2" x 1/2"	----
90120	2" x 3/4"	----
90121	2" x 1"	----
90122	2" x 1-1/4"	----
90123	2" x 1-1/2"	----
	2-1/2" x 2"	----
	3" x 1"	----
90126	3" x 1-1/4"	----
90127	3" x 1-1/2"	----
90128	3" x 2"	----
	3" x 2-1/2"	----
	4" x 1"	----
90130	4" x 2"	----
90131	4" x 3"	----
90132	6" x 4"	----
	6" x 2"	----
	6" x 3"	----

PART #	DESCRIPTION	
	1/2" x 1/4"	----
	3/4" x 1/2"	----
	1" x 1/4"	----
	1" x 3/8"	----
92110*	1" x 1/2"	----
	1" x 3/4"	----
	1-1/2" x 1/2"	----
	1-1/2" x 3/4"	----
92116	1-1/2" x 1"	----
	2" x 1/2"	----
	2" x 3/4"	----
92121	2" x 1"	----
	2" x 1-1/4"	----
	2" x 1-1/2"	----
92128	3" x 2"	----

WARNING: This product can expose you to chemicals, including Nickel, which are known to the State of California to cause cancer. For more information, visit www.P65Warnings.ca.gov

FORGED STEEL FLANGES

NIPPLES AND FITTINGS

ASTMA105
ASME SA105
ANSI B16.5

CARBON STEEL FLANGES

• A105 Forged Steel • CLASS 150
(1-1/2 thru 6" available in #316 Stainless Steel add SS to part#)

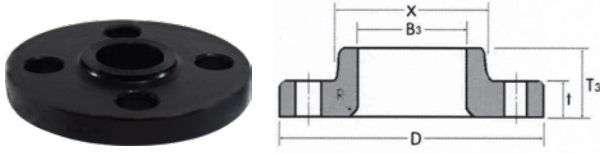

SLIP-ON 1/16" RAISED FACE CARBON STEEL FLANGE

PART #	SIZE	
	1/2"	----
	3/4"	----
	1"	----
	1-1/4"	----
107024	1-1/2"	----
107025	2"	----
107026	2-1/2"	----
107027	3"	----
107029	4"	----
107031	6"	----
107032	8"	----
	10"	----
	12"	----

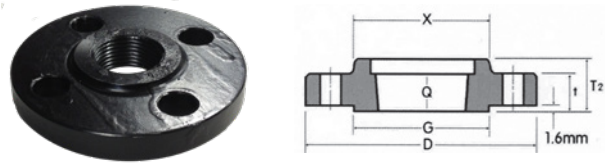

THREADED 1/16" RAISED FACE CARBON STEEL FLANGE

PART #	SIZE	
107060	1/2"	----
107061	3/4"	----
107062	1"	----
107063	1-1/4"	----
107064	1-1/2"	----
107065	2"	----
107066	2-1/2"	----
107067	3"	----
107069	4"	----
107071	6"	----
107072	8"	----
107073	10"	----
	12"	----

Nominal Pipe Size	Depth of Socket in. Y	Bolt Circle Diameter	Number of Holes	Diameter of Holes	Diameter of Bolts (inch)	Machine Bolt Length			Welding Neck LBS	Slip-on and Threaded LBS	Blind LBS
						Raised Face	Raised Face	Ring Joint			
1/2	.382	2.382	4	.618	1/2	2.00	2.252	-	1.146	1.036	1.036
3/4	.441	2.752	4	.618	1/2	2.00	2.50	-	2.028	1.653	1.389
1	.500	3.118	4	.618	1/2	2.252	2.50	3.00	2.425	1.893	2.094
1-1/4	.559	3.50	4	.618	1/2	2.252	2.752	3.252	3.086	3.086	3.086
1-1/2	.618	3.882	4	.618	1/2	2.50	2.752	3.252	3.99	3.109	3.571
2	.689	4.752	4	.752	5/8	2.752	3.252	3.752	6.173	4.982	5.82
2-1/2	.752	5.5	4	.752	5/8	3.00	3.50	4.00	9.436	7.562	8.951
3	.811	6.0	4	.752	5/8	3.00	3.50	4.00	11.42	8.818	11.023
4	.941	7.50	8	.752	5/8	3.00	3.50	4.00	16.138	12.677	16.535
6	1.059	9.50	8	.882	3/4	3.252	4.00	4.50	24.824	17.196	26.455
8	1.252	11.752	8	.882	3/4	3.50	4.252	4.752	39.683	28.66	44.092
10	1.311	14.252	12	1.00	7/8	4.00	4.50	5.00	55.116	37.699	66.139
12	1.559	17	12	1.00	7/8	4.00	4.752	5.252	85.936	61.024	97.003

WARNING: This product can expose you to chemicals, including Nickel, which are known to the State of California to cause cancer. For more information, visit www.P65Warnings.ca.gov

FORGED STEEL FLANGES

NIPPLES AND FITTINGS

ASTMA105
ASME SA105
ANSI B16.5

• A105 Forged Steel

• CLASS 150

(1-1/2 thru 6" available in #316 Stainless Steel add SS to part#)

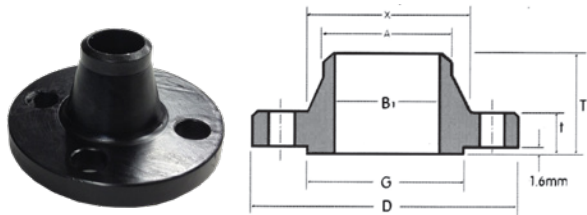

WELD NECK CARBON STEEL FLANGE

Part #	Size	
	1/2"	----
	3/4"	----
	1"	----
	1-1/4"	----
107004	1-1/2"	----
107005	2"	----
	2-1/2"	----
107007	3"	----
107009	4"	----
107011	6"	----
107012	8"	----
	10"	----
	12"	----

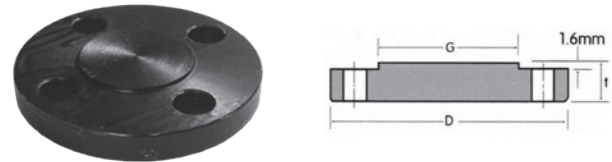

BLIND 1/16" RAISED FACE CARBON STEEL FLANGE

PART #	SIZE	
	1/2"	----
	3/4"	----
107042	1"	----
	1-1/4"	----
107044	1-1/2"	----
107045	2"	----
	2-1/2"	----
107047	3"	----
107049	4"	----
	6"	----
	8"	----
	10"	----
	12"	----

Nominal Pipe Size	Outside Diameter	O.D of Raised Face	Diameter at Base of Hub	Thickness	Welding Neck Socket Welding	Welding Neck	Slip-on Threaded Socket Welding
	D	G	X		T	B1	T1
1/2	3.504	1.382	1.189	.441	.618	1.882	.618
3/4	3.898	1.689	1.50	.50	.819	2.059	.618
1	4.252	2.00	1.941	.559	1.051	2.189	.689
1-1/4	4.606	2.50	2.311	.618	1.382	2.252	.811
1-1/2	5.00	2.882	2.559	.689	1.610	2.441	.882
2	5.984	3.618	3.059	.752	2.071	2.50	1.00
2-1/2	7.008	4.118	3.559	.882	2.469	2.752	1.118
3	7.52	5.00	4.252	.941	3.071	2.752	1.189
4	9.016	6.189	5.311	.941	4.031	3.00	1.311
6	10.984	8.50	7.559	1.00	6.071	3.50	1.559
8	13.504	10.618	9.689	1.118	7.980	4.00	1.752
10	15.984	12.752	12.00	1.189	10.02	4.00	1.941
12	19.016	15.00	14.382	1.252	12.00	4.50	2.189

WARNING: This product can expose you to chemicals, including Nickel, which are known to the State of California to cause cancer. For more information, visit www.P65Warnings.ca.gov



BLACK AND GALV. DUCTILE IRON REDUCING COMPANION FLANGES

NIPPLES AND FITTINGS

THREADED COMPANION FLANGE CLASS 125 PATTERN (BLACK & GALVANIZED)

- * DIMENSIONS, FACED AND DRILLED IN ACCORDANCE WITH ASME B16.42/AWWA C110
- * COATING: AVAILABLE IN BLACK ELECTROPHORETIC COATING AND HOT DIP GALVANIZED
- * HOT-DIPPED GALVANIZED CONFORM TO ASTM A153; COMPANION FLANGE THREADS CONFORM TO ASME B1.20.1
- * APPLICATION: WATERWORKS, PUMP, IRRIGATION
- * 150PSI

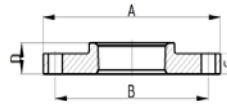

BLACK

PART #	DESCRIPTION (DI FLANGE)	A (INCH)	B (INCH)	C (INCH)	D (INCH)	BOLT HOLE SIZE	NO. OF HOLES	UNIT WEIGHT (KG)	
108075	3" x 2"	7.50	6.00	0.75	1.19	φ0.75	4	4.3827	----
108076	3" x 2-1/2"	7.50	6.00	0.75	1.19	φ0.75	4	4.2013	----
108077	4" x 1-1/2"	9.00	7.50	0.94	1.31	φ0.75	8	6.8352	----
108088	4" x 2"	9.00	7.50	0.94	1.31	φ0.75	8	6.4168	----
108089	4" x 2-1/2"	9.00	7.50	0.94	1.31	φ0.75	8	6.3343	----
108090	4" x 3"	9.00	7.50	0.94	1.31	φ0.75	8	6.081	----
108091	5" x 4"	10.00	8.50	0.94	1.44	φ0.875	8	6.8761	----
108094	6" x 2"	11.00	9.50	1.00	1.56	φ0.875	8	10.6349	----
108095	6" x 3"	11.00	9.50	1.00	1.56	φ0.875	8	10.1831	----
108092	6" x 4"	11.00	9.50	1.00	1.56	φ0.875	8	9.4563	----
108096	8" x 4"	13.50	11.75	1.12	1.75	φ0.875	8	17.1296	----
108097	8" x 6"	13.50	11.75	1.12	1.75	φ0.875	8	15.2184	----
108098	8" x 2"	16.00	14.25	1.19	1.94	φ1	12	26.54	----
108099									
108100									
108101									

GALVANIZED

108031	2-1/2" x 2"	6.00	4.75	0.75	1.19	φ0.75	4	3.623	
108032	3" x 2"	7.50	6.00	0.75	1.19	φ0.75	4	4.3827	
108033	3" x 2-1/2"	7.50	6.00	0.75	1.19	φ0.75	4	4.2013	----
108034	4" x 2"	9.00	7.50	0.94	1.31	φ0.75	8	6.4168	
108035	4" x 2-1/2"	9.00	7.50	0.94	1.31	φ0.75	8	6.3343	----
108036	4" x 3"	9.00	7.50	0.94	1.31	φ0.75	8	6.081	----
108038	6" x 2"	11.00	9.50	1.00	1.56	φ0.875	8	10.6349	----
108039	6" x 2-1/2"	11.00	9.50	1.00	1.56	φ0.875	8	10.5386	----
108037	6" x 4"	11.00	9.50	1.00	1.56	φ0.875	8	9.4563	----
108040	8" x 4"	13.50	11.75	1.12	1.75	φ0.875	8	17.1296	----
108041	8" x 6"	13.50	11.75	1.12	1.75	φ0.875	8	15.2184	

WARNING: This product can expose you to chemicals, including Nickel, which are known to the State of California to cause cancer. For more information, visit www.P65Warnings.ca.gov



BLACK AND GALVANIZED COMPANION FLANGES

NIPPLES AND FITTINGS

DUCTILE IRON THREADED COMPANION FLANGES

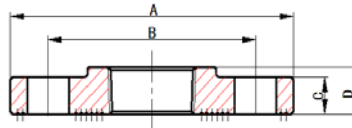

*DIMENSIONS, FACED AND DRILLED IN ACCORDANCE WITH ASME B16.42/AWWA C110

*COATING: AVAILABLE IN BLACK ELECTROPHORETIC COATING AND HOT DIP GALVANIZED

*HOT-DIPPED GALVANIZED CONFORM TO ASTM A153; COMPANION FLANGE THREADS CONFORM TO ASME B1.20.1

*APPLICATION: WATERWORKS, PUMP, IRRIGATION

BLACK

PART # (BLACK)	DESCRIPTION (THREADED)	SIZE (INCH)	A (INCH)	B (INCH)	C (INCH)	D (INCH)	BOLT HOLE SIZE	NO. OF HOLES	UNIT WEIGHT (KG)	
108062	1 150	1"	4.25	3.12	0.44	0.75	φ0.625	4	0.8347	----
108063	1 1/4 150	1-1/4"	4.62	3.5	0.5	0.81	φ0.625	4	1.0797	----
108064	1 1/2 150	1-1/2"	5	3.88	0.56	0.88	φ0.625	4	1.3217	----
108065	2 150	2"	6	4.75	0.62	1	φ0.75	4	2.1457	----
108066	2 1/2 150	2-1/2"	7	5.5	0.69	1.12	φ0.75	4	3.4182	----
108067	3 150	3"	7.5	6	0.75	1.19	φ0.75	4	3.9051	----
108069	4 150	4"	9	7.5	0.94	1.31	φ0.75	8	5.5254	----
108071	6 150	6"	11	9.5	1	1.56	φ0.875	8	7.5328	----
108072	8 150	8"	13.5	11.75	1.12	1.75	φ0.875	8	13.0201	----
108073	10 150	10"	16	14.25	1.19	1.94	φ1	12	22.854	----
108074	12 150	12"	19	17	1.25	2.19	φ1	12	26.5451	----

GALVANIZED

108025	2 150	2"	6	4.75	0.62	1	φ0.75	4	2.1457	----
108026	2 1/2 150	2-1/2"	7	5.5	0.69	1.12	φ0.75	4	3.4182	----
108027	3 150	3"	7.5	6	0.75	1.19	φ0.75	4	3.9051	----
108028	4 150	4"	9	7.5	0.94	1.31	φ0.75	8	5.5254	----
108029	6 150	6"	11	9.5	1	1.56	φ0.875	8	7.5328	----

BLIND FLANGES



PART # (BLACK)	DESCRIPTION (THREADED)	SIZE (INCH)	A (INCH)	B (INCH)	C (INCH)	BOLT HOLE SIZE	NO. OF HOLES	UNIT WEIGHT (KG)	
108065BF		2"	6	4.75	0.62	φ0.75	4	2.3731	
108067BF		3"	7.5	6	0.94	φ0.75	4	4.8547	
108069BF		4"	9	7.5	0.94	φ0.75	8	6.5341	
108071BF		5"	10	8.5	0.94	φ0.875	8	7.9894	
108070BF		6"	11	9.5	1	φ0.875	8	10.811	
108072BF		8"	13.5	11.75	1.12	φ0875	8	18.6264	
108073BF		10"	16	14.25	1.19	φ1	12	26.2487	

WARNING: This product can expose you to chemicals, including Nickel, which are known to the State of California to cause cancer. For more information, visit www.P65Warnings.ca.gov

WROT SOLDER JOINT

NIPPLES AND FITTINGS

COPPER FITTINGS



SYMBOL OF JOINT ENDS

- C** Solder joint fitting end made to receive copper tube diameter
 - Ftg.** Solder joint fitting end made to copper tube diameter
 - F** Internal ANSI Standard Taper Pipe Thread-Female
 - M** External ANSI Standard Taper Pipe Thread-Male
- Threaded ends ANSI/ ASME B1. Solder ends ASTM B88

- Temp range 32° to 200°F
- Pressure @100° - 1/8-1 : 500 PSI
- 1-1/4-2 : 400 PSI
- 2-1/2 - 3: 300 PSI

**NSF - 61 CERTIFIED
ALLOY C12200**

PRICING FILE AVAILABLE ONLINE

THE ABOVE CONFORMS TO ASTM B 88 & ASTM B 306, A 306

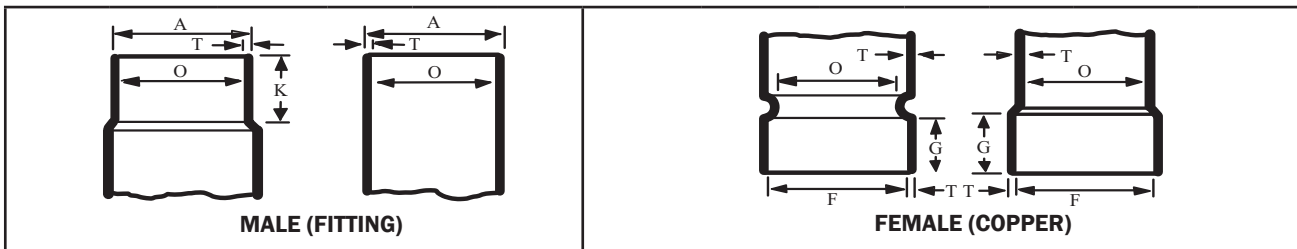

Nom- inal Size	Joint Ends										Metal Thick- ness T (in)	Inside Diam- eter O (in)
	Male End					Female End						
	Outside Diam- eter (A) in	Average Toler- ance (mm)	Ac- tual MIN in	O.D. MAX in		Inside Diam- eter F (in)	Average Toler- ance (mm)	Ac- tual MIN in	O.D. MAX in			
1/8	2/8	0.03	2/8	2/8	3/8	2/8	0.03	2/8	2/8	3/8	0	2/8
1/4	3/8		3/8	3/8	3/8	3/8		3/8	3/8	3/8	0	2/8
3/8	4/8		4/8	4/8	3/8	4/8		4/8	4/8	3/8	0	3/8
1/2	5/8		5/8	5/8	4/8	5/8		5/8	5/8	3/8	0	4/8
5/8	6/8		6/8	6/8	5/8	6/8		6/8	6/8	5/8	0	4/8
3/4	7/8		7/8	7/8	6/8	7/8		7/8	7/8	5/8	0	5/8

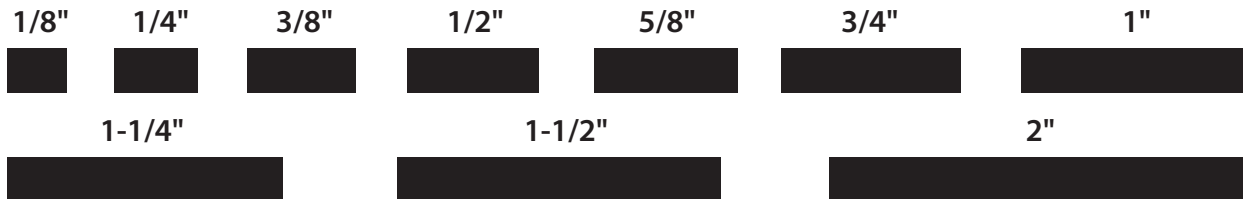

WARNING: This product can expose you to chemicals, including Nickel, which are known to the State of California to cause cancer.
 For more information, visit www.P65Warnings.ca.gov

WROT SOLDER JOINT

NIPPLES AND FITTINGS

90° ELL C X C



PART#	NOMINAL (ID)	OD	APPROX NET WT.	IND #
77101	1/4"	3/8"	0.01	W 02009
77102	3/8"	1/2"	0.03	W 02017
77104	1/2"	5/8"	0.04	W 02022
77108	3/4"	7/8"	0.09	W 02034
77110	1"	1-1/8"	0.17	W 02047
77113	1-1/4"	1-3/8"	0.27	W 02077
77114	1-1/2"	1-5/8"	0.41	W 02085
77116	2"	2-1/8"	0.73	W 02086
77119	3"			

WE-500-R 607-R 107-C

90° STREET ELL FTG. X C



PART#	NOMINAL (ID)	OD	APPROX NET WT.	IND #
77124	1/4"	3/8"	0.01	W 02312
77125	3/8"	1/2"	0.03	W 02321
77126	1/2"	5/8"	0.05	W 01652
77128	3/4"	7/8"	0.12	W 01654
77129	1"	1-1/8"	0.22	W 02344
77130	1-1/4"	1-3/8"	0.33	W 02384
77131	1-1/2"	1-5/8"	0.45	W 02385
77132	2"	2-1/8"	0.87	W 02386
77134	3"			

90° LONG TURN ELL C X C



PART#	NOMINAL (ID)	OD	APPROX NET WT.	IND #
77143	1/2"	5/8"	0.06	W 02722
77144	5/8"	3/4"	0.10	W 02728
77145	3/4"	7/8"	0.15	W 02734

WE-500-L 607-LT 107-L

90° LONG TURN ST. ELL FTG. X C



PART#	NOMINAL (ID)	OD	APPROX NET WT.	IND #
77156	5/8"	3/4"	0.11	
77159	1-1/4"	1-3/8"	0.46	W 02828
77160	1-1/2"	1-5/8"	0.64	W 02834

WE-503-L 607-2LT

45° ELL C X C



PART#	NOMINAL	APPROX NET WT.	IND #
77163	3/8"	0.02	W 03021
77164	1/2"	0.04	W 03026
77166	3/4"	0.10	W 03034
77167	1"	0.19	W 03044
77168	1-1/4"	0.27	W 03050
77169	1-1/2"	0.39	W 03055
77170	2"	0.75	W 03059

WE-504 606 106

* See midlandindustries.com for larger sizes

WARNING: This product can expose you to chemicals, including Nickel, which are known to the State of California to cause cancer. For more information, visit www.P65Warnings.ca.gov

NIPPLES & FITTINGS

WROT SOLDER JOINT

NIPPLES AND FITTINGS

STREET 45° FTG. X C



PART#	NOMINAL	APPROX NET WT.	IND #	
77179	1/2"	0.06	W 03326	----
77181	3/4"	0.10	W 03334	----
77182	1"	0.18	W 03344	----
77183	1-1/4"	0.27	W 03350	----

WE-505 606-2

COUPLING (SOCKET) W/ ROLLED UP TUBE STOP C X C

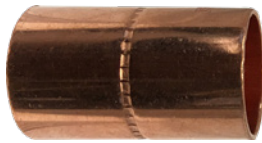

PART#	NOMINAL	APPROX NET WT.	IND #	
77201	1/8"	0.01	W 01003	----
77202	1/4"	0.01	W 01009	----
77203	3/8"	0.02	W 01017	----
77204	1/2"	0.03	W 01022	----
77205	5/8"	0.04	W 01028	----
77206	3/4"	0.06	W 01034	----
77207	1"	0.10	W 01047	----
77208	1-1/4"	0.15	W 01055	----
77209	1-1/2"	0.22	W 01063	----
77210	2"	0.39	W 01072	----
77212	3"			

WC-400 100

COUPLING (SOCKET) LESS TUBE STOP C X C



PART#	NOMINAL	APPROX NET WT.	IND #	
77220	1/4"	0.01	W 01901	----
77222	1/2"	0.03	W 01903	----
77223	3/4"	0.06	W 01905	----
77224	1"	0.10	W 01906	----
77225	1-1/4"	0.15	W 01907	----
77226	1-1/2"	0.22	W 01908	----
77227	2"	0.39	W 01909	----

WC-400NS 601

COUPLING (SOCKET) W/ DIMPLED TUBE STOP C X C



PART#	NOMINAL	APPROX NET WT.	IND #	
77238	1/2"	0.03		----
77240	3/4"	0.06		----
77241	1"	0.10		----

WC-400S

WARNING: This product can expose you to chemicals, including Nickel, which are known to the State of California to cause cancer. For more information, visit www.P65Warnings.ca.gov

* See midlandindustries.com for larger sizes

WROT SOLDER JOINT

NIPPLES AND FITTINGS

REDUCER COUPLING W/ STOP C X C



PART#	NOMINAL	APPROX NET WT.	IND #	
77252	1/4" x 1/8"	0.01	W 01011	----
77253	3/8" x 1/4"	0.02	W 01019	----
77256	1/2" x 1/4"	0.03	W 01023	----
77255	1/2" x 3/8"	0.03	W 01021	----
77258	5/8" x 1/2"	0.04	W 01025	----
77262	3/4" x 1/2"	0.06	W 01029	----
77267	1"x1/2"	0.10	W 01049	----
77265	1"x3/4"	0.12	W 01038	----
77269	1 -1/4" x 3/4"	0.17	W 01056	----
77268	1-1/4" x 1"	0.17	W 01051	----
77272	1-1/2" x1"	0.24	W 01064	----
77271	1-1/2" x 1-1/4"	0.24	W 01060	----
77277	2" x 1"	0.48	W 01074	----
77276	2 x 1-1/4"	0.46	W 01073	----
77275	2" x 1-1/2"	0.42	W 01069	----

• 21 more sizes available - see website

WC-400R 600-R

FITTING REDUCER FTG. C X C



PART#	NOMINAL	APPROX NET WT.	IND #	
77294	1/2" x 1/4"	0.03	W 01317	----
77298	3/4" x 3/8"	0.05	W 01327	----
77297	3/4" x 1/2"	0.06	W 01326	----
77352	1" x 1/2"	0.10	W 01265	----
77300	1"x3/4"	0.11	W 01337	----
77355	1 -1/4" x 3/4"	0.15	W 01345	----
77354	1-1/4" x1"	0.17	W 01343	----
77359	1 -1/2" x 3/4"	0.21	W 01353	----
77358	1-1/2"x1"	0.22	W 01351	----
77357	1 -1/2" X 1-1/4"	0.21	W 01350	----
77361	2" x 1-1/2"	0.39	W 01358	----

WC-403 600-2

MALE ADAPTER C X M

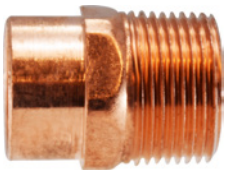

PART#	NOMINAL	APPROX NET WT.	IND #	
77398	3/8"	0.06	W 01125	----
77401	1/2"	0.08	WB01131	----
77306	3/4"	0.14	WB01146	----
77309	1"	0.24	WB01163	----
77314	1-1/4"	0.41	W 01171	----
77318	1-1/2"	0.50	W 01179	----
77322	2"	0.87	W 01187	----
77308	3/8" x 1/2"			
77311	1/2" x 3/8"	0.18		----
77315	3/4" x 1/2"	0.31		----
77307	3/4" x 1"	0.29	W 01145	----
77312	1" x 3/4"	0.18	W 01164	----

• 14 more reducing sizes available

WC-401 604

* See midlandindustries.com for more sizes

WARNING: This product can expose you to chemicals, including Nickel, which are known to the State of California to cause cancer. For more information, visit www.P65Warnings.ca.gov

NIPPLES & FITTINGS

WROT SOLDER JOINT

NIPPLES AND FITTINGS

FTG. MALE ADAPTER FTG. X M

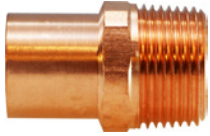

PART#	NOMINAL	APPROX NET WT.	IND #	
77331	1/2"	0.09	W 01431	----
77333	3/4"	0.15	W 01446	----
77334	1"	0.15	W 01463	----
77335	1-1/4"	0.41	W 01471	----

WC-404 604-2

COPPER TUBING

SEE COPPER TUBING FOR REFRIGERATION AND DRINKING WATER



FEMALE ADAPTERS C X F

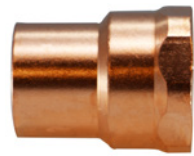

PART#	NOMINAL	APPROX NET WT.	IND #	
77340	3/8"			
77343	1/2"	0.10	WB01231	----
77349	3/4"	0.14	WB01246	----
77402	1"	0.24	WB01263	----
77406	1-1/4"	0.43	W 01271	----
77410	1-1/2"	0.58	W 01279	----
77413	2"	0.74	W 01287	----
77341	3/8" x 1/2"	0.10	W 01224	----
77347	1/2" x 1/4"	0.05	W 01233	----
77346	1/2" x 3/8"	0.70	W 01232	----
77345	1/2" x 3/4"	0.15	WB01230	----

FEMALE FTG. ADAPT. FTG. X F

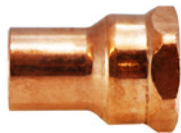

PART#	NOMINAL	APPROX NET WT.	IND #	
77420	1/2"	0.11	W 01531	----
77423	3/4"	0.19	W 01546	----
77424	1			----
77425	1 1/4			----

WC405 603-2 WC405R 603R

CAP



PART#	NOMINAL	APPROX NET WT.	IND #	
77430	3/8"	0.01	W 07006	----
77431	1/2"	0.02	WB07007	----
77432	5/8"	0.03	W 07008	----
77433	3/4"	0.04	WB07009	----
77434	1"	0.08	WB07011	----
77435	1-1/4"	0.11	W 07012	----
77436	1-1/2"	0.18	W 07013	----
77437	2"	0.30	W 07014	----

• More sizes available

WC402 603 WC402R 603R

WARNING: This product can expose you to chemicals, including Nickel, which are known to the State of California to cause cancer. For more information, visit www.P65Warnings.ca.gov



WROT SOLDER JOINT

NIPPLES AND FITTINGS

UNIONS C X C

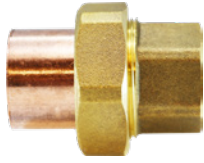

• LF = Lead Free

PART#	NOMINAL	APPROX NET WT.	IND #	
77455LF	1/2"	0.17	W 08003	----
77456LF	3/4"	0.37	W 08004	----
77457LF	1"	0.51	W 08005	----
77606LF	1-1/4"	0.98	W08006	----
77607LF	1-1/2"	1.21	W08007	----
77608LF	2"		W08008	----

WC-415 617

U-TYPE STRAP



PART#	NOMINAL	APPROX NET WT.	IND #	
77461	1/2"	0.03	A 02529	----
77462	3/4"	0.03	A 02574	----

WC-407
WS-1100

TEE C X C X C

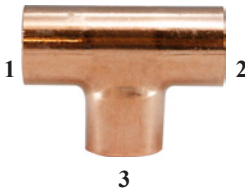

PART#	NOMINAL 1 X 2 X 3	APPROX NET WT.	IND #	
77467	1/8"	0.02	W 40306	----
77468	1/4"	0.03	W 04000	----
77470	3/8"	0.05	W 04001	----
77473	1/2"	0.08	WB04006	----
77483	3/4"	0.18	WB04031	----
77490	1"	0.35	WB04048	----
77504	1-1/4"	0.58	W 04068	----
77519	1-1/2"	0.72	W 04084	----
77543	2"	1.35	W 40102	----
77489	3/4"x1/2"x1/2"	0.15	WB04043	----
77488	3/4" x 1/2" x 3/4"	0.19	WB04041	----
77486	3/4" x 3/4" x 1/2"	0.15	WB04033	----
77485	3/4"x3/4"x1"	0.25	W 04065	----
77501	1"x1/2"x1"	0.34	W 04061	----
77499	1"x3/4"x3/4"	0.31	W 04056	----
77496	1"x1"x1/2"	0.24	WB04051	----
77493	1"x1"x3/4"	0.29	WB04049	----
77523	1-1/2" x 1-1/2" x 3/4"	0.51	W 04087	----
77522	1-1/2" x 1-1/2" x 1"	0.60	W 04086	----
77547	2"x2"x1"	0.99	W 40105	----

WT-600 611

DROP EAR ELBOWS

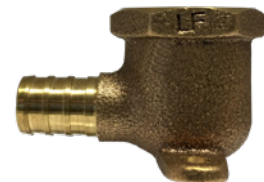

• Lead Free Bronze • Lead Free Brass

• Lead Free Brass

• Lead Free Bronze

PART #	SWT X FIP	
44840LF	1/2 x 1/2 Bronze	----
44841LF	1/2 x 1/2 Brass	----
44842LF	3/4 x 1/2 Brass	----
44843LF	3/4 x 3/4 Brass	----

PART #	SWT X SWT	
44844LF	1/2 x 1/2	----

PART #	PEX X FIP	
44845LF	1/2 x 1/2	----

WARNING: This product can expose you to chemicals, including Nickel, which are known to the State of California to cause cancer. For more information, visit www.P65Warnings.ca.gov

PLASTIC FITTINGS



SCH 80 PVC NIPPLES



Machined Schedule 80 PVC nipples comply fully with ASTM D2464, threads conform to ASTM F1498, and the pipe is extruded from PVC 1120-1220 meeting ASTM D1784 and meets ASTM D1785, products standard 21-70

PIPE FITTINGS



- Nylon
- Polyethylene
- Polypropylene

HOSE BARB FITTINGS



- Nylon
- Polyethylene
- Polypropylene

NYLON & POLYPROPYLENE COMPRESSION FITTINGS



POLYPROPYLENE PUSH-IN TUBE FITTINGS AND VALVES



GARDEN HOSE FITTINGS



- Nylon

Machined Schedule 80 PVC nipples comply fully with ASTM D2464,

- NSF 61 certified for use with drinking (potable) water
- Max Temperature: 140°F
- Max Pressure: Not Rated

SCH 40 PVC FITTINGS



- NSF 61 certified for use with drinking (potable) water
 - Max Temperature: 140°F
 - Max Pressure: Not Rated
- Resistant to corrosion, strong and rigid - commonly used in low pressure plumbing applications. ASTM D1784 and D2466.

SCH 80 PVC FITTINGS



PVC Material is Type 1 according to the American Society for Testing Materials (ASTM) D-1784. Fittings conform to ASTM D-2464 & ASTM D-2467. Temperature rating is 140°F. PSI is based on water at 73°F. Derate 50% at 110°F and 78% at 140°F. Not recommended for use in compressed air or gas systems.

SEE MIDLAND BLANKET ORDER PROGRAM FOR PVC FITTINGS

PRICING FILE AVAILABLE ONLINE

SEE MIDLANDINDUSTRIES.COM

SEE MIDLANDINDUSTRIES.COM

PLASTIC PIPE

PLASTIC FITTINGS

SCHEDULE 80 PVC NIPPLES

Machined Schedule 80 PVC nipples comply fully with ASTM D2464, threads conform to ASTM F1498, and the pipe is extruded from PVC 1120-1220 meeting ASTM D1784 and meets ASTM D1785, products standard 21-70



- Dark Grey
- NSF-61 Cert.

1/2" DIAMETER 420 PSI

PART #	LENGTH	
55060	X Close (1-1/8")	----
55061	1-1/2"	----
55062	2"	----
55063	2-1/2"	----
55064	3"	----
55065	3-1/2"	----
55066	4"	----
55067	4-1/2"	----
55068	5"	----
55069	5-1/2"	----
55070	6"	----
55072	8"	----
55074	10"	----
55075	11"	----
55076	12"	----
	18"	----
55241	24"	----

1" DIAMETER 315 PSI

PART #	LENGTH	
55100	X Close (1-1/2")	----
55101	2"	----
55102	2-1/2"	----
55103	3"	----
55104	3-1/2"	----
55105	4"	----
55106	4-1/2"	----
55107	5"	----
55108	5-1/2"	----
55109	6"	----
55111	8"	----
55115	12"	----
55116	18"	----
55117	36"	----

3/4" DIAMETER 340 PSI

PART #	LENGTH	
55080	x Close (1-3/8")	----
55081	1-1/2"	----
55082	2"	----
55083	2-1/2"	----
55084	3"	----
55085	3-1/2"	----
55086	4"	----
55087	4-1/2"	----
55088	5"	----
55089	5-1/2"	----
55090	6"	----
55092	8"	----
55093	10"	----
55096	12"	----
55097	18"	----
55098	24"	----

1-1/4" DIAMETER 210 PSI

PART #	LENGTH	
55120	X Close (1-5/8")	----
55121	2"	----
55122	2-1/2"	----
55123	3"	----
55124	3-1/2"	----
55125	4"	----
55126	4-1/2"	----
55127	5"	----
55128	5-1/2"	----
55129	6"	----
55132	12"	----

PLASTIC PIPE

PLASTIC FITTINGS

1-1/2" DIAMETER 234 PSI

PART	LENGTH	
55140	X Close (1-5/8")	----
55141	2"	----
55142	2-1/2"	----
55143	3"	----
55144	3-1/2"	----
55145	4"	----
55146	4-1/2"	----
55147	5"	----
55148	5-1/2"	----
55149	6"	----
55150	8"	----
55151	12"	----

3" DIAMETER

PART #	LENGTH	BOX QTY	
55200	x Close	25	----
55201	3"	20	----
55203	4"	30	----
55205	5"	20	----
55207	6"	20	----
55209	8"	10	----
55211	10"	10	----
55213	12"	10	----

2" DIAMETER 200 PSI

PART #	LENGTH	
55160	X Close (2")	----
55161	2-1/2"	----
55162	3"	----
55163	3-1/2"	----
55164	4"	----
55165	4-1/2"	----
55166	5"	----
55167	5-1/2"	----
55168	6"	----
55170	8"	----
55174	12"	----
55179	60"	----

PIPE-NYLON POLY

AVAILABLE IN THREE TYPES OF PLASTIC

(W) White Nylon

Made from virgin grade formulated to resist physical stress and abrasion. This material meets F.D.A. requirements of Code of Federal Regulation part 177.1500 and is therefore suitable for food contact surfaces.

Temperature Range: -40°F to 200° F

Working Pressure: 125 PSI maximum.

(B) Black Polyethylene

Made from a high molecular weight linear polyethylene formulated for chemical compatibility and high impact resistance at lower temperatures. Polyethylene is NSF approved for potable water.

Temperature Range: -65°F to 190°F

Working Pressure: 125 PSI maximum.

(P) Polypropylene

Made from the finest polypropylene resins. Polypropylene is used for its resistance to a wide range of chemicals. Working pressures decrease as temperatures increase.

- NSF-approved materials
- FDA-approved materials

Note: Do not use with compressed air or gas.

ELBOW



P

POLYPROPYLENE ELBOWS

PART #	SIZE	
28702P	3/8"	----
28704P	3/4"	----



W

NYLON ELBOWS

PART #	SIZE	
28703W	1/2"	----
28704W	3/4"	----
28705W	1"	----
28706W	1-1/4"	----
28707W	1-1/2"	----
28708W	2"	----

TEE



P

POLYPROPYLENE TEES

PART #	SIZE	
28741P	1/4"	----
28742P	3/8"	----
28743P	1/2"	----
28744P	3/4"	----



W

NYLON TEES

PART #	SIZE	
28741W	1/4"	----
28743W	1/2"	----
28744W	3/4"	----
28745W	1"	----
28746W	1-1/4"	----
28747W	1-1/2"	----
28748W	2"	----

STREET ELBOW



P

POLYPROPYLENE STREET ELBOW

PART #	SIZE	
28819P	1/8"	----
28723P	1/2"	----
28820P	2"	----



W

NYLON STREET ELBOW

PART #	SIZE	
28819W	1/8"	----
28720W	1/4"	----
28721W	3/8"	----
28723W	1/2"	----
28724W	3/4"	----
28725W	1"	----
28726W	1-1/4"	----
28727W	1-1/2"	----
28820W	2"	----

- 10% Fiberglass fill for extra strength

HEX HEAD PLUGS



- Cored

B

POLYETHYLENE PLUGS

PART #	SIZE	
28601B	1/8"	----
28602B	1/4"	----
28603B	3/8"	----
28604B	1/2"	----
28605B	3/4"	----



W

NYLON PLUGS

PART #	SIZE	
28601W	1/8"	----
28602W	1/4"	----
28603W	3/8"	----
28604W	1/2"	----
28605W	3/4"	----
28606W	1"	----
28607W	1-1/4"	----
28608W	1-1/2"	----
28609W	2"	----

PLASTIC PIPE

PLASTIC FITTINGS

HEX BUSHING



POLYPROPYLENE BUSHINGS

PART #	SIZE	
28659P	1/4 x 1/8"	----
28660P	3/8 x 1/8"	----
28661P	3/8 x 1/4"	----
28811P	1/2 x 1/8"	----
28663P	1/2 x 1/4"	----
28664P	1/2 x 3/8"	----
28666P	3/4 x 1/4"	----
28668P	3/4 x 1/2"	----
28671P	1 x 1/2"	----
28672P	1 x 3/4"	----
28675P	1-1/4" x 1"	----
28814P	1-1/2" x 1/2"	----
28678P	1-1/2 x 3/4"	----
28680P	1-1/2 x 1-1/4"	----
28816P	2 x 1-1/4"	----
28818P	3 x 2"	----



NYLON BUSHINGS

PART #	SIZE	
28659W	1/4 x 1/8"	----
28660W	3/8 x 1/8"	----
28661W	3/8 x 1/4"	----
28663W	1/2 x 1/4"	----
28664W	1/2 x 3/8"	----
28666W	3/4 x 1/4"	----
28667W	3/4 x 3/8"	----
28668W	3/4 x 1/2"	----
28671W	1 x 1/2"	----
28672W	1 x 3/4"	----
28674W	1-1/4 x 3/4"	----
28675W	1-1/4 x 1"	----
28678W	1-1/2 x 3/4"	----
28679W	1-1/2 x 1"	----
28680W	1-1/2 x 1-1/4"	----
28815W	2" x 1/2"	----
28682W	2 x 3/4"	----
28683W	2 x 1"	----
28685W	2 x 1-1/2"	----
28818W	3" x 2"	----

HEX NIPPLES



POLYETHYLENE HEX NIPPLES

PART #	SIZE	
28611B	1/8"	----
28612B	1/4"	----
28613B	3/8"	----
28614B	1/2"	----



POLYPROPYLENE HEX NIPPLES

PART #	SIZE	
28612P	1/4"	----
28613P	3/8"	----
28614P	1/2"	----
28615P	3/4"	----
28619P	2"	----



NYLON HEX NIPPLES

PART #	SIZE	
28611W	1/8"	----
28612W	1/4"	----
28613W	3/8"	----
28614W	1/2"	----
28615W	3/4"	----
28616W	1"	----
28617W	1 1/4"	----
28618W	1 1/2"	----
28619W	2"	----

REDUCER NIPPLES



POLYETHYLENE HEX NIPPLES

PART #	SIZE	
28623B	1/2 x 1/4"	----
28624B	1/2 x 3/8"	----
28628B	3/4 x 3/8"	----
28625B	3/4 x 1/2"	----

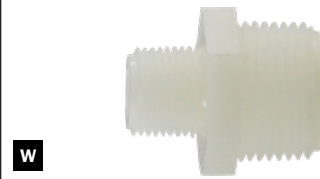

NYLON REDUCING HEX NIPPLES

PART #	SIZE	
28620W	1/4 x 1/8"	----
28622W	3/8 x 1/4"	----
28623W	1/2 x 1/4"	----
28624W	1/2 x 3/8"	----
28628W	3/4 x 3/8"	----
28625W	3/4 x 1/2"	----
28663W	1-1/4 x 1"	----

P = Polypropylene
W = White Nylon
B = Black Polyethylene

PLASTIC PIPE/ HOSE BARB

PLASTIC FITTINGS

COUPLING

P



POLYPROPYLENE COUPLINGS

PART #	SIZE	
28761P	1/4"	----
28762P	3/8"	----
28763P	1/2"	----
28764P	3/4"	----

W



NYLON COUPLINGS

PART #	SIZE	
28761W	1/4"	----
28762W	3/8"	----
28763W	1/2"	----
28764W	3/4"	----
28765W	1"	----
28803W	1-1/4"	----
28767W	1-1/2"	----
28768W	2"	----

PIPE CAP

W



NYLON CAPS

PART #	SIZE	
28640W	1/4"	----
28641W	3/8"	----
28642W	1/2"	----
28643W	3/4"	----

PLASTIC BULKHEAD FITTINGS

P



20% Glass Filled Polypropylene
w/ Santoprene Gasket

PART #	FPT	HOLE	
28693P	1/2"	1-3/8"	----
28694P	3/4"	1-3/8"	----
28695P	1"	1-3/4"	----
28696P	1-1/4"	2"	----
28697P	1-1/2"	3"	----
28698P	2"	3"	----
28699P	3"	4-1/2"	----

P = Polypropylene
W = White Nylon
B = Black Polyethylene

MALE ADAPTERS

B



POLYETHYLENE BARB X MALE PIPE

PART #	SIZE	
33002B	3/16 x 1/8"	----
33003B	3/16 x 1/4"	----
33004B	1/4 x 1/8"	----
33005B	1/4 x 1/4"	----
33006B	1/4 x 3/8"	----
33007B	1/4 x 1/2"	----
33008B	5/16 x 1/8"	----
33009B	5/16 x 1/4"	----
33012B	3/8 x 1/4"	----
33013B	3/8 x 3/8"	----
33014B	3/8 x 1/2"	----
33026B	3/8 x 3/4"	----
33015B	1/2 x 1/4"	----
33016B	1/2 x 3/8"	----
33017B	1/2 x 1/2"	----
33018B	1/2 x 3/4"	----
33020B	5/8 x 1/2"	----
33021B	5/8 x 3/4"	----
33022B	3/4 x 1/2"	----
33023B	3/4 x 3/4"	----
33024B	1 x 3/4"	----
33025B	1 x 1"	----

P



POLYPROPYLENE HOSE BARB Hose ID x MIP

PART #	SIZE	
33012P	3/8 x 1/4"	----
33013P	3/8 x 3/8"	----
33014P	3/8 x 1/2"	----
33015P	1/2 x 1/4"	----
33016P	1/2 x 3/8"	----
33017P	1/2 x 1/2"	----
33018P	1/2 x 3/4"	----
33020P	5/8 x 1/2"	----
33022P	3/4 x 1/2"	----
33023P	3/4 x 3/4"	----
33000P	3/4 x 1"	----
33024P	1 x 3/4"	----
33025P	1 x 1"	----

PLASTIC BARBS

PLASTIC FITTINGS

W



NYLON BARB MALE ADAPTERS
Hose ID x MIP

PART #	SIZE	
33002W	3/16 x 1/8"	----
33003W	3/16 x 1/4"	----
33004W	1/4 x 1/8"	----
33005W	1/4 x 1/4"	----
33006W	1/4 x 3/8"	----
33007W	1/4 x 1/2"	----
33380W	1/4 x 3/4"	----
33008W	5/16 x 1/8"	----
33009W	5/16 x 1/4"	----
33010W	5/16 x 3/8"	----
33011W	3/8 X 1/8"	----
33012W	3/8 x 1/4"	----
33013W	3/8 x 3/8"	----
33014W	3/8 x 1/2"	----
33026W	3/8 x 3/4"	----
33015W	1/2 x 1/4"	----
33016W	1/2 x 3/8"	----
33017W	1/2 x 1/2"	----
33018W	1/2 x 3/4"	----
33303W	1/2" x 1"	----
33019W	5/8 x 3/8"	----
33020W	5/8 x 1/2"	----
33021W	5/8 x 3/4"	----
33306W	3/4" x 3/8"	----
33022W	3/4 x 1/2"	----
33023W	3/4 x 3/4"	----
33000W	3/4 x 1"	----
33318W	3/4" x 1-1/4"	----
33024W	1 x 3/4"	----
33025W	1 x 1"	----
33029W	1 x 1-1/4"	----
33320W	1" x 1-1/2"	----
33027W	1-1/8" x 1"	----
33028W	1-1/4 x 1"	----
33030W	1-1/4 x 1-1/4"	----
33032W	1-1/4 x 1-1/2"	----
33321W	1-1/2" x 1-1/4"	----
33033W	1-1/2 x 1-1/2"	----
33322W	2" x 1-1/2"	----
33035W	2 x 2"	----

ELBOWS

B



POLYETHYLENE ELBOWS
Hose ID x MALE PIPE

PART #	SIZE	
33308B	3/16 x 1/8	----
33038B	1/4 x 1/8	----
33039B	1/4 x 1/4	----
33309B	1/4 x 3/8	----
33046B	3/8 x 1/8	----
33041B	3/8 x 1/4	----
33042B	3/8 x 3/8	----
33047B	3/8 x 1/2	----
33043B	1/2 x 3/8	----
33311B	1/2 x 1/2	----
33385B	1/2 x 3/4	----
33044B	5/8 x 3/8	----
33045B	5/8 x 1/2	----
33312B	5/8 x 3/4	----
33313B	3/4 x 1/2	----
33314B	3/4 x 3/4	----
33316B	1 x 1	----

P



POLYPROPYLENE BARB ELBOW

PART #	SIZE	
33048P	1/2 x 1/4	----
33311P	1/2 x 1/2	----
33385P	1/2 x 3/4	----
33313P	3/4 x 1/2	----
33314P	3/4 x 3/4	----
33316P	1 x 1	----
33334P	1-1/4 x 1	----
33461P	1-1/4 x 1-1/4	----
33463P	1-1/2 x 1-1/2	----

W



NYLON BARB X MIP ELBOWS

PART #	SIZE	
33381W	3/16 x 1/4	----
33038W	1/4 x 1/8	----
33039W	1/4 x 1/4	----
33309W	1/4 x 3/8	----
33351W	1/4 x 1/2	----
33040W	5/16 x 1/4	----
33310W	5/16 x 3/8	----
33046W	3/8 x 1/8	----
33041W	3/8 x 1/4	----
33042W	3/8 x 3/8	----
33047W	3/8 x 1/2	----
33384W	3/8 x 3/4	----
33048W	1/2 x 1/4	----
33043W	1/2 x 3/8	----
33311W	1/2 x 1/2	----
33385W	1/2 x 3/4	----
33044W	5/8 x 3/8	----
33045W	5/8 x 1/2	----
33312W	5/8 x 3/4	----
33329W	5/8" x 1"	----
33313W	3/4 x 1/2	----
33314W	3/4 x 3/4	----
33315W	3/4 x 1	----
33386W	1x3/4	----
33316W	1 x 1	----
33460W	1 x 1-1/4	----
33050W	1-1/8" x 1"	----
33461W	1-1/4 x 1-1/4	----
33462W	1-1/2 x 1-1/4	----
33463W	1-1/2 x 1-1/2	----
33464W	2 x 2	----

P = Polypropylene
W = White Nylon
B = Black Polyethylene

PLASTIC BARBS

PLASTIC FITTINGS

HOSE BARB X FE ADAPTERS



B

POLYETHYLENE ADAPTER

Hose ID x FIP

PART #	SIZE	
33053B	1/4 x 1/4"	----



W

NYLON ADAPTER Barb x FIP

PART #	SIZE	
33052W	1/4 x 1/8"	----
33053W	1/4 x 1/4"	----
33058W	3/8 x 1/4"	----
33059W	3/8 x 3/8"	----
33060W	3/8 x 1/2"	----
33442W	3/8 x 3/4"	----
33066W	1/2 x 1/4"	----
33062P	1/2 x 3/8"	----
33061W	1/2 x 1/2"	----
33067W	1/2 x 3/4"	----
33068W	5/8 x 1/2"	----
33063W	5/8 x 3/4"	----
33064W	3/4 x 1/2"	----
33065W	3/4 x 3/4"	----

HOSE BARB X FE ELBOW



P

W

NYLON ELBOW Hose ID x Female Pipe

PART #	SIZE	
33342W	3/8 x 1/2"	----
33402W	1/2 x 3/8"	----
33343P	1/2 x 1/2"	----
33343W	1/2 x 1/2"	----
33344P	5/8 x 3/4"	----
33344W	5/8 x 3/4"	----
33470W	5/8 x 1/2"	----
33345W	3/4 x 1/2"	----
33471W	3/4 x 3/4"	----
33471P	3/4 x 3/4"	----

UNION ELBOWS



B

POLYETHYLENE ELBOW

PART #	SIZE	
33390B	1/4	----
33391B	3/8	----
33394B	1/2	----
33395B	5/8	----
33396B	3/4	----



W

NYLON ELBOW

PART #	SIZE	
33390W	1/4	----
33391W	3/8	----
33394W	1/2	----
33395W	5/8	----
33396W	3/4	----
33397W	1	----
33398W	1-1/4	----
33399W	1-1/2	----
33389W	2	----

SPLICERS



B

POLYETHYLENE SPLICER

PART #	SIZE	
33091B	1/8	----
33092B	3/16	----
33093B	1/4	----
33095B	3/8	----
33096B	1/2	----
33097B	5/8	----
33098B	3/4	----



POLYPROPYLENE SPLICER

PART #	SIZE	
33095P	3/8	----
33096P	1/2	----
33098P	3/4	----
33099P	1	----

SPLICERS



W

NYLON SPLICES

PART #	SIZE	
33091W	1/8	----
33092W	3/16	----
33093W	1/4	----
33094W	5/16	----
33095W	3/8	----
33096W	1/2	----
33097W	5/8	----
33098W	3/4	----
33099W	1	----
33480W	1-1/4	----
33481W	1-1/2	----
33482W	2	----

REDUCING SPLICERS



B

POLYETHYLENE SPLICES

PART #	SIZE	
33406B	3/8 x 1/4	----
33407B	1/2 x 1/4	----
33408B	1/2 x 3/8	----
33410B	5/8 x 1/2	----



W

NYLON SPLICES

PART #	SIZE	
33079W	1/4 x 1/8	----
33347W	1/4 x 3/16	----
33406W	3/8 x 1/4	----
33348W	3/8 x 5/16	----
33407W	1/2 x 1/4	----
33408W	1/2 x 3/8	----
33409W	5/8 x 3/8	----
33410W	5/8 x 1/2	----
33089W	3/4 x 1/2	----

PLASTIC BARBS

PLASTIC FITTINGS

TEES BARBED ON ALL SIDES

B



POLYETHYLENE TEE

PART #	SIZE	
33415B	1/8	----
33418B*	3/16	----
33420B	3/16	----
33422B	1/4	----
33426B	5/16	----
33429B	3/8	----
33433B	1/2	----
33436B	5/8	----
33437B	3/4	----
33438B	1	----

P



POLYPROPYLENE TEE

PART #	SIZE	
33440P	1-1/2	----

ALL HOSE BARB "Y"

P



POLYPROPYLENE WYE

PART #	SIZE	
33300P*	1/4"	----
33301P*	3/8"	----
33302P*	1/2"	----

**Natural Polypro*

W



NYLON WYE

PART #	SIZE	
33301W	3/8"	----

W



NYLON TEE

PART #	SIZE	
33415W	1/8	----
33417W	5/32	----
33420W	3/16	----
33422W	1/4	----
33426W	5/16	----
33429W	3/8	----
33433W	1/2	----
33436W	5/8	----
33437W	3/4	----
33438W	1	----
33439W	1-1/4	----
33440W	1-1/2	----
33441W	2	----

REDUCING TEES

B



POLYETHYLENE TEE

PART #	SIZE	
33430B	1/2 x 1/2 x 3/8	----
33434B	1/2 x 1/2 x 5/8	----
33435B	3/4 x 3/4 x 1/2	----

W

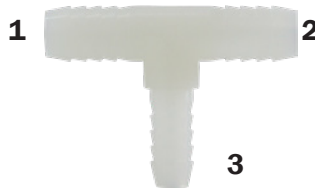

NYLON TEE

PART #	SIZE	
33430W	1/2 x 1/2 x 3/8	----
33431W	5/8 x 5/8 x 3/8	----
33432W	3/8 x 3/8 x 1/2	----
33435W	3/4 x 3/4 x 1/2	----

MALE BRANCH TEE

W



NYLON BRANCH TEE

PART #	SIZE	
33448W	1/4 x 1/4	----
33450W	3/8 x 1/4	----
33451W	3/8 x 3/8	----
33454W	1/2 x 3/8	----
33455W	1/2 x 1/2	----
33456W	3/4 x 3/4	----

PLASTIC GARDEN HOSE

PLASTIC FITTINGS

GARDEN HOSE

PLASTIC GARDEN HOSE FITTINGS

FITTINGS WITH GARDEN HOSE THREAD

GARDEN HOSE CAP

• Washer not included



• White Nylon

P

PART #	SIZE	
30103P	3/4"	----

GARDEN HOSE THREAD ADAPTERS

BARB X MALE GARDEN HOSE



• White Nylon

PART #	SIZE	
31038	1/4"	----
31039	3/8"	----
31040	1/2"	----
31041	5/8"	----
31042	3/4"	----

GARDEN HOSE ADAPTER INSERTS

• for assembly with 31-022



• White Nylon

PART #	SIZE	
31030	1/4"	----
31031	3/8"	----
31032	1/2"	----
31033	5/8"	----
31034	3/4"	----

GARDEN HOSE NUT



• White Nylon

PART #	SIZE	
31022	3/4"	----

MALE GARDEN HOSE X FEMALE PIPE



• White Nylon

PART #	SIZE	
31067	MGH X 1/4	----
31068	MGH X 1/2 FIP	----
31069	MGH X 3/4	----

FEMALE GARDEN HOSE X MALE PIPE

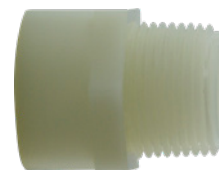

• White Nylon

PART #	SIZE	
31093	FGH X 3/4 MPT	----
31095	FGH X 3/4 MGH	----

FEMALE GARDEN HOSE X FEMALE PIPE



• White Nylon

PART #	SIZE	
31096	FGH X 1/2 FIP	----
31097	FGH X 3/4 FIP	----

MALE GARDEN HOSE X MALE PIPE



• White Nylon

PART #	SIZE	
31055	GHT X 3/8 MPT	----
31058	GHT X 1/2 MPT	----
31063	GHT X 3/4 MPT	----
31064	GHT X 1 MPT	----



VIEW PRICING AND AVAILABLE STOCK ONLINE

PLASTIC COMPRESSION

PLASTIC FITTINGS

PLASTIC COMPRESSION FITTINGS

Corrosion resistant thermoresins designed to resist vibration, provide good electrical insulation, low flow resistance, and resistance to scale buildup.

The letter on the end of part no. denotes the type.

N = Nylon

P = Polypropylene

Standard nut and sleeves will be provided (sleeve is integral part of nut). Other sizes available upon request.

FDA and NSF Listed

UNION & REDUCING UNION CONNECTORS

P



PART #	SIZE	
17064P	1/4"	----
17066P	3/8"	----
17079P	3/8" x 1/4"	----
17068P	1/2"	----
17081P	1/2" x 3/8"	----

• Nylon



PART #	SIZE	
17064N	1/4"	----
17065N	5/16"	----
17078N	5/16" x 1/4"	----
17066N	3/8"	----
17079N	3/8" x 1/4"	----
17068N	1/2"	----

BULKHEAD UNIONS

• Nylon

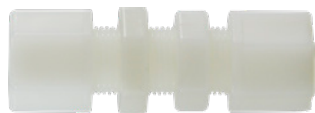

PART #	SIZE	
17088N	1/4"	----
17090N	3/8"	----
17091N	1/2"	----

• SEE MIDLANDINDUSTRIES.COM FOR MORE SIZES

UNION TEES



• Nylon

PART #	SIZE	
17103N	1/4"	----
17105N	3/8"	----
17106N	1/2"	----

UNION ELBOWS

P



PART #	SIZE	
17124P	1/4"	----
17126P	3/8"	----
17127P	1/2"	----

• Nylon



PART #	SIZE	
17124N	1/4"	----
17126N	3/8"	----

FEMALE CONNECTORS

P



PART #	SIZE	
17145P	1/4 x 1/8	----
17153P	3/8 x 1/4	----
17154P	3/8 x 3/8	----
17158P	1/2 x 3/8	----
17159P	1/2 x 1/2	----

• Nylon



PART #	SIZE	
17146N	1/4 x 1/4	----
17153N	3/8 x 1/4	----

MALE CONNECTORS

P



PART #	SIZE	
17179P	1/4 x 1/8	----
17180P	1/4 x 1/4	----
17188P	3/8 x 1/4	----
17189P	3/8 x 3/8	----
17190P	3/8 x 1/2	----
17193P	1/2 x 1/4	----
17194P	1/2 x 3/8	----
17195P	1/2 x 1/2	----

• Nylon



PART #	SIZE	
17176N	1/8 x 1/8"	----
17179N	1/4 x 1/8	----
17180N	1/4 x 1/4	----
17188N	3/8 x 1/4	----
17189N	3/8 x 3/8	----
17190N	3/8 x 1/2	----
17193N	1/2 x 1/4	----
17194N	1/2 x 3/8	----
17195N	1/2 x 1/2	----

MALE ELBOWS

P



PART #	SIZE	
17225P	1/4 x 1/4	----
17233P	3/8 x 1/4	----
17234P	3/8 x 3/8	----
17237P	1/2 x 3/8	----
17238P	1/2 x 1/2	----

• Nylon



PART #	SIZE	
17224N	1/4 x 1/8	----
17225N	1/4 x 1/4	----
17233N	3/8 x 1/4	----
17234N	3/8 x 3/8	----
17237N	1/2 x 3/8	----
17238N	1/2 x 1/2	----

PLASTIC PUSH-IN

PLASTIC FITTINGS

PLASTIC PUSH-IN TUBE FITTINGS

Manufactured from safe, non-toxic materials meeting the requirements of the US FDA, WRAS, ANSI/NSF-51, 61, and SK Zert. Our products are widely used in water purification, food/beverage and pneumatic systems.

- **Function & Quality :** provides quick and convenient assembly - saving time & expense. Our ISO9001, 14001 registered quality system ensures our customers a superior level of product quality. Defects are easily detectable and maintenance is easy with its easy dismantling for access.
- **Collet Design :** Unique oval collet design is superior and more practical.
- **Applications :** Beyond water and food use, fittings can be used with air, gases, vacuum, & liquids. And all connections can be assembled & disassembled repeatedly.
- **Material :** Grey Acetal Copolymer, also known as POM. Highly durable and resistant to fatigue and creep. It has high resistance to a wide range of organic & inorganic chemicals and detergents. Not recommended for use with strong acids or repeated exposure to strong oxidizers. (polypropylene may be subbed)

Temperature	SIZE	Small Size					Large Size						
		5/32"	3/16"	1/4"	5/16"	3/8"	1/2"	5/8"	7/8"	1"	1 1/8"		
		4mm	5mm	6mm	8mm	10mm	12mm	15mm	16mm	18mm	22mm	28mm	
1°C (34°F)		16bar (230PSI)					11bar (170PSI)		11bar (170PSI)				
20°C (68°F)		16bar (230PSI)					11bar (170PSI)		11bar (170PSI)				
65°C (150°F)		10bar (150PSI)					7bar (100PSI)		7bar (100PSI)				

- Fittings are not recommended for use with liquids other than water and food or beverage products.
- Do not use pipe dope or other liquid thread sealers. Use only Teflon tape to seal threaded connections.
- After assembling a tube connection, tug with moderate force to check for proper gripping of the tube.
- Before disassembling tube connections, always verify that pressure has been removed from the system.

UNION CONNECTOR



PART #	TUBE OD	
20018P	5/32"	----
20019P	1/4"	----
20020P	3/8"	----
20021P	1/2"	----

UNION TEE



PART #	TUBE OD	
20028P	1/4"	----
20029P	3/8"	----
20030P	1/2"	----

UNION ELBOW



PART #	TUBE OD	
20152P	1/4"	----
20153P	3/8"	----
20154P	1/2"	----

REDUCING UNION



PART #	TUBE OD	TUBE OD	
20750P	1/4"	3/16"	----
20755P	3/8"	1/4"	----
20756P	3/8"	5/16"	----
20758P	1/2"	3/8"	----

REDUCING BRANCH TEE



PART #	TUBE OD 1	TUBE OD 2	
20725P	3/8"	1/4"	----
20724P	1/2"	3/8"	----

REDUCING ELBOW



PART #	TUBE OD	TUBE OD	
20734P	3/8"	1/4"	----
20736P	1/2"	3/8"	----

BULKHEAD UNION



PART #	TUBE OD	
20127P	1/4"	----
20128P	3/8"	----
20129P	1/2"	----

PLASTIC PUSH-IN

PLASTIC FITTINGS

FEMALE CONNECTOR



Female Pipe

PART #	TUBE OD	THREAD NPTF	
20993P	1/4"	1/8"	----
20035P	1/4"	1/4"	----
20944P	3/8"	1/8"	----
20036P	3/8"	1/4"	----



Female Flare

PART #	TUBE OD	FE FLARE	
20936P	1/4"	1/4"	----
20937P	3/8"	1/4"	----
20938P	3/8"	3/8"	----



Female UNS Cone Type

PART #	TUBE OD	UNS	
20939P	1/4"	7/16"	----
20940P	3/8"	7/16"	----



Female Comp

PART #	TUBE OD	FE COMP	
20941P	3/8"	9/16-24"	----



20-152P + 20-525P = 20-964P

MALE CONNECTOR



Male Pipe

PART #	TUBE OD	THREAD NPTF	
20050P	5/32"	1/8"	----
20054P	1/4"	1/8"	----
20055P	1/4"	1/4"	----
20056P	1/4"	3/8"	----
20057P	3/8"	1/8"	----
20058P	3/8"	1/4"	----
20059P	3/8"	3/8"	----
20062P	3/8"	1/2"	----
20061P	1/2"	3/8"	----
20063P	1/2"	1/2"	----



Male BSP

AMCB

PART #	TUBE OD	BSP	
20958P	3/8"	3/8"	----



AMCF

PART #	TUBE OD	MALE FLARE	
20960P	3/8"	1/4"	----
20961P	3/8"	1/2"	----

STEM ADAPTER



Part #	stem OD	Thread NPTF	
20524P	1/4"	1/8"	----
20525P	1/4"	1/4"	----
20528P	3/8"	1/4"	----
20529P	3/8"	3/8"	----

REDUCER

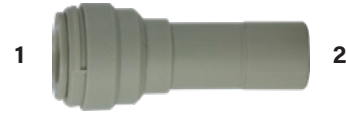

PART #	TUBE OD 1	STEM OD 2	
20512P	3/8"	1/4"	----
20763P	3/8"	5/16"	----
20514P	1/2"	3/8"	----

TUBE BARB CONNECTOR



ATBC

PART #	STEM OD	HOSE BARB ID	
20964P	1/4"	1/4"	----
20965P	3/8"	1/4"	----
20966P	3/8"	3/8"	----
20967P	3/8"	1/2"	----
20968P	1/2"	3/8"	----
20969P	1/2"	1/2"	----

FIXED ELBOW



Part #	Tube OD	Thread NPTF	
20068P	1/4"	1/8"	----
20069P	1/4"	1/4"	----
20070P	1/4"	3/8"	----
20072P	3/8"	1/4"	----
20073P	3/8"	3/8"	----

SWIVEL ELBOW

Union Elbow + Stem Adapter



AMES

PART #	STEM OD	TUBE ID	
20973P	1/4"	1/4"	----
20974P	3/8"	3/8"	----

PLASTIC PUSH-IN

PLASTIC FITTINGS

PLUG-IN ELBOW



PART #	TUBE OD	STEM	
20740P	5/32"	5/32"	----
20742P	1/4"	1/4"	----
20745P	3/8"	1/4"	----
20747P	3/8"	3/8"	----
20748P	1/2"	1/2"	----

TUBE ELBOW BARB CONNECTOR



PART #	STEM OD	HB ID	
20970P	1/4"	1/4"	----
20971P	3/8"	1/4"	----
20972P	3/8"	3/8"	----

ADAPTABILITY

- For maximum flexibility, fittings may be combined to provide wider functions.
- Unlike some competitors products, separation and reuse is easy.

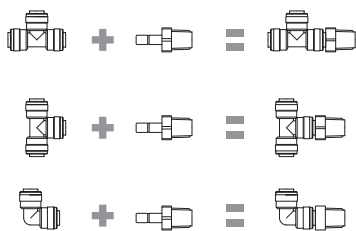

2-WAY DIVIDER



PART #	TUBE OD	LIST PRICE
20775P	1/4"	----
20776P	5/16"	----
20777P	3/8"	----

PLUG



PART #	TUBE OD	
20876P	5/32"	----
20878P	1/4"	----
20880P	3/8"	----
20881P	1/2"	----

TUBE END STOP



PART #	TUBE OD	
20925P	1/4"	----
20927P	3/8"	----



AFAN

Female Garden Hose

Tube

PART #	TUBE OD	FGH	
20950P	1/4"	3/4"	----
20951P	3/8"	3/4"	----



AFAB

Female BSP

Tube

PART #	TUBE OD	BSP	
20953P	1/4"	1/2"	----
20954P	1/4"	3/4"	----
20955P	3/8"	3/4"	----
20956P	5/8"	3/4"	----

PL X PL



PART #	TUBE OD	
20900P	1/4"	----
20901P	3/8"	----

PL X MALE NPTF



PART #	TUBE OD	MALE THREAD NPTF	
20904P	1/4"	1/4"	----
20905P	3/8"	3/8"	----

PLASTIC PUSH-IN

PLASTIC FITTINGS

CHECK VALVE



PART #	TUBE OD	
20778P	1/4"	----
20779P	3/8"	----

STOP VALVES

CONNECTOR: Flows in both directions by connection.

DISCONNECTOR: Stop flows in both directions by with separation where pulling to the open position.



ASTVBU

PART #	TUBE OD	
20910P	1/4"	----

LOCKING CLIP



ALC

PART #	TUBE OD	
20975P	1/4"	----
20976P	3/8"	----
20977P	1/2"	----

FLOW BEND CLIP



AFBC

PART #	TUBE OD	
20980P	1/4"	----
20981P	3/8"	----

SPANNER



PART #	SIZES	
20983P	3/16, 1/4, 5/16 3/8, 1/2	----

STOP & FAUCET ADAPTER VALVES

AV range of Stop & Faucet Valve Adaptor valves and Slip Tee Valves are manufactured in white Polypropylene, reinforced plastic with EPDM O-rings which provides value-added advantages in the installation of water supply line mainly.

AV range of Stop & Faucet Valve Adaptors and Slip Tee Valves are designed for use in drinking water systems, Refrigerators, Ice-Makers, Humidifiers and Water filtration applications, etc.,. Our valves offer greater efficiency than any traditional valves.

AV valves have been approved in NSF/ANSI 61 & 372.

AV range is 1/4" Turn valves.

STOP VALVE ADAPTER



3/8 MALE COMP X
3/8 FEMALE COMP

PART #	TUBE OD	
20985P	1/4"	----
20986P	3/8"	----

SLIPTEE VALVE



PART #	RUN X RUN	BRANCH	
20988P	5/8"	1/4"	----
20989P	5/8"	3/8"	----
20990P	7/8"	1/4"	----

HOSE ACCESSORIES



CAM AND GROOVE



ALUMINIUM



POLYPROPYLENE



STAINLESS STEEL



BRASS

COMBINATION HOSE NIPPLES



FIRE HOSE FITTINGS



UNIVERSAL/ GROUND JOINT COUPLINGS



ALUMINUM CAM AND GROOVE

HOSE ACCESSORIES

cam and groove**MALE ADAPTER X FEMALE NPT
TYPE A**CGA
6191X

PART#	SIZE	
CGA-050-A1	1/2"	----
CGA-075-A1	3/4"	----
CGA-100-A1	1"	----
CGA-125-A1	1-1/4"	----
CGA-150-A1	1-1/2"	----
*CGA-200-A1	2"	----
CGA-250-A1	2-1/2"	----
*CGA-300-A1	3"	----
*CGA-400-A1	4"	----
CGA-500-A1	5"	----
CGA-600-A1	6"	----
CGA-800-A1	8"	----
CGA-1000-A	10"	----

**FEMALE COUPLER X HOSE SHANK
TYPE C**CGC
6193X

PART#	SIZE	
CGC-050-A1	1/2"	----
CGC-075-A1	3/4"	----
CGC-100-A1	1"	----
CGC-125-A1	1-1/4"	----
CGC-150-A1	1-1/2"	----
*CGC-200-A1	2"	----
CGC-250-A1	2-1/2"	----
*CGC-300-A1	3"	----
*CGC-400-A1	4"	----
CGC-500-A1	5"	----
CGC-600-A1	6"	----
CGC-800-A1	8"	----
CGC-1000-A	10"	----

**FEMALE COUPLER X MALE NPT
TYPE B**CGB
6192X

PART#	SIZE	
CGB-050-A1	1/2"	----
CGB-075-A1	3/4"	----
CGB-100-A1	1"	----
CGB-125-A1	1-1/4"	----
CGB-150-A1	1-1/2"	----
CGB-200-A1	2"	----
CGB-250-A1	2-1/2"	----
CGB-300-A1	3"	----
*CGB-400-A1	4"	----
CGB-500-A1	5"	----
CGB-600-A1	6"	----
CGB-800-A1	8"	----
CGB-1000-A	10"	----

**FEMALE COUPLER X FEMALE NPT
TYPE D**CGD
6194X

PART#	SIZE	
CGD-050-A1	1/2"	----
CGD-075-A1	3/4"	----
CGD-100-A1	1"	----
CGD-125-A1	1-1/4"	----
CGD-150-A1	1-1/2"	----
*CGD-200-A1	2"	----
CGD-250-A1	2-1/2"	----
*CGD-300-A1	3"	----
*CGD-400-A1	4"	----
CGD-500-A1	5"	----
CGD-600-A1	6"	----
CGD-800-A1	8"	----
CGD-1000-A	10"	----

*Ductile Iron in Houston

ALL IN STOCK IN HOUSTON AND KANSAS CITY

ALUMINUM CAM AND GROOVE

HOSE ACCESSORIES

MALE ADAPTER X HOSE SHANK

TYPE E



CGE
61-95X

PART#	SIZE	
CGE-050-A1	1/2"	----
CGE-075-A1	3/4"	----
CGE-100-A1	1"	----
CGE-125-A1	1-1/4"	----
CGE-150-A1	1-1/2"	----
*CGE-200-A1	2"	----
CGE-250-A1	2-1/2"	----
*CGE-300-A1	3"	----
*CGE-400-A1	4"	----
CGE-500-A1	5"	----
CGE-600-A1	6"	----
CGE-800-A1	8"	----
CGE-1000-A	10"	----

DUST CAP

TYPE DC



CDC
61-97X

PART#	SIZE	
CDC-050-A1	1/2"	----
CDC-075-A1	3/4"	----
CDC-100-A1	1"	----
CDC-125-A1	1-1/4"	----
CDC-150-A1	1-1/2"	----
*CDC-200-A1	2"	----
CDC-250-A1	2-1/2"	----
*CDC-300-A1	3"	----
*CDC-400-A1	4"	----
CDC-500-A1	5"	----
CDC-600-A1	6"	----
CDC-800-A1	8"	----
CDC-1000-A	10"	----

MALE ADAPTER X MALE NPT

TYPE F



CGF
61-96X

PART#	SIZE	
CGF-050-A1	1/2"	----
CGF-075-A1	3/4"	----
CGF-100-A1	1"	----
CGF-125-A1	1-1/4"	----
CGF-150-A1	1-1/2"	----
*CGF-200-A1	2"	----
CGF-250-A1	2-1/2"	----
CGF-300-A1	3"	----
*CGF-400-A1	4"	----
CGF-500-A1	5"	----
CGF-600-A1	6"	----
CGF-800-A1	8"	----
CGF-1000-A	10"	----

DUST PLUG

TYPE DP



CDP
61-98X

PART#	SIZE	
CDP-050-A1	1/2"	----
CDP-075-A1	3/4"	----
CDP-100-A1	1"	----
CDP-125-A1	1-1/4"	----
CDP-150-A1	1-1/2"	----
CDP-200-A1	2"	----
CDP-250-A1	2-1/2"	----
CDP-300-A1	3"	----
CDP-400-A1	4"	----
CDP-500-A1	5"	----
CDP-600-A1	6"	----
CDP-800-A1	8"	----
CDP-1000-A	10"	----

*Ductile Iron in Houston

ALL IN STOCK IN HOUSTON AND KANSAS CITY

ALUMINUM CAM AND GROOVE

HOSE ACCESSORIES

ALUMINUM (AL) SPOOL & PART A**MALE ADAPTER X MALE ADAPTER
ALUMINUM
SPOOL ADAPTER**SA-XXX-A
61910

PART#	SIZE	PART#	
SA-100-A	1"	61872	----
SA-150-A	1-1/2"	*61873	----
SA-200-A	2"	*61874	----
SA-2030-A	2" x 3"	*61875	----
SA-250-A	2-1/2"	61876	----
SA-300-A	3"	*61877	----
SA-3040-A	3" x 4"	*61878	----
SA-400-A	4"	*61879	----

**REDUCER ADAPTER FEMALE
NPT ALUMINUM**

CGA-XXX-A

MALE ADAPTER X FEMALE PIPE

PART#	SIZE	PART#	
CGA-1520-A	1-1/2" x 2"		----
CGA-2015-A	2" x 1-1/2"		----
CGA-2030-A	2" x 3"	*61-851	----
CGA-3040-A	3" x 4"	*61-853	----
CGA-4030-A	4" x 3"	*61-854	----
*CGA-6040-A	6" x 4"		----

ALUMINUM SWIVEL

PART#	SIZE	
CGASV-300-A	3"	----
CGASV-400-A	4"	----

*IN STOCK IN HOUSTON

**REDUCER COUPLER M NPT
PART B**

CGB-XXX-A

FEMALE COUPLER X MALE PIPE

PART#	SIZE	PART#	
CGB-3020-A	3" x 2"	61859	----
CGB-3040-A	3" x 4"	*61860	----
CGB-4030-A	4" x 3"	*61861	----

**ALUMINUM 90°
PART C**

PART#	SIZE	
CGC-1590-A	1-1/2"	----
CGC-2090-A	2"	----

**REDUCER COUPLER SHANK
PART C**

CGC

PART#	SIZE	
CGC-2015-A	2" x 1-1/2"	----
CGC-3020-A	3" x 2"	----
CGC-3025-A	3" x 2-1/2"	----
CGC-4030-A	4" x 3"	----

ALUMINUM CAM AND GROOVE

HOSE ACCESSORIES

REDUCER COUPLER ADAPTER PART D



DA-XXX-A

FEMALE COUPLER X MALE ADAPTER

PART#	SIZE	PART#	
DA-1510-A	1-1/2" x 1"	619001	----
DA-1520-A	1-1/2" x 2"	*619002	----
DA-2015-A	2" x 1-1/2"	*619003	----
DA-2030-A	2" x 3"	*619004	----
DA-2040-A	2" x 4"	619005	----
DA-3015-A	3" x 1-1/2"	619006	----
DA-3020-A	3" x 2"	*619007	----
DA-3040-A	3" x 4"	*619008	----
DA-4020-A	4" x 2"	*619009	----
DA-4030-A	4" x 3"	*619010	----
DA-4060-A	4" x 6"	*619011	----
DA-6040-A	6" x 4"	*619012	----

REDUCER COUPLER FEMALE NPT PART D



CGD

FEMALE COUPLER X FEMALE PIPE

PART#	SIZE	PART#	
CGD-1510-A	1-1/2" x 1"	61865	----
CGD-2015-A	2" x 1-1/2"	61866	----
CGD-3020-A	3" x 2"	61867	----
CGD-4030-A	4" x 3"	61868	----

SPOOL COUPLER PART D



DD

FEMALE COUPLER X FEMALE COUPLER

PART#	SIZE	PART#	
*DD-1515-A	1-1/2" x 1-1/2"	*619440	----
*DD-2020-A	2" x 2"	*619450	----
*DD-2030-A	2" x 3"		----
*DD-3030-A	3" x 3"	*619470	----
*DD-3040-A	3" x 4"		----
*DD-4040-A	4" x 4"	*619480	----

*IN STOCK IN HOUSTON

SWIVEL PART D



FEMALE COUPLER X FEMALE PIPE

CGDSV

PART#	SIZE	
*CGDSV-300-A	3"	----
*CGDSV-400-A	4"	----

REDUCER ADAPTER MALE NPT PART F



CGF

MALE ADAPTER X MIP

Part#	Size		
CGF-1520-A	1-1/2" x 2"		----
*CGF-2030-A	2" x 3"		----
*CGF-3020-A	3" x 2"	61870	----
*CGF-3040-A	3" x 4"	61871	----
CGF-4030-A	4" x 3"		----
CGF-4060-A	4" x 6"		----

*IN STOCK IN HOUSTON

POLY CAM AND GROOVE

HOSE ACCESSORIES

POLYPROPYLENE (PP)

MALE ADAPTER X FEMALE NPT TYPE A



35-91X

PART#	SIZE	
CGA-050-PP	1/2"	----
CGA-075-PP	3/4"	----
CGA-100-PP	1"	----
CGA-125-PP	1-1/4"	----
CGA-150-PP	1-1/2"	----
*CGA-200-PP	2"	----
CGA-300-PP	3"	----
CGA-400-PP	4"	----

FEMALE COUPLER X HOSE SHANK TYPE C



CGC
35-93X

PART#	SIZE	
CGC-050-PP	1/2"	----
CGC-075-PP	3/4"	----
CGC-100-PP	1"	----
CGC-125-PP	1-1/4"	----
CGC-150-PP	1-1/2"	----
*CGC-200-PP	2"	----
*CGC-300-PP	3"	----
CGC-400-PP	4"	----

FEMALE COUPLER X MALE NPT TYPE B



CGB
35-92X

PART#	SIZE	
CGB-050-PP	1/2"	----
CGB-075-PP	3/4"	----
CGB-100-PP	1"	----
CGB-125-PP	1-1/4"	----
CGB-150-PP	1-1/2"	----
*CGB-200-PP	2"	----
*CGB-300-PP	3"	----
CGB-400-PP	4"	----

FEMALE COUPLER X FEMALE NPT TYPE D



35-94X

PART#	SIZE	
CGD-050-PP	1/2"	----
CGD-075-PP	3/4"	----
CGD-100-PP	1"	----
CGD-125-PP	1-1/4"	----
CGD-150-PP	1-1/2"	----
*CGD-200-PP	2"	----
CGD-300-PP	3"	----
CGD-400-PP	4"	----

*IN STOCK IN HOUSTON

ALL IN STOCK IN HOUSTON AND KANSAS CITY

POLYPROPYLENE CAM AND GROOVE

HOSE ACCESSORIES

MALE ADAPTER X HOSE SHANK TYPE E



35-95X

PART#	SIZE	
CGE-050-PP	1/2"	----
CGE-075-PP	3/4"	----
CGE-100-PP	1"	----
CGE-125-PP	1-1/4"	----
CGE-150-PP	1-1/2"	----
*CGE-200-PP	2"	----
*CGE-300-PP	3"	----
CGE-400-PP	4"	----

MALE ADAPTER X MALE NPT TYPE F



35-96X

PART#	SIZE	
CGF-050-PP	1/2"	----
CGF-075-PP	3/4"	----
CGF-100-PP	1"	----
CGF-125-PP	1-1/4"	----
CGF-150-PP	1-1/2"	----
*CGF-200-PP	2"	----
*CGF-300-PP	3"	----
CGF-400-PP	4"	----

DUST CAP TYPE DC



CDC
35-97X

PART#	SIZE	
CDC-050-PP	1/2"	----
CDC-075-PP	3/4"	----
CDC-100-PP	1"	----
CDC-125-PP	1-1/4"	----
CDC-150-PP	1-1/2"	----
*CDC-200-PP	2"	----
*CDC-300-PP	3"	----
CDC-400-PP	4"	----

DUST PLUG TYPE DP



CDP
35-98X

PART#	SIZE	
CDP-050-PP	1/2"	----
CDP-075-PP	3/4"	----
CDP-100-PP	1"	----
CDP-125-PP	1-1/4"	----
CDP-150-PP	1-1/2"	----
CDP-200-PP	2"	----
CDP-300-PP	3"	----
CDP-400-PP	4"	----

*IN STOCK IN HOUSTON



USE OUR TEXT LINE **855-609-3729** TO COMMUNICATE WITH MIDLAND MORE CONVENIENTLY



STAINLESS STEEL CAM AND GROOVE #316

HOSE ACCESSORIES

MALE ADAPTER X FEMALE NPT TYPE A



CGA
6391X

PART#	SIZE	
CGA-050-SS1	1/2"	----
*CGA-075-SS1	3/4"	----
*CGA-100-SS1	1"	----
*CGA-125-SS1	1-1/4"	----
*CGA-150-SS1	1-1/2"	----
*CGA-200-SS1	2"	----
*CGA-250-SS1	2-1/2"	----
*CGA-300-SS1	3"	----
*CGA-400-SS1	4"	----
*CGA-500-SS1	5"	----
CGA-600-SS1	6"	----
CGA-800-SS1	8"	----

FEMALE COUPLER X HOSE SHANK TYPE C



CGC
6393X

PART#	SIZE	
CGC-050-SS1	1/2"	----
*CGC-075-SS1	3/4"	----
*CGC-100-SS1	1"	----
*CGC-125-SS1	1-1/4"	----
*CGC-150-SS1	1-1/2"	----
*CGC-200-SS1	2"	----
CGC-250-SS1	2-1/2"	----
*CGC-300-SS1	3"	----
*CGC-400-SS1	4"	----
CGC-500-SS1	5"	----
*CGC-600-SS1	6"	----
CGC-800-SS1	8"	----

FEMALE COUPLER X MALE NPT TYPE B



CGB
6392X

PART#	SIZE	
CGB-050-SS1	1/2"	----
*CGB-075-SS1	3/4"	----
*CGB-100-SS1	1"	----
CGB-125-SS1	1-1/4"	----
*CGB-150-SS1	1-1/2"	----
*CGB-200-SS1	2"	----
CGB-250-SS1	2-1/2"	----
*CGB-300-SS1	3"	----
*CGB-400-SS1	4"	----
CGB-500-SS1	5"	----
CGB-600-SS1	6"	----
CGB-800-SS1	8"	----

FEMALE COUPLER X FEMALE NPT TYPE D



CGD
6394X

PART#	SIZE	
*CGD-050-SS1	1/2"	----
*CGD-075-SS1	3/4"	----
*CGD-100-SS1	1"	----
*CGD-125-SS1	1-1/4"	----
*CGD-150-SS1	1-1/2"	----
*CGD-200-SS1	2"	----
*CGD-250-SS1	2-1/2"	----
*CGD-300-SS1	3"	----
*CGD-400-SS1	4"	----
*CGD-500-SS1	5"	----
CGD-600-SS1	6"	----

8" AVAILABLE ONLINE

*IN STOCK IN HOUSTON

WARNING: This product can expose you to chemicals, including Chromium, which are known to the State of California to cause cancer and birth defects or other reproductive harm. For more information, visit www.P65Warnings.ca.gov



STAINLESS STEEL CAM AND GROOVE #316

HOSE ACCESSORIES

MALE ADAPTER X HOSE SHANK TYPE E



SA
6395X

PART#	SIZE	
CGE-050-SS1	1/2"	----
*CGE-075-SS1	3/4"	----
*CGE-100-SS1	1"	----
*CGE-125-SS1	1-1/4"	----
*CGE-150-SS1	1-1/2"	----
*CGE-200-SS1	2"	----
*CGE-250-SS1	2-1/2"	----
*CGE-300-SS1	3"	----
*CGE-400-SS1	4"	----
*CGE-500-SS1	5"	----
*CGE-600-SS1	6"	----
CGE-800-SS1	8"	----

DUST CAP TYPE DC



6397X

PART#	SIZE	
CDC-050-SS1	1/2"	----
*CDC-075-SS1	3/4"	----
*CDC-100-SS1	1"	----
CDC-125-SS1	1-1/4"	----
*CDC-150-SS1	1-1/2"	----
*CDC-200-SS1	2"	----
CDC-250-SS1	2-1/2"	----
*CDC-300-SS1	3"	----
*CDC-400-SS1	4"	----
CDC-500-SS1	5"	----
CDC-600-SS1	6"	----
CDC-800-SS1	8"	----

MALE ADAPTER X MALE NPT TYPE F



CGF
6396X

PART#	SIZE	
CGF-050-SS1	1/2"	----
*CGF-075-SS1	3/4"	----
*CGF-100-SS1	1"	----
CGF-125-SS1	1-1/4"	----
*CGF-150-SS1	1-1/2"	----
*CGF-200-SS1	2"	----
CGF-250-SS1	2-1/2"	----
*CGF-300-SS1	3"	----
*CGF-400-SS1	4"	----
CGF-500-SS1	5"	----
*CGF-600-SS1	6"	----
CGF-800-SS1	8"	----

DUST PLUG TYPE DP



6398X

PART#	SIZE	
*CDP-050-SS1	1/2"	----
*CDP-075-SS1	3/4"	----
*CDP-100-SS1	1"	----
CDP-125-SS1	1-1/4"	----
*CDP-150-SS1	1-1/2"	----
*CDP-200-SS1	2"	----
CDP-250-SS1	2-1/2"	----
*CDP-300-SS1	3"	----
*CDP-400-SS1	4"	----
CDP-600-SS1	6"	----
CDP-800-SS1	8"	----

*IN STOCK IN HOUSTON

STAINLESS STEEL CAM AND GROOVE #316

HOSE ACCESSORIES

**PART A SPOOL ADAPTER
STAINLESS**

PART#	SIZE	PART#	
SA-100-SS	1"	63850	----
SA-150-SS	1-1/2"	63851	----
SA-1520-SS	1-1/2" x 2"	63852	----
SA-200-SS	2"	63853	----
SA-2030-SS	2" x 3"	63854	----
SA-300-SS	3"	63855	----
SA-3040-SS	3" x 4"	63856	----
SA-400-SS	4"	63857	----

**PART D SPOOL COUPLER
STAINLESS 316**

PART#	SIZE	PART#	
*DD-1515-SS	1-1/2" x 1-1/2"	639440	----
*DD-2020-SS	2" x 2"	639450	----
*DD-2030-SS	2" x 3"		----
*DD-3030-SS	3" x 3"	639470	----
*DD-3040-SS	3" x 4"		----
*DD-4040-SS	4" x 4"	639480	----

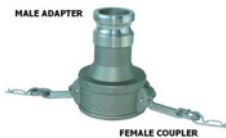
**PART D REDUCER COUPLER
ADAPTER STAINLESS 316**

PART#	SIZE	PART#	
*DA-2030-SS	2" x 3"		----
*DA-3020-SS	3" x 2"	639002	----
*DA-3040-SS	3" x 4"		----
*DA-4030-SS	4" x 3"	639003	----
*DA-6040-SS	6" x 4"	639004	----

**PART D STAINLESS
90° ELBOW**

PART#	SIZE	
*CGD-2090-SS	2"	----

*IN STOCK IN HOUSTON

THE ELEPHANT ROPE

A gentleman was walking through an elephant camp, and he spotted that the elephants weren't being kept in cages or held by the use of chains.

All that was holding them back from escaping the camp, was a small piece of rope tied to one of their legs.

As the man gazed upon the elephants, he was completely confused as to why the elephants didn't just use their strength to break the rope and escape the camp. They could easily have done so, but instead, they didn't try to at all.

Curious and wanting to know the answer, he asked a trainer nearby why the elephants were just standing there and never tried to escape.

The trainer replied;
"when they are very young and much smaller we use the same size rope to tie them and, at that age, it's enough to hold them. As they grow up, they are conditioned to believe they cannot break away. They believe the rope can still hold them, so they never try to break free."

The only reason that the elephants weren't breaking free and escaping from the camp was that over time they adopted the belief that it just wasn't possible.

Moral of the story:
No matter how much the world tries to hold you back, always continue with the belief that what you want to achieve is possible. Believing you can become successful is the most important step in actually achieving it.

- UNKNOWN

BRASS CAM AND GROOVE

HOSE ACCESSORIES

BRASS

MALE ADAPTER X FEMALE NPT
TYPE A



4491X

PART#	SIZE	
CGA-050-B1	1/2"	----
*CGA-075-B1	3/4"	----
*CGA-100-B1	1"	----
CGA-125-B1	1-1/4"	----
CGA-150-B1	1-1/2"	----
*CGA-200-B1	2"	----
CGA-250-B1	2-1/2"	----
*CGA-300-B1	3"	----
*CGA-400-B1	4"	----
CGA-500-B1	5"	----
*CGA-600-B1	6"	----

FEMALE COUPLER X HOSE SHANK
TYPE C



4493X

PART#	SIZE	
CGC-050-B1	1/2"	----
*CGC-075-B1	3/4"	----
*CGC-100-B1	1"	----
CGC-125-B1	1-1/4"	----
CGC-150-B1	1-1/2"	----
*CGC-200-B1	2"	----
CGC-250-B1	2-1/2"	----
*CGC-300-B1	3"	----
*CGC-400-B1	4"	----
CGC-500-B1	5"	----
*CGC-600-B1	6"	----

FEMALE COUPLER X MALE NPT
TYPE B



4492X

PART#	SIZE	
CGB-050-B1	1/2"	----
*CGB-075-B1	3/4"	----
*CGB-100-B1	1"	----
CGB-125-B1	1-1/4"	----
*CGB-150-B1	1-1/2"	----
*CGB-200-B1	2"	----
CGB-250-B1	2-1/2"	----
*CGB-300-B1	3"	----
*CGB-400-B1	4"	----
CGB-500-B1	5"	----
CGB-600-B1	6"	----

*IN STOCK IN HOUSTON

FEMALE COUPLER X FEMALE NPT
TYPE D



4494X

PART#	SIZE	
CGD-050-B1	1/2"	----
*CGD-075-B1	3/4"	----
*CGD-100-B1	1"	----
*CGD-125-B1	1-1/4"	----
CGD-150-B1	1-1/2"	----
*CGD-200-B1	2"	----
CGD-250-B1	2-1/2"	----
*CGD-300-B1	3"	----
*CGD-400-B1	4"	----
CGD-500-B1	5"	----
*CGD-600-B1	6"	----

WARNING: This product can expose you to chemicals, including lead, which are known to the State of California to cause cancer and birth defects or other reproductive harm. For more information, visit www.P65Warnings.ca.gov

HOSE ACCESSORIES

BRASS CAM AND GROOVE

HOSE ACCESSORIES

**MALE ADAPTER X HOSE SHANK
TYPE E**

4495X

PART#	SIZE	
CGE-050-B1	1/2"	----
*CGE-075-B1	3/4"	----
*CGE-100-B1	1"	----
*CGE-125-B1	1-1/4"	----
*CGE-150-B1	1-1/2"	----
*CGE-200-B1	2"	----
CGE-250-B1	2-1/2"	----
*CGE-300-B1	3"	----
*CGE-400-B1	4"	----
CGE-500-B1	5"	----
*CGE-600-B1	6"	----

**MALE ADAPTER X MALE NPT
TYPE F**

4496X

PART#	SIZE	
CGF-050-B1	1/2"	----
*CGF-075-B1	3/4"	----
*CGF-100-B1	1"	----
*CGF-125-B1	1-1/4"	----
*CGF-150-B1	1-1/2"	----
*CGF-200-B1	2"	----
CGF-250-B1	2-1/2"	----
*CGF-300-B1	3"	----
*CGF-400-B1	4"	----
CGF-500-B1	5"	----
CGF-600-B1	6"	----

*IN STOCK IN HOUSTON

**DUST CAP
TYPE DC**

4497X

PART#	SIZE	
CDC-050-B1	1/2"	----
*CDC-075-B1	3/4"	----
*CDC-100-B1	1"	----
CDC-125-B1	1-1/4"	----
CDC-150-B1	1-1/2"	----
*CDC-200-B1	2"	----
CDC-250-B1	2-1/2"	----
*CDC-300-B1	3"	----
*CDC-400-B1	4"	----
CDC-500-B1	5"	----
CDC-600-B1	6"	----

**DUST PLUG
TYPE DP**

4498X

PART#	SIZE	
CDP-050-B1	1/2"	----
*CDP-075-B1	3/4"	----
*CDP-100-B1	1"	----
CDP-125-B1	1-1/4"	----
CDP-150-B1	1-1/2"	----
*CDP-200-B1	2"	----
CDP-250-B1	2-1/2"	----
*CDP-300-B1	3"	----
*CDP-400-B1	4"	----
CDP-500-B1	5"	----
CDP-600-B1	6"	----

Brass Stool Adapter and Brass Type DA available online at www.midlandindustries.com

CRIMPLOK

SELF LOCKING CAM & GROOVE



STAINLESS STEEL &
ALUMINUM

UNIVERSAL FITTINGS

CRIMPLOCK KING NIPPLES



CRIMPLOK FERRULES - PLATED STEEL - STAINLESS STEEL ALUMINUM



SOLID

DEPENDABLE

SAFE

FEATURES AND BENEFITS

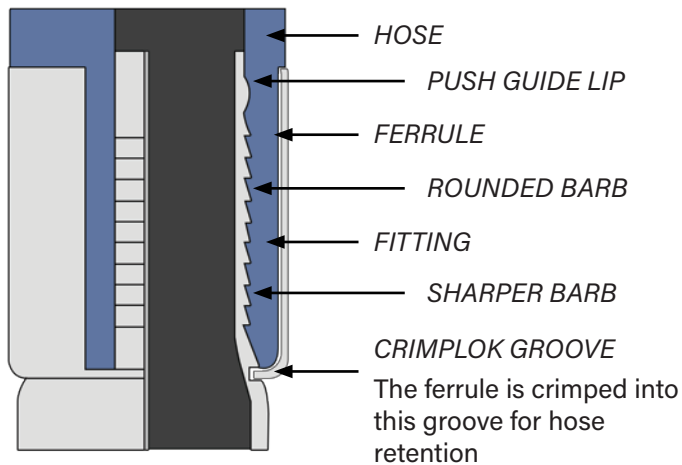

Crimplok is the best way to ensure a perfect hose connection every time!

- All fittings have a Crimplok groove for the ferrule end the Lok into for a strong permanent seal.
- Serrations on the couplings and fittings are not as sharp at the top, but become sharper towards the Crimplok groove.
- The length of the barb and sleeve/ ferrule are matched for a safer, cleaner connection.
- Crimplok connections do not have sharp clamp buckles or edges
- Interchangeable with most market systems

CRIMPLOK

HOSE ACCESSORIES

ALUMINUM SELF LOCKING CAM & GROOVE

- Automatic Self-Locking Arms Prevent Accidental Disconnection
- Machined multi-serrated shank with interlocking groove
- Aluminum with Brass Self Locking Arms
- 316 Stainless with Investment Cast Self-Locking Arms
- Available in sizes 2" through 6"
- 2" @250 psi 3" & 4" @150 psi 6" @75 psi
- 6" @150 psi 4 arms
- Configurations
 - Dust Cap
 - Part B
 - Part C
 - Part D

Sample item code	Description
CDCSL-XXX-A1	X" DUST CAP ALUMINUM CRIMPLOK SELF LOCKING
CGBSL-XXX-A1	X" PART B ALUMINUM CRIMPLOK SELF LOCKING
CGCSL-XXXCR-A1	X" PART C ALUMINUM CRIMPLOK SELF LOCKING
CGDSL-XXX-A1	X" PART D ALUMINUM PRIMPLOK SELF LOCKING

Designed for use with Buchanan Crimp Sleeves and Interlocking Ferrules

FEMALE COUPLER X MALE NPT TYPE B



CGBSL

PART#	SIZE	NET
CGBSL-200-A1	2"	----
CGBSL-300-A1	3"	----
CGBSL-400-A1	4"	----
CGBSL-600-A1	6"	----

FEMALE COUPLER X FEMALE NPT TYPE D



CGDSL

PART#	SIZE	NET
CGDSL-200-A1	2"	----
CGDSL-300-A1	3"	----
CGDSL-400-A1	4"	----
CGDSL-600-A1	6"	----

FEMALE COUPLER X HOSE SHANK TYPE C



CGCSL

PART#	SIZE	NET
CGCSL-200CR-A1	2"	----
CGCSL-300CR-A1	3"	----
CGCSL-400CR-A1	4"	----
CGCSL-600CR-A1	6"	----
CGCSL-600CR-A4	6" w/4 arms	----

DUST CAP TYPE DC



CDCSL

PART#	SIZE	NET
CDCSL-200-A1	2"	----
CDCSL-300-A1	3"	----
CDCSL-400-A1	4"	----
CDCSL-600-A1	6"	----

STAINLESS STEEL SELF LOCKING CAM & GROOVE

- Automatic Self-Locking Arms Prevent Accidental Disconnection
- Machined multi-serrated shank with interlocking groove
- Aluminum with Brass Self Locking Arms
- 316 Stainless with Investment Cast Self-Locking Arms
- Available in sizes 2" through 6"
- 2" @250 psi 3" & 4" @150 psi 6" @75 psi
- 6" @150 psi 4 arms
- Configurations
 - Dust Cap
 - Part B
 - Part C
 - Part D

Sample item code	Description
CDCL-XXX-SS1	X" DUST CAP STAINLESS CRIMPLOK 316 SELF LOCKING
CGBSL-XXX-SS1	X" PART B STAINLESS CRIMPLOK 316 SELF LOCKING
CGCSL-XXXCR-SS1	X" PART C STAINLESS 316 CRIMPLOK SELF LOCKING
CGDSL-XXX-SS1	X" PART D STAINLESS CRIMPLOK 316 SELF LOCKING

Designed for use with Buchanan Crimp Sleeves and Interlocking Ferrules

FEMALE COUPLER X MALE NPT
TYPE B

CGBSL



PART#	SIZE	NET
CGBSL-200-SS1	2"	----
CGBSL-300-SS1	3"	----
CGBSL-400-SS1	4"	----
CGBSL-600-SS1	6"	----

FEMALE COUPLER X FEMALE NPT
TYPE D

CGDSL



PART#	SIZE	NET
CGDSL-200-SS1	2"	----
CGDSL-300-SS1	3"	----
CGDSL-400-SS1	4"	----
CGDSL-600-SS1	5"	----

FEMALE COUPLER X HOSE SHANK
TYPE C

CGCSL



PART#	SIZE	NET
CGCSL-200CR-SS1	2"	----
CGCSL-300CR-SS1	3"	----
CGCSL-400CR-SS1	4"	----
CGCSL-600CR-SS1	6"	----

DUST CAP
TYPE DC

CDCSL



PART#	SIZE	NET
CDCSL-200-SS1	2"	----
CDCSL-300-SS1	3"	----
CDCSL-400-SS1	4"	----
CDCSL-600-SS1	5"	----

CRIMPLOK

HOSE ACCESSORIES

CRIMPLOK ALUMINUM CAM & GROOVE COUPLINGS

TYPE C



PART#	SIZE	
CGC-150CR-A1	1-1/2"	----
CGC-200CR-A1	2"	----
CGC-250CR-A1	2-1/2"	----
CGC-300CR-A1	3"	----
CGC-400CR-A1	4"	----
CGC-600CR-A1	6"	----
CGC-800CS-A1	8"	----

TYPE E



PART#	SIZE	
CGE-150CR-A1	1-1/2"	----
CGE-200CR-A1	2"	----
CGE-250CR-A1	2-1/2"	----
CGE-300CR-A1	3"	----
CGE-400CR-A1	4"	----
CGE-600CR-A1	6"	----
CGE-800CS-A1	8"	----

Project Information: For use with CRIMPLOK Ferrules CF-XXXXX-SP

CRIMPLOK STAINLESS CAM & GROOVE COUPLINGS

TYPE C



PART#	SIZE	
CGC-100CR-SS1	1"	----
CGC-150CR-SS1	1-1/2"	----
CGC-200CR-SS1	2"	----
CGC-300CR-SS1	3"	----
CGC-400CR-SS1	4"	----

TYPE E



PART#	SIZE	
CGE-100CR-SS1	1"	----
CGE-150CR-SS1	1-1/2"	----
CGE-200CR-SS1	2"	----
CGE-300CR-SS1	3"	----
CGE-400CR-SS1	4"	----

Project Information: For use with CRIMPLOK Ferrules CF-XXXXX-SS304

HANDLES, RINGS AND PINS

HOSE ACCESSORIES

QUICKKLOK HANDLE FOR ALUMINUM, BRASS & SS



PART#	SIZE	
HSK2-200-SS	1-1/2"	----
HSK2-300-SS	3"	----

QUICKKLOK HANDLE FOR SS AND ALUMINUM



PART#	SIZE	
HSK5-200-SS	1-1/2-2"	----
HSK5-300-SS	3-4"	----

INVESTMENT CAST STAINLESS STEEL HANDLE, RING & PIN



PART#	SIZE	
61447	3/4"	----
61448	1"	----
61449	1-1/4" - 2-1/2"	----
61452	3" & 4"	----
61454	6"	----

FORGED BRASS HANDLE - RING & PIN STEEL



PART#	SIZE	
61455	3/4"	----
61450	1"	----
61451	1-1/4" - 2-1/2"	----
61453	3" & 4"	----
61457	6"	----

SAFETY CLIP



PART #	SIZE	
66015	1-1/4" - 2-1/2"	----

HANDLE + PIN + RING BRASS

GASKETS

HOSE ACCESSORIES

CAMLOCK GASKET EPDM

PART#	SIZE	
CG-050-EPDM	1/2"	----
CG-200-EPDM	2"	----
CG-300-EPDM	3"	----

CAMLOCK GASKET NBR

PART#	SIZE	
CG-075-NBR	3/4	----
CG-100-NBR	1	----
CG-125-NBR	1-1/4	----
CG-150-NBR	1-1/2	----
CG-200-NBR	2	----
CG-250-NBR	2-1/2	----
CG-300-NBR	3	----
CG-400-NBR	4	----
CG-500-NBR	5	----
CG-600-NBR	6	----
CG-800-NBR	8	----

CAMLOCK GASKET VITON

PART#	SIZE	
CG-050-VI	1/2	----
CG-075-VI	3/4	----
CG-100-VI	1	----
CG-125-VI	1-1/4	----
CG-150-VI	1-1/2	----
CG-200-VI	2	----
CG-250-VI	2-1/2	----
CG-300-VI	3	----
CG-400-VI	4	----

BUNA-N GASKET

PART#	SIZE	
BG50	1/2"	----
BG75	3/4"	----
BG100	1"	----
BG125	1-1/4"	----
BG150	1-1/2"	----
BG200	2"	----
BG250	2-1/2"	----
BG300	3"	----
BG400	4"	----
BG500	5"	----
BG600	6"	----
BG800	8"	----

SILICONE GASKET

PART#	SIZE	
SG300	3"	----
SG400	4"	----

VITON GASKET

PART#	SIZE	
VG100	1"	----
VG150	1-1/2"	----
VG200	2"	----
VG250	2-1/2"	----
VG300	3"	----



GO ONLINE TO UPLOAD YOUR LOGO TO UTILIZE ALL OF OUR CUSTOMIZABLE TOOLS!

KING NIPPLES

HOSE ACCESSORIES

COMBINATION NIPPLES

HOSE BARB X MALE PIPE

STEEL HOSE NIPPLES



CNT-XXX-S

▪ BLACK

(BARB X MALE PIPE)

PART #	HOSE SIZE	
*973850	1/2"	----
*973851	3/4"	----
*973852	1"	----
*973853	1-1/4"	----
*973854	1-1/2"	----
*973855	2"	----
*973856	2-1/2"	----
*973857	3"	----
*973858	4"	----
*CNT-600-S	6"	----
*973861	8"	----
*CNT-1200-S	12"	----

ZINC PLATED STEEL



CNT-XXX-SP

PART #	SIZE	
*973870	1/2"	----
*973871	3/4"	----
*973872	1"	----
*973873	1-1/4"	----
*973874	1-1/2"	----
*973875	2"	----
*973876	2-1/2"	----
*973877	3"	----
*973878	4"	----
*973879	5"	----
*973880	6"	----
*973881	8"	----
CNT-1200-SP	12"	----

COMBINATION NIPPLE 316 STAINLESS



CNT-XXX-S316

PART #	SIZE	
973697	1/4" 1/4"	
973698	3/8" x 3/8"	
973699	1/2" x 3/8"	
*973700	1/2"	----
*973701	3/4"	----
*973702	1"	----
973703	1-1/4"	----
*973704	1-1/2"	----
*973705	2"	----
973706	2-1/2"	----
973707	3"	----
973708	4"	----

*IN STOCK IN HOUSTON

ZINC PLATED STEEL EXPANDER & REDUCER



EXP
RED

HOSE X MIP

PART #	SIZE	
*973862	3/4 x 1	----
*973884	1 x 3/4	----
973863	1 x 1-1/4	----
*973885	1-1/4 x 1	----
*973886	1-1/4 x 1-1/2	----
*973887	1-1/2 x 1-1/4	----
*973864	1-1/2 x 2	----
*973888	2 x 1-1/2	----
*973859	2 x 2-1/2	----
*973869	2-1/2 x 2	----
*973865	2-1/2 x 3	----
*973867	3 x 2-1/2	----
*973866	3 x 4	----
*973868	4 x 3	----

*IN STOCK IN HOUSTON



HELP US HELP YOU! GO ONLINE TO UPDATE YOUR CUSTOMER PROFILE SO THAT WE CAN UPDATE ALL THE APPROPRIATE DEPARTMENTS AND PERSONNEL AT YOUR COMPANY ON NEW CATALOGS, PRICING UPDATES, NEW MARKETING TOOLS, AND OTHER IMPORTANT INFORMATION. THANK YOU!

KING NIPPLES

HOSE ACCESSORIES

**COMBINATION NIPPLES
HOSE BARB X MALE PIPE**

BRASS



CNT-XXX-B

▪ LEAD FREE

PART #	SIZE	
973600	1/2"	----
973601	3/4"	----
973602	1"	----
973603	1-1/4"	----
973604	1-1/2"	----
973605	2"	----
973606	2-1/2"	----
973607	3"	----
CNT-400-B	4"	----

ALUMINUM



CNT-XXX-A

PART #	SIZE	
973620	1/2"	----
973621	3/4"	----
973622	1"	----
973623	1-1/4"	----
973624	1-1/2"	----
*973625	2"	----
*973626	2-1/2"	----
*973627	3"	----
*973628	4"	----

*IN STOCK IN HOUSTON

**victaulic grooved
combination nipples**COMBINATION NIPPLE PLAIN STEEL
VICTAULIC GROOVED

CNG-S

PART #	HOSE SIZE	
*CNG-200-S	2"	----
*CNG-300-S	3"	----
*CNG-400-S	4"	----
*CNG-600-S	6"	----

COMBINATION NIPPLE
PLATED VICTAULIC GROOVED

PART#	SIZE	
CNG-150-SP	1-1/2"	----
*CNG-200-SP	2"	----
CNG-250-SP	2-1/2"	----
CNG-300-SP	3"	----
*CNG-400-SP	4"	----
CNG-500-SP	5"	----
*CNG-600-SP	6"	----



SEE WEBSITE TO DOWNLOAD YOUR MOST UPDATED PRICING

CRIMPLOK
HOSE ACCESSORIES

CRIMPLOK CRIMP UNIVERSAL FITTINGS



PART#	SIZE	MAX OPERATING PSI 70F	
FHE-075-MP	3/4	150	----
HE-050CF-SP	1/2	150	----
HE-075CF-SP	3/4	150	----
HE-075CR-SP	3/4	150	----
HE-100CF-SP	1	150	----
HE-100CR-SP	1	150	----
HE-101CF-SP	1	150	----

HIGH PRESSURE FEMALE STEM



PART#	SIZE	
GJS-050CR-SP	1/2	----
GJS-075CR-SP	3/4	----
GJS-100CR-SP	1	----
GJS-125CR-SP	1-1/4	----
GJS-150CR-SP	1-1/2	----
GJS-200CR-SP	2	----
GJS-250CR-SP	2-1/2	----
GJS-300CR-SP	3	----
GJS-400CR-SP	4	----

HIGH PRESSURE MALE STEM



PART#	SIZE	
GJM-050CR-SP	1/2	----
GJM-075CR-SP	3/4	----
GJM-100CR-SP	1	----
GJM-125CR-SP	1-1/4	----
GJM-150CR-SP	1-1/2	----
GJM-200CR-SP	2	----
GJM-250CR-SP	2-1/2	----
GJM-300CR-SP	3	----
GJM-400CR-SP	4	----

CRIMPLOK KING NIPPLES

HOSE ACCESSORIES

**CRIMPLOK CRIMP COMBINATION
NIPPLES PLATED STEEL**

PART#	SIZE	
*CNT-100CR-SP	1"	----
*CNT-125CR-SP	1-1/4"	----
*CNT-150CR-SP	1-1/2"	----
*CNT-200CR-SP	2"	----
*CNT-250CR-SP	2-1/2"	----
*CNT-300CR-SP	3"	----
*CNT-400CR-SP	4"	----
*CNT-600CR-SP	6"	----

Project Information: For use with
CRIMPLOK Ferrules CF-XXXXX-SP

**CRIMPLOK CRIMP COMBINATION
NIPPLES STAINLESS**

PART#	SIZE	
*CNT-100CR-SS316	1"	----
CNT-125CR-SS316	1-1/4"	----
*CNT-150CR-SS316	1-1/2"	----
*CNT-200CR-SS316	2"	----
*CNT-250CR-SS316	2-1/2"	----
*CNT-300CR-SS316	3"	----
*CNT-400CR-SS316	4"	----
*CNT-600CR-SS316	6"	----

Project Information: For use with
CRIMPLOK Ferrules CF-XXXXX-SS304

**CRIMPLOK COMBINATION
NIPPLE PLATED LONG NPT**

PART#	SIZE	
*CNL-200CR-SP	2"	----
*CNL-250CR-SP	2-1/2"	----
*CNL-300CR-SP	3"	----
*CNL-400CR-SP	4"	----

Project Information: For use with
CRIMPLOK Long Ferrules CF-XXXXXL-SP

**CRIMPLOK HD COMBINATION NIPPLE
PLATED**

PART#	SIZE	
*CNT-400CS-SP	4"	----
*CNT-600CS-SP	6"	----
*CNT-800CS-SP	8"	----

Project Information: For use with
CRIMPLOK Sleeves CSL-XXXXX-SP

**CRIMPLOK HD COMBINATION NIPPLE
UNPLATED**

PART#	SIZE	
*CNT-400CS-S	4"	----
*CNT-600CS-S	6"	----
CNT-800CS-S	8"	----

Project Information: For use with
CRIMPLOK Sleeves CSL-XXXXX-SP

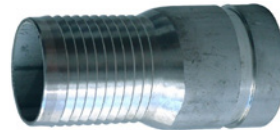
**CRIMPLOK HD COMBINATION NIPPLE
VICTAULIC PLATED**

PART#	SIZE	
*CNG-400CS-SP	4"	----
*CNG-600CS-SP	6"	----
*CNG-800CS-SP	8"	----

Project Information: For use with
CRIMPLOK Sleeves CSL-XXXXX-SP

**CRIMPLOK HD COMBINATION NIPPLE
VICTAULIC UNPLATED**

PART#	SIZE	
*CNG-400CS-S	4"	----
*CNG-600CS-S	6"	----
*CNG-800CS-S	8"	----

Project Information: For use with
CRIMPLOK Sleeves CSL-XXXXX-SP

CRIMPLOK KING NIPPLES

HOSE ACCESSORIES

CRIMPLOK CRIMP VICTAULIC COMBINATION NIPPLES PLATED STEEL

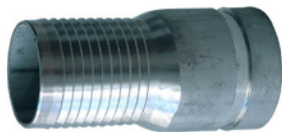

PART#	SIZE	
*CNG-200CR-SP	2"	----
*CNG-300CR-SP	3"	----
*CNG-400CR-SP	4"	----
*CNG-600CR-SP	6"	----

Project Information: For use with CRIMPLOK Ferrules CF-XXXXX-SP

CRIMPLOK CRIMP VICTAULIC COMBINATION NIPPLES STAINLESS



PART#	SIZE	
CNG-200CR-SS316	2"	----
CNG-250CR-SS316	2-1/2"	----
CNG-300CR-SS316	3"	----
CNG-400CR-SS316	4"	----

Project Information: For use with CRIMPLOK Ferrules CF-XXXXX-SS304

CRIMPLOK FIXED FLANGE NIPPLE STEEL 125 - 150#



PART#	SIZE	
*CNFL-200CR-S	2"	----
*CNFL-300CR-S	3"	----
*CNFL-400CR-S	4"	----
*CNFL-600CR-S	6"	----

Project Information: For use with CRIMPLOK Ferrules CF-XXXXX-SP
Stainless Steel available - add S316 to part #

CRIMPLOK CRIMP TURNBACK COMBINATION NIPPLES STEEL



PART#	SIZE	
*CNTB-200CR-S	2"	----
*CNTB-300CR-S	3"	----
*CNTB-400CR-S	4"	----
*CNTB-600CR-S	6"	----

Project Information: For use with CRIMPLOK Ferrules CF-XXXXX-SP

CRIMPLOK CRIMP TURN BACK NIPPLES STAINLESS



PART#	SIZE	
*CNTB-200CR-SS316	2"	----
*CNTB-300CR-SS316	3"	----
*CNTB-400CR-SS316	4"	----
*CNTB-600CR-SS316	6"	----

Project Information: For use with CRIMPLOK Ferrules CF-XXXXX-SS304

CRIMPLOK CRIMP SQUARE CUT COMBINATION NIPPLES UNPLATED



PART#	SIZE	
*CNCS-300CR-SP	3"	----
*CNCS-400CR-SP	4"	----

Project Information: For use with CRIMPLOK Ferrules CF-XXXXX-SP

CRIMPLOK FIXED FLANGE NIPPLE STAINLESS STEEL 125 - 150#



PART#	SIZE	
*CNFL-200CR-SS316	2"	----
*CNFL-300CR-SS316	3"	----
*CNFL-400CR-SS316	4"	----
*CNFL-600CR-SS316	6"	----

Project Information: For use with CRIMPLOK Ferrules CF-XXXXX-SP

HOSE MENDERS

HOSE ACCESSORIES

hose menders**MENDER PLAIN STEEL**

HM-S

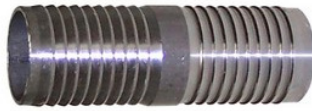

PART #	HOSE SIZE	
973890	1/2"	----
HM-063-S	5/8"	----
973891	3/4"	----
973892	1"	----
973893	1-1/4"	----
973894	1-1/2"	----
973895	2"	----
HM-300-S	3"	----
HM-400-S	4"	----
HM-600-S	6"	----
HM-800-S	5"	----

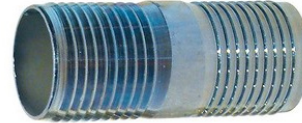
MENDER PLATED STEEL

PART #	SIZE	
973650	3/8"	----
973651	1/2"	----
HM-063-SP	5/8"	----
973652	3/4"	----
973653	1"	----
973654	1-1/4"	----
973655	1-1/2"	----
973656	2"	----
973657	2-1/2"	----
973658	3"	----
973659	4"	----
HM-600-SP	6"	----
HM-800-SP	8"	----

316 STAINLESS STEEL HOSE MENDER

PART #	SIZE	
73669	1/2"	----
73670	3/4"	----
73671	1"	----
73672	1-1/4"	----
73673	1-1/2"	----
73674	2"	----
73675	2-1/2"	----
73676	3"	----
73677	4"	----

BRASS HOSE MENDER

• LEAD FREE

PART #	SIZE	
73983	3/4"	----
73984	1"	----
73985	1-1/4"	----
73986	1-1/2"	----
73987	2"	----



USE OUR APP WITH YOUR FREE BIN LABELS TO MANAGE
YOUR CUSTOMERS INVENTORY MORE EFFICIENTLY

UNIVERSAL COUPLINGS

HOSE ACCESSORIES

UNIVERSAL COUPLING

MALE NPT ENDS

- Twist claw/ universal/ chicago



- Malleable iron
- ISO PSI

ME-XXX-SP

* Safety clip included

PART #	SIZE	
ME-025-SP	1/4	----
66005	3/8"	----
66006	1/2"	----
66007	3/4"	----
66008	1"	----

WASHER



PART #	
66000	----

FEMALE NPT ENDS



* Safety clip included

PART #	SIZE	
FE-025-SP	1/4"	----
66009	3/8"	----
66010	1/2"	----
66011	3/4"	----
66012	1"	----
FE-125-SP	1-1/4"	----
FE-150-SP	1-1/2"	----
FE-200-SP	2"	----

HOSE END



SEE CRIMPLOK SECTION

HE-XXX-SP

* Safety clip included

PART #	SIZE	
66001	3/8"	----
66002	1/2"	----
66003	3/4"	----
66004	1"	----
HE-125-SP	1-1/4"	----
HE-150-SP	1-1/2"	----
HE-200-SP	2"	----

TRIPLE CONNECTIONS



UW-300-SP

PART #	
66013	----

UNIVERSAL BLANK END



ISO PSI

PART #	SIZE	
BE-300-SP		----

GROUND JOINT COUPLINGS

HOSE ACCESSORIES

GROUND JOINT COUPLING**HIGH PRESSURE FEMALE+ WING NUT+FEMALE SPUD**

PART #	SIZE	
73003	1/2	----
73004	3/4	----
73005	1	----
73006	1-1/4	----
73007	1-1/2	----
73008	2	----
73009	2-1/2	----
73010	3	----
73011	4	----

HIGH PRESSURE WING NUT

PART #	SIZE	PART #	
73033	1/2	*GJN-050-DP	----
73035	3/4	*GJN-075-DP	----
73036	1-1/4	*GJN-125-DP	----
73037	1-1/2	*GJN-150-DP	----
73038	2	*GJN-200-DP	----
73039	2-1/2		
73040	3	*GJN-300-DP	----
73041	4		

HIGH PRESSURE FEMALE STEM

PART #	SIZE	PART #	
73023	1/2	*GJS-050-SP	----
73024	3/4	*GJS-075-DP	----
73025	1	*GJS-100-DP	----
73026	1-1/4	*GJS-125-DP	----
73027	1-1/2	*GJS-150-DP	----
73028	2	*GJS-200-DP	----
73029	2-1/2"		
73030	3"		
73031	4"		

HIGH PRESSURE FEMALE SPUD

PART #	SIZE	PART #	
73063	1/2	*GJF-050-SP	----
73064	3/4	*GJF-075-DP	----
73065	1	*GJF-100-DP	----
73066	1-1/4	*GJF-125-DP	----
73067	1-1/2	*GJF-150-DP	----
73068	2	*GJF-200-DP	----
73070	3	*GJF-300-DP	----

HIGH PRESSURE DOUBLE SPUD

PART #	SIZE	
GDS-050-B	1/2	----
*GDS-075-B	3/4	----

*IN STOCK IN HOUSTON

GROUND JOINT COUPLINGS/ ALUMINUM SHORT SHANKS

HOSE ACCESSORIES

2 BOLT HIGH PRESSURE CLAMP



PART #	HOSE ID	CLAMP RANGE	MAX BOLT TORQUE	
*BC2-075A-DP	3/4"	1-5/32"-1-9/32"	21FT LBS	----
*BC2-075C-DP	3/4"	1-5/16"-1-1/2"	21FT LBS	----

4 BOLT HIGH PRESSURE CLAMP



PART #	HOSE ID	CLAMP RANGE	MAX BOLT TORQUE	
BC4-100B-DP	1"	1.53-1.72	21FT LBS	----
BC4-125-DP	1-1/4"	2.06-2.25	40FT LBS	----
BC4-200A-DP	2"	2-11/32"-2-17/32"	60FT LBS	----
BC4-200-DP	2-1/2"	3-3/32"-3-7/16"	60FT LBS	----

HIGH PRESSURE MALE STEM



PART #	LIST	SIZE	PART #	
73043		1/2	*GJM-050-SP	----
73044		3/4	*GJM-075-SP	----
73045		1	*GJM-100-SP	----
73046		1-1/4	*GJM-125-DP	----
73047		1-1/2	*GJM-150-DP	----
73048		2	*GJM-200-DP	----
73049		2-1/2		
73050		3		
73051		4		

NPT STEEL HEX NIPPLE



PART #	SIZE	
HNC-04-02-SP	1/4 x 1/8	----
HNC-04-04-SP	1/4 x 1/4	----
HNC-06-04-SP	3/8 x 1/4	----
HNC-06-06-SP	3/8 x 3/8	----
HNC-08-06-SP	1/2 x 3/8	----
HNC-08-08-SP	1/2 x 1/2	----
HNC-12-08-SP	3/4 x 1/2	----
HNC-16-12-SP	1 x 3/4	----

SHORT SHANK ALUMINUM SET NPS



PART #	SIZE	
PL-150-AD	1-1/2	----
*PL-200-AD	2	----
*PL-300-AD	3	----
*PL-400-AD	4	----

FEMALE END

PART #	SIZE	
PF-150-AD	1-1/2	----
PF-200-AD	2	----
PF-300-AD	3	----
PF-400-AD	4	----
PF-600-AD	6	----

MALE END

PART #	SIZE	
PM-150-A	1-1/2	----
PM-200-A	2	----
PM-300-A	3	----

STRAINERS/ NOZZLES

HOSE ACCESSORIES

**LARGE SAFETYCHECK FOR HOSE/
HOSE AND HOSE/TOOL**

HOSE TO HOSE

PART #	SIZE	
WHIP-L	1-1/2" HOSE, 37" LONG	----
WHIP-S	1/2-1-1/4" HOSE 22" LONG	----

FOOT VALVE

PART #	SIZE	
*FV-200-DP	2	----
*FV-300-DP	3	----
*FV-400-DP	4	----
*FV-600-DP	6	----

STRAINER ROUND HOLE

PART #	SIZE	
*SR-200-SP	2	----
*SR-250-SP	2-1/2	----
*SR-300-SP	3	----
*SR-400-SP	4	----
*SR-600-SP	6	----
*SR-800-SP	8	----

**STRAINER ROUND HOLE
LONG THIN**

PART #	SIZE	
*SL-200-SP	2	----
*SL-300-SP	3	----

*IN STOCK IN HOUSTON

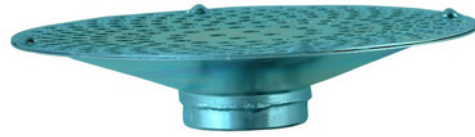
STRAINER BOTTOM HOLE

PART #	SIZE	STRAINER HOSE SIZE	
SB-200-SP	2		----
SB-300-SP	3		----

**STRAINER
STRAINER BOTTOM HOLE**

PART #	SIZE	
SCR-300-SS304	3	----
SCR-400-SS304	4	----

**PLASTIC FOG
NOZZLE GHT**

PART #	SIZE	
FN-075	3/4	----
FN-075R	3/4	----

**PLASTIC FOG
NOZZLE NPS**

PART #	SIZE	
FN-100	1	----
*FN-150	1-1/2	----
FN-200	2	----

**GREEN ABS FOG
NOZZLE GHT**

PART #	SIZE	
FN-075G	3/4	----

FIRE HOSE FITTINGS

HYDRANT ADAPTERS - BRASS



PART #	DESCRIPTION	
444011	1-1/2" NST x 3/4" GHT	----
444000	2-1/2" NST x 3/4" GHT	----
444001	2-1/2" NST x 3/4" NPT	----
444002	2-1/2" NST x 1" NPT	----
444005	2-1/2" NST x 1-1/2" NPT	----
444007	2-1/2" NST x 2" NPSH	----
444008	2-1/2" NST x 2" NPT	----
444006	2-1/2" NST x 1-1/2" NST	----

DOUBLE MALE HEX NIPPLE - BRASS



PART #	DESCRIPTION	
444042	1-1/2" NPT x 1-1/2" NPSH	----
444040	1-1/2" NPT x 1-1/2" NST	----
444048	2" NPT x 2-1/2" NST	----
444095	2-1/2" NST x 1-1/2" NST	----
444045	2-1/2" NPT x 2-1/2" NST	----
444049	3" NPT x 2-1/2" NST	----

FEMALE TO MALE HEX ADAPTER - BRASS



PART #	FEMALE X MALE	
444021	1-1/2" NST x 1-1/2" NPSH	----
444023	1-1/2" NPT x 1-1/2" NPSH	----
444020	1-1/2" NST x 1-1/2" NPT	----
444318	2 NPT x 2-1/2" NST	----
444026	2-1/2" NST x 2-1/2" NPT	----

MALE SWIVEL ADAPTER - BRASS W/ LUGS



PART #	DESCRIPTION FEMALE X MALE	
444111	2-1/2" NST x 2" NPT	----
444112	2-1/2" NST x 2-1/2" NPT	----
444113	2-1/2" NST x 3" NPT	----

CAP - BRASS



PART #	DESCRIPTION	
444062	2-1/2" NST	----
444313	4-1/2" NST	----
444320	2-1/2" NST PLUG	----
444060	1-1/2" NST	----

BRASS NOZZLE



PART #	PIPE	
HN-075-B	3/4"	----
*HN-100-B	1"	----
HN-125-B	1-1/4"	----
HN-150-B	1-1/2"	----
HN-200-B	2"	----
HN-250-B	2-1/2"	----

*IN STOCK IN HOUSTON

BUCHANAN HOSE
HOSE ACCESSORIES

BUCHANAN HOSE
STOCKED IN HOUSTON
(WILL STOCK IN OTHER LOCATIONS BY REQUEST)



WITH SIX LOCATIONS TO SERVE YOU:



TORONTO
EDMONTON

MONTREAL
HOUSTON

KANSAS CITY
COMING SOON
LOS ANGELES





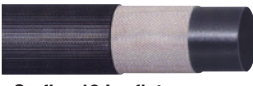
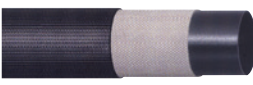

HOSE INFORMATION

HOSE ACCESSORIES

PRODUCT	DESCRIPTION	APPLICATION	PRESSURE	SIZES	TEMPERATURE
Air Hoses - Also Available: Montana, Hi-Temp Steelflex Air, Oroflex Air, Oroflex 20, Duraflex 20 & Hot Air Blower					
	Yellow cut and abrasion resistant cover with blue stripe. Tube is oil resistant synthetic rubber.	A superior quality mining, construction and industrial hose.	400 PSI	1/2" - 4"	-35°C to +80°C -30°F to +180°F
Super Service Air					
	Yellow cut and abrasion resistant rubber cover with oil mist resistant synthetic rubber tube.	For mining, construction, and industrial use.	250 - 300 PSI	1/2" - 4"	-35°C to +80°C -30°F to +180°F
Contractors Air					
	Yellow cut and abrasion resistant cover with red stripe. Tube is oil resistant synthetic rubber.	High pressure steel reinforced air service for mining, construction and industrial use. More resistant to external abuse than textile air hose. Mandrel built.	400 - 1000 PSI	1/2" - 4"	-35°C to +80°C -30°F to +180°F
Steelflex Air					
	Smooth Yellow cut and abrasion resistant rubber cover with oil mist resistant synthetic rubber tube.	An economical air hose for jackhammer and other uses on construction sites. Also for general industrial use.	300 PSI	3/4"	-35°C to +80°C -30°F to +180°F
Jackhammer					
General Purpose - Also Available: General Purpose, Urethane General Purpose & Self Storing Air					
	Red, oil, grease, weather and abrasion resistant nitrile/pvc cover with nitrile tube.	A premium quality long length hose for petroleum based fluids, lubricating oils, air, hot water and some chemical solutions.	250 - 300 PSI	1/4" - 1 1/2"	-32°C to +85°C -25°F to +185°F
Premium General Purpose - Non Conductive					
	Smooth red abrasion and weather resistant EPDM synthetic rubber tube and cover.	Air, water, agricultural spray solutions, and other dilute chemicals. Excellent resistance to heat and weathering. Also resists animal fats, vegetable oils and Methyl Ethyl Ketone.	150 - 250 PSI	1/4" - 2"	-30°C to +93°C -20°F to +200°F
EPDM General Purpose					
	Clear smooth PVC.	An economical FDA quality hose for handling air, water, oil, mild chemicals, and alkalis. Clear wall allows visual inspection of product. 3A/USDA/NSF-51 Compliant.	65 - 250 PSI	3/16" - 2"	-5°C to +65°C +25°F to +150°F
Clear Reinforced PVC					
	Black, Grey, Red, Blue, or Yellow oil, weather and abrasion resistant nitrile/pvc cover with nitrile tube.	Transmission of most petroleum-based hydraulic fluids, mineral oil, diesel fuel, engine coolant solutions, agricultural sprays and a wide range of chemical solutions.	250 - 300 PSI	1/4" - 3/4"	-32°C to +80°C -25°F to +180°F
Push On					
	Blue weather and oil resistant synthetic rubber specially compounded for arctic service featuring a static wire.	A premium general purpose hose for conveying air, water, petroleum products and some chemicals under arctic conditions.	300 PSI	1/2" - 2"	-54°C to +65°C -65°F to +150°F
Arctic General Purpose					
Water Discharge - Also Available: H.D Water Discharge, Garden Hose, High Pressure Water Discharge, Papermill, Packers Washdown, White Sanitary & Single Jacket Industrial Mill					
	Black abrasion, weather and oil resistant nitrile rubber cover with oil resistant nitrile rubber tube.	A lightweight high pressure, extremely strong hose for general water and oil discharge, and for some chemicals.	150 - 200 PSI	1 1/2" - 8"	-20°C to +80°C 0°F to +180°F
Oroflex 10 Layflat					
	Black abrasion, weather and oil resistant nitrile rubber.	This is a lightweight high pressure, extremely strong hose for general water discharge service. Ideal for rental service where long life and competitive pricing is paramount. Its compact characteristics make this an ideal hose for use with portable pumps. Especially suited for pumping oily contaminated water.	150 - 200 PSI	2" - 6"	-20°C to +80°C 0°F to +180°F
Duraflex - Rubber Layflat					
	Smooth cover blue and black (also wrapped version) oil resistant synthetic rubber cover. One high tensile steel braid with oil resistant synthetic rubber tube.	Extremely flexible, compact hose for use on pressure washers with working pressures up to 3000 psi. Available in 4500 psi, 250°F.	3000 PSI	3/8"	-29°C to +100°C -20°F to +212°F
Pressure Washer					

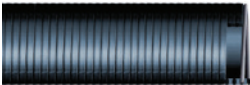
HOSE INFORMATION

HOSE ACCESSORIES

PRODUCT	DESCRIPTION	APPLICATION	PRESSURE	SIZES	TEMPERATURE
Water Discharge - Also Available: <i>H.D Water Discharge, Garden Hose, High Pressure Water Discharge, Papermill, Packers Washdown & White Sanitary</i>					
	Blue, Brown or Green PVC impregnation.	Light (Blue) to Heavy (Brown and Green) duty layflat hose for portable pump and irrigation use.	30 - 150 PSI	3/4" - 12"	-10°C to +60°C +15°F to +140°F
PVC Layflat					
	Black abrasion and weather resistant synthetic rubber cover with synthetic rubber tube.	A lightweight water discharge hose which is ideal for use with portable pumps, and general water discharge service.	75 - 100 PSI	1 1/4" - 12"	-35°C to +80°C -30°F to +180°F
Contractors and Contractors Plus Water Discharge					
	Black abrasion and weather resistant synthetic rubber cover with synthetic rubber tube.	For use on construction sites and general water service.	150 - 300PSI	1/2" - 1"	-35°C to +80°C -30°F to +180°F
Contractors Water Discharge - Industrial Garden Hose					
Water Suction - Also Available: <i>EPDM Aggie Water S & D</i>					
	A hose constructed with extra soft PVC, a feature that ensures greater flexibility and ease of handling at very low temperatures. Also available with static wire.	Can be used for light oil, grease and animal fat suction. It can also be used in more general applications where great flexibility is required at very low temperatures.	35 - 70 PSI 29" HG	2" - 6"	-40°C to +60°C -40°F to +140°F
Superflex					
	Black smooth abrasion and weather resistant synthetic rubber.	A heavy duty wire reinforced rubber suction hose for construction, quarries and general use.	50 - 200 PSI 29" HG	3/4" - 12"	-30°C to +80°C -22°F to +180°F
Rubber Water S & D					
	Clear abrasion and weather resistant extra soft low temperature PVC with blue helix	An economical, flexible hose for construction pumps, septic tank & marine pump-out service. Resistant to some chemicals, mild acids & alkalis. Consult us for recommendations. Soft low temperature compounds allow for increased flexibility.	25 - 45 PSI 29" HG	3/4" - 6"	-40°C to +65°C -40°F to +150°F
Saturn Water S & D					
	Clear abrasion and weather resistant PVC.	An economical, flexible hose for construction pumps, septic tank & marine pump-out service. Resistant to some chemicals, mild acids & alkalis. Consult us for recommendations.	25 - 90 PSI 28 - 29" HG	3/4" - 8"	-20°C to +65°C -5°F to +150°F
Saturn Green PVC Water S & D					
	Clear abrasion and weather resistant extra soft PVC.	An economical, flexible hose for construction pumps, septic tank & marine pump-out service. Resistant to some chemicals, mild acids & alkalis. Consult us for recommendations. Specially formulated compounds allow for increased flexibility at low temperatures.	35 - 90 PSI 29" HG	3/4" - 6"	-40°C to +65°C -40°F to +150°F
Saturn Low Temperature PVC Water S & D					
	Clear abrasion and weather resistant PVC.	An economical, flexible hose for construction pumps, septic tank & irrigation lines. Resistant to some chemicals, mild acids & alkalis. Consult us for recommendations.	15 - 45 PSI 26 - 29" HG	1" - 12"	-40°C to +65°C -40°F to +150°F
Saturn Grey PVC Water S & D					
	Clear abrasion and weather resistant PVC with high tensile synthetic yarn reinforcement.	Good for both suction and discharge applications, this heavy duty hose can be used for rental/construction pumping as well as fish suction hose.	40 - 110 PSI 28 - 29" HG	2" - 10"	-23°C to +65°C -10°F to +150°F
Textile Reinforced S & D					
	Clear abrasion and weather resistant PVC with white helix.	An economical, flexible hose for construction pumps, septic tank & marine pump-out service. Can also be used in air seeder applications.	35 - 90 PSI	3/4" - 8"	-20°C to +65°C -4°F to +150°F
Saturn White PVC Water Suction and Discharge Hose					







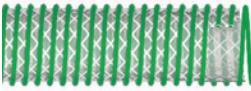

HOSE INFORMATION

HOSE ACCESSORIES

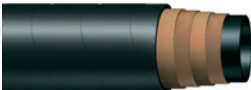
PRODUCT	DESCRIPTION	APPLICATION	PRESSURE	SIZES	TEMPERATURE
Water Suction - Also Available: EPDM Aggie Water S & D					
	Green polypropylene and Black EPDM.	Agricultural suction, general industrial use where high working pressures are not required.	22 - 50 PSI 29" HG	1 1/2" - 6"	-40°C to +60°C -40°F to +140°F
EPDM Water Suction					
Steam - Also Available: Textile Steam					
	Red, heat, weather and abrasion resistant EPDM synthetic rubber tube and cover.	An extremely flexible steel reinforced hose for use with saturated steam at pressures to 250 PSI.	250 PSI	1/2" - 3"	-40°C to +210°C -40°F to +406°F
Steam 250					
	Red abrasion resistant EPDM cover with Chlorobutyl synthetic rubber tube.	An extremely flexible steel reinforced hose for use with saturated steam at pressures to 250 PSI. Chlorobutyl tube has a low permeation factor resulting in resistance to popcorning of tube.	250 PSI	1/2" - 2"	-40°C to +210°C -40°F to +406°F
CB Steam 250					
Petroleum - Also Available: Agricultural Farm Tank, Tank Truck Drop, SAE100R4, W187 Vapour Recovery & Hot Tar & Asphalt					
	Black, abrasion, gasoline and oil resistant synthetic rubber with blue stripe.	An all purpose petroleum suction and discharge hose for use with gasoline, kerosene, diesel, oil suspensions and emulsions. May also be used as hydraulic return line and suction.	150 PSI 29" HG	3/4" - 6"	-35°C to +93°C -30°F to +200°F
Tank Truck					
	Black, abrasion, gasoline and oil resistant synthetic rubber with blue stripe and pressure.	An all purpose petroleum suction and discharge hose for use with gasoline, kerosene, diesel, oil suspensions and emulsions up to 250 PSI. May also be used as hydraulic return line and suction.	250 PSI	2" - 6"	-35°C to +93°C -30°F to +200°F
Super Black 250					
	Blue weather and oil resistant synthetic rubber specially compounded for arctic service. Corrugated with white stripe.	Specially designed to remain flexible while handling a wide range of petroleum products, including gasoline and diesel under arctic conditions.	150 PSI	1 1/2" - 6"	-54°C to +90°C -65°F to +195°F
LW Arctic Superflex 150 Petroleum					
	Black, abrasion and oil resistant synthetic rubber with red stripe.	Specially designed for conveying hot oil and/or Glycol at temperatures up to 120°C (250°F).	150 PSI	2" - 4"	up to +120°C 250°F
H.O.T Oil Tank Truck					
	Black, abrasion, gasoline and oil resistant synthetic rubber with green stripe.	An all purpose lightweight and flexible petroleum suction and discharge hose for use with gasoline, kerosene, diesel, oil suspensions and emulsions. May also be used as hydraulic return line and suction.	150 PSI	2" - 6"	-40°C to +93°C -40°F to +200°F
LW Petroleum Tank 150					
	Red, heat, oil and weather resistant Neoprene cover with nitrile tube.	For handling a wide range of petroleum products, including gasoline, as well as a number of chemical solutions.	150 - 200 PSI	3/4" - 4"	-35°C to +88°C -30°F to +190°F
Petroleum Discharge					
	Black, heat, oil and weather resistant Neoprene.	For handling a wide range of petroleum products, including gasoline, as well as a number of chemical solutions.	250 PSI	2" - 6"	-35°C to +88°C -30°F to +190°F
Petroleum Discharge 250					
	Orange PVC helix with high tensile synthetic yarn reinforcement and built in static wire.	For use as a tank truck gravity drop hose. Also for use with oil, fuel and grease transfer, oil slurry, hydrocarbons and animal fat handling. Features an external helix that protects the hose cover as well as enabling the hose to slide over rough surface.	65 - 70 PSI 28" HG	2" - 4"	-29°C to +65°C -20°F to +150°F
Petroleum Drop Hose					

HOSE INFORMATION







HOSE ACCESSORIES

PRODUCT	DESCRIPTION	APPLICATION	PRESSURE	SIZES	TEMPERATURE
Petroleum - Also Available: <i>Agricultural Farm Tank, Tank Truck Drop, SAE100R4, W187 Vapour Recovery & Hot Tar & Asphalt</i>					
	Green PVC Helix with polyurethane cover. BDROP is clear wall for flow visibility and BDROPB is black with added UV resistance.	For use as a tank truck gravity drop hose with biofuel, gasoline, diesel and ethanol. Lightweight and flexible with exposed pvc helix making it very user friendly.	65 PSI	3" - 4"	-40°C to +65°C -40°F to +150°F
Urethane Bio-Drop Fuel Hose					
	Convuluted yellow helix.	Vapour recovery from petroleum transfer operations. Embedded static wire serves to dissipate static electricity. NOT SUITABLE FOR CONVEYING LIQUIDS	9 - 17 PSI	2" - 4"	-40°C to +65°C -40°F to +150°F
Vapour Thane Dust & Vapour Recovery Hose					
Material Handling - Also Available: <i>Tan Bulkmaster, Furnace Door Cooling, Concrete Boom, Concrete Placement & Bulkmaster Hardwall</i>					
	Thick black corrugated abrasion and weather resistant synthetic blend cover. Red 3/8" thick super abrasion resistant natural rubber tube.	Primarily designed for handling abrasive slurries in mines and quarries. Can also be used for dry material handling of sand, gravel, grain, slag, and other such materials. External re-usable bolt on flanges allow for ease of installation, and uninterrupted free flow.	150 PSI 30" HG	3" - 12"	-40°C to +80°C -40°F to +180°F
Aztec					
	Black abrasion and weather resistant synthetic rubber cover with black abrasion resistant natural rubber tube. Green stripe on 1/4" thick tube.	Dry bulk discharge including limestone, ground silica, chalk, dry cement, fertilizer etc. May also be used for wet abrasive applications.	75 PSI	3" - 6"	-30°C to +80°C -25°F to +180°F
Bulkmaster Softwall					
	Black static conductive synthetic rubber cover with thick black static conductive abrasion resistant natural rubber tube.	For conducting sand, steel shot, and other abrasives for blast cleaning.	150 PSI	1/2" - 3"	-35°C to +80°C -30°F to +180°F
Sandblast					
	Black weather and abrasion resistant cover with black abrasion resistant pure gum rubber tube.	For handling abrasive dust from wood, metal, rock, marble and concrete grinding machines under vacuum.	40 PSI 10 - 24" HG	1" - 6"	-30°C to +80°C -25°F to +180°F
Industrial Vacuum					
Chemical - Also Available: <i>Hypalon Acid S & D, Viton Lined S & D, EPDM Acid S & D</i>					
	Green smooth chemical resistant EPDM rubber cover with cross-linked polyethylene tube.	The cross-linked polyethylene tube makes this one of the most versatile types of hose available to the chemical industry today. It will handle 90% of known chemical and petroleum products in both suction and discharge applications.	200 PSI 29" HG	1/2" - 4"	-29°C to +120°C -20°F to +248°F
Chemical					
	Green corrugated chemical resistant EPDM rubber with FDA UHMW polyethylene tube.	Similar to Chemical hose above but may be used at lower temperatures. More versatile than our Chemical hose, Flexchem handles 98 per cent of known chemicals and can be steam cleaned. Corrugated cover results in more flexible hose.	200 PSI 29" HG	3/4" - 4"	-40°C to +65°C -40°F to +150°F
Flexchem					
Material Handling Polyurethane and PVC - Also Available: <i>Grey PVC Vacuum</i>					
	Corrugated clear PVC rigid helix. FDA, 3A and USDA compliant.	Conveying of dry powders, grains and plastic pellets where viewing the product is important. B Flex Static has built-in static wire.	25 - 45 PSI 29" HG	1 1/2" - 3" and 39mm	-23°C to +65°C -10°F to +150°F
B Flex/B Flex Static					
	Corrugated clear PVC with clear rigid PVC helix. FDA, 3A and USDA compliant.	Suction and discharge of liquids, grains, plastic pellets and powders where moderate abrasion is a factor. Neptune Static has built-in static wire.	20 - 55 PSI 29" HG	1" - 8"	-23°C to +65°C -10°F to +150°F
Neptune Suction/Neptune Static Suction					

Other Hoses Available: *Auto Heater Hose, Marine Hardwall/Softwall/Fuel Fill Hose, Silicone Coolant and Heater Hose, Garage Exhaust Hose, Welding Hose, Pressure Washer Hose, Paint Spray Hose, Auto Fuel Line Hose.*

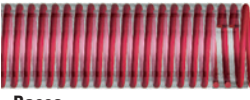
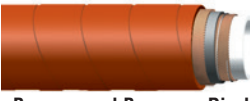
HOSE INFORMATION

HOSE ACCESSORIES

PRODUCT	DESCRIPTION	APPLICATION	PRESSURE	SIZES	TEMPERATURE
Material Handling Polyurethane and PVC - Also Available: Grey PVC Vacuum					
	Corrugated clear abrasion and weather resistant Polyurethane with grey PVC helix. FDA, 3A and USDA compliant.	Ideal for applications where conventional rubber or PVC hose will wear rapidly, i.e. grain transfer, abrasive powder recovery, leaf collection. PU Vac Static has built-in static wire.	3 - 50 PSI 29" HG	1 1/2" - 6"	-40°C to +65°C -40°F to +150°F
PU Vac/PU Vac Lite/PU Vac Static					
	Blue HMW PVC up to 5" I.D. Black cover in 6" and 8" I.D.	Used in a variety of material handling application where a good resistance to abrasion is required, such as transfer of sands, plastic pellets, gravel, wood chips, slurries and fly ash. Also for use on vacuum excavation trucks. Cover is a specially formulated static dissipative compound with low temperature flexibility.	30 - 45 PSI 28 - 29" HG	2" - 8"	-40°C to +65°C -40°F to +150°F
ARI HD					
	This hose has a polyurethane tube with an HMC cover. Cover is a specially formulated technical alloy that makes this hose antistatic.	Used in a variety of material handling application where a good resistance to abrasion is required, such as transfer of sands, plastic pellets, gravel, wood chips, slurries and fly ash.	30 - 45 PSI 29" HG	2" - 8"	-40°C to +65°C -40°F to +150°F
ARI					
Food - Also Available: Pure Gum Tubing, Polyethylene Tubing & Clear Vinyl Tubing					
	Smooth clear, food grade PVC non-marking with red rigid PVC helix. FDA, 3A and USDA compliant.	Alcoholic beverages up to 25% alcohol content. Fruit juices, soft drinks and other liquid foodstuffs. Also suitable for dry bulk foodstuffs.	35 - 85 PSI 29" HG	3/4" - 5" and 38 - 50mm	-23°C to +65°C -10°F to +150°F
Bacco					
	Red abrasion resistant natural rubber tube and cover.	Will handle a wide range of non fatty-oily food products up to 80°C where taste and aroma must not be affected.	140 PSI	3/4" - 3"	-35°C to +80°C -30°F to +180°F
Brewers and Beverage Discharge					
	Smooth clear PVC with wire helix. Super Wirevac has additional layer of fabric reinforcement. FDA, 3A, USDA and NSF-51 compliant.	An extremely flexible transparent hose for use where full vacuum performance is required while monitoring the contents of the hose. Ideal for use with most foodstuffs, cosmetics, beverages, and a wide range of chemical solutions. Also suitable for lubricating oils and animal fats.	45 - 250 PSI 28" HG	3/8" - 3"	-10°C to +65°C +15°F to +150°F
Wirevac					
	Clear PVC non-marking. FDA, 3A and USDA compliant.	For dry bulk foodstuffs, pharmaceuticals, cosmetics, milk, fruit and vegetable juices, soft drinks, alcoholic beverages, flour, sugar etc. Clear wall allows visual inspection of the product.	50 - 85 PSI 29" HG	3/4" - 4"	-23°C to +65°C -10°F to +150°F
Foodflex PVC S & D					
	Clear PVC non-marking with high tensile yarn reinforcement. FDA, 3A and USDA compliant.	For liquid or dry bulk foodstuffs, pharmaceuticals, cosmetics, milk, fruit and vegetable juices, soft drinks, alcoholic beverages, flour, sugar, poultry or meat packing etc. Clear wall allows visual inspection of the product.	60 - 110 PSI 28 - 29" HG	2" - 8"	-23°C to +65°C -10°F to +150°F
Foodflex Textile Reinforced S & D (Food Grade)					

HOSE INFORMATIONHOSE ACCESSORIES

Buchanan Rubber Hose found on the following pages are shipped from our Houston, TX Warehouse. Orders for hose will have a \$2,500 prepaid freight.



AIR & GENERAL PURPOSE HOSE

HOSE ACCESSORIES

CLEAR REINFORCED PVC (FOOD QUALITY)



APPLICATION:An economical hose for handling air, water, oil, mild chemicals, and alkalis. Clear wall allows visual inspection of product. **COVER:**Clear smooth PVC **REINFORCEMENT:**Multiple layers of synthetic yarns **TUBE:**Clear smooth PVC

TEMPERATURE:-5C to +65C(+25F to +150F)

PART #	NOM. ID"	NOM. OD"	PSI	STD PACK	WEIGHT#	
CRPVC-019	3/16	0.38	250	300	0.05	----
CRPVC-025	1/4	0.43	250	300	0.07	----
CRPVC-025-100	1/4	0.43	250	100	0.07	----
CRPVC-031	5/16	0.53	300	300	0.08	----
CRPVC-031-100	5/16	0.53	300	100	0.08	----
*CRPVC-038	3/8	0.59	250	300	0.09	----
CRPVC-038-100	3/8	0.59	250	100	0.09	----
*CRPVC-050	1/2	0.71	250	300	0.15	----
*CRPVC-050-100	1/2	0.71	250	100	0.15	----
CRPVC-063	5/8	0.87	200	300	0.17	----
CRPVC-063-100	5/8	0.87	200	100	0.17	----
CRPVC-075	3/4	1.02	180	300	0.23	----
CRPVC-075-100	3/4	1.02	180	100	0.23	----
*CRPVC-100	1	1.30	150	300	0.32	----
*CRPVC-100-100	1	1.30	150	100	0.32	----
CRPVC-125	1-1/4	1.61	100	100	0.58	----
CRPVC-150	1-1/2	1.89	85	100	0.69	----
CRPVC-200	2	2.44	65	100	1.00	----

Standard Length: 3/16"-3/4" 100'/300' coil, 1" 100'/200' coil, 1-1/4"-2" 100' coil

Product Info: Compliant with the applicable requirements and standards of FDA USDA 3-A and NSF-51. Please specify length when ordering i.e. 100' or 300'

Safety Info: Working pressure ratings are based on 20C (68F). At operating temperature of +65C (150F) reduce working pressure by 50%. Recommended Couplings: Combination nipples, short shank, brass barbed, cam and groove. All coupling recommendations are to be used as guidelines and are derived from past user preference. In some cases the preferred coupling is of a lesser pressure rating than the hose. Never exceed the working pressure of the lowest rated component in the assembly.

*IN STOCK IN HOUSTON



VIEW PRICING AND AVAILABLE STOCK ONLINE

AIR & GENERAL PURPOSE HOSE

HOSE ACCESSORIES

HOT AIR BLOWER HOSE

APPLICATION:FOR CONVEYING HOT AIR FROM BLOWER TO TANK ON DRY BULK TRUCKS.

COVER:Black heat and weather resistant EPDM rubber.

REINFORCEMENT:High tensile wire helix embedded between layers of heat resistant synthetic fabric.

TUBE:Black specially compounded heat resistant EPDM rubber.

TEMPERATURE:-40C to +163C(-40F to +350F)

PART #	NOM. ID"	NOM. OD"	PSI	BEND RADIUS	STD PACK	WEIGHT#	
*BLOW150-300	3	3.62	150	12.00	100	1.75	----
*BLOW150-400	4	4.65	150	15.00	100	2.40	----

Standard Length: 100'

Recommended Couplings: Cam and groove, combination nipples or short shank. Crimplok cam and groove, Crimplok combination nipple. All coupling recommendations are to be used as guidelines and are derived from past user preference. In some cases the preferred coupling is of a lesser pressure rating than the hose. Never exceed the working pressure of the lowest rated component in the assembly.

*IN STOCK IN HOUSTON

JACKHAMMER - AIR

APPLICATION:AN ECONOMICAL AIR HOSE FOR JACKHAMMER AND OTHER USES ON CONSTRUCTION SITES. ALSO FOR GENERAL INDUSTRIAL USE

COVER:Red smooth cut and abrasion resistant REINFORCEMENT:Multiple layers of synthetic yarn

TUBE:Synthetic oil mist resistant

TEMPERATURE:-35C to +80C(-30F to +180F)

PART #	NOM. ID"	NOM. OD"	PSI	STD PACK	WEIGHT#	COLOR	
JACK-075-50	3/4	1.14	300	50	0.40	Yellow	----
JACK-075R-50	3/4	1.14	300	50	0.40	Red	----
JACK-075G-50	3/4	1.14	300	50	0.40	Green	----
JACK-075BL-50	3/4	1.14	300	50	0.40	Blue	----
JACK-075-CUASSP*	3/4"	1.14	300	50	0.40	Yellow	----
JACK-075R-CUASSP	3/4"	1.14	300	50	.40	Red	

Standard Length: 50'

Recommended Couplings: High Pressure, mine stem and nut, Universal quick acting. Crimplok universals. All coupling recommendations are to be used as guidelines and are derived from past user preference. In some cases the preferred coupling is of a lesser pressure rating than the hose. Never exceed the working pressure of the lowest rated component in the assembly.

* C/W CRIMP UNIVERSAL ASSEMBLED

AIR & GENERAL PURPOSE HOSE

HOSE ACCESSORIES

EPDM GENERAL PURPOSE 300



APPLICATION: Air, water, agricultural spray solutions, and other dilute chemicals Excellent resistance to heat and weathering Also resists animal fats, vegetable oils.

COVER: Smooth red abrasion and weather resistant EPDM synthetic rubber

REINFORCEMENT: Multiple layers of synthetic yarn TUBE: Synthetic oil mist resistant EPDM synthetic rubber

TEMPERATURE: -30C to +93C (-20F to +200F)

PART #	NOM. ID"	NOM. OD"	PSI	STD PACK	WEIGHT#	
*GPE-025-300	1/4	0.55	300	300	0.14	----
*GPE-038-300	3/8	0.70	300	300	0.20	----
*GPE-050-300	1/2	0.87	300	300	0.27	----
*GPE-063-300	5/8	0.98	300	300	0.31	----
GPE-075-300	3/4	1.16	300	300	0.44	----
*GPE-100-300	1	1.42	300	300	0.59	----

Standard Length: 300'

Recommended Couplings: High Pressure, Short shank, universal, or Combination nipples all other sizes. All coupling recommendations are to be used as guidelines and are derived from past user preference. In some cases the preferred coupling is of a lesser pressure rating than the hose. Never exceed the working pressure of the lowest rated component in the assembly.

*IN STOCK IN HOUSTON

PREMIUM GENERAL PURPOSE NON CONDUCTIVE WITH REEL



PART #	NOM. ID"	NOM. OD"	PSI	STD PACK	WEIGHT#	
PREMR-038-300	3/8	0.67	300	300	0.17	----
PREMR-050-300	1/2	0.79	300	300	0.21	----
PREMR-075-300	3/4	1.14	300	300	0.39	----
PREMR-100-300	1	1.42	300	300	0.51	----
PREM-125-250	1-1/4	1.77	300	200	0.70	----

Standard Length: 1/4"- 1" 50'/100'/300! 1-1/4" - 2" 50'/100'

Recommended Couplings: High Pressure 1" to 1-1/2" for air service if the working pressure exceeds 150 psi. High Pressure, Short shank, universal, or Combination nipples all other sizes. Crimplok universals. All coupling recommendations are to be used as guidelines and are derived from past user preference. In some cases the preferred coupling is of a lesser pressure rating than the hose. Never exceed the working pressure of the lowest rated component in the assembly.

AIR & GENERAL PURPOSE HOSE

HOSE ACCESSORIES

PUSH-ON BLACK

APPLICATION:Transmission of most petroleum-based hydraulic fluids, mineral oil, diesel fuel, engine coolant solutions, agricultural sprays and a wide range of chemical solutions. Also suitable for air and water service

COVER:Black, oil, weather and abrasion resistant Neoprene.

REINFORCEMENT:Multiple layers of polyester yarns.

TUBE:Black oil resistant nitrile rubber.

TEMPERATURE:-32C to +80C(-25F to +180F)

PART #	NOM. ID"	NOM. OD"	PSI	STD PACK	WEIGHT#	
PON-025-B	1/4	0.50	250	700'	0.10	----
PON-038-B	3/8	0.63	250	700'	0.14	----
PON-050-B	1/2	0.75	250	700'	0.17	----
PON-063-B	5/8	0.91	250	700'	0.19	----
PON-075-B	3/4	1.03	250	700'	0.19	----

Standard Length: Supplied on reels

Recommended Couplings: Push-on

MARINE EXHAUST HARDWALL

APPLICATION:Marine exhaust applications, and other general applications where non-standard sizes are specified. Meets SAEJ 2006 R1

COVER:Black heat and weather resistant synthetic rubber with blue identification stripe.

REINFORCEMENT:High tensile wire helix embedded between layers of textile cords.

TUBE:Black heat resistant rubber specially compounded for wet marine exhaust service.

TEMPERATURE:-40C to +100C(-40F to +212F)

PART #	NOM. ID"	NOM. OD"	STD PACK	WEIGHT#	
MXH-238	2-3/8	2.68	100'	1.98	----
MXH-250	2-1/2	2.81	100'	1.82	----
MXH-300	3	3.54	100'	2.12	----
MXH-350	3-1/2	4.09	100'	2.77	----
MXH-400	4	4.57	100'	3.22	----
MXH-500	5	5.55	100'	3.59	----

Standard Length: not on reels

Recommended Couplings: Push-on



GO ONLINE TO VIEW OPEN ORDERS, ORDER HISTORY, AND TRACKING INFORMATION ON ALL SHIPMENTS

MATERIAL HANDLING

HOSE ACCESSORIES

FUEL LINE



APPLICATION:Fuel and vapour emission lines, meets SAE 30R7 specification and is USCG Type B and BIA approved.

COVER:Black heat and fuel resistant Hypalon.

REINFORCEMENT:Two layers of synthetic yarns.

TUBE:Black fuel resistant nitrile rubber.

TEMPERATURE:-40C to +120C(-40F to +250F)

PART #	NOM. ID"	NOM. OD"	PSI	STD PACK	WEIGHT#	
FUEL-025	1/4	0.49	50	300'	0.10	----
FUEL-031	5/16	0.58	50	300'	0.13	----
FUEL-038	3/8	0.63	50	300'	0.13	----

Cut Lengths: Plus 5%

Standard Length: 300' coils:

Recommended Couplings: Barbed short shank, combination nipples.

ARI SUCTION



APPLICATION:Used in a variety of material handling application where a good resistance to abrasion is required, such as transfer of sands, plastic pellets, gravel, wood chips, slurries and fly ash. Cover is a specially formulated static dissipative compound with low temperature flexibility.

COVER:Black HMW PVC

REINFORCEMENT:Anti shock rigid pvc helix

TUBE:Polyurethane

TEMPERATURE:-40C to +65C(-40F to +150F)

PART #	NOM. ID"	NOM. OD"	VACUUM	PSI	BEND RADIUS"	STD PACK	WEIGHT#	
ARI-300	3	3.65	29	40	4.00	100'	1.18	----
ARI-400	4	4.76	29	35	6.00	100'	1.95	----
ARI-600	6	6.80	28	30	12.00	100'	3.51	----

Standard Length: 100'

Safety Info: Suction and pressure ratings are based on a temperature of 20C (68F), reduce ratings by 50% at maximum working temperature. This

hose has no fabric reinforcement and normally should not be used under pressure for service at temperatures above 25C (75F).

Recommended Couplings: Cam and groove



USE OUR TEXT LINE [855-609-3729](tel:855-609-3729) TO COMMUNICATE WITH MIDLAND MORE CONVENIENTLY

MATERIAL HANDLING

HOSE ACCESSORIES

BULKMASTER SOFTWALL

APPLICATION:Dry bulk discharge including limestone, ground silica, chalk, dry cement, fertilizer etc. May also be used for wet abrasive applications.

COVER:Black abrasion and weather resistant synthetic rubber.

REINFORCEMENT:Multiple layers of high tensile synthetic cords.

TUBE:Black abrasion resistant ant-static natural rubber in 1/8", 3/16" and 1/4"

TEMPERATURE:-30C to +80C(-25F to +180F)

PART #	NOM. ID"	NOM. OD"	PSI	STD PACK	WEIGHT#	
BSB-400-187	4	4.64	75	100'	2.33	----
BSB-400-250	4	4.72	75	100'	2.65	----
BSB-450-125	4-1/2	5.00	75	100'	2.09	----
BSB-500-187	5	5.63	75	100'	2.75	----
BSB-500-250	5	5.79	75	100'	3.50	----
BSB-600-250	6	6.81	75	100'	4.29	----

Standard Length: 100'

Product Info: Longer lengths available, check for price and availability

Recommended Couplings: Cam and groove. All coupling recommendations are to be used as guidelines and are derived from past user preference. In some cases the preferred coupling is of a lesser pressure rating than the hose. Never exceed the working pressure of the lowest rated component in the assembly.

INDUSTRIAL VACUUM HEAVY DUTY LENGTHS

APPLICATION:For handling abrasive dust from wood, metal, rock, marble and concrete grinding machines under vacuum.

COVER:Black abrasion resistant rubber, corrugated for flexibility.

REINFORCEMENT:A high tensile steel helix embedded between layers of textile cords.

TUBE:1/4" or 1/8" red Pure Gum abrasion resistant rubber standard.

TEMPERATURE:-30C to +80C(-25F to +180F)

PART #	ASSEMBLY DESCRIPTION	NOM. OD"	VACUUM	PSI	BEND RADIUS"	WEIGHT#	
IVB-800-250RPG2	8"x25' H.D.IND VAC. 1/4" Red w/cuffs	9.01	28	50	30.00	190.00	----
IVB-800-250RPG3	8"x32' H.D.IND VAC. 1/4" Red w/cuffs	9.01	28	50	30.00	243.80	----
IVB-800-250RPG7	8"x70' H.D.IND VAC. 1/4" Red Tube	9.01	28	50	30.00	716.10	----



GO ONLINE TO UPLOAD YOUR LOGO TO UTILIZE ALL OF OUR CUSTOMIZABLE TOOLS!

MATERIAL HANDLING

HOSE ACCESSORIES

SANDBLAST



APPLICATION:For conducting sand, steel shot, and other abrasives for blast cleaning.

COVER:Black static conductive synthetic rubber.

REINFORCEMENT:Two (SBB) or Four (SBB4) layers of synthetic textile cords.

TUBE:Thick black static conductive abrasion resistant natural rubber.

TEMPERATURE:-35C to +80C(-30F to +180F)

PART #	NOM. ID"	NOM. OD"	PSI	STD PACK	WEIGHT#	
SBB-075-100	3/4	1.50	150	100'	0.68	----
SBB-075-50	3/4	1.50	150	50'	0.68	----
SBB-125-100S	1-1/4	2.16	150	100'	1.22	----
SBB-125-50S	1-1/4	2.16	150	50'	1.22	----
SBB-150-50	1-1/2	2.36	150	50'	1.36	----
SBB-300	3	3.98	150	100'	2.57	----

Standard Length: 50'/100'

Product Info: Longer lengths available up to 200'. Surcharges may apply

Recommended Couplings: Sandblast

EPDM WATER SUCTION

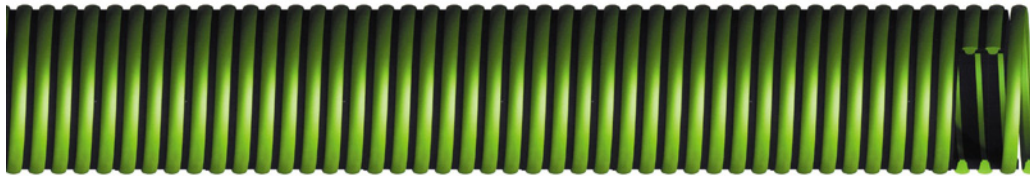

APPLICATION:For use in liquid waste suction application. Also for use with liquid or dry chemical suction applications or general industrial use where high working pressures are not required.

COVER:Green Polyethylene helix and specially formulated rubber.

REINFORCEMENT:Rigid green Polyethylene helix.

TUBE:Smooth specially formulated rubber

TEMPERATURE:-40C to +60C(-40F to +140F)

PART #	NOM. ID"	NOM. OD"	VACUUM	PSI	BEND RADIUS"	STD PACK	WEIGHT#	
EPDM-150	1-1/2	1.85	29	50	3.50	100'	0.40	----
EPDM-200	2	2.44	29	50	5.50	100'	0.67	----
EPDM-300	3	3.52	29	42	7.50	100'	1.10	----
EPDM-400	4	4.61	29	38	12.00	100'	1.84	----

Standard Length: 100'

Recommended Couplings: Cam and groove or short shank, Crimplok cam and groove, Crimplok combination nipple. All coupling recommendations are to be used as guidelines and are derived from past user preference. In some cases the preferred coupling is of a lesser pressure rating than the hose. Never exceed the working pressure of the lowest rated component in the assembly.

PETROLEUM STEAM & CHEMICAL HOSE

HOSE ACCESSORIES

FLEXLITE UHMW

APPLICATION:The (UHMW) Ultra High Molecular Weight polyethylene tube makes this one of the most versatile types of hose available to the chemical industry today. It will handle 94% of common chemical and petroleum products in both suction and discharge applications. This hose is very flexible due to its corrugated cover and low temperature characteristics. This hose can also be used in dry food applications due to its FDA Compliant tube.

COVER:Green corrugated chemical resistant EPDM rubber

REINFORCEMENT:High tensile wire helix embedded between layers of textile cords.

TUBE:Smooth chemical resistant (UHMW) Ultra High Molecular Weight polyethylene FDA Compliant tube

TEMPERATURE:-40C to +100C(-40F to +212F) Can be open end steam cleaned to 120C or 248F for 30 minutes

PART #	NOM. ID"	NOM. OD"	VACUUM	PSI	BEND RADIUS"	STD PACK	WEIGHT#	
FLX-075	3/4	1.22	29	200	2.00	100'	0.40	----
FLX-100	1	1.46	29	200	2.50	100'	0.47	----
FLX-150	1-1/2	2.01	29	200	3.75	100'	0.80	----
FLX-200	2	2.52	29	200	5.00	100'	1.00	----
FLX-300	3	3.58	29	200	7.50	100'	1.74	----
FLX-400	4	4.64	29	150	10.00	100'	2.48	----

Standard Length: 100'

Recommended Couplings: Cam and groove, combination nipple. Crimplok cam and groove, Crimplok combination nipple. All coupling recommendations are to be used as guidelines and are derived from past user preference. In some cases the preferred coupling is of a lesser pressure rating than the hose.

FLEXCHEMS

APPLICATION:The (UHMW) Ultra High Molecular Weight polyethylene tube makes this one of the most versatile types of hose available to the chemical industry today. It will handle 94% of common chemical and petroleum products in both suction and discharge applications. This hose is very flexible due to its corrugated cover and low temperature characteristics. This hose can also be used in dry food applications due to its FDA Compliant tube.

COVER:Green chemical resistant EPDM rubber

REINFORCEMENT:High tensile wire helix embedded between layers of textile cords.

TUBE:Smooth chemical resistant (UHMW) Ultra High Molecular Weight polyethylene FDA Compliant tube

TEMPERATURE:-40C to +100C(-40F to +212F) Can be open end steam cleaned to 120C or 248F for 30 minutes

PART #	NOM. ID"	NOM. OD"	VACUUM	PSI	BEND RADIUS"	STD PACK	WEIGHT#	
FLXS-100	1	1.46	29	200	4.00	100'	0.62	----
FLXS-200	2	2.60	29	200	6.00	100'	1.14	----
FLXS-300	3	3.62	29	200	8.00	100'	2.26	----
FLXS-400	4	4.65	29	200	12.00	100'	3.25	----

Standard Length: 100'

Recommended Couplings: Cam and groove, combination nipple. Crimplok cam and groove, Crimplok combination nipple. All coupling recommendations are to be used as guidelines and are derived from past user preference. In some cases the preferred coupling is of a lesser pressure rating than the hose. Never exceed the working pressure of the lowest rated component in the assembly.

PETROLEUM STEAM AND CHEMICAL HOSE

HOSE ACCESSORIES

FLEXLITE PETROLEUM TANK 150



APPLICATION:An all purpose lightweight and flexible petroleum suction and discharge hose for use with gasoline, kerosene, diesel, oil suspensions and emulsions. May also be used as hydraulic suction and return line.
COVER:Black corrugated, abrasion, gasoline and oil resistant synthetic rubber with green stripe.
REINFORCEMENT:High tensile wire helix embedded between layers of textile cords.
TUBE:Black nitrile rubber for maximum oil resistance.
TEMPERATURE:-40C to +93C(-40F to +200F)

PART #	NOM. ID"	NOM. OD"	VACUUM	PSI	BEND RADIUS"	STD PACK	WEIGHT#	
TTD150-200	2	2.53	29	150	4.00	100'	1.44	----
TTD150-300	3	3.62	29	150	6.00	100'	2.48	----
TTD150-400	4	4.72	29	150	9.00	100'	3.63	----

Standard Length: 100'

Product Info: Longer lengths available on request. Please check for availability and pricing

Recommended Couplings: Cam and groove, combination nipple. Crimplok cam and groove, Crimplok combination nipple. All coupling recommendations are to be used as guidelines and are derived from past user preference. In some cases the preferred coupling is of a lesser pressure rating than the hose. Never exceed the working pressure of the lowest rated component in the assembly.

TANK TRUCK 150



APPLICATION: An all purpose petroleum suction and discharge hose for use with gasoline, kerosene, diesel, oil suspensions and emulsions. May also be used as hydraulic suction and return line.
COVER:Black, abrasion, gasoline and oil resistant synthetic rubber with red stripe and pressure.
REINFORCEMENT:High tensile wire helix embedded between layers of textile cords.
TUBE:Black nitrile rubber for maximum oil resistance.
TEMPERATURE:-35C to +93C(-30F to +200F)

PART #	NOM. ID"	NOM. OD"	VACUUM	PSI	BEND RADIUS"	STD PACK	WEIGHT#	
TLBS150-100	1	1.42	29	150	3.00	100	0.57	----
TLBS150-150	1-1/2	1.93	29	150	4.00	100	0.81	----
TLBS150-200	2	2.52	29	150	4.50	100	1.38	----
TLBS150-300	3	3.54	29	150	7.00	100	2.19	----
TLBS150-400	4	4.68	29	150	10.00	100	3.56	----
TLBS150-600	6	6.89	29	150	21.00	100	6.65	----

Standard Length: 100'

Recommended Couplings: Cam and groove, combination nipple. Crimplok cam and groove, Crimplok combination nipple. All coupling recommendations are to be used as guidelines and are derived from past user preference. In some cases the preferred coupling is of a lesser pressure rating than the hose. Never exceed the working pressure of the lowest rated component in the assembly.

PETROLEUM STEAM & CHEMICAL HOSE

HOSE ACCESSORIES

TANK TRUCK

APPLICATION:An all purpose petroleum suction and discharge hose for use with gasoline, kerosene, diesel, oil suspensions and emulsions. May also be used as hydraulic suction and return line.

COVER:Black, abrasion, gasoline and oil resistant synthetic rubber with blue stripe and pressure

REINFORCEMENT:High tensile wire helix embedded between layers of textile cords.

TUBE:Black nitrile rubber for maximum oil resistance.

TEMPERATURE:-35C to +93C(-30F to +200F)

PART #	NOM. ID"	NOM. OD"	VACUUM	PSI	BEND RADIUS"	STD PACK	WEIGHT#	
TLB-075	3/4	1.14	29	150	3.00	100'	0.43	----
TLB-100	1	1.42	29	150	3.00	100'	0.57	----
TLB-125	1-1/4	1.65	29	150	3.50	100'	0.62	----
TLB-150	1-1/2	1.93	29	150	4.00	100'	0.81	----
TLB-200	2	2.52	29	150	4.50	100'	1.38	----
TLB-250	2-1/2	2.99	29	150	4.75	100'	1.72	----
TLB-400	4	4	29	150	10.00	100'	3.56	----
TLB-600	6	6	29	150	21.00	100'	6.65	----

OIL VACUUM - SMOOTH

• Corrugated oil vacuum hose available in Houston

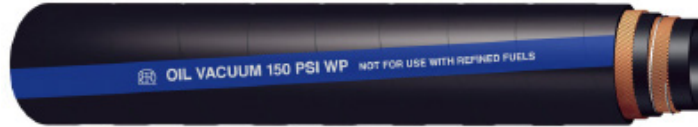

APPLICATION:An all purpose petroleum suction and discharge hose for use with gasoline, kerosene, diesel, oil suspensions and emulsions. May also be used as hydraulic suction and return line.

COVER:Black, abrasion, gasoline and oil resistant synthetic rubber with red stripe and pressure.

REINFORCEMENT:High tensile wire helix embedded between layers of textile cords.

TUBE:Black nitrile rubber for maximum oil resistance.

TEMPERATURE:-35C to +93C(-30F to +200F)

PART #	NOM. ID"	NOM. OD"	VACUUM	PSI	BEND RADIUS"	STD PACK	WEIGHT#	
OILVS-150	1-1/2	1.89	29	150	4.00	100	0.75	----
OILVS-200	2	2.43	29	150	4.50	100	1.07	----
OILVS-300	3	3.47	29	150	7.00	100	1.78	----
OILVS-400	4	4.52	29	150	10.00	100	2.58	----
OILVS-600	6	6.60	29	150	21.00	100	5.50	----

Standard Length: 100'

Recommended Couplings: Cam and groove, combination nipple. Crimplok cam and groove, Crimplok combination nipple. All coupling recommendations are to be used as guidelines and are derived from past user preference. In some cases the preferred coupling is of a lesser pressure rating than the hose. Never exceed the working pressure of the lowest rated component in the assembly.

PETROLEUM STEAM AND CHEMICAL HOSE

HOSE ACCESSORIES

TANK TRUCK 300



APPLICATION:An all purpose petroleum suction and discharge hose for use with gasoline, kerosene, diesel, oil suspensions and emulsions up to 300 PSI. May also be used as hydraulic suction and return line.

COVER:Black, abrasion, gasoline and oil resistant synthetic rubber with red stripe and pressure

REINFORCEMENT:High tensile wire helix embedded between layers of textile cords.

TUBE:Black nitrile rubber for maximum oil resistance.

TEMPERATURE:-35C to +93C(-30F to +200F)

PART #	NOM. ID"	NOM. OD"	VACUUM	PSI	BEND RADIUS"	STD PACK	WEIGHT#	
TLBS300-200	2	2.62	29	300	5.00	100'	1.43	----
TLBS300-300	3	3.67	29	300	7.00	100'	2.20	----
TLBS300-400	4	4.71	29	300	10.00	100'	3.63	----
TLBS300-600	6	6.91	29	300	21.00	100'	6.90	----

Standard Length: 100'

Recommended Couplings: Cam and groove, combination nipple. Crimplok cam and groove, Crimplok combination nipple. All coupling recommendations are to be used as guidelines and are derived from past user preference. In some cases the preferred coupling is of a lesser pressure rating than the hose. Never exceed the working pressure of the lowest rated component in the assembly.

OIL VACUUM CORRUGATED



APPLICATION:Designed for transferring petroleum waste, sediments, sludge, diluted mild chemicals, brine and water in oil field tank and waste pit recovery applications, not suitable for refined petroleum products or high concentrations of chemicals

COVER:Black, corrugated abrasion oil resistant synthetic rubber with blue stripe and pressure

REINFORCEMENT:High tensile wire helix embedded between layers of textile cords.

TUBE:Black synthetic rubber for maximum oil resistance.

TEMPERATURE:-35C to +93C(-30F to +200F)

PART #	NOM. ID"	NOM. OD"	VACUUM	PSI	BEND RADIUS"	STD PACK	WEIGHT#	
OILVC-200	2	2.44	29	150	4.00	100'	0.89	----
OILVC-300	3	3.46	29	150	6.00	100'	1.42	----
OILVC-400	4	4.52	29	150	9.00	100'	2.44	----

Standard Length: 100'

Recommended Couplings: Cam and groove, combination nipple. Crimplok cam and groove, Crimplok combination nipple. All coupling recommendations are to be used as guidelines and are derived from past user preference. In some cases the preferred coupling is of a lesser pressure rating than the hose. Never exceed the working pressure of the lowest rated component in the assembly.

PETROLEUM STEAM AND CHEMICAL HOSE**HOSE ACCESSORIES****FRACLIN 400**

APPLICATION:For handling a wide range of petroleum products, including gasoline, as well as a number of chemical solutions. Specifically designed for use in Frac service.

COVER:Black, heat, oil and weather resistant Neoprene.

REINFORCEMENT:Multiple layers of synthetic textile cords, with static wire.

TUBE:Black, heat and oil resistant synthetic rubber.

TEMPERATURE:-35C to +88C(-30F to +190F)

PART #	NOM. ID"	NOM. OD"	PSI	STD PACK	WEIGHT#	
FRAC400-300	3	3.65	400	100'	1.80	----
FRAC400-400	4	4.80	400	100'	2.81	----
FRAC400-600	6	6.80	400	100'	5.20	----

Standard Length: 100'

Recommended Couplings: Crimplok combination nipple. All coupling recommendations are to be used as guidelines and are derived from past user preference. In some cases the preferred coupling is of a lesser pressure rating than the hose. Never exceed the working pressure of the lowest rated component in the assembly.

PETROLEUM DISCHARGE

APPLICATION:For handling a wide range of petroleum products, including gasoline, as well as a number of chemical solutions.

COVER:Red, heat, oil and weather resistant Neoprene.

REINFORCEMENT:Multiple layers of synthetic textile cords, with static wire.

TUBE:Black, heat and oil resistant synthetic rubber.

TEMPERATURE:-35C to +88C(-30F to +190F)

PART #	NOM. ID"	NOM. OD"	PSI	STD PACK	WEIGHT#	
PDR-125	1-1/4	1.69	150	100'	0.58	----
PDR-150	1-1/2	1.97	150	100'	0.78	----
PDR-300	3	3.50	150	100'	1.64	----
PDR-400	4	4.57	150	100'	2.46	----
PDR-600	6	6.72	150	100'	3.89	----

Standard Length: 50'/100'

Recommended Couplings: Cam and groove, combination nipple. Crimplok cam and groove, Crimplok combination nipple. All coupling recommendations are to be used as guidelines and are derived from past user preference.



HELP US HELP YOU! [GO ONLINE TO UPDATE YOUR CUSTOMER PROFILE](#) SO THAT WE CAN UPDATE ALL THE APPROPRIATE DEPARTMENTS AND PERSONNEL AT YOUR COMPANY ON NEW CATALOGS, PRICING UPDATES, NEW MARKETING TOOLS, AND OTHER IMPORTANT INFORMATION. THANK YOU!

PETROLEUM STEAM AND CHEMICAL HOSE

HOSE ACCESSORIES

PETROLEUM DISCHARGE 250



APPLICATION:For handling a wide range of petroleum products, including gasoline, as well as a number of chemical solutions. Specifically designed for use in Frac service.

COVER:Black, heat, oil and weather resistant Neoprene.

REINFORCEMENT:Multiple layers of synthetic textile cords, with static wire.

TUBE:Black, heat and oil resistant synthetic rubber.

TEMPERATURE:-35C to +88C(-30F to +190F)

PART #	NOM. ID"	NOM. OD"	PSI	STD PACK	WEIGHT#	
PDB250-200	2	2.50	250	100'	1.14	----
PDB250-300	3	3.54	250	100'	1.80	----
PDB250-400	4	4.64	250	100'	2.81	----
PDB250-600	6	6.69	250	100'	5.20	----

Standard Length: 50'/100'

Recommended Couplings: Cam and groove, combination nipple. Crimplok cam and groove, Crimplok combination nipple. All coupling recommendations are to be used as guidelines and are derived from past user preference. In some cases the preferred coupling is of a lesser pressure rating than the hose. Never exceed the working pressure of the lowest rated component in the assembly.

HOT TAR AND ASPHALT



APPLICATION:Specially designed for conveying hot tar and asphalt at temperatures up to 160 C (350 F).

COVER:Black Neoprene synthetic rubber.

REINFORCEMENT:High tensile wire helix embedded between multiple layers of heat resistant synthetic yarns

TUBE:Specially compounded heat resistant synthetic rubber compound.

TEMPERATURE:up to +177C(350F)

PART #	NOM. ID"	NOM. OD"	PSI	STD PACK	WEIGHT#	
HTA-300	3	3.77	150	100'	2.94	----
HTA-400	4	4.85	150	100'	4.20	----

Standard Length: 100'

Recommended Couplings: Cam and Grove, combination nipple. Crimplok cam and groove, Crimplok nipple. All coupling recommendations are to be used as guidelines and are derived from past user preference. In some cases the preferred coupling is of a lesser pressure rating than the hose. Never exceed the working pressure of the lowest rated component in the assembly.

PETROLEUM STEAM AND CHEMICAL HOSE

HOSE ACCESSORIES

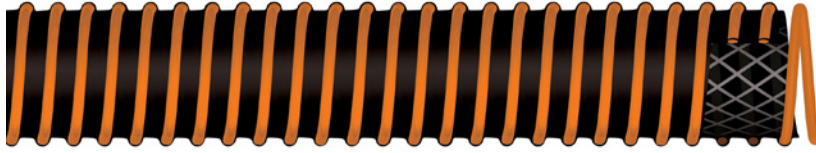
PETROLEUM TRANSFER

APPLICATION:For use with oil, fuel and grease transfer, oil slurry, hydrocarbons and animal fat handling. Features an external helix that protects the hose cover as well as enabling the hose to slide over rough surface. Static wire embedded in helix for ease of grounding.

COVER:Orange PVC Helix with built in static wire

REINFORCEMENT:High tensile synthetic textile yarn

TUBE:Specially formulated compound for fuel transfer

TEMPERATURE:-40C to +93C(-40F to +200F)

PART #	NOM. ID"	NOM. OD"	PSI	BEND RADIUS"	STD PACK	WEIGHT#	
FLDROP-200	2	2.87	150	5.00	100'	1.29	----
FLDROP-400	4	5.00	75	12.00	100'	2.51	----

Standard Length: 50'/100'

Recommended Couplings: Cam and groove, combination nipple. Crimplok cam and groove, Crimplok combination nipple. All coupling recommendations are to be used as guidelines and are derived from past user preference. In some cases the preferred coupling is of a lesser pressure rating than the hose. Never exceed the working pressure of the lowest rated component in the assembly.

STEAM 250 BLACK

APPLICATION:An extremely flexible hose for use with saturated steam at pressures to 250 PSI .

COVER:Black abrasion and heat resistant EPDM rubber, with embossed brand and pressure.

REINFORCEMENT:Multiple layers of high tensile steel cords.

TUBE:Black heat resistant EPDM synthetic rubber.

TEMPERATURE:-40C to +210C(-40F to +406F)

PART #	NOM. ID"	NOM. OD"	PSI	STD PACK	WEIGHT#	
ST250B-075-50	3/4	1.26	250	50'	0.48	----
ST250B-100-50	1	1.50	250	50'	0.60	----
ST250B-150-50	1-1/2	2.13	250	50'	1.10	----
ST250B-200-50	2	2.64	250	50'	1.48	----

Standard Length: 50'

Recommended Couplings: High Pressure with interlocking clamps



SEE WEBSITE TO DOWNLOAD YOUR MOST UPDATED PRICING

PETROLEUM STEAM AND CHEMICAL HOSE

HOSE ACCESSORIES

STEAM 250



APPLICATION:An extremely flexible hose for use with saturated steam at pressures to 250 PSI .

COVER:Red abrasion and heat resistant EPDM rubber, with embossed brand and pressure.

REINFORCEMENT:Multiple layers of high tensile steel cords.

TUBE:Black heat resistant EPDM synthetic rubber.

TEMPERATURE:-40C to +210C(-40F to +406F)

PART #	NOM. ID"	NOM. OD"	PSI	STD PACK	WEIGHT#	
ST250-075-50	3/4	1.26	250	50'	0.48	----
ST250-075-100	3/4	1.26	250	100'	0.48	----
ST250-100-50	1	1.50	250	50'	0.60	----
ST250-100-100	1	1.50	250	100'	0.60	----
ST250-200-50	2	2	250	50'	1.48	----
ST250-200-100	2	2	250	100'	1.48	----
ST250-300	3	3	250	100'	3.40	----

Standard Length: 50'/100'

Product Info: Longer lengths available on request. Please check for availability and pricing

Recommended Couplings: High Pressure with interlocking clamps



USE OUR APP WITH YOUR FREE BIN LABELS TO MANAGE YOUR CUSTOMERS INVENTORY MORE EFFICIENTLY

WATER SUCTION & DISCHARGE HOSE

HOSE ACCESSORIES

BLUE LAYFLAT

APPLICATION: A LIGHT DUTY LAYFLAT HOSE FOR PORTABLE PUMP AND IRRIGATION USE.

COVER: Blue PVC impregnation. REINFORCEMENT: Woven high tensile synthetic yarns. TUBE: Blue PVC impregnation.

TEMPERATURE: -10C to +55C (15F to +130F)

PART #	NOM. ID"	NOM. OD"	PSI	STD PACK	WEIGHT#	
BLAY-100	1	1.11	150	300	0.13	----
BLAY-125	1-1/4	1.37	130	300	0.15	----
BLAY-150	1-1/2	1.63	70	300	0.15	----
*BLAY-200	2	2.13	65	300	0.20	----
BLAY-250	2-1/2	2.63	65	300	0.27	----
*BLAY-300	3	3.13	60	300	0.33	----
*BLAY-400	4	4.14	60	300	0.46	----
*BLAY-600	6	6.15	35	300	0.78	----

Standard Length: Multiples of 50' up to 300' maximum

Product Info: Please specify length required when ordering, i.e. 50', 100'

Safety Info: Reduce pressures by 50% at maximum working temperature

Recommended Couplings: Cam and groove or short shank

BLUE LAYFLAT ASSEMBLY

PART #	ASSEMBLY DESCRIPTION	WEIGHT#	
BLAY-150-CASS	1-1/2" X 50' BLUE LAYFLAT +C/E CAMLOCK	7.00	----
BLAY-200-CASS	2" X 50' BLUE LAYFLAT +C/E CAMLOCK	12.20	----
*BLAY-300-CASS	3" X 50' BLUE LAYFLAT +C/E CAMLOCK	20.63	----
*BLAY-400-CASS	4" X 50' BLUE LAYFLAT +C/E CAMLOCK	29.49	----
BLAY-600-CASS	6" X 50' BLUE LAYFLAT +C/E CAMLOCK	51.08	----

*IN STOCK IN HOUSTON

WATER SUCTION & DISCHARGE HOSE

HOSE ACCESSORIES

BROWN LAYFLAT - HEAVY DUTY



APPLICATION: Heavy duty layflat hose for portable pump and irrigation use.

COVER: Brown PVC impregnation.

REINFORCEMENT: Woven high tensile synthetic yarns.

TUBE: Brown heavy PVC impregnation.

TEMPERATURE: -10C to +60C(15F to +140F)

PART #	NOM. ID"	NOM.OD"	PSI	STD PACK	WEIGHT#	
BRLAYHD-200	2	2.15	150	300'	0.26	----
BRLAYHD-300	3	3.19	150	300'	0.52	----
BRLAYHD-400	4	4.27	135	300'	0.74	----
BRLAYHD-600	6	6.26	115	300'	1.21	----

Successful people maintain a positive focus in life no matter what is going on around them. They stay focused on their past successes rather than their past failures, and on the next action steps they need to take to get them closer to the fulfillment of their goals rather than all the other distractions that life presents to them.

- Jack Canfield



VIEW PRICING AND AVAILABLE STOCK ONLINE

WATER SUCTION & DISCHARGE HOSE

HOSE ACCESSORIES

DURAFLEX - RUBBER LAYFLAT

APPLICATION:SPECIFICALLY MANUFACTURED TO COMPETE WITH OROFLEX IMITATION HOSE. THIS IS A LIGHTWEIGHT HIGH PRESSURE, EXTREMELY STRONG HOSE FOR GENERAL WATER DISCHARGE SERVICE. IDEAL FOR RENTAL SERVICE WHERE LONG LIFE AND

competitive pricing is paramount. Its compact characteristics make this an ideal hose for use with portable pumps. Especially suited for pumping oily contaminated water. COVER:Black abrasion, weather and oil resistant nitrile rubber. REINFORCEMENT:Circular woven synthetic yarns.

TUBE:Black abrasion and oil resistant nitrile rubber.

TEMPERATURE:-20C to +80C(0F to +180F)

PART #	NOM. ID"	NOM. OD"	PSI	STD PACK	WEIGHT#	
DURFL-200	2	2.18	200	300	0.31	----
*DURFL-300	3	3.22	175	300	0.59	----
*DURFL-400	4	4.24	150	300	0.65	----
*DURFL-600	6	6.26	150	300	1.10	----

Standard Length: 50'/100'

Product Info: 200 Lengths Will Be Shipped Unless Otherwise Specified On Duraflex

Recommended Couplings: Cam and groove, combination nipples or short shank. All coupling recommendations are to be used as guidelines and are derived from past user preference. In some cases the preferred coupling is of a lesser pressure rating than the hose. Never exceed the working pressure of the lowest rated component in the assembly.

*IN STOCK IN HOUSTON

DURAFLEX - RUBBER LAYFLAT ASSEMBLY

PART #	ASSEMBLY DESCRIPTION	WEIGHT#	
DURFL-200-CASSP	2"x50' DURAFLEX + C/E CAMLOCK	14.20	----
DURFL-300-CASSP	3"x50' DURAFLEX + C/E CAMLOCK	21.63	----
DURFL-400-CASSP	4"x50' DURAFLEX + C/E CAMLOCK	28.99	----
DURFL-600-CASSP	6"x50' DURAFLEX + C/E CAMLOCK	51.67	----

WATER SUCTION & DISCHARGE HOSE

HOSE ACCESSORIES

HIGH PRESSURE CONTRACTORS WATER DISCHARGE

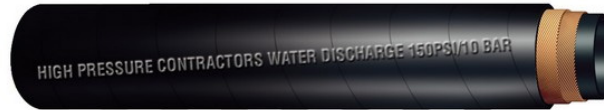

APPLICATION:For use on construction sites and general water service. High pressure allows pumping against greater vertical heads

COVER:Black abrasion and weather resistant synthetic rubber, with embossed brand and pressure.

REINFORCEMENT:Multiple layers of synthetic yarn.

TUBE:Black synthetic rubber compounded for water service.

TEMPERATURE:-35C to +80C(-30F to +180F)

PART #	NOM. ID"	NOM. OD"	PSI	STD PACK	WEIGHT#	
HPCWB-150	1-1/2	1.77	150	100'	0.49	----
HPCWB-200	2	2.28	150	100'	0.48	----
HPCWB-300	3	3.35	150	100'	1.08	----
HPCWB-400	4	4.37	150	100'	1.38	----
HPCWB-600	6	6.46	150	100'	2.62	----

Standard Length: 50'/100'

Recommended Couplings: Cam and groove, combination nipples or short shank. Crimplok cam and groove, Crimplok nipple. All coupling recommendations are to be used as guidelines and are derived from past user preference. In some cases the preferred coupling is of a lesser pressure rating than the hose. Never exceed the working pressure of the lowest rated component in the assembly.

HIGH PRESSURE WATER DISCHARGE 250

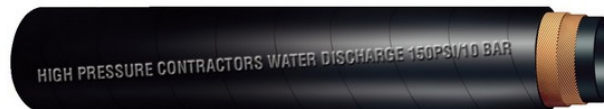

APPLICATION:For use on construction sites and general water service. High pressure allows pumping against greater vertical heads

COVER:Black abrasion and weather resistant synthetic rubber, with embossed brand and pressure.

REINFORCEMENT:Multiple layers of synthetic yarn.

TUBE:Black synthetic rubber compounded for water service.

TEMPERATURE:-35C to +80C(-30F to +180F)

PART #	NOM. ID"	NOM. OD"	PSI	STD PACK	WEIGHT#	
HPCWB200-150	1-1/2			100'		----
HPCWB250-200	2	2.40	250	100'	1.15	----
HPCWB250-300	3	3.46	250	100'	1.60	----
HPCWB200-400	4	4.48	200	100'	2.15	----

Standard Length: 100'

Recommended Couplings: Cam and groove, combination nipples or short shank. Crimplok cam and groove, Crimplok combination nipple. All coupling recommendations are to be used as guidelines and are derived from past user preference. In some cases the preferred coupling is of a lesser pressure rating than the hose. Never exceed the working pressure of the lowest rated component in the assembly.

WATER SUCTION & DISCHARGE HOSE

HOSE ACCESSORIES

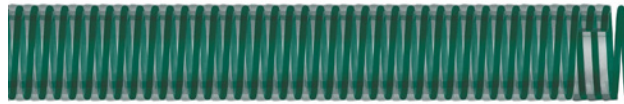
SATURN GREEN PVC WATER S&D

APPLICATION:An economical, flexible hose for construction pumps, septic tank & marine pump-out service. Resistant to some chemicals, mild acids & alkalis. Consult us for recommendations.

COVER:Clear abrasion and weather resistant PVC.

REINFORCEMENT:Green PVC helix.

TUBE:Smooth clear PVC.

TEMPERATURE:-20C to +65C(-5F to +150F)

PART #	NOM. ID"	NOM. OD"	VACUUM	PSI	BEND RADIUS"	STD PACK	WEIGHT#	
SATG-075	3/4	0.95	29	90	2.00	100	0.16	----
*SATG-100	1	1.24	29	85	3.00	100	0.26	----
*SATG-125	1-1/4	1.54	29	80	4.00	100	0.34	----
*SATG-150	1-1/2	1.81	29	70	6.00	100	0.44	----
*SATG-200	2	2.29	29	65	5.00	100	0.57	----
SATG-250	2-1/2	2.85	29	60	6.00	100	0.87	----
*SATG-300	3	3.43	29	60	12.00	100	1.21	----
SATG-400	4	4.45	29	50	10.00	100	1.78	----

Standard Length: 100'

Safety Info: Reduce pressures by 50% at maximum working temperature

Recommended Couplings: Cam and groove, combination nipple or short shank. Crimplok cam and groove, Crimplok nipple. All coupling recommendations are to be used as guidelines and are derived from past user preference. In some cases the preferred coupling is of a lesser pressure rating than the hose. Never exceed the working pressure of the lowest rated component in the assembly.

*IN STOCK IN HOUSTON

SATURN OLIVE GREEN PVC WATER S&D

APPLICATION:AN ECONOMICAL, FLEXIBLE HOSE FOR CONSTRUCTION PUMPS, SEPTIC TANK & MARINE PUMP-OUT SERVICE. RESISTANT TO SOME CHEMICALS, MILD ACIDS & ALKALIS. CONSULT US FOR RECOMMENDATIONS.

COVER:Green abrasion and weather resistant PVC.

REINFORCEMENT:Green PVC helix

TUBE:Smooth green PVC

TEMPERATURE:-20C to +65C(-5F to +150F)

PART #	NOM. ID"	NOM. OD"	VACUUM	BEND RADIUS"	STD PACK	WEIGHT#	
*SATO-200	2	2.34	29	5.00	100	0.66	----
*SATO-300	3	3.46	29	12.00	100	1.24	----
SATO-400	4	4.49	29	10.00	100	1.85	----

Standard Length: 100'

Safety Info: Suction and Pressure ratings are based on a temperature of 20C (68F), reduce by 50% at maximum working temperature

Recommended Couplings: Cam and groove, combination nipple or short shank. Crimplok cam and groove, Crimplok nipple. All coupling recommendations are to be used as guidelines and are derived from past user preference. In some cases the preferred coupling is of a lesser pressure rating than the hose. Never exceed the working pressure of the lowest rated component in the assembly.

WATER SUCTION & DISCHARGE HOSE

HOSE ACCESSORIES

SATURN PVC WATER S&D



APPLICATION:An economical, flexible hose for construction pumps, septic tank & marine pump-out service. Resistant to some chemicals, mild acids & alkalis. Consult us for recommendations. Specially formulated compounds and a slightly corrugated cover allow for increased flexibility at low temperatures.

COVER:Clear abrasion and weather resistant extra soft PVC.

REINFORCEMENT:Blue PVC helix. SAT-XXX-BLK - Black helix

TUBE:Smooth clear extra soft PVC.

TEMPERATURE:-40C to +65C(-40F to +150F)

PART #	NOM. ID"	NOM. OD"	VACUUM	PSI	BEND RADIUS"	STD PACK	WEIGHT#	
SAT-200	2	2.35	26	35	5.00	100'	0.49	----
SAT-300	3	3.42	24	30	7.50	100'	0.81	----
SAT-400	4	4.50	22	25	10.00	100'	1.52	----
SAT-600	6	6.58	22	21	15.00	100'	2.72	----

Standard Length: 100'

Safety Info: Suction and Pressure ratings are based on a temperature of 20C (68F), reduce by 50% at maximum working temperature
Recommended Couplings: Cam and groove, combination nipple or short shank. Crimplok cam and groove, Crimplok nipple. All coupling recommendations are to be used as guidelines and are derived from past user preference. In some cases the preferred coupling is of a lesser pressure rating than the hose. Never exceed the working pressure of the lowest rated component in the assembly.

SATURN WHITE PVC WATER SUCTION AND DISCHARGE HOSE



APPLICATION:An economical, flexible hose for construction pumps, septic tank & marine pump-out service. Resistant to some chemicals, mild acids & alkalis. Consult us for recommendations.

COVER:Clear abrasion and weather resistant PVC.

REINFORCEMENT:White PVC helix.

TUBE:Smooth clear PVC.

TEMPERATURE:-20C to +65C(-5F to +150F)

PART #	NOM. ID"	NOM. OD"	VACUUM	PSI	BEND RADIUS"	STD PACK	WEIGHT#	
SATW-100	1	1.18	29	85	3.00	100'	0.19	----
SATW-125	1-1/4	1.47	29	80	3.00	100'	0.29	----
SATW-150	1-1/2	1.72	29	70	4.00	100'	0.35	----
SATW-200	2	2.29	29	65	5.00	100'	0.57	----
SATW-300	3	3.35	29	55	8.00	100'	1.03	----
SATW-400	4	4.45	29	50	10.00	100'	1.78	----
SATW-600	6	6.56	29	40	24.00	100'	3.70	----

Standard Length: 100'

Safety Info: Suction and Pressure ratings are based on a temperature of 20C (68F), reduce by 50% at maximum working temperature
Recommended Couplings: Cam and groove, combination nipple or short shank. Crimplok cam and groove, Crimplok nipple. All coupling recommendations are to be used as guidelines and are derived from past user preference. In some cases the preferred coupling is of a lesser pressure rating than the hose. Never exceed the working pressure of the lowest rated component in the assembly.

WATER SUCTION & DISCHARGE HOSE

HOSE ACCESSORIES

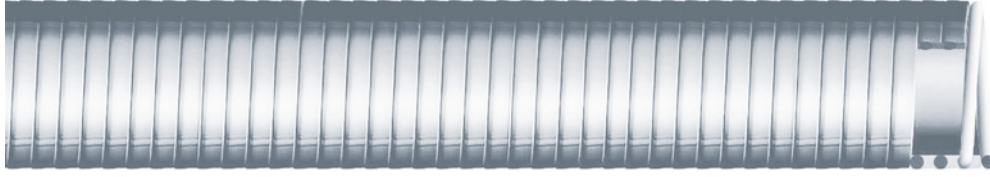
SUPERFLEX PVC SUCTION

APPLICATION:Specially designed for use in the installation of pool, spa and hot tubs. Can also be used in a variety of water transfer applications where flexible lines are needed to replace rigid piping.

COVER:Soft white PVC

REINFORCEMENT:White PVC helix

TUBE:Smooth white PVC

TEMPERATURE:-20C to +65C(-5F to +150F)

PART #	NOM. ID"	NOM. OD"	VACUUM	PSI	BEND RADIUS"	STD PACK	WEIGHT#	
SUPER-200	2	2.39	29	70	7.00	100'	0.75	----

Standard Length: 100'

Product Info: Our warranty does not cover damage caused by rodents or any insect. Not for underground use in areas infested by termites.

Safety Info: Suction and Pressure ratings are based on a temperature of 20C (68F), reduce by 50% at maximum working temperature

Recommended Couplings: SCH40

RUBBER WATER S&D

APPLICATION:A heavy duty wire reinforced rubber suction hose for construction, quarries and general use.

COVER:Black smooth abrasion and weather resistant synthetic rubber. **REINFORCEMENT:**High tensile wire helix embedded between layers of textile cords. **TUBE:**Smooth black synthetic rubber.

TEMPERATURE:-30C to +80C(-22F to +180F)

PART #	NOM. ID"	NOM. OD"	VACUUM	PSI	BEND RADIUS"	STD PACK	WEIGHT#	
WSB-125	1-1/4	1.65	29	150	4.00	100	0.77	----
*WSB-150	1-1/2	1.93	29	150	4.00	100	1.00	----
*WSB-200	2	2.48	29	150	5.00	100	1.37	----
*WSB-300	3	3.50	29	150	10.00	100	2.23	----
*WSB-400	4	4.64	29	150	14.00	100	3.73	----
*WSB-600	6	6.66	29	150	30.00	100	5.99	----

Standard Length: 3/4" to 4" - 50'/100' -- 5" and 6" - 20'/100' -- 8" - 20'/60' -- 10" - 40' -- 12" - 20'

Recommended Couplings: Cam and groove, combination nipple or short shank. Crimplok cam and groove, Crimplok nipple. Cam and groove, combination nipple. Crimplok cam and groove, Crimplok combination nipple. All coupling recommendations are to be used as guidelines and are derived from past user preference. In some cases the preferred coupling is of a lesser pressure rating than the hose. Never exceed the working pressure of the lowest rated component in the assembly.

*IN STOCK IN HOUSTON

WATER SUCTION & DISCHARGE HOSE

HOSE ACCESSORIES

TEXTILE REINFORCED S&D

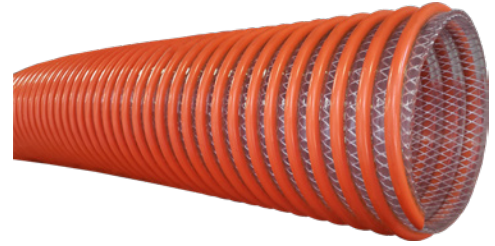

APPLICATION:GOOD FOR BOTH SUCTION AND DISCHARGE APPLICATIONS, THIS HEAVY DUTY HOSE CAN BE USED FOR RENTAL/CONSTRUCTION PUMPING AS WELL AS FISH SUCTION HOSE.

COVER:Clear abrasion and weather resistant PVC. REINFORCEMENT:Orange PVC helix with high tensile synthetic textile yarn. TUBE:Smooth clear PVC.

TEMPERATURE:-23C to +65C(-10F to +150F)

PART #	NOM. ID"	NOM. OD"	VACUUM	PSI	BEND RADIUS"	STD PACK	WEIGHT#	
*RSPVC -200	2	2.59	29	110	4.00	100	0.65	----
*RSPVC-300	3	3.71	29	100	6.00	100	1.12	----
*RSPVC-400	4	4.78	29	80	7.00	100	1.74	----
*RSPVC-600	6	7.17	28	70	10.50	100	3.87	----

Standard Length: 100'

Safety Info: Reduce pressures by 50% at maximum working temperature

Recommended Couplings: Cam and groove, combination nipple or short shank. Crimplok cam and groove, Crimplok nipple. All coupling recommendations are to be used as guidelines and are derived from past user preference. In some cases the preferred coupling is of a lesser pressure rating than the hose. Never exceed the working pressure of the lowest rated component in the assembly.



GO ONLINE TO VIEW OPEN ORDERS, ORDER HISTORY, AND TRACKING INFORMATION ON ALL SHIPMENTS

CRIMPLOK FERRULES PLATED

HOSE ACCESSORIES

**CRIMPLOK FERRULES STEEL PLATED FOR 3/4" HOSE - LD FOR UNIVERSAL**

PART#	SIZE	CAMPBELL PART	FERRULE ID"	FERRULE LENGTH"	WALL THICKNESS	
CFT-08106T-SP	3/4	FLPS075112	1.1875"	2.14"	0.04	----
CFT-08107T-SP	3/4	FLPS075114	1.2188"	2.14"	0.04	----
CFT-08108T-SP	3/4	FLPS075116	1.2500"	2.14"	0.04	----
CFT-08109T-SP	3/4	FLPS075118	1.2812	2.14"	0.04	----

Project Information: For use with CRIMPLOK Universal Crimp fittings (HE-XXXCR-SP). Ferrule thickness is .040"

CRIMPLOK FERRULES STEEL PLATED FOR 3/4" HOSE - HD FOR UNIVERSAL

PART#	SIZE	CAMPBELL PART	FERRULE ID"	FERRULE LENGTH"	WALL THICKNESS	
CF-05101S-SP	3/4	FPS050104S	1.0625"	1.41"	0.06	----

Project Information: For use with CRIMPLOK crimp ground joints (GJM/GJS-XXXCR-SP) I.D Tolerance = +/-0.012

CRIMPLOK FERRULES STEEL PLATED FOR 3/4" HOSE

PART#	SIZE	CAMPBELL PART	FERRULE ID"	FERRULE LENGTH"	WALL THICKNESS	
CF-08105-SP	3/4	FPS075120	1.3125"	2.14"	0.06	----

Project Information: For use with CRIMPLOK Universal Crimp fittings (HE-XXXCR-SP). Ferrule thickness is .040"

CRIMPLOK FERRULES STEEL PLATED FOR 1" HOSE - LD FOR UNIVERSAL

PART#	SIZE	CAMPBELL PART	FERRULE ID"	FERRULE LENGTH"	WALL THICKNESS	
CFT-10114T-SP	1	FLPS100128	1.4375"	2.29"	0.04	----
CFT-10115T-SP	1	FLPS100130	1.4687"	2.29"	0.04	----
CFT-10117T-SP	1	FLPS100134	1.5000"	2.29"	0.04	----
CFT-10118T-SP	1	FLPS100136	1.5312"	2.29"	0.04	----

Project Information: For use with CRIMPLOK Universal Crimp fittings (HE-XXXCR-SP). Ferrule thickness is .040"

CRIMPLOK FERRULES STEEL PLATED FOR 1" HOSE

PART#	SIZE	CAMPBELL PART	FERRULE ID"	FERRULE LENGTH"	WALL THICKNESS	
CF-10109-SP	1	FPS100136	1.5625"	2.29"	0.06	----
CF-10110-SP	1	FPS100140	1.6250"	2.29"	0.06	----
CF-10111-SP	1	FPS100144	1.6875"	2.29"	0.06	----

Project Information: For use with CRIMPLOK crimp cam and groove fitting (CGC/CGE-XXXCR-A1) and CRIMPLOK crimp combination nipples (CNT-XXXCR-SP) I.D. Tolerance = +/-0.012"

CRIMPLOK FERRULES STEEL PLATED FOR 1-1/4" HOSE

PART#	SIZE	CAMPBELL PART	FERRULE ID"	FERRULE LENGTH"	WALL THICKNESS	
CF-13113-SP	1-1/4	FPS125152	1.8125"	2.32"	0.06	----
CF-13114-SP	1-1/4	FPS125156	1.8750"	2.32"	0.06	----

Project Information: For use with CRIMPLOK crimp cam and groove fitting (CGC/CGE-XXXCR-A1) and CRIMPLOK crimp combination nipples (CNT-XXXCR-SP) I.D. Tolerance = +/-0.012"

CRIMPLOK FERRULES PLATED

HOSE ACCESSORIES



CRIMPLOK FERRULES STEEL PLATED FOR 1-1/2" HOSE

PART#	SIZE	CAMPBELL PART	FERRULE ID"	FERRULE LENGTH"	WALL THICKNESS	
CF-15115-SP	1-1/2	FPS150160	1.9375"	2.36"	0.06	----
CF-15201-SP	1-1/2	FPS150204	2.0625"	2.36"	0.06	----
CF-15202-SP	1-1/2	FPS150208	2.1250"	2.36"	0.06	----
CF-15203-SP	1-1/2	FPS150212	2.1875"	2.36"	0.06	----
CF-15205-SP	1-1/2	FPS150220	2.3125	2.36"	0.06	----

Project Information: For use with CRIMPLOK crimp cam and groove fitting (CGE/CGE-XXXCR-A1) and CRIMPLOK crimp combination nipples (CNT-XXXCR-SP) I.D. Tolerance = +/-0.012"

CRIMPLOK FERRULES STEEL PLATED FOR 1-1/2" HOSE - LONG

PART#	SIZE	CAMPBELL PART	FERRULE ID"	FERRULE LENGTH"	WALL THICKNESS	
CF-15202L-SP	1-1/2	FPS150208L	2.1250"	2.91	0.06	----

Project Information: For use with CRIMPLOK ground joint fittings (GJM/GJS-XXXCR-SP) and CRIMPLOK long crimp combination nipples (CNL-XXXCR-SP) I.D. Tolerance = +/-0.012"

CRIMPLOK FERRULES STEEL PLATED FOR 2" HOSE

PART#	SIZE	CAMPBELL PART	FERRULE ID"	FERRULE LENGTH"	WALL THICKNESS	
CF-20208-SP	2	FPS200232	2.5000"	2.79"	0.06	----
CF-20209-SP	2	FPS200236	2.5625"	2.79"	0.06	----
CF-20210-SP	2	FPS200240	2.6250"	2.79"	0.06	----
CF-20211-SP	2	FPS200244	2.6875"	2.79"	0.06	----
CF-20212-SP	2	FPS200248	2.7500"	2.79"	0.06	----
CF-20213-SP	2	FPS200252	2.8125"	2.79"	0.06	----
CF-20214-SP	2	FPS200256	2.8750"	2.79"	0.06	----
CF-20215-SP	2	FPS200260	2.9375"	2.79"	0.06	----

Project Information: For use with CRIMPLOK crimp cam and groove fitting (CGE/CGE-XXXCR-A1) and CRIMPLOK crimp combination nipples (CNT-XXXCR-SP) I.D. Tolerance = +/-0.012"

CRIMPLOK FERRULES STEEL PLATED FOR 2" HOSE - LONG

PART#	SIZE	CAMPBELL PART	FERRULE ID"	FERRULE LENGTH"	WALL THICKNESS	
CF-20209L-SP	2	FPS200236L	2.5625"	3.41"	0.06	----
CF-20211L-SP	2	FPS200244L	2.6875"	3.41"	0.06	----
CF-20212L-SP	2	FPS200248L	2.7500"	3.41"	0.06	----
CF-20213L-SP	2	FPS200252L	2.8125"	3.41"	0.06	----

Project Information: For use with CRIMPLOK ground joint fittings (GJM/GJS-XXXCR-SP) and CRIMPLOK long crimp combination nipples (CNL-XXXCR-SP) I.D. Tolerance = +/-0.012"



USE OUR TEXT LINE [855-609-3729](tel:855-609-3729) TO COMMUNICATE WITH MIDLAND MORE CONVENIENTLY

CRIMPLOK FERRULES PLATED

HOSE ACCESSORIES

CRIMPLOK FERRULES STEEL PLATED FOR 2-1/2" HOSE

PART#	SIZE	CAMPBELL PART	FERRULE ID"	FERRULE LENGTH"	WALL THICKNESS	
CF-25303-SP	2-1/2	FPS250312	3.1875"	3.11"	0.06	----

Project Information: For use with CRIMPLOK crimp cam and groove fitting (CGE/CGE-XXXCR-A1) and CRIMPLOK crimp combination nipples (CNT-XXXCR-SP) I.D. Tolerance = +/-0.012"

CRIMPLOK FERRULES STEEL PLATED FOR 2-1/2" HOSE - LONG

PART#	SIZE	CAMPBELL PART	FERRULE ID"	FERRULE LENGTH"	WALL THICKNESS	
CF-25303L-SP	2-1/2	FPS250312L	3.1875"	3.88"	0.06	----

Project Information: For use with CRIMPLOK ground joint fittings (GJM/GJS-XXXCR-SP) and CRIMPLOK long crimp combination nipples (CNL-XXXCR-SP) I.D. Tolerance = +/-0.012"

CRIMPLOK FERRULES STEEL PLATED FOR 3" HOSE

PART#	SIZE	CAMPBELL PART	FERRULE ID"	FERRULE LENGTH"	WALL THICKNESS	
CF-30309-SP	3	FPS300336	3.5625"	3.94"	0.09	----
CF-30310-SP	3	FPS300340	3.6250"	3.94"	0.09	----
CF-30311-SP	3	FPS300344	3.6875"	3.94"	0.09	----
CF-30312-SP	3	FPS300348	3.7500"	3.94"	0.09	----
CF-30313-SP	3	FPS300352	3.8125"	3.94"	0.09	----
CF-30314-SP	3	FPS300356	3.8750"	3.94"	0.09	----
CF-30315-SP	3	FPS300360	3.9375"	3.94"	0.09	----
CF-30400-SP	3	FPS300400	4.000"	3.94"	0.09	----

Project Information: For use with CRIMPLOK crimp cam and groove fitting (CGE/CGE-XXXCR-A1) and CRIMPLOK crimp combination nipples (CNT-XXXCR-SP) I.D. Tolerance = +/-0.012"

CRIMPLOK FERRULES STEEL PLATED FOR 3" HOSE - LONG

PART#	SIZE	CAMPBELL PART	FERRULE ID"	FERRULE LENGTH"	WALL THICKNESS	
CF-30310L-SP	3	FPS300340L	3.6250"	4.36"	0.09	----
CF-30311L-SP	3	FPS300344L	3.6875"	4.36"	0.09	----
CF-30312L-SP	3	FPS300348L	3.7500"	4.36"	0.09	----
CF-30313L-SP	3	FPS300352L	3.8125"	4.36"	0.09	----
CF-30314L-SP	3	FPS300356L	3.8750"	4.36"	0.09	----
CF-30315L-SP	3	FPS300360L	3.9375"	4.36"	0.09	----
CF-30400L-SP	3	FPS300400L	4.000"	4.36"	0.09	----

Project Information: For use with CRIMPLOK crimp cam and groove fitting (CGE/CGE-XXXCR-A1) and CRIMPLOK crimp combination nipples (CNT-XXXCR-SP) I.D. Tolerance = +/-0.012"



GO ONLINE TO UPLOAD YOUR LOGO TO UTILIZE ALL OF OUR CUSTOMIZABLE TOOLS!

CRIMPLOK FERRULES PLATED

HOSE ACCESSORIES



CRIMPLOK FERRULES STEEL PLATED FOR 4" HOSE

PART#	SIZE	CAMPBELL PART	FERRULE ID"	FERRULE LENGTH"	WALL THICKNESS	
CF-40409-SP	4	FPS400436	4.5625"	4.19"	0.09	----
CF-40410-SP	4	FPS400440	4.6250"	4.19"	0.09	----
CF-40411-SP	4	FPS400444	4.6875"	4.19"	0.09	----
CF-40412-SP	4	FPS400448	4.7500"	4.19"	0.09	----
CF-40413-SP	4	FPS400452	4.8125"	4.19"	0.09	----
CF-40414-SP	4	FPS400456	4.8750"	4.19"	0.09	----
CF-40415-SP	4	FPS400460	4.9375"	4.19"	0.09	----
CF-40500-SP	4	FPS400500	5.000"	4.19"	0.09	----
CF-40501-SP	4	FPS400504	5.0625"	4.19"	0.09	----

Project Information: For use with CRIMPLOK crimp cam and groove fitting (CGE/CGE-XXXCR-A1) and CRIMPLOK crimp combination nipples (CNT-XXXCR-SP) I.D. Tolerance = +/-0.012"

CRIMPLOK FERRULES STEEL PLATED FOR 4" HOSE - LONG

PART#	SIZE	CAMPBELL PART	FERRULE ID"	FERRULE LENGTH"	WALL THICKNESS	
CF-40410L-SP	4	FPS400440L	4.6250"	5.20"	0.09	----
CF-40411L-SP	4	FPS400444L	4.6875"	5.20"	0.09	----
CF-40412L-SP	4	FPS400448L	4.7500"	5.20"	0.09	----
CF-40413L-SP	4	FPS400452L	4.8125"	5.20"	0.09	----
CF-40414L-SP	4	FPS400456L	4.8750"	5.20"	0.09	----
CF-40415L-SP	4	FPS400460L	4.9375"	5.20"	0.09	----
CF-40500L-SP	4	FPS400500L	5.000"	5.20"	0.09	----
CF-40501L-SP	4	FPS400504L	5.0625"	5.20"	0.09	----

Project Information: For use with CRIMPLOK ground joint fittings (GJM/GJS-XXXCR-SP) and CRIMPLOK long crimp combination nipples (CNL-XXXCR-SP) I.D. Tolerance = +/-0.012"

CRIMPLOK FERRULES STEEL PLATED FOR 6" HOSE

PART#	SIZE	CAMPBELL PART	FERRULE ID"	FERRULE LENGTH"	WALL THICKNESS	
CF-60610-SP	6	FPS600640	6.6250"	5.67"	0.12	----
CF-60612-SP	6	FPS600648	6.7500"	5.67"	0.12	----
CF-60614-SP	6	FPS600656	6.8750"	5.67"	0.12	----
CF-60702-SP	6	FPS600708	7.1250"	5.67"	0.12	----
CF-60704-SP	6	FPS600716	7.2500"	5.67"	0.12	----

Project Information: For use with CRIMPLOK ground joint fittings (GJM/GJS-XXXCR-SP) and CRIMPLOK long crimp combination nipples (CNL-XXXCR-SP) I.D. Tolerance = +/-0.012"



HELP US HELP YOU! GO ONLINE TO UPDATE YOUR CUSTOMER PROFILE SO THAT WE CAN UPDATE ALL THE APPROPRIATE DEPARTMENTS AND PERSONNEL AT YOUR COMPANY ON NEW CATALOGS, PRICING UPDATES, NEW MARKETING TOOLS, AND OTHER IMPORTANT INFORMATION. THANK YOU!

CRIMPLOK FERRULES STAINLESS

HOSE ACCESSORIES

**CRIMPLOK FERRULES STAINLESS 304 FOR 1/2" HOSE**

PART#	SIZE	CAMPBELL PART	FERRULE ID"	FERRULE LENGTH"	WALL THICKNESS	
CF-05101-SS304	1/2	FSS050104	1.0625"	2.14"	0.06	----
CF-05102-SS304	1/2	FSS050108	1.1250"	2.14"	0.06	----

Project Information: For use with CRIMPLOK crimp ground joints (GJM/GJS-XXXCR-SP) I.D. Tolerance = +/-0.012"

CRIMPLOK FERRULES STAINLESS 304 FOR 3/4" HOSE

PART#	SIZE	CAMPBELL PART	FERRULE ID"	FERRULE LENGTH"	WALL THICKNESS	
CF-08105-SS304	3/4	FSS075120	1.3125"	2.14"	0.06	----
CF-08106-SS304	3/4	FSS075124	1.3750"	2.14"	0.06	----
CF-08108-SS304	3/4	FSS075132	1.5000"	2.14"	0.06	----

Project Information: For use with CRIMPLOK crimp ground joints (GJM/GJS-XXXCR-SP) I.D. Tolerance = +/-0.012"

CRIMPLOK FERRULES STAINLESS 304 FOR 3/4" HOSE - LD FOR UNIVERSAL

PART#	SIZE	CAMPBELL PART	FERRULE ID"	FERRULE LENGTH"	WALL THICKNESS	
CFT-08104T-SS304	3/4	FLSS075108	1.1250"	2.14"	0.04	----
CFT-08106T-SS304	3/4	FLSS075112	1.1875"	2.14"	0.04	----
CFT-08107T-SS304	3/4	FLSS075114	1.2188"	2.14"	0.04	----
CFT-08108T-SS304	3/4	FLSS075116	1.2500"	2.14"	0.04	----
CFT-08109T-SS304	3/4	FLSS075118	1.2812"	2.14"	0.04	----

Project Information: For use with CRIMPLOK Universal crimp fittings (HE-XXXCR-SP) Ferrule thickness is .040"

CRIMPLOK FERRULES STAINLESS 304 FOR 1" HOSE

PART#	SIZE	CAMPBELL PART	FERRULE ID"	FERRULE LENGTH"	WALL THICKNESS	
CF-10108-SS304	1	FSS100132	1.5000"	2.29"	0.06	----
CF-10109-SS304	1	FSS100136	1.5625"	2.29"	0.06	----
CF-10110-SS304	1	FSS100140	1.6250"	2.29"	0.06	----
CF-10111-SS304	1	FSS100144	1.6875"	2.29"	0.06	----

Project Information: For use with CRIMPLOK crimp cam and groove fitting (CGE/CGE-XXXCR-A1) and CRIMPLOK crimp combination nipples (CNT-XXXCR-SP) I.D. Tolerance = +/-0.012"

CRIMPLOK FERRULES STAINLESS 304 FOR 1" HOSE - LD FOR UNIVERSAL

PART#	SIZE	CAMPBELL PART	FERRULE ID"	FERRULE LENGTH"	WALL THICKNESS	
CFT-10117T-SS304	1	FLSS100134	1.5312"	2.29"	0.04	----

Project Information: For use with CRIMPLOK Universal crimp fittings (HE-XXXCR-SP) Ferrule thickness is .040"



SEE WEBSITE TO DOWNLOAD YOUR MOST UPDATED PRICING

CRIMPLOK FERRULES STAINLESS

HOSE ACCESSORIES



CRIMPLOK FERRULES STAINLESS 304 FOR 1-1/4" HOSE

PART#	SIZE	CAMPBELL PART	FERRULE ID"	FERRULE LENGTH"	WALL THICKNESS	
CF-13114-SS304	1-1/4	FSS125156	1.8750"	2.32"	0.06	----
CF-13115-SS304	1-1/4	FSS125160	1.9375"	2.32"	0.06	----

Project Information: For use with CRIMPLOK crimp cam and groove fitting (CGE/CGE-XXXCR-A1) and CRIMPLOK crimp combination nipples (CNT-XXXCR-SP) I.D. Tolerance = +/-0.012"

CRIMPLOK FERRULES STAINLESS 304 FOR 1-1/2" HOSE

PART#	SIZE	CAMPBELL PART	FERRULE ID"	FERRULE LENGTH"	WALL THICKNESS	
CF-15115-SS304	1-1/2	FSS150160	1.9375"	2.36"	0.06	----
CF-15200-SS304	1-1/2	FSS150200	2.000"	2.36"	0.06	----
CF-15201-SS304	1-1/2	FSS150204	2.0625"	2.36"	0.06	----
CF-15202-SS304	1-1/2	FSS150208	2.1250"	2.36"	0.06	----
CF-15203-SS304	1-1/2	FSS150212	2.1875"	2.36"	0.06	----
CF-15204-SS304	1-1/2	FSS150216	2.2500"	2.36"	0.06	----
CF-15205-SS304	1-1/2	FSS150220	2.3125"	2.36"	0.06	----

Project Information: For use with CRIMPLOK crimp cam and groove fitting (CGE/CGE-XXXCR-A1) and CRIMPLOK crimp combination nipples (CNT-XXXCR-SS316) I.D. Tolerance = +/-0.012"

CRIMPLOK FERRULES STAINLESS 304 FOR 2" HOSE

PART#	SIZE	CAMPBELL PART	FERRULE ID"	FERRULE LENGTH"	WALL THICKNESS	
CF-20208-SS304	2	FSS200232	2.5000"	2.79"	0.06	----
CF-20209-SS304	2	FSS200236	2.5625"	2.79"	0.06	----
CF-20210-SS304	2	FSS200240	2.6250"	2.79"	0.06	----
CF-20211-SS304	2	FSS200244	2.6875"	2.79"	0.06	----
CF-20212-SS304	2	FSS200248	2.7500"	2.79"	0.06	----
CF-20213-SS304	2	FSS200252	2.8125"	2.79"	0.06	----
CF-20214-SS304	2	FSS200256	2.8750"	2.79"	0.06	----

Project Information: For use with CRIMPLOK crimp cam and groove fitting (CGE/CGE-XXXCR-A1) and CRIMPLOK crimp combination nipples (CNT-XXXCR-SS316) I.D. Tolerance = +/-0.012"

CRIMPLOK FERRULES STAINLESS 304 FOR 3" HOSE

PART#	SIZE	CAMPBELL PART	FERRULE ID"	FERRULE LENGTH"	WALL THICKNESS	
CF-30309-SS304	3	FSS300336	3.5625"	3.94"	0.10	----
CF-30310-SS304	3	FSS300340	3.6250"	3.94"	0.10	----
CF-30311-SS304	3	FSS300344	3.6875"	3.94"	0.10	----
CF-30312-SS304	3	FSS300348	3.7500"	3.94"	0.10	----
CF-30313-SS304	3	FSS300352	3.8125"	3.94"	0.10	----
CF-30314-SS304	3	FSS300356	3.8750"	3.94"	0.10	----
CF-30315-SS304	3	FSS300360	3.9375"	3.94"	0.10	----
CF-30400-SS304	3	FSS300400	4.000"	3.94"	0.10	----

Project Information: For use with CRIMPLOK crimp cam and groove fitting (CGE/CGE-XXXCR-A1) and CRIMPLOK crimp combination nipples (CNT-XXXCR-SS316) I.D. Tolerance = +/-0.012"

CRIMPLOK SLEEVES ALUMINUM

HOSE ACCESSORIES

CRIMPLOK FERRULES STAINLESS 304 FOR 4" HOSE

PART#	SIZE	CAMPBELL PART	FERRULE ID"	FERRULE LENGTH"	WALL THICKNESS	
CF-40410-SS304	4	FSS400440	4.6250"	4.19"	0.10	----
CF-40411-SS304	4	FSS400444	4.6875"	4.19"	0.10	----
CF-40412-SS304	4	FSS400448	4.7500"	4.19"	0.10	----
CF-40413-SS304	4	FSS400452	4.8125"	4.19"	0.10	----
CF-40414-SS304	4	FSS400456	4.8750"	4.19"	0.10	----
CF-40415-SS304	4	FSS400500	5.000"	4.19"	0.10	----

Project Information: For use with crimp cam and groove fitting (CGE/CGE-XXXCR-A1), CRIMPLOK crimp long combination nipples (CNL-XXXCR-SP) and CRIMPLOK (CNT/G-XXXCS-S/P) I.D. Tolerance = +/-0.012"

**CRIMPLOK SLEEVES ALUMINUM FOR 2" HOSE**

PART#	SIZE	CAMPBELL PART	SLEEVE ID"	SLEEVE LENGTH"	WALL THICKNESS	
CSL-20209-A	2	SAL200236	2.5625"	2.79"	0.12	----

Project Information: For use with cam and groove fitting (CGE/CGE-XXXCR-A1), CRIMPLOK crimp long combination nipples (CNL-XXXCR-SP) and CRIMPLOK (CNT/G-XXXCS-S/P) I.D. Tolerance = +/-0.012"

CRIMPLOK SLEEVES ALUMINUM FOR 2" HOSE

PART#	SIZE	CAMPBELL PART	SLEEVE ID"	SLEEVE LENGTH"	WALL THICKNESS	
CSL-20210-A	2	SAL200240	2.6250"	2.79"	0.12	----
CSL-20211-A	2	SAL200244	2.6875"	2.79"	0.12	----

Project Information: For use with cam and groove fitting (CGE/CGE-XXXCR-A1), CRIMPLOK crimp long combination nipples (CNL-XXXCR-SP) and CRIMPLOK (CNT/G-XXXCS-S/P) I.D. Tolerance = +/-0.012"

CRIMPLOK SLEEVES ALUMINUM FOR 3" HOSE

PART#	SIZE	CAMPBELL PART	SLEEVE ID"	SLEEVE LENGTH"	WALL THICKNESS	
CSL-30310-A	3	SAL300340	3.6250"	3.94"	0.12	----
CSL-30313-A	3	SAL300352	3.8125"	3.94"	0.12	----
CSL-30314-A	3	SAL300356	3.8750"	3.94"	0.12	----
CSL-30315-A	3	SAL300360	3.9375"	3.94"	0.12	----

Project Information: For use with cam and groove fitting (CGE/CGE-XXX-A1), CRIMPLOK crimp long combination nipples (CNL-XXXCR-SP) and CRIMPLOK (CNT/G-XXXCS-S/P) I.D. Tolerance = +/-0.012"

CRIMPLOK SLEEVES ALUMINUM FOR 4" HOSE

PART#	SIZE	CAMPBELL PART	SLEEVE ID"	SLEEVE LENGTH"	WALL THICKNESS	
CSL-40411-A	4	SAL400444	4.6875"	4.19"	0.12	----
CSL-40412-A	4	SAL400448	4.7500"	4.19"	0.12	----
CSL-40413-A	4	SAL400452	4.8125"	4.19"	0.12	----
CSL-40414-A	4	SAL400456	4.8750"	4.19"	0.12	----

Project Information: For use with cam and groove fitting (CGE/CGE-XXX-A1), CRIMPLOK crimp long combination nipples (CNL-XXXCR-SP) and CRIMPLOK (CNT/G-XXXCS-S/P) I.D. Tolerance = +/-0.012"

CRIMPLOK SLEEVES PLATED

HOSE ACCESSORIES



CRIMPLOK SLEEVES STEEL PLATED FOR 2" HOSE

PART#	SIZE	CAMPBELL PART	SLEEVE ID"	SLEEVE LENGTH"	WALL THICKNESS	
CSL-08106-SP	3/4	SPS075124	1.3750"	2.14"	0.06	----

Project Information: For use with cam and groove fitting (CGE/CGE-XXXCR-A1), CRIMPLOK crimp long combination nipples (CNL-XXXCR-SP) and CRIMPLOK (CNT/G-XXXCS-S/P) I.D. Tolerance = +/-0.012"

CRIMPLOK SLEEVES STEEL PLATED FOR 3/4" HOSE - SHORT

PART#	SIZE	CAMPBELL PART	SLEEVE ID"	SLEEVE LENGTH"	WALL THICKNESS	
CSL-05100S-SP	1/2	SPS050100S	1.0000"	0.91"	0.06	----
CSL-08102S-SP	3/4	SPS075108S	1.1250"	1.10"	0.06	----
CSL-08105S-SP	3/4	SPS075120S	1.3125"	1.10"	0.06	----

Project Information: For use with regular combination nipples (CNT-XXX-S/SP) and short shank fittings (PL-XXX-AD) I.D. Tolerance = +/-0.012"

CRIMPLOK SLEEVES STEEL PLATED FOR 1" HOSE

PART#	SIZE	CAMPBELL PART	SLEEVE ID"	SLEEVE LENGTH"	WALL THICKNESS	
CSL-10107-SP	1	SPS100128	1.4375"	2.29"	0.06	----
CSL-10108-SP	1	SPS100132	1.5000"	2.29"	0.06	----
CSL-10109-SP	1	SPS100136	1.5625"	2.29"	0.06	----
CSL-10110-SP	1	SPS100140	1.6250"	2.29"	0.06	----
CSL-10111-SP	1	SPS100144	1.6875"	2.29"	0.06	----
CSL-10112-SP	1	SPS100148	1.7500"	2.29"	0.06	----

Project Information: For use with cam and groove fitting (CGE/CGE-XXXCR-A1), CRIMPLOK crimp long combination nipples (CNL-XXXCR-SP) and CRIMPLOK (CNT/G-XXXCS-S/P) I.D. Tolerance = +/-0.012"

CRIMPLOK SLEEVES STEEL PLATED FOR 1" HOSE - SHORT

PART#	SIZE	CAMPBELL PART	SLEEVE ID"	SLEEVE LENGTH"	WALL THICKNESS	
CSL-10107S-SP	1	SPS100128S	1.4375"	2.26"	0.06	----
CSL-10108S-SP	1	SPS100132S	1.5000"	2.26"	0.06	----
CSL-10109S-SP	1	SPS100136S	1.5625"	2.26"	0.06	----
CSL-10111S-SP	1	SPS100144S	1.6875"	2.26"	0.06	----

Project Information: For use with regular combination nipples (CNT-XXX-S/SP) and short shank fittings (PL-XXX-AD) I.D. Tolerance = +/-0.012"

CRIMPLOK SLEEVES STEEL PLATED FOR 1-1/4" HOSE - SHORT

PART#	SIZE	CAMPBELL PART	SLEEVE ID"	SLEEVE LENGTH"	WALL THICKNESS	
CSL-13113S-SP	1-1/4	SPS125152S	1.8125"	1.26"	0.06	----
CSL-13114S-SP	1-1/4	SPS125156S	1.8750"	1.26"	0.06	----

Project Information: For use with regular combination nipples (CNT-XXX-S/SP) and short shank fittings (PL-XXX-AD) I.D. Tolerance = +/-0.012"

CRIMPLOK SLEEVES PLATED

HOSE ACCESSORIES

CRIMPLOK SLEEVES STEEL PLATED FOR 1-1/2" HOSE

PART#	SIZE	CAMPBELL PART	SLEEVE ID"	SLEEVE LENGTH"	WALL THICKNESS	
CSL-15112-SP	1-1/2	SPS150148	1.7500"	2.36"	0.06	----
CSL-15115-SP	1-1/2	SPS150160	1.9375"	2.36"	0.06	----
CSL-15200-SP	1-1/2	SPS150200	2.0000"	2.36"	0.06	----
CSL-15201-SP	1-1/2	SPS150204	2.0625"	2.36"	0.06	----
CSL-15202-SP	1-1/2	SPS150208	2.1250"	2.36"	0.06	----
CSL-15203-SP	1-1/2	SPS150212	2.1875"	2.36"	0.06	----
CSL-15204-SP	1-1/2	SPS150216	2.2500"	2.36"	0.06	----
CSL-15205-SP	1-1/2	SPS150220	2.3125"	2.36"	0.06	----
CSL-15206-SP	1-1/2	SPS150224	2.3750"	2.36"	0.06	----

Project Information: For use with cam and groove fitting (CGE/CGE-XXXCR-A1), CRIMPLOK crimp long combination nipples (CNL-XXXCR-SP) and CRIMPLOK (CNT/G-XXXCS-S/P) I.D. Tolerance = +/-0.012"

CRIMPLOK SLEEVES STEEL PLATED FOR 1-1/2" HOSE - SHORT

PART#	SIZE	CAMPBELL PART	SLEEVE ID"	SLEEVE LENGTH"	WALL THICKNESS	
CSL-15202S-SP	1-1/2	SPS150208S	2.1250"	1.46"	0.06	----

Project Information: For use with regular combination nipples (CNT-XXX-S/SP) and short shank fittings (PL-XXX-AD) I.D. Tolerance = +/-0.012"

CRIMPLOK SLEEVES STEEL PLATED FOR 2" HOSE

PART#	SIZE	CAMPBELL PART	SLEEVE ID"	SLEEVE LENGTH"	WALL THICKNESS	
CSL-20204-SP	2	SPS200216	2.2500"	2.79"	0.06	----
CSL-20206-SP	2	SPS200224	2.3750"	2.79"	0.06	----
CSL-20207-SP	2	SPS200228	2.4375"	2.79"	0.06	----
CSL-20208-SP	2	SPS200232	2.5000"	2.79"	0.06	----
CSL-20209-SP	2	SPS200236	2.5625"	2.79"	0.06	----
CSL-20210-SP	2	SPS200240	2.6250"	2.79"	0.06	----
CSL-20211-SP	2	SPS200244	2.6875"	2.79"	0.06	----
CSL-20212-SP	2	SPS200248	2.7500"	2.79"	0.06	----
CSL-20213-SP	2	SPS200252	2.8125"	2.79"	0.06	----
CSL-20214-SP	2	SPS200256	2.8750"	2.79"	0.06	----
CSL-20215-SP	2	SPS200260	2.9375"	2.79"	0.06	----
CSL-20300-SP	2	SPS200300	3.0000"	2.79"	0.06	----

Project Information: For use with cam and groove fitting (CGE/CGE-XXX-A1), CRIMPLOK crimp long combination nipples (CNL-XXXCR-SP) and CRIMPLOK (CNT/G-XXXCS-S/P) I.D. Tolerance = +/-0.012"

CRIMPLOK SLEEVES STEEL PLATED FOR 2" HOSE - SHORT

PART#	SIZE	CAMPBELL PART	SLEEVE ID"	SLEEVE LENGTH"	WALL THICKNESS	
CSL-20206S-SP	2	SPS200224S	2.3750"	1.81"	0.06	----
CSL-20207S-SP	2	SPS200228S	2.4375"	1.81"	0.06	----
CSL-20209S-SP	2	SPS200236S	2.5625"	1.81"	0.06	----
CSL-20210S-SP	2	SPS200240S	2.6250"	1.81"	0.06	----
CSL-20211S-SP	2	SPS200244S	2.6875"	1.81"	0.06	----

Project Information: For use with regular combination nipples (CNT-XXX-S/SP) and short shank fittings (PL-XXX-AD) I.D. Tolerance = +/-0.012"



USE OUR APP WITH YOUR FREE BIN LABELS TO MANAGE YOUR CUSTOMERS INVENTORY MORE EFFICIENTLY

CRIMPLOK SLEEVES PLATED

HOSE ACCESSORIES



CRIMPLOK SLEEVES STEEL PLATED FOR 2-1/2" HOSE

PART#	SIZE	CAMPBELL PART	SLEEVE ID"	SLEEVE LENGTH"	WALL THICKNESS	
CSL-25302-SP	2-1/2	SPS250308	3.1250"	3.11"	0.06	----
CSL-25306-SP	2-1/2	SPS250324	3.3750"	3.11"	0.06	----

Project Information: For use with cam and groove fitting (CGE/CGE-XXXCR-A1), CRIMPLOK crimp long combination nipples (CNL-XXXCR-SP) and CRIMPLOK (CNT/G-XXXCS-S/P) I.D. Tolerance = +/-0.012"

CRIMPLOK SLEEVES STEEL PLATED FOR 3" HOSE

PART#	SIZE	CAMPBELL PART	SLEEVE ID"	SLEEVE LENGTH"	WALL THICKNESS	
CSL-30304-SP	3	SPS300316	3.2500"	3.94"	0.09	----
CSL-30306-SP	3	SPS300324	3.3750"	3.94"	0.09	----
CSL-30307-SP	3	SPS300328	3.4375"	3.94"	0.09	----
CSL-30308-SP	3	SPS300332	3.5000"	3.94"	0.09	----
CSL-30309-SP	3	SPS300336	3.5625"	3.94"	0.09	----
CSL-30310-SP	3	SPS300340	3.6250"	3.94"	0.09	----
CSL-30311-SP	3	SPS300344	3.6875"	3.94"	0.09	----
CSL-30312-SP	3	SPS300348	3.7500"	3.94"	0.09	----
CSL-30313-SP	3	SPS300352	3.8125"	3.94"	0.09	----
CSL-30314-SP	3	SPS300356	3.8750"	3.94"	0.09	----
CSL-30400-SP	3	SPS300400	4.000"	3.94"	0.09	----

Project Information: For use with cam and groove fitting (CGE/CGE-XXXCR-A1), CRIMPLOK crimp long combination nipples (CNL-XXXCR-SP) and CRIMPLOK (CNT/G-XXXCS-S/P) I.D. Tolerance = +/-0.012"

CRIMPLOK SLEEVES STEEL PLATED FOR 3" HOSE - SHORT

PART#	SIZE	CAMPBELL PART	SLEEVE ID"	SLEEVE LENGTH"	WALL THICKNESS	
CSL-30306S-SP	3	SPS300324S	3.3750"	2.44"	0.09	----
CSL-30308S-SP	3	SPS300332S	3.5000"	2.44"	0.09	----
CSL-30309S-SP	3	SPS300336S	3.5625"	2.44"	0.09	----
CSL-30310S-SP	3	SPS300340S	3.6250"	2.44"	0.09	----
CSL-30311S-SP	3	SPS300344S	3.6875"	2.44"	0.09	----
CSL-30312S-SP	3	SPS300348S	3.7500"	2.44"	0.09	----
CSL-30313S-SP	3	SPS300352S	3.8125"	2.44"	0.09	----
CSL-30314S-SP	3	SPS300356S	3.8750"	2.44"	0.09	----

Project Information: For use with regular combination nipples (CNT-XXX-S/SP) and short shank fittings (PL-XXX-AD) I.D. Tolerance = +/-0.012"



VIEW PRICING AND AVAILABLE STOCK ONLINE

CRIMPLOK SLEEVES PLATED

HOSE ACCESSORIES

CRIMPLOK SLEEVES STEEL PLATED FOR 4" HOSE

PART#	SIZE	CAMPBELL PART	SLEEVE ID"	SLEEVE LENGTH"	WALL THICKNESS	
CSL-40406-SP	4	SPS400424	4.3750"	4.19"	0.09	----
CSL-40408-SP	4	SPS400432	4.5000"	4.19"	0.09	----
CSL-40409-SP	4	SPS400436	4.5625"	4.19"	0.09	----
CSL-40410-SP	4	SPS400440	4.6250"	4.19"	0.09	----
CSL-40411-SP	4	SPS400444	4.6875"	4.19"	0.09	----
CSL-40412-SP	4	SPS400448	4.7500"	4.19"	0.09	----
CSL-40413-SP	4	SPS400452	4.8125"	4.19"	0.09	----
CSL-40414-SP	4	SPS400456	4.8750"	4.19"	0.09	----
CSL-40415-SP	4	SPS400460	4.9375"	4.19"	0.09	----
CSL-40500-SP	4	SPS400500	5.0000"	4.19"	0.09	----

Project Information: For use with cam and groove fitting (CGE/CGE-XXXCR-A1), CRIMPLOK crimp long combination nipples (CNL-XXXCR-SP) and CRIMPLOK (CNT/G-XXXCS-S/P) I.D. Tolerance = +/-0.012"

CRIMPLOK SLEEVES STEEL PLATED FOR 4" HOSE - SHORT

PART#	SIZE	CAMPBELL PART	SLEEVE ID"	SLEEVE LENGTH"	WALL THICKNESS	
CSL-40410S-SP	4	SPS400440S	4.6250"	3.31"	0.09	----
CSL-40411S-SP	4	SPS400444S	4.6875"	3.31"	0.09	----
CSL-40412S-SP	4	SPS400448S	4.7500"	3.31"	0.09	----
CSL-40413S-SP	4	SPS400452S	4.8125"	3.31"	0.09	----
CSL-40414S-SP	4	SPS400456S	4.9375"	3.31"	0.09	----
CSL-40500S-SP	4	SPS400500S	5.0000"	3.31"	0.09	----

Project Information: For use with regular combination nipples (CNT-XXX-S/SP) and short shank fittings (PL-XXX-AD) I.D. Tolerance = +/-0.012"

CRIMPLOK SLEEVES STEEL PLATED FOR 6" HOSE

PART#	SIZE	CAMPBELL PART	SLEEVE ID"	SLEEVE LENGTH"	WALL THICKNESS	
CSL-60604-SP	6	SPS600616	6.2500"	5.67"	0.12	----
CSL-60606-SP	6	SPS600624	6.3750"	5.67"	0.12	----
CSL-60608-SP	6	SPS600632	6.5000"	5.67"	0.12	----
CSL-60610-SP	6	SPS600640	6.6250"	5.67"	0.12	----
CSL-60612-SP	6	SPS600648	6.7500"	5.67"	0.12	----
CSL-60614-SP	6	SPS600656	6.8750"	5.67"	0.12	----
CSL-60700-SP	6	SPS600700	7.0000"	5.67"	0.12	----
CSL-60702-SP	6	SPS600708	7.1250"	5.67"	0.12	----
CSL-60704-SP	6	SPS600716	7.2500"	5.67"	0.12	----

Project Information: For use with cam and groove fitting (CGE/CGE-XXXCR-A1), CRIMPLOK crimp long combination nipples (CNL-XXXCR-SP) and CRIMPLOK (CNT/G-XXXCS-S/P) I.D. Tolerance = +/-0.012"

CRIMPLOK SLEEVES STEEL PLATED FOR 8" HOSE

PART#	SIZE	CAMPBELL PART	SLEEVE ID"	SLEEVE LENGTH"	WALL THICKNESS	
CSL-80812-SP	8	SPS800848	8.7500"	6.50"	0.12	----
CSL-80900-SP	8	SPS800900	9.0000"	6.50"	0.12	----
CSL-80904-SP	8	SPS800916	9.2500"	6.50"	0.12	----
CSL-80908-SP	8	SPS800932	9.5000"	6.50"	0.12	----

Project Information: For use with cam and groove fitting (CGE/CGE-XXXCR-A1), CRIMPLOK crimp long combination nipples (CNL-XXXCR-SP) and CRIMPLOK (CNT/G-XXXCS-S/P) I.D. Tolerance = +/-0.012"

CRIMPLOK SLEEVES STAINLESS

HOSE ACCESSORIES

CRIMPLOK SLEEVES STEEL PLATED FOR 10" HOSE

PART#	SIZE	CAMPBELL PART	SLEEVE ID"	SLEEVE LENGTH"	WALL THICKNESS	
CSL-100108-SP	10	SPS100132	10.5000"	7.25"	0.12	
CSL-100114-SP	10	SPS100156	10.8750"	7.25"	0.12	

Project Information: For use with cam and groove fitting (CGE/CGE-XXXCR-A1), CRIMPLOK crimp long combination nipples (CNL-XXXCR-SP) and CRIMPLOK (CNT/G-XXXCS-S/P) I.D. Tolerance = +/-0.012"



CRIMPLOK SLEEVES STAINLESS 304 FOR 1/2" HOSE - SHORT

PART#	SIZE	CAMPBELL PART	SLEEVE ID"	SLEEVE LENGTH"	WALL THICKNESS	
CSL-05100S-SS304	1/2	SSS050100S	1.000"	0.91"	0.06	----

Project Information: For use with regular combination nipples (CNT-XXX-SS/SS316) I.D. Tolerance = +/-0.012"

CRIMPLOK SLEEVES STAINLESS 304 FOR 3/4" HOSE

PART#	SIZE	CAMPBELL PART	SLEEVE ID"	SLEEVE LENGTH"	WALL THICKNESS	
CSL-08104-SS304	3/4	SSS075116	1.2500"	2.14"	0.06	----

Project Information: For use with cam and groove fitting (CGE/CGE-XXX-SS1), CRIMPLOK crimp long combination nipples (CNL-XXXCR-SP) and CRIMPLOK (CNT/G-XXXCS-S/P) I.D. Tolerance = +/-0.012"

CRIMPLOK SLEEVES STAINLESS 304 FOR 3/4" HOSE - SHORT

PART#	SIZE	CAMPBELL PART	SLEEVE ID"	SLEEVE LENGTH"	WALL THICKNESS	
CSL-08104S-SS304	3/4	SSS075116S	1.2500"	1.10"	0.06	----

Project Information: For use with regular combination nipples (CNT-XXX-SS/SS316) I.D. Tolerance = +/-0.012"

CRIMPLOK SLEEVES STAINLESS 304 FOR 1" HOSE

PART#	SIZE	CAMPBELL PART	SLEEVE ID"	SLEEVE LENGTH"	WALL THICKNESS	
CSL-10108-SS304	1	SSS100132	1.5000"	2.29"	0.06	----
CSL-10110-SS304	1	SSS100140	1.6250"	2.29"	0.06	----
CSL-10112-SS304	1	SSS100148	1.7500"	2.29"	0.06	----

Project Information: For use with cam and groove fitting (CGE/CGE-XXX-SS1) I.D. Tolerance = +/-0.012"

CRIMPLOK SLEEVES STAINLESS 304 FOR 1" HOSE - SHORT

PART#	SIZE	CAMPBELL PART	SLEEVE ID"	SLEEVE LENGTH"	WALL THICKNESS	
CSL-10109S-SS304	1	SSS100136S	1.5625"	1.26"	0.06	----
CSL-10110S-SS304	1	SSS100140S	1.6250"	1.26"	0.06	----

Project Information: For use with regular combination nipples (CNT-XXX-SS/SS316) I.D. Tolerance = +/-0.012"

CRIMPLOK SLEEVES STAINLESS

HOSE ACCESSORIES

CRIMPLOK SLEEVES STAINLESS 304 FOR 1-1/4" HOSE

PART#	SIZE	CAMPBELL PART	SLEEVE ID"	SLEEVE LENGTH"	WALL THICKNESS
CSL-13114-SS304	1-1/4	SSS125156	1.8750"	2.32"	0.06

Project Information: For use with cam and groove fitting (CGE/CGE-XXX-SS1) I.D. Tolerance = +/-0.012"**CRIMPLOK SLEEVES STAINLESS 304 FOR 1-1/4" HOSE - SHORT**

PART#	SIZE	CAMPBELL PART	SLEEVE ID"	SLEEVE LENGTH"	WALL THICKNESS
CSL-13113S-SS304	1-1/4	SSS125152S	1.8125"	1.26"	0.06

Project Information: For use with regular combination nipples (CNT-XXX-SS/SS316) I.D. Tolerance = +/-0.012"**CRIMPLOK SLEEVES STAINLESS 304 FOR 1-1/2" HOSE**

PART#	SIZE	CAMPBELL PART	SLEEVE ID"	SLEEVE LENGTH"	WALL THICKNESS
CSL-15201-SS304	1-1/2	SSS150204	2.0625"	2.36"	0.06

Project Information: For use with cam and groove fitting (CGE/CGE-XXX-SS1) I.D. Tolerance = +/-0.012"**CRIMPLOK SLEEVES STAINLESS 304 FOR 2" HOSE**

PART#	SIZE	CAMPBELL PART	SLEEVE ID"	SLEEVE LENGTH"	WALL THICKNESS
CSL-20206-SS304	2	SSS200224	2.3750"	2.79"	0.06
CSL-20207-SS304	2	SSS200228	2.4375"	2.79"	0.06
CSL-20208-SS304	2	SSS200232	2.5000"	2.79"	0.06
CSL-20209-SS304	2	SSS200236	2.5625"	2.79"	0.06
CSL-20210-SS304	2	SSS200240	2.6250"	2.79"	0.06
CSL-20211-SS304	2	SSS200244	2.6875"	2.79"	0.06
CSL-20212-SS304	2	SSS200248	2.7500"	2.79"	0.06
CSL-20214-SS304	2	SSS200256	2.8750"	2.79"	0.06

Project Information: For use with cam and groove fitting (CGE/CGE-XXX-SS1) I.D. Tolerance = +/-0.012"**CRIMPLOK SLEEVES STAINLESS 304 FOR 3" HOSE**

PART#	SIZE	CAMPBELL PART	SLEEVE ID"	SLEEVE LENGTH"	WALL THICKNESS
CSL-30309-SS304	3	SSS300336	3.5625"	3.94"	0.10
CSL-30310-SS304	3	SSS300340	3.6250"	3.94"	0.10
CSL-30311-SS304	3	SSS300344	3.6875"	3.94"	0.10
CSL-30312-SS304	3	SSS300348	3.7500"	3.94"	0.10
CSL-30313-SS304	3	SSS300352	3.8125"	3.94"	0.10
CSL-30314-SS304	3	SSS300356	3.8750"	3.94"	0.10

Project Information: For use with cam and groove fitting (CGE/CGE-XXX-SS1) I.D. Tolerance = +/-0.012"

GO ONLINE TO VIEW OPEN ORDERS, ORDER HISTORY, AND TRACKING INFORMATION ON ALL SHIPMENTS

HOSE CLAMPS

HOSE CLAMPS

HOSE CLAMPS

PRICING FILE AVAILABLE ONLINE



	WORM GEAR		QUICK RELEASE
	MEGA & MAXI T-BOLT CLAMPS		SPRING LOADED T-BOLT
	CONSTANT TORQUE & V-BAND		DOUBLE BOLT CLAMP
	SPIRAL CLAMP MAXI CLAMP		MUFFLER & EXHAUST
	1 EAR, 2 EAR, GAPLESS		HAMMERLOCK & PUNCH-LOK
	TOOLS		NON-PERFORATED OR LINED BAND MARINE CLAMPS
	RUBBER LINED		HOSE FERRULES

WARNING: This product can expose you to chemicals, including Chromium, which are known to the State of California to cause cancer and birth defects or other reproductive harm. For more information, visit www.P65Warnings.ca.gov

CLAMPS

300 & 600 WORM GEAR CLAMPS

HOSE CLAMPS

WORM GEAR CLAMPS

MINIATURE CLAMPS - 5/16" BAND



Stainless Steel band with Carbon Steel Housing and Screw

300 Series

- 1/4" Hex Slotted Carbon Steel Screw
- 5/16" Wide 301 Stainless Steel Band
- Carbon Steel Housing

Applications: For marine, agricultural, industrial and automotive uses. Corrosion resistance varies with stainless components.

Mechanically interlocked, 3 piece construction for service sealing pressure without spot welding.

5/16" band, 1/4" screw

PART #	DIA. RANGE		BOX/CASE	
	MIN.	MAX.		
3000004	7/32"	5/8"	200/2400	----
3000005	7/16"	11/16"	200/2400	----
3000006	5/16"	7/8"	200/2400	----
3000008	7/16"	1"	200/1200	----
3000010	1/2"	1-1/16"	200/1200	----
3000012	9/16"	1-1/4"	200/1200	----
3000016	11/16"	1-1/2"	200/1200	----
3000020	7/8"	1-3/4"	200/1200	----

1/2" BAND CLAMPS



Stainless Steel band with Carbon Steel Housing and Screw

1/2" band, 5/16" screw

600 Series

- 5/16" Hex Slotted Carbon Steel Screw
- 1/2" Wide 201 Stainless Steel Band
- Carbon Steel Housing

Applications: A general purpose clamp for automobiles, plumbing, home and garden general clamping applications, with anti-corrosive properties varying with the number of components made from stainless steel.

- No PSI Rating
- 50lb/ Inch Torque Rating Die Set Function

PART #	#	DIA. RANGE		BAG/CASE	
		MIN.	MAX.		
600006	6	3/8"	7/8"	100/600	----
600008	8	7/16"	1"	100/600	----
600010	10	9/16"	1-1/16"	100/600	----
600012	12	9/16"	1-1/4"	100/600	----
600016	16	11/16"	1-1/2"	100/600	----
600020	20	3/4"	1-3/4"	100/300	----
600024	24	1-1/16"	2"	100/300	----
600028	28	1-5/16"	2-1/4"	100/300	----
600032	32	1-9/16"	2-1/2"	100/300	----
600036	36	1-13/16"	2-3/4"	50/200	----
600040	40	2-1/16"	3"	50/200	----
600044	44	2-5/16"	3-1/4"	50/200	----
600048	48	2-9/16"	3-1/2"	50/200	----
600052	52	2-13/16"	3-3/4"	25/100	----
600056	56	3-1/16"	4"	25/100	----
600060	60	3-5/16"	4-1/4"	25/100	----
600064	64	2-1/2"	4-1/2"	25/100	----
600072	72	3"	5"	25/100	----
600080	80	3-1/2"	5-1/2"	10/100	----
600088	88	4"	6"	10/100	----
600096	96	4-1/2"	6-1/2"	10/100	----
600104	104	5"	7"	10/100	----

WARNING: This product can expose you to chemicals, including Chromium, which are known to the State of California to cause cancer and birth defects or other reproductive harm. For more information, visit www.P65Warnings.ca.gov

325 & 611 WORM GEAR CLAMPS

HOSE CLAMPS

MINIATURE CLAMPS - 5/16" BAND



325 Series

- 1/4" Hex Slotted Carbon Steel Screw
- 5/16" Wide 301 Stainless Steel Band
- 301 Stainless Steel Housing

Applications: For agricultural, industrial and automotive uses. Corrosion resistance varies with stainless components.

Mechanically interlocked, 3 piece construction for service sealing pressure without spot welding.

Stainless Steel band and housing with Carbon Steel Screw

5/16" band, 1/4" screw

PART #	DIA. RANGE		BOX/CASE	
	MIN.	MAX.		
325004	7/32"	5/8"	200/2400	----
325005	7/16"	11/16"	200/2400	----
325006	5/16"	7/8"	200/2400	----
325008	7/16"	1"	200/1200	----
325010	1/2"	1-1/16"	200/1200	----
325012	9/16"	1-1/4"	200/1200	----
325016	11/16"	1-1/2"	200/1200	----
325020	7/8"	1-3/4"	200/1200	----

1/2" BAND CLAMPS



611 Series

- 5/16" Hex Slotted Carbon Steel Screw
- 1/2" Wide 201 Stainless Steel Band
- 301 Stainless Steel Housing

Applications: The perfect clamp for automobiles, plumbing, home and garden general clamping applications, with anti-corrosive properties varying with the number of components made from stainless steel.

- No PSI Rating
- 50lb/ Inch Torque Rating Die Set Function

Stainless Steel band and housing with Carbon Steel Screw

1/2" band, 5/16" screw

PART #	#	DIA. RANGE		BAG/CASE	
		MIN.	MAX.		
611006	6	3/8"	7/8"	100/600	----
611008	8	7/16"	1"	100/600	----
611010	10	9/16"	1-1/16"	100/600	----
611012	12	9/16"	1-1/4"	100/600	----
611016	16	11/16"	1-1/2"	100/600	----
611020	20	3/4"	1-3/4"	100/300	----
611024	24	1-1/16"	2"	100/300	----
611028	28	1-5/16"	2-1/4"	100/300	----
611032	32	1-9/16"	2-1/2"	100/300	----
611036	36	1-13/16"	2-3/4"	50/200	----
611040	40	2-1/16"	3"	50/200	----
611044	44	2-5/16"	3-1/4"	50/200	----
611048	48	2-9/16"	3-1/2"	50/200	----
611052	52	2-13/16"	3-3/4"	25/100	----
611056	56	3-1/16"	4"	25/100	----
611060	60	3-5/16"	4-1/4"	25/100	----
611064	64	2-1/2"	4-1/2"	25/100	----
611072	72	3"	5"	25/100	----
611080	80	3-1/2"	5-1/2"	10/100	----
611088	88	4"	6"	10/100	----
611096	96	4-1/2"	6-1/2"	10/100	----
611104	104	5"	7"	10/100	----
611116	116	5-3/4"	7-3/4"	100/100	----
611128	128	6-1/2"	8-1/2"	100/100	----
611152	152	2"	10"	100/100	----
611164	164	1-3/4"	10-3/4"	100/100	----
611176	176	9-1/4"	11-1/4"	100/100	----
611188	188	2-1/16"	12-1/4"	100/100	----
611200	200	11"	13"	100/100	----
611212	212	11-3/4"	13-3/4"	100/100	----
611224	224	12-1/2"	14-1/2"	100/100	----
611248	248	10-3/4"	16"	100/100	----
611270	270	15-3/8"	17-3/8"	100/100	----
611312	312	18"	20"	100/100	----
611332	332	19-1/8"	21-1/4"	100/100	----
611390	390	22-7/8"	24-7/8"	100/100	----

350 & 620 WORM GEAR CLAMPS

HOSE CLAMPS

MINIATURE CLAMPS - 5/16" BAND



350 Series

- 1/4" Hex Slotted 410 Stainless Steel Screw
- 5/16" Wide 301 Stainless Steel Band
- 301 stainless Steel Housing
- 6mm thick

All Stainless Steel
5/16" band, 1/4" screw

PART #	DIA. RANGE		BOX/CASE	
	MIN.	MAX.		
350004	7/32"	5/8"	200/2400	----
350005	7/16"	11/16"	200/2400	----
350006	5/16"	7/8"	200/2400	----
350008	7/16"	1"	200/1200	----
350010	1/2"	1-1/16"	200/1200	----
350012	9/16"	1-1/4"	200/1200	----
350016	11/16"	1-1/2"	200/1200	----
350020	7/8"	1-3/4"	200/1200	----

Applications: For agricultural, industrial and automotive uses. Corrosion resistance varies with stainless components.

Mechanically interlocked, 3 piece construction for service sealing pressure without spot welding.

1/2" WIDE BAND CLAMPS (12.70MM)



620 Series

- 5/16" Hex Slotted 305 Stainless Steel Screw
- 1/2" Wide 301 Stainless Steel Band
- 301 Stainless Steel Housing
- 60mm Thickness
- Use for underground and other high corrosive applications.
- For a sure grip application.
- Especially suited to industrial applications

All Stainless Steel
1/2" band, 5/16" screw

PART #	#	DIA. RANGE		BOX/CASE	
		MIN.	MAX.		
620006	6	3/8"	7/8"	100/600	----
620008	8	7/16"	1"	100/600	----
620010	10	9/16"	1-1/16"	100/600	----
620012	12	9/16"	1-1/4"	100/600	----
620016	16	11/16"	1-1/2"	100/600	----
620020	20	3/4"	1-3/4"	100/300	----
620024	24	1-1/16"	2"	100/300	----
620028	28	1-5/16"	2-1/4"	100/300	----
620032	32	1-9/16"	2-1/2"	100/300	----
620036	36	1-13/16"	2-3/4"	50/200	----
620040	40	2-1/16"	3"	50/200	----
620044	44	2-5/16"	3-1/4"	50/200	----
620048	48	2-9/16"	3-1/2"	50/200	----
620052	52	2-13/16"	3-3/4"	25/100	----
620056	56	3-1/16"	4"	25/100	----
620060	60	3-5/16"	4-1/4"	25/100	----
620064	64	2-1/2"	4-1/2"	25/100	----
620072	72	3"	5"	25/100	----
620080	80	3-1/2"	5-1/2"	10/100	----
620088	88	4"	6"	10/100	----
620096	96	4-1/2"	6-1/2"	10/100	----
620104	104	5"	7"	10/100	----
620116	116	5-3/4"	7-3/4"	100/100	----
620128	128	6-1/2"	8-1/2"	100/100	----
620152	152	2"	10"	100/100	----
620164	164	1-3/4"	10-3/4"	100/100	----
620176	176	9-1/4"	11-1/4"	100/100	----
620188	188	9.9"	12-1/4"	100/100	----
620200	200	11"	13"	100/100	----
620212	212	11-3/4"	13-3/4"	100/100	----
620224	224	12-1/2"	14-1/2"	100/100	----
620248	248	10-3/4"	16"	100/100	----
620270	270	15-3/8"	17-3/8"	100/100	----
620312	312	18"	20"	100/100	----
620332	332	19-1/8"	21-1/4"	100/100	----
620390	390	22-7/8"	24-7/8"	100/100	----

WARNING: This product can expose you to chemicals, including Chromium, which are known to the State of California to cause cancer and birth defects or other reproductive harm. For more information, visit www.P65Warnings.ca.gov

#316 MARINE WORM GEAR CLAMPS

HOSE CLAMPS

MINIATURE CLAMPS - 5/16" BAND



All #316 SS for Marine Environments

5/16" band, 1/4" screw

PART #	DIA. RANGE		BOX/CASE	
	MIN.	MAX.		
350004SS	7/32"	5/8"	200/2400	----
350005SS	7/16"	11/16"	200/2400	----
350006SS	5/16"	7/8"	200/2400	----
350008SS	7/16"	1"	200/1200	----
350010SS	1/2"	1-1/16"	200/1200	----
350012SS	9/16"	1-1/4"	200/1200	----
350016SS	11/16"	1-1/2"	200/1200	----
350020SS	7/8"	1-3/4"	200/1200	----

350SS Series

- 1/4" Hex Slotted 316 Stainless Steel Screw
- 316 Stainless Steel Band
- 8mm wide
- 60 mm thick
- 316 stainless Steel Housing

Applications: For marine, agricultural, industrial and automotive uses. Corrosion resistance varies with stainless components.

Mechanically interlocked, 3 piece construction for service sealing pressure without spot welding.

1/2" WIDE BAND CLAMPS (12.70MM)



All #316 SS for Marine Environments

1/2" band, 5/16" screw

ALL 316SS PART #	#	DIA. RANGE		BOX/CASE	
		MIN.	MAX.		
620006SS	6	3/8"	7/8"	100/600	----
620008SS	8	7/16"	1"	100/600	----
620010SS	10	9/16"	1-1/16"	100/600	----
620012SS	12	9/16"	1-1/4"	100/600	----
620016SS	16	11/16"	1-1/2"	100/600	----
620020SS	20	3/4"	1-3/4"	100/300	----
620024SS	24	1-1/16"	2"	100/300	----
620028SS	28	1-5/16"	2-1/4"	100/300	----
620032SS	32	1-9/16"	2-1/2"	100/300	----
620036SS	36	1-13/16"	2-3/4"	50/200	----
620040SS	40	2-1/16"	3"	50/200	----
620044SS	44	2-5/16"	3-1/4"	50/200	----
620048SS	48	2-9/16"	3-1/2"	50/200	----
620052SS	52	2-13/16"	3-3/4"	25/100	----
620056SS	56	3-1/16"	4"	25/100	----
620060SS	60	3-5/16"	4-1/4"	25/100	----
620064SS	64	2-1/2"	4-1/2"	25/100	----
620072SS	72	3"	5"	25/100	----

620SS Series

- 5/16" Hex Slotted 316 Stainless Steel Screw
- 1/2" Wide 316 Stainless Steel Band
- 316 Stainless Steel Housing
- 60mm Thickness
- Use for marine, underground and other high corrosive applications.



USE OUR TEXT LINE [855-609-3729](tel:855-609-3729) TO COMMUNICATE WITH MIDLAND MORE CONVENIENTLY

QUICK RELEASE

HOSE CLAMPS

QUICK RELEASE**500/550 SERIES**

These clamps feature a unique quick release design between the one piece housing and band allowing for quick and easy installation in restricted or difficult areas.

Applications: Quick release action permits easy installation in applications where clamp must be opened to be applied. Quick release clamps are used extensively in the telecommunications industry on cable enclosures where open air application demands durability.

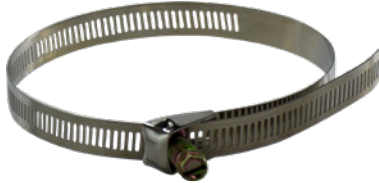

Open/Close design allows easy installation.

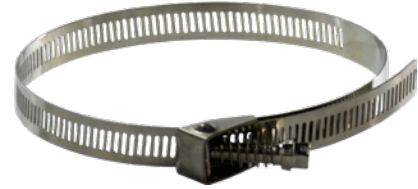
**500 Series**

- 5/16" Hex Slotted Carbon Steel Screw
- 1/2" 301 Stainless Steel band
- 301 Stainless Steel Housing
- 410 Stainless Steel Bridge

550 Series

- 5/16" Hex Slotted 410 Stainless Steel Screw
- 1/2" 301 Stainless Steel band
- 301 Stainless Steel Housing
- 410 Stainless Steel Bridge

PART #	#	DIA. RANGE		PART #	
		MIN.	MAX.		
500012	12	1/2"	1-1/4"	550012	----
500020	20	3/4"	1-3/4"	550020	----
500028	28	1"	2-1/4"	550028	----
500036	36	1"	2-3/4"	550036	----
500048	48	1-1/2"	3-1/2"	550048	----
500056	56	1"	4"	550056	----
500072	72	2"	5"	550072	----
500088	88	2-1/16"	6"	550088	----
500104	104	1-3/4"	7"	550104	----
500128	128	1-3/4"	8-9/16"	550128	----
500152	152	2"	10"	550152	----
500188	188	2-1/16"	12-5/16"	550188	----
500216	216	10-3/16"	14"	550216	----
500248	248	10-3/4"	16"	550248	----
500280	280	14-1/4"	18"	550280	----
	312	14"	20"	550312	----



GO ONLINE TO UPLOAD YOUR LOGO TO UTILIZE ALL OF OUR CUSTOMIZABLE TOOLS!

WARNING: This product can expose you to chemicals, including Chromium, which are known to the State of California to cause cancer and birth defects or other reproductive harm. For more information, visit www.P65Warnings.ca.gov

T-BOLT CLAMPS

HOSE CLAMPS

T-Bolt Clamps

- All designs meet SAE J1508 specifications.
- .025" Band Thickness
- 3/4" Wide Band
- Band Material: 301 Series Stainless Steel
- Bolt Material: 304 Series Stainless Steel
- Nut Material: 304 Series Stainless Steel
- Nuts are Self-locking
- Torque Rating 75 in/lb

Opens 1/16" above and tightens 1/8" smaller
 then nominal I.D. for a total of 3/16" range
 for clamps sizes 150 through 250. Opens
 1/16" above and tightens 7/32" smaller
 then nominal I.D. for clamps sizes 256
 through 750.



Purpose: To provide a quick, yet effective means of clamping a variety of fittings to a wide range of hose. T-Bolts can be applied with a standard 7/16" socket wrench. They provide 3600 sealing surface by using a shoe or formed bridge.

Services: The T-Bolt clamp is a high strength, reliable clamp with numerous applications in both the commercial and industrial markets including hose and ductwork connections for air, oil, water, other types of low pressure fluid lines, engine air intake, exhaust, hose and filters.

ALL STAINLESS STEEL

NOMINAL SIZE	O.D. RANGE		PART#	
	FROM:	TO:		
1-1/4	1-5/32"	1-15/32"	840131	----
1-1/2	1-3/8"	1-9/16"	840150	----
1-3/4	1-5/8"	1-13/16"	840175	----
1-7/8	1-3/4"	1-15/16"	840188	----
2	1-7/8"	2-1/16"	840200	----
2-1/4	2-1/8"	2-5/16"	840225	----
2-3/8	2-1/4"	2-7/16"	840238	----
2-1/2	2-3/8"	2-9/16"	840250	----
2-9/16	2-11/32"	2-5/8"	840256	----
2-5/8	2-13/32"	2-11/16"	840263	----
2-3/4	2-17/32"	2-13/16"	840275	----
2-7/8	2-21/32"	2-15/16"	840288	----
3	2-25/32"	3-1/16"	840300	----
3-1/8	2-29/32"	3-3/16"	840312	----
3-1/4	3-1/32"	3-5/16"	840325	----
3-1/2	3-9/32"	3-9/16"	840350	----
3-3/4	3-17/32"	3-13/16"	840375	----
3-53/64	3-19/32"	3-7/8"	840382	----
4	3-25/32"	4-1/16"	840400	----
4-1/4	4-1/32"	4-5/16"	840425	----
4-1/2	4-9/32"	4-9/16"	840450	----
4-3/4	4-17/32"	4-13/16"	840475	----
5	4-25/32"	5-1/16"	840500	----
5-1/4	5-1/32"	5-5/16"	840525	----
5-1/2	5-9/32"	5-9/16"	840550	----
5-3/4	5-17/32"	5-13/16"	840575	----
6	5-25/32"	6-1/16"	840600	----
6-1/4	6-1/32"	6-5/16"	840625	----
6-1/2	6-9/32"	6-9/16"	840650	----
6-3/4	6-17/32"	6-13/16"	840675	----
7	6-25/32"	7-1/16"	840700	----
7-1/2	7-9/32"	7-9/16"	840750	----
8	7-25/32"	8-1/16"	840800	----
8-1/4	8-9/32"	8-9/16"	840850	----
8-7/8	8-21/32"	8-15/16"	840888	----
10-7/8	10-21/32"	10-15/16"	8401088	----

WARNING: This product can expose you to chemicals, including Chromium, which are known to the State of California to cause cancer and birth defects or other reproductive harm. For more information, visit www.P65Warnings.ca.gov

HOSE CLAMPS

HOSE CLAMPS

mega clamps

Rugged heavy duty wide band clamps for use in medium duty air and water, general industrial, automotive, food and agricultural applications.

MEGAKLAMP

IMPORT

Megaklamp Series

Clamp sizes for hose O.D. from 17 mm to 252 mm

Yellow zinc plated steel Band/Bridge/Trunnion/Sleeve/Bolt

Band gauge from 0.6 mm to 1.7 mm depending upon clamp size

Band width from 18 mm to 26 mm depending upon clamp size

Bolt size from 5 mm to 10 mm depending upon clamp size

PART #	SIZE MM	DECIMAL MIN"	DECIMAL MAX"	WIDTH	
MKL-019-SP	17-19	0.67	0.75	1.02	----
MKL-022-SP	20-22	0.79	0.87	1.02	----
MKL-025-SP	23-25	0.87	0.98	1.02	----
MKL-028-SP	26-28	1.02	1.10	1.02	----
MKL-031-SP	29-31	1.14	1.22	1.02	----
MKL-035-SP	32-35	1.26	1.38	1.02	----
MKL-039-SP	36-39	1.42	1.54	1.02	----
MKL-043-SP	40-43	1.57	1.69	0.87	----
MKL-047-SP	44-47	1.73	1.85	0.87	----
MKL-051-SP	48-51	1.89	2.01	0.87	----
MKL-055-SP	52-55	2.05	2.17	0.87	----
MKL-059-SP	56-59	2.20	2.32	0.87	----
MKL-063-SP	60-63	2.36	2.48	0.87	----
MKL-067-SP	64-67	2.52	2.64	0.94	----
MKL-073-SP	68-73	2.68	2.87	0.94	----
MKL-079-SP	74-79	2.91	3.11	0.94	----
MKL-085-SP	80-85	3.15	3.35	0.94	----
MKL-091-SP	86-91	3.39	3.58	0.94	----
MKL-097-SP	92-97	3.62	3.82	0.94	----
MKL-103-SP	98-103	3.86	4.06	0.94	----
MKL-112-SP	104-112	4.09	4.41	0.94	----
MKL-121-SP	113-121	4.45	4.76	0.94	----
MKL-130-SP	122-130	4.80	5.12	0.94	----
MKL-139-SP	131-139	5.16	5.47	1.02	----
MKL-148-SP	140-148	5.51	5.83	1.02	----
MKL-161-SP	149-161	5.87	6.34	1.02	----
MKL-174-SP	162-174	6.38	6.85	1.02	----
MKL-187-SP	175-187	6.89	7.36	1.02	----
MKL-200-SP	188-200	7.40	7.87	1.02	----
MKL-213-SP	201-213	7.91	8.39	1.02	----
MKL-226-SP	214-226	8.43	8.90	1.02	----
MKL-239-SP	227-239	8.94	9.41	1.02	----

M6 MAXI CLAMP LIGHT

IMPORT

M6 Maxiclamp Series

Clamp sizes for hose O.D. from 23 mm to 43 mm

Silver (clear) zinc plated steel Band/Bridge/Trunnion/Sleeve/Bolt

Band gauge from 0.6 mm to 0.8 mm depending upon clamp size

Band width from 18 mm to 20 mm depending upon clamp size

Bolt size from 5 mm to 6 mm depending upon clamp size

PART #	SIZE MM	DECIMAL MIN"	DECIMAL MAX"	WIDTH	
M6-23	23-25	0.87	1.01	0.71	----
M6-26	26-28	1.02	1.13	0.71	----
M6-29	29-31	1.14	1.25	0.79	----
M6-32	32-35	1.26	1.41	0.79	----
M6-36	36-39	1.42	1.56	0.79	----
M6-40	40-43	1.57	1.72	0.79	----

M6 STAINLESS MAXI CLAMP LIGHT

PART #	SIZE MM	DECIMAL MIN"	DECIMAL MAX"	WIDTH	
M6S-23	23-25	0.87	1.01	0.71	----
M6S-26	26-28	1.02	1.13	0.71	----
M6S-29	29-31	1.14	1.25	0.79	----
M6S-32	32-35	1.26	1.41	0.79	----
M6S-36	36-39	1.42	1.56	0.79	----
M6S-40	40-43	1.57	1.72	0.79	----

WARNING: This product can expose you to chemicals, including Chromium, which are known to the State of California to cause cancer and birth defects or other reproductive harm. For more information, visit www.P65Warnings.ca.gov



HOSE CLAMPS

HOSE CLAMPS

M8 MAXI CLAMP STANDARD

IMPORT



M8 Maxiclamp Series

Clamp sizes for hose O.D. from 44 mm to 130 mm

Silver (clear) zinc plated steel Band/Bridge/Trunnion/Sleeve

8 mm silver zinc plated bolt

Band gauge from 1.2 mm to 1.5 mm depending upon clamp size

Band width from 22 mm to 24 mm depending upon clamp size

PART #	SIZE MM	DECIMAL MIN"	DECIMAL MAX"	WIDTH	
M8-44	44-47	1.73	1.88	0.87	----
M8-48	48-51	1.89	2.04	0.87	----
M8-52	52-55	2.05	2.17	0.87	----
M8-56	56-59	2.20	2.35	0.87	----
M8-60	60-63	2.36	2.51	0.87	----
M8-64	64-67	2.52	2.67	0.87	----
M8-68	68-73	2.68	2.90	0.94	----
M8-74	74-79	2.91	3.14	0.94	----
M8-80	80-85	3.15	3.38	0.94	----
M8-86	86-91	3.39	3.61	0.94	----
M8-92	92-97	3.62	3.85	0.94	----
M8-98	98-103	3.86	4.08	0.94	----
M8-104	104-112	4.09	4.44	0.94	----
M8-113	113-121	4.45	4.79	0.94	----
M8-122	122-130	4.80	5.15	0.94	----

M8 MAXI CLAMP STANDARD

IMPORT



M8S Maxiclamp Series

Clamp sizes for hose O.D. from 44 mm to 130 mm

301 Stainless steel Band/Bridge/Trunnion/Sleeve

8 mm A2-70 Stainless steel bolt

0.8 mm thick band

Band width from 22 mm to 24 mm depending upon clamp size

PART #	SIZE MM	DECIMAL MIN"	DECIMAL MAX"	WIDTH	
M8S-44	44-47	1.73	1.88	0.87	----
M8S-48	48-51	1.89	2.04	0.87	----
M8S-52	52-55	2.05	2.17	0.87	----
M8S-56	56-59	2.20	2.35	0.87	----
M8S-60	60-63	2.36	2.51	0.87	----
M8S-64	64-67	2.52	2.67	0.87	----
M8S-68	68-73	2.68	2.90	0.94	----
M8S-74	74-79	2.91	3.14	0.94	----
M8S-80	80-85	3.15	3.38	0.94	----
M8S-86	86-91	3.39	3.61	0.94	----
M8S-92	92-97	3.62	3.85	0.94	----
M8S-98	98-103	3.86	4.08	0.94	----
M8S-104	104-112	4.09	4.44	0.94	----
M8S-113	113-121	4.45	4.79	0.94	----
M8S-122	122-130	4.80	5.15	0.94	----
M8S-131	131-139	5.16	5.50	1.02	----
M8S-140	140-148	5.51	5.86	1.02	----
M8S-149	149-161	5.87	6.37	1.02	----
M8S-162	162-174	6.38	6.88	1.02	----

M10 MAXI CLAMP HEAVY

IMPORT



M10S Maxiclamp Series

Select sizes available

301 Stainless steel Band/Bridge/Trunnion/Sleeve

10 mm A2-70 Stainless steel bolt

1.7 mm thick x 26 mm wide band

PART #	SIZE MM	DECIMAL MIN"	DECIMAL MAX"	WIDTH	
M10-131	131-139	5.16	5.50	1.02	----
M10-140	140-148	5.51	5.86	1.02	----
M10-149	149-161	5.87	6.37	1.02	----
M10-162	162-174	6.38	6.88	1.02	----
M10-175	175-187	6.89	7.39	1.02	----
M10-188	188-200	7.40	7.86	1.02	----
M10-201	201-213	7.91	8.42	1.02	----
M10-214	214-226	8.43	8.90	1.02	----
M10-227	227-239	8.94	9.44	1.02	----
M10-240	240-252	9.45	9.92	1.02	----

SPRING LOADED T-BOLT

HOSE CLAMPS

SPRING LOADED T-BOLT HOSE CLAMP

- Per SAE standard J1508 Type "SLTB"
- .025 Band Thickness
- 3/4 (19mm) band width
- Heavy duty springs
- Band Material: 300 stainless
- T-bolt: Carbon steel w/ zinc plating
- Housing (Bridge): 300 Stainless
- Hex nut: Carbon Steel, Nylon insert
- Torque rating: 150 in-lbs (8.5 mm)



Purpose: To provide constant tension performance to compensate for the expansion and contraction when temperatures fluctuate. Provides high strength and a 360° seal. Tighten with a 7/16" wrench or hex nutdriver.

Services: Designed for use in high vibration and large diameter applications common in heavy trucks, industrial machinery, off road equipment, agricultural irrigation and machinery, for air intake and coolant adapter

PART #	SAE #	MIN - MAX	WGT	BOX QTY	
844213	40	2.13 - 2.44	0.170	100	----
844225	44	2.25 - 2.56	0.174	100	----
844238	48	2.38 - 2.69	0.179	100	----
844250	52	2.50 - 2.81	0.181	100	----
844263	56	2.63 - 2.94	0.183	100	----
844275	60	2.75 - 3.06	0.185	100	----
844300	68	3 - 3.31	0.187	100	----
844306	70	3.06 - 3.38	0.190	100	----
844313	72	3.13 - 3.44	0.192	100	----
844325	76	3.25 - 3.56	0.194	100	----
844338	80	3.38 - 3.69	0.196	100	----
844350	84	3.50 - 3.81	0.196	100	----
844356	86	3.56 - 3.88	0.196	100	----
844363	88	3.63 - 3.94	0.198	100	----
844375	92	3.75 - 4.06	0.198	100	----
844406	102	4.06 - 4.38	0.203	100	----
844413	104	4.13 - 4.44	0.209	100	----
844425	108	4.25 - 4.56	0.214	100	----
844456	118	4.56 - 4.88	0.216	100	----
844500	132	5 - 5.31	0.218	100	----
844525	140	5.25 - 5.56	0.220	100	----
844600	164	6 - 6.31	0.223	100	----
844625	172	6.25 - 6.56	0.225	100	----

Automatically adjust diameter for hose expansion and contraction due to temperature changes.



HELP US HELP YOU! [GO ONLINE TO UPDATE YOUR CUSTOMER PROFILE](#) SO THAT WE CAN UPDATE ALL THE APPROPRIATE DEPARTMENTS AND PERSONNEL AT YOUR COMPANY ON NEW CATALOGS, PRICING UPDATES, NEW MARKETING TOOLS, AND OTHER IMPORTANT INFORMATION. THANK YOU!

Constant Torque Hose Clamps

- All designs meet SAE J1508 specifications type "SLHD"
- .028 Band thickness
- Band material: 304 thickness
- Band width: 9/16" for 45in-lb
5/8" for 90in-lb
- Band material: 304 stainless
- Housing: 304 stainless steel
- Bridge: 410 stainless steel
- Hex screw: 410 stainless steel



Purpose: To eliminate leaks by automatically increasing or decreasing the clamps diameter, decreasing the need for retightening. Constant torque clamps have an extended tail on the band to protect soft hose or tube from being cut.

Services: Constant torque clamps are an excellent choice for fluctuating and extreme temperature applications and thermal compensation.

PART #	CLAMPING RANGE	BAND WIDTH	TORQUE	SCREW SIZE	WGT	BOX QTY	
842010	9/16" - 1 1/16"	9/16"	72 in-lb	5/16"	0.106	100	----
842012	11/16" - 1 1/4"	9/16"	72 in-lb	5/16"	0.108	100	----
842016	13/16" - 1 1/2"	9/16"	72 in-lb	5/16"	0.112	100	----
842020	13/16" - 1 3/4"	9/16"	72 in-lb	5/16"	0.119	100	----
842024	1 1/16" - 2"	9/16"	72 in-lb	5/16"	0.121	100	----
842200	1 1/4" - 2 1/8"	5/8"	130 in-lb High	3/8"	0.207	100	----
842250	1 3/4" - 2 5/8"	5/8"	130 in-lb High	3/8"	0.216	100	----
842300	2 1/4" - 3 1/8"	5/8"	130 in-lb High	3/8"	0.220	100	----
842350	2 3/4" - 3 5/8"	5/8"	130 in-lb High	3/8"	0.225	100	----
842400	3 1/4" - 4 1/8"	5/8"	130 in-lb High	3/8"	0.231	100	----
842450	3 3/4" - 4 5/8"	5/8"	130 in-lb High	3/8"	0.238	100	----
842500	4 1/4" - 5 1/8"	5/8"	130 in-lb High	3/8"	0.256	100	----
842550	4-3/4"-5-5/8"	5/8"	130 in-lb High	3/8"	0.284	100	----

V-BAND HOSE CLAMPS

- Band thickness: see chart
- Band width: see chart
- Band material: 300 stainless
- Trunnion: 300 stainless
- 1/4" T-bolt: 300 Ziac plated steel

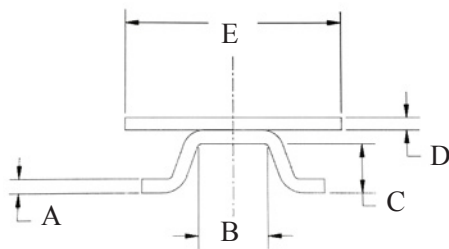

Purpose: to provide a fast, secure coupling for connecting flanged joints.

Services: V-Band clamps feature high strength and positive sealing integrity for applications including: heavy duty diesel engine exhaust and turbochargers, filter housings, emissions and general industrial applications.

PART#	NOMINAL DIAMETER	V-INSERT SECTIONS			BANDS		WGT	BOX QTY	
		A	B	C	D	E			
843321	3.21	0.050	0.262	0.141	0.035	0.750	0.525	100	----
843382	3.82	0.077	0.207	0.281	0.040	0.875	0.531	100	----
843388	3.88	0.050	0.400	0.281	0.040	0.875	0.536	100	----
843450	4.50	0.077	0.207	0.281	0.040	0.875	0.547	100	----
843461	4.61	0.050	0.156	0.281	0.035	0.750	0.549	100	----
843475	4.75	0.050	0.400	0.281	0.040	0.875	0.553	100	----
843525	5.25	0.050	0.262	0.141	0.035	0.750	0.567	100	----
843588	5.88	0.050	0.400	0.281	0.040	0.875	0.575	100	----

HOSE CLAMPS

HOSE CLAMPS

DOUBLE BOLT CLAMPS

IMPORT

DBC Series

Rugged, heavy duty two bolt clamps
with saddles
Zinc plated ductile iron clamps and
saddles
Zinc plated carbon steel bolt and nuts



PART #	SIZE	SIZE RANGE	MAX TORQUE FT LBS	
DBC-40-DP	1-5/16	1-5/16" - 1-19/32"	20	----
DBC-60-DP	1-7/8	1-7/8" - 2-3/8"	25	----
DBC-76-DP*	2-3/8	2-3/8" - 3-1/16"	25	----
DBC-94-DP*	3-1/2	3-1/2" - 3-11/16"	40	----
DBC-400-DP*	3-1/2	3-1/2" - 4"	40	----
DBC-431-DP	3-13/16	3-13/16" - 4-1/16"	40	----
DBC-463-DP	4-1/16	4-1/16" - 4-7/16"	40	----
DBC-525-DP*	4-3/16	4-3/16" - 5"	60	----
DBC-550-DP*	5	5" - 5-1/2"	60	----
DBC-600-DP*	5-1/2	5-1/2" - 5-15/16"	60	----
DBC-639-DP	5-11/16	5-11/16" - 5-15/16"	60	----
DBC-675-DP*	6-1/8	6-1/8" - 6-7/8"	60	----
DBC-769-DP*	6-15/16	6-15/16" - 7-5/8"	60	----
DBC-818-DP	7-11/16	7-11/16" - 8-3/16"	125	----
DBC-875-DP*	8-1/4	8-1/4" - 8-7/8"	125	----
DBC-988-DP*	8-15/16	8-15/16" - 9-7/8"	125	----
DBC-1125-DP*	9-15/16	9-15/16" - 11-3/8"	125	----
DBC-1275-DP*	11-3/16	11-3/16" - 13"	125	----
DBC-1360-DP	12-3/16	12-3/16" - 14"	200	----

*IN STOCK IN HOUSTON



R88 Series

IMPORT

Rugged, heavy duty two bolt clamps
without saddles
Zinc plated ductile iron clamp
Zinc plated carbon steel bolt and nuts



PART #	SIZE	SIZE RANGE	MAX TORQUE FT LBS	
R88DB-12-DP*	1-1/8	1-1/8" - 1-1/4"	15	----
R88DB-16-DP*	1-3/8	1-3/8" - 1-1/2"	20	----
R88DB-20-DP*	1-5/8	1-5/8" - 1-3/4"	25	----
R88DB-24-DP*	2	2" - 2-1/8"	25	----
R88DB-32-DP*	2-1/4	2-1/4" - 2-3/8"	30	----

*IN STOCK IN HOUSTON



SEE WEBSITE TO DOWNLOAD YOUR MOST UPDATED PRICING

HOSE CLAMPS

HOSE CLAMPS

SC SPIRAL CLAMP SERIES

Spiral wound clamps specifically designed for use on heavily corrugated suction hoses. Available in left hand (counter clockwise) and right hand (clockwise) spiral. Zinc plated steel construction.



IMPORT



PART #	LIST	HOSE ID	O.D. RANGE MM	PART #	
SC-200R-SP*	----	2"	51 - 56	SC-200L-SP	----
SC-250R-SP	----	2-1/2"	61 - 76	SC-250L-SP	----
SC-300R-SP*	----	3"	76 - 90	SC-300L-SP	----
SC-400R-SP*	----	4"	106 - 118	SC-400L-SP	----
SC-500R-SP	----	5"	129 - 140	SC-500L-SP	----
SC-600R-SP*	----	6"	151 - 170	SC-600L-SP	----
SC-800R-SP	----	8"	198 - 217	SC-800L-SP	----
SC-1000R-SP	----	10"	274 - 290	SC-1000L-SP	----
SC-1200R-SP	----	12"	304 - 329	SC-1200L-SP	----

*IN STOCK IN HOUSTON



IMPORT

M10DC MAXICLAMP SERIES

Clamp sizes for hose O.D. from 131 mm to 252 mm

Silver (clear) zinc plated steel Band/Bridge/Trunnion/Sleeve/Bolt

10 mm silver zinc plated steel bolts

1.7 mm thick x 30 mm wide band

Suggested installation torque 30 Nm (22 Ft lbs)

Minimum breaking torque 40 Nm (29.5 ft.lbs.)

PART #	SIZE MM	RANGE	
M10DC-86	86 - 91	3.38" - 3.58"	----
M10DC-92	92 - 97	3.62" - 3.82"	----
M10DC-104	104 - 112	4.09" - 4.41"	----
M10DC-113	113 - 121	4.45" - 4.76"	----
M10DC-122	122 - 130	4.80" - 5.12"	----
M10DC-131	131 - 139	5.16" - 5.47"	----
M10DC-140	140 - 148	5.51" - 5.83"	----
M10DC-149	149 - 161	5.87" - 6.34"	----
M10DC-162	162 - 174	6.38" - 6.85"	----
M10DC-175	175 - 187	6.89" - 7.36"	----
M10DC-188	188 - 200	7.40" - 7.87"	----
M10DC-200	200 - 220	7.87" - 8.66"	----
M10DC-220	220 - 240	8.66" - 9.45"	----
M10DC-240	240 - 260	9.45" - 10.24"	----
M10DC-260	260 - 280	10.24" - 11.02"	----
M10DC-280	280 - 300	11.02" - 11.81"	----
M10DC-300	300 - 325	11.81" - 12.80"	----
M10DC-325	325 - 350	12.80" - 13.78"	----
M10DC-350	350 - 375	13.78" - 14.76"	----
M10DC-375	375 - 400	14.76" - 15.75"	----
M10DC-400	400 - 425	15.75" - 16.73"	----
M10DC-425	425 - 450	17.73" - 17.72"	----
M10DC-450	450 - 475	17.72" - 18.70"	----



USE OUR APP WITH YOUR FREE BIN LABELS TO MANAGE YOUR CUSTOMERS INVENTORY MORE EFFICIENTLY

MUFFLER

HOSE CLAMPS

MUFFLER Clamps

Muffler Clamps are designed with elongated and tapered holes that pulls the legs around the pipe as the nuts tighten, making a tight seal. Other clamp legs do not wrap around the pipe, they stay straight and the clamp only connects at two points.

- Carbon steel band, housing and bridge
- All muffler clamps are zinc plated for superior corrosion resistance
- Heavy duty U-Bolt and band construction
- 3/8 U-bolt
- Base 2.4mm

SADDLE



PART #	SIZE	WGT	BOX QTY	
841175	1-3/4"	0.335	50	----
841200	2"	0.410	50	----
841250	2-1/2"	0.448	50	----
841300	3"	0.582	50	----
841350	3-1/2"	0.741	50	----
841400	4"	0.847	25	----
841450	4-1/2"	1.023	25	----
841500	5"	1.067	25	----

FLAT BAND



PART #	SIZE	WGT	BOX QTY	
841004	4"	0.847	25	----
841005	5"	1.093	25	----

GUILLOTINE - PROVIDES A COMPLETE 360° HEAVY DUTY SEAL



PART #	SIZE	WGT	BOX QTY	
841040	4"	0.820	25	----
841045	4-1/2"	0.847	25	----
841050	5"	0.988	25	----



VIEW PRICING AND AVAILABLE STOCK ONLINE

WARNING: This product can expose you to chemicals, including Cobalt, which are known to the State of California to cause cancer. For more information, visit www.P65Warnings.ca.gov



EXHAUST Clamps

Complete with:

- One metal band - 76mm width
- One spacer
- Two bolts
- Two reaction blocks
- Individually boxed

- Pre-attached hardware for easy and accurate installation.

- Conforms to pipe and flex tubing to create the best seal available without distorting any pipes.

ALUMINIZED STEEL BUTT CLAMPS

- .7mm band thickness
- 76mm band width



PART #	SIZE	WGT	BOX QTY	
845200	2"	0.970	50	----
845300	3"	1.058	50	----
845350	3.50"	1.102	50	----
845400	4"	1.146	50	----
845500	5"	1.235	50	----
845600	6"	1.323	50	----

*Light pattern .5mm band thickness

ALUMINIZED STEEL LAP CLAMPS

- .7mm band thickness
- 76mm band width



PART #	SIZE	WGT	BOX QTY	
846200	2"	0.970	50	----
846250	2.50"	1.014	50	----
846275	2.75"	1.036	50	----
846300	3"	1.058	50	----
846350	3.50"	1.102	50	----
846400	4"	1.146	50	----
846500	5"	1.235	50	----

STAINLESS STEEL LAP CLAMPS

- .5mm band thickness
- 76mm band width



PART #	SIZE	WGT	BOX QTY	
847200	2"	0.926	50	----
847250	2.50"	0.970	50	----
847275	2.75"	0.992	50	----
847300	3"	1.014	50	----
847350	3.50"	1.058	50	----
847400	4"	1.102	50	----
847500	5"	1.190	50	----
847600	6"	1.279	50	----

STAINLESS STEEL EASY-FORM CLAMPS

- .5mm band thickness
- 76mm band width



PART #	SIZE	WGT	BOX QTY	
848200	2"	0.926	50	----
848225	2.25"	0.948	50	----
848250	2.50"	0.970	50	----
848275	2.75"	0.992	50	----
848300	3"	1.014	50	----
848350	3.50"	1.058	50	----
848400	4"	1.102	50	----
848500	5"	1.190	50	----
848600	6"	1.279	50	----
848700	7"	1.367	50	----

WARNING: This product can expose you to chemicals, including chromium, which are known to the State of California to cause cancer and birth defects or other reproductive harm. For more information, visit www.P65Warnings.ca.gov

CARBON STEEL 1-EAR

HOSE CLAMPS

CARBON STEEL 1-EAR CLAMPS

1-Ear Clamps are intended for low pressure applications such as automotive (not fuel lines), appliances, industrial machinery, underground irrigation systems and beverage dispensing equipment. They are specifically designed for mass production applications where inexpensive clamps are needed.

Pressure:

As a guideline, 1-Ear Clamps have held

30 bar - 441 psi.

This was done using a static water pressure test.

• 100 PER BAG



Material:

Hot dipped galvanized carbon steel band - G90

PART #	REF#	NOMINAL SIZE	INCHES		
			CLOSE	OPEN	
1050000	105	3/8"	0.350	0.414	----
1050001	113	7/16"	0.381	0.444	----
1050002	123	15/32"	0.394	0.486	----
1050003	133	1/2"	0.453	0.524	----
1050006	140	35/64"	0.472	0.551	----
1050007	145	9/16"	0.496	0.571	----
1050008	157	5/8"	0.543	0.618	----
1050009	170	11/16"	0.594	0.669	----
1050010	185	23/32"	0.618	0.728	----
1050011	198	3/4"	0.669	0.779	----
1050012	210	13/16"	0.716	0.827	----
1050013	226	7/8"	0.779	0.890	----
1050014	241	15/16"	0.839	0.949	----
1050015	256	1"	0.898	1.008	----
1050016	271	1-1/16"	0.945	1.067	----
1050017	286	1-1/8"	1.004	1.126	----
1050018	301	1-3/16"	1.063	1.185	----
1050020	331	1-5/16"	1.181	1.303	----
1050021	346	1-3/8"	1.240	1.362	----
1050023	376	1-15/32"	1.358	1.480	----
1050025	396	1-9/16"	1.437	1.559	----
1050026	410	1-5/8"	1.492	1.614	----
1050029	455	1-3/4"	1.669	1.791	----
1050030	470	1-16/16"	1.728	1.850	----
1050032	500	1-15/16"	1.846	1.968	----
1050033	515	2"	1.905	2.028	----

The art of communication is the language of leadership. - James Humes

WARNING: This product can expose you to chemicals, including Cobalt, which are known to the State of California to cause cancer. For more information, visit www.P65Warnings.ca.gov

HOSE CLAMPS

HOSE CLAMPS

EAR CLAMPS

2-EAR PINCH CLAMPS

Robust, durable one-piece design offers positive, tamper resistant seal for air and fluid media lines smooth edges prevent damage to hose designed for one time use only

CIRCLE CLAMP 2 EAR

White zinc plated carbon steel



PART #	SIZE	CLOSED	OPEN	
CC-1113	1/2	0.433	0.512	----
CC-1315	9/16	0.512	0.591	----
CC-1517	19/32	0.591	0.669	----
CC-1518	5/8	0.591	0.709	----
CC-1720	3/4	0.669	0.787	----
CC-2023	7/8	0.787	0.906	----
CC-2225	15/16	0.866	0.984	----
CC-2327	1	0.906	1.063	----
CC-2528	1-1/16	0.984	1.102	----
CC-2731	1-1/8	1.063	1.220	----
CC-3134	1-5/16	1.220	1.339	----
CC-3437	1-7/16	1.339	1.457	----
CC-3740	1-1/2	1.457	1.575	----

GAPLESS EAR CLAMPS

Features

- Assured clamping seal
- For low durometer and/ or thin-walled hose/ tubing
- Perfect for silicon, vinyl, polyurethane or other high tech materials used in all industries.
- Once installed, smooth inner band circumference prevents damage to the hose while the unique tongue-in-groove design provides a 360° seal
- There are no steps or gaps inside clamp



Material

- Stainless steel tubing UNS S30400 or DIN 1.4301
- 100 PER BAG

PART #	NOMI- NAL SIZE	BAND WIDTH	INCHES		
			CLOSE	OPEN	
16700001	9/32"	5mm	0.228	0.276	----
16700004	3/8"	5mm	0.307	0.374	----
16700007	7/16"	5mm	0.378	0.445	----
16700010	1/2"	7mm	0.425	0.524	----
16700012	35/64"	7mm	0.453	0.551	----
16700013	9/16"	7mm	0.472	0.571	----
16700016	5/8"	7mm	0.520	0.618	----
16700017	11/16"	7mm	0.571	0.669	----
16700022	3/4"	7mm	0.654	0.780	----
16700024	13/16"	7mm	0.701	0.827	----

hammerlock CLAMPS

HAMMERLOCK CPHL SERIES

Double wrapped galvanized steel band preformed to a given diameter and ready for application.



IMPORT



PART #	SIZE	WIDTH	
CPHL-03	1-3/16"	3/8"	----
CPHL-04	1"	5/8"	----
CPHL-05*	1-1/4"	5/8"	----
CPHL-06	1-1/2"	5/8"	----
CPHL-07*	1-3/4"	5/8"	----
CPHL-08*	2"	5/8"	----
CPHL-09	2-1/4"	5/8"	----
CPHL-10*	2-1/2"	5/8"	----
CPHL-11*	2-3/4"	5/8"	----
CPHL-12	3"	5/8"	----
CPHL-14*	3-1/2"	5/8"	----
CPHL-16*	4"	5/8"	----
CPHL-18	4-1/2"	5/8"	----
CPHL-20*	5"	5/8"	----
CPHL-24*	6"	5/8"	----
CPHL-26	6-1/2"	5/8"	----
CPHL-28*	7"	5/8"	----
CPHL-32	8"	5/8"	----

*IN STOCK IN HOUSTON

HAMMERLOCK CPHLS SERIES

Double wrapped stainless steel band preformed to a given diameter and ready for application. Stainless steel lok for strength.

IMPORT



PART #	SIZE	WIDTH	
CPHLS-04*	1"	5/8"	----
CPHLS-05*	1-1/4"	5/8"	----
CPHLS-06*	1-1/2"	5/8"	----
CPHLS-07*	1-3/4"	5/8"	----
CPHLS-08*	2"	5/8"	----
CPHLS-09*	2-1/4"	5/8"	----
CPHLS-10*	2-1/2"	5/8"	----
CPHLS-11*	2-3/4"	5/8"	----
CPHLS-12*	3"	5/8"	----
CPHLS-14*	3-1/2"	5/8"	----
CPHLS-16*	4"	5/8"	----
CPHLS-18*	4-1/2"	5/8"	----
CPHLS-20*	5"	5/8"	----
CPHLS-24*	6"	5/8"	----
CPHLS-28*	7"	5/8"	----
CPHLS-32	8"	5/8"	----

*IN STOCK IN HOUSTON

CLAMPING TOOLS

HOSE CLAMPS

MODEL 1098 I STANDARD JAW PINCERS

Domestic

PART #		
OETP-1098		----

Import

PART #		
CCP-1098		----



PART #		
1410118		----

SIDE JAW PINCERS

This dual purpose, side jaw design allows clamps to be applied or removed in confined areas with pincers held parallel to the hose. Also used like standard Pincers.

Domestic



PART #		
1410083	Model 10991	----

TPT TOOLS AND PARTS



PART #		
TPT-1		----

HOSE CRIMPER



HOSE CRIMPER COMES WITH 5 DIES
Die Sizes = 5/8", 37/64", 12/32", 31/64", 11/16"

PART #		
308070	Hose Crimper	----

LOKING TOOL



PART #		
F38		----

Portable hand tool used to apply punch Type 3/8 & 5/8 Clamps

BUCHANAN TYPE



LOKING TOOL



PART #		
F40		----

Used to apply Punch Type 3/8 & 5/8 clamps. Order mallet separately

LOKING TOOL



Used to apply Punch Type 3/8 & 5/8 clamps. Order mallet separately

PART #		
F100		----

LOKING TOOL HD

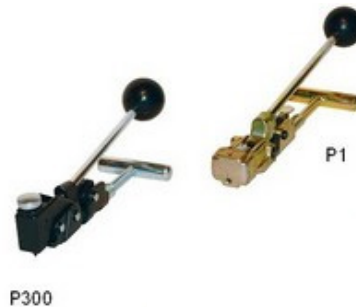

PART #		
P1	HEAVY DUTY	----
P300	IMPORTED VERSION	----

WARNING: This product can expose you to chemicals, including Cobalt, which are known to the State of California to cause cancer. For more information, visit www.P65Warnings.ca.gov

LINED BAND CLAMPS

HOSE CLAMPS



Features unique one-piece housing, rolled-up band edges and a non-perforated (embossed) band that protects the hose. For added corrosion resistance, the band in the 12mm Standard is made of Aluzinc which gives three times the protection offered by conventional galvanized steel.

- Features high clamping force and high durability torque.
 - Stainless: All parts in AISI 304 Stainless Steel.
- A non-perforated band with rolled up edges eliminates hose damage while increasing clamping force. Per SAE standard J1508 Type "FEO"

GENERAL PURPOSE EMBOSSED WORM-GEAR HOSE CLAMPS

- Minimum Qty may apply

Part # Aluzinc	SAE Size	Clamping Range		Bag	Part# 304 SS
		Inches	mm		
88024	8	5/8-1	15-24	1000	89024
88028	10	3/4-1-1/8	19-28	500	89028
88032	12	7/8-1-1/4	22-32	500	89032
88038	16	1-1/16-1-1/2	26-38	500	89038
	20	1-1/4-1-3/4	32-44	500	89044
88050	24	1-1/2-2	38-50	500	89050
88056	28	1-3/4-2-1/4	44-56	500	89056
88065	32	2-2-9/16	50-65	200	89065
88075	40	2-5/16-3	58-75	200	89075
88085	44	2-11/16-3-3/8	68-85	200	89085
88095	52	3-3-3/4	77-95	200	89095
88112	64	3-7/16-4-7/16	87-112	200	89112

MINI CLAMPS

Sure seal for small, thin walled hoses. The nut is secured to the clamp, making installation easier and the hexagonal head can be tightened with a socket wrench or screw driver. Bandwidth is 9mm.

PAINTED ALUZINC STANDARD MINI CLAMPS



PART # ALUZINC	CLAMPING RANGE		QTY PER BAG
	INCHES	MM	
92010	.36-.41	9-10.5	1000
92011	.37-.45	9.5-11.5	900
92012	.41-.49	10.5-12.5	800
92013	.45-.53	11.5-13.5	800
92014	.49-.57	12.5-14.5	700
92015	.53-.61	13.5-15.5	600
92016	.55-.65	14-16.5	500
92017	.59-.69	15-17.5	500



MARINE - EMBOSSED NON-PERFORATED WORM GEAR CLAMPS

- Meets the DIN 3017 Standard
- Replaces the Ultra Clamps 316 stainless steel
- 12mm band widths
- Installation torque 60lbs
- General purpose non perforated band especially suited for most hoses and soft silicone hoses.
- Band edges rolled to protect soft hoses from shearing and fraying
- Common applications include: vehicular, industrial, mechanical engineering, plumbing and marine.
- ROLLED EDGES
- BAND WILL NOT DAMAGE SOFT HOSES

ALL #316 SS MATERIAL

12MM WIDE EMBOSSED ALL 316 BAND CLAMPS

PART #	RANGE OF ADJUST (IN MM)	RANGE OF ADJUST (INCHES)
96022	12-22	.469-.859
96027	16-27	.625-1.06
96032	20-32	.787-1.26
96040	25-40	.984-1.575
96050	35-50	1.26-1.969
96060	40-60	1.575-2.362
96070	50-70	1.969-2.756
96080	60-80	2.362-3.15
96090	70-90	2.756-3.543
96100	80-100	3.15-3.937
96110	90-110	3.543-4.33
96120	100-120	3.937-4.724
96130	110-130	4.33-5.118
96140	120-140	4.72-5.512
96150	130-150	5.118-5.906
96160	140-160	5.512-6.299

MINI CLAMPS

304 SS MINI CLAMPS



PART # 304 SS	CLAMPING RANGE		QTY PER BAG
	INCHES	MM	
93008	.30-.34	7.5-8.5	1000
93009	.34-.37	8.5-9.5	1000
93011	.41-.47	10.5-12	900
93013	.49-.55	12.5-14	800
93017	.63-.71	16-18	500

LINED, MINI/ RUBBER LINED

HOSE CLAMPS

**RUBBER LINED CLAMPS**

Multiple uses for holding cable, wire, pipe and hose. The rubber cushion absorbs vibration, provides protection against scratching and is made of black EPDM type rubber.

Rubber cushion clamps are used in a variety of industries and applications including automotive, truck, hydraulics and pneumatics, ship building, refrigeration, large equipment packaging etc.

Bandwidths and mounting hose sizes vary by diameter and material.

- Aluzinc clamps have a .26 hole diameter
- Stainless Steel .20 diameter

PART # ALUZ- INC	QTY PER BAG		CLAMPING RANGE		PART# 304 SS	QTY PER BAG	
			INCHES	MM			
95300	100	----	1/8	3			
95301	100	----	3/16	5	96301	1000	----
95302	100	----	1/4	6	96302	200	----
95303	100	----	5/16	8	96303	1000	----
95304	100	----	3/8	10	96304	100	----
95305	100	----	7/16	11	96305	1000	----
95306	100	----	1/2	13	96306	100	----
95307	100	----	9/16	14	96307	100	----
95308	100	----	5/8	16	96308	100	----
95309	50	----	11/16	18			
95310	50	----	3/4	19	96310	500	----
95311	50	----	13/16	21			
95312	50	----	7/8	22	96312	500	----
95313	50	----	15/16	24			
95314	50	----	1	25	96314	500	----
95315	50	----	1-1/16	27			
95316	50	----	1-1/8	29	96316	500	----
95317	50	----	1-3/16	30			
95318	50	----	1-1/4	32	96318	500	----
95319	50	----	1-5/16	33			
95320	50	----	1-3/8	35	96320	500	----
95321	50	----	1-7/16	36			
95322	500	----	1-1/2	38	96322	100	----
95326	50	----	1-5/8	41			
95323	25	----	1-3/4	45	96323	500	----
95328	25	----	1-7/8	47			
95324	25	----	2	51			
95325	25	----	2-1/8	54			
95329	25	----	2-3/8	60			
95327	25	----	2-1/2	65			
95330	15	----	2-15/16	74			
95331	10	----	4-5/16	110			

**RUBBER CUSHIONED CLAMP, ZINC PLATED STEEL**

PART #	MOUNTING DIA	CLAMP DIA	
95402	3/8"	1/4"	----
95404	3/8"	3/8"	----
95406	3/8"	1/2"	----
95408	3/8"	5/8"	----
95410	3/8"	3/4"	----
95414	3/8"	1"	----
95418	3/8"	1 1/4"	----
95422	3/8"	1 1/2"	----
95424	3/8"	2"	----
95427	3/8"	2 1/2"	----
95432	3/8"	3"	----
95433	3/8"	4"	----

**GALVANIZED STEEL VINYL COATED CLAMP**

PART #	MOUNTING DIA	CLAMP DIA	
95504	1/4"	3/8"	----
95506	1/4"	1/2"	----
95508	1/4"	5/8"	----
95510	1/4"	3/4"	----
95512	1/4"	7/8"	----
95514	1/4"	1"	----
95516	1/4"	1 1/8"	----
95518	1/4"	1 1/4"	----
95522	1/4"	1 1/2"	----
95523	1/4"	1 3/4"	----
95524	1/4"	2"	----

HOSE FERRULES

HOSE CLAMPS

HOSE FERRULES

Brass Hose Ferrules offer an alternative to hose clamps. After crimping, the ferrule will provide a permanent clamping force on both the hose and fitting.

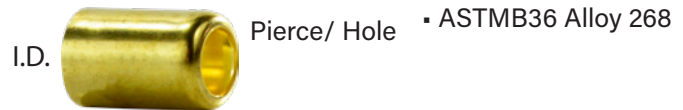

PART #	FER-RULE #	I.D.	LENGTH	PIERCE	GAUGE	
32500	6231	0.330	0.49	0.250	0.020	----
32501	833	0.358	0.500	0.265	0.020	----
32503	833B	0.375	0.718	0.265	0.025	----
32502	622	0.380	0.500	0.265	0.020	----
32550	619	0.400	0.47	0.27	0.020	----
32504	620	0.410	0.500	0.265	0.020	----
32551	769R	0.450	0.562	0.343	0.020	----
32552	4750	0.478	0.687	0.328	0.025	----
32553	624R	0.500	0.500	0.343	0.020	----
32506	7322A	0.500	1.000	0.343	0.025	----
32554	7322	0.500	1.000	0.328	0.025	----
32555	625	0.525	0.47	0.36	0.020	----
32517	625A	0.525	0.56	0.360	0.020	----
32556	7323	0.525	1.000	0.375	0.025	----
32521	9974	0.525	1.000	0.437	0.025	----
32557	7324	0.531	1.000	0.375	0.025	----
32558	626	0.550	0.484	0.375	0.020	----
32507	3588	0.56	0.75	0.375	0.020	----
32559	7325	0.56	1.000	0.437	0.025	----
32561	7326	0.593	1.000	0.437	0.025	----
32563	JJ	0.600	0.500	0.500	0.020	----
32526	II	0.625	0.500	0.500	0.020	----
32564	7327	0.625	1.000	0.437	0.025	----
32565	HH	0.650	0.500	0.500	0.020	----
32566	7328	0.656	1.000	0.437	0.025	----
32567	GG	0.675	0.515	0.500	0.020	----
32568	7329	0.69	1.000	0.500	0.025	----

PART #	FER-RULE #	I.D.	LENGTH	PIERCE	GAUGE	
32570	7330	0.718	1.000	0.500	0.025	----
32508	7330A	0.718	1.000	0.625	0.025	----
32571	EE	0.725	0.530	0.500	0.020	----
32572	DD	0.750	0.531	0.500	0.020	----
32510	7331B	0.75	1.00	0.500	0.025	----
32573	7331	0.750	1.000	0.625	0.025	----
32574	CC	0.775	0.531	0.500	0.020	----
32533	7332B	0.781	1.000	0.500	0.025	----
32575	7332	0.781	1.000	0.625	0.025	----
32576	BB	0.800	0.546	0.562	0.020	----
32577	7333	0.812	1.000	0.625	0.025	----
32578	AA	0.825	0.546	0.562	0.020	----
32535		0.85	0.968	0.687	0.025	----
32579	7244	0.875	0.843	0.687	0.025	----
32539	5029A	0.900	0.875	0.687	0.025	----
32580	7113	0.925	0.968	0.750	0.025	----
32543	5028A	0.975	0.843	0.687	0.025	----
32545	5235A	1.000	0.843	0.687	0.025	----
32549	7145A	1.050	0.843	0.687	0.025	----
32584	5027	1.100	0.843	0.812	0.025	----
32586	7104A	1.15	0.843	0.875	0.025	----
32588	7088A	1.175	0.875	0.875	0.025	----
32590	875L	1.200	0.843	0.875	0.025	----
32591	7291	1.225	0.968	0.875	0.025	----
32592	7255	1.25	0.968	1.000	0.04	----
32596	8000	1.425	0.875	1.062	0.025	----
32597	1500	1.50	0.875	1.125	0.025	----



STAINLESS STEEL FERRULES

PART #	CROSS #	I.D.	LENGTH	HOLE	METAL THICKNESS	
32552SS	x4750	.478	.687	.328	.020	----
32557SS	7324	.531	1.00	.438	.020	----
32559SS	7325	.56	1.00	.437	.020	----
32561SS	7326	.593	1.00	.437	.020	----
32564SS	7327	.625	1.00	.437	.020	----
32566SS	7328	.656	1.00	.437	.020	----
32568SS	7329	.69	1.00	.50	.020	----
32570SS	7330	.718	1.00	.625	.020	----
32575SS	7332	.781	1.00	.625	.020	----
32577SS	7333	.812	1.00	.625	.020	----
32588SS	7088A	1.175	.844	.875	.020	----

MORE SIZES AVAILABLE

AVAILABLE IN ALUMINUM AND STEEL ALSO

WARNING: This product can expose you to chemicals, including Chromium, which are known to the State of California to cause cancer and birth defects or other reproductive harm. For more information, visit www.P65Warnings.ca.gov

CLAMPS

TUBING
TUBING

TUBING



POLYURETHANE



POLYETHYLENE

Sold individually boxed

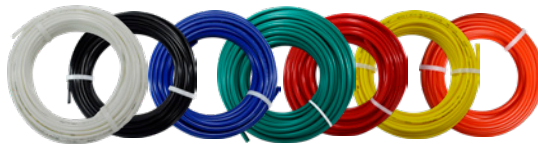
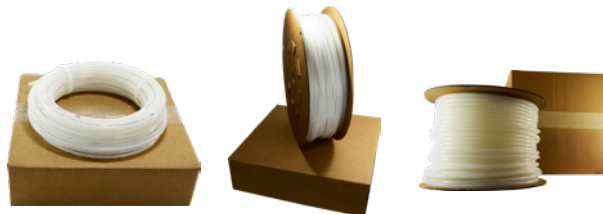

Natural, Black, Blue, Green, Red, Yellow, Orange

NYLON

Sold individually boxed



PVC

• Clear

Sold individually boxed



COPPER AND ALUMINUM



TYPE L AND REFRIGERATION

ALUMINUM



PRICING FILE AVAILABLE ONLINE

POLYURETHANE NSF 51®



NSF 51® polyurethane (PUR) Shore A 98 tubing is made from the highest quality raw materials available. It is etherbased to provide excellent hydrolysis, oil and cold resistance. Polyurethane NSF 51® is strong and flexible and offers superior kink resistance compared to other tubing. It is 5 to 10 times more wear resistant and lighter in weight than any rubber hose.

Polyurethane NSF 51® tubing has an outside diameter made to extremely tight tolerances. It is ideal for use with push-to-connect fittings, as well as barb-type and compression fittings for simple installation.

Features

- Strong
- Lightweight
- Flexible
- Abrasion Resistant
- Heat & Cold Resistant
- Chemical Resistant
- Kink Resistant
- NSF 51® Certified
- Meets NSF 61® Requirements

Specifications

Temperature Range: -40°F to +160°F
 Hardness: Shore A 98
 Vacuum Rating:
 To 28" Hg
 Tolerances:
 1/8"-1/2" O.D. +/- .005
 9/16"-3/4" O.D. +/- .006
 RoHS Compliant

Applications

Pneumatic Tools Lube Lines
 Pneumatic Piping Painting Systems
 Vacuum Food & Beverages
 Laboratories
 Robotics
 Motion Control
 Instrumentation
 Agriculture

100' FOOT LENGTHS

CLEAR

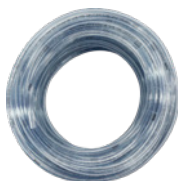

PART #	O.D. (IN)	I.D. (IN)	WALL THICKNESS (IN)	BEND RADIUS (IN)	W.P. @70°F (PSI)	W.P. @150°F (PSI)	3:1 BURST PRES-SURE	PACKAGE WEIGHT (LBS)
973341	4mm, 5/32	.093	.031	.250	200	85	600	.70
973343	.250	.156	.047	.476	180	70	540	1.50
973345	.375	.250	.063	1.000	150	70	450	3.40

BLACK



PART #	O.D. (IN)	I.D. (IN)	WALL THICKNESS (IN)	BEND RADIUS (IN)	W.P. @70°F (PSI)	W.P. @150°F (PSI)	3:1 BURST PRES-SURE	PACKAGE WEIGHT (LBS)
73341B	4mm, 5/32	.093	.031	.250	200	85	600	.70
73343B	.250	.156	.047	.476	180	70	540	1.50
73345B	.375	.250	.063	1.000	150	70	450	3.40
73346B	.500	.328	.086	1.102	150	70	450	5.60

BLUE



PART #	O.D. (IN)	I.D. (IN)	WALL THICKNESS (IN)	BEND RADIUS (IN)	W.P. @70°F (PSI)	W.P. @150°F (PSI)	3:1 BURST PRES-SURE	PACKAGE WEIGHT (LBS)
73341U	4mm, 5/32	.093	.031	.250	200	85	600	.70
73343U	.250	.156	.047	.476	180	70	540	1.50
73345U	.375	.250	.063	1.000	150	70	450	3.40

RED



PART #	O.D. (IN)	I.D. (IN)	WALL THICKNESS (IN)	BEND RADIUS (IN)	W.P. @70°F (PSI)	W.P. @150°F (PSI)	3:1 BURST PRES-SURE	PACKAGE WEIGHT (LBS)
73341R	4mm, 5/32	.093	.031	.250	200	85	600	.70
73343R	.250	.156	.047	.476	180	70	540	1.50
73345R	.375	.250	.063	1.000	150	70	450	3.40
73346R	.562	.375	.093	1.142	140	60	420	5.60

OD Sizes Available

.125, .187, 1/4(1/8), 8mm(5/16)
 .562, .625 and .750

Other sizes, Lengths and
 Colors available

- Available in longer lengths upon request
- Other colors available

POLYETHYLENE

LINEAR LOW DENSITY POLYETHYLENE TUBING (LLDPE)

Features

- Chemically Inert
- Chemical Resistant
- Lightweight & Flexible
- Good Dielectric Properties
- Impermeable to Gases
- Meets FDA Requirements
- Multiple Colors Available
- Vacuum rating to 28" Hg

Polyethylene is made from 100% non-toxic ingredients. It's inert nature and FDA compliant status makes it perfect for food, water and beverage piping. It is ideal for use in pneumatic, drain piping, lab use and chemical transfer applications which require an inexpensive tubing.

Polyethylene is highly-resistant to stress cracking from chemicals, aging and ultraviolet exposure. For use with barb-type, push-to-connect or compression-style fittings.

Specifications

Temperature Range: -50°F to +140°F

Hardness: Shore A 93A

Shore D 45D

Applications

Food & Beverage Process Control
 Pneumatic Tools Laboratories
 Pneumatic Piping
 Electrical Jacketing
 Drain Lines
 Instrumentation
 Chemical Transfer



100' LENGTH



500' LENGTH



1000' LENGTH

100' LENGTH - Natural

PART #	TUBE O.D.	TUBE ID	TUBE WALL	WORKING PRESSURE	
973200	1/8"	0.08	0.022	250	----
973201	5/32"				
973203	1/4"	0.17	0.040	150	----
973204	1/4"	0.125	0.0625	350	----
973205	8mm/5/16"	0.236	0.038	150	----
973206	3/8"	0.25	0.0625	150	----
973207	1/2"	0.375	0.0625	125	----
973208	5/8"	0.50	0.0625	100	----
973211	3/4"				

500' LENGTH

PART #	TUBE O.D.	TUBE ID	TUBE WALL	WORKING PRESSURE	
73200N5	1/8"	0.085	0.020	250	----
73203N5	1/4"	0.17	0.040	150	----
73204N5	1/4"	0.125	0.0625	350	----
73206N5	3/8"	0.25	0.0625	150	----
73207N5	1/2"	0.375	0.0625	125	----

1000' LENGTH

PART #	TUBE O.D.	TUBE ID	TUBE WALL	WORKING PRESSURE	
73203N1	1/4"	0.17	0.040	150	----
73206N1	3/8"	0.25	0.0625	150	----

POLYETHYLENE

TUBING

LLDPE POLYETHYLENE TUBING - COLORS



BLACK

- 100'
- 500'
- 1000'

PART #	COLOR	LENGTH	NOMINAL O.D.	
73203B	Black	100'	1/4"	----
73204B	Black	100'	1/4"	----
73205B	Black	100'	5/16"	----
73206B	Black	100'	3/8"	----
73207B	Black	100'	1/2"	----
73208B	Black	100'	5/8"	----
73203B5	Black	500'	1/4"	----
73205B5	Black	500'	5/16"	----
73206B5	Black	500'	3/8"	----
73207B5	Black	500'	1/2"	----
73203B1	Black	1000'	1/4"	----
73206B1	Black	1000'	3/8"	----



BLUE

- 100'
- 500'
- 1000'

PART #	COL-OR	LENGTH	NOMI-NAL O.D.	
73203U	Blue	100'	1/4"	----
73206U	Blue	100'	3/8"	----
73207U	Blue	100'	1/2"	----
73203U5	Blue	500'	1/4"	----
73206U5	Blue	500'	3/8"	----
73203U1	Blue	1000'	1/4"	----

GREEN



- 100'
- 500'
- 1000'

PART #	COLOR	LENGTH	NOMI-NAL O.D.	
73203G	Green	100'	1/4"	----

RED



- 100'
- 500'
- 1000'

PART #	COL-OR	LENGTH	NOMI-NAL O.D.	
73203R	Red	100'	1/4"	----
73206R	Red	100'	3/8"	----
73203R5	Red	500'	1/4"	----
73206R5	Red	500'	3/8"	----
73203R1	Red	1000'	1/4"	----



GO ONLINE TO VIEW OPEN ORDERS, ORDER HISTORY, AND TRACKING INFORMATION ON ALL SHIPMENTS

NYLON
TUBING

NYLON 12 TUBING

Nylon 12 tubing is recognized as an industry standard for applications which require higher working pressures and higher heat and/or chemical resistance. It is ideal for outdoor use applications because of its superior stress crack resistance. Nylon 12 is strong, lightweight and has a very low moisture absorption rate compared to other nylons. By not absorbing moisture, Nylon 12 remains more flexible, which in turn extends it's service life. Nylon 12 tubing can be used with standard push-to-connect fittings and compression fittings for simple installation.

Because of it's semi-rigid properties, a thinner tube wall provides higher flow rates and working pressure.

Features

- Strong
- Lightweight
- Flexible
- Abrasion Resistant
- Heat Resistant
- Chemical Resistant
- Heat/ Light Stabilized
- Black - UV Rated

Specifications

Temperature Range: -60°F to +200°F
 Hardness: Rockwell 78 R
 Shore D 70
 Vacuum Rating: To 28" Hg
 Higher Flow Rates & Working Pressure
 Tolerances: 1/8"-1/4" +/- .004
 3/4"-1/2" +/- .006

Applications

Pneumatic Tools Chemical Transfer
 Pneumatic Piping Vacuum
 Instrumentation Process Control
 Lube Lines Fuel Lines
 Coolants Paint Supply Lines
 Refrigeration Laboratories

Part #'s shown are for natural. 500' and 1000' reels available on request.



100' LENGTH



BLACK TUBING & MISC.



METRIC LENGTH

100' LENGTH

PART #	TUBE O.D.	TUBE ID	TUBE WALL	WORKING PRESSURE	
973230	1/8"	0.08	.022	420	----
973231	5/32"	0.106	.025	350	----
973232	1/4"	0.18	.035	290	----
973238	1/4"	0.15	.05	800	----
973226	5/16"	0.236	.039	250	----
973233	3/8"	0.275	.050	250	----
973234	1/2"	0.375	.062	240	----

BLACK TUBING & MISC.

PART #	O.D.	TUBE ID	WALL	WORKING PRESSURE	
73230B	1/8	0.08	0.022	420	----
73231B	5/32	0.106	0.025	350	----
73232B	1/4	0.18	0.035	290	----
73238B	1/4	0.15	0.05	800	----
73233B	3/8	0.275	0.05	250	----
73232N5*	1/4	0.18	0.035	290	----
73238U**	1/4	0.15	0.075	800	----

• 500' Natural **Blue

*METRIC LENGTH - 100 ft. coils • available in natural color only

PART #	MM O.D.	MM I.D.	MM WALL	WORKING PRESSURE	
973323	4	2.7	0.65	350	----
973326	6	3.5	1.25	350	----
973325	6	4	1	340	----
973327	8	6	1	250	----
973329	10	8	1	225	----
973332	12	10	1	200	----
973334	14	11	1.5	175	----

PVC TUBING AND TUBING CUTTERS

TUBING

PVC POLYVINYLCHLORIDE TUBING - NSF61



PVC is suited for general, low-pressure, industrial applications for the conveyance of liquids and solids of suitable granular size. Made from a PVC compound that complies with FDA regulations. Although it is primarily intended for applications where pressure is not essential, it will withstand the pressures shown.

The clear PVC Tubing provides good chemical resistance, is lightweight, flexible and economically priced.

Features

- Lightweight
- Flexible
- Food Grade
- Clear Color/ Blue tint

Specifications

Temperature Range: +25°F to +150°F
 Hardness: Shore A 75 PVC
 Meets FDA requirements
 NSF 61 Certified
 USP Class VI rated materials
 RoHS Compliant

Applications

Beverage Dispensing Distilled Water Transfer
 Drain Tubing Light Vacuum
 Potable Water Wire Harness
 Laboratory Tubing 3:1 Burst Pressure
 Wine Transfer
 Low Pressure Air Line

Colors Available: Clear

Package Lengths: 100'

100' LENGTH

PART #	TUBE I.D.	TUBE O.D.	TUBE WALL	WORKING PRESSURE	
973224	1/8 (.125)	1/4 (.25)	1/16 (.032)	50	----
973223	3/16 (.187)	5/16 (.313)	1/16 (.062)	55	----
973215	1/4 (.25)	3/8 (.375)	1/16 (.062)	55	----
973252	5/16 (.312)	7/16 (.438)	1/16 (.062)	50	----
973253	5/16 (.312)	1/2 (.500)	3/32 (.094)	55	----
973216	3/8 (.375)	1/2 (.500)	1/16 (.062)	45	----
973255	3/8 (.375)	5/8 (.625)	1/8 (.125)	55	----
973262	3/8 (.375)	9/16 (.563)	3/32 (.094)	50	----
973217	1/2 (.500)	5/8 (.625)	1/16 (.062)	30	----
973219	3/4 (.750)	1 (1.00)	1/8 (.125)	35	----
973221	1 (1.00)	1-1/4 (1.25)	1/8 (.125)	25	----

TUBE CUTTERS

MINI-TUBING CUTTER

- Great for tight places



Part #	Size	
990571	3mm-22mm (1/8"-7/8")	----

TUBING CUTTER



PART #	SIZE	
990570	1/8"-1-1/8"	----

PLASTIC TUBE CUTTER

Range: 1/8" - 3/8" I.D. (3mm-10mm)



PART #	DESCRIPTION	
91707	Cutter w/Blade	----

MOUNTING RACKS



- Route and secure multiple tubing lines
- Mounting versatility
 - Racks can be easily hand separated down to single holders.
 - Thru holes provided (all sizes)
- Standard color is BLACK.
Other colors available on special request.

NOTE: MOUNTING SCREWS NOT PROVIDED

PART #	TUB-ING OD	DESCRIP.	CHAN-NELS	
28988	1/4	non-adhesive	10	----
28989	1/4	adhesive	10	----
28990	3/8	non-adhesive	7	----
28991	1/2	non-adhesive	5	----

ALUMINUM AND COPPER

TUBING

ALUMINUM TUBING - EASY BEND

Alloy
3003-0
ASTM
B-483



Material
to ASTM
B-483

900 PSI max
3700 Burst PSI

Bend this tubing into the shape you need without special tools or elbow fittings. It is also known as Alloy 3003. Tubing has seamless construction, which provides a smooth interior and allows it to be flared without splitting. Use with water, air, alcohol and oil. Tubing meets ASTM B483 and has a soft (annealed) temper. OD tolerance is ± 0.004 "

ALUMINUM VERSATUBE 50' COILS

PART #	O.D.	WALL THICK	ID	MAX PSI @ 100°F	CASE	50' COILS
972190	1/8	.025	.075"	2,300	10 coils	----
972191	3/16	.028	.132"	1,600	10 coils	----
972192	1/4	.032	.186"	1,400	10 coils	----
972193	5/16	.035	.243"	1,200	10 coils	----
972194	3/8	.035	.305"	1,000	10 coils	----
972195	1/2	.035	.43"	740	10 coils	----

COPPER TUBING - REFRIGERATION TUBING

ASTMB280



- Temp range: 32° to 400°F
- Bend with a bending tool
- Use with copper solder-connect fittings

This copper Alloy 122 tube comes cleaned and capped to prevent moisture and dirt from contaminating the inside. It's often called refrigeration and air conditioning tubing. Use with water, natural gas, oil and R22 refrigerant. Tubing meets ASTM B280. It has seamless construction, which provides a smooth interior. Tubing has a soft (annealed) temper.

REFRIGERATION COPPER TUBE 50' COILS

PART #	TUBE SIZE	OD	WALL	ID	MAX PSI @ 100°F	WEIGHT PER 50' COIL	50' COILS
972180	-	1/8	.030	.065"	3,000	1.74	----
972181	-	3/16	.030	.128"	1,900	2.88	----
972182	1/8	1/4	.030	.19"	1,400	4.02	----
972183	-	5/16	.032	.248"	1,100	5.45	----
972184	1/4	3/8	.032	.311"	980	6.70	----
972185	3/8	1/2	.032	.436"	720	9.10	----
972186	1/2	5/8	.035	.555"	610	12.55	----
972187	5/8	3/4	.035	.68'	510	15.25	----

COPPER TUBING - DRINKING WATER

For residential water lines



- Temp range: 32° to 180°F
- Bend with a bending tool
- Use with copper solder-connect fittings

NSF 61 certified for drinking (potable) water, this copper Alloy 122 tubing is also called type L. Tubing meets ASTM B88. It has seamless construction, which provides a smooth interior. Coils - Have a soft (annealed) temper.

• Water service • Natural, liquified and petroleum gases • Fire protection • Solar • Fuel/ Fuel oil • HVAC • Snow melting - Air Brake

TYPE L SOFT COPPER TUBING 60' COILS

PART #	TUBE SIZE	OD	WALL	ID	MAX PSI @ 100°F	WEIGHT PER 60' COIL	60' COILS
972171	1/4	3/8"	.03"	.315"	910	7.56	----
972172	3/8	1/2	.035"	.43"	770	11.88	----
972173	1/2	5/8"	.04"	.545"	720	17.10	----

WARNING: This product can expose you to chemicals, including Lead, which are known to the State of California to cause cancer and birth defects or other reproductive harm. For more information, visit www.P65Warnings.ca.gov

HIGH PRESSURE SPRAYERS



STRAIGHT THROUGH QDS



FITTINGS AND SWIVELS

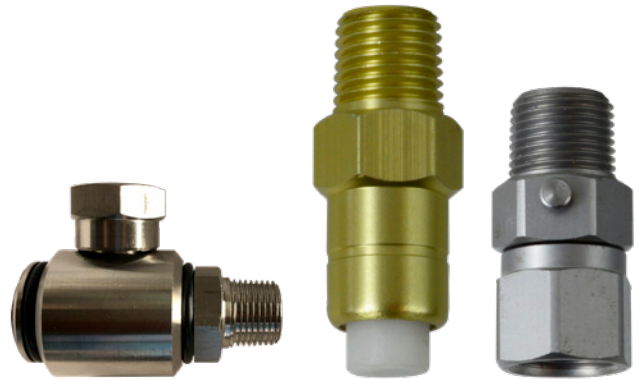

NOZZLES



SPRAY GUNS AND WANDS



WARNING: This product can expose you to chemicals, including Chromium, which are known to the State of California to cause cancer and birth defects or other reproductive harm. For more information, visit www.P65Warnings.ca.gov

HIGH PRESSURE SPRAYER

NOZZLES

HIGH PRESSURE SPRAYER



NOZZLES

OFFERED EXCLUSIVELY THROUGH MIDLAND INDUSTRIES

QUICK DISCONNECT NOZZLE

0-degree red tip nozzle, 15-degree yellow tip nozzle, 25-degree green tip nozzle, 40-degree white tip nozzle, and 65-degree black tip detergent nozzle. All nozzles are 4000 PSI and stainless steel, except for detergent nozzle, which is 600 PSI and brass. All Nozzles are rated for temperatures up to 300°F. Nozzles attach with 1/4" quick disconnect plug.



PART #	DEGREE OF SPRAY	GPM @ 4000PSI	
DX250030	0	3.0	----
DX251530	15	3.0	----
DX252530	25	3.0	----
DX254030	40	3.0	----
DX250040	0	4.0	----
DX251540	15	4.0	----
DX252540	25	4.0	----
DX254040	40	4.0	----
DX250050	0	5.0	----
DX251550	15	5.0	----
DX252550	25	5.0	----
DX254050	40	5.0	----
DX250060	0	6.0	----
DX251560	15	6.0	----
DX252560	25	6.0	----
DX254060	40	6.0	----
DX256500	65		----

MEG NOZZLE

Available in 0-degree nozzle, 15-degree nozzle, 25-degree nozzle, or 40-degree nozzle. Nozzle sizes 3.0, 4.0, 5.0, 6.0 or 7.0. All nozzles are 7250 PSI 300°F, stainless steel and 1/4" male pipe thread.



PART #	DEGREE OF SPRAY	GPM @ 4000PSI	
DX140030MG	0	3.0	----
DX141530MG	15	3.0	----
DX142530MG	25	3.0	----
DX144030MG	40	3.0	----
DX140040MG	0	4.0	----
DX141540MG	15	4.0	----
DX142540MG	25	4.0	----
DX144040MG	40	4.0	----
DX140050MG	0	5.0	----
DX141550MG	15	5.0	----
DX142550MG	25	5.0	----
DX144050MG	40	5.0	----
DX140060MG	0	6.0	----
DX141560MG	15	6.0	----
DX142560MG	25	6.0	----
DX144060MG	40	6.0	----
DX140070MG	0	7.0	----
DX141570MG	15	7.0	----
DX142570MG	25	7.0	----
DX144070MG	40	7.0	----

QUICK DISCONNECT NOZZLE 5-PIECE KIT

PART #	GPM @ 4000PSI	
DX259520	2.0	----
DX259530	3.0	----
DX259540	4.0	----
DX259550	5.0	----
DX259560	6.0	----
DX259570	7.0	----



WARNING: This product can expose you to chemicals, including Chromium, which are known to the State of California to cause cancer and birth defects or other reproductive harm. For more information, visit www.P65Warnings.ca.gov



SWIVELS

HIGH PRESSURE SPRAYER



SWIVELS

OFFERED EXCLUSIVELY THROUGH MIDLAND INDUSTRIES

RUBBER-TIP TURBO NOZZLE

Rubber tip, rotating turbo nozzle, 1/4" NPT with steel male quick disconnect plug adaptor, rated for temperatures up to 300°F.



PART #	PSI	GPM @ 4000PSI	
DX722530	2500	3.0	----
DX722540	2500	4.0	----
DX722550	2500	5.0	----
DX722560	2500	6.0	----
DX723230	3200	3.0	----
DX723240	3200	4.0	----
DX723250	3200	5.0	----
DX723260	3200	6.0	----
DX724030	4000	3.0	----
DX724040	4000	4.0	----
DX724050	4000	5.0	----
DX724060	4000	6.0	----
DX725030	5000	3.0	----
DX725040	5000	4.0	----
DX725050	5000	5.0	----
DX725060	5000	6.0	----

STAINLESS STEEL LIVE SWIVEL

MxF straight through live swivel, NBR or Viton seal, 416 SS, 10.6 gpm, 180F max, 3500 PSI



PART #	SEAL	SIZE	
DX60021	NBR	1/4"	----
DX60022	NBR	3/8"	----
DX60023	NBR	1/2"	----
DX60021V	Viton	1/4"	----
DX60022V	Viton	3/8"	----
DX60023V	Viton	1/2"	----

THERMAL RELIEF VALVE

140F Thermal Relief Valve, Brass, 300 PSI

- Attaches directly to pump



PART #	SIZE	
DX35TR25	1/4"	----
DX35TR38	3/8"	----

90° BOOM SWIVEL

Male x Female 90° Boom swivel, Stainless Steel, 5000 PSI, 7GPM, 300°F



PART #	SIZE	
DX60092	3/8"	----

WARNING: This product can expose you to chemicals, including Chromium, which are known to the State of California to cause cancer and birth defects or other reproductive harm. For more information, visit www.P65Warnings.ca.gov

HIGH PRESSURE SPRAYER

SPRAY GUNS
HIGH PRESSURE SPRAYER



SPRAYERS

OFFERED EXCLUSIVELY THROUGH



CHROMED STEEL WAND

1/4" MNPT x 1/4" Extension Wands, 10.5 GPM, 300F

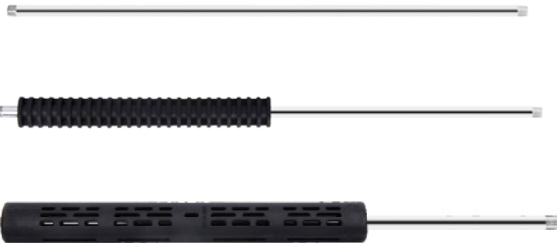

PART #	SIZE	GRIP	
DX4324	24"	No Grip	----
DX4336	36"	No Grip	----
DX4424	24"	Molded Grip	----
DX4436	36"	Molded Grip	----
DX4524VG	24"	Vented Grip	----
DX4536VG	36"	Vented Grip	----

SPRAY GUN

Rear entry spray gun, 4000 PSI, 7 GPM, 212F max, inlet 3/8", outlet 1/4"



PART #	PRESSURE	FLOW	TEMPERATURE	
DX5090	4000	7	212	----
DX5022	4000	6.6	300	----
DX5005	5075	10.5	300	----

WEEPING SPRAY GUN

Rear entry spray gun, weeping, 5000 PSI, 10.5 GPM, 300F, , inlet 3/8", outlet 1/4"

Weep style spray guns allow for a continuous flow of water by way of a small hole in the bottom of the gun that produces a slight leak, or a weeping effect. This helps prevent lines freezing in cold weather or scalding water temperatures in hot weather that could damage the pumps.



PART #	
DX5006	----

SPRAY GUN WITH EXTENSION*

Rear entry spray gun with 12" extension, 4000psi, 7gpm, 300F max, inlet 3/8", outlet M22



PART #	
DX5190	----

SPRAY GUN WITH EXTENSION*

Rear entry spray gun with 12" extension, 5075psi, 10.5gpm, 300F max, inlet 3/8", outlet M22



PART #	
DX5197	----

*Requires a 86-005 for MEG Nozzle and a 86-005 & 86-030 for QD Nozzle

WARNING: This product can expose you to chemicals, including Chromium, which are known to the State of California to cause cancer and birth defects or other reproductive harm. For more information, visit www.P65Warnings.ca.gov



COUPLERS/ PLUGS

HIGH PRESSURE SPRAYER

QUICK DISCONNECTS

- Brass couplers have brass bodies and brass valves, 8 steel locking balls, Buna-N seal, and stainless steel springs
- Stainless steel couplers have stainless steel bodies, 8 stainless steel locking balls, Buna-N seal, and stainless steel springs
- Plugs are steel with green blue zinc plating or stainless steel
- Straight through design means there is no positive shut-off after disconnect
- Fully interchangeable with Parker, Hansen, Foster and Adams
- Use with liquids, hydraulic service, compressed air, gases, water and vacuum
- Ideal for applications such as high pressure water, steam washers, and carpet cleaners
- Max. Temp. 212°F for Couplers/ 300°F for Plugs • Max Flow: 10.5 GPM

STRAIGHT THROUGH STYLE

MALE BRASS COUPLERS



PART #	BODY SIZE	THREAD SIZE	PSI	
86030	1/4	1/4	4000	----
86031	3/8	3/8	4000	----
86032	1/2	1/2	4000	----

FEMALE BRASS COUPLERS

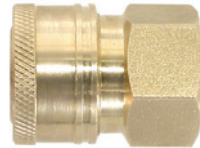

PART #	BODY SIZE	THREAD SIZE	PSI	
86035	1/4	1/4	4000	----
86036	3/8	3/8	4000	----
86037	1/2	1/2	4000	----

MALE STAINLESS STEEL COUPLERS



PART #	BODY SIZE	THREAD SIZE	PSI	
86030SS	1/4	1/4	6000	----
86031SS	3/8	3/8	6000	----

FEMALE STAINLESS STEEL COUPLERS

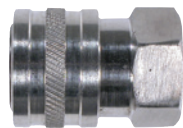

PART #	BODY SIZE	THREAD SIZE	PSI	
86035SS	1/4	1/4	6000	----
86036SS	3/8	3/8	6000	----

MALE STEEL PLUGS



PART #	BODY SIZE	THREAD SIZE	PSI	
86040	1/4	1/4	4000	----
86041	3/8	3/8	4000	----
86042	1/2	1/2	4000	----

FEMALE STEEL PLUGS



PART #	BODY SIZE	THREAD SIZE	PSI	
86045	1/4	1/4	4000	----
86046	3/8	3/8	4000	----
86047	1/2	1/2	4000	----

MALE STAINLESS STEEL PLUGS

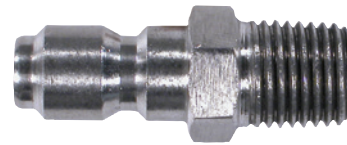

PART #	BODY SIZE	THREAD SIZE	PSI	
86040SS	1/4	1/4	6000	----
86041SS	3/8	3/8	6000	----

FEMALE STAINLESS STEEL PLUGS

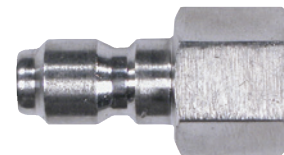

PART #	BODY SIZE	THREAD SIZE	PSI	
86045SS	1/4	1/4	6000	----
86046SS	3/8	3/8	6000	----

COUPLERS/ KNOBS

HIGH PRESSURE SPRAYER

MOLDED GRIP MALE BRASS COUPLER



PART #	THREAD SIZE	THREAD SIZE	PSI	
86030RG	1/4	1/4	4000	----
86031RG	3/8	3/8	4000	----

MOLDED GRIP FEMALE BRASS COUPLER



PART #	THREAD SIZE	PLUG	PSI	
86035RG	1/4	1/4	4000	----
86036RG	3/8	3/8	4000	----

M22 SCREW TYPE X MNPT

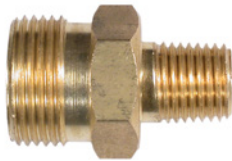

PART #	THREAD SIZE	MALE	PSI	
86001	M22	1/4	4000	----
86002	M22	3/8	4000	----

M22 SCREW TYPE X FNPT

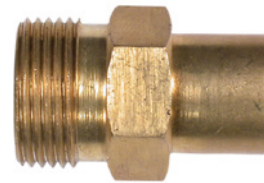

PART #	THREAD SIZE	FEMALE SIZE	PSI	
86005	M22	1/4	4000	----
86006	M22	3/8	4000	----

INSULATED KNOB

M22 INSULATED KNOB X MNPT



PART #	THREAD SIZE	MALE SIZE	PSI	
86012	M22	1/4	4000	----
86013	M22	3/8	4000	----

M22 INSULATED KNOB X FNPT

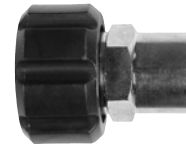

PART #	THREAD SIZE	FEMALE SIZE	PSI	
86017	M22	1/4	4000	----
86018	M22	3/8	4000	----

M22 X M22 FNPT



PART #	THREAD SIZE	THREAD SIZE	PSI	
86022	M22	M22	4000	----

M22 INSULATED KNOB X QC PLUG



PART #	THREAD SIZE	PLUG	PSI	
86020	M22	3/8	4000	----

WARNING: This product can expose you to chemicals, including lead, which are known to the State of California to cause cancer and birth defects or other reproductive harm. For more information, visit www.P65Warnings.ca.gov



PNEUMATICS



1/4" 3/8" 1/2" 1/4" 1/4" 3/8" 1/4" 1/4" 3/8"
 INDUSTRIAL INTERCHANGE ARO AUTO AUTO LINCOLN STRAIGHT THRU STRAIGHT THRU

QUICK DISCONNECTS



- Universal
- ARO 210
- Lincoln
- Industrial
- Automotive
- ST Series - High Flow

BREATHER VENTS, MUFFLERS



- Mufflers
- Snubbers
- In-line filters
- Breather vents
- Control valves
- Manifolds

PNEUMATIC ACCESSORIES



- Kits NEW
- Tire gauge
- Tank and vent valves
- Blow guns
- Air chucks
- Inflators

GAUGES



- Liquid filled & Dry
- Lower mount & center mount
- Water test
- Syphons

PRICING FILE AVAILABLE ONLINE

WARNING: This product can expose you to chemicals, including lead, which are known to the State of California to cause cancer and birth defects or other reproductive harm. For more information, visit www.P65Warnings.ca.gov

INDUSTRIAL INTERCHANGE

• Couplers are brass or plated steel body with brass or steel valves, 6 steel locking balls, NBR seal and stainless steel springs

6 Steel locking balls (1/2" body size has 8 steel locking balls)

- Plugs are brass or steel with green blue zinc plating
- Industry standard design for compressed air, water, grease, paint, limited vacuum and limited gases
- Manual retract for connecting and disconnecting
- Maximum working pressure is 250 PSI

BRASS FEMALE COUPLER



PART#	BODY SIZE	THREAD SIZE	
28540	1/4"	1/4"	----
28541	1/4"	3/8"	----

BRASS MALE COUPLER

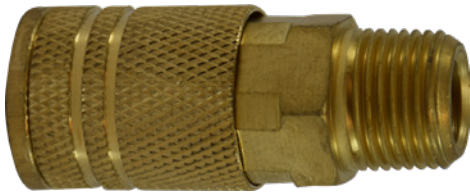

PART#	BODY SIZE	THREAD SIZE	
28552	1/4"	1/4"	----
28553	1/4"	3/8"	----

STEEL FEMALE COUPLER



PART#	BODY SIZE	THREAD SIZE	
28540S	1/4"	1/4"	----
28541S	1/4"	3/8"	----
98810	3/8"	1/4"	----
98811	3/8"	3/8"	----
98812	3/8"	1/2"	----
99812	1/2"	1/2"	----

STEEL MALE COUPLER

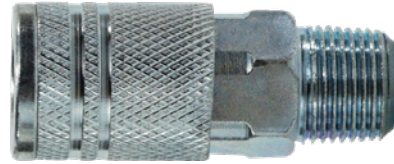

PART#	BODY SIZE	THREAD SIZE	
28552S	1/4"	1/4"	----
28553S	1/4"	3/8"	----
98823	3/8"	1/4"	----
98824	3/8"	3/8"	----
98825	3/8"	1/2"	----
99825	1/2"	1/2"	----
99826	1/2"	3/4"	----

BRASS HOSE ID COUPLER



PART#	BODY SIZE	BARB SIZE	
28562	1/4"	1/4"	----
28564	1/4"	3/8"	----

STEEL HOSE ID COUPLER

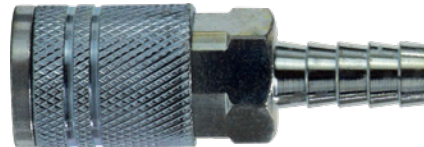

PART#	BODY SIZE	BARB SIZE	
28562S	1/4"	1/4"	----
28564S	1/4"	3/8"	----
98840	3/8"	1/4"	----
98841	3/8"	3/8"	----
99841	1/2"	3/8"	----
99843	1/2"	1/2"	----

BRASS PUSH-ON HOSE COUPLER

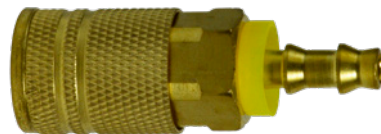

PART#	BODY SIZE	BARB SIZE	
28565	1/4"	1/4"	----
28566	1/4"	3/8"	----

WARNING: This product can expose you to chemicals, including lead, which are known to the State of California to cause cancer and birth defects or other reproductive harm. For more information, visit www.P65Warnings.ca.gov

STEEL PUSH-ON HOSE COUPLER



PART#	BODY SIZE	BARB SIZE	
28565S	1/4"	1/4"	----
28566S	1/4"	3/8"	----
98842	3/8"	3/8"	----

STEEL MALE PLUG



PART#	BODY SIZE	THREAD SIZE	
28545	1/4"	1/8"	----
28546	1/4"	1/4"	----
28547	1/4"	3/8"	----
98814	3/8"	1/4"	----
98815	3/8"	3/8"	----
99816	1/2"	1/2"	----
99817	1/2"	3/4"	----

STEEL FEMALE PLUG



PART#	BODY SIZE	THREAD SIZE	
28533	1/4"	1/8"	----
28534	1/4"	1/4"	----
28535	1/4"	3/8"	----
98801	3/8"	1/4"	----
98802	3/8"	3/8"	----
99803	1/2"	1/2"	----
99804	1/2"	3/4"	----

BRASS MALE PLUG



PART#	BODY SIZE	THREAD SIZE	
28546B	1/4"	1/4"	----

BRASS FEMALE PLUG



PART#	BODY SIZE	THREAD SIZE	
28534B	1/4"	1/4"	----

STEEL HOSE ID PLUG



PART#	BODY SIZE	BARB SIZE	
28557	1/4"	1/4"	----
28559	1/4"	3/8"	----
98828	3/8"	3/8"	----
99828	1/2"	3/8"	----
99830	1/2"	1/2"	----

STEEL PUSH-ON HOSE PLUG



PART#	BODY SIZE	BARB SIZE	
28558	1/4"	1/4"	----
28561	1/4"	3/8"	----
98830	3/8"	3/8"	----

STEEL SWIVEL MALE PLUG



PART#	BODY SIZE	THREAD SIZE	
320065	1/4"	1/4"	----

WARNING: This product can expose you to chemicals, including lead, which are known to the State of California to cause cancer and birth defects or other reproductive harm. For more information, visit www.P65Warnings.ca.gov

UNIVERSAL SERIES COUPLERS

- Automatic Coupler means flow will cut off automatically at time of disconnect
- Brass Couplers have brass body and brass sleeve with brass valve, 6 steel locking balls, NBR seal and 6 stainless steel springs.
- Stainless Steel Couplers have stainless steel body and stainless steel sleeve with stainless steel valve, 6 steel locking balls, FKM seal, and stainless steel springs
- Coupler compatible with ARO 210, Parker Interchange and Industrial Interchange plugs
- Maximum working pressure is 250 PSI

BRASS MALE COUPLER



PART#	BODY SIZE	THREAD SIZE	
28579	1/4"	1/4"	----
28589	1/4"	3/8"	----

BRASS FEMALE COUPLER

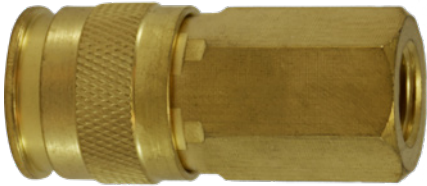

PART#	BODY SIZE	THREAD SIZE	
28560	1/4"	1/4"	----

BRASS HOSE ID COUPLER



PART#	BODY SIZE	BARB SIZE	
28690	1/4"	1/4"	----
28691	1/4"	3/8"	----

STAINLESS STEEL MALE COUPLER



PART#	BODY SIZE	THREAD SIZE	
28579SS	1/4"	1/4"	----

STAINLESS STEEL FEMALE COUPLER



PART#	BODY SIZE	THREAD SIZE	
28560SS	1/4"	1/4"	----

STAINLESS STEEL INDUSTRIAL MALE PLUG



PART#	BODY SIZE	THREAD SIZE	
28546SS	1/4"	1/4"	----

STAINLESS STEEL INDUSTRIAL FEMALE PLUG



PART#	BODY SIZE	THREAD SIZE	
28534SS	1/4"	1/4"	----

WARNING: This product can expose you to chemicals, including lead, which are known to the State of California to cause cancer and birth defects or other reproductive harm. For more information, visit www.P65Warnings.ca.gov

ARO 210 INTERCHANGE

- Couplers have brass bodies and brass valves, 6 steel locking balls, NBR seal, and stainless steel springs
- Plugs are steel with green blue zinc plating
- Couplers have a full opening tubular valve for maximum flow and a built-in sleeve guard to minimize accidental disconnect
- Maximum working pressure is 250 PSI

MALE COUPLER

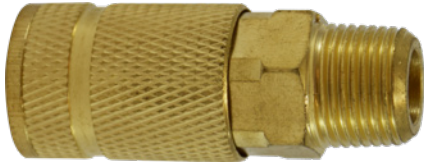

PART#	BODY SIZE	THREAD SIZE	
28592	1/4"	1/8"	----
28593	1/4"	1/4"	----
28594	1/4"	3/8"	----

FEMALE COUPLER



PART#	BODY SIZE	THREAD SIZE	
28583	1/4"	1/8"	----
28584	1/4"	1/4"	----
28585	1/4"	3/8"	----

HOSE ID COUPLER



PART#	BODY SIZE	BARB SIZE	
28601	1/4"	1/4"	----
28603	1/4"	3/8"	----

MALE PLUG



PART#	BODY SIZE	THREAD SIZE	
28586	1/4"	1/8"	----
28587	1/4"	1/4"	----

FEMALE PLUG



PART#	BODY SIZE	THREAD SIZE	
28578	1/4"	1/4"	----

HOSE ID PLUG



PART#	BODY SIZE	BARB SIZE	
28595	1/4"	1/4"	----
28597	1/4"	3/8"	----



USE OUR TEXT LINE [855-609-3729](tel:855-609-3729) TO COMMUNICATE WITH MIDLAND MORE CONVENIENTLY

WARNING: This product can expose you to chemicals, including lead, which are known to the State of California to cause cancer and birth defects or other reproductive harm. For more information, visit www.P65Warnings.ca.gov

AUTOMOTIVE/ PARKER INTERCHANGE

PNEUMATICS

AUTOMOTIVE/ PARKER INTERCHANGE (Tru-Flate)

- Brass couplers are brass bodies with brass valves, 6 steel locking balls, NBR seal, and stainless steel springs. Steel couplers are steel bodies with steel valves, 6 stainless steel locking balls, NBR seal, and stainless steel springs.
- Plugs are brass or steel with green blue zinc plating
- Unique design has been field proven as a long-lasting, high performance coupling especially when used with pneumatic tools
- Maximum working pressure is 300 PSI

BRASS MALE COUPLER



PART#	BODY SIZE	THREAD SIZE	
28515	1/4"	1/8"	----
28516	1/4"	1/4"	----
28517	1/4"	3/8"	----

BRASS FEMALE COUPLER

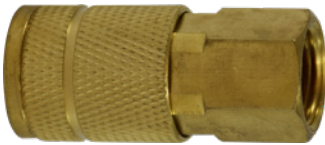

PART#	BODY SIZE	THREAD SIZE	
28507	1/4"	1/4"	----
28508	1/4"	3/8"	----

STEEL MALE COUPLER



PART#	BODY SIZE	THREAD SIZE	
28516S	1/4"	1/4"	----
28514S	3/8"	1/4"	----
28519S	3/8"	3/8"	----

STEEL FEMALE COUPLER



PART#	BODY SIZE	THREAD SIZE	
28507S	1/4"	1/4"	----
28525S	3/8"	1/4"	----
28526S	3/8"	3/8"	----

BRASS MALE PLUG



PART#	BODY SIZE	THREAD SIZE	
28510B	1/4"	1/4"	----

BRASS FEMALE PLUG

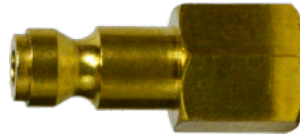

PART#	BODY SIZE	THREAD SIZE	
28501B	1/4"	1/4"	----

STEEL MALE PLUG



PART#	BODY SIZE	THREAD SIZE	
28509	1/4"	1/8"	----
28510	1/4"	1/4"	----
28511	1/4"	3/8"	----
28512	3/8"	1/4"	----
28513	3/8"	3/8"	----

STEEL FEMALE PLUG

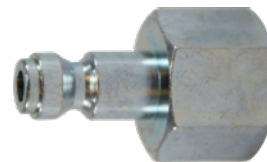

PART#	BODY SIZE	THREAD SIZE	
28500	1/4"	1/8"	----
28501	1/4"	1/4"	----
28502	1/4"	3/8"	----
28503	3/8"	1/4"	----
28504	3/8"	3/8"	----

WARNING: This product can expose you to chemicals, including lead, which are known to the State of California to cause cancer and birth defects or other reproductive harm. For more information, visit www.P65Warnings.ca.gov

AUTOMOTIVE/ PARKER INTERCHANGE

PNEUMATICS

HOSE ID COUPLER



PART#	BODY SIZE	BARB SIZE	
28528	1/4"	1/4"	----
28530	1/4"	3/8"	----
28536	3/8"	1/4"	----

HOSE ID PLUG



PART#	BODY SIZE	BARB SIZE	
28518	1/4"	1/4"	----
28520	1/4"	3/8"	----
28523	3/8"	1/4"	----
28524	3/8"	3/8"	----

PUSH-ON HOSE COUPLER

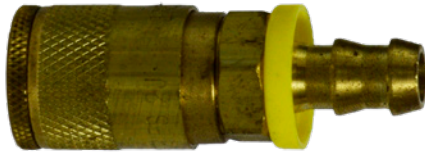

PART#	BODY SIZE	BARB SIZE	
28531	1/4"	1/4"	----
28532	1/4"	3/8"	----

PUSH-ON HOSE PLUG

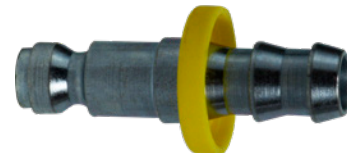

PART#	BODY SIZE	BARB SIZE	
28521	1/4"	1/4"	----
28522	1/4"	3/8"	----

LINCOLN INTERCHANGE

- Couplers have brass bodies with steel sleeves, Acetal valves, 6 steel locking balls, Nitrile seal and stainless steel springs
- Plugs are steel with green blue zinc plating
- Manual style
- Unique design includes long nose and short ball groove
- Maximum working pressure is 250 PSI

MALE COUPLER



PART#	BODY SIZE	THREAD SIZE	
28683	1/4"	1/4"	----

STEEL MALE PLUG



PART#	BODY SIZE	THREAD SIZE	
28685	1/4"	1/8"	----
28686	1/4"	1/4"	----

FEMALE COUPLER



PART#	BODY SIZE	THREAD SIZE	
28684	1/4"	1/4"	----

STEEL FEMALE PLUG



PART#	BODY SIZE	THREAD SIZE	
28687	1/4"	1/4"	----

WARNING: This product can expose you to chemicals, including lead, which are known to the State of California to cause cancer and birth defects or other reproductive harm. For more information, visit www.P65Warnings.ca.gov

PNEUMATICS

COUPLERS

PNEUMATICS

ST SERIES...HIGH FLOW

SPECIFICATIONS

Brass - Coupler & Steel Plug	
Temperature Range	-40° to 250°

- Non-valved couplings for applications where maximum flow is required. Ideal for applications such as high pressure water and steam washers, carpet cleaners and mold coolant lines. They are often used in food processing, on fluid and dye transfer lines.
- Standard seals are Buna-N (Nitrile).

MALE PIPE COUPLER

BRASS



PART #	BODY & THREAD SIZE	
28667	1/8"	----
28665	1/4"	----
28666	3/8"	----
28668	1/2"	----
28669	3/4"	----
28670	1"	----

FEMALE PIPE COUPLER

BRASS



PART #	BODY & THREAD SIZE	
28671	1/8"	----
28651	1/4"	----
28652	3/8"	----
28672	1/2"	----
28673	3/4"	----
28674	1"	----

MALE PLUG

STEEL



PART #	SIZE	
28675	1/8"	----
28639	1/4"	----
28640	3/8"	----
28676	1/2"	----
28677	3/4"	----

FEMALE PLUG

STEEL



PART #	SIZE	
28688	1/8"	----
28619	1/4"	----
28620	3/8"	----
28679	1/2"	----
28680	3/4"	----
28681	1"	----

MOLD COOLANT-LINE QUICK COUPLERS

OPERATING PRESSURE:
200 PSIG (14.06 Kg/sq. cm)
Standard Seal:
SILICONE: -90°F to 400°F (-68°C to + 205°C)

- MIDLAND coolant couplers are engineered for optimum speed and performance in connecting coolant lines to molds used for thermoplastic, thermo-setting, blow molding, diecasting and on other types of tooling and equipment utilizing a constant fluid flow pumped through cooling channels.



MALE PLUG (BRASS)

1/4" BASIC SIZE

PART #	SIZE	A	B	
29900	1/8"	0.69	0.69	----
29901	1/4"	0.84	0.94	----
29902	3/8"	1.00	0.97	----

3/8" BASIC SIZE

PART #	SIZE	A	B	
29906	1/4"	1.00	0.94	----
29907	3/8"	1.00	1.13	----
29908	1/2"	1.81	1.25	----

1/2" BASIC SIZE

PART #	SIZE	A	B	
29911	1/2"	1.25	1.50	----
29912	3/4"	1.50	1.56	----



FEMALE PLUG (STEEL)

1/4" BASIC SIZE

PART #	SIZE	
29903	1/8"	----
29904	1/4"	----
29905	3/8"	----

3/8" BASIC SIZE

PART #	SIZE	
29909	1/4"	----
29910	3/8"	----

1/2" BASIC SIZE

PART #	SIZE	
29913	1/2"	----
29914	3/4"	----

MINI TYPE QUICK DISCONNECTS

MALE COUPLER



PART #	SIZE	
28605	1/8"	----

FEMALE PLUG



PART #	SIZE	
28608	1/8"	----

WARNING: This product can expose you to chemicals, including lead, which are known to the State of California to cause cancer and birth defects or other reproductive harm. For more information, visit www.P65Warnings.ca.gov

MUFFLERS/ VENTS

PNEUMATICS

BRASS MUFFLERS

Materials:

Body: Brass

Element: Sintered Bronze

Max Operating Pressure: 300PSI

Temperature: 35° to 300°F

• Application: Designed to diffuse Air & Muffler noise to acceptable levels within OSHA noise requirements.

• Used on exhaust ports, valves, cylinders and air tools.

• Construction: Porous sintered bronze 40 micron filter element secured to a brass body



PART #	SIZE	
300020	10/32"	----
300021	1/8"	----
300022	1/4"	----
300023	3/8"	----
300024	1/2"	----
300026	3/4"	----
300028	1"	----

40 Micron element

STAINLESS MUFFLERS



Materials:

Body: 303 Grade Stainless Steel

Element: 316 Grade Stainless Steel

Max Operating Pressure: 300PSI

Temperature: 35° to 392°F

PART #	SIZE	
300031	10/32"	----
300032	1/8"	----
300033	1/4"	----
300034	3/8"	----
300035	1/2"	----
300036	3/4"	----
300037	1"	----

BRASS BREATHER VENT



Materials:

Body: Brass

Element: Sintered Bronze

Max Operating Pressure: 150PSI

Temperature: 35° to 300°F

• Application: Prevents Dirt and Foreign Particles from Entering Ports Open to Atmosphere. Typically used on Acting Cylinders

• Additional Use is Vacuum Relief or Pressure Equalization on Storage Vessels or Tanks

• Construction: Porous Sintered Bronzed 40 Micron Filter Element Secured to a brass body

PART #	SIZE	
300000	10-32"	----
300001	1/8"	----
300002	1/4"	----
300003	3/8"	----
300004	1/2"	----
300006	3/4"	----
300008	1"	----

40 Micron element

STAINLESS BREATHER VENT

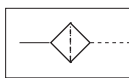

Materials:

Body: 303 Grade Stainless Steel

Element: 316 Grade Stainless Steel

Max Operating Pressure: 150PSI

Temperature: 35° to 390°F

PART #	SIZE	
300014	1/8"	----
300015	1/4"	----
300017	3/8"	----
300018	1/2"	----
300019	3/4"	----
300007	1"	----

PRESSURE SNUBBER

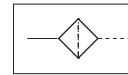

Materials:

Body: Brass

Element: Sintered Bronze

Max Operating Pressure: 9000PSI

Temperature: 35° to 300°F

• Applications: Protect pressure instruments from sudden pressure surges and fluctuations providing more accurate gauge readings

• Construction: Solid brass housing with porous bronze element

• Can be used for mini in-line filters

• 5 different porosity elements per package, allows each user to adjust snubbing capacity for the specific application

PART #	SIZE	POROSITY	
28354	1/4"	40 um	----
28353	1/4"	30 um	----
28352	1/4"	25 um	----
28351	1/4"	20 um	----
28350	1/4"	10 um	----

Recommended Element Porosity Rating

Rating	Color	Recommended Application
40 um	None	Viscous Fluids (over 500 ssu)

SPEED CONTROL VALVE

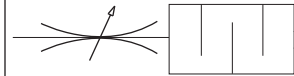

Materials:

Body: Brass

Element: 40 Micron Sintered Bronze

Max Operating Pressure: 300PSI

Temperature: 35° to 300°F

• Application: Provide infinite variation of metering air flow at acceptable sound levels on air valve exhaust ports with complete safety

• The speed of an operating cylinder or air tool may be increased or decreased with the adjusting screw, the final position is locked in place by a lock nut

• Objectionable exhaust air noise is eliminated by the surrounding sleeve - 40 um sintered bronze

• Brass Body

• Max operating pressure: 300PSI

• Operating temperature: 35° F to 300° F

PART #	SIZE	
940800	1/8"	----
940801	1/4"	----
940803	3/8"	----
940804	1/2"	----
940805	3/4"	----
940806	1"	----

WARNING: This product can expose you to chemicals, including Chromium, which are known to the State of California to cause cancer and birth defects or other reproductive harm. For more information, visit www.P65Warnings.ca.gov



VALVES/ MUFFLERS/ FILTERS

PNEUMATICS

STAINLESS SPEED CONTROL VALVE

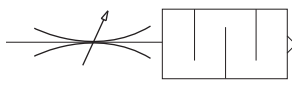

70 Micron filter element

Materials:
Body: 303 Grade Stainless Steel
Element: 316 Grade Stainless Steel
Max Operating Pressure: 300PSI
Temperature: 35° to 392°F

PART #	SIZE	
940810	1/8"	----
940811	1/4"	----
940812	3/8"	----
940813	1/2"	----
940814	3/4"	----
940815	1"	----

MUFFLER W/ FLOW ADJUSTMENT

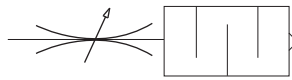

Materials:
Body: Brass
Element: Sintered Bronze
Max Operating Pressure: 300PSI
Temperature: 35° to 300°F

PART #	SIZE	
28379	1/8"	----
28380	1/4"	----
28381	3/8"	----
28382	1/2"	----

HIGH FLOW ALUMINUM MUFFLER

• hole pattern



Materials:
Body: Aluminum
Element: 50 Mesh Stainless Steel
Max Operating Pressure: 300PSI
Temperature: 35° to 160°F

PART #	SIZE	
940822	1/8"	----
940823	1/4"	----
940824	3/8"	----
940825	1/2"	----
940826	3/4"	----
940827	1"	----

HIGH FLOW STEEL MUFFLER

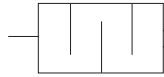

Materials:
Body: Steel
Element: 50 Mesh Stainless Steel
Max Operating Pressure: 300PSI
Temperature: 35° to 160°F

PART #	SIZE	
28373	1/8"	----
28374	1/4"	----
28375	3/8"	----
28376	1/2"	----
28377	3/4"	----
28378	1"	----

ALUMINUM HIGH FLOW MUFFLER



Materials:
Body: Aluminum
Element: 50 Mesh Stainless Steel
Max Operating Pressure: 300PSI
Temperature: 35° to 160°F

- Slit pattern
- Application: Used exhaust ports of Pneumatic valves or manifolds to reduce work area noise
- Construction: Aluminum body, 50 mesh self cleaning stainless steel screen corrosion resistant aluminum shell
- High flow & minimal back pressure

PART #	SIZE	
28367	1/8"	----
28368	1/4"	----
28369	3/8"	----
28370	1/2"	----
28371	3/4"	----
28372	1"	----

PLASTIC HIGH FLOW MUFFLER

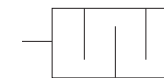

Materials:
Body: Black Nylon
Element: 50 Mesh Stainless Steel
Max Operating Pressure: 150PSI
Temperature: 35° to 120°F

PART #	SIZE	
28363	1/8"	----
28364	1/4"	----
28365	3/8"	----
28366	1/2"	----

NIPPLE INLINE FILTER

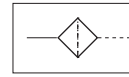

Materials:
Body: Brass
Element: 40 Micron Sintered Bronze
Max Operating Pressure: 300PSI
Temperature: 35° to 300°F

PART #	SIZE	
940845	1/8"	----
940846	1/4"	----
940847	3/8"	----
940848	1/2"	----

REPAIRABLE AIR/ OIL INLINE FILTER

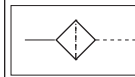

Materials:
Body: Anodized Aluminum
Element: 40 Micron Sintered Bronze
Max Operating Pressure: 300PSI
Temperature: 35° to 200°F

- Application: Protect small air tools i.e. impact wrench grinders, screwdrivers and low pressure hydraulic applications
- Construction: All anodized, lightweight aluminum housing
- Can be installed directly before the air tool
- Features cleanable or replaceable 40 micron filter element

PART #	SIZE	
940840	1/8"	----
940841	1/4"	----
940842	3/8"	----
940843	1/2"	----
940844	3/4"	----

WARNING: This product can expose you to chemicals, including Chromium, which are known to the State of California to cause cancer and birth defects or other reproductive harm. For more information, visit www.P65Warnings.ca.gov



MANIFOLDS AND AIR REGULATORS

PNEUMATICS

MANIFOLDS

MANIFOLDS - ALUMINUM WITH BLACK ANODIZING

Materials:

Aluminum with black anodizing for corrosion resistance.

Specifications:

Max Operating Pressure: 1000PSI

Temperature: -10° to 200°F

Media: Air and liquids compatible with materials of construction.

• Ports column = # of ports in top of manifold

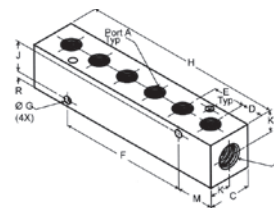

THREADED PORTS

Part #	Ports		A - out NPT	B - in NPT	C	D	E	F	G	H	J	K	M	R
28450	4	----	1/8"	1/4"	1.00	0.50	0.75	1.5	0.17	3.25	0.70	0.50	0.88	0.15
28452	6	----						3.00		4.75				
28456	10	----						6.00		7.75				
28458	3	----	1/4"	3/8"	1.25	0.63	0.88	0.88	0.20	3.00	0.89	0.63	1.06	0.18
28460	5	----						2.63		4.75				
28464	9	----						6.13		8.25				
28465	10	----						7.00		9.13				
28467	3	----						1.13		4.25				
28468	4	----						2.25		5.38				
28469	5	----	3/8"	3/8"	1.25	1.00	1.13	3.38	0.20	6.50	0.89	0.63	1.56	0.18
28470	6	----						4.50		7.63				

3 IN 1 ALUMINUM AIR MANIFOLD

No need to connect and disconnect every time you want to change tools. Supply 3 air tools from one outlet. These manifolds have one inlet with three 1/4 outlets.



PART #	SIZE	
320120	1/4" Inlet	----
320121	3/8" Inlet	----
320122	1/2" Inlet	----
three 1/4" Outlets		

AIR REGULATOR

- Rated for Inlet Pressrue up to 140PSI(10bar).
- Ambient and Fluid Tempreature:5~60°C(41~140°F)
- Port Threads:NPT
- Flow Capacity:See Below,at 0.7Mpa Inlet Pressure and set at 0.5Mpa.
- Assembly Bracket is included.



PART #	SIZE	GAUGE PORT	REGULATING RANGE	
AR2	1/4"	1/8	0.05~0.85Mpa(0.5~8.5kgf/cm2)(7.25psi~123psi)	----

WARNING: This product can expose you to chemicals, including Chromium, which are known to the State of California to cause cancer and birth defects or other reproductive harm. For more information, visit www.P65Warnings.ca.gov



PNEUMATICS

SAFETY VALVES

ASME CODED

- Valves are manufactured to ASME standards and certified by the national board of boiler and pressure vessel inspectors.
- Bubble tight to 10% of set pop-off pressure.
- ASME safety valves are interchangeable with all other ASME valves of same size and pressure.
- Brass construction. Marked ASME, NB
- 1/ Blister card.



PART #	MALE NPT	POP-OFF PRESSURE	AIR FLOW	
87001	1/4"	70 PSI	70 CFM	----
87002	1/4"	125 PSI	120 CFM	----
87003	1/4"	150 PSI	140 CFM	----
87004	1/4"	200 PSI	170 CFM	----

Note: Valve resets after pressure drops 50%

NON-CODED SAFETY RELIEF VALVES

- Non-coded safety valves are constructed of the same materials as the AMSE safety valves but are not national board certified and cannot be used on applications requiring ASME components.
- Valves are equipped with a lift ring for instant relief and are staked at the factory at the pre set pop-off pressure.
- Marked ASME, UV, NB



PART #	MALE NPT	POP-OFF PRESSURE	
87008	1/4"	125 PSI	----
87009	1/4"	150 PSI	----

Warning: These valves are not to be used on compressors with a capacity over 15 CFM or 3 HP or 12 gallon storage tank.

COMPRESSOR TANK CHECK VALVES

- Used in compressor tanks to prevent air volume and pressure from escaping back into compressor heads while the compressor is not operating.
- Brass body with Teflon poppet.
- 1/8" Female NPT side port for pressure switch application.
- Maximum working pressure: 450 PSI
- Maximum temperature: 400°F

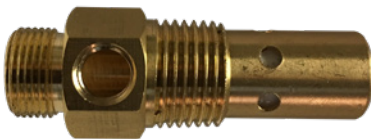

PART #	TANK BUNG HOLE SIZE	COMPRESSOR AIR LINE SIZE	SCFM	
87020	1/2" NPT Male	3/8" Tube Compression male	20	----
87021	1/2" NPT Male	1/2" Tube Compression male	20	----

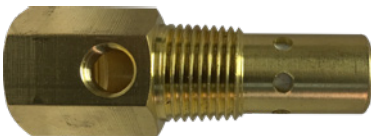

87023	1/2" NPT Male	1/2" NPT Female	20	----
-------	---------------	-----------------	----	------



GO ONLINE TO UPLOAD YOUR LOGO TO UTILIZE ALL OF OUR CUSTOMIZABLE TOOLS!

WARNING: This product can expose you to chemicals, including lead, which are known to the State of California to cause cancer and birth defects or other reproductive harm. For more information, visit www.P65Warnings.ca.gov

tank valves

BRASS BICYCLE PUMP FITTING

Screw on swivel chuck for most hand operated tire pumps.
Buna-N-Seal • Deflator

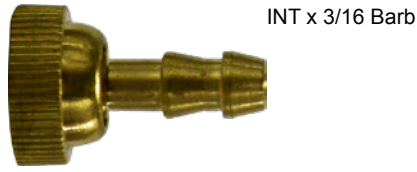

INT x 3/16 Barb

PART #	SIZE	
32782	3/16"	----

INFLATOR



INT x 3/16

PART #	SIZE	
32783	3/16"	----

PNEUMATIC SLIDE VALVE

- Max Operating Pressure: 200 psig
- Temperatures: -20°F to +200°F

Manually operated slide valves provide simple on/off airflow control. They can be mounted horizontally, vertically or at any angle.

Open Position



MALE X FEMALE

PART #	SIZE	L	HEX	
20780	1/8"	2.15	9/16"	----

INT = Inflation needle thread .305 in. OD x 32 threads per inch
 (see page 371)

TANK & VENT VALVES

Three standard styles of valve bodies, complete with short core, for air lifts, water pumps, vacuum, pressurized containers, air jacks, and other pneumatic devices.
 REGULAR: 300 PSI and cracking pressure 80 PSI

1/8" NPT - .9" LONG SPRING CORE

7/16" Hex

1/8 x INT



PART #	SIZE	
46620	1/8	----

1/8" NPT 1.207" LONG SPRING CORE

7/16" Hex

1/8 x INT



PART #	SIZE	
46621	1/8	----

1/4" NPT 1.46" LONG SPRING CORE

9/16" Hex

w/ Black cap

1/4 x INT



PART #	SIZE	
46622	1/4	----

TANK VALVE ACCESSORIES

BLACK PLASTIC CAP

No gasket



Inflation
 needle threads

PART #	
46630	----

SHORT NICKEL PLATED DOME CAP

Dome skirted type



Inflation
 needle thread

PART #	
46631	----

WARNING: This product can expose you to chemicals, including lead, which are known to the State of California to cause cancer and birth defects or other reproductive harm. For more information, visit www.P65Warnings.ca.gov

BLOW GUNS/ NOZZLES

PNEUMATICS

COMPACT BLOW GUN W/RUBBER TIP

- Includes One Rubber Tip and One Safety Tip
- Zinc Alloy Body
- 1/4" FPT Inlet
- Maximum 150 psi (Recommended Working Pressure 90-120 psi)
- Safety Tip Limits Air Pressure to 30 psi When Dead-Ended per OSHA requirement
- Maximum 87 dba
- 1/8" Outlet



PART #	SIZE	
320053	1/4"	----

SAFETY BLOW GUN

- Heavy-Duty Design
- Internal Safety Valve that Limits Air Pressure to Less than 30 psi When dead-ended per OSHA
- Aluminium Alloy Body
- 1/4" FPT Inlet
- Maximum 150 psi (Recommended Working Pressure 90-120 psi)
- Safety Tip Limits Air Pressure to 30 psi When Dead-Ended per OSHA Requirement
- Maximum 87 dba
- 1/8" Outlet



PART #	SIZE	
320054	1/4"	----

SAFETY BLOW GUN

- N/P steel handle with plastic sleeve
- Brass Valve
- Zinc body
- Aluminum nozzle



1/8" Outlet

PART #	SIZE	
320050	1/4" Inlet	----

5114 51-124 401 20430AD 5148 D204-30 6475

COMPACT BLOW GUN

- With standard tip and safety tip
- Zinc Alloy Body
- 1/4" FPT Inlet
- Maximum 150 psi (Recommended Working Pressure 90-120 psi)
- Safety Tip Limits Air Pressure to 30 psi When Dead-Ended per OSHA Requirement
- Maximum 87 dba



PART #	SIZE	
320055	1/4"	----

PISTOL GRIP BLOW GUN

- Lightweight, Ergonomic Design
- Delrin® Body
- Trigger Air Flow Control
- 1/4" FPT Inlet
- 3" Nozzle Ideal for Tight Spaces
- Recommended Working Pressure 90-120 psi
- Maximum 87 Dba



PART #	SIZE	
320036	1/4"	----

PISTOL GRIP BLO-GUN

Material

- Body: POM (engineering plastic)
- Nozzle: nickel plated carbon steel
- Blue Handle Color

Features

- Simple construction, economic
- Global thread connection
- Durable and versatile applications
- 4 inch nozzle



150 PSI

PART #	SIZE	
320035	1/4"	----

RUBBER TIPPED NOZZLE



MAKES POSITIVE SEAL BETWEEN GUN AND FUEL LINE OR OTHER OPENINGS. USE ONLY ON AIR LINE

PART #	THREAD SIZE	
320070	1/8 - 27	----

51-521 2058 D201RT 411R

HIGH FLOW SAFETY NOZZLE



MEETS OSHA REGULATIONS OF 30 PSI MAXIMUM OUTLET PRESSURE WHEN LINE PRESSURE IS 150 PSI OR LESS. HAS AN AIR PRESSURE BYPASS WHICH PREVENTS BUILD UP OF TIP PRESSURE EVEN IF NOZZLE IS BLOCKED. ADAPTS TO ANY BLOW GUN WITH A 1/8" NPT NOZZLE PORT

PART #	SIZE	
320075	1/8 MIP x Female Needle Thread	----

51-338 SST10 411BT 2056

WARNING: This product can expose you to chemicals, including lead, which are known to the State of California to cause cancer and birth defects or other reproductive harm. For more information, visit www.P65Warnings.ca.gov

TIRE GAUGES

PNEUMATICS

tire gauges

M - TIRE GAUGE

320-021



HEAVY DUTY DUAL FOOT TIRE GAUGE

320-022



DUAL ANGLE FOOT TRUCK PENCIL GAUGE

320-023



PART #	PRESSURE RANGE	INCREMENT	HEAD	BODY	BAR(PSI/KPA)	
320021	20-120psi	2 psi	Metal	Metal	4 sided plastic	----
320022	10-120psi	2 psi	Plastic	Metal	4 sided plastic	----
320023	20-120psi	2 psi	Metal	Metal	4 sided plastic	----

INFLATION NEEDLE



• See thread note below

PART #	
320095	----

1 PIECE BLOW GUN TAPERED NOZZLE



PART #	SIZE	
320076	NT	----

1 PIECE BLOW GUN STANDARD NOZZLE



PART #	SIZE	
320077		----

VOLUME REGULATOR

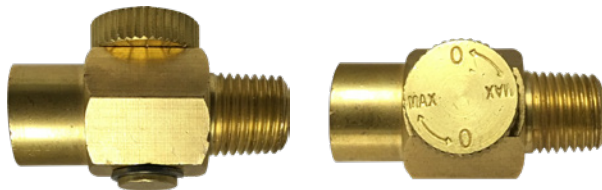

PART #	FIP X MIP	
46615	1/4	----

What size thread is an inflation needle (INT)?

Metric: 7.7mm OD, thread root diameter is 6.9mm x 0.794 pitch

English: 0.305 OD, threadroot diameter 0.302 in x 32 tpi (threads per inch)

1 PIECE DIAL TIRE GAUGE



PART #	
320410	----

1 PIECE EXTENSION



PART #	SIZE	
320080	NT	----

1 PIECE BLOW GUN ADAPTER



PART #	SIZE	
320078	Female NT x 1/8 MPT	----

NYLON COIL AIR HOSE

- 200 psi working pressure
- 4:1 Safety factor (burst vs working pressure)
- Spring end sleeves to prevent kinking
- 1/4 MPT Brass fittings on both ends
- Temperature range 32°F to 120°F
- Packaged for retail sale



PART #	DESCRIPTION	SIZE	
307030	25'	1/4" NPT	----
307031	50'	1/4" NPT	----

WARNING: This product can expose you to chemicals, including lead, which are known to the State of California to cause cancer and birth defects or other reproductive harm. For more information, visit www.P65Warnings.ca.gov

PNEUMATICS

CHUCKS
PNEUMATICS

foot chucks

HEX BALL FOOT CHUCK



PART #		
46600	1/4 FPT Live Air	----

MALE BALL FOOT CHUCK



PART #		
46605	1/4 MIP Live Air	----

BALL FOOT CHUCK W/ 1/4 ID HOSE BARB



PART #		
46607	1/4 ID Live Air	----

DUAL HEAD STRAIGHT AIR CHUCK



DUAL HEAD AIR CHUCK 1/4"FNPT,THE LENGTH IS 6.08",THE HEAD IS ZINC-ALLOY,AND THE NUT IS BRASS WITH CHROME PLATED.

PART #		
320000	1/4	----

DUAL HEAD ANGLE FOOT AIR CHUCK



DUAL HEAD STRAIGHT FOOT AIR CHUCK 1/4"FNPT FOR INNER DUALS;BOTH ENDS LOCK ON VALVE CORE THREADS,THE LENGTH IS 6.66",THE HEAD IS ZINC-ALLOY,AND THE NUT IS BRASS WITH

PART #		
320005	1/4	----

INFLATORS WITH GAUGE

INFLATOR/ GAUGE

- RUGGED ZINC CAST BODY WITH BRASS INTERNALS FOR LONG LIFE
- SOLID BRASS GAUGE BAR
- BUILT-IN AIR RELIEF VALVE



320-010

INFLATOR/ GAUGE

- RUGGED ZINC CAST BODY WITH BRASS INTERNALS FOR LONG LIFE
- EASY TO VIEW BUILT-IN SIGHT GAUGE
- FULL SWIVEL HOSE FITTINGS
- PROTECTIVE RUBBER BUMPER
- BUILT-IN AIR RELIEF VALVE
- 6"DUAL-FOOT AIR CHUCK



320-011

PART #	PRESSURE RANGE	INCREMENT	INLET	HOSE LENGTH	
320010	10-120 psi	2 psi	1/4 FPT	12"	----
320011	10-120 psi	2 psi	1/4 FPT	12"	----

WARNING: This product can expose you to chemicals, including lead, which are known to the State of California to cause cancer and birth defects or other reproductive harm. For more information, visit www.P65Warnings.ca.gov

AIR ACCESSORY SET

PNEUMATICS

16PCS-AIR ACCESSORY SET

PART# 87-400



LIST PRICE: —

CONTENTS OF BLISTER CARD PACKAGE

COMPONENTS AND PART#'S

1pc-1/4"FNPT industrial coupler	28540
2pcs-1/4"FNPT industrial plugs	28534
2pcs-1/4"MNPT industrial plugs	28546
1pc-1/4" male connector	28212
1pc-1/4" double female connector	28059
1pc-ball foot chuck	46600
1pc-blow gun	320050
1pc-dial tire gauge	320410
1pc-tapered rubber tip	320070
1pc-blow gun safety nozzle	320075
1pc-blow gun tapered nozzle	320076
2pcs-inflation needles	320095
1pc-25ft. nylon recoil hose	307030

10PCS-AIR ACCESSORY SET

PART# 87-402



LIST PRICE: —

CONTENTS OF BLISTER CARD PACKAGE

COMPONENTS AND PART#'S

1pc-1/4"female connector	28059
1pc-blow gun safety nozzle	320075
1pc-blow gun tapered nozzle	320076
1pc-ball foot chuck	46605
1pc-blow gun	320050
1pc-1/4"FNPT industrial coupler	28540
1pc-1/4" FNPT industrial plug	28534
1pc-1/4"MNPT industrial plug	28546
2pcs-inflation needles	320095

7PCS-AIR ACCESSORY SET

PART# 87-404



LIST PRICE: —

CONTENTS OF BLISTER CARD PACKAGE

COMPONENTS AND PART#'S

1pc-blow gun rubber tip	320070
1pc-blow gun safety nozzle	320075
1pc-blow gun tapered nozzle	320076
1pc-extension	320080
1pc-blow gun	320050
2pcs-inflation needles	320095

11PCS-AIR ACCESSORY SET

PART# 87-406



LIST PRICE: —

CONTENTS OF BLISTER CARD PACKAGE

COMPONENTS AND PART#'S

1pc-blow gun rubber tip	320070
1pc-blow gun safety nozzle	320075
1pc-blow gun tapered nozzle	320076
1pc-blow gun standard nozzle	320077
1pc-blow gun adapter	320078
1pc-hose&chuck assembly	320414
1pc-blow gun	320050
1pc-inflation needle	320095
1pc-1/4"FNPT industrial coupler	28540
1pc-1/4" FNPT industrial plug	28534
1pc-1/4"MNPT industrial plug	28546

WARNING: This product can expose you to chemicals, including lead, which are known to the State of California to cause cancer and birth defects or other reproductive harm. For more information, visit www.P65Warnings.ca.gov

PNEUMATICS

AIR ACCESSORY SET

PNEUMATICS

17PCS-AIR ACCESSORY SET

PART# 87-408



LIST PRICE: —

CONTENTS OF BLISTER CARD PACKAGE

COMPONENTS AND PART#'S

1pc-1/4" double female connector	50004
2pcs-1/4" double male connectors	54044
1pc-blow gun safety nozzle	320075
1pc-blow gun tapered nozzle	320076
1pc-dual-foot tire chuck	320005
1pc-tire gauge	320021
1pc-blow gun	320050
1pc-1/4" FNPT industrial coupler	28540S
2pcs-1/4" FNPT industrial plug	28534
4pcs-1/4" MNPT industrial plug	28546
2pcs-inflation needles	320095

12PCS-AIR ACCESSORY SET

PART# 87-410



LIST PRICE: —

CONTENTS OF BLISTER CARD PACKAGE

COMPONENTS AND PART#'S

1pc-blow gun safety nozzle	320075
1pc-blow gun tapered nozzle	320076
1pc-blow gun rubber nozzle	320070
1pc-ball foot tire chuck	46600
1pc-blow gun	320050
1pc-1/4"FNPT industrial coupler	28540
1pc-1/4" MNPT industrial coupler	28552
2pcs-1/4"FNPT industrial plug	28534B
2pcs-1/4"MNPT industrail plug	28546B
1pc-inflation needle	320095

20PCS-AIR ACCESSORY SET

PART# 87-412



LIST PRICE: —

CONTENTS OF BLISTER CARD PACKAGE

COMPONENTS AND PART#'S

1pc-dual-foot tire chuck	320005
1pc-tire gauge	320021
1pc-blow gun rubber nozzle	320070
1pc-blow gun adapter	320078
1pc-1/4" double male connector	54044
1pc-1/4" double female connector	50004
1pc-blow gun safety nozzle	320075
1pc-blow gun tapered nozzle	320076
1pc-thread seal tape	982107
1pc-blow gun	320050
2pcs-1/4"FNPT industrial coupler	28540S
2pcs-1/4"FNPT industrial plug	28534
3pcs-1/4"MNPT industrial plug	28546
2pcs-inflation needles	320095
1pc-1/4"x 25Ft coil Nylon hose	307030

WARNING: This product can expose you to chemicals, including lead, which are known to the State of California to cause cancer and birth defects or other reproductive harm. For more information, visit www.P65Warnings.ca.gov

QUICK DISCONNECT KITS

PNEUMATICS

1/4" X 1/4" NPT INDUSTRIAL 7PCS

PART# 87-414

CONTENTS OF BLISTER CARD PACKAGE



LIST PRICE: —

COMPONENTS AND PART#'S

2pc-1/4"x1/4" FNPT T I/M coupler	28540S
2pcs-1/4"x1/4" FNPT I/M plugs	28534
2pcs-1/4"x1/4" MNPT I/M plugs	28546
1pc-double 1/4" MNPT fitting	54044

1/4" X 1/4" NPT INDUSTRIAL 5PCS

PART# 87-416

CONTENTS OF BLISTER CARD PACKAGE



LIST PRICE: —

COMPONENTS AND PART#'S

1pc-1/4"x1/4"FNPT I/M coupler	28540S
4pc-1/4"X1/4" MNPT I/M plug	28546

1/4" X 1/4" NPT INDUSTRIAL 5PCS

PART# 87-418

CONTENTS OF BLISTER CARD PACKAGE



LIST PRICE: —

COMPONENTS AND PART#'S

1pc-1/4"x1/4"FNPT I/M coupler	28540S
1pc-1/4"x1/4"FNPT I/M plug	28534
1pc-1/4"X1/4" MNPT I/M plug	28546
1pc-double 1/4" MNPT fitting	54044

1/4" X 1/4" NPT INDUSTRIAL 3PCS

PART# 87-420

CONTENTS OF BLISTER CARD PACKAGE



LIST PRICE: —

COMPONENTS AND PART#'S

1pc-1/4"x1/4" FNPT I/M coupler	28540S
1pc-1/4"x1/4" FNPT I/M plug	28534
1pc-1/4"x1/4" MNPT I/M plug	28546

3/8" X 1/4" NPT AUTOMOTIVE 5PCS KIT

PART# 87-422

CONTENTS OF BLISTER CARD PACKAGE



LIST PRICE: —

COMPONENTS AND PART#'S

1pc-3/8"x1/4" FNPT Automotive coupler	28525S
2pcs-3/8"x1/4"MNPT Automotive plugs	28512
1pc-double 1/4"MNPT fitting	28212
1pc-double 1/4"FNPT fitting	28059

GAUGES
PNEUMATICS

gauges

STANDARD DRY GAUGES

STEEL CASE

All the gauges supplied by Midland Industries. are designed for long, reliable service under rugged conditions. Typical applications include compressors, filter regulators, water pumps, beverage dispensing equipment, hydraulic and pneumatic systems, and other applications, where the media does not corrode brass. ALL CONNECTIONS ARE BRASS.



1-1/2" FACE
1/8" NPT LOWER MOUNT

PART #	PSI	
80501	0-15	----
80502	0-30	----
80503	0-60	----
80504	0-100	----
80505	0-160	----
80506	0-200	----

LOWER MOUNT

- Plastic lens (window)



2" FACE
1/4" LOWER MOUNT

PART #	PSI	
80001	0-15	----
80002	0-30	----
80003	0-60	----
80004	0-100	----
80005	0-160	----
80006	0-200	----
80007	0-300	----
80020	30-0 Vacuum	----



2-1/2" FACE
1/4" LOWER MOUNT

PART #	PSI	
80031	0-15	----
80032	0-30	----
80033	0-60	----
80034	0-100	----
80035	0-160	----
80036	0-200	----



1-1/2" FACE
1/8" NPT CENTER BACK MOUNT

PART #	PSI	
80511	0-15	----
80512	0-30	----
80513	0-60	----
80514	0-100	----
80515	0-160	----
80516	0-200	----

CENTER BACK MOUNT



2" FACE
1/4" CENTER BACK MOUNT

PART #	PSI	
80301	0-15	----
80302	0-30	----
80303	0-60	----
80304	0-100	----
80305	0-160	----
80306	0-200	----
80307	0-300	----



2-1/2" FACE
1/4" CENTER BACK MOUNT

PART #	PSI	
80331	0-15	----
80332	0-30	----
80333	0-60	----
80334	0-100	----
80335	0-160	----
80336	0-200	----

WARNING: This product can expose you to chemicals, including lead, which are known to the State of California to cause cancer and birth defects or other reproductive harm. For more information, visit www.P65Warnings.ca.gov

LIQUID FILLED GAUGES

STAINLESS CASE

Liquid filled gauges enhance the reliability and integrity of the measuring system for long periods. The glycerine filling helps dampen the effects of vibration and pulsation. It also lubricates the movement which extends the life of the gauge. ALL



**1-1/2" FACE
1/8" LOWER MOUNT**

PART #	PSI	
80601	0-15	----
80602	0-30	----
80603	0-60	----
80604	0-100	----
80605	0-160	----
80606	0-200	----



**2-1/2" FACE
1/4" LOWER MOUNT**

PART #	PSI	
80061	0-15	----
80062	0-30	----
80063	0-60	----
80064	0-100	----
80065	0-160	----
80066	0-200	----
80067	0-300	----
80068	0-400	----
80069	0-600	----
80100	0-1000	----
80101	0-1500	----
80102	0-2000	----
80103	0-3000	----
80104	0-5000	----
80105	0-10000	----
80080	30-0 Vacuum	----
80081	-30 to +30	----



**4" FACE
1/4" LOWER MOUNT**

PART #	PSI	
80463	0-100	----

- Liquid Filled Gauges with a stainless case are used for protection in harsh environments.
- Stainless Steel Case
- Copper Alloy Wetted parts
- Polycarbonate window
- ± 1.5% of span accuracy
- Temp. Range -104°F to 158°F

CENTER BACK MOUNT



**1-1/2" FACE
1/8" CENTER BACK MOUNT**

PART #	PSI	
80611	0-15	----
80612	0-30	----
80613	0-60	----
80614	0-100	----
80615	0-160	----
80616	0-200	----



**2-1/2" FACE
1/4" CENTER BACK MOUNT**

PART #	PSI	
80201	0-15	----
80202	0-30	----
80204	0-60	----
80203	0-160	----
80205	0-100	----
80206	0-200	----
80207	0-300	----
80208	0-400	----
80209	0-600	----

WARNING: This product can expose you to chemicals, including lead, which are known to the State of California to cause cancer and birth defects or other reproductive harm. For more information, visit www.P65Warnings.ca.gov

GAUGES/ SYPHON

PNEUMATICS

Water Test Gauge

0-300 PSI DIAL
3/4" FEMALE HOSE
CONNECTION



PART #	FACE SIZE	
991249	2"	----
991250	2-1/2"	----

Water Test Gauge w/Lazy Hand (Maximum pointer)

2-1/2" GAUGE
0-300 PSI DIAL
3/4" FEMALE HOSE
CONNECTION



Regular pressure hand pushes LAZY hand to peak operating or surge pressure point where it remains until you manually reset it. Excellent to determine if P/T valve is leaking from failure or if leaking is caused by surge of excessive pressures. (Attach gauge to Boiler Drain Valve overnight.) LAZY hand operates over entire gauge range of 0-300psi

PART #	
991251	----

GAS TEST GAUGE

Pressure test residential and commercial pipe systems



PART #	FACE SIZE	
GT15	0-15	----
GT30	0-30	----
GT60	0-60	----

BODY ONLY



PART #	FACE SIZE	
991259	3/4" FIP x 1/4" TAP	----

SYPHON

BRASS

Syphons protect instruments from effects of hot pressure media commonly used in steam applications



PART #	SIZE	
995210	1/4" 90°	----
995211	1/4" 180°	----
995212	1/4" 270°	----
995213	1/4" 360°	----

STEEL

Syphons protect instruments from effects of hot pressure media commonly used in steam applications



PART #	SIZE	
995214	1/4" 90°	----
995215	1/4" 180°	----
995216	1/4" 270°	----
995217	1/4" 360°	----

WARNING: This product can expose you to chemicals, including lead, which are known to the State of California to cause cancer and birth defects or other reproductive harm. For more information, visit www.P65Warnings.ca.gov

TAPES/ SEALANT

PNEUMATICS

PTFE THREAD SEAL TAPE

- Density 0.4
- Thickness 3.5 MIL
- Meets MIL specs



PART #	SIZE	CASE QTY	
982107	1/2" x 260"	500	----
982108	1/2" x 520"	500	----
982109	3/4" x 260"	350	----
982110	3/4" x 520"	350	----

POP OUT COVERED SPOOL

GREY STAINLESS STEEL

- Density 1.2
- Thickness 4MIL
- Meets MIL specs



PART #	SIZE	CASE QTY	
982135	1/2" x 260"	250	----
982136	1/2" x 520"	150	----
982137	3/4" x 260"	150	----
982138	3/4" x 520"	150	----

GREEN OXYGEN TAPE

- Density 1.2
- Thickness 3.5MIL
- Meets MIL specs

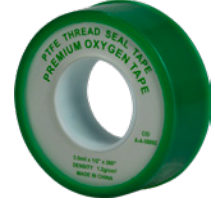

PART #	SIZE	CASE QTY	
982130	1/2" x 260"	250	----
982131	1/2" x 520"	150	----
982132	3/4" x 520"	150	----

PTFE BLUE SEAL TAPE

- Professional grade top -450 to +450°F
- Super long roll
- Twice the density of standard tape for less passes, lasts longer
- Density 0.8
- Thickness 3.5 MIL
- Meets MIL Spec



PART #	SIZE	CASE QTY	
982120	1/2" x 1368"	250	----
982121	3/4" x 1368"	150	----
982122	1" x 1296"	150	----

YELLOW GAS LINE TAPE

- Density 0.9
- Thickness 4MIL
- Meets MIL specs



PART #	SIZE	CASE QTY	
982125	1/2" x 260"	250	----
982126	1/2" x 520"	150	----

PVC ELECTRICAL TAPE

- Rated to 176 degrees fahrenheit
- Suitable for use up to 600V
- UL Listed
- Individually wrapped in cellophane



PART #	SIZE	
982140	3/4" X 60' Black	----

THREAD SEALANT

GASOILA SOFT-SET THREAD WITH PTFE



PART#	SIZE	UNITS PER CASE	
983100	1/4 pt. Brush	24	----
983101	1/2 pt. Brush	24	----

PLS 2 PREMIUM THREAD AND GASKET SEALER



PART#	SIZE	UNITS PER CASE	
983110	1/4 pt. Brush	12	----
983111	1 pt. Brush	6	----

GASOILA NT NON-PTFE THREAD SEALANT



PART#	SIZE	UNITS PER CASE	
983120	1/2 pt. Brush	12	----
983121	1 pt. Brush	6	----

JC-30 GASOILA HIGH-FILL



PART#	SIZE	UNITS PER CASE	
983115	1/4 pt. Brush	12	----
983116	1 pt. Brush	6	----

FREE ALL DEEP PENETRATING OIL



PART#	SIZE	UNITS PER CASE	
983125	6 oz. Aerosol	12	----
983126	11 oz. Aerosol	12	----

LUBE-IT ALL DEEP LUBRI-



PART#	SIZE	UNITS PER CASE	
983130	6 oz. Aerosol	12	----

TRUCK AND TRAILER



INDUSTRY GRADE NYLON AIR COIL ASSEMBLY - SET

- Each kit contains one Emergency (Red) and one service (Blue) 1/2" O.D. nylon tubing assembly.
- 1/2" -14 NPTF end fitting with heavy gauge spring.
- Assemblies meet SAE J844 and DOT FMVSS 106 requirements.
- Temp rating -40° - +208°



PART #	LENGTH	PIGTAIL LENGTH TRACTOR END	PIGTAIL LENGTH TRAILER END	
39404	12'	6"	6"	----
39400	15'	12"	12"	----
39402	15'	40"	12"	----
39406	20'	12"	12"	----

FIFTH WHEEL SLIDER COIL

- Temperatures range -40 to 208°F
- 150 psi max pressure rating
- Meets SAE J844 and DOT FMVSS 106 requirements.
- (2) 1/4" OD fittings assembled



PART #	DESCRIPTION	LENGTH	FITTINGS	
39839	5th Wheel slider coil	up to 54"	(2) 1/4" MPT	----
39838	5th Wheel slider coil	up to 72"	(2) 1/4" MPT	----

3-IN-1 AND 4-IN-1 COMBINATION AIRLINE CABLE

- (2) 3/8" ID SAE J1402 rubber service and emergency with blue (service) and red (emergency) gladhand grip handle
- Color-coded grip helps to minimize incorrect tractor/trailer connections have glad handle with Vibraseal
- ABS power line (green) – meets SAE J2222 requirements
- Auxiliary power line (yellow) – fitted with SAESS60 plugs that have an inverted (male) ground pin 4-in-1 only
- SAE J560 Plugs with sleeves for superior corrosion protection and strain relief
- Corrosion resistant all brass fittings 1/2" male NPT w/ Vibraseal
- Tapered grip flexes with airline during tight turns for kink protection
- Temp rating -40 - 208°F



PART #	DESCRIPTION	
39825	Combo 3 in 1 assembly 15 ft.	----
39962	Combo 4 in 1 assembly 15 ft.	----

WARNING: This product can expose you to chemicals, including lead, which are known to the State of California to cause cancer and birth defects or other reproductive harm. For more information, visit www.P65Warnings.ca.gov

hose support

AIRBRAKE HOSE REPAIR KIT



- Fittings to repair hose with a minimum 3/4" OD
- Meets DOT 106 SAE j1402
- Brass sleeve and barb
- Pre-applied sealant

PART #	DESCRIPTION	
39855	3/8" Quick fix hose fitting	----
*39856	3/8" Quick fix hose kit- clam pack	----
39857	1/2" Quick fix hose fitting	----

*Supplied with hex tool



39425

39426

POGO STICKS CANNISTER STYLE

- Large diameter housing eliminates spring binding
- Increased resistance to sagging and bending
- Thick gauge heavy duty spring
- Used for all nylon and rubber air brake hose
- Forged steel mounting stud 7/16-20 thread
- All Pogo Sticks include Eyebolt and Nut

PART #	SIZE	DESCRIPTION	
39425	40"	Chrome finish	----
39426	40"	Zinc Plated Steel	----

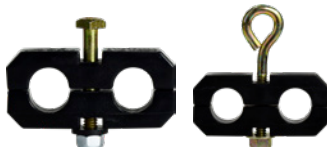

39409

39410

HOSE HOLDERS

- ABS Plastic
- 2, 3 and 4 Hold

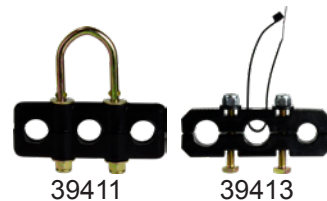

39411

39413

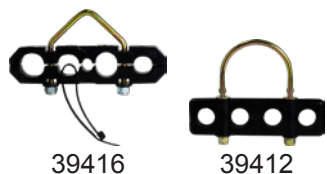

39416

39412

PART #	SIZE	DESCRIPTION	
39409	1/2"	2-Hose Holder Hex Head	----
39410	1/2"	2-Hose Holder	----
39411	1/2"	3-Hose Holder	----
39413	1/2"	3-Hose Hex Head w Cable tie	----
39416	1/2"	4-Hose V Bolt w Cable Tie	----
39412	1/2"	4-Hose Holder	----

HOSE SEPARATORS

- ABS Plastic



39415

39418

PART #	SIZE	DESCRIPTION	
39414	3/8"	2-Hose Separator	----
39415	3/8"	4-Hose Separator	----
39418	1/2"	2-Hose Separator	----
39419	1/2"	4-Hose Separator	----

HOSE SUPPORT

TRUCK AND TRAILER



39469



39473



39472



39411

TENDER KIT COMPONENTS

PART #	DESCRIPTION	
39411	3 hole holder	----
39469	Clip Carabiner	----
39472	1-1/2" ID Hanger Bracket	----
39473	Yoke	----

• Sold individually



39477

39471

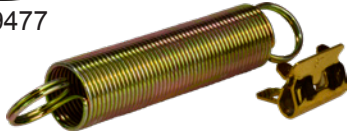

39463

SPRING WITH TANDEM FRAME CLIP

- Steel spring and clip - yellow dichromate finish
- 3/4" OD
- Beam clip

PART #	DESCRIPTION	
39477	Frame Clip with Cable Tie	----

PART #	LENGTH	DESCRIPTION	
39463	6" Spring	Tandem frame clip	----
39464	3" Spring	Tandem frame clip	----
39471		Frame clip only	----



95631



95640

CLIPS

PART #	DESCRIPTION	
95631	ABS Clip for 1/2" Air Hose	----
95640	5" Axle Clip	----
95641	5-3/4" Axle Clip	----

WARNING: This product can expose you to chemicals, including Cobalt, which are known to the State of California to cause cancer. For more information, visit www.P65Warnings.ca.gov



HELP US HELP YOU! GO ONLINE TO UPDATE YOUR CUSTOMER PROFILE SO THAT WE CAN UPDATE ALL THE APPROPRIATE DEPARTMENTS AND PERSONNEL AT YOUR COMPANY ON NEW CATALOGS, PRICING UPDATES, NEW MARKETING TOOLS, AND OTHER IMPORTANT INFORMATION. THANK YOU!

HOSE SUPPORT

TRUCK AND TRAILER



TENDER KIT

Complete Tender Kit includes:

- Large snap Clip
- Heavy duty spring
- Protective tube

PART #	SPRING & TUBE LENGTH/ #PCS	ONE CLIP	3 HOLE CLAMP	YOKE	
39442	16" / 1pc	1pc	1pc		----
39444	16" / 2 pcs	1pc	1pc	2pcs	----
39446	20" / 1pc	1pc	1pc		----
39448	20" / 2pcs	1pc	1pc	2pcs	----
39452	25" / 1pc	1pc	1pc		----
39453	25" / 2pcs	1pc	1pc	2pcs	----

HYDRAULIC TENDER KIT

PART #	SPRING & TUBE LENGTH/ #PCS	LARGE CLIP	HANGER BRACKET	YOKE	
39457	25" / 2pcs	1pcs	1pc	2pcs	----



SLIDER BAR KITS

PART #	SPRING & TUBE LENGTH/ #PCS	LARGE CLIP	3 HOLE CLAMP	SLIDER BAR LENGTH	YOKE	
39437	16" / 1pc	1pc	1pc	43"		----
39438	16" / 2pcs	1pc	1pc	43"	2pcs	----
39459	20" / 2pcs	1pc	1pc	43"	2pcs	----
39460	25" / 1pc	1pc	1pc	43"		----
39461	25" / 2pcs	1pc	1pc	43"	2pcs	----
39470	16" / 1pc	1pc	1pc	38"		----
39462	16" / 2pcs	1pc	1pc	38"	2pcs	----
39451	25" / 1pc	1pc	1pc	38"		----
39454	25" / 2pcs	1pc	1pc	38"	2pcs	----



BARS, SPRINGS, TUBES

PART #	SPRING & TUBE LENGTH/ #PCS	
39443	16" Tube only	----
39447	20" Tube only	----
39436	25" Tube only	----
39466	16" Spring only	----
39467	20" Spring only	----
39468	25" Spring only	----
39474	38" Slider Bar	----
39475	43" Slider Bar	----

gladhands

ALUMINUM GLADHANDS

- 1/2 " FPT port
- Aluminum Casting
- Permanent Clamp Screw
- Black rubber seals
- Stainless Steel filter
- Meet SAE J318 requirements



PORT A

PART #	DESCRIPTION	MATERIAL	SEAL	FILTER	PORT A	
39870	Universal	Aluminum	Blk Rubber	No	1/2"	----
39871	Universal with filter	Aluminum	Blk Rubber	Yes	1/2"	----
39877	Emergency Red	Aluminum	Blk Rubber	No	1/2"	----
39878	Emergency with filter	Aluminum	Blk Rubber	Yes	1/2"	----
39874	Service Blue	Aluminum	Blk Rubber	No	1/2"	----
39875	Service with filter	Aluminum	Blk Rubber	Yes	1/2"	----

PLATED ALUMINUM GLADHANDS



PART #	DESCRIPTION	MATERIAL	SEAL	FILTER	PORT A	
39832	Universal Standard	Plated Aluminum	Blk Rubber	No	1/2"	----
39833	Service - Blue	Plated Aluminum	Blk Rubber	No	1/2"	----
39834	Emergency - Red	Plated Aluminum	Blk Rubber	No	1/2"	----
39828	Service 38 degree	Plated Aluminum	Blk Rubber	No	1/2"	----
39829	Emergency 38 degree	Plated Aluminum	Blk Rubber	No	1/2"	----
39830	Service 38 degree	Plated Aluminum	Blk Rubber	No	3/8"	----
39831	Emergency 38 degree	Plated Aluminum	Blk Rubber	No	3/8"	----

CAST IRON GLADHANDS

- 1/2 " FPT port
- One-piece casting eliminates problems with clamp separation
- "Positive-stop" post, assures a perfect connection
- Polyurethane seal resist oils, chemicals & provide improved sealing & service life
- Gladhands meet SAE J318 requirements including breakaway requirement.

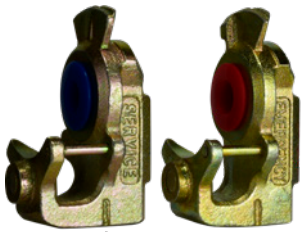

PORT A

PART #	DESCRIPTION	MATERIAL	SEAL	FILTER	PORT A	
39506	Universal	Cast Iron	Black Polyurethane	No	1/2"	----
39507	Emergency	Cast Iron	Red Polyurethane	No	1/2"	----
39508	Service	Cast Iron	Blue Polyurethane	No	1/2"	----

ANGLE MOUNT ALUMINUM GLADHANDS

- For use in trailer mounting locations
- Dual port provides connection options
- Powder-coated clamp plates are color coded for easy identification
- Port "A" comes standard as unplugged
- (2) 3/8 inch FPT Ports (one plugged).
- (2) 11/32 inch diameter mounting holes.
- Available with Port "B" plugged or unplugged (plug is included, loose in bag)
- Meet SAE J318



PORT A

PORT B

PART #	TYPE	MATERIAL	SEAL	FILTER	PORT A	PORT B	
39511	Emergency	Aluminum	Blk Rubber	No	Unplugged	Plugged	----
39512	Service	Aluminum	Blk Rubber	No	Unplugged	Plugged	----

WARNING: This product can expose you to chemicals, including Chromium, which are known to the State of California to cause cancer and birth defects or other reproductive harm. For more information, visit www.P65Warnings.ca.gov



PORT A

POWDER COATED IRON GLADHAND

- Tough powder coating improves wear & corrosion resistance
- Vividly colored to provide improved identification of service & emergency lines
- Stainless steel plate eliminates corrosion of the mating surface
- Polyurethane seal resist oil, chemicals, provide improved sealing & service life
- Meet or exceeds SAE J318 standard

PART #	DESCRIPTION	FILTER	PORT A	
39509	Service with blue poly seal	Yes	1/2"	----
39510	Emergency with red poly seal	Yes	1/2"	----



BRACKET MOUNT SWING AWAY GLADHAND

- Bracket allows 180° rotation allowing for easy hookups, eliminating the need to twist lines during connections
- Helps protect rear-trailer gladhands when not in use
- Filter and closed seal are recommended
- Spring design provides consistent tension throughout rotation
- Design provides both back port and bottom port capabilities
Gladhand mount - 1/2" Male Thread

PART #	DESCRIPTION	MATERIAL	SEAL	FILTER	
39515	Service (Blue)	Aluminum	Blk Rubber	yes	----
39516	Emergency (Red)	Aluminum	Blk Rubber	yes	----



KNOB STYLE SHUTOFF GLADHAND

- Economical trailer shutoff gladhand
- Centered low-profile "snap-stop" knob
- Full face rubber seal
- Available with assembled or separate fittings.
- Meets SAE J318

PART #	DESCRIPTION	MATERIAL	SEAL	FILTER	
39520	1/2" Service (Blue)	Aluminum	Blk Rubber	No	----
39521	3/8" Service (Blue)	Aluminum	Blk Rubber	No	----
39522	1/2" Emergency (Red)	Aluminum	Blk Rubber	No	----
39524	3/8" Emergency (Red)	Aluminum	Blk Rubber	No	----



PORT A

LEVER STYLE SHUTOFF GLADHAND

- Flange mount
- Metal handle shutoff
- Full face rubber seal
- Tough metal Ball valve
- Color coded
- Meets SAE J318

PART #	DESCRIPTION	MATERIAL	SEAL	FILTER	PORT A NPT	PORT B NPT	
39531	Emergency (Red)	Aluminum	Blk Rubber	No	3/8"	1/4"	----
39530	Service (Blue)	Aluminum	Blk Rubber	No	3/8"	1/4"	----

WARNING: This product can expose you to chemicals, including Chromium, which are known to the State of California to cause cancer and birth defects or other reproductive harm. For more information, visit www.P65Warnings.ca.gov

AIR
TRUCK AND TRAILER

GLADHAND GRIPS



1/2" NPTF.

- Comes with hardware and sealant
- Color-coded red and blue for easy air line identification - clamshell
- Handles are heat, oil and UV-resistant.
- Meet SAE J318

PART #	DESCRIPTION	
39535	Poly grip hardware	----

ALUMINUM GLADHAND GRIPS



- 1/2" NPTF
- Each pack contains (1) red and (1) blue - clamshell
- One piece design
- No screws or plastic parts
- Easy to install
- Class II anodized coating provides greater corrosion resistance

PART #	DESCRIPTION	
39537	Sure grip	----

GLADHAND PACIFIER SEAL



- Seals Gladhand from moisture, dirt and debris

PART #	DESCRIPTION	
39566	Gladhand pacifier	----

GLADHAND SEALS

Seal Options:

- Rubber
- Polyurethane
- With screen filter
- Double lip
- Filter screen only



PART #	DESCRIPTION	
39541	Blue, Polyurethane	----
39542	Red, Polyurethane	----
39543	Black, Polyurethane	----
39556	Blue with a screen filter Polyurethane	----
39557	Red with a screen filter Polyurethane	----
39558	Black with a screen filter Polyurethane	----
39550	Blue Double lip, Polyurethane	----
39551	Red Double Lips, Polyurethane	----
39552	Double Lip, Polyurethane	----
39544	Grey, Closed Style, Polyurethane	----
39560	Filter, Screen, Gladhand	----
39559	Filter, Screen, Gladhand	----

WARNING: This product can expose you to chemicals, including Chromium, which are known to the State of California to cause cancer and birth defects or other reproductive harm. For more information, visit www.P65Warnings.ca.gov

AIR

TRUCK AND TRAILER



DUMMY GLADHAND COUPLING KIT

- 6 1/2" coupling length

PART #	CONNECTION	VENT	MATERIAL	
39563	Chain	Yes	Steel Yellow Zinc plated	----
39564	Chain	No	Steel Yellow Zinc plated	----
39565	Cable	N/A	Aluminum	----

39565

NYLON GLADHAND AND PLUG HOLDER

- Stores Gladhand and electrical hook ups at a 45° angle.
- Can accept heavy ABS plug
- Standard mounting holes to install on back of cab.
- Glass-filled nylon, non-corrosive construction.



39574

39575

PART #	DESCRIPTION	
39574	1 plug slot	----
39575	2 plug slot	----

GLADHAND HOLDER KIT

- Steel - Zinc Yellow Dichromate
- Holds gladhands when disconnected

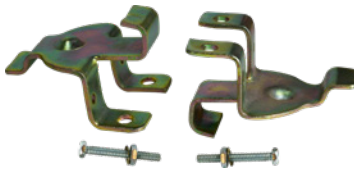

PART #	DESCRIPTION	
39573	Holder Kit	----
39572	Bracket only	----

GLADHAND LOCK

- Red molded plastic
- Prevents unwanted connections with trailers
- Protects idle units
- Universal for Aluminum and Iron Gladhands
- Supplied with 2-keys



PART #	DESCRIPTION	
39570	Gladhand Lock w/ 2 keys	----

*** Not an Anti theft device**

KING PIN LOCK-ANTI HOOK UP

- Cast, Zinc plated
- Anti-tractor, trailer hook-up
- Supplied with 2 keys



PART #	DESCRIPTION	
39860	King Pin Lock w/ 2 keys	----

AIR

TRUCK AND TRAILER

AIR CYLINDER

- 300 series stainless steel cylinder shafts provide excellent corrosion resistance and extended cycle life -cylinders tested to over 500,000 cycles.
- Lightweight, corrosion resistant aluminum tube with die cast aluminum end caps.
- Rear clevis cast as integral part of the rear cover for improved durability and mounting integrity.
- Double acting, Emralon-coated piston cup assures smooth long lasting operation even in cold weather conditions to (- 40°F).
- Front end cap assembly includes pressure seal, dirt seal and oil impregnated bronze bushing.
- Cylinder tube imprinted with part number and date code for quick identification.
- All cylinders are factory pressure and leak tested prior to shipping.
- Front Cover Kit-Includes front cover with bushing and seals installed and two cylinder gaskets.
- Rear Cover Kit-Includes rear cover with two cylinder gaskets.
- Piston Cup Kit-Includes piston cup, lock nut and two cylinder gaskets.
- Shaft Kit-Includes shaft, lock nut and two cylinder gaskets.

PART #	SIZE	STROKE	RETRACTED	EXTENDED	TYPE	
39672	2 1/2"	4.0"	9.89"	13.89"	push/pull	----
39673	2 1/2"	6.0"	11.89"	17.89"	push/pull	----
39674	2 1/2"	8.0"	13.89"	21.89"	push/pull	----
39675	2 1/2"	6.0"	13.75"	19.75"	Spring return	----
39676	3 1/2"	8.0"	15.60"	24.28"	push/pull	----
39677	3 1/2"	10.0"	16.92"	26.95"	push/pull	----



SEE WEBSITE TO DOWNLOAD YOUR MOST UPDATED PRICING

WARNING: This product can expose you to chemicals, including Chromium, which are known to the State of California to cause cancer and birth defects or other reproductive harm. For more information, visit www.P65Warnings.ca.gov



TAILGATE AIR CYLINDERS

- Die cast aluminum with mount hole for 1/2" pin and 1/4" NPT port
- Molded piston cup
- Stainless steel piston rod with 5/8" – 18 thread
- 10 PSI – 120 PSI
- 10 psi min-120 psi max



PART #	DIA.	STROKE	LENGTH	TYPE	
39655	2-1/2"	4.0"	13.37	Push/Pull	----
39656	2-1/2"	6.0"	17.37	Push/Pull	----
39657	2-1/2"	8.0"	21.37	Push/Pull	----
39658	2-1/2"	4.0"	14.71	Spring Ret	----
39659	2-1/2"	6.0"	19.75	Spring Ret	----
39660	3-1/2"	6.0"	20.23	Push/Pull	----
39661	3-1/2"	8.0"	24.23	Push/Pull	----
39662	3-1/2"	8.0"	26.98	Push/Pull	----
39663	3-1/2"	10.0"	28.98	Push/Pull	----



TAILGATE AIR CYLINDERS

- Machined aluminum, 5/8" diameter, stainless steel shaft with 5/8" - 18 threads, "O" rings and a UHMW polyethylene wear band
- Direct replacements to Haldex and MGM
- Standard operating pressure 100 psi
- 90psi min to 150 psi max

PART #	DIA.	STROKE	BRACKET	TYPE	
39665	6"	3"	Yes	Spring Ret	----
39667	6"	4.38"	No	Spring Ret	----



FIFTH WHEEL AIR CYLINDER

- 1/4" FPT port cast aluminum front and rear
- 2-1/2" Bore
- 6-3/4" stroke
- Front and rear mounting hole for 17/32" clevis,
- 100 psi
- Gold anodized tube for corrosion resistance

PART #	DESCRIPTION	
39669	Fifth Wheel Air Cylinder	----

WARNING: This product can expose you to chemicals, including Chromium, which are known to the State of California to cause cancer and birth defects or other reproductive harm. For more information, visit www.P65Warnings.ca.gov

AIR TANK DRAIN PULL VALVE



PART #	SIZE	DESCRIPTION	
39595	1/4" male	5ft nylon coated pull cable	----
39596	1/4" male	4ft nylon coated pull cable	----
39597	1/4" male	3ft nylon coated pull cable	----
39600	1/4" male	Air valve only	----

AIR TANK CHECK VALVE

- Single check valves allow air to pass from a single source to its destination, and prevent air travel in the opposite direction.



PART #	MALE X FEMALE	
39604	1/4"	----
39605	3/8"	----
39606	1/2"	----

D-2 STYLE AIR BRAKE GOVERNOR

- Opening and closing pressures of 100 to 120 psi
- High temperature O-ring construction
- Gasket and plugs included
- Replaces Bendix 275491 & Midland KN18530



PART #	THREAD	DESCRIPTION	
39592	6-1/8" NPT	Air Brake Governors D-2 style	----

IN-LINE QUICK RELEASE VALVE

- Quick release for the air brake system
- 3/8" female exhaust port
- 2-3/8" female delivery port
- Cracking pressure: 1 PSI
- Helps meet the FMVSS -121 requirement for timing



PART #	DESCRIPTION	
39610*	3/8" NPT In-Line quick release valve	----
39611**	1/2" NPT In-Line quick release valve	----

* Replaces Bendix 229859, 288351 & Midland KN32005

** Replaces Bendix 229860 & Midland KN32011

R-12 RELAY VALVE

- 1/4" Relay Valve with multiple delivery ports
- Replaces Bendix 102166, 102626, 103009



PART #	SUPPLY PORT	DELIVERY PORT	DESCRIPTION	
39613	1/2" NPT	4, 1/2"NPT	4 psi no Bracket	----
39614	1/2" NPT	4, 1/2"NPT	4 psi Relay Valve	----
39615	3/4" NPT	2, 1/2" NPT	4 psi Relay Valve	----

WARNING: This product can expose you to chemicals, including Chromium, which are known to the State of California to cause cancer and birth defects or other reproductive harm. For more information, visit www.P65Warnings.ca.gov

AIR

TRUCK AND TRAILER



R-14 RELAY VALVE

- 1/4" Relay Valve with two delivery and supply ports
- Replaces Bendix 103010

PART #	SUPPLY PORT	DELIVERY PORT	DESCRIPTION	
39616	2-3/4"NPT	2-1/2"NPT	4 psi Relay Valve	----



THREE WAY SOLENOID

- Operates a minimum GF 50,000 cycles
- Inlet port normally closed
- Must be mounted vertically with the air inlet port facing up
- 1/4" female NPT ports
- 12 Volts
- 100-120 psi operating pressure
- Attached mounting bracket with two 9/32" diameter mounting holes on 2-1/2" centers

PART #	SUPPLY PORT	DESCRIPTION	
39684	2, 1/4" FPT	Three way Solenoid	----



UNIVERSAL SOLENOID

- Operates a minimum of 50,000 cycles.
- 125 amps at 12 volts.
- Continuous voltage.
- One on/off circuit
- 5/16 inch side studs, No. 10 top stud(s).
- 2 1/8 on Center
- 5/16 x 19/32
- Hardware included.
- Normally open

PART #	DESCRIPTION	
39687	4 stud Solenoid	---
39688	3 stud Solenoid	---



AIR SOLENOID VALVE

- Operates a minimum of 50,000 cycles.
- 100 psi max pressure.
- 1/4" Thread
- 10 Watts, 12 VDC
- Replaces Neway 90054075

PART #	DESCRIPTION	
39689	12V Closed	---
39690	12V Open	---

WARNING: This product can expose you to chemicals, including Chromium, which are known to the State of California to cause cancer and birth defects or other reproductive harm. For more information, visit www.P65Warnings.ca.gov

TRUCK & TRAILER

coiled cable

SEVEN-WAY COILED CABLE ASSEMBLIES



- ABS assemblies are heavy duty to power trailers
- HD Green gives clear ABS identification
- Resists abrasion, great coil retention
- Heavy duty plugs with spring guards
- ABS Cable meets SAE J2394
- Operating temperature range of -55° to +185°F

PIN LOCATION	COLOR CODE	GAUGE	CIRCUIT
1	White	8	Ground
2	Black	12	Clearance, side and ID lamps
3	Yellow	12	Left turn and Hazard
4	Red	10	Stop lamp and Anti-lock
5	Green	12	Right turn and Hazard
6	Brown	12	Tail and Plate lamp

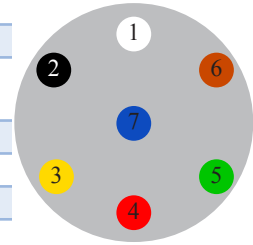

ABS

PART #	LENGTH	DESCRIPTION	
39736	12'	Coiled Electrical Cord, ABS w/12 in lead, w/plugs, Green	----
39737	15'	Coiled Electrical Cord, ABS w/12 in lead, w/plugs, Green	----

SEVEN-WAY COILED CABLE BLACK

- This high quality, durable construction is recommended for single-trailer configurations using standard lighting on non-ABS vehicles.
- Durable black outer jacket with heavy duty zinc die cast plugs and two spring guards included.



PIN	COLOR CODE	HD GAUGE	ECO GAUGE	CIRCUIT
1	White	10	12	Ground
2	Black	12	14	Clearance, side and ID lamps
3	Yellow	12	14	Left turn and Hazard
4	Red	12	14	Stop lamp and Anti-lock
5	Green	12	14	Right turn and Hazard
6	Brown	12	14	Tail and Plate lamp
7	Blue	12	14	ABS Power Aux

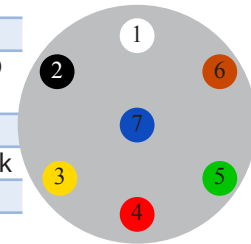

STANDARD - HEAVY DUTY

PART #	LENGTH	DESCRIPTION	
39738	12'	Coiled Electrical Cord, w/12 in lead, w/plugs, Black	----
39739	15'	Coiled Electrical Cord, w/15 in lead, w/plugs, Black	----

STANDARD - ECONOMY

PART #	LENGTH	DESCRIPTION	
39740	12'	Coiled Electrical Cord, w/12 in lead, w/plugs, Black	----
39741	15'	Coiled Electrical Cord, w/12 in lead, w/plugs, Black	----

WARNING: This product can expose you to chemicals, including Chromium, which are known to the State of California to cause cancer and birth defects or other reproductive harm. For more information, visit www.P65Warnings.ca.gov



SIX WAY COILED ELECTRIC CABLE ASSEMBLY



- 6', 8', 12' Length
- Includes 2 Thermoseal 6-way plugs
- For light duty towing applications such as boats and utility trailers
- Plugs are molded for moisture and corrosion resistance
- 4/14 Gauge cable
- Flexible from -55°F to 150°F (-66°C to 66°C)

PART #	DESCRIPTION	
39752	6ft, 14awg w/12" Lead at 2 ends	----
39753	8 ft, 14awg w/12" Lead at 2 ends	----
39754	12ft,14awg w/12" Lead at 2 ends	----

FOUR WAY COILED ELECTRIC CABLE ASSEMBLY



- 4/14 Gauge cable
- 12' & 15' length
- Includes 2 Thermoseal 4-way plugs
- For light duty towing applications such as boats and utility trailers
- Plugs are molded for moisture and corrosion resistance
- Flexible from -55°F to 150°F (-66°C to 66°C)

PART #	DESCRIPTION	
39748	12' with 12" Lead, both ends 4/14awg	----
39749	15' with 12" Lead, both ends 4/14awg	----

DUEL POLE COILED ELECTRIC CABLE ASSEMBLY



- Black Jacket
- 12' & 15' length
- 200 Amp at 12 VDC.
- Zinc die cast plugs.
- 4 gauge cable.

PART #	DESCRIPTION	
39744	12' Coil With 12" Lead at 2 ends 4awg	----
39745	15' Coil With 12" Lead at 2 ends 4awg	----

SINGLE POLE COILED ELECTRIC CABLE ASSEMBLY



- Black Jacket
- 12' & 15' length
- For applications that require direct electrical power to trailer lift gates.
- Rated at 265 amps on/off service (30 seconds on/50 seconds off).
- Zinc die cast plugs with spring guards included.
- 4 gauge cable.

PART #	DESCRIPTION	
39742	12' Coil With 12" Lead both ends 4awg	----
39743	15' Coil With 12" Lead both ends 4awg	----

WARNING: This product can expose you to chemicals, including Chromium, which are known to the State of California to cause cancer and birth defects or other reproductive harm. For more information, visit www.P65Warnings.ca.gov

ELECTRICAL
TRUCK AND TRAILER

7 WAY PLUGS AND SOCKETS



39758



39757



39772



- Heavy-duty, nickel-plated zinc die cast housings
- Brass terminal pins for maximum current carrying ability
- Field repairable with standard tools
- Fully interchangeable with other SAE-type, 7-way connectors
- ATA marked wire terminals.
- Internal clamp holds cable securely in place.
- Standard seven-way plugs meet ATA and SAE J560 requirements
- ISO plugs meet ISO 3731:1997 requirements.
- ISO socket prevents connections with Non-ISO plugs - Used in tractor/trailer systems
- ISO color-coded yellow, non-corrosive reinforced nylon housing.

PLUGS

PART #	DESCRIPTION	
39757	7-Way Single Grip Plug w/Spring Guard	----
39758	7-Way Single Grip Plug NO Spring.	----
39772	7-Way Double Grip Plug w/Spring.	----
39773	7-Way Double Grip Plug NO Spring Guard	----
39788	7-way ISO plug	----

SOCKETS

PART #	DESCRIPTION	
39774	Solid Pin 7-Way Metal Socket	----
39775	Split Pin 7-Way Metal Socket	----
39789	7-way, ISO socket	----

7 WAY DOUBLE GRIP PLUG

- T-Grip weather guard
- Plastic grip

PART #	DESCRIPTION	
39818	7-Way Double Grip Plug, Plastic	----

6 AND 7 WAY ADAPTER

PART #	DESCRIPTION	
39786	Seven way plug to Six Way Socket Adapter	----
39787	Six way plug to Seven Way socket Adapter	----

RV 7-WAY PLUG

- Primarily used in RV applications.
- Constructed of molded PVC for impact resistance
- Blade Style Pin

PART #	DESCRIPTION	
39819	7-way Plastic plug	----

RV 7-WAY SOCKET

- RV Screw-type socket
- 6-24 VDC.
- Mounting 2-1/4" inch on center .
- Constructed of molded PVC

PART #	DESCRIPTION	
39820	7-way socket	----

WARNING: This product can expose you to chemicals, including Nickel, which are known to the State of California to cause cancer. For more information, visit www.P65Warnings.ca.gov





6 - WAY PLUGS AND SOCKETS

PART #	DESCRIPTION	
39782	6-Way Double Grip Metal Plug w/Spring Guard.	----
39783	6-Way Metal Socket.	----

4 WAY PLUGS AND SOCKETS

- Heavy-duty zinc die cast housings on plugs and sockets.
- Plug locking system works with socket door to ensure proper hookup and prevent unintentional disconnections.
- Spring guard supports and protects cable.



4 - WAY

PART #	DESCRIPTION	
39778	4-Way Double Grip Metal Plug w/Spring Guard.	----
39779	4-Way Metal Socket.	----

2 POLE PLUGS AND SOCKETS

- 200 amp 4 gauge wire capacity.
- Heavy-duty zinc die cast housing.
- Internal ground.
- Spring guard supports and protects cable.



PART #	DESCRIPTION	
39768	2 Pole Double Grip Metal Plug w/Spring Guard.	----
39769	2 Pole Metal Socket	----

SINGLE POLE PLUGS AND SOCKETS

- Used to provide power to heavy draw auxiliary trailer equipment.
- Heavy-duty zinc die cast housings.
- Power and ground terminals hold up to 1/0 gauge wire.



PART #	DESCRIPTION	
39764	1-Way Double Grip Plug w/Spring Guard.	----
39765	1-Way Double Grip Plug w/Spring Guard and Ground Kit	----
39766	1-Way Metal Socket	----

GROUND KIT



PART #	DESCRIPTION	
39809	Ground Kit (Bolt, Nut and Wire Lug) for 1-Way Plug or Socket	----

PROTECTOR BOOT FOR PLUG

- Protective rubber boot seals out moisture and contaminants



PART #	DESCRIPTION	
39807	Protector Boot	----

WARNING: This product can expose you to chemicals, including Nickel, which are known to the State of California to cause cancer. For more information, visit www.P65Warnings.ca.gov

ELECTRICAL

TRUCK AND TRAILER

7 WAY SOCKET WITH CIRCUIT BREAKER



- Non-corrosive, reinforced nylon housing for added durability.
- Designed for No. 8 ring terminals.
- ATA color-coded contacts.
- Solid brass split pins are zinc-plated for corrosion resistance.
- Each socket includes automatic reset circuit breakers with positive snap action to eliminate arcing (unless otherwise noted).
- Mounting holes are 4 1/2 inch on center and include steel bushings for added housing protection.
- Adhesive-backed mounting gasket included.
- Circuit breaker sockets meet SAE J560 requirements.

PART #	DESCRIPTION	
39792	No circuit breakers	----
39793	15amp Plastic with circuit breakers	----
39794	20amp Plastic with circuit breakers	----
39795	30amp Plastic with circuit breakers	----



7 WAY CIRCUIT CHASER

- Instantly finds short or faulty circuits
- Portable

PART #	DESCRIPTION	
39805	7 way circuit	----

CIRCUIT BREAKERS - PLASTIC

- Colored Battery molded Stud
- 12 Volt
- Meets SAE j553 requirements
- Nuts included



PART #	DESCRIPTION	
39800	15 AMP	----
39801	20 AMP	----
39802	25 AMP	----
39803	30 AMP	----

NOSE BOX - DEEP

- Zinc - extra deep



PART #	DESCRIPTION	
39814	Deep Nose Box	----

WARNING: This product can expose you to chemicals, including Chromium, which are known to the State of California to cause cancer and birth defects or other reproductive harm. For more information, visit www.P65Warnings.ca.gov



BATTERY GROUND STRAP



- 4 gauge wire.
- Molded zinc-plated steel lugs and tin-plated copper stranding.
- 7/16 inch diameter bolt hole.
- 12" Long

PART #	DESCRIPTION	
39712	12", 4 Gauge ground strap	----

STAINLESS STEEL BATTERY NUT



PART #	TYPE	
39713	3/8"	----

RUBBER GROMMET

- Black Rubber



PART #	ID	OD	
95450	5/16"	9/16"	----
95451	5/8"	1 1/4"	----
95452	3/4"	1 3/4"	----



USE OUR APP WITH YOUR FREE BIN LABELS TO MANAGE YOUR CUSTOMERS INVENTORY MORE EFFICIENTLY

WARNING: This product can expose you to chemicals, including Chromium, which are known to the State of California to cause cancer and birth defects or other reproductive harm. For more information, visit www.P65Warnings.ca.gov

ACCESSORIES

TRUCK AND TRAILER

ACCESSORIES**CABLE TIE STRAPS - NYLON**

- Used to secure and bundle
- CSA Certified
- RoHs Compliant
- UV or Standard

**STANDARD**

PART #	LENGTH	STRENGTH	PACKAGE QTY	
95601	7 1/2"	50lb	100	----
95602	11"	50 lb	100	----
95603	14.5"	50 lb	100	----
95604	24"	175 lb	50	----
95605	36"	175lb	50	----
95606	48"	175 lb	50	----

UV BLACK

PART #	LENGTH	STRENGTH	PACKAGE QTY	
95610	7 1/2"	50lb	100	----
95611	14"	50 lb	100	----
95612	24"	175lb	50	----
95613	36"	175lb	50	----



VIEW PRICING AND AVAILABLE STOCK ONLINE

WARNING: This product can expose you to chemicals, including Chromium, which are known to the State of California to cause cancer and birth defects or other reproductive harm. For more information, visit www.P65Warnings.ca.gov



ACCESSORIES

TRUCK AND TRAILER

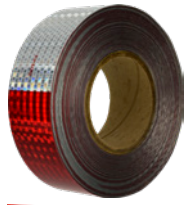

95620

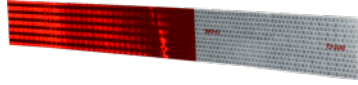

95625



95627



95628

CONSPICUITY TAPE

Tape is designed for trucks, trailers, and other vehicles for easy nighttime vehicle recognition and increased road safety. It is a high quality, durable microprismatic retroreflective material with a pressure sensitive adhesive. The solid construction does not require edge sealing. Conspicuity tape provides superior reflectivity and may help reduce accidents.

- DOT -C2 Certified
- Meets or exceeds NHTSA, FMVSS 108 & ASTM D4956
- Meets Canada TSD 108
- 10 year durability

PART #	DESCRIPTION	APP. WT.	
95620	2" x 150' Roll of 11" Red / 7" White	0.32	----
95621	2" x 150' Roll of 6" Red / 6" White	0.32	----
95622	2" x 150' Roll of solid white	0.32	----
95623	2" x 18", kiss cut strip, white	0.03	----
95624	2" x 18" kiss cut strip of 11" Red / 7" White	0.03	----

- Meets or exceeds ANSI/SAE S279, ANSI/SAE S276 & ASTM D-4956
- 7 year durability

PART #	DESCRIPTION	APP. WT.	
95625	1" X 150' Roll of solid yellow	0.17	----
95626	2" X 150' Roll of solid yellow	0.32	----
95627	3" round all plastic reflector, Red	0.06	----
95628	3 3/4" x 6 1/2" American flag, type IV HIP	0.02	----

TARP STRAPS

- Heavy Duty EPDM tarp straps
- Longer lasting than rubber
- Greater stretch length
- Ozone and weather resilient
- Made in the USA



PART #	STRAP LENGTH	MATERIAL	DESCRIPTION	QTY	
990790	10"	EPDM	Tarp strap with S hook	50	----
990791	15"	EPDM	Tarp strap with S hook	50	----
990792	21"	EPDM	Tarp strap with S hook	50	----
990793	31"	EPDM	Tarp strap with S hook	50	----
990794	41"	EPDM	Tarp strap with S hook	50	----

NYLON DOT AIR BRAKE TUBING

TRUCK AND TRAILER



- Air Brake Tubing available from inventory in a large variety of colors and sizes
- Superior cold weather flexibility and abrasion resistance
- UV and ozone resistant nylon
- Meets or exceeds SAEJ844 (Type A - non-reinforced & Type B - reinforced)
- Meets or exceeds DOT requirements for use with compression fittings (NOTE: SAE does not recognize 1/8", 5/32" or 3/16" O.D. tubing for use with air brake systems)
- Air Brake Tubing identified per SAE J844 & FMVSS No. 106 Brake Hoses, 49 CFR 571.106
- Conforms to our own rigorous qualification and inspection testing which exceeds SAE and DOT requirements
- Designed to operate at up to 150 psi in air brake systems
- Resistant to attack by gasoline, diesel fuel and commonly used road and cleaning chemicals
- Air Brake Tubing available on bulk spools or by packages
- Operating range: -40° - 200°F - Not made for fuel

PART NUMBER	COLOR	LENGTH	NOMINAL O.D.	NOMINAL WALL	
38950B2	Black	2000'	1/8"	0.023"	----
38950	Black	100'	1/8"	0.023"	----
3895BA	Black	50'	1/8"	0.023"	----
38951B1	Black	1000'	5/32"	0.032"	----
38951	Black	100'	5/32"	0.032"	----
38951BA	Black	50'	5/32"	0.032"	----
38953B1	Black	1000'	3/16"	0.035"	----
38953	Black	100'	3/16"	0.035"	----
38953BA	Black	50'	3/16"	0.035"	----
389523	Black	1000'	1/4"	0.040"	----
389522	Black	500'	1/4"	0.040"	----
38952	Black	100'	1/4"	0.040"	----
38952BA	Black	50'	1/4"	0.040"	----
38952U1	Blue	1000'	1/4"	0.040"	----
38952U	Blue	100'	1/4"	0.040"	----
38952UA	Blue	50'	1/4"	0.040"	----
38952O	Orange	100'	1/4"	0.040"	----
38952OA	Orange	50'	1/4"	0.040"	----
38952G1	Green	1000'	1/4"	0.040"	----
38952G	Green	100'	1/4"	0.040"	----
38952GA	Green	50'	1/4"	0.040"	----
38952R1	Red	1000'	1/4"	0.040"	----
38952R	Red	100'	1/4"	0.040"	----
38952RA	Red	50'	1/4"	0.040"	----
38952Y1	Yellow	1000'	1/4"	0.040"	----
38952Y	Yellow	100'	1/4"	0.040"	----
38952YA	Yellow	50'	1/4"	0.040"	----
38954B5	Black	500'	5/16"	0.040"	----
38954	Black	100'	5/16"	0.040"	----
38954BA	Black	50'	5/16"	0.040"	----
38960B5	Black	500'	3/8"	0.062"	----
38960	Black	100'	3/8"	0.062"	----
38960BA	Black	50'	3/8"	0.062"	----
38960U5	Blue	500'	3/8"	0.062"	----
38960U	Blue	100'	3/8"	0.062"	----
38960UA	Blue	50'	3/8"	0.062"	----
38960O5	Orange	500'	3/8"	0.062"	----
38960O	Orange	100'	3/8"	0.062"	----
38960OA	Orange	50'	3/8"	0.062"	----
38960G5	Green	500'	3/8"	0.062"	----
38960G	Green	100'	3/8"	0.062"	----
38960GA	Green	50'	3/8"	0.062"	----
38960R5	Red	500'	3/8"	0.062"	----
38960R	Red	100'	3/8"	0.062"	----

PART NUMBER	COLOR	LENGTH	NOMINAL O.D.	NOMINAL WALL	
38960RA	Red	50'	3/8"	0.062"	----
38960Y5	Yellow	500'	3/8"	0.062"	----
38960Y	Yellow	100'	3/8"	0.062"	----
38960YA	Yellow	50'	3/8"	0.062"	----
38965B5	Black	500'	1/2"	0.062"	----
38965	Black	100'	1/2"	0.062"	----
38965BA	Black	50'	1/2"	0.062"	----
38965U5	Blue	500'	1/2"	0.062"	----
38965U	Blue	100'	1/2"	0.062"	----
38965UA	Blue	50'	1/2"	0.062"	----
38965O5	Orange	500'	1/2"	0.062"	----
38965O	Orange	100'	1/2"	0.062"	----
38965OA	Orange	50'	1/2"	0.062"	----
38965G5	Green	500'	1/2"	0.062"	----
38965G	Green	100'	1/2"	0.062"	----
38965GA	Green	50'	1/2"	0.062"	----
38965R5	Red	500'	1/2"	0.062"	----
38965R	Red	100'	1/2"	0.062"	----
38965RA	Red	50'	1/2"	0.062"	----
38965Y5	Yellow	500'	1/2"	0.062"	----
38965Y	Yellow	100'	1/2"	0.062"	----
38965YA	Yellow	50'	1/2"	0.062"	----
38970BC	Black	250'	5/8"	0.092"	----
38970	Black	100'	5/8"	0.092"	----
38970BA	Black	50'	5/8"	0.092"	----
38970GC	Green	250'	5/8"	0.092"	----
38970G	Green	100'	5/8"	0.092"	----
38970GA	Green	50'	5/8"	0.092"	----
38970RC	Red	250'	5/8"	0.092"	----
38970R	Red	100'	5/8"	0.092"	----
38970RA	Red	50'	5/8"	0.092"	----
38975BC	Black	250'	3/4"	0.092"	----
38975	Black	100'	3/4"	0.092"	----
38975BA	Black	50'	3/4"	0.092"	----
38975GC	Green	250'	3/4"	0.092"	----
38975G	Green	100'	3/4"	0.092"	----
38975GA	Green	50'	3/4"	0.092"	----

FUEL LINE AND AIR BRAKE HOSE

TRUCK AND TRAILER

FUEL LINE AND VAPOR EMISSION

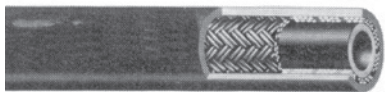

- SAE 30R7
- Nitrile tube w/ spiral synthetic cord, hypalon cover.
- 50 p.s.i. working pressure. 1/2 -35 PSI
- 40° F to + 257° F temperature range.
- Low pressure/ high temperature fuel for cars, light trucks, and small engines.
- Meets SAE J1402

PART #	ID	OD	LENGTH	
38920	3/16	13/32	25'	----
38926	5/16	9/16	25'	----
38923	1/4	1/2	25'	----
38927	3/8	5/8	50'	----

AIR BRAKE HOSE



- BLACK

- Spiral synthetic cord reinforcement with neoprene cover.
- 40° F to +200° F temperature range.
- Max operating pressure 255 psi
- Max burst pressure 900 psi
- Meets SAE J1402

PART #	ID	OD	LENGTH	
38910	3/8	3/4	50'	----
38915	1/2	7/8	50'	----

The Butterfly

A man found a cocoon of a butterfly.

One day a small opening appeared. He sat and watched the butterfly for several hours as it struggled to force its body through that little hole.

Until it suddenly stopped making any progress and looked like it was stuck.

So the man decided to help the butterfly. He took a pair of scissors and snipped off the remaining bit of the cocoon. The butterfly then emerged easily, although it had a swollen body and small, shriveled wings.

The man didn't think anything of it and sat there waiting for the wings to enlarge to support the butterfly. But that didn't happen. The butterfly spent the rest of its life unable to fly, crawling around with tiny wings and a swollen body.

Despite the kind heart of the man, he didn't understand that the restricting cocoon and the struggle needed by the butterfly to get itself through the small opening; were God's way of forcing fluid from the body of the butterfly into its wings. To prepare itself for flying once it was out of the cocoon.

Moral of the story:

Our struggles in life develop our strengths. Without struggles, we never grow and never get stronger, so it's important for us to tackle challenges on our own, and not be relying on help from others.

- UNKNOWN



GO ONLINE TO VIEW OPEN ORDERS, ORDER HISTORY, AND TRACKING INFORMATION ON ALL SHIPMENTS

HYDRAULIC ADAPTERS

HYDRAULIC ADAPTERS

HYDRAULIC ADAPTERS & ACCESSORIES

STEEL ADAPTERS

Technical information**Profile size chart**

Steel Pipe Swivels
 37° JIC Flare Straights
 37° JIC Flare Shapes
 Bulkhead Adapters
 Steel Pipe Fittings
 O-Ring Adapters Straight
 JIC Swivels
 O-Ring Adapters
 O-Ring Face Seal
 BSPT/ BSPP Adapters
 Metric Adapters
 Flange Adapters
 Stainless Steel Adapters
 SS Hose Fittings

HYDRAULIC QUICK
DISCONNECTS

Thread to Connect - Wing
 ISO A Interchange
 ISO B Interchange
 Flush Face ISO
 VEP Series
 AG Interchange
 Hydraulic Jack Q/D

HYDRAULIC VALVES &
ACCESSORIES

Flow Control Valve
 Variable Flow Control
 Air Breathers

PLATING SPECIFICATION

Midland's standard Trivalent, Cr⁺³ plating performs at nearly double the S.A.E. corrosion resistance requirement. The plating meets ASTM B633, Fe/Zn 5. The thickness is 5um-13um. This plating is silver in appearance and has been testing at 96 hours to white rust and 120 hours to red rust.

TECHNICAL INFORMATION

WORKING PRESSURE

The tables on the following pages list the recommended working pressure for a variety of hydraulic fittings made in accordance with certain industry standards. Many factors such as impulse, vibration, mechanical shock, and improper assembly may affect the integrity of the fitting connection.

Midland Industries recommends sufficient testing be conducted to ensure that performance levels will be safe and satisfactory, especially if installed in systems operating at elevated pressures or in severe conditions. Working pressure ratings are capable of a 4 to 1 minimum burst. All steel fittings meet or exceed the minimum SAE pressure ratings. Always consider application and maximum pressure requirements when selecting fittings.

METHODS FOR INSTALLING FITTINGS

There are three methods for installing a fitting:

- Torque wrench
- Flats From Wrench Resistance
- Turns From Finger Tight

For Flare and NPSM Fittings, Midland recommends the flats from wrench resistance method be used whenever possible.

The differences in material, plating, and surface finish impacts the coefficient of friction when installing or connecting fittings. To minimize these variances, Midland recommends that fitting connections are lubricated when installed. Connections that are lubricated provide a more accurate installation torque, which results in fewer leaks.

USING A TORQUE WRENCH

The torque values given in the tables on the following pages are for reference purposes only based on industry standard practice and for low carbon steel mating with steel/iron components. Actual torque values may need to be adjusted due to variances described above.

SAE recommends always making a wet (lubricated) installation or connection to reduce friction on moving parts, O-rings, and variances in material and plating. The torque values in these tables are based off SAE values using a .17 coefficient of friction as per SAE J2593. Many hydraulic leaks are a result of over-torque, which causes excessive deformation of material or exceeds the yield strength of the material, which may reduce the load or clamping force between seal contacts.

If more than one value or range is given, use the lower value first and increase only if required. Over-torquing can damage a fitting or mating component.

TECHNICAL INFORMATION

HYDRAULIC ADAPTERS

SAE O-Ring Boss Port Specifications

O-ring Boss ports (ORB) provide a seal by trapping the fitting's O-ring inside a port cavity. When a fitting is installed into the port, the O-ring is trapped between the fitting body hex or washer and port cavity.

Straight fittings include a hex, and sometimes an additional cylindrical shoulder below the hex and above the threads, to trap the O-ring in the port cavity.

Elbow and Tee fittings require a backup washer and a locknut above the O-ring on the threaded stud to permit a 360° orientation of the fitting around the port.

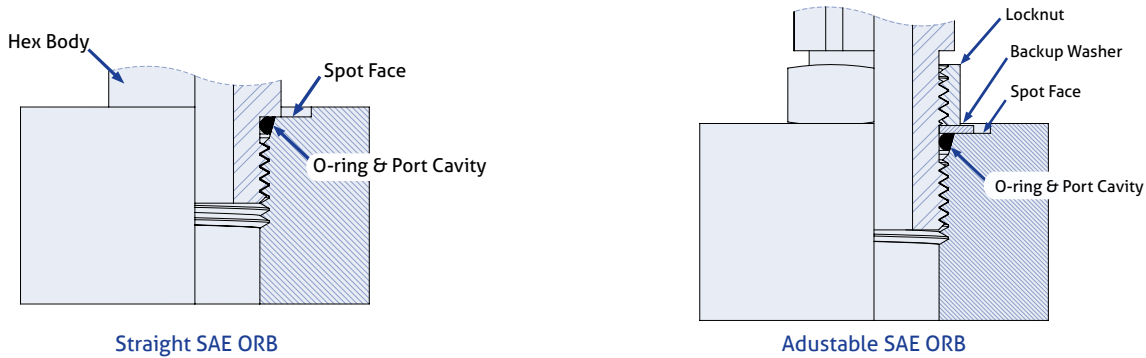

The following table lists the specifications for SAE O-Ring Boss Ports.

SAE O-Ring Boss Specifications									
Dash Size	Tube Size	Thread	SAE-ORB to JIC and Pipe Fittings*			SAE-ORB to ORFS Fittings**			
			Torque		Working Pressure		Torque		Working Pressure
			Adjustable & Non-Adjustable	Adjustable	Non-Adjustable	Adjustable & Non-Adjustable	Adjustable	Non-Adjustable	
			(ft-lbs) +25% -0%	(psi)	(psi)	(ft-lbs) +25% -0%	(psi)	(psi)	
02	1/8	5/16-24	6	4500	4500	-	-	-	
03	3/16	3/8-24	7	4500	4500	7	5800	9100	
04	1/4	7/16-20	13	4500	4500	15	5800	9100	
05	5/16	1/2-20	18	4500	4500	18	5800	9100	
06	3/8	9/16-18	22	3600	4500	26	5800	9100	
08	1/2	3/4-16	37	3600	4500	52	5800	9100	
10	5/8	7/8-14	44	2900	3600	74	5800	9100	
12	3/4	1-1/16-12	70	2900	3600	125	5800	5800	
14	7/8	1-3/16-12	92	2300	2900	158	5800	5800	
16	1	1-5/16-12	111	2300	2900	199	4500	5800	
20	1 1/4	1-5/8-12	147	1800	2300	210	3600	3600	
24	1 1/2	1-7/8-12	155	1800	2300	273	2900	3600	
32	2	2-1/2-12	221	1450	1800	-	-	-	

* = Light duty studs included on JIC, NPTF and NPSM fittings per SAE J1926/3 & J514
 ** = Heavy duty studs included on ORFS fittings per SAE J1926/2 & J1453

Note: Torque values are for wet torque and are allowed up to 25% the listed value according to SAE J2593.

TECHNICAL INFORMATION

HYDRAULIC ADAPTERS

JIC Adapter Specifications

Male flared fittings include a conical nose with external threads for clamping.

A flared fitting or tube assembly is tightened against the cone with a swivel nut. By forcing the flare against the cone during the torquing process, the nose cone is slightly deformed and meshes to create a metal to metal seal between the flare and the cone.

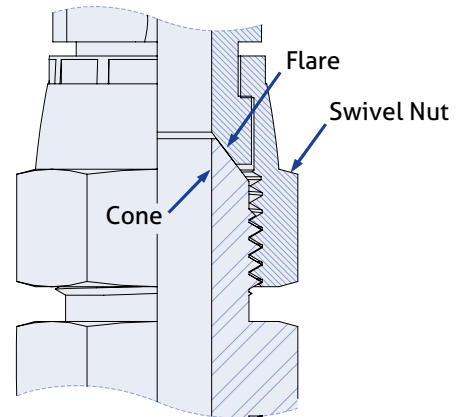

The following table lists the specifications for JIC adapters.

JIC Specifications							
Dash Size	Tube Size	Thread	Working Pressure		Torque		
			Male	Female Swivel Nut	JIC Rigid	JIC Swivel	Bulkhead Locknut
			(psi)	(psi)	(FFWR)	(FFWR)	(ft-lbs) +25% -0%
02	1/8	5/16-24	5000	5000	1/4 - 1/2	2	4
03	3/16	3/8-24	5000	5000	1/4 - 1/2	2	6
04	1/4	7/16-20	5000	4500	1/4 - 1/2	2	10
05	5/16	1/2-20	5000	4000	1/4 - 1/2	2	13
06	3/8	9/16-18	5000	4000	1/4 - 1/2	2	16
08	1/2	3/4-16	4500	4000	1/4 - 1/2	2	27
10	5/8	7/8-14	3500	3000	1/4 - 1/2	1 1/2	32
12	3/4	1-1/16-12	3500	3000	1/4 - 1/2	1 1/2	52
14	7/8	1-3/16-12	3000	2500	1/4 - 1/2	1 1/2	66
16	1	1-5/16-12	3000	2500	1/4 - 1/2	1 1/2	85
20	1 1/4	1-5/8-12	2500	2000	1/4 - 1/2	1	111
24	1 1/2	1-7/8-12	2000	1500	1/4 - 1/2	1	114
32	2	2-1/2-12	1500	1125	1/4 - 1/2	1	162

Values are per SAE J514

It has been my observation that most people get ahead during the time that others waste. -Henry Ford

TECHNICAL INFORMATION

HYDRAULIC ADAPTERS

Pipe & Pipe Swivel Adapter Specifications

NPSM fittings include an inverted 60° cone inside an internally threaded swivel union nut. Male NPTF fittings that have a 30° internal chamfer that make a 60° inverted cone, will mate with NPSM swivel unions.

NOTE: THE MATING MALE THREADS MUST INCLUDE AN INSIDE CHAMFER ON THE END OF THE FITTING THAT MATES WITH THE INVERTED CONE. THREADS ARE FOR CLAMPING FORCE ONLY AND THE SEALING OCCURS ON A SMALL RADIAL SECTION BETWEEN THE MALE FITTING INTERNAL CHAMFER AND THE SWIVEL UNION INVERTED CONE.

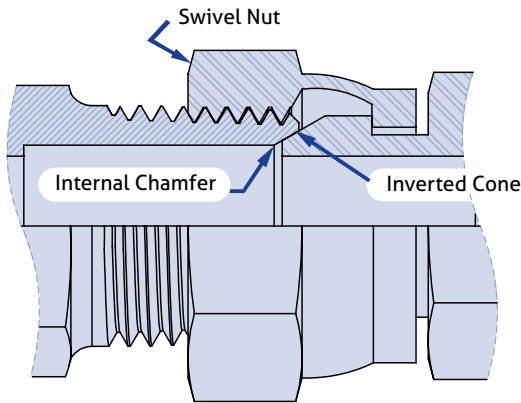

Figure 7 : NPTF & NPSM Union

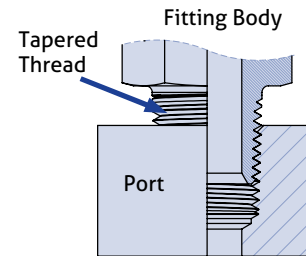

Figure 8: NPT & NPTF Assembly

NPT and NPTF pipe threads seal by wedging the tapered threads through deformation into each other. Both of these threads require thread sealants to complete a seal.

The following table lists the specifications for NPT, NPTF, and NPSM Pipe adapters.

NPT, NPTF, and NPSM Pipe Specifications						
Dash Size	Thread Size	Major OD* (inch)	Working Pressure		Torque	
			NPT, NPTF Male and Female	NPSM Female Swivel Nut	NPT, NPTF	NPSM Swivel Union
			(psi)	(psi)	(TFFT)	(FFWR)
02	1/8-27	.405	5000	5000	2-3	2
04	1/4-18	.540	4000	5000	2-3	2
06	3/8-18	.675	3000	4000	2-3	2
08	1/2-14	.84	3000	3500	2-3	2
12	3/4-14	1.050	2500	2250	2-3	2
16	1-11 1/2	1.315	2000	2000	1 1/2 - 2 1/2	1 1/2
20	1 1/4-11 1/2	1.660	1150	1625	1 1/2 - 2 1/2	1 1/2
24	1 1/2-11 1/2	1.900	1000	1250	1 1/2 - 2 1/2	1 1/2
32	2-11 1/2	2.375	1000	1125	1 1/2 - 2 1/2	1 1/2

Values are per SAE J514 & J2593

Table 3: NPT, NPTF, and NPSM Pipe Specifications

Folks who never do any more than they are paid for, never get paid for any more than they do.

-Elebert Hubbard

TECHNICAL INFORMATION

HYDRAULIC ADAPTERS

O-ring Face Seal Adapter Specifications

O-ring face seal fittings include a precision groove in the face of the male fitting. Sealing occurs when an O-ring is trapped in the groove by a smooth flat flange that is clamped against the face with a nut or nut and sleeve. The flat flange may be formed or brazed onto the end of a tube, or is machined on a fitting.

There are two SAE groove types:

- Type A: The original style A O-ring has no retaining ledge.
- Type B: The Type B groove has a retaining ledge (half dovetail) that improves O-ring retention. The Type B style is more commonly found and is a design improvement over the Type A.

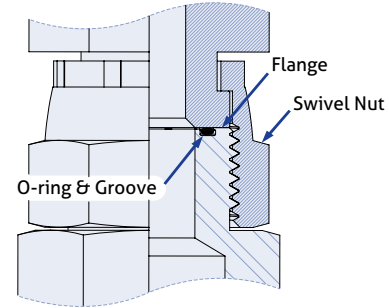

ORFS Fitting Assembly

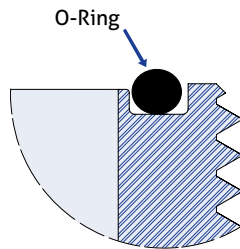

Detail View of Cross Section of Groove Type A

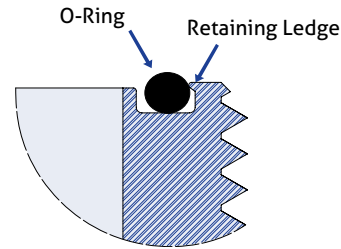

View of Groove Type B

The following table lists the specifications for O-ring Face Seal adapters.

ORFS Specifications								
Dash Size	Tube Size	Thread Size	Working Pressure		Torque			
			Male	Female Swivel Nut	Male & Female	Bulkhead Locknut	Tube Nuts	Swivel Nuts
			(psi)	(psi)	(ft-lbs) +25% -0%	(ft-lbs) +25% -0%		
04	1/4	9/16-18	6000	6000	18	16	1/4-1/2	1/2-3/4
06	3/8	11/16-16	6000	6000	29	22	1/4-1/2	1/2-3/4
08	1/2	13/16-16	6000	6000	41	29	1/4-1/2	1/2-3/4
10	5/8	1-14	6000	6000	44	44	1/4-1/2	1/2-3/4
12	3/4	1-3/16-12	6000	6000	66	66	1/4-1/2	1/3-1/2
16	1	1-7/16-12	6000	5000	92	92	1/4-1/2	1/3-1/2
20	1 1/4	1-11/16-12	4000	4000	125	111	1/4-1/2	1/3-1/2
24	1 1/2	2-12	4000	3000	147	125	1/4-1/2	1/3-1/2

Note: Values are per SAE J2593 & J1453

Torque values are for wet installation of steel components. Reduce torque values for softer material components.

Table 4 : ORFS Specifications

TECHNICAL INFORMATION

HYDRAULIC ADAPTERS

BSPT, BSPP and Metric Adapter Specifications

BSPT and Metric tapered threads install and work in the same manner as NPT and NPTF.

Male BSPP fittings include an inverted 60° cone inside an internally threaded swivel union nut. Male BSPP fittings that have a 30° internal chamfer that make a 60° inverted cone, will mate with Female BSPP swivel unions.

NOTE: THE MATING MALE THREADS MUST INCLUDE AN INSIDE CHAMFER ON THE END OF THE FITTING THAT MATES WITH THE INVERTED CONE. THREADS ARE FOR CLAMPING FORCE ONLY AND THE SEALING OCCURS ON A SMALL RADIAL SECTION BETWEEN THE MALE FITTING INTERNAL CHAMFER AND THE SWIVEL UNION INVERTED CONE.

DIN swivel unions have a 24° inverted cone and may be installed into DIN bite-ring compression fittings. To provide enhanced performance, an O-ring is sometimes included in the cone of some DIN swivel unions.

British Standard Pipe Parallel (BSPP) and Metric Parallel threaded ports do not include a port cavity like the O-ring Boss or ISO 6149 port. Instead, an O-ring sits on top of the spot face or external surface and is surrounded by a metal retaining ring or other retaining component to trap the O-ring between the fitting hex, body, and spot face.

Elbow and Tee fittings have a locknut, backup washer, O-ring and retaining washer to permit 360° orientation around the axis of the port.

The following table lists the specifications for **BSPP & BSPT Adapters**

BSPP & BSPT Specifications				
Dash Size	BSPT & BSPP		Torque	
	THREAD SIZE	MAJOR OD* (inch)	BSPP Swivel Union	BSPT
02	1/8-28	0.383	2	2-3
04	1/4-19	0.518	2	2-3
06	3/8-19	0.656	2	2-3
08	1/2-14	0.825	2	2-3
10	5/8-14	0.929	2	2-3
12	3/4-14	1.041	2	2-3
16	1-11	1.309	1 1/2	1 1/2 - 2 1/2
20	1 1/4-11	1.650	1 1/2	1 1/2 - 2 1/2
24	1 1/2-11	1.882	1 1/2	1 1/2 - 2 1/2
32	2-11	2.347	1 1/2	1 1/2 - 2 1/2

The following table lists the specifications for **Metric Adapters**

Metric DIN 3852-1 Threads	
Dash Size	THREAD SIZE (mm)
08	8 x 1.0
10	10 x 1.0
12	12 x 1.5
14	14 x 1.5
16	16 x 1.5
18	18 x 1.5
20	20 x 1.5
22	22 x 1.5
24	24 x 1.5
26	26 x 1.5
27	27 x 2.0
30	30 x 2.0
33	33 x 2.0
39	39 x 2.0
42	42 x 2.0
48	48 x 2.0
60	60 x 2.0

Values are from DIN 3852-1

TECHNICAL INFORMATION

HYDRAULIC ADAPTERS

PROFILE SIZE CHART

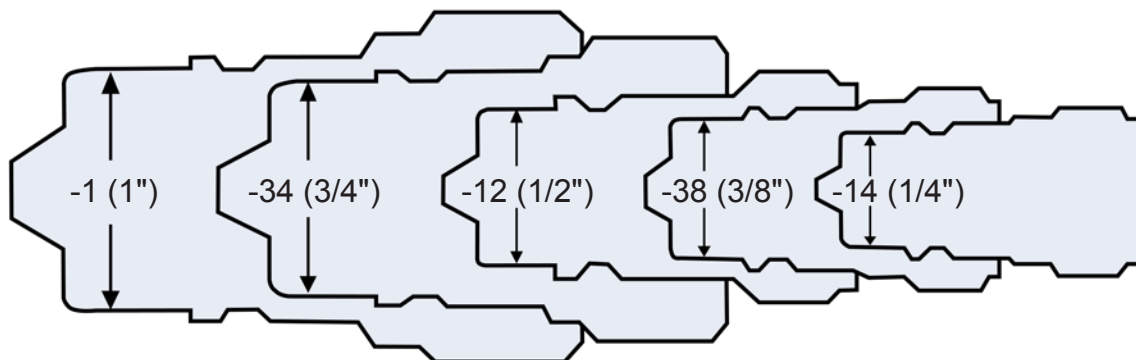
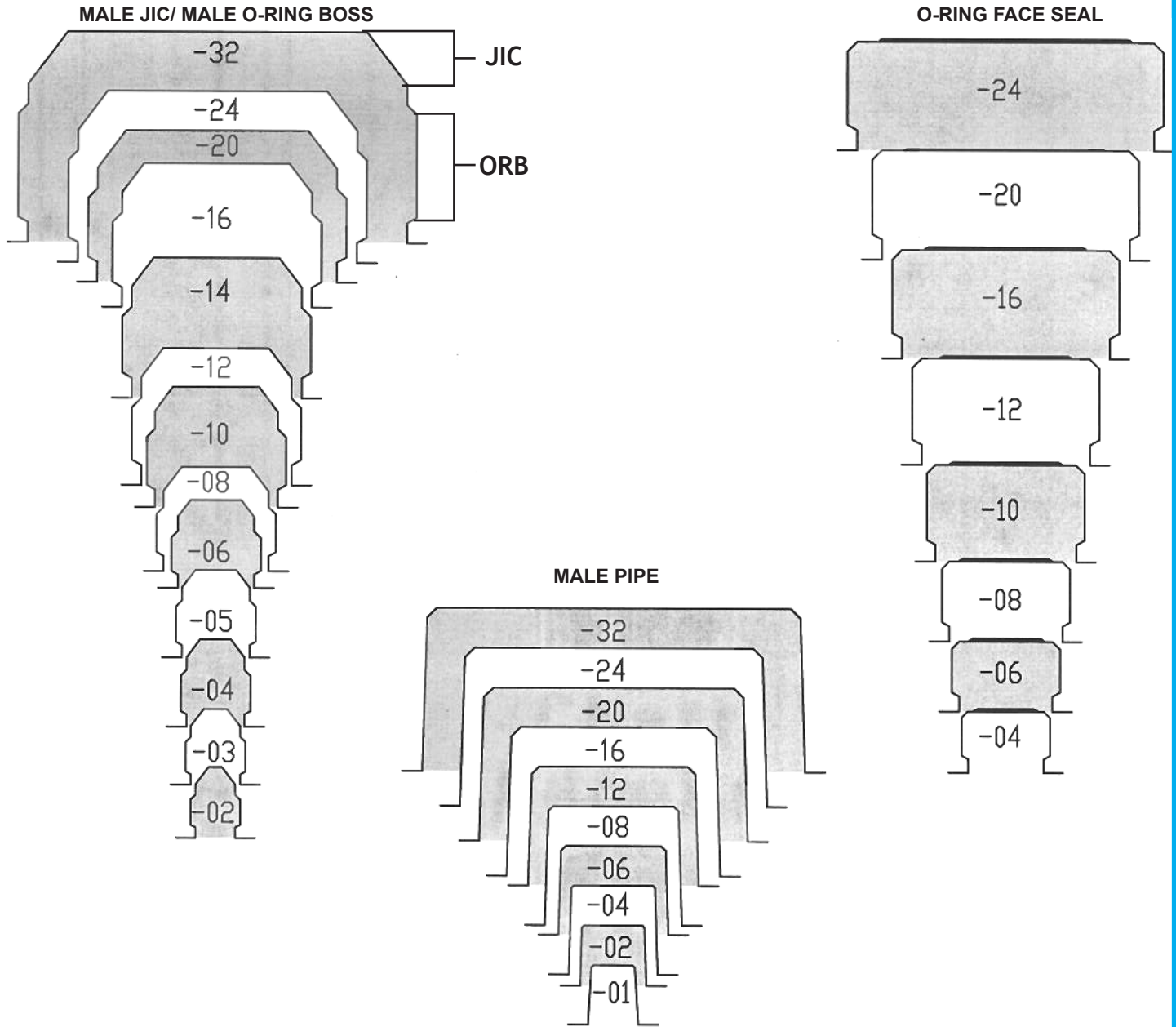

AG INTERCHANGE - NV SERIES

TECHNICAL INFORMATION

HYDRAULIC ADAPTERS

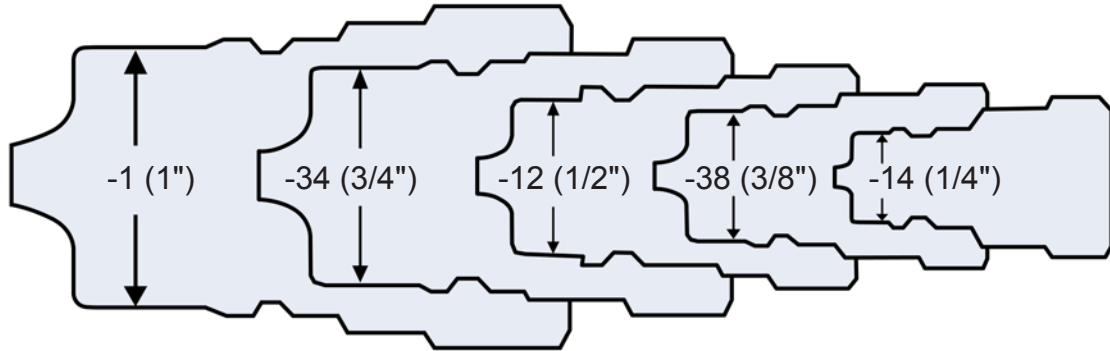

ISO 7241 - 1 - ISO A - ANV SERIES

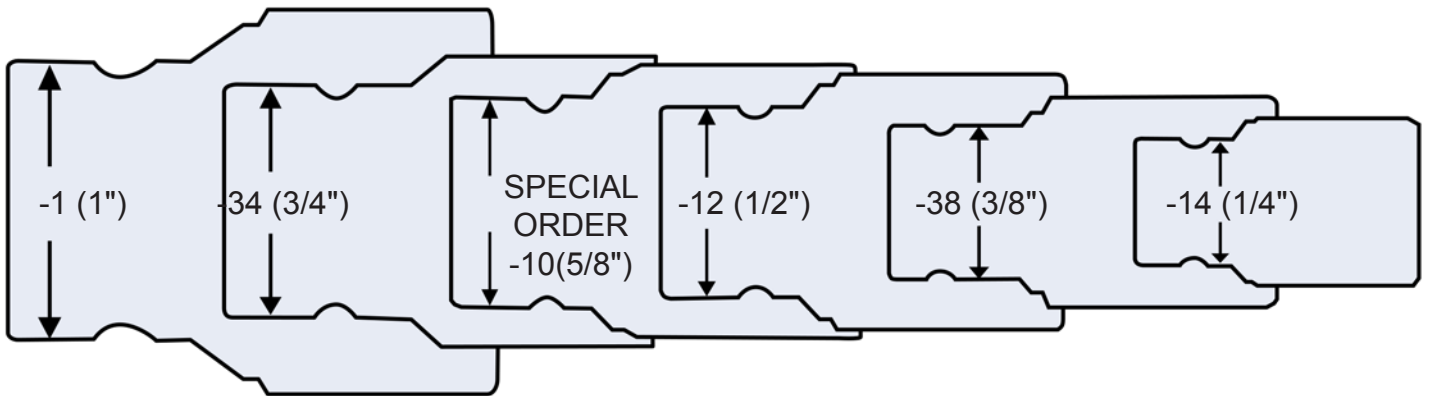

ISO 16028 - FF SERIES

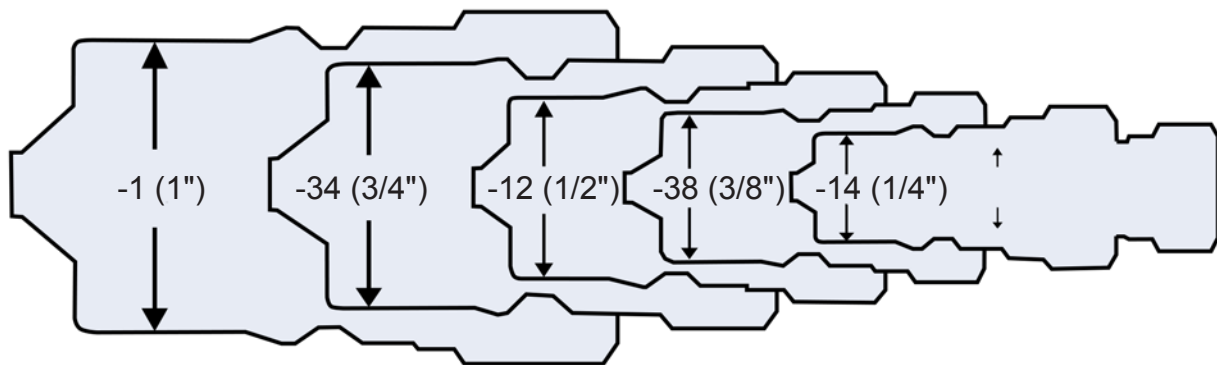

ISO 7241 - 1 ISO B - HNV SERIES

STEEL PIPE SWIVEL ADAPTERS

HYDRAULIC ADAPTERS

MALE PIPE SWIVEL ADAPTER

SAE 140130



PART #	MALE PIPE 1	FEMALE NPSM 2	
140422	1/8	1/8	----
140442	1/4	1/8	----
140444	1/4	1/4	----
140464	3/8	1/4	----
140466	3/8	3/8	----
140468	3/8	1/2	----
140484	1/2	1/4	----
140486	1/2	3/8	----
140488	1/2	1/2	----
1404812	1/2	3/4	----
1404126	3/4	3/8	----
1404128	3/4	1/2	----
14041212	3/4	3/4	----
14041216	3/4	1	----
14041612	1	3/4	----
14041616	1	1	----
14041620	1	1-1/4	----
14042024	1-1/4	1-1/2	----
14042016	1-1/4	1	----
14042020	1-1/4	1-1/4	----
14042424	1-1/2	1-1/2	----
14043232	2	2	----

1404 2045R 1210 9205R 0107

FEMALE PIPE SWIVEL ADAPTER

SAE 140131



PART #	FEMALE PIPE 1	FEMALE NPSM 2	
140522	1/8	1/8	----
140542	1/4	1/8	----
140544	1/4	1/4	----
140546	1/4	3/8	----
140564	3/8	1/4	----
140566	3/8	3/8	----
140586	1/2	3/8	----
140568	3/8	1/2	----
140584	1/2	1/4	----
140588	1/2	1/2	----
1405812	1/2	3/4	----
1405128	3/4	1/2	----
14051212	3/4	3/4	----
14051216	3/4	1	----
14051612	1	3/4	----
14051616	1	1	----
14052020	1-1/4	1-1/4	----
14052424	1-1/2	1-1/2	----
14053232	2	2	----

1405 2046R 1212 9255 C207

MALE PIPE ELBOW SWIVEL ADAPTER

SAE 140230



PART #	MALE PIPE 1	FEMALE NPSM 2	
150122	1/8	1/8	----
150124	1/8	1/4	----
150142	1/4	1/8	----
150144	1/4	1/4	----
150146	1/4	3/8	----
150148	1/4	1/2	----
150164	3/8	1/4	----
150166	3/8	3/8	----
1501612	3/8	3/4	----
150184	1/2	1/4	----
150186	1/2	3/8	----
150188	1/2	1/2	----
1501126	3/4	3/8	----
1501128	3/4	1/2	----
15011212	3/4	3/4	----
15011216	3/4	1	----
1501168	1	1/2	----
15011612	1	3/4	----
15011616	1	1	----
15012016	1-1/4	1	----
15012020	1-1/4	1-1/4	----
15013232	2	2	----

1501 2047R 1218 9405 2107

FEMALE UNION ELBOW SWIVEL ADAPTER

SAE 140231



PART #	FEMALE PIPE 1	FEMALE NPSM 2	
150222	1/8	1/8	----
150242	1/4	1/8	----
150244	1/4	1/4	----
150246	1/4	3/8	----
150264	3/8	1/4	----
150266	3/8	3/8	----
150268	3/8	1/2	----
150284	1/2	1/4	----
150286	1/2	3/8	----
150288	1/2	1/2	----
1502812	1/2	3/4	----
1502128	3/4	1/2	----
15021212	3/4	3/4	----
15021616	1	1	----
15022020	1-1/4	1-1/4	----
15022424	1-1/2	1-1/2	----

1502 2207 1216 9455R

FEMALE PIPE SWIVELS

HYDRAULIC ADAPTERS

MALE 45° PIPE ELBOW SWIVEL ADAPTER

SAE 140330

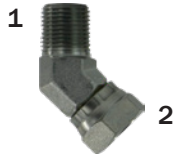

PART #	MALE PIPE 1	FEMALE NPSM 2	
150322	1/8	1/8	----
150344	1/4	1/4	----
150346	1/4	3/8	----
150364	3/8	1/4	----
150366	3/8	3/8	----
150368	3/8	1/2	----
150384	1/2	1/4	----
150386	1/2	3/8	----
150388	1/2	1/2	----
1503812	1/2	3/4	----
1503128	3/4	1/2	----
15031212	3/4	3/4	----
15031216	3/4	1	----
15031612	1	3/4	----
15031616	1	1	----
15031620	1	1-1/4	----
15032020	1-1/4	1-1/4	----

1503 2049R 3107 1214 9355R

FEMALE 45° UNION ELBOW SWIVEL ADAPTER

SAE 140331



PART #	FEMALE PIPE 1	FEMALE NPSM 2	
150422	1/8	1/8	----
150444	1/4	1/4	----
150466	3/8	3/8	----
150488	1/2	1/2	----
15041212	3/4	3/4	----
15041616	1	1	----

1504 2050R 1249 9385R

MALE SWIVEL BRANCH TEE

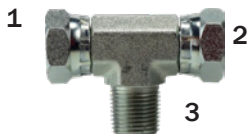

PART #	FEMALE NPSM 1 & 2	MALE PIPE 3	
160122	1/8	1/8	----
160144	1/4	1/4	----
160166	3/8	3/8	----
160188	1/2	1/2	----
16011212	3/4	3/4	----
16011616	1	1	----

1601 2254R 1258 9406R

FEMALE SWIVEL TEE

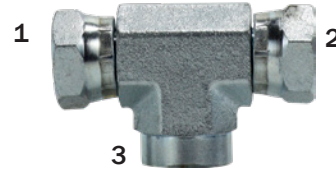

PART #	FEMALE NPSM 1 & 2	FEMALE PIPE 3	
160244	1/4	1/4	----
160266	3/8	3/8	----
160288	1/2	1/2	----
16021212	3/4	3/4	----
16021616	1	1	----

1602 2253R 1259 9456R

FEMALE SWIVEL UNION TEE



PART #	FEMALE NPSM 1,2 & 3	
160344	1/4	----
160366	3/8	----
160388	1/2	----
16031212	3/4	----
16031616	1	----

1603 2255 1223 9705R

STRAIGHTS STEEL JIC FLARE 37°

HYDRAULIC ADAPTERS

LONG JIC TUBE NUT

SAE 070111



PART #	TUBE O.D	JIC THREAD SIZE	
03044	1/4	7/16-20	----
03046	3/8	9/16-18	----
03048	1/2	3/4-16	----
030410	5/8	7/8-14	----
030412	3/4	1-1/16-12	----
030416	1	1-5/16-12	----

304 221000 0304 C5115

CAP

SAE 070112
MS 51532



PART #	TUBE O.D.	JIC THREAD SIZE	
0304C2	1/8	5/16-24	----
0304C3	3/16	3/8-24	----
0304C4	1/4	7/16-20	----
0304C5	5/16	1/2-20	----
0304C6	3/8	9/16-18	----
0304C8	1/2	3/4-16	----
0304C10	5/8	7/8-14	----
0304C12	3/4	1-1/16-12	----
0304C14	7/8	1-3/16-12	----
0304C16	1	1-5/16-12	----
0304C20	1-1/4	1-5/8-12	----
0304C24	1-1/2	1-7/8-12	----
0304C32	2	2-1/2-12	----

820 304 210292 FNTX 1329 C5129

JIC TUBE NUT (SLEEVE REQUIRED)

SAE 070110
MS 51531



PART #	TUBE O.D	JIC THREAD SIZE	
03182	1/8	5/16-24	----
03183	3/16	3/8-24	----
03184	1/4	7/16-20	----
03185	5/16	1/2-20	----
03186	3/8	9/16-18	----
03188	1/2	3/4-16	----
031810	5/8	7/8-14	----
031812	3/4	1-1/16-12	----
031814	7/8	1-3/16-12	----
031816	1	1-5/16-12	----
031820	1-1/4	1-5/8-12	----
031824	1-1/2	1-7/8-12	----

318 1290 BTX 1311 C5105

JIC TUBE SLEEVE

SAE 070115
MS 51533



PART #	TUBE O.D	
03192	1/8	----
03193	3/16	----
03194	1/4	----
03195	5/16	----
03196	3/8	----
03198	1/2	----
031910	5/8	----
031912	3/4	----
031914	7/8	----
031916	1	----
031920	1-1/4	----
031924	1-1/2	----
031932	2	----

319 900605 TX 1253 C5165

JIC TUBE UNION

SAE 070101
MS 51501



PART #	JIC THREAD SIZE 1	JIC THREAD SIZE 2	
240322	5/16-24	5/16-24	----
240333	3/8-24	3/8-24	----
240344	7/16-20	7/16-20	----
240355	1/2-20	1/2-20	----
240366	9/16-18	9/16-18	----
240364	9/16-18	7/16-20	----
240384	3/4-16	7/16-20	----
240388	3/4-16	3/4-16	----
240386	3/4-16	9/16-18	----
24031010	7/8-14	7/8-14	----
2403108	7/8-14	3/4-16	----
24031212	1-1/16-12	1-1/16-12	----
2403126	1-1/16-12	9/16-18	----
2403128	1-1/16-12	3/4-16	----
24031210	1-1/16-12	7/8-14	----
24031414	1-3/16-12	1-3/16-12	----
24031616	1-5/16-12	1-5/16-12	----
24031612	1-5/16-12	1-1/16-12	----
24032016	1-5/8-12	1-5/16-12	----
24032020	1-5/8-12	1-5/8-12	----
240324	1-7/8-12	1-7/8-12	----
240332	2-1/2-12	2-1/2-12	----

2403 2027 HTX 1204 C5305

WARNING: This product can expose you to chemicals, including Cobalt, which are known to the State of California to cause cancer. For more information, visit www.P65Warnings.ca.gov

STRAIGHTS STEEL JIC FLARE 37°

HYDRAULIC ADAPTERS

JIC MALE CONNECTORSAE 070102
MS 51500

1



2

PART #	JIC THREAD SIZE 1	MALE PIPE THREAD 2	
240422	5/16-24	1/8	----
240432	3/8-24	1/8	----
240434	3/8-24	1/4	----
240442	7/16-20	1/8	----
240444	7/16-20	1/4	----
240446	7/16-20	3/8	----
240448	7/16-20	1/2	----
240462	9/16-18	1/8	----
240464	9/16-18	1/4	----
240466	9/16-18	3/8	----
240468	9/16-18	1/2	----
2404612	9/16-18	3/4	----
240484	3/4-16	1/4	----
240486	3/4-16	3/8	----
240488	3/4-16	1/2	----
2404812	3/4-16	3/4	----
2404816	3/4-16	1	----
2404104	7/8-14	1/4	----
2404106	7/8-14	3/8	----
2404108	7/8-14	1/2	----
24041012	7/8-14	3/4	----
2404126	1-1/16-12	3/8	----
2404128	1-1/16-12	1/2	----
24041212	1-1/16-12	3/4	----
24041216	1-1/16-12	1	----
24041612	1-5/16-12	3/4	----
24041616	1-5/16-12	1	----
24041620	1-5/16-12	1-1/4	----
24041624	1-5/16-12	1-1/2	----
24042012	1-5/8-12	3/4	----
24042016	1-5/8-12	1	----
24042020	1-5/8-12	1-1/4	----
24042024	1-5/8-12	1-1/2	----
24042416	1-7/8-12	1	----
24042420	1-7/8-12	1-1/4	----
24042424	1-7/8-12	1-1/2	----
24042432	1-7/8-12	2	----
24043224	2-1/2-12	1-1/2	----
24043232	2-1/2-12	2	----

2404 2021R FTX 1202R C5205 816

JIC FEMALE CONNECTORSAE 070103
MS 51503

1

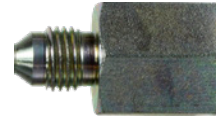

2

PART #	JIC THREAD SIZE 1	FEMALE PIPE SIZE 2	
240522	5/16-24	1/8	----
240532	3/8-24	1/8	----
240542	7/16-20	1/8	----
240544	7/16-20	1/4	----
240546	7/16-20	3/8	----
240564	9/16-18	1/4	----
240566	9/16-18	3/8	----
240584	3/4-16	1/4	----
240586	3/4-16	3/8	----
240588	3/4-16	1/2	----
2405812	3/4-16	3/4	----
2405106	7/8-14	3/8	----
2405108	7/8-14	1/2	----
2405128	1-1/16-12	1/2	----
24051212	1-1/16-12	3/4	----
24051216	1-1/16-12	1	----
24051612	1-5/16-12	3/4	----
24051616	1-5/16-12	1	----
24052020	1-5/8-12	1-1/4	----

2405 2022R GTX 1230R C5255

WARNING: This product can expose you to chemicals, including Cobalt, which are known to the State of California to cause cancer. For more information, visit www.P65Warnings.ca.gov



STRAIGHTS STEEL JIC FLARE 37°

HYDRAULIC ADAPTERS

JIC REDUCER/ EXPANDER

SAE 070123 1



2

PART #	FEMALE JIC THREAD SIZE 1	MALE JIC THREAD SIZE 2	
240664	9/16-18	7/16-20	----
240665	9/16-18	1/2-20	----
240668	9/16-18	3/4-16	----
240684	3/4-16	7/16-20	----
240686	3/4-16	9/16-18	----
2406812	3/4-16	1-1/16-12	----
2406104	7/8-14	7/16-20	----
2406106	7/8-14	9/16-18	----
2406108	7/8-14	3/4-16	----
2406124	1-1/16-12	7/16-20	----
2406126	1-1/16-12	9/16-18	----
2406128	1-1/16-12	3/4-16	----
24061210	1-1/16-12	7/8-14	----
24061216	1-1/16-12	1-5/16-12	----
2406164	1-5/16-12	7/16-20	----
2406166	1-5/16-12	9/16-18	----
2406168	1-5/16-12	3/4-16	----
24061612	1-5/16-12	1-1/16-12	----
24061620	1-5/16-12	1-5/8-12	----
2406208	1-5/8-12	3/4-16	----
24062012	1-5/8-12	1-1/16-12	----
24062012	1-5/8-12	1-1/16-12	----
24062016	1-5/8-12	1-5/16-12	----
24062416	1-7/8-12	1-5/16-12	----
24062420	1-7/8-12	1-5/8-12	----
24063224	2-1/2-12	1-7/8-12	----

2406 C5015 2215 TRTX 1246

PLUG

SAE 070109
MS 51518



PART #	TUBE O.D.	JIC THREAD SIZE	
24082	1/8	5/16-24	----
24083	3/16	3/8-24	----
24084	1/4	7/16-20	----
24085	5/16	1/2-20	----
24086	3/8	9/16-18	----
24088	1/2	3/4-16	----
240810	5/8	7/8-14	----
240812	3/4	1-1/16-12	----
240814	7/8	1-3/16-12	----
240816	1	1-5/16-12	----
240820	1-1/4	1-5/8-12	----
240824	1-1/2	1-7/8-12	----
240832	2	2-1/2-12	----

2408 430549 PNTX 1254 C5229

STEEL 37° JIC FLARE SHAPES

JIC UNION ELBOW

SAE 070201 1
MS 51505



2

PART #	JIC THREAD SIZE 1	JIC THREAD SIZE 2	
250022	5/16-24	5/16-24	----
250044	7/16-20	7/16-20	----
250055	1/2-20	1/2-20	----
250066	9/16-18	9/16-18	----
250064	9/16-18	7/16-20	----
250088	3/4-16	3/4-16	----
250086	3/4-16	9/16-18	----
25001010	7/8-14	7/8-14	----
25001212	1-1/16-12	1-1/16-12	----
25001612	1-5/16-12	1-1/16-12	----
25001616	1-5/16-12	1-5/16-12	----
25002020	1-5/8-12	1-5/8-12	----
25002424	1-7/8-12	1-7/8-12	----
25003232	2-1/2-12	2-1/2-12	----

2500 2039 1234 C5505 821

WARNING: This product can expose you to chemicals, including Cobalt, which are known to the State of California to cause cancer.
 For more information, visit www.P65Warnings.ca.gov

HYDRAULICS

STRAIGHTS STEEL JIC FLARE 37°

HYDRAULIC ADAPTERS

JIC MALE ELBOW

SAE 070202
MS 51504



PART #	JIC THREAD SIZE 1	MALE PIPE SIZE 2	
250122	5/16-24	1/8	----
250142	7/16-20	1/8	----
250144	7/16-20	1/4	----
250146	7/16-20	3/8	----
250148	7/16-20	1/2	----
250162	9/16-18	1/8	----
250164	9/16-18	1/4	----
250166	9/16-18	3/8	----
250168	9/16-18	1/2	----
2501612	9/16-18	3/4	----
250184	3/4-16	1/4	----
250186	3/4-16	3/8	----
250188	3/4-16	1/2	----
2501812	3/4-16	3/4	----
2501816	3/4-16	1	----
2501106	7/8-14	3/8	----
2501108	7/8-14	1/2	----
2501128	1-1/16-12	1/2	----
25011212	1-1/16-12	3/4	----
25011216	1-1/16-12	1	----
25011612	1-5/16-12	3/4	----
25011616	1-5/16-12	1	----
25011620	1-5/16-12	1-1/4	----
25012016	1-5/8-12	1	----
25012020	1-5/8-12	1-1/4	----
25012024	1-5/8-12	1-1/2	----
25012420	1-7/8-12	1-1/4	----
25012424	1-7/8-12	1-1/2	----
25013232	2-1/2-12	2	----

1208R C5405 2501 2024R CTX 822

JIC FEMALE ELBOW

SAE 070203
MS 51506

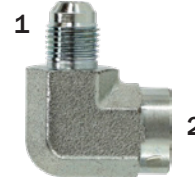

PART #	JIC THREAD SIZE 1	FEMALE PIPE SIZE 2	
250242	7/16-20	1/8	----
250244	7/16-20	1/4	----
250246	7/16-20	3/8	----
250262	9/16-18	1/8	----
250264	9/16-18	1/4	----
250266	9/16-18	3/8	----
250268	9/16-18	1/2	----
250284	3/4-16	1/4	----
250286	3/4-16	3/8	----
250288	3/4-16	1/2	----
2502128	1-1/16-12	1/2	----
25021212	1-1/16-12	3/4	----
25021612	1-5/16-12	3/4	----
25021616	1-5/16-12	1	----
25022020	1-5/8-12	1-1/4	----

2502 2025R DTX 1240R C5455

JIC MALE 45° ELBOW

SAE 070302
MS 51508



PART #	JIC THREAD SIZE 1	MALE PIPE SIZE 2	
250322	5/16-24	1/8	----
250342	7/16-20	1/8	----
250344	7/16-20	1/4	----
250346	7/16-20	3/8	----
250362	9/16-18	1/8	----
250364	9/16-18	1/4	----
250366	9/16-18	3/8	----
250368	9/16-18	1/2	----
2503612	9/16-18	3/4	----
250384	3/4-16	1/4	----
250386	3/4-16	3/8	----
250388	3/4-16	1/2	----
2503106	7/8-14	3/8	----
2503108	7/8-14	1/2	----
25031012	7/8-14	3/4	----
25031212	1-1/16-12	3/4	----
25031216	1-1/16-12	1	----
25031616	1-5/16-12	1	----
25031620	1-5/16-12	1-1/4	----
25032016	1-5/8-12	1	----
25032020	1-5/8-12	1-1/4	----

2503 2023R VTX 1206R C5355 823

SHAPES STEEL JIV FLARE 37°

HYDRAULIC ADAPTERS

JIC MALE BRANCH TEE

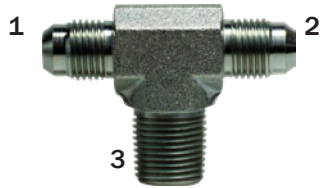

PART #	JIC THREAD SIZE 1&2	PIPE THREAD SIZE 3	
260144	7/16-20	1/4	----
260166	9/16-18	3/8	----
260188	3/4-16	1/2	----
26011212	1-1/16-12	3/4	----

2601 2030R STX 1221R C5605

JIC FEMALE BRANCH TEE

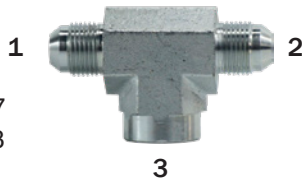

SAE 070427
MS 51513

PART #	JIC THREAD SIZE 1 & 2	FEMALE PIPE SIZE 3	
260244	7/16-20	1/4	----
260266	9/16-18	3/8	----
260288	3/4-16	1/2	----

2602 2031R OTX 1228R C6566

JIC UNION TEE

SAE 070401
MS 51510



PART #	JIC THREAD SIZE 1 & 2	JIC THREAD SIZE 3	
260322	5/16-24	5/16-24	----
260333	3/8-24	3/8-24	----
260344	7/16-20	7/16-20	----
260366	9/16-18	9/16-18	----
260388	3/4-16	3/4-16	----
26031010	7/8-14	7/8-14	----
26031212	1-1/16-12	1-1/16-12	----
26031616	1-5/16-12	1-5/16-12	----

2603 2033 JTX 1220 C5705

STEEL BULKHEAD FITTINGS

LOCK NUT

SAE 070118
MS 51860



* Lock Nut no longer included on fittings

PART #	THREAD SIZE	
03062	5/16-24	----
03064	7/16-20	----
03065	1/2-20	----
03066	9/16-18	----
03068	3/4-16	----
030610	7/8-14	----
030612	1-1/16-12	----
030614	1-3/16-12	----
030616	1-5/16-12	----
030620	1-5/8-12	----

1306 894 210212 WLN 1332 C5624

JIC BULKHEAD UNION

SAE 070601
MS 51520



PART #	JIC THREAD SIZE 1	JIC THREAD SIZE 2	
270022	5/16-24	5/16-24	----
270044	7/16-20	7/16-20	----
270055	1/2-20	1/2-20	----
270066	9/16-18	9/16-18	----
27008	3/4-16	3/4-16	----
270010	7/8-14	7/8-14	----
270012	1-1/16-12	1-1/16-12	----
270014	1-3/16-12	1-3/16-12	----
270016	1-5/16-12	1-5/16-12	----

2700 2041R WTX 1260 C5325

WARNING: This product can expose you to chemicals, including Cobalt, which are known to the State of California to cause cancer.
 For more information, visit www.P65Warnings.ca.gov

STEEL BULKHEAD FITTINGS

HYDRAULIC ADAPTERS

JIC BULKHEAD UNION ELBOW

1

SAE 070701
MS 51507



2

PART #	JIC THREAD SIZE 1	JIC BULKHEAD THREAD 2	
27014	7/16-20	7/16-20	----
27015	1/2-20	1/2-20	----
27016	9/16-18	9/16-18	----
27018	3/4-16	3/4-16	----
270110	7/8-14	7/8-14	----
270112	1-1/16-12	1-1/16-12	----
270116	1-5/16-12	1-5/16-12	----
270120	1-5/8-12	1-5/8-12	----

2701 2043R WETX 1262 C5525

JIC BULKHEAD UNION 45° ELBOW

1

SAE 070801
MS 51509



2

PART #	JIC THREAD SIZE 1	JIC THREAD SIZE 2	
27024	7/16-20	7/16-20	----
27026	9/16-18	9/16-18	----
27028	3/4-16	3/4-16	----
270210	7/8-14	7/8-14	----
270212	1-1/16-12	1-1/16-12	----
270216	1-5/16-12	1-5/16-12	----

2702 2042 WNTX 1261 C5375

JIC BULKHEAD BRANCH TEE

1

SAE 070959
MS 51515



2

3

PART #	JIC THREAD SIZE 1&2	JIC THREAD SIZE 3	
27034	7/16-20	7/16-20	----
27036	9/16-18	9/16-18	----
27038	3/4-16	3/4-16	----
270310	7/8-14	7/8-14	----
270312	1-1/16-12	1-1/16-12	----
270316	1-5/16-12	1-5/16-12	----

2703 203002 WJT 1283 C5725

JIC BULKHEAD RUN TEE

1

SAE 070958
MS 51516

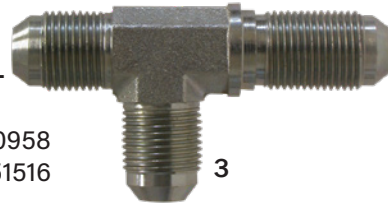

2

3

PART #	JIC THREAD SIZE 1&3	JIC THREAD SIZE 2	
27044	7/16-20	7/16-20	----
27046	9/16-18	9/16-18	----
27048	3/4-16	3/4-16	----
270410	7/8-14	7/8-14	----
270412	1-1/16-12	1-1/16-12	----
270416	1-5/16-12	1-5/16-12	----

2704 203008 WJIT 1284 C5726

JIC TO FEMALE PIPE BULKHEAD

1

PART #

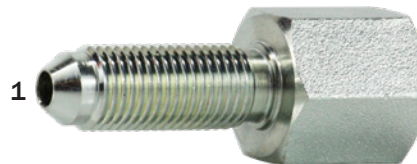

2

PART #	JIC THREAD SIZE 1	FEMALE PIPE SIZE 2	
270544	7/16-20		----
270566	9/16-18	3/8	----
270588	3/4-16	1/2	----
27051212	1-1/16-12	3/4	----
27051616	1-5/16-12	1	----
27052020	1-5/8-12	1-1/4	----

2705 2239 WGTX C5275

JIC TO MALE PIPE BULKHEAD

1

PART #

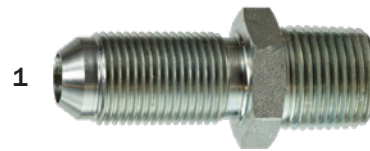

2

PART #	JIC THREAD SIZE 1	PIPE THREAD SIZE 2	
270644	7/16-20	1/4	----
270666	9/16-18	3/8	----
270688	3/4-16	1/2	----
27061212	1-1/16-12	3/4	----
27061616	1-5/16-12	1	----

2706 2240

WARNING: This product can expose you to chemicals, including Cobalt, which are known to the State of California to cause cancer. For more information, visit www.P65Warnings.ca.gov



* Lock Nuts sold separately - pg. 403

STEEL PIPE FITTINGS

HYDRAULIC ADAPTERS

SAE 140138 PIPE COUPLING 910



PART #	FEMALE PIPE 1	FEMALE PIPE 2	
50002	1/8	1/8	----
500042	1/4	1/8	----
50004	1/4	1/4	----
500064	3/8	1/4	----
500066	3/8	3/8	----
500084	1/2	1/4	----
500086	1/2	3/8	----
50008	1/2	1/2	----
5000128	3/4	1/2	----
50001212	3/4	3/4	----
5000168	1	1/2	----
50001612	1	3/4	----
500016	1	1	----
50002020	1-1/4	1-1/4	----
500024	1-1/2	1-1/2	----
500032	2	2	----

5000 2096 GG 1273 C3309

HEX PIPE NIPPLES



PART #	MALE PIPE 1	MALE PIPE 2	
54042	1/8	1/8	----
540442	1/4	1/8	----
54044	1/4	1/4	----
540462	3/8	1/8	----
540464	3/8	1/4	----
54046	3/8	3/8	----
540484	1/2	1/4	----
540486	1/2	3/8	----
54048	1/2	1/2	----
5404126	3/4	3/8	----
5404128	3/4	1/2	----
540412	3/4	3/4	----
5404166	1	3/8	----
5404168	1	1/2	----
54041612	1	3/4	----
540416	1	1	----
54042012	1-1/4	3/4	----
54042016	1-1/4	1	----
540420	1-1/4	1-1/4	----
54042412	1-1/2	3/4	----
54042416	1-1/2	1	----
54042420	1-1/2	1-1/4	----
540424	1-1/2	1-1/2	----
54043224	2	1-1/2	----

5404 2083 FF 1252 C3069 911

EXPANDING PIPE ADAPTER



PART #	MALE PIPE 1	FEMALE PIPE 2	
540522	1/8	1/8	----
540524	1/8	1/4	----
540542	1/4	1/8	----
540544	1/4	1/4	----
540548	1/4	1/2	----
540564	3/8	1/4	----
540566	3/8	3/8	----
540568	3/8	1/2	----
5405612	3/8	3/4	----
540588	1/2	1/2	----
5405812	1/2	3/4	----
5405816	1/2	1	----
54051212	3/4	3/4	----
54051216	3/4	1	----
54051220	3/4	1-1/4	----
54051616	1	1	----
54051620	1	1-1/4	----
54052020	1-1/4	1-1/4	----
54052024	1-1/4	1-1/2	----
54052424	1-1/2	1-1/2	----

920 5405 2040 FG-(R) 1274 C3209(R)

WARNING: This product can expose you to chemicals, including Cobalt, which are known to the State of California to cause cancer. For more information, visit www.P65Warnings.ca.gov



5406 2081 PTR 1250 C3109 912

STEEL PIPE FITTINGS

HYDRAULIC ADAPTERS

HEX REDUCER BUSHING

SAEF1
140140

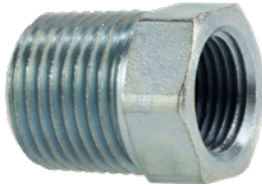

PART #	MALE PIPE	FEMALE PIPE	
540642	1/4	1/8	----
540662	3/8	1/8	----
540664	3/8	1/4	----
540682	1/2	1/8	----
540684	1/2	1/4	----
540686	1/2	3/8	----
5406124	3/4	1/4	----
5406126	3/4	3/8	----
5406128	3/4	1/2	----
5406164	1	1/4	----
5406166	1	3/8	----
5406168	1	1/2	----
54061612	1	3/4	----
5406206	1-1/4	3/8	----
5406208	1-1/4	1/2	----
54062012	1-1/4	3/4	----
54062016	1-1/4	1	----
5406248	1-1/2	1/2	----
54062412	1-1/2	3/4	----
54062416	1-1/2	1	----
54062420	1-1/2	1-1/4	----
54063212	2	3/4	----
54063216	2	1	----
54063220	2	1-1/4	----
54063224	2	1-1/2	----

HEX HEAD PLUG

SAE 130109E



PART #	MALE PIPE	
5406P2	1/8	----
5406P4	1/4	----
5406P6	3/8	----
5406P8	1/2	----
5406P12	3/4	----
5406P16	1	----
5406P20	1-1/4	----
5406P24	1-1/2	----
5406P32	2	----

933 5406P 2082 HP 1251 C3159

HOLLOW HEX PLUG

SAE 130109



PART #	MALE PIPE	
5406HHP2	1/8	----
5406HHP4	1/4	----
5406HHP6	3/8	----
5406HHP8	1/2	----
5406HHP12	3/4	----
5406HHP16	1	----
5406HHP20	1-1/4	----
5406HHP24	1-1/2	----

C3169 2222

FLUSH HOLLOW HEX PLUG W/ 7/8 TAPER



PART #	MALE PIPE	
5406FLP2	1/8	----
5406FLP4	1/4	----
5406FLP6	3/8	----
5406FLP8	1/2	----
5406FLP12	3/4	----

SQUARE HEAD PLUG

SAE 130109A



PART #	MALE PIPE	
5406SHP2	1/8	----
5406SHP4	1/4	----
5406SHP6	3/8	----
5406SHP8	1/2	----
5406SHP12	3/4	----
5406SHP16	1	----
5406SHP20	1-1/4	----
5406SHP24	1-1/2	----
5406SHP32	2	----

C3179

STEEL PIPE FITTINGS

HYDRAULIC ADAPTERS

PIPE CAP



PART #	FEMALE PIPE	
5406C2	1/8	----
5406C4	1/4	----
5406C6	3/8	----
5406C8	1/2	----
5406C12	3/4	----
5406C16	1	----

HPC

MALE ELBOW

SAE 140237



PART #	MALE PIPE 1	MALE PIPE 2	
55002	1/8	1/8	----
550042	1/4	1/8	----
55004	1/4	1/4	----
550064	3/8	1/4	----
55006	3/8	3/8	----
550084	1/2	1/4	----
550086	1/2	3/8	----
55008	1/2	1/2	----
5500128	3/4	1/2	----
55001212	3/4	3/4	----
55001612	1	3/4	----
550016	1	1	----
55001612	1	3/4	----
55002016	1-1/4	1	----
55002020	1-1/4	1-1/4	----
550024	1-1/2	1-1/2	----
550032	2	2	----

919 5500 2085 CR 1275 C3529

WARNING: This product can expose you to chemicals, including Cobalt, which are known to the State of California to cause cancer. For more information, visit www.P65Warnings.ca.gov

HYDRAULICS

STEEL PIPE FITTINGS

HYDRAULIC ADAPTERS

45° MALE ELBOW

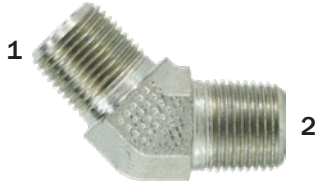

PART #	MALE PIPE 1	MALE PIPE 2	
550122	1/8	1/8	----
550144	1/4	1/4	----
550166	3/8	3/8	----
55018	1/2	1/2	----
55011212	3/4	3/4	----
55011616	1	1	----

5501 2247

90° STREET ELBOW

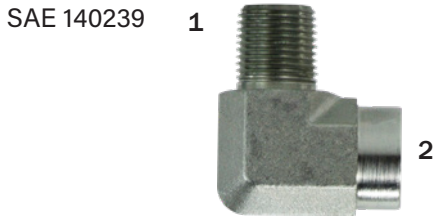

PART #	MALE PIPE 1	FEMALE PIPE 2	
55022	1/8	1/8	----
55024	1/4	1/4	----
550264	3/8	1/4	----
55026	3/8	3/8	----
550268	3/8	1/2	----
550284	1/2	1/4	----
550286	1/2	3/8	----
550288	1/2	1/2	----
550212	3/4	3/4	----
5502812	1/2	3/4	----
5502128	3/4	1/2	----
55021612	1	3/4	----
55021616	1	1	----
550220	1-1/4	1-1/4	----
550224	1-1/2	1-1/2	----

5502 2089 CD 1234R C3409 914

45° STREET ELBOW

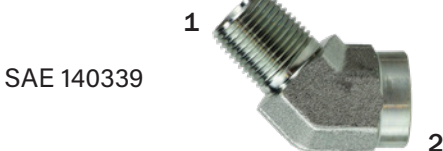

PART #	MALE PIPE 1	FEMALE PIPE 2	
55032	1/8	1/8	----
55034	1/4	1/4	----
55036	3/8	3/8	----
55038	1/2	1/2	----
55031212	3/4	3/4	----
550316	1	1	----

5503 CD45 1244

FEMALE ELBOW

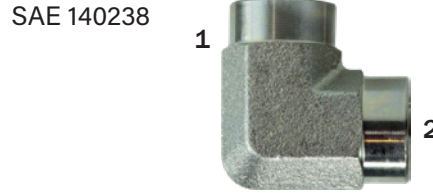

PART #	FEMALE PIPE 1	FEMALE PIPE 2	
55042	1/8	1/8	----
550442	1/4	1/8	----
55044	1/4	1/4	----
55046	3/8	3/8	----
550484	1/2	1/4	----
550486	1/2	3/8	----
55048	1/2	1/2	----
5504128	3/4	1/2	----
550412	3/4	3/4	----
55041612	1	3/4	----
550416	1	1	----
550420	1-1/4	1-1/4	----
550424	1-1/2	1-1/2	----

5504 2087 DD 1245 C3509 916

45° FEMALE ELBOW

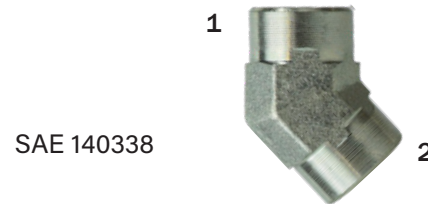

PART #	FEMALE PIPE 1	FEMALE PIPE 2	
55054	1/4	1/4	----
55056	3/8	3/8	----
55058	1/2	1/2	----
550512	3/4	3/4	----
550516	1	1	----
550520	1-1/4	1-1/4	----

5505 DD45 1241 C3559

WARNING: This product can expose you to chemicals, including Cobalt, which are known to the State of California to cause cancer. For more information, visit www.P65Warnings.ca.gov



STEEL PIPE FITTINGS

HYDRAULIC ADAPTERS

MALE PIPE TEE

SAE 140437

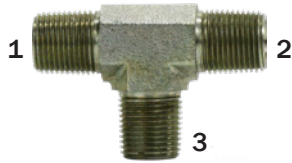

PART #	MALE PIPE 1 & 2	MALE PIPE 3	
560022	1/8	1/8	----
560044	1/4	1/4	----
560066	3/8	3/8	----
560088	1/2	1/2	----
560012	3/4	3/4	----
560016	1	1	----

5600 2257 RRS

FEMALE BRANCH PIPE TEE

SAE 140427

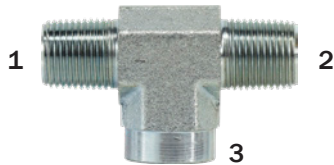

PART #	MALE PIPE 1 & 2	FEMALE PIPE 3	
560122	1/8	1/8	----
560144	1/4	1/4	----
560166	3/8	3/8	----
560112	3/4	3/4	----
560116	1	1	----

901 5601 2256

STREET PIPE TEE

SAE 140424

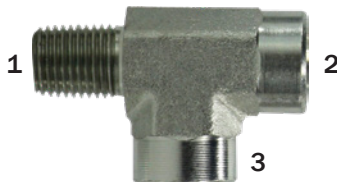

PART #	MALE PIPE 1	FEMALE PIPE 2 & 3	
560222	1/8	1/8	----
560244	1/4	1/4	----
560266	3/8	3/8	----
560288	1/2	1/2	----
560212	3/4	3/4	----
560216	1	1	----

902 5602 2092 MRO 1276 C3759

FEMALE RUN PIPE TEE

SAE 1404276

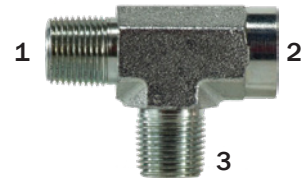

PART #	MALE PIPE 1 & 3	FEMALE PIPE 2	
560322	1/8	1/8	----
560344	1/4	1/4	----
560366	3/8	3/8	----
560388	1/2	1/2	----
560312	3/4	3/4	----
560316	1	1	----

5603 2093 MMO 1277

MALE BRANCH PIPE TEE

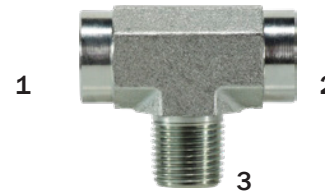

PART #	FEMALE PIPE 1 & 2	MALE PIPE 3	
560422	1/8	1/8	----
560444	1/4	1/4	----
560466	3/8	3/8	----
560488	1/2	1/2	----
560412	3/4	3/4	----
560416	1	1	----

904 5604 2091 MMS 1278 C3609

FEMALE PIPE TEE

SAE 140438

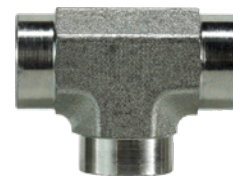

PART #	FEMALE PIPE	
560522	1/8	----
560544	1/4	----
560566	3/8	----
56058	1/2	----
560512	3/4	----
560516	1	----
560520	1-1/4	----

917 5605 2090 1225 C3709

WARNING: This product can expose you to chemicals, including Cobalt, which are known to the State of California to cause cancer. For more information, visit www.P65Warnings.ca.gov



STEEL O-RING ADAPTERS

HYDRAULIC ADAPTERS

JIC TO O-RING CONNECTOR

SAE 070120
MS 51525



PART #	JIC THREAD SIZE 1	O-RING THREAD 2	
64002	5/16-24	5/16-24	----
64003	3/8-24	3/8-24	----
64004	7/16-20	7/16-20	----
640042	7/16-20	5/16-24	----
640046	7/16-20	9/16-18	----
640048	7/16-20	3/4-16	----
64005	1/2-20	1/2-20	----
64006	9/16-18	9/16-18	----
640064	9/16-18	7/16-20	----
640068	9/16-18	3/4-16	----
6400610	9/16-18	7/8-14	----
6400612	9/16-18	1-1/16-12	----
6400616	9/16-18	1-5/16-12	----
64008	3/4-16	3/4-16	----
640084	3/4-16	7/16-20	----
640086	3/4-16	9/16-18	----
6400810	3/4-16	7/8-14	----
6400812	3/4-16	1-1/16-12	----
640010	7/8-14	7/8-14	----
6400106	7/8-14	9/16-18	----
6400108	7/8-14	3/4-16	----
64001012	7/8-14	1-1/16-12	----
640012	1-1/16-12	1-1/16-12	----
6400128	1-1/16-12	3/4-16	----
64001210	1-1/16-12	7/8-14	----
64001214	1-1/16-12	1-3/16-12	----
64001216	1-1/16-12	1-5/16-12	----
640016	1-5/16-12	1-5/16-12	----
64001612	1-5/16-12	1-1/16-12	----
64001620	1-5/16-12	1-5/8-12	----
64001624	1-5/16-12	1-7/8-12	----
640020	1-5/8-12	1-5/8-12	----
64002012	1-5/8-12	1-1/16-12	----
64002016	1-5/8-12	1-5/16-12	----
64002024	1-5/8-12	1-7/8-12	----
640024	1-7/8-12	1-7/8-12	----
64002420	1-7/8-12	1-5/8-12	----
64002432	1-7/8-12	2-1/2-12	----
640032	2-1/2-12	2-1/2-12	----
64003224	2-1/2-12	1-7/8-12	----

6400 202702R F50X 1231 C5315

O-RING TO PIPE ADAPTER



PART #	O-RING THREAD 1	MALE PIPE THREAD 2	
640142	7/16-20	1/8	----
640144	7/16-20	1/4	----
640164	9/16-18	1/4	----
640166	9/16-18	3/8	----
640186	3/4-16	3/8	----
640188	3/4-16	1/2	----
6401812	3/4-16	3/4	----
6401108	7/8-14	1/2	----
6401128	1-1/16-12	1/2	----
64011212	1-1/16-12	3/4	----
64011616	1-5/16-12	1	----
64012020	1-5/8-12	1-1/4	----
64012020	1-5/8-12	1-1/4	----
64012424	1-7/8-12	1-1/2	----

6401 F5X 1264R C3249

O-RING TO 37° JIC - SWIVEL ADAPTER



PART #	O-RING THREAD 1	JIC THREAD SIZE 2	
6402O44	7/16-20	7/16-20	----
6402O66	9/16-18	9/16-18	----
6402O68	9/16-18	3/4-16	----
6402O88	3/4-16	3/4-16	----
6402O86	3/4-16	9/16-18	----
6402O1010	7/8-14	7/8-14	----
6402O1212	1-1/16-12	1-1/16-12	----

6402 2266 F65X 1213 9316

O-RING HEX NIPPLE UNION



PART #	O-RING THRD 1	O-RING THRD 2	
6403O4	7/16-20	7/16-20	----
6403O6	9/16-18	9/16-18	----
6403O8	3/4-16	3/4-16	----
6403O12	1-1/16-12	1-1/16-12	----
6403O16	1-5/16-12	1-5/16-12	----

WARNING: This product can expose you to chemicals, including Cobalt, which are known to the State of California to cause cancer. For more information, visit www.P65Warnings.ca.gov



STEEL O-RING ADAPTERS

HYDRAULIC ADAPTERS

FEMALE O-RING TO MALE PIPE ADAPTER



PART #	O-RING THREAD 1	MALE PIPE THREAD 2	
640442	7/16-20	1/8	----
640444	7/16-20	1/4	----
640464	9/16-18	1/4	----
640466	9/16-18	3/8	----
640468	9/16-18	1/2	----
640486	3/4-16	3/8	----
640488	3/4-16	1/2	----
6404108	7/8-14	1/2	----
64041212	1-1/16-12	3/4	----
64041616	1-5/16-12	1	----

6404 2246R 1267R C3239 FHGS

O-RING TO FEMALE PIPE ADAPTER



PART #	O-RING THREAD 1	FEMALE PIPE THREAD 2	
6405O22	5/16-24	1/8	----
6405O42	7/16-20	1/8	----
6405O32	3/8-24	1/8	----
6405O34	3/8-24	1/4	----
6405O44	7/16-20	1/4	----
6405O52	1/2-20	1/8	----
6405O54	1/2-20	1/4	----
6405O62	9/16-18	1/8	----
6405O64	9/16-18	1/4	----
6405O66	9/16-18	3/8	----
6405O68	9/16-8	1/2	----
6405O84	3/4-16	1/4	----
6405O86	3/4-16	3/8	----
6405O88	3/4-16	1/2	----
6405O812	3/4-16	3/4	----
6405O104	7/8-14	1/4	----
6405O106	7/8-14	3/8	----
6405O108	7/8-14	1/2	----
6405O126	1-1/16-12	3/8	----
6405O128	1-1/16-12	1/2	----
6405O1212	1-1/16-12	3/4	----
6405O1216	1-1/16-12	1	----
6405O1612	1-5/16-12	3/4	----
6405O1616	1-5/16-12	1	----
6405O2020	1-5/8-12	1-1/4	----
6405O2416	1-7/8-12	1	----
6405O2420	1-7/8-12	1-1/4	----
6405O2424	1-7/8-12	1-1/2	----
6405O3224	2-1/2-12	1-1/2	----
6405O3232	2-1/2-12	2	----

6405 2216R F50G 1268R C3269

O-RING HEX HEAD PLUG

SAE 090109A



* Not all sizes are solid

PART #	O-RING THREAD	
6408O2	5/16-24	----
6408O4	7/16-20	----
6408O5	1/2-20	----
6408O6	9/16-18	----
6408O8	3/4-16	----
6408O10	7/8-14	----
6408O12	1-1/16-12	----
6408O14	1-3/16-12	----
6408O16	1-5/16-12	----
6408O20	1-5/8-12	----
6408O24	1-7/8-12	----

6408 900598 P50N 1265 7237

O-RING HOLLOW - HEX HEAD PLUG

SAE 090109B



PART #	O-RING THREAD	
6408HO2	5/16-24	----
6408HO4	7/16-20	----
6408HO5	1/2-20	----
6408HO6	9/16-18	----
6408HO8	3/4-16	----
6408HO10	7/8-14	----
6408HO12	1-1/16-12	----
6408HO14	1-3/16-12	----
6408HO16	1-5/16-12	----
6408HO20	1-5/8-12	----
6408HO24	1-7/8-12	----

6408HHP FF2138 HP50N 1256 7238 6409

WARNING: This product can expose you to chemicals, including Cobalt, which are known to the State of California to cause cancer. For more information, visit www.P65Warnings.ca.gov

FEMALE SWIVELS JIC

HYDRAULIC ADAPTERS

O-RING PORT REDUCER/EXPANDER



PART #	O-RING THREAD 1	O-RING THREAD 2	
6410O46	7/16-20	9/16-18	----
6410O64	9/16-18	7/16-20	----
6410O68	9/16-18	3/4-16	----
6410O84	3/4-16	7/16-20	----
6410O86	3/4-16	9/16-18	----
6410O88	3/4-16	3/4-16	----
6410O812	3/4-16	1-1/16-12	----
6410O124	1-1/16-12	7/16-20	----
6410O126	1-1/16-12	9/16-18	----
6410O128	1-1/16-12	3/4-16	----
6410O166	1-5/16-12	9/16-18	----
6410O168	1-5/16-12	3/4-16	----
6410O1612	1-5/16-12	1-1/16-12	----
6410O2012	1-5/8-12	1-1/16-12	----
6410O2016	1-5/8-12	1-5/16-12	----
6410O2412	1-7/8-12	1-1/16-12	----
6410O2416	1-7/8-12	1-5/16-12	----
6410O2420	1-7/8-12	1-5/8-12	----
6410O3216	2-1/2-12	1-5/16-12	----
6410O3220	2-1/2-12	1-5/8-12	----
6410O3224	2-1/2-12	1-7/8-12	----

6410 FF1010 F50G5 1270 7033

JIC SWIVEL NUT ELBOW

SAE 070221
MS 51521



PART #	JIC THREAD SIZE 1	JIC THREAD SIZE 2	
65004	7/16-20	7/16-20	----
65006	9/16-18	9/16-18	----
65008	3/4-16	3/4-16	----
650086	3/4-16	9/16-18	----
650010	7/8-14	7/8-14	----
6500108	7/8-14	3/4-16	----
650012	1-1/16-12	1-1/16-12	----
650016	1-5/16-12	1-5/16-12	----
650020	1-5/8-12	1-5/8-12	----
650024	1-7/8-12	1-7/8-12	----
650032	2-1/2-12	2-1/2-12	----

6500 2071R C6X 1236 G5506

JIC SWIVEL TO MALE PIPE ELBOW



PART #	JIC THREAD SIZE 1	MALE PIPE THREAD 2	
650142	7/16-20	1/8	----
650144	7/16-20	1/4	----
650164	9/16-18	1/4	----
650166	9/16-18	3/8	----
650186	3/4-16	3/8	----
650188	3/4-16	1/2	----
6501108	7/8-14	1/2	----
65011212	1-1/16-12	3/4	----
65011616	1-5/16-12	1	----
65012020	1-5/8-12	1-1/4	----
65012424	1-7/8-12	1-1/2	----
65013232	2-1/2-12	2	----

6501 2250 1247R TF5406

JIC SWIVEL 45° ELBOW

SAE 070321
MS 51522



PART #	JIC THREAD SIZE 1	JIC THREAD SIZE 2	
65024	7/16-20		----
65026	9/16-18	9/16-18	----
65028	3/4-16	3/4-16	----
650210	7/8-14	7/8-14	----
650212	1-1/16-12	1-1/16-12	----
650216	1-5/16-12	1-5/16-12	----

JIC SWIVEL TO FEMALE - PIPE ELBOW



PART #	JIC THREAD SIZE 1	FEMALE PIPE THREAD 2	
650344	7/16-20	1/4	----
650364	9/16-18	1/4	----
650366	9/16-18	3/8	----
650386	3/4-16	3/8	----
650388	3/4-16	1/2	----
65031212	1-1/16-12	3/4	----

6502 2070R V6X 1237 C5356

WARNING: This product can expose you to chemicals, including Cobalt, which are known to the State of California to cause cancer. For more information, visit www.P65Warnings.ca.gov



FEMALE SWIVELS

HYDRAULIC ADAPTERS

JIC SWIVEL CONNECTOR



PART #	JIC THREAD SIZE 1	JIC THREAD SIZE 2	
650444	7/16-20	7/16-20	----
650466	9/16-18	9/16-18	----
650488	3/4-16	3/4-16	----
65041010	7/8-14	7/8-14	----
65041212	1-1/16-12	1-1/16-12	----
65041616	1-5/16-12	1-5/16-12	----
65042020	1-5/8-12	1-5/8-12	----

6504 1205

JIC SWIVEL TO MALE - PIPE ADAPTER



PART #	JIC THREAD SIZE 1	MALE PIPE THREAD 2	
650542	7/16-20	1/8	----
650544	7/16-20	1/4	----
650546	7/16-20	3/8	----
650564	9/16-18	1/4	----
650566	9/16-18	3/8	----
650586	3/4-16	3/8	----
650588	3/4-16	1/2	----
6505128	1-1/16-12	1/2	----
65051212	1-1/16-12	3/4	----
65051612	1-5/16-12	3/4	----
65051616	1-5/16-12	1	----
65052424	1-7/8-12	1-1/2	----

6505 2018 F6X 1211 9100R

JIC SWIVEL TO FEMALE PIPE ADAPTER



PART #	JIC THREAD SIZE 1	FEMALE PIPE THREAD 2	
650642	7/16-20	1/8	----
650644	7/16-20	1/4	----
650664	9/16-18	1/4	----
650666	9/16-18	3/8	----
650668	9/16-18	1/2	----
650686	3/4-16	3/8	----
650688	3/4-16	1/2	----
6506106	7/8-14	3/8	----
6506128	1-1/16-12	1/2	----
65061212	1-1/16-12	3/4	----
65061616	1-5/16-12	1	----
65062020	1-5/8-12	1-1/4	----
65062424	1-7/8-12	1-1/2	----
65063232	2-1/2-12	2	----

6506 2242 1215

JIC SWIVEL BRANCH TEE

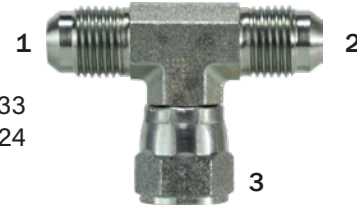

SAE 070433
MS 51524

PART #	JIC THREAD SIZE 1 & 2	JIC FEMALE THREAD 3	
660044	7/16-20	7/16-20	----
660066	9/16-18	9/16-18	----
660088	3/4-16	3/4-16	----
660010	7/8-14	7/8-14	----
660012	1-1/16-12	1-1/16-12	----
660016	1-5/16-12	1-5/16-12	----
660020	1-5/8-12	1-5/8-12	----

6600 203101R 55X 1227 C5707

JIC SWIVEL RUN TEE

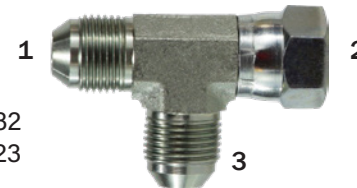

SAE 070432
MS 51523

PART #	JIC THREAD SIZE 1 & 3	JIC FEMALE THREAD 2	
66024	7/16-20	7/16-20	----
66025	1/2-20	1/2-20	----
66026	9/16-18	9/16-18	----
66028	3/4-16	3/4-16	----
660212	1-1/16-12	1-1/16-12	----
660216	1-5/16-12	1-5/16-12	----
660224	1-7/8-12	1-7/8-12	----

6602 203102R R6X 1248 C5706

JIC TO O-RING RUN TEE

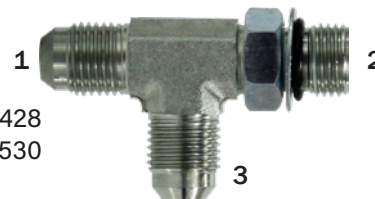

SAE 070428
MS 51530

PART #	JIC THREAD SIZE 1 & 3	O-RING THREAD SIZE 2	
6804NWO4	7/16-20	7/16-20	----
6804NWO6	9/16-18	9/16-18	----
6804NWO8	3/4-16	3/4-16	----
6804NWO10	7/8-14	7/8-14	----
6804NWO12	1-1/16-12	1-1/16-12	----
6804NWO16	1-5/16-12	1-5/16-12	----

6804 203005R R50X 1266R C5716

WARNING: This product can expose you to chemicals, including Cobalt, which are known to the State of California to cause cancer. For more information, visit www.P65Warnings.ca.gov

STEEL O-RING ADAPTERS

HYDRAULIC ADAPTERS

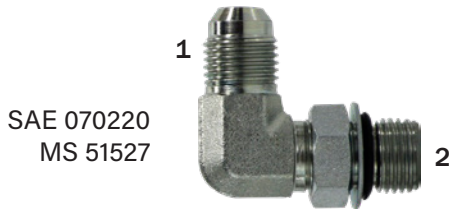
JIC TO O-RING ELBOW CONNECTOR

PART #	JIC THREAD SIZE 1	O-RING THREAD SIZE 2	
6801NWO4	7/16-20	7/16-20	----
6801NWO46	7/16-20	9/16-18	----
6801NWO48	7/16-20	3/4-16	----
6801NWO6	9/16-18	9/16-18	----
6801NWO64	9/16-18	7/16-20	----
6801NWO68	9/16-18	3/4-16	----
6801NWO612	9/16-18	1-1/16-12	----
6801NWO8	3/4-16	3/4-16	----
6801NWO86	3/4-16	9/16-18	----
6801NWO810	3/4-16	7/8-14	----
6801NWO812	3/4-16	1-1/16-12	----
6801NWO816	3/4-16	1-5/16-12	----
6801NWO10	7/8-14	7/8-14	----
6801NWO106	7/8-14	9/16-18	----
6801NWO108	7/8-14	3/4-16	----
6801NWO1016	7/8-14	1-5/16-12	----
6801NWO12	1-1/16-12	1-1/16-12	----
6801NWO128	1-1/16-12	3/4-16	----
6801NWO1210	1-1/16-12	7/8-14	----
6801NWO1216	1-1/16-12	1-5/16-12	----
6801NWO16	1-5/16-12	1-5/16-12	----
6801NWO1612	1-5/16-12	1-1/16-12	----
6801NWO1620	1-5/16-12	1-5/8-12	----
6801NWO20	1-5/8-12	1-5/8-12	----
6801NWO2016	1-5/8-12	1-5/16-12	----
6801NWO2024	1-5/8-12	1-7/8-12	----
6801NWO24	1-7/8-12	1-7/8-12	----
6801NWO32	2-1/2-12	2-1/2-12	----

6801 2062R C50X 1238L C5515

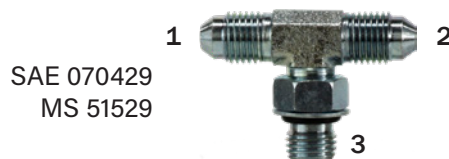
JIC TO O-RING - BRANCH TEE

PART #	JIC THREAD SIZE 1 & 2	O-RING THREAD SIZE 3	
6803NWO4	7/16-20	7/16-20	----
6803NWO6	9/16-18	9/16-18	----
6803NWO8	3/4-16	3/4-16	----
6803NWO10	7/8-14	7/8-14	----
6803NWO12	1-1/16-12	1-1/16-12	----
6803NWO16	1-5/16-12	1-5/16-12	----

6803 203003X S50X 1265R C5715

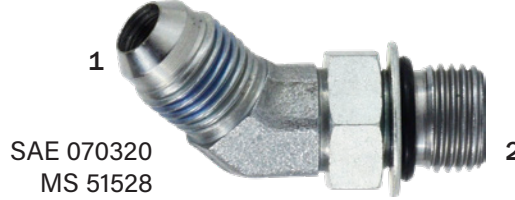
JIC TO O-RING 45° ELBOW

PART #	JIC THREAD SIZE 1	O-RING THREAD SIZE 2	
6802NWO2	5/16-24	5/16-24	----
6802NWO4	7/16-20	7/16-20	----
6802NWO46	7/16-20	9/16-18	----
6802NWO6	9/16-18	9/16-18	----
6802NWO68	9/16-18	3/4-16	----
6802NWO8	3/4-16	3/4-16	----
6802NWO86	3/4-16	9/16-18	----
6802NWO810	3/4-16	7/8-14	----
6802NWO812	3/4-16	1-1/16-12	----
6802NWO10	7/8-14	7/8-14	----
6802NWO108	7/8-14	3/4-16	----
6802NWO1012	7/8-14	1-1/16-12	----
6802NWO12	1-1/16-12	1-1/16-12	----
6802NWO1216	1-1/16-12	1-5/16-12	----
6802NWO16	1-5/16-12	1-5/16-12	----
6802NWO1612	1-5/16-12	1-1/16-12	----
6802NWO1620	1-5/16-12	1-5/8-12	----
6802NWO20	1-5/8-12	1-5/8-12	----
6802NWO2016	1-5/8-12	1-5/16-12	----
6802NWO24	1-7/8-12	1-7/8-12	----
6802NWO32	2-1/2-12	2-1/2-12	----

6802 2061 V50X 1240R C5365

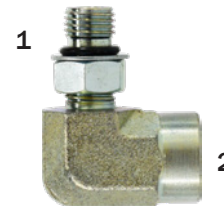
O-RING TO - FEMALE PIPE ELBOW

PART #	O-RING THREAD SIZE 1	PIPE THREAD SIZE 2	
6805NWO42	7/16-20	1/8	----
6805NWO44	7/16-20	1/4	----
6805NWO64	9/16-18	1/4	----
6805NWO66	9/16-18	3/8	----
6805NWO86	3/4-16	3/8	----
6805NWO88	3/4-16	1/2	----
6805NWO108	7/8-14	1/2	----
6805NWO128	1-1/16-12	1/2	----
6805NWO1212	1-1/16-12	3/4	----
6805NWO1616	1-5/16-12	1	----
6805NWO2020	1-5/8-12	1-1/4	----
6805NWO2424	1-7/8-12	1-1/2	----

6805 206801R AE0G 1264 C3459

WARNING: This product can expose you to chemicals, including Cobalt, which are known to the State of California to cause cancer. For more information, visit www.P65Warnings.ca.gov



STEEL O-RINGS

HYDRAULIC ADAPTERS

O-RING TO MALE PIPE ELBOW



PART #	O-RING THREAD SIZE 1	PIPE THREAD SIZE 2	
6806NWO44	7/16-20	1/4	----
6806NWO66	9/16-18	3/8	----
6806NWO88	3/4-16	1/2	----
6806NWO1212	1-1/16-12	3/4	----
6806NWO1616	1-5/16-12	1	----

6806 1263 TF3569

O-RING TO 37° JIC SWIVEL NUT TO O-RING ELBOW



PART #	O-RING THREAD SIZE 1	JIC THREAD SIZE 2	
6809NWO44	7/16-20	7/16-20	----
6809NWO66	9/16-18	9/16-18	----
6809NWO88	3/4-16	3/4-16	----
6809NWO1212	1-1/16-12	1-1/16-12	----

FEMALE O-RING TO MALE O-RING ELBOW



PART #	O-RING THREAD SIZE 1	O-RING THREAD SIZE 2	
6815NWO44	7/16-20	7/16-20	----
6815NWO66	9/16-18	9/16-18	----
6815NWO88	3/4-16	3/4-16	----
6815NWO1010	7/8-14	7/8-14	----
6815NWO1212	1-1/16-12	1-1/16-12	----

MALE O-RING SWIVEL ADAPTER

SAE 140157



PART #	O-RING THREAD SIZE 1	FEMALE NPSM SIZE 2	
6900O42	7/16-20	1/8	----
6900O44	7/16-20	1/4	----
6900O46	7/16-20	3/8	----
6900O48	7/16-20	1/2	----
6900O64	9/16-18	1/4	----
6900O66	9/16-18	3/8	----
6900O68	9/16-18	1/2	----
6900O84	3/4-16	1/4	----
6900O86	3/4-16	3/8	----
6900O88	3/4-16	1/2	----
6900O812	3/4-16	3/4	----
6900O104	7/8-14	1/4	----
6900O106	7/8-14	3/8	----
6900O108	7/8-14	1/2	----
6900O1012	7/8-14	3/4	----
6900O128	1-1/16-12	1/2	----
6900O1212	1-1/16-12	3/4	----
6900O1612	1-5/16-12	3/4	----
6900O1616	1-5/16-12	1	----

6900 2066R 1235 9315

WARNING: This product can expose you to chemicals, including Cobalt, which are known to the State of California to cause cancer. For more information, visit www.P65Warnings.ca.gov

STEEL SAE O-RING

HYDRAULIC ADAPTERS

90° O-RING SWIVEL ADAPTER

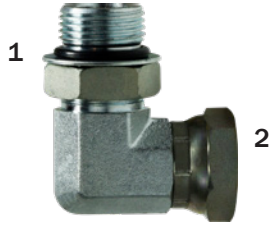

SAE 140257

PART #	O-RING THREAD SIZE 1	FEMALE NPSM SIZE 2	
6901NWO42	7/16-20	1/8	----
6901NWO44	7/16-20	1/4	----
6901NWO64	9/16-18	1/4	----
6901NWO66	9/16-18	3/8	----
6901NWO68	9/16-18	1/2	----
6901NWO84	3/4-16	1/4	----
6901NWO86	3/4-16	3/8	----
6901NWO88	3/4-16	1/2	----
6901NWO812	3/4-16	3/4	----
6901NWO104	7/8-14	1/4	----
6901NWO106	7/8-14	3/8	----
6901NWO108	7/8-14	1/2	----
6901NWO126	1-1/16-12	3/8	----
6901NWO128	1-1/16-12	1/2	----
6901NWO1212	1-1/16-12	3/4	----
6901NWO1612	1-5/16-12	3/4	----
6901NWO1616	1-5/16-12	1	----
6901NWO2016	1-5/8-12	1	----
6901NWO2020	1-5/8-12	1-1/4	----
6901NWO2424	1-7/8-12	1-1/2	----
6901NWO3232	2-1/2-12	2	----

45° O-RING SWIVEL ADAPTER

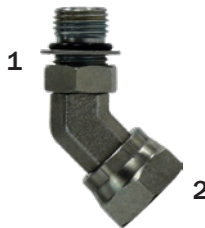

SAE 140357

PART #	O-RING THREAD SIZE 1	FEMALE NPSM SIZE 2	
6902NWO42	7/16-20	1/8	----
6902NWO44	7/16-20	1/4	----
6902NWO46	7/16-20	3/8	----
6902NWO64	9/16-18	1/4	----
6902NWO66	9/16-18	3/8	----
6902NWO68	9/16-18	1/2	----
6902NWO84	3/4-16	1/4	----
6902NWO86	3/4-16	3/8	----
6902NWO88	3/4-16	1/2	----
6902NWO108	7/8-14	1/2	----
6902NWO128	1-1/16-12	1/2	----
6902NWO1212	1-1/16-12	3/4	----
6902NWO1616	1-5/16-12	1	----

6902 2067R 1272 9365

O-RINGS

VITON 75 SAE BOSS O-RING



Fluorocarbon

PART #	O-RING THREAD	
400122	5/16-24	----
400144	7/16-20	----
400166	9/16-18	----
400188	3/4-16	----
400110	7/8-14	----
400112	1-1/16-12	----
400116	1-5/16-12	----
400120	1-5/8-12	----
400124	1-7/8-12	----
400132	2-1/2-12	----

NITRILE 90 SAE BOSS O-RING



PART #	O-RING THREAD	
400022	5/16-24	----
400044	7/16-20	----
400066	9/16-18	----
400088	3/4-16	----
400010	7/8-14	----
400012	1-1/16-12	----
400014	1-3/16-12	----
400016	1-5/16-12	----
400020	1-5/8-12	----
400024	1-7/8-12	----
400032	2-1/2-12	----

BRAZE TUBE NUT (SLEEVE REQUIRED)



SAE 520110

PART #	TUBE O.D.	BRAZE TUBE O.D.	
FSO3184	1/4	.25	----
FSO3186	3/8	.38	----
FSO3188	1/2	.50	----
FSO31810	5/8	.62	----
FSO31812	3/4	.72	----
FSO31816	1	1.00	----
FSO31820	1 1/4	1.25	----
FSO31824	1 1/2	1.50	----

WARNING: This product can expose you to chemicals, including Cobalt, which are known to the State of California to cause cancer. For more information, visit www.P65Warnings.ca.gov



FF318 FF1311

O-RING FACE SEAL ADAPTERS

HYDRAULIC ADAPTERS

BRAZE TUBE SLEEVE

SAE 520115



PART #	TUBE O.D.	
FSO3194	1/4	----
FSO3196	3/8	----
FSO3198	1/2	----
FSO31910	5/8	----
FSO31912	3/4	----
FSO31916	1	----
FSO31920	1-1/4	----

FF319 FF3019

See Page 414 for JIC Nut and Sleeve

CAP

SAE 520112



• Two Piece
Nut/ Insert

PART #	TUBE O.D.	FACE SEAL THREAD	
FSO304C4	1/4	9/16-18	----
FSO304C6	3/8	11/16-16	----
FSO304C8	1/2	13/16-16	----
FSO304C10	5/8	1-14	----
FSO304C12	3/4	1-3/16-12	----
FSO304C16	1	1-7/16-12	----
FSO304C20	1-1/4	1-11/16-12	----
FSO304C24	1-1/2	2-12	----

FF304C

BULKHEAD LOCKNUT

SAE 520118



PART #	THREAD SIZE	
FSO3064	9/16-18	----
FSO3066	11/16-16	----
FSO3068	13/16-16	----
FSO30612	1-3/16-12	----
FSO30616	1-7/16-12	----

FF403

MALE UNION CONNECTOR

SAE 520102



PART #	TUBE O.D.	FACE SEAL THREAD 1&2	
FSO240344	1/4	9/16-18	----
FSO240366	3/8	11/16-16	----
FSO240388	1/2	13/16-16	----
FSO24031212	3/4	1-3/16-12	----
FSO24031616	1	1-7/16-12	----

FF2403 FF1203

MALE O-RING FACE SEAL ADAPTER



PART #	FACE SEAL THREAD 1	MALE PIPE SIZE 2	
FSO240444	9/16-18	1/4-18	----
FSO240446	9/16-18	3/8	----
FSO240464	11/16-16	1/4-18	----
FSO240466	11/16-16	3/8-18	----
FSO240484	13/16-16	1/4-18	----
FSO240486	13/16-16	3/8	----
FSO240488	13/16-16	1/2-14	----
FSO2404108	1-14	1/2	----
FSO24041212	1-3/16-12	3/4-14	----
FSO24041616	1-7/16-12	1-11/16-12	----
FSO24042020	1-11/16-12	1-1/4	----
FSO24042424	2-12	1-1/2	----

FF2404 4205 FLO

FEMALE ORFS TO MALE ORFS REDUCER



PART #	FEMALE FACE SEAL SIZE 1	MALE FACE SEAL THREAD 2	
FSO240664	11/16-16	9/16-18	----
FSO240684	13/16-16	9/16-18	----
FSO2406106	1-14	11/16-16	----
FSO2406108	1-14	13/16-16	----
FSO2406126	1-3/16-12	11/16-16	----

FF2406 TRLON

O-RING FACE SEAL ADAPTERS

HYDRAULIC ADAPTERS

PLUG



SAE 520109

PART #	TUBE O.D.	FACE SEAL THREAD	
FSO24084	1/4	9/16-18	----
FSO24086	3/8	11/16-16	----
FSO24088	1/2	13/16-16	----
FSO240810	5/8	1-14	----
FSO240812	3/4	1-3/8-12	----
FSO240816	1	1-7/16-12	----
FSO240820	1-1/4	1-11/16-12	----
FSO240824	1-1/2	2-12	----

FF2408 FF1254 4229 PNLO

ORFS UNION ELBOW 90°



PART #	FACE SEAL THREAD 1	FACE SEAL THREAD 2	
FS250044	9/16-18	9/16-18	----
FS250066	11/16-16	11/16-16	----
FS25001010	1-14	1-14	----
FS25001212	1-3/16-12	1-3/16-12	----
FS25001616	1-7/16-12	1-7/16-12	----

FF2500 4505 ELO

ORFS TO MALE ELBOW

SAE 520202



PART #	FACE SEAL THREAD 1	MALE PIPE THREAD 2	
FS250144	9/16-18	1/4	----
FS250164	11/16-16	1/4	----
FS250166	11/16-16	3/8	----
FS250186	13/16-16	3/8	----
FS250188	13/16-16	1/2	----
FS2501812	13/16-16	3/4	----
FS2501108	1-14	1/2	----
FS25011012	1-14	3/4	----
FS2501128	1-3/8-12	1/2	----
FS25011212	1-3/8-12	3/4	----
FS25011216	1-3/8-12	1	----
FS25011616	1-7/16-12	1	----
FS25012020	1-11/16-12	1-1/4	----
FS25012424	2-12	1-1/2	----

FF2501 FF1208 4405 CLO

ORFS TO PIPE ELBOW 45°



PART #	FACE SEAL THREAD 1	MALE PIPE THREAD 2	
FS250344	9/16-18	1/4	----
FS250366	11/16-16	3/8	----
FS250388	13/16-16	1/2	----
FS25031212	1-3/16-12	3/4	----
FS25031616	1-7/16-12	1	----

FF2503 4355 VLO

ORFS UNION TEE

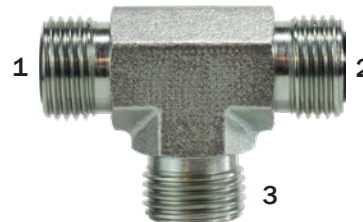

PART #	FACE SEAL THREAD 1+2+3	
FS260344	9/16-18	----
FS260366	11/16-16	----
FS260388	13/16-16	----
FS26031212	1-3/16-12	----

MALE FLAT FACE TO FEMALE 37° SWIVEL



PART #	FACE SEAL THREAD 1	JIC THREAD 2	
FS640244	9/16-18	7/16-20	----
FS640266	11/16-16	9/16-18	----
FS640288	13/16-16	3/4-16	----
FS64021010	1-14	7/8-14	----
FS64021212	1-3/16-12	1-1/16-12	----

FF6402 FF1294

WARNING: This product can expose you to chemicals, including Cobalt, which are known to the State of California to cause cancer. For more information, visit www.P65Warnings.ca.gov



O-RING FACE SEAL ADAPTERS

HYDRAULIC ADAPTERS

MALE ORFS TO ORB CONNECTOR

SAE 520120



PART #	FACE SEAL THREAD 1	O-RING THREAD 2	
FS6400O44	9/16-18	7/16-20	----
FS6400O46	9/16-18	9/16-18	----
FS6400O64	11/16-16	7/16-20	----
FS6400O66	11/16-16	9/16-18	----
FS6400O68	11/16-16	3/4-16	----
FS6400O86	13/16-16	9/16-18	----
FS6400O88	13/16-16	3/4-16	----
FS6400O810	13/16-16	7/8-14	----
FS6400O108	1-14	3/4-16	----
FS6400O1010	1-14	7/8-14	----
FS6400O1012	1-14	1-1/16-12	----
FS6400O128	1-3/16-12	3/4-16	----
FS6400O1210	1-3/16-12	7/8-14	----
FS6400O1212	1-3/16-12	1-1/16-12	----
FS6400O1216	1-3/16-12	1-5/16-12	----
FS6400O1612	1-7/16-12	1-1/16-12	----
FS6400O1616	1-7/16-12	1-5/16-12	----
FS6400O1620	1-7/16-12	1-5/8-12	----
FS6400O2020	1-11/16-12	1-5/8-12	----
FS6400O2024	1-11/16-12	1-7/8-12	----
FS6400O2424	2-12	1-7/8-12	----

4315 FF6400 FF1231

SWIVEL NUT ELBOW



PART #	FACE SEAL THREAD 1	FACE SEAL THREAD 2	
FS650044	9/16-18	9/16-18	----
FS650066	11/16-16	11/16-16	----
FS650088	13/16-16	13/16-16	----
FS65001212	1-3/16-12	1-3/16-12	----

FF6500 FF1236

MALE JIC 37° FLARE TO FEMALE FLAT FACE SWIVEL



PART #	JIC THREAD SIZE 1	FACE SEAL THREAD 2	
FS650444	7/16-20	9/16-18	----
FS650466	9/16-18	11/16-16	----
FS650488	3/4-16	13/16-16	----
FS65041010	7/8-14	1-14	----
FS65041616	1-5/16-12	1-7/16-12	----

FF6504 FF1296

O-RING ELBOW CONNECTOR



PART #	FACE SEAL THREAD 1	O-RING THREAD 2	
FS680144	9/16-18	7/16-20	----
FS680146	9/16-18	9/16-18	----
FS680164	11/16-16	7/16-20	----
FS680166	11/16-16	9/16-18	----
FS680168	11/16-16	3/4-16	----
FS680186	13/16-16	9/16-18	----
FS680188	13/16-16	3/4-16	----
FS6801810	13/16-16	7/8-14	----
FS6801108	1-14	3/4-16	----
FS68011012	1-14	1-1/16-12	----
FS68011210	1-3/16-12	7/8-14	----
FS68011212	1-3/16-12	1-1/16-12	----
FS68011216	1-3/16-12	1-5/16-12	----
FS68011616	1-7/16-12	1-5/16-12	----
FS68011620	1-7/16-12	1-5/8-12	----
FS68012016	1-11/16-12	1-5/16-12	----
FS68012020	1-11/16-12	1-5/8-12	----
FS68012424	2-12	1-7/8-12	----

FF6801 FF1238 4515

ORFS TO O-RING ELBOW 45°



PART #	FACE SEAL THREAD 1	O-RING SIZE 2	
FS680244	9/16-18	7/16-20	----
FS680266	11/16-16	9/16-18	----
FS680288	13/16-16	3/4-16	----
FS68021010	1-14	7/8-14	----
FS68021212	1-3/16-12	1-1/16-12	----
FS68021616	1-7/16-12	1-5/16-12	----
FS68022020	1-11/16-12	1-5/8-12	----

FF6802 4365 V50LO

WARNING: This product can expose you to chemicals, including Cobalt, which are known to the State of California to cause cancer.
 For more information, visit www.P65Warnings.ca.gov

STEEL BSPT ADAPTERS

HYDRAULIC ADAPTERS

STRAIGHT THREAD SWIVEL NUT ELBOW



PART #	O-RING THREAD 1	FACE SEAL THREAD 2	
FS680944	7/16-20	9/16-18	----
FS680966	9/16-18	11/16-16	----
FS680988	3/4-16	13/16-16	----
FS68091212	1-1/16-12	1-3/16-12	----

FF6809 FF1239 4535 AOELC

STEEL BSPT ADAPTERS

JIC MALE CONNECTOR BSPT



PART #	JIC THREAD SIZE 1	MALE BSPT 2	
700042	7/16-20	1/8-28	----
700044	7/16-20	1/4-19	----
700064	9/16-18	1/4-19	----
700066	9/16-18	3/8-19	----
700068	9/16-18	1/2-14	----
700086	3/4-16	3/8-19	----
700088	3/4-16	1/2-14	----
7000812	3/4-16	3/4-14	----
7000108	7/8-14	1/2-14	----
70001012	7/8-14	3/4-14	----
7000128	1-1/16-12	1/2-14	----
70001212	1-1/16-12	3/4-14	----
70001616	1-5/16-12	1-11	----

3404 305

JIC MALE ELBOW BSPT



PART #	JIC THREAD SIZE 1	MALE BSPT 2	
720042	7/16-20	1/8-28	----
720044	7/16-20	1/4-19	----
720064	9/16-18	1/4-19	----
720066	9/16-18	3/8-19	----
720068	9/16-18	1/2-14	----
720086	3/4-16	3/8-19	----
720088	3/4-16	1/2-14	----
72001212	1-1/16-12	3/4-14	----

3501 315

BSPT HEX NIPPLE



PART #	MALE BSPT 1	MALE BSPT 2	
752022	1/8-28	1/8-28	----
752044	1/4-19	1/4-19	----
752066	3/8-19	3/8-19	----
752088	1/2-14	1/2-14	----
75201010	5/8-14	5/8-14	----
75201212	3/4-14	3/4-14	----

3520 MBT

BSPT PLUG



PART #	BSPT	
95082	1/8-28	----
95084	1/4-19	----
95086	3/8-19	----
95088	1/2-14	----
950812	3/4-14	----
950816	1-11	----

100B-Y KA-RM MHL 296

STEEL BSPP ADAPTERS

BSPP HEX NIPPLE

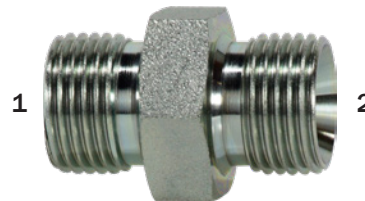

PART #	MALE BSPP 1	MALE BSPP 2	
742022	1/8-28	1/8-28	----
742042	1/4-19	1/8-28	----
742064	3/8-19	1/4-19	----
742066	3/8-19	3/8-19	----
742086	1/2-14	3/8-19	----
742088	1/2-14	1/2-14	----
7420108	5/8-14	1/2-14	----
7420128	3/4-14	1/2-14	----
74201212	3/4-14	3/4-14	----
74201612	1-11	3/4-14	----
74201616	1-11	1-11	----

3420 MB 9022

WARNING: This product can expose you to chemicals, including Cobalt, which are known to the State of California to cause cancer. For more information, visit www.P65Warnings.ca.gov



STEEL BSPP ADAPTERS

HYDRAULIC ADAPTERS

BSPP COUPLING



PART #	BSPP	
74252	1/8-28	----
74254	1/4-19	----
74258	1/2-14	----
742510	5/8-14	----
742512	3/4-14	----
742516	1-11	----

3425 FB

JIC TO FEMALE BSPP STRAIGHT SWIVEL



PART #	JIC THREAD SIZE 1	FEMALE BSPP SWIVEL 2	
72404	7/16-20	1/4-19	----
72406	9/16-18	3/8-19	----
72408	3/4-16	1/2-14	----
724010	7/8-14	5/8-14	----
724012	1-1/16-12	3/4-14	----
724016	1-5/16-12	1-11	----

3240 MJFBS

JIC TO BSPP MALE ELBOW



PART #	JIC THREAD SIZE 1	MALE BSPP 2	
7202NWO42	7/16-20	1/8-28	----
7202NWO44	7/16-20	1/4-19	----
7202NWO64	9/16-18	1/4-19	----
7202NWO66	9/16-18	3/8-19	----
7202NWO68	9/16-18	1/2-14	----
7202NWO86	3/4-16	3/8-19	----
7202NWO88	3/4-16	1/2-14	----
7202NWO812	3/4-16	3/4-14	----
7202NWO108	7/8-14	1/2-14	----
7202NWO1212	1-1/16-12	3/4-14	----
7202NWO1216	1-1/16-12	1-11	----
7202NWO1616	1-5/16-12	1-11	----

3801 315

JIC TO BSPP 45° ELBOW



PART #	JIC THREAD SIZE 1	MALE BSPP 2	
78024	7/16-20	1/4-19	----
78026	9/16-18	3/8-19	----
78028	3/4-16	1/2-14	----
780212	1-1/16-12	3/4-14	----
780216	1-5/16-12	1-11	----

3802 35J

BSPP TO MALE PIPE NIPPLE



PART #	MALE BSPP SIZE 1	MALE PIPE THREAD SIZE 2	
78252	1/8-28	1/8	----
78254	1/4-19	1/4	----
78256	3/8-19	3/8	----
78258	1/2-14	1/2	----
782512	3/4-14	3/4	----
782516	1-11	1	----

MBMP 3825

JIC TO BSPP MALE CONNECTOR



PART #	JIC THREAD SIZE 1	MALE BSPP 2	
700242	7/16-20	1/8-28	----
700244	7/16-20	1/4-19	----
700246	7/16-20	3/8-19	----
700248	7/16-20	1/2-14	----
700264	9/16-18	1/4-19	----
700266	9/16-18	3/8-19	----
700268	9/16-18	1/2-14	----
700286	3/4-16	3/8-19	----
700288	3/4-16	1/2-14	----
7002812	3/4-16	3/4-14	----
7002108	7/8-14	1/2-14	----
70021212	1-1/16-12	3/4-14	----
70021216	1-1/16-12	1-11	----
70021616	1-5/16-12	1-11	----

30J 3800

STEEL BSPP ADAPTERS

HYDRAULIC ADAPTERS

JIC TO BSPP STRAIGHT SWIVEL



PART #	JIC THREAD SIZE 1	MALE BSPP 2	
702242	7/16-20	1/8-28	----
702244	7/16-20	1/4-19	----
702266	9/16-18	3/8-19	----
702288	3/4-16	1/2-14	----
7022108	7/8-14	1/2-14	----
70221212	1-1/16-12	3/4-14	----
70221616	1-5/16-12	1-11	----

3402 3055

HEX HEAD PLUG BSPP



PART #	MALE BSPP	
9522P2	1/8-28	----
9522P4	1/4-19	----
9522P6	3/8-19	----
9522P8	1/2-14	----
9522P12	3/4-14	----
9522P16	1-11	----

3408

HOLLOW HEX PLUG BSPP



PART #	MALE BSPP	
9522H2	1/8-28	----
9522H4	1/4-19	----
9522H6	3/8-19	----
9522H8	1/2-14	----
9522H12	3/4-14	----
9522H16	1-11	----

3408 HHP

FEMALE ADAPTER BSPP

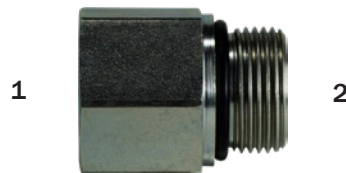

PART #	FEMALE PIPE 1	MALE BSPP 2	
704222	1/8	1/8-28	----
704242	1/4	1/8-28	----
704244	1/4	1/4-19	----
704266	3/8	3/8-19	----
704288	1/2	1/2-14	----
70421212	3/4	3/4-14	----
70421616	1	1-11	----

3455 MMFP

STEEL METRIC ADAPTERS

MALE CONNECTOR



PART #	JIC THREAD SIZE 1	METRIC THREAD 2	
7005410	7/16-20	10x1.0	----
7005412	7/16-20	12x1.5	----
7005414	7/16-20	14x1.5	----
7005418	7/16-20	18x1.5	----
7005512	1/2-20	12x1.5	----
7005514	1/2-20	14x1.5	----
7005614	9/16-18	14x1.5	----
7005616	9/16-18	16x1.5	----
7005618	9/16-18	18x1.5	----
7005816	3/4-16	16x1.5	----
7005818	3/4-16	18x1.5	----
7005822	3/4-16	22x1.5	----
70051018	7/8-14	18x1.5	----
70051020	7/8-14	20x1.5	----
70051022	7/8-14	22x1.5	----
70051222	1-1/16-12	22x1.5	----

Port-seal crush washer and O-ring included

7400 30J (R) 7011

WARNING: This product can expose you to chemicals, including Cobalt, which are known to the State of California to cause cancer. For more information, visit www.P65Warnings.ca.gov



STEEL METRIC ADAPTERS

HYDRAULIC ADAPTERS

MALE ELBOW



PART #	JIC THREAD SIZE 1	METRIC THREAD 2	
7205NWO410	7/16-20	10x1.0	----
7205NWO412	7/16-20	12x1.5	----
7205NWO414	7/16-20	14x1.5	----
7205NWO512	1/2-20	12x1.5	----
7205NWO614	9/16-18	14x1.5	----
7205NWO616	9/16-18	16x1.5	----
7205NWO816	3/4-16	16x1.5	----
7205NWO818	3/4-16	18x1.5	----
7205NWO822	3/4-16	22x1.5	----
7205NWO1018	7/8-14	18x1.5	----

Port-seal crush washer and O-ring included

7801 315 (R)



PART #	JIC THREAD SIZE 1	METRIC THREAD 2	
7025410	7/16-20	10x1.0	----
7025412	7/16-20	12x1.5	----
7025512	1/2-20	12x1.5	----
7025614	9/16-18	14x1.5	----
7025616	9/16-18	16x1.5	----
7025816	3/4-16	16x1.5	----
70251022	7/8-14	22x1.5	----
70251227	1-1/16-12	27x2.0	----
70251633	1-5/16-12	33x2.0	----

7402 30JS (R)

HEX HEAD PLUG METRIC PARALLEL



PART #	METRIC THREAD	
8555P10	10x1.0	----
8555P12	12x1.5	----
8555P14	14x1.5	----
8555P16	16x1.5	----
8555P18	18x1.5	----
8555P20	20x1.5	----
8555P22	22x1.5	----
8555P26	26x1.5	----
8555P30	30x1.5	----

7408

HOLLOW HEX HEAD PLUG



PART #	METRIC THREAD	
8555H10	10x1.0	----
8555H12	12x1.5	----
8555H14	14x1.5	----
8555H16	16x1.5	----
8555H18	18x1.5	----
8555H20	20x1.5	----
8555H22	22x1.5	----
8555H26	26x1.5	----
8555H30	30x1.5	----

7408 HHP

FEMALE ADAPTER

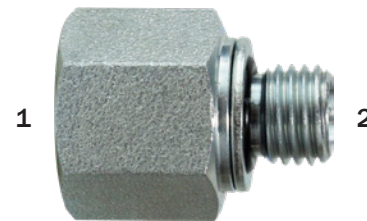

PART #	FEMALE PIPE THREAD 1	METRIC THREAD 2	
7045210	1/8	10x1.0	----
7045412	1/4	12x1.5	----
7045414	1/4	14x1.5	----
7045612	3/8	12x1.5	----
7045616	3/8	16x1.5	----
7045618	3/8	18x1.5	----
7045816	1/2	16x1.5	----
7045818	1/2	18x1.5	----
7045822	1/2	22x1.5	----
70451227	3/4	27x2.0	----
70451633	1	33x2.0	----

MMFP (R)

WARNING: This product can expose you to chemicals, including Cobalt, which are known to the State of California to cause cancer. For more information, visit www.P65Warnings.ca.gov

ISO A AND B INTERCHANGE

HYDRAULIC ADAPTERS



- Brass Body
- Steel Wing Nut
- Buna-Seal (-40° to +250°F)

Aeroquip 5100
Parker 6100
Snaptite B78



- Bonded Face Seal
- External ORing Alleviates Full Connection

PART #	BODY SIZE	FEMALE NPT	MAX PSI		PART #	BODY SIZE	FEMALE NPT	MAX PSI	
61150	3/4	1/2	3000	----	61050	3/4	1/2	3000	----
61152	3/4	3/4	3000	----	61052	3/4	3/4	3000	----
61153	1	1	3000	----	61053	1	1	3000	----
61154	1-1/4	1-1/4	2750	----	61054	1-1/4	1-1/4	2750	----

FEATURES - ISO A and ISO B

- Poppet valves to prevent uncoupled leakage
- Critical parts are induction hardened for durability
- Dependable ball-locking mechanism holds the mating halves together
- Socket and plug are precision machined from solid barstock
- Standard nitrile seals temp range -40°F to +250°F



ISO-A FEMALE PIPE COUPLER

PART #	BODY SIZE	NPT	
ANV14F	1/4"	1/4"	----
ANV38F	3/8"	3/8"	----
ANV12F	1/2"	1/2"	----
ANV34F	3/4"	3/4"	----
ANV1F	1"	1"	----

Body Size	ISO 7241-1 ISO-A Interchange (Connected)			
	Steel Coupler/ Plug			
	Maximum Working		Burst	
	PSI	Bar	PSI	Bar
1/4"	5,000	345	18,270	1,200
3/8"	4,000	275	18,270	1,200
1/2"	4,000	275	16,500	1,100
3/4"	4,000	275	14,800	1,000
1"	4,000	275	12,400	850

ISO-A FEMALE PIPE PLUG

PART #	BODY SIZE	NPT	
ANV14M	1/4"	1/4"	----
ANV38M	3/8"	3/8"	----
ANV12M	1/2"	1/2"	----
ANV34M	3/4"	3/4"	----
ANV1M	1"	1"	----

INTERCHANGE DATA:

- Parker 6600, Aeroquip/ Eaton FD56, Dixon 'K' Series.
- Hansen HA 15000, Safeway S56



Body Size	ISO 7241-1 Series B ISO-B Interchange (Connected)							
	Steel Coupler/ Plug				Brass Coupler/ Plug			
	Max. Working		Burst		Max. Working		Burst	
	PSI	Bar	PSI	Bar	PSI	Bar	PSI	Bar
1/4"	5,000	345	22,500	1,550	3,000	200	15,000	1,000
3/8"	4,000	275	16,500	1,150	2,500	175	12,000	800
1/2"	4,000	275	16,000	1,100	2,500	175	11,500	750
3/4"	4,000	275	16,500	1,150	2,000	150	12,000	800
1"	4,000	275	16,000	1,100	1,500	100	8,500	800

INTERCHANGE DATA:

- Parker 60 Series, Snap-tite 72 series, Dixon 'H' series
- Hansen HK - series, Aeroquip/ Eaton FDH5

ISO-B FEMALE PIPE COUPLER

PART #	BODY SIZE	NPT	
HNV14F	1/4"	1/4"	----
HNV14FB	1/4"	1/4"	----
HNV38F	3/8"	3/8"	----
HNV38FB	3/8"	3/8"	----
HNV12F	1/2"	1/2"	----
HNV12FB	1/2"	1/2"	----
HNV34F	3/4"	3/4"	----
HNV34FB	3/4"	3/4"	----



B=BRASS



BRASS - HNV SERIES PLUG



BRASS - HNV SERIES COUPLER

ISO-B FEMALE PIPE PLUG

PART #	BODY SIZE	NPT	
HNV14M	1/4"	1/4"	----
HNV14MB	1/4"	1/4"	----
HNV38M	3/8"	3/8"	----
HNV38MB	3/8"	3/8"	----
HNV12M	1/2"	1/2"	----
HNV12MB	1/2"	1/2"	----
HNV34M	3/4"	3/4"	----
HNV34MB	3/4"	3/4"	----



WARNING: This product can expose you to chemicals, including lead, which are known to the State of California to cause cancer and birth defects or other reproductive harm. For more information, visit www.P65Warnings.ca.gov

FLUSH FACE ISO

HYDRAULIC ADAPTERS

FEATURES

- Steel construction, zinc plated trivalent finish. Hardened Nipples and sleeves and solid barstock construction for maximum resistance to damage from hydraulic and mechanical shock.
- This Anti-Blowout Nitrile/ PTFE bonded seal is designed to prevent blow out or damage during severe service conditions.
- Durable ball-locking mechanism assures reliable connection everytime.
- Temp Range -65° to +250°

ISO 16028

Body Size	FLUSH FACE			
	Steel Coupler/ Plug Coupled			
	Maximum Working		Burst	
	PSI	Bar	PSI	Bar
1/4"	5,000	345	18,270	1,200
3/8"	4,000	275	18,270	1,200
1/2"	4,000	275	16,500	1,100
5/8"	4,000	275	14,800	1,000
3/4"	4,000	275	12,400	850
1"	3,000	200	12,600	850

FF Series
HTMC
74C



FEMALE PIPE COUPLER

PART #	BODY SIZE	NPT	
FF14F	1/4"	1/4"	----
FF38F	3/8"	3/8"	----
FF12F	1/2"	1/2"	----
FF3812F	3/8"	1/2"	----
FF1234F	1/2"	3/4"	----
FF3416F	3/4"	1"	----
FF34F	3/4"	3/4"	----
FF-1-F	1"	1"	----

FF Series
HTMN
74N



FEMALE PIPE PLUG

PART #	BODY SIZE	NPT	
FF14M	1/4"	1/4"	----
FF38M	3/8"	3/8"	----
FF12M	1/2"	1/2"	----
FF3812M	3/8"	1/2"	----
FF1234M	1/2"	3/4"	----
FF3416M	3/4"	1"	----
FF34M	3/4"	3/4"	----
FF1M	1"	1"	----

FLAT FACE THREAD LOCK - VEP QUICK COUPLING

SPECIFICATIONS

BODY SIZE (IN)	1/2(12)	3/4(34)	1(1)	1-1/2(24)
Rated Pressure (PSI)	7000	7000	6000	5000
Rated Flow (GPM)	12	50	88	152
Temperature Range	-20°C +120°C			

Standard seal material is **NBR**

Test Fluid-Oil = 200 SUS

APPLICATIONS

- Widely used in public equipment
- Portable construction equipment.
- Hydraulic tools
- Vehicles

FEATURES

- New valve design provides better resistance from high flow and the pressure of impulse, thus providing advanced performance.
- Special nipple design for connecting under pressure, allows connection and disconnection with high residual pressures.
- The LSQ-VEP series employs a threaded sleeve locking mechanism, mates with matching male threads on the coupler.
- New plating treatment provides advanced anti-rust performance.
- LSQ-VEP series couplings employ flush valving when connecting or disconnecting, therefore only a small amount of fluid can be lost during disconnecting or air inclusion during reconnection.
- The Anti-Blowout bonded seal is designed to prevent blow-out or damage during severe service conditions.
- Machined form solid steel barstock for durability. Compatible with most other VEP series.
- O-Ring SAE Boss Thread available with import lead time (same list price)

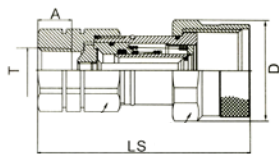

FEMALE COUPLER

PART #	LS	D	A	NPT	
LSQVEP12SF	4.09	1.13	0.67	1/2	----
LSQVEP34SF	4.49	2.13	0.79	3/4	----
LSQVEP1SF	5.28	2.33	0.83	1	----
LSQVEP20SF	5.71	2.72	0.83	1-1/4	----
LSQVEP24SF	7.41	3.63	0.83	1-1/2	----

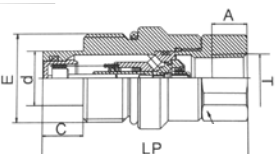

FEMALE PLUG

PART #	LS	D	A	NPT	
LSQVEP12PF	4.09	1.13	0.67	1/2	----
LSQVEP34PF	4.49	2.13	0.79	3/4	----
LSQVEP1PF	5.28	2.33	0.83	1	----
LSQVEP20PF	5.71	2.72	0.83	1-1/4	----
LSQVEP24PF	7.41	3.63	0.83	1-1/2	----

QUICK DISCONNECT - HYDRAULIC JACK

HYDRAULIC ADAPTERS

Nominal Size	Steel Coupler/ Plug			
	Maximum Working		Burst	
	PSI	Bar	PSI	Bar
1/4"	4,000	275	21,000	1,500
3/8"	4,000	275	23,100	1,600
1/2"	4,000	275	16,500	1,100
3/4"	3,000	200	10,300	700
1"	3,000	200	13,000	900

Snap-Tite 60 Series

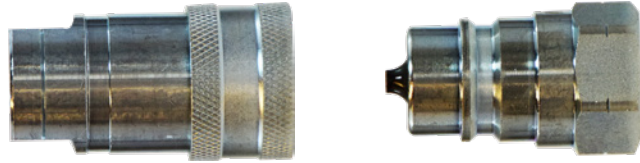

FEMALE PIPE COUPLER				FEMALE PIPE PLUG			
Part #	Body Size	NPT		Part #	Body Size	NPT	
NV14F	1/4"	1/4"	----	NV14M	1/4"	1/4"	----
NV38F	3/8"	3/8"	----	NV38M	3/8"	3/8"	----
NV12F	1/2"	1/2"	----	NV12M	1/2"	1/2"	----
NV34F	3/4"	3/4"	----	NV34M	3/4"	3/4"	----
NV1F	1"	1"	----	NV1M	1"	1"	----

FEATURES

- Heavy duty heat treated poppet: valves are standard with rugged, specially-designed seals made of nitrite for leak-free performance in the toughest application.
- High-strength steel valve guides designed for high flow rates and made extra tough for agricultural service.
- Dependable hardened chrome alloy steel locking balls. Heat treated plugs and sleeves.
- Standard seals temp range -40°F to +250°F

THREAD LOCK HYDRAULIC JACK COUPLING

SPECIFICATIONS

Body Size	1/4(14)	3/8(38)
Rated Pressure	10,000	
Rated Flow (GPM)	3	6
Temperature Range	-20°C +120°C	
Standard seal material is NBR		

APPLICATIONS

- Thread lock couplings with their threaded union locking system and precision ball-type check valves are designed for extreme high pressure applications such as portable hydraulic jacks.
- **Ball Type.**

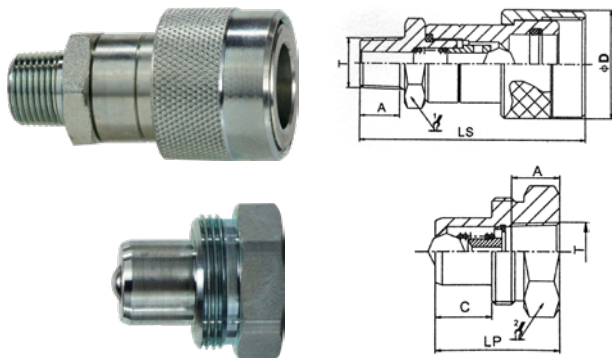

MALE COUPLER

PART #	LS	D	HEX	A	NPT	
KZEB14SM	2.40	1.14	0.87	0.55	1/4	----
KZEB38SM	2.91		0.98	0.57	3/8	----

FEMALE COUPLER

PART #	LS	D	HEX	A	NPT	
KZEB14PF	1.30	0.44	0.75	0.51	1/4	----
KZEB38PF	1.38	0.63	1.26	0.55	3/8	----

WARNING: This product can expose you to chemicals, including Cobalt, which are known to the State of California to cause cancer. For more information, visit www.P65Warnings.ca.gov



HYDRAULIC FLOW CONTROL/ NEEDLE VALVES

HYDRAULIC ADAPTERS

MM-FC SERIES FLOW CONTROL VALVES

FEATURES:

- Micrometer adjustment knob for accurate valve setting.
- Rugged construction.

TECHNICAL DATA:

• Materials

Body: Carbon steel w/ black oxide plating
 Handle: Zinc Alloy
 Set Screw: Steel
 Packing: Buna O-Ring/ PTFE stem packing

Maximum Pressure: 5000PSI
 Temperature Ratings: -4°F to 176°F (-20°C to 80°C)
 Flow Rate: 0-42 GPM



INLET

<< FREE FLOW

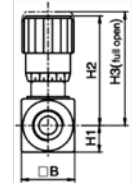
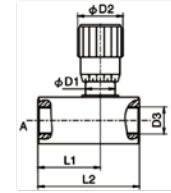

Part#	B	D1	D2	D3	H1	H2	H3	L1	L2	WEIGHT (lbs)	
MMFC4NPT	1.10	0.76	1.18	1/4 NPT	0.55	2.41	2.67	1.54	2.52	0.90	----
MMFC6NPT	1.10	0.76	1.18	3/8 NPT	0.55	2.41	2.67	1.69	2.75	0.90	----
MMFC8NPT	1.50	0.95	1.46	1/2 NPT	0.75	3.07	3.41	2.05	3.27	2.00	----
MMFC12NPT	1.50	0.95	1.46	3/4 NPT	0.75	3.08	3.41	2.19	3.50	2.00	----
MMFC16NPT	1.89	1.38	1.89	1 NPT	0.94	4.03	4.50	2.79	4.60	4.20	----
MMFC20NPT	2.38	1.96	2.28	1-1/4 NPT	1.18	5.25	5.88	3.39	6.07	9.55	----

MM-NV SERIES NEEDLE VALVES

FEATURES:

- Micrometer adjustment knob for accurate valve setting.
- Rugged construction.

TECHNICAL DATA:

• Materials

Body: Carbon steel w/ black oxide plating
 Handle: Zinc Alloy
 Set Screw: Steel
 Packing: Buna O-Ring/ PTFE stem packing

Maximum Pressure: 5000PSI
 Temperature Ratings: -4°F to 176°F (-20°C to 80°C)
 Flow Rate: 0-42 GPM

• FULL SHUT-OFF

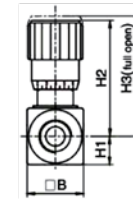
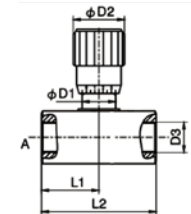

Part#	B	D1	D2	D3	H1	H2	H3	L1	L2	WEIGHT (lbs)	
MMNV4NPT	1.10	0.76	1.18	1/4 NPT	0.55	2.41	2.67	1.07	2.13	0.90	----
MMNV6NPT	1.10	0.76	1.18	3/8 NPT	0.55	2.41	2.67	1.07	2.13	0.90	----
MMNV8NPT	1.50	0.95	1.46	1/2 NPT	0.75	3.07	3.41	1.34	2.38	2.00	----
MMNV12NPT	1.50	0.95	1.46	3/4 NPT	0.75	3.08	3.41	1.54	3.09	2.00	----
MMNV16NPT	1.89	1.38	1.89	1 NPT	0.94	4.03	4.50	1.81	3.62	4.20	----

WARNING: This product can expose you to chemicals, including cobalt, which are known to the State of California to cause cancer and birth defects or other reproductive harm. For more information, visit www.P65Warnings.ca.gov



HYDRAULIC FLOW CONTROL/ BREATHERS

HYDRAULIC ADAPTERS

PRESSURE COMPENSATING VARIABLE FLOW CONTROL

FEATURES:

MFC-51 model is a full range pressure compensating variable flow control. It is designed so that the orifice area varies as the lever is rotated. The outlet flow is smooth and constant regardless of the pressure on the control flow or excess flow ports. An adjustable ball spring relief allows for pressure compensated flow up to the pressure setting on the relief. Relief valves are preset at 1500 PSI and field adjustable from 750 to 3000 PSI.

- Materials: Cast Iron Body, Heat Treated Compensator Spool, Stainless Steel Rotary Spool, Buna N "O" Rings (Standard)
- **ALL ARE STANDARD FLOW CONTROL**
- **ALL HAVE ADJUSTABLE BALL SPRING RELIEF**
- **SAE PORT AVAILABLE. MINIMUM ORDER REQUIRED**

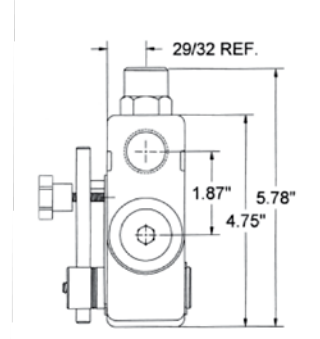
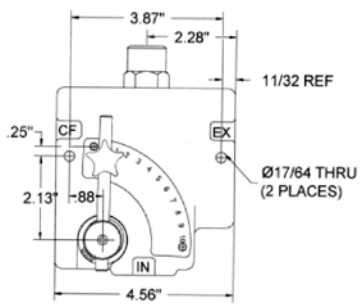

Part#	Size	Flow	
MFC38N	3/8" - NPT	0-8 gpm	----
MFC12N	1/2" - NPT	0-16 gpm	----
MFC34N	3/4" - NPT	0-30 gpm	----

SCREW-ON TYPE AIR BREATHERS



- **Chrome Plated Steel**
- **1/4 To 1 Inch NPT**
- **40 Micron Breather**

PART NUMBER	FLOW CFM	NPT	
MB4004	10	1/4	----
MB4006	10	3/8	----
MB4008	10	1/2	----
MB4012	25	3/4	----
MB4016	25	1	----

WARNING: This product can expose you to chemicals, including Chromium, which are known to the State of California to cause cancer and birth defects or other reproductive harm. For more information, visit www.P65Warnings.ca.gov



FLANGE ADAPTERS

HYDRAULIC ADAPTERS

STEEL FLANGE ADAPTERS

CONFORMANCE

- SAE J518

MATERIALS

- Steel per SAE J518 with either black phosphate finish or plated zinc finish or iridite dip. Stainless Steel available upon request.

WORKING PRESSURES

The following table lists the recommended working pressures for steel Four-bolt Solid and Split Flange Fittings and Hose Ends manufactured in accordance with SAE standards J518 and J517. SAE recommends sufficient testing to be conducted to assure that performance levels will be safe and satisfactory, especially if installed in systems operating at elevated pressures or in severe conditions. When using Flanged Fittings that have a threaded connection on one end, use the lower pressure rating of the two.

Caution: Although many Four-bolt Flanged Fittings have sufficient structural integrity to support the weight of many components, we recommend consulting with our technical support department for guidance in selection of parts for this purpose.

SAE J518 FOUR-BOLT CODE 61 FLANGE PRESSURE RATINGS

Dash Size	Flange Head OD Inches	4 TO 1 Minimum Burst PSI
-8	1-3/16 - 1.188	5000
-12	1-1/2 - 1.500	5000
-16	1-3/4 - 1.750	5000
-20	2 - 2.000	4000
-24	2-3/8 - 2.375	3000
-32	2-13/16 - 2.812	3000
-40	3-5/16 - 3.312	2500
-48	4 - 4.000	2000
-56	4-1/2 - 4.500	500
-64	5 - 5.000	500
-80	6 - 6.000	500

SAE J518 FOUR-BOLT CODE 62 FLANGE PRESSURE RATINGS

Dash Size	Flange Head OD Inches	4 TO 1 Minimum Burst PSI
-8	1-1/4 - 1.250	6000
-12	1-5/8 - 1.625	6000
-16	1-7/8 - 1.875	6000
-20	2-1/8 - 2.125	6000
-24	2-1/2 - 2.500	6000
-32	3-1/8 - 3.125	6000

STEEL FLANGE ADAPTERS ASSEMBLY INSTRUCTIONS

RECOMMENDED SOLID FOUR-BOLT

- Inspect port area to be smooth and free of nicks, burrs, scratches, or contaminants.
- Lubricate the o-ring and place in flange head groove.
- Lubricate screw threads, slip lock washers onto screws, and insert screws into flange.
- Position flange on port and finger tighten all screws.
- Torque the screws in a figure eight sequence, incrementally until the appropriate torque value in the following table is achieved.

J518 CODE 61 AND CODE 62 FLANGE MINIMUM TORQUE VALUES

Dash Size	Port Size	Code 61 Foot/Lbs.	Code 62 Foot/Lbs.
-8	1/2"	15-19	15-19
-12	3/4"	20-29	25-33
-16	1"	27-35	41-50
-20	1-1/4"	35-46	62-75
-24	1-1/2"	46-58	116-133
-32	2"	53-67	200-217
-40	2-1/2"	79	NA
-48	3"	137	NA
-56	3-1/2"	116	NA
-64	4"	116	NA
-80	5"	116	NA

RECOMMENDED SPLIT FOUR-BOLT

- Follow steps 1 through 3 above, then proceed to the following steps.
- Position both flanges on port and turn one screw in each flange about three turns.
- Rotate each flange away from the port for sufficient clearance to position hose or fitting flange head on port.
- Close each flange until it properly captures flange head. Insert remaining screws and finger tighten.
- Torque the screws in a figure eight sequence incrementally until the appropriate torque value in the preceding table is achieved.

WHY WET TORQUE?

Due to the difference in plating types and thickness, materials, and thread quality of different components, the coefficient of friction varies greatly on any given assembly. Lubrication not only produces a more consistent coefficient of friction, it increases clamping force on sealing area with less torque on the threads. Overtightening causes threads to yield, deform and lose their ability to maintain an adequate load or clamping force on the seating area. Extended operation and severe conditions cause further yielding which results in leaks. Overtightening is the single greatest cause for leaks in metal to metal seat hydraulic connections. It is our firm position, that to not wet torque, is to compromise consistency and quality for convenience.

FLANGE ADAPTERS

HYDRAULIC ADAPTERS

JIC FLANGE ADAPTER

CODE 61

6840
503

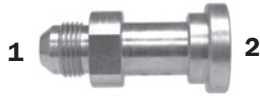

3000 PSI

PART #	JIC THREAD SIZE 1	FLANGE SIZE 2	
170088	3/4-16	1/2	----
1700812	3/4-16	3/4	----
17001212	1-1/16-12	3/4	----
17001216	1-1/16-12	1	----
17001616	1-5/16-12	1	----
17001620	1-5/16-12	1-1/4	----
17001624	1-5/16-12	1-1/2	----
17002016	1-5/8-12	1	----
17002020	1-5/8-12	1-1/4	----
17002032	1-5/8-12	2	----
17002424	1-7/8-12	1-1/2	----
17003232	2-1/2-12	2	----
17002024	1-5/8-12	1-1/2	----
17002420	1-7/8-12	1-1/4	----
17001612	1-5/16-12	3/4	----
17002432	1-7/8-12	2	----

6840 503

JIC FLANGE 450 ADAPTER

CODE 61

6845
505



3000 PSI

Part #	JIC Thread Size 1	Flange Size 2	
170388	3/4-16	1/2	----
1703812	3/4-16	3/4	----
17031212	1-1/16-12	3/4	----
17031216	1-1/16-12	1	----
17031616	1-5/16-12	1	----
17031620	1-5/16-12	1-1/4	----
17032016	1-5/8-12	1	----
17032020	1-5/8-12	1-1/4	----
17032024	1-5/8-12	1-1/2	----
17033232	2-1/2-12	2	----
17032420	1-7/8-12	1-1/4	----
17032424	1-7/8-12	1-1/2	----
17032432	1-7/8-12	2	----
17031612	1-5/16-12	3/4	----

6845 505

JIC FLANGE 90° ADAPTER

CODE 61



3000 PSI

Part #	JIC Thread Size 1	Flange Size 2	
170488	3/4-16	1/2	----
1704812	3/4-16	3/4	----
17041016	7/8-14	1	----
17041212	1-1/16-12	3/4	----
17041216	1-1/16-12	1	----
17041220	1-1/16-12	1-1/4	----
17041612	1-5/16-12	3/4	----
17041616	1-5/16-12	1	----
17041620	1-5/16-12	1-1/4	----
17041624	1-5/16-12	1-1/2	----
17042016	1-5/8-12	1	----
17042020	1-5/8-12	1-1/4	----
17042024	1-5/8-12	1-1/2	----
17042420	1-7/8-12	1-1/4	----
17042432	1-7/8-12	2	----
17043232	2-1/2-12	2	----
17042032	1-5/8-12	2	----
17042424	1-7/8-12	1-1/2	----

6890 504

JIC FLANGE ADAPTER

CODE 62



6000 PSI

Part #	JIC Thread Size 1	Flange Size 2	
180088	3/4-16	1/2	----
18001212	1-1/16-12	3/4	----
18001216	1-1/16-12	1	----
18001616	1-5/16-12	1	----
18001620	1-5/16-12	1-1/4	----
18002016	1-5/8-12	1	----
18002020	1-5/8-12	1-1/4	----
18002024	1-5/8-12	1-1/2	----
18002424	1-7/8-12	1-1/2	----
18003232	2-1/2-12	2	----
18001612	1-5/16-12	3/4	----
18001624	1-5/16-12	1-1/2	----
18002420	1-7/8-12	1-1/4	----

6842

FLANGE ADAPTERS

HYDRAULIC ADAPTERS

JIC FLANGE 45° ADAPTER

CODE 62



6000 PSI

PART #	JIC THREAD SIZE 1	FLANGE SIZE 2	
18031212	1-1/16-12	3/4	----
18031216	1-1/16-12	1	----
18031616	1-5/16-12	1	----
18031620	1-5/16-12	1-1/4	----
18032016	1-5/8-12	1	----
18032020	1-5/8-12	1-1/4	----
18032024	1-5/8-12	1-1/2	----
18032424	1-7/8-12	1-1/2	----
18033232	2-1/2-12	2	----
18031612	1-5/16-12	3/4	----
18031624	1-5/16-12	1-1/2	----
18032420	1-7/8-12	1-1/4	----

6847 508

JIC FLANGE 90° ADAPTER - CODE 62



6000 PSI

PART #	JIC THREAD SIZE 1	FLANGE SIZE 2	
18041212	1-1/16-12	3/4	----
18041216	1-1/16-12	1	----
18041616	1-5/16-12	1	----
18041620	1-5/16-12	1-1/4	----
18042016	1-5/8-12	1	----
18042020	1-5/8-12	1-1/4	----
18042024	1-5/8-12	1-1/2	----
18042424	1-7/8-12	1-1/2	----
18043232	2-1/2-12	2	----
18041612	1-5/16-12	3/4	----
18041624	1-5/16-12	1-1/2	----
18042420	1-7/8-12	1-1/4	----

6842

SPLIT FLANGE PLUG - CODE 61



3000 PSI

PART #	FLANGE SIZE	
196112	3/4	----
196116	1	----
196120	1-1/4	----
196124	1-1/2	----
196132	2	----

6861P

SPLIT FLANGE PLUG

CODE 62

6862P



6000 PSI

PART #	FLANGE SIZE	
196212	3/4	----
196216	1	----
196220	1-1/4	----
196224	1-1/2	----
196232	2	----

6862P

SPLIT FLANGE KIT

CODE 61

SFK



3000 PSI

PART #	FLANGE SIZE	FLANGE HEAD DIA.	
190112	3/4	1.50	----
190116	1	1.75	----
190120	1-1/4	2.00	----
190124	1-1/2	2.38	----
190132	2	2.81	----

SPLIT FLANGE KIT

CODE 62

SFXK



6000 PSI

PART #	FLANGE SIZE	FLANGE HEAD DIAMETER	
190212	3/4	1.63	----
190216	1	1.88	----
190220	1-1/4	2.12	----
190224	1-1/2	2.50	----
190232	2	3.12	----

FLANGE ADAPTERS

HYDRAULIC ADAPTERS

**SPLIT FLANGE HALF
CODE 61**

SF



3000 PSI

PART #	FLANGE SIZE	FLANGE HEAD DIAMETER	
206112	3/4	1.50	----
206116	1	1.75	----
206120	1-1/4	2.00	----
206124	1-1/2	2.38	----
206132	2	2.81	----

**SPLIT FLANGE HALF
CODE 62**

SFX



6000 PSI

PART #	FLANGE SIZE	FLANGE HEAD DIAMETER	
206212	3/4	1.63	----
206216	1	1.88	----
206220	1-1/4	2.12	----
206224	1-1/2	2.50	----
206232	2	3.12	----

**PIPE THREAD FLANGE PAD
CODE 61**

W43



3000 PSI

PART #	PIPE SIZE	
226188	1/2	----
2261212	3/4	----
22611616	1	----
22612020	1-1/4	----
22612424	1-1/2	----
22613232	2	----

**PIPE THREAD FLANGE PAD
CODE 62**

W44



6000 PSI

PART #	PIPE SIZE	
22621212	3/4	----
22621616	1	----
22622020	1-1/4	----
22622424	1-1/2	----
22623232	2	----

**O-RING FLANGE PAD
CODE 61**

W46



3000 PSI

PART #	O-RING THREAD SIZE	PAD SIZE	
23611212	1-1/16-12	3/4	----
23611616	1-5/16-12	1	----
23612020	1-5/8-12	1-1/4	----
23612424	1-7/8-12	1-1/2	----

**O-RING FLANGE PAD
CODE 62**

W48



6000 PSI

PART #	O-RING THREAD SIZE	PAD SIZE	
23621212	1-1/16-12	3/4	----
23621616	1-5/16-12	1	----
23622020	1-5/8-12	1-1/4	----
23622424	1-7/8-12	1-1/2	----

STAINLESS STEEL ADAPTERS

316 STAINLESS STEEL ADAPTERS

STAINLESS STEEL ADAPTERS

PIPE SWIVELS



JIC FITTINGS



BULKHEAD FITTINGS



PIPE FITTINGS



SAE O-RING BOSS



JIC FEMALE SWIVELS



HOSE CRIMP FITTINGS



ALL MALE THREADS SHIPPED WITH PROTECTIVE COVER



STAINLESS ADAPTERS

TECHNICAL INFORMATION**316 STAINLESS STEEL ADAPTERS****PRESSURE RATINGS**

The hydraulic tube fittings represented by Stainless Adapters Inc. conform to the performance requirements specified in SAE J514, SAE J518, SAE J1453, SAE J1926/ISO 11926 and related standards.

The working pressure ratings listed below are based on a 4:1 design factor for minimum burst. As specified in SAE J514, these are dynamic pressure ratings and the fittings are capable of passing a cyclic endurance (impulse) test for one million cycles at 133 % of the corresponding working pressure.

The rated working pressure for any fitting is based on the lowest pressure rated fitting end. For example, a fitting may include one -4 (1/4") male 37-degree tube end and one -6 (3/8") male pipe end. From the tables below, the rated working pressure for the -4 male 37-degree tube end is 34.5 MPa (5,000 psi) and the rated working pressure of the -6 (3/8") male pipe end is 21 MPa (3,000 psi). The rated working pressure of the fitting would be 21 MPa (3,000 psi).

For proper performance, the design of any hydraulic system should take into consideration the rated working pressures for each of the components of the system, including standard ratings for hose and tubing components and assemblies. For any application, testing should be performed to assure safe and satisfactory performance.

Pressure Ratings for Fittings With NPTF Pipe Threads and Adapter Unions							
Nominal Pipe Size		Thread Size		Working Pressures			
Nom SAE Dash Size	Nom Inch Pipe O.D.	Dryseal Pipe Thread (NPTF ¹) Male and Female	Straight Pipe Thread (NPSM ²) Female Swivels	Fittings With NPTF Pipe Threads		Adapter Unions	
				MPa	psi	MPa	psi
-2	1/8	1/8-27	1/8-27	34.5	5,000	34.5	5,000
-4	1/4	1/4-18	1/4-18	27.5	4,000	34.5	5,000
-6	3/8	3/8-18	3/8-18	21	3,000	27.6	4,000
-8	1/2	1/2-14	1/2-14	21	3,000	24.1	3,500
-12	3/4	3/4-14	3/4-14	17	2,500	15.5	2,250
-16	1	1-11-1/2	1-11-1/2	14	2,000	13.8	2,000
-20	1 1/4	1-1/4-11-1/2	1-1/4-11-1/2	8	1,150	11.2	1,625
-24	1 1/2	1-1/2-11-1/2	1-1/2-11-1/2	7	1,000	8.6	1,250
-32	2	2-11-1/2	2-11-1/2	7	1,000	7.8	1,125

1) Dryseal American Standard Taper Pipe Thread

2) American Standard Straight Pipe Thread for Mechanical Joints

■ Temperature Rating

Material	Identify	Max. Temperature °F(°C)
316 Stainless Steel	SS	1000(537)
Brass	B	400(204)
Carbon Steel	C	375(190)



USE OUR TEXT LINE [855-609-3729](tel:855-609-3729) TO COMMUNICATE WITH MIDLAND MORE CONVENIENTLY

TECHNICAL INFORMATION

316 STAINLESS STEEL ADAPTERS

Pressure Ratings

37° Flare SAE J514

Allowable Working Pressure Ratings (Capable of 4 to 1 Min. Burst)

Nom.SAE Dash Size	Nom.Tube O.D Inches	37°Flare Straight Thread	Nom.Pipe Size	SAE St. Threads Union and Bulkhead (psi)	Fittings with Pipe Threads (psi)
2	1/8	5/16" - 24	1/8"	5000	5000
3	3/16	3/8" - 24	1/8"	5000	5000
4	1/4	7/16" - 20	1/8"	5000	5000
5	5/16	1/2" - 20	1/8"	5000	5000
6	3/8	9/16" - 18	1/4"	5000	5000
8	1/2	3/4" - 16	3/8"	4500	4000
10	5/8	7/8" - 14	1/2"	3500	3000
12	3/4	1 1/16" - 12	3/4"	3500	3000
14	7/8	1 3/16" - 12	3/4"	3000	2500
16	1	1 5/16" - 12	1"	3000	2000
20	1 1/4	1 5/8" - 12	1 1/4"	2500	1150
24	1 1/2	1 7/8" - 12	1 1/2"	2000	1000
32	2	2 1/2" - 12	2"	1500	1000

JIC threads conform to SAE J514 specifications

NPT

Size Designator	NPT Size	316 Stainless Steel			
		Male		Female	
		psig	bar	psig	bar
1	1/16	11000	757	6700	461
2	1/8	10000	689	6500	447
4	1/4	8000	551	6600	454
6	3/8	7800	537	5300	365
8	1/2	7700	530	4900	337
12	3/4	7300	502	4600	316
16	1	5300	365	4400	303
20	1 1/4	6000	413	5000	344
24	1 1/2	5000	344	4600	316
32	2	3900	268	3900	268

NPT threads meet the requirements of ASME/ANSI B.1.20.1



GO ONLINE TO UPLOAD YOUR LOGO TO UTILIZE ALL OF OUR CUSTOMIZABLE TOOLS!

FEMALE PIPE SWIVELS

316 STAINLESS STEEL ADAPTERS

MALE NPT X FEMALE NPSM SWIVEL

PART #	(A) MNPT SIZE	(B) FNPT SIZE	(A) MNPT THREAD	(B) FNPT THREAD	(L)	
SS1404-04-04	1/4	1/4	1/4-18	1/4-18	1.440	----
SS1404-06-06	3/8	3/8	3/8-18	3/8-18	1.560	----
SS1404-08-08	1/2	1/2	1/2-14	1/2-14	1.940	----
SS1404-12-12	3/4	3/4	3/4-14	3/4-14	2.060	----
SS1404-16-16	1	1	1-11 1/2	1-11 1/2	2.380	----

SSP: PSX-XC / PARKER: 0107-X-X-SS / AEROQUIP: 259-2045-X-X

316 STAINLESS STEEL FEMALE NPT X FEMALE NPSM SWIVEL

PART	(A) FNPT SIZE	(B) FNPT SIZE	(A) FNPT THREAD	(B) FNPT THREAD	(L)	
SS1405-04-04	1/4	1/4	1/4-18	1/4-18	1.440	----
SS1405-06-06	3/8	3/8	3/8-18	3/8-18	1.560	----
SS1405-08-08	1/2	1/2	1/2-14	1/2-14	1.830	----
SS1405-12-12	3/4	3/4	3/4-14	3/4-14	1.960	----
SS1405-16-16	1	1	1-11 1/2	1-11 1/2	2.300	----

SSP: PSX-XFC / PARKER: 0207-X-X-SS / AEROQUIP: 259-2046-X-X

Control Your Temper

There once was a little boy who had a very bad temper. His father decided to hand him a bag of nails and said that every time the boy lost his temper, he had to hammer a nail into the fence.

On the first day, the boy hammered 37 nails into that fence.

The boy gradually began to control his temper over the next few weeks, and the number of nails he was hammering into the fence slowly decreased.

He discovered it was easier to control his temper than to hammer those nails into the fence.

Finally, the day came when the boy didn't lose his temper at all. He told his father the news and the father suggested that the boy should now pull out a nail every day he kept his temper under control.

The days passed and the young boy was finally able to tell his father that all the nails were gone. The father took his son by the hand and led him to the fence.

"you have done well, my son, but look at the holes in the fence. The fence will never be the same. When you say things in anger, they leave a scar just like this one. You can put a knife in a man and draw it out. It won't matter how many times you say I'm sorry, the wound is still there."

Moral of the story:

Control your anger, and don't say things to people in the heat of the moment, that you may later regret. Some things in life, you are unable to take back.

- Unknown

JIC 37°

316 STAINLESS STEEL ADAPTERS

JIC TUBE SLEEVE



PART	(A) SIZE	(L)	
SS319-04	1/4	.409	----
SS319-06	3/8	.500	----
SS319-08	1/2	.559	----
SS319-10	5/8	.661	----
SS319-12	3/4	.681	----
SS319-16	1	.779	----

SSP: JXS / PARKER: XTX-SS / AEROQUIP: 259-900605-X

JIC TUBE NUT



PART	(A) FJIC SIZE	(A) THREAD	HEX	(L)	
SS318-04	1/4	7/16-20	9/16	.622	----
SS318-06	3/8	9/16-18	11/16	.728	----
SS318-08	1/2	3/4-16	7/8	.850	----
SS318-10	5/8	7/8-14	1	.980	----
SS318-12	3/4	1-1/16-12	1-1/4	1.031	----
SS318-16	1	1-5/16-12	1-1/2	1.129	----

SSP: JXN / PARKER: XBTX-SS / AEROQUIP: 259-1290-X

JIC CAP



PART	(A) FJIC SIZE	(A) THREAD	HEX	(L) LENGTH	
SS304-C-04	1/4	7/16-20	9/16	.594	----
SS304-C-06	3/8	9/16-18	11/16	.625	----
SS304-C-08	1/2	3/4-16	7/8	.748	----
SS304-C-10	5/8	7/8-14	1	.842	----
SS304-C-12	3/4	1-1/16-12	1-1/4	.905	----
SS304-C-16	1	1-5/16-12	1-1/2	1.015	----

SSP: AJXZ / PARKER: X FNTX-SS / AEROQUIP: 259-210292-X



SEE WEBSITE TO DOWNLOAD YOUR MOST UPDATED PRICING

STRAIGHTS JIC FLARE 37°

316 STAINLESS STEEL ADAPTERS

STAINLESS ADAPTERS

MALE JIC UNION



PART	(A) MJIC SIZE	(B) MJIC SIZE	(A) MJIC THREAD	(B) MJIC THREAD	(L)	
SS2403-04-04	1/4	1/4	7/16-20	7/16-20	1.370	----
SS2403-06-04	3/8	1/4	9/16-18	7/16-20	1.401	----
SS2403-06-06	3/8	3/8	9/16-18	9/16-18	1.409	----
SS2403-08-04	1/2	1/4	3/4-16	7/16-20	1.511	----
SS2403-08-06	1/2	3/8	3/4-16	9/16-18	1.519	----
SS2403-08-08	1/2	1/2	3/4-16	3/4-16	1.618	----
SS2403-10-08	5/8	1/2	7/8-14	3/4-16	1.779	----
SS2403-10-10	5/8	5/8	7/8-14	7/8-14	1.881	----
SS2403-12-04	3/4	1/4	1-1/16-12	7/16-20	1.850	----
SS2403-12-06	3/4	3/8	1-1/16-12	9/16-18	1.850	----
SS2403-12-08	3/4	1/2	1-1/16-12	3/4-16	1.948	----
SS2403-12-12	3/4	3/4	1-1/16-12	1-1/16-12	2.161	----
SS2403-16-12	1	3/4	1-5/16-12	1-1/16-12	2.318	----
SS2403-16-16	1	1	1-5/16-12	1-5/16-12	2.251	----

SSP: JX-XU / PARKER: HTX-SS / AEROQUIP: 259-2027-X-X

MALE JIC X MALE NPT ADAPTER



PART	(A) MJIC SIZE	(B) MNPT SIZE	(A) MJIC THREAD	(B) MNPT THREAD	(L)	
SS2404-04-02	1/4	1/8	7/16-20	1/8-27	1.220	----
SS2404-04-04	1/4	1/4	7/16-20	1/4-18	1.421	----
SS2404-04-06	1/4	3/8	7/16-20	3/8-18	1.421	----
SS2404-04-08	1/4	1/2	7/16-20	1/2-14	1.681	----
SS2404-06-04	3/8	1/4	9/16-18	1/4-18	1.429	----
SS2404-06-06	3/8	3/8	9/16-18	3/8-18	1.440	----
SS2404-06-08	3/8	1/2	9/16-18	1/2-14	1.688	----
SS2404-08-04	1/2	1/4	3/4-16	1/4-18	1.519	----
SS2404-08-06	1/2	3/8	3/4-16	3/8-18	1.531	----
SS2404-08-08	1/2	1/2	3/4-16	1/2-14	1.712	----
SS2404-08-12	1/2	3/4	3/4-16	3/4-14	1.850	----
SS2404-08-16	1/2	1	3/4-16	1-11 1/2	2.050	----
SS2404-10-08	5/8	1/2	7/8-14	1/2-14	1.889	----
SS2404-12-08	3/4	1/2	1-1/16-12	1/2-14	2.059	----
SS2404-12-12	3/4	3/4	1-1/16-12	3/4-14	2.059	----
SS2404-12-16	3/4	1	1-1/16-12	1-11 1/2	2.250	----
SS2404-16-08	1	1/2	1-5/16-12	1/2-14	2.100	----
SS2404-16-12	1	3/4	1-5/16-12	3/4-14	2.110	----
SS2404-16-16	1	1	1-5/16-12	1-11 1/2	2.299	----

SWAGELOK: SS-X-AN-1-X / SSP: JXC / PARKER: X FTX-SS / AEROQUIP 259-2021-X-X



USE OUR APP WITH YOUR FREE BIN LABELS TO MANAGE YOUR CUSTOMERS INVENTORY MORE EFFICIENTLY

STRAIGHTS JIC FLARE 37°

316 STAINLESS STEEL ADAPTERS

MALE JIC X FEMALE NPT ADAPTER



PART	(A) MJIC SIZE	(B) FNPT SIZE	(A) MJIC THREAD	(B) FNPT THREAD	(L)	
SS2405-04-04	1/4	1/4	7/16-20	1/4-18	1.389	----
SS2405-06-04	3/8	1/4	9/16-18	1/4-18	1.409	----
SS2405-06-06	3/8	3/8	9/16-18	3/8-18	1.470	----
SS2405-08-08	1/2	1/2	3/4-16	1/2-14	1.790	----
SS2405-12-12	3/4	3/4	1-1/16-12	3/4-14	2.059	----
SS2405-16-16	1	1	1-5/16-12	1-11 1/2	2.350	----

SSP: JX-XFC / PARKER: XXGTX-SS / AEROQUIP: 259-2022-X-X

FEMALE JIC X MALE JIC (REDUCER-EXPANDER)



PART	(A) FJIC SIZE	(B) MJIC SIZE	(A) FJIC THREAD	(B) MJIC THREAD	(L)	
SS2406-06-04	3/8	1/4	9/16-18	7/16-20	1.118	----
SS2406-08-04	1/2	1/4	3/4-16	7/16-20	1.448	----
SS2406-08-06	1/2	3/8	3/4-16	9/16-18	1.311	----
SS2406-10-08	5/8	1/2	7/8-14	3/4-16	1.409	----
SS2406-12-04	3/4	1/4	1-1/16-12	7/16-20	1.500	----
SS2406-12-06	3/4	3/8	1-1/16-12	9/16-18	1.480	----
SS2406-12-08	3/4	1/2	1-1/16-12	3/4-16	1.559	----
SS2406-16-04	1	1/4	1-5/16-12	7/16-20	1.570	----
SS2406-16-06	1	3/8	1-5/16-12	9/16-18	1.578	----
SS2406-16-08	1	1/2	1-5/16-12	3/4-16	1.669	----
SS2406-16-12	1	3/4	1-5/16-12	1-1/16-12	1.877	----

SSP: PSX-XFC / PARKER: 0207-X-X-SS / AEROQUIP: 259-2046-X-X

JIC PLUG



PART	(A) MJIC SIZE	(A) MJIC THREAD	HEX	(L)	
SS2408-04	1/4	7/16-20	1/2	.799	----
SS2408-06	3/8	9/16-18	5/8	.838	----
SS2408-08	1/2	3/4-16	13/16	.940	----
SS2408-10	5/8	7/8-14	15/16	1.098	----
SS2408-12	3/4	1-1/16-12	1-1/8	1.279	----
SS2408-16	1	1-5/16-12	1-3/8	1.330	----

SSP: JXP / PARKER: XRNTX-SS / AEROQUIP: 259-900599-X



VIEW PRICING AND AVAILABLE STOCK ONLINE

BULKHEAD FITTINGS

316 STAINLESS STEEL ADAPTERS

JIC BULKHEAD NUT

PART	(A) BN SIZE	(A) THREAD	HEX	(L)	
SS306-04	1/4	7/16-20	11/16	.279	----
SS306-06	3/8	9/16-18	13/16	.271	----
SS306-08	1/2	3/4-16	1	.311	----
SS306-10	5/8	7/8-14	1-1/8	.358	----
SS306-12	3/4	1-1/16-12	1-3/8	.409	----
SS306-16	1	1-5/16-12	1-5/8	.409	----

SSP: XBN / PARKER: XWLN-SS / AEROQUIP: 259-210212-X-X

MALE JIC BULKHEAD UNION

PART	(A) MJIC SIZE	(B) MJIC SIZE	(A) MJIC THREAD	(B) MJIC THREAD	(L)	
SS2700-04-04	1/4	1/4	7/16-20	7/16-20	2.070	----
SS2700-06-06	3/8	3/8	9/16-18	9/16-18	2.181	----
SS2700-08-08	1/2	1/2	3/4-16	3/4-16	2.440	----
SS2700-12-12	3/4	3/4	1-1/16-12	1-1/16-12	3.090	----
SS2700-16-16	1	1	1-5/16-12	1-5/16-12	3.141	----

SSP: JXBU / PARKER: XWTX-SS / AEROQUIP: 259-2041-X-X

FEMALE NPT X MALE JIC BULKHEAD CONNECTOR

PART	(A) FNPT SIZE	(B) MJIC SIZE	(A) FNPT THREAD	(B) MJIC THREAD	(L)	
SS2705-04-04	1/4	1/4	1/4-18	7/16-20	2.078	----
SS2705-06-06	3/8	3/8	3/8-18	9/16-18	2.220	----
SS2705-08-08	1/2	1/2	1/2-14	3/4-16	2.610	----
SS2705-12-12	3/4	3/4	3/4-14	1-1/16-12	2.992	----
SS2705-16-16	1	1	1-11 1/2	1-5/16-12	3.228	----

SSP: JX-XBFC / PARKER: X-XWGTX-SS / AEROQUIP: 259-2239-X-X

FEMALE PIPE BULKHEAD UNION

PART	(A) FNPT SIZE	(B) FNPT SIZE	(A) FNPT THREAD	(B) FNPT THREAD	(L)	
SS2707-04-04	1/4	1/4	1/4-18	1/4-18	1.500	----
SS2707-06-06	3/8	3/8	3/8-18	3/8-18	1.311	----
SS2707-08-08	1/2	1/2	1/2-14	1/2-14	1.500	----

SSP: AXAC

PIPE FITTINGS

316 STAINLESS STEEL ADAPTERS

HEX PIPE COUPLING



PART	(A) FNPT SIZE	(B) FNPT SIZE	(A) FNPT THREAD	(B) FNPT THREAD	(L)	
SS5000-02-02	1/8	1/8	1/8-27	1/8-27	.748	----
SS5000-04-04	1/4	1/4	1/4-18	1/4-18	1.129	----
SS5000-06-04	3/8	1/4	3/8-18	1/4-18	1.129	----
SS5000-06-06	3/8	3/8	3/8-18	3/8-18	1.129	----
SS5000-08-06	1/2	3/8	1/2-14	3/8-18	1.500	----
SS5000-08-08	1/2	1/2	1/2-14	1/2-14	1.500	----
SS5000-12-12	3/4	3/4	3/4-14	3/4-14	1.531	----
SS5000-16-08	1	1/2	1-11 1/2	1/2-14	1.889	----
SS5000-16-12	1	3/4	1-11 1/2	3/4-14	1.889	----
SS5000-16-16	1	1	1-11 1/2	1-11 1/2	1.889	----

SWAGELOK: SS-XHGG-X / SSP: XHC / PARKER: XGG-SS / AEROQUIP: 259-2096-X-X

HEX PIPE NIPPLE



PART	(A) MNPT SIZE	(B) MNPT SIZE	(A) MNPT THREAD	(B) MNPT THREAD	L	
SS5404-02-02	1/8	1/8	1/8-27	1/8-27	1.059	----
SS5404-04-02	1/4	1/8	1/4-18	1/8-27	1.259	----
SS5404-04-04	1/4	1/4	1/4-18	1/4-18	1.448	----
SS5404-06-04	3/8	1/4	3/8-18	1/4-18	1.448	----
SS5404-06-06	3/8	3/8	3/8-18	3/8-18	1.448	----
SS5404-08-04	1/2	1/4	1/2-14	1/4-18	1.700	----
SS5404-08-06	1/2	3/8	1/2-14	3/8-18	1.700	----
SS5404-08-08	1/2	1/2	1/2-14	1/2-14	1.889	----
SS5404-12-04	3/4	1/4	3/4-14	1/4-18	1.771	----
SS5404-12-06	3/4	3/8	3/4-14	3/8-18	1.771	----
SS5404-12-08	3/4	1/2	3/4-14	1/2-14	1.960	----
SS5404-12-12	3/4	3/4	3/4-14	3/4-14	1.960	----
SS5404-16-08	1	1/2	1-11 1/2	1/2-14	2.090	----
SS5404-16-12	1	3/4	1-11 1/2	3/4-14	2.149	----
SS5404-16-16	1	1	1-11 1/2	1-11 1/2	2.338	----

SWAGELOK: SS-X-HN-X / SSP: XHN / PARKER: X-XFF-SS / AEROQUIP: 259-2083-X-X

PIPE NIPPLE



PART	(A) MNPT SIZE	(A) MNPT THREAD	(L)	
SSCN-04	1/4	1/4-18	1.120	----
SSCN-06	3/8	3/8-18	1.125	----
SSCN-08	1/2	1/2-14	1.507	----
SSCN-12	3/4	3/4-14	1.500	----
SSCN-16	1	1-11 1/2	1.880	----

SWAGELOK: SS-X-CN / PARKER: X-X MCN-SS / AEROQUIP: 259-2083-X-X

STEEL PIPE FITTINGS

316 STAINLESS STEEL ADAPTERS

MALE NPT X FEMALE NPT EXPANDER



PART	(A) MNPT SIZE	(B) FNPT SIZE	(A) MNPT THREAD	(B) FNPT THREAD	(L)	
SS5405-02-02	1/8	1/8	1/8-27	1/8-27	1.039	----
SS5405-02-04	1/8	1/4	1/8-27	1/4-18	1.208	----
SS5405-04-04	1/4	1/4	1/4-18	1/4-18	1.389	----
SS5405-04-06	1/4	3/8	1/4-18	3/8-18	1.440	----
SS5405-04-08	1/4	1/2	1/4-18	1/2-14	1.681	----
SS5405-06-06	3/8	3/8	3/8-18	3/8-18	1.440	----
SS5405-06-08	3/8	1/2	3/8-18	1/2-14	1.681	----
SS5405-06-12	3/8	1/2	3/8-18	3/4-14	1.740	----
SS5405-08-08	1/2	1/2	1/2-14	1/2-14	1.870	----
SS5405-08-12	1/2	3/4	1/2-14	3/4-14	1.929	----
SS5405-08-16	1/2	1	1/2-14	1-11 1/2	2.181	----
SS5405-12-12	3/4	3/4	3/4-14	3/4-14	1.929	----
SS5405-12-16	3/4	1	3/4-14	1-11 1/2	2.181	----
SS5405-16-16	1	1	1-11 1/2	1-11 1/2	2.370	----

SWAGELOK: SS-X-RA-X / SSP: XXXRA / PARKER: X-XFG-SS / AEROQUIP: 259-2040-X-X

MALE NPT X FEMALE NPT BUSHING/ REDUCER



PART	(A) MNPT SIZE	(B) FNPT SIZE	(A) MNPT THREAD	(B) FNPT THREAD	(L)	
SS5406-04-02	1/4	1/8	1/4-18	1/8-27	.850	----
SS5406-06-04	3/8	1/4	3/8-18	1/4-18	.850	----
SS5406-08-04	1/2	1/4	1/2-14	1/4-18	1.098	----
SS5406-08-06	1/2	3/8	1/2-14	3/8-18	1.098	----
SS5406-12-04	3/4	1/4	3/4-14	1/4-18	1.169	----
SS5406-12-06	3/4	3/8	3/4-14	3/8-18	1.169	----
SS5406-12-08	3/4	1/2	3/4-14	1/2-14	1.169	----
SS5406-16-04	1	1/4	1-11 1/2	1/4-18	.940	----
SS5406-16-06	1	3/8	1-11 1/2	3/8-18	.940	----
SS5406-16-08	1	1/2	1-11 1/2	1/2-14	.940	----
SS5406-16-12	1	3/4	1-11 1/2	3/4-14	.940	----
SS5406-20-12	1-1/4	3/4	1-1/4-11 1/2	3/4-14	1.47	----

SWAGELOK: SS-XRB-X / SSP: XXXRA / PARKER: XXXPTR-SS / AEROQUIP: 259-2081-X-X

HEX PIPE PLUG



PART	(A) MNPT SIZE	(A) MNPT THREAD	HEX SIZE	(L)	(L)	
SS5406-P-04	1/4	1/4-18	9/16	.751	.850	----
SS5406-P-06	3/8	3/8-18	11/16	.779	.850	----
SS5406-P-08	1/2	1/2-14	7/8	1.118	1.098	----
SS5406-P-12	3/4	3/4-14	1-1/8	1.169	1.098	----
SS5406-P-16	1	1-11 1/2	1-3/8	1.397	1.169	----

SWAGELOK: SS-X-P / SSP: XXXRA / PARKER: X-HHP-SS / AEROQUIP: 259-2082-X

HOLLOW HEX PIPE PLUG



PART	(A) MNPT SIZE	(A) MNPT THREAD	HEX SIZE	(L)	(L)	
SS5406-HHP-04	1/4	1/4-18	1/4	.460	.850	----
SS5406-HHP-06	3/8	3/8-18	5/16	.460	.850	----
SS5406-HHP-08	1/2	1/2-14	3/8	.610	1.098	----
SS5406-HHP-12	3/4	3/4-14	9/16	.618	1.098	----
SS5406-HHP-16	1	1-11 1/2	5/8	.771	1.169	----

SWAGELOK: SS-X-HP / SSP: XCP / PARKER: X-HP-SS / AEROQUIP: 259-2222-X

STEEL PIPE FITTINGS

316 STAINLESS STEEL ADAPTERS

HEX PIPE CAP



PART	(A) FNPT SIZE	(A) FNPT THREAD	HEX	(L)	
SS5406-C-04	1/4	1/4-18	3/4	.811	----
SS5406-C-06	3/8	3/8-18	7/8	.811	----
SS5406-C-08	1/2	1/2-14	1	1.000	----
SS5406-C-12	3/4	3/4-14	1-5/16	1.129	----
SS5406-C-16	1	1-11 1/2	1-5/8	1.500	----

SWAGELOK: SS-X-C / SSP: XMM / PARKER: XCR-SS / AEROQUIP: 259-2085-X-X

MALE PIPE ELBOW 90°



PART	(A) MNPT SIZE	(B) MNPT SIZE	(A) MNPT THREAD	(B) MNPT THREAD	(L)	
SS5500-02-02	1/8	1/8	1/8-27	1/8-27	.748	----
SS5500-04-04	1/4	1/4	1/4-18	1/4-18	1.129	----
SS5500-06-06	3/8	3/8	3/8-18	3/8-18	1.129	----
SS5500-08-08	1/2	1/2	1/2-14	1/2-14	1.129	----
SS5500-12-12	3/4	3/4	3/4-14	3/4-14	1.500	----
SS5500-16-16	1	1	1-11 1/2	1-11 1/2	1.500	----

SWAGELOK: SS-X-ME / SSP: XMM / PARKER: XCR-SS / AEROQUIP: 259-2085-X-X

MALE NPT X FEMALE NPT STREET ELBOW 90°



PART	(A) MNPT SIZE	(B) FNPT SIZE	(A) MNPT THREAD	(B) FNPT THREAD	
SS5502-02-02	1/8	1/8	1/8-27	1/8-27	----
SS5502-04-04	1/4	1/4	1/4-18	1/4-18	----
SS5502-06-06	3/8	3/8	3/8-18	3/8-18	----
SS5502-08-08	1/2	1/2	1/2-14	1/2-14	----
SS5502-12-12	3/4	3/4	3/4-14	3/4-14	----
SS5502-16-16	1	1	1-11 1/2	1-11 1/2	----

SWAGELOK: SS-X-ME / SSP: XMM / PARKER: XCR-SS / AEROQUIP: 259-2085-X-X



GO ONLINE TO VIEW OPEN ORDERS, ORDER HISTORY, AND TRACKING INFORMATION ON ALL SHIPMENTS

STEEL PIPE FITTINGS**316 STAINLESS STEEL ADAPTERS****FEMALE PIPE ELBOW 90°**

PART	(A) FNPT SIZE	(B) FNPT SIZE	(A) FNPT THREAD	(B) FNPT THREAD	
SS5504-02-02	1/8	1/8	1/8-27	1/8-27	----
SS5504-04-04	1/4	1/4	1/4-18	1/4-18	----
SS5504-06-06	3/8	3/8	3/8-18	3/8-18	----
SS5504-08-08	1/2	1/2	1/2-14	1/2-14	----
SS5504-12-12	3/4	3/4	3/4-14	3/4-14	----
SS5504-16-16	1	1	1-11 1/2	1-11 1/2	----

SWAGELOK: SS-X-E / SSP: XFF / PARKER: XDD-SS / AEROQUIP: 259-2087-X-X

MALE PIPE TEE

PART	(A) MNPT SIZE	(B) MNPT SIZE	(C) MNPT SIZE	(A) MNPT THREAD	(B) MNPT THREAD	(C) MNPT THREAD	
SS5600-04-04-04	1/4	1/4	1/4	1/4-18	1/4-18	1/4-18	----
SS5600-06-06-06	3/8	3/8	3/8	3/8-18	3/8-18	3/8-18	----
SS5600-08-08-08	1/2	1/2	1/2	1/2-14	1/2-14	1/2-14	----
SS5600-12-12-12	3/4	3/4	3/4	3/4-14	3/4-14	3/4-14	----
SS5600-16-16-16	1	1	1	1-11 1/2	1-11 1/2	1-11 1/2	----

SWAGELOK: SS-X-MT / SSP: XMMM / PARKER: XRRS-SS / AEROQUIP: 259-2257-X-X

FEMALE PIPE TEE

PART	(A) FNPT SIZE	(B) FNPT SIZE	(C) FNPT SIZE	(A) FNPT THREAD	(B) FNPT THREAD	(C) FNPT THREAD	
SS5605-02-02-02	1/8	1/8	1/8	1/8-27	1/8-27	1/8-27	----
SS5605-04-04-04	1/4	1/4	1/4	1/4-18	1/4-18	1/4-18	----
SS5605-06-06-06	3/8	3/8	3/8	3/8-18	3/8-18	3/8-18	----
SS5605-08-08-08	1/2	1/2	1/2	1/2-14	1/2-14	1/2-14	----
SS5605-12-12-12	3/4	3/4	3/4	3/4-14	3/4-14	3/4-14	----
SS5605-16-16-16	1	1	1	1-11 1/2	1-11 1/2	1-11 1/2	----

SWAGELOK: SS-X-T / SSP: XFF / PARKER: XMMO-SS / AEROQUIP: 259-2090-X-X



USE OUR TEXT LINE [855-609-3729](tel:855-609-3729) TO COMMUNICATE WITH MIDLAND MORE CONVENIENTLY

SAE O-RING BOSS (ORB)

316 STAINLESS STEEL ADAPTERS

MALE JIC X MALE SAE O-RING BOSS



PART	(A) MJIC SIZE	(B) MORB SIZE	(A) MJIC THREAD	(B) MORB THREAD	(L)	
SS6400-04-04	1/4	1/4	7/16-20	7/16-20	1.228	----
SS6400-04-06	1/4	3/8	7/16-20	9/16-18	1.291	----
SS6400-06-06	3/8	3/8	9/16-18	9/16-18	1.299	----
SS6400-06-08	3/8	1/2	9/16-18	3/4-16	1.377	----
SS6400-06-10	3/8	5/8	9/16-18	7/8-14	1.500	----
SS6400-08-06	1/2	3/8	3/4-16	9/16-18	1.440	----
SS6400-08-08	1/2	1/2	3/4-16	3/4-16	1.488	----
SS6400-08-10	1/2	5/8	3/4-16	7/8-14	1.598	----
SS6400-08-12	1/2	3/4	3/4-16	1-1/16-12	1.759	----
SS6400-12-08	3/4	1/2	1-1/16-12	3/4-16	1.940	----
SS6400-12-12	3/4	3/4	1-1/16-12	1-1/16-12	1.968	----
SS6400-12-16	3/4	1	1-1/16-12	1-5/16-12	1.988	----
SS6400-16-12	1	3/4	1-5/16-12	1-1/16-12	2.039	----
SS6400-16-16	1	1	1-5/16-12	1-5/16-12	2.039	----

SWAGELOK: SS-X-SAE-1-XAN / SSP: JXGC / PARKER: XF50X-SS / AEROQUIP: 259-202702-X-X

MALE SAE O-RING BOSS X FEMALE JIC SWIVEL



PART	(A) MORB SIZE	(B) FJIC SIZE	(A) MORB THREAD	(B) FJIC THREAD	(L)	
SS6402-04-04	1/4	1/4	7/16-20	7/16-20	1.625	----
SS6402-06-06	3/8	3/8	9/16-18	9/16-18	1.842	----
SS6402-08-08	1/2	1/2	3/4-16	3/4-16	2.078	----
SS6402-12-12	3/4	3/4	1-1/16-12	1-1/16-12	2.582	----
SS6402-16-16	1	1	1-5/16-12	1-5/16-12	2.807	----

SSP: JSX6C / PARKER: XF650X-SS / AEROQUIP: 259-2266-X-X

MALE SAE O-RING BOSS X FEMALE NPT



PART	(A) MORB SIZE	(B) FNPT SIZE	(A) MORB THREAD	(B) FNPT SIZE	(L)	
SS6405-04-04	1/4	1/4	7/16-20	1/4-18	1.161	----
SS6405-06-04	3/8	1/4	9/16-18	1/4-18	1.090	----
SS6405-06-06	3/8	3/8	9/16-18	3/8-18	1.330	----
SS6405-08-08	1/2	1/2	3/4-16	1/2-14	1.468	----
SS6405-12-08	3/4	1/2	1-1/16-12	1/2-14	1.409	----
SS6405-12-12	3/4	3/4	1-1/16-12	3/4-14	1.590	----
SS6405-16-16	1	1	1-5/16-12	1-11 1/2	1.897	----

SWAGELOK: SS-X-SAE-7-X / SSP: XXXGCF / PARKER: XXX-F50G-SS / AEROQUIP: 259-2216-X-X



GO ONLINE TO UPLOAD YOUR LOGO TO UTILIZE ALL OF OUR CUSTOMIZABLE TOOLS!

SAE O-RING BOSS (ORB)

316 STAINLESS STEEL ADAPTERS

MALE SAE O-RING BOSS HEX PLUG

PART	(A) MORB SIZE	(A) MORB THREAD	HEX	(L)	
SS6408-04	1/4	7/16-20	9/16	.669	----
SS6408-06	3/8	9/16-18	11/16	.728	----
SS6408-08	1/2	3/4-16	7/8	.779	----
SS6408-10	5/8	7/8-14	1"	.929	----
SS6408-12	3/4	1-1/16-12	1-1/4	1.090	----
SS6408-16	1	1-5/16-12	1-1/2	1.118	----

SWAGELOK: SS-X-HPST / SSP: XCGP /
PARKER: XHP50N-SS / AEROQUIP: 259-FF2138-X

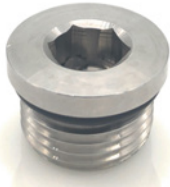
MALE SAE O-RING BOSS HOLLOW HEX PLUG

PART	(A) MORB SIZE	(A) MORB THREAD	HEX SIZE	(L)	
SS6408-HH-02	1/8	5/16-24	1/8	.401	----
SS6408-HH-04	1/4	7/16-20	3/16	.468	----
SS6408-HH-06	3/8	9/16-18	1/4	.500	----
SS6408-HH-08	1/2	3/4-16	5/16	.578	----
SS6408-HH-10	5/8	7/8-14	3/8	.649	----
SS6408-HH-12	3/4	1-1/16-12	9/16	.767	----
SS6408-HH-16	1	1-5/16-12	5/8	.767	----

SWAGELOK: SS-X-PST / SSP: XGP / PARKER: XP50N-SS /
AEROQUIP: 259-900598-X



HELP US HELP YOU! GO ONLINE TO UPDATE YOUR CUSTOMER PROFILE SO THAT WE CAN UPDATE ALL THE APPROPRIATE DEPARTMENTS AND PERSONNEL AT YOUR COMPANY ON NEW CATALOGS, PRICING UPDATES, NEW MARKETING TOOLS, AND OTHER IMPORTANT INFORMATION. THANK YOU!

FEMALE JIC SWIVELS

316 STAINLESS STEEL ADAPTERS

MALE NPT X FEMALE JIC SWIVEL



PART	(A) MNPT SIZE	(B) FJIC SIZE	(A) MNPT THREAD	(B) FJIC THREAD	(L)	
SS6505-04-04	1/4	1/4	1/4-18	7/16-20	1.807	----
SS6505-06-06	3/8	3/8	3/8-18	9/16-18	1.952	----
SS6505-08-08	1/2	1/2	1/2-14	3/4-16	2.358	----
SS6505-12-12	3/4	3/4	3/4-14	1-1/16-12	2.668	----
SS6505-16-16	1	1	1-11 1/2	1-5/16-12	3.055	----

SWAGELOK: JSX-XC / PARKER: XXXF6X-SS / AEROQUIP: 259-2018-X-X

FEMALE NPT X FEMALE JIC SWIVEL



PART	(A) FNPT SIZE	(B) FJIC SIZE	(A) FNPT THREAD	(B) FJIC THREAD	(L)	
SS6506-04-04	1/4	1/4	1/4-18	7/16-20	1.862	----
SS6506-06-06	3/8	3/8	3/8-18	9/16-18	2.011	----
SS6506-08-08	1/2	1/2	1/2-14	3/4-16	2.389	----
SS6506-12-12	3/4	3/4	3/4-14	1-1/16-12	2.673	----
SS6506-16-16	1	1	1-11 1/2	1-5/16-12	3.114	----

SWAGELOK: JSX-XFC / PARKER: X-XG6X-SS / AEROQUIP: 259-2242-X-X



SEE WEBSITE TO DOWNLOAD YOUR MOST UPDATED PRICING

CRIMP HOSE FITTINGS

316 STAINLESS STEEL ADAPTERS

STRAIGHT MALE NPT PIPE - RIGID

PART	HOSE DASH SIZE	HOSE I.D. (INCHES)	THREAD DASH SIZE	MNPT THREAD	(L)	
SS43-04-04MP	-04	1/4	-04	1/4-18	1.862	----
SS43-04-06MP	-04	1/4	-06	3/8-18	2.011	----
SS43-06-04MP	-06	3/8	-04	1/4-18	2.389	----
SS43-06-06MP	-06	3/8	-06	3/8-18	2.673	----
SS43-08-08MP	-08	1/2	-08	1/2-14	3.114	----
SS43-10-08MP	-10	5/8	-08	1/2-14	1.590	----
SS43-12-12MP	-12	3/4	-12	3/4-14	1.897	----
SS43-16-16MP	-16	1	-16	1-11-1/2		----

PARKER: 10143-X-XC

STRAIGHT FEMALE JIC - SWIVEL

PART	HOSE DASH SIZE	HOSE I.D. (INCHES)	THREAD DASH SIZE	FJIC THREAD	(L)	
SS43-04-04FJ	-04	1/4	-04	7/16-20	1.862	----
SS43-04-06FJ	-04	1/4	-06	9/16-18	2.011	----
SS43-06-04FJ	-06	3/8	-04	7-16-20	2.389	----
SS43-06-06FJ	-06	3/8	-06	9/16-18	2.673	----
SS43-06-08FJ	-06	3/8	-08	3/4-16	3.114	----
SS43-08-08FJ	-08	1/2	-08	3/4-16	1.590	----
SS43-08-10FJ	-08	1/2	-10	7/8-14	1.897	----

PARKER: 10643-X-XC

90 DEGREE FEMALE JIC - SWIVEL

PART	HOSE DASH SIZE	HOSE I.D. (INCHES)	THREAD DASH SIZE	FJIC THREAD	
SS43-04-04FJ90	-04	1/4	-04	7/16-20	----
SS43-04-06FJ90	-04	1/4	-06	9/16-18	----
SS43-06-06FJ90	-06	3/8	-06	9/16-18	----
SS43-08-08FJ90	-08	1/2	-08	3/4-16	----
SS43-12-12FJ90	-12	3/4	-12	1-1/16-12	----
SS43-16-16FJ90	-16	1	-16	1-5/16-12	----

PARKER: 10143-X-XC

STRAIGHT MALE NPT - API

PART	HOSE DASH SIZE	HOSE I.D. (INCHES)	THREAD DASH SIZE	MNPT THREAD	
BW-16-16API-C	-16	1	-16	1-11 1/2	----

PRODUCT SPECIFICATIONS - BW SERIES MALE API BOP CRIMP FITTING

PART	O.D. (INCHES)	I.D. (INCHES)	LENGTH (INCHES)	
BOPF-C	2.360	2.225	5.195	----

PRODUCT SPECIFICATIONS - BW SERIES MALE API BOP CRIMP FERRULE

MIDLAND INDUSTRIES

NUMERICAL INDEX

Part#	Page	Part#	Page	Part#	Page	Part#	Page	Part#	Page	Part#	Page
1591	301-6249	5406HHP4592	6408HO6597	6802NWO20600	6901NWO68602
1591	301-6449	5406HHP6592	6408HO8597	6802NWO24600	6901NWO84602
1591	301-6649	5406HHP8592	6408HO10597	6802NWO32600	6901NWO86602
1-1/2591	301-6849	5406HHP12592	6408HO12597	6802NWO46600	6901NWO88602
1-1/4591	301-8449	5406HHP16592	6408HO14597	6802NWO68600	6901NWO104602
1/2591	301-8649	5406HHP20592	6408HO16597	6802NWO86600	6901NWO106602
1/2591	301-8849	5406HHP24592	6408HO20597	6802NWO108600	6901NWO108602
1/2591	301-10649	5406P2592	6408HO24597	6802NWO810600	6901NWO126602
1/2"531	301-10849	5406P4592	6408O2597	6802NWO812600	6901NWO128602
1/2"531	301-12849	5406P6592	6408O4597	6802NWO1012600	6901NWO812602
1/4591	301-61249	5406P8592	6408O5597	6802NWO1216600	6901NWO1212602
1/4591	301-81249	5406P12592	6408O6597	6802NWO1612600	6901NWO1612602
1/4"531	301-101249	5406P16592	6408O8597	6802NWO1620600	6901NWO1616602
1/4"531	301-121249	5406P20592	6408O10597	6802NWO2016600	6901NWO2016602
1/8591	301-161249	5406P24592	6408O12597	6803NWO4600	6901NWO2020602
2591	301-161649	5406P32592	6408O14597	6803NWO6600	6901NWO2424602
3/4591	0304C2585	5406SHP2592	6408O16597	6803NWO8600	6901NWO3232602
3/4591	0304C3585	5406SHP4592	6408O20597	6803NWO10600	6902NWO42602
3/8591	0304C4585	5406SHP6592	6408O24597	6803NWO12600	6902NWO44602
3/8591	0304C5585	5406SHP8592	6410O46598	6803NWO16600	6902NWO46602
3/8"531	0304C6585	5406SHP12592	6410O64598	6804NWO4599	6902NWO64602
10-33081	0304C8585	5406SHP16592	6410O68598	6804NWO6599	6902NWO66602
10-33181	0304C10585	5406SHP20592	6410O84598	6804NWO8599	6902NWO68602
28-21612	0304C12585	5406SHP24592	6410O86598	6804NWO10599	6902NWO84602
29PO1-4249	0304C14585	5406SHP32592	6410O88598	6804NWO12599	6902NWO86602
29PO1-4449	0304C16585	06100-022	6410O124598	6804NWO16599	6902NWO88602
29PO1-4649	0304C20585	06100-042	6410O126598	6805NWO42600	6902NWO108602
29PO1-4849	0304C24585	06100-062	6410O128598	6805NWO44600	6902NWO128602
29PO1-5249	0304C32585	06100-082	6410O166598	6805NWO64600	6902NWO1212602
29PO1-5449	311-4249	06100-122	6410O168598	6805NWO66600	6902NWO1616602
29PO1-6249	311-4449	6402O44596	6410O812598	6805NWO86600	07201-040249
29PO1-6449	311-5249	6402O66596	6410O1612598	6805NWO88600	07201-040449
29PO1-6649	311-5449	6402O68596	6410O2012598	6805NWO108600	07201-040649
29PO1-6849	311-6249	6402O86596	6410O2016598	6805NWO128600	07201-050249
29PO1-8449	311-6449	6402O88596	6410O2412598	6805NWO1212600	07201-050449
29PO1-8649	311-6649	6402O1010596	6410O2416598	6805NWO1616600	07201-060249
29PO1-8849	311-6849	6402O1212596	6410O2420598	6805NWO2020600	07201-060449
29PO1-10649	311-8649	6403O4596	6410O3216598	6805NWO2424600	07201-060649
29PO1-10849	311-8849	6403O6596	6410O3220598	6806NWO44601	07201-060849
29PO1-12849	311-10849	6403O8596	6410O3224598	6806NWO66601	07201-061249
29PO1-61249	311-12849	6403O12596	6801NWO68600	6806NWO88601	07201-080449
29PO1-81249	311-121249	6403O16596	6801NWO4600	6806NWO1212601	07201-080649
29PO1-81649	03044585	6405O22597	6801NWO6600	6806NWO1616601	07201-080849
29PO1-101249	03046585	6405O32597	6801NWO8600	6809NWO44601	07201-081249
29PO1-121249	03048585	6405O34597	6801NWO10600	6809NWO66601	07201-100649
29PO1-121649	03062589	6405O42597	6801NWO12600	6809NWO88601	07201-100849
29PO1-161249	03064589	6405O44597	6801NWO16600	6809NWO1212601	07201-101249
29PO1-161649	03065589	6405O52597	6801NWO20600	6815NWO44601	07201-120849
46-068194	03066589	6405O54597	6801NWO24600	6815NWO66601	07201-121249
46-135196	03068589	6405O62597	6801NWO32600	6815NWO88601	07201-161249
59-200SMLS375	03182585	6405O64597	6801NWO46600	6815NWO1010601	07201-161649
59-201SMLS375	03183585	6405O66597	6801NWO48600	6815NWO1212601	7202NWO42607
59-202SMLS375	03184585	6405O68597	6801NWO64600	6900O42601	7202NWO44607
59-203SMLS375	03185585	6405O84597	6801NWO86600	6900O44601	7202NWO64607
59-204SMLS375	03186585	6405O86597	6801NWO106600	6900O46601	7202NWO66607
59-205SMLS375	03188585	6405O88597	6801NWO108600	6900O48601	7202NWO68607
59-206SMLS375	03192585	6405O104597	6801NWO128600	6900O64601	7202NWO86607
59-207SMLS375	03193585	6405O106597	6801NWO612600	6900O66601	7202NWO88607
59-208SMLS375	03194585	6405O108597	6801NWO810600	6900O68601	7202NWO108607
59-209SMLS375	03195585	6405O126597	6801NWO812600	6900O84601	7202NWO812607
59-210SMLS375	03196585	6405O128597	6801NWO816600	6900O86601	7202NWO1212607
59-211SMLS375	03198585	6405O812597	6801NWO1016600	6900O88601	7202NWO1216607
59-212SMLS375	3895BA572	6405O1212597	6801NWO1210600	6900O104601	7202NWO1616607
59-213SMLS375	5406C2593	6405O1216597	6801NWO1216600	6900O106601	7205NWO410609
59-320SMLS375	5406C4593	6405O1612597	6801NWO1612600	6900O108601	7205NWO412609
59-322SMLS375	5406C6593	6405O1616597	6801NWO1620600	6900O128601	7205NWO414609
59-324SMLS375	5406C8593	6405O2020597	6801NWO2016600	6900O812601	7205NWO512609
59-326SMLS375	5406C12593	6405O2416597	6801NWO2024600	6900O1012601	7205NWO614609
59-328SMLS375	5406C16593	6405O2420597	6802NWO2600	6900O1212601	7205NWO616609
65-319385	5406FLP2592	6405O2424597	6802NWO4600	6900O1612601	7205NWO816609
301-4249	5406FLP4592	6405O3224597	6802NWO6600	6900O1616601	7205NWO818609
301-4449	5406FLP6592	6405O3232597	6802NWO8600	6901NWO42602	7205NWO822609
301-4649	5406FLP8592	6408HO2597	6802NWO10600	6901NWO44602	7205NWO1018609
301-5249	5406FLP12592	6408HO4597	6802NWO12600	6901NWO64602	07220-040249
301-5449	5406HHP2592	6408HO5597	6802NWO16600	6901NWO66602	07220-040449

MIDLAND INDUSTRIES

NUMERICAL INDEX

Part#	Page	Part#	Page	Part#	Page	Part#	Page	Part#	Page	Part#	Page
07220-0502	49	9650EX1236	310	9660G8SE	309	10045	71	10110LF	227	10210LF	228
07220-0504	49	9650EX1248	310	9660G10	309	10046	72	10111	74	10211	76
07220-0602	49	9650EX1260	310	9660G10SE	309	10047	72	10111LF	227	10211LF	228
07220-0604	49	9650EX1272	310	9660G12	309	10048	72	10112	74	10212	76
07220-0606	49	9650EX2324	310	9660G12SE	309	10049	72	10115	75	10212LF	228
07220-0608	49	9650EX2336	310	9660L2	309	10051	72	10116	75	10213	76
07220-0806	49	9650EX2348	310	9660L2.5	309	10052	72	10117	75	10214	76
07220-0808	49	9650EX2360	310	9660L2SE	309	10052LF	226	10118	75	10214LF	228
07220-1008	49	9650EX2372	310	9660L3	309	10053	72	10118LF	227	10215	76
07220-1208	49	9650EX4624	310	9660L3SE	309	10054	72	10119	75	10215LF	228
07220-1212	49	9650EX4636	310	9660L4	309	10054LF	226	10120	75	10216	76
8555H10	609	9650EX4648	310	9660L4SE	309	10055	72	10120LF	227	10217	76
8555H12	609	9650EX4660	310	9660L5	309	10056	72	10121	75	10218	76
8555H14	609	9650EX4672	310	9660L5SE	309	10056LF	226	10121LF	227	10218LF	228
8555H16	609	9650G2	308	9660L6	309	10058	72	10122	75	10219	76
8555H18	609	9650G2.5	308	9660L6SE	309	10062	72	10122LF	227	10220	76
8555H20	609	9650G2.5SE	308	9660L8	309	10063	72	10123	75	10227	77
8555H22	609	9650G2SE	308	9660L8SE	309	10064	72	10123LF	227	10227LF	228
8555H26	609	9650G3	308	9660L10	309	10064LF	228	10126	75	10228	77
8555H30	609	9650G3SE	308	9660L10SE	309	10065	72	10127	75	10228LF	228
8555P10	609	9650G4	308	9660L12	309	10066	72	10131*	74	10228LF	228
8555P12	609	9650G4SE	308	9660L12SE	309	10066LF	228	10132	74	10229	77
8555P14	609	9650G6	308	10001	71	10067	72	10133*	74	10229LF	228
8555P16	609	9650G6SE	308	10002	71	10067LF	228	10135	84	10229LF	228
8555P18	609	9650G8	308	10003	71	10068	72	10136	84	10230	77
8555P20	609	9650G8SE	308	10004	71	10068LF	228	10137	84	10230LF	228
8555P22	609	9650G10	308	10005	71	10069	72	10138	84	10231	77
8555P26	609	9650G10SE	308	10006	71	10073	73	10139	84	10231LF	228
8555P30	609	9650G12	308	10007	71	10074	73	10157	75	10232	77
9522H2	608	9650G12SE	308	10008	71	10075 *	73	10157LF	227	10232LF	228
9522H4	608	9650G23	310	10013	70	10075EH	73	10158	75	10233	77
9522H6	608	9650G46	310	10013	120	10075LF	227	10158LF	227	10233LF	228
9522H8	608	9650G120	310	10013LF	226	10076	73	10159	75	10234	77
9522H12	608	9650G812	310	10014	70	10076LF	227	10159LF	227	10234LF	228
9522H16	608	9650IP23	310	10014LF	226	10077 *	73	10160	75	10235	77
9522P2	608	9650IP46	310	10015	70	10077LF	227	10160LF	227	10235LF	228
9522P4	608	9650IP812	310	10015L	70	10078	73	10161	75	10235LF	228
9522P6	608	9650L2	308	10015LF	226	10078LF	227	10161LF	227	10236	77
9522P8	608	9650L2.5	308	10016	70	10079	73	10162	75	10236LF	228
9522P12	608	9650L2SE	308	10016LF	226	10079LF	227	10162LF	227	10236LF	228
9522P16	608	9650L3	308	10017	70	10080	73	10163	75	10237	77
9600FJ3	317	9650L3SE	308	10017L	70	10080LF	227	10163LF	227	10237L	77
9600FJ4	317	9650L4	308	10017LF	226	10081	73	10164	75	10237LF	228
9600FJ6	317	9650L4SE	308	10018	70	10082	73	10165	75	10238	77
9600FJ8	317	9650L5	308	10018LF	226	10084	73	10170	76	10238LF	228
9600FJ10	317	9650L5SE	308	10019	70	10085	73	10171	76	10239	77
9600FJ12	317	9650L6	308	10019L	70	10086	73	10172	76	10239LF	228
9600FL3	315	9650L6SE	308	10019LF	226	10087	73	10173	76	10240	77
9600FL4	315	9650L8	308	10020	70	10088	73	10174	76	10240LF	228
9600FL6	315	9650L8SE	308	10020L	70	10089	73	10174LF	227	10241	77
9600FL8	315	9650L10	308	10020LF	226	10090	73	10175	76	10241LF	228
9600FL10	315	9650L10SE	308	10021	70	10094	73	10175LF	227	10241LF	228
9600FL12	315	9650L12	308	10021LF	226	10095	73	10176	76	10242	77
9600FL25	315	9650L12SE	308	10022	70	10097	73	10178	76	10242	77
9600MJ3	316	9650L23	310	10023	70	10098	73	10179	76	10242LF	228
9600MJ4	316	9650L46	310	10024	70	10099	73	10180	76	10242LF	228
9600MJ6	316	9650L120	310	10025	70	10100	73	10181	76	10243	77
9600MJ8	316	9650L812	310	10026	70	10104	74	10181LF	227	10243LF	228
9600MJ10	316	9650RP12	310	10028	71	10104LF	227	10182	76	10244	77
9600MJ12	316	9650RP23	310	10030	71	10105	74	10182LF	227	10244L	77
9610F3	314	9650RP46	310	10031	71	10105LF	227	10187	76	10244LF	228
9610F4	314	9650WH23	310	10032	71	10106	74	10188	76	10245	77
9610F6	314	9650WH46	310	10033	71	10106EH	74	10189	76	10245LF	228
9610F8	314	9650WH812	310	10038	71	10106L	74	10189LF	227	10246	77
9610F10	314	9660G2	309	10039	71	10106LF	227	10203	76	10247	77
9610F12	314	9660G2.5	309	10039LF	226	10107	74	10204	76	10247LF	228
9610F25	314	9660G2.5SE	309	10040	71	10107LF	227	10204LF	228	10248	77
9610NYCF3	314	9660G2SE	309	10041	71	10108	74	10205	76	10251LF	229
9610NYCF4	314	9660G3	309	10041LF	226	10108L	74	10205LF	228	10252LF	229
9610NYCF6	314	9660G3SE	309	10042	71	10108LF	227	10206	76	10253	78
9610NYCF8	314	9660G4	309	10042LF	226	10109	74	10206LF	228	10253LF	229
9610NYCF10	314	9660G4SE	309	10043	71	10109L	74	10207	76	10254	78
9610NYCF12	314	9660G6	309	10043LF	226	10109LF	227	10208	76	10254LF	229
9610NYCF25	314	9660G6SE	309	10044	71	10110	74	10209	76	10255	78
9650EX1224	310	9660G8	309	10044LF	226	10110L	74	10210	76	10255EH	78

MIDLAND INDUSTRIES

NUMERICAL INDEX

Part#	Page	Part#	Page	Part#	Page	Part#	Page	Part#	Page	Part#	Page
10255L	78	10289LF	230	10324B*	81	10461	85	12030	98	12108	98
10255LF	229	10290	80	10324LF	231	10462	85	12031	98	12110	100
10256	78	10290B*	80	10325	81	10463	85	12032	98	12111	100
10256EHLF	229	10290LF	230	10325L	81	10464	85	12033	98	12112	100
10256L	78	10291	80	10325LF	231	10467	85	12034	98	12114	99
10256LF	229	10291B*	80	10326	81	10468	85	12035	98	12115	100
10256WC	74	10291LF	230	10326LF	231	10469	85	12036	98	12118	101
10257	78	10292	80	10327	81	10470	85	12037	98	12119	101
10257LF	229	10293	80	10328	81	10471	85	12038	98	12120	101
10258	78	10293B*	80	10328LF	231	10473	85	12039	98	12121	101
10258LF	229	10293LF	230	10329	81	10481	86	12040	98	12127	101
10259	78	10294	80	10329LF	231	10481LF	229	12041	98	12128	101
10259L	78	10294B*	80	10331LF	231	10482	86	12042	98	12129	101
10259LF	229	10294LF	230	10333	81	10482LF	229	12043	98	12130	101
10260	78	10295**	80	10340	82	10483	86	12044	98	12144	102
10260L	78	10295B*	80	10343	82	10483L	86	12045	98	12145	102
10260LF	229	10295L	80	10344	82	10483LF	229	12046	98	12146	102
10261	78	10295LF	230	10344B	82	10484	86	12047	98	12147	102
10261LF	229	10296**	80	10345	82	10484L	86	12048	98	12148	102
10262	78	10296LF	230	10347	82	10484LF	229	12049	98	12149	102
10262LF	229	10297	80	10348	82	10485	86	12050	98	12150	102
10263	78	10297LF	230	10350	82	10485LF	229	12051	98	12151	102
10263L	78	10298	80	10351	82	10486	86	12052	98	12200	102
10263LF	229	10298B*	80	10352	82	10487	86	12053	98	12202	102
10264	78	10298LF	230	10353	82	10487LF	229	12054*	99	12205	104
10264L	78	10299	80	10354	82	10488	86	12055	98	12206	103
10264LF	229	10299B*	80	10355	82	10488LF	229	12056	99	12207	103
10265	78	10299LF	230	10357	82	10489	86	12057	99	12208	103
10265L	78	10300	80	10359	82	10493	86	12058	99	12209	103
10265LF	229	10300B*	80	10360	82	10494	86	12059	99	12210	103
10266	78	10300LF	230	10373	82	10495	86	12060	99	12211	103
10266LF	229	10301	80	10374	82	10496	86	12061	99	12212	103
10267	78	10301LF	230	10375	82	10497	86	12062	99	12213*	103
10267LF	229	10302	80	10376	82	10600	87	12063	99	12214*	103
10268	78	10302B*	80	10382	83	10602	87	12064	99	12215	103
10268L	78	10302LF	230	10404	83	10611	87	12065	99	12216	103
10268LF	229	10303	80	10405	83	10612	87	12066	99	12217	103
10269	78	10303B*	81	10406	83	10613	87	12067	99	12218*	103
10269L	78	10303LF	230	10406B*	83	10614	87	12068	99	12220	103
10269LF	229	10304	81	10406LF	230	10615	87	12069	99	12221	103
10270	78	10304LF	230	10407	83	10616	87	12070	100	12222*	103
10270LF	229	10305	81	10407LF	230	10617	87	12072	100	12224	103
10271	78	10305LF	230	10408	83	10618	87	12073	100	12230	103
10272	79	10306	81	10409	83	10619	87	12074	100	12250	104
10272L	79	10306B*	81	10409B*	83	10620	87	12075	100	12252	104
10272LF	229	10306LF	230	10409LF	230	10621	87	12076	100	12254	104
10273	79	10307	81	10410	83	10622	87	12077	100	12256	104
10273L	79	10308	81	10410LF	230	12000	96	12079	100	12257	104
10273LF	229	10309	81	10411	83	12001	96	12080	99	12260	97
10274	79	10311	80	10412	83	12002	96	12081	99	12261	97
10274LF	229	10312	81	10416	84	12003	96	12082	99	12262	97
10275	79	10313	81	10419	84	12004	96	12083	96	12263	97
10275LF	229	10313B*	81	10419LF	230	12005	96	12084	96	12264	97
10276	79	10313LF	231	10421	84	12006	96	12085	100	12266	97
10276LF	229	10314	81	10438	85	12007	96	12086	100	12268	97
10277	79	10314B*	81	10440	85	12008	96	12087	100	12269	97
10278	79	10314LF	231	10441	85	12009	96	12088	100	12270	97
10278LF	229	10315	81	10442	85	12010	96	12089	100	12274	97
10279	79	10316	81	10443	85	12011	96	12090	100	12275*	97
10280	79	10316B*	81	10444	85	12012	96	12091	100	12310	103
10283	80	10317	81	10448	84	12013	96	12092	100	12326	104
10283B*	80	10318	81	10448B*	84	12014	96	12093	100	12327	104
10284	80	10319	81	10449	84	12015	96	12094	100	12328	104
10284B*	80	10319B*	81	10450	84	12016	96	12095	100	12329	104
10284LF	230	10319LF	231	10451	84	12017	96	12096	100	12330	104
10285	80	10320	81	10452	84	12018	96	12097	100	12335	104
10286	80	10320B*	81	10452B*	84	12019	96	12098	100	12336	104
10286B*	80	10320LF	231	10453	84	12022	97	12099	98	12337	104
10286LF	230	10321	81	10454	84	12023	97	12100	101	12339	104
10287	80	10321L	81	10455	84	12024	97	12101	101	12341	104
10287B*	80	10321LF	231	10455B*	84	12025	97	12102	101	12342	104
10287LF	230	10322	81	10456	84	12026	97	12103	101	12343	104
10288**	80	10322LF	231	10457	84	12027	97	12104	98	12344	104
10288LF	230	10323	81	10458	84	12028	97	12105	98	12345	104
10289	80	10324	81	10460	84	12029	98	12107	98	12415	101

MIDLAND INDUSTRIES

NUMERICAL INDEX

Part#	Page	Part#	Page	Part#	Page	Part#	Page	Part#	Page	Part#	Page
14001	87	17194P	418	18046LF	233	18102LF	234	18151LF	236	18190L	110
14011	88	17195N	418	18047	115	18103	108	18152	109	18190LF	237
14016	88	17195P	418	18047LF	233	18103B	108	18152LF	236	18191	110
14017	88	17224N	418	18048	115	18103LF	234	18153	109	18191LF	237
14018	87	17225N	418	18048LF	233	18104	108	18153L	109	18192	110
14025	87	17225P	418	18049	115	18104B	108	18153LF	236	18192LF	237
16001	118	17233N	418	18049LF	233	18104LF	234	18154	109	18193	110
16002	118	17233P	418	18050	115	18105	108	18154L	109	18193L	110
16003	118	17234N	418	18050LF	233	18105B	108	18154LF	236	18193LF	237
16004	118	17234P	418	18054LF	242	18105LF	234	18155	109	18194	110
16005	118	17237N	418	18055LF	242	18106	108	18155LF	236	18194L	110
16006	118	17237P	418	18056LF	242	18106LF	234	18156	109	18194LF	237
16007	118	17238N	418	18057LF	242	18107	108	18156LF	236	18195	110
16009	118	17238P	418	18062	107	18107LF	234	18157	109	18195L	110
16010	118	18001	106	18062LF	234	18108	108	18157LF	236	18195LF	237
16011	118	18001LF	232	18063	107	18109	108	18158	109	18196	110
16012	118	18002	106	18063LF	234	18109LF	234	18158L	109	18196LF	237
16090	118	18002LF	232	18064	107	18110	108	18158LF	236	18197	110
16117	118	18003	106	18064L	107	18110LF	235	18159	109	18197LF	237
16118	118	18003LF	232	18064LF	234	18111	108	18159L	109	18198	110
16119	118	18004	106	18065	107	18114	108	18159LF	236	18198LF	237
16120	118	18004LF	232	18065LF	234	18114LF	235	18160	109	18199	110
16121	118	18005	106	18066	107	18115	108	18160LF	236	18199LF	237
16122	118	18005LF	232	18066DLF	234	18115LF	235	18161LF	236	18200	110
16123	118	18006	106	18066L	107	18116	108	18162	109	18200LF	237
16125	118	18006LF	232	18066LF	234	18116LF	235	18162L	109	18201	110
16127	118	18007	106	18067	107	18117	108	18162LF	236	18201LF	237
16128	118	18007LF	232	18067LF	234	18117LF	235	18163	109	18202	110
16129	118	18008	106	18068	107	18118	108	18163LF	236	18202LF	237
16130	118	18008LF	232	18068DLF	234	18118LF	235	18164	109	18203	110
16131	118	18009	106	18068L	107	18119	108	18164LF	236	18203LF	237
16133	118	18009LF	232	18068LF	234	18122B	108	18165	109	18204	110
17064N	418	18010	106	18069	107	18122LF	235	18165LF	236	18204LF	237
17064P	418	18010LF	232	18069DLF	234	18123	108	18166	109	18205	110
17065N	418	18011	106	18069L	107	18123LF	235	18166LF	236	18205LF	237
17066N	418	18015	120	18069LF	234	18124	108	18167	109	18206	110
17066P	418	18015	120	18070	107	18124LF	235	18167LF	236	18207	110
17068N	418	18016	120	18070LF	234	18125	108	18171LF	236	18208	117
17068P	418	18016	120	18071	107	18125LF	235	18175	110	18208LF	238
17078N	418	18017	120	18071DLF	234	18126	108	18176	110	18209	117
17079N	418	18017	120	18071L	107	18126LF	235	18176LF	237	18209LF	238
17079P	418	18018	120	18071LF	234	18127	108	18177	110	18210	117
17081P	418	18018	120	18072	107	18127LF	235	18177LF	237	18210LF	238
17088N	418	18019	120	18076	107	18128	108	18177TLF	238	18211	117
17090N	418	18019	120	18076LF	234	18128LF	235	18178	110	18211LF	238
17091N	418	18028	115	18077	107	18129	108	18178LF	237	18212	117
17103N	418	18029	115	18077LF	234	18129LF	235	18179	110	18212LF	238
17105N	418	18030	115	18078	107	18130	108	18179L	110	18213	117
17106N	418	18031	115	18078LF	234	18130LF	235	18179LF	237	18213LF	238
17124N	418	18032	115	18079	107	18135	109	18180	110	18214	117
17124P	418	18033	106	18079LF	234	18135LF	235	18180L	110	18214LF	238
17126N	418	18033LF	233	18080	107	18136	109	18180LF	237	18215	117
17126P	418	18034	106	18080LF	234	18136LF	235	18181	110	18215LF	238
17127P	418	18034LF	233	18081	107	18137	109	18181LF	237	18216	110
17145P	418	18035	106	18081LF	234	18137LF	235	18182	110	18219	111
17146N	418	18035L	106	18082	107	18138LF	235	18182LF	237	18220	111
17153N	418	18035LF	233	18082LF	234	18142	109	18183	110	18220B*	111
17153P	418	18036	106	18083	107	18142LF	236	18183LF	237	18220LF	238
17154P	418	18036LF	233	18083LF	234	18143	109	18184	110	18221	111
17158P	418	18037	106	18084	107	18143LF	236	18184L	110	18221B*	111
17159P	418	18037L	106	18085	107	18144	109	18184LF	237	18221LF	238
17176N	418	18037LF	233	18086	107	18144LF	236	18185	110	18223	111
17179N	418	18038	106	18088	116	18145	109	18185LF	237	18223B*	111
17179P	418	18038LF	233	18090	116	18145L	109	18186	110	18223LF	238
17180N	418	18039	106	18092	116	18145LF	236	18186LF	237	18224	111
17180P	418	18039L	106	18093	116	18146	109	18187	110	18224B*	111
17188N	418	18039LF	233	18093	116	18146L	109	18187L	110	18224LF	238
17188P	418	18040	106	18094	116	18146LF	236	18187LF	237	18225	111
17189N	418	18040L	106	18095	116	18147LF	236	18188	110	18225B*	111
17189P	418	18040LF	233	18096	116	18148	109	18188L	110	18225LF	238
17190N	418	18041	106	18101	108	18148LF	236	18188LF	237	18226	111
17190P	418	18041LF	233	18101B	108	18149	109	18189	110	18226B	111
17193N	418	18042	106	18101LF	234	18149LF	236	18189L	110	18226LF	238
17193P	418	18042LF	233	18102	108	18150	109	18189LF	237	18227	111
17194N	418	18043	106	18102B	108	18150LF	236	18190	110	18227LF	238

MIDLAND INDUSTRIES

NUMERICAL INDEX

Part#	Page	Part#	Page	Part#	Page	Part#	Page	Part#	Page
18228	111	18260LF	239	18303	114	20022N	138	20056C	156
18228B*	111	18261	112	18303LF	240	20023	133	20056N	139
18228LF	238	18262	112	18304	114	20023N	139	20056P	420
18229	111	18262B	112	18307	114	20024C	155	20057	133
18229B*	111	18262LF	239	18307LF	240	20024N	138	20057C	156
18229LF	238	18263	112	18314	114	20025	132	20057N	139
18230	111	18263LF	239	18315LF	240	20025C	155	20057P	420
18230LF	238	18264	112	18316	114	20025N	138	20058	133
18231	111	18264LF	239	18321	115	20026	132	20058C	156
18232	111	18265	112	18322	115	20026C	155	20058N*	139
18232B*	111	18265LF	239	18322LF	240	20026N*	138	20058P	420
18232LF	238	18266	112	18323	115	20027	132	20059	133
18233	111	18267	112	18323LF	240	20027C	155	20059C	156
18233B*	111	18267LF	239	18324	115	20028	132	20059N*	139
18233LF	238	18268	112	18325	115	20028C	155	20059P	420
18234	111	18268LF	239	18325LF	240	20028N*	138	20060	133
18234B*	111	18269	112	18326	115	20028P	419	20060C	156
18234LF	238	18269LF	239	18327	115	20029	132	20060N	139
18235	111	18270	112	18327LF	240	20029C	155	20061	133
18235B*	111	18272	113	18328	115	20029N*	138	20061C	156
18235LF	238	18273	113	18329	115	20029P	419	20061N*	139
18236	111	18273B*	113	18330	115	20030	132	20061P	420
18236B*	111	18273LF	239	18330B	115	20030C	155	20062	133
18236LF	238	18274	113	18330LF	239	20030N*	138	20062C	156
18237	111	18274B*	113	18331	115	20030P	419	20062N	139
18237B*	111	18274LF	239	18332	115	20031*	132	20062P	420
18237LF	238	18275	113	18333	115	20031C	155	20063	133
18238	111	18275LF	239	18333B	115	20031N*	138	20063C	156
18238B*	111	18276	113	18333LF	239	20032	132	20063N*	139
18238LF	238	18276LF	239	18334	115	20032N	138	20063P	420
18239	111	18277	113	18334LF	239	20034	132	20064	134
18239LF	238	18277LF	239	18335	115	20034C	156	20065	134
18240	111	18278	113	18335LF	239	20034N	138	20066	134
18240LF	238	18279	113	18336	115	20035	132	20067	134
18241	112	18279B	113	18336LF	239	20035C	156	20068	134
18241B*	112	18279LF	239	18338	115	20035N	138	20068N	139
18241LF	238	18280	113	18338LF	239	20035P	420	20068P	420
18242	112	18280LF	239	18339	115	20036	132	20069	134
18242LF	238	18281	113	18339LF	239	20036C	156	20069N	139
18243	112	18281LF	239	18500LF	241	20036N	138	20069P	420
18243LF	238	18282	113	18501LF	241	20036P	420	20070	134
18245	112	18283	113	18502LF	240	20037	132	20070P	420
18245LF	238	18284	113	18503LF	240	20037C	156	20071	134
18246	112	18289	114	18510LF	241	20037N	138	20072	134
18246LF	238	18289B	114	20001C	155	20038	132	20072N	139
18247	111	18289LF	240	20009	136	20038N	138	20072P	420
18247LF	238	18290	114	20010	136	20039	133	20073	134
18248	111	18290LF	240	20011	136	20045	133	20073N	139
18248B*	111	18291	114	20012	132	20046	133	20073P	420
18248LF	238	18291B*	114	20013	136	20046N*	139	20074	134
18250	112	18291LF	240	20015C	155	20047*	133	20075	134
18250LF	239	18292	114	20015N*	138	20047N	139	20076**	133
18251	112	18292B	114	20016C	155	20048	133	20076N*	140
18251B*	112	18292LF	240	20016N	138	20048N	139	20077	133
18251LF	239	18293	114	20017	132	20049*	133	20077C*	157
18252	112	18293LF	240	20017C	155	20049C*	157	20078**	133
18252B*	112	18294	114	20017N	138	20049N*	139	20078C	157
18252LF	239	18294B	114	20018	132	20050	133	20079	133
18253	112	18294LF	240	20018C	155	20050C	156	20079C	157
18253B*	112	18295	114	20018N*	138	20050N*	139	20079N	140
18253LF	239	18295LF	240	20018P	419	20050P	420	20080	133
18254	112	18296	114	20019	132	20051*	133	20080C*	157
18254B*	112	18296B	114	20019C	155	20052	133	20080N*	140
18254LF	239	18296LF	240	20019N*	138	20053*	133	20081	133
18255	112	18297	114	20019P	419	20053C	156	20081C	157
18255LF	239	18297LF	240	20020	132	20053N*	139	20081N*	140
18256	112	18298	114	20020C	155	20054	133	20082	133
18256LF	239	18299	114	20020N*	138	20054C	156	20082C	157
18257	112	18299B*	114	20020P	419	20054N*	139	20082N*	140
18257LF	239	18299LF	240	20021	132	20054P	420	20083	133
18258	112	18300	114	20021C	155	20055	133	20083C	157
18258LF	239	18300LF	240	20021N*	138	20055C	156	20083N*	140
18259	112	18301	114	20021P	419	20055N*	139	20084	133
18259LF	239	18301LF	240	20022	132	20055P	420	20084C	157
18260	112	18302	114	20022C	155	20056	133	20084N*	140

MIDLAND INDUSTRIES

NUMERICAL INDEX

Part#	Page	Part#	Page	Part#	Page	Part#	Page	Part#	Page	Part#	Page
20119	135	20167C	158	20270	127	20531	133	20632	161	20703N	144
20120	135	20167N	140	20271	127	20531C	156	20632N*	144	20704N*	144
20121C	158	20168N	140	20272	127	20531N*	139	20633	161	20705N*	144
20123N*	141	20170	136	20273	127	20532	133	20633N*	144	20706N	144
20124	136	20170C	159	20274	127	20532N	139	20634	161	20707N	144
20124N	141	20171	136	20275	127	20535*	133	20634N*	144	20708N*	144
20125	136	20171C	159	20276	127	20535C*	157	20635	161	20709N*	144
20125N*	141	20172	136	20277	127	20535N	140	20635N	144	20710N	144
20126	136	20172C	159	20278	127	20537C	157	20636	161	20711*	161
20127	136	20173C	159	20279	127	20537N*	140	20636N*	144	20711N*	144
20127C	158	20174	135	20282	127	20538*	133	20637	161	20712*	161
20127N*	141	20174C	158	20287	127	20538C	157	20637N*	144	20712N	144
20127P	419	20174N	140	20288	127	20538N*	140	20638	161	20713*	161
20128	41	20175C	159	20289*	127	20539*	133	20638N*	144	20713N*	144
20128	136	20176C	159	20290	127	20539C*	157	20642	161	20714*	161
20128C	158	20179C	159	20291	127	20539N	140	20642N*	144	20714N	144
20128N*	141	20181C	158	20292	127	20551	136	20655	161	20715N	144
20128P	419	20181N	140	20293	127	20551C	155	20655N	144	20716N*	145
20129	136	20182C	155	20294	127	20552	136	20656	161	20717*	162
20129C	158	20184C	157	20295	127	20553	136	20656N*	144	20717N	145
20129N*	141	20184N	140	20296	127	20553C	155	20657	161	20718*	162
20129P	419	20185C	155	20300	127	20555C	155	20657N*	144	20718N	145
20135C*	158	20187C	159	20301	127	20557C	159	20658	161	20719N	145
20136C*	158	20188C	159	20302	127	20572C	157	20658N*	144	20720*	161
20137C*	158	20189C	159	20303	127	20573C	157	20659	161	20720N	145
20138C*	158	20192	134	20304	127	20574C	157	20659N*	144	20721*	161
20139C	158	20193C	159	20305	127	20579C	157	20660	160	20721N	145
20140C	158	20194C	159	20308	128	20580C	157	20660N*	143	20722N	145
20142	136	20195C	159	20309	128	20581C	157	20661	160	20723N	143
20143	136	20200	125	20310	128	20582C	157	20661N*	143	20724N	143
20149C	155	20201	129	20311	128	20583C	157	20668N	145	20724P	419
20150	132	20203	129	20312	128	20584C	157	20669N	145	20725N	143
20150C	155	20204	129	20313	128	20591C	157	20670	161	20725P	419
20150N	138	20205	129	20314	128	20595C	157	20670N	145	20726N	143
20151	132	20206	129	20317	128	20596C	157	20672	161	20727C	159
20151C	155	20206N*	143	20318	128	20597C	157	20672N	145	20727N*	143
20151N*	138	20207	129	20319	128	20598C	157	20673	161	20728C	159
20152	132	20208	129	20320	128	20600	160	20673N	145	20728N	143
20152C	155	20211	125	20321	128	20600N*	143	20674	161	20729N	143
20152N*	138	20212	125	20322	128	20601	160	20674N	145	20730N	143
20152P	419	20213	125	20323	128	20601N*	143	20675	161	20731N	145
20153	132	20218	129	20324	128	20602	160	20676	161	20732N*	145
20153C	155	20219	129	20327	128	20603	160	20676N	145	20733N	145
20153N*	138	20220	129	20328	128	20603N*	143	20677	161	20734N*	145
20153P	419	20221	129	20330*	126	20604	160	20677N	145	20734P	419
20154	132	20222	129	20333	126	20604N*	143	20678	161	20735N*	145
20154C	155	20223	129	20334	126	20610	160	20678N	145	20736N*	145
20154N*	138	20227	128	20337	125	20610	162	20679	161	20736P	419
20154P	419	20228	128	20338	125	20610N*	143	20679N	145	20737N*	145
20155	132	20229	128	20339	125	20611	160	20680*	162	20738N	143
20155C	155	20230	128	20487C	159	20611	162	20680N*	145	20739N	143
20155N*	138	20231	128	20488C	159	20611N*	143	20682	162	20740	160
20156N	141	20232	128	20489C	159	20612	160	20682N*	145	20740N	143
20157N	141	20240	125	20510	136	20612	162	20683	162	20740P	421
20158C*	158	20241	125	20510N	141	20612*	143	20683N*	145	20741N	143
20158N	141	20242	125	20511	136	20613	160	20684	162	20742N	143
20159N	140	20243	125	20511N	141	20613	162	20684N*	145	20742P	421
20160	135	20244	125	20512	136	20613N*	143	20685	162	20743N	143
20160C*	158	20245	125	20512N	141	20614	160	20686	162	20744N	143
20161	135	20248	126	20512P	420	20614N*	143	20686N*	145	20745N	143
20162	135	20249	126	20513N	141	20619N	144	20687	162	20745P	421
20162C	158	20250	126	20514N	141	20620N	144	20687N*	145	20746	162
20162N	140	20251	126	20514P	420	20621N*	144	20688	162	20746N	143
20163	135	20252	126	20515C	155	20622N	144	20688N*	145	20747P	421
20163C	158	20253	126	20516C	155	20623N	144	20689	162	20748N	143
20163N	140	20256	126	20517C*	157	20624N	144	20689N*	145	20748P	421
20164	135	20257	126	20518C*	157	20625N*	144	20690*	161	20749N	143
20164N	140	20259	126	20519C*	158	20626N	144	20690N	145	20750N	143
20165	135	20260	126	20524P	420	20627N	144	20691N	145	20750P	419
20165C	158	20261	126	20525P	420	20628N	144	20692*	161	20751N	143
20165N	140	20262	126	20528P	420	20629N	144	20698*	161	20752N	143
20166	135	20263	126	20529P	420	20630	161	20699*	161	20753N	143
20166C	158	20265	126	20530	133	20630N*	144	20700N	144	20755P	419
20166N	140	20268	127	20530C	156	20631	161	20701N	144	20756P	419
20167	135	20269	127	20530N*	139	20631N*	144	20702N*	144	20758P	419

MIDLAND INDUSTRIES

NUMERICAL INDEX

Part#	Page	Part#	Page	Part#	Page	Part#	Page	Part#	Page	Part#	Page
20762N	140	20859*	161	21113	42	26005	121	27015	590	28042	3
20763P	420	20860*	162	21115	42	26005LF	233	27016	590	28042LF	213
20775P	421	20861	160	21117	42	26007	121	27018	590	28043	3
20776P	421	20862	160	21119	42	26007LF	233	27024	590	28043LF	213
20777P	421	20862	162	21121	42	26008	121	27026	590	28044	3
20778P	422	20876P	421	21151	42	26008LF	233	27028	590	28044LF	213
20779P	422	20878P	421	21153	42	26011	123	27034	590	28045	3
20780	541	20880P	421	21155	42	26014	123	27036	590	28045LF	213
20780C	159	20881P	421	21159	42	26015LF	233	27038	590	28046	3
20781C	159	20900P	421	21161	42	26016LF	233	27044	590	28047	3
20782C	159	20901P	421	21174	391	26021	123	27046	590	28048	3
20785C	159	20904P	421	21175	391	26023	123	27048	590	28049	4
20786C	159	20905P	421	21176	391	26062	121	28001	2	28050	4
20787C	159	20910P	422	21177	391	26063	121	28001LF	212	28051	4
20788C	159	20925P	421	21178	391	26064	121	28002	2	28052	4
20789C	159	20927P	421	21179	391	26065	121	28002LF	212	28053B	2
20790	161	20936P	420	21180	391	26066	121	28003	2	28057	4
20801	161	20937P	420	21193	43	26068	121	28003LF	212	28058	4
20801N	144	20938P	420	21195	43	26069	121	28004	2	28058L	4
20802	162	20939P	420	21207	43	26079	121	28004LF	212	28058LF	213
20803	161	20940P	420	22008	120	26102	121	28005	2	28059	4
20803N*	144	20941P	420	22008A	120	26103	121	28005LF	212	28059	545
20805	161	20944P	420	22008LF	233	26105	121	28009	2	28059	545
20805N*	144	20950P	421	22009	120	26142	121	28009LF	212	28059	547
20806	160	20951P	421	22009A	120	26145	121	28010	2	28059EHLF	213
20807	160	20953P	421	22009LF	233	26146	121	28010LF	212	28059L	4
20807N*	143	20954P	421	22010	120	26153	121	28011	2	28059LF	213
20808	160	20955P	421	22010A	120	26175	122	28011LF	212	28060	4
20808N*	143	20956P	421	22010B	120	26176	122	28012	2	28060L	4
20809	162	20958P	420	22010LF	233	26177	122	28012LF	212	28060LF	213
20809N*	145	20960P	420	22011	120	26178	122	28013	2	28061	4
20810	162	20961P	420	22011A	120	26179	122	28013LF	212	28061L	4
20810N*	145	20964P	420	22011LF	233	26180	122	28014	2	28061LF	213
20811	161	20965P	420	22012	120	26180L	122	28015	2	28062	4
20811N	145	20966P	420	22012LF	233	26181	122	28015B	2	28062L	4
20813	162	20967P	420	22013	120	26182	122	28015LF	212	28062LF	213
20813N	143	20968P	420	22013LF	233	26183	122	28016	2	28063	4
20814	162	20969P	420	22014	120	26184	122	28016B	2	28067	5
20814N	143	20970P	421	22014LF	233	26188	122	28017	2	28067LF	214
20815	162	20971P	421	22015	120	26189	122	28018	2	28068	5
20815N	143	20972P	421	24002	120	26190	122	28018LF	212	28068LF	214
20816	162	20973P	420	24003	120	26193	122	28019	2	28069	5
20817*	162	20974P	420	24004	120	26194	122	28019LF	212	28069LF	214
20818	162	20975P	422	24005	120	26195	122	28020	2	28070	5
20819*	162	20976P	422	24006	120	26198	122	28021B	2	28070LF	214
20820*	162	20977P	422	24007	120	26220	122	28022	3	28071	5
20821*	162	20980P	422	24008	120	26220B	122	28023	3	28071LF	214
20822*	162	20981P	422	24082	587	26221	122	28024	3	28075	6
20823*	162	20983P	422	24083	587	26221B	122	28024LF	213	28075LF	214
20824*	162	20985P	422	24084	587	26223	122	28025	3	28076	6
20825*	162	20986P	422	24085	587	26224	122	28025LF	213	28076LF	214
20826*	162	20988P	422	24086	587	26224B	122	28026	3	28077	6
20827*	162	20989P	422	24088	587	26225	122	28026LF	213	28077LF	214
20830C*	158	20990P	422	25001	119	26225B	122	28027	3	28078	6
20831C*	158	20993P	420	25002	119	26226	122	28027LF	213	28078LF	214
20832C*	158	21003	41	25003	119	26228	122	28028	3	28079	6
20833C*	158	21007	41	25033	119	26229	122	28028LF	213	28079LF	214
20834C*	158	21009	41	25062	119	26232	122	28029	3	28080	6
20835C*	158	21021	41	25064	119	26233	122	28030	3	28084	9
20841N	139	21023	41	25175	119	26233B	122	28031	3	28084LF	214
20842N	139	21025	41	25176	119	26234	122	28032	3	28084SLF	214
20843N	139	21027	41	25177	119	26235	122	28032LF	213	28085	9
20844N	139	21033	41	25179	119	26237	122	28033	3	28085LF	214
20845N	139	21043	41	25219	119	26238	122	28033LF	213	28085SLF	214
20846N	139	21044	41	25220	119	26291	123	28034	3	28086	9
20847N	139	21046	41	25221	119	26292	123	28034LF	213	28086LF	214
20848N*	140	21049	41	25224	119	26293	123	28035	3	28086SLF	214
20850N	141	21082	41	26001	121	26296	123	28035LF	213	28087	9
20851N	140	21083	41	26001LF	233	27001	120	28036	3	28087LF	214
20852N	140	21084	41	26002	121	27002	120	28036LF	213	28087SLF	214
20853N	140	21084	41	26002LF	233	27003	120	28038	3	28088	9
20854*	161	21095	42	26003	121	27005	120	28039	3	28088LF	214
20855*	161	21097	42	26003LF	233	27006	120	28039LF	213	28088SLF	214
20856*	161	21099	42	26004	121	27008	589	28041	3	28089	9
20857*	161	21111	42	26004LF	233	27014	590	28041LF	213	28090	7

MIDLAND INDUSTRIES

NUMERICAL INDEX

Part#	Page	Part#	Page	Part#	Page	Part#	Page	Part#	Page	Part#	Page
28091	8	28135LF	216	28185	5	28214LF	216	28267B	17	28322	20
28092	9	28136	11	28185L	5	28215	12	28267BLF	219	28325	21
28093	9	28140	11	28185LF	217	28215L	12	28267LF	219	28328	18
28093LF	214	28140LF	216	28187	5	28215LF	216	28268	17	28329	18
28094	9	28141	11	28188*	5	28216L	12	28268B	17	28330	18
28094LF	214	28141LF	216	28189*	5	28216LF	216	28268LF	219	28331	18
28095	9	28142	11	28189LF	217	28218	13	28268LF	219	28332	18
28095LF	214	28142LF	216	28190	16	28220	13	28269	17	28333	18
28096	9	28143	11	28190L	16	28220L	13	28269B	17	28335	18
28096LF	214	28143LF	216	28190LF	217	28220LF	217	28269LF	219	28336	18
28097	9	28144	11	28191	16	28221	13	28270B	17	28337	18
28097LF	214	28144LF	216	28191L	16	28221L	13	28272LF	219	28338	18
28101	8	28145	11	28191LF	217	28221LF	217	28273LF	219	28339	18
28102	8	28145LF	216	28192	16	28222	13	28274	17	28340	18
28102L	8	28146	11	28192L	16	28222L	13	28275	17	28345	21
28102LF	215	28146LF	216	28192LF	217	28222LF	217	28275LF	219	28346	20
28103	8	28147	11	28193	16	28223	13	28276	17	28346BN	20
28103LF	215	28147LF	216	28193L	16	28223L	13	28276B	17	28347	20
28104	8	28148	11	28193LF	217	28223LF	217	28276LF	219	28347SN	20
28104L	8	28148LF	216	28194	16	28224	13	28281	17	28348	20
28104LF	215	28149	11	28194L	16	28224L	13	28281F	18	28350	537
28105	8	28149LF	216	28194LF	217	28224LF	217	28281LF	219	28351	537
28105L	8	28150	11	28195	16	28225	13	28282	17	28352	537
28105LF	215	28150LF	216	28195L	16	28225L	13	28282F	18	28353	537
28106	8	28151	11	28195LF	217	28225LF	217	28282LF	219	28354	537
28106L	8	28152	11	28196	16	28227	13	28283	17	28363	538
28106LF	215	28153	11	28196L	16	28230	14	28283LF	219	28364	538
28107	8	28154	11	28196LF	217	28230LF	218	28284	17	28365	538
28107L	8	28155	11	28197	16	28231	14	28284LF	219	28366	538
28107LF	215	28156	6	28198	16	28231LF	218	28285	17	28367	538
28108	8	28156LF	218	28198LF	217	28232	14	28290	18	28368	538
28108LF	215	28156S	6	28199	16	28232LF	218	28290LF	219	28369	538
28109L	8	28156SLF	217	28199LF	217	28233	14	28291	18	28370	538
28109LF	215	28157	6	28200	10	28233LF	218	28291LF	219	28371	538
28110L	8	28157LF	218	28201	10	28234	14	28292	18	28372	538
28110LF	215	28157S	6	28201LF	215	28234LF	218	28292LF	219	28373	538
28111	8	28157SLF	217	28201S	10	28238	14	28293	18	28374	538
28111L	8	28158	6	28201SLF	215	28239	14	28294	18	28375	538
28111LF	215	28158LF	218	28202	10	28240	14	28295	14	28376	538
28112	8	28158SLF	217	28202LF	215	28245	15	28296	14	28377	538
28112LF	215	28159	6	28202S	10	28245LF	218	28298	14	28378	538
28113	8	28159LF	218	28202SLF	215	28246	15	28299	19	28379	538
28113LF	215	28159SLF	217	28203	10	28246LF	218	28300	19	28380	538
28114	8	28160	6	28203LF	215	28247	15	28300SS	21	28381	538
28114LF	215	28160LF	218	28203S	10	28247LF	218	28301	19	28382	538
28115	8	28160SLF	217	28203SLF	215	28248	15	28301SN	19	28400	142
28115LF	215	28161	6	28204	10	28248LF	218	28301SS	21	28401	142
28116	7	28165	6	28204LF	215	28249	15	28302	19	28402	142
28116LF	215	28165LF	218	28204S	10	28249LF	218	28302SN	19	28403	142
28117	7	28166	6	28204SLF	215	28253	15	28303	19	28404	142
28117LF	215	28166LF	218	28205	10	28253LF	218	28303SN	19	28405	142
28118	7	28167	6	28205LF	215	28254	15	28303SS	21	28407	142
28118LF	215	28167LF	218	28205S	10	28254LF	218	28304	19	28415	27
28119	7	28168	6	28206	10	28255	15	28304SS	21	28417	27
28120	7	28168LF	218	28206S	10	28255LF	218	28306	19	28424	13
28121	7	28169	6	28207	16	28256	15	28307	19	28425	13
28121LF	215	28169LF	218	28208	16	28257	15	28308	19	28426	13
28122	7	28174	9	28208L	16	28259*	7	28309	21	28427	13
28123	10	28175	9	28208LF	217	28260	7	28310	21	28440	18
28124	10	28176	9	28209	16	28261	7	28311	19	28441	18
28125	10	28178	5	28209LF	217	28261B	7	28312	20	28442	18
28126	10	28179	5	28210	12	28261LF	218	28313	20	28443	18
28127	10	28180	5	28211	12	28262	7	28313BN	20	28450	539
28128	7	28180LF	217	28211L	12	28262LF	218	28315	19	28452	539
28129	7	28181	5	28211LF	216	28263	7	28316**	19	28456	539
28130	7	28181L	5	28212	12	28264	7	28317	19	28458	539
28131	11	28181LF	217	28212	545	28264LF	218	28317SN	19	28460	539
28131LF	216	28182	5	28212	547	28265	7	28318	19	28464	539
28132	11	28182LF	217	28212L	12	28265B*	7	28318SN	19	28465	539
28132LF	216	28183	5	28212LF	216	28265LF	218	28318STL	19	28467	539
28133	11	28183L	5	28213	12	28266	17	28319	19	28468	539
28133LF	216	28183LF	217	28213L	12	28266B	17	28319SNXL	19	28469	539
28134	11	28184	5	28213LF	216	28266BLF	219	28319STLXL	19	28470	539
28134LF	216	28184L	5	28214	12	28266LF	219	28320	20	28475	11
28135	11	28184LF	217	28214L	12	28267	17	28321	20	28481	11

MIDLAND INDUSTRIES

NUMERICAL INDEX

Part#	Page	Part#	Page	Part#	Page	Part#	Page	Part#	Page	Part#	Page
28487	11	28546	546	28618W	412	28688	536	28761W	413	30011	58
28493	11	28546	547	28619	536	28690	532	28762F	94	30011LF	223
28497	11	28546	547	28619P	412	28691	532	28762P	413	30012	58
28498	11	28546	547	28619W	412	28693P	413	28762W	413	30012LF	223
28499	11	28546	547	28620	536	28694P	413	28763P	413	30013	58
28500	534	28546B	531	28620W	412	28695P	413	28763W	413	30013LF	225
28501	534	28546B	546	28622W	412	28696P	413	28764P	413	30016	58
28501B	534	28546SS	532	28623B	412	28697P	413	28764W	413	30016LF	224
28502	534	28547	531	28623W	412	28698P	413	28765W	413	30017	58
28503	534	28552	530	28624B	412	28699P	413	28766F	94	30018	58
28504	534	28552	546	28624W	412	28701	93	28767W	413	30019	58
28507	534	28552S	530	28625B	412	28702	93	28768F	94	30019LF	225
28507S	534	28553	530	28625W	412	28702P	411	28768W	413	30020	58
28508	534	28553S	530	28628B	412	28703	93	28770F	94	30020LF	225
28509	534	28557	531	28628W	412	28703W	411	28772F	94	30021	60
28510	534	28558	531	28639	536	28704	93	28773F	94	30021LF	225
28510B	534	28559	531	28640	536	28704P	411	28774F	94	30022	60
28511	534	28560	532	28640W	413	28704W	411	28777F	94	30022LF	225
28512	534	28560SS	532	28641W	413	28705	93	28778F	94	30025	63
28512	547	28561	531	28642W	413	28705W	411	28780F	94	30025LF	223
28513	534	28562	530	28643W	413	28706	93	28781F	94	30026	61
28514S	534	28562S	530	28651	536	28706W	411	28783F	94	30027	63
28515	534	28564	530	28652	536	28707	93	28784F	94	30027LF	223
28516	534	28564S	530	28659P	412	28707W	411	28786F	94	30027SS	63
28516S	534	28565	530	28659W	412	28708	93	28803W	413	30028	63
28517	534	28565S	531	28660P	412	28708W	411	28811P	412	30028LF	223
28518	535	28566	530	28660W	412	28709	93	28814P	412	30028SS	63
28519S	534	28566S	531	28661P	412	28710	93	28815W	412	30029	63
28520	535	28578	533	28661W	412	28711	93	28816P	412	30029LF	223
28521	535	28579	532	28663P	412	28712	93	28818P	412	30029SS	63
28522	535	28579SS	532	28663W	412	28713	93	28818W	412	30030	63
28523	535	28583	533	28663W	412	28714	93	28819P	411	30031	63
28524	535	28584	533	28664P	412	28715	93	28819W	411	30031LF	223
28525S	534	28585	533	28664W	412	28716	93	28820P	411	30032	63
28525S	547	28586	533	28665	536	28717	93	28820W	411	30032LF	223
28526S	534	28587	533	28666	536	28718	93	28957	93	30032SS	63
28528	535	28589	532	28666P	412	28719	93	28958	93	30033	63
28530	535	28592	533	28666W	412	28720W	411	28959	93	30033LF	223
28531	535	28593	533	28667	536	28721W	411	28960	93	30033SS	63
28532	535	28594	533	28667W	412	28722F	94	28961	93	30034	63
28533	531	28595	533	28668	536	28723P	411	28962	93	30034LF	223
28534	531	28597	533	28668P	412	28723W	411	28963	93	30034SS	63
28534	545	28601	533	28668W	412	28724F	94	28964	93	30035	63
28534	545	28601B	411	28669	536	28724W	411	28966	93	30039	63
28534	545	28601W	411	28670	536	28725W	411	28969	93	30039LF	223
28534	546	28602B	411	28671	536	28726W	411	28970	93	30040	63
28534	546	28602W	411	28671P	412	28727W	411	28971	93	30040LF	223
28534	547	28603	533	28671W	412	28728F	94	28972	93	30040SS	63
28534	547	28603B	411	28672	536	28729F	94	28973	94	30041	63
28534	547	28603W	411	28672P	412	28731F	94	28974	94	30041LF	223
28534B	531	28604B	411	28672W	412	28733F	94	28975	94	30041SS	63
28534B	546	28604W	411	28673	536	28734F	94	28988	521	30042	63
28534SS	532	28605	536	28674	536	28736F	94	28989	521	30042LF	223
28535	531	28605B	411	28674W	412	28738F	94	28990	521	30042SS	63
28536	535	28605W	411	28675	536	28740F	94	28991	521	30043	63
28540	530	28606W	411	28675P	412	28741P	411	29900	536	30044	63
28540	545	28607W	411	28675W	412	28741W	411	29901	536	30045	63
28540	545	28608	536	28676	536	28742F	94	29902	536	30046	63
28540	545	28608W	411	28677	536	28742P	411	29903	536	30047	59
28540	546	28609W	411	28678P	412	28743P	411	29904	536	30047LF	224
28540S	530	28611B	412	28678W	412	28743W	411	29905	536	30048	59
28540S	546	28611W	412	28679	536	28744P	411	29906	536	30048LF	224
28540S	546	28612B	412	28679W	412	28744W	411	29907	536	30049	59
28540S	547	28612P	412	28680	536	28745W	411	29908	536	30049LF	224
28540S	547	28612W	412	28680P	412	28746W	411	29909	536	30050	62
28540S	547	28613B	412	28680W	412	28747W	411	29910	536	30050LF	241
28540S	547	28613P	412	28681	536	28748	93	29911	536	30051	62
28541	530	28613W	412	28682W	412	28748W	411	29912	536	30051LF	241
28541S	530	28614B	412	28683	535	28749	93	29913	536	30052	62
28545	531	28614P	412	28683W	412	28752	93	29914	536	30053	60
28546	531	28614W	412	28684	535	28753	93	30000**	58	30053LF	225
28546	545	28615P	412	28685	535	28754	93	30001	58	30054	60
28546	545	28615W	412	28685W	412	28756	93	30001LF	224	30055	59
28546	545	28616W	412	28686	535	28760F	94	30006	58	30055LF	241
28546	546	28617W	412	28687	535	28761P	413	30006LF	224	30056	59

MIDLAND INDUSTRIES

NUMERICAL INDEX

Part#	Page	Part#	Page	Part#	Page	Part#	Page	Part#	Page	Part#	Page
30058	60	30203	49	30270	53	30398	51	30560	65	31237LF	243
30058LF	225	30203LF	219	30271	51	30399	51	30561	65	31238LF	243
30058S*	60	30203SS	56	30275	53	30400	51	30562	65	31260LF	243
30058SLF	225	30204	49	30276	53	30401	40	30563	65	031810	585
30063**	60	30204LF	219	30277	53	30402	51	30565	65	031812	585
30063BE***	60	30204SS	56	30279	53	30403	51	30566	65	031814	585
30063LF	225	30205	49	30280	53	30406	40	30567	65	031816	585
30063S	60	30206	49	30282	53	30407	39	30568	65	031820	585
30064	60	30206LF	219	30283	53	30408	39	30570	65	031824	585
30065	60	30206SS	56	30284	53	30409	39	30571	65	031910	585
30066	60	30207	49	30286	53	30410	40	30572	65	031912	585
30066LF	224	30207LF	219	30290	52	030410	585	30573	65	031914	585
30067	60	30207SS	56	30291	52	30411	40	30600	68	031916	585
30067LF	224	30208	49	30292	52	030412	585	30609	68	031920	585
30068	60	30209	49	30293	52	30413	40	030610	589	031924	585
30068LF	224	30210	49	30294	52	30415	39	030612	589	031932	585
30073	60	30210SS	56	30295	34	030416	585	030614	589	32001	24
30073LF	224	30211	49	30297	52	30417	39	030616	589	32001LF	220
30074	60	30212	49	30298	52	30420	40	30620	68	32001SS	45
30075	60	30213	49	30299	52	30421	40	030620	589	32002	24
30078	59	30214	49	30300	50	30422	50	30626	67	32002LF	220
30078LF	224	30215	49	30301	50	30423	50	30627	67	32002SS	45
30083	59	30215SS	56	30302	50	30424	50	30629	67	32003	24
30083LF	224	30216	49	30303	50	30426	52	30630	68	32003LF	220
30087	59	30217	49	30304	50	30427	52	30631	66	32003SS	45
30088	59	30218	49	30305	50	30428	52	30637	68	32004	24
30088LF	224	30219	49	30310	54	30429	53	30638	68	32004LF	220
30088S	59	30220	51	30311	54	30430	54	30640	68	32004SS	45
30093	59	30221	51	30312	54	30431	39	31022	417	32005	24
30093L*	59	30222	51	30313	54	30433	39	31030	417	32005LF	220
30094	59	30223	51	30314	54	30450	62	31031	417	32005SS	45
30094LF	224	30224	51	30315	54	30451	62	31032	417	32006	24
30098	60	30225	51	30316	54	30452	62	31033	417	32006LF	220
30098LF	224	30226	51	30340	54	30453	64	31034	417	32006SS	45
30099	60	30227	51	30341	54	30454	64	31038	417	32007	24
30099LF	224	30229	51	30342	54	30455	64	31039	417	32007LF	220
30100*	60	30230	52	30343	54	30457	64	31040	417	32008	24
30101	60	30230LF	219	30344	54	30458	64	31041	417	32008LF	220
30103	61	30230SS	56	30345	54	30459	64	31042	417	32008SS	45
30103B	61	30231	52	30346	54	30464	64	31055	417	32009	24
30103LF	225	30232	52	30349	54	30466	64	31058	417	32009LF	220
30103P	417	30233	52	30358	50	30467	64	31063	417	32009SS	45
30123	62	30234	52	30359	50	30468	64	31064	417	32010	24
30128	62	30234SS	56	30360	50	30469	64	31066LF	242	32010LF	220
30133	62	30235	52	30361	50	30471	64	31067	417	32010SS	45
30135	62	30236	52	30362	50	30472	64	31068	417	32011	24
30136	62	30237	52	30363	50	30473	64	31068LF	242	32011LF	220
30137	62	30238	49	30366	50	30480	55	31069	417	32011SS	45
30138	62	30239	49	30370	49	30482	55	31079LF	242	32012	24
30139	62	30240	51	30371	49	30483*	55	31081LF	242	32012LF	220
30140	67	30241	51	30372	49	30484	55	31082LF	242	32012SS	45
30140LF	225	30243	51	30373	49	30486	55	31083LF	242	32013	24
30141	67	30245	51	30374	49	30505	64	31093	417	32013LF	220
30142	61	30246	51	30375	49	30506	64	31095	417	32013SS	45
30149	62	30247	51	30376	49	30507	64	31096	417	32014	24
30150	61	30249	51	30377	49	30508	64	31097	417	32014LF	220
30150R	61	30250	53	30378	49	30510	64	31105LF	242	32014SS	45
30151	61	30251	53	30379	49	30511	64	31106LF	242	32015	25
30160	67	30252	53	30381	49	30512	64	31126LF	242	32015LF	220
30161	66	30253	53	30382	49	30513	64	31127LF	242	32015SS	45
30162	66	30254	53	30383	49	30516	64	31137LF	242	32016	25
30163	66	30255	53	30384	51	30517	64	31154LF	242	32016LF	220
30180	61	30257	53	30385	50	30518	64	31155LF	242	32016SS	45
30180F	61	30258	53	30386	50	30540	65	31158LF	242	32017	25
30181*	59	30259	53	30387	50	30541	65	31159LF	242	32017LF	220
30182*	59	30260	53	30388	50	30542	65	31171LF	243	32017SS	45
30183	59	30261	53	30389	50	30543	65	31188LF	243	32018	25
30184*	59	30264	53	30390	50	30545	65	31189LF	243	32018LF	220
30200	49	30265	53	30391	51	30546	65	31190LF	243	32018SS	45
30200LF	219	30266	53	30392	49	30547	65	31194LF	243	32019	25
30200SS	56	30266SS	56	30393	51	30548	65	31195LF	243	32019LF	220
30201	49	30267	53	30394	51	30550	65	31198LF	243	32019SS	45
30201LF	219	30268	53	30395	51	30551	65	31233LF	243	32020	25
30201SS	56	30269	53	30396	51	30552	65	31234LF	243	32020LF	220
30202	49	30269SS	56	30397	51	30553	65	31235LF	243	32020SS	45

MIDLAND INDUSTRIES

NUMERICAL INDEX

Part#	Page	Part#	Page	Part#	Page	Part#	Page	Part#	Page	Part#	Page
32021	25	32056	28	32102	34	32309LF	222	32384	37	32510	515
32021LF	220	32056LF	221	32103	34	32310	29	32385	37	32517	515
32021SS	45	32057	28	32104	34	32310B	30	32386	26	32521	515
32022	25	32057LF	221	32105	34	32311	29	32387	37	32526	515
32022LF	220	32058	28	32105C	34	32311B	30	32388	37	32533	515
32022SS	45	32058LF	221	32105LF	222	32311LF	222	32389	32	32535	515
32023	25	32059	28	32106	34	32311SS	45	32391	29	32539	515
32023LF	220	32059LF	221	32107	34	32312	29	32392	32	32543	515
32023SS	45	32060	28	32107C**	34	32313	29	32394	34	32545	515
32024	25	32060LF	221	32109*	31	32313LF	222	32394**	34	32549	515
32024LF	220	32061	28	32110	31	32314 *	29	32400 *	30	32550	515
32024SS	45	32061LF	221	32111	31	32314B	30	32401	30	32551	515
32025	25	32062	28	32112	31	32314SS	45	32402	30	32552	515
32025LF	220	32062LF	221	32113	31	32315	29	32403	30	32552SS	515
32026	24	32063	28	32114	31	32316	25	32404	30	32553	515
32026LF	220	32063LF	221	32115	31	32317	28	32405	30	32554	515
32027	24	32064	28	32116	31	32317LF	221	32406	30	32555	515
32027LF	220	32064LF	221	32117	29	32318	28	32407	30	32556	515
32028	25	32065	28	32118	29	32318LF	221	32409	30	32557	515
32029	25	32065LF	221	32119	29	32319	29	32410	30	32557SS	515
32030	32	32066	32	32120	29	32320	28	32411	30	32558	515
32031	32	32067	32	32121	29	32321	28	32412	31	32559	515
32032	32	32068	32	32122	29	32322	33	32413 *	31	32559SS	515
32033	32	32069	32	32123	29	32326	34	32414	31	32561	515
32034	32	32070	32	32124	29	32327	34	32415	31	32561SS	515
32036	29	32071	32	32125	29	32328	34	32416 *	31	32563	515
32036B	30	32072	32	32126 **	30	32329	26	32417	31	32564	515
32036LF	222	32073	32	32126LF	222	32330 **	29	32418	31	32564SS	515
32038	29	32074	32	32128 *	30	32331	26	32419	31	32565	515
32038B	30	32075	32	32129	29	32332	26	32420 *	31	32566	515
32038LF	222	32076	32	32130	29	32334	35	32425	31	32566SS	515
32038SS	45	32077	32	32131	29	32335	35	32429	31	32567	515
32039	29	32078	32	32132	29	32336C	35	32433	31	32568	515
32039B	30	32079	27	32133	29	32337	34	32434	31	32568SS	515
32039LF	222	32080	27	32150	43	32337C**	34	32435	31	32570	515
32039SS	45	32081	33	32151	43	32338	35	32436	31	32570SS	515
32040	29	32082	33	32153	43	32338C	35	32437	40	32571	515
32040B	30	32083	33	32159	43	32338SS**	35	32438*	40	32572	515
32040LF	222	32084	33	32160	43	32339	34	32439	40	32573	515
32041	29	32085	33	32170	44	32340	34	32440*	40	32574	515
32041B	30	32086	33	32171	44	32341	34	32441	28	32575	515
32041LF	222	32087	27	32176	37	32341C	34	32441LF	221	32575SS	515
32041SS	45	32088	27	32177	37	32341C**	34	32443	28	32576	515
32042	29	32089	27	32178	37	32342	34	32444	28	32577	515
32042B	30	32090	27	32179	37	32345	31	32445	28	32577SS	515
32042LF	222	32091	27	32180	37	32346	31	32446	28	32578	515
32042SS	45	32091LF	222	32181	37	32349	26	32447	28	32579	515
32043	29	32091SS	45	32182	37	32350 *	30	32448	28	32580	515
32043B	30	32092	27	32183	37	32351	26	32449	28	32584	515
32043LF	222	32092LF	222	32184	37	32352 *	30	32450	26	32586	515
32043SS	45	32093	27	32185	37	32353	30	32451	26	32588	515
32044	29	32093LF	222	32186	38	32354	29	32452	26	32588SS	515
32045	29	32093SS	45	32187	38	32355	26	32453	26	32590	515
32046	29	32094	27	32188	38	32356	26	32454	26	32591	515
32046B	30	32094LF	222	32189	38	32357	26	32455	26	32592	515
32046LF	222	32094SS	45	32190	38	32359	32	32456	26	32596	515
32047	29	32095	27	32191	38	32360	26	32457	26	32597	515
32047B	30	32095LF	222	32192	38	32361	30	32458	26	32608	31
32047LF	222	32095SS	45	32194	38	32362	32	32460	32	32609	31
32048	29	32096	27	32195	38	32363	30	32461	32	32610	31
32048B	30	32096	62	32200	26	32364	32	32462	32	32749	36
32048LF	222	32096LF	222	32201	26	32365 **	30	32463	32	32751	36
32049	28	32096SS	45	32202	26	32365LF	222	32470	28	32752	36
32050	28	32097	27	32300	24	32366	30	32472	28	32753	36
32050LF	221	32097	62	32301	24	32366LF	222	32473	28	32754	36
32051	28	32097LF	222	32302	24	32367 *	30	32475	28	32755	36
32051LF	221	32098	27	32303	25	32368	30	32476	28	32756	36
32052	28	32098	62	32304	25	32375	27	32500	515	32758	36
32052LF	221	32098LF	222	32305	25	32376	27	32501	515	32759	36
32053	28	32098SS	45	32306	25	32377	37	32502	515	32760	36
32053LF	221	32099	27	32306LF	220	32379	27	32503	515	32761	36
32054	28	32099	62	32307	25	32380	27	32504	515	32770	36
32054LF	221	32100	34	32308	29	32381	37	32506	515	32771	36
32055	28	32100LF	222	32309	29	32382	37	32507	515	32772	36
32055LF	221	32101	34	32309B	30	32383	37	32508	515	32773	36

NUMERICAL INDEX

MIDLAND INDUSTRIES

NUMERICAL INDEX

Part#	Page	Part#	Page	Part#	Page	Part#	Page	Part#	Page	Part#	Page
32774	36	33022W	414	33099P	415	33417W	416	34114	92	34610	47
32775	36	33023B	413	33099W	415	33418B*	416	34120	92	34611	47
32781	27	33023P	413	33300P*	416	33420B	416	34121	92	34612	47
32782	541	33023W	414	33301P*	416	33420W	416	34122	92	34613	47
32783	541	33024B	413	33301W	416	33422B	416	34123	92	34621T	47
32900	52	33024P	413	33302P*	416	33422W	416	34130	90	34622T	47
32901	52	33024W	414	33303W	414	33426B	416	34131	90	34624	46
32902	52	33025B	413	33306W	414	33426W	416	34141	90	34625	46
32903	52	33025P	413	33308B	414	33429B	416	34143	92	34626	46
32905	52	33025W	414	33309B	414	33429W	416	34160	92	34633	47
32906	52	33026B	413	33309W	414	33430B	416	34170	92	34633T	47
32907	52	33026W	414	33310W	414	33430W	416	34174	92	34635T	47
32912	24	33027W	414	33311B	414	33431W	416	34176	92	34638T	47
32915	25	33028W	414	33311P	414	33432W	416	34501	46	34650T	47
32950	24	33029W	414	33311W	414	33433B	416	34502	46	34652T	47
32951	24	33030W	414	33312B	414	33433W	416	34504	46	34658	47
32952	24	33032W	414	33312W	414	33434B	416	34510	46	34661	47
32953	24	33033W	414	33313B	414	33435B	416	34525	47	34710	46
32954	24	33035W	414	33313P	414	33435W	416	34526	47	34711	46
32954LF	220	33038B	414	33313W	414	33436B	416	34529	47	34712	46
32956	24	33038W	414	33314B	414	33436W	416	34531	47	34713	46
32957	24	33039B	414	33314P	414	33437B	416	34532	46	34714	46
32958	24	33039W	414	33314W	414	33437W	416	34533	46	34715	46
32960	27	33040W	414	33315W	414	33438B	416	34533T	46	34716	46
32961	27	33041B	414	33316B	414	33438W	416	34534	46	34717	46
32962	32	33041W	414	33316P	414	33439W	416	34535	46	34718	46
33000P	413	33042B	414	33316W	414	33440P	416	34535T	46	34719	46
33000W	414	33042W	414	33318W	414	33440W	416	34536	46	34720	46
33002B	413	33043B	414	33320W	414	33441W	416	34537	46	34721	46
33002W	414	33043W	414	33321W	414	33442W	415	34538	46	34722	46
33003B	413	33044B	414	33322W	414	33448W	416	34539	46	34723	46
33003W	414	33044W	414	33329W	414	33450W	416	34540	46	34724	46
33004B	413	33045B	414	33334P	414	33451W	416	34540T	46	34725	46
33004W	414	33045W	414	33342W	415	33454W	416	34541T	46	34726	46
33005B	413	33046B	414	33343P	415	33455W	416	34543	46	34727	46
33005W	414	33046W	414	33343W	415	33456W	416	34543T	46	34728	46
33006B	413	33047B	414	33344P	415	33460W	414	34550	47	34826	47
33006W	414	33047W	414	33344W	415	33461P	414	34551	47	34854	47
33007B	413	33048P	414	33345W	415	33461W	414	34551T	47	35130	88
33007W	414	33048W	414	33347W	415	33462W	414	34552	47	35131	88
33008B	413	33050W	414	33348W	415	33463P	414	34552T	47	35132	88
33008W	414	33052W	415	33351W	414	33463W	414	34553T	47	35133	88
33009B	413	33053B	415	33380W	414	33464W	414	34561	47	35134	88
33009W	414	33053W	415	33381W	414	33470W	415	34562	47	35135	88
33010W	414	33058W	415	33384W	414	33471P	415	34562T	47	35136	88
33011W	414	33059W	415	33385B	414	33471W	415	34563	47	35142	88
33012B	413	33060W	415	33385P	414	33480W	415	34563T	47	35186	88
33012P	413	33061W	415	33385W	414	33481W	415	34564T	47	35403LF	262
33012W	414	33062P	415	33386W	414	33482W	415	34565	47	35403SS	262
33013B	413	33063W	415	33389W	415	34001	89	34565T	47	35404LF	262
33013P	413	33064W	415	33390B	415	34011	89	34567	47	35404SS	262
33013W	414	33065W	415	33390W	415	34012	89	34567T	47	35405LF	262
33014B	413	33066W	415	33391B	415	34016	89	34568	47	35405SS	262
33014P	413	33067W	415	33391W	415	34022	89	34568T	47	35406LF	262
33014W	414	33068W	415	33394B	415	34031	89	34572	46	35406SS	262
33015B	413	33079W	415	33394W	415	34041	90	34572T	46	35407LF	262
33015P	413	33089W	415	33395B	415	34046	90	34574	46	35407SS	262
33015W	414	33091B	415	33395W	415	34051	90	34574T	46	35408LF	262
33016B	413	33091W	415	33396B	415	34060	91	34579	46	35408SS	262
33016P	413	33092B	415	33396W	415	34061	91	34580	46	35413LF	262
33016W	414	33092W	415	33397W	415	34062	91	34581	46	35413SS	262
33017B	413	33093B	415	33398W	415	34063	91	34583	46	35414LF	262
33017P	413	33093W	415	33399W	415	34064	91	34584	46	35414SS	262
33017W	414	33094W	415	33402W	415	34065	91	34585	46	35415LF	262
33018B	413	33095B	415	33406B	415	34072	91	34586	46	35415SS	262
33018P	413	33095P	415	33406W	415	34073	91	34587	46	35416LF	262
33018W	414	33095W	415	33407B	415	34074	91	34588	46	35416SS	262
33019W	414	33096B	415	33407W	415	34079	92	34589	46	35417LF	262
33020B	413	33096P	415	33408B	415	34080	91	34590	46	35417SS	262
33020P	413	33096W	415	33408W	415	34082	91	34591	46	35418LF	262
33020W	414	33097B	415	33409W	415	34084	91	34592	46	35418SS	262
33021B	413	33097W	415	33410B	415	34088	91	34595	46	35420LF	262
33021W	414	33098B	415	33410W	415	34111	92	34597	46	35420SS	262
33022B	413	33098P	415	33415B	416	34112	92	34600	47	36110	188
33022P	413	33098W	415	33415W	416	34113	92	34601	47	36110SS	188

MIDLAND INDUSTRIES

NUMERICAL INDEX

Part#	Page	Part#	Page	Part#	Page	Part#	Page	Part#	Page	Part#	Page
36111	188	38005	177	38101	179	38209	183	38364	186	38960OA	572
36112	188	38009	177	38101S	180	38210	183	38368	187	38960R	572
36113	188	38010	177	38102	179	38211	183	38369	187	38960R5	572
36114	188	38011	177	38103	179	38212	183	38370	187	38960RA	572
36116	188	38012	177	38104	179	38213	183	38371	187	38960U	572
36116SS	188	38013	177	38104S	180	38217	183	38372	187	38960U5	572
36118	188	38014	177	38105	179	38218	183	38711	119	38960UA	572
36120	188	38015	186	38106	179	38221	183	38715	119	38960Y	572
36120SS	188	38016	186	38107	179	38222	183	38718	119	38960Y5	572
36121	188	38018	177	38108	179	38223	183	38732	119	38960YA	572
36130	188	38019	177	38109	179	38224	183	38761	119	38965	572
36130SS	188	38020	177	38110	179	38225	183	38769	119	38965B5	572
36132	189	38021	177	38111	179	38226	183	38770	119	38965BA	572
36140	189	38022	177	38113	180	38227	183	38800	37	38965G	572
36140SS	189	38023	177	38114	180	38228	183	38802	37	38965G5	572
36141	189	38028	177	38115	180	38229	183	38806	37	38965GA	572
36142	189	38029	177	38116	180	38235	183	38808	37	38965O	572
36144	189	38030	177	38117	180	38236	183	38810	37	38965O5	572
36146	189	38035	177	38118	180	38237	183	38828	38	38965OA	572
36146SS	189	38036	177	38119	180	38239	183	38830	38	38965R	572
36147	189	38037	177	38120	180	38240	183	38832	38	38965R5	572
36148	189	38038	177	38132	180	38241	183	38834	38	38965RA	572
36150	189	38039	177	38133	180	38243	183	38836	38	38965U	572
36150SS	189	38040	177	38134	180	38244	183	38860	38	38965U5	572
36152	189	38041	177	38136	180	38246	183	38861	38	38965UA	572
36160	190	38042	177	38137	180	38247	183	38862	38	38965Y	572
36164	190	38043	177	38138	180	38252	184	38864	38	38965Y5	572
36164SS	190	38044	178	38139	180	38253	184	38866	38	38965YA	572
36166	190	38045	178	38140	180	38255	184	38868	38	38970	572
36166SS	190	38046	178	38141	180	38256	184	38869	38	38970BA	572
36168	190	38047	178	38142	180	38257	184	38873	38	38970BC	572
36170	190	38048	177	38143	180	38259	184	38874	38	38970G	572
36172	190	38049	178	38144	181	38264	184	38910	187	38970GA	572
36174	190	38052	178	38146	181	38265	184	38910	573	38970GC	572
36176	190	38053	178	38148	181	38266	184	38915	187	38970R	572
36178	190	38054	178	38149	181	38267	184	38915	573	38970RA	572
36180	191	38055	178	38150	181	38269	184	38920	573	38970RC	572
36182	191	38057	178	38151	181	38278	184	38923	573	38975	572
36184	191	38059	178	38152	181	38279	184	38926	573	38975BA	572
36186	191	38060	178	38152S	181	38280	184	38927	573	38975BC	572
36188	191	38061	178	38153	181	38281	184	38950	572	38975G	572
36200	191	38062	178	38154	181	38287	184	38950B2	572	38975GA	572
36205	191	38063	178	38154S	181	38288	184	38951	572	38975GC	572
36210	191	38064	178	38155	181	38290	184	38951B1	572	39318	186
36212	191	38065	178	38156	181	38291	184	38951BA	572	39319	186
36214	191	38066	178	38157	181	38292	184	38952	572	39357	186
36216	191	38067	178	38158	181	38294	184	38952BA	572	39358	186
36220	191	38068	178	38161	182	38300	185	38952G	572	39409	553
36300	192	38069	179	38162	182	38301	185	38952G1	572	39410	553
36301	192	38070	179	38163	182	38306	185	38952GA	572	39411	553
36304	192	38072	179	38164	182	38307	185	38952O	572	39411	554
36305	192	38073	179	38165	182	38312	185	38952OA	572	39412	553
36306	192	38074	179	38170	182	38313	185	38952R	572	39413	553
36307	192	38075	179	38171	182	38318	186	38952R1	572	39414	553
36308	192	38076	179	38172	182	38319	186	38952RA	572	39415	553
36309*	192	38077	179	38173	182	38324	187	38952U	572	39416	553
36310	192	38078	179	38174	182	38325	187	38952U1	572	39418	553
36311	192	38078S	179	38179	182	38326	187	38952UA	572	39419	553
36340	192	38079	179	38180	182	38327	187	38952Y	572	39425	553
36350	192	38080	179	38181	182	38328	187	38952Y1	572	39426	553
36360	192	38081	179	38182	182	38333	187	38952YA	572	39436	555
36362	192	38081S	179	38183	182	38334	187	38953	572	39437	555
36370	192	38082	179	38188	182	38335	187	38953B1	572	39438	555
36371	192	38083	179	38189	182	38336	187	38953BA	572	39442	555
36372	192	38084	179	38190	182	38337	187	38954	572	39443	555
36373	192	38085	179	38191	182	38342	187	38954B5	572	39444	555
36374	192	38086	179	38196	182	38343	187	38954BA	572	39446	555
36375	192	38087	179	38197	182	38344	187	38960	572	39447	555
36376	192	38088	179	38198	182	38345	187	38960B5	572	39448	555
36377	192	38090	179	38199	182	38346	187	38960BA	572	39451	555
38000	177	38091	179	38204	183	38351	186	38960G	572	39452	555
38001	177	38092	179	38205	183	38352	186	38960G5	572	39453	555
38002	177	38093	179	38206	183	38357	186	38960GA	572	39454	555
38003	177	38094	179	38207	183	38358	186	38960O	572	39457	555
38004	177	38095	179	38208	183	38363	186	38960O5	572	39459	555

MIDLAND INDUSTRIES

NUMERICAL INDEX

Part#	Page	Part#	Page	Part#	Page	Part#	Page	Part#	Page	Part#	Page
39460	555	39658	561	39832	556	40069	321	40152	323	41065	326
39461	555	39659	561	39833	556	40070	321	40153	323	41066	326
39462	555	39660	561	39834	556	40071	321	40154	323	41067	326
39463	554	39661	561	39855	553	40072	321	40155	323	41068	326
39464	554	39662	561	*39856	553	40073	321	40156	323	41069	326
39466	555	39663	561	39857	553	40074	321	40160	324	41070	326
39467	555	39665	561	39860	559	40075	321	40161	324	41074	326
39468	555	39667	561	39870	556	40076	321	40162	324	41075	326
39469	554	39669	561	39871	556	40079	321	40163	324	41076	326
39470	555	39672	560	39874	556	40080	322	40164	324	41077	326
39471	554	39673	560	39875	556	40081	322	40165	324	41079	326
39472	554	39674	560	39877	556	40082	322	40166	324	41080	327
39473	554	39675	560	39878	556	40083	322	40167	324	41081	327
39474	555	39676	560	40001	320	40084	322	40168	324	41082	327
39475	555	39677	560	40002	320	40085	322	40169	324	41083	327
39477	554	39684	563	40003	320	40086	322	40170	324	41084	327
39506	556	39687	563	40004	320	40087	322	40171	324	41085	327
39507	556	39688	563	40005	320	40088	322	40172	324	41086	327
39508	556	39689	563	40006	320	40089	322	40173	324	41087	327
39509	557	39690	563	40007	320	40090	322	40174	324	41088	327
39510	557	39712	569	40008	320	40091	322	40175	324	41089	327
39511	556	39713	569	40009	320	40092	322	40176	324	41090	327
39512	556	39736	564	40010	320	40093	322	40178	324	41100	327
39515	557	39737	564	40011	320	40094	322	40179	324	41101	327
39516	557	39738	564	40012	320	40095	322	40180	324	41102	327
39520	557	39739	564	40013	320	40096	322	40181	324	41103	327
39521	557	39740	564	40014	320	40097	322	40182	324	41104	327
39522	557	39741	564	40015	320	40098	322	40183	324	41105	327
39524	557	39742	565	40016	320	40100	322	40184	324	41106	327
39530	557	39743	565	40017	320	40101	322	40185	324	41107	327
39531	557	39744	565	40018	320	40102	322	40186	324	41108	327
39535	558	39745	565	40019	320	40103	322	40187	324	41109	327
39537	558	39748	565	40020	320	40104	322	40193	324	41244	326
39541	558	39749	565	40021	320	40105	322	40200	325	41245	326
39542	558	39752	565	40022	320	40106	322	40201	325	43200L	270
39543	558	39753	565	40023	320	40107	322	40202	325	43200T	270
39544	558	39754	565	40024	320	40108	322	40203	325	43204L	270
39550	558	39757	566	40025	320	40109	322	40204	325	43206L	270
39551	558	39758	566	40026	320	40110	322	40205	325	43265LF	243
39552	558	39764	567	40027	320	40111	322	40206	325	43266LF	243
39556	558	39765	567	40028	320	40112	322	40207	325	44100	329
39557	558	39766	567	40029	320	40113	322	40209	325	44100LF	329
39558	558	39768	567	40030	320	40114	322	40213	325	44101	329
39559	558	39769	567	40031	320	40115	322	40220	325	44101LF	329
39560	558	39772	566	40032	320	40118	322	40221	325	44102	329
39563	559	39773	566	40033	320	40119	322	40222	325	44102LF	329
39564	559	39774	566	40034	320	40120	323	40223	325	44103	329
39565	559	39775	566	40035	320	40121	323	40224	325	44103LF	329
39566	558	39778	567	40036	320	40122	323	40225	325	44104	329
39570	559	39779	567	40040	321	40123	323	40226	325	44104LF	329
39572	559	39782	567	40041	321	40124	323	40234	325	44105	329
39573	559	39783	567	40042	321	40125	323	40245	321	44105LF	329
39574	559	39786	566	40043	321	40126	323	40254	325	44106	329
39575	559	39787	566	40044	321	40127	323	40256	325	44106LF	329
39592	562	39788	566	40045	321	40128	323	40259	325	44107	329
39595	194	39789	566	40046	321	40129	323	40260	325	44107LF	329
39595	562	39792	568	40047	321	40130	323	40261	325	44108	329
39596	194	39793	568	40048	321	40131	323	41040	326	44108LF	329
39596	562	39794	568	40049	321	40132	323	41041	326	44109	329
39597	194	39795	568	40050	321	40133	323	41042	326	44109LF	329
39597	562	39800	568	40051	321	40134	323	41043	326	44110	329
39600	194	39801	568	40052	321	40135	323	41044	326	44110LF	329
39600	562	39802	568	40053	321	40136	323	41045	326	44112	329
39604	562	39803	568	40054	321	40140	323	41046	326	44112LF	329
39605	562	39805	568	40055	321	40141	323	41047	326	44120	329
39606	562	39807	567	40056	321	40142	323	41048	326	44120LF	329
39610*	562	39809	567	40060	321	40143	323	41049	326	44121LF	329
39611**	562	39814	568	40061	321	40144	323	41050	326	44122	329
39613	562	39818	566	40062	321	40145	323	41054	326	44122LF	329
39614	562	39819	566	40063	321	40146	323	41056	326	44123	329
39615	562	39820	566	40064	321	40147	323	41060	326	44123LF	329
39616	563	39828	556	40065	321	40148	323	41061	326	44124	329
39655	561	39829	556	40066	321	40149	323	41062	326	44124LF	329
39656	561	39830	556	40067	321	40150	323	41063	326	44125	329
39657	561	39831	556	40068	321	40151	323	41064	326	44125LF	329

MIDLAND INDUSTRIES

NUMERICAL INDEX

Part#	Page	Part#	Page	Part#	Page	Part#	Page	Part#	Page
44126LF	329	44204	331	44344LF	333	44449	335	44515	337
44127	329	44204LF	331	44351LF	333	44449LF	335	44515LF	337
44127LF	329	44205	331	44391	331	44450	335	44516*	337
44128LF	329	44205LF	331	44391LF	331	44450LF	335	44516LF*	337
44129LF	329	44206	331	44392	331	44451	335	44517	337
44130LF	329	44206LF	331	44392LF	331	44451LF	335	44517LF	337
44131	329	44207	331	44393	331	44452	335	44518	337
44131LF	329	44207LF	331	44393LF	331	44452LF	335	44518LF	337
44132LF	329	44208	331	44394	331	44453	335	44519*	337
44133LF	329	44208LF	331	44394LF	331	44453LF	335	44519LF	337
44134	329	44250	332	44395	331	44454	335	44520*	337
44134LF	329	44250LF	332	44395LF	331	44454LF	335	44520LF	337
44135LF	329	44251	332	44396	331	44456	335	44521*	337
44136LF	329	44251LF	332	44396LF	331	44456LF	335	44521LF*	337
44137	329	44252	332	44397	331	44458	335	44522*	337
44137LF	329	44252LF	332	44397LF	331	44458LF	335	44522LF*	337
44138LF	329	44253	332	44398	331	44461	335	44523	337
44140	329	44253LF	332	44398LF	331	44461LF	335	44523LF	337
44140LF	329	44254	332	44410	334	44462	335	44524	337
44141LF	329	44254LF	332	44410LF	334	44462LF	335	44524LF	337
44142LF	329	44255	332	44411	334	44463	335	44527*	337
44146LF	329	44255LF	332	44411LF	334	44463LF	335	44527LF	337
44150LF	329	44256	332	44412	334	44470	336	44528*	337
44160	330	44256LF	332	44412LF	334	44470LF	336	44528LF	337
44160LF	330	44257	332	44413	334	44471	336	44529*	337
44161	330	44257LF	332	44413LF	334	44471LF	336	44529LF*	337
44161LF	330	44258	332	44414	334	44472	336	44530	337
44162	330	44258LF	332	44414LF	334	44472LF	336	44530LF	337
44162LF	330	44259	332	44415	334	44473	336	44531	337
44163	330	44259LF	332	44415LF	334	44473LF	336	44531LF	337
44163LF	330	44260	332	44416	334	44474	336	44532	337
44164	330	44260LF	332	44416LF	334	44474LF	336	44532LF	337
44164LF	330	44261LF	332	44417	334	44475	336	44533LF	337
44165	330	44268LF	333	44417LF	334	44475LF	336	44534	337
44165LF	330	44270LF	333	44418	334	44476	336	44534LF	337
44166	330	44273LF	333	44418LF	334	44476LF	336	44535	337
44166LF	330	44276	333	44419	334	44477	336	44535LF	337
44167	330	44276LF	333	44419LF	334	44477LF	336	44537	337
44167LF	330	44279LF	333	44420	334	44478	336	44537LF	337
44168	330	44280	333	44420LF	334	44478LF	336	44538	337
44168LF	330	44280LF	333	44421LF	334	44479	336	44538LF	337
44169	330	44282	333	44430	335	44479LF	336	44539	337
44169LF	330	44282LF	333	44430LF	335	44480	336	44539LF	337
44170	330	44283	333	44431	335	44480LF	336	44541	337
44170LF	330	44283LF	333	44431LF	335	44481LF	336	44541LF	337
44180	330	44286	333	44432	335	44500	337	44542LF	337
44180LF	330	44286LF	333	44432LF	335	44500LF	337	44543	337
44181	330	44287	333	44433	335	44501	337	44543LF	337
44181LF	330	44287LF	333	44433LF	335	44501LF	337	44557	337
44182	330	44288LF	333	44434	335	44502	337	44600	336
44182LF	330	44290LF	333	44434LF	335	44502LF	337	44600LF	336
44183	330	44291	333	44435	335	44503	337	44601	336
44183LF	330	44291LF	333	44435LF	335	44503LF	337	44601LF	336
44184	330	44292LF	333	44436	335	44504	337	44602	336
44184LF	330	44293LF	333	44436LF	335	44504LF	337	44602LF	336
44185	330	44296	333	44437	335	44505	337	44603	336
44185LF	330	44296LF	333	44437LF	335	44505LF	337	44603LF	336
44186	330	44298	333	44438	335	44506	337	44604	336
44186LF	330	44298LF	333	44438LF	335	44506LF	337	44604LF	336
44187	330	44301	333	44440	335	44507	337	44605	336
44187LF	330	44301LF	333	44440LF	335	44507LF	337	44605LF	336
44188	330	44303	333	44441	335	44508	337	44606	336
44188LF	330	44303LF	333	44441LF	335	44508LF	337	44606LF	336
44189	330	44306	333	44442	335	44509	337	44607	336
44189LF	330	44306LF	333	44442LF	335	44509LF	337	44607LF	336
44190	330	44314LF	333	44444	335	44510*	337	44608	336
44190LF	330	44315LF	333	44444LF	335	44510LF*	337	44608LF	336
44191LF	330	44316LF	333	44445	335	44511*	337	44609	336
44200	331	44318LF	333	44445LF	335	44511LF	337	44609LF	336
44201	331	44322LF	333	44446	335	44512	337	44610	336
44201LF	331	44327LF	333	44446LF	335	44512LF	337	44610LF	336
44202	331	44328LF	333	44447	335	44513	337	44611LF	336
44202LF	331	44330LF	333	44447LF	335	44513LF	337	44630LF	338
44203	331	44334LF	333	44448	335	44514	337	44631LF	338
44203LF	331	44336LF	333	44448LF	335	44514LF	337	44632LF	338

MIDLAND INDUSTRIES

NUMERICAL INDEX

Part#	Page	Part#	Page	Part#	Page	Part#	Page	Part#	Page	Part#	Page
44706LF	338	45183	342	46022LF	244	46141	196	46522	210	46903I	278
44707	338	45184	342	46023	198	46142	196	46523	210	46903SS	295
44707LF	338	45185	342	46023LF	244	46143	196	46523A	210	46904I	278
44708	338	45200	341	46029LF	244	46151	196	46524	210	46904SS	295
44708LF	338	45201	341	46036	199	46152	196	46524A	210	46905SS	295
44720	339	45202	341	46038	199	46152T*	196	46526	210	46910	206
44721	339	45203	341	46039	199	46153	196	46529	210	46912	206
44722	339	45204	341	46040	199	46160	196	46530	210	46912SS	295
44723	339	45250	342	46045	199	46161	196	46530A	210	46913SS	295
44724	339	45251	342	46045LF	244	46161T*	196	46531	210	46914SS	295
44725	339	45252	342	46046	199	46162	196	46531A	210	46920	206
44726	339	45252LF	341	46046LF	244	46165	196	46532	210	46921	206
44727	339	45253	342	46048	199	46166	196	46532A	210	46922	206
44728	339	45253LF	341	46048S*	199	46166T*	196	46533	210	46922A	206
44729	339	45254	342	46050	199	46167	196	46533A	210	46922I	278
44730M	339	45255	342	46051	199	46174LF	245	46539	209	46922SS	295
44740	339	45393	341	46051LF	245	46175LF	245	46540	20	46923	206
44742	339	45394	341	46055*	199	46177LF	245	46541	20	46923I	278
44753	339	45410	342	46055LF	244	46200	208	46560	208	46923SS	295
44780LF	340	45411	342	46056	199	46201	208	46560V	208	46924	206
44781LF	340	45412	342	46056LF	244	46202	208	46561	208	46924I	278
44782LF	340	45412LF	341	46056P*	199	46241	205	46561V	208	46924SS	295
44783LF	340	45413	342	46060	199	46243	205	46562	208	46925	206
44784LF	340	45413LF	341	46060LF	244	46244	205	46562V	208	46930	280
44785LF	340	45414	342	46061	199	46247	204	46563	208	46930S	280
44790LF	340	45415	342	46061L	199	46248	204	46563V	208	46930SS	294
44791LF	340	45432	342	46061LF	244	46250	204	46564	208	46930T	280
44792LF	340	45435	342	46064	194	46251	204	46564V	208	46931	280
44793LF	340	45438	342	46066	194	46252	204	46565	208	46931S	280
44794LF	340	45439	342	46067	194	46255	205	46566	208	46931SS	294
44795LF	340	45470	342	46069	194	46256	205	46567	208	46931T	280
44796LF	340	45471	342	46070	194	46257	205	46568	208	46932	280
44797LF	340	45472	342	46071	194	46260	205	46569	208	46932S	280
44798LF	340	45473	342	46072	194	46270	306	46570	208	46932SS	294
44799LF	340	45474	342	46073	194	46277	306	46571	208	46932T	280
44800LF	340	45475	342	46074	195	46400	202	46572	208	46933	280
44827LF	340	45502	342	46075	195	46400M	203	46573	208	46933S	280
44828LF	340	45504	342	46076	195	46401	202	46575	208	46933SS	294
44829LF	340	45505	342	46077	195	46401M	203	46576	208	46933T	280
44830LF	340	45509	342	46078	195	46402	202	46577	208	46934	279
44831LF	340	45513	342	46079	195	46402M	203	46578	208	46934LS	279
44840LF	343	45600	342	46080	195	46406M	203	46600	544	46934LT	279
44840LF	407	45601	342	46081	195	46411	202	46600	545	46934SS	294
44841LF	343	45602	342	46082	195	46411M	203	46600	546	46935	279
44841LF	407	45603	342	46083	195	46429M	203	46605	544	46935LS	279
44842LF	343	45604	342	46084*	195	46430M	203	46605	545	46935LT	279
44842LF	407	45605	342	46085	195	46440	207	46607	544	46935SS	294
44843LF	343	45606	342	46086	195	46443	207	46615	543	46936	279
44843LF	407	45652	342	46087	195	46450	200	46620	541	46936LS	279
44844LF	343	45653	342	46088	195	46451	200	46621	541	46936LT	279
44844LF	407	45654	342	46089	195	46455	200	46622	541	46936SS	294
44845LF	343	45655	342	46089A	195	46456	200	46630	541	46937	279
44845LF	407	45657	342	46090ALF	245	46457	200	46631	541	46937LS	279
45100	341	46001	198	46090HLF	245	46465	200	46650	142	46937SS	294
45101	341	46002	198	46091LF	245	46466	200	46651	142	46951	207
45102	341	46002LF	244	46093LF	245	46467	200	46652	142	46956	207
45102LF	341	46003	198	46099LF	245	46475	201	46653	142	46980	206
45103	341	46003LF	244	46100	197	46476	201	46660	142	46981	206
45103LF	341	46004	198	46101	197	46485	201	46661	142	46986	210
45104	341	46005	198	46102	197	46500	209	46662	142	46987	210
45104LF	341	46005LF	244	46103	197	46505	209	46663	142	46988	210
45105	341	46011	198	46104	197	46510	209	46670	142	46989	210
45105LF	341	46011LF	244	46107	197	46511	209	46671	142	47042	206
45124	341	46011X	198	46115	197	46512	209	46672	142	48001	347
45127	341	46012	198	46117	197	46513	209	46680	142	48002	347
45160	341	46012LF	244	46118	197	46514	209	46681	142	48003	347
45161	341	46013	198	46125	197	46515	209	46682	142	48004	347
45162	341	46013LF	244	46126	197	46516	209	46830	207	48005	347
45163	341	46015LF	244	46127	197	46517	209	46832	207	48006	347
45163LF	341	46016	198	46128	197	46518	209	46833	207	48007	347
45164	341	46016LF	244	46130	196	46519	209	46834	207	48008	347
45165	341	46020	198	46131	196	46520	210	46875	207	48009	347
45180	342	46021	198	46132	196	46520A	210	46878	207	48010	347
45181	342	46021LF	244	46134	196	46521	210	46900	206	48011	347
45182	342	46022	198	46140	196	46521A	210	46903	206	48015	347

MIDLAND INDUSTRIES

NUMERICAL INDEX

Part#	Page	Part#	Page	Part#	Page	Part#	Page	Part#	Page	Part#	Page
48020	347	48115	349	49028	347	49128	350	55063	409	55174	410
48021	347	48120	350	49029	347	49129	350	55064	409	55179	410
48022	347	48121	350	49030	347	49140	350	55065	409	55200	410
48023	347	48122	350	49031	347	49141	350	55066	409	55201	410
48024	347	48123	350	49032	347	49142	350	55067	409	55203	410
48025	347	48124	350	49033	347	49143	350	55068	409	55205	410
48026	347	48125	350	49034	347	49144	350	55069	409	55207	410
48027	347	48126	350	49035	347	49145	350	55070	409	55209	410
48028	347	48127	350	49036	347	49146	350	55072	409	55211	410
48029	347	48128	350	49037	347	49147	350	55074	409	55213	410
48030	347	48129	350	49038	347	49148	350	55075	409	55241	409
48031	347	48131	350	49040	348	49149	350	55076	409	56001	361
48032	347	48135	350	49041	348	49151	350	55080	409	56002	361
48034	347	48140	350	49042	348	49153	350	55081	409	56003	361
48036	347	48141	350	49043	348	49160	351	55082	409	56004	361
48040	348	48142	350	49044	348	49161	351	55083	409	56005	361
48041	348	48143	350	49045	348	49162	351	55084	409	56006	361
48042	348	48144	350	49046	348	49163	351	55085	409	56007	361
48043	348	48145	350	49047	348	49164	351	55086	409	56008	361
48044	348	48146	350	49048	348	49165	351	55087	409	56009	361
48045	348	48147	350	49049	348	49166	351	55088	409	56010	361
48046	348	48148	350	49050	348	49167	351	55089	409	56011	361
48047	348	48149	350	49052	348	49168	351	55090	409	56012	361
48048	348	48151	350	49054	348	49169	351	55092	409	56013	361
48049	348	48152	350	49060	348	49170	351	55093	409	56014	361
48050	348	48153	350	49061	348	49200	351	55096	409	56015	361
48052	348	48155	350	49062	348	49201	351	55097	409	56017	361
48053	348	48160	351	49063	348	49203	351	55098	409	56020	361
48054	348	48161	351	49064	348	49205	351	55100	409	56021	361
48056	348	48162	351	49065	348	49207	351	55101	409	56022	361
48060	348	48163	351	49066	348	49209	351	55102	409	56023	361
48061	348	48164	351	49067	348	49213	351	55103	409	56024	361
48062	348	48165	351	49068	348	49220	351	55104	409	56025	361
48063	348	48166	351	49069	348	49223	351	55105	409	56026	361
48064	348	48167	351	49070	348	49234	351	55106	409	56027	361
48065	348	48168	351	49072	348	49236	351	55107	409	56028	361
48066	348	48169	351	49074	348	49240	351	55108	409	56029	361
48067	348	48170	351	49076	348	50001	86	55109	409	56030	361
48068	348	48171	351	49080	349	50002	591	55111	409	56031	361
48069	348	48172	351	49081	349	50004	546	55115	409	56032	361
48070	348	48174	351	49082	349	50004	546	55116	409	56033	361
48071	348	48180	351	49083	349	50004	591	55117	409	56034	361
48072	348	48181	351	49084	349	50008	591	55120	409	56035	361
48073	348	48187	351	49085	349	50011	86	55121	409	56036	361
48074	348	48193	351	49086	349	50016	58	55122	409	56038	361
48075	348	48200	351	49087	349	54042	591	55123	409	56040	362
48076	348	48201	351	49088	349	54044	546	55124	409	56041	362
48080	349	48203	351	49089	349	54044	546	55125	409	56042	362
48081	349	48205	351	49090	349	54044	547	55126	409	56043	362
48082	349	48207	351	49091	349	54044	547	55127	409	56044	362
48083	349	48209	351	49092	349	54044	591	55128	409	56045	362
48084	349	48213	351	49094	349	54046	591	55129	409	56046	362
48085	349	48220	351	49096	349	54048	591	55132	409	56047	362
48086	349	48227	351	49100	349	55002	593	55140	410	56048	362
48087	349	49001	347	49101	349	55004	593	55141	410	56049	362
48088	349	49002	347	49102	349	55006	593	55142	410	56050	362
48089	349	49003	347	49103	349	55008	593	55143	410	56051	362
48090	349	49004	347	49104	349	55018	594	55144	410	56052	362
48091	349	49005	347	49105	349	55022	594	55145	410	56053	362
48092	349	49006	347	49106	349	55024	594	55146	410	56054	362
48094	349	49007	347	49107	349	55026	594	55147	410	56055	362
48096	349	49008	347	49108	349	55032	594	55148	410	56056	362
48100	349	49009	347	49109	349	55034	594	55149	410	56058	362
48101	349	49010	347	49110	349	55036	594	55150	410	56058	362
48102	349	49011	347	49111	349	55038	594	55151	410	56060	362
48103	349	49013	347	49113	349	55042	594	55151	410	56061	362
48104	349	49017	347	49115	349	55044	594	55160	410	56062	362
48105	349	49020	347	49120	350	55046	594	55161	410	56063	362
48106	349	49021	347	49121	350	55048	594	55162	410	56064	362
48107	349	49022	347	49122	350	55048	594	55163	410	56065	362
48108	349	49023	347	49123	350	55054	594	55164	410	56066	362
48109	349	49024	347	49124	350	55056	594	55165	410	56067	362
48110	349	49025	347	49125	350	55058	594	55166	410	56068	362
48111	349	49026	347	49126	350	55060	409	55167	410	56069	362
48113	349	49027	347	49127	350	55061	409	55168	410	56070	362
						55062	409	55170	410	56071	362

NUMERICAL INDEX

MIDLAND INDUSTRIES

NUMERICAL INDEX

Part#	Page	Part#	Page	Part#	Page	Part#	Page	Part#	Page	Part#	Page
56072	362	56165	366	56275	365	57064	362	57153	365	57223	367
56073	362	56166	366	56276	365	57065	362	57154	365	57223TV	377
56074	362	56167	366	56280	365	57066	362	57155	365	57223V	378
56075	362	56168	366	56281	365	57067	362	57160	366	57224	367
56076	362	56169	366	56282	365	57068	362	57161	366	57225	367
56080	363	56170	366	56283	365	57069	362	57162	366	57226	367
56081	363	56171	366	56285	365	57070	362	57162GBS	378	57227	367
56082	363	56172	366	56286	365	57071	362	57162TV	377	57227TV	377
56083	363	56173	366	56290	366	57072	362	57162V	378	57227V	378
56084	363	56174	366	56291	366	57073	362	57163	366	57228	367
56085	363	56180	366	56292	366	57074	362	57164	366	57228TV	377
56086	363	56181	366	56293	366	57075	362	57164TV	377	57228V	378
56087	363	56182	366	56294	366	57076	362	57164V	378	57229	367
56088	363	56183	366	56295	366	57080	363	57165	366	57229TV	377
56089	363	56184	366	56296	366	57081	363	57166	366	57229V	378
56090	363	56185	366	56297	366	57082	363	57167	366	57240	362
56091	363	56186	366	56300	368	57083	363	57168	366	57241	362
56092	363	56187	366	56330	367	57084	363	57168TV	377	57242	362
56093	363	56188	366	56331	367	57085	363	57168V	378	57243	362
56094	363	56189	366	56332	367	57086	363	57169	366	57244	362
56095	363	56190	366	56430	362	57087	363	57170	366	57245	362
56096	363	56191	366	57001	361	57088	363	57170TV	377	57246	362
56100	364	56192	366	57002	361	57089	363	57170V	378	57247	362
56101	364	56193	366	57003	361	57090	363	57171	366	57250	363
56102	364	56200	367	57004	361	57091	363	57172	366	57251	363
56103	364	56201	367	57005	361	57092	363	57172TV	377	57252	363
56104	364	56202	367	57006	361	57093	363	57172V	378	57253	363
56105	364	56203	367	57007	361	57094	363	57173	366	57254	363
56106	364	56204	367	57008	361	57095	363	57174	366	57255	363
56107	364	56205	367	57009	361	57096	363	57174TV	377	57256	363
56108	364	56206	367	57010	361	57100	364	57174V	378	57257	363
56109	364	56207	367	57011	361	57101	364	57180	366	57260	364
56110	364	56208	367	57012	361	57102	364	57181	366	57261	364
56111	364	56209	367	57013	361	57103	364	57182	366	57262	364
56112	364	56210	367	57014	361	57104	364	57183	366	57263	364
56113	364	56211	367	57015	361	57105	364	57184	366	57264	364
56114	364	56212	367	57017	361	57106	364	57185	366	57265	364
56115	364	56213	367	57020	361	57107	364	57186	366	57266	364
56120	365	56220	367	57021	361	57108	364	57187	366	57267	364
56121	365	56221	367	57022	361	57109	364	57188	366	57267V	364
56122	365	56222	367	57023	361	57110	364	57188	366	57270	365
56123	365	56223	367	57024	361	57111	364	57189	366	57271	365
56124	365	56224	367	57025	361	57112	364	57190	366	57272	365
56125	365	56226	367	57026	361	57113	364	57191	366	57273	365
56126	365	56227	367	57027	361	57114	364	57192	366	57275	365
56127	365	56228	367	57028	361	57115	364	57193	366	57275	365
56128	365	56229	367	57029	361	57116	364	57200	367	57276	365
56129	365	56240	362	57030	361	57120	365	57201	367	57280	365
56130	365	56241	362	57031	361	57121	365	57201GBS	378	57281	365
56131	365	56242	362	57032	361	57122	365	57201TV	377	57282	365
56132	365	56243	362	57033	361	57123	365	57201V	378	57283	365
56133	365	56244	362	57034	361	57124	365	57202	367	57285	365
56134	365	56245	362	57035	361	57125	365	57203	367	57286	365
56135	365	56246	362	57036	361	57126	365	57203TV	377	57290	366
56140	365	56247	362	57040	362	57127	365	57203V	378	57291	366
56141	365	56250	363	57041	362	57128	365	57204	367	57292	366
56142	365	56251	363	57042	362	57129	365	57205	367	57293	366
56143	365	56252	363	57043	362	57130	365	57206	367	57294	366
56144	365	56253	363	57044	362	57131	365	57207	367	57295	366
56145	365	56254	363	57045	362	57132	365	57207TV	377	57296	366
56146	365	56255	363	57046	362	57133	365	57207V	378	57297	366
56147	365	56256	363	57047	362	57134	365	57208	367	57300	368
56148	365	56257	363	57048	362	57135	365	57209	367	57301	368
56149	365	56260	364	57049	362	57140	365	57209TV	377	57304	368
56150	365	56261	364	57050	362	57141	365	57209V	378	57305	368
56151	365	56262	364	57051	362	57142	365	57210	367	57306	368
56152	365	56263	364	57052	362	57143	365	57211	367	57308	368
56153	365	56264	364	57053	362	57144	365	57211TV	377	57311	367
56154	365	56265	364	57054	362	57145	365	57211V	378	57320	368
56155	365	56266	364	57055	362	57146	365	57212	367	57322	368
56160	366	56267	364	57056	362	57147	365	57213	367	57324	368
56161	366	56270	365	57056	362	57148	365	57213TV	377	57326	368
56162	366	56271	365	57060	362	57149	365	57213V	378	57328	368
56163	366	56272	365	57061	362	57150	365	57220	367	57330	367
56164	366	56273	365	57062	362	57151	365	57222GBS	378	57331	367
				57063	362	57152	365	57222TV	377	57332	367

MIDLAND INDUSTRIES

NUMERICAL INDEX

Part#	Page	Part#	Page	Part#	Page	Part#	Page	Part#	Page
57332TV	377	59084SMLS	372	59162V	378	59227TV	377	62250	354
57332V	378	59085SMLS	372	59163SMLS	374	59227V	378	62251	354
57400GBS	378	59086SMLS	372	59163SMLSXX	376	59228SMLS	375	62252	354
57430	362	59086SMLSXX	376	59164SMLS	374	59229SMLS	375	62253	354
57431	362	59087SMLS	372	59164SMLSXX	376	59229TV	377	62254	354
57500GBS	378	59088SMLS	372	59164TV	377	59229V	378	62255	354
57600GBS	378	59089SMLS	372	59164V	378	59231SMLS	375	62256	354
59001SMLS	370	59090SMLS	372	59165SMLS	374	59231TV	377	62257	354
59002SMLS	370	59090SMLSXX	376	59166SMLS	374	59231V	378	62258	354
59003SMLS	370	59091SMLS	372	59166SMLSXX	376	59300SMLS	375	62259	354
59004SMLS	370	59092SMLS	372	59167SMLS	374	59301SMLS	375	62260	354
59005SMLS	370	59094SMLS	372	59168SMLS	374	59305SMLS	375	62391	354
59006SMLS	370	59096SMLS	372	59168SMLSXX	376	59306SMLS	375	62392	354
59007SMLS	370	59100SMLS	372	59168TV	377	59308SMLS	375	62393	354
59009SMLS	370	59100SMLSXX	376	59168V	378	61447	439	62394	354
59010SMLS	370	59101SMLS	372	59169SMLS	374	61448	439	62395	354
59011SMLS	370	59101SMLSXX	376	59169SMLSXX	376	61449	439	62396	354
59020SMLS	370	59102SMLS	372	59170SMLS	374	61450	439	62397	354
59021SMLS	370	59103SMLS	372	59170SMLSXX	376	61451	439	62398	354
59022SMLS	370	59103SMLSXX	376	59170TV	377	61452	439	62410	355
59023SMLS	370	59104SMLS	372	59170V	378	61453	439	62410B	355
59024SMLS	370	59105SMLS	372	59171SMLS	374	61454	439	62411	355
59025SMLS	370	59105SMLSXX	376	59171SMLSXX	376	61455	439	62411B	355
59026SMLS	370	59106SMLS	372	59172SMLS	374	61457	439	62412	355
59027SMLS	370	59107SMLS	372	59172SMLSXX	376	61775	345	62412B	355
59028SMLS	370	59108SMLS	372	59172TV	377	61775	380	62413	355
59029SMLS	370	59109SMLS	372	59172V	378	61776	345	62413B	355
59030SMLS	370	59109SMLSXX	376	59173SMLS	374	61776	380	62414	355
59031SMLS	370	59110SMLS	372	59174SMLS	374	61777	345	62414B	355
59032SMLS	370	59111SMLS	372	59174SMLSXX	376	61777	380	62415	355
59033SMLS	370	59111SMLSXX	376	59174TV	377	61778	345	62415B	355
59034SMLS	370	59112SMLS	372	59174V	378	61778	380	62415DC	345
59036SMLS	370	59113SMLS	372	59179SMLSXX	376	62075	356	62415HDDC	345
59040SMLS	371	59114SMLS	372	59180SMLS	374	62076	356	62416	355
59041SMLS	371	59115SMLS	372	59181SMLS	374	62077	356	62416B	355
59042SMLS	371	59115SMLSXX	376	59182SMLS	374	62078	356	62416DC	345
59043SMLS	371	59120SMLS	373	59183SMLS	374	62079	356	62416HDDC	345
59044SMLS	371	59121SMLS	373	59184SMLS	374	62080	356	62417	355
59045SMLS	371	59122SMLS	373	59185SMLS	374	62081	356	62417B	355
59046SMLS	371	59123SMLS	373	59186SMLS	374	62082	356	62417DC	345
59047SMLS	371	59124SMLS	373	59187SMLS	374	62083	356	62417HDDC	345
59048SMLS	371	59125SMLS	373	59188SMLS	374	62100	353	62418	355
59049SMLS	371	59126SMLS	373	59189SMLS	374	62101	353	62418B	355
59050SMLS	371	59127SMLS	373	59190SMLS	374	62102	353	62418DC	345
59052SMLS	371	59128SMLS	373	59191SMLS	374	62103	353	62418HDDC	345
59054SMLS	371	59129SMLS	373	59192SMLS	374	62104	353	62419	355
59056SMLS	371	59130SMLS	373	59193SMLS	374	62105	353	62420	355
59060SMLS	371	59131SMLS	373	59196SMLS	374	62106	353	62420B	355
59060SMLSXX	376	59132SMLS	373	59197SMLS	374	62107	353	62421	355
59061SMLS	371	59133SMLS	373	59198SMLS	374	62108	353	62428	355
59062SMLS	371	59134SMLS	373	59199SMLS	374	62109	353	62430	355
59062SMLSXX	376	59135SMLS	373	59201TV	377	62110	353	62431	355
59063SMLS	371	59140SMLS	373	59201V	378	62112	353	62432	355
59064SMLS	371	59141SMLS	373	59203TV	377	62160	353	62433	355
59064SMLSXX	376	59142SMLS	373	59203V	378	62161	353	62434	355
59065SMLS	371	59143SMLS	373	59207TV	377	62162	353	62435	355
59066SMLS	371	59144SMLS	373	59207V	378	62163	353	62436	355
59066SMLSXX	376	59145SMLS	373	59209TV	377	62164	353	62437	355
59067SMLS	371	59146SMLS	373	59209V	378	62165	353	62438	355
59068SMLS	371	59147SMLS	373	59211TV	377	62166	353	62440	355
59069SMLS	371	59148SMLS	373	59211V	378	62167	353	62441	355
59070SMLS	371	59149SMLS	373	59213TV	377	62168	353	62442	355
59070SMLSXX	376	59150SMLS	373	59213V	378	62169	353	62445	355
59071SMLS	371	59151SMLS	373	59220SMLS	375	62180	353	62446	355
59072SMLS	371	59152SMLS	373	59221SMLS	375	62181	353	62447	355
59073SMLS	371	59153SMLS	373	59221TV	377	62182	353	62448	355
59074SMLS	371	59154SMLS	373	59221V	378	62183	353	62449	355
59075SMLS	371	59155SMLS	373	59222TV	377	62184	353	62450	355
59076SMLS	371	59160SMLS	374	59223SMLS	375	62185	353	62451	355
59080SMLS	372	59160SMLSXX	376	59224SMLS	375	62186	353	62452	355
59080SMLSXX	376	59161SMLS	374	59225SMLS	375	62187	353	62453	355
59081SMLS	372	59161SMLSXX	376	59225TV	377	62188	353	62454	355
59082SMLS	372	59162SMLS	374	59225V	378	62189	353	62455	355
59082SMLSXX	376	59162SMLSXX	376	59226SMLS	375	62190	353	62456	355
59083SMLS	372	59162TV	377	59227SMLS	375	62191	353	62457	355

MIDLAND INDUSTRIES

NUMERICAL INDEX

Part#	Page	Part#	Page	Part#	Page	Part#	Page	Part#	Page	Part#	Page
62657	358	63180	353	63449	355	63656	358	64114	383	64282	385
62658	358	63181	353	63450	355	63657	358	64122	383	64283	385
62659	358	63182	353	63452	355	63658	358	64123	383	64286	385
62660	358	63183	353	63453	355	63660	359	64124	383	64287	386
62670	358	63184	353	63454	355	63661	359	64126	383	64288	386
62671	358	63185	353	63455	355	63662	359	64127	383	64289	385
62672	358	63186	353	63459	355	63663	359	64130	383	64291	385
62700	358	63187	353	63470	356	63664	359	64131	383	64294	386
62701	358	63188	353	63471	356	63665	359	64133	383	64296	386
62702	358	63190	353	63472	356	63670	358	64134	383	64297	386
62703	358	63192	353	63473	356	63671	358	64136	383	64298	385
62704	358	63214	21	63474	356	63672	358	64137	383	64299	385
62705	358	63215	21	63475	356	63680	359	64138	383	64300	385
62706	358	63216	21	63476	356	63681	359	64140	383	64301	385
62707	358	63217	21	63477	356	63682	359	64141	383	64303	385
62708	358	63218	21	63478	356	63683	359	64142	383	64306	385
62720	354	63250	354	63480	356	63684	359	64145	383	64309	386
62721	354	63251	354	63500	357	63701	358	64146	383	64316	385
62722	354	63252	354	63501	357	63702	358	64148	383	64317	385
62723	354	63253	354	63502	357	63703	358	64160	383	64318	385
62724	354	63254	354	63504	357	63704	358	64161	383	64319	385
62725	354	63255	354	63505	357	63705	358	64162	383	64322	385
62726	354	63256	354	63506	357	63706	358	64163	383	64327	385
62727	354	63257	354	63507	357	63707	358	64164	383	64328	385
62728	354	63258	354	63508	357	63708	358	64165	383	64330	385
62740	354	63260	354	63509	357	63720	354	64166	383	64334	385
62741	354	63261	354	63510	357	63721	354	64167	383	64336	385
62742	354	63390	354	63511	357	63722	354	64168	383	64343	385
62744	354	63391	354	63512	357	63723	354	64169	383	64351	385
62745	354	63392	354	63513	357	63724	354	64170	383	64363	386
62747	354	63393	354	63516	357	63725	354	64171	383	64364	386
62748	354	63394	354	63517	357	63726	354	64180	384	64372	386
62749	354	63395	354	63518	357	63727	354	64181	384	64383	386
62770	356	63396	354	63521	357	63728	354	64182	384	64384	386
62771	356	63397	354	63522	357	63740	354	64183	384	64385	386
62772	356	63398	354	63523	357	63741	354	64184	384	64386	386
62773	356	63400	354	63524	357	63742	354	64185	384	64390	384
62774	356	63401	354	63526	357	63744	354	64186	384	64391	384
62775	356	63410	355	63527	357	63745	354	64187	384	64392	384
62776	356	63410B	355	63528	357	63747	354	64188	384	64393	384
62777	356	63411	355	63529	357	63748	354	64189	384	64394	384
62778	356	63411B	355	63530	357	63749	354	64190	384	64395	384
62779	356	63412	355	63531	357	63759	359	64191	384	64396	384
63075	356	63412B	355	63534	357	63760	359	64192	384	64397	384
63076	356	63413	355	63535	357	63761	359	64200	384	64398	384
63077	356	63413B	355	63537	357	63762	359	64201	384	64399	384
63078	356	63414	355	63538	357	63763	359	64202	384	64400	384
63079	356	63414B	355	63539	357	63764	359	64203	384	64410	387
63080	356	63415	355	63540	357	63765	359	64204	384	64411	387
63081	356	63415B	355	63541	357	63771	356	64205	384	64412	387
63082	356	63416	355	63543	357	63772	356	64206	384	64413	387
63083	356	63416B	355	63550	357	63773	356	64207	384	64414	387
63100	353	63417	355	63600	356	63774	356	64208	384	64415	387
63101	353	63417B	355	63601	356	63775	356	64209	384	64416	387
63102	353	63418	355	63602	356	63776	356	64210	384	64417	387
63103	353	63418B	355	63603	356	63777	356	64211	384	64418	387
63104	353	63419	355	63604	356	63778	356	64250	385	64419	387
63105	353	63420	355	63605	356	64002	596	64251	385	64420	387
63106	353	63421	355	63606	356	64003	596	64252	385	64421	387
63107	353	63430	355	63607	356	64004	596	64253	385	64422	387
63108	353	63431	355	63608	356	64005	596	64254	385	64430	387
63109	353	63432	355	63610	356	64006	596	64255	385	64431	387
63110	353	63433	355	63630	358	64008	596	64256	385	64432	387
63112	353	63434	355	63631	358	64100	383	64257	385	64433	387
63160	353	63435	355	63632	358	64101	383	64258	385	64434	387
63161	353	63436	355	63633	358	64102	383	64259	385	64435	387
63162	353	63437	355	63634	358	64103	383	64260	385	64436	387
63163	353	63438	355	63635	358	64104	383	64261	385	64437	387
63164	353	63440	355	63636	358	64105	383	64262	385	64438	387
63165	353	63441	355	63637	358	64106	383	64268	385	64439	387
63166	353	63442	355	63638	358	64107	383	64269	385	64440	387
63167	353	63445	355	63641	358	64108	383	64273	385	64441	387
63168	353	63446	355	63653	358	64109	383	64276	385	64442	387
63170	353	63447	355	63654	358	64110	383	64279	385	64443	387
63171	353	63448	355	63655	358	64112	383	64280	385	64444	387

MIDLAND INDUSTRIES

NUMERICAL INDEX

Part#	Page	Part#	Page	Part#	Page	Part#	Page	Part#	Page	Part#	Page
64445	387	64542*	388	64778H	380	65201	384	65342	385	65459	387
64446	387	64543	388	64779	380	65202	384	65343	385	65460	387
64447	387	64544	388	64780	380	65203	384	65346	386	65461	387
64448	387	64545*	388	64780H	380	65204	384	65347	386	65462	387
64449	387	64546*	388	64781	380	65205	384	65348	386	65463	387
64450	387	64547*	388	64781H	380	65206	384	65349	386	65464	387
64451	387	64549	388	64963	390	65207	384	65350	386	65465	387
64452	387	64549*	388	64964	390	65208	384	65351	385	65466	387
64453	387	64550	388	64968	390	65209	384	65359	385	65467	387
64454	387	64551	388	65004	598	65210	384	65363	386	65468	387
64456	387	64552	388	65006	598	65211	384	65364	386	65470	389
64457	387	64553*	388	65008	598	65250	385	65372	386	65471	389
64458	387	64573	390	65024	598	65251	385	65375	386	65472	389
64459	387	64574	390	65026	598	65252	385	65377	386	65473	389
64460	387	64575	390	65028	598	65253	385	65383	386	65474	389
64461	387	64576	390	65100	383	65254	385	65384	386	65475	389
64462	387	64577	390	65101	383	65255	385	65385	386	65476	389
64463	387	64578	390	65102	383	65256	385	65386	386	65477	389
64464	387	64583	390	65103	383	65257	385	65387	386	65478	389
64465	387	64584	390	65104	383	65258	385	65388	386	65479	389
64470	389	64585	390	65105	383	65259	385	65390	384	65480	389
64471	389	64586	390	65106	383	65260	385	65391	384	65481	389
64472	389	64587	390	65107	383	65261	385	65392	384	65482	389
64473	389	64588	390	65108	383	65262	385	65393	384	65486	387
64474	389	64600	389	65109	383	65264	385	65394	384	65491	387
64475	389	64601	389	65110	383	65267	386	65395	384	65500	388
64476	389	64602	389	65112	383	65268	385	65396	384	65501	388
64477	389	64603	389	65114	383	65269	385	65397	384	65502	388
64478	389	64604	389	65115	383	65273	385	65398	384	65503	388
64479	389	64605	389	65122	383	65276	385	65399	384	65504	388
64480	389	64606	389	65123	383	65279	385	65400	384	65505	388
64481	389	64607	389	65124	383	65280	385	65401	384	65506	388
64482	389	64608	389	65126	383	65281	386	65410	387	65507	388
64486	387	64609	389	65127	383	65282	385	65411	387	65508	388
64500	388	64610	389	65130	383	65283	385	65412	387	65509	388
64501	388	64611	389	65131	383	65286	385	65413	387	65510*	388
64502	388	64651	389	65133	383	65287	386	65414	387	65511*	388
64503	388	64652	389	65134	383	65288	386	65415	387	65512	388
64504	388	64653	389	65136	383	65289	385	65416	387	65513	388
64505	388	64654	389	65137	383	65291	385	65417	387	65514*	388
64506	388	64655	389	65138	383	65292	386	65418	387	65515*	388
64507	388	64656	389	65139	383	65293	386	65419	387	65516*	388
64508	388	64657	389	65140	383	65294	386	65420	387	65517	388
64509	388	64658	389	65141	383	65295	386	65421	387	65518	388
64510*	388	64659	389	65142	383	65296	386	65422	387	65518DT	391
64511*	388	64660	389	65145	383	65297	386	65429	387	65519*	388
64512	388	64661	389	65146	383	65298	385	65430	387	65520*	388
64513	388	64692	391	65148	383	65299	385	65431	387	65521*	388
64514*	388	64693	391	65160	383	65300	385	65432	387	65522*	388
64515*	388	64694	391	65161	383	65301	385	65433	387	65522DT	391
64516*	388	64695	391	65162	383	65302	386	65434	387	65523	388
64517	388	64696	391	65163	383	65303	385	65435	387	65523DT	391
64518	388	64703	390	65164	383	65304	386	65436	387	65524	388
64519*	388	64704	390	65165	383	65305	386	65437	387	65525*	388
64520*	388	64705	390	65166	383	65306	385	65438	387	65526	388
64521*	388	64706	390	65167	383	65309	386	65439	387	65527*	388
64522*	388	64707	390	65168	383	65310	386	65440	387	65527DT	391
64523	388	64708	390	65169	383	65311	386	65441	387	65528*	388
64524	388	64721	385	65170	383	65312	386	65442	387	65528DT	391
64525*	388	64729	385	65171	383	65313	386	65443	387	65529*	388
64526	388	64733	385	65180	384	65314	386	65444	387	65529DT	391
64527*	388	64770	380	65181	384	65316	385	65445	387	65530	388
64528*	388	64771	380	65182	384	65317	385	65446	387	65530DT	391
64529*	388	64772	380	65183	384	65318	385	65447	387	65531	388
64530	388	64773	380	65184	384	65322	385	65448	387	65531DT	391
64531	388	64773H	380	65185	384	65323	386	65449	387	65532*	388
64532*	388	64774	380	65186	384	65325	386	65450	387	65533*	388
64533*	388	64774H	380	65187	384	65327	385	65451	387	65534	388
64534	388	64775	380	65188	384	65328	385	65452	387	65535	388
64535	388	64775H	380	65189	384	65330	385	65453	387	65537*	388
64537*	388	64776	380	65190	384	65332	386	65454	387	65538	388
64538	388	64776H	380	65191	384	65334	385	65455	387	65539	388
64539	388	64777	380	65192	384	65335	385	65456	387	65540	388
64540	388	64777H	380	65194	384	65335	386	65457	387	65541*	388
64541*	388	64778	380	65200	384	65336	385	65458	387	65541DT	391

MIDLAND INDUSTRIES

NUMERICAL INDEX

Part#	Page	Part#	Page	Part#	Page	Part#	Page	Part#	Page	Part#	Page
65542*	388	65771API	381	66505	392	67635	393	69416	394	73203G	519
65543	388	65771H	380	66506	392	67636	393	69417	394	73203N1	518
65544	388	65772	380	66507	392	67637	393	69418	394	73203N5	518
65545*	388	65772API	381	66508	392	67638	393	69432	395	73203R	519
65546*	388	65772H	380	66509	392	67653	393	69434	395	73203R1	519
65547*	388	65773	380	66510	392	67654	393	69435	395	73203R5	519
65549*	388	65773API	381	66511	392	67655	393	69438	395	73203U	519
65550	388	65773H	380	66512	392	67656	393	69441	395	73203U1	519
65551	388	65774	380	66513	392	67657	393	69442	395	73203U5	519
65552	388	65774API	381	66630	393	67658	393	69471	395	73204B	519
65553*	388	65774H	380	66631	393	67670	393	69472	395	73204N5	518
65555	388	65775	380	66632	393	67671	393	69473	395	73205B	519
65557	388	65775API	381	66633	393	67672	393	69474	395	73205B5	519
65558	388	65775H	380	66634	393	67700	392	69475	395	73206B	519
65559	388	65776	380	66635	393	67702	392	69476	395	73206B1	519
65560	388	65776API	381	66636	393	67704	392	69477	395	73206B5	519
65573	390	65776H	380	66637	393	67705	392	69478	395	73206N1	518
65574	390	65777	380	66638	393	67708	392	69600	395	73206N5	518
65575	390	65777API	381	66653	393	67709	392	69601	395	73206R	519
65576	390	65777H	380	66654	393	67713	392	69602	395	73206R5	519
65577	390	65778	380	66655	393	67760	393	69603	395	73206U	519
65578	390	65778API	381	66656	393	67761	393	69604	395	73206U5	519
65583	390	65778H	380	66657	393	67762	393	69605	395	73207B	519
65584	390	65779	380	66658	393	67763	393	69606	395	73207B5	519
65585	390	65779API	381	66670	393	67764	393	69607	395	73207N5	518
65586	390	65779H	380	66671	393	67765	393	69608	395	73207U	519
65587	390	65780	380	66672	393	67766	393	72404	607	73208B	519
65588	390	65780API	381	66705	392	67767	393	72406	607	73208B	519
65600	389	65780H	380	66709	392	67768	393	72408	607	73230B	520
65601	389	65781	380	66760	393	67769	393	73003	448	73231B	520
65602	389	65781API	381	66761	393	67770	393	73004	448	73232B	520
65603	389	65781H	380	66762	393	67771	393	73005	448	73232N5*	520
65604	389	65782	380	66763	393	67772	393	73006	448	73233B	520
65605	389	65783	380	66764	393	67773	393	73007	448	73238B	520
65606	389	65783API	381	66765	393	67774	393	73007	448	73238U**	520
65607	389	65784API	381	66766	393	67775	393	73008	448	73341B	517
65608	389	65963	390	66767	393	67776	393	73009	448	73341R	517
65609	389	65964	390	66768	393	67777	393	73010	448	73341U	517
65610	389	65965	390	66769	393	67778	393	73011	448	73343B	517
65611	389	65966	390	66770	393	69101	394	73023	448	73343R	517
65621	391	65967	390	66771	393	69102	394	73024	448	73343U	517
65622	391	65968	390	66772	393	69103	394	73025	448	73345B	517
65650	389	65969	390	66773	393	69104	394	73026	448	73345R	517
65651	389	65970	390	66774	393	69105	394	73027	448	73345U	517
65652	389	65971	390	66775	393	69106	394	73028	448	73346B	517
65653	389	66000	447	66776	393	69107	394	73029	448	73346R	517
65654	389	66001	447	66777	393	69108	394	73030	448	73669	446
65655	389	66002	447	66778	393	69161	394	73031	448	73670	446
65656	389	66003	447	67470	392	69162	394	73033	448	73671	446
65657	389	66004	447	67471	392	69163	394	73035	448	73672	446
65658	389	66005	447	67472	392	69164	394	73036	448	73673	446
65659	389	66006	447	67473	392	69165	394	73037	448	73674	446
65660	389	66007	447	67474	392	69166	394	73038	448	73675	446
65661	389	66008	447	67475	392	69167	394	73039	448	73676	446
65662	389	66009	447	67476	392	69168	394	73040	448	73677	446
65664	389	66010	447	67477	392	69181	394	73041	448	73951	358
65690	391	66011	447	67500	392	69182	394	73043	449	73952	358
65691	391	66012	447	67501	392	69183	394	73044	449	73952	358
65692	391	66013	447	67502	392	69184	394	73045	449	73953	358
65693	391	66015	439	67503	392	69185	394	73046	449	73953	358
65694	391	66024	599	67504	392	69186	394	73047	449	73954	358
65695	391	66025	599	67505	392	69187	394	73048	449	73954	358
65696	391	66026	599	67506	392	69188	394	73049	449	73955	358
65703	390	66028	599	67507	392	69252	394	73050	449	73955	358
65704	390	66470	392	67508	392	69253	394	73051	449	73956	358
65705	390	66471	392	67509	392	69254	394	73063	448	73956	358
65706	390	66472	392	67510	392	69255	394	73064	448	73957	358
65707	390	66473	392	67511	392	69256	394	73065	448	73957	358
65708	390	66474	392	67512	392	69257	394	73066	448	73958	358
65721	385	66475	392	67513	392	69258	394	73067	448	73958	358
65733	385	66500	392	67630	393	69411	394	73068	448	73958	358
65770	380	66501	392	67631	393	69412	394	73070	448	73959	358
65770API	381	66502	392	67632	393	69413	394	73200N5	518	73959	358
65770H	380	66503	392	67633	393	69414	394	73203B	519	73960	358
65771	380	66504	392	67634	393	69415	394	73203B1	519	73960	358
								73203B5	519	73961	358

MIDLAND INDUSTRIES

NUMERICAL INDEX

Part#	Page	Part#	Page	Part#	Page	Part#	Page	Part#	Page	Part#	Page
73970	45	77209	404	77435	406	80207	549	87001	540	93127	396
73970	359	77210	404	77436	406	80208	549	87002	540	93128	396
73971	45	77212	404	77437	406	80209	549	87003	540	93130	396
73971	359	77220	404	77455LF	407	80301	548	87004	540	93131	396
73972	45	77222	404	77456LF	407	80302	548	87008	540	93139	396
73972	359	77223	404	77457LF	407	80303	548	87009	540	93212*	396
73973	45	77224	404	77461	407	80304	548	87020	540	95082	606
73973	359	77225	404	77462	407	80305	548	87021	540	95084	606
73974	45	77226	404	77467	407	80306	548	87023	540	95086	606
73974	359	77227	404	77468	407	80307	548	88024	513	95088	606
73975	45	77238	404	77470	407	80331	548	88028	513	95300	514
73975	359	77240	404	77473	407	80332	548	88032	513	95301	514
73976	45	77241	404	77483	407	80333	548	88038	513	95302	514
73976	359	77252	405	77485	407	80334	548	88050	513	95303	514
73977	45	77253	405	77486	407	80335	548	88056	513	95304	514
73977	359	77255	405	77488	407	80336	548	88065	513	95305	514
73979	45	77256	405	77489	407	80463	549	88075	513	95306	514
73979	359	77258	405	77490	407	80501	548	88085	513	95307	514
73980	45	77262	405	77493	407	80502	548	88095	513	95308	514
73980	359	77265	405	77496	407	80503	548	88112	513	95309	514
73981	45	77267	405	77499	407	80504	548	90002	396	95310	514
73981	359	77268	405	77501	407	80505	548	90003	396	95311	514
73982	45	77269	405	77504	407	80506	548	90004	396	95312	514
73982	359	77271	405	77519	407	80511	548	90005	396	95313	514
73983	446	77272	405	77522	407	80512	548	90008	396	95314	514
73984	446	77275	405	77523	407	80513	548	90011	396	95315	514
73985	446	77276	405	77543	407	80514	548	90103*	397	95316	514
73986	446	77277	405	77547	407	80515	548	90104*	397	95317	514
73987	446	77294	405	77606LF	407	80516	548	90105*	397	95318	514
74252	607	77297	405	77607LF	407	80601	549	90106*	397	95319	514
74254	607	77298	405	77608LF	407	80602	549	90107*	397	95320	514
74258	607	77300	405	78024	607	80603	549	90110*	397	95321	514
77101	403	77306	405	78026	607	80604	549	90111*	397	95322	514
77102	403	77307	405	78028	607	80605	549	90114	397	95323	514
77104	403	77308	405	78252	607	80606	549	90115	397	95324	514
77108	403	77309	405	78254	607	80611	549	90116	397	95325	514
77110	403	77311	405	78256	607	80612	549	90117	397	95326	514
77113	403	77312	405	78258	607	80613	549	90119	397	95327	514
77114	403	77314	405	80001	548	80614	549	90120	397	95328	514
77116	403	77315	405	80002	548	80615	549	90121	397	95329	514
77119	403	77318	405	80003	548	80616	549	90122	397	95330	514
77124	403	77322	405	80004	548	86001	528	90123	397	95331	514
77125	403	77331	406	80005	548	86002	528	90126	397	95402	514
77126	403	77333	406	80006	548	86005	528	90127	397	95404	514
77128	403	77334	406	80007	548	86006	528	90128	397	95406	514
77129	403	77335	406	80020	548	86012	528	90130	397	95408	514
77130	403	77340	406	80031	548	86013	528	90131	397	95410	514
77131	403	77341	406	80032	548	86017	528	90132	397	95414	514
77132	403	77343	406	80033	548	86018	528	90140	397	95418	514
77134	403	77345	406	80034	548	86020	528	90141	397	95422	514
77143	403	77346	406	80035	548	86022	528	90212	396	95424	514
77144	403	77347	406	80036	548	86030	527	90213	396	95427	514
77145	403	77349	406	80061	549	86030RG	528	91008	396	95432	514
77156	403	77352	405	80062	549	86030SS	527	92010	513	95433	514
77159	403	77354	405	80063	549	86031	527	92011	513	95450	569
77160	403	77355	405	80064	549	86031RG	528	92012	513	95451	569
77163	403	77357	405	80065	549	86031SS	527	92013	513	95452	569
77164	403	77358	405	80066	549	86032	527	92014	513	95504	514
77166	403	77359	405	80067	549	86035	527	92015	513	95506	514
77167	403	77361	405	80068	549	86035RG	528	92016	513	95508	514
77168	403	77398	405	80069	549	86035SS	527	92017	513	95510	514
77169	403	77401	405	80080	549	86036	527	92110*	397	95512	514
77170	403	77402	406	80081	549	86036RG	528	92116	397	95514	514
77179	404	77406	406	80100	549	86036SS	527	92121	397	95516	514
77181	404	77410	406	80101	549	86037	527	92128	397	95518	514
77182	404	77413	406	80102	549	86040	527	93001*	396	95522	514
77183	404	77420	406	80103	549	86040SS	527	93008	513	95523	514
77201	404	77423	406	80104	549	86041	527	93009	513	95524	514
77202	404	77424	406	80105	549	86041SS	527	93011	513	95601	570
77203	404	77425	406	80201	549	86042	527	93013	513	95602	570
77204	404	77430	406	80202	549	86045	527	93017	513	95603	570
77205	404	77431	406	80203	549	86045SS	527	93113	396	95604	570
77206	404	77432	406	80204	549	86046	527	93121	396	95605	570
77207	404	77433	406	80205	549	86046SS	527	93122	396	95606	570
77208	404	77434	406	80206	549	86047	527	93123	396	95610	570

MIDLAND INDUSTRIES

NUMERICAL INDEX

Part#	Page	Part#	Page	Part#	Page	Part#	Page	Part#	Page	Part#	Page
95611	570	107007	399	108099	400	190212	617	240544	586	270044	589
95612	570	107009	399	108100	400	190216	617	240546	586	270055	589
95613	570	107011	399	108101	400	190220	617	240564	586	270066	589
95620	571	107012	399	140422	583	190224	617	240566	586	270110	590
95621	571	107024	398	140442	583	190232	617	240584	586	270112	590
95622	571	107025	398	140444	583	195456	264	240586	586	270116	590
95623	571	107026	398	140464	583	195457	264	240588	586	270120	590
95624	571	107027	398	140466	583	195458	264	240664	587	270210	590
95625	571	107029	398	140468	583	195459	264	240665	587	270212	590
95626	571	107031	398	140484	583	195460	264	240668	587	270216	590
95627	571	107032	398	140486	583	195461	264	240684	587	270310	590
95628	571	107042	399	140488	583	195462	264	240686	587	270312	590
95631	554	107044	399	140522	583	195470	264	240810	587	270316	590
95640	554	107045	399	140542	583	195471	264	240812	587	270410	590
95641	554	107047	399	140544	583	195472	264	240814	587	270412	590
96022	513	107049	399	140546	583	195473	264	240816	587	270416	590
96027	513	107060	398	140564	583	195474	264	240820	587	270544	590
96032	513	107061	398	140566	583	195475	264	240824	587	270566	590
96040	513	107062	398	140568	583	195476	264	240832	587	270588	590
96050	513	107063	398	140584	583	195481	264	250022	587	270644	590
96060	513	107064	398	140586	583	195502	264	250044	587	270666	590
96070	513	107065	398	140588	583	195510	264	250055	587	270688	590
96080	513	107066	398	150122	583	195511	264	250064	587	300000	537
96090	513	107067	398	150124	583	195512	264	250066	587	300001	537
96100	513	107069	398	150142	583	195520	264	250086	587	300002	537
96110	513	107071	398	150144	583	195521	264	250088	587	300003	537
96120	513	107072	398	150146	583	196112	617	250122	588	300004	537
96130	513	107073	398	150148	583	196116	617	250142	588	300005	496
96140	513	108025	401	150164	583	196120	617	250144	588	300006	537
96150	513	108026	401	150166	583	196124	617	250146	588	300007	537
96160	513	108027	401	150184	583	196132	617	250148	588	300008	537
96203LW	312	108028	401	150186	583	196212	617	250162	588	300010	496
96203UL	312	108029	401	150188	583	196216	617	250164	588	300012	496
96204LW	312	108031	400	150222	583	196220	617	250166	588	300014	537
96204UL	312	108032	400	150242	583	196224	617	250168	588	300015	537
96206LW	312	108033	400	150244	583	196232	617	250184	588	300016	496
96206UL	312	108034	400	150246	583	206112	618	250186	588	300017	537
96208LW	312	108035	400	150264	583	206116	618	250188	588	300018	537
96208UL	312	108036	400	150266	583	206120	618	250242	588	300019	537
98801	531	108037	400	150268	583	206124	618	250244	588	300020	537
98802	531	108038	400	150284	583	206132	618	250246	588	300021	537
98810	530	108039	400	150286	583	206212	618	250262	588	300022	537
98811	530	108040	400	150288	583	206216	618	250264	588	300023	537
98812	530	108041	400	150322	584	206220	618	250266	588	300024	537
98814	531	108062	401	150344	584	206224	618	250268	588	300026	537
98815	531	108063	401	150346	584	206232	618	250284	588	300028	537
98823	530	108064	401	150364	584	226188	618	250286	588	300031	537
98824	530	108065	401	150366	584	240322	585	250288	588	300032	537
98825	530	108065BF	401	150368	584	240324	585	250322	588	300033	537
98828	531	108066	401	150384	584	240332	585	250342	588	300034	537
98830	531	108067	401	150386	584	240333	585	250344	588	300035	537
98840	530	108067BF	401	150388	584	240344	585	250346	588	300036	537
98841	530	108069	401	150422	584	240355	585	250362	588	300037	537
98842	531	108069BF	401	150444	584	240364	585	250364	588	307030	543
99803	531	108070BF	401	150466	584	240366	585	250366	588	307030	545
99804	531	108071	401	150488	584	240384	585	250368	588	307030	546
99812	530	108071BF	401	160122	584	240386	585	250384	588	307031	543
99816	531	108072	401	160144	584	240388	585	250386	588	308070	512
99817	531	108072BF	401	160166	584	240422	586	250388	588	320000	544
99825	530	108073	401	160188	584	240432	586	260144	589	320005	544
99826	530	108073BF	401	160244	584	240434	586	260166	589	320005	546
99828	531	108074	401	160266	584	240442	586	260188	589	320005	546
99830	531	108075	400	160288	584	240444	586	260244	589	320010	544
99841	530	108076	400	160344	584	240446	586	260266	589	320011	544
99843	530	108077	400	160366	584	240448	586	260288	589	320021	543
100025	304	108088	400	160388	584	240462	586	260322	589	320021	546
100035	304	108089	400	170088	616	240464	586	260333	589	320021	546
100045	304	108090	400	170388	616	240466	586	260344	589	320022	543
100065	304	108091	400	170488	616	240468	586	260366	589	320023	543
100085	304	108092	400	180088	616	240484	586	260388	589	320035	542
100145	304	108094	400	190112	617	240486	586	270010	589	320036	542
100165	304	108095	400	190116	617	240488	586	270012	589	320050	542
100185	304	108096	400	190120	617	240522	586	270014	589	320050	545
107004	399	108097	400	190124	617	240532	586	270016	589	320050	545
107005	399	108098	400	190132	617	240542	586	270022	589	320050	545

MIDLAND INDUSTRIES

NUMERICAL INDEX

Part#	Page	Part#	Page	Part#	Page	Part#	Page	Part#	Page	Part#	Page
320050	545	350020SS	499	500280	500	550224	594	600088	496	620080	498
320050	546	389522	572	540402	168	550264	594	600096	496	620088	498
320050	546	389523	572	540402S	168	550268	594	600104	496	620096	498
320050	546	400010	602	540402SC	174	550284	594	611006	497	620104	498
320053	542	400012	602	540404	168	550286	594	611008	497	620116	498
320054	542	400014	602	540404S	168	550288	594	611010	497	620128	498
320055	542	400016	602	540404SC	174	550316	594	611012	497	620152	498
320061	513	400020	602	540406SC	174	550412	594	611016	497	620164	498
320065	531	400022	602	540412	591	550416	594	611020	497	620176	498
320070	542	400024	602	540416	591	550420	594	611024	497	620188	498
320070	545	400032	602	540420	591	550424	594	611028	497	620200	498
320070	545	400044	602	540424	591	550442	594	611032	497	620212	498
320070	545	400066	602	540442	591	550484	594	611036	497	620224	498
320070	546	400088	602	540462	591	550486	594	611040	497	620248	498
320070	546	400110	602	540464	591	550512	594	611044	497	620270	498
320075	542	400112	602	540484	591	550516	594	611048	497	620300	164
320075	545	400116	602	540486	591	550520	594	611052	497	620300C	171
320075	545	400120	602	540522	591	560012	595	611056	497	620312	498
320075	545	400122	602	540524	591	560016	595	611060	497	620332	498
320075	545	400124	602	540542	591	560022	595	611064	497	620390	498
320075	546	400132	602	540544	591	560044	595	611072	497	620400	164
320075	546	400144	602	540548	591	560066	595	611080	497	620400C	171
320075	546	400166	602	540564	591	560088	595	611088	497	620409C	175
320076	543	400188	602	540566	591	560112	595	611096	497	620453C	171
320076	545	444000	451	540568	591	560116	595	611104	497	620532	164
320076	545	444001	451	540588	591	560122	595	611116	497	620532C	171
320076	545	444002	451	540602	168	560144	595	611128	497	620553C	175
320076	545	444005	451	540602S	168	560166	595	611152	497	620555C	175
320076	546	444006	451	540602SC	174	560212	595	611164	497	620557C	175
320076	546	444007	451	540604	168	560216	595	611176	497	620558C	175
320076	546	444008	451	540604S	168	560222	595	611188	497	620559C	175
320077	543	444011	451	540604SC	174	560244	595	611200	497	620600	164
320077	545	444020	451	540606	168	560266	595	611212	497	620600C	171
320078	543	444021	451	540606S	168	560288	595	611224	497	620604	164
320078	545	444023	451	540606SC	174	560312	595	611248	497	620604C	175
320078	546	444026	451	540608	168	560316	595	611270	497	620606C	175
320080	543	444040	451	540608SC	174	560322	595	611312	497	620800	164
320080	545	444042	451	540642	592	560344	595	611332	497	620800C	171
320095	543	444045	451	540662	592	560366	595	611390	497	620806C	175
320095	545	444048	451	540664	592	560388	595	620006	498	620808C	175
320095	545	444049	451	540682	592	560412	595	620006SS	499	621000	164
320095	545	444060	451	540684	592	560416	595	620008	498	621000C	171
320095	545	444062	451	540686	592	560422	595	620008SS	499	621200	164
320095	546	444095	451	540802C	174	560444	595	620010	498	621200C	171
320095	546	444111	451	540804	168	560466	595	620010SS	499	640010	596
320095	546	444112	451	540804S	168	560488	595	620012	498	640012	596
320120	539	444113	451	540804SC	174	560512	595	620012SS	499	640016	596
320121	539	444313	451	540806	168	560516	595	620016	498	640020	596
320122	539	444318	451	540806S	168	560520	595	620016SS	499	640024	596
320410	543	444320	451	540806SC	174	560522	595	620020	498	640032	596
320410	545	466900	142	540808	168	560544	595	620020SS	499	640042	596
320414	545	466901	142	540808S	168	560566	595	620024	498	640046	596
325004	497	466902	142	540808SC	174	590400	164	620024SS	499	640048	596
325005	497	500012	500	541006	168	590600	164	620028	498	640064	596
325006	497	500016	591	541006SC	174	590800	164	620028SS	499	640068	596
325008	497	500020	500	541008	168	595320	164	620032	498	640084	596
325010	497	500024	591	541008S	168	600006	496	620032SS	499	640086	596
325012	497	500028	500	541008SC	174	600008	496	620036	498	640142	596
325016	497	500032	591	541206C	174	600010	496	620036SS	499	640144	596
325020	497	500036	500	541208	168	600012	496	620040	498	640164	596
350004	498	500042	591	541208SC	174	600016	496	620040SS	499	640166	596
350004SS	499	500048	500	541212	168	600020	496	620044	498	640186	596
350005	498	500056	500	545302C	174	600024	496	620044SS	499	640188	596
350005SS	499	500064	591	550016	593	600028	496	620048	498	640300C	171
350006	498	500066	591	550024	593	600032	496	620048SS	499	640400	164
350006SS	499	500072	500	550032	593	600036	496	620052	498	640400C	171
350008	498	500084	591	550042	593	600040	496	620052SS	499	640406C	171
350008SS	499	500086	591	550064	593	600044	496	620056	498	640442	597
350010	498	500088	500	550084	593	600048	496	620056SS	499	640444	597
350010SS	499	500104	500	550086	593	600052	496	620060	498	640464	597
350012	498	500128	500	550122	594	600056	496	620060SS	499	640466	597
350012SS	499	500152	500	550144	594	600060	496	620064	498	640468	597
350016	498	500188	500	550166	594	600064	496	620064SS	499	640486	597
350016SS	499	500216	500	550212	594	600072	496	620072	498	640488	597
350020	498	500248	500	550220	594	600080	496	620072SS	499	640600	164

MIDLAND INDUSTRIES

NUMERICAL INDEX

Part#	Page	Part#	Page	Part#	Page	Part#	Page	Part#	Page	Part#	Page
640600C	171	660606	165	690608	166	705302C	173	742516	607	840625	501
640604	164	660606C	171	690608S	166	705304C	173	746435	258	840650	501
640800	164	660608C	171	690608SC	172	710402	167	746436	258	840675	501
640800C	171	660802C	171	690804	166	710402S	167	746437	258	840700	501
640804	164	660804	165	690804S	166	710402SC	173	746438	258	840750	501
641000	164	660804C	171	690804SC	172	710404	167	746439	258	840800	501
641000C	171	660806	165	690806	166	710404S	167	746440	258	840850	501
641200	164	660806C	171	690806S	166	710404SC	173	746446	258	840888	501
645320C	171	660808	165	690806SC	172	710604	167	746456	258	841004	508
650010	598	660808C	171	690808	166	710604S	167	746457	258	841005	508
650012	598	661008C	171	690808S	166	710604SC	173	746466	258	841040	508
650016	598	665302C	171	690808SC	172	710606	167	746470	258	841045	508
650020	598	665304C	171	690812SC	172	710606S	167	746506	259	841050	508
650024	598	680302	165	691006	166	710606SC	173	746535	259	841175	508
650032	598	680302C	172	691006S	166	710608	167	746536	259	841200	508
650086	598	680304C	172	691006SC	172	710608SC	173	746537	259	841250	508
650142	598	680402	165	691008	166	710804C	173	746538	259	841300	508
650144	598	680402C	172	691008S	166	710804S	167	746546	259	841350	508
650164	598	680404	165	691008SC	172	710806	167	746556	259	841400	508
650166	598	680404C	172	691012SC	172	710806S	167	746566	259	841450	508
650186	598	680406	165	691208	166	710806SC	173	746567	259	841500	508
650188	598	680406C	172	691208S	166	710808C	173	746570	259	842010	505
650210	598	680408C	172	691208SC	172	710808S	167	752022	606	842012	505
650212	598	680421	165	691212	166	715301C	173	752044	606	842016	505
650216	598	680602	165	691212S	166	715302C	173	752066	606	842020	505
650344	598	680602C	172	691212SC	172	715304C	173	752088	606	842024	505
650364	598	680604	165	695302	166	720042	606	770402	169	842200	505
650366	598	680604C	172	695304SC	172	720044	606	770402C	174	842250	505
650386	598	680606	165	695322	166	720064	606	770404	169	842300	505
650388	598	680606C	172	695322S	166	720066	606	770404C	174	842350	505
650400	164	680608	165	695322SC	172	720068	606	770604	169	842400	505
650400C	171	680608C	172	700042	606	720086	606	770604C	174	842450	505
650444	599	680804	165	700044	606	720088	606	770806C	174	842500	505
650466	599	680804C	172	700064	606	720302	168	771004C	174	842550	505
650488	599	680806	165	700066	606	720402	168	780212	607	843321	505
650542	599	680806C	172	700068	606	720402S	169	780216	607	843382	505
650544	599	680808	165	700086	606	720402SC	174	782512	607	843388	505
650546	599	680808C	172	700088	606	720404	168	782516	607	843450	505
650564	599	681006	165	700242	607	720404S	169	820400	169	843461	505
650566	599	681006C	172	700244	607	720404SC	174	820400C	175	843475	505
650586	599	681008	165	700246	607	720406SC	174	820600	169	843525	505
650588	599	681008C	172	700248	607	720602S	169	820600C	175	843588	505
650600	164	681012C	172	700264	607	720602SC	174	820800	169	844213	504
650600C	171	681206C	172	700266	607	720604	168	820800C	175	844225	504
650642	599	681208	165	700268	607	720604S	169	821000	169	844238	504
650644	599	681208C	172	700286	607	720604SC	174	821000C	175	844250	504
650664	599	681212	165	700288	607	720606	168	825320C	175	844263	504
650666	599	681212C	172	700402	167	720606S	169	830808	169	844275	504
650668	599	685301C	172	700402SC	173	720606SC	174	840131	501	844300	504
650686	599	685302C	172	700404	167	720608C	174	840150	501	844306	504
650688	599	685304C	172	700404S	167	720804	168	840175	501	844313	504
650800	164	685320	165	700404SC	173	720804C	174	840188	501	844325	504
650800C	171	685321	165	700406	167	720804S	169	840200	501	844338	504
655320	164	685322	165	700406SC	173	720806	168	840225	501	844350	504
655320C	171	690302	166	700602	167	720806S	169	840238	501	844356	504
660010	599	690302SC	172	700602C	173	720806SC	174	840250	501	844363	504
660012	599	690402	166	700604	167	720808	168	840256	501	844375	504
660016	599	690402S	166	700604SC	173	720808S	169	840263	501	844406	504
660020	599	690402SC	172	700606	167	720808SC	174	840275	501	844413	504
660044	599	690404	166	700606SC	173	721006C	174	840288	501	844425	504
660066	599	690404S	166	700608SC	173	721008C	174	840300	501	844456	504
660088	599	690404SC	172	700804C	173	724010	607	840312	501	844500	504
660212	599	690406	166	700806	167	724012	607	840325	501	844525	504
660216	599	690406S	166	700806SC	173	724016	607	840350	501	844600	504
660224	599	690406SC	172	700808	167	725301C	174	840375	501	844625	504
660302C	171	690408SC	172	700808SC	173	725302C	174	840382	501	845200	509
660402	165	690602	166	702242	608	725304C	174	840400	501	845300	509
660402C	171	690602S	166	702244	608	742022	606	840425	501	845350	509
660404	165	690602SC	172	702266	608	742042	606	840450	501	845400	509
660404C	171	690604	166	702288	608	742064	606	840475	501	845500	509
660406C	171	690604S	166	704222	608	742066	606	840500	501	845600	509
660602	165	690604SC	172	704242	608	742086	606	840525	501	846200	509
660602C	171	690606	166	704244	608	742088	606	840550	501	846250	509
660604	165	690606S	166	704266	608	742510	607	840575	501	846275	509
660604C	171	690606SC	172	704288	608	742512	607	840600	501	846300	509

MIDLAND INDUSTRIES

NUMERICAL INDEX

Part#	Page	Part#	Page	Part#	Page	Part#	Page	Part#	Page	Part#	Page
846350	509	922812	261	940145LF	253	940352LF	253	941122NP	269	943203	270
846400	509	922818	261	940146LF	253	940353	288	941123NP	269	943204	270
846500	509	922824	261	940147LF	253	940353LF	253	941124NP	269	943205	270
847200	509	922912	261	940171	266	940354	288	941125NP	269	943206	270
847250	509	922918	261	940171L	267	940354LF	253	941126NP	269	943207	270
847275	509	922924	261	940171LF	248	940355	288	941127NP	269	943212	277
847300	509	923112	261	940171T	267	940355LF	253	941128NP	269	943213	277
847350	509	923124	261	940172	266	940356	288	941133	286	943233LF	249
847400	509	923136	261	940172L	267	940356LF	253	941134	286	943234LF	249
847500	509	923148	261	940172LF	248	940357	288	941135	286	943235LF	249
847600	509	923161	261	940172T	267	940357LF	253	941136	286	943236LF	249
848200	509	923196	261	940173	266	940358	288	941137	286	943237LF	249
848225	509	923209	260	940173L	267	940358LF	253	941138	286	943284	283
848250	509	923212	260	940173LF	248	940359	288	941140	286	943287	283
848275	509	923216	260	940173T	267	940359LF	253	941141	286	943311	277
848300	509	923220	260	940174	266	940360	288	941151LF	247	943312	277
848350	509	923409	260	940174L	267	940360LF	253	941151NP	268	943313	277
848400	509	923412	260	940174LF	248	940362LF	253	941152LF	247	943314	277
848500	509	923416	260	940174T	267	940363LF	253	941152NP	268	943331	277
848600	509	923420	260	940175	266	940364LF	253	941153LF	247	943332	277
848700	509	923509	260	940175L	267	940365LF	253	941153NP	268	943342	277
860402	169	923512	260	940175LF	248	940366LF	253	941154LF	247	943343	277
860402C	175	923520	260	940176	266	940367LF	253	941154NP	268	943344	277
860404	169	923648	261	940176L	267	940403LF	250	941155LF	247	943345	277
860404C	175	923660	261	940176LF	248	940404LF	250	941155NP	268	943347	277
860604	169	923672	261	940177	266	940405LF	250	941156LF	247	943348	277
860604C	175	923684	261	940177L	267	940406LF	250	941156NP	268	943350	277
860606	169	923936	261	940177LF	248	940407LF	250	941157LF	247	943351	277
860606C	175	923948	261	940178	266	940408LF	250	941157NP	268	943612LF	248
860806C	175	923960	261	940178L	267	940409LF	250	941158LF	247	943613LF	248
860808	169	923972	261	940178LF	248	940410LF	250	941158NP	268	943614LF	248
860808C	175	940175*	266	940179*	266	940411LF	250	941159LF	247	943751LF	248
865304C	175	924118	261	940179LF	248	940461	282	941160LF	247	943616LF	248
880402C	175	924124	261	940180*	266	940462	282	941161LF	247	943617LF	248
880404C	175	924248	261	940180LF	248	940464	282	941163LF	247	943750LF	252
880406C	175	924260	261	940181*	266	940465	282	941164LF	247	943751LF	252
899000	305	924272	261	940181LF	248	940521	287	941165LF	247	943752LF	252
899001	305	924284	261	940212LF	249	940522	287	941166LF	247	944100	281
899002	305	924297	261	940213LF	249	940523	287	941167LF	247	944101	281
899003	305	935044LF	241	940214LF	249	940523LF	253	941168LF	247	944102	281
899004	305	935045LF	241	940215LF	249	940524	287	941169LF	247	944106	281
899005	305	939132	285	940216LF	249	940525	287	941170LF	247	944107	281
899050	305	939133	285	940217LF	249	940526	287	941171LF	247	944109	281
899051	305	939134	285	940281	305	940527	287	942100	283	944110	281
899052	305	939135	285	940282	305	940528	287	942101	283	944112	281
899053	305	939136	285	940284	305	940529	287	942102	283	944113	281
899054	305	939137	285	940285	305	940530	287	942110LF	255	944116	281
899055	305	939138	285	940286	305	940800	537	942111LF	255	944117	281
922009	261	939139	285	940287	305	940801	537	942112LF	255	944128	281
922012	260	939140	285	940288	305	940803	537	942113LF	255	944130	281
922012	261	940121	282	940289	305	940804	537	942123LF	255	944132	281
922016	260	940122	282	940291	305	940805	537	942132LF	256	944134	281
922020	260	940123	282	940292	305	940806	537	942133LF	256	944134LF	223
922024	261	940130	284	940294	305	940810	538	942134LF	256	944134LF	281
922030	260	940130LF	253	940295	305	940811	538	942135LF	256	944136	281
922030	261	940131	284	940296	305	940812	538	942142	283	944138	281
922036	260	940131LF	253	940297	305	940813	538	942142LF	257	944139	281
922036	261	940132	284	940298	305	940814	538	942143LF	257	944140	281
922048	261	940132LF	253	940299	305	940815	538	942144LF	257	944142	281
922060	261	940133	284	940300	305	940822	538	942145LF	257	944142LF	223
922072	261	940133LF	253	940301	305	940823	538	942150LF	254	944142LF	281
922096	261	940134	284	940302	305	940824	538	942151LF	254	944401	290
922112	260	940134LF	253	940325	306	940825	538	942152LF	254	944402	290
922116	260	940135	284	940326	306	940826	538	942162LF	256	944403	290
922120	260	940135LF	253	940327	306	940827	538	942163LF	256	944404	290
922130	260	940136	284	940328	306	940840	538	942164LF	256	944405	290
922136	260	940136LF	253	940329	306	940841	538	942165LF	256	944406	290
922412	260	940137	284	940330	306	940842	538	942170	283	944407	290
922416	260	940137LF	253	940331	306	940843	538	942171	283	944408	290
922420	260	940138	284	940332	306	940844	538	942208	270	944409	290
922430	260	940139	284	940333	306	940845	538	942209	270	944410	290
922436	260	940140	284	940334	306	940846	538	942210	270	944411	290
922712	261	940142LF	253	940335	306	940847	538	943200	270	944428	289
922718	261	940143LF	253	940336	306	940848	538	943201	270	944429	289
922724	261	940144LF	253	940352	288	941121NP	269	943202	270	944430	289

NUMERICAL INDEX

MIDLAND INDUSTRIES

NUMERICAL INDEX

Part#	Page	Part#	Page	Part#	Page	Part#	Page	Part#	Page	Part#	Page
944430LF	253	948173	271	949403	297	970257	263	973326	520	*973861	441
944431	289	948173L	274	949404	297	970258	263	973327	520	*973862	441
944431LF	253	948173T	273	949405	297	970300	343	973329	520	973863	441
944432	289	948174	271	949406	297	970301	343	973332	520	*973864	441
944432LF	253	948174L	274	949407	297	970302	343	973334	520	*973865	441
944433	289	948174T	273	949408	297	970303	343	973341	517	*973866	441
944433LF	253	948175	271	949430	296	970304	343	973343	517	*973867	441
944434	289	948175L	274	949431	296	970305	343	973345	517	*973868	441
944434LF	253	948176	271	949432	296	970306	343	973567	369	*973869	441
944435LF	253	948176L	274	949441	299	970307	343	973568	369	*973870	441
944436LF	253	948176T	273	949442	299	970308	343	973569	369	*973871	441
944437LF	253	948177	271	949443	299	970309	343	973570	368	*973872	441
944438LF	253	948177L	274	949444	299	970310	343	973571	368	*973873	441
945601LF	251	949101	292	949445	299	970311	343	973572	368	*973874	441
945602LF	251	949102	292	949446	299	970312	343	973573	368	*973875	441
945603LF	251	949103	292	949447	299	970313	343	973574	368	*973876	441
945604LF	251	949104	292	949448	299	970314	343	973575	368	*973877	441
945605LF	251	949105	292	949451	298	970330	343	973600	442	*973878	441
945606LF	251	949106	292	949452	298	970331	343	973601	442	*973879	441
945611LF	251	949107	292	949453	298	970332	343	973602	442	*973880	441
945612LF	251	949108	292	949454	298	970333	343	973603	442	*973881	441
945613LF	251	949111	302	949455	298	970700	343	973604	442	*973884	441
945614LF	251	949112	302	949471	298	970701	343	973605	442	*973885	441
945615LF	251	949113	302	949472	298	970702	343	973606	442	*973886	441
945616LF	251	949114	302	949473	298	970703	343	973607	442	*973887	441
945621LF	251	949115	302	949474	298	970704	343	973620	442	*973888	441
945622LF	251	949116	302	949475	298	970705	343	973621	442	973890	446
945623LF	251	949117	302	949481	299	970706	343	973622	442	973891	446
945631LF	251	949118	302	949482	299	970707	343	973623	442	973892	446
945632LF	251	949121	301	949483	299	972171	522	973624	442	973893	446
945633LF	251	949122	301	949484	299	972172	522	*973625	442	973894	446
945640LF	251	949123	301	949485	299	972173	522	*973626	442	973895	446
945650LF	251	949124	301	949486	299	972180	522	*973627	442	973900	344
945651LF	251	949125	301	949487	299	972181	522	*973628	442	973901	344
945652LF	251	949126	301	949488	299	972182	522	973650	446	973902	344
947055	257	949127	301	949521	300	972183	522	973651	446	973903	344
947055LF	257	949128	301	949522	300	972184	522	973652	446	973904	344
947103	275	949161	293	949523	300	972185	522	973653	446	973905	344
947104	275	949162	293	949524	300	972186	522	973654	446	973906	344
947105	275	949163	293	949525	300	972187	522	973655	446	973907	344
947111	275	949164	293	949526	300	972190	522	973656	446	973908	344
947112	275	949165	293	949527	300	972191	522	973657	446	973909	344
947113	275	949166	293	949528	300	972192	522	973658	446	973910	344
947125	276	949167	293	950812	606	972193	522	973659	446	973911	344
947126	276	949168	293	950816	606	972194	522	973667	369	973912	344
947133	283	949170	293	962003	313	972195	522	973668	369	973913	344
947134	283	949171	291	962004	313	973200	518	973669	369	973914	344
947140	289	949172	291	962006	313	973201	518	973670	368	973925	344
947141	289	949173	291	962008	313	973203	518	973671	368	973925SS	345
947142	289	949174	291	962010	313	973204	518	973672	368	973926SS	345
947143	289	949175	291	962010LW	312	973205	518	973673	368	973927	344
947144	289	949176	291	962010UL	312	973206	518	973674	368	973927SS	345
947145	289	949177	291	962012	313	973207	518	973675	368	973928	344
948101	272	949178	291	962012LW	312	973208	518	973697	441	973928SS	345
948102	272	949180	293	962012UL	312	973211	518	973698	441	973929	344
948103	272	949253	300	963002	311	973215	521	973699	441	973930	344
948104	272	949254	300	963003	311	973216	521	*973700	441	973930SS	345
948105	272	949255	300	963004	311	973217	521	*973701	441	973947SS	345
948106	272	949256	300	963005	311	973219	521	*973702	441	973948	344
948107	272	949257	300	963006	311	973221	521	973703	441	973948SS	345
948108	272	949258	300	963008	311	973223	521	*973704	441	973949	344
948131	276	949303	300	963010	311	973224	521	*973705	441	973949SS	345
948132	276	949304	300	963012	311	973226	520	973706	441	973951	45
948133	276	949305	300	963014	311	973230	520	973707	441	973951	358
948134	276	949306	300	963016	311	973231	520	973708	441	973952	45
948135	276	949307	300	963025	311	973232	520	*973850	441	973952	358
948170	271	949308	300	970207	263	973233	520	*973851	441	973953	45
948170L	274	949353	300	970208	263	973234	520	*973852	441	973953	358
948170T	273	949354	300	970217	263	973238	520	*973853	441	973954	45
948171	271	949355	300	970218	263	973252	521	*973854	441	973954	358
948171L	274	949356	300	970227	263	973253	521	*973855	441	973955	45
948171T	273	949357	300	970228	263	973255	521	*973856	441	973955	358
948172	271	949358	300	970253	263	973262	521	*973857	441	973956	45
948172L	274	949401	297	970254	263	973323	520	*973858	441	973956	358
948172T	273	949402	297	970255	263	973325	520	*973859	441	973957	45

MIDLAND INDUSTRIES

NUMERICAL INDEX

Part#	Page	Part#	Page	Part#	Page	Part#	Page	Part#	Page	Part#	Page
973957	358	990790	571	2403108	585	6501108	598	15031216	584	18002424	616
973958	45	990791	571	2403126	585	6505128	599	15031612	584	18003232	616
973958	358	990792	571	2403128	585	6506106	599	15031616	584	18031212	617
973959	45	990793	571	2404104	586	6506128	599	15031620	584	18031216	617
973959	358	990794	571	2404106	586	7000108	606	15032020	584	18031612	617
973960LF	345	991249	550	2404108	586	7000128	606	15041212	584	18031616	617
973961LF	345	991250	550	2404126	586	7000812	606	15041616	584	18031620	617
973962LF	345	991251	550	2404128	586	7002108	607	16011212	584	18031624	617
973963LF	345	991259	550	2404612	586	7002812	607	16011616	584	18032016	617
973965	344	995210	550	2404812	586	7005410	608	16021212	584	18032020	617
973965LF	345	995211	550	2404816	586	7005412	608	16021616	584	18032024	617
973966	344	995212	550	2405106	586	7005414	608	16031212	584	18032420	617
973966LF	345	995213	550	2405108	586	7005418	608	16031616	584	18032424	617
973967	344	995214	550	2405128	586	7005512	608	16700001	511	18033232	617
973967LF	345	995215	550	2405812	586	7005514	608	16700004	511	18041212	617
973969LF	345	995216	550	2406104	587	7005614	608	16700007	511	18041216	617
973970LF	345	995217	550	2406106	587	7005616	608	16700010	511	18041612	617
973971LF	345	1000105	304	2406108	587	7005618	608	16700012	511	18041616	617
973975	344	1000125	304	2406124	587	7005816	608	16700013	511	18041620	617
973975LF	345	1000265	304	2406126	587	7005818	608	16700016	511	18041624	617
973976	344	1000365	304	2406128	587	7005822	608	16700017	511	18042016	617
973976LF	345	1000465	304	2406164	587	7022108	608	16700022	511	18042020	617
973977	344	1000665	304	2406166	587	7025410	609	16700024	511	18042024	617
973978	344	1000865	304	2406168	587	7025412	609	17001212	616	18042420	617
973979	344	1001125	304	2406208	587	7025512	609	17001216	616	18042424	617
973980	344	1001165	304	2406812	587	7025614	609	17001612	616	18043232	617
973980SS	345	1001205	304	2501106	588	7025616	609	17001616	616	22611212	618
973981	344	1001245	304	2501108	588	7025816	609	17001620	616	22611616	618
973982	344	1001465	304	2501128	588	7045210	609	17001624	616	22612020	618
973982SS	345	1001665	304	2501612	588	7045412	609	17002016	616	22612424	618
973985SS	345	1001865	304	2501812	588	7045414	609	17002020	616	22613232	618
973990	45	1050000	510	2501816	588	7045612	609	17002024	616	22621212	618
973990	358	1050001	510	2502128	588	7045616	609	17002032	616	22621616	618
973991	45	1050002	510	2503106	588	7045618	609	17002420	616	22622020	618
973991	358	1050003	510	2503108	588	7045816	609	17002424	616	22622424	618
974264	344	1050006	510	2503612	588	7045818	609	17002432	616	22623232	618
974265	344	1050007	510	3000004	496	7045822	609	17003232	616	23611212	618
974266	344	1050008	510	3000006	496	7420108	606	17031212	616	23611616	618
974267	344	1050009	510	3000008	496	7420128	606	17031216	616	23612020	618
982107	546	1050010	510	3000020	496	8401088	501	17031612	616	23612424	618
982107	551	1050011	510	5000128	591	10001065	304	17031616	616	23621212	618
982108	551	1050012	510	5000168	591	10001265	304	17031620	616	23621616	618
982109	551	1050013	510	5404126	591	10011265	304	17032016	616	23622020	618
982110	551	1050014	510	5404128	591	10011665	304	17032020	616	23622424	618
982120	551	1050015	510	5404166	591	10012065	304	17032024	616	24031010	585
982121	551	1050016	510	5404168	591	10012465	304	17032420	616	24031210	585
982122	551	1050017	510	5405612	591	14041212	583	17032424	616	24031212	585
982125	551	1050018	510	5405812	591	14041216	583	17032432	616	24031414	585
982126	551	1050020	510	5405816	591	14041612	583	17033232	616	24031612	585
982130	551	1050021	510	5406124	592	14041616	583	17041016	616	24031616	585
982131	551	1050023	510	5406126	592	14041620	583	17041212	616	24032016	585
982132	551	1050025	510	5406128	592	14042016	583	17041216	616	24032020	585
982135	551	1050026	510	5406164	592	14042020	583	17041220	616	24041012	586
982136	551	1050029	510	5406166	592	14042024	583	17041612	616	24041212	586
982137	551	1050030	510	5406168	592	14042424	583	17041616	616	24041216	586
982138	551	1050032	510	5406206	592	14043232	583	17041620	616	24041612	586
982140	551	1050033	510	5406208	592	14051212	583	17041624	616	24041616	586
983100	551	1404126	583	5406248	592	14051216	583	17042016	616	24041620	586
983101	551	1404128	583	5500128	593	14051612	583	17042020	616	24041624	586
983110	551	1404812	583	5502128	594	14051616	583	17042024	616	24042012	586
983111	551	1405128	583	5502812	594	14052020	583	17042032	616	24042016	586
983115	551	1405812	583	5504128	594	14052424	583	17042420	616	24042020	586
983116	551	1410083	512	6400106	596	14053232	583	17042424	616	24042024	586
983120	551	1410118	512	6400108	596	15011212	583	17042432	616	24042416	586
983121	551	1501126	583	6400128	596	15011216	583	17043232	616	24042420	586
983125	551	1501128	583	6400610	596	15011612	583	18001212	616	24042424	586
983126	551	1501168	583	6400612	596	15011616	583	18001216	616	24042432	586
983130	551	1501612	583	6400616	596	15012016	583	18001612	616	24043224	586
990571	521	1502128	583	6400810	596	15012020	583	18001616	616	24043232	586
990781	369	1502812	583	6400812	596	15013232	583	18001620	616	24051212	586
990782	369	1503128	584	6401108	596	15021212	583	18001624	616	24051216	586
990783	369	1503812	584	6401128	596	15021616	583	18002016	616	24051612	586
990784	369	1700812	616	6401812	596	15022020	583	18002020	616	24051616	586
990785	369	1703812	616	6404108	597	15022424	583	18002024	616	24052020	586
990786	369	1704812	616	6500108	598	15031212	584	18002420	616	24061210	587

MIDLAND INDUSTRIES

NUMERICAL INDEX

Part#	Page	Part#	Page	Part#	Page	Part#	Page	Part#	Page	Part#	Page
24061216	587	55001212	593	74201612	606	CC-2528	511	CDP-150-B1	434	CF-20215-SP	483
24061612	587	55001612	593	74201616	606	CC-2731	511	CDP-150-PP	429	CF-25303L-SP	484
24061620	587	55001612	593	75201010	606	CC-3134	511	*CDP-150-SS1	431	CF-25303-SP	484
24062012	587	55002016	593	75201212	606	CC-3437	511	CDP-200-A1	425	CF-30309-SP	484
24062012	587	55002020	593	ANV1F	610	CC-3740	511	*CDP-200-B1	434	CF-30309-SS304	487
24062016	587	55011212	594	ANV1M	610	CCP-1098	512	CDP-200-PP	429	CF-30310L-SP	484
24062416	587	55011616	594	ANV12F	610	CDC-050-A1	425	*CDP-200-SS1	431	CF-30310-SP	484
24062420	587	55021612	594	ANV12M	610	CDC-050-B1	434	CDP-250-A1	425	CF-30310-SS304	487
24063224	587	55021616	594	ANV14F	610	CDC-050-PP	429	CDP-250-B1	434	CF-30311L-SP	484
25001010	587	55031212	594	ANV14M	610	CDC-050-SS1	431	CDP-250-SS1	431	CF-30311-SP	484
25001212	587	55041612	594	ANV34F	610	CDC-075-A1	425	CDP-300-A1	425	CF-30311-SS304	487
25001612	587	64001012	596	ANV34M	610	*CDC-075-B1	434	*CDP-300-B1	434	CF-30312L-SP	484
25001616	587	64001210	596	ANV38F	610	CDC-075-PP	429	CDP-300-PP	429	CF-30312-SP	484
25002020	587	64001214	596	ANV38M	610	*CDC-075-SS1	431	*CDP-300-SS1	431	CF-30312-SS304	487
25002424	587	64001216	596	AR2	539	CDC-100-A1	425	CDP-400-A1	425	CF-30313L-SP	484
25003232	587	64001612	596	ARI-300	463	*CDC-100-B1	434	*CDP-400-B1	434	CF-30313-SP	484
25011212	588	64001620	596	ARI-400	463	CDC-100-PP	429	CDP-400-PP	429	CF-30313-SS304	487
25011216	588	64001624	596	ARI-600	463	*CDC-100-SS1	431	*CDP-400-SS1	431	CF-30314L-SP	484
25011612	588	64002012	596	Ball	252	CDC-125-A1	425	CDP-500-A1	425	CF-30314-SP	484
25011616	588	64002016	596	*BC2-075A-DP	449	CDC-125-B1	434	CDP-500-B1	434	CF-30314-SS304	487
25011620	588	64002024	596	*BC2-075C-DP	449	CDC-125-PP	429	CDP-600-A1	425	CF-30315L-SP	484
25012016	588	64002420	596	BC4-100B-DP	449	CDC-125-SS1	431	CDP-600-B1	434	CF-30315-SP	484
25012020	588	64002432	596	BC4-125-DP	449	CDC-150-A1	425	CDP-600-SS1	431	CF-30315-SS304	487
25012024	588	64003224	596	BC4-200A-DP	449	CDC-150-B1	434	CDP-800-A1	425	CF-30400L-SP	484
25012420	588	64011212	596	BC4-200-DP	449	CDC-150-PP	429	CDP-800-SS1	431	CF-30400-SP	484
25012424	588	64011616	596	BE-300-SP	447	*CDC-150-SS1	431	CDP-1000-A	425	CF-30400-SS304	487
25013232	588	64012020	596	BG50	440	*CDC-200-A1	425	CF-05101-SS304	486	CF-40409-SP	485
25021212	588	64012020	596	BG75	440	*CDC-200-B1	434	CF-05101S-SP	482	CF-40410L-SP	485
25021612	588	64012424	596	BG100	440	*CDC-200-PP	429	CF-05102-SS304	486	CF-40410-SP	485
25021616	588	64041212	597	BG125	440	*CDC-200-SS1	431	CF-08105-SP	482	CF-40410-SS304	488
25022020	588	64041616	597	BG150	440	CDC-250-A1	425	CF-08105-SS304	486	CF-40411L-SP	485
25031012	588	64060604C	171	BG200	440	CDC-250-B1	434	CF-08106-SS304	486	CF-40411-SP	485
25031212	588	65011212	598	BG250	440	CDC-250-SS1	431	CF-08108-SS304	486	CF-40411-SS304	488
25031216	588	65011616	598	BG300	440	*CDC-300-A1	425	CF-10108-SS304	486	CF-40412L-SP	485
25031616	588	65012020	598	BG400	440	*CDC-300-B1	434	CF-10109-SP	482	CF-40412-SP	485
25031620	588	65012424	598	BG500	440	*CDC-300-PP	429	CF-10109-SS304	486	CF-40412-SS304	488
25032016	588	65013232	598	BG600	440	*CDC-300-SS1	431	CF-10110-SP	482	CF-40413L-SP	485
25032020	588	65031212	598	BG800	440	*CDC-400-A1	425	CF-10110-SS304	486	CF-40413-SP	485
26011212	589	65041010	599	BLAY-100	474	*CDC-400-B1	434	CF-10111-SP	482	CF-40413-SS304	488
26031010	589	65041212	599	BLAY-125	474	CDC-400-PP	429	CF-10111-SS304	486	CF-40414L-SP	485
26031212	589	65041616	599	BLAY-150	474	*CDC-400-SS1	431	CF-13113-SP	482	CF-40414-SP	485
26031616	589	65042020	599	BLAY-150-CASS	474	CDC-500-A1	425	CF-13114-SP	482	CF-40414-SS304	488
27051212	590	65051212	599	*BLAY-200	474	CDC-500-B1	434	CF-13114-SS304	487	CF-40415L-SP	485
27051616	590	65051612	599	BLAY-200-CASS	474	CDC-500-SS1	431	CF-13115-SS304	487	CF-40415-SP	485
27052020	590	65051616	599	BLAY-250	474	CDC-600-A1	425	CF-15115-SP	483	CF-40415-SS304	488
27061212	590	65052424	599	*BLAY-300	474	CDC-600-B1	434	CF-15115-SS304	487	CF-40500L-SP	485
27061616	590	65061212	599	*BLAY-300-CASS	474	CDC-600-SS1	431	CF-15200-SS304	487	CF-40500-SP	485
50001212	591	65061616	599	*BLAY-400	474	CDC-800-A1	425	CF-15201-SP	483	CF-40501L-SP	485
50001612	591	65062020	599	*BLAY-400-CASS	474	CDC-800-SS1	431	CF-15201-SS304	487	CF-40501-SP	485
50002020	591	65062424	599	*BLAY-600	474	CDC-1000-A	425	CF-15202L-SP	483	CF-60610-SP	485
54041612	591	65063232	599	BLAY-600-CASS	474	CDCSL-200-A1	436	CF-15202-SP	483	CF-60612-SP	485
54042012	591	70001012	606	*BLOW150-300	460	CDCSL-200-SS1	437	CF-15202-SS304	487	CF-60614-SP	485
54042016	591	70001212	606	*BLOW150-400	460	CDCSL-300-A1	436	CF-15203-SP	483	CF-60702-SP	485
54042412	591	70001616	606	Body	252	CDCSL-300-SS1	437	CF-15203-SS304	487	CF-60704-SP	485
54042416	591	70021212	607	BOPF-C	634	CDCSL-400-A1	436	CF-15204-SS304	487	CFT-08104T-SS304	486
54042420	591	70021216	607	BRLAYHD-200	475	CDCSL-400-SS1	437	CF-15205-SP	483	CFT-08106T-SP	482
54043224	591	70021616	607	BRLAYHD-300	475	CDCSL-600-A1	436	CF-15205-SS304	487	CFT-08106T-SS304	486
54051212	591	70051018	608	BRLAYHD-400	475	CDCSL-600-SS1	437	CF-20208-SP	483	CFT-08107T-SP	482
54051216	591	70051020	608	BRLAYHD-600	475	CDP-050-A1	425	CF-20208-SS304	487	CFT-08107T-SS304	486
54051220	591	70051022	608	BSB-400-187	464	CDP-050-B1	434	CF-20209L-SP	483	CFT-08108T-SP	482
54051616	591	70051222	608	BSB-400-250	464	CDP-050-PP	429	CF-20209-SP	483	CFT-08108T-SS304	486
54051620	591	70221212	608	BSB-450-125	464	*CDP-050-SS1	431	CF-20209-SS304	487	CFT-08109T-SP	482
54052020	591	70221616	608	BSB-500-187	464	CDP-075-A1	425	CF-20210-SP	483	CFT-08109T-SS304	486
54052024	591	70251022	609	BSB-500-250	464	*CDP-075-B1	434	CF-20210-SS304	487	CFT-10114T-SP	482
54052424	591	70251227	609	BSB-600-250	464	CDP-075-PP	429	CF-20211L-SP	483	CFT-10115T-SP	482
54061612	592	70251633	609	BW-16-16API-C	634	*CDP-075-SS1	431	CF-20211-SP	483	CFT-10117T-SP	482
54062012	592	70421212	608	Cap	252	CDP-100-A1	425	CF-20211-SS304	487	CFT-10117T-SS304	486
54062016	592	70421616	608	CC-1113	511	*CDP-100-B1	434	CF-20212L-SP	483	CFT-10118T-SP	482
54062412	592	70451227	609	CC-1315	511	CDP-100-PP	429	CF-20212-SP	483	CG-050-EPDM	440
54062416	592	70451633	609	CC-1517	511	*CDP-100-SS1	431	CF-20212-SS304	487	CG-050-VI	440
54062420	592	71060404	167	CC-1518	511	CDC-125-A1	425	CF-20213L-SP	483	CG-075-VI	440
54063212	592	71060406	167	CC-1720	511	CDP-125-B1	434	CF-20213-SP	483	CG-100-NBR	440
54063216	592	72001212	606	CC-2023	511	CDP-125-PP	429	CF-20213-SS304	487	CG-100-VI	440
54063220	592	72060404	168	CC-2225	511	CDP-125-SS1	431	CF-20214-SP	483	CG-125-NBR	440
54063224	592	74201212	606	CC-2327	511	CDP-150-A1	425	CF-20214-SS304	487		

MIDLAND INDUSTRIES

NUMERICAL INDEX

Part#	Page	Part#	Page	Part#	Page	Part#	Page	Part#	Page	Part#	Page
CG-125-VI	440	*CGB-075-SS1	430	*CGC-200-PP	428	*CGD-400-A1	424	CGE-600-A1	425	*CNG-400CR-SP	445
CG-150-NBR	440	CGB-100-A1	424	*CGC-200-SS1	430	*CGD-400-B1	433	*CGE-600-B1	434	CNG-400CR-SS316	445
CG-150-VI	440	*CGB-100-B1	433	CGC-250-A1	424	CGD-400-PP	428	CGE-600CR-A1	438	*CNG-400CS-S	444
CG-200-EPDM	440	CGB-100-PP	428	CGC-250-B1	423	*CGD-400-SS1	430	*CGE-600-SS1	431	*CNG-400CS-SP	444
CG-200-NBR	440	*CGB-100-SS1	430	CGC-250CR-A1	438	CGD-500-A1	424	CGE-800-A1	425	*CNG-400-S	442
CG-200-VI	440	CGB-125-A1	424	CGC-250-SS1	430	CGD-500-B1	433	CGE-800CS-A1	438	*CNG-400-SP	442
CG-250-NBR	440	CGB-125-B1	433	*CGC-300-A1	424	*CGD-500-SS1	430	CGE-800-SS1	431	CNG-500-SP	442
CG-250-VI	440	CGB-125-PP	428	CGC-300-B1	423	CGD-600-A1	424	CGE-1000-A	425	*CNG-600CR-SP	445
CG-300-EPDM	440	CGB-125-SS1	430	CGC-300CR-A1	438	*CGD-600-B1	433	CGF-050-A1	425	*CNG-600CS-S	444
CG-300-NBR	440	CGB-150-A1	424	CGC-300CR-SS1	438	CGD-600-SS1	430	CGF-050-B1	434	*CNG-600CS-SP	444
CG-300-VI	440	*CGB-150-B1	433	*CGC-300-PP	428	CGD-800-A1	424	CGF-050-PP	429	*CNG-600-S	442
CG-400-NBR	440	CGB-150-PP	428	*CGC-300-SS1	430	CGD-1000-A	424	CGF-050-SS1	431	*CNG-600-SP	442
CG-400-VI	440	*CGB-150-SS1	430	*CGC-400-A1	424	CGD-1510-A	427	CGF-075-A1	425	*CNG-800CS-S	444
CG-500-NBR	440	CGB-200-A1	424	*CGC-400-B1	433	CGD-2015-A	427	*CGF-075-B1	434	*CNG-800CS-SP	444
CG-600-NBR	440	*CGB-200-B1	433	CGC-400CR-A1	438	*CGD-2090-SS	432	CGF-075-PP	429	*CNL-200CR-SP	444
CG-800-NBR	440	*CGB-200-PP	428	CGC-400CR-SS1	438	CGD-3020-A	427	*CGF-075-SS1	431	*CNL-250CR-SP	444
CGA-050-A1	424	*CGB-200-SS1	430	CGC-400-PP	428	CGD-4030-A	427	CGF-100-A1	425	*CNL-300CR-SP	444
CGA-050-B1	433	CGB-250-A1	424	*CGC-400-SS1	430	CGDSL-200-A1	436	*CGF-100-B1	434	*CNL-400CR-SP	444
CGA-050-PP	428	CGB-250-B1	433	CGC-500-A1	424	CGDSL-200-SS1	437	CGF-100-PP	429	*CNL-400CR-SP	444
CGA-050-SS1	430	CGB-250-SS1	430	CGC-500-B1	423	CGDSL-300-A1	436	*CGF-100-SS1	431	*CNL-400CR-SP	444
CGA-075-A1	424	CGB-300-A1	424	CGC-500-SS1	430	CGDSL-300-SS1	437	CGF-125-A1	425	*CNL-400CR-SP	444
*CGA-075-B1	433	*CGB-300-B1	433	CGC-600-A1	424	CGDSL-400-A1	436	*CGF-125-B1	434	*CNL-400CR-SP	444
CGA-075-PP	428	*CGB-300-PP	428	*CGC-600-B1	433	CGDSL-400-SS1	437	CGF-125-PP	429	*CNL-400CR-SP	444
*CGA-075-SS1	430	CGC-300-SS1	430	CGC-600CR-A1	438	CGDSL-600-A1	436	CGF-125-SS1	431	*CNL-400CR-SP	444
CGA-100-A1	424	*CGB-400-A1	424	*CGC-600-SS1	430	CGDSL-600-SS1	437	CGF-150-A1	425	*CNL-400CR-SP	444
*CGA-100-B1	433	*CGB-400-B1	433	CGC-800-A1	424	*CGDSV-300-A	427	*CGF-150-B1	434	*CNL-400CR-SP	444
CGA-100-PP	428	CGB-400-PP	428	CGC-800CS-A1	438	*CGDSV-400-A	427	CGF-150-PP	429	*CNL-400CR-SP	444
*CGA-100-SS1	430	*CGB-400-SS1	430	CGC-800-SS1	430	CGE-050-A1	425	*CGF-150-SS1	431	*CNL-400CR-SP	444
CGA-125-A1	424	CGB-500-A1	424	CGC-1000-A	424	CGE-050-B1	434	*CGF-200-A1	425	*CNL-400CR-SP	444
CGA-125-B1	433	CGB-500-B1	433	CGC-1590-A	426	CGE-050-PP	429	*CGF-200-B1	434	*CNL-400CR-SP	444
CGA-125-PP	428	CGB-500-SS1	430	CGC-2015-A	426	CGE-050-SS1	431	*CGF-200-PP	429	*CNL-400CR-SP	444
*CGA-125-SS1	430	CGB-600-A1	424	CGC-2090-A	426	CGE-075-A1	425	*CGF-200-SS1	431	*CNL-400CR-SP	444
CGA-150-A1	424	CGB-600-B1	433	CGC-3020-A	426	*CGE-075-B1	434	CGF-250-A1	425	*CNL-400CR-SP	444
CGA-150-B1	433	CGB-600-SS1	430	CGC-3025-A	426	CGE-075-PP	429	CGF-250-B1	434	*CNL-400CR-SP	444
CGA-150-PP	428	CGB-800-A1	424	CGC-4030-A	426	*CGE-075-SS1	431	CGF-250-SS1	431	*CNL-400CR-SP	444
*CGA-150-SS1	430	CGB-800-SS1	430	CGCSL-200CR-A1	436	CGE-100-A1	425	CGF-300-A1	425	*CNL-400CR-SP	444
*CGA-200-A1	424	CGB-1000-A	424	CGCSL-200CR-SS1	437	*CGE-100-B1	434	*CGF-300-B1	434	*CNL-400CR-SP	444
*CGA-200-B1	433	CGB-3020-A	426	CGCSL-300CR-A1	436	CGE-100CR-SS1	438	*CGF-300-PP	429	*CNL-400CR-SP	444
*CGA-200-PP	428	CGB-3040-A	426	CGCSL-300CR-SS1	437	CGE-100-PP	429	*CGF-300-SS1	431	*CNL-400CR-SP	444
*CGA-200-SS1	430	CGB-4030-A	426	CGCSL-400CR-A1	436	*CGE-100-SS1	431	*CGF-400-A1	425	*CNL-400CR-SP	444
CGA-250-A1	424	CGBSL-200-A1	436	CGCSL-400CR-SS1	437	CGE-125-A1	425	*CGF-400-B1	434	*CNL-400CR-SP	444
CGA-250-B1	433	CGBSL-200-SS1	437	CGCSL-600CR-A1	436	*CGE-125-B1	434	CGF-400-PP	429	*CNL-400CR-SP	444
*CGA-250-SS1	430	CGBSL-300-A1	436	CGCSL-600CR-A4	436	CGE-125-PP	429	*CGF-400-SS1	431	*CNL-400CR-SP	444
*CGA-300-A1	424	CGBSL-300-SS1	437	CGCSL-600CR-SS1	437	*CGE-125-SS1	431	CGF-500-A1	425	*CNL-400CR-SP	444
*CGA-300-B1	433	CGBSL-400-A1	436	CGD-050-A1	424	CGE-150-A1	425	CGF-500-B1	434	*CNL-400CR-SP	444
CGA-300-PP	428	CGBSL-400-SS1	437	CGD-050-B1	433	*CGE-150-B1	434	CGF-500-SS1	431	*CNL-400CR-SP	444
*CGA-300-SS1	430	CGBSL-600-A1	436	CGD-050-PP	428	CGE-150CR-A1	438	CGF-600-A1	425	*CNL-400CR-SP	444
*CGA-400-A1	424	CGBSL-600-SS1	437	*CGD-050-SS1	430	CGE-150CR-SS1	438	CGF-600-B1	434	*CNL-400CR-SP	444
*CGA-400-B1	433	CGC-050-A1	424	CGD-075-A1	424	CGE-150-PP	429	*CGF-600-SS1	431	*CNL-400CR-SP	444
CGA-400-PP	428	CGC-050-B1	433	CGD-075-B1	433	*CGE-150-SS1	431	CGF-800-A1	425	*CNL-400CR-SP	444
*CGA-400-SS1	430	CGC-050-PP	428	CGD-075-PP	428	*CGE-200-A1	425	CGF-800-SS1	431	*CNL-400CR-SP	444
CGA-500-A1	424	CGC-050-SS1	430	*CGD-075-SS1	430	*CGE-200-B1	434	CGF-1000-A	425	*CNL-400CR-SP	444
CGA-500-B1	433	CGC-075-A1	424	CGD-100-A1	424	CGE-200CR-A1	438	CGF-1520-A	427	*CNL-400CR-SP	444
*CGA-500-SS1	430	*CGC-075-B1	433	*CGD-100-B1	433	CGE-200CR-SS1	438	*CGF-2030-A	427	*CNL-400CR-SP	444
CGA-600-A1	424	CGC-075-PP	428	CGD-100-PP	428	*CGE-200-PP	429	*CGF-3020-A	427	*CNL-400CR-SP	444
*CGA-600-B1	433	*CGC-075-SS1	430	*CGD-100-SS1	430	*CGE-200-SS1	431	*CGF-3040-A	427	*CNL-400CR-SP	444
CGA-600-SS1	430	CGC-100-A1	424	CGD-125-A1	424	CGE-250-A1	425	CGF-4030-A	427	*CNL-400CR-SP	444
CGA-800-A1	424	*CGC-100-B1	433	CGD-125-B1	433	CGE-250-B1	434	CGF-4060-A	427	*CNL-400CR-SP	444
CGA-800-SS1	430	CGC-100CR-SS1	438	CGD-125-PP	428	CGE-250CR-A1	438	*CNFL-200CR-S	445	*CNFL-200CR-SS316	445
CGA-1000-A	424	CGC-100-PP	428	*CGD-125-SS1	430	*CGE-250-SS1	431	*CNFL-300CR-S	445	*CNFL-300CR-SS316	445
CGA-1520-A	426	*CGC-100-SS1	430	CGD-150-A1	424	*CGE-300-A1	425	*CNFL-300CR-SS316	445	*CNFL-400CR-S	445
CGA-2015-A	426	CGC-125-A1	424	CGD-150-B1	433	*CGE-300-B1	434	*CNFL-400CR-SS316	445	*CNFL-600CR-S	445
CGA-2030-A	426	CGC-125-B1	433	CGD-150-PP	428	CGE-300CR-A1	438	*CNFL-600CR-SS316	445	*CNFL-600CR-SS316	445
CGA-3040-A	426	CGC-125-PP	428	*CGD-150-SS1	430	CGE-300CR-SS1	438	*CNFL-600CR-SS316	445	*CNFL-600CR-SS316	445
CGA-4030-A	426	*CGC-125-SS1	430	*CGD-200-A1	424	*CGE-300-PP	429	*CNFL-600CR-SS316	445	*CNFL-600CR-SS316	445
*CGA-6040-A	426	*CGC-150-SS1	430	*CGD-200-B1	433	*CGE-300-SS1	431	NNG-150-SP	442	*CNFL-600CR-SS316	445
CGASV-300-A	426	CGC-150-A1	424	*CGD-200-PP	428	*CGE-400-A1	425	*CNG-200CR-SP	445	*CNG-200CR-SS316	445
CGASV-400-A	426	CGC-150-B1	433	*CGD-200-SS1	430	*CGE-400-B1	434	*CNG-200-SP	442	*CNG-200-SS1	431
CGB-050-A1	424	CGC-150CR-A1	438	CGD-250-A1	424	CGE-400CR-A1	438	*CNG-250CR-SS316	445	*CNG-250CR-SS316	445
CGB-050-B1	433	CGC-150CR-SS1	438	CGD-250-B1	433	CGE-400CR-SS1	438	*CNG-250-SP	442	*CNG-250CR-SS316	445
CGB-050-PP	428	CGC-150-PP	428	*CGD-250-SS1	430	CGE-400-PP	429	*CNG-250-SS1	431	*CNG-250CR-SS316	445
CGB-050-SS1	430	*CGC-150-SS1	430	*CGD-300-A1	424	*CGE-400-SS1	431	*CNG-300CR-SP	445	*CNG-250CR-SS316	445
CGB-075-A1	424	*CGC-200-A1	433	*CGD-300-B1	433	CGE-500-A1	425	*CNG-300CR-SS316	445	*CNG-250CR-SS316	445
*CGB-075-B1	433	*CGC-200-B1	433	CGD-300-PP	428	CGE-500-B1	434	*CNG-300-S	442	*CNG-250CR-SS316	445
CGB-075-PP	428	CGC-200CR-A1	438	*CGD-300-SS1	430	*CGE-500-SS1	431	NNG-300-SP	442	*CNG-250CR-SS316	445
CGB-075-SS1	430	CGC-200CR-SS1	438								

MIDLAND INDUSTRIES

NUMERICAL INDEX

Part#	Page	Part#	Page	Part#	Page	Part#	Page	Part#	Page	Part#	Page
CPHLS-11*	511	CSL-20209-SS304	494	CSL-60702-SP	492	DX5090	526	F100	512	FS260366	604
CPHLS-12*	511	CSL-20209S-SP	490	CSL-60704-SP	492	DX5190	526	FE-025-SP	447	FS260388	604
CPHLS-14*	511	CSL-20210-A	488	CSL-80812-SP	492	DX5197	526	FE-125-SP	447	FS640244	604
CPHLS-16*	511	CSL-20210-SP	490	CSL-80900-SP	492	DX60021	525	FE-150-SP	447	FS640266	604
CPHLS-18*	511	CSL-20210-SS304	494	CSL-80904-SP	492	DX60021V	525	FE-200-SP	447	FS640288	604
CPHLS-20*	511	CSL-20210S-SP	490	CSL-80908-SP	492	DX60022	525	FF-1-F	611	FS650044	605
CPHLS-24*	511	CSL-20211-A	488	CSL-100108-SP	493	DX60022V	525	FF1M	611	FS650066	605
CPHLS-28*	511	CSL-20211-SP	490	CSL-100114-SP	493	DX60023	525	FF12F	611	FS650088	605
CPHLS-32	511	CSL-20211-SS304	494	DA-1510-A	427	DX60023V	525	FF12M	611	FS650444	605
CRPVC-019	459	CSL-20211S-SP	490	DA-1520-A	427	DX60092	525	FF14F	611	FS650466	605
CRPVC-025	459	CSL-20212-SP	490	DA-2015-A	427	DX140030MG	524	FF14M	611	FS650488	605
CRPVC-025-100	459	CSL-20212-SS304	494	DA-2030-A	427	DX140040MG	524	FF34F	611	FS680144	605
CRPVC-031	459	CSL-20213-SP	490	*DA-2030-SS	432	DX140050MG	524	FF34M	611	FS680146	605
CRPVC-031-100	459	CSL-20214-SP	490	DA-2040-A	427	DX140060MG	524	FF38F	611	FS680164	605
*CRPVC-038	459	CSL-20214-SS304	494	DA-3015-A	427	DX140070MG	524	FF38M	611	FS680166	605
CRPVC-038-100	459	CSL-20215-SP	490	DA-3020-A	427	DX141530MG	524	FF1234F	611	FS680168	605
*CRPVC-050	459	CSL-20300-SP	490	*DA-3020-SS	432	DX141540MG	524	FF1234M	611	FS680186	605
*CRPVC-050-100	459	CSL-25302-SP	491	DA-3040-A	427	DX141550MG	524	FF3416F	611	FS680188	605
CRPVC-063	459	CSL-25306-SP	491	*DA-3040-SS	432	DX141560MG	524	FF3416M	611	FS680244	605
CRPVC-063-100	459	CSL-30304-SP	491	DA-4020-A	427	DX141570MG	524	FF3812F	611	FS680266	605
CRPVC-075	459	CSL-30306-SP	491	DA-4030-A	427	DX142530MG	524	FF3812M	611	FS680288	605
CRPVC-075-100	459	CSL-30306S-SP	491	*DA-4030-SS	432	DX142540MG	524	FHE-075-MP	443	FS680944	606
*CRPVC-100	459	CSL-30307-SP	491	DA-4060-A	427	DX142550MG	524	FLDROP-200	472	FS680966	606
*CRPVC-100-100	459	CSL-30308-SP	491	DA-6040-A	427	DX142560MG	524	FLDROP-400	472	FS680988	606
CRPVC-125	459	CSL-30308S-SP	491	*DA-6040-SS	432	DX142570MG	524	FLX-075	466	FS2501108	604
CRPVC-150	459	CSL-30309-SP	491	DBC-40-DP	506	DX144030MG	524	FLX-100	466	FS2501128	604
CRPVC-200	459	CSL-30309-SS304	494	DBC-60-DP	506	DX144040MG	524	FLX-150	466	FS2501812	604
CSL-05100S-SP	489	CSL-30309S-SP	491	DBC-76-DP*	506	DX144050MG	524	FLX-200	466	FS2501812	604
CSL-05100S-SS304	493	CSL-30310-A	488	DBC-94-DP*	506	DX144060MG	524	FLX-300	466	FS6801108	605
CSL-08102S-SP	489	CSL-30310-SP	491	DBC-400-DP*	506	DX144070MG	524	FLX-400	466	FS25001010	604
CSL-08104S-SS304	493	CSL-30310-SS304	494	DBC-431-DP	506	DX250030	524	FLXS-100	466	FS25001212	604
CSL-08105S-SP	489	CSL-30310S-SP	491	DBC-463-DP	506	DX250040	524	FLXS-200	466	FS25001616	604
CSL-08106-SP	489	CSL-30311-SP	491	DBC-525-DP*	506	DX250050	524	FLXS-300	466	FS25011012	604
CSL-08107-SP	489	CSL-30311-SS304	494	DBC-550-DP*	506	DX250060	524	FLXS-400	466	FS25011212	604
CSL-08108-SP	489	CSL-30311S-SP	491	DBC-600-DP*	506	DX251530	524	FN-075	450	FS25011216	604
CSL-08108-SS304	493	CSL-30312-SP	491	DBC-639-DP	506	DX251540	524	FN-075G	450	FS25011616	604
CSL-10107S-SP	489	CSL-30312-SS304	494	DBC-675-DP*	506	DX251550	524	FN-075R	450	FS25012020	604
CSL-10108-SP	489	CSL-30312S-SP	491	DBC-769-DP*	506	DX251560	524	FN-100	450	FS25012424	604
CSL-10108-SS304	493	CSL-30313-A	488	DBC-818-DP	506	DX252530	524	*FN-150	450	FS25031212	604
CSL-10108S-SP	489	CSL-30313-SP	491	DBC-875-DP*	506	DX252540	524	FN-200	450	FS25031616	604
CSL-10109-SP	489	CSL-30313-SS304	494	DBC-988-DP*	506	DX252550	524	FRAC400-300	470	FS26031212	604
CSL-10109S-SP	489	CSL-30313S-SP	491	DBC-1125-DP*	506	DX252560	524	FRAC400-400	470	FS64021010	604
CSL-10109S-SS304	493	CSL-30314-A	488	DBC-1275-DP*	506	DX254030	524	FRAC400-600	470	FS64021212	604
CSL-10110-SP	489	CSL-30314-SP	491	DBC-1360-DP	506	DX254040	524	FS6400O44	605	FS64021212	605
CSL-10110-SS304	493	CSL-30314-SS304	494	*DD-1515-A	427	DX254050	524	FS6400O46	605	FS65041010	605
CSL-10111-SP	489	CSL-30314S-SP	491	*DD-1515-SS	432	DX254060	524	FS6400O64	605	FS65041616	605
CSL-10111S-SP	489	CSL-30315-A	488	*DD-2020-A	427	DX256500	524	FS6400O66	605	FS68011012	605
CSL-10112-SP	489	CSL-30400-SP	491	*DD-2020-SS	432	DX259520	524	FS6400O68	605	FS68011210	605
CSL-10112-SS304	493	CSL-40406-SP	492	*DD-2030-A	427	DX259530	524	FS6400O86	605	FS68011212	605
CSL-13113S-SP	489	CSL-40408-SP	492	*DD-2030-SS	432	DX259540	524	FS6400O88	605	FS68011216	605
CSL-13113S-SS304	494	CSL-40409-SP	492	*DD-3030-A	427	DX259550	524	FS6400O108	605	FS68011616	605
CSL-13114-SS304	494	CSL-40410-SP	492	*DD-3030-SS	432	DX259560	524	FS6400O128	605	FS68011620	605
CSL-13114S-SP	489	CSL-40410S-SP	492	*DD-3040-A	427	DX259570	524	FS6400O810	605	FS68012016	605
CSL-15112-SP	490	CSL-40411-A	488	*DD-3040-SS	432	DX722530	525	FS6400O1010	605	FS68012020	605
CSL-15115-SP	490	CSL-40411-SP	492	*DD-4040-A	427	DX722540	525	FS6400O1012	605	FS68012424	605
CSL-15200-SP	490	CSL-40411S-SP	492	*DD-4040-SS	432	DX722550	525	FS6400O1210	605	FS68021010	605
CSL-15201-SP	490	CSL-40412-A	488	DURFL-200	476	DX722560	525	FS6400O1212	605	FS68021212	605
CSL-15201-SS304	494	CSL-40412-SP	492	DURFL-200-CASSP	476	DX723230	525	FS6400O1216	605	FS68021616	605
CSL-15202-SP	490	CSL-40412S-SP	492	*DURFL-300	476	DX723240	525	FS6400O1612	605	FS68022020	605
CSL-15202S-SP	490	CSL-40413-A	488	DURFL-300-CASSP	476	DX723250	525	FS6400O1616	605	FS68091212	606
CSL-15203-SP	490	CSL-40413-SP	492	*DURFL-400	476	DX723260	525	FS6400O1620	605	FSO304C4	603
CSL-15204-SP	490	CSL-40413S-SP	492	DURFL-400-CASSP	476	DX724030	525	FS6400O2020	605	FSO304C6	603
CSL-15205-SP	490	CSL-40414-A	488	*DURFL-600	476	DX724040	525	FS6400O2024	605	FSO304C8	603
CSL-15206-SP	490	CSL-40414-SP	492	DURFL-600-CASSP	476	DX724050	525	FS6400O2424	605	FSO304C10	603
CSL-20204-SP	490	CSL-40414S-SP	492	DX35TR25	525	DX724060	525	FS250044	604	FSO304C12	603
CSL-20206-SP	490	CSL-40415-SP	492	DX35TR38	525	DX725030	525	FS250066	604	FSO304C16	603
CSL-20206-SS304	494	CSL-40500-SP	492	DX4324	526	DX725040	525	FS250144	604	FSO304C20	603
CSL-20206S-SP	490	CSL-40500S-SP	492	DX4336	526	DX725050	525	FS250164	604	FSO304C24	603
CSL-20207-SP	490	CSL-60604-SP	492	DX4424	526	DX725060	525	FS250166	604	FSO3064	603
CSL-20207-SS304	494	CSL-60606-SP	492	DX4436	526	EPDM-150	465	FS250186	604	FSO3066	603
CSL-20207S-SP	490	CSL-60608-SP	492	DX4524VG	526	EPDM-200	465	FS250188	604	FSO3068	603
CSL-20208-SP	490	CSL-60610-SP	492	DX4536VG	526	EPDM-300	465	FS250188	604	FSO3068	603
CSL-20208-SS304	494	CSL-60612-SP	492	DX5005	526	EPDM-400	465	FS250344	604	FSO3184	602
CSL-20209-A	488	CSL-60614-SP	492	DX5006	526	F38	512	FS250366	604	FSO3186	602
CSL-20209-SP	490	CSL-60700-SP	492	DX5022	526	F40	512	FS250388	604	FSO3188	602
								FS260344	604	FSO3194	603

MIDLAND INDUSTRIES

NUMERICAL INDEX

Part#	Page	Part#	Page	Part#	Page	Part#	Page	Part#	Page	Part#	Page
FSO3196	603	GJS-100CR-SP	443	HNV34FB	610	M8-122	503	MKL-067-SP	502	*PL-200-AD	449
FSO3198	603	GJS-125CR-SP	443	HNV34M	610	M8S-44	503	MKL-073-SP	502	*PL-300-AD	449
FSO24084	604	GJS-150CR-SP	443	HNV34MB	610	M8S-48	503	MKL-079-SP	502	*PL-400-AD	449
FSO24086	604	GJS-200CR-SP	443	HNV38F	610	M8S-52	503	MKL-085-SP	502	PM-150-A	449
FSO24088	604	GJS-250CR-SP	443	HNV38FB	610	M8S-56	503	MKL-091-SP	502	PM-200-A	449
FSO30612	603	GJS-300CR-SP	443	HNV38M	610	M8S-60	503	MKL-097-SP	502	PM-300-A	449
FSO30616	603	GJS-400CR-SP	443	HNV38MB	610	M8S-64	503	MKL-103-SP	502	PON-025-B	462
FSO31810	602	*GPE-025-300	461	HPCWB-150	477	M8S-68	503	MKL-112-SP	502	PON-038-B	462
FSO31812	602	*GPE-038-300	461	HPCWB-200	477	M8S-74	503	MKL-121-SP	502	PON-050-B	462
FSO31816	602	*GPE-050-300	461	HPCWB200-150	477	M8S-80	503	MKL-130-SP	502	PON-063-B	462
FSO31820	602	*GPE-063-300	461	HPCWB200-400	477	M8S-86	503	MKL-139-SP	502	PON-075-B	462
FSO31824	602	GPE-075-300	461	HPCWB250-200	477	M8S-92	503	MKL-148-SP	502	PREM-125-250	461
FSO31910	603	*GPE-100-300	461	HPCWB250-300	477	M8S-98	503	MKL-161-SP	502	PREMR-038-300	461
FSO31912	603	Gripper Ring	252	HPCWB-300	477	M8S-104	503	MKL-174-SP	502	PREMR-050-300	461
FSO31916	603	GT15	550	HPCWB-400	477	M8S-113	503	MKL-187-SP	502	PREMR-075-300	461
FSO31920	603	GT30	550	HPCWB-600	477	M8S-122	503	MKL-200-SP	502	PREMR-100-300	461
FSO240344	603	GT60	550	HSK2-200-SS	439	M8S-131	503	MKL-213-SP	502	Push Ring	252
FSO240366	603	HAM100-200-SET	379	HSK2-300-SS	439	M8S-140	503	MKL-226-SP	502	R88DB-12-DP*	506
FSO240388	603	HAM100-300-SET	379	HSK5-200-SS	439	M8S-149	503	MKL-239-SP	502	R88DB-16-DP*	506
FSO240664	603	HAM100-400CR-SET	379	HSK5-300-SS	439	M8S-162	503	MMFC4NPT	613	R88DB-20-DP*	506
FSO240684	603	HAM100-400-SET	379	HTA-300	471	M10-131	503	MMFC6NPT	613	R88DB-24-DP*	506
FSO240810	604	HAM100-600CR-SET	379	HTA-400	471	M10-140	503	MMFC8NPT	613	R88DB-32-DP*	506
FSO240812	604	HAM100-600-SET	379	HTA-800-250RPG2	464	M10-149	503	MMFC12NPT	613	*RSPVC-200	481
FSO240816	604	HAM100-800-SET	379	IVB-800-250RPG3	464	M10-162	503	MMFC16NPT	613	*RSPVC-300	481
FSO240820	604	HAM100-1000-SET	379	IVB-800-250RPG7	464	M10-175	503	MMFC20NPT	613	*RSPVC-400	481
FSO240824	604	HAM200-200-SET	379	JACK-075-50	460	M10-188	503	MMNV4NPT	613	*RSPVC-600	481
FSO2406106	603	HAM200-300-SET	379	JACK-075BL-50	460	M10-201	503	MMNV6NPT	613	SA-100-A	426
FSO2406108	603	HAM200-400-SET	379	JACK-075-CUASSP*	460	M10-214	503	MMNV8NPT	613	SA-100-SS	432
FSO2406126	603	HAM200-500-SET	379	JACK-075G-50	460	M10-227	503	MMNV12NPT	613	SA-150-A	426
FSO24031212	603	HAM206-200-SET	379	JACK-075R-50	460	M10-240	503	MMNV16NPT	613	SA-150-SS	432
FSO24031616	603	HAM206-300-SET	379	JACK-075R-CUASSP	460	M10DC-86	507	MXH-238	462	SA-200-A	426
FUEL-025	463	HAM206-400-SET	379	KZEB14PF	612	M10DC-92	507	MXH-250	462	SA-200-SS	432
FUEL-031	463	HAM206-500-SET	379	KZEB14SM	612	M10DC-104	507	MXH-300	462	SA-250-A	426
FUEL-038	463	HAM206-600-SET	379	KZEB38PF	612	M10DC-113	507	MXH-350	462	SA-300-A	426
*FV-200-DP	450	HAM206-800-SET	379	KZEB38SM	612	M10DC-122	507	MXH-400	462	SA-300-SS	432
*FV-300-DP	450	Handle	252	Liner	252	M10DC-131	507	MXH-500	462	SA-400-A	426
*FV-400-DP	450	HE-050CF-SP	443	Lock Nut	252	M10DC-140	507	NV1F	612	SA-400-SS	432
*FV-600-DP	450	HE-075CF-SP	443	Lock Ring	252	M10DC-149	507	NV1M	612	SA-1520-SS	432
GDS-050-B	448	HE-075CR-SP	443	Lock Washer	252	M10DC-162	507	NV12F	612	SA-2030-A	426
*GDS-075-B	448	HE-100CF-SP	443	LSQVEP1PF	611	M10DC-175	507	NV12M	612	SA-2030-SS	432
GE3L1NPT	303	HE-100CR-SP	443	LSQVEP1SF	611	M10DC-188	507	NV14F	612	SA-3040-A	426
GE3L04SAE	303	HE-101CF-SP	443	LSQVEP12PF	611	M10DC-200	507	NV14M	612	SA-3040-SS	432
GE3L06SAE	303	HE-125-SP	447	LSQVEP12SF	611	M10DC-220	507	NV34F	612	SAT-200	479
GE3L08SAE	303	HE-150-SP	447	LSQVEP20PF	611	M10DC-240	507	NV34M	612	SAT-300	479
GE3L12NPT	303	HE-200-SP	447	LSQVEP20SF	611	M10DC-260	507	NV38F	612	SAT-400	479
GE3L12SAE	303	HM-063-S	446	LSQVEP24PF	611	M10DC-280	507	NV38M	612	SAT-600	479
GE3L14NPT	303	HM-063-SP	446	LSQVEP24SF	611	M10DC-300	507	OETP-1098	512	SATG-075	478
GE3L16SAE	303	HM-300-S	446	LSQVEP34PF	611	M10DC-325	507	OILVC-200	469	*SATG-100	478
GE3L34NPT	303	HM-400-S	446	LSQVEP34SF	611	M10DC-350	507	OILVC-300	469	*SATG-125	478
GE3L38NPT	303	HM-600-SP	446	M6-23	502	M10DC-375	507	OILVC-400	469	*SATG-150	478
GE3L112TNPT	303	HM-600-S	446	M6-26	502	M10DC-400	507	OILVS-150	468	*SATG-200	478
GE3L114TNPT	303	HM-800-S	446	M6-29	502	M10DC-425	507	OILVS-200	468	SATG-250	478
GE21NPT	303	HM-800-SP	446	M6-32	502	M10DC-450	507	OILVS-300	468	*SATG-300	478
GE204SAE	303	HN-075-B	451	M6-36	502	MB4004	614	OILVS-400	468	SATG-400	478
GE206SAE	303	*HN-100-B	451	M6-40	502	MB4006	614	OILVS-600	468	*SATO-200	478
GE208SAE	303	HN-125-B	451	M6S-23	502	MB4008	614	O-Ring	252	*SATO-300	478
GE212NPT	303	HN-150-B	451	M6S-26	502	MB4012	614	P1	512	SATO-400	478
GE212SAE	303	HN-200-B	451	M6S-29	502	MB4016	614	P300	512	SATW-100	479
GE214NPT	303	HN-250-B	451	M6S-32	502	ME-025-SP	447	Packing	252	SATW-125	479
GE216SAE	303	HNC-04-02-SP	449	M6S-36	502	MFC12N	614	Packing Nut	252	SATW-150	479
GE234NPT	303	HNC-04-04-SP	449	M6S-40	502	MFC34N	614	PDB250-200	471	SATW-200	479
GE238NPT	303	HNC-06-04-SP	449	M8-44	503	MFC38N	614	PDB250-300	471	SATW-300	479
GE2112TNPT*	303	HNC-06-06-SP	449	M8-48	503	MKL-019-SP	502	PDB250-400	471	SATW-400	479
GE2114TNPT*	303	HNC-08-06-SP	449	M8-52	503	MKL-022-SP	502	PDB250-600	471	SATW-600	479
GJM-050CR-SP	443	HNC-08-08-SP	449	M8-56	503	MKL-025-SP	502	PDR-125	470	SB-200-SP	450
GJM-075CR-SP	443	HNC-12-08-SP	449	M8-60	503	MKL-028-SP	502	PDR-150	470	SB-300-SP	450
GJM-100CR-SP	443	HNC-16-12-SP	449	M8-64	503	MKL-031-SP	502	PDR-300	470	SBB-075-50	465
GJM-125CR-SP	443	HNV12F	610	M8-68	503	MKL-035-SP	502	PDR-400	470	SBB-075-100	465
GJM-150CR-SP	443	HNV12FB	610	M8-74	503	MKL-039-SP	502	PDR-600	470	SBB-125-50S	465
GJM-200CR-SP	443	HNV12M	610	M8-80	503	MKL-043-SP	502	PF-150-AD	449	SBB-125-100S	465
GJM-250CR-SP	443	HNV12MB	610	M8-86	503	MKL-047-SP	502	PF-200-AD	449	SBB-150-50	465
GJM-300CR-SP	443	HNV14F	610	M8-92	503	MKL-051-SP	502	PF-300-AD	449	SBB-300	465
GJM-400CR-SP	443	HNV14FB	610	M8-98	503	MKL-055-SP	502	PF-400-AD	449	SC-200R-SP*	507
GJS-050CR-SP	443	HNV14M	610	M8-104	503	MKL-059-SP	502	PF-600-AD	449	SC-250R-SP	507
GJS-075CR-SP	443	HNV14MB	610	M8-113	503	MKL-063-SP	502	PL-150-AD	449	SC-300R-SP*	507
		HNV34F	610								

MIDLAND INDUSTRIES

NUMERICAL INDEX

NUMERICAL INDEX

Part#	Page	Part#	Page	Part#	Page	Part#	Page	Part#	Page	Part#	Page
SC-400R-SP*	507	SS2403-04-04	624	SS5000-12-12	627	SS5504-08-08	630	ST250B-075-50	472		
SC-500R-SP	507	SS2403-06-04	624	SS5000-16-08	627	SS5504-12-12	630	ST250B-100-50	472		
SC-600R-SP*	507	SS2403-06-06	624	SS5000-16-12	627	SS5504-16-16	630	ST250B-150-50	472		
SC-800R-SP	507	SS2403-08-04	624	SS5000-16-16	627	SS5600-04-04-04	630	ST250B-200-50	472		
SC-1000R-SP	507	SS2403-08-06	624	SS5404-02-02	627	SS5600-06-06-06	630	Stem	252		
SC-1200R-SP	507	SS2403-08-08	624	SS5404-04-02	627	SS5600-08-08-08	630	SUPER-200	480		
SCR-300-SS304	450	SS2403-10-08	624	SS5404-04-04	627	SS5600-12-12-12	630	TLB-075	468		
SCR-400-SS304	450	SS2403-10-10	624	SS5404-06-04	627	SS5600-16-16-16	630	TLB-100	468		
Seat	252	SS2403-12-04	624	SS5404-06-06	627	SS5605-02-02-02	630	TLB-125	468		
Seat Ring	252	SS2403-12-06	624	SS5404-08-04	627	SS5605-04-04-04	630	TLB-150	468		
SG300	440	SS2403-12-08	624	SS5404-08-06	627	SS5605-06-06-06	630	TLB-200	468		
SG400	440	SS2403-12-12	624	SS5404-08-08	627	SS5605-08-08-08	630	TLB-250	468		
*SL-200-SP	450	SS2403-16-12	624	SS5404-12-04	627	SS5605-12-12-12	630	TLB-400	468		
*SL-300-SP	450	SS2403-16-16	624	SS5404-12-06	627	SS5605-16-16-16	630	TLB-600	468		
*SR-200-SP	450	SS2404-04-02	624	SS5404-12-08	627	SS6400-04-04	631	TLBS150-100	467		
*SR-250-SP	450	SS2404-04-04	624	SS5404-12-12	627	SS6400-04-06	631	TLBS150-150	467		
*SR-300-SP	450	SS2404-04-06	624	SS5404-16-08	627	SS6400-06-06	631	TLBS150-200	467		
*SR-400-SP	450	SS2404-04-08	624	SS5404-16-12	627	SS6400-06-08	631	TLBS150-300	467		
*SR-600-SP	450	SS2404-06-04	624	SS5404-16-16	627	SS6400-06-10	631	TLBS150-400	467		
*SR-800-SP	450	SS2404-06-06	624	SS5405-02-02	628	SS6400-08-06	631	TLBS150-600	467		
SS43-04-04FJ	634	SS2404-06-08	624	SS5405-02-04	628	SS6400-08-08	631	TLBS300-200	469		
SS43-04-04FJ90	634	SS2404-08-04	624	SS5405-04-04	628	SS6400-08-10	631	TLBS300-300	469		
SS43-04-04MP	634	SS2404-08-06	624	SS5405-04-06	628	SS6400-08-12	631	TLBS300-400	469		
SS43-04-06FJ	634	SS2404-08-08	624	SS5405-04-08	628	SS6400-12-08	631	TLBS300-600	469		
SS43-04-06FJ90	634	SS2404-08-12	624	SS5405-06-06	628	SS6400-12-12	631	TPT-1	512		
SS43-04-06MP	634	SS2404-08-16	624	SS5405-06-08	628	SS6400-12-16	631	TTD150-200	467		
SS43-06-04FJ	634	SS2404-10-08	624	SS5405-06-12	628	SS6400-16-16	631	TTD150-300	467		
SS43-06-04MP	634	SS2404-12-08	624	SS5405-08-08	628	SS6402-04-04	631	TTD150-400	467		
SS43-06-06FJ	634	SS2404-12-12	624	SS5405-08-12	628	SS6402-06-06	631	VG100	440		
SS43-06-06FJ90	634	SS2404-12-16	624	SS5405-08-16	628	SS6402-08-08	631	VG150	440		
SS43-06-06MP	634	SS2404-16-08	624	SS5405-12-12	628	SS6402-12-12	631	VG200	440		
SS43-06-08FJ	634	SS2404-16-12	624	SS5405-12-16	628	SS6402-16-16	631	VG250	440		
SS43-08-08FJ	634	SS2404-16-16	624	SS5405-16-16	628	SS6405-04-04	631	VG300	440		
SS43-08-08FJ90	634	SS2405-04-04	625	SS5406-04-02	628	SS6405-06-04	631	WHIP-L	450		
SS43-08-08MP	634	SS2405-06-04	625	SS5406-06-04	628	SS6405-06-06	631	WHIP-S	450		
SS43-08-10FJ	634	SS2405-06-06	625	SS5406-08-04	628	SS6405-08-08	631	WSB-125	480		
SS43-10-08MP	634	SS2405-08-08	625	SS5406-08-06	628	SS6405-12-08	631	*WSB-150	480		
SS43-12-12FJ90	634	SS2405-12-12	625	SS5406-12-04	628	SS6405-12-12	631	*WSB-200	480		
SS43-12-12MP	634	SS2405-16-16	625	SS5406-12-06	628	SS6405-16-16	631	*WSB-300	480		
SS43-16-16FJ90	634	SS2406-06-04	625	SS5406-12-08	628	SS6408-04	632	*WSB-400	480		
SS43-16-16MP	634	SS2406-08-04	625	SS5406-16-04	628	SS6408-06	632	*WSB-600	480		
SS304-C-04	623	SS2406-08-06	625	SS5406-16-06	628	SS6408-08	632				
SS304-C-06	623	SS2406-10-08	625	SS5406-16-08	628	SS6408-10	632				
SS304-C-08	623	SS2406-12-04	625	SS5406-16-12	628	SS6408-12	632				
SS304-C-10	623	SS2406-12-06	625	SS5406-20-12	628	SS6408-16	632				
SS304-C-12	623	SS2406-12-08	625	SS5406-C-04	629	SS6408-HH-02	632				
SS304-C-16	623	SS2406-16-04	625	SS5406-C-06	629	SS6408-HH-04	632				
SS306-04	626	SS2406-16-06	625	SS5406-C-08	629	SS6408-HH-06	632				
SS306-06	626	SS2406-16-08	625	SS5406-C-12	629	SS6408-HH-08	632				
SS306-08	626	SS2406-16-12	625	SS5406-C-16	629	SS6408-HH-10	632				
SS306-10	626	SS2408-04	625	SS5406-HHP-04	628	SS6408-HH-12	632				
SS306-12	626	SS2408-06	625	SS5406-HHP-06	628	SS6408-HH-16	632				
SS306-16	626	SS2408-08	625	SS5406-HHP-08	628	SS6505-04-04	633				
SS318-04	623	SS2408-10	625	SS5406-HHP-12	628	SS6505-06-06	633				
SS318-06	623	SS2408-12	625	SS5406-HHP-16	628	SS6505-08-08	633				
SS318-08	623	SS2408-16	625	SS5406-P-04	628	SS6505-12-12	633				
SS318-10	623	SS2700-04-04	626	SS5406-P-06	628	SS6505-16-16	633				
SS318-12	623	SS2700-06-06	626	SS5406-P-08	628	SS6506-04-04	633				
SS318-16	623	SS2700-08-08	626	SS5406-P-12	628	SS6506-06-06	633				
SS319-04	623	SS2700-12-12	626	SS5406-P-16	628	SS6506-08-08	633				
SS319-06	623	SS2700-16-16	626	SS5500-02-02	629	SS6506-12-12	633				
SS319-08	623	SS2705-04-04	626	SS5500-04-04	629	SS6506-16-16	633				
SS319-10	623	SS2705-06-06	626	SS5500-06-06	629	SSCN-04	627				
SS319-12	623	SS2705-08-08	626	SS5500-08-08	629	SSCN-06	627				
SS319-16	623	SS2705-12-12	626	SS5500-12-12	629	SSCN-08	627				
SS1404-04-04	622	SS2705-16-16	626	SS5500-16-16	629	SSCN-12	627				
SS1404-06-06	622	SS2707-04-04	626	SS5502-02-02	629	SSCN-16	627				
SS1404-08-08	622	SS2707-06-06	626	SS5502-04-04	629	ST250-075-50	473				
SS1404-12-12	622	SS2707-08-08	626	SS5502-06-06	629	ST250-075-100	473				
SS1404-16-16	622	SS5000-02-02	627	SS5502-08-08	629	ST250-100-50	473				
SS1405-04-04	622	SS5000-04-04	627	SS5502-12-12	629	ST250-100-100	473				
SS1405-06-06	622	SS5000-06-04	627	SS5502-16-16	629	ST250-200-50	473				
SS1405-08-08	622	SS5000-06-06	627	SS5504-02-02	630	ST250-200-100	473				
SS1405-12-12	622	SS5000-08-06	627	SS5504-04-04	630	ST250-300	473				
SS1405-16-16	622	SS5000-08-08	627	SS5504-06-06	630						

ANDERSON METALS

NUMERICAL INDEX

Part#	Page	Part#	Page	Part#	Page	Part#	Page	Part#	Page
00039-04	115	00066-0604	109	00069-0812	111	00078-0806	115	00261-03	121
00039-06	115	00066-0606	109	00069-1006	111	00078-1002	115	00261-04	121
00039-08	115	00066-0608	109	00069-1008	112	00081-04	115	00261-05	121
00039-10	115	00066-0612	109	00069-1012	112	00081-06	115	00261-06	121
00060-02	106	00066-0804	109	00069-1208	112	00081-08	115	00261-08	121
00060-03	106	00066-0806	109	00069-1212	112	00081-10	115	00261-10	121
00060-04	106	00066-0808	109	00069-1408	112	00082-0402	107	00261-12	121
00060-05	106	00066-0812	109	00069-1412	112	00082-0403	107	00261-14	121
00060-06	106	00066-1008	109	00070-0202	112	00082-0504	107	00262-02	121
00060-07	106	00066-1012	109	00070-0302	112	00082-0604	107	00262-03	121
00060-08	106	00066-1208	109	00070-0402	112	00082-0605	107	00262-04	121
00060-10	106	00066-1212	109	00070-0404	112	00082-0806	107	00262-05	121
00060-12	106	00066-1408	109	00070-0406	112	00082-1006	107	00262-06	121
00060-14	106	00066-1412	109	00070-0408	112	00082-1008	107	00262-08	121
00061-02	106	00068-0202	110	00070-0502	112	00082-1406	107	00262-10	121
00061-03	106	00068-0302	110	00070-0504	112	00082-1408	107	00264-02	121
00061-04	106	00068-0304	110	00070-0602	112	00082-1410	107	00264-03	121
00061-05	106	00068-0402	110	00070-0604	112	00083-04	116	00264-04	121
00061-06	106	00068-0404	110	00070-0606	112	00083-06	116	00264-06	121
00061-07	106	00068-0406	110	00070-0608	112	00083-10	116	00264-08	121
00061-08	106	00068-0408	110	00070-0612	112	00084-040402	108	00266-0202	121
00061-10	106	00068-0502	110	00070-0804	112	00084-040406	108	00266-0402	121
00061-12	106	00068-0504	110	00070-0806	112	00084-050504	108	00266-0404	121
00061-14	106	00068-0506	110	00070-0808	112	00084-060404	108	00266-0604	121
00062-02	107	00068-0508	110	00070-0812	112	00084-060604	108	00266-0606	121
00062-03	107	00068-0602	110	00070-1006	112	00084-080804	108	00266-0608	121
00062-04	107	00068-0604	110	00070-1008	112	00084-080806	108	00266-0806	121
00062-05	107	00068-0606	110	00070-1012	112	00084-101006	108	00266-0808	121
00062-06	107	00068-0608	110	00070-1208	112	00084-101008	108	00266-1008	121
00062-07	107	00068-0612	110	00071-0202	113	00085-0604	109	00268-0202	122
00062-08	107	00068-0704	110	00071-0302	113	00085-0806	109	00268-0302	122
00062-10	107	00068-0706	110	00071-0402	113	00085-1006	109	00268-0304	122
00062-12	107	00068-0804	110	00071-0404	113	00085-1008	109	00268-0402	122
00062-14	107	00068-0806	110	00071-0502	113	00086-0610	109	00268-0404	122
00062-16	107	00068-0808	110	00071-0504	113	00088-0302	117	00268-0406	122
00063-0202	116	00068-0812	110	00071-0602	113	00088-0402	117	00268-0408	122
00063-0302	116	00068-1004	110	00071-0604	113	00088-0404	117	00268-0502	122
00063-0402	116	00068-1006	110	00071-0606	113	00088-0604	117	00268-0504	122
00063-0502	116	00068-1008	110	00071-0806	113	00088-0606	117	00268-0604	122
00063-0604	116	00068-1012	110	00071-0808	113	00088-0608	117	00268-0606	122
00064-02	108	00068-1208	110	00071-1008	113	00088-0806	117	00268-0608	122
00064-03	108	00068-1212	110	00071-1208	113	00088-0808	117	00268-0804	122
00064-04	108	00068-1408	110	00071-1212	113	00088-1008	117	00268-0806	122
00064-05	108	00068-1412	110	00072-0202	114	00088-1012	117	00268-0808	122
00064-06	108	00068-1416	110	00072-0302	114	00089-0610	111	00268-1008	122
00064-07	108	00068-1612	110	00072-0402	114	00095-0302	115	00268-1212	122
00064-08	108	00068-1616	110	00072-0404	114	00095-0402	115	00268-1412	122
00064-10	108	00069-0202	111	00072-0502	114	00095-0404	115	00269-0202	122
00064-12	108	00069-0302	111	00072-0504	114	00095-0502	115	00269-0302	122
00064-14	108	00069-0304	111	00072-0602	114	00095-0504	115	00269-0304	122
00065-02	108	00069-0402	111	00072-0604	114	00095-0604	115	00269-0402	122
00065-03	108	00069-0402B	111	00072-0606	114	00095-0606	115	00269-0404	122
00065-04	108	00069-0404	111	00072-0608	114	00095-0806	115	00269-0406	122
00065-05	108	00069-0406	111	00072-0804	114	00095-0808	115	00269-0502	122
00065-06	108	00069-0408	111	00072-0806	114	00095-1008	115	00269-0504	122
00065-08	108	00069-0502	111	00072-0808	114	00096-0808	109	00269-0602	122
00065-10	108	00069-0504	111	00072-1008	114	00096-1006	109	00269-0604	122
00065-12	108	00069-0506	111	00072-1208	114	00161-03	120	00269-0606	122
00065-14	108	00069-0508	111	00072-1212	114	00161-04	120	00269-0608	122
00066-0202	109	00069-0602	111	00075-040202	114	00161-05	120	00269-0806	122
00066-0302	109	00069-0604	111	00076-0202	114	00161-06	120	00269-0808	122
00066-0304	109	00069-0606	111	00076-0302	114	00161-08	120	00269-1008	122
00066-0402	109	00069-0606B	111	00076-0402	114	00161-10	120	00269-1212	122
00066-0404	109	00069-0608	111	00076-0604	114	00161-12	120	00272-0402	123
00066-0406	109	00069-0612	111	00078-0402	115	00260-02	120	00272-0404	123
00066-0408	109	00069-0704	111	00078-0404	115	00260-03	120	00272-0502	123
00066-0502	109	00069-0706	111	00078-0602	115	00260-04	120	00272-0604	123
00066-0504	109	00069-0804	111	00078-0604	115	00260-06	120	00282-0604	121
00066-0506	109	00069-0806	111	00078-0606	115	00260-08	120	00360-04	182
00066-0602	109	00069-0808	111	00078-0802	115	00261-02	121	00360-06	182

ANDERSON METALS

NUMERICAL INDEX

Part#	Page	Part#	Page	Part#	Page	Part#	Page	Part#	Page
00360-08	182	00372-0606	184	00469-0404	179	00561-06	120	02068-0602	133
00360-10	182	00372-0806	184	00469-0406	179	00561-08	120	02068-0604	133
00360-12	182	00372-0808	184	00469-0602	179	00561-10	120	02068-0606	133
00361-04	182	00372-1008	184	00469-0604	179	00561-12	120	02068-0608	133
00361-06	182	00395-0402	184	00469-0606	179	00668-1008	243	02068-0804	133
00361-08	182	00395-0404	184	00469-0608	179	00840-53	119	02068-0806	133
00361-10	182	00395-0602	184	00469-0804	179	00848-5302	119	02068-0808	133
00361-12	182	00395-0604	184	00469-0806	179	00849-0202	119	02068-5300	133
00362-04	182	00395-0606	184	00469-0808	179	00849-5302	119	02068-5302	133
00362-06	182	00395-0608	184	00469-1006	179	00880-02	118	02068-5304	133
00362-08	182	00395-0806	184	00469-1008	179	00880-03	118	02069-0202	134
00362-10	182	00395-0808	184	00469-1012	179	00880-04	118	02069-0302	134
00362-12	182	00395-1008	184	00469-1208	179	00880-06	118	02069-0402	134
00364-04	182	00460-04	177	00469-1212	179	00881-02	118	02069-0404	134
00364-06	182	00460-06	177	00470-0402	180	00881-03	118	02069-0406	134
00364-08	182	00460-08	177	00470-0404	180	00881-04	118	02069-0602	134
00364-10	182	00460-10	177	00470-0602	180	00881-05	118	02069-0604	134
00365-04	182	00460-12	177	00470-0604	180	00881-06	118	02069-0606	134
00365-06	182	00461-03	177	00470-0606	180	00881-08	118	02069-0804	134
00365-08	182	00461-04	177	00470-0806	180	00881-10	118	02069-0806	134
00365-10	182	00461-06	177	00470-0808	180	00888-0202	118	02069-0808	134
00366-0402	183	00461-08	177	00470-1008	180	00888-0302	118	02069-5302	134
00366-0404	183	00461-10	177	00471-0402	180	00888-0402	118	02070-0202	134
00366-0602	183	00461-12	177	00471-0404	180	00888-0404	118	02070-0402	134
00366-0604	183	00462-03	177	00471-0604	180	00888-0502	118	02070-0404	134
00366-0606	183	00462-04	177	00471-0606	180	00888-0504	118	02070-0604	134
00366-0806	183	00462-06	177	00471-0806	180	00888-0604	118	02070-5302	134
00366-0808	183	00462-08	177	00472-0402	180	00889-0202	118	02071-0202	135
00366-1006	183	00462-10	177	00472-0404	180	00889-0302	118	02071-0302	135
00366-1008	183	00462-12	177	00472-0602	180	00889-0402	118	02071-0402	135
00366-1208	183	00463-04	177	00472-0604	180	00889-0502	118	02071-0404	135
00368-0402	183	00463-06	177	00472-0606	180	00889-0604	118	02071-0602	135
00368-0404	183	00463-08	177	00472-0806	180	02059-04	136	02071-0604	135
00368-0604	183	00463-10	177	00472-0808	180	02059-06	136	02071-0606	135
00368-0606	183	00463-12	177	00472-1008	180	02059-08	136	02071-0806	135
00368-0608	183	00464-04	178	00472-080606	180	02059-53	136	02072-0202	135
00368-0804	183	00464-06	178	00473-04	177	02062-02	132	02072-0402	135
00368-0806	183	00464-08	178	00473-06	177	02062-04	132	02072-0404	135
00368-0808	183	00464-10	178	00473-08	177	02062-06	132	02072-0602	135
00368-1006	183	00465-04	178	00473-10	177	02062-08	132	02072-0604	135
00368-1008	183	00465-06	178	00473-12	177	02062-53	132	02072-0606	135
00368-1208	183	00465-08	178	00483-04	177	02064-02	132	02072-0806	135
00369-0402	183	00465-10	178	00483-06	177	02064-03	132	02072-5302	135
00369-0404	183	00466-0402	178	00483-08	177	02064-04	132	02082-02	136
00369-0406	183	00466-0404	178	00483-10	177	02064-06	132	02082-03	136
00369-0604	183	00466-0602	178	00495-0402	181	02064-08	132	02082-04	136
00369-0606	183	00466-0604	178	00495-0404	181	02064-53	132	02082-06	41
00369-0608	183	00466-0606	178	00495-0602	181	02065-02	132	02082-06	136
00369-0806	183	00466-0806	178	00495-0604	181	02065-04	132	02082-08	136
00369-0808	183	00466-0808	178	00495-0606	181	02065-06	132	02082-53	136
00369-1006	183	00466-1006	178	00495-0608	181	02065-08	132	02086-0402	136
00369-1008	183	00466-1008	178	00495-0804	181	02065-53	132	02086-0404	136
00369-1208	183	00466-1208	178	00495-0806	181	02066-0202	132	02086-0604	136
00370-0402	184	00468-0402	179	00495-0808	181	02066-0402	132	02089-0402	136
00370-0404	184	00468-0404	179	00495-1008	181	02066-0404	132	02089-0404	136
00370-0602	184	00468-0406	179	00495-1208	181	02066-0604	132	02089-5353	136
00370-0604	184	00468-0602	179	00560-04	120	02066-0606	132	02169-0202	133
00370-0606	184	00468-0604	179	00560-04	232	02066-5302	132	02169-0400	133
00370-0806	184	00468-0606	179	00560-05	120	02068-0200	133	02169-0402	133
00370-1008	184	00468-0608	179	00560-05	232	02068-0201	133	02169-0404	133
00371-0402	184	00468-0804	179	00560-06	120	02068-0202	133	02169-0406	133
00371-0404	184	00468-0806	179	00560-06	232	02068-0204	133	02169-0602	133
00371-0604	184	00468-0808	179	00560-08	120	02068-0300	133	02169-0604	133
00371-0606	184	00468-0812	179	00560-08	232	02068-0302	133	02169-0606	133
00371-0806	184	00468-1006	179	00560-10	120	02068-0400	133	02169-0608	133
00371-0808	184	00468-1008	179	00560-10	232	02068-0402	133	02169-0806	133
00371-1008	184	00468-1012	179	00561-02	120	02068-0404	133	02169-0808	133
00372-0402	184	00468-1208	179	00561-03	120	02068-0406	133	02169-5300	133
00372-0404	184	00468-1212	179	00561-04	120	02068-0502	133	02169-5302	133
00372-0604	184	00469-0402	179	00561-05	120	02068-0504	133	02169-5304	133

ANDERSON METALS

NUMERICAL INDEX

Part#	Page	Part#	Page	Part#	Page	Part#	Page	Part#	Page
02170-0402	134	02468-5300	165	02571-0404	167	02670-0302	127	04019-08	72
02170-0404	134	02468-5301	165	02571-0604	167	02670-0402	127	04019-10	72
02170-0604	134	02468-5302	165	02571-0606	167	02670-0404	127	04020-0504	72
02170-0606	134	02469-0402	166	02571-0806	167	02670-0604	127	04020-0604	72
02170-0806	134	02469-0404	166	02571-0808	167	02670-0806	127	04020-0605	72
02171-0202	135	02469-0406	166	02572-0402	169	02671-0202	128	04020-0806	72
02171-0402	135	02469-0602	166	02572-0404	169	02671-0302	128	04020-1006	72
02171-0404	135	02469-0604	166	02572-0604	169	02671-0402	128	04020-1008	72
02171-0604	135	02469-0606	166	02572-0606	169	02671-0404	128	04020-1208	72
02171-0606	135	02469-0608	166	02572-0804	169	02671-0502	128	04020-1210	72
02171-0806	135	02469-0804	166	02572-0806	169	02671-0604	128	04030-0804	86
02171-0808	135	02469-0806	166	02572-0808	169	02671-0806	128	04030-1204	86
02171-5302	135	02469-0808	166	02642-04	125	02672-0202	128	04030-1206	86
02172-0202	135	02469-1006	166	02642-06	125	02672-0302	128	04030-1208	86
02172-0402	135	02469-1008	166	02648-04	126	02672-0402	128	04032-08	86
02172-0404	135	02469-1208	166	02648-06	126	02672-0404	128	04032-12	86
02172-0604	135	02469-1212	166	02656-0604	125	02672-0502	128	04039-02	72
02172-0606	135	02469-5302	166	02659-04	129	02672-0602	128	04039-03	72
02172-0806	135	02470-0402	167	02659-06	129	02672-0604	128	04039-04	72
02172-0808	135	02470-0404	167	02659-08	129	02672-0806	128	04039-05	72
02172-5300	135	02470-0406	167	02660-04	129	02677-0402	128	04039-06	72
02172-5302	135	02470-0604	167	02660-05	129	02677-0404	128	04039-08	72
02454-0402	168	02470-0606	167	02660-06	129	02677-0406	128	04039-10	72
02454-0404	168	02470-0808	167	02660-08	129	02679-0604	126	04039-12	72
02454-0602	168	02471-0402	167	02662-02	125	02682-04	125	04040-02	73
02454-0604	168	02471-0404	167	02662-03	125	02682-05	125	04040-03	73
02454-0606	168	02471-0604	167	02662-04	125	02682-06	125	04040-04	73
02454-0608	168	02471-0606	167	02662-05	125	02682-08	125	04040-05	73
02454-0804	168	02471-0806	167	02662-06	125	02760-02	129	04040-06	73
02454-0806	168	02472-0402	168	02662-08	125	02760-04	129	04040-08	73
02454-1008	168	02472-0404	168	02664-02	126	02760-06	129	04040-10	73
02459-04	164	02472-0604	168	02664-04	126	02761-02	128	04040-12	73
02459-06	164	02472-0606	168	02664-05	126	02761-03	128	04041-02	71
02459-08	164	02472-0804	168	02664-06	126	02761-04	128	04041-03	71
02459-53	164	02472-0806	168	02664-08	126	02761-05	128	04041-04	71
02462-04	164	02477-0402	169	02666-0202	126	02761-06	128	04041-05	71
02462-06	164	02482-04	169	02666-0302	126	02761-08	128	04041-06	71
02462-08	164	02482-06	169	02666-0402	126	02961-02	129	04041-08	71
02462-10	164	02482-08	169	02666-0404	126	02961-04	129	04041-10	71
02462-12	164	02482-10	169	02666-0502	126	02961-05	129	04041-12	71
02462-53	164	02486-0402	169	02666-0602	126	02961-06	129	04042-02	74
02464-04	164	02486-0404	169	02666-0604	126	02961-08	129	04042-03	74
02464-06	164	02486-0604	169	02666-0806	126	04014-02	70	04042-04	74
02464-08	164	02554-0402	168	02668-0202	127	04014-02	120	04042-05	74
02464-12	164	02554-0404	168	02668-0302	127	04014-03	70	04042-06	74
02465-04	164	02554-0602	168	02668-0400	127	04014-04	70	04042-08	74
02465-06	164	02554-0604	168	02668-0401	127	04014-05	70	04042-10	74
02465-08	164	02554-0606	168	02668-0402	127	04014-06	70	04042-12	74
02465-53	164	02554-0804	168	02668-0404	127	04014-07	70	04042-14	74
02466-0402	165	02554-0806	168	02668-0406	127	04014-08	70	04043-0402	74
02466-0404	165	02554-0808	168	02668-0502	127	04014-10	70	04043-0604	74
02466-0604	165	02554-1008	168	02668-0504	127	04014-12	70	04044-02	75
02466-0606	165	02569-0402	166	02668-0602	127	04014-14	70	04044-03	75
02466-0804	165	02569-0404	166	02668-0604	127	04014-16	70	04044-04	75
02466-0806	165	02569-0406	166	02668-0606	127	04016-04	71	04044-05	75
02466-0808	165	02569-0602	166	02668-0804	127	04016-05	71	04044-06	75
02468-0402	165	02569-0604	166	02668-0806	127	04016-06	71	04044-08	75
02468-0404	165	02569-0606	166	02668-0808	127	04016-08	71	04044-10	75
02468-0406	165	02569-0608	166	02669-0202	127	04016-10	71	04044-12	75
02468-0602	165	02569-0804	166	02669-0302	127	04016-12	71	04044-14	75
02468-0604	165	02569-0806	166	02669-0402	127	04018-03	71	04045-0202	76
02468-0606	165	02569-0808	166	02669-0404	127	04018-04	71	04045-0302	76
02468-0608	165	02569-1006	166	02669-0406	127	04018-05	71	04045-0402	76
02468-0804	165	02569-1008	166	02669-0502	127	04018-06	71	04045-0404	76
02468-0806	165	02569-1208	166	02669-0602	127	04018-08	71	04045-0406	76
02468-0808	165	02569-1212	166	02669-0604	127	04018-10	71	04045-0408	76
02468-1006	165	02569-5302	166	02669-0606	127	04018-12	71	04045-0502	76
02468-1008	165	02570-0402	167	02669-0806	127	04018-14	71	04045-0504	76
02468-1208	165	02570-0404	167	02669-0808	127	04019-04	72	04045-0602	76
02468-1212	165	02571-0402	167	02670-0202	127	04019-06	72	04045-0604	76

ANDERSON METALS

NUMERICAL INDEX

Part#	Page	Part#	Page	Part#	Page	Part#	Page	Part#	Page
04045-0606	76	04049-0504	80	04052-10	82	04061-0610	85	04099-06	73
04045-0608	76	04049-0506	80	04053-020204	83	04061-0804	85	04330-03	96
04045-0804	76	04049-0508	80	04053-040404	83	04061-0806	85	04330-04	96
04045-0806	76	04049-0602	80	04053-040406	83	04061-0810	85	04335-0304	96
04045-0808	76	04049-0604	80	04055-02	83	04061-1006	85	04339-03	100
04045-0812	76	04049-0604B	80	04055-03	83	04061-1008	85	04339-04	100
04045-1006	76	04049-0606	80	04055-04	83	04061-1012	85	04339-05	100
04045-1008	76	04049-0608	80	04055-05	83	04061-1210	85	04339-06	100
04045-1012	76	04049-0612	80	04055-06	83	04063-03	73	04340-02	96
04045-1208	76	04049-0802	80	04055-08	83	04063-04	73	04340-03	96
04045-1212	76	04049-0804	80	04055-10	83	04063-05	73	04340-04	96
04046-0202	77	04049-0806	80	04055-12	83	04063-06	73	04340-05	96
04046-0302	77	04049-0806B	80	04055-14	83	04063-08	73	04340-06	96
04046-0402	77	04049-0808	80	04056-0402	75	04063-10	73	04340-08	96
04046-0404	77	04049-0808B	80	04056-0403	75	04063-12	73	04340-10	96
04046-0406	77	04049-0812	80	04056-0504	75	04064-03	73	04340-12	96
04046-0408	77	04049-1004	80	04056-0604	75	04064-04	73	04341-02	96
04046-0502	77	04049-1006	80	04056-0605	75	04064-05	73	04341-03	96
04046-0504	77	04049-1008	80	04056-0804	75	04064-06	73	04341-04	96
04046-0506	77	04049-1012	81	04056-0806	75	04064-08	73	04341-05	96
04046-0602	77	04049-1206	81	04056-1006	75	04064-10	73	04341-06	96
04046-0604	77	04049-1208	81	04056-1008	75	04064-12	73	04341-08	96
04046-0606	77	04049-1212	81	04056-1208	75	04066-0402	85	04341-10	96
04046-0608	77	04049-1216	81	04056-1210	75	04066-0404	85	04342-02	97
04046-0612	77	04049-1412	81	04057-0604	84	04066-0604	85	04342-03	97
04046-0804	77	04049-1612	81	04057-0804	84	04066-0806	85	04342-04	97
04046-0806	77	04049-1616	81	04057-0806	84	04066-0808	85	04342-05	97
04046-0808	77	04050-0302	81	04057-1006	84	04070-04	86	04342-06	97
04046-0812	77	04050-0402	81	04057-1008	84	04070-05	86	04342-08	97
04046-1006	77	04050-0404	81	04057-1208	84	04070-06	86	04344-02	100
04046-1008	77	04050-0406	81	04057-1210	84	04070-08	86	04344-03	100
04046-1012	77	04050-0408	81	04058-040402	83	04070-10	86	04344-04	100
04046-1208	77	04050-0502	81	04058-040404	83	04070-12	86	04344-05	100
04046-1212	77	04050-0504	81	04058-060604	83	04071-0404	86	04344-06	100
04046-1412	77	04050-0602	81	04058-060606	83	04071-0606	86	04344-08	100
04048-0202	78	04050-0604	81	04058-080806	83	04071-0808	86	04345-0302	101
04048-0302	78	04050-0606	81	04058-080808	83	04071-1010	86	04345-0402	101
04048-0302	78	04050-0608	81	04059-040506	76	04071-1212	86	04345-0502	101
04048-0402	78	04050-0612	81	04059-050504	76	04075-0604	86	04345-0604	101
04048-0404	78	04050-0804	81	04059-060404	76	04075-0806	86	04346-0302	98
04048-0406	78	04050-0806	81	04059-060406	76	04075-1008	86	04346-0402	98
04048-0408	78	04050-0808	81	04059-060604	76	04082-0404	87	04346-0404	98
04048-0502	78	04050-0812	81	04059-060608	76	04082-0406	87	04346-0502	98
04048-0504	78	04050-1006	81	04059-060610	76	04082-0606	87	04346-0604	98
04048-0506	78	04050-1008	81	04059-080408	76	04082-0608	87	04346-0704	98
04048-0602	78	04050-1012	81	04059-080606	76	04082-0808	87	04346-0806	98
04048-0604	78	04050-1208	81	04059-080608	76	04082-1010	87	04346-1008	98
04048-0606	78	04050-1212	81	04059-080804	76	04082-1212	87	04346-1212	98
04048-0608	78	04050-1412	81	04059-080806	76	04088-080806	88	04348-0202	98
04048-0804	78	04051-0302	82	04059-080810	76	04091-040404	82	04348-0302	98
04048-0806	78	04051-0402	82	04059-080812	76	04091-060606	82	04348-0304	98
04048-0808	78	04051-0404	82	04059-100606	76	04091-060608	82	04348-0402	98
04048-0812	78	04051-0406	82	04059-100608	76	04091-060808	82	04348-0404	98
04048-1004	78	04051-0502	82	04059-100610	76	04091-080806	82	04348-0502	98
04048-1006	79	04051-0504	82	04059-100808	76	04093-06060608	83	04348-0504	98
04048-1008	79	04051-0602	82	04059-100810	76	04095-0302	84	04348-0506	98
04048-1208	79	04051-0604	82	04059-101006	76	04095-0402	84	04348-0602	98
04048-1212	79	04051-0606	82	04059-101008	76	04095-0404	84	04348-0604	98
04048-1408	79	04051-0608	82	04059-121210	76	04095-0502	84	04348-0606	98
04048-1412	79	04051-0804	82	04060-04	84	04095-0504	84	04348-0704	98
04048-1612	79	04051-0806	82	04060-06	84	04095-0604	84	04348-0804	98
04048-1616	79	04051-0806	82	04060-08	84	04095-0606	84	04348-0806	98
04049-0202	80	04051-0808	82	04060-10	84	04095-0608	84	04348-0808	98
04049-0302	80	04051-1008	82	04060-12	84	04095-0806	84	04348-1008	98
04049-0304	80	04051-1208	82	04061-0403	85	04095-0808	84	04348-1208	98
04049-0402	80	04051-1212	82	04061-0406	85	04095-1006	84	04348-1212	98
04049-0404	80	04052-04	82	04061-0406	85	04095-1008	84	04348-1608	98
04049-0406	80	04052-05	82	04061-0408	85	04095-1208	84	04348-1616	98
04049-0408	80	04052-06	82	04061-0604	85	04096-040404	83	04349-0202	99
04049-0502	80	04052-08	82	04061-0608	85	04099-04	73	04349-0302	99

ANDERSON METALS

NUMERICAL INDEX

Part#	Page	Part#	Page	Part#	Page	Part#	Page	Part#	Page
04349-0402	99	06101-12	3	06114-04	9	06130-02	17	06303-04	4
04349-0404	99	06102-02	3	06114-06	9	06130-04	17	06303-06	4
04349-0502	99	06102-04	3	06114-08	9	06130-06	17	06303-08	4
04349-0504	99	06102-06	3	06115-02	9	06130-08	17	06303-12	4
04349-0602	99	06102-08	3	06115-04	9	06131-02	17	06322-04	12
04349-0604	99	06102-12	3	06115-06	9	06131-04	17	07001-0202	24
04349-0606	99	06103-02	4	06115-08	9	06131-06	17	07001-0204	24
04349-0804	99	06103-04	4	06116-02	6	06131-08	17	07001-0302	24
04349-0806	99	06103-06	4	06116-04	6	06131-12	17	07001-0304	24
04349-0808	99	06103-08	4	06116-08	6	06140-0402	7	07001-0402	24
04349-1006	99	06103-12	4	06116-12	6	06140-0602	7	07001-0404	24
04349-1008	99	06104-02	5	06117-02	9	06140-0604	7	07001-0406	24
04349-1208	99	06104-04	5	06117-04	9	06140-0806	7	07001-0408	24
04350-0320	100	06104-06	5	06117-06	9	06140-1208	7	07001-0502	24
04350-0402	100	06104-08	5	06118-02	6	06140-1608	7	07001-0504	24
04350-0502	100	06104-12	5	06118-04	6	06140-1612	7	07001-0506	24
04350-0604	100	06107-02	2	06118-06	6	06200-02	2	07001-0602	24
04351-0302	101	06107-04	2	06119-0402	5	06200-04	2	07001-0604	24
04351-0402	101	06108-02	6	06119-0602	5	06200-06	2	07001-0606	24
04351-0502	101	06108-04	6	06119-0604	5	06200-08	2	07001-0608	24
04351-0604	101	06108-06	6	06119-0802	5	06200-12	2	07001-0612	24
04352-0502	101	06108-08	6	06119-0804	5	06201-02	3	07001-0704	24
04352-0604	101	06108-12	6	06119-0806	5	06201-04	3	07001-0706	24
04355-04	101	06108-16	6	06119-1204	5	06201-06	3	07001-0804	25
04355-06	101	06109-12	9	06119-1608	5	06201-08	3	07001-0806	25
04394-0202	100	06109-16	9	06119-1612	5	06201-12	3	07001-0808	25
04394-0302	100	06110-0201	8	06120-0202	16	06202-02	4	07001-0812	25
04394-0402	100	06110-0402	8	06120-0402	16	06202-04	4	07001-1006	25
04394-0502	100	06110-0602	8	06120-0404	16	06202-06	4	07001-1008	25
04394-0504	100	06110-0604	8	06120-0602	16	06202-08	4	07001-1012	25
04394-0506	99	06110-0802	8	06120-0604	16	06205-0402	2	07001-1206	25
04394-0602	100	06110-0804	8	06120-0606	16	06205-0604	2	07001-1208	25
04394-0604	100	06110-0806	8	06120-0802	16	06205-0806	2	07001-1212	25
04394-0806	100	06110-1202	8	06120-0804	16	06206-020204	3	07001-1216	25
04394-1008	100	06110-1204	8	06120-0806	16	06206-040402	3	07001-1612	25
04394-1412	99	06110-1206	8	06120-0808	16	06206-060604	3	07001-1616	25
04394-1616	99	06110-1208	8	06120-1212	16	06206-080806	3	07001-2016	25
04448-0404	78	06110-1602	8	06121-02	10	06206-121208	3	07002-0202	28
04448-0606	78	06110-1604	8	06121-04	10	06216-02	6	07002-0204	28
04448-0612	78	06110-1606	8	06121-06	10	06216-04	6	07002-0302	28
04448-0806	78	06110-1608	8	06121-08	10	06216-06	6	07002-0304	28
04448-1012	79	06110-1612	8	06121-12	10	06216-08	6	07002-0402	28
04741-15	88	06111-02	10	06122-02	12	06216-12	6	07002-0404	28
04746-1508	88	06111-04	10	06122-04	12	06224-02	14	07002-0406	28
04746-1512	88	06111-06	10	06122-06	12	06224-04	14	07002-0408	28
04748-1508	88	06111-08	10	06122-08	12	06224-06	14	07002-0502	28
04748-151208	88	06111-12	10	06122-12	12	06227-02	15	07002-0504	28
04800-06	87	06112-02	11	06122-16	12	06227-04	15	07002-0506	28
04802-06	88	06112-04	11	06123-0402	13	06227-06	15	07002-0602	28
04806-0606	87	06112-06	11	06123-0602	13	06227-08	15	07002-0604	28
04806-0608	87	06112-08	11	06123-0604	13	06227-12	15	07002-0606	28
04806-0612	87	06112-12	11	06123-0804	13	06228-0204	7	07002-0608	28
04808-0606	88	06113-0224	11	06123-0806	13	06228-0402	7	07002-0804	28
04808-0608	88	06113-0232	11	06123-1208	13	06228-0406	7	07002-0806	28
04809-0608	88	06113-0240	11	06123-1612	13	06228-0604	7	07002-0808	28
04844-06	88	06113-0248	11	06124-02	14	06228-0608	7	07002-1212	28
04850-0608	88	06113-0424	11	06124-04	14	06228-0806	7	07002-1612	28
05200	89	06113-0432	11	06124-06	14	06230-02	17	07002-1616	28
05204	89	06113-0440	11	06124-08	14	06230-04	17	07003-0404	26
05205	90	06113-0448	11	06124-12	14	06230-06	17	07003-0602	26
05206	90	06113-0624	11	06125-02	10	06230-08	17	07003-0604	26
05207	90	06113-0632	11	06125-04	10	06232-02	18	07003-0606	26
05208	90	06113-0640	11	06125-06	10	06232-04	18	07003-0806	26
05220	89	06113-0648	11	06125-08	10	06232-06	18	07003-0808	26
05221	89	06113-0824	11	06125-12	10	06232-08	18	07003-1212	26
05225	89	06113-0832	11	06127-02	15	06232-12	18	07004-0304	33
06101-02	3	06113-0840	11	06127-04	15	06235-0402	17	07004-0404	33
06101-04	3	06113-0848	11	06127-06	15	06235-0604	17	07004-0406	33
06101-06	3	06113-1224	11	06127-08	15	06235-0806	17	07004-0505	33
06101-08	3	06114-02	9	06127-12	15	06303-02	4	07004-0606	33

ANDERSON METALS

NUMERICAL INDEX

Part#	Page	Part#	Page	Part#	Page	Part#	Page	Part#	Page
07004-0608	33	07040-812	65	07205-0808	52	07211-0406	53	07482-1212	59
07004-0808	33	07040-1012	65	07205-0810	52	07211-0505	53	07484-1208	59
07008-0202	32	07040-1212	65	07205-1008	52	07211-0506	53	07484-1212	59
07008-0302	32	07042-08	64	07205-1010	52	07211-0606	53	07484-121208	59
07008-0304	32	07042-10	64	07205-1210	52	07211-0806	53	07486-1212	60
07008-0402	32	07042-12	64	07205-1212	52	07211-0808	53	07486-121208	60
07008-0404	32	07045-0002	31	07206-0403	53	07211-1010	53	07487-1208	58
07008-0406	32	07045-0402	31	07206-0404	53	07211-1212	53	07492-0808	58
07008-0504	32	07045-0404	31	07206-0405	53	07212-0404	53	07492-1212	58
07008-0604	32	07045-0504	31	07206-0504	53	07212-0406	53	07493-1212	58
07008-0606	32	07045-0602	31	07206-0505	53	07212-0506	53	07495-0612	62
07008-0608	32	07045-0604	31	07206-0506	53	07212-0606	53	07495-0812	62
07008-0806	32	07045-0606	31	07206-0605	53	07212-0808	53	07495-1012	62
07008-0808	32	07045-0804	31	07206-0606	53	07212-1010	53	07499-0612	62
07008-1212	32	07045-0806	31	07206-0608	53	07212-1212	53	07499-0812	62
07009-0202	29	07045-1006	31	07206-0806	53	07213-0403	54	07629-0306	39
07009-0302	29	07046-0812	64	07206-0808	53	07213-0404	54	07629-0309	39
07009-0304	29	07046-1012	64	07206-1010	53	07213-0405	54	07629-0409	39
07009-0402	29	07046-1212	64	07207-0402	51	07213-0505	54	07629-0509	39
07009-0404	29	07048-0612	64	07207-0404	51	07213-0605	54	07629-0609	39
07009-0406	29	07048-0812	64	07207-0406	51	07213-0606	54	07639-0306*	39
07009-0504	29	07048-1012	64	07207-0502	51	07213-0808	54	07639-0309	39
07009-0604	29	07048-1212	64	07207-0504	51	07214-04	50	07639-0409	39
07009-0606	29	07062-02	41	07207-0602	51	07214-05	50	07639-0509	39
07009-0608	29	07062-04	41	07207-0604	51	07214-06	50	07639-0609	39
07009-0806	29	07062-06	41	07207-0606	51	07214-08	50	07651-0904	40
07009-0808	29	07064-02	42	07207-0608	51	07214-10	50	07651-0906	40
07010-0303	34	07064-04	42	07207-0612	51	07214-12	50	07651-0909	40
07010-0304	34	07064-06	42	07207-0804	51	07215-0310	34	07652-0904	40
07010-0304	34	07065-02	42	07207-0806	51	07215-0403	52	07652-0906	40
07010-0404	34	07065-04	42	07207-0808	51	07215-0404	52	07652-0909	40
07010-0405	34	07065-06	42	07207-0812	51	07215-0405	52	07654-0202	32
07010-0405	34	07068-0202	41	07207-1006	51	07215-0505	52	07654-0402	32
07010-0406	34	07068-0204	41	07207-1008	51	07215-0606	52	07654-0404	32
07010-0505	34	07068-0402	41	07207-1012	51	07215-0808	52	07654-0604	32
07010-0506	34	07068-0806	41	07207-1208	51	07215-1010	52	07654-0606	32
07010-0606	34	07069-0202	42	07207-1212	51	07215-1212	52	07654-0806	32
07010-0608	34	07069-0204	42	07207-1612	51	07217-040804	35	07654-0808	32
07010-0808	34	07069-0402	42	07207-1616	51	07217-040904	35	07654-1212	32
07010-0810	34	07069-0404	42	07208-0402	54	07217-041004	35	07656-0404	32
07010-1212	34	07069-0606	42	07208-0404	54	07217-061004	35	07656-0808	32
07014-02	27	07072-0202	43	07208-0406	54	07217-061006	35	08060-06	185
07014-03	27	07202-0404	50	07208-0604	54	07217-061104	35	08060-08	185
07014-04	27	07202-0604	50	07208-0606	54	07217-061106	35	08061-06	185
07014-05	27	07202-0606	50	07208-0608	54	07217-061204	35	08061-08	185
07014-06	27	07202-0806	50	07208-0808	54	07217-081408	35	08062-06	186
07014-08	27	07202-0808	50	07208-0812	54	07401-1208	58	08062-08	186
07014-10	27	07202-1212	50	07208-1012	54	07401-1212	58	08066-0612	186
07014-10	62	07204-0404	51	07208-1212	54	07402-12	58	08066-0814	186
07014-12	27	07204-0405	51	07209-0402	50	07403-12	58	08068-0604	187
07014-12	62	07204-0406	51	07209-0404	50	07405-12	61	08068-0606	187
07014-16	27	07204-0505	51	07209-0406	50	07406-12	60	08068-0608	187
07020-0302	29	07204-0604	51	07209-0604	50	07407-12	60	08068-0806	187
07020-0402	29	07204-0605	51	07209-0606	50	07408-12	61	08068-0808	187
07020-0404	29	07204-0606	51	07209-0608	50	07411-1202	58	08070-06	186
07020-0502	29	07204-0608	51	07209-0808	50	07411-1204	58	08070-08	186
07020-0504	29	07204-0608	53	07209-0812	50	07412-12	61	08071-06	185
07020-0506	29	07204-0808	51	07209-1012	50	07420-1204	59	08071-08	185
07020-0602	29	07204-0810	51	07209-1212	50	07420-1206	59	08078-0604	187
07020-0604	29	07204-1008	51	07210-0404	52	07420-1206	59	08078-0606	187
07020-0606	29	07204-1010	51	07210-0405	52	07420-1208	59	08078-0608	187
07020-0608	29	07204-1210	51	07210-0505	52	07478-1206	60	08078-0806	187
07020-0804	29	07204-1212	51	07210-0608	52	07478-1208	60	08078-0808	187
07020-0806	29	07205-0404	52	07210-0808	52	07478-1208	60	08086-0604	186
07020-0808	29	07205-0405	52	07210-0810	52	07478-121208	60	08086-0606	186
07020-1006	29	07205-0406	52	07210-1008	52	07480-1204	60	08086-0806	186
07020-1008	29	07205-0604	52	07210-1010	52	07480-1206	60	08088-0604	187
07024-04	30	07205-0605	52	07210-1210	52	07480-1208	60	08088-0606	187
07024-05	30	07205-0606	52	07211-0404	53	07480-1212	60	08088-0806	187
07024-06	30	07205-0608	52	07211-0405	53	07482-1208	59	08088-0808	187

ANDERSON METALS

NUMERICAL INDEX

Part#	Page	Part#	Page	Part#	Page	Part#	Page	Part#	Page
08098-0604	187	08701-1008	37	09201-0502	196	09515-04	205	38105-0806	329
08098-0606	187	08701-1012	37	09201-0504	196	09515-06	205	38105-1204	329
08098-0608	187	08701-1208	37	09201-0604	196	09540-0606	201	38105-1208	329
08098-0806	187	08701-1212	37	09201-0606	196	09540-0608	201	38105-1612	329
08098-0808	187	08706-0404	38	09204-0402	197	09540-0612	201	38105-2016	329
08302	191	08706-0405	38	09204-0404	197	09540-0808	201	38105-2416	329
08304	191	08706-0504	38	09204-0502	197	09540-0812	201	38105-3216	329
08310	188	08706-0505	38	09204-0504	197	09603-0402	123	38106-080804	333
08311	188	08706-0506	38	09204-0604	197	09603-0504	123	38106-080812	333
08313	188	08706-0605	38	09204-0606	197	09606-04	123	38106-120808	333
08314	188	08706-0606	38	09204-0608	197	09606-06	123	38106-121204	333
08315	188	08720-0402	38	09204-0806	197	022661-04	125	38106-121206	333
08316	188	08720-0502	38	09204-0808	197	022661-05	125	38106-121208	333
08321	188	08720-0504	38	09205-0606	197	022661-06	125	38106-161212	333
08324	189	08720-0602	38	09205-0608	197	28212EHLF	216	38106-161612	333
08341	189	08720-0604	38	09205-0808	197	38100-02	329	38106-202008	333
08342	189	08720-0606	38	09205-1012	197	38100-04	329	38106-202012	333
08343	189	08720-0806	38	09206-04	196	38100-06	329	38106-202016	333
08346	189	08720-0808	38	09206-05	196	38100-08	329	38107-02	330
08347	189	08720-1006	38	09206-06	196	38100-12	329	38107-04	330
08349	189	08720-1008	38	09206-08	196	38100-16	329	38107-06	330
08351	191	08720-1208	38	09208-02	196	38100-20	329	38107-08	330
08352	191	08722-0404	38	09208-04	196	38100-24	329	38107-12	330
08373	190	08722-0405	38	09208-06	196	38100-32	329	38107-16	330
08374	190	08722-0505	38	09210-04	197	38100-40	329	38107-20	330
08375	190	08722-0605	38	09210-05	197	38100-48	329	38107-24	330
08391	190	08722-0606	38	09210-06	197	38100-64	329	38107-32	330
08392	190	08942-1008	201	09210-08	197	38101-02	332	38107-40	330
08393	190	08944-0606	200	09210-10	197	38101-04	332	38107-48	330
08394	190	08944-0806	200	09234-02	196	38101-06	332	38108-02	336
08395	190	08944-1006	200	09234-04	196	38101-08	332	38108-04	336
08396	190	08944-1008	200	09234-06	196	38101-12	332	38108-06	336
08397	191	08944-1206	200	09235-02	196	38101-16	332	38108-08	336
08398	191	08944-1208	200	09235-04	196	38101-20	332	38108-12	336
08399	191	08945-0606	200	09235-06	196	38101-24	332	38108-16	336
08601	102	08945-0608	200	09403-02	194	38101-32	332	38108-20	336
08603	102	08945-0808	200	09403-04	194	38101-40	332	38108-24	336
08604	102	08947-0606	200	09404-02	194	38101-48	332	38108-32	336
08605	102	08947-1006	200	09404-04	194	38102-04	331	38108-40	336
08606	102	08949-0604	201	09404-06	194	38102-06	331	38108-48	336
08607	102	08949-0606	201	09404-08	194	38102-08	331	38109-02	338
08608	102	08949-0608	201	09420-02	195	38102-12	331	38109-04	338
08609	102	08949-0806	201	09420-04	195	38102-16	331	38109-06	338
08661-0304	103	08949-0808	201	09420-06	195	38102-20	331	38109-08	338
08661-0305	103	08949-1008	201	09430-02	195	38102-24	331	38109-12	338
08661-0403	103	09101-0302	198	09430-04	195	38103-02	334	38109-16	338
08661-0405	103	09101-0402	198	09432-02	195	38103-04	334	38109-20	338
08661-0504	103	09101-0404	198	09432-04	195	38103-06	334	38109-24	338
08661-0506	103	09101-0502	198	09432-06	195	38103-08	334	38109-32	338
08661-0605	103	09101-0604	198	09432-08	195	38103-12	334	38109-40	338
08664-0409	103	09102-0402	199	09440-02	195	38103-16	334	38109-48	338
08664-0809	103	09102-0604	199	09440-04	195	38103-20	334	38109-64	338
08664-0908	103	09103-0402	198	09442-02	195	38103-24	334	38110-0402	337
08664-030920	103	09103-0404	198	09442-04	195	38103-32	334	38110-0602	337
08664-090918	103	09103-0502	198	09500-02	203	38103-40	334	38110-0604	337
08681	103	09103-0602	198	09500-04	203	38103-48	334	38110-0802	337
08683	103	09103-0604	198	09500-06	203	38104-02	336	38110-0804	337
08684	103	09106-04	198	09501-04	203	38104-04	336	38110-0806	337
08685	103	09106-05	198	09502-04	203	38104-06	336	38110-1202	337
08701-0302	37	09106-06	198	09505-0402	203	38104-08	336	38110-1204	337
08701-0402	37	09108-02	199	09505-0404	203	38104-12	336	38110-1206	337
08701-0404	37	09108-04	199	09505-0604	203	38104-16	336	38110-1208	337
08701-0502	37	09110-04	199	09505-0606	203	38104-20	336	38110-1602	337
08701-0504	37	09110-06	199	09505-0608	203	38104-24	336	38110-1604	337
08701-0602	37	09134-02	199	09505-0806	203	38104-32	336	38110-1606	337
08701-0604	37	09134-04	199	09508-02	204	38104-40	336	38110-1608	337
08701-0606	37	09135-02	199	09508-04	204	38104-48	336	38110-1612	337
08701-0806	37	09135-04	199	09508-06	204	38105-0402	329	38110-2004	337
08701-0808	37	09201-0402	196	09514-04	205	38105-0604	329	38110-2006	337
08701-1006	37	09201-0404	196	09514-06	205	38105-0804	329	38110-2008	337

ANDERSON METALS

NUMERICAL INDEX

NUMERICAL INDEX

Part#	Page	Part#	Page	Part#	Page	Part#	Page	Part#	Page
38110-2012	337	38119-2008	335	80300-0620	321	80300-2060	323	81100-08	341
38110-2016	337	38119-2012	335	80300-0625	321	80300-2070	323	81100-12	341
38110-2404	337	38119-2016	335	80300-0630	321	80300-2080	323	81100-16	341
38110-2406	337	38119-2408	335	80300-0635	321	80300-2090	323	81101-02	342
38110-2408	337	38119-2412	335	80300-0640	321	80300-2092	323	81101-04	342
38110-2412	337	38119-2416	335	80300-0645	321	80300-2094	323	81101-06	342
38110-2416	337	38119-2420	335	80300-0650	321	80300-2096	323	81101-08	342
38110-2420	337	38119-3208	335	80300-0655	321	80300-2420	323	81101-12	342
38110-3208	337	38119-3212	335	80300-0660	321	80300-2425	323	81101-16	342
38110-3212	337	38119-3216	335	80300-0670	321	80300-2430	323	81102-08	341
38110-3216	337	38119-3220	335	80300-0680	321	80300-2435	323	81102-12	341
38110-3220	337	38119-3224	335	80300-0690	321	80300-2440	323	81103-02	342
38110-3224	337	38119-4024	335	80300-0692	321	80300-2445	323	81103-04	342
38110-4016	337	38119-4032	335	80300-0694	321	80300-2450	323	81103-06	342
38110-4024	337	38119-4832	335	80300-0696	321	80300-2455	323	81103-08	342
38110-4032	337	38119-4840	335	80300-0815	321	80300-2460	323	81103-12	342
38110-4824	337	38124-02	331	80300-0820	321	80300-2470	323	81103-16	342
38110-4832	337	38124-04	331	80300-0825	321	80300-2480	323	81104-02	342
38110-4840	337	38124-06	331	80300-0830	321	80300-2490	323	81104-04	342
38110-6432	337	38124-08	331	80300-0835	321	80300-2492	323	81104-12	342
38110-6448	337	38124-12	331	80300-0840	321	80300-2494	323	81104-16	342
38111-02	338	38124-16	331	80300-0845	321	80300-2496	323	81104-20	342
38111-04	338	38124-20	331	80300-0850	321	80300-3225	324	81105-0806	341
38111-06	338	38124-24	331	80300-0855	321	80300-3230	324	81105-1208	341
38111-08	338	38124-32	331	80300-0860	321	80300-3235	324	81107-02	342
38111-12	338	80300-02	320	80300-0870	321	80300-3240	324	81107-06	342
38111-16	338	80300-04	320	80300-0880	321	80300-3245	324	81107-12	342
38111-20	338	80300-06	321	80300-0890	321	80300-3250	324	81107-16	342
38111-24	338	80300-08	321	80300-0892	321	80300-3255	324	81108-02	342
38111-32	338	80300-12	322	80300-0894	321	80300-3260	324	81108-04	342
38114-02	339	80300-16	322	80300-0896	321	80300-3270	324	81108-06	342
38114-04	339	80300-20	323	80300-1215	322	80300-3280	324	81108-08	342
38114-06	339	80300-24	323	80300-1220	322	80300-3290	324	81108-12	342
38114-08	339	80300-32	324	80300-1225	322	80300-3292	324	81108-16	342
38114-12	339	80300-40	324	80300-1230	322	80300-3294	324	81109-06	342
38114-16	339	80300-48	325	80300-1235	322	80300-3296	324	81109-08	342
38114-20	339	80300-64	325	80300-1240	322	80300-4030	324	81109-16	342
38114-24	339	80300-0215	320	80300-1245	322	80300-4035	324	81110-0804	342
38114-32	339	80300-0220	320	80300-1250	322	80300-4040	324	81110-1612	342
38115-08	338	80300-0225	320	80300-1255	322	80300-4045	324	81116-08	341
38115-12	338	80300-0230	320	80300-1260	322	80300-4050	324	81116-15	341
38115-16	338	80300-0235	320	80300-1270	322	80300-4055	324	81119-0806	342
38115-20	338	80300-0240	320	80300-1280	322	80300-4060	324	81119-1208	342
38115-24	338	80300-0245	320	80300-1290	322	80300-4830	325	81119-1612	342
38115-32	338	80300-0250	320	80300-1292	322	80300-4835	325	81124-02	341
38115-40	338	80300-0255	320	80300-1294	322	80300-4840	325	81124-04	341
38115-48	338	80300-0260	320	80300-1296	322	80300-4845	325	81124-06	341
38116-02	330	80300-0270	320	80300-1620	322	80300-4850	325	81124-08	341
38116-04	330	80300-0280	320	80300-1625	322	80300-4855	325	81124-12	341
38116-06	330	80300-0290	320	80300-1630	322	80300-4860	325	81300-06	326
38116-08	330	80300-0292	320	80300-1635	322	80300-4880	325	81300-08	326
38116-12	330	80300-0294	320	80300-1640	322	80300-4896	325	81300-12	327
38116-16	330	80300-0296	320	80300-1645	322	80300-6430	325	81300-16	327
38116-20	330	80300-0415	320	80300-1650	322	80300-6435	325	81300-0615	326
38116-24	330	80300-0420	320	80300-1655	322	80300-6440	325	81300-0620	326
38116-32	330	80300-0425	320	80300-1660	322	80300-6445	325	81300-0625	326
38116-40	330	80300-0430	320	80300-1670	322	80300-6450	325	81300-0630	326
38116-48	330	80300-0435	320	80300-1680	322	80300-6455	325	81300-0635	326
38119-0402	335	80300-0440	320	80300-1690	322	80300-6460	325	81300-0640	326
38119-0602	335	80300-0445	320	80300-1692	322	80300-129918	322	81300-0645	326
38119-0604	335	80300-0450	320	80300-1694	322	80300-129924	322	81300-0650	326
38119-0802	335	80300-0455	320	80300-1696	322	80300-209918	323	81300-0655	326
38119-0804	335	80300-0460	320	80300-2020	323	80300-249918	323	81300-0660	326
38119-0806	335	80300-0470	320	80300-2025	323	80300-329918	324	81300-0692	326
38119-1204	335	80300-0480	320	80300-2030	323	80300-329924	324	81300-0696	326
38119-1206	335	80300-0490	320	80300-2035	323	80300-329936	324	81300-0815	326
38119-1208	335	80300-0492	320	80300-2040	323	80300-329948	324	81300-0820	326
38119-1606	335	80300-0494	320	80300-2045	323	81100-02	341	81300-0825	326
38119-1608	335	80300-0496	320	80300-2050	323	81100-02	341	81300-0830	326
38119-1612	335	80300-0615	321	80300-2055	323	81100-06	341	81300-0835	326

ANDERSON METALS

NUMERICAL INDEX

Part#	Page	Part#	Page	Part#	Page	Part#	Page	Part#	Page
81300-0840	326	700065-08	235	700069-0602	238	700082-0504	234	700682-1006	242
81300-0845	326	700065-10	235	700069-0604	238	700082-0604	234	700682-1008	242
81300-0850	326	700065-12	235	700069-0606	238	700082-0605	234	700685-1006	242
81300-0855	326	700065-14	235	700069-0608	238	700082-0806	234	700686-0610	243
81300-0860	326	700066-0202	236	700069-0612	238	700082-1006	234	704014-02	226
81300-0892	326	700066-0302	236	700069-0704	238	700082-1008	234	704014-03	226
81300-0896	326	700066-0304	236	700069-0804	238	700084-040402	235	704014-04	226
81300-1215	327	700066-0402	236	700069-0806	238	700084-040406	235	704014-05	226
81300-1220	327	700066-0404	236	700069-0808	238	700084-060604	235	704014-06	226
81300-1225	327	700066-0406	236	700069-0812	238	700084-080804	235	704014-08	226
81300-1230	327	700066-0408	236	700069-1006	238	700084-080806	235	704014-10	226
81300-1235	327	700066-0502	236	700069-1008	238	700084-101006	235	704014-12	226
81300-1240	327	700066-0504	236	700069-1012	238	700085-0604	235	704018-04	226
81300-1245	327	700066-0506	236	700069-1208	238	700085-0806	235	704018-06	226
81300-1250	327	700066-0602	236	700069-1212	238	700085-1006	235	704018-08	226
81300-1255	327	700066-0604	236	700069-1412	238	700085-1008	235	704018-10	226
81300-1260	327	700066-0606	236	700070-0202	239	700086-0610	236	704018-12	226
81300-1620	327	700066-0608	236	700070-0302	239	700093-0404	240	704020-0604	226
81300-1625	327	700066-0612	236	700070-0402	239	700094-0404	240	704020-0806	226
81300-1630	327	700066-0804	236	700070-0404	239	700095-0402	239	704020-1008	226
81300-1635	327	700066-0806	236	700070-0406	239	700095-0404	239	704039-04	228
81300-1640	327	700066-0808	236	700070-0408	239	700095-0604	239	704039-06	228
81300-1645	327	700066-0812	236	700070-0502	239	700095-0606	239	704039-08	228
81300-1650	327	700066-1006	236	700070-0504	239	700095-0806	239	704039-10	228
81300-1655	327	700066-1008	236	700070-0602	239	700095-0808	239	704040-04	227
81300-1660	327	700066-1012	236	700070-0604	239	700095-1008	239	704040-05	227
83115-64	338	700066-1208	236	700070-0606	239	700097-0806	241	704040-06	227
700060-02	232	700066-1212	236	700070-0608	239	700261-02	233	704040-08	227
700060-03	232	700066-1408	236	700070-0612	239	700261-03	233	704040-10	227
700060-04	232	700066-1412	236	700070-0806	239	700261-04	233	704042-02	227
700060-05	232	700068-0202	237	700070-0808	239	700261-05	233	704042-03	227
700060-06	232	700068-0302	237	700070-1006	239	700261-06	233	704042-04	227
700060-07	232	700068-0304	237	700070-1008	239	700261-08	233	704042-05	227
700060-08	232	700068-0402	237	700070-1012	239	700261-10	233	704042-06	227
700060-10	232	700068-0404	237	700071-0302	239	700261-12	233	704042-08	227
700060-12	232	700068-0406	237	700071-0402	239	700261-14	233	704042-10	227
700060-14	232	700068-0408	237	700071-0404	239	700561-02	233	704042-12	227
700061-02	233	700068-0502	237	700071-0502	239	700561-03	233	704044-02	227
700061-03	233	700068-0504	237	700071-0504	239	700561-04	233	704044-03	227
700061-04	233	700068-0506	237	700071-0604	239	700561-05	233	704044-04	227
700061-05	233	700068-0508	237	700071-0606	239	700561-06	233	704044-05	227
700061-06	233	700068-0602	237	700071-0806	239	700561-08	233	704044-06	227
700061-07	233	700068-0604	237	700072-0202	240	700561-10	233	704044-08	227
700061-08	233	700068-0606	237	700072-0302	240	700661-04	242	704044-10	227
700061-10	233	700068-0608	237	700072-0402	240	700661-06	242	704045-0402	228
700061-12	233	700068-0612	237	700072-0404	240	700661-08	242	704045-0404	228
700061-14	233	700068-0704	237	700072-0502	240	700661-10	242	704045-0406	228
700062-02	234	700068-0706	237	700072-0504	240	700662-06	242	704045-0604	228
700062-03	234	700068-0804	237	700072-0602	240	700662-08	242	704045-0606	228
700062-04	234	700068-0806	237	700072-0604	240	700664-06	242	704045-0608	228
700062-05	234	700068-0808	237	700072-0606	240	700664-08	242	704045-0806	228
700062-06	234	700068-0812	237	700072-0806	240	700665-06	242	704045-0808	228
700062-07	234	700068-1006	237	700072-0808	240	700665-08	242	704045-1008	228
700062-08	234	700068-1008	237	700072-1008	240	700666-0606	242	704046-0302	228
700062-10	234	700068-1012	237	700072-1212	240	700666-0608	242	704046-0402	228
700062-12	234	700068-1208	237	700073-060604	241	700666-0806	242	704046-0404	228
700062-14	234	700068-1212	237	700073-060606	241	700666-0808	242	704046-0406	228
700064-02	234	700068-1408	237	700075-040202	240	700668-0604	243	704046-0408	228
700064-03	234	700068-1412	237	700076-0404	240	700668-0606	243	704046-0502	228
700064-04	234	700068-1416	237	700078-0602	240	700668-0608	243	704046-0504	228
700064-05	234	700069-0202	238	700078-0604	240	700668-0806	243	704046-0602	228
700064-06	234	700069-0302	238	700078-0606	240	700668-0808	243	704046-0604	228
700064-08	234	700069-0304	238	700078-1002	240	700669-0604	243	704046-0606	228
700064-10	234	700069-0402	238	700081-04	233	700669-0606	243	704046-0608	228
700064-14	234	700069-0404	238	700081-05	233	700669-0608	243	704046-0612	228
700065-02	235	700069-0406	238	700081-06	233	700669-0806	243	704046-0804	228
700065-03	235	700069-0408	238	700081-08	233	700669-0808	243	704046-0806	228
700065-04	235	700069-0502	238	700081-10	233	700670-0608	243	704046-0808	228
700065-05	235	700069-0504	238	700082-0402	234	700682-0604	242	704046-0812	228
700065-06	235	700069-0506	238	700082-0403	234	700682-0806	242	704046-1006	228

ANDERSON METALS

NUMERICAL INDEX

Part#	Page	Part#	Page	Part#	Page	Part#	Page	Part#	Page
704046-1008	228	704056-1008	227	706112-12	216	706124-12	218	707001-0606	220
704046-1012	228	704057-0806	230	706113-0224	216	706125-02	215	707001-0608	220
704046-1212	228	704059-060604	227	706113-0232	216	706125-04	215	707001-0612	220
704048-0202	229	704059-060608	227	706113-0240	216	706125-06	215	707001-0804	220
704048-0302	229	704059-080806	227	706113-0248	216	706125-08	215	707001-0806	220
704048-0304	229	704059-080810	227	706113-0424	216	706127-02	218	707001-0808	220
704048-0402	229	704059-101008	227	706113-0432	216	706127-04	218	707001-0812	220
704048-0404	229	704070-04	229	706113-0440	216	706127-06	218	707001-1006	220
704048-0406	229	704070-05	229	706113-0448	216	706127-08	218	707001-1008	220
704048-0408	229	704070-06	229	706113-0624	216	706127-12	218	707001-1012	220
704048-0502	229	704070-08	229	706113-0632	216	706130-02	219	707001-1206	220
704048-0504	229	704070-10	229	706114-02	214	706130-04	219	707001-1208	220
704048-0506	229	704075-0604	229	706114-04	214	706131-02	219	707001-1212	220
704048-0508	229	704075-0806	229	706114-06	214	706131-04	219	707001-1612	220
704048-0602	229	704448-0404	229	706114-08	214	706131-06	219	707001-1616	220
704048-0604	229	706100-02	212	706114-12	214	706131-08	219	707002-0202	221
704048-0606	229	706100-04	212	706115-02	214	706140-0402	215	707002-0204	221
704048-0608	229	706100-06	212	706115-04	214	706140-0604	215	707002-0302	221
704048-0612	229	706100-08	212	706115-06	214	706140-0806	215	707002-0304	221
704048-0804	229	706100-12	212	706115-08	214	706140-1208	215	707002-0402	221
704048-0806	229	706101-02	213	706115-12	214	706200-02	212	707002-0404	221
704048-0808	229	706101-04	213	706116-02	217	706200-04	212	707002-0406	221
704048-0812	229	706101-06	213	706116-04	217	706200-06	212	707002-0502	221
704048-1006	229	706101-08	213	706116-06	217	706200-08	212	707002-0504	221
704048-1008	229	706101-12	213	706116-08	217	706200-12	212	707002-0506	221
704048-1012	229	706102-02	213	706116-12	217	706201-02	213	707002-0604	221
704048-1208	229	706102-04	213	706118-02	218	706201-04	213	707002-0606	221
704048-1212	229	706102-06	213	706118-04	218	706201-06	213	707002-0608	221
704048-1412	229	706102-08	213	706118-06	218	706201-08	213	707002-0804	221
704049-0302	230	706102-12	213	706119-0402	217	706201-12	213	707002-0806	221
704049-0402	230	706103-02	213	706119-0602	217	706205-0604	212	707002-0808	221
704049-0404	230	706103-04	213	706119-0604	217	706206-060604	213	707002-1212	221
704049-0406	230	706103-06	213	706119-0802	217	706216-02	218	707010-0606	222
704049-0408	230	706103-08	213	706119-0804	217	706216-04	218	707010-0808	222
704049-0502	230	706103-12	213	706119-0806	217	706216-06	218	707014-03	222
704049-0504	230	706104-02	214	706119-1206	5	706216-08	218	707014-04	222
704049-0602	230	706104-04	214	706119-1208	5	706216-12	218	707014-05	222
704049-0604	230	706104-06	214	706119-1208	217	706227-02	218	707014-06	222
704049-0606	230	706104-08	214	706120-0202	217	706227-04	218	707014-08	222
704049-0608	230	706104-12	214	706120-0402	217	706227-06	218	707014-10	222
704049-0612	230	706107-02	212	706120-0404	217	706228-0402	218	707014-12	222
704049-0804	230	706107-04	212	706120-0602	217	706228-0406	218	707020-0402	222
704049-0806	230	706108-02	214	706120-0604	217	706228-0608	218	707020-0404	222
704049-0808	230	706108-04	214	706120-0606	217	706228-0806	218	707020-0502	222
704049-0812	230	706108-06	214	706120-0804	217	706230-02	219	707020-0504	222
704049-1006	230	706108-08	214	706120-0806	217	706230-04	219	707020-0602	222
704049-1008	230	706108-12	214	706120-0808	217	706230-06	219	707020-0604	222
704049-1012	230	706109-02	214	706120-1208	217	706230-08	219	707020-0606	222
704049-1208	230	706109-04	214	706120-1212	217	706230-08	219	707020-0608	222
704049-1212	230	706109-06	214	706121-02	215	706232-02	219	707020-0804	222
704050-0402	231	706109-08	214	706121-04	215	706232-04	219	707020-0806	222
704050-0404	231	706109-12	214	706121-06	215	706232-06	219	707020-0808	222
704050-0604	231	706110-0402	215	706121-08	215	706235-0402	219	707024-04	222
704050-0606	231	706110-0602	215	706121-12	215	706235-0602	219	707024-05	222
704050-0608	231	706110-0604	215	706122-02	216	706235-0604	219	707024-06	222
704050-0612	231	706110-0802	215	706122-04	216	706235-0806	219	707042-06	223
704050-0806	231	706110-0804	215	706122-06	216	706303-04	213	707042-08	223
704050-0808	231	706110-0806	215	706122-08	216	707001-0202	220	707042-10	223
704050-0812	231	706110-1202	215	706122-12	216	707001-0204	220	707042-12	223
704050-1008	231	706110-1204	215	706122-16	216	707001-0302	220	707046-0612	223
704050-1012	231	706110-1206	215	706123-0402	217	707001-0304	220	707046-0812	223
704050-1212	231	706110-1208	215	706123-0602	217	707001-0402	220	707046-1012	223
704055-04	230	706110-1604	215	706123-0604	217	707001-0404	220	707046-1212	223
704055-05	230	706110-1606	215	706123-0804	217	707001-0406	220	707048-0612	223
704055-08	230	706110-1608	215	706123-0806	217	707001-0408	220	707048-0812	223
704055-10	230	706110-1612	215	706123-1208	217	707001-0502	220	707048-1012	223
704056-0604	227	706112-02	216	706124-02	218	707001-0504	220	707048-1212	223
704056-0804	227	706112-04	216	706124-04	218	707001-0506	220	707201-0402	219
704056-0806	227	706112-06	216	706124-06	218	707001-0602	220	707201-0404	219
704056-1006	227	706112-08	216	706124-08	218	707001-0604	220	707201-0604	219

ANDERSON METALS

NUMERICAL INDEX

Part#	Page	Part#	Page	Part#	Page	Part#	Page	Part#	Page
707201-0606	219	738100-40	329	738106-060604	333	738110-1606	337	738119-2408	335
707201-0608	219	738100-48	329	738106-080804	333	738110-1608	337	738119-2412	335
707201-0808	219	738100-64	329	738106-080806	333	738110-1612	337	738119-2416	335
707210-0404	219	738101-02	332	738106-080812	333	738110-2004	337	738119-2420	335
707401-1208	224	738101-04	332	738106-120808	333	738110-2006	337	738119-3212	335
707401-1212	224	738101-06	332	738106-120812	333	738110-2008	337	738119-3216	335
707402-12	223	738101-08	332	738106-121204	333	738110-2012	337	738119-3220	335
707403-12	223	738101-12	332	738106-121206	333	738110-2016	337	738119-3224	335
707404-12	225	738101-16	332	738106-121208	333	738110-2404	337	738119-4032	335
707406-12	225	738101-20	332	738106-160808	333	738110-2406	337	738124-04	331
707407-12	225	738101-24	332	738106-160812	333	738110-2408	337	738124-06	331
707411-1202	224	738101-32	332	738106-161604	333	738110-2412	337	738124-08	331
707420-1204	224	738101-40	332	738106-161606	333	738110-2416	337	738124-12	331
707420-1206	224	738101-48	332	738106-161608	333	738110-2420	337	738124-16	331
707420-1208	224	738101-64	332	738106-161612	333	738110-3208	337	738124-20	331
707461-12	225	738102-04	331	738106-202008	333	738110-3212	337	738124-24	331
707478-1206	225	738102-06	331	738106-202012	333	738110-3216	337	738124-32	331
707478-1208	225	738102-08	331	738106-202016	333	738110-3220	337	738150-08	340
707478-120808	225	738102-12	331	738106-241212	333	738110-3224	337	738150-16	340
707478-121208	225	738102-16	331	738106-323208	333	738110-4016	337	738150-20	340
707480-1204	224	738102-20	331	738106-323216	333	738110-4020	337	738150-24	340
707480-1206	224	738102-24	331	738106-323224	333	738110-4024	337	738150-32	340
707480-1208	224	738102-32	331	738106-484832	333	738110-4032	337	738150-40	340
707480-1212	224	738103-02	334	738107-02	330	738110-4824	337	738150-48	340
707482-1208	224	738103-04	334	738107-04	330	738110-4832	337	738150-64	340
707482-1212	224	738103-06	334	738107-06	330	738110-4840	337	738151-08	340
707484-121208	224	738103-08	334	738107-08	330	738110-6432	337	738151-12	340
707486-1212	224	738103-12	334	738107-12	330	738110-6440	337	738151-16	340
707486-121208	224	738103-16	334	738107-16	330	738110-6448	337	738151-24	340
709101-0402	244	738103-20	334	738107-20	330	738111-04	338	738151-32	340
709101-0404	244	738103-24	334	738107-24	330	738111-06	338	760001	243
709101-0604	244	738103-32	334	738107-32	330	738111-08	338	760008	243
709103-0402	244	738103-40	334	738107-40	330	738111-12	338	780111-02	338
709103-0404	244	738103-48	334	738107-48	330	738111-16	338	780114-40	339
709103-0502	244	738103-64	334	738107-64	330	738111-20	338	780114-48	339
709103-0602	244	738104-02	336	738108-02	336	738111-24	338	780124-04	342
709103-0604	244	738104-04	336	738108-04	336	738111-32	338	780150-12	340
709104-0404	244	738104-06	336	738108-06	336	738114-02	339	780150-80	340
709106-04	244	738104-08	336	738108-08	336	738114-04	339	780151-20	340
709106-05	244	738104-12	336	738108-12	336	738114-06	339	781100-06	341
709106-06	244	738104-16	336	738108-16	336	738114-08	339	781100-08	341
709108-04	245	738104-20	336	738108-20	336	738114-12	339	781100-12	341
709110-04	244	738104-24	336	738108-24	336	738114-16	339	781100-16	341
709110-06	244	738104-32	336	738108-32	336	738114-20	339	781103-06	341
709134-02	244	738104-40	336	738108-40	336	738114-24	339	781103-08	341
709134-04	244	738104-48	336	738108-48	336	738114-32	339	781104-08	342
709135-02	244	738104-64	336	738108-64	336	738116-02	330	781107-08	342
709135-04	244	738105-0402	329	738109-02	338	738116-04	330	781109-12	342
709178-0406	245	738105-0602	329	738109-04	338	738116-06	330	781110-0604	342
709178-0410	245	738105-0604	329	738109-06	338	738116-08	330	781110-0806	342
709178-0606	245	738105-0804	329	738109-08	338	738116-12	330	781110-1208	342
709190	245	738105-0806	329	738109-12	338	738116-16	330	781116-06	341
709195-04	245	738105-1204	329	738109-16	338	738116-20	330	781116-08	341
709195-05	245	738105-1206	329	738109-20	338	738116-24	330	781116-12	341
709195-06	245	738105-1208	329	738109-24	338	738116-32	330	CVSE1F-12D-1/8TAP* ..81	
709199-04	245	738105-1604	329	738109-32	338	738116-40	330		
730097-0604	241	738105-1608	329	738109-40	338	738116-48	330		
734822-0606	241	738105-1612	329	738109-48	338	738119-0402	335		
737422-1204	241	738105-2012	329	738109-64	338	738119-0602	335		
737422-1206	241	738105-2016	329	738110-0402	337	738119-0604	335		
737469-0612	241	738105-2408	329	738110-0602	337	738119-0804	335		
738100-02	329	738105-2412	329	738110-0604	337	738119-0806	335		
738100-04	329	738105-2416	329	738110-0802	337	738119-1204	335		
738100-06	329	738105-2420	329	738110-0804	337	738119-1206	335		
738100-08	329	738105-3216	329	738110-0806	337	738119-1208	335		
738100-12	329	738105-3220	329	738110-1202	337	738119-1608	335		
738100-16	329	738105-3224	329	738110-1204	337	738119-1612	335		
738100-20	329	738105-4032	329	738110-1206	337	738119-2008	335		
738100-24	329	738105-4832	329	738110-1208	337	738119-2012	335		
738100-32	329	738106-040402	333	738110-1604	337	738119-2016	335		

CHAMPION BRASS

NUMERICAL INDEX

Part#	Page	Part#	Page	Part#	Page	Part#	Page
1W-66	200	41S-3	96	49I-4A	99	60TF-3	119
1W-86	200	41S-4	96	49I-4B	99	61A-2	106
1W-88	200	41S-5	96	49I-5A	99	61A-3	106
04MF-04MI	104	41S-6	96	49I-5B	99	61A-4	106
5A-12A	58	41S-7	96	49I-6A	99	61A-5	106
5A-12B	58	41S-8	96	49I-6B	99	61A-6	106
5A-12C	58	41S-10	96	49I-6C	99	61A-7	106
5A-12D	59	41S-12	96	49I-8C	99	61A-12	106
5A-12E	59	41S-67	96	49I-8D	99	61A-14	106
5AS-12D	58	41ISL-3	96	49I-10C	99	61AH-8	106
5AS-12E	58	41ISL-4	96	49I-10D	99	61AH-10	106
06MF-06MI	104	42D	194	49NV	199	61NAB-3	177
18A-12B	60	42I-2	97	49PC	196	61NAB-4	177
18A-12C	60	42I-3	97	50I-3A	100	61NAB-6	177
18A-12D	60	42I-4	97	50I-4A	100	61NAB-8	177
18A-12E	60	42I-5	97	50I-5A	100	61NAB-10	177
18AV-12E	66	42I-6	97	50I-6B	100	61NAB-12	177
19A-12C	60	42I-8	97	50PC	196	61TF-2	119
19A-12D	60	42IF-2	97	51I-3A	101	61TF-2.5	119
19A-12F	60	42IF-3	97	51I-4A	101	62A-22	107
19AF-12DE	60	42IF-4	97	51I-5A	101	62A-33	107
19AF-12E	60	42IF-5	97	51I-6B	101	62A-42	107
20A-12C	59	42IF-6	97	52I-3A	101	62A-43	107
20A-12D	59	42IF-8	97	54I-3A	101	62A-44	107
20A-12E	59	42IFR-32	97	54I-4A	101	62A-54	107
20A-12ED	59	42IFR-43	97	54I-5A	101	62A-55	107
22A-12	58	42IFR-53	97	57CC	196	62A-64	107
22AS-12E	58	42IFR-54	97	57SAE	197	62A-65	107
23A-12	60	42IFR-64	97	58CC	196	62A-66	107
23A-16	60	42IFR-65	97	58SAE	197	62A-77	107
24AS-12	58	43D	194	58SD	202	62A-86	107
24AV-12	66	44D	194	59A-8	177	62A-88	107
27CC	196	44I-3	100	59A-10	177	62A-106	107
27SAE	197	44I-4	100	59A-12	177	62A-108	107
28CC	196	44I-5	100	60A-2	106	62A-1010	107
28SAE	197	44I-6	100	60A-3	106	62A-1212	107
29MBS-2	41	44I-8	100	60A-4	106	62A-1414	107
29MBS-2L	41	46I-3A	98	60A-5	106	62BH-4	116
29MBS-4	41	46I-4A	98	60A-6	106	62BH-6	116
29MBS-6	41	46I-5A	98	60A-7	106	62MBH-4	41
29MBS-42	41	46I-6B	98	60A-8	106	62NAB-4	177
29MBS-43	41	46I-8C	98	60A-10	106	62NAB-6	177
29MBS-62	41	46WH-612	62	60A-12	106	62NAB-8	177
29MBS-64	41	47I-34	103	60A-14	106	62NAB-10	177
29MBS-250	41	47I-35	103	60AE-2	120	62NAB-12	177
30CC	196	47I-43	103	60AE-3	120	62NABH-3	177
31NV	199	47I-45	103	60AE-4	120	62NABH-4	177
31PC	196	47I-45-HEX	103	60AE-5	120	62NABH-6	177
32NV	199	47I-47-HEX	103	60AE-6	120	62NABH-8	177
32PC	196	47I-55-HEX	103	60AE-8	120	62NABH-10	177
32SD	202	47I-56	103	60AE-10	120	62TF-2	119
37D	194	47I-65	103	60AE-12	120	62TF-2.5	119
38D	194	48I-2A	98	60AP-4	120	63A-2A	116
40D	194	48I-3A	98	60AP-5	120	63A-4A	116
40PC	196	48I-4A	98	60AP-6	120	63A-6B	116
41AS-6	70	48I-4B	98	60AP-8	120	63NAB-4	177
41AS-8	70	48I-5A	98	60AP-10	120	63NAB-6	177
41AS-10	70	48I-5B	98	60NAB-3	177	64A-22	108
41D	194	48I-6A	98	60NAB-4	177	64A-33	108
41IB-2	96	48I-6B	98	60NAB-6	177	64A-44	108
41IB-3	96	48I-6C	98	60NAB-8	177	64A-55	108
41IB-4	96	48I-8B	98	60NAB-10	177	64A-66	108
41IB-5	96	48I-8C	98	60NAB-12	177	64A-77	108
41IB-6	96	48I-8D	98	60SA-2	120	64A-88	108
41IB-8	96	48I-10D	98	60SA-3	120	64A-442	108
41IP-3	100	48I-12E	98	60SA-4	120	64A-446	108
41IP-4	100	48NV	199	60SA-6	120	64A-554	108
41IP-5	100	48PC	196	60SA-8	120	64A-644	108
41IP-6	100	49I-2A	99	60TF-2	119	64A-664	108
41IS-2	96	49I-3A	99	60TF-2.5	119	64A-884	108

CHAMPION BRASS

NUMERICAL INDEX

Part#	Page	Part#	Page	Part#	Page	Part#	Page
64A-886	108	68A-4A	110	69A-6A	111	71A-6C	113
64A-1212	108	68A-4B	110	69A-6B	111	71A-8C	113
64A-1414	108	68A-4C	110	69A-6C	111	71A-10D	113
64A-10106	108	68A-4D	110	69A-6D	111	71A-10D	113
64A-10108	108	68A-5A	110	69A-6E	111	71A-12D	113
64AF-44	108	68A-5B	110	69A-7B	111	71NAB-4A	180
64AF-66	108	68A-5C	110	69A-8B	111	71NAB-4B	180
64NAB-4	178	68A-5D	110	69A-8C	111	71NAB-6B	180
64NAB-6	178	68A-6A	110	69A-8D	111	71NAB-6C	180
64NAB-8	178	68A-6B	110	69A-8E	111	71NAB-8C	180
64NAB-10	178	68A-6C	110	69A-10C	111	71NAB-8D	180
64NAB-664	178	68A-6D	110	69A-10D	112	71NAB-10D	180
64NAB-886	178	68A-6E	110	69A-10E	112	71NAB-64B	180
65A-22	108	68A-7B	110	69A-12D	112	72A-3A	114
65A-33	108	68A-7C	110	69A-12E	112	72A-4A	114
65A-55	108	68A-8B	110	69A-14E	112	72A-4B	114
65A-64	109	68A-8C	110	69AF-3A	111	72A-5A	114
65A-66	108	68A-8D	110	69AF-4A	111	72A-5B	114
65A-86	109	68A-8E	110	69AF-4B	111	72A-6A	114
65A-88	108	68A-10C	110	69AF-5A	111	72A-6B	114
65A-106	109	68A-10D	110	69AF-5B	111	72A-6C	114
65A-108	109	68A-10E	110	69AF-6B	111	72A-8C	114
65A-1010	108	68A-12D	110	69AF-6C	111	72A-8D	114
65A-1212	108	68A-12E	110	69NAB-3A	179	72A-10D	114
65A-1414	108	68A-14D	110	69NAB-3B	179	72A-12D	114
65AF-44	108	68A-14E	110	69NAB-4A	179	72A-12E	114
65NAB-4	178	68ATS-4A	117	69NAB-4B	179	72A-22	114
65NAB-6	178	68ATS-4B	117	69NAB-4C	179	72nab-3a	180
65NAB-8	178	68ATS-6B	117	69NAB-6A	179	72NAB-4A	180
65NAB-10	178	68ATS-6C	117	69NAB-6B	179	72NAB-4B	180
66A-2A	109	68ATS-8C	117	69NAB-6C	179	72NAB-6A	180
66A-3A	109	68ATS-8D	117	69NAB-6D	179	72NAB-6B	180
66A-3B	109	68CC	196	69NAB-8B	179	72NAB-6C	180
66A-4A	109	68MB-4A	41	69NAB-8C	179	72NAB-8B	180
66A-4B	109	68MB-4B	41	69NAB-8D	179	72NAB-8C	180
66A-4C	109	68NAB-3A	179	69NAB-10C	179	72NAB-8D	180
66A-4D	109	68NAB-3B	179	69NAB-10D	179	72NAB-10D	180
66A-5A	109	68NAB-3X	179	69NAB-10E	179	72NAB-64B	180
66A-5B	109	68NAB-4A	179	69NAB-12D	179	72NAB-86C	180
66A-5C	109	68NAB-4B	179	69NAB-12E	179	76A-4A	114
66A-6A	109	68NAB-4C	179	69TF-2.5A	119	76A-4B	114
66A-6B	109	68NAB-4X	179	69TF-2A	119	76A-6B	114
66A-6C	109	68NAB-6A	179	69TF-2X	119	76PC	196
66A-6D	109	68NAB-6B	179	70A-2A	112	77A-4A	115
66A-6E	109	68NAB-6C	179	70A-3A	112	77PC	196
66A-8B	109	68NAB-6D	179	70A-4A	112	77SD	203
66A-8C	109	68NAB-8B	179	70A-4B	112	78PC	196
66A-8D	109	68NAB-8C	179	70A-4C	112	79NAB-4A	181
66A-8E	109	68NAB-8D	179	70A-5A	112	79NAB-4B	181
66A-10C	109	68NAB-8E	179	70A-6A	112	79NAB-6A	181
66A-10D	109	68NAB-10C	179	70A-6B	112	79NAB-6B	181
66A-10E	109	68NAB-10D	179	70A-6C	112	79NAB-6C	181
66A-12D	109	68NAB-10E	179	70A-6D	112	79NAB-6D	181
66A-12E	109	68NAB-12C	179	70A-8B	112	79NAB-8B	181
66A-14E	109	68NAB-12D	179	70A-8C	112	79NAB-8C	181
66AS-610	109	68NAB-12E	179	70A-8D	112	79NAB-8D	181
66NAB-4A	178	68SAE	197	70A-8E	112	79NAB-10C	181
66NAB-4B	178	68TF-2.5A	119	70A-10C	112	79NAB-10D	181
66NAB-6A	178	68TF-2.5X	119	70A-10D	112	79NAB-12D	181
66NAB-6B	178	68TF-2A	119	70A-10E	112	81LB-4	118
66NAB-6C	178	68TF-2X	119	70A-12D	112	94I-3A	100
66NAB-8C	178	69A-2A	111	70A-12E	112	94I-4A	100
66NAB-8D	178	69A-2X	111	71A-2A	113	94I-5A	100
66NAB-10C	178	69A-3B	111	71A-3A	113	94I-5B	100
66NAB-10D	178	69A-4B	111	71A-4A	113	94I-6B	100
67SAE	197	69A-4C	111	71A-4B	113	94I-8C	100
68A-2A	110	69A-4D	111	71A-5A	113	94I-10D	100
68A-2X	110	69A-5A	111	71A-5B	113	97V-10P	200
68A-3A	110	69A-5B	111	71A-6A	113	100-45A-A	2
68A-3B	110	69A-5C	111	71A-6B	113	100-45A-B	2

CHAMPION BRASS

NUMERICAL INDEX

Part#	Page	Part#	Page	Part#	Page	Part#	Page
100A-A	2	108MP	199	113A-D15	11	113RB-E3	322
100A-B	2	108SAE	198	113A-D25	11	113RB-E4	322
100A-C	2	108SD-2	204	113A-E2	11	113RB-E5	322
100A-D	2	108SD-4	204	113A-E15	11	113RB-E6	322
100A-DC	2	108SD-6	204	113CC	198	113RB-E7	322
100A-E	2	109A-A	9	113RB-A2	320	113RB-E8	322
100AF-A	2	109A-B	9	113RB-A3	320	113RB-E9	322
100AF-B	2	109A-C	9	113RB-A4	320	113RB-E10	322
100AF-BA	2	109A-D	9	113RB-A5	320	113RB-E11	322
100AF-C	2	109A-E	9	113RB-A6	320	113RB-E12	322
100AF-CB	2	109A-F	9	113RB-A7	320	113RB-E15	322
100AF-D	2	109AS-D	9	113RB-A8	320	113RB-E25	322
100AF-E	2	109AS-E	9	113RB-A9	320	113RB-E35	322
100C-L	205	109CS-A	9	113RB-A10	320	113RB-E45	322
100X-45-D	2	109CS-B	9	113RB-A11	320	113RB-E55	322
101A-A	3	109CS-C	9	113RB-A12	320	114SD	205
101A-B	3	109CS-D	9	113RB-A15	320	115SAE	199
101A-C	3	110A-BA	8	113RB-A25	320	116A-A	6
101A-D	3	110A-CA	8	113RB-A35	320	116A-AMB	6
101A-E	3	110A-CB	8	113RB-A45	320	116A-B	6
101AF-A	3	110A-DA	8	113RB-A55	320	116A-C	6
101AF-B	3	110A-DB	8	113RB-B2	320	116A-E	6
101AF-C	3	110A-DC	8	113RB-B3	320	116AF-A	6
101AF-D	3	110A-EA	8	113RB-B4	320	116AF-B	6
101AF-E	3	110A-EB	8	113RB-B5	320	116AF-C	6
101AF-F	3	110A-EC	8	113RB-B6	320	116AF-D	6
101CP	198	110A-ED	8	113RB-B7	320	116AF-E	6
101CP-4	198	110A-FB	8	113RB-B8	320	116AH-C	6
102A-A	3	110A-FC	8	113RB-B9	320	116AH-D	6
102A-B	3	110A-FD	8	113RB-B10	320	116AM-A	17
102A-C	3	110A-FE	8	113RB-B11	320	116AM-B	17
102A-D	3	110AH-BA	8	113RB-B12	320	116AM-BA	17
102A-E	3	110AH-CB	8	113RB-B15	320	116AM-C	17
102AF-A	4	110AH-DA	8	113RB-B25	320	116AM-CB	17
102AF-B	4	110AH-DB	8	113RB-B35	320	116AM-D	17
102AF-C	4	110AH-DC	8	113RB-B45	320	116AM-DC	17
102AF-D	4	110AH-ED	8	113RB-B55	320	117A-A	9
102-C	198	110C-J	204	113RB-C2	321	117A-B	9
103-4CC	198	110C-N	204	113RB-C3	321	117A-C	9
103A-A	4	110FB-CB	7	113RB-C4	321	119A-BA	5
103A-B	4	110FB-DC	7	113RB-C5	321	119A-CB	5
103A-C	4	110FB-ED	7	113RB-C6	321	119A-DA	5
103A-D	4	110MP	199	113RB-C7	321	119A-DB	5
103A-E	4	110SAE	199	113RB-C8	321	119A-DC	5
103AH-A	4	111A-A	10	113RB-C9	321	119A-EC	5
103AH-B	4	111A-B	10	113RB-C10	321	119A-ED	5
103AH-C	4	111A-C	10	113RB-C11	321	119AH-BA	5
103AH-D	4	111A-D	10	113RB-C12	321	119AH-CB	5
103AH-E	4	112A-A	11	113RB-C15	321	119AH-DB	5
103AH-F	4	112A-B	11	113RB-C25	321	119AH-DC	5
103CC	198	112A-C	11	113RB-C35	321	120A-AA	16
103SAE	199	112A-D	11	113RB-C45	321	120A-BA	16
103SD-2	202	112A-E	11	113RB-C55	321	120A-BB	16
103SD-4	202	112RB-A	320	113RB-D2	321	120A-CA	16
103SD-6	202	112RB-B	320	113RB-D3	321	120A-CB	16
104A-A	5	112RB-C	321	113RB-D4	321	120A-CC	16
104A-B	5	112RB-D	321	113RB-D5	321	120A-DB	16
104A-C	5	112RB-E	322	113RB-D6	321	120A-DD	16
104A-D	5	113A-A2	11	113RB-D7	321	120A-DC	16
104SAE	198	113A-A3	11	113RB-D8	321	120A-ED	16
105C-L	205	113A-A15	11	113RB-D9	321	120AH-AA	16
105SAE	198	113A-A25	11	113RB-D10	321	120AH-BA	16
106CC	198	113A-B2	11	113RB-D11	321	120AH-BB	16
107CC	198	113A-B3	11	113RB-D12	321	120AH-BB-BW	7
108A-A	6	113A-B15	11	113RB-D15	321	120AH-CB	16
108A-B	6	113A-B25	11	113RB-D25	321	120AH-CC	16
108A-C	6	113A-C2	11	113RB-D35	321	120AH-CC-BW	7
108A-D	6	113A-C3	11	113RB-D45	321	120AH-DC	16
108A-E	6	113A-C15	11	113RB-D55	321	120AH-DD	16
108A-F	6	113A-D2	11	113RB-E2	322	120C-L	205

CHAMPION BRASS

NUMERICAL INDEX

Part#	Page	Part#	Page	Part#	Page	Part#	Page
121A-A	10	129A-C	19	201A-6B	24	201GH-16FXL	64
121A-B	10	129A-C-SN	19	201A-6C	24	202D	195
121A-C	10	129A-C-STL	19	201A-6D	24	202GHS-88	64
121A-D	10	129A-D	19	201A-6E	24	202GHS-1010	64
121A-E	10	129A-E	19	201A-7B	24	202GHS-1212	64
121AS-A	10	129A-F	19	201A-8A	24	202GHSH-8XL	64
121AS-B	10	129AS-A	19	201A-8B	25	202GHSH-10XL	64
121AS-C	10	129AS-B	19	201A-8C	25	202GHSH-12XL	64
121AS-D	10	129AS-B-SN	19	201A-8D	25	202GHSH-66	63
121AS-E	10	129AS-B-STL	19	201A-8E	25	202GHSH-88	63
122A-A	12	129FC-1	19	201A-10C	25	202GHSH-1010	63
122A-B	12	129FC-1-SN	19	201A-10D	25	202GHSH-1212	63
122A-C	12	129FC-2	21	201A-10E	25	202GHSH-1616	63
122A-D	12	129FC-2-STL	21	201A-12C	25	203CC	198
122A-E	12	129FC-3	20	201A-12D	25	203SAE	199
122AH-A	12	129FC-3-SN	20	201A-12E	25	204SAE	199
122AH-B	12	129FC-3-STL	20	201A-12F	25	205AB-54	38
122AH-C	12	129FC-3-STL-XL	20	201A-16D	25	205AB-55	38
122AH-D	12	129FC-4	19	201A-16E	25	205AB-56	38
122AH-E	12	129FC-4-SN	19	201A-16F	25	205AB-66	38
122AS-2A	32	129FC-4-SN-XL	19	201A-20E	25	205AB-90-44	38
122AS-4A	32	129FC-4-STL	19	201A-20F	25	205AB-90-45	38
122AS-4B	32	129FC-4-STL-XL	19	201AB-3A	37	205AB-90-55	38
122AS-6B	32	129FC-4-XL	19	201AB-4A	37	205AB-90-66	38
122AS-6C	32	129FC-5-STL	21	201AB-4B	37	209A-2A	28
122AS-6D	32	129fc-6	20	201AB-5A	37	209A-2B	28
122AS-8C	32	129FC-7	20	201AB-5B	37	209A-3A	28
122AS-8D	32	129fc-7-sn	20	201AB-6A	37	209A-3B	28
122AS-12E	32	129FC-8	20	201AB-6B	37	209A-4A	28
122AS-22UN	32	129FC-8-SN	20	201AB-6C	37	209A-4B	28
122AS-44UN	32	133C-5J	196	201AB-8B	37	209A-4C	28
122LWA-B	40	143CP	198	201AB-8C	37	209A-4D	28
122LWA-C	40	161A-3	120	201AB-8D	37	209A-5A	28
122RWA-A	40	161A-4	120	201AB-10C	37	209A-5B	28
122RWA-B	40	161A-5	120	201AB-10D	37	209A-5C	28
122RWA-C	40	161A-6	120	201AB-12D	37	209A-6A	28
122RWA-UNION	40	161A-8	120	201AB-12E	37	209A-6B	28
123A-BA	13	161A-10	120	201AB-16E	37	209A-6C	28
123A-CA	13	161A-12	120	201AS-3A	26	209A-6D	28
123A-CB	13	161SAE	197	201AS-3B	26	209A-6E	28
123A-DB	13	163SAE	197	201AS-4A	26	209A-8B	28
123A-DC	13	164SAE	197	201AS-4B	26	209A-8C	28
123AH-BA	13	181A-2	118	201AS-6B	26	209A-8D	28
123AH-CA	13	181A-3	118	201AS-6C	26	209A-8E	28
123AH-CB	13	181A-4	118	201AS-8C	26	209A-10C	28
123AH-DB	13	181A-5	118	201AS-8D	26	209A-10D	28
123AH-DC	13	188A-2A	118	201AS-12E	26	209A-10E	28
123AH-ED	13	188A-3A	118	201AS-16F	26	209A-12D	28
124A-A	14	188A-4A	118	201BF-34	33	209A-12E	28
124A-B	14	188A-5A	118	201BF-44	33	209A-16E	28
124A-C	14	189A-2A	118	201BF-46	33	209A-16F	28
124A-D	14	189A-3A	118	201BF-55	33	209AF-4B	28
124A-E	14	189A-4A	118	201BF-66	33	209AF-6B	28
124AF-C	14	200C-N	205	201BF-68	33	209AF-6C	28
127A-A	15	200D	195	201BF-88	33	209AF-8C	28
127A-B	15	200DH	195	201D	195	209AF-8D	28
127A-C	15	201A-2A	24	201DH	195	209AFSG-2A	29
127A-D	15	201A-2B	24	201GH-6E	64	209AFSG-3A	29
127A-E	15	201A-3A	24	201GH-6EX	63	209AFSG-3B	29
127AF-A	15	201A-3B	24	201GH-8E	64	209AFSG-4A	29
127AF-C	15	201A-4A	24	201GH-8EX	63	209AFSG-4B	29
127BT-1	102	201A-4B	24	201GH-8EXL	64	209AFSG-4C	29
127BT-3	102	201A-4C	24	201GH-10E	64	209AFSG-5B	29
127BT-4	102	201A-4D	24	201GH-10EX	63	209AFSG-6B	29
128A-BA	7	201A-4X	24	201GH-10EXL	64	209AFSG-6C	29
128A-CB	7	201A-5A	24	201GH-12E	64	209AFSG-6D	29
129A-A	19	201A-5B	24	201GH-12EX	63	209AFSG-8C	29
129A-B	19	201A-5C	24	201GH-12EXL	64	209AFSG-8D	29
129A-B-SN	19	201A-5D	24	201GH-16EX	63	209AFSG-8E	29
129A-B-STL	19	201A-6A	24	201GH-16FX	63	209AFSG-10E	29

CHAMPION BRASS

NUMERICAL INDEX

Part#	Page	Part#	Page	Part#	Page	Part#	Page
209AFSG-12E	29	260PF-4	129	262PPC-14MM	160	264PF-4	126
209AS-2A	32	260PF-5	129	262PPC-16MM	160	264PF-5	126
209AS-3A	32	260PF-6	129	262PPC-42	155	264PF-6	126
209AS-3B	32	260PF-8	129	262PPC-42.5	155	264PF-8	126
209AS-4A	32	260PFB-2	129	262PPC-54	155	264PF-664	126
209AS-4B	32	260PFB-3	129	262PPC-64	155	264PP-2	132
209AS-4C	32	260PFB-4	129	262PPC-65	155	264PP-2.5	132
209AS-5B	32	260PFB-6	129	262PPC-86	155	264PP-3	132
209AS-5C	32	261A-4	182	262PPCDOT-2.5	171	264PP-4	132
209AS-6B	32	261A-6	182	262PPCDOT-3	171	264PP-6	132
209AS-6C	32	261A-8	182	262PPCDOT-4	171	264PP-8	132
209AS-6D	32	261A-10	182	262PPCDOT-6	171	264PPC-2	155
209AS-8C	32	261A-12	182	262PPCDOT-8	171	264PPC-2.5	155
209AS-8D	32	261PF-4	125	262PPCDOT-10	171	264PPC-2.54	155
209AS-12E	32	261PF-5	125	262PPCDOT-12	171	264PPC-3	155
209ASF-33	34	261PF-6	125	262PPCDOT-42.5	171	264PPC-4	155
209ASF-44	34	261PFB-2	128	262PPCDOT-64	171	264PPC-4MM	160
209ASF-46	34	261PFB-3	128	262PPCDOT-86	171	264PPC-5	155
209ASF-55	34	261PFB-4	128	262PPDOT-2	164	264PPC-6	155
209ASF-56	34	261PFB-5	128	262PPDOT-2.5	164	264PPC-6MM	160
209ASF-66	34	261PFB-6	128	262PPDOT-3	164	264PPC-8	155
209ASF-68	34	261PFB-8	128	262PPDOT-4	164	264PPC-8MM	160
209ASF-88	34	261PFN-2	129	262PPDOT-5	164	264PPC-10MM	160
209ASF-1212	34	261PFN-4	129	262PPDOT-6	164	264PPC-12MM	160
209ASJ-46	35	261PFN-5	129	262PPDOT-8	164	264PPC-14MM	160
209ASJ-56	35	261PFN-6	129	262PPDOT-10	164	264PPC-16MM	160
209ASJ-1212	35	261PFN-8	129	262PPDOT-12	164	264PPC-42.5	155
209GHS-4E	64	262A-4	182	262PPNI-2	138	264PPC-46	155
209GHS-6E	64	262A-6	182	262PPNI-2.5	138	264PPC-54	155
209GHS-6EH	63	262A-8	182	262PPNI-3MM	143	264PPC-64	155
209GHS-8E	64	262A-10	182	262PPNI-4	138	264PPC-65	155
209GHS-8EH	63	262A-12	182	262PPNI-4MM	143	264PPC-86	155
209GHS-8EHL	64	262BHPPCDOT-2.5	175	262PPNI-5	138	264PPCDOT-2.5	171
209GHS-10E	64	262BHPPCDOT-4	175	262PPNI-5MM	143	264PPCDOT-3	171
209GHS-10EH	63	262BHPPCDOT-6	175	262PPNI-6	138	264PPCDOT-4	171
209GHS-10EHL	64	262BHPPCDOT-8	175	262PPNI-6MM	143	264PPCDOT-6	171
209GHS-12E	64	262BHPPCDOT-10	175	262PPNI-6MMX4MM	143	264PPCDOT-8	171
209GHS-12EH	63	262BHPPDOT-4	169	262PPNI-8	138	264PPCDOT-10	171
209GHS-12EHL	64	262BHPPDOT-6	169	262PPNI-8MM	143	264PPCDOT-446	171
209GHS-16EH	63	262BHPPDOT-8	169	262PPNI-8MMX6MM	143	264PPCDOT-664	171
209GHS-16FH	63	262BHPPDOT-10	169	262PPNI-10MM	143	264PPCDOT-886	171
209GHS-16FHXL	64	262BHPP-SS-6	153	262PPNI-10MMX8MM	143	264PPDOT-2.5	164
209LWA-3	39	262PF-2	125	262PPNI-12MM	143	264PPDOT-4	164
209LWA-4	39	262PF-3	125	262PPNI-12MMX10MM	143	264PPDOT-6	164
209LWA-5	39	262PF-4	125	262PPNI-14MM	143	264PPDOT-8	164
209LWA-6	39	262PF-5	125	262PPNI-42.5	138	264PPDOT-10	164
209LWA-NUT	40	262PF-6	125	262PPNI-64	138	264PPDOT-12	164
209NPSM-8EH	65	262PF-8	125	262PPNI-86	138	264PPDOT-664	164
209NPSM-12EH	65	262PP-2	132	262PPNIC-2	146	264PPDOT-884	164
209RWA-3	39	262PP-2.5	132	262PPNIC-2.5	146	264PPNI-2	138
209RWA-4	39	262PP-4	132	262PPNIC-4	146	264PPNI-2.5	138
209RWA-5	39	262PP-6	132	262PPNIC-4MM	148	264PPNI-3MM	143
209RWA-6	39	262PP-8	132	262PPNIC-5	146	264PPNI-4	138
209RWA-NUT	40	262PP-64	132	262PPNIC-6	146	264PPNI-4MM	143
209WA-3	40	262PPC-2	155	262PPNIC-6MM	148	264PPNI-5	138
209WA-4	40	262PPC-2.5	155	262PPNIC-8	146	264PPNI-5MM	143
209WA-5	40	262PPC-3	155	262PPNIC-8MM	148	264PPNI-6	138
209WA-6	40	262PPC-4	155	262PPNIC-10MM	148	264PPNI-6MM	143
220C-J	205	262PPC-4MM	160	262PPNIC-12MM	148	264PPNI-8	138
220C-L	205	262PPC-5	155	262PP-SS-2.5	150	264PPNI-8MM	143
227CC	196	262PPC-6	155	262PP-SS-3	150	264PPNI-10MM	143
227SAE	197	262PPC-6MM	160	262PP-SS-4	150	264PPNI-12MM	143
252PP-4	136	262PPC-6MMX4MM	160	262PP-SS-5	150	264PPNI-14MM	143
252PP-6	136	262PPC-8	155	262PP-SS-6	150	264PPNIC-2	146
256PF-64	125	262PPC-8MM	160	262PP-SS-8	150	264PPNIC-2.5	146
260A-4	182	262PPC-8MMX6MM	160	264A-44	182	264PPNIC-4	146
260A-6	182	262PPC-10MM	160	264A-66	182	264PPNIC-4MM	148
260A-8	182	262PPC-10MMX8MM	160	264A-88	182	264PPNIC-5	132
260A-10	182	262PPC-12MM	160	264A-1010	182	264PPNIC-5	146
260A-12	182	262PPC-12MMX10MM	160	264PF-2	126	264PPNIC-6	146

CHAMPION BRASS

NUMERICAL INDEX

Part#	Page	Part#	Page	Part#	Page	Part#	Page
264PPNIC-6MM	148	266BHPPCDOT-6B	175	266PPNI-2A	138	268PF-8B	127
264PPNIC-8	146	266BHPPCDOT-6C	175	266PPNI-2B	138	268PF-8C	127
264PPNIC-8MM	148	266BHPPCDOT-8C	175	266PPNI-4A	138	268PF-8D	127
264PPNIC-10MM	148	266BHPPCDOT-8D	175	266PPNI-4B	138	268PP-2.5A	133
264PPNIC-12MM	148	266BHPPDOT-4A	169	266PPNI-6B	138	268PP-2.5B	133
264PP-SS-2.5	150	266BHPPDOT-4B	169	266PPNI-6C	138	268PP-2.5X1032	133
264PP-SS-4	150	266BHPPDOT-6B	169	266PPNIC-2.5A	146	268PP-2A	133
264PP-SS-5	150	266BHPPDOT-6C	169	266PPNIC-2.5X1032	146	268PP-2B	133
264PP-SS-6	150	266BHPPDOT-8C	169	266PPNIC-2A	146	268PP-2X	133
264PP-SS-8	150	266PF-2A	126	266PPNIC-2X1032	146	268PP-2X1032	133
265A-44	182	266PF-4A	126	266PPNIC-4A	146	268PP-3A	133
265PP-2	132	266PF-4B	126	266PPNIC-4B	146	268PP-3X1032	133
265PP-2.5	132	266PF-5A	126	266PPNIC-4C	146	268PP-4A	133
265PP-4	132	266PF-6B	126	266PPNIC-4MMX1/8	149	268PP-4B	133
265PP-6	132	266PF-8C	126	266PPNIC-5B	146	268PP-4C	133
265PP-8	132	266PP-2A	132	266PPNIC-5C	146	268PP-4X	133
265PPC-2	155	266PP-4A	132	266PPNIC-6B	146	268PP-4X1032	133
265PPC-2.5	155	266PP-4B	132	266PPNIC-6C	146	268PP-6A	133
265PPC-3	155	266PP-6B	132	266PPNIC-6D	146	268PP-6B	133
265PPC-4	155	266PP-6C	132	266PPNIC-6MMX1/4	149	268PP-6C	133
265PPC-4MM	160	266PP25A	132	266PPNIC-6MMX1/8	149	268PP-6D	133
265PPC-5	155	266PPC-2.5A	156	266PPNIC-8C	146	268PP-8B	133
265PPC-6	155	266PPC-2.5B	156	266PPNIC-8MMX1/4	149	268PP-8C	133
265PPC-6MM	160	266PPC-2A	156	266PPNIC-8MMX1/8	149	268PP-8D	133
265PPC-8	155	266PPC-2X1032	156	266PPNIC-10MMX1/4	149	268PPC-2.5A	156
265PPC-8MM	160	266PPC-3A	156	266PPNIC-10MMX3/8	149	268PPC-2.5B	156
265PPC-10MM	160	266PPC-4A	156	266PP-SS-2.5A	150	268PPC-2.5X1032	156
265PPC-12MM	160	266PPC-4B	156	266PP-SS-2.5B	150	268PPC-2A	156
265PPC-14MM	160	266PPC-4MMX1/4	160	266PP-SS-2.5X1032	150	268PPC-2B	156
265PPC-16MM	160	266PPC-4MMX1/8	160	266PP-SS-4A	150	268PPC-2X	156
265PPCDOT-2.5	171	266PPC-5A	156	266PP-SS-4B	150	268PPC-2X1032	156
265PPCDOT-4	171	266PPC-5B	156	266PP-SS-4C	150	268PPC-3A	156
265PPCDOT-6	171	266PPC-5C	156	266PP-SS-4D	150	268PPC-3B	156
265PPCDOT-8	171	266PPC-6A	156	266PP-SS-4X1032	150	268PPC-4A	156
265PPCDOT-10	171	266PPC-6B	156	266PP-SS-5A	150	268PPC-4B	156
265PPDOT-3	164	266PPC-6C	156	266PP-SS-5B	150	268PPC-4C	156
265PPDOT-4	164	266PPC-6D	156	266PP-SS-5C	150	268PPC-4D	156
265PPDOT-6	164	266PPC-6MMX1/4	160	266PP-SS-5D	150	268PPC-4MMX1/4	161
265PPDOT-8	164	266PPC-6MMX1/8	160	266PP-SS-6B	150	268PPC-4MMX1/8	161
265PPNI-2	138	266PPC-8B	156	266PP-SS-6C	150	268PPC-4MMXM5	161
265PPNI-2.5	138	266PPC-8C	156	266PP-SS-6D	150	268PPC-4X1032	156
265PPNI-4	138	266PPC-8MMX1/4	160	266PP-SS-8B	150	268PPC-5A	156
265PPNI-5	138	266PPC-8MMX1/8	160	266PP-SS-8C	150	268PPC-5B	156
265PPNI-6	138	266PPC-10MMX3/8	160	266PP-SS-8D	150	268PPC-5C	156
265PPNI-8	138	266PPC-12MMX1/2	160	268A-4A	183	268PPC-6A	156
265PPNIC-2	146	266PPC-12MMX3/8	160	268A-4B	183	268PPC-6B	156
265PPNIC-2.5	146	266PPCDOT-2.5A	171	268A-4C	183	268PPC-6C	156
265PPNIC-4	146	266PPCDOT-2.5B	171	268A-6A	183	268PPC-6D	156
265PPNIC-4MM	149	266PPCDOT-3	171	268A-6B	183	268PPC-6MMX1/2	161
265PPNIC-5	146	266PPCDOT-4A	171	268A-6C	183	268PPC-6MMX1/4	161
265PPNIC-6	146	266PPCDOT-4B	171	268A-6D	183	268PPC-6MMX1/8	161
265PPNIC-6MM	149	266PPCDOT-4C	171	268A-8B	183	268PPC-6MMX3/8	161
265PPNIC-8	146	266PPCDOT-6A	171	268A-8C	183	268PPC-6MMXM5	161
265PPNIC-8MM	149	266PPCDOT-6B	171	268A-8D	183	268PPC-8B	156
265PP-SS-2.5	150	266PPCDOT-6C	171	268A-10C	183	268PPC-8C	156
265PP-SS-4	150	266PPCDOT-6D	171	268A-10D	183	268PPC-8D	156
265PP-SS-5	150	266PPCDOT-8A	171	268A-12D	183	268PPC-8MMX1/2	161
265PP-SS-6	150	266PPCDOT-8B	171	268A-12E	183	268PPC-8MMX1/4	161
265PP-SS-8	150	266PPCDOT-8C	171	268PF-2A	127	268PPC-8MMX1/8	161
266A-4A	183	266PPCDOT-8D	171	268PF-2X1032	127	268PPC-8MMX3/8	161
266A-4B	183	266PPCDOT-10D	171	268PF-3A	127	268PPC-10MMX1/2	161
266A-6A	183	266PPDOT-2.5A	165	268PF-4A	127	268PPC-10MMX1/4	161
266A-6B	183	266PPDOT-4A	165	268PF-4B	127	268PPC-10MMX1/8	161
266A-6C	183	266PPDOT-4B	165	268PF-4C	127	268PPC-10MMX3/8	161
266A-8C	183	266PPDOT-6A	165	268PF-4X1032	127	268PPC-12MMX1/2	161
266A-8D	183	266PPDOT-6B	165	268PF-5A	127	268PPC-12MMX1/4	161
266A-10D	183	266PPDOT-6C	165	268PF-5B	127	268PPC-12MMX3/8	161
266BHPPCDOT-2.5B	175	266PPDOT-8B	165	268PF-6A	127	268PPC-14MMX1/2	161
266BHPPCDOT-4A	175	266PPDOT-8C	165	268PF-6B	127	268PPC-14MMX3/8	161
266BHPPCDOT-4B	175	266PPDOT-8D	165	268PF-6C	127	268PPCDOT-2.5A	172

CHAMPION BRASS

NUMERICAL INDEX

Part#	Page	Part#	Page	Part#	Page	Part#	Page
268PPCDOT-2.5B	172	268PPNI-8C	139	269A-8B	183	269PPS-8C	133
268PPCDOT-2.5X	172	268PPNI-8D	139	269A-8C	183	269PPS-8D	133
268PPCDOT-3A	172	268PPNI-8MMX1/2	144	269A-8D	183	269PPSC-2.5A	157
268PPCDOT-3B	172	268PPNI-8MMX1/4	144	269A-10D	183	269PPSC-2.5B	157
268PPCDOT-4A	172	268PPNI-8MMX1/8	144	269A-12D	183	269PPSC-2.5X1032	157
268PPCDOT-4B	172	268PPNI-8MMX3/8	144	269EXTPPSC-4A	157	269PPSC-2A	157
268PPCDOT-4C	172	268PPNI-10MMX1/2	144	269EXTPPSC-4B	157	269PPSC-2B	157
268PPCDOT-4D	172	268PPNI-10MMX1/4	144	269EXTPPSC-4C	157	269PPSC-2X	157
268PPCDOT-6A	172	268PPNI-10MMX3/8	144	269EXTPPSC-6B	157	269PPSC-2X1032	157
268PPCDOT-6B	172	268PPNI-12MMX1/2	144	269EXTPPSC-6C	157	269PPSC-3A	157
268PPCDOT-6C	172	268PPNI-12MMX1/4	144	269EXTPPSC-6D	157	269PPSC-4A	157
268PPCDOT-6D	172	268PPNI-12MMX3/8	144	269EXTPPSC-8B	157	269PPSC-4B	157
268PPCDOT-8B	172	268PPNI-14MMX1/2	144	269EXTPPSC-8C	157	269PPSC-4C	157
268PPCDOT-8C	172	268PPNI-14MMX3/8	144	269EXTPPSC-8D	157	269PPSC-4D	157
268PPCDOT-8D	172	268PPNIC-2.5A	147	269PF-2A	127	269PPSC-4MMX1/4	161
268PPCDOT-10C	172	268PPNIC-2.5B	147	269PF-3A	127	269PPSC-4MMX1/8	161
268PPCDOT-10D	172	268PPNIC-2.5X1032	147	269PF-4A	127	269PPSC-4X1032	157
268PPCDOT-10E	172	268PPNIC-2A	147	269PF-4B	127	269PPSC-5A	157
268PPCDOT-12C	172	268PPNIC-2B	147	269PF-4C	127	269PPSC-5B	157
268PPCDOT-12D	172	268PPNIC-2X1032	147	269PF-5A	127	269PPSC-5C	157
268PPCDOT-12E	172	268PPNIC-4A	147	269PF-6A	127	269PPSC-6A	157
268PPDOT-2.5A	165	268PPNIC-4B	147	269PF-6B	127	269PPSC-6B	157
268PPDOT-2.5X	165	268PPNIC-4C	147	269PF-6C	127	269PPSC-6C	157
268PPDOT-3A	165	268PPNIC-4MMX1/4	149	269PF-8C	127	269PPSC-6D	157
268PPDOT-3B	165	268PPNIC-4MMX1/8	149	269PF-8D	127	269PPSC-6MMX1/2	161
268PPDOT-3X	165	268PPNIC-4X1032	147	269PP-2.5A	134	269PPSC-6MMX1/4	161
268PPDOT-3 x 10/32	165	268PPNIC-5A	147	269PP-2A	134	269PPSC-6MMX1/8	161
268PPDOT-4A	165	268PPNIC-5B	147	269PP-3A	134	269PPSC-6MMX3/8	161
268PPDOT-4B	165	268PPNIC-5C	147	269PP-4A	134	269PPSC-8B	157
268PPDOT-4C	165	268PPNIC-6A	147	269PP-4B	134	269PPSC-8C	157
268PPDOT-4X	165	268PPNIC-6B	147	269PP-4C	134	269PPSC-8D	157
268PPDOT-6A	165	268PPNIC-6C	147	269PP-6A	134	269PPSC-8MMX1/2	161
268PPDOT-6B	165	268PPNIC-6D	147	269PP-6B	134	269PPSC-8MMX1/4	161
268PPDOT-6C	165	268PPNIC-6MMX1/4	149	269PP-6C	134	269PPSC-8MMX1/8	161
268PPDOT-6D	165	268PPNIC-6MMX1/8	149	269PP-8B	134	269PPSC-8MMX3/8	161
268PPDOT-8B	165	268PPNIC-8B	147	269PP-8C	134	269PPSC-10MMX1/2	161
268PPDOT-8C	165	268PPNIC-8C	147	269PP-8D	134	269PPSC-10MMX1/4	161
268PPDOT-8D	165	268PPNIC-8D	147	269PPDOT-2.5A	166	269PPSC-10MMX1/8	161
268PPDOT-8E	165	268PPNIC-8MMX1/4	149	269PPDOT-2.5X	166	269PPSC-10MMX3/8	161
268PPDOT-10C	165	268PPNIC-8MMX1/8	149	269PPDOT-3A	166	269PPSC-12MMX1/2	161
268PPDOT-10D	165	268PPNIC-8MMX3/8	149	269PPDOT-4A	166	269PPSC-12MMX1/4	161
268PPDOT-10E	165	268PPNIC-10MMX1/4	149	269PPDOT-4B	166	269PPSC-12MMX3/8	161
268PPDOT-12D	165	268PPNIC-10MMX3/8	149	269PPDOT-4C	166	269PPSC-14MMX1/2	161
268PPDOT-12E	165	268PPNIC-12MMX1/4	149	269PPDOT-6A	166	269PPSC-14MMX3/8	161
268PPNI-2.5A	139	268PP-SS-2.5A	151	269PPDOT-6B	166	269PPSCDOT-2.5A	172
268PPNI-2.5B	139	268PP-SS-2.5B	151	269PPDOT-6C	166	269PPSCDOT-2.5B	172
268PPNI-2.5X1032	139	268PP-SS-2.5X1032	151	269PPDOT-6D	166	269PPSCDOT-3A	172
268PPNI-2A	139	268PP-SS-2X1032	151	269PPDOT-8B	166	269PPSCDOT-4A	172
268PPNI-2B	139	268PP-SS-4A	151	269PPDOT-8C	166	269PPSCDOT-4B	172
268PPNI-2X1032	139	268PP-SS-4B	151	269PPDOT-8D	166	269PPSCDOT-4C	172
268PPNI-4A	139	268PP-SS-4C	151	269PPDOT-10C	166	269PPSCDOT-4D	172
268PPNI-4B	139	268PP-SS-4D	151	269PPDOT-10D	166	269PPSCDOT-6A	172
268PPNI-4C	139	268PP-SS-4X1032	151	269PPDOT-12D	166	269PPSCDOT-6B	172
268PPNI-4MMX1/4	144	268PP-SS-5A	151	269PPDOT-12E	166	269PPSCDOT-6C	172
268PPNI-4MMX1/8	144	268PP-SS-5B	151	269PPNI-4A	139	269PPSCDOT-6D	172
268PPNI-4X1032	139	268PP-SS-5C	151	269PPNI-4B	139	269PPSCDOT-8B	172
268PPNI-5A	139	268PP-SS-5D	151	269PPNI-6B	139	269PPSCDOT-8C	172
268PPNI-5B	139	268PP-SS-6B	151	269PPNI-6C	139	269PPSCDOT-8D	172
268PPNI-5C	139	268PP-SS-6C	151	269PPS-2.5A	133	269PPSCDOT-8E	172
268PPNI-5MMX1/4	144	268PP-SS-6D	151	269PPS-2.5B	133	269PPSCDOT-10C	172
268PPNI-5MMX1/8	144	268PP-SS-8B	151	269PPS-2.5X1032	133	269PPSCDOT-10D	172
268PPNI-6A	139	268PP-SS-8C	151	269PPS-2A	133	269PPSCDOT-10E	172
268PPNI-6B	139	268PP-SS-8D	151	269PPS-4A	133	269PPSCDOT-12D	172
268PPNI-6C	139	269A-4A	183	269PPS-4B	133	269PPSCDOT-12E	172
268PPNI-6D	139	269A-4B	183	269PPS-4C	133	269PPSDOT-2.5A	166
268PPNI-6MMX1/2	144	269A-4C	183	269PPS-4X1032	133	269PPSDOT-2.5B	166
268PPNI-6MMX1/4	144	269A-6A	183	269PPS-6A	133	269PPSDOT-4A	166
268PPNI-6MMX1/8	144	269A-6B	183	269PPS-6B	133	269PPSDOT-4B	166
268PPNI-6MMX3/8	144	269A-6C	183	269PPS-6C	133	269PPSDOT-4C	166
268PPNI-8B	139	269A-6D	183	269PPS-6D	133	269PPSDOT-6A	166

CHAMPION BRASS

NUMERICAL INDEX

Part#	Page	Part#	Page	Part#	Page	Part#	Page
269PPSDOT-6B	166	269PPSNIC-8MMX1/8	149	270PPSCDOT-6C	173	271ppscdot-86D	173
269PPSDOT-6C	166	269PPSNIC-8MMX3/8	149	270PPSCDOT-6D	173	271PPSDOT-4A	167
269PPSDOT-6E	166	269PPSNIC-10MMX1/4	149	270PPSCDOT-8B	173	271PPSDOT-4B	167
269PPSDOT-6E	166	269PPSNIC-10MMX3/8	149	270PPSCDOT-8C	173	271PPSDOT-6B	167
269PPSDOT-8B	166	269PPS-SS-2.5A	151	270PPSCDOT-8D	173	271PPSDOT-6C	167
269PPSDOT-8C	166	269PPS-SS-2.5B	151	270PPSDOT-4A	167	271PPSDOT-8B	167
269PPSDOT-8D	166	269PPS-SS-2.5X1032	151	270PPSDOT-4B	167	271PPSDOT-8C	167
269PPSDOT-10C	166	269PPS-SS-4A	151	270PPSDOT-6B	167	271PPSDOT-8D	167
269PPSDOT-10D	166	269PPS-SS-4B	151	271A-4A	184	271PPSNI-2.5A	140
269PPSDOT-10E	166	269PPS-SS-4C	151	271A-4B	184	271PPSNI-2.5B	140
269PPSDOT-12C	166	269PPS-SS-4D	151	271A-6B	184	271PPSNI-2A	140
269PPSDOT-12D	166	269PPS-SS-4X1032	151	271A-6C	184	271PPSNI-2B	140
269PPSDOT-12E	166	269PPS-SS-5A	151	271PF-4A	128	271PPSNI-4A	140
269PPSNI-2.5A	140	269PPS-SS-5B	151	271PF-4B	128	271PPSNI-4B	140
269PPSNI-2.5B	140	269PPS-SS-5C	151	271PF-6B	128	271PPSNI-4MMX1/4	145
269PPSNI-2.5X1032	140	269PPS-SS-5D	151	271PF-8C	128	271PPSNI-4MMX1/4	161
269PPSNI-2A	140	269PPS-SS-6A	151	271PP-2A	135	271PPSNI-4MMX1/8	145
269PPSNI-2B	140	269PPS-SS-6B	151	271PP-4A	135	271PPSNI-5MMX1/8	145
269PPSNI-4A	140	269PPS-SS-6C	151	271PP-4B	135	271PPSNI-5MMX1/8	161
269PPSNI-4B	140	269PPS-SS-6D	151	271PP-6B	135	271PPSNI-6B	140
269PPSNI-4C	140	269PPS-SS-8B	151	271PP-6C	135	271PPSNI-6C	140
269PPSNI-4MMX1/4	144	269PPS-SS-8C	151	271PPDOT-4A	167	271PPSNI-6D	140
269PPSNI-4MMX1/8	144	269PPS-SS-8D	151	271PPDOT-4B	167	271PPSNI-6MMX1/4	145
269PPSNI-5A	140	270A-4A	184	271PPDOT-6B	167	271PPSNI-6MMX1/8	145
269PPSNI-5B	140	270A-4B	184	271PPDOT-6C	167	271PPSNI-8B	140
269PPSNI-5C	140	270A-6A	184	271PPDOT-8C	167	271PPSNI-8C	140
269PPSNI-5MMX1/8	144	270A-6B	184	271PPDOT-64B	167	271PPSNI-8D	140
269PPSNI-6A	140	270A-6C	184	271PPDOT-64C	167	271PPSNI-8MMX1/2	145
269PPSNI-6B	140	270A-8C	184	271PPS-2.5A	135	271PPSNI-8MMX1/4	145
269PPSNI-6C	140	270A-10D	184	271PPS-2A	135	271PPSNI-8MMX1/8	145
269PPSNI-6D	140	270PF-4A	127	271PPS-4A	135	271PPSNI-8MMX3/8	145
269PPSNI-6MMX1/4	144	270PF-4B	127	271PPS-4B	135	271PPSNI-10MMX1/2	145
269PPSNI-6MMX1/8	144	270PF-6B	127	271PPS-6B	135	271PPSNI-10MMX1/4	145
269PPSNI-8B	140	270PF-8C	127	271PPS-6C	135	271PPSNI-10MMX3/8	145
269PPSNI-8C	140	270PP-2.5A	134	271PPS-8C	135	271PPSNI-12MMX1/2	145
269PPSNI-8D	140	270PP-2A	134	271PPS-8D	135	271PPSNI-12MMX3/8	145
269PPSNI-8MMX1/2	144	270PP-4A	134	271PPSC-2.5A	158	271PPSNIC-2A	148
269PPSNI-8MMX1/4	144	270PP-4B	134	271PPSC-2.5B	158	271PPSNIC-2X1032	148
269PPSNI-8MMX1/8	144	270PP-6B	134	271PPSC-2.5X1032	158	271PPSNIC-4A	148
269PPSNI-8MMX3/8	144	270PPDOT-4A	167	271PPSC-2A	158	271PPSNIC-4B	148
269PPSNI-10MMX1/2	144	270PPDOT-4B	167	271PPSC-2X1032	158	271PPSNIC-4C	148
269PPSNI-10MMX1/4	144	270PPDOT-4C	167	271PPSC-4A	158	271PPSNIC-6B	148
269PPSNI-10MMX3/8	144	270PPDOT-6B	167	271PPSC-4B	158	271PPSNIC-6C	148
269PPSNI-12MMX1/2	144	270PPDOT-6C	167	271PPSC-4C	158	271PPSNIC-6D	148
269PPSNI-12MMX3/8	144	270PPDOT-8C	167	271PPSC-4X1032	158	271PPSNIC-8C	148
269PPSNI-14MMX1/2	144	270PPDOT-8D	167	271PPSC-5A	158	271PPSNIC-8D	148
269PPSNI-14MMX3/8	144	270PPS-4A	134	271PPSC-5B	158	271PPS-SS-2.5A	152
269PPSNIC-2.5A	147	270PPS-4B	134	271PPSC-5C	158	271PPS-SS-2.5B	152
269PPSNIC-2.5X1032	147	270PPS-6B	134	271PPSC-6A	158	271PPS-SS-2.5X1032	152
269PPSNIC-2A	147	270PPS-8C	134	271PPSC-6B	158	271PPS-SS-4A	152
269PPSNIC-2B	147	270PPS-25A	134	271PPSC-6C	158	271PPS-SS-4B	152
269PPSNIC-2X1032	147	270PPSC-2.5A	157	271PPSC-6D	158	271PPS-SS-4C	152
269PPSNIC-4A	147	270PPSC-2.5B	157	271PPSC-8B	158	271PPS-SS-4D	152
269PPSNIC-4B	147	270PPSC-2A	157	271PPSC-8C	158	271PPS-SS-4X1032	152
269PPSNIC-4C	147	270PPSC-4A	157	271PPSC-8D	158	271PPS-SS-5A	152
269PPSNIC-4MMX1/4	149	270PPSC-4B	157	271PPSCDOT-2.5A	173	271PPS-SS-5B	152
269PPSNIC-4MMX1/8	149	270PPSC-4C	157	271PPSCDOT-2.5B	173	271PPS-SS-5C	152
269PPSNIC-5B	147	270PPSC-4X1032	157	271PPSCDOT-2.5X	173	271PPS-SS-5D	152
269PPSNIC-5C	147	270PPSC-5A	157	271PPSCDOT-4A	173	271PPS-SS-6B	152
269PPSNIC-6A	147	270PPSC-6A	157	271PPSCDOT-4B	173	271PPS-SS-6C	152
269PPSNIC-6B	147	270PPSC-6B	157	271PPSCDOT-6B	173	271PPS-SS-6D	152
269PPSNIC-6C	147	270PPSC-6C	157	271PPSCDOT-6C	173	271PPS-SS-8B	152
269PPSNIC-6D	147	270PPSC-8C	157	271PPSCDOT-6D	173	271PPS-SS-8C	152
269PPSNIC-6MMX1/4	149	270PPSCDOT-2.5A	173	271PPSCDOT-8B	173	271PPS-SS-8D	152
269PPSNIC-6MMX1/8	149	270PPSCDOT-2.5B	173	271PPSCDOT-8C	173	272PF-2A	128
269PPSNIC-6MMX5	149	270PPSCDOT-4A	173	271PPSCDOT-8D	173	272PF-4A	128
269PPSNIC-8B	147	270PPSCDOT-4B	173	271PPSCDOT-10D	173	272PF-4B	128
269PPSNIC-8C	147	270PPSCDOT-4C	173	271ppscdot-64B	173	272PF-5A	128
269PPSNIC-8D	147	270PPSCDOT-6A	173	271ppscdot-64C	173	272PF-6A	128
269PPSNIC-8MMX1/4	149	270PPSCDOT-6B	173	271ppscdot-84D	173	272PF-6B	128

CHAMPION BRASS

NUMERICAL INDEX

Part#	Page	Part#	Page	Part#	Page	Part#	Page
272PF-8C	128	272PPSCDOT-8C	174	272PPS-SS-6D	152	283PPC-5	158
272PP-2.5A	135	272PPSCDOT-8D	174	272PPS-SS-8B	152	283PPC-6	158
272PP-4A	135	272PPSCDOT-10C	174	272PPS-SS-8C	152	283PPC-8	158
272PP-4B	135	272PPSCDOT-10D	174	272PPS-SS-8D	152	283PPNI-2	141
272PP-6A	135	272PPSDOT-4A	169	277PF-4B	128	283PPNI-2.5	141
272PP-6B	135	272PPSDOT-4B	169	277PF-4C	128	283PPNI-3MM	145
272PP-6C	135	272PPSDOT-6A	169	277PPDOT-4A	169	283PPNI-4	141
272PP-8C	135	272PPSDOT-6B	169	277PPDOT-4B	169	283PPNI-4MM	145
272PPDOT-2.5A	168	272PPSDOT-6C	169	277PPDOT-6B	169	283PPNI-5	141
272PPDOT-4A	168	272PPSDOT-6D	169	277PPDOT-6C	169	283PPNI-5MM	145
272PPDOT-4B	168	272PPSDOT-8B	169	277PPSCDOT-4A	174	283PPNI-6	141
272PPDOT-6B	168	272PPSDOT-8C	169	277PPSCDOT-4B	174	283PPNI-6MM	145
272PPDOT-6C	168	272PPSDOT-8D	169	277PPSCDOT-6B	174	283PPNI-8	141
272PPDOT-6D	168	272PPSNI-2.5A	141	277PPSCDOT-8C	174	283PPNI-8MM	145
272PPDOT-8C	168	272PPSNI-2.5B	141	277PPSCDOT-10B	174	283PPNI-10MM	145
272PPS-2.5A	135	272PPSNI-2A	141	279PPDOT-4A	168	283PPNI-12MM	145
272PPS-2.5A x 10.32	135	272PPSNI-4A	141	279PPDOT-4B	168	283PPNIC-2.5	148
272PPS-2A	135	272PPSNI-4B	141	279PPDOT-6A	168	283PPNIC-4	148
272PPS-4A	135	272PPSNI-4C	141	279PPDOT-6B	168	283PPNIC-4MM	149
272PPS-4B	135	272PPSNI-4MMX1/4	145	279PPDOT-6C	168	283PPNIC-5	148
272PPS-6B	135	272PPSNI-4MMX1/8	145	279PPDOT-6D	168	283PPNIC-6	148
272PPS-6C	135	272PPSNI-5MMX1/8	145	279PPDOT-8B	168	283PPNIC-8	148
272PPS-8C	135	272PPSNI-6B	141	279PPDOT-8C	168	283PPNIC-8MM	149
272PPS-8D	135	272PPSNI-6C	141	279PPDOT-8D	168	283PP-SS-2.5	153
272PPSC-2.5A	158	272PPSNI-6D	141	279PPDOT-10C	168	283PP-SS-4	153
272PPSC-2.5B	158	272PPSNI-6MMX1/4	145	279PPDOT-10D	168	283PP-SS-5	153
272PPSC-2.5X1032	158	272PPSNI-6MMX1/8	145	279PPDOT-12D	168	283PP-SS-6	153
272PPSC-2A	158	272PPSNI-8B	141	279PPDOT-12E	168	283PP-SS-8	153
272PPSC-2B	158	272PPSNI-8C	141	279PPSC-4A	158	284PP-2.5	136
272PPSC-2X	158	272PPSNI-8D	141	279PPSC-4B	158	284PP-4	136
272PPSC-2X1032	158	272PPSNI-8MMX1/2	145	279PPSCDOT-2.5A	174	284PP-6	136
272PPSC-4A	158	272PPSNI-8MMX1/4	145	279PPSCDOT-4A	174	284PP-8	136
272PPSC-4B	158	272PPSNI-8MMX1/8	145	279PPSCDOT-4B	174	285PPC-4MM	162
272PPSC-4C	158	272PPSNI-8MMX3/8	145	279PPSCDOT-4C	174	285PPC-6MM	162
272PPSC-4MMX1/4	162	272PPSNI-10MMX1/2	145	279PPSCDOT-6A	174	285PPC-8MM	162
272PPSC-4MMX1/8	162	272PPSNI-10MMX1/4	145	279PPSCDOT-6B	174	285PPC-10MM	162
272PPSC-4X1032	158	272PPSNI-10MMX3/8	145	279PPSCDOT-6C	174	285PPC-12MM	162
272PPSC-5A	158	272PPSNI-12MMX1/2	145	279PPSCDOT-6D	174	286PP-42	136
272PPSC-5B	158	272PPSNI-12MMX3/8	145	279PPSCDOT-8A	174	286PP-42.5	136
272PPSC-5C	158	272PPSNI-14MMX1/2	145	279PPSCDOT-8B	174	286PP-64	136
272PPSC-6A	158	272PPSNI-14MMX3/8	145	279PPSCDOT-8C	174	286PPNI-42	141
272PPSC-6B	158	272PPSNIC-2A	148	279PPSCDOT-8D	174	286PPNI-42.5	141
272PPSC-6C	158	272PPSNIC-2X1032	148	279PPSCDOT-10C	174	286PPNI-64	141
272PPSC-6D	158	272PPSNIC-4A	148	279PPSCDOT-10D	174	286PPNI-84	141
272PPSC-6MMX1/4	162	272PPSNIC-4B	148	279PPSCDOT-12C	174	286PPNI-86	141
272PPSC-6MMX1/8	162	272PPSNIC-4C	148	279PPSCDOT-12D	174	287PP-4A	136
272PPSC-8B	158	272PPSNIC-5A	148	279PPSDOT-4A	168	287PP-4B	136
272PPSC-8C	158	272PPSNIC-5B	148	279PPSDOT-4B	168	287PP-6B	136
272PPSC-8D	158	272PPSNIC-5C	148	279PPSDOT-6A	168	287PPC-4A	159
272PPSC-8MMX1/4	162	272PPSNIC-6B	148	279PPSDOT-6B	168	287PPC-4B	159
272PPSC-8MMX1/8	162	272PPSNIC-6C	148	279PPSDOT-6C	168	287PPC-6B	159
272PPSC-8MMX3/8	162	272PPSNIC-6D	148	279PPSDOT-6D	168	287PPC-6C	159
272PPSC-10MMX1/2	162	272PPSNIC-8B	148	279PPSDOT-8B	168	287PP-SS-2.5A	153
272PPSC-10MMX1/4	162	272PPSNIC-8C	148	279PPSDOT-8C	168	287PP-SS-2.5B	153
272PPSC-10MMX3/8	162	272PPSNIC-8D	148	279PPSDOT-8D	168	287PP-SS-2.5X1032	153
272PPSC-12MMX1/2	162	272PPS-SS-2.5A	152	279PPSDOT-10C	168	287PP-SS-4A	153
272PPSC-12MMX1/4	162	272PPS-SS-2.5B	152	279PPSDOT-10D	168	287PP-SS-4B	153
272PPSC-12MMX3/8	162	272PPS-SS-2.5X1032	152	279PPSDOT-12E	168	287PP-SS-4C	153
272PPSC-14MMX3/8	162	272PPS-SS-4A	152	282PF-4	125	287PP-SS-4D	153
272PPSCDOT-2.5A	174	272PPS-SS-4B	152	282PF-5	125	287PP-SS-4X1032	153
272PPSCDOT-2.5B	174	272PPS-SS-4C	152	282PF-6	125	287PP-SS-5A	153
272PPSCDOT-2.5X	174	272PPS-SS-4D	152	282PF-8	125	287PP-SS-5B	153
272PPSCDOT-4A	174	272PPS-SS-4X1032	152	283PP-2	136	287PP-SS-5C	153
272PPSCDOT-4B	174	272PPS-SS-5A	152	283PP-2.5	136	287PP-SS-5D	153
272PPSCDOT-4C	174	272PPS-SS-5B	152	283PP-4	136	287PP-SS-6B	153
272PPSCDOT-6A	174	272PPS-SS-5C	152	283PP-6	136	287PP-SS-6C	153
272PPSCDOT-6B	174	272PPS-SS-5D	152	283PP-8	136	287PP-SS-6D	153
272PPSCDOT-6C	174	272PPS-SS-6A	152	283PPC-2	158	287PP-SS-8B	153
272PPSCDOT-6D	174	272PPS-SS-6B	152	283PPC-2.5	158	287PP-SS-8C	153
272PPSCDOT-8B	174	272PPS-SS-6C	152	283PPC-4	158	287PP-SS-8D	153

CHAMPION BRASS

NUMERICAL INDEX

Part#	Page	Part#	Page	Part#	Page	Part#	Page
288PPSC-4A	159	303-1010	52	322D	195	958PPC-4A	159
288PPSC-4B	159	303-1212	52	323D	195	958PPC-4B	159
288PPSC-6B	159	303ACC	198	327-4	194	958PPC-6C	159
288PPSC-6C	159	303CC	198	327-5	194	958PPC-8D	159
288PPSC-6D	159	303SAE	199	340AV	199	959PPC-2	159
288PPSC-8C	159	304-44	50	350BV-J	206	959PPC-2.5	159
288PPSC-8D	159	304-55	50	350BV-L	206	959PPC-4	159
288PPSCDOT-4A	175	304-66	50	350BVR-J	206	959PPC-5	159
288PPSCDOT-4B	175	304-88	50	350BVR-L	206	959PPC-6	159
288PPSCDOT-4C	175	304-1010	50	351BV-J	206	959PPC-8	159
288PPSCDOT-6B	175	304-1212	50	351BV-L	206	961A-2	121
288PPSCDOT-6C	175	305-43	53	352BV-J	206	961A-3	121
288PPSCDOT-8C	175	305-44	53	352BV-JXL	206	961A-4	121
288PPSCDOT-8D	175	305-45	53	352BV-L	206	961A-5	121
289PP-2.5	136	305-55	53	357BV-4J	206	961A-6	121
289PP-4	136	305-56	53	357BV-4L	206	961A-8	121
289PPC-2	155	305-65	53	357BV-6L	206	961A-10	121
289PPC-2.5	155	305-66	53	360A-6	185	961A-12	121
289PPC-4	155	305-88	53	360A-8	185	961A-14	121
289PPC-4MM	162	305-1010	53	361A-6	185	962A-22	121
289PPC-4MMX6MM	162	306-43	54	361A-6G	185	962A-33	121
289PPC-5	155	306-44	54	361A-8	185	962A-44	121
289PPC-6	155	306-45	54	361A-8G	185	962A-55	121
289PPC-6MM	162	306-55	54	362A-6	186	962A-64	121
289PPC-6MMX8MM	162	306-65	54	362A-8	186	962A-66	121
289PPC-8	155	306-66	54	362BV-J	207	962A-88	121
289PPC-8MM	162	306-88	54	362BV-L	207	962A-1010	121
289PPC-8MMX10MM	162	307-46	53	362BV-N	207	964A-22	121
289PPC-10MM	162	307-56	53	362BV-P	207	964A-33	121
289PPC-12MM	162	307-66	53	366A-6	186	964A-44	121
289PPC-46	155	307-86	53	366A-8	186	964A-66	121
289PPC-64	155	307-1212	53	368A-6B	187	964A-88	121
289PPCDOT-4	175	308-46	53	368A-6C	187	966A-2A	121
289PPCDOT-6	175	308-56	53	368A-6D	187	966A-4A	121
289PPCDOT-8	175	308-66	53	368A-8C	187	966A-4B	121
289PPCDOT-10	175	308-86	53	368A-8D	187	966A-6B	121
289PPCDOT-46	175	308-88	53	371A-6	186	966A-6C	121
289PPCDOT-64	175	308-1212	53	371A-8	186	966A-6D	121
289PPNI-6MM	143	308-1616	53	371AS-6	186	966A-8C	121
289PP-SS-2.5	153	309-44	52	371AS-8	186	966A-8D	121
289PP-SS-4	153	309-45	52	378A-6B	187	966A-10D	121
289PP-SS-5	153	309-55	52	378A-6C	187	968A-2A	122
289PP-SS-6	153	309-65	52	378A-6D	187	968A-2X	122
289PP-SS-8	153	309-68	52	378A-8C	187	968A-3A	122
300D	195	309-88	52	378A-8D	187	968A-3B	122
301D	195	309-108	52	388A-12B	187	968A-4A	122
301S-42	50	309-810	52	388A-12C	187	968A-4B	122
301S-44	50	309-1010	52	388A-12D	187	968A-4C	122
301S-64	50	310-44	52	388A-14C	187	968A-4D	122
301S-66	50	310-46	52	388A-14D	187	968A-5A	122
301S-86	50	310-66	52	389A-6B	186	968A-5B	122
301S-88	50	310-88	52	389A-6C	186	968A-6B	122
301S-108	50	310-1010	52	389A-6D	186	968A-6C	122
301S-1212	50	310-1212	52	389A-8C	186	968A-6D	122
302-44	51	312-42	50	389A-8D	186	968A-8B	122
302-45	51	312-44	50	392BV-JXJ	207	968A-8C	122
302-55	51	312-64	50	411B-10	96	968A-8D	122
302-65	51	312-66	50	420D	195	968A-10D	122
302-66	51	312-68	50	421D	195	968A-12E	122
302-88	51	312-88	50	491-8B	99	968A-14E	122
302-1010	51	312-108	50	500AM4-3	68	969A-2A	122
302-1212	51	312-1212	50	541-6B	101	969A-3A	122
302D	195	317S-44	55	650-6F6F-B	209	969A-4A	122
303-43	52	317S-66	55	670C-J	203	969A-4B	122
303-44	52	318S-44	55	670C-L	203	969A-5A	122
303-45	52	318S-66	55	670C-N	203	969A-5B	122
303-55	52	318S-88	55	672C-L	203	969A-6A	122
303-66	52	318S-1212	55	675C-6L	203	969A-6B	122
303-68	52	320D	195	675C-6N	203	969A-6C	122
303-88	52	321D	195	850-8F8F-B	209	969A-8C	122

CHAMPION BRASS

NUMERICAL INDEX

Part#	Page	Part#	Page	Part#	Page	Part#	Page
969A-8D	122	B1-8	73	E1F-6A	80	HBT2-664	30
969A-10D	122	B1-10	73	E1F-6B	80	HBT2-886	30
969A-12E	122	B2-4	73	E1F-6C	80	HBT2-12128	30
972A-4A	123	B2-5	73	E1F-8B	80	HBV-6C	200
972A-4B	123	B2-6	73	E1F-8C	80	HE1-3A	29
972A-6B	123	B2-8	73	E1F-8D	80	HE1-3B	29
1484X4	177	B2-10	73	E1F-45-6B	84	HE1-4A	29
1484X6	177	B2-12	73	E2-2	83	HE1-4B	29
1484X8	177	B362A-6	186	E2-3	83	HE1-4C	29
1484X10	177	B362A-8	186	E2-4	83	HE1-5A	29
1484X12	177	B368A-6B	187	E2-5	83	HE1-5B	29
2302X2	97	B368A-6C	187	E2-8	83	HE1-5C	29
2302X3	97	B368A-6D	187	E2-10	83	HE1-6A	29
2302X4	97	B368A-8C	187	E2-12	83	HE1-6B	29
2302X5	97	B368A-8D	187	E2-14	83	HE1-6C	29
2302X6	97	C1-4444	82	E2F-6	83	HE1-6D	29
2302X8	97	C1-5555	82	E3-3A	81	HE1-8B	29
2302X10	97	C1-6666	82	E3-4A	81	HE1-8C	29
02621-04	128	C1-8888	82	E3-4B	81	HE1-8D	29
02621-06	128	C1-101010	82	E3-4C	81	HE1-10C	29
3099-42	51	CVS127A-D-1/8TAPX1*	15	E3-5A	81	HE1-10D	29
3099-44	51	CVS127A-D-1/8TAPX2*	15	E3-5B	81	HE1-10E	29
3099-46	51	E1-2A	80	E3-6A	81	HE1-12D	29
3099-52	51	E1-3A	80	E3-6B	81	HE1-16E	29
3099-54	51	E1-3B	80	E3-6C	81	HE1-16F	29
3099-62	51	E1-4A	80	E3-6D	81	HE1-45-4A	31
3099-64	51	E1-4B	80	E3-6E	81	HE1-45-4B	31
3099-66	51	E1-4C	80	E3-8B	81	HE1-45-5A	31
3099-68	51	E1-4D	80	E3-8C	81	HE1-45-5B	31
3099-84	51	E1-4S-3A	84	E3-8D	81	HE1-45-6A	31
3099-86	51	E1-5A	80	E3-8E	81	HE1-45-6B	31
3099-88	51	E1-5B	80	E3-10C	81	HE1-45-6C	31
3099-108	51	E1-5C	80	E3-10D	81	HE1-45-8B	31
3099-128	51	E1-5D	80	E3-10E	81	HE1-45-8C	31
3099-812	51	E1-6A	80	E3-12D	81	HE1-45-8D	31
3099-1212	51	E1-6B	80	E3-12E	81	HE1-45-10C	31
3099-1616	51	E1-6C	80	E3-14E	81	HE1-45-12D	31
3099S-42	54	E1-6D	80	E3F-6C	81	HE1B-4A	38
3099S-44	54	E1-6E	80	ER2-64	84	HE1B-5A	38
3099S-46	54	E1-8A	80	ER2-84	84	HE1B-5B	38
3099S-64	54	E1-8B	80	ER2-86	84	HE1B-6A	38
3099S-66	54	E1-8C	80	ER2-106	84	HE1B-6B	38
3099S-68	54	E1-8D	80	ER2-108	84	HE1B-6C	38
3099S-88	54	E1-8E	80	ER2-1210	84	HE1B-8B	38
3099S-812	54	E1-10B	80	ES4-44	86	HE1B-8C	38
3099S-1212	54	E1-10C	80	ES4-66	86	HE1B-10B	38
3222BV-JJXJ	207	E1-10D	80	ES4-88	86	HE1B-10C	38
3222BV-LLXL	207	E1-10E	81	ES4-1010	86	HE1B-10D	38
4122BV-LL	207	E1-12C	81	ES4-1212	86	HE1B-12D	38
5818X8	201	E1-12D	81	GHN1	60	HE1B-12E	38
5818X12	201	E1-12E	81	GHN1-H	60	HE1F-12E	29
6945A-3A	115	E1-12F	81	GHN1-HC	60	HE3-4A	30
6945A-4A	115	E1-14E	81	GHN5	61	HE3-4B	30
6945A-4B	115	E1-16E	81	GHN5-CHAIN	61	HE3-6A	30
6945A-5A	115	E1-45-4A	84	GHN5-DC	61	HE3-6B	30
6945A-5B	115	E1-45-4B	84	GHP1	61	HE3-6C	30
6945A-6B	115	E1-45-5A	84	GH-W	61	HE3-8B	30
6945A-6C	115	E1-45-5B	84	GH-W-RED	61	HE3-8C	30
6945A-8C	115	E1-45-6B	84	GH-W-SCREEN	61	HE3-8D	30
6945A-8D	115	E1-45-6C	84	H130C-L	194	HE3-12E	30
6945A-10D	115	E1-45-6D	84	HBT2-2	30	HM-2	27
7814X8X8X90	201	E1-45-8C	84	HBT2-3	30	HM-3	27
7814X8X90	201	E1-45-8D	84	HBT2-4	30	HM-4	27
7814X8X90X1	201	E1-45-10C	84	HBT2-5	30	HM-5	27
7912	103	E1-45-10D	84	HBT2-6	30	HM-6	27
ABV1-B	201	E1-45-12D	84	HBT2-6B	30	HM-8	27
ABV1-C	201	E1F-3A	80	HBT2-8	30	HM-10	27
ABV1-D	201	E1F-4A	80	HBT2-10	30	HM-10	62
B1-4	73	E1F-4B	80	HBT2-12	30	HM-12	27
B1-6	73	E1F-5A	80	HBT2-442	30	HM-12	62

CHAMPION BRASS

NUMERICAL INDEX

Part#	Page	Part#	Page	Part#	Page	Part#	Page
HM-16	27	NS4-3	71	T1-10E	76	U1-8C	78
HM-42	27	NS4-4	71	T1-12D	76	U1-8D	78
HM-54	27	NS4-5	71	T1-12E	76	U1-8E	78
HM-64	27	NS4-6	71	T1F-4A	76	U1-10B	78
HM-65	27	NS4-8	71	T2-2	75	U1-10C	79
HM-86	27	NS4-10	71	T2-3	75	U1-10D	79
HM-90-2	31	NS4-12	71	T2-4	75	U1-12D	79
HM-90-3	31	NS4-14	71	T2-5	75	U1-12E	79
HM-90-4	31	NSR4-54	72	T2-6	75	U1-14D	79
HM-90-5	31	NSR4-64	72	T2-8	75	U1-14E	79
HM-90-6	31	NSR4-65	72	T2-10	75	U1-16E	79
HM-90-8	31	NSR4-86	72	T2-12	75	U1-16F	79
HM-90-10	31	NSR4-106	72	T2F-4	75	U1GA-10DE	88
HM-90-12	31	NSR4-108	72	T3-3A	82	U2-2	74
HM-106	27	NSR4-128	72	T3-4A	82	U2-3	74
HM-108	27	NSR4-1210	72	T3-4B	82	U2-4	74
HM-128	27	P2-3	72	t3-4c	82	U2-5	74
HM-1210	27	P2-4	72	T3-5A	82	U2-6	74
HM-1612	27	P2-5	72	T3-5B	82	U2-8	74
HV1-6C	200	P2-6	72	T3-6A	82	U2-10	74
HV1-8C	200	P2-8	72	T3-6B	82	U2-12	74
HV1-10C	200	P2-10	72	T3-6C	82	U2-14	74
HV1-10D	200	P2-12	72	T3-6D	82	u3-2a	77
HV1-12C	200	POL-LTP	89	T3-8C	82	U3-3A	77
HV1-12D	200	POL-LTPH	89	T3-8D	82	U3-4A	77
HV1-PH-10C	200	POL-N	89	T3-10C	82	U3-4B	77
K1-8	86	POL-N5	89	T3-10D	82	U3-4C	77
N1-2	70	POL-NLTP	89	T3-12D	82	U3-4D	77
N1-2	120	POL-T1	89	T3-12E	82	U3-5A	77
N1-3	70	POL-U2-6	90	T4-4A	83	U3-5B	77
N1-4	70	POL-U2-8	90	T4-4B	83	u3-5c	77
N1-5	70	POL-U2-10	90	T4-6B	83	U3-6A	77
N1-6	70	PSN76	68	T9-222	17	U3-6B	77
N1-7	70	RAB6-50	187	T9-444	17	U3-6C	77
N1-8	70	RAB6-250	187	T9-666	17	U3-6D	77
N1-10	70	RAB8-50	187	T9-888	17	U3-6E	77
N1-12	70	RAB8-250	187	T9-121212	17	U3-8B	77
N1-14	70	RU1-4A	78	T13-4A	83	U3-8C	77
N1-16	70	RU1-4B	78	T13-4B	83	U3-8E	77
N1-64	70	RU1-5B	78	TR2-446	76	U3-10C	77
N1-86	70	RU1-6B	78	TR2-664	76	U3-10D	77
N1-108	70	RU1-6C	78	TR2-668	76	U3-10E	77
N2-2	71	RU1-6D	78	TR2-686	76	U3-12D	77
N2-3	71	RU1-6E	78	TR2-868	76	U3-12E	77
N2-4	71	RU1-8C	78	TR2-884	76	U3-14E	77
N2-5	71	RU1-8D	78	TR2-886	76	U4-4	84
N2-6	71	RU1-10C	79	TR2-1068	76	U4-6	84
N2-8	71	RU1-10D	79	TR2-1088	76	U4-8	84
N2-10	71	RU1-10E	79	TR2-6610	76	U5-4A	85
N2-12	71	RU3-4A	77	TR2-8810	76	U5-4B	85
N4-4	71	RU3-6B	77	TR2-8812	76	U5-6B	85
N4-5	71	RU3-6D	77	TR2-10106	76	U5-8C	85
N4-6	71	RU3-8C	77	TR2-10108	76	U5-8D	85
N4-8	71	RU3-8D	77	TR2-10610	76	UR2-54	75
N4-10	71	T1-2A	76	TR2-10810	76	UR2-64	75
N4-12	71	T1-3A	76	U1-2A	78	UR2-65	75
N5-3	73	T1-4B	76	U1-3A	78	UR2-84	75
N5-4	73	T1-4D	76	U1-3B	78	UR2-86	75
N5-5	73	T1-5A	76	U1-4A	78	UR2-106	75
N5-6	73	T1-5B	76	U1-4B	78	UR2-108	75
N5-8	73	T1-6A	76	U1-4C	78	UR2-128	75
N5-10	73	T1-6B	76	U1-4D	78	UR2-1210	75
N5-12	73	T1-6C	76	U1-5A	78	UR3-46	85
N5CT-4	115	T1-6D	76	U1-5B	78	UR3-64	85
N5CT-6	115	T1-8B	76	U1-5C	78	UR3-68	85
N5CT-8	115	T1-8C	76	U1-6A	78	UR3-84	85
N5CT-10	115	T1-8D	76	U1-6B	78	UR3-86	85
NE-127A-B-1/8TAP	15	T1-8E	76	U1-6C	78	UR3-106	85
NE-127A-C-1/8TAP	15	T1-10C	76	U1-6D	78	UR3-108	85
NE-127A-D-1/8TAP	15	T1-10D	76	U1-8B	78	UR3-610	85

CHAMPION BRASS

NUMERICAL INDEX

Part#	Page	Part#	Page	Part#	Page	Part#	Page
UR3-810	85						
UR3-1012	85						
UR3-1210	85						
US3-44	87						
US3-46	87						
US3-66	87						
US3-1010	87						
US3-1212	87						
US4-4	86						
US4-5	86						
US4-6	86						
US4-8	86						
US4-10	86						
US4-12	86						
US4-64	86						
US4-86	86						
US4-108	86						
W1-6	62						
W1-B	59						
W1-C	59						
W1-CX	59						
W1-D	59						
W1-E	59						

MID-AMERICA FITTINGS

NUMERICAL INDEX

Part#	Page	Part#	Page	Part#	Page	Part#	Page	Part#	Page	Part#	Page
13GH	58	29BB-108	37	29E-68	29	29FMB-22	41	29MB-48	41	29PO2-44	51
16GH	58	29BB-128	37	29E-68BS	30	29FMB-24	41	29MB-66	41	29PO2-46	51
16KNGH*	58	29BB-1212	37	29E-84	29	29FMB-44	41	29MB-68	41	29PO2-52	51
20PO10-45	52	29BB-1612	37	29E-84BS	30	29FMB-46	41	29MBE-21	42	29PO2-54	51
22IFS-43	99	29BEMB-2	42	29E-86	29	29FMB-66	41	29MBE-22	42	29PO2-62	51
22IFS-53	99	29BEMB-4	42	29E-86BS	30	29FS-22	32	29MBE-24	42	29PO2-64	51
22IFS-54	99	29BEMB-6	42	29E-88	29	29FS-32	32	29MBE-42	42	29PO2-66	51
22IFS-64	99	29C	196	29E-88BS	30	29FS-34	32	29MBE-44	42	29PO2-68	51
22IFS-65	99	29CJIC-66	35	29E-106	29	29FS-36	32	29MBE-66	42	29PO2-84	51
27C	196	29CJIC-66*	35	29E-108	29	29FS-42	32	29MBFE-22	42	29PO2-86	51
27SAE	197	29CJIC-1212*	35	29E-1212BS	30	29FS-44	32	29MBFE-44	42	29PO2-88	51
28C	196	29CSAE-34	34	29ESB-42	38	29FS-46	32	29MBFT-22	43	29PO2-106	51
28SAE	197	29CSAE-36	34	29ESB-52	38	29FS-54	32	29MBHS-2	41	29PO2-108	51
29-10	24	29CSAE-44	34	29ESB-54	38	29FS-56	32	29MBHS-4	41	29PO2-128	51
29-11	24	29CSAE-44	34	29ESB-62	38	29FS-64	32	29MBHS-6	41	29PO2-612	51
29-20	24	29CSAE-66	34	29ESB-64	38	29FS-66	32	29MBMRT-22	43	29PO2-812	51
29-21	24	29CSAE-66	34	29ESB-66	38	29FS-68	32	29MBMRT-42	43	29PO2-1012	51
29-22	24	29CSAE-88	34	29ESB-86	38	29FS-86	32	29MBMT-22	43	29PO2-1212	51
29-24	24	29CSAE-88	34	29ESB-88	38	29FS-88	32	29MBMT-42	43	29PO2-1612	51
29-31	24	29CSAE-122	34	29ESB-106	38	29FS-1212	32	29MBMT-44	43	29PO2-1616	51
29-32	24	29CSAE-1010	34	29ESB-108	38	29FW-3	40	29MBP-2	43	29PO3-44	51
29-34	24	29CSAE-1212	34	29ESB-128	38	29FW-4	40	29MBP-4	43	29PO3-45	51
29-36	24	29CT-24	33	29ESB-1212	38	29FW-5	40	29MBP-6	43	29PO3-46	51
29-41	24	29CT-33	33	29ESB-1612	38	29FW-6	40	29MBT-2	42	29PO3-55	51
29-42	24	29CT-34	33	29F-22	28	29FWE3-6	39	29MBT-4	42	29PO3-64	51
29-44	24	29CT-43	33	29F-24	28	29FWE3-9	39	29MBT-6	42	29PO3-65	51
29-46	24	29CT-44	33	29F-32	28	29FWE4-9	39	29MBTR-442	42	29PO3-66	51
29-48	24	29CT-45	33	29F-34	28	29FWE5-6	39	29MBTR-464	42	29PO3-68	51
29-52	24	29CT-46	33	29F-42	28	29FWE6-9	39	29MBTR-662	42	29PO3-88	51
29-54	24	29CT-54	33	29F-44	28	29FWL3-6	39	29MBTR-664	42	29PO3-106	51
29-56	24	29CT-55	33	29F-46	28	29FWL3-9	39	29MDB-22	43	29PO3-108	51
29-58	24	29CT-63	33	29F-48	28	29FWL4-9	39	29MDB-24	43	29PO3-810	51
29-62	24	29CT-64	33	29F-52	28	29FWL5-9	39	29MDB-44	43	29PO3-1010	51
29-64	24	29CT-66	33	29F-54	28	29FWL6-9	39	29MGH-8LG	64	29PO3-1210	51
29-66	24	29CT-88	33	29F-56	28	29FWN-9L	40	29MGH-10LG	64	29PO3-1212	51
29-68	24	29DB-20	43	29F-58	28	29FWN-9R	40	29MGH-12LG	64	29PO4-42	54
29-74	24	29DBBE-2	44	29F-62	28	29GHS-8H	63	29MGH-16LG	64	29PO4-44	54
29-76	24	29DBBE-4	44	29F-64	28	29GHS-8LGH	64	29MGH-412	64	29PO4-46	54
29-78	24	29DBBE-532	44	29F-66	28	29GHS-8MHK	64	29MGH-612	63	29PO4-64	54
29-82	24	29DBE-22	44	29F-68	28	29GHS-10H	63	29MGH-0612	64	29PO4-66	54
29-84	25	29DBE-24	44	29F-82	28	29GHS-10LGH	64	29MGH-812	63	29PO4-68	54
29-86	25	29DBE-42	44	29F-84	28	29GHS-10MHK	64	29MGH-812	64	29PO4-88	54
29-88	25	29DBE-44	44	29F-86	28	29GHS-12H	63	29MGH-1012	63	29PO4-108	54
29-104	25	29DBT-2	43	29F-88	28	29GHS-12LGH	64	29MGH-1012	64	29PO4-812	54
29-106	25	29DBT-4	43	29F-106	28	29GHS-12MHK	64	29MGH-1212	63	29PO4-1012	54
29-108	25	29DS-34	34	29F-108	28	29GHS-16H	63	29MGH-1212	64	29PO4-1212	54
29-124	25	29DS-44	34	29F-128	28	29GHS-65H	63	29MGH-1612	63	29PO5-44	52
29-126	25	29DS-45	34	29F-612	28	29HPS-44	27	29MGH-1616	63	29PO5-45	52
29-128	25	29DS-55	34	29F-812	28	29HPS-64	27	29MS-32	26	29PO5-55	52
29-166	25	29DS-68	34	29F-1012	28	29IFS-44	38	29MS-34	26	29PO5-65	52
29-168	25	29DS-88	34	29F-1212	28	29IFS-45	38	29MS-42	26	29PO5-68	52
29-412	24	29DS-810	34	29F-1612	28	29IFS-54	38	29MS-44	26	29PO5-88	52
29-512	24	29E-42	29	29F-1616	28	29IFS-55	38	29MS-46	26	29PO5-108	52
29-612	24	29E-42BS	30	29F-2016	28	29IFS-56	38	29MS-62	26	29PO5-810	52
29-812	25	29E-44	29	29FGH-8LGH	64	29IFS-65	38	29MS-64	26	29PO5-1010	52
29-816	25	29E-44BS	30	29FGH-10LGH	64	29IFS-66	38	29MS-64HF	27	29PO5-1210	52
29-1012	25	29E-46	29	29FGH-12LGH	64	29IMES-44	38	29MS-66	26	29PO6-44	53
29-1016	25	29E-46BS	30	29FGH-16LGH	64	29IMES-45	38	29MS-68	26	29PO6-45	53
29-1212	25	29E-52	29	29FGH-412	64	29IMES-55	38	29MS-86	26	29PO6-46	53
29-1216	25	29E-52BS	30	29FGH-0612	64	29IMES-65	38	29MS-88	26	29PO6-55	53
29-1612	25	29E-54	29	29FGH-612H	63	29IMES-66	38	29MS-1212	26	29PO6-56	53
29-1616	25	29E-54BS	30	29FGH-812	64	29JIC-46	35	29MS-1616	26	29PO6-65	53
29-1620	25	29E-56	29	29FGH-812H	63	29JIC-56	35	29MSAE-34	33	29PO6-66	53
29-2012	25	29E-56BS	30	29FGH-812MHK	64	29JIC-1212	35	29MSAE-44	33	29PO6-68	53
29-2016	25	29E-62	29	29FGH1012H	63	29MB-12	41	29MSAE-46	33	29PO6-86	53
29-2020	25	29E-62BS	30	29FGH-1012MHK	64	29MB-21	41	29MSAE-55	33	29PO6-88	53
29BB-84	37	29E-64	29	29FGH-1212H	63	29MB-22	41	29MSAE-66	33	29PO6-1010	53
29BB-86	37	29E-64BS	30	29FGH-1212MHK	64	29MB-24	41	29MSAE-68	33	29PO6-1212	53
29BB-88	37	29E-66	29	29FGH-1612H	63	29MB-42	41	29MSAE-88	33	29PO7-44	53
29BB-106	37	29E-66BS	30	29FGH-1616H	63	29MB-44	41	29PO2-42	51	29PO7-46	53

MID-AMERICA FITTINGS

NUMERICAL INDEX

Part#	Page	Part#	Page	Part#	Page	Part#	Page	Part#	Page	Part#	Page
29PO7-56	53	29PO16-88	53	29SR-63	27	40RG-15	88	43-64	74	46IF-32	98
29PO7-66	53	29PO16-1010	53	29SR-64	27	41FT-6	87	44F-2	75	46IF-42	98
29PO7-86	53	29PO19-442	54	29SR-65	27	41FB-2	96	44F-3	75	46IF-44	98
29PO7-88	53	29PO19-444	54	29SR-84	27	41FB-3	96	44F-4	75	46IF-52	98
29PO7-1010	53	29PO19-664	54	29SR-86	27	41FB-4	96	44F-5	75	46IF-64	98
29PO7-1212	53	29PO19-666	54	29SR-104	27	41FB-5	96	44F-6	75	46IF-66	98
29PO7-1616	53	29RU17-484	35	29SR-106	27	41FB-6	96	44F-8	75	46IF-74	98
29PO8-4	50	29RU17-494	35	29SR-108	27	41FB-8	96	44F-10	75	46IF-84	98
29PO8-5	50	29RU17-4104	35	29SR-126	27	41FB-10	96	44F-12	75	46IF-86	98
29PO8-6	50	29RU17-5104	35	29SR-128	27	41FB-12	96	44F-14	75	46IF-108	98
29PO8-8	50	29RU17-6104	35	29SR-168	27	41FB-16	96	44FR-446	76	46IF-1212	98
29PO8-10	50	29RU17-6106	35	29SR-1210	27	41FS-2	96	44FR-554	76	46RG-158	88
29PO8-12	50	29RU17-6114	35	29SR-1610	27	41FS-3	96	44FR-644	76	46RG-1512	88
29PO9-42	50	29RU17-6116	35	29SR-1612	27	41FS-3L	96	44FR-646	76	48-22	78
29PO9-44	50	29RU17-6124	35	29SR-88	35	41FS-4	96	44FR-664	76	48-32	78
29PO9-62	50	29RU17-8148	35	29SWT-128	35	41FS-4L	96	44FR-668	76	48-34	78
29PO9-64	50	29S-2	27	29SWT-1210	35	41FS-5	96	44FR-848	76	48-42	78
29PO9-66	50	29S-3	27	29SWT-1214	35	41FS-6	96	44FR-866	76	48-44	78
29PO9-86	50	29S-4	27	29SWT-1616	35	41FS-7	96	44FR-868	76	48-46	78
29PO9-88	50	29S-5	27	29T-4	30	41FS-8	96	44FR-884	76	48-48	78
29PO9-108	50	29S-6	27	29T-5	30	41FS-10	96	44FR-886	76	48-52	78
29PO9-1212	50	29S-8	27	29T-6	30	41FS-12	96	44FR-1066	76	48-54	78
29PO10-43	52	29S-8	62	29TRM-664	30	41FS-14	96	44FR-6610	76	48-56	78
29PO10-44	52	29S-10	27	29UFS-22	29	41FS-16	96	44FR-8810	76	48-58	78
29PO10-55	52	29S-10	62	29UFS-32	29	41L-2	71	44FR-10104	76	48-62	78
29PO10-66	52	29S-12	27	29UFS-34	29	41L-3	71	44FR-10106	76	48-64	78
29PO10-68	52	29S-12	62	29UFS-42	29	41L-4	71	44FR-10108	76	48-66	78
29PO10-88	52	29S-16	27	29UFS-44	29	41L-5	71	44FR-10810	76	48-68	78
29PO10-1010	52	29S-16	62	29UFS-46	29	41L-6	71	44FR-121012	76	48-84	78
29PO10-1212	52	29S-20	27	29UFS-54	29	41L-8	71	44FR-121210	76	48-86	78
29PO11-44	52	29SAE-33	34	29UFS-64	29	41L-10	71	44FT-6	88	48-88	78
29PO11-45	52	29SAE-34	34	29UFS-66	29	41L-12	71	44IF-2	100	48-104	78
29PO11-46	52	29SAE-36	34	29UFS-68	29	41LN-4	75	44IF-3	100	48-106	79
29PO11-64	52	29SAE-44	34	29UFS-86	29	41LN-6	75	44IF-4	100	48-108	79
29PO11-65	52	29SAE-45	34	29UFS-88	29	41LN-8	75	44IF-5	100	48-128	79
29PO11-66	52	29SAE-46	34	29UFS-812	29	41SR-64	70	44IF-6	100	48-148	79
29PO11-68	52	29SAE-55	34	29UFS-1012	29	41SR-86	70	44IF-8	100	48-168	79
29PO11-88	52	29SAE-56	34	29UFS-1212	29	41SR-108	70	44IF-14	100	48-812	78
29PO11-108	52	29SAE-66	34	30C	196	41SRG	88	45IF-32	101	48-1012	79
29PO11-810	52	29SAE-68	34	30SAE	197	42-2	74	45IF-42	101	48-1212	79
29PO11-1010	52	29SAE-88	34	31P	196	42-3	74	45IF-52	101	48-1412	79
29PO11-1210	52	29SAE-1010	34	32P	196	42-4	74	45IF-64	101	48-1612	79
29PO11-1212	52	29SB-32	37	39-2	72	42-5	74	46-22	77	48-1616	79
29PO11-1612	52	29SB-42	37	39-3	72	42-6	74	46-32	77	48FT-66	88
29PO11-1616	52	29SB-44	37	39-4	72	42-8	74	46-42	77	48FT-68	88
29PO12-42	50	29SB-52	37	39-5	72	42-10	74	46-44	77	48IF-22	98
29PO12-44	50	29SB-54	37	39-6	72	42-12	74	46-46	77	48IF-32	98
29PO12-64	50	29SB-62	37	39-8	72	42-14	74	46-48	77	48IF-34	98
29PO12-66	50	29SB-64	37	39-10	72	42BH-4	75	46-52	77	48IF-42	98
29PO12-68	50	29SB-66	37	39-12	72	42BH-6	75	46-54	77	48IF-44	98
29PO12-88	50	29SB-84	37	39-14	72	42BH-8	75	46-62	77	48IF-46	98
29PO12-1012	50	29SB-86	37	39IF-3	100	42BH-10	75	46-64	77	48IF-52	98
29PO12-1212	50	29SB-88	37	39IF-4	100	42BH-12	75	46-66	77	48IF-54	98
29PO13-43	54	29SB-106	37	39IF-5	100	42FT-6	88	46-68	77	48IF-56	98
29PO13-44	54	29SB-108	37	39IF-6	100	42R-42	75	46-84	77	48IF-62	98
29PO13-45	54	29SB-128	37	39IFB-6	100	42R-43	75	46-86	77	48IF-64	98
29PO13-55	54	29SB-168	37	39IFB-8	100	42R-54	75	46-88	77	48IF-66	98
29PO13-65	54	29SB-812	37	39IFB-10	100	42R-64	75	46-106	77	48IF-74	98
29PO13-66	54	29SB-1012	37	39IFB-12	100	42R-65	75	46-108	77	48IF-84	98
29PO13-88	54	29SB-1212	37	40-2	73	42R-84	75	46-128	77	48IF-86	98
29PO16-43	53	29SB-1612	37	40-3	73	42R-86	75	46-148	77	48IF-88	98
29PO16-44	53	29SB-1616	37	40-4	73	42R-106	75	46-612	77	48IF-108	98
29PO16-45	53	29SB-1616	37	40-5	73	42R-108	75	46-812	77	48IF-128	98
29PO16-54	53	29SB-1816	37	40-6	73	42R-128	75	46-1012	77	48IF-1012	98
29PO16-55	53	29SBBHS-5	20	40-8	73	42R-1210	75	46-1212	77	48IF-1212	98
29PO16-56	53	29SBBHS-6	20	40-10	73	42RBH-68	75	46-1412	77	48IF-1412	98
29PO16-65	53	29SDB-62	44	40-12	73	42RBH-86	75	46FT-66	87	48IF-1612	98
29PO16-66	53	29SR-42	27	40-14	73	43-42	74	46FT-68	87	48IF-1616	98
29PO16-68	53	29SR-54	27	40FT-6	87	43-44	74	46FT-612	87	48P	196
29PO16-86	53	29SR-62	27	40P	196	43-52	74	46IF-22	98	48RGT-158	88

MID-AMERICA FITTINGS

NUMERICAL INDEX

Part#	Page	Part#	Page	Part#	Page	Part#	Page	Part#	Page	Part#	Page
48RGT-1512	88	49S-44	87	53F-42	83	60P-8	232	63-52	116	66-1412	109
48S-44	87	49S-66	87	53F-44	83	60P-10	120	63-64	116	66GH-1216	60
48S-46	87	49S-88	87	53F-64	83	60P-10	232	63P-2	120	66GH-1616	60
48S-64	87	50F-32	81	53FM-224	83	60V	201	63P-2	233	66S-410*	109
48S-66	87	50F-42	81	53FM-444	83	61-2	106	63P-3	120	66S-610*	109
48S-68	87	50F-44	81	53FM-666	83	61-4	106	63P-3	233	66S-810*	109
48S-88	87	50F-46	81	53FP-6668*	83	61-5	106	63P-4	120	66T-88**	109
48S-810	87	50F-48	81	53IF-32	101	61-6	106	63P-4	233	67SAE	197
48S-1010	87	50F-52	81	53IF-42	101	61-7	106	63P-5	120	68-21	110
48S-1014	87	50F-54	81	55F-2	83	61-8	106	63P-5	233	68-32	110
48S-1212	87	50F-62	81	55F-3	83	61-10	106	63P-6	120	68-34	110
48S-1214	87	50F-64	81	55F-4	83	61-12	106	63P-6	233	68-42	110
48S-1414	87	50F-66	81	55F-5	83	61-14	106	63P-8	120	68-44	110
48S-1618	87	50F-68	81	55F-6	83	61CC-2	115	63P-8	233	68-52	110
48S-1818	87	50F-84	81	55F-8	83	61CC-3	115	63P-10	120	68-54	110
48WT-66-820	88	50F-86	81	55F-10	83	61CC-4	115	63P-12	120	68-56	110
48WT-662	88	50F-88	81	55F-12	83	61CC-6	115	64F-2	108	68-58	110
48WT-664	88	50F-106	81	55F-14	83	61CC-8	115	64F-3	108	68-62	110
48WT-686	88	50F-108	81	55FR-64	84	61CC-10	115	64F-4	108	68-64	110
48WT-886	88	50F-128	81	55FR-84	84	61CC-12	115	64F-5	108	68-66	110
49F-22	80	50F-612	81	55FR-86	84	61LN-2	116	64F-6	108	68-68	110
49F-32	80	50F-812	81	55FR-106	84	61LN-3	116	64F-7	108	68-76	110
49F-34	80	50F-1012	81	55FR-108	84	61LN-4	116	64F-8	108	68-84	110
49F-42	80	50F-1212	81	55FR-128	84	61LN-5	116	64F-10	108	68-86	110
49F-44	80	50F-1412	81	55FR-1210	84	61LN-6	116	64F-12	108	68-88	110
49F-46	80	50FT-68	88	55IF-4	101	61LN-8	116	64F-14	108	68-104	110
49F-48	80	50IF-32	100	55IF-5	101	61LN-10	116	64FCS-3	121	68-108	110
49F-52	80	50IF-42	100	55IF-6	101	61X3	106	64FCS-4	121	68-128	110
49F-54	80	50IF-52	100	55IF-8	101	62-2	107	64FCS-6	121	68-148	110
49F-56	80	50IF-64	100	57C	196	62-3	107	64FR-442	108	68-612	110
49F-62	80	50IF-86	100	57SAE	197	62-4	107	64FR-446	108	68-812	110
49F-64	80	50P	196	58C	196	62-5	107	64FR-554	108	68-1012	110
49F-66	80	51F-32	82	58FP-42	83	62-6	107	64FR-644	108	68-1212	110
49F-68	80	51F-42	82	58FP-44	83	62-7	107	64FR-664	108	68-1412	110
49F-84	80	51F-44	82	58FP-64	83	62-8	107	64FR-884	108	68-1416	110
49F-86	80	51F-46	82	58FP-66	83	62-10	107	64FR-886	108	68-1612	110
49F-88	80	51F-52	82	58FP-86	83	62-14	107	64FR-10106	108	68-1616	110
49F-104	80	51F-54	82	58FP-88	83	62BH-3	116	64FR-10108	108	68C	196
49F-106	80	51F-62	82	58SAE	197	62BH-4	116	65F-10	108	68CS-21	122
49F-126	81	51F-64	82	59IF-22	100	62BH-5	116	65F-12	108	68CS-22	122
49F-128	81	51F-66	82	59IF-32	100	62BH-6	116	65F-14	108	68CS-32	122
49F-612	80	51F-68	82	59IF-42	100	62BH-8	116	65FR-64	109	68CS-34	122
49F-812	80	51F-84	82	59IF-52	100	62BH-10	116	65FR-86	109	68CS-42	122
49F-1012	81	51F-86	82	59IF-54	100	62CS-2	121	65R-106	109	68CS-44	122
49F-1212	81	51F-88	82	59IF-62	100	62CS-3	121	65R-108	109	68CS-46	122
49F-1412	81	51F-106	82	59IF-64	100	62CS-4	121	66-22	109	68CS-48	122
49F-1612	81	51F-108	82	59IF-86	100	62CS-5	121	66-32	109	68CS-52	122
49F-1616	81	51F-128	82	59IF-108	100	62CS-6	121	66-34	109	68CS-54	122
49FT-68	88	51F-668	82	60-2	106	62CS-8	121	66-42	109	68CS-64	122
49IF-22	99	51F-886	82	60-3	106	62CS-10	121	66-44	109	68CS-66	122
49IF-32	99	51F-1212	82	60-4	106	62CS-64	121	66-46	109	68CS-68	122
49IF-42	99	51FP-44	82	60-5	106	62FC-6	107	66-48	109	68CS-84	122
49IF-44	99	51FP-66	82	60-6	106	62R-32	107	66-52	109	68CS-86	122
49IF-52	99	51FP-68	82	60-7	106	62R-42	107	66-54	109	68CS-88	122
49IF-54	99	51IF-32	101	60-8	106	62R-43	107	66-56	109	68CS-108	122
49IF-56	99	51IF-42	101	60-10	106	62R-54	107	66-62	109	68GH-1216	60
49IF-62	99	51IF-52	101	60-12	106	62R-64	107	66-64	109	68GH-1616	60
49IF-64	99	51IF-64	101	60-14	106	62R-65	107	66-66	109	68LP-68	110
49IF-66	99	51IF-86	101	60CSP-4	115	62R-106	107	66-68	109	68SAE	197
49IF-84	99	52F-4	82	60CSP-5	115	62R-108	107	66-84	109	68T-22	117
49IF-86	99	52F-5	82	60CSP-6	115	62R-146	107	66-86	109	68T-32	117
49IF-88	99	52F-6	82	60CSP-8	115	62T-2	107	66-88	109	68T-34	117
49IF-106	99	52F-8	82	60CSP-10	115	62T-4	107	66-106	109	68T-42	117
49IF-108	99	52F-10	82	60P-4	120	62T-6	107	66-108	109	68T-44	117
49IF-128	99	52IF-32	101	60P-4	232	62T-8	107	66-128	109	68T-46	117
49IF-1212	99	52IF-42	101	60P-5	120	62T-10	107	66-148	109	68T-48	117
49IF-1412	99	52IF-52	101	60P-5	232	62T-14	107	66-612	109	68T-54	117
49IF-1616	99	52IF-64	101	60P-6	120	63-22	116	66-812	109	68T-56	117
49IFRH-42	99	52IF-86	101	60P-6	232	63-32	116	66-1012	109	68T-64	117
49P	196	52IF-88	101	60P-8	120	63-42	116	66-1212	109	68T-66	117

MID-AMERICA FITTINGS

NUMERICAL INDEX

Part#	Page	Part#	Page	Part#	Page	Part#	Page	Part#	Page	Part#	Page
68T-68	117	70F-108	112	84GHS	59	106SAE	198	111-6	10	120-42	16
68T-76	117	70F-128	112	85GH	59	107C	198	111-8	10	120-44	16
68T-86	117	70F-612	112	85GHL	59	108-2	6	111-12	10	120-48	16
68T-88	117	70F-812	112	85GHT	59	108-4	6	112-2	11	120-62	16
68T-108	117	70F-1012	112	86GH	60	108-6	6	112-4	11	120-64	16
68T-1012	117	70V	201	86GH-16H	60	108-8	6	112-6	11	120-66	16
68T-1212	117	71F-22	113	86GH-1612H	60	108-12	6	112-8	11	120-68	16
68T-1416	117	71F-32	113	86GHT	60	108-16	6	112-12	11	120-82	16
69-42	111	71F-42	113	94GH	62	108-20	6	113-224	11	120-84	16
69-66	111	71F-44	113	95GH	62	108-24	6	113-232	11	120-86	16
69F-22	111	71F-52	113	96GH	62	108-32	6	113-240	11	120-88	16
69F-32	111	71F-54	113	98GH	62	108P	199	113-248	11	120-124	16
69F-34	111	71F-62	113	99GH	62	108SAE	198	113-256	11	120-126	16
69F-42	111	71F-64*	113	100F-2	2	109-2	9	113-424	11	120-128	16
69F-44	111	71F-66	113	100F-4	2	109-4	9	113-432	11	120-164	16
69F-46	111	71F-86	113	100F-6	2	109-6	9	113-440	11	120-166	16
69F-48	111	71F-88	113	100F-8	2	109-8	9	113-448	11	120-168	16
69F-52	111	71F-108	113	100F-12	2	109-12	9	113-456	11	120-328	16
69F-54	111	71F-128	113	100FR-42	2	109-16	9	113-624	11	120-1612	16
69F-56	111	71F-1212	113	100FR-64	2	109AL-1	9	113-632	11	120-1616	16
69F-58	111	72F-22	114	100FR-86	2	109AL-2	9	113-640	11	120-3212	16
69F-62	111	72F-42	114	100GH	62	109AL-4	9	113-648	11	120-3224	16
69F-64	111	72F-44	114	101C	198	109AL-6	9	113-656	11	120-3232	16
69F-68	111	72F-52	114	101F-2	3	109AL-8	9	113-824	11	120C-4	205
69F-74	111	72F-54	114	101F-4	3	109AL-12	9	113-832	11	120XL-220	18
69F-76	111	72F-62	114	101F-6	3	109AL-16	9	113-840	11	120XL-228	18
69F-84	111	72F-64	114	101F-8	3	109SD-2	9	113-848	11	120XL-248	18
69F-86	111	72F-66	114	101F-12	3	109SD-4	9	113-856	11	120XL-425	18
69F-88	111	72F-68	114	101FR-224	3	109SD-6	9	113-1224	11	120XL-429	18
69F-106	111	72F-84	114	101FR-442	3	109SD-8	9	113-1232	11	120XL-433	18
69F-108	112	72F-86	114	101FR-446	3	109SD-12	9	113-1240	11	121-1	10
69F-128	112	72F-88	114	101FR-646	3	109SD-16	9	113-1248	11	121-2	10
69F-148	112	72F-108	114	101FR-664	3	110-21	8	113C	198	121-4	10
69F-612	111	72F-128	114	101FR-886	3	110-42	8	113CCS	123	121-6	10
69F-812	111	72F-1212	114	101FR-12128	3	110-62	8	115SAE	199	121-8	10
69F-1012	112	72FCS-42	123	101FR-12812	3	110-64	8	116F-2	6	121-12	10
69F-1212	112	72FCS-44	123	102C	198	110-82	8	116F-4	6	121-16	10
69F-1412	112	72FCS-52	123	102F-2	4	110-84	8	116F-6	6	121-20	10
69FCS-22	122	72FCS-64	123	102F-4	4	110-86	8	116F-8	6	121-24	10
69FCS-32	122	73GH	58	102F-6	4	110-122	8	116F-12	6	121-32	10
69FCS-34	122	74GH	58	102F-8	4	110-124	8	116XL-219	18	121S-2	10
69FCS-42	122	75F-42	114	102GH	59	110-126	8	116XL-223	18	121S-4	10
69FCS-44	122	75GH	58	102GH-LNG	59	110-128	8	116XL-227	18	121S-6	10
69FCS-46	122	76F-42	114	103-2	4	110-162	8	116XL-230	18	121S-8	10
69FCS-52	122	76F-64	114	103-4	4	110-164	8	116XL-419	18	121S-12	10
69FCS-54	122	76GH	60	103-6	4	110-166	8	116XL-423	18	121S-16	10
69FCS-62	122	76P	196	103-8	4	110-168	8	116XL-427	18	122-2	12
69FCS-64	122	77GH	60	103-12	4	110-328	8	116XL-430	18	122-4	12
69FCS-66	122	77P	196	103-16	4	110-1612	8	116XL-436	18	122-4BSPT	12
69FCS-68	122	77SAE	197	103C	198	110-3212	8	116XL-628	18	122-6	12
69FCS-86	122	78-42	115	103CCS	123	110-3216	8	117-2	9	122-8	12
69FCS-88	122	78-44	115	103GH	59	110-3220	8	117-4	9	122-12	12
69S-610**	111	78-62	115	103GH-LNG	59	110-3224	8	117-6	9	122-16	12
70DE-108**	112	78-64	115	103SAE	199	110F-42	7	117-8	9	122-20	12
70F-22	112	78-66	115	104-2	5	110F-62	7	119-42	5	122-24	12
70F-32	112	78-82	115	104-4	5	110F-64	7	119-62	5	122-32	12
70F-42	112	78-86	115	104-6	5	110F-82	7	119-64	5	122LWA-94	40
70F-44	112	78-102	115	104-8	5	110F-84	7	119-82	5	122LWA-96	40
70F-46	112	78GH	60	104-12	5	110F-86	7	119-84	5	122LWA-99	40
70F-48	112	78GHS	60	104C	198	110F-124	7	119-86	5	122RWA-92	40
70F-52	112	78P	196	104GH	59	110F-126	7	119-124	5	122RWA-96	40
70F-54	112	79GH	60	104GHHN	59	110F-128	7	119-126	5	122RWA-99	40
70F-62	112	79GHT	60	104GH-LNG	59	110F-168	7	119-128	5	123-42	13
70F-64	112	79GHTS	60	104SAE	198	110F-1612	7	119-164	5	123-62	13
70F-66	112	80GH	60	105C	198	110GH-124	60	119-166	5	123-64	13
70F-68	112	81GH	60	105GH	59	110GH-126	60	119-168	5	123-82	13
70F-84	112	82GH	59	105GHXD	59	110P	199	119-1612	5	123-84	13
70F-86	112	83GH	59	106C	198	110SAE	199	120-20	16	123-86	13
70F-88	112	84GH	59	106CCS	123	111-2	10	120-22	16	123-122	13
70F-106	112	84GH-126	59	106GH	58	111-4	10	120-41	16	123-124	13

MID-AMERICA FITTINGS

NUMERICAL INDEX

Part#	Page	Part#	Page	Part#	Page	Part#	Page	Part#	Page	Part#	Page
123-126	13	161SAE	197	246X4X6	77	254X4X4	84	264X8	108	271X4*	113
123-128	13	161SAE	197	246X5	77	254X5*	84	264X10	108	271X5*	113
123-164	13	163SAE	197	246X5X4	77	254X6*	84	264X12	108	271X6*	113
123-166	13	164SAE	197	246X6	77	254X6X6*	84	264X14	108	272X2*	114
123-168	13	167SAE	197	246X6X2	77	254X8*	84	264X16	108	272X3	114
123-328	13	170C-2	202	246X6X6	77	254X8X8*	84	265X2	108	272X4*	114
123-1612	13	170C-4	202	246X6X8	77	254X10*	84	265X3	108	272X4X4*	114
123-3212	13	170C-6	202	246x8	77	254X10X6*	84	265X4	108	272X5*	114
123-3216	13	172C-4	202	246x8x8	77	255X4*	83	265X5	108	272X6*	114
123-3220	13	176C-6	202	246X8X12	77	255X5*	83	265X6	108	272X8*	114
123-3224	13	190BV-4	201	246X10	77	255X6*	83	265X8	108	273X4*	114
124F-2	14	190BV-6	201	248X2	78	255X8*	83	266X4	109	273X4*	115
124F-4	14	190BV-8	201	248X3	78	255X10*	83	266X4X4	109	273X6*	115
124F-6	14	200C-4	205	248X4	78	260-2M	120	266X6	109	273X6*	115
124GH-412	62	200C-6	205	248X4X4	78	260-3M	120	266X6X6	109	276X2*	114
125GH-612	62	200IS	89	248X4X6	78	260-4M	120	266X8	109	276X3*	114
126GH	62	200P	195	248X4X8	78	260-8M	120	266X8X8	109	276X4*	114
127-2	15	201P	195	248X5	78	260X2	106	266X10	109	280X2	119
127-4	15	202P	195	248X5X4	78	260X3	106	268CS-44	122	280X3	119
127-6	15	202P	199	248X6	78	260X4	106	268X2	110	280X4	119
127-8	15	203C	198	248X6X2	78	260X5	106	268X3	110	280X50	119
127-12	15	203SAE	199	248X6X6	78	260X6	106	268X4	110	281X2	119
127F-2	15	204SAE	199	248X6X8	78	260X6M	120	268X4X4	110	281X3	119
127F-4	15	207ACBH-2	19	248X6X12	78	260X7	106	268X4X6	110	281X4	119
127F-6	15	207ACBH-2S	19	248X7	78	260X8	106	268X4X8	110	281X50	119
127F-8	15	207ACBH-4	19	248X8	78	260X10	106	268X5	110	282X2N	119
127F-12	15	207ACBH-6	19	248X8X2	78	260X12	106	268X5X4	110	282X2X1N	119
127GH	62	207ACBH-8	19	248X8X4	78	260X16	106	268X6X2	110	282X3	119
127R-212	15	207ACBH-12	19	248X8X8	78	260X16	106	268X6X4	110	282X4	119
127R-424	15	207ACBH-16	19	248X8X12	78	261CAX2	121	268X6X6	110	282X5IS	119
127R-646	15	207ACBH-45	19	248X10	79	261CAX3	121	268X6X8	110	282X52S	119
127R-868	15	207ACBHLH-4	19	248X10X4	78	261CAX4	121	268X7	110	283X2	119
127R-884	15	207BH-6FML	20	248X10X6	79	261CAX5	121	268X8	110	283X4	119
128F-42	7	207BH-8FML	20	248X10X12	79	261CAX6	121	268X8X4	110	283X50S	119
128F-46	7	209GHS-1012	64	248X12	79	261CAX8	121	268X8X8	110	284X2	119
128F-64	7	209GHS-1212	64	248X12X12	79	261CAX10	121	268X10	110	284X2X1N	119
128F-68	7	210C-2	204	249X2	80	261X2	106	268X10X6	110	284X3	119
128F-86	7	210C-4	204	249X3	80	261X3	106	269CS-22	122	284X4	119
128GH	62	210C-6	204	249X4	80	261X4	106	269CS-32	122	284X51SN	119
129GH-812	62	215C-4	205	249X4X4	80	261X5	106	269CS-42	122	284X52S	119
130F-2	17	215C-6	205	249X4X6	80	261X6	106	269CS-44	122	295SAE	197
130F-4	17	220C-2	205	249X5	80	261X7	106	269CS-64	122	295X2	120
130F-6	17	220C-4	205	249X5X4	80	261X8	106	269X2	111	295X3	120
130F-8	17	220C-4LC	205	249X6	80	261X10	106	269X2X1	111	295X5	120
130FR-42	17	227C	196	249X6X2	80	261X12	106	269X3	111	302C	198
130FR-62	17	227SAE	197	249X6X6	80	261X14	106	269X3X4	111	302P	195
130FR-64	17	229C	196	249X6X8	80	261X16	106	269X4	111	303C	198
130FR-86	17	229SAE	197	249X6X12	80	262RX6X4	107	269X4X4	111	303P	195
131-2	17	242RX6X4	75	249X7	80	262RX8X4	107	269X4X6	111	303SAE	199
131-4	17	242RX8X4	75	249X8	80	262RX8X6	107	269X5	111	304P	199
131-6	17	242RX8X6	75	249X8X4	80	262RX10X8	107	269X5X4	111	305P	199
131-8	17	242RX10X6	75	249X8X8	80	262RX14X8	107	269X6	111	320P	195
131-12	17	242RX10X8	75	249X8X12	80	262RX14X10	107	269X6X2	111	321P	195
131F-2	18	242X2	74	249X10	80	262RX14X12	107	269X6X6	111	322P	195
131F-4	18	242X3	74	249X10	81	262X2	107	269X6X8	111	323P	195
131F-6	18	242X4	74	249X10X6	80	262X3	107	269X6X12	111	350BV-22	206
131F-8	18	242X5	74	249X10X12	81	262X4	107	269X8	111	350BV-44	206
131R-21	17	242X6	74	249X12	81	262X5	107	269X8X4	111	351BV-22	206
131R-42	17	242X7	74	249X12X12	81	262X6	107	269X8X8	111	351BV-44	206
131R-64	17	242X8	74	250X4	81	262X8	107	269X10	112	352BV-22	206
131R-86	17	242X10	74	250X4X4	81	262X10	107	269X10X6	111	352BV-22	207
131R-128	17	242X12	74	250X5	81	262X12	107	270X2*	112	352BV-24	206
132F-2	18	244X4	75	250X6	81	262X14	107	270X3*	112	352BV-44	206
132F-4	18	244X5	75	250X6X6	81	262X16	107	270X4*	112	352BV-44	207
132F-6	18	244X6	75	250X6X8	81	264X2	108	270X4X4*	112	352BV-66	207
132F-8	18	244X8	75	250X8	81	264X3	108	270X6*	112	352BV-88	207
132F-12	18	244X10	75	250X10	81	264X4	108	270X8*	112	357BV-42	206
133C	198	246X3	77	251X4	82	264X5	108	270X10	112	357BV-44	206
137yb-4fm	14	246X4	77	253X3	83	264X6	108	271X2*	113	357BV-54	206
143C	198	246X4X4	77	254X4*	84	264X7	108	271X3*	113	357BV-64	206

MID-AMERICA FITTINGS

NUMERICAL INDEX

Part#	Page	Part#	Page	Part#	Page	Part#	Page	Part#	Page	Part#	Page
357BV-66	206	641L-4	71	1104SAE	198	6945F-52	115	23325X6X2	13	23506X2	2
357BV-88	206	641L-5	71	1390-64	187	6945F-54	115	23325X6X4	13	23506X4	2
392BV-22	207	641L-6	71	1390-66	187	6945F-64	115	23325X8	12	23508X4	2
392BV-44	207	641L-8	71	1390-68	187	6945F-66	115	23325X8X4	13	23508X6	2
420P	195	641L-10	71	1390-86	187	6945F-86	115	23325X8X6	13	23512X4	2
421P	195	641L-12	71	1390-88	187	6945F-88	115	23325X8X6TP*	13	23512X6	2
463-3	73	641S-3	71	2000	89	6945F-108	115	23325X12	12	23512X8	2
463-4	73	641S-4	71	2001	89	10045-2	2	23325X12X8	13	23600X2	17
463-5	73	641S-5	71	2001A	89	10045-4	2	23325X16	12	23600X4	17
463-6	73	641S-6	71	2001AB	89	10045-6	2	23325X16X12	13	23600X6	17
463-8	73	641S-8	71	2001AHB	89	10045-8	2	23332X16	5	23600X8	17
463-10	73	641S-10	71	2001AHN	89	21110X2	120	23350X1	14	23600X12	17
463-12	73	641S-12	71	2001B	89	21611-4	120	23350X2	14	23700X1	3
464-3	73	641S-14	71	2001BLH	89	21611X5	120	23350X2X1	14	23700X2	3
464-4	73	641SFP-4	71	2004	89	21611X6	120	23350X4	14	23700X2X1	3
464-5	73	641SFP-6	71	2005	90	21611X8	120	23350X4X1	14	23700X4	3
464-6	73	641SFP-8	71	2006	90	21611X10	120	23350X4X2	14	23700X4X2	3
464-8	73	641SFP-10	71	2007	90	21611X12	120	23350X4X6	14	23700X6	3
464-10	73	641SH-4	72	2008	90	23152X2	10	23350X6	14	23700X6X4	3
464-12	73	641SH-5	72	2009	90	23152X4	10	23350X6X2	14	23700X8	3
557C	196	641SH-6	72	2014	90	23152X6	10	23350X6X4	14	23700X8X6	3
577SAE	197	641SH-8	72	2139X4	73	23152X8	10	23350X6X8	14	23700X12	3
600F-4	84	641SH-10	72	2200X5	98	23152X12	10	23350X8	14	23700X12X8	3
600F-6	84	641SH-12	72	2202X4	98	23200X2	16	23350X8X2	14	23750X2	15
600F-8	84	641SH-14	72	2202X5	98	23200X2X1	16	23350X8X4	14	23750X4	15
600F-10	84	652	189	2202X6	98	23200X4	16	23350X8X6	14	23750X6	15
600F-12	84	662S-54	72	2202X8	98	23200X6	16	23350X12	14	23750X8	15
601-34	85	662S-64	72	2202X8X8	98	23200X8	16	23350X12X6	14	23750X12	15
601-43	85	662S-65	72	2234X4	98	23200X12	16	23350X12X8	14	23950X1	3
601-45	85	662S-86	72	2236X6	98	23206X2	16	23400X1	6	23950X2	3
601-46	85	662S-106	72	2402X4	99	23206X4	16	23400X2	6	23950X4	3
601-48	85	662S-108	72	2402X6	99	23208X4	16	23400X4	6	23950X6	3
601-54	85	662S-128	72	2905X4**	114	23208X6	16	23400X6	6	23950X8	3
601-56	85	662S-1210	72	2945-42BS*	31	23212X6	16	23400X8	6	23950X12	3
601-64	85	664-42	85	2945-44BS*	31	23212X8	16	23400X8X12	6	26100X2	118
601-68	85	664-44	85	2945F-42	31	23224X2	8	23400X12	6	26100X3	118
601-84	85	664-64	85	2945F-52	31	23226X2	8	23401X2	6	26100X4	118
601-86	85	664-68	85	2945F-54	31	23226X4	8	23401X4	6	26100X5	118
601-104	85	664-86	85	2945F-62	31	23228X2	8	23401X6	6	26100X6	118
601-106	85	664-88	85	2945F-64	31	23228X4	8	23402X1	6	26100X8	118
601-108	85	664S-64*	85	2945F-66	31	23228X6	8	23402X1*	7	26100X10	118
601-126	85	680	189	2945F-84	31	23232X2	8	23402X4	6	26104X2	118
601-128	85	688	188	2945F-86	31	23232X4	8	23402X4*	7	26104X3	118
601-412	85	700-4	86	2945F-88	31	23232X6	8	23404X2	6	26104X4	118
601-610	85	700-5	86	2945F-106	31	23232X8	8	23404X2	16	26104X5	118
601-612	85	700-6	86	3044PFH	199	23236X8	8	23404X2*	7	26104X6	118
601-810	85	700-8	86	3055P	199	23236X12	8	23404X6*	7	26200X2	118
601-812	85	700-10	86	3055PFH	199	23300X1	4	23406X2	6	26200X2X21	118
601-1012	85	700-12	86	4945F-32	84	23300X2	4	23406X4	6	26200X3	118
601-1210	85	700R-64	86	4945F-42	84	23300X4	4	23406X4*	7	26200X4	118
601RG-1015	85	700R-86	86	4945F-44	84	23300X6	4	23406X8*	7	26200X4X4	118
601WG-46	85	700R-108	86	4945F-52	84	23300X8	4	23408X4	6	26200X5	118
601WG-54	85	700SH-6	86	4945F-54	84	23300X12	4	23408X4*	7	26200X5X4	118
601WG-64	85	700SH-8	86	4945F-64	84	23300X16	4	23408X6	6	26200X6	118
601WG-68	85	700SH-10	86	4945F-66	84	23300X32	4	23408X6*	7	26400X2	118
601WG-86	85	710	190	4945F-68	84	23302X1	5	23455X2	17	26400X2X21	118
601WG-108	85	712	190	4945F-84	84	23304X2	5	23455X4	17	26400X3	118
601WG-810	85	713	190	4945F-86	84	23306X2	5	23455X4X4BSPT	17	26400X4	118
601WG-1012	85	728	190	4945F-88	84	23306X4	5	23455X6	17	26400X5	118
607	188	743	190	4945F-106	84	23308X4	5	23455X8	17	26400X6	118
608	190	810	190	4945F-108	84	23308X6	5	23455X8X6	17	AB60-4	182
610	188	812	190	4945F-128	84	23312X4	5	23455X12	17	AB60-5	182
611	188	813	190	6242CF-44	117	23312X6	5	23500X1	2	AB60-6	182
612	188	910	191	6242CF-46	117	23312X8	5	23500X2	2	AB60-8	182
613	188	911	189	6242CF-66	117	23325X1	12	23500X4	2	AB60-10	182
627	188	912	191	6242CF-68	117	23325X2	12	23500X6	2	AB60-12	182
629	189	913	191	6242CF-88	117	23325X2X1	13	23500X8	2	AB60-16	182
636	189	1010SAE	197	6945F-32	115	23325X4	12	23500X12	2	AB61-4	182
637	189	1101C	198	6945F-42	115	23325X4X2	13	23502X1	2	AB61-5	182
641	189	1102CCS	123	6945F-44	115	23325X6	12	23504X2	2	AB61-6	182

MID-AMERICA FITTINGS

NUMERICAL INDEX

Part#	Page	Part#	Page	Part#	Page	Part#	Page	Part#	Page	Part#	Page
AB61-8	182	AB271X6	184	HE68G-68	187	LF29F-106	221	LF48-48	229	LF68-54	237
AB61-10	182	AB6945-42	184	HE68G-86	187	LF29F-108	221	LF48-62	229	LF68-62	237
AB61-12	182	AB6945-44	184	HE68G-88	187	LF29F-1212	221	LF48-64	229	LF68-64	237
AB62-4	182	AB6945-62	184	HE68S-64	186	LF29FGH-412	223	LF48-66	229	LF68-66	237
AB62-6	182	AB6945-64	184	HE68S-66	186	LF29FGH-612	223	LF48-68	229	LF68-68	237
AB62-8	182	AB6945-66	184	HE68S-68	186	LF29FGH-812	223	LF48-84	229	LF68-84	237
AB62-10	182	AB6945-68	184	HE68S-86	186	LF29FGH-1012	223	LF48-86	229	LF68-86	237
AB62-12	182	AB6945-84	184	HE68S-88	186	LF29FGH-1212	223	LF48-88	229	LF68-88	237
AB64-4	182	AB6945-88	184	HE68SB-6	186	LF29GHS-4H	223	LF48-106	229	LF68-106	237
AB64-6	182	AB6945-106	184	HE68SB-8	186	LF29GHS-6H	223	LF48-108	229	LF68-108	237
AB64-8	182	AB6945-108	184	HE685B-6B0	186	LF29GHS-8H	223	LF48-128	229	LF68-128	237
AB64-10	182	AV-2S	199	HE685B-8B0	186	LF29GHS-10H	223	LF48-248X4X4	229	LF68-148	237
AB65-4	182	AV48-44	78	HPHN-12	12	LF29GHS-12H	223	LF48-612	229	LF68-612	237
AB65-6	182	ECD-12*	58	K1-48	86	LF29MGH-412H	223	LF48-812	229	LF68-812	237
AB65-8	182	ECF8	58	K1-412	86	LF29MGH-612H	223	LF48-1012	229	LF68-1012	237
AB65-10	182	ECF12	58	K1-612	86	LF29MGH-812H	223	LF48-1212	229	LF68-1212	237
AB66-42	183	ECF12H	58	K1-812	86	LF29MGH-1012H	223	LF48-1412	229	LF68-1412	237
AB66-44	183	ES4-44	86	KG-8	86	LF29MGH-1212H	223	LF53	223	LF68-1416	237
AB66-62	183	ES4-66	86	KG-12	86	LF29S-2	222	LF55F-6	230	LF68GH-1216	225
AB66-64	183	ES4-68	86	LF13GH	223	LF29S-3	222	LF61CC-4	233	LF68T-32	238
AB66-66	183	ES4-88	86	LF29-22	220	LF29S-4	222	LF61CC-5	233	LF68T-42	238
AB66-86	183	ES4-1010	86	LF29-24	220	LF29S-5	222	LF61CC-6	233	LF68T-44	238
AB66-88	183	ES4-1212	86	LF29-32	220	LF29S-6	222	LF61CC-8	233	LF68T-64	238
AB66-106	183	FTC5-4	73	LF29-34	220	LF29S-8	222	LF61CC-10	233	LF68T-66	238
AB66-108	183	FTC5-6	73	LF29-42	220	LF29S-10	222	LF62-10	234	LF68T-68	238
AB68-42	183	GHPW	61	LF29-42	220	LF29S-12	222	LF62-12	234	LF68T-86	238
AB68-44	183	GHPW-60	61	LF29-44	220	LF39-4	228	LF62-14	234	LF68T-88	238
AB68-62	183	GHNH	60	LF29-46	220	LF39-6	228	LF62R-42	234	LF69F-86	238
AB68-64	183	GHNK	60	LF29-48	220	LF39-8	228	LF62R-43	234	LF69F-88	238
AB68-66	183	GHP	61	LF29-52	220	LF39-10	228	LF62R-54	234	LF69F-108	238
AB68-68	183	GHPH	61	LF29-54	220	LF40-4	227	LF62R-64	234	LF69F-1412	238
AB68-84	183	GHW	61	LF29-56	220	LF40-5	227	LF62R-65	234	LF70F-64	239
AB68-86	183	GHW-12-PE	61	LF29-62	220	LF40-6	227	LF62R-86	234	LF73GH	224
AB68-88	183	GHW-12R	61	LF29-64	220	LF40-8	227	LF62R-106	234	LF74GH	224
AB68-106	183	GHW-16	61	LF29-66	220	LF40-10	227	LF62R-108	234	LF76GH	225
AB68-108	183	H32P	196	LF29-68	220	LF40-12	227	LF62T-6	234	LF77GH	225
AB68-128	183	H37P	194	LF29-84	220	LF41S-2	226	LF62T-8	234	LF78GH	225
AB69-42	183	H38P	194	LF29-86	220	LF41S-3	226	LF62T-10	234	LF78GHS	225
AB69-44	183	H49P	194	LF29-88	220	LF41S-4	226	LF62T-14	234	LF79GH	225
AB69-46	183	H49P	196	LF29-106	220	LF41S-5	226	LF64-14	234	LF79GHT	225
AB69-64	183	H77P	196	LF29-108	220	LF41S-6	226	LF66-22	236	LF80GH	224
AB69-66	183	HC-12BS	61	LF29-126	220	LF41S-7	226	LF66-32	236	LF80GH-126	224
AB69-68	183	HC12BSW	61	LF29-128	220	LF41S-8	226	LF66-42	236	LF81GH	224
AB69-86	183	HC-12WC	61	LF29-612	220	LF41S-10	226	LF66-44	236	LF82GH	224
AB69-88	183	HE60-6	185	LF29-812	220	LF41S-12	226	LF66-46	236	LF83GH	224
AB69-106	183	HE60-8	185	LF29-1012	220	LF41XS-4	226	LF66-48	236	LF84GHS	224
AB69-108	183	HE61-6	185	LF29-1212	220	LF41XS-6	226	LF66-56	236	LF85GHT	224
AB69-128	183	HE61-8	185	LF29-1612	220	LF41XS-8	226	LF66-62	236	LF86GHT	224
AB70-42	184	HE61G-6	186	LF29-1616	220	LF41XSR-64	226	LF66-64	236	LF100-2	212
AB70-44	184	HE61G-8	186	LF29E-44BS	222	LF41XSR-86	226	LF66-66	236	LF100-4	212
AB70-62	184	HE61N-6	185	LF29E-64BS	222	LF46-42	228	LF66-68	236	LF100-6	212
AB70-64	184	HE61N-8	185	LF29E-66BS	222	LF46-44	228	LF66-86	236	LF100-8	212
AB70-66	184	HE61NG-6	186	LF29F-22	221	LF46-46	228	LF66-88	236	LF100-12	212
AB70-86	184	HE61NG-8	186	LF29F-24	221	LF46-64	228	LF66-106	236	LF100R-64	212
AB70-108	184	HE62-6	186	LF29F-32	221	LF46-66	228	LF66-108	236	LF101-2	213
AB71-42	184	HE62-8	186	LF29F-34	221	LF46-68	228	LF66-128	236	LF101-4	213
AB71-44	184	HE62B-6	186	LF29F-42	221	LF46-84	228	LF66-148	236	LF101-6	213
AB71-66	184	HE62B-8	186	LF29F-44	221	LF46-86	228	LF66-612	236	LF101-8	213
AB71-86	184	HE68-64	187	LF29F-46	221	LF46-88	228	LF66-812	236	LF101-12	213
AB71-88	184	HE68-66	187	LF29F-48	221	LF46-108	228	LF66-1012	236	LF102-2	213
AB71-108	184	HE68-68	187	LF29F-52	221	LF46-612	228	LF66-1212	236	LF102-4	213
AB71F-64	184	HE68-86	187	LF29F-54	221	LF46-812	228	LF66-1412	236	LF102-6	213
AB72-42	184	HE68-88	187	LF29F-56	221	LF46-1012	228	LF68-22	237	LF102-8	213
AB72-44	184	HE68B-64	187	LF29F-62	221	LF46-1212	228	LF68-32	237	LF102-12	213
AB72-64	184	HE68B-66	187	LF29F-64	221	LF48-22	229	LF68-34	237	LF102GH	224
AB72-66	184	HE68B-68	187	LF29F-66	221	LF48-32	229	LF68-42	237	LF103-2	213
AB72-84	184	HE68B-86	187	LF29F-68	221	LF48-34	229	LF68-44	237	LF103-4	213
AB72-86	184	HE68B-88	187	LF29F-84	221	LF48-42	229	LF68-46	237	LF103-6	213
AB72-88	184	HE68G-64	187	LF29F-86	221	LF48-44	229	LF68-48	237	LF103-8	213
AB72-108	184	HE68G-66	187	LF29F-88	221	LF48-46	229	LF68-52	237	LF103-12	213

MID-AMERICA FITTINGS

NUMERICAL INDEX

Part#	Page	Part#	Page	Part#	Page	Part#	Page	Part#	Page	Part#	Page
LF103GH	224	LF113-448	216	LF128-86	218	LF264X6X6X4	235	MA1309	21	MP60-8	129
LF104-2	214	LF113-624	216	LF131-2	219	LF264X8	234	MA1310	21	MP60B-2	129
LF104-4	214	LF113-632	216	LF131-4	219	LF264X8X8X6	235	MA1317	19	MP60B-3	129
LF104-6	214	LF113-640	216	LF131-6	219	LF264X10	234	MA1318	19	MP60B-4	129
LF104-8	214	LF113-648	216	LF131-8	219	LF264X10X10X6	235	MA1319	19	MP60B-6	129
LF104-12	214	LF113-824	216	LF242X2	227	LF265X4	235	MA1325	21	MP61-2	129
LF104GH	224	LF113-832	216	LF242X3	227	LF265X6	235	MA1329	104	MP61-3	129
LF105GH	224	LF113-840	216	LF242X4	227	LF265X8	235	MA1330	104	MP61-4	129
LF108-2	214	LF113-848	216	LF242X6	227	LF265X10	235	MA1342	20	MP61-5	129
LF108-4	214	LF116-2	218	LF242X6x4	227	LF269X4	238	MA1345	21	MP61-6	129
LF108-6	214	LF116-4	218	LF242X8	227	LF269X4X4	238	MA1348	20	MP61-8	129
LF108-8	214	LF116-6	218	LF242X8x4	227	LF269X4X6	238	MA1441	102	MP61B-2	128
LF108-12	214	LF116-8	218	LF242X8X6	227	LF269X6	238	MA1442	104	MP61B-3	128
LF109-2	214	LF116F-8	218	LF242X10	227	LF269X6X2	238	MA1443	104	MP61B-4	128
LF109-4	214	LF116F-12	218	LF242X10x6	227	LF269X6X6	238	MA1512	103	MP61B-5	128
LF109-6	214	LF119-42	217	LF242X10X8	227	LF269X6X8	238	MA1513	103	MP61B-6	128
LF109-8	214	LF119-62	217	LF242X12	227	LF269X10X6	238	MA1518	104	MP61B-8	128
LF109-12	214	LF119-64	217	LF248X6	229	LF269X10X12	238	MA1522	104	MP61P-4	125
LF109-16	214	LF119-82	217	LF249X4X2	230	LF270X6X6	239	MA1553	104	MP61P-4BLK	125
LF109AL-2	214	LF119-84	217	LF249X4X4	230	LF270X8	239	MA1554	104	MP61P-5	125
LF109AL-4	214	LF119-86	217	LF249X4X6	230	LF270X8X8	239	MA1563	104	MP61P-5BLK	125
LF109AL-6	214	LF119-126	217	LF249X5	230	LF270X10	239	MA1594	104	MP61P-6	125
LF109AL-8	214	LF119-128	217	LF249X5X4	230	LF272X4	240	MA2345	104	MP61P-6BLK	125
LF109AL-12	214	LF120-22	217	LF249X6X2	230	LF641S-10	226	MA6600	194	MP61P-8BLK	125
LF109SD-2	214	LF120-42	217	LF249X6X4	230	LF700-4	229	MA6660	195	MP61PCP-4	128
LF109SD-4	214	LF120-44	217	LF249X6X6	230	LF700-6	229	MA6783	195	MP61PCP-6	128
LF109SD-6	214	LF120-62	217	LF249X6X8	230	LF700-8	229	MA7727	103	MP62-2	125
LF109SD-8	214	LF120-64	217	LF249X6X12	230	LF700-10	229	MA7732	103	MP62-3	125
LF109SD-12	214	LF120-66	217	LF249X8X4	230	LF700R-64	229	MA7771	103	MP62-4	125
LF109SD-16	214	LF120-82	217	LF249X8X6	230	LF700R-86	229	MA7817	103	MP62-5	125
LF109SD-20	214	LF120-84	217	LF249X8X8	230	LF6242CF-44	240	MA7818	103	MP62-6	125
LF109SD-24	214	LF120-86	217	LF249X8X12	230	LF6242CF-46	240	MA7828	103	MP62-8	125
LF109SD-32	214	LF120-88	217	LF249X10	230	LF23300X2	213	MA7829	103	MP62C-4	125
LF110-42	215	LF120-126	217	LF249X12	230	LF23300X4	213	MA7897	102	MP62C-5	125
LF110-62	215	LF120-128	217	LF249X12X12	230	LF23300X6	213	MA7898	102	MP62C-6	125
LF110-64	215	LF120-1212	217	LF255X4	230	LF23300X8	213	MA7900	102	MP64-2	126
LF110-82	215	LF120-1612	217	LF260X2	232	LF23325X2	216	MA7901	102	MP64-3	126
LF110-84	215	LF121-2	215	LF260X3	232	LF23325X4	216	MA7904	102	MP64-4	126
LF110-86	215	LF121-4	215	LF260X4	232	LF23325X6	216	MA7905	102	MP64-5	126
LF110-122	215	LF121-6	215	LF260X5	232	LF23325X8	216	MA7906	102	MP64-6	126
LF110-124	215	LF121-8	215	LF260X6	232	LF23455X2	219	MA7908	103	MP64-8	126
LF110-126	215	LF121-12	215	LF260X7	232	LF23455X4	219	MA7909	103	MP66-22	126
LF110-128	215	LF121-16	215	LF260X8	232	LFECF8*	225	MA7910	103	MP66-32	126
LF110-162	215	LF121S-2	215	LF260X10	232	LFECF12*	225	MA7911	103	MP66-34	126
LF110-164	215	LF121S-4	215	LF260X12	232	LFECF12H**	225	MA7912	103	MP66-42	126
LF110-166	215	LF121S-6	215	LF260X14	232	LF6HNNH	225	MA7913	103	MP66-44	126
LF110-168	215	LF121S-8	215	LF261CAX4	233	LF6HNNK	225	MA7914	102	MP66-52	126
LF110-1612	215	LF121S-12	215	LF261CAX6	233	LF6H-12W	225	MA7915	103	MP66-54	126
LF110F-42	215	LF121S-16	215	LF261CAX8	233	LF51	224	MA7916	103	MP66-62	126
LF110F-62	215	LF122-2	216	LF261X2	233	LF52	224	MA7917	103	MP66-64	126
LF110F-64	215	LF122-4	216	LF261X3	233	M670C-2	203	MA7933	102	MP66-86	126
LF110F-84	215	LF122-6	216	LF261X4	233	M670C-4	203	MA7934A	104	MP66-88	126
LF110F-86	215	LF122-8	216	LF261X5	233	M670C-6	203	MA7935	104	MP68-20	127
LF110F-124	215	LF122-12	216	LF261X6	233	M671C-4	203	MA7936	104	MP68-21	127
LF110F-126	215	LF122-16	216	LF261X7	233	M672C-4	203	MA7937	104	MP68-22	127
LF110F-128	215	LF122-20	216	LF261X8LP	233	M675C-42	203	MA7970	104	MP68-32	127
LF110F-1612	215	LF122-24	216	LF261X10	233	M675C-44	203	MA7972	104	MP68-40	127
LF110GH-124	224	LF122-32	216	LF261X12	233	M675C-64	203	MA7973	104	MP68-41	127
LF112-2	216	LF123-42	217	LF261X14	233	M675C-66	203	MA7974	104	MP68-42	127
LF112-4	216	LF123-62	217	LF262X2	234	MA105X3X4	96	MA7975	104	MP68-44	127
LF112-6	216	LF123-64	217	LF262X3	234	MA105X6X7	96	MP56-64	125	MP68-46	127
LF112-8	216	LF123-84	217	LF262X4	234	MA130	195	MP56-86	125	MP68-48	127
LF-112-12	216	LF123-86	217	LF262X5	227	MA140	195	MP59-4	129	MP68-52	127
LF113-224	216	LF123-128	217	LF262X6	234	MA185	195	MP59-6	129	MP68-54	127
LF113-232	216	LF124-2	218	LF262X8	234	MA230	195	MP59-8	129	MP68-62	127
LF113-240	216	LF124-4	218	LF262X10	234	MA595	194	MP60-4BLK	129	MP68-64	127
LF113-248	216	LF124-6	218	LF262X12	234	MA595-36	194	MP60-4W	129	MP68-66	127
LF113-424	216	LF124-8	218	LF264X3	234	MA595-60	194	MP60-5	129	MP68-68	127
LF113-432	216	LF128-42	218	LF264X4	234	MA595-68	194	MP60-6BLK	129	MP68-84	127
LF113-440	216	LF128-68	218	LF264X6	234	MA1074	103	MP60-6W	129	MP68-86	127

MID-AMERICA FITTINGS

NUMERICAL INDEX

Part#	Page	Part#	Page	Part#	Page	Part#	Page	Part#	Page	Part#	Page
MP68-88	127	MQ62-4	146	MQ69-32	134	MQ72-22	135	NT63B-6	177	NT69L-86VS	179
MP69-21	127	MQ62-6	132	MQ69-42	134	MQ72-22	148	NT63B-8	177	NT69SWV-66VS	180
MP69-22	127	MQ62-6	146	MQ69-44	134	MQ72-42	135	NT63B-10	177	NT69SWV-86VS	180
MP69-32	127	MQ62-8	132	MQ69-46	134	MQ72-42	148	NT63B-12	177	NT70-42	180
MP69-42	127	MQ62-8	146	MQ69-62	134	MQ72-44	135	NT63SSI-3	177	NT70-44	180
MP69-44	127	MQ62-64	132	MQ69-64	134	MQ72-44	148	NT63SSI-4	177	NT70F-62	180
MP69-46	127	MQ62-532	132	MQ69-66	134	MQ72-62	135	NT63SSI-6	177	NT70F-64	180
MP69-52	127	MQ62-532	146	MQ69-84	134	MQ72-64	135	NT63SSI-8	177	NT70F-66	180
MP69-62	127	MQ64-2	132	MQ69-86	134	MQ72-64	148	NT63SSI-10	177	NT70F-86	180
MP69-64	127	MQ64-2	146	MQ69-88	134	MQ72-66	135	NT63SSI-12	177	NT70F-88	180
MP69-66	127	MQ64-3	132	MQ69-5322	134	MQ72-66	148	NT64FR-664	178	NT70F-108	180
MP69-86	127	MQ64-4	132	MQ69S-22	133	MQ72-68	148	NT64R-466	178	NT71-42VS	180
MP69-88	127	MQ64-4	146	MQ69S-22	147	MQ72-84	148	NT64R-668	178	NT71-44VS	180
MP70-22	127	MQ64-5	132	MQ69S-24	133	MQ72-86	135	NT64R-868	178	NT71-86VS	180
MP70-32	127	MQ64-6	132	MQ69S-24	147	MQ72-86	148	NT65-4	178	NT71-88VS	180
MP70-42	127	MQ64-6	146	MQ69S-40	133	MQ72-88	148	NT65-8	178	NT71-108VS	180
MP70-44	127	MQ64-8	132	MQ69S-42	133	MQ72-532	135	NT65-10	178	NT71-644VS	180
MP70-64	127	MQ64-8	146	MQ69S-42	147	MQ72S-22	135	NT66-42	178	NT71-646VS	180
MP70-86	127	MQ64-532	132	MQ69S-44	133	MQ72S-42	135	NT66-44	178	NT72-42VS	180
MP71-22	128	MQ64-532	146	MQ69S-44	147	MQ72S-44	135	NT66-62	178	NT72-44VS	180
MP71-32	128	MQ65-2	132	MQ69S-46	133	MQ72S-64	135	NT66-64	178	NT72-62VS	180
MP71-42	128	MQ65-2	146	MQ69S-46	147	MQ72S-64	135	NT66-66	178	NT72-86VS	180
MP71-44	128	MQ65-4	132	MQ69S-54	133	MQ72S-86	135	NT66-86	178	NT72-88VS	180
MP71-52	128	MQ65-4	146	MQ69S-54	147	MQ72S-88	135	NT66-88	178	NT72-108VS	180
MP71-64	128	MQ65-5	132	MQ69S-56	133	MQ72S-5320	135	NT66-106	178	NT72-644VS	180
MP71-86	128	MQ65-5	146	MQ69S-56	147	MQ72S-5322	135	NT66-108	178	NT72-866VS	180
MP72-22	128	MQ65-6	132	MQ69S-62	133	MQ82-2	136	NT66-128	178	NT-78-64	181
MP72-32	128	MQ65-6	146	MQ69S-62	147	MQ82-3	136	NT66-128	183	NT-78-84	181
MP72-42	128	MQ65-8	132	MQ69S-64	133	MQ82-4	136	NT66-812	178	NT-78-104	181
MP72-44	128	MQ65-8	146	MQ69S-64	147	MQ82-4	148	NT68-31VS	179	NT207BH-6	20
MP72-52	128	MQ65-42	146	MQ69S-66	133	MQ82-5	148	NT68-32VS	179	NT207BH-8	20
MP72-62	128	MQ65-44	146	MQ69S-66	147	MQ82-6	136	NT68-41VS	179	NT265X6	178
MP72-64	128	MQ65-64	146	MQ69S-68	133	MQ82-6	148	NT68-42VS	179	nt270x3	180
MP72-86	128	MQ65-66	146	MQ69S-68	147	MQ82-8	136	NT68-44VS	179	NT271X6X6VS	180
MP77-42	128	MQ65-532	132	MQ69S-84	147	MQ82-8	148	NT68-46VS	179	NT272X6VS	180
MP77-44	128	MQ65-532	146	MQ69S-86	133	MQ82-532	136	NT68-62VS	179	NT272X6X6VS	180
MP77-46	128	MQ65-5322	146	MQ69S-86	147	MQ82-532	148	NT68-64VS	179	NT6945-42VS	181
MP79-64	126	MQ66-22	132	MQ69S-88	133	MQ86-42	136	NT68-66VS	179	NT6945-44VS	181
MP82-4	125	MQ66-22	146	MQ69S-88	147	MQ86-44	136	NT68-68VS	179	NT6945-62VS	181
MP82-5	125	MQ66-24	132	MQ69S-5320	133	MQ86-64	136	NT68-84VS	179	NT6945-64VS	181
MP82-6	125	MQ66-42	132	MQ69S-5320	147	MQ89-42	136	NT68-86VS	179	NT6945-66VS	181
MP82-8	125	MQ66-44	132	MQ69S-5322	133	MQ89-44	136	NT68-88VS	179	NT6945-68VS	181
MP82C-4	126	MQ66-64	132	MQ69S-5322	147	MQ89-532	136	NT68-106VS	179	NT6945-84VS	181
MP82C-6	126	MQ66-66	132	MQ69S-5324	133	MQ97-24	136	NT68-108VS	179	NT6945-86VS	181
MQ6-22	147	MQ66-5322	132	MQ70-22	134	MQ97-46	136	NT68-126VS	179	NT6945-88VS	181
MQ6-24	147	MQ68-20	133	MQ70-42	134	MQ97-5324	136	NT68-812VS	179	NT6945-106VS	181
MQ6-40	147	MQ68-20	147	MQ70-44	134	NT60-3	177	NT68-1012VS	179	NT6945-108VS	181
MQ6-42	147	MQ68-21	133	MQ70-64	134	NT60-4	177	NT68-1212VS	179	NT6945-128VS	181
MQ6-44	147	MQ68-22	133	MQ70-5322	134	NT60-6	177	NT68-1218VS	179	NT6945SWV-66VS	181
MQ6-46	147	MQ68-24	133	MQ70S-42	134	NT60-8	177	NT68SWW-66VS	179	NT6945SWV-86VS	181
MQ6-52	147	MQ68-30	133	MQ70S-44	134	NT60-10	177	NT68SWW-86VS	179	NT7272X8X4VS	180
MQ6-54	147	MQ68-32	133	MQ70S-64	134	NT60-12	177	NT69-32VS	179	PGH4X2	24
MQ6-56	147	MQ68-40	133	MQ70S-66	134	NT61-3	177	NT69-34VS	179	PGH4X4	24
MQ6-62	147	MQ68-42	133	MQ70S-86	134	NT61-4	177	NT69-42VS	179	PGH5X4	24
MQ6-64	147	MQ68-44	133	MQ70S-5322	134	NT61-6	177	NT69-44VS	179	PGH6X4	24
MQ6-66	147	MQ68-46	133	MQ71-22	135	NT61-8	177	NT69-46VS	179	PGH6X6	24
MQ6-68	147	MQ68-52	133	MQ71-42	135	NT61-10	177	NT69-62VS	179	PGH6X8	24
MQ6-84	147	MQ68-54	133	MQ71-44	135	NT61-12	177	NT69-64VS	179	PGH8X4	25
MQ6-86	147	MQ68-56	133	MQ71-64	135	NT62-3	177	NT69-66VS	179	PGH8X6	25
MQ6-88	147	MQ68-62	133	MQ71-66	135	NT62-4	177	NT69-68VS	179	PGH8X8	25
MQ6-5320	147	MQ68-64	133	MQ71-86	135	NT62-6	177	NT69-84VS	179	PGH10X6	25
MQ6-5322	147	MQ68-66	133	MQ71S-22	135	NT62-8	177	NT69-86VS	179	PGH10X8	25
MQ6-5324	147	MQ68-68	133	MQ71S-42	135	NT62-10	177	NT69-88VS	179	PGH10X12	25
MQ59-4	136	MQ68-84	133	MQ71S-44	135	NT62-12	177	NT69-106VS	179	PGH12X8	25
MQ59-6	136	MQ68-86	133	MQ71S-64	135	NT62BH-3	177	NT69-108VS	179	PGH12X12	25
MQ59-8	136	MQ68-88	133	MQ71S-66	135	NT62BH-4	177	NT69-126VS	179	PRC601-4	194
MQ59-532	136	MQ68-5320	133	MQ71S-86	135	NT62BH-6	177	NT69-128VS	179	R42XH-4	74
MQ62-2	132	MQ68-5322	133	MQ71S-88	135	NT62BH-8	177	NT69-1012VS	179	R48XH-42	78
MQ62-2	146	MQ68-5324	133	MQ71S-5322	135	NT62BH-10	177	NT69-1212VS	179	R49F-66	80
MQ62-4	132	MQ69-22	134	MQ72-20	148	NT63B-4	177	NT69L-64VS	179	R49F-88	80

MID-AMERICA FITTINGS

NUMERICAL INDEX

Part#	Page	Part#	Page	Part#	Page	Part#	Page	Part#	Page	Part#	Page
R49F-88L	80										
S1*	58										
S2*	58										
S3*	58										
S5	58										
T6-444**	83										
TV44-66	200										
TV44-86	200										
TV44-106	200										
TV44-108	200										
TV44-126	200										
TV44-128	200										
TV44PH-66	200										
TV44PH-106	200										
TV45-66	200										
TV45-68	200										
TV45-88	200										
TV49-64	201										
TV49-66	201										
TV49-68	201										
TV49-86	201										
TV49-88	201										
TV49-108	201										
TV412-108	201										
WH42-2	32										
WH42-4	32										
WH42-6	32										
WH42-8	32										
WH48-22	32										
WH48-42	32										
WH48-44	32										
WH48-64	32										
WH48-66	32										
WH48-68	32										
WH48-86	32										
WH48-88	32										
WH48-1212	32										

Standard Terms and Conditions of Sale

Any order by a person ("Buyer") for goods (an "Order"), if accepted, is accepted subject to these Midland Industries Standard Terms and Conditions of Sale ("T&Cs"), which are incorporated into any acceptance, acknowledgement, invoice and other document issued by Midland Industries ("Seller") in response to such Order (each a "Response"), and any reference thereto shall include these T&Cs. No waiver, alteration, or modification of these T&Cs shall be valid unless expressly agreed to in writing by Seller. The T&Cs constitute the entire agreement between the parties and any different, additional or conflicting terms or conditions set forth in Buyer's purchase order or any other document issued by Buyer are expressly objected to by Seller and the terms hereof, including those contained in the applicable Response, shall exclusively govern the purchase and sale of the goods covered by the Response unless there is another manually signed agreement between the parties, which shall control to the extent there is a conflict between the terms of such agreement and these T&Cs.

Payment Terms. Payment terms are 2%-10days/net 30 on approved accounts in good standing and shall be paid in United States dollars. The 2% discount terms is for purchased goods only-there is no discount off of freight. Any additional discounts taken will be charged back to the account, and is due by the customer. The allowed discount amount is stated on each invoice. Shipment may be held if account is past due. Buyer agrees that any overdue amounts shall be subject to a late payment charge on the overdue balance of 1.5% per month or such lesser amount as is the maximum rate of interest allowed by law. Buyer shall pay any and all reasonable costs, including attorneys' fees, incurred by Seller while collecting any delinquent balance. Debit memos are not accepted unless approved.

Price. The Seller list or quoted price is subject to change without notice. The goods are invoiced at prices in effect on date of shipment. Prices do not include taxes, if any, based upon or measured by the sales price, which taxes will be added to the prices where applicable. Any taxes which Seller may be required to pay or collect, upon or with respect to the sale, purchase, delivery, storage, processing, use, or transportation of the goods purchased hereunder, shall be for Buyer's account, and shall be paid promptly by Buyer to Seller upon demand.

Delivery Terms. All goods are sold FOB our shipping USA locations. Title and risk of loss passes to the buyer upon delivery to the carrier. Freight is prepaid via the carrier of our choice on orders totaling \$1,500 or more to any destination in the USA. Backorders for items from prepaid orders that are marked in our price list as "stock" items will be shipped prepaid along with upcoming prepaid orders when possible. Non-stocked or special-ordered items will be shipped when available. Buyer is responsible for costs associated with shipment upon acceptance if so assigned based on freight classification (*i.e.*, "prepaid" or FOB)

Title/Security. Unless a conditional sale is noted in this Agreement, title to the goods covered by this Agreement shall pass to Buyer upon delivery to carrier. Buyer hereby grants Seller and Seller hereby reserves a purchase money security interest in and to the goods sold to Buyer together with all proceeds thereof to secure Buyer's performance and payment. Buyer agrees upon Seller's request to do all acts and execute all documents reasonably necessary to assist Seller's perfection and maintenance of any such security title and right of possession, including, but not limited to, executing and filing documents with the appropriate governmental agency.

Orders. (A) Domestic (USA) Sales. Buyer shall submit a purchase order ("Purchase Order") for the goods which shall, at minimum, include: (a) part number of the goods ordered; (b) quantity; (c) price of the goods; (d) requested delivery date; and (e) shipping instructions and shipping address, including a statement that the goods will be shipped in accordance with these T&Cs. All Purchase Orders are subject to acceptance by Seller. Buyer shall be responsible for all additional costs resulting from errors made in connection with telephone, online, or hand written Purchase Orders accepted by Seller and any errors related to such a Purchase Order must be disputed within 1 hour from Seller's receipt of the Purchase Order. Confirming Purchase Orders are not accepted by Seller. If such a confirming Purchase Order is sent to Seller, it may be treated as an original open Order and duplicated. Seller will not be responsible for expenses or inconveniences incurred thereby. If Buyer's Order is in the form of a blanket Purchase Order, Buyer agrees that each release shall be treated as a separate sales transaction hereunder, that all releases shall be non-cancelable and, unless agreed in writing by Seller, all releases under such blanket Purchase Order shall be accepted by Buyer within 12 months of Seller's Order acknowledgement. If the aggregate purchase price of goods pursuant to a Purchase Order is under \$50, or such other amount that is agreed to from time to time by the parties, then the cost of such goods shall be rounded up to that minimum order value.

Order Cancellation/Amendment. Orders cannot be canceled or amended except with Seller's consent. Cancellation charges may be applied at Seller's discretion. Seller may, in its sole discretion and without liability, alter the specifications for any goods.

Acceptance. Buyer shall conduct any incoming inspection tests on the goods within 5 days of delivery. In the event of any shortage, damage or discrepancy in or to a shipment of goods or pricing discrepancies, Buyer shall promptly give notice, but in no event later than within 15 days of delivery thereof to Seller and shall furnish such written evidence or other documentation as Seller reasonably may deem appropriate. If such evidence indicates, in Seller's reasonable judgment, that such shortage, damage or discrepancy existed at the time of delivery of the goods to the carrier, Seller shall promptly deliver additional or substitute goods to Buyer; provided, however, that Seller may, in its sole discretion, require Buyer to return all damaged goods prior to delivery of substitute goods. If Buyer shall fail to timely give Seller such written notice, the goods shall be deemed to conform to the warranty and Buyer shall be deemed to have accepted the goods and shall pay for the goods in accordance herewith.

Termination. Seller shall have the right to cancel for default hereunder all or any part of Buyer's order. This right of cancellation is in addition to and not in lieu of any other remedies which Seller may have in law or equity.

Returns. Returns without the proper paperwork will not be accepted. Once the return paperwork has been received by the buyer, that return goods authorization will expire in 30 days. No goods shall be returned to Seller without Seller's prior written authorization to Buyer to make such returns and must be returned within 30 days of such authorization at Buyer's cost. If Buyer returns goods in the manner required under the previous sentence, and if the returned goods are (a) in new, unused, unopened and undamaged condition; and (b) not more than 12 months after the original invoice date; the returned goods will, subject to the applicable handling charge, be accepted by Seller for return. Used or discontinued goods or parts or goods specially manufactured will not be accepted for credit unless specifically agreed to by Seller in its sole discretion. Buyer's sole remedy for returns of goods shall be a credit for the purchase price less any handling charges. Normal returned goods are subject to a 10% restocking fee. Some returns, such as inventory returns, are subject to a 25% restocking fee, unless otherwise approved by Midland. Returns found to be free of material and workmanship defects will be held for 20 days and if Buyer does not provide Seller repair or return instructions, the Seller will scrap the goods.

Buyer's Specifications. Buyer shall be solely responsible for ensuring that all specifications, drawings, information, advice, recommendations or requests provided to Seller by Buyer or any of its agents are accurate and suitable. Seller's examination or consideration of any such specifications, drawings, information, advice, recommendations or requests shall not result in any liability on the part of Seller.

GENERAL INFORMATION

Seller Warranty. Seller warrants that goods sold hereunder are warranted to be free from defects in material and workmanship for a period of one year from the date of invoice when used according to the manufacturer's recommended usage and in an ordinary manner. Seller's liability for breach of this warranty is limited to the repair of or replacement in kind or credit, at Seller's option, of any items proved defective, in Seller's reasonable discretion, provided the allegedly defective goods are returned to Seller prepaid. All costs and expense related to shipping of any replacement parts or goods shall be paid by Seller if there is a breach of this warranty but Buyer shall pay for all installation costs. Buyer must provide prompt written notice to Seller of any breach of this warranty to obtain its benefits. THE WARRANTY EXPRESSED ABOVE IS IN LIEU OF AND EXCLUSIVE OF ALL OTHER WARRANTIES. THERE ARE NO OTHER WARRANTIES, EXPRESSED OR IMPLIED, EXCEPT AS STATED HEREIN. THERE ARE NO IMPLIED WARRANTIES OF MERCHANTABILITY OR FITNESS FOR A PARTICULAR PURPOSE, WHICH ARE SPECIFICALLY DISCLAIMED. SELLER'S LIABILITY FOR BREACH OF WARRANTY IS AS HEREIN STATED AND IS THE EXCLUSIVE REMEDY AND IN NO EVENT SHALL SELLER BE LIABLE OR RESPONSIBLE FOR INCIDENTAL, SPECIAL, INDIRECT, PUNITIVE, OR CONSEQUENTIAL DAMAGES OR LOST PROFITS, OR EVEN IF THE POSSIBILITY OF SUCH INCIDENTAL, SPECIAL, INDIRECT, PUNITIVE OR CONSEQUENTIAL DAMAGES, OR LOST PROFITS HAS BEEN MADE KNOWN TO SELLER. THE WARRANTY SET FORTH ABOVE IS SOLELY FOR THE BENEFIT OF BUYER. **All claims hereunder shall be made by Buyer and not by Buyer's customers.** It shall not be deemed a "defect," and Seller will not be liable under the warranty in this Section 11, if the goods have been exposed to any: (1) maintenance, repair, or other use that is improper for the good's ordinary use or otherwise not in compliance with Seller's instruction; (2) goods alteration, modification or repair by anyone other than Seller or authorized by Seller; (3) damage after shipment to Buyer; (4) improper voltage or wiring; or (5) use of parts that are not 100% compatible with the goods.

Buyer Warranty. Buyer shall provide a no defect in materials or workmanship warranty with respect to each product sold to an end customer for a period not less than the then remaining warranty period related to such product and afforded to Buyer pursuant to Section (Seller Warranty) above. Except with respect to the remedies provided by Seller to Buyer under Section (Seller Warranty), any other warranties or representations, or remedies for breach thereof, which Buyer may provide to its end customers shall be the sole responsibility of Buyer, and Seller shall not be bound thereby. Unless Buyer receives Seller's prior written consent, Buyer will not sell Seller's products to end-users or intermediaries that sell to end-users that will use or sell the products in a nuclear or in-aircraft application or for any other application that Seller may notify Buyer of in writing.

Damages Amount Limitation. Other than as set forth in Section (Buyer Indemnification) and any breaches of Section (Confidentiality) hereof, Seller's cumulative liability for damages to Buyer for any cause whatsoever, and regardless of the form of action, whether in contract or in tort, including, but not limited to, negligence, shall be limited to the total contract price of the goods sold hereunder, plus or minus, as applicable, the amounts of all unpaid accounts payable and receivable between the parties, if any.

Damages Limitation. In no event shall Seller's liability of any kind include any special, indirect, incidental or consequential loss or damage or lost profits, even if Seller shall have been advised of the possibility of such potential loss or damage.

Sole Remedy. The sole and exclusive remedy for breach of any non-warranty obligation of Seller and the sole remedy for Seller's liability of any kind (including liability for negligence) with respect to the goods and services provided to Buyer shall be to use all commercially reasonable efforts to promptly cure such breach. Buyer must commence any suit for a cause of action arising hereunder within one year from the date in which the facts that gave rise to the cause of action first occurred.

Buyer Indemnification. Buyer shall hold harmless, indemnify and defend (at Seller's request) Seller for any and all damages, liabilities, costs and expenses (including any costs of litigation, including but not limited to, attorneys' fees and any other costs and expenses), fines, or losses in connection with any threatened or actual claims, actions, demands, investigations, or suits, including, but not limited to, claims or suits by third parties, arising out of any of the following: (a) Buyer's negligent or willful acts, or those of its employees and/or agents, (b) such goods being repaired or altered by persons other than Seller (unless expressly authorized in writing by Seller), (c) in the event that Buyer modifies, or combines with any non-Seller goods, any of the goods purchased from Seller, and such modification or combination results in the actual or alleged infringement of any intellectual property rights of any third party, (d) from goods produced by Seller according to Buyer's specifications, (e) any violations of export control laws by Buyer, or (f) Buyer's breach of any provision in these T&Cs.

Confidentiality. "Confidential Information" means any of Seller's business information, specifications and all related writings, drawings, designs and similar works or any other information which is disclosed by Seller and labeled or marked as confidential, proprietary or its equivalent, or oral or visual information that is designated confidential, proprietary or its equivalent at the time of its disclosure. All Confidential Information shall be the exclusive property of Seller, and Seller retains all its right, title and interest. Buyer agrees to use Confidential Information for the exclusive purpose of performance under the Purchase Order and not to disclose or provide any Confidential Information to any third party and to take all necessary measures to prevent any such disclosure by its employees, agents, contractors or consultants. Upon request of Seller or completion of the Order, Buyer shall return all Confidential Information to Seller and provide certification of such return.

Tooling. Charges made for tools, dies, gauges, jigs, fixtures or equipment made or acquired by Seller in connection with the work do not convey title to or any proprietary interest in such tools. All such tools will remain the exclusive property of Seller.

Force Majeure. Seller shall not be liable for any failure to perform this agreement when such failure is due to circumstances beyond its control. Circumstances beyond the control of Seller shall be deemed to include, but shall not be limited to, acts of God, governmental action, accidents, labor trouble, and inability to obtain materials, equipment or transportation.

Waiver. No oral statements, recommendations or assistance given by a representative and/or distributor of Seller to Buyer or its representatives in connection with the use of the goods shall constitute a waiver by Seller of any of the provisions hereof, or affect Seller's liability herein.

Arbitration. Except for any action where the sole relief sought is an injunction, any controversy or claim arising out of or relating to these T&Cs, or the making, performance or interpretation thereof, including without limitation alleged fraudulent inducement thereof, shall be settled by binding arbitration in the city of Seller's choosing in the state of Seller's business address as shown on the Response, by one arbitrator in accordance with the Commercial Arbitration Rules of the American Arbitration Association. Judgment upon any arbitration award may be entered in any court having jurisdiction thereof.

Representation of Buyer. Buyer is duly organized, validly existing and in good standing under the laws of the state of its formation and has full corporate power and authority to own, operate or lease the properties and assets now owned, operated or leased by it and to carry on its business as currently conducted. Buyer is duly licensed or qualified to do business and is in good standing in each jurisdiction in which such licensing or qualification is necessary. The execution and delivery by Buyer of this Agreement, the performance by Buyer of its obligations hereunder and thereunder and the consummation by Buyer of the transactions contemplated

GENERAL INFORMATION

hereby have been duly authorized by all requisite corporate action on the part of Buyer, and this Agreement constitutes a legal, valid and binding obligation of Buyer enforceable against Buyer in accordance with its terms.

Risk of Loss. Commencing at the time of delivery, Buyer shall bear all risk of loss, damage, destruction, theft and condemnation to or of the Equipment from any cause whatsoever.

Events of Default. Each of the following events is an "Event of Default" under this Agreement: (a) if Buyer fails to pay when due any installment of the purchase price or any other amount under this Agreement; (b) if Buyer defaults in the observance or performance of any other term, covenant or condition of Buyer under this Agreement and Buyer shall fail to remedy such default within ten days after notice by Seller to Buyer of such default; (c) if Buyer's interest or any portion thereof in this Agreement devolve on or pass to any person, whether by operation of law or otherwise; (d) if Buyer: (i) does not, or is unable to, or admits in writing its inability to, pay its debts as they become due; (ii) commences or institutes any case, proceeding or other action seeking relief on its behalf as debtor, or to adjudicate it a bankrupt or insolvent, or seeking reorganization, arrangement, adjustment, winding up, liquidation, dissolution, composition or other relief with respect to it or its debts under any existing or future law of any jurisdiction, domestic or foreign, relating to bankruptcy, insolvency, reorganization or relief of debtors; (iii) commences or institutes any case, proceeding or other action seeking appointment of a receiver, trustee, custodian or other similar official for it or for all or any substantial part of its property; or (iv) makes a general assignment for the benefit of creditors; (e) if a receiver, trustee, custodian or other similar official is appointed for any substantial part of the assets of Buyer which appointment is not vacated or stayed within 30 days; (f) if Buyer sells, transfers or disposes of all or substantially all of its assets, or merges or consolidates with any other entity; or (g) a breach of any representation or warranty of Buyer.

Headings. The headings in this Agreement are for reference only and shall not affect the interpretation of this Agreement.

Entire Agreement. This Agreement, including any exhibits and schedules, constitutes the sole and entire agreement of the parties to this Agreement with respect to the subject matter contained herein and therein, and supersedes all prior and contemporaneous understandings, agreements, representations and warranties, both written and oral, with respect to such subject matter.

Amendment and Modification. No amendment to this Agreement is effective unless it is in writing and signed by each party to this Agreement.

Cumulative Remedies. All rights and remedies provided in this Agreement are cumulative and not exclusive, and the exercise by either party of any right or remedy does not preclude the exercise of any other rights or remedies that may now or subsequently be available at law, in equity, by statute, in any other agreement between the parties or otherwise.

Assignment. Buyer may not assign any of its rights under this Agreement without the prior written consent of Seller and provided that such assignment shall not relieve Buyer of its obligations under this Agreement, and Buyer shall remain primarily liable under this Agreement. Any purported assignment in violation of this Section is null and void.

Successors and Assigns. This Agreement is binding on and inures to the benefit of the parties to this Agreement and their respective successors and permitted assigns.

No Third-party Beneficiaries. This Agreement benefits solely the parties to this Agreement and their respective successors and permitted assigns and nothing in this Agreement, express or implied, confers on any third party any legal or equitable right, benefit or remedy of any nature whatsoever under or by reason of this Agreement.

Waiver of Jury Trial. Each party acknowledges and agrees that any controversy that may arise under this Agreement, including any exhibits attached to this Agreement, is likely to involve complicated and difficult issues and, therefore, each such party irrevocably and unconditionally waives any right it may have to a trial by jury in respect of any legal action arising out of or relating to this Agreement, including any exhibits attached to this Agreement, or the transactions contemplated hereby.

Drafting. No provision of this Agreement shall be interpreted for or against any party hereto on the basis that such party was the draftsman of such provision, and no presumption or burden of proof shall arise favoring or disfavoring any party by virtue of the authorship of any of the provisions of this Agreement.

Counterparts. This Agreement may be executed in counterparts, each of which is deemed an original, but all of which together is deemed to be one and the same agreement. A signed copy of this Agreement delivered by facsimile, e-mail or other means of electronic transmission is deemed to have the same legal effect as delivery of an original signed copy of this Agreement.

Miscellaneous. All provisions set forth herein regarding warranty, confidential information, indemnification, liability and limits thereon, and any other provisions that survive by their terms will survive any termination or expiration of any Response delivered in connection herewith pursuant to the terms of such sections. In the event that any provision of these terms is held to be illegal, invalid or unenforceable under any present or future law, rule or regulation, such provision shall be deemed stricken from these T&Cs, but such illegality, invalidity or unenforceability shall not invalidate any of the other provisions of these T&Cs. Buyer represents and covenants that it has, and will continue to, comply with all laws and regulations related to the goods sold hereunder, including, but not limited to, export control laws. This sale transaction shall be governed, construed and enforced solely by the laws of the State of Seller's business address as shown on the Response. The United Nations Convention on the International Sale of Goods shall not be applicable to these T & C. The relationship of Buyer and Seller is that of independent contractors.

California Customers. Midland Industries does not guarantee that all products meet California environmental laws of Proposition 65. It is the sole responsibility and liability of the Midland distributor to order products for use in California that comply with California laws.

Threading Information

Abbreviation	System Name
BSPP	British Standard Pipe Parallel
BSPT	British Standard Pipe Taper
CHT	American Standard Fire Hose Thread (1" National Hose Thread is Chemical Hose Thread , also known as Booster Hose Thread)
GHT	Garden Hose Thread (FGH - Female Garden Hose) (MGH - Male Garden Hose)
IPS	Iron Pipe Straight Thread
IPT	Iron Pipe Thread
JIC	Joint Industrial Committee
NH or NST	American Standard Fire Hose Coupling Thread (National Hose thread also known as National Standard Thread)
NPT	American Standard Taper Pipe Thread (National Pipe Tapered)
NPTF	American Standard Taper Pipe Fuel Dryseal Thread (National Pipe Tapered)(Dryseal)
NPSH	American Standard Straight Pipe for Hose Couplings (National Pipe Straight Hose)
NPSM	American Standard Straight Mechanical Joints (National Pipe Straight Mechanical)

Association Abbreviations

SAE International (SAE) is a professional organization for mobility engineering professionals in the aerospace, automotive, and commercial vehicle industries. The Society is a standards development organization for the engineering of powered vehicles of all kinds, including cars, trucks, boats, aircraft, and others.

AGA - American Gas Association

JIC - Joint Industrial Committee

ASA - American Statistical Association

ASME - American Society of Mechanical Engineers

For more detailed information, suggested sealing methods, thread compatibility, etc... visit **www.midlandindustries.com** and click on "**Knowledge Bank**"

Need help identifying a fitting?

Let our engineering team assist you!

Step 1 - Determine material. (Brass, Steel, Stainless, etc...)

Step 2 - Check Threads. (See Intro page 20 for threading types)

Step 3 - Measure Outer Diameter(O.D.) , Inner Diameter (I.D.), Length and any other relevant measurement.

Step 4 - If you have the fitting with you, place it on the grid below and take a photo. If the fitting cannot be placed on the grid please use any photo available.

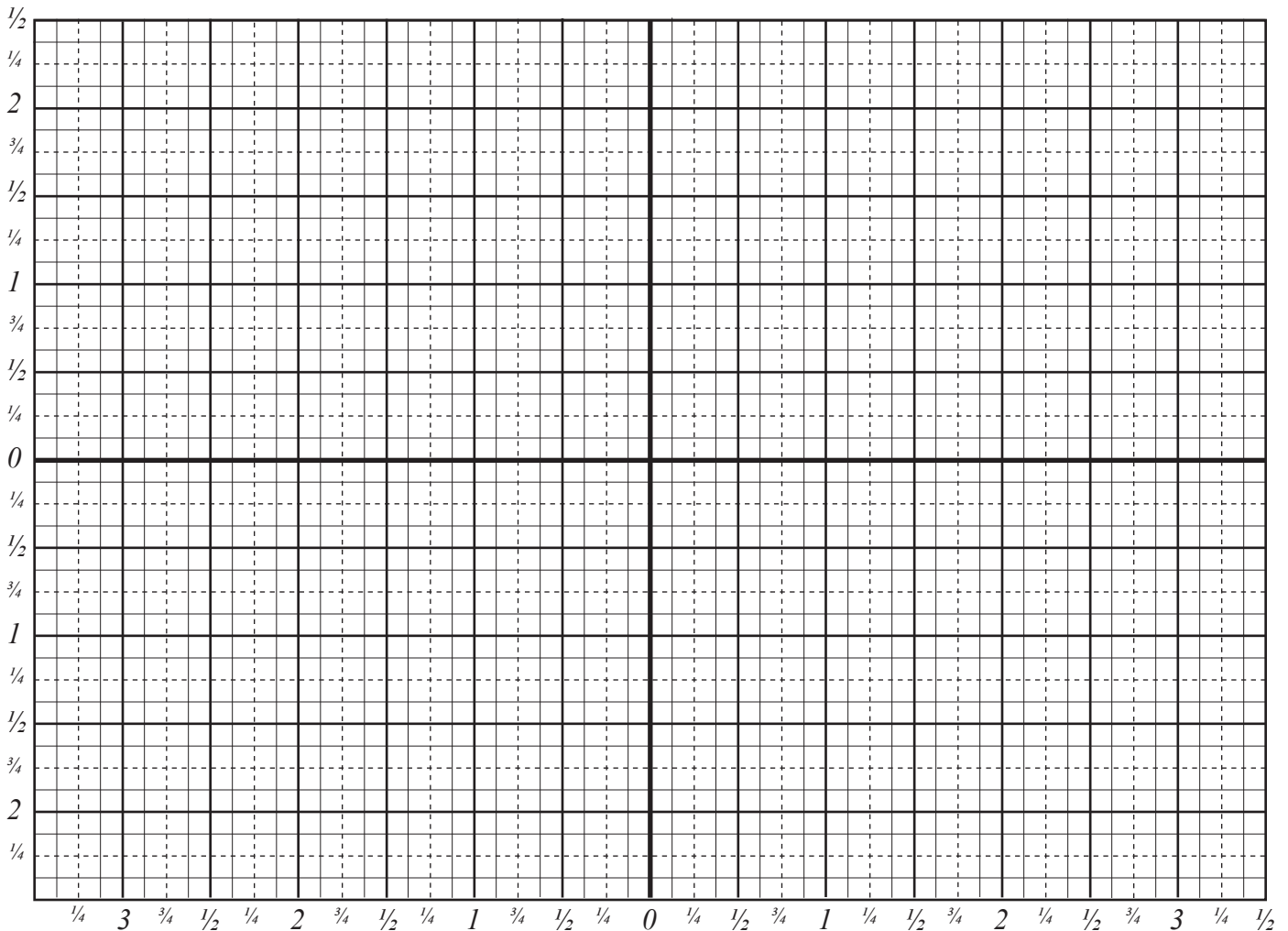

Step 5- Email photo of fitting along with information collected to :

engineer@midlandindustries.com

Please allow up to 1 business day for a response. If the request is urgent please call 1-800-821-5725

PLASTIC TUBING

INFORMATION

CORROSION RESISTANCE VALUES for Plastic Tubing

Ratings based on tests at 70°F and should not be exposed to higher temperature without testing

F-5000 Poly Vinyl Chloride

U-2000 Polyurethane

E-1000 Low Density Polyethylene

N-6000 Nylon

P-1100 Polypropylene

D-4000 EVA

T-7000 Teflon

U-8000 Special Plasticizers PVC

G-Good

L-Limited

P-Poor

N-Not Tested

FUELS:	F	U	E	N	P	D	T	U
Butane (1).....	G	G	L	G	L	G	G	N
Diesel Fuel.....	L	G	L	G	L	P	N	G
Gasoline (regular).....	L	G	P	G	L	N	G	G
Kerosene.....	L	G	P	G	G	P	G	G
Methane (nat. gas)(1).....	G	G	L	G	G	N	N	N
Propane (1).....	G	G	L	G	L	N	N	N
OTHERS:								
Acetylene.....	N	G	G	G	G	N	N	N
Ammonia gas.....	P	G	G	G	G	G	N	N
Ammonium salts.....	G	G	G	G	G	G	N	N
Amyl acetate.....	P	P	L	G	P	P	G	N
Aniline.....	P	P	L	L	G	P	G	N
Animal oils.....	G	G	P	G	G	N	G	G
Bleach, 7%.....	G	P	G	L	L	N	N	G
Bromine.....	L	G	P	P	P	P	G	N
Butandiol.....	G	G	G	G	G	N	N	N
Calcium salts incl. Chloride....	G	G	G	G	G	N	G	G
Chlorine gas, dry.....	G	G	P	P	P	P	N	N
Dibutyl phthalate.....	N	P	L	G	L	P	N	G
Glucose.....	G	G	G	G	G	G	G	G
Glycerine.....	G	G	G	G	G	G	N	G
Hydrogen peroxide 10%.....	G	G	G	G	G	G	G	G
Hydrogen peroxide 25%.....	L	G	G	P	G	G	G	G
Hydrogen sulfide.....	G	P	G	L	G	N	G	N
Isocyanates.....	N	G	G	G	N	P	N	N
Lead salts (3).....	G	G	G	G	G	N	N	N
Magnesium salts.....	G	G	G	G	G	N	G	N
Mercury.....	G	G	G	G	G	G	N	N
Milk.....	G	G	G	G	G	G	N	G
Mineral Oil.....	G	G	L	G	L	P	G	G
Nitrous Oxide (1).....	G	G	L	G	G	N	N	N
Oxygen (1).....	G	G	G	G	G	G	G	G
Ozone, ambient.....	G	G	L	G	L	N	N	G
Paint, oil base.....	L	G	L	G	G	N	N	G
Polyglycols.....	G	G	G	G	G	N	N	N
Potassium salts.....	G	G	G	G	G	N	G	N
Pydraul.....	P	P	P	G	N	N	N	N
Pyridine.....	P	L	G	L	G	N	G	N
Salt Water.....	G	G	G	G	G	G	G	G
Silver Nitrate.....	G	G	G	G	G	G	G	N
Skydrol.....	P	P	P	G	N	N	N	N
Soap solution (conc.).....	G	G	L	G	G	N	G	G
Sodium salts.....	G	G	G	G	G	N	G	G
Sodium thiosulphate.....	G	G	G	G	G	N	G	G
Styrene.....	P	G	P	G	N	N	N	G
Trisodium phosphate.....	G	G	N	G	G	G	N	G
Ucon oil.....	G	G	G	G	N	N	N	N
Urea.....	G	G	G	G	G	N	G	G
Vegetable oils (1).....	G	G	G	G	G	P	N	G
Water at 730F.....	G	G	G	G	G	G	G	G
Water at 1400F.....	L	G	G	G	G	G	G	G
Water at 1700F.....	P	L	N	L	G	P	N	G
Whiskey, wine (1).....	N	G	G	G	G	G	N	G
Zinc Chloride.....	G	G	G	G	G	G	G	N

ACIDS & BASES	F	U	E	N	P	D	T	U
Acetic, 50%.....	G	P	P	L	G	P	G	G
Boric.....	G	G	G	G	G	G	G	G
Carbolic (phenol).....	P	P	G	P	G	P	N	N
Fatty.....	G	G	P	G	G	N	G	N
Formic, 90%.....	G	P	G	P	G	G	G	G
Hydrochloric, 10%.....	G	G	G	L	G	G	G	G
Hydrochloric, 25%.....	G	L	G	P	G	L	G	G
Hydrochloric, 50%.....	G	L	G	P	G	L	G	G
Hydrocyanic, 50%.....	L	P	G	P	G	G	G	G
Maleic.....	G	P	G	G	G	N	N	N
Nitric, 10%.....	G	P	G	L	G	L	G	G
Nitric, 30%.....	G	P	G	P	L	L	G	G
Oleic.....	L	G	L	G	G	P	N	N
Phosphoric, 25%.....	G	L	G	G	G	G	N	N
Sulfuric, 30%.....	G	L	G	L	G	L	G	G
Sulfuric, 70%.....	L	P	P	P	G	P	G	G
Sulfuric, 98%.....	P	P	P	P	G	P	G	G
Sulfurous, 30%.....	G	P	G	L	G	N	G	G
Tannic.....	G	P	G	G	G	N	G	G
Ammonium hydroxide, 25%.....	P	G	L	G	G	G	N	N
Potassium hydroxide, 25%.....	L	G	G	G	G	G	G	G
Sodium hydroxide, 50%.....	G	G	G	G	G	L	G	G

SOLVENTS:	F	U	E	N	P	D	T	U
Acetone.....	P	P	G	G	L	P	G	G
Benzene.....	P	L	P	G	P	P	G	G
Carbon tetrachloride.....	P	L	L	L	P	P	G	G
Chloroform.....	P	P	P	L	P	P	G	G
Cyclohexanone.....	P	P	P	G	L	P	G	G
Dimethylformamide.....	P	P	L	N	G	N	N	N
Dioxane.....	N	N	P	G	L	N	N	N
Ethyl acetate.....	P	L	G	G	L	P	G	G
Ethyl alcohol (1).....	L	G	G	L	G	G	G	G
Ethyl ether.....	L	L	G	G	L	P	N	N
Ethylene glycol.....	G	G	G	G	G	G	N	N
Formaldehyde.....	G	G	G	G	L	N	N	N
Freon - 12'.....	L	L	G	G	L	N	G	G
Methyl alcohol.....	L	G	G	L	G	N	N	N
Methylene chloride.....	P	P	L	G	L	P	N	N
Methyl ethyl ketone.....	P	P	G	G	L	P	N	N
Naphthas (2).....	P	G	P	G	L	P	G	G
Tolulene.....	P	G	P	G	L	P	N	N
Triclorethylene.....	P	P	P	L	P	P	G	G
Turpentine.....	G	G	P	G	L	P	G	G
Xylene.....	P	G	P	G	L	P	N	N

HYDRAULIC FLUIDS:	F	U	E	N	P	D	T	U
Diester base grease.....	N	G	P	G	L	P	N	N
Petroleum base grease.....	G	G	L	G	L	P	N	N
Phosphate ester.....	L	P	P	G	G	N	N	N
Polyol ester.....	P	N	P	G	G	N	N	N
Water-glycol.....	G	G	G	G	G	N	N	N
SAE motor oils.....	G	G	G	G	G	N	N	N
Machine oil.....	G	G	L	G	L	N	N	N
MIL-L-7808 H.....	G	G	L	G	G	N	N	N
Brake Fluid.....	N	N	N	N	N	N	N	N

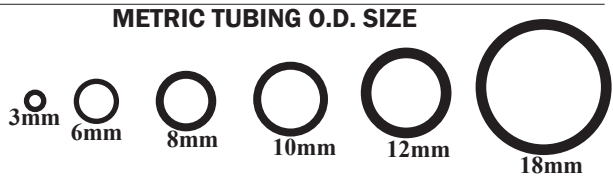
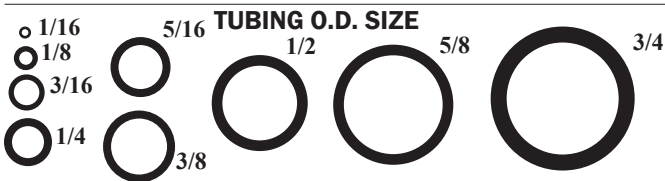

CONVERSION CHART

INFORMATION

Conversion chart

Fraction / Decimal / mm

Fraction	Decimal	mm
1/64	0.0156	0.3969
1/32	0.0313	0.7938
3/64	0.0469	1.1906
1/16	0.0625	1.5875
5/64	0.0781	1.9844
3/32	0.0938	2.3813
7/64	0.1094	2.7781
1/8	0.125	3.175
9/64	0.1406	3.5719
5/32	0.1563	3.9688
11/64	0.1719	4.3656
3/16	0.1875	4.7625
13/64	0.2031	5.1594
7/32	0.2188	5.5563
15/64	0.2344	5.9531
1/4	0.25	6.35
17/64	0.2656	6.7469
9/32	0.2813	7.1438
19/64	0.2969	7.5406
5/16	0.3125	7.9375
21/64	0.3281	8.3344
11/32	0.3438	8.7313
23/64	0.3594	9.1281
3/8	0.375	9.525
25/64	0.3906	9.9219
13/32	0.4063	10.3188
27/64	0.4219	10.7156
7/16	0.4375	11.1125
29/64	0.4531	11.5094
15/32	0.4688	11.9063
31/64	0.4844	12.3031
1/2	0.5	12.7

Fraction	Decimal	mm
33/64	0.5156	13.0969
17/32	0.5313	13.4938
35/64	0.5469	13.8906
9/16	0.5625	14.2875
37/64	0.5781	14.6844
19/32	0.5938	15.0813
39/64	0.6094	15.4781
5/8	0.625	15.875
41/64	0.6406	16.2719
21/32	0.6563	16.6688
43/64	0.6719	17.0656
11/16	0.6875	17.4625
45/64	0.7031	17.8594
23/32	0.7188	18.2563
47/64	0.7344	18.6531
3/4	0.75	19.05
49/64	0.7656	19.4469
25/32	0.7813	19.8438
51/64	0.7969	20.2406
13/16	0.8125	20.6375
53/64	0.8281	21.0344
27/32	0.8438	21.4313
55/64	0.8594	21.8281
7/8	0.875	22.225
57/64	0.8906	22.6219
29/32	0.9063	23.0188
59/64	0.9219	23.4156
15/16	0.9375	23.8125
61/64	0.9531	24.2094
31/32	0.9688	24.6063
63/64	0.9844	25.0031
1	1	25.4

	Midland	Parker	Tomco	Amflo	Breco	Milton	Dixon	Hansen	Foster
Industrial Interchange 1/4	28560	UC304F-4	UC2-16	C60		745			
	28579	UC304M-4	UC2-15	C61		746			
	28589	UC304M-6	UC2-20	C61-03					
	28551	B22A	M180	C20-01	B2CM1-B		DC2101	900	2903
	28552	B22	M181	C21	B2CM2-B	716M	DC21	1100	3103
	28553	B22E	M182	C21-03	B2CM3-B	719M	DC2103	1300	3303
	28539	B23A	M183	C20-21	B2CF1-B		DC2021	800	2803
	28540	B23	M184	C20	B2CF2-B	715M	DC20	1000	3003
	28541	B23E	M185	C20-23	B2CF3-B	718M	DC2023	1200	3203
	28562	B20-3B	M186	C20-42	B2CS2-B	717M	DC2042		
	28564	B20-5B	M187		B2CS3-B	717-6M	DC2044	1700	3703
	28565	B20-3BP	M189	C20-42L	B2CPS2-B	1717-4M	DC2042L	1600P	1513
	28566	B20-5BP	M190	C20-44L	B2CPS3-B	1717-6M	DC2044L	1700P	1713
	28545	H0C	1802	CP21-01	BB2M1-S	726	DCP2101	12	12-3
	28546	H2C	1804	CP21	BB2M2-S	727	DCP21	10	10-3
	28547	H2C-E	1806	CP21-03	BB2M3-S	733	DCP2103	14	14-3
	28533	H1C	1803	CP20-21	BB2F1-S	729	DCP2021	13	13-3
	28534	H3C	1805	CP20	BB2F2-S	728	DCP20	11	11-3
	28535	H3C-E	1807	CP20-23	BB2F3-S	732	DCP2023	15	15-3
	28557	H8C	1824	CP21-42	BB2S2-S	736	DCP2142	16	16-3
	28559	H9C	1826	CP21-44	BB2S3-S	736-6	DCP2144	17	17-3
	28558	H8CP	1850	CP21-42L	BB2PS2-S	1736-4	DCP2142L		51-3
	28561	H9CP	1860	CP21-44L	BB2PS3-S	1736-6	DCP2144L		71-3
	28515	B12A	A2180	C1-01	B2JM1-B		DC101	B21QS-12M	TF2903
	28516	B12	A2181	C1	B2JM2-B	786	DC1	B21QS-25M	TF3103
28517	B12E	A2182	C1-03	B2JM3-B	789	DC103	B21QS-37M	TF3303	
28506	B13A	A2183	C2-21	B2JF1-B		DC221	B21QS-12F	TF2803	
28507	B13	A2184	C2	B2JF2-B	785	DC2	B21QS-25F	TF3003	
28508	B13E	A2185	C2-23	B2JF3-B	788	DC223	B21QS-37F	TF3203	
28528	B10-3B	A2186	C2-42	B2JS2-B	786-4	DC242	B21QS-25H	TF3603	
28530	B10-5B	A2188	C2-44	B2JS3-B	786-6	DC244	B21QS-37H	TF3703	
28531	B10-3BP	A2189	C2-42L	B2JPS2-B	1786-4	DC242L	B21QS-25HP	TF1513	
28532	B10-5BP	A2190	C2-44L	B2JPS3-B	1786-6	DC244L	B21QS-37HP	TF1713	
28509	0C	2152	CP1-01	BJ2M1-S		DCP101		TF12	
28510	2C	2154	CP1	BJ2M2-S	783	DCP1	21AP-25M	TF10	
28511	2C-E	2156	CP1-03	BJ2M3-S		DCP103	21AP-37M	TF14	
28500	1C	2153	CP2-21	BJ2F1-S		DCP221		TF13	
28501	3C	2155	CP2	BJ2F2-S	784	DCP2	21AP-25F	TF11	
28502	3C-E		CP2-23	BJ2F3-S		DCP223	21AP-37F	TF15	
28518	8C	2164	CP1-42	BJ2S2-S	783-4	DCP142	21AP-25H	TF16	
28520	9C	2166	CP1-44	BJ2S3-S	783-6	DCP144	21AP-37H	TF17	
28521	8CP	2150	CP1-42L	BJ2PS2-S	1783-4	DCP142L		TF51	
28522	9CP	2160	CP1-44L	BJ2PS3-S	1783-6	DCP144L		TF71	
28592		A102		B20M1-B					
28593	B52	A101	C45	B20M2-B	776	DC37	20AS-25M	210-3103	
28594	B52E	A107		B20M3-B		DC3703	20AS-37M	210-3303	
28583		A103		B20F1-B					
28584	B53	A100	C38B	B20F2-B	775	DC38	20AS25F	210-3003	
28585	B53E	A106		B20F3-B		DC3823	20AS37F	210-3203	
28601		A104		B20S2-B	776-4	DC3842			
28603		A105		B20S3-B	776-6	DC3844			
28586		202		B02M1-S				210-12	
28587	A2C	200	CP37	B02M2-S	777	DCP37	20AP-25M	210-10	
28577		302		B02F1-S					
28578	A3C	300	CP38	B02F2-S	778	DCP38		210-11	
28595	A8C	400	CP37-42	B02S2-S	777-7	DCP3742			
28597		500		B02S3-S	777-6	DCP3744			
28667	BST-1M	ST1M	CST1B	1STM1-B				12MS	
28665	BST-2M	ST2M	CST3B	2STM2-B	1762	STMC2	2-S15	25MS	
28666	BST-3M	ST3M	CST5B	3STM3-B		STMC3	3-S20	38MS	
28668	BST-4M	ST4M	CST7B	4STM4-B		STMC4	4-S25	50MS	
28669	BST-6M	ST6M				STMC6	6-S30	75MS	
28670	BST-8M	ST8M				STMC8	8-S35	100MS	
28671	BST-1	ST1	CST2B	1STF1-B				12FS	
28651	BST-2	ST2	CST4B	2STF2-B	1761	STFC2	2-S16	25FS	
28652	BST-3	ST3	CST6B	3STF3-B		STFC3	3-S21	38FS	
28672	BST-4	ST4	CST8B	4STF4-B		STFC4	4-S26	50FS	
28673	BST-6	ST6				STFC6	6-S31	75FS	
28674	BST-8	ST8				STFC8	8-S36	100FS	
28675	ST-N1M	SP1M-S	CPST1	ST1M1-S				12MP	
28639	ST-N2M	SP2M-S	CPST3	ST2M2-S	1763	STMP2	2-T15	25MP	
28640	ST-N3M	SP3M-S	CPST5	ST3M3-S		STMP3	3-T20	38MP	
28676	ST-N4M	SP4M-S	CPST7	ST4M4-S		STMP4	4-T25	50MP	
28677	ST-N6M	SP6M-S				STMP6	6-T30	75MP	
28678	ST-N8M	SP8M-S				STMP8	8-T35	100MP	
28688	ST-N1	SP1-S	CPST2	ST1F1-S					
28619	ST-N2	SP2-S	CPST4	ST2F2-S	1764	STFP2	2-T16	25FP	
28620	ST-N3	SP3-S	CPST6	ST3F3-S		STFP3	3-T21	38FP	
28679	ST-N4	SP4-S	CPST8	ST4F4-S		STFP4	4-T26	50FP	
28680	ST-N6	SP5-S				STFP6	6-T31	75FP	
28681	ST-N8	SP6-S				STFP8	8-T3	100FP	
28682		1102							
28683	B72	1101	C27	B-2LM2-B	794	DC27		LM3103	
28684	B73	1100	C28	B-2LF2-B	790	DC28		LM3003	
28685		1106							
28686	L2C	1109	CP27	B-L2M2-S	791	DCP27		LM10	
28687	L3C	1110	CP28	B-L2F2-S	792	DCP28		LM11	
98823	24C	T410	C25-02	B-3CM2-S	1834	DC2502	410	4104	
98824	24	T430	C25	B-3CM3-S	1836	DC25	430	4304	
98810	25C	T400	C26-22	B-3CF2-S	1833	DC2622	400	4004	
98811	25	T420	C26	B-3CF3-S	1835	DC26	420	4204	
98814	H0E	T40	CP25-02	B-B3M2-S	1839	DCP2502	40	40-4	
98815	H2E	T42	CP25	B-B3M3-S	1837	DCP25	42	42-4	
98801	H1E	T41	CP26-22	B-B3F2-S	1840	DCP2622	41	41-4	
98802	H3E	T43	CP26	B-B3F3-S	1838	DCP26	43	43-4	

STRAIGHTS JIC FLARE 37°

INFORMATION

Thread Chart

DASH SIZE	2	3	4	5	6	7	8	10	12	14	16	20	24	32	40	48
O.D. TUBING SIZE	1/8	5/32	3/16	1/4	5/16	3/8	7/16	1/2	3/4	7/8	1	1-1/4	1-1/2	2	2-1/2	3
STANDARD PIPE SIZE N.P.T.F. (DRYSEAL)*	1/8-27		1/4-18		3/8-18		1/2-14		3/4-14		1-11 1/2	1 1/4-11 1/2	1 1/2-11 1/2	2-11 1/2	2 1/2 -8	3-8
S.A.E. 45° FLARE	5/16-24		7/16-20	1/2-20	5/8-18	11/16-16	3/4-16	7/8-14	1 1/16-14	1 1/4-12	1 3/8-12					
INVERTED FLARE	5/16-24		7/16-24	1/2-20	5/8-18	11/16-18	3/4-18	7/8-18	1 1/16-16							
J.I.C. 37° FLARE	5/16-24		7/16-20	1/2-20	9/16-18		3/4-16	7/8-14	1 1/16-12	1 3/16-12	1 5/16-12	1 5/8-12	1 7/8-12	2 1/2-12	3-12	3 1/2-12
COMPRESSION	5/16-24	5/16-24	7/16-24	1/2-24	9/16-24	5/8-24	11/16-20	13/16-18	1 -18	1 1/8-18						
FLARELESS																
COMPRESSION (PLASTIC TUBE)	5/16-24		3/8-24	7/16-24	1/2-24		11/16-20									
AIR BRAKE - PLASTIC TUBE			7/16-24		17/32-24		11/16-20	13/16-18	1 -18							
AIR BRAKE - COPPER TUBE			7/16-24	1/2-24	17/32-24		11/16-20	13/16-18	1 -18							
DOUBLE COMPRESSION	5/16-24		7/16-24	1/2-20	9/16-20		11/16-16									
STEEL																
COMPRESSION (HIGH PRESSURE)	5/16-24		7/16-20	1/2-20	9/16-18		3/4-16	7/8-14	1 1/16-12	1 3/16-12	1 5/16-12	1 5/8-12	1 7/8-12	2 1/2-12		
S.A.E. O-RING	5/16-24		7/16-20	1/2-20	9/16-18		3/4-16	7/8-14	1 1/16-12	1 3/16-12	1 5/16-12	1 5/8-12	1 7/8-12	2 1/2-12		
INTERNAL O-RING			1/2-20	9/16-18	5/8-18		7/8-14	1 -14	1 1/8-12	1 1/2-12	1 3/4-12	2 -12				
NPSM SWIVEL THREAD	1/8-27		1/4-18		3/8-18		1/2-14		3/4-14		1-11 1/2	1 1/4 -11 1/2	1 1/2 - 11 1/2	2-11 1/2		
FLAT FACE THREAD			9/16-18		11/16-16		13/16-16	1-14	1 3/16-12		1 7/16-12	1 11/16-12	2-12			
BRITISH THREAD BSPP/BSPT	1/8-28		1/4-19		3/8-19		1/2-14		3/4-14		1-11	1 1/4-11	1 1/2-11	2-11		
METRIC THREAD	10		14	16	18	20	22	24	26	27	30	33	36	42	48	
CODE 61			M12x1.5	M14x1.5	M16x1.5	M18x1.5	M20x1.5	M22x1.5	M24x1.5	M26x1.5	M27x2.0	M30x2.0	M33x2.0	M36x2.0	M42x2.0	M48x2.0
FLANGE HEAD O.D							1.19	1.335	1.50		1.75	2.00	2.38	2.81	3.31	4.00
CODE 62																
FLANGE HEAD O.D							1.25		1.62		1.88	2.12	2.50	3.12		

THREAD PROFILES

INFORMATION

Pipe Threads

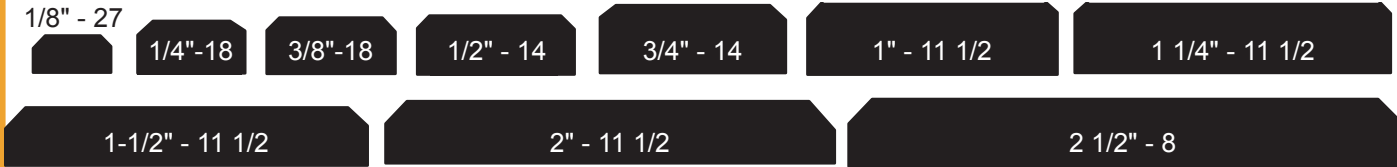

Hose Barbs

• Actual profile

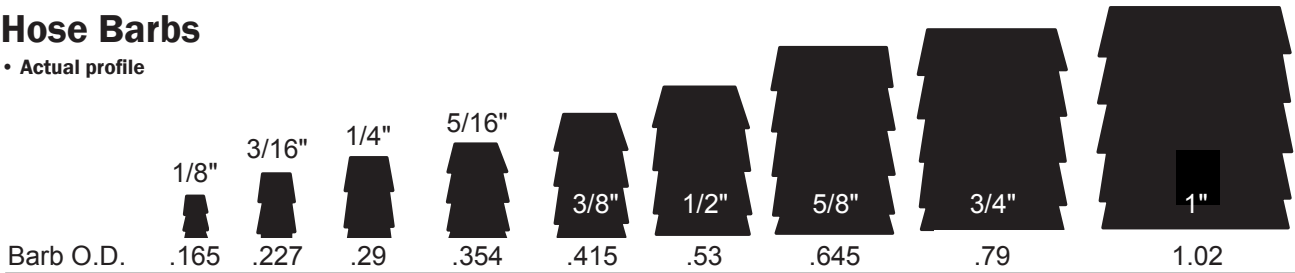

Push-On Barbs

• Actual profile



Garden Hose Fittings

Male Garden Hose Threads are 3/4" with O.D. of 1.0625 and 11-1/2 threads per inch

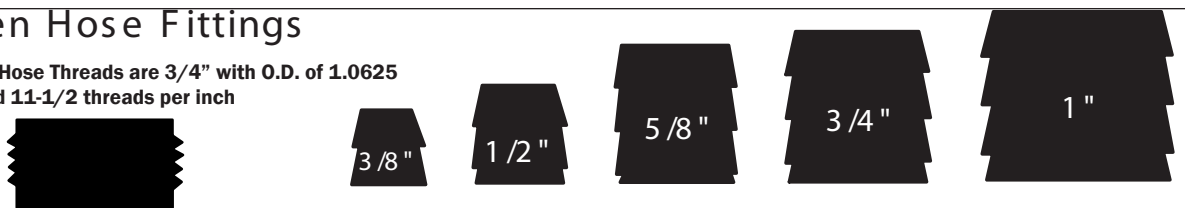

Brass 45° Flared Tube Fittings

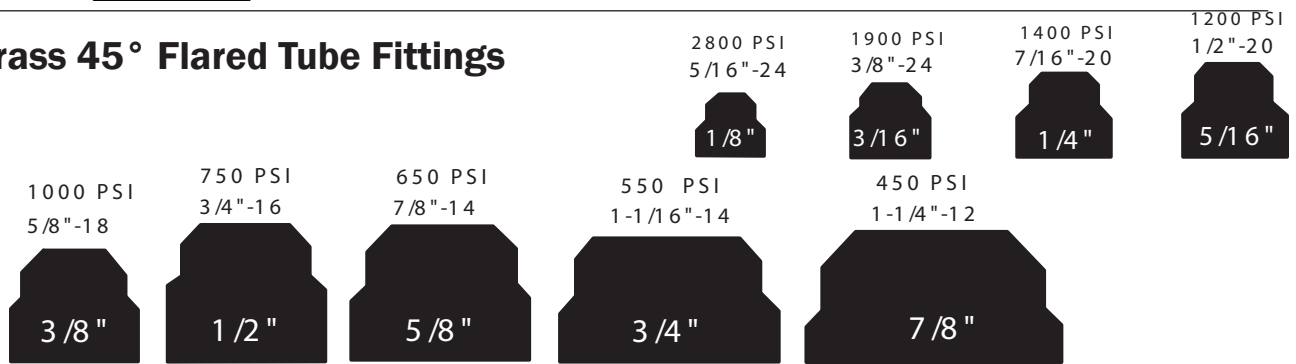

Brass Inverted Flare Fittings

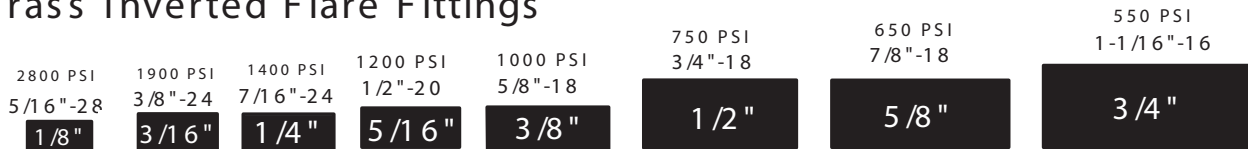

Brass Compression Fittings

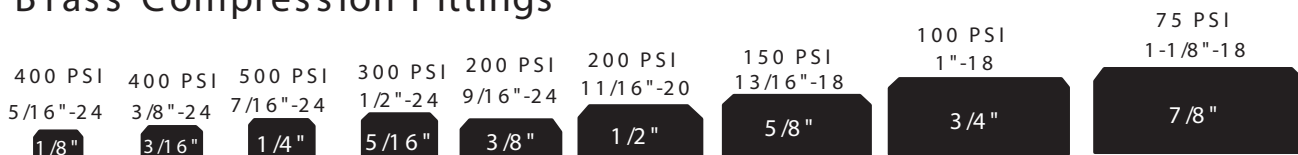

Tubing O.D. Size



MIDLAND INDUSTRIES APP START USING THESE GREAT FEATURES TODAY



- CHECK STOCK
- CHECK PRICING
- SCAN BARCODES
- PLACE ORDER/ REPLENISH STOCK

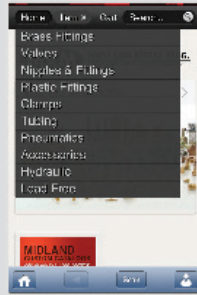
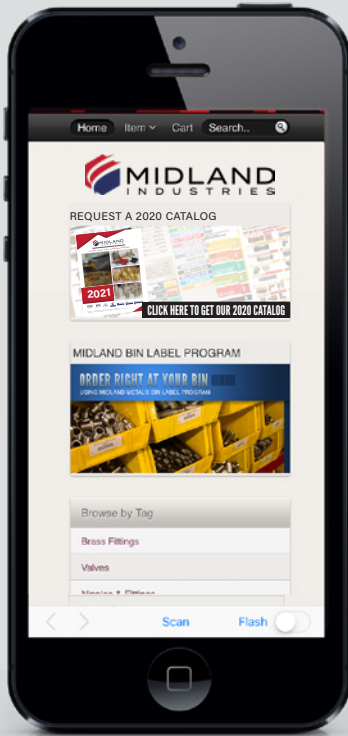

View all Products/ Categories



See product, price and stock



Scan barcodes for easy ordering



The Midland app provides a convenient way to browse Midland's entire product catalog, check product availability and place restocking orders. The built-in barcode scanner feature provides an easy way to quickly build and submit orders directly at the bin. No longer do you need to write down the part numbers and quantities and then manually enter your order at a later time while sitting at a computer. You simply press the "Scan" button and aim the camera at the item barcode label (Labels available through our "Bin Label on demand" program). Once the barcode is successfully scanned, you enter the desired quantity and move onto the next item until your order is complete.

Visit www.MIDLANDINDUSTRIES.com/app for more information.

CUSTOM CATALOGS BUILDING ADVANTAGE STARTS WITH VISIBILITY EXPAND YOUR BUSINESS WITHOUT ADDING INVENTORY

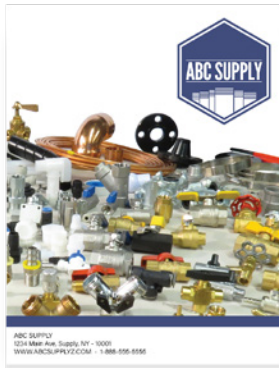

CUSTOM COVER

Our designers will work with you to create a cover that incorporates your logo, colors and photos.

CUSTOM PRICING

List price, net price or anywhere in between. You set the pricing that is right for you.

YOUR INFORMATION

Your company logo and contact information will print on the footer of each page.

Visit www.MIDLANDINDUSTRIES.com/custom

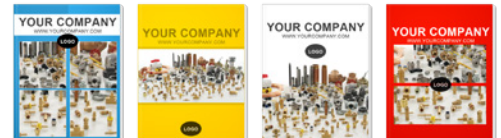

BIN LABELS ON DEMAND

Now you can create and print personalized Bin Labels on demand for any product that Midland carries. Labels can be customized with your logo or name. Multiple sizes available

4" x 2"



3.5" x 2"



2.625" x 1"



FAST • ACCURATE • EASY • FREE

to learn more about how Bin Labels on Demand can help your business, visit www.MIDLANDINDUSTRIES.com/bin

NEW PRODUCTS INTRO PGS 7-8

PICTORIAL INDEX PGS 21-49

BRASS PGS 1-210

LEAD FREE PGS 211-245

LF VALVES & PLUMBING PGS 246-264

VALVES PGS 265-317

NIPPLES & FITTINGS PGS 318-407

PLASTIC PGS 408-422

HOSE ACCESSORIES PGS 423-481

HOSE PGS 452-494

CLAMPS PGS 495-515

TUBING PGS 516-522

PRESSURE WASHER 523-528

PNEUMATICS PGS 529-551

TRUCK & TRAILER PGS 552-573

HYDRAULICS PGS 574-618

STAINLESS STEEL ADAPTERS 619-634

NUMERICAL INDEX 635-702

...TOO CONVENIENT NOT TO BUY FROM

TOLL FREE PHONE

800-821-5725

INTERNATIONAL PHONE

816-842-0493

TOLL FREE FAX

800-877-5391

INTERNATIONAL FAX

816-842-6707

Email: Sales@MidlandIndustries.com

6 FULL STOCKING LOCATIONS

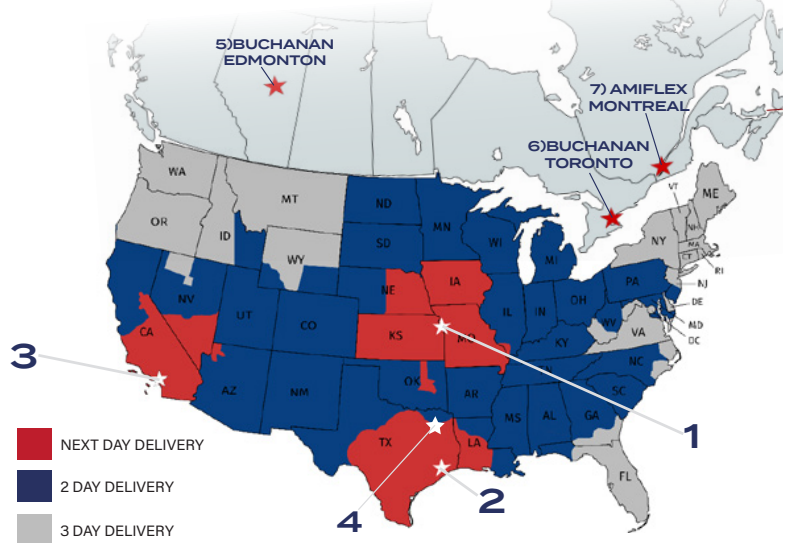

1) MIDWEST DISTRIBUTION

Full Stocking Location
3145 Oak Street
Kansas City, MO 64111

2) TEXAS DISTRIBUTION

Full Stocking Location
5544 Armour Drive,
Houston, TX 77020

4) TEXAS DISTRIBUTION

Full Stocking Location
600 E. Centre Park
DeSoto, TX 75115

3) WEST COAST DISTRIBUTION

Full Stocking Location
659 E Ball Rd
Anahiem, CA 92805

CANADIAN DISTRIBUTION

5) BUCHANAN RUBBER - EDMONTON

9547-12 Ave SW, Edmonton, AB T6X-0C3

6) BUCHANAN RUBBER-TORONTO

50 Fasken Drive (units 11-21), Etobicoke, ON M9W-1K5

7) AMIFLEX-MONTREAL

9555 Henri Bourassa Ouest, Montreal, QC H4S-1S7

WWW.MIDLANDINDUSTRIES.COM



MIDLAND
INDUSTRIES

