



# MARINCO®



MARINE  
EMERGENCY VEHICLE  
INDUSTRIAL  
RV



Battery Management  
DC Power Connections  
Horns  
Lighting  
Power Conversion  
Shore Power  
Ventilation  
Wiper Systems



# What makes Marince different:

## Founder's Vision

Since 1972, Marince power inlets and cords have set the industry standard. They are built to withstand the harshest marine environments. Marince has continued to expand their product line to offer a complete range of shore power cords from 16 to 100 amps, as well as a broad range of cord adapters. Marince is also a leading supplier of wipers, spotlights and horns to the marine industry. Quality, innovation, and our passion for boating are what define Marince.

## Innovation & Engineering

Marince engineers and manufactures a range of high quality electrical solutions designed for the harsh Marine and RV environments. Every product we make meets exacting performance specifications and is designed to withstand extreme conditions both at sea, and on land.

## Selection

Over 800 electrical products are designed to work together as a system

## Fast Delivery

Products stocked in multiple global locations ensures rapid order fulfillment

## Worldwide Access to Product

A distribution network in over 45 countries provides access to products when they are needed

## Information

24-hour access to pro tools, and technical articles online

## Industry Standards

Industry involvement ensures products meet ABYC, NMMA, and Coast Guard standards

## Quality

Product quality is managed in a manner consistent with international standards



# 2020 **NEW** Products



27

## Marine Surge & Safety Pigtails

Marine surge protection pigtails provide a convenient and cost effective solution to detect and protect from unsafe electrical conditions such as open ground, open neutral, and reverse polarity. In addition, they are designed to protect marine electronics from power surges by absorbing the surge, and indicating that the product has been compromised.

- Part # 1RPCSP 30A
- Part # 1RPC50SP 50A



55

## 6 Amp Portable Battery Charger

New updated design and improved clamps. CEC and DOE compliant.

Part # 2606A-B



56

## Universal AC Plug Holder+

No need to cut, strip or splice wires! Mount in an easy-to-reach location for safe AC power cord connection. Available in black or white.

- Part # 150PHB Black
- Part # 150PHW White



57

## Charger DC Cable Extenders

Universal design for all marine chargers with ring terminal cables. No cutting, stripping or splicing required.

- Part # 27505 5 ft
- Part # 27515 15 ft

45

## 12/24V 4.8A Dual USB Chargers

Offer 4.8 total amps of charging power for modern devices, with 2.4A available at each USB receptacle. The increased amperage is used by devices such as tablets and laptops as well as many newer phones. Three configurations are available, including a circular mount and two Contura mount options.

**Part # 12VDUSB48**

**Part # 12VCDUSB48** Contura

**Part # 12VCDUSB48A** Contura with volt/amp meter



80

## Hybrid Wiper Blades

Use a multi-material construction for maximum flexibility and durability. They conform to all windshield shapes and reduce wind lift while the boat is underway. Three unique components work together to create a high-quality blade that has been performance tested to 500,000 cycles.

**Part # 32012B** 12 inch

**Part # 32014B** 14 inch

**Part # 32016B** 16 inch

**Part # 32018B** 18 inch

**Part # 32020B** 20 inch

**Part # 32022B** 22 inch

**Part # 32024B** 24 inch

**OEM # 32112B** 12 inch

**OEM # 32114B** 14 inch

**OEM # 32116B** 16 inch

**OEM # 32118B** 18 inch

**OEM # 32120B** 20 inch

**OEM # 32122B** 22 inch

**OEM # 32124B** 24 inch



## **UPDATED** Product

### Right Angle Adapters

New ergonomic 90 degree (right angle) female connector.

*\*New design coming in 2021.*



28

# Table of Contents

## SHORE POWER

Dock Side to Boat Side Selection Guide	10
Inlets	12
Cordsets	18
Extension Cords	20
Adapters	22
Devices & Accessories	29
Boxes / Covers / Replacement Parts	34
16A Shore Power Systems	35
32A Shore Power Systems	36
63A Shore Power Systems	37
100A Shore Power Systems	38



## DC POWER CONNECTIONS

12V Receptacles / Plugs / Accessories	43
USB Chargers	45
Charging / Trolling Systems	46



## POWER CONVERSION

On-Board Battery Chargers	52
Maintainer	54
Portable Battery Chargers	55
Battery Charger Accessories	56



## BATTERY MANAGEMENT

Dynaplates	60
Battery Switches	61



## WIPER SYSTEMS

Wiper Motors	66
Wiper Motors Kits	74
Wiper Arms	75
Wiper Blades	78
Wiper System Accessories	81



## HORNS

Hidden Horns	85
Compact Horns	89
Trumpet Horns	90



## LIGHTING

Spot Lights	94
Deck Lamps	97
Docking Lights	97



## VENTILATION

Solar Vents	101
Cowl & Clam Shell Vents	104
Deck Plates	105
Fans	106



## INDEX

Part Number Index	107
-------------------	-----

# SHORE POWER

## Inlets

12



Marinco® power inlets are the industry standard. Offered in three styles, featuring robust construction and corrosion-resistant materials for long life in the harsh marine environment. All inlets have an IP56 rating.

## Cordsets

18



All Marinco® cordsets are made of the highest quality, marine grade construction with features you won't find on other power cords.

## 15A Marine Grade Locking Extension Cords

20

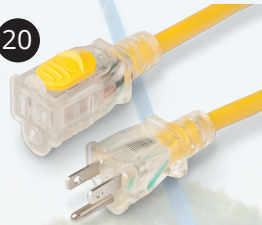

15 amp extension cords contain a universal slide locking mechanism to prevent cable disconnection. Available in 25' and 50' lengths.

## Cordset Accessories

21



Marinco offers everything you need to manage your shore power equipment.

# SHORE POWER

## Adapters

22

Marinco® Shore Power Adapters give you more power hook-up flexibility and resolve a variety of dock side power center / boat side inlet power incompatibility problems.



## Devices & Accessories

29

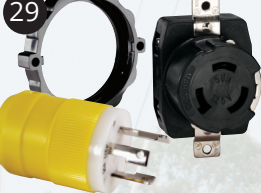

Everything you need to maintain and repair your shore power equipment.

## International Shore Power

35



Marinco offers inlets, connectors and cordsets for 16 amp, 32 amp and 63 amp Shore Power systems.

## 100 Amp Shore Power

38



Marinco 100 amp cordsets are for use with or without on-board isolation transformers, as male plug only power supply, and extension cord applications. Constructed with watertight and corrosion resistant plugs and connectors, and oil, water, and UV resistant cable, rated to 221°F (105°C).

Marinco® power inlets and cords have been the industry standard and are designed and built to withstand the rigors of the marine environment.



## Marinco® Dock Side to Boat Side Selection Guide

### DOCK SIDE

**Marine Receptacles**  
(pg 29-33)  
Corrosion resistant reinforced nylon construction.

**Weatherproof Covers**  
(pg 34)  
Yellow LEXAN® polycarbonate with lift lid, for use with Marinco® receptacles.

**Male Plugs**  
(pg 29-33)  
Superior strain-relief system. Dust seal keeps contaminants out of terminals.

**Weatherproof Covers**  
(pg 29-33)  
Heavy-duty vinyl construction, use with male plugs for superior seal.

**30A**  
125V

2-Pole  
3-Wire  
Locking



305CRR



7420CR



305CRPN



102N

**50A**  
125V

2-Pole  
3-Wire  
Locking



6370CR



7788CR



6361CRN



7717N

**50A**  
125/250V

2-Pole  
4-Wire  
Locking



6369CR



7788CR



6365CRN



7717N

**Cable TV/  
Internet**



TV97

### Marinco® Color Coding System



**BOAT SIDE**

**Shore Power Cord Sets**

(pg 18-19)  
 Marine grade cable, watertight molded plug and connector, line-up ridge for easy blade alignment.

**Weatherproof Covers**

(pg 29-33)  
 Heavy-duty vinyl construction, use with female connector for superior seal.

**Female Connectors**

(pg 29-33)  
 Ribbed nylon construction, color coded terminal pockets and screws.

**Power Inlets**

(pg 13-15, 20)  
 Styled to complement any boat, Marinc® power inlets are simple to install and feature a protective rear safety enclosure that provides safe, reliable strain relief. IP56 rated.



CS30-50



103ELN



305CRCN



CS503-50



7715CRN



6360CRN



CS504-50



7715CRN



6364CRN



TVHD



PH6629



## Inlets

Marinco® power inlets are the industry standard. Offered in three styles, they all feature robust construction and corrosion-resistant materials for long life in the harsh marine environment. Each has technical features that make them easy to install and a pleasure to use for the marine professional or the casual recreational boater. All inlets have an IP56 rating.



### Stainless Steel

Marinco stainless steel inlets are solid cast marine grade 316 stainless steel and include a heavy duty cap strap for strength and durability.



### Contoured

Marinco contoured inlets feature UV stabilized glass-filled polyester construction for long-lasting strength.



### Standard

Marinco standard inlets feature UV stabilized glass-filled polyester construction for long-lasting strength.

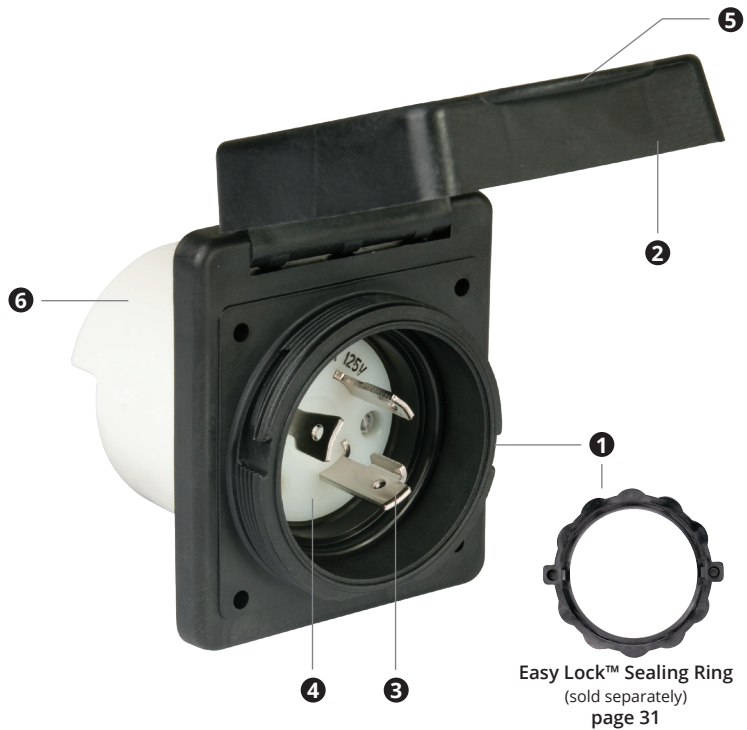

- 1 Easy Lock™—Marinco's exclusive Easy Lock System has been designed to connect the cordset (with an Easy Lock sealing ring installed) to the inlet and turn the locking ring less than a quarter turn. The tabs on the locking ring lock into the inlet for a positive watertight hook-up while eliminating any chance of cross threading. Easy Lock inlets have a threaded boss that will accept standard threaded cordsets as well.
- 2 The covers on all Marinco inlets are designed to stay hinged open when the cover is lifted up. This allows the boater to connect their shore power cord while the cover remains open and out of the way. A soft touch unlocks it for closing.
- 3 Blades are nickel plated brass for maximum corrosion resistance.
- 4 Interior hardware is marine grade stainless steel.
- 5 **IMPROVED** Extra large tab provides more area to simplify opening and closing.
- 6 **Rear Enclosure**
  - Made of flame-resistant UL 94V0 plastic.
  - All rear enclosures are glass-filled polyester for strength.
  - Integral strain relief complies with ABYC requirements.
  - Multiple positions allow for maximum installation flexibility.



**30A**  
125V

## 30 Amp 125V Inlets

**IP56**  
See inside back cover

NEMA L5-30P  30A 125V Locking

Meets or Exceeds  
**ABYC**  
Standards



### Stainless Steel Power Inlet

- Cast 316 stainless steel

Part # 303SSEL-B  
OEM # 303SSEL-B.OEM



### Contour Power Inlet

- Stainless steel trim

Part # 304EL-B  
OEM # 304EL-B.OEM



### Contour Power Inlet

- Without stainless steel trim

OEM # 304EL-B.NT white  
OEM # 199136 black



### Power Inlet

- Stainless steel trim

Part # 301EL-B white  
OEM # 301EL-B.OEM white  
Part # 301ELCB replacement cap & bezel

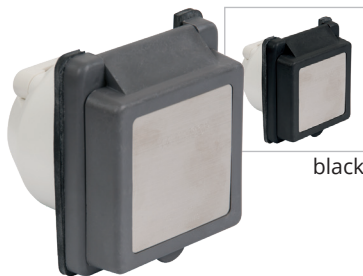

### Power Inlet

- Stainless steel trim

Part # 301EL-B.GRAY gray  
Part # 301EL-B.BLACK black



### Power Inlet

- ABYC shore power warning label on cap

Part # 301EL-B.W/L



### Power Inlet

- Stainless steel trim
- Hole in rear enclosure accommodates snap-in strain relief (not included)

Part # 301EL-B.FR



### Breaker Inlet

- Includes cap & bezel and breaker plate
- Breaker not included

Part # 3050BI



### Stainless Steel Power Outlet

- Female 30A 125V configuration
- NEMA configuration L5-30R

Part # 303SSO

**50A**  
125V

## 50 Amp 125V Inlets

**IP56**  
See inside back cover

NEMA  
SS1-50P  
W 50A  
125V  
Locking  
G

Meets or Exceeds  
**ABYC**  
Standards

**SP**  
**UL** LISTED



### Stainless Steel Power Inlet

- Cast 316 stainless steel

Part # 6371EL-B  
OEM # 6371EL-B.OEM



### Stainless Steel Power Inlet

- Cast 316 stainless steel
- Without rear safety enclosure

Part # 6371EL



### Power Inlet

- Stainless steel trim
- Without rear safety enclosure

Part # 6351EL



### Power Inlet

- Without stainless steel trim
- ABYC shore power warning label on cap

Part # 6351EL-B



### Contour Power Inlet

- Stainless steel trim

Part # 6343EL-B

## TECH tip

### 50A Devices Explained

There are two categories of 50A devices: 50A 125V (50A 3-wire) and 50A 125/250V (50A 4-wire). The 4-wire devices have two "hot" legs, each carrying 50A 125V. These two categories are not interchangeable. A 3-wire plug must never be altered to insert into a 4-wire connector or receptacle.

**50A**  
125/250V

## 50 Amp 125/250V Inlets

**IP56**  
See inside back cover

NEMA  
SS2-50P

Y  
X  
G  
W

50A  
125/250V  
Locking

Meets or Exceeds  
**ABYC**  
Standards

SP  
UL LISTED



### Stainless Steel Power Inlet

- Cast 316 stainless steel

Part # 6373EL-B  
OEM # 6373EL-B.OEM  
Part # 6373EL-B.W/L w/separate warning label



### Stainless Steel Power Inlet

- Cast 316 stainless steel
- Without rear safety enclosure

Part # 6373EL  
OEM # 6373EL.OEM



### Contour Chrome Power Inlet

- Chrome finish cover

OEM # 6344EL-BCR.OEM



### Contour Power Inlet

- Without stainless steel trim

Part # 6344EL-B.NT



### Power Inlet

- Stainless steel trim

Part # 6353EL-B  
OEM # 6353EL-B.OEM  
Part # 6353ELCB replacement cap & bezel



### Power Inlet

- Stainless steel trim
- Black

OEM # 6353EL-B.BLACK.OEM



### Power Inlet

- Stainless steel trim
- Gray

Part # 6353EL-B.GRAY



### Power Inlet

- Stainless steel trim
- Without rear safety enclosure

Part # 6353EL

## ELCI Inlets

Marinco®'s solution to the ABYC E-11 requirement is based on our industry-standard marine inlets. We have taken the best available technology and built it into our inlets to provide boat builders and owners with the safest, best looking and most durable solution possible. All of our ELCI Inlets are ignition protected to comply with ABYC standards.

We provide two modules in addition to the standard inlet. One houses the ELCI Marine Sensing Module, the other the breaker. Unlike competing systems, our ELCI Marine sensing module has a 3/4" diameter coil that accepts up to three 6-gauge conductors. This sensing module, which also incorporates a test circuit, is compatible with 30A 125V, 50A 125V and 50A 125/250V systems. There is a different breaker for 30A and 50A systems.

### TECH tip™

#### ELCI ABYC Standards

Electrical current leakage is a serious safety concern for any boat connected to shore power. Because of this ABYC requirements now include specific measures for avoiding this danger. ABYC E-11.11.1 states "An Equipment Leakage Circuit Interrupter (ELCI) shall be installed with or in addition to the main shore power disconnect circuit breaker(s) or at the additional overcurrent protection as required by E-11.10.2.8.3 whichever is closer to the shore power connection."

#### Single Phase 120V AC 30A (Hot, Neutral, Ground)

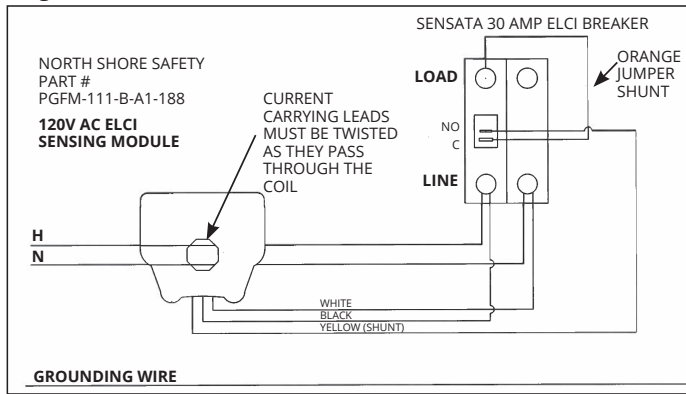

#### Split Phase 120/240V AC 50A (Line 1, Line 2, Neutral, Ground)

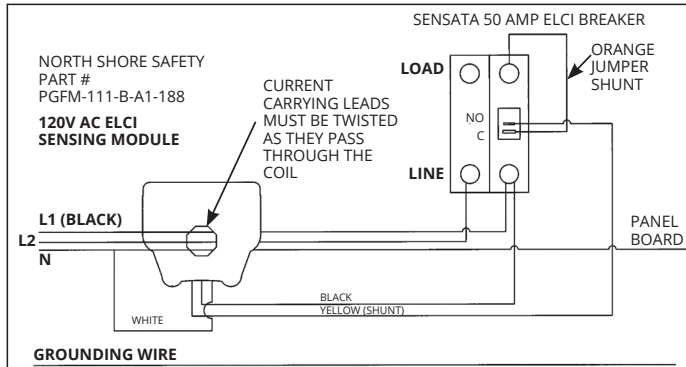

#### Standard Sensing Breaker & Module Kits

- Module & breaker packaged together

30A 120V AC Single Phase OEM # 301RCDKITIGN.OEM  
50A 120/240V AC Split Phase OEM # 6353RCDKITIGN.OEM



#### Stainless Steel Housing for Sensing Modules

- Cast 316 stainless steel
- OEM # 303SSRCDPL.OEM

#### Stainless Steel Housing for 30A or 50A Sensing Breakers

- Cast 316 stainless steel
- OEM # 303SSBKRPL.OEM



#### Standard Housing for Sensing Modules

OEM # 301RCDPL.OEM

#### Standard Housing for 30A or 50A Sensing Breakers

OEM # 301BKRPL.OEM

Cable  
TV  
Internet**Cable TV / Internet****Stainless Steel Phone & Cable TV Inlet**

- Cast 316 stainless steel

Part # PH6592TV-SS  
OEM # PH6592TV-SS.OEM

**Phone & Cable TV Inlet**

- Stainless steel trim

Part # PH6574TV  
Part # PH6574TV.W/L w/ warning label

**Stainless Steel Cable TV / Internet Inlet**

- Cast 316 stainless steel

Part # TV6592  
OEM # TV6592.OEM

**Cable TV / Internet Inlet**

Part # TV6574

**Contour Cable TV / Internet Inlet**

Part # TV6444

**Female Phone Plug**

- MARINEGUARD II Cover

Part # PH6629

**Telephone Adapter**

- Use to hook up telephone to cordset PH6599. No inlet installation required.

Part # PH6600

**Telephone Adapter**

- Use to hook up a locking type inlet to a modular telephone connection

Part # PH6601





## EEL Shore Power Cordsets

**One Hand. A Simple Twist. Full Power.**

The EEL (Easily Engaged Lock) Shore Power Cordset has a patented, industry first, jaw-clamp design providing one-handed operation and a secure waterproof seal which completely eliminates the need for a locking ring. The EEL connection is built for the harshest environments and is UL approved. This easy-to-use cordset features a built-in cord light which serves as an alert to boaters when the cord is left plugged in. And, best of all, it works with your current inlet. In addition to cordsets with the EEL System, Marinco® also has a full set of Pigtail and Y adapters all using the new EEL technology.

### Patented EEL Technology:

- Designed for use with standard inlets (NEMA)
- Single-handed operation
- No sealing ring required
- Patented jaw-clamp technology provides a watertight seal every time

### Features & Benefits:

- Built-in cord light for added safety – alert light indicates if you are plugged into the dock and cord is powered
- Power indicator light on both ends informs you full power is flowing through the cord
- Meets and exceeds rigorous UL testing standards
- 30 amp and 50 amp cordset models, 12', 25' and 50' lengths in white and yellow available
- EEL product line includes connectors, pigtail, straight and "Y" adapters



**5 YEAR WARRANTY**



Length	Color	Part #
<b>30 Amp 125V Cordsets</b>		
12'	yellow	CS30-12
25'	yellow	CS30-25
50'	yellow	CS30-50
50'	white	CS30-50W
<b>50 Amp 125V Cordsets</b>		
25'	yellow	CS503-25
50'	yellow	CS503-50
<b>50 Amp 125/250V Cordsets</b>		
25'	yellow	CS504-25
50'	yellow	CS504-50
50'	white	CS504-50W



30A 125V Locking



50A 125V Locking



50A 125/250V Locking

Amp	Volts	Plug	Connector
30A	125V AC	L5-30P	L5-30R
50A	125V AC	SS1-50P	SS1-50R
50A	125/250V AC	SS2-50P	SS2-50R



CS504-50W

CS30-50

### TECH tip

#### Blade Function Letter Codes

- |                  |                      |
|------------------|----------------------|
| <b>G</b> Ground  | <b>X</b> Phase 1 Hot |
| <b>W</b> Neutral | <b>Y</b> Phase 2 Hot |

## Power Cord Plus® Cordsets

All Marincos® cordsets are made of the highest quality, marine grade construction with features you won't find on other power cords.

- 1 Watertight molded plug and connector for safety and durability
- 2 Heavy-duty, super flexible marine grade cable (30 amp 10 gauge, 50 amp 6 gauge)
- 3 All models include a standard threaded ring for hook-up to ordinary threaded inlets
- 4 Corrosion resistant, nickel plated contacts
- 5 Power Indicator Light: Boat side connector features a molded-in LED light. When it glows red, you know you have power to the boat.
- 6 Contour Grip with Thumbprint Locator: Both plug and connector ends are molded to fit the contour of your hand. When the thumbprint is in the 12 o'clock position, the blades line up for easy connection.
- 7 Marincos Easy Lock™ system: Quickly locks the cord set to the inlet in just 1/8 of a turn. The exclusive locking tabs engage slots built into all Marincos inlets (sold separately).



### Easy Lock™ system



NEMA L5-30R  
30A 125V Locking



NEMA S51-50R  
50A 125V Locking



NEMA S52-50R  
50A 125/250V Locking

Length	Color	Pkg	Part #	OEM #
<b>30 Amp Power Cord Plus® Cordsets</b>				
12'	yellow	sleeve pack	199116	—
25'	yellow	sleeve pack	199117	—
25'	white	sleeve pack	25SPPW	—
25'	gray	sleeve pack	199117G	—
35'	yellow	sleeve pack	35SPP	—
50'	yellow	sleeve pack	199119	50SPP.OEM
50'	white	sleeve pack	199120	50SPPW.OEM
50'	gray	sleeve pack	199119G	—
75'	yellow	box	—	75SPP.OEM
<b>50 Amp 125 Volt Power Cord Plus® Cordsets (3-Wire)</b>				
25'	yellow	box	6153SPP-25	—
50'	yellow	box	6153SPP	—
50'	white	box	6153SPPW	—
75'	yellow	box	6153SPP-75	—
<b>50 Amp 125/250 Volt PowerCord Plus® Cordsets (4-Wire)</b>				
12'	yellow	box	6152SPP-12SC	—
25'	yellow	box	6152SPP-25	—
25'	white	box	6152SPPW-25	—
25'	gray	box	6152SPPG-25	—
40'	yellow	box	6152SPP-40	—
50'	yellow	box	6152SPP	—
50'	white	box	6152SPPW	—
50'	gray	box	6152SPPG	—
75'	yellow	box	6152SPP-75	—
<b>50 Amp Plug End Only Cordsets</b>				
55'	white	box	6152SPPW-55.P/O	—
75'	white	box	6152SPPW-75.P/O	—

## 15 Amp Marine Grade Extension Cords

- Marine grade SJTOW cable
- Clear ends with lighted female end for visual power indication on 14/3 models
- Female end contains slide button lock for protection against cable disconnection\*
- Slide button lock compatible with all other manufacturers' products\*
- ETL certified to UL standards

Cable	Length	Description	Part #
14/3	25'	Locking and Lighted	150025
	50'	Locking and Lighted	150050
	25'	Lighted	150025NL
	50'	Lighted	150050NL
12/3	25'	Heavy-duty	151225
	50'	Heavy-duty	151250

\*150025 and 150050 models only

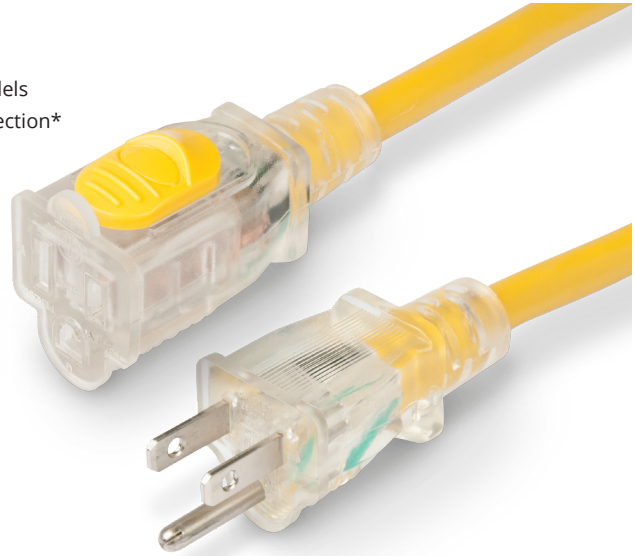

Cable  
TV  
Internet

## Cable TV/Internet

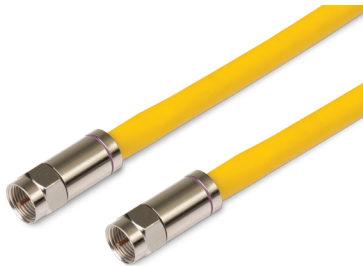

### HDTV / Internet Cable

- 50' yellow cable
- 75 ohm, 3G Hz RG6 Quad Shield cable with gasket sealed
- Weatherproof F-type connections on both ends

Part # TVHD



### Combo TV/Phone Cordset

- Both cables are jacketed together
- Telephone and TV connections are molded on each end
- Features 18" of spliced cable at dock side for connections which are in separate power centers

Part # PHTV6599 50'



### Telephone Cordset

- 3 conductor 16 AWG SJTO vinyl cord provides portable telephone connection for RV's and pleasure boats

Part # PH6599 50'



### TV Cable Cordset

- Standard 75 ohm, RG59-U with quick, slip-on connections and heavy duty boots included on both ends

Part # TV99-25 25' yellow

Part # TV99W 50' white



### Cable TV Outlet

- Spring-loaded lift cover
- Weatherproof closure
- Fits FS & FD boxes

Part # TV97

OEM # TV97.OEM



### Telephone & Cable TV Outlet

- Spring-loaded lift cover
- Fits FS & FD boxes

Part # PH6597TV

OEM # PH6597TV.OEM

## Cordset Accessories



### Cord Clips

- Includes six cord clips with stainless steel mounting screws
- Keeps shore power cable out of the water
- Holds 10 gauge 30A cable
- Easy to install
- Use on deck or edge of dock
- Organize shore power cable

Part # CLIP

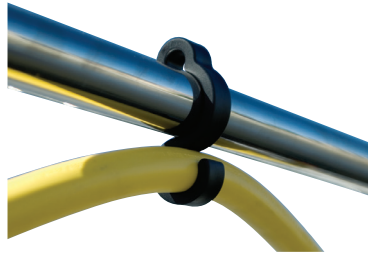

### Railmount Cord Clips

- For 30A cords
- Organize shore power cords quickly and easily
- Can be used on tube or wire rails
- Packaged as set of 6 clips
- UV stable
- Practically unbreakable

Part # CLIP-01 black



### Organizer Bag

- Heavy-duty nylon zippered bag with handle
- Ideal for storing cordsets and adapters
- Dimensions 20" x 15" x 8"

Part # BAG

### Cord Cover

- Keep shore power cables neat and bundled
- Holds 50A or 30A cordsets, can hold multiple cables
- UV resistant, machine washable marine grade fabric
- 24'

Part # CCVR-24 black



### Carrying Strap

Bundle and organize your shore power cables or hoses with this durable and flexible nylon carrying strap. Its adjustable design fits around cordsets or hoses up to 9" in diameter while, the ergonomic, rubber handle makes carrying even larger 50 amp cord sets easy on your hand. A metal, reinforced grommet allows for hanging and storage.

Part # STRAP



## Adapters

The Marinc® Shore Power Adapters give you more power hook-up flexibility and resolve a variety of dock side power center / boat side inlet power incompatibility problems.

### TECH tip™

#### Choosing the Correct Adapter

##### Step 1: Boat Side – Identify Your Boat's Inlet Electrical System



The voltage and amperage should be printed on the outside cover of your existing boat inlet(s)



The voltage and amperage should be printed inside the boat Inlet(s) next to the blades

30A 125V



50A 125V

Check the blade orientation of the various inlets pictured and compare to your boat inlet(s)



50A 125/250V

Pay special attention to the differences in the 50A 125V and the 50A 125/250V. The blades look similar, but they are different. The plugs and receptacles for these systems are NOT interchangeable!!

*Notice the additional grounding blade on the 50A 125/250V inlets.*

##### IMPORTANT 50 AMP INFORMATION:

If you are connecting to 50A dock side power service, it is **CRITICAL** to know the dock side receptacle's voltage rating (50A 125V or 50A 125/250V). An adapter designed for 50A 125V will not plug into a dock side receptacle rated for 50A 125/250V service, and vice versa.

##### Step 2: Identify the Dock Side Power Source

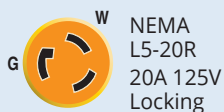

NEMA  
L5-20R  
20A 125V  
Locking



NEMA  
L5-30R  
30A 125V  
Locking

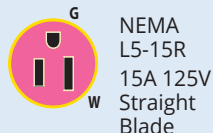

NEMA  
L5-15R  
15A 125V  
Straight  
Blade



NEMA  
SS1-50R  
50A 125V  
Locking



NEMA  
SS2-50R  
50A 125/250V  
Locking

##### Step 3: Choose a Marinc Adapter From page 23–28

Match your boat side inlet(s) to the appropriate dock side receptacle or other power source. Adapter ends are color coded for easier selection.

## Types of Adapters



**Straight Adapters** are high-quality, one-piece adapters similar in usage to Pigtail Adapters. However, they do not have sealing collars and are not recommended for use in wet locations. Use only in an enclosed, dry location, such as powering your boat from a 15A power receptacle inside your house.

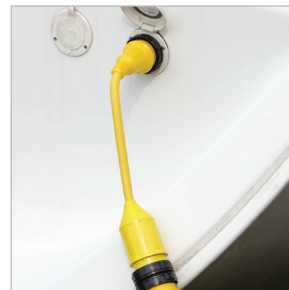

**Pigtail Adapters\*** allow you to connect from one dock side receptacle (or other power source receptacle) to one boat side inlet or equipment of dissimilar power configuration. These adapters are fully molded and equipped with Marinc's unique sealing collar (where indicated) and covers for use in wet locations.



**"Y" Adapters\*** let you split one dock side receptacle between two boat inlets of similar or dissimilar power configurations. "Y" adapters are fully molded and equipped with Marinc's unique sealing collar and covers (where indicated) for use in wet locations.

**The Reverse "Y" Adapter** (Part # RY504-2-30) The reverse "Y" provides 50A 125/250V power when only two 30A 125V receptacles are available.

\*Available with standard locking rings or with the new EEL quick locking system

# Straight Adapters

Not recommended for use in wet locations.  
Includes power LED.

**Part #**

**S20-15**  
Replaces the 80A.



**S30-15**  
Replaces the 81A.



**S15-30**  
Replaces the 83A.



**S20-30**  
Replaces the 84A.



**S15-504**



## DOCK SIDE

**MALE PLUG**  
Attaches to dock side receptacle or cordset



## BOAT SIDE

**FEMALE CONNECTOR**  
Attaches to boat inlet or cordset

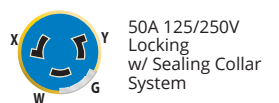
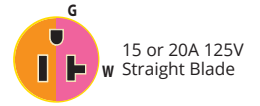

# EEL Pigtail Adapters

These adapters are equipped with sealing collars and are for use in wet locations.



**Part #**

- P15-30
- P15-30-25 25'
- P15-30-25W 25', white



**P30-15**



**P30-503**



**P30-504**



**P503-30**



**P504-30**



**P504-503**



## DOCK SIDE

**MALE PLUG**  
Attaches to dockside receptacle or cordset



## BOAT SIDE

**FEMALE CONNECTOR**  
Attaches to boat inlet or cordset

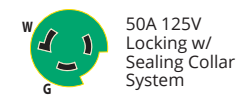
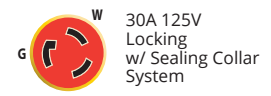
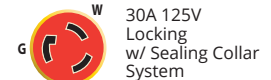
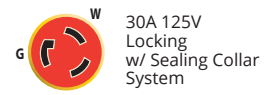

**Related Products**



Sealing Rings  
page 29-31

# Pigtail Adapters

These adapters are equipped with covers and sealing collars (where indicated), and are for use in wet locations.

**Part #**

- 104SPP**
- 104SPPG** gray
- 104SPP.OEM**
- 104SPP-25.OEM** 25'
- 104SPP-50.OEM** 50'

LED Power-on indicator and thumbgrip locator



LED Power-on indicator and thumbgrip locator



**115A**

LED Power-on indicator and thumbgrip locator



**150SPP**

LED Power-on indicator and thumbgrip locator



**106A**

**105SPP**  
**105SPPG** gray

LED Power-on indicator and thumbgrip locator



**111A**

LED Power-on indicator and thumbgrip locator



**117A**

LED Power-on indicator and thumbgrip locator



**110A**

**118A**

LED Power-on indicator and thumbgrip locator



**121A**

**123A**

## DOCK SIDE

### MALE PLUG

Attaches to dockside receptacle or cordset



15A 125V Straight-Blade w/ Locking Screw



15A 125V Straight-Blade w/ Locking Screw



15A 125V Straight-Blade w/ Locking Screw



20A 125V Locking



30A 125V Locking



30A 125V Locking



30A 125V Locking



50A 125V Locking



50A 125V Locking



50A 125V/250V Locking



50A 125V/250V Locking

## BOAT SIDE

### FEMALE CONNECTOR

Attaches to boat inlet or cordset



30A 125V Locking w/ Sealing Collar System



50A 125V Locking w/ Sealing Collar System



50A 125V/250V Locking w/ Sealing Collar System



30A 125V Locking w/ Sealing Collar System



15A 125V Straight Blade



50A 125V Locking w/ Sealing Collar System



50A 125V/250V Locking w/ Sealing Collar System



30A 125V Locking w/ Sealing Collar System



50A 125V/250V Locking w/ Sealing Collar System



30A 125V Locking w/ Sealing Collar System



50A 125V Locking w/ Sealing Collar System



## EEL "Y" Adapters

These adapters are equipped with sealing collars and are for use in wet locations.

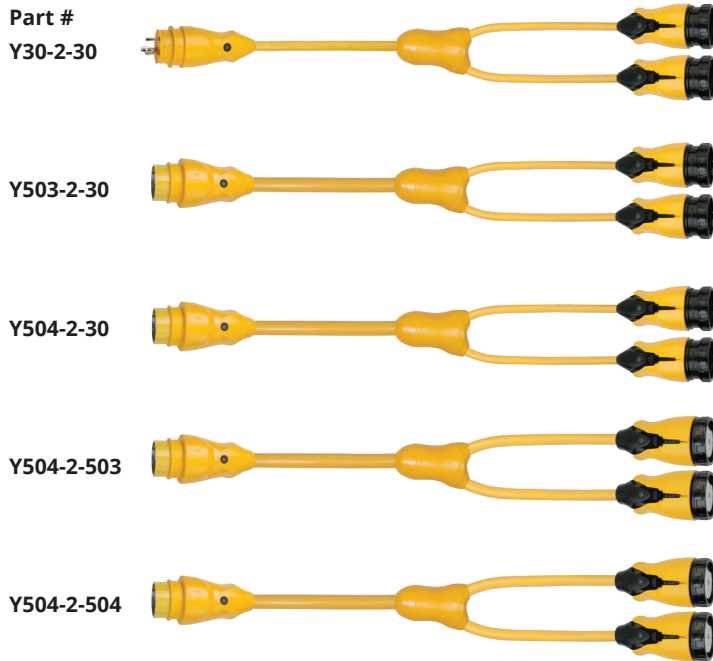

### DOCK SIDE

**MALE PLUG**  
Attaches to dock side receptacle or cordset



### BOAT SIDE

**FEMALE CONNECTOR**  
Attaches to boat inlet or cordset



## "Y" Adapters

These adapters are equipped with covers and sealing collars (where indicated), and are for use in wet locations.



### DOCK SIDE

**MALE PLUG**  
Attaches to dock side receptacle or cordset



### BOAT SIDE

**FEMALE CONNECTOR**  
Attaches to boat inlet or cordset

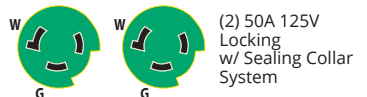
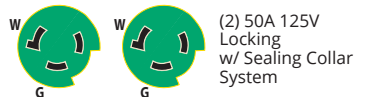

## Reverse "Y" Adapter

The Reverse "Y" Adapter has two (2) male plugs with special power isolation circuitry for added safety. When one (1) plug is connected to a receptacle, the circuitry isolates the second plug. The reverse "Y" provides 50A 125/250V power when only two (2) 30A 125V receptacles are available.

Note: Reverse "Y" will NOT work with 50A, 125V, 3-wire inlets. Power is provided in both circuits to the 4-wire inlet, but the dock side receptacles limit the current in each circuit to 30A. The two (2) 30A 125V receptacles must be supplied from a single power source providing 208V to 250V between them for proper operation.

Part #  
RY504-2-30



### DOCK SIDE

#### MALE PLUG

Attaches to dock side receptacle or cordset



### BOAT SIDE

#### FEMALE CONNECTOR

Attaches to boat inlet or cordset

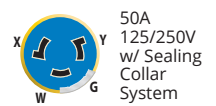

## Marine Surge & Safety Pigtails **NEW**

Detect faulty pedestal wiring conditions before they damage your equipment.

Faulty and unsafe shorepower can damage your sensitive electronics. These new pigtail adapters not only detect defective wiring at the pedestal, but also protect against electrical surges. Integrated LEDs provide visual indication of several unsafe conditions such as open ground, open neutral, and reverse polarity. Built-in surge protection with indicator that alerts that the adapter has been compromised.

- Ergonomic 90 degree (right angle) dockside plug
- Boat side connectors feature locking sealing collar system
- Bright 3-color LED electrical status indicators
- Surge failure indicator
- Surge protection ratings:  
30A: 825 joules  
50A: 1650 joules

Part #  
1RPCSP  
(30 amp)



### DOCK SIDE

#### MALE PLUG

Attaches to dock side receptacle or cordset



### BOAT SIDE

#### FEMALE CONNECTOR

Attaches to boat inlet or cordset

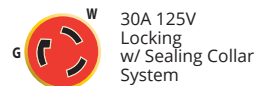

Part #  
1RPC50SP  
(50 amp)



### Related Products



Sealing Rings  
page 29-31

## Right Angle Adapters **UPDATED**

\*New design coming in 2021.

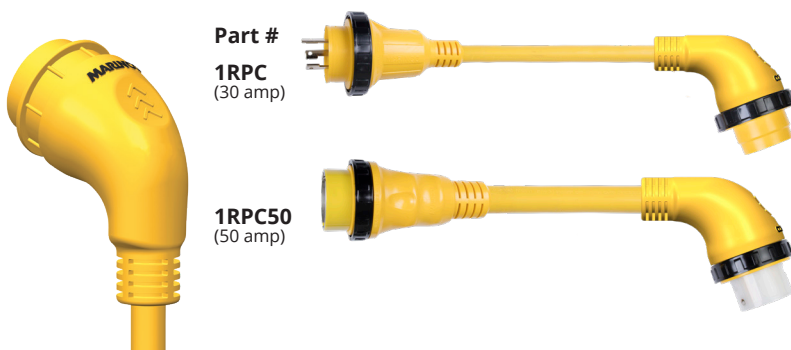

Part #

**1RPC**  
(30 amp)

**1RPC50**  
(50 amp)

### DOCK SIDE

**MALE PLUG**  
Attaches to dock side  
receptacle or cordset



30A 125V  
Locking

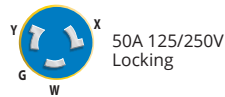

50A 125/250V  
Locking

### BOAT SIDE

**FEMALE CONNECTOR**  
Attaches to boat inlet  
or cordset

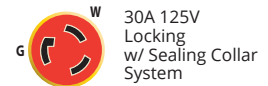

30A 125V  
Locking  
w/ Sealing Collar  
System



50A 125/250V  
Locking w/  
Sealing Collar  
System

## Dock Side 30 Amp to 15 Amp Adapter with GFCI

Part #  
**199128**



### DOCK SIDE

**MALE PLUG**  
Attaches to dock side  
receptacle or cordset



30A 125V  
Locking

### BOAT SIDE

**FEMALE CONNECTOR**  
Attaches to boat inlet  
or cordset

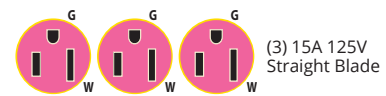

(3) 15A 125V  
Straight Blade

- Provides safer hook-up to 30A dock side power
- Provides protection against harmful electric shock
- Reduces the possibility of fire
- Offers protection for up to three (3) attached tools
- Corrosion resistant and rain-proof rated for outdoor use
- GFI trip level of 4-6 mA
- Can also be used for other outdoor, harsh environments such as construction sites or wherever ground fault protection is desired

Note: A Ground Fault Circuit Interrupter (GFCI) limits the duration of an electrical shock to a period considered safe for healthy people. It does not prevent electric shock. This device does not protect against electric shock due to contact with both circuit conductors or a fault in any wiring supplying this device.

### TECH tip™

#### GFCI Protection

According to ABYC standard E-11.11, A Ground Fault Circuit Interrupter (GFCI) may be used on single phase AC circuits to provide additional protection for personnel and equipment.

**30A**  
125V**30 Amp 125V Devices & Accessories****Male Plug**

Part # 305CRPN  
OEM # 305CRPN.OEM

**Female Connector**

Part # 305CRCN  
OEM # 305CRCN.OEM

**Male Plug & Cover**

• Weather resistant cover  
Part # 305CRPN.VPK

**Female Connector w/ Cover**

• Weather resistant cover  
Part # 305CRCN.VPK

**Locking Receptacle**

• Corrosion resistant  
• Reinforced nylon construction  
• Yellow  
Part # 305CRR

**Locking Receptacle**

• Corrosion resistant  
• Reinforced nylon construction  
• Black  
Part # 305CRRB  
OEM # 305CRRB.OEM

**Weatherproof Cover w/ Threaded Sealing Ring**

• Use with 305CRCN or 205CRCN  
Part # 103RN  
OEM # 103RN.OEM

**Weatherproof Cover w/ Easy Lock™ Sealing Ring**

• Use with 305CRCN or 205CRCN  
Part # 103ELN

**Weatherproof Cover**

• Use with 305CRPN or 205CRPN  
Part # 102N

**Easy Lock™ Sealing Ring**

• Use with 30 amp Marinco® Inlets  
Part # 100EL

**Threaded Sealing Ring**

• Use with 30 amp systems  
Part # 100R

**Sealing Collar w/ Threaded Ring**

• Provides maximum moisture protection between cordset & adapter  
• Use with 20 & 30 amp locking systems  
Part # 110R

**50A**  
125V**50 Amp 125V Devices & Accessories****Male Plug**

- 2-pole, 3-wire

Part # 6361CRN

**Female Connector**

- 2-pole, 3-wire

Part # 6360CRN  
OEM # 6360CRN.OEM**Wire Dock Side Receptacle**

- 2-pole, 3-wire

Part # 6370CR

**50A**  
125/250V**50 Amp 125/250V Devices & Accessories****Male Plug**

- 3-pole, 4-wire

Part # 6365CRN  
OEM # 6365CRN.OEM**Female Connector**

- 3-pole, 4-wire

Part # 6364CRN  
OEM # 6364CRN.OEM**Wire Dock Side Receptacle**

- 3-pole, 4-wire

Part # 6369CR  
OEM # 6369CR.OEM

## 50 Amp Accessories



### Weatherproof Cover w/ Threaded Sealing Ring

- Use with 6360CRN or 6364CRN

Part # 7715CRN  
OEM # 7715CRN.OEM



### Weatherproof Cover w/ Easy Lock™ Sealing Ring

- Use with 6360CRN or 6364CRN

Part # 7715ELN  
OEM # 7715ELN.OEM

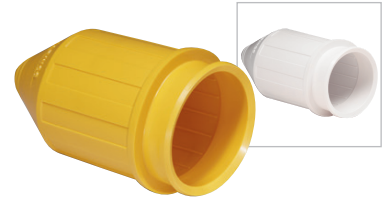

### Weatherproof Cover

- Use with 6361CRN or 6365CRN
- Can be used on both male & female ends

Part # 7717N yellow  
OEM # 7717N.OEM yellow  
Part # 102182 white



### Easy Lock™ Sealing Ring

- Use with 50 amp Marincó® Inlets

Part # 500EL



### Threaded Locking Sealing Ring

- Use with 50 amp systems

Part # 500R



### Sealing Collar w/ Threaded Ring

- Provides maximum moisture protection between cordset & adapter
- Use with 50 amp only systems

Part # 510R



### Universal Watertight Connector Cap

- For use on 16 or 32 amp products for CE compliance
- For use on 30 or 50 amp products to protect the connector when not in use

Part # 199111PK 16A/30A/32A/50A/63A



### Watertight Connector Cap

- For use on 16 or 32 amp products for CE compliance
- For use on 30 or 50 amp products to protect the connector when not in use

Part # 199109PK 16A/30A  
Part # 199110PK 32A/50A

**15A**  
125V**15 Amp 125V Devices & Accessories****Male Plug**

- Straight blade

Part # 5266CR

**Female Connector**

- Straight blade

Part # 5269CR

**Male Plug**

- Locking type

Part # 4721CR

**Female Connector**

- Locking type

Part # 4731CR

**Duplex Locking Receptacle**

- Yellow

Part # 4700CR

**Duplex Straight Receptacle**

Part # 5262CRR yellow  
Part # 5262CRR.GRY gray

**Ground Fault Circuit Interrupter (GFCI)**

**CAUTION:** Ground Fault Circuit Interrupter protection is required when using electrical products outdoors or near water. GFCI Protection is required by the ABYC where a receptacle is in a head, galley, machinery space or weather deck.

Part # 1591-FI ivory  
Part # 1591-FI.WHITE white  
OEM # 1591-FI.GRY.OEM gray



**20A**  
125V**20 Amp 125V Devices & Accessories****Male Plug**

- Straight blade

Part # 5366CR

**Female Connector**

- Straight blade

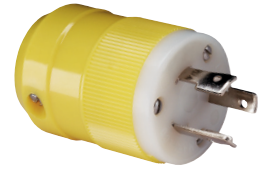
Part # 5369CR  
OEM # 5369CR.OEM**Male Plug**

- Locking type
- Uses weatherproof cover 102N

Part # 205CRPN

**Female Connector**

- Locking type
- Uses weatherproof cover 103RN

Part # 205CRCN

**Locking Receptacle**

Part # 205CRR

**15 & 20 Amp Accessories****Weatherproof Cover**

- Use with 5366CR or 5266CR plugs

Part # 6017

**Weatherproof Cover**

- Use with 5369CR or 5269CR connectors

Part # 6018

**Weatherproof Cover**

- Can be used on 15 & 20 amp

OEM # 1520BI.OEM



## Boxes / Covers / Replacement Parts



### FS Box

- Black non-metallic, with two 3/4" K.O. holes
- Accepts 15A, 20A and 30A receptacles, and 7420CR weatherproof covers

Part # 6080

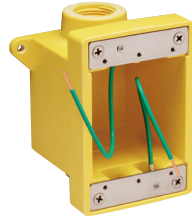

### FD Box with 3/4" or 1" K.O. Holes

- Yellow fiberglass, with two K.O. holes
- Accepts 15A, 20A, 30A & 50A receptacles, and 7420CR & 7788CR covers

Part # 6083CR 3/4" holes

Part # 6084CR 1" holes



### Weatherproof Cover

- Yellow LEXAN® polycarbonate with lift lid
- Fits 15A, 20A, & 30A single receptacles

Part # 7420CR

OEM # 7420CR.OEM



### Weatherproof Cover

- Yellow LEXAN® polycarbonate with lift lid
- Fits 50A receptacles 6369CR & 6370CR

Part # 7788CR

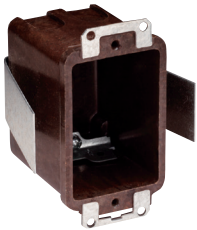

### Plastic Switch/Outlet Box

- 3-9/32" x 2-3/16" x 2-1/2" D
- Can be secured against the back of wall or wall facing
- Accepts 15A, 20A & 30A receptacles, telephone outlets and TV coax connectors

Part # 6079



### 302 Stainless Steel Sealed Cover with Lift Lid

- Fits 4700CR, 5262CRR, & 5739CR duplex receptacles

Part # 7879CR



### 302 Stainless Steel Sealed Cover with Lift Lid

- Fits GFCI duplex receptacles

Part # 7879CR-FI

OEM # 7879CR-FI.OEM



### Replacement Interior

- Fits 50A 125/250V Easy Lock 4-wire stainless steel or standard inlets manufactured after 8-1-93

Part # 6373ELMB



### Replacement Interior

- Fits 303SSEL-B, 303SSI-B & 301EL-B boat inlets

Part # 305CRMB



### Replacement Interior

- Fits 30A standard non-metallic inlets manufactured prior to 1/1/91

Part # 301CRMB



### Replacement Boss Ring

- For use on 30A or 50A stainless steel inlets

Part # 102167 30A

Part # 102164 50A



### Warning Labels

- For use on standard inlets
- For warning label placement use per ABYC standard 11.6.2.2.3

Part # 101739

## International Shore Power 16 Amp 230V, 50Hz Locking

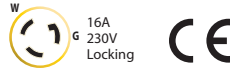

### Stainless Steel Inlet

- 316 stainless steel
- Easy Lock™ system
- Soft touch cap design
- Rear safety enclosure with strain relief
- IP56 rated

Part # 303SSEL-BXPK  
OEM # 303SSEL-BX



### Standard Inlet

- Easy Lock™ system
- Glass-filled polyester
- Watertight
- Rear safety enclosure with strain relief
- IP56 rated

Part # 301EL-BXPK  
OEM # 301EL-BX



### Contour Inlet

- Easy Lock™ system
- Glass-filled polyester
- Watertight
- Rear safety enclosure with strain relief
- IP56 rated

OEM # 304EL-BX.NT  
OEM # 304EL-BX stainless steel trim



### Female Connector

- Corrosion resistant contacts and terminals
- Use with cover 103RNX and cap 199109

Part # 305CRCXNPK  
OEM # 305CRCXN



### Weatherproof Cover w/ Threaded Ring

- Use with 305CRCXN

Part # 103RNXPK  
OEM # 103RNX



### Connector Kit

- Includes female connector, weatherproof cover with threaded ring and watertight cap

Part # 199114



### Locking Shore Power Cordset

- H07BQ-F 3G 2.50 mm<sup>2</sup> harmonized cable
- IEC 60309 plug 2P+E [6H], 250V/50Hz
- Watertight connector sealing cap for CE compliance
- NEMA L5-30 moulded connector with LED power indicator light

Part # 25MSPPXP 25 meters  
Part # 20MSPPXP 20 meters  
Part # 15MSPPXP 15 meters  
Part # 10MSPPXP 10 meters  
Part # 1MSPPXP 1 meters



### Harmonized Cable Cordset

- Blunt cut
- H07BQ-F 3G 2.50 mm<sup>2</sup> harmonized cable
- Watertight connector sealing cap for CE compliance
- NEMA L5-30 moulded connector with LED power indicator light

Part # 25MSPPX 25 meters  
Part # 20MSPPX 20 meters  
Part # 15MSPPX 15 meters  
Part # 10MSPPX 10 meters  
Part # 1MSPPX 1 meters



### 12/3 Cable Cordset

- Blunt cut
- 12/3 (3.3 mm<sup>2</sup>) cable 16A/220V 50Hz
- Watertight connector sealing cap for CE compliance
- NEMA L5-30 moulded connector with LED power indicator light

Part # 50SPPX 50'  
Part # 25SPPX 25'

## International Shore Power 32 Amp 230V, 50Hz Locking



### Stainless Steel Inlet

- 316 stainless steel
- Easy Lock™ system
- Soft Touch cap design
- Rear safety enclosure with strain relief
- IP56 rated (see inside back cover)

Part # 6371EL-BX

OEM # 6371ELX no enclosure



### Standard Inlet

- Easy Lock™ system
- Glass-filled polyester
- Watertight
- Rear safety enclosure with strain relief
- IP56 rated (see inside back cover)

OEM # 6351EL-BX



### Contour Inlet

- Easy Lock™ system
- Glass-filled polyester
- Watertight
- Rear safety enclosure with strain relief
- IP56 rated (see inside back cover)

OEM # 6343EL-BX



### Female Connector

- Corrosion resistant contacts and terminals
- Use with cover 7715CRN and sealing cap 199110

Part # 6360CRNXPX

OEM # 6360CRNX



### Weatherproof Cover w/ Threaded Ring

- Use with 6360CRNX, 6401CRCX, 6401CRPX, 6402CRCX, or 6402CRPX

Part # 7715CRNXPX

OEM # 7715CRNX



### Connector Kit

- Includes female connector, weatherproof cover with treaded ring and watertight cap

Part # 199115



### Locking Shore Power Cordset

- H07BQ-F 3G 4 mm<sup>2</sup> harmonized cable
- IEC 60309 plug 2P+E [6H], 250V/50Hz
- Watertight connector sealing cap for CE compliance
- NEMA SS-1 moulded connector with LED power indicator light

Part # 15M32AXP 15 meters

Part # 1M32AXP 1 meter



### Harmonized Cable Cordset

- Blunt cut
- H07BQ-F 3G 4 mm<sup>2</sup> harmonized cable
- Watertight connector sealing cap for CE compliance
- NEMA SS-1 moulded connector with LED power indicator light

Part # 15M32AX 15 meters



### 8/3 Cable Cordset

- Male end blunt cut
- 8/3 (8.6 mm<sup>2</sup>) cable
- Moulded connector with LED power indicator light

Part # 6153SPPX 50'

## International Shore Power 63 Amp 230V, 50Hz Locking Single Phase, 3-Wire

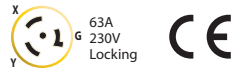

### Stainless Steel Inlet

- 316 stainless steel
- Easy Lock™ System
- Soft touch cap design
- Rear safety enclosure with strain relief
- IP56 rated (see inside back cover)

Part # 6401EL-BX



### Female Connector

- Corrosion resistant contacts and terminals

Part # 6401CRCX

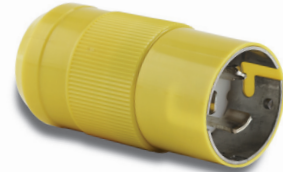

### Male Connector

- Corrosion resistant contacts and terminals

Part # 6401CRPX

## 63 Amp 230V, 50Hz Locking Three Phase, 4 Wire

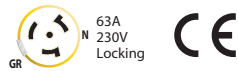

### Stainless Steel Inlet

- 316 Stainless steel
- Easy Lock™ system
- Soft touch cap design
- Rear safety enclosure with strain relief
- IP56 rated (see inside back cover)

Part # 6402EL-BX



### Female Connector

- Corrosion resistant contacts and terminals

Part # 6402CRCX



### Male Connector

- Corrosion resistant contacts and terminals

Part # 6402CRPX



### Weatherproof Cover w/ Threaded Ring

- Use with 6360CRNX, 6401CRCX, 6401CRPX, 6402CRCX, or 6402CRPX

Part # 7715CRNXPX

OEM # 7715CRNX

## 100 Amp 125/250V 3-Pole 4-Wire



### Cordsets

All Marinco® cordsets are made of the highest quality, marine grade construction with features you won't find on other power cords.

- For use with 100 amp 125V/250V shore power systems
- High visibility, 2 AWG, flexible yellow STOW cable is oil, water, UV resistant, and rated to 221°F (105°C)
- Ergonomic non-slip TPE coated gripping surfaces
- IEC pin & sleeve plugs and connectors are designed for harsh environments, watertight, and corrosion resistant. Feature integrated locking rings.
- Internal frame terminals provide high clamping force for safe and secure contact
- Options for use with on-board isolation transformers, male plug only power supply, and extension purposes
- UL and ABYC approved components

Length	Neutral Wire	Female End	Application	Color	Part #
75'	no	yes	Isolation transformer cordset	yellow	CS75IT4
75'	yes	yes	Standard cordset	yellow	CS754
75'	yes	no, blunt cut	Cable winch	yellow	CW754
100'	no	yes	Isolation transformer cordset	yellow	CS100IT4
100'	no	no, blunt cut	Cable winch w/ isolation transformer	yellow	CW100IT4
100'	yes	yes	Standard cordset	yellow	CS1004
100'	yes	no, blunt cut	Cable winch	yellow	CW1004
125'	no	no, blunt cut	Cable winch w/ isolation transformer	yellow	CW125IT4
Extension Cord					
50'	yes	yes	Extension cable	yellow	CS50EXT4*

\*CS50EXT4 extension cord has connector body M4100C12 shown below.



**5 YEAR WARRANTY**



### Plug w/ Gasketed Locking Ring

- Mate with M4100R12 receptacle

Part # M4100P12



### Connector Body

- Mate with plug on extension cords or adapters. Note: It does not mate with shore power inlet.

Part # M4100C12

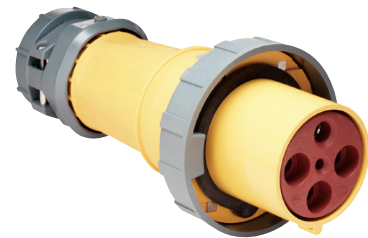

### Connector Body w/ Gasketed Locking Ring

- Mate with M4100B12R inlet

Part # M4100C12R

### Dock Side Receptacle

- Spring loaded cover providing a IP67 watertight rating when tightened (see inside back cover)

Part # M4100R12



### Shore Power Inlet

- Spring loaded cover providing a IP67 watertight rating when tightened (see inside back cover)

Part # M4100B12R



# 100 Amp 3ØY 120V/208V 4-Pole 5-Wire



## Cordsets

All Marinco® cordsets are made of the highest quality, marine grade construction with features you won't find on other power cords.

- For use with 100 amp 120V/208V shore power systems
- High visibility, 2 AWG, flexible yellow STOW cable is oil, water, UV resistant, and rated to 221°F (105°C)
- Ergonomic non-slip TPE coated gripping surfaces
- IEC pin & sleeve plugs and connectors are designed for harsh environments, watertight, and corrosion resistant. Feature integrated locking rings.
- Internal frame terminals provide high clamping force for safe and secure contact
- Options for use with on-board isolation transformers and male plug only power supply purposes
- UL and ABYC approved components



Length	Neutral Wire	Female End	Application	Color	Part #
75'	No	yes	Isolation transformer cordset	yellow	CS75IT5
100'	No	yes	Isolation transformer cordset	yellow	CS100IT5
100'	No	no, blunt cut	Cable winch w/ isolation transformer	yellow	CW100IT5
125'	No	no, blunt cut	Cable winch w/ isolation transformer	yellow	CW125IT5



### Plug w/ Gasketed Locking Ring

- Mate with M5100R9 receptacle

Part # M5100P9



### Connector Body

- Mate with plug on extension cords or adapters. Note: It does not mate with shore power inlet.

Part # M5100C9

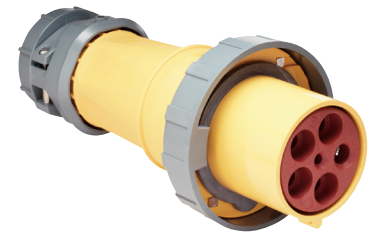

### Connector Body w/ Gasketed Locking Ring

- Mate with M5100B9R inlet

Part # M5100C9R

### Dock Side Receptacle

- Spring loaded cover providing a IP67 watertight rating when tightened (see inside back cover)

Part # M5100R9



### Shore Power Inlet

- Spring loaded cover providing a IP67 watertight rating when tightened (see inside back cover)

Part # M5100B9R



# DC POWER CONNECTIONS

## 12V Receptacles & Plugs



Marinco offers a wide selection of high quality DC electrical products that are designed specifically for harsh marine environments.

## 12V Receptacles & Plug Accessories



Mounting brackets, plates, extension cords, and other essential accessories for managing your 12V receptacles and plugs.

## 12/24V Dual USB Receptacles



A wide range of USB receptacles for charging mobile device, tablets, and other accessories.

# DC POWER CONNECTIONS

## Charging / Trolling / Downrigger System



Marinco offers a complete line of plugs and receptacles designed exclusively for trolling motors and downriggers. Including the 70 amp trolling motor plug.

## Battery Direct Connect



Terminate up to four (4) electronic instruments on each set of battery terminals.



Charging today's mobile devices on the go is a necessity and requires products built to withstand the marine environment.





## The importance of a quality DC electrical system

There's an old axiom that states, "The strongest chain is only as reliable as its weakest link," and the same analogy can be applied to your boat's DC electrical system. Put it in a harsh salt water or fresh water environment, where a vessel's wiring and components are subjected to more concentrated abuse in one season than your family car would experience in five years, and it's easy to realize that small electrical problems can get out of hand very quickly.

Safety onboard starts with a reliable DC electrical system that is installed and designed with the proper high quality wiring, components and connections to fulfill all of your intended DC tasks. If you're tempted to take shortcuts when wiring your boat, don't, as these types of cost-cutting measures can come back to bite you at the worst possible moments, potentially compromising the safety of your boat and crew.

So, whether you ply fresh water lakes, back bays, coastal areas or make long distance blue water runs to the edge of the continental shelf, Marinc® offers a wide selection of high quality, low voltage DC electrical products designed specifically for the harsh marine environment.

Now you can spend more time enjoying your boating experience and less time dealing with unwanted electrical hassles.

### SeaLink® 12V

The SeaLink® 12V family of products are manufactured from corrosion resistant marine grade materials. Exclusive to SeaLink products is a unique interconnecting system that securely locks the plug into the receptacle resulting in a positive and moisture-proof connection. The plug and receptacle feature optimized metal connection points for maximum conductivity.

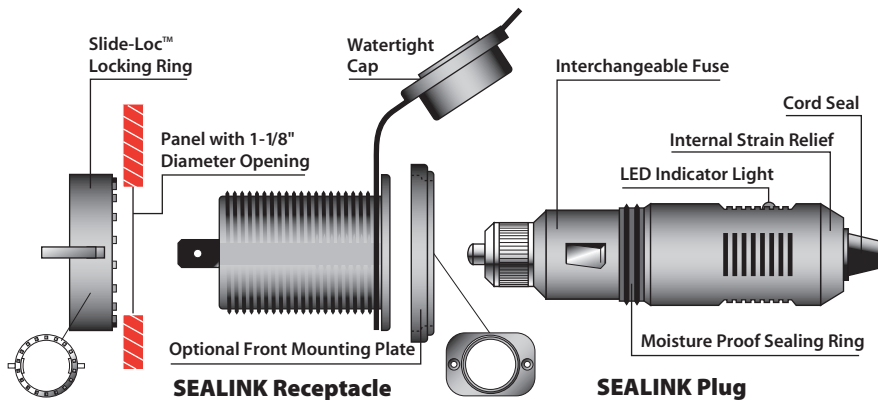

### ConnectPro® Charging & Trolling

The ConnectPro® trolling motor plug and receptacle is a revolutionary concept in trolling motor DC connections. The ConnectPro system has superior electric current carrying capacity that eliminates problems that rob motors of power and reduce battery life. The ConnectPro system features a locking plug and receptacle and spring clamping connection, which provides a secure electrical contact.

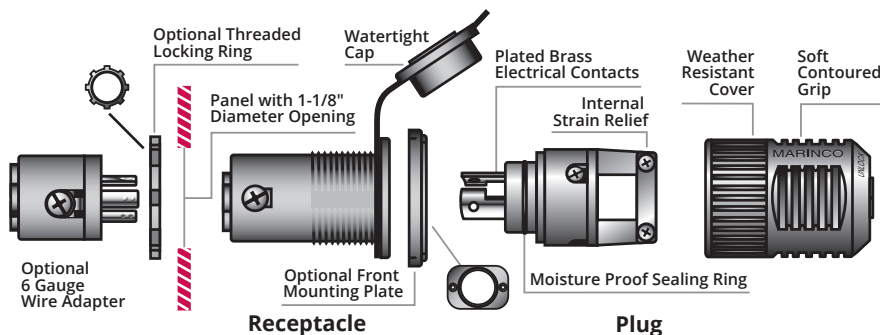

## 12V Receptacles / Plugs / Accessories

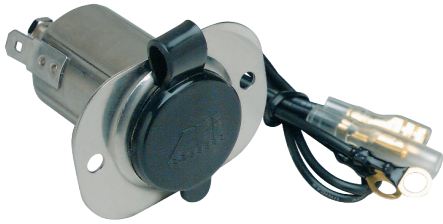

### 12V Receptacle with Protective Cap

- Stainless Steel
- Includes stainless steel mounting plate and wire set
- Max rating is 15 amps

Part # 20036



### SeaLink® Deluxe 12V Receptacle w/ Old Style Ring

- Watertight sealing cap
- Easy to install with locking ring for rear access installation
- Compatible with standard 12V plugs
- Max rating is 15 amps

OEM # 12VRCO

OEM # 12VRCO.PG w/gasket

OEM # 12VRCY sealed seams



12VRC



12VRCW



12VRC.OEM



12VRCW.OEM

### SeaLink® Deluxe 12V Receptacle

- Watertight sealing cap
- Easy to install, with supplied mounting plate for front panel installation, or locking ring for rear access installation
- Compatible with standard 12V plugs
- Max rating is 15 amps

Part # 12VRC black

Part # 12VRC.PG black w/gasket

Part # 12VRCW white

### SeaLink® Deluxe 12V Receptacle

- Watertight sealing cap
- Easy to install with locking ring for rear access installation
- Compatible with standard 12V plugs
- No mounting plate
- Max rating is 15 amps

OEM # 12VRC.OEM black

OEM # 12VRCW.OEM white



### SeaLink® Deluxe 12V Plug

- Moisture proof sealing ring
- LED power indicator light
- Interchangeable 10A fuse
- Internal strain relief and cord seal
- Compatible with standard 12V receptacles
- Max rating is 10 amps

Part # 12VPG

OEM # 12VPG.OEM



### SeaLink® Deluxe 12V Receptacle & Plug

- 12VRC and 12VPG packaged together

Part # 12VPK

## 12V Receptacles / Plugs / Accessories



12MP.OEM

300259

### SeaLink® Mounting Plate

- Easy to install or retrofit
- 12MP.OEM use with 12VRCY, 12VRC.OEM, 12VRCO, or 12VBR.OEM
- 300259 use with 12VRCW.OEM

OEM # 12MP.OEM black  
OEM # 300259 white



### SeaLink® Receptacle Mounting Bracket

- Bracket for under dash mounting of the SeaLink® or ConnectPro® receptacles
- Receptacle installs with rear mounting threaded nut
- Marine grade anodized aluminum
- Dimensions: 2" W x 2-1/2" H

Part # 12BKT



### Boot

- For use with 12V products
- Creates a weatherproof seal

Part # 300275



### Trolling Motor Adapter Terminal

- 6-gauge

Part # 12VPL.OEM



### USB Port

- 6' cable
- USB extension cable with weatherproof cap

Part # USBA6  
OEM # USBA6.OEM



### SeaLink® Deluxe 12V Extension Cord

- Heavy-duty 18-gauge wire, extends to over six (6) feet
- Watertight cap
- Plug features an LED indicator light, moisture proof sealing ring, strain relief and built-in 10A fuse
- SeaLink® locking system
- Works with any standard 12V plug and receptacle

Part # 12VXT



### SeaLink® Deluxe 12V Dual Outlet Cord

- Heavy-duty 18-gauge wire, extends to over one (1) foot
- Watertight caps
- Plug features an LED indicator light, moisture proof sealing ring, strain relief and built-in 10A fuse
- SeaLink® locking system
- Works with any standard 12V plug and receptacle

Part # 12VAD

## USB Chargers

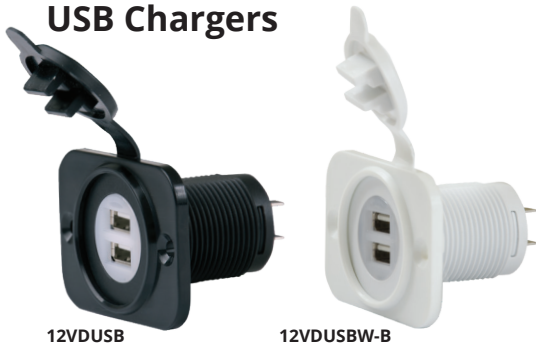

12VDUSB

12VDUSBW-B

### SeaLink® Deluxe Dual USB Charger Receptacle

- 12V to 24V DC input
- 5V, 2.1 amp total output
- LED power indicator light for USB
- Water resistant cover protects against dust and water

Part #	12VDUSB	black (with insulated terminals)
OEM #	12VDUSB-B	black
OEM #	12VDUSBN-B	black no LED
OEM #	12VDUSBW-B	white



### 12/24V 4.8A Dual USB Charger **NEW**

- Dual USB ports with 4.8 amps total output
- Cover prevents dust and water from damaging receptacles

Part # 12VDUSB48



### 12/24V 4.8A Contura Dual USB Charger **NEW**

- Dual USB ports with 4.8 amps total output
- Blue LED shows power is available
- Installs in standard Contura switch footprint
- Cover prevents dust and water from damaging receptacles

Part # 12VCDUSB48



12VCOMBO

12VCOMBOW-B

### SeaLink® Deluxe Dual USB Charger & 12V Receptacle

- 12V DC input
- Dual USB has 5V, 2.1 amp total output
- LED power indicator light for USB
- Receptacle has 12V DC output, rated up to 15 amps
- Water resistant covers protects against dust and water

Part #	12VCOMBO	black (with insulated terminals)
OEM #	12VCOMBO-B	black
OEM #	12VCOMBON-B	black no LED
OEM #	12VCOMBOW-B	white



### 12/24V 4.8A Contura Dual USB Charger with Volt/Amp Meter **NEW**

- Dual USB ports with 4.8 amps total output
- 3-digit blue LED volt/amp meter
- Installs in standard Contura switch footprint
- Cover prevents dust and water from damaging receptacles

Part # 12VCDUSB48A

## 3-Wire 70A Charging / Trolling System



### 70A Trolling Motor Receptacle

- 70A continuous rating
- Universal design for 2 or 3-wire configuration 12V, 24V, 12/24V, 24/36V, 36V or 48V systems
- Floating pin design for maximum connectivity and durability
- Corrosion resistant, plated brass electrical components
- Watertight sealing cap
- Accepts 8 and 6 AWG wire

Part # 12VBR53

OEM # 12VBR53.OEM



### 70A Trolling Motor Plug

- 70A continuous rating
- Universal design for 2 or 3-wire configuration 12V, 24V, 12/24V, 24/36V, 36V or 48V systems
- Floating pin design for maximum connectivity and durability
- Corrosion resistant, plated brass electrical components
- Integrated strain relief
- Keyed design with thumbprint locator
- Accepts 8 and 6 AWG wire

Part # 12VBPS3

OEM # 12VBPS3.OEM



### 70A Trolling Motor Plug & Receptacle

- 70A continuous rating
- Universal design for 2 or 3-wire configuration 12V, 24V, 12/24V, 24/36V, 36V or 48V systems
- Floating pin design for maximum connectivity and durability
- Corrosion resistant, plated brass electrical components
- Receptacle contains watertight sealing cap
- Plug contains integrated strain relief and keyed design with thumbprint locator
- Accepts 8 and 6 AWG wire

Part # 12VCP53



## TECH tip™

### Trolling Motor Amperages

Marinco offers multiple trolling motor plugs and receptacles to accommodate many different trolling motors. To select the correct plug and receptacle for your trolling motor, identify the amperage and voltage rating of your trolling motor. All Marinco trolling motor plugs and receptacles are rated at the stated amperage for continuous use and the amperage rating may vary by voltage. If a trolling motor plug and receptacle is undersized based on the amperage and voltage of the trolling motor, issues may occur.

## 2-Wire ConnectPro® Charging / Trolling System / Downrigger



### ConnectPro® Receptacle

- Works with 12V, 24V, or 36V 2-wire systems
- For front mount panel installations
- Weather resistant sealing cap
- Drain holes in receptacle keep water away from electrical components
- Perma-Lock™ screw terminals will not loosen under extreme hull vibration
- Fits standard 1-1/8" diameter mounting hole
- Accepts up to 10 AWG wire

Part # 12VBRS2  
OEM # 12VBRS2.OEM



### ConnectPro® Plug

- O-ring seal for waterproof connections
- Weather resistant plug cover
- Corrosion resistant, plated brass electrical components
- Accepts 16 to 8 AWG wire
- Ergonomic contoured grip for easy hook-up and ground blade alignment
- Max rating is 40 amps

Part # 12VBPS2  
OEM # 12VBPS2.OEM



### ConnectPro® Receptacle & Plug

- 12VBRS2 and 12VBPS2 packaged together

Part # 12VCPS2

## 3-Wire ConnectPro® Charging / Trolling System



### ConnectPro® Receptacle

- Universal design for 2 or 3-wire configuration 12V, 24V, 12/24V, 24/36V or 36V systems
- Watertight sealing cap
- Corrosion resistant, plated brass electrical components
- Drain holes in receptacle keep water away from electrical components
- Perma-Lock™ screw terminals will not loosen under extreme hull vibration
- Standard 1-1/8" diameter mounting hole
- Easy to install, with supplied mounting plate for front panel installation, or locking ring for rear access installation
- Accepts 10 and 8 AWG wire
- Easily replaces other trolling motor plugs and receptacles
- Max rating is 40 amps

Part # 12VBR with mounting plate  
OEM # 12VBR.OEM without mounting plate



### ConnectPro® Plug

- O-ring seal for waterproof connections
- Weather resistant plug cover
- Corrosion resistant, plated brass electrical components
- Accepts 16 to 8 AWG wire
- Ergonomic contoured grip for easy hook-up and ground blade alignment
- Max rating is 40 amps

Part # 12VBP  
OEM # 12VBP.OEM



### ConnectPro® Receptacle & Plug

- 12VBR and 12VBP packaged together

Part # 12VCP



### 6 Gauge ConnectPro® Wire Receptacle Adapter

- Allows 6 AWG wire connection to ConnectPro® receptacle
- Corrosion resistant, plated brass electrical components

Part # 12VBRAD  
OEM # 12VBRAD.OEM



### ConnectPro® Receptacle, Plug & 6 Gauge Adapter

- 12VBR and 12VBP and 12VBRAD packaged together
- Max rating is 40 amps

Part # 12VCP6

## 3-Wire 30 Amp 125V Locking Charging / Trolling System



### Male Plug

- Short housing, black nylon with internal strain relief system and recessed fasteners

Part # 305BP  
OEM # 305BP.OEM



### Female Connector

- Short housing, black nylon with internal strain relief system and recessed fasteners

Part # 305BC



### Receptacle

- Corrosion resistant reinforced nylon.
- Accepts 8 AWG stranded wire or up to 6 AWG with spade terminals

Part # 305CRRB  
OEM # 305CRRB.OEM

## 4-Wire 12/24V Locking Charging / Trolling System

The 4-wire trolling/charging system eliminates the need for a charge/run switch. Install the receptacle on the boat, mount the black trolling motor plug on the trolling motor, and the red charger plug on the leads of the battery charger. Simply plug in the black plug to troll, or plug in the red plug to charge.



### Charger Plug (Male)

- Accepts up to 10 AWG wire
- Red

Part # 2018BP-12



### Trolling Motor Plug (Male)

- Connects to trolling motor
- Jumpered internally to supply 12V & 24V power to the trolling motor when plugged into the receptacle
- Accepts up to 8 AWG wire
- Max rating is 60 amps
- Black

Part # 2018BP-24  
OEM # 2018BP-24.OEM



### Receptacle & Bracket

- Spring loaded flip lid cover and 2018BR receptacle, pre-assembled

Part # 2018BR-MB



### Trolling-Charging System Package

- Includes the 2018BP-12, 2018BP-24, and 2018BR-MB

Part # 2018PKG



### Bracket

- Spring loaded flip lid cover, without receptacle

Part # 2018MB  
OEM # 2018MB.OEM



### Receptacle

- Glass-reinforced corrosion resistant nylon. Accepts 8 AWG stranded wire or up to 6 AWG with spade terminals.

Part # 2018BR  
OEM # 2018BR.OEM  
OEM # 2018BR.OEM.BPS (case pack)

## Battery Direct Connect™ Multi Connection Battery Terminals

- Terminate up to four electronic instruments on each set of terminals
- Comes complete with quick-connect terminals
- Positive molded in red, negative molded in black
- All one-piece, no screws or parts to lose
- Cover snaps tight when closed
- Meets ABYC standard E-10.8

Part # 12VTR

OEM # 12VTR.OEM

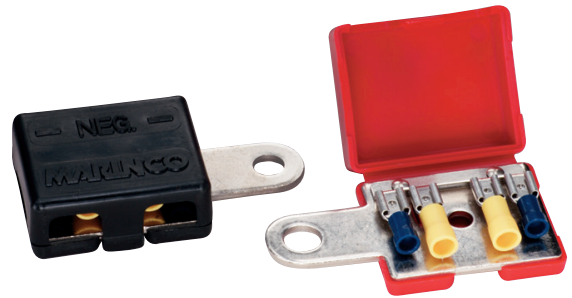

TECH tip™

### Battery Direct Connect™ Details

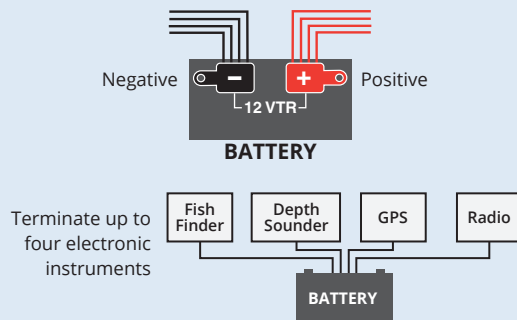



# POWER CONVERSION

## Guest ChargePro™ On-Board Battery Chargers

52



New line of Guest chargers ranging from 5 to 40 amps, with fully automatic 5-stage performance charging for 12V lead acid and AGM batteries. Chargers have dedicated outputs, aluminum housings and expanded LED charge status. 100% waterproof and shock resistant for all fresh and salt water applications.

## 1.5 Amp ChargePro™ Maintainer

54



Keep your battery charged with this highly reliable, Guest 1.5 amp maintainer. Extends battery life and will charge, monitor and re-charge your battery if the voltage drops below 12.9V. The maintainer can be safely connected to the battery for short or long periods of time.



# POWER CONVERSION

## GUEST Portable Battery Chargers

55

NEW



Take the charger to the battery with the Guest portable charger. Charges and maintains a full charge without the fear of overcharging or boiling electrolytes.

## Battery Charger Accessories

56

NEW

NEW



Intuitive new charger accessories simplify installation and operation.



# CHARGEPRO™

## Guest On-Board Battery Chargers

For 12V, 24V, 36V and 48V systems (model specific)

Guest On-Board battery chargers have been redesigned from the inside out with the customer in mind. Our newest generation On-Board Marine battery chargers include leading advancements in digital charging technology and waterproof design/construction. Designed to maximize individual battery performance, extend battery life and show battery status better than ever before.

Every Guest charger has a dedicated output that delivers the full amount of amps per bank. The easy to read graphics indicates the status of each battery bank through the charging process.

ChargePro's low profile flangeless extruded aluminum housing is sealed by gaskets with heavy duty end caps for 100% waterproof performance to IP67. This new construction design delivers an increase in charging and thermal management performance. The new ChargePro Series is up to 40% lighter while increasing durability and ease of installation over prior generations of older technology epoxy filled plastic body chargers.

- All high frequency, digital charging technology
- Microprocessor and software control for precision, fully automatic 5-stage performance charging
- Dedicated battery charging, sensing and control per bank
- Expanded LED charge status monitor
- Wiring and battery fault detection
- Auto-maintain energy saver mode
- Up to 40% lighter
- 100% Waterproof (IP67) and shock resistant for all fresh and saltwater applications
- All models are pre-wired for easy installation
- For all 12V flooded and AGM lead acid batteries
- Built-in safety: reverse polarity, over-current, over-voltage, over-temperature and ignition protection. In-line fuses for maximum DC wire protection.
- 2-year warranty



2713A



2711A



2708A



Expanded LED display

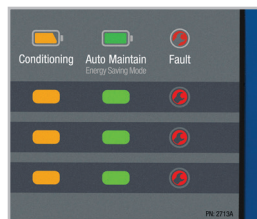

Battery fault detection LEDs



Heavy-Duty strain reliefs

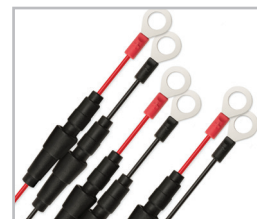

In-line safety fuses

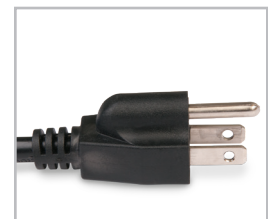

NEMA 5-15P plug



Certified to:  
UL STD 1236  
CSA C22.2 No. 107.2  
FCC Class B

IP67  
See inside  
back cover



Designed and  
Constructed to:  
ABYC-31  
Setting Standards for Safer Boating

## Guest ChargePro™ Series Selection ChargePro 5A to 20A Models



Model	ChargePro 5	ChargePro 4/4	ChargePro 10	ChargePro 5/5	ChargePro 5/5/5	ChargePro 10/10
Part #	2708A	2707A	2710A	2711A	2713A	2720A
Input Volts	90-135V AC 50/60Hz	90-135V AC 50/60Hz	90-135V AC 50/60Hz	90-135V AC 50/60Hz	90-135V AC 50/60Hz	90-135V AC 50/60Hz
DC System Voltage	12	12/24	12	12/24	12/24/36	12/24
Banks	1	2	1	2	3	2
Amps	5	4/4	10	5/5	5/5/5	10/10
Amps Per Bank	5	4	10	5	5	10
AC Cord Length	6'	6'	6'	6'	6'	6'
Size (W x H x L)	7.5" x 2.4" x 7.2" 191 x 61 x 183 mm	7.5" x 2.4" x 9.0" 191 x 61 x 229 mm	7.5" x 2.4" x 9.0" 191 x 61 x 229 mm	7.5" x 2.4" x 9.0" 191 x 61 x 229 mm	7.5" x 2.4" x 12.9" 191 x 61 x 328 mm	7.5" x 2.4" x 12.9" 191 x 61 x 328 mm
Weight (lbs)	3.2	4.5	4.2	4.7	6.7	6.6

## ChargePro 30A and 40A Models

Designed for demanding 12V, 24V, 36V and 48V battery systems requiring 10 amps per battery for the fastest charge times.



Model	ChargePro 10/10/10	ChargePro 10/10/10/10
Part #	2731A	2740A
Input Volts	90-135V AC 50/60Hz	90-135V AC 50/60Hz
DC System Voltage	12/24/36	12/24/36/48
Banks	3	4
Amps	10/10/10	10/10/10/10
Amps Per Bank	10	10
AC Cord Length	6'	6'
Size (W x H x L)	9.0" x 4.1" x 8.7" 229 x 104 x 221 mm	9.0" x 4.1" x 8.7" 229 x 104 x 221 mm
Weight (lbs)	8.0	8.5



Fan



Expanded LED display



Heavy-Duty Strain Reliefs

## Fully Automatic Multi-Stage Performance Charging Overview

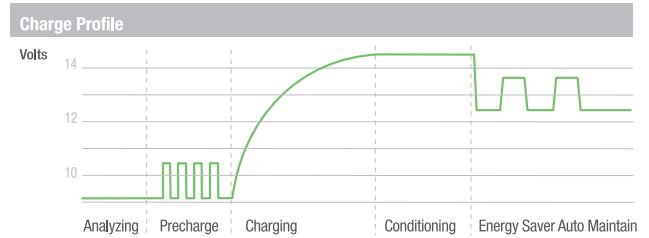

### Chargepro's 5-Stage Performance Charging Algorithm is Fully Automatic and Designed to Maximize Battery Performance and Extend Battery Life.

**Stage 1 - Analyze Mode:** AC power is applied. ChargePro's red charging LED will flash indicating it is analyzing individual wiring connections for proper connection/polarity and that each battery is over 4.0V DC and capable of accepting a precharge. When completed, any errors will trip a battery specific red fault LED, or if no faults are present the red charging LED will illuminate solid red.

**Stage 2 - Precharge Mode:** For batteries under 10V, this mode is designed to pulse the battery up to 10V before accepting full rated constant current (Stage 3). During this mode the red charging LED will be illuminated with a solid on.

**Stage 3 - Charging Mode Constant Current:** During this mode the red charging LED will be illuminated with a solid on indicating each battery is being charged in constant current mode as controlled by temperature until the battery voltage is raised to a precise 14.6V DC and the red charging LED will shut off.

**Stage 4 - Conditioning Mode Constant Voltage:** During this mode the amber conditioning LED will be solid on indicating each battery is being conditioned at 14.6V for up to 3 hours until the battery is fully charged. Followed by the amber LED turning off while the charger enters into Stage 5.

**Stage 5 - Storage Recondition Mode:** During this mode the blue AC power and green auto maintain LED will be solid on indicating each battery is being monitored while the charger is in standby mode consuming little to no power until the battery drops under 12.8V (fully charged) and the charger will turn on and auto maintain the battery in a fully charged state. This is fully automatic and safe for short and long term storage.

## Related Products



AC Plug Holder  
page 56



Cable Extender  
page 57

## 1.5 Amp ChargePro™ Maintainer

Keep your battery charged with this highly reliable, Guest 1.5 amp maintainer. Extends battery life and will charge, monitor and re-charge your battery if the voltage drops below 12.9V. The maintainer can be safely connected to the battery for short or long periods of time. To increase versatility the maintainer comes with alligator clips and ring terminals for the output cable. This maintainer will charge smaller batteries and maintain batteries up to 150Ah (group 31).

- Ideal for sport fishing boats, ski boats, jet ski's, ATVs, automobiles, tractors, riding lawn mowers and more
- For Flooded, Gel and AGM batteries
- Charge batteries 1.2 Ah to 40 Ah
- Maintain batteries 1.2 Ah to 150 Ah
- Energy savings mode automatically shuts off the charger when the battery is charged. The charger periodically monitors the battery and turns back on when the battery falls below 12.9V.
- Maintainer can safely stay connected to the battery for long periods of time
- LEDs let you know when the Power is ON, battery is being charged and when charging is complete.
- Includes ring terminals and alligator clips for connection to the battery
- Weather resistant, IP65
- 3-wire AC plug, NEMA 5-15P
- 3-year warranty
- Meets UL 1236 and CSA Standards, cETLus



Concealed Mounting

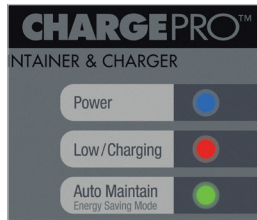

Expanded LED Status Center



Portable Foam Resting Pad



Included DC Cable Assemblies

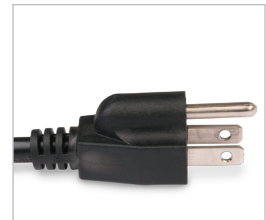

NEMA 5-15P Plug

Part #	Output Volts	Output Amps	Banks	Cable Length	Size (WxHxD)	Weight	AC In
2701A	12V DC	1.5 amps	1	6'	5.0"x5.8"x2.0" 127 x 147 x 51 mm	2.3 lbs	120V AC 60Hz



Conforms to:  
Marine UL 1236 SB  
CSA C22.2 No. 107.2  
FCC Class A

Designed and  
Constructed to:  
ABYC A-31  
**ABYC**  
Setting Standards for Safer Boating

## Portable Battery Chargers



	6 Amp Battery Charger	3 Amp Battery Charger
Part #	2606A-B	2603-B
Total amps	6	3
Outputs	1	1
Amps per out	6	3
Battery System	12V	12V
Input Voltage	100-130V AC / 60Hz	100-130V AC/60Hz
Output Voltage	12V	12V
AC	6' AC cord with standard plug	18" AC cord with standard plug
Dimensions	5.5" x 5.0" x 2.4" 140 x 127 x 61 mm	3.10" x 3.50" x 2.34" 79 x 89 x 59 mm
Weight	3.5 lbs / 1.6 kg	1.0 lbs / 0.5 kg



## Universal AC Plug Holder+ **NEW**

Universal design for all standard 120V AC plugs

- Plug clamp insert included—converts plug holder to an AC inlet for Guest engineered chargers
- No cutting, stripping or rewiring of AC power cord
- Watertight and UV resistant cover
- Easy to reach safe AC power cord connections
- Stainless steel mounting screws included
- Easy installation
- Compatible with Guest ConnectCharge™ plug

Part # 150PHB Black

Part # 150PHW White



Plug Clamp Insert

Available in  
black or white

### AC Plug Holder Configurations—Multi-Use Design

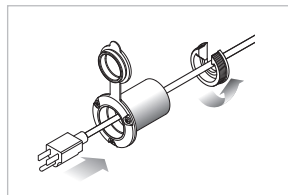

**Universal Plug Holder**  
Fits marine chargers with  
120V plugs.

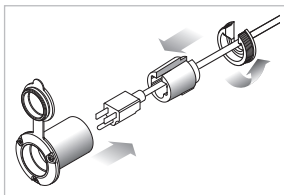

**With Plug Clamp Insert**  
For all ProMariner chargers,  
Bass Pro shops, Cabela's and  
Guest chargers.

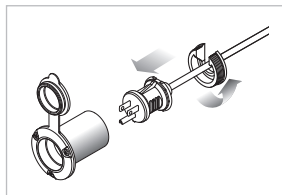

**ConnectCharge™ Plug**  
Guest and Marinc  
ConnectCharge plug



## Hard Wired Charger Inlets

- 15A or 20A 125V straight blade inlet
- Low profile cap won't catch fishing line
- Mounts easily to fiberglass and aluminum hulls
- Perma-Lock™ terminals and color coded wire entrance holes make wiring a snap
- UV resistant housing/cap



Amp	Color	Universal Mount Part #	Front Mount OEM #	Rear Mount OEM #
15	Black	150BBI	150BBI.OEM	150BBI-TM
15	White	150BBIW	150BBIW.OEM	—
20	White	—	200BBIW.OEM	—



15A 125V  
Straight Blade



20A 125V  
Straight Blade

## Charger DC Cable Extenders **NEW**

Universal design for all marine chargers with ring terminal cables

- Rated up to 30 amps
- Color coded for quick and easy installation
- No cutting, stripping or splicing required
- Slide & snap fully insulated connection covers
- Corrosion resistant tinned 12 AWG copper wire and gold plated hardware
- Dual inline waterproof fuses for maximum wire protection
- Available in 5 ft or 15 ft cable lengths
- Use with all on-board marine battery chargers when standard battery charger cables do not reach your bow, center mount or stern battery compartment locations

Part # 27505 5 ft

Part # 27515 15 ft



### Easy to extend charger cables with two 1/2" wrenches

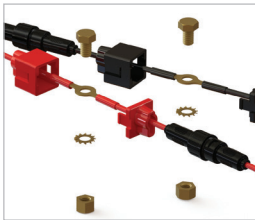

**Step 1:**  
Align charger red and black wires and assemble hardware as shown

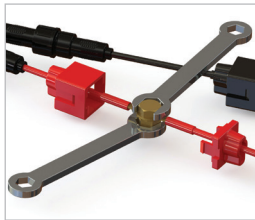

**Step 2:**  
Tighten all hardware to approximately 12 ft. lbs.

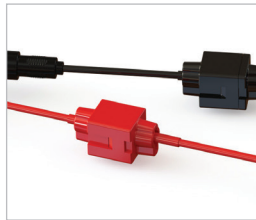

**Step 3:**  
Slide and snap connection cover





# BATTERY MANAGEMENT

## Dynaplates

60



Improve the performance of electronics and reduce RF interference. Deters electrolysis and galvanic corrosion.

## Universal Mount Switches

61



Longer stud length for easier assembly and cable routing.



# BATTERY MANAGEMENT

## Battery Selector Switches

61



Durable polycarbonate case. Available with or without alternator field disconnect. For 6V, 12V, 24V, or 36V systems.

## Heavy-duty Diesel Power Battery Switches

61



Constructed with heavy-duty copper sweep contacts to ensure positive circuit control. Features alternator field disconnect to protect the electrical system during switching.

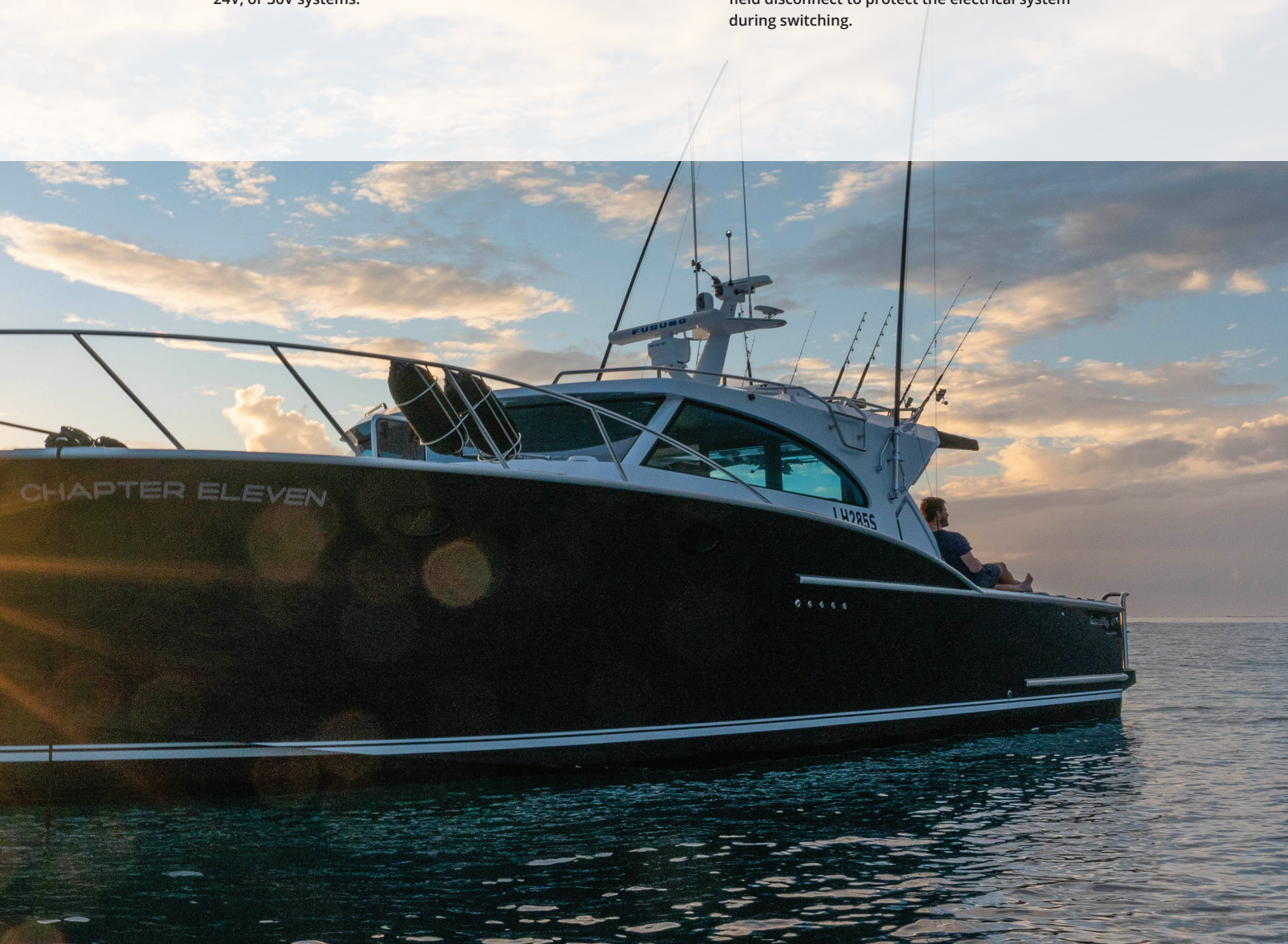

Battery management systems protect and support rechargeable batteries by extending the charge and life cycle of your batteries.

## Dynaplates for Hull Bonding & Grounding

- Improves performance of electronics and reduces RF interference
- Offers the best path for hull bonding without long runs of copper foil
- Deters electrolysis and galvanic corrosion
- Sintered porous bronze sphere construction for maximum conductivity in a compact size
- Low drag, non-fouling shape
- Easy to clean with wire brush
- Conforms to ABYC standards
- Mounting hardware included
- Gold plated mounting bolt
- Bronze mounting nuts



	Standard	Large	Giant	Super
Part #	4006	4008	4012	4018
Use for	bonding and grounding	bonding, grounding and Loran use	bonding, grounding and Loran use	SSB radio
Dimensions	6" x 2" x .5" 152 x 51 x 13 mm	8" x 2.5" x .5" 203 x 64 x 13 mm	12" x 3" x .5" 305 x 76 x 13 mm	18" x 6" x .5" 457 x 152 x 13 mm
Mounting holes	2-1/2" center to center	4" center to center	6" center to center	9.875" center to center; 3" top to bottom
Weight	1.4 lbs / .6 kg	2.1 lbs / 1 kg	3.7 lbs / 1.7 kg	11.1 lbs / 5 kg

### Accessories for dynaplates

Part	Material	Use with:	Dimensions	Part #
Washer	Bronze	4006/4008	1/4" x 20"	P-11D03
		4012/4018	3/8" x 16"	P-11D04
Bolt	Bronze	4006/4008	1/4" x 20"	P-12D34
		4012/4018	3/8" x 16"	P-12D36
	Bronze Gold Plate	4006/4008	1/4" x 20"	P-12D35
		4012/4018	3/8" x 16"	P-12D37

Part	Material	Use with:	Dimensions	Part #
Nut	Bronze	4006/4008	1/4" x 20"	P-13A27
		4012/4018	3/8" x 16"	P-13A29
Nut	Bronze Gold Plate	4006/4008	1/4" x 20"	P-13A28
		4012/4018	3/8" x 16"	P-13A2A



### Choosing a Battery Switch

ABYC requires a battery switch on every boat with a battery over 800 Cold Cranking amps (CCA). This requirement exists so the potentially destructive energy in the batteries can be isolated in the event of a fire.

### Universal Mount Switches

- Longer stud lengths for improved assembly and easier cable routing
- Built with heavy-duty copper sweep contacts to ensure positive circuit control
- Rugged internal components protected by a tough, impact resistant polycarbonate housing that is impervious to the elements
- Cable Lug Size: 3/8"
- Dimensions: 5.0" x 2.75"



#### Selector Switch w/out AFD

Continuous amps: 230A  
Momentary amps: 345A



Part # 2111A black  
Part # 2111A-O orange  
Part # 2111A-17 red  
OEM # 2111A-B black

#### Selector Switch with AFD

Continuous amps: 230A  
Momentary amps: 345A



Part # 2110A black  
OEM # 2110A-B black

#### On/Off Switch w/out AFD

Continuous amps: 230A  
Momentary amps: 345A



Part # 2112A black  
OEM # 2112A-B black

### Battery Selector Switches

- Polycarbonate case
- For 6V, 12V, 24V or 36V systems
- Surface mount
- Cable Lug Size: 3/8"
- Dimensions: 5.50" x 2.63"



#### Selector Switch with AFD

Continuous amps: 230A  
Momentary amps: 345A



Part # 2100 orange  
OEM # 2100-B orange

#### Selector Switch w/out AFD

Continuous amps: 230A  
Momentary amps: 345A



Part # 2101 orange  
OEM # 2101-B orange

#### On/Off Switch w/out AFD

Continuous amps: 230A  
Momentary amps: 345A



Part # 2102 orange  
OEM # 2102-B orange

### Heavy-duty Diesel Power Battery Switches

- For 6V, 12V, 24V or 36V systems
- Built with heavy-duty copper sweep contacts to ensure positive circuit control
- Rugged internal components protected by a tough, impact resistant polycarbonate housing that is impervious to the elements
- All feature Alternator Field Disconnect (AFD) allowing selection of any position, including "off", without damage to alternator or electrical system
- Cable lug size: 1/2"
- 2304A and 2304A-B have 3 studs



#### Heavy-duty On/Off Switch

Continuous amps: 450A  
Momentary amps: 800A



Part # 2303A gray  
OEM # 2303A-B gray

#### Extra-duty On/Off Switch

Continuous amps: 600A  
Momentary amps: 1000A



Part # 2304A gray  
OEM # 2304A-B gray

#### Battery Selector Switch

Continuous amps: 360A  
Momentary amps: 600A



Part # 2300A gray  
OEM # 2300A-B gray

## Battery Switch Operation Diagrams

As more and more electronics and electrical accessories are added to your boat (autopilot, refrigeration, etc.) the use of multi-batteries becomes a necessity. Guest components allow you to set up the system (from simple to complex) for your boat's application. The following diagrams are for use in identifying and designing the right system for your boating needs.

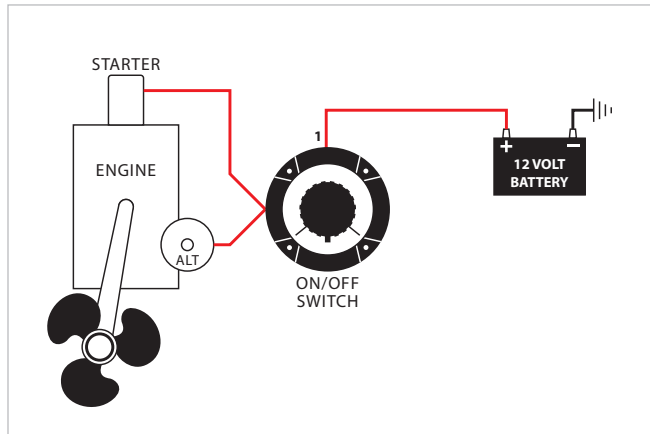

### Single battery

Installation: To shut off all power at source. Recommended installation by approved authorities.

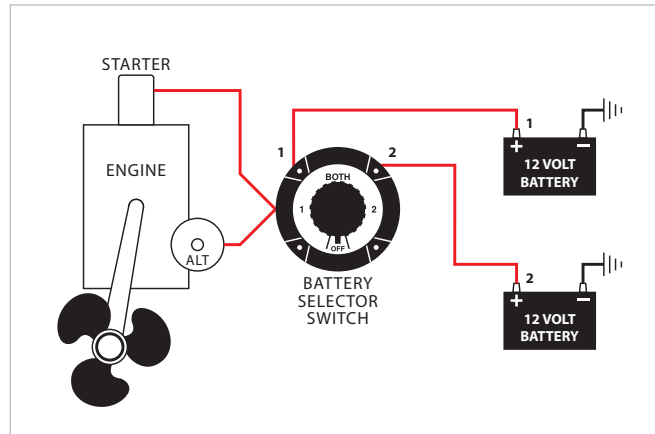

### Two batteries without isolator

Installation: To select a starter battery and ship service battery. Manually isolates each battery, parallels both batteries for emergency start, master disconnect, manually selects batteries for charging.

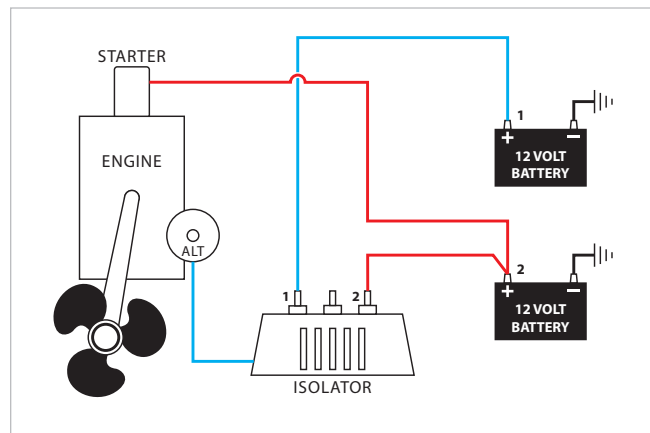

### Two batteries with isolator

Installation: Isolator automatically selects lower charged battery to be charged first. Full battery can't discharge to drained battery. Dedicated system, no flexibility, no emergency parallel or disconnect function.

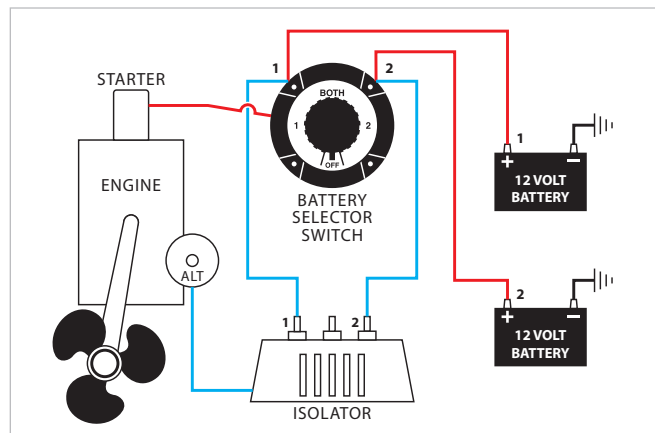

### Two batteries with emergency parallel

Installation: An isolator automatically isolates each battery, lower charged battery will automatically be charged first. Two different size batteries can be used, larger for ship services, smaller for engine cranking. Switch selects usage, master disconnect, emergency parallel function.

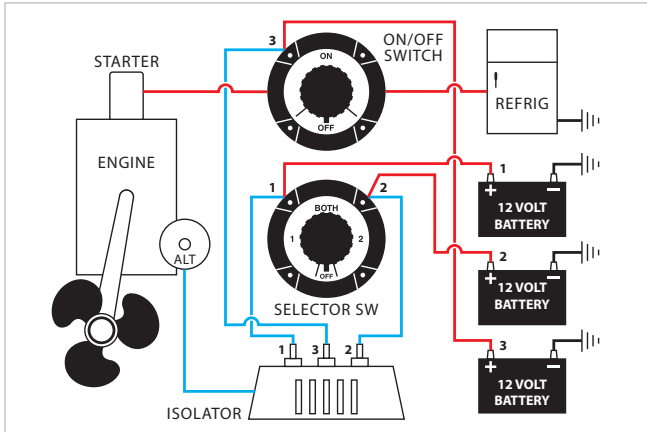

**One battery selector switch, one On/Off selector switch automatic battery isolation and automatically charges three batteries**

Installation: Use for sailboats and trawlers. Third battery isolated from other ship circuits. All batteries being automatically charged while running through isolator. To be used for refrigeration or other heavy load devices. Isolator protects other batteries.

**Switch selector usage:**

- 1. Master disconnect
- 2. Emergency parallel function

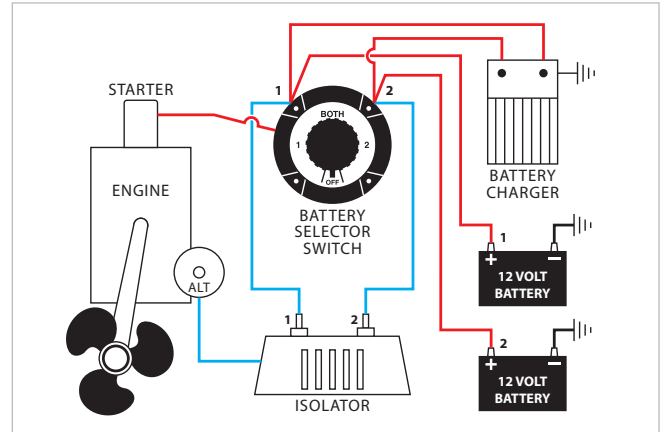

**Adding automatic battery charger/converters to system**

Installation: At dock side multi-bank charger built in isolator which will automatically charge lower battery.

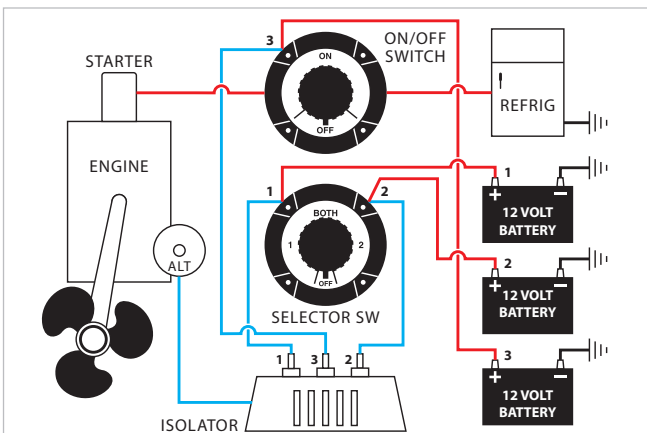

**Three batteries, one battery selector switch, one On/Off or selector switch, two alternators, one isolator**

Installation: Isolator separates both alternators so both alternators will charge simultaneously. Automatically charges lowest battery first. All batteries can be used for start, third battery, ship's source.

**Alternator Field Disconnect (AFD)**

Allows selection of any position, including "Off," without damage to alternator or electrical system. AFD is required on some electrical systems.

- Heavy-duty copper sweep contacts
- Positive click-stop on all positions
- "Make before break" contacts allow selection of all positions except "Off" while engine is running
- New design is easy to retrofit into existing hole patterns
- Use with 6V, 12V, 24V or 36V systems
- Built-in skirt protects connections
- Surface or rear panel mounting
- Marine grade construction

**Important Note: The boater's electrical needs and problems should be discussed with your boatyard's electrical technician.**



Exclusive flat 360 "sweep" contact design provides up to 60% more contact area than other switch designs.

# WIPER SYSTEMS

## Wiper Motors & Kits

66



Marinco® motors are split into three categories, Standard, Heavy-Duty, and Heavy-Duty Plus, with the categories being defined by the power range of the motors. Within the three categories, there are motors designed for interior or protected installations, and motors designed for exterior installations. We offer wiper motors for all windshield sizes up to 45", which could be covered by a 30" arm and 30" blade combination, driven by a 3.0 motor.

## Wiper Arms

75



Wiper arms are available in Standard, Deluxe, and Premier styles and the primary construction material in all wiper arms is stainless steel. Deluxe arms are used on Standard and Heavy-Duty motors. The arms are available in a wide range of sizes, in both black and stainless steel finish, and regular and pantographic models. Pantographic arms use a set of two arms joined together to give a flatter and somewhat wider sweep pattern.



# WIPER SYSTEMS

## Wiper Blades

80

NEW



Standard, Deluxe and Premier Plus wiper blades are offered in different sizes and styles to fit all of the different types of wiper arms. Premier and Deluxe styles have stainless steel frame construction and high-end silicone rubber squeegees. For maximum performance of all blade styles, replacement of wiper blades is recommended every six (6) months.

## Windshield Washer Kits

81



A full line of easy-to-install windshield washer kits are available.



Wiper assembly systems ensure your visibility remains clear through a storm or vicious passages.



## Wiper Motors

The motor choice is based primarily on the size of the windshield and where the motor is to be installed, either in an exterior or interior location. Marincó® motors are split into three categories, Standard, Heavy-Duty, and Heavy-Duty Plus, with the categories being defined by the power range of the motors. Within the three categories, there are motors designed for interior or protected installations, and motors designed for exterior installations. We offer wiper motors for all windshield sizes up to 45", which could be covered by a 30" arm and 30" blade combination, driven by a 3.0 motor.







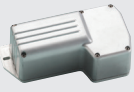

The Standard motor category includes the STD, WMW, and 500, which are all designed for light duty use, defined as being able to drive a 14" arm and a 14" blade.

When coverage of a larger windshield is required, Marincó® offers the Heavy-Duty motors, which are capable of driving a

wide range of arm and blade sizes, up to a 26" x 26" Deluxe arm and blade combination, which would cover windshields up to 39". The 1000 motor can pull up to a 16" x 16" Deluxe arm and blade combination. The MRV is built for interior or well-protected locations, and has the power to pull a 22" x 22" Deluxe arm and blade combination. The 1.5 motor has the power to pull a 22" x 22" Deluxe arm and blade combination like the MRV, but is waterproof and built for exposed installations. The 2.5 motor has the power to pull a 26" x 26" Deluxe arm and blade combination and is waterproof for exposed installations.

The 3.0 motor is the motor that makes up the Heavy-Duty Plus category. This motor has an external linkage shaft drive that gives it the power and torque to drive a 30" Premier pantographic arm and Premier blade combination.

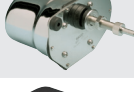
### Choosing the Right Motor

	Model	Voltage	Speeds	Stall Torque/ Stall Current	Compatible Blade Lengths	Available Shaft Lengths	Sweep Angles	Housing
	3.0	12V & 24V	Single	165 in-lbs / 12.5-14.5 amps	30" Premier Plus single or pantographic	2.5" 3.5"	Factory preset to 110° Adjustable to 45°, 60°	External linkage - no housing
	2.5	12V & 24V	2 speed	139 in-lbs / 9-10.5 amps	26" Deluxe 24" Premier	1.5" 2.5"	Factory preset: 80° or 110° Adjustable: 45° or 60°	Fully sealed powder coated aluminum
	1.5	12V & 24V	2 speed	109 in-lbs / 11.5-13 amps	22" Deluxe 20" Premier	1.5" 2.5"	Factory preset: 80° or 110° Adjustable: 45° or 60°	Fully sealed powder coated aluminum
	3000	12V	2 speed	159 in-lbs / 10.2-12.2 amps	26" Deluxe 26" Premier	1.5" 2.5"	Factory preset: 80° or 110° Adjustable to 40°, 50°, 60°, 70°, 80°, 90°, 100° or 110°	Fully sealed aluminum
	1000	12V	Single	55 in-lbs / 9.8-10 amps	16" Deluxe 18" Premier	1.5" 2.5"	Factory preset: 80° or 110° Adjustable: 50°, 65°, 80° or 110°	Fully sealed, UV stabilized hi-temp thermoplastic
	MRV	12V & 24V	2 speed (but can be operated as 1)	109 in-lbs / 11.5-13 amps	22" Deluxe 20" Premier (at 80° sweep)	1.5" 2.5" 3.5"	Factory preset: 80° or 110° Adjustable: 45°, 60°, 80° or 110°	Corrosion resistant cast housing
	500	12V	Single	—	14" Deluxe	2.5"	Factory preset: 80° or 110°	Fully sealed, UV stabilized hi-temp thermoplastic
	WMW	12V	Single	—	14" Deluxe	2.5"	Factory preset: 110°	Chrome plated brass case
	STD	12V	Single	—	14" Deluxe	2.5" 3.5"	Factory preset: 80° or 110° Adjustable: 80° or 110°	Corrosion proof aluminum alloy case

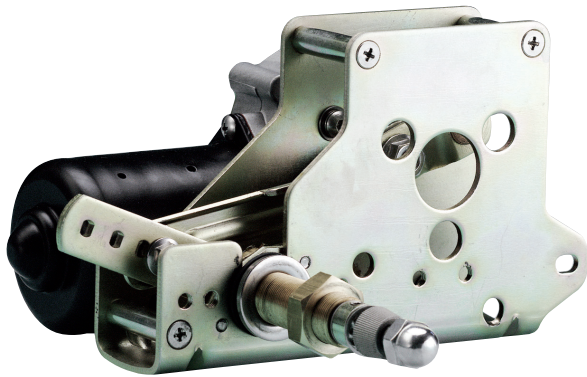

**3 YEAR WARRANTY**

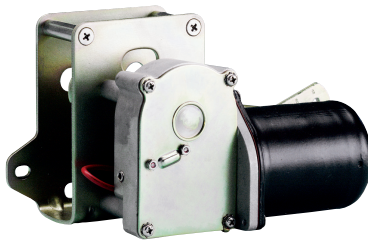

## Heavy-Duty Plus 3.0 Motor

The Heavy-Duty Plus 3.0 Motor is Marincor®'s only external linkage motor. This design easily powers a 30" Premier arm and 30" Premier Plus blade combination to provide coverage up to 45" of windshield area.

- Available in two (2) shaft lengths: 2.5" and 3.5" (knurled arm fitting adds 2" to overall length)
- Tapered knurled drive shaft
- Factory pre-set sweep angle of 110°, with easy adjustment to 45° or 60°
- Sealed 6" wire leads, 16 AWG
- For interior installations
- Adjustable right or left self parking
- 18 mm diameter shaft
- Measures approximately 8.5" L x 4.625" W x 4.375" D (See below for detailed dimensional drawings)
- Stall torque: 165 in-lbs (190 kgf/cm; 18.6 Nm)
- Stall current: 12.5–14.5 amps
- No load current: 0.8–2.0 amps
- Recommended fuse: 6 amp fuse
- Available in 12V and 24V models
- Coast to park
- RF shielded circuitry

### Related Products



Intermittent Wiper Motor Controller  
page 73

	Voltage	Sweep	OEM #
3.5" Shaft	12V	110°	73113
	24V	110°	73313

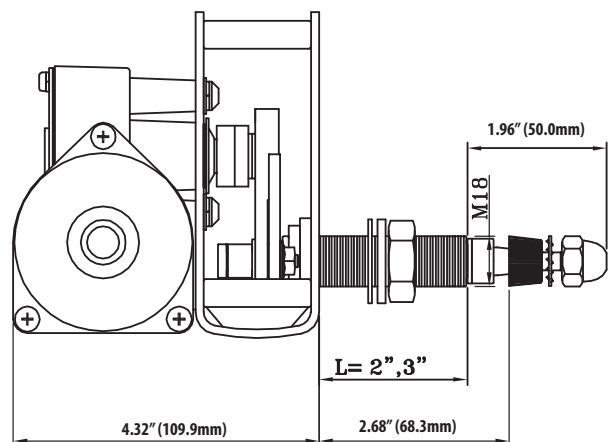
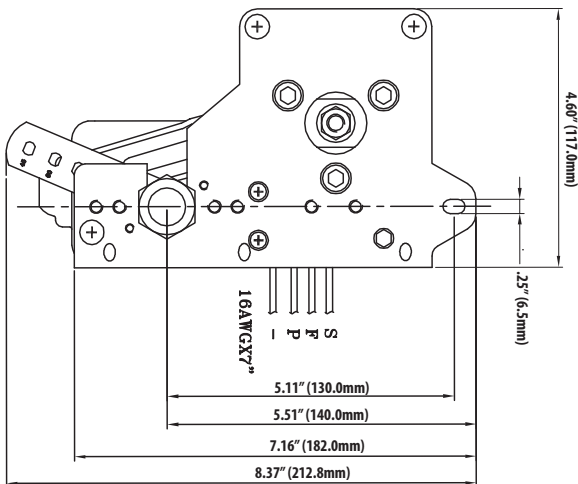



**3 YEAR WARRANTY**  
CE

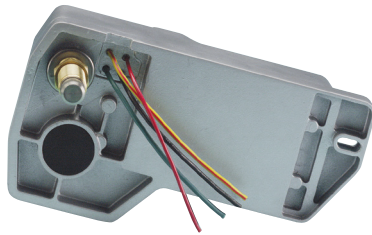

## 2.5 Waterproof Wiper Motor

- Fully sealed powder coated aluminum waterproof base and housing
- Powers a 26" Deluxe arm and Deluxe blade combination or a 24" Premier arm and Deluxe blade combination
- Available in two (2) shaft lengths: 1.5" and 2.5" (includes .5" length of knurled arm fitting)
- Factory pre-set sweep angles of 80° or 110°, with easy adjustment to 45° or 60°
- Chrome plated solid brass knurled drive nut with brass and stainless steel drive shaft
- Two-speed motor
- Sealed 6" wire leads, 16 AWG
- Adjustable right or left self parking
- .625" diameter shaft (16 mm)
- Available in 12V and 24V models
- Coast to park
- RF shielded circuitry
- Retail version includes 6 amp fuse and holder (operating switch not included)
- Measures approximately 7.875" L x 4.25" W x 3" D (see below for detailed dimensional drawings)
- Stall torque: 139 in-lbs (160 kgf/cm; 15.7 Nm)
- Stall current: 9.0-10.5 amps
- No load current: 1.0 -1.6 amps

### Related Products



Intermittent Wiper Motor Controller  
page 73

	Voltage	Sweep	Part #	OEM #
1.5" Shaft	12V	80°	82081	82181
2.5" Shaft	12V	80°	82082	82182
	24V	110°	82312	82212

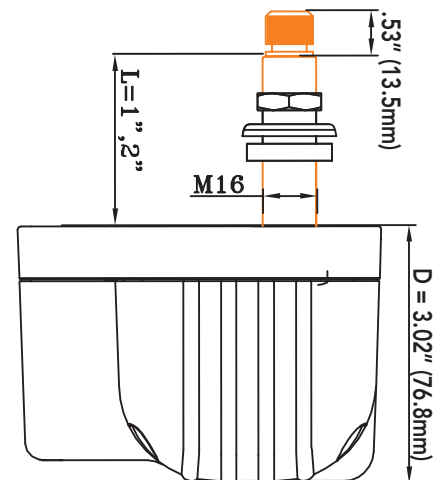
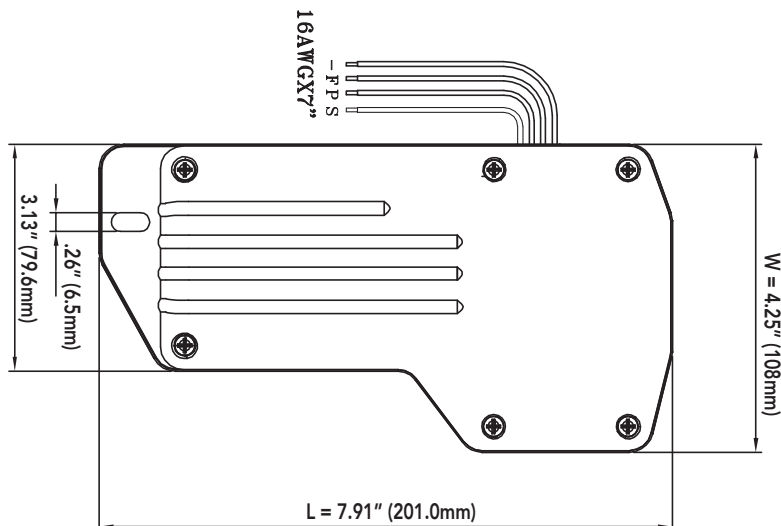

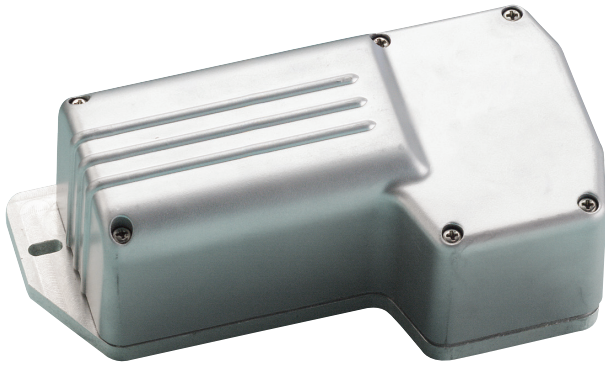

**3 YEAR WARRANTY**  
**CE**

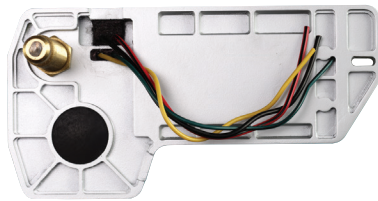

## 1.5 Waterproof Wiper Motor

- Fully sealed powder coated aluminum waterproof base and housing
- Powers a 22" Deluxe arm and 22" Deluxe blade combination or a 20" Premier arm and 20" Deluxe blade combination
- Available in three (3) shaft lengths: 1.5" and 2.5" (includes .5" length of knurled arm fitting)
- Factory pre-set sweep angles of 80° or 110°, with easy adjustment to 45° or 60°
- Chrome plated solid brass knurled drive nut with brass and stainless steel drive shaft
- Two-speed motor
- Sealed 6" wire leads, 16 AWG
- Adjustable right or left self parking
- .625" diameter shaft (16 mm)
- Available in 12V
- Coast to park
- RF shielded circuitry
- Retail version includes 5 amp fuse and holder (operating switch not included)
- Measures approximately 7.75" L x 4" W x 2.75" D (see below for detailed dimensional drawings)
- Stall torque: 109 in-lbs (125 kgf/cm; 12.3 Nm)
- Stall current: 11.5–13.0 amps
- No load current: 0.5–1.2 amps
- Replaces AFI 2000 motor

### Related Products



Intermittent Wiper Motor Controller  
 page 73

	Voltage	Sweep	Part #	OEM #
1.5" Shaft	12V	80°	<b>71081</b>	—
		110°	<b>71011</b>	—
2.5" Shaft	12V	80°	<b>71082</b>	<b>71182</b>
		110°	<b>71012</b>	<b>71112</b>

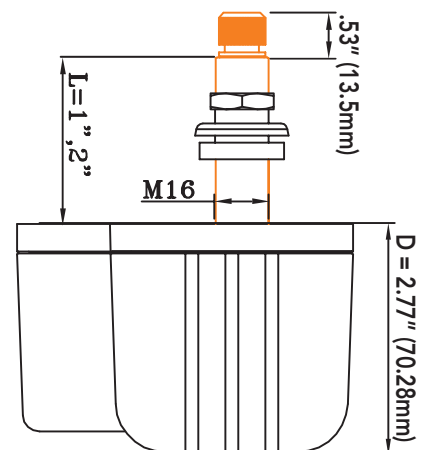
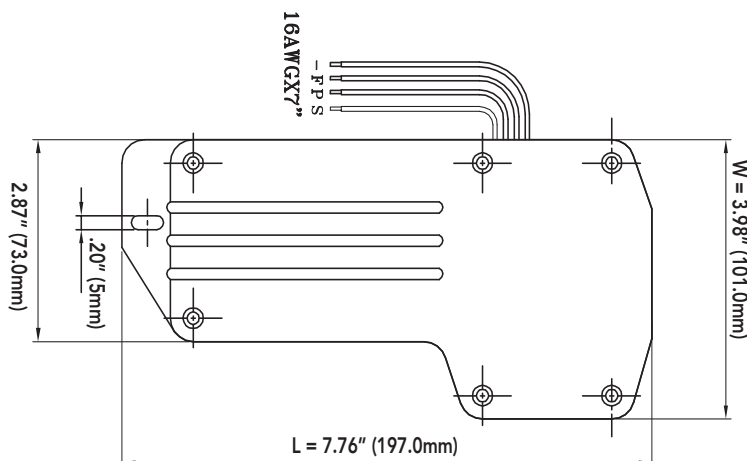

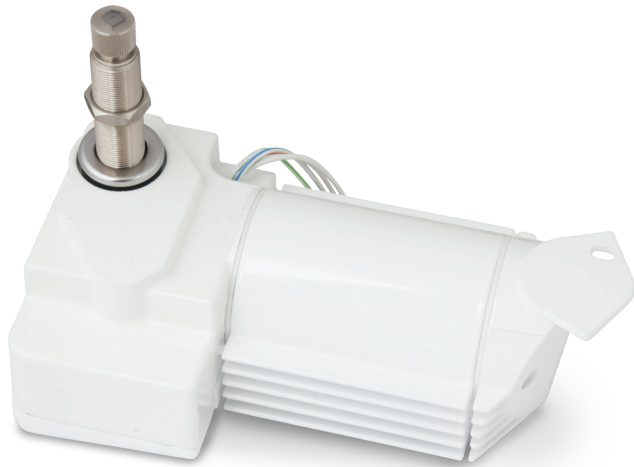

**3 YEAR  
WARRANTY**



## 3000 Waterproof Wiper Motor

- Fully sealed powder coated aluminum waterproof base and housing
- Powers a 26" Deluxe arm and Deluxe blade combination or a 24" Premier arm and Deluxe blade combination
- Available in two (2) shaft lengths: 1.5" and 2.5" (includes .5" length of knurled arm fitting)
- .625" diameter shaft (16 mm)
- Factory preset sweep angles of 80° or 110°, with easy adjustment from 40° to 110° at 10° increments
- Sealed 6" wire leads, 16 AWG
- Adjustable right or left self parking
- Two-speed settings
- Retail version includes 5 amp fuse and holder (on/off switch not included)
- Isolated ground
- Stall torque: 159 in-lbs (183 kgf/cm; 18 Nm)
- Stall current: 10.2–12.20 amps
- IP66 rated

	Voltage	Sweep	Part #	OEM #
1.5" Shaft	12V	80°	<b>83081</b>	<b>83181</b>
		110°	<b>83011</b>	<b>83111</b>
2.5" Shaft	12V	80°	<b>83082</b>	<b>83182</b>
		110°	<b>83012</b>	<b>83112</b>

### Related Products



Intermittent Wiper  
Motor Controller  
page 73

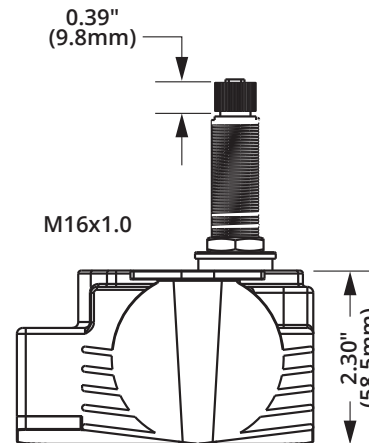
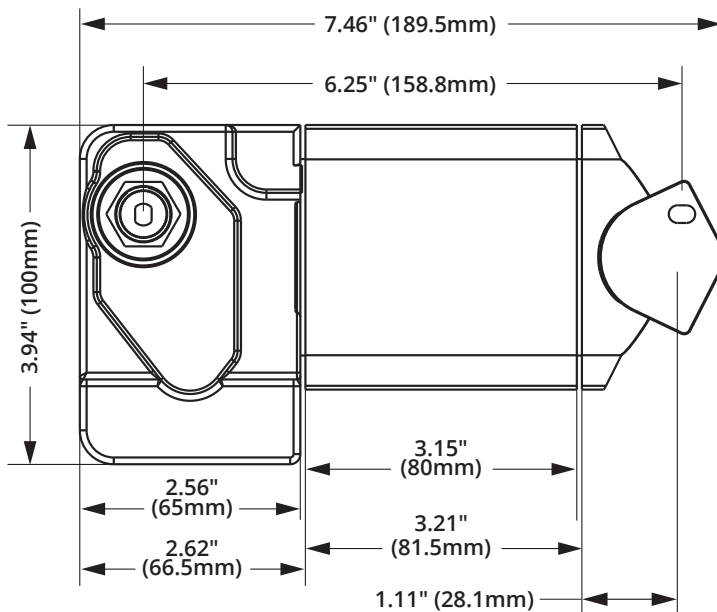



**3 YEAR WARRANTY**  
**CE**

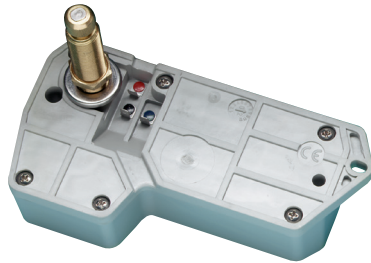

### 1000 Waterproof Wiper Motor

- Powers 18" Deluxe arm and 18" Deluxe blade combination at sweep sets of 80° or less (not compatible with pantograph arms)
- Powers 16" Deluxe arm and 16" Deluxe blade combinations at a sweep set of 110° (not compatible with pantograph arms)
- Factory pre-set sweep of 80° or 110° adjustable to 50°, 65°, 80°, or 110°
- .625" diameter shaft (16 mm)
- Fully sealed waterproof housing made of UV stabilized, high-temperature, high-impact thermoplastic
- 12V heavy-duty motor with anti-rotation drive shaft
- Knurled drive shaft and solid brass arm drive nut
- Coast to park with adjustable right or left self parking
- Retail version includes 5 amp fuse and holder (on/off switch not included)
- RF shielded circuitry
- Weight: 1.75 lbs
- Available in two (2) shaft lengths: 1.5" and 2.5" (includes .5" length of knurled arm fitting)
- Measures approximately 6.625" L x 3.375" W x 2" D
- Stall torque: 55 in-lbs (63 kgf/cm; 6.2 Nm)
- Stall current: 9.8-10.0 amps
- No load current: 0.8-1.2 amps

#### Related Products



Intermittent Wiper Motor Controller  
 page 73

	Voltage	Sweep	Item#	OEM #
1.5" Shaft	12V	65°	—	36161
		80°	36180	36181
		110°	36110	36111
2.5" Shaft	12V	65°	—	37161
		80°	37180	37181
		110°	37110	37111
2.5" Shaft Kits	12V	80°	37100	—
		110°	37200	—

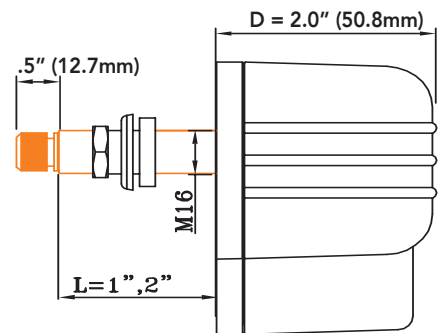
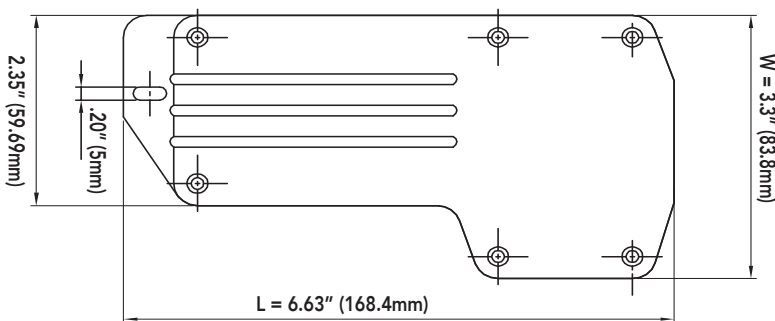



**3 YEAR WARRANTY**



## MRV Wiper Motor

- Easily powers 22" x 22" deluxe arm/blade combinations, or a 20" x 20" premier arm/blade combination at sweep sets of 80° or less
- Factory pre-set sweep of 80° or 110° adjustable from 40° to 110° in 10° increments
- .625" diameter shaft (16 mm)
- Available in three (3) shaft lengths: 1.5", 2.5" and 3.5" (includes .5" length of knurled arm fitting)
- Corrosion-resistant casing
- Heavy-duty motor with right angle drive
- Two-speed motor, can be operated as one speed
- Solid brass knurled drive nut with brass and stainless steel drive shaft
- Adjustable right or left self parking, coast to park
- Retail version includes 5 amp fuse and holder
- Stainless steel fasteners and mounting bracket
- Use with three-position switch (not included)
- Compact size – 7.625" L x 4" W x 2" D
- Stall torque: 109 in-lbs (125 kgf/cm: 12.3 Nm)
- Stall current: 11.5–13.0 amps
- No load current: 0.5–1.2 amps

	Voltage	Sweep	Item#	OEM #
1.5" Shaft	12V	80°	<b>34001</b>	<b>38001</b>
		110°	<b>34011</b>	<b>38011</b>
2.5" Shaft	12V	80°	<b>34000</b>	<b>38000</b>
	24V	110°	<b>34210</b>	—
3.5" Shaft	12V	80°	<b>34005</b>	<b>38005</b>
		110°	<b>34015</b>	—

### Related Products



Intermittent Wiper Motor Controller  
page 73

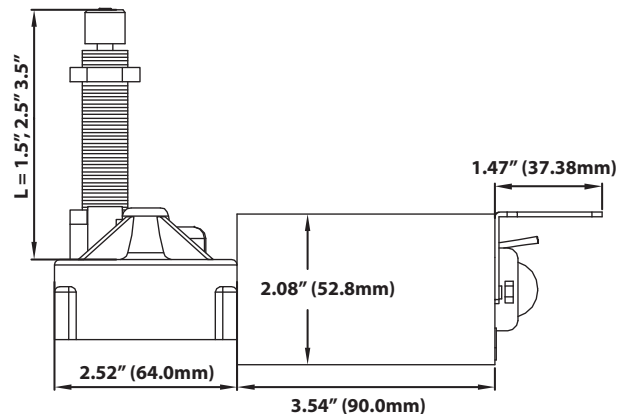
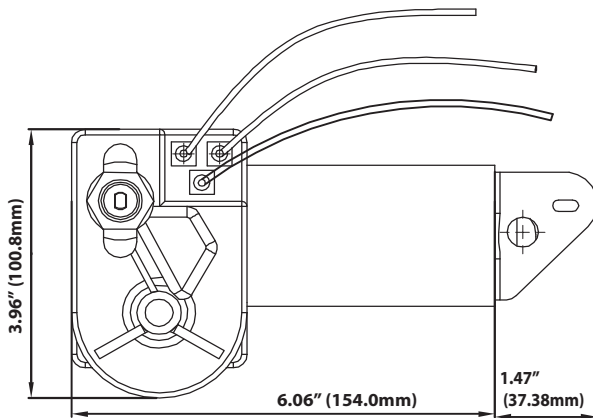

## MRV Wiper Motor Cover

- Constructed of white ABS plastic
- Easily installed

Part # 33025 White  
OEM # 33125 White  
OEM # 33126 Black

## WMW Wiper Motor

**Windshield Mount: .375" shaft diameter**

- Powers up to 14" x 14" arm/blade combinations
- Water-resistant sealed motor
- Chrome-plated brass case and shaft housing
- Stainless steel front plate and wiper shaft
- Maximum current draw: 2 amps
- Shaft diameter: .375"
- For external use in open cabin boats
- Dimensions: 4.25" L x 2.75" W x 3.5" D

	Voltage	Sweep	Part #	OEM #
2.5" Shaft	12V	80°	—	<b>35000</b>
		110°	—	<b>35010</b>

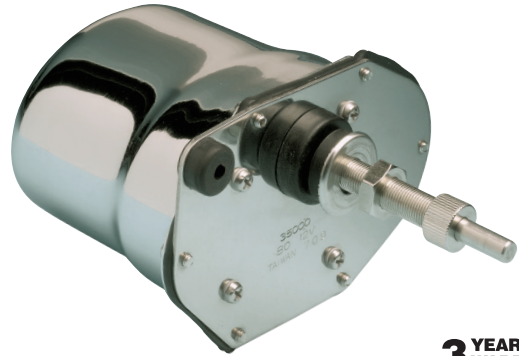

**3 YEAR WARRANTY**

## STD Wiper Motor

**Windshield Mount: .375" shaft diameter**

**Deck Mount: .5" shaft diameter**

- Deck mount version includes deck mount adapter kit (33000)
- Powers up to 14" x 14" arm/blade combinations
- Corrosion-proof aluminum alloy case with black crackle finish
- Base & mounting plates are chrome plated naval brass
- Maximum current draw: 2 amps
- 80° or 110° adjustable sweep, adjustable right or left self-parking
- Shaft diameter: .375" windshield mount, .5" deck mount
- Dimensions: 3.875" L x 2.25" W x 3.5" D

	Voltage	Sweep	Part #	OEM #
2.5" Shaft	12V	80°	<b>35040</b>	—



**3 YEAR WARRANTY**

## Intermittent Wiper Motor Controller

- Single-speed and dual-speed options
- Allows for the control of single motor systems, and synchronized control of dual motor systems
- Intuitive automotive-style functionality—features adjustable intermittent settings, adjustable continuous settings, and washer system operation
- IP67—Potted case for harsh environment durability (see inside back cover)
- Includes Contura Switch, SPDT (On)-Off-(On) (retail only)
- Easy to install with 1/4" spade connectors
- Reverse polarity protection
- Compatible with 12V and 24V DC motors

Single Speed	<b>Part #</b>	<b>76090</b>	<b>OEM #</b>	<b>76190</b>
Dual Speed	<b>Part #</b>	<b>76080</b>	<b>OEM #</b>	<b>76180</b>



**76080**





**3 YEAR WARRANTY**

## WMW Wiper Motor Kit

**Windshield Mount: .375" shaft diameter**

- Powers up to 14" x 14" arm/blade combinations
- Water-resistant sealed motor
- Chrome-plated brass case and shaft housing
- Stainless steel front plate and wiper shaft
- Maximum current draw: 2 amps
- Shaft diameter: .375"
- For external use in open cabin boats
- Dimensions: 4.25" L x 2.75" W x 3.5" D

Kit includes:

- WMW wiper motor
- 11.5" Deluxe stainless steel curved blade (33004)
- Deluxe adjustable (6.75" to 10.5") stainless steel arm (33006AS)

	Voltage	Sweep	Part #	OEM #
2.5" Shaft	12V	80°	30000	—
2.5" Shaft	12V	110°	30002	—



**3 YEAR WARRANTY**

## STD Wiper Motor Kit

**Windshield Mount: .375" shaft diameter**

**Deck Mount: .5" shaft diameter**

- Deck Mount version includes deck mount adapter kit (33000)
- Powers up to 14" x 14" arm/blade combinations
- Corrosion-proof aluminum alloy case with black crackle finish
- Base & mounting plates are chrome plated naval brass
- Maximum current draw: 2 amps
- 80° or 110° adjustable sweep, adjustable right or left self-parking
- Shaft diameter: .375" windshield mount, .5" deck mount
- Dimensions: 3.875" L x 2.25" W x 3.5" D

Kit includes:

- STD wiper motor (recommended for interior installations only)
- 11.5" Deluxe stainless steel curved blade (33004)
- Deluxe adjustable (6.75" to 10.5") stainless steel arm (33006AS)

	Voltage	Sweep	Part #	OEM #
2.5" Shaft	12V	80°	—	32000
		110°	—	32002
3.5" Shaft	12V	80°	—	32001



**3 YEAR WARRANTY**

## 500 Wiper Kit

**Windshield Mount: .5" shaft diameter**

Kit includes:

- 500 Waterproof wiper motor
- 11.5" Deluxe stainless steel curved blade (33004)
- Deluxe adjustable (6.75" to 10.5") stainless steel arm (33006AS)

	Voltage	Sweep	Part #
2.5" Shaft	12V	80°	30004
2.5" Shaft	12V	110°	30005



## Hand-operated Wiper Blade

- Chrome-plated brass handle
- Includes stainless steel 7-1/2" to 12" adjustable wiper arm, 11" blade, and all parts for installation
- Economical—an inexpensive alternative to wiper motor kit
- Requires 7/16" diameter hole for installation
- Can be installed up to 7/8" thick material
- For use on flat windshields only

**Part # 31000**

**OEM # 33101** Replacement blade

## Wiper Arms

Wiper arms are available in Standard, Deluxe, and Premier styles and the primary construction material in all wiper arms is stainless steel. Standard arms are used with Standard blades and can only be used with the line of Standard motors, while the Deluxe arms are used on Standard and Heavy-Duty motors. When choosing arms (and blades) it is very important to use only the recommended lengths for the motor that you are using.

The arms are available in a wide range of sizes, in both black and stainless steel finish, and regular and pantographic models. Pantographic arms use a set of two arms joined together to give a flatter and somewhat wider sweep pattern. The Deluxe arms are available in a polished stainless steel finish or a black powder-coated finish. Premier arms are the top of the line product in this category, utilizing heavy-duty stainless steel tubing and components, and they can only be used with the Heavy-Duty and Heavy-Duty Plus motors. Premier arms come in adjustable length sizes, ranging from 10" to 30", in both regular and pantographic versions. The longer length Premier arms (25"-30" long) have been designed for added strength and have a tapered wiper shaft fitting made especially to fit the larger, more powerful 3.0 wiper motor. These arms also have a saddle style tip for a stronger connection with the longer length Premier blades (26", 28", and 30" lengths).

Premier arms are also available as "wet arm" versions, with the water hose and sprayer nozzle built into the wiper arm. All that is needed is a water delivery system that the arm can be tied into. For those wanting a windshield washer system for the Deluxe arms, there is a complete washer kit system that is made especially to fit the Deluxe arms.



## Wiper Arm Compatibility Chart

Style	Wet/ Dry	Length (adjustable)	Color	Material	Part #	OEM #	Motor Compatibility Chart					
							3.0	2.5	3000	1.5	1000	MRV
<b>Premier Plus</b>												
single	dry	25"-30"	stainless	stainless	-	33188	✓	-	-	-	-	-
single	wet	25"-30"	stainless	stainless	-	33188W	✓	-	-	-	-	-
<b>Premier</b>												
single	dry	10"-15"	stainless	stainless	33082	33182	-	✓	✓	✓	-	✓
single	dry	15"-20"	stainless	stainless	33084	33184	-	✓	✓	✓	-	✓
single	dry	20"-25"	stainless	stainless	33086	33186	-	✓	✓	-	-	-
single	wet	15"-20"	stainless	stainless	33084W	33184W	-	✓	✓	✓	-	✓
single	wet	20"-25"	stainless	stainless	33086W	33186W	-	✓	✓	-	-	-
pantographic	dry	12"-17"	stainless	stainless	33090	33190	-	✓	✓	✓	-	✓
pantographic	dry	17"-22"	stainless	stainless	33092	33192	-	✓	✓	-	-	max 20"
pantographic	dry	22"-26"	stainless	stainless	33094	33194	-	✓	✓	-	-	-
pantographic	wet	12"-17"	stainless	stainless	33090W	-	-	✓	✓	✓	-	✓
pantographic	wet	17"-22"	stainless	stainless	33092W	33192W	-	✓	✓	-	-	max 20" ≤ 80"
pantographic	wet	22"-26"	stainless	stainless	-	33194W	-	✓	✓	-	-	-
<b>Deluxe Adjustable</b>												
single	dry	6.75"-10.5"	stainless	stainless	33006A	33106A	-	✓	✓	✓	✓	✓
single	dry	10"-14"	stainless	stainless	33007A	33107A	-	✓	✓	✓	✓	✓
single	dry	14"-20"	stainless	stainless	33010A	33110A	-	✓	✓	✓	max 18" ≤ 80° max 16" @ 110°	✓
single	dry	10"-14"	black	stainless	33012A	33112A	-	✓	✓	✓	✓	✓
single	dry	14"-20"	black	stainless	33014A	33114A	-	✓	✓	✓	max 18" ≤ 80° max 16" @ 110°	✓
single	dry	18"-24"	black	stainless	33070A	33170A	-	✓	✓	-	-	max 22"
<b>Deluxe Pantographic</b>												
pantographic	dry	12"-17"	black	stainless	33032A	33132A	-	✓	✓	✓	-	✓
pantographic	dry	17"-22"	black	stainless	33037A	33137A	-	✓	✓	✓	-	✓

## Premier Plus Stainless Steel Adjustable Single and Pantographic Wiper Arm

- Heavy-duty component design for use with the 3.0 wiper motor
- Stainless steel and chrome-plated die cast construction
- Motor shaft mount with notched "teeth" and tapered design for secure operation
- Features "articulating/bend back" design that locks arm in upright position for windshield cleaning



single - adjusts 25" to 30"

Style	Wet/Dry	Length (adjustable)	Color	Material	Part #	OEM #
single	dry	25"-30"	stainless	stainless	—	33188

**Note:** For use only with Premier Plus Wiper Blades and Heavy Duty Plus 3.0 Motor

## Premier Plus Stainless Steel Single and Pantographic Wet Arms

- Premier wet arms add a built-in washer system to the high-end, heavy-duty construction of the Premier wiper arms
- Premier wet arms feature a black PVC hose that runs up the center of the arm and ends in a four-nozzle fixture that is part of the arm itself
- Each solid brass nozzle is adjustable for maximum coverage



Style	Wet/Dry	Length (adjustable)	Color	Material	Part #	OEM #
single	wet	25"-30"	stainless	stainless	—	33188W

**Note:** For use only with Premier Plus Wiper Blades and Heavy Duty Plus 3.0 Motor

## Premier Stainless Steel Single and Pantographic Dry Arms

- Heavy-duty component design for use with most Marince® motors
- Stainless steel construction
- Features "articulating/bend back" design that locks arm in upright position for windshield cleaning
- Motor shaft mount with notched teeth



Single



Pantographic

Style	Wet/Dry	Length (adjustable)	Color	Material	Part #	OEM #
single	dry	15"-20"	stainless	stainless	33084	33184
single	dry	20"-25"	stainless	stainless	33086	33186
pantographic	dry	12"-17"	stainless	stainless	33090	33190
pantographic	dry	17"-22"	stainless	stainless	33092	33192
pantographic	dry	22"-26"	stainless	stainless	33094	33194

**Pantographic wiper arms will only function properly with wiper motor sweep angles 80° or less**

## Premier Stainless Steel Wiper Wet Arms

- Heavy-duty component design for use with most Marinco® motors
- Features “articulating/bend back” design that locks arm in upright position for windshield cleaning
- Built-in wet arm system that allows for a clean and easy installation of a washer system
- Black PVC hose runs up the center of the arm and ends in an adjustable four-nozzle fixture that is an integral part of the wiper arm itself



Style	Wet/Dry	Length (adjustable)	Color	Material	Part #	OEM #
single	wet	15"-20"	stainless	stainless	33084W	33184W
single	wet	20"-25"	stainless	stainless	33086W	33186W
pantographic	wet	17"-22"	stainless	stainless	33092W	33192W

Pantographic wiper arms will only function properly with wiper motor sweep angles 80° or less

## Deluxe Adjustable Wiper Arm

- All arms are stainless steel
- Arm has “articulating/bend-back” feature
- Motor shaft mounting has additional set screw clamping



Style	Wet/Dry	Length (adjustable)	Color	Material	Part #	OEM #
single	dry	6.75"-10.5"	stainless	stainless	33006A	33106A
single	dry	10"-14"	stainless	stainless	33007A	33107A
single	dry	14"-20"	stainless	stainless	33010A	33110A
single	dry	10"-14"	black	stainless	33012A	—
single	dry	14"-20"	black	stainless	33014A	33114A
single	dry	18"-24"	black	stainless	33070A	33170A

## Deluxe Adjustable Pantographic Arm

- For Use with 2.5, 1.5 and MRV Motors
- Stainless steel
- Arm has “articulating/bend-back” feature
- Motor shaft mounting has additional set screw clamping

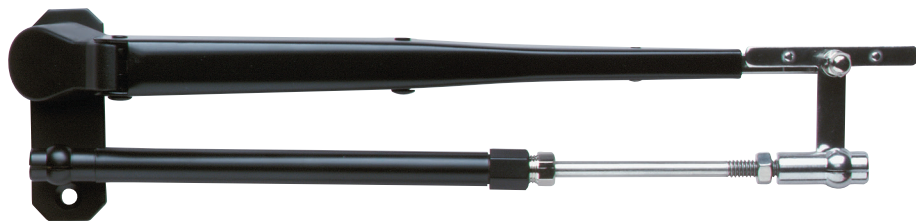

Style	Wet/Dry	Length (adjustable)	Color	Material	Part #	OEM #
pantographic	dry	12"-17"	black	stainless	33032A	33132A
pantographic	dry	17"-22"	black	stainless	33037A	33137A

## Wiper Blade Selection Charts

**Step 1:** Find the type and part number of wiper arm you have along the left side of the chart.

**Step 2:** Follow along to the right until you match up with the type and length of wiper blade you want.

**Step 3:** The bold number is the part number and the lighter number is the OEM number (if available).



Premier Plus Blades

Color/ Material	Stainless/ Stainless	Black/ Stainless		
		26"	28"	30"
<b>Premier Plus Wiper Arms</b>				
<b>Single Arm</b>				
33088 33188	dry	<b>33026S</b> 33126S	<b>33028S</b>	<b>33030S</b> 33130S
33088W 33188W	wet	<b>33026S</b> 33126S	<b>33028S</b>	<b>33030S</b> 33130S
<b>Pantograph</b>				
33096 33196	dry	<b>33026S</b> 33126S	<b>33028S</b>	<b>33030S</b> 33130S
33096W 33196W	wet	<b>33026S</b> 33126S	<b>33028S</b>	<b>33030S</b> 33130S



Deluxe Blades



Color/ Material	Stainless/ Stainless	Black/ Stainless											
		12"	14"	16"	18"	20"	22"	24"	26"	12"	14"	16"	18"
<b>Premier Wiper Arms</b>													
<b>Single Arm</b>													
33082 33182	dry	<b>34012S</b> 34112S	<b>34014S</b> 34114S	<b>34016S</b> 34116S	<b>34018S</b> 34118S	<b>34020S</b> 34120S	<b>34022S</b> 34122S	<b>34024S</b> 34124S	<b>34026S</b> 34126S	<b>34012B</b> 34112B	<b>34014B</b> 34114B	<b>34016B</b> 34116B	<b>34018B</b> 34118B
33084 33184	dry	<b>34012S</b> 34112S	<b>34014S</b> 34114S	<b>34016S</b> 34116S	<b>34018S</b> 34118S	<b>34020S</b> 34120S	<b>34022S</b> 34122S	<b>34024S</b> 34124S	<b>34026S</b> 34126S	<b>34012B</b> 34112B	<b>34014B</b> 34114B	<b>34016B</b> 34116B	<b>34018B</b> 34118B
33084W 33184W	wet	<b>34012S</b> 34112S	<b>34014S</b> 34114S	<b>34016S</b> 34116S	<b>34018S</b> 34118S	<b>34020S</b> 34120S	<b>34022S</b> 34122S	<b>34024S</b> 34124S	<b>34026S</b> 34126S	<b>34012B</b> 34112B	<b>34014B</b> 34114B	<b>34016B</b> 34116B	<b>34018B</b> 34118B
33086 33186	dry	<b>34012S</b> 34112S	<b>34014S</b> 34114S	<b>34016S</b> 34116S	<b>34018S</b> 34118S	<b>34020S</b> 34120S	<b>34022S</b> 34122S	<b>34024S</b> 34124S	<b>34026S</b> 34126S	<b>34012B</b> 34112B	<b>34014B</b> 34114B	<b>34016B</b> 34116B	<b>34018B</b> 34118B
33086W 33186W	wet	<b>34012S</b> 34112S	<b>34014S</b> 34114S	<b>34016S</b> 34116S	<b>34018S</b> 34118S	<b>34020S</b> 34120S	<b>34022S</b> 34122S	<b>34024S</b> 34124S	<b>34026S</b> 34126S	<b>34012B</b> 34112B	<b>34014B</b> 34114B	<b>34016B</b> 34116B	<b>34018B</b> 34118B
<b>Pantograph Arm</b>													
33090 33190	dry	<b>34012S</b> 34112S	<b>34014S</b> 34114S	<b>34016S</b> 34116S	<b>34018S</b> 34118S	<b>34020S</b> 34120S	<b>34022S</b> 34122S	<b>34024S</b> 34124S	<b>34026S</b> 34126S	<b>34012B</b> 34112B	<b>34014B</b> 34114B	<b>34016B</b> 34116B	<b>34018B</b> 34118B
33090W 33190W	wet	<b>34012S</b> 34112S	<b>34014S</b> 34114S	<b>34016S</b> 34116S	<b>34018S</b> 34118S	<b>34020S</b> 34120S	<b>34022S</b> 34122S	<b>34024S</b> 34124S	<b>34026S</b> 34126S	<b>34012B</b> 34112B	<b>34014B</b> 34114B	<b>34016B</b> 34116B	<b>34018B</b> 34118B
33092 33192	dry	<b>34012S</b> 34112S	<b>34014S</b> 34114S	<b>34016S</b> 34116S	<b>34018S</b> 34118S	<b>34020S</b> 34120S	<b>34022S</b> 34122S	<b>34024S</b> 34124S	<b>34026S</b> 34126S	<b>34012B</b> 34112B	<b>34014B</b> 34114B	<b>34016B</b> 34116B	<b>34018B</b> 34118B
33092W 33192W	wet	<b>34012S</b> 34112S	<b>34014S</b> 34114S	<b>34016S</b> 34116S	<b>34018S</b> 34118S	<b>34020S</b> 34120S	<b>34022S</b> 34122S	<b>34024S</b> 34124S	<b>34026S</b> 34126S	<b>34012B</b> 34112B	<b>34014B</b> 34114B	<b>34016B</b> 34116B	<b>34018B</b> 34118B
33094 33194	dry	<b>34012S</b> 34112S	<b>34014S</b> 34114S	<b>34016S</b> 34116S	<b>34018S</b> 34118S	<b>34020S</b> 34120S	<b>34022S</b> 34122S	<b>34024S</b> 34124S	<b>34026S</b> 34126S	<b>34012B</b> 34112B	<b>34014B</b> 34114B	<b>34016B</b> 34116B	<b>34018B</b> 34118B
33094W 33194W	wet	<b>34012S</b> 34112S	<b>34014S</b> 34114S	<b>34016S</b> 34116S	<b>34018S</b> 34118S	<b>34020S</b> 34120S	<b>34022S</b> 34122S	<b>34024S</b> 34124S	<b>34026S</b> 34126S	<b>34012B</b> 34112B	<b>34014B</b> 34114B	<b>34016B</b> 34116B	<b>34018B</b> 34118B
<b>Deluxe Wiper Arms</b>													
<b>Single Arm</b>													
33006A 33106A	dry	<b>34012S</b> 34112S	<b>34014S</b> 34114S	<b>34016S</b> 34116S	<b>34018S</b> 34118S	<b>34020S</b> 34120S	<b>34022S</b> 34122S	<b>34024S</b> 34124S	<b>34026S</b> 34126S	<b>34012B</b> 34112B	<b>34014B</b> 34114B	<b>34016B</b> 34116B	<b>34018B</b> 34118B
33007A 33107A	dry	<b>34012S</b> 34112S	<b>34014S</b> 34114S	<b>34016S</b> 34116S	<b>34018S</b> 34118S	<b>34020S</b> 34120S	<b>34022S</b> 34122S	<b>34024S</b> 34124S	<b>34026S</b> 34126S	<b>34012B</b> 34112B	<b>34014B</b> 34114B	<b>34016B</b> 34116B	<b>34018B</b> 34118B
33010A 33110A	dry	<b>34012S</b> 34112S	<b>34014S</b> 34114S	<b>34016S</b> 34116S	<b>34018S</b> 34118S	<b>34020S</b> 34120S	<b>34022S</b> 34122S	<b>34024S</b> 34124S	<b>34026S</b> 34126S	<b>34012B</b> 34112B	<b>34014B</b> 34114B	<b>34016B</b> 34116B	<b>34018B</b> 34118B
33012A 33112A	dry	<b>34012S</b> 34112S	<b>34014S</b> 34114S	<b>34016S</b> 34116S	<b>34018S</b> 34118S	<b>34020S</b> 34120S	<b>34022S</b> 34122S	<b>34024S</b> 34124S	<b>34026S</b> 34126S	<b>34012B</b> 34112B	<b>34014B</b> 34114B	<b>34016B</b> 34116B	<b>34018B</b> 34118B
33014A 33114A	dry	<b>34012S</b> 34112S	<b>34014S</b> 34114S	<b>34016S</b> 34116S	<b>34018S</b> 34118S	<b>34020S</b> 34120S	<b>34022S</b> 34122S	<b>34024S</b> 34124S	<b>34026S</b> 34126S	<b>34012B</b> 34112B	<b>34014B</b> 34114B	<b>34016B</b> 34116B	<b>34018B</b> 34118B
33070A 33170A	dry	<b>34012S</b> 34112S	<b>34014S</b> 34114S	<b>34016S</b> 34116S	<b>34018S</b> 34118S	<b>34020S</b> 34120S	<b>34022S</b> 34122S	<b>34024S</b> 34124S	<b>34026S</b> 34126S	<b>34012B</b> 34112B	<b>34014B</b> 34114B	<b>34016B</b> 34116B	<b>34018B</b> 34118B
<b>Pantograph Arm</b>													
33032A 33132A	dry	<b>34012S</b> 34112S	<b>34014S</b> 34114S	<b>34016S</b> 34116S	<b>34018S</b> 34118S	<b>34020S</b> 34120S	<b>34022S</b> 34122S	<b>34024S</b> 34124S	<b>34026S</b> 34126S	<b>34012B</b> 34112B	<b>34014B</b> 34114B	<b>34016B</b> 34116B	<b>34018B</b> 34118B
33037A 33137A	dry	<b>34012S</b> 34112S	<b>34014S</b> 34114S	<b>34016S</b> 34116S	<b>34018S</b> 34118S	<b>34020S</b> 34120S	<b>34022S</b> 34122S	<b>34024S</b> 34124S	<b>34026S</b> 34126S	<b>34012B</b> 34112B	<b>34014B</b> 34114B	<b>34016B</b> 34116B	<b>34018B</b> 34118B

Pantographic wiper arms will only function properly with wiper motor sweep angles 80° or less

# Wiper Blades EXPANDED OFFERING

Standard, Premier, and Deluxe wiper blades are offered in different sizes and styles to fit all of the different types of wiper arms. Standard styles have plastic frame construction and marine grade rubber squeegees.

Premier and Deluxe styles have stainless steel frame construction and high-end silicone rubber squeegees. These two styles have multiple frame construction, allowing for equal pressure of the entire length of the blade and silicone rubber squeegees that are durable and create a smoother wiping motion. In addition, longer length Premier Plus blades (26", 28", and 30") are specifically designed with a saddle style attachment for the longer length Premier Plus arms. (25"-30").

For maximum performance of all blade styles, replacement of wiper blades is recommended every 6 months.



### Deluxe Blades (cont)

### Hybrid Blades

Black/ Stainless (cont)				Black/ Polymer							
20"	22"	24"	26"	12"	14"	16"	18"	20"	22"	24"	
34020B 34120B	34022B 34122B	34024B 34124B	34026B 34126B	32012B 32112B	32014B 32114B	32016B 32116B	32018B 32118B	32020B 32120B			
34020B 34120B	34022B 34122B	34024B 34124B	34026B 34126B	32012B 32112B	32014B 32114B	32016B 32116B	32018B 32118B	32020B 32120B	32022B 32122B	32024B 32124B	
34020B 34120B	34022B 34122B	34024B 34124B	34026B 34126B	32012B 32112B	32014B 32114B	32016B 32116B	32018B 32118B	32020B 32120B	32022B 32122B	32024B 32124B	
34020B 34120B	34022B 34122B	34024B 34124B	34026B 34126B	32012B 32112B	32014B 32114B	32016B 32116B	32018B 32118B	32020B 32120B	32022B 32122B	32024B 32124B	
34020B 34120B	34022B 34122B	34024B 34124B	34026B 34126B	32012B 32112B	32014B 32114B	32016B 32116B	32018B 32118B	32020B 32120B	32022B 32122B	32024B 32124B	
34020B 34120B	34022B 34122B	34024B 34124B	34026B 34126B	32012B 32112B	32014B 32114B	80° only	80° only	80° only			
34020B 34120B	34022B 34122B	34024B 34124B	34026B 34126B	32012B 32112B	32014B 32114B	80° only	80° only	80° only			
34020B 34120B	34022B 34122B	34024B 34124B	34026B 34126B	32012B 32112B	32014B 32114B	32016B 32116B	32018B 32118B	32020B 32120B	32022B 32122B	80° only	
34020B 34120B	34022B 34122B	34024B 34124B	34026B 34126B	32012B 32112B	32014B 32114B	32016B 32116B	32018B 32118B	32020B 32120B	32022B 32122B	80° only	
34020B 34120B	34022B 34122B	34024B 34124B	34026B 34126B	32012B 32112B	32014B 32114B	32016B 32116B	32018B 32118B	32020B 32120B	32022B 32122B	32024B 32124B	
34020B 34120B	34022B 34122B	34024B 34124B	34026B 34126B	32012B 32112B	32014B 32114B	32016B 32116B	32018B 32118B	32020B 32120B	32022B 32122B	32024B 32124B	
34020B 34120B	34022B 34122B	34024B 34124B	34026B 34126B	32012B 32112B	32014B 32114B	32016B 32116B					
34020B 34120B	34022B 34122B	34024B 34124B	34026B 34126B	32012B 32112B	32014B 32114B	32016B 32116B	32018B 32118B	32020B 32120B			
34020B 34120B	34022B 34122B	34024B 34124B	34026B 34126B	32012B 32112B	32014B 32114B	32016B 32116B	32018B 32118B	32020B 32120B	32022B 32122B	32024B 32124B	
34020B 34120B	34022B 34122B	34024B 34124B	34026B 34126B	32012B 32112B	32014B 32114B	32016B 32116B	32018B 32118B	32020B 32120B			
34020B 34120B	34022B 34122B	34024B 34124B	34026B 34126B	32012B 32112B	32014B 32114B	32016B 32116B	32018B 32118B	32020B 32120B	32022B 32122B	32024B 32124B	
34020B 34120B	34022B 34122B	34024B 34124B	34026B 34126B	32012B 32112B	32014B 32114B	32016B 32116B	32018B 32118B	32020B 32120B			
34020B 34120B	34022B 34122B	34024B 34124B	34026B 34126B	32012B 32112B	32014B 32114B	32016B 32116B	32018B 32118B	32020B 32120B	32022B 32122B	32024B 32124B	

## Premier Plus Stainless Steel Wiper Blades

- All stainless steel construction
- Marine grade silicone squeegee
- Extra squeegee "claws" spread pressure evenly allowing the blade to conform to a curved windshield



Length	Color	Material	Part #	OEM #
26"	stainless	stainless	33026S	33126S
28"	stainless	stainless	33028S	—
30"	stainless	stainless	33030S	—

**Note: For use only with Premier Plus Wiper Arms and Heavy-Duty Plus 3.0 Motor**

## Deluxe Stainless Steel Wiper Blades

- Works well on curved or flat windshields
- All stainless steel construction
- Marine grade silicone squeegee



Length	Color	Material	Part #	OEM #
12"	stainless	stainless	34012S	34112S
14"	stainless	stainless	34014S	34114S
16"	stainless	stainless	34016S	34116S
18"	stainless	stainless	34018S	34118S

Length	Color	Material	Part #	OEM #
20"	stainless	stainless	34020S	34120S
22"	stainless	stainless	34022S	34122S
24"	stainless	stainless	34024S	34124S
26"	stainless	stainless	34026S	34126S



Length	Color	Material	Part #	OEM #
12"	black	stainless	34012B	34112B
14"	black	stainless	34014B	34114B
16"	black	stainless	34016B	34116B
18"	black	stainless	34018B	34118B

Length	Color	Material	Part #	OEM #
20"	black	stainless	34020B	34120B
22"	black	stainless	34022B	34122B
24"	black	stainless	34024B	34124B
26"	black	stainless	34026B	34126B

## Hybrid Wiper Blades **NEW**

Hybrid Multi-Material Construction. Electro coated galvanized steel frame, with durable polycarbonate shell.

- Designed for maximum flexibility to conform to all windshield shapes
- Marine grade construction will not rust or corrode
- Graphite-coated natural rubber squeegee for optimal wipe quality and durability
- Streamlined shape for reduced wind-lift
- Performance-tested to 500,000 cycles

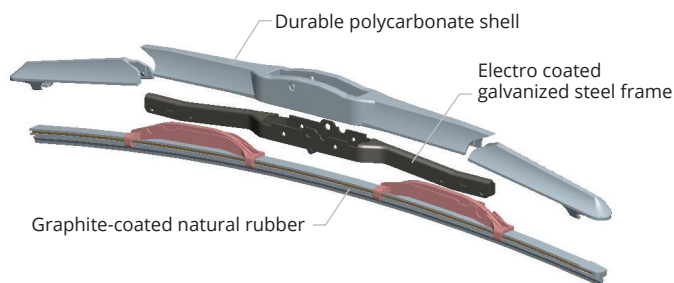

Length	Color	Material	Part #	OEM #
12"	black	hybrid	32012B	32112B
14"	black	hybrid	32014B	32114B
16"	black	hybrid	32016B	32116B
18"	black	hybrid	32018B	32118B

Length	Color	Material	Part #	OEM #
20"	black	hybrid	32020B	32120B
22"	black	hybrid	32022B	32122B
24"	black	hybrid	32024B	32124B

## Classic Stainless Steel Straight Wiper Blades

- Replaces most standard blades in boats made before 1990
- Hook and catch style

Length	Color	Material	Part #	OEM #
11"	stainless	stainless	<b>33901</b>	—
14"	stainless	stainless	<b>33919</b>	—

**Note: NOT for use with currently offered arms**

## Add-On Windshield Washer Kits

- Can be used on new or existing Deluxe wiper arm and blade sets
- Kit includes parts to outfit two (2) wiper arms
- Sprayer fittings (kit includes two) each have four (4) adjustable brass nozzles to provide maximum spray coverage for most any windshield
- Plastic parts are numbered to make installation easy

### Complete Kit

Includes:

- Water tank with mounting bracket
- 12V pump motor
- Under deck tee fitting
- Thru deck fitting and hardware
- Below deck clear tubing (16')
- Above deck black tubing (6')
- Large and small rivet clips
- Wiper arm clips
- Sprayer fittings with clamps

**Part # 33505**

**OEM # 33515**

### Below Deck Kit

Includes:

- Water tank with mounting bracket
- 12V pump motor
- Under deck tee fitting
- Thru deck fitting and hardware
- Below deck clear tubing (16')

**OEM # 33513**

### Above Deck Kit for One Small Arm

Includes:

- Small rivet clip
- Wiper arm clips
- Sprayer fitting with narrow clamp
- Thru deck fitting
- Above deck black tubing (6')

**OEM # 33517**



## Intelligent Wiper Switch

Microcontroller based "intelligent" switch provides all necessary wiper motor functions in one small component.

- Settings for two (2) continuous speed functions and three (3) intermittent speed functions (2-, 4-, or 8-second delay)
- Washer system operation function
- Blinking LED lights in switch indicate operating function
- Works with 12V or 24V DC motors
- Fits standard switch size openings, requires 2.65"/67.5 mm depth
- Includes one (1) ten pole connector with female pins and two (2) female quick-connects

Single Motor **Part # 76030** **OEM # 76130**





# HORNS

## Hidden Horns

85



Marinco®, the inventor of the first below-deck horn offers a complete line of below deck horn products.

## Compact Horns

89



Marinco compact electric horns feature a low profile design and a lower frequency which provides a deeper sound.

# HORNS

## Electric Trumpet Horns

90



Classic design electric trumpet horns feature a lower frequency which provides a deeper sound.

## Air Trumpet Horns

91

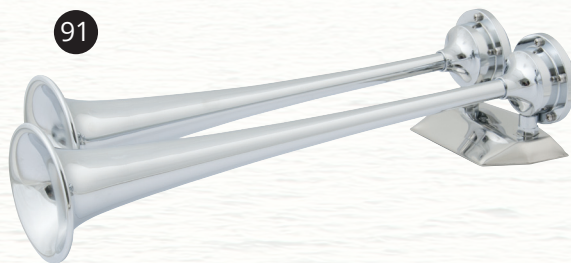

Classic design, featuring solid brass construction with a non-corrosive LEXAN polycarbonate diaphragm.



## Marinco® Horns

Marinco is the leading supplier of horns to the marine industry, with over fifty years of experience in designing and manufacturing sound devices specifically for use in harsh marine environments. Stainless steel is used for all critical components such as trumpets, motor cover, diaphragms, and assembly and mounting hardware. In the case of the XLP trumpet horns, the horn is given extra protection through the complete over-molding of the internal motor cover housing. It is this extra process that provides the added protection needed to back up the five-year warranty.

Marinco offers a complete line of marine horn products designed to meet almost any need, including electric and air trumpet horns, compact horns, electric and air below deck horns, and a comprehensive line of drop-in horns with a wide assortment of grill options. After developing the first below deck horn for the marine industry in the late 1980's, the offering of that product line has continued to expand.

- Meets the ABYC Regulation #A23 for boats up to 12 meters
- Meets the U.S. Coast Guard's C.O.L.R.E.G.S. and U.S. Inland Navigation Rules, Annex III Regulations for boats up to 20 meters
- Listed in the NMMA's Certification Program Type Accepted
- Horns are set at a lower frequency to provide greater range as the sound travels across the water

### Marinco Horn Relative Loudness Comparison Chart

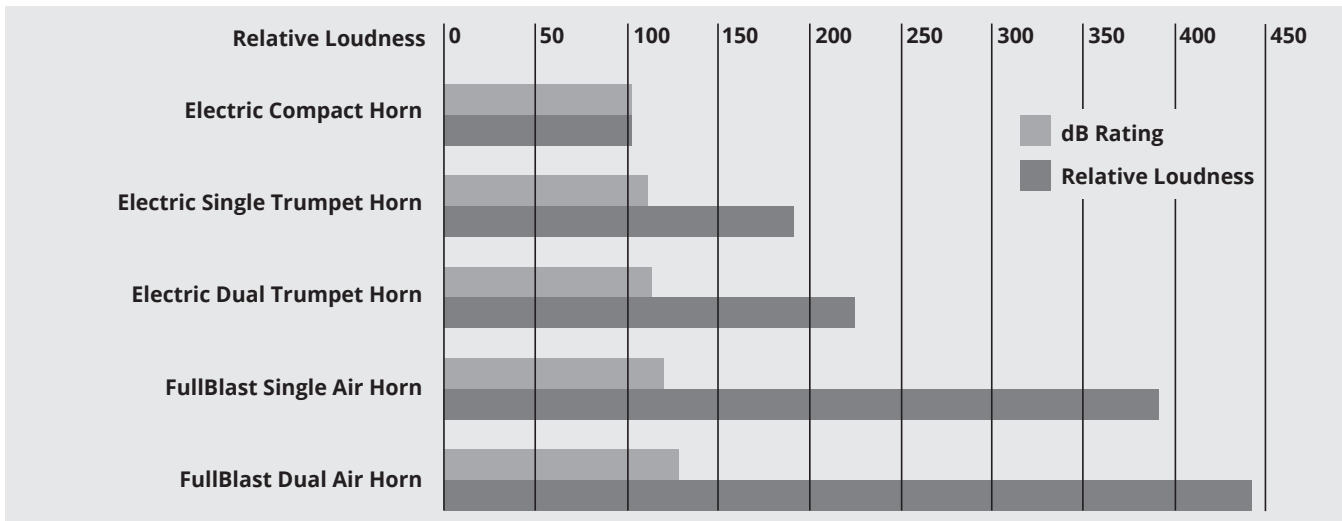

### TECH tip

#### EMI and Horns

In order to operate, an electric horn rapidly makes and breaks an electric circuit. This operation creates electromagnetic disturbance, which may cause electrical "noise" in communications equipment. Because a horn is only used temporarily, any interference in electronic equipment is stopped when the horn is turned off.

The International Marine Certification Institute (IMCI), which certifies boats to the European Community Regulations (CE), has determined that boats using electric horns can comply with CE requirements on electromagnetic compatibility provided the above message is given to the boat owners in their manual.

Marinco®, the inventor of the first below deck horns, offers a full line of below deck horn products. Concealed horns utilize an upright horn installation and a large grill opening to offer greater sound volume. Drop-in Hidden Horns use a fabric lined grill for water-resistant installations. The concealed trumpet horns are all air horns and provide the maximum amount of sound available in a below deck horn installation.

Marinco’s Drop-in Hidden Horns combine a number of desired features into one unit including:

- Simple, drop-in installation
- Stylish snap-on grill with water-resistant fabric
- Authentic marine sound
- Easy aftermarket retrofit

**Important: Please note the space requirement dimensions on some of the below deck models to ensure there is adequate room on the interior of the mounting area to house the horn assembly. Concealed horn models require a minimum 45° mounting angle to ensure proper drainage.**

## Low Profile Hidden Horn

### With Black and White Grills

- New louder dB(A) rating: 111 at one meter
- Fundamental frequency: 360±20Hz
- 12V DC
- Easy installation: 2.75" diameter hole x 1" deep
- Maximum amp draw: 4 amps
- Comes with both white ASA and black ABS screw-in grills
- Grills have water resistant fabric liners
- Mounts from the outside, grill screws on for easy install
- Easy retrofit

Part # 10080

### Without Grill

- Same as 10080 without grill
- When purchasing bulk version, grill must be ordered separately

OEM # 11080



(( Lower Frequency ))  
for a Deeper Sound



## Grills for Low Profile Hidden Horn

- Water resistant fabric liner
- Screw-in
- 4" from hole to hole

Type	Color	Vertical Style OEM #	Horizontal Style OEM #	Dimensions
Screw-in	White ASA	11080SC-W	11187	5.25" x 3.375" x .75"
	Off-White ASA	—	11194	5.25" x 3.375" x .75"
	Black ABS	11080SC-B	11188	5.25" x 3.375" x .75"
	Stainless Steel	11080SC-SS	—	5.25" x 3.375" x .75"



Vertical Style ASA/ABS



Vertical Style Stainless Steel



Horizontal Style



### Stainless Steel Grill Cover

- Horizontal style grill design
- Installs over plastic horizontal style grills (11187, 11194, or 11188)
- Installation requires plastic grill
- Grill dimensions: 5.3125" W x 3.4375" H x .875" D

OEM # 11196 Stainless steel grill

OEM # 11096 Kit (includes: stainless steel grill cover and plastic screw-in grill (11187))

## Drop-in Hidden Horns

### With Black and White Grills

- dB(A) rating: 107 at one meter
- Fundamental frequency: 370±20Hz
- 12V DC
- Internal space requirements: 2" H x 3.375" W x 3.25" D
- Maximum amp draw: 4 amps
- Comes with both black ABS and white ASA snap-in grills
- Distinctive marine horn sound
- Enclosed sound unit
- Easy installation or retrofit, mounts from the outside

Part # 10079

### Enclosed without Grill

- Same as 10079 without grill
- When purchasing 11079, grill must be ordered separately

OEM # 11079



### Without Grill

- dB(A) rating: 105 at one meter
- Fundamental frequency: 430±20Hz
- 12V DC
- Internal space requirements: 2.25" H x 3.625" W x 3.5" D
- Maximum amp draw: 3 amps
- Mounts from the outside, horn grill snaps on for easy installation
- Easy retrofit
- Grill must be ordered separately

OEM # 11095

(( Lower Frequency ))  
for a Deeper Sound ))



## Grills for Drop-in Hidden Horns

- Water resistant fabric liner
- Choose between snap-in or screw-in.
- 4" from hole to hole

Type	Color	Vertical Style OEM #	Horizontal Style OEM #	Dimensions
Snap-In	White ASA	11079SN-W	11090	5" x 2.625" x .5"
	Black ABS	11079SN-B	11091	5" x 2.625" x .5"
	Chrome Plated ABS	11079SN-C	11225	5" x 2.625" x .5"
Screw-In	White ASA	11079SC-W	11190	5" x 2.625" x .5"
	Black ABS	11079SC-B	11191	5" x 2.625" x .5"
	Chrome Plated ABS	11079SC-C	11226	5" x 2.625" x .5"
	Stainless Steel	11079SC-SS	—	5" x 2.625" x .5"



Vertical Style  
ASA/ABS



Vertical Style  
Stainless Steel



Horizontal Style

### Stainless Steel Grill Cover

- Installs over screw-in plastic grill
- Requires plastic screw-in grill for installation
- Grill dimensions: 5.0625 W x 2.75 H x .5 D

OEM # 11124 Stainless steel grill

OEM # 11024 Kit (includes: stainless steel grill cover and plastic screw-in grill)



## Under Deck Horn

- dB(A) rating: 110 at one meter
- Fundamental frequency: 420±20Hz
- 12V DC
- Dimensions: 4" W x 3.625" H x 5.75" L
- Permanently mounted grill to protect against water intrusion
- Available with and without 2-way weather pack connector pigtail

OEM # 11044   Horn with Pigtail  
 OEM # 11045   Horn without Pigtail

(( Lower Frequency ))  
 (( for a Deeper Sound ))



## Mini Hidden Horn

- dB(A) rating: 105 at one meter
- Fundamental frequency: 430±20Hz
- 12V DC
- Dimensions: 3.25" W x 1.75" H x 3" L
- Maximum amp draw: 3 amps
- Type 304 stainless steel diaphragm
- This horn is not designed for installation in exposed areas

Part # 10031  
 OEM # 11031

(( Lower Frequency ))  
 (( for a Deeper Sound ))



### With Grill Bracket

- Same horn motor as 11031 but includes grill mounting bracket
- Grill must be ordered separately

OEM # 11034



## Grills for Mini Hidden Horn 11034

- Screw-In
- Black ABS version includes gasket for watertight seal
- 4" from hole to hole

Type	Color	Vertical Style OEM #	Horizontal Style OEM #	Dimensions
Screw-In	Black ABS	11034SC-B	11168	5" x 2.625" x .375"
	Stainless Steel	11034SC-SS	11088	5" x 2" x .25"



Vertical Style ASA/ABS



Vertical Style Stainless Steel



Horizontal Style



## Electronic Horn

### With White Grill

- 107 dB(A) at one meter
- Fundamental frequency: 550±100Hz
- 12V DC
- Internal space requirements: 2.25" W x 2.25" H x 2" D
- Grill dimensions: 4.875" W x 2.75" H x .5"D
- Draws less than one amp, maximum draw: 0.8 amp
- Electronic piezo horn sound
- One piece water resistant housing, grill is molded to horn
- Mounts in a standard 2.25" opening
- Stainless steel grill cover 11185 sold separately

Part # 10082

### Stainless Steel Grill Cover for Electronic Horn 10082

- Grill dimensions: 4.9375" W x 2.8125" H x .5" D
- 4" from hole to hole

OEM # 11185



## Concealed Single Mini Air Horn

- dB rating: 126 at one meter, 1/3 octave band
- Fundamental frequency: 630±15Hz
- 12V DC
- Internal space requirements: 13" H x 5" W x 3.75" D
- Air compressor dimensions: 2.625" D x 5" L
- Maximum amp draw: 20 amps
- Solid brass construction
- Includes compressor, air tubing, fittings, and hardware
- Grill must be ordered separately

OEM # 11059

### Stainless Steel Grill for 11059

- Dimensions: 4.6875" H x 4.6875" W

OEM # 11064



## Concealed Dual Trumpet Air Horn

- dB rating: 121 at one meter, 1/3 octave band
- Fundamental frequency: 375±15/315±15Hz
- 12V DC
- Internal space requirements: 10" W x 18.5" H x 3.75" D
- Air compressor dimensions: 5" L x 2.625" D
- Maximum amp draw: 20 amps
- Solid brass construction
- Can be mounted side by side with dual grill 11066 or separately with two single grills 11064
- Includes compressor, air tubing, fittings, and hardware

OEM # 11058

### Stainless Steel Grill for 11058

- Dimensions: 9.375" W x 4.6875" H

OEM # 11066



### MiniBlast™ Compact Electric Horns

- dB(A) rating: 106 at one meter (3 feet)
- Fundamental frequency: 430±20Hz
- 12V DC
- Dimensions: 4.375" L x 3.375" W x 2" H
- Maximum amp draw: 3 amps
- Long lasting, non-corrosive ASA plastic cover
- Sealed sound unit with stainless steel diaphragm
- Mounts in same hole pattern as the 10035 horn

White Part # 10099 OEM # 11099  
 Black Part # 10098 OEM # 11098



(( Lower Frequency  
for a Deeper Sound ))

### Mini Compact Electric Horn

- dB(A) rating: 106 at one meter
- Fundamental frequency: 430±20Hz
- 12V DC
- Dimensions: 3" L x 3.25" W x 1.75" H
- Maximum amp draw: 3 amps
- Totally sealed sound unit
- Type 304 stainless steel cover, diaphragm, mounting bracket

Part # 10035  
 OEM # 11035



(( Lower Frequency  
for a Deeper Sound ))

### Mini Twin Electric Horn

- dB(A) rating: 109 at one meter
- Fundamental frequency: 490±20/430±20Hz
- 12V DC
- Dimensions: 3" L x 8" W x 1.75" H
- Maximum amp draw: 6 amps
- Type 304 stainless steel covers, diaphragms, and mounting bracket

Part # 10001  
 OEM # 11001



(( Lower Frequency  
for a Deeper Sound ))

### International Shorty Horn

- dB(A) rating: 123 at one meter
- Fundamental frequency: 310±20 Hz
- 12V DC
- Dimensions: 4.25" L x 5" W x 6.5" H
- Maximum amp draw: 4 amps
- Stainless steel diaphragm and mounting bracket
- ABS, triple chrome-plated housing

Part # 10036





## Single Trumpet Electric Horn

- dB(A) rating: 118 at one meter
- Fundamental frequency: 370±20Hz
- Dimensions: 16.5" L x 4" W x 4.75" H
- Maximum amp draw: 5 amps
- 100% stainless steel exterior
- Type 304 stainless steel diaphragm

### Premium XLP

12V Part # 10028XLP OEM # 11028XLP  
 24V Part # 10017XL OEM # 11017XLP Max amp draw: 2.5 amps

**5 YEAR**  
WARRANTY



(( Lower Frequency ))  
for a Deeper Sound ))

## Dual Trumpet Electric Horn

- dB(A) rating: 123 at one meter
- Fundamental frequency: 370±20/310±20Hz
- Dimensions: 18.5" L x 8" W x 5" H
- Maximum amp draw: 10 amps
- 100% stainless steel exterior
- Type 304 stainless steel diaphragm

### Premium XLP

12V Part # 10029XLP OEM # 11029XLP  
 24V Part # 10018XL OEM # 11018XLP Max amp draw: 5 amps

**5 YEAR**  
WARRANTY

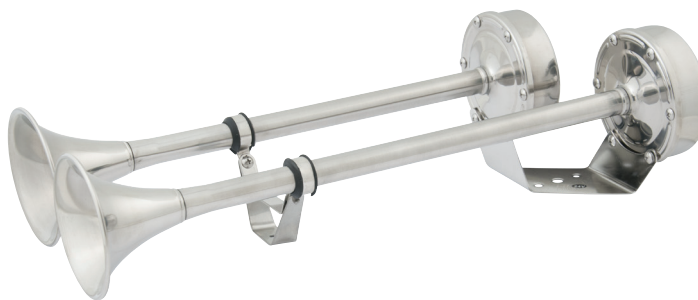

## Compact Single Trumpet Electric Horn

- dB(A) rating: 110 at one meter
- Fundamental frequency: 420±20Hz
- 12V DC
- Dimensions: 14" L x 3.5" W x 4" H
- Maximum amp draw: 3.5 amps
- Compact design makes it easier to install in smaller spaces
- 100% stainless steel exterior
- Type 304 stainless steel diaphragm

Part # 10010



(( Lower Frequency ))  
for a Deeper Sound ))

## Compact Dual Trumpet Electric Horn

- dB(A) rating: 115 at one meter
- Fundamental frequency: 420±20/370±20Hz
- 12V DC
- Dimensions: 16" L x 7.5" W x 4" H
- Maximum amp draw: 7 amps
- Compact design makes it easier to install in smaller spaces
- 100% stainless steel exterior
- Type 304 stainless steel diaphragm

Part # 10011



All of our air horns produce sound levels ranging between 120dB and 127dB, which means all of our air horns meet the ABYC and NMMA regulations for boats up to 20 meters/66 feet. Both 12V and 24V compressors are CE listed.

### Single Trumpet Mini Air Horns

- dB rating: 126 at one meter, 1/3 octave band
- Fundamental frequency: 630±15Hz
- Dimensions: 9.5" L x 3.5" W x 3.5" H
- Maximum amp draw: 20 amps (12V DC)
- Solid brass construction with non-corrosive LEXAN® polycarbonate diaphragm
- Includes compressor, air tubing, fittings, and hardware

Chrome Plated      **Part # 10107**    **OEM # 11107**  
 White Epoxy Coated    **Part # 10104**    **OEM # 11114**



Air Compressor included

### Dual Trumpet Mini Air Horns

- dB(A) rating: 127 at one meter, 1/3 octave band
- Fundamental frequency: 630±15/525±15Hz
- Dimensions: 9.5" L x 5" W x 3.75" H
- Maximum amp draw: 20 amps (12V DC)
- Solid brass construction with non-corrosive LEXAN® polycarbonate diaphragm
- Includes compressor, air tubing, fittings, and hardware

Chrome Plated      **Part # 10108**



Air Compressor included

### Single Trumpet Air Horns

- dB rating: 120 at one meter, 1/3 octave band
- Fundamental frequency: 315±15Hz
- Dimensions: 17" L x 3.75" W x 3.75" H
- Maximum amp draw: 20 amps (12V DC), 10 amps (24V DC)
- Solid brass construction with non-corrosive LEXAN® polycarbonate diaphragm
- Includes compressor, air tubing, fittings, and hardware

12 Volt      **Part # 10105**    **OEM # 11115**  
 24 Volt      **Part # 10524**

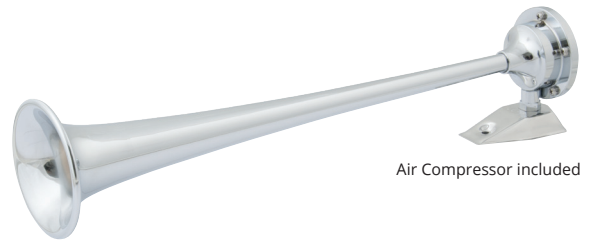

Air Compressor included

### Dual Trumpet Air Horns

- dB rating: 121 at one meter, 1/3 octave band
- Fundamental frequency: 375±15/315±15Hz
- Dimensions: 17" L x 7" W x 3.75" H
- Maximum amp draw: 20 amps (12V DC), 10 amps (24V DC)
- Solid brass construction with non-corrosive LEXAN® polycarbonate diaphragm
- Includes compressor, air tubing, fittings, and hardware

12V Chrome Plated      **Part # 10106**    **OEM # 11106**  
 12V White Epoxy Coated    **Part # 10122**  
 24V Chrome Plated      **Part # 10624**  
 24V White Epoxy Coated    **Part # 12224**    **OEM # 22224**

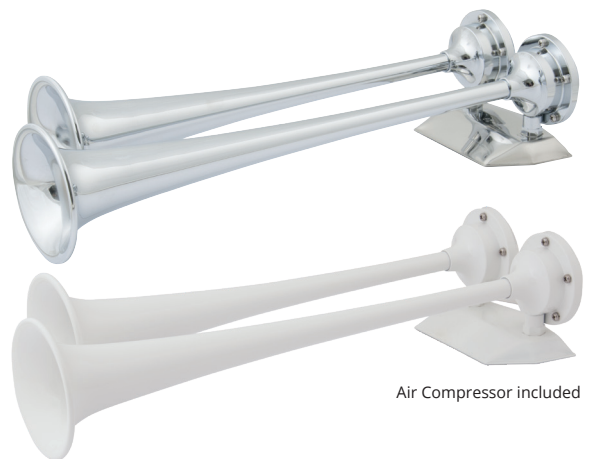

Air Compressor included

### Air Compressor

- Replacement compressor fits all Marinco® and AFI™ Air Horns
- Maximum amp draw: 20 amps (12V DC), 10 amps (24V DC)
- Produces 9–11 PSI
- Dimensions: 2.625" D x 5" L
- Includes mounting bracket

12V    **OEM # 10102**  
 24V    **OEM # 10224**



LEXAN® is a registered trademark of Sabic Innovative Plastics IP B.V., Netherlands

# LIGHTING

## Precision Wireless Controlled Spotlight

94



Controlled by wireless remote control. Provides 370° sweep and 120° tilt. Designed for harsh marine environments, it is moisture, salt, and vibration resistant.

## IP67 Stainless Steel Spot/Floodlight

95



Wireless remote communication. Stainless steel construction.

## 5" Stainless Steel Spot/Floodlight

96



Remote control / joystick operated stainless steel construction.



# LIGHTING

## IP67 Stainless Steel Spot/Floodlight

95



Features a 7", 12 LED array, and IP67 stainless construction. Creates approx. three times concentrated spot diameter while drawing roughly half the power of comparable halogen spotlights. Wireless communication using mounted bridge or hand held remote.

## Deck Lamps

97



State-of-the-art free form lens reflector technology allows for 30% more light output than comparable 55W lamps.

## Docking Lights

97



Compact flush mount docking lights for a variety of applications.



Proper lighting is necessary for safety and operational activities aboard vessels.



**3 YEAR WARRANTY**

Bulb:	100 Watt, H3 Halogen
Power (Input voltage):	12V or 24V
Current draw (idle/in use):	0.03 amps / 7.0 amps
Peak Beam Intensity:	210,000 Cp
Peak Beam Distance:	917 ft (280 m)
Lux @ 66' (20 m):	525 Lux
Coverage at 66' (20 m):	132 sq ft (12 sq m)
Rotation:	370° (built in limit stops)
Tilt:	120° Tilt (75° up & 45° down)
Wireless range:	200 ft (65 m)
Dimensions:	7.5"W x 7.5"H x 9.25"D (19 x 19 x 23.5 cm)
Weight:	3.30 lbs (1.5 kg)
Housing material:	UV resistant PC/ASA
Lens material:	UV resistant Lexan®
operating temp range:	5°F-113°F (-15°C-45°C)
IP Rating:	IP56 (see inside back cover)

## Precision Wireless Controlled Spotlight

- Universal 12V/24V circuit with bright 100W, H3 halogen bulb
- UV resistant, IP56 Weatherproof ABS housing and Lexan® lens
- O-ring sealed housing, designed for the harsh marine environment – moisture, salt, shock and vibration tested
- Universal snap-in mounting system (can be mounted upside down)
- Super-quiet, all-weather motor with limit stops provides a full range of coverage
- 370° sweep and 120° tilt (75° up and 45° down)
- One-touch auto sweep and S.O.S. function
- Wireless dash mount remote standard; (hard wired & handheld remotes are optional)
- Three-year limited warranty
- Available in white, black and chrome



### Spotlights

Description	Color	Part #	OEM #
12V/24V, 100 Watt	white	<b>SPL-12W</b>	—
12V/24V, 100 Watt	black	<b>SPL-12B</b>	—
12V/24V, 100 Watt	chrome	<b>SPL-12C</b>	—
12V, 100 Watt	white	—	<b>SPL-12W.OEM</b>
12V, 100 Watt	black	—	<b>SPL-12B.OEM</b>
12V, 100 Watt	chrome	—	<b>SPL-12C.OEM</b>
24V, 100 Watt	white	—	<b>SPL-24W.OEM</b>
24V, 100 Watt	black	—	<b>SPL-24B.OEM</b>
24V, 100 Watt	chrome	—	<b>SPL-24C.OEM</b>

### Replacement Bulbs

Description	Part #
12V, H3 Halogen	<b>202319</b>
24V, H3 Halogen	<b>202320</b>



### Remote Options



**SPLR-2**

**Included**



**SPLR-1**

(optional)



**SPLR-3**

(optional)

	SPLR-2	SPLR-1	SPLR-3
Remote Specifications	Wireless Communication Bridge Remote	Hand Held Bridge Remote	Wired Bridge Remote
Power	12 or 24 volt (hard wired)	CR2450 button cell battery	12 or 24 volt (hard wired)
Current draw (idle / in use)	negligible	negligible	negligible
Wireless range	200 ft (65m)	200 ft (65m)	—
Estimated battery life	—	> 40 hours (continuous use)	—
Dimensions	3.5"W x 2.25"H x .75"D 88 x 57 x 19 mm	2.0"W x 3.78"H x 1"D 51 x 96 x 25 mm	3.5"W x 2.25"H x .75"D 88 x 57 x 19 mm
Weight	2.12 oz (60g)	2.82 oz (80g)	2.12 oz (60g)
Housing material	UV resistant PC/ASA	UV resistant PC/ASA	UV resistant PC/ASA
Button material	Silicone (glow in the dark)	Silicone (glow in the dark)	Silicone (glow in the dark)
Operating temp range	5°F-113°F (-15°C-45°C)	5°F-113°F (-15°C-45°C)	5°F-113°F (-15°C-45°C)
IP Rating	IP54 (see inside back cover)	IP56 (see inside back cover)	IP54 (see inside back cover)

## IP67 Halogen Stainless Steel Spot/Floodlight

- Wireless remote communication
- 316 stainless steel base, 304 stainless steel head
- 350° horizontal, 60° vertical two speed movement

Peak beam intensity	165,000 CP spot
Amp draw	Spot 8.3A, flood 7.5A @ 12V Spot 4.15A, flood 3.75A @ 24V
Power (Input voltage)	12V & 24V
Bulb	H4 halogen
Dimensions	9.875"H x 4.75"W x 8.35"L
Weight	6 lbs.
IP Rating	IP67 (see inside back cover)

Description	Part #
12V Spot/Flood with Remote (22250-R)	<b>22050A</b>
12V Spot/Flood Only	<b>22051A</b>
24V Spot/Flood with Remote (22350-R)	<b>22150A</b>
24V Spot/Flood Only	<b>22151A</b>



**3 YEAR WARRANTY**

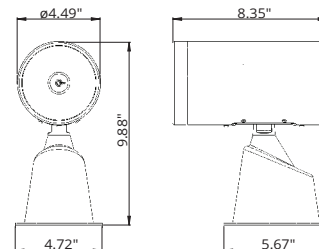

### Remote Options



**22250-R** 12V



**22250-HH** 12/24V

Remote Specifications	Wireless Communication Bridge Remote		Hand Held Bridge Remote
	22250-R 12V	22350-R 24V	22250-HH 12/24V
Power	12V DC	24V DC	Battery: L1028F Alkaline 12V
Wireless range	100 ft (30m)		100 ft (30m)
Dimensions	2.2"W x 3.65"H x 0.9"D		2.25"W x 3.95"H x 1.2"D
Housing material	ASA		ASA
Button material	Silicone (glow in the dark)		Silicone (glow in the dark)

## IP67 LED Stainless Steel Spotlight

- Wireless remote communication
- 316 stainless steel base, 304 stainless steel head
- 350° horizontal, 60° vertical two speed movement

Light Output	92,000 CD
Amp Draw	3A @ 12V DC 1.5A @ 24V DC
Power (Input voltage)	12V or 24V DC
# of LEDs	12
Dimensions	9.875"H x 4.75"W x 8.35"L
Weight	11.36 lbs (5.2 kg)
IP Rating	IP67 (see inside back cover)

Description	Part #
12V Spotlight with Remote (23250-R)	<b>23050A</b>
12V Spotlight Only	<b>23051A</b>
24V Spotlight with Remote (23350-R)	<b>23150A</b>
24V Spotlight Only	<b>23151A</b>



**3 YEAR WARRANTY**

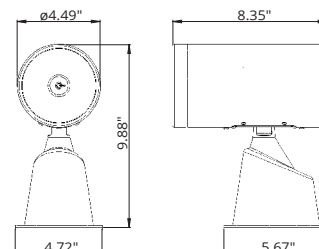

### Remote Options



**23250-R** 12V



**23250-HH**

Remote Specifications	Wireless Communication Bridge Remote		Hand Held Bridge Remote
	23250-R 12V	23350-R 24V	23250-HH
Power	12V DC	24V DC	Battery: L1028F Alkaline 12V
Wireless range	100 ft (30m)		100 ft (30m)
Dimensions	2.2"W x 3.65"H x 0.9"D		2.25"W x 3.95"H x 1.2"D
Housing material	ASA		ASA
Button material	Silicone (glow in the dark)		Silicone (glow in the dark)

## 5" Stainless Steel Spot/Floodlight

- Remote control, joystick operation
- 316 stainless steel base, 304 stainless steel head
- Dual station option available
- Light can be directed manually without damaging motors
- One year warranty

**Part # 22040A** Spot/Flood Kit  
**Part # 22041A** Spot/Flood Only

Spot Power:	72,000 CP
Flood Power:	30,000 CP
Amp Draw:	7 amps
Operation:	12V Incandescent
Bulb:	Replaceable Incandescent
Lamp Dimensions:	9.5" H x 4.5" W x 7.5" L
Base Dimensions:	5.5" L x 3.5" W
Weight:	6 lbs (2.7 kg)
Joystick requires:	2.75" installation hole



Spot/Flood kit includes joystick control and 15' wiring cable with easy to install plug ends

## Replacement Bulb

- 12V Incandescent

**Part # 22014-P**

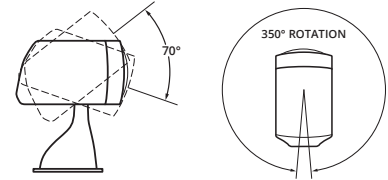

## Spotlight Parts & Accessories

### Stainless Steel Spot/Flood Parts and Accessories

Part #	Oval Panel	Rectangular Control	Dual Station Control Kit	Replacement Bulb Kit
22040A	22240-R	22208A	22218A	22014-P
22041A	22240-R	22208A	22218A	22014-P

### Beamer™ Parts and Accessories

Part #	Control Panel	Dual Station Control Kit	Replacement Bulb Kit	Extension Cable Kit	Wires in Cable
500, 500A	729823-P	729823-P	729493	—	1
501, 501A	729825	729825	729493	—	Wireless
502, 502A	729827-P	729828-P	729493	729528	5
502-1	U-3605	729488	729493	729528	5
502-2	729489	729489	729493	729528	5
503, 503A	729829-P	729830-P	729494	729528	6
503-1	U-3606	729491	729494	729528	6
503-2	—	729492	729494	729528	6



### M100 Remote Halogen Spot Parts and Accessories

Part #	Joystick Control	Dual Station Control Kit	Replacement Bulb Kit
22200	22209	22219A	22230-P
22201	22209	22219A	22230-P

### Cables

Length	Replacement Male to Male	Extension Male to Female
25 ft	22011A-P	—
35 ft	22012A-P	22012MA-P

Use with: 22040A, 22041A, 22044, 22045, 22200 or 22201 Lights



### Universal Halogen Deck Lamps

State-of-the-art free form lens reflector technology allows for 30% more light output than comparable 55W lamps. Universal mounting brackets and compact size make for easy installation anywhere. Lamp housing is made of UV stabilized plastic and all hardware is 316 chrome plated stainless steel. Includes 12V, 55W halogen bulb and is 24V, 70W compatible.

Bulbs:	Replaceable H3 12V 55W/H3 24V 70W
Dimensions:	3.75" H x 3.375" W x 5.5" L
Mounting Height:	4" with bracket

- Part # **ML-005BW/DSP**      OEM # **ML-005BW-STC**      Black
- Part # **ML-005WW/DSP**      OEM # **ML-005WW-STC**      White



### Flush Mount Deck Lamp

In addition to our highly popular conventional halogen deck lamps, we now offer a flush mount version. Ideally suited for fiberglass hardtop installations and allows for a very clean and finished installation. Free Form lens reflector technology guarantees maximum output. Lamp is completely waterproof and constructed of impact resistant UV stable plastic. Comes complete with 12V 55W halogen H3 bulb. Also suitable for 24V 70W bulbs.

Bulbs:	Replaceable H3 12V 55W/H3 24V 70W
Dimensions:	3.375" H x 1.5" W x 5.625" L
Cutout:	3" hole

- Part # **ML-005NWW**



### Flush Mount Docking Lights—Convex Lens

Compact flush mount docking lights for a variety of applications. Easy to install through a 2" hole. Ideal for Pontoon and Deck boat docking lamps, spreader lamps or rear docking lamps for motor homes. Features a high performance convex lens with a 12V 37.5W halogen bulb for optimum performance. Available with and without stainless steel frame. Pigtail required.

Bulbs:	Replaceable #893 12V 37.5W Halogen
Dimensions:	ø = 2-1/2" Frame thickness: 7/8" Overall depth: 2-7/8" Mounting depth: 2"
Mounting Depth:	2"

- Part # **M051B**      With out frame
- Part # **M051B-SS**      Stainless frame
- Part # **11-004-N**      Pigtail for M051B and M051B-SS



### Flush Mount Docking Lights—Flat Lens

Compact flush mount docking lights for a variety of applications. Easy to install through a 2" hole. Ideal for Pontoon and Deck boat docking lamps, spreader lamps or rear docking lamps for motor homes. Features a high performance free form reflector with a 12V 35W halogen bulb for optimum performance. Available with and without stainless steel frame.

Bulbs:	Replaceable MR16 12V 35W Halogen
Dimensions:	ø = 2-1/2" Frame thickness: 7/8" Overall depth: 2-7/8" Mounting depth: 2"
Mounting Depth:	2"

- Part # **M051A**      With out frame
- Part # **M051A-SS**      Stainless frame

### Slim Line Docking Light

This slim line docking lamp was specifically designed for flush mount installations on Pontoon boats. Includes low profile, stainless steel mounting bracket and 12V 35W halogen H3 bulb.

Bulbs:	Replaceable H3 12V 35W
Dimensions:	6-7/8" x 2-3/8" x 1-1/2"
Mounting Height:	2-1/4" with bracket



- Part # **WJ-B2005-A-35W**



# VENTILATION

## Day/Night Solar Vent

102



Day/Night solar vents offer 24-hour ventilation in a compact footprint. The new design can be removed from the deck and features LED lights and additional controls that are accessed from the cabin.

## MiniVent 1000

103



The MiniVent 1000 is the smallest and most economical solar vent in the Marinc® line. At just 7" in diameter and approximately 1-3/4" high, the MiniVent 1000 is compact yet effective. This solar powered model is an exhaust vent only.

## Air Vent 500 Passive Exhaust Ventilation

103

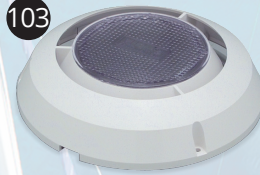

Marinco offers the AirVent 500 as a non-solar ventilation option that can passively move 600 to 1,000 cubic feet of air per hour in a 15 knot breeze. Marinco's engineering expertise created this vent to be strong, compact and effective.



# VENTILATION

## Cowl Vents

104



Cowl Vents are available in both low profile and standard height contours. These vents are a perfect air intake supplement to solar ventilation, and are also commonly used as a bilge ventilating system with or without a mechanical blower.

## Clam Shell Vents

105

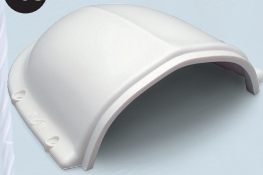

Clam shell vents are ideal for ventilation needs where a taller vent would foul lines or restrict crew movement. These vents work well as stern mounted ventilators for engine compartments.

## Deck Plates

105

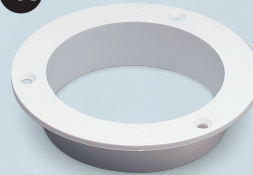

Deck plates are used to attach ventilators to the deck, hatch or hose. These plates create a clean installation and can be used with multiple material thicknesses.

## Fans

106



Marincos fans provide cabin comfort by direct wiring into a 12V DC system. Multiple models are available to accommodate different installations.

Properly ventilated vessels provide for a more comfortable environment aboard and eliminates the accumulation of dangerous fumes.

## TECH tip

### Ventilation Explained

#### Maintenance Ventilation

In most climates, boats that have been closed for a period of time will become “stuffy.” The temperature differential that develops between the boat cabin and the outdoor environment will cause the humidity level inside the boat cabin to rise. When the humidity level in the closed cabin rises, moisture forms, resulting in mold, mildew and musty air. In these conditions, fabrics, boat electronics and even the boat’s fiberglass structure can be damaged. By consistently replacing trapped, stale air in the closed boat with fresh outside air, the humidity equalizes from inside to outside, resulting in effective maintenance ventilation.

#### Comfort Ventilation

Combining different types of vents, with one vent providing “intake” air flow while another vent provides “exhaust” air flow, creates cross-flow ventilation. A cross-flow ventilation system will make the interior cabin more comfortable and pleasurable because air is constantly moving throughout the cabin. No matter what your boat size or cabin configuration is, you can increase your boating enjoyment with the addition of ventilation.

#### Safety Ventilation

Most boaters are unaware of the hazards that exist in the boating environment. Any number of serious ventilation problems can occur when a boat is left unattended. And even if you are underway, these problems don’t go away. Fumes and gasses, ranging from carbon monoxide to hydrogen gas from battery charging, to gasoline, propane or solvents stored below, are unpleasant, and can sometimes be dangerous. Also, any open flame devices in the cabin require proper ventilation. Ventilation helps to eliminate these hazards by providing constant air circulation resulting in effective safety ventilation.

#### How Much Ventilation Is Required For Your Boat?

Ideally, the air in the interior of a boat should be circulated once every hour. A typical 30-foot boat contains approximately 800 cubic feet of air. As you will see, our solar powered models can move between 600 and 1,000 cubic feet of air every hour. The general guidelines for providing maintenance ventilation are as follows:

Boat Size	Recommended Ventilation
Up to 24’.	1 Exhaust Vent*
24’ to 40’.	1 Exhaust Vent & 1 Intake Vent
40’ and larger	2 Exhaust Vents & 1 Intake Vent

\* For effective maintenance ventilation, one vent assumes there will be access for air to get into the cabin (i.e., cowl vent, clamshell vent or louvered panel)

It is important to evaluate the cabin layout of your boat to determine optimal locations for both intake and exhaust ventilation. These illustrations suggest placement for Marincor® solar powered vents and Marincor® passive vents.

**Note how the placement of the vents creates cross flow ventilation.**

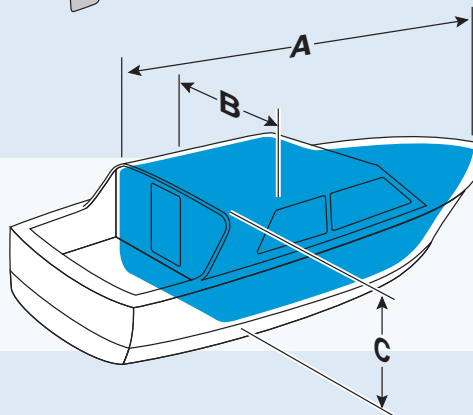
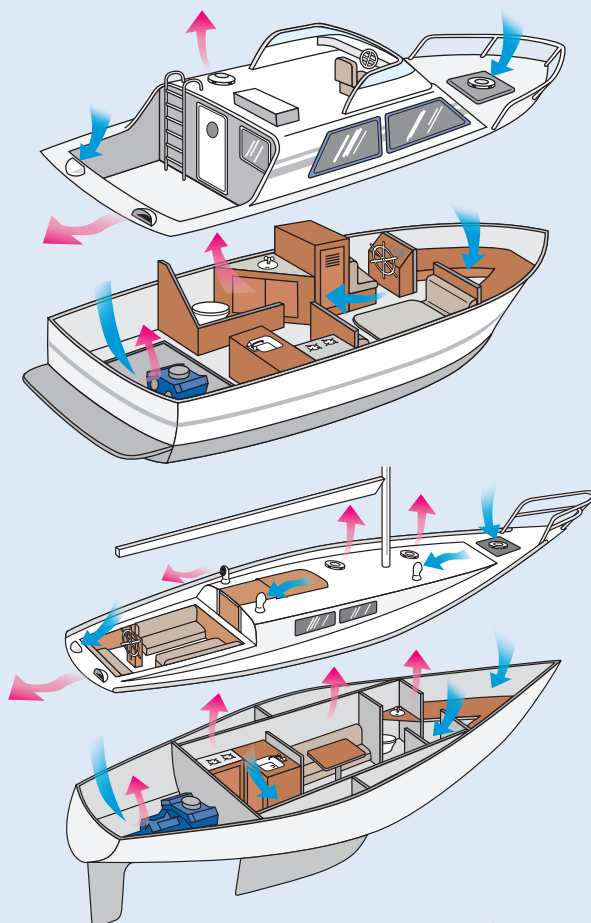

**To specifically calculate your boat’s air volume, use this simple formula:**





























$A \times B \times C \times 70\% = \text{Boat Interior Volume}$

**A** Dimension is the interior length (excluding cockpit)

**B** Dimension is the boat width

**C** Dimension is the average interior height

## Ventilation Selection Chart

	Airflow Size	Hole Size Diameter	Deck Plate	Mounting Flange Depth	Operation		Cubic Feet of Air	Intake	Exhaust
					Day	Night			
	4" / 102 mm	4-3/4"	Screw-In (6" Outer Diameter)	2.75"	 Solar	 Rechargeable Battery Power	1000 ft <sup>3</sup> /hour 28 m <sup>3</sup> 24,000 ft <sup>3</sup> /day 680 m <sup>3</sup>	 Fan (switch)	 Fan
	3" / 76 mm	3-3/4"	Screw-In (5" Outer Diameter)	2.75"	 Solar	 Rechargeable Battery Power	800 ft <sup>3</sup> /hour 23 m <sup>3</sup> 19,200 ft <sup>3</sup> /day 550 m <sup>3</sup>	 Fan (switch)	 Fan
	3" / 76 mm	3-3/4"	None (Direct to Deck Mounting)	1"	 Solar	 Passive	700 ft <sup>3</sup> /hour 20 m <sup>3</sup> 5,600 ft <sup>3</sup> /day 160 m <sup>3</sup>	 Exhaust fan only	 Fan
	3" / 76 mm	3-3/4"	None (Direct to Deck Mounting)	1"	 Passive	 Passive	600 ft <sup>3</sup> /hour 17 m <sup>3</sup> In a 15 Knot Breeze	 Passive	 Passive
	4" / 102 mm	4-3/4"	Snap-In (6" Outer Diameter)	1"	 Passive	 Passive	—	 Passive	 Passive
	3" / 76 mm	3-3/4"	Snap-In (5" Outer Diameter)	1"	 Passive	 Passive	—	 Passive	 Passive

### TECH tip™

### Vent Installation Explained

#### Installation

All Marincos® ventilation products include clear, easy-to-understand installation instructions. These instructions address all of the key factors of a professional installation, such as:

- Proper hole measurement and cutting procedures
- Proper deck plate installation
- Use of sealants to waterproof your vent installation
- Installing vents in hatches
- Installing vents in "cambered" or slightly curved decks
- Use of interior trim rings to "dress up" the cabin

The high quality level of Marincos Ventilation products must be combined with a sound installation to guarantee that your vent performs in all conditions. Marincos will make sure that your installation will be easy and successful so that you can enjoy the benefits of installation for a long time to come.

#### Marincos® Ventilation Installation Systems Snap-In Deck Plate Installation

The 12V vent, 12V combo vent and cowl vents use the Marincos Snap-In deck plate system. The snap-in system allows the easy exchange of any snap-in part for upgrading or convenience, as well as the use of a snap-in cover that completely seals the deck plate making it water tight.

#### Direct-To-Deck Installation

The Day/Night Plus, MiniVent 1000 and AirVent 500 are designed to be installed directly to the deck without the requirement for a deck plate. All of these vent systems have built-in shut-off dampers that operate from below.

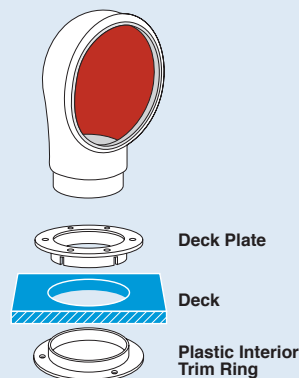

## Day/Night Solar Vent

- Circulates fresh air in boat cabin eliminating mold, mildew and musty air
- Moves 1,000 cubic feet of air/hour or 24,000 cubic feet of air/day (4" model)
- Rechargeable battery allows for 24-hour continuous operation
- No wiring required
- Built-in on/off fan switch, LED lights and intake/exhaust switch
- High capacity NiMh battery operates vent for up to 24-hours without sunlight on a full charge
- Threads into included deck plate and can be removed from outside without tools
- Complete air and green water shut-off from below
- All Day/Night Plus models come complete with white plastic interior trim ring, insect screen, mounting hardware and an easy-to-understand installation manual
- **Replaces NICRO 3" & 4" snap-in deck plates (fits existing holes once snap-in deck plates are removed)**

3" White	Part #	N20803W
3" Stainless Steel	Part #	N20803S
4" White	Part #	N20804W
4" Stainless Steel	Part #	N20804S



### Replacement NiMh Battery

- High capacity battery pack
- 4.8V, 2.5 amp-hours
- Replacement battery pack for current Day/Night Vents

Part # N20890



### Solar Vent Cap

- Includes screw-in watertight cap

Part #	N20803CAP	for 3" vents
Part #	N20804CAP	for 4" vents



### Replacement Trim Ring

Part #	N20803RING	for 3" vents
Part #	N20804RING	for 4" vents



## Original Day/Night Plus Vent Accessories

### Replacement NiMh Battery

- High capacity C-cell battery
- 1.2V, 2.0 amp-hours
- Replacement battery for older Day/Night Plus Vents, as well as, older model PowerVent 3000 and Day/Night 2000 Vents

Part # N20790



### Gasket Kit

- Includes gaskets and fasteners for both 3" and 4" vents

Part # 202432



## MiniVent 1000

The MiniVent 1000 is the smallest and most economical solar vent in the Marinco® line. At just 7" in diameter and approximately 1-3/4" high, the MiniVent 1000 is compact yet effective. This solar powered model is an exhaust vent only. It will keep the boat cabin cool when you need it most, during the hot sunlight hours. Under solar power, the MiniVent 1000 will move 700 cubic feet of air an hour. At night, even a light breeze will continue to ventilate the boat passively.

Built-in shut-off damper prevents water intrusion in rough seas. Fits a 3-3/4" diameter installation hole. The vent can be retrofitted to an existing hole of up to 6" in diameter. Available in white ABS plastic or stainless steel. Optional stainless steel cover is also available separately.

- Solar powered exhaust ventilation during daylight and passive exhaust at night
- No batteries or wiring required
- Whisper-quiet fan operation
- Durable white ABS construction
- Shut-off damper to prevent water intrusion in rough seas
- Dimensions: 7" diameter X 1-3/4" high
- All MiniVent 1000 models come complete with white plastic interior trim ring, mounting hardware and an easy-to-understand installation manual

3" White                    **Part # N20020**  
 3" Stainless Steel      **Part # N20030**



**2 YEAR WARRANTY**

## Air Vent 500 Passive Exhaust Ventilation

Marinco® offers the AirVent 500 as a non-solar ventilation option that can passively move 600 to 1,000 cubic feet of air per hour in a 15 knot breeze. Marinco's engineering expertise created this vent to be strong, compact and effective. The AirVent 500 is an economical way to provide ventilation in your boat or it can be used in conjunction with other solar powered or 12V vents to create cross flow air circulation.

- Compact size: 7" diameter x 1-3/4" high
- High air flow volume 1,000 cu. ft./hour in a 15 knot breeze
- Strong U.V. stabilized white ABS construction
- Center panel is translucent plastic allowing light to pass through it below deck
- Center damper shuts vent off from below
- Easy installation – attaches directly to deck in compact 3-3/4" diameter hole and can be retrofitted to an existing hole of up to 6" in diameter

**Part # N28810**



**2 YEAR WARRANTY**

## Cowl Vents

Cowl Vents are available in both low profile and standard height contours. These vents are a perfect air intake supplement to solar ventilation, and are also commonly used as a bilge ventilating system with or without a mechanical blower. Marincó® was the first supplier of soft, durable PVC vents that are flexible and safe. For interchangeability, Marincó 4" cowl vent models fit into the same 4" Snap-In deck plates used by the combo and 12V vents (3" or 4" sizes).

- Soft and durable PVC construction returns to original shape if stepped on
- Safer than metal cowl vents – prevents injury and resists snagging lines
- Snap-In vents include deck plate and cover
- 4" models interchangeable with Marincó® Combo and 12V Vent 4" snap-in deck plates
- Marincó adapter accessories make installing below-deck duct hose easy

### Snap-In Deluxe Low Profile PVC Cowl Vent

- White with bright red interior
- Available in 3" or 4" sizes
- 3" size measures 4-1/2" high
- 4" size measures 5-1/2" high
- Includes white Snap-In deck plate and cover

3" Part # N10863

4" Part # N10864



### Snap-In Deluxe Standard PVC Cowl Vent

- White with bright red interior
- Available in 3" or 4" sizes
- 3" size measures 8" high
- 4" size measures 10" high
- Includes white Snap-In deck plate and cover

3" Part # N10963

4" Part # N10964



## Clam Shell Vents

- Ideal for ventilation needs where a taller vent would foul lines or restrict crew movement
- Work well as stern mounted ventilators for engine compartment
- Can be used for cabin ventilation with dorade boxes
- Flexible PVC construction
- Small clam shell dimensions: 2-1/2" H x 4-1/2" W x 5" L
- Large clam shell dimensions: 3" H x 5-3/8" W x 6-3/4" L

Small Part # N10873  
 Large Part # N10874

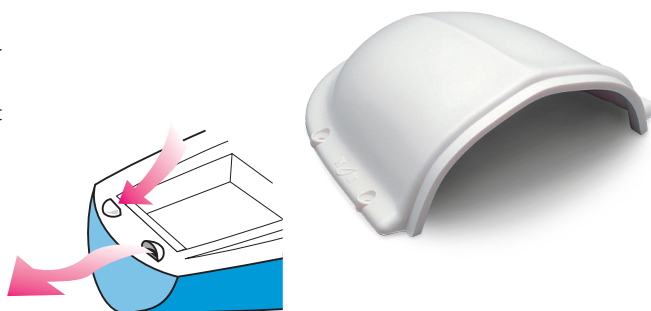

## White Snap-In Deck Plate

- Includes Snap-In watertight cover
- Use with any Marinc® Snap-In vent system
- N10863DW requires a 3-3/4" diameter hole cutout
- N10864DW requires a 4-3/4" diameter hole cutout

3" Part # N10863DW  
 4" Part # N10864DW



## Plastic Interior Trim Ring

- Finishes off interior installation of vent
- Can be installed in decks between 1" and 2" thick
- Available in 3" and 4" sizes
- White plastic construction
- **Note: Interior trim rings are not compatible with threaded deck plates**

3" Part # N10866  
 4" Part # N10867



## Thru Bulkhead Hose Adapter

- For termination attachment of hose to bulkhead
- For attaching hose to cowl vent
- Can be used with Snap-In or threaded deck plates
- For use in decks or bulk heads of more than 1" thick

3" Part # N10869  
 4" Part # N10870

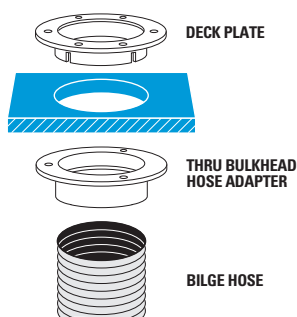





**1 YEAR WARRANTY**

## Marine Fan

- 120° adjustable oscillating fan
- Can be set for stationary operation
- Mount on wall, ceiling or dash
- Built-in on/off switch
- Installation hardware included
- 12V DC operation, 1.2 amp draw
- Translucent fan blades
- 7.5" vinyl-coated fan guard
- Mounting base dimensions: 3.375" L x 1.5" W
- Stands 8" from mounting surface

**Part # 900**



**1 YEAR WARRANTY**

## Folding Fan

- Fan folds out of the way when not in use
- Rotating louver directs air flow
- Mount on wall, ceiling or dash
- Built-in on/off switch
- Installation hardware included
- 12V DC operation, .8 amp draw
- Dimensions: 6.75" W x 5.06" H x 1.93" D

**Part # 902**



**1 YEAR WARRANTY**

## Personal Fan

- 180° adjustable swivel fan
- Mount on wall, ceiling or dash
- Built-in on/off switch
- Installation hardware included
- 12V DC operation, 0.5 amp draw
- Compact design installs anywhere
- Great for windshield defogging
- Base Dimensions: 3" diameter
- Stands 5" from mounting surface

**Part # 903-5**

PN	Page	PN	Page	PN	Page	PN	Page	PN	Page
10001	89	104SPP.OEM	25	11080SC-W	85	12VBPS2.OEM	47	12VTR	49
10010	90	104SPPG	25	11088	87	12VBPS3	46	12VTR.OEM	49
10011	90	10524	91	11090	86	12VBPS3.OEM	46	12VXT	44
10017XL	90	105SPP	25	11091	86	12VBR	47	150025	20
10018XL	90	105SPPG	25	11095	86	12VBR.OEM	47	150025NL	20
10028XLP	90	10624	91	11096	85	12VBRAD	47	150050	20
10029XLP	90	106A	25	11098	89	12VBRAD.OEM	47	150050NL	20
10031	87	10MSPPX	35	11099	89	12VBRS2	47	150BBI	56
10035	89	10MSPPXP	35	110A	25	12VBRS2.OEM	47	150BBI-TM	56
10036	89	11-004-N	97	110R	29	12VBRS3	46	150BBI.OEM	56
10079	86	11001	89	11106	91	12VBRS3.OEM	46	150BBIW	56
10080	85	11017XLP	90	11107	91	12VCDUSB48	45	150BBIW.OEM	56
10082	88	11018XLP	90	11114	91	12VCDUSB48A	45	150PHB	56
10098	89	11024	86	11115	91	12VCOMBO	45	150PHW	56
10099	89	11028XLP	90	11124	86	12VCOMBO-B	45	150SPP	25
100EL	29	11029XLP	90	11168	87	12VCOMBON-B	45	151225	20
100R	29	11031	87	11185	88	12VCOMBOW-B	45	151250	20
10102	91	11034	87	11187	85	12VCP	47	1520BI.OEM	33
10104	91	11034SC-B	87	11188	85	12VCP6	47	152AY	26
10105	91	11034SC-SS	87	11190	86	12VCPS2	47	153AY	26
10106	91	11035	89	11191	86	12VCPS3	46	154AY	26
10107	91	11044	87	11194	85	12VDUSB	45	157AY	26
10108	91	11045	87	11196	85	12VDUSB-B	45	1591-FI	32
10122	91	11058	88	111A	25	12VDUSB48	45	1591-FI.GRY.OEM	32
101739	34	11059	88	11225	86	12VDUSBN-B	45	1591-FI.WHITE	32
102164	34	11064	88	11226	86	12VDUSBW-B	45	15M32AX	36
102167	34	11066	88	115A	25	12VPG	43	15M32AXP	36
102182	31	11079	86	117A	25	12VPG.OEM	43	15MSPPX	35
10224	91	11079SC-B	86	118A	25	12VPK	43	15MSPPXP	35
102N	29	11079SC-C	86	121A	25	12VPL.OEM	44	162AY	26
103ELN	29	11079SC-SS	86	12224	91	12VRC	43	165AY	26
103RN	29	11079SC-W	86	123A	25	12VRC.OEM	43	199109PK	31
103RN.OEM	29	11079SN-B	86	12BKT	44	12VRC.PG	43	199110PK	31
103RNX	35	11079SN-C	86	12MP.OEM	44	12VRCO	43	199111PK	31
103RNXPK	35	11079SN-W	86	12VAD	44	12VRCO.PG	43	199114	35
104SPP	25	11080	85	12VBP	47	12VRCW	43	199115	36
104SPP-25.OEM	25	11080SC-B	85	12VBP.OEM	47	12VRCW.OEM	43	199116	19
104SPP-50.OEM	25	11080SC-SS	85	12VBPS2	47	12VRCY	43	199117	19

PN	Page	PN	Page	PN	Page	PN	Page	PN	Page
199117G	19	2102-B	61	23151A	95	301RCDKITIGN.OEM	16	32020B	80
199119	19	2110A	61	23250-HH	95	301RCDPL.OEM	16	32022B	80
199119G	19	2110A-B	61	23250-R	95	303SSBKRPL.OEM	16	32024B	80
199120	19	2111A	61	23350-R	95	303SSEL-B	13	32112B	80
199128	28	2111A-17	61	25MSPPX	35	303SSEL-B.OEM	13	32114B	80
199136	13	2111A-B	61	25MSPPXP	35	303SSEL-BX	35	32116B	80
1M32AXP	36	2111A-O	61	25SPPW	19	303SSEL-BXPK	35	32118B	80
1MSPPX	35	2112A	61	25SPPX	35	303SSO	13	32120B	80
1MSPPXP	35	2112A-B	61	2603-B	55	303SSRCDPL.OEM	16	32122B	80
1RPC	28	22011A-P	96	2606A-B	55	304EL-B	13	32124B	80
1RPC50	28	22012A-P	96	2701A	54	304EL-B.NT	13	33006A	77
1RPC50SP	27	22012MA-P	96	2707A	53	304EL-B.OEM	13	33007A	77
1RPCSP	27	22014-P	96	2708A	53	304EL-BX	35	33010A	77
20036	43	22040A	96	2710A	53	304EL-BX.NT	35	33012A	77
200BBIW.OEM	56	22041A	96	2711A	53	3050BI	13	33014A	77
2018BP-12	48	22050A	95	2713A	53	305BC	48	33025	72
2018BP-24	48	22051A	95	2720A	53	305BP	48	33026S	80
2018BP-24.OEM	48	22150A	95	2731A	53	305BP.OEM	48	33028S	80
2018BR	48	22151A	95	2740A	53	305CRCN	29	33030S	80
2018BR-MB	48	22208A	96	27505	57	305CRCN.OEM	29	33032A	77
2018BR.OEM	48	22209	96	27515	57	305CRCN.VPK	29	33037A	77
2018BR.OEM.BPS	48	22218A	96	30000	74	305CRCXN	35	33070A	77
2018MB	48	22219A	96	30002	74	305CRCXNPK	35	33084	76
2018MB.OEM	48	22224	91	30004	74	305CRMB	34	33084W	77
2018PKG	48	22230-P	96	30005	74	305CRPN	29	33086	76
202319	94	22240-R	96	300259	44	305CRPN.OEM	29	33086W	77
202320	94	22250-HH	95	300275	44	305CRPN.VPK	29	33090	76
202432	102	22250-R	95	301BKRPL.OEM	16	305CRR	29	33092	76
205CRCN	33	22350-R	95	301CRMB	34	305CRRB	29	33092W	77
205CRPN	33	2300A	61	301EL-B	13	305CRRB.OEM	29	33094	76
205CRR	33	2300A-B	61	301EL-B.BLACK	13	31000	74	33101	74
20MSPPX	35	2303A	61	301EL-B.FR	13	32000	74	33106A	77
20MSPPXP	35	2303A-B	61	301EL-B.GRAY	13	32001	74	33107A	77
2100	61	2304A	61	301EL-B.OEM	13	32002	74	33110A	77
2100-B	61	2304A-B	61	301EL-B.W/L	13	32012B	80	33114A	77
2101	61	23050A	95	301EL-BX	35	32014B	80	33125	72
2101-B	61	23051A	95	301EL-BXPK	35	32016B	80	33126	72
2102	61	23150A	95	301ELCB	13	32018B	80	33126S	80

PN	Page	PN	Page	PN	Page	PN	Page	PN	Page
33132A	77	34024S	80	38005	72	6152SPPW-55.P/O	19	6373EL	15
33137A	77	34026B	80	38010	72	6152SPPW-75.P/O	19	6373EL-B	15
33170A	77	34026S	80	38011	72	6153SPP	19	6373EL-B.OEM	15
33184	76	34112B	80	4006	60	6153SPP-25	19	6373EL-B.W/L	15
33184W	77	34112S	80	4008	60	6153SPP-75	19	6373EL.OEM	15
33186	76	34114B	80	4012	60	6153SPPW	19	6373ELMB	34
33186W	77	34114S	80	4018	60	6153SPPX	36	6401CRCX	37
33188	76	34116B	80	4700CR	32	6343EL-B	14	6401CRPX	37
33188W	76	34116S	80	4721CR	32	6343EL-BX	36	6401EL-BX	37
33190	76	34118B	80	4731CR	32	6344EL-B.NT	15	6402CRCX	37
33192	76	34118S	80	500EL	31	6344EL-BCR.OEM	15	6402CRPX	37
33192W	77	34120B	80	500R	31	6351EL	14	6402EL-BX	37
33194	76	34120S	80	50SPP.OEM	19	6351EL-B	14	71011	69
33505	81	34122B	80	50SPPW.OEM	19	6351EL-BX	36	71012	69
33513	81	34122S	80	50SPPX	35	6353EL	15	71081	69
33515	81	34124B	80	510R	31	6353EL-B	15	71082	69
33517	81	34124S	80	5262CRR	32	6353EL-B.BLACK.OEM	15	71112	69
33901	80	34126B	80	5262CRR.GRY	32	6353EL-B.GRAY	15	71182	69
33919	80	34126S	80	5266CR	32	6353EL-B.OEM	15	729488	96
34000	72	34210	72	5269CR	32	6353ELCB	15	729489	96
34001	72	35000	73	5366CR	33	6353RCDKITIGN.OEM	16	729491	96
34005	72	35010	73	5369CR	33	6360CRN	30	729492	96
34010	72	35040	73	5369CR.OEM	33	6360CRN.OEM	30	729493	96
34011	72	35SPP	19	6017	33	6360CRNX	36	729494	96
34012B	80	36110	71	6018	33	6360CRNXPK	36	729528	96
34012S	80	36111	71	6079	34	6361CRN	30	729823-P	96
34014B	80	36161	71	6080	34	6364CRN	30	729825	96
34014S	80	36180	71	6083CR	34	6364CRN.OEM	30	729827-P	96
34015	72	36181	71	6084CR	34	6365CRN	30	729828-P	96
34016B	80	37100	71	6152SPP	19	6365CRN.OEM	30	729829-P	96
34016S	80	37110	71	6152SPP-12SC	19	6369CR	30	729830-P	96
34018B	80	37111	71	6152SPP-25	19	6369CR.OEM	30	73113	67
34018S	80	37161	71	6152SPP-40	19	6370CR	30	73313	67
34020B	80	37180	71	6152SPP-75	19	6371EL	14	7420CR	34
34020S	80	37181	71	6152SPPG	19	6371EL-B	14	7420CR.OEM	34
34022B	80	37200	71	6152SPPG-25	19	6371EL-B.OEM	14	75SPP.OEM	19
34022S	80	38000	72	6152SPPW	19	6371EL-BX	36	76030	81
34024B	80	38001	72	6152SPPW-25	19	6371ELX	36	76080	73

PN	Page	PN	Page	PN	Page	PN	Page	PN	Page
76090	73	CS1004	38	ML-005NWW	97	P15-30	24	STRAP	21
76130	81	CS100IT4	38	ML-005WW-STC	97	P15-30-25	24	TV6444	17
76180	73	CS100IT5	39	ML-005WW/DSP	97	P15-30-25W	24	TV6574	17
76190	73	CS30-12	18	N10863	104	P30-15	24	TV6592	17
7715CRN	31	CS30-25	18	N10863DW	105	P30-503	24	TV6592.OEM	17
7715CRN.OEM	31	CS30-50	18	N10864	104	P30-504	24	TV97	20
7715CRNX	36	CS30-50W	18	N10864DW	105	P503-30	24	TV97.OEM	20
7715CRNXP	36	CS503-25	18	N10866	105	P504-30	24	TV99-25	20
7715ELN	31	CS503-50	18	N10867	105	P504-503	24	TV99W	20
7715ELN.OEM	31	CS504-25	18	N10869	105	PH6574TV	17	TVHD	20
7717N	31	CS504-50	18	N10870	105	PH6574TV.W/L	17	U-3605	96
7717N.OEM	31	CS504-50W	18	N10873	105	PH6592TV-SS	17	U-3606	96
7788CR	34	CS50EXT4*	38	N10874	105	PH6592TV-SS.OEM	17	USBA6	44
7879CR	34	CS754	38	N10963	104	PH6597TV	20	USBA6.OEM	44
7879CR-FI	34	CS75IT4	38	N10964	104	PH6597TV.OEM	20	WJ-B2005-A-35W	97
7879CR-FI.OEM	34	CS75IT5	39	N20020	103	PH6599	20	Y30-2-30	26
82012	68	CW1004	38	N20030	103	PH6600	17	Y503-2-30	26
82081	68	CW100IT4	38	N20790	102	PH6601	17	Y504-2-30	26
82082	68	CW100IT5	39	N20803CAP	102	PH6629	17	Y504-2-503	26
82181	68	CW125IT4	38	N20803RING	102	PHTV6599	20	Y504-2-504	26
82182	68	CW125IT5	39	N20803S	102	RY504-2-30	27		
82212	68	CW754	38	N20803W	102	S15-30	23		
82312	68	M051A	97	N20804CAP	102	S15-504	23		
83011	70	M051A-SS	97	N20804RING	102	S20-15	23		
83012	70	M051B	97	N20804S	102	S20-30	23		
83081	70	M051B-SS	97	N20804W	102	S30-15	23		
83082	70	M4100B12R	38	N20890	102	SPL-12B	94		
83111	70	M4100C12	38	N28810	103	SPL-12B.OEM	94		
83112	70	M4100C12R	38	P-11D03	60	SPL-12C	94		
83181	70	M4100P12	38	P-11D04	60	SPL-12C.OEM	94		
83182	70	M4100R12	38	P-12D34	60	SPL-12W	94		
900	106	M5100B9R	39	P-12D35	60	SPL-12W.OEM	94		
902	106	M5100C9	39	P-12D36	60	SPL-24B.OEM	94		
903-5	106	M5100C9R	39	P-12D37	60	SPL-24C.OEM	94		
BAG	21	M5100P9	39	P-13A27	60	SPL-24W.OEM	94		
CCVR-24	21	M5100R9	39	P-13A28	60	SPLR-1	94		
CLIP	21	ML-005BW-STC	97	P-13A29	60	SPLR-2	94		
CLIP-01	21	ML-005BW/DSP	97	P-13A2A	60	SPLR-3	94		

# Ingress Protection (IP) Ratings Guide













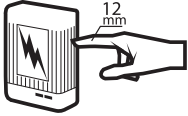

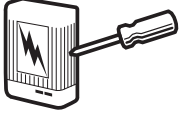
Example:

An IP65 rating can be determined using the adjacent table and example:

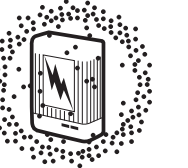
- The first number of the rating example, 6, in the gray column means the enclosure is dust tight
- The second number of the rating example, 5, in the blue column means the enclosure is protected against jets of water

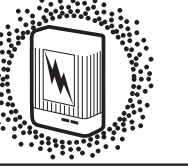
The IP rating system was established by the International Electrotechnical Commission (IEC), an organization for international standards and conformity assessment. The IEC collaborates closely with the International Organization for Standardization (ISO). A complete description of the IP ratings and associated tests is found in IEC Publication 529. Although these ratings were initially developed as a way to classify enclosures, they now provide a convenient, practical way to compare levels of sealing. Many electrical products have an Ingress Protection (IP) rating which identifies the environmental factors needing consideration prior to the product's installation.

This is important when deciding when to mount products in a dry and clean environment versus a wet and/or dusty environment. The IP rating indicates the degree of protection provided. The numbers following IP represent levels of sealing and can range from no protection to full protection against dust and water. The table provides a description of the protection at each level.

SOLIDS		WATER	
1	 Protected against a solid object greater than 50 mm such as a hand.	1	 Protected against vertically falling drops of water. Limited ingress permitted.
2	 Protected against a solid object greater than 12 mm such as a finger.	2	 Protected against vertically falling drops of water with enclosure tilted up to 15 degrees from the vertical. Limited ingress permitted.
3	 Protected against a solid object greater than 2.5 mm such as a screwdriver.	3	 Protected against sprays of water up to 60 degrees from the vertical. Limited ingress permitted for three minutes.
4	 Protected against a solid object greater than 1 mm such as a wire.	4	 Protected against water splashed from all directions. Limited ingress permitted.
5	 Dust Protected. Limited ingress of dust permitted. Will not interfere with operation of the equipment. Two to eight hours.	5	 Protected against jets of water. Limited ingress permitted.
6	 Dust tight. No Ingress of dust. Two to eight hours.	6	 Water from heavy seas or water projected in powerful jets shall not enter the enclosure in harmful quantities.
		7	 Protection against the effects of immersion in water between 15 cm and 1 m for 30 minutes.
		8	 Protection against the effects of immersion in water under pressure for long periods.

Rating Example:

**IP65**

INGRESS PROTECTION