

INSTRUCTION MANUAL

Finishing Sander

BO4555

BO4556

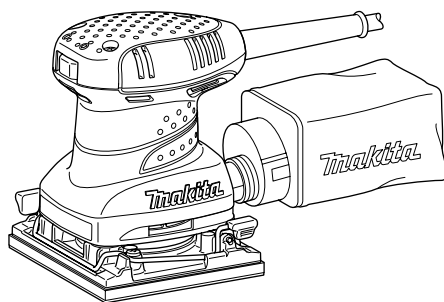

008320



DOUBLE
INSULATION

⚠ WARNING:

For your personal safety, READ and UNDERSTAND before using.
SAVE THESE INSTRUCTIONS FOR FUTURE REFERENCE.

SPECIFICATIONS

Model	BO4555	BO4556
Pad size	112mm(4-3/8")×102mm(4")	
Orbits per minute	14,000	
Dimensions (L x W x H)	131 mm x 112 mm x 142 mm (5-1/8" x 4-3/8" x 5-5/8")	131 mm x 112 mm x 141 mm (5-1/8" x 4-3/8" x 5-9/16")
Net weight	1.1 kg (2.4 lbs)	

- Due to our continuing programme of research and development, the specifications herein are subject to change without notice.
- Note: Specifications may differ from country to country.

GEA001-3

GENERAL SAFETY RULES

WARNING! Read all instructions. Failure to follow all instructions listed below may result in electric shock, fire and/or serious injury. The term "power tool" in all of the warnings listed below refers to your mains-operated (corded) power tool or battery-operated (cordless) power tool.

SAVE THESE INSTRUCTIONS.

Work area safety

1. **Keep work area clean and well lit.** Cluttered and dark areas invite accidents.
2. **Do not operate power tools in explosive atmospheres, such as in the presence of flammable liquids, gases or dust.** Power tools create sparks which may ignite the dust or fumes.
3. **Keep children and bystanders away while operating a power tool.** Distractions can cause you to lose control.

Electrical Safety

4. **Power tool plugs must match the outlet. Never modify the plug in any way. Do not use any adapter plugs with earthed (grounded) power tools.** Unmodified plugs and matching outlets will reduce risk of electric shock.
5. **Avoid body contact with earthed or grounded surfaces such as pipes, radiators, ranges and refrigerators.** There is an increased risk of electric shock if your body is earthed or grounded.
6. **Do not expose power tools to rain or wet conditions.** Water entering a power tool will increase the risk of electric shock.
7. **Do not abuse the cord. Never use the cord for carrying, pulling or unplugging the power tool. Keep cord away from heat, oil, sharp edges or moving parts.** Damaged or entangled cords increase the risk of electric shock.
8. **When operating a power tool outdoors, use an extension cord suitable for outdoor use.** Use of a cord suitable for outdoor use reduces the risk of

electric shock.

Personal Safety

9. **Stay alert, watch what you are doing and use common sense when operating a power tool. Do not use a power tool while you are tired or under the influence of drugs, alcohol or medication.** A moment of inattention while operating power tools may result in serious personal injury.
10. **Use safety equipment. Always wear eye protection.** Safety equipment such as dust mask, non-skid safety shoes, hard hat, or hearing protection used for appropriate conditions will reduce personal injuries.
11. **Avoid accidental starting. Ensure the switch is in the off-position before plugging in.** Carrying power tools with your finger on the switch or plugging in power tools that have the switch on invites accidents.
12. **Remove any adjusting key or wrench before turning the power tool on.** A wrench or a key left attached to a rotating part of the power tool may result in personal injury.
13. **Do not overreach. Keep proper footing and balance at all times.** This enables better control of the power tool in unexpected situations.
14. **Dress properly. Do not wear loose clothing or jewellery. Keep your hair, clothing, and gloves away from moving parts.** Loose clothes, jewellery or long hair can be caught in moving parts.
15. **If devices are provided for the connection of dust extraction and collection facilities, ensure these are connected and properly used.** Use of these devices can reduce dust-related hazards.

Power tool use and care

16. **Do not force the power tool. Use the correct power tool for your application.** The correct power tool will do the job better and safer at the rate for which it was designed.
17. **Do not use the power tool if the switch does**

not turn it on and off. Any power tool that cannot be controlled with the switch is dangerous and must be repaired.

18. **Disconnect the plug from the power source and/or the battery pack from the power tool before making any adjustments, changing accessories, or storing power tools.** Such preventive safety measures reduce the risk of starting the power tool accidentally.
19. **Store idle power tools out of the reach of children and do not allow persons unfamiliar with the power tool or these instructions to operate the power tool.** Power tools are dangerous in the hands of untrained users.
20. **Maintain power tools. Check for misalignment or binding of moving parts, breakage of parts and any other condition that may affect the power tools operation. If damaged, have the power tool repaired before use.** Many accidents are caused by poorly maintained power tools.
21. **Keep cutting tools sharp and clean.** Properly maintained cutting tools with sharp cutting edges are less likely to bind and are easier to control.
22. **Use the power tool, accessories and tool bits etc. in accordance with these instructions and in the manner intended for the particular type of power tool, taking into account the working conditions and the work to be performed.** Use of the power tool for operations different from those intended could result in a hazardous situation.

SERVICE

23. **Have your power tool serviced by a qualified repair person using only identical replacement parts.** This will ensure that the safety of the power tool is maintained.
24. **Follow instruction for lubricating and changing accessories.**
25. **Keep handles dry, clean and free from oil and grease.**

GEB021-1

SPECIFIC SAFETY RULES

DO NOT let comfort or familiarity with product (gained from repeated use) replace strict adherence to sander safety rules. If you use this tool unsafely or incorrectly, you can suffer serious personal injury.

1. **Hold power tools by insulated gripping surfaces when performing an operation where the cutting tool may contact hidden wiring or its own cord.** Contact with a "live" wire will make exposed metal parts of the tool "live" and shock the operator.
2. **Always use safety glasses or goggles.**

Ordinary eye or sun glasses are NOT safety glasses.

3. **Hold the tool firmly.**
4. **Do not leave the tool running. Operate the tool only when hand-held.**
5. **This tool has not been waterproofed, so do not use water on the workpiece surface.**
6. **Ventilate your work area adequately when you perform sanding operations.**
7. **Some material contains chemicals which may be toxic. Take caution to prevent dust inhalation and skin contact. Follow material supplier safety data.**
8. **Use of this tool to sand some products, paints and wood could expose user to dust containing hazardous substances. Use appropriate respiratory protection.**
9. **Be sure that there are no cracks or breakage on the pad before use. Cracks or breakage may cause a personal injury.**

SAVE THESE INSTRUCTIONS.







WARNING:

MISUSE or failure to follow the safety rules stated in this instruction manual may cause serious personal injury.

USD205-1

Symbols

The followings show the symbols used for tool.

- | | |
|---|-------------------------|
|  | · volts |
|  | · amperes |
|  | · hertz |
|  | · alternating current |
|  | · no load speed |
|  | · Class II Construction |
|  | · orbits per minute |

FUNCTIONAL DESCRIPTION

⚠CAUTION:

- Always be sure that the tool is switched off and unplugged before adjusting or checking function on the tool.

Switch action

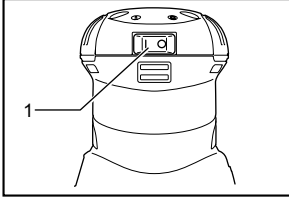

008302

1. Switch

⚠CAUTION:

- Before plugging in the tool, always check to see that the tool is switched off.

To start the tool, press the "I" side of the switch. To stop the tool, press the "O" side of the switch.

ASSEMBLY

⚠CAUTION:

- Always be sure that the tool is switched off and unplugged before carrying out any work on the tool.

Installing or removing abrasive paper

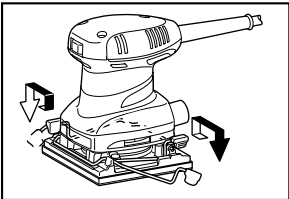

008299

Open the paper clamp by raising on the lever to release from the locking port and then insert the paper end into the clamping part, aligning the paper edges even and parallel with the sides of the base. (Bending the paper beforehand makes attachment easier). Once the paper is in place, return the lever to its original position.

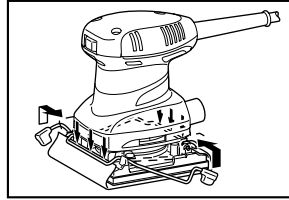

008293

Repeat the same process for the other end of the base, maintaining the proper paper tension.

After inserting the paper, make sure the clamping part hold it securely. Otherwise the paper will be loose and subject to slippage, resulting in uneven sanding operation.

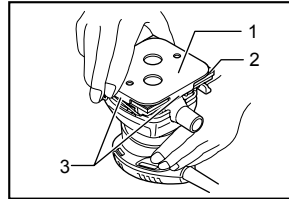

008297

1. Punch plate
2. Sandpaper
3. Guide

When using the dust bag, make holes in the abrasive paper using the punch plate as follows:

1. Set the tool upside down.
2. Place the punch plate over the abrasive paper so that the bent sides of the punch plate are flush with the paper edges.
3. Press the punch plate to make holes in the abrasive paper.

⚠CAUTION:

- Be sure to remove the punch plate before operating the tool.

Model BO4555 only

NOTE:

Use Makita hook-and-loop sandpaper with this sander.

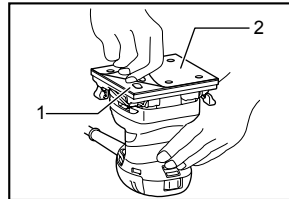

008296

1. Velcro sandpaper
2. Base

1. Set the tool upside down so that the pad is on top.
2. Position the sandpaper to fit the shape of the base. Be sure to align the holes on the sandpaper with the holes on the pad (the dust will be sucked into these holes; it is therefore important to leave them open).
3. Press the paper firmly over the pad.

To remove the sandpaper:

1. Set the tool upside down so that the sandpaper is on top.
2. Grasping one corner of the sandpaper, peel it from the pad.

NOTE:

- If the sandpaper is in good condition, save it for further use.

Dust bag

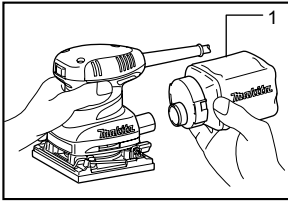

008301

1. Dust bag

The use of the dust bag makes sanding operations clean and dust collection easy. To attach the dust bag, fit the bag's entry port onto the dust spout on the tool. Make sure that the hole in the bag's entry port is just over the pimple-like protrusion on the dust spout.

For the best results, empty the dust bag when it becomes approximately half full, tapping it lightly to remove as much dust as possible.

Installing paper dust bag (optional accessory)

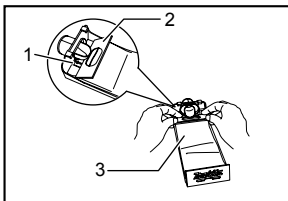

003742

1. Groove
2. Front fixing cardboard
3. Front side of paper dust bag

Place the paper dust bag on the paper dust bag holder with its front side upward. Insert the front fixing cardboard of the paper dust bag into the groove of the paper dust bag holder.

Then press the upper part of the front fixing cardboard in arrow direction to hook it onto the claws.

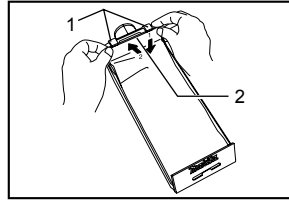

003743

1. Claws
2. Upper part

Insert the notch of the paper dust bag into the guide of the paper dust bag holder. Then install the paper dust bag holder set on the tool.

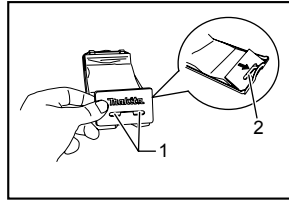

003744

1. Notch
2. Guide

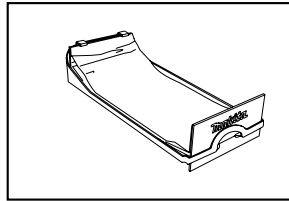

003745

OPERATION

Sanding operation

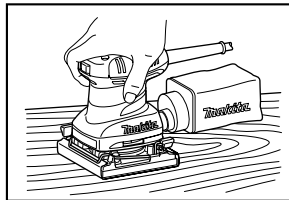

008294

CAUTION:

- Never run the tool without the abrasive paper. You may seriously damage the pad.
- Never force the tool. Excessive pressure may decrease the sanding efficiency, damage the abrasive paper and/or shorten tool life.

Hold the tool firmly. Turn the tool on and wait until it attains full speed. Then gently place the tool on the workpiece surface. A finishing sander is generally used to remove only a small amount of material at a time. Since the quality of the surface is more important than the amount of stock removed, do not bear down on the tool. Keep the base flush with the workpiece at all times.

MAINTENANCE

CAUTION:

- Always be sure that the tool is switched off and unplugged before attempting to perform inspection or maintenance.

To maintain product SAFETY and RELIABILITY, repairs, carbon brush inspection and replacement, any other maintenance or adjustment should be performed by Makita Authorized or Factory Service Centers, always using Makita replacement parts.

ACCESSORIES

CAUTION:

- These accessories or attachments are recommended for use with your Makita tool specified in this manual. The use of any other accessories or attachments might present a risk of injury to persons. Only use accessory or attachment for its stated purpose.

If you need any assistance for more details regarding these accessories, ask your local Makita Service Center.

- Abrasive paper (without pre-punched holes)
- Paper dust bag
- Paper dust bag holder
- Punch plate
- Dust bag
- Hose 19-2.5