



Electronic Sander Polisher

180 mm (7")

MODEL 9227C

MODEL 9227CY

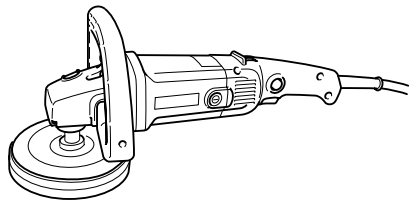

INSTRUCTION MANUAL

⚠ WARNING:

For your personal safety, READ and UNDERSTAND before using.
SAVE THESE INSTRUCTIONS FOR FUTURE REFERENCE.

SPECIFICATIONS

| | |
|---------------------|------------------|
| Model | 9227C/9227CY |
| No load speed (RPM) | 0 - 3,000/min. |
| Overall length | 470 mm (18-1/2") |
| Net weight | 3.0 kg (6.6 lbs) |
| Spindle thread | 5/8" - 11UNC |

- Manufacturer reserves the right to change specifications without notice.
- Specifications may differ from country to country.

GENERAL SAFETY RULES

USA001-2

(For All Tools)

⚠ WARNING:

Read and understand all instructions. Failure to follow all instructions listed below, may result in electric shock, fire and/or serious personal injury.

SAVE THESE INSTRUCTIONS

Work Area

1. **Keep your work area clean and well lit.** Cluttered benches and dark areas invite accidents.
2. **Do not operate power tools in explosive atmospheres, such as in the presence of flammable liquids, gases, or dust.** Power tools create sparks which may ignite the dust or fumes.
3. **Keep bystanders, children, and visitors away while operating a power tool.** Distractions can cause you to lose control.

Electrical Safety

4. **Grounded tools must be plugged into an outlet properly installed and grounded in accordance with all codes and ordinances. Never remove the grounding prong or modify the plug in any way. Do not use any adaptor plugs. Check with a qualified electrician if you are in doubt as to whether the outlet is properly grounded.** If the tools should electrically malfunction or break down, grounding provides a low resistance path to carry electricity away from the user.

-
5. **Avoid body contact with grounded surfaces such as pipes, radiators, ranges and refrigerators.** There is an increased risk of electric shock if your body is grounded.
 6. **Do not expose power tools to rain or wet conditions.** Water entering a power tool will increase the risk of electric shock.
 7. **Do not abuse the cord. Never use the cord to carry the tools or pull the plug from an outlet. Keep cord away from heat, oil, sharp edges or moving parts. Replace damaged cords immediately.** Damaged cords increase the risk of electric shock.
 8. **When operating a power tool outside, use an outdoor extension cord marked “W-A” or “W”.** These cords are rated for outdoor use and reduce the risk of electric shock.

Personal Safety

9. **Stay alert, watch what you are doing and use common sense when operating a power tool. Do not use tool while tired or under the influence of drugs, alcohol, or medication.** A moment of inattention while operating power tools may result in serious personal injury.
10. **Dress properly. Do not wear loose clothing or jewelry. Contain long hair. Keep your hair, clothing, and gloves away from moving parts.** Loose clothes, jewelry, or long hair can be caught in moving parts.
11. **Avoid accidental starting. Be sure switch is off before plugging in.** Carrying tools with your finger on the switch or plugging in tools that have the switch on invites accidents.
12. **Remove adjusting keys or wrenches before turning the tool on.** A wrench or a key that is left attached to a rotating part of the tool may result in personal injury.
13. **Do not overreach. Keep proper footing and balance at all times.** Proper footing and balance enables better control of the tool in unexpected situations.
14. **Use safety equipment. Always wear eye protection.** Dust mask, non-skid safety shoes, hard hat, or hearing protection must be used for appropriate conditions. Ordinary eye or sun glasses are NOT eye protection.

Tool Use and Care

15. **Use clamps or other practical way to secure and support the workpiece to a stable platform.** Holding the work by hand or against your body is unstable and may lead to loss of control.
16. **Do not force tool. Use the correct tool for your application.** The correct tool will do the job better and safer at the rate for which it is designed.
17. **Do not use tool if switch does not turn it on or off.** Any tool that cannot be controlled with the switch is dangerous and must be repaired.
18. **Disconnect the plug from the power source before making any adjustments, changing accessories, or storing the tool.** Such preventive safety measures reduce the risk of starting the tool accidentally.
19. **Store idle tools out of reach of children and other untrained persons.** Tools are dangerous in the hands of untrained users.
20. **Maintain tools with care. Keep cutting tools sharp and clean.** Properly maintained tools with sharp cutting edges are less likely to bind and are easier to control.
21. **Check for misalignment or binding of moving parts, breakage of parts, and any other condition that may affect the tools operation. If damaged, have the tool serviced before using.** Many accidents are caused by poorly maintained tools.
22. **Use only accessories that are recommended by the manufacturer for your model.** Accessories that may be suitable for one tool, may become hazardous when used on another tool.

SERVICE

23. Tool service must be performed only by qualified repair personnel. Service or maintenance performed by unqualified personnel could result in a risk of injury.

24. When servicing a tool, use only identical replacement parts. Follow instructions in the Maintenance section of this manual. Use of unauthorized parts or failure to follow Maintenance instructions may create a risk of electric shock or injury.

USE PROPER EXTENSION CORD: Use only three-wire extension cords that have three-prong grounding-type plugs and three-pole receptacles that accept the tool's plug. Make sure your extension cord is in good condition. Replace or repair damaged or worn cord immediately. When using an extension cord, be sure to use one heavy enough to carry the current your product will draw. An undersized cord will cause a drop in line voltage resulting in loss of power and overheating. Table 1 shows the correct size to use depending on cord length and nameplate ampere rating. If in doubt, use the next heavier gage. The smaller the gage number, the heavier the cord.

Table 1: Minimum gage for cord

| Ampere Rating | | Volts | Total length of cord in feet | | | |
|---------------|---------------|-------|------------------------------|--------|-----------------|---------|
| | | 120 V | 25 ft. | 50 ft. | 100 ft. | 150 ft. |
| More Than | Not More Than | AWG | | | | |
| 0 | 6 | | 18 | 16 | 16 | 14 |
| 6 | 10 | | 18 | 16 | 14 | 12 |
| 10 | 12 | | 16 | 16 | 14 | 12 |
| 12 | 16 | | 14 | 12 | Not Recommended | |

GROUNDING INSTRUCTIONS

This tool should be grounded while in use to protect the operator from electric shock. The tool is equipped with a three-conductor cord and three-prong grounding type plug to fit the proper grounding type receptacle. The green (or green and yellow) conductor in the cord is the grounding wire. Never connect the green (or green and yellow) wire to a live terminal. Your unit is for use on 120 volts and has a plug that looks like Fig. "A".

An adapter Fig. "B" and "C" is available for connecting Fig. "A" type plugs to two-prong receptacles. The green-colored rigid ear, lug, etc., extending from the adapter must be connected to a permanent ground, such as a properly grounded outlet box.

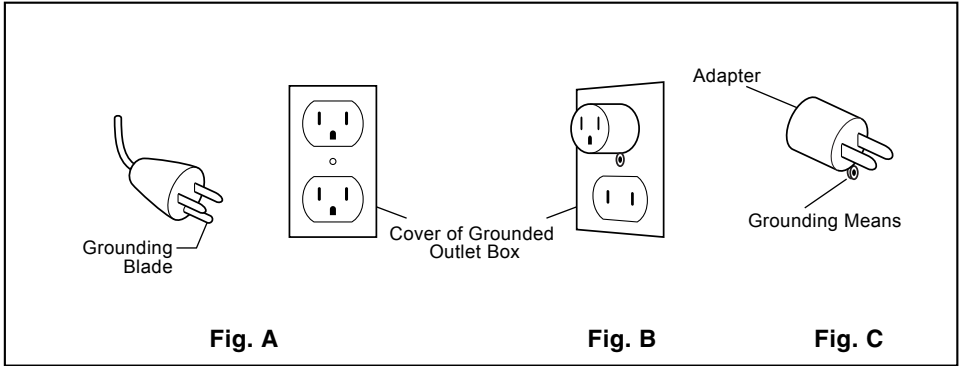

SPECIFIC SAFETY RULES

USB047-3

DO NOT let comfort or familiarity with product (gained from repeated use) replace strict adherence to polisher safety rules. If you use this tool unsafely or incorrectly, you can suffer serious personal injury.

1. **Accessories must be rated for at least the speed recommended on the tool warning label.** Wheels and other accessories running over rated speed can fly apart and cause injury.
2. **Hold tool by insulated gripping surfaces when performing an operation where the cutting tool may contact hidden wiring or its own cord.** Contact with a "live" wire will make exposed metal parts of the tool "live" and shock the operator.
3. **Check the backing pad carefully for cracks, damage or deformity before operation.** Replace cracked, damaged or deformed pad immediately.
4. **NEVER** use tool with wood cutting blades or other sawblades. Such blades when used on a polisher frequently kick and cause loss of control leading to personal injury.
5. **Hold the tool firmly.**
6. **Keep hands away from rotating parts.**
7. **Make sure the abrasive disc or wool bonnet is not contacting the workpiece before the switch is turned on.**
8. **When sanding metal surfaces, watch out for flying sparks.** Hold the tool so that sparks fly away from you and other persons or flammable materials.

-
- 9. Do not leave the tool running. Operate the tool only when hand-held.
 - 10. Do not touch the workpiece immediately after operation; it may be extremely hot and could burn your skin.
 - 11. Check that the workpiece is properly supported.
 - 12. Pay attention that the wheel continues to rotate after the tool is switched off.
 - 13. This tool has not been waterproofed, so do not use water on the workpiece surface.
 - 14. Ventilate your work area adequately when you perform sanding operations.
 - 15. Use of this tool to sand some products, paints and wood could expose user to dust containing hazardous substances. Use appropriate respiratory protection.
-

SAVE THESE INSTRUCTIONS

⚠ WARNING:
MISUSE or failure to follow the safety rules stated in this instruction manual may cause serious personal injury.

SYMBOLS

USD101-2

The followings show the symbols used for tool.

V volts

A amperes

Hz hertz

 alternating current

n_0 no load speed

.../min..... revolutions or reciprocation per minute

FUNCTIONAL DESCRIPTION

⚠ CAUTION:

- Always be sure that the tool is switched off and unplugged before adjusting or checking function on the tool.

Shaft lock

⚠ CAUTION:

- Never actuate the shaft lock when the spindle is moving. The tool may be damaged.

Press the shaft lock to prevent spindle rotation when installing or removing accessories.

003432

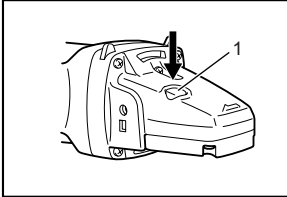

1. Shaft lock

Switch action

⚠ CAUTION:

- Before plugging in the tool, always check to see that the switch trigger actuates properly and returns to the “OFF” position when released.
- Switch can be locked in “ON” position for ease of operator comfort during extended use. Apply caution when locking tool in “ON” position and maintain firm grasp on tool.

To start the tool, simply pull the switch trigger. Tool speed is increased by increasing pressure on the switch trigger. Release the switch trigger to stop.

For continuous operation, pull the switch trigger and then push in the lock button.

To stop the tool from the locked position, pull the switch trigger fully, then release it.

003435

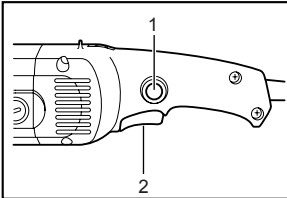

1. Lock button
2. Switch trigger

Speed adjusting dial

The tool speed can be changed by turning the speed adjusting dial to a given number setting from 1 to 6. (At the time when the switch trigger is fully pulled.)

Higher speed is obtained when the dial is turned in the direction of number 6. And lower speed is obtained when it is turned in the direction of number 1.

003440

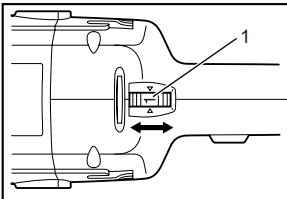

1. Speed adjusting dial

| Number | RPM |
|--------|-------|
| 1 | 600 |
| 2 | 900 |
| 3 | 1,500 |
| 4 | 2,100 |
| 5 | 2,700 |
| 6 | 3,000 |

Refer to the table for the relationship between the number settings on the dial and the approximate tool speed.

⚠ CAUTION:

- If the tool is operated continuously at low speeds for a long time, the motor will get overloaded, resulting in tool malfunction.
- The speed adjusting dial can be turned only as far as 6 and back to 1. Do not force it past 6 or 1, or the speed adjusting function may no longer work.

ASSEMBLY

003448

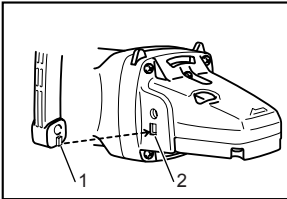

1. Protrusion of loop handle
2. Matching hole in gear housing

⚠ CAUTION:

- Always be sure that the tool is switched off and unplugged before carrying out any work on the tool.

Installing loop handle (For 9227C only)

Always install the loop handle on the tool before operation. Hold the tool's switch handle and the loop handle firmly with both hands during operation.

Install the loop handle so that its protrusion will fit into the matching hole in the gear housing.

003449

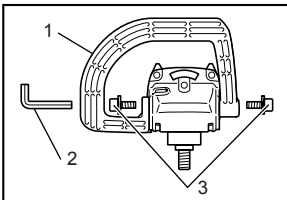

1. Loop handle
2. Hex wrench
3. Bolt

Install the bolts and tighten them with the hex wrench. The loop handle can be installed in two different directions as shown in the figures whichever is convenient for your work.

003450

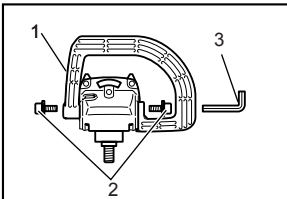

1. Loop handle
2. Bolt
3. Hex wrench

003805

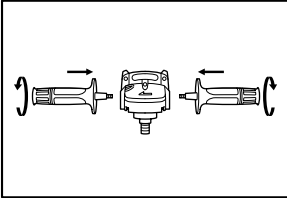

Installing side grip (handle) (For 9227CY only)

⚠ CAUTION:

- Always be sure that the side grip is installed securely before operation.

Screw the side grip securely on the position of the tool as shown in the figure.

003467

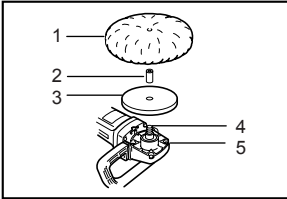

Installing or removing the wool bonnet (optional accessory)

To install the wool bonnet, first remove all dirt or foreign matter from the backing pad. Press the shaft lock and screw the backing pad onto the spindle. Insert the sleeve 18 into the center hole of the backing pad.

Using the sleeve 18 as a positioning guide, install the wool bonnet on the backing pad with the sleeve 18 inserted through the center hole of the wool bonnet. Then remove the sleeve 18 from the backing pad.

To remove the wool bonnet, just tear it off the backing pad. Then unscrew the backing pad while pressing the shaft lock.

1. Wool bonnet
2. Sleeve 18
3. Backing pad
4. Spindle
5. Shaft lock

003457

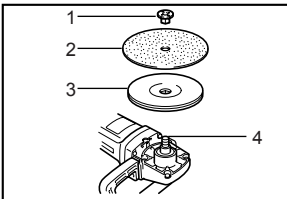

Installing or removing abrasive disc (optional accessory)

NOTE:

- Use sander accessories specified in this manual. These must be purchased separately.

Mount the rubber pad onto the spindle. Fit the abrasive disc on the rubber pad and screw the lock nut onto the spindle.

1. Lock nut
2. Abrasive disc
3. Rubber pad
4. Spindle

003458

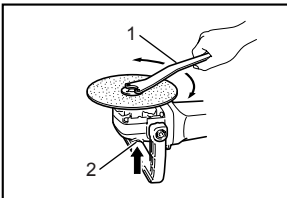

To tighten the lock nut, press the shaft lock firmly so that the spindle cannot revolve, then use the lock nut wrench and securely tighten clockwise.

To remove the disc, follow the installation procedure in reverse.

1. Lock nut wrench
2. Shaft lock

OPERATION

003478

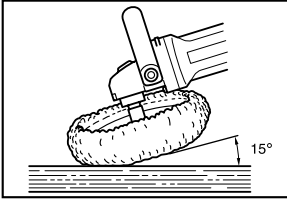

Polishing operation

⚠ CAUTION:

- Always wear safety glasses or a face shield during operation.

Hold the tool firmly. Turn the tool on and then apply the wool bonnet to the workpiece.

In general, keep the wool bonnet at an angle of about 15 degrees to the workpiece surface.

Apply slight pressure only. Excessive pressure will result in poor performance and premature wear to wool bonnet.

003473

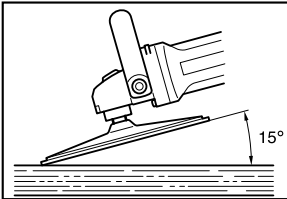

Sanding operation

⚠ CAUTION:

- Always wear safety goggles or a face shield during operation.
- Never switch on the tool when it is in contact with the workpiece, it may cause an injury to operator.
- Never run the tool without the abrasive disc. You may seriously damage the pad.

Hold the tool firmly. Turn the tool on and then apply the abrasive disc to the workpiece.

In general, keep the abrasive disc at an angle of about 15 degrees to the workpiece surface.

Apply slight pressure only. Excessive pressure will result in poor performance and premature wear to abrasive disc.

MAINTENANCE

⚠ CAUTION:

- Always be sure that the tool is switched off and unplugged before attempting to perform inspection or maintenance.

001145

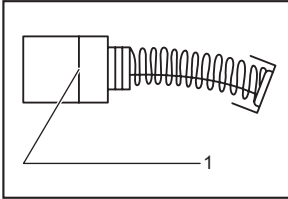

1. Limit mark

Replacing carbon brushes

Remove and check the carbon brushes regularly. Replace when they wear down to the limit mark. Keep the carbon brushes clean and free to slip in the holders. Both carbon brushes should be replaced at the same time. Use only identical carbon brushes.

003483

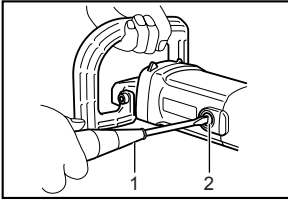

1. Screwdriver
2. Brush holder cap

Use a screwdriver to remove the brush holder caps. Take out the worn carbon brushes, insert the new ones and secure the brush holder caps.

To maintain product SAFETY and RELIABILITY, repairs, any other maintenance or adjustment should be performed by Makita Authorized or Factory Service Centers, always using Makita replacement parts.

ACCESSORIES

⚠ CAUTION:

- These accessories or attachments are recommended for use with your Makita tool specified in this manual. The use of any other accessories or attachments might present a risk of injury to persons. Only use accessory or attachment for its stated purpose.

If you need any assistance for more details regarding these accessories, ask your local Makita service center.

- Wool bonnet 180 (Hook & loop)
- Backing pad 165 (Hook & loop)
- Abrasive discs
- Rubber pad 170
- Sanding lock nut 5/8 - 48
- Lock nut wrench 28
- Sleeve 18
- Grip 36
- Loop handle

WARNING

Some dust created by power sanding, sawing, grinding, drilling, and other construction activities contains chemicals known to the State of California to cause cancer, birth defects or other reproductive harm. Some examples of these chemicals are:

- lead from lead-based paints,
- crystalline silica from bricks and cement and other masonry products, and
- arsenic and chromium from chemically-treated lumber.

Your risk from these exposures varies, depending on how often you do this type of work. To reduce your exposure to these chemicals: work in a well ventilated area, and work with approved safety equipment, such as those dust masks that are specially designed to filter out microscopic particles.