

MultiStrip 10

Art. Nr. 12 42 195

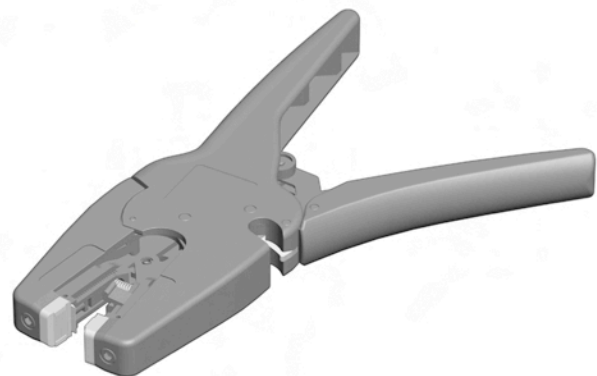

KNIPEX-Werk
C. Gustav Putsch KG

Instructions for use
Please read and save these
instructions!

Stripping wire

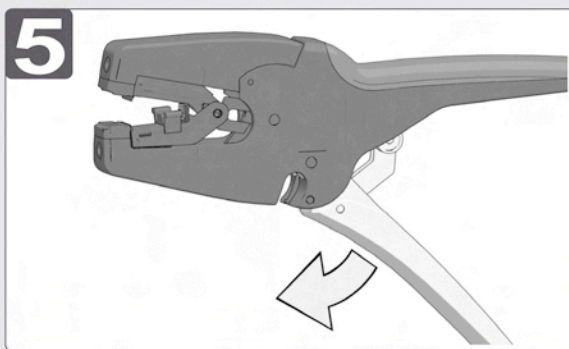
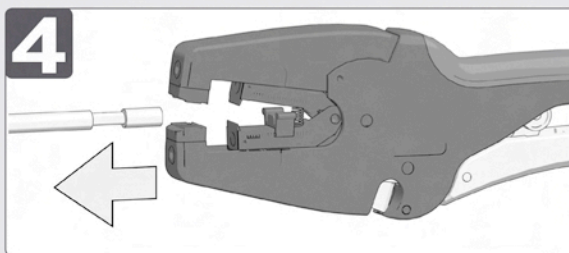
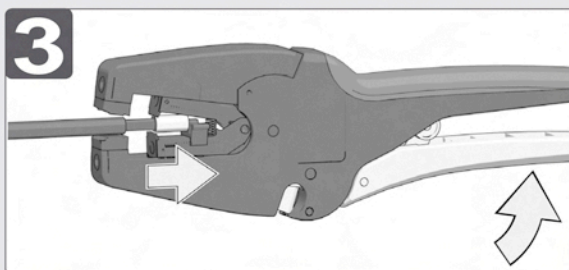
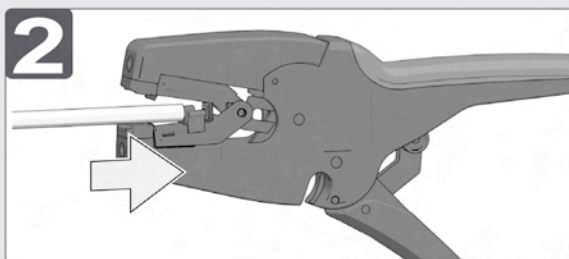
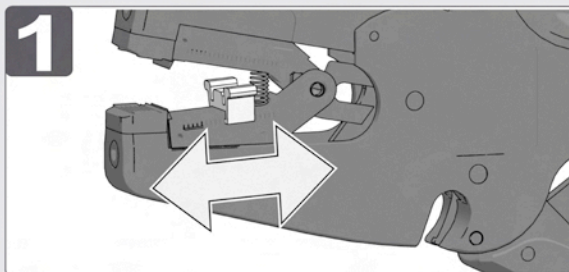

Specified Conditions of Use

The „Multistrip 10“ stripping tool is designed for high-quality stripping of standard insulated cables in a wire size range of 0,03 to 10,0 mm². A patented adjusting system serves to set the stripping blades for the whole range automatically to that position where the inserted cable is stripped best and no wire is damaged.

KEEP OUT OF REACH OF CHILDREN! Designed and manufactured pursuant to state-of-the-art technical requirements and safety standards, the MultiStrip 10 may be used only when in good working order, undamaged and in strict compliance with acknowledged safety rules. **MISUSE MAY CAUSE PERSONAL INJURY.**

The tool may be used only for the intended application. The manufacturer is not liable for damages caused by improper use or unauthorized technical modifications of the tool. Any unauthorized modification voids the manufacturer's warranty.



Risk of injury! Sharp Blade!

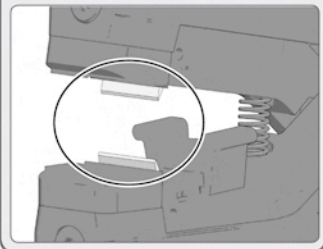

Longitudinal stop

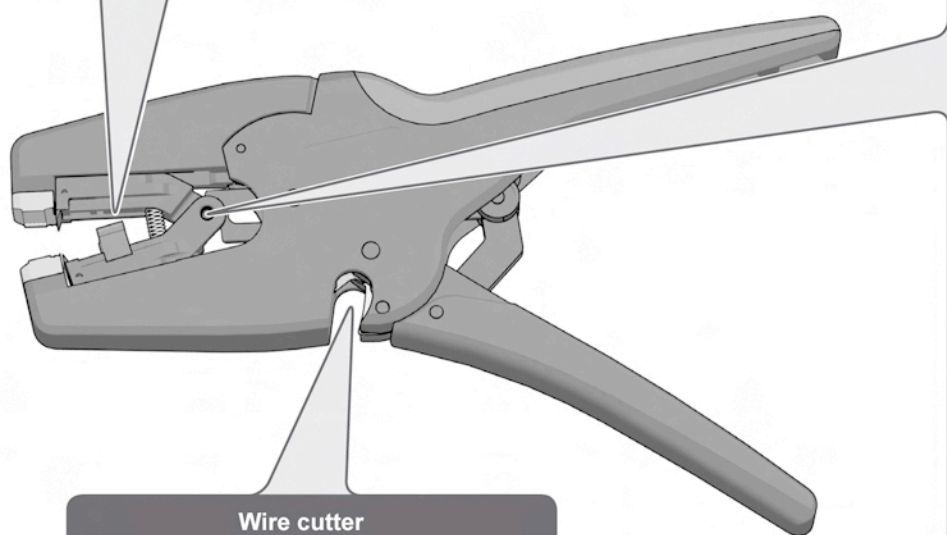
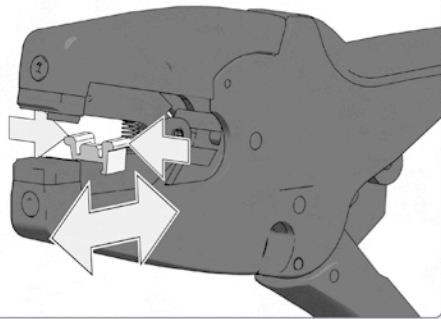

Wire cutter

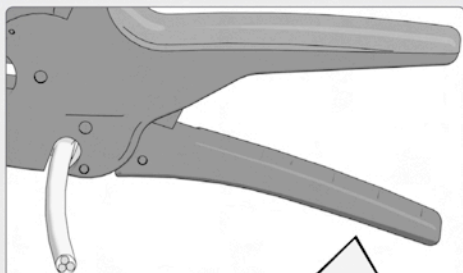

- max 10 mm²
- max 6 mm²

1

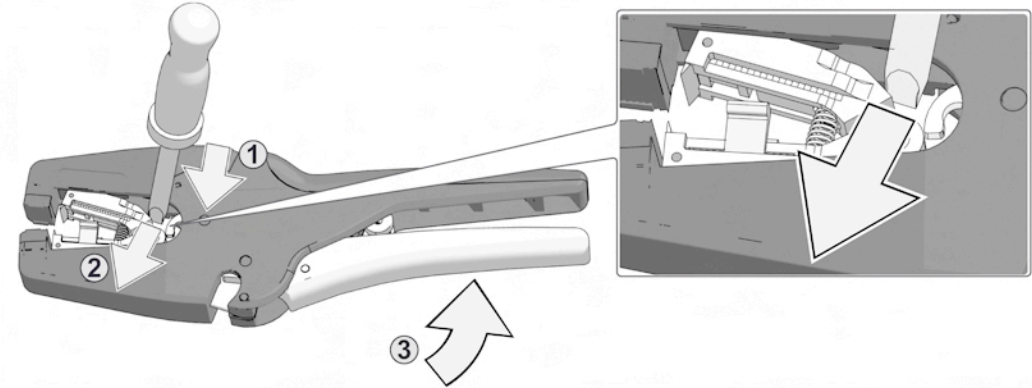
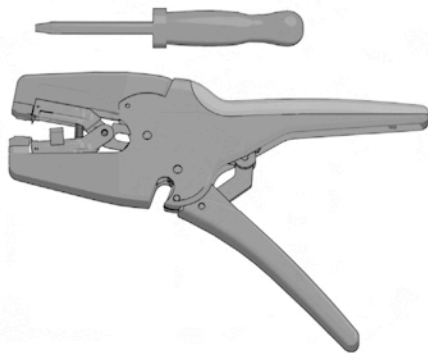

2

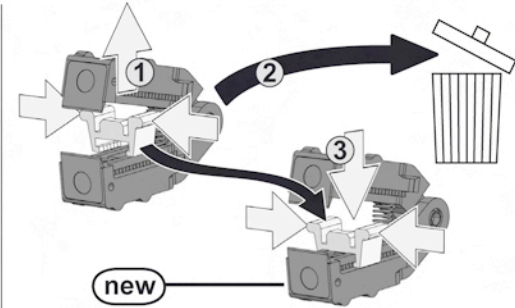
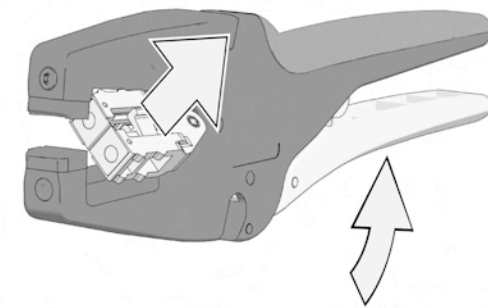
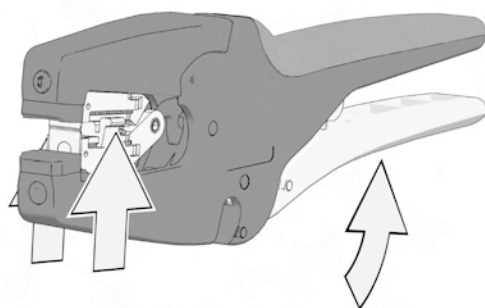

3

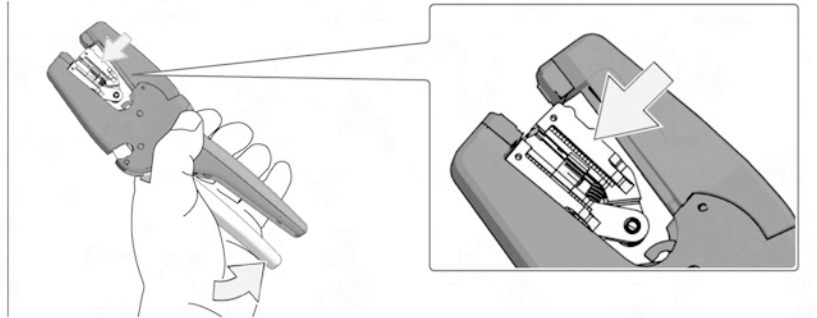
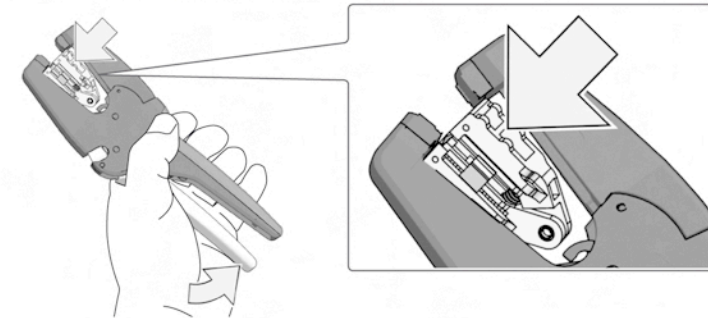

4

