



2021

Ken-Tool[®]

WHEREVER TIRES ARE CHANGED[™]

PRODUCT CATALOG
KT20210602 Supersedes
Catalog No. KT20201102



Ken-Tool

768



Ken-Tool's 100,000 Square Foot Akron, Ohio Facility



Ken-Tool HERITAGE

WHEREVER, WHENEVER TIRES ARE CHANGED...

A lot of change has occurred within Ken-Tool over the years, from its beginning with the innovative Pacific Rim Tool, through a variety of other product lines, affiliations, and ownerships. Throughout that period, its long-time slogan, "Wherever Tires Are Changed," has held true. Ken-Tool's brand name and reputation has been the best in the tire-service industry, and its leaders strive to make sure that remains true for years to come.

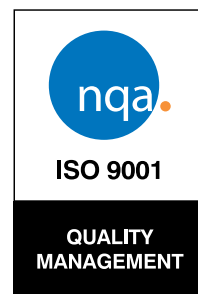
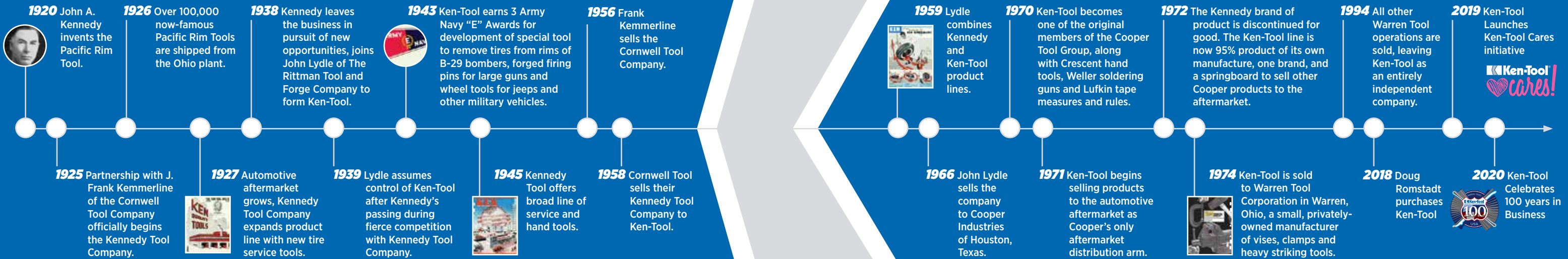

CATEGORIES

Tire Irons (mount/demount) 10
Wrench Products 20
Sockets & Torquing Tools 26
Hammers & Wedges 40
Balancing & Bead Tools 44
Wheel Products 48
Tire Cages 52
TPMS & Valve Products 56
Front End Service Tools 60
Miscellaneous 62
Vises & Clamps 64
Aligning & Pry Bars 66
Air Brake Tools 68
Air Service 70
Tire Management Solutions 74

PRODUCTS BY CATEGORY

Tire Irons (mount/demount) 10
BLUE COBRA® Truck Tire Demount Tool 10
BLUE COBRA® Truck Tire Service Sets 11
BLUE COBRA® Truck Tire Demount Tool 35440 11
Deluxe BLUE COBRA® Truck Tire Service Set 35444 11
Nineteen-Five™ Mounting/Demounting Tool 33199 12
17.5 Sidewinder™ Kit 35459 12
Nineteen-Five™ Tire Mounting & Demount Tool Set for 19.5" Tires 33195 12
Tubeless Tire Irons & Sets 13
Standard Tire Iron Set 34746 T46 13
Heavy Duty Tire Iron Set 34846 T47 13
Tubeless Tire Iron 34644 T45A-2000K™ Style 13
Serpent™ Demount Tool 35449 T2001 14
Serpent™ Mount Tool 35450 T2002 14
Serpent™ 4 Pc. Tire Changing Set 35453 14
Mount & Demount Tire Irons 14
Super Serpent™ Mount Tool 35447 T2005 15
Super Serpent™ Demount Tool 35448 T2006 15
Super Serpent™ 5 Pc. Tire Changing Set 35446 15
Super Serpent Mount & Demount Tire Irons 15
Tire Mount/Demount Spoons 16
Motorcycle/Small Wheel 39805 T43A 16
Mount/Demount Tire Tools - Small Tire 32106 T6A 16
Tire Irons - Small Tire 16
Small Tire Mount/Demount Irons 16
Tire Snake® 16
IRONMAN™ Ergonomic Wheel Lifting Bar 34950 T950 17
Manual Tire Changers 17
T601 Floor Mount 38601 17
T600 Bench/Rim Clamp Mount 38600 17
European Style Tools 17
Industrial Wheel Lock Ring Set 32129 18
Truck Lock Ring Remover 32123 T23® 18
Truck Lock Ring Remover 33223 T23A® 18
Combination Rim/Ring Tool 33224 T23B 18
Rim Lock Tool 32125 T25 18
Special Lock Ring Tool 32127 T27 18
Lock Ring Tool 32128 T27A 18
Heavy-Duty Lock Ring Tool 34648 T48A 18
Lock Ring Tools 18
Tire Mount / Demount Lubricants 19
Tiger Paste Lubricant 35837 19
Lubricant Applicators 19
Bead Lubricant Swab 30511 B111 19
Bead-Eze® Tire Lubricant 6 pk. 35847 T147A 19
Ultra Lube 35839 19
Bead-Eze® Tire Lubricant 1 Gal. 35847S T147A 19
White Tire Paste 35848 19
Euro Style Lube Brush 30512 19
Detecto Mist Leak Locator 35805 D105A 19
Heavy Paste Lube 35840 19
Tire Spreaders 19
Tire Spreader with Lock Pin 31551 T51 19
Ratchet Action Truck Tire Spreader 31554 T54 19

Wrench Products

8-in-One Wrench 20
Metric 8-in-1 Wrench 35776 20
SAE 8-in-1 Wrench 35775 20
Heavy-Duty Truck Wrench 34401 TR10 21
Truck Wrench Handle 21
Extra Leverage 1-1/2" Lug Nut Wrench 34420 21
Wrench Support Stand 32610 21
Double-End Truck Wrenches 21
HexChex® Multi-Size Loose Wheel Nut Indicators 22
Ken-Tool Porkchop 22
Combination Cap Nut Wrench 30620 TX50 22
Heavy-Duty Cap Nut Wrenches 22
Cap Nut Wrenches 22
Power Wrench 23
Basic Power Wrench Set 34543 TR43 23
Budd-Wheel Power Wrench Set 34545 TR44X 23
Universal Power Wrench Set 34547 TR44SW 23
Chrome Lug Nut Cover Remover 30606 23
Pilot Sleeve™ 30631 23
Four-Way Lug Wrenches 24
Heavy-Duty Truck Lug Wrenches 24
Professional Lug Wrenches 24
Standard Lug Wrenches 24
Economy Lug Wrenches 24
Economy Four-Way Lug Wrenches for the Do-It-Yourselfer 25
Passenger Car Lug 25
Folding Passenger Car Lug 35633 25
Telescoping Passenger Car Lug 35634 25
Passenger Car Lug 35637 25
Light Truck/RV Lug 25
Stow & Go™ 4-Way HD Lug Wrench 35636 25

Sockets & Torquing Tools

Industrial Torque Wrench 30532 26
2 PC Torque Wrench Kit 3/4" Drive 30536 26
2 PC Torque Wrench Kit 1" Drive 30538 26
Heavy-Duty Impact Sockets 27
Special Purpose Impact Sockets Off-Road Budd, Square, and SAE 27
Combination Budd Wheel - SAE 27
Impact Extensions 27
Deep Length Impact Sockets - Metric 27
6 PC Deep Thin-Wall Impact Socket Set* 30113 27
Impact Socket Sets 27
7 PC Thin-Wall Impact Socket Set 30259 27
Twist Socket Sets with Organizer Bars 28
5 PC Deep Twist Socket Set 30116 28
Individual Twist Sockets - Fluted 28
8 PC Twist Socket Set 30117 28
9 PC Twist Socket Set 30109 28
13 PC Twist Socket Set 30108 28
Twist Socket Sets with Plastic Cases 29
5 PC Twist Socket Set with Punch 30118 29
9 PC Twist Socket Set with Punch 30107 29
10 PC Slim Twist Socket Set with External Hex 30271 29
13 PC Twist Socket Set with Punch 30106 29
Specialty Sockets 30
3 PC 6-Fluted Twist Flip Socket Set 30101 30
Deep, Thin-Wall Flip Socket 30
3 pC 12-Fluted Twist Flip Socket Set 30102 30
3 PC 6-Pt. & 12-Fluted Twist Flip Socket Set 30103 30
3 PC Thin-Wall Flip Socket Set 30110 30
Specialty Sockets 31
6 PC Thick and Thin Flip Socket Set* 30112 31
5 pC Double-Duty Oil Drain Plug Removal Flip Socket Set 30114 31
3 PC Lug & Lock Flip Socket Set 30115 31
5 PC Thin-Wall Flip Socket Set* 30119 31
6 PC Double-Duty Flip Socket Set 30111 31
TORQUE MASTER® Torque Limiting Socket Kits 32
TORQUE MASTER® 4 PC Starter Kit 30174 32
TORQUE MASTER® 6 PC Kit 30176 32
TORQUE MASTER® 9 PC Kit 30179 32
TORQUE MASTER® 11" x 17" Application Paper Wall Chart 30199 32
TORQUE MASTER® 22" X 24" Laminated Socket Torque Wall Chart 30299 32
TORQUE MASTER® 10 PC Kit 30180 32
TORQUE MASTER® 12 PC Kit 30190 33
TORQUE MASTER® 4 PC SUV Kit 30175 33
TORQUE MASTER® Individual Sockets 33
TORQUE MASTER® Individual Torque Extensions 34
TORQUE MASTER® Individual Heavy-Duty Truck Torque Extensions 34
TORQUE MASTER® Torque Extension Kits 35

TORQUE MASTER® 4 PC Extension Kit - Passenger Car - 1/2" Drive 30234 35
TORQUE MASTER® 5 PC Extension Kit - Passenger Car - 1/2" Drive 30235 35
Wire Brush 30515 T15 35
TORQUE MASTER® 10 PC Extension Kit - Passenger Car & Light Truck 30251 35
Axle Nut Socket Set 30415 36
9 PC Wheel Cover & Wheel Lock Removal Kit 30170 36
13 PC Wheel Cover & Wheel Lock Removal Kit 30171 36
Universal Emergency Wheel Lock Remover 30161 36
Dual Wheel Lug Stud Remover 30165 37
4 PC Lug Nut Remover Socket Set 30254 37
Rust Hog™ Hub Cleaning Tool 37
4 PC HD Wheel Stud Remover Set 30649 37

Hammers & Wedges

Fiberglass Handled Wedge 35429 TG1E 40
Replacement Rubber Heads 41
General Purpose Tire Hammers 41
Epoxy Kits 41
Heavy Duty Tire Hammers 41
Tire Knocker 35110 41
Replacement Handles 42
Cross-Pein/Blacksmith Hammer 42
New England Pattern Hand-Drilling Hammers 42
Double-Face Sledge Hammers 42
Dead Blow Hammers 43
Professional Dead Blow Hammer 43
Economy Strike Pro™ Hammer 43
2 lb. Rubber Mallet 35310 T32 43
Duck-Billed Bead Breaking Wedges 43
Wood Handled Wedge 43
Fiberglass Handled Wedge 43
Polymer Handled Wedge 43

Balancing & Bead Tools

Balancing Beads 44
Pneumatic Bead Expanders 45
Tire Bead Seaters 45
Bead Seating Tools 45
Easy-Lift™ Bead Seating Stand 45
TIRE & RIM CONDITIONER 35870 45
White Tire Paste 35848 45
Swan Neck Leverage Bar 33341 T41 46
30" Bead Breaker 33342 T42 46
Bead Breaker Leverage Bar 34652 T52 46
Bead-Breaking Tools Truck/Farm/OTR 46
Portable Bead Breaker 34670 T100 46
Bead-Breaking Tool/Driving Iron 32126 T26A 46
Floor Type Bead Breaker 35998 T98 46
ATV Bead Breaker 38620 46
Impact Bead Breakers 47
Bead Holding Devices 47
Bead Holding Device 31710 47
Aluminum Bead Holder For Steel & Aluminum Wheels 47
Bead Holder For 19.5" Aluminum Wheels 33196 47

Wheel Products

Shark Fin™ Dual Wheel Separation Bag 34555 48
Pro Super Hub Shark® Bearing & Rotor Pulling System 7326 49
Wheel Cover Puller/Replacers 49
Professional Wheel Cover Puller/Replacers 31567 T67 49
Standard Wheel Cover Puller/Replacers 31568 T68 49
Standard Wheel Weight Tool 35355 B232 50
Wheel Weight Hammer 35361 50
Professional Wheel Weight Tool 35354 B230 50
Truck Tire Changing Stand 36015 T115 50
No-Mar Rim Guard™ 30605 50
Aluminum Wheel Protector 31810 50
Super Single Axle Drain Pan 30600 50
Dual Wheel Separator 34549 51

Tire Cages

Tire Inflation Cages 52
Earthmover Tire Inflation Cages 53
Earthmover 12-Bar Tire Inflation Cage 36012 T112 53
Earthmover 7-Bar Tire Inflation Cage 36020 T120 53
Earthmover 10-Bar Tire Inflation Cage 36011 T111 53
Passenger and Light Truck Cage 53
Portable Wide Base and Standard 2-Bar Cages 53
Tall 3-Bar Cage (OTR and Farm) 53
4-Bar Cage 36002 54
EZ Tire Rotators™ 54
EZ Tire Rotator™ 36014 T114 54
Truck and Off-Road Tire Inflation Cages 54

5-Bar Cage 36005 54
EZ Tire Rotator™ with Ramp 36018 T118 54
3-Bar Cage 36006 54
Magnum EZ Tire Rotator™ with Ramp 36013 T113 54
7-Bar Cage 36008 54
Magnum™ 5-Bar Cage 36009 T109 55
Magnum™ Tire Inflation Cages 55
SuperMagnum™ 5-Bar Cage 36010 T110 55
Portable Magnum™ 2-Bar Cage 36019 T119 55

TPMS & Valve Products

Air-Flexx® Truck Tire Valve Extensions 56
reCore® 12 Piece TPMS Sensor Saver System 29980 57
reCore® TPMS Sensor Saver Refill Kit 29981 57
reCore® 7 piece TPMS Stem Repair Kit 29975 57
Tire Valve Installer 29850 58
Valve Breaker™ 58
VALVECAPPER® PRO Cap & Core Tool 29999 58
VALVECAPPER® PRO 25 Piece Counter Display 29999M 58

Front End Service Tools

Impact Separator Tool 35939 T39B 60
Front End Service Tools 61
Separator Tool 32036 B36 61
Pitman Arm Wedge 32037 B37 61
Shock Link and Tie Rod Separator 32039 B39 61
Ball Joint Separator 32040 B40 61
MacPherson Strut Coil Spring Compressor Set 39730 61
Heavy Duty Tie Rod End Tool 32031 61

Miscellaneous

Tire & Wheel Service Centers 62
Tire & Wheel Service Center 36047 62
Passenger Tire & Wheel Service Center 36049 62
Professional Tire Tool and Lug Wrench Merchandisers 63
10 Piece Lug Wrench Assortment with Rack 35648 63
Hanging 4-Way Display Rack 35651 63
OSHA Tire Service Charts 39998 63
Deluxe Tire & Wheel Service Center 36045 63
Tire & Wheel Service Center 36046 63
Professional Mechanic's Vises 64

Vises & Clamps

Professional Reversible Mechanic's Vises 65
Professional C-Clamps 65

Aligning & Pry Bars

Aligning Bars 66
Close Quarters Bars 66
Die Setter Bars 66

Air Brake Tools

Bendix ADB22X™ Air Disc Brake Tool Kits 68
ADB22X Complete Kit 80000 (Bendix #K029164) 68
Tappet & Boot 7 pc. Replacement Tool Kit 80001 (Bendix #K028829) 68
Guide Pin / Pin Boot 13 pc. Service Tool Kit 80002 (Bendix #K029107) 68
Air Brake Slack Adjusters 69
2 pc. Automatic Slack Adjuster Set (Meritor®) 33200 69
Haldex® Slack Adjuster Tool 33205 69
Bendix® Slack Adjuster Tool 33206 69
4 Pc. Automatic Slack Adjuster Tool Set 33210 69

Air Service

Premium Reinforced Hybrid Air Hose 70
Air Boss® Mini Stubby Impact Wrench 71
Air Boss® Impact Wrench 26404 71
Air Boss® Heavy Duty Impact Wrench 26406 71
Air Boss® Heavy Duty Impact Wrench 26408 71
Air Boss® Pneumatic Tools 71
Air Boss® Micro Stubby Impact Wrench 71
Air Boss® Impact Wrench 26405 71
Air Boss® Heavy Duty Impact Wrench 26407 71
Air Boss® Heavy Duty Impact Wrench 26409 71
HD Truck Tire Inflation Kit w/ Glad Hand & Dual Foot Air Chuck 26050 72
Whip Hose 26024 72
Premium Digital Tire Inflator 26081 73
Handheld Automatic Tire Inflator 26012 73
Premium Digital Tire Inflator 26082 73

Tire Management Solutions

Elite Tire Sealant 35851 75
OTR Elite Tire Sealant 35861 75
Tire & Rim Conditioner 35870 76
Ken-Tool Hand Pump 35800 76

ALL WEIGHTS AND MEASURES ARE NOMINAL. VARIATIONS IN MANUFACTURE MAY OCCUR.

HexChex[®]
Multi-Size Loose Wheel Nut Indicators
Item Numbers 30601, 30602, 30603, 30603R, 30603G, 30603B, 30604



Installs over a lug nut without tools – fastening securely with a ratcheting closure!
See page 22 for details.

Pilot Sleeve[™]
Polyamide Wheel Centering Sleeves
Item Numbers 30631, 30632, 30633, 30630



Sleeves take up the gap between the 22mm stud and the 26mm wheel opening, realigning the wheel to the TRUE CENTER of the hub bearing.
See page 23 for details.

Balancing Beads
Wheel End Balancing
Item Numbers 31600, 31601, 31602, 31603, 31604, 31606, 31608, 31610, 31612, 31614, 31616



Injected through the valve stem to completely balance the axle end on existing vehicles without dismantling the tire and wheel!
See page 44 for details.

Air-Flexx[®]
Truck Tire Valve Extensions
Item Numbers 20075, 20085, 20105, 20145, 20185, 20215, 20315, 20415, 21000



Flexible but rigid enough to eliminate the need for a rim holder, clamp or stabilizer during inflation, saving time and money!
See page 56 for details.

Stow & Go[™]
4-Way HD Lug Wrench
Item Number 35636



Fixed 17, 19 and 21 mm lug nut sockets plus 1/2" square drive adapter.
See page 25 for details.

Torque Wrenches
Industrial & Two Piece Break Back Torque Wrenches
Item Numbers 30532, 30535



Made with durable materials, these wrenches feature precise torquing capabilities.
See page 26 for details.

Tire Sealants
Tire Management Solutions
Item Numbers 35851, 35852, 35861, 35862, 35870, 35871



Tire Sealants and Tire & Rim Conditioner work to improve tire performance and safety.
See page 75 for details.

Mega Air Blast
Bead Seating Tools, 5 & 10 gallon
Item Number 31443, 31445



Digital air pressure gauge and aluminum push button safety release valve included for operator convenience and safety.
See page 45 for details.

FEATURED PRODUCTS



Hybrid Air Hoses

Premium Reinforced

Item Numbers 26024, 26032, 26065, 26100



Whip Hose

¼" swivel male fitting one end, ¼" female fitting on the other.
See page 72 for details.

Advanced Hybrid Hose features the Strength of reinforced PVC with the superior flexibility of rubber!

See page 70 for details.



Air Boss®

Pneumatic Tools

Item Numbers 26400, 26401, 26402, 26403, 26404, 26405, 26406, 26407, 26408, 26409



The Air Boss line of pneumatic tools offer a unique and innovative design featuring ultra-comfortable ergonomics!

See page 71 for details.



HEAVY DUTY TRUCK TIRE INFLATION KIT

with Glad Hand and Dual Foot Air Chuck
Item Number 26050



A simple way to top off your tires utilizing your on-board compressor!

See page 72 for details.



Tire Inflators

Premium Digital Tire Inflators

Item Numbers 26012, 26081, 26082



Tire Inflators feature 3-in-1 capabilities: inflate, deflate and check tire pressure.

See page 73 for details.

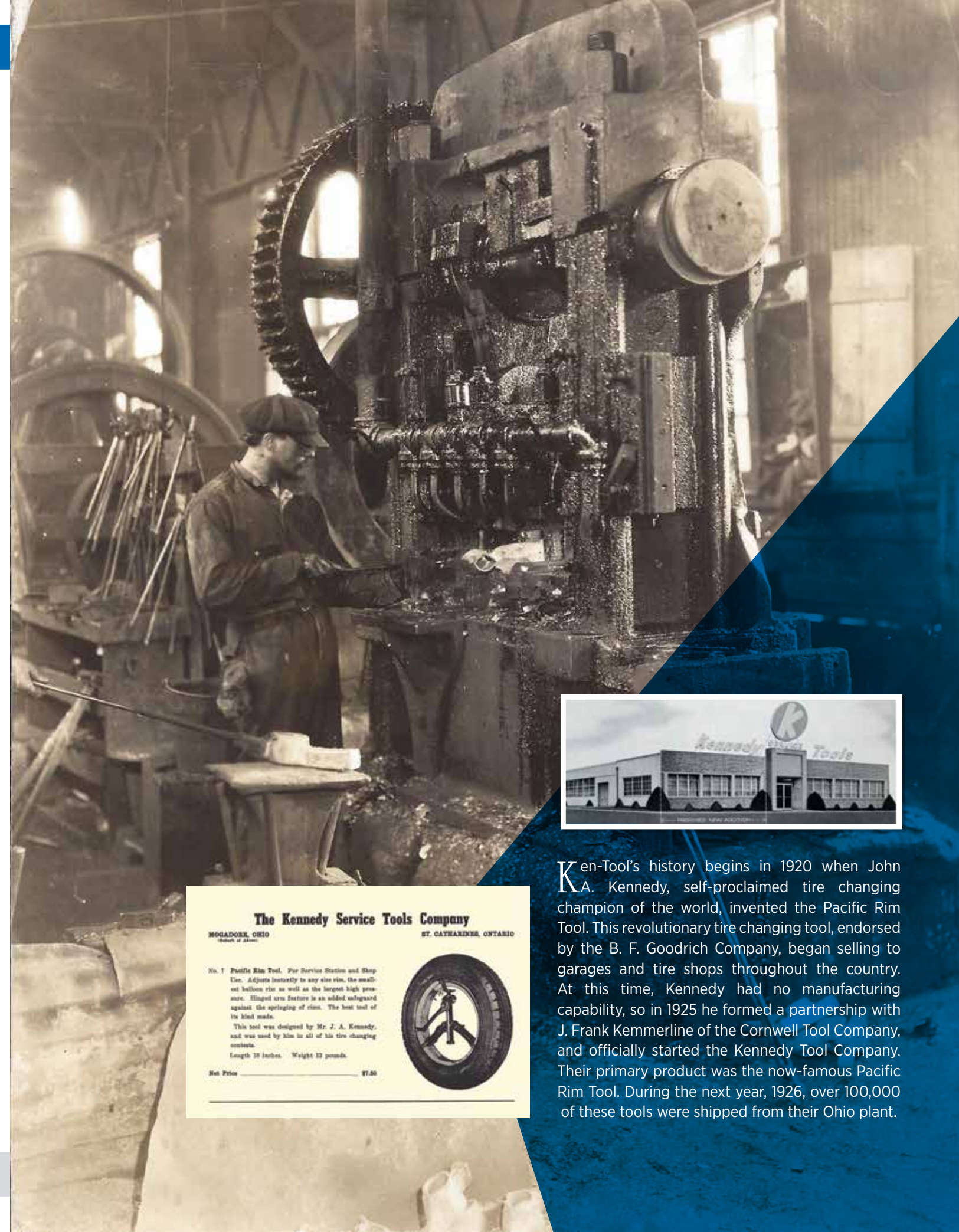

Ken-Tool's history begins in 1920 when John A. Kennedy, self-proclaimed tire changing champion of the world, invented the Pacific Rim Tool. This revolutionary tire changing tool, endorsed by the B. F. Goodrich Company, began selling to garages and tire shops throughout the country. At this time, Kennedy had no manufacturing capability, so in 1925 he formed a partnership with J. Frank Kemmerline of the Cornwell Tool Company, and officially started the Kennedy Tool Company. Their primary product was the now-famous Pacific Rim Tool. During the next year, 1926, over 100,000 of these tools were shipped from their Ohio plant.

01

TIRE IRONS (MOUNT/DEMOUNT)



BLUE COBRA® TRUCK TIRE DEMOUNT TOOL

Herramienta de desmontaje de neumáticos de camiones BLUE COBRA®
Outil de démontage de pneus de camion BLUE COBRA®

Quickly demount nearly any 22.5" and 24.5" tubeless truck tire, up to a 13" wide wheel. Allows demounting of the tire without lifting the entire wheel and tire off the ground — reduces back injuries. Imported.

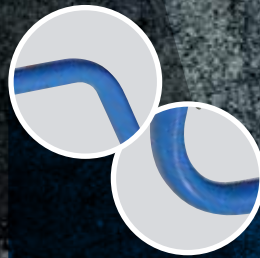

ERGONOMIC SHAPED STEEL HANDLE REDUCES BACK INJURIES



NO-SLIP GRIP FOR OPTIMUM LEVERAGE



ALUMINUM BEAD SUPPORT TO GRAB THE TOP BEAD OF SUPER SINGLE AND SUPER WIDE TIRES



SOLID STEEL COBRA HEAD IS PRESS-FIT INTO THE STEEL HANDLE — NO FASTENERS TO LOOSEN OR FALL OUT



2 HEAVY-DUTY NYLON ROLLERS ARE EASILY REPLACED WHEN WORN



BLUE COBRA® TRUCK TIRE DEMOUNT TOOL 35440

Weight: 22 lbs. (10 kg), Length: 54" (137 cm)

SPECIAL BONUS!

Ken-Tool's patented leather wheel protector No. 31810 included to help protect expensive alloy wheels!



BLUE COBRA® TRUCK TIRE SERVICE SETS

Juego de servicio de neumáticos de camiones BLUE COBRA®
Ensemble d'entretien de pneus de camion BLUE COBRA®

The Blue Cobra® Truck Tire Service Sets contain all the tools you need to change most 22.5" & 24.5" tubeless truck tires quickly and easily.



BLUE COBRA® TRUCK TIRE SERVICE SET 35442

Accessories Set Weight: 40 lbs. (18.2 kg)

Item No.	Description	QTY
35440	Blue Cobra® Truck Tire Demount Tool	1
34645C	T45AC Classic Tubeless Tire Iron	1
33052	Double-End Tire Spoon	1
35848	8 lb. Bucket White Tire Paste	1
30512	Euro-Style Lube Applicator Brush	1
31713	Aluminum C-Lok™ Bead Holder	2
31810	Leather Rim Protector	1

DELUXE BLUE COBRA® TRUCK TIRE SERVICE SET 35444

Accessories Set Weight: 57 lbs. (26 kg)

Item No.	Description	QTY
35440	Blue Cobra® Truck Tire Demount Tool	1
34645	T45A Tubeless Tire Iron - Our Best Selling Bar!	1
33052	Double-End Tire Spoon	1
35330	T11ES Bead Breaking Wedge w/Safety Handle	1
35323	T35 H.D. Tire Hammer	1
35848	8 lb. Bucket White Tire Paste	1
30512	Euro-Style Lube Applicator Brush	1
31713	Aluminum C-Lok™ Bead Holder	2
31810	Leather Rim Protector	1



NINETEEN-FIVE™ MOUNTING/DEMOUNTING TOOL 33199

Nineteen-Five™ bars are specially designed to work on the hub side to make your job easier, faster and safer! New tire bar uniquely designed to work on hubside of wheel — where hub protrudes above rim. Specially designed ends manipulate tire with less effort. Tools are powder coated to protect from rust and corrosion. Forged from 3/4" diameter high-grade carbon steel and heat-treated for long-lasting strength and durability.



BENT END
For mounting and demounting bottom bead



CURVED END
For mounting and demounting top bead

NINETEEN-FIVE™ TIRE MOUNTING & DEMOUNT TOOL SET FOR 19.5" TIRES 33195

Juego de herramientas de montaje y desmontaje de neumáticos de 19.5" Nineteen-Five™ 33195
Jeu d'outils de montage - démontage de pneus de 19,5 po Nineteen-Five™

19.5" tires must be mounted and demounted with the wheel's Hub Side Up because the Drop Center of the wheel is closer to the hub! This makes changing the 19.5" tires notoriously difficult because the hub gets in the way of conventional bars and spoons. 19.5" tires are also stiffer with high ply ratings and thick beads. Patented Bead Holder to hold bead on 19.5" aluminum wheels.

Accessories Set Weight: 9.35 Lbs (4.25 kg)

Item No.	Description	Length	Weight	QTY
33199	Tire Mounting/Demounting Tool	38" (97 cm)	7 lbs (3.2 kg)	2
33196	Patented Bead Holder for 19.5" Aluminum Wheels	7-1/2" (19 cm)	1 lb (.5 kg)	1
31710	Bead Holder for Steel Wheels - Solid Brass	4-1/2" (11.5 cm)	1 lb (.5 kg)	1
31810	Aluminum Wheel Protector - Leather	6" (15 cm)	.35 lbs (.15 kg)	1

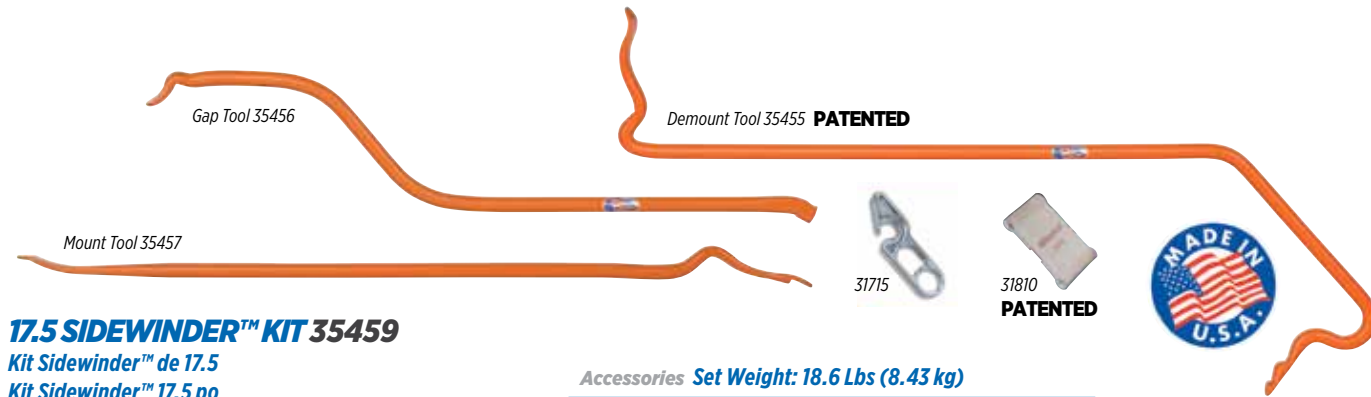

17.5 SIDEWINDER™ KIT 35459

Kit Sidewinder™ de 17.5
Kit Sidewinder™ 17,5 po

The first tire tools designed exclusively for 17.5" tires found on vehicle transporter moving vans and high volume trailers!

- Patent-Pending revolutionary SIDEWINDER™ demount bar demounts the tire from the wheel by pushing against the tire sidewall for leverage
- Unique Gap tool aids in demounting - makes mounting/demounting a 1-man job
- Innovative balanced aluminum bead holder specifically designed to stay in place when mounting the problematic bottom bead on 17.5"

Accessories Set Weight: 18.6 Lbs (8.43 kg)

Item No.	Description	Length	QTY
31715	17.5" Bead Holder	9" (23 cm)	1
31810	Leather Rim Protector	6" (15 cm)	1
35455	Demount Tool	38" (96 cm)	1
35456	Gap Tool	32" (81 cm)	1
35457	Mount Tool	38" (96 cm)	1

35459 set ships in 1 Box, weighing 18.6 lbs, UPS shippable.



TUBELESS TIRE IRONS & SETS

Juegos y barras para llantas sin cámara

Démonte-pneus individuels & en ensemble pour pneus sans chambre à air

Sets provide all irons necessary for a variety of tire changing applications. Use "C" bar with the "B" extension bar for easier use on large, wide-base truck tires. Use on standard and large truck tires, including industrial, farm, buses, and tractors.

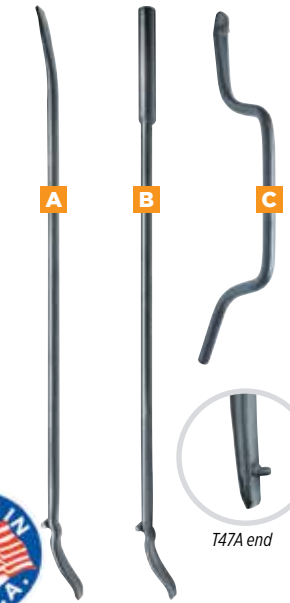

TUBELESS TRUCK TIRE MOUNT/DEMOUNT IRONS

Barras para montaje/desmontaje de llantas de camiones sin cámara
Démonte-pneu de montage/démontage pour pneus de camion sans chambre à air

Ken-Tool manufactures the largest and most diverse selection of tire mount/demount irons in the world. From the T45A® and T45AC™ Classic for standard truck tires, to the Serpent™ and Super Serpent™ Tire Changing Systems for wide-base Super Singles, Ken-Tool makes a tire iron for all your tire changing needs. Use on truck, agricultural, and industrial tires. One-piece manufacturing process and design assures long life and superior performance. Heat-treated for strength. Use in pairs. T45A® is a registered trademark of Ken-Tool.



Mount



Demount



STANDARD TIRE IRON SET 34746 T46

Estándar | Standard

T46 Accessories Set Weight: 12 Lbs (5.4 kg)

Model	Item No.	Description	Length	Stock	Weight
A	T46A	Straight Mount/Demount Tool	36" 91 cm	3/4" 19 mm	4.5 lbs 2 kg
B	T46B	Straight Mount/Demount Tool "B" Extension for T46C	36" 91 cm	3/4" 19 mm	4.5 lbs 2 kg
C	T46C	Offset Mount "C" Bar	22" 56 cm	3/4" 19 mm	3 lbs 1.4 kg

HEAVY DUTY TIRE IRON SET 34846 T47

De alta resistencia | Robuste

T47 Accessories Set Weight: 29 Lbs (13.1 kg)

Model	Item No.	Description	Length	Stock	Weight
A	T47A	Straight Mount/Demount Tool	52" 132 cm	1" 25 mm	11 lbs 5 kg
B	T47B	Straight Mount/Demount Tool "B" Extension for T47C	49-1/2" 126 cm	1" 25 mm	11 lbs 5 kg
C	T47C	Offset Mount "C" Bar	27" 69 cm	1" 25 mm	6.6 lbs 3 kg



Ken-Tool® brings back an old favorite - T45AC Classic™
Ken-Tool's patented designs offer one-piece construction, and assure long life for many tire-changing applications. Tip ends insert easily and will not cut or rip bead or sidewall. These designs make it easier to mount and demount tires without changing the way the tool is used.

Model	Item No.	Length	Stock	Weight
D	T45A®	37" (94 cm)	3/4" (19 mm)	4.6 lbs (2.1 kg)
E	T45AC™	37" (94 cm)	3/4" (19 mm)	4.6 lbs (2.1 kg)
	T45AS	52" (132 cm)	7/8" (22mm)	9 lbs (4.1 kg)
	T45HD	41" (104 cm)	7/8" (22 mm)	7 lbs (3.2 kg)
	T47A	52" (132 cm)	1" (25 mm)	11 lbs (5 kg)



Demount end: Precision-forged angled tip slides between bead and rim easily. Forged design won't slip when demounting the second bead.

Mount end: Precision forged knob grips rim. New design won't slip during tire mounting. Special curve design always grabs the bead edge.

TUBELESS TIRE IRON 34644 T45A-2000K™ STYLE
Barra de hierro para montaje/desmontaje de neumáticos sin cámara estilo T45A-2000K™
Démonte-pneu pour pneus sans chambre à air T45A-2000K™

Length 37" (94 cm) | Stock 3/4" (19 mm) | Weight 5 lbs (2.2 kg)

Design allows for less effort, provides excellent wheel/rim surface contact area for less side to side movement. Improved blade and knob design. Tip on one end for 'grabbing' the rim.

Serpent™ MOUNT & DEMOUNT TIRE IRONS

Take the struggle out of mounting and demounting truck tires...everything you need to change larger tires easily and effortlessly.

SERPENT™ DEMOUNT TOOL 35449 T2001

Herramienta de desmontaje
Outil de démontage

Length: 39" (99 cm) | Stock: 3/4" (19 mm) | Weight: 6.5 lbs (3 kg)

Makes demounting easier than ever. Demounts both beads on most larger truck tires without the need for lifting the tire/wheel assembly off the ground, and then dropping it. Made of heat-treated alloy steel for maximum durability and strength.



Use this end to demount first bead, opposite end to demount second bead.



SERPENT™ MOUNT TOOL 35450 T2002

Herramienta para montar
Outil d'assemblage

Length: 38" (96 cm) | Stock: 11/16" (17.5 mm) | Weight: 4 lbs (1.8 kg)

Makes mounting easier than ever. Designed to stop against the rim, and then remove itself effortlessly from between the rim and bead. The small end of the tool easily gets under the stretched bead for that last pull.



SERPENT™ 4 PC. TIRE CHANGING SET 35453

Juego de 4 piezas para cambiar llantas
Ensemble 4 pièces de changement de pneu

Accessories Set Weight: 12 Lbs (5.4 kg)

Model	Item No.	Description	QTY
T2001	35449	Serpent Demount Tool	1
T2002	35450	Serpent Mount Tool	1
	31710	Brass Bead Holding Device	1
	31810	Aluminum Wheel Protector	1

Demount Tool T2001 - 35449

PATENTED

Mount Tool T2002 - 35450



Wheel Protector 31810



Bead Holding Device 31710 Imported.

SUPER SERPENT MOUNT & DEMOUNT TIRE IRONS

Finally - tools specially designed to handle big, big tires that actually work!
Now, mounting and demounting the biggest, heaviest truck tire is made easy.

SUPER SERPENT™ MOUNT TOOL 35447 T2005

Herramienta para montar
Outil d'assemblage

Length: 37" (94 cm) | Stock: 3/4" (19 mm) | Weight: 6.6 lbs (3 kg)

This mount tool for super singles weighs about 6½ pounds and seems "funny-looking," but every inch of this innovative design is purely serious. It makes interference of the second bead, while mounting the first a thing of the past, and delivers twice the leverage of any "straight-type" tire mounting tool. It even has the small end that easily gets under the bead for that "last pull."



SUPER SERPENT™ DEMOUNT TOOL 35448 T2006

Herramienta de desmontaje
Outil de démontage

Length: 37" (94 cm) | Stock: 3/4" (19 mm) | Weight: 5.5 lbs (2.5 kg)

Weighing in at only 5½ pounds, this unique, lightweight demount tool for super singles can be lugged around on a fingertip, yet delivers the incredible leverage right where it's needed to easily pop those heavyweights right off their wheels.



PATENTED



Demount Tool T2006 - 35448



Bead Holding Device 31710 Imported.

Mount Tool T2005 - 35447

SUPER SERPENT™ 5 PC. TIRE CHANGING SET 35446

Juego de 5 piezas para cambiar llantas
Ensemble 5 pièces de changement de pneu

Accessories Set Weight: 19 Lbs (8.6 kg)

Model	Item No.	Description	QTY
T2005	35447	Super Serpent Mount Tool	1
T2006	35448	Super Serpent Demount Tool	1
	31710	Brass Bead Holding Device	2
	31810	Aluminum Wheel Protector	1

TIRE MOUNT/DEMOUNT SPOONS

Espátula para montaje/desmontaje de llantas
Cuillères de montage/démontage de pneus

These tools are designed for fast and efficient tire changing. Use the 18" and 24" spoons to mount or demount passenger car, motorcycle, ATV, and light truck tires. The 30" spoons provide enough strength and leverage to work on large truck, bus, off-road vehicle, tractor, and aircraft tires.

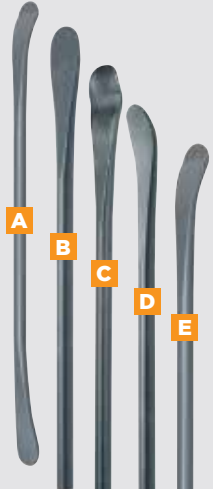

Model	Item No.	Length	Stock	Weight
-------	----------	--------	-------	--------

A 33052 30" (76cm)

Straight (Recta / Droite)

B T1X	32101	18" (46 cm)	11/16" (17.5 mm)	1.8 lbs (.8 kg)
T19	32119	24" (61 cm)	11/16" (17.5 mm)	2.5 lbs (1.1 kg)
T19A	33219	30" (76 cm)	11/16" (17.5 mm)	3 lbs (1.4 kg)
T19M	33022	30" (76 cm)	3/4" (19 mm)	3.4 lbs (1.54 kg)
T38	33238	30" (76 cm)	7/8" (22 mm)	4.8 lbs (2.2 kg)

Drop-Center (Combinación con base con caída / Base creuse)

C T21R	32121	18" (46 cm)	11/16" (17.5 mm)	1.8 lbs (.8 kg)
T21F	34121	24" (61 cm)	11/16" (17.5 mm)	2.5 lbs (1.1 kg)
T21A	33020	30" (76 cm)	11/16" (17.5 mm)	3.1 lbs (1.4 kg)
T21M	33024	30" (76 cm)	3/4" (19 mm)	3.4 lbs (1.54 kg)
T21HD	34122	30" (76 cm)	7/8" (22 mm)	4.5 lbs (2.0 kg)

Curved (Curva / Courbe)

D T2X	32102	18" (46 cm)	11/16" (17.5 mm)	1.8 lbs (.8 kg)
T20	32120	24" (61 cm)	11/16" (17.5 mm)	2.4 lbs (1.1 kg)
T20A	33220	30" (76 cm)	11/16" (17.5 mm)	3.1 lbs (1.4 kg)
T20M	33023	30" (76 cm)	3/4" (19 mm)	3.4 lbs (1.54 kg)
T39	33239	30" (76 cm)	7/8" (22 mm)	4.5 lbs (2.0 kg)

Curved with Flat (Curva con punta plana / Courbe avec embout plat)

E T22R	31820	18" (46 cm)	11/16" (17.5 mm)	1.8 lbs (.8 kg)
T22F	32420	24" (61 cm)	11/16" (17.5 mm)	2.5 lbs (1.1 kg)
T22A	33021	30" (76 cm)	11/16" (17.5 mm)	3.1 lbs (1.4 kg)
T22M	33025	30" (76 cm)	3/4" (19 mm)	3.4 lbs (1.54 kg)
T22HD	33026	30" (76 cm)	7/8" (22 mm)	3.4 lbs (1.54 kg)

SMALL TIRE MOUNT/DEMOUNT IRONS

Barras para montaje/desmontaje de llantas pequeñas
Leviers de montage/démontage de petits pneus

New designs are based on popular European styles. Extended length of the flat curved sliding surface provides mounting ability comparable to much longer traditional tire irons. Sizes available for motorcycle, passenger, truck, and heavy-duty tires. Designed for mounting and demounting tires. Best if used in pairs.



MOTORCYCLE/SMALL WHEEL 39805 T43A

Ruedas pequeñas/de motocicleta | Motocycllette/Petites roues

Length: 15" (38 cm) Stock: 3/4" (19 mm) Weight: 1.8 lbs (.8 kg)



MOUNT/DEMOUNT TIRE TOOLS - SMALL TIRE 32106 T6A

Herramientas para montaje y desmontaje de llantas - Llantas pequeñas

Outils de montage/démontage de pneus - Petits pneus

Length: 16-1/2" (42 cm) Stock: 5/8" (16 mm) Weight: 1.5 lbs (.7 kg)



TIRE IRONS - SMALL TIRE

Barras para llantas - Llantas pequeñas
Démonte-pneus - Petits pneus

Pro tire changing tools for small tires. Ideal for mounting and demounting motorcycle, ATV, lawn tractor, golf cart, and small tires by hand. Rounded ends will not pinch tube.



Model	Item No.	Length	Stock	Weight
-------	----------	--------	-------	--------

E T9A	32109	9" (23 cm)	7/16" (11 mm)	.4 lbs (.16 kg)
F T16A	32116	16" (41 cm)	7/16" (11 mm)	.7 lbs (.3 kg)
T9C	32110	2 pc. Carded Set - Contains: Qty. (2) T9A 9" Bars		
T16C	32117	2 pc. Carded Set - Contains: Qty. (2) T16A 16" Bars		
G T5*	32115	16" (41 cm)	7/16" (11 mm)	.8 lbs (.36 kg)
H T8*	32118	16" (41 cm)	7/16" (11 mm)	.8 lbs (.36 kg)
	32114	2 Pc. Small Tire Iron Set Contains: Qty. (1) T5 (32115), Qty. (1) T8 (32118)		1.6 lbs (.7 kg)

*Sturdy, comfortable plastic handles.

TIRE SNAKE®

'Snake' para llantas
'Snake' Outil à pneu Snake



Model	Item No.	Length	Stock	Weight
-------	----------	--------	-------	--------

TS72	34672	22" (56 cm)	5/8" (2 cm)	2 lbs (.9 kg)
TS74	34674	28" (71 cm)	5/8" (2 cm)	2.5 lbs (1.1 kg)
TS42	34678	42" (102 cm)	3/4" (19 mm)	5.3 lbs (2.4 kg)

Tire Snake mounting and demounting tools for use with center post tire changers. Included with T600 Tire Changer, designed for wheels from 4" to 12". Included with T601 Tire Changer, designed for wheels from 4" to 15", the longer length provides greater leverage. **PATENTED.**

IRONMAN™ ERGONOMIC WHEEL LIFTING BAR 34950 T950

Barra ergonómica para el levantamiento de neumáticos Ironman™
Barre ergonomique de levée de roue Ironman™

Length: 58" (147 cm) Stock: 1" (25 mm) Weight: 10 lbs (4.5 kg)



Reduces back strain. Easily and safely lift heavy, awkward truck tire and wheel assemblies. Extremely useful in outdoor conditions - when truck tire and wheel assemblies can become wet and slippery. Lift all sizes and types of small and large heavy truck wheels: Standard sizes including 22.5" and 24.5" wheels, plus European (which have 1" lug holes), Super Wide and even the Super Single (can weigh over 400 lbs.) size. IronMan can pick them up!



Specially designed forged knob end for hub side up



Specially designed spoon end for hub side down

DON'T RISK INJURY

ERGONOMIC: Use the leverage created by the tool - NOT YOUR BACK! Specially designed forged ends work from either side of the wheel assembly as it lays flat.



EUROPEAN STYLE TOOLS

Herramientas de estilo europeo
Outils de style européen



Use on car, motorcycle, truck, and agricultural tires. Designed for mounting and demounting tires. Best if used in pairs.

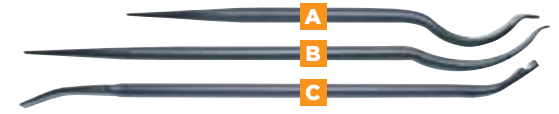

Model	Item No.	Length	Stock	Weight
-------	----------	--------	-------	--------

A T43C	39806	21" (53 cm)	7/8" (22 mm)	3.1 lbs (1.4 kg)
B T43D	39810	30" (76 cm)	7/8" (22 mm)	4.5 lbs (2.0 kg)
C T44	39808	31" (79 cm)	7/8" (22 mm)	5.3 lbs (2.4 kg)



T44 illustration

Ken-Tool No.	T43A	T43C	T43D	T44	T41
--------------	------	------	------	-----	-----

CPM	Livraison Ref. 1547	Face 68 Ref.426/68	Force Ref. 1289	Halte Ref. 1060	Sayam Ref. 858
-----	---------------------	--------------------	-----------------	-----------------	----------------

MANUAL TIRE CHANGERS

Cambiadores de llantas manuales | Démonteurs de pneus manuels



T601 FLOOR MOUNT 38601

Montaje de piso | Montage au sol

Height: 32" (81 cm) Weight: 31 lbs (14 kg)

Mounts and demounts a full range of tires on rim diameters from 4 to 15 inches. Tapered bearing guide positively centers straight shaft hubs of all diameters. A built-in, infinitely adjustable bead breaker works on rims up to 15" in diameter and 24" in width without disassembly. Includes a Ken-Tool exclusive, 28" Tire Snake® mount/demount tire tool.



Threadscrew has been milled to fit MTD wheels.

T600 BENCH/RIM CLAMP MOUNT 38600

Montaje de banco/abrazadera de llantas | Montage sur banc/crapaud

Height: 16-1/2" (42 cm) Weight: 21.7 lbs (10 kg)

Mounts and demounts a full range of tires on rim diameters from 4 to 12 inches. Mounts easily to a bench or in any standard, four-position rim-clamp tire changer. A built-in, three fin centering device mounts standard lug-type rims with 2" and larger center hole. Square base prevents turning in the changer during use. Includes a Ken-Tool exclusive, 22" Tire Snake® mount/demount tire tool.

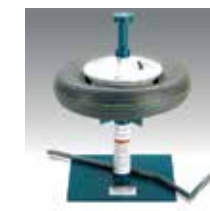

Threadscrew has been milled to fit MTD wheels.

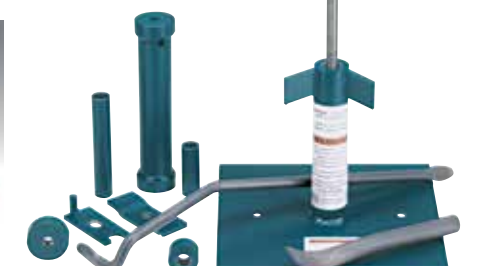



INDUSTRIAL WHEEL LOCK RING SET 32129

*Juego de anillos de traba para ruedas industriales
Jeu d'anneaux verrouilleurs de roues industrielles*

Weight: 3.3 Lbs (1.5 kg).

Specially designed to remove & replace lock rings on multi-piece industrial forklift wheels. Removing and replacing lock rings on multi-piece industrial wheels presents its own set of unique problems – these tools are specifically designed to make that job easier, faster, and safer. Helps prevent injury – easier to keep hands safely outside of press cage! Powder coated to protect from rust and corrosion; bright orange color helps prevent lost tools. Forged from high-grade carbon steel and heat-treated for long-lasting strength and durability. **PATENTED.**

Item No.	Description	Length	Stock	Weight
A 32130	Mount Demount Tool	15-3/4" (40 cm)	5/8" (16 mm)	1.8 lbs (.8 kg)
B 32131	Demount Prep Tool	15-1/2" (40 cm)	5/8" (16 mm)	1.5 lbs (.7 kg)

Separator end separates split ring from solid flange ring

Pry-out end reaches behind slotted end of split ring to pry it out and over the flange of the wheel

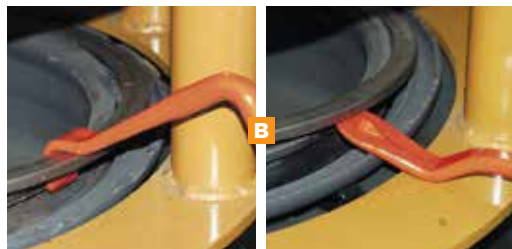
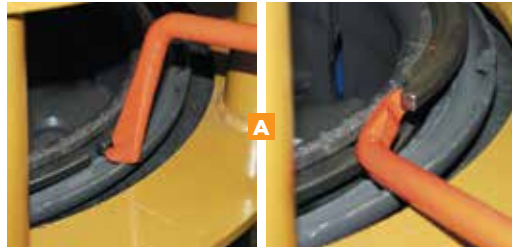

Mount end is used to mount split ring

Demount end lifts and fully demounts split ring



LOCK RING TOOLS

*Herramientas para anillos de seguridad
Outils pour anneau verrouilleur*

These tools are designed to remove most truck lock rings. A must-have for anyone mounting or demounting multi-piece rims. Use in pairs.

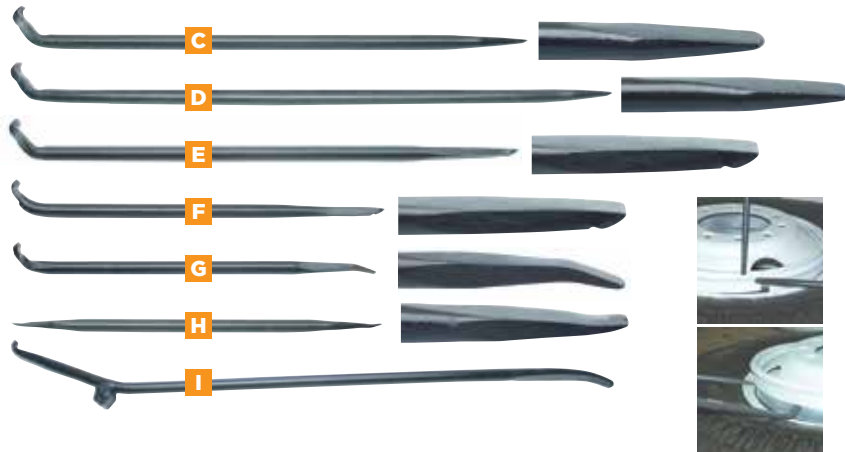

C TRUCK LOCK RING REMOVER 32123 T23®

*Desmontador para anillos de seguridad para camiones
Dégageur d'anneau verrouilleur pour camions*
Length: 24" (61 cm) Stock: 11/16" (17.5 mm) Weight: 2.4 lbs (1 kg)

Designed for smaller diameter wheels.

D TRUCK LOCK RING REMOVER 33223 T23A®

*Desmontador para anillos de seguridad para camiones
Dégageur d'anneau verrouilleur pour camions*
Length: 30" (76 cm) Stock: 11/16" (17.5 mm) Weight: 3.1 lbs (1.4 kg)

Designed for smaller diameter wheels.

E COMBINATION RIM/RING TOOL 33224 T23B

*Herramienta para combinación de llantas/anillos
Deux en un pour jante/anneau*
Length: 23-1/2" (60 cm) Stock: 11/16" (17.5 mm) Weight: 2.4 lbs (1 kg)

Flat tapered end ideal for all around ring and rim work.

F RIM LOCK TOOL 32125 T25

*Herramienta para anillos de seguridad de llantas
Bloque-talons*
Length: 18" (46 cm) Stock: 11/16" (17.5 mm) Weight: 1.8 lbs (.8 kg)

For servicing wide base rims.

G SPECIAL LOCK RING TOOL 32127 T27

*Herramienta para anillos de seguridad especiales
Outil spécial pour anneau verrouilleur*
Length: 18" (46 cm) Stock: 11/16" (17.5 mm) Weight: 1.8 lbs (.8 kg)

Long tapered curved end for continuous side rings.

H LOCK RING TOOL 32128 T27A

*Herramienta para anillos de seguridad
Outil pour anneau verrouilleur*
Length: 18" (46 cm) Stock: 11/16" (17.5 mm) Weight: 1.8 lbs (.8 kg)

Removes continuous side rings on two-piece truck rims.

I HEAVY-DUTY LOCK RING TOOL 34648 T48A

*Herramienta para anillos de seguridad de alta resistencia
Outil robuste pour anneau verrouilleur*
Length: 37" (94 cm) Stock: 3/4" (19 mm) Weight: 4.6 lbs (2.1 kg)



Use for multi-piece wheels, especially hub type.

TIRE MOUNT / DEMOUNT LUBRICANTS

*Lubricantes para montaje/desmontaje de neumáticos
Lubrifiants de montage & démontage de pneus*

Professional grade lubricants make tire mounting and demounting easier and more efficient.



BEAD-EZE® TIRE LUBRICANT 6 PK. 35847 T147A

*Lubricante para neumáticos Bead-Eze®
Lubrifiant de pneu Bead-Eze®*

Penetrating water-based lubricant for tire mounting/demounting, can be diluted for leak detection, six-pack.
54 lbs (24.5 kg)



BEAD-EZE® TIRE LUBRICANT 1 GAL. 35847S T147A

*Lubricante para neumáticos Bead-Eze®
Lubrifiant de pneu Bead-Eze®*

Penetrating water-based lubricant for tire mounting/demounting, can be diluted for leak detection.
9 lb. (4.1 kg)



DETECTO MIST LEAK LOCATOR 35805 D105A

*Localizador de fugas Detecto Mist
Localisateur de fuites Detecto Mist*

Spray on tire to instantly detect air leaks, concentrated formula dilutes with water.
One Quart 2.3 lb. (1 kg)



TIGER PASTE LUBRICANT 35837 35839

*Lubricante Tiger Paste
Lubrifiant Tiger Paste*
Superior formulation for use in mounting and demounting commercial, OTR and specialty equipment tires, with rust inhibitor.
7.5 lb. (3.4 kg)



ULTRA LUBE 35839

*Lubricante Ultra Lube
Lubrifiant Ultra Lube*
Premium rim and rust retardant and tire mounting/demounting lubricant for demanding applications.
25 lb. (11.4 kg)



WHITE TIRE PASTE 35848

*Lubricante Blanco Paste Lube
Lubrifiant Blanc Paste Lube*
Premium tire mounting/demounting lubricant dries tacky to prevent rim slippage, with rust retardant.
8 lb. (3.6 kg)



HEAVY PASTE LUBE 35840

*Lubricante Denso Paste Lube
Lubrifiant Dense Paste Lube*
Concentrated economical tire mounting/demounting and bead packing lubricant, makes up to 15 gallons.
25 lb. (11.4 kg)

LUBRICANT APPLICATORS

*Aplicadores de lubricantes
Applicateurs de lubrifiant*



BEAD LUBRICANT SWAB 30511 B11I

*Estropajo para lubricante de talones
Écouvillon pour lubrifiant de talon*
Durable cotton applicator quickly holds and applies lube, twisted wire construction and wood handle.
Length: 12" (30.5 cm) Weight: 3 oz (.1 kg)



EURO STYLE LUBE BRUSH 30512

*Pincel para lubricante estilo europeo
Brosse de lubrification style européen*
Designed to the ideal angle to fit between the tire bead and rim. Imported.
Length: 11" (28 cm) Weight: 10 oz (.3 kg)



TIRE SPREADERS

*Separadores de llantas
Écarte-pneus*



TIRE SPREADER WITH LOCK PIN 31551 T51

*Separador de llanta con pasador de bloqueo
Écarte-pneu avec goupille de sécurité*
Spread Capacity: 4"-6" (10-15 cm) Weight: 3.9 lbs (1.7 kg) Imported.



RATCHET ACTION TRUCK TIRE SPREADER 31554 T54

*Separador de llantas para camiones Ratchet Action
Écarte-pneu à rochet pour camions*

Spread Capacity: 3-1/2" - 14" (9 - 36 cm) Weight: 7.3 lbs (3.3 kg)



02

WRENCH PRODUCTS

8-IN-ONE WRENCH

Eight of the most popular wrench sizes in one strong, professional, compact and convenient tool! Exceptional "Must Have" convenience tool for multiple markets including automotive, maintenance, farm equipment, DIY, home projects, sporting/recreational, all engine repair, electrical, plumbing, HVAC, bikes, motorcycles, furniture assembly. Meets 150% ANSI specifications. Wrench engagement requires minimal clearance around the fastener. Limited Lifetime Warranty. **PATENTED.**



SOLD IN A CONVENIENT 6 PIECE MERCHANDISING DISPLAY, 5" W X 6" D X 8" H



"12 POINT" DESIGN REQUIRES ONLY 30 DEGREE SWING ARC RE-ENGAGEMENT

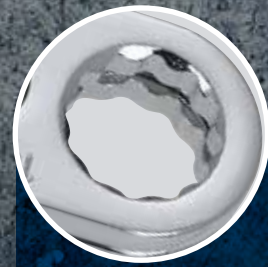

ALLOWS LONG THREADED STUDS AND FASTENERS TO PASS THROUGH



METRIC 8-IN-1 WRENCH 35776

Weight: .55 lbs (.25 kg)

Easy carry / store 7-1/2" profile.
Sizes: 10mm, 11mm, 12mm, 13mm, 14mm, 15mm, 16mm, 17mm

SAE 8-IN-1 WRENCH 35775

Weight: .55 lbs (.25 kg)

Easy carry / store 7-1/2" profile.
Sizes: 5/16", 3/8", 7/16", 1/2", 9/16", 5/8", 11/16", 3/4"

02 WRENCH PRODUCTS

WRENCH SUPPORT STAND 32610

Base de soporte para llave
Support de soutien pour clé

Weight: 5.5 lbs (2.5 kg)

Commercial-duty stand used to support a double-end truck wrench, a 4-way lug wrench, or a torque wrench, when removing or replacing lug nuts. Adjusts from 14-1/2" to 22-1/2" high. Rated to 300 pounds.



DOUBLE-END TRUCK WRENCHES

Llaves dobles para camiones
Clés à double tête pour camions

Use on trucks, buses, farm, and off-road vehicles. Great for on-the-road service. Sizes available for all SAE and metric lug nuts. All wrenches are forged from 1" alloy steel for long lasting strength. Length: 16" (41 cm). Use TR5 truck wrench handle.



Model	Item No.	Socket Sizes	Weight
SAE (SOCIEDAD DE INGENIEROS AUTOMOTRICES [SAE])			
TR1	32501	1-1/8" with 13/16" Sq. x 1-1/2"	4.6 lbs (2 kg)
TR2	32502	1" with 5/8" Sq. x 1-1/4"	4.3 lbs (1.9 kg)
TR3	32503	7/8" x 1-1/16"	4.5 lbs (2 kg)
TR3A	32505	1-1/16" x 1-1/8"	4.5 lbs (2 kg)
TR3X*	32506	1-3/16" x 1-1/16" 1-3/4" Stud Depth	4.6 lbs (2 kg)
TR98	32508	1-1/2" x 13/16" Sq.	4.5 lbs (2 kg)
TR9	32509	1-1/4" x 1-1/16"	4.4 lbs (2 kg)

Caterpillar and Bobcat equipment, and hub piloted wheels:

TR2A	32512	1" with 5/8" sq x 1-3/16"	4.5 lbs (2.0 kg)
------	-------	---------------------------	------------------

METRIC (MÉTRICO • MÉTRIQUE)

TRM2	32552	24 mm x 33 mm	4.4 lbs (2 kg)
TRM3*	32553	27 mm x 30 mm 1-3/4" Stud Depth	4.6 lbs (2 kg)
TRM6	32556	21 mm sq. x 41 mm	4.5 lbs (2 kg)
TRM7*	32557	30 mm x 33 mm 1-3/4" Stud Depth	4.6 lbs (2 kg)

Metric inner and outer Budd nuts, and hub piloted wheels.

TRM6A	32559	33 mm with 21 mm sq x 41 mm	4.5 lbs (2 kg)
-------	-------	-----------------------------	----------------

*Updated with longer stud clearance - 1-3/4" stud depth

SAE / METRIC

SAE inner and outer Budd nuts, and hub piloted wheels.

TR99	32519	33 mm with 13/16" sq x 1-1/2"	4.5 lbs (2 kg)
------	-------	-------------------------------	----------------

HEAVY-DUTY TRUCK WRENCH 34401 TR10

Llaves para camiones de alta resistencia
Clé robuste pour camions

Length: 29-1/2" (75 cm) Socket Size: 1-3/4" Hex & 15/16" sq.

Use for off-the-road Budd-type wheels. Use TR11 handle. Long length provides extra leverage. Stock: 1-1/4" (3.1 cm)

TRUCK WRENCH HANDLE

Mango de llave para camiones
Manche de clé pour camions

Heat-treated for strength and durability. Fits all Ken-Tool Double-end truck wrenches

Model	Item No.	Length	Stock	Weight
TR5	32318	22" (56 cm)	3/4" Hex	3 lbs (1.4 kg)
TR11	34402	30" (76 cm)	1" Round	6.7 lbs (3 kg)
TR5A	32319	30" (76 cm)	3/4" Hex	4 lbs (1.8 kg)

EXTRA LEVERAGE 1-1/2" LUG NUT WRENCH 34420

Llave de tuercas de rueda de 1-1/2" con mayor palanca
Clé pour écrou de roue de 1,5 po à effet de levier supplémentaire

Length	Socket Size	Weight
25.5" (64.7 cm)	1.5" Hex (3.8 cm)	14 lbs (6.4 kg)
44" Extended (111.7 cm)	1.24" Depth (3.1 cm)	

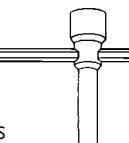

Break loose stubborn nuts. CAUTION: Not for tightening! Original Military Version. Provides up to 700 ft-lbs of torque!



FEATURED PRODUCT



HEXCHEX® MULTI-SIZE LOOSE WHEEL NUT INDICATORS

Indicadores de tuercas de ruedas sueltas de varios tamaños
Indicateurs d'écrou de roue desserrés multi-tailles

Cover 31 lug nut sizes from 3/4" (19 mm) to 2" (50 mm) and fit 6-, 8- and 10-sided lug nuts. Installs over a lug nut without tools – fastening securely with a ratcheting closure. Made from a durable, reusable bright yellow polymer, each HexChex has a clocking pointer to alert a driver when a lug nut is beginning to loosen. The Ken-Tool HexChex indicators will not melt under heavy braking unless a hub overheats, alerting the driver to hub problems. A melted HexChex is easily removed without damage.

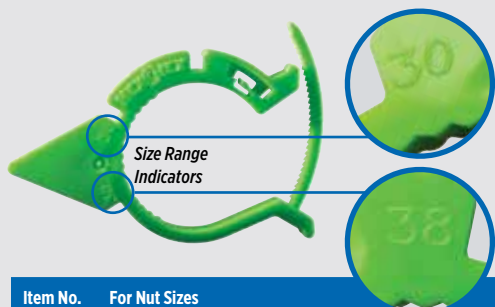

Item No.	For Nut Sizes
A 30601	SAE: 3/4" to 1", Metric: 19mm – 23mm
B 30602	SAE: 1" to 1-3/16", Metric: 23mm – 30mm
C 30603	SAE: 1-3/16" to 1-1/2", Metric: 30mm – 38mm
D 30603R	SAE: 1-3/16" to 1-1/2", Metric: 30mm – 38mm
E 30603G	SAE: 1-3/16" to 1-1/2", Metric: 30mm – 38mm
F 30603B	SAE: 1-3/16" to 1-1/2", Metric: 30mm – 38mm
G 30604	SAE: 1-1/2" to 2", Metric: 38mm – 50mm

CAP NUT WRENCHES

Llaves de tuercas ciegas
Clés à écrou borgne



KEN-TOOL PORKCHOP™

Wrench holds outer cap nut on dual wheels while the inner nut is turned. Lip fits in hole to secure wrench in place. Sizes offered fit standard and metric cap nuts.

Model	Item No.	Description	Size	Weight
TX9®	30609	SAE	1-1/2"	.7 lbs (.3 kg)
TX10	30610	Metric	35 mm	.7 lbs (.3 kg)
TX12	30612	Metric	41 mm	.7 lbs (.3 kg)



COMBINATION CAP NUT WRENCH 30620 TX50

Llave de tuercas ciegas de combinación | Clé à écrou borgne deux en un

SAE & Metric, Size: 1-1/2" (41 mm) Weight: 1.3 lbs (.6 kg)

Offers the versatility of two wrenches in one unique product design. Fit one end onto the outer cap nut with the other end through the center hole. Wrench slides underneath center disc of wheel, reducing slipping during nut removal.



HEAVY-DUTY CAP NUT WRENCHES

Llaves de tuercas ciegas de alta resistencia | Clés robustes à écrou borgne

Heavy-duty design will not slip out of position. Wrench rests snugly against the center hole, reducing the possibility of rim damage. Ideal for aluminum wheels. **PATENTED.**

Model	Item No.	Description	Size	Weight
TX200	30618	SAE	1-1/2"	2.6 lbs (1.2 kg)
TX241	30619	Metric	41 mm	2.6 lbs (1.2 kg)

POWER WRENCH

Llave eléctrica
Clé à chocs



Designed for dual nut systems. Has 13/16" sq. end to hold inner nut, with a 1-1/2" hex drive to spin outer nut off. Also adaptable to remove any nut size with a TR55 adapter. 3-to-1 ratio provides mechanical power advantage necessary to remove any stubborn nut found on trucks, farm vehicles, buses, aircraft, and RV's. Tremendous power allows one man operation. Heat-treated portable components for extra strength. All sockets are 3/4" drive.



BASIC POWER WRENCH SET

34543 TR43

Juego de llaves eléctricas básicas
Jeu de clés à chocs de base

Accessories Set Weight: 19 lbs. (8.6 kg)

Model	Item No.	Description
A		Power Drive
B TR45	34543-02	20-1/2" (52 cm) Bar Handle
TR46	34543-03	20" (51 cm) Tube Handle

BUDD-WHEEL POWER WRENCH SET 34545 TR44X

Juego de llaves eléctricas para ruedas tipo Budd
Jeu de clés à chocs pour roues à disque

Accessories Set Weight: 20 lbs. (9.1 kg)

Model	Item No.	Description
A		Power Drive
B TR45	34543-02	20-1/2" (52 cm) Bar Handle
C TR52	34543-15	13/16" Sq. Adapter
D TR53	34543-16	36" (91 cm) Tube Handle
E TR55	34543-17	3/4" Service Adapter

The 3/4" service adapter allows you to use any 3/4" drive socket. Drive end is 1-1/2" hex. 13/16" square adapter for inner nut.

UNIVERSAL POWER WRENCH SET 34547 TR44SW

Juego de llaves eléctricas universales
Jeu de clés à chocs universelles

Accessories Set Weight: 29 lbs. (13.2 kg)

Model	Item No.	Description
A		Power Drive
B TR45	34543-02	20-1/2" (52 cm) Bar Handle
C TR52	34543-15	13/16" Sq. Adapter
D TR53	34543-16	36" (91 cm) Tube Handle
E TR55	34543-17	3/4" Service Adapter

Impact Sockets:

S20	30128	7/8" S24 (30136) 1-1/8"
S21	30130	15/16" S25 (30138) 1-3/16"
S23	30134	1-1/16" S33 (30133) 33 mm

FEATURED PRODUCT



PILOT SLEEVE™ 30631

Mangas de centrado de poliamida
Manchons de centrage de roue en polyamide

Polyamide Wheel Centering Sleeves. Over time, the pilots on the hub can lose tolerances originally intended from the factory, allowing an offset between the wheel and the hub bearing.

Polyamide Wheel Centering Sleeves take up the gap between the 22mm stud and the 26mm wheel opening, realigning the wheel to the TRUE CENTER of the hub bearing.

Item No.	Description
30631	6 pc. Pack
30632	100 pc. Bucket
30633	1,000 pc. Bucket
30630	Zip Tool (REQUIRED for installation of Pilot Sleeves on INSIDE DUAL WHEELS)



CHROME LUG NUT COVER REMOVER 30606

Desmontador profesional de cubierta con tuercas
Dégageur professionnel d'écrous d'enjoliveurs de roues
1.3 lbs (.6 kg)

Special coating will not scratch or damage chrome, painted, or coated lug nut covers. Adjusts to fit larger lug nuts.

FOUR-WAY LUG WRENCHES

Llaves cruz | Clés à goujon à quatre têtes

Ken-Tool offers the world's largest selection of quality lug wrenches, available in sizes to fit all your tire changing needs - SAE and Metric.



PROFESSIONAL LUG WRENCHES

Llaves profesionales | Clés à goujon professionnelles

These wrenches are America's premier professional lug wrenches for cars, light trucks, SUV's, RV's, and vans. Drop-forged centers for extra strength. Keep wrenches in trunk for emergencies or everyday use.



Model	Item No.	Description	Socket Sizes	Length	Stock	Weight
T56	35656	Passenger	17, 19, 21, 22 mm	23" (58 cm)	5/8" (16 mm)	4 lbs (1.8 kg)
A T57*	35657	Passenger	3/4", 13/16", 7/8", 15/16"	23" (58 cm)	5/8" (16 mm)	4.5 lbs (2 kg)

STANDARD LUG WRENCHES

Llaves estándar | Clés à goujon standard

Welded center construction for strength and durability. Premium grade, special bar quality steel for extra strength.

Model	Item No.	Description	Socket Sizes	Length	Stock	Weight
B T59	35659	Passenger	3/4", 13/16", 7/8", 15/16"	22" (56 cm)	5/8" (16 mm)	4.2 lbs (1.9 kg)
T90	35690	Light Truck	7/8" deep well, 15/16", 1", 1-1/16"	25" (64 cm)	3/4" (19 mm)	7.2 lbs (3.2 kg)

ECONOMY LUG WRENCHES

Llaves económicas • Clés à goujon économiques

These wrenches have fully welded centers which stand up to everyday use. 3/4" SAE is also 19 mm.

Model	Item No.	Description	Socket Sizes	Length	Stock	Weight
T9520	35620	Passenger	3/4", 13/16", 7/8", 17 mm	20" (51 cm)	9/16" (14 mm)	3.4 lbs (1.5 kg)
R23	35623	Passenger	3/4", 13/16", 7/8", 17 mm	20" (51 cm)	9/16" (14 mm)	3.8 lbs (1.7 kg)
R24	35624	Passenger	17, 19, 21, 22 mm	20" (51 cm)	9/16" (14 mm)	3.8 lbs (1.7 kg)
C T61	35661	Passenger	3/4", 13/16", 7/8", 17 mm	22" (56 cm)	9/16" (14 mm)	3.8 lbs (1.7 kg)
T62	35662	Passenger	3/4", 13/16", 7/8", 17 mm	18" (46 cm)	9/16" (14 mm)	3.2 lbs (1.5 kg)
T63	35663	Passenger	17, 19, 21, 22 mm	18" (46 cm)	9/16" (14 mm)	3.2 lbs (1.5 kg)
R20	35820	Passenger	17, 19, 21, 22 mm	20" (51 cm)	9/16" (14 mm)	3.5 lbs (1.6 kg)

HEAVY-DUTY TRUCK LUG WRENCHES

Llaves para camiones de alta resistencia | Clés à goujon pour camions lourds

Use on heavy-duty trucks, buses, and tractors. Drop-forged or welded center provides strength and durability. T95, TM95, T95A, and TC95 wrenches have center hole for a leverage bar. Socket sizes provided fit most metric or SAE lug nuts on today's trucks. Stock: 1" (25 mm).

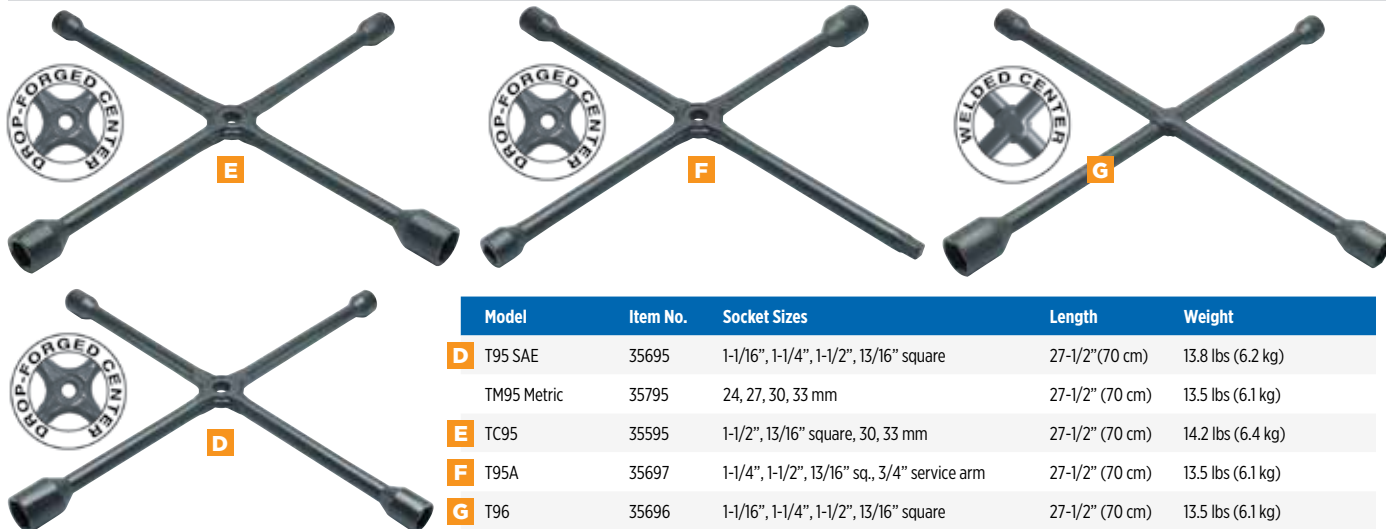

Model	Item No.	Socket Sizes	Length	Weight
D T95 SAE	35695	1-1/16", 1-1/4", 1-1/2", 13/16" square	27-1/2" (70 cm)	13.8 lbs (6.2 kg)
TM95 Metric	35795	24, 27, 30, 33 mm	27-1/2" (70 cm)	13.5 lbs (6.1 kg)
E TC95	35595	1-1/2", 13/16" square, 30, 33 mm	27-1/2" (70 cm)	14.2 lbs (6.4 kg)
F T95A	35697	1-1/4", 1-1/2", 13/16" sq., 3/4" service arm	27-1/2" (70 cm)	13.5 lbs (6.1 kg)
G T96	35696	1-1/16", 1-1/4", 1-1/2", 13/16" square	27-1/2" (70 cm)	13.5 lbs (6.1 kg)

ECONOMY FOUR-WAY LUG WRENCHES FOR THE DO-IT-YOURSELF

Llaves cruz económicas para aficionados | Clés à goujon à quatre têtes économiques pour le bricoleur

A complete line of lug wrenches value priced and merchandised to maximize your DIY business... And they're all tough and dependable.

PASSENGER CAR LUG

Vehículo de pasajeros | Automobile

Chrome-plated finish, welded center. Imported.

Item No.	Socket Sizes	Length	Stock	Weight
35630	17 mm (11/16"), 19 mm (3/4"), 21 mm (13/16"), 22 mm (7/8")	20" (51 cm)	5/8" (16 mm)	3.7 lbs (1.7 kg)
35635	17 mm (11/16"), 19 mm (3/4"), 21 mm (13/16"), 22 mm (7/8")	14" (36 cm)	5/8" (16 mm)	2.6 lbs (1.2 kg)

FOLDING PASSENGER CAR LUG 35633

Vehículo de pasajeros con asientos plegables

Voiture automobile, pliable

Chrome-plated finish. Imported.

Length: 14" (36 cm) Stock: 9/16" (14 mm) Weight: 2.7 lbs (1.2 kg)
 Socket Sizes: 17 mm (11/16"), 19 mm (3/4"), 21 mm (13/16"), 22 mm (7/8")

TELESCOPING PASSENGER CAR LUG 35634

Automóvil de pasajeros con asientos extensibles

Voiture automobile, télescopique

Chrome-plated finish. Imported.

Length: 3 lbs (1.4 kg) Stock: 14" - 21" (36 cm - 53 cm) Weight: 2.7 lbs (1.2 kg)
 Socket Sizes: 17 mm (11/16"), 19 mm (3/4"), 21 mm (13/16"), 23 mm (7/8")

PASSENGER CAR LUG 35637

Vehículo de pasajeros | Automobile

Painted finish, welded center.

Length: 18" (46 cm) Stock: 9/16" (14 mm) Weight: 3.6 lbs (1.6 kg)
 Socket Sizes: 17 mm (11/16"), 19 mm (3/4"), 21 mm (13/16"), 22 mm (7/8")

LIGHT TRUCK/RV LUG

Camión liviano/vehículo de recreación | Camionnette/VR

Painted finish, welded center.

Model	Item No.	Socket Sizes	Length	Stock	Weight
R90	35627	7/8", 15/16", 1", 1-1/16"	23" (58 cm)	11/16" (17.5 mm)	5.5 lbs (2.4 kg)
	35638	22 mm (7/8"), 24 mm (15/16"), 25 mm (1")	23" (58 cm)	11/16" (17.5 mm)	5.6 lbs (2.5 kg)



STOW & GO™ 4-WAY HD LUG WRENCH 35636

Llave Lug de 4 vías
Clé à molette HD 4 voies

Length: 16 inches (40.6 cm)
 Width: 2 inches (5 cm); Folded Height: 17.5 in. (44.5 cm), Weight: 2.9 pounds (1.32 kg).

Fixed 17, 19 and 21 mm lug nut sockets plus 1/2" square drive adapter. Doubles as a heavy duty, high torque wrench for removal of other bolts or nuts.

To collapse, push the locking button on the hub, fold movable arms to the "store" position. Manufactured from black anodized, high strength tool grade steel alloy.

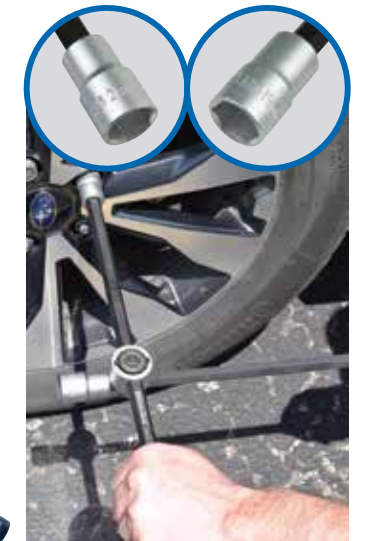

03

SOCKETS & TORQUING TOOLS

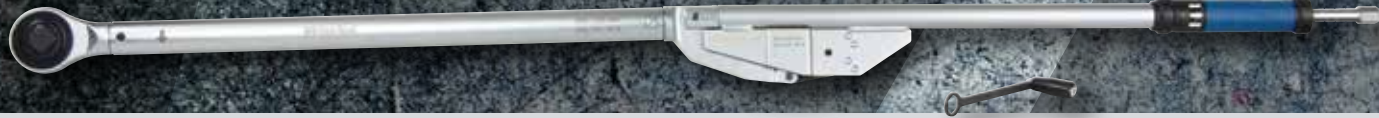

The break back wrench retains the original 'Industrial' wrench's robustness and clear torque signal and improves on the scale for more accurate setting. Can be split into two parts for easy storage and economic shipping. Removal of calibrated nuts reduces calibration expense. Quick and easy torque adjustments. Operator handle designed to 'guide' the technicians hand into the proper position. Meets ISO 6789-1:2017 requirements.

2 PC TORQUE WRENCH KIT 3/4" DRIVE 30536

Juego de llave dinamométrica de dos piezas de 3/4" Ensemble de clé dynamométrique en deux pièces à entraînement 3/4"

Kit Contents

Item No.	Description
30535	2 PC Break Back Torque Wrench 3/4" Drive 200-750 FtLB
30432	Torque Wrench Adapter 3/4" - 3/4"
30356	33MM Deep Socket 3/4" Drive
30434	13" 3/4" M x 3/4" M, Extension

2 PC TORQUE WRENCH KIT 1" DRIVE 30538

Juego de llave dinamométrica de dos piezas de 1" Ensemble de clé dynamométrique en deux pièces à entraînement 1"

Kit Contents

Item No.	Description
30537	Ken Tool 2 PC Break Back Torque Wrench 1" Drive 200-750 Ft LB
30433	Torque Wrench Adapter 3/4" - 1"
30366	33MM Deep Socket 1" Drive
30246	13" 3/4" M x 1" M, Extension



EASY TO READ ADJUSTING SCALE IN THE HANDLE



SPLIT DESIGN ASSEMBLY ALLOWS FOR EASY, BEHIND-THE-SEAT STORAGE IN SERVICE VEHICLES



PUSH-THROUGH RATCHET ALLOWS TWO DIRECTION TORQUING



REPLACEABLE RATCHET ASSEMBLY FOR WORN/DAMAGED HEADS



INDUSTRIAL TORQUE WRENCH 30532

Llave dinamométrica industrial Clé dynamométrique industrielle
1/2" Drive 30-250 Ft LB



1/2" DRIVE

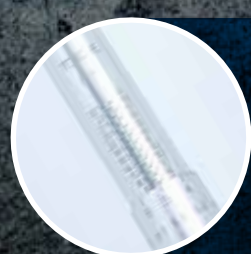

FEAURES 2 UNITS OF MEASUREMENT, PRIMARY, SECONDARY SCALES AND



ADJUSTMENT RING

HEAVY-DUTY IMPACT SOCKETS

Llaves de tubo de impacto de alta resistencia Douilles résistantes aux chocs



SPECIAL PURPOSE IMPACT SOCKETS OFF-ROAD BUDD, SQUARE, AND SAE
Llaves de tubo de impacto especializados para todo terreno tipo Budd, cuadrados, y de SAE Douilles carrées, SAE, ou pour roues à disques, spécialement conçues pour résister aux chocs

COMBINATION BUDD WHEEL - SAE
Rueda de combinación tipo Budd - SAE Deux en un pour roues à disques - SAE

DEEP LENGTH IMPACT SOCKETS - METRIC
Llaves de tubo de impacto de longitud profunda-métrica Douilles de grande longueur - métrique

IMPACT SOCKET SETS

Juegos de dados impacto Jeux de douilles à choc



6 PC DEEP THIN-WALL IMPACT SOCKET SET* 30113
Juego de dados de impacto profundo de pared delgada, seis piezas Jeu de six douilles profondes à choc à paroi mince

For the difficult aftermarket and manufacturers' wheels.

7 PC THIN-WALL IMPACT SOCKET SET 30259
Juego de dados de impacto de pared delgada, siete piezas Jeu de douilles à choc (sept pièces) à paroi mince

Non-Marring sockets for delicate wheels with minimal clearance for Car / Light Truck. Made from chrome-moly steel. Made in Taiwan.

Weight: 1.4 lbs (.6 kg)

Item No.	Description	Drive
A 30120	13/16" square	3/4"
30149	13/16" square	1"

Special 1-1/2" hex deep heavy-duty impact socket designed for outer cap nuts on Budd-style truck wheels. The 1-1/2" hex depth is limited to help prevent socket contact with the wheel. The socket is deep style to eliminate contact with the inner cap nut. Imported.

Weight: 3.1 lbs (1.4 kg)

Item No.	Description	Drive
B 30121	1-1/2" x 13/16" square	3/4"
30150	1-1/2" x 13/16" square	1"

Weight: 1.6 lbs (.7 kg)

Item No.	Description	Drive
C 30356	33 mm deep, 6 Point	3/4"
D 30366	33 mm deep, 6 Point	1"

Accessories

Set Weight: 3 lbs (1.3 kg)

Item No.	Socket Size	Drive
30113-01	17 mm	1/2"
30113-02	19 mm, 3/4"	1/2"
30113-03	21 mm	1/2"
30113-04	13/16"	1/2"
30113-05	7/8"	1/2"
30110-06	3" extension	1/2"

Accessories

Set Weight: 5 lbs (2.3 kg)

Item No.	Socket Size	Drive
30259-03	13/16"	1/2"
30259-04	7/8"	1/2"
30259-05	1"	1/2"
30259-07	17 mm	1/2"
30259-08	19 mm	1/2"
30259-09	21 mm	1/2"

IMPACT EXTENSIONS

Extensiones de impacto Rallonges à choc



Item No.	Description	Drive	Weight
E 30110-06	3" Impact Extension	1/2"	.3 lbs (0.14 kg)
F 30245	1" Drive x 13" Impact Extension. Provides access to hard-to-reach areas with 1" impact socket applications.	1"	5 lbs (2.27 kg)
G 30246	3/4" Sq. Dr. Male x 1" Sq. Dr. Male 13" Impact Extension. Provides access to deep budd wheels.	3/4"	4.75 lbs (2.15 kg)
H 30434	13" 3/4" M x 3/4" M, Extension	3/4"	4 lbs (1.81 kg)
I 30433	Torque Wrench Adapter 3/4" - 1"	3/4"-1"	.4 lbs (0.18 kg)
J 30432	Torque Wrench Adapter 3/4" - 3/4"	3/4"	.5 lbs (0.23 kg)

SOCKETS AND SOCKET SETS HAVE A LIMITED LIFETIME WARRANTY

**Thinwall sockets are not currently warrantied.*

TWIST SOCKET SETS WITH ORGANIZER BARS

Dados giratorios
Douilles de torsion

Twist sockets are specifically designed to easily remove damaged, rounded or corroded nuts, wheel lugs, bolts, pipes, pipe nipples or studs. Simply place the socket so it barely catches the head of the fastener and turn with an air ratchet, hand ratchet, or breaker bar. The unique spiral fluting bites onto the damaged fastener and won't let go. Designed for general automotive applications. Twist sockets are **NOT** recommended for use with impact wrenches.



5 PC DEEP TWIST SOCKET SET 30116

Juego de dados giratorios profundos de cinco piezas
Jeu de cinq douilles profondes de torsion

5 Pc. Set w/Organizer Bar

Accessories
Set Weight: 2.5 lbs (1.1 kg)

Item No.	Socket Size	Drive
30116-02	3/4" (19 mm)	1/2"
30116-04	13/16"	1/2"
30116-05	7/8"	1/2"
30116-07	15/16"	1/2"
30116-08	1"	1/2"



8 PC TWIST SOCKET SET 30117

Juego de dados giratorios de ocho piezas
Jeu de huit douilles de torsion

8 Pc. Set w/Organizer Bar

Accessories
Set Weight: .9 lbs (.4 kg)

Item No.	Socket Size	Drive
30117-06	6 mm	1/4"
30117-08	8 mm	1/4"
30117-10	10 mm	1/4"
30117-12	12 mm	1/4"
30117-13	13 mm	1/4"
30117-15	15 mm	1/4"
30117-14	14 mm	1/4"
30117-17	17 mm	1/4"



9 PC TWIST SOCKET SET 30109

Juego de dados giratorios de nueve piezas
Jeu de neuf douilles de torsion

9 Pc. Set w/Organizer Bar

Accessories
Set Weight: 2.8 lbs (1.2 kg)

Item No.	Socket Size	Drive
30106-05	10 mm	3/8"
30106-07	7/16", 11 mm	3/8"
30106-11	12 mm	3/8"
30106-13	13 mm	3/8"
30106-15	14 mm	3/8"
30106-19	15 mm	3/8"
30106-25	17 mm	3/8"
30106-21	5/8", 16 mm	3/8"
30106-27	3/4", 19 mm	3/8"



13 PC TWIST SOCKET SET 30108

Juego de dados giratorios de trece piezas
Jeu de treize douilles de torsion

13 Pc. Set w/Organizer Bar

Accessories
Set Weight: 1.6 lbs (.7 kg)

Item No.	Socket Size	Drive
30106-01	3/8"	3/8"
30106-05	10 mm	3/8"
30106-07	7/16", 11mm	3/8"
30106-09	1/2"	3/8"
30106-11	12 mm	3/8"
30106-13	13 mm	3/8"
30106-15	14 mm	3/8"
30106-17	9/16"	3/8"
30106-19	15 mm	3/8"
30106-25	17 mm	3/8"
30106-21	5/8", 16 mm	3/8"
30106-27	3/4", 19 mm	3/8"



INDIVIDUAL TWIST SOCKETS - FLUTED

Dados giratorios individuales, estriados
Douilles de torsion individuelles - cannelées

Item No.	Socket Size	Fluted	Drive	Weight
30151	3/4", 19 mm & 13/16", 21 mm	12	1/2"	.4 lbs (.18 kg)
A 30152*	3/4", 19 mm & 13/16", 21 mm	6	1/2"	.4 lbs (.18 kg)
B 30153	7/8" x 1"	12	1/2"	.4 lbs (.18 kg)
30154*	7/8" x 1"	6	1/2"	.4 lbs (.18 kg)
30116-08	1"		1/2"	.4 lbs (.18 kg)

*Includes C Punch Pin. Punch Pin not sold separately.

TWIST SOCKET SETS WITH PLASTIC CASES

Juegos de dados giratorios
Jeux de douilles de torsion



5 PC TWIST SOCKET SET WITH PUNCH 30118

Juego de dados giratorios de cinco piezas con punzón
Jeu de cinq douilles de torsion avec poinçon

5 Pc. Set w/Plastic Case

Accessories
Set Weight: 2 lbs (.9 kg)

Item No.	Socket Size	Drive
30118-03	19 mm, 3/4"	1/2"
30118-04	13/16"	1/2"
30118-05	7/8"	1/2"
30118-06	15/16"	1/2"
30118-07	1"	1/2"
30170-80	Punch	



9 PC TWIST SOCKET SET WITH PUNCH 30107

Juego de dados giratorios de nueve piezas con punzón
Jeu de neuf douilles de torsion avec poinçon

9 Pc. Set w/Plastic Case

Accessories
Set Weight: 1.5 lbs (.7 kg)

Item No.	Socket Size	Drive
30106-05	10 mm	3/8"
30106-07	7/16", 11mm	3/8"
30106-11	12 mm	3/8"
30106-13	13 mm	3/8"
30106-15	14 mm	3/8"
30106-19	15 mm	3/8"
30106-21	5/8", 16 mm	3/8"
30106-25	17 mm	3/8"
30106-27	3/4", 19 mm	3/8"
30170-80	Punch	



10 PC SLIM TWIST SOCKET SET WITH EXTERNAL HEX 30271

Juego de dados giratorios delgados con cuadro hexagonal externo
Jeu de dix douilles minces de torsion avec extérieur hexagonal

10 Pc. Set w/Plastic Case

Accessories
Set Weight: 1 lb (.5 kg)

Item No.	Socket Size	Drive
30270-01	9 mm; ext. hex 5/8"	3/8"
30270-02	10 mm, 3/8"; ext. hex 5/8"	3/8"
30270-03	11 mm, 7/16"; ext. hex 11/16"	3/8"
30270-04	12 mm; ext. hex 3/4"	3/8"
30270-05	13 mm, 1/2"; ext. hex 3/4"	3/8"
30270-06	14 mm, 9/16"; ext. hex 13/16"	3/8"
30270-07	15 mm; ext. hex 7/8"	3/8"
30270-08	16 mm, 5/8"; ext. hex 15/16"	3/8"
30270-09	17 mm, 11/16"; ext. hex 1"	3/8"
30270-10	19 mm, 3/4"; ext. hex 1-1/16"	3/8"



13 PC TWIST SOCKET SET WITH PUNCH 30106

Juego de dados giratorios de trece piezas con punzón
Jeu de treize douilles de torsion avec poinçon

13 Pc. Set w/Plastic Case

Accessories
Set Weight: 1.9 lbs (.9 kg)

Item No.	Socket Size	Drive
30106-01	3/8"	3/8"
30106-05	10 mm	3/8"
30106-07	7/16", 11 mm	3/8"
30106-09	1/2"	3/8"
30106-11	12 mm	3/8"
30106-13	13 mm	3/8"
30106-15	14 mm	3/8"
30106-17	9/16"	3/8"
30106-19	15 mm	3/8"
30106-21	5/8", 16 mm	3/8"
30106-23	11/16"	3/8"
30106-25	17 mm	3/8"
30106-27	3/4", 19 mm	3/8"
30170-80	Punch	

Removes damaged or rounded nuts, bolts, studs, and socket head cap screws. Through hole design allows for use on long studs. Fits SAE 3/8" - 3/4" and metric 9mm - 19mm. Use where standard twist sockets will not fit, with open-end wrench or socket.

SPECIALTY SOCKETS

Dados abatibles
Douilles inversées



3 PC 6-FLUTED TWIST FLIP SOCKET SET 30101
Juego de dados abatibles giratorios con 6 estrías, tres piezas
Jeu de trois douilles de torsion inversées à 6 cannelures

3 Pc. Set w/Plastic Case



3 PC 12-FLUTED TWIST FLIP SOCKET SET 30102
Juego de dados abatibles giratorios con 12 estrías, tres piezas
Jeu de trois douilles de torsion inversées à 12 cannelures

3 Pc. Set w/Plastic Case



3 PC 6-PT. & 12-FLUTED TWIST FLIP SOCKET SET 30103
Juego de dados abatibles giratorios, 6 puntas y 12 estrías, tres piezas
Jeu de trois douilles de torsion inversées à 12 cannelures et 3 points

3 Pc. Set w/Plastic Case



3 PC THIN-WALL FLIP SOCKET SET 30110
Juego de dados abatibles de pared delgada, tres piezas
Jeu de trois douilles inversées à paroi mince

One end is a standard 6-point socket for everyday use. Flip socket over and you have a 6-point socket of larger size.

Accessories
Set Weight: 1.3 lbs (.6 kg)

Item No.	Socket Size	Drive
30152	19 mm & 13/16", 21 mm socket, 6-Fluted	1/2"
30154	7/8" & 1" socket	1/2"
30110-06	3" extension	1/2"

Accessories
Set Weight: 1.3 lbs (.6 kg)

Item No.	Socket Size	Drive
30151	19 mm & 13/16", 21 mm socket	1/2"
30153	7/8" & 1" socket	1/2"
30110-06	3" extension	1/2"

Accessories
Set Weight: 1.3 lbs (.6 kg)

Item No.	Socket Size	Drive
30103-01	17 mm socket	1/2"
30103-02	19 mm socket	1/2"
30110-06	3" extension	1/2"

Accessories
Set Weight: 1.2 lbs (.54 kg)

Item No.	Socket Size	Drive
30110-01	19 mm - 21 mm	1/2"
30110-02	3/4" - 13/16"	1/2"
30110-06	3" extension	1/2"

DEEP, THIN-WALL FLIP SOCKET

Llave de tubo movable, de paredes finas y profundidad
Douille double tête profonde à paroi étroite

1/2" square drive, black impact socket is deep and thin walled to reach areas conventional sockets won't. Flip socket provides two socket sizes which cover virtually all SAE automotive wheel lug sizes. Imported.



Item No.	Socket Size	Drive	Weight
A 30156	3/4", 13/16"	1/2"	.4 lbs (.18 kg)
30158	19 mm, 21 mm	1/2"	.4 lbs (.18 kg)

SPECIALTY SOCKETS

Dados abatibles
Douilles inversées



6 PC THICK AND THIN FLIP SOCKET SET* 30112
Juego de dados abatibles gruesos y delgados, seis piezas
Jeu de six douilles inversées fines et épaisse

For those ever changing aftermarket and manufacturers' wheels. One end is a standard 6-point socket for everyday use. Flip socket over and you have a thinwall socket of the same size for wheels with minimal clearance.

Accessories
Set Weight: 3 lbs (1.3 kg)

Item No.	Socket Size	Drive
30112-01	17 mm	1/2"
30112-02	19 mm, 3/4"	1/2"
30112-03	21 mm	1/2"
30112-04	13/16"	1/2"
30112-05	7/8"	1/2"
30110-06	3"	1/2"



5 PC DOUBLE-DUTY OIL DRAIN PLUG REMOVAL FLIP SOCKET SET 30114
Juego de dados abatibles para extracción del tapón del cárter de aceite de doble servicio, cinco piezas
Jeu de cinq douilles inversées à double fonction d'extraction de bouchon de purge d'huile

One end is a standard 6-point socket for everyday use. Flip socket over and you have a twist socket damaged oil drain plug remover of the same size.

Accessories
Set Weight: 3 lbs (1.3 kg)

Item No.	Socket Size	Drive
30114	17 mm	3/8"
30114	19 mm, 3/4"	3/8"
30114-03	14 mm	3/8"
30114-04	15 mm	3/8"
30114-05	16 mm, 5/8"	3/8"



3 PC LUG & LOCK FLIP SOCKET SET 30115
Juego de dados abatibles para trabas/ruedas, tres piezas
Jeu de trois douilles de torsion inversées d'arrêt et de roue

One end is a standard 6-fluted twist socket for removing damaged wheel lugs. Flip socket over and you have a 12-fluted twist socket for removing wheel locks.

Accessories
Set Weight: 1.6lbs (.7kg)

Item No.	Socket Size	Drive
30115-02	19 mm, 3/4"	1/2"
30115-05	7/8"	1/2"
30110-06	3" extension	1/2"



5 PC THIN-WALL FLIP SOCKET SET* 30119
Juego de dados abatibles de pared delgada, cinco piezas
Jeu de cinq douilles inversées à paroi mince

One end is a standard 6-point socket for everyday use. Flip socket over and you have a 6-point socket of larger size.

Accessories
Set Weight: 2.1 lbs (1 kg)

Item No.	Socket Size	Drive
30110-01	19 mm - 21 mm	1/2"
30110-02	3/4" - 13/16"	1/2"
30119-03	7/8" - 15/16"	1/2"
30119-04	17 mm - 19 mm	1/2"
30110-06	3" extension	1/2"



6 PC DOUBLE-DUTY FLIP SOCKET SET 30111
Juego de dados abatibles de doble servicio, seis piezas
Jeu de six douilles inversées double action

One end is a standard 6-point socket for everyday use. Flip socket over and you have a 6-fluted twist socket for removing damaged or rounded wheel lugs.

Accessories
Set Weight: 2.8 lbs (1.2 kg)

Item No.	Socket Size	Drive
30111-01	17 mm	1/2"
30111-02	19 mm, 3/4"	1/2"
30111-03	21 mm	1/2"
30111-04	13/16"	1/2"
30111-05	7/8"	1/2"
30110-06	3" extension	1/2"

TORQUE MASTER® TORQUE LIMITING SOCKET KITS

Llaves de tubo limitadoras del par motor principal
 Douilles de limitation de couple TORQUE MASTER

For foreign and domestic cars and light trucks. Tighten nuts to factory specifications each time the wheels are replaced. Color and letter coded for quick size and torque reference. Converts any impact gun, including those with an extended anvil, into an instant torque wrench by bleeding torque off the impact gun. Limited lifetime warranty.



TORQUE MASTER® INDIVIDUAL SOCKETS

Dados individuales
 Douilles individuelles

Item No.	Description	Socket Opening	Torque	Weight
30181	Brown (A)	13/16"	100 ft-lbs	.5 lbs (.2 kg)
30182	Orange (B)	21 mm	80 ft-lbs	.5 lbs (.2 kg)
30183	Gray (C)	19 mm (3/4")	100 ft-lbs	.5 lbs (.2 kg)
30184	Black (D)	21 mm	60 ft-lbs	.5 lbs (.2 kg)
30185	Blue (E)	19 mm (3/4")	80 ft-lbs	.5 lbs (.2 kg)
30186	Yellow (F)	19 mm (3/4")	65 ft-lbs	.5 lbs (.2 kg)
30187	Red (G)	17 mm	80 ft-lbs	.5 lbs (.2 kg)
30188	Dark Green (H)	17 mm	45 ft-lbs	.5 lbs (.2 kg)
30189	White (I)	7/8"	120 ft-lbs	.5 lbs (.2 kg)
30195	Tan (J)	1"	140 ft-lbs	.5 lbs (.2 kg)
30196	Light Purple (K)	17 mm	110 ft-lbs	.5 lbs (.2 kg)
30197	Green (L)	1"	170 ft-lbs	.5 lbs (.2 kg)
30198	Crimson Red (V)	1-1/16"	140 ft-lbs	.5 lbs (.2 kg)
30200	Aqua (Q)	7/8"	140 ft-lbs	.5 lbs (.2 kg)
30201	Bright Green (T)	15/16"	135 ft-lbs	.5 lbs (.2 kg)
30202	Navy Blue (Y)	7/8"	100 ft-lbs	.5 lbs (.2 kg)
30203	Light Tan (Z)	7/8"	65 ft-lbs	.5 lbs (.2 kg)
30204	Turquoise (BB)	21 mm	150 ft-lbs	.5 lbs (.2 kg)
30205	Light Pink (CC)	17 mm	90 ft-lbs	.5 lbs (.2 kg)
30206	Sky Blue (DD)	21 mm	100 ft-lbs	.5 lbs (.2 kg)
30207	Safety Purple (EE)	22 mm	140 ft-lbs	.5 lbs (.2 kg)
30208	Yellow Gray (FF)	19 mm	180 ft-lbs	.5 lbs (.2 kg)
30211	Quartz Gray (KK)	19 mm	120 ft-lbs	.5 lbs (.2 kg)
30212	Fuchsia (LL)	22 mm	175 ft-lbs	.5 lbs (.2 kg)
30213	Gold (NN)	19 mm	90 ft-lbs	.5 lbs (.2 kg)
30214	Salmon (QQ)	22 mm	95 ft-lbs	.5 lbs (.2 kg)
30216	Deep Purple (UU)	14 mm	75 ft-lbs	.5 lbs (.2 kg)
30217	Vanilla (XX)	13/16"	160 ft-lbs	.5 lbs (.2 kg)
30218	Honey Yellow (JJ)	19 mm	145 ft-lbs	.5 lbs (.2 kg)
30222	Silver Sparkle (SS)	21 mm	110 ft-lbs	.5 lbs (.2 kg)
30199	11" x 17" Application Wall Chart (WC)			.5 lbs (.2 kg)
30299	22" x 24" Laminated Socket Torque Wall Chart			.5 lbs (.2 kg)



TORQUE MASTER® 4 PC STARTER KIT 30174

Equipo básico de cuatro piezas
 kit de base de quatre pièces

Accessories
 Set Weight: 4.4 lbs (2 kg)

Item No.	Color	Torque
30181	Brown (A)	100 ft/lbs.
30183	Gray (C)	100 ft/lbs.
30185	Blue (E)	80 ft/lbs.
30189	White (I)	120 ft/lbs.



TORQUE MASTER® 6 PC KIT 30176

Juego de seis piezas
 Kit six pièces

Accessories
 Set Weight: 6.9 lbs (3.1 kg)

Item No.	Color	Torque
30181	Brown (A)	100 ft/lbs.
30183	Gray (C)	100 ft/lbs.
30184	Black (D)	60 ft/lbs.
30185	Blue (E)	80 ft/lbs.
30186	Yellow (F)	65 ft/lbs.
30189	White (I)	120 ft/lbs.



TORQUE MASTER® 9 PC KIT 30179

Juego de nueve piezas
 Kit neuf pièces

Accessories
 Set Weight: 8.75 lbs (4 kg)

Item No.	Color	Torque
30181	Brown (A)	100 ft/lbs.
30182	Orange (B)	80 ft/lbs.
30183	Gray (C)	100 ft/lbs.
30184	Black (D)	60 ft/lbs.
30185	Blue (E)	80 ft/lbs.
30186	Yellow (F)	65 ft/lbs.
30187	Red (G)	80 ft/lbs.
30188	Dark Green (H)	45 ft/lbs.
30189	White (I)	120 ft/lbs.



TORQUE MASTER® 10 PC KIT 30180

Juego de diez piezas
 Kit dix pièces

Accessories
 Set Weight: 9.5 lbs (4.3 kg)

Item No.	Color	Torque
30181	Brown (A)	100 ft/lbs.
30182	Orange (B)	80 ft/lbs.
30183	Gray (C)	100 ft/lbs.
30184	Black (D)	60 ft/lbs.
30185	Blue (E)	80 ft/lbs.
30186	Yellow (F)	65 ft/lbs.
30187	Red (G)	80 ft/lbs.
30188	Dark Green (H)	45 ft/lbs.
30189	White (I)	120 ft/lbs.
30200	Aqua (Q)	140 ft/lbs.



TORQUE MASTER® 12 PC KIT 30190

Juego de doce piezas
 Kit douze pièces

Accessories
 Set Weight: 10.5 lbs (4.8 kg)

Item No.	Color	Torque
30181	Brown (A)	100 ft/lbs.
30182	Orange (B)	80 ft/lbs.
30183	Gray (C)	100 ft/lbs.
30184	Black (D)	60 ft/lbs.
30185	Blue (E)	80 ft/lbs.
30186	Yellow (F)	65 ft/lbs.
30187	Red (G)	80 ft/lbs.
30188	Dark Green (H)	45 ft/lbs.
30189	White (I)	120 ft/lbs.
30200	Aqua (Q)	140 ft/lbs.
30202	Navy Blue (Y)	100 ft/lbs.
30213	Gold (NN)	90 ft/lbs.



TORQUE MASTER® 4 PC SUV KIT 30175

Juego de cuatro piezas para SUVs
 Kit quatre pièces pour les SUV

Accessories
 Set Weight: 4.5 lbs (2 kg)

Item No.	Color	Torque
30181	Brown (A)	100 ft/lbs.
30183	Gray (C)	100 ft/lbs.
30200	Aqua (Q)	140 ft/lbs.
30204	Turquoise (BB)	150 ft/lbs.

For domestic and foreign SUVs. Tighten lug nuts to factory specifications. Color and letter coded for quick size and torque reference.

WARNING: Torque sockets and truck torque extensions cannot be used to take off wheel nuts. Calibrate your impact gun and follow all manufacturers' recommended procedures when using Torque Master products.

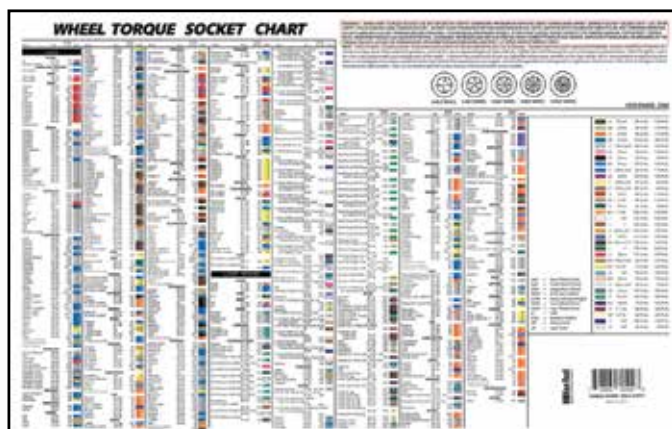

Application charts can be wall mounted.

TORQUE MASTER® 11" X 17" APPLICATION PAPER WALL CHART 30199

Cuadro de aplicación de 11 "x 17" | Affiche Murale Application 11 "x 17"

TORQUE MASTER® 22" X 24" LAMINATED SOCKET TORQUE WALL CHART 30299

TORQUE MASTER® Diagrama de pared de torque de zócalo laminado de 22 "X 24" | Tableau mural TORQUE MASTER® 22 "X 24" à douille laminée



TORQUE MASTER® INDIVIDUAL TORQUE EXTENSIONS

Extensiones de torsión individuales
Rallonges de couple individuelles



Item No.	Description	Socket Opening	Torque	Weight
30255	Black Oxide (A)	3/8"	30 ft-lbs	.5 lbs (.2 kg)
30256	Black Oxide (B)	3/8"	40 ft-lbs	.5 lbs (.2 kg)
30257	Black Oxide (C)	3/8"	50 ft-lbs	.5 lbs (.2 kg)
30258	Black Oxide (D)	3/8"	60 ft-lbs	.5 lbs (.2 kg)
30219	Orange (B)	1/2"	160 ft-lbs	.7 lbs (.3 kg)
30220	Aqua (Q)	1/2"	140 ft-lbs	.7 lbs (.3 kg)
30221	Light Blue (S)	1/2"	55 ft-lbs	.7 lbs (.3 kg)
30223	Gray (C)	1/2"	100 ft-lbs	.7 lbs (.3 kg)
30224	Black (D)	1/2"	60 ft-lbs	.7 lbs (.3 kg)
30225	Blue (E)	1/2"	80 ft-lbs	.7 lbs (.3 kg)
30226	Yellow (F)	1/2"	65 ft-lbs	.7 lbs (.3 kg)
30227	Fuchsia (LL)	1/2"	175 ft-lbs	.7 lbs (.3 kg)
30228	Dark Green (H)	1/2"	45 ft-lbs	.7 lbs (.3 kg)
30229	White (I)	1/2"	120 ft-lbs	.7 lbs (.3 kg)
30243	Turquoise (G)	1/2"	150 ft-lbs	.7 lbs (.3 kg)
30244	Bright Green (T)	1/2"	135 ft-lbs	.7 lbs (.3 kg)
30247	Gold (NN)	1/2"	90 ft-lbs	.7 lbs (.3 kg)
30248	Light Purple (K)	1/2"	110 ft-lbs	.7 lbs (.3 kg)
30249	Neon Yellow (OO)	1/2"	75 ft-lbs	.7 lbs (.3 kg)
30250	Green (L)	1/2"	170 ft-lbs	.7 lbs (.3 kg)



TORQUE MASTER® INDIVIDUAL HEAVY-DUTY TRUCK TORQUE EXTENSIONS

Extensiones de torsión individuales de alta resistencia para camiones
Rallonges individuelles robustes de couple pour camions



Convert your own sockets into torque sockets for use on commercial, heavy-duty trucks, and buses.

Item No.	Description	Socket Opening	Torque	Weight
30230	Yellow (O)	3/4 "	175 ft-lbs	.75 lbs (.3 kg)
30231	Yellow (N)	3/4 "	250 ft-lbs	.75 lbs (.3 kg)
30232	Yellow (U)	3/4 "	350 ft-lbs	.75 lbs (.3 kg)
30233	Yellow (M)	3/4 "	475 ft-lbs	.75 lbs (.3 kg)
30236	Yellow (T)	1"	175 ft-lbs	1 lb (.5 kg)
30237	Yellow (R)	1"	250 ft-lbs	1 lb (.5 kg)
30238	Yellow (S)	1"	350 ft-lbs	1 lb (.5 kg)
30239	Yellow (P)	1"	475 ft-lbs	1 lb (.5 kg)
30240	Yellow (W)	1"	650 ft-lbs	1 lb (.5 kg)
30241	Yellow (Q)	1"	300 ft-lbs	1 lb (.5 kg)
30242	Yellow (Y)	1"	550 ft-lbs	1 lb (.5 kg)

TORQUE MASTER® TORQUE EXTENSION KITS

Juegos de extensiones para torque
Kits de rallonges de couple



Convert your own sockets into torque sockets.



TORQUE MASTER® 4 PC EXTENSION KIT - PASSENGER CAR - 1/2\"/>

Juego de extensión de cuatro piezas para automóviles de pasajeros – entrada de 1/2 pulgada
Kit de rallonge de quatre pièces pour automobiles - Prise 1/2 po

Accessories
Set Weight: 3 lbs (1.3 kg)

Item No.	Color	Torque
30223	Gray (C)	100 ft/lbs
30225	Blue (E)	80 ft/lbs
30226	Yellow (F)	65 ft/lbs
30229	White (I)	120 ft/lbs



TORQUE MASTER® 5 PC EXTENSION KIT - PASSENGER CAR - 1/2\"/>

Juego de extensiones de cinco piezas para automóviles. Cuadro de 1/2"
Kit (cinq pièces) de rallonges pour voitures - prise demi pouce

Accessories
Set Weight: 4 lbs (1.8 kg)

Item No.	Color	Torque
30220	Aqua (Q)	140 ft/lbs.
30223	Gray (C)	100 ft/lbs.
30225	Blue (E)	80 ft/lbs.
30226	Yellow (F)	65 ft/lbs.
30229	White (I)	120 ft/lbs.



TORQUE MASTER® 10 PC EXTENSION KIT - PASSENGER CAR & LIGHT TRUCK 30251

Juego de extensiones de diez piezas para automóviles y camiones livianos
Kit (dix pièces) de rallonges pour voitures et camions légers

Accessories
Set Weight: 7.6 lbs (3.5 kg)

Item No.	Color	Torque
30220	Aqua (Q)	140 ft/lbs.
30223	Gray (C)	100 ft/lbs.
30224	Black (D)	60 ft/lbs.
30225	Blue (E)	80 ft/lbs.
30226	Yellow (F)	65 ft/lbs.
30228	Dark Green (H)	45 ft/lbs.
30229	White (I)	120 ft/lbs.
30248	Light Purple (K)	110 ft/lbs.
30249	Neon Yellow (OO)	75 ft/lbs.
30247	Gold (NN)	90 ft/lbs.

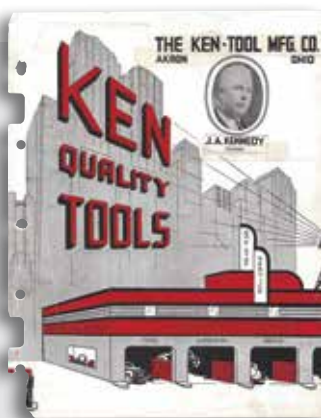

1938



1950

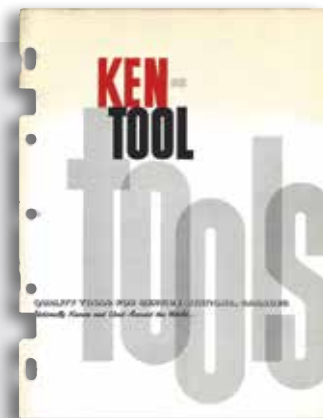

1961



1969

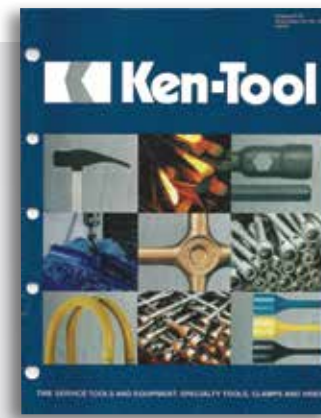

1995



WIRE BRUSH 30515 T15

Cepillo de alambre
Brosse métallique

Cleans rust from rims and wheels.

Length: 14" (36 cm) Weight: 5 oz. (.2 kg)



AXLE NUT SOCKET SET 30415

*Juego de dados de tuerca de eje
Jeu de douilles d'écrou d'axe*

The 5 most common axle nut sizes for Ford, Dodge, Toyota and GM vehicles! 6 and 8 point designs have tight tolerances that grip axle nuts firmly to resist rounding out. The 3/4" drive is designed to be used with torque wrenches and hand tools. Each socket is made from cold pressed tool steel with a black e-coat surface to protect against corrosion and wear. Set ships in poly bags individually in a standard carton. Also available in individual sizes.



Accessories

Set Weight: 16 lbs (7.2 kg)

Item No.	Description	Weight
A 30410	3.25" 8 pt. Axle Nut Socket	2.7 lbs (1.2 kg)
B 30411	3.5" 6 pt. Axle Nut Socket	2.95 lbs (1.3 kg)
C 30412	3.75" 8 pt. Axle Nut Socket	3.15 lbs (1.4 kg)
D 30413	4" 6 pt. Axle Nut Socket	3.35 lbs (1.5 kg)
E 30414	4.375" 8 pt. Axle Nut Socket	3.5 lbs (1.5 kg)



3/4" DRIVE

« Stamped sizes are easy to read. »



9 PC WHEEL COVER & WHEEL LOCK REMOVAL KIT 30170

*Juego de nueve piezas
Kit neuf pièces*

Remove and replace GM, Ford, Chrysler hubcap locks and aftermarket wheel lug locks without the factory issued key. Save time! Will not damage the lock or stud.

Accessories

Set Weight: 3.1 lbs (1.4 kg) Drive: 1/2"

Item No.	Description
30170-10	Ford & Chrysler Hubcap Locks/Lg. GM Triangle Wheel locks
30170-20	GM Spline Hubcap Locks
30170-30	GM Hubcap Locks
30170-40	18 mm Lugs/GM Wheel Cover Locks/Ford Wheel Locks
30170-50	Corvette/GM "N" & "F" Body Wheel Locks
30170-60	Std. McGard-Style Wheel Locks/Lg. GM Wheel Cover
30170-70	Oversized McGard-Style Wheel Locks
30170-80	Punch
30170-90	Lg. Dia. Chrysler Lock



13 PC WHEEL COVER & WHEEL LOCK REMOVAL KIT 30171

*Juego de trece piezas
Kit treize pièces*

Accessories

Set Weight: 4.9 lbs (2.2 kg) Drive: 1/2"

Item No.	Description
30170-10	Ford & Chrysler Hubcap Locks / Lg. GM Triangle Wheel Locks
30170-20	GM Spline Hubcap Locks
30115-02	3/4", 19mm Damaged Wheel Lug & Oversized Wheel Lock Remover
30170-30	GM Hubcap Locks
30115-05	7/8" Damaged Wheel Lug & Oversized Wheel Lock Remover
30170-40	18 mm Lugs/GM Wheel Cover Locks/Ford Wheel Locks
30171-45	18 mm Nut/Corvette GM Lock
30170-50	Corvette/GM "N" & "F" Body Wheel Locks
30170-60	Std. McGard-Style Wheel Locks/ Lg. GM Wheel Cover
30170-70	Oversized McGard-Style Wheel Locks
30170-80	Punch
30170-90	Lg. Dia. Chrysler Lock
30110-06	3" Impact Extension

UNIVERSAL EMERGENCY WHEEL LOCK REMOVER 30161

*Desmontador universal para anillos de seguridad de ruedas de emergencia
Dégageur de bloqueur de roue universel de secours*

Drive: 1/2" Weight: 1lb (.5 kg)

Removes wheel locks when the key is lost or misplaced. 1" I.D. Tapered socket fits over most car wheel locks. Use soft-faced hammer to drive onto wheel lock. Limited use.



DUAL WHEEL LUG STUD REMOVER 30165

*Desmontador de tuercas para ruedas dobles
Extracteur de goujons de roues de camions à prise double*

Special self-tapping splines provide maximum grip to remove stripped lug studs. Use with TR1, TR98 truck wrenches. Can also be used with an open end wrench. Use with soft faced hammer.

Fits 13/16" sq. inner nut. Weight: 1lb (.5 kg)



Special self-tapping splines



PATENTED

4 PC LUG NUT REMOVER SOCKET SET 30254

*Juego de dados para extractor de tuercas de rueda, cuatro piezas
Jeu de douilles d'extracteur (4 pièces) d'écrou de roue*

Use for removing wheel locks or damaged lug nuts. Made from chrome-moly steel. Made in Taiwan.

Accessories

Set Weight: 1.4 lbs (.6 kg)

Item No.	Description	Drive
30254-06	3/4" Socket	1/2"
30254-07	13/16" Socket	1/2"
30254-08	1" Socket	1/2"
30254-09	1-1/8" Socket	1/2"



PATENTED

4 PC HD WHEEL STUD REMOVER SET 30649

*Juego de extractores de pernos de ruedas de alta resistencia, cuatro piezas
Jeu d'extracteurs robustes (4 pièces) de goujon de roue*

Inner Budd Nut & Wheel Stud Removal Set. Removes damaged wheel studs and inner Budd nuts. Internal tapered reverse Inner Budd Nut & Wheel Stud Removal Set threads lock onto damaged stud or nut and easily pulls off using impact wrench. Wheel Stud Removers are 3/4" hex drive. Budd Nut Removers are 1-1/8" hex drive. Made from chrome-moly steel. 90 PSI maximum. Made in Taiwan.

Accessories

Set Weight: 3.5 lbs (1.6 kg)

Item No.	Description	Drive
30649-01	5/8" Socket	3/4" Hex
30649-02	3/4" Socket	3/4" Hex
30649-03	Budd Wheel Inner Nut LH	1-1/8" Hex
30649-04	Budd Wheel Inner Nut RH	1-1/8" Hex

Accessories

Set Weight: 3.5 lbs (1.6 kg)

Item No.	Description	Weight
30167	4 Pc. Rust Hog™ Set Includes: Aluminum driver tool & 3 abrasive pads	.4 lbs (.18 kg)
30168	5 Pc. Rust Hog™ Replacement Pad Set Includes: 5 replacement pads	.2 lbs (.09 kg)



RUST HOG™ HUB CLEANING TOOL

*Rust Hog™ Herramienta de limpieza de cubos
Rust Hog™ Outil de nettoyage de moyeu*

Blasts away rust and debris in seconds! Eliminates risk of improper torque, balancing issues, and wheel offs. Compatible with all 1/2" drive impact guns – air and electric. Super abrasive synthetic pads are tough, effective, and long lasting. 5 piece replacement pack keeps you "rust hogging" all season!





04

HAMMERS & WEDGES



FIBERGLASS HANDLED WEDGE
35429 TG11E

Con mango de fibra de vidrio
Manche en fibre de verre

Length: 32" (81 cm) Weight: 10.1 lbs (4.6 kg)

These Duck-Billed Bead Breaking Wedges are our most popular bead breakers. Handle number TG11EH (see "TG11EH" on page 42).

FIBERGLASS
HANDLE 4X
STRONGER THAN
WOOD

**GENERAL PURPOSE
TIRE HAMMERS**

Martillos para llantas universales
Masse à tout usage



Designed for tire service in a variety of sizes and styles. Use rubber head replacement T11RH (35104).

HEAVY DUTY TIRE HAMMERS

Martillos para llantas de alta resistencia
Masse à pneu robuste



Hammers are used for mounting and demounting tires. They make tire changing faster and easier for passenger car, truck, bus, farm tractor, and aircraft tires. A variety of weights and sizes are offered to meet all your tire changing needs. Non-marring rubber end can be used for driving on lock rings. Use rubber head replacement T34RH (35105).



Model	Item No.	Handle No.	Length	Weight
Wood Handled (Con mango de madera Manche en bois)				
A	T11B	T11BH	14-1/2" (37 cm)	4.5 lbs (2.0 kg)
B	T33R	T11HN	14" (36 cm)	2.3 lbs (1.0 kg)
Fiberglass Handled (Con mango de fibra de vidrio Manche en fibre de verre)				
C	TG11B	TG11BH	16" (41 cm)	4.8 lbs (2.1 kg)
D	TG33R	TG31H	16" (41 cm)	2.5 lbs (1.1 kg)

Model	Item No.	Handle No.	Length	Head Weight	Weight
Wood Handled (Con mango de madera Manche en bois)					
E	T34	T11CH	17" (43 cm)	4.8 lbs (2.2 kg)	5.4 lbs (2.4 kg)
F	T35	T11DH	16-1/2" (42 cm)	5.5 lbs (2.5 kg)	6.1 lbs (2.7 kg)
G	T36	T11CH	16-1/2" (42 cm)	5.8 lbs (2.6 kg)	5.3 lbs (2.4 kg)
Fiberglass Handled (Con mango de fibra de vidrio Manche en fibre de verre)					
H	TG34	TG11CH	18" (46 cm)	5.5 lbs (2.5 kg)	6 lbs (2.7 kg)
I	TG35	TG11DH	18" (46 cm)	4.8 lbs (2.2 kg)	6.6 lbs (3.0 kg)
J	TG36	TG11CH	18" (46 cm)	5.8 lbs (2.6 kg)	6 lbs (2.7 kg)

REPLACEMENT RUBBER HEADS
Cabezas de goma de repuesto
Tête de remplacement en caoutchouc



Model	Item No.	Description	For Hammer No.
T11RH	35104	Rubber Head	T11R, TG11R, T33R, TG31
T34RH	35105	Rubber Head	T34, TG34, T35, TG35, T36, TG36

EPOXY KITS
Equipos de epoxy
Ensembles en époxy

Model	Item No.	Description	For Hammer No.
T12B	35201	Epoxy Kit	TG11B, TG11R, TG31, TG33R
T12D	35202	Epoxy Kit	TG34, TG36, TG37



TIRE KNOCKER 35110

Golpeadores de llantas
Bâtons de vérification de pression des pneus

Length: 18" (46 cm)
Weight: .7 lbs (.3 kg)



REPLACEMENT HANDLES

Mangos de repuesto
Manches de remplacement



New T11EHS orange safety grip handle. Specially formulated granulated handle coating provides extra grip for sure control of the steel bead breaking wedge.



Model	Item No.	For Hammer No.	Length	Weight
Top Quality U.S. Hickory (U.S. Hickory de máxima calidad Qualité supérieur U.S. Hickory)				

T11BH	35111	T11B	15" (38 cm)	.75 lbs (.3 kg)
T11HN	35113	T11R, T31, T33R	15" (38 cm)	.75 lbs (.2 kg)
T11CH	35119	T11C, T34, T36	17" (43 cm)	.75 lbs (.3 kg)
T11DH	35127	T11D, T35	17" (43 cm)	.75 lbs (.3 kg)
A T11EH	35129	T11E*	30" (76 cm)	1.2 lbs (.5 kg)
B T11EHS	35131	T11E*	30" (76 cm)	1.2 lbs (.5 kg)
80H-3H	37012	80H-3, 80H-4	10" (25 cm)	.5 lbs (.2 kg)
85H-3H	37023	85H-3, 84H-2, 84H-4	15" (38 cm)	.75 lbs (.3 kg)
84H-8H	37025	84H-8, 84H-10, 84H-12, 84H-16	36" (91 cm)	1.4 lbs (.6 kg)
84H-20H	37089	84H-20	36" (91 cm)	1.4 lbs (.6 kg)

Aluminum (Aluminio | Aluminium)

C T11AH	35529	T11E*, TG11E	32" (81 cm)	4.3 lbs (2 kg)
----------------	-------	--------------	-------------	----------------

Polymer (Polímero | Polymère) PATENTED

D T11KH	35230	T11KTM	32" (81 cm)	2.3 lbs (1.0 kg)
----------------	-------	--------	-------------	------------------

Fiberglass (Fibra de vidrio | Fibre de verre)

E TG31H	35206	TG11R, TG31, TG33R	16" (41 cm)	1 lb (.5 kg)
TG11BH	35211	TG11B	16" (41 cm)	1.3 lbs (.6 kg)
TG11CH	35219	TG11C, TG34, TG36	18" (46 cm)	2.5 lbs (1.1 kg)
TG11DH	35227*	TG11D, TG35	18" (46 cm)	1.2 lbs (.5 kg)
TG11EH	35229*	TG11E	32" (81 cm)	2.3 lbs (1.0 kg)

* Nulok adapter (others use epoxy).

CROSS-PEIN/BLACKSMITH HAMMER

Martillo de mano/de peña

Marteau à panne de travers/de forgeron

High carbon steel with machine polished face.

Top Grade U.S. Hickory Handle (Mango U.S. Hickory de primera calidad • Manche de qualité supérieure U.S. Hickory)

Model	Item No.	Length	Face	Eye Size	Head Weight
F 85H-3	37103	15" (38 cm)	1-5/8"	1 x 1-3/4"	3 lbs (1.4 kg)
85H-3H	37023	15" (38 cm)	Replacement Handle		

NEW ENGLAND PATTERN HAND-DRILLING HAMMERS

Martillos perforadores de mano con patrones de Nueva Inglaterra
Perforateur manuel modèle 'New England'

Top Grade U.S. Hickory Handle (Mango U.S. Hickory de primera calidad • Manche de qualité supérieure U.S. Hickory)

Model	Item No.	Length	Face	Eye Size	Head Weight
80H-3	37003	10" (25 cm)	1-1/2"	1 x 3/4"	3 lbs (1.4 kg)
G 80H-4	37004	10" (25 cm)	1-5/8"	1 x 3/4"	4 lbs (1.8 kg)
80H-3H	37012	10" (25 cm)	Replacement Handle for 80H-3, 80H-4		

DOUBLE-FACE SLEDGE HAMMERS

Mazas dobles • Masses à double-face

High carbon steel, heat treated. Machined, polished face.

Top Grade U.S. Hickory Handle (Mango U.S. Hickory de primera calidad | Manche de qualité supérieure U.S. Hickory)

Model	Item No.	Length	Face	Eye Size	Head Weight
84H-2	37302	15" (38 cm)	1-1/2"	3/4" x 1"	2.5 lbs (1.1 kg)
H 84H-4	37304	15" (38 cm)	1-3/4"	3/4" x 1"	4 lbs (1.8 kg)
84H-8	37308	36" (91 cm)	2"	1" x 1-3/8"	8 lbs (3.6 kg)
84H-10	37310	36" (91 cm)	2-1/8"	1" x 1-3/8"	10 lbs (4.5 kg)
84H-12	37312	36" (91 cm)	2-1/8"	1" x 1-3/8"	12 lbs (5.4 kg)
84H-16	37316	36" (91 cm)	2-3/8"	1" x 1-3/8"	16 lbs (7.2 kg)
84H-20	37320	36" (91 cm)	3"	2" x 1.5"	20 lbs (9 kg)
85H-3H	37023	15" (38 cm)	Replacement Handle for 85H-3, 84H-2, 84H-4		
84H-8H	37025	36" (91 cm)	Replacement Handle for 84H-8, 84H-10, 84H-12, 84H-16		
84H-20H	37089	36" (91 cm)	Replacement Handle for 84H-20		

DEAD BLOW HAMMERS

Martillos de golpe seco
Masse sans rebond

Head is shot filled for maximum force with no bounce effect. Safest non-marring, non-sparking hammers available. Great for tire changing and general shop use. High quality materials to withstand years of hard use.



PROFESSIONAL DEAD BLOW HAMMER

Martillo de golpe seco profesional
Masse professionnelle sans rebond

Power-drive fiberglass handle gives 20% more driving power, yet reduces user fatigue.

Model	Item No.	Description	Length	Nominal Weight
TG332	35332	2 lb Head (.9 kg)	13-1/2" (34 cm)	1.9 lbs (.9 kg)
TG333	35333	3 lb Head (1.4 kg)	14-1/2" (37 cm)	2.7 lbs (1.2 kg)
TG334	35334	4 lb Head (1.8 kg)	15-1/2" (40 cm)	3.4 lbs (1.5 kg)
K TG337	35337	Steel Face / Soft Face	13-1/2" (34 cm)	2.2 lbs (1 kg)



ECONOMY STRIKE PRO® HAMMER

Económico
Économique

Dead blow action in high visibility colors.

Model	Item No.	Color	Length	Nominal Weight
T335	35335	Safety Yellow	12" (31 cm)	1 lb (.5 kg)
L T336	35336	Safety Orange	12" (31 cm)	1.5 lbs (.7 kg)



2 LB. RUBBER MALLET 35310 T32

Mazo de goma de 2 libras

Maillet en caoutchouc de 2 lb

Handle Length: 17" (43 cm) Head Weight: 2 lbs (.9 kg)

Rubber head minimizes marring surfaces.

WARNING: Always wear safety goggles when using striking or struck tools. Never use one hammer to strike another hammer. Never use a tool with a loose or damaged handle. Discard any striking or struck tool if tool shows dents, cracks, chips, or mushrooming.

DUCK-BILLED BEAD BREAKING WEDGES

Our most popular bead breakers.

Cuñas desmontadoras de llantas de boca plana
Coins d'écartement de talons en bec de canard



WOOD HANDLED WEDGE

Con mango de madera | Manche en bois

Increased contact area between the handle and the hammer head causes the handle to have a tighter fit when the head is seated on the handle. By increasing end-taper of the handle the hammer head cannot come off the end of the handle. No slits in the top of the handle minimizes the effect of Humidity/Climate (expansion & contraction) on the handle.

Model	Item No.	Handle No.	Length	Weight
T11D	35327	T11DH	17" (43 cm)	4.8 lbs (2.2 kg)
I T11E*	35329	T11EH	30" (76 cm)	9.2 lbs (4.2 kg)
J T11ES	35330	T11EHS	30" (76 cm)	9.2 lbs (4.2 kg)

New T11ES orange safety grip handle. Specially formulated granulated handle coating provides extra grip for sure control of the steel bead breaking wedge.



FIBERGLASS HANDLED WEDGE

Con mango de fibra de vidrio | Manche en fibre de verre

Model	Item No.	Handle No.	Length	Weight
TG11D	35427	TG11DH	18" (46 cm)	4.8 lbs (2.2 kg)
K TG11E	35429	TG11EH	32" (81 cm)	10.1 lbs (4.6 kg)

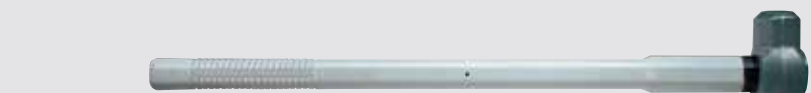

POLYMER HANDLED WEDGE

Con mango de polímero | Manche en polymère

Hump Design prevents tool from wedging between rim and bead. Breaks the bead with little or no prying. New polymer handle design for longer lasting everyday use. Full length fiberglass core for greater strength. Coating on handle provides durability. Patented.

Model	Item No.	Handle No.	Length	Weight
T11K™	35460	T11KH (35230)*	32" (81 cm)	10.5 lbs (4.8 kg)

*New handle design T11KH (35230) will not work with old style T11E head



Handle cross section

05

BALANCING & BEAD TOOLS



BALANCING BEADS

Complete wheel end balancing

Ken-Tool Balancing Beads have you covered from motorcycle, passenger, light truck, off-road and class 5-8 vehicles. Our easy-to-use drop in bag saves time and money on new tire installation and can be injected through the valve stem to completely balance the axle end on existing vehicles without dismounting the tire and wheel. Memory technology keeps the beads stabilized, providing a completely balanced axle end in all wheel positions. Ken-Tool Balancing Beads balance the complete axle end...the tire, the wheel and all the moving components of the wheel assembly. TPMS compatible.



LEAD FREE,
ENVIRONMENTALLY
FRIENDLY

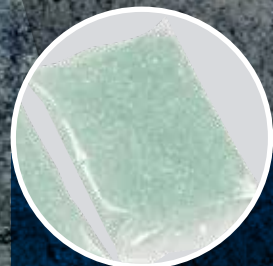

EASY TO USE,
DROP IN BAG OR
INSTALL THROUGH
VALVE STEM



SPECIALY
COATED KEN-TOOL
BALANCING BEADS
REPEL MOISTURE
AND AVOID
CLUMPING

Item No.	Description	Amount
31600	Bead Injection Tool for easy installation into the valve stem	
31601	1 oz bags	Case of 160
31602	2 oz bags	Case of 128
31603	3 oz bags	Case of 96
31604	4 oz bags	Case of 92
31606	6 oz bags	Case of 64
31608	8 oz bags	Case of 52
31610	10 oz bags	Case of 40
31612	12 oz bags	Case of 36
31614	14 oz bags	Case of 32
31616	16 oz bags	Case of 28

WARNING: Always wear safety goggles when using hand tools.



PNEUMATIC BEAD EXPANDERS

Expansores neumáticos de llantas
Tubes d'extension de talon pneumatiques

Expanders fit most bias ply tubeless tires. A pliable neoprene rubber tube is encased in a tough, long-lasting nylon cover. Expanders slip easily over tire and withstand contact with oil, grease, solvents, and acids. Expands passenger and light truck beads by compressing tread. **T131** is for smaller tires, **T132** for belted bias ply tires and steel belted radials, and **T133** for standard bias ply tires. All models feature an over-pressure relief valve and external pressure quick release valve for safe operation.

Model No.	Item No.	Min/Max Tire OD	Tube Diameter	Weight
A	T131	10 - 22" (26 - 56 cm)	2-1/4" (6 cm)	2 lbs (.9 kg)
	T132	24 - 34" (61 - 86 cm)	2-1/4" (6 cm)	2.8 lbs (1.3 kg)
	T133	22 - 32" (60 - 81 cm)	3/4" (2 cm)	.75 lbs (.3 kg)
	T134	13 - 26" (33 - 70 cm)	2-1/4" (6 cm)	2.7 lbs (1.2 kg)



TIRE BEAD SEATERS

Calzador para llantas
Cordons de talon de pneus

One-piece rubber tube for mounting hard-to-seat radial, bias-belted, or conventional truck tires. As tire is inflated, the lubricated bead seater forms a seal between the rim and tire, allowing the air pressure to force the beads into the rim flange. As proper pressure is reached, the bead seater slides out and over the rim. Use bead lubricant with bead seaters.

Item No.	Fits Rim Sizes	Weight
	Passenger / Light Truck (Camión liviana/vehículo de pasajeros / Automobile/camion léger)	
31446	14-15" (36 - 38 cm)	1.5 lbs (.7 kg)
	Truck (Camión Camion)	
E 31437	16-1/2" to 17-1/2" (42 to 45 cm)	2 lbs (.9 kg)
31438	19-1/2" (50 cm)	2.3 lbs (1 kg)
31439	22-1/2" to 24-1/2" (57 to 62 cm)	2.3 lbs (1 kg)



Mega AIRBLAST

BEAD SEATING TOOLS

Used on Auto, ATV, and Truck Tires. Designed for use on tires up to 24-1/2" diameter. Digital air pressure gauge and safety release valve included for operator convenience and safety. Plastic nose clip protects chrome and alloy wheels; replacements available.

Item No.	Description	Dimensions	Weight
B 31443	10 gallon Aluminum	23 5/8" x 19" x 14 1/8" (600 x 480 x 360 mm)	18.3 lbs / 8.3 kg
C 31444	5 gallon Steel	25 1/2" x 16 1/2" x 11 1/2" (648 x 419 x 292 mm)	26 lbs / 12 kg
D 31445	5 gallon Aluminum	25 1/2" x 17" x 11 1/2" (648 x 431 x 292 mm)	11 lbs / 5 kg



EASY-LIFT™ BEAD SEATING STAND

Soporte para calzado de talón Easy-Lift™
Poste de portée de talon Easy-Lift™

Safety First! ERGONOMIC: Reduces back strain while handling 22.5" tubeless tire & wheel assemblies. Aligns beads concentrically on wheel for improved ride & longer tire life. Portable for field service, or can be bolted to the floor. Made of high grade steel. Length: 24" high x 26" wide x 27" long. **PATENTED.**

Model No.	Item No.	Description	Weight
T116	36016	Standard Crown for 8-3/4" diameter hubs	36 lbs (16.4 kg)
T117	36017	Large Crown for 11" Euro hubs	37 lbs (16.8 kg)



TIRE & RIM CONDITIONER 35870

Acondicionador de llantas y llantas
Conditionneur pour pneus et jantes

Ken-Tool Tire & Rim Conditioner is a premium, eco-friendly liquid formula that will save you money while keeping your tires safe. When added to the air chamber in any tire, Ken-Tool Tire & Rim Conditioner works to improve performance and safety.



WHITE TIRE PASTE 35848

Lubricante Blanco Paste Lube
Lubrifiant Blanc Paste Lube

Premium tire mounting/demounting lubricant dries tacky to prevent rim slippage, with rust retardant.

8 lb. (3.6 kg)

BEAD-BREAKING TOOLS TRUCK/FARM/OTR

Herramientas desmontadoras de llantas para camiones/vehículos de granja/de carretera
Outils de décollage des talons pour camions/tracteurs/véhicules tout terrain

These lightweight, portable tools are a great alternative to handled bead breaking wedges or hydraulic bead breakers. One end is used to remove frozen or rusted beads from all types of rims. On the T52, the other end can be used as a leverage bar when inserted into the 35695 or 35697 Truck Lug Wrench.



PORTABLE BEAD BREAKER 34670 T100

Desmontadora de llantas portátil
Démonte-talons portatif

Portable bead-breakers are great for custom and foreign wheels. They break beads on most sizes of passenger tires and light trucks.

Length: 36" (91 cm) Weight: 5.2 lbs (2.3 kg)



BEAD-BREAKING TOOL/DRIVING IRON 32126 T26A

Herramienta desmontadora de llantas/barra de hierro desmontadora
Outil de décollage des talons/Levier d'entraînement

Driving iron is used for loosening rusted truck and bus beads. Will speed truck tire repair work and save labor and time.

Length: 11-3/4" (30 cm) Stock: 1-1/4" (32 mm) Weight: 4.4 lbs (2 kg)



SWAN NECK LEVERAGE BAR 33341 T41

Palanca de cuello de cisne
Barre de levage à col de cygne

Length: 30" (76 cm) Stock: 7/8" (22 mm)
Weight: 5.3 lbs (2.4 kg)



30" BEAD BREAKER 33342 T42

Desmontadora de llantas de 30 pulgadas
Démonte-talons de 30 po

Length: 30" (76 cm) Stock: 7/8" (22 mm)
Weight: 4.8 lbs (2.2 kg)



BEAD BREAKER LEVERAGE BAR 34652 T52

Palanca desmontadora de llantas
Barre de levage pour démonte-talons

Also for use with the T95 wrenches.

Length: 33" (84 cm) Stock: 7/8" (22 mm)
Weight: 5.5 lbs (2.5 kg)

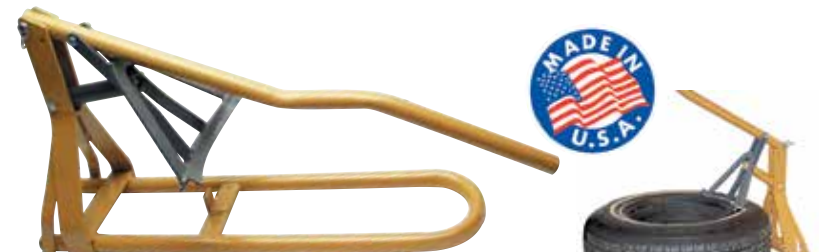

FLOOR TYPE BEAD BREAKER 35998 T98

Desmontadoras de llantas con pie
Démonte-talons sur sol

For Passenger and Light Truck. Ideal for stubborn tires. Use to prevent the bending of wheels. A great solution for custom and foreign wheels.

Tread Width: up to 11" (28 cm) Weight: 29.8 lbs (13.5 kg)



ATV BEAD BREAKER 38620

Desmontadora de llantas para vehículos todo terreno
Décolleur de talon pour VTT

Constructed of heavy-duty steel, the ATV Bead Breaker works with any center post tire changing machine and adjusts to sizes of 6 to 12 inch ATV rims without the hassle of clevis pins. No hammers, wrenches, or additional tools are required. **PATENTED.**

Weight: 7 lbs (3.2 kg)

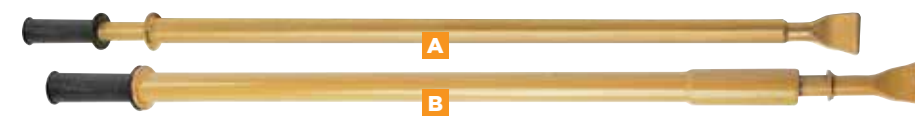

IMPACT BEAD BREAKERS

Desmontadoras de llantas de impacto
Démonte-talons à chocs

Bead breaker loosens beads with bead-breaking foot and ram bar, but never cuts the bead of the tire. The wedge foot is forced between the bead and rim flange. Breaker is designed for shop or road use. No other bead breaking tools are necessary. Provides greater accuracy than other conventional bead breakers.

Model No.	Item No.	Description	Length	Length Ext.	Weight
A	T24B	Economy - 1" Dia. Ram	46" (117 cm)	72" (183 cm)	13.5 lbs (6.1 kg)
B	T26B	Heavy Duty - 1-1/4" Dia. Ram	50" (127 cm)	80" (203 cm)	23 lbs (10.4 kg)

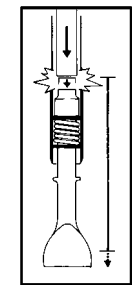

T26B has exclusive spring action design to reduce user fatigue associated with slide hammer kickback.



BEAD HOLDING DEVICES

Dispositivos de fijación de talón
Dispositifs de retenue des talons



BEAD HOLDING DEVICE 31710

Dispositivo para soporte de llantas
Dispositif de retenue des talons

Solid Brass Bead Holding Device now reaches over extra wide bead of super singles. Holds the bead in place against the wheel when mounting the tire on to the wheel. Do not use to pry. Imported.

Weight: 1.8 lbs (.8 kg)



ALUMINUM BEAD HOLDER FOR STEEL & ALUMINUM WHEELS

Sujetador de talón de aluminio para ruedas de acero y aluminio
Support de talon en aluminium pour roues en acier et en aluminium

Special C-Lok™ shape fits nearly all passenger, light truck, agriculture and truck wheels without slipping off. Aluminum design is lightweight but very strong and is less likely to mar alloy wheels. Great for super singles and super wide wheels — fits both steel and aluminum wheels. Available as a cabled pair No. 31714 for difficult wheels. Imported.

Item No.	Description	Length	Weight
31713	Single Aluminum Bead Holder	5.5" (14 cm)	8 oz (.2 kg)
31714	32" Cabled Pair		1 lb (.5 kg)



BEAD HOLDER FOR 19.5" ALUMINUM WHEELS 33196

Sujetador de talón para ruedas de acero y aluminio de 19.5"
Support de talon pour roues en aluminium de 19,5 po

Weight: 1 lb (.5 kg)

Weight: 1 lb (.5 kg)

Steel bead holder for 19.5" aluminum truck wheels that fit 9/16" diameter studs. Always mount/demount 19.5" wheels with hub side up. **PATENTED.**



06

WHEEL PRODUCTS

SHARK FIN™ DUAL WHEEL SEPARATION BAG 34555

Bolsa de separación de doble rueda
Sac de séparation à deux roues

The first wheel separation solution for steel, aluminum and chrome wheels! No metal on metal contact! Works on 15" to 24.5" dual and single wheels and tires on trucks & trailers

Weight: 1.31 lbs (.59 kg)
Deflated: 9.75" x 8" x 3/8"
Fully Inflated: 5.5"

SHARK FIN™



SIMPLY TURN VALVE CAP TO DEFLATE

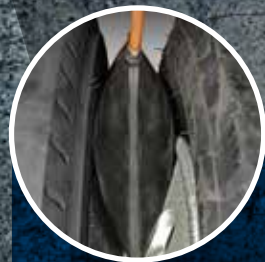

INFLATES TO SEPARATE STUCK OR FROZEN DUAL WHEELS - 2.5 TONS (5000 LBS) OF STATIC PRESSING FORCE!



3 FOOT INFLATION HOSE MAKES ACCESS EASY AND SAFE. 90 PSI MAX PUSHING PRESSURE, 150 PSI MAXIMUM RATED PRESSURE



KEVLAR INNER INFLATION BAG IS INDUSTRIAL GRADE AND NEARLY PUNCTURE PROOF



PRO SUPER HUB SHARK® BEARING & ROTOR PULLING SYSTEM 7326

Sistema de tracción de rotores y rodamientos
Système d'extraction de rotors & de coussinets

Weight: 58 lbs (26.3 kg)



Replace the front wheel bearings on front wheel drive vehicles without removing the steering knuckle from the vehicle or realigning the front end - in about 20 minutes per wheel. Save time and money, keeping more jobs in house - no need to send bearings out to be machine pressed. Pull and press any hub or bearing on domestic and import vehicles. Pull inner bearing race from the hub. Always be sure the center screw thread is clean and well lubricated. **No. 7326U Upgrade Kit available for previous Hub-Shark™ owners (case included).**



WHEEL COVER PULLER/REPLACERS



Extractor/cambiadores de cubiertas
Extracteur de garde-roues/garde-roues d'échange

Removes wheel covers quickly and easily without gouging or scratching them. Rubber head T11RH prevents damage to hub cap and is replaceable.



PROFESSIONAL WHEEL COVER PULLER/REPLACERS 31567 T67

Profesional
Professionnel

Length: 17-1/2" (45 cm) Stock: 9/16" (14.3 mm)
Weight: 1.8 lbs (.8 kg)



STANDARD WHEEL COVER PULLER/REPLACERS 31568 T68

Estándar
Standard

Length: 14" (36 cm) Stock: 7/16" (11.1 mm)
Weight: 1.3 lbs (.6 kg)





TRUCK TIRE CHANGING STAND 36015 T115

*Soporte para cambio de llantas de camiones
Support de démontage pour pneus de camions*

Weight: 1 lbs (9.5 kg)

Stand handles wheels or open rims 16.5" to 24". Double-slide adjustment with locking device prevents twisting so it stays aligned with the wheel or rim. Stand is the ideal height for driving off beads or demounting tires. It must be used to be appreciated.



ALUMINUM WHEEL PROTECTOR 31810

*Protector de cubiertas de aluminio
Protecteur pour roues en aluminium*

Length: 6" (15 cm) Weight: 6 oz (.2 kg)

Protects expensive rims from damage during manual tire changing. Prevents tire tools from marring or scratching aluminum or steel rims when using Ken-Tool's manual tire changing tools. Durable leather protector fits on the rim and protects inside of the rim well. Use with an assortment of tire tools including: T45A® - style tire irons, Serpent™, tire spoons, and other Ken-Tool tire changing tools. When one end wears out, flip it over and use the opposite end. Great for roadside service or in the shop. **PATENTED.**

PROFESSIONAL WHEEL WEIGHT TOOL 35354 B230
*Herramientas profesional para pesar ruedas
Outil professionnel pour masses d'équilibrage*

Weight: 1 lb (.5 kg)

Clip-claw crowbar, punch designed handles, and heavy hammerhead provide years of use. Imported.

STANDARD WHEEL WEIGHT TOOL 35355 B232
*Herramientas estándar para pesar ruedas
Outil standard pour masses d'équilibrage*

Weight: 1 lb (.5 kg)

This passenger car wheel weight tool is the industry standard. Imported.

WHEEL WEIGHT HAMMER 35361

*Martillos de peso de rueda
Marteaux pour masses d'équilibrage*

Length: 11" (28 cm) Weight: 1 lb (.5 kg)

"The last wheel weight hammer you'll ever need!" Safe for use on STEEL, ALUMINUM, and CHROME! No modification to hook needed to fit smaller weights. Refurbish kit (35362, .25 lbs. [.11kg]) available to replace the hook and replace the anti-marring face.

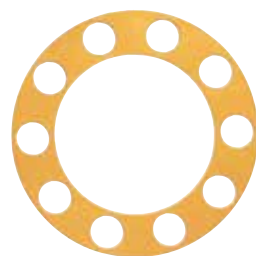

NO-MAR RIM GUARD™ 30605
*Tapa para llantas No-Mar
Protection de jante antimarque*

Weight: .5 lbs (.2 kg)

Protective cover prevents damage to chrome and aluminum rims and wheels when removing or replacing lug nuts. Imprinted with torque sequence number for proper torquing of disc wheels. Imported from Canada.



SUPER SINGLE AXLE DRAIN PAN 30600
*Súper bandeja de drenaje de eje único
Bac de récupération pour essieu simple super*

Weight: 1.3 lbs (.6 kg)

Extended applications: Fits most 10-hole Super Single and Dual Disc Wheels. Lightweight molded plastic pan locks inside truck and trailer wheels to keep tire and wheel clean. Fits most steel and aluminum 22.5" and 24.5" 10-hole hub, and stud-piloted tubeless wheels. HDPE high density polyethylene design won't warp if oil is warm. 124 oz. capacity with self-draining shelves for hub and axle nuts. Flat bottom avoids spillage on workbench or floor. Two built-in drip-proof drainage spouts for easy waste disposal. **PATENTED.**



DUAL WHEEL SEPARATOR 34549

Case Dimensions: 6.5" x 9.5" x 2.5" Weight: 5.3 lbs (2.4 kg)

Makes removing stuck or frozen dual steel wheels quick and easy. Ideal for use on nearly any truck, bus, van or trailer that has dual steel wheels. Forcing Screw and Pullers have powerful 1-1/8" diameter x 11 threads for years of reliable service. Use with air or electric impact wrench. Limited Lifetime Warranty. (Component parts available.)



Components are laser-etched for easy identification

Innovative "One-piece" Pusher won't fall apart during use

Includes two pullers to cover large truck, trailer and smaller light truck dual wheel applications



Components have black oxide or bright nickel plating finish for rust and corrosion resistance



Pusher is ball bearing-driven for near-zero turning resistance and is heat treated for long-lasting strength and durability

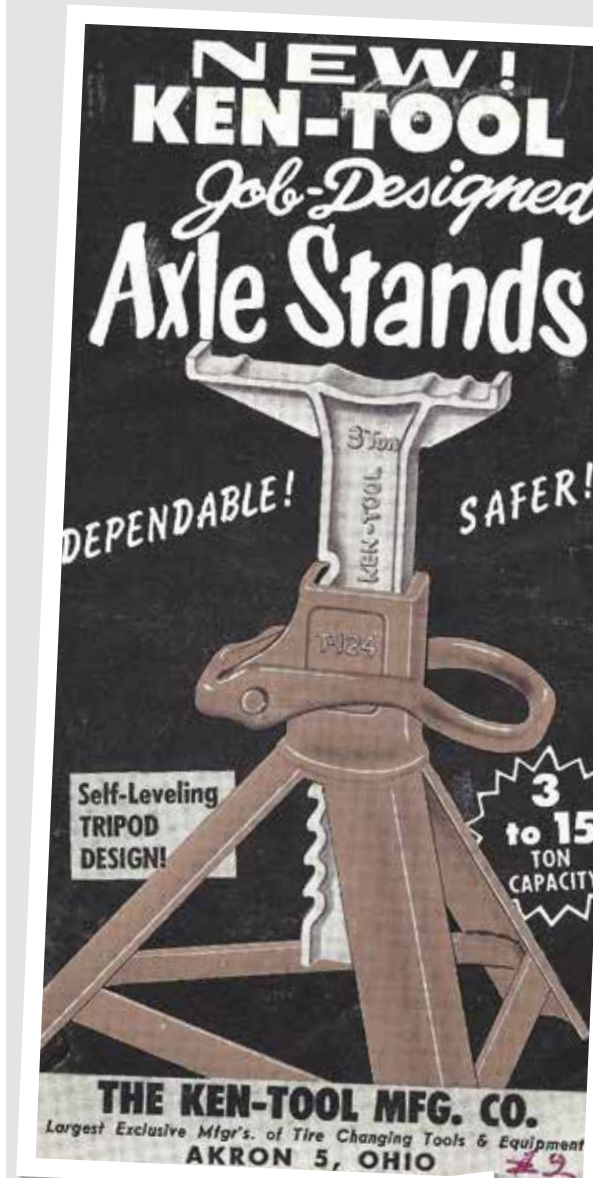

07

TIRE CAGES

TIRE INFLATION CAGES

Cajas para inflado de llantas
Cages de sécurité pour gonflement de pneus

Mandatory for any shop working with tubeless and multi-piece rims. Made from heavy-gauge steel tubing welded to a steel base. Guards against blown lock rings and rims. Follows OSHA regulation 29-CFR Part 1910.177. Read safety label on cage. Designed to meet OSHA regulation requirements for Medium, Heavy-Duty Truck, OTR, Tractor, and Super Singles. Ken-Tool offers sizes and designs for all your needs. For additional safety labels or instructions, call Ken-Tool customer service.



Earthmover 12-Bar Tire Inflation Cage

Work safely. Always use an inflation cage when inflating tires. Follow OSHA regulation 29-CFR Part 1910.177 whenever changing tires.



07 TIRE CAGES

EARTHMOVER TIRE INFLATION CAGES

Jaula de inflado para neumáticos de excavadoras
Cage de gonflage de pneu d'engin de génie civil

HD all steel cages protect workers, equipment and facilities. For large Earthmover & Agricultural tires.

EARTHMOVER 12-BAR TIRE INFLATION CAGE 36012 T112

Caja de 12 barras
Cage à 12 barres

For large Earthmover & Agricultural tires. 12-bar design fits wheels 87" total height by 48" wide. (Photo on opposite page.) **PATENTED.**

Height A**	Width B	Base	Height	Max PSI	Weight
86-1/2" (220 cm)	60" (152 cm)	84" x 54" (213 cm x 137 cm)	99-1/2" (253 cm)	100	1,100 lbs (499 kg)



EARTHMOVER 7-BAR TIRE INFLATION CAGE 36020 T120

Caja de 7 barras
Cage à 7 barres

For Mining and heavy equipment. **PATENTED.**

Height A**	Width B	Base	Height	Max PSI	Weight
65-1/2" (166 cm)	32" (81 cm)	38-1/2" x 54" (98 cm x 137 cm)	76" (193 cm)	100	488 lbs (221 kg)



EARTHMOVER 10-BAR TIRE INFLATION CAGE 36011 T111

Caja de 10 barras
Cage à 10 barres

New patented design with 10-bar construction. Fits up to 29.5R25 L-3 Earthmover. **PATENTED.**

Height A**	Width B	Base	Height	Max PSI	Weight
77-1/2" (197 cm)	42" (107 cm)	72" x 48" (183 cm x 123 cm)	90-1/2" (230 cm)	100	820 lbs (372 kg)

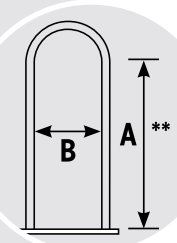

**For reference only. Height A refers to the approximate height to the inside bend of the cage.

PASSENGER AND LIGHT TRUCK CAGE

Jaula para camión liviano y para pasajeros
Cabine passager et véhicule utilitaire léger

A must for run-flat, low-profile, and other tires that are difficult to seat.

Model	Item No.	Height A**	Width B	Base	Height	Max PSI	Weight
T103	36003	30" (76 cm)	16" (41 cm)	21-1/2" x 22" (55 cm x 56 cm)	40-1/2" (103 cm)	130	80 lbs (36.2 kg)



PORTABLE WIDE BASE AND STANDARD 2-BAR CAGES

Caja de dos barras con base amplia portátil
Cage portative à deux barres, à base large

Designed for wide base truck tires, the T101A portable inflation cage will hold super singles, and super wide radial tires. Fits comparable tires up to: 455/55R22.5. T101 fits standard truck tires.

Model	Item No.	Height A**	Width B	Base	Height	Max PSI	Weight
T101A	36007	43-1/2" (110 cm)	20-1/2" (52 cm)	7" x 26" (18 cm x 66 cm)	56-1/2" (144 cm)	130	72 lbs (32.6 kg)
T101	36001	41" (104 cm)	16" (41 cm)	7" x 21-1/2" (18 cm x 55 cm)	51-1/2" (131 cm)	130	60 lbs (27.2 kg)



TALL 3-BAR CAGE (OTR AND FARM)

Caja de 3 barras (de carretera/vehículos de granja)
Cage à 3 barres (pneus tout terrain/tracteurs)

Model	Item No.	Height A**	Width B	Base	Height	Max PSI	Weight
T104	36004	63" (160 cm)	24" (61 cm)	30" x 27" (76 cm x 69 cm)	77-1/2" (197 cm)	130	158 lbs (72.6 kg)



TIRE INFLATION CAGES:

WARNING: Tire changing can be dangerous, and should be done only by trained personnel using proper tools and equipment as directed by Federal OSHA Standard No. 29 CFR Part 1910.177. Tires may explode during inflation causing injury to operator or bystander. Wear safety goggles. Keep all parts of body outside cage. Use extension hose, clip-on chuck, and remote valve. See supervisor for safety procedures.

WARNING: Do not alter cage in any way. Cage must be freestanding and at least three feet from other objects. Discard cage if bent, cracked, or otherwise damaged. Always wear safety goggles.

TRUCK AND OFF-ROAD TIRE INFLATION CAGES

*Jaulas para inflado de llantas de camiones y vehículos todo terreno
Cages de gonflage de pneu camion et tout-terrain*

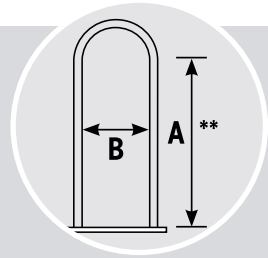

***For reference only. Height A refers to the approximate height to the inside bend of the cage.*

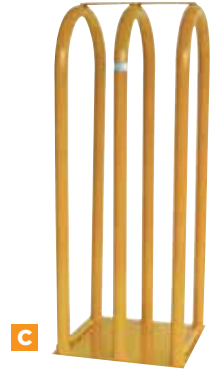

4-BAR CAGE 36002
Caja de 4 barras
Cage à 4 barres

5-BAR CAGE 36005
Caja de 5 barras
Cage à 5 barres

3-BAR CAGE 36006
Caja de 3 barras
Cage à 3 barres

7-BAR CAGE 36008
Caja de 7 barras
Cage à 7 barres

Max PSI: 130 Weight: 146 lbs (66.2 kg)

Max PSI: 130 Weight: 182 lbs (82.5 kg)

Max PSI: 130 Weight: 134 lbs (60.7 kg)

Max PSI: 130 Weight: 485 lbs (220 kg)

Height A**	Width B	Base	Height
A 43-1/2" (110 cm)	20-1/2" (52 cm)	31-1/2" x 26" (80 cm x 66 cm)	56-1/2" (144 cm)
B 43-1/2" (110 cm)	20-1/2" (52 cm)	41" x 26" (104 cm x 66 cm)	56-1/2" (144 cm)

Height A**	Width B	Base	Height
D 43-1/2" (110 cm)	20-1/2" (52 cm)	26" x 22" (66 cm x 56 cm)	56-1/2" (144 cm)
D 46" (117 cm)	29" (74 cm)	34" x 56" (86 cm x 142 cm)	63" (160 cm)

EZ TIRE ROTATORS™

*Rotador de neumáticos EZ Tire Rotator™
Rotateur de pneu EZ Tire Rotator™*

Reduces handling, back strain and user fatigue; increases safety. Easily installed or moved to another cage – no fastening required. No assembly required, simply place in the center of the cage. Works as a portable tread inspection and stone removal station outside of cage. Features heavy-duty 2" ball-bearing steel rollers and 1-1/4" thick steel stock for long service. Boxed and UPS shippable. **PATENTED.**



EZ TIRE ROTATOR™ 36014 T114
Rotador de neumáticos EZ Tire Rotator™
Rotateur de pneu EZ Tire Rotator™

Dimensions: 17-1/2" x 25-1/2" (44.5 cm x 64.8 cm) x 2-1/2" (6.6 cm) with ramp Weight: 16 lbs (7.3 kg)

Fits any Ken-Tool® 3-Bar, 4-Bar and 5-Bar Inflation Cage, plus many competitive cages. Quickly rotate assembly inside cage for easy valve access.



EZ TIRE ROTATOR™ WITH RAMP 36018 T118

*Rotador de neumáticos EZ Tire Rotator™ con rampa
Rotateur de pneu EZ Tire Rotator™ avec rampe*

Dimensions: 25" x 25" (64 cm x 64 cm) x 2-5/8" (6.6 cm) with ramp Weight: 21 lbs (9.5 kg)



MAGNUM EZ TIRE ROTATOR™ WITH RAMP 36013 T113

*Rotador de neumáticos Magnum EZ Tire Rotator™ con rampa
Rotateur de pneu Magnum EZ Tire Rotator™ avec rampe*

Dimensions: 25" x 28" (64 cm x 71 cm) x 2-5/8" (6.6 cm) with ramp Weight: 22 lbs (10 kg)

Ramp lifts tire onto rollers with ease. Fits Ken-Tool® Magnum and SuperMagnum Inflation Cages. **PATENTED.**

MAGNUM™ TIRE INFLATION CAGES

*Jaulas para inflado de llantas Magnum™
Cages de gonflage de pneu Magnum™*

Designed to accept the new generation of Super Single and Super Wide-Base truck tires with their higher inflation pressures and air volumes.

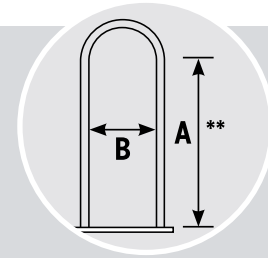

***For reference only. Height A refers to the approximate height to the inside bend of the cage.*



MAGNUM™ 5-BAR CAGE 36009 T109

*Caja de 5 barras Magnum
Cage à 5 barres Magnum*

Max PSI: 130 Weight: 211 lbs (96 kg)

Height A**	Width B	Base	Height
41-1/2" (105 cm)	24-1/2" (62 cm)	48" x 30" (122 cm x 76 cm)	55" (140 cm)

SUPERMAGNUM™ 5-BAR CAGE 36010 T110

*Caja de 5 barras SuperMagnum
Cage à 5 barres SuperMagnum*

36010 with steel mesh diffuses 93% of blast force from zipper rupture!

Max PSI: 130 Weight: 248 lbs (112.7 kg)

Height A**	Width B	Base	Height
41-1/2" (105 cm)	24-1/2" (62 cm)	48" x 30" (122 cm x 76 cm)	55" (140 cm)

PORTABLE MAGNUM™ 2-BAR CAGE 36019 T119

*Caja de 2 barras portátil Magnum
Cage portative à 2 barres Magnum*

Max PSI: 130 Weight: 80 lbs (36.2 kg)

Height A**	Width B	Base	Height
49-1/2" (126 cm)	24-1/2" (62 cm)	7" x 30" closed (18 cm x 76 cm)	64" (163 cm)

TIRE INFLATION CAGES:

WARNING: Tire changing can be dangerous, and should be done only by trained personnel using proper tools and equipment as directed by Federal OSHA Standard No. 29 CFR Part 1910.177. Tires may explode during inflation causing injury to operator or bystander. Wear safety goggles. Keep all parts of body outside cage. Use extension hose, clip-on chuck, and remote valve. See supervisor for safety procedures.

WARNING: Do not alter cage in any way. Cage must be freestanding and at least three feet from other objects. Discard cage if bent, cracked, or otherwise damaged. Always wear safety goggles.



See page 45 for details..



31443 Mega Air Blast Bead Seating Tool 10 Gallon Aluminum Tank



31445 Mega Air Blast Bead Seating Tool 5 Gallon Aluminum Tank



26012 Handheld Automatic Tire Inflator
Features a 12" hose with spring protector. Clip-on chuck and 8" dual foot chuck included.

See page 73 for details.

08

TPMS & VALVE PRODUCTS



AIR-FLEXX® TRUCK TIRE VALVE EXTENSIONS

Extensiones de válvula de neumático de camión Air-Flexx®
Rallonges de valve de pneu de camion Air-Flexx®

FEATURED PRODUCT

Air-Flexx valve extensions are flexible but rigid enough to eliminate the need for a rim holder, clamp or stabilizer during inflation, saving time and money. If the extension is severed or broken no pressure is lost from the tire. For use on spare wheels with angled extensions of 45°, 90°, 135° or 180°.

Item No.	Description
20075	2 1/8" (75mm) Air-Flexx Valve Extension, Steer and Single Wheels with Hubcaps
20085	3 1/4" (85mm) Air-Flexx Valve Extension, Steer and Single Wheels with Hubcaps
20105	4 1/8" (105mm) Air-Flexx Valve Extension, Inner Dual Tires or Steer & Single Wheels with Hubcaps
20145	5 1/4" (145mm) Air-Flexx Valve Extension, Inner Dual Tires
20185	7 1/4" (185mm) Air-Flexx Valve Extension, Inner Dual Tires
20215	8 3/4" (215mm) Air-Flexx Valve Extension, Inner Dual Tires
20315	12 3/8" (315mm) Air-Flexx Valve Extension, Inner Dual Tires or Spare Tire
20415	16 1/8" (412mm) Air-Flexx Valve Extension, Inner Dual Tires or Spare Tire
21000	39 3/8" (1000mm) Air-Flexx Valve Extension, Inner Dual Tires or Spare Tires

CHECK AIR PRESSURE AT ANY TIME WITHOUT REMOVING HUB CAPS FROM SINGLE WHEELS!

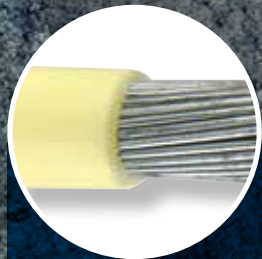

PROTECTIVE DURABLE PLASTIC COVER STAYS FLEXIBLE IN EXTREME COLD AND HEAT



STAINLESS STEEL JACKET

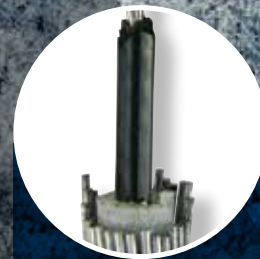

INNER AIR PIPE

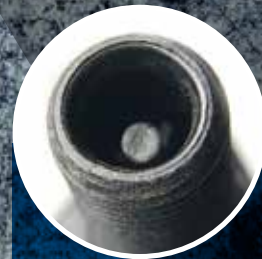

MOVING INNER PIN OPENS TIRE VALVE ONLY WHEN CHECKING PRESSURE OR INFLATING

reCore®

Over 3.5 million test miles!



RECORE® 12 PIECE TPMS SENSOR SAVER SYSTEM 29980

Sistema de reparación de sensores TPMS
Système d'économiseur de capteurs TPMS

5 lbs (2.3 kg)

Now you can repair TPMS Sensors without even taking the tires off the vehicle! Kit includes: 12 TPMS Sensor Savers, TPMS Valve Core Torque Tool (preset at 4-in-lbs), High Speed Dual Cutter, Countersink Drill Bit, Tap, Tap Holder with T-handle, Ken-Lok™ Thread Sealant, easy to follow instructions, Blow-molded plastic storage case. **PATENTED.**



RECORE® TPMS SENSOR SAVER REFILL KIT 29981

Kit de repuestos para reparación de sensores TPMS
Kit de rechange pour économiseur de capteurs TPMS

.5 lbs (.2 kg)

Includes 25 TPMS Sensor Savers plus a fresh Tap. **PATENTED.**



	If Your Per-Sensor Repair Fee Is:		
12 pc. Starter Kit 29980	\$39	\$49	\$59
Kit Cost	\$199	\$199	\$199
Revenue	\$468	\$588	\$708
Per kit Profit	\$269	\$389	\$509
Profit per Sensor	\$22.42	\$32.42	\$42.42
Your Profit % Is	57%	66%	72%

	If Your Per-Sensor Repair Fee Is:		
25 pc. Refill Kit 29981	\$39	\$49	\$59
Kit Cost	\$199	\$199	\$199
Revenue	\$975	\$1,225	\$1,475
Per kit Profit	\$776	\$1,026	\$1,276
Profit per Sensor	\$31	\$41	\$51
Your Profit % Is	80%	84%	87%



Galvanic corrosion causes TPMS failures.



RECORE® 7 PIECE TPMS STEM REPAIR KIT 29975

Sistema de reparación de sensores TPMS
Système d'économiseur de capteurs TPMS

Weight: .55 lbs (.25kg)

Easily repair damaged aluminum TPMS valve stems! Repair 2 sensors for less than the cost of one replacement TPMS unit. Additional tools needed are a high speed drill, needle nose pliers, and eye protection. **PATENTED.**



Stems are damaged by corrosion from weather, steel valve caps, and improper valve cores



Save Your TPMS sensor without having to remove the wheel or demount the tire

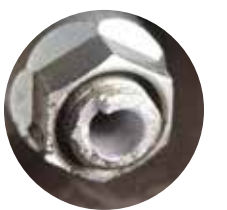

Repairs can be completed in 20 minutes



TIRE VALVE INSTALLER 29850
Instalador de válvula de llantas
Installer de vannes à pneus



Threaded installer grips any standard tire valve! Screws on to cap of threads on tire valve and handle is used as a lever to pull tire valve into rim hole. Robust and durable for fleet use - steel construction provides leverage without bending.

Length: 12" (30.5 cm) Weight: .6 lbs (.27 kg)



Polymer rim guard doesn't mar or damage chrome or alloy wheels



Slip resistant ergonomic handle feels great in hand



Swivel head allows for ease of use at any angle



VALVECAPPER® PRO CAP & CORE TOOL 29999
Instalador de válvula de llantas
Installer de vannes à pneus



4 tools in 1, the Valvecapper® Pro makes it easier to check the inside dual tire! Designed by a trucker to make a difficult job easier, this patent pending design holds on to cores for easy removal and installation. No more moving your rig to position valve stems just to get to the caps, no more dropped caps - holds onto caps and valve cores for removing and replacing. The longer valve cap grip works on flow-through, double seal valve caps. At 11 3/4 inches it has enough reach to get the job done. Unbreakable under normal use, the Valvecapper® Pro is designed for use on metal and plastic valve caps.

Weight: 1.5 oz (.04kg)



VALVECAPPER® PRO 25 PIECE COUNTER DISPLAY 29999M
Instalador de válvula de llantas
Installer de vannes à pneus

4 tools in 1!

Weight: 3 lbs (1.4 kg)



VALVE BREAKER™
Herramienta para romper válvulas Valve Breaker™
Outil casse-valve Valve Breaker™

Now Available in Steel and Alloy Models!

Quickly and easily remove valve stems from steel and alloy wheels! Made in USA from quality, high-grade steel. Heat-treated punch for top performance and long life. Pinch-preventing Safety Grip with vibration dampening tube grip. Long-lasting baked powder coat finish. T34B designed to fit into most 30" toolboxes. Simple to re-build - only 3 components. **Patented.**

Model	Item No.	Description	Length	Tip Diameter	Weight
A	T34B	Valve Breaker	27" (69 cm)	.5" (14mm)	9 lbs (4.1 kg)
B	T36B	Valve Breaker	45" (114 cm)	.5" (14mm)	16 lbs (7.2 kg)
C	T38B	Metric Valve Breaker	45" (114 cm)	.35" (9mm)	16 lbs (7.2 kg)
D	35935	3 Pc. Valve Breaker Repair Kit	.5" (14mm)	1 lb (.5 kg)	
E	35937	3 Pc. Metric Valve Breaker Repair Kit	.35" (9mm)	1 lb (.5 kg)	



Solid ram bar (not hollow pipe) drives more energy into valve



The Cooper Group

CRESCENT · KEN-TOOL · LUFKIN ·

In May of 1966, John Lydle sold the company to Cooper Industries of Houston, Texas. Ken-Tool was the third non-energy- service venture of Cooper and their first hand tool acquisition. In 1970, Ken-Tool became one of the original members of the Cooper Tool Group, along with Crescent hand tools, Weller soldering guns and Lufkin tape measures and rules. In 1971 Ken-Tool began selling these products to the automotive aftermarket as Cooper's only aftermarket distribution arm. As Ken-Tool became Cooperized, most of the non-Cooper buy-for-resale items were dropped from the line as focus was placed on those items of Ken-Tool's manufacture. In 1972, the Kennedy brand of product was discontinued for good. The Ken-Tool line was now 95% product of its own manufacture and a springboard to sell other Cooper products to the aftermarket.

the indestructibles
 another first from Ken-Tool!
 Fiberglass handles that last the life of the Tool

SEEDGE HAMMER
 KEN-TOOL FIBERGLASS HANDLE HAMMERS
 Now from one source—the industry's most complete line of fiberglass handle hammers. Alloy steel heads are permanently epoxy-bonded to handles so they can't work loose or fly off. Each has a shock-absorbing, non-slip, comfortably cushioned grip.

SURFACE PROTECTIVE HAMMER with non-bounceable tip
 KEN-TOOL'S indestructible fiberglass handles are stronger than steel... lighter than aluminum—absorb rebound, shock, and sting. Unaffected by climatic conditions... impervious to dry rot, termites, mild, grease, and common chemicals... won't splinter, warp, or rust and outlast wood 80 to 1.

TRUCK TIRE HAMMER
 KEN-TOOL FIBERGLASS HANDLE KITs... make all your sensitive handle hammers INDESTRUCTIBLE... There's a bit to replace every axle, tire, and wheel from your fleet's most important use. Easy to reset. Simply heat and use.

ALL-PURPOSE HAMMER

WRITE FOR ADDITIONAL INFORMATION
KEN-TOOL MANUFACTURING Co.
 AKRON, OHIO 44305
 A DIVISION OF COOPER INDUSTRIES INC.

better battery service... from the service tool people

- **B-97 THERMO-BATTERY TESTER** Instant-reading for fast testing.
- **678 AUTOMATIC BATTERY FILLER** Self-leveling for proper level.
- **B-62 TWO-PIECE BATTERY CARRIER** Quick adjust for 6 or 12 volt batteries.
- **B-25-BATTERY CARE KIT**, 3 pcs. clamp lifter, pliers, clamp spreader/cleaner.

Contact: Drake America Corporation
 477 Madison Ave., New York, N.Y. 10022 U.S.A.

KT KEN-TOOL MANUFACTURING Co.
 A DIVISION OF COOPER INDUSTRIES INC.
 Akron, Ohio, U.S.A., 44305

Ken Cargo-Lok
 Prevents loads from SHIFTING, SLIDING and FALLING while truck is in transit

B-60 Complete As Shown
 One size fits all trucks. Wt. 22 lbs.

B-60 Complete As Shown
 One size fits all trucks. Wt. 22 lbs.

Form 30-2

• RUGGEDLY MADE OF STURDY STEEL—YET LIGHTWEIGHT FOR EASY HANDLING
• FRICTION TYPE JACK—EASY TO OPERATE—LOCKS FRIGHT IN ANY POSITION
• CARGO-LOK FEET ARE MOUNTED ON NEW EXCLUSIVE SWIVEL BALL JOINTS
• NON-SLIP, HEAVY DUTY RUBBER PADS COVER CARGO-LOK FEET
• CLOSED—6" ... OPENS TO FIT ANY TRUCK
• CAN BE INSTALLED IN ANY PART OF TRUCK IN SECONDS—VERTICALLY OR HORIZONTALLY
• ONE ALL-PURPOSE, HEAVY DUTY, FULL SHAFT CARGO-LOK FOR ANY JOB

09

FRONT END SERVICE TOOLS

IMPACT SEPARATOR TOOL 35939 T39B

Impacto de la herramienta de separación
Outil impacteur

Length: 36-1/2" (92.71 cm), Weight: 9.8 lbs (4.5 kg)

Heavy-duty impact front end service tool. Hits harder and straighter than a hammer, but no more misses or glancing blows. Two easily interchangeable hardened steel forks. Use the T39B-1 fork to separate shock absorber links and tie rods; Use the T39B-2 fork on spindle support arms to remove ball joints without damaging other suspension parts. Services compact cars and light duty trucks too. Made in USA. Includes impact separator tool with 2 forks: **Patent Pending.**



35939-01:
T39B-1 TIE ROD
FORK
FORK OPENING:
5/8" (2 CM)

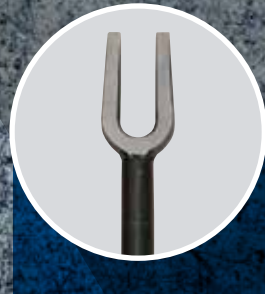

35939-02:
T39B-2 BALL
JOINT FORK
FORK OPENING:
15/16" (2 CM)

09 FRONT END SERVICE TOOLS

FRONT END SERVICE TOOLS

Herramientas para el mantenimiento delantero
Outils de service du train avant



These tools are manufactured from a single piece of alloy steel, forged, and heat-treated for long life. Essential when replacing suspension parts. Striking ends have been enlarged to provide a bigger and safer striking surface. Painted finish for rust resistance. Ken-Tool offers a size and design for all your needs.



SEPARATOR TOOL 32036 B36

Herramienta separadora
Séparateur

Length: 11" (28 cm), Stock: 7/8" (2 cm), Fork Opening: 1-7/16" (4 cm), Weight: 1.9 lbs (.8 kg)

Use to remove camber adjustment sleeves on Ford 4 x 2 and 4 x 4 pickups. Use as Pitman arm wedge on medium and heavy-duty trucks.



PITMAN ARM WEDGE 32037 B37

Cuña para la biela de mando de la dirección
Coin pour bielle pendante

Length: 11" (28 cm), Stock: 7/8" (2 cm), Fork Opening: 1-1/8" (3 cm), Weight: 1.8 lbs (.8 kg)

Removes Pitman arms on cars and light trucks.



SHOCK LINK AND TIE ROD SEPARATOR 32039 B39

Separador de la barra de acoplamiento y la unión del amortiguador
Fourche à barre d'accouplement et articulation d'amortisseur

Length: 16" (41 cm), Stock: 7/8" (2 cm), Fork Opening: 5/8" (2 cm), Weight: 2.1 lbs (.9 kg)

Use to separate shock absorber links and tie rods.



BALL JOINT SEPARATOR 32040 B40

Separador de juntas de rótulas
Séparateur de joint à rotule

Length: 16" (41 cm), Stock: 7/8" (2 cm), Fork Opening: 15/16" (2 cm), Weight: 2.8 lbs (1.2 kg)

Use on spindle support arms to remove ball joints without damaging other suspension parts. Services compact cars and light duty trucks.



MACPHERSON STRUT COIL SPRING COMPRESSOR SET 39730

Equipo compresor de resorte espiral
de montante MacPherson
Groupe compresseur de ressort
hélicoïdal à jambe de suspension

Weight: 7 lbs (3.1 kg)

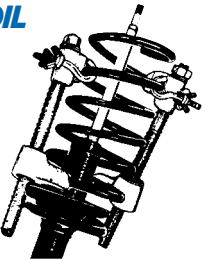

Compressor works on most MacPherson Strut assemblies and is for use with replacements. Use the compressor when replacing bent strut or strut tube and damaged spindles. Use it on or off the car. Acme threaded screw for durability. Do not use on General Motors "A", "C", "J", or "X" body cars. **Imported.**



HEAVY DUTY TIE ROD END TOOL 32031

Herramienta de servicio pesado para el extremo de la barra
de acoplamiento
Outil robuste pour embout d'accouplement

The 3/4" square drive Tie Rod Socket is designed for use on 9,000 through 20,000 pound axles or classes 7 & 8. The U-shaped slot measures 1-7/8" x 1-1/2" with an inside diameter of 3" in the socket. The length is 3-1/2".

Drive: 3/4" Square, Weight: 4 lbs (1.8 kg)

10

MISCELLANEOUS



Eye-catching 15" x 17" full color display card with photos and descriptions!

TIRE & WHEEL SERVICE CENTERS

Besides featuring Ken-Tool's most popular tire tool products, these new merchandisers attract attention! Each photo has a box so that a 1" x 2.5" barcode price label can be added. The sturdy 12" x 16" freestanding, powder-coated wire rack features bright color graphics to let your customers know they are buying Ken-Tool's professional quality tire tools and lug wrenches. Included at no extra cost is a 3" high 4-wheel dolly with strong and durable caster wheels to enable the loaded rack to be easily moved to different locations and to facilitate floor cleaning. The rack and dolly take up a small 15" x 16" footprint and can be placed on the floor or, without the dolly, on a standard 18" gondola base shelf.

TIRE & WHEEL SERVICE CENTER 36047

Centro de mantenimiento para ruedas y llantas No. 36047
entre de service pneus et roues no 36047

Weight: 125 Lbs (57 kg) Shipped in 5 boxes.

Item No.	Description	Quantity
35110	18" 35110 USA Hickory Tire Kicker	2
32119	24" T19 Straight Tire Spoon	2
33220	30" T20A Curved Tire Spoon	2
34645	37" T45A* Tubeless Tire Iron	2
34645C	37" T45AC* Classic Tubeless Tire Iron	2
34647	41" T45HD HD Tubeless Tire Iron	2
34747	36" T46A Tubeless Tire Iron	2
35323	16-1/2" T35 HD Tire Hammer, Wood Handle	1
35429	32" TG11E Bead Breaking Wedge, Fiberglass Handle	1
35637	18" 35637 Passenger 4-Way Lug Wrench, SAE/Metric	2
35638	23" 35638 Light Truck/RV 4-Way Lug Wrench, SAE/Metric	2
35595	27" TC95 HD Truck Lug Wrench, Popular Lug Sizes	1
30721	Wire Rack with Roller Base	1
36047-98	Planogram Card with Tie Strap	1

PASSENGER TIRE & WHEEL SERVICE CENTER 36049

Centro de mantenimiento para ruedas y llanta de automóviles No. 36049
Centre de service pneus et roues pour occupant no. 36049

Weight: 120 Lbs (54 kg) Shipped in 4 boxes.

Item No.	Description	Quantity
33220	30" T20A Curved Tire Spoon	2
34645	37" T45A* Tubeless Tire Iron	2
35429	32" TG11E Bead Breaking Wedge, Fiberglass Handle	1
34645C	37" T45AC* Classic Tubeless Tire Iron	2
34747	36" T46A Tubeless Tire Iron	2
35110	18" 35110 USA Hickory Tire Kicker	2
35620	20" T9520 4-Way Lug Wrench	1
35657	23" T57 4-Way Lug Wrench	1
35659	22" T59 4-Way Lug Wrench	2
35663	18" T63 Metric 4-Way Lug Wrench	1
34647	41" T45HD HD Tubeless Tire Iron	2
30721	Wire Rack with Roller Base	1
36047-98	Planogram Card with Tie Strap	1

Convenient mobile base makes positioning for optimum sales a breeze!

WARNING: Always wear safety goggles when using hand tools.

10 MISCELLANEOUS

PROFESSIONAL TIRE TOOL AND LUG WRENCH MERCHANDISERS

Comerciantes de llaves y herramientas para llantas profesionales
Présentoirs de clés à goujon et de démonte-pneus professionnels

With assortment #36046 you get 15 of our best selling tools. Assortment #36045 offers a larger assortment of 20 equally fast-selling tire and wheel service tools. Both assortments come complete with a sturdy, freestanding wire rack (no assembly required). Both the wire rack and planogram card can be purchased separately.



10 PIECE LUG WRENCH ASSORTMENT WITH RACK 35648

10 piezas. Surtido de llaves para ruedas con soporte No. 35649
Jeu de clés à goujon avec râtelier de 10 pièces no 35649

Weight: 50 Lbs (23 kg). Set Includes:

Item No.	Description	Quantity
35620	20" T9520 4-Way Wrench	2
35636	23" T56 Deluxe Metric 4-Way Wrench	1
35657	23" T57 4-Way Lug Nut Wrench	2
35659	22" T59 4-Way Lug Nut Wrench	2
35663	18" T63 Metric 4-Way Wrench	1
35690	25" T90 4-Way Wrench - Truck	2
35649	Empty Display Stand	1

HANGING 4-WAY DISPLAY RACK 35651

Estante de exhibición colgante de 4 vías
Présentoir suspendu à 4 voies

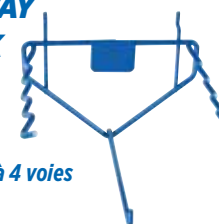

DELUXE TIRE & WHEEL SERVICE CENTER 36045

Centro de mantenimiento para ruedas y llantas de lujo No. 36045
Centre de service de luxe pneus et roues no 36045

Weight: 128 Lbs (58 kg). Set Includes:



TIRE & WHEEL SERVICE CENTER 36046

Centro de mantenimiento para ruedas y llantas No. 36046
Centre de service pneus et roues no 36046

Weight: 73 Lbs (33 kg). Set Includes:

Item No.	Description	Quantity	Item No.	Description	Quantity
32318	22" TR5 Truck Wrench Handle/Leverage Bar	2	32116	16" Small Tire Mount/Demount Spoon	2
32501	16" TR1 1-1/8" Hex with 13/16" Sq. x 1-1/2 Hex Double-End Wrench	1	33220	30" T20A Curved Tire Spoon	1
32508	16" TR98 1-1/2" Hex x 13/16" Sq. Double-End Wrench	1	33223	30" T23A Truck Lock Ring Removal Tool	1
32509	16" TR9 1-1/4" Hex x 1-1/16" Hex Double-End Wrench	1	34645	37" T45A Truck Tire Mount/Demount Iron	2
32552	16" TRM2 24 mm x 33 mm Double-End Wrench	1	35129	30" T11EH Hickory Replacement Handle (fits 35329)	1
33220	30" T20A Curved Tire Spoon	2	35229	31" TG11EH Fiberglass Replacement Handle (fits 35429)	1
33223	30" T23A Truck Lock Ring Removal Tool	1	35429	31" TG11E Fiberglass Handled Bead Breaking Wedge	1
34645	37" T45A Truck Tire Mount/Demount Iron	2	35620	20" T9520 Economy Passenger Car 4-Way - SAE	1
34647	41" T45HD Truck Tire Mount/Demount Iron	1	35657	23" T57 Professional Gold Passenger Car 4-Way - SAE	1
35229	31" TG11EH Fiberglass Replacement Handle (fits 35429)	1	35659	22" T59 Professional Passenger Car 4-Way - SAE	1
35323	16.5" T35 Hickory Handled Tire Hammer	1	35663	18" T63 Economy Passenger Car 4-Way - Metric	1
35429	32" TG11E Fiberglass Handled Bead Breaking Wedge	1	35690	25" T90 Light Truck 4-Way, Welded - SAE	1
35690	25" T90 Light Truck 4-Way, Welded - SAE	2	35695	27" T95 Heavy-Duty Truck 4-Way, Drop-Forged - SAE	1
35595	27" TC95 Heavy-Duty Truck 4-Way, Drop-Forged - SAE	2	30720	Wire Rack	1
35924	46" T24B Slide-Action, Impact Bead Breaker	1	36046-10	Planogram Card with Tie Strap	1
30720	Wire Rack	1			
36045-10	Planogram Card with Tie Strap	1			

OSHA TIRE SERVICE CHARTS 39998

Cuadros de servicio de neumáticos OSHA | Diagrammes d'entretien des pneus OSHA



Weight: 1 lb (.5 kg) 24" x 70" High Quality posters. Suitable for wall mounting in service area per OSHA 29 CFR 1910.77. 3 poster set includes (A) Demounting & Mounting Procedures for Tube-type Truck & Bus Tires Chart (OSHA 3402 10R-11), (B) Demounting & Mounting Procedures for Tubeless Truck & Bus Tires Chart (OSHA 3401 10R-11) (C) Multi-Piece Rim Matching Chart (OSHA 3403 10R-11)

11

VISES & CLAMPS



PROFESSIONAL MECHANIC'S VISES

Tornillos de banco para taller profesionales
Étaux pour ateliers professionnels

With high quality construction for extra durability and full-strength performance at any jaw opening, these vises are made for the professional - strong, durable, and built to last. "V" notched, replaceable/reversible jaws made of carbon steel and heat-treated for extra strength, diamond cut on one side - smooth on the other.

Model No.	Item No.	Jaw Width	Jaw Opening	Throat Depth	Pipe Jaw Capacity	Weight	Replacement Jaw Set No.
K55	64055	5-1/2" (14 cm)	7-1/2" (19.1 cm)	3-1/4" (8.3 cm)	1/8" - 2-1/2" (.3 - 6.4 cm)	27 lbs (12.3 kg)	15505
A K65*	64065	6-1/2" (16.5 cm)	9" (22.9 cm)	3-7/8" (9.8 cm)	1/8" - 3-1/2" (.3 - 8.9 cm)	38 lbs (17.3 kg)	16505

**KEN-TOOL VISES
HAVE A LIFETIME
WARRANTY ON
THE CASTING.**



JAW FACES HAVE "V" NOTCHES FOR VERTICAL GRIPPING



BUILT-IN PIPE JAWS



GEAR-TYPE LOCKING SYSTEM WITH DOUBLE LOCK-DOWN BOLTS - LOCKS VISE SECURELY IN POSITION



360° SWIVEL BASE, MACHINED FOR SMOOTH SWIVEL



HEAVY-DUTY JAW BEAM COVERS SCREW, BUILT-IN ANVILS

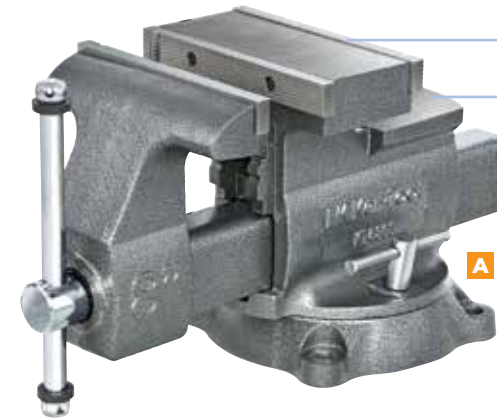

2 BUILT-IN ANVILS PROVIDE MORE WORK SURFACE AREA THAN ANY OTHER VISE

PROFESSIONAL REVERSIBLE MECHANIC'S VISES

Tornillos de banco reversibles para mecánicos profesionales
Étaux professionnels réversibles de mécanicien

With our Reversible Vises you get all of the high quality features and rugged durability of the Pro Workshop Vises, and more! Significantly increase your gripping capacity when you reverse the position of the front jaw. **Ken-Tool Vises have a lifetime warranty on the casting.**

Model No.	Item No.	Jaw Width	Jaw Opening	Throat Depth	Pipe Jaw Capacity	Weight	Replacement Jaw Set No.
KT4650	64650	6-1/2"	9" - 12" (16.5 cm)	4" (22.9 - 30.5 cm)	1/8" - 4" (10.1 cm)	52 lbs (.3 - 10.1 cm)	14655 (23.6 kg)
A KT4800	64800	8"	11 - 14" (20.3 cm)	4-7/8" (28 - 35.6 cm)	1/8" - 4-1/4" (12.4 cm)	74 lbs (.3 - 10.8 cm)	14805 (33.6 kg)

Professional Reversible Mechanic's Vises feature:

It's simple...Remove the jaw from the front of the base, swivel the base 180°, then re-insert the jaw:

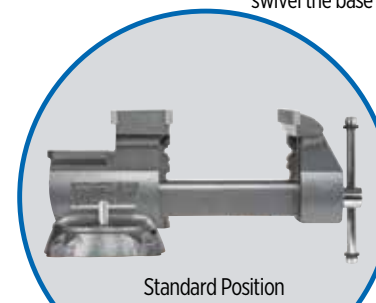

Standard Position

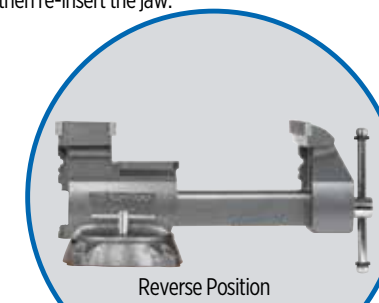

Reverse Position



PROFESSIONAL C-CLAMPS

Abrazaderas en C profesionales
Serre-joints en C professionnels

This c-clamp is for the professional. Designed for strength and toughness, with sliding pin handle and acme-thread screw. Imported.

Model No.	Item No.	Jaw Opening	Depth	Screw Diameter	Weight
KT-4	39604	4" (10 cm)	2-1/16" (5 cm)	5/8" (1.5 cm)	1.8 lbs (.8 kg)
KT-6	39606	6" (15 cm)	2-3/4" (7 cm)	5/8" (1.5 cm)	2.5 lbs (1.1 kg)
KT-8	39608	8" (20 cm)	3-1/4" (8 cm)	3/4" (2 cm)	3.5 lbs (1.6 kg)



ALIGNING & PRY BARS

ALIGNING BARS

Barras de alineación
Barres d'alignement

A forged, alloy steel, heat-treated bar that can be used for prying, aligning and positioning many heavier jobs in the shop. The finish is black oxide.

Item No.	Stock	Length	Weight
7025	5/8" (16 mm)	18" (45.7 cm)	1.4 lbs (.6 kg)
7026	3/4" (19 mm)	20" (50.8 cm)	2.3 lbs (1 kg)
7027	3/4" (19 mm)	24" (61 cm)	2.8 lbs (1.3 kg)
7028	7/8" (22 mm)	30" (76.2 cm)	5 lbs (2.3 kg)



CLOSE QUARTERS BARS

Barras de cuartos cerrados
Barres à distance rapprochée

These bars are made of forged, alloy steel, and heat-treated. Designed for use in tight spots, their balanced construction provides very powerful leverage. The finish is black oxide.

Item No.	Stock	Length	Weight
7030	3/8" (10 mm)	9" (22.9 cm)	.31 lbs (.14 kg)
7031	1/2" (13 mm)	16" (40.6 cm)	.89 lbs (.4 kg)
7032	5/8" (16 mm)	18" (45.7 cm)	1.5 lbs (.7 kg)



DIE SETTER BARS

Barras troqueladoras
Barres de monte de matrices

A practical and useful shop tool for the quick separation of punch and die holder. The bars are made of forged, alloy steel and heat-treated for strength. The finish is black oxide.

Item No.	Stock	Length	Weight
7035	5/8" (16 mm)	18" (45.7 cm)	1.7 lbs (.8 kg)
7037	3/4" (19 mm)	30" (76.2 cm)	4.2 lbs (1.9 kg)



In April 1974, Ken-Tool was sold to Warren Tool Corporation in Warren, Ohio, a small, privately-owned manufacturer of vises, clamps and heavy striking tools. Under Warren Tool, Ken-Tool quickly dropped the product lines from Cooper and replaced them with those of its new sister divisions, Columbian vises, Warren striking tools, and Hargrave clamps. Three years later, Warren acquired Kal-Equip Company, a manufacturer of automotive diagnostic test equipment, and formed a new organization, The Warren Automotive Group. After several years, Warren Tool made the decision to sell Kal-Equip and re-establish Ken-Tool as a free standing, autonomous division of the Warren Tool Corporation. That structure continued until 1994, when all other Warren Tool operations were sold, leaving Ken-Tool as an entirely independent company.

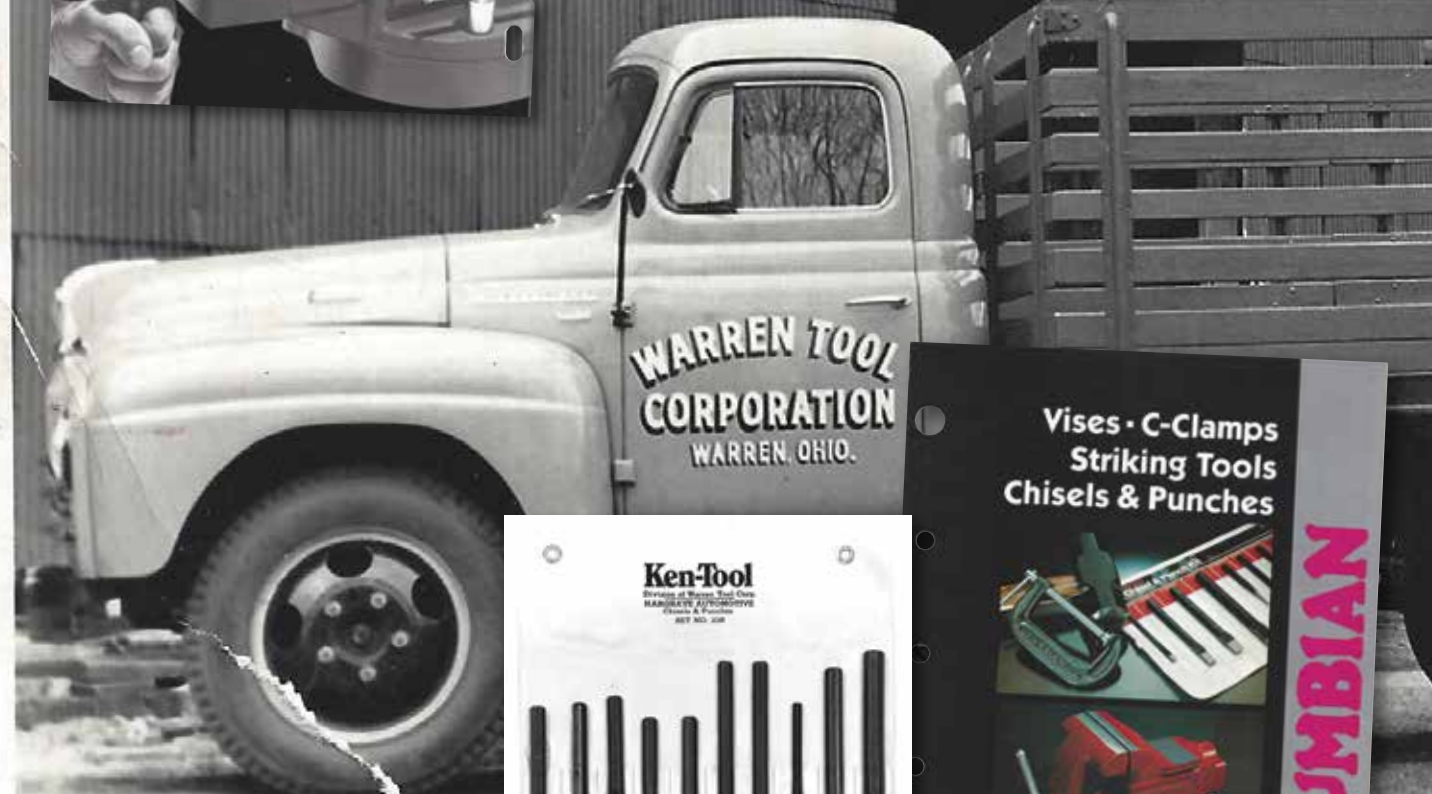

13

AIR BRAKE TOOLS

BENDIX ADB22X™ AIR DISC BRAKE TOOL KITS

These kits provide specialized tools for the replacement of Bendix® air disc brake tappet and boot assemblies, tappet inner seals, and guide pins and boots.



ADB22X COMPLETE KIT 80000 (BENDIX #K029164)

Juego completo No. 80000 ADB22X
Kit complet ADB22X No. 80000

Weight: 22 Lbs (10 kg)

Includes Kit No. 80001 and Kit No. 80002 listed below:

TAPPET & BOOT 7 PC. REPLACEMENT TOOL KIT 80001 (BENDIX #K028829)

Juego de herramientas de reemplazo de balancines y capuchones
Kit d'outillage de remplacement de poussoir et de démarrage

Weight: 7 Lbs (3.2 kg)

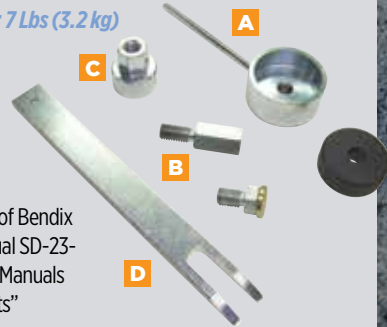

See page 25 of Bendix Service Manual SD-23-7541 on the "Manuals and Parts Lists"

Bendix No.	Ken-Tool No.	Description
T01	80101	KT01 Cup
A T02	80102	KT02 Handle for KT01 Cup
T03	80103	KT03 Swivel assembly made up of KT03-1 Short Body, KT03-2 Brass Disc, and KT03-3 Retaining Spring
B T04	80104	KT04 Long Strut
C T09	80109	KT09 Flange
D T15	80115	KT15 Fork
T24	80124	KT24 Black Nylon Disc

GUIDE PIN / PIN BOOT 13 PC. SERVICE TOOL KIT 80002 (BENDIX #K029107)

Juego de herramientas para servicio del pasador guía/capuchón del pasador
Kit d'outillage d'entretien de broche de démarrage / broche de guidage

Weight: 15 Lbs (6.8 kg)

For detailed instructions, see the Bendix ADB22X service manual SD-23-7541 on the "Manuals and Parts Lists" link



Bendix No.	Ken-Tool No.	Description
E T05	80105	KT05 1-3/8" Black Disc
F T06	80106	KT06 1-1/2" Black Disc
G T07	80107	KT07 2" Dia. Sleeve
T08	80108	KT08 2-1/8" Dia. Disc
T10	80110	KT10 8" Bolt
H T12	80112	KT12 3-7/8" Long Sleeve
T13	80113	KT13 10" Bolt
I T14	80114	KT14 Brass Nut
J T16	80116	KT16 Dimpling Tool made up of KT16-1 Main Body, KT16-2 Crimper Screw, KT16-3 Expansion Ring, KT16-4 Plunger, KT16-5 Dimpling Pins, and KT16-6 Set Screw
T20	80120	KT20 8" Bolt
K T21	80121	KT21 Half Sleeve
L T26	80126	KT26 Cap Tool made up of KT26-1 Retaining Ring, KT26-2 Mandrel and KT26-3 Sleeve
M T27	80127	KT27 Cap Tool made up of KT26-1 Retaining Ring, KT26-2 Mandrel and KT27-3 Sleeve

Washers included

AIR BRAKE SLACK ADJUSTERS

Ajustadores de holgura del freno de aire
Frein pneumatique



Avoid costly fines and downtime – make sure your brakes are always operating at their best! Slack Adjusters for Haldex®, Bendix®, and Meritor® Air Brake Systems



2 PC. AUTOMATIC SLACK ADJUSTER SET (MERITOR®) 33200

Weight: .7 lbs (.3 kg), Length: 12" (30.5 cm)

No more prying and risking damaging the anti-reverse mechanism! Set includes 33200-01 Fork End Tool (holds release of anti-reverse pin during adjustment) and 33200-02 5/16" ratchet size with double square offset reversible wrench (allows more power with less fatigue). Ergonomic slip resistant molded resin handles.



HALDEX® SLACK ADJUSTER TOOL 33205

Weight: .65 lbs (.29 kg), Length: 14.5" (36.8 cm)

7/16" ratchet size, extra long 14.5" handle adds leverage and makes overcoming the anti-reverse mechanism easier than ever! Vinyl grip is slip resistant and protects ratchet head.



BENDIX® SLACK ADJUSTER TOOL 33206

Weight: 1 lb (.5 kg), Length: 14.5" (36.8 cm)

9/16" ratchet size, deeper Hex allows reach to recessed slack adjusters. A must have tool for owner / operators!



4 PC. AUTOMATIC SLACK ADJUSTER TOOL SET 33210

Weight: 2.5 lbs (1.1 kg)

Set includes 33200 2 Pc. Automatic Slack Adjuster Set (Meritor®), 33205 Haldex® Slack Adjuster Tool, 33206 Bendix® Slack Adjuster Tool

14

AIR SERVICE



PREMIUM REINFORCED HYBRID AIR HOSE

Manguera de aire híbrida reforzada premium
Tuyau à air hybride renforcé de qualité supérieure

Advanced Hybrid Hose features the Strength of reinforced PVC with the superior flexibility of rubber!

WITH 1/4" BRASS MALE FITTINGS AND HOSE GUARDS ON BOTH ENDS.



STAYS FLEXIBLE IN THE COLD,
DOESN'T KINK IN THE HEAT



32 ft. SPECIFICATIONS



65 ft. SPECIFICATIONS



100 ft. SPECIFICATIONS

Item No.	26032
Length	32 feet / 10m
Male Fittings	1/4" Brass
Max Pressure	300 psi
Inside Diameter	3/8" (9.2mm)

Item No.	26065
Length	65 feet / 20m
Male Fittings	1/4" Brass
Max Pressure	300 psi
Inside Diameter	3/8" (9.2mm)

Item No.	26100
Length	100 feet / 30m
Male Fittings	1/4" Brass
Max Pressure	300 psi
Inside Diameter	3/8" (9.2mm)

AIR BOSS® PNEUMATIC TOOLS

Herramientas neumáticas Air Boss®
Outils pneumatiques Air Boss®

AIR BOSS TOOLS
COVERED BY 1 YEAR
WARRANTY



The Air Boss line of pneumatic tools offer a unique and innovative design featuring ultra-comfortable ergonomics. The high quality build provides a longer life of the tool.

AIR BOSS® MINI STUBBY IMPACT WRENCH

Air Pressure: 90psi
Air Inlet & Minimum Air Hose: 1/4"

AW-80T (26400 and 26401) Mini Stubby Impact Wrench featuring twin hammer clutch type. 9,000 RPM Free Speed.

Part Number	Drive	Torque Range (ft-lb)	Max Torque	Overall Length	Net Weight (lbs)	Air Consumption (Gal/Min)
26400	3/8"	25-225	428	3.74"	2.62	79.25
26401	1/2"	25-225	450	3.74"	2.62	79.25



AIR BOSS® MICRO STUBBY IMPACT WRENCH

Air Pressure: 90psi
Air Inlet & Minimum Air Hose: 1/4"

AW-80J (26402 and 26403) Micro Stubby Impact Wrench featuring jumbo hammer clutch type. 9,000 RPM Free Speed.

Part Number	Drive	Torque Range (ft-lb)	Max Torque	Overall Length	Net Weight (lbs)	Air Consumption (Gal/Min)
26402	3/8"	21-190	375	3.3"	2.44	79.25
26403	1/2"	25-225	406	3.42"	2.46	79.25



AIR BOSS® IMPACT WRENCH 26404

Air Pressure: 90psi
Air Inlet: 1/4"
Minimum Air Hose: 3/8"

AW-130P 1/2" drive with twin hammer clutch.

Part Number	Free Speed (RPM)	Torque Range (ft-lb)	Max Torque	Overall Length	Net Weight (lbs)	Air Consumption (Gal/Min)
26404	6,200	50 - 552	780	6.45"	4.9	179.63



AIR BOSS® IMPACT WRENCH 26405

Air Pressure: 90psi
Air Inlet: 1/4"
Minimum Air Hose: 3/8"

AW-130PL 1/2" drive with twin hammer clutch, 2.5" anvil.

Part Number	Free Speed (RPM)	Torque Range (ft-lb)	Max Torque	Overall Length	Net Weight (lbs)	Air Consumption (Gal/Min)
26405	6,200	50 - 552	780	7.64"	5.1	179.63



AIR BOSS® HEAVY DUTY IMPACT WRENCH 26406

Air Pressure: 90psi
Air Inlet: 1/4"
Minimum Air Hose: 3/8"

AW-140P 1/2" drive with twin hammer clutch.

Part Number	Free Speed (RPM)	Torque Range (ft-lb)	Max Torque	Overall Length	Net Weight (lbs)	Air Consumption (Gal/Min)
26406	6,700	50 - 596	1253	6.53"	4.9	179.63



AIR BOSS® HEAVY DUTY IMPACT WRENCH 26407

Air Pressure: 90psi
Air Inlet: 1/4"
Minimum Air Hose: 3/8"

AW-140PL 1/2" drive with twin hammer clutch, 2.5" anvil.

Part Number	Free Speed (RPM)	Torque Range (ft-lb)	Max Torque	Overall Length	Net Weight (lbs)	Air Consumption (Gal/Min)
26407	6,700	50 - 596	1253	7.75"	5	179.63



AIR BOSS® HEAVY DUTY IMPACT WRENCH 26408

Air Pressure: 90psi
Air Inlet: 3/8" & Minimum Air Hose: 3/8"

AW-220P 3/4" Drive with twin hammer clutch.

Part Number	Free Speed (RPM)	Torque Range (ft-lb)	Max Torque	Overall Length	Net Weight (lbs)	Air Consumption (Gal/Min)
26408	4,800	349-929	1328	8.66"	9.9	132.08



AIR BOSS® HEAVY DUTY IMPACT WRENCH 26409

Air Pressure: 90psi
Air Inlet & Minimum Air Hose: 1/2"

AW-322GL 1" Drive with swing hammer clutch.

Part Number	Free Speed (RPM)	Torque Range (ft-lb)	Max Torque	Overall Length	Net Weight (lbs)	Air Consumption (Gal/Min)
26409	4,200	668-1459	1852	20.87"	22	158.5





HD TRUCK TIRE INFLATION KIT W/ GLAD HAND & DUAL FOOT AIR CHUCK 26050

Kit de inflado de neumáticos para camiones de servicio pesado con Gladhand y mandril de aire de doble pie
Kit de gonflage de pneus pour poids lourds avec mandrin pneumatique Gladhand et double pied

Length: 50 ft. (15.24m)
 Male Fittings: 1/4" Brass
 Max Pressure: 300 psi
 Inside Diameter: 3/8" (9.2mm)

A simple way to top off your tires utilizing your on-board compressor!

- Glad Hand Attaches Painlessly to Heavy-Duty Air Brake Equipped Trucks
- 50 Foot Hose Length Provides Necessary Range Reaching All Tires
- Lightweight, Non-Marring 300 PSI Hybrid Hose Construction for Easy Storage and Lifting
- Quick Inflation with Straight-On Dual Foot Chuck



Glad Hand Attaches Painlessly to Heavy-Duty Air Brake Equipped Trucks

Quick Inflation with Straight-On Dual Foot Chuck



WHIP HOSE 26024

Latiguillo
Tuyau fouet

Length: 2 ft. (61cm)
 Max Pressure: 300 psi

This 3/8" premium reinforced hybrid air hose features a 1/4" swivel male fitting one end and 1/4" female fitting on the other. The whip hose short length is designed for connecting accessories.



FOR USE WITH AIR BOSS® AND OTHER KEN-TOOL AIR TOOLS!

1/4" swivel male fitting one end and 1/4" female fitting on the other.



HANDHELD AUTOMATIC TIRE INFLATOR 26012

Inflador de neumáticos automático de mano
Gonfleur de pneu automatique portatif

Features a 12" hose with spring protector. Clip-on chuck and 8" dual foot chuck included.

- Digital display, audible warning, 2 presetable inflation settings.
- Auto Inflate and deflate with Over Pressure setting and underinflation protection
- Underinflation warning, will not auto inflate if tire pressure is less than 80% of the desired tire pressure.
- 12 foot hose with spring protector, Clip-on chuck & 8" dual foot chuck included
- 1/4" NPT thread for all air connection
- Accuracy: ± 0.3 p.s.i. @ 25-75 p.s.i.
- Charger voltage: Input AC 110 - 240 V (50-60 Hz)
- Batteries: DC 12V rechargeable Li-Ion battery
- Black Rubber cover
- Operating temperature: +14 to +122 degrees F (-10 to +50 C)
- Automatic turn on and shut off to save battery life



PREMIUM DIGITAL TIRE INFLATOR 26081

Inflador de neumáticos digital premium
Gonfleur de pneu numérique haut de gamme

Features a 24" hose with spring protector. Clip-on chuck and 8" dual foot chuck included.

- 3-in-1 function: inflate, deflate and measure tire pressure
- Accuracy: +/- 2 PSI accuracy across full range
- Solid metal alloy housing for extended service
- 1/4" NPT thread for all air connection
- Max pressure, 175psi / 1,200 kPa / 12 Bar / 12 kgf
- Operating temperature: +14 to +140 degrees F (-20 to +60 C)
- Automatic turn on and shut off to save battery life

PREMIUM DIGITAL TIRE INFLATOR 26082

Inflador de neumáticos digital premium
Gonfleur de pneu numérique haut de gamme

Features a 12' hose with 6" spring protector. Clip-on chuck and 8" dual foot chuck included.

- 3-in-1 function: inflate, deflate and measure tire pressure
- Accuracy: +/- 2 PSI accuracy across full range
- Solid metal alloy housing for extended service
- 1/4" NPT thread for all air connection
- Max pressure, 175psi / 1,200 kPa / 12 Bar / 12 kgf
- Operating temperature: +14 to +140 degrees F (-20 to +60 C)
- Automatic turn on and shut off to save battery life

15

TIRE MANAGEMENT SOLUTIONS



Accreditation

Ken-Tool Elite line of products is the only tire casing product that has been tested and passed by ARDL, one of the most recognized labs in the world for tire/rubber testing. The test was based on OEM test standards and TMC RP 246.

Ken-Tool Elite line of products advanced technology is the only product in its class qualified as a ground-up technology by the Scientific Research and Experimental Development of Canada (SRED).



ELITE TIRE SEALANT 35851 Sellador de neumáticos Elite Scellant pour pneus Elite

For use on trucks, busses, construction and off road applications. High speed of 125 MPH / 210 KPH. Operates between -58°F to 370°F (-50°C to 188°C) and will not freeze. Also available in a 250 Gallon Tote (Part Number 35852).

PERFORMANCE

- Prevents air loss by sealing around puncture-creating objects (nails, bolts, glass etc.) up to ½" or 1.3 cm in diameter, while a combination of biodegradable fibers stop moisture from entering the steel belt area
- Stops air loss and retains correct pressure by sealing the entire casing from normal casing porosity
- Improves the seal over buffed areas
- Reduces heat buildup in tires
- Balances wheel end assembly
- Protects the casing from heat, oxidation and UV damage
- Dissipates tire chamber heat so that tires run cooler
- Does not pool to the bottom or block the valve system
- DOES NOT deteriorate during the life of the tread
- Absorbs moisture
- Performs with compressed air and Nitrogen
- Approved for use with TPMS
- Helps retain casing integrity
- Continually self-seals punctures up to ½" (1.3 cm) in diameter
- Stops Bead/Rim/O-ring and Vent leaks
- Washes out easily

SAFETY

- Added safety for recapped tires
- Biodegradable, Non-toxic and Environmentally friendly
- Does not freeze, lump up, dry out or harden
- Flash point of 789 degrees Fahrenheit
- Non Flammable, will not cause retread chamber fires
- Does not void the tire manufacturer's warranty
- DOES NOT cause wheel or tire vibration
- DOES NOT consist of polyethylene chips, crushed rubber, latex or silicon or toxic glycols



OTR ELITE TIRE SEALANT 35861 Sellador de neumáticos Elite Scellant pour pneus Elite

For use on AG, construction, Industrial, mining, logging, lawn and garden and OTR applications. Low Speed of 70 MPH / 113 KPH. Operates between -20°F to 240°F (-29°C to 115.6°C) and will not freeze. Also available in a 250 Gallon Tote (Part Number 35862).

PERFORMANCE

- Prevents air loss by sealing around puncture-creating objects (nails, bolts, glass etc.) up to ½" or 1.3 cm in diameter, while a combination of biodegradable fibers stop moisture from entering the steel belt area
- Stops air loss and retains correct pressure by sealing the entire casing from normal casing porosity
- Improves the seal over buffed areas
- Reduces heat buildup in tires
- Balances wheel end assembly
- Protects the casing from heat, oxidation and UV damage
- Dissipates tire chamber heat so that tires run cooler
- Does not pool to the bottom or block the valve system
- DOES NOT deteriorate during the life of the tread
- Absorbs moisture
- Performs with compressed air and Nitrogen
- Approved for use with TPMS
- Helps retain casing integrity
- Continually self-seals punctures up to ½" (1.3 cm) in diameter
- Stops Bead/Rim/O-ring and Vent leaks
- Washes out easily

SAFETY

- Added safety for recapped tires
- Biodegradable, Non-toxic and Environmentally friendly
- Does not freeze, lump up, dry out or harden
- Flash point of 789 degrees Fahrenheit
- Non Flammable, will not cause retread chamber fires
- Does not void the tire manufacturer's warranty
- DOES NOT cause wheel or tire vibration
- DOES NOT consist of polyethylene chips, crushed rubber, latex or silicon or toxic glycols



PERFORMANCE

- Protects tire liners from degrading and preserves original state
- Protects wheels/rims against rust scale
- Improves air retention by sealing natural liner porosity and vent hole leakage
- Prevents cracks and blisters on inner liners
- Improves the seal over buffed areas when a proper repair has been installed
- Reduces heat buildup in tires and tire failure

COST SAVINGS

- Eliminates the need for rim clean up and painting
- Improves tire repair ability
- Decreases labor costs for tire dismounting and air checks

SAFETY

- Excellent leak detector that safely identifies cracks in the rim base
- Non-hazardous, biodegradable and non-toxic

Used As A Dynamic Balance Media

Ken-Tool Tire & Rim Conditioner can also be used as a tire/wheel end balancer and acts far superior than traditional metal weights, powder balancing, glass beads or disc balancers. Balancing tires is a costly business at almost \$35-\$45 per tire. Companies who balance their drive and trailer tires must do so frequently and that can take a toll on your revenues. With the dynamic balance system, you add KEN-TOOL ELITE LINE OF PRODUCTS inside the tire. The physics statement for this process is: a free floating mass in a spinning assembly will seek equilibrium. In other words, it self balances. As an overall concept this system re-balances the assembly each time you accelerate from a stop. In tests we have conducted, self-balance improves the tire life on trucks and buses between 10 and 20% compared to ones with no balance.

TIRE & RIM CONDITIONER 35870

Acondicionador de llantas y llantas
Conditionneur pour pneus et jantes

Ken-Tool Tire & Rim Conditioner is a premium, eco-friendly liquid formula that will save you money while keeping your tires safe. Also available in a 250 Gallon Tote (part number 35871).



KEN-TOOL HAND PUMP 35800

For 5 Gallon Pail Tire Sealants and Tire & Rim Conditioner.



Model #	Page #, Item #
B36	61, see also 32036
B37	61, see also 32037
B39	61, see also 32039
B40	61, see also 32040
B111	19, see also 30511
B230	50, see also 35354
B232	50, see also 35355
D105A	19, see also 35805
K55	64, see also 64055
K65	64, see also 64065
KT-4	65, see also 39604
KT-6	65, see also 39606
KT-8	65, see also 39608
KT4650	65, see also 64650
KT4800	65, see also 64800
R20	24, see also 35820
R23	24, see also 35623
R24	24, see also 35624
R90	25, see also 35627
S20	23, see also 30128
S21	23, see also 30130
S23	23, see also 30134
T1X	16, see also 32101
T2X	16, see also 32102
T5	16, see also 32115
T6A	16, see also 32106
T8	16, see also 32118
T9A	16, see also 32109
T9C	16, see also 32110
T11AH	42, see also 35529
T11B	41, see also 35311
T11BH	42, see also 35111
T11CH	42, see also 35119
T11D	43, see also 35327
T11DH	42, see also 35127
T11E*	43, see also 35329
T11EH	42, see also 35129
T11EHS	42, see also 35131
T11ES	43, see also 35330
T11HN	42, see also 35113
T11KH	42, see also 35230
T11K**	43, see also 35460
T11RH	41, see also 35104
T12B	41, see also 35201
T12D	41, see also 35202
T15	35, see also 30515
T16A	16, see also 32116
T16C	16, see also 32117
T19	16, see also 32119
T19A	16, see also 33219
T19M	16, see also 33022
T20	16, see also 31551
T20A	16, see also 33220
T20M	16, see also 33023

Model #	Page #, Item #
T21A	16, see also 33020
T21F	16, see also 34121
T21HD	16, see also 34122
T21M	16, see also 33024
T21R	16, see also 32121
T22A	16, see also 33021
T22F	16, see also 32420
T22HD	16, see also 33026
T22M	16, see also 33025
T22R	16, see also 31820
T23*	18, see also 32123
T23A*	18, see also 33223
T23B	18, see also 35224
T24B	47, see also 35924
T25	53, see also 36001
T26A	46, see also 32126
T26B	47, see also 35926
T27	18, see also 32127
T27A	18, see also 32128
T33R	41, see also 35317
T34	41, see also 35321
T34B	58, see also 35934
T34RH	41, see also 35105
T35	41, see also 35323
T36	41, see also 35325
T36B	58, see also 35936
T38	45, see also 36017
T38B	58, see also 35938
T39	55, see also 36019
T39B	60, see also 35939
T39B-1	60, see also 35939-01
T39B-2	60, see also 31432
T41	46, see also 33341
T42	46, see also 33342
T43A	16, see also 39805
T43C	17, see also 39806
T43D	17, see also 39810
T44	17, see also 34950
T45A*	13, see also 34645
T45A-2000K™	13, see also 34644
T45AC™	13, see also 34645C
T45AS	13, see also 34649
T45HD	13, see also 34647
T46	24, see also 34746
T46A	13, see also 34747
T46B	13, see also 34748
T46C	13, see also 34749
T47A	13, see also 34847
T47B	13, see also 35227
T47C	13, see also 34849
T48A	18, see also 34648
T51	19, see also 31551
T52	46, see also 34652
T54	19, see also 31554

Model #	Page #, Item #
T56	24, see also 35656
T57*	24, see also 35657
T59	24, see also 35659
T61	24, see also 35661
T62	24, see also 35662
T63	24, see also 35663
T67	49, see also 31567
T68	49, see also 31568
T90	24, see also 35690
T95A	24, see also 35697
T95 SAE	24, see also 35695
T96	24, see also 35696
T98	46, see also 35998
T100	46, see also 34670
T101	53, see also 36001
T101A	53, see also 36007
T103	53, see also 36003
T104	53, see also 36004
T109	55, see also 36009
T110	55, see also 36010
T111	53, see also 36011
T112	53, see also 36012
T113	54, see also 36013
T114	54, see also 36014
T115	50, see also 36015
T116	45, see also 36016
T117	45, see also 36017
T118	54, see also 36018
T119	55, see also 36019
T120	53, see also 36020
T131	45, see also 31431
T132	45, see also 31432
T133	45, see also 31433
T134	45, see also 31434
T147A	19, see also 35847, 35847S
T335	43, see also 35335
T336	43, see also 35336
T950	17, see also 34950
T2001	14, see also 35449
T2002	14, see also 35450
T2005	15, see also 35447
T2006	15, see also 35448
T9520	24, see also 35620
TC95	24, see also 35595
TG11B	41, see also 35411
TG11BH	42, see also 35211
TG11CH	42, see also 35219
TG11D	43, see also 35427
TG11DH	42, see also 35227
TG11E	40, 43, see also 35429
TG11EH	42, see also 35229
TG31H	42, see also 35206
TG33R	41, see also 35417
TG34	41, see also 35421
TG35	41, see also 35423

Model #	Page #, Item #
TG36	41, see also 35425
TG332	43, see also 35332
TG333	43, see also 35333
TG334	43, see also 35334
TG337	43, see also 35337
TM95 Metric	24, see also 35795
TR1	21, see also 32501
TR2	21, see also 32502
TR2A	21, see also 32512
TR3	21, see also 32503
TR3A	21, see also 32505
TR3X	21, see also 32506
TR5	21, see also 32318
TR5A	21, see also 32319
TR9	21, see also 32509
TR10	21, see also 34401
TR11	21, see also 34402
TR43	23, see also 34543
TR44SW	23, see also 34547
TR44X	23, see also 34545
TR45	23, see also 34543-02
TR46	23, see also 34543-03
TR52	23, see also 34543-15
TR53	23, see also 34543-16
TR55	23, see also 34543-17
TR98	21, see also 32508
TR99	21, see also 32519
TRM2	21, see also 32552
TRM3	21, see also 32553
TRM6	21, see also 32556
TRM7A	21, see also 32559
TRM7	21, see also 32557
TS42	16, see also 34678
TS72	16, see also 34672
TS74	16, see also 34674
TX9*	22, see also 30609
TX10	22, see also 30610
TX12	22, see also 30612
TX50	22, see also 30620
TX200	22, see also 30618
TX241	22, see also 30619
80H-3	42, see also 37003
80H-4	42, see also 37004
80H-3H	42, see also 37012
84H-2	42, see also 37302
84H-4	42, see also 37304
84H-8	42, see also 37308
84H-8H	42, see also 37025
84H-10	42, see also 37310
84H-12	42, see also 37312
84H-16	42, see also 37316
84H-20	42, see also 37320
84H-20H	42, see also 37089
85H-3	42, see also 37103
85H-3H	42, see also 37023

Inventors Wanted!

If you have an idea for a new tool please let us know!
Your idea could earn you cash or a royalty.

Ken-Tool
WHEREVER TIRES ARE CHANGED™



Toronto Trade Show, 1957



Toronto Trade Show, 1953



Henry Lemmon, Scott Meyer, Ralph Wirz, 1935



Atlanta Automotive Show, 1955



Los Angeles Trade Show, 1952



Look for the YouTube Icon next to specific products in this catalog and scan the QR code to view one or more tool-related videos.

We believe all Ken-Tool customers should be satisfied with the performance, quality, and workmanship of whatever product they buy. All Ken-Tool products are warranted against defects in materials and workmanship for one year from the date of purchase. Any Ken-Tool branded product that fails to perform its intended function, due to a defect in workmanship or materials will, at our option, be replaced or repaired free of charge. Warranty claims for items that have broken or are no longer useful due to normal wear, misuse, abuse, alteration, grinding, or heating, will not be honored. Proof of purchase including the purchase date is required for warranty consideration. Please contact Ken-Tool by phone or email if you have a warranty claim.

Discover other impact sockets and sets on our website.