



## TABLE OF CONTENTS

Warnings	2
Installation Instructions	3
Wiring Instructions	3
Mounting Instructions	4
Replacement Element Installation	5
Replacement Parts	5
Heater Coverage Areas	6
General Notes	6
Maintenance Instructions	6
Trouble Shooting	7
Location Suggestions	7

## WARNINGS

### READ ALL INSTRUCTIONS BEFORE USING HEATER

Unit may be a source of possible shock. NEVER attempt to service heater without disconnecting its power source. Source of possible ignition.

## CAUTION

High Temperature, risk of fire, keep electrical cords, drapery, furnishings and other combustibles at least 3' (0.9m) from the front of heater and away from sides and rear.

## MOUNTING HEIGHT/CLEARANCES

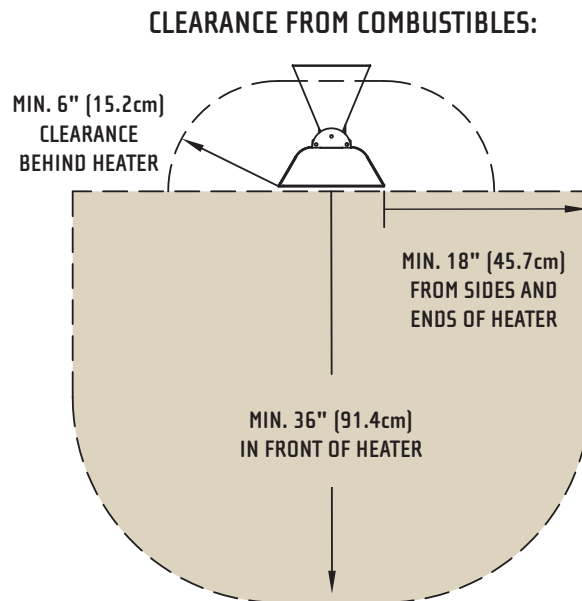

- For Wall-Mounting, do not install heater closer than 18" (45.7cm) from adjacent walls and 6" (15.2cm) from ceiling and do not install less than 6' (1.8m) if the heater is labeled as UL Listed and 8' (2.4m) if the heater is labeled as UL/CUL Listed from floor, while heater is set at a downward angle of 30 to 60 degrees.
- For Ceiling-Mounting, do not install heater closer than 18" (45.7cm) from adjacent walls and 6" (15.2cm) from ceiling and do not install less than 6' (1.8m) if the heater is labeled as UL Listed and 8' (2.4m) if the heater is labeled as UL/CUL Listed from floor, while heater is at a maximum 30 degrees.
- Adjacent Heaters to be installed no less than 3' (0.9m) apart.
- Do NOT operate within 25' (7.6m) of flammable/explosive material.
- Never block heater.
- Heaters greater than 240 Volts are for "Commercial Use Only. Risk of fire. Do not use as a residential or household heater."
- A means for disconnection of the appliance must be incorporated in accordance with the local wiring codes.
- Do not use if the heating element is damaged or cracked.

**"IMPORTANT INSTRUCTIONS"**  
**"SAVE THESE INSTRUCTIONS"**

## INSTALLATION INSTRUCTIONS

This heater must be permanently installed and hard wired by a licensed electrician in accordance with local electrical codes. Assembly procedure must be performed with no electrical power to unit.

**Step 1:** Check UL/CUL/CE label on heater for proper voltage.

**Step 2:** Follow supplied wiring instructions. (See wiring instructions below)

**Step 3:** Heater must be mounted with reflector angled down.

**Step 4:** All electrical connections must be in compliance with the National Electric Code (NEC) and local codes for outdoor wiring.

**Step 5:** Use only wiring components UL/CUL/CE listed for outdoor use with IPX4 minimum rating.

## WIRING INSTRUCTIONS

The heater is drilled and threaded for standard 1/2" conduit fittings. The installing electrician will need to provide the appropriate rigid metallic, flexible or liquid tight conduit for the installation location.

- Observe local electrical code regulations.
- Remove cover plate from junction box.
- Attach conduit.
- Use only copper wire suitable for 90°C.
- Replace cover plate.

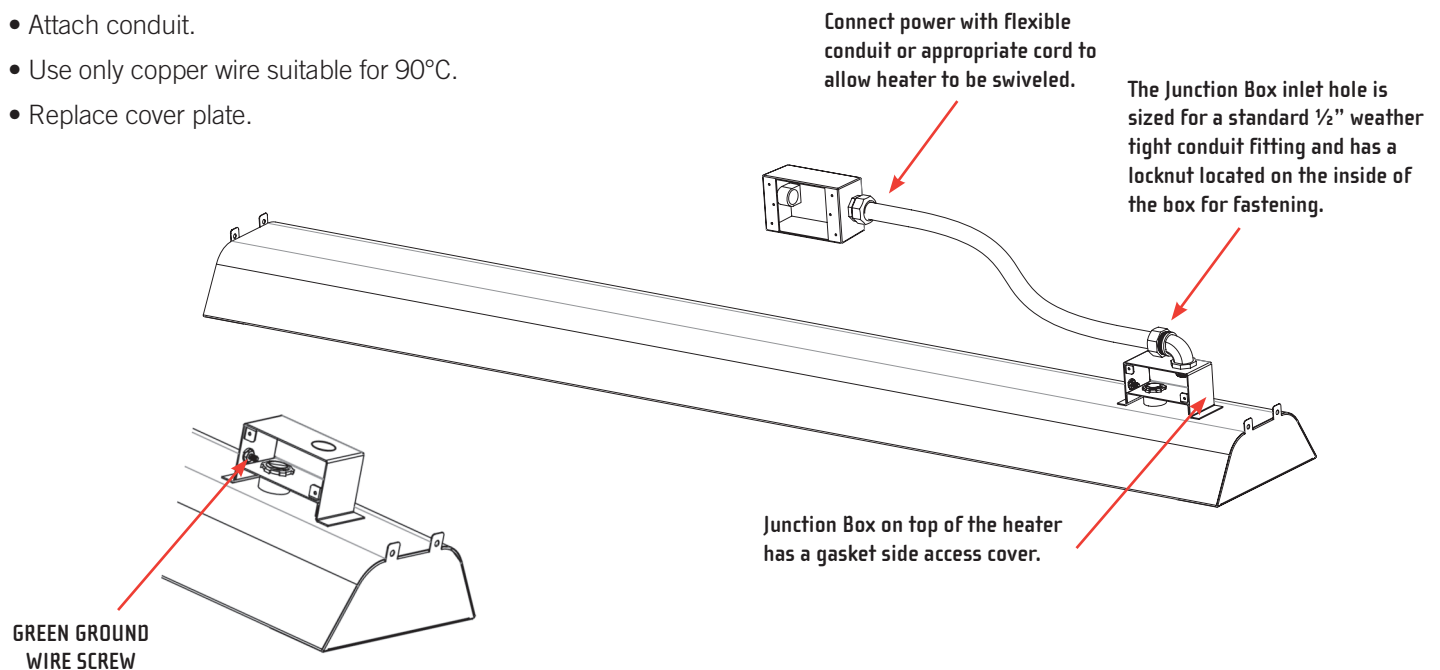

### TYPICAL WIRING OPTIONS

#### TYPICAL 120V WIRING FOR A SINGLE POLE SWITCH

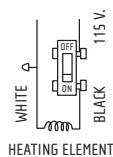

#### TYPICAL 240V WIRING FOR A TWO POLE SWITCH

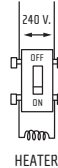

#### WIRING FOR OPTIONAL 120V/240V CONTROLS

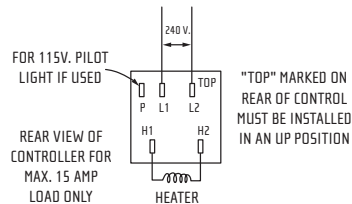

## MOUNTING INSTRUCTIONS

These models may be chain or bracket mounted to any ceiling or horizontal surface. Installation must be such that 18" (45.7cm) minimum clearance is maintained around the heater on all four sides and 36" (91.4cm) directly in front. A minimum of 6" (15.24cm) of clearance provided by mounting brackets is required behind the plane of the face. Heater can be hung using chains or custom brackets. Heater must be level, but can be rotated around its horizontal axis.

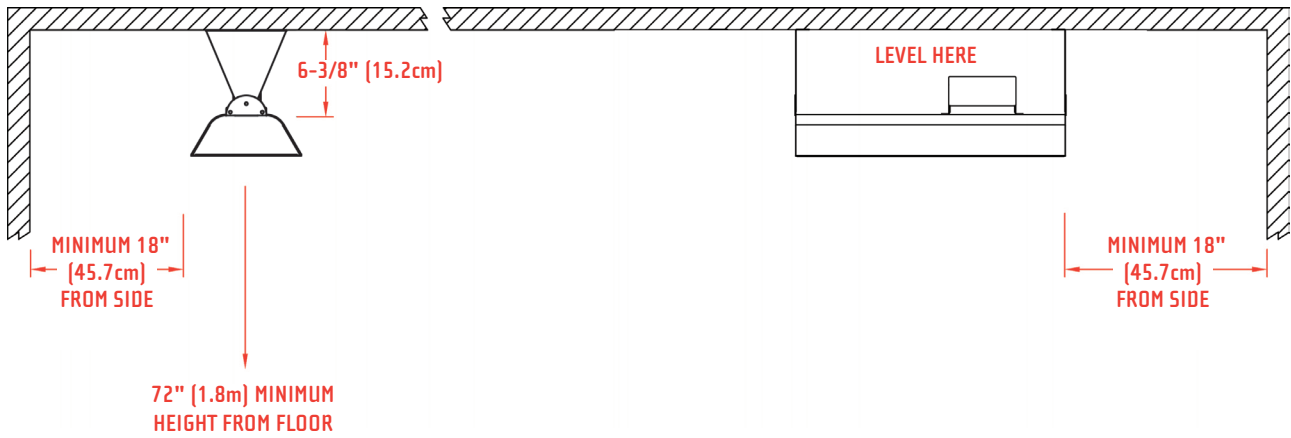
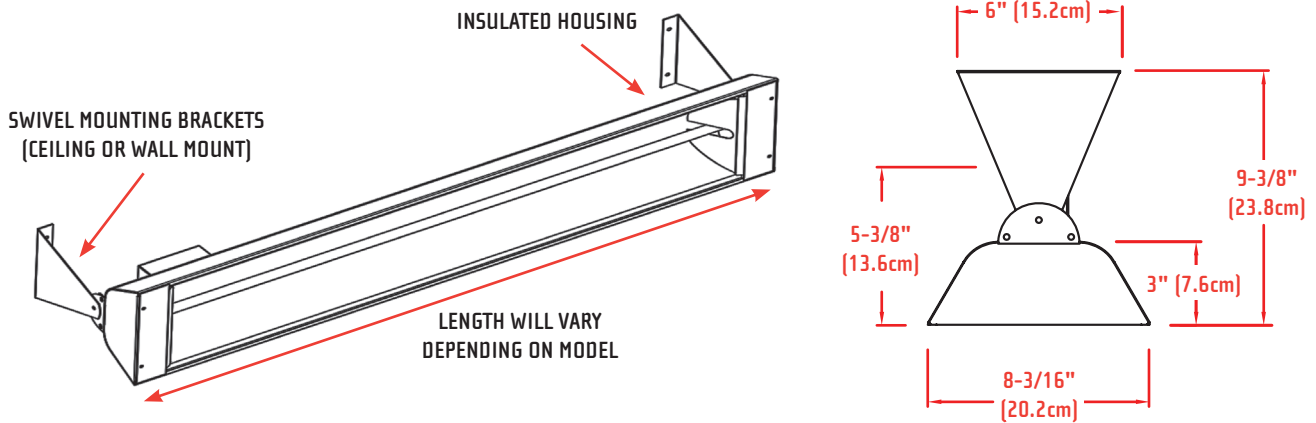

Heater must be installed with the quartz tube horizontally level. For maximum tube life, use a carpenter's level tool to find the optimum level position for the heater's body. Always maintain the minimum clearances from the heater body to any combustible materials.

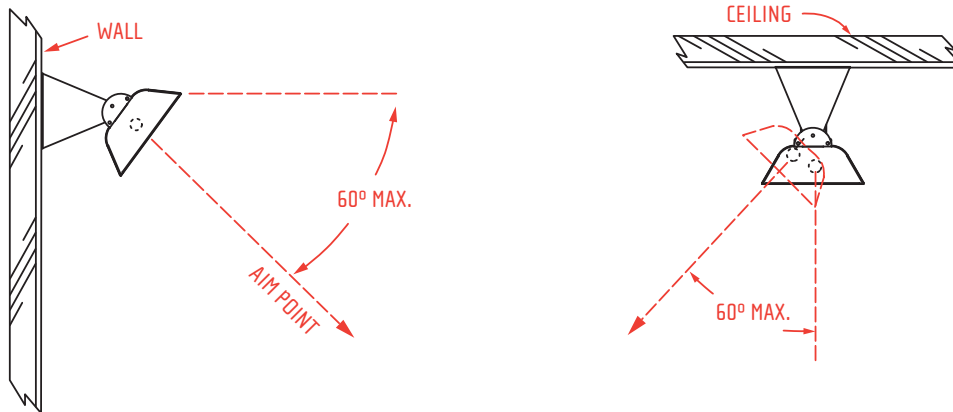

## REPLACEMENT ELEMENT INSTALLATION (VISIT INFRATECH-USA.COM FOR VIDEO INSTRUCTIONS)

Disconnect the power at the breaker. Remove the grill by grasping it in the middle, flex grill up and lift it off. Unscrew and remove both end reflectors. Unhook element clips at each end of the heater and remove nuts from end of element to remove the existing quartz tube. Carefully install the new element. Remove one nut from end of the new element. Install wire by sliding high temperature ring terminal onto element screw and replace nut. Use a thin 11/32" wrench to hold inside nut. Nuts must make a tight connection. Close element clips over tube, reinstall end reflectors, then snap protective grill back in place.

NOTE: Hold ceramic element firmly while tightening nut to prevent damage to element. Nut should be tightened snug. A loose connection can cause the element to short or fail prematurely.

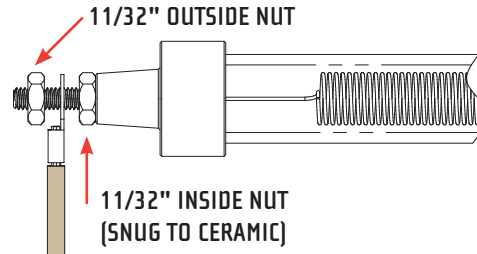

## REPLACEMENT ELEMENTS (OTHER VOLTAGES ALSO AVAILABLE)

PART NUMBER	ELEMENT NUMBER	LENGTH	WATTS	VOLTS	FITS
10-1020	E-7512	16-1/2" (0.4m)	750	120	W-7512
10-1050	E-1412	30" (0.8m)	1500	120	W-1512
10-1055	E-1424	30" (0.8m)	1500	240	W-1524/WD-3024
10-1085	E-2024	36" (0.9m)	2000	240	W-2024/WD-4024
10-2010	E-2524	36" (0.9m)	2500	240	W-2524/WD-5024
10-2030	E-3024	58" (1.5m)	3000	240	W-3024/WD-6024
10-2055	E-4024	58" (1.5m)	4000	240	W-4024

Consult the label on back of heater for proper watts, voltage, and replacement element part number.

**Need help?** To order replacement elements for your Infratech heating system.

## REPLACEMENT PARTS

PART NUMBER	PART DESCRIPTION	QUANTITY
13-1210	Single Element End Reflector (Set of 2)	1
13-1252	Dual Element End Reflector (Set of 2)	1
13-1202, 13-1200, 13-1205	Body Reflector – Fits 33" (0.8m), 39" (1.0m), 61-1/4" (1.6m)	1
13-1242, 13-1240, 13-1245	Grill Guard – Fits 33" (0.8m), 39" (1.0m), 61-1/4" (1.6m)	1
13-1232, 13-1230, 13-1235	Lead Wire Set – Fits 33" (0.8m), 39" (1.0m), 61-1/4" (1.6m)*	1
22-1151	SS Mounting Bracket (Set of 2)	1
18-2295, 18-2300, 18-2305	Flush Mount SS Plaster Frame – Fits 33" (0.8m), 39" (1.0m), 61-1/4" (1.6m)	1

\* Note: Dual Element Heaters require 2 Lead Wire Sets per Heater

## SINGLE ELEMENT AREAS COVERED (FEET)

MODEL	WATTS	MOUNTING HEIGHT	AVERAGE	COLD	PROTECTED
<b>W-1512 SS</b>	1,500	6' - 8' (1.8m - 2.4m)	5' x 5' (1.5m x 1.5m)	3' x 3' (0.91m x 0.91m)	7' x 7' (2.1m x 2.1m)
<b>W-2024 SS</b>	2,000	7' - 9' (2.1m - 2.7m)	6' x 6' (1.8m x 1.8m)	4' x 4' (1.2m x 1.2m)	8' x 8' (2.4m x 2.4m)
<b>W-2524 SS</b>	2,500	7' - 9' (2.1m - 2.7m)	7' x 7' (2.1m x 2.1m)	5' x 5' (1.5m x 1.5m)	9' x 9' (2.7m x 2. m)
<b>W-3024 SS</b>	3,000	7' - 9' (2.1m - 2.7m)	8' x 8' (2.4m x 2.4m)	6' x 6' (1.8m x 1.8m)	10' x 10' (3.0m x 3.0m)
<b>W-4024 SS</b>	4,000	8' - 11' (2.4m - 3.4m)	10' x 10' (3.0m x 3.0m)	8' x 8' (2.4m x 2.4m)	12' x 12' (3.7m x 3.7m)

## DUAL ELEMENT AREAS COVERED (FEET)

MODEL	WATTS	MOUNTING HEIGHT	AVERAGE	COLD	PROTECTED
<b>WD-3024 SS</b>	3,000	7' - 9' (2.1m x 2.7m)	7' x 7' (2.1m x 2.1m)	5' x 5' (1.5m x 1.5m)	9' x 9' (2.7m x 2.7m)
<b>WD-4024 SS</b>	4,000	8' - 12' (2.4m - 3.7m)	8' x 10' (2.4m x 3.0m)	6' x 8' (1.8m x 2.4m)	10' x 12' (3.0m x 3.7m)
<b>WD-5024 SS</b>	5,000	8' - 12' (2.4m - 3.7m)	9' x 10' (2.7m x 3.0m)	7' x 8' (2.1m x 2.4m)	11' x 12' (3.4m x 3.7m)
<b>WD-6024 SS</b>	6,000	10' - 14' (3.0m - 4.3m)	11' x 11' (3.4m x 3.4m)	10' x 10' (3.0m x 3.0m)	12' x 12' (3.7m x 3.7m)

NOTE: Mounting height should not be less than 6' (1.8m) if the heater is labeled as UL Listed and 8' (2.4m) if the heater is labeled as CUL Listed. Indoor or well-protected environments will generally exceed average. Heaters can provide less than average coverage in extremely cold/windy conditions.

## GENERAL NOTES

- INFRATECH QUARTZ TUBE ELECTRIC HEATERS are furnished with wall/ceiling mount swivel brackets. These brackets may be discarded when the heater is hung with chains, special bracketing, or used in conjunction with our flush mount frame.
- See sales literature and price list for full listing of models, descriptions, amperages, and voltages. At times, especially when the mounting height might be quite low, an increased number of smaller heaters can help prevent overheating.
- Heaters up to 15 AMPS can be controlled with a simple INF Input Regulator. This low cost controller, which is actually an infinite switch, gently pulses the heat on and off at regular intervals when not on full power.
- Dual Element Heaters can be wired with our Duplex/Stack Switch, which enables the ability to turn on and off each element independently, providing for half power/full power capabilities.
- For ideal comfort heat, the best solution is to heat from two sides rather than from just one side. However, there are times when this is not practical.
- Coverage areas are approximate dimensions and will vary depending on prevailing and personal comfort levels.
- Indoor or well-protected environments will generally exceed average (see charts). Heaters can provide less than average coverage in extremely cold/windy conditions.

## MAINTENANCE INSTRUCTIONS

- Before performing any maintenance, power must be disconnected and the heater cool to touch.
- Heater housing, reflectors, and heating element can be rinsed with a hose or wiped down with isopropyl alcohol, acetone, or glass cleaner. Use a clean, scratch-free rag or paper towel. Any oxidation, surface rust, or discoloration can be removed with a stainless steel cleaner or metal polish on the bare metal surface.
- Make sure all water, solvents, or cleaners are removed and the heater is dry before reconnecting the power.

## TROUBLESHOOTING

### PROBLEM

### WHAT TO DO

#### Heater does not glow

- Check supply voltage to confirm it matches voltage of heating element.

#### Low heat output

- A 240V element connected to 110V or 208V will warm, but not glow orange or generate sufficient heat for typical applications (Matching your voltage is extremely important). If element is visibly orange, but there is insufficient heat, refer to the areas covered with respect to conditions and mounting heights.
- Replace or clean dirty or non reflective reflectors.

#### Heater does not work

- Disconnect power and check element with an ohm meter for continuity. If there is any continuity across the bulb, the problem is in the wiring/controls.
- Check that there is proper voltage to the heater.
- Check that the control/switch is working.
- Check main power circuit breaker.
- Check wiring for a loose connection or burned wire.

## LOCATION SUGGESTIONS

Unless heaters are installed over 12' (3.7m) high, it is generally recommended that all radiant heaters be mounted on an angle to assure that radiant warmth is distributed from the sides rather than straight down on the heads and shoulders of the people being warmed.

### RECOMMENDED POSITIONING



Angle fixture 30° to 60° from horizontal face down. Best angle is approximately 45°.

### INSTALLATION DIRECTION

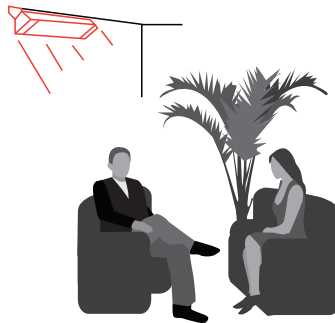

Install fixture to heat the area from the “cold side” if possible. This helps compensate for increased body heat losses due to exposure. Warm floors reradiate heat. Warmer air rises from floor. Some heat reflects from floor. Mounting a heater directly over a table or other obstruction will block the energy, primarily heating the object. It is best to move heater to the side, allowing complete body and floor coverage.

### OUTDOORS

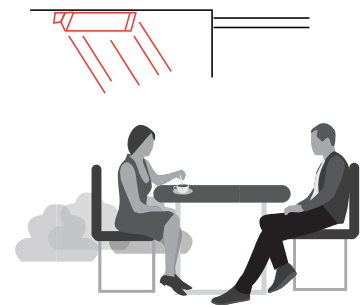

When outdoors, hang heater under protective roof or weather cover whenever possible. Even though heater is all-weather construction, it will last longer and look better if it is protected from rain and snow.