



# Gardner-Westcott Company

Quality Chrome Plated and Stainless Steel Fasteners

## AUTOMOTIVE FASTENER CATALOG



**AMERICAN  
AND  
METRIC  
THREADS**

**SERVING THE AUTO ENTHUSIAST FOR OVER 4 DECADES**

# Table of Contents



1

<b>Index</b>	<b>2</b>
<b>Technical Information</b>	<b>3-7</b>
<i>Specifications and Sizes</i> .....	4
<i>Style Chart and How to Measure</i> .....	5
<i>Thread Identification Fittings</i> .....	6
<i>Conversion, Reference and Equivalent Charts</i> .....	7
<b>Engine Dress Up Kits</b>	<b>8-14</b>
<i>Product Emblem Stamped Identification Part Number Chart</i> .....	8
<i>Chevrolet and Emblem Stamped Chevy Bowtie, SS, RS, 350 and 454</i> .....	10
<i>Pontiac and Oldsmobile Emblem Stamped Arrow, GTO, GT and Olds Rocket</i> .....	11
<i>Mopar and Emblem Stamped Chrysler Pentastar, Mopar, Dodge Ram and Hemi</i> ....	12
<i>Ford, Flathead and Emblem Stamped Ford Oval, Vintage, V8 and Ford Mustang</i> ....	13
<i>6-71 Series Blower Dress Up &amp; Nissan Z Engine Dress Up Kits</i> .....	14
<b>Individual Sets</b>	<b>15-22</b>
<i>Chevrolet</i> .....	16
<i>Emblem Stamped Chevy Bowtie, SS, RS, 350 and 454</i> .....	17
<i>Emblem Stamped Pontiac, GTO, GT and Oldsmobile Rocket</i> .....	17
<i>Ford</i> .....	18
<i>Emblem Stamped Ford Oval, V8 and Mustang</i> .....	19
<i>Emblem Stamped Flame and Skull</i> .....	19
<i>Mopar</i> .....	20
<i>Emblem Stamped Mopar, Chrysler Pentastar, Dodge Ram and Hemi</i> .....	20
<i>Buick and VW</i> .....	20
<i>Interior Screw Sets</i> .....	21
<b>Bulk Fasteners- (Chrome, Stainless and Zinc)* Also see Alphabetical Index on Pg. 2</b>	<b>23-56</b>
<i>American Thread</i> .....	24
<i>Metric Thread</i> .....	49
<b>Assortments/Trays</b>	<b>57-68</b>
<b>Fittings- (Brass and Hand Polished Chrome Plated)</b>	<b>69-74</b>
<b>Product Display Units- (Floor and Counter Displays)</b>	<b>75-90</b>



# Alphabetical Index by Part

## Bolts

	American			Metric		
	Chr.	SS	Zinc	Chr.	SS	Zinc
Body Bolts.....	28	---	---	---	---	---
Bumper Bolts.....	---	36	---	---	---	---
Carriage Bolts.....	28	36	---	---	53	---
Flange Bolts.....	---	---	---	---	---	---
Hex Caps.....	26	40	45	51	53	55
Hex Head Sems.....	28	---	---	---	---	---
Spinlock Bolts.....	28	---	---	---	---	---
Step Bolts.....	28	---	---	---	---	---

## Washers

	American			Metric		
	Chr.	SS	Zinc	Chr.	SS	Zinc
Cup Washers.....	32	---	---	---	---	---
External Lock Washers.....	31	41	46	---	---	---
External Countersunk.....	31	41	---	---	---	---
Internal Lock Washers.....	31	41	46	---	---	---
Finishing.....	32	41	---	---	---	---
Flush.....	32	---	---	---	---	---
Flat Washers.....	31	41	46	52	54	56
Flat Washers AN.....	31	41	---	---	---	---
Flat Washers USS.....	32	---	---	---	---	---
GW Hardened Washers.....	31	41	---	---	---	---
High Collar Lock Washers.....	31	41	---	---	---	---
Lock Washers.....	31	41	46	52	54	56
Neoprene Backed Washers.....	---	42	---	---	---	---
White Nylon Washers.....	---	42	---	---	---	---
Super Flat Washers.....	32	41	46	52	---	---
Wave Washers.....	---	---	---	52	54	---

## Nuts

	American			Metric		
	Chr.	SS	Zinc	Chr.	SS	Zinc
Acorn Nuts.....	34	42	---	52	---	---
Acorn Nuts Low Crown.....	34	---	---	---	---	---
Acorn Push on Covers.....	34	---	---	---	---	---
Allen Nuts.....	33	---	---	---	---	---
Castle Nuts.....	---	42	---	---	---	---
Flange Nuts.....	35	---	---	52	---	---
Flexloc Nuts.....	33	---	---	---	---	---
Hex Nuts.....	33	42	46	52	54	56
Jam Flexloc Nuts.....	33	---	---	---	---	---
Jam Nuts Thin.....	33	43	46	52	54	---
Jam Nylon Insert Lock Nuts.....	33	43	46	54	56	---
Left Hand Thread.....	35	---	---	---	---	---
Nylon Insert Lock Nuts.....	33	42	46	52	54	56
Slotted Nuts.....	33	---	---	---	---	---
Spike Nuts.....	34	---	---	---	---	---
Spin Locks.....	---	43	---	---	---	---
Wing Nuts.....	35	---	---	---	---	---
Wing Nuts Wide Base.....	35	---	---	---	---	---

## Other Items

	American			Metric		
	Chr.	SS	Zinc	Chr.	SS	Zinc
Assortments.....	57	62	63	65	68	---
Axle Kits, VW.....	---	---	---	20	---	---
Blower Kit for 6-71 & 8-71.....	14	14	---	---	---	---
Bulk.....	23	36	45	49	53	56
Chevrolet Engine Kits.....	10	10	---	10	10	---
Chevy Bow Tie Product Line.....	27	37	---	---	---	---
Cotter Pins.....	35	35	35	---	---	---
Fittings Brass.....	69	---	---	---	---	---
Fittings Chrome.....	69	---	---	---	---	---
Ford Engine Kits.....	13	13	---	---	---	---
Ford Flathead Acorn Kit.....	13	---	---	---	---	---
Ford Oval Product Line.....	29	38	---	---	---	---
Grease Fittings.....	35	---	---	---	---	---
Hinge Pins.....	21	20	---	---	---	---
Hole Plugs.....	35	42	---	---	---	---
Hose Clamps.....	---	36	---	---	---	---
Interior Kits.....	21	22	---	---	---	---
License Plate Kits.....	16	---	---	---	---	---
Line Clamps.....	---	36	---	---	---	---
Metal Trays & Cabinets.....	58	---	---	---	---	---
Mopar Engine Kits.....	12	12	---	---	---	---
Mopar Emblem Product Line.....	20	20	---	---	---	---
Muffler Clamps.....	---	36	---	---	---	---
Mustang Front End Kits.....	18	---	---	---	---	---
Nissan 3.0 V-6 Engine Kits.....	---	---	---	14	14	---
Oldsmobile Engine Kits.....	11	11	---	---	---	---
Pipe Plugs Allen Style.....	35	42	---	---	---	---
Pontiac Engine Kits.....	11	11	---	---	---	---
Product Display Units.....	73	77	---	---	---	---
Spacers.....	34	---	---	---	---	---
Threaded Rod.....	---	42	---	---	---	---
Throttle Return Springs.....	28	28	---	---	---	---
Zinc L-9 Bolts.....	---	---	45	---	---	---
Zinc L-9 Washers.....	---	---	46	---	---	---
Zinc L-9 Nuts.....	---	---	46	---	---	---

## Screws

	American			Metric		
	Chr.	SS	Zinc	Chr.	SS	Zinc
Allen Screws.....	24	39	45	50	53	---
Button Head Allen Screws.....	24	39	---	50	53	---
Button Head Torx Screws.....	26	---	---	---	---	---
Flat Head Allen Screws.....	25	39	---	50	53	---
12 Point Screws.....	25	---	---	51	---	---
Ford Hinge Screws.....	22	---	---	---	---	---
Machine Screws.....	30	44	47	---	54	48
Sheet Metal Screws.....	30	44	47	---	54	48
Set Screws.....	---	40	---	---	---	---
Wood Screws.....	30	44	47	---	---	48



## Inside This Section

<b>Specifications and Sizes</b>	
<i>American Thread</i> .....	4
<i>Metric Thread</i> .....	4
<i>Washer Specifications</i> .....	4
<i>Wrench Sizes</i> .....	4
<i>Tensile Requirements</i> .....	4
<i>Torx and Bit Sizes</i> .....	4
<b>Style Chart</b>	
<i>Bolt and Screws Head Styles</i> .....	5
<b>How to Measure</b>	
<i>Bolt Length</i> .....	5
<i>Screw Shank</i> .....	5
<i>Bolt Gage</i> .....	5
<b>Thread Identification</b>	
<i>SAE 45° Flare</i> .....	6
<i>Inverted Flare</i> .....	6
<i>Pipe</i> .....	6
<i>Compression</i> .....	6
<i>Double Compression</i> .....	6
<b>Conversion and Reference Charts</b>	
<i>Wrench Size</i> .....	7
<i>Threads per Inch</i> .....	7
<i>Thread Pitch</i> .....	7
<i>Metric Conversion</i> .....	7
<i>Equivalents</i> .....	7

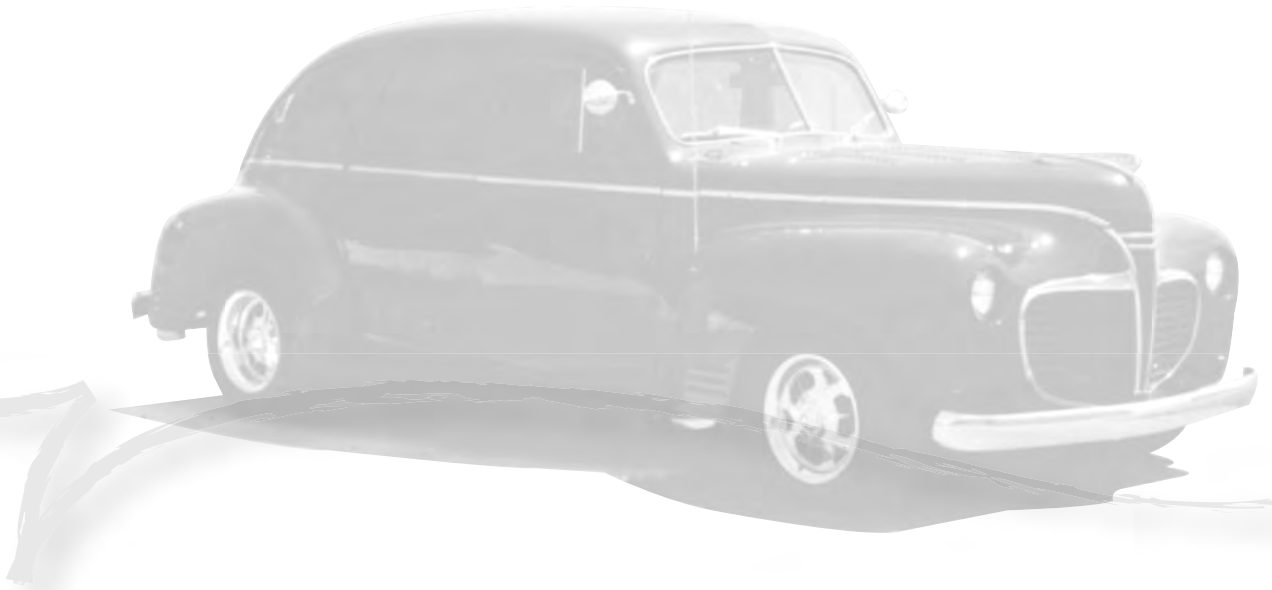



# Specifications and Sizes

## American Thread

Size	Decimal Equivalent	Threads Per Inch		Allen Screw		Button Heads		Flat Heads	
		Coarse & Fine		Maximum Key Size	Maximum Head O.D.	Maximum Key Size	Maximum Head O.D.	Maximum Key Size	Maximum Head O.D.
#4	.112	40	40	0/02	.100	1/16	.212	1/16	.255
#5	.125	40	44	3/32	.205	5/64	.238	5/64	.281
#6	.138	32	40	7/64	.226	5/64	.262	5/64	.307
#8	.164	32	36	9/64	.270	3/32	.312	3/32	.359
#10 (3/16)	.190	24	32	5/32	.312	1/8	.361	1/8	.411
1/4	.250	20	28	3/16	.375	5/32	.437	5/32	.531
5/16	.3125	18	24	1/4	.469	3/16	.547	3/16	.656
3/8	.375	16	24	5/16	.562	7/32	.656	7/32	.781
7/16	.4375	14	20	3/8	.656	---	---	1/4	.844
1/2	.500	13	20	3/8	.750	5/16	.875	5/16	.938
5/8	.625	11	18	1/2	.938	3/8	1.00	3/8	1.188
3/4	.750	10	16	5/8	1.125	---	---	---	---

## Torx Size and Bit Sizes

Torx Size	Bit Size
6/32	T-10
8/32	T-15
10/24	T-25
10/32	T-25
1/4	T-27
5/16	T-40
3/8	T-45
1/2	T-55
5/8	T-60

## Flat Washer Specifications

Size	Flat Washers			AN Washers			GW Washers		
	O.D.	I.D.	Thickness	O.D.	I.D.	Thickness	O.D.	I.D.	Thickness
#6	3/8	5/32	3/64	---	---	---	---	---	---
#8	7/16	3/16	3/64	---	---	---	---	---	---
#10	1/2	7/32	3/64	.437	.203	1/32	---	---	---
#12	9/16	1/4	1/16	---	---	---	---	---	---
1/4	5/8	9/32	1/16	.500	.265	1/16	5/8	.260	.08
5/16	11/16	11/32	1/16	.562	.328	1/16	11/16	.323	.09
3/8	13/16	13/32	1/16	.625	.390	1/16	13/16	.385	.09
7/16	59/64	15/32	1/16	.750	.453	1/16	59/64	.448	.10
1/2	1-1/16	17/32	3/32	.875	.516	1/16	1-1/16	.510	.11
9/16	1-3/16	19/32	3/32	1.062	.578	1/16	---	---	---
5/8	1-5/16	21/32	3/32	1.187	.641	1/16	1-5/16	.635	.12
3/4	1-1/2	13/16	9/64	---	---	---	---	---	---

## Metric Flat Washer Specifications

Size	Flat Washers		
	O.D.	I.D.	Thickness
4mm	9	4.3	0.8
5mm	10	5.3	1
6mm	12	6.4	11.6
7mm	14	7.4	1.6
8mm	16	8.4	1.6
10mm	20	10.5	2
12mm	24	13	2.5
14mm	28	15	2.5
16mm	30	17	3
18mm	34	19	3

## American Wrench Sizes (Width across flats) - Hex Bolts

Wrench Size	Bolt Diameter
7/16	1/4
1/2	5/16
9/16	3/8
5/8	7/16
3/4	1/2
13/16	9/16
15/16	5/8
1 1/8	3/4

## Metric Wrench Sizes (Width across flats) - Hex Bolts

Wrench Size	Bolt Diameter
5.5mm	3mm
7mm	4mm
8mm	5mm
10mm	6mm
11mm	7mm
13mm	8mm
17mm	10mm
19mm	12mm

## Metric Thread

Size	Threads Per Inch		Allen Screw		Button Heads		Flat Heads	
	Coarse & Fine		Key Size	Maximum Head O.D.	Key Size	Maximum Head O.D.	Key Size	Maximum Head O.D.
3mm	0.5	---	2.5mm	5.5mm	2mm	5.70mm	2mm	6.40mm
4mm	0.7	---	3mm	7.0mm	2.5mm	7.60mm	2.5mm	8.60mm
5mm	0.8	---	4mm	8.5mm	3mm	9.50mm	3mm	10.60mm
6mm	1.0	---	5mm	10.00mm	4mm	10.50mm	4mm	12.60mm
8mm	1.25	1.00	6mm	13.00mm	5mm	14.00mm	5mm	16.80mm
10mm	1.50	1.25	8mm	16.00mm	6mm	17.50mm	6mm	21.00mm
12mm	1.75	1.50	10mm	18.00mm	8mm	21.00mm	8mm	25.00mm

## Tensile Strengths of Material Requirements

Material	LBS.
Stainless Steel	85,000
Grade 2	85,000
Grade 5	120,000
Grade 8	150,000

# Style Chart and Measuring



## Styles in Chrome



**H= Hex Caps**  
Chrome Plated

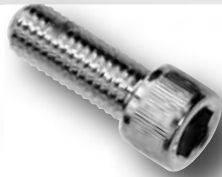

**S= Allen Screws**  
Chrome Plated



**B= Button Head**  
Chrome Plated



**N= 12 Point**  
Chrome Plated



**P= Allen Screws**  
Polished Chrome Plated

## Styles in Stainless Steel



**HS= Hex Bolts**  
Stainless Steel



**SS= Allen Screws**  
Stainless Steel



**SB= Button Head**  
Stainless Steel



**HSP= Hex Bolts**  
Stainless Steel  
Polished



**SSP= Allen Screws**  
Stainless Steel  
Polished

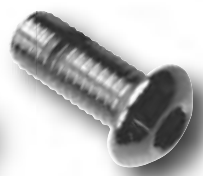

**SBP= Button Head**  
Stainless Steel  
Polished

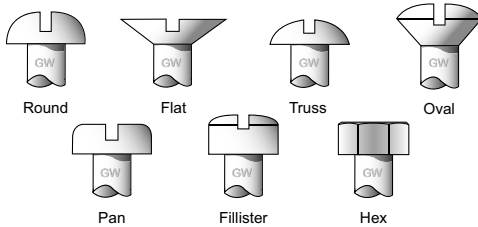

Acorn Nut  
and Slotted Stud  
Kits



Sheet Metal  
Screw

Wood Screw

Machine Screw

## How to Measure

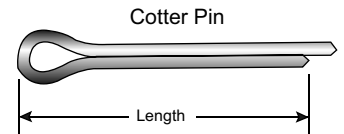
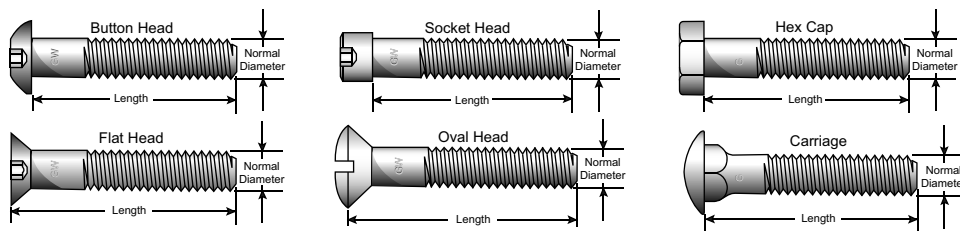

## Actual Shank Sizes

To Determine Sizes  
of Screws. Lay screw  
flat within parallel  
lines shown in border

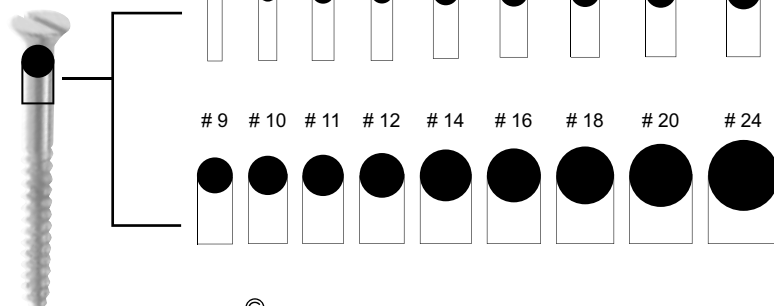

©

## Bolt Gage

Combined American and Metric gage to measure bolts, nuts and screws is an every day necessity to the dealer. These gages are available and can be ordered by **Part # gage**

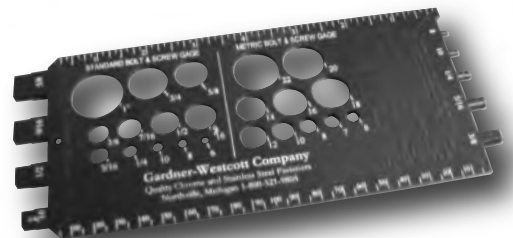



# Thread Identification Fittings

## Standard Thread Identification

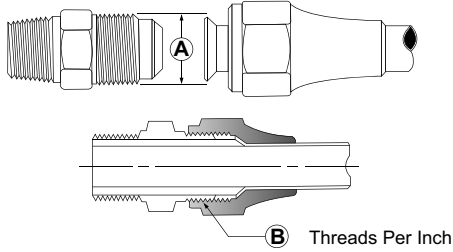

### S.A.E 45° Flare

<b>Tube O.D.</b>	1/8	3/16	1/4	5/16	3/8	7/16	1/2	5/8	3/4
<b>Diameter A</b>	5/16	3/8	7/16	1/2	5/8	11/16	3/4	7/8	1 1/16
<b>Thread Size B</b>	24	24	20	20	18	16	16	14	14

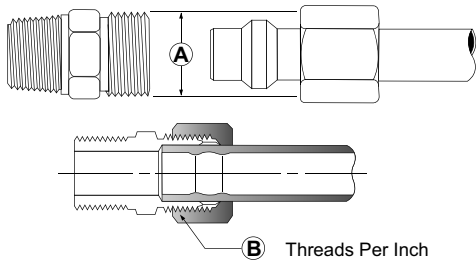

### Compression

<b>Tube O.D.</b>	1/8	3/16	1/4	5/16	3/8	7/16	1/2	5/8	3/4	1
<b>Diameter A</b>	5/16	3/8	7/16	1/2	9/16	5/8	11/16	13/16	1	1 1/4
<b>Thread Size B</b>	24	24	24	24	24	24	20	18	18	18

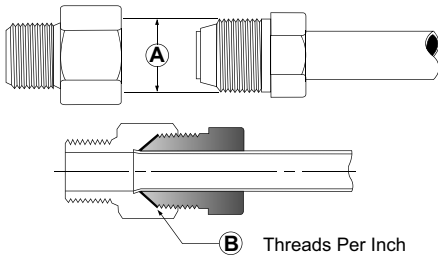

### Double Compression

<b>Tube O.D.</b>	1/8	3/16	1/4	5/16	3/8	7/16	1/2
<b>Diameter A</b>	5/16	3/8	7/16	1/2	9/16	5/8	11/16
<b>Thread Size B</b>	24	24	24	20	20	18	16

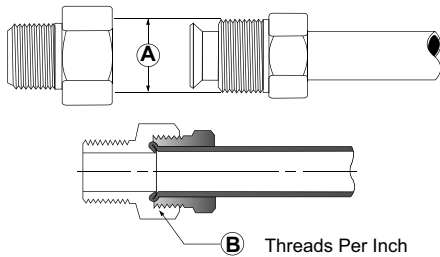

### Inverted Flare

<b>Tube O.D.</b>	1/8	3/16	1/4	5/16	3/8	7/16	1/2	5/8	3/4	7/8	1
<b>Diameter A</b>	5/16	3/8	7/16	1/2	5/8	11/16	3/4	7/8	1 1/16	1 3/16	1 5/16
<b>Thread Size B</b>	28	24	24	20	18	18	18	18	16	16	16

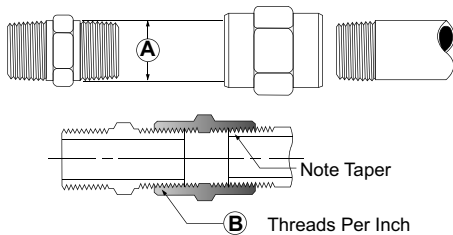

### Pipe

<b>Pipe Size A</b>	1/16	1/8	1/4	3/8	1/2	3/4	1
<b>Thread Size B</b>	1/16-27	1/8-27	1/4-18	3/8-18	1/2-14	3/4-14	1-11 1/2
<b>Working Pressure</b>	1200	1200	1200	1200	1200	1000	1000
<b>Thread OD</b>	1/4	3/8	1/2	5/8	3/4	1	1 1/4

# Conversion and Reference Charts



## American Equivalents

Fraction	Decimal	Millimeter
1/64	.0156	0.397
1/32	.0312	0.794
3/64	.0468	1.191
1/16	.0625	1.588
5/64	.0781	1.984
3/32	.0937	2.381
7/64	.1093	2.778
<b>1/8</b>	<b>.1250</b>	<b>3.175</b>
9/64	.1406	3.572
5/32	.1562	3.969
11/64	.1718	4.366
3/16	.1875	4.763
13/64	.2031	5.159
7/32	.2187	5.556
15/64	.2343	5.953
<b>1/4</b>	<b>.2500</b>	<b>6.350</b>
17/64	.2656	6.747
9/32	.2812	7.144
19/64	.2968	7.541
5/16	.3125	7.938
21/64	.3281	8.334
11/32	.34375	8.731
23/64	.3593	9.128
<b>3/8</b>	<b>.3750</b>	<b>9.525</b>
25/64	.3906	9.922
13/32	.4062	10.319
27/64	.4218	10.716
7/16	.4375	11.113
29/64	.4531	11.509
15/32	.4687	11.906
31/64	.4843	12.303
<b>1/2</b>	<b>.5000</b>	<b>12.700</b>
33/64	.5156	13.097
17/32	.5312	13.494
35/64	.5468	13.891
9/16	.5625	14.288
37/64	.5781	14.684
19/32	.5937	15.081
39/64	.6093	15.478
<b>5/8</b>	<b>.6250</b>	<b>15.875</b>
41/64	.6406	16.272
21/32	.6562	16.669
43/64	.6718	17.066
11/16	.6875	17.463
45/64	.7031	17.859
23/32	.7187	18.256
47/64	.7343	18.653
<b>3/4</b>	<b>.7500</b>	<b>19.050</b>
49/64	.7656	19.447
25/32	.7812	19.844
51/64	.7968	20.241
13/16	.8125	20.638
53/64	.8281	21.034
27/32	.8437	21.431
55/64	.8593	21.828
<b>7/8</b>	<b>.8750</b>	<b>22.225</b>
57/64	.8906	22.622
29/32	.9062	23.019
59/64	.9218	23.416
15/16	.9275	23.813
61/64	.9531	24.209
31/32	.9687	24.606
63/64	.9843	25.003
<b>1"</b>	<b>1.0000</b>	<b>25.400</b>

## Metric Conversion Chart

Inches	Millimeters
1/4	6mm
5/16	8mm
3/8	10mm
1/2	12mm
5/8	16mm
3/4	20mm
1	25mm
1-3/16	30mm
1-3/8	35mm
1-9/16	40mm
1-3/4	45mm
2	50mm
2-3/16	55mm
2-3/8	60mm
2-9/16	65mm
2-3/4	70mm
3	75mm
3-3/16	80mm
3-3/8	85mm
3-1/2	90mm
4	100mm
4-3/8	110mm
4-3/4	120mm

Technical  
Info

## Threads Per Inch American

Coarse	Fine
10/24	10/32
1/4-20	1/4-28
5/16-18	5/16-24
3/8-16	3/8-24
7/16-14	7/16-20
1/2-13	1/2-20
9/16-12	9/16-18
5/8-11	5/8-18
3/4-10	3/4-16

## Threads Pitches Metric

Diameter	Pitch
6mm	1.0
8mm	1.25
8mm Fine	1.0
10mm	1.50
10mm Fine	1.25
12mm	1.75
12mm Fine	1.50
14mm	2.0
14mm Fine	1.50





# Awesome

**Product Emblem Stamped Hex Caps Chrome Plated and Polished Stainless Steel**



Ford Oval use Part Prefix  
11-56250 to order



Chevy Bowtie use Part Prefix  
10-56490 to order

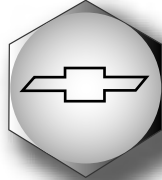

Mopar use Part Prefix  
23-56330 to order

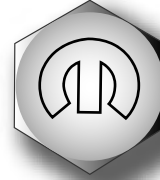

Pontiac Arrow use Part Prefix  
12-56490 to order

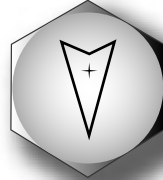

Ford V8 use Part Prefix  
24-xxxxx to order



Chevy SS use Part Prefix  
13-xxxxx to order



Pontiac GTO use Part Prefix  
20-xxxxx to order



Chrysler Pentastar use Part Prefix  
21-xxxxx to order



Ford Mustang use Part Prefix  
25-xxxxx to order



Chevy RS use Part Prefix  
16-xxxxx to order



Pontiac GT use Part Prefix  
15-xxxxx to order



Hemi Mopar use Part Prefix  
27-xxxxx to order



Flames use Part Prefix  
17-xxxxx to order



350 use Part Prefix  
18-xxxxx to order



454 use Part Prefix  
19-xxxxx to order



Dodge Ram use Part Prefix  
22-xxxxx to order



Skulls use Part Prefix  
14-xxxxx to order



Olds Rocket use Part Prefix  
26-xxxxx to order

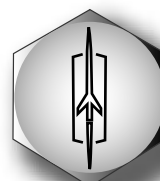

**What better way to make a statement!**

**Select style when ordering:**

**H = Chrome Plated or HSP = Stainless Steel Polished.**

**Example:** Engine Dress Up Kit Part # XX - XXXXX - **H** or **HSP**

└─ Emblem Prefix Number  
└─ Engine Kit Number



## Inside This Section

<b>Chevrolet Engine Sets</b>	
<i>Small Block, Big Block, LT1, Vortec and LS1-LS6.....</i>	<i>10</i>
<b>Emblem Stamped Chevy Bowtie, SS, RS, 350 &amp; 454</b>	
<i>Small Block, Big Block, LT1, Vortec and LS1-LS6.....</i>	<i>10</i>
<b>Pontiac Engine Sets</b>	
<i>Engine 326-455 Displacements.....</i>	<i>11</i>
<b>Emblem Stamped Pontiac Arrow, GTO and GT</b>	
<i>Engine 326-455 Displacements.....</i>	<i>11</i>
<b>Oldsmobile Engine Sets</b>	
<i>Engine 260-455 Displacements.....</i>	<i>11</i>
<b>Emblem Stamped Oldsmobile Rocket</b>	
<i>Engine 260-455 Displacements.....</i>	<i>11</i>
<b>Chrysler Mopar Engine Sets</b>	
<i>Small Block.....</i>	<i>12</i>
<i>Big Block.....</i>	<i>12</i>
<b>Emblem Stamped Mopar, Chrysler Pentastar, Dodge Ram and Hemi</b>	
<i>Small Block.....</i>	<i>12</i>
<i>Big Block.....</i>	<i>12</i>
<b>Ford Engine Sets</b>	
<i>Small Block.....</i>	<i>13</i>
<i>Big Block.....</i>	<i>13</i>
<i>Flathead.....</i>	<i>13</i>
<b>Emblem Stamped Ford Oval, Ford Vintage V8 &amp; Ford Mustang Pony</b>	
<i>Small Block.....</i>	<i>13</i>
<i>Big Block.....</i>	<i>13</i>
<b>6-71 and 8-71 Mooneyham Blower Dress Up Kits</b>	
<i>Big Block.....</i>	<i>14</i>
<b>Nissan Z Engine Dress Up Kits</b>	
<i>3.0 V-6.....</i>	<i>14</i>

All automobile manufacturers brand names listed are registered trademarks ®





# Chevrolet Engine Dress Up Kits

\* For other bolt head styles see the Pick Your Style chart at the top of page 14 in the Individual Applications Section



## Chevy Small and Big Block Kits Contain:

Intake Manifold, Valve Cover, Water Neck, Water Pump, Timing Cover, Fuel Pump, Oil Pan, Distributor Hold Down and either Headers or Standard Exhaust Bolts. Washers are supplied where applicable.

**Note:** Small Block Kit contains the Short Water Pump & Big Block contains the Extended Water Pump.

**Also: LS1-LS6 Engine's Kits will Contain:** Oil Pan, Header Bolts, Front Cover, Water Crossover, Crank Sender, Water Pump, Valve Cover, Thermostat Housing, Throttle Body, Manifold Hold Down, Kick Down & Fuel Rail Fasteners. **Please specify aluminum or steel valve covers when ordering.**

Engine Dress Up Kit  
Part # 56490



## Description

Description	Part #
Small Block Chevy with Headers.....	56490
Small Block Chevy with Standard Exhaust Bolts.....	56492
Big Block Chevy with Headers.....	56491
LT1 Chevy Engine with Headers.....	56495
Vortec 350 Chevy Small Block with Headers.....	56494
LS1-LS6 Engine with Headers (4 bolt valve covers in this kit).....	56404
LS1-LS6 Engine with Standard Exhaust Bolts (same as above kit).....	56405

## Chevy Bowtie Stamped Dress Up Kits

Gardner-Westcott is now offering a new and different look for engine dress up bolts, The Chevy Bowtie emblem stamped directly onto the head of the bolts. They are available in decorative Polished Chrome Plated or Stainless Steel versions, in all the sizes needed to give your car that special look. What better way to make a statement than with these unique bolts.

**Gardner-Westcott** is exclusively licensed by **GM** to produce this product. Same as above engine kits. **Please specify steel or aluminum valve covers when ordering.**

Chevy Bow Tie  
Engine Dress Up Kit  
# 10-56492H

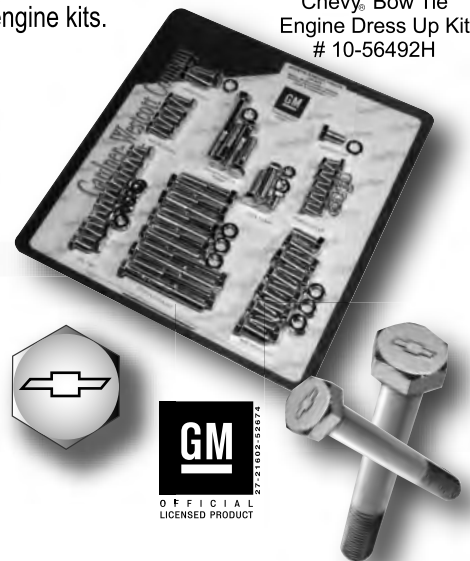

Select style when ordering: **H** = Chrome Plated or **HSP** = Stainless Steel Polished.

**Example:** Engine Dress Up Kit Part # 10-56490- **H** or **HSP**

## Description

Description	Part #
Small Block Chevy with Headers.....	10-56490
Small Block Chevy with Standard Exhaust Bolts.....	10-56492
Big Block Chevy with Headers.....	10-56491
LT1 Chevy Engine with Headers.....	10-56495
Vortec 350 Chevy Small Block with Headers.....	10-56494
LS1-LS6 Engine with Headers (4 bolt valve covers in this kit).....	10-56404
LS1-LS6 Engine with Standard Exhaust Bolts (same as above kit).....	10-56405

## Emblem Engine Dress Up Sets Available For

Chevy SS  
Part #

- 13-56490
- 13-56492
- 13-56491
- 13-56495
- 13-56494



Chevy RS  
Part #

- 16-56490
- 16-56492
- 16-56491
- 16-56495
- 16-56494



Chevy 350  
Part #

- 18-56490
- 18-56492
- 18-56491
- 18-56494



Chevy 454  
Part #

- 19-56491
- 19-56495



## 6-71 Blower Engine Dress Up Kit

Part #

Chevy Big Block 6-71 Blower Engine Dress Up Kit..... 56671-P

(This kit will cover the entire top end of a Mooneyham or similar blower unit, Also you can add the finishing touch to your 6-71 Blower by adding (36) - 5/16 chrome hole covers Part # 43570 and (26) - 1/4 chrome hole covers Part # 43569)

# Pontiac & Olds Engine Dress Up Kits



Engine Dress Up Kits

\* For other bolt head styles see the Pick Your Style chart at the top of page 16 in the Individual Applications Section



## Pontiac Engine Kits Contain:

Intake Manifold, Valve Cover, Thermostat Housing, Water Pump, Timing Cover, Timing Cover to Intake Manifold, Fuel Pump, Oil Pan, Distributor Hold Down and Oil Filter Adapter. Washers are supplied where applicable. **Please specify steel or aluminum valve covers.**



### Description

### Part #

Engine Dress Up Kit for 326 - 455 (with no exhaust).....	56500
Engine Dress Up Kit for 350, 389, 400, 421 - 455 (with no exhaust).....	56505

## Pontiac ▼

### Pontiac Arrow, GTO and GT Engine Dress Up Kits

Dress up your Pontiac Gardner-Westcott is now offering a new and different look for engine dress up bolts, The Pontiac Arrow, GTO and GT emblem stamped directly onto the head of the bolts. They are available in decorative Polished Chrome Plated or Stainless Steel versions, in all the sizes needed to give your car that special look. What better why to make a statement than with these unique bolts. Gardner-Westcott is exclusively licensed by GM to produce this product.

**Select style when ordering:**

**H** = Chrome Plated or **HSP** = Stainless Steel Polished.

**Example:**

Engine Dress Up Kit Part # 12-56500- **H** or **HSP**

### Description

### Part #

Engine Dress Up Kit for 326 - 455 (with no exhaust).....	12-56500
Engine Dress Up Kit for 350, 389, 400, 421 - 455 (with no exhaust).....	12-56505



**Pontiac GTO**  
Part #



20-56500  
20-56505

**Pontiac GT**  
Part #



15-56500  
15-56505

## Oldsmobile



### Oldsmobile Engine Kits Contain:

Intake Manifold, Valve Cover, Water Neck, Water Pump, Timing Cover, Fuel Pump, Oil Pan, Distributor Hold Down and Oil Filter Housing. Washers are supplied where applicable.

**Please specify steel or aluminum valve covers.**

### Description

### Part #

Engine Dress Up Kit for 260 - 455 (with no exhaust).....	56501
--	-------

### Olds Rocket Engine Dress Up Kit

### Part #

Engine Dress Up Kit for 260 - 455 (with no exhaust).....	26-56501
--	----------



Oldsmobile Rocket use Part Prefix 26-xxxxx to order





# Chrysler Engine Dress Up Kits

\* For other bolt head styles see the Pick Your Style chart at the top of page 18 in the Individual Applications Section



**Gardner-Westcott's** Engine Dress Up Kits are available Chrome Plated, Stainless Steel and Polished Stainless Steel. Bolt Styles available include Hex Caps, Allen Screws, Button Head, 12 Point also Mopar, Chrysler Pentastar and Dodge Ram Stamped Hex Cap Bolts.

## Chrysler Mopar Small and Big Block Kits Contain:

Please specify steel or aluminum valve covers.

Intake Manifold, Valve Cover, Water Pump, Timing Cover, Fuel Pump, Oil Pan, and either Headers or Standard Exhaust Bolts. Washers are supplied where applicable.

Description	Part #
Small Block Mopar with Headers.....	56330
Small Block Mopar with Standard Exhaust.....	56331
Big Block Mopar with Headers.....	56332



Engine Dress Up Kit Part # 56331-H

## Mopar Stamped Dress Up Kits

Dress up your Mopar! Gardner-Westcott Company is now offering a new and different look for engine dress up bolts, The Mopar emblem stamped directly onto the head of the bolts. They are available in decorative Polished Chrome Plated or Stainless Steel versions in all the sizes needed to give your car that special look. What better way to make a Mopar statement than with these unique bolts! **Gardner-Westcott Company** is licensed by Mopar to produce this product



MOPAR, JEEP, DODGE, HEMI, PLYMOUTH, RAM, SRT, CHRYSLER and related logos, vehicle model names and trade dress are trademarks of Chrysler Group LLC and used under license by (licensee name). ©2015 Chrysler Group LLC.

## Mopar, Chrysler Pentastar, Dodge Ram and Hemi Kits Contain:

Please specify steel or aluminum valve covers.

Intake Manifold, Valve Cover, Water Pump, Timing Cover, Fuel Pump, Oil Pan, and either Headers or Standard Exhaust Bolts. Washers are supplied where applicable.

Select style when ordering: **H** = Chrome Plated or **HSP** = Stainless Steel Polished.



**Example:** Engine Dress Up Kit Part # 23-56331- **H** or **HSP**

Description	Part #
Small Block Mopar with Headers.....	23-56330
Small Block Mopar with Standard Exhaust.....	23-56331
Big Block Mopar with Headers.....	23-56332

## Emblem Engine Dress Up Sets Available in:

Chrysler Pentastar Part #

- 21-56330
- 21-56331
- 21-56332



Dodge Ram Part #

- 22-56330
- 22-56331
- 22-56332



Hemi Mopar Part #

- 27-56330
- 27-56331
- 27-56332

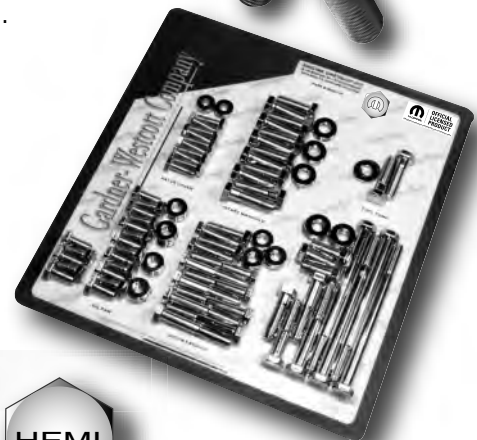

Engine Dress Up Kit Part # 23-56331-HSP

# Ford Engine Dress Up Kits



\* For other bolt head styles see the Pick Your Style chart at the top of page 16 in the Individual Applications Section



**Gardner Westcott's** Engine Dress Up Kits are available Chrome Plated, Stainless Steel and Polished Stainless Steel. Bolt Styles available include Hex Caps, Allen Screws, Button Head, 12 Point, Ford Oval, Ford V8 & Ford Mustang Stamped Hex Cap Bolts.

## Ford 289, 302 only Kits Contain:

Intake Manifold, Valve Cover, Filler Neck, Timing Cover, Fuel Pump, Oil Pan, and either Headers or Standard Exhaust Bolts. Washers are supplied where applicable. **Note: Water Pump Bolts are not included.**

### Description

	Part #
289, 302 Ford with Headers.....	56250
289, 302 Ford with Standard Exhaust.....	56251
390, 428 Ford with Headers.....	56253
429, 460 Ford with Headers.....	56254
351 Cleveland.....	56255
400 Modified.....	56256

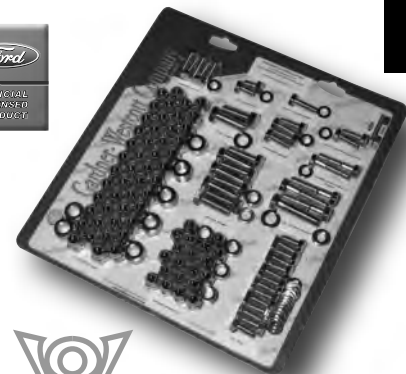

### Description

	Part #
8BA 49-53 Chrome acorn covers for both Cylinder Heads and Intake Manifold.....	56263-AC
8BA 49-53 Chrome acorn nuts for both Cylinder Heads and Intake Manifold along with Stamped V8 Hex Caps for Timing Cover, Coil Bracket, Fan Shaft, Distributor Hold Down, Coolant Neck, Water Pump, Fuel Pump Stand Off, Stand Off to Fuel Pump, Oil Filter Mount and Oil Pan.....	24-56264-AC



Flathead Engine Dress Up Kit Part # 24-56264-AC

## Ford Stamped Engine Dress Up Kits

**Dress up your Ford!** We now offer a new and different look for engine dress up bolts, The Ford Oval emblem stamped directly onto the head of the bolts. They are available in decorative Polished Chrome Plated or Stainless Steel versions in all the sizes needed to give your car that special look. What better way to make a Ford statement than with these unique bolts.

## Ford Oval, V8 & Mustang Emblem Stamped Dress Up Kits

Ford Oval Engine Dress Up Kit Part # 11-56256-HSP

### Description

	Part #
289, 302 Ford with Headers.....	11-56250
289, 302 Ford with Standard Exhaust.....	11-56251
390, 428 Ford with Headers.....	11-56253
429, 460 Ford with Headers.....	11-56254
351 Cleveland.....	11-56255
400 Modified with Standard Exhaust.....	11-56256

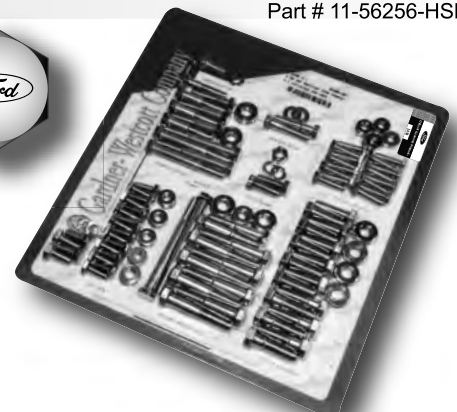

### Emblem Engine Dress Up Sets Available in:

**Ford V8**  
Part #

**Ford Mustang**  
Part #

- 24-56250
- 24-56251
- 24-56253
- 24-56254
- 24-56255
- 24-56256



- 25-56250
- 25-56251
- 25-56253
- 25-56254
- 25-56255
- 25-56256



**Select style when ordering:**

**H** = Chrome Plated or **HSP** = Stainless Steel Polished.

**Example:**

Engine Dress Up Kit Part # 11-56250- **H** or **HSP**

Engine Dress Up Kits



# 6-71 Blower Dress Up Kit

**Gardner-Westcott Company** has created a dress-up kit especially for the very popular 6-71 and 8-71 supercharger blower. Now you can dress up your show blower with either chrome or polished chrome allen fasteners. We also have an accessory kit of chrome hole plugs, that will add that clean definitive touch and really set off your supercharger. The kit contains fasteners for the top end of a 6-71 or 8-71 series blower, which includes; the Upper Pulley, Bearing Support Front Cover Plate, Front Cover, Bearing Rear Cover Plate, Bearing Plate, Upper Plenum to Intake, Thermostat Housing and Burp Valve.



S= Allen Screws  
Chrome Plated

P= Allen Screws  
Polished Chrome  
Plated  
Knurles Removed

SS= Allen Screws  
Stainless Steel

SSP= Allen Screws  
Stainless Steel  
Polished  
Knurles Removed

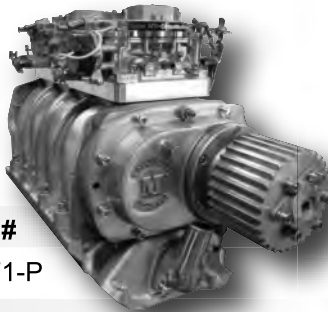

Blower Dress Up Kit  
Part # 56671-P

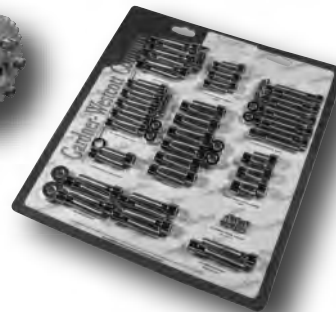

## Blower Dress Up Kit

Part #

Big Block Chevy 6-71 thru 8-71 - (Mooneyham Blower)..... 56671-P

## Optional Hole Plugs to detail Allen Screws

Part #

5/16 Size for 3/8 Allens - (36 required)..... 43570

1/4 Size for 5/16 Allens - (26 required)..... 43569

**NOTE:** Some blower configurations may differ, in which case we can offer complete american and metric bulk assortments to detail any engine build or custom project.

# Nissan Dress Up Kits

## Nissan Z 3.0 V-6 Engine Dress Up Kits

Fits 1984 - 89

### Style Description

- HSPA** = Hex Cap Polished Stainless Steel with Polished Stainless Steel Rubber Backed Washers
- HA** = Hex Cap Chrome with Polished Stainless Steel Rubber Backed Washers
- HSP** = Hex Cap Polished Stainless Steel
- H** = Hex Cap Chrome Plated
- P** = Polished Chrome Allens Screws
- SSP** = Stainless Steel Polished Allen Screws
- C** = Chrome Plated Flat Head Allen Screws
- B** = Button Head Chrome Plated Allen Screws
- BSP** = Button Head Stainless Steel Polished Allen Screws



Valve Covers  
56102-H



Manifold Cover  
56103-C

### Valve Cover Part #

Valve Cover..... 56102-H  
 Valve Cover..... 56102-HA  
 Valve Cover..... 56102-HSP  
 Valve Cover..... 56102-HSPA  
 Valve Cover..... 56102-P  
 Valve Cover..... 56102-SSP

### Fender Bolts Part #

Fender Bolts..... 56104-B  
 Fender Bolts..... 56104-BSP  
 Fender Bolts..... 56104-H  
 Fender Bolts..... 56104-HA  
 Fender Bolts..... 56104-HSP  
 Fender Bolts..... 56104-HSPA

### Manifold Cover Part #

Manifold Cover..... 56103-C  
 Manifold Cover..... 56103-FASP

### Hood Hinge Part #

Hood Hidge & Latch..... 56105-H  
 Hood Hidge & Latch..... 56105-HA  
 Hood Hidge & Latch..... 56105-HSP  
 Hood Hidge & Latch..... 56105-HSPA



Fender Bolts  
56104-H



Hood Hinge & Latch  
56105-H



## Inside This Section

<i>Chevrolet.....</i>	<i>16</i>
<i>Emblem Stamped Chevy Bow Tie, SS, RS, 350 and 454.....</i>	<i>17</i>
<i>Emblem Stamped Pontiac, GTO and GT.....</i>	<i>17</i>
<i>Ford.....</i>	<i>18</i>
<i>Emblem Stamped Ford Oval, Ford V8 and Ford Mustang.....</i>	<i>19</i>
<i>Emblem Stamped Flame and Skull.....</i>	<i>19</i>
<i>Mopar.....</i>	<i>20</i>
<i>Emblem Stamped Mopar, Chrysler Pentastar, Dodge Ram and Hemi.....</i>	<i>20</i>
<i>Buick.....</i>	<i>20</i>
<i>VW.....</i>	<i>20</i>
<i>Interior Screw Sets.....</i>	<i>21</i>

**Individual Sets**

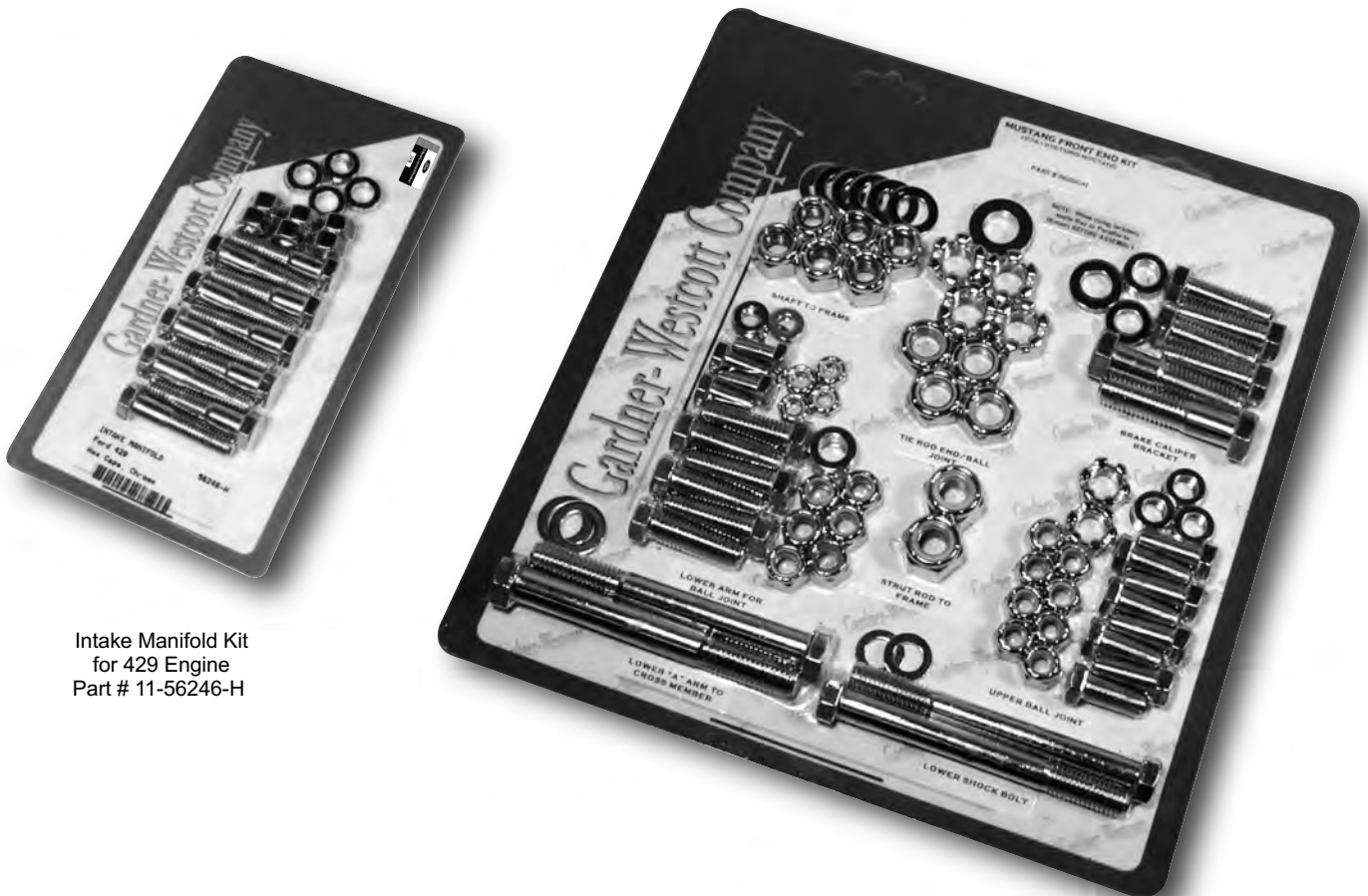

Intake Manifold Kit  
for 429 Engine  
Part # 11-56246-H

Mustang Front End Kit  
Part # 56260-H





# Chevrolet Individual Sets

## Pick your style of fastener

Style



H= Hex Caps Chrome Plated    S= Allen Screws Chrome Plated    B= Button Head Chrome Plated    N= 12 Point Chrome Plated    P= Allen Screws Polished Chrome Plated    HS= Hex Bolts Stainless Steel    SS= Allen Screws Stainless Steel    SB= Button Head Stainless Steel    HSP= Hex Bolts Stainless Steel Polished    SSP= Allen Screws Stainless Steel Polished    SBP= Button Head Stainless Steel Polished

Description	Part #
Alternator Jam Nut Chrome.....	15574
Axle Truck 10 Bolt, 2 & 4 Wheel Drive.....	56458
Axle Truck 12 Bolt, 2 & 4 Wheel Drive.....	56459
Bell Housing.....	56484
Bumper Bolt Kit 67 - 69 Camaro Frt.....	56850
Bumper Bolt Kit 67 - 69 Camaro Rr.....	56851
Bumper Bolt Kit 67 - 69 Camaro Frt, (w/washers & nuts)..	56852
Bumper Bolt Kit 67 - 69 Camaro Rr, (w/washers & nuts)...	56853
Carburetor Stud Kits with 4 Studs, (w/washers & nuts)	
1 3/8" overall length Stainless Steel.....	4086
1 1/2" overall length Stainless Steel.....	4087
2" overall length Stainless Steel.....	4088
1 3/8" overall length Chrome Plated.....	4083
1 1/2" overall length Chrome Plated.....	4084
2" overall length Chrome Plated.....	4085
Coil Mount to Block.....	56478
Exhaust Manifold.....	56477
Exhaust Manifold Studs Standard in Stainless Steel	
3/8-16 x 2 1/4" sold each.....	88347
3/8-16 x 2 3/4" sold each.....	88349
3/8-16 x 3" sold each.....	88348
Fan Spacer Bolts Extended.....	56457
Fan Spacer Bolts Short.....	56456
Front Cover Bolts.....	56464
Fuel Pump.....	56460
Head Bolt Washers.....	56473W
Head Bolts Outside Small Block.....	56472
Head Bolts Outside Big Block.....	56493
Head Bolts Outside Aluminum Small Block.....	56480
Header Bolts LT-1 Engine.....	56498
Header Bolts 350 Vortec Engine 1".....	56702
Header Bolts Big Block.....	56488
Header Bolts, (small 3/8" Hex 3/4" long).....	56415-H
Header Bolts Small Block, (small 3/8" Hex 1" long).....	56416-H
Header Bolts Small Block 1" Long.....	56418
Header Bolts Small Block.....	56461
Header Bolts LS1 - LS6.....	56406
Hood Hinge Bolts.....	56481
Injection Mount LT-1 Engine.....	56499
Intake Manifold V6 1977 to 1981.....	56421

Description	Part #
Intake Manifold LT-1 Engine.....	56402
Intake Manifold 350 Vortec Engine.....	56700
Intake Manifold Big Block.....	56479
Intake Manifold Small Block.....	56469
Intake Manifold Small Block (except undersized 3/8" Hex Chrome).....	56469-UH
Intake Manifold Small Block (except undersized 3/8" Hex Stainless Polished).....	56469-UHSP
License Plate Screw Kit Chrome Plated.....	56220
License Plate Kit for Plastic inserts.....	56401
Mag Wheel Washers Chrome (Sold Each).....	23578
Mag Wheel Washers Stainless (Sold Each).....	75578
Oil Pan LT-1 Engine.....	56497
Oil Pan Small Block.....	56465
Oil Pan Big Block.....	56487
Rear Cover 10 Bolt.....	56475
Rear Cover 12 Bolt.....	56476
Timing Cover LT-1 Engine.....	56400
Timing Cover 502 Big Block.....	56455
Transmission Pan Cover 700R4.....	56236
Transmission Pan Small Block.....	56474
Tune Port Injection System.....	56417
Valve Cover Flange Small Block.....	56410
Valve Cover Acorns and Studs.....	56462A
Valve Cover LT-1 Engine.....	56403
Valve Cover 350 Vortec Engine.....	56701
Valve Cover Aluminum Big Block.....	56486
Valve Cover Aluminum Small Block.....	56466
Valve Cover Steel Big Block.....	56485
Valve Cover Steel Small Block.....	56463
Valve Cover Long Big Block.....	56489
Valve Cover LS1 - LS6 (with coil packs).....	56407
Valve Cover Spike Nut & Studs (Steel).....	56462-X1
Valve Cover Spike Nut & Studs (Aluminum).....	56462-X2
Water Neck 45°.....	56471
Water Neck 90°.....	56470
Water Pump LT-1 Engine.....	56496
Water Pump Extended.....	56467
Water Pump Short Small Block.....	56468

# Individual Sets for Chevy®



You can also order the listed Individual sets with the Emblems Stamped on the Hex Caps as shown below by using the Part Prefix associated with that emblem.



*Chevy Bowtie*  
use Part Prefix  
10-xxxxx to order



*Chevy SS*  
use Part Prefix  
13-xxxxx to order



*Chevy RS*  
use Part Prefix  
16-xxxxx to order



*350*  
use Part Prefix  
18-xxxxx to order



*454*  
use Part Prefix  
19-xxxxx to order

**Select style when ordering: H = Chrome Plated or HSP = Stainless Steel Polished.**  
**Example:** Engine Dress Up Kit Part # 10-56458- *H* or *HSP*

**Individual Sets**

Description	Part #
Axle Truck 10 Bolt, 2 & 4 Wheel Drive.....	10-56458
Axle Truck 12 Bolt, 2 & 4 Wheel Drive.....	10-56459
Bell Housing.....	10-56484
Coil Mount to Block.....	10-56478
Exhaust Manifold.....	10-56477
Fan Spacer Bolts Extended.....	10-56457
Fan Spacer Bolts Short.....	10-56456
Fuel Pump.....	10-56460
Head Bolts- Outside Sm. Block.....	10-56472
Head Bolts- Outside Big Block.....	10-56493
Header Bolts LT-1 Engine.....	10-56498
Header Bolts 350 Vortec Engine.....	10-56702
Header Bolts Big Block.....	10-56488
Header Bolts Sm. Block 1" Long.....	10-56418
Header Bolts Sm. Block.....	10-56461
Header Bolts LS1-LS6.....	10-56406
Hood Hinge Bolts.....	10-56481
Hood Hinge Bolts 1955 to 1957.....	10-56482
Hood Hinge Bushing Kits GM (late model)....	10-56419
Injection Mount LT-1 Engine.....	10-56499
Intake Manifold LT-1 Engine.....	10-56402
Intake Manifold 350 Vortec Engine.....	10-56700
Intake Manifold Big Block.....	10-56479
Intake Manifold Sm. Block.....	10-56469

Description	Part #
License Plate Kit.....	10-56401
Oil Pan LT-1 Engine.....	10-56497
Oil Pan Sm. Block.....	10-56465
Oil Pan Big Block.....	10-56487
Rear Cover 10 Bolt.....	10-56475
Rear Cover 12 Bolt.....	10-56476
Timing Cover Bolts.....	10-56464
Timing Cover LT-1 Engine.....	10-56400
Transmission Pan Cover 700R4.....	10-56236
Transmission Pan Sm. Block.....	10-56474
Valve Cover Flange Bolts Sm. Block.....	10-56412
Valve Cover LT-1 Engine.....	10-56403
Valve Cover 350 Vortec Engine.....	10-56701
Valve Cover Aluminum Big Block.....	10-56486
Valve Cover Aluminum Sm. Block.....	10-56466
Valve Cover Steel Big Block.....	10-56485
Valve Cover Steel Sm. Block.....	10-56463
Valve Cover LS1-LS6 (with coil packs).....	10-56407
Water Neck 45°.....	10-56471
Water Neck 90°.....	10-56470
Water Pump LT-1 Engine.....	10-56496
Water Pump Extended.....	10-56467
Water Pump Short Sm. Block.....	10-56468

# Pontiac ▼

**Example:** Engine Dress Up Kit Part # 12-56500- *H* or *HSP*



*Pontiac Arrow*  
use Part Prefix  
12-xxxxx to order



*Pontiac GTO*  
use Part Prefix  
20-xxxxx to order



*Pontiac GT*  
use Part Prefix  
15-xxxxx to order

Description	Part #
326-455 Engine Dress Up Kit.....	56500
350,389,400 & 455 H.O. Exhaust Kit.....	56517
326-455 Intake Manifold.....	56522
326-455 Intake Manifold.....	56522-HS
350-455 Intake Manifold.....	56521
Water Pump.....	56533
350-455 Timing Cover.....	56515
350, 389 Oil Pan.....	56531

*Part Numbers Listed here are Individual Kits w/o Emblem Stamped Prefix Numbers.*

Description	Part #
326, 455 Oil Pan.....	56532
350 Aluminum Value Cover.....	56529
326 Valve Cover.....	56528
326 Steel Valve Cover.....	56258-H
326 Timing Cover.....	56516
Fuel Pump.....	56519
350-455 Engine Dress Up Kit.....	56505



## Pick your style of fastener



H= Hex Caps Chrome Plated    S= Allen Screws Chrome Plated    B= Button Head Chrome Plated    N= 12 Point Chrome Plated    P= Allen Screws Polished Chrome Plated    HS= Hex Bolts Stainless Steel    SS= Allen Screws Stainless Steel    SB= Button Head Stainless Steel    HSP= Hex Bolts Stainless Steel Polished    SSP= Allen Screws Stainless Steel Polished    SBP= Button Head Stainless Steel Polished

### Description

### Part #

Alternator Jam Nut Chrome (Sold Each).....	15574
Bed Bolt Set - 1953 to 1956 (F-100).....	56252
Cylinder Head Flathead (Chrome Acorn Covers).....	56259-AC
Exhaust Manifold 289 and 302.....	56248
Fuel Pump 289 and 302.....	56240
Fuel Pump 351 Cleveland and 400.....	56243
Header Bolts (3/8-16 x 1 with 7/16 wrench).....	56223
Header Bolts (3/8-16 x 1 with 3/8 wrench).....	56200
Intake Manifold 429.....	56246
Intake Manifold FE Engine.....	56245
Intake Manifold 289.....	56221
Intake Manifold 351 Cleveland.....	56222
Intake Manifold Flathead (Chrome Acorn Covers).....	56257-AC
Mustang Front End Kit.....	56260
Rack Bolts 5/8 x 4" (Grade 8 Chrome Plated).....	56261
Oil Pan 289 and 302.....	56231
Oil Pan 351 Cleveland and 400.....	56232
Oil Pan 390 and 428.....	56233
Tie Rod Nuts 11/16-18 (Stainless Left Hand Thread, sold each).....	67561-L
Tie Rod Nuts 11/16-18 (Stainless Right Hand Thread, sold each).....	67561-R
Timing Cover 289 and 302.....	56242
Timing Cover 390.....	56244
Transmission Pan Cover C4.....	56235
Transmission Pan Cover C6.....	56234
Valve Cover Aluminum 289 and 302.....	56227
Valve Cover Aluminum 351 Cleveland.....	56228
Valve Cover Steel 289.....	56224
Valve Cover Steel 351 Cleveland.....	56225
Valve Cover Steel 428.....	56226
Water Neck.....	56230

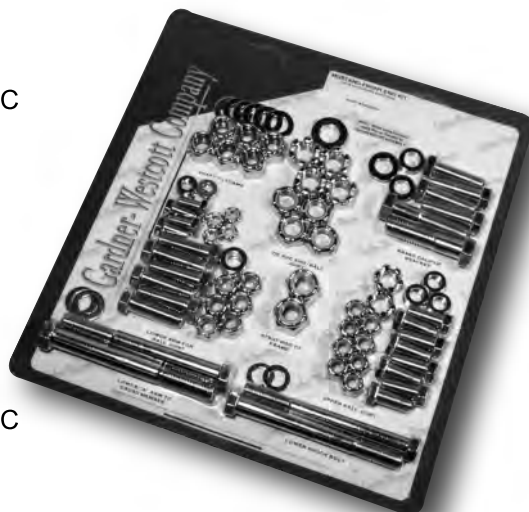

Mustang Front End Kit  
Part # 56260-H



Cylinder Head  
8BA 49-53 Ford Flathead  
Part # 56250-AC

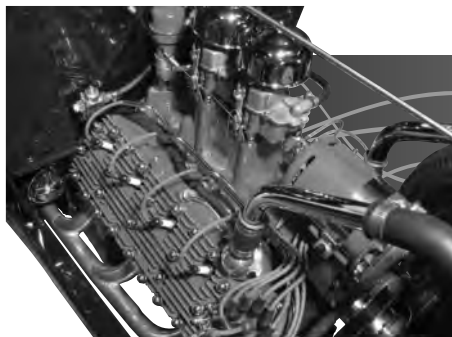

# Flatheads



# Individual Sets for Ford



You can also order the listed Individual Applications sets with the Emblems Stamped on the Hex Caps as shown below by using the Part Prefix associated with that emblem.

**Select style when ordering:**

**H** = Chrome Plated or **HSP** = Stainless Steel Polished.

**Example:** Engine Dress Up Sets Part #  $\boxed{XX}$  -  $\boxed{XXXXX}$  - **H** or **HSP**  
Emblem Prefix Number  
Individual Kit Number

**Individual Sets**

Ford Oval use  
Part Prefix  
11-56xxx-H to order



Flames use  
Part Prefix  
17-56xxx to order



Ford V8 use  
Part Prefix  
24-56xxx to order



Skulls use  
Part Prefix  
14-56xxx to order



Ford Mustang use  
Part Prefix  
25-56xxx to order



**We also carry these other selected Custom Emblems to choose from**

**Description**

**Part #**

Bed Bolt Set 1953 to 1956 F-100.....	11-56252
Exhaust Manifold 289 and 302.....	11-56248
Fuel Pump 289 and 302.....	11-56240
Fuel Pump 351 Cleveland and 400.....	11-56243
Header Bolts.....	11-56223
Intake Manifold 429.....	11-56246
Intake Manifold FE Engine.....	11-56245
Intake Manifold 289.....	11-56221
Intake Manifold 351 Cleveland.....	11-56222
Mustang Front End Kit.....	11-56260
Rack Bolts 5/8 x 4" Grade 8 Chrome Plated.....	11-56261
Oil Pan 289 and 302.....	11-56231
Oil Pan 351 Cleveland and 400.....	11-56232
Oil Pan 390 and 428.....	11-56233
Timing Cover 289 and 302.....	11-56242
Timing Cover 390.....	11-56244
Transmission Pan Cover C4.....	11-56235
Transmission Pan Cover C6.....	11-56234
Valve Cover Aluminum 289 and 302.....	11-56227
Valve Cover Aluminum 351 Cleveland.....	11-56228
Valve Cover Steel 289.....	11-56224
Valve Cover Steel 351 Cleveland.....	11-56225
Valve Cover Steel 428.....	11-56226
Water Neck.....	11-56230



Intake Manifold Kit for 429 Engine  
Part # 11-56246-H





# Individual Sets for Mopar

## Pick your style of fastener



H= Hex Caps Chrome Plated    S= Allen Screws Chrome Plated    B= Button Head Chrome Plated    N= 12 Point Chrome Plated    P= Allen Screws Polished Chrome Plated    HS= Hex Bolts Stainless Steel    SS= Allen Screws Stainless Steel    SB= Button Head Stainless Steel    HSP= Hex Bolts Stainless Steel Polished    SSP= Allen Screws Stainless Steel Polished    SBP= Button Head Stainless Steel Polished

Description	Part #
Oil Pan Small Block.....	56301
Intake Manifold Small Block.....	56302
Header Bolts Small Block.....	56303
Valve Cover Small Block.....	56304
Water Pump Small Block.....	56305
Fuel Pump Small Block.....	56306

Description	Part #
Oil Pan Big Block.....	56307
Intake Manifold Big Block.....	56308
Header Bolts Big Block.....	56309
Valve Cover Big Block.....	56310
Water Pump Big Block.....	56311
Fuel Pump Big Block.....	56312

You can also order the listed Individual Sets with the Emblems Stamped on the Hex Caps as shown below by using the Part Prefix associated with that emblem.

## Mopar

Chrysler Pentastar use Part Prefix  
21-56xxx to order



Dodge Ram use Part Prefix  
22-56xxx to order



Mopar use Part Prefix  
23-56xxx to order



Hemi Mopar use Part Prefix  
27-56xxx to order



OFFICIAL  
LICENSED  
PRODUCT

MOPAR, JEEP, DODGE, HEMI, PLYMOUTH, RAM, SRT, CHRYSLER and related logos, vehicle model names and trade dress are trademarks of Chrysler Group LLC and used under license by (licensee name). ©2015 Chrysler Group LLC

Select style when ordering:

H = Chrome Plated or HSP = Stainless Steel Polished.

**Example:**

Engine Dress Up Kit Part # 21-56301- **H** or **HSP**

Description	Part #
Oil Pan Small Block.....	21-56301
Intake Manifold Small Block.....	21-56302
Header Bolts Small Block.....	21-56303
Valve Cover Small Block.....	21-56304
Water Pump Small Block.....	21-56305
Fuel Pump Small Block.....	21-56306

Description	Part #
Oil Pan Big Block.....	21-56307
Intake Manifold Big Block.....	21-56308
Header Bolts Big Block.....	21-56309
Valve Cover Big Block.....	21-56310
Water Pump Big Block.....	21-56311
Fuel Pump Big Block.....	21-56312

## Buick

Description	Part #
Intake Manifold V6, 1977 - 1981.....	56420
Water Pump V6, 1977 - 1981.....	56422
Crank Pulley V6, 1977 - 1981.....	56423
Valve Cover V6.....	56424

## VW

Description	Part #
Transmission Axle Swing Acorn Kit, (Metric Thread).....	56800-A
Transmission Axle IRS Acorn Kit, (Metric Thread).....	56801-A

# Interior Screw Kits

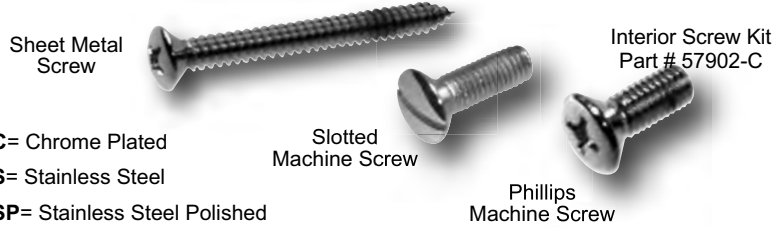

**Individual Sets**

**C=** Chrome Plated  
**S=** Stainless Steel  
**SP=** Stainless Steel Polished

Interior Screw Kit  
 Part # 57902-C

**Kits include sheet metal screws and/or machine screws. Washers are supplied where applicable.**

Make	Model	Styles Available	Part #
<b>Chevrolet</b>			
1937 - 1941	Four Door	C S SP	57900
1937 - 1941	Coupe	C S SP	57901
1937 - 1941	Two Door Sedan	C S SP	57902
1956 - 1957	Two Door Sedan	C S SP	57939
	Latch Striker Dovetail Kit Two Doors	C S SP	57001
	Latch Striker Dovetail Kits thru 1958	-- S SP	56904
<b>Buick</b>			
1940	Limited Four Door with Side Mounts	C S SP	57400
<b>Oldsmobile</b>			
1947	Four Door 78 Series	C S SP	57501
<b>Plymouth</b>			
1941	Four Door	C S SP	57605
1946	Two Door Sedan	C S SP	57602
<b>Dodge</b>			
1933	Coupe with Rumble Seat	C S SP	57500
1939	Two Door Sedan	C S SP	57603
1939	Two Door Coupe	C S SP	57604
<b>Door Screws</b>			
	Latch and Dovetail 1/4-20 x 1/2 #12 Head Stainless Steel	-- S SP	89206-12
	Latch and Dovetail 1/4-20 x 1/2 #12 Head Chrome Plated	C -- ----	40206-12
	Striker Mounting Screws 1/4-20 x 1 #10 Head Stainless Steel	-- S SP	94214-10
	Striker Mounting Screws 1/4-20 x 1 #10 Head Chrome Plated	C -- ----	39214-10
<b>Hinge Screws</b>			
5/16-24	x 3/4 Hex Head 9/16 across the flats Stainless Steel	-- S SP	88275
5/16-24	x 1 Flat Phillips Hinge Screw Stainless Steel	-- S SP	94281
5/16-24	x 1 Flat Phillips Hinge Chrome Plated	C -- ----	39281
5/16-24	x 1 Oval Phillips Hinge Screw Stainless Steel	-- S SP	89281
5/16-24	x 1 Oval Phillips Hinge Screw Chrome Plated	C -- ----	40281
5/16	External Countersunk Washers Stainless Steel	-- S ----	89570
5/16	External Countersunk Washers Chrome Plated	C -- ----	35570



# Interior Screw Kits

**Kits include sheet metal screws and/or machine screws.  
Washers are supplied where applicable.**

<b>Ford (Stainless Steel Only)</b>	<b>Part #</b>
1928 - 1929 Coupe.....	J-286
1928 - 1929 Two Door.....	J-287
1930 - 1931 Coupe.....	J-308
1930 - 1931 Two Door.....	J-309
1932 Phaeton.....	J-321
1932 Coupe 3 Window.....	J-322
1932 Coupe 5 Window.....	J-323
1932 Coupe Two Door.....	J-324
1933 - 1934 Roadster.....	J-330
1933 - 1934 Coupe.....	J-332
1935 - 1936 Coupe.....	J-352
1936 Two Door.....	J-353
1937 Coupe.....	J-371
1937 Two Door.....	J-372
1938 - 1939 Coupe.....	J-380
1938 - 1939 Two Door.....	J-381
1938 - 1939 Convertible.....	J-383
1940 Coupe.....	J-400
1940 Two Door.....	J-401
1941 Coupe.....	J-410
1941 Two Door.....	J-411
1941 Convertible.....	J-413
1942 - 1948 Two Door and Coupe.....	J-420
1942 - 1948 Convertible.....	J-422

Interior Screw Kit  
Part # J-401



<b>Hinge Screws (Chrome Plated Only)</b>	<b>Part #</b>
1928 - 1934 5/16-24 x 1 sold each.....	59281
1928 - 1934 5/16-24 x 3 sold each.....	59299
5/16 Recessed Washers.....	23549

<b>Hinge Pins (Chrome Plated Only)</b>	<b>Part #</b>
1928 - 1931 Closed Car.....	59028
1931 Slant Windshield.....	59029
1928 - 1931 Roadster/Phaeton.....	59030
1932 - 1948 V-8.....	59031

<b>Hinge Pins (Stainless Steel Polished Only)</b>	<b>Part #</b>
10/32 x 1/2 Screw no slot.....	59034
5/16 - 24 Cage Nuts.....	59035

<b>Assortments</b>	<b>Part #</b>
Interior & Door Screws in Stainless Steel.....	56900
Interior & Door Screws in Stainless Steel Polished.....	56901
Interior & Door Screws in Chrome Plated.....	56902



Cage Nuts  
Part # 59035



Hinge Screws  
Chrome Plated  
Part # 59281

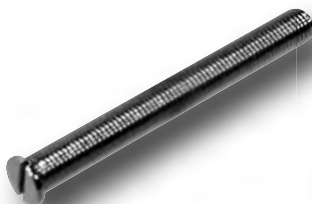

Hinge Screws  
Chrome Plated  
Part # 59299



Hinge Pins  
Chrome Plated  
Part # 59031



Hinge Pins  
Chrome Plated  
Part # 59030



## Inside This Section

### American Thread Chrome Plated

Allen Screws.....	24
Button Head Screws.....	24
Flat Head Allen Screws.....	25
12 Point Screws.....	25
Hex Cap Screws.....	26
Torx Button Head Screws.....	26
Chevy Bowtie Hex Caps.....	27
Carriage, Body, Sems, Spinloc & Step.....	28
Ford Oval Hex Caps.....	29
Machine Screws.....	30
Washers.....	31-32
Nuts.....	33
Acorn Nuts, Covers & 12 Pt. Nuts.....	34
Spacers.....	34
Cotter Pins, Hole Plugs, Pipe Plugs, Flange, Wing Nuts.....	35

### American Stainless Steel

Clamps.....	36
Chevy Bowtie Hex Caps.....	37
Ford Oval Hex Caps.....	38
Allen Screws.....	39
Button Head Screws.....	39
Flat Head Allen Screws.....	39
Hex Caps Screws.....	40
Set Screws.....	40
Washers.....	41-42
Nuts.....	42-43
Machine Screws.....	44

### American Zinc Plated

Hex Caps (Grade 5, 8 and L-9 Products).....	45
Allen Screws (Grade 8).....	45
Washers and L-9 Products.....	46
Nuts and L-9 Products.....	46
Machine Screws.....	47

**Bulk Fasteners  
Chrome Plated  
Stainless and Zinc**







# Bulk Chrome Fasteners American

## Allen Screws Chrome Plated and Polished Chrome



**12xxx**  
for Chrome Allen  
with Knurls



**10xxx**  
for Polished Chrome Allen  
with Knurls Removed

	4/40	6/32	8/32	10/24	10/32	1/4 -20	1/4 -28	5/16 -18	5/16 -24	3/8 -16	3/8 -24	7/16 -14	7/16 -20	1/2 -13	1/2 -20	5/8 -11	5/8 -18
3/8	12088	12104	12128	12152	12153	12204	12205	12268	12269								
1/2	12089	12106	12130	12154	12155	12206	12207	12270	12271	12322	12323						
5/8	12090	12108	12132	12156	12157	12208	12209	12272	12273	12324	12325						
3/4	12091	12110	12134	12158	12159	12210	12211	12274	12275	12326	12327	12374	12375	12414	12415		
7/8		12112	12136	12160	12161	12212	12213	12278	12279	12328	12329						
1		12114	12138	12162	12163	12214	12215	12280	12281	12330	12331	12376	12377	12416	12417	12488	12489
1 1/4			12140	12166	12167	12218	12219	12284	12285	12334	12335	12378	12379	12418	12419	12490	
1 1/2			12142	12168	12169	12220	12221	12286	12287	12336	12337	12380	12381	12420	12421	12492	12493
1 3/4				12170	12171	12222	12223	12288	12289	12338	12339	12382	12383	12422	12423	12494	12495
2				12172	12173	12224	12225	12290	12291	12340	12341	12384	12385	12424	12425	12496	12497
2 1/4				12174	12175	12226	12227	12292	12293	12342	12343	12386	12387	12426	12427	12498	12499
2 1/2				12176	12177	12228	12229	12294	12295	12344	12345	12388	12389	12428	12429	12500	12501
2 3/4					12179	12230	12231	12296	12297	12346	12347	12390	12391	12430	12431	12502	
3						12232	12233	12298	12299	12348	12349	12392	12393	12432	12433	12504	12505
3 1/4						12234	12235	12300	12301	12350	12351	12394	12395	12434	12435	12506	
3 1/2						12236	12237	12302	12303	12352	12353	12396	12397	12436	12437	12508	12509
4						12240	12241	12306	12307	12356	12357	12400		12440	12441	12512	12513
4 1/2						12244		12310	12311	12360	12361	12404		12442	12443	12514	
5						12246		12312	12313	12362	12363	12406		12444	12445	12516	12517
5 1/2								12316	12317	12366	12367	12410		12446	12447	12518	12519
6						12248			12319	12368		12412		12448		12520	

## Button Head Allen Screws Chrome Plated

Button Head Allen



	4/40	6/32	8/32	10/24	10/32	12/24	1/4 -20	1/4 -28	5/16 -18	5/16 -24	3/8 -16	3/8 -24	7/16 -14	7/16 -20	1/2 -13	1/2 -20	5/8 -11
1/4	13087	13102	13126	13150	13151												
3/8	13088	13104	13128	13152	13153		13204	13205	13268	13269							13415
1/2	13089	13106	13130	13154	13155	13186	13206	13207	13270	13271	13322	13323					
5/8	13090	13108	13132	13156	13157		13208	13209	13272	13273	13324						
3/4	13091	13110	13134	13158	13159		13210	13211	13274	13275	13326	13327			13414		
7/8			13136	13160	13161		13212	13213	13278	13279	13328						
1		13114	13138	13162	13163	13194	13214	13215	13280	13281	13330	13331	13376		13416	13417	13488
1 1/4			13140	13166	13167		13218	13219	13284	13285	13334	13335	13378	13379	13418	13419	13490
1 1/2				13168	13169		13220	13221	13286	13287	13336	13337	13380	13381	13420	13421	13492
1 3/4							13222	13223	13288	13289	13338	13339	13382		13422		
2							13224	13225	13290	13291	13340	13341	13384	13385	13424	13425	13496
2 1/4							13226		13292		13342	13343					
2 1/2							13228		13294		13344	13345		13389	13428	13429	13500
2 3/4									13296		13346						
3							13232		13298		13348	13349			13432	13433	13504
3 1/2							13236				13352						13508
4							13240				13356		13400		13440	13441	

# Bulk Chrome Fasteners American



## Flat Head Allen Screws Chrome Plated

Flat Head Allen



**American  
Bulk Chrome**

	6/32	8/32	10/24	10/32	12/24	1/4 -20	1/4 -28	5/16 -18	5/16 -24	3/8 -16	3/8 -24	7/16 -14	1/2 -13	1/2 -20
1/4	14102													
3/8	14104	14128	14152	14153		14204	14205							
1/2	14106	14130	14154	14155	14186	14206	14207	14270	14271	14322				
5/8	14108	14132	14156	14157		14208	14209	14272	14273	14324	14325			
3/4	14110	14134	14158	14159	14190	14210	14211	14274	14275	14326	14327	14374	14414	14527
7/8		14136	14160	14161		14212	14213	14278	14279	14328				
1	14114	14138	14162	14163	14194	14214	14215	14280	14281	14330	14331	14376	14416	14417
1 1/4		14140	14166	14167		14218	14219	14284	14285	14334	14335	14378	14418	14419
1 1/2		14142	14168	14169		14220	14221	14286	14287	14336	14337	14380	14420	14421
1 3/4			14170			14222		14288		14338		14382	14422	14423
2						14224		14290		14340		14384	14424	14425
2 1/4								14292		14342		14386	14426	
2 1/2						14228		14294		14344		14388	14428	
2 3/4						14230				14346				
3						14232		14302		14348		14392	14432	
3 1/2						14236				14352		14396	14436	
4						14240		14306					14440	
4 1/2										14360				

## 12 Point Screws Chrome Plated

12 Point Screw



	1/4 -20	1/4 -28	5/16 -18	5/16 -24	3/8 -16	3/8 -24	7/16 -14	7/16 -20	1/2 -13	1/2 -20	5/8 -11	5/8 -18
3/8												
1/2	29206	29207	29270	29271	29322	29323						
5/8	29208	29209	29272	29273								
3/4	29210	29211	29274	29275	29326	29327	29374		29414	29527		
7/8	29212	29213										
1	29214	29215	29280	29281	29330	29331	29376	29377	29416	29417	29488	29489
1 1/4	29218	29219	29284	29285	29334	29335	29378	29379	29418	29419	29490	29491
1 1/2	29220	29221	29286	29287	29336	29337	29380	29381	29420	29421	29492	29493
1 3/4	29222	29223	29288	29289	29338	29339	29382	29383	29422	29423	29494	29495
2	29224	29225	29290	29291	29340	29341	29384	29385	29424	29425	29496	29497
2 1/4	29226	29227	29292	29293	29342	29343	29386	29387	29426	29427	29498	
2 1/2	29228	29229	29294	29295	29344	29345	29388	29389	29428	29429	29500	29501
2 3/4	29230	29231	29296	29297	29346	29347	29390	29391	29430		29502	
3	29232	29233	29298	29299	29348	29349	29392	29393	29432	29433	29504	29505
3 1/4			29300	29301	29350	29351	29394		29434			
3 1/2			29302	29303	29352	29353	29396	29397	29436	29437	29508	29509
4					29356	29357	29400		29440		29512	
4 1/2					29360				29442		29514	
5					29362				29444		29516	



# Bulk Chrome Fasteners American

## Hex Caps Screws Chrome Plated Grade 5 & Grade 8

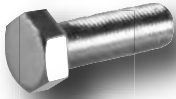

**11xxx**  
for Grade 5  
Chrome Hex Caps

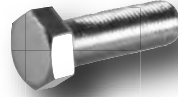

**31xxx**  
for Grade 8  
Chrome Hex Caps

	1/4 -20	1/4 -28	5/16 -18	5/16 -24	3/8 -16	3/8 -24	7/16 -14	7/16 -20	1/2 -13	1/2 -20	9/16 -12	9/16 -18	5/8 -11	5/8 -18
1/2	11206	11207	11270	11271	11322	11323								
5/8	11208	11209	11272	11273	11324	11325								
3/4	11210	11211	11274	11275	11326	11327	11374	11375	11414	11527				
7/8	11212	11213	11278	11279	11328	11329								
1	11214	11215	11280	11281	11330	11331	11376	11377	11416	11417	11452	11453	11488	11489
1 1/4	11218	11219	11284	11285	11334	11335	11378	11379	11418	11419	11454	11455	11490	11491
1 1/2	11220	11221	11286	11287	11336	11337	11380	11381	11420	11421	11456	11457	11492	11493
1 3/4	11222	11223	11288	11289	11338	11339	11382	11383	11422	11423	11458	11459	11494	11495
2	11224	11225	11290	11291	11340	11341	11384	11385	11424	11425	11460	11461	11496	11497
2 1/4	11226	11227	11292	11293	11342	11343	11386	11387	11426	11427	11462	11463	11498	11499
2 1/2	11228	11229	11294	11295	11344	11345	11388	11389	11428	11429	11464	11465	11500	11501
2 3/4	11230	11231	11296	11297	11346	11347	11390	11391	11430	11431	11466	11467	11502	11503
3	11232	11233	11298	11299	11348	11349	11392	11393	11432	11433	11468	11469	11504	11505
3 1/4	11234	11235	11300	11301	11350	11351	11394	11395	11434	11435	11470	11471	11506	11507
3 1/2	11236	11237	11302	11303	11352	11353	11396	11397	11436	11437	11472	11473	11508	11509
4	11240	11241	11306	11307	11356	11357	11400	11401	11440	11441	11476	11477	11512	11513
4 1/2	11244		11310	11311	11360	11361	11404	11405	11442	11443	11478	11479	11514	11515
5	11246		11312	11313	11362	11363	11406	11407	11444	11445	11480	11481	11516	11517
5 1/2	11246-B	11247-C	11316	11317	11366	11367	11410	11411	11446	11447	11482	11483	11518	11519
6	11246-A	11247-A	11318	11319	11368	11369	11412		11448	11449	11484	11485	11520	11521

## Torx Button Head Screws Chrome Plated

Torx Button Head



	8/32	10/24	10/32	1/4 -20	1/4 -28	5/16 -18	5/16 -24	3/8 -16	3/8 -24	1/2 -13
1/4	46126	46150	46151							
3/8	46128	46152	46153	46204	46205	46268	46269			
1/2	46130	46154	46155	46206	46207	46270	46271	46322	46323	
5/8	46132	46156	46157	46208	46209	46272	46273	46324		
3/4	46134	46158	46159	46210	46211	46274	46275	46326		
7/8		46160	46160	46212		46278		46328		
1		46162	46163	46214	46215	46280	46281	46330	46331	46416
1 1/4				46218				46334		46418
1 1/2				46220				46336		46420
1 3/4				46222				46338		
2				46224				46340		
2 1/4				46226				46342		
2 1/2				46228				46344		
2 3/4								46346		
3				46232				46348		

# Bulk Chrome Fasteners American



27

## Screws

Bowtie Hex Cap



### Bowtie Hex Caps

	1/4 -20	1/4 -28	5/16 -18	5/16 -24	3/8 -16	3/8 -24	7/16 -14	7/16 -20	1/2 -13	1/2 -20	9/16 -12	9/16 -18	5/8 -11	5/8 -18
1/2	10-11206	10-11207	10-11270	10-11271	10-11322	10-11323								
5/8	10-11208	10-11209	10-11272	10-11273	10-11324	10-11325								
3/4	10-11210	10-11211	10-11274	10-11275	10-11326	10-11327	10-11374	10-11375	10-11414	10-11527				
7/8	10-11212	10-11213	10-11278	10-11279	10-11328	10-11329								
1	10-11214	10-11215	10-11280	10-11281	10-11330	10-11331	10-11376	10-11377	10-11416	10-11417	10-11452	10-11453	10-11488	10-11489
1 1/4	10-11218	10-11219	10-11284	10-11285	10-11334	10-11335	10-11378	10-11379	10-11418	10-11419	10-11454	10-11455	10-11490	10-11491
1 1/2	10-11220	10-11221	10-11286	10-11287	10-11336	10-11337	10-11380	10-11381	10-11420	10-11421	10-11456	10-11457	10-11492	10-11493
1 3/4	10-11222	10-11223	10-11288	10-11289	10-11338	10-11339	10-11382	10-11383	10-11422	10-11423	10-11458	10-11459	10-11494	10-11495
2	10-11224	10-11225	10-11290	10-11291	10-11340	10-11341	10-11384	10-11385	10-11424	10-11425	10-11460	10-11461	10-11496	10-11497
2 1/4	10-11226	10-11227	10-11292	10-11293	10-11342	10-11343	10-11386	10-11387	10-11426	10-11427	10-11462	10-11463	10-11498	10-11499
2 1/2	10-11228	10-11229	10-11294	10-11295	10-11344	10-11345	10-11388	10-11389	10-11428	10-11429	10-11464	10-11465	10-11500	10-11501
2 3/4	10-11230	10-11231	10-11296	10-11297	10-11346	10-11347	10-11390	10-11391	10-11430	10-11431	10-11466	10-11467	10-11502	10-11503
3	10-11232	10-11233	10-11298	10-11299	10-11348	10-11349	10-11392	10-11393	10-11432	10-11433	10-11468	10-11469	10-11504	10-11505
3 1/4	10-11234	10-11235	10-11300	10-11301	10-11350	10-11351	10-11394	10-11395	10-11434	10-11435	10-11470	10-11471	10-11506	10-11507
3 1/2	10-11236	10-11237	10-11302	10-11303	10-11352	10-11353	10-11396	10-11397	10-11436	10-11437	10-11472	10-11473	10-11508	10-11509
4	10-11240	10-11241	10-11306	10-11307	10-11356	10-11357	10-11400	10-11401	10-11440	10-11441	10-11476	10-11477	10-11512	10-11513
4 1/2	10-11244		10-11310	10-11311	10-11360	10-11361	10-11404	10-11405	10-11442	10-11443	10-11478	10-11479	10-11514	10-11515
5	10-11246		10-11312	10-11313	10-11362	10-11363	10-11406	10-11407	10-11445	10-11446	10-11480	10-11481	10-11516	10-11517
5 1/2	10-11246-B	10-11247-C	10-11316	10-11317	10-11366	10-11367	10-11410	10-11411	10-11447	10-11448	10-11482	10-11483	10-11518	10-11519
6	10-11246-A	10-11247-A	10-11318	10-11319	10-11368	10-11369	10-11412	10-11413	10-11449	10-11450	10-11484	10-11485	10-11520	10-11521

### Bowtie Body Bolts

Size	Part #
14 x 3/4 - 3/8 Hex	10-55669-P3
14 x 3/4 - 7/16 Hex	10-55669-P7
5/16 x 13/16	10-22276
5/16 x 1 1/4	10-22284
<b>Stainless Steel Only</b>	
5/16 x 13/16	10-88276



Body Bolt

### Bowtie Spinloc Bolts

Size	Part #
1/4-20 x 5/8	10-43208
5/16-18 x 3/4	10-43274
5/16-18 x 1	10-43280
5/16-18 x 1 1/4	10-43284
5/16-24 x 1	10-43281
3/8-16 x 1	10-43330



Spinloc Bolt

### Bowtie Hex Washer Sems Polished & Chrome Plated

With Washer Loose From Head		
Size	Washer O.D.	Part #
1/4-20 x 7/8	3/4"	10-25212
5/16-18 x 1	1"	10-25280
3/8-16 x 3/4	1"	10-25326
3/8-16 x 1	1"	10-25330
3/8-16 x 1 1/2	1"	10-25336



Hex Washer Sem



OFFICIAL LICENSED PRODUCT

### Bolts Also Available In These Selected Emblem Stamped Hex Cap Styles

<b>Chevy SS</b> Use Part Prefix 13-xxxxx to order	<b>Chevy RS</b> Use Part Prefix 16-xxxxx to order	<b>Chevy 350</b> Use Part Prefix 18-xxxxx to order	<b>Chevy 454</b> Use Part Prefix 19-xxxxx to order	<b>Flame</b> Use Part Prefix 17-xxxxx to order
<b>Pontiac</b> Use Part Prefix 12-xxxxx to order	<b>GTO</b> Use Part Prefix 20-xxxxx to order	<b>GT</b> Use Part Prefix 15-xxxxx to order	<b>Olds Rocket</b> Use Part Prefix 26-xxxxx to order	<b>Skull</b> Use Part Prefix 14-xxxxx to order



# Bulk Chrome Fasteners American

## Screws

### Carriage Bolts

Carriage Bolt

	3/16	1/4	5/16	3/8	7/16	1/2
1/2	27154	27206				
3/4		27210	27274	27326		
1	27162	27214	27280	27330	27376	27416
1 1/2	27168	27220	27286	27336	27380	27420
1 3/4		27222			27382	27422
2		27224	27290	27340	27384	27424
2 1/4		27226	27292			
2 1/2		27228	27294	27344	27388	27428
2 3/4			27296			
3		27232	27298	27348	27392	27432
3 1/2		27236	27302	27352	27396	27436
4		27240	27306	27356	27400	27440
4 1/2			27310	27360	27404	27442
5		27246	27312	27362	27406	27444
5 1/2					27410	27446
6			27318	27368		27448



### Spinloc Bolts

Spinloc Bolt

Size	Part #
1/4-20 x 5/8	43208
5/16-18 x 3/4	43274
5/16-18 x 1	43280
5/16-18 x 1 1/4	43284
5/16-24 x 1	43281
3/8-16 x 1	43330



### Step Bolts

Step Bolt

Size	Part #
1/4 x 1	28214
1/4 x 1 1/2	28220
1/4 x 2	28224
5/16 x 1	28280
5/16 x 1 1/2	28286
5/16 x 2 1/2	28294
3/8 x 1	28330
3/8 x 1 1/2	28336



### Body Bolts

Body Bolt

Size	Part #
14 x 3/4-3/8 Hex	55669-3
14 x 3/4-7/16 Hex	55669-7
14 x 3/4-3/8 Hex w/ loose washer	55669-W3
14 x 3/4-7/16 Hex w/ loose washer	55669-W7
<b>Body Bolts with Polished Heads</b>	
14 x 3/4-3/8 Hex	55669-P3
14 x 3/4-7/16 Hex	55669-P7
5/16 x 13/16	22276
5/16 x 1 1/4	22284
<b>Body Bolts in Stainless Steel</b>	
5/16 x 13/16	88276
<b>Body Bolts Unpolished</b>	
5/16 x 13/16	09276
5/16 x 1 1/4	09284



**Body & Spinloc Bolt Assortment**  
20 Sizes with 200 pieces Part # A-201

### Mag Wheel Washers

Size	O.D. is 1 1/8"	Part #
11/16	Chrome	23578
	Stainless	75578
	Stainless Polished	SP-75578

### Throttle Return Springs

Size	Part #
Chrome Plated Inner & Outer	09012
Chrome Outer & Gold Plated Inner	09013
Gold Plated Inner & Outer	09015
Gold Plated Outer & Chrome Inner	09014
Black	09012-black
Red	09012-red
White	09012-white
Blue	09012-blue

### Hex Washer Sems Polished and Chrome Plated

With washer loose from head

Hex Washer Sem

Size	Washer O.D.	Part #
1/4-20 x 7/8	3/4"	25212
5/16-18 x 1	1"	25280
3/8-16 x 3/4	1"	25326
3/8-16 x 1	1"	25330
3/8-16 x 1 1/2	1 1/8"	25336



Throttle Return Springs

# Bulk Chrome Fasteners American



## Screws

Ford Oval Hex Cap

### Ford Oval Hex Caps

	1/4 -20	1/4 -28	5/16 -18	5/16 -24	3/8 -16	3/8 -24	7/16 -14	7/16 -20	1/2 -13	1/2 -20	9/16 -12	9/16 -18	5/8 -11	5/8 -18
1/2	11-11206	11-11207	11-11270	11-11271	11-11322	11-11323								
5/8	11-11208	11-11209	11-11272	11-11273	11-11324	11-11325								
3/4	11-11210	11-11211	11-11274	11-11275	11-11326	11-11327	11-11374	11-11375	11-11414	11-11527				
7/8	11-11212	11-11213	11-11278	11-11279	11-11328	11-11329								
1	11-11214	11-11215	11-11280	11-11281	11-11330	11-11331	11-11376	11-11377	11-11416	11-11417	11-11452	11-11453	11-11488	11-11489
1 1/4	11-11218	11-11219	11-11284	11-11285	11-11334	11-11335	11-11378	11-11379	11-11418	11-11419	11-11454	11-11455	11-11490	11-11491
1 1/2	11-11220	11-11221	11-11286	11-11287	11-11336	11-11337	11-11380	11-11381	11-11420	11-11421	11-11456	11-11457	11-11492	11-11493
1 3/4	11-11222	11-11223	11-11288	11-11289	11-11338	11-11339	11-11382	11-11383	11-11422	11-11423	11-11458	11-11459	11-11494	11-11495
2	11-11224	11-11225	11-11290	11-11291	11-11340	11-11341	11-11384	11-11385	11-11424	11-11425	11-11460	11-11461	11-11496	11-11497
2 1/4	11-11226	11-11227	11-11292	11-11293	11-11342	11-11343	11-11386	11-11387	11-11426	11-11427	11-11462	11-11463	11-11498	11-11499
2 1/2	11-11228	11-11229	11-11294	11-11295	11-11344	11-11345	11-11388	11-11389	11-11428	11-11429	11-11464	11-11465	11-11500	11-11501
2 3/4	11-11230	11-11231	11-11296	11-11297	11-11346	11-11347	11-11390	11-11391	11-11430	11-11431	11-11466	11-11467	11-11502	11-11503
3	11-11232	11-11233	11-11298	11-11299	11-11348	11-11349	11-11392	11-11393	11-11432	11-11433	11-11468	11-11469	11-11504	11-11505
3 1/4	11-11234	11-11235	11-11300	11-11301	11-11350	11-11351	11-11394	11-11395	11-11434	11-11435	11-11470	11-11471	11-11506	11-11507
3 1/2	11-11236	11-11237	11-11302	11-11303	11-11352	11-11353	11-11396	11-11397	11-11436	11-11437	11-11472	11-11473	11-11508	11-11509
4	11-11240	11-11241	11-11306	11-11307	11-11356	11-11357	11-11400	11-11401	11-11440	11-11441	11-11476	11-11477	11-11512	11-11513
4 1/2	11-11244		11-11310	11-11311	11-11360	11-11361	11-11404	11-11405	11-11442	11-11443	11-11478	11-11479	11-11514	11-11515
5	11-11246		11-11312	11-11313	11-11362	11-11363	11-11406	11-11407	11-11445	11-11446	11-11480	11-11481	11-11516	11-11517
5 1/2	11-11246-B	11-11247-C	11-11316	11-11317	11-11366	11-11367	11-11410	11-11411	11-11447	11-11448	11-11482	11-11483	11-11518	11-11519
6	11-11246-A	11-11247-A	11-11318	11-11319	11-11368	11-11369	11-11412	11-11413	11-11449	11-11450	11-11484	11-11485	11-11520	11-11521

### Ford Oval Body Bolts

Size	Part #
1/4 x 3/4 - 3/8 Hex	11-55669-P3
1/4 x 3/4 - 7/16 Hex	11-55669-P7
5/16 x 13/16	11-22276
5/16 x 1 1/4	11-22284
<b>Stainless Steel Only</b>	
5/16 x 13/16	11-88276

### Ford Oval Spinloc Bolts

Size	Part #
1/4-20 x 5/8	11-43208
5/16-18 x 3/4	11-43274
5/16-18 x 1	11-43280
5/16-18 x 1 1/4	11-43284
5/16-24 x 1	11-43281
3/8-16 x 1	11-43330

### Ford Oval Hex Washer Sems Polished & Chrome Plated

Size	Washer O.D.	Part #
1/4-20 x 7/8	3/4"	11-25212
5/16-18 x 1	1"	11-25280
3/8-16 x 3/4	1"	11-25326
3/8-16 x 1	1"	11-25330
3/8-16 x 1 1/2	1"	11-25336



Body Bolt



Spinloc Bolt



Hex Washer Sem

**Example:** Part # 24-11210 to Purchase: 1/4-20 x 3/4 Ford V-8 Stamped Hex Cap in Chrome



**Ford Oval**  
Use Part Prefix  
11-xxxxx to order



**Ford V8**  
Use Part Prefix  
24-xxxxx to order



**Ford Mustang**  
Use Part Prefix  
25-xxxxx to order



# Bulk Chrome Fasteners American

## Machine and Sheet Metal Screws Chrome Plated

**Example:** To order a **8/32 x 5/8 Oval Phillips Machine Screw**: Use **Chart #1** for the type of head style required, take those first two digits for the beginning part number which would be **"40"**. Now look up the diameter and length from **Chart #2 or #3** for last three digits for **8/32 x 5/8** is **"132"**. Put the two together for a part number of **40132**, or simply order by style and size.

**Chart #1: Select Styles**

Style	Chrome Slotted	Phillips
Round Head	33xxx	38xxx
Flat Head	36xxx	39xxx
Truss Head	51xxx	53xxx
Oval Head	34xxx	40 / 57*
Pan Head	35xxx	41xxx
Fillister	37xxx	n/a
Hex	55xxx	n/a
Round Wood	33xxx	n/a
Flat Wood	47xxx	49xxx
Oval Wood	48xxx	50xxx

**\*NOTE: Not all styles available in all sizes**

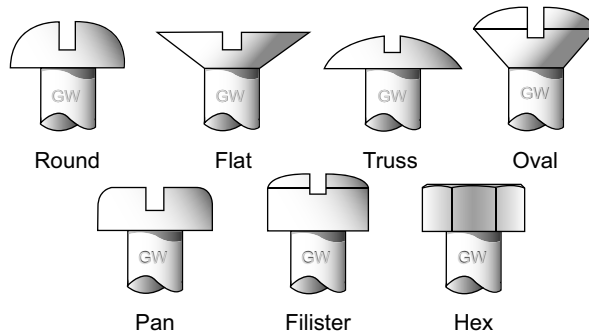

**\*NOTE: Oval Phillips Sheet Metal Screws use Prefix 57 not 40**

**Chart #2: Machine Screw Sizes**

	6/32	8/32	10/24	10/32	12/24	1/4 -20	1/4 -28	5/16 -18	5/16 -24	3/8 -16
3/8	104	128	152	153	184	204				
1/2	106	130	154	155	186	206		270		
5/8		132	156	157	188	208	209			
3/4	110	134	158	159	190	210	211	274	275	
7/8		136	160	161	192	212				
1	114	138	162	163	194	214	215	280	281	330
1 1/4	116	140	166	167	196	218	219	284	285	334
1 1/2	118	142	168	169	198	220	221	286	287	336
1 3/4			170	171		222		288	289	338
2	122		172	173		224		290	291	340



Machine Screw

**Chart #3: Sheet Metal & Wood Screw Sizes**

	#6	#8	#10	#12	#14
1/2	616	628	641	654	667
5/8	617	629	642	655	668
3/4	618	630	643	656	669
1	620	632	645	658	671
1 1/4	621	633	646	659	672
1 1/2	622	634	647	660	673
1 3/4	623	680	648	661	674
2	624	635	649	662	675
2 1/4				663	676
2 1/2				664	677



Sheet Metal Screw



Woodscrew



**American Bulk Chrome**

## Washers Chrome Plated

### Flat Washers Standard SAE

Size	Part #
4	23564
6	23565
8	23566
10	23567
12	23568
1/4	23569
5/16	23570
3/8	23571
7/16	23572
1/2	23573
9/16	23574
5/8	23575
3/4	23576

Flat Washer



### Hardened Flat Washer "G-W" Washers

Size	Part #
1/4	33569
5/16	33570
3/8	33571
7/16	33572
1/2	33573
5/8	33575

Hardened Flat Washer



### AN Flat Washers Small OD Chrome

Size	Part #
10	26567
1/4	26569
5/16	26570
3/8	26571
7/16	26572
1/2	26573
9/16	26574
5/8	26575
3/4	26576
1	26577

AN Flat Washer



### Lock Washers

Size	Part #
4	24564
6	24565
8	24566
10	24567
12	24568
1/4	24569
5/16	24570
3/8	24571
7/16	24572
1/2	24573
9/16	24574
5/8	24575
3/4	24576

Lock Washer



## Also Available in Assortments

All Items shown on this page can be purchased individually

### High Collar Lock Washers

Size	Part #
8	25566
10	25567
1/4	25569
5/16	25570
3/8	25571
7/16	25572
1/2	25573
5/8	25575



### Internal Lock Washers

Size	Part #
6	29565
8	29566
10	29567
12	29568
1/4	29569
5/16	29570
3/8	29571
7/16	29572
1/2	29573
5/8	29575



### External Countersunk Washers

Size	Part #
6	35565
8	35566
10	35567
12	35568
1/4	35569
5/16	35570



### External Lock Washers

Size	Part #
6	32565
8	32566
10	32567
12	32568
1/4	32569
5/16	32570
3/8	32571
7/16	32572
1/2	32573



**Note:** O.D. of Washer is the same as the Head of the Allen Screw





## Washers Chrome Plated

### Cup Washers

Size	Part #
3/8 x 1 1/4	22334
1/2 x 1 1/4	22418
1/2 x 1 7/16	22420
5/8 x 1 1/4	22490



22334  
Cup Washer

22418  
Cup Washer

22420  
Cup Washer

22490  
Cup Washer

Cup Washers Sold Each.

### Finishing Washer

Size	Part #
6	34565
8	34566
10	34567
12	34568
14	34569



Finishing Washer

### Flush Washer

Size	Part #
6	41565
8	41566
10	41567



Flush Washer

### Flat Washer USS Standard

Size	I.D.	O.D.	Part #
1/4	5/16	3/4	23274
5/16	3/8	7/8	23328
3/8	7/16	1	23376
7/16	1/2	1 1/4	23418
1/2	9/16	1 3/8	23456
9/16	5/8	1 1/2	23492



Flat Washer

For  
Stainless Steel  
Super Flat  
Fender Washers  
See page 41

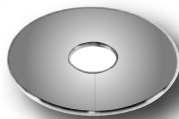

Super  
Flat Washers  
Sold Each.

### Super Flat Fender Washers

Size	O.D.	Thickness	Part #
#8	3/4		23134
#10	3/4		23158
#10	1		23162
5/16	5/32	3/64	23128
3/16	1		23162
1/4	7/8		23212
1/4	1		23214
1/4	1 1/4		23218
5/16	1		23280
5/16	3/4		23274
5/16	13/16	3/32	23278
5/16	1 1/8		23282
5/16	1 1/4		23284
5/16	1 1/2		23286
5/16	1 1/2	1/8	23286H
11/32	1 1/32		23283
13/32	11/16	1/16	23326
3/8	3/4	.060	23326A
3/8	7/8		23328
3/8		Heat Treat	23329
3/8	1 1/4		23334
3/8	1 1/2		23336
3/8	1 1/2	1/8	23336H
3/8	2	1/16	23340
7/16	29/32	.190	23374
7/16	15/16		23375
7/16	1	1/8	23376
7/16	1 1/8	5/32	23377
7/16	1 1/8		23379
1/2	13/16		23415
1/2	1 1/8		23416
1/2	1 1/4		23418
1/2	2		23424
9/16	1 3/8		23456
5/8	1 1/2		23492
5/8	1 3/4		23495
21/32	1 1/16		23488
11/16	1 3/8	3/16	23496
11/16	1 3/8	Pivot Shaft	23579
7/16	2		23594



## Nuts Chrome Plated

### Hex Nuts

Size	Part #
4/40	15536
5/40	15537
6/32	15538
8/32	15540
10/24	15542
10/32	15543
12/24	15544
1/4-20	15546
1/4-28	15547
5/16-18	15548
5/16-24	15549
3/8-16	15550
3/8-24	15551
7/16-14	15552
7/16-20	15553
1/2-13	15554
1/2-20	15555
9/16-12	15556
9/16-18	15557
5/8-11	15558
5/8-18	15559
3/4-10	15560
3/4-16	15561



Hex Nuts  
1/4, 5/16 and 3/8  
Sold  
100 per bag.



### Nylon Insert Lock Nuts

Size	Part #
4/40	17536
5/40	17537
6/32	17538
8/32	17540
10/24	17542
10/32	17543
12/24	17544
1/4-20	17546
1/4-28	17547
5/16-18	17548
5/16-24	17549
3/8-16	17550
3/8-24	17551
7/16-14	17552
7/16-20	17553
1/2-13	17554
1/2-20	17555
9/16-12	17556
9/16-18	17557
5/8-11	17558
5/8-18	17559
3/4-10	17560
3/4-16	17561

### Thin Jam Lock Nuts

Size	Part #
1/4-20	27546
1/4-28	27547
5/16-18	27548
5/16-24	27549
3/8-16	27550
3/8-24	27551
7/16-14	27552
7/16-20	27553
1/2-13	27554
1/2-20	27555
9/16-12	27556
9/16-18	27557
5/8-11	27558
5/8-18	27559
3/4-10	27560
3/4-16	27561



### Flexloc Nuts (All Metal)

Size	Part #
10/24	18542
10/32	18543
1/4-20	18546
1/4-28	18547
5/16-18	18548
5/16-24	18549
3/8-16	18550
3/8-24	18551
7/16-14	18552
7/16-20	18553
1/2-13	18554
1/2-20	18555
9/16-12	18556
9/16-18	18557
5/8-11	18558
5/8-18	18559
3/4-10	18560
3/4-16	18561

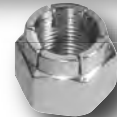

All items shown on this page can be purchased individually

American Bulk Chrome

### Slotted Nuts

Size	Part #
1/4-20	22546
1/4-28	22547
5/16-18	22548
5/16-24	22549
3/8-16	22550
3/8-24	22551
7/16-14	22552
7/16-20	22553
1/2-13	22554
1/2-20	22555
9/16-12	22556
9/16-18	22557
5/8-11	22558
5/8-18	22559
3/4-10	22560
3/4-16	22561



### Allen Nuts

Size	Part #
10/24	19542
10/32	19543
1/4-20	19546
1/4-28	19547
5/16-18	19548
5/16-24	19549
3/8-16	19550
3/8-24	19551
7/16-14	19552
7/16-20	19553
1/2-13	19554
1/2-20	19555
5/8-11	19558
5/8-18	19559



### Thin Jam Hex Nuts

Size	Part #
1/4-20	16546
1/4-28	16547
5/16-18	16548
5/16-24	16549
3/8-16	16550
3/8-24	16551
7/16-14	16552
7/16-20	16553
1/2-13	16554
1/2-20	16555
9/16-12	16556
9/16-18	16557
5/8-11	16558
5/8-18	16559
3/4-10	16560
3/4-16	16561

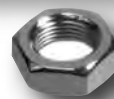

### Thin Jam Flexloc Nuts (All Metal)

Size	Part #
1/4-20	28546
1/4-28	28547
5/16-18	28548
5/16-24	28549
3/8-16	28550
3/8-24	28551
7/16-14	28552
7/16-20	28553
1/2-13	28554
1/2-20	28555
9/16-12	28556
9/16-18	28557
5/8-11	28558
5/8-18	28559
3/4-10	28560
3/4-16	28561





# Bulk Chrome Fasteners American

## Nuts Chrome Plated

### Acorn Nuts

Coarse and Fine Thread

Size	Part #
4/40	21536
6/32	21538
8/32	21540
10/24	21542
10/32	21543
12/24	21544
1/4-20	21546
1/4-28	21547
5/16-18	21548
5/16-24	21549
3/8-16	21550
3/8-24	21551
7/16-14	21552
7/16-20	21553
1/2-13	21554
1/2-20	21555
9/16-12	21556
9/16-18	21557
5/8-11	21558
5/8-18	21559
3/4-10	21560
3/4-16	21561
1-14	21565



### Low Crown Acorn Nuts

Coarse and Fine Thread

Size	Part #
8/32	33540
10/24	33542
10/32	33543
1/4-20	33546
1/4-28	33547
5/16-18	33548
5/16-24	33549
3/8-16	33550
3/8-24	33551
7/16-14	33552
7/16-20	33553
1/2-13	33554
1/2-20	33555
5/8-11	33558
5/8-18	33559



### Acorn Push On Covers

Wrench Size	Part #	Bolt/Nut Diameter
7/16	45552	1/4
1/2	45554	5/16
9/16	45556	3/8
5/8	45558	7/16
11/16	45559	
7/8	45562	
3/4	45560	

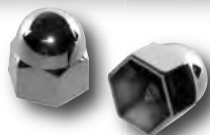

## Spacers Chrome Plated

ID	OD	Length	Part #
1/4	7/16	3/16	20080
1/4	7/16	1/4	20081
1/4	7/16	3/8	20082
1/4	7/16	1/2	20082-A
1/4	7/16	5/8	20083
1/4	7/16	3/4	20084
1/4	7/16	7/8	20094
1/4	7/16	1 1/16	20085
1/4	5/8	1/8	20040
1/4	5/8	1/4	20036
1/4	5/8	3/8	20037
1/4	5/8	1/2	20038
1/4	5/8	3/4	20039
1/4	5/8	1	20041
5/16	7/16	5/8	20045
5/16	1/2	3/16	20049
5/16	1/2	1/4	20050
5/16	1/2	3/8	20050-A
5/16	1/2	1/2	20051
5/16	1/2	17/32	20093
5/16	1/2	3/4	20052
5/16	1/2	1	20053
5/16	1/2	1 1/4	20054
5/16	5/8	1/8	20055
5/16	5/8	3/16	20056
5/16	5/8	1/4	20057
5/16	5/8	3/8	20058
5/16	5/8	1/2	20059
5/16	5/8	3/4	20060
5/16	5/8	1	20061
3/8	9/16	1/8	20087

ID	OD	Length	Part #
3/8	9/16	3/8	20086
3/8	13/16	5/32	20091
3/8	5/8	1/4	20067
3/8	5/8	3/8	20068
3/8	1	5/16	C-31-32
3/8	5/8	1/2	20069
3/8	13/16	1/2	20092
3/8	5/8	3/4	20070
3/8	13/16	29/32	20092-A
3/8	5/8	1	20072
3/8	5/8	1 1/2	20075
3/8	3/4	1/8 Tapered	20021
3/8	3/4	1/4	20022
3/8	3/4	3/8	20023
3/8	3/4	1/2	20024
3/8	3/4	3/4	20025
3/8	3/4	1	20026
3/8	7/8	5/8	20089
7/16	3/4	3/32	23580
7/16	11/16	5/16	20088
1/2	5/16	15/16	20095
1/2	3/4	1/8	20030
1/2	3/4	1/4	20031
1/2	3/4	1/2	20032
1/2	3/4	3/4	20033
1/2	3/4	1	20034
1/2	7/8	3/8	20097
1/2	15/16	21/32	20096
1/2	1 1/16	5/16	23200
9/16	7/8	3/4	20100
5/8	1 1/2	3/8	C-31-100
13/32	1	.322	23327

### Spike Nuts

Coarse and Fine Thread

Size	Part #
1/4-20	26546
1/4-28	26547
5/16-18	26548
5/16-24	26549
3/8-16	26550
3/8-24	26551
7/16-14	26552
7/16-20	26553
1/2-13	26554
1/2-20	26555
5/8-18	26559



All Items shown on this page can be purchased individually

Non-Alcoholic but may be habit forming



# Bulk Chrome Fasteners American



35

## Cotter Pins Chrome, Stainless or Zinc

Size	Chrome Part #	Stainless Part #	Zinc Part #
1/16 x 1/2		78580	01587
1/16 x 3/4		78587	01588
1/16 x 1 1/4		78588A	01588A
5/64 x 3/4		78581	01589
3/32 x 3/4	29589	78589	01590
3/32 x 1	29590	78590	01591
3/32 x 1 1/4	29591A	78591	
3/32 x 1 1/2		78591A	
3/32 x 1 3/4	29587		01592
1/8 x 3/4	29592	78592	
1/8 x 1		78584	01593
1/8 x 1 1/4	29593	78593	
1/8 x 1 1/2	29585	78585	
1/8 x 1 3/4		78585A	
1/8 x 2		78595	
5/32 x 1		78585B	01599
5/32 x 1 1/2	29588	78588	
5/32 x 1 3/4	29586	78586	01594
3/16 x 1	29594	78594	
3/16 x 1 3/4		78597	



**American Bulk Chrome**

Cotter Pin Assortments A-34 Zinc or A-34C Chrome Plated

### Flange & Locking Flange Nuts

Size	Part #	Locking #
1/4-20	44546	44546-L
5/16-18	44548	44548-L
5/16-24	44549	44549-L
3/8-16	44550	44550-L
3/8-24	44551	44551-L
7/16-14	44552	----
1/2-13	44554	----
1/2-20	44555	----



### Wide Base Wing Nut

Size	Part #
1/4-20	23546-W



### Grease Fittings Chrome Plated

Size	Part #
1/4-28 Straight	57547
1/4-28 90°	57548
1/4-28 45°	57546
1/8 Pipe Straight	57550
1/8 Pipe 45°	57549



### Wing Nuts

Size	Part #
1/4-20	23546
5/16-18	23548
3/8-16	23550



### Allen Pipe Plugs

Size	Part #
1/16	31587
1/8	31588
1/4	31569
3/8	31571
1/2	31573
3/4	31576



Note: See Fitting Section for more Pipe Plugs

### Hole Plugs

Size	Part #	Use with Allen Screw
3/16	43567	1/4
1/4	43569	5/16
5/16	43570	3/8
3/8	43571	7/16
7/16	43572	
1/2	43573	
5/8	43575	
3/4	43576	
7/8	43577	
1	43578	
1 1/4	43579	
1 1/2	43580	

Note: Hole Plugs available in Flat or Gloss black finish add - FB (flat black) or - GB (gloss black) to the end of part #

All Items shown on this page can be purchased individually

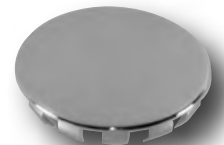



## American Thread Stainless Steel

### Clamps

#### Muffler Clamps O.D. Pipe Size Polished Stainless Steel



Size	Part #
1 3/4	SP-67338
1 7/8	SP-67339
2 1/4	SP-67342

#### Line Clamps in Stainless Steel

\*14 x 3/4 Drill Point Sheet Metal Screw, Stainless Steel

Size	Part #
*14 x 3/4	67002
3/16	67003
1/4	67004
5/16	67005
3/8	67006



### Hose Clamps in Stainless Steel

Entire clamp is Stainless Steel including the screw. This product is manufactured in Sweden with rolled up band edges and smooth inside surface of the clamp this spares the hose and insures a high and uniform tightening force. With the flexible screwdriver you can tighten and slacken the clamp from an angle of 90° without slipping.

Size	Min. Dia.	Max. Dia.	Part #
3	5/16	5/8	67014
4	7/16	3/4	67017
6	1/2	7/8	67020
8	5/8	1 1/16	67024
10	3/4	1 3/16	67028
12	7/8	1 7/16	67032
1	1 1/16	1 5/8	67038
20	1 1/4	1 7/8	67044
24	1 1/2	2 1/16	67050
28	1 3/4	2 3/8	67056
32	2	2 11/16	67065
36	2 5/16	3 1/8	67075
44	2 11/16	3 1/2	67085
48	3	3 7/8	67095



### Screws

#### Carriage Bolts

	3/16	1/4	5/16	3/8	1/2
1/2	79154	79206			
3/4	79158	79210	79274	79326	
1	79162	79214	79280	79330	79416
1 1/2	79168	79220	79286	79336	79420
1 3/4		79222		79338	79422
2	79172	79224	79290	79340	79424
2 1/4		79226	79292		
2 1/2		79228	79294	79334	79428
2 3/4			79296		
3		79232	79298	79348	79432
3 1/2		79236	79302	79352	79436
4		79240	79306	79356	79440
4 1/2				79360	79442
5				79362	79444
6				79368	79448



Carriage Bolt

*Note: Some larger size carriage bolt part numbers may not be listed, please call for various sizes and prices.*

#### Bumper Bolts Stainless Steel Capped

Size	Part #
5/16 x 3/4	18274
3/8 x 1	18330
3/8 x 1 1/2	18336
7/16 x 1	18376
7/16 x 1 1/4	18378
7/16 x 1 1/2	18380
7/16 x 1 3/4	18382
1/2 x 1 3/8	18420

*Bumper bolt is made from Steel, Zinc Plated with a Stainless Steel cap.*

*Note: See carriage bolts for entire bolt made of Stainless Steel*

**NOTE: Add the prefix SP when ordering Polished Stainless Steel Example: SP-18420**

# Bulk Stainless Fasteners American



## Screws

Bowtie Hex Cap



### Bowtie Hex Caps

	1/4 -20	1/4 -28	5/16 -18	5/16 -24	3/8 -16	3/8 -24	7/16 -14	7/16 -20	1/2 -13	1/2 -20	9/16 -12	9/16 -18	5/8 -11	5/8 -18
1/2	10-77206	10-77207	10-77270	10-77271	10-77322	10-77323								
5/8	10-77208	10-77209	10-77272	10-77273	10-77324	10-77325					NOTE: Some 9/16 and 5/8 sizes are not listed on chart but certain sizes may be available upon request. Also add the prefix SP when ordering Polished Stainless Steel.			
3/4	10-77210	10-77211	10-77274	10-77275	10-77326	10-77327	10-77374							
7/8	10-77212	10-77213	10-77278	10-77279	10-77328	10-77329								
1	10-77214	10-77215	10-77280	10-77281	10-77330	10-77331	10-77376	10-77377	10-77416	10-77417				
1 1/4	10-77218	10-77219	10-77284	10-77285	10-77334	10-77335	10-77378	10-77379	10-77418	10-77419	10-77454			
1 1/2	10-77220	10-77221	10-77286	10-77287	10-77336	10-77337	10-77380	10-77381	10-77420	10-77421				10-77493
1 3/4	10-77222	10-77223	10-77288	10-77289	10-77338	10-77339	10-77382	10-77383	10-77422	10-77423				
2	10-77224	10-77225	10-77290	10-77291	10-77340	10-77341	10-77384	10-77385	10-77424	10-77425	10-77460			10-77497
2 1/4	10-77226	10-77227	10-77292	10-77293	10-77342	10-77343	10-77386	10-77387	10-77426	10-77427				10-77499
2 1/2	10-77228	10-77229	10-77294	10-77295	10-77344	10-77345	10-77388	10-77389	10-77428	10-77429				10-77501
2 3/4	10-77230	10-77231	10-77296	10-77297	10-77346	10-77347	10-77390	10-77391	10-77430	10-77431				10-77503
3	10-77232	10-77233	10-77298	10-77299	10-77348	10-77349	10-77392	10-77393	10-77432	10-77433	10-77468			10-77505
3 1/4	10-77234	10-77235	10-77300	10-77301	10-77350	10-77351	10-77394		10-77434	10-77435				
3 1/2	10-77236	10-77237	10-77302	10-77303	10-77352	10-77353	10-77396		10-77436	10-77437	10-77472	10-77473		10-77509
4	10-77240	10-77241	10-77306	10-77307	10-77356	10-77357	10-77400		10-77440	10-77441	10-77476			
4 1/2	10-77244		10-77310	10-77311	10-77360	10-77361	10-77404		10-77442	10-77443	10-77478		10-77514	10-77515
5	10-77246		10-77312	10-77313	10-77362	10-77363	10-77406		10-77444		10-77480		10-77516	
5 1/2			10-77316	10-77317	10-77366	10-77367	10-77410		10-77446		10-77482		10-77518	
6	10-77246-A		10-77318	10-77319	10-77368	10-77369	10-77412		10-77448		10-77484		10-77520	

You can also order the above listed Stainless Steel Part Numbers with the Emblems Stamped on the Hex Cap Bolts as shown below by using the Part Prefix associated with that emblem.

**Example:** Dress Up Bolt Part # 10-77210 to Purchase: 1/4-20 x 3/4 Chevy Bowtie Stamped Hex Cap in Polished Stainless Steel

Bolts are hand polished stainless steel then stamped with your choice of emblem



Chevy Bowtie  
use Part Prefix  
10-77xxx to order

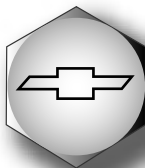

Chevy SS  
use Part Prefix  
13-77xxx to order



Chevy RS  
use Part Prefix  
16-77xxx to order



350  
use Part Prefix  
18-77xxx to order



454  
use Part Prefix  
19-77xxx to order



We also carry these other selected General Motors Emblems to choose from

Pontiac Arrow  
use Part Prefix  
12-77xxx to order



Pontiac GTO  
use Part Prefix  
20-77xxx to order



Pontiac GT  
use Part Prefix  
15-77xxx to order



Olds Rocket  
use Part Prefix  
26-77xxx to order

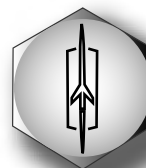



# Bulk Stainless Steel American

## Screws

Ford Oval Hex Cap



### Ford Oval Hex Caps

	1/4 -20	1/4 -28	5/16 -18	5/16 -24	3/8 -16	3/8 -24	7/16 -14	7/16 -20	1/2 -13	1/2 -20	9/16 -12	9/16 -18	5/8 -11	5/8 -18
1/2	11-77206	11-77207	11-77270	11-77271	11-77322	11-77323								
5/8	11-77208	11-77209	11-77272	11-77273	11-77324	11-77325								
3/4	11-77210	11-77211	11-77274	11-77275	11-77326	11-77327	11-77374							
7/8	11-77212	11-77213	11-77278	11-77279	11-77328	11-77329								
1	11-77214	11-77215	11-77280	11-77281	11-77330	11-77331	11-77376	11-77377	11-77416	11-77417				
1 1/4	11-77218	11-77219	11-77284	11-77285	11-77334	11-77335	11-77378	11-77379	11-77418	11-77419	11-77454			
1 1/2	11-77220	11-77221	11-77286	11-77287	11-77336	11-77337	11-77380	11-77381	11-77420	11-77421				11-77493
1 3/4	11-77222	11-77223	11-77288	11-77289	11-77338	11-77339	11-77382	11-77383	11-77422	11-77423				
2	11-77224	11-77225	11-77290	11-77291	11-77340	11-77341	11-77384	11-77385	11-77424	11-77425	11-77460			11-77497
2 1/4	11-77226	11-77227	11-77292	11-77293	11-77342	11-77343	11-77386	11-77387	11-77426	11-77427				11-77499
2 1/2	11-77228	11-77229	11-77294	11-77295	11-77344	11-77345	11-77388	11-77389	11-77428	11-77429				11-77501
2 3/4	11-77230	11-77231	11-77296	11-77297	11-77346	11-77347	11-77390	11-77391	11-77430	11-77431				11-77503
3	11-77232	11-77233	11-77298	11-77299	11-77348	11-77349	11-77392	11-77393	11-77432	11-77433	11-77468			11-77505
3 1/4	11-77234	11-77235	11-77300	11-77301	11-77350	11-77351	11-77394		11-77434	11-77435				
3 1/2	11-77236	11-77237	11-77302	11-77303	11-77352	11-77353	11-77396		11-77436	11-77437	11-77472	11-77473		11-77509
4	11-77240	11-77241	11-77306	11-77307	11-77356	11-77357	11-77400		11-77440	11-77441	11-77476			
4 1/2	11-77244		11-77310	11-77311	11-77360	11-77361	11-77404		11-77442	11-77443	11-77478		11-77514	11-77515
5	11-77246		11-77312	11-77313	11-77362	11-77363	11-77406		11-77444		11-77480		11-77516	
5 1/2			11-77316	11-77317	11-77366	11-77367	11-77410		11-77446		11-77482		11-77518	
6			11-77318	11-77319	11-77368	11-77369	11-77412		11-77448		11-77484		11-77520	

NOTE: Some 9/16 and 5/8 sizes are not listed on chart but certain sizes may be available upon request. Also add the prefix SP when ordering Polished Stainless Steel.



You can also order the above listed Stainless Steel Part Numbers with the Emblems Stamped on the Hex Cap Bolts as shown below by using the Part Prefix associated with that emblem.

Ford Oval  
use Part Prefix  
11-77xxx to order



Ford V8  
use Part Prefix  
24-77xxx to order



Ford Mustang  
use Part Prefix  
25-77xxx to order



Flames  
use Part Prefix  
17-77xxx to order



Skulls  
use Part Prefix  
14-77xxx to order



**Example:** Dress Up Bolt Part # 11-77210 to Purchase: 1/4-20 x 3/4 Ford Oval Stamped Hex Cap in Polished Stainless Steel



Mopar  
use Part Prefix  
23-xxxxx to order



Chrysler Pentastar  
use Part Prefix  
21-xxxxx to order



Hemi Mopar  
use Part Prefix  
27-xxxxx to order



Dodge Ram  
use Part Prefix  
22-xxxxx to order



We also carry these other selected Chrysler Emblems to choose from

# Bulk Stainless Fasteners American



**American Bulk Stainless**

## Allen Screws Stainless Steel

	6/32	8/32	10/24	10/32	1/4 -20	1/4 -28	5/16 -18	5/16 -24	3/8 -16	3/8 -24	7/16 -14	1/2 -13	5/8 -11
3/8	73104	73128	73152	73153	73204						Allen		
1/2	73106	73130	73154	73155	73206	73207	73270		73322				
5/8		73132	73156	73157	73208	73209	73272	73273	73324				
3/4	73110	73134	73158	73159	73210	73211	73274	73275	73326	73327	73374	73414	
7/8		73136	73160	73161	73212		73278		73328				
1	73114	73138	73162	73163	73214	73215	73280	73281	73330	73331	73376	73416	
1 1/4		73140	73166	73167	73218	73219	73284	73285	73334	73335	73378	73418	
1 1/2		73142	73168	73169	73220	73221	73286	73287	73336	73337	73380	73420	73492
1 3/4			73170	73171	73222	73223	73288	73289	73338	73339	73382	73422	73494
2	73122		73172	73173	73224	73225	73290	73291	73340	73341	73384	73424	73496
2 1/4			73174		73226	73227	73292		73342		73386	73426	73498
2 1/2			73176		73228		73294	73295	73344	73345	73388	73428	73500
2 3/4					73230		73296		73346			73430	
3					73232		73298	73299	73348		73392	73432	73504
3 1/2					73236		73302		73352	73353	73396	73436	73508
4					73240		73306		73356	73347	73400	73440	73512



73xxx for Stainless Steel Allen with Knurls



SP - 73xxx for Polished Stainless Steel Allen with Knurls Removed

## Button Head Allen Screws

	6/32	8/32	10/24	10/32	1/4 -20	1/4 -28	5/16 -18	5/16 -24	3/8 -16	3/8 -24	1/2 -13
1/4	72102	72126	72150	72151							
3/8	72104	72128	72152	72153	72204						
1/2	72106	72130	72154	72155	72206		72270		72322		
5/8		72132	72156	72157	72208		72272				
3/4	72110	72134	72158	72159	72210	72211	72274	72275	72326	72327	
1	72114	72138	72162	72163	72214	72215	72280	72281	72330	72331	72416
1 1/4			72166	72167	72218		72284	72285	72334	72335	72418
1 1/2			72168	72169	72220		72286	72287	72336	72337	72420
1 3/4					72222						
2			72172	72173	72224		72290	72291	72340		72424
2 1/2							72294		72344		72428
3					72232		72298		72348		72432
3 1/2					72236						
4					72240		72306				

72xxx for Stainless Steel Button Head Allen



SP - 72xxx for Polished Stainless Steel Button Head Allen

## Flat Head Allen Screws

	6/32	8/32	10/24	10/32	1/4 -20	1/4 -28	5/16 -18	5/16 -24	3/8 -16	1/2 -13	5/8 -11
3/8	71104		71152	71153	71204						
1/2	71106	71130	71154	71155	71206		71270				
5/8		71132	71156	71157	71208		71272				
3/4		71134	71158	71159	71210	71211	71274		71326		
1	71114	71138	71162	71163	71214	71215	71280	71281	71330	71416	71488
1 1/4		71140	71166	71167	71218	71219	71284		71334	71418	71490
1 1/2		71142	71168	71169	71220	71221	71286		71336	71420	71492
1 3/4					71222		71288		71338	71422	71494
2					71224		71290		71340	71424	71496
2 1/2									71344		
3							71298		71348	71432	

71xxx for Stainless Steel Flat Head Allen



SP - 71xxx for Polished Stainless Steel Flat Head Allen





# Bulk Stainless Steel American

## Hex Caps Screws Stainless Steel

**77xxx**  
for Stainless Steel  
Hex Cap Screws

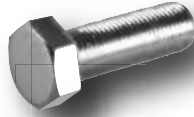

**SP - 77xxx**  
for Polished Stainless Steel  
Hex Cap Screws

NOTE: 9/16 & 5/8 sizes are not listed on chart but certain sizes may be available upon request.

	4/40	6/32	8/32	10/24	10/32	12/24	1/4 -20	1/4 -28	5/16 -18	5/16 -24	3/8 -16	3/8 -24	7/16 -14	7/16 -20	1/2 -13	1/2 -20
3/8	77088		77128	77152	77153		77204	77205	77268							
1/2		77106	77130	77154	77155	77186	77206	77207	77270	77271	77322	77323				
5/8			77132	77156	77157		77208	77209	77272	77273	77324	77325				
3/4			77134	77158	77159		77210	77211	77274	77275	77326	77327			77414	
7/8			77136				77212	77213	77278	77279	77328	77329				
1		77114	77138	77162	77163	77194	77214	77215	77280	77281	77330	77331	77376	77377	77416	77417
1 1/4				77166	77167		77218	77219	77284	77285	77334	77335	77378	77379	77418	77419
1 1/2			77142	77168	77169		77220	77221	77286	77287	77336	77337	77380	77381	77420	77421
1 3/4							77222	77223	77288	77289	77338	77339	77382	77383	77422	77423
2							77224	77225	77290	77291	77340	77341	77384	77385	77424	77425
2 1/4							77226	77227	77292	77293	77342	77343	77386	77387	77426	77427
2 1/2							77228	77229	77294	77295	77344	77345	77388	77389	77428	77429
2 3/4							77230	77231	77296		77346			77391	77430	
3							77232	77233	77298	77299	77348	77349	77392	77393	77432	77433
3 1/4							77234		77300	77301	77350		77394		77434	77435
3 1/2							77236	77237	77302		77352	77353	77396		77436	77437
3 3/4							77238		77304		77354				77438	
4							77240		77306		77356	77357	77400		77440	77441
4 1/2							77244		77310	77311	77360	77361	77404		77442	77443
5							77246		77312	77313	77362		77406		77444	
5 1/2									77316		77366				77446	
6							77246-A		77318		77368		77412		77448	

## Set Screws Plain Steel

	6/32	8/32	10/24	10/32	1/4 -20	1/4 -28	5/16 -18	5/16 -24	3/8 -16	3/8 -24
1/4	47102	47126	47150	47151						
3/8	47104	47128	47152	47153	47204	47205	47268			
1/2	47106	47130	47154	47155	47206	47207	47270	47271	47322	47323
5/8	47108	47132	47156	47157	47208	47209	47272	47273	47324	47325
3/4	47110	47134	47158	47159	47210	47211	47274	47275	47326	47327
1	47114	47138	47162	47163	47214	47215	47280	47281	47330	47331
1 1/4			47166	47167	47218	47219	47284	47285	47334	47335
1 1/2			47168	47169	47220	47221	47286	47289	47336	47337
1 3/4					47222		47288			
2					47224	47225	47290	47291	47340	47341
2 1/2					47228		47294		47344	

Set Screws  
Sold Each



**Stainless Steel Available**



**American Bulk Stainless**

## Washers Stainless Steel

### Flat Washers

Size	Part #
4	75564
6	75565
8	75566
10	75567
1/4	75569
5/16	75570
3/8	75571
7/16	75572
1/2	75573
5/8	75575
3/4	75576



### AN Washers Small OD

Size	Part #
6	84565
8	84566
10	84567
1/4	84569
5/16	84570
3/8	84571
7/16	84572
1/2	84573
5/8	84575
3/4	84576



### Lock Washers

Size	Part #
4	76564
6	76565
8	76566
10	76567
1/4	76569
5/16	76570
3/8	76571
7/16	76572
1/2	76573
5/8	76575
3/4	76576



### Finishing Washers

Size	Part #
6	78565
8	78566
10	78567
1/4	78569
5/16	78570



### High Collar Lock Washers

Size	Part #
1/4	80569
5/16	80570
3/8	80571
1/2	80573



All Items shown on this page can be purchased individually

## GW Stainless Steel Flat Washers



Size	Part #
1/4	70569
5/16	70570
3/8	70571
7/16	70572
1/2	70573
5/8	70575

Our Stainless Steel washer is thicker than standard flat washers and has a close tolerance ID for a snug fit. It has a standard OD so it can be used anywhere a regular washer was.

## Super Flat Washers

Size	Part #
#6 x 5/8	66108
#8 x 3/4	66134
3/16 x 11/16	66157
3/16 x 3/4	66158
3/16 x 1	66162
3/8 x 1	66330
3/8 x 1 1/4	66334
1/4 x 1	66214
1/4 x 1 1/4	66218
5/16 x 3/4	SP- 66274
5/16 x 1 1/2	66286
3/8 x 7/8	SP- 66328
3/8 x 1 1/2	66336
7/16 x 1	66376
7/16 x 1 1/8	SP- 66377
1/2 x 1 1/4	SP- 66418
1/2 x 1 1/2	66420
1/2 x 2	66424
5/8 x 1 1/2	SP- 66492
5/8 x 1 3/4	66494
3/4 x 1 3/4	66528

(SP-) Super Flat Washers Polished Stainless Steel in that size only

### Internal Lock Washers

Size	Part #
4	82564
6	82565
8	82566
10	82567
1/4	82569
5/16	82570
3/8	82571
7/16	82572
1/2	82573
5/8	82575



### External Lock Washers

Size	Part #
4	83564
6	83565
8	83566
10	83567
1/4	83569
5/16	83570
3/8	83571
7/16	83572
1/2	83573
5/8	83575



### External Countersunk Washers

Size	Part #
6	89565
8	89566
10	89567
1/4	89569
5/16	89570

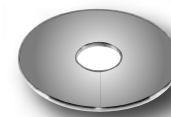



# Bulk Stainless Steel American

## Washers Stainless Steel

### White Nylon Flat Washers

Size	Part #
8	87566
10	87567
1/4	87569
5/16	87570
3/8	87571
7/16	87572
1/2	87573
5/8	87575



### Neoprene Backed Flat Washers

Size	Part #
10	81567
1/4	81569
5/16	81570
3/8	81571
1/2	81573



Available in  
Stainless Steel Polished  
Add SP-81xxx

### Pipe Plugs Allen Style

Size	Part #
1/8	86588
1/4	86569
3/8	86571
1/2	86573
3/4	86576



### Threaded Rod Stainless Steel

Size	Part #
6/32	63122
8/32	63148
10/24	63180
10/32	63181
1/4-20	63232
1/4-28	63233
5/16-18	63298
5/16-24	63299
3/8-16	63348
3/8-24	63349
7/16-14	63392
7/16-20	63393
1/2-13	63432
1/2-20	63433
5/8-11	63504

Threaded Rod  
Sold in Three Foot Lengths

All Items shown on this page can  
be purchased individually

## Nuts Stainless Steel

### Acorn Nuts

Size	Part #
6/32	68538
8/32	68540
10/24	68542
10/32	68543
1/4-20	68546
1/4-28	68547
5/16-18	68548
5/16-24	68549
3/8-16	68550
3/8-24	68551
7/16-14	68552
7/16-20	68553
1/2-13	68554
1/2-20	68555
5/8-11	68558
5/8-18	68559



### Castle Nuts

Size	Part #
3/8-24	81551
1/2-13	81554
1/2-20	81555
5/8-11	81558



For Stainless Steel Polished  
Order with the SP-Prefix than the  
five digit Part # SP-xxxxx

### Hex Nuts

Size	Part #
6/32	70538
8/32	70540
10/24	70542
10/32	70543
1/4-20	70546
1/4-28	70547
5/16-18	70548
5/16-24	70549
3/8-16	70550
3/8-24	70551
7/16-14	70552
7/16-20	70553
1/2-13	70554
1/2-20	70555
9/16-12	70556
9/16-18	70557
5/8-11	70558
5/8-18	70559
3/4-10	70560
3/4-16	70561



### Nylon Lock Nuts

Size	Part #
4/40	69536
6/32	69538
8/32	69540
10/24	69542
10/32	69543
1/4-20	69546
1/4-28	69547
5/16-18	69548
5/16-24	69549
3/8-16	69550
3/8-24	69551
7/16-14	69552
7/16-20	69553
1/2-13	69554
1/2-20	69555
9/16-12	69556
9/16-18	69557
5/8-11	69558
5/8-18	69559
3/4-10	69560
3/4-16	69561





## Nuts Stainless Steel

### Jam Nuts

Size	Part #
1/4-20	67546
1/4-28	67547
5/16-18	67548
5/16-24	67549
3/8-16	67550
3/8-24	67551
7/16-14	67552
7/16-20	67553
1/2-13	67554
1/2-20	67555
9/16-18	67557
5/8-11	67558
5/8-18	67559
3/4-16	67561
3/4-10	67560

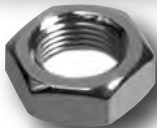

### Jam Lock Nuts

Size	Part #
1/4-20	66546
1/4-28	66547
5/16-18	66548
5/16-24	66549
3/8-16	66550
3/8-24	66551
7/16-14	66552
7/16-20	66553
1/2-13	66554
1/2-20	66555
5/8-11	66558
5/8-18	66559
3/4-16	66561



### Spin Locks

Size	Part #
1/4-20	65546
5/16-18	65548
5/16-24	65549
3/8-16	65550
3/8-24	65551



All Items shown on this page can be purchased individually





## Machine and Sheet Metal Screws Stainless Steel

**Example:** To order a **8/32 x 5/8 Oval Phillips Machine Screw**: Use **Chart #1** for head style required, take those first two digits for the beginning part number which would be "40" Now look up the diameter and length from **Chart #2 or #3** for last three digits for **8/32 x 5/8** is "132" Put the two together for a part number of **89132**, or simply order by style and size.

### Chart #1: Select Styles

Style	Stainless Steel Slotted	Stainless Steel Phillips
Round Head	99	95
Flat Head	98	94
Truss Head	93	80
Oval Head	97	89
Pan Head	96	92
Fillister	78	n/a
Hex	77	n/a
Round Wood	83	n/a
Flat Wood	85	n/a
Oval Wood	84	81

Include the prefix **SP-89132** for **Stainless Steel Polished**

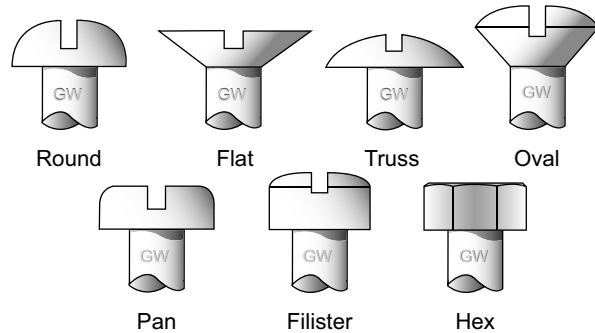

### Chart #2: Machine Screw Sizes

	6/32	8/32	10/24	10/32	12/24	1/4 -20	1/4 -28	5/16 -18	5/16 -24	3/8 -16
3/8	104	128	152	153	184	204				
1/2	106	130	154	155	186	206		270		
5/8		132	156	157	188	208	209			
3/4	110	134	158	159	190	210	211	274	275	
7/8		136	160	161	192	212			279	
1	114	138	162	163	194	214	215	280	281	330
1 1/4	116	140	166	167	196	218	219	284	285	334
1 1/2	118	142	168	169	198	220	221	286	287	336
1 3/4			170	171		222		288	289	338
2	122		172	173		224		290	291	340



Machine Screw

Head Styles: Oval, Flat or Pan  
Note: Not all styles available in all sizes

### Chart #3: Sheet Metal & Wood Screw Sizes

	#6	#8	#10	#12	#14
1/2	616	628	641	654	667
5/8	617	629	642	655	668
3/4	618	630	643	656	669
1	620	632	645	658	671
1 1/4	621	633	646	659	672
1 1/2	622	634	647	660	673
1 3/4	623	680	648	661	674
2	624	635	649	662	675
2 1/4	625	636	650	663	676
2 1/2	626	637	651	664	677



Sheet Metal Screw



Woodscrew

# Bulk Zinc Fasteners American



45

## Hex Cap Screws Zinc Plated and L-9 Products

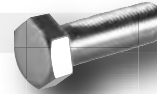

07xxx  
for Grade 5  
Hex Cap Screws

	1/4 -20	1/4 -28	5/16 -18	5/16 -24	3/8 -16	3/8 -24	7/16 -14	7/16 -20	1/2 -13	1/2 -20	5/8 -11	5/8 -18
1/2	07206	07207	07270	07271	07322	07323						
5/8	07208	07209	07272	07273	07324	07325						
3/4	07210	07211	07274	07275	07326	07327	07374	07375	07414			
7/8	07212	07213	07278	07279	07328	07329						
1	07214	07215	07280	07281	07330	07331	07376	07377	07416	07417	07488	07489
1 1/4	07218	07219	07284	07285	07334	07335	07378	07379	07418	07419	07490	07491
1 1/2	07220	07221	07286	07287	07336	07337	07380	07381	07420	07421	07492	07493
1 3/4	07222	07223	07288	07289	07338	07339	07382	07383	07422	07423	07494	07495
2	07224	07225	07290	07291	07340	07341	07384	07385	07424	07425	07496	07497
2 1/4	07226	07227	07292	07293	07342	07343	07386	07387	07426	07427	07498	07499
2 1/2	07228	07229	07294	07295	07344	07345	07388	07389	07428	07429	07500	07501
2 3/4	07230	07231	07296	07297	07346	07347	07390	07391	07430	07431	07502	07503
3	07232	07233	07298	07299	07348	07349	07392	07393	07432	07433	07504	07505
3 1/4	07234	07235	07300	07301	07350	07351	07394	07395	07434	07435	07506	07507
3 1/2	07236	07237	07302	07303	07352	07353	07396	07397	07436	07437	07508	07509
4	07240	07241	07306	07307	07356	07357	07400	07401	07440	07441	07512	07513
4 1/2	07244		07310	07311	07360	07361	07404	07405	07442	07443	07514	07515
5	07246		07312	07313	07362	07363	07406	07407	07444	07445	07516	07517
5 1/2			07316	07317	07366	07367	07410	07411	07446	07447	07518	07519
6				07319	07368		07412		07448	07449	07520	07521

48xxx  
for Grade 8  
Hex Cap Screws  
(Yellow)

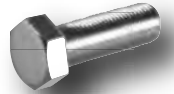

When Ordering  
L-9 Zinc Plated  
Hex Caps  
use: 52xxx  
for the first two  
numers in Part #

## Allen Screws Zinc Plated Grade 8



08xxx  
for Grade 8  
Allen Screws

NOTE: Some sizes  
shown may not be  
available.

	6/32	8/32	10/24	10/32	1/4 -20	1/4 -28	5/16 -18	5/16 -24	3/8 -16	3/8 -24	7/16 -14	7/16 -20	1/2 -13	1/2 -20	5/8 -11	5/8 -18
3/8	08104	08128	08152	08153												
1/2	08106	08130	08154	08155	08206	08207	08270	08271	08322	08323						
5/8	08108	08132	08156	08157	08208	08209	08272	08273	08324	08325						
3/4	08110	08134	08158	08159	08210	08211	08274	08275	08326	08327	08374	08375	08414	08415		
7/8	08112	08136	08160	08161	08212	08213	08278	08279	08328	08329						
1	08114	08138	08162	08163	08214	08215	08280	08281	08330	08331	08376	08377	08416	08417	08488	08489
1 1/4		08140	08166	08167	08218	08219	08284	08285	08334	08335	08378	08379	08418	08419	08490	
1 1/2		08142	08168	08169	08220	08221	08286	08287	08336	08337	08380	08381	08420	08421	08492	08493
1 3/4			08170	08171	08222	08223	08288	08289	08338	08339	08382	08383	08422	08423	08494	08495
2			08172	08173	08224	08225	08290	08291	08340	08341	08384	08385	08424	08425	08496	08497
2 1/4			08174	08175	08226	08227	08292	08293	08342	08343	08386	08387	08426	08427	08498	
2 1/2			08176	08177	08228	08229	08294	08295	08344	08345	08388	08389	08428	08429	08500	
2 3/4					08230	08231	08296	08297	08346	08347	08390	08391	08430	08431	08502	
3					08232	08233	08298	08299	08348	08349	08392	08393	08432	08433	08504	
3 1/4					08234		08300	08301	08350	08351	08394	08395	08434	08435	08506	
3 1/2					08236		08302	08303	08352	08353	08396	08397	08436	08437	08508	
4							08306	08307	08356				08440	08441	08512	
4 1/2							08310	08311	08360				08442		08514	
5							08312	08313	08362				08444		08516	
5 1/2							08316	08317	08366				08446		08518	
6								08319	08368				08448		08520	

American  
Bulk Stainless



# Bulk Zinc Fasteners American

## Washers Zinc Plated and L-9 Products

### Flat Washers and L-9

Size	Part #	L-9 #
4	04564	--
6	04565	--
8	04566	--
10	04567	--
12	04568	--
1/4	04569	55569
5/16	04570	55570
3/8	04571	55571
7/16	04572	55572
1/2	04573	55573
9/16	04574	55574
5/8	04575	55575
3/4	04576	--
7/8	04577	--



### Fender Washers

Size	Part #
10 x 1	01567
1/4 x 1	01569
1/4 x 1 1/4	01218
1/4 x 1 1/2	09569
5/16 x 1 1/4	01284
5/16 x 1 1/2	01570
3/8 x 1 1/2	01571



### External Lock Washers

Size	Part #
4	02564
6	02565
8	02566
10	02567
12	02568
1/4	02569
5/16	02570
3/8	02571
7/16	02572
1/2	02573



### Internal Lock Washers

Size	Part #
4	03564
6	03565
8	03566
10	03567
12	03568
1/4	03569
5/16	03570
3/8	03571
7/16	03572
1/2	03573
5/8	03575
3/4	03576



### Lock Washers and L-9

Size	Part #	L-9 #
4	05564	--
6	05565	--
8	05566	--
10	05567	--
12	05568	--
1/4	05569	52569
5/16	05570	52570
3/8	05571	52571
7/16	05572	52572
1/2	05573	52573
9/16	05574	52574
5/8	05575	52575
3/4	05576	--
7/8	05577	--
1	05578	--



## Nuts Zinc Plated and L-9 Products

### Hex Nuts & L-9

Size	Part #	L-9 #
4/40	06536	--
5/40	06537	--
6/32	06538	--
8/32	06540	--
10/24	06542	--
10/32	06543	--
1/4-20	06546	52546
1/4-28	06547	52547
5/16-18	06548	52548
5/16-24	06549	52549
3/8-16	06550	52550
3/8-24	06551	52551
7/16-14	06552	52552
7/16-20	06553	52553
1/2-13	06554	52554
1/2-20	06555	52555
9/16-12	06556	06556
9/16-18	06557	--
5/8-11	06558	52558
5/8-18	06559	52559
3/4-10	06560	--
3/4-16	06561	--



### Nylon Lock Nuts

Size	Part #
4/40	03536
5/40	03537
6/32	03538
8/32	03540
10/24	03542
10/32	03543
1/4-20	03546
1/4-28	03547
5/16-18	03548
5/16-24	03549
3/8-16	03550
3/8-24	03551
7/16-14	03552
7/16-20	03553
1/2-13	03554
1/2-20	03555
9/16-12	03556
9/16-18	03557
5/8-11	03558
5/8-18	03559
3/4-10	03560
3/4-16	03561



### Jam Hex Nuts

Size	Part #
1/4-20	04546
1/4-28	04547
5/16-18	04548
5/16-24	04549
3/8-16	04550
3/8-24	04551
7/16-14	04552
1/2-20	04555
9/16-18	04557
5/8-18	04559
3/4-16	04561



### Jam Lock Nuts

Size	Part #
1/4-20	02546
1/4-28	02547
5/16-18	02548
5/16-24	02549
3/8-16	02550
3/8-24	02551
7/16-14	02552
7/16-20	02553
1/2-13	02554
1/2-20	02555
9/16-12	02556
9/16-18	02557
5/8-11	02558
5/8-18	02559



All Items shown on this page can be purchased individually



## Machine and Sheet Metal Screws Zinc Plated

**Example:** To order a **8/32 x 5/8 Oval Phillips Machine Screw**: Use **Chart #1** for the type of head style required, take those first two digits for the beginning part number which would be **"40"**. Now look up the diameter and length from **Chart #2 or #3** for last three digits for **8/32 x 5/8** is **"132"** Put the two together for a part number of **40132**, or simply order by style and size.

**Note;** When placing your order please ask for Zinc Plated Screws.

### Chart #1: Select Styles

*Note; Not all Sizes and Styles Available*

Style	Slotted	Phillips
Round Head	04	05
Flat Head	02	03
Truss Head	01	n/a
Pan Head	04	n/a
Fillister	06	n/a



Round



Flat



Truss

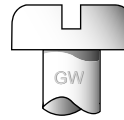

Pan



Fillister

### Chart #2: Machine Screw Sizes

	6/32	8/32	10/24	10/32	12/24	1/4 -20	1/4 -28	5/16 -18	5/16 -24	3/8 -16
3/8	104	128	152	153	184	204				
1/2	106	130	154	155	186	206		270		
5/8		132	156	157	188	208	209			
3/4	110	134	158	159	190	210	211	274	275	
7/8		136	160	161	192	212			279	
1	114	138	162	163	194	214	215	280	281	330
1 1/4	116	140	166	167	196	218	219	284	285	334
1 1/2	118	142	168	169	198	220	221	286	287	336
1 3/4			170	171		222		288	289	338
2	122		172	173		224		290	291	340

Machine Screws are sold each



Machine Screw

### Chart #3: Sheet Metal Sizes

	#6	#8	#10	#12	#14
1/2	616	628	641	654	667
5/8	617	629	642	655	668
3/4	618	630	643	656	669
1	620	632	645	658	671
1 1/4	621	633	646	659	672
1 1/2	622	634	647	660	673
1 3/4	623	680	648	661	674
2	624	635	649	662	675
2 1/4	625	636	650	663	676
2 1/2	626	637	651	664	677

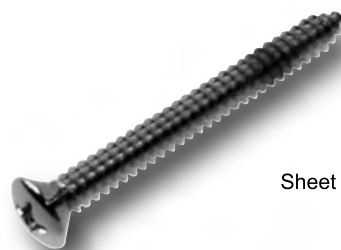

Sheet Metal Screw





# We have the fasteners for any project

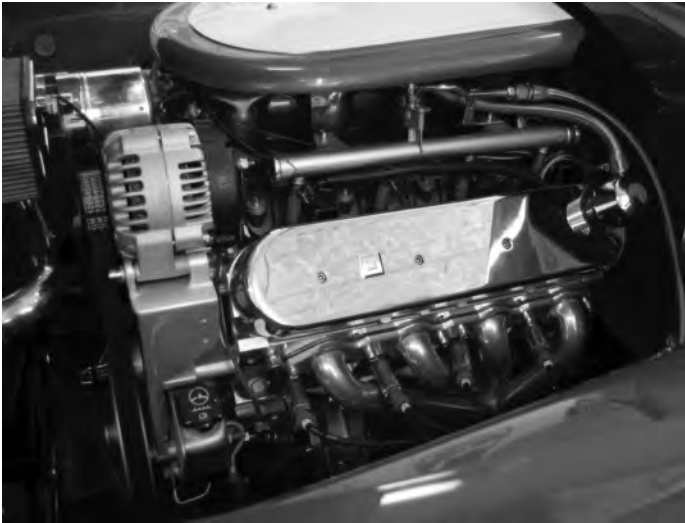



## Inside This Section

### *Metric Thread Chrome Plated*

<i>Allen Screws.....</i>	<i>50</i>
<i>Button Head Screws.....</i>	<i>50</i>
<i>Flat Head Allen Screws.....</i>	<i>50</i>
<i>Hex Cap Screws.....</i>	<i>51</i>
<i>12 Point Screws.....</i>	<i>51</i>
<i>Nuts.....</i>	<i>52</i>
<i>Washers.....</i>	<i>52</i>

### *Metric Stainless Steel*

<i>Allen Screws.....</i>	<i>53</i>
<i>Button Head Screws.....</i>	<i>53</i>
<i>Flat Head Allen Screws.....</i>	<i>53</i>
<i>Hex Caps Screws.....</i>	<i>53</i>
<i>Carriage Bolts.....</i>	<i>53</i>
<i>Washers.....</i>	<i>54</i>
<i>Nuts.....</i>	<i>54</i>
<i>Machine Screws.....</i>	<i>54</i>

### *Metric Zinc Plated*

<i>Allen Screws.....</i>	<i>55</i>
<i>Hex Caps.....</i>	<i>55</i>
<i>Washers.....</i>	<i>56</i>
<i>Nuts.....</i>	<i>56</i>

**Bulk Fasteners  
Chrome Plated  
Stainless and Zinc**





# Bulk Chrome Fasteners Metric

## Allen Screws Chrome Plated and Polished



For Metric Chrome Allen  
with Knurls  
use 12xxx



For Polished Chrome Allen  
with Knurls Removed  
use 10xxx

	4mm/ 0.7	5mm/ 0.8	6mm/ 1.0	8mm/ 1.25	Fine Thread 8mm/ 1.0	10mm/ 1.50	Fine Thread 10mm/ 1.25	12mm/ 1.75
8		12721	12734					
10	12711	12722	12735	12770				
12	12712	12723	12736	12771				
16	12714	12725	12738	12772				
20	12715	12726	12739	12773	12773F	12794	12816	
25	12716	12727	12740	12774	12774F	12795	12817	12836
27			12740A		12775F			
30	12717	12728	12741	12775	12776F	12796	12818	12837
35		12729	12742	12776	12777F	12797	12819	12838
40		12730	12743	12777	12778F	12798	12820	12839
45		12731	12744	12778	12779F	12799	12821	12840
50		12732	12745	12779		12800	12822	12841
55			12746	12780		12801	12823	12842
60		12733	12747	12781		12802	12824	12843
65			12748	12782		12803	12825	12844
70			12749	12783		12804	12826	12845
75			12750	12784		12805	12827	12846
80			12751	12785		12806	12828	12847
85				12786		12807	12829	12848
90			12753	12787		12808	12830	12849
95			12754					
100			12755	12788		12809	12831	12850
110			12756	12789		12810		
115			12756A					
120			12757	12790		12811		

**Key: Read Across For Diameter  
Read Down For Length**

---

*Call if you do not see  
the sizes you need !*

## Button Head Allen Screws

## Flat Head Allen Screws



	4mm/ 0.7	5mm/ 0.8	6mm/ 1.0	8mm/ 1.25	10mm/ 1.50	12mm/ 1.75
6	13709					
8	13710	13721	13734			
10	13711	13722	13735	13770		
12	13712	13723	13736	13771		
16	13714	13725	13738	13772	13793	
20	13715	13726	13739	13773	13794	13835
25	13716	13727	13740	13774	13795	
30		13728	13741	13775	13796	13837
35			13742	13776	13797	13838
40	13719		13743	13777	13798	13839
45				13778	13799	
50				13779	13800	13841
60				13781	13802	13843
70				13783	13804	13845
80				13785	13806	
90				13787	13808	13849
100						13850

	4mm/ 0.7	5mm/ 0.8	6mm/ 1.0	8mm/ 1.25	10mm/ 1.50
6	14709				
8	14710	14721	14734		
10	14711	14722	14735		
12	14712	14723	14736	14771	
16	14714	14725	14738	14772	14793
20	14715	14726	14739	14773	14794
25	14716	14727	14740	14774	14795
30	14717	14728	14741	14775	14796
35	14718	14729	14742	14776	14797
40	14719	14730	14743	14777	14798
45	14720A	17731	17744	14778	14799



## Hex Cap Screws Chrome Plated

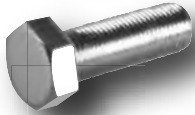

	4mm/ 0.7	5mm/ 0.8	6mm/ 1.0	7mm/ 1.0	8mm/ 1.25	10mm/ 1.50	Fine Thread 10mm/ 1.25	12mm/ 1.75	Fine Thread 12mm/ 1.50	14mm/ 2.00	Fine Thread 14mm/ 1.50
10	11711	11722	11735	11760	11770						
16	11712	11725	11738	11762	11772	11793					
20	11714	11726	11739	11763	11773	11794	11816	11835	11856	11873	
25	11715	11727	11740	11764	11774	11795	11817	11836	11857	11874	11895
30	11716	11728	11741	11765	11775	11796	11818	11837	11858	11875	
35	11717	11729	11742	11766	11776	11797	11819	11838	11859	11876	
40		11730	11743	11767	11777	11798	11820	11839	11860	11877	
45		11731	11744		11778	11799	11821	11840	11861		11899
50		11732	11745	11769	11779	11800	11822	11841	11862	11879	
55			11746		11780	11801	11823	11842	11863		11901
60			11747		11781	11802	11824	11843	11864	11881	
65			11748		11782	11803	11825	11844	11865		
70			11749		11783	11804	11826	11845	11866	11883	
75			11750		11784	11805		11846	11867		
80			11751		11785	11806	11828	11847	11868	11885	
90			11753		11787	11808	11830	11849	11870	11887	
100			11755		11788	11809	11831	11850	11871	11888	
110			11756		11789	11810		11851			
120			11757		11790	11811		11852			
130								11853		11891	
140					11792	11813				11892	

## 12 Point Flange



**Key: Read Across For Diameter  
Read Down For Length**

*Call if you do not see  
the sizes you need !*

	6mm/ 1.0	8mm/ 1.25	10mm/ 1.50	12mm/ 1.75
16	29738	29772		
20	29739	29773		
25	29740	29774	29795	29836
30	29741	29775	29796	29837
35	29742	29776	29797	29838
40	29743	29777	29798	29839
45	29744	29778	29799	29840
50	29745	29779	29800	29841
55		29780	29801	29842
60		29781	29802	29843
65		29782	29803	
70		29783	29804	
75		29784		
80		29785	29806	
90			29807	29849
100			29808	29850
110				
120				



**Demand only the finest Quality Fasteners**



# Bulk Chrome Fasteners Metric

## Nuts Chrome Plated

### Acorn Nuts

Size	Part #
4mm x .70	21950
5mm x .80	21952
6mm x 1.0	21954
7mm x 1.0	21956
8mm x 1.0	
8mm x 1.25	21958
10mm x 1.25	21961
10mm x 1.50	21962
12mm x 1.25	21963
12mm x 1.50	21965
12mm x 1.75	21966



### Hex Nuts

Size	Part #
4mm x .70	15950
5mm x .80	15952
6mm x 1.0	15954
7mm x 1.0	15956
8mm x 1.0	15957
8mm x 1.25	15958
10mm x 1.25	15961
10mm x 1.50	15962
12mm x 1.25	15963
12mm x 1.50	15965
12mm x 1.75	15966
14mm x 1.50	15967
14mm x 2.00	15968
16mm x 1.50	15969
16mm x 2.00	15970

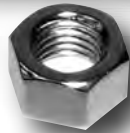

### Jam Nuts

Size	Part #
8mm x 1.0	16957
8mm x 1.25	16958
10mm x 1.25	16961
10mm x 1.50	16962
12mm x 1.25	16963
12mm x 1.50	16965
12mm x 1.75	16966
14mm x 1.50	16967
14mm x 2.00	16968
16mm x 1.50	16969
16mm x 2.00	16970



### Nylon Lock Nuts

Size	Part #
4mm x .70	17950
5mm x .80	17952
6mm x 1.0	17954
7mm x 1.0	17956
8mm x 1.0	17957
8mm x 1.25	17958
10mm x 1.25	17961
10mm x 1.50	17962
12mm x 1.25	17963
12mm x 1.50	17965
12mm x 1.75	17966
14mm x 1.50	17967
14mm x 2.00	17968
16mm x 1.50	17969
16mm x 2.00	17970



All Items shown on this page can be purchased individually

### Flange Nuts

Size	Part #
6mm x 1.0	44954
8mm x 1.25	44958
10mm x 1.50	44962
12mm x 1.75	44966
16mm x 2.0	44970



### Flange Lock Nuts

Size	Part #
8mm x 1.25	44958-L
10mm x 1.50	44962-L
12mm x 1.75	44966-L
16mm x 2.0	44970-L



### Washers Chrome Plated

#### Flat Washers

Size	Part #
4mm	23985
5mm	23986
6mm	23987
7mm	23988
8mm	23989
10mm	23990
12mm	23991
14mm	23992
16mm	23993



#### Lock Washers

Size	Part #
4mm	24985
5mm	24986
6mm	24987
7mm	24988
8mm	24989
10mm	24990
12mm	24991
14mm	24992
16mm	24993



#### Wave Washers

Size	Part #
8mm	23989W
12mm	24991W



### Super Flat Washers

Size	Part #
6mm x 10	23735
6mm x 18	23278A
8mm x 24	23773A

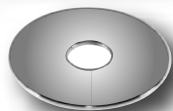

Note: See specification for dimensions  
Page 4



## Allen Screws Stainless Steel



*73xxx for Stainless Steel Allens with Knurls or for Polished add SP-73xxx*

	4mm/ 0.7	5mm/ 0.8	6mm/ 1.0	8mm/ 1.25	10mm/ 1.50	12mm/ 1.75
8		73721	73734			
10	73711	73722	73735	73770		
12	73712	73723	73736	73771		
16	73714	73725	73738	73772		
20	73715	73726	73739	73773	73794	73835
25	73716	73727	73740	73774	73795	73836
30	73717	73728	73741	73775	73796	73837
35		73729	73742	73776	73797	73838
40		73730	73743	73777	73798	73839
45		73731	73744	73778	73799	73840
50		73732	73745	73779	73800	73841
55			73746	73780	73801	73842
60			73747	73781	73802	73843
65			73748	73782	73803	73844
70			73749	73783	73804	73845
75			73750	73784	73805	73846
80			73751	73785	73806	73847
90			73753	73787	73808	73849
100				73788	73809	73850

## Hex Caps Screws

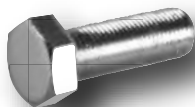

*77xxx for Stainless Steel Hex Caps or for Polished add SP-77xxx*

	4mm/ 0.7	5mm/ 0.8	6mm/ 1.0	8mm/ 1.25	10mm/ 1.50	12mm/ 1.75
10	77711	77722	77735	77770		
16	77714	77725	77738	77772	77793	
20	77715	77726	77739	77773	77794	77835
25	77716	77727	77740	77774	77795	77836
30	77717	77728	77741	77775	77796	77837
35		77729	77742	77776	77797	77838
40		77730	77743	77777	77798	77839
45		77731	77744	77778	77799	77840
50		77732	77745	77779	77800	77841
55			77746	77780	77801	77842
60			77747	77781	77802	77843
65			77748	77782	77803	77844
70			77749	77783	77804	77845
75			77750	77784	77805	77846
80			77751	77785	77806	77847
90			77753	77787	77808	77849
100			77755	77788	77809	77850
110			77756	77789	77810	77851

## Button Head Allen Screws



*72xxx for Stainless Steel Allen Button Heads or for Polished add SP-72xxx*

	4mm/ 0.7	5mm/ 0.8	6mm/ 1.0	8mm/ 1.25	10mm/ 1.50
8	72710	72721	72734		
10	72711	72722	72235	72770	
12	72712	72723	72736	72771	
16	72714	72725	72738	72772	72793
20		72726	72739	72773	72794
25		72727	72740	72774	72795
30		72728	72741	72775	72796

## Flat Head Allen Screws



*71xxx for Stainless Steel Flat Head Allens or for Polished add SP-71xxx*

	4mm/ 0.7	5mm/ 0.8	6mm/ 1.0	8mm/ 1.25	10mm/ 1.50
6	71709				
8	71710	71721	71734		
10	71711	71722	71235		
12	71712	71723	71736	71771	
16	71714	71725	71738	71772	71793
20	71715	71726	71739	71173	71794
25	71716	71727	71740	71774	71795
30	71717	71728	71741	71775	71796

## Carriage Bolts



*79xxx for Stainless Steel Flat Head Allens or for Polished add SP-79xxx*

	10mm/ 1.50
25	79795
50	79800
60	79802

**Key: Read Across For Diameter  
Read Down For Length**

*Call if you do not see  
the sizes you need !*

**Metric  
Bulk Stainless**



# Bulk Stainless Fasteners Metric

## Washers Stainless Steel

### Flat Washers

Size	Part #
4mm	75985
5mm	75986
6mm	75987
8mm	75989
10mm	75990
12mm	75991
14mm	75992
16mm	75993



### Lock Washers

Size	Part #
4mm	76985
5mm	76986
6mm	76987
8mm	76989
10mm	76990
12mm	76991
14mm	76992
16mm	76993



### Wave Washers

Size	Part #
5mm	76986W
6mm	76987W
8mm	76989W
10mm	76990W



**Example:** To order a 6 x 10 Oval Phillips Machine Screw: Use **Chart #1** for head style part number which would be "89". Look up diameter and length from **Chart #2** for last three digits 6 x 10 is 735. Put the two together for a part number of **89735**, or simply order by style and size. **Include the Prefix SP-89735 for Stainless Steel Polished**



Cheesehead

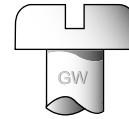

Pan



Oval

## Nuts Stainless Steel

### Hex Nuts

Size	Part #
4mm x .70	70950
5mm x .80	70952
6mm x 1.0	70954
7mm x 1.0	70956
8mm x 1.25	70958
10mm x 1.0	70959
10mm x 1.25	70961
10mm x 1.50	70962
12mm x 1.50	70965
12mm x 1.75	70966



### Jam Nuts

Size	Part #
8mm x 1.25	67958
10mm x 1.50	67962
12mm x 1.75	67966



*For Stainless Steel Polished Order with the SP-Prefix than the five digit Part # SP-xxxxx*

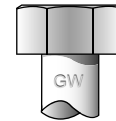

Hex



Flat

### Chart #1: Select Styles

Style	Slotted	Phillips
Round Head	99	N/A
Flat Head	98	94
Truss Head	93	N/A
Oval Head	97	89
Pan Head	96	92
Cheesehead	78	N/A
Hex	77	N/A

### Chart #2: Metric Machine Screws

	m3	m4	m5	m6	m8
8mm	701	710	721	734	770
10mm	702	711	722	735	771
12mm	703	712	723	736	772
16mm	705	714	725	738	773
29mm	706	715	726	739	774
25mm	707	716	727	740	775
30mm	708	717	728	741	776
35mm				742	777

### Nylon Lock Nuts

Size	Part #
4mm x .70	69950
5mm x .80	69952
6mm x 1.0	69954
8mm x 1.25	69958
10mm x 1.50	69962
12mm x 1.75	69966



All Items shown on this page can be purchased individually



## Hex Cap Screws Zinc Plated

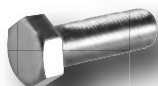

07xxx for Zinc  
Hex Caps

	4mm/ 0.7	5mm/ 0.8	6mm/ 1.0	7mm/ 1.0	8mm/ 1.25	10mm/ 1.50	Fine Thread		Fine Thread	
							10mm/ 1.25	12mm/ 1.75	12mm/ 1.50	
10	07711	07722	07735	07760	07770					
16	07714	07725	07738	07762	07772	07793				
20	07715	07726	07739	07763	07773	07794	07816	07835	07856	
25	07716	07727	07740	07764	07774	07795	07817	07836	07857	
30	07717	07728	07741	07765	07775	07796	07818	07837	07858	
35		07729	07742	07766	07776	07797	07819	07838	07859	
40		07730	07743	07767	07777	07798	07820	07839	07860	
45		07731	07744		07778	07799	07821	07840	07861	
50		07732	07745	07769	07779	07800	07822	07841	07862	
55			07746		07780	07801	07823	07842	07863	
60			07747		07781	07802	07824	07843	07864	
65			07748		07782	07803	07825	07844	07865	
70			07749		07783	07804	07826	07845	07866	
75			07750		07784	07805		07846	07867	
80			07751		07785	07806	07828	07847	07868	
90			07753		07787	07808	07830	07849	07870	
100			07755		07788	07809	07831	07850	07871	
110			07756		07789	07810		07851	07872	
120			07757		07790	07811	07833	07852		

Metric Bulk Zinc

## Allen Screws Zinc Plated



For Metric Zinc Allen  
with Knurls use 08xxx

**Key: Read Across For Diameter  
Read Down For Length**

Call if you do not see  
the sizes you need !

	4mm/ 0.7	5mm/ 0.8	6mm/ 1.0	8mm/ 1.25	8mm/ 1.0	10mm/ 1.50	10mm/ 1.25	12mm/ 1.75
8		08721	08734					
10	08711	08722	08735	08770				
12	08712	08723	08736	08771				
16	08714	08725	08738	08772				
20	08715	08726	08739	08773		08794		
25	08716	08727	08740	08774	08774F	08795		08836
27			08740A					
30	08717	08728	08741	08775	08776F	08796	08818	08837
35	08718	08729	08742	08776		08797	08819	08838
40	08719	08730	08743	08777	08778F	08798		08839
45	08720	08731	08744	08778		08799	08821	08840
50	08720A	08732	08745	08779		08800	08822	08841
55			08746	08780		08801		08842
60			08747	08781		08802	08824	08843
65			08748	08782		08803	08825	08844
70			08749	08783		08804		08845
75			08750	08784		08805		08846
80				08785		08806		08847
85							08829	
90						08808	08830	08849
95								
100						08809	08831	
110								
115								
120						08811		





# Bulk Zinc Fasteners Metric

## Washers Zinc Plated

### Flat Washers

Size	Part #
4mm	04985
5mm	04986
6mm	04987
8mm	04989
10mm	04990
12mm	04991
14mm	04992
16mm	04993



### Lock Washers

Size	Part #
4mm	05985
5mm	05986
6mm	05987
8mm	05989
10mm	05990
12mm	05991
14mm	05992
16mm	05993



## Nuts Zinc Plated

### Hex Nuts

Size	Part #
4mm x .70	06950
5mm x .80	06952
6mm x 1.0	06954
7mm x 1.0	06956
8mm x 1.0	06957
8mm x 1.25	06958
10mm x 1.25	06961
10mm x 1.50	06962
12mm x 1.25	06963
12mm x 1.50	06965
12mm x 1.75	06966
14mm x 1.50	06967
14mm x 2.00	06968
16mm x 1.50	06969
16mm x 2.00	06970

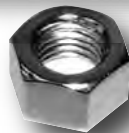

### Nylon Insert Lock Nuts

Size	Part #
4mm x .70	03950
5mm x .80	03952
6mm x 1.0	03954
7mm x 1.0	03956
8mm x 1.0	03957
8mm x 1.25	03958
10mm x 1.25	03961
10mm x 1.50	03962
12mm x 1.25	03963
12mm x 1.50	03965
12mm x 1.75	03966
14mm x 1.50	03967
14mm x 2.00	03968
16mm x 1.50	03969
16mm x 2.00	03970



*Gardner-Westcott*

**SECOND TO NONE**



## Inside This Section

### American Thread Chrome Plated

Tray Assortments.....	58-59
Speciality Assortments.....	60
Shop Master Assortments.....	61

### American Thread Stainless Steel

Tray Assortments.....	62
Allen Screws.....	62
Hex caps.....	62
Hex Nuts and Lock Nuts.....	62
Washers.....	62

### Zinc Plated

Tray Assortments.....	63
Allen Screw.....	63
Hex Caps.....	63
Hex Nuts.....	63
Washers and Lock Nuts.....	63
The Shop Master.....	63

### Brass Fittings Chrome Plated

Tray Assortment.....	64
----------------------	----

**Assortments in  
Chrome Plated,  
Stainless Steel & Zinc**



**Custom  
and  
Speciality  
Assortments  
Available**



# Assortments in American Thread

## Tray Assortments (Chrome Plated)

### Acorn Nuts

Acorn Nuts #8 thru 5/8 Coarse & Fine - (14 Sizes & 109 Pieces).....	A-7	---
Acorn Nuts 1/4 thru 1/2 Coarse & Fine - (12 Sizes & 120 pieces).....	A-5	---
Acorn Nuts Low Crown 8/32-5/8-18 - (15 Sizes & 108 Pieces).....	A-148	---



Acorn Nut

Low  
Crown  
Acorn

### Allen Head Screws

4-40, 6/32, 8/32, 12/24 - (24 Sizes & 240 Pieces).....	A-39	A-39-P
10/24 & 10/32 - (23 Sizes & 230 Pieces).....	A-38	A-38-P
8/32, 10/24, 10/32, 1/4-28 - (24 Sizes & 205 Pieces).....	A-41	A-41-P
1/4-20 - (16 Sizes & 150 Pieces).....	A-40	A-40-P
1/4-28 - (12 Sizes & 120 Pieces).....	A-37	A-37-P
5/16-18 - (12 Sizes & 110 Pieces).....	A-42	A-42-P
5/16-24 - (12 Sizes & 115 Pieces).....	A-43	A-43-P
3/8-16 - (12 Sizes & 90 Pieces).....	A-44	A-44-P
3/8-24 - (12 Sizes & 85 Pieces).....	A-45	A-45-P
7/16 -14 - (11 Sizes & 72 Pieces).....	A-46	A-46-P
7/16-20 - (10 Sizes & 59 Pieces).....	A-47	A-47-P
1/2-13 - (11 Sizes & 72 Pieces).....	A-48	A-48-P
1/2-20 - (10 Sizes & 57 Pieces).....	A-49	A-49-P
1/4, 5/16, 3/8 Coarse - (24 Sizes & 220 Pieces).....	24-CA	24-CAP
1/4, 5/16, 3/8 Fine - (23 Sizes & 210 Pieces).....	24-FA	24-FAP



Chrome Allen



Polished Allen

### Body & Spinloc Bolts

1/16, 3/32, 1/8, 3/16 - (20 Sizes & 200 Pieces).....	A-201	---
--	-------	-----

Body Bolt



### Button Head Allen Screws

8/32, 10/24, 10/32, 1/4-28 - (20 Sizes & 101 Pieces).....	A-25	---
1/4-20, 5/16-18, 3/8-16 - (24 Sizes & 112 Pieces).....	A-26	---
1/4-28, 5/16-18, 3/8-16 - (24 Sizes & 112 Pieces).....	A-26F	---
5/16-24, 3/8-24, 1/2-13 - (14 Sizes & 67 Pieces).....	A-27	---

Button Head Allen



### Cotter Pins

1/16, 3/32, 1/8, 3/16 - (9 Sizes & 425 Pieces).....	A-34C	---
---	-------	-----

### Flat Head Allen Screws

8/32, 10/24, 10/32, 1/4-28 - (24 Sizes & 240 Pieces).....	A-10	---
8/32, 10/32, 1/4-28, 5/16-24, 3/8-24 - (16 Sizes & 160 Pieces).....	A-9	---
1/4, 5/16, 3/8 Coarse - (24 Sizes 112 Pieces).....	A-28	---
1/4, 5-16, 3/8 Fine - (24 Sizes 112 Pieces).....	A-28F	---

Flat Head Allen



### Flexloc® Nuts

#10 thru 1/2 Coarse & Fine - (12 Sizes & 110 Pieces).....	A-11	---
---	------	-----

Flexloc®  
Nut

### Flexloc® Jam Nuts

#10 thru 1/2 Coarse & Fine - (12 Sizes & 110 Pieces).....	A-12	---
Nuts & Jam Flexloc Nuts 1/4 thru 5/8 - (24 Sizes & 240 Pieces).....	A-19	---

Flexloc®  
Jam Nut

### Hex Cap Screws

1/4, 5/16, 3/8 Coarse - (24 Sizes & 220 Pieces).....	24-C	---
1/4, 5/16, 3/8 Fine - (24 Sizes & 220 Pieces).....	24-F	---
7/16 & 1/2 Coarse - (11 Sizes & 80 Pieces).....	23-C	---
7/16 & 1/2 Fine - (12 Sizes & 90 Pieces).....	23-F	---
7/16 & 1/2 Coarse - (2 Diameters at various length with 90 Pieces).....	31-C	---
7/16 & 1/2 Fine - (2 Diameters at various length with 90 Pieces).....	31-F	---

Hex Cap



### Hex Nuts

6/32 thru 5/8 Coarse & Fine - (16 Sizes & 534 Pieces).....	A-30	---
1/4 thru 3/8 Hex Nuts, Flat & Lock Washers - (12 Sizes & 1200 Pieces).....	12-W	---
7/16 thru 5/8 Hex Nuts, Flat & Lock Washers - (12 Sizes & 540 Pieces).....	23-W	---

Hex Nut









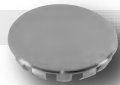
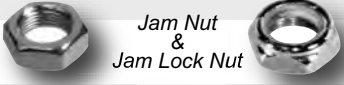

# Assortments in American Thread



**Assortments  
Chrome**

## Tray Assortments (Chrome Plated)

	Chrome Part #	
<b>Fillister Head Slotted</b> ( <i>Machine Screws</i> )		
6/32 thru 1/4-20 Coarse & Fine - (24 Sizes & 240 Pieces).....	A-179	Slotted Fillister
<b>Flat Head Slotted</b> ( <i>Machine Screws</i> )		
6/32 thru 1/4-20 Coarse & Fine - (24 Sizes & 240 Pieces).....	A-73-C	
<b>Flat Head Slotted</b> ( <i>Sheet Metal Screws</i> )		
#4 thru #14 - (23 Sizes & 230 Pieces).....	A-75-C	
<b>Hole Plugs</b>		
Brass & Chrome 3/16 thru 1 1/2 - (16 Sizes & 219 Pieces).....	A-76	Hole Plug
Chrome 3/16 thru 3/4 - (7 Sizes & 130 Pieces).....	A-77	
Flat Black 3/16 thru 1 1/2 - (16 Sizes & 219 Pieces).....	A-76-FB	
Gloss Black 3/16 thru 3/4 - (7 Sizes & 130 Pieces).....	A-77-GB	
<b>Jam Nuts &amp; Jam Lock Nuts</b>		
1/4 thru 5/8 Coarse & Fine - (24 Sizes & 220 Pieces).....	A-14	Jam Nut & Jam Lock Nut
1/4 thru 1/2 Coarse & Fine - (20 Sizes & 160 Pieces).....	A-55	
<b>Lock Nuts Nylon Insert</b>		
#10 thru 5/8 Coarse & Fine - (11 Sizes & 190 Pieces).....	A-8	Nylon Insert Lock Nut
4/40 thru 3/4 Coarse & Fine - (20 Sizes & 274 Pieces).....	A-18	
<b>Oil Line Fitting</b> ( <i>Chrome Plated Brass</i> )		
Special selected fittings - (12 Sizes & 75 Pieces).....	A-52	(See Upper Portion of Pg. 64 For more Details)
<b>Oval Head</b> ( <i>Machine Screws</i> )		
4/40 thru 3/8 Phillips Coarse & Fine - (24 Sizes & 240 Pieces).....	A-175	Oval Phillips Machine Screw
4/40 thru 3/8 Slotted Coarse & Fine - (24 Sizes & 240 Pieces).....	A-176	
<b>Oval Head</b> ( <i>Sheet Metal Screws</i> )		
#4 thru #14 Phillips - (24 Sizes & 240 Pieces).....	A-202	Oval Slotted Machine Screw
#4 thru #14 Slotted - (24 Sizes & 240 Pieces).....	A-203	
<b>Pan Head Slotted</b> ( <i>Sheet Metal Screws</i> )		
#8, #10, #12 & #14 - (24 Sizes & 240 Pieces).....	A-74-C	Oval Phillips Sheet Metal Screw
<b>Round Head Slotted</b> ( <i>Sheet Metal Screws</i> )		
4/40, 5/40, 6/32 & 8/32 - (23 Sizes & 230 Pieces).....	A-71-C	
10/24, 10/32 & 12/24 - (21 Sizes & 210 Pieces).....	A-72-C	
<b>Spacers</b>		(See Pg. 60 For more Details)
<b>Torx Button Head</b>		
8/32, 10/24, 10/32, 1/4-28 - (24 Sizes & 240 Pieces).....	A-180	Torx Button Head
1/4-20, 5/16, 3/8, 1/2 - (24 Sizes & 235 Pieces).....	A-181	
<b>Washers</b>		
#8 thru 5/8 Flat & Lock Washers - (16 Sizes & 960 Pieces).....	A-31	Flat Washer
#6 thru 5/8 Internal, External & AN - (22 Sizes & 435 Pieces).....	A-33	Lock Washer
<b>Washers G-W Heat Treated</b>		
#8 thru 5/8 Flat & Lock Washers - (16 Sizes & 960 Pieces).....	A-29	(See Lower Portion of Pg. 60 For more Details)
AN #8 thru 3/4 & Std. 1/4 thru 5/8 - (21 Sizes & 435 Pieces).....	A-160	
<b>12 Point Screws</b>		
1/4-20 Coarse - (16 Sizes & 155 Pieces).....	A-240	12 Point Screw
1/4-28 Fine - (20 Sizes & 141 Pieces).....	A-241	
5/16-18 Coarse - (12 Sizes & 102 Pieces).....	A-242	
5/16-24 Fine - (12 Sizes & 97 Pieces).....	A-243	
3/8-16 Coarse - (12 Sizes & 105 Pieces).....	A-244	
3/8-24 Fine - (12 Sizes & 105 Pieces).....	A-245	
7/16-14 & 7/16-20 - (6 Sizes & 75 Pieces).....	A-247	
1/2-13 & 1/2-20 - (16 Sizes & 80 Pieces).....	A-248	
1/4, 5/16, 3/8 Coarse - (24 Sizes & 220 Pieces).....	A-24-C	
1/4, 5/16, 3/8 Fine - (24 Sizes & 220 Pieces).....	A-24-F	



# Assortments in American Thread

## Speciality Assortments (Chrome Plated)

Chrome Part # Polished Part #

### Allen Head Assortment Groups (Includes; 6 Metal Trays & 1 Cabinet with items listed below)

A-40 - (1/4-20 Sizes), A-41 - (8/32, 10/24, 10/32, 1/4-28 Sizes), A-42 - (5/16-18 Sizes),  
 A-43 - (5/16-24 Sizes), A-44 - (3/8-16 Sizes), A-45 - (3/8-24 Sizes)..... A-50 A-50-P

### 12 Point Screw Assortment Groups (Includes; 6 Metal Trays & 1 Cabinet with items listed below)

A-240 - (1/4-20 Sizes), A-241 - (1/4-28 Sizes), A-242 - (5/16-18 Sizes),  
 A-243 - (5/16-24 Sizes), A-244 - (3/8-16 Sizes), A-245 - (3/8-24 Sizes)..... A-250 ---

### Chrome Plated Brass Fitting Assortment (Includes; 1 Metal Tray with items listed below)

Chrome Plated Brass Fittings - (Straight Hose Barb Male Pipe Rigid, Straight  
 Street Elbow, 45° Street Elbow, Hose Tee, Socket Pipe Plug, Hex Head Pipe Plug,  
 Sleeve Nut & Washer Seals)..... A-52 ---

### Spacer Assortments (Includes; 1 Metal Tray with a 12 or 16 size compartment either with items listed below)

Featuring 12 Sizes - (I.D.'s 3/8, 7/16 & 5/8)..... A-16 ---  
 Featuring 16 Sizes - (I.D.'s 1/4 & 5/16 with Lengths from 1/4 to 1 1/4)..... A-15 ---

### Spike Nuts

Featuring 11 Sizes - (11 Sizes & 78 Pieces)..... A-97 ---

Non-Alcoholic but may be habit forming



Sizes	1/4 -20	1/4 -28	5/16 -18	5/16 -24	3/8 -16	3/8 -24
Part #	26546	26547	26548	26549	26550	26551
	7/16 -14	7/16 -20	1/2 -13	1/2 -20	5/8 -18	
	26552	26553	26554	26555	26559	

Can be purchased individually

## The G-W Hardened Flat Washer

**GARDNER-WESTCOTT COMPANY** is proud to supply the first flat washer strong enough to use on motor mounts or belt sprockets and with the exceptional cosmetic quality to be used on a show bike. This hardened steel washer is thicker than standard flat washers and has a close tolerance ID for a snug fit. It has a standard OD so it can be used anywhere a regular washer was. Now available in bulk from 1/4" thru 5/8" or in Assortment # A-29 which includes; #8, #10, 1/4, 5/16, 3/8, 7/16, 1/2 and 5/8 diameter G-W Hardened Flat Washers including Lock Washers -- all show chromed, labeled and in a metal tray.



Also Available in Stainless Steel Sold Individually

### G-W Heat Treated Washer & Lock Washer (Includes; 1 Metal Tray with Items Listed Below)

Chrome Part # Polished Part #

Flat Washers - (#8, #10, 1/4, 5/16, 3/8, 7/16, 1/2, 5/8)  
 Lock Washers - (#8, #10, 1/4, 5/16, 3/8, 7/16, 1/2, 5/8)..... A-29 ---



**Assortments  
Chrome**

## MASTER ASSORTMENT

Part # A-98 consists of 6 trays (2,221 individual pieces) and includes the sliding drawer cabinet. Each tray is clearly labeled for ease in identification and re-ordering. This assortment contains 2 trays of Hex Caps 1/4, 5/16 and 3/8 inch diameter both coarse and fine thread; (Note Allen Screws or Bow Tie Hex Caps may be substituted for the Hex Caps) 1 Tray with Washers and Hex Nuts 1/4, 5/16 & 3/8 and 1 Tray each of Button Head Allens, Flat Head Allens and Oval Phillips Machine Screws.

Trays can be purchased separately also. To organize your current stock you can purchase empty trays and bins. We offer hundreds of assortments - call us to customize trays for your shop.

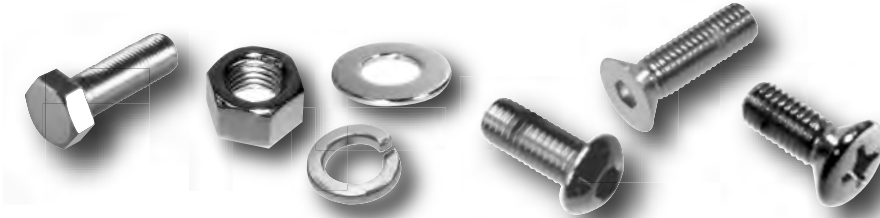

Hex Caps	Part #
Coarse Thread 1/4 thru 3/8..... 24 Sizes.....	# 24-C
Fine Thread 1/4 thru 3/8..... 24 Sizes.....	# 24-F
<b>Hex Nuts, Flat and Lock Washers</b>	
1/4 thru 3/8..... 12 Sizes.....	#12-W
<b>Button Head Allen Screws</b>	
8/32 thru 1/4-28..... 20 Sizes.....	# A-25
<b>Flat Head Allen Screws</b>	
8/32 thru 3/8-16..... 24 Sizes.....	# A-10
<b>Machine Screws Oval Head Phillips</b>	
4/40 thru 3/8-24..... 24 Sizes.....	# A-175



*When You Demand The Best  
Why Settle For Less...*





# Assortments in American Thread

## Tray Assortments (Stainless Steel)

### Acorn Nuts

Acorn Nuts #8 thru 5/8 Coarse & Fine - (14 Sizes & 113 Pieces)..... A-7-S A-7-SP



Low Crown  
Acorn Nut

### Allen Head Screws

4-40, 6/32, 8/32, 12/24 - (24 Sizes & 240 Pieces)..... A-39-S A-39-SP

1/4-20 - (12 Sizes & 120 Pieces)..... A-40-S A-40-SP

8/32, 10/24, 10/32, 1/4-28 - (21 Sizes & 190 Pieces)..... A-41-S A-41-SP

5/16-18 - (12 Sizes & 120 Pieces)..... A-42-S A-42-SP

5/16-24 - (10 Sizes & 100 Pieces)..... A-43-S A-43-SP

3/8-16 - (12 Sizes & 90 Pieces)..... A-44-S A-44-SP

3/8-24 - (9 Sizes & 75 Pieces)..... A-45-S A-45-SP

7/16 -14 Coarse & Fine - (12 Sizes & 82 Pieces)..... A-46-S ----

1/4-28, 5/16-24, 3/8-24 Fine - (24 Sizes & 210 Pieces)..... ---- 24-FASP



Stainless Steel  
Knurled Allen



Stainless Steel  
Polished Allen

### Allen Head Screw Assortment Group

Contains; 1 Metal Cabinet with 6 Trays & the following 6 sets

A-40-S, A-41-S, A-42-S, A-43-S, A-44-S, A-45-S - (83 Sizes & 621 Pieces)..... A-50-S A-50-SP

### Button Head Allen Screws

8/32, 10/24, 10/32, 1/4-28 - (20 Sizes & 102 Pieces)..... A-25-S ----

1/4-20, 5/16-18, 3/8-16 - (24 Sizes & 114 Pieces)..... A-26-S ----

5/16-24, 3/8-24, 1/2-13 - (14 Sizes & 64 Pieces)..... A-27-S A-27-SSP



Button Head Allen

### Flat Head Allen Screws

8/32, 10/24, 10/32, 1/4-28 - (20 Sizes & 200 Pieces)..... A-10-S A-10-SSP



Flat Head Allen

### Hex Caps

1/4, 5/16, 3/8 Coarse - (24 Sizes & 227 Pieces)..... A-24-CS A-24-CSP

1/4, 5/16, 3/8 Fine - (24 Sizes & 227 Pieces)..... A-24-FS A-24-FSP

7/16, 1/2 Coarse & Fine - (20 Sizes & 155 Pieces)..... A-23-CS A-23-CSSP

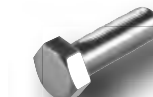

Hex Cap

### Hex Nuts

6/32 thru 5/8 Coarse & Fine - (16 Sizes & 534 Pieces)..... A-30-S A-30-SP

1/4 thru 3/8 Hex Nuts, Flat & Lock Washers - (12 Sizes & 1200 Pieces)... 12-W-S 12-W-SP

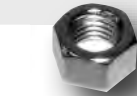

Hex Nut

### Lock Nuts Nylon Insert

6/32 thru 5/8-18 Coarse & Fine - (16 Sizes & 279 Pieces)..... A-32-S A-32-SP



Nylon Insert Lock Nut

### Slotted Fillister Head (Machine Screw)

6/32, 8/32, 10/24, 10/32, 12/24, 1/4 - (24 Sizes & 240 Pieces)..... A-178 ----



Slotted  
Fillister

### Washers

#8 thru 5/8 Flat & Lock Washers - (16 Sizes & 960 Pieces)..... A-31-S A-31-SP

#6 thru 5/8 Internal, External & AN - (22 Sizes & 880 Pieces)..... A-33-S ----



Flat & Lock Washer



## Zinc Plated Fastener Assortments THE SHOP MASTER

Offering a full line of fastener assortments is important. Custom Vehicles need custom fasteners and that's why we make fastener assortments with the custom builder in mind. The organization of your stock is important, why waste time looking for a nut or bolt. **Gardner-Westcott's** assortments organize styles and sizes for fast access and easy stock control. All assortments come in metal tray and are labeled inside and outside for your convenience.....

**Assortments  
Zinc**

**A-70**  
6 Trays  
in Cabinet

Part #

**A-34**



Contents of each Tray

**Cotter Pins**

**A-71**



**Round Slotted Screws 4/40, 5/40, 6/32, 8/32**

**A-72**



**Round Slotted Screws 10/24, 10/32, 12/24**

**A-73**



**Flat Head Slotted Screws 4/40, 6/32, 8/32, 10/24, 10/32**

**A-74**



**Pan Slotted Sheet Metal Screws #4, 6, 8, 10, 12**

**A-75**



**Flat Head Slotted Sheet Metal Screws #4, 6, 8, 10, 12, 1/4"**

**A-76**



**Hole Plugs 3/16" thru 1"**

**A-90**  
4 Trays  
in Cabinet

**A-91**



**Hex Nuts American Thread #4/40 thru 3/4-16**

**A-92**



**Nylon Lock Nuts American Thread #4/40 thru 3/4-16**

**A-93**



**Flat Washers & Lock Washers #4 thru 3/4"**

**A-94**



**External, Internal Star, AN sm. OD & Fender lg. OD Washers**

**A-80**  
4 Trays  
in Cabinet

**A-82**



**Hex Cap American Thread 1/4-20 & 1/4-28 Diameter**

**A-83**



**Hex Cap American Thread 5/16-18 & 5/16-24 Diameter**

**A-84**



**Hex Cap American Thread 3/8-16 Diameter**

**A-85**



**Hex Cap American Thread 3/8-24 Diameter**

**A-81**  
2 Trays  
in Cabinet

**A-86**



**Hex Cap American Thread 7/16-14 & 7/16-20 Diameter**

**A-87**



**Hex Cap American Thread 1/2-13 & 1/2-20 Diameter**

Part # A-100





# Assortments in American Thread

## Hand Polished Brass Chrome Plated

Part #

**Brass Fittings Chrome Plated** ..... 12 Sizes..... # A-52

includes select sizes of the following fittings: Straight Hose Barb Male Pipe Rigid, Straight Hose Barb Male Pipe Rigid, Street Elbow, 45° Street Elbow, Hose Tee, Socket Pipe Plug, Hex Head Pipe Plug, Sleeve Nut and Washer Seal.



Chrome Plated Brass Tray Assortment #A-52

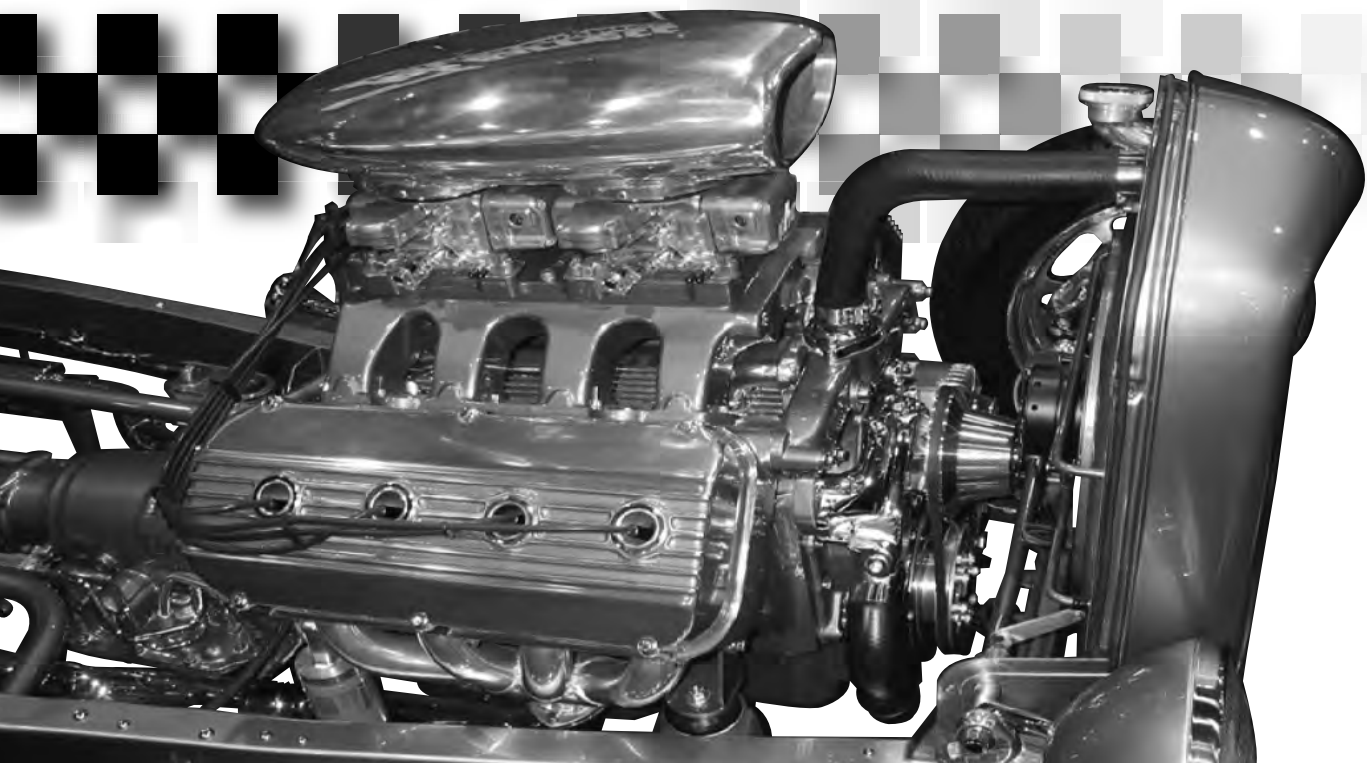



## Inside This Section

### Metric Thread Chrome Plated

- Tray Assortments..... 66
- Acorn Nuts & Spacers..... 66
- Allen Head Screws..... 66
- Hex Caps..... 66
- Nylon Insert Lock Nuts..... 66
- Flat & Lock Washers..... 66
- Speciality Dealer Assortments..... 67

### Metric Thread Stainless Steel

- Tray Assortments..... 68
- Allen Head Screws..... 68
- Hex Caps..... 68
- Hex Nuts & Lock Nuts..... 68
- Flat & Lock Washers..... 68

### Metric Thread Zinc Plated

- Tray Assortments..... 68
- Allen Head Screws..... 68
- Hex Caps..... 68
- Hex Nuts & Lock Nuts..... 68
- Flat & Lock Washers..... 68

**Assortments in  
Chrome Plated and  
Stainless Steel**

**Detailed Custom  
Assortments with  
Speciality Lengths  
and Diameters  
Available**





# Assortments in Metric Thread

## Tray Assortments (Chrome Plated)

### Acorn Nuts and Spacers Combination

Acorn Nuts 4mm thru 12mm

Spacers 1/4 x 1/4 thru 3/8 x 1 - (15 Sizes & 140 Pieces)..... A-62

Chrome  
Part #

Polished  
Part #



Acorn Nut

### Allen Head Screws

4mm & 5mm - (24 Sizes & 210 Pieces)..... A-301-C

A-301-P

5mm & 6mm - (16 Sizes & 240 Pieces)..... A-21

A-21-P

6mm with (special 6m x 27m & 8m - 70m) - (16 Sizes & 160 Pieces)..... A-325-C

A-325-P

6mm (8m - 75m) - (24 Sizes & 120 Pieces)..... A-302-C

A-302-P

8mm x 1.25 (10m - 80m) - (16 Sizes & 130 Pieces)..... A-326-C

A-326-P

8mm x 1.25 (10m - 60m)

also 8mm x 1.0 (25m - 50m) - (16 Sizes & 124 Pieces)..... A-303-C

A-303-P

8mm (10m - 50m) & 10mm x 1.50 (25m - 65m)..... -----

A-328-P

10mm x 1.50 (20m - 75m) - (12 Sizes & 95 Pieces)..... A-327-C

A-327-P

10mm x 1.50 (20m - 65m)

also 10mm x 1.25 (25m - 50m) - (16 Sizes & 120 Pieces)..... A-304-C

A-304-P

10mm x 1.50 (70m - 100m)

also 10mm x 1.25 (55m - 90m) - (12 Sizes & 60 Pieces)..... A-308-C

A-308-P

12mm x 1.75 (25m - 90m) - (12 Sizes & 60 Pieces)..... A-305-C

A-305-P



Chrome Allen



Polished Allen

### Allen Screw Combination

Allens - 5mm x 12 - 10mm x 1.5 x 55

Flat Head - 4mm x 12 - 6mm x 16, 6mm x 35

Button Head - 6mm x 16 - 6mm x 30 - (25 Sizes & 205 Pieces)..... A-25-C

A-25-P



Flat  
Head Allen

### Button Head Allen Screws

4mm x 6m - 4m x 25, 5mm x 5 - 5m x 30

also 6mm x 8m - 6m x 35m - (23 Sizes & 230 Pieces)..... A-315

-----



Button Head

### Hex Caps

6mm x 12 - 6m x 50, 8mm x 12 - 8m x 55

also 10mm x 1.25 x 20 - 10m x 1.25 x 50 - (24 Sizes & 205 Pieces)..... 24-M

-----

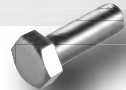

Hex Cap

### Hex Nut and Nylon Insert Lock Nut Combination

Hex Nuts 4mm thru 12mm

Lock Nuts 4mm thru 12mm - (24 Sizes & 365 Pieces)..... A-61-C

-----



Hex Nut

### Flat & Lock Washer Combination

Flat Washers 3mm thru 14mm

Lock Washers 3mm thru 14mm - (16 Sizes & 430 Pieces)..... A-60-C

-----



Flat & Lock Washers



A-326-P



A-60



A-61

# Assortments in Metric Thread



**Metric  
Chrome**

## Metric Master Assortment

This Chrome Fastener set up will make it easy to customize your vehicle. Featuring **Metric Allen Screws**, including the following items. Flat Washers, Lock Washers, Hex Nuts and Lock Nuts all in **Show Chrome**. Contains all six metal tray assortments housed in a metal drawer cabinet.

A-301-P		Metric Polished Allen Screws Chrome Finish 4 mm and 5 mm Gardner-Westcott Assortment # A-301-P	Allen Screws 4mm and 5mm
A-325-P		Metric Polished Allen Screws Chrome Finish 6mm Gardner-Westcott Assortment # A-325-P	Allen Screws 6mm
A-326-P		Metric Polished Allen Screws Chrome Finish 8mm Gardner-Westcott Assortment # A-326-P	Allen Screws 8mm
A-327-P		Metric Polished Allen Screws Chrome Finish 10mm Gardner-Westcott Assortment # A-327-P	Allen Screws 10mm
A-60		Metric Flat & Lock Washers Chrome Finish 3mm - 14mm Gardner-Westcott Assortment # A-60	Flat Washers and Lock Washers
A-61		Metric Hex Nuts & Nylon Lock Nuts Chrome Finish Gardner-Westcott Assortment # A-61	Hex Nuts and Lock Nuts

All above is in Cabinet **Part # A-330-P** with Polished Chrome Allens, it is also available with Knurled Chrome Allens in Cabinet **Part # A-330-C**.

## Metric Assortments

**Part # A-300-P** is specially designed for the builder in mind. This assortment offers a wide range of sizes starting at 4mm up to 12mm. Includes special fine thread 8 & 10mm and also with longer lengths. The six metal trays are clearly labeled for ease in identification and the assortment includes the cabinet.

<p>Not included order separately</p>	A-301-P		Allen Head Screws 4mm and 5mm Gardner-Westcott Assortment # A-301-P	Allen Screws 4mm and 5mm	<p>Not included order separately</p>
	A-302-P		Allen Head Screws 6mm Gardner-Westcott Assortment # A-302-P	Allen Screws 6mm	
	A-303-P		Allen Head Screws 8mm Gardner-Westcott Assortment # A-303-P	Allen Screws 8mm Coarse & Fine	
	A-304-P		Allen Head Screws 10mm Gardner-Westcott Assortment # A-304-P	Allen Screws 10mm Coarse & Fine	
	A-308-P		Allen Head Screws 10mm Long Gardner-Westcott Assortment # A-308-P	Allen Screws 10mm Long Coarse & Fine	
	A-305-P		Allen Head Screws 12mm Gardner-Westcott Assortment # A-305-P	Allen Screws 12mm	
<p><b>Part #A-60-C includes Chrome Flat Washers and Lock Washers 3mm to 14mm</b></p>	A-61-C	<p><b>Part #A-61-C includes Hex Nuts and Lock Nuts in coarse and fine thread 4mm to 12mm</b></p>			



# Assortments in Metric Thread

## Tray Assortments (Stainless Steel)

### Allen Head Screws

	Stainless Part #	Polished Part #
5mm & 6mm - (16 Sizes & 200 Pieces).....	A-64	A-64-SP
4mm & 5mm - (24 Sizes & 205 Pieces).....	A-301-S	A-301-SP
6mm x 1.0 x 8 thru 6mm x 1.0 x 75 - (16 Sizes & 140 Pieces).....	A-302-S	A-302-SP
8mm x 1.25 x 12 thru 8mm x 1.25 x 80 - (15 Sizes & 120 Pieces).....	A-326-S	A-326-SP
8mm x 1.25 x 10 thru 8mm x 1.25 x 80 - (16 Sizes & 124 Pieces).....	A-303-S	A-303-SP
10mm x 20 thru 10mm x 75 - (12 Sizes & 95 Pieces).....	A-327-S	A-327-SP
10mm x 1.50 x 20 thru 10mm x 1.50 x 75 - (12 Sizes & 90 Pieces).....	A-304-S	A-304-SP
12mm x 1.75 x 25 thru 12mm x 1.75 x 90 - (12 Sizes & 60 Pieces).....	A-305-S	A-305-SP



Stainless Steel  
Knurled Allen



Stainless Steel  
Polished Allen

### Hex Caps

6mm x 12 thru 8mm x 1.25 x 50 - (16 Sizes & 160 Pieces).....	A-63	A-63-SP
6mm x 12 - 6m x 50, 8mm x 12 - 8m x 55 also 10mm x 1.25 x 20 - 10m x 1.25 x 50 - (24 Sizes & 205 Pieces).....	24-MS	-----

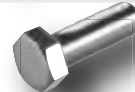

Hex Cap

### Hex Nut and Nylon Insert Lock Nut Combination

Hex Nuts 4mm thru 12mm Lock Nuts 4mm thru 12mm - (24 Sizes & 365 Pieces).....	A-65-S	A-65-SP
--	--------	---------

### Flat & Lock Washer Combination

Flat Washers 3mm thru 14mm Lock Washers 3mm thru 14mm - (16 Sizes & 430 Pieces).....	A-60-S	A-60-SP
---	--------	---------

## Tray Assortments (Zinc)

### Allen Head Screws

	Zinc Part #
4mm & 5mm - (24 Sizes & 205 Pieces).....	A-301-Z
6mm x 1.0 x 8 thru 6mm x 1.0 x 75 - (16 Sizes & 140 Pieces).....	A-325-Z
8mm x 1.25 x 10 thru 8mm x 1.25 x 80 - (16 Sizes & 124 Pieces).....	A-326-Z
10mm x 1.50 x 20 thru 10mm x 1.50 x 75 - (12 Sizes & 90 Pieces).....	A-327-Z
12mm x 1.75 x 25 thru 12mm x 1.75 x 90 - (12 Sizes & 60 Pieces).....	A-305-Z
8mm x 1.25 x 10 thru 8mm x 1.25 x 80 - (16 Sizes & 124 Pieces).....	A-303-Z
10mm x 1.50 x 20 thru 10mm x 1.50 x 75 - (12 Sizes & 90 Pieces).....	A-304-Z
10mm x 1.50 x 20 thru 10mm x 1.50 x 75 - Long - (12 Sizes & 90 Pieces).....	A-308-Z

Stainless Steel  
Knurled Allen



### Master Metric Zinc Allen Assortment

4mm & 5mm, 8mm x 1.25, 8mm x 1.0, 10mm x 1.25, 10mm x 1.50, 12mm x 1.75 x 90, 4mm thru 12mm Hex Nuts, Lock Nuts, Flat Washers & Lock Washers all in a (6) trayed cabinet.....	A-300-Z
--	---------

### Hex Caps

6mm x 1.0 x 8 thru 6mm x 1.0 x 75 - (16 Sizes & 140 Pieces).....	A-302-HZ
6mm x 1.0 x 8 thru 6mm x 1.0 x 75 - (16 Sizes & 140 Pieces).....	A-325-HZ
10mm x 20 thru 10mm x 75 - (12 Sizes & 95 Pieces).....	A-327-HZ
12mm x 1.75 x 25 thru 12mm x 1.75 x 90 - (12 Sizes & 60 Pieces).....	A-305-HZ
6mm, 8mm & 10mm - Long - (24 Sizes & 205 Pieces).....	A-24M-HZ



Nylon Insert  
Lock Nut

### Hex Nut and Nylon Insert Lock Nut Combination

Hex Nuts & Nylon Insert Lock Nuts 4mm thru 12mm - (24 Sizes & 365 Pieces).....	A-61-Z
--	--------



Hex Nut

### Flat & Lock Washer Combination

Flat Washers & Lock Washers 3mm thru 14mm - (16 Sizes & 430 Pieces).....	A-60-Z
--	--------

Flat & Lock  
Washers

### Flat & Lock Washer Hex Nuts Combination

Flat Washers, Lock Washers & Hex Nuts 6mm, 8mm & 10mm.....	A-12-WMZ
--	----------





## Inside This Section

### Fittings

<i>Pipe Fittings</i> .....	70-71
<i>Inverted Flare Fittings</i> .....	71-72
<i>Compression Fittings</i> .....	72-73
<i>Special Fittings</i> .....	73
<i>Vacuum Connectors</i> .....	74

**Chrome and Brass  
Fittings**





# Pipe Fittings

## Pipe Fittings

### Straight Hose Barb Male Pipe

Hose Size	Pipe Size	Brass Part #	Chrome Part #
3/8	1/8	90TD-6 x 2	7-90TD-6 x 2
1/4	1/8	90TD-4 x 2	7-90TD-4 x 2
3/8	1/4	90TD-6 x 4	7-90TD-6 x 4
1/2	1/4	90TD-8 x 4	7-90TD-8 x 4



### Straight Hose Barb Male Pipe

Hose Size	Pipe Size	Brass Part #	Chrome Part #
3/16	1/8	90HB-3 x 2	7-90HB-3 x 2
1/4	1/8	90HB-4 x 2	7-90HB-4 x 2
1/4	1/4	90HB-4 x 4	7-90HB-4 x 4
5/16	1/8	90HB-5 x 2	7-90HB-5 x 2
5/16	1/4	90HB-5 x 4	7-90HB-5 x 4
3/8	1/8	90HB-6 x 2	7-90HB-6 x 2
3/8	1/4	90HB-6 x 4	7-90HB-6 x 4



### 90° Hose Barb Male Pipe

Hose Size	Pipe Size	Brass Part #	Chrome Part #
1/4	1/8	91HB-4 x 2	7-91HB-4 x 2
1/4	1/4	91HB-4 x 4	7-91HB-4 x 4
5/16	1/8	91HB-5 x 2	7-91HB-5 x 2
5/16	1/4	91HB-5 x 4	7-91HB-5 x 4
3/8	1/8	91HB-6 x 2	7-91HB-6 x 2
3/8	1/4	91HB-6 x 4	7-91HB-6 x 4
3/8	3/8	91HB-6 x 6	7-91HB-6 x 6



### Street Elbows

Pipe Size	Brass Part #	Chrome Part #
1/8	116PSE-2	7-116PSE-2
1/4	116PSE-4	7-116PSE-4
3/8	116PSE-6	7-116PSE-6



### Street Elbows 45°

Pipe Size	Brass Part #	Chrome Part #
1/8	124PSE-2	7-124PSE-2
1/4	124PSE-4	7-124PSE-4
3/8	124PSE-6	7-124PSE-6



### Socket Pipe Plug

Pipe Size	Brass Part #	Chrome Part #
1/8	107CSP-2	7-107CSP-2
1/4	107CSP-4	7-107CSP-4
3/8	107CSP-6	7-107CSP-6



### Slotted Pipe Plug

Pipe Size	Brass Part #	Chrome Part #
1/8	117SPP-2	7-117SPP-2
1/4	117SPP-4	7-117SPP-4
3/8	117SPP-6	7-117SPP-6



### Hex Head Pipe Plug

Pipe Size	Brass Part #	Chrome Part #
1/8	121PP-2	7-121PP-2
1/4	121PP-4	7-121PP-4
3/8	121PP-6	7-121PP-6
1/2	121PP-8	7-121PP-8

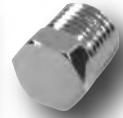

### Square Head Pipe Plug

Pipe Size	Brass Part #	Chrome Part #
1/8	109PP-2	7-109PP-2
1/4	109PP-4	7-109PP-4
3/8	109PP-6	7-109PP-6
1/2	109PP-8	7-109PP-8

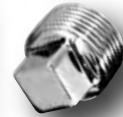

### Close Nipple

Pipe Size	Brass Part #	Chrome Part #
1/8	112PCN-2	7-112PCN-2
1/4	112PCN-4	7-112PCN-4
3/8	112PCN-6	7-112PCN-6



### Long Nipple

Pipe Size	Brass Part #	Chrome Part #
1/8 x 1 1/2	113PLN-2 x 1.5	7-113PLN-2 x 1.5
1/8 x 2	113PLN-2 x 2	7-113PLN-2 x 2
1/8 x 2 1/2	113PLN-2 x 2.5	7-113PLN-2 x 2.5
1/8 x 3	113PLN-2 x 3	7-113PLN-2 x 3
1/4 x 1 1/2	113PLN-4 x 1.5	7-113PLN-4 x 1.5
1/4 x 2	113PLN-4 x 2	7-113PLN-4 x 2
1/4 x 2 1/2	113PLN-4 x 2.5	7-113PLN-4 x 2.5
1/4 x 3	113PLN-4 x 3	7-113PLN-4 x 3
3/8 x 1 1/2	113PLN-6 x 1.5	7-113PLN-6 x 1.5
3/8 x 2	113PLN-6 x 2	7-113PLN-6 x 2



### Hex Nipple

Pipe Size	Brass Part #	Chrome Part #
1/8	122PHN-2	7-122PHN-2
1/4	122PHN-4	7-122PHN-4
3/8	122PHN-6	7-122PHN-6



### Hex Reducing Nipple

Pipe Size	Brass Part #	Chrome Part #
1/4 x 1/8	123PRN-4 x 2	7-123PRN-4 x 2
3/8 x 1/4	123PRN-6 x 4	7-123PRN-6 x 4



### Adapter

Pipe Size	Brass Part #	Chrome Part #
1/8 x 1/8	120PA-2 x 2	7-120PA-2 x 2
1/4 x 1/8	120PA-4 x 2	7-120PA-4 x 2
1/4 x 1/4	120PA-4 x 4	7-120PA-4 x 4
3/8 x 1/4	120PA-6 x 4	7-120PA-6 x 4





Fittings

## Pipe Bushing

Pipe Size	Brass Part #	Chrome Part #
1/4 x 1/8	110PB-4 x 2	7-110PB-4 x 2
3/8 x 1/8	110PB-6 x 2	7-110PB-6 x 2
3/8 x 1/4	110PB-6 x 4	7-110PB-6 x 4
1/2 x 1/4	110PB-8 x 4	7-110PB-8 x 4
1/2 x 3/8	110PB-8 x 6	7-110PB-8 x 6



## Inverted Flare Fittings

### Brass Inverted Flare Tube Nut

O.D. Tube	Brass Part #	Chrome Part #
3/16	411NB-3	7-411NB-3
1/4	411NB-4	7-411NB-4
5/16	411NB-5	7-411NB-5
3/8	411NB-6	7-411NB-6



## Pipe Thread Lock Nut

Pipe Size	Brass Part #	Chrome Part #
1/8	111PLN-2	7-111PLN-2
1/4	111PLN-4	7-111PLN-4
3/8	111PLN-6	7-111PLN-6



### Steel Inverted Flare Long Tube Nut

O.D. Tube	Brass Part #	Chrome Part #
3/16	411NL-3	7-411NL-3
1/4	411NL-4	7-411NL-4



## Pipe Tee

Pipe Size	Brass Part #	Chrome Part #
1/8	101PT-2	7-101PT-2
1/4	101PT-4	7-101PT-4
3/8	101PT-6	7-101PT-6



### Inverted Flare Male Connectors

O.D. Tube	O.D. Pipe	Brass Part #	Chrome Part #
3/16	1/8	48IC-3 x 2	7-48IC-3 x 2
1/4	1/8	48IC-4 x 2	7-48IC-4 x 2
5/16	1/8	48IC-5 x 2	7-48IC-5 x 2
5/16	1/4	48IC-5 x 4	7-48IC-5 x 4
3/8	1/8	48IC-6 x 2	7-48IC-6 x 2
3/8	1/4	48IC-6 x 4	7-48IC-6 x 4



## Pipe Street Tee

Pipe Size	Brass Part #	Chrome Part #
1/8	127PT-2	7-127PT-2
1/4	127PT-4	7-127PT-4
3/8	127PT-6	7-127PT-6



### Inverted Flare Male Elbow

O.D. Tube	O.D. Pipe	Brass Part #	Chrome Part #
3/16	1/8	49IE-3 x 2	7-49IE-3 x 2
1/4	1/8	49IE-4 x 2	7-49IE-4 x 2
5/16	1/8	49IE-5 x 2	7-49IE-5 x 2
5/16	1/4	49IE-5 x 4	7-49IE-5 x 4
3/8	1/8	49IE-6 x 2	7-49IE-6 x 2
3/8	1/4	49IE-6 x 4	7-49IE-6 x 4



## Straight Heater Hose Barb

Hose Size	Pipe Size	Brass Part #	Chrome Part #
5/8	3/8	68HHB-10 x 6	7-68HHB-10 x 6
5/8	1/2	68HHB-10 x 8	7-68HHB-10 x 8
3/4	1/2	68HHB-12 x 8	7-68HHB-12 x 8
3/8	3/8	68HHB-6 x 6	7-68HHB-6 x 6
1/2	3/8	68HHB-8 x 6	7-68HHB-8 x 6



### Inverted Male Rigid Hose Barb

Hose Size	O.D. Tube	Brass Part #	Chrome Part #
1/4	1/4	93HB-4 x 4	7-93HB-4 x 4
1/4	5/16	93HB-4 x 5	7-93HB-4 x 5
5/16	1/4	93HB-5 x 4	7-93HB-5 x 4
5/16	5/16	93HB-5 x 5	7-93HB-5 x 5
5/16	3/8	93HB-5 x 6	7-93HB-5 x 6
3/8	5/16	93HB-6 x 5	7-93HB-6 x 5



## Extended Straight Heater Hose Barb

Hose Size	Pipe Size	Chrome Part #
5/8	1/2	7-68HHBL-10 x 8



## 90° Heater Hose Barb

Hose Size	Pipe Size	Brass Part #	Chrome Part #
5/8	3/8	69HHB-10 x 6	7-69HHB-10 x 6
5/8	1/2	69HHB-10 x 8	7-69HHB-10 x 8
3/4	1/2	69HHB-12 x 8	7-69HHB-12 x 8
3/8	3/8	69HHB-6 x 6	7-69HHB-6 x 6
1/2	3/8	69HHB-8 x 6	7-69HHB-8 x 6



### Inverted Flare Reducing Nut

O.D. Tube	Inv. Nut	Brass Part #	Chrome Part #
3/16	1/4	411NR-3 x 4	7-411NR-3 x 4
3/16	5/16	411NR-3 x 5	7-411NR-3 x 5
3/16	9/16	411NR-3 x 9/16	7-411NR-3 x 9/16
1/4	9/16	411NR-4 x 9/16	7-411NR-4 x 9/16







# Inverted and Special Fittings

## Steel Inverted Flare Nut

O.D. Tube	Brass Part #	Chrome Part #
3/16	41INS-3	7-41INS-3
1/4	41INS-4	7-41INS-4
5/16	41INS-5	7-41INS-5
3/8	41INS-6	7-41INS-6



## Inverted Flare Steel Plug

O.D. Tube	Brass Part #	Chrome Part #
3/16	W131-3	7-W131-3
1/4	W131-4	7-W131-4
5/16	W131-5	7-W131-5
3/8	W131-6	7-W131-6



## Inverted Flare Union Tee

O.D. Tube	Brass Part #	Chrome Part #
3/16	W702-3	7-W702-3
1/4	W702-4	7-W702-4
5/16	W702-5	7-W702-5

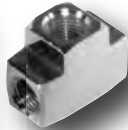

## Inverted Flare Brake Line Union

O.D. Tube	Brass Part #	Chrome Part #
3/16	42IU-3	7-42IU-3
1/4	42IU-4	7-42IU-4
5/16	42IU-5	7-42IU-5
3/8	42IU-6	7-42IU-6



## Brake Line Tee Mount Inverted Flare

O.D. Tube	Brass Part #	Chrome Part #
3/16	W7812	7-W7812
1/4	W7765	7-W7765

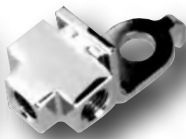

## Metric Brake Line Adapter

Inverted Female x Male Thread	Brass Part #	Chrome Part #
3/16 std 10mm x 1.0	202M-10	7-202M-10
10mm x 1.0 x 11mm x 1.5	202M-11	7-202M-11
10mm x 1.0 x 12mm x 1.0	202M-12	7-202M-12
10mm x 1.0 x 13mm x 1.5	202M-13	7-202M-13

## Inverted Flare Male Branch Tee

Size	Brass Part #	Chrome Part #
3/16	W600-3 x 2	7-W600-3 x 2
1/4	W600-4 x 2	7-W600-4 x 2
5/16	W600-5 x 2	7-W600-5 x 2
3/8	W600-6 x 4	7-W600-6 x 4



## Compression Fittings Brass

### Compression Sleeve

O.D. Tube	Part #
1/8	6460CS-2
3/16	6460CS-3
1/4	6460CS-4
5/16	6460CS-5
3/8	6460CS-6



### Compression Nut

O.D. Tube	Brass Part #	Chrome Part #
1/8	61CN-2	7-61CN-2
3/16	61CN-3	7-61CN-3
1/4	61CN-4	7-61CN-4
5/16	61CN-5	7-61CN-5
3/8	61CN-6	7-61CN-6



### Compression Tube Inserts

O.D. Tube	Part #
1/8	60TI-2
3/16	60TI-3
1/4	60TI-4
5/16	60TI-5
3/8	60TI-6



### Compression Full Union

O.D. Tube	Brass Part #	Chrome Part #
1/8	62CU-2	7-62CU-2
3/16	62CU-3	7-62CU-3
1/4	62CU-4	7-62CU-4
5/16	62CU-5	7-62CU-5
3/8	62CU-6	7-62CU-6



### Compression 3 Way Tee

O.D. Tube	Brass Part #	Chrome Part #
1/8	64CT-2	7-64CT-2
3/16	64CT-3	7-64CT-3
1/4	64CT-4	7-64CT-4
5/16	64CT-5	7-64CT-5
3/8	64CT-6	7-64CT-6





## Compression Male Connector

O.D. Tube	Brass Part #	Chrome Part #
1/8 x 1/8	68CC-2 x 2	7-68CC-2 x 2
3/16 x 1/8	68CC-3 x 2	7-68CC-3 x 2
1/4 x 1/8	68CC-4 x 2	7-68CC-4 x 2
1/4 x 1/4	68CC-4 x 4	7-68CC-4 x 4
5/16 x 1/8	68CC-5 x 2	7-68CC-5 x 2
5/16 x 1/4	68CC-5 x 4	7-68CC-5 x 4
3/8 x 1/8	68CC-6 x 2	7-68CC-6 x 2
3/8 x 1/4	68CC-6 x 4	7-68CC-6 x 4
3/8 x 3/8	68CC-6 x 6	7-68CC-6 x 6
1/2 x 1/4	68CC-8 x 4	7-68CC-8 x 4



## Hose Tee

Hose	Brass Part #	Chrome Part #
1/4	94HBT-4	7-94HBT-4
5/16	94HBT-5	7-94HBT-5
3/8	94HBT-6	7-94HBT-6



Fittings

## Compression Male Elbow

O.D. Tube	Brass Part #	Chrome Part #
1/8 x 1/8	69CE-2 x 2	7-69CE-2 x 2
3/16 x 1/8	69CE-3 x 2	7-69CE-3 x 2
1/4 x 1/8	69CE-4 x 2	7-69CE-4 x 2
1/4 x 1/4	69CE-4 x 4	7-69CE-4 x 4
5/16 x 1/8	69CE-5 x 2	7-69CE-5 x 2
5/16 x 1/4	69CE-5 x 4	7-69CE-5 x 4
3/8 x 1/8	69CE-6 x 2	7-69CE-6 x 2
3/8 x 1/4	69CE-6 x 4	7-69CE-6 x 4
3/8 x 3/8	69CE-6 x 6	7-69CE-6 x 6



## Transmission Adapter

Inv. Flare Str. Pipe	Brass Part #	Chrome Part #
5/16 x 1/8		



## Special Fittings

### Dual Brake Reducing Adapter

Hose/Hose	Brass Part #	Chrome Part #
3/16 x 1/4	203-3 x 4	7-203-3 x 4
3/16 x 5/16	203-3 x 5	7-203-3 x 5
1/4 x 3/16	203-4 x 3	7-203-4 x 3
1/4 x 5/16	203-4 x 5	7-203-4 x 5
5/16 x 1/4	203-5 x 4	7-203-5 x 4
5/16 x 3/8	203-5 x 6	7-203-5 x 6
3/8 x 5/16	203-6 x 5	7-203-6 x 5
1/4 x 1/4 (9/16-18)	203-7908	7-203-7908
3/16 x 3/16 (9/16-20)	203-7910	7-203-7910
3/16 x 3/16 (9/16-18)	203-7911	7-203-7911
3/16 (9/16-18) x 5/16	203-7912	7-203-7912
3/16 (1/2-20) x 3/16 (9/16-18)	203-7913	7-203-7913
5/16 x 5/16 w/seal	203F-1074	7-203F-1074
1/4 x 5/16 w/seal	203F-7727	7-203F-7727
1/4 x 7/16-20 w/seal	203F-7732	7-203F-7732
3/16 x 5/16 w/seal	203F-7817	7-203F-7817



## Metric Brake Union

Thread/Flare	Brass Part #	Chrome Part #
3/16 Std/Bubble 3	300B-3	7-300B-3
10mm x 1.0 Standard	300M-3	7-300M-3
10mm x 1.0 Bubble 2	300MB-3	7-300MB-3



## Hose Splicer

Hose/Hose	Brass Part #	Chrome Part #
3/16 x 3/16	92HB-3 x 3	7-92HB-3 x 3
1/4 x 1/4	92HB-4 x 4	7-92HB-4 x 4
5/16 x 5/16	92HB-5 x 5	7-92HB-5 x 5
3/8 x 3/8	92HB-6 x 6	7-92HB-6 x 6





# Chrome and Brass Fittings

## Drain Cocks

Size	Brass #	Chrome #
1/4	326DC-4	7-326DC-4



## Brake Bleeder Screws Chrome

Size	Part #
3/8-24 x 1 1/2	45-9400
3/8-24 x 1 1/8	45-9402
5/16-24 x 1	45-9403
1/4-28 x 1	45-9404
8mm x 1.25 x 23.8	45-9405
10mm x 1.5 x 27.5	45-9406



## Grease Fittings

Size	Part #
1/4-28 45° (Chrome)	57546
1/4-28 Straight	57547
1/4-28 Straight-Long	57547-L
1/4-28 90°	57548
1/8 45°	57549
1/8 Straight	57550
1/8 90°	57551
1/4-28 90° (Stainless)	88546
1/4-28 Straight	88547
1/8 Straight	88610
1/8 90°	88613
1/8 45°	88688



## Steel Brake Line Coil

Size	Part #
3/16	64542
1/4	64546
5/16	64548
3/8	64550



## Vacuum Connectors

### Vacuum Hose Splicer Plastic

Hose/Hose	Part #
1/8 x 1/8	62NU-2
3/16 x 3/16	62NU-3
1/4 x 1/4	62NU-4
5/16 x 5/16	62NU-5
3/8 x 3/8	62NU-6
3/16 x 1/8	62NUR-3 x 2
3/16 x 1/4	62NUR-3 x 4
1/4 x 1/8	62NUR-4 x 2
1/4 x 3/8	62NUR-4 x 6



### Vacuum Hose Elbow Plastic

Hose/Hose	Part #
3/16 x 3/16	64NE-3
3/16 x 1/8	64NE-3 x 2
3/16 x 1/4	64NE-3 x 4
1/4 x 1/4	64NE-4



### Vacuum Hose Tee Plastic

Hose/Hose	Part #
1/8	64NT-2
3/32	64NT-2.5
1/8 x 3/16 x 1/8	64NT-2 x 3 x 2
3/16	64NT-3
3/16 x 1/8 x 3/16	64NT-3 x 2 x 3
3/16 x 3/16 x 1/8	64NT-3 x 3 x 2
3/16 x 1/4 x 3/16	64NT-3 x 4 x 3
1/4	64NT-4
1/4 x 1/4 x 3/16	64NT-4 x 4 x 3
5/16	64NT-5
3/8	64NT-6
3/8 x 3/8 x 1/4	64NT-6 x 6 x 4



### Vacuum Rubber Caps

I.D.Hose	Part #
1/8	64CAP-2
5/32	64CAP-2.5
3/16	64CAP-3
1/4	64CAP-4
5/16	64CAP-5
3/8	64CAP-6





## Inside This Section

Detail Listing on each Unit

<b>J1POP-1</b> Hex Caps and Hex Nuts (Chrome Plated).....	76
<b>J1POP-2</b> Washers, Body Bolts and Pipe Plugs (Chrome Plated).....	76
<b>J1POP-3</b> Oval Phillips, Slotted Machine and Sheet Metal Screws (Chrome Plated).....	77
<b>J1POP-4</b> Button Head, Carriage Bolts and Lock Nuts (Chromed Plated).....	77
<b>J1POP-5</b> Brass Fittings Hand Polished (Chrome Plated).....	78
<b>LOGO DISPLAYERS</b> Counter Top Unit with Stamped Hex Caps.....	78
<b>J1POP-6</b> Ford and Chrysler Mopar Bolt Kits (Chrome & Polished Stainless).....	79
<b>J1POP-7</b> Chevy Kits and Bowtie Stamped Bolts.....	80
<b>J1POP-8</b> Chevy Bowtie and Ford Oval Stamped Bolts Kits.....	81
<b>J1POP-9</b> Chevy, Ford and Mopar Kits.....	82
<b>J1POP-10</b> Metric Screw Kits (Chrome Plated).....	83
<b>J1POP-11</b> Ford Oval Stamped Bolt Kits (Chrome Plated & Polished Stainless).....	84
<b>J1POP-12</b> Metric Screw Kits (Stainless Steel).....	85
<b>J1POP-14</b> Ford & Ford Oval Stamped Bolt Kits (Chrome Plated).....	86
<b>J1POP-15</b> Ford Oval Stamped Bolt Kits (Chrome Plated).....	86
<b>J1POP-16</b> Pontiac Arrow Stamped Bolt Kits (Chrome Plated).....	87
<b>J2POP-1</b> Combination of J1POP-1 & J1POP-2 Units (Chrome Plated).....	88
<b>J2POP-2</b> Combination of J1POP-3 & J1POP-4 Units (Chrome Plated).....	89
<b>J2POP-3</b> Nuts, Washers, Button Heads, Hex Caps, Lock Nuts & Sheet Metal Screws (Polished Stainless).....	90

## Product Display Units

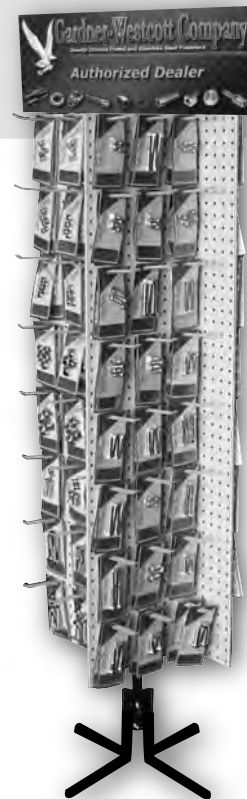

Hex Caps and Hex Nuts  
Chrome Plated  
#J1POP-1 Full Floor Unit



Brass Fittings Chrome Plated  
#J1POP-5 Counter Top Unit



Logo Stamped  
Counter Top Display Unit

What a simple way to organized and showcase your chrome plated and stainless steel fastener products.

- **Increases product visibility.**
- **Contains the most popular sizes sought after by auto enthusiasts.**
- **Allows wider range of product in least amount of space.**
- **Simple to stock and reorder.**
- **Customizing available to fit your needs.**



# P.O.P. Unit Descriptions

## COUNTER TOP UNITS



### J1POP-1 Hex Caps & Hex Nuts - contains (48) items in chrome and (2) ea. carded kits of the following fasteners:

Kit Part #	Description	Qty. per card	Kit Part #	Description	Qty. per card	Kit Part #	Description	Qty. per card
J0012	- 1/4-20 x 1/2 Hex Caps	(4)	J0108	- 3/8-16 x 1 1/2 Hex Caps	(4)	J0765	- 10/24 Hex Nuts	(12)
J0016	- 1/4-20 x 3/4 Hex Caps	(4)	J0110	- 3/8-16 x 1 3/4 Hex Caps	(4)	J0766	- 10/32 Hex Nuts	(12)
J0020	- 1/4-20 x 1 Hex Caps	(4)	J0112	- 3/8-16 x 2 Hex Caps	(4)	J0768	- 1/4-20 Hex Nuts	(15)
J0050	- 5/16-18 x 5/8 Hex Caps	(4)	J0114	- 3/8-16 x 2 1/4 Hex Caps	(4)	J0769	- 1/4-28 Hex Nuts	(15)
J0052	- 5/16-18 x 3/4 Hex Caps	(4)	J0116	- 3/8-16 x 2 1/2 Hex Caps	(4)	J0770	- 5/16-18 Hex Nuts	(13)
J0053	- 5/16-24 x 3/4 Hex Caps	(4)	J0118	- 3/8-16 x 2 3/4 Hex Caps	(3)	J0771	- 5/24-24 Hex Nuts	(13)
J0056	- 5/16-18 x 1 Hex Caps	(4)	J0120	- 3/8-16 x 3 Hex Caps	(3)	J0772	- 3/8-16 Hex Nuts	(11)
J0059	- 5/16-18 x 1 1/4 Hex Caps	(4)	J0148	- 7/16-14 x 1 Hex Caps	(3)	J0773	- 3/8-24 Hex Nuts	(11)
J0065	- 5/16-18 x 2 Hex Caps	(4)	J0150	- 7/16-14 x 1 1/4 Hex Caps	(3)	J0774	- 7/16-14 Hex Nuts	(7)
J0068	- 5/16-24 x 2 1/4 Hex Caps	(4)	J0156	- 7/16-14 x 2 Hex Caps	(3)	J0775	- 7/16-20 Hex Nuts	(7)
J0069	- 5/16-18 x 2 1/2 Hex Caps	(4)	J0184	- 1/2-13 x 1 Hex Caps	(3)	J0776	- 1/2-13 Hex Nuts	(6)
J0098	- 3/8-16 x 3/4 Hex Caps	(4)	J0188	- 1/2-13 x 1 1/2 Hex Caps	(3)	J0777	- 1/2-20 Hex Nuts	(6)
J0099	- 3/8-24 x 3/4 Hex Caps	(4)	J0189	- 1/2-20 x 1 1/2 Hex Caps	(3)	J0778	- 9/16-12 Hex Nuts	(5)
J0102	- 3/8-16 x 1 Hex Caps	(4)	J0192	- 1/2-13 x 2 Hex Caps	(3)	J0779	- 9/16-18 Hex Nuts	(5)
J0103	- 3/8-24 x 1 Hex Caps	(4)	J0196	- 1/2-13 x 2 1/2 Hex Caps	(3)	J0780	- 5/8-11 Hex Nuts	(5)
J0106	- 3/8-16 x 1 1/4 Hex Caps	(4)	J0197	- 1/2-20 x 2 1/2 Hex Caps	(3)	J0781	- 5/8-18 Hex Nuts	(5)

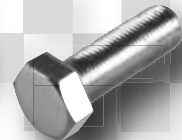

### J1POP-2 Washers, Body Bolts & Pipe Plugs - contains (48) Items in chrome and (2) ea. carded kits of the following:

Kit Part #	Description	Qty. per card	Kit Part #	Description	Qty. per card	Kit Part #	Description	Qty. per card
J0852	- #10 Flat Washers	(14)	J0876	- 5/16 AN Washers	(11)	J2229	- 5/16 x 13/16 Pol. Body Bolts	(4)
J0854	- 1/4 Flat Washers	(15)	J0877	- 3/8 AN Washers	(10)	J2230	- 5/16 x 1 1/4 Pol. Body Bolts	(3)
J0855	- 5/16 Flat Washers	(13)	J0878	- 7/16 AN Washers	(8)	J2255	- 1/4-20 x 7/8 Hex Sems	(4)
J0856	- 3/8 Flat Washers	(11)	J0879	- 1/2 AN Washers	(7)	J2256	- 5/16-18 x 1 Hex Sems	(4)
J0857	- 7/16 Flat Washers	(10)	J0880	- 9/16 AN Washers	(6)	J2257	- 3/8-16 x 3/4 Hex Sems	(3)
J0858	- 1/2 Flat Washers	(9)	J0881	- 5/8 AN Washers	(6)	J2258	- 3/8-16 x 1 Hex Sems	(3)
J0859	- 9/16 Flat Washers	(8)	J2250	- 3/8 x 1 1/4 Shock Washers	(4)	J2259	- 3/8-16 1 1/2 Hex Sems	(3)
J0860	- 5/8 Flat Washers	(8)	J2251	- 1/2 x 1 1/4 Shock Washers	(4)	J2261	- 1/4-20 x 5/8 Spin Locks	(6)
J0865	- 1/4 Lock Washers	(15)	J2252	- 1/2 x 1 7/16 Shock Washers	(4)	J2262	- 5/16-18 x 3/4 Spinlocks	(4)
J0866	- 5/16 Lock Washers	(13)	J2253	- 5/8 x 1 1/4 Shock Washers	(4)	J2263	- 5/16-18 x 1 Spinlocks	(4)
J0867	- 3/8 Lock Washers	(11)	J2223	- 5/16-18 x1 SS Body Bolts	(1)	J2264	- 5/16-18 X 1 1/4 Spinlocks	(4)
J0868	- 7/16 Lock Washers	(10)	J2224	- 14 x 3/4 Body Bolts 3/8 AF	(10)	J2265	- 3/8-16 x 1 Spinlocks	(3)
J0869	- 1/2 Lock Washers	(9)	J2225	- 14 x 3/4 Pol. Body Bolts 3/8 AF	(9)	J2266	- 5/16-24 x 1 Spinlocks	(5)
J0870	- 9/16 Lock Washers	(8)	J2226	- 14 x 3/4 Body Bolts 7/16 AF	(9)	J2267	- 3/8 Pipe Plugs	(3)
J0871	- 5/8 Lock Washers	(8)	J2227	- 5/16 x 13/16 Body Bolts	(7)	J2268	- 1/2 Pipe Plugs	(2)
J0875	- 1/4 AN Washers	(12)	J2228	- 5/16 x 1 1/4 Body Bolts	(4)	J2269	- 3/4 Pipe Plugs	(2)



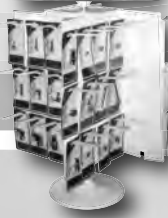

# P.O.P Unit Descriptions



## COUNTER TOP UNITS

**J1POP-3 Oval Slotted & Phillips Machine Screws - contains (48) items in chrome and (2) ea. carded kits of the following fasteners:**

Kit Part #	Description	Qty. per card	Kit Part #	Description	Qty. per card	Kit Part #	Description	Qty. per card
J0982	- 6/32 x 3/8 Oval Slot MS	(5)	J1020	- 12/24 x 1 Oval Slot MS	(4)	J1298	- 8 x 3/4 Oval Phillips SMS	(6)
J0983	- 6/32 x 1/2 Oval. Sl. MS	(5)	J1025	- 1/4-20 x 1 Oval. Sl. MS	(6)	J1299	- 8 x 3/4 Oval. Ph. # 6 Hds. SMS	(6)
J0985	- 6/32 x 3/4 Oval. Sl. MS	(5)	J1036	- 5/16-24 x 1 Oval. Sl. MS	(5)	J1300	- 8 x 7/8 Oval. Ph. SMS	(6)
J0986	- 6/32 x 1 Oval. Sl. MS	(5)	J1157	- 10/32 x 3/8 Oval. Ph. MS	(6)	J1301	- 8 x 7/8 Oval. Ph. # 6 Hds. SMS	(6)
J0992	- 8/32 x 1/2 Oval. Sl. MS	(7)	J1159	- 10/32 x 1/2 Oval. Ph. MS	(6)	J1302	- 8 x 1 Oval. Ph. SMS	(6)
J1001	- 10/24 x 1/2 Oval. Sl. MS	(6)	J1162	- 10/24 x 3/4 Oval. Ph. MS	(6)	J1303	- 8 x 1 Oval. Ph. # 6 Hds. SMS	(6)
J1002	- 10/32 x 1/2 Oval. Sl. MS	(6)	J1163	- 10/32 x 3/4 Oval. Ph. MS	(6)	J1304	- 8 x 1 1/4 Oval. Ph. SMS	(6)
J1005	- 10/24 x 3/4 Oval. Sl. MS	(6)	J1166	- 10/24 x 1 Oval. Ph. MS	(6)	J1305	- 8 x 1 1/4 Oval. Ph. # 6 Hds. SMS	(5)
J1006	- 10/32 x 3/4 Oval. Sl. MS	(6)	J1167	- 10/32 x 1 Oval. Ph. MS	(6)	J1306	- 8 x 1 1/2 Oval. Ph. SMS	(5)
J1008	- 10/32 x 1 Oval. Sl. MS	(6)	J1182	- 1/4-20 x 3/4 Oval. Ph. MS	(6)	J1307	- 8 x 1 1/2 Oval. Ph. # 6 Hds. SMS	(5)
J1010	- 10/32 x 1 1/4 Oval. Sl. MS	(4)	J1183	- 1/4-20 x 1 Oval. Ph. MS	(6)	J1308	- 8 x 3/4 Oval. Ph. # 6 Hds. SMS	(4)
J1012	- 10/32 x 1 1/2 Oval. Sl. MS	(4)	J1186	- 1/4-20 x 1 1/2 Oval. Ph. MS	(6)	J1309	- 8 x 3/4 Oval. Ph. SMS	(6)
J1013	- 10/32 x 1 3/4 Oval. Sl. MS	(4)	J1294	- 8 x 1/2 Oval. Ph. SMS	(6)	J1310	- 8 x 2 Oval. Ph. SMS	(5)
J1014	- 10/32 x 2 Oval. Sl. MS	(4)	J1295	- 8 x 1/2 Oval. Ph. HD SMS	(6)	J1311	- 8 x 2 Oval. Ph. # 6 Hds. SMS	(4)
J1017	- 12/24 x 1/2 Oval. Sl. MS	(4)	J1296	- 8 x 5/8 Oval. Ph. SMS	(6)	J1315	- 10 x 3/4 Oval. Ph. SMS	(7)
J1019	- 12/24 x 3/4 Oval Sl. MS	(4)	J1297	- 8 x 5/8 Oval. Ph. #6 Hds.	(6)	J1317	- 12 x 1 Oval. Ph. SMS	(4)

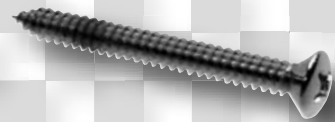

**J1POP-4 Button Heads, Carriage Bolts & Super Washers - contains (48) items in chrome and (2) ea. carded kits of the following:**

Kit Part #	Description	Qty. per card	Kit Part #	Description	Qty. per card	Kit Part #	Description	Qty. per card
J0535	- 8/32 x 1/2 Button Heads	(4)	J0618	- 3/8-16 x 1 1/2 Btn. Hds.	(2)	J0891	- 1/4 x 1 1/2 Carriage Bolts w/HN	(4)
J0546	- 10/24 x 1/2 Btn. Hds.	(4)	J0793	- 1/4-20 Lock Nuts	(8)	J0901	- 5/16 x 1 Carriage Bolts w/HN	(4)
J0547	- 10/32 x 1/2 Btn. Hds.	(4)	J0794	- 1/4-28 Lock Nuts	(8)	J0903	- 5/16 x 1 1/2 Carriage Bolts w/HN	(4)
J0550	- 10/24 x 3/4 Btn. Hds.	(4)	J0795	- 5/16-18 Lock Nuts	(8)	J0914	- 3/8-16 x 1 Carriage Bolts w/HN	(4)
J0551	- 10/32 x 3/4 Btn. Hds.	(4)	J0796	- 5/16-24 Lock Nuts	(8)	J0917	- 3/8-16 x 2 Carriage Bolts w/HN	(4)
J0564	- 1/4-20 x 1/2 Btn. Hds.	(4)	J0797	- 3/8-16 Lock Nuts	(6)	J0918	- 3/8 x 2 1/2 Carriage Bolts w/HN	(3)
J0568	- 1/4-20 x 3/4 Btn. Hds.	(4)	J0798	- 3/8-24 Lock Nuts	(6)	J0926	- 7/16-14 x 1 1/4 Cge. Bolts w/HN	(3)
J0572	- 1/4-20 x 1 Btn. Hds.	(4)	J0799	- 7/16-14 Lock Nuts	(5)	J0928	- 7/16-14 x 1 3/4 Cge. Bolts w/HN	(3)
J0574	- 1/4-20 x 1 1/4 Btn. Hds.	(4)	J0800	- 7/16-20 Lock Nuts	(5)	J0938	- 1/2-13 x 1 3/4 Cge. Bolts w/HN	(3)
J0588	- 5/16-18 x 3/4 Btn. Hds.	(4)	J0801	- 1/2-13 Lock Nuts	(5)	J2271	- 3/16 x 1 Super Washers	(5)
J0589	- 5/16-24 x 3/4 Btn. Hds.	(4)	J0802	- 1/2-20 Lock Nuts	(5)	J2272	- 1/4 x 1 Super Washers	(5)
J0592	- 5/16-18 x 1 Btn. Hds.	(4)	J0803	- 9/16-12 Lock Nuts	(4)	J2273	- 5/16 x 1 1/8 Super Washers	(5)
J0593	- 5/16-24 x 1 Btn. Hds.	(4)	J0804	- 9/16-18 Lock Nuts	(4)	J2274	- 5/16 x 1 1/2 Super Washers	(4)
J0596	- 5/16-18 x 1 1/2 Btn. Hds.	(3)	J0805	- 5/8-11 Lock Nuts	(4)	J2275	- 3/8 x 1 1/2 Super Washers	(4)
J0610	- 3/8-16 x 3/4 Btn. Hds.	(4)	J0806	- 5/16-16 Lock Nuts	(4)	J2276	- 7/16 x 1 Super Washers	(6)
J0614	- 3/8-16 x 1 Btn. Hds.	(4)	J0888	- 1/4 x 3/4 Carriage w/HN	(4)	J2277	- 1/2 x 1 1/4 Super Washers	(6)

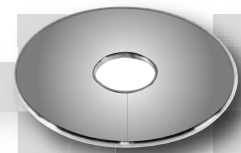



# P.O.P. Unit Descriptions

## COUNTER TOP UNITS



### J1POP-5 Polished Brass Fittings Show Chrome Plated -

*contains (47) items in chrome and (3) ea. carded kits of the following fasteners:*

*Gardner-Westcott took the standard brass fitting and hand polished it to a smooth mirror finish, than we Show Chrome Plated it. We then carded our hottest selling parts to create this counter top display unit. This turnable display unit contains 3 each of 47 different carded skin packed items.*

#### Heater Hose Barb 90°

- J9001 5/8" Hose 1/2" Pipe (3)
- J9002 5/8" Hose 3/8" Pipe (3)

#### Heater Hose Barb Straight

- J9003 5/8" Hose 1/2" Pipe (3)
- J9004 5/8" Hose 3/8" Pipe (3)
- J9005 3/4" Hose 1/2" Pipe (3)

#### Hex Head Pipe Plugs

- J9006 1/2" (3)
- J9007 3/8" (3)
- J9008 1/4" (3)
- J9009 1/8" (3)

#### Inverted Flare Fittings

- J9010 3/16" Tube 1/8" Pipe 45° Male Elbow (3)
- J9011 3/16" x 1/4" Reducing Nut (3)
- J9023 1/8" Tube Nut Steel (3)
- J9024 Brake Line Union 3/16" (3) □
- J9040 3/16" Flare 1/8" Pipe Male Connector (3)
- J9041 3/16" x 1/8" Inv. Flare Female Branch Tee (3)

#### Transmission Adapter

- J9012 5/16" x 5/16" Inv. Flare Trans. Adapter (3)
- J9013 3/8" x 3/8" Inv. Nut Trans. Adapter (3)

#### Socket Pipe Plugs

- J9014 1/8" Socket Pipe Plugs (3)
- J9015 1/4" Socket Pipe Plugs (3)
- J9016 3/8" Socket Pipe Plugs (3)
- J9017 1/2" Socket Pipe Plugs (3)

#### Pipe Bushing

- J9018 1/4" x 1/8" (3)
- J9019 3/8" x 1/8" (3)
- J9020 3/8" x 1/4" (3)

#### Street Elbow Fittings

- J9021 1/8" (3)
- J9022 1/4" (3)



Counter Top  
Display Unit



Part # J1POP-5  
Hand Polished Brass Fittings  
Show Chrome Plated  
Contains (3) each carded of 47 Items

#### Adapter

- J9025 1/8" x 1/8" Adapter (3)

#### Straight Hose Barb - Male Pipe

- J9026 3/16" Hose 1/8" Pipe M.H.B.P. (3)
- J9027 1/4" Hose 1/8" Pipe M.H.B.P. (3)
- J9028 5/16" Hose 1/8" Pipe M.H.B.P. (3)
- J9029 3/8" Hose 1/8" Pipe M.H.B.P. (3)
- J9030 3/8" Hose 1/4" Pipe M.H.B.P. (3)

#### 90° Hose Barb - Male Pipe

- J9031 5/16" Hose 1/8" Pipe 90° (3)
- J9032 3/8" Hose 1/8" Pipe 90° (3)
- J9033 3/8" Hose 1/4" Pipe 90° (3)

#### Brake Line Tee and Union

- J9034 3/16" Brake Line Tee w/Mount (3)
- J9035 3/16" Inv. Flare Union Tee (3)

#### Nipple

- J9036 1/8" Close Nipple (3)
- J9037 1/8" x 1 1/2" Long Nipple (3)

#### Drain Cock

- J9038 1/4" Drain Cocks (3)

#### Male Pipe Rigid Straight Hose Barb

- J9043 1/8" Hose 1/8" Pipe (3)
- J9044 1/4" Hose 1/8" Pipe (3)
- J9045 3/8" Hose 1/4" Pipe (3)

#### Brake Bleeder Screws

- J9046 3/8"-24 x 1 1/2" (3)
- J9047 3/8"-24 x 1 1/4" (3)
- J9048 5/16"-24 x 1" (3)
- J9049 1/4"-28 x 1" (3)

## Logo Displayer Counter Top Unit

*Gardner-Westcott also has a great way to showcase our very popular line of emblem stamped hex caps. Now your customers can see first hand the exceptional quality of each hand stamped emblem displayed on a green plastic stand that measures 7" high x 7" wide with a 3" base and can be placed in a highly visible area on your counter top. Each logo hex cap is identified with white letters clearly showing the Chevy Bowtie, Chevy SS, Chevy RS, Pontiac, Pontiac GT, Pontiac GTO, 350, 454, Oldsmobile Rocket, Chrysler Pentastar, Chrysler Mopar, Hemi Mopar, Dodge Ram, Ford Oval, Ford Vintage V-8, Mustang Pony, Flame and Skull. And we have added a few head styles to round out the display like Hex Caps Chrome Plated, Hex Caps Polished Stainless Steel, Allen Head Chrome Plated, Allen Head Stainless Steel Polished, 12 Point Chrome Plated, Button Head Allen Chrome Plated, Torx Button Head Chrome Plated and Flat Head Allen Chrome Plated.*



Logo Display Counter Top Unit  
Chrome Plated and Polished  
Stainless Steel Fasteners  
Part # Logo Display

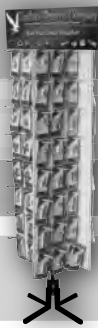

# P.O.P Unit Descriptions



## FULL FLOOR UNITS

**J1POP-6 Ford and Mopar Engine Dress up kits - contains (80) items in chrome and polished stainless steel (1) & (2) ea. carded kits of the following kits:**



### Ford Chrome Hex Cap Kits

Kit Part #	Description	Qty. of cards
56255-H	- 351 Cleveland Engine Dress Up Kit	(1)
56250-H	- S/B Engine Dress Up Kit	(1)
56248-H	- 302 Exhaust Manifold Kit	(2)
56246-H	- 429 Intake Manifold Kit	(2)
56244-H	- 390 Timing Cover Kit	(2)
56242-H	- 289 Timing Cover Kit	(2)
56243-H	- 351 Cleveland Fuel Pump Kit	(2)
56240-H	- 289, 302 Fuel Pump Kit	(2)
56236-H	- 700-R4 Trans Pan (1986) Kit	(2)
56235-H	- C-4 Transmission Kit	(2)
56234-H	- C-6 Trans Pan Kit	(2)
56232-H	- 351 Cleveland & 400 Oil Pan Kit	(2)
56231-H	- 289, 302 Oil Pan Kit	(2)
56230-H	- Water Neck Kit	(2)
56227-H	- 289 Aluminum Valve Cover Kit	(2)
56226-H	- 428 Steel Valve Cover Kit	(2)
56225-H	- 400 Steel Valve Cover Kit	(2)
56224-H	- 289 Steel Valve Cover Kit	(2)
56223-H	- 7/16 Header Bolts Kit	(2)
56222-H	- 351 Cleveland Intake Manifold Kit	(2)
56221-H	- 289 Intake Manifold Kit	(2)

### Ford Stainless Steel Hex Cap Kits

Kit Part #	Description	Qty. of cards
56255-HSP	- 351 Cleveland Engine Dress Up Kit	(1)
56250-HSP	- S/B Engine Dress Up Kit	(1)
56248-HSP	- 302 Exhaust Manifold Kit	(2)
56246-HSP	- 429 Intake Manifold Kit	(2)
56244-HSP	- 390 Timing Cover Kit	(2)
56242-HSP	- 289 Timing Cover Kit	(2)
56243-HSP	- 351 Cleveland Fuel Pump Kit	(2)
56240-HSP	- 289, 302 Fuel Pump Kit	(2)
56236-HSP	- 700-R4 Trans Pan (1986) Kit	(2)
56235-HSP	- C-4 Transmission Kit	(2)
56234-HSP	- C-6 Trans Pan Kit	(2)
56232-HSP	- 351 Cleveland & 400 Oil Pan Kit	(2)
56231-HSP	- 289, 302 Oil Pan Kit	(2)
56230-HSP	- Water Neck Kit	(2)
56227-HSP	- 289 Aluminum Valve Cover Kit	(2)
56226-HSP	- 428 Steel Valve Cover Kit	(2)
56225-HSP	- 400 Steel Valve Cover Kit	(2)
56224-HSP	- 289 Steel Valve Cover Kit	(2)
56223-HSP	- 7/16 Header Bolts Kit	(2)
56222-HSP	- 351 Cleveland Intake Manifold Kit	(2)
56221-HSP	- 289 Intake Manifold Kit	(2)



**OFFICIAL LICENSED PRODUCT**

MOPAR, JEEP, DODGE, HEMI, PLYMOUTH, RAM, SRT, CHRYSLER and related logos, vehicle model names and trade dress are trademarks of Chrysler Group LLC and used under license by (licensee name). ©2015 Chrysler Group LLC

### Mopar Chrome Hex Cap Kits

Kit Part #	Description	Qty. of cards
56332-H	- B/B Engine Dress Up Kit	(1)
56330-H	- S/B Engine Dress Up Kit	(1)
56306-H	- B/B Fuel Pump Kit	(2)
56305-H	- S/B Water Pump Kit	(2)
56304-H	- S/B Valve Cover Kit	(2)
56303-H	- S/B Header Bolt Kit	(2)
56302-H	- S/B Intake Manifold Kit	(2)
56301-H	- S/B Oil Pan Kit	(2)
09012	- Chrome Throttle Return Spring	(2)
09012 - Blu	- Blue Throttle Return Spring	(2)
09015	- Gold Throttle Return Spring	(2)
P-31-100	- Ch. Valve Stem Covers	(2)
56220-B	- Ch. Bullet License Plate Kit	(2)
4083	- Ch. 5/16 x 1 3/8 Carb Stud Kit	(2)
4084	- Ch. 5/16 x 1 1/2 Carb Stud Kit	(2)
57605-C	- Interior Trim 4 Dr. Screw Kit	(2)
57602-C	- Interior Trim 2 Dr. Screw Kit	(2)
J9001	- 90° Heater Hose 5/8 x 1/2	(2)
J9002	- 90° Heater Hose 5/8 x 3/8	(2)

### Mopar Stainless Steel Hex Cap Kits

Kit Part #	Description	Qty. of cards
56332-HSP	- B/B Engine Dress Up Kit	(1)
56330-HSP	- S/B Engine Dress Up Kit	(1)
56306-HSP	- B/B Fuel Pump Kit	(2)
56305-HSP	- S/B Water Pump Kit	(2)
56304-HSP	- S/B Valve Cover Kit	(2)
56303-HSP	- S/B Header Bolt Kit	(2)
56302-HSP	- S/B Intake Manifold Kit	(2)
56301-HSP	- S/B Oil Pan Kit	(2)
09012-Re	- Red Throttle Return Spring	(2)
09012-BLK	- Black Throttle Return Spring	(2)
67561-L	- 11/16-18 Left Hand Jam Nuts	(2)
67561-R	- 11/16-18 Right Hand Jam Nuts	(2)
4086	- SS. 5/16 x 1 3/8 Carb Stud Kit	(2)
4087	- SS. 5/16 x 1 1/2 Carb Stud Kit	(2)
J9003	- 5/8 x 1/2 Straight Heater Hose	(2)
J9004	- 5/8 x 3/8 Straight Heater Hose	(2)
J9005	- 3/4 x 1/2 Straight Heater Hose	(2)
J9038	- 1/4 Drain Cocks	(2)





# P.O.P. Unit Descriptions

## FULL FLOOR UNITS

**J1POP-7 Chevy Engine Dress Up Application - contains (98) items in chrome and polished stainless steel (1) & (2) ea. carded kits of the following:**



**Exclusively From** *Gardner-Westcott*

**Make a Chevy Statement with Gardner-Westcott's very popular Chevy Bow Tie Bolts, The emblem is stamped directly onto the head of the bolts. Available in our Show Chrome Plated version or Polished Stainless Steel.**



### Chrome Plated Hex Cap Kits

Kit Part #	Description	Qty. of cards
56490-H	- S/B Chevy Engine Dress Up Kit	(1)
56465-H	- Oil Pan Bolts S/B & LT-1 Kit	(1)
56485-H	- Steel Valve Covers B/B Kit	(1)
56468-H	- Water Pump S/B Short Kit	(1)
56464-H	- Timing Cover Kit	(1)
56484-H	- Bell Housing Kit	(1)
4083	- 5/16 x 1 3/8 Carb Stud Kit	(1)
4084	- 5/16 x 1 1/2 Carb Stud Kit	(1)
09112	- Chrome Throttle Return Springs	(3)
56220	- License Plate Kit	(1)
56461-H	- Header Bolts Kit	(1)
56418-H	- S/B Header Bolts 1" Long Kit	(1)
56477-H	- Exhaust Manifold w/ Flat Washers Kit	(1)
56469-H	- Intake Manifold S/B Kit	(1)

H= Hex Caps  
Chrome Plated

### Polished Chrome Allen Head Screw Kits

Kit Part #	Description	Qty. of cards
56490-P	- S/B Chevy Engine Dress Up Kit	(1)
56465-P	- Oil Pan Bolts S/B & LT-1 Kit	(1)
56485-P	- Valve Covers B/B Kit	(1)
56468-P	- Water Pump S/B Short Kit	(1)
56464-P	- Timing Cover Kit	(1)
56484-P	- Bell Housing Kit	(1)
56220-B	- Bullet License Plate Kit	(1)
56477-P	- Exhaust Manifold w/ Flat Washers Kit	(1)
56469-P	- Intake Manifold S/B Kit	(1)

P= Allen Screws  
Polished Chrome  
Plated

### Polished Stainless Steel Hex Cap Kits

Kit Part #	Description	Qty. of cards
56490-HSP	- S/B Chevy Engine Dress Up Kit	(1)
56465-HSP	- S/B & LT-1 Oil Pan Bolts Kit	(1)
56485-HSP	- B/B Steel Valve Covers Kit	(1)
56468-HSP	- S/B Water Pump Short Kit	(1)
56464-HSP	- Timing Cover Kit	(1)
56484-HSP	- Bell Housing Kit	(1)
56461-HSP	- S/B Header Bolt 3/4" Kit	(1)
56477-HSP	- Exhaust Manifold Kit	(1)
56469-HSP	- S/B Intake Manifold Kit	(1)
4086	- 1 3/8 Stainless Steel Carb Kit	(1)
4084	- 1 1/2 Stainless Steel Carb Kit	(1)
09113	- Stainless Steel Throttle Return Spring	(3)

HSP= Hex Caps  
Stainless Steel  
Polished

### Polished Stainless Steel Allen Head Screw Kits

Kit Part #	Description	Qty. of cards
56490-SSP	- S/B Chevy Engine Dress Up Kit	(1)
56465-SSP	- S/B & LT-1 Oil Pan Bolts Kit	(1)
56485-SSP	- B/B Valve Covers Kit	(1)
56468-SSP	- S/B Water Pump Short Kit	(1)
56464-SSP	- Timing Cover Kit	(1)
56484-SSP	- Bell Housing Kit	(1)
56461-SSP	- S/B Header Bolt Kit	(1)
56477-SSP	- Exhaust Manifold Kit	(1)
56469-SSP	- S/B Intake Manifold Kit	(1)
56220-SSP	- License Plate Kit	(2)

SSP= Allen Screws  
Stainless Steel  
Polished

### Chrome Chevy Bow Tie Hex Cap Kits

Kit Part #	Description	Qty. of cards
10-56490-H	- S/B Chevy Engine Dress Up Kit	(1)
10-56495-H	- LT-1 Engine Dress Up Kit	(1)
10-56465-H	- S/B Oil Pan Bolts Kit	(2)
10-56463-H	- S/B Valve Cover Steel Kit	(2)
10-56468-H	- S/B Short Water Pump Kit	(2)
10-56467-H	- S/B Extended Water Pump Kit	(2)
10-56464-H	- Timing Cover Kit	(2)
10-56400-H	- Timing Cover LT-1 Kit	(2)
10-56466-H	- S/B Valve Cover Aluminum Kit	(2)
10-56478-H	- Coil Mt. to Blk. & Flat Washer Kit	(2)
10-56461-H	- S/B Header Bolt Kit	(1)
10-56418-H	- S/B Header Bolt 1" Long Kit	(1)
10-56477-H	- Exhaust Manifold Kit	(2)
10-56469-H	- S/B Intake Manifold Kit	(2)

### Polished Stainless Bow Tie Hex Caps Kits

Kit Part #	Description	Qty. of cards
10-56490-HSP	- S/B Chevy Engine Dress Up Kit	(1)
10-56491-HSP	- B/B Engine Dress Up Kit	(1)
10-56465-HSP	- S/B Oil Pan Bolts Kit	(2)
10-56463-HSP	- S/B Valve Cover Steel Kit	(2)
10-56468-HSP	- S/B Short Water Pump Kit	(2)
10-56467-HSP	- S/B Extended Water Pump Kit	(2)
10-56464-HSP	- Timing Cover Kit	(2)
10-56484-HSP	- Bell Housing Kit	(2)
10-56466-HSP	- S/B Valve Cover Aluminum Kit	(2)
10-56401-HSP	- License Plate Bolt Kit	(2)
10-56461-HSP	- S/B Header Bolt Kit	(1)
10-56418-HSP	- S/B Header Bolt 1" Long Kit	(1)
10-56477-HSP	- Exhaust Manifold Kit	(2)
10-56469-HSP	- S/B Intake Manifold Kit	(2)

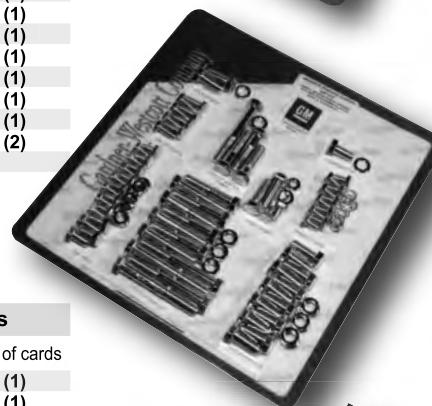



# P.O.P Unit Descriptions



## FULL FLOOR UNITS

**J1POP-8 Chevy Bow Tie & Ford Oval Stamped Fastener Kits - contains (89) items in chrome and stainless steel (2 & 3) ea. carded kits of the following:**

### Chevy Bow Tie Hex Cap Chrome Plated and Stainless Steel Kits

Engine Dress-Up Chrome Kits			Bow Tie Chrome Kits			Bow Tie Stainless Kits		
Kit Part #	Description	Qty. of cards	Kit Part #	Description	Qty. of cards	Kit Part #	Description	Qty. of cards
10-56490-H	S/B Engine Set	(2)	X-10-11206	1/4-20 x 1/2	(3)	X-10-77206	1/4-20 X 1/2	(3)
10-56464-H	Front Cover	(3)	X-10-11210	1/4-20 x 3/4	(3)	X-10-77210	1/4-20 x 3/4	(3)
10-56456-H	Short Fan Spacer Bolts	(3)	X-10-11214	1/4-20 x 1	(3)	X-10-77214	1/4-20 x 1	(3)
10-56460-H	S/B Fuel Pump	(2)	X-10-11218	1/4-20 x 1 1/4	(3)	X-10-77218	1/4-20 x 1 1/4	(3)
10-56461-H	Header Bolts	(2)	X-10-11220	1/4-20 x 1 1/2	(3)	X-10-77220	1/4-20 x 1 1/2	(3)
10-56469-H	Intake Manifold	(2)	X-10-11224	1/4-20 x 2	(3)	X-10-77224	1/4-20 x 2	(3)
10-56465-H	S/B & LT-1 Oil Pan	(3)	X-10-11274	5/16-18 x 3/4	(3)	X-10-77274	5/16-18 x 3/4	(3)
10-56474-H	Trans Pan with Washers	(2)	X-10-11280	5/16-18 x 1	(3)	X-10-77280	5/16-18 x 1	(3)
10-56463-H	Steel Valve Cover	(3)	X-10-11284	5/16-18 x 1 1/4	(3)	X-10-77284	5/16-18 x 1 1/4	(3)
10-56471-H	Water Neck 45 W/F/W	(3)	X-10-11286	5/16-18 x 1 1/2	(3)	X-10-77286	5/16-18 x 1 1/2	(3)
10-56468-H	Water Pump Short	(3)	X-10-11290	5/16-18 x 2	(3)	X-10-77290	5/16-18 x 2	(3)
10-56401-H	License Plate Kit	(2)	X-10-11326	3/8-16 x 3/4	(3)	X-10-77326	3/8-16 x 3/4	(3)
			X-10-11330	3/8-16 x 1	(3)	X-10-77330	3/8-16 x 1	(3)
			X-10-11334	3/8-16 x 1 1/4	(3)	X-10-77334	3/8-16 x 1 1/4	(3)
			X-10-11336	3/8-16 x 1 1/2	(3)	X-10-77336	3/8-16 x 1 1/2	(3)
			X-10-11340	3/8-16 x 2	(3)	X-10-77340	3/8-16 x 2	(3)



### Ford Oval Hex Cap Chrome Plated and Stainless Steel Kits

Engine Dress-Up Chrome Kits			Ford Oval Chrome Kits			Ford Oval Stainless Kits		
Kit Part #	Description	Qty. of cards	Kit Part #	Description	Qty. of cards	Kit Part #	Description	Qty. of cards
11-56250-H	S/B Engine Set	(2)	X-11-11206	1/4-20 x 1/2	(3)	X-11-77206	1/4-20 X 1/2	(3)
11-56240-H	282, 302 Fuel Pump	(3)	X-11-11210	1/4-20 x 3/4	(3)	X-11-77210	1/4-20 x 3/4	(3)
11-56223-H	7/16 Header Bolts	(2)	X-11-11214	1/4-20 x 1	(3)	X-11-77214	1/4-20 x 1	(3)
11-56231-H	289, 302 Oil Pan	(3)	X-11-11218	1/4-20 x 1 1/4	(3)	X-11-77218	1/4-20 x 1 1/4	(3)
11-56242-H	289 Timing Cover	(3)	X-11-11220	1/4-20 x 1 1/2	(3)	X-11-77220	1/4-20 x 1 1/2	(3)
11-56235-H	C-4 Transmission	(3)	X-11-11224	1/4-20 x 2	(3)	X-11-77224	1/4-20 x 2	(3)
11-56224-H	289 Steel Valve Cover	(3)	X-11-11274	5/16-18 x 3/4	(3)	X-11-77274	5/16-18 x 3/4	(3)
11-56226-H	428 Steel Valve Cover	(3)	X-11-11280	5/16-18 x 1	(3)	X-11-77280	5/16-18 x 1	(3)
11-56230-H	Water Neck	(3)	X-11-11284	5/16-18 x 1 1/4	(3)	X-11-77284	5/16-18 x 1 1/4	(3)
11-56260-H	74 to 78 Mustang Front End	(3)	X-11-11286	5/16-18 x 1 1/2	(3)	X-11-77286	5/16-18 x 1 1/2	(3)
11-56227-H	289 Aluminum Valve Cover	(3)	X-11-11290	5/16-18 x 2	(3)	X-11-77290	5/16-18 x 2	(3)
11-56233-H	390, 428 Oil Pan	(3)	X-11-11326	3/8-16 x 3/4	(3)	X-11-77326	3/8-16 x 3/4	(3)
11-56248-H	302 Exhaust Manifold	(3)	X-11-11330	3/8-16 x 1	(3)	X-11-77330	3/8-16 x 1	(3)
			X-11-11334	3/8-16 x 1 1/4	(3)	X-11-77334	3/8-16 x 1 1/4	(3)
			X-11-11336	3/8-16 x 1 1/2	(3)	X-11-77336	3/8-16 x 1 1/2	(3)
			X-11-11340	3/8-16 x 2	(3)	X-11-77340	3/8-16 x 2	(3)



When limited space is a commodity and you want your products to be organized, easy to maintain and reordering to be a snap. Than our Point of Purchase Product Display Floor Units will meet your requirements and more.



# P.O.P. Unit Descriptions

## FULL FLOOR UNITS

**J1POP-9 Chevy, Ford and Chrysler Stamped Fastener Kits with various Chrome Plated Brass Fittings - this unit contains (77) items (1-3) ea. carded kits of the following:**

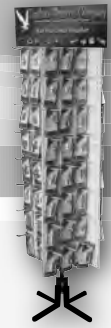

### Chevy Bow Tie Chrome Kits

Kit Part #	Description	Qty. of cards
10-56490-H	- S/B w/Headers Engine Dress Up Kit	(2)
10-56491-H	- B/B w/headers Engine Dress Up Kit	(2)
10-56488-H	- B/B Header Bolt Kit	(3)
10-56487-H	- B/B Oil Pan Kit	(3)
10-56486-H	- B/B Aluminum Valve Cover Kit	(3)
10-56467-H	- S/B Extended Water Pump Kit	(3)
10-56479-H	- B/B Intake Manifold Kit	(3)
10-56477-H	- Exhaust Manifold Kit	(3)
10-56489-H	- B/B Long Valve Cover Kit	(3) □
10-56464-H	- S/B Timing Cover Kit	(3)
10-56456-H	- Fan Spacer Bolt Short Kit	(3)
10-56460-H	- S/B Fuel Pump Kit	(3)
10-56461-H	- S/B Header Bolt Kit	(3)
10-56469-H	- S/B Intake Manifold Kit	(3)
10-56465-H	- S/B Oil Pan Kit	(3)
10-56466-H	- S/B Aluminum Valve Cover Kit	(3)
10-56471-H	- S/B 45° Water Neck Kit	(3)
10-56468-H	- S/B Short Water Pump Kit	(3)

### Ford Oval Chrome Kits

Kit Part #	Description	Qty. of cards
11-56250-H	- S/B w/Headers Engine Dress Up Kit	(2)
11-56240-H	- 282, 302 Fuel Pump Kit	(3)
11-56223-H	- 7/16 Header Bolt Kit	(3)
11-56231-H	- 289, 302 Oil Pan Kit	(3)
11-56242-H	- 289 Timing Cover Kit	(3)
11-56235-H	- C-4 Transmission Pan Cover Kit	(3)
11-56224-H	- 289 Steel Valve Cover Kit	(3)
11-56226-H	- 428 Steel Valve Cover Kit	(3)
11-56230-H	- Water Neck Kit	(3) □
11-56227-H	- 289 Aluminum Valve Cover Kit	(3)
11-56233-H	- 390, 428 Oil Pan Kit	(3)
11-56248-H	- 289, 302 Exhaust Manifold Kit	(3)
11-56260-H	- 74-78 Mustang Front End Kit	(1)
09012	- Chrome Plated Throttle Return Spring	(2)
09015	- Gold Plated Throttle Return Spring	(2)



### Mopar Chrome Kits

Kit Part #	Description	Qty. of cards
23-56330-H	- S/B w/Headers Engine Dress Up Kit	(2)
23-56332-H	- B/B w/Headers Engine Dress Up Kit	(2)
23-56301-H	- S/B Oil Pan Kit	(3)
23-56303-H	- S/B Header Bolt Kit	(3)
23-56304-H	- S/B Valve Cover Kit	(3)
23-56305-H	- S/B Water Pump Kit	(3)
23-56306-H	- S/B Fuel Pump Kit	(3)
23-56302-H	- S/B Intake Manifold Kit	(3)
23-56307-H	- B/B Oil Pan Kit	(3) □
23-56308-H	- B/B Intake Manifold Kit	(3)
23-56309-H	- B/B Header Bolt Kit	(3)
23-56310-H	- B/B Valve Cover Kit	(3)
23-56311-H	- B/B Water Pump Kit	(3)
23-56312-H	- B/B Fuel Pump Kit	(3)

### Chrome Plated Brass Fittings

Kit Part #	Description	Qty. of cards
J9015	- 1/4 Socket Pipe Plug	(2)
J9016	- 3/8 Socket Pipe Plug	(2)
J9017	- 1/2 Socket Pipe Plug	(2)
J9019	- 3/8 x 1/8 Pipe Bushing	(2)
J9020	- 3/8 x 1/4 Pipe Bushing	(2)
J9021	- 1/8 Street Elbow	(2)
J9025	- Adapter 1/8 x 1/8	(2)
J9026	- Straight Hose Barb Male Pipe 3/16 x 1/8	(2)
J9030	- Straight Hose Barb Male Pipe 3/8 x 1/4	(2) □
J9031	- 90° Hose Barb Male Pipe 5/16 x 1/8	(2)
J9032	- 90° Hose Barb Male Pipe 3/8 x 1/8	(2)
J9033	- 90° Hose Barb Male Pipe 3/8 x 1/4	(2)
J9034	- 3/16 Brake Line Tee with Mount	(2)
J9035	- Inverted Flare Union Tee 3/16	(2)

### Chrome Plated Brass Fittings

Kit Part #	Description	Qty. of cards
J9001	- 90° Heater Hose Barb 5/8 x 1/2	(2)
J9002	- 90° Heater Hose Barb 5/8 x 3/8	(2)
J9003	- Straight Heater Hose Barb 3/8 x 1/2	(2)
J9004	- Straight Heater Hose Barb 5/8 x 3/8	(2)
J9005	- Straight Heater Hose Barb 3/4 x 1/2	(2)
J9006	- 1/2 Hex Head Pipe Plug	(2)
J9007	- 3/8 Hex Head Pipe Plug	(2)
J9010	- Inverted Flare 45° Male Elbow 3/16 x 1/8	(2)
J9014	- 1/8 Socket Pipe Plug	(2)

### Chrome Plated Brass Fittings

Kit Part #	Description	Qty. of cards
J9038	- 1/4 Drain Cocks	(2)
J9040	- Inverted Flare Male Pipe 3/16 x 1/8	(2)
J9041	- Inverted Flare Female Branch Tee	(2)
J9044	- Male Pipe Rigid Hose Barb 1/4 x 1/8	(2)
J9045	- Male Pipe Rigid Hose Barb 3/8 x 1/4	(2)
J9047	- Brake Bleeder Screws 3/8-24 x 1 1/2	(2)
J9048	- Brake Bleeder Screws 5/16-24 x 1	(2)
J9049	- Brake Bleeder Screws 1/4-28 x 1	(2)





# P.O.P Unit Descriptions



## COUNTER TOP UNITS

**J1POP-10 Metric Hex Cap Screws, Hex Nuts and Flat Washers in Chrome - contains (48) items and (3) ea. carded kits of the following:**

### Chrome Metric Hex Cap Screw Kits (Side 1)

Kit Part #	Description	Qty. of cards	Qty. per card
X-11725	- 5mm x 0.8 x 16	(3)	(4)
X-11726	- 5mm x 0.8 x 20	(3)	(4)
X-11727	- 5mm x 0.8 x 25	(3)	(4)
X-11728	- 5mm x 0.8 x 30	(3)	(4)
X-11729	- 5mm x 0.8 x 35	(3)	(4)
X-11730	- 5mm x 0.8 x 40	(3)	(4)
X-11731	- 5mm x 0.8 x 45	(3)	(4)
X-11732	- 5mm x 0.8 x 50	(3)	(4)
X-11738	- 6mm x 1.0 x 16	(3)	(4)
X-11739	- 6mm x 1.0 x 20	(3)	(4)
X-11740	- 6mm x 1.0 x 25	(3)	(4)
X-11741	- 6mm x 1.0 x 30	(3)	(4)

### Chrome Metric Hex Cap Screw Kits (Side 3)

Kit Part #	Description	Qty. of cards	Qty. per card
X-11794	- 10mm x 1.5 x 20	(3)	(3)
X-11795	- 10mm x 1.5 x 25	(3)	(3)
X-11796	- 10mm x 1.5 x 30	(3)	(3)
X-11797	- 10mm x 1.5 x 35	(3)	(3)
X-11798	- 10mm x 1.5 x 40	(3)	(3)
X-11799	- 10mm x 1.5 x 45	(3)	(3)
X-11800	- 10mm x 1.5 x 50	(3)	(3)
X-11835	- 12mm x 1.75 x 20	(3)	(3)
X-11836	- 12mm x 1.75 x 25	(3)	(3)
X-11837	- 12mm x 1.75 x 30	(3)	(3)
X-11838	- 12mm x 1.75 x 35	(3)	(3)
X-11839	- 12mm x 1.75 x 40	(3)	(3)

### Chrome Metric Hex Cap Screw Kits (Side 2)

Kit Part #	Description	Qty. of cards	Qty. per card
X-11742	- 6mm x 1.0 x 35	(3)	(4)
X-11743	- 6mm x 1.0 x 40	(3)	(4)
X-11744	- 6mm x 1.0 x 45	(3)	(4)
X-11745	- 6mm x 1.0 x 50	(3)	(4)
X-11773	- 8mm x 1.25 x 20	(3)	(4)
X-11774	- 8mm x 1.25 x 25	(3)	(4)
X-11775	- 8mm x 1.25 x 30	(3)	(4)
X-11776	- 8mm x 1.25 x 35	(3)	(4)
X-11777	- 8mm x 1.25 x 40	(3)	(4)
X-11778	- 8mm x 1.25 x 45	(3)	(4)
X-11779	- 8mm x 1.25 x 50	(3)	(4)
X-11781	- 8mm x 1.25 x 60	(3)	(4)

### Chrome Metric Hex Cap Screw Kits (Side 4)

Kit Part #	Description	Qty. of cards	Qty. per card
X-11840	- 12mm x 1.75 x 45	(3)	(3)
X-11841	- 12mm x 1.75 x 50	(3)	(3)

### Chrome Metric Hex Nut Kits

Kit Part #	Description	Qty. of cards	Qty. per card
X-15952	- 5mm x .80	(3)	(6)
X-15954	- 6mm x 1.0	(3)	(6)
X-15958	- 8mm x 1.25	(3)	(6)
X-15962	- 10mm x 1.50	(3)	(6)
X-15966	- 12mm x 1.75	(3)	(4)

### Chrome Metric Flat Washer Kits

Kit Part #	Description	Qty. of cards	Qty. per card
X-23986	- 5mm	(3)	(10)
X-23987	- 6mm	(3)	(10)
X-23989	- 8mm	(3)	(10)
X-23990	- 10mm	(3)	(8)
X-23991	- 12mm	(3)	(8)

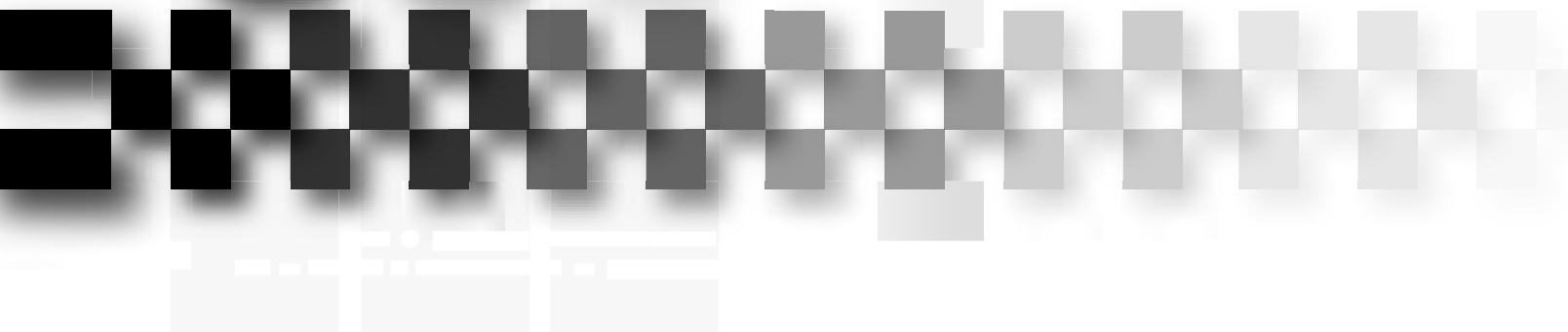
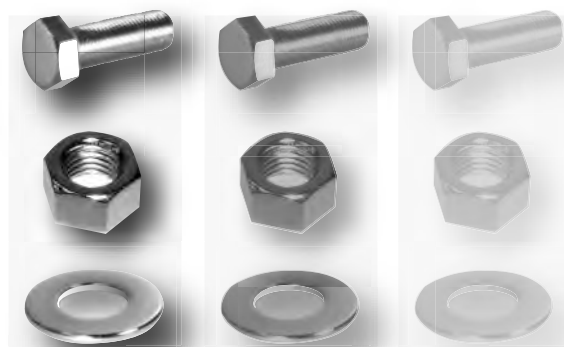



# P.O.P. Unit Descriptions

## FULL FLOOR UNITS



**J1POP-11 Ford Oval Stamped and Non-Stamped Hex Cap Engine Dress Up Kits - contains (50) items in chrome and polished stainless steel (2 & 3) ea. carded kits of the following:**



### Ford Oval Chrome Kits

Kit Part #	Description	Qty. of cards
11-56250-H	S/B Engine Set Hex Caps	(2)
11-56240-H	282, 302 Fuel Pump	(3)
11-56223-H	7/16 Header Bolts	(3)
11-56231-H	289, 302 Oil Pan	(3)
11-56242-H	289 Timing Cover	(3)
11-56235-H	C-4 Transmission	(3)
11-56224-H	289 Steel Valve Cover	(3)
11-56226-H	428 Steel Valve Cover	(3)
11-56230-H	Water Neck	(3)
11-56260-H	74 thru 78 Mustang Front End	(3)
11-56227-H	289 Aluminum Valve Cover	(3)
11-56233-H	390, 428 Oil Pan	(3)
11-56248-H	302 Exhaust Manifold	(3)

### Ford Oval Stainless Steel Kits

Kit Part #	Description	Qty. of cards
11-56250-HSP	S/B Engine Set Hex Caps	(2)
11-56240-HSP	282, 302 Fuel Pump	(3)
11-56223-HSP	7/16 Header Bolts	(3)
11-56231-HSP	289, 302 Oil Pan	(3)
11-56242-HSP	289 Timing Cover	(3)
11-56235-HSP	C-4 Transmission	(3)
11-56224-HSP	289 Steel Valve Cover	(3)
11-56226-HSP	428 Steel Valve Cover	(3)
11-56230-HSP	Water Neck	(3)
11-56227-HSP	289 Aluminum Valve Cover	(3)
11-56233-HSP	390, 428 Oil Pan	(3)
11-56248-HSP	302 Exhaust Manifold	(3)

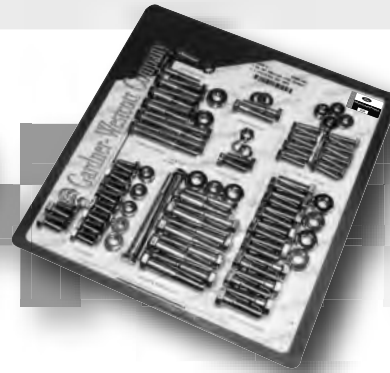

Engine Dress Up Kit  
Part # 56250-HSP

### Ford Standard Chrome Kits

Kit Part #	Description	Qty. of cards
56250-H	S/B Engine Set Hex Caps	(2)
56240-H	282, 302 Fuel Pump	(3)
56223-H	7/16 Header Bolts	(3)
56231-H	289, 302 Oil Pan	(3)
56242-H	289 Timing Cover	(3)
56235-H	C-4 Transmission	(3)
56224-H	289 Steel Valve Cover	(3)
56226-H	428 Steel Valve Cover	(3)
56230-H	Water Neck	(3)
56260-H	74 thru 78 Mustang Front End	(3)
56227-H	289 Aluminum Valve Cover	(3)
56233-H	390, 428 Oil Pan	(3)
56248-H	302 Exhaust Manifold	(3)

### Ford Standard Stainless Steel Kits

Kit Part #	Description	Qty. of cards
56250-HSP	S/B Engine Set Hex Caps	(2)
56240-HSP	282, 302 Fuel Pump	(3)
56223-HSP	7/16 Header Bolts	(3)
56231-HSP	289, 302 Oil Pan	(3)
56242-HSP	289 Timing Cover	(3)
56235-HSP	C-4 Transmission	(3)
56224-HSP	289 Steel Valve Cover	(3)
56226-HSP	428 Steel Valve Cover	(3)
56230-HSP	Water Neck	(3)
56227-HSP	289 Aluminum Valve Cover	(3)
56233-HSP	390, 428 Oil Pan	(3)
56248-HSP	302 Exhaust Manifold	(3)



# P.O.P Unit Descriptions



## COUNTER TOP UNITS

**J1POP-10 Metric Hex Cap Screws, Hex Nuts and Flat Washers in Stainless Steel - contains (48) items and (3) ea. carded kits of the following:**

### Stainless Steel Metric Hex Cap Screw Kits (Side 1)

Kit Part #	Description	Qty. of cards	Qty. per card
X-77725	- 5mm x 0.8 x 16	(3)	(4)
X-77726	- 5mm x 0.8 x 20	(3)	(4)
X-77727	- 5mm x 0.8 x 25	(3)	(4)
X-77728	- 5mm x 0.8 x 30	(3)	(4)
X-77729	- 5mm x 0.8 x 35	(3)	(4)
X-77730	- 5mm x 0.8 x 40	(3)	(4)
X-77731	- 5mm x 0.8 x 45	(3)	(4)
X-77732	- 5mm x 0.8 x 50	(3)	(4)
X-77738	- 6mm x 1.0 x 16	(3)	(4)
X-77739	- 6mm x 1.0 x 20	(3)	(4)
X-77740	- 6mm x 1.0 x 25	(3)	(4)
X-77741	- 6mm x 1.0 x 30	(3)	(4)

### Stainless Steel Metric Hex Cap Screw Kits (Side 2)

Kit Part #	Description	Qty. of cards	Qty. per card
X-77742	- 6mm x 1.0 x 35	(3)	(4)
X-77743	- 6mm x 1.0 x 40	(3)	(4)
X-77744	- 6mm x 1.0 x 45	(3)	(4)
X-77745	- 6mm x 1.0 x 50	(3)	(4)
X-77773	- 8mm x 1.25 x 20	(3)	(4)
X-77774	- 8mm x 1.25 x 25	(3)	(4)
X-77775	- 8mm x 1.25 x 30	(3)	(4)
X-77776	- 8mm x 1.25 x 35	(3)	(4)
X-77777	- 8mm x 1.25 x 40	(3)	(4)
X-77778	- 8mm x 1.25 x 45	(3)	(4)
X-77779	- 8mm x 1.25 x 50	(3)	(4)
X-77781	- 8mm x 1.25 x 60	(3)	(4)

### Stainless Steel Metric Hex Cap Screw Kits (Side 3)

Kit Part #	Description	Qty. of cards	Qty. per card
X-77794	- 10mm x 1.5 x 20	(3)	(3)
X-77795	- 10mm x 1.5 x 25	(3)	(3)
X-77796	- 10mm x 1.5 x 30	(3)	(3)
X-77797	- 10mm x 1.5 x 35	(3)	(3)
X-77798	- 10mm x 1.5 x 40	(3)	(3)
X-77799	- 10mm x 1.5 x 45	(3)	(3)
X-77800	- 10mm x 1.5 x 50	(3)	(3)
X-77835	- 12mm x 1.75 x 20	(3)	(3)
X-77836	- 12mm x 1.75 x 25	(3)	(3)
X-77837	- 12mm x 1.75 x 30	(3)	(3)
X-77838	- 12mm x 1.75 x 35	(3)	(3)
X-77839	- 12mm x 1.75 x 40	(3)	(3)

### Stainless Steel Metric Hex Cap Screw Kits (Side 4)

Kit Part #	Description	Qty. of cards	Qty. per card
X-77840	- 12mm x 1.75 x 45	(3)	(3)
X-77841	- 12mm x 1.75 x 50	(3)	(3)

### Stainless Steel Metric Hex Nut Kits

Kit Part #	Description	Qty. of cards	Qty. per card
X-70952	- 5mm x .80	(3)	(6)
X-70954	- 6mm x 1.0	(3)	(6)
X-70958	- 8mm x 1.25	(3)	(6)
X-70962	- 10mm x 1.50	(3)	(6)
X-70966	- 12mm x 1.75	(3)	(4)

### Stainless Steel Metric Flat Washer Kits

Kit Part #	Description	Qty. of cards	Qty. per card
X-75986	- 5mm	(3)	(10)
X-75987	- 6mm	(3)	(10)
X-75989	- 8mm	(3)	(10)
X-75990	- 10mm	(3)	(8)
X-75991	- 12mm	(3)	(8)

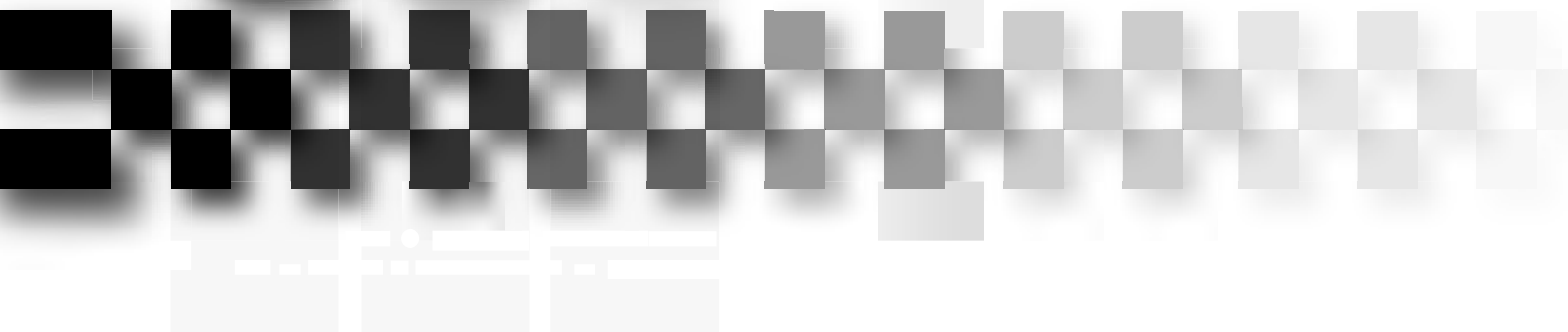
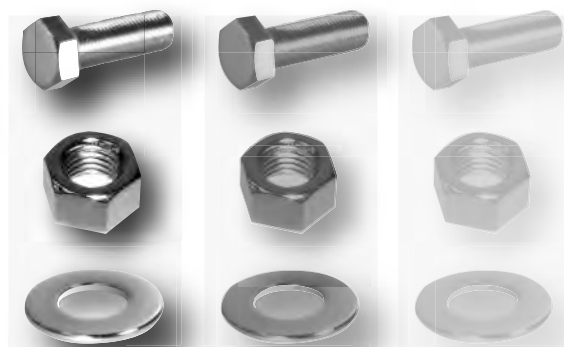



# P.O.P. Unit Descriptions

## COUNTER TOP UNITS



**J1POP-14 Ford and Ford Oval Stamped Hex Cap Engine Dress Up Kits**  
*Contains (24) items in chrome (2 & 3) ea. carded kits of the following:*

### Ford Chrome Kits

Kit Part #	Description	Qty. of cards
56250-H	- S/B Engine Dress Up Set	(2)
56221-H	- 289, 302 Intake Manifold Kit	(3)
56240-H	- 282, 302 Fuel Pump Kit	(3)
56223-H	- 7/16 Header Bolts Kit	(3)
56231-H	- 289, 302 Oil Pan Kit	(3)
56242-H	- 289 Timing Cover Kit	(3)
56224-H	- 289 Steel Valve Cover Kit	(3)
56230-H	- Water Neck Kit	(3)
56220-H	- License Plate Kit	(3)
56401-H	- License Plate Bolt Kit	(3)
11-56250-H	- S/B Engine Set Hex Caps	(2)

### Ford Oval Chrome Kits

Kit Part #	Description	Qty. of cards
11-56221-H	- 289, 302 Intake Manifold	(3)
11-56240-H	- 282, 302 Fuel Pump	(3)
11-56223-H	- 7/16 Header Bolts	(3)
11-56231-H	- 289, 302 Oil Pan	(3)
11-56242-H	- 289 Timing Cover	(3)
11-56224-H	- 289 Steel Valve Cover	(3)
11-56230-H	- Water Neck	(3)
09012-blk	- Black Throttle Return Spring	(3)
09012-re	- Red Throttle Return Spring	(3)
09012-wht	- White Throttle Return Spring	(3)
09012-blu	- Blue Throttle Return Spring	(3)
09012	- Chrome Throttle Return Spring	(3)



## FULL FLOOR UNITS

**J1POP-15 Ford Oval Stamped Hex Cap Engine Dress Up Kits**  
*Contains (63) items in chrome (2 & 3) ea. carded kits of the following:*

### Ford Oval Chrome Kits

Kit Part #	Description	Qty. of cards	Kit Part #	Description	Qty. of cards
11-56256-H	- 400 w/St'rd Exhaust Eng. Dress Up Kit	(2)	X-11-11206	- 1/4-20 x 1/2	(3)
11-56255-H	- 351 Cleveland Engine Dress Up Kit	(2)	X-11-11208	- 1/4-20 x 5/8	(3)
11-56254-H	- 429, 460 w/Headers Eng. Dress Up Kit	(2)	X-11-11210	- 1/4-20 x 3/4	(3)
11-56253-H	- 390, 428 w/Headers Eng. Dress Up Kit	(2)	X-11-11212	- 1/4-20 x 7/8	(3)
11-56251-H	- 289, 302 w/St'rd Exhaust Eng. Dress Up Kit	(2)	X-11-11214	- 1/4-20 x 1	(3)
11-56250-H	- 289, 302 w/Headers Eng. Dress Up Kit	(2)	X-11-11218	- 1/4-20 x 1 1/4	(3)
11-56248-H	- 302 Exhaust Manifold Kit	(3)	X-11-11222	- 1/4-20 x 1 3/4	(3)
11-56247-H	- 390, 428 Intake Manifold Kit	(3)	X-11-11220	- 1/4-20 x 1 1/2	(3)
11-56246-H	- 429 Intake Manifold Kit	(3)	X-11-11224	- 1/4-20 x 2	(3)
11-56242-H	- 289 Timing Cover Kit	(3)	X-11-11270	- 5/16-18 x 1/2	(3)
11-56240-H	- 289, 302 Fuel Pump Kit	(3)	X-11-11272	- 5/16-18 x 5/8	(3)
11-56238-H	- 390, 429 Fuel Pump Kit	(3)	X-11-11274	- 5/16-18 x 3/4	(3)
11-56237-H	- 429, 460 Oil Pan Kit	(3)	X-11-11278	- 5/16-18 x 7/8	(3)
11-56235-H	- C-4 Transmission Kit	(3)	X-11-11280	- 5/16-18 x 1	(3)
11-56234-H	- C-6 Trans Pan Kit	(3)	X-11-11284	- 5/16-18 x 1 1/4	(3)
11-56233-H	- 390, 428 Oil Pan Kit	(3)	X-11-11286	- 5/16-18 x 1 1/2	(3)
11-56231-H	- 289, 302 Oil Pan Kit	(3)	X-11-11288	- 5/16-18 x 1 3/4	(3)
11-56230-H	- Water Neck Kit	(3)	X-11-11290	- 5/16-18 x 2	(3)
11-56229-H	- 429, 460 Valve Cover Kit	(3)	X-11-11326	- 3/8-16 x 3/4	(3)
11-56227-H	- 289 Aluminum Valve Cover Kit	(3)	X-11-11330	- 3/8-16 x 1	(3)
11-56226-H	- 428 Steel Valve Cover Kit	(3)	X-11-11334	- 3/8-16 x 1 1/4	(3)
11-56224-H	- 289 Steel Valve Cover Kit	(3)	X-11-11336	- 3/8-16 x 1 1/2	(3)
11-56223-H	- 7/16 Header Bolts Kit	(3)	X-11-11338	- 3/8-16 x 1 3/4	(3)
11-56222-H	- 351 Cleveland Intake Manifold Kit	(3)	X-11-11340	- 3/8-16 x 2	(3)
11-56221-H	- 289 Intake Manifold Kit	(3)	X-11-55669-P3	- 14 x 3/4 3/8 Hex	(3)
11-56260-H	- 74-78 Mustang Front End Kit	(2)	X-11-56669-P7	- 14 x 3/4 7/16 Hex	(3)
11-56261-H	- Rack Bolts 5/8 x 4" Grade 8	(3)	X-11-22276	- 5/16 X 13/16 Body Bolts	(3)
11-56220-H	- License Plate Stamped Ford Oval Kit	(3)	X-11-22284	- 5/16 X 1 1/4 Body Bolts	(3)
11-56401-H	- License Plate for Plastic Ford Oval Kit	(3)	X-11-25212	- 1/4-20 x 7/8	(3)
J1784	- License Plate Truss Slot Kit	(3)	X-11-25280	- 5/16-18 x 1	(3)
X-11-25330	- 3/8-16 x 1 Sems	(3)	X-11-25336	- 3/8-16 x 1 1/2 Sems	(3)





# P.O.P Unit Descriptions



## FULL FLOOR UNITS

**J1POP-16 Pontiac Engine Dress Up Kits with Pontiac and GT Stamped Hex Caps - contains (68) items in chrome (2 & 3) ea. carded kits of the following:**

### Engine Dress-Up Chrome Kits

Kit Part #	Description	Qty. of cards	Kit Part #	Description	Qty. of cards
56500-H	- S/B Engine Dress Up Kit	(2)	12-56500-H	- S/B Engine Dress Up Kit	(2)
56522-H	- 326 S/B Intake Manifold Kit	(3)	12-56522-H	- 326 S/B Intake Manifold Kit	(3)
56521-H	- 350 B/B Intake Manifold Kit	(3)	12-56521-H	- 350 B/B Intake Manifold Kit	(3)
56533-H	- Water Pump Kit	(3)	12-56533-H	- Water Pump Kit	(3)
56515-H	- 350 B/B Timing Cover Kit	(3)	12-56515-H	- 350 B/B Timing Cover Kit	(3)
56531-H	- 350, 389 Oil Pan Kit	(3)	12-56531-H	- 350, 389 Oil Pan Kit	(3)
56532-H	- 326, 453 Oil Pan Kit	(3)	12-56532-H	- 326, 453 Oil Pan Kit	(3)
56529-H	- 350 Aluminum Valve Cover Kit	(3)	12-56529-H	- 350 Aluminum Valve Cover Kit	(3)
56528-H	- 326 S/B Valve Cover Kit	(3)	12-56528-H	- 326 S/B Valve Cover Kit	(3)
56516-H	- 326 S/B Timing Cover Kit	(3)	12-56516-H	- 326 S/B Timing Cover Kit	(3)
56519-H	- Fuel Pump Kit	(3)	12-56519-H	- Fuel Pump Kit	(3)
56505-H	- B/B Engine Dress Up Kit	(2)	12-56505-H	- B/B Engine Dress Up Kit	(2)
56220-H	- License Plate Kit	(3)	12-56220-H	- Pontiac Logo License Plate Kit	(3)
56220-B	- Bullet License Plate Kit	(3)	15-56500-H	- S/B Engine Dress Up Kit	(2)
09012	- Chrome Throttle Return Spring	(3)	15-56522-H	- 326 S/B Intake Manifold Kit	(3)
09015	- Gold Throttle Return Spring	(3)	15-56521-H	- 350 B/B Intake Manifold Kit	(3)
09012-black	- Black Throttle Return Spring	(3)	15-56533-H	- Water Pump Kit	(3)
09012-red	- Red Throttle Return Spring	(3)	15-56515-H	- 350 B/B Timing Cover Kit	(3)
09012-white	- White Throttle Return Spring	(3)	15-56531-H	- 350, 389 Oil Pan Kit	(3)
09012-blue	- Blue Throttle Return Spring	(3)	15-56532-H	- 326, 453 Oil Pan Kit	(3)
X-29591	- 3/32 x 1 1/4 Cotter Pin	(3)	15-56529-H	- 350 Aluminum Valve Cover Kit	(3)
X-29587	- 3/32 x 1 3/4 Cotter Pin	(3)	15-56528-H	- 326 S/B Valve Cover Kit	(3)
X-29593	- 1/8 x 1 1/4 Cotter Pin	(3)	15-56516-H	- 326 S/B Timing Cover Kit	(3)
X-29585	- 1/8 x 1 1/2 Cotter Pin	(3)	15-56519-H	- Fuel Pump Kit	(3)
X-29588	- 5/32 x 1 1/2 Cotter Pin	(3)	15-56505-H	- B/B Engine Dress Up Kit	(2)
X-25212	- 1/4-20 X 7/8 Sems	(3)	15-56220-H	- GT Logo License Plate Kit	(3)
X-25280	- 5/16-18 x 1 Sems	(3)	X-43567	- 3/16 Hole Plug	(3)
X-25326	- 3/8-16 x 3/4 Sems	(3)	X-43569	- 1/4 Hole Plug	(3)
X-25330	- 3/8-16 x 1 Sems	(3)	X-43570	- 5/16 Hole Plug	(3)
X-25336	- 3/8-16 x 1 1/2 Sems	(3)	X-43571	- 3/8 Hole Plug	(3)
4083	- 5/16 x 1 3/8 Carb Studs	(3)	X-43572	- 7/16 Hole Plug	(3)
4084	- 5/16 x 1 1/2 Carb Studs	(3)	X-43573	- 1/2 Hole Plug	(3)
4085	- 5/16 x 2 Carb Studs	(3) □	X-43575	- 5/8 Hole Plug	(3)
			X-43576	- 3/4 Hole Plug	(3)







# P.O.P. Unit Descriptions

## FULL FLOOR UNITS

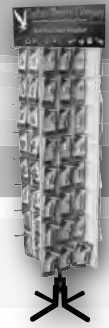

**J2POP-1 is a combination of J1POP-1 and J1POP-2 Units**

**Contains (96) items all in chrome (2) ea. carded kits of the following fasteners:**

### Chrome Hex Nuts and Hex Cap Screws

Kit Part #	Description	Qty. per card	Kit Part #	Description	Qty. per card	Kit Part #	Description	Qty. per card
J0765	10/24 Hex Nuts	(12)	J0012	1/4-20 x 1/2 Hex Caps	(4)	J0108	3/8-16 x 1 1/2 Hex Caps	(4)
J0766	10/32 Hex Nuts	(12)	J0016	1/4-20 x 3/4 Hex Caps	(4)	J0110	3/8-16 x 1 3/4 Hex Caps	(4)
J0768	1/4-20 Hex Nuts	(15)	J0020	1/4-20 x 1 Hex Caps	(4)	J0112	3/8-16 x 2 Hex Caps	(4)
J0769	1/4-28 Hex Nuts	(15)	J0050	5/16-18 x 5/8 Hex Caps	(4)	J0114	3/8-16 x 2 1/4 Hex Caps	(4)
J0770	5/16-18 Hex Nuts	(13)	J0052	5/16-18 x 3/4 Hex Caps	(4)	J0116	3/8-16 x 2 1/2 Hex Caps	(4)
J0771	5/24-24 Hex Nuts	(13)	J0053	5/16-24 x 3/4 Hex Caps	(4)	J0118	3/8-16 x 2 3/4 Hex Caps	(3)
J0772	3/8-16 Hex Nuts	(11)	J0056	5/16-18 x 1 Hex Caps	(4)	J0120	3/8-16 x 3 Hex Caps	(3)
J0773	3/8-24 Hex Nuts	(11)	J0059	5/16-18 x 1 1/4 Hex Caps	(4)	J0148	7/16-14 x 1 Hex Caps	(3)
J0774	7/16-14 Hex Nuts	(7)	J0065	5/16-18 x 2 Hex Caps	(4)	J0150	7/16-14 x 1 1/4 Hex Caps	(3)
J0775	7/16-20 Hex Nuts	(7)	J0068	5/16-24 x 2 1/4 Hex Caps	(4)	J0156	7/16-14 x 2 Hex Caps	(3)
J0776	1/2-13 Hex Nuts	(6)	J0069	5/16-18 x 2 1/2 Hex Caps	(4)	J0184	1/2-13 x 1 Hex Caps	(3)
J0777	1/2-20 Hex Nuts	(6)	J0098	3/8-16 x 3/4 Hex Caps	(4)	J0188	1/2-13 x 1 1/2 Hex Caps	(3)
J0778	9/16-12 Hex Nuts	(5)	J0099	3/8-24 x 3/4 Hex Caps	(4)	J0189	1/2-20 x 1 1/2 Hex Caps	(3)
J0779	9/16-18 Hex Nuts	(5)	J0102	3/8-16 x 1 Hex Caps	(4)	J0192	1/2-13 x 2 Hex Caps	(3)
J0780	5/8-11 Hex Nuts	(5)	J0103	3/8-24 x 1 Hex Caps	(4)	J0196	1/2-13 x 2 1/2 Hex Caps	(3)
J0781	5/8-18 Hex Nuts	(5)	J0106	3/8-16 x 1 1/4 Hex Caps	(4)	J0197	1/2-20 x 2 1/2 Hex Caps	(3)

### Chrome Washers, Body, Hex Sems, Spin Lock Bolts and Pipe Plugs

Kit Part #	Description	Qty. per card	Kit Part #	Description	Qty. per card	Kit Part #	Description	Qty. per card
J0852	#10 Flat Washers	(14)	J0876	5/16 AN Washers	(11)	J2229	5/16 x 13/16 Pol. Body Bolts	(4)
J0854	1/4 Flat Washers	(15)	J0877	3/8 AN Washers	(10)	J2230	5/16 x 1 1/4 Pol. Body Bolts	(3)
J0855	5/16 Flat Washers	(13)	J0878	7/16 AN Washers	(8)	J2255	1/4-20 x 7/8 Hex Sems	(4)
J0856	3/8 Flat Washers	(11)	J0879	1/2 AN Washers	(7)	J2256	5/16-18 x 1 Hex Sems	(4)
J0857	7/16 Flat Washers	(10)	J0880	9/16 AN Washers	(6)	J2257	3/8-16 x 3/4 Hex Sems	(3)
J0858	1/2 Flat Washers	(9)	J0881	5/8 AN Washers	(6)	J2258	3/8-16 x 1 Hex Sems	(3)
J0859	9/16 Flat Washers	(8)	J2250	3/8 x 1 1/4 Shock Washers	(4)	J2259	3/8-16 1 1/2 Hex Sems	(3)
J0860	5/8 Flat Washers	(8)	J2251	1/2 x 1 1/4 Shock Washers	(4)	J2261	1/4-20 x 5/8 Spin Locks	(6)
J0865	1/4 Lock Washers	(15)	J2252	1/2 x 1 7/16 Shock Washers	(4)	J2262	5/16-18 x 3/4 Spin Locks	(4)
J0866	5/16 Lock Washers	(13)	J2253	5/8 x 1 1/4 Shock Washers	(4)	J2263	5/16-18 x 1 Spin Locks	(4)
J0867	3/8 Lock Washers	(11)	J2223	5/16-18 x1 SS Body Bolts	(1)	J2264	5/16-18 X 1 1/4 Spin Locks	(4)
J0868	7/16 Lock Washers	(10)	J2224	14 x 3/4 Body Bolts 3/8 AF	(10)	J2265	3/8-16 x 1 Spin Locks	(3)
J0869	1/2 Lock Washers	(9)	J2225	14 x 3/4 Body Bolts 3/8 AF	(9)	J2266	5/16-24 x 1 Spin Locks	(5)
J0870	9/16 Lock Washers	(8)	J2226	14 x 3/4 Body Bolts 7/16 AF	(9)	J2267	3/8 Pipe Plugs	(3)
J0871	5/8 Lock Washers	(8)	J2227	5/16 x 13/16 Body Bolts	(7)	J2268	1/2 Pipe Plugs	(2)
J0875	1/4 AN Washers	(12)	J2228	5/16 x 1 1/4 Body Bolts	(4)	J2269	3/4 Pipe Plugs	(2)

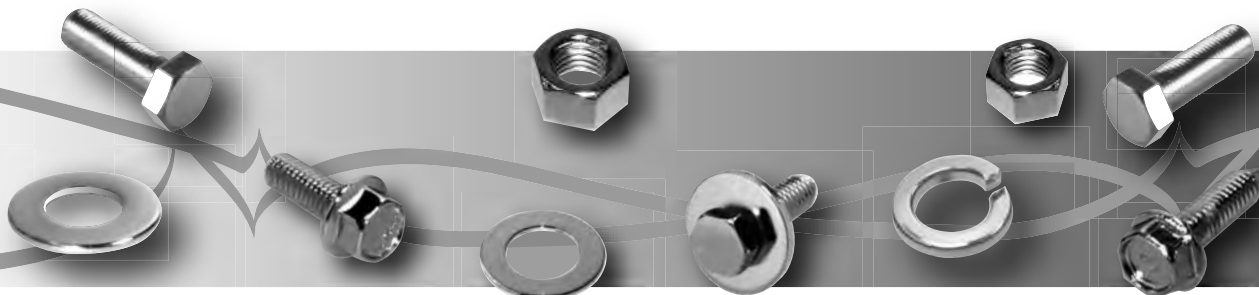



# P.O.P Unit Descriptions



## FULL FLOOR UNITS

**J2POP-2 is a combination of J1POP-3 and J1POP-4 Units**

**Contains (96) items all in chrome (2)ea. carded kits of the following fasteners:**

### Chrome Oval Slotted, Phillips Machine and Sheet Metal Screws

Kit Part #	Description	Qty. per card	Kit Part #	Description	Qty. per card	Kit Part #	Description	Qty. per card
J0982	- 6/32 x 3/8 Oval Slot MS	(5)	J1020	- 12/24 x 1 Oval Sl. MS	(4)	J1298	- 8 x 3/4 Oval Phillips SMS	(6)
J0983	- 6/32 x 1/2 Oval Sl. MS	(5)	J1025	- 1/4-20 x 1 Oval Sl. MS	(6)	J1299	- 8 x 3/4 Oval Ph. # 6 SMS	(6)
J0985	- 6/32 x 3/4 Oval Sl. MS	(5)	J1036	- 5/16-24 x 1 Oval Sl. MS	(5)	J1300	- 8 x 7/8 Oval Ph. SMS	(6)
J0986	- 6/32 x 1 Oval Sl. MS	(5)	J1157	- 10/32 x 3/8 Oval Ph. MS	(6)	J1301	- 8 x 7/8 Oval Ph. # 6 SMS	(6)
J0992	- 8/32 x 1/2 Oval Sl. MS	(7)	J1159	- 10/32 x 1/2 Oval Ph. MS	(6)	J1302	- 8 x 1 Oval Ph. SMS	(6)
J1001	- 10/24 x 1/2 Oval Sl. MS	(6)	J1162	- 10/24 x 3/4 Oval Ph. MS	(6)	J1303	- 8 x 1 Oval Ph. # 6 SMS	(6)
J1002	- 10/32 x 1/2 Oval Sl. MS	(6)	J1163	- 10/32 x 3/4 Oval Ph. MS	(6)	J1304	- 8 x 1 1/4 Oval Ph. SMS	(6)
J1005	- 10/24 x 3/4 Oval Sl. MS	(6)	J1166	- 10/24 x 1 Oval Ph. MS	(6)	J1305	- 8 x 1 1/4 Oval Ph. # 6 SMS	(5)
J1006	- 10/32 x 3/4 Oval Sl. MS	(6)	J1167	- 10/32 x 1 Oval Ph. MS	(6)	J1306	- 8 x 1 1/2 Oval Ph. SMS	(5)
J1008	- 10/32 x 1 Oval Sl. MS	(6)	J1182	- 1/4-20 x 3/4 Oval Ph. MS	(6)	J1307	- 8 x 1 1/2 Oval Ph. # 6 SMS	(5)
J1010	- 10/32 x 1 1/4 Oval Sl. MS	(4)	J1183	- 1/4-20 x 1 Oval Ph. MS	(6)	J1308	- 8 x 3/4 Oval Ph. # 6 SMS	(4)
J1012	- 10/32 x 1 1/2 Oval Sl. MS	(4)	J1186	- 1/4-20 x 1 1/2 Oval Ph. MS	(6)	J1309	- 8 x 3/4 Oval Ph. SMS	(6)
J1013	- 10/32 x 1 3/4 Oval Sl. MS	(4)	J1294	- 8 x 1/2 Oval Ph. SMS	(6)	J1310	- 8 x 2 Oval Ph. SMS	(5)
J1014	- 10/32 x 2 Oval Sl. MS	(4)	J1295	- 8 x 1/2 Oval Ph. SMS	(6)	J1311	- 8 x 2 Oval Ph. # 6 SMS	(4)
J1017	- 12/24 x 1/2 Oval Sl. MS	(4)	J1296	- 8 x 5/8 Oval Ph. SMS	(6)	J1315	- 10 x 3/4 Oval Ph. SMS	(7)
J1019	- 12/24 x 3/4 Oval Sl. MS	(4)	J1297	- 8 x 5/8 Oval Ph. #6 SMS	(6)	J1317	- 12 x 1 Oval Ph. SMS	(4)

### Chrome Button Heads, Lock Nuts, Carriage Bolts and Super Washers

Kit Part #	Description	Qty. per card	Kit Part #	Description	Qty. per card	Kit Part #	Description	Qty. per card
J0535	- 8/32 x 1/2 Button Heads	(4)	J0618	- 3/8-16 x 1 1/2 Btn. Hds.	(2)	J0891	- 1/4 x 1 1/2 Carriage	(4)
J0546	- 10/24 x 1/2 Btn. Hds.	(4)	J0793	- 1/4-20 Lock Nuts	(8)	J0901	- 5/16 x 1 Carriage	(4)
J0547	- 10/32 x 1/2 Btn. Hds.	(4)	J0794	- 1/4-28 Lock Nuts	(8)	J0903	- 5/16 x 1 1/2 Carriage	(4)
J0550	- 10/24 x 3/4 Btn. Hds.	(4)	J0795	- 5/16-18 Lock Nuts	(8)	J0914	- 3/8-16 x 1 Carriage	(4)
J0551	- 10/32 x 3/4 Btn. Hds.	(4)	J0796	- 5/16-24 Lock Nuts	(8)	J0917	- 3/8-16 x 2 Carriage	(4)
J0564	- 1/4-20 x 1/2 Btn. Hds.	(4)	J0797	- 3/8-16 Lock Nuts	(6)	J0918	- 3/8 x 2 1/2 Carriage	(3)
J0568	- 1/4-20 x 3/4 Btn. Hds.	(4)	J0798	- 3/8-24 Lock Nuts	(6)	J0926	- 7/16-14 x 1 1/4 Carriage	(3)
J0572	- 1/4-20 x 1 Btn. Hds.	(4)	J0799	- 7/16-14 Lock Nuts	(5)	J0928	- 7/16-14 x 1 3/4 Carriage	(3)
J0574	- 1/4-20 x 1 1/4 Btn. Hds.	(4)	J0800	- 7/16-20 Lock Nuts	(5)	J0938	- 1/2-13 x 1 3/4 Carriage	(3)
J0588	- 5/16-18 x 3/4 Btn. Hds.	(4)	J0801	- 1/2-13 Lock Nuts	(5)	J2271	- 3/16 x 1 Super Washers	(5)
J0589	- 5/16-24 x 3/4 Btn. Hds.	(4)	J0802	- 1/2-20 Lock Nuts	(5)	J2272	- 1/4 x 1 Super Washers	(5)
J0592	- 5/16-18 x 1 Btn. Hds.	(4)	J0803	- 9/16-12 Lock Nuts	(4)	J2273	- 5/16 x 1 1/8 Super Washers	(5)
J0593	- 5/16-24 x 1 Btn. Hds.	(4)	J0804	- 9/16-18 Lock Nuts	(4)	J2274	- 5/16 x 1 1/2 Super Washers	(4)
J0596	- 5/16-18 x 1 1/2 Btn. Hds.	(3)	J0805	- 5/8-11 Lock Nuts	(4)	J2275	- 3/8 x 1 1/2 Super Washers	(4)
J0610	- 3/8-16 x 3/4 Btn. Hds.	(4)	J0806	- 5/16-16 Lock Nuts	(4)	J2276	- 7/16 x 1 Super Washers	(6)
J0614	- 3/8-16 x 1 Btn. Hds.	(4)	J0888	- 1/4 x 3/4 Carriage w/HN	(4)	J2277	- 1/2 x 1 1/4 Super Washers	(6)

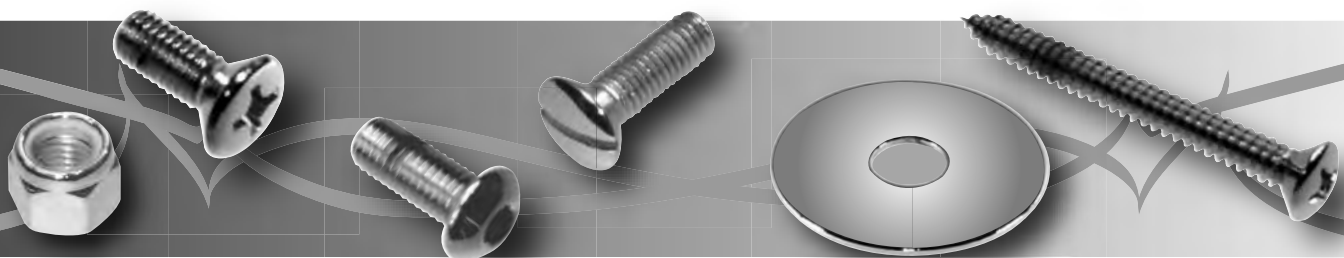



# P.O.P. Unit Descriptions

## FULL FLOOR UNITS



**J2POP-3 is a Product Display Unit of Polished Stainless Steel**  
**Contains (96) items of (1) ea. carded kits of the following fasteners:**

**Polished Stainless Steel Hex Caps, Hex Nuts, Button Head Allen Screws, Flat Washers, Nylon Lock Nuts and Oval Phillips Sheet Metal Screws**

Kit Part #	Description	Qty. per card	Kit Part #	Description	Qty. per card
J7000	- 1/4-20 x 1/2 Hex Caps	(7)	J7048	- 10/32 x 1/2 Button Head Allens	(8)
J7001	- 1/4-20 x 3/4 Hex Caps	(7)	J7049	- 10/24 x 3/4 Button Head Allens	(7)
J7002	- 1/4-20 x 1 Hex Caps	(7)	J7050	- 10/32 x 3/4 Button Head Allens	(7)
J7003	- 5/16-18 x 5/8 Hex Caps	(6)	J7051	- 1/4-20 x 1/2 Button Head Allens	(6)
J7004	- 5/16-18 x 3/4 Hex Caps	(6)	J7052	- 1/4-20 x 3/4 Button Head Allens	(6)
J7005	- 5/16-18 x 1 Hex Caps	(6)	J7053	- 1/4-20 x 1 Button Head Allens	(6)
J7006	- 5/16-18 x 1 1/4 Hex Caps	(6)	J7054	- 1/4-20 x 1 1/4 Button Head Allens	(5)
J7007	- 5/16-18 x 2 Hex Caps	(5)	J7055	- 5/16-18 x 3/4 Button Head Allens	(5)
J7008	- 5/16-18 x 2 1/2 Hex Caps	(4)	J7056	- 5/16-24 x 3/4 Button Head Allens	(2)
J7009	- 3/8-16 x 3/4 Hex Caps	(6)	J7057	- 5/16-18 x 1 Button Head Allens	(4)
J7010	- 3/8-16 x 1 Hex Caps	(6)	J7058	- 5/16-24 x 1 Button Head Allens	(2)
J7011	- 3/8-16 x 1 1/4 Hex Caps	(5)	J7059	- 5/16-18 x 1 1/2 Button Head Allens	(4)
J7012	- 3/8-16 x 1 1/2 Hex Caps	(4)	J7060	- 3/8-16 x 3/4 Button Head Allens	(4)
J7013	- 3/8-16 x 1 3/4 Hex Caps	(4)	J7061	- 3/8-16 x 1 Button Head Allens	(3)
J7014	- 3/8-16 x 2 Hex Caps	(4)	J7062	- 3/8-16 x 1 1/2 Button Head Allens	(3)
J7015	- 3/8-16 x 2 1/4 Hex Caps	(4)	J7063	- 3/16 Flat Washers	(10)
J7016	- 3/8-16 x 2 1/2 Hex Caps	(3)	J7064	- 1/4 Flat Washers	(10)
J7017	- 3/8-16 x 2 3/4 Hex Caps	(3)	J7065	- 5/16 Flat Washers	(9)
J7018	- 3/8-16 x 3 Hex Caps	(3)	J7066	- 3/8 Flat Washers	(8)
J7019	- 7/16-14 x 1 Hex Caps	(4)	J7067	- 7/16 Flat Washers	(7)
J7020	- 7/16-14 x 1 1/4 Hex Caps	(4)	J7068	- 1/2 Flat Washers	(6)
J7021	- 7/16-14 x 2 Hex Caps	(3)	J7069	- 5/8 Flat Washers	(5)
J7022	- 1/2-13 x 1 Hex Caps	(3)	J7070	- 1/4-20 Nylon Lock Nuts	(4)
J7023	- 1/2-13 x 1 1/2 Hex Caps	(3)	J7071	- 1/4-28 Nylon Lock Nuts	(4)
J7024	- 1/2-13 x 2 Hex Caps	(3)	J7072	- 5/16-18 Nylon Lock Nuts	(4)
J7025	- 1/2-13 x 2 1/2 Hex Caps	(2)	J7073	- 5/16-24 Nylon Lock Nuts	(4)
J7026	- 5/16-24 x 3/4 Hex Caps	(6)	J7074	- 3/8-16 Nylon Lock Nuts	(3)
J7027	- 5/16-24 x 2 1/4 Hex Caps	(4)	J7075	- 3/8-24 Nylon Lock Nuts	(3)
J7028	- 3/8-24 x 3/4 Hex Caps	(6)	J7076	- 7/16-14 Nylon Lock Nuts	(3)
J7029	- 3/8-24 x 1 Hex Caps	(5)	J7077	- 7/16-20 Nylon Lock Nuts	(5)
J7030	- 1/2-20 x 1 1/2 Hex Caps	(2)	J7078	- 1/2-13 Nylon Lock Nuts	(3)
J7031	- 1/2-20 x 2 1/2 Hex Caps	(2)	J7079	- 1/2-20 Nylon Lock Nuts	(2)
J7032	- 10/24 Hex Nuts	(4)	J7080	- 5/8-11 Nylon Lock Nuts	(2)
J7033	- 1/4-20 Hex Nuts	(4)	J7081	- 5/8-18 Nylon Lock Nuts	(2)
J7034	- 5/16-18 Hex Nuts	(4)	J7082	- #8 x 1/2 Oval Phillips Sheet Metal Screws	(8)
J7035	- 3/8-16 Hex Nuts	(4)	J7083	- #8 x 3/4 Oval Phillips Sheet Metal Screws	(8)
J7036	- 7/16-14 Hex Nuts	(3)	J7084	- #8 x 1 Oval Phillips Sheet Metal Screws	(8)
J7037	- 1/2-13 Hex Nuts	(3)	J7085	- #8 x 1 1/4 Oval Phillips Sheet Metal Screws	(8)
J7038	- 5/8-11 Hex Nuts	(2)	J7086	- 8 x 3/4 #6 Oval Phillips Sheet Metal Screws	(6)
J7039	- 10/32 Hex Nuts	(4)	J7087	- 8 x 1 #6 Oval Phillips Sheet Metal Screws	(6)
J7040	- 1/4-28 Hex Nuts	(4)	J7088	- 8 x 1 1/4 #6 Oval Phillips Sheet Metal Screws	(6)
J7041	- 5/16-24 Hex Nuts	(4)	J7089	- 8 x 1 1/2 #6 Oval Phillips Sheet Metal Screws	(6)
J7042	- 3/8-24 Hex Nuts	(4)	J7090	- 8/32 x 3/4 Oval Phillips Sheet Metal Screws	(8)
J7043	- 7/16-20 Hex Nuts	(3)	J7091	- 10/32 x 1/2 Oval Phillips Sheet Metal Screws	(8)
J7044	- 1/2-20 Hex Nuts	(3)	J7092	- 10/32 x 3/4 Oval Phillips Sheet Metal Screws	(8)
J7045	- 5/8-18 Hex Nuts	(2)	J7093	- 10/32 x 1 Oval Phillips Sheet Metal Screws	(8)
J7046	- 8/32 x 1/2 Button Head Allens	(8)	J7094	- 10/24 x 3/4 Oval Phillips Sheet Metal Screws	(8)
J7047	- 10/24 x 1/2 Button Head Allens	(8)	J7095	- 12/24 x 1 Oval Phillips Sheet Metal Screws	(6)

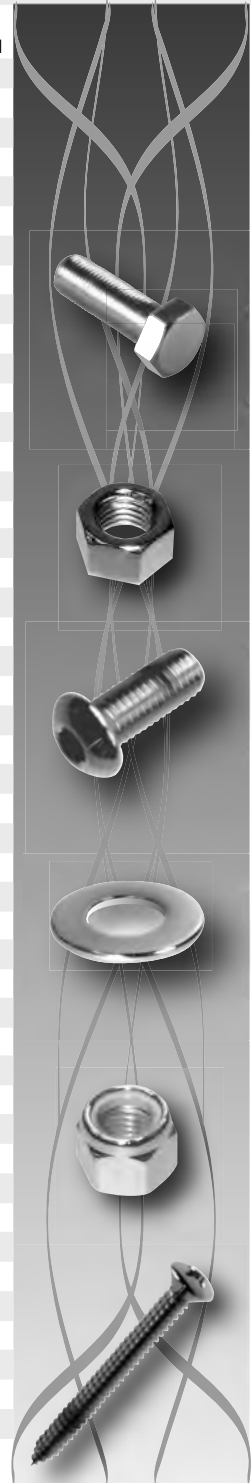

**When only the very BEST will do, Demand what the Pro's use...**

*Gardner-Westcott*

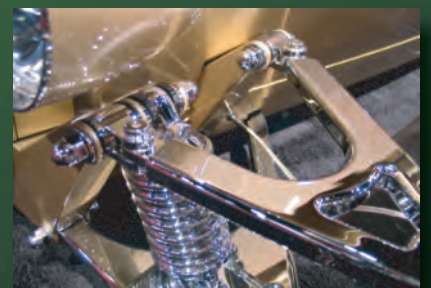

Discover other engine components on our website.