



Rapid-Mic Electronic Micrometer



Rapid-Mic Battery Cover
Part Number: 062.276.01



Rapid-Mic Port Cover
Part Number: 061.276.12

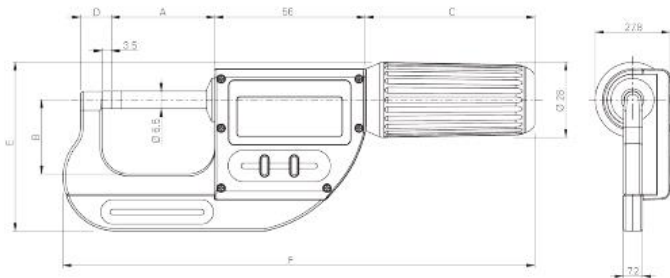

Dimensions(mm):	A	B	C	D	E	F
54-815-030-0	38.5	27.5	63	11.5	63	176
54-815-060-0	74.5	43	75	12.5	85	231
54-815-100-0	110.5	60	75	13.5	106	270

***Specialty Micrometers available,
Contact the Fowler Technical Department.**

Part Number	Range	Resolution	Max Error
54-815-030-0	0-1.18"/0-30mm	0.00005"/1µm	.00012"/.003mm
54-815-060-0	1.18"-2.6"/30-66mm	0.00005"/1µm	.00016"/.004mm
54-815-100-0	2.6"-4.0"/66-102mm	0.00005"/1µm	.00020"/.005mm
Bluetooth Model			
54-815-130-0	0-1.18"/0-30mm	0.00005"/1µm	.00012"/.003mm
Set			
54-815-111-0	0-102mm RAPID Mic Set		
Accessories			
54-815-222-0	Stand		
54-115-246-BT	USB Bluetooth Receiver		

LIFETIME WARRANTY

IP67

Fowler PROXIMITY INTERFACE



Swiss Quality!



0-1" Now available with Bluetooth

*Rapid spindle Movement
Extended range
Adjustable Measuring Force*





Ball Attachment



XTRA-VALUE Digi-Micrometers



No. 54-815-001-0



Black Thimble Collar
Part Number: 05-100-002



Black and Silver Thimble Knob
Part Number: 05-100-001



Ratchet Spring
Part Number: 05-100-213



Locking Lever L1
Part Number: 05-100-004



Battery Cover B1
Part Number: 05-100-003

Part Number	Range	Accuracy	Resolution
54-815-001-2	0-1" / 0-25mm	± .00016"	.00005" / .001mm
54-815-002-2	1-2" / 25-50mm	± .00016"	.00005" / .001mm
54-815-003-2	2-3" / 50-75mm	± .0002"	.00005" / .001mm
Set			
54-815-103-0	0-3" / 0-75mm Set		
Replacement Battery			
54-100-350-0	CR2032 Replacement Battery		



Electronic Coolant Resistant Micrometers



Rubber Coated Thimble Cover
Part Number: 05-100-333



Battery Cover B2
Part Number: 05-100-005



Rubber Seal (Battery Cover B2)
Part Number: 05-100-006

Part Number	Range	Accuracy	Resolution
54-860-001-1	0-1"/0-25mm	.00016"	.00005"/.001mm
54-860-002-1	1-2"/25mm-50mm	.00016"	.00005"/.001mm
54-860-003-1	2-3"/50mm-75mm	.0002"	.00005"/.001mm
54-860-004-1	3-4"/75mm-100mm	.0002"	.00005"/.001mm
54-860-005-1	4-5"/100mm-125mm	.00024"	.00005"/.001mm
54-860-006-1	5-6"/125mm-150mm	.00024"	.00005"/.001mm
Set			
54-860-103-1	0-3"/0-75mm		
54-860-106-1	0-6"/0-150mm		
Accessories			
54-100-350-0	Replacement CR2032 Battery		
54-115-781-0	RS232 Cable		

Xtra Value II Electronic Micrometers



Rubber Coated Thimble Cover
Part Number: 05-100-333



Battery Cover B2
Part Number: 05-100-005



Rubber Seal (Battery Cover B2)
Part Number: 05-100-006

Part Number	Range	Accuracy	Resolution
54-870-001-0	0-1"/0-25mm	±.00016"	.00005"/.001mm
54-870-002-0	1-2"/25-50mm	±.00016"	.00005"/.001mm
54-870-003-0	2-3"/50-75mm	±.0002"	.00005"/.001mm
54-870-004-0	3-4"/75-100mm	±.0002"	.00005"/.001mm
Set			
54-870-103-0	0-3"/0-75mm Set		
Accessories			
54-100-350-0	Replacement CR2032 Battery		
54-115-781-0	RS232 Cable		



QuadraMic Electronic 4-way Reading Micrometer



Micrometer reads 4 ways for incredible versatility!



Battery Cover B3
Part Number: 05-100-007



Battery Cover Ring (B3)
Part Number: 05-100-008



Plastic Thimble Knob
Part Number: 05-100-019



Port Cover P1
Part Number: 05-100-020



Part Number	Range	Resolution	Thimble
54-866-001-0	0-1.2"/0-30	.00005"/.001mm	Friction
54-866-002-0	1-2.2"/25-55mm w/standard	.00005"/.001mm	Friction
54-866-003-0	2-3.2"/50-80mm w/standard	.00005"/.001mm	Friction
54-866-004-0	3-4.2"/75-100mm w/standard	.00005"/.001mm	Friction
54-866-005-0	4-5.2"/100-130mm w/standard	.00005"/.001mm	Friction
54-866-006-0	5-6.2"/125-155mm w/standard	.00005"/.001mm	Friction
Accessories			
54-115-779-0	Computer Connect Kit		
54-100-350-0	Replacement Battery		



Digit Counter Outside Micrometers



No. 52-224-001-0



Ratchet Assembly R1
Part Number: 05-100-009



Black Locking Assembly
Part Number: 05-100-014



Inch Counter Cover
Part Number: 05-100-010



Inch Counter Mechanics
Part Number: 05-100-012



Metric Counter Cover
Part Number: 05-100-011



Metric Counter Mechanics
Part Number: 05-100-013



Micrometer Wrench
Part Number: 05-100-212



No. 52-224-103-0

Part Number	Range	Graduation	Accuracy
Inch			
52-224-001-0	0-1"	.0001"	±0.00016"
52-224-002-0	1-2" w/standard	.0001"	±0.00016"
52-224-003-0	2-3" w/standard	.0001"	±0.0002"
52-224-004-0	3-4" w/standard	.0001"	±0.0002"
52-224-005-0	4-5" w/standard	.0001"	±0.00024"
52-224-006-0	5-6" w/standard	.0001"	±0.00024"
Metric			
52-224-009-0	0-25mm	.01mm	±0.004mm
52-224-010-0	25-50mm	.01mm	±0.004mm
52-224-011-0	50-75mm	.01mm	±0.005mm
Sets			
52-224-103-0	0-3" w/standards & case	.0001"	
52-224-104-0	0-4" w/standards & case	.0001"	
52-224-220-0	0-75mm w/standards & case	.01mm	



Swiss Style Inch Micrometers



No. 52-229-213-0



No. 52-229-201-0

 Black Thimble Collar
Part Number: 05-100-002

 Black and Silver Thimble Knob
Part Number: 05-100-001

 Ratchet Spring
Part Number: 05-100-213

 Locking Lever L2
Part Number: 05-100-015

 Micrometer Wrench
Part Number: 05-100-212

Part Number	Range	Graduation	Accuracy
Inch			
52-229-201-0	0-1"	.0001"	± .00016"
52-229-202-0	1-2" w/standard	.0001"	± .00016"
52-229-203-0	2-3" w/standard	.0001"	± .0002"
52-229-204-0	3-4" w/standard	.0001"	± .0002"
52-229-205-0	4-5" w/standard	.0001"	± .00024"
52-229-206-0	5-6" w/standard	.0001"	± .00024"
Metric			
52-229-209-0	0-25mm	.01mm	± .004mm
52-229-210-0	25-50mm w/standard	.01mm	± .004mm
52-229-211-0	50-75mm w/standard	.01mm	± .005mm
52-229-212-0	75-100mm w/standard	.01mm	± .005mm
Sets (inch)			
52-229-213-0	0-3" set w/standards & case	.0001"	
52-229-214-0	0-4" set w/standards & case	.0001"	
Sets (mm)			
52-229-215-0	0-75mm set w/standards & case	.01mm	
52-229-220-0	0-100mm set w/standards & case	.01mm	



Inch Outside Micrometers



No. 52-235-001-1



Black Thimble Collar
Part Number: 05-100-002



Black and Silver Thimble Knob
Part Number: 05-100-001



Ratchet Spring
Part Number: 05-100-213



Micrometer Wrench
Part Number: 05-100-212



No. 52-235-100

Part Number	Range	Graduation	Thimble
Inch Series:			
52-235-001-1	0-1"	.0001"	Ratchet
52-235-002-2	1-2" w/standard	.0001"	Ratchet
52-235-003-2	2-3" w/standard	.0001"	Ratchet
Set (inch)			
52-235-100-0	0-3" set w/standards & case	.0001"	



Interchangeable Anvil Micrometers



No. 52-401-222-1

4 to 6 mics in one



Silver Locking Assembly
Part Number: 05-100-016



Ratchet Assembly R1
Part Number: 05-100-009



Micrometer Wrench
Part Number: 05-100-212



Part Number	Description
05-100-446-0	(0) Rod for 52-401-221-1
05-100-447-0	1" Rod for 52-401-221-1
05-100-448-0	2" Rod for 52-401-221-1
05-100-449-0	3" Rod for 52-401-221-1
05-100-450-0	4" Rod for 52-401-221-1
05-100-451-0	5" Rod for 52-401-221-1

Note: Larger sizes available by special order. Please contact the Fowler Repair Department for more information.



Part Number	Range	Graduation	Accuracy
52-401-221-1	0-6" w/standards & case	.0001"	.00024"
52-401-222-1	6-12" w/standards & case	.0001"	.00024"
52-401-204-1	12-16" w/standards & case	.001"	.00036"
52-401-205-1	16-20" w/standards & case	.001"	.00036"

Fowler

Outside Inch Micrometers



No. 52-253-001-1

.001" Graduations



Black and Silver Thimble Knob

Part Number: 05-100-001

Note: For friction micrometers.



Silver Locking Assembly

Part Number: 05-100-016



Ratchet Assembly R1

Part Number: 05-100-009

Note: For ratchet micrometers.



Micrometer Wrench

Part Number: 05-100-212

- Hammertone blue baked enamel finish.
- Microfine graduations on satin chrome finish and carbide tipped measuring faces.
- Graduation: .001"
- Includes standard with sizes 2" and over.
- Diameter of measuring faces: .256"
- Friction stop thimble for exact and repetitive readings.
- Flatness: .00003"
- Accuracy: $\pm .001$ " for 0-1"
- Parallelism: .00005" for 0-1"
- Positive lever locking clamp ensures reliable measurement.
- Anvil & spindle hardened and precision ground with microlap finish on tips.
- All micrometers meet or exceed U.S. Federal specifications for accuracy.
- Includes a wrench and case.

Part Number	Range	Graduation	Accuracy	Thimble
52-253-001-1	0-1"	.001"	$\pm .001$ "	Friction
52-253-101-1	0-1"	.001"	$\pm .001$ "	Ratchet
52-253-002-1	1-2" w/standard	.001"	$\pm .001$ "	Friction
52-253-102-1	1-2" w/standard	.001"	$\pm .001$ "	Ratchet
52-253-003-1	2-3" w/standard	.001"	$\pm .001$ "	Ratchet
52-253-004-1	3-4" w/standard	.001"	$\pm .001$ "	Ratchet
52-253-005-1	4-5" w/standard	.001"	$\pm .001$ "	Ratchet
52-253-006-1	5-6" w/standard	.001"	$\pm .001$ "	Ratchet
Sets				
52-253-400-1	0-4" w/standards & case			
52-253-600-1	0-6" w/standards & case			



Outside Inch Micrometers



No. 52-240-001-1

.0001" Graduations



Black and Silver Thimble Knob
Part Number: 05-100-001
Note: For friction micrometers.



Silver Locking Assembly
Part Number: 05-100-016



Ratchet Assembly R1
Part Number: 05-100-009
Note: For ratchet micrometers.



Micrometer Wrench
Part Number: 05-100-212



Part Number	Range	Graduation	Accuracy	Thimble
52-240-001-1	0-1"	.0001"	±.00015"	Friction
52-240-101-1	0-1"	.0001"	±.00015"	Ratchet
52-240-002-1	1-2" w/standard	.0001"	±.00015"	Friction
52-240-102-1	1-2" w/standard	.0001"	±.00015"	Ratchet
52-240-003-1	2-3" w/standard	.0001"	±.0002"	Ratchet
52-240-004-1	3-4" w/standard	.0001"	±.0002"	Ratchet
52-240-005-1	4-5" w/standard	.0001"	±.00025"	Ratchet
52-240-006-1	5-6" w/standard	.0001"	±.00025"	Ratchet
52-240-007-1	6-7" w/standard	.0001"	±.0003"	Ratchet
52-240-008-1	7-8" w/standard	.0001"	±.0003"	Ratchet
52-240-009-1	8-9" w/standard	.0001"	±.0003"	Ratchet
52-240-010-1	9-10" w/standard	.0001"	±.0003"	Ratchet
52-240-011-1	10-11" w/standard	.0001"	±.00035"	Ratchet
52-240-012-1	11-12" w/standard	.0001"	±.00035"	Ratchet
52-215-003-1	0-3" w/standards & case	3-piece Micrometer Set. (Includes No. 52-240-001-1 thru No. 52-240-003-1)		
52-215-004-1	0-4" w/standards & case	4-piece Micrometer Set. (Includes No. 52-240-001-1 thru No. 52-240-004-1)		
52-215-006-1	0-6" w/standards & case	6-piece Micrometer Set. (Includes No. 52-240-001-1 thru No. 52-240-006-1)		
52-215-012-1	0-12" w/standards & case	12-piece Micrometer Set. (Includes No. 52-240-001-1 thru No. 52-240-012-1)		
52-215-612-1	6-12" w/standards & case	6-piece Micrometer Set. (Includes No. 52-240-007-1 thru No. 52-240-012-1)		



Large Capacity Inch Micrometers



No. 52-240-013-1



Micrometer Wrench

Part Number: 05-100-212



Black Locking Lever Assembly

Part Number: 05-100-233

For larger applications, Series No. 52-240 is available in sizes up to a 20". Each micrometer offers superior design and workmanship to ensure high precision and long life — and at economical prices.

Features:

- Hammetone blue baked enamel finish.
- Microfine graduations on satin chrome finish and carbide tipped measuring faces.
- Diameter of measuring faces: .295"
- Ratchet stop thimble for exact and repetitive readings.
- Graduation: .001"
- Flatness: .00003"
- Quick, easy zero adjustment on sleeve.
- Positive lever locking clamp ensures reliable measurement setting at all times.
- Anvil & spindle hardened and precision ground with microlap finish on tips.
- All micrometers meet or exceed U.S. Federal specifications for accuracy.
- Includes standard
- Includes a wrench and case.

Part Number	Range	Graduation	Accuracy
52-240-013-0	12-13" w/standard	.001"	.0004"
52-240-014-0	13-14" w/standard	.001"	.0004"
52-240-015-0	14-15" w/standard	.001"	.0004"
52-240-016-0	15-16" w/standard	.001"	.0004"
52-240-017-0	16-17" w/standard	.001"	.0005"
52-240-018-0	17-18" w/standard	.001"	.0005"
52-240-019-0	18-19" w/standard	.001"	.0005"
52-240-020-0	19-20" w/standard	.001"	.0005"



Outside Metric Micrometers



No. 52-248-001-0



No. 52-248-101-0

 Black and Silver Thimble Knob
Part Number: 05-100-001

 Black Thimble Collar
Part Number: 05-100-002

 Ratchet Spring
Part Number: 05-100-213

 Silver Locking Assembly
Part Number: 05-100-016

 Micrometer Wrench
Part Number: 05-100-212

 Ratchet Assembly R1
Part Number: 05-100-009

 Silver Locking Assembly
Part Number: 05-100-016

 Micrometer Wrench
Part Number: 05-100-212

Part Number	Range	Graduation	Accuracy	Thimble
52-248-001-1	0-25mm	.01mm	.004mm	Friction
52-248-101-0	0-25mm	.01mm	.004mm	Ratchet
52-248-002-1	25-50mm w/standard	.01mm	.004mm	Friction
52-248-102-0	25-50mm w/standard	.01mm	.004mm	Ratchet
52-248-003-1	50-75mm w/standard	.01mm	.005mm	Ratchet
52-248-004-1	75-100mm w/standard	.01mm	.005mm	Ratchet
52-248-005-1	100-125mm w/standard	.01mm	.006mm	Ratchet
52-248-006-1	125-150mm w/standard	.01mm	.006mm	Ratchet
52-248-007-1	150-175mm w/standard	.01mm	.007mm	Ratchet
52-248-008-1	175-200mm w/standard	.01mm	.007mm	Ratchet
52-248-009-1	200-225mm w/standard	.01mm	.008mm	Ratchet
52-248-010-1	225-250mm w/standard	.01mm	.008mm	Ratchet
52-248-011-1	250-275mm w/standard	.01mm	.009mm	Ratchet
52-248-012-1	275-300mm w/standard	.01mm	.009mm	Ratchet
Sets:				
52-217-075-0	0-75mm w/standards & case	3-piece Micrometer Set. (Includes No. 52-248-001 thru No. 52-248-003)		
52-217-150-1	0-150mm w/standards & case	6-piece Micrometer Set. (Includes No. 52-248-001 thru No. 52-248-006)		
52-217-300-1	0-300mm w/standards & case	12-piece Micrometer Set. (Includes No. 52-248-001 thru No. 52-248-012)		

Fowler

Electronic Indicating Micrometers



No. 54-245-777-0

Shown with No. 54-245-800-0 stand sold separately.

Parts Available By
Special Order.



Spring Loaded
Extended Range
0.00005" Resolution

Part Number	Range	Resolution (switchable)	Accuracy
54-245-777-0	0-1.25"/0-30mm	0.0005"/0.00005" (0.01/0.001mm)	.00015" (4 μ m)
54-245-780-0	1.25"-2.50"/30-60mm	0.0005"/0.00005" (0.01/0.001mm)	.00020" (5 μ m)
Accessories			
54-245-800-0	Bench stand for above units		
54-245-825-0	Dual bench stand for above units		
54-115-525-0	Opto USB Cable		
Replacement Battery			
54-100-350-0	CR2032 Lithium replacement battery		



INDI-X[®] Indicating Micrometers

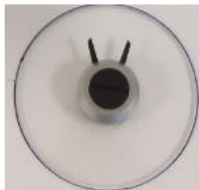

Glass Cover w/ Prongs
Part Number: 05-100-017

Part Number	Range	Accuracy
54-245-501-0	0-1"	.00016"
54-245-502-0	1-2"	.00016"



Deep Throat Micrometer



No. 52-517-611-1



Ratchet Assembly R1

Part Number: 05-100-009



Micrometer Wrench

Part Number: 05-100-212

Fowler's "U"-frame Deep Throat Micrometers are available with depths of 6" and 12". Use Deep Throat Micrometers for taking accurate measurements of steel and plastic sheets and plates whenever a depth measurement of 2" to 12" is needed.

Features:

- Hammertone blue baked enamel frame.
- Graduations are microfine on satin chrome finish for easy reading.
- All models feature a ratchet stop thimble for exact and repetitive readings.
- The spindle thread is hardened, ground and lapped. The anvil and spindle are hardened and precision ground with microlap finish on carbide tipped measuring faces.
- Diameter of measuring faces = .256".
- Positive lever locking clamp ensures reliable measurement at all times.
- Wrench furnished with each micrometer for fast, easy zero adjustment on the sleeve.
- Flatness: .00003"
- Parallelism: .00005"
- 52-517-612-1 supplied with a ball anvil.
- Meets or exceeds Federal accuracy specs.
- Includes case.



Part Number	Range	Graduation	Accuracy	Anvil	Throat Depth
52-517-611-1	0-1"	.0001"	.00016"	Flat	6"
52-517-612-1	0-1"	.0001"	.0002"	Ball	11.875"

Fowler

Electronic IP54 Ball-Anvil Micrometers



No. 54-860-113-0 Ball Anvil



No. 54-860-211-0 Ball Anvil & Ball Spindle

Fowler
RS-232
DIRECT

IP54



Timble Barrel Cover

Part Number: 05-100-018

Note: Different lengths based on age of micrometer, only 1.34" version available.



Plastic Thimble Knob

Part Number: 05-100-019



Port Cover P1

Part Number: 05-100-020

Part

Part Number	Description	Range	Resolution	Accuracy
54-860-113-0	Ball Anvil & Flat Spindle	0-1"/0-25mm	.00005"/.001mm	.00016"/.004mm
54-860-114-0	Ball Anvil & Flat Spindle	1-2"/25-50mm	.00005"/.001mm	.00016"/.004mm
54-860-211-0	Ball Anvil & Ball Spindle	0-1"/0-25mm	.00005"/.001mm	.00016"/.004mm
54-860-212-0	Ball Anvil & Ball Spindle	1-2"/25-50mm	.00005"/.001mm	.00016"/.004mm

Accessories

54-115-779-0	Computer Connect Kit
Replacement Battery	
54-902-110-0	Type 357 Replacement Battery



Ball Anvil

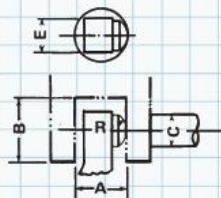

Ball Anvil & Spindle

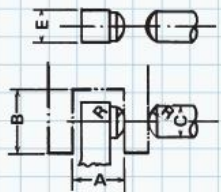

TECHNICAL DATA

	English inch
A	.430"
B	.300"
C	.256"
R	.236"
E	.256"



Digit Counter Ball-Anvil Micrometers



No. 52-244-201-1



Ratchet Assembly R1

Part Number: 05-100-009



Black Locking Assembly

Part Number: 05-100-014



Inch Counter Cover

Part Number: 05-100-010



Inch Counter Mechanics

Part Number: 05-100-012



Metric Counter Cover

Part Number: 05-100-011



Metric Counter Mechanics

Part Number: 05-100-013



Micrometer Wrench

Part Number: 05-100-212

Features:

- Microfine graduations on satin chrome. Digital counter reads to .001"; sleeve reads to .0001".
- Hammetone blue baked enamel frame furnished with deluxe heat insulator.
- No. 52-244-201-1 spindle hardened and precision ground with a carbide tipped measuring face.
- No. 52-244-301-1 anvil is hardened and precision ground.
- Spindle thread hardened, ground & lapped.
- Ratchet stop thimble on all models.
- Positive locking nut on spindle.
- Accuracy = .00016".
- Includes wrench for quick, easy zero adjustment on sleeve and a case.

Part Number	Description	Range	Graduation	Accuracy
52-244-201-1	Ball Anvil	0-1"	.0001"	.00016"
52-244-202-1	Ball Anvil with standard	1-2"	.0001"	.00016"
52-244-301-1	Ball Anvil & Spindle	0-1"	.0001"	.00016"



Ball-Anvil Micrometers



No. 52-244-101-1



Silver Locking Assembly
Part Number: 05-100-016



Ratchet Assembly R1
Part Number: 05-100-009



Micrometer Wrench
Part Number: 05-100-212

The back side of the anvil stem of Fowler Ball-Anvil Tube Micrometers is cut away, making it slim enough to insert into small parts such as sleeves, collars, tubing and other cylindrical workpieces to measure wall thickness.

Measure dimensions from inside of holes to outside edges. The spherical anvil or spindle contacts the inside curved surface at a single point, permitting accurate gaging of wall thickness to .0001" or .001mm.

Features:

- Hammertone blue baked enamel frame.
- Microfine graduations on satin chrome.
- Anvil and spindle hardened and ground; spindle thread hardened, ground and lapped.
- Positive lever-locking clamp assures accurate settings.
- A wrench is furnished with each tool for quick and easy zero adjustment on sleeve.
- Ratchet stop thimble for exact readings.
- Accuracy: .0001".
- Meets or exceeds Federal accuracy specs.
- Includes case.

Part Number	Description	Range	Graduation	Accuracy
Inch				
52-244-001-1	Ball Anvil	0-1"	.0001"	.00016"
52-244-101-1	Ball Anvil & Ball Spindle	0-1"	.0001"	.00016"
Metric				
52-244-025-0	Ball Anvil	0-25mm	.001mm	.004mm
52-244-125-0	Ball Anvil& Ball Spindle	0-25mm	.001mm	.004mm

Ball Anvil

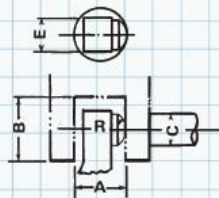

Ball Anvil & Spindle

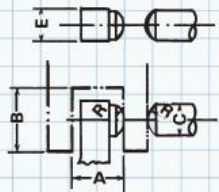

TECHNICAL DATA

	English inch	Metric mm
A	.325"	8.25mm
B	.450"	11.5mm
C	.250"	6.35mm
R	.236"	6mm
E	.250"	6.35mm

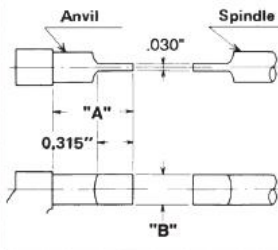

TECHNICAL DATA

A = .600", B = .235"

Electronic IP54 Blade Micrometer

No. 54-860-241-0



Timble Barrel Cover

Part Number: 05-100-018

Note: Different lengths based on age of micrometer, only 1.34" version available.



Plastic Thimble Knob

Part Number: 05-100-019



Port Cover P1

Part Number: 05-100-020

Use for measuring the outside diameters of workpieces with narrow grooves, T-slots & other dimensions blocked by shoulders or lands inaccessible by standard micrometers

Features:

- Water Resistant to IP54 specifications.
- True inch/metric conversion
- Resolution: .00005"/.001mm
- Direct RS232 output
- Large easy-to-read LCD display.
- Friction Thimble
- Sizes over 1" include standard.
- Includes case.

Part Number	Range	Resolution	Accuracy
54-860-241-0	0-1"/0-25mm	.00005"/.001mm	.00016"
54-860-242-0	1-2"/25-50mm	.00005"/.001mm	.00016"
54-860-243-0	2-3"/50-75mm	.00005"/.001mm	.00016"
54-860-244-0	3-4"/75-100mm	.00005"/.001mm	.00016"
Accessories			
54-115-779-0	Computer Connect Kit		
Replacement Battery			
54-902-110-0	Type 357 Replacement Battery		



Inch Blade Micrometers



No. 52-246-001-1



Black Thimble Collar

Part Number: 05-100-002



Black and Silver Thimble Knob

Part Number: 05-100-001



Ratchet Spring

Part Number: 05-100-213



Micrometer Wrench

Part Number: 05-100-212

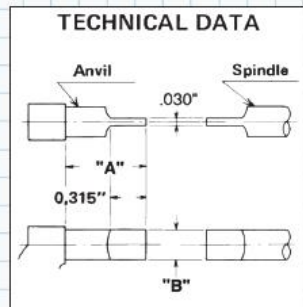

Use Fowler No. 52-246 Blade Micrometers to measure the outside diameter of workpieces which have narrow grooves, "T" slots and other dimensions blocked by shoulders or lands where standard type micrometers cannot be applied.

Features:

- Hammertone blue baked enamel frame
- Microfine graduations on satin chrome finish for easy reading.
- Anvil & spindle hardened & precision ground with microlap finish on ends. Spindle thread is hardened, ground and lapped.
- Non-rotating spindle
- Ratchet thimble
- Blade thickness = $.030''$; blade width = $.256''$; blade penetration = $.315''$
- Accuracy = $.0001''$ for 0—1"
- Wrench included for quick and easy zero adjustment on sleeve.
- Sizes over 1" include a standard.
- Includes case.

Part Number	Range	Graduation	Accuracy	Dim. "A"	Dim. "B"
52-246-001-1	0-1"	.0001"	.00016"	.515"	.238"
52-246-002-1	1-2"	.0001"	.00016"	.515"	.238"
52-246-003-1	2-3"	.0001"	.0002"	.515"	.238"
52-246-004-1	3-4"	.0001"	.0002"	.710"	.238"



Digit Counter Point Micrometer



No. 52-226-801-1

Technical Data

R = .012"

R = .012" - 0.3mm
 Error of Traverse
 Maximum .00012 - .003mm



Ratchet Assembly R1
Part Number: 05-100-009



Black Locking Assembly
Part Number: 05-100-014



Inch Counter Cover
Part Number: 05-100-010



Inch Counter Mechanics
Part Number: 05-100-012



Micrometer Wrench
Part Number: 05-100-212



Part Number	Range	Graduation	Accuracy	Point°	Point Length
52-226-801-1	0-1"	.0001"	.00016"	60°	.21"



Electronic IP54 Disc Micrometer



No. 54-860-301-0



Timble Barrel Cover
Part Number: 05-100-018

Note: Different lengths based on age of micrometer, only 1.34" version available.



Plastic Thimble Knob
Part Number: 05-100-019



Port Cover P1
Part Number: 05-100-020

Features extra large diameter discs which easily enter hard-to-reach narrow grooves, slots & recesses.

Features:

- Water Resistant to IP54 specifications.
- True inch/metric conversion.
- Resolution: .00005"/.001mm.
- Direct RS232 output.
- Friction thimble
- Large easy-to-read LCD display.
- Extra large .788" disc with .035" edge thickness.
- Easily enters hard-to-reach areas.
- Includes case.

Part Number	Range	Resolution	Accuracy
54-860-301-0	0-1"/0-25mm	.00005"/.001mm	.00016"
54-860-302-0	1-2"/25-50mm w/standard	.00005"/.001mm	.00016"

- Accessories
- 54-115-779-0 Computer Connect Kit
- Replacement Battery
- 54-902-110-0 Type 357 Replacement Battery

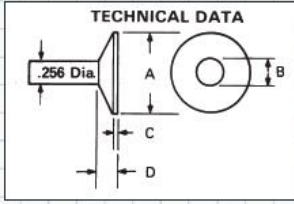

	English inch	Metric mm
A	.788"	20mm
B	.315"	85mm
C	.035"	.89mm
D	.130"	3.3mm



Digit Counter Disc Micrometers



No. 52-250-301-1

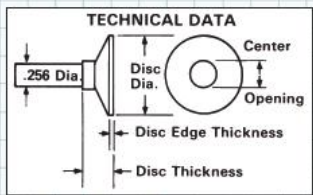

Black Locking Assembly
Part Number: 05-100-014



Ratchet Assembly R1
Part Number: 05-100-009



Inch Counter Cover
Part Number: 05-100-010



Inch Counter Mechanics
Part Number: 05-100-012



Metric Counter Cover
Part Number: 05-100-011



Metric Counter Mechanics
Part Number: 05-100-013



Micrometer Wrench
Part Number: 05-100-212



Part Number	Range	Graduation	Accuracy
52-250-301-1	0-1"	.0001"	.00016"
52-250-302-1	1-2"	.0001"	.00016"
Metric			
52-250-425-1	0-25mm	.001mm	.004mm

Fowler

Disc Micrometers



No. 52-250-111-1



Silver Locking Assembly

Part Number: 05-100-016



Ratchet Assembly R1

Part Number: 05-100-009



Micrometer Wrench

Part Number: 05-100-212

Fowler Disc Micrometers simplify measuring thickness of difficult, closely spaced sections, ribs, keys, fins, cutting edges on forming tools, chordal thickness of gear teeth and more. The extra large diameter disc will enter normally inaccessible places such as narrow grooves, slots and recesses.

Features:

- Hammettone blue baked enamel frame is tapered for hard-to-get-at places.
- Anvil and spindle are hardened and precision ground with microlap finish on measuring faces.
- Positive lever locking clamp.
- Quick and easy zero adjustment on sleeve
- Ratchet thimble for repeatability
- Flatness: .0004"
- Accuracy and parallelism: 1" & 2": .00016"; 3" & 4": .00024".
- Meets or exceeds Federal accuracy specs.
- Sizes over 1" include standards
- Includes case.

Dimensions

Part Number	Dim. "A"	Dim. "B"	Dim. "C"	Dim. "D"
52-250-111-1	.787"	.315"	.039"	.250"
52-250-112-1	.787"	.276"	.039"	.250"
52-250-113-1	.787"	.276"	.039"	.250"
52-250-114-1	.945"	.394"	.039"	.250"

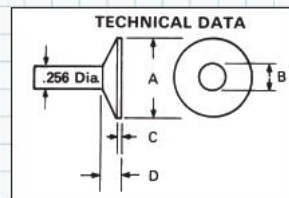

Part Number	Range	Graduations	Accuracy
52-250-111-1	0-1"	.0001"	.00016"
52-250-112-1	1-2"	.0001"	.00016"
52-250-113-1	2-3"	.0001"	.0002"
52-250-114-1	3-4"	.0001"	.0002"

Technical Data

Cylindrical

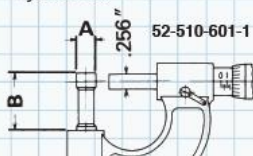

A = .315" (8mm)
B = 1.083" (27.5mm)

Spherical

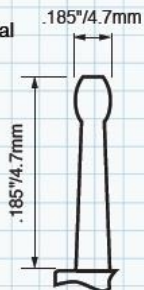

52-510-602-1

Cylindrical/Spherical Tube Micrometers



No. 52-510-601-1



No. 52-510-602-1



Micrometer Wrench
Part Number: 05-100-212



Ratchet Assembly R1
Part Number: 05-100-009



Part Number	Range	Graduation	Accuracy	Type
52-510-601-1	0-1"	.0001"	.00024"	Cylindrical
52-510-602-1	0-1"	.0001"	.00024"	Spherical
52-510-101-1	0-25mm	.001mm	.006mm	Cylindrical



Multi-Anvil Micrometer



No. 52-252-001-0



Ratchet Spring R2

Part Number: 05-100-214



Silver Thimble Knob

Part Number: 05-100-064

2 Mics in one

Fowler's Multi-Anvil-Micrometer with a satin chrome finish is supplied with both a rod and flat anvil.

Features:

- Friction thimble for exact, repetitive readings.
- Positive lever locking clamp for reliable measurements at all times.
- Anvil rod is .120" in diameter and 1" long.
- Flat anvil thickness is .065" and 1" long.
- Spindle face is carbide tipped.
- Easily measures difficult to reach locations.
- Graduation .0001"
- Includes a rod and flat anvil, allen key and spanner wrench and a case.



Part Number	Description	Graduation	Accuracy
52-252-001-0	0-1" Multi-Anvil Micrometer	.0001"	.00016"



Digit Counter Spline Micrometers

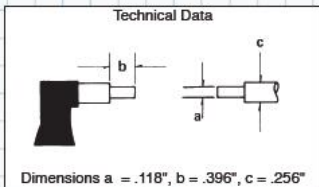
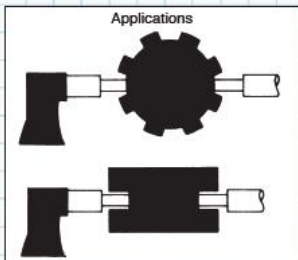

*Measure recesses,
grooves & splines*



No. 52-218-301-1



Black Locking Assembly
Part Number: 05-100-014



Ratchet Assembly R1
Part Number: 05-100-009



Inch Counter Cover
Part Number: 05-100-010



Inch Counter Mechanics
Part Number: 05-100-012



Micrometer Wrench
Part Number: 05-100-212

Part Number	Range	Graduation	Accuracy
52-218-301-1	0-1"	.0001"	.00016"
52-218-302-1	1-2"	.0001"	.00016"

Vernier Spline Micrometer



No. 52-218-111-0



Silver Locking Assembly
Part Number: 05-100-016

Part Number	Range	Graduation	Accuracy
52-218-111-0	0-1"	.0001"	.0001"



Universal Electronic Micrometer



No. 54-817-777-0



Interchangeable Anvil Set F0500

Part Number: 05-100-427

The Fowler Universal Anvil Micrometer accepts 7 pairs of individual anvils making it possible to gage a variety of dimensions unacheivable with a single micrometer.

Features:

- Resolution 0.00005" (0.001mm)
- Non-rotating spindle
- Direct inch metric conversion
- ABS/INC measuring mode
- Tolerance & preset function
- Comes complete with 7 anvil sets
- Satin chrome finish
- Includes case.
- Sizes over 1" include a standard.

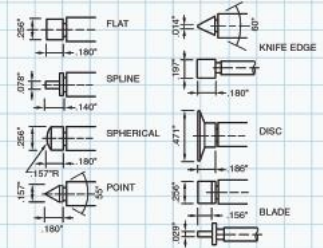

Replace 7 different micrometers with one tool creating up to 49 different combinations making this a truly universal tool!



Part Number	Range	Resolution	Accuracy
54-817-777-0	0-1"/0-25mm	.00005"/.001mm	.00016"
Replacement Battery			
54-902-110-0	Type 357 Replacement Battery		



Digital Micrometer Heads



Sylvac Battery Tray B1
Part Number: M281.221-101

Additional Parts
Available By
Special Order

Specifications		
Measuring range	No. 54-210-100-0 0-1" (0-25mm)	No. 54-210-200-0 0-2" (0-50mm)
Max Error	0.0002"/5mm	0.00032"/8mm
Repeatability	0.000080"/2mm	0.000080"/2mm
Resolution	0.000050"/0.001mm	0.000050"/0.001mm
A	2.93"/74.5mm	3.88"/98.5mm
B	1.30"/33.1mm	2.25"/57.1mm
Selection of measuring direction		✓
PRESET function		✓
Absolute or relative measurement		✓

Part Number	Description
54-210-100-0	0-1"/25mm Digital Micrometer Heads
54-210-200-0	0-2"/50mm Digital Micrometer Heads
Accessories	
54-210-301-0	Fine Adjustment Device
54-210-302-0	Handwheel, 50mm with crank handle for fast motion
54-210-303-0	Handwheel Ø 35mm



Accessories

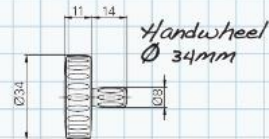
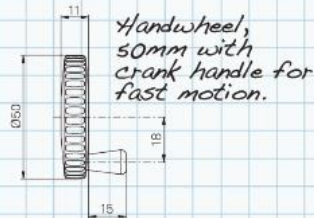
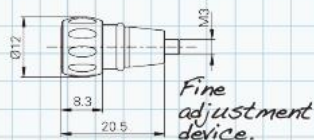

Make your stage travel smooth and easy to read.





Electronic IP54 Micrometer Head



Battery Cover B2
Part Number: 05-100-005



Rubber Seal (Battery Cover B2)
Part Number: 05-100-006

Part Number	Description	Accuracy
54-220-777-1	0-1"/25mm Electronic IP54 Micrometer Head	.00012"/.003mm
Accessories		
54-115-779-0	Computer Connect Kit	
Replacement Battery		
54-100-350-0	Replacement Battery	

Digital Micrometer Head



No. 52-222 series



Inch Counter Cover
Part Number: 05-100-010



Inch Counter Mechanics
Part Number: 05-100-012



Micrometer Wrench
Part Number: 05-100-212



Black Locking Assembly
Part Number: 05-100-014

Part Number	Range	Grads.	Accuracy	Overall Length	Mounting Shoulder Dia.	Mounting Shoulder Length
52-222-222-1	0-1"	.0001"	.00012"	5.25"	.625"	.670"



Inside Micrometers



No. 52-275-001-1



Micrometer Wrench
Part Number: 05-100-212



Ratchet Assembly R1
Part Number: 05-100-009

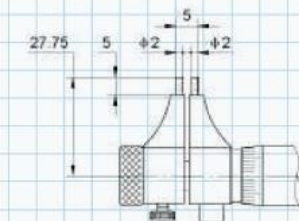

No. 52-275-001
and 52-275-025

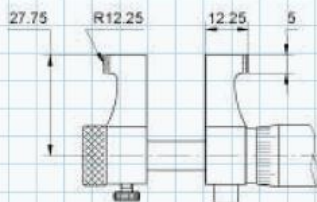

No. 52-275-403
and 52-275-404



No. 52-275-005



Micrometer Wrench
Part Number: 05-100-212



Ratchet Assembly for 52-275-005
Part Number: 05-100-215

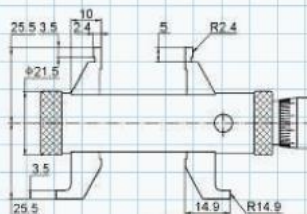

No. 52-275-005

Part Number	Range	Graduation	Accuracy
Inch			
52-275-001-1	.2-1.2"	.001"	.0002"
52-275-002-1	1-2"	.001"	.00024"
52-275-005-0	.2-2.2"	.001"	.00024"
Metric			
52-275-025-1	5-25mm	.01mm	.005mm
52-275-050-1	25-50mm	.01mm	.006mm





Inside Micrometers

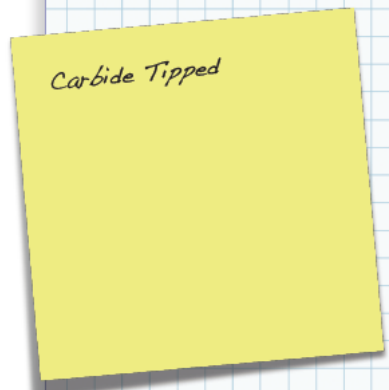
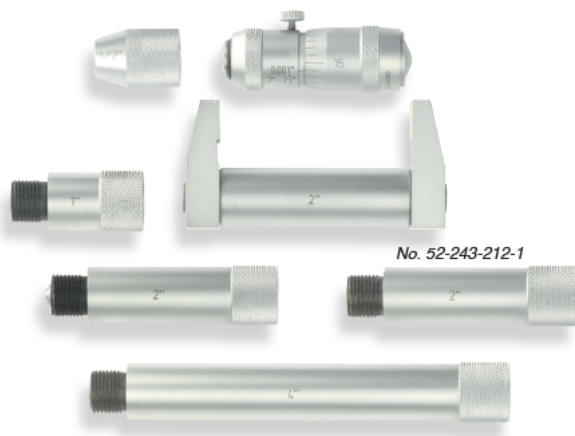

Locking Screw 026-260
Part Number: 05-100-021
Note: For Micrometers ending in 026-260



Locking Screw 480-512
Part Number: 05-100-022
Note: For Micrometers ending in 480-512

Name and part number for spare micrometer head and extensions fitting units ending in -026 through -260	
Micrometer Head 026-260	05-100-023
1/2" Extension for 026-260	05-100-024
1" Extension for 026-260	05-100-025
2" Extension for 026-260	05-100-026
4" Extension for 026-260	05-100-027
6" Extension for 026-260	05-100-028
8" Extension for 026-260	05-100-029
12" Extension for 026-260	05-100-030

Name and part number for spare micrometer head and extensions fitting units ending in -480 through -512	
Micrometer Head 480-512	05-100-031
1/2" Extension for 480-512	05-100-032
1" Extension for 480-512	05-100-033
2" Extension for 480-512	05-100-034
4" Extension for 480-512	05-100-035
8" Extension for 480-512	05-100-036
16" Extension for 480-512	05-100-037



Individual 2" Standard
Part Number: 05-100-216



Individual 50mm Standard
Part Number: 05-100-217

Part Number	Measuring Range	Graduation
Inch		
52-243-026-1	2-6"	.001"
52-243-212-1	2-12"	.001"
52-243-220-1	2-20"	.001"
52-243-240-1	2-40"	.001"
52-243-260-1	2-60"	.001"
52-243-480-1	4-80"	.001"
52-243-512-1	4-120"	.001"
Metric		
52-243-705-1	50-300mm	.01mm
52-243-710-1	50-500mm	.01mm
52-243-715-1	50-1000mm	.01mm
52-243-720-1	50-1500mm	.01mm

