

AUTO TOOL CRIB

2017

REV. 0617

NEW!

ULTRA-CAL V ELECTRONIC CALIPER

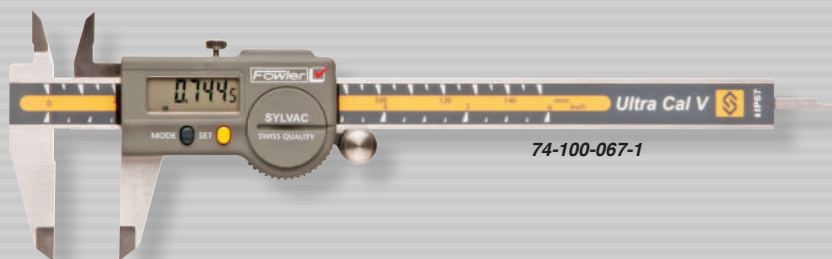

LIFETIME WARRANTY 



- IP67 rated against fluids and debris
- 4-way measurement, inside, outside, depth and step. (6" & 8" models)
- Hardened stainless steel construction
- Direct RS-232 output
- Features Absolute/Relative Measuring Modes
- Thumbroll (6" model only)

Order No.	Description	Accuracy	Resolution
74-100-067-1	6"/150mm	0.0008"/20µm	0.0005"/0.01mm
Connectivity Kits			
74-115-526-0	Proximity cable with USB connection		
74-115-527-0	Proximity cable with serial connection		

Dial Cal Plus



- IP54 rated against fluid and debris
- 4-way measurement
- 0.100" per revolution
- Thumbroll for fine adjustment
- Carriage lock screw
- Heavy duty stainless steel frame - 4mm thick
- Adjustable bezel with lock

Order No.	Description	Accuracy	Graduation
72-008-050-0	0 - 6" - White-face	± 0.001"	0.001"
72-008-051-0	0 - 6" - Black-face	± 0.001"	0.001"
72-008-052-0	0 - 150mm - White-face	± 0.03mm	0.02mm

NEW!

DEPTH BASE ATTACHMENT



- Turn your dial or electronic indicator into a depth gage (may reduce range)
- 4" length
- Fits indicators with 3/8" mounting stem
- Ground and lapped base

Order No.	Description
72-125-004-0	Depth Base Attachment

CALIPER JAW ATTACHMENTS



72-249-010-0



Caliper shown not included

- Clamps on to caliper jaws, allows attachment of standard micrometer anvils
- Used alone or in pairs
- Contacts can be mixed or offset for unique applications
- Max. caliper jaw thickness 0.135"
- Made of stainless steel

Contacts sold separately!



Order No.	Description
72-249-010-0	Caliper Jaw Attachment
72-249-001-0	Spline: 0.100" dia.
72-249-002-0	Knife: 0.188" x 0.031" tip, 30° taper
72-249-003-0	Super Spline: 0.050" dia.
72-249-004-0	Blade: 0.188" x 0.031"
72-249-005-0	Point: 0.020" tip, 30° taper
72-249-006-0	Disc: 0.500" dia.
72-249-007-0	Complete 7 piece Contact Set, includes 1 Ball Contact



Look for this symbol for more new tools!

Prices and specifications are subject to change without notice.

Rotocal[®] Reach

Electronic Rotor Gage

NEW!



Features:

- Range: 0-3.25"/0-82.5mm
- Resolution: .0005"/.01mm (fractions in 1/64" increments)
- Solid 1 piece construction
- Water resistant to IP54 standards
- Floating zero
- Twin conical anvils with the ability to measure low points on both sides of the rotor.
- Includes molded case



Measures most rotors while the wheels are still mounted on the vehicle!

(fits most applications)



INCH • METRIC • FRACTION

Order Number	Description
74-150-005-0	Rotocal Reach

Rotocal® ELECTRONIC ROTOR GAGES



- Range: 5.5"/140mm
- Reads in inch, metric, and fractions
- Direct inch/metric/fraction conversion
- Resolution: .0005"/.01mm (fractions in 1/64" increments)
- Water resistant to IP54 standards.
- Conical anvil for groove measurement.
- 3.5" jaw depth for larger rotors
- Includes molded case

with TWIN CONICAL ANVILS

- Conical anvils measure scored surfaces.



74-150-004-0

with 6" EXTENDED JAW DEPTH

- 6" jaw depth.
- Includes wooden case



Order Number	Description	74-150-002-0
74-150-006-0	Rotocal Electronic Rotor Gage	
74-150-004-0	Rotocal Electronic Rotor Gage with Twin Conical Anvils	
74-150-002-0	Rotocal Electronic Rotor Gage with 6" Extended Jaw Depth	
74-100-350-0	Replacement battery	

EZ-Drum ELECTRONIC BRAKE DRUM GAGE



Inch! Metric! Fractions!

- 4" to 20"/100 to 500mm Capacity
- Inch/Metric/Fraction Conversion
- 4" drum preset
- Zero set
- Hold function
- Preset depth at 1" and 1.5"
- Resolution 0.0005"/0.01mm (fractions in 1/64" increments)
- Protected to IP54 specifications
- Beam has vernier scale to double check reading.
- Thumb lock
- Direct RS-232 output
- Can be used to check some disc measurements.
- Includes wooden case



Dust, Water & Oil Resistant

Order Number	Description
74-150-020-0	EZ-Drum Electronic Brake Drum Gage
74-100-350-0	Replacement battery

EZ-Drum Reach ELECTRONIC BRAKE DRUM GAGE

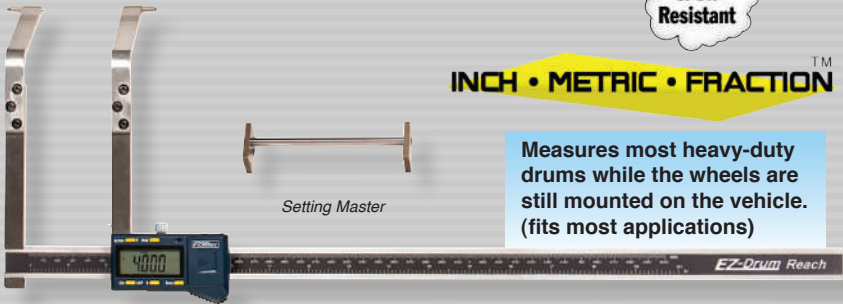

Dust, Water & Oil Resistant

INCH • METRIC • FRACTION

Measures most heavy-duty drums while the wheels are still mounted on the vehicle. (fits most applications)

- 4"-18.7"/100-475mm capacity (internal measurements)
- Inch/metric/fraction conversion
- The included 4" setting master and 4" drum preset (101.60mm) ensure accurate internal measurements.
- Floating zero sets zero anywhere
- Hold function
- Resolution: 0.0005"/.01mm/fractions in 1/64th" increments
- Accuracy: 0.005"/.13mm
- Dust, water and oil resistant to IP54 standards
- RS232 output for direct computer connection
- Beam has vernier scale to double check reading
- Conversion chart on back of main carriage
- Steel conical contact points
- Carriage lock screw
- Includes fitted case

Order Number	Description
74-150-050	EZ-Drum Reach Electronic Brake Drum Gage

12" & 16" DRUM AND ROTOR MEASURING KITS

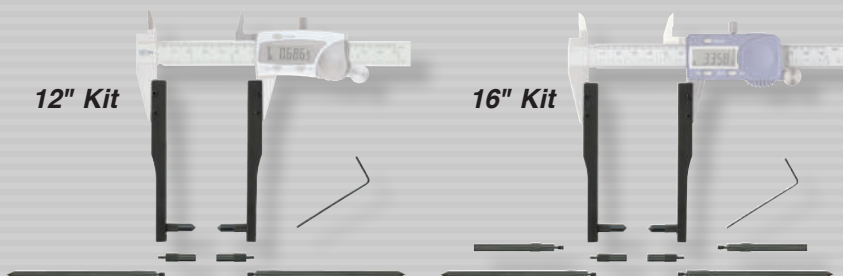

12" Kit

16" Kit

Drum and Rotor Kit features:

- Measures disc brakes and up to 12"/300mm or 16"/400mm on brake drums.
- Includes set of clamps; 4 sets of set screws; 1 Allen wrench; 1 set of 3 3/4" contact points; 1 set of 3/4" cone contact points & 1 set of 3/4" flat contact points in plastic tube.
- 16"/400mm Set includes 1 pair of 2" extensions
- When measuring brake drums only, add 8" to measurement—allows for long cone & jaw widths.
- For use with 6" & 8" calipers.

XTRA-VALUE CAL

Caliper features:

- Range: 6"/150mm
- Stainless steel frame.
- Large easy-to-read display.
- Resolution: .0005"/.01mm
- Direct inch/metric conversion.
- 4-way measurement, inside, outside, depth and step.
- Includes molded case.

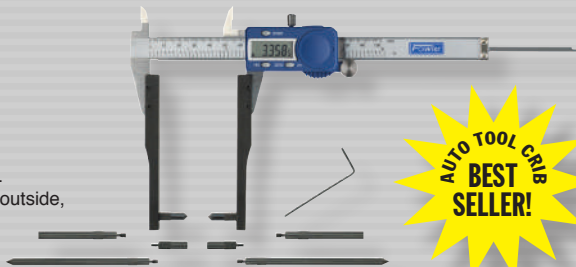

**AUTO TOOL CRIE
BEST
SELLER!**

Dust, Water and Oil Resistant Caliper features:

- Dust, water and oil resistant to IP54 specifications.
- Range: 6"/150mm
- Stainless steel frame.
- Direct Inch/Metric conversion.
- Accuracy: .001"/.02mm
- Resolution: .0005"/.01mm
- Large easy to read LCD display.
- 4-way measurement, inside, outside, depth and step.
- Includes molded case.

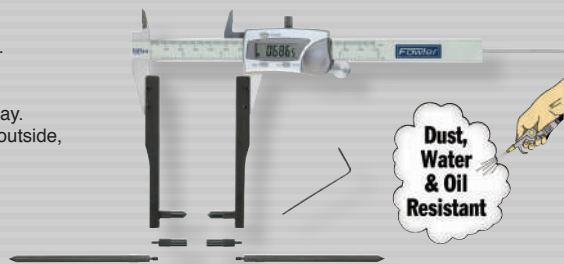

**Dust,
Water
& Oil
Resistant**

Order Number	Description
72-010-777-0	12"/300mm Drum and Rotor Kit
72-010-888-0	16"/400mm Drum and Rotor Kit
with Xtra-Value Cal	
74-101-777-0	12"/300mm Drum and Rotor Kit with 6" Xtra-Value Cal
74-101-888-0	16"/400mm Drum and Rotor Kit with 6" Xtra-Value Cal
With IP54 Caliper	
74-100-775-0	12"/300mm Drum and Rotor Kit with Dust, Water and Oil Resistant Caliper

Rotomike®

EXTENDED RANGE DISC BRAKE MICROMETERS

Extended Range Vernier Disc Brake Micrometer:

- Sharp black graduations on satin chrome finish.
- Range: 0.3"-1.7"
- Graduation: .0001"
- Jaw depth: 3.5"
- Ratchet thimble.
- Carbide tipped measuring faces.
- Includes case and measuring standard.

**Fits the most popular range
of disc brake sizes!**

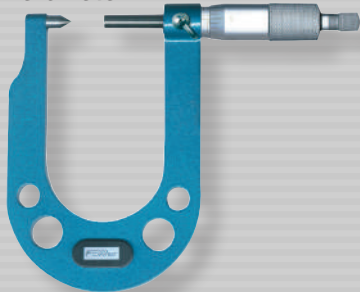

Order Number	Description
72-234-402-0	Extended Range Vernier Disc Brake Micrometer

Extended Range Digit Disc Brake Micrometer:

Inch/Metric

- Fast, easy-to-read digit counter.
- Range: 0.3"-1.7"/10-45mm
- Digital counter reads .001"/0.01mm sleeve reads .0001"/0.01mm
- Ratchet thimble.
- Carbide tipped measuring faces.
- Includes case and measuring standard.

**Fits the most popular range
of disc brake sizes!**



**AUTO TOOL CRIE
BEST
SELLER!**

Order Number	Description
72-234-422-0	Extended Range Digit Disc Brake Micrometer
72-234-423-0	Extended Range Digit Disc Brake Micrometer—Metric

EXTENDED RANGE DIGIT DISC BRAKE MICROMETER WITH TWIN CONICAL ANVILS:

Inch/Metric

- Fast, easy-to-read digit counter.
- Range: 0.3"-1.7"/10-45mm
- Digital counter reads .001"/0.01mm sleeve reads .0001"/0.01mm
- Ratchet thimble.
- Carbide tipped measuring faces.
- Includes case and measuring standard.

**Fits the most popular range
of disc brake sizes!**



**Now
available with
Twin
Conical Anvils!**

Order Number	Description
72-234-522-0	Extended Range Digit Disc Brake Micrometer
72-234-523-0	Extended Range Digit Disc Brake Micrometer—Metric

VERNIER DISC BRAKE MICROMETER

- Sharp black graduations on satin chrome finish.
- Range: 0.3"-1.3"
- Graduation: .0001"
- Jaw depth: 3.5"
- Ratchet thimble.
- Carbide tipped measuring faces.
- Includes case and measuring standard.

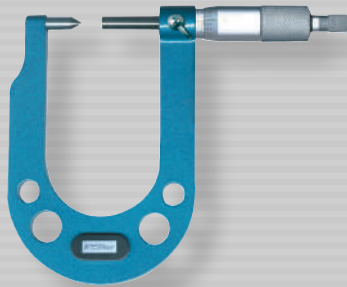

Order Number	Description
72-234-202-0	Vernier Disc Brake Micrometer

DIGIT COUNTER DISC BRAKE MICROMETERS

- Fast, easy-to-read digit counter.
- Digital counter reads .001"/.01mm sleeve reads .0001"/.01mm
- Jaw depth: 3.5"
- Ratchet thimble
- Carbide tipped measuring faces.
- Includes case and measuring standard.



Order Number	Description
72-234-222-0	0.3"-1.3" Digit Counter Disc Brake Micrometer
72-234-223-0	7-32mm Digit Counter Disc Brake Micrometer

ELECTRONIC EXTENDED RANGE DISC BRAKE MICROMETER

- Range: 0.3"-1.7"/7-44mm
- Resolution: .00005"/.001mm
- IP54: Water, oil & resistant.
- Jaw depth: 3.5"
- Friction thimble.
- Carbide tipped measuring faces.
- Auto-shutoff.
- ABS/INC measurement.
- Preset recall.
- Direct Inch/Metric conversion.
- Direct RS-232 output
- Includes case and measuring standard.



Fits the most popular range of disc brake sizes!

Order Number	Description
74-860-434-0	Electronic Extended Range Disc Brake Micrometer
74-902-110-0	Type 357 Replacement Battery

DISC AND ROTOR/BALL JOINT GAGE



- Checks ball joint wear and disc rotor runout.
- Checks tire and wheel runout, gear backlash, valve guide wear, etc.
- Meets state inspection requirements.
- Indicator features 0-1" travel, and .001" graduations.; Inch/Metric 1"/25mm, .001"/.01mm grad.
- Includes shop-hardened case.



Order Number	Description	Model
72-520-717-0	Disc and Rotor/Ball Joint Gage	Premium Model
72-520-757-0	Disc and Rotor/Ball Joint Gage	Economy Model
72-520-730-0	Disc and Rotor/Ball Joint Gage	Inch/Metric Model
72-520-110-0	Indicator Only	Inch ONLY (0-1")

DISC AND ROTOR/BALL JOINT GAGE

with X-Proof IP54 Shockproof Indicator



- Checks ball joint wear and disc rotor runout.
- Checks tire and wheel runout, gear backlash, valve guide wear, etc.
- Meets state inspection requirements.
- Dust, water and Oil resistant Indicator features 0-1" travel, and .001" graduations.; Inch/Metric 1"/25mm, .001"/.01mm grad.
- Includes shop-hardened case.



X-PROOF[®]

Order Number	Description
72-520-767-0	Disc and Rotor/Ball Joint Gage with X-Proof Indicator

FLEX CHROME KIT®

Combo Kit includes both....

Disc & Rotor/Ball Joint Gage with Chrome Flex Arm



14 LED Flashlight with Flex Bar Attachment



- 14 LED Ultra-Bright flashlight
- Quick release mounting bracket.
- 3 "AAA" batteries included.

- Checks ball joint wear and disc rotor runout.
- Checks tire and wheel runout, gear backlash, valve guide wear, etc.
- Corrosion resistant.
- Chrome plated 12" flex arm.
- Meets all state inspection requirements.
- Indicator features 0-1" travel and .001" graduation

Everything packed in a convenient, shop-hardened case!

Order Number	Description
72-520-451-0	Disc and Rotor Flex Chrome Kit

DISC AND ROTOR COMBO KITS

Combo Kit includes both...

Disc & Rotor/Ball Joint Gage



Digit Disc Brake Micrometer



- Checks ball joint wear and disc rotor runout.
- Checks tire and wheel runout, gear backlash, valve guide wear, etc.
- Mounted to the vise grip the 12"/300mm flex arm can be set to almost any measuring position desired.
- Indicator features 0-1"/25mm travel, and .001"/.01mm graduations.

- Measures thickness, thickness variation and score depth.
- Carbide tipped anvil faces.
- Includes measuring standard.
- Jaw depth: 3.5"/90mm
- Digit counter graduations: .001"/.01mm
- Vernier graduations: .0001"/.01mm
- Measuring range: .300"-1.300"/7-32mm
- Positive locking nut on spindle.

Everything packed in a convenient, shop-hardened case!

Order Number	Description
72-520-222-0	Inch Disc and Rotor Combo Kit
72-520-223-0	Metric Disc and Rotor Combo Kit

ANYFORM AND ROTOR COMBO KIT

This kit provides a combination of holding applications. Use the vise grip and flex arm to check ball joint wear, brake and rotor runout. Attach the flex arm to the Anyform base for magnetically mounting on virtually any metallic surface.

Combo Kit includes both...

Disc & Rotor/Ball Joint Gage



**ANY TOOL CASE
BEST
SELLER!**



Anyform Magnetic Base

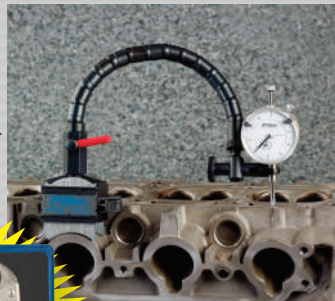

- Checks ball joint wear and disc rotor runout.
- Checks tire and wheel runout, gear backlash, valve guide wear, etc.
- Mounted to the vise grip the 12" flex arm can be set to almost any measuring position desired.

- Indicator features 0-1" travel, and .001" graduations.
- Fit mag base to any shape or form.
- Magnetic segments conform to any odd shape.
- Rigid one piece construction.
- 40 lb. pull.

Everything packed in a convenient, shop-hardened case!

Order Number	Description
72-520-700-0	Anyform and Rotor Combo Kit

DISC ROTOR THICKNESS GAGE



Dial Gage is designed to check wearing of disc rotors. Also used to determine deviation in thickness of rotors as well depth of disc-scoring caused by worn brakes.

In compliance with state inspection requirements. Supplied with 1" setting standard.

- Range .300-1.300"
- Graduation .0005"
- Reading 0-50; 50-0
- Includes conical contact point.

Order Number	Description
72-520-727-0	Disc Rotor Thickness Gage

AutoCal ELECTRONIC CALIPER

Great for Garage and Shop Environments!



INCH • METRIC • FRACTION

NEW!

**Dust,
Water
& Oil
Resistant**



- Inch/Metric/Fraction reading: .0005"/.01mm/ 1/128"
- Dust, water and oil resistant to IP54 standards making it **great for garage and shop environments**
- Heavy Duty frame for extra rigidity and wear
- Floating zero
- Super large, easy to read 14 x 52mm display
- 4-way measuring
- Combined thumbrest and thumbroll for fine adjustment
- Includes spare battery and fitted case.

Order Number	Description
74-102-006-0	AutoCal Electronic Caliper

FLIP PLUS ELECTRONIC CALIPERS



**The Flip Display allows
RIGHT or LEFT handed operation!**

54-200-506-0

NEW!

- Display flips 180° with display rotation function for true left handed operation
- Can also be positioned for top viewing
- Available in 6", 8" and 12" models
- 4-way measuring - OD, ID, depth and step
- Stainless steel frame
- Thumbroll for smooth measuring
- Heavy duty frame is 0.140"/3.5mm thick
- Resolution 0.0005"/0.01mm
- Floating zero
- Includes fitted case

Left-Handed View



Top View



Order Number	Range	Accuracy
74-200-506-0	0-6"/150mm Caliper	.0012"/.03mm
74-200-508-0	0-8"/200mm Caliper	.0012"/.03mm
74-200-512-0	0-12"/300mm Caliper	.0016"/.04mm

Prices and specifications are subject to change without notice.

EURO-CAL IV ELECTRONIC CALIPER



INCH • METRIC • FRACTION



- Accuracy: $\pm .001"/.02\text{mm}$
- Range: 6"/150mm
- Resolution: $.0005"/.01\text{mm}$ (fractions in 1/64th increments).
- Absolute incremental measurement
- Unique full-size decimal characters.
- Dust, water and oil resistant to IP54 standards
- Stainless steel frame
- 4-way measuring
- Direct RS-232 output
- Includes molded plastic case.

Order Number	Description
74-100-330-1	Euro-Cal IV Electronic Caliper

PRO-MAX ELECTRONIC CALIPER

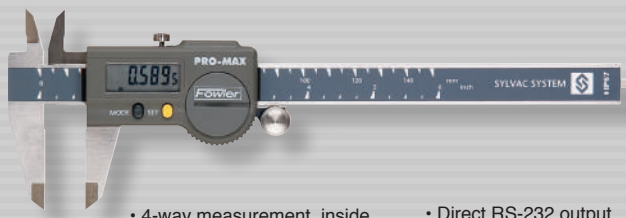

- 4-way measurement, inside, outside, depth and step.
- Resolution: $.0005"/.01\text{mm}$
- Repeatability: $.0005"/.01\text{mm}$
- Hardened stainless steel construction.
- Direct RS-232 output
- Features Absolute/Relative Measuring Modes.
- Hold function
- Includes molded case.



Order Number	Range	Max. Error
74-200-777-1	0-6"/150mm	$.001"/.02\text{mm}$

DUST, WATER AND OIL RESISTANT ELECTRONIC CALIPER



- Dust, water and oil resistant to IP54 specifications.
- Stainless steel frame.
- Resolution: $.0005"/.01\text{mm}$
- Large easy to read LCD display.
- Absolute referencing.
- 4-way measurement, inside, outside, depth and step.
- Includes molded case.
- Direct RS-232C output

Order Number	Range	Accuracy
74-100-777-2	0-6"/150mm Caliper	$.001"/.02\text{mm}$
74-100-712-2	0-12"/300mm Caliper	$.0015"/.04\text{mm}$

WATER RESISTANT ELECTRONIC CALIPER

from **sylvac**

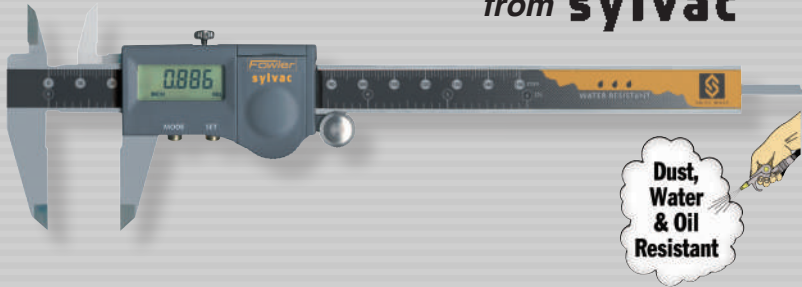

- Maximum Error: .001"/.02mm
- Inductive measuring system.
- 4-way measurement, inside, outside, depth and step.
- Hardened stainless steel construction.
- Dust, water and oil resistant to IP54 standards
- Repeatability/Resolution: .0005"/.01mm
- Range: 6"/150mm.
- Direct RS-232 output.
- Includes storage case.

Order Number	Description
74-100-444-0	6"/150mm Water Resistant Electronic Caliper

6" and 12" VALUE CAL ELECTRONIC CALIPERS



- Stainless steel frame.
- Resolution: .0005"/.01mm
- Large easy to read LCD display.
- Absolute referencing
- 4-way measurement, inside, outside, depth and step.
- Includes molded case.

Order Number	Range	Accuracy
74-100-000-2	0-6"/150mm Caliper	.001"/.02mm
74-100-112-2	0-12"/300mm Caliper	.0015"/.04mm

Poly-Cal® ELECTRONIC CALIPER *Inch/Metric/Fraction*

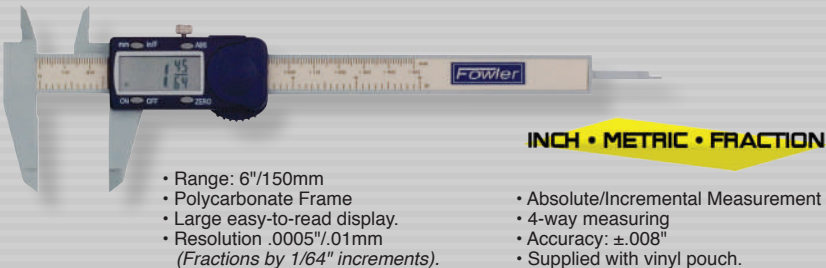

- Range: 6"/150mm
- Polycarbonate Frame
- Large easy-to-read display.
- Resolution .0005"/.01mm
(Fractions by 1/64" increments).
- Absolute/Incremental Measurement
- 4-way measuring
- Accuracy: ±.008"
- Supplied with vinyl pouch.

Order Number	Description
74-101-175-0	Poly-Cal Electronic Caliper
74-100-350-0	Replacement Battery

XTRA-VALUE CAL ELECTRONIC CALIPERS



74-101-600-1



74-101-200-1

**NEW Caliper Design for
74-101-150-2 Model!**

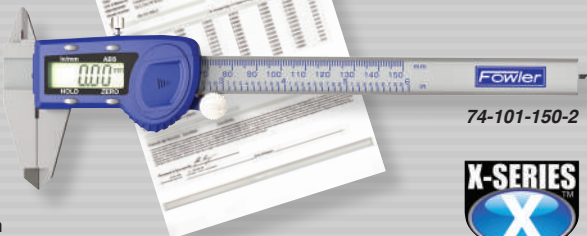

74-101-150-2

- Accuracy: 0.001"/0.02mm (6" models)
- Stainless steel frame
- Large easy-to-read display
- Resolution: 0.0005"/0.01mm
- Absolute/Incremental Measurement
- 4-way measuring



Order Number	Range	Display Type
74-101-150-2	6"/150mm	Regular Display (New Design) - includes FREE NIST Cert.
74-101-600-1	6"/150mm	Super Large Display with hold feature
74-101-200-1	8"/200mm	Regular Display
74-101-800-1	8"/200mm	Super Large Display with hold feature
74-101-300-1	12"/300mm	Regular Display
74-101-900-1	12"/300mm	Super Large Display with hold feature

XTRA-RANGE® ELECTRONIC CALIPERS

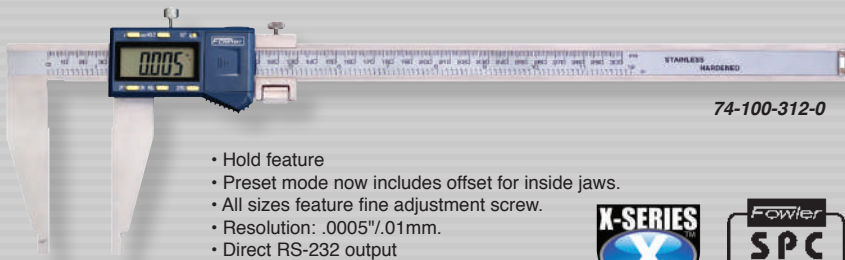

74-100-312-0

- Hold feature
- Preset mode now includes offset for inside jaws.
- All sizes feature fine adjustment screw.
- Resolution: .0005"/.01mm.
- Direct RS-232 output
- Includes wooden case.



Order Number	Range	Jaw Depth	Accuracy
74-100-312-0	0-12"/300mm Caliper	3.5"	.002"/.04mm
74-100-024-1	0-24"/600mm Caliper	4"	.003"/08mm
74-100-042-1	0-40"/1000mm Caliper	4.9"	.004"/10mm

INCH/METRIC VERNIER CALIPERS

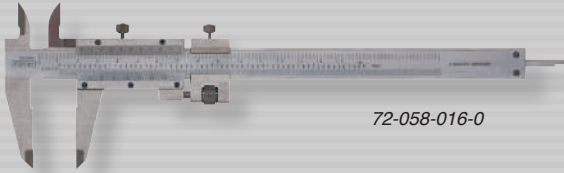

72-058-016-0

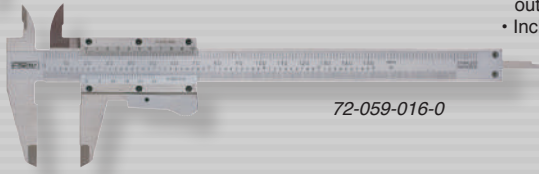

72-059-016-0

- Range: 6"/150mm
- Graduations: .001"/.02mm
- Jaw depth: 1.6"
- Hardened stainless steel construction
- Depth rod
- 4-way measurement, inside, outside, depth and step
- Includes fitted case.

Order Number	Description
72-058-016-0	Inch/Metric Vernier Caliper w/fine adjustment
72-059-016-0	Inch/Metric Vernier Caliper w/thumb lock

INCH & METRIC DIAL CALIPERS

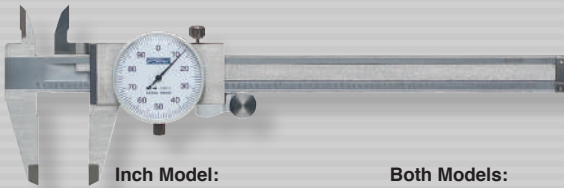

Inch Model:

- Range: 0-6"
- Range per revolution: .100"
- Graduation: .001"

Metric Model:

- Range: 0-150mm
- Range per revolution: .2mm
- Graduation: .02mm

Both Models:

- Thumbroll for rapid setting.
- 4-way measurement, inside, outside, depth and step.
- Hardened stainless steel throughout.
- Knurled lock assures precise settings.
- Adjustable dial.
- Includes fitted case.

Order Number	Description
72-008-007-0	Inch Caliper
72-015-020-0	Metric Caliper

INCH/METRIC READING DIAL CALIPER

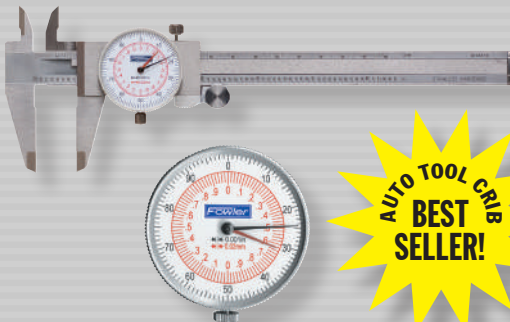

Caliper Face



- Range: 6"/150mm; 12"/300mm
- Graduations: .001"/.02mm
- Dial face reads in both inch (black) and metric (red).
- Hardened stainless steel throughout.
- 4-way measurement, inside, outside, depth and step.
- Covered, stainless steel rack.
- Includes fitted case.

Order Number	Description
72-030-006-0	6" Inch & Metric Reading Dial Caliper
72-030-012-0	12" Inch & Metric Reading Dial Caliper

SHOCKPROOF DIAL CALIPERS with Thumbroll!



72-008-714-0

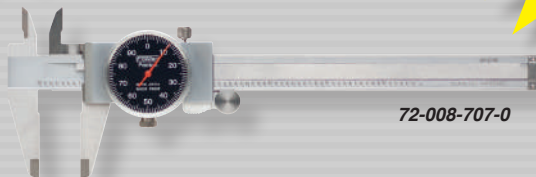

72-008-707-0



72-008-712-0

- 4-way measurement
- Solid stainless steel construction.
- Silky smooth movement throughout.
- .100" range per revolution.
- .001" reading dial face.
- Tough shockproof design.
- Supplied in shop-hardened case.

Order Number	Description	Range	Dial Face Color
72-008-704-0	Shockproof Dial Caliper	0-4"	White
72-008-714-0	Shockproof Dial Caliper	0-4"	Black
72-008-706-0	Shockproof Dial Caliper	0-6"	White
72-008-707-0	Shockproof Dial Caliper	0-6"	Black
72-008-712-0	Shockproof Dial Caliper	0-12"	White

T-BAR DEPTH BASE ATTACHMENT

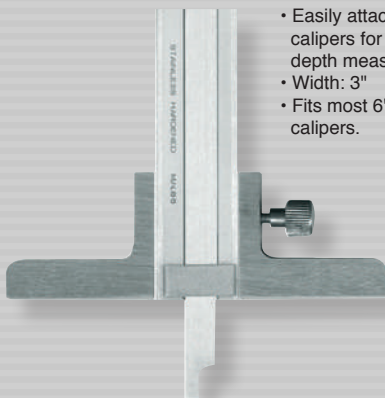

- Easily attaches to calipers for use in depth measurement.
- Width: 3"
- Fits most 6" and 8" calipers.

Caliper shown not included.

Order Number	Description
72-565-700-0	T-Bar Depth Base Attachment

OUTSIDE MICROMETERS



72-229-201-0

- .0001" graduations.
- Measuring faces are carbide tipped.
- Friction/ratchet style thimbles.
- Insulated frames.
- Positive lever-locking clamp.
- Sizes over 1" include standard.
- Includes wrench and fitted case.



72-229-213-0

Order Number	Description	Accuracy	Range
72-229-201-0	Outside Micrometer	±0.00016"	0—1"
72-229-202-0	Outside Micrometer	±0.00016"	1—2" w/standard
72-229-203-0	Outside Micrometer	±0.0002"	2—3" w/standard
72-229-204-0	Outside Micrometer	±0.0002"	3—4" w/standard
72-229-205-0	Outside Micrometer	±0.00024"	4—5" w/standard
72-229-206-0	Outside Micrometer	±0.00024"	5—6" w/standard
Sets:			
72-229-213-0	Outside Micrometer Set	(See individual units)	0-3" w/standards
72-229-214-0	Outside Micrometer Set	(See individual units)	0-4" w/standards

METRIC OUTSIDE MICROMETERS



72-229-209-0

- .01mm graduations.
- Measuring faces are carbide tipped.
- Friction/ratchet style thimbles.
- Insulated frames.
- Positive lever-locking clamp.
- Sizes over 25mm include standard.
- Includes wrench and fitted case.



72-229-220-0

Order Number	Description	Accuracy	Range
72-229-209-0	Metric Outside Micrometer	±0.004mm	0-25mm
72-229-210-0	Metric Outside Micrometer	±0.004mm	25-50mm
72-229-211-0	Metric Outside Micrometer	±0.005mm	50-75mm
72-229-212-0	Metric Outside Micrometer	±0.005mm	75-100mm
Sets:			
72-229-220-0	Metric Outside Micrometer Set	(See individual units)	0-100mm w/standards
72-229-215-0	Metric Outside Micrometer Set	(See individual units)	0-75mm w/standards

OUTSIDE INCH MICROMETER



- Satin chrome finished forged steel frame.
- Microfine black graduations.
- Anvil and spindle hardened and precision ground, with microlapped ends.
- Positive locking clamp.
- Friction/Ratchet style thimble.
- Carbide faces on anvil and spindle.
- Diameter of measuring faces: .256"
- Graduation: .0001"
- Includes fitted case and wrench.

Order Number	Description	Range
72-235-001-1	Outside Inch Micrometer	0-1"

DIGIT COUNTER OUTSIDE MICROMETERS



- Digital counter reads .001"/0.1mm sleeve reads .0001"/.01mm
- Carbide tipped measuring faces.
- Insulated frames
- Spindle thread is hardened, ground and lapped.
- Ratchet stop thimble on all models.
- Positive locking nut on spindle.
- Sizes over 1" include standard.
- Includes wrench and fitted case.

Order Number	Description	Accuracy	Range
Inch:			
72-224-001-0	Inch Digit Counter Outside Micrometer	±0.00016"	0-1"
72-224-002-0	Inch Digit Counter Outside Micrometer	±0.00016"	1-2" w/standard
72-224-003-0	Inch Digit Counter Outside Micrometer	±0.0002"	2-3" w/standard
72-224-004-0	Inch Digit Counter Outside Micrometer	±0.0002"	3-4" w/standard
Metric:			
72-224-009-0	Metric Digit Counter Outside Micrometer	±0.004mm	0-25mm
72-224-010-0	Metric Digit Counter Outside Micrometer	±0.004mm	25-50mm
72-224-011-0	Metric Digit Counter Outside Micrometer	±0.005mm	50-75mm
Sets:			
72-224-103-0	Digit Counter Outside Micrometer Set	(See individual units)	0-3" w/standard
72-224-104-0	Digit Counter Outside Micrometer Set	(See individual units)	0-4" w/standard
72-224-220-0	Digit Counter Outside Micrometer Set	(See individual units)	0-75mm w/standard

INDIVIDUAL MICROMETER STANDARDS



- Measuring faces .315" diameter.
- Standards come with heat insulating covers.
- Measuring faces hardened and precision ground with microlapped finish.
- Meets or exceeds Federal accuracy specs.

Inch

Order Number	Size
72-227-001-1	1"
72-227-002-1	2"
72-227-003-1	3"
72-227-004-1	4"

Metric

Order Number	Size
72-227-221-0	25mm
72-227-222-0	50mm
72-227-223-0	75mm
72-227-224-0	100mm

XTRA-VALUE II ELECTRONIC MICROMETER



- Jet black, grey enamel finish.
- Large LCD display.
- Resolution: .00005"/.001mm
- Direct RS 232 output.
- Carbide measuring faces.
- Absolute and incremental modes.
- Ratchet thimble.
- Includes shop hardened case.

Order Number	Description	Accuracy	Range
74-870-001-0	Xtra-Value II Electronic Micrometer	±.00016"/.004mm	0-1"/0-25mm
74-100-350-0	Replacement Battery		

WATER RESISTANT ELECTRONIC MICROMETER



- Protected to IP54 specification.
- Large LCD Display.
- Automatic switch off.
- Resolution: .00005"/.001mm.
- Direct RS-232 output.
- Friction thimble.
- Carbide measuring faces.
- Includes shop-hardened case.

Order Number	Description	Accuracy	Range
74-860-001-1	Water Resistant Electronic Micrometer	±.00016"/.004mm	0-1"/0-25mm
74-902-110-0	LR44 Replacement Battery		

ELECTRONIC OUTSIDE MICROMETER



- Protected to IP54 specifications.
- Rugged steel design
- Large LCD display
- Absolute & incremental modes
- Automatic switch off
- Resolution: .00005"/.001mm
- Direct RS-232 output
- Ratchet thimble.
- Carbide measuring faces
- Includes shop-hardened case.

Order Number	Description	Accuracy	Range
74-815-001-2	Electronic Outside Micrometer	±.00016"/.004mm	0-1"/0-25mm
74-902-110-0	Type 357 Replacement Battery		

ECONOMY DEPTH MICROMETER

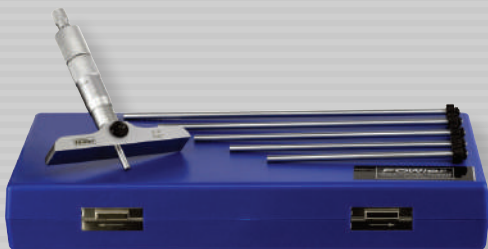

- Satin chrome finish
- Base surface hardened, ground & lapped.
- Ratchet thimble.
- Locking clamp.
- .001" Graduation.
- Rod diameter: .176"
- Includes shop-hardened case.

Order Number	Range	Graduation	Base
72-225-110-0	0-4"	.001"	2.5"
72-225-112-0	0-6"	.001"	2.5"
72-225-114-0	0-4"	.001"	4"
72-225-116-0	0-6"	.001"	4"

0-6" DIGIT COUNTER DEPTH MICROMETER



- Range: 0-6"
- Easy to read Digit Counter
- .001" Graduations
- 6 Rods
- Satin chrome finish
- Ratchet thimble
- Locking clamp
- Rod diameter: .176"
- Includes wrench and fitted case.

Order Number	Description	Base
72-225-176-0	Economy Digit Counter Depth Micrometer	2.5"
72-225-226-0	Economy Digit Counter Depth Micrometer	4"

0-22" DEPTH GAGE

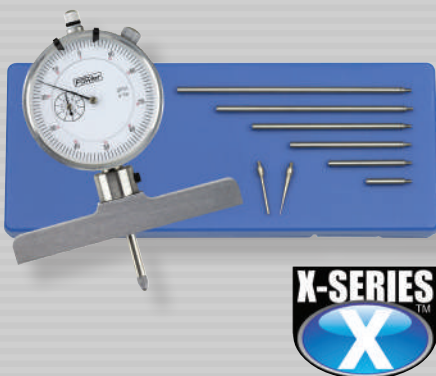

X-DEPTH 22[®]

Twice the range of competitive products!

- 0-1" travel indicator.
- .001" Graduations.
- Rods connect together for full 22" capacity.
- Satin chrome finish.
- Base size: 4"
- Includes 2 extra points for small hole applications; one 0.078" dia. x 1" long and one needle point x 1" long.
- Includes shop-hardened case.

Order Number	Description	Base
72-125-006-1	0-22" Depth Gage	4"

XTRA-VALUE DEPTH GAGE *Inch/Metric/Fraction*

- Spring-loaded and hold measurement button for ease-of-use.
- Super-large display
- Travel: 0-1"/25mm
- Range: 0-16"/400mm
- Resolution: .0005"/.01mm
(Fractions in 1/64" increments).
- Supplied in shop-hardened case.



INCH • METRIC • FRACTION

Order Number	Description
74-225-555-0	Xtra-Value Depth Gage
74-100-350-0	Replacement Battery

X-TREAD TIRE GAGE

For tire tread thickness measurement!
Reads in inch, metric and fractions!

- Spring-loaded and hold measurement button for ease-of-use.
- Super-large display
- Range: 1"/25mm
- Resolution: .0005"/.01mm. (Fractions in 1/64" increments).
- Supplied in vinyl holster.
- 2.1" base
- .095" diameter rod



**AUTO TOOL CRIB
BEST
SELLER!**

INCH • METRIC • FRACTION

Order Number	Description
74-225-500-0	X-Tread Tire Gage
74-100-350-0	Replacement Battery

X-TREAD TIRE TREAD GAGE AND PRESSURE GAGE SET

The X-Tread Electronic Tread Depth Gage

- **Reads in Inch, Metric and Fractions!**
- Spring-loaded and hold measurement button for ease-of-use.
- Super-large display
- Range: 1"/25mm
- Resolution: .0005"/.01mm,
(Fractions in 1/64" increments).
- Supplied in vinyl holster.

Electronic Tire Pressure Gage

- Portable with key ring attachment
- Hold feature
- Quickly and accurately take pressure readings.

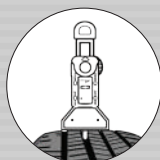

Order Number	Description
74-225-525-0	Tire Tread Gage & Pressure Gage Set
74-100-350-0	Replacement Battery

TOOLMAKER UNIVERSAL MEASURING SET



- 6" Dial Caliper - .001" graduations (Part No. 72-008-007-0 see page 17)
- 0-1" Micrometer - .0001" graduations (Part No. 72-229-201-0 see page 19)
- 6" Flexible rule with 32nds, 64ths, 10ths & 100ths graduations (Part No. 72-300-006-0 page 52)
- All contained in a fitted, shop-hardened case.

Order Number	Description
72-095-007-0	Toolmaker Universal Measuring Set

MECHANICS MEASURING SET

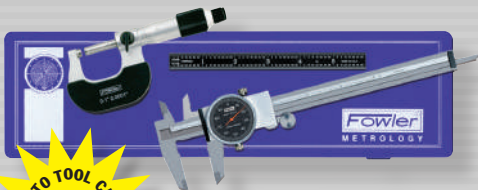

**AUTO TOOL CRIB
BEST
SELLER!**

- 0-6" One-Rev Shockproof Dial Caliper with .001" graduations on a black dial face with orange needle (Part No. 72-008-707-0 see page 18)
- 0-1" Outside Micrometer with .0001" graduations and insulated frame (Part No. 72-229-201-0 see page 19)
- 6" EZ- Read Steel Rule (Part No. 72-297-006-0 page 52)
- All contained in a fitted, shop-hardened case.

Order Number	Description
72-229-711-0	Mechanics Measuring Set

ELECTRONIC CALIPER & MICROMETER MEASURING SET



- 6"/150mm Electronic Caliper (Part No. 74-100-000-2 see page 15)
- 0-1"/25mm Electronic Micrometer (Part No. 74-870-001-0 see page 21)
- All contained in a fitted, shop-hardened case.

Order Number	Description
74-004-850-0	Electronic Caliper & Micrometer Measuring Set

WATER RESISTANT ELECTRONIC MEASURING SET



X-PROOF®

- Caliper and Micrometer are protected to IP54 standards.
- 0-6" /150mm IP54 Electronic Caliper (Part No. 74-100-777-2 see page 14)
- 0-1"/25mm IP54 Electronic Micrometer (Part No. 74-860-001-1 see page 21)
- All contained in a fitted, shop-hardened case.

Order Number	Description
74-004-877-0	X-Proof Water Resistant Electronic Measuring Set

X-PROOF IP-54 ELECTRONIC MEASURING SET

- Caliper and Micrometer are protected to IP54 standards.
- All contained in a fitted, shop-hardened case.

6"/150mm Euro-Cal IV

- (Part No. 74-100-330-1 see page 14)
- Reads in Inch, Metric and Fractions.
- Resolution: .0005"/.01mm (fractions in 1/64th increments)

XTRA-VALUE Electronic Micrometer

- (Part No. 74-815-001-2 see page 21)
- Range: 0-1"/0-25mm
- Resolution: .00005"/.001mm



INCH • METRIC • FRACTION



Order Number	Description
74-004-875-0	IP54 Resistant Electronic Measuring Set

BLACK FACE MEASURING SET

- Black face Indicator (Part No. 72-562-778-0 see page 36)
- 6" Shockproof Dial Caliper with thumbroll (Part No. 72-008-707-0 see page 18)
- 0-1" Outside Micrometer (Part No. 72-229-201-0 see page 19)
- All contained in a fitted, shop-hardened case.

INCH • METRIC • FRACTION



Order Number	Description
72-229-770-0	Black Face Measuring Set with Indicator
72-229-710-0	Black Face Measuring Set without Indicator

XTRA-VALUE DEPTH GAGE AND POLY-CAL® KIT

Poly-Cal

- (Part No. 74-101-175-0 see page 15)
- Range 6"/150mm
- Polycarbonate Frame.
- Resolution: .0005"/.01mm, fractions by 1/64 increments.

Xtra-Value Depth Gage (Part No. 74-225-555-0 see page 23)

- Spring-loaded with a hold measurement button for ease-of-use.
- Super-large display
- Travel: 0-1"/25mm
- Application range: 0-22"/550mm
- Resolution: .0005"/.01mm (Fractions in 1/64" increments).
- Supplied in shop-hardened case.



INCH • METRIC • FRACTION



Order Number	Description
74-004-255-0	Xtra Value Depth Gage and Poly-Cal Kit

XTRA-VALUE DEPTH GAGE AND EURO-CAL IV KIT

Euro-Cal IV (Part No. 74-100-330-1 see page 14)

- Range: 6"/150mm
- Water resistant to IP54 standards.
- Resolution: .0005"/.01mm, fractions by 1/64 increments.

Xtra-Value Depth Gage

(Part No. 74-225-555-0 see page 23)

- Spring-loaded with a hold measurement button for ease-of-use.
- Super-large display
- Travel: 0-1"/25mm
- Application range: 0-22"/550mm
- Resolution: .0005"/.01mm (Fractions in 1/64" increments).
- Supplied in shop-hardened case.



INCH • METRIC • FRACTION



Order Number	Description
74-004-330-0	Xtra Value Depth Gage and Euro-Cal IV Kit

SHOCKPROOF DIAL CALIPER & DEPTH ATTACHMENT COMBO with WOODEN CASE



Available with
White or Black Face.

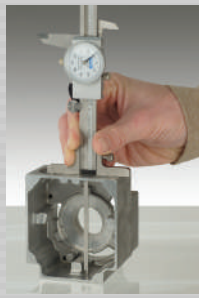

Easy depth measurement!

Shockproof Dial Caliper:

- Tough shockproof design
- 4-way measuring
- Solid stainless steel construction
- Silky-smooth movement throughout
- .100" range per revolution
- .001" reading dial face

Depth Attachment:

- Attaches quickly
- Positive locking screw
- Precision-ground contact surface

**Packed in a custom-fit
wooden case!**

Order Number	Description
72-008-700-0	Combo with 6" Whiteface Shockproof Dial Caliper
72-008-710-0	Combo with 6" Blackface Shockproof Dial Caliper
72-100-002-0	Wooden Case Only

XTRA-VALUE CAL & DEPTH ATTACHMENT COMBO with WOODEN CASE



Easy depth measurement!

Xtra-Value Caliper:

- Accuracy: $\pm .001"/.02\text{mm}$
- Range: 6"/150mm
- Large easy-to-read display.
- Resolution: .0005"/.01mm
- Direct inch/metric conversion.
- Absolute/incremental measurement.
- 4 way measuring.

Depth Attachment:

- Attaches quickly
- Positive locking screw
- Precision-ground contact surface

Packed in a custom-fit wooden case!

Order Number	Description
74-008-715-0	Xtra-Value Caliper & Depth Attachment Combo
72-100-002-0	Wooden Case Only



The Digi-Pro electronic protractor includes embedded magnets for unique measurement areas.

On/Off, Zero, Hold and Reverse feature to invert the display for easier reading in certain situations.

- Embedded 25 lb. pull magnets.
- Full, 360° measuring range.
- Accuracy: $\pm .2^\circ$
- Repeatability: $\pm .05^\circ$
- Resolution: $.05^\circ$
- Invertible display feature
- Uses standard 3V lithium battery
- US Patent 7,726,034

Ideal for fabrication applications!



USE THE DIGI-PRO TO MAKE FAST AND ACCURATE ANGULAR MEASUREMENTS

Order Number	Range/Description
74-440-740-1	4" Digi-Pro Electronic Protractor
74-440-775-1	12" Digi-Pro Electronic Protractor

XTRA-VALUE DIGI-LEVEL

The Xtra Value Digi-Level provides instant 360° digital inclination display of any angle, aluminum housing, with large LCD, reading hold, absolute 0° at sea level.

- Measuring Range: 360° (4 x 90°)
- Resolution: $.05^\circ$
- Accuracy: $\pm .2^\circ$ maximum error
- Repeatability: $\pm .05^\circ$
- Dimension: 4" L x 1" W x 3" H
- Voltage: Standard 9V Battery
- Battery Life: up to 250 hrs.
- Operating Temp: -5°C to 50°C (23°F to 122°F)
- Storage Temp: -20°C to 65°C (-4°F to 176°F)
- Weight: 1.1 lbs.



(angle block not included)

Order Number	Description
74-422-444-0	Xtra-Value Digi-Level

XTRA-VALUE 9" ELECTRONIC LEVEL

Fowler's 9" Laser Level provides instant 4 x 90° digital inclination display. With embedded magnets on its measuring surface, a beam splitter projects a 90° laser cross hair for leveling at-a-distance. It also includes a 1/4-20 mount for tripod use.

- Measuring range: 4 x 90°
- Resolution: .05°
- Accuracy: ±.1°
- Repeatability: ±.05
- Standard 9 volt battery (250 hours life)
- Dimensions: 9" L x 1"W x 2-1/4"H
- Includes two-way level and plumb vials.
- Reversible reading for inverted use.



(bar not included)

Order Number	Description
74-440-600-0	Xtra-Value 9" Electronic Level

mini-MAG Protractor

The mini-MAG Protractor provides instant 360° digital inclination display of any angle with the additional unique feature of embedded magnets on both sides and the bottom which make it ideal for a variety of measurements.



- Embedded magnets with 3.5lb. pull.
- Uses standard 9V battery (250 hrs.)
- Measuring range: 360° (4 x 90°)
- Display inverts.
- Resolution: .05°
- Accuracy: ±.2°
- Repeatability: .05°
- Hold feature



Display inverts for easy reading!

Dimensions:
L: 2.375" x W: 1.375" x H: 2.375"

Order Number	Description
74-422-450-1	Mini-Mag Protractor

Mini-Mag Plus

The Mini-Mag PLUS Protractor features a USB rechargeable battery, a backlit display, Tilt% function and IP54 protection against water, oil, and fluids.

- IP54 protected against debris and fluids
- USB rechargeable battery with status light (cable included)
- 6 month battery life
- Backlit display
- Tilt % function
- Auto off after 5 minutes
- Embedded magnets
- Measuring range: 360° (4 x 90)
- Display automatically inverts
- Resolution: 0.05°
- Accuracy: ± 0.2°
- Repeatability: 0.05°
- Hold feature
- Zero function
- Smaller size: 2.12" x 2.12" x .9"
- Light weight: 2.7 oz.



Order Number	Description
74-422-500-0	Mini-Mag Plus

Magnetic Bases & Indicators

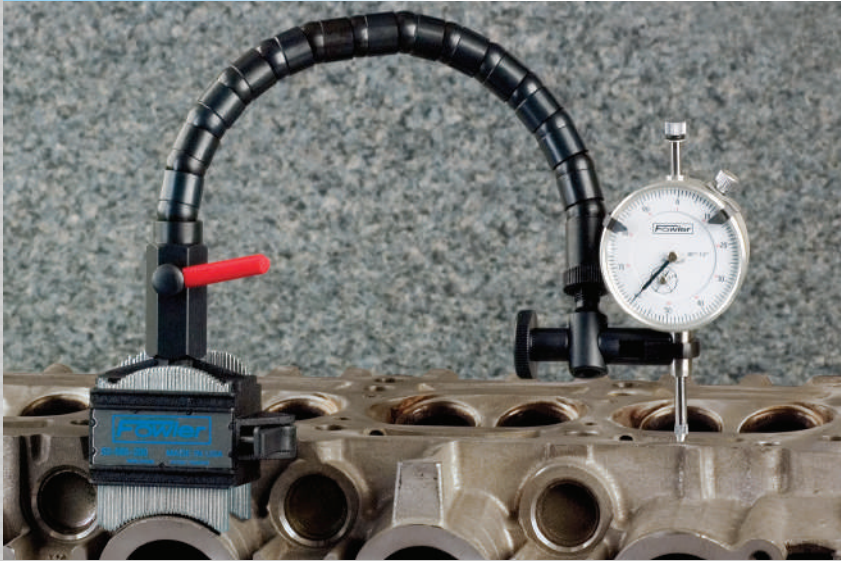

NEW!

CHROME FLEX MAG SET[®] with Anyform Base and X-PROOF[®] Indicator



Flex Arm Anyform Mag Base features:

- Corrosion resistant chrome plated flex arm
- Holds rigidly in almost any position.
- 40 lb. pull magnet
- Versatile—70 steel segments work like a contour gage to fit the mag base securely to practically any shape or form

X-Proof IP54 Indicator features:

Specifications:

- Robust, shockproof design
- Travel: 1"
- Reading: .001"
- Continuous reading: 0-100
- Tolerance markers
- AGD Group 2, 2-1/4" dia.
- Lugback and carbide point

Protection Includes:

- Rubber bellows on stem.
- O-ring seal on safety cap.
- O-ring protection for bezel and rotating dial
- Sealed back plate



All in a shop-hardened case.

Order Number	Description	Dial Face Color
72-585-245-0	Chrome Flex Mag w/Anyform Base and X-Proof Indicator Set	White
72-585-255-0	Chrome Flex Mag w/Anyform Base and X-Proof Indicator Set	Black

Prices and specifications are subject to change without notice.

MAGNETIC BASE & WHITE FACE INDICATOR WITHOUT FINE ADJUST



Magnetic Base (72-585-005):

- Accepts all AGD dial indicators.
- Base dimensions: 2" x 2-11/32" x 1-13/16"
- V-base for placing on round surfaces.
- Mounts test indicators with 1/4" posts.
- Magnet features 85 lb. pull.
- On-Off lever release magnet.

Indicator (72-520-110):

- Range: 0-1"
- Graduation: .001"
- Meets AGD specifications
- Continuous reading 0-100
- Revolution counter
- Tolerance indicators

Order Number	Description
72-585-115-0	Indicator & Base
72-520-110-0	Indicator Only
72-585-005-0	Magnetic Base without fine adjust Only

MAGNETIC BASE & BLACK FACE INDICATOR WITH FINE ADJUST



Magnetic Base (72-585-010):

- Fine adjustment
- Base dimensions: 2" x 2-11/32" x 1-13/16"
- Also mounts test indicators with 1/4" post.
- 85 lb. pull
- On-Off lever release magnet.
- V-base for placing on round surfaces.

Indicator (72-520-109):

- Range: 0-1"
- Graduation: .001"
- Meets AGD specifications
- Continuous reading 0-100
- Revolution counter
- Tolerance indicators



Order Number	Description
72-520-199-0	Indicator & Base
72-520-109-0	Indicator Only
72-585-010-0	Magnetic Base w/ fine adjust Only

FINE ADJUST MAG BASE SET with MAG BACK

With **INDI-Xblue** Electronic Indicator or AGD White face Indicator

Included Magnetic Indicator Back for mounting to most metal surfaces!



AGD Indicator features:

- AGD Group 2
- Dial diameter: 2-1/4"
- Travel: 1"
- Reading: .001"
- Continuous reading: 0-100
- Carbide tipped point

Magnetic Indicator Back features:

- Use for positioning the indicator on most metal surfaces.
- Protective coating



Indi-X Blue Indicator features:

- Direct Inch/Metric Conversion
- 1"/25mm travel
- 2-1/4" dial face
- Lugback and 3/8" stem diameter
- Resolution .0005"/.01mm
- Tolerance indicators
- Absolute/incremental reading
- Floating zero
- Carbide tipped point

Magnetic Base features:

- 85 lb. pull
- Fine adjustment.
- V-bottom base.

See the Indi-X Blue on page 37!

All in a shop-hardened case.

Order Number	Description
74-585-075-0	Fine Adjust Mag Base Set with Indi-X Blue Electronic Indicator Set
72-585-125-0	Fine Adjust Mag Base with AGD White Face Indicator Set

Prices and specifications are subject to change without notice.

ARTICULATING MAG BASE AND INDICATOR COMBOS



Tired of adjusting your flex arm?

More flexibility than flex-arm type base!

Can be set up in almost unlimited positions!



AGD Indicator

- 1" travel.
- Continuous reading: 0-100.
- AGD group 2, 2-1/4" dial diameter.
- Revolution counter
- Tolerance markers
- Lug back mount
- Carbide point

Articulating Mag Base:

- Adjust in almost unlimited ways.
- Fine adjust
- 85 lb. pull
- V-slot on base for mounting on rounded surfaces.



Indi-X blue FRACTION

Electronic Indicator:

- Direct Inch/Metric/Fraction Conversion
- Auto Off feature
- 2-1/4" dial face
- Lugback and 3/8" stem mountings
- Resolution .0005"/.01mm/64ths
- Tolerance indicators
- Absolute/incremental reading
- Floating zero
- Carbide tipped point

Articulating Mag Base:

- Adjust in almost unlimited ways.
- Fine adjust
- 85 lb. pull
- V-slot on base for mounting on rounded surfaces.



Order Number	Description
72-585-150-0	Articulating Mag Base & Indicator Combo
72-520-110-0	AGD Indicator only
72-585-008-0	Articulating Mag Base only

Order Number	Description
74-585-250-0	Indi-X Blue Fraction Electronic Indicator & Articulating Mag Base
74-520-260-0	Indi-X Blue Fraction Electronic Indicator
72-585-008-0	Articulating Mag Base

Sets includes shop-hardened case!

FLEX ARM BASE & WHITE FACE DIAL INDICATOR COMBO



Flex-Arm Mag Base (72-585-015):

- 85 lb. pull
- Holds rigidly in any position desired.
- V-base for placing on round surfaces.
- On-Off lever release magnet.

Indicator (72-520-110):

- 1" travel
- AGD group 2
- 2-1/4" dial diameter
- Reading: .001"
- Continuous reading: 0-100
- Revolution counter
- Tolerance indicators



Order Number	Description
72-641-300-0	Indicator & Base
72-520-110-0	Indicator Only
72-585-015-0	Flex-arm Magnetic Base Only

CHROME FLEX MAG SET

With **INDI-X Blue** Electronic Indicator or **AGD Black face Indicator**

Indi-X Blue Indicator features:

- Direct Inch/Metric Conversion
- 1"/25mm travel
- 2-1/4" dial face
- Lugback and 3/8" stem diameter
- Resolution .0005"/.01mm
- Tolerance indicators
- Absolute/incremental reading
- Floating zero
- Carbide tipped point

Included Magnetic Indicator Back for mounting to most metal surfaces!



Flex Arm Mag Base features:

- Corrosion resistant chrome plated flex arm.
- 85 lb. pull magnet
- Holds rigidly in almost any position.
- V-base for mounting on rounded surfaces.

Magnetic Indicator Back features:

- Use for positioning the indicator on most metal surfaces.
- Protective coating



AGD Indicator features:

- AGD Group 2
- Dial diameter: 2-1/4"
- Travel: 1"
- Reading: .001"
- Continuous reading: 0-100
- Carbide tipped point

All in a shop-hardened case.

See the Indi-X Blue on page 37!

Order Number	Description
74-585-100-0	Chrome Flex Mag and Indi-X Blue Electronic Indicator Set
72-585-500-0	Chrome Flex Mag and AGD Black Face Indicator Set

X-PROOF® WATER RESISTANT INDICATOR SET



Magnetic Base (72-585-010):

- Fine adjustment
- Base dimensions: 2" x 2-11/32" x 1-13/16"
- Also mounts test indicators with 1/4" post.
- 85 lb. pull
- On-Off lever release magnet.
- V-base for placing on round surfaces.



X-Proof Indicator (72-520-450):

- Travel: 1"
- Reading: .001"
- Continuous reading: 0-100
- Tolerance markers
- AGD Group 2, 2-1/4" dia.
- Lugback and carbide point
- Robust, shockproof design.
- Rubber bellows on stem.
- O-ring seal on safety cap.
- O-ring protection for bezel and rotating dial.
- Sealed back plate.



Order Number	Description
72-585-155-0	X-Proof Water Resistant Indicator Set

CHROME FLEX MAG SET

With X-PROOF™ Indicator

Flex Arm Mag Base features:

- Corrosion resistant chrome plated flex arm
- 85 lb. pull magnet
- Holds rigidly in almost any position.
- V-base for mounting on rounded surfaces

Included Magnetic Indicator Back for mounting to most metal surfaces!



Magnetic Indicator Back features:

- Use for positioning the indicator on most metal surfaces
- Protective coating

X-Proof IP54 Indicator features:

Specifications:

- Robust, shockproof design
- Travel: 1"
- Reading: .001"
- Continuous reading: 0-100
- Tolerance markers
- AGD Group 2, 2-1/4" dia.
- Lugback and carbide point

Protection Includes:

- Rubber bellows on stem.
- O-ring seal on safety cap.
- O-ring protection for bezel and rotating dial
- Sealed back plate



All in a shop-hardened case.



Order Number	Description	Dial Color
72-585-450-0	Chrome Flex Mag and X-Proof Indicator Set	White
72-585-455-0	Chrome Flex Mag and X-Proof Indicator Set	Black

Indicator & Mini Mag Set

- AGD group 1 indicator
- 0.250" range
- 0.001" graduations, 0-100 reading
- Tolerance markers
- Carbide contact point
- Mag base with fine adjust (also accepts test indicators with dovetails), base measures 1.8" x 1.2"
- On/off switch for secure holding and easy removal
- 37 lbs. of magnetic pull
- 22 piece contact point set — flat, radius, cone and spline type contacts
- Fitted aluminum case



Order No.	Description
72-585-310-0	Indicator & Mini Mag Set

HOLD XTEC Holding Systems



52-565-038-0
(Indicator not included)



52-585-085-0
(Indicator not included)

- All accept 3/8" indicators
- Mag base and HOLD-TEC with fine adjust also accepts 8mm indicators
- All have dovetail clamps for test indicators
- Mag base features 2 fine adjusts making it a **6-Axis Mag Base**
- HOLD-TEC can be mounted in drill chucks, collets, dial gage stands with 8mm mount diameter to make a quick transfer stand
- Mag base has 180 lb. pull
- Adjust to any position
- Powerful On/Off mag base
- Central locking system

MACHINIST GRADE!
For MAXIMUM Precision

Order No.	Description
72-585-085-0	HOLD-Tec Mag Base with Double Fine Adjust
72-565-036-0	HOLD-Tec without Fine Adjust
72-565-038-0	HOLD-Tec with Fine Adjust

ANYFORM MAGNETIC BASE

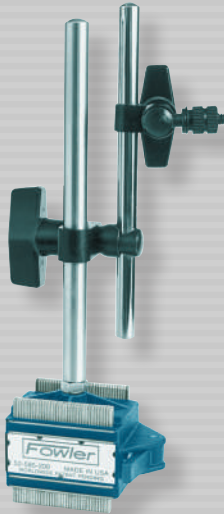

- Versatile—70 steel segments work like a contour gage to fit mag base securely to any shape or form.
- Unlock the cam mechanism and magnetic segments will conform to any odd shape.
- Rigid one-piece construction with permanent powerful magnet holds securely.
- There's no longer any need to make extra fixtures to set indicators.
- Unlimited versatility—used with coolant systems, lamps, etc.
- Side arm clamp holds all AGD dial indicators and all test indicators with a 1/4" dia. stem.

Order Number	Base Width	Base Height	Base Depth	Lbs. Pull
72-585-200-0	2-1/4"	2-1/8"	1-3/4"	40

XTRA MAG®

A VERSATILE UNIVERSAL & MAG BASE COMBO!



Virtually unlimited positioning as a Universal Base!



Mag Base: (72-585-000)

- 2 universal ball sockets
- Microfine adjustment screw
- 3-9/16" extension arm
- Dovetail mounting

Test Indicator: (72-562-778)

- Range: .030"
- Reading: 0-15-0
- Jewelled movement
- Graduation: .0005"
- Auto-reversing
- .080" diameter point.

All complete in a shop-hardened case!

Order Number	Description
72-585-105-0	Xtra Mag only
72-585-100-0	Xtra Mag with Test Indicator

INDI-X^{blue} ELECTRONIC INDICATORS

Now available in .5"/12.5mm & 1"/25mm ranges!

- Direct Inch/Metric Conversion
- 2-1/4" dial face
- Lugback and 3/8" stem mountings
- Resolution .0005"/.01mm
- Tolerance indicators
- Absolute/incremental reading
- Floating zero
- Carbide tipped point



**Low Cost,
High Quality,
Multi-Function
Indicators**



Carbide-tipped point!

Order Number	Description
74-520-250-0	1"/25mm Indi-X Blue Electronic Indicator
74-520-255-0	.5"/12.5mm Indi-X Blue Electronic Indicator
74-100-350-0	Replacement battery

INDI-X^{blue} ELECTRONIC INDICATORS

with FRACTIONS

INCH • METRIC • FRACTION

- Direct Inch/Metric/Fraction Conversion
- Auto Off feature
- 2-1/4" dial face
- Lugback and 3/8" stem mountings
- Resolution .0005"/.01mm/64ths
- Tolerance indicators
- Absolute/incremental reading
- Floating zero
- Carbide tipped point



**Low Cost,
High Quality,
Multi-Function
Indicators**



Carbide-tipped point!

Order Number	Description
74-520-260-0	1"/25mm/Fraction Indi-X Blue Electronic Indicator
74-100-350-0	Replacement battery

AGD INDICATORS

- 1" travel.
- Continuous reading: 0-100.
- AGD 2 series 2-1/4" dial diameter.
- Revolution counter
- Tolerance markers
- Lug back mount
- Carbide points



72-520-110



72-520-109



72-520-129



Order Number	Reading	Dial Face Color
72-520-110-0	.001"	White
72-520-109-0	.001"	Black
72-520-129-0	.0005"	White

INCH METRIC READING DIAL INDICATOR



- AGD 2 series 2-1/4" dial diameter.
- Dial face reads in inch (black) or metric (red).
- Range: 1"/25mm
- Graduation: .001"/.01mm
- Reading: 0-100/0-100-0
- Separated dial for Inch & Metric
- Rotating bezel with clamp
- Lugback included

Order Number	Description
72-530-110-0	Inch Metric Reading Dial Indicator

MAGNETIC BACK



Magnetic Back features:

- Use for positioning on any metal surface.
- Protective coating.
- Can be used with any indicator on this page.

Order Number	Description
72-585-495-0	Magnetic Back only
72-520-485-0	Magnetic Back w/72-520-110 ind.

X-PROOF® INDICATORS



NEW!

Dust, Water & Oil Resistant

Protection Includes:

- Rubber bellows on stem.
- O-ring seal on safety cap.
- O-ring protection for bezel and rotating dial
- Sealed back plate

Specifications:

- Robust, shockproof design
- Travel: 1"
- Reading: .001"
- Continuous reading: 0-100
- Tolerance markers
- AGD Group 2, 2-1/4" dia.
- Lugback and carbide point



Order Number	Dial Color
72-520-450-0	White
72-520-455-0	Black

TIMING GAGE



Mounts directly in spark plug hole. Small in size, it allows the operator to work in a confined space. Used on 2 cycle engines with straight holes. Cannot be used on spark plug holes that are angled.

- Lug back indicator with 1" travel for mounting on a mag base.
- 2 Adaptors: 14mm and 18mm. Adaptor can be screwed down into plug hole.

Order Number	Description
72-520-747-0	Timing Gage

LONG RANGE INDICATOR TEST SET

- For direct measurements.
- Rotates for setting at any point.
- Includes mag base with post and dual diameter rod.
- Includes indicator which features 1" range; .001" graduations; reading: 0-100; 2-1/4" dial diameter and includes rod connector and holding clamp.
- Carbide contact point.
- Includes shop-hardened case.



Order Number	Description
72-520-707-0	Long Range Indicator Test Set

MAGNETIC BASE & DIAL INDICATOR COMBO

- Includes 1" indicator and mag base, plus rods, swivel clamp and case.
- The 2-1/4" diameter .001" indicator features: satin chrome finish, tolerance hands, lug back and revolution counter.
- The 6" high mag base features a 1.5" x 1.5" x 1.75" 50 lb. pull base and a 4.5" long sidearm. All exposed metal is finished in anodized black for corrosion resistance.
- Includes shop-hardened case.



Order Number	Description
72-522-101-0	Magnetic Base & Dial Indicator Combo



Cylinder & Bore Measurement

EXTENDER 1.4" to 6" or 35 to 160mm DIAL BORE GAGE SET with Carbide Anvils

XTENDER

Industry's two most popular bore gage ranges combined in one set!

Carbide Anvils

- Easy-to-read
- Economical
- Graduation: .0005", .0001" or .01mm
- Insulated grip
- 1.4" to 6" range or 35 to 160mm
- Chrome plated handle.
- Includes extension holder and fitted case.

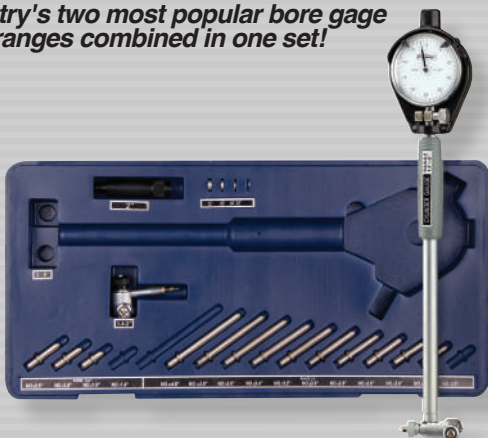

Order Number	Description	Graduation
72-646-500-0	Inch X-Tender Bore Gage Set	.0001"
72-646-400-0	Inch X-Tender Bore Gage Set	.0005"
72-646-220-0	Metric X-Tender Bore Gage Set	.01mm

EXTENDER-E ELECTRONIC 1.4" to 6" DIAL BORE GAGE SET

XTENDER-E

Industry's two most popular bore gage ranges combined in one easy-to-use ELECTRONIC set!



All the same benefits included in the X-Tender Dial Bore Gage are now available with an electronic indicator providing inch/metric reading capability, preset size of master for absolute reading and minimum hold feature to lock on the bore size as the gage is rocked in the part to be measured.

Bore Gage Features:

- Range: 1.4"-6"/35mm-150mm
- Carbide anvils
- Easily adjustable
- Self-centering
- Includes extension holder.
- Shop hardened case

Indicator Features:

- Dual reading inch/metric electronic indicator.
- Bar graph and numeric digital display
- Resolution: .00005"/.001mm
- Preset with recall
- ABS/INC measurement
- Min/Max/TIR



Includes **FREE** Instructional CD!



Order Number	Description
74-646-401-0	XTender-E Bore Gage Set

DIAL CYLINDER BORE GAGE SETS with Carbide Anvils

Carbide anvils

- Easy-to-read
- Economical
- Graduation: .0005"
- Chrome plated handle
- Insulated grip
- Includes extension holder and fitted case.



72-646-300-0



72-646-100-0

Order Number	Description	Range
72-646-100-0	Dial Bore Gage Set	.7—1.5"
72-646-300-0	Dial Bore Gage Set	2—6"

BORE GAGE SETTING MASTER KITS

Fowler's Bore Gage Setting Master Kit is used for accurately setting any bore gage up to 6" in diameter to an accuracy of .0001"/.003mm

Each Set includes:

Setting Device (53-646-000-1 - Inch Model)

- Base anvil: 3.950" x 1.050"
- Adjustable anvil 2.375" x .375" (two each)
- Internal capacity: 6"/150mm
- Depth capacity: 1"/25mm
- Centralizer capacity width: 2.750"
- Quick-release holder for fast adjustment
- **Can also be used for external setting, depending on application (external mics, snap gages, caliper gages)**

Economy Gage Block Sets

Inch model:

- 36 piece
- Tolerances to .00005"
- Certificate of Calibration to N.I.S.T.

Metric model:

- 33 piece
- AS-2 grade
- Certificate of Calibration to N.I.S.T.



53-646-000-1
(Bore gage shown not included.)



53-646-010-0

Includes:
Bore gage setting master
and gage block set.
All in a custom-fitted
case!

Order Number	Description
73-646-000-1	Bore Gage Setting Master Kit
73-646-010-0	Metric Bore Gage Setting Master Kit

X-TRA RANGE®

4" to 12" BORE GAGE

with Carbide Anvils

Carbide Anvils

- 4" to 12" range
- 10" measuring depth
- Easy-to-read
- Economical
- Graduation: .0005"
- Insulated grip
- Chrome plated handle.
- Includes extension holder and wooden case.



Order Number	Description
72-646-600-0	X-tra Range 4" to 12" Bore Gage

2" to 6" RIGHT ANGLE DIAL BORE GAGE

with Carbide Anvils

For measuring main bores, cam bores & other hard-to-reach areas directly!

Carbide Anvils

- Easy-to-read
- Economical
- Range: 2" to 6"
- Graduation: .0005"
- No passing through other bores to measure inboard journals.
- .050" travel in .0005" increments
- Chrome plated handle.
- 3 spacers, 11 probes
- Insulated grip.
- Includes extension holder and fitted wooden case.

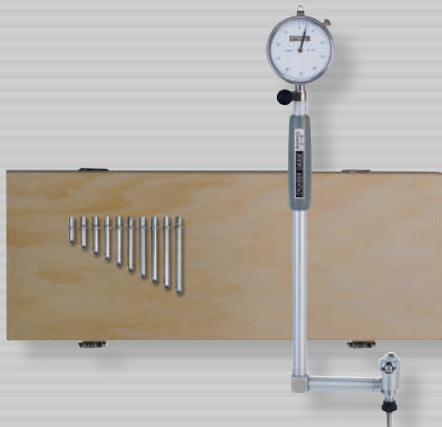

Order Number	Description
72-646-250-0	2" to 6" Right Angle Dial Bore Gage

DIAL CYLINDER BORE GAGE



- Measure cylinder taper and out-of-roundness without removal of the piston.
- Measure bore diameter to 8" depth.
- Graduations: .001"
- Range: 2.6" to 7"
- Includes gage, contact extensions and indicator.

Order Number	Description
72-646-200-0	Dial Cylinder Bore Gage

INSIDE MICROMETERS

- Each set consists of an inside micrometer head and a series of fully hardened and lapped extension rods of different lengths.
- Anvil and spindle are hardened and precision ground with microlap finish on ends.
- Spindle thread hardened, ground & lapped.
- .001" Microfine graduations on satin chrome.
- Positive locking nut on spindle.
- Meets or exceeds Federal accuracy specs.
- Reference standard included with set.
- Includes a wrench and a fitted case.

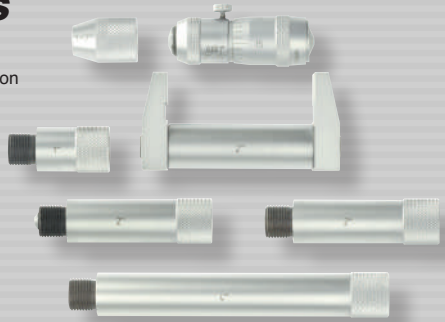

Order Number	Description
72-243-026-1	2"-6" Inside Micrometer
72-243-212-1	2"-12" Inside Micrometer
72-243-220-1	2"-20" Inside Micrometer

12" TELESCOPING GAGE SET



Another great tool for easy and accurate measurements. Under spring tension, the plungers of the gage expand from the center to the size of the hole being measured and are then locked in place using the knurled knob. Final hole size is obtained by measuring over the contacts with a micrometer or vernier caliper.



12" Reach!

- Contact points are constructed of hardened tool steel, precision ground.
- Double action rigid handle with self-centering feature for quick checking of inside measurements
- Constant spring tension for uniform feel
- **Covers a measuring range of 5/16" to 6" with measurable depths of 12"**
- Includes fitted vinyl case

Order Number	Description
72-470-007-0	12" Telescoping Gage Set

TELESCOPING GAGES

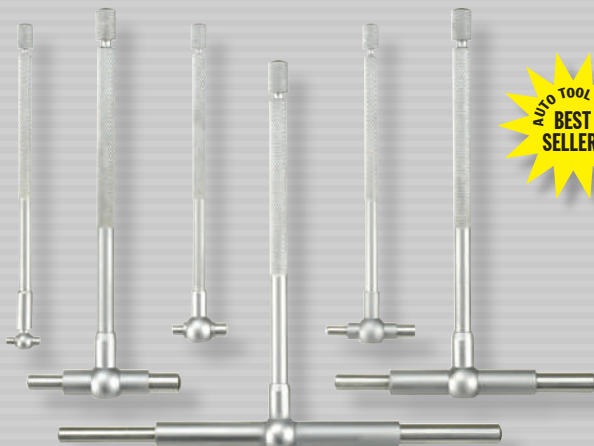

Another great tool for easy and accurate measurements. Under spring tension, the plungers of the gage expand from the center to the size of the hole being measured and are then locked in place using the knurled knob. Final hole size is obtained by measuring over the contacts with a micrometer or vernier caliper.

- Double action rigid handle with self centering feature for quick checking of inside measurements.
- Constant spring tension for uniform feel.
- Contact point ends are hardened tool steel and precision ground on a radius of the smallest hole the gage will enter.
- Covers a measuring range of 5/16" to 6" with measurable depths of 4" to 5".
- Includes fitted vinyl case.

Order Number	Description	Depth
72-470-004-0	4 piece 5/16" to 2-1/8"	4 to 5"
72-470-006-0	6 piece 5/16" to 6"	4 to 5"

TELESCOPING GAGE SET with Titanium Coated contact points!

- Contact points are constructed of hardened tool steel, precision ground and Titanium coated for accuracy and durability.
- Double action rigid handle with self-centering feature for quick checking of inside measurements.
- Constant spring tension for uniform feel.
- Covers a measuring range of 5/16" to 6" with measurable depths of 4" to 5".
- Includes fitted vinyl case.



Order Number	Description
72-470-000-0	Telescoping Gage Set with Titanium coated contact points

SMALL HOLE GAGE SET



- Knurled knob at the end of handle is used for size adjustment.
- Hole size is obtained by measuring over the contact points with a micrometer.
- The gaging surface is a full-round with a flat bottom.
- This permits use in the smallest of shallow holes, slots and grooves, etc.
- Gaging surface is fully hardened to ensure long tool life.
- Extra long for gaging deep and shallow slots and similar work.
- The complete set of four gages covers a range of .125"-.500".
- Includes fitted vinyl case.

Order Number	Description	Range	
72-472-104-0	Small Hole Gage Set	.125"-.500"	Set of 4 Gages

XTRA-VALUE INTERNAL & EXTERNAL ELECTRONIC CALIPER GAGES



- Robust housing
- Large LCD display
- Reading: .01"/.3mm/1/64ths
- Accuracy: .01"/.3mm/1/64ths
- Battery: CR2032
- Spring loaded with locking nut



Order Number	Description	Range
74-554-630-0	Outside Caliper Gage	0-6"/150mm
74-554-730-0	Inside Caliper Gage	.5-6"/150mm

SPRING CALIPERS & DIVIDERS

- Ends fully rounded on Outside/Inside Spring Calipers and Spring Hermaphrodite Calipers.
- Outside Spring Calipers meet Federal Specification Type II, Class I. Inside Spring Calipers meet Federal Specification Type I, Class I.
- Quick, positive adjustment.
- Spring Dividers meet Federal Specification Type A, Class 2 and supplied with a plastic point protector. Points fully hardened/tempered. High carbon steel legs heat treated.
- Adjustment screw centrally located; legs are well balanced with uniform tension.
- Natural polished steel finish.



72-107 series



72-105 series



72-115 series

Order Number	Description
72-105-006-0	6" Outside Spring Caliper
72-106-006-0	6" Outside Spring Caliper with quick nut
72-107-006-0	6" Inside Spring Caliper
72-108-006-0	6" Inside Spring Caliper with quick nut
72-115-006-0	6" Spring Divider
72-116-006-0	6" Spring Divider with quick nut

DRILL GAGES



72-480-005

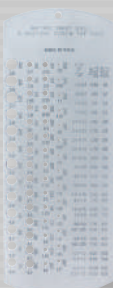

72-480-006



72-480-008



72-480-010



72-480-015



72-480-020

Order Number	Description
72-480-005-0	1/16" - 1/2" Jobber Drill-29 holes
72-480-006-0	1mm - 5.9mm Jobber Drill; 57 holes
72-480-008-0	1.5mm - 12.5mm Drill Gage; 30 holes
72-480-010-0	#1 - #60 Number Drill; 60 holes
72-480-015-0	#61 - #80 Number Drill; 20 holes
72-480-020-0	A - Z Letter Drill; 26 holes

TRANSFER PUNCH SETS

- Punches are made of hardened and tempered tool steel, black oxide finished.
- All sizes are marked on index base and diameters are slightly undersized for easy handling.
- Supplied with index stand

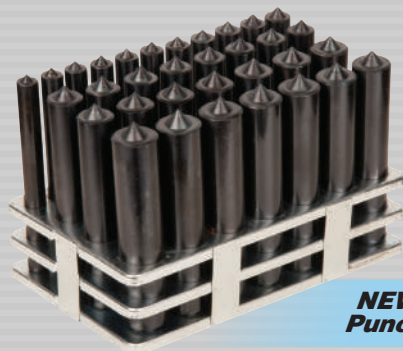

NEW Set!
Punches up to 1"

Order Number	Description	Range
72-482-028-0	28 Piece Transfer Punch Set	3/32" - 1/2"
72-482-030-0	33 Piece Transfer Punch Set	1/2" - 1"

XTA-PUNCH Heavy Duty Transfer Punch Set



Sizes ideal for heavy duty applications. Simply select the sleeve for the size required, place it on one of the master punches for that range and it is ready to use

- 1/2" - 1" range in 1/64"
- 36 piece set, 3 master punches and 33 individually sized sleeves
- Each sleeve and punch is clearly laser etched with its size
- Simply select the sleeve for the size required, place it on one of the master punches for that range and it is ready to use
- Punches and sleeve ranges are color coded for easy pairing
- Heavy duty for larger applications
- Punch tips are hardened 48-55 HRC
- Master punches are 4-7/8" in length and sleeves are 1" in length
- 1/4 the weight of a conventional transfer punch set with this range (approximately 4.5 lbs.)
- Supplied in a fitted, shop hardened case



Order Number	Description
72-482-040-0	36 Piece Transfer Punch Set

BELL PUNCH

- Easily locates and allows center punching of ends on round stock
- Hardened to 48-52 HRC
- Accurate to 0.0016"/0.04mm



Order Number	Description
72-500-150-0	Bell Punch
72-500-155-0	Replacement Punch

CENTER PUNCH SET

- Housing finished in black nitrate.
- Chrome alloy steel; hardened both ends.
- Knurled finger grip for easy handling.
- All sizes marked for fast and easy use.
- Point sizes 3/64", 5/64", 7/64", 9/64" and 11/64"
- Includes fitted case.



Order Number	Description
72-500-015-0	Center Punch Set

HEAVY DUTY AUTOMATIC CENTER PUNCH

- Knurled steel handle.
- Moveable components made of hardened steel.
- Point easily removed for sharpening.
- Features adjustable compression for marking a variety of materials.



Order Number	Description
72-500-290-0	Heavy Duty Automatic Center Punch

UNIVERSAL TRANSFER PUNCH



- Covers a large range with just 1 punch
- Spring loaded assures perfect hole center alignment
- Self centering
- Made of hardened tool steel

Order Number	Description
72-482-001-0	1/4" - 3/4" Universal Transfer Punch
72-482-002-0	1/4" - 11/16" Universal Transfer Punch

SPARK FREE BRASS DRIVE PIN PUNCH SET

- Made of brass.
- Punch section centerless ground.
- Length is 4".
- Hexagonal body style.
- Used in spark-free environments.
- Point sizes 1/16", 3/32", 1/8", 5/32", 3/16", 7/32", 1/4" and 5/16".
- Includes fitted case.



Order Number	Description
72-500-068-0	8 Drive Pin Punch Set

EXTRA LONG DRIVE PIN PUNCH SET

- Black nitrate finished housing. Made of chrome alloy steel. Hardened on both ends.
- Knurled finger grip. Length is 8".
- Point sizes: 1/8", 3/16", 1/4", 5/16" and 3/8"
- Includes fitted case.



Order Number	Description
72-500-300-0	Extra Long Drive Pin Punch Set

STRAIGHT EDGES

- Made of selected steels.
- Hardened for superior wear resistance.
- Matched to precision masters to insure precision.
- Width and thickness have been carefully determined to provide optimum rigidity-to-weight ratios.

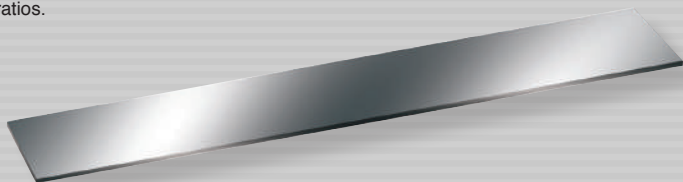

Order Number	Length	Width	Straightness	Thick
72-480-050-0	18"	1.320"	.0003"	.150"
72-480-055-0	24"	1.675"	.0003"	.170"
72-480-060-0	36"	2.730"	.0004"	.225"

COMBINATION SQUARE & COMPONENTS

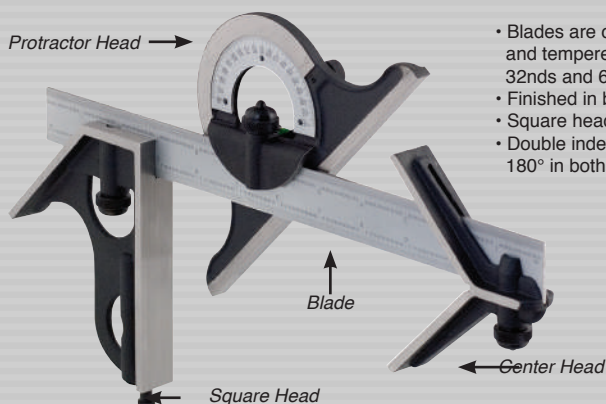

- Blades are chrome plated, fully hardened and tempered, graduated in 8ths, 16ths, 32nds and 64ths.
- Finished in baked blue enamel.
- Square head has level and scriber point.
- Double indexed protractor is graduated 180° in both directions.



Square Sets

Order Number	Description
72-386-006-0	Square and Center head with 6" blade
72-373-012-0	Square head with 12" blade
72-370-012-0	Square, Protractor and Center Head with 12" blade

Components

Order Number	Blade Size	Graduation
Blades—Inch Series: 72-400-012-0	12"	1/64", 1/32", 1/16", 1/8"
Blades—Metric Series: 72-400-015-0		
Order Number	Description	Accepts Blade Size
Heads:		
72-410-010-0	Square Head	12"
72-415-010-0	Center Head	12"
72-421-000-0	Reversible Protractor Head	12"

EZ-READ BLACK RULES

- Hardened stainless steel.
- White easy-to-read microfine graduations against black non-glare finish.

72-307-006-0 (Front)



(Back)

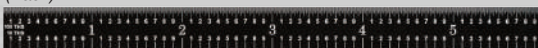

72-379-006-0 (Front)



(Back)

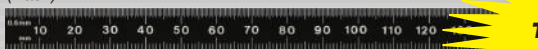

**Now available the
TWO MOST POPULAR
Automotive Graduations!**

GRADUATIONS

5R:	32nds, 64ths, 10ths, 100ths
E/M:	.5mm, 1mm, 32nds, 64ths

Order Number	Description	Size	Type	Graduation
72-307-006-0	Black EZ Read Rule	6"	Flexible	5R
72-379-006-0	Black EZ Read Rule	6"/150mm	Flexible	E/M

Prices and specifications are subject to change without notice.

FLEXIBLE STEEL RULES



- Hardened stainless steel.
- Etched, non-glare, black finish.
- 5R graduations: 32nds and 64ths, 10ths and 100ths.
- 4R graduations: 8ths, 16ths, 32nds & 64ths
- Flexible rules: .020" thick.
- Gold rules are titanium coated.

FLEXIBLE STEEL RULES

Order Number	Finish	Size	Reading
72-295-006-0	Satin Chrome	6"	4R
72-297-006-0	Black	6"	4R
72-299-006-0	Golden	6"	4R
72-295-012-0	Satin Chrome	12"	4R
72-297-012-0	Black	12"	4R
72-299-012-0	Golden	12"	4R
72-300-006-0	Satin Chrome	6"	5R
72-307-006-0	Black	6"	5R
72-309-006-0	Golden	6"	5R
72-300-012-0	Satin Chrome	12"	5R
72-307-012-0	Black	12"	5R
72-309-012-0	Golden	12"	5R

6"/150mm POCKET STEEL RULE



**AUTO TOOL CLUB
BEST
SELLER!**

- Rounded edge prevents damage to shirt pocket.
- Rule width: .470"
- Inch graduations are in 64ths.
- Rule thickness: .021"
- Metric scale is in 1mm increments.

Order Number	Description
72-380-100-0	6"/150mm Pocket Steel Rule

METAL ETCHING PEN

A "must" for any tool room and machine shop for general marking purposes, Fowler's metal etching pen is used on copper, copper alloy, stainless steel, hardened steel tools and castings, etc.

Use it to initial personal tools. Its low-cost, disposable design offers limitless applications.



Order Number	Description
72-730-005-0	Disposable Felt Tip Metal Etching Pen. Overall length is 6-1/4"

2 IN 1 SCRIBER & CENTER PUNCH



- Contains a carbide tipped scribe and a steal center punch all in 1 tool
- Carbide tip is reversible for double the life
- Knurled finger grip
- 1/8" center punch tip
- Supplied with convenient pocket clip

← Remove Scribe Tip To Access Center Punch Below!



NEW!

Order Number	Description
72-500-060-0	2 in 1 Scriber & Center Punch

CARBIDE TIPPED SCRIBER VALUES!



- Lightweight
- Retractable carbide tip
- Knurled grip
- Machined aluminum body
- Pocket clip

Order Number	Description	Overall Length
72-500-050-0	Carbide Super Scriber	6.5"
72-500-055-0	Carbide Refills	



- Lightweight
- Retractable carbide tip
- Fluted grip
- Blue anodized aluminum body
- Pocket clip

Order Number	Description	Overall Length
72-500-000-0	Pocket Carbide Scriber	6.0"
72-515-046-0	Carbide Refills	



- Heavy duty
- Replaceable carbide tip
- Knurled grip
- Pocket clip
- Magnetic end cap

Order Number	Description	Overall Length
72-500-080-0	Replaceable Tip Carbide with magnetic end cap	5.75"
72-500-085-0	Carbide Refills	



- Heavy duty
- Fixed carbide tip
- Pencil-like design
- Pocket clip

Order Number	Description	Overall Length
72-500-090-0	Fixed Tip Scriber	6.0"

SWISS PATTERN FILE SET

Swiss Pattern Files are economically priced and each set includes a fitted case and 12 of the finest quality files in the most popular shapes.

Swiss Pattern Files are fine precision cutting tools used by tool and die makers, model makers, delicate instrument and part finishers for a variety of filing jobs. Made to closer tolerances than American pattern files, they are primarily finishing tools for removing burrs, trueing narrow grooves, notches, keyways, cleaning corners, smoothing small parts and similar jobs.

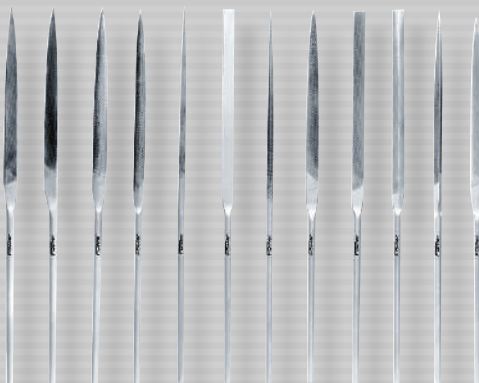

Order Number	Description	Length	Cut No.
75-130-060-0	12 pc. Swiss Pattern File Set	6"	#0
75-130-062-0	12 pc. Swiss Pattern File Set	6"	#2

DIAMOND FILE & DEBURRING SET



DIAMOND IMPREGNATED
for use on even the
HARDEST ALLOYS!



Set includes:

- 1 handle, providing maximum grip comfort.
- 5 piece set of diamond impregnated files consisting of a round, flat, square, triangle and half-round file, 5-1/2" long with 2-1/2" length of cut.
- 2 triangular scraper/deburring tools (single and double ended).
- Fitted storage case.

Order Number	Description
72-483-666-0	Diamond File & Deburring Set

DISPOSABLE DEBURRING TOOL

with Pocket Clip

Disposable deburring tool includes S-10 blade for steel, aluminum and plastic mounted in an aluminum handle

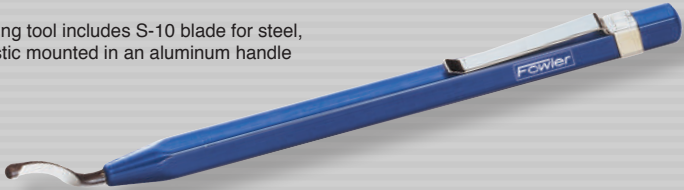

Order Number	Description
72-483-125-0	Disposable Deburring Tool

DEBURRING CUTTERS

- "Quick-change" thumb operated button for instant removal, insertion and locking of new blades.
- Supplied with three blades: 1) for steel and aluminum, 2) for brass and cast iron, 3) for straight edges on all types of metals.
- Hollow handle with a removable end cap for storage of blades.
- Unique rounded head blades for safe deburring of drilled and machined holes, end milled areas, tubing, backside of holes and an almost unlimited amount of uses.
- Curved blades swivel freely to automatically follow shapes, contours and holes.
- Molded to comfortably fit the user's hand without slippage or fatigue.



Order Number	Description
72-483-003-0	Adjustable Scraper & Deburring Cutter with three blades

RAPID BURR

- "Quick-change" thumb operated button for instant removal, insertion and locking of new blades.
- Supplied with a blade for steel and aluminum.
- Unique rounded head blade for safe deburring of drilled and machined holes, end milled areas, tubing, backside of holes and an almost unlimited amount of uses.
- Curved blades swivel freely to automatically follow shapes, contours and holes.
- Adapts to all S-blades
- Molded to comfortably fit the user's hand without slippage or fatigue.

for steel & aluminum

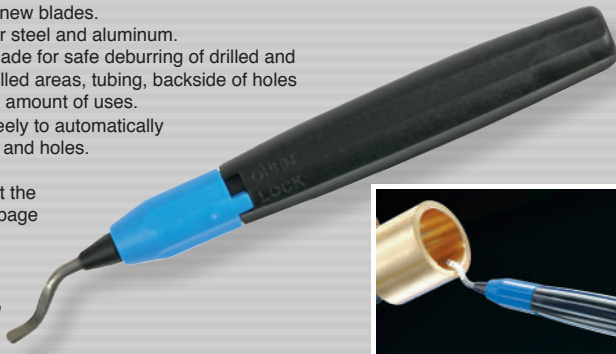

Order Number	Description
72-483-025-0	Rapid Burr

4 PIECE DEBURRING CUTTER SET

4pc Deburring Cutter Set features four separate color coded cutters. Each color indicates the material that the cutter is intended for.

- Colored sleeves rotate to lock and unlock blades for easy changing.
- Unique rounded head blades for safe deburring of drilled and machined holes, end milled areas, tubing, backside of holes and an almost unlimited amount of uses.
- Curved blades swivel freely to automatically follow shapes, contours and holes.



Order Number	Description
72-483-777-0 For replacement blades see Fowler's Main Catalog	4 pc. Deburring Cutter Set

UNIVERSAL DEBURRING, CLEANING & COUNTERSINK SET

A complete kit for the Auto Repair Professional!



Set includes:

- 1 Universal Handle
- 2 Adapters
- 2 Deburring Blades
- 1 Countersink for 20mm/.47" diameter.
- 1 Countersink for 30mm/1.18" diameter.
- 4 Cleaner Blades, for sheet metal, small ridges, relieving corners and for narrow slots.
- Combined in a compact molded case.

Order Number	Description
72-483-888-0	Universal Deburring, Cleaning & Countersink Set

3 PIECE DEBURRING CUTTER SET

- Most economical
- 3 deburring tools
- Blades are replaceable
- 3 different blades from heavy duty to extra fine.

for brass & cast iron

for steel & aluminum

for plastic



Order Number	Description
72-483-555-0	3 pc. Deburring Cutter Set
For replacement blades see Fowler's Main Catalog	

UNIVERSAL MAGNETIC MINI FLEX BASE with LED Flashlight



This product is ideal for focused applications in Industrial and Automotive!

- Zoomable 150 lumens Ultra-bright flashlight with 3 modes; bright, dim and flashing
- Powerful, low-profile magnetic base
- Slim, articulating flex bar allows easy and accurate positioning.
- Quick releasemounting bracket clamp
- Batteries included



Order Number	Description
72-630-451-1	Universal Magnetic Mini Flex Bar with light

DEEP HOLE LIGHT

- Deep Hole Light permits viewing in deep holes, around corners, under grooves, etc.
- Includes battery case for 2 penlight batteries and a battery case for one battery for use where space is limited; batteries not included.
- Features a positive switch. Curved and straight light conveying devices place intense illumination at their ends directly on the bottom of the hole being viewed. A small mirror permits viewing in a manner similar to a dentist examining teeth.
- Includes plastic case.



Order Number	Description
72-270-000-0	Deep Hole Light

SCREWDRIVER KIT



- This precision Screwdriver and Tool Set is ideal for miniature work.
- Features knurled and chromed swiveling handles.
- Screwdriver and Tool Set contains 9 screwdrivers, 1 tapered point scratch awl and 1 magnetic pick-up tool.
- Screwdriver size range: #00, #0, #1, 1/32", 3/64" 1/16", 5/64", 3/32" and 1/8".

Order Number	Description
72-490-003-0	Screwdriver Kit

X-BLOX® V-BLOCK SET



2 each @:

- Dimensions: 1-1/2" L x 1-1/4" W x 1-1/4" H.
- Work capacity: Approximately 1"

2 each @:

- Dimensions: 2" L x 1-1/2" W x 1-1/2" H.
- Work capacity: 1-1/2"

All feature:

- Surfaces are square and parallel within .0005".
- V-grooves are square and parallel with all surfaces within .0005".
- Corresponding dimensions for each pair are alike within .0005".
- All enclosed in shop-hardened case.

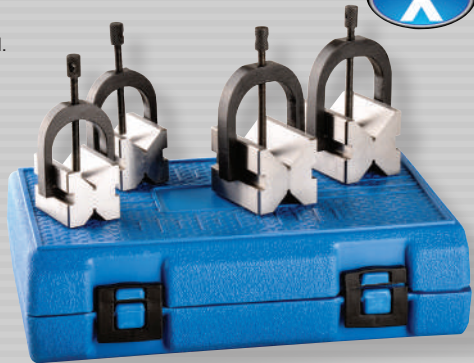

Order Number	Description
72-475-500-0	X-Blox V-Block Set

RECTANGULAR HEAD PROTRACTOR

- Measures angles from 0-180 degrees.
- Used to transfer angles and to set bevels.
- 6" arm with knurled thumb lock nut.
- Made of chrome steel with satin finish.
- Measures 3-5/16" x 2". Rectangular head provides four working edges. Blade secured firmly at any angle by a lock joint and knurled nut.



Order Number	Description
72-450-010-0	Rectangular Head Protractor

VALVE SEAT RUNOUT GAGES

Small, compact dial gages designed to measure valve seat runout on most gasoline engines including automobiles, motorcycles, outboard and inboard engines, trucks, snowmobiles, etc. Valve seat runout tolerances for engines are within $\pm .001$ ".

Gage should be positioned on pilot, adjustable probe should be set on the valve seat and the gage is then turned 360°. A complete range of adaptors are available for different pilots. Gage contains jewelled bearings.

- Range .200"
- Graduation .001"
- Reading 0—50—0



Order Number	Description	Adaptor Size	For Pilots*
72-644-000-0	Valve Seat Runout Gage	3/8"	Black & Decker, K.O.Lee, Neway, Olcott
72-644-200-0	Valve Seat Runout Gage	3/8" + .010"	Sioux

TAP-X Cam-Locking Tap Wrench

3-times the Range of Most Tap Wrenches!

1/8" to 1/2" (3 to 12mm)

QUICK RELEASE CAM!

FAST & TIGHT!

CHANGE TAPS FAST!

Features:

- Fits wide range of tap sizes: 1/8" to 1/2" (M3 to M12)
- Patented Revolutionary Cam-Lock System.
- Quick-action clamping for easy replacement.
- Taps will never release during use.
- Heavy-duty design for reliability and long life.
- Handles extreme torque.
- Can be used as a hand drill for sizes: 1/16" to 5/16"



Order Number	Description
72-492-350-0	Tap-X Cam-Locking Tap Wrench

Prices and specifications are subject to change without notice.