

# Temperature Control Products

2016 Illustrated

PART I



**4 SEASONS**





**2016**

**Temperature Control  
Products**

# TABLE OF CONTENTS

## ILLUSTRATION GUIDE

SECTION	PAGE	SECTION	PAGE
<b>AC System Seal Kits</b>		<b>Compressors (Cont'd)</b>	
Cap and Valve	1	H Series	228
O-Rings and Gaskets	1	Halla Series	234
<b>Blend Door Levers and Actuators</b>		Halla Series Electric	237
Blend Door Actuator	3	Hitachi	237
<b>Blower Motors</b>		Keihin	239
Blower Motor Chart	10	Matsushita/Panasonic	240
Blower Motor & Assembly	20	Mitsubishi	242
Auxillary Fan	67	Mitsubishi Electric	246
Blower Motor Vent Tube	67	R4 Series	246
Blower Motors / Wheel (Shaft Adapter)	67	Sanden	249
Blower Motor Wheels	68	Seiko Seiki	274
<b>Cabin Air Filters</b>		York/Tecumseh	275
Cabin Air Filters	72	<b>Condensers</b>	
<b>Clutch Assemblies</b>		Condensers	279
Clutch Assemblies Chart	74	Condenser Drier Assembly	343
Chrysler - A590	81	<b>Electric Fans and Accessories</b>	
Chrysler - Airtemp RV2	81	Reversible Fans	344
Chrysler - C171	81	Dual Fans	344
Diesel Kiki - Selttec - Zexel	81	Fan Accessories	344
Ford - FS6	82	<b>Evaporator Cores</b>	
Ford - Scroll	82	Evaporator Cores	345
Ford - FS10 / FX15	82	Evaporator Core Repair Kits	394
Frigidaire / Harrison - A6	83	<b>Expansion Valves and Orifice Tubes</b>	
Frigidaire / Harrison - R4	83	Expansion Valves and Orifice Tubes Chart	395
GM - CVC	84	Expansion Valve	409
Harrison - DA6-HR6-HD6-HT6-HE6	84	Evaporator Core Repair Kits	464
Harrison - V5 Variable Displacement	85	Expansion Service Valve	464
Hitachi - Nihon Radiator	85	Orifice Tubes	464
HR980 Radial	85	POA, EPR, STV Valves	466
Nihon/Calsonic - CWV618	85	Refrigerant Filter	466
Nippondenso - 10P, 6P, 6E	85	<b>Fan Clutches</b>	
Nippondenso - 10PA	87	Fan Clutch Chart	467
Nippondenso - 10S	89	Fan Clutches	472
Sanden / Sankyo - SD508	89	Fan Blades	485
Sanden / Sankyo - SD709	89	<b>Filter Drier, Accumulator and Desiccant</b>	
Sanden / Sankyo - TRF090	90	Accumulator	487
Sanden / Sankyo - TRS090	90	Accumulator Tube	513
York & Tecumseh	90	Hose Assembly	514
<b>Clutch Parts Miscellaneous</b>		Accumulator w/ Tubes	519
Bearings Chart	94	Condenser Drier Assembly	519
Clutch Coil Chart	95	Desiccant Bag Kit	519
Bearings	96	Filter Drier	521
Clutch Coil	96	Filter Drier Fuse Plug	579
Clutch Hub	96	Universal Tank Accumulator	580
Clutch Pulley	97	<b>Fittings</b>	
Harness Connectors	97	Fitting Charts	581
<b>Compressor Parts Miscellaneous</b>		AC Hose Repair System	603
Compressor Control Valve	100	Adapter	603
Compressor Conversion Kits	100	Clamp	603
Gaskets - Individual	100	Compressor	604
Pressure Relief Valve	101	Compressor Bolt Kit	610
Gasket Kits	101	Evaporator Core Repair Kits	610
O-Rings Kits	102	Ferrule	610
<b>Compressors</b>		<b>Gaskets and O-Rings</b>	
Compressor Charts	103	O-Ring Assortment Kit	612
Rear Head Identification	150	Gaskets - Individual	614
A6	154	Expansion Device Parts	617
Bosch Series	156	Gasket Kits	617
Calsonic / Zexel	156	O-Rings - Individual	618
CVC	172	O-Rings Kits	626
Delphi Series	175	<b>Heater Fittings</b>	
Denso	176	Heater Fittings	627
Denso Electric	212	<b>Heater Valves</b>	
Dodge/Chrysler	212	Heater Valves	632
Doowan Series	213	<b>Hose Assemblies</b>	
FS Series	213	Hose Size Chart	640
GM V Series	223	Hose Assembly	641

# TABLE OF CONTENTS

## ILLUSTRATION GUIDE

SECTION	PAGE	Index
<b>Idle Pulleys and Tensioners</b>		
Idle Assembly	823	Index 1012
Pulleys	823	
Parts and Eccentrics	834	
<b>Oil Coolers</b>		
Transmission Oil Coolers	835	
Transmission Oil Cooler Accessories	836	
<b>Radiator Fan Assembly and Motors</b>		
Fan Assemblies	837	
Fan Motors	876	
Cooling Fan Retainer Clip	891	
<b>Relays</b>		
A.T.C. Power Modules	892	
Relays (Compressor Control)	892	
Radiator Fan Control Modules	892	
Relays	893	
Harness Connectors	906	
<b>Switches</b>		
Axle Shift	909	
Binary	909	
Blower	911	
Condenser Fan	915	
Coolant Temp Sensor Switch	917	
High Pressure Cut-Out	923	
High Temperature Cut-Out	926	
Knob	926	
Low Pressure Cut-Out	926	
Radiator Fan	928	
Radiator Mount Cooling Fan Temp Switch	933	
Refrigerant Temp Sensor	936	
Resistor Block	937	
Rocker	958	
Selector	958	
Speed Sensor	958	
Sys. Mount Adj. Cycling Temp Switch	958	
Sys. Mount Cycling Pressure Switch	960	
Sys. Mount Preset Cycling Temp Switch	961	
Thermal Limiter Fuse	962	
Transducer	963	
Trinary	964	
Universal	966	
<b>Tools and Service Items</b>		
Lubricants	969	
Tools - A/C Thermometer / Pyrometers	972	
Tools - A/C Can Taps	972	
Tools - A/C Service Cap	972	
Tools - A/C Valve Core Tools	973	
Tools - A/C Valve Cores	973	
Tools - AC Springlock Tools	974	
Tools - Charging Equipment	974	
Tools - Chrysler /Jeep	974	
Tools - Clamp Pliers	974	
Tools - Diagnostic Tool	975	
Tools - Flushing Equipment	975	
Tools - Ford	975	
Tools - General Motors	975	
Tools - General Service Item	976	
Tools - Leak Detection	977	
Tools - Manifold Gauge,Hose & parts	978	
Tools - Manifold Gauges	978	
AC Service Adapters	980	
Tools - Retrofit Component	980	
Tools - Retrofit Kit	981	
Tools - Sanden	982	
Tools - Tape	982	
Tools - Vacuum Pump & Adapters	982	
<b>Water Outlets</b>		
Water Outlets	983	



# AC System Seal Kits

## Rapid-Seal

Patent Pending



O-Ring / Gasket Kit

Vehicle Specific A/C System Seal Kits containing necessary components to complete the job.



Cap / Valve Core Kit

Cap and Valve	O-Rings and Gaskets	Cap and Valve	O-Rings and Gaskets
<p><b>26775</b> Buick (13-94); Cadillac (13-94); Chevy (13-93); GMC (13-94); Isuzu (08-06); Olds (04-94); Pontiac (10-93); Saturn (10-94)</p> <p><b>26776</b> Buick (93-91); Chevy (93-91)</p> <p><b>26777</b> Acura (93-86); Audi (93-69); BMW (93-66); Buick (90-65); Cadillac (93-65); Chevy (93-65); Chrysler (93-65); Daihatsu (92-88); Dodge (93-65); Eagle (93-88); Ford (93-65); Geo (93-89); GMC (93-68); Honda (93-73); Hyundai (93-83); Infiniti (93-90); Int'l (80-65); Isuzu (93-81); Jaguar (96-65); Jeep (93-65); Kia (93); Land Rover (93); Lexus (93-90); Lincoln (93-65) Mazda (93-71); Mercedes (93-60); Mercury (93-65); Merkur (89-85); Mitsubishi (93-83); Nissan (93-65); Olds (93-65); Peugeot (91-67); Plymouth (93-65); Pontiac (93-65); Porsche (93-65); Renault (87-68); Saab (93-65); Saturn (93-91); Shelby (67-65); Sterling (91-87); Subaru (93-71); Suzuki (93-80); Toyota (93-67); Volvo (93-65); VW (93-65)</p> <p><b>26778</b> Buick (05-94); Cadillac (08-96); Chevy (05-94); GMC (05-98); Olds (03-01); (99-94); Pontiac (05-94)</p>	<p><b>26779</b> Buick (96-94); Cadillac (13-04), (95-94); Chevy (07-95); Dodge (13-04); Ford (12-95); Jeep (13-07); Lincoln (13-99); Mazda (11-01); Mercury (09-94); Olds (98-97), (95); Pontiac (02-94)</p> <p><b>26780</b> Ford (11-94); Lincoln (08-94); Mazda (10-94); Mercury (11-94)</p> <p><b>26781</b> Audi (13-07); Ford (97-94); Lincoln (96-94); Mercury (97-94); VW (10-06)</p> <p><b>26782</b> Chrysler (10-94); Dodge (10-94); Eagle (98-94); Jeep (06-94); Plymouth (01-94)</p> <p><b>26783</b> Acura (13-94); Audi (06-94); Buick (11-06); Cadillac (13-09), (07-06); Chevy (11-08), (04-98), (94); Ford (99-94); Geo (97-94); GMC (04-98); Honda (13-94); Hyundai (05-94) Infiniti (13-94); Isuzu (05-94); Jaguar (05-97); Kia (05-94); Lexus (13-94); Lincoln (02-94); Mazda (13-94); Mercedes (09-06); Mercury (99-94); Mitsubishi (13-94); Nissan (13-94) Pontiac (99-94); Subaru (13-94); Suzuki (10-94); Toyota (13-94); Volvo (07-94); VW (05-94)</p> <p><b>26784</b> BMW (02-94); Dodge (09-06); Mercedes (12-94)</p>	<p><b>26826</b> Audi (13-08); BMW (13-03); Jaguar (13-06); Mercedes (13-05); Mini (13-02); Volvo (09-08)</p> <p><b>26711</b> Dodge (88-84); Plymouth (88-84)</p> <p><b>26712</b> Chrysler (93-90); Dodge (93-89); Plymouth (93-89)</p> <p><b>26713</b> Chrysler (02-00); Dodge (05-95); Plymouth (01-95)</p> <p><b>26714</b> Chrysler (95-89); Dodge (95-90); Plymouth (95-92)</p> <p><b>26715</b> Ford (05-83); Lincoln (05-86); Mercury (05-82)</p> <p><b>26716</b> Lincoln (85-82); Mercury (85-81); Toyota (02)</p> <p><b>26717</b> Ford (04-81); Mercury (99-91), (87-81)</p> <p><b>26718</b> Ford (08-98)</p> <p><b>26719</b> Ford (04-84); Lincoln (06-80); Mercury (05-84)</p> <p><b>26720</b> Ford (03-95); Mercury (02-93); Nissan (04), (02-93)</p> <p><b>26721</b> Ford (05-82); Lincoln (06-98)</p> <p><b>26722</b> Ford (08-91); Mazda (05-91); Mercury (07-97)</p>	<p><b>26723</b> Ford (97-86)</p> <p><b>26724</b> Ford (08-83); Mercury (07-04)</p> <p><b>26725</b> Saturn (02-91)</p> <p><b>26726</b> Saturn (05-02)</p> <p><b>26727</b> Saturn (05-00)</p> <p><b>26728</b> Buick (05-97); Cadillac (04-98); Chevy (05-95); Olds (04-93); Pontiac (05-97)</p> <p><b>26729</b> Buick (96-87); Chevy (97-84), (82-77); Olds (97-87); Pontiac (97-87)</p> <p><b>26730</b> Buick (86-77); Cadillac (86-77); Chevy (86-77); Olds (86-74), (71-68); Pontiac (93-75)</p> <p><b>26731</b> Buick (05-88); Cadillac (05-85); Chevy (05-95); Olds (99-88); Pontiac (05-92)</p> <p><b>26732</b> Buick (91-89); Cadillac (91-90); Olds (91-87); Pontiac (91-89)</p> <p><b>26733</b> Buick (88-87); Olds (88-87); Pontiac (88-87)</p>

# AC System Seal Kits

O-Rings and Gaskets Cont'd			
<b>26734</b> Buick (98-92); Chevy (93-87); Olds (98-92); Pontiac (05-92)	<b>26751</b> Chevy (88-85); Toyota (89-67)	<b>26773</b> BMW (95-84)	<b>26805</b> Dodge (07); Jeep (07)
<b>26735</b> Buick (91-77); Cadillac (89-77); Chevy (91-76); GMC (87-78); Olds (91-77); Pontiac (91-84)	<b>26752</b> Mazda (05-00), (98-89)	<b>26774</b> BMW (87), (85-75)	<b>26806</b> Dodge (08-04)
<b>26736</b> Chevy (02-98); Pontiac (02-98)	<b>26753</b> Mazda (04), (91-79)	<b>26785</b> Subaru (05-72)	<b>26807</b> Chrysler (06-98); Dodge (04-99)
<b>26737</b> Chevy (96-90); Isuzu (97-90); Olds (04-90); Pontiac (99-90)	<b>26754</b> Mazda (05-72)	<b>26786</b> Subaru (06-05)	<b>26808</b> Chrysler (07-04)
<b>26738</b> Buick (07-02); Cadillac (07-02), (00-99); Chevy (08-97); GMC (08-99); Pontiac (08-06)	<b>26755</b> Mazda (05-98)	<b>26787</b> Subaru (04-00)	<b>26809</b> Ford (07-02)
<b>26739</b> Chevy (91-73); GMC (91-73); Olds (91)	<b>26756</b> Mazda (06-03), (95-88)	<b>26788</b> Isuzu (05-03)	<b>26810</b> Pontiac (05-01)
<b>26740</b> Chevy (02-98); GMC (02-98)	<b>26757</b> Jeep (01-97)	<b>26789</b> Isuzu (95-81)	<b>26811</b> Chrysler (06-02)
<b>26741</b> Chevy (97-77); GMC (97-77)	<b>26758</b> Jeep (96-76)	<b>26790</b> Volvo (04-00)	<b>26812</b> Cadillac (08-03)
<b>26742</b> Chevy (05-92); GMC (05-92); Isuzu (00-96); Olds (04-96), (94-92)	<b>26759</b> Jeep (04-99)	<b>26791</b> Volvo (05-03)	<b>26813</b> Dodge (10-02)
<b>26743</b> Chevy (02-92); GMC (02-92)	<b>26760</b> Jeep (98-93)	<b>26792</b> Volvo (04-98)	<b>26814</b> Chrysler (10-05); Dodge (07-05)
<b>26744</b> Acura (05-94); Honda (01-86); Isuzu (04-96), (94)	<b>26761</b> Jeep (05-02)	<b>26793</b> Volvo (07-00)	<b>26815</b> Acura (11-99); Honda (11-97)
<b>26745</b> Acura (93-86); Honda (96-73); Isuzu (93-89)	<b>26762</b> Jeep (06-97)	<b>26794</b> Volvo (05-97)	<b>26816</b> Lexus (10-99); Toyota (10-98)
<b>26746</b> Honda (02-94); Isuzu (04-98)	<b>26763</b> Jeep (95-87)	<b>26795</b> Volvo (93-75)	<b>26817</b> Jeep (10-05)
<b>26747</b> Infiniti (93-90); Nissan (93-68)	<b>26764</b> Dodge (00-91), (86-85); Mitsubishi (04-83); Plymouth (94-85)	<b>26796</b> Volvo (98-91)	<b>26818</b> Ford (10-06); Lincoln (07-06); Mercury (08-06)
<b>26748</b> Infiniti (05-94); Nissan (05-94)	<b>26765</b> Audi (93-69); VW (93-74)	<b>26797</b> Hyundai (05-99); Kia (06-01)	<b>26819</b> Ford (09-06); Lincoln (10-06); Mercury (10-06)
<b>26749</b> Chevy (04-98); Geo (97-93); Lexus (02-94); Toyota (04-92)	<b>26766</b> VW (05-04)	<b>26798</b> Hyundai (98-89); Kia (02-94)	<b>26820</b> Ford (10-05); Lincoln (08-06); Mercury (10-06)
<b>26750</b> Chevy (88); Geo (92-89); Lexus (93-90); Toyota (94-86), (72-68)	<b>26767</b> Audi (05-94); VW (06-92)	<b>26799</b> Hyundai (01-95); Kia (06-03)	<b>26821</b> Ford (10-07); Lincoln (11-07)
	<b>26768</b> Mercedes (05-95)	<b>26800</b> Hyundai (05-01); Kia (07-00)	<b>26822</b> Ford (10-07); Lincoln (10-07); Mercury (09-08)
	<b>26769</b> Mercedes (97-85)	<b>26801</b> Hyundai (95-92), (89-83)	<b>26823</b> Ford (10-08); Mercury (10-08)
	<b>26770</b> Mercedes (05-98)	<b>26802</b> Toyota (07-05)	<b>26824</b> Buick (10-08); Chevy (10-02); Pontiac (10-04)
	<b>26771</b> Mercedes (87), (85-60)	<b>26803</b> Chrysler (07-04)	<b>26825</b> Cadillac (01-97)
	<b>26772</b> Audi (05-04); BMW (06-96)	<b>26804</b> Buick (07-05); Cadillac (08-04); Chevy (11-04); Pontiac (06-99); Saturn (07-05)	

# Blend Door Levers and Actuators

## Blend Door Actuator



**37530**  
Temperature Blend Door Actuator  
Door Linkage: Female  
Buick (09-05); Cadillac (09-04); Chevy  
(10-04); Pontiac (08-04)  
General Motors Corp: 22754988



**37533**  
Temperature Blend Door Actuator  
Door Linkage: Male  
Ford (10-02); Mercury (02)  
Ford: 1L2Z19E616CA



**37536**  
Temperature Blend Door Actuator  
Door Linkage: Male  
Ford (07-96); Mercury (05-96)  
Ford: XF1Z19E616CA



**37539**  
Temperature Blend Door Actuator  
Door Linkage: Female  
Cadillac (02); Chevy (02-99); GMC  
(02-99)  
General Motors Corp: 52474810



**37531**  
Temperature Blend Door Actuator  
Door Linkage: Male  
Ford (10-96); Lincoln (04-02); Mercury  
(01-97)  
Ford: YL5Z19E616AA

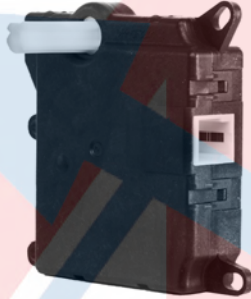

**37534**  
Temperature Blend Door Actuator  
Door Linkage: Male  
Ford (04-97); Lincoln (02-00)  
Ford: 2L3Z19E616BA

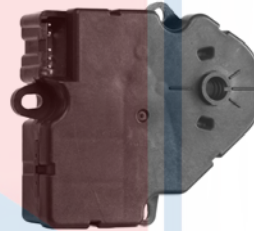

**37537**  
Temperature Blend Door Actuator  
Door Linkage: Female  
Buick (05-94); Cadillac (14-98),  
(96-94); Chevy (14-97); GMC (14-03);  
Olds (03-94); Pontiac (05-97)  
General Motors Corp: 89018365



**37540**  
Floor Mode Actuator  
Door Linkage: Female  
International (11-01)  
Climatech: MA1715  
Kysor: 2113006  
NaviStar: 2611234C1, 3542606C1  
TRP Parts: MA17150



**37532**  
Temperature Blend Door Actuator  
Door Linkage: Male  
Ford (07-99)  
Ford: 3C3Z19E616BA, XF2Z19E616FB



**37535**  
Temperature Blend Door Actuator  
Door Linkage: Male  
Ford (10-96); Lincoln (05-98); Mercury  
(10-96)  
Ford: F7DZ19E616BA



**37538**  
Temperature Blend Door Actuator  
Door Linkage: Female  
Buick (05-97); Chevy (05-95); GMC  
(99-95); Olds (04-97); Pontiac (05-97)  
General Motors Corp: 89018681



**73000**  
Floor Mode Actuator



**73001**  
Temperature Blend Door Actuator



# Blend Door Levers and Actuators

## Blend Door Actuator Cont'd



**73002**  
Floor Mode Actuator



**73003**  
Temperature Blend Door Actuator



**73004**  
Floor Mode Actuator

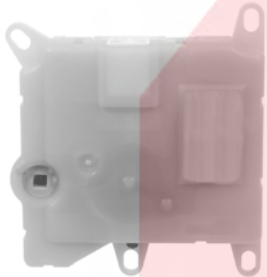

**73005**  
Temperature Blend Door Actuator



**73006**  
Temperature Blend Door Actuator



**73007**  
Recirculation Mode Door Actuator



**73008**  
Temperature Blend Door Actuator



**73009**  
Temperature Blend Door Actuator

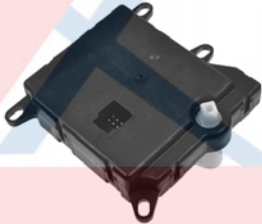

**73010**  
Recirculation Mode Door Actuator

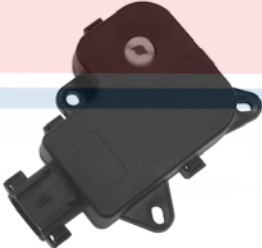

**73011**  
Floor Mode Actuator



**73012**  
Recirculation Mode Door Actuator



**73013**  
Floor Mode Actuator

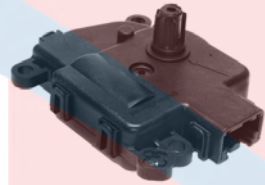

**73014**  
Recirculation Mode Door Actuator



**73015**  
Floor Mode Actuator



**73016**  
Floor Mode Actuator



**73017**  
Temperature Blend Door Actuator



**73018**  
Temperature Blend Door Actuator



**73019**  
Temperature Blend Door Actuator





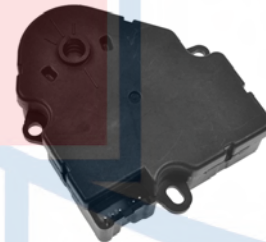











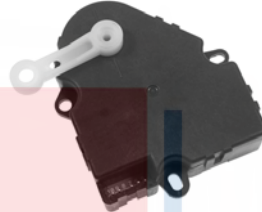

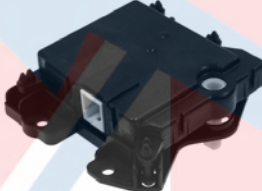
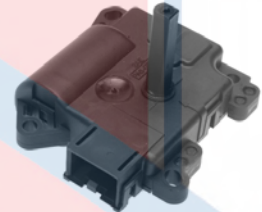

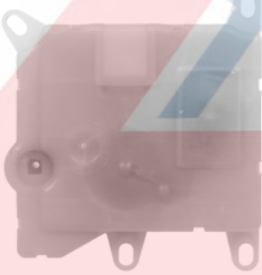
**73020**  
Floor Mode Actuator

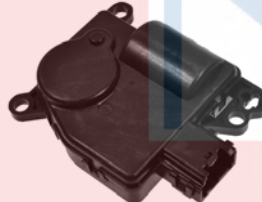

**73021**  
Recirculation Mode Door Actuator

# Blend Door Levers and Actuators

Blend Door Actuator Cont'd			
 <p><b>73022</b> Temperature Blend Door Actuator</p>	 <p><b>73027</b> Floor Mode Actuator</p>	 <p><b>73032</b> Temperature Blend Door Actuator</p>	 <p><b>73037</b> Temperature Blend Door Actuator</p>
 <p><b>73023</b> Floor Mode Actuator</p>	 <p><b>73028</b> Temperature Blend Door Actuator</p>	 <p><b>73033</b> Temperature Blend Door Actuator</p>	 <p><b>73038</b> Floor Mode Actuator</p>
 <p><b>73024</b> Temperature Blend Door Actuator</p>	 <p><b>73029</b> Floor Mode Actuator</p>	 <p><b>73034</b> Floor Mode Actuator</p>	 <p><b>73039</b> Temperature Blend Door Actuator</p>
 <p><b>73025</b> Temperature Blend Door Actuator</p>	 <p><b>73030</b> Floor Mode Actuator</p>	 <p><b>73035</b> Temperature Blend Door Actuator</p>	 <p><b>73040</b> Floor Mode Actuator</p>
 <p><b>73026</b> Recirculation Mode Door Actuator</p>	 <p><b>73031</b> Temperature Blend Door Actuator</p>	 <p><b>73036</b> Recirculation Mode Door Actuator</p>	 <p><b>73041</b> Floor Mode Actuator</p>

# Blend Door Levers and Actuators

## Blend Door Actuator Cont'd



**73042**  
Temperature Blend Door Actuator



**73043**  
Temperature Blend Door Actuator

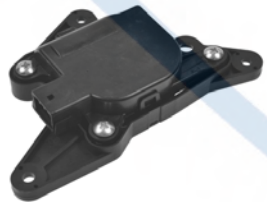

**73044**  
Temperature Blend Door Actuator

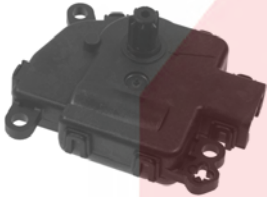

**73045**  
Recirculation Mode Door Actuator



**73046**  
Temperature Blend Door Actuator



**73047**  
Temperature Blend Door Actuator



**73048**  
Floor Mode Actuator

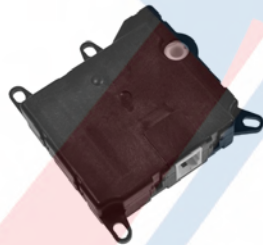

**73049**  
Floor Mode Actuator



**73050**  
Temperature Blend Door Actuator



**73051**  
Floor Mode Actuator



**73052**  
Temperature Blend Door Actuator



**73053**  
Floor Mode Actuator

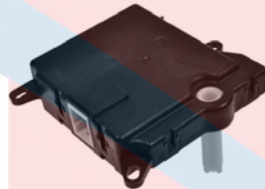

**73054**  
Temperature Blend Door Actuator



**73055**  
Recirculation Mode Door Actuator



**73056**  
Recirculation Mode Door Actuator



**73057**  
Recirculation Mode Door Actuator



**73058**  
Temperature Blend Door Actuator

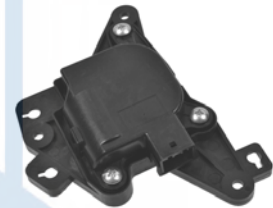

**73059**  
Temperature Blend Door Actuator

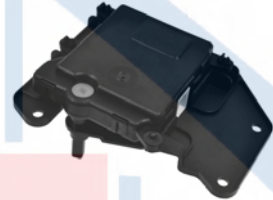

**73060**  
Floor Mode Actuator

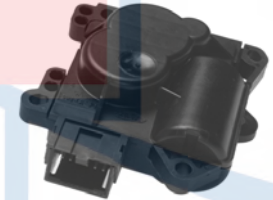

**73061**  
Floor Mode Actuator



# Blend Door Levers and Actuators

## Blend Door Actuator Cont'd



**73062**  
Temperature Blend Door Actuator

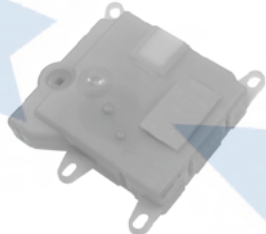

**73063**  
Temperature Blend Door Actuator



**73064**  
Temperature Blend Door Actuator

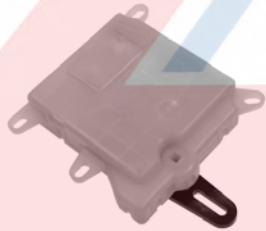

**73065**  
Floor Mode Actuator



**73066**  
Floor Mode Actuator



**73067**  
Floor Mode Actuator

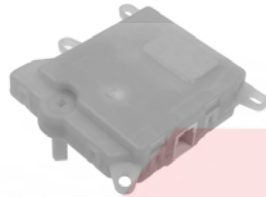

**73068**  
Temperature Blend Door Actuator

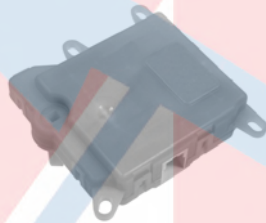

**73069**  
Recirculation Mode Door Actuator



**73070**  
Floor Mode Actuator



**73071**  
Temperature Blend Door Actuator



**73072**  
Temperature Blend Door Actuator

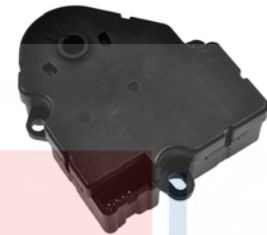

**73073**  
Temperature Blend Door Actuator

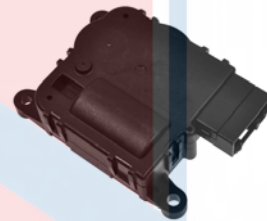

**73074**  
Floor Mode Actuator

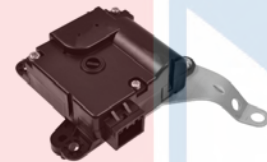

**73075**  
Floor Mode Actuator



**73076**  
Temperature Blend Door Actuator

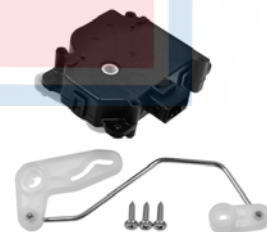

**73077**  
Temperature Blend Door Actuator



**73078**  
Temperature Blend Door Actuator



**73079**  
Floor Mode Actuator



**73080**  
Temperature Blend Door Actuator

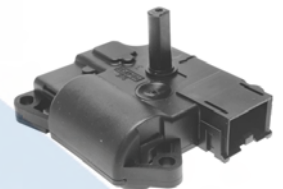

**73081**  
Recirculation Mode Door Actuator



**73082**  
Floor Mode Actuator



**73083**  
Temperature Blend Door Actuator

# Blend Door Levers and Actuators

## Blend Door Actuator Cont'd



**73084**  
Temperature Blend Door Actuator

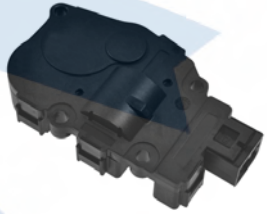

**73085**  
Floor Mode Actuator



**73086**  
Recirculation Mode Door Actuator

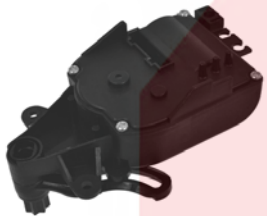

**73087**  
Floor Mode Actuator

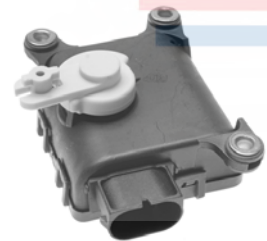

**73088**  
Floor Mode Actuator



**73089**  
Recirculation Mode Door Actuator



**73090**  
Temperature Blend Door Actuator

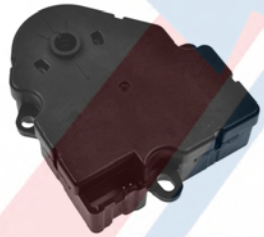

**73091**  
Floor Mode Actuator

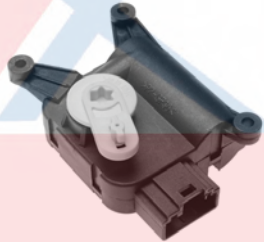

**73092**  
Floor Mode Actuator



**73093**  
Temperature Blend Door Actuator



**73094**  
Temperature Blend Door Actuator

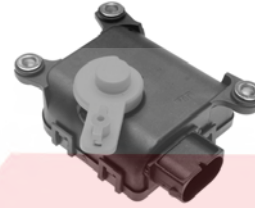

**73095**  
Floor Mode Actuator

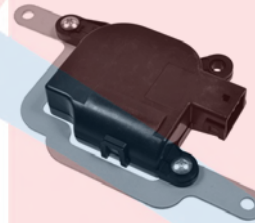

**73096**  
Temperature Blend Door Actuator



**73097**  
Recirculation Mode Door Actuator



**73098**  
Floor Mode Actuator



**73099**  
Recirculation Mode Door Actuator



**73100**  
Recirculation Mode Door Actuator



**73101**  
Temperature Blend Door Actuator

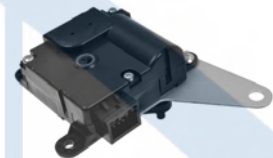



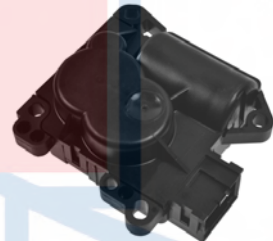







**73102**  
Floor Mode Actuator

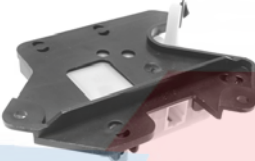
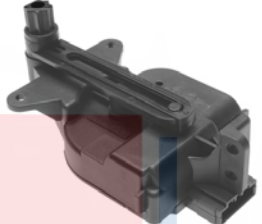

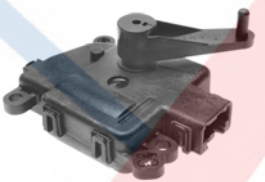
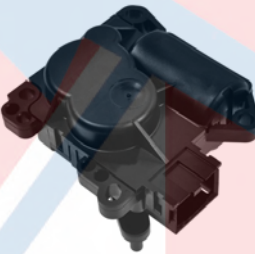
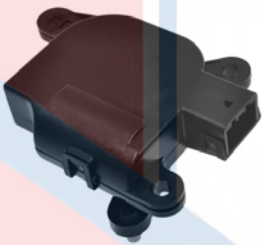
**73103**  
Floor Mode Actuator

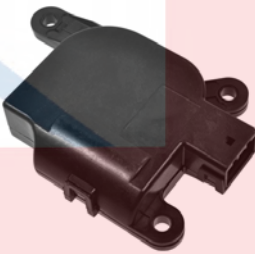
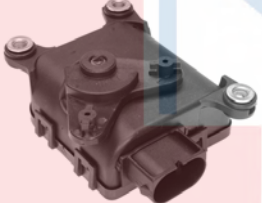
# Blend Door Levers and Actuators

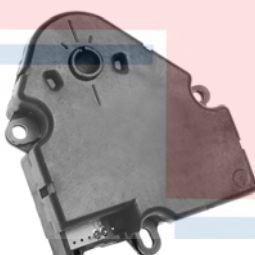
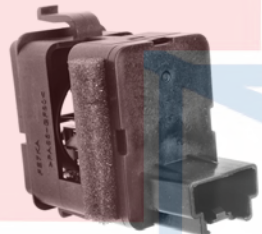
Blend Door Actuator Cont'd			
 <p><b>73104</b> Floor Mode Actuator</p>	 <p><b>73109</b> Temperature Blend Door Actuator</p>	 <p><b>73114</b> Recirculation Mode Door Actuator</p>	 <p><b>73119</b> Temperature Blend Door Actuator</p>
 <p><b>73105</b> Recirculation Mode Door Actuator</p>	 <p><b>73110</b> Floor Mode Actuator</p>	 <p><b>73115</b> Floor Mode Actuator</p>	 <p><b>73120</b> Recirculation Mode Door Actuator</p>
 <p><b>73106</b> Temperature Blend Door Actuator</p>	 <p><b>73111</b> Recirculation Mode Door Actuator</p>	 <p><b>73116</b> Floor Mode Actuator</p>	 <p><b>73121</b> Recirculation Mode Door Actuator</p>
 <p><b>73107</b> Temperature Blend Door Actuator</p>	 <p><b>73112</b> Recirculation Mode Door Actuator</p>	 <p><b>73117</b> Temperature Blend Door Actuator</p>	 <p><b>73122</b> Temperature Blend Door Actuator</p>
 <p><b>73108</b> Floor Mode Actuator</p>	 <p><b>73113</b> Temperature Blend Door Actuator</p>	 <p><b>73118</b> Temperature Blend Door Actuator</p>	



# Blower Motor Dimension Chart

**CCW = Counterclockwise**  
**CCWLE = Counterclockwise Lead End**  
**CW = Clockwise**  
**CWLE = Clockwise Lead End**  
**REV = Reversible**

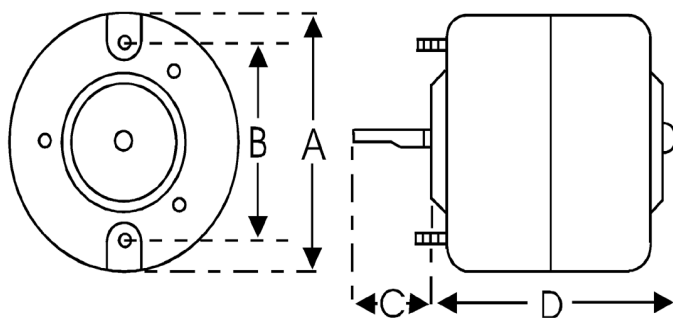

**A = Motor Diameter**  
**B = Stud Center Distance**  
**C = Shaft Length**  
**D = Motor Length**

**NOTE: Rotation determined by viewing motor from shaft end.**

Part No.	Design	Voltage	Rotation	Shaft Dia.	Shaft Length	Motor Length	Motor Dia.	Type
35001	Flanged	12	CW/CCW	5/16	1-1/2	4	3-1/4	Vented w/o Wheel
35003	Flanged	12	CW	5/16	1-7/16	3-13/16	3-1/4	Vented w/o Wheel
35004	Flanged	12	CW/CCW	5/16	1-1/2	4-1/2	3-1/4	Vented w/o Wheel
35005	Flanged	12	CW/CCW	5/16	1-5/8	3-7/8	3	Vented w/o Wheel
35007	Double Shaft	12	CCW	5/16	1-3/4	3-5/8	2-3/4	Vented w/o Wheel
35008	Flanged	12	CW	5/16	1-3/8	4-1/8	3-1/4	Vented w/o Wheel
35009	Flanged	12	CCW	5/16	1-1/8	4-9/16	3-1/4	Vented w/o Wheel
35010	Flanged	12	CCW	5/16	1-3/4	4-1/8	3-1/4	Vented w/o Wheel
35011	Flanged	12	CW/CCW	5/16	1-5/16	4-1/8	3-1/4	Vented w/o Wheel
35015	Flanged	12	CW	5/16	1-3/8	3-11/16	3	Vented w/o Wheel
35016	Flanged	12	CW/CCW	5/16	1-7/16	4-5/16	3-1/4	Vented w/o Wheel
35057	Double Shaft	12	CCWLE	3/8	4-3/8	5-1/16	3-5/8	Vented w/o Wheel
35061	Single Shaft	12	CW/CCW	5/16	1-7/16	4-3/16	3-1/4	Vented w/o Wheel
35062	Single Shaft	12	CW	5/16	1-1/2	4-3/16	3-1/4	Vented w/o Wheel
35065	Single Shaft	12	CW	5/16	1-1/2	4-13/16	3	Non Vented w/o Wheel
35067	Single Shaft	12	CW	5/16	1-1/2	4-13/16	3	Non Vented w/o Wheel
35068	Single Shaft	12	CW	5/16	1-3/4	4-13/16	3	Non Vented w/o Wheel
35069	Single Shaft	12	CW	5/16	3-1/8	4-5/16	3	Non Vented w/o Wheel
35071	Flanged	12	CW/CCW	5/16	1-1/4	4-9/16	3-1/4	Vented w/o Wheel
35073	Flanged	12	CW/CCW	5/16	1-1/2	4	3-1/4	Vented w/o Wheel
35075	Double Shaft	12	CCWLE	5/16	2-11/16	4-5/16	3	Vented w/o Wheel
35076	Single Shaft	12	CCW	5/16	1-1/2	3-13/16	3-1/4	Vented w/o Wheel
35103	Flanged	12	CCW	5/16	1-5/8	3-7/8	3-1/4	Vented w/o Wheel
35111	Flanged	12	CCW	5/16	1-3/8	4-1/8	3-1/4	Vented w/o Wheel
35115	Flanged	12	CCW	5/16	1-3/4	4-1/8	3-1/4	Vented w/o Wheel
35116	Flanged	12	CCW	5/16	1-3/4	4-1/8	3-1/4	Non Vented w/o Wheel
35117	Flanged	12	CCW	5/16	1-3/4	4-1/8	3-1/4	Non Vented w/o Wheel
35118	Single Shaft	12	CCW	5/16	1-3/8	4-7/16	3	Vented w/o Wheel
35120	Single Shaft	12	CW/CCW	5/16	1-21/32	3-7/8	3	Vented w/o Wheel
35126	Single Shaft	12	CW/CCW	5/16	1-9/16	4-7/16	3-1/4	Vented w/o Wheel
35127	Single Shaft	12	CCW	5/16	1-3/4	4-1/8	3-1/4	Vented w/o Wheel
35128	Flanged	12	CCW	5/16	1-3/4	4-1/8	3-1/4	Vented w/o Wheel
35152	Flanged	12	CCW	5/16	1-3/8	4-9/16	3-1/4	Vented w/o Wheel
35167	Flanged	12	CCW	5/16	1-5/16	4-7/16	3	Vented w/o Wheel
35168	Flanged	12	CCW	5/16	1-1/2	4-7/16	3	Vented w/o Wheel
35174	Flanged	12	CCW	5/16	1-3/8	4-1/4	3-1/4	Vented w/o Wheel
35177	Flanged	12	CW/CCW	5/16	1-21/32	3-7/8	3	Vented w/o Wheel
35178	Single Shaft	12	CW/CCW	5/16	1-1/4	4-1/4	3	Vented w/o Wheel
35182	Single Shaft	12	CCW	5/16	1-3/16	3-11/16	3	Vented w/o Wheel
35184	Flanged	24	CW/CCW	5/16	2-1/16	3-7/8	3	Vented w/o Wheel
35190	Flanged	12	CCW	5/16	1-7/16	4-1/4	3-1/4	Vented w/o Wheel
35221	Single Shaft	12	CW	5/16	1-1/2	5	3-5/8	Non Vented w/o Wheel
35223	Single Shaft	12	CW	5/16	1	4-1/4	3	Non Vented w/o Wheel
35229	Single Shaft	12	CCW	5/16	2	4-5/8	3	Non Vented w/o Wheel
35233	Flanged	12	CCW	5/16	1-7/8	3-15/16	3-1/4	Non Vented w/o Wheel
35241	Flanged	12	CW/CCW	5/16	1-3/8	4-1/8	3	Vented w/o Wheel
35242	Flanged	12	CCW	5/16	1-3/4	4-1/8	3-1/4	Vented w/o Wheel

## **Blower Motor Dimension Chart**

Part No.	Design	Voltage	Rotation	Shaft Dia.	Shaft Length	Motor Length	Motor Dia.	Type
35244	Flanged	12	CW/CCW	5/16	1-7/8	3-7/8	3	Vented w/o Wheel
35245	Flanged	12	CW/CCW	5/16	1-1/4	4-1/8	3	Vented w/o Wheel
35246	Flanged	12	CW/CCW	5/16	1-11/16	4-1/2	3-1/4	Vented w/o Wheel
35247	Flanged	12	CW/CCW	5/16	1-7/8	3-7/8	3-1/4	Vented w/o Wheel
35248	Flanged	12	CW/CCW	5/16	1-5/8	3-7/8	3-1/4	Vented w/o Wheel
35250	Single Shaft	12	CCW	5/16	1-3/8	4-5/16	3-1/4	Vented w/o Wheel
35252	Flanged	12	CCW	5/16	1-7/16	4-5/16	3-1/4	Vented w/o Wheel
35253	Flanged	12	CW/CCW	5/16	1-1/2	4	3-1/4	Vented w/o Wheel
35256	Flanged	12	CCW	5/16	1-3/4	4	3-1/4	Vented w/o Wheel
35258	Single Shaft	12	CW/CCW	5/16	1-9/16	5	3	Vented w/o Wheel
35259	Flanged	12	CCW	5/16	1-7/16	4-1/4	3-1/4	Vented w/o Wheel
35260	Flanged	12	CW/CCW	5/16	1-5/16	4-7/16	3	Vented w/o Wheel
35262	Flanged	12	CW/CCW	5/16	1-5/16	4-7/16	2-7/8	Vented w/o Wheel
35263	Flanged	12	CCW	5/16	1-5/8	3-3/8	3	Vented w/o Wheel
35264	Flanged	12	CCW	5/16	1-3/4	4-1/8	3-1/4	Vented w/o Wheel
35266	Flanged	12	CW	5/16	1-1/4	4-7/16	3-1/4	Vented w/o Wheel
35267	Flanged	12	CW/CCW	5/16	1-1/4	4-7/16	3-1/4	Vented w/o Wheel
35279	Flanged	12	CCW	5/16	1-3/4	4-7/16	3-1/4	Vented w/o Wheel
35280	Flanged	12	CW	5/16	1-3/16	4-5/16	3-1/4	Vented w/o Wheel
35281	Flanged	12	CCW	5/16	1-3/8	4-5/16	3-1/4	Vented w/o Wheel
35283	Single Shaft	12	CW	5/16	1-1/2	4-1/2	3	Vented w/o Wheel
35286	Flanged	12	CCW	5/16	1-1/4	4-7/16	3-1/4	Vented w/o Wheel
35293	Double Shaft	12	CCWLE	5/16	1-3/16	4-1/4	3	Vented w/o Wheel
35298	Flanged	12	CW	5/16	1-1/4	4-7/16	3-1/4	Vented w/o Wheel
35299	Flanged	12	CW/CCW	5/16	1-3/8	4-1/8	3	Vented w/o Wheel
35322	Flanged	12	CCW	5/16	1-3/4	4-1/8	3-1/4	Vented w/o Wheel
35331	Single Shaft	12	CW	5/16	11/16	4	3	Vented w/o Wheel
35346	Flanged	12	CCW	5/16	1-5/16	4-7/16	3-1/4	Vented w/o Wheel
35348	Flanged	12	CCW	5/16	1-1/4	4-7/16	3-1/4	Vented w/o Wheel
35349	Single Shaft	12	CW	5/16	1-1/2	4-1/2	3	Vented w/o Wheel
35350	Flanged	12	CCW	5/16	1-5/16	4-5/16	3-1/4	Vented w/o Wheel
35351	Flanged	12	CCW	5/16	1-1/2	4-5/16	3-1/4	Vented w/o Wheel
35356	Flanged	12	CCW	5/16	1-7/8	4-1/8	3-1/4	Vented w/o Wheel
35357	Flanged	12	CCW	5/16	1-3/8	4-1/8	3-1/4	Vented w/o Wheel
35361	Flanged	12	CW	5/16	1-1/4	4-7/16	3-1/4	Vented w/o Wheel
35362	Flanged	12	CW	5/16	1-1/4	4-7/16	3-1/4	Vented w/o Wheel
35363	Flanged	12	CCW	5/16	1-3/8	4-1/8	3-1/4	Vented w/o Wheel
35364	Flanged	12	CCW	5/16	1-1/2	4	3-1/4	Vented w/o Wheel
35365	Flanged	12	CW/CCW	67/250	1-13/16	3-13/16	2-3/4	Vented w/o Wheel
35366	Flanged	12	CW/CCW	5/16	1-13/16	3-13/16	2-3/4	Vented w/o Wheel
35367	Flanged	12	CW/CCW	5/16	1-5/16	3-7/8	3	Vented w/o Wheel
35368	Flanged	12	CW/CCW	5/16	1-7/8	3-7/8	3	Vented w/o Wheel
35369	Flanged	12	CW/CCW	5/16	1-7/8	3-7/8	3	Vented w/o Wheel
35370	Flanged	12	CW/CCW	5/16	2-1/16	3-7/8	3	Vented w/o Wheel
35372	Flanged	12	CW	5/16	1-1/2	4-7/16	3	Vented w/o Wheel
35373	Double Shaft	12	CCWLE	5/16	3-1/8	4	3	Vented w/o Wheel
35375	Flanged	12	CW	67/250	1-3/16	3-7/8	3	Vented w/o Wheel
35382	Flanged	12	CW	5/16	1-1/4	4-7/16	3	Vented w/o Wheel
35386	Double Shaft	12	CCWLE	5/16	2-5/8	4-3/4	3	Vented w/o Wheel
35388	Flanged	12	CCW	5/16	1-7/16	4-1/4	3-1/4	Vented w/o Wheel
35390	Flanged	12	CW	5/16	1-1/4	4-7/16	3-1/4	Vented w/o Wheel
35391	Flanged	12	CW	5/16	1-1/4	4-7/16	3-1/4	Vented w/o Wheel
35392	Flanged	12	CCW	5/16	1-1/4	4-7/16	3-1/4	Vented w/o Wheel
35398	Flanged	12	CW/CCW	67/250	1-7/8	3-7/8	3	Vented w/o Wheel
35399	Flanged	12	CCW	5/16	1-1/4	4-7/16	3	Vented w/o Wheel
35401	Flanged	12	CW	5/16	1-1/4	4-7/16	3-1/4	Vented w/o Wheel
35402	Flanged	12	CW	5/16	1-1/4	4-7/16	3-1/4	Vented w/o Wheel
35409	Flanged	12	CCW	5/16	1-5/16	4-1/8	3	Vented w/o Wheel
35417	Double Shaft	12	CW/CCW	3/8	5	14-15/16	3-1/4	Vented w/o Wheel
35419	Single Shaft	12	CW	5/16	1-5/8	4-3/4	3	Vented w/o Wheel
35420	Single Shaft	12	CW/CCW	5/16	1-1/8	4-5/16	3	Vented w/o Wheel

# Blower Motor Dimension Chart

Part No.	Design	Voltage	Rotation	Shaft Dia.	Shaft Length	Motor Length	Motor Dia.	Type
35421	Flanged	12	CCW	5/16	1-11/16	4-1/8	3-1/4	Vented w/o Wheel
35422	Single Shaft	12	CW/CCW	5/16	1-7/8	4-15/16	3	Vented w/o Wheel
35423	Single Shaft	12	CW/CCW	5/16	1-9/16	4-5/16	3	Vented w/o Wheel
35424	Single Shaft	12	CW	5/16	1-1/2	4-13/16	3	Vented w/o Wheel
35425	Single Shaft	12	CW	5/16	1-1/8	4-3/4	3	Non Vented w/o Wheel
35426	Double Shaft	12	CCWLE	5/16	1-7/8	4-3/4	3	Non Vented w/o Wheel
35428	Double Shaft	12	CCWLE	5/16	3-3/8	4-1/4	3	Vented w/o Wheel
35430	Single Shaft	12	CCW	5/16	1-1/2	4-5/8	3	Vented w/o Wheel
35431	Single Shaft	12	CCW	1/4	1-1/2	4-5/8	3	Non Vented w/o Wheel
35432	Single Shaft	12	CCW	5/16	1-5/8	4-5/8	3	Vented w/o Wheel
35433	Single Shaft	12	CCW	1/4	1-5/16	3-7/8	3	Non Vented w/o Wheel
35434	Single Shaft	12	CW	5/16	1-1/8	5	3	Vented w/o Wheel
35435	Flanged	12	CCW	5/16	1-5/16	4-5/8	3	Vented w/o Wheel
35436	Flanged	12	CCW	5/16	1-11/16	4-1/8	3-1/4	Vented w/o Wheel
35437	Flanged	12	CCW	5/16	1-11/16	4-1/8	3-1/4	Vented w/o Wheel
35438	Flanged	12	CCW	5/16	1-11/16	4-1/8	3-1/4	Vented w/o Wheel
35439	Flanged	12	CCW	5/16	1-13/16	4-5/16	3-1/4	Vented w/o Wheel
35440	Flanged	12	CCW	5/16	1-13/16	4-5/16	3-1/4	Vented w/o Wheel
35461	Single Shaft	12	CW	5/16	1-5/16	4-7/16	3	Vented w/o Wheel
35463	Flanged	12	CCW	5/16	1-1/2	4-9/16	3	Vented w/o Wheel
35467	Flanged	12	CW	5/16	1-7/16	3-7/8	3	Vented w/o Wheel
35468	Single Shaft	24	CCW	5/16	1-3/16	4-13/16	3	Vented w/o Wheel
35469	Flanged	12	CW/CCW	67/250	2-1/16	3-7/8	3	Vented w/o Wheel
35470	Flanged	12	CW/CCW	67/250	2-1/16	3-7/8	3	Vented w/o Wheel
35471	Flanged	12	CW	5/16	1-5/16	4-5/16	3-1/4	Vented w/o Wheel
35472	Flanged	12	CW	5/16	1-5/16	4-5/16	3-1/4	Vented w/o Wheel
35474	Flanged	12	CW/CCW	5/16	1-1/2	4-7/16	3-1/4	Vented w/o Wheel
35475	Flanged	12	CW/CCW	5/16	1-5/16	4-7/16	3-1/4	Vented w/o Wheel
35476	Flanged	12	CW/CCW	5/16	1-1/8	4-7/8	3-1/4	Vented w/o Wheel
35477	Flanged	12	CW/CCW	5/16	1-3/8	4-5/16	3-1/4	Vented w/o Wheel
35478	Single Shaft	12	CCW	5/16	1-1/2	5	3-5/8	Vented w/o Wheel
35479	Single Shaft	12	CW/CCW	5/16	1-1/2	4-1/8	3	Vented w/o Wheel
35480	Double Shaft	24	CW/CCW	3/8	4-5/16	5	3-1/2	Vented w/o Wheel
35481	Single Shaft	12	CCW	3/8	7/8	5	3-1/2	Vented w/o Wheel
35482	Single Shaft	12	CW/CCW	1/4	1-1/2	4-1/8	3	Non Vented w/o Wheel
35483	Flanged	12	CW/CCW	67/250	2-1/16	3-7/8	3	Vented w/o Wheel
35484	Flanged	12	CW/CCW	67/250	1-15/16	3-7/8	3	Vented w/o Wheel
35486	Double Shaft	12	CW/CCW	5/16	3	4	3	Non Vented w/o Wheel
35487	Single Shaft	12	CW	5/16	1-1/2	5-1/16	3-5/8	Vented w/o Wheel
35489	Flanged	12	CW	5/16	1-1/8	4-7/8	3-1/4	Vented w/o Wheel
35490	Single Shaft	12	CW/CCW	5/16	1-7/16	3-7/8	3	Non Vented w/o Wheel
35491	Flanged	12	CW	5/16	1-3/16	4-7/8	3-1/4	Vented w/o Wheel
35492	Flanged	12	CCW	5/16	1-3/16	4-7/8	3-1/4	Vented w/o Wheel
35493	Flanged	12	CW/CCW	67/250	2-1/16	3-7/8	3	Vented w/o Wheel
35495	Single Shaft	12	CW	5/16	1-3/16	4-1/2	3	Vented w/o Wheel
35496	Flanged	12	CW/CCW	5/16	1-3/16	4-7/16	3-1/4	Vented w/o Wheel
35497	Flanged	12	CW/CCW	5/16	1-3/16	4	3-1/4	Non Vented w/o Wheel
35498	Flanged	12	CW	5/16	1-3/8	4	3-1/4	Non Vented w/o Wheel
35499	Flanged	12	CCW	5/16	1-1/8	4-7/16	3	Vented w/o Wheel
35500	Double Shaft	12	CW/CCW	5/16	2-7/8	4	3	Non Vented w/o Wheel
35501	Double Shaft	12	CW/CCW	5/16	3-1/8	3-3/4	3	Vented w/o Wheel
35502	Single Shaft	12	CW/CCW	5/16	1-5/16	4-1/2	3	Vented w/o Wheel
35504	Single Shaft	12	CW/CCW	5/16	1-1/2	4-3/16	3	Non Vented w/o Wheel
35505	Single Shaft	12	CW/CCW	5/16	1-1/2	4-3/4	3-1/4	Non Vented w/o wheel
35506	Single Shaft	24	CW/CCW	1/4	1-1/2	3-3/4	3	Non Vented w/o Wheel
35507	Single Shaft	12	CW	5/16	1-3/8	4-7/8	3-1/4	Vented w/o Wheel
35508	Single Shaft	12	CW/CCW	5/16	2	4-5/16	3	Non Vented w/o Wheel
35509	Flanged	12	CCW	5/16	1-11/16	4-1/8	3-1/4	Vented w/o Wheel
35510	Double Shaft	12	CW/CCW	5/16	2-7/8	4	3	Vented w/o Wheel
35511	Single Shaft	12	CW/CCW	5/16	1-3/8	3-3/4	3	Non Vented w/o Wheel
35512	Single Shaft	6	CW/CCW	1/4	1-1/2	3-3/4	3	Non Vented w/o Wheel



## Blower Motor Dimension Chart

Part No.	Design	Voltage	Rotation	Shaft Dia.	Shaft Length	Motor Length	Motor Dia.	Type
35513	Flanged	12	CW	5/16	1-11/16	4-1/8	3-1/4	Vented w/o Wheel
35514	Single Shaft	12	CW/CCW	5/16	2-1/8	4-1/2	3	Vented w/o Wheel
35515	Single Shaft	12	CW/CCW	5/16	1-1/4	3-7/8	3	Non Vented w/o Wheel
35516	Flanged	12	CW	67/250	2-1/8	3-7/8	3	Non Vented w/o Wheel
35517	Flanged	12	CW	67/250	1-3/4	3-5/16	3	Vented w/o Wheel
35522	Single Shaft	12	CCW	5/16	1-3/8	3-7/8	3	Non Vented w/o Wheel
35523	Single Shaft	12	CW	5/16	1-1/4	4-5/8	3	Vented w/o Wheel
35524	Single Shaft	12	CCW	5/16	1-1/4	4-9/16	3	Vented w/o Wheel
35526	Flanged	12	CW/CCW	5/16	1-3/16	4-1/8	3-1/4	Vented w/o Wheel
35527	Flanged	12	CW	67/250	2-1/16	4-7/16	3	Non Vented w/o Wheel
35532	Flanged	12	CW/CCW	5/16	1-11/16	3-3/8	3	Vented w/o Wheel
35537	Flanged	12	CCW	5/16	1-1/2	4-13/16	3-1/4	Vented w/o Wheel
35538	Flanged	12	CCW	5/16	1-1/4	4-7/16	3	Vented w/o Wheel
35540	Single Shaft	12	CW	5/16	1-5/16	4-5/8	3	Non Vented w/o Wheel
35541	Single Shaft	12	CW	1/4	1-3/16	4-13/16	3	Vented w/o Wheel
35542	Single Shaft	12	CCW	5/16	1-3/16	4-13/16	3	Vented w/o Wheel
35543	Double Shaft	12	CCWLE	5/16	3-1/4	4	3	Vented w/o Wheel
35544	Double Shaft	12	CW/CCW	5/16	2-9/16	4-11/16	3-1/4	Vented w/o Wheel
35545	Flanged	12	CCW	5/16	1-1/8	4-3/4	3-1/4	Vented w/o Wheel
35546	Double Shaft	12	CCWLE	5/16	2-5/16	4-3/4	3	Vented w/o Wheel
35547	Double Shaft	24	CWLE	5/16	3-1/4	4	3	Vented w/o Wheel
35548	Single Shaft	24	CCW	5/16	3/4	3-3/8	3	Non Vented w/o Wheel
35549	Double Shaft	24	CCWLE	5/16	2-9/16	4-11/16	3-1/4	Vented w/o Wheel
35550	Flanged	12	CW	5/16	1-5/16	4-3/4	3-1/4	Vented w/o Wheel
35551	Single Shaft	12	CW/CCW	5/16	1-7/16	4-7/8	3-1/4	Vented w/o Wheel
35552	Single Shaft	24	CW	5/16	1-5/16	4-5/8	3	Non Vented w/o Wheel
35553	Double Shaft	24	CCWLE	5/16	2-5/16	4-3/4	3	Vented w/o Wheel
35554	Flanged	12	CW	5/16	1-5/16	4-3/4	3-1/4	Vented w/o Wheel
35555	Flanged	12	CW	5/16	2-1/2	4-13/16	3-1/4	Vented w/o Wheel
35556	Single Shaft	12	CCW	5/16	1-3/8	4-3/4	3	Vented w/o Wheel
35557	Single Shaft	12	CW	5/16	1-5/16	4-5/8	3	Vented w/o Wheel
35559	Single Shaft	12	CW	5/16	2-1/8	4-1/2	3	Vented w/o Wheel
35560	Single Shaft	12	CW/CCW	5/16	1-1/4	4-3/16	3	Vented w/o Wheel
35561	Flanged	12	CCW	5/16	1-1/4	4-7/16	3	Non Vented w/o Wheel
35562	Flanged	12	CCW	5/16	1-5/16	4-1/2	3	Vented w/o Wheel
35563	Flanged	12	CW	5/16	1-1/2	4-1/4	3-1/4	Vented w/o Wheel
35565	Flanged	12	CW	5/16	1-3/8	4-9/16	3-1/4	Vented w/o Wheel
35566	Flanged	12	CW	5/16	2-3/16	4	3	Vented w/o Wheel
35567	Flanged	12	CW	5/16	1-3/4	4	3-1/4	Vented w/o Wheel
35568	Flanged	12	CW	5/16	1-1/16	4-7/16	3-1/4	Vented w/o Wheel
35570	Flanged	12	CW	5/16	1-5/8	4-1/8	3	Vented w/o Wheel
35571	Flanged	12	CW/CCW	5/16	1-1/16	4-7/8	3-1/4	Vented w/o Wheel
35572	Flanged	12	CW/CCW	5/16	1-1/16	4-7/16	3-1/4	Vented w/o Wheel
35576	Single Shaft	12	CW/CCW	1/4	1-1/2	3-3/4	3	Non Vented w/o Wheel
35577	Single Shaft	12	CW/CCW	5/16	1-1/16	4-15/16	3	Vented w/o Wheel
35578	Single Shaft	32	CW/CCW	1/4	1-1/2	3-3/4	3	Non Vented w/o Wheel
35579	Flanged	12	CW	5/16	1-1/2	4-7/16	3-1/4	Vented w/o Wheel
35582	Flanged	12	CCW	5/16	1-5/16	4-5/16	3-1/4	Vented w/o Wheel
35583	Flanged	12	CCW	5/16	1-1/8	4-3/4	3-1/4	Vented w/o Wheel
35585	Flanged	12	CW/CCW	5/16	2-1/16	3-7/8	3	Vented w/o Wheel
35587	Flanged	12	CW	5/16	1-1/8	4-3/4	3-1/4	Vented w/o Wheel
35588	Flanged	12	CW	5/16	1-5/16	4-5/16	3-1/4	Vented w/o Wheel
35590	Double Shaft	12	CW	5/16	3-3/16	4-1/4	3	Non Vented w/o Wheel
35591	Single Shaft	12	CW	5/16	3-1/4	3-3/4	3	Non Vented w/o Wheel
35592	Single Shaft	12	CCW	5/16	13/16	3-3/8	3	Non Vented w/o Wheel
35593	Single Shaft	12	CW/CCW	5/16	1-7/8	4-1/8	3	Vented w/o Wheel
35595	Single Shaft	12	CW/CCW	1/4	3/4	3-3/8	3	Non Vented w/o Wheel
35596	Flanged	12	CW/CCW	5/16	1-5/16	4-7/16	3-1/4	Vented w/o Wheel
35615	Flanged	12	CW/CCW	5/16	1-3/8	4-1/8	3-1/4	Vented w/o Wheel
35620	Single Shaft	12	CW	5/16	1-1/2	4-1/8	3-1/2	Non Vented w/o Wheel
35626	Flanged	12	CCW	5/16	1-9/16	4-1/8	3-1/4	Non Vented w/o Wheel

# Blower Motor Dimension Chart

Part No.	Design	Voltage	Rotation	Shaft Dia.	Shaft Length	Motor Length	Motor Dia.	Type
35627	Flanged	12	CCW	5/16	1-1/2	3-7/8	3	Vented w/o Wheel
35628	Flanged	12	CW	5/16	1-3/8	4-1/4	3	Vented w/o Wheel
35630	Flanged	12	CW/CCW	67/250	2-1/16	3-7/8	3	Vented w/o Wheel
35631	Flanged	12	CW/CCW	67/250	2-1/16	3-7/8	3	Vented w/o Wheel
35632	Flanged	12	CW/CCW	67/250	2-1/16	3-7/8	3	Vented w/o Wheel
35634	Flanged	12	CW/CCW	5/16	1-5/16	4-1/8	3	Vented w/o Wheel
35638	Flanged	12	CW/CCW	67/250	2-1/16	3-7/8	3	Vented w/o Wheel
35640	Flanged	12	CW/CCW	67/250	2-1/16	3-7/8	3	Non Vented w/o Wheel
35647	Flanged	12	CW/CCW	5/16	1-3/8	4-1/8	3-1/4	Vented w/o Wheel
35649	Flanged	12	CW	5/16	1-1/8	4-1/8	3	Vented w/o Wheel
35650	Flanged	12	CCW	5/16	1-9/16	4-7/8	3-1/4	Vented w/o Wheel
35671	Flanged	12	CW	5/16	1-1/8	4-3/4	3-1/4	Vented w/o Wheel
35672	Double Shaft	12	CCWLE	5/16	2-7/8	5-1/4	3-1/16	Vented w/o Wheel
35674	Double Shaft	12	CW/CCW	5/16	4-11/16		3	Non Vented w/o Wheel
35675	Flanged	12	CW/CCW	1/4	1-5/8	3-7/8	3	Vented w/o Wheel
35678	Flanged	12	CCW	69/250	1-3/4	4-7/16	3	Vented w/o Wheel
35679	Flanged	12	CW	69/250	1-1/2	3-7/8	3	Vented w/o Wheel
35680	Flanged	12	CCW	69/250	1-11/16	4-7/16	3	Vented w/o Wheel
35681	Flanged	12	CCW	5/16	1-3/8	4-1/4	3-1/4	Vented w/o Wheel
35682	Flanged	12	CW/CCW	67/250	2-1/16	3-13/16	3	Vented w/o Wheel
35683	Flanged	12	CW/CCW	67/250	2-1/16	3-13/16	3	Vented w/o Wheel
35684	Flanged	12	CW/CCW	5/16	1-7/16	3-13/16	3	Vented w/o Wheel
35685	Flanged	12	CW/CCW	1/4	1-5/8	3-13/16	3	Vented w/o Wheel
35686	Flanged	12	CW/CCW	67/250	2-1/16	3-13/16	3	Vented w/o Wheel
35687	Flanged	12	CW/CCW	67/250	2-1/16	3-13/16	3	Vented w/o Wheel
35688	Flanged	12	CW/CCW	67/250	2-1/16	3-13/16	3	Vented w/o Wheel
35689	Flanged	12	CW/CCW	67/250	2-1/16	3-13/16	3	Vented w/o Wheel
35690	Flanged	12	CW/CCW	1/4	1-5/8	3-13/16	3	Vented w/o Wheel
75005	Double Shaft	12	CCWLE	5/16	2-7/8	4-1/4	3	Vented w/o Wheel
75019	Single Shaft	12	CCW	5/16	1-3/4	5-9/16	3	Vented w/o Wheel
75020	Single Shaft	12	CCW	5/16	1-3/4	5-1/4	3	Vented w/o Wheel
75021	Single Shaft	12	CCW	5/16	1-3/4	5-1/4	3	Vented w/o Wheel
75700	Flanged	12	CW	5/16	1-1/4	4-1/8	3-1/4	Vented w/o Wheel
75701	Flanged	12	CCW	5/16	1-11/16	4	3-1/4	Vented w/o Wheel
75705	Single Shaft	12	CCW	5/16	1-1/4	4-7/16	3-1/4	Vented w/o Wheel
75706	Double Shaft	12	CCW	1/4	3-5/8	3-11/16	2-3/4	Vented w/o Wheel
75707	Double Shaft	12	CW	1/4	1-7/8	3-11/16	2-3/4	Vented w/o Wheel
75710	Flanged	12	CW	67/250	1-1/2	4-1/8	3	Non Vented w/o Wheel
75764	Flanged	12	CCW	5/16	1-3/8	4-1/8	3-1/4	Vented w/o Wheel
75779	Single Shaft	12	CW	5/16	1-5/8	3-5/8	3	Non Vented w/o Wheel
75780	Single Shaft	12	CW	5/16	1-5/8	3-5/8	3	Vented w/o Wheel
75781	Single Shaft	12	CW/CCW	5/16	1-1/8	4	3	Vented w/o Wheel
75782	Double Shaft	24	CCWLE	5/16	3-1/4	4-13/16	3	Non Vented w/o Wheel
75783	Single Shaft	12	CCW	5/16	1-5/8	4	3	Vented w/o Wheel
75784	Single Shaft	12	CCW	5/16	1-3/4	4	3	Vented w/o Wheel
75785	Single Shaft	12	CW	5/16	1-3/4	4	3	Vented w/o Wheel
75786	Single Shaft	24	CW	5/16	1-1/4	4	3	Non Vented w/o Wheel
75787	Single Shaft	12	CCW	5/16	1-9/16	3-9/16	3	Vented w/o Wheel
75790	Single Shaft	12	CW	5/16	1-7/16	4	3	Vented w/o Wheel
75791	Single Shaft	24	CW	3/8	2-3/8	4-1/2	3	Non Vented w/o Wheel
75792	Single Shaft	12	CW	5/16	1-3/8	3-13/16	3	Vented w/o Wheel
75793	Single Shaft	12	CW	5/16	1-1/4	4	3	Non Vented w/o Wheel
75794	Single Shaft	12	CCW	5/16	3-3/4	4	3	Vented w/o Wheel
75797	Single Shaft	12	CW	5/16	1-1/2	3-9/16	3	Vented w/o Wheel
75798	Single Shaft	24	CW	5/16	1-1/2	4	3	Non Vented w/o Wheel
75799	Double Shaft	12	CCWLE	5/16	3	4-5/16	3	Vented w/o Wheel
75801	Single Shaft	12	CW	1/4	11/16	2-13/16	3	Non Vented w/o Wheel
75802	Single Shaft	12	CW	5/16	1-1/2	4-1/16	3	Vented w/o Wheel
75803	Flanged	12	CCW	5/16	1-1/2	4-1/8	3	Vented w/o Wheel
75814	Single Shaft	12	CCW	5/16	1-13/16	4-1/8	3-1/4	Vented w/o Wheel
75825	Single Shaft	12	CW	5/16	1-5/8	3-3/16	3	Vented w/o Wheel

## Blower Motor Dimension Chart

Part No.	Design	Voltage	Rotation	Shaft Dia.	Shaft Length	Motor Length	Motor Dia.	Type
75829	Double Shaft	12	CCWLE	5/16	2-3/16	5	3	Vented w/o Wheel
75858	Flanged	12	CW	5/16	1-1/4	4-5/16	3	Vented w/o Wheel
76955	Flanged	12	CW	5/16	2	4-5/16	3-1/4	Vented w/o Wheel
35002	Flanged	12	CCW	5/16	1-3/16	4-7/16	3-1/4	Vented w/ Wheel
35055	Flanged	12	CCW	5/16	15/16	4-9/16	3-1/4	Vented w/ Wheel
35059	Single Shaft	12	CCW	5/16	1-3/16	4-7/16	3-1/4	Vented w/ Wheel
35064	Flanged	12	CCW	5/16	1-9/16	4-3/4	3	Non Vented w/ Wheel
35070	Flanged	12	CW	5/16	1-5/16	4-3/8	3	Vented w/ Wheel
35074	Flanged	12	CW	5/16	1-1/16	4-7/16	3-1/4	Vented w/ Wheel
35078	Flanged	12	CW	5/16	1-11/16	3-11/16	3	Vented w/ Wheel
35079	Flanged	12	CCW	5/16	1-11/16	3-11/16	3	Vented w/ Wheel
35080	Flanged	12	CCW	5/16	1-1/8	3-15/16	3-1/4	Vented w/ Wheel
35084	Flanged	12	CCW	5/16	1-5/16		3-1/4	Vented w/ Wheel
35085	Flanged	12	CW	5/16	1-5/16		3-1/4	Vented w/ Wheel
35086	Flanged	12	CW	5/16	1-3/8	3-1/2	3-3/16	Vented w/ Wheel
35106	Flanged	12	CW/CCW	5/16	1-3/4	3-13/16	3	Vented w/ Wheel
35108	Flanged	12	CW/CCW	5/16	1-3/4	3-13/16	3	Vented w/ Wheel
35119	Flanged	12	CW	5/16	1-9/16	4-1/4	3-1/4	Vented w/ Wheel
35121	Flanged	12	CCW	5/16	1-1/8	3-15/16	3-1/4	Non Vented w/ Wheel
35139	Flanged	12	CW	5/16	1-5/16	4-5/16	3-1/4	Vented w/ Wheel
35143	Flanged	12	CW	5/16	1-9/16	4-1/4	3-1/4	Vented w/ Wheel
35185	Flanged	12	CW	5/16	2	4	3	Vented w/ Wheel
35186	Flanged	12	CW	5/16	2	4	3	Vented w/ Wheel
35201	Flanged	12	CCW	5/16	1-1/2	3	3-1/4	Vented w/ Wheel
35202	Flanged	12	CCW	5/16	1-1/2	3	3-1/4	Vented w/ Wheel
35237	Single Shaft	12	CCW	5/16	1-3/16	4-7/16	3-1/4	Vented w/ Wheel
35276	Double Shaft	12	CW	5/16	3	4-1/8	2-7/8	Vented w/ Wheel
35282	Flanged	12	CW	5/16	1-1/2	4-5/16	3-1/4	Vented w/ Wheel
35284	Flanged	12	CCW	5/16	1-3/8	4-1/8	3-1/4	Vented w/ Wheel
35290	Flanged	12	CCW	5/16	1-9/16	4-1/8	3-1/4	Vented w/ Wheel
35291	Flanged	12	CCW	5/16	1-1/4	3-219/500	3-1/4	Vented w/ Wheel
35318	Flanged	12	CW	5/16	1-11/16	4-1/8	3-1/4	Vented w/ Wheel
35319	Flanged	12	CCW	5/16	1-11/16	4-1/8	3-1/4	Vented w/ Wheel
35333	Flanged	12	CCW	5/16	1-5/16	4-5/16	3-1/4	Vented w/ Wheel
35334	Flanged	12	CW	5/16	1-5/16	4-5/16	3-1/4	Vented w/ Wheel
35337	Flanged	12	CCW	5/16	1-5/16	4-5/16	3-1/4	Vented w/ Wheel
35339	Flanged	12	CW	5/16	1-11/16	4-1/8	3-1/4	Vented w/ Wheel
35340	Flanged	12	CCW	5/16	1-5/16	4-5/16	3-1/4	Non Vented w/ Wheel
35342	Flanged	12	CCW	5/16	1-1/2	4-5/16	3-1/4	Vented w/ Wheel
35343	Flanged	12	CCW	5/16	1-5/16	4-5/16	3-1/4	Vented w/ Wheel
35344	Flanged	12	CW	5/16	1-5/16	4-5/16	3-1/4	Vented w/ Wheel
35345	Flanged	12	CW	5/16	1-5/16	4-5/16	3-1/4	Non Vented w/ Wheel
35352	Flanged	12	CCW	5/16	1-3/8	4-1/8	3-1/4	Vented w/ Wheel
35383	Flanged	12	CCW	5/16	1-5/16	4-5/16	3-1/4	Vented w/ Wheel
35384	Flanged	12	CCW	5/16	1-5/16	4-5/16	3-1/4	Vented w/ Wheel
35385	Flanged	12	CCW	5/16	1-1/2	4-5/16	3-1/4	Vented w/ Wheel
35406	Flanged	12	CW	5/16	1-5/16	4-5/16	3-1/4	Vented w/ Wheel
75002	Double Shaft	12	CW					Vented w/ Wheel
75011	Double Shaft	12	CCWLE					Vented w/ Wheel
75012	Flanged	12	CW					Vented w/ Wheel
75013	Flanged	12	CW					Vented w/ Wheel
75015	Flanged	12	CCW					Vented w/ Wheel
75016	Flanged	12	CW					Vented w/ Wheel
75017	Flanged	12	CW					Vented w/ Wheel
75018	Flanged	12	CCW					Vented w/ Wheel
75022	Flanged	12	CCW					Vented w/ Wheel
75023	Flanged	12	CCW					Vented w/ Wheel
75024	Flanged	12	CCW					Vented w/ Wheel
75025	Flanged	12	CCW					Vented w/ Wheel
75026	Flanged	12	CCW					Vented w/ Wheel
75027	Single Shaft	12	CW					Vented w/ Wheel



# Blower Motor Dimension Chart

Part No.	Design	Voltage	Rotation	Shaft Dia.	Shaft Length	Motor Length	Motor Dia.	Type
75033	Flanged	12	CCW					Vented w/ Wheel
75712	Flanged	12	CW	5/16	1-3/16	3-5/8	3-1/4	Non Vented w/ Wheel
75713	Flanged	12	CCW	5/16	2-1/8	3-1/2	6-1/4	Non Vented w/ Wheel
75714	Flanged	12	CW	5/16	1-1/2	6	3-5/8	Non Vented w/ Wheel
75735	Flanged	12	CCW	5/16	1-3/16	4-1/2	3	Vented w/ Wheel
75736	Flanged	12	CCW	5/16	1	4-1/2	2-11/16	Vented w/ Wheel
75737	Flanged	12	CCW	5/16	1-1/4	4-5/8	3	Vented w/ Wheel
75738	Flanged	12	CCW	5/16	1-3/16	3-7/8	3	Vented w/ Wheel
75739	Flanged	12	CW	5/16	1-1/4	4-3/4	3	Vented w/ Wheel
75740	Flanged	12	CW	5/16	1-1/4	4-1/2	3	Vented w/ Wheel
75741	Flanged	12	CCW	5/16	1-3/16	4-9/16	2-11/16	Vented w/ Wheel
75742	Flanged	12	CW	5/16	1-5/8	3-5/8	3-5/8	Vented w/ Wheel
75743	Flanged	12	CCW	5/16	1-1/4	4-3/4	3	Vented w/ Wheel
75744	Flanged	12	CW	5/16	1-3/8		3-1/4	Vented w/ Wheel
75748	Flanged	12	CW	5/16	1-1/2	4-1/4	3-1/4	Vented w/ Wheel
75749	Flanged	12	CCW	5/16	1-3/16		3-1/4	Vented w/ Wheel
75753	Flanged	12	CCW	5/16	1-1/4	3-219/500	3-1/16	Vented w/ Wheel
75754	Flanged	12	CCW	5/16	1-1/4	4-1/4	3-9/16	Vented w/ Wheel
75755	Flanged	12	CW	5/16	1-7/16	4-15/16	3-1/4	Vented w/ Wheel
75759	Flanged	12	CCW	5/16	1-1/8	3-5/8	3-7/16	Vented w/ Wheel
75763	Flanged	12	CW	5/16	1-5/16		3-1/4	Vented w/ Wheel
75770	Flanged	12	CW	5/16	1-1/8	4	3	Vented w/ Wheel
75771	Flanged	12	CCW	5/16	1-1/4	4-1/4	3-1/4	Vented w/ Wheel
75772	Flanged	12	CCW	5/16	1-1/8	5-1/4	3	Vented w/ Wheel
75773	Flanged	12	CCW	5/16	1-3/8	4-11/16	3	Vented w/ Wheel
75774	Flanged	12	CCW	5/16	1-241/400	3-1/8	3-7/16	Vented w/ Wheel
75775	Flanged	12	CCW	5/16	1-1/4	5-1/8	3-1/4	Vented w/ Wheel
75777	Flanged	12	CCW	5/16	1-1/2	4-1/4	3-5/16	Vented w/ Wheel
75778	Flanged	12	CCW	5/16	1-1/2	4-1/4	3-5/16	Vented w/ Wheel
75788	Flanged	12	CCW	5/16	1-1/2	4-5/8	3-5/16	Vented w/ Wheel
75789	Flanged	12	CCW	5/16	13/16	4-7/8	3-1/4	Vented w/ Wheel
75795	Flanged	12	CCW	5/16	2	5	3	Vented w/ Wheel
75796	Flanged	12	CW	5/16	2	5	3	Vented w/ Wheel
75800	Flanged	12	CCW	5/16	2	4-1/4	3-1/2	Vented w/ Wheel
75804	Single Shaft	12	CCW	5/16	1-1/2	3-5/16	3-1/4	Vented w/ Wheel
75805	Flanged	12	CCW	5/16	2	3-5/16	3	Vented w/ Wheel
75806	Flanged	12	CCW	5/16	1	4-1/4	3	Vented w/ Wheel
75807	Flanged	12	CW	5/16	1	4-1/4	3-1/8	Vented w/ Wheel
75808	Double Shaft	12	CCWLE	5/16	1-1/2	4-1/2	3	Vented w/ Wheel
75809	Flanged	12	CCW	5/16	1-1/2	3-5/16	3-1/4	Vented w/ Wheel
75810	Flanged	12	CCW	5/16	1-3/4	4-1/4	3-1/4	Vented w/ Wheel
75816	Flanged	12	CCW	5/16	1-1/4	3-13/16	3	Vented w/ Wheel
75817	Flanged	12	CCW	5/16	1-1/2	3-3/8	3	Vented w/ Wheel
75818	Flanged	12	CCW	5/16	1-1/16	3-3/4	3-9/16	Vented w/ Wheel
75819	Flanged	12	CW	5/16	2	3-9/16	3-3/16	Vented w/ Wheel
75820	Flanged	12	CW	5/16	1-3/4	3-5/8	3-9/16	Vented w/ Wheel
75821	Flanged	12	CCW	5/16	1	4	2-7/8	Vented w/ Wheel
75822	Flanged	12	CCW	5/16	1-1/2	4-3/16	3-5/16	Vented w/ Wheel
75823	Flanged	12	CCW	5/16	1-11/16	4	3	Vented w/ Wheel
75826	Flanged	12	CW	5/16	1-3/4	4-3/16	3	Vented w/ Wheel
75827	Flanged	12	CW	5/16	1-13/16	4	3	Vented w/ Wheel
75828	Double Shaft	12	CCWLE	5/16	2-7/16	4	3	Vented w/ Wheel
75830	Flanged	12	CCW	5/16	1-7/8	4	3	Vented w/ Wheel
75832	Flanged	12	CW	5/16	1-3/8	3-7/8	3	Vented w/ Wheel
75833	Flanged	12	CCW	5/16	2	3-5/16	3	Vented w/ Wheel
75834	Flanged	12	CW	5/16	1-1/8	3-3/4	3-1/4	Vented w/ Wheel
75835	Flanged	12	CCW	5/16	1	3-11/16	3-1/4	Vented w/ Wheel
75836	Flanged	12	CW	15/16	1-13/16	3-15/16	3	Vented w/ Wheel
75837	Flanged	12	CW	5/16	1-5/16	3-5/8	3	Vented w/ Wheel
75838	Flanged	12	CCW	5/16	1	5-3/16	3-1/4	Vented w/ Wheel
75839	Flanged	12	CCW	5/16	1-3/4	3-1/2	3	Vented w/ Wheel

## **Blower Motor Dimension Chart**

Part No.	Design	Voltage	Rotation	Shaft Dia.	Shaft Length	Motor Length	Motor Dia.	Type
75840	Flanged	12	CCW	5/16	1-1/2	3-9/16	3	Vented w/ Wheel
75841	Flanged	12	CCW	5/16	1-13/16	2-9/16	3	Vented w/ Wheel
75842	Flanged	12	CCW	5/16	1-1/16	3-9/16	3	Vented w/ Wheel
75843	Flanged	12	CW	5/16	1-1/2	3-1/4	3-1/4	Vented w/ Wheel
75844	Flanged	12	CCW	5/16	1-3/4	4-1/4	3	Vented w/ Wheel
75845	Flanged	12	CCW	5/16	1-3/4	4-1/4	3	Vented w/ Wheel
75846	Flanged	12	CCW	5/16	2	4	3	Vented w/ Wheel
75847	Flanged	12	CCW	5/16	7/8	3-1/8	2-1/4	Vented w/ Wheel
75848	Flanged	12	CCW	5/16	1-9/16	3-7/16	3-1/4	Vented w/ Wheel
75849	Flanged	12	CCW	5/16	1-7/8	3-5/8	3	Vented w/ Wheel
75850	Flanged	12	CCW	5/16	1-11/16	3-5/8	3	Vented w/ Wheel
75851	Flanged	12	CCW	5/16	1-7/8	3-1/4	3-1/4	Vented w/ Wheel
75852	Flanged	12	CW	5/16	1	4-15/16	3-1/4	Vented w/ Wheel
75853	Flanged	12	CCW	5/16	1-3/4	4-1/8	3-1/4	Vented w/ Wheel
75854	Flanged	12	CW	5/16	1-5/8	3-5/8	3	Vented w/ Wheel
75855	Flanged	12	CCW	5/16	1-5/8	3-5/8	3	Vented w/ Wheel
75856	Flanged	12	CW	5/16	1-3/8	3-5/8	3	Vented w/ Wheel
75857	Flanged	12	CW	5/16	2	4-1/16	3	Vented w/ Wheel
75859	Flanged	12	CW	5/16	2	4-1/16	3	Vented w/ Wheel
75860	Flanged	12	CW	5/16	1-3/4	4	3	Vented w/ Wheel
75861	Single Shaft	12	CW	5/16	1	5	3	Vented w/ Wheel
75862	Flanged	12	CCW	5/16	1	4	3-1/4	Vented w/ Wheel
75863	Flanged	12	CCW	5/16	1-1/2	3-1/8	4-13/16	Vented w/ Wheel
75864	Flanged	12	CW	3-1/8	1-11/16	5-1/4	2-7/8	Vented w/ Wheel
75865	Flanged	12	CCW	5/16	1-7/8	4-1/8	3	Vented w/ Wheel
75866	Single Shaft	12	CCW	5/16	2	3-13/16	3-1/4	Vented w/ Wheel
75867	Flanged	12	CCW	5/16	1-15/16	4-1/16	3	Vented w/ Wheel
75868	Flanged	12	CW	5/16	1-7/16	3-5/8	3	Vented w/ Wheel
75869	Flanged	12	CW	5/16	1-13/16	3-5/8	3	Vented w/ Wheel
75870	Flanged	12	CCW	5/16	2-3/16	3-5/8	3	Vented w/ Wheel
75871	Flanged	12	CW	5/16	1-5/16	3-5/8	3	Vented w/ Wheel
75872	Flanged	12	CCW	5/16	1-1/4	4-1/2	3-1/8	Vented w/ Wheel
75873	Flanged	12	CW	5/16	1-5/16	4-1/8	3	Vented w/ Wheel
75874	Flanged	12	CCW	5/16	1-1/2	4-1/8	3	Vented w/ Wheel
75875	Flanged	12	CCW	5/16	1-1/2	3-7/8	3-1/4	Vented w/ Wheel
75876	Flanged	12	CCW	5/16	1-1/2	4-1/4	3	Vented w/ Wheel
75877	Flanged	12	CCW	5/16	2-3/4	4-5/16	3-1/8	Vented w/ Wheel
75878	Flanged	12	CCW	5/16	1-3/4	3-5/8	3	Vented w/ Wheel
75879	Flanged	12	CCW	5/16	1-13/16	3-5/8	3	Vented w/ Wheel
75880	Flanged	12	CCW	5/16	1-1/2	4	3-1/4	Vented w/ Wheel
75881	Flanged	12	CCW	5/16	2	3-3/8	3	Vented w/ Wheel
75882	Flanged	12	CCW	5/16	1-1/2	4-1/16	3	Vented w/ Wheel
75883	Flanged	12	CCW	5/16	1-7/8	4-1/16	3	Vented w/ Wheel
75884	Flanged	12	CCW	5/16	1-1/16	3-1/4	3	Vented w/ Wheel
75885	Flanged	12	CW	5/16	1-9/16	4-3/16	3	Vented w/ Wheel
75886	Flanged	12	CW	5/16	1-9/16	4-1/16	3	Vented w/ Wheel
75887	Flanged	12	CCW	5/16	2	3-7/16	3-1/4	Vented w/ Wheel
75888	Flanged	12	CW	5/16	1-5/8	4-7/16	3	Vented w/ Wheel
75889	Flanged	12	CW	5/16	1-1/4	4-9/16	3-1/4	Vented w/ Wheel
75890	Flanged	12	CW	5/16	1-5/16	4-1/2	3-1/4	Vented w/ Wheel
75891	Flanged	12	CW	5/16	1-5/16	4-1/2	3-1/4	Vented w/ Wheel
75892	Flanged	12	CCW	5/16	2	3-5/8	3	Vented w/ Wheel
75894	Flanged	12	CW	5/16	1-7/8	4-1/16	3	Vented w/ Wheel
75895	Flanged	12	CCW	5/16	1-5/8	5-9/16	3-9/16	Vented w/ Wheel
75896	Flanged	12	CCW	5/16	1-9/16	4-7/8	3-9/16	Vented w/ Wheel
75897	Flanged	12	CW	5/16	1-3/8	4-5/8	3-3/16	Vented w/ Wheel
75898	Flanged	12	CCW	5/16	1-3/8	5-3/8	3-3/16	Vented w/ Wheel
75899	Flanged	12	CCW	5/16	1-15/16	4-1/16	3	Vented w/ Wheel
75903	Single Shaft	12	CW					Vented w/ Wheel
75905	Double Shaft	24	CCW					Vented w/ Wheel
75906	Double Shaft	24	CCW					Vented w/ Wheel



# Blower Motor Dimension Chart

Part No.	Design	Voltage	Rotation	Shaft Dia.	Shaft Length	Motor Length	Motor Dia.	Type
75907	Double Shaft	24	CCW					Vented w/ Wheel
76900	Flanged	12	CW	5/16	2	3-7/16	3-1/4	Vented w/ Wheel
76901	Single Shaft	12	CW					Vented w/ Wheel
76902	Flanged	12	CCW	5/16	1-13/16	3-7/8	3-1/4	Vented w/ Wheel
76903	Flanged	12	CCW	5/16	1-7/8	3-7/8	3-1/4	Vented w/ Wheel
76904	Flanged	12	CCW	5/16	1-11/16	4	3	Vented w/ Wheel
76908	Flanged	12	CCW	5/16	1-3/4	4	3	Vented w/ Wheel
76909	Flanged	12	CW	5/16	1-7/8	3-7/8	3-1/4	Vented w/ Wheel
76910	Flanged	12	CW	5/16	1-7/8	3-7/8	3-1/4	Vented w/ Wheel
76911	Flanged	12	CW	5/16	1-7/8	3-5/16	3-1/4	Vented w/ Wheel
76912	Flanged	12	CCW	5/16	1-7/8	3-7/8	3-1/4	Vented w/ Wheel
76913	Flanged	12	CCW	5/16	1-13/16	3-7/8	3-1/4	Vented w/ Wheel
76914	Flanged	12	CCW	5/16	2	3-5/8	3	Vented w/ Wheel
76915	Double Shaft	24	CW					Vented w/ Wheel
76916	Flanged	12	CCW	5/16	1-1/4	4-7/16	3-1/4	Vented w/ Wheel
76917	Flanged	12	CW	5/16	1-5/8	4-1/16	3	Vented w/ Wheel
76918	Flanged	12	CCW	5/16	1-1/2	3	3	Vented w/ Wheel
76919	Flanged	12	CW	5/16	2	3-5/8	3	Vented w/ Wheel
76921	Single Shaft	24	CW					Vented w/ Wheel
76923	Double Shaft	12	CW					Vented w/ Wheel
76924	Double Shaft	12	CW					Vented w/ Wheel
76925	Double Shaft	12	CW					Vented w/ Wheel
76926	Double Shaft	12	CW					Vented w/ Wheel
76927	Flanged	12	CCW	5/16	1-9/16	3-5/8	3	Vented w/ Wheel
76928	Flanged	12	CCW	5/16	1-1/2	4-5/8	3-1/4	Vented w/ Wheel
76929	Flanged	12	CCW	5/16	1-7/8	3-3/4	3-1/4	Vented w/ Wheel
76930	Flanged	12	CW	5/16	1-1/2	3-5/8	3	Vented w/ Wheel
76932	Flanged	12	CCW	5/16	2	3-5/8	3	Vented w/ Wheel
76933	Flanged	12	CCW	5/16	1-11/16	4-1/16	3	Vented w/ Wheel
76934	Flanged	12	CCW	5/16	1-1/2	3-5/8	3	Vented w/ Wheel
76935	Double Shaft	12	CCWLE	5/16	2-1/8	3-1/8	3-1/16	Vented w/ Wheel
76936	Flanged	12	CW					Vented w/ Wheel
76937	Flanged	12	CCW	5/16	1-13/16	3-1/8	3-1/2	Vented w/ Wheel
76938	Flanged	12	CCW	5/16	1-13/16	4-13/16	3-7/16	Vented w/ Wheel
76939	Flanged	12	CCW	5/16	1-13/16	4-3/4	3-1/2	Vented w/ Wheel
76940	Double Shaft	12	CCW					Vented w/ Wheel
76941	Double Shaft	12	CCW					Vented w/ Wheel
76942	Flanged	12	CW	5/16	1-1/2	3-13/16	3	Vented w/ Wheel
76943	Flanged	12	CCW	5/16	1-9/16	4-1/16	3	Vented w/ Wheel
76944	Flanged	12	CW	5/16	2	2-3/4	3-5/8	Vented w/ Wheel
76945	Flanged	12	CCW	5/16	1-3/4	4-1/2	3-15/16	Vented w/ Wheel
76946	Double Shaft	12	CCWLE	5/16	2-1/8	5-3/16	2-7/8	Vented w/ Wheel
76947	Flanged	12	CW	5/16	2	3-3/4	3-1/4	Vented w/ Wheel
76948	Flanged	12	CCW	5/16	1-9/16	4-63/1000	3	Vented w/ Wheel
76949	Flanged	12	CW	5/16	1-5/16	4-1/2	3-1/4	Vented w/ Wheel
76950	Flanged	12	CCW	5/16	1-1/2	4-1/2	3	Vented w/ Wheel
76951	Flanged	12	CCW	5/16	2	3-5/8	3	Vented w/ Wheel
76952	Flanged	12	CCW	5/16	1-13/16	3-5/8	3	Vented w/ Wheel
76953	Flanged	12	CCW	5/16	1-13/16	3-5/8	3	Vented w/ Wheel
76954	Flanged	12	CCW	5/16	2	3-5/8	3	Vented w/ Wheel
76956	Flanged	12	CCW	5/16	2	3-5/8	3-1/4	Vented w/ Wheel
76957	Flanged	12	CCW	5/16	2	3-5/8	3	Vented w/ Wheel
76958	Flanged	12	CCW	5/16	1-5/8	3	3	Vented w/ Wheel
76959	Flanged	12	CCW	5/16	1-3/4	3-3/4	3	Vented w/ Wheel
76960	Flanged	12	CCW	5/16	1-1/2	4-3/16	3-1/4	Vented w/ Wheel
76961	Flanged	12	CCW	5/16	1-5/8	4-1/16	3	Vented w/ Wheel
76962	Flanged	12	CW	5/16	1-7/8	4-1/8	3	Vented w/ Wheel
76963	Flanged	12	CCW	5/16	1-1/2	3-5/8	3	Vented w/ Wheel
76964	Flanged	12	CCW	5/16	1-1/2	2-9/16	3	Vented w/ Wheel
76965	Flanged	12	CW	5/16	2	4-5/8	3-1/2	Vented w/ Wheel
76966	Flanged	12	CW	5/16	1-1/2	4	3-1/4	Vented w/ Wheel

## **Blower Motor Dimension Chart**

<b>Part No.</b>	<b>Design</b>	<b>Voltage</b>	<b>Rotation</b>	<b>Shaft Dia.</b>	<b>Shaft Length</b>	<b>Motor Length</b>	<b>Motor Dia.</b>	<b>Type</b>
76967	Flanged	12	CCW	5/16	1-1/2	3-5/8	3	Vented w/ Wheel
76968	Flanged	12	CCW	5/16	1-1/2	2-9/16	3	Vented w/ Wheel
76969	Flanged	12	CW	5/16	1-7/8	3-7/8	3-1/4	Vented w/ Wheel
76970	Flanged	12	CCW	5/16	1-3/4	2-5/16	3	Vented w/ Wheel
76971	Flanged	12	CCW	5/16	1-9/16	3-5/8	3	Vented w/ Wheel
76972	Flanged	12	CCW	5/16	1-11/16	4-13/16	2-7/8	Vented w/ Wheel
76973	Flanged	12	CW	5/16	1-13/16	4-5/16	3	Vented w/ Wheel
76974	Flanged	12	CW	5/16	1-7/8	3-5/8	3	Vented w/ Wheel
76975	Double Shaft	12	CCWLE	5/16	2-3/8	3-1/2	3	Vented w/ Wheel
76976	Flanged	12	CCW	5/16	1-3/4	3-5/8	3	Vented w/ Wheel
76977	Flanged	12	CCW	5/16	1-3/4	3-5/8	3	Vented w/ Wheel
76978	Flanged	12	CCW	5/16	1-7/8	4-1/16	3	Vented w/ Wheel
76979	Flanged	12	CCW	5/16	2	3-13/16	3	Vented w/ Wheel
76980	Flanged	12	CCW	5/16	1-1/2	3-13/16	3	Vented w/ Wheel
76981	Flanged	12	CCW	5/16	1-1/2	3-5/8	3	Vented w/ Wheel
76982	Flanged	12	CCW	5/16	2	3-3/4	3-1/4	Vented w/ Wheel
76983	Flanged	12	CCW	5/16	2	3-1/4	3-1/4	Vented w/ Wheel
76984	Flanged	12	CCW	5/16	1-7/8	4-1/16	3-1/4	Vented w/ Wheel
76985	Double Shaft	12	CCWLE	5/16		4-1/4	3	Vented w/ Wheel
76986	Flanged	12	CCW	5/16	2	4-1/16	3	Vented w/ Wheel
76987	Flanged	12	CW	5/16	1-7/8	4-1/16	3-1/4	Vented w/ Wheel
76988	Flanged	12	CW	5/16	2	4-1/4	3	Vented w/ Wheel
76989	Flanged	12	CW	5/16	2	4-1/2	3	Vented w/ Wheel
76990	Flanged	12	CCW	5/16	1-1/2	3-5/8	3	Vented w/ Wheel
76991	Flanged	12	CCW					Vented w/ Wheel
76992	Flanged	12	CW					Vented w/ Wheel
76993	Flanged	12	CW			2-7/16	3	Vented w/ Wheel
76994	Flanged	12	CW				3	Vented w/ Wheel

# Blower Motors

## Blower Motor & Assembly



**35001**  
CW/CCW  
2 Lead Wires  
Style: Flanged  
Voltage: 12  
Mazda (87-83)  
Mazda: GA9776424B



**35002**  
CCW  
2 Lead Wires w/ Connector  
Style: Flanged  
Voltage: 12  
Buick (05-97); Chevy (04-97); Olds (02-97); Pontiac (03-97)  
General Motors Corp: 19131212, 19179473, 19210741, 52472520, 52479913, 52487088

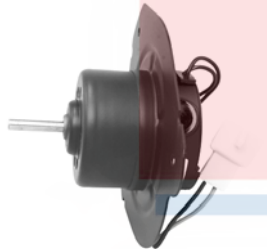

**35003**  
CW  
2 Lead Wires w/ Connector  
Style: Flanged  
Voltage: 12  
Ford (97-86); Mercury (02-93); Nissan (02-93)  
Nissan: 273811B700



**35004**  
CW/CCW  
2 Lead Wires  
Style: Flanged  
Voltage: 12  
Dodge (03-98)

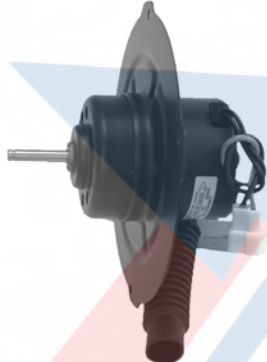

**35005**  
CW/CCW  
2 Lead Wires w/ Connector  
Style: Flanged  
Voltage: 12  
Acura (99-98); Honda (99-98); Isuzu (99-98)  
Honda: 8972316420

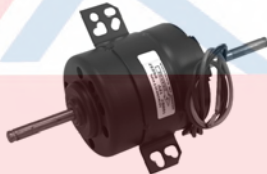

**35007**  
CCW  
2 Lead Wires  
Style: Double Shaft  
Voltage: 12  
Honda (93-90)  
Honda: 79310SM4A01



**35008**  
CW  
2 Lead Wires  
Style: Flanged  
Voltage: 12  
Mazda (96-89)  
Mazda: LA0161B10A

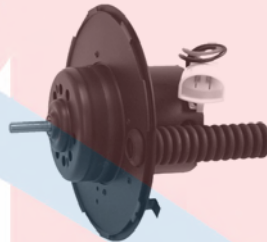

**35009**  
CCW  
2 Lead Wires w/ Connector  
Style: Flanged  
Voltage: 12  
Ford (00-95); Mercury (02-95)



**35010**  
CCW  
2 Lead Wires  
Style: Flanged  
Voltage: 12  
Infiniti (99-96); Nissan (99-95); Subaru (98-93)



**35011**  
CW/CCW  
2 Lead Wires  
Style: Flanged  
Voltage: 12  
Mazda (95-93)  
Mazda: FD0161B10



**35015**  
CW  
2 Lead Wires  
Style: Flanged  
Voltage: 12  
Cadillac (99); Chevy (00-97); GMC (00-97)  
General Motors Corp: 12472426, 12472436  
Kysor: 1010009

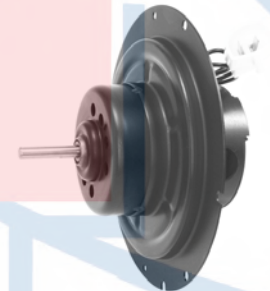

**35016**  
CW/CCW  
2 Lead Wires w/ Connector  
Style: Flanged  
Voltage: 12  
Ford (07-97); Mazda (04-01); Mercury (07-04), (02-99); Nissan (02-99)  
Ford: XC3Z19805CA, XF2Z19805FA  
Kysor: 1011008

# Blower Motors

## Blower Motor & Assembly Cont'd



**35055**  
CCW  
2 Lead Wires w/ connector  
Style: Flanged  
Voltage: 12  
Chevy (05-03); Pontiac (05-03)  
General Motors Corp: 89018229



**35057**  
CCWLE  
4 Lead Wires; 3 speed motor  
Style: Double Shaft  
Voltage: 12  
Allis Chalmers: 05780416, 578041  
ARA: 1120076  
Case New Holland: 271438, A42566, F89388  
Dallas Truck AC: 0217052  
Deutz: 0034213, 578041  
Egging: 21537  
Euclid: E803021  
Evans: AM86533, AM86560, AM86592, HV29257, HV31606  
Frigiking: 3233987, 9133987  
Hesston: 841320  
Hinker: 116002018  
Hupp: 62495G1, 64803G1  
Hy-Capacity: 0000088124, 8812333812  
John Deere: AH80194  
Massey Ferguson: 1048515M91, 1680361M91, 48515M91  
NaviStar: 117784C3  
New Idea: 732314  
Northern: BM333812  
Steiger: 211127  
Stopler: 1301V152  
Versatile: 35313



**35059**  
CCW  
2 Lead Wires w/ connector  
Style: Single Shaft  
Voltage: 12  
Buick (05-97)  
General Motors Corp: 52472207, 88960339, 89018435

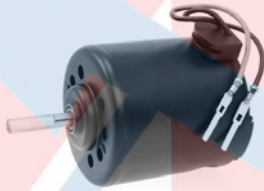

**35061**  
CW/CCW  
2 Lead Wires w/ connector  
Style: Single Shaft  
Voltage: 12  
Chevy (05); Ford (16-11), (08-00); Lincoln (16-13), (11-01); Mercury (07-02); Saturn (07-02)  
Ford: 4F2Z19805AA, 6L1Z19805A, YL7Z18504AA  
General Motors Corp: 19188868



**35062**  
CW  
2 Lead Wires w/ connector  
Style: Single Shaft  
Voltage: 12  
Cadillac (07-03); Chevy (07-03); GMC (07-03); Infiniti (10-04); Nissan (15-14), (10-04)  
Infiniti: 27375ZC30A  
Nissan: 27375ZC30A



**35064**  
CCW  
2 Lead Wires w/ connector  
Style: Flanged  
Voltage: 12  
Kysor: 1012006  
Mack: 4379RD5114890  
Red Dot: 73R3062, RD5114890P  
TRP Parts: HA21550

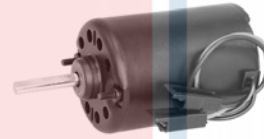

**35065**  
CW  
2 Lead Wires  
Style: Single Shaft  
Voltage: 12  
Red Dot: RD565260P

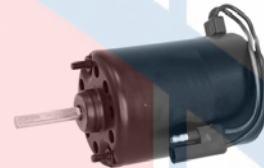

**35067**  
CW  
2 Lead Wires  
Style: Single Shaft  
Voltage: 12



**35068**  
CW  
2 Lead Wires  
Style: Single Shaft  
Voltage: 12  
Caterpillar: 2488218  
Climatech: HA1820  
Kysor: 1018003  
Mack: 4379RD5109050  
Red Dot: 73R0442, RD5109050P



**35069**  
CW  
2 Lead Wires  
Style: Single Shaft  
Voltage: 12  
Red Dot: 73R0622, RD552690P



**35070**  
CW  
2 Terminal Connector  
Style: Flanged  
Voltage: 12  
Ford (96-95)

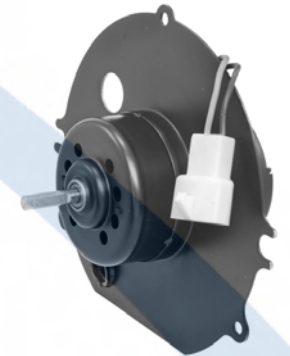

**35071**  
CW/CCW  
2 Lead Wires w/ connector  
Style: Flanged  
Voltage: 12  
Ford (07-01); Mercury (05-01)



# Blower Motors

## Blower Motor & Assembly Cont'd



**35073**  
CW/CCW  
2 Lead Wires w/ connector  
Style: Flanged  
Voltage: 12  
Cadillac (09-04); Volvo (05-00)  
General Motors Corp: 19129868



**35074**  
CW  
2 Lead Wires  
Style: Flanged  
Voltage: 12  
Ford (91-77)

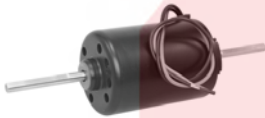

**35075**  
CCWLE  
2 Lead Wires  
Style: Double Shaft  
Voltage: 12



**35076**  
CCW  
2 Lead Wires w/ connector  
Style: Single Shaft  
Voltage: 12  
Infiniti (10-04); Nissan (15-04)



**35078**  
CW  
2 Lead Wires w/ connector  
Style: Flanged  
Voltage: 12  
Kia (03-98)  
Kia: 1K2A161B10A, 1K2N161B10

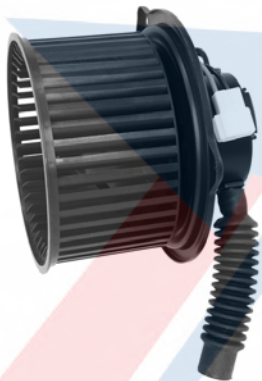

**35079**  
CCW  
2 Lead Wires w/ connector  
Style: Flanged  
Voltage: 12  
Hyundai (06-01); Kia (06-01)  
Hyundai: 971132D010  
Kia: 971123F000



**35080**  
CCW  
2 Lead Wires w/ connector  
Style: Flanged  
Voltage: 12  
Pontiac (08-03)  
General Motors Corp: 88973567



**35084**  
CCW  
2 Lead Wires w/ connector  
Style: Flanged  
Voltage: 12  
Buick (07-02); Chevy (09-01); Olds  
(04-01); Pontiac (09-01); Saturn  
(07-05)  
General Motors Corp: 15809345

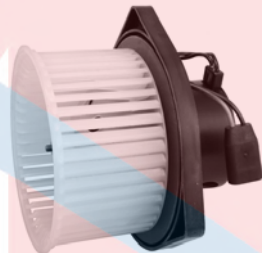

**35085**  
CW  
2 Lead Wires w/ connector  
Style: Flanged  
Voltage: 12  
Buick (07-05); Chevy (09-01); Olds  
(04-01); Pontiac (09-01), (98-97);  
Saturn (07-05)  
General Motors Corp: 15249638



**35086**  
CW  
2 Terminal Connector  
Style: Flanged  
Voltage: 12  
Kia (01-98)  
Kia: 0K08A61B10



**35103**  
CCW  
2 Lead Wires w/ Connector  
Style: Flanged  
Voltage: 12  
Mazda (03-99)  
Mazda: CB0761B10A











**35106**  
CW/CCW  
2 Lead Wires w/ Connector  
Style: Flanged  
Voltage: 12  
Hyundai (06-99); Kia (07-01)  
Hyundai: 9710938000



**35108**  
CW/CCW  
2 Lead Wires w/ Connector  
Style: Flanged  
Voltage: 12  
Hyundai (08-99)  
Hyundai: 9711624951

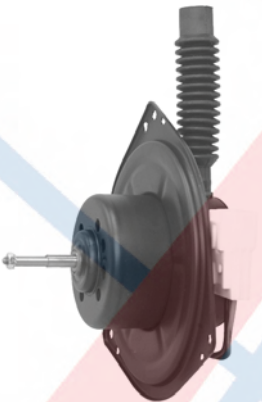
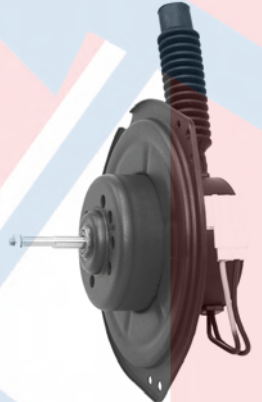
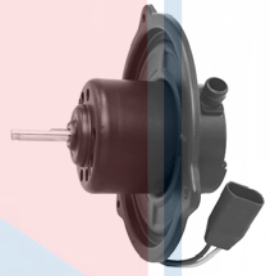

# Blower Motors

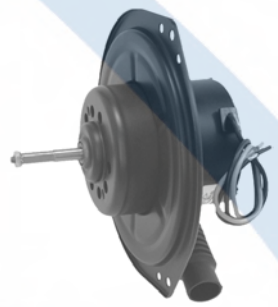
Blower Motor & Assembly Cont'd			
 <p><b>35111</b> CCW 2 Lead Wires w/ connector Style: Flanged Voltage: 12 Scion (06-04); Toyota (05-00) Toyota: 8710352040</p>	 <p><b>35116</b> CCW 2 Lead Wires w/ connector Style: Flanged Voltage: 12 Infiniti (04-99); Nissan (03-99); Subaru (06-00)</p>	 <p><b>35119</b> CW 2 Lead Wires Style: Flanged Voltage: 12 Dodge (92-90); Eagle (92-88) Chrysler: R3504902</p>	 <p><b>35126</b> CW/CCW 2 Lead Wires Style: Single Shaft Voltage: 12 Mazda (95-92) Mazda: HG3061B10</p>
 <p><b>35115</b> CCW 2 Lead Wires w/ connector Style: Flanged Voltage: 12 Acura (03-99) Acura: 79310S0KA01 Honda: 79310S0KA01</p>	 <p><b>35117</b> CCW 2 Lead Wires w/ connector Style: Flanged Voltage: 12 Nissan (04-00)</p>	 <p><b>35120</b> CW/CCW 2 Lead Wires Style: Single Shaft Voltage: 12 Cadillac (06-02); Chevy (06-00); GMC (06-00) General Motors Corp: 12475857</p>	 <p><b>35127</b> CCW 2 Lead Wires w/ connector Style: Single Shaft Voltage: 12 Infiniti (03-99); Nissan (04-01); Subaru (99) Subaru: 72210AC150</p>
 <p><b>35118</b> CCW 2 Lead Wires Style: Single Shaft Voltage: 12 Chrysler (96-93); Dodge (96-93); Eagle (96-93)</p>		 <p><b>35121</b> CCW 3 Lead Wires w/ Connector Style: Flanged Voltage: 12 Cadillac (02-94); Chevy (99-97); GMC (99-97) General Motors Corp: 52494108 Kysor: 1010012</p>	 <p><b>35128</b> CCW 2 Lead Wires Style: Flanged Voltage: 12 Nissan (00)</p>

# Blower Motors

## Blower Motor & Assembly Cont'd



**35139**  
CW  
2 Terminal Connector  
Style: Flanged  
Voltage: 12  
Chevy (02-98); GMC (02-98); Olds (01-98)  
General Motors Corp: 19168614



**35143**  
CW  
2 Lead Wires w/ Connector  
Style: Flanged  
Voltage: 12  
Cadillac (07-02), (99); Chevy (07-99); GMC (07-99)  
General Motors Corp: 89019321

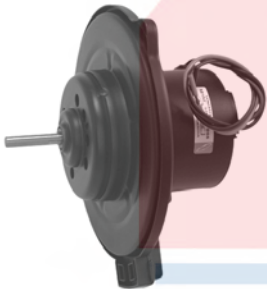

**35152**  
CCW  
2 Lead Wires  
Style: Flanged  
Voltage: 12  
Jeep (01-99)  
Chrysler: 5015860AA



**35167**  
CCW  
2 Lead Wires  
Style: Flanged  
Voltage: 12  
Chrysler (02-01); Dodge (05-00); Plymouth (01-00)

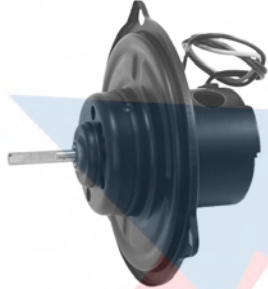

**35168**  
CCW  
2 Lead Wires  
Style: Flanged  
Voltage: 12  
Dodge (02)



**35174**  
CCW  
2 Lead Wires w/ Connector  
Style: Flanged  
Voltage: 12  
Dodge (93-92); Ford (07-02); Jaguar (04-00); Lincoln (06-98); Mazda (06-05); Mercury (07-02)  
Ford: XW4Z19805EA, YW1Z19805CA



**35177**  
CW/CCW  
2 Lead Wires w/ Connector  
Style: Flanged  
Voltage: 12  
Acura (99-96); Honda (02-00), (97-94); Isuzu (04-88)  
Acura: 8971064923  
Isuzu: 8970694111, 8971064923, 8972119530, 8972316420



**35178**  
CW/CCW  
2 Lead Wires  
Style: Single Shaft  
Voltage: 12  
Isuzu (89-88)  
Isuzu: 8944818080



**35182**  
CCW  
2 Lead Wires, 1 Spade, 1 Circle  
Style: Single Shaft  
Voltage: 12  
Chevy (91-78); GMC (91-78)



**35184**  
CW/CCW  
2 Lead Wires w/ Connector  
Style: Flanged  
Voltage: 24  
Toyota (89), (87-81)  
Toyota: 8710490A06













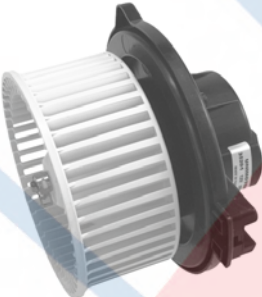

**35185**  
CW  
2 Lead Wires w/ connector  
Style: Flanged  
Voltage: 12  
Freightliner (04-89); Volvo HD (01-97)  
Bergstrom: 203147, 868790  
Caterpillar: 2328802  
Climatch: HA1870, HA2360, HB1640, HB1880  
Euclid: E803122  
Kysor: 1099063  
Mack: 4379RD5114660  
Red Dot: 73R3002, RD5114660P  
TRP Parts: HB18800

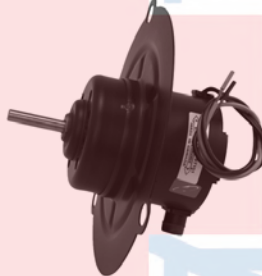

**35186**  
CW  
2 Lead Wires  
Style: Flanged  
Voltage: 12  
Euclid: E803128  
Kysor: 1018002  
Red Dot: 73R3032

# Blower Motors

Blower Motor & Assembly Cont'd			
 <p><b>35190</b> CCW 2 Lead Wires w/ connector Style: Flanged Voltage: 12 Cadillac (07-03); Chevy (06-00); GMC (06-00)</p>	 <p><b>35221</b> CW 2 Lead Wires Style: Single Shaft Voltage: 12 Bergstrom: 203177 Caterpillar: 2669675 Climatech: HA1695 Dallas Truck AC: 0217012 Kysor: 1015005, 1099035 Mack: 4379RD591000 NaviStar: 426616C1</p>	 <p><b>35233</b> CCW 2 Lead Wires w/ connector Style: Flanged Voltage: 12 Lexus (06-04); Toyota (08-02) Toyota: 8710308051</p>	 <p><b>35242</b> CCW 2 Lead Wires Style: Flanged Voltage: 12 Nissan (01-93) Nissan: 272201E400, 272205B600, 272209E000</p>
 <p><b>35201</b> CCW 2 Terminal Connector Style: Flanged Voltage: 12 Acura (04-01); Honda (04-98) Honda: 79310S84A01</p>	 <p><b>35223</b> CW 3 Lead Wires, 1 Circle - 2 Speed Motor Style: Single Shaft Voltage: 12 Bergstrom: 203221 Deutz: 4317575 Euclid: E803030 Kysor: 1012003 Mack: 4379RD564400 NaviStar: 345511C92 Northern: BM334812</p>	 <p><b>35237</b> CCW 2 Lead Wires w/ connector Style: Single Shaft Voltage: 12 Buick (07-04); Chevy (09-02); GMC (09-02); Isuzu (08-03); Olds (04-02); Saab (09-05) General Motors Corp: 89018747</p>	 <p><b>35244</b> CW/CCW 2 Lead Wires w/ Connector Style: Flanged Voltage: 12 Saab (92-79) General Motors Corp: 19188997</p>
 <p><b>35202</b> CCW 2 Terminal Connector Style: Flanged Voltage: 12 Lexus (96-92); Mazda (02-98); Toyota (08-92) Toyota: 8710306021, 871030C022, 8710320060, 8710320070, 871033302</p>	 <p><b>35229</b> CCW 2 Lead Wires Style: Single Shaft Voltage: 12 Euclid: E803011 Red Dot: RD310613 Western Star: 600095005</p>	 <p><b>35241</b> CW/CCW 2 Lead Wires Style: Flanged Voltage: 12 Mazda (91-88) Mazda: HE0161B10</p>	 <p><b>35245</b> CW/CCW 2 Lead Wires Style: Flanged Voltage: 12 Nissan (98-95) Nissan: 2722070F01</p>



# Blower Motors

## Blower Motor & Assembly Cont'd



**35246**  
CW/CCW  
2 Lead Wires  
Style: Flanged  
Voltage: 12  
Mazda (02-95)  
Mazda: TA0161B10B



**35247**  
CW/CCW  
2 Lead Wires  
Style: Flanged  
Voltage: 12  
Mazda (96-95)  
Mazda: BCYM6114Z



**35248**  
CW/CCW  
2 Lead Wires  
Style: Flanged  
Voltage: 12  
Mazda (98-97)  
Mazda: BG1P61B10



**35250**  
CCW  
2 Lead Wires  
Style: Single Shaft  
Voltage: 12  
Infiniti (95-93)  
Infiniti: 2722010Y60

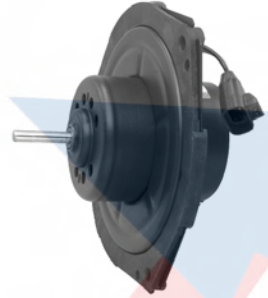

**35252**  
CCW  
2 Lead Wires  
Style: Flanged  
Voltage: 12  
Chevy (02-98)  
General Motors Corp: 52486805



**35253**  
CW/CCW  
2 Lead Wires  
Style: Flanged  
Voltage: 12  
Hyundai (89-86); Mitsubishi (89-87)  
Hyundai: 9713021000



**35256**  
CCW  
2 Lead Wires  
Style: Flanged  
Voltage: 12  
Subaru (01-97)



**35258**  
CW/CCW  
2 Lead Wires  
Style: Single Shaft  
Voltage: 12  
Case New Holland: 284742  
Euclid: E803018  
John Deere: AH80698  
Massey Ferguson: 274939M3  
Red Dot: 73R0302



**35259**  
CCW  
2 Lead Wires w/ Connector  
Style: Flanged  
Voltage: 12  
Ford (97-93); Mazda (97-93)  
Mazda: GA2A61B10



**35260**  
CW/CCW  
2 Lead Wires  
Style: Flanged  
Voltage: 12  
Dodge (99-95); Plymouth (99-95)  
Chrysler: 4644918





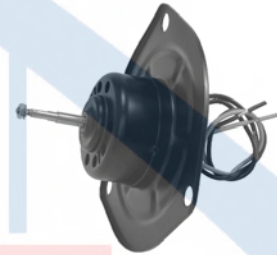



**35262**  
CW/CCW  
2 Lead Wires  
Style: Flanged  
Voltage: 12  
Chrysler (04-02), (00-95); Dodge  
(00-95); Plymouth (00-96)  
Chrysler: 4797372



**35263**  
CCW  
2 Lead Wires  
Style: Flanged  
Voltage: 12  
Mazda (98-89)  
Mazda: LA0361D80

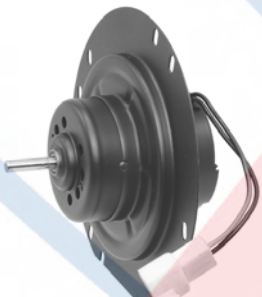
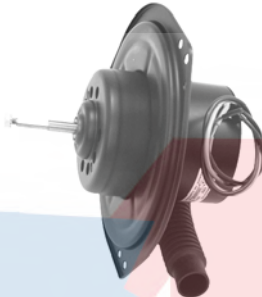
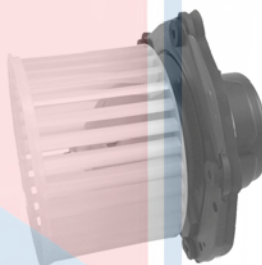

# Blower Motors

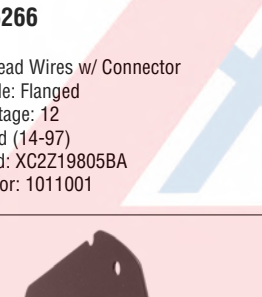
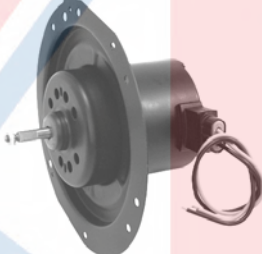
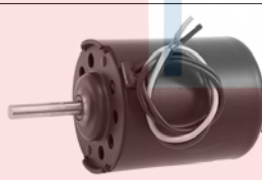
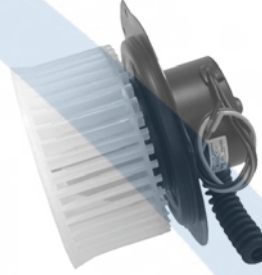
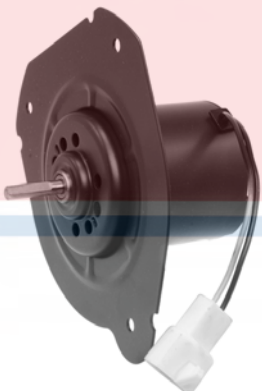
Blower Motor & Assembly Cont'd			
 <p><b>35264</b> CCW 2 Lead Wires Style: Flanged Voltage: 12 Nissan (96-94) Nissan: 2722048P00</p>	 <p><b>35276</b> CW 2 Spade Connector Style: Double Shaft Voltage: 12 Massey Ferguson: 3310831M91</p>	 <p><b>35281</b> CCW 2 Lead Wires w/ Connector Style: Flanged Voltage: 12 Ford (00-97); Lincoln (00-98) Ford: XL7Z19805EA Kysor: 1011007</p>	 <p><b>35284</b> CCW 2 Lead Wires Style: Flanged Voltage: 12 Saturn (02-91) General Motors Corp: 19189024 Saturn: 21031332</p>
 <p><b>35279</b> CCW 2 Lead Wires Style: Flanged Voltage: 12 Nissan (00-95)</p>	 <p><b>35279</b> CCW 2 Lead Wires Style: Flanged Voltage: 12 Nissan (00-95)</p>	 <p><b>35282</b> CW 1 Spade Style: Flanged Voltage: 12 Cadillac (99); Chevy (00-97); GMC (00-97) General Motors Corp: 19131213 Kysor: 1010003</p>	 <p><b>35286</b> CCW 2 Lead Wires w/ Connector Style: Flanged Voltage: 12 Lincoln (97)</p>
 <p><b>35266</b> CW 2 Lead Wires w/ Connector Style: Flanged Voltage: 12 Ford (14-97) Ford: XC2Z19805BA Kysor: 1011001</p>	 <p><b>35280</b> CW 2 Lead Wires Style: Flanged Voltage: 12 Bergstrom: 203125, 890063 Climatech: HA1990 Euclid: E803129 Kysor: 1013004, 203125 NaviStar: 1698779C1 Red Dot: 73R3082 TRP Parts: HA19900</p>	 <p><b>35283</b> CW 2 Lead Wires Style: Single Shaft Voltage: 12 Chrysler (99-96); Dodge (99-96); Eagle (97); Plymouth (99-96) Dallas Truck AC: 0217046 Kysor: 1015003</p>	 <p><b>35290</b> CCW 2 Lead Wires Style: Flanged Voltage: 12 Audi (92-88); VW (92-85)</p>
 <p><b>35267</b> CW/CCW 2 Lead Wires w/ Connector Style: Flanged Voltage: 12 Ford (91)</p>			

# Blower Motors

## Blower Motor & Assembly Cont'd



**35291**  
CCW  
2 Lead Wires w/ Connector  
Style: Flanged  
Voltage: 12  
VW (02-93)  
Volkswagen: 1H1820021

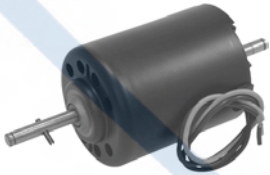

**35293**  
CCWLE  
2 Lead Wires  
Style: Double Shaft  
Voltage: 12  
BMW (00-91)  
BMW: 64118390208



**35298**  
CW  
2 Lead Wires  
Style: Flanged  
Voltage: 12  
Chrysler (95-90), (88); Dodge (95-88);  
Plymouth (95-88)



**35299**  
CW/CCW  
2 Lead Wires w/ Connector  
Style: Flanged  
Voltage: 12  
Dodge (96-91); Eagle (96-92); Mazda  
(06-99), (97-90); Mitsubishi (04-91);  
Plymouth (94-92); Suzuki (02-95);  
Toyota (05-89)  
Mitsubishi: MR315962  
Toyota: 8710316040, 8710389105

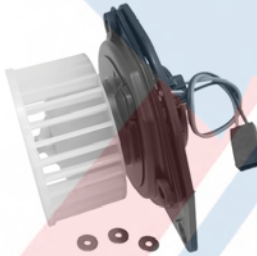

**35318**  
CW  
2 Lead Wires w/ Connector  
Style: Flanged  
Use when updating a one terminal to a  
two terminal  
Voltage: 12  
Volvo (95-85)



**35319**  
CCW  
2 Lead Wires w/ Connector  
Style: Flanged  
Use when updating a one terminal to a  
two terminal  
Voltage: 12  
Volvo (98-92), (90-88)



**35322**  
CCW  
2 Lead Wires  
Style: Flanged  
Voltage: 12  
Nissan (89-86)  
Nissan: 2722029R02



**35331**  
CW  
2 Lead Wires  
Style: Single Shaft  
Voltage: 12



**35333**  
CCW  
1 Spade  
Style: Flanged  
Voltage: 12  
Buick (98-82), (79-78); Cadillac  
(88-86); Chevy (05-81); GMC (05-81);  
Olds (98-85); Pontiac (98-85)  
General Motors Corp: 52498870,  
88959521, 88959522  
Euclid: E803105



**35334**  
CW  
1 Spade  
Style: Flanged  
Use when replacing a one terminal  
motor  
Voltage: 12  
Buick (93-74); Cadillac (92-77); Chevy  
(96-77); GMC (96-77); Olds (93-77);  
Pontiac (91-66); Volvo (95-84)  
General Motors Corp: 52498869  
Volvo: 30676867  
Euclid: E803106, E803119  
Kysor: 1010004





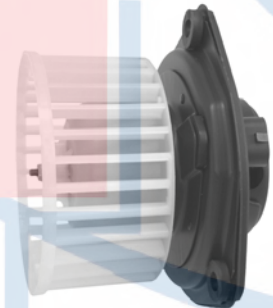



**35337**  
CCW  
1 Spade  
Style: Flanged  
Voltage: 12  
Cadillac (85); Chevy (95-82); GMC  
(95-82); Olds (94-91)  
Euclid: E803107  
Kysor: 1010013

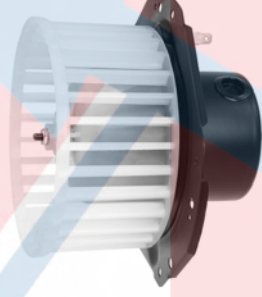
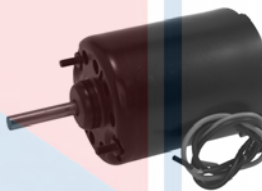

**35339**  
CW  
2 Terminal Connector  
Style: Flanged  
Use when replacing a two terminal  
motor  
Voltage: 12  
Buick (96-91); Cadillac (96-93); Chevy  
(96-91); Olds (92-91)  
General Motors Corp: 12491241

# Blower Motors

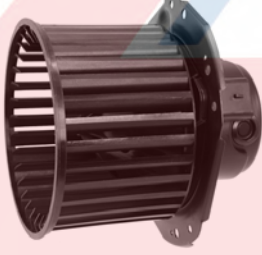
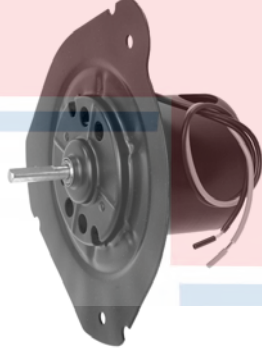
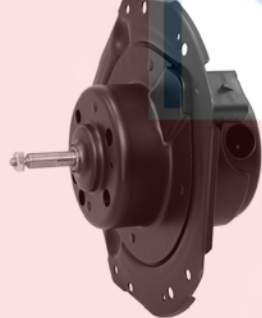
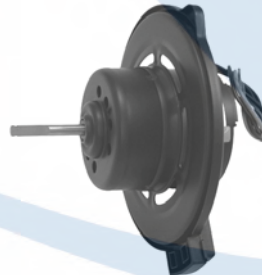
Blower Motor & Assembly Cont'd			
 <p><b>35340</b> CCW 1 Spade Style: Flanged Voltage: 12 Pontiac (89-87) General Motors Corp: 52461456</p>	 <p><b>35344</b> CW 2 Terminal Connector Style: Flanged Voltage: 12 Buick (90-88); Chevy (05-87); GMC (05-94); Isuzu (00-96); Olds (01-96); Pontiac (92-89) General Motors Corp: 12491240, 19189064 Kysor: 1010011</p>	 <p><b>35348</b> CCW 2 Lead Wires w/ Connector Style: Flanged Voltage: 12 Ford (14-89), (87-86); Lincoln (96-93); Mercury (97-84) Ford: 2C2Z19805A Kysor: 1011002</p>	 <p><b>35351</b> CCW 2 Terminal Connector Style: Flanged Voltage: 12 Buick (96-90); Cadillac (93-90); Olds (96-90)</p>
 <p><b>35342</b> CCW 2 Terminal Connector Style: Flanged Voltage: 12 Buick (99-90); Cadillac (93-90); Olds (99-90); Pontiac (99-90) General Motors Corp: 88960337</p>	 <p><b>35345</b> CW 1 Spade Style: Flanged Use when replacing a one terminal motor Voltage: 12 Buick (91-63); Chevy (96-77); GMC (96-77); Olds (92-77); Pontiac (98-64) General Motors Corp: 19131214 Euclid: E803110 Kysor: 1010001 NaviStar: 701012</p>	 <p><b>35349</b> CW 2 Lead Wires Style: Single Shaft Voltage: 12 Ford (90-86); Mercury (94-86)</p>	 <p><b>35352</b> CCW 2 Terminal Connector Style: Flanged Use when replacing a two terminal motor Voltage: 12 Buick (96-88); Chevy (05-90); Olds (04-88); Pontiac (05-88); Saturn (02-91) General Motors Corp: 19153679, 21031332, 52464930, 52472505, 52498952</p>
 <p><b>35343</b> CCW 2 Terminal Connector Style: Flanged Voltage: 12 Buick (90-86); Cadillac (93-92), (90-86); Chevy (96-90); Olds (96-86); Pontiac (96-87) General Motors Corp: 88959520</p>	 <p><b>35346</b> CCW 2 Lead Wires Style: Flanged Voltage: 12 Ford (97-92) Euclid: E803114, E803115</p>	 <p><b>35350</b> CCW 2 Terminal Connector Style: Flanged Voltage: 12 Buick (90-86); Cadillac (93-92), (90-86); Chevy (96-90); Olds (96-86); Pontiac (96-87)</p>	 <p><b>35356</b> CCW 2 Lead Wires Style: Flanged Voltage: 12 Lexus (97-90); Toyota (97-89) Lexus: 8710330330 Toyota: 8710322030</p>



# Blower Motors

## Blower Motor & Assembly Cont'd



**35357**  
CCW  
2 Lead Wires  
Style: Flanged  
Voltage: 12  
Geo (97-93); Lexus (97-96); Toyota (97-90)  
Lexus: 8710326020  
Toyota: 8710312040, 8710326020



**35361**  
CW  
2 Lead Wires w/ Connector  
Style: Flanged  
Voltage: 12  
Ford (00-96); Mercury (00-96)

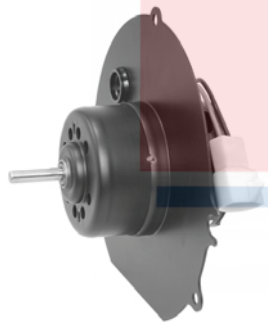

**35362**  
CW  
2 Lead Wires w/ Connector  
Style: Flanged  
Voltage: 12  
Lincoln (02-95)



**35363**  
CCW  
2 Lead Wires  
Style: Flanged  
Voltage: 12  
Lexus (05-92); Toyota (07-98)

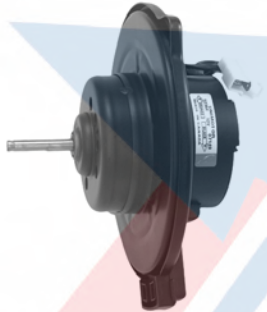

**35364**  
CCW  
2 Lead Wires w/ Connector  
Style: Flanged  
Voltage: 12  
Acura (04-96); Chevy (04-98); Chrysler (05-95); Dodge (05-95); Eagle (98-95); Honda (09-98); Lexus (06-92); Mazda (11-97); Mitsubishi (06-94); Scion (09-05); Suzuki (04-99); Toyota (08-90)  
General Motors Corp: 19189077, 91175896  
Lexus: 8710344020  
Mazda: LC7061B10  
Mitsubishi: MR500469  
Toyota: 8710320100

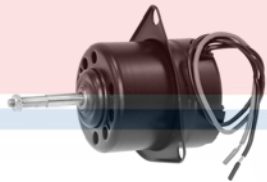

**35365**  
CW/CCW  
2 Lead Wires  
Style: Flanged  
Voltage: 12  
Honda (87-83)



**35366**  
CW/CCW  
2 Lead Wires w/ Connector  
Style: Flanged  
Voltage: 12  
Acura (89-86); Honda (89-82)  
Acura: 79310SE0013  
Honda: 79310SE0013



**35367**  
CW/CCW  
2 Lead Wires w/ Connector  
Style: Flanged  
Voltage: 12  
Chevy (01-95); Ford (97-94); Geo (97-95); Hyundai (99-89); Kia (97-94); Mitsubishi (94-90); Suzuki (01-95)  
Hyundai: 9711624051  
Mitsubishi: 9711624051  
Suzuki: 7425060G10



**35368**  
CW/CCW  
2 Lead Wires  
Style: Flanged  
Voltage: 12  
Mazda (98-89); Subaru (94-87)  
Subaru: 772073180



**35369**  
CW/CCW  
2 Lead Wires w/ Connector  
Style: Flanged  
Voltage: 12  
Ford (92-90); Toyota (89-84)  
Toyota: 8710412210

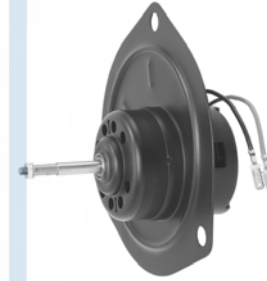

**35370**  
CW/CCW  
2 Lead Wires w/ Connector  
Style: Flanged  
Voltage: 12  
Dodge (91-89); Eagle (94-89); Mitsubishi (94-89); Plymouth (94-89)  
Mitsubishi: MB568800

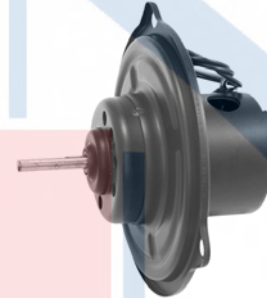

**35372**  
CW  
2 Lead Wires  
Style: Flanged  
Voltage: 12  
Dodge (01-94); Jeep (98-93)  
Chrysler: 4720006  
General Motors Corp: 19189084  
Jeep: 4720006



# Blower Motors

## Blower Motor & Assembly Cont'd



**35373**  
 CCWLE  
 2 Lead Wires  
 Style: Double Shaft  
 Voltage: 12  
 Chevy (95-74); GMC (95-74)  
 General Motors Corp: 19179470  
 Bergstrom: 203179  
 Kysor: 275152  
 Northern: BM334810



**35383**  
 CCW  
 1 Spade  
 Style: Flanged  
 Voltage: 12  
 Chevy (05-82); GMC (05-82); Olds (94-91)  
 General Motors Corp: 89018962  
 Euclid: E803108



**35386**  
 CCWLE  
 2 Lead Wires  
 Style: Double Shaft  
 Voltage: 12  
 Bergstrom: 203061, 203070, 203080, 203198, 203203  
 Climatech: HA1910, HB1016, HB1035, HB1670, K318201  
 Kenworth: HB1610  
 Mack: 4379RD568010  
 NaviStar: 1691704C91, 1691733C91, 19348



**35391**  
 CW  
 2 Lead Wires w/ Connector  
 Style: Flanged  
 Voltage: 12  
 Ford (11-95); Mazda (09-99); Mercury (01-97)  
 Ford: 1L5Z18456CA



**35375**  
 CW  
 2 Lead Wires  
 Style: Flanged  
 Voltage: 12  
 Chevy (88-85); Pontiac (88-85)  
 General Motors Corp: 96052616

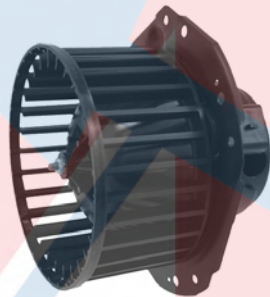

**35384**  
 CCW  
 2 Terminal Connector  
 Style: Flanged  
 Voltage: 12  
 Buick (90-86); Cadillac (90-86); Chevy (96-90); Olds (96-90); Pontiac (96-90)  
 General Motors Corp: 19153682

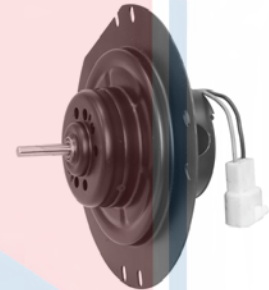

**35388**  
 CCW  
 2 Lead Wires w/ Connector  
 Style: Flanged  
 Voltage: 12  
 Ford (03-95)



**35392**  
 CCW  
 2 Lead Wires w/ Connector  
 Style: Flanged  
 Voltage: 12  
 Ford HD (97-91); Sterling (05-93)  
 Kysor: 1011014  
 Red Dot: 73R2212

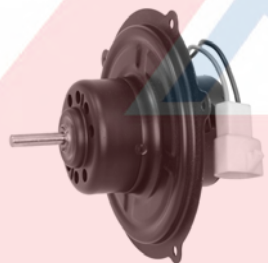

**35382**  
 CW  
 2 Lead Wires w/ Connector  
 Style: Flanged  
 Voltage: 12  
 Ford (04-94)



**35385**  
 CCW  
 2 Terminal Connector  
 Style: Flanged  
 Voltage: 12  
 Buick (93-91); Cadillac (93-91); Olds (92-91)  
 General Motors Corp: 52498883



**35390**  
 CW  
 2 Lead Wires w/ Connector  
 Style: Flanged  
 Voltage: 12  
 Ford (97-95); Mazda (98-95)  
 Mack: ZZM061B10



**35398**  
 CW/CCW  
 2 Lead Wires w/ Connector  
 Style: Flanged  
 Voltage: 12  
 Subaru (87-79)  
 Subaru: 772073050

# Blower Motors

## Blower Motor & Assembly Cont'd



**35399**  
CCW  
2 Lead Wires w/ Connector  
Style: Flanged  
May require use of Wiring Harness  
Voltage: 12  
Ford (02-91); Mercury (99-91)  
Ford: 8U2Z19805A



**35401**  
CW  
2 Lead Wires w/ Connector  
Style: Flanged  
Voltage: 12  
Ford (94-92); Mazda (94-92)  
Euclid: E803116

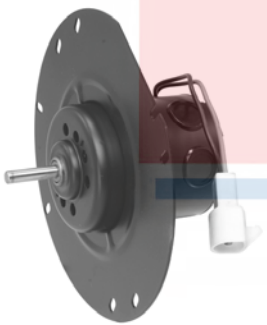

**35402**  
CW  
2 Lead Wires w/ Connector  
Style: Flanged  
Voltage: 12  
Ford (96-91)  
Euclid: E803113, E803117  
Kysor: 1011003  
Red Dot: 73R2142



**35406**  
CW  
2 Terminal Connector  
Style: Flanged  
Voltage: 12  
Chevy (04-94); GMC (04-94); Isuzu (00-96)  
General Motors Corp: 19179472, 19189102  
Isuzu: 8191794720  
Kysor: 1010010



**35409**  
CCW  
2 Lead Wires  
Style: Flanged  
Voltage: 12



**35417**  
CW/CCW  
2 Lead Wires  
Style: Double Shaft  
Voltage: 12  
Hy-Capacity: 8812335417  
John Deere: AR82005, AR82010, RE25160  
Northern: BM3335417



**35419**  
CW  
2 Lead Wires  
Style: Single Shaft  
Voltage: 12  
Mack (84-75); Peterbilt (04-94)  
Bergstrom: 203059, 203132, 203174, 203178, 203220  
Climatech: HA1055, HA1070, HA1175, HA1980  
Euclid: E803052  
Kysor: 1012008  
Mack: 2790HV32742, 4379RD565260  
NaviStar: 117283C91, 1691721C91, 19269  
Northern: BM33816  
Peterbilt: 73R0422  
Red Dot: RD56526, RD565260  
TRP Parts: HA10700



**35420**  
CW/CCW  
2 Lead Wires  
Style: Single Shaft  
Voltage: 12  
Northern: BM3339604  
Red Dot: RD545500



**35421**  
CCW  
2 Lead Wires  
Style: Flanged  
Voltage: 12  
Buick (99-95); Infiniti (96-93); Nissan (97-86); Olds (99-95)  
General Motors Corp: 19189111, 22136155  
Nissan: 2722001G03



**35422**  
CW/CCW  
2 Lead Wires  
Style: Single Shaft  
Voltage: 12  
Freightliner (99-89); John Deere (96-89)  
Bergstrom: 203209  
Caterpillar: 2328758  
Climatech: HA1075  
Dallas Truck AC: 0217050  
Euclid: E803025, E803054, E803121  
Kysor: 1099034  
Mack: 4379RD582040  
NaviStar: 19350, 2503277C1  
Northern: BM333842, BM334824



**35423**  
CW/CCW  
2 Lead Wires  
Style: Single Shaft  
Voltage: 12  
Dallas Truck AC: 0217007, 0217017  
Euclid: E803053  
Mack: 4379RD552690  
NaviStar: 19260  
Red Dot: 73R0962

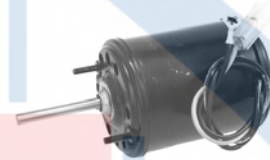

**35424**  
CW  
2 Lead Wires  
Style: Single Shaft  
Voltage: 12  
AMC: 8956002007  
Bergstrom: 203175  
Climatech: HA1085, HA1180  
Euclid: E803055  
Kysor: 1099023  
Mack: 4379RD559070  
NaviStar: 701008  
Red Dot: 73R0462

# Blower Motors

## Blower Motor & Assembly Cont'd



**35425**  
 CW  
 2 Lead Wires  
 Style: Single Shaft  
 Voltage: 12  
 Climatech: HA1010, HA1090, HA1520, HA1735, HA1975  
 Euclid: E803033  
 Kysor: 275165  
 Mack: 4379RD552300, 7979275130  
 Red Dot: 73R0522, RD536900, RD537530, RD537534P



**35426**  
 CCWLE  
 2 Lead Wires  
 Style: Double Shaft  
 Voltage: 12  
 Climatech: HB1055  
 Mack: 4379RD5375712  
 Red Dot: 73R4202, RD5375712



**35428**  
 CCWLE  
 2 Lead Wires, 1 Spade, 1 Circle  
 Style: Double Shaft  
 Voltage: 12  
 Kenworth (00-95)  
 Bergstrom: 205840, 205853, 557712  
 Dallas Truck AC: 0217009, 0217049  
 Euclid: E803039, E803125  
 Kenworth: 274271, 2809551007, PF2865Q  
 NaviStar: 701004  
 Red Dot: 73R4502, RD550490, RD55121



**35430**  
 CCW  
 2 Lead Wires  
 Style: Single Shaft  
 Voltage: 12  
 Freightliner (88-78); Peterbilt (87-76); Western Star (00-88)  
 Bergstrom: 203320, 205620  
 Climatech: HA1725  
 Dallas Truck AC: 0217027  
 Euclid: E803032, E803045  
 Kysor: 1011012  
 Peterbilt: 275141  
 Red Dot: 73R0402, 73R0932, A2221403001, RD4122, RD537531  
 Western Star: RD537531



**35431**  
 CCW  
 2 Lead Wires  
 Style: Single Shaft  
 Voltage: 12  
 NaviStar: 19245, 19261  
 Red Dot: 73R0912, RD555120, RD55634



**35432**  
 CCW  
 2 Lead Wires  
 Style: Single Shaft  
 Voltage: 12  
 Bergstrom: 203075, 203224  
 Caterpillar: 2328786  
 Climatech: HA1165, HA1380, HA1605, HA1920  
 Dallas Truck AC: 0217155  
 Kysor: 1014003  
 Mack: 4379RD555120, 4379RD580160  
 NaviStar: 16299  
 Red Dot: 73R0352, 73R0382, RD553100, RD556340, RD56472



**35433**  
 CCW  
 2 Lead Wires  
 Style: Single Shaft  
 Voltage: 12  
 Red Dot: RD310618P

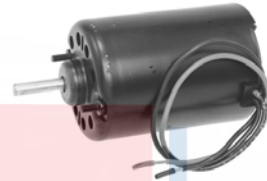

**35434**  
 CW  
 2 Lead Wires  
 Style: Single Shaft  
 Voltage: 12  
 Kenworth (97-95)  
 Bergstrom: 203172  
 Kysor: 1099011  
 Red Dot: 73R0702, RD549270

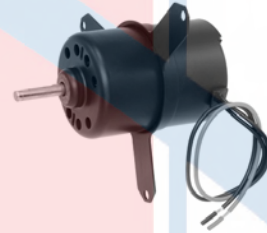

**35435**  
 CCW  
 2 Lead Wires  
 Style: Flanged  
 Voltage: 12  
 Volvo HD (96-88)  
 Euclid: E803047  
 Red Dot: 73R0982

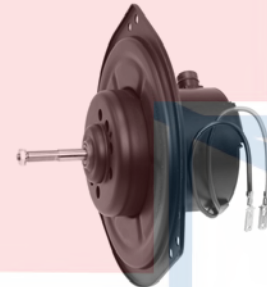

**35436**  
 CCW  
 2 Lead Wires w/ Connector  
 Style: Flanged  
 Voltage: 12  
 Nissan (93-90)



**35437**  
 CCW  
 2 Lead Wires  
 Style: Flanged  
 Voltage: 12  
 Nissan (94-89)  
 Nissan: 2722040F00



**35438**  
 CCW  
 2 Lead Wires w/ Connector  
 Style: Flanged  
 Voltage: 12  
 Infiniti (96-91); Nissan (94-89)  
 Nissan: 2722062J00, 2722085E02



**35439**  
 CCW  
 2 Lead Wires w/ Connector  
 Style: Flanged  
 Voltage: 12  
 Nissan (90-86)  
 Nissan: B722060A12



# Blower Motors

## Blower Motor & Assembly Cont'd



**35440**  
CCW  
2 Lead Wires  
Style: Flanged  
Voltage: 12  
Nissan (89-85)  
Nissan: B722013E11



**35461**  
CW  
2 Lead Wires w/ Connector  
Style: Single Shaft  
Voltage: 12  
Isuzu (93-91), (87-85)  
Isuzu: 8944166281

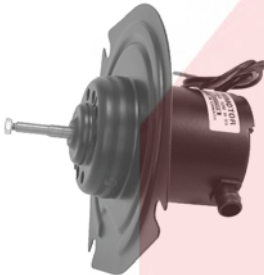

**35463**  
CCW  
2 Lead Wires  
Style: Flanged  
Voltage: 12  
Nissan (86-82)  
Nissan: 27220D1603



**35467**  
CW  
2 Lead Wires  
Style: Flanged  
Voltage: 12  
Renault (87-83)  
AMC: 8134610  
Renault: 8134610

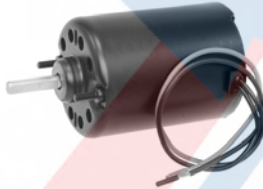

**35468**  
CCW  
2 Lead Wires  
Style: Single Shaft  
Voltage: 24  
General Motors Corp: 19189149  
Euclid: E803035  
Kysor: 274268, 275231, 275241  
Northern: BM334814  
Red Dot: 73R0404, 73R0454



**35469**  
CW/CCW  
2 Lead Wires  
Style: Flanged  
Voltage: 12  
Dodge (89-87); Mitsubishi (89-85);  
Plymouth (88-87)



**35470**  
CW/CCW  
2 Lead Wires w/ Connector  
Style: Flanged  
Voltage: 12  
Chrysler (89-87); Dodge (93-81);  
Mitsubishi (96-83); Plymouth (91-81)  
Mitsubishi: MB568983

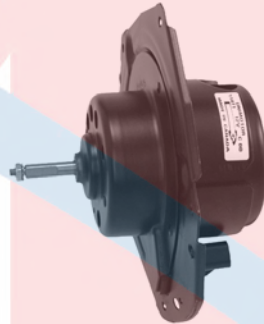

**35471**  
CW  
2 Terminal Connector  
Style: Flanged  
Voltage: 12  
Buick (90-88); Chevy (92-87); Pontiac  
(92-89)



**35472**  
CW  
1 Spade  
Style: Flanged  
Non-Vented Motor  
Voltage: 12  
Buick (91-63); Chevy (96-77); GMC  
(96-77); Olds (90-76); Pontiac (98-64)



**35474**  
CW/CCW  
2 Lead Wires  
Style: Flanged  
Voltage: 12  
Chrysler (78-74); Dodge (97-79),  
(77-74); Jeep (96-84); Plymouth (81),  
(77-74)  
Chrysler: 4186886, 4638064  
AMC: 8956000173  
Euclid: E803084

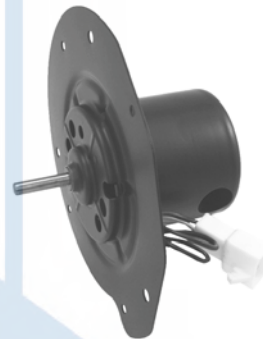

**35475**  
CW/CCW  
2 Lead Wires w/ Connector  
Style: Flanged  
Voltage: 12  
Ford (98-87)  
Euclid: E803091, E803111  
Kysor: 1011009

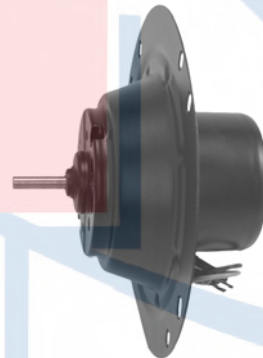

**35476**  
CW/CCW  
2 Lead Wires  
Style: Flanged  
Voltage: 12  
Ford (94-77); Lincoln (87-82), (80-77);  
Mercury (94-90), (88-77)  
Euclid: E803070



# Blower Motors

## Blower Motor & Assembly Cont'd



**35477**  
CW/CCW  
2 Lead Wires  
Style: Flanged  
Voltage: 12  
Ford (88-86); Lincoln (92-88); Mercury (88-87)  
Euclid: E803097



**35478**  
CCW  
3 Lead Wires, 1 Circle - 2 Speed Motor  
Style: Single Shaft  
Voltage: 12  
Chevy (89-61); GMC (89-66)  
Dallas Truck AC: 0217054  
Euclid: E803005  
Evans: AM86548  
Hupp: 61291G2, 61742G1  
Kysor: 1099001, 274248  
Mack: 2790HV221470  
Massey Ferguson: 1031020M91, 1032941M91, 250868M91, 271047M9  
NaviStar: 224558R92, 258874C92, 442983C1  
Red Dot: 73R1152



**35479**  
CW/CCW  
3 Lead Wires, 1 Circle - 2 Speed Motor  
Style: Single Shaft  
Voltage: 12



**35480**  
CW/CCW  
4 Lead Wires  
Style: Double Shaft  
Voltage: 24  
ARA: 1120116  
Caterpillar: 3P8379  
Dallas Truck AC: 0217152  
Egging: 21543  
Euclid: E803024  
Evans: AM86585  
Frigiking: 9140824  
Hupp: 62495G2, 64803G2  
John Deere: AH8019424  
NaviStar: 631991C91  
Northern: BM333834



**35481**  
CCW  
4 Lead Wires w/ Connector - 3 Speed Motor  
Style: Single Shaft  
Voltage: 12  
Bergstrom: 203136  
Climatech: HA1210  
Dallas Truck AC: 0217028  
Euclid: E803020  
Evans: AM86549, AM86575  
Kysor: 1018001, 274233, 274245  
Mack: 4379RD549320  
NaviStar: 12623  
Red Dot: 73R1052



**35482**  
CW/CCW  
5 Lead Wires - 2 Speed Motor  
Style: Single Shaft  
Voltage: 12  
General Motors Corp: 19189159  
Bergstrom: 202520, 203222  
Climatech: HA1020, HA1600, HA1715  
Euclid: E803010  
NaviStar: 2503275C1  
Northern: BM334806, BM33868



**35483**  
CW/CCW  
2 Lead Wires  
Style: Flanged  
Voltage: 12  
Mazda (85), (83-79)  
Mazda: 887176453A

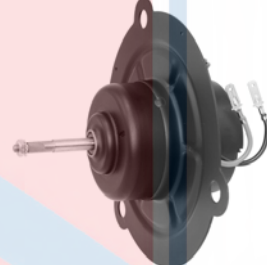

**35484**  
CW/CCW  
2 Lead Wires w/ Connector  
Style: Flanged  
Voltage: 12  
Ford (93-88); Mazda (86-81); Suzuki (95-85)  
Mazda: 374376454



**35486**  
CW/CCW  
2 Lead Wires  
Style: Double Shaft  
Voltage: 12  
Evans: AM86537, AM86538, HV22731, HV29791, HV32347  
Frigiking: 3217482, 9117482



**35487**  
CW  
2 Lead Wires  
Style: Single Shaft  
Voltage: 12  
Euclid: E803009, E803049  
Evans: AM86530, AM86547, HV22714, HV27682, HV28434  
Hupp: 61482G1, 61742G2, 63303G1  
Kysor: 1013001, 274234  
Massey Ferguson: 249743M91  
NaviStar: 11900, 421843C2, 421844C1, 85374R91  
Northern: BM3339602, BM336484, BM33859



**35489**  
CW  
2 Lead Wires w/ Connector  
Style: Flanged  
Voltage: 12  
Ford (95-86); Lincoln (94-88); Mercury (95-86)

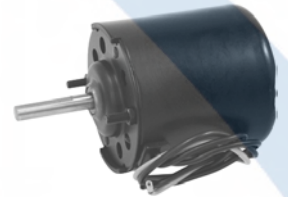

**35490**  
CW/CCW  
2 Lead Wires  
Style: Single Shaft  
Voltage: 12  
Ford (89-86)  
Euclid: E803099

# Blower Motors

## Blower Motor & Assembly Cont'd



**35491**  
CW  
2 Lead Wires  
Style: Flanged  
Voltage: 12  
Chrysler (95-86); Dodge (00-86);  
Plymouth (95-86)  
Chrysler: 4443132AB  
Euclid: E803090



**35492**  
CCW  
2 Lead Wires  
Style: Flanged  
Voltage: 12  
Chrysler (95-90), (88-86), (73-72);  
Dodge (95-86); Plymouth (95-86), (64)  
Euclid: E803087

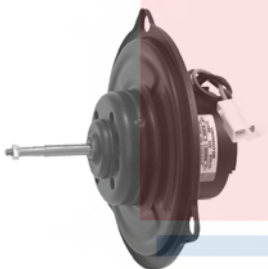

**35493**  
CW/CCW  
2 Lead Wires w/ Connector  
Style: Flanged  
Voltage: 12  
Chevy (94-85); Ford (89); Mazda  
(93-86); Mercury (89-88); Subaru  
(94-85); Suzuki (98-89); Toyota  
(92-79)  
General Motors Corp: 19189168,  
96059569  
Mazda: BF6761B10, UB3961B10,  
UB9461B10  
Toyota: 8710412150, 8710424020,  
8710489110, 8710495A00



**35495**  
CW  
2 Lead Wires  
Style: Single Shaft  
Voltage: 12  
Chrysler (85-82); Dodge (85-83);  
Plymouth (85-83)  
Climatech: 203115BSM  
Dallas Truck AC: 0217008  
NaviStar: 1691702C91, 238748R91,  
346931C91, 701020  
Northern: BM334809  
Red Dot: 73R0222

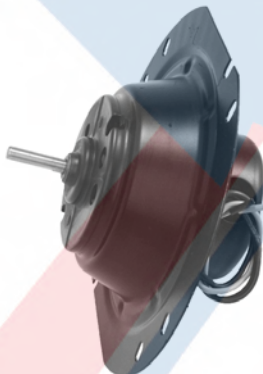

**35496**  
CW/CCW  
2 Lead Wires  
Style: Flanged  
Voltage: 12  
Ford (87-81); Mercury (87-81)



**35497**  
CW/CCW  
2 Lead Wires  
Style: Flanged  
Will replace motor stamped  
E43H-18527-AA or AB only.  
Voltage: 12  
Ford (94-81); Mercury (94-81)



**35498**  
CW  
2 Lead Wires w/ Connector  
Style: Flanged  
Voltage: 12  
Ford (94-82); Ford Medium Duty (98);  
Mazda (94), (92-91)  
Euclid: E803067, E803112  
Kysor: 1011006  
NaviStar: 15388

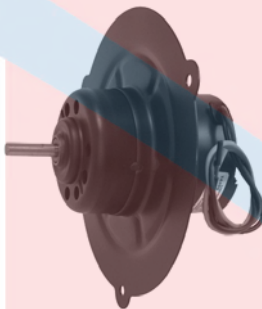

**35499**  
CCW  
2 Lead Wires  
Style: Flanged  
Voltage: 12  
Chevy (82-80); Isuzu (91-81)  
Isuzu: 8942331623



**35500**  
CW/CCW  
2 Lead Wires  
Style: Double Shaft  
Voltage: 12  
AMC (78-66); Chevy (89-61); Chrysler  
(78-59); Dodge (87-81), (79-60); Ford  
(71-70), (68-67), (65-60); GMC  
(89-66); Honda (79-76); Int'l (80);  
Jeep (79-71); Mazda (74-72); Mercury  
(74-67)  
Mercury (65-60); Plymouth (79-59)  
General Motors Corp: 19168615,  
88890698  
AMC: 8121592, 8121843, SE2087075,  
SE2087236  
ARA: 1120057  
Brookway: 20578P  
Euclid: E803028, E803043, E803127  
John Deere: AH63511, AR62497  
Kenworth: 275102  
Kysor: 1015002, 1099002, 275154,  
275156  
Mack: 4379RD551210, RD55121  
NaviStar: 12886  
Peterbilt: RD55121  
Red Dot: 73R4062, 73R4252



**35501**  
CW/CCW  
4 Lead Wires w/ Connector, 1 Circle  
Style: Double Shaft  
Voltage: 12  
Chevy (76-74); GMC (76-74); Int'l  
(80); Jeep (75-74); Mazda (82-72);  
Nissan (78-74)  
General Motors Corp: 19189175  
ARA: 1119700, 1120015  
Case New Holland: 130185, F89750  
Dallas Truck AC: 0217003  
Euclid: E803012  
Evans: AM86524, HV86524  
Frigiking: 3236995, 9136995  
Full Vison: 172815, 521250  
Hesston: 7025851  
Hy-Capacity: 0881233880  
Kysor: 1011015, 274230, 274249,  
274250  
Mack: 4379RD537380  
NaviStar: 11028, 117789C1, 14811  
Red Dot: 73R4102  
Steiger: 251044, 261335  
Versatile: 9115622  
Year-A-Round: 14011389

# Blower Motors

## Blower Motor & Assembly Cont'd



**35502**  
CW/CCW  
2 Lead Wires  
Style: Single Shaft  
Voltage: 12  
AMC (80-70); Chrysler (73-65); Dodge (85-81), (73-65); Ford (85-63); Jeep (86-80); Mercury (81-66); Plymouth (81), (73-65)  
AMC: 3020586, 3198978, 3220586, 3224864  
ARA: 1120049  
Dallas Truck AC: 0217016  
Euclid: E803089  
Evans: AM86546  
Western Star: 600095003



**35504**  
CW/CCW  
2 Lead Wires  
Style: Single Shaft  
Voltage: 12  
AMC (79); Chevy (66-64); Chrysler (81-77), (73-65); Dodge (83-76), (74-72), (69-68), (66-65); Ford (78-65); GMC (66-65); Int'l (68-61); Jeep (86-66); Mercury (78-72), (70-66)  
Plymouth (80-76), (74-72), (69-65)  
General Motors Corp: 19189177  
Allis Chalmers: 1175326  
AMC: 8125069, 8125939, 8126992, 8127021, 8128778, 816250  
ARA: 1120163  
Caterpillar: 2328743, 2328746  
Climatech: HA1030, HA1620, HA1645, HA1730  
Dallas Truck AC: 0217021  
Euclid: E803013  
Evans: AM86503, AM86535, HV25463, HV29142, HV31839, HV33107  
John Deere: 73R0202  
Kenworth: 73R0202, RD310618  
Kysor: 1011011, 1014002, 1075010, 274264  
Mack: 4379RD41830, 4379RD5103900, 4379RD536900  
NaviStar: 12608, 1691702C1, 1691702C91, 238748R91  
Red Dot: 73R0152, 73R0532, 73R0562, RD310618, RD5310618, RD535950  
Western Star: 600095015



**35505**  
CW/CCW  
2 Lead Wires  
Style: Single Shaft  
Voltage: 12  
Hy-Capacity: 8812331839, 8812334812  
Massey Ferguson: 250936M92  
Northern: BM331839

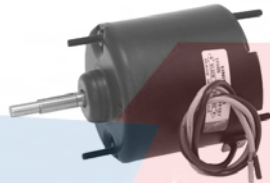

**35506**  
CW/CCW  
2 Lead Wires  
Style: Single Shaft  
Voltage: 24  
Dallas Truck AC: 0248102  
Euclid: E803016  
Evans: AM86542, HV30088, HV30183  
Kysor: 1075006, 274284  
Northern: BM33896  
Red Dot: 73R0054, 73R0104, 73R0204

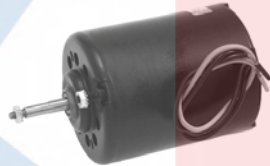

**35507**  
CW  
2 Lead Wires  
Style: Single Shaft  
Voltage: 12  
Climatech: HA1190  
Dallas Truck AC: 0217025  
Euclid: E803015  
Evans: AM86550  
Kysor: 1010017, 1099029, 1099031, 1099060, 274247, 275186  
NaviStar: 13635  
Red Dot: 73R0952



**35508**  
CW/CCW  
2 Lead Wires  
Style: Single Shaft  
Voltage: 12  
AMC (87-65), (60); Chrysler (64-59); Dodge (61-60); Mazda (76); Plymouth (61-59)  
AMC: 3127296, 31272967, 3134111, 3169614, 3181124, 3188975, 3194646, 3194647, 3194648, 3196408, 3198956, 3198992, 3210893, 3215722, 3217296, 3238873, 3238874, 3741261

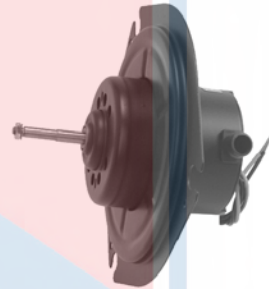

**35509**  
CCW  
2 Lead Wires  
Style: Flanged  
Voltage: 12  
Subaru (97-90)  
Subaru: 72023AA100

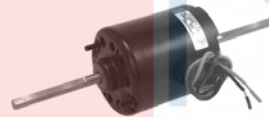

**35510**  
CW/CCW  
2 Lead Wires  
Style: Double Shaft  
Voltage: 12  
Chevy (77-75); GMC (77-75)  
General Motors Corp: 12306581  
Case New Holland: 86010530  
Dallas Truck AC: 0217001, 0217005  
Euclid: E803124  
Kysor: 275193  
NaviStar: 11444, 12569, 1691704C91  
Northern: BM33831  
Red Dot: 73R4052, 73R4152  
Versatile: PU2323Q



**35511**  
CW/CCW  
2 Lead Wires  
Style: Single Shaft  
Voltage: 12  
Chevy (77-67), (63-59); Chrysler (73-59); Dodge (81-71); GMC (77-67); Lincoln (63); Plymouth (79-76)  
General Motors Corp: 88890697  
AMC: 8123010, SE2087043  
ARA: 1120078  
Dallas Truck AC: 0218003  
Deutz: 0034227  
Euclid: E803000, E803002  
Evans: AM86566  
Kenworth: 20227P  
Kysor: 1010006, 1099008, 274237, 274251, 275166  
NaviStar: 12594, 301323C91, 442987C1  
Year-A-Round: 14011427



**35512**  
CW/CCW  
2 Lead Wires  
Style: Single Shaft  
Voltage: 6  
Ford (55-48); Jeep (70-66); Pontiac (54-50)  
General Motors Corp: 19189184  
AMC: 3118538, 3138426, 3143068, 3154472, 3202374, 816251, 955075, 958733



**35513**  
CW  
2 Lead Wires  
Style: Flanged  
Voltage: 12  
Chevy (00-92); GMC (00-92)  
General Motors Corp: 19131216  
Kysor: 1010008



# Blower Motors

## Blower Motor & Assembly Cont'd



**35514**  
CW/CCW  
2 Lead Wires  
Style: Single Shaft  
Voltage: 12  
Ford (98-80); Jeep (79-78); Mercury (86-81)  
Kysor: 274289  
Mack: 3230224766  
Red Dot: 73R0332, 73R0342, RD537532



**35515**  
CW/CCW  
2 Lead Wires  
Style: Single Shaft  
Voltage: 12  
Isuzu (87-86)  
Isuzu: 8944150010  
Hy-Capacity: 0881233882

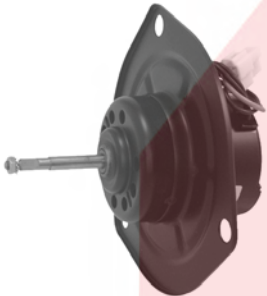

**35516**  
CW  
2 Lead Wires w/ Connector  
Style: Flanged  
Voltage: 12  
Toyota (86-80)  
Toyota: 8710412120



**35517**  
CW  
2 Lead Wires w/ Connector  
Style: Flanged  
Voltage: 12  
Mazda (80-73)  
Toyota: 8710416030  
Euclid: E803074

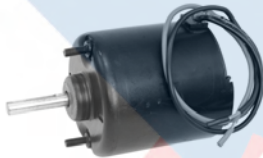

**35522**  
CCW  
2 Lead Wires  
Style: Single Shaft  
Voltage: 12  
Ford (89-80)  
Bergstrom: 203169, 203193  
Climatech: HA1030, HA1620, HA1645, HA1720, HA1730  
Euclid: E803050  
Kysor: 275131  
Mack: 4379RD310618  
NaviStar: 1691702C91, 238748R91, 346931C91  
Northern: BM334816, BM33824  
Red Dot: 73R0102, 73R0202



**35523**  
CW  
3 Lead Wires, 2 w/Connector, 1 Circle - 2 Speed Motor  
Style: Single Shaft  
Voltage: 12  
AMC (64-61); Ford (79), (66-65); Int'l (79-69)  
Bergstrom: 201320, 201520, 20302, 203020, 203088  
Blue Bird: 22806  
Brockway: 20152P, 20302, 20302P, 20562P  
Caterpillar: 2328742  
Climatech: HA1420, HA1595, HA1805, HA1970  
Dallas Truck AC: 0217004  
Euclid: E803008, E803014, E803042  
Evans: AM86552, AM86576  
Hupp: 60663G3  
John Deere: 20152P1, 203012, 20302P, 20562P, 73R0552  
Kenworth: 20152P1, 203012, 20302P, 20562P, 273140, 2807517041, 2807517043, 73R0552, RD2030, RD310612, RD31062  
Kysor: 1013009, 1099006, 273140, 274040  
Mack: 2790HV86511, 4379RD310612  
NaviStar: 1076362R91, 11635, 19341, 19343, 2503279C1, 419992C91, 422984C1  
Northern: BM33887  
Peterbilt: 20302P, 273140  
Red Dot: 73R0652, RD2030, RD310612, RD5310612, RD5310613  
Western Star: 701024, RD310612



**35524**  
CCW  
3 Lead Wires, 2 w/Connector, 1 Circle - 2 Speed Motor  
Style: Single Shaft  
Voltage: 12  
AMC: 3172923, 3178499, 977572  
Bergstrom: 202020, 203171  
Blue Bird: 22808  
Brockway: 20202P  
Climatech: HA1120  
Euclid: E803006  
Evans: AM86531, AM86554, AM86570, HV23416  
Hupp: 60601G2, 61148G2  
Kenworth: 2807517019, RD310613  
Kysor: 1099005, 274239, 275191, 275313  
Mack: 4379RD310613, RD310613  
NaviStar: 0680952R93, 11032, 1691719C91, 680952R93  
Northern: BM33844  
Red Dot: 73R0602, 73R0604

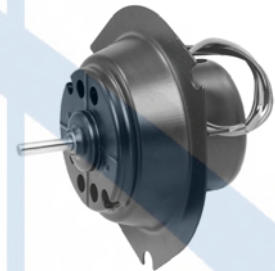

**35526**  
CW/CCW  
2 Lead Wires  
Style: Flanged  
Voltage: 12  
Chrysler (85-75); Dodge (87-66); Plymouth (86-76)



# Blower Motors

## Blower Motor & Assembly Cont'd

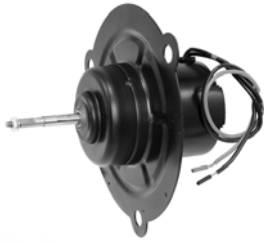

**35527**  
 CW  
 2 Lead Wires  
 Style: Flanged  
 Voltage: 12  
 Dodge (86-79); Honda (83-79);  
 Mitsubishi (86-83); Plymouth (84-80)  
 Honda: 39430692671  
 Mitsubishi: MB080603

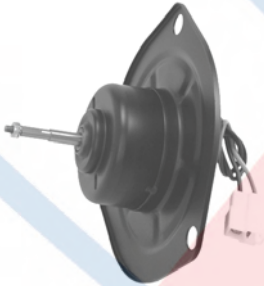

**35532**  
 CW/CCW  
 2 Lead Wires w/ Connector  
 Style: Flanged  
 Voltage: 12  
 Ford (93-88); Mitsubishi (06-01)  
 Mazda: 395376454  
 Mack: 395376454



**35537**  
 CCW  
 2 Lead Wires  
 Style: Flanged  
 Voltage: 12  
 Dodge (80-72); Plymouth (80-74)  
 Euclid: E803086



**35538**  
 CCW  
 2 Lead Wires w/ Connector  
 Style: Flanged  
 Voltage: 12  
 Ford (03-97); Mercury (99-97)

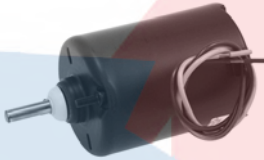

**35540**  
 CW  
 2 Lead Wires  
 Style: Single Shaft  
 Voltage: 12  
 AMC (63); Dodge (97-78), (73-72),  
 (68-62); Ford (80), (71-70), (68-66),  
 (64-60); Jeep (77-74); Mazda (74-72);  
 Mercury (70-67); Plymouth (64)  
 Allis Chalmers: 1183560, 11882875,  
 275130, 711882878  
 AMC: 5751834, 8124478  
 ARA: 1120009, 1120070  
 Bergstrom: 203056, 203168, 203184  
 Case New Holland: 539047R2, 80417384  
 Climatech: HA1955  
 Dallas Truck AC: 0217502, 0248002  
 Deutz: 0034607  
 Evans: AM86545, HV86504  
 Full Vison: 58538  
 John Deere: AR49962  
 Kysor: 1099013, 275130  
 Massey Ferguson: D45090200  
 NaviStar: 11642  
 Northern: BM33882  
 Peterbilt: 275130  
 Red Dot: 73R0502, 73R0542



**35541**  
 CW  
 2 Lead Wires  
 Style: Single Shaft  
 Voltage: 12  
 Lincoln (65-64); Mercury (68-67)  
 Bergstrom: 203165  
 Climatech: HA1135  
 Euclid: E803031  
 Evans: HV29925  
 John Deere: 275140  
 Kenworth: 275140  
 Kysor: 1099012, 274228  
 Peterbilt: 275140

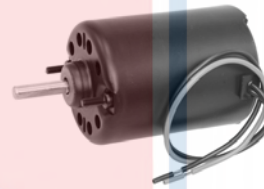

**35542**  
 CCW  
 2 Lead Wires  
 Style: Single Shaft  
 Voltage: 12  
 Ford (85); Mercury (85-84)  
 ARA: 1120072  
 AutoCar: 73R0352  
 Bergstrom: 203173, 203225  
 Climatech: HA1150, HA1155  
 Evans: AM86500  
 Kysor: 1099027, 275141  
 Mack: 4379RD549270  
 NaviStar: 488831C1, 488843C91,  
 498554C92



**35543**  
 CCWLE  
 2 Lead Wires  
 Style: Double Shaft  
 Voltage: 12  
 Climatech: HA1710, HB1030  
 Hy-Capacity: 8812333846  
 Kysor: 1017003, 1099015, 1099049,  
 274318, 275102  
 Mack: 274318, 275102, 275152,  
 2790275102, 4379RD556140,  
 7979275102  
 NaviStar: 1691705C91, 19270  
 Northern: BM333846  
 Peterbilt: 275102  
 Red Dot: 73R4122



**35544**  
 CW/CCW  
 2 Lead Wires  
 Style: Double Shaft  
 Voltage: 12  
 Allis Chalmers: 02573368, 257336,  
 702573361  
 ARA: 1120074  
 Bergstrom: 205780S  
 Kysor: 273551  
 NaviStar: 1691733C91

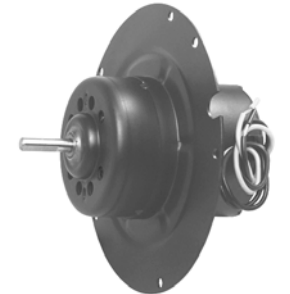

**35545**  
 CCW  
 2 Lead Wires  
 Style: Flanged  
 Voltage: 12  
 Dodge (97-86)  
 Chrysler: 3895797  
 Euclid: E803061, E803096  
 Evans: AM86534, AM86561, AM86583,  
 HV29093, HV29351, HV29547,  
 HV30083, HV30084, HV30702,  
 HV31858, HV33015  
 Kysor: 1015001, 1017001, 274246  
 Mack: 2790HV220733, 2790HV29093,  
 HV29093  
 NaviStar: 13634  
 Red Dot: 73R2262

# Blower Motors

## Blower Motor & Assembly Cont'd



**35546**  
CCWLE  
2 Lead Wires  
Style: Double Shaft  
Voltage: 12  
Allis Chalmers: 275152  
AMC: 3423087  
ARA: 1120073  
AutoCar: 3945237  
Bergstrom: 206085, 868541  
Case New Holland: 80430411  
Caterpillar: 2328823, 2328828  
Climatech: HA1750, HB1085, HB1570,  
HB1625, HB1660, HB1665, HB1675,  
HB1680  
Dallas Truck AC: 0217018, 0217022  
Euclid: E803029  
Hy-Capacity: 8812334805  
John Deere: 73R4322  
Kenworth: 73R4322, K318201,  
RD550490  
Kysor: 1018004, 1018005, 1099004,  
1099018, 1099026, 1099065, 1099089  
274296, 274319, 275120, 275158  
Mack: 4379RD5100680, 7979275152  
NaviStar: 11645, 1691705C91  
Northern: BM334805  
Red Dot: 73R4162, 73R4352



**35547**  
CWLE  
2 Lead Wires  
Style: Double Shaft  
Voltage: 24  
ARA: 1120003, 1120059  
Bergstrom: 203188  
Climatech: HB1060, HB1395  
Evans: AM86564  
Frigiking: 3207366, 9107366  
John Deere: 557712  
Kysor: 1075011, 1075015, 275202,  
275254, 275258  
Red Dot: 73R4264



**35548**  
CCW  
2 Lead Wires  
Style: Single Shaft  
Voltage: 24  
Case New Holland: 275211  
Kysor: 275211



**35549**  
CCWLE  
2 Lead Wires  
Style: Double Shaft  
Voltage: 24  
Dallas Truck AC: 0217101, 0217173  
Euclid: E803023, E803036  
Kenworth: 557712  
Kysor: 275222  
Northern: BM334815  
Red Dot: 73R4204

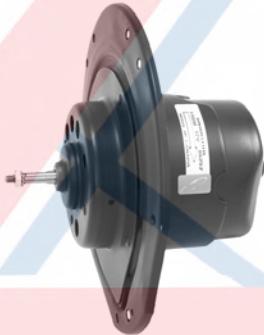

**35550**  
CW  
1 Spade  
Style: Flanged  
Voltage: 12  
International (96-89), (84-81)  
Bergstrom: 203046, 203156, 890063  
Caterpillar: 2328797  
Climatech: HA1245, HA1585, HA1925,  
HA1990, HA2000  
Euclid: E803071, E803101  
Kysor: 1013003, 1099014  
Mack: 4379RD549370, 4379RD588050  
NaviStar: 16096, 1669786C91, 19847



**35551**  
CW/CCW  
2 Lead Wires  
Style: Single Shaft  
Voltage: 12  
Ford (68-67); Mercury (68-67)  
Case New Holland: 130220  
NaviStar: 393347C91, 4266162C1



**35552**  
CW  
2 Lead Wires  
Style: Single Shaft  
Voltage: 24  
Bergstrom: 205630  
Climatech: HA1810  
Dallas Truck AC: 0217504  
Egging: 17334, 17335  
Euclid: E803034  
Kysor: 1072012, 1075012, 275230  
NaviStar: 701014  
Northern: BM334813  
Red Dot: 73R0504, 73R0514, 73R0544



**35553**  
CCWLE  
2 Lead Wires  
Style: Double Shaft  
Voltage: 24  
Dallas Truck AC: 0217105, 0217109,  
0217118  
Kysor: 1099019, 275252  
Northern: BM333833  
Red Dot: 73R4064, 73R4254



**35554**  
CW  
1 Spade  
Style: Flanged  
Voltage: 12  
Jeep (90-87)  
Euclid: E803080, E803102  
NaviStar: 14165, 469455C1, 489455C1  
Red Dot: 73R2232

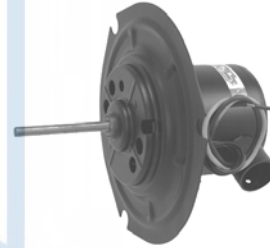









**35555**  
CW  
2 Lead Wires  
Style: Flanged  
Voltage: 12  
Dodge (80-74); Plymouth (80-74)  
Euclid: E803062

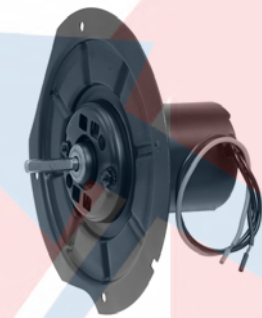
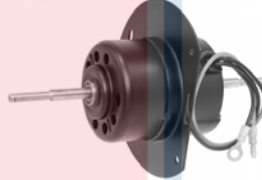
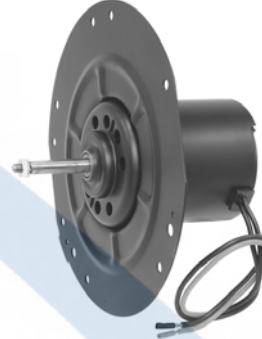

**35556**  
CCW  
2 Lead Wires  
Style: Single Shaft  
Voltage: 12  
Bergstrom: 203067, 203211, 203620  
Caterpillar: 2328776  
Climatech: HA1050, HA1965  
Dallas Truck AC: 0247017  
Deutz: 0034579  
Kysor: 1075035, 274229  
Mack: 4379RD5100720, RD537530  
NaviStar: 11899, 13628, 16298,  
2503278C1, 421843C1, 421843C3,  
488831C1, 488843C91, 498554C92,  
701003, 701021  
Northern: BM334811  
Peterbilt: RD53753  
Red Dot: 73R0972

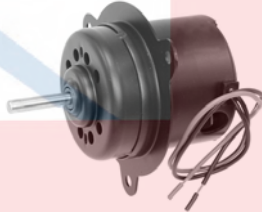
# Blower Motors

Blower Motor & Assembly Cont'd			
 <p><b>35557</b>            CW            2 Lead Wires w/ Connector            Style: Single Shaft            Voltage: 12            AMC: 5047878            ARA: 1120071, 120071            AutoCar: 275140            Dallas Truck AC: 0217002            Evans: AM86502, AM86505            Kenworth: RD537530            Kysor: 1075008, 1099009, 1099024,            274160, 274231, 274265, 275140,            275160            Mack: 275140            Navistar: 11643, 488832C1, 488842C1,            488842C91, 701022            Red Dot: RD55435</p>	 <p><b>35561</b>            CCW            2 Lead Wires w/ Connector            Style: Flanged            Voltage: 12            Mercury (98-93); Nissan (98-93)</p>	 <p><b>35565</b>            CW            2 Lead Wires            Style: Flanged            Voltage: 12            Chrysler (76-75); Dodge (76-71);            Plymouth (76-70)</p>	 <p><b>35568</b>            CW            2 Lead Wires            Style: Flanged            Voltage: 12            Ford (72-67); Lincoln (71-69)            ARA: 1120044            Bergstrom: 203176            Caterpillar: 2328793            Climatech: HA1250, HA1325            Dallas Truck AC: 0217034            Euclid: E803064            Evans: AM86556            Kysor: 1011005, 1011016, 274244            Mack: 4379RD5103880            Navistar: 1676657C1            Red Dot: 73R2152</p>
 <p><b>35559</b>            CW            2 Lead Wires            Style: Single Shaft            Voltage: 12            Jeep (91-85)            Bergstrom: 203095            Climatech: HA1700            Navistar: 11025, 19262, 701009            Red Dot: 73R1002</p>	 <p><b>35562</b>            CCW            2 Lead Wires            Style: Flanged            Voltage: 12            Ford (73-65); Mercury (73-67)</p>	 <p><b>35566</b>            CW            2 Lead Wires, 1 Spade, 1 Circle            Style: Flanged            When replacing a 3-Speed motor.            Switch/Resistor is required:            Voltage: 12            Volvo (93-74)</p>	 <p><b>35570</b>            CW            2 Lead Wires            Style: Flanged            Voltage: 12            Jeep (95-91)</p>
 <p><b>35560</b>            CW/CCW            2 Lead Wires            Style: Single Shaft            Voltage: 12            Chrysler (81-75); Dodge (97-66);            Plymouth (90-71); Renault (83)            Evans: HV86505            Kysor: 1099022, 274270            Navistar: 117283C91, 1669342C1,            1676648C1</p>	 <p><b>35563</b>            CW            2 Lead Wires            Style: Flanged            Voltage: 12            Chrysler (73-65); Dodge (73-65);            Plymouth (73-65)</p>	 <p><b>35567</b>            CW            2 Lead Wires            Style: Flanged            Voltage: 12            Honda (01-97)            Honda: 79310S30A01</p>	



# Blower Motors

## Blower Motor & Assembly Cont'd



**35571**  
CW/CCW  
2 Lead Wires  
Style: Flanged  
Voltage: 12  
Ford (80-89); Lincoln (79-70); Mercury (80-73), (71-69)



**35572**  
CW/CCW  
2 Lead Wires  
Style: Flanged  
Voltage: 12  
Ford (91-72); Lincoln (76-72); Mercury (76-72)  
ARA: 1120045  
Euclid: E803058  
Evans: AM86567, AM86593  
NaviStar: 13729, 1676657C1  
Red Dot: 73R2242



**35576**  
CW/CCW  
2 Lead Wires  
Style: Single Shaft  
Voltage: 12  
Cadillac (65), (56-55); Chevy (66-65), (63-57); Chrysler (58-56); GMC (66-65), (63-60); Mercury (68-67); Olds (63-61); Plymouth (58-56); Pontiac (63-55)  
Audi: ZVW227318  
Volkswagen: ZVW227318  
Allis Chalmers: 1175327, 11753274, 1192657  
AMC: 3145960, 3146672, 4477318, 8111227  
ARA: 111990, 1119900, 1120007, 119900  
Bergstrom: 202270  
Brockway: 20227P, HV23416  
Climatech: HA1575  
Dallas Truck AC: 0217035  
Euclid: E803027  
Evans: AM86536, HV29738, HV29739, HV33106  
Kysor: 1011010, 1075005, 274235, 274281  
NaviStar: 12607  
Northern: BM33822, BM33825

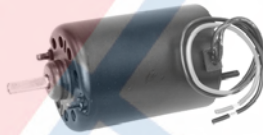

**35577**  
CW/CCW  
2 Lead Wires  
Style: Single Shaft  
Voltage: 12  
Euclid: E803017  
Evans: HV30926  
Hupp: 60663G2  
Mack: RD55634  
Red Dot: 73R0902, 73R0922, RD556341

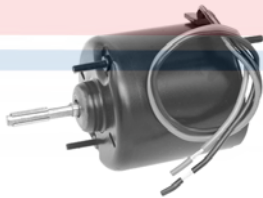

**35578**  
CW/CCW  
2 Lead Wires  
Style: Single Shaft  
Voltage: 32  
Peterbilt: 404255



**35579**  
CW  
2 Lead Wires w/ Connector  
Style: Flanged  
Voltage: 12  
Buick (73); Ford (04-79); Lincoln (98-80); Mercury (04-79)  
General Motors Corp: 19189238  
Euclid: E803063  
Kysor: 1011013, 274285  
NaviStar: 15390  
Red Dot: 73R2112

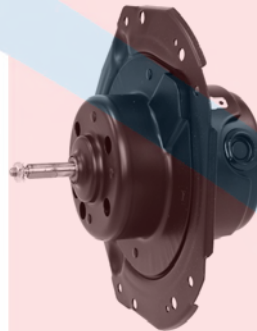

**35582**  
CCW  
1 Spade  
Style: Flanged  
Voltage: 12  
Buick (86-85), (80-78); Cadillac (85); Chevy (95-82), (80-77); GMC (95-82); Olds (85), (80-78); Pontiac (88-84), (80-75)  
General Motors Corp: 88960338  
Bergstrom: 203191  
Climatech: HA1745  
Dallas Truck AC: 0217040  
Euclid: E803078











**35583**  
CCW  
1 Spade  
Style: Flanged  
Voltage: 12  
Euclid: E803103



**35585**  
CW/CCW  
2 Lead Wires  
Style: Flanged  
Voltage: 12  
Jeep (86); Toyota (89), (87-84)  
Toyota: 8710487007  
AMC: 5461581

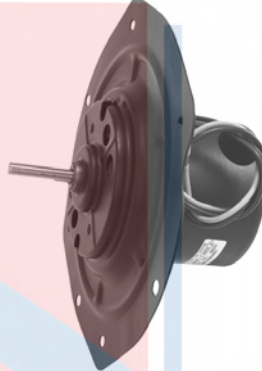

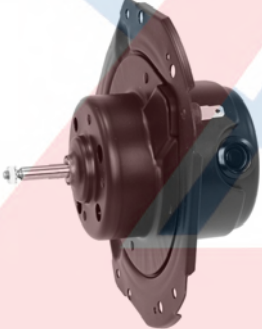
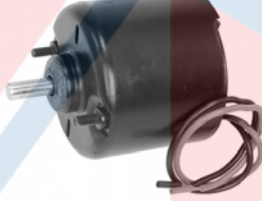
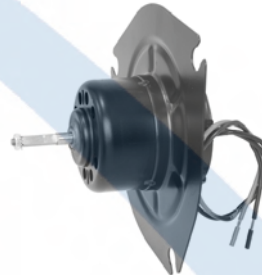
# Blower Motors

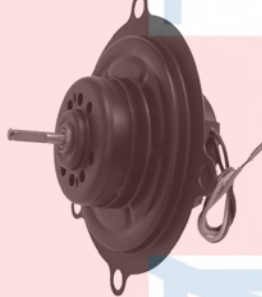
Blower Motor & Assembly Cont'd			
	 <p><b>35590</b> CW 4 Lead Wires, 3 Spade, 1 Circle Style: Double Shaft Voltage: 12 AMC (79-66); Ford (96-67); Mercury (90-71), (68-67) AMC: 8124704 Northern: BM33880</p>	 <p><b>35595</b> CW/CCW 2 Lead Wires Style: Single Shaft Voltage: 12 Kysor: 273910, 273930 Red Dot: 73R0052 Western Star: 600095009</p>	 <p><b>35620</b> CW 3 Lead Wires, 1 Circle - 2 Speed Motor Style: Single Shaft Voltage: 12 AutoCar: 73R0552 Climatech: HA1005 Dallas Truck AC: 0217053 Evans: HV24711 Red Dot: 73R1102</p>
<p><b>35587</b> CW 1 Spade Style: Flanged Vented Motor Voltage: 12 Buick (84-63); Cadillac (77-59); Chevy (90-57); GMC (87-64); Int'l (80-73); Olds (85-64); Pontiac (85-64) AMC: 8122172 ARA: 1120029 Dallas Truck AC: 0217024 Euclid: E803057, E803082 Evans: AM86581 Kysor: 1010007 NaviStar: 16249</p>	 <p><b>35591</b> CW 2 Lead Wires Style: Single Shaft Voltage: 12 Chrysler (95-90), (88); Dodge (95-87); Plymouth (95-88)</p>		 <p><b>35626</b> CCW 2 Lead Wires w/ Connector Style: Flanged Voltage: 12 Nissan (78-73) Nissan: 27070U0100, 27070U1700</p>
	 <p><b>35592</b> CCW 2 Lead Wires Style: Single Shaft Voltage: 12 Jeep (70-66) AMC: 955033, 958732 Kysor: 274253, 275111</p>	<p><b>35596</b> CW/CCW 2 Lead Wires Style: Flanged Voltage: 12 Ford (91-89) Euclid: E803104 Kysor: 1011004 Red Dot: 73R2132</p>	 <p><b>35627</b> CCW 2 Lead Wires Style: Flanged Voltage: 12 Nissan (84-80) Nissan: 27220N8502, 27220W2104</p>
<p><b>35588</b> CW 1 Spade Style: Flanged Voltage: 12 Buick (92-74); Cadillac (90-77); Chevy (96-76); GMC (96-77); GMC &amp; CHEVY (90-85); Olds (96-76); Pontiac (91), (89-66); Volvo (95-84) General Motors Corp: 88890696 ARA: 1120060 Dallas Truck AC: 0217032 Euclid: E803060, E803076, E803098 Evans: AM86551 Kysor: 1010005, 1010016, 1099003, 274243, 274267 NaviStar: 13728, 274243 Red Dot: 73R2052</p>	 <p><b>35593</b> CW/CCW 6 Lead Wires, w/Connectors - 3 Speed Motor Style: Single Shaft Voltage: 12 AMC (87-80); Dodge (80-78); Jeep (95-91), (87-80); Mazda (76), (74-72); Plymouth (81-80) AMC: 8126691, 8127552, 8128125 ARA: 1120104 Dallas Truck AC: 0218005 Euclid: E803046 Hy-Capacity: 0000088123 Northern: BM333835</p>	 <p><b>35615</b> CW/CCW 2 Lead Wires Style: Flanged Voltage: 12 Toyota (97-94) Toyota: 8710328030</p>	

# Blower Motors

## Blower Motor & Assembly Cont'd



**35628**  
CW  
2 Lead Wires  
Style: Flanged  
Voltage: 12  
Nissan (80-79)  
Nissan: 27170P7103

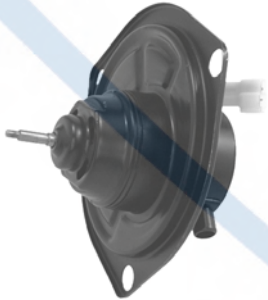

**35630**  
CW/CCW  
2 Lead Wires w/ Connector  
Style: Flanged  
Voltage: 12  
Toyota (85-81)  
Toyota: 8710414100

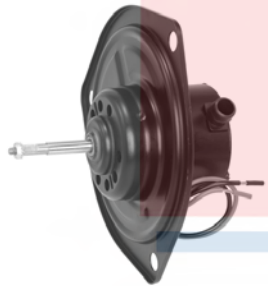

**35631**  
CW/CCW  
2 Lead Wires w/ Connector  
Style: Flanged  
Voltage: 12  
Dodge (86-85); Plymouth (86-85);  
Toyota (86-79)  
Toyota: 8710414090, 8710422110,  
8710432020



**35632**  
CW/CCW  
3 Lead Wires  
Style: Flanged  
Voltage: 12  
Toyota (81-78)  
Toyota: 8710414070



**35634**  
CW/CCW  
2 Lead Wires w/ Connector  
Style: Flanged  
Voltage: 12  
Acura (01-94); Chrysler (08-07);  
Dodge (08-01); Geo (92-89); Honda  
(06-92); Isuzu (99-96); Mercury (74);  
Toyota (92-88)  
General Motors Corp: 19189269  
Toyota: 8710312020

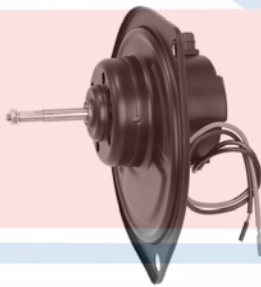

**35638**  
CW/CCW  
2 Lead Wires  
Style: Flanged  
Voltage: 12  
Toyota (90-81)  
Toyota: 8710490A00



**35640**  
CW/CCW  
2 Lead Wires w/ Connector  
Style: Flanged  
Voltage: 12  
Toyota (89-84)  
Toyota: 8710428010

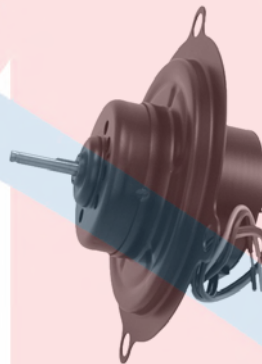

**35647**  
CW/CCW  
2 Lead Wires  
Style: Flanged  
Voltage: 12  
Toyota (93-91)  
Toyota: 8710395D00



**35649**  
CW  
2 Lead Wires  
Style: Flanged  
Voltage: 12  
Nissan (86-80)  
Nissan: 2722003W21

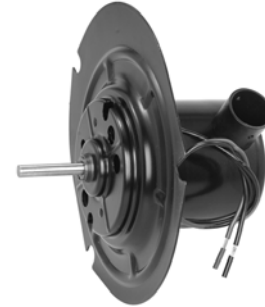

**35650**  
CCW  
2 Lead Wires  
Style: Flanged  
Voltage: 12  
Dodge (78-72)  
Euclid: E803085

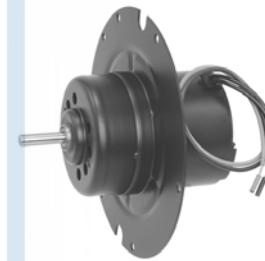

**35671**  
CW  
2 Lead Wires  
Style: Flanged  
Voltage: 12  
Bergstrom: 203181  
Climatech: HA1740  
Dallas Truck AC: 0217044  
Euclid: E803066  
Evans: AM86559, HV33208  
NaviStar: 13839, 16364, 1691720C91  
Peterbilt: HV33208  
Red Dot: 73R2002

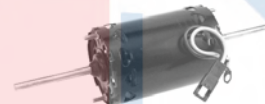







**35672**  
CCWLE  
2 Lead Wires, 1 Spade, 1 Circle  
Style: Double Shaft  
Voltage: 12  
NaviStar: 13501

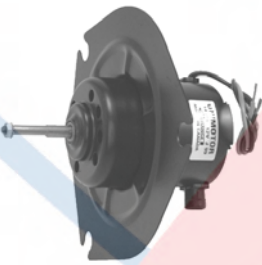
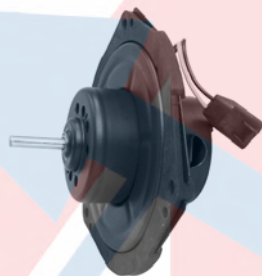
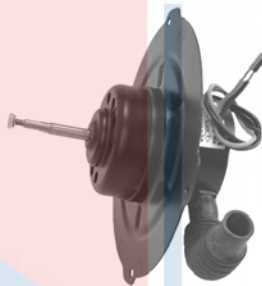

**35674**  
CW/CCW  
2 Lead Wires w/ Spade Terminals  
Style: Double Shaft  
Voltage: 12  
Dallas Truck AC: 0217015, 0217073  
Euclid: E803037  
Kysor: 1012001, 1017002  
NaviStar: 11270, 16278  
Northern: BM3331800  
Red Dot: 73R4302

# Blower Motors

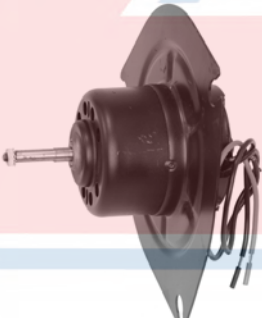
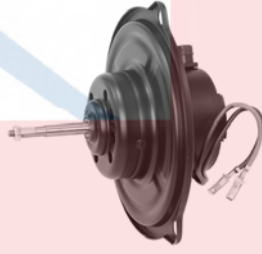
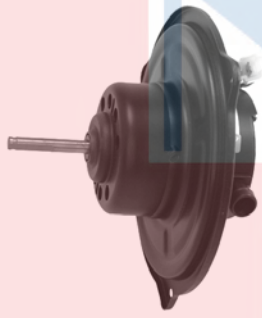
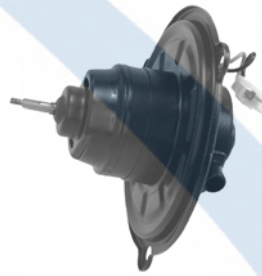
Blower Motor & Assembly Cont'd			
 <p><b>35675</b> CW/CCW 2 Lead Wires w/ Connector Style: Flanged Voltage: 12 Lexus (91-90); Mazda (89-88); Toyota (91-86) Mazda: GJY161B10 Toyota: 8710332030</p>	 <p><b>35680</b> CCW 2 Lead Wires w/ Connector Style: Flanged Voltage: 12 Nissan (89-84) Nissan: 2722001P04, 2722001P12</p>	 <p><b>35683</b> CW/CCW 2 Lead Wires w/ Connector Style: Flanged Voltage: 12 Acura (93-86); Honda (91-88) Acura: 79310SD4013 Honda: 79310SD4013</p>	 <p><b>35686</b> CW/CCW 2 Lead Wires Style: Flanged Voltage: 12 Toyota (87-86) Toyota: 8710420180</p>
 <p><b>35678</b> CCW 2 Lead Wires Style: Flanged Voltage: 12 Nissan (88-84) Nissan: 2722032F00</p>	 <p><b>35681</b> CCW 2 Lead Wires Style: Flanged Voltage: 12 Chevy (02-96); GMC (02-96) Kysor: 1010015</p>	 <p><b>35684</b> CW/CCW 2 Lead Wires Style: Flanged Voltage: 12 Geo (93-90); Isuzu (93-90) Isuzu: 8943805961</p>	 <p><b>35687</b> CW/CCW 2 Lead Wires w/ Connector Style: Flanged Voltage: 12 Chevy (91-89); Geo (94-89); Pontiac (94), (91-89); Suzuki (94-89); Toyota (89-85) General Motors Corp: 19189302 Suzuki: 7425060B11 Toyota: 8710417060</p>
 <p><b>35679</b> CW 2 Lead Wires Style: Flanged Voltage: 12 Nissan (86-83) Nissan: 2722004A01, 27220W1015</p>	 <p><b>35682</b> CW/CCW 2 Lead Wires w/ Connector Style: Flanged Voltage: 12 Honda (91-88)</p>	 <p><b>35685</b> CW/CCW 2 Lead Wires w/ Connector Style: Flanged Voltage: 12 Toyota (89-87) Toyota: 8710332020</p>	 <p><b>35688</b> CW/CCW 2 Lead Wires w/ Connector Style: Flanged Voltage: 12 Toyota (88-85) Toyota: 8710422120, 8710422140, 8710422150</p>



# Blower Motors

## Blower Motor & Assembly Cont'd



**35689**  
CW/CCW  
2 Lead Wires  
Style: Flanged  
Voltage: 12  
Toyota (88-83)  
Toyota: 8710416110

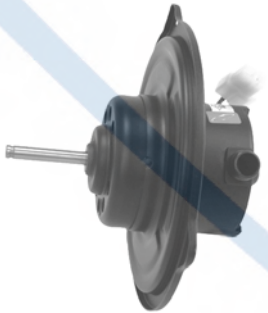

**35690**  
CW/CCW  
2 Lead Wires w/ Connector  
Style: Flanged  
Voltage: 12  
Toyota (90-86)  
Toyota: 8710316020



**75002**  
CW  
4 Lead Wires w/ Connector, 1 Circle  
Style: Double Shaft  
Voltage: 12  
Kysor: 1099077  
NaviStar: 2598644C1



**75005**  
CCWLE  
2 Lead Wires w/ Spade Terminals  
Style: Double Shaft  
Voltage: 12  
Kenworth (07-80)  
Red Dot: 73R4322, RD5100680P



**75011**  
CCWLE  
2 Lead Wires w/ Connector  
Style: Double Shaft  
Voltage: 12  
BMW (06-97); Land Rover (12-03)  
BMW: 64118372493, 64118385558  
Land Rover: JNB000060

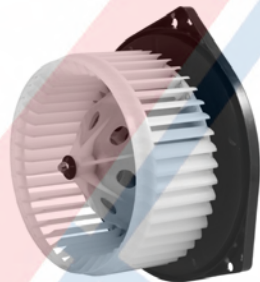

**75012**  
CW  
2 Lead Wires w/ Connector  
Style: Flanged  
Voltage: 12  
Nissan (15-12)  
Nissan: 272201PA0A



**75013**  
CW  
2 Lead Wires w/ Connector  
Style: Flanged  
Voltage: 12  
Nissan (15-12)  
Nissan: 272263AN0A



**75015**  
CCW  
2 Lead Wires w/ Connector  
Style: Flanged  
Voltage: 12  
Land Rover (04-00)



**75016**  
CW  
2 Lead Wires w/ Connector  
Style: Flanged  
Voltage: 12  
Acura (01-94); Honda (06-92)  
Acura: 79310SR3A01  
Honda: 79310SR3A01



**75017**  
CW  
2 Lead Wires w/ Connector  
Style: Flanged  
Voltage: 12  
Honda (01-95)



**75018**  
CCW  
2 Lead Wires w/ Connector  
Style: Flanged  
Voltage: 12  
Land Rover (14-05)



**75019**  
CCW  
2 Lead Wires  
Style: Single Shaft  
Voltage: 12  
Carrier: 540062100, 540065300













**75020**  
CCW  
2 Lead Wires  
Style: Single Shaft  
Voltage: 12  
Carrier: 540062101, 540065301

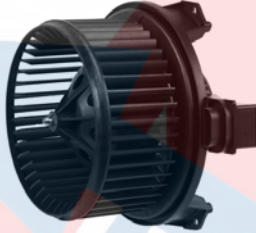
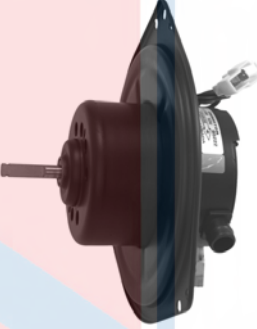

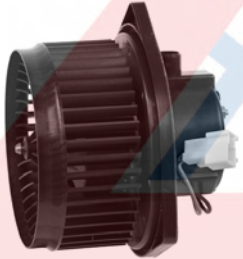
**75021**  
CCW  
2 Lead Wires  
Style: Single Shaft  
Voltage: 12  
Carrier: 540062102, 540065302

# Blower Motors

Blower Motor & Assembly Cont'd			
 <p><b>75022</b> CCW 2 Lead Wires w/ Connector Style: Flanged Voltage: 12 Hyundai (15-13) Hyundai: 971134Z000</p>	 <p><b>75025</b> CCW 3 Spade Terminal Style: Flanged Voltage: 12 Jeep (15-14) Jeep: 68232369AA</p>	 <p><b>75033</b> CCW 2 Lead Wires w/ Connector Style: Flanged Voltage: 12 BMW (08-02) BMW: 64116913401</p>	 <p><b>75705</b> CCW 2 Lead Wires w/ connector Style: Single Shaft Voltage: 12 Lincoln (98)</p>
 <p><b>75023</b> CCW 2 Lead Wires w/ Connector Style: Flanged Voltage: 12 Nissan (15-13) Nissan: 272263LM0A</p>	 <p><b>75026</b> CCW 3 Spade Terminal Style: Flanged Voltage: 12 Dodge (15-14) Chrysler: 68232372AC</p>	 <p><b>75700</b> CW 2 Lead Wires w/ Connector Style: Flanged Voltage: 12 Mitsubishi (07-02) Mitsubishi: MR996982</p>	 <p><b>75706</b> CCW 2 Lead Wires Style: Double Shaft Voltage: 12 Acura (98-95) Acura: 79310SW5A01</p>
 <p><b>75024</b> CCW 2 Lead Wires w/ Connector Style: Flanged Voltage: 12 Infiniti (04-00); Nissan (03-02), (00) Nissan: 272202Y910</p>	 <p><b>75027</b> CW 2 Lead Wires w/ Connector Style: Single Shaft Voltage: 12 BMW (15-10) BMW: 64119242607</p>	 <p><b>75701</b> CCW 2 Lead Wires w/ connector Style: Flanged Voltage: 12 Nissan (06-01) Nissan: 272205M000</p>	 <p><b>75707</b> CW 2 Lead Wires Style: Double Shaft Voltage: 12 Acura (95-91) Acura: 79310SP0003</p>

# Blower Motors

## Blower Motor & Assembly Cont'd



**75710**  
CW  
2 Lead Wires  
Style: Flanged  
Voltage: 12  
Mercury (94-91); Nissan (82-79),  
(73-68)



**75712**  
CW  
2 Terminal Connector  
Style: Flanged  
Voltage: 12  
Jeep (01-97)  
Jeep: 4886150AA



**75713**  
CCW  
4 Pin Plug  
Style: Flanged  
Voltage: 12  
Chrysler (00-96); Dodge (00-96);  
Plymouth (00-96)  
Chrysler: 4798680



**75714**  
CW  
2 Terminal Connector  
Style: Flanged  
Voltage: 12  
VW (03-90)  
Volkswagen: 357820021



**75735**  
CCW  
2 Terminal Connector  
Style: Flanged  
Voltage: 12  
Acura (12-04); Honda (14-03)  
Acura: 79310SJAA02  
Honda: 79310SJCA03



**75736**  
CCW  
2 Terminal Connector  
Style: Flanged  
Voltage: 12  
Honda (11-01); Mitsubishi (05-04);  
Suzuki (07-02)  
Honda: 79310S7AG12, 79310SCVA01  
Mitsubishi: MR958965  
Suzuki: 7425054G10



**75737**  
CCW  
2 Terminal Connector  
Style: Flanged  
Voltage: 12  
Lexus (07-03); Toyota (09-03)  
Toyota: 8710335060



**75738**  
CCW  
2 Terminal Connector  
Style: Flanged  
Voltage: 12  
Lexus (09-98); Toyota (07-01)  
Toyota: 8710348020



**75739**  
CW  
2 Lead Wires w/ Connector  
Style: Flanged  
Voltage: 12  
Chrysler (08-96); Dodge (07-96);  
Plymouth (00-96)  
Chrysler: 4874204AB, 4885475AC





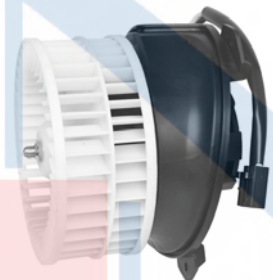









**75740**  
CW  
2 Lead Wires w/ Connector  
Style: Flanged  
Voltage: 12  
Dodge (04-01)  
Chrysler: 4885669AC



**75741**  
CCW  
2 Lead Wires w/ connector  
Style: Flanged  
Voltage: 12  
Chrysler (04-99); Dodge (04-99)  
Chrysler: 4596217, 4885148AC



# Blower Motors

Blower Motor & Assembly Cont'd			
 <p><b>75742</b> CW 2 Lead Wires w/ connector Style: Flanged Voltage: 12 Chrysler (05-01)</p>	 <p><b>75748</b> CW 2 Lead Wires w/ Connector Style: Flanged Voltage: 12 Cadillac (09-03); Chevy (09-03); GMC (09-03) General Motors Corp: 19153680, 89019320</p>	 <p><b>75754</b> CCW 2 Terminal Connector Style: Flanged Voltage: 12 Ford (13-00); Jaguar (08-02) Ford: 2T1Z18568A</p>	 <p><b>75763</b> CW 2 Terminal Connector Style: Flanged Voltage: 12 Chevy (05-94); GMC (05-94); Isuzu (00-96) General Motors Corp: 89019300</p>
 <p><b>75743</b> CCW 2 Terminal Connector Style: Flanged Voltage: 12 Dodge (09-02); Dodge Medium Duty Truck (10-09); Jeep (04-02) Chrysler: 5096255AA</p>	 <p><b>75749</b> CCW 3 Lead Wires w/ Connector Style: Flanged Voltage: 12 Buick (05-00); Cadillac (05-98); Olds (03-01); Pontiac (05-00) General Motors Corp: 19153333, 19213206</p>	 <p><b>75755</b> CW 2 Lead Wires w/ connector Style: Flanged Voltage: 12 Cadillac (00); Chevy (02-00); GMC (02-00) General Motors Corp: 52401826</p>	 <p><b>75764</b> CCW 2 Lead Wires w/ connector Style: Flanged Voltage: 12 Cadillac (07-03)</p>
 <p><b>75744</b> CW 2 Lead Wires w/ Connector Style: Flanged Original blower motor cover will not be used with replacement motor Voltage: 12 Chevy (12-04); GMC (12-04); Isuzu (08-06) General Motors Corp: 89019086, 89019178</p>	 <p><b>75753</b> CCW 2 Terminal Connector Style: Flanged Voltage: 12 Buick (09-05); Chevy (14-04); Pontiac (08-04) General Motors Corp: 22792042</p>	 <p><b>75759</b> CCW 2 Terminal Connector Style: Flanged Voltage: 12 Acura (08-04); Honda (07-03) Honda: 79310SDNA01</p>	 <p><b>75770</b> CW 2 Lead Wires w/ Connector Style: Flanged Voltage: 12 Dodge (09-07); Jeep (09-07) Chrysler: 68003996AA Jeep: 68003996AA</p>

# Blower Motors

## Blower Motor & Assembly Cont'd



**75771**  
CCW  
2 Lead Wires w/ Connector  
Style: Flanged  
Voltage: 12  
Chevy (11-04); Pontiac (10-05)  
General Motors Corp: 95978693



**75772**  
CCW  
2 Lead Wires w/ Connector  
Style: Flanged  
Voltage: 12  
Chrysler (06-01); Dodge (06-01)  
Chrysler: 68000497AA

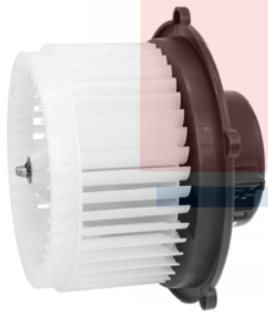

**75773**  
CCW  
2 Terminal Connector  
Style: Flanged  
Voltage: 12  
Chevy (08-04)  
General Motors Corp: 15929377



**75774**  
CCW  
2 Terminal Connector  
Style: Flanged  
Voltage: 12  
Toyota (09-01)  
Toyota: 8710347050

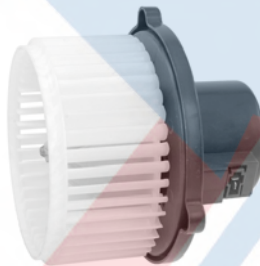

**75775**  
CCW  
2 Lead Wires w/ Connector  
Style: Flanged  
Voltage: 12  
Kia (09-04)  
Kia: 971132F000



**75777**  
CCW  
2 Lead Wires w/ Connector  
Style: Flanged  
Voltage: 12  
Chevy (12-09); Pontiac (10-05); Saturn (09-07)  
General Motors Corp: 15863480



**75778**  
CCW  
2 Lead Wires w/ connector  
Style: Flanged  
Voltage: 12  
Chevy (11-05); Pontiac (09-05); Saturn (07-03)  
General Motors Corp: 25776197



**75779**  
CW  
2 Lead Wires w/ connector  
Style: Single Shaft  
Voltage: 12

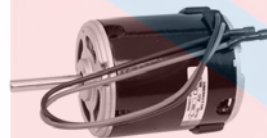

**75780**  
CW  
2 Lead Wires  
Style: Single Shaft  
Voltage: 12  
Kenworth: 274265  
Kysor: 1099007  
Red Dot: 73R0422



**75781**  
CW/CCW  
2 Lead Wires  
Style: Single Shaft  
Voltage: 12  
Mack: 4379RD537530  
Red Dot: 73R0452



**75782**  
CCWLE  
2 Lead Wires w/ connector  
Style: Double Shaft  
Voltage: 24  
Red Dot: 73R4274



**75783**  
CCW  
2 Lead Wires w/ connector  
Style: Single Shaft  
Voltage: 12



**75784**  
CCW  
2 Lead Wires w/ connector  
Style: Single Shaft  
Voltage: 12  
Bergstrom: 203133  
Climatech: HA1035, HA1040, HA1060  
Mack: 3230224765, 34868090300019, 4379RD565261



**75785**  
CW  
2 Lead Wires w/ Connector  
Style: Single Shaft  
Voltage: 12  
Bergstrom: 203166  
Kysor: 1015006  
Mack: 4379RD110870, 4379RD5103370  
TRP Parts: HA23400

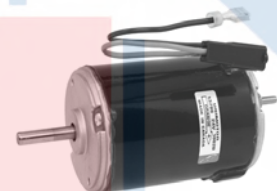

**75786**  
CW  
2 Lead Wires w/ Connector  
Style: Single Shaft  
Voltage: 24  
Climatech: HA1795  
Mack: 4379RD5512024, 4379RD5712924  
Peterbilt: 301071BSM  
Red Dot: RD5512024, RD5712924P

# Blower Motors

## Blower Motor & Assembly Cont'd

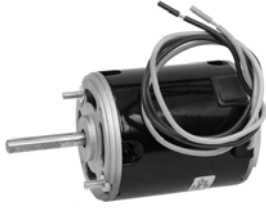

**75787**  
CCW  
2 Lead Wires w/ Connector  
Style: Single Shaft  
Voltage: 12  
Freightliner (97-89), (83-78); Mack (98-86); Volvo HD (88-84)  
Red Dot: 73R0322, RD565310, RD565310P



**75788**  
CCW  
2 Lead Wires w/ Connector  
Style: Flanged  
Voltage: 12  
Chevy (14-96); GMC (14-97); GMC & CHEVY (14-03)  
General Motors Corp: 89019113



**75789**  
CCW  
2 Lead Wires w/ Connector  
Style: Flanged  
Voltage: 12  
Cadillac (15-03); Chevy (15-08), (06-00); GMC (15-08), (06-00)  
General Motors Corp: 25783777



**75790**  
CW  
2 Lead Wires w/ Connector  
Style: Single Shaft  
Voltage: 12  
Mack: 4379RD551200  
Red Dot: 73R0512, RD551200P



**75791**  
CW  
2 Lead Wires w/ Connector  
Style: Single Shaft  
Voltage: 24  
Caterpillar: 1741495



**75792**  
CW  
2 Lead Wires w/ Connector  
Style: Single Shaft  
Voltage: 12  
Bergstrom: 203183  
Kenworth: 203115BSM, 203236BSM  
Kysor: 1012002, 1014005  
Mack: 2790275140  
Red Dot: 73R0232, RD5103920P  
TRP Parts: HA16050



**75793**  
CW  
2 Lead Wires w/ connector  
Style: Single Shaft  
Voltage: 12



**75794**  
CCW  
2 Lead Wires w/ connector  
Style: Single Shaft  
Voltage: 12  
Case New Holland: 1974779C1  
NaviStar: 1974779C1  
Red Dot: RD551210



**75795**  
CCW  
2 Terminal Connector  
Style: Flanged  
Voltage: 12  
Chrysler (07-05); Dodge (07-05)



**75796**  
CW  
2 Terminal Connector  
Style: Flanged  
Voltage: 12  
Mazda (10-04)  
Mazda: BP4K61B10

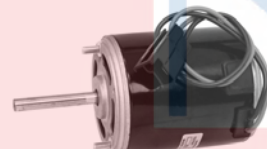

**75797**  
CW  
2 Lead Wires w/ Connector  
Style: Single Shaft  
Voltage: 12  
Bergstrom: 203167, 203204, 890050, 890068  
Caterpillar: 2328747  
Climatech: HA1825  
Mack: 4379RD582120  
Red Dot: RD582120



**75798**  
CW  
2 Lead Wires  
Style: Single Shaft  
Voltage: 24  
Mack: 4379RD5369024  
Red Dot: R5369024P



**75799**  
CCWLE  
2 Lead Wires w/ connector  
Style: Double Shaft  
Voltage: 12  
Climatech: HA1905  
Kenworth: 203076, 205840  
Mack: 4379RD550491  
Peterbilt: 205840  
Red Dot: 4379RD550491, 73R4422, RD550491P



**75800**  
CCW  
2 Lead Wires w/ connector  
Style: Flanged  
Voltage: 12  
Ford (09-06); Lincoln (09-06); Mercury (09-06)  
Ford: 8E5Z19805C



**75801**  
CW  
3 Lead Wires  
Style: Single Shaft  
Voltage: 12  
Caterpillar: 0539296  
Mack: 4379RD31334  
Red Dot: 4379RD5103790, 73R0032



# Blower Motors

## Blower Motor & Assembly Cont'd



**75802**  
CW  
2 Lead Wires  
Style: Single Shaft  
Voltage: 12  
Red Dot: 73R0552, RD310612P  
Western Star: 027008314



**75803**  
CCW  
2 Lead Wires w/ connector  
Style: Flanged  
Voltage: 12  
Bergstrom: 203113  
Kysor: 1013005  
NaviStar: 1699949C1



**75804**  
CCW  
2 Lead Wires w/ connector  
Style: Single Shaft  
Voltage: 12  
Honda (08-05); Subaru (09-05);  
Toyota (05-04)  
Subaru: 72223AG01A  
Toyota: 8710342060



**75805**  
CCW  
2 Lead Wires w/ Connector  
Style: Flanged  
Voltage: 12  
Hyundai (13-03); Kia (14), (12-06)  
Hyundai: 971121C000, 971131E000,  
971132E060, 971132L000, 971144D00  
Kia: 971132G000, 971144D000

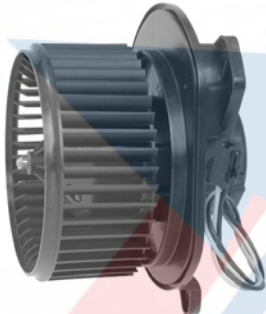

**75806**  
CCW  
2 Lead Wires w/ Connector  
Style: Flanged  
Voltage: 12  
Jeep (10-05)  
Jeep: 5143099AA

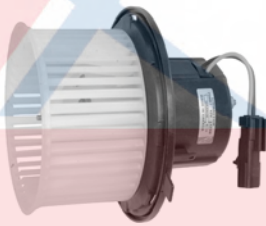

**75807**  
CW  
2 Lead Wires w/ Connector  
Style: Flanged  
Voltage: 12  
Jeep (06-02)  
Jeep: 68028890AA



**75808**  
CCWLE  
2 Lead Wires w/ Connector  
Style: Double Shaft  
Voltage: 12  
BMW (08-00)  
BMW: 64119204154



**75809**  
CCW  
2 Lead Wires w/ Connector  
Style: Flanged  
Voltage: 12  
Acura (06-05); Cadillac (14-07); Honda  
(08-05); Lexus (09-07); Toyota (10-06)  
General Motors Corp: 19130001  
Honda: 79310S3VA01  
Toyota: 8710308080, 8710308090



**75810**  
CCW  
2 Terminal Connector  
Style: Flanged  
Voltage: 12  
Audi (06-00); Porsche (13-97); VW  
(10-98)  
Porsche: 99662410701  
Volkswagen: 1J1819021C



**75814**  
CCW  
2 Lead Wires w/ Connector  
Style: Single Shaft  
Voltage: 12  
Nissan (07-02)



**75816**  
CCW  
2 Lead Wires w/ Connector  
Style: Flanged  
Voltage: 12  
Ford (09-05)  
Ford: 4R3Z19805AA, 5R3Z19805A

# Blower Motors

## Blower Motor & Assembly Cont'd



### 75817

CCW  
2 Terminal Connector  
Style: Flanged  
Voltage: 12  
Acura (15-07); Buick (11-06); Cadillac (11-06); Chrysler (14-07); Dodge (14-07); Dodge Medium Duty Truck (15-11); Ford (14-07); Honda (15-07); Jaguar (15-09); Jeep (15-07); Lincoln (14-07)  
Mazda (14-07); Subaru (14-06); Toyota (14-07)  
Acura: 79310STKA41, 79310STXA01, 79310TK4A41, 79310TZ3A41  
Chrysler: 5191345AA, 68048905AB  
Ford: 7T4Z19805A  
General Motors Corp: 25770668  
Honda: 79310STXA01, 79310TK4A41  
Jaguar: C2Z6519  
Jeep: 5191345AA  
Mazda: TD1161B10  
Subaru: 72223XA00A  
Toyota: 8710335100



### 75818

CCW  
2 Terminal Connector  
Style: Flanged  
Voltage: 12  
Ford (10-02); Lincoln (05-03); Mercury (10-02)  
Ford: 1L2Z19805EB, 8L2Z19805A



### 75819

CW  
2 Lead Wires w/ Connector  
Style: Flanged  
Voltage: 12  
Dodge (11-05); Mitsubishi (10-06)  
Chrysler: 5161007AB

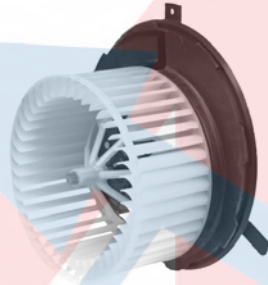

### 75820

CW  
2 Terminal Connector  
Style: Flanged  
Voltage: 12  
Audi (10-06); VW (14-05)  
Volkswagen: 1K1819015E, 5C1819015

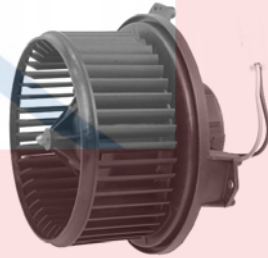

### 75821

CCW  
2 Lead Wires w/ Connector  
Style: Flanged  
Voltage: 12  
Honda (11-06); Jeep (10-07)  
Chrysler: 68004195AA  
Honda: 80030SNA305  
Jeep: 68004195AA



### 75822

CCW  
2 Terminal Connector  
Style: Flanged  
Voltage: 12  
Audi (02-97); VW (05-98)  
Audi: 8D1820021C  
Volkswagen: 8D1820021C

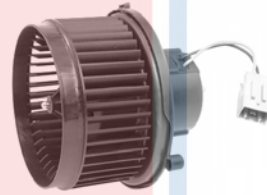

### 75823

CCW  
2 Lead Wires w/ Connector  
Style: Flanged  
Voltage: 12  
Chevy (15-06); GMC (15-10); Pontiac (09-06); Saturn (10-08); Suzuki (09-07)  
General Motors Corp: 22896430



### 75825

CW  
2 Lead Wires w/ Connector  
Style: Single Shaft  
Voltage: 12  
Kysor: 1017004, 1019001  
Mack: 4379RD5103360  
NaviStar: ZGG701017  
Red Dot: 73R0042, RD5103360P  
TRP Parts: HA18250



### 75826

CW  
2 Lead Wires w/ Connector  
Style: Flanged  
Voltage: 12  
Freightliner (09-02)  
Bergstrom: 301527, 869701  
Caterpillar: 2328803  
Climatech: HA2170  
Kysor: 1099064  
Mack: 4379RD5103930, 4379RD5114880  
Red Dot: 73R3052, RD5105020P, RD5114880P  
TRP Parts: HA21700



### 75827

CW  
6 Terminal Connector  
Style: Flanged  
Voltage: 12  
Bergstrom: 203368  
Case New Holland: 86983967  
Climatech: HA2385  
Kysor: 1012016  
Red Dot: 73R3122  
TRP Parts: HA23850



### 75828

CCWLE  
2 Lead Wires w/ Connector  
Style: Double Shaft  
Voltage: 12  
Bergstrom: 203356  
Climatech: HA2365  
Kysor: 1018006  
Mack: BOA8041500769  
Red Dot: 73R5652

# Blower Motors

## Blower Motor & Assembly Cont'd



**75829**  
CCWLE  
2 Lead Wires  
Style: Double Shaft  
Voltage: 12  
Kenworth: 203080  
Kysor: 1017005, 1099020, 1099047  
Peterbilt: 203080BSM, P93CAA030101S  
Red Dot: 73R4182, RD568010  
TRP Parts: HB16100

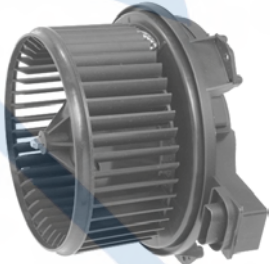

**75830**  
CCW  
3 Spade Terminal  
Style: Flanged  
Voltage: 12  
Lexus (15-05); Toyota (14-05)  
Lexus: 871030E040, 8710330451,  
8710360400  
Toyota: 871030C040, 871030E040,  
8710333090, 8710360400, 871300707  
8713028580



**75832**  
CW  
2 Lead Wires w/ Connector  
Style: Flanged  
Voltage: 12  
Kia (05-02)  
Kia: 1K55261C07C



**75833**  
CCW  
2 Lead Wires w/ Connector  
Style: Flanged  
Voltage: 12  
Kia (15-10), (06-03)  
Kia: 971093E400, 971132K000,  
97113B2000



**75834**  
CW  
2 Lead Wires w/ Connector  
Style: Flanged  
Voltage: 12  
Toyota (10-06)  
Toyota: 8710308070

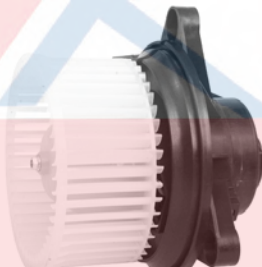

**75835**  
CCW  
2 Terminal Connector  
Style: Flanged  
Voltage: 12  
Chrysler (10-07); Dodge (09-04)  
Chrysler: 5061381AA



**75836**  
CW  
2 Terminal Connector  
Style: Flanged  
Voltage: 12  
Kia (97-95)  
Kia: 0K01A61B10

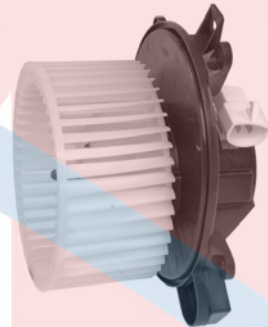

**75837**  
CW  
2 Lead Wires w/ Connector  
Style: Flanged  
Voltage: 12  
Mazda (06-03)  
Mazda: GKKT61B10



**75838**  
CCW  
2 Terminal Connector  
Style: Flanged  
Voltage: 12  
Saturn (05-00)  
Saturn: 22683022



**75839**  
CCW  
3 Spade Terminal  
Style: Flanged  
Voltage: 12  
Toyota (15-06)  
Toyota: 8710302210, 871030R010,  
8710342101, 8710347041



**75840**  
CCW  
2 Lead Wires w/ Connector  
Style: Flanged  
Voltage: 12  
Pontiac (10-09); Scion (14-08); Toyota  
(15-06)  
General Motors Corp: 19184660,  
19184662  
Toyota: 8710302200



**75841**  
CCW  
2 Lead Wires w/ Connector  
Style: Flanged  
Voltage: 12  
Scion (14-08); Toyota (12-07)  
Toyota: 8710352141



# Blower Motors

## Blower Motor & Assembly Cont'd



**75842**  
CCW  
2 Lead Wires w/ Connector  
Style: Flanged  
Voltage: 12  
Chrysler (15-08); Dodge (15-08); VW (14-09)  
Chrysler: 68029719AB, 68037308AA, 68238029AA



**75843**  
CW  
2 Lead Wires w/ Connector  
Style: Flanged  
Voltage: 12  
Cadillac (14-10); Chevy (14-10); GMC (14-10)  
General Motors Corp: 20883404, 22741027, 22741028

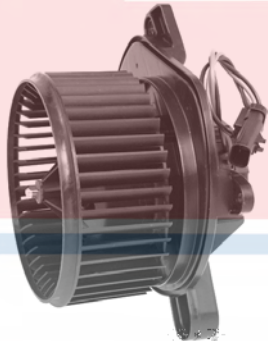

**75844**  
CCW  
2 Lead Wires w/ Connector  
Style: Flanged  
Voltage: 12  
Chrysler (10-06)  
Chrysler: 5179476AA



**75845**  
CCW  
2 Lead Wires w/ Connector  
Style: Flanged  
Voltage: 12  
Ford (11-08)  
Ford: 9S4Z19805B

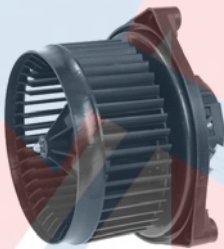

**75846**  
CCW  
2 Lead Wires w/ Connector  
Style: Flanged  
Voltage: 12  
Toyota (14-05)  
Toyota: 8710304044



**75847**  
CCW  
2 Terminal Connector  
Style: Flanged  
Voltage: 12  
Acura (06-02); Honda (08-03)  
Acura: 79310S2K003  
Honda: 79310S2K003



**75848**  
CCW  
2 Lead Wires w/ Connector  
Style: Flanged  
Voltage: 12  
Mitsubishi (14-07)  
Mitsubishi: 7802A217, 7802A218

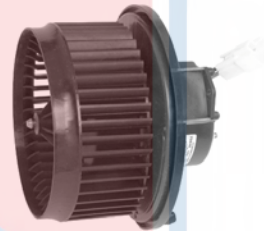

**75849**  
CCW  
2 Lead Wires w/ Connector  
Style: Flanged  
Voltage: 12  
Honda (15-10)  
Honda: 79310TJ5F02

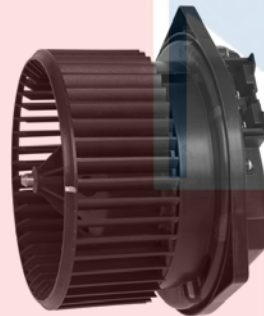

**75850**  
CCW  
2 Terminal Connector  
Style: Flanged  
Voltage: 12  
Infiniti (15-02); Nissan (15-03)  
Infiniti: 272251EA0A, 27225JK61A  
Nissan: 272251EA0A, 27225JK61A



**75851**  
CCW  
2 Lead Wires w/ Connector  
Style: Flanged  
Voltage: 12  
Cadillac (07-03); Lexus (06-04); Toyota (08-02)  
General Motors Corp: 25740408  
Lexus: 871030E010  
Toyota: 8710306031, 8710306041



**75852**  
CW  
2 Lead Wires w/ Connector  
Style: Flanged  
Voltage: 12  
Ford (11-05); Mercury (11-05)  
Ford: 4W7Z19805AA



**75853**  
CCW  
6 Terminal Connector  
Style: Flanged  
Voltage: 12  
Audi (02-97); VW (05-98)  
Audi: 8D1820021B  
Volkswagen: 8D1820021B

# Blower Motors

## Blower Motor & Assembly Cont'd



**75854**  
CW  
2 Lead Wires w/ Connector  
Style: Flanged  
Voltage: 12  
Ford (12-08); Mazda (11-08); Mercury (11-08)  
Ford: 7C3Z19805B, 8L8Z19805C  
Mazda: ZZD076453



**75855**  
CCW  
2 Lead Wires w/ Connector  
Style: Flanged  
Voltage: 12  
Ford (11-08); Lincoln (11-09); Mercury (09-08)  
Ford: 8G1Z19805BB, AE9Z19805B

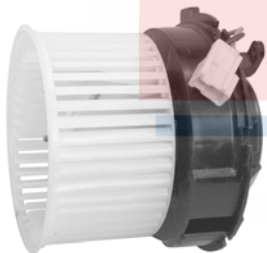

**75856**  
CW  
2 Lead Wires w/ Connector  
Style: Flanged  
Voltage: 12  
Nissan (15-07)  
Nissan: 27225ET00A, 27225ET10A, 27225JM01B



**75857**  
CW  
2 Lead Wires w/ Connector  
Style: Flanged  
Voltage: 12  
Kysor: 1013008  
NaviStar: 3542611C2  
Red Dot: 73R3132  
TRP Parts: HA17050

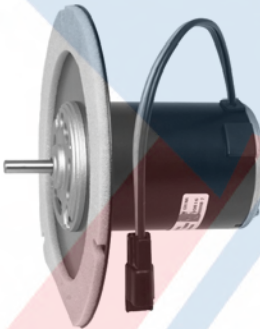

**75858**  
CW  
2 Lead Wires w/ Connector  
Style: Flanged  
Voltage: 12  
Red Dot: 73R3142

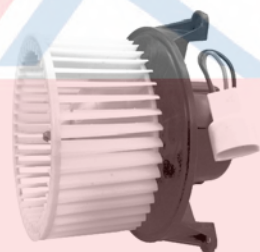

**75859**  
CW  
2 Lead Wires w/ Connector  
Style: Flanged  
Voltage: 12  
Ford (08-03); Lincoln (08-03); Mercury (07-04)



**75860**  
CW  
2 Lead Wires w/ Connector  
Style: Flanged  
Voltage: 12  
Dodge (11-10); Jeep (12-10)  
Chrysler: 68038826AB  
Jeep: 68038826AB

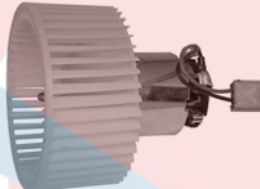

**75861**  
CW  
2 Lead Wires w/ Connector  
Style: Single Shaft  
Voltage: 12  
Volvo (14-99)  
Volvo: 31320393



**75862**  
CCW  
2 Terminal Connector  
Style: Flanged  
Voltage: 12  
Volvo (04-98)  
Volvo: 30755485



**75863**  
CCW  
2 Terminal Connector  
Style: Flanged  
Voltage: 12  
Volvo (97-93)



**75864**  
CW  
2 Lead Wires w/ Connector and Jumper Harness  
Style: Flanged  
Voltage: 12  
Mercedes (03-95)  
Mercedes Benz: 2108205242, 2108206842



**75865**  
CCW  
2 Lead Wires w/ Connector  
Style: Flanged  
Voltage: 12  
Buick (14-08); Chevy (14-07); GMC (14-07); Saturn (10-07)  
General Motors Corp: 20911076, 22961461  
Saturn: 20826649, 20907444

# Blower Motors

## Blower Motor & Assembly Cont'd



**75866**  
CCW  
2 Lead Wires w/ Connector  
Style: Single Shaft  
Voltage: 12  
Pontiac (09-06); Saturn (10-07)  
General Motors Corp: 10397097  
Saturn: 10397097

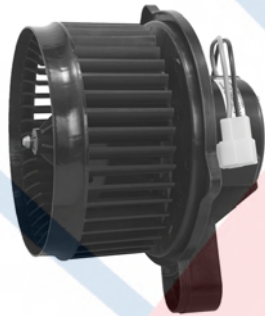

**75867**  
CCW  
2 Lead Wires w/ Connector  
Style: Flanged  
Voltage: 12  
Hyundai (15-07); Kia (14-11), (09-07)  
Hyundai: 971131U000, 971132B000,  
971132B005, 971132H000,  
971132Y000, 971133M000,  
971133X000  
Kia: 971123F100, 971131U000,  
971132Y000, 971133X000

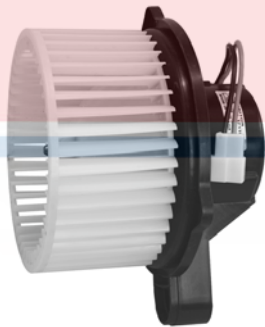

**75868**  
CW  
2 Lead Wires w/ Connector  
Style: Flanged  
Voltage: 12  
Kia (09-07)  
Kia: 971093E260



**75869**  
CW  
2 Lead Wires w/ Connector  
Style: Flanged  
Voltage: 12  
Ford (14-10); Lincoln (14-10)  
Ford: AE9Z19805D

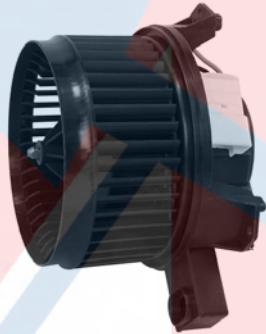

**75870**  
CCW  
2 Lead Wires w/ Connector  
Style: Flanged  
Voltage: 12  
Ford (14-10)  
Ford: AR3Z19805B



**75871**  
CW  
2 Lead Wires w/ Connector  
Style: Flanged  
Voltage: 12  
Mazda (08-07)  
Mazda: GK3J61B10C



**75872**  
CCW  
2 Lead Wires w/ Connector  
Style: Flanged  
Voltage: 12  
Hyundai (09-05); Kia (10-05)  
Hyundai: 971132E300  
Kia: 971132E300



**75873**  
CW  
2 Lead Wires w/ Connector  
Style: Flanged  
Voltage: 12  
Ford (14-09); Lincoln (14-09)  
Ford: AL1Z19805A, CL1Z19805A



**75874**  
CCW  
2 Lead Wires w/ Connector  
Style: Flanged  
Voltage: 12  
Ford (14-10); Lincoln (14-10); Mercury  
(11-10)  
Ford: AE5Z19805D



**75875**  
CCW  
2 Lead Wires w/ Connector  
Style: Flanged  
Voltage: 12  
Hyundai (15-10); Kia (14-06)  
Hyundai: 971111R000, 971112V000,  
971132M000, 971132P000,  
971144D050  
Kia: 971131D000, 971131G000,  
971132P000, 971144D050



**75876**  
CCW  
2 Lead Wires w/ Connector  
Style: Flanged  
Voltage: 12  
Cadillac (12-10); Chevy (14-10); GMC  
(14-10)  
General Motors Corp: 22803996,  
22816162



**75877**  
CCW  
2 Terminal Connector  
Style: Flanged  
Voltage: 12  
Suzuki (08-04)  
Suzuki: 7425085Z00



# Blower Motors

## Blower Motor & Assembly Cont'd



**75878**  
CCW  
2 Lead Wires w/ Connector  
Style: Flanged  
Voltage: 12  
Honda (13-09)  
Honda: 79310TF0G01



**75879**  
CCW  
2 Lead Wires w/ Connector  
Style: Flanged  
Voltage: 12  
Nissan (12-07)  
Nissan: 27226EE91B, 27226EE91C



**75880**  
CCW  
2 Lead Wires w/ Connector  
Style: Flanged  
Voltage: 12  
Land Rover (00-94); Lexus (08-92);  
Toyota (07-96), (93-90)  
Lexus: 8710333050, 8710333081,  
8710348040, 8710350030, 871036025  
8710524020  
Toyota: 8710333031, 8710335022,  
8710344020, 8710360250



**75881**  
CCW  
2 Lead Wires w/ Connector  
Style: Flanged  
Voltage: 12  
Subaru (14-00)  
Subaru: 72223SA030, 72240FC010

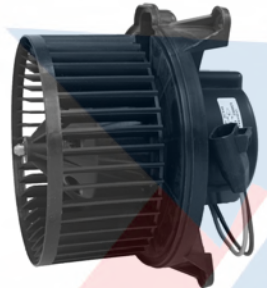

**75882**  
CCW  
2 Lead Wires w/ Connector  
Style: Flanged  
Voltage: 12  
Nissan (15-05)  
Nissan: 27226EA000, 27226EA010

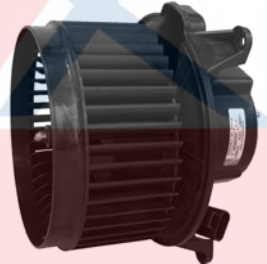

**75883**  
CCW  
2 Lead Wires w/ Connector  
Style: Flanged  
Voltage: 12  
Infiniti (10-04); Nissan (15-04)  
Nissan: 27226ZH00A



**75884**  
CCW  
2 Lead Wires w/ Connector  
Style: Flanged  
Voltage: 12  
Mitsubishi (12-06)  
Mitsubishi: 7801A115, 7802A026

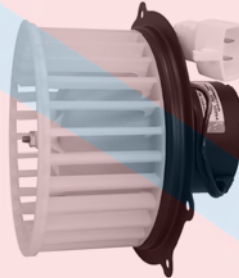

**75885**  
CW  
2 Lead Wires w/ Connector  
Style: Flanged  
Voltage: 12  
Ford (04-94)



**75886**  
CW  
2 Lead Wires w/ connector  
Style: Flanged  
Voltage: 12  
Cadillac (07-03); Chevy (07-03); GMC  
(07-03)  
General Motors Corp: 88986838



**75887**  
CCW  
2 Lead Wires w/ Connector  
Style: Flanged  
Voltage: 12  
Ford (07-00); Jaguar (04-00); Lincoln  
(06-00); Mazda (06-01); Mercury  
(07-01), (99); Nissan (02-99)  
Ford: 1L2Z19805FA, 5L8Z19805AA,  
YL8Z19805DA















**75888**  
CW  
2 Lead Wires w/ Connector  
Style: Flanged  
Voltage: 12  
Dodge (02-94); Jeep (98-93)  
Chrysler: 5015866AA  
Jeep: 4778417

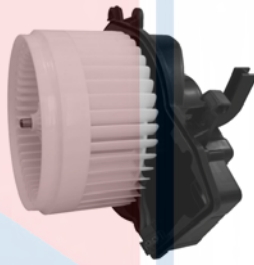

**75889**  
CW  
2 Lead Wires w/ Connector  
Style: Flanged  
Voltage: 12  
Ford (07-01); Mercury (05-01)  
Ford: 1F1Z19805AA

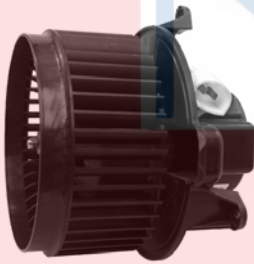
# Blower Motors

Blower Motor & Assembly Cont'd			
 <p><b>75890</b> CW 2 Lead Wires w/ Connector Style: Flanged Voltage: 12 Ford (14-97)</p>	 <p><b>75894</b> CW 2 Lead Wires w/ Connector Style: Flanged Voltage: 12 Ford (08-07); Lincoln (08-07) Ford: 7L1Z19805D</p>	 <p><b>75897</b> CW 2 Spade Connectors, Jumper Wire Style: Flanged Voltage: 12 Chrysler (08-04); Mercedes (04-96) Chrysler: 5139032AA Mercedes Benz: 2028209342</p>	 <p><b>75903</b> CW 2 Lead Wires w/ Connector Style: Single Shaft Voltage: 12 Case New Holland: 330137A1</p>
 <p><b>75891</b> CW 2 Lead Wires w/ Connector Style: Flanged Voltage: 12 Ford (11-95); Mazda (09-99); Mercury (01-97) Ford: XL2Z19805EA</p>	 <p><b>75895</b> CCW 2 Lead Wires w/ Connector Style: Flanged Voltage: 12 Mercedes (11-03) Mercedes Benz: 2118300408, 2118300908</p>	 <p><b>75898</b> CCW 2 Lead Wires w/ Connector Style: Flanged Voltage: 12 Mercedes (15-01) Mercedes Benz: 2038202514</p>	 <p><b>75905</b> CCW 2 Lead Wires w/ Connector Style: Double Shaft Voltage: 24</p>
 <p><b>75892</b> CCW 2 Lead Wires w/ Connector Style: Flanged Voltage: 12 Cadillac (09-04); Chevy (15-05) General Motors Corp: 23456469</p>	 <p><b>75896</b> CCW 2 Lead Wires w/ Connector Style: Flanged Voltage: 12 BMW (15-04) BMW: 64119227670</p>	 <p><b>75899</b> CCW 2 Lead Wires w/ Connector Style: Flanged Voltage: 12 Chevy (05); Ford (07-05); Mercury (07-05); Saturn (07-02) Ford: 5F9Z19805DA General Motors Corp: 15788056</p>	 <p><b>75906</b> CCW 2 Spade Terminals Style: Double Shaft Voltage: 24 Case New Holland: 205004R0 Red Dot: 73R5554, RD585831P</p>
			 <p><b>75907</b> CCW 2 Lead Wires w/ Spade Terminals Style: Double Shaft Voltage: 24 Case New Holland: 401233 Red Dot: 73R5634, RD3929024P</p>

# Blower Motors

## Blower Motor & Assembly Cont'd



**76900**  
CW  
2 Lead Wires w/ Connector  
Style: Flanged  
Voltage: 12  
Ford (07-97); Mercury (07-04)



**76903**  
CCW  
2 Lead Wires w/ Connector  
Style: Flanged  
Voltage: 12  
Mazda (11-04); Scion (09-05); Toyota (08-98)  
Mazda: FE0161B10  
Toyota: 8710302021, 8710302370, 8710320160, 8710342040



**76909**  
CW  
2 Lead Wires w/ Connector  
Style: Flanged  
Voltage: 12  
Mitsubishi (07-02)  
Mitsubishi: MR568593



**76912**  
CCW  
2 Lead Wires w/ Connector  
Style: Flanged  
Voltage: 12  
Mazda (14-09)  
Mazda: EG2261B10



**76901**  
CW  
2 Lead Wires w/ Connector  
Style: Single Shaft  
Voltage: 12  
John Deere: AL110881, AL39043, AL75105, AL80700  
Red Dot: 73R5572



**76904**  
CCW  
2 Lead Wires w/ Connector  
Style: Flanged  
Voltage: 12  
Buick (15-10); Cadillac (15-10); Chevy (15-11); Saab (11-10)  
General Motors Corp: 13263279, 13369460, 22957138



**76910**  
CW  
2 Lead Wires w/ Connector  
Style: Flanged  
Voltage: 12  
Acura (04-96); Chrysler (05-01); Dodge (05-01); Mazda (06-00); Mercedes (05-98); Mitsubishi (06-00)  
Acura: 79310SZ3A01  
Chrysler: MR500469  
Mazda: LA0161B10B  
Mercedes Benz: 1638204142  
Mitsubishi: MR398725



**76913**  
CCW  
2 Lead Wires w/ Connector  
Style: Flanged  
Voltage: 12  
Suzuki (06-03)  
Suzuki: 7425054J10



**76902**  
CCW  
2 Lead Wires w/ Connector  
Style: Flanged  
Voltage: 12  
Chevy (13-11); Pontiac (09-08); Subaru (15-10)  
General Motors Corp: 92191992, 92191993  
Subaru: 72223AJ01A, 72223FJ001

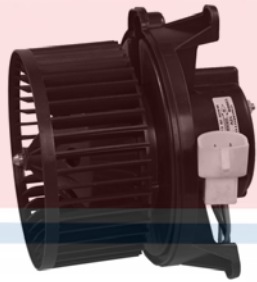

**76908**  
CCW  
2 Lead Wires w/ Connector  
Style: Flanged  
Voltage: 12  
Lincoln (11-03)  
Ford: 3W1Z19805AA











**76911**  
CW  
2 Lead Wires w/ Connector  
Style: Flanged  
Voltage: 12  
Mazda (08-06)  
Mazda: EG2161B10



**76914**  
CCW  
2 Lead Wires w/ Connector  
Style: Flanged  
Voltage: 12  
Suzuki (13-09)  
Suzuki: 7415076K12

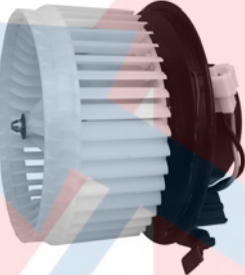

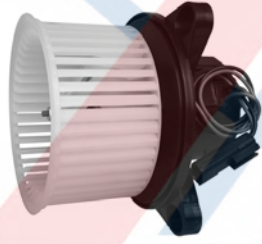
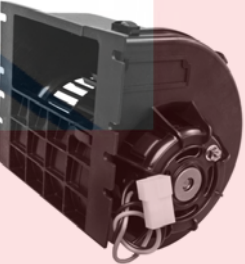
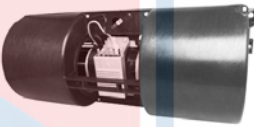
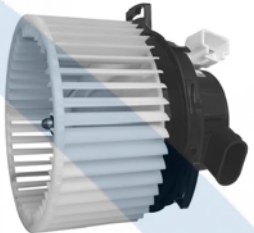
# Blower Motors

Blower Motor & Assembly Cont'd			
 <p><b>76915</b> CW 2 Spade Connector Style: Double Shaft Voltage: 24</p>	 <p><b>76918</b> CCW 2 Lead Wires w/ Connector Style: Flanged Voltage: 12 Acura (06-02); Honda (05-02) Acura: 79307S6MA42 Honda: 79307S6MA42</p>	 <p><b>76924</b> CW 2 Spade Terminals Style: Double Shaft Voltage: 12 Red Dot: 73R5552, RD585830P</p>	 <p><b>76928</b> CCW 2 Lead Wires w/ Connector Style: Flanged Voltage: 12 Jeep (01-99) Jeep: 5015860AA</p>
 <p><b>76916</b> CCW 2 Lead Wires w/ Connector Style: Flanged Voltage: 12 Ford (14-92)</p>	 <p><b>76919</b> CW 2 Lead Wires w/ Connector Style: Flanged Voltage: 12 Suzuki (13-07) Suzuki: 7415080J10</p>	 <p><b>76925</b> CW 2 Lead Wires w/ Spade Terminals Style: Double Shaft Voltage: 12 Red Dot: 73R5632, RD392900P</p>	 <p><b>76929</b> CCW 2 Lead Wires w/ Connector Style: Flanged Voltage: 12 BMW (08-02) BMW: 64116927598</p>
 <p><b>76917</b> CW 2 Lead Wires w/ Connector Style: Flanged Voltage: 12 Chrysler (02-01); Dodge (05-00); Plymouth (01-00) Chrysler: 4885326AA</p>	 <p><b>76921</b> CW 2 Lead Wires w/ Connector Style: Single Shaft Voltage: 24 Red Dot: 73R5574, RD5919424P</p>	 <p><b>76926</b> CW 2 Spade Terminals Style: Double Shaft Voltage: 12</p>	 <p><b>76930</b> CW 2 Lead Wires w/ Connector Style: Flanged Voltage: 12 Mazda (13-10) Mazda: BBM461B10</p>
	 <p><b>76923</b> CW 2 Lead Wires w/ Spade Terminals Style: Double Shaft Voltage: 12</p>	 <p><b>76927</b> CCW 2 Lead Wires w/ Connector Style: Flanged Voltage: 12 Chevy (14-10) General Motors Corp: 23438987</p>	

# Blower Motors

## Blower Motor & Assembly Cont'd



**76932**  
CCW  
2 Lead Wires w/ Connector  
Style: Flanged  
Voltage: 12  
Buick (15-13); Chevy (15-12)  
General Motors Corp: 95472959,  
95920148



**76933**  
CCW  
2 Lead Wires w/ Connector  
Style: Flanged  
Voltage: 12  
Buick (15-12); Cadillac (15-14); Chevy  
(15-11)  
General Motors Corp: 22765358,  
22954786

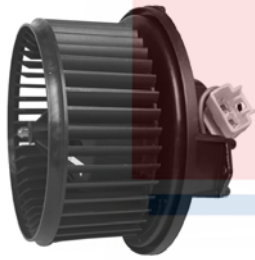

**76934**  
CCW  
2 Lead Wires w/ Connector  
Style: Flanged  
Voltage: 12  
Acura (13-10); Dodge (15-09); Dodge  
Medium Duty Truck (15); Jeep  
(13-11); Lexus (09-08); Scion (14-13)  
Acura: 79310SZNA41  
Chrysler: 68048903AB  
Jeep: 68089118AA  
Lexus: 8710360330  
Toyota: SU00302079



**76935**  
CCWLE  
2 Lead Wires w/ Connector  
Style: Double Shaft  
Voltage: 12  
BMW (11-02)  
BMW: 64116933910



**76936**  
CW  
2 Lead Wires w/ Connector  
Style: Flanged  
Voltage: 12  
Dodge (09-03); Mercedes (15-10)  
Chrysler: 5103806AA  
Mercedes Benz: 0008356207,  
0028303108

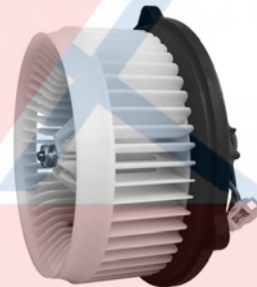

**76937**  
CCW  
2 Terminal Connector  
Style: Flanged  
Voltage: 12  
Lexus (05-01)  
Lexus: 8710353020



**76938**  
CCW  
2 Terminal Connector  
Style: Flanged  
Voltage: 12  
Dodge (09-07); Mercedes (15-10)  
Chrysler: 68012680AA  
Mercedes Benz: 0008356107



**76939**  
CCW  
2 Terminal Connector  
Style: Flanged  
Voltage: 12  
Audi (05-99)  
Audi: 4B1820021B



**76940**  
CCW  
2 Lead Wires w/ Spade Terminals  
Style: Double Shaft  
Voltage: 12  
Kysor: 1099097



**76941**  
CCW  
2 Terminal Connector  
Style: Double Shaft  
Voltage: 12  
Red Dot: 73R5622, RD592040P



**76942**  
CW  
2 Terminal Connector  
Style: Flanged  
Voltage: 12  
Chrysler (15-06); Dodge (15-06); Ford  
(16-07); Jeep (10-06); Lincoln (16-07);  
VW (14-09)  
Chrysler: 5183147AA  
Volkswagen: 7B0819015



**76943**  
CCW  
2 Lead Wires w/ Connector  
Style: Flanged  
Voltage: 12  
Hyundai (15-11); Kia (11)  
Hyundai: 971133S000, 971134R000  
Kia: 971133S000



**76944**  
CW  
6 Terminal Connector  
Style: Flanged  
Voltage: 12  
Kysor: 1012017  
Red Dot: 73R3152, RD5130700P  
TRP Parts: HA24050

# Blower Motors

## Blower Motor & Assembly Cont'd



**76945**  
CCW  
2 Terminal Connector  
Style: Flanged  
Voltage: 12  
Dodge (06-03)  
Chrysler: 5133435AA

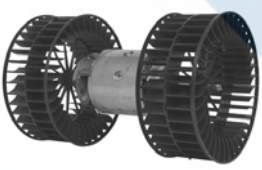

**76946**  
CCWLE  
2 Spade Terminals  
Style: Double Shaft  
Voltage: 12  
BMW (98-85)  
BMW: 64118390935

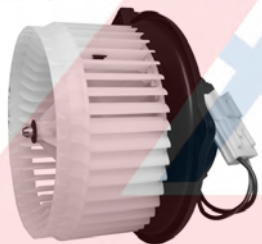

**76947**  
CW  
2 Lead Wires w/ Connector  
Style: Flanged  
Voltage: 12  
Mitsubishi (03-99)  
Mitsubishi: MR460373



**76948**  
CCW  
2 Lead Wires w/ Connector  
Style: Flanged  
Voltage: 12  
Ford (14-11); Mazda (13-09)  
Ford: BC3Z19805C  
Mazda: GS3L61B10

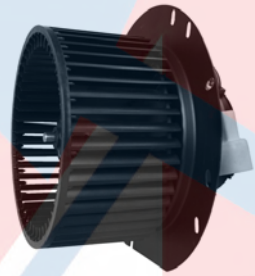

**76949**  
CW  
2 Lead Wires w/ Connector  
Style: Flanged  
Voltage: 12  
Ford (14-97)

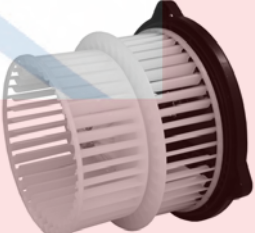

**76950**  
CCW  
2 Terminal Connector  
Style: Flanged  
Voltage: 12  
Scion (06-04); Toyota (05-00)  
Toyota: 8710352080



**76951**  
CCW  
2 Lead Wires w/ Connector  
Style: Flanged  
Voltage: 12  
Suzuki (08-06)  
Suzuki: 7415076K12, 7425076K12



**76952**  
CCW  
2 Lead Wires w/ Connector  
Style: Flanged  
Voltage: 12  
Nissan (15-09)  
Nissan: 272261FC0B, 272261KL0A,  
272261KM0A

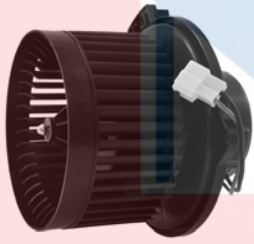

**76953**  
CCW  
2 Lead Wires w/ Connector  
Style: Flanged  
Voltage: 12  
Honda (08-07)  
Honda: 79310SAA305



**76954**  
CCW  
2 Lead Wires w/ Connector  
Style: Flanged  
Voltage: 12  
Infiniti (03-96); Nissan (04-95); Subaru (06-93)  
Infiniti: 272202Y910, 272207J201,  
272207J211  
Nissan: 272207J201  
Subaru: 72223AE000, 72240AC000,  
72240FA000



**76955**  
CW  
2 Lead Wires w/ Connector  
Style: Flanged  
Voltage: 12  
Ford (11-05); Mercury (11-05)

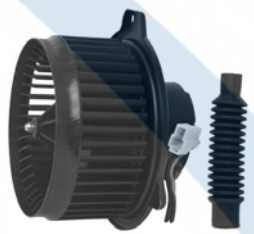

**76956**  
CCW  
2 Lead Wires w/ Connector  
Style: Flanged  
Voltage: 12  
Mazda (03-99)



# Blower Motors

## Blower Motor & Assembly Cont'd



**76957**  
CCW  
2 Lead Wires w/ Connector  
Style: Flanged  
Voltage: 12  
Nissan (06-95); Subaru (01-97)  
Nissan: 272202M100, 272204B000,  
272204Z900, 272208B410  
Subaru: 72240FA020

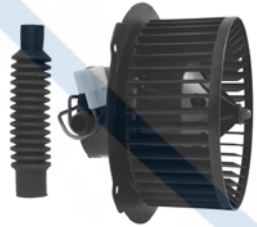

**76958**  
CCW  
2 Lead Wires w/ Connector  
Style: Flanged  
Voltage: 12  
Honda (02-00); Isuzu (04-99)  
Honda: 8972296131  
Isuzu: 8972296131



**76959**  
CCW  
2 Lead Wires w/ Connector  
Style: Flanged  
Voltage: 12  
Eagle (96-92); Mazda (97-90);  
Mitsubishi (99-92); Toyota (05-89)  
Mazda: NA0161B10  
Mitsubishi: MB657229  
Toyota: 8710304030, 8710342020,  
8710352060



**76960**  
CCW  
2 Lead Wires w/ Connector  
Style: Flanged  
Voltage: 12  
Acura (03-99)

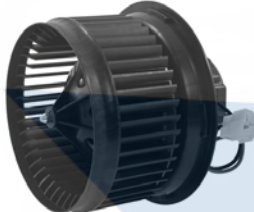

**76961**  
CCW  
2 Lead Wires w/ Connector  
Style: Flanged  
Voltage: 12  
Kia (13-10)  
Kia: 971131M000, 971131M001

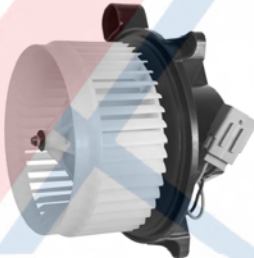

**76962**  
CW  
2 Lead Wires w/ Connector  
Style: Flanged  
Voltage: 12  
Ford (14-11)  
Ford: AV1Z19805B, BK3Z19805A

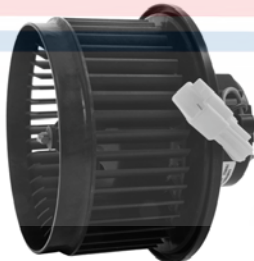

**76963**  
CCW  
2 Lead Wires w/ Connector  
Style: Flanged  
Voltage: 12  
Dodge (13-11); Jeep (13-11)  
Chrysler: 68079477AB



**76964**  
CCW  
2 Lead Wires w/ Connector  
Style: Flanged  
Voltage: 12  
Acura (15-14); Honda (15-12); Infiniti  
(13-10)  
Honda: 79310T0AA01, 79310T2FA01,  
79311TR6A71

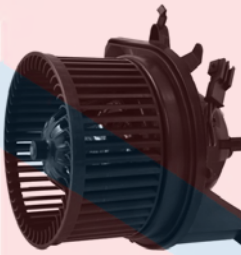

**76965**  
CW  
2 Lead Wires w/ Connector  
Style: Flanged  
Voltage: 12  
Mini (15-07)  
BMW: 64113422644, 64119266899

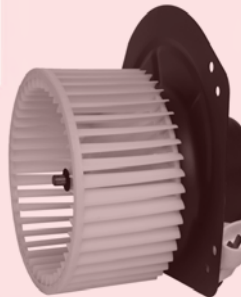

**76966**  
CW  
2 Lead Wires w/ Connector  
Style: Flanged  
Voltage: 12  
Ford (04-79); Lincoln (98-80); Mercury  
(04-79)



**76967**  
CCW  
2 Lead Wires w/ Connector  
Style: Flanged  
Voltage: 12  
Ford (14-12); Lincoln (14-12)  
Ford: CG1Z19805C, DG1Z19805D



**76968**  
CCW  
2 Lead Wires w/ Connector  
Style: Flanged  
Voltage: 12  
Acura (13); Honda (13-12)  
Honda: 80030TR0305

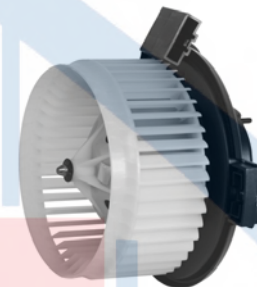

**76969**  
CW  
2 Lead Wires w/ Connector  
Style: Flanged  
Voltage: 12  
Pontiac (06-04)  
General Motors Corp: 92144213

# Blower Motors

## Blower Motor & Assembly Cont'd



**76970**  
CCW  
2 Lead Wires w/ Connector  
Style: Flanged  
Voltage: 12  
Toyota (14-13)  
Toyota: 8710352180



**76971**  
CCW  
2 Lead Wires w/ Connector  
Style: Flanged  
Voltage: 12  
Dodge (15-13)  
Chrysler: 68163782AA, 68225055AA

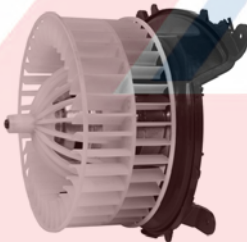

**76972**  
CCW  
2 Lead Wires w/ Connector  
Style: Flanged  
Voltage: 12  
Mercedes (06-00)  
Mercedes Benz: 2208203142



**76973**  
CW  
2 Lead Wires w/ Connector  
Style: Flanged  
Voltage: 12  
Ford (16-12)  
Ford: DV6Z19805B, DV6Z19805C

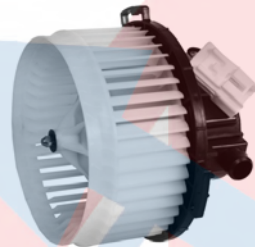

**76974**  
CW  
2 Lead Wires w/ Connector  
Style: Flanged  
Voltage: 12  
Mazda (14-12), (10-08)  
Mazda: CE4961B10

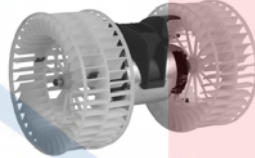

**76975**  
CCWLE  
2 Spade Terminals  
Style: Double Shaft  
Voltage: 12  
Mercedes (95-86)  
Mercedes Benz: 0008308208



**76976**  
CCW  
2 Lead Wires w/ Connector  
Style: Flanged  
Voltage: 12  
Buick (12-08); Cadillac (12-07); Chevy  
(12-07); GMC (12-07); Saturn (10-07)  
General Motors Corp: 15920865



**76977**  
CCW  
2 Lead Wires w/ Connector  
Style: Flanged  
Voltage: 12  
Buick (14-13); Cadillac (15-13); Chevy  
(15-13); GMC (15-13)  
General Motors Corp: 23442881



**76978**  
CCW  
2 Lead Wires w/ Connector  
Style: Flanged  
Voltage: 12  
Ford (09)  
Ford: 8A8Z19805A



**76979**  
CCW  
2 Lead Wires w/ Connector  
Style: Flanged  
Voltage: 12  
Mazda (13-06)  
Mazda: NE5161B10



**76980**  
CCW  
2 Lead Wires w/ Connector  
Style: Flanged  
Voltage: 12  
Chevy (15-13)  
General Motors Corp: 95193241



**76981**  
CCW  
2 Lead Wires w/ Connector  
Style: Flanged  
Voltage: 12  
Dodge (15-14); Jeep (15-14)  
Chrysler: 68224166AB  
Jeep: 68224166AB

# Blower Motors

## Blower Motor & Assembly Cont'd



**76982**  
CCW  
2 Lead Wires w/ Connector  
Style: Flanged  
Voltage: 12  
Ford (10-06); Mercury (10-06)  
Ford: 6L2Z19805B



**76983**  
CCW  
2 Lead Wires w/ Connector  
Style: Flanged  
Voltage: 12  
Mazda (15-13)  
Mazda: GHP961140B, GHP961B10,  
KD4561B10, KR2261140

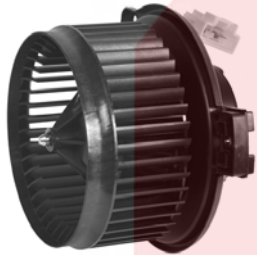

**76984**  
CCW  
2 Lead Wires w/ Connector  
Style: Flanged  
Voltage: 12  
Mazda (15-14)  
Mazda: GHR161B10



**76985**  
CCWLE  
2 Lead Wires; w/ Terminals  
Style: Double Shaft  
Voltage: 12  
BMW (02-94)  
BMW: 64118391809



**76986**  
CCW  
2 Lead Wires w/ Connector  
Style: Flanged  
Voltage: 12  
Nissan (15-13)  
Nissan: 272263SG0A



**76987**  
CW  
2 Lead Wires w/ Connector  
Style: Flanged  
Voltage: 12  
Kia (14-12)  
Kia: 971111W100



**76988**  
CW  
2 Lead Wires w/ Connector  
Style: Flanged  
Voltage: 12  
Kysor: 1013012  
NaviStar: 3599581C2



**76989**  
CW  
2 Lead Wires w/ Connector  
Style: Flanged  
Voltage: 12  
Kysor: 1013013  
NaviStar: 3674285C1



**76990**  
CCW  
2 Lead Wires w/ Connector  
Style: Flanged  
Voltage: 12  
Dodge (15-14)



**76991**  
CCW  
2 Lead Wires w/ Connector  
Style: Flanged  
Voltage: 12  
Acura (16-14)



**76992**  
CW  
2 Terminal Connector  
Style: Flanged  
Voltage: 12  
Smart (15-08)  
Mercedes Benz: 4518300108,  
4518301600, 4518350007

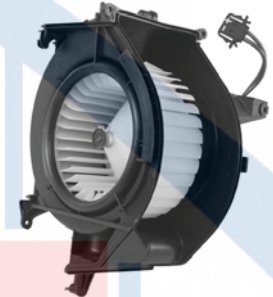

**76993**  
CW  
2 Lead Wires w/ Connector  
Style: Flanged  
Voltage: 12  
Audi (14), (12-06)  
Audi: 4F0820020A



# Blower Motors

## Blower Motor & Assembly Cont'd



### 76994

CW  
2 Terminal Connector  
Style: Flanged  
Voltage: 12  
Audi (15-07); Porsche (10-08),  
(06-03); VW (10-04)  
Audi: 7L0820021Q  
Volkswagen: 7L0820021Q



### 35320

CW  
Black Plastic Guard with a Metal Base.  
Voltage: 12  
General Motors Corp: 19189052  
Climatech: HD1025  
Dallas Truck AC: 0219054  
Euclid: E803469  
Kysor: 1299006, 170384  
NaviStar: 16329, 4507329R1  
Red Dot: 73R9054

## Auxillary Fan

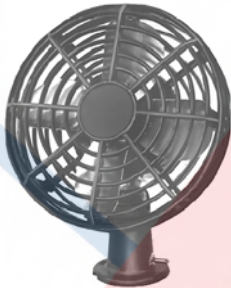

### 35310

CW  
Black Plastic Guard with a Metal Base.  
Voltage: 12  
Bergstrom: 756726  
Blue Bird: DF880  
Climatech: HD1015  
Dallas Truck AC: 0219052, 0219062  
Euclid: E803465, E803468  
Kysor: 1299001, 1299002, 170383  
Mack: 101RD41P2, 4379RD545750  
NaviStar: 16332, 3529060C91, 703005,  
703006, 703007  
Red Dot: 73R9052

## Blower Motor Vent Tube

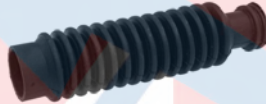

### 75769

Vent Tube  
Style: Vent Tube

## Blower Motors / Wheel (Shaft Adapter)

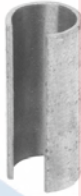

### 35210

Style: 5/16 x 1/4  
Euclid: E803798  
Northern: BM3351

# Blower Motor Wheels

**Non-Reversible**

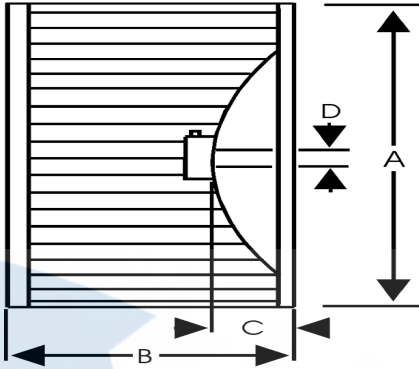



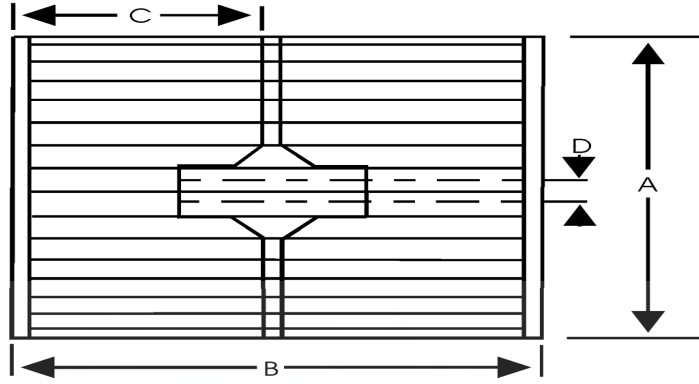

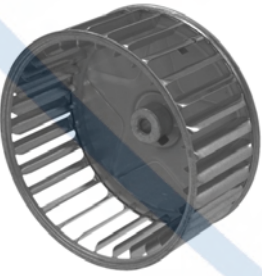
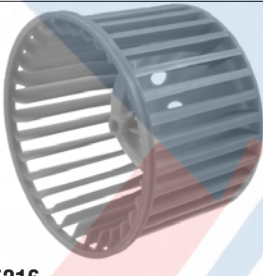
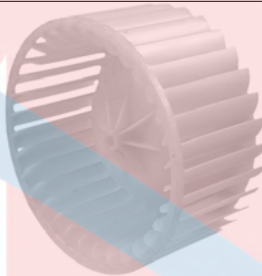
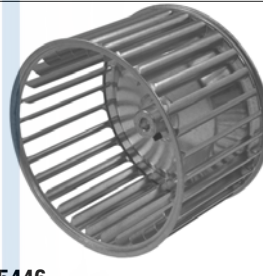
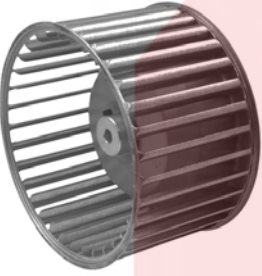
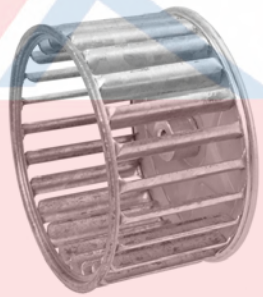
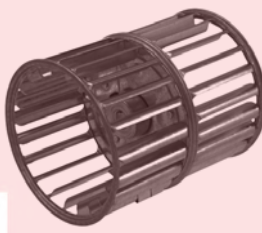

**Reversible**

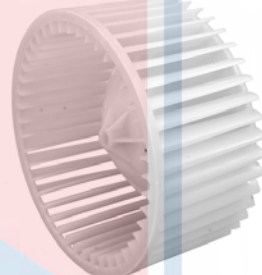

**NOTE: Check blade angle for proper direction of air flow.**

Blower Motor Wheels																																			
 <p><b>35213</b></p> <table border="1"> <tr><th>A</th><th>B</th><th>C</th><th>D</th></tr> <tr><td>5-1/4</td><td>2-3/8</td><td>Flat</td><td>5/16</td></tr> </table> <p>CW Material: Metal Shaft Shape: Round</p>	A	B	C	D	5-1/4	2-3/8	Flat	5/16	 <p><b>35216</b></p> <table border="1"> <tr><th>A</th><th>B</th><th>C</th><th>D</th></tr> <tr><td>5-5/8</td><td>3-5/8</td><td>1-13/16</td><td>5/16</td></tr> </table> <p>CW Material: Plastic Shaft Shape: Dual Flat Side</p> <p>Northern: BM2803</p>	A	B	C	D	5-5/8	3-5/8	1-13/16	5/16	 <p><b>35219</b></p> <table border="1"> <tr><th>A</th><th>B</th><th>C</th><th>D</th></tr> <tr><td>6</td><td>2-7/8</td><td>1-3/8</td><td>5/16</td></tr> </table> <p>CCW Material: Plastic Shaft Shape: D-Shaped</p> <p>Chevy (05); Dodge (03-98); Ford (09-95); Lincoln (06-98); Mazda (06-01); Mercury (07-02); Saturn (07-02)</p> <p>Euclid: E803805 NaviStar: 702007</p>	A	B	C	D	6	2-7/8	1-3/8	5/16	 <p><b>35446</b></p> <table border="1"> <tr><th>A</th><th>B</th><th>C</th><th>D</th></tr> <tr><td>5-1/8</td><td>3-1/2</td><td>3/4</td><td>5/16</td></tr> </table> <p>CCW Material: Metal Shaft Shape: Round</p> <p>Bergstrom: 510003 Caterpillar: 2328846 Climatech: HC1400 Dallas Truck AC: 0216013, 0216034 Euclid: E803826 Kysor: 1199010, 260801 Mack: 4379RD586180 NaviStar: 11030, 1691700C1 Northern: BM2889 Red Dot: 73R6050, 73R6250, 73R8100, RD31069, RD538000 Western Star: 600105001</p>	A	B	C	D	5-1/8	3-1/2	3/4	5/16
A	B	C	D																																
5-1/4	2-3/8	Flat	5/16																																
A	B	C	D																																
5-5/8	3-5/8	1-13/16	5/16																																
A	B	C	D																																
6	2-7/8	1-3/8	5/16																																
A	B	C	D																																
5-1/8	3-1/2	3/4	5/16																																
 <p><b>35214</b></p> <table border="1"> <tr><th>A</th><th>B</th><th>C</th><th>D</th></tr> <tr><td>5-3/4</td><td>3-1/2</td><td>1-3/4</td><td>5/16</td></tr> </table> <p>CCW Material: Metal Shaft Shape: Round</p> <p>Dodge (97-79)</p> <p>Chrysler: 56004806 General Motors Corp: 3037551 Northern: BM2784</p>	A	B	C	D	5-3/4	3-1/2	1-3/4	5/16	 <p><b>35218</b></p> <table border="1"> <tr><th>A</th><th>B</th><th>C</th><th>D</th></tr> <tr><td>4-1/4</td><td>2-1/2</td><td>Flat</td><td>5/16</td></tr> </table> <p>CW Material: Metal Shaft Shape: Round</p> <p>Euclid: E803800 Kysor: 260241, 260421 NaviStar: 11619</p>	A	B	C	D	4-1/4	2-1/2	Flat	5/16	 <p><b>35224</b></p> <table border="1"> <tr><th>A</th><th>B</th><th>C</th><th>D</th></tr> <tr><td>3-3/4</td><td>5</td><td>2-1/2</td><td>3/8</td></tr> </table> <p>CCW Material: Metal Shaft Shape: Round</p> <p>Euclid: E803812 John Deere: R65832 Northern: BM2793</p>	A	B	C	D	3-3/4	5	2-1/2	3/8									
A	B	C	D																																
5-3/4	3-1/2	1-3/4	5/16																																
A	B	C	D																																
4-1/4	2-1/2	Flat	5/16																																
A	B	C	D																																
3-3/4	5	2-1/2	3/8																																

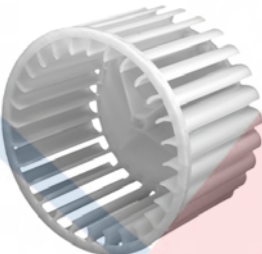
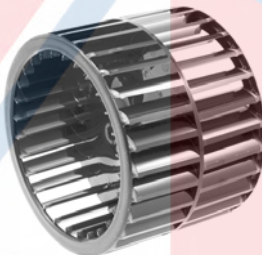
# Blower Motor Wheels

Blower Motor Wheels Cont'd																																											
 <p><b>35447</b></p> <table border="1"> <tr><th>A</th><th>B</th><th>C</th><th>D</th></tr> <tr><td>5-1/4</td><td>4-1/8</td><td>2</td><td>5/16</td></tr> </table> <p>CW Material: Metal Shaft Shape: Round Ford (98-78); Renault (83-81)</p> <p>Euclid: E803822 Kysor: 1199005 Red Dot: 73R7150 Renault: 7711054059</p>	A	B	C	D	5-1/4	4-1/8	2	5/16	 <p><b>35528</b></p> <table border="1"> <tr><th>A</th><th>B</th><th>C</th><th>D</th></tr> <tr><td>3-1/8</td><td>3-3/4</td><td>1-7/8</td><td>5/16</td></tr> </table> <p>CCW Material: Plastic Shaft Shape: Round AMC (79-66); Chevy (77-74); Chrysler (78-74); Dodge (77-66); Ford (96-87), (85-69); GMC (77-74); Jeep (79-74); Mercury (90-71); Plymouth (77-74)</p> <p>AMC: 8121899 Euclid: E803811 Evans: AM84031, HV31071 John Deere: AR66028 Kysor: 1199004, 1199009, 260680 NaviStar: 11029, 14810, 446986C1, 702002, 702004 Northern: BM2792 Peterbilt: 260680 Red Dot: 73R7000, 73R7050</p>	A	B	C	D	3-1/8	3-3/4	1-7/8	5/16	 <p><b>35533</b></p> <table border="1"> <tr><th>A</th><th>B</th><th>C</th><th>D</th></tr> <tr><td>6-1/4</td><td>3-7/16</td><td>Flat</td><td>5/16</td></tr> </table> <p>CCW Material: Metal Shaft Shape: Round</p>  <p><b>35534</b></p> <table border="1"> <tr><th>A</th><th>B</th><th>C</th><th>D</th></tr> <tr><td>6</td><td>2-15/1</td><td>1-5/8</td><td>5/16</td></tr> </table> <p>CW Material: Plastic Shaft Shape: D-Shaped Cadillac (07-03); Chevy (07-03); Ford (16-69); GMC (07-03); Jeep (93-84); Lincoln (16-13), (10-70); Mercury (11-67)</p> <p>AMC: 8956000174 Bergstrom: 510027, 790033 Climatech: HC1390, HC1405 Kysor: 1111003 Mack: 4379RD5107530 NaviStar: 1699947C1, 702001</p>	A	B	C	D	6-1/4	3-7/16	Flat	5/16	A	B	C	D	6	2-15/1	1-5/8	5/16	 <p><b>35535</b></p> <table border="1"> <tr><th>A</th><th>B</th><th>C</th><th>D</th></tr> <tr><td>6-1/4</td><td>2-7/8</td><td>Flat</td><td>5/16</td></tr> </table> <p>CCW Material: Metal Shaft Shape: Round Ford (79-72); Lincoln (76-72); Mercury (76-72)</p> <p>Northern: BM2787</p>	A	B	C	D	6-1/4	2-7/8	Flat	5/16
A	B	C	D																																								
5-1/4	4-1/8	2	5/16																																								
A	B	C	D																																								
3-1/8	3-3/4	1-7/8	5/16																																								
A	B	C	D																																								
6-1/4	3-7/16	Flat	5/16																																								
A	B	C	D																																								
6	2-15/1	1-5/8	5/16																																								
A	B	C	D																																								
6-1/4	2-7/8	Flat	5/16																																								
 <p><b>35448</b></p> <table border="1"> <tr><th>A</th><th>B</th><th>C</th><th>D</th></tr> <tr><td>5</td><td>3</td><td>9/16</td><td>5/16</td></tr> </table> <p>CW Material: Plastic Shaft Shape: Dual Flat Side</p> <p>Euclid: E803810 Kysor: 1113002 NaviStar: 14606, 16314, 435502C1, 465502C1 Northern: BM2762, BM2790 TRP Parts: HC13850</p>	A	B	C	D	5	3	9/16	5/16	 <p><b>35529</b></p> <table border="1"> <tr><th>A</th><th>B</th><th>C</th><th>D</th></tr> <tr><td>4-7/16</td><td>3-3/8</td><td>1-1/8</td><td>5/16</td></tr> </table> <p>CCW Material: Plastic Shaft Shape: Round AMC (87-75); Chrysler (79-77); Dodge (87-76), (74); Jeep (87-76); Plymouth (79-74)</p> <p>Allis Chalmers: 11842697, 13267158 AMC: 8126991, 8127556 Bergstrom: 510037 Caterpillar: 2328863 Climatech: HC1000, HC1050 Euclid: E803820 Kenworth: 589540 Kysor: 1199007, 1199035, 260650 Mack: 4379RD5103460 NaviStar: 1691727C1, 1691728C1, 2503271C1 Peterbilt: 589540 TRP Parts: HC10500</p>	A	B	C	D	4-7/16	3-3/8	1-1/8	5/16		 <p><b>35536</b></p> <table border="1"> <tr><th>A</th><th>B</th><th>C</th><th>D</th></tr> <tr><td>5-3/4</td><td>2-7/16</td><td>3/4</td><td>5/16</td></tr> </table> <p>CCW Material: Metal Shaft Shape: Round Chevy (02-82); GMC (02-82)</p>	A	B	C	D	5-3/4	2-7/16	3/4	5/16																
A	B	C	D																																								
5	3	9/16	5/16																																								
A	B	C	D																																								
4-7/16	3-3/8	1-1/8	5/16																																								
A	B	C	D																																								
5-3/4	2-7/16	3/4	5/16																																								



# Blower Motor Wheels

## Blower Motor Wheels Cont'd



### 35601

A	B	C	D
5-3/4	3-7/16	1-11/1	5/16

CW  
Material: Metal  
Shaft Shape: Round  
Buick (92-74); Cadillac (85-77); Chevy (95-77); Dodge (73-72); Ford (96-83); GMC (96-77); Mazda (94-91); Olds (93-77); Pontiac (92-66); Volvo (95-84)

General Motors Corp: 52451060  
Euclid: E803825  
Kysor: 1110001  
NaviStar: 15370

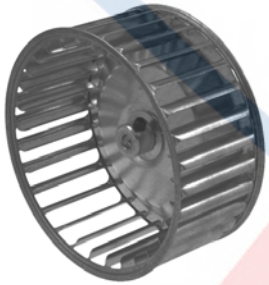

### 35602

A	B	C	D
5-1/4	2-7/16	7/8	5/16

CW  
Material: Metal  
Shaft Shape: Round  
Buick (91-59); Cadillac (76-64); Chevy (95-70), (68-65); Chrysler (85-82), (78-75); Dodge (84-74); Ford (94-66); GMC (95-74); Mercury (94-67); Olds (96-94), (90-77); Plymouth (95-86); Pontiac (84-74); Pontiac (98-55)

AMC: 8122173, 8122174, 8123207  
Euclid: E803804  
Kysor: 1110002, 1199015  
NaviStar: 11031  
Red Dot: 73R6100  
Western Star: 027073625



### 35603

A	B	C	D
5-3/4	2-7/16	1-11/1	5/16

CW  
Material: Metal  
Shaft Shape: Round  
Buick (89-85), (79-78); Cadillac (88-82); Chevy (90-76); Chrysler (88-82); Dodge (00-78); GMC (89-85); Mitsubishi (04-97); Olds (89-82); Plymouth (90-80); Pontiac (91), (89-81)

Euclid: E803806, E803818  
Kysor: 1110003  
Northern: BM2785

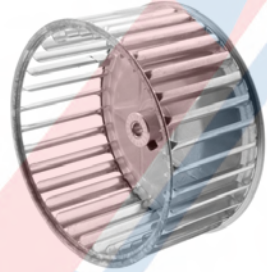

### 35604

A	B	C	D
5-3/4	2-7/8	13/16	5/16

CW  
Material: Metal  
Shaft Shape: Round  
Chrysler (79-75); Dodge (78-72)

Bergstrom: 510028, 510046  
Climatech: HC1325, HC1550  
Kysor: 1113003  
Mack: 4379RD556010



### 35605

A	B	C	D
5	3-5/8	1.125"	5/16

CCW  
Material: Plastic  
Shaft Shape: Round  
Jeep (86-80)

AMC: 5463800  
NaviStar: 1691731C1



### 35606

A	B	C	D
5	2-7/16	1-3/16	5/16

CCW  
Material: Plastic  
Shaft Shape: Round

Euclid: E803823  
Northern: BM2702



### 35608

A	B	C	D
5-1/4	3-7/16	13/16	5/16

CW  
Material: Metal  
Shaft Shape: Round  
AMC (78-71); Chrysler (81); Ford (98-82)

AMC: 8124479  
Bergstrom: 510047  
Climatech: HC1280, HC1345  
Euclid: E803824  
Kenworth: 52980P  
Kysor: 1115001, 1199008, 260800, KH1115001  
Mack: 4379RD552630  
NaviStar: 11033, 11034, 1691701C1, 702003  
Red Dot: 73R6200, 73R6230  
TRP Parts: HC13450

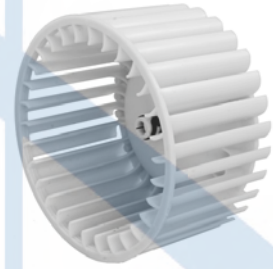

### 35609

A	B	C	D
5-1/4	2-7/8	1/2	5/16

CCW  
Material: Plastic  
Shaft Shape: D-Shaped  
AMC (87-68); Ford (96-77); Mercury (87-81)

AMC: 3212883  
Euclid: E803802  
NaviStar: 1691707C1  
Northern: BM2758

# Blower Motor Wheels

## Blower Motor Wheels Cont'd



### 35610

A	B	C	D
4-1/4	2-7/16	Flat	5/16

CW

Material: Metal  
 Shaft Shape: Round  
 Chrysler (81-77); Dodge (89-78);  
 Plymouth (85-78)

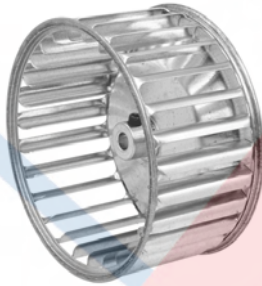

### 35611

A	B	C	D
4-3/4	2-7/16	13/16	5/16

CW

Material: Metal  
 Shaft Shape: Round  
 Ford (80-70); Mercury (80-75)

Euclid: E803803  
 Northern: BM2759

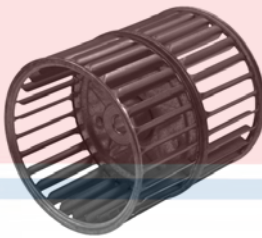

### 35613

A	B	C	D
3-3/4	4-1/16	2	3/8

CCW

Material: Metal  
 Shaft Shape: Round

Euclid: E803813  
 John Deere: 484107, AH84107  
 NaviStar: 16282  
 Northern: BM2891  
 Red Dot: 73R7100



### 35614

A	B	C	D
3-3/4	4-1/4	2	5/16

CCW

Material: Metal  
 Shaft Shape: Round

Kysor: 260550, 260551



### 35617

A	B	C	D
6	3	1-9/16	5/16

CW

Material: Plastic  
 Shaft Shape: D-Shaped  
 Ford (14-95); Mazda (09-99); Mercury  
 (07-97)

Ford: AC2Z19834A

# Cabin Air Filters

## Cabin Air Filters



**28000**  
1 Piece Cabin Air Filter  
Material: Paper  
Length: 12.500  
Depth: 1-7/8  
Height: 6-1/2  
John Deere (14-06)  
John Deere: RE187966, RE345646

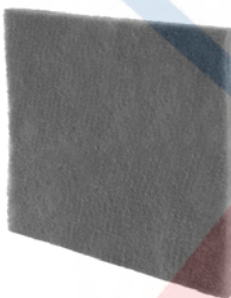

**28001**  
1 Piece Cabin Air Filter  
Material: Polyester Fiber  
Length: 10.500  
Depth: 5/8  
Height: 10-1/2  
Mack (09-02)  
Kysor: 3199030  
Mack: 4379RD5105930, 7787525784  
TRP Parts: GD11500



**28002**  
1 Piece Cabin Air Filter  
Material: Paper  
Length: 8.625  
Depth: 1  
Height: 8-3/8  
Freightliner (10-03)  
Bergstrom: 1000039637  
Kysor: 3112012  
Red Dot: 75R5430, RD5118360



**28003**  
1 Piece Cabin Air Filter  
Material: Paper  
Length: 8.500  
Depth: 5/8  
Height: 7-1/2  
Freightliner (06-02)  
Kysor: 3112001  
TRP Parts: GD11650

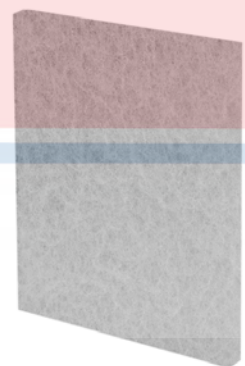

**28004**  
1 Piece Cabin Air Filter  
Material: Polyester Fiber  
Length: 7.750  
Depth: 5/8  
Height: 6-1/4  
Freightliner (07-02)



**28005**  
1 Piece Cabin Air Filter  
Material: Paper  
Length: 12.250  
Depth: 1-5/16  
Height: 9-1/8  
Volvo HD (10-03)  
Bergstrom: 1000039641  
Kysor: 3118003  
Red Dot: 78R5242  
TRP Parts: GD11900



**28006**  
1 Piece Cabin Air Filter  
Material: Paper  
Length: 10.625  
Depth: 3/4  
Height: 10-5/8  
Freightliner (06-02)  
Kysor: 3112006  
Red Dot: RD5112240  
TRP Parts: GD11450



**28007**  
1 Piece Cabin Air Filter  
Material: Paper  
Length: 8.625  
Depth: 1  
Height: 7-5/8  
Freightliner (10-02)  
Climatech: GD1140  
Kysor: 3112005  
TRP Parts: GD11400









**28008**  
1 Piece Cabin Air Filter  
Material: Paper  
Length: 12.250  
Depth: 7/8  
Height: 8-3/8  
Volvo HD (02-98)  
Bergstrom: 1000039640  
Kysor: 3118002  
TRP Parts: GD11850



**28009**  
1 Piece Cabin Air Filter  
Material: Paper  
Length: 13.750  
Depth: 7/8  
Height: 10  
Peterbilt (09-02)  
Kenworth: 525507BSM  
Kysor: 3114001  
Peterbilt: 525507BSM  
Red Dot: 78R5420, RD5107450  
TRP Parts: GD11800

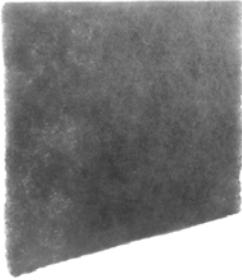

# Cabin Air Filters

Cabin Air Filters Cont'd			
			
<p><b>28010</b> 1 Piece Cabin Air Filter Material: Paper Length: 12.375 Depth: 1 Height: 7-1/4 International (10-00) Bergstrom: 1000159324 Climatech: GD1170 Kysor: 3113006 NaviStar: 2506656C1, 2506656C2 TRP Parts: GD11700</p>	<p><b>28012</b> 1 Piece Cabin Air Filter Material: Paper Length: 12.375 Depth: 1-1/8 Height: 6-1/8 International (11-06) Kysor: 3199085 NaviStar: 3839141C1</p>	<p><b>28015</b> 1 Piece Cabin Air Filter Material: Polyester Fiber Length: 10.750 Depth: 5/8 Height: 12 International (00-97) Kysor: 3199020 NaviStar: 1696834C1</p>	
			
<p><b>28011</b> 1 Piece Cabin Air Filter Material: Paper Length: 10.625 Depth: 1 Height: 10-5/8 Freightliner (10-08) Kysor: 3112007 Red Dot: 78R5237 TRP Parts: GE11450</p>	<p><b>28013</b> 1 Piece Cabin Air Filter Material: Paper Length: 10.250 Depth: 3/4 Height: 6-3/4 Peterbilt: 5X000180, 5X000190</p>		
	 <p><b>28014</b> 1 Piece Cabin Air Filter Material: Paper Length: 11.438 Depth: 1-3/4 Height: 4-3/4</p>		

# Clutch Assemblies

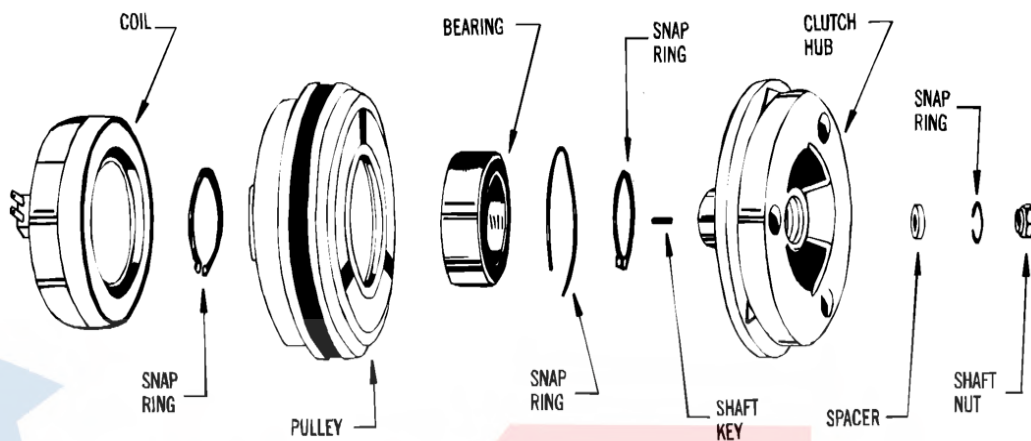

Part No.	Pulley Groove	New/Reman	Pulley Dia.	Belt Width	Coil Connector	Compressor Type	Clutch Gauge Line A	Clutch Gauge Line B
<b>Chrysler - A590</b>								
47840	1 Groove	New	5-3/4	7/16	Double Spade	A590	2-35/64	
<b>Chrysler - Airtemp RV2</b>								
48833	2 Groove	Reman	5-1/4	3/8	1 Lead Wire	Airtemp RV2		
<b>Chrysler - C171</b>								
47325	1 Groove	New	5-13/16	7/16	No Connector Available	C171		
47818	2 Groove	New	5-3/4	7/16	Eyelet	C171	1-41/64	
47819	2 Groove	New	5-5/8	7/16	Eyelet	C171	1-41/64	
47830	2 Groove	New	5-3/4	3/8	Spade	C171	2	2-35/64
47831	2 Groove	New	5-9/16	3/8	Spade	C171	1-21/32	
47839	1 Groove	New	5-3/4	7/16	Spade	C171		
<b>Diesel Kiki - Seltec - Zexel</b>								
47355	4 Groove	New	5-1/4	5/8	Spade	DKS16H		
47605	2 Groove	New	5-15/16	1/2	Bullet Connector	DKS15BH	1-11/16	
47900	1 Groove	New	4-7/8	1/2	Bullet Connector	DKS15CH		
47901	1 Groove	New	6-1/4	7/8	Bullet Connector	DKS15CH		
47902	2 Groove	New	5-1/4	1/2	Bullet Connector	DKS15CH	1-5/64	
47903	2 Groove	New	5-1/4	1/2	Bullet Connector	DKS15CH	15/16	
47904	1 Groove	New	6-1/4	1/2	Bullet Connector	DKS15CH		
47989	5 Groove	New	5	3/4	Pin	DKV11	1-15/64	
<b>Ford - FS6</b>								
47848	1 Groove	New	5-3/4	1/2	Pin	FS6	2-1/2	
47849	1 Groove	New	5-29/32	1/2	Pin	FS6	2	
47854	6 Groove	New	5	7/8	Pin	FS6	1-47/64	
48849	1 Groove	Reman	5-29/32	1/2	2 Pin	FS6		
48854	6 Groove	Reman	5	7/8	Pin	FS6	1-47/64	
<b>Ford - Scroll</b>								
47885	6 Groove	New	3-15/16		Pin	Scroll		
<b>Ford - FS10 / FX15</b>								
47857	6 Groove	New	5	7/8	Butt Connector	FX15	1-45/64	
47859	6 Groove	New	5-3/4	5/8	Pin	FX15	7/8	
47867	6 Groove	New	5	7/8	Pin	FS10	1/2	
47868	8 Groove	New	5-1/8	1-3/16	Pin	FS10		
47869	6 Groove	New	5-5/8	7/8	Pin	FS10		
47871	5 Groove	New	5	3/4	Pin	FS10		
47874	6 Groove	New	5	7/8	Pin	FS10		
47876	6 Groove	New	5	7/8	Pin	FS10		
47877	4 Groove	New	5-1/4	5/8	Pin	FS10		

## Clutch Assemblies

Part No.	Pulley Groove	New/ Reman	Pulley Dia.	Belt Width	Coil Connector	Compressor Type	Clutch Gauge Line A	Clutch Gauge Line B
<b>Ford - FS10 / FX15</b>								
47878	8 Groove	New	4-1/2	1-3/16	Pin	FS10		
47880	7 Groove	New	4-1/2	1	Pin	FS10		
47881	6 Groove	New	4-1/2	7/8	Pin	FS10		
47882	6 Groove	New	4-1/2	7/8	Pin	FS10	2	
<b>Frigidaire / Harrison - A6</b>								
48275	1 Groove	Reman	6-7/8	7/16	No Connector Available	Frigidaire/Harrison A6		
48284	1 Groove	Reman	5	7/16	Spade	Frigidaire/Harrison A6	2	
<b>Frigidaire / Harrison - R4</b>								
47298	1 Groove	New	5-1/2	1/2	Spade	Frigidaire/Harrison R4 Radial		
47620	1 Groove	New	5-1/8	1/2	Spade	Frigidaire/Harrison R4 Radial		
47622	6 Groove	New	4-1/4	7/8	Spade	Frigidaire/Harrison R4 Radial		
47633	6 Groove	New	5	7/8	Spade	Frigidaire/Harrison R4 Radial	1-15/16	
47656	6 Groove	New	4-1/4	7/8	Pin	Frigidaire/Harrison R4 Radial		
47670	1 Groove	New	5-23/64	1/2	Spade	Frigidaire/Harrison R4 Radial		
47671	6 Groove	New	5	7/8	8mm Pin Connector	Frigidaire/Harrison R4 Radial	1-15/16	
47720	1 Groove	New	5	1/2	Spade	Frigidaire/Harrison R4 Radial		
48633	6 Groove	Reman	5	7/8	Spade	Frigidaire/Harrison R4 Radial	1-15/16	
48656	6 Groove	Reman	4-1/4	7/8	Pin	Frigidaire/Harrison R4 Radial		
48657	6 Groove	Reman	4-1/4	7/8	Spade	Frigidaire/Harrison R4 Radial		
<b>GM - CVC</b>								
47280	5 Groove	New	4		Pin	CVC		
<b>Harrison - DA6-HR6-HD6-HT6-HE6</b>								
47631	6 Groove	New	4-1/4		8mm Pin Connector	Harrison DA6-HR6-HD6-HT6-HE6		
47651	1 Groove	New	5		Spade	Harrison DA6-HR6-HD6-HT6-HE6		
47655	6 Groove	New	4-1/4		8mm Pin Connector	Harrison DA6-HR6-HD6-HT6-HE6		
47658	6 Groove	New	4-1/4	7/8	Spade	Harrison DA6-HR6-HD6-HT6-HE6		
47662	6 Groove	New	5-5/8	7/8	Spade	Harrison DA6-HR6-HD6-HT6-HE6		
47665	6 Groove	New	5-5/8	7/8	8mm Pin Connector	Harrison DA6-HR6-HD6-HT6-HE6		
47667	6 Groove	New	5		8mm Pin Connector	Harrison DA6-HR6-HD6-HT6-HE6		
48622	6 Groove	Reman	4-1/4	7/8	Spade	Harrison DA6-HR6-HD6-HT6		



## ***Clutch Assemblies***

Part No.	Pulley Groove	New/Reman	Pulley Dia.	Belt Width	Coil Connector	Compressor Type	Clutch Gauge Line A	Clutch Gauge Line B
48655	6 Groove	Reman	4-1/4	7/8	8mm Pin Connector	Harrison DA6-HR6-HD6-HT6		
48658	6 Groove	Reman	4-1/4	7/8	Spade	Harrison DA6-HR6-HD6-HT6		
48661	6 Groove	Reman	5-5/8	7/8	Spade	Harrison DA6-HR6-HD6-HT6		
48665	6 Groove	Reman	5-5/8	7/8	8mm Pin Connector	Harrison DA6-HR6-HD6-HT6		
48667	6 Groove	Reman	5	7/8	8mm Pin Connector	Harrison DA6-HR6-HD6-HT6		

### **Harrison - V5 Variable Displacement**

47654	6 Groove	New	4-1/4	7/8	8mm Pin Connector	Harrison V5 Variable Displacement		
47692	6 Groove	New	5-1/8		8mm Pin Connector	Harrison V5 Variable Displacement		
48654	6 Groove	Reman	4-1/4	7/8	8mm Pin Connector	Harrison V5 Variable Displacement		
48660	6 Groove	Reman	4-5/8	7/8	8mm Pin Connector	Harrison V5 Variable Displacement		
48663	6 Groove	Reman	5-5/8	7/8	8mm Pin Connector	Harrison V5 Variable Displacement		
48664	5 Groove	Reman	5	3/4	8mm Pin Connector	Harrison V5 Variable Displacement		

### **Hitachi - Nihon Radiator**

47990	10 Groove	New	5-3/4	1/2	Eyelet	Hitachi - Nihon Radiator	1-11/16	
47992	10 Groove	New	5-3/4	1/2	Eyelet	Hitachi - Nihon Radiator		

### **HR980 Radial**

47847	1 Groove	New	5-3/4	7/16	Pin	Tecumseh HR980 Radial		
-------	----------	-----	-------	------	-----	-----------------------	--	--

### **Nihon/Calsonic - CWV618**

47523	5 Groove	New	5-1/4		Spade	CWV618		
47553	6 Groove	New	5-1/2		Spade	CWV618		

### **Nippondenso - 10P, 6P, 6E**

47321	6 Groove	New	5-5/8	7/8	Spade	6C17	11/32	
47322	1 Groove	New	5-1/2	1/2	Spade	6C17		
47337	8 Groove	New	5-1/2		Eyelet	10P		
47338	1 Groove	New	5-5/8		Eyelet	10P		
47339	1 Groove	New	5-11/16		Eyelet	10P		
47345	1 Groove	New	5-3/4	1/2	Eyelet	10P, 6P, 6E		
47535	1 Groove	New	5	1/2	Eyelet	10P	1-5/8	
47569	1 Groove	New	5-1/4	1/2	2 Lead Wires	10P	1-5/8	
47579	1 Groove	New	5-13/16	1/2	Eyelet	10P, 6P, 6E		
47599	6 Groove	New	5	7/8	Eyelet	10P		
47851	5 Groove	New	4-7/8	3/4	Pin	10P, 6P		
47853	6 Groove	New	4-7/8	7/8	Pin	10P, 6P		
47890	5 Groove	New	4-3/4	3/4	2 Lead Wires	10P	1-1/16	
48853	6 Groove	Reman	4-7/8	7/8	2 Pin	10P, 6P	1-5/64	

# Clutch Assemblies

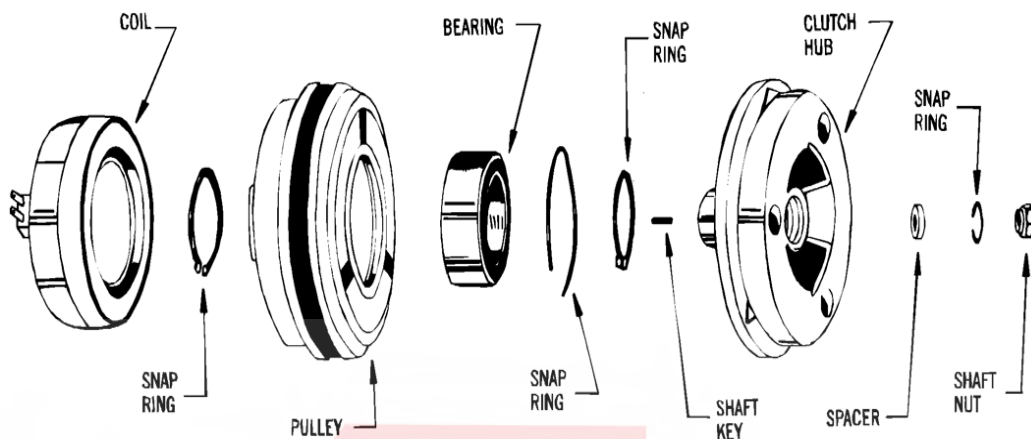

Part No.	Pulley Groove	New/Reman	Pulley Dia.	Belt Width	Coil Connector	Compressor Type	Clutch Gauge Line A	Clutch Gauge Line B
<b>Nippondenso - 10PA</b>								
47315	6 Groove	New	5-1/8		Butt Connector	10PA	2-13/32	
47318	1 Groove	New	5-1/4	1/2	Spade	10PA	61/64	
47319	6 Groove	New	5-1/2	7/8	Spade	10PA	11/32	
47320	1 Groove	New	5-5/8	1/2	Spade	10PA	61/64	
47331	4 Groove	New	4-1/4		Eyelet	10PA		
47332	8 Groove	New	5-1/2		Eyelet	10PA		
47333	8 Groove	New	4-3/4		Bare Wire	10PA		
47335	1 Groove	New	4-3/4		Eyelet	10PA		
47336	2 Groove	New	4-1/2		Bare Wire	10PA		
47361	6 Groove	New	4-7/8		2 Lead Wires w/ Connector	10PA		
47390	1 Groove	New	6		Bare Wire	10PA		
47391	8 Groove	New	4-3/4		Bare Wire	10PA		
47392	1 Groove	New	5-3/4		Bare Wire	10PA		
47536	6 Groove	New	5	1-5/8	Eyelet	10PA	11/16	
47563	5 Groove	New	4-1/4	3/4	Eyelet	10PA	11/16	
47564	6 Groove	New	5-1/8	7/8	2 Lead Wires w/ Connector	10PA	1-1/8	
47565	7 Groove	New	5-1/8	1	2 Lead Wires w/ Connector	10PA	1-5/32	
47567	1 Groove	New	5-1/4	1/2	Eyelet	10PA		
47570	6 Groove	New	5-1/4	7/8	Eyelet	10PA	1-15/32	
47571	6 Groove	New	4-1/2		2 Lead Wires	10PA	1-5/8	
47592	1 Groove	New	5-1/2	1/2	Eyelet	10PA	1-41/64	
47594	1 Groove	New	5-1/2	1/2	Eyelet	10PA	1-41/64	
47598	4 Groove	New	5-1/2	5/8	2 Lead Wires w/ Connector	10PA	17/32	
47821	1 Groove	New	5-1/4	1/2	Eyelet	10PA	63/64	
47824	5 Groove	New	5-1/2	3/4	Eyelet	10PA	1-19/32	
47826	4 Groove	New	4-3/4	5/8	Eyelet	10PA	7/8	
47861	6 Groove	New	4-7/8	7/8	2 Pin	10PA		
47866	6 Groove	New	5	3/4	Butt Connector	10PA	61/64	
47889	6 Groove	New	6-1/4	7/8	Eyelet	10PA	61/64	
47893	5 Groove	New	6-1/2	3/4	Eyelet	10PA	49/64	
48318	1 Groove	Reman	5-1/4	1/2	2 Lead Wires	10PA	61/64	
48598	4 Groove	Reman	5-1/2	5/8	2 Lead Wires w/ Connector	10PA	17/32	
48824	5 Groove	Reman	5-1/2	3/4	2 Lead Wires w/ Connector	10PA	1-19/32	
<b>Nippondenso - 10S</b>								
47348	6 Groove	New	4-1/2		Pin	10S17F		
47362	4 Groove	New	4-19/64		Pin	10S17F		

## ***Clutch Assemblies***

Part No.	Pulley Groove	New/ Reman	Pulley Dia.	Belt Width	Coil Connector	Compressor Type	Clutch Gauge Line A	Clutch Gauge Line B
<b>Nippondenso - 10S</b>								
47374	6 Groove	New	5-1/8		Pin	10S20H		
47375	6 Groove	New	5-7/16		Pin	10S20C		
47378	4 Groove	New	4-15/16		Pin	10S17C		
<b>Sanden / Sankyo - SD508</b>								
47330	6 Groove	New	5	3/8	Bullet Connector	SD508	1-7/8	
47586	2 Groove	New	5-1/4	1/2	Bullet Connector	SD508		
47607	2 Groove	New	5-1/8	3/8	Spade	SD508	1-11/16	
47995	10 Groove	New	5	1-7/16	Spade	SD508		2
47998	1 Groove	New	6-1/4		Butt Connector	SD508		
<b>Sanden / Sankyo - SD709</b>								
47351	6 Groove	New	4-3/4	7/16	Bullet Connector	SD709		1-29/64
47996	2 Groove	New	5-1/2	1/2	Butt Connector	SD709	1-5/8	
47997	6 Groove	New	4-7/8	7/8	Butt Connector	SD709	1-45/64	
47999	1 Groove	New	6	5/8	Bare Wire	SD709	2-1/2	
<b>Sanden / Sankyo - TRF090</b>								
47554	5 Groove	New	4-55/64		Bullet Connector	TRF090		
<b>Sanden / Sankyo - TRS090</b>								
47560	4 Groove	New	4		Eyelet	TRS090		1-61/64





# Clutch Assemblies

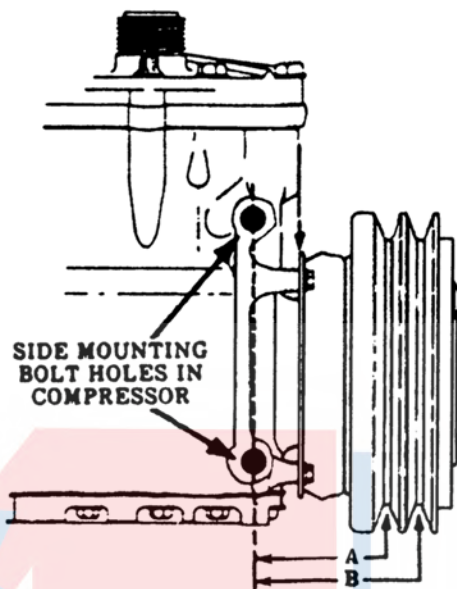

On Vehicle Measuring:

- A = Distance between side mounting bolt hole in compressor and the center of the back belt groove (closest to compressor)
- B = Distance between side mounting bolt hole in compressor and the center of the front belt groove (farthest from compressor)

Part No.	Pulley Groove	New/Reman	Pulley Dia.	Belt Width	Coil Connector	Compressor Type	Clutch Gauge Line A	Clutch Gauge Line B
<b>York &amp; Tecumseh</b>								
47323	2 Groove	New	5-3/4	3/8	Butt Connector	206, 209, 210, HG850, HG1000	1-7/8	2-1/2
47531	2 Groove	New	6	1/2	Butt Connector	206, 209, 210, HG850, HG1000	1-5/8	2-1/4
47534	2 Groove	New	7	1/2	Bullet Connector	206, 209, 210, HG850, HG1000	1-5/8	2-1/4
47541	2 Groove	New	6	1/2	Spade	206, 209, 210, HG850, HG1000	1-5/8	2-1/4
47551	2 Groove	New	6	1/2	Bullet Connector	206, 209, 210, HG850, HG1000	1-5/8	2-1/4
47581	2 Groove	New	6	1/2	Bullet Connector	206, 209, 210, HG850, HG1000	1-5/32	2-5/16
47582	2 Groove	New	5	1/2	Bullet Connector	206, 209, 210, HG850, HG1000	27/32	2-5/16
47809	1 Groove	New	6-1/4	1/2	Butt Connector	206, 209, 210, HG850, HG1000	2-7/8	
47811	1 Groove	New	6	1/2	Butt Connector	206, 209, 210, HG850, HG1000	2-5/8	
47815	6 Groove	New	5-3/4		Pin	206, 209, 210, HG850, HG1000	1-47/64	
47905	1 Groove	New	6	1/2	Spade	206, 209, 210, HG850, HG1000	2-3/4	
47906	1 Groove	New	6	1/2	Pin	206, 209, 210, HG850, HG1000	2-3/4	
47907	2 Groove	New	6	1/2	1 Lead Wire	206, 209, 210, HG850, HG1000	1-11/16	2-5/16
47908	2 Groove	New	6-3/4	1/2	Pin	206, 209, 210, HG850, HG1000	61/64	2-5/16
47909	1 Groove	New	6-1/4	5/8	Pin	206, 209, 210, HG850, HG1000	2-3/4	

## ***Clutch Assemblies***

<b>Part No.</b>	<b>Pulley Groove</b>	<b>New/ Reman</b>	<b>Pulley Dia.</b>	<b>Belt Width</b>	<b>Coil Connector</b>	<b>Compressor Type</b>	<b>Clutch Gauge Line A</b>	<b>Clutch Gauge Line B</b>
47910	2 Groove	New	6	1/2	Pin	206, 209, 210, HG850, HG1000	2-1/8	2-3/4
47926	2 Groove	New	6	1/2	Pin	206, 209, 210, HG850, HG1000	1-5/8	2-1/4
47927	6 Groove	New	6	7/8	Pin	206, 209, 210, HG850, HG1000	2-1/16	
47928	8 Groove	New	6-5/16	1-1/8	Pin	206, 209, 210, HG850, HG1000	1-15/16	
47931	1 Groove	New	6-1/8	1/2	1 Lead Wire	206, 209, 210, HG850, HG1000	2-5/8	
47935	2 Groove	New	6	1/2	Spade	206, 209, 210, HG850, HG1000	2	2-5/8
47938	2 Groove	New	7	1/2	Bullet Connector	206, 209, 210, HG850, HG1000	1-11/16	2-5/16
47939	2 Groove	New	6	1/2	Bullet Connector	206, 209, 210, HG850, HG1000	1-11/16	2-5/16
47959	6 Groove	New	6	7/8	Pin	206, 209, 210, HG850, HG1000	2	
47960	8 Groove	New	5-1/2	1-3/16	Pin	206, 209, 210, HG850, HG1000	61/64	
47968	1 Groove	New	6-3/4	1/2	Bullet Connector	206, 209, 210, HG850, HG1000	2-3/4	
47971	1 Groove	New	6-3/4	5/8	Bullet Connector	206, 209, 210, HG850, HG1000	2-3/4	
47994	1 Groove	New	7	3/4	Bullet Connector	206, 209, 210, HG850, HG1000	1-15/16	
48531	2 Groove	Reman	6	1/2		206, 209, 210, HG850, HG1000	1-5/8	2-1/4
48534	2 Groove	Reman	7	1/2	Bullet Connector	206, 209, 210, HG850, HG1000	1-5/8	2-1/4
48809	1 Groove	Reman	6-1/4	1/2	Bullet Connector	206, 209, 210, HG850, HG1000	2-7/8	
48811	1 Groove	Reman	6	1/2	Bullet Connector	206, 209, 210, HG850, HG1000	2-5/8	
48812	1 Groove	Reman	6-15/16	1/2	1 Lead Wire	206, 209, 210, HG850, HG1000	2-3/4	

# Clutch Assemblies

## Chrysler - A590



**47840** New w/ Coil  
A590  
Pulley Dia.: 5-3/4  
1 Groove  
12 Volt  
Chrysler (91-85); Dodge (92-85);  
Plymouth (92-85)  
Chrysler: 3848982  
Euclid: E802677

## Chrysler - Airtemp RV2



**48833** Reman w/ Coil  
Airtemp RV2  
Pulley Dia.: 5-1/4  
2 Groove  
12 Volt  
Chrysler (79-69); Dodge (80-62);  
Plymouth (80-62)

## Chrysler - C171

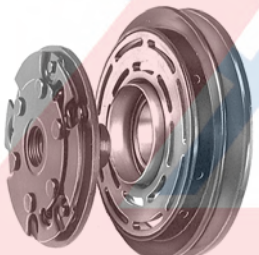

**47325** New w/o Coil  
C171  
Pulley Dia.: 5-13/16  
1 Groove  
12 Volt  
Chrysler (84-82); Dodge (84-80);  
Plymouth (84-79)  
Euclid: E802676



**47818** New w/ Coil  
C171  
Pulley Dia.: 5-3/4  
2 Groove  
12 Volt  
Chrysler (85-82); Dodge (84-81);  
Plymouth (84-81)



**47819** New w/ Coil  
C171  
Pulley Dia.: 5-5/8  
2 Groove  
12 Volt  
Chrysler (84-79); Dodge (84-79);  
Dodge Medium Duty Truck (81);  
Plymouth (83-79)

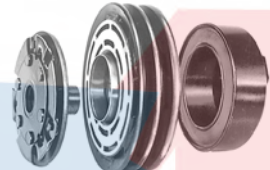

**47830** New w/ Coil  
C171  
Pulley Dia.: 5-3/4  
2 Groove  
12 Volt  
Chrysler (85); Dodge (88-84);  
Plymouth (87-85)  
Frigiking: 9131857

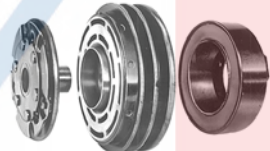

**47831** New w/ Coil  
C171  
Pulley Dia.: 5-9/16  
2 Groove  
12 Volt  
Chrysler (89-85); Dodge (92-85);  
Plymouth (89-84)  
Chrysler: 3848981

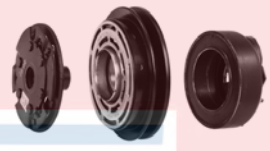

**47839** New w/ Coil  
C171  
Pulley Dia.: 5-3/4  
1 Groove  
12 Volt  
Dodge (86-85), (80-79)

## Diesel Kiki - Seltec - Zexel



**47355** New w/ Coil  
DKS16H  
Pulley Dia.: 5-1/4  
4 Groove  
12 Volt  
Nissan (95-89)  
Nissan: 926607E010

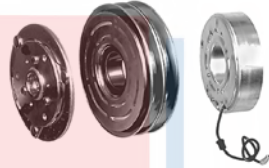

**47605** New w/ Coil  
DKS15BH  
Pulley Dia.: 5-15/16  
2 Groove  
12 Volt  
Big Bud Tractor (90-79)  
Bergstrom: 650499  
Climatech: KA1030  
Dallas Truck AC: 0113307  
Euclid: E802252  
Kenworth: K332D562  
NaviStar: 13065  
Red Dot: 75R0212



**47900** New w/ Coil  
DKS15CH  
Pulley Dia.: 4-7/8  
1 Groove  
12 Volt  
Bergstrom: 511575, 650505  
Climatech: KA1055  
Euclid: E802254  
Kysor: 1399002  
Mack: 4379RD566460  
NaviStar: 16355, 1691736C1  
Red Dot: 75R0182



**47901** New w/ Coil  
DKS15CH  
Pulley Dia.: 6-1/4  
1 Groove  
12 Volt  
Euclid: E802255  
Kysor: 1399014, 1399037  
NaviStar: 704007  
Red Dot: 75R1412



**47902** New w/ Coil  
DKS15CH  
Pulley Dia.: 5-1/4  
2 Groove  
12 Volt  
Bergstrom: 650507  
Climatech: KA1160  
Euclid: E802249, E802256  
Kysor: 1399001, 402955  
Red Dot: 75R0232



**47903** New w/ Coil  
DKS15CH  
Pulley Dia.: 5-1/4  
2 Groove  
12 Volt  
Autocar (94-85)  
Bergstrom: 650504  
Climatech: KA1025  
Dallas Truck AC: 0113407  
Euclid: E802253  
NaviStar: 704005  
Red Dot: 75R0222



# Clutch Assemblies

## Diesel Kiki - Seltec - Zexel Cont'd



**47904** New w/ Coil  
DKS15CH  
Pulley Dia.: 6-1/4  
1 Groove  
12 Volt  
Euclid: E802251  
Kysor: 402956  
NaviStar: 16360

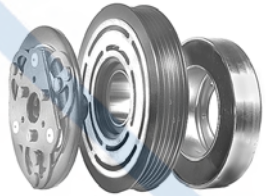

**47989** New w/ Coil  
DKV11  
Pulley Dia.: 5  
5 Groove  
12 Volt  
Saturn (98-91)  
General Motors Corp: 19190320

## Ford - FS6

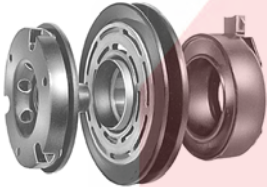

**47848** New w/ Coil  
FS6  
Pulley Dia.: 5-3/4  
1 Groove  
12 Volt  
Ford (92-82)  
Euclid: E802686, E802688  
Kysor: 1399063  
Red Dot: 75R4732



**47849** New w/ Coil  
**48849** Reman w/ Coil  
FS6  
Pulley Dia.: 5-29/32  
1 Groove  
12 Volt  
Ford (92-82); Mercury (85-84)  
Kysor: 1399064  
Red Dot: 75R4722

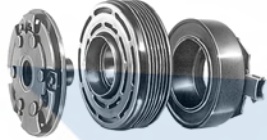

**47854** New w/ Coil  
**48854** Reman w/ Coil  
FS6  
Pulley Dia.: 5  
6 Groove  
12 Volt  
Ford (93-81); Lincoln (88-80); Mercury (88-80)  
Kysor: 1399065  
Red Dot: 75R4702

## Ford - Scroll



**47885** New w/ Coil  
Scroll  
Pulley Dia.: 3-15/16  
6 Groove  
12 Volt  
Ford (07-02); Lincoln (06-02); Mercury (05-02)  
Ford: 1L2Z19D798AA, 6C2Z19D786A

## Ford - FS10 / FX15



**47857** New w/ Coil  
FX15  
Pulley Dia.: 5  
6 Groove  
12 Volt  
**47857** 16 Spline Compressor Shaft,  
**47867** 21 Spline Compressor Shaft  
Ford (92-88); Lincoln (91-90); Mercury (92-88)  
Euclid: E802669  
Kysor: 1399051

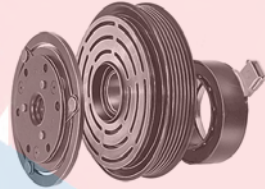

**47859** New w/ Coil  
FX15  
Pulley Dia.: 5-3/4  
6 Groove  
12 Volt  
**47859** 16 Spline Compressor Shaft,  
**47869** 21 Spline Compressor Shaft  
Ford (91-89)  
Kysor: 1399052

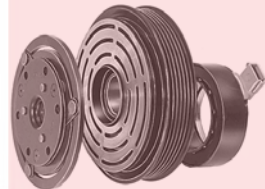

**47867** New w/ Coil  
FS10  
Pulley Dia.: 5  
6 Groove  
12 Volt  
Ford (11-88); Lincoln (94-91); Mazda (07-91); Mercury (01-91), (89)  
Kysor: 1399053

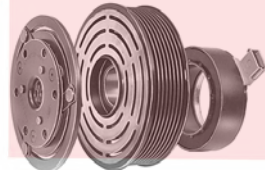

**47868** New w/ Coil  
FS10  
Pulley Dia.: 5-1/8  
8 Groove  
12 Volt  
Ford (07-91); Lincoln (02)  
Kysor: 1399054



**47869** New w/ Coil  
FS10  
Pulley Dia.: 5-5/8  
6 Groove  
12 Volt  
Ford (03-90); Mazda (01-94)  
Euclid: E802672  
Kysor: 1399055



**47871** New w/ Coil  
FS10  
Pulley Dia.: 5  
5 Groove  
12 Volt  
Ford (94-92); Mercury (94-92)

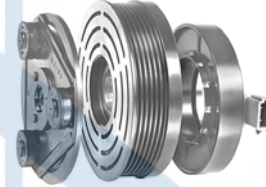

**47874** New w/ Coil  
FS10  
Pulley Dia.: 5  
6 Groove  
12 Volt  
Ford (07-92); Lincoln (02-95); Mazda (06-01); Mercury (06-05), (02-92)

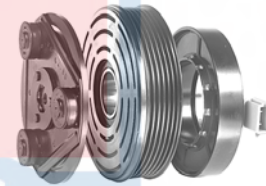

**47876** New w/ Coil  
FS10  
Pulley Dia.: 5  
6 Groove  
12 Volt  
Ford (09-93); Mazda (09), (06); Mercury (02-93)  
Ford: 6S4Z19D786AA  
Kysor: 1399056

# Clutch Assemblies

## Ford - FS10 / FX15 Cont'd



### 47877 New w/ Coil

FS10  
Pulley Dia.: 5-1/4  
4 Groove  
12 Volt  
Hyundai (05-03), (01-90); Kia (01-98);  
Mercury (02-93); Nissan (02-93)

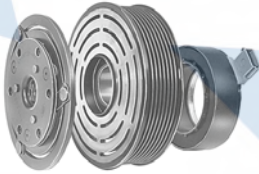

### 47878 New w/ Coil

FS10  
Pulley Dia.: 4-1/2  
8 Groove  
12 Volt  
Ford (03-97); Lincoln (02-98)

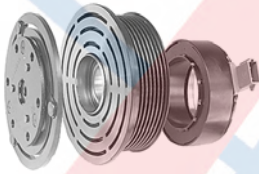

### 47880 New w/ Coil

FS10  
Pulley Dia.: 4-1/2  
7 Groove  
12 Volt  
Ford (93-92); Lincoln (93-91); Mercury  
(93-92)

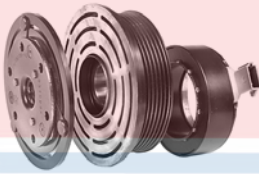

### 47881 New w/ Coil

FS10  
Pulley Dia.: 4-1/2  
6 Groove  
12 Volt  
Ford (07-90); Lincoln (06), (02-93);  
Mercury (07-04), (02-91)  
Kysor: 1399057



### 47882 New w/ Coil

FS10  
Pulley Dia.: 4-1/2  
6 Groove  
12 Volt  
Ford (07-99); Mercury (05-01)

## Frigidaire / Harrison - A6



### 48275 Reman w/o Coil

Frigidaire/Harrison A6  
Pulley Dia.: 6-7/8  
1 Groove  
12 Volt  
Case New Holland: A44935  
Kysor: 202778  
Massey Ferguson: 533719M91  
Northern: 600255

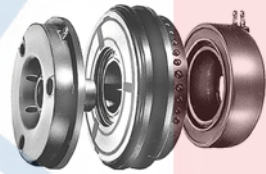

### 48284 Reman w/ Coil

Frigidaire/Harrison A6  
Pulley Dia.: 5  
1 Groove  
12 Volt  
Hub:  
Audi (86), (84-78); Buick (85-62);  
Cadillac (79-77), (72-63); Chevy  
(93-62); Ford (80-72); GMC (93-62);  
Jaguar (92-71); Lincoln (80-71);  
Mercedes (85-65); Mercury (80-75);  
Olds (79-77)  
Olds (75), (71-62); Pontiac (81-62);  
Rolls Royce (84); Volvo (81-76)  
Kysor: 1310002, 402581  
NaviStar: 13302, 576625C91  
Red Dot: 75R0062

## Frigidaire / Harrison - R4



### 47298 New w/ Coil

Frigidaire/Harrison R4 Radial  
Pulley Dia.: 5-1/2  
1 Groove  
12 Volt  
Coil: **48255**  
Light Weight Only  
AMC (81-80); Buick (90-75); Cadillac  
(89-77); Chevy (93-74); GMC (93-74);  
Mercedes (84); Olds (90-75); Pontiac  
(89-75)

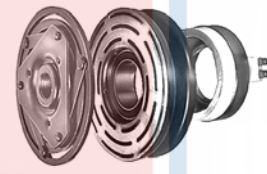

### 47620 New w/ Coil

Frigidaire/Harrison R4 Radial  
Pulley Dia.: 5-1/8  
1 Groove  
12 Volt  
Hub: **48240**  
Coil: **48255**  
Buick (86-83); Chevy (91-83); Chrysler  
(90-89); Dodge (93-92); GMC (91-84);  
Olds (86-83); Plymouth (92); Pontiac  
(88-83)  
General Motors Corp: 19190246

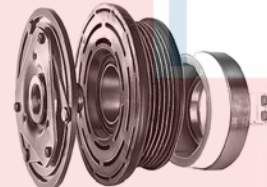

### 47622 New w/ Coil

**48622 Reman w/ Coil**  
Frigidaire/Harrison R4 Radial  
Pulley Dia.: 4-1/4  
6 Groove  
12 Volt  
Hub: **48240**  
Chevy (91-86), (84); GMC (91-87);  
Olds (91)



### 47633 New w/ Coil

**48633 Reman w/ Coil**  
Frigidaire/Harrison R4 Radial  
Pulley Dia.: 5  
6 Groove  
12 Volt  
Hub: **48240**  
Coil: **48255**  
Buick (87-86); Chevy (91-85); GMC  
(91-87); Isuzu (92-89); Pontiac  
(89-87)  
General Motors Corp: 19190247

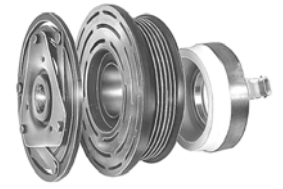

### 47656 New w/ Coil

**48656 Reman w/ Coil**  
Frigidaire/Harrison R4 Radial  
Pulley Dia.: 4-1/4  
6 Groove  
12 Volt  
Hub: **48240**  
Pulley: **48222**  
Coil: **48260**  
Buick (93-91); Cadillac (93); Chevy  
(95-91), (87); GMC (95-92); Olds  
(94-91)



### 47670 New w/ Coil

Frigidaire/Harrison R4 Radial  
Pulley Dia.: 5-23/64  
1 Groove  
12 Volt  
Hub: **48240**  
Coil: **48255**  
Buick (85); Chevy (85)



# Clutch Assemblies

## Frigidaire / Harrison - R4 Cont'd



### 47671 New w/ Coil

Frigidaire/Harrison R4 Radial  
Pulley Dia.: 5

6 Groove

12 Volt

Hub: **48240**

Coil: **48260**

Cadillac (92-90); Chevy (93-90); GMC (93-92); Pontiac (92-89)



### 47720 New w/ Coil

Frigidaire/Harrison R4 Radial  
Pulley Dia.: 5

1 Groove

Buick (85); Chevy (87-84); GMC (87-84); Pontiac (85)

General Motors Corp: 6580056

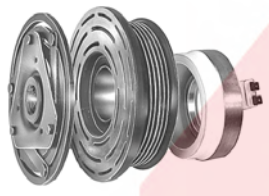

### 48657 Reman w/ Coil

Frigidaire/Harrison R4 Radial  
Pulley Dia.: 4-1/4

6 Groove

12 Volt

Hub: **48240**

Pulley: **48222**

Chevy (92); GMC (92); Olds (93-92)  
Kysor: 1310012

## GM - CVC



### 47280 New w/ Coil

CVC

Pulley Dia.: 4

5 Groove

12 Volt

Chevy (10-02); Pontiac (07-02); Saturn (07-03)

## Harrison - DA6-HR6-HD6-HT6-HE6



### 47631 New w/ Coil

Harrison DA6-HR6-HD6-HT6-HE6

Pulley Dia.: 4-1/4

6 Groove

12 Volt

Chevy (02-99); GMC (02-99); GMC & CHEVY (07-03)

General Motors Corp: 88891576

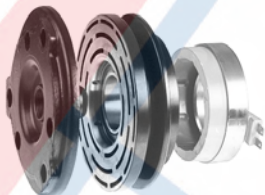

### 47651 New w/ Coil

Harrison DA6-HR6-HD6-HT6-HE6

Pulley Dia.: 5

1 Groove

12 Volt

Buick (86-83); Chevy (91-83); GMC (91-85); Olds (86-83); Pontiac (88-83)



### 47655 New w/ Coil

Harrison DA6-HR6-HD6-HT6-HE6

Pulley Dia.: 4-1/4

6 Groove

12 Volt

Cadillac (93-89); Chevy (05-91); GMC (05-91); Isuzu (00-98); Olds (01-98), (93-92); Pontiac (94-92)



### 47658 New w/ Coil

Harrison DA6-HR6-HD6-HT6-HE6

Pulley Dia.: 4-1/4

6 Groove

12 Volt

Hub: **48237**

Pulley: **48222**

Cadillac (88-85); Chevy (96-92), (90); GMC (96-92), (90)

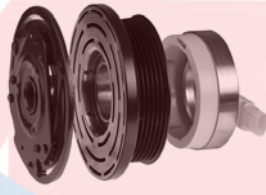

### 47662 New w/ Coil

Harrison DA6-HR6-HD6-HT6-HE6

Pulley Dia.: 5-5/8

6 Groove

12 Volt

Buick (89-86); Olds (89-86); Pontiac (86)

General Motors Corp: 6580045

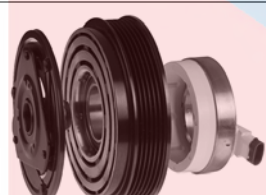

### 47665 New w/ Coil

Harrison DA6-HR6-HD6-HT6-HE6

Pulley Dia.: 5-5/8

6 Groove

12 Volt

Hub: **48237**

Pulley: **48223**

Coil: **48257**

Buick (95-89); Chevy (95-92); Olds (95-89); Pontiac (95-89)

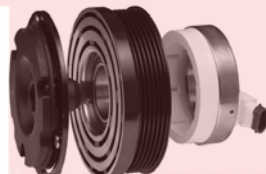

### 47667 New w/ Coil

Harrison DA6-HR6-HD6-HT6-HE6

Pulley Dia.: 5

6 Groove

12 Volt

Acura (99-98); Buick (96-94); Cadillac (02-93), (85); Chevy (05-93); GMC (05-96); Isuzu (00-97); Olds (99-95); Pontiac (97-93)



### 48655 Reman w/ Coil

Harrison DA6-HR6-HD6-HT6

Pulley Dia.: 4-1/4

6 Groove

12 Volt

Hub: **48237**

Pulley: **48222**

Coil: **48257**

Cadillac (93-89); Chevy (05-91); GMC (05-91); Isuzu (00-99); Olds (01-98), (93-92); Pontiac (93-92)

General Motors Corp: 19190376

Kysor: 1310007



### 48658 Reman w/ Coil

Harrison DA6-HR6-HD6-HT6

Pulley Dia.: 4-1/4

6 Groove

12 Volt

Hub: **48237**

Pulley: **48222**

Cadillac (88-85); Chevy (96-92), (90); GMC (96-92), (90)

Kysor: 1310005

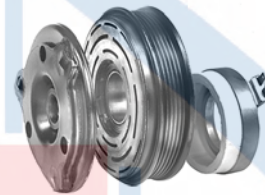

### 48661 Reman w/ Coil

Harrison DA6-HR6-HD6-HT6

Pulley Dia.: 5-5/8

6 Groove

12 Volt

Hub: **48237**

Pulley: **48223**

Coil: **48255**

Buick (89-85); Olds (89-85); Pontiac (88-85)



# Clutch Assemblies

## Harrison - DA6-HR6-HD6-HT6-HE6 Cont'd



**48665 Reman w/ Coil**  
Harrison DA6-HR6-HD6-HT6  
Pulley Dia.: 5-5/8  
6 Groove  
12 Volt  
Hub: **48237**  
Pulley: **48223**  
Coil: **48257**  
Buick (95-89); Chevy (95-92); Olds (95-89); Pontiac (95-89)



**48667 Reman w/ Coil**  
Harrison DA6-HR6-HD6-HT6  
Pulley Dia.: 5  
6 Groove  
12 Volt  
Hub: **48237**  
Coil: **48257**  
Acura (99-98); Buick (96-94); Cadillac (02-93), (85); Chevy (05-93); GMC (04-96); Isuzu (00-97); Olds (99-95); Pontiac (97-93)

## Harrison - V5 Variable Displacement

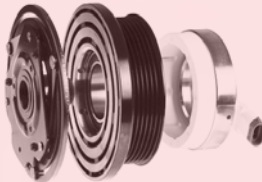

**47654 New w/ Coil**  
Harrison V5 Variable Displacement  
Pulley Dia.: 4-1/4  
6 Groove  
12 Volt  
Pulley: **48222**  
Coil: **48257**  
Buick (05-89); Chevy (03-89); GMC (97); Isuzu (97-96); Olds (04-89); Pontiac (05-89)



**47692 New w/ Coil**  
Harrison V5 Variable Displacement  
Pulley Dia.: 5-1/8  
6 Groove  
12 Volt  
Buick (05-96); Chevy (02-98), (94-90); GMC (93-92); Olds (99-96), (93-91); Pontiac (05-96), (94-91)  
General Motors Corp: 6580044

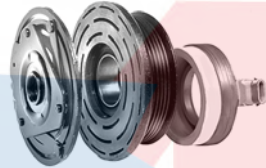

**48654 Reman w/ Coil**  
Harrison V5 Variable Displacement  
Pulley Dia.: 4-1/4  
6 Groove  
12 Volt  
Pulley: **48222**  
Coil: **48257**  
Buick (05-89); Chevy (03-89); GMC (97); Isuzu (97-96); Olds (04-89); Pontiac (05-89)

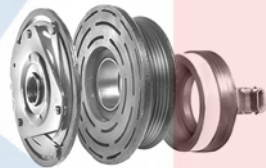

**48660 Reman w/ Coil**  
Harrison V5 Variable Displacement  
Pulley Dia.: 4-5/8  
6 Groove  
12 Volt  
Coil: **48257**  
Buick (04-96), (91), (89); Chevy (03-89); GMC (96), (94); Olds (99-98), (94-89); Pontiac (03-89)

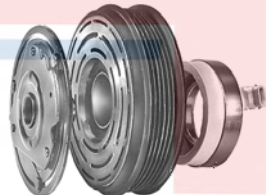

**48663 Reman w/ Coil**  
Harrison V5 Variable Displacement  
Pulley Dia.: 5-5/8  
6 Groove  
12 Volt  
Pulley: **48223**  
Coil: **48257**  
Buick (93-92); Olds (93-92); Pontiac (93-92)



**48664 Reman w/ Coil**  
Harrison V5 Variable Displacement  
Pulley Dia.: 5  
5 Groove  
12 Volt  
Coil: **48257**  
Buick (95-92); Chevy (02-89); Olds (95-90); Pontiac (02-90)

## Hitachi - Nihon Radiator

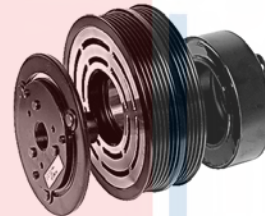

**47990 New w/ Coil**  
Hitachi - Nihon Radiator  
Pulley Dia.: 5-3/4  
10 Groove  
12 Volt  
Nissan (88-87)  
Nissan: 9266016E08

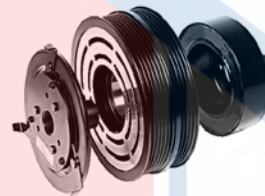

**47992 New w/ Coil**  
Hitachi - Nihon Radiator  
Pulley Dia.: 5-3/4  
10 Groove  
12 Volt  
Nissan (87-85)  
Nissan: 9266016E07



**47847 New w/ Coil**  
Tecumseh HR980 Radial  
Pulley Dia.: 5-3/4  
1 Groove  
12 Volt  
Ford (87-83); Mercury (87-83)  
Warner: 141391

## Nihon/Calsonic - CWV618



**47523 New w/ Coil**  
CWV618  
Pulley Dia.: 5-1/4  
5 Groove  
12 Volt  
For Compressor with 40mm Nose  
Infiniti (00-97); Nissan (01-96)  
Infiniti: 926600W000  
Nissan: 926600W000



**47553 New w/ Coil**  
CWV618  
Pulley Dia.: 5-1/2  
6 Groove  
12 Volt  
Infiniti (97-96); Nissan (97-95)  
Infiniti: 9266031U00  
Nissan: 9266031U00

## Nippondenso - 10P, 6P, 6E



**47321 New w/ Coil**  
6C17  
Pulley Dia.: 5-5/8  
6 Groove  
12 Volt  
Coil: NA  
May Require use of OE Manifold  
Chrysler (93-90); Dodge (93-90); Plymouth (92-90)  
Chrysler: 4462928, 4540370

# Clutch Assemblies

Nippondenso - 10P, 6P, 6E  
Cont'd



**47322 New w/ Coil**

6C17  
Pulley Dia.: 5-1/2  
1 Groove  
12 Volt  
Coil: NA  
May Require use of OE Manifold  
Chrysler (91-89); Dodge (93-88);  
Plymouth (92-89)  
Chrysler: 4462927



**47337 New w/ Coil**

10P  
Pulley Dia.: 5-1/2  
8 Groove  
12 Volt  
May Require use of OE Manifold



**47338 New w/ Coil**

10P  
Pulley Dia.: 5-5/8  
1 Groove  
12 Volt  
May Require use of OE Manifold  
John Deere: RE46657

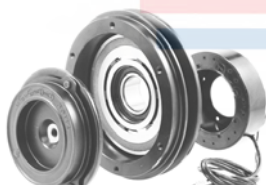

**47339 New w/ Coil**

10P  
Pulley Dia.: 5-11/16  
1 Groove  
12 Volt  
May Require use of OE Manifold  
John Deere: RE64024



**47345 New w/ Coil**

10P, 6P, 6E  
Pulley Dia.: 5-3/4  
1 Groove  
12 Volt  
May Require use of OE Manifold; For  
OE 6E171 Compressor Only



**47535 New w/ Coil**

10P  
Pulley Dia.: 5  
1 Groove  
12 Volt  
May Require use of OE Manifold  
Mercedes (91-86)  
Mercedes Benz: 0001301706

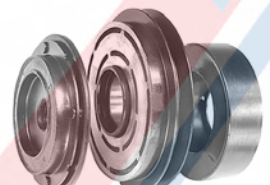

**47569 New w/ Coil**

10P  
Pulley Dia.: 5-1/4  
1 Groove  
12 Volt  
May Require use of OE Manifold  
Audi (94-85)

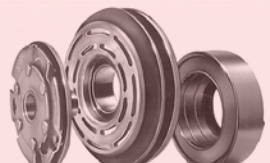

**47579 New w/ Coil**

10P, 6P, 6E  
Pulley Dia.: 5-13/16  
1 Groove  
12 Volt  
May Require use of OE Manifold  
Toyota (88), (85-78)  
Toyota: 8841022070, 8841036390



**47599 New w/ Coil**

10P  
Pulley Dia.: 5  
6 Groove  
12 Volt  
Coil: NA  
May Require use of OE Manifold  
Mercedes (94-82)  
Mercedes Benz: 0001310588

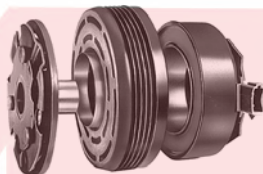

**47851 New w/ Coil**

10P, 6P  
Pulley Dia.: 4-7/8  
5 Groove  
12 Volt  
May Require use of OE Manifold  
Ford (89-81); Mercury (87-81)



**47853 New w/ Coil**

**48853 Reman w/ Coil**  
10P, 6P  
Pulley Dia.: 4-7/8  
6 Groove  
12 Volt  
May Require use of OE Manifold  
Ford (95-82); Lincoln (90-88); Mercury  
(94-82)  
Frigiking: 3005884, 9105884

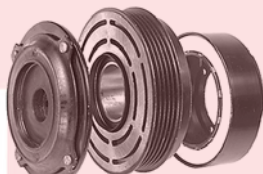

**47890 New w/ Coil**

10P  
Pulley Dia.: 4-3/4  
5 Groove  
12 Volt  
May Require use of OE Manifold  
Mazda (92-88)  
Mazda: GJ5161L10  
Mack: GJ5161L10



# Clutch Assemblies

## Nippondenso - 10PA



**47315** New w/ Coil  
10PA  
Pulley Dia.: 5-1/8  
6 Groove  
12 Volt  
May Require use of OE Manifold  
Honda (98-95); Isuzu (99-96)  
Honda: 38900P1E003

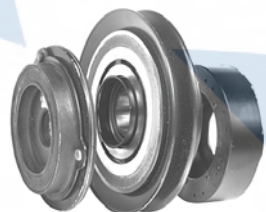

**47318** New w/ Coil  
**48318** Reman w/ Coil  
10PA  
Pulley Dia.: 5-1/4  
1 Groove  
12 Volt  
Coil: NA  
May Require use of OE Manifold  
Dodge (95-93); Plymouth (95-93)  
Chrysler: 4740025

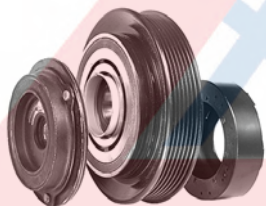

**47319** New w/ Coil  
10PA  
Pulley Dia.: 5-1/2  
6 Groove  
12 Volt  
Coil: NA  
May Require use of OE Manifold  
Chrysler (95-93); Dodge (95-93);  
Plymouth (95-93)  
Chrysler: 4740026, 5264450



**47320** New w/ Coil  
10PA  
Pulley Dia.: 5-5/8  
1 Groove  
12 Volt  
Coil: NA  
May Require use of OE Manifold  
Chrysler (04-91); Dodge (04-91); Eagle  
(97-93); Plymouth (01-91)  
Chrysler: 4723014



**47331** New w/ Coil  
10PA  
Pulley Dia.: 4-1/4  
4 Groove  
12 Volt  
May Require use of OE Manifold  
Toyota (95-91)  
Toyota: 8841028100

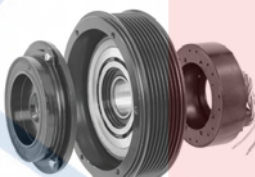

**47332** New w/ Coil  
10PA  
Pulley Dia.: 5-1/2  
8 Groove  
24 Volt  
May Require use of OE Manifold

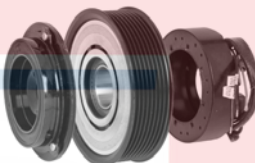

**47333** New w/ Coil  
10PA  
Pulley Dia.: 4-3/4  
8 Groove  
12 Volt  
May Require use of OE Manifold  
John Deere: AL78779



**47335** New w/ Coil  
10PA  
Pulley Dia.: 4-3/4  
1 Groove  
12 Volt  
May Require use of OE Manifold

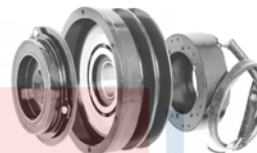

**47336** New w/ Coil  
10PA  
Pulley Dia.: 4-1/2  
2 Groove  
12 Volt  
May Require use of OE Manifold



**47361** New w/ Coil  
10PA  
Pulley Dia.: 4-7/8  
6 Groove  
12 Volt  
May Require use of OE Manifold  
Acura (99-98); Honda (02-98)

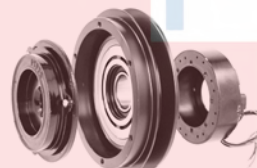

**47390** New w/ Coil  
10PA  
Pulley Dia.: 6  
1 Groove  
12 Volt  
May Require use of OE Manifold  
John Deere: AT215510



**47391** New w/ Coil  
10PA  
Pulley Dia.: 4-3/4  
8 Groove  
24 Volt  
May Require use of OE Manifold  
John Deere: AT211603



**47392** New w/ Coil  
10PA  
Pulley Dia.: 5-3/4  
1 Groove  
24 Volt  
May Require use of OE Manifold  
John Deere: AT163272



**47536** New w/ Coil  
10PA  
Pulley Dia.: 5  
6 Groove  
12 Volt  
May Require use of OE Manifold  
Mercedes (02-86)  
Mercedes Benz: 0002301528



**47563** New w/ Coil  
10PA  
Pulley Dia.: 4-1/4  
5 Groove  
12 Volt  
May Require use of OE Manifold  
BMW (99-88)  
BMW: 64521392745, 64528353032,  
64528391021



# Clutch Assemblies

## Nippondenso - 10PA Cont'd



**47564** New w/ Coil  
10PA  
Pulley Dia.: 5-1/8  
6 Groove  
12 Volt  
May Require use of OE Manifold  
Chrysler (00); Dodge (00-96); Jeep  
(04-93); Plymouth (00-96)  
Chrysler: 4720834, 5010170AA  
Jeep: 4720834

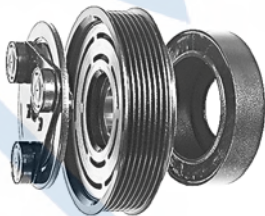

**47565** New w/ Coil  
10PA  
Pulley Dia.: 5-1/8  
7 Groove  
12 Volt  
May Require use of OE Manifold  
Jeep (98-93)  
Chrysler: 4740683  
Jeep: 4740683



**47567** New w/ Coil  
10PA  
Pulley Dia.: 5-1/4  
1 Groove  
12 Volt  
Coil: NA  
May Require use of OE Manifold  
Kia (01-95); Toyota (95-89)  
Toyota: 8841035120

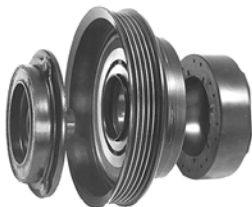

**47570** New w/ Coil  
10PA  
Pulley Dia.: 5-1/4  
6 Groove  
12 Volt  
May Require use of OE Manifold  
Lexus (98), (93-90); Mazda (95-94);  
Toyota (93-88)  
Toyota: 8841032050

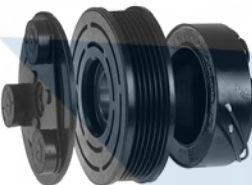

**47571** New w/ Coil  
10PA  
Pulley Dia.: 4-1/2  
6 Groove  
12 Volt  
May Require use of OE Manifold  
Chevy (96-88)  
General Motors Corp: 10243784

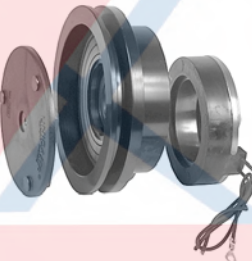

**47592** New w/ Coil  
10PA  
Pulley Dia.: 5-1/2  
1 Groove  
12 Volt  
May Require use of OE Manifold  
Dodge (89); Eagle (94-93); Mitsubishi  
(94-88); Plymouth (94-90); Toyota  
(95-88)  
Toyota: 8841035080, 8841035110,  
8841035150



**47594** New w/ Coil  
10PA  
Pulley Dia.: 5-1/2  
1 Groove  
12 Volt  
May Require use of OE Manifold  
Mitsubishi (95-94); Toyota (90-88)  
Mitsubishi: MB609193, MR117258



**47598** New w/ Coil  
**48598** Reman w/ Coil  
10PA  
Pulley Dia.: 5-1/2  
4 Groove  
12 Volt  
May Require use of OE Manifold  
Acura (05-90); Geo (97-93); Honda  
(97-96); Toyota (02-88)  
General Motors Corp: 19190242



**47821** New w/ Coil  
10PA  
Pulley Dia.: 5-1/4  
1 Groove  
12 Volt  
May Require use of OE Manifold  
Mazda (94-89); Toyota (88-87)  
Toyota: 8841022190



**47824** New w/ Coil  
**48824** Reman w/ Coil  
10PA  
Pulley Dia.: 5-1/2  
5 Groove  
12 Volt  
May Require use of OE Manifold  
Lexus (91-90); Toyota (01-86)  
Toyota: 8841006070



**47826** New w/ Coil  
10PA  
Pulley Dia.: 4-3/4  
4 Groove  
12 Volt  
May Require use of OE Manifold  
Toyota (93-86)  
Toyota: 8841014210

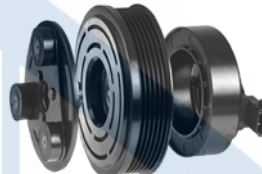

**47861** New w/ Coil  
10PA  
Pulley Dia.: 4-7/8  
6 Groove  
12 Volt  
May Require use of OE Manifold  
Ford (91-89); Lincoln (92-89); Mercury  
(91-89)

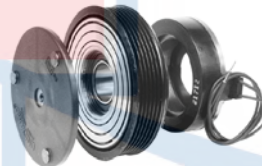

**47866** New w/ Coil  
10PA  
Pulley Dia.: 5  
6 Groove  
12 Volt  
May Require use of OE Manifold  
Chrysler (00-96); Dodge (00-96);  
Plymouth (00-96)  
Chrysler: 4797378, 4797390

# Clutch Assemblies

## Nippondenso - 10PA Cont'd



**47889** New w/ Coil  
10PA  
Pulley Dia.: 6-1/4  
6 Groove  
12 Volt  
May Require use of OE Manifold  
Acura (97-95); Honda (97-94)  
Acura: 38900PAAA01  
Honda: 38900PAAA01

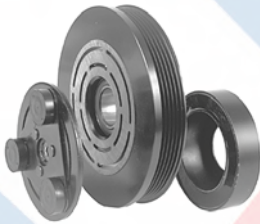

**47893** New w/ Coil  
10PA  
Pulley Dia.: 6-1/2  
5 Groove  
12 Volt  
May Require use of OE Manifold  
Honda (93-90)  
Honda: 38900POGA01

## Nippondenso - 10S



**47348** New w/ Coil  
10S17F  
Pulley Dia.: 4-1/2  
6 Groove  
12 Volt  
Chevy (11-03); GMC (11-03)



**47362** New w/ Coil  
10S17F  
Pulley Dia.: 4-19/64  
4 Groove  
12 Volt  
Cadillac (09-02); Chevy (13-00); GMC (13-00); GMC & CHEVY (13-09)

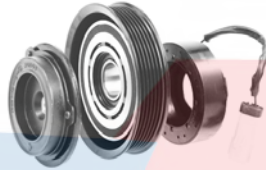

**47374** New w/ Coil  
10S20H  
Pulley Dia.: 5-1/8  
6 Groove  
12 Volt  
Chrysler (07-01); Dodge (07-01)



**47375** New w/ Coil  
10S20C  
Pulley Dia.: 5-7/16  
6 Groove  
12 Volt  
Chrysler (03-01); Dodge (07-04), (02-01)

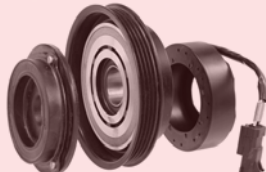

**47378** New w/ Coil  
10S17C  
Pulley Dia.: 4-15/16  
4 Groove  
12 Volt  
Dodge (02-00); Plymouth (01-00)

## Sanden / Sankyo - SD508



**47330** New w/ Coil  
SD508  
Pulley Dia.: 5  
6 Groove  
12 Volt  
AMC (83-80); Jeep (90-88), (86-81)  
Chrysler: 4778022  
AMC: 83501844, 8983501844  
Climatech: KA1155, KA1515  
Kysor: 1399059  
Mack: 4379RD555740  
NaviStar: ZGG704006  
Sanden: 65206010

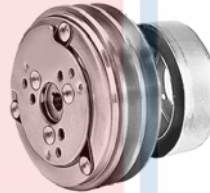

**47586** New w/ Coil  
SD508  
Pulley Dia.: 5-1/4  
2 Groove  
12 Volt  
Alfa Romeo (89-82); Dodge (83); Jeep (90-80); Mazda (83-71); Mercury (89-87); Peugeot (91-80); Plymouth (83); Porsche (78-77); Renault (87-80); Subaru (82-81); Volvo (86-82); VW (84-79)  
Allis Chalmers: 2085169  
AMC: 7701024547, 8133195, 8134180, 8134181  
Dallas Truck AC: 0113110  
Euclid: E802145  
Hy-Capacity: 0000885025  
Kysor: 1399042  
Massey Ferguson: 1069215M91  
NaviStar: 11207, 16362  
Northern: 600393, 600394, 600729  
Red Dot: 75R0202  
Steiger: 13759

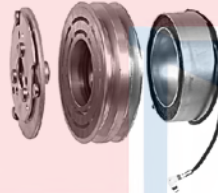

**47607** New w/ Coil  
SD508  
Pulley Dia.: 5-1/8  
2 Groove  
12 Volt  
Jeep (91-87)  
Chrysler: 4778024  
AMC: 83510033



**47995** New w/ Coil  
SD508  
Pulley Dia.: 5  
10 Groove  
12 Volt  
Mazda (85-83)



**47998** New w/ Coil  
SD508  
Pulley Dia.: 6-1/4  
1 Groove  
12 Volt  
Bergstrom: 650536  
Climatech: KA1200, KA1510  
Dallas Truck AC: 0113112  
Euclid: E802144  
Kysor: 1399016, 1399030, 402773, 402774  
Mack: 4379RD554890  
NaviStar: 11044, 11209, 11529, 653480C91  
Red Dot: 75R1402

## Sanden / Sankyo - SD709

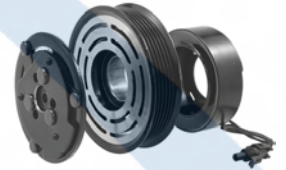

**47351** New w/ Coil  
SD709  
Pulley Dia.: 4-3/4  
6 Groove  
12 Volt  
Jeep (96-94)  
Jeep: 4762973

# Clutch Assemblies

## Sanden / Sankyo - SD709 Cont'd



### 47996 New w/ Coil

SD709  
Pulley Dia.: 5-1/2  
2 Groove  
12 Volt  
Climatech: KA1370  
Dallas Truck AC: 0113113  
Kenworth: K332B25  
Kysor: 1399041, 1399043, 402602  
Mack: 4379RD554870  
Red Dot: 75R0194, 75R0204  
Sanden: 65193210, 65196210



### 47997 New w/ Coil

SD709  
Pulley Dia.: 4-7/8  
6 Groove  
12 Volt  
Ford (97-87); Mazda (94-93), (91);  
Mercury (91-88)  
Euclid: E802160



### 47999 New w/ Coil

SD709  
Pulley Dia.: 6  
1 Groove  
12 Volt  
Euclid: E802159  
Steiger: 13733

## Sanden / Sankyo - TRF090



### 47554 New w/ Coil

TRF090  
Pulley Dia.: 4-55/64  
5 Groove  
12 Volt  
Honda (96-92)  
Honda: 38900P14A02, 38924P13J03

## Sanden / Sankyo - TRS090



### 47560 New w/ Coil

TRS090  
Pulley Dia.: 4  
4 Groove  
12 Volt  
Honda (01-94)

## York & Tecumseh

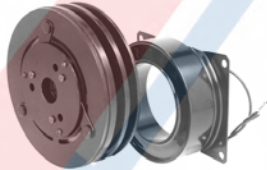

### 47323 New w/ Coil

206, 209, 210, HG850, HG1000  
Pulley Dia.: 5-3/4  
2 Groove  
12 Volt  
AMC (79-75); Jeep (90-74)  
AMC: 3224193, 3227685, 3692973,  
5761332, 8129533, J5761332  
Pitts: 8134  
Warner: 143697



### 47531 New w/ Coil

### 48531 Reman w/ Coil

206, 209, 210, HG850, HG1000  
Pulley Dia.: 6  
2 Groove  
12 Volt  
Audi (77-70); Dodge (79-75); Ford  
(85-70), (67); Ford Medium Duty  
(77-75); Jaguar (79-72); Mercury  
(84-71), (67); Plymouth (79-76);  
Porsche (77-74)  
Bergstrom: 650482, 650483, 650515  
Case New Holland: A66057  
Climatech: KA1135, KA1360, KA1395  
Dallas Truck AC: 0107531  
Deutz: 0033938  
Egging: 21579  
Euclid: E802501, E802502, E802517  
Evans: AM80119, AM80131, HV27228,  
HV30709  
Frigiking: 3000204  
Full Vison: 172931  
Hesston: 3317V002  
Hupp: 64157G1  
John Deere: AH79301  
Kenworth: K332C27  
Kysor: 1313005, 402400, 402500,  
402669, 402918  
Mack: 4379RD549670, 7979402500,  
IMX240, IMX242, IMXA246  
NaviStar: 12135, 1647566C91,  
1687819C1  
Northern: 600227, 600283  
Oliver: 402165  
Pitts: 7531  
Warner: 141118



# Clutch Assemblies

## York & Tecumseh Cont'd



**47534** New w/ Coil  
**48534** Reman w/ Coil  
 206, 209, 210, HG850, HG1000  
 Pulley Dia.: 7  
 2 Groove  
 12 Volt  
 Jaguar (79-72)  
 Allis Chalmers: 1182664, 11826641, 11826644, 711826644  
 AMC: SE2087026, SE2087027  
 ARA: 459928  
 AutoCar: 17B01383  
 Bergstrom: 650481, 650496  
 Carrier: 143405C91, 162008  
 Case New Holland: 130223, 603441, A162008, A64956  
 Climatech: KA1090  
 Dallas Truck AC: 0107534  
 Deutz: 0034530, 1182664  
 Egging: 21580  
 Euclid: E802500, E802562, E802580  
 Evans: AM80024, HV30682, HV80024, HV80028  
 Frigiking: 3000203, 3000267  
 Full Vison: 172932  
 Hesston: 702704  
 Hinker: 116013038, 116015038  
 John Deere: AH85847, K332B23  
 Kenworth: K33223, K33229, K33232, K332B23, K332C23, K332C29  
 Kysor: 1399004, 1399046, 402041, 402412, 402499, 402585, 402656, 402917  
 Mack: 141141, 141172, 1MX1280, 1MX2456, 1MX246, 1MZA1281, 4379RD549940, 7979402412, 7979402499, IMX246, IMXA240  
 Massey Ferguson: 1070592M91, 470039M91  
 NaviStar: 111631C91, 12136, 143405C91, 1669746C91, 1687801C91, 425450C92, 435450C92, A66057  
 Northern: 600281, 600312, 600460, 600472  
 Oliver: 401800, 402895  
 Peterbilt: 181866  
 Pitts: 10795, 7534  
 Red Dot: 75R3452, 75R4502, RD54987, RD54988  
 Stopler: 23523, 38523  
 Versatile: 17906  
 Warner: 141141, 141172  
 Year-A-Round: 14009100



**47541** New w/ Coil  
 206, 209, 210, HG850, HG1000  
 Pulley Dia.: 6  
 2 Groove  
 12 Volt  
 Volvo (84-75)  
 Volvo: 1259281  
 AMC: 8128865  
 Pitts: 12364



**47551** New w/ Coil  
 206, 209, 210, HG850, HG1000  
 Pulley Dia.: 6  
 2 Groove  
 12 Volt  
 Chrysler (79-75); Dodge (83-70); Plymouth (83-74)  
 AutoCar: 031104973  
 Case New Holland: 81417397  
 Euclid: E802507, E802564  
 Hesston: 8045695  
 Hinker: 116015023, 116015051  
 John Deere: AH85864, K332B19, K332B27  
 Kenworth: K33237, K33244, K332B19, K332B27  
 Kysor: 402044  
 Massey Ferguson: D45054900  
 NaviStar: 11566, 1647556C91, 165129C91, 481808C91, 482808C91  
 Northern: 600313  
 Peterbilt: 1802572, 181222  
 Pitts: 7551  
 Red Dot: 75R0452  
 Stopler: 3117V004  
 Western Star: 611035002



**47581** New w/ Coil  
 206, 209, 210, HG850, HG1000  
 Pulley Dia.: 6  
 2 Groove  
 12 Volt  
 Audi (82-80); Jaguar (79-72)  
 Kysor: 402121  
 Pitts: 10889  
 Warner: 141112



**47582** New w/ Coil  
 206, 209, 210, HG850, HG1000  
 Pulley Dia.: 5  
 2 Groove  
 12 Volt  
 AMC (79-77); Dodge (84-71); Nissan (79-77); Plymouth (83-76)  
 Nissan: 27632H7215  
 AMC: 3693221  
 Kysor: 1399073  
 Pitts: 10954  
 Warner: 14121

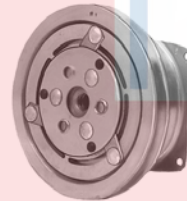

**47809** New w/ Coil  
**48809** Reman w/ Coil  
 206, 209, 210, HG850, HG1000  
 Pulley Dia.: 6-1/4  
 1 Groove  
 12 Volt  
 Ford (82-64); Ford Medium Duty (77-76); Lincoln (68); Mercury (82-63)  
 AMC: 3692944  
 ARA: 459787  
 Euclid: E802513  
 John Deere: K332B26  
 Northern: 600239, 600241  
 Pitts: 7809  
 Warner: 140670



**47811** New w/ Coil  
**48811** Reman w/ Coil  
 206, 209, 210, HG850, HG1000  
 Pulley Dia.: 6  
 1 Groove  
 12 Volt  
 AMC (82-65); Audi (87-80); Ford (79-65); Int'l (80-73); Jeep (86-71); Lincoln (71-68); Mercury (79), (76-70); VW (88-85)  
 AMC: 3176724, 3186607, 3217215, 3217290, 3217331, 3228639, 3692974, 4486589, 8121282, 8121822, 8122111, 8126139  
 ARA: 459788, 460023  
 Euclid: E802537  
 NaviStar: 704002  
 Northern: 600396  
 Pitts: 7811  
 Warner: 143690



**47815** New w/ Coil  
 206, 209, 210, HG850, HG1000  
 Pulley Dia.: 5-3/4  
 6 Groove  
 12 Volt  
 Kysor: 1313001



**47905** New w/ Coil  
 206, 209, 210, HG850, HG1000  
 Pulley Dia.: 6  
 1 Groove  
 12 Volt  
 Caterpillar: 2329039  
 Euclid: E802516, E802536, E803536  
 Kenworth: K33253  
 Kysor: 1313008, 1399005, 1399013, 402927  
 Mack: 4379RD596650  
 NaviStar: 12141, 2592004C91, 4818100C91  
 Red Dot: 75R0302, 75R0402

# Clutch Assemblies

## York & Tecumseh Cont'd



**47906 New w/ Coil**  
206, 209, 210, HG850, HG1000  
Pulley Dia.: 6  
1 Groove  
12 Volt  
Bergstrom: 650543  
Caterpillar: 2329039  
Climatech: KA1460  
Euclid: E802543, E803543  
Kysor: 1399013  
Mack: 4379RD596650  
NaviStar: 14191, 4818100C91  
Red Dot: 75R1222



**47907 New w/ Coil**  
206, 209, 210, HG850, HG1000  
Pulley Dia.: 6  
2 Groove  
12 Volt  
ARA: 459929  
Carrier: 65338C91  
Climatech: KA1000, KA1040, KA10400  
Egging: 21596  
Euclid: E802594  
Frigiking: 3031876, 9131876  
Full Vison: 11699  
Hesston: 8045695  
John Deere: AH85846  
Kenworth: K33214, K33219, K33224, K33227  
Kysor: 1380001, 1399003, 402550, 402667, 402721, 402901, 402915  
Mack: 1MX240, 1MX242, 4379RD549721, 7979402424, IMXA1230, IMXA1280, IMXA242  
NaviStar: 1676647C91  
Peterbilt: 141139, 181210  
Pitts: 10884  
Red Dot: 75R1202, RD54972, RD54978  
TRP Parts: KA10400  
Warner: 141139  
Western Star: A0122964



**47908 New w/ Coil**  
206, 209, 210, HG850, HG1000  
Pulley Dia.: 6-3/4  
2 Groove  
12 Volt  
Carrier: 118161C91  
Caterpillar: 2329083  
Climatech: KA1035, KA1120  
Euclid: E802530  
John Deere: K332C23, K332C32  
Mack: 4379RD5103700, 4379RD549870, IMXA1281  
NaviStar: 11565, 4818106C91  
Red Dot: 75R3502  
Western Star: 027074272, 027089233



**47909 New w/ Coil**  
206, 209, 210, HG850, HG1000  
Pulley Dia.: 6-1/4  
1 Groove  
12 Volt  
Bergstrom: 650547  
Climatech: KA1490  
Euclid: E802561  
Kysor: 1313002, 1999029, 402075, 402352, 402475  
Mack: 4379RD5103970  
NaviStar: 19845, 2016403C1, 2592006C1, 2595006C1  
Red Dot: 75R0352, 75R1342  
TRP Parts: KA14900



**47910 New w/ Coil**  
206, 209, 210, HG850, HG1000  
Pulley Dia.: 6  
2 Groove  
12 Volt  
Bergstrom: 650544  
Climatech: KA1475  
Euclid: E802548  
NaviStar: 11526, 1669745C1, 1669745C91



**47926 New w/ Coil**  
206, 209, 210, HG850, HG1000  
Pulley Dia.: 6  
2 Groove  
12 Volt  
Bergstrom: 650868  
Caterpillar: 2329053  
Climatech: KA1525, KA15250  
Kenworth: K332595  
Kysor: 1380002, 1399007  
Mack: 4379RD594560, IMXA3291  
NaviStar: 19776, 2016366C93, 2592000C91, 2592001C91  
Red Dot: 75R1302  
TRP Parts: KA15250

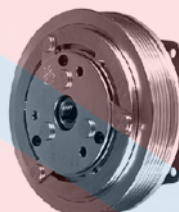

**47927 New w/ Coil**  
206, 209, 210, HG850, HG1000  
Pulley Dia.: 6  
6 Groove  
12 Volt  
ARA: 459918, 459978  
Climatech: KA1405, KA1535  
Kenworth: K332597  
Kysor: 1312003, 1380004, 1399008, 1399018, 402414, 402658, 402901  
NaviStar: 19323, 704000  
Peterbilt: 181208  
Red Dot: 75R0502



**47928 New w/ Coil**  
206, 209, 210, HG850, HG1000  
Pulley Dia.: 6-5/16  
8 Groove  
12 Volt  
Caterpillar: 2329048  
Climatech: KA1400, KA1405  
Kenworth: K332594, KA1405  
Kysor: 1380006, 1399009  
Mack: 4379RD5103650, IMAX3294  
NaviStar: 19310, 19841  
Peterbilt: K332594, KA1405



**47931 New w/ Coil**  
206, 209, 210, HG850, HG1000  
Pulley Dia.: 6-1/8  
1 Groove  
12 Volt  
Dallas Truck AC: 0107931  
Kysor: 402547, 402939  
NaviStar: 19311, 434668C91, 481800C91, 481807C91, 4818107C91  
Northern: 6001214, 600721  
Pitts: 7931  
Warner: 141136



**47935 New w/ Coil**  
206, 209, 210, HG850, HG1000  
Pulley Dia.: 6  
2 Groove  
12 Volt  
ARA: 460025  
Bergstrom: 650544  
Caterpillar: 2329052  
Climatech: KA1475  
Euclid: E802538, E802539  
Kysor: 1313006, 402663  
Mack: 4379RD597980  
NaviStar: 400728C91, 416095C91  
Northern: 6001213, 600305, 600307, 600474  
Warner: 146621



**47938 New w/ Coil**  
206, 209, 210, HG850, HG1000  
Pulley Dia.: 7  
2 Groove  
24 Volt  
Bergstrom: 650513  
Caterpillar: 2329090  
Climatech: KA1375  
Dallas Truck AC: 0110223  
Kysor: 1399049, 1399086, 402945  
Mack: 4379RD583820  
Pitts: 11212  
Red Dot: 75R3454, 75R4554  
Warner: 141186

# Clutch Assemblies

## York & Tecumseh Cont'd



**47939 New w/ Coil**  
 206, 209, 210, HG850, HG1000  
 Pulley Dia.: 6  
 2 Groove  
 24 Volt  
 ARA: 459600  
 Dallas Truck AC: 0110204  
 Euclid: E802592  
 Kenworth: K33241  
 Kysor: 1399048  
 NaviStar: 13304  
 Red Dot: 75R0754  
 Warner: 141150



**47959 New w/ Coil**  
 206, 209, 210, HG850, HG1000  
 Pulley Dia.: 6  
 6 Groove  
 12 Volt  
 Bergstrom: 650451, 650545  
 Climatech: KA1390, KA1480  
 Dallas Truck AC: 0107951  
 Euclid: E802593  
 Kysor: 1312002  
 Mack: 4379RD580090  
 NaviStar: 167813C1, 1687801C91,  
 1687819C1, 18414, 2592004C92,  
 2597637C91  
 Red Dot: 75R0612



**47960 New w/ Coil**  
 206, 209, 210, HG850, HG1000  
 Pulley Dia.: 5-1/2  
 8 Groove  
 12 Volt  
 Bergstrom: 650546, 650923  
 Caterpillar: 2329047  
 Climatech: KA1485  
 Dallas Truck AC: 0107981  
 Euclid: E802558  
 Kysor: 1380007, 1399006  
 Mack: 4379RD598020  
 NaviStar: 1818128C1, 1818128C92,  
 2592005C1, 2592005C91  
 Red Dot: 75R0662  
 TRP Parts: KA14850



**47968 New w/ Coil**  
 206, 209, 210, HG850, HG1000  
 Pulley Dia.: 6-3/4  
 1 Groove  
 12 Volt  
 ARA: 459920, 459924  
 AutoCar: 031104968  
 Bergstrom: 650484  
 Climatech: KA1045  
 Dallas Truck AC: 0110581, 0110586,  
 0110589  
 Euclid: E802508  
 Evans: AM80014, HV80014, HV80016,  
 HV80019  
 Kenworth: 402637, K33228, K33245,  
 K332B28, K332C28  
 Kysor: 1310016, 1312001, 402086,  
 402095, 402416, 402637  
 Massey Ferguson: 250375M91  
 NaviStar: 11553, 1676660C1,  
 1676660C91, 393580C91, 395083C91  
 Northern: 600202, 600204, 600205,  
 600206, 600364  
 Peterbilt: 1802573  
 Pitts: 10586  
 Red Dot: 75R3002, 75R3302, RD54984,  
 RD54987  
 Warner: 141170



**47971 New w/ Coil**  
 206, 209, 210, HG850, HG1000  
 Pulley Dia.: 6-3/4  
 1 Groove  
 12 Volt  
 ARA: 459930  
 Bergstrom: 650492, 650494, 650534  
 Climatech: KA1140, KA1325, KA1385,  
 KA1445  
 Dallas Truck AC: 0110591  
 Euclid: E802523, E802524, E802531  
 Evans: AM80004, AM80015, HV80015,  
 HV80018  
 Frigiking: 3031854, 9131854  
 Hy-Capacity: 0000885154  
 Kenworth: K332B17, K332B26  
 Kysor: 1399023, 402038, 402067  
 Mack: 208RD31, 4379RD549760,  
 4379RD549880  
 NaviStar: 11549, 11567, 393578C91,  
 481802C91, 4818103C91  
 Peterbilt: 1802570  
 Pitts: 10990  
 Red Dot: 75R1802, 75R3152, 75R3602,  
 RD54988, RD54993  
 Warner: 140649



**47994 New w/ Coil**  
 206, 209, 210, HG850, HG1000  
 Pulley Dia.: 7  
 1 Groove  
 12 Volt  
 ARA: 459799  
 Bergstrom: 650485  
 Climatech: KA1010  
 Dallas Truck AC: 0110761  
 Euclid: E802511  
 Evans: AM80001  
 Frigiking: 3000263  
 John Deere: K33215, K33221, K33225  
 Kenworth: K33215, K33221, K33225  
 Kysor: 1399021, 1399027, 402503,  
 402662, 402919  
 Mack: 140697, 1MX3268, 1MXA3268,  
 4379RD549950, IMX3268, IMXA1279,  
 IMXA3268  
 NaviStar: 11564  
 Peterbilt: 1802434, 181214  
 Red Dot: 75R2852, 75R4652  
 Warner: 140697



**48812 Reman w/ Coil**  
 206, 209, 210, HG850, HG1000  
 Pulley Dia.: 6-15/16  
 1 Groove  
 12 Volt



## Clutch Parts - Bearings

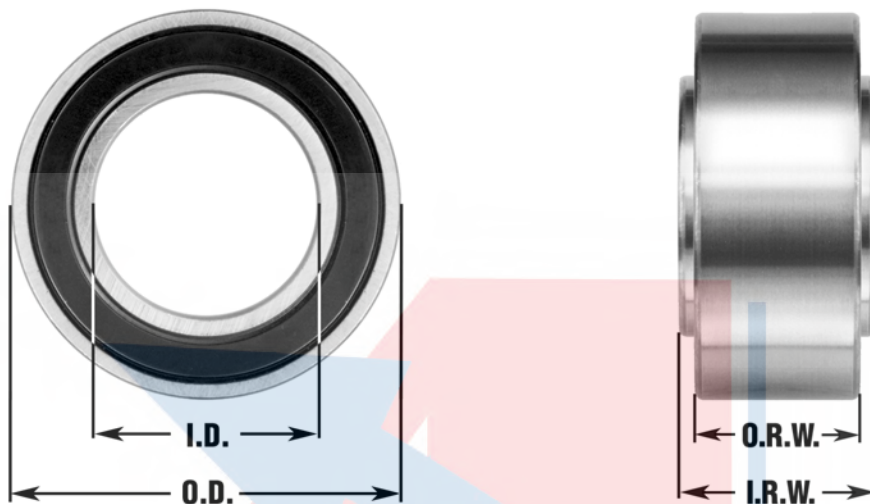

Part No.	O.D. Inch	O.D. MM	I.D. Inch	I.D. MM	O.R.W. Inch	O.R.W. MM	I.R.W. Inch	I.R.W. MM
<b>Bearings</b>								
25203	2-7/16	62.000	1-9/16	40.000	13/16	20.600	13/16	20.6
25204	2-5/32	55.000	1-11/64	30.000	29/32	23.000	29/32	23.000
25207	2-7/16	62.000	1-11/64	30.000	5/8	16.000	15/16	24.000
25208	2-7/16	62.000	1-11/64	30.000	5/8	16.000	5/8	16.000
25211	2-3/64	52.000	1-11/64	30.000	7/8	22.000	7/8	22.000
25212	2-5/32	55.000	1-23/64	35.000	25/32	20.000	25/32	20.000

## **Clutch Parts - Clutch Coil**

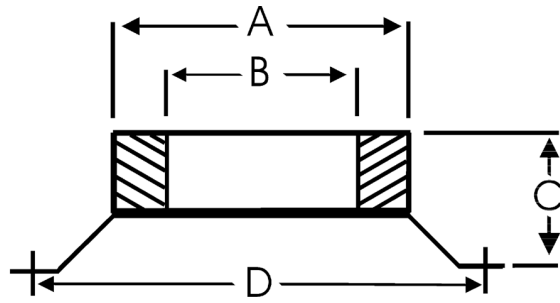

Part No.	New / Reman	Type	A	B	C	D
<b>Clutch Coil</b>						
47794	New	York & Tecumseh	4-5/8	2-15/16	1-7/16	4-5/8
47800	New	Sanden/Sankyo	4-1/16	2-7/8	1-1/2	1-1/2
48255	Reman	GM	3-5/8	2-1/8	1-1/4	1-1/4
48257	Reman	GM	3-5/8	2	1-1/4	1-1/4
48260	Reman	GM	3-5/8	2	1-1/4	
48799	Reman	York & Tecumseh	4-5/8	3	1-3/4	4-5/8

All clutch coils meet or exceed original equipment specifications. For clutch coil identification, use the illustration and chart above. Pitts and Warner type coils are not interchangeable on York/Tecumseh clutch assemblies. Ford clutches will not interchange between Ford, Warner, and Nippondenso components. Chrysler coils have a flat I.D. and a stepped beveled I.D. which are not interchangeable.

# Clutch Parts Miscellaneous

## Bearings



**25203**  
Frigidaire/Harrison/General Motors A6, R4, DA/HR6, HU6, HT6, V5, V7 Clutches  
General Motors Corp: 6559469  
Allis Chalmers: 02697449  
AMC: 8131991  
Case New Holland: A44934  
Evans: AM80121  
Hinker: 116016093  
Hy-Capacity: H88590  
John Deere: AR49805, AR71288  
Mack: 33276556349  
Massey Ferguson: 42300M91  
NaviStar: 576626C91  
New Idea: 733291  
Northern: 440313



**25204**  
York & Tecumseh 'Pitts' Type Clutches, Ford FS10/FX15, Diesel Kiki DKS16, Nihon NVR140  
Evans: AM80122  
Northern: 440394



**25207**  
Sanden/Sankyo Clutches w/ SD708, 709, 7H15 Compressors  
Deutz: 1159662, 1159663  
Evans: AM80090  
Northern: 440202



**25208**  
For Warner Replaced Ford Clutches  
Northern: 440201



**25211**  
Nippondenso Clutches w/ 10PA & TV Series Compressors  
Toyota: 9009910135  
Northern: 440948



**25212**  
Diesel Kiki DCW17, Tama TM08, TM13, TM15, Zexel DCV11, DKV14A (Saturn)  
Northern: 440718, 440757

## Clutch Coil

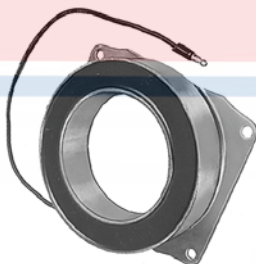

**47794**  
New  
Warner York-Tech  
12 Volt  
Case New Holland: A44568  
Evans: AM80133  
Northern: 600216



**47800**  
New  
Sankyo/Sanden  
12 Volt  
Climatech: LJ1010  
Dallas Truck AC: 0114110  
Kysor: 402599, 402601  
Mack: 4379RD557520  
NaviStar: 13344  
Northern: 600411  
Red Dot: 75R5102  
Steiger: 25237



**48255**  
Reman  
DA6, Lt R4, HR6, V-5  
12 Volt  
Harness Connector: **37201**



**48257**  
Reman  
DA6, HR6, V5, HD6, HT6  
12 Volt  
Harness Connector: **37215**  
General Motors Corp: 89019185

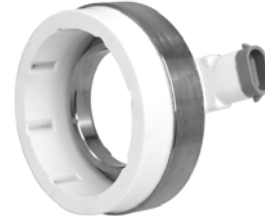

**48260**  
Reman  
Lt R4  
12 Volt  
Harness Connector: **37215**  
General Motors Corp: 6552649

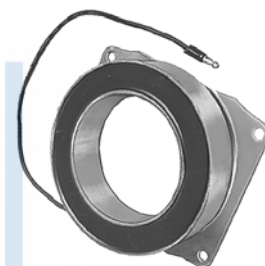

**48799**  
Reman  
Pitts, York, Tech.  
12 Volt

## Clutch Hub



**48237**  
Reman  
HR6 Hub  
General Motors Corp: 6580590, 89019049

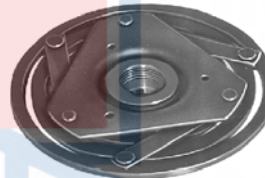

**48240**  
Reman  
Fits Lt R4, DA6



# Clutch Parts Miscellaneous

## Clutch Pulley



**48222**  
Reman  
DA6, Lt R4, HR6,V-5  
Pulley Dia.: 4-1/2  
Belt Width: 7/8  
Groove: 6 Groove  
General Motors Corp: 6580037

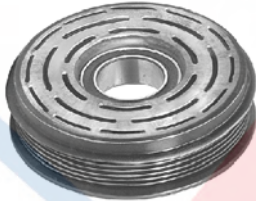

**48223**  
Reman  
V5  
Pulley Dia.: 5-5/8  
Belt Width: 7/8  
Groove: 6 Groove  
General Motors Corp: 6580640

## Harness Connectors

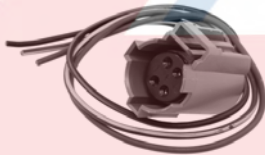

**20954**  
Harness Connector  
Connector Pin Quantity: 4  
Chrysler (11-93); Dodge (11-93); Eagle (97-93); Jeep (11-06); Plymouth (00-96)



**35900**  
Harness Connector Boot  
Climatech: FA1060  
Dallas Truck AC: 0313037  
Euclid: E807250  
Kysor: 2299100  
NaviStar: 16666  
Red Dot: 71R4500, RD54621



**37201**  
Repair Kit for GM 2 Terminal Coil w/ Diode  
Connector Pin Quantity: 2  
AMC (81-80); Audi (86-78); Buick (91-62); Cadillac (93), (89-62); Chevy (96-62); Chrysler (90-89); Dodge (93-92); Ford (88-83), (80-72); GMC (96-62); GMC & CHEVY (92-90), (88-87), (84-80)  
Isuzu (92-89); Jaguar (92-71); Lincoln (80-71); Mercedes (87), (85-63); Mercury (86-83), (80-71); Olds (93-62); Plymouth (92); Pontiac (93-62); Rolls Royce (84); Volvo (87-83), (81-76)  
Northern: 110240



**37202**  
Harness Connector for 5 Terminal Relay  
Connector Pin Quantity: 5  
Buick (90-77); Cadillac (86-82); Chevy (94-76); GMC (94-77); Olds (94-76); Pontiac (90-65)



**37203**  
Harness Connector for 5 Terminal Relay & Blower Switch  
Connector Pin Quantity: 5  
AMC (80-68); Buick (77-64); Cadillac (85-66); Chevy (79-62); Chrysler (91-83), (76-74), (67); Dodge (91-72); Dodge Medium Duty Truck (80-78); Ford (82-75); GMC (77-65); Olds (78-66)  
Plymouth (91-83), (80-74); Pontiac (77-67); Subaru (97-78); VW (80-76)

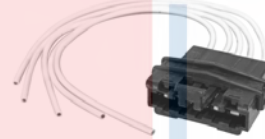

**37205**  
Harness Connector for 5 Terminal Mode Switch  
Connector Pin Quantity: 5  
Chevy (91-78); GMC (91-78)

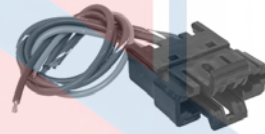

**37206**  
Harness Connector for 4 Terminal Power Switch  
Connector Pin Quantity: 4  
Buick (96-78); Cadillac (83-82); Chevy (95-78); GMC (95-78); Olds (95), (88-77); Pontiac (94-77)



**37207**  
Harness Connector for 4 Terminal Blower Switch  
Connector Pin Quantity: 4  
Chrysler (89-74); Dodge (90-74); Dodge Medium Duty Truck (81); Mercury (83-82); Plymouth (89-74)



**37208**  
Harness Connector for 5 Terminal Relay  
Connector Pin Quantity: 5  
Buick (88-80); Cadillac (84-82); Chevy (89-80); GMC (89-82); Olds (88-80); Pontiac (93-82)



**37209**  
12" Extension Coil Wire for GM Products.  
AMC (81-80); Audi (86-78); Buick (91-62); Cadillac (93), (89-62); Chevy (96-62); Chrysler (90-89); Dodge (93-92); Ford (88-83), (80-72); GMC (96-62); GMC & CHEVY (92-90), (88-87), (84-80)  
Isuzu (92-89); Jaguar (92-71); Lincoln (80-71); Mercedes (87), (85-63); Mercury (86-83), (80-71); Olds (93-62); Plymouth (92); Pontiac (93-62); Rolls Royce (84); Volvo (87-83), (81-76)  
General Motors Corp: 19189713  
Northern: 110027



**37210**  
Harness Connector for Bosch Relays 4 or 5  
Connector Pin Quantity: 5  
Buick (93-84), (81); Cadillac (93-77); Chevy (96), (94-86); Chrysler (95-89); Dodge (96-89), (86), (84-80); Ford (01-86); Geo (97-93); GMC (96), (94-88); Infiniti (05), (99-92)  
Jeep (87-84); Lexus (03-92); Mercury (01-96); Nissan (99-93); Olds (93-83); Plymouth (95-89), (84-80); Pontiac (93-85); Renault (87-83); Toyota (05-90)

## Clutch Parts Miscellaneous

### Harness Connectors Cont'd



**37211**  
 Harness Connector for Bosch Relays 4 or 5  
 Connector Pin Quantity: 5  
 Audi (96-78); BMW (85-78), (76-67); Buick (94-86); Cadillac (01-97), (93-80); Chevy (97-90); Chrysler (05-89); Dodge (05-90); Eagle (97-88); Ford (07-87); Jeep (05-04), (01-87); Lincoln (07-90); Mercury (07-87); Mitsubishi (01); Olds (96-86); Plymouth (99-92); Pontiac (97-88); Porsche (91-86); VW (95-82)  
 Euclid: E807373  
 Kysor: 221755



**37212**  
 Harness Repair Kit for Ford Radiator Fan Controller  
 Connector Pin Quantity: 10  
 Ford (93-82); Mercury (91-82)



**37213**  
 Repair Kit for GM 2 Terminal  
 Connector Pin Quantity: 2  
 Buick (07-80); Cadillac (00-82); Chevy (05-80); Chrysler (83); Dodge (08-04); Geo (89); GMC (02-98), (92-90); Isuzu (89-85); Olds (04-80); Pontiac (05-80); Saturn (02-91)



**37214**  
 Coil Harness  
 Connector Pin Quantity: 2  
 Ford (94-81); Honda (83-82); Lincoln (90-81); Mercury (94-81)



**37215**  
 Coil Harness w/ Diode  
 Connector Pin Quantity: 2  
 Acura (99-98); Buick (05-89); Cadillac (02-89), (85); Chevy (05-89), (87); Ford (00-95); GMC (05-91); Isuzu (01-96); Olds (04-89); Pontiac (05-89); SRT (10-91); VW (00-91)



**37216**  
 Harness Connector Adapter  
 AMC (81-80); Audi (86-78); Buick (91-62); Cadillac (93), (89-62); Chevy (96-62); Chrysler (90-89); Dodge (93-92); Ford (88-83), (80-72); GMC (96-62); GMC & CHEVY (92-90), (88-87), (84-80)  
 Isuzu (92-89); Jaguar (92-71); Lincoln (80-71); Mercedes (87), (85-63); Mercury (86-83), (80-71); Olds (93-62); Plymouth (92); Pontiac (93-62); Rolls Royce (84); Volvo (87-83), (81-76)  
 Northern: 110093

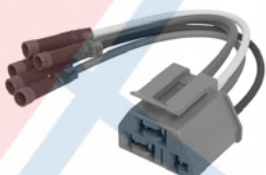

**37217**  
 Harness Connector for Ford Blower Motor Switch  
 Connector Pin Quantity: 2  
 Ford (91-75); Lincoln (83-77); Mercury (89-75)

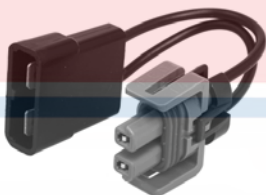

**37218**  
 Harness Connector Adapter  
 Acura (99-98); Buick (05-89); Cadillac (02-89), (85); Chevy (05-89), (87); Ford (00-95); GMC (05-91); Isuzu (01-96); Olds (04-89); Pontiac (05-89); SRT (10-91); VW (00-91)  
 Northern: 110092



**37219**  
 Pressure Switch Harness Connector  
 Connector Pin Quantity: 2  
 AMC (87-80); Audi (84-78); Buick (96-76); Cadillac (96-93), (88-82), (77); Chevy (96-73); Chrysler (95-75), (71-70); Dodge (96-84), (79-78), (74-71); GMC (95-73); Honda (87-73); Jeep (94-82); Lexus (91-90); Mazda (89-85); Mercedes (97-77); Nissan (89-77); Olds (93-76); Plymouth (94-70); Pontiac (93-75); Subaru (87-79); Toyota (94-75); Volvo (92-73)  
 Hy-Capacity: 0000881181

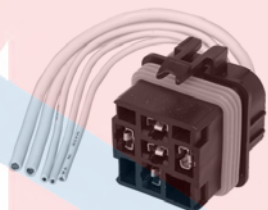

**37220**  
 Harness Connector 5 Terminal  
 Connector Pin Quantity: 5  
 Buick (94-88); Cadillac (93-86); Olds (93-88); Pontiac (93-88)  
 General Motors Corp: 12101882  
 Kysor: 2099008  
 Mack: RD582100P  
 Red Dot: 71R1910, RD582100P



**37222**  
 Harness Connector  
 Connector Pin Quantity: 2  
 Buick (01-77); Cadillac (13-77); Chevy (13-77); Dodge (97-94); GMC (13-77); Jeep (96-94); Olds (95-77); Pontiac (95-77)



**37223**  
 Nippondenso Clutch Coil Connector w/ 1 Wire  
 Connector Pin Quantity: 1  
 Chrysler (84-79); Dodge (86), (84-79); Dodge Medium Duty Truck (81); Plymouth (84-79)



**37224**  
 Nippondenso Clutch Coil Connector w/ 1 Wire, w/o Diode  
 Connector Pin Quantity: 1  
 Dodge (91-85); Eagle (94-93); Ford (93-89); Geo (97-89); Hyundai (91-89); Mitsubishi (94-85); Plymouth (94-85); Toyota (98-81)



**37225**  
 Chrysler Wiring Harness Connector w/ Diode  
 Connector Pin Quantity: 2  
 Chrysler (04-83); Dodge (05-81); Eagle (97-93); Plymouth (01-84), (81)



**37227**  
 Harness Connector  
 Connector Pin Quantity: 2  
 Buick (95-83); Cadillac (13-77); Chevy (13-83); Dodge (97-94); GMC (13-83); Olds (01-77); Pontiac (98-77)



**37228**  
 Nippondenso Clutch Coil Wire w/ Connector.  
 Connector Pin Quantity: 2  
 Chrysler (04-83); Dodge (05-81); Eagle (97-93); Plymouth (01-84), (81)

## Clutch Parts Miscellaneous

### Harness Connectors Cont'd

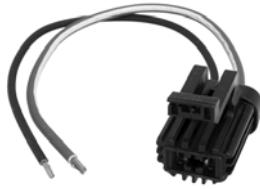

**37229**

Connector for Ford Blower Motors and Radiator Fan Motors  
Buick (73); Dodge (93-92); Ford (14-79); Ford HD (97-91); Jaguar (04-00); Lincoln (06-80); Mazda (09-92); Mercury (07-79); Sterling (05-93)  
General Motors Corp: 19189731



**37230**

Wire Harness Connector  
Connector Pin Quantity: 1  
Buick (88-80); Cadillac (92-82); Chevy (91-80); Olds (91-90), (88-80); Pontiac (92-80)  
General Motors Corp: 12102621



**37231**

Wire Harness Connector  
Acura (99-96); Buick (07-85); Cadillac (08-80); Chevy (08-85); Chrysler (97-85); Dodge (00-85); Eagle (96-93); Geo (93-91); GMC (07-85); Honda (02-94); Isuzu (06-88), (86); Jeep (96-91)  
Mitsubishi (96-94); Olds (04-85); Plymouth (96-85); Pontiac (07-82); Saturn (08-00)  
General Motors Corp: 19189733, 88987993



**37232**

Harness Connector for 5 Terminal Relay  
Connector Pin Quantity: 5  
Buick (99-91); Cadillac (01-94); Chevy (05-93); GMC (04-93); Isuzu (00-96); Olds (01), (99-93); Pontiac (02-93), (87)  
General Motors Corp: 15306045

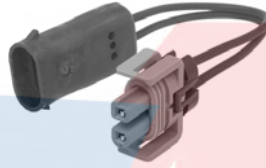

**37233**

Wire Harness Connector  
Acura (99-98); Buick (05-89); Cadillac (02-89), (85); Chevy (05-89), (87); Ford (00-95); GMC (05-91); Isuzu (01-96); Olds (04-89); Pontiac (05-89); SRT (10-91); VW (00-91)



**37234**

Harness Connector  
Ford (02), (97-80); Hyundai (98-95); Jeep (96-93); Lincoln (98-80); Mazda (96-91); Mercury (98-80); Nissan (98-93)



**37235**

Harness Connector  
Ford (12-93); Ford Medium Duty (10-05), (01); Lincoln (11-94); Mazda (08-94); Mercury (11-94); Nissan (02-99)



**37236**

Harness Connector  
Buick (14-88); Cadillac (14-98), (96-94); Chevy (15-90); Dodge (99-95); Ford (10-06); GMC (15-95); Honda (02-95); Isuzu (08-05), (98-96); Jeep (07-97); Lincoln (10-06); Mercury (10-06)  
Olds (04-87); Plymouth (99-95); Pontiac (10-88); Porsche (92-87); Saab (11), (09-06); Saturn (10-00)

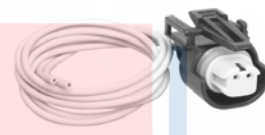

**37237**

Harness Connector  
Cadillac (13-00); Chevy (13-00); GMC (13-00); GMC & CHEVY (02-01)

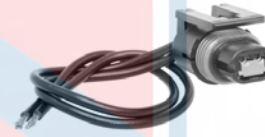

**37238**

Harness Connector  
Chrysler (95-89); Dodge (98-89); Jeep (98-94); Plymouth (95-91)



**37239**

Harness Connector  
Connector Pin Quantity: 5  
Ford (01-98); Mercury (99-98)  
Ford: 1U2Z14S411BHA



**37240**

Harness Connector  
Connector Pin Quantity: 2  
Buick (07-04); Cadillac (09-07), (02-94); Chevy (13-99); GMC (13-99); Isuzu (08-03); Saab (09-05)  
General Motors Corp: 15306302



**37241**

Harness Connector

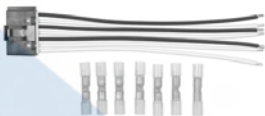

**37242**

Buick (07-97); Cadillac (06-02); Chevy (09-97); GMC (09-99); Isuzu (08-03); Olds (04-97); Pontiac (07-97); Saturn (06-05)  
General Motors Corp: 15862656



# Compressor Parts Miscellaneous

## Compressor Control Valve



**38843**  
POA, EPR, STV Valves  
Style: Compressor Control Valve  
Type: Repair Part  
R12



**38846**  
POA, EPR, STV Valves  
Style: Compressor Control Valve  
Type: Repair Part  
R134a  
General Motors Corp: 2724331,  
2724790, 89019193, 89019194

## Compressor Conversion Kits



**65125**  
Conversion Kits  
Style: w/o Compressor  
Type: New Compressor Conversion  
Climatech: HE1120  
Dallas Truck AC: 7585033  
Euclid: E801908  
Hy-Capacity: 88COM5033  
Kysor: 1407008, 416113  
Mack: 4379RD550310  
NaviStar: 51199  
Northern: 95033  
Red Dot: 75R6000

## Gaskets - Individual



**21103**  
Gaskets  
Style: Compressor  
Type: Gasket  
10PA15C Small Manifold Gasket -  
Mercedes Benz  
General Motors Corp: 19187540



**24066**  
Gaskets  
Style: Compressor  
Type: Gasket  
Sanden Discharge Port Gasket  
General Motors Corp: 19188264



**24067**  
Gaskets  
Style: Compressor  
Type: Gasket  
Sanden Suction Port Gasket



**24101**  
Gaskets  
Style: Compressor  
Type: Gasket  
Packaged in Quantities of: 10  
Suction and Discharge Flange Gasket  
Allis Chalmers: 1164257  
Case New Holland: 1164257  
Dallas Truck AC: 0128005  
Deutz: 1164257  
Euclid: E809728  
Hy-Capacity: 000088444  
Northern: 440242, 440477

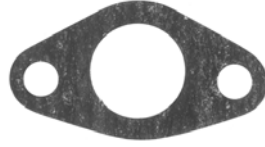

**24118**  
Gaskets  
Style: Compressor  
Type: Gasket  
Packaged in Quantities of: 10  
RV2 Discharge Service Manifold  
Gasket  
General Motors Corp: 19187560  
Northern: 440261

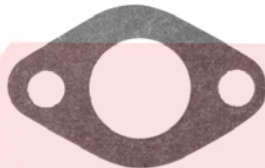

**24119**  
Gaskets  
Style: Compressor  
Type: Gasket  
Packaged in Quantities of: 10  
RV2 Suction Service Manifold Gasket  
Early Model  
General Motors Corp: 19187561

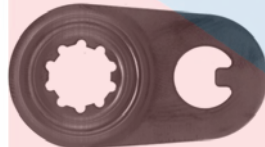

**24124**  
Filter Drier Flange Port Gasket  
Style: Flange Port  
Type: Filter Drier  
Packaged in Quantities of: 1  
Chrysler Drier Gasket .0377 Pilot Small  
Chrysler: 4720747



**24127**  
Gaskets  
Style: Compressor  
Type: Gasket  
10PA15C Manifold Gasket  
Mercedes Benz: 0009978149



**24134**  
Gaskets  
Style: Compressor  
Type: Gasket  
Packaged in Quantities of: 10  
6C17 Suction Side Gasket  
General Motors Corp: 19187563  
Euclid: E809711

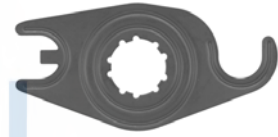

**24136**  
Gaskets  
Style: Compressor  
Type: Gasket  
Packaged in Quantities of: 10  
Sanden and Sankyo Discharge Flange  
Gasket  
Euclid: E809705  
Northern: 440610



**24137**  
Gaskets  
Style: Compressor  
Type: Gasket  
Packaged in Quantities of: 10  
RV2 Compressor Suction Port Gasket  
-Late Model



**24140**  
Gaskets  
Style: Compressor  
Type: Gasket  
Packaged in Quantities of: 10  
Suction Port Gasket  
Euclid: E809708

# Compressor Parts Miscellaneous

## Gaskets - Individual Cont'd



**24151**  
Gaskets  
Style: Compressor  
Type: Gasket  
Packaged in Quantities of: 10  
C171 and A590 Suction and Discharge  
Gasket  
General Motors Corp: 19187569  
Euclid: E809712

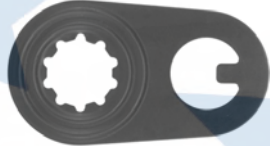

**24152**  
Filter Drier Flange Port Gasket  
Style: Flange Port  
Type: Filter Drier  
Packaged in Quantities of: 10  
Chrysler Drier Gasket .473 Pilot Large  
Chrysler: 3847083  
General Motors Corp: 19188266  
Euclid: E809710, E809716



**24154**  
Gaskets  
Style: Compressor  
Type: Gasket  
Packaged in Quantities of: 10  
RV2 Compressor Suction Flange Port  
Euclid: E809704



**24156**  
Gaskets  
Style: Compressor  
Type: Gasket  
Packaged in Quantities of: 10  
10PA17C Compressor Manifold Gasket  
General Motors Corp: 19188305



**24157**  
Gaskets  
Style: Compressor  
Type: Gasket  
Packaged in Quantities of: 10  
6C17 Discharge Port Gasket  
General Motors Corp: 19187571  
Euclid: E809714



**24158**  
Gaskets  
Style: Compressor  
Type: Gasket  
Packaged in Quantities of: 10  
6C17 Suction Port Gasket  
Chrysler: 4638189  
Euclid: E809713



**24333**  
Gaskets  
Style: Compressor  
Type: Gasket  
Chrysler 10S Compressor manifold Kit  
General Motors Corp: 19187578

## Pressure Relief Valve

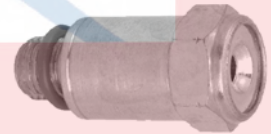

**35745**  
Relief Valve  
York & Tech and FS6 Compressor  
Type: Pressure



**35753**  
Relief Valve  
A6, STD R4, LTR4, DA6, HR6, and V5  
Compressor  
Type: Pressure  
Allis Chalmers: 02567881  
AMC: 3201430, 3629994, 3692994  
Case New Holland: A44942  
Caterpillar: 1P6355  
John Deere: AR49808  
Kysor: 404130  
NaviStar: 14897, 576621C1  
Northern: 440676

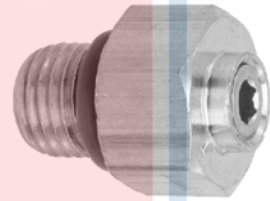

**35762**  
Relief Valve  
Sanden and GM Compressor  
Type: Pressure

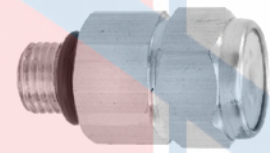

**35763**  
Relief Valve  
Sanden SD7V16 Compressor  
Type: Pressure

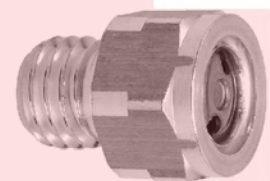

**35773**  
Relief Valve  
Nippondenso Compressor  
Type: Pressure  
General Motors Corp: 15781535,  
19187630

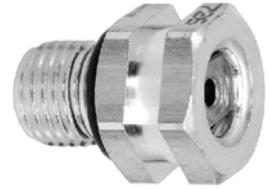

**35781**  
Relief Valve  
Sanden Compressor  
Type: Pressure  
General Motors Corp: 15208784,  
88892739



**35784**  
Relief Valve  
MSC Compressor  
Type: Pressure

## Gasket Kits

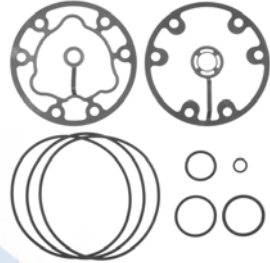

**24012**  
Gasket Kit  
Style: HDHT  
Type: Compressor  
HD6 & HT6 Gasket Kit -96 & Up

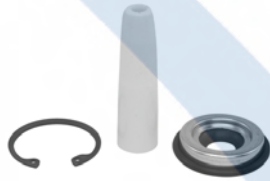

**24013**  
Gaskets  
Style: Lip Seal  
Type: Shaft Seal Kit  
LTR4, DA6, HR6, HT6 (Small Shaft),  
V5 (Lip Seal)  
General Motors Corp: 89019204  
Northern: 440630

# Compressor Parts Miscellaneous

## Gasket Kits Cont'd

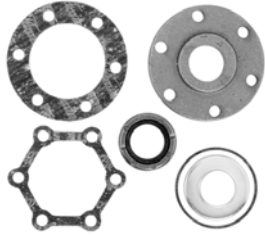

**24014**  
Gaskets  
Style: Lip Seal  
Type: Shaft Seal Kit  
YORK , TECH 6 BOLT 3/8 Head Beveled Seal Plate  
AMC: 3202320, 3205070, 3205646, 3208712  
Evans: AM80438  
Hy-Capacity: 0000088223  
Northern: 440214, 440217  
Red Dot: 75R6500



**24015**  
Gaskets  
Style: Steel  
Type: Shaft Seal Kit  
A6 R4 Steel Seal  
Evans: AM80436  
Hy-Capacity: 0000088235  
Kysor: 402718  
Northern: 440212



**24016**  
Gaskets  
Style: Ceramic  
Type: Shaft Seal Kit  
A6, R4 CERMIC SEAL  
General Motors Corp: 6556077  
Allis Chalmers: 02567865  
AMC: 3212113, 8131965, 8131985, 8141985  
Case New Holland: A44929  
Dallas Truck AC: 0112121  
Deutz: 256786  
Hinker: 116016090  
Hy-Capacity: 0000088236  
John Deere: AR49806  
Mack: 33276599114  
Massey Ferguson: 386982M91, 836982M91  
NaviStar: 576617C91  
New Idea: 733290  
Northern: 440218, 440635

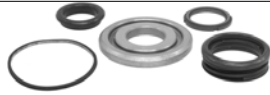

**24017**  
Gaskets  
Style: Lip Seal  
Type: Shaft Seal Kit  
TECH HG850-1000 6 BOLT 3/8 Head Flat Seal Plate  
Dallas Truck AC: 0112124  
Deutz: 1164259  
Evans: AM80439  
Hy-Capacity: 0000088226  
Kysor: 402101  
Red Dot: 75R6520

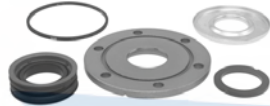

**24019**  
Gaskets  
Style: Lip Seal  
Type: Shaft Seal Kit  
York 206, 209, 210 Compressor w/ 6 bolt seal plate & 1/4" head bolts.  
Nissan: 27730B8065  
Allis Chalmers: 2083996  
AMC: 8120180, 8121820, SE2087001  
Bergstrom: 869121  
Climatech: VH1270  
Dallas Truck AC: 0112122  
Euclid: E801551  
Evans: AM80437  
Full Vison: 58544  
Hy-Capacity: 0000088222  
John Deere: AH80721  
Kysor: 1407010, 415502  
Mack: 4379RD583380  
NaviStar: 13458  
Northern: 440216  
Red Dot: 75R6510

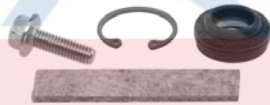

**24020**  
Gaskets  
Style: Lip Seal  
Type: Shaft Seal Kit  
Ford FS10/FX 15 Compressor  
Ford: F1VY19D665A



**24021**  
Gaskets  
Style: Carbon  
Type: Shaft Seal Kit  
Sanden SD507, 508, 510  
Allis Chalmers: 2084687  
AMC: 133183, 8133183  
Dallas Truck AC: 0112120  
Evans: AM80440  
Hy-Capacity: 0000088212  
Northern: 440346, 440993  
Red Dot: 75R6540

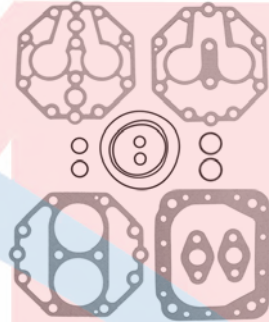

**24027**  
Gasket Kit  
Style: 206/209/210  
Type: Compressor  
York Compressor Gasket Kit for 206, 209, 210  
Allis Chalmers: 2084196  
AMC: 3201707, 3205060, 3205641, 3208714, 4485642, 8121621, 8121819, 8122073  
Case New Holland: A42964  
Full Vison: 58589  
John Deere: AH80724  
Northern: 440226

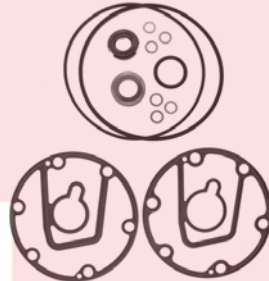

**24032**  
Gaskets  
Style: Carbon  
Type: Shaft Seal Kit  
Nippondenso FS6, A590, C171 Compressor  
Toyota: 8836010010, 8836030280



**24043**  
Gaskets  
Style: Lip Seal  
Type: Shaft Seal Kit  
CH TYPE DIESEL KIKI DKS15, TM15, SDH14, SD7H15  
Northern: 440766  
Red Dot: 75R6530, 75R6545  
Steiger: 25230

## O-Rings Kits

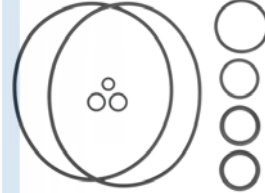

**24008**  
O-Ring Kit  
Style: A6  
Type: Compressor  
Packaged in Quantities of: new template  
A6 Compressor Gasket Kit  
Northern: 440251



**24507**  
O-Ring Kit  
Style: V5  
Type: Compressor  
V5 Compressor Control Valve O-Ring  
General Motors Corp: 19188374



# Compressors

Part No.	Pulley Dia.	Coil Clock	New / Reman	Groove	Type	Mount Dist to Groove Midpoint	Mount	Manifold
<b>A6</b>								
158050	4-13/16	Wire Lead	New	8 Groove	A6	1-7/16	Direct Mount	
57055	5	10	Reman	1 Groove	A6	2	Direct Mount	Block Mount
57060	5-5/8	2	Reman	1 Groove	A6	2	Direct Mount	Block Mount
57077	5	10	Reman	1 Groove	A6	2	Direct Mount	Block Mount
57078	5-3/4	10	Reman	1 Groove	A6	2	Direct Mount	Block Mount
57079	5-5/8	2	Reman	1 Groove	A6	1-7/16	Direct Mount	Block Mount
57084	6-7/8	10	Reman	1 Groove	A6	2	Direct Mount	Block Mount
57085	5-5/8	10	Reman	1 Groove	A6	2	Direct Mount	Block Mount
57086	6-7/8	10	Reman	1 Groove	A6	2	Direct Mount	Block Mount
57087	5-3/4	2	Reman	1 Groove	A6	2-3/32	Direct Mount	Block Mount
57088	5-1/8	2	Reman	2 Groove	A6	1-61/64	Direct Mount	Block Mount
57089	5	2	Reman	1 Groove	A6	2	Direct Mount	Block Mount
57091	5-5/8	2	Reman	1 Groove	A6	2-13/32	Direct Mount	Block Mount
57092	5-1/8	2	Reman	1 Groove	A6	1-61/64	Direct Mount	Block Mount
57093	5-3/4	2	Reman	1 Groove	A6	2	Direct Mount	Block Mount
57094	5-1/8	2	Reman	1 Groove	A6	2	Direct Mount	Block Mount
57095	5-1/8	2	Reman	1 Groove	A6	2	Direct Mount	Block Mount
57096	5-1/8	2	Reman	1 Groove	A6	2	Direct Mount	Block Mount
57098	5-1/8	2	Reman	1 Groove	A6	2	Direct Mount	Block Mount
58047	5-1/2	10	New	6 Groove	A6	1-1/2	Direct Mount	O-Ring
58051	4-51/64	10	New	8 Groove	A6	1-25/64	Flange	
58053	6-49/64	10	New	1 Groove	A6	2	Direct Mount	Block Mount
58058	5-1/2	2	New	6 Groove	A6	1-1/2	Direct Mount	O-Ring
58077	5	2	New	1 Groove	A6	2	Direct Mount	O-Ring
58078	5-3/4	10	New	1 Groove	A6	2	Direct Mount	O-Ring
58084	6-7/8	10	New	1 Groove	A6	2	Direct Mount	O-Ring
58087	6	2	New	1 Groove	A6	2-3/32	Direct Mount	O-Ring
58088	5-1/8	2	New	2 Groove	A6	1-61/64	Direct Mount	O-Ring
58089	5	2	New	1 Groove	A6	2	Direct Mount	O-Ring
58096	5-1/8	2	New	1 Groove	A6	2	Direct Mount	O-Ring
58097	5-37/64	2	New	1 Groove	A6	2	Direct Mount	Block Mount
58098	4-7/8	2	New	1 Groove	A6	2	Direct Mount	O-Ring
58099	5-37/64	2	New	1 Groove	A6	2	Direct Mount	Block Mount
57052			Reman		A6		Direct Mount	Block Mount
57062			Reman		A6		Direct Mount	Block Mount
<b>Bosch Series</b>								
57400	5-1/4	12	Reman	1 Groove	Bosch	2-3/4	Boss Mount	Threaded
57401	5-1/4	12	Reman	1 Groove	Bosch	2-1/2	Boss Mount	Threaded
57402	5-1/4	12	Reman	1 Groove	Bosch	2-1/2	Boss Mount	Threaded
<b>Calsonic / Zexel</b>								
58887	4-5/32		New	6 Groove	CR-10			
58890	4-21/64		New	6 Groove	CR-10	1-13/32		O-Ring
57888	4-5/8	Wire Lead	Reman	6 Groove	CR08	2-17/64		O-Ring
57892	3-15/16	Wire Lead	Reman	7 Groove	CR08	1-9/32		O-Ring
58892	3-15/16		New	8 Groove	CR08	1-9/32		O-Ring
58893	3-15/16	Wire Lead	New	6 Groove	CR08	1-29/64		
57887	4-5/16	Wire Lead	Reman	6 Groove	CR10	1-13/32		O-Ring
57890	4-21/64	Wire Lead	Reman	6 Groove	CR10	1-13/32		O-Ring
57883	5	Wire Lead	Reman	4 Groove	CR14	55/64		O-Ring
57885	4-1/2	Wire Lead	Reman	7 Groove	CR14	1-1/2		O-Ring
58883	5	Wire Lead	New	4 Groove	CR14	55/64		O-Ring
58885	4-1/2	Wire Lead	New	7 Groove	CR14	1-1/2		O-Ring
67457	5	Wire Lead	Reman	6 Groove	CR14	1-21/32		O-Ring
67653	4-3/4	Wire Lead	Reman	4 Groove	CR14	55/64		O-Ring
67658	5	Wire Lead	Reman	4 Groove	CR14	53/64		O-Ring
68457	5	Wire Lead	New	6 Groove	CR14	1-21/32		O-Ring
68653	4-3/4	Wire Lead	New	4 Groove	CR14	55/64		O-Ring
68880	5-5/16		New	4 Groove	CR14	1-23/32		
58647	4-11/32	Wire Lead	New	6 Groove	CSE17C	1-1/2		O-Ring
97448	4-5/16	Wire Lead	Reman	4 Groove	CSE17C	61/64		
67682	4-17/32	Wire Lead	Reman	7 Groove	CSE617	51/64		O-Ring

# Compressors

Part No.	Pulley Dia.	Coil Clock	New / Reman	Groove	Type	Mount Dist to Groove Midpoint	Mount	Manifold
<b>Calsonic / Zexel</b>								
68682	4-17/32	Wire Lead	New	7 Groove	CSE617	51/64		O-Ring
97447	4-1/4	Wire Lead	Reman	6 Groove	CSE717	15/16		
98447	4-1/4	Wire Lead	New	6 Groove	CSE717	15/16		
98448	4-5/16	Wire Lead	New	4 Groove	CSE717	61/64		
77404	4-1/4	Wire Lead	Reman	6 Groove	CSV511	1-13/32		O-Ring
78404	4-1/4	Wire Lead	New	6 Groove	CSV511	1-13/32		O-Ring
67660	4-5/16	Wire Lead	Reman	4 Groove	CSV613	1-1/8		O-Ring
68660	4-5/16	Wire Lead	New	4 Groove	CSV613	1-1/8		O-Ring
67469	4-21/64	Wire Lead	Reman	6 Groove	CSV614	2-13/32		O-Ring
97442	4-11/16	Wire Lead	Reman	4 Groove	CSV717	15/16		O-Ring
97444	4-1/2	Wire Lead	Reman	4 Groove	CSV717	1-1/16		O-Ring
98442	4-5/16	Wire Lead	New	4 Groove	CSV717	15/16		O-Ring
98444	4-5/16	Wire Lead	New	4 Groove	CSV717	1-1/16		O-Ring
67642	5-1/4	Wire Lead	Reman	4 Groove	CWE615M	13/32		O-Ring
67436	5-1/4	Wire Lead	Reman	4 Groove	CWE618	29/64		O-Ring
67643	4-7/8	Wire Lead	Reman	6 Groove	CWE618	9/16		O-Ring
68436	5-19/64	Wire Lead	New	4 Groove	CWE618	7/16		O-Ring
67422	5-1/4	Wire Lead	Reman	4 Groove	CWV615	55/64		O-Ring
67439	5-1/4	Wire Lead	Reman	4 Groove	CWV615	13/32		O-Ring
68439	5-1/4	Wire Lead	New	4 Groove	CWV615M	13/32		O-Ring
67421	5-1/4	Wire Lead	Reman	4 Groove	CWV617	55/64		O-Ring
67651	5-1/4	Wire Lead	Reman	4 Groove	CWV617	61/64		O-Ring
57423	5-1/4	Wire Lead	Reman	5 Groove	CWV618	1-7/32		O-Ring
67424	5-1/4	Wire Lead	Reman	6 Groove	CWV618	55/64		O-Ring
67425	5-1/4	Wire Lead	Reman	4 Groove	CWV618	1-13/32		O-Ring
67427	5-1/4	Wire Lead	Reman	5 Groove	CWV618	1-7/32		O-Ring
67434	4-7/8	Wire Lead	Reman	4 Groove	CWV618	7/16		O-Ring
67435	5-1/4	Wire Lead	Reman	4 Groove	CWV618	13/32		O-Ring
67453	5-1/2	Wire Lead	Reman	6 Groove	CWV618	1		O-Ring
67655	5-1/4	Wire Lead	Reman	6 Groove	CWV618	55/64		O-Ring
67656	5	Wire Lead	Reman	4 Groove	CWV618	39/64		O-Ring
67657	5	Wire Lead	Reman	6 Groove	CWV618	29/64		O-Ring
67659	4-7/8	Wire Lead	Reman	4 Groove	CWV618	39/64		O-Ring
68427	5-1/4	Wire Lead	New	5 Groove	CWV618	1-7/32		O-Ring
68435	5-1/4	Wire Lead	New	4 Groove	CWV618	13/32		O-Ring
68453	5-1/2	Wire Lead	New	6 Groove	CWV618	1		O-Ring
68655	5-1/4	Wire Lead	New	6 Groove	CWV618	55/64		O-Ring
68657	5	Wire Lead	New	6 Groove	CWV618	29/64		O-Ring
68659	4-7/8	Wire Lead	New	4 Groove	CWV618	39/64		O-Ring
97443	4-7/8	Wire Lead	Reman	6 Groove	CWV618	9/16		O-Ring
97446	5-1/4	Wire Lead	Reman	6 Groove	CWV618	9/16		O-Ring
68663	4-23/64	Wire Lead	New	4 Groove	DCS-141C	1-5/16		O-Ring
67681	4-17/32	Wire Lead	Reman	7 Groove	DCS-171C	51/64		O-Ring
67662	4-1/2	Wire Lead	Reman	6 Groove	DCS171C	1-13/32		O-Ring
67663	4-3/8	Wire Lead	Reman	4 Groove	DCS171C	1-21/64		O-Ring
67664	5	Wire Lead	Reman	6 Groove	DCS171C	1-13/64		O-Ring
67667	4-1/2	Wire Lead	Reman	7 Groove	DCS171C	51/64		O-Ring
68662	4-1/2	Wire Lead	New	6 Groove	DCS171C	1-13/32		O-Ring
68664	5	Wire Lead	New	6 Groove	DCS171C	1-13/64		O-Ring
68667	4-1/2	Wire Lead	New	7 Groove	DCS171C	51/64		O-Ring
68681	4-17/32	Wire Lead	New	7 Groove	DCS171C	51/64		O-Ring
58489	4-33/100		New	6 Groove	DCS17E			
67646	4-5/16	Coil Less	Reman	6 Groove	DCS17E	1-15/64		O-Ring
67665	5-1/4	Wire Lead	Reman	4 Groove	DCS17E	7/16		O-Ring
67666	5	Wire Lead	Reman	6 Groove	DCS17E	35/64		O-Ring / Gasket
67668	4-1/2	Wire Lead	Reman	7 Groove	DCS17E	3/4		O-Ring / Gasket
67674	4-1/2	Wire Lead	Reman	7 Groove	DCS17E	25/32		O-Ring
67675	5-1/8	Wire Lead	Reman	6 Groove	DCS17E	1-33/64		O-Ring
68646	4-5/16	Coil Less	New	6 Groove	DCS17E	1-15/64		O-Ring
68666	4-29/32	Wire Lead	New	6 Groove	DCS17E	35/64		O-Ring / Gasket
68674	4-1/2	Wire Lead	New	7 Groove	DCS17E	25/32		O-Ring
68675	5-1/8	Wire Lead	New	6 Groove	DCS17E	1-33/64		O-Ring
57526	5	Wire Lead	Reman	5 Groove	DCV11A	1-15/64		O-Ring

# Compressors

Part No.	Pulley Dia.	Coil Clock	New / Reman	Groove	Type	Mount Dist to Groove Midpoint	Mount	Manifold
<b>Calsonic / Zexel</b>								
57533	5	Wire Lead	Reman	5 Groove	DCV11A	1-15/64		O-Ring
57529	5	2	Reman	5 Groove	DCV11G	1-15/64		O-Ring
57527	5-1/4	Wire Lead	Reman	5 Groove	DCV14A	1-15/64		O-Ring
58527	5-1/4	Wire Lead	New	5 Groove	DCV14A	1-15/64		Pad Mount
57543	5	2	Reman	5 Groove	DCV14J	1-13/64		O-Ring
57546	5	2 O'Clock	Reman	6 Groove	DCV14J	1-13/64		O-Ring
67654	4-3/4	Wire Lead	Reman	4 Groove	DCW17	1		Pad Mount
57450	5	Wire Lead	Reman	6 Groove	DCW17B	1-45/64		O-Ring
67638	5	Wire Lead	Reman	6 Groove	DCW17B	1-45/64		O-Ring
68638	5	Wire Lead	New	6 Groove	DCW17B	1-45/64		O-Ring
67451	4-3/4	Wire Lead	Reman	4 Groove	DCW17D	1-61/64		O-Ring
68451	4-3/4	Wire Lead	New	4 Groove	DCW17D	1-61/64		O-Ring
57457	5-1/4	Wire Lead	Reman	1 Groove	DKS13	1-55/64		Pad Mount
67631	5-1/4	Wire Lead	Reman	1 Groove	DKS13CH	1-55/64		Pad Mount
57459	4-3/4	Wire Lead	Reman	1 Groove	DKS13G	1-3/4		Pad Mount
67630	4-7/8	Wire Lead	Reman	9 Groove	DKS13G			Pad Mount
67633	4-3/4	Wire Lead	Reman	1 Groove	DKS13G	1-55/64		O-Ring
57420	5	Wire Lead	Reman	1 Groove	DKS15	1-51/64		Pad Mount
57435	5	Wire Lead	Reman	1 Groove	DKS15	1-11/32		Pad Mount
58514	6-1/4	Wire Lead	New	1 Groove	DKS15	1-35/64		O-Ring
58522	6-1/4	Wire Lead	New	1 Groove	DKS15	29/32		Rear Head
57521	5-1/4	Wire Lead	Reman	2 Groove	DKS15BH	61/64		O-Ring
58512	5-1/4	12	New	2 Groove	DKS15BH	29/32		O-Ring
58521	5-1/4	Wire Lead	New	2 Groove	DKS15BH	61/64		O-Ring
57513	5	Wire Lead	Reman	1 Groove	DKS15CH	2-13/32		O-Ring
57517	5-1/4	Wire Lead	Reman	2 Groove	DKS15CH	61/64		O-Ring
57519	4-11/16	Wire Lead	Reman	6 Groove	DKS15CH	1-19/64		O-Ring
57520	4-3/4	Wire Lead	Reman	6 Groove	DKS15CH	1-1/8		O-Ring
58513	5	Wire Lead	New	1 Groove	DKS15CH	2-13/32		O-Ring
58515	5-1/4	Wire Lead	New	2 Groove	DKS15CH	61/64		O-Ring
58519	4-11/16	Wire Lead	New	6 Groove	DKS15CH	1-19/64		O-Ring
58520	4-3/4	Wire Lead	New	6 Groove	DKS15CH	1-1/8		O-Ring
67467	4-5/8	Wire Lead	Reman	6 Groove	DKS15CH	1-19/64		O-Ring
67647	4-11/16	Wire Lead	Reman	5 Groove	DKS15CH	13/32		O-Ring
67652	4-3/4	Wire Lead	Reman	4 Groove	DKS15CH	1-3/32		Pad Mount
68467	4-5/8	Wire Lead	New	6 Groove	DKS15CH	1-19/64		O-Ring
68647	4-11/16	Wire Lead	New	5 Groove	DKS15CH	13/32		O-Ring
68652	4-3/4	Wire Lead	New	4 Groove	DKS15CH	13/32		O-Ring
57455	4-5/8	Wire Lead	Reman	4 Groove	DKS16H	2-13/64		Pad Mount
57460	5-5/8	Wire Lead	Reman	4 Groove	DKS16H	1-29/64		O-Ring
58460	5-5/8	Wire Lead	New	4 Groove	DKS16H	1-29/64		O-Ring
67423	5-1/4	Wire Lead	Reman	4 Groove	DKS16H	1-19/32		Pad Mount
67650	5-1/4	Wire Lead	Reman	4 Groove	DKS16H	1-1/4		O-Ring
67648	4-5/8	Wire Lead	Reman	6 Groove	DKS17CH	1-19/64		O-Ring
68648	4-5/8	Wire Lead	New	6 Groove	DKS17CH	1-19/64		O-Ring
157486	4-29/32	Wire Lead	Reman	4 Groove	DKS17D	1-3/64		O-Ring
158486	4-29/32	Wire Lead	New	4 Groove	DKS17D	1-3/64		O-Ring
168661	4-1/2	Wire Lead	New	6 Groove	DKS17D	2-13/32		O-Ring
57410	4-1/2	Wire Lead	Reman	7 Groove	DKS17D	1-1/2		O-Ring
57411	4-7/8	Wire Lead	Reman	6 Groove	DKS17D	2-19/64		O-Ring
57461	4-7/8	Wire Lead	Reman	6 Groove	DKS17D	1-9/16		O-Ring
57462	4-1/2	Wire Lead	Reman	6 Groove	DKS17D	2-13/32		O-Ring
57544	5-1/4	Wire Lead	Reman	6 Groove	DKS17D	1-19/64		O-Ring
58410	4-1/2	Wire Lead	New	7 Groove	DKS17D	1-1/2		O-Ring
58411	4-7/8	Wire Lead	New	6 Groove	DKS17D	2-19/64		O-Ring
58461	4-7/8	Wire Lead	New	6 Groove	DKS17D	1-9/16		O-Ring
58462	4-1/2	Wire Lead	New	6 Groove	DKS17D	2-13/32		O-Ring
58544	5-1/4	Wire Lead	New	6 Groove	DKS17D	1-19/64		O-Ring
67438	5-1/4	Wire Lead	Reman	6 Groove	DKS17D	1/2		O-Ring
67465	4-11/16	Wire Lead	Reman	6 Groove	DKS17D	45/64		O-Ring
67641	4-1/2	Wire Lead	Reman	7 Groove	DKS17D	1/2		O-Ring
67661	4-5/8	Wire Lead	Reman	6 Groove	DKS17D	1-13/32		O-Ring
67671	4-1/2	Wire Lead	Reman	7 Groove	DKS17D	15/32		O-Ring / Gasket



# Compressors

Part No.	Pulley Dia.	Coil Clock	New / Reman	Groove	Type	Mount Dist to Groove Midpoint	Mount	Manifold
<b>Calsonic / Zexel</b>								
67672	4-33/64	Wire Lead	Reman	6 Groove	DKS17D	2-15/32		O-Ring
67673	4-5/8	Wire Lead	Reman	6 Groove	DKS17D	15/32		O-Ring
68438	5-1/4	Wire Lead	New	6 Groove	DKS17D	19/32		Pad Mount
68465	4-11/16	Wire Lead	New	6 Groove	DKS17D	5/64		O-Ring
68641	4-1/2	Wire Lead	New	7 Groove	DKS17D	1/2		O-Ring
68661	4-5/8	Wire Lead	New	6 Groove	DKS17D	1-13/32		Sealing Washer
68671	4-1/4	Wire Lead	New	7 Groove	DKS17D	15/32		O-Ring / Gasket
68672	4-33/64	Wire Lead	New	6 Groove	DKS17D	2-15/32		O-Ring / Gasket
68673	4-5/8	Wire Lead	New	6 Groove	DKS17D	15/32		O-Ring / Gasket
97483	4-3/4	Wire Lead	Reman	4 Groove	DKS17D	1-25/64		O-Ring
97484	4-5/8	Wire Lead	Reman	6 Groove	DKS17D	15/32		O-Ring
97488	4-15/32	Wire Lead	Reman	6 Groove	DKS17D	3-1/32		O-Ring
97490	4-57/64	Wire Lead	Reman	6 Groove	DKS17D	2-1/8		O-Ring
98483	4-3/4	Wire Lead	New	4 Groove	DKS17D	1-25/64		O-Ring
98484	4-5/8	Wire Lead	New	6 Groove	DKS17D	15/32		O-Ring
98490	4-57/64	Wire Lead	New	6 Groove	DKS17D	2-1/8		O-Ring
167661	4-1/2	Wire Lead	Reman	6 Groove	DKS17DS	2-13/32		O-Ring
67678	4-3/4	Wire Lead	Reman	6 Groove	DKS17DS	1-1/32		O-Ring
67692	4-59/64	Wire Lead	Reman	6 Groove	DKS17DS	2-33/64		O-Ring
68678	4-3/4	Wire Lead	New	6 Groove	DKS17DS	1-1/32		O-Ring / Gasket
68692	4-29/32	Wire Lead	New	6 Groove	DKS17DS	2-33/64		O-Ring
97673	4-921/1000	Wire Lead	Reman	6 Groove	DKS17DS	2-1/4		O-Ring / Gasket
98454	4-17/32	N/R	New	6 Groove	DKS17DS	1-61/64		
98488	4-15/32	Wire Lead	New	6 Groove	DKS17DS	3-1/32		O-Ring
98673	4-921/1000	Wire Lead	New	6 Groove	DKS17DS	2-1/4		O-Ring / Gasket
67635	4-3/4	Wire Lead	Reman	2 Groove	DKS17G	1-5/32		Pad Mount
67637	5-1/4	Wire Lead	Reman	1 Groove	DKS17G	1-51/64		Pad Mount
197486	4-5/16	Wire Lead	Reman	6 Groove	DKS17S	1-21/32		O-Ring
67634	4-3/4	Wire Lead	Reman	2 Groove	DKS17S	1-5/32		Pad Mount
67636	5-23/64	Wire Lead	Reman	1 Groove	DKS17S	1-55/64		Pad Mount
167660	4-33/64	Wire Lead	Reman	6 Groove	DKS20	2-13/32		O-Ring
167662	4-1/2	Wire Lead	Reman	4 Groove	DKS20	1-61/64		O-Ring
168660	4-33/64	Wire Lead	New	6 Groove	DKS20	2-13/32		O-Ring
168662	4-1/2	Wire Lead	New	4 Groove	DKS20	1-61/64		O-Ring
157485	4-21/64	Wire Lead	Reman	6 Groove	DKV10R	61/64		O-Ring / Gasket
158485	4-19/64		New	6 Groove	DKV10R	2-33/64		
58492	4-5/16		New	6 Groove	DKV10R	1-15/32		
97485	3-7/8	Wire Lead	Reman	4 Groove	DKV10R	47/64		O-Ring
98485	4-1/16	Wire Lead	New	4 Groove	DKV10R	49/64		O-Ring
57528	5	Wire Lead	Reman	5 Groove	DKV11A	1-15/64		O-Ring
57541	4-7/8	Wire Lead	Reman	5 Groove	DKV11A	1-1/4		O-Ring
67460	5-1/4	Wire Lead	Reman	6 Groove	DKV11G	1		O-Ring
68452	4-29/32	Wire Lead	New	6 Groove	DKV11G	1		O-Ring
57442	5-1/4	Wire Lead	Reman	4 Groove	DKV14C	2-55/64		Pad Mount
57445	4-3/4	Wire Lead	Reman	4 Groove	DKV14C	2-19/64		Pad Mount
58442	5-1/4	Wire Lead	New	4 Groove	DKV14C	2-55/64		Pad Mount
58445	4-3/4	Wire Lead	New	4 Groove	DKV14C	2-19/64		Pad Mount
58449	5-5/8		New	6 Groove	DKV14C	2-3/32		Pad Mount
67428	5-5/8	Wire Lead	Reman	4 Groove	DKV14C	1-3/32		O-Ring
67429	5-5/8	Wire Lead	Reman	4 Groove	DKV14C	1-3/32		O-Ring
67442	4-3/4	Wire Lead	Reman	4 Groove	DKV14C	1-5/32		O-Ring
67449	4-3/4	Wire Lead	Reman	4 Groove	DKV14C	1-5/32		O-Ring
67454	5-5/8	Wire Lead	Reman	6 Groove	DKV14C	1-3/32		O-Ring
67455	5-1/2	Wire Lead	Reman	1 Groove	DKV14C	1-3/32		O-Ring
67456	5-1/2	Wire Lead	Reman	1 Groove	DKV14C	1-3/32		O-Ring
68428	5-5/8	Wire Lead	New	4 Groove	DKV14C	1-3/32		O-Ring
68442	4-3/4	Wire Lead	New	4 Groove	DKV14C	1-3/16		Pad Mount
68449	4-3/4	Wire Lead	New	4 Groove	DKV14C	1-5/32		Pad Mount
68455	5-1/2	Wire Lead	New	1 Groove	DKV14C	1-3/32		O-Ring
57451	5-1/4	Wire Lead	Reman	4 Groove	DKV14D	1-3/4		O-Ring
57456	5-5/8	Wire Lead	Reman	6 Groove	DKV14D	1		O-Ring
57458	4-1/4	Wire Lead	Reman	4 Groove	DKV14D	1-13/64		O-Ring
57474	5-5/8	Wire Lead	Reman	6 Groove	DKV14D	1		O-Ring

# Compressors

Part No.	Pulley Dia.	Coil Clock	New / Reman	Groove	Type	Mount Dist to Groove Midpoint	Mount	Manifold
<b>Calsonic / Zexel</b>								
57509	5	Wire Lead	Reman	6 Groove	DKV14D	63/64		O-Ring
58451	5-1/4	Wire Lead	New	4 Groove	DKV14D	1-3/4		Pad Mount
58456	5-5/8	Wire Lead	New	6 Groove	DKV14D	1		Pad Mount
58458	4-1/4	Wire Lead	New	4 Groove	DKV14D	1-13/64		Pad Mount
58474	5-5/8	Wire Lead	New	6 Groove	DKV14D	1		O-Ring
67443	5	Wire Lead	Reman	4 Groove	DKV14D	3/4		O-Ring
67448	5	Wire Lead	Reman	6 Groove	DKV14D	55/64		O-Ring
67450	5-1/4	Wire Lead	Reman	4 Groove	DKV14D	1-3/4		O-Ring
68443	5	Wire Lead	New	4 Groove	DKV14D	3/8		O-Ring
68448	5	Wire Lead	New	6 Groove	DKV14D	55/64		O-Ring
68454	5-5/8	Wire Lead	New	6 Groove	DKV14D	1-3/32		O-Ring
168484	4-29/32	Wire Lead	New	6 Groove	DKV14G			O-Ring
67437	5	Wire Lead	Reman	4 Groove	DKV14G	45/64		O-Ring
67444	5	Wire Lead	Reman	4 Groove	DKV14G	3/4		O-Ring
67445	5	Wire Lead	Reman	4 Groove	DKV14G	3/4		O-Ring
67452	4-29/32	Wire Lead	Reman	6 Groove	DKV14G	51/64		O-Ring
67466	5	Wire Lead	Reman	6 Groove	DKV14G	1-19/32		O-Ring
68437	5	Wire Lead	New	4 Groove	DKV14G	45/64		O-Ring
68444	5	Wire Lead	New	4 Groove	DKV14G	3/4		Pad Mount
68445	5	Wire Lead	New	4 Groove	DKV14G	3/4		O-Ring
68466	5	Wire Lead	New	6 Groove	DKV14G	1-19/32		O-Ring
68484	4-29/32	Wire Lead	New	6 Groove	DKV14G	51/64		Pad Mount
97440	5-5/8	Wire Lead	Reman	6 Groove	DKV14G	61/64		O-Ring
97441	5-5/8	Wire Lead	Reman	6 Groove	DKV14G	61/64		O-Ring
97445	4-7/8	Wire Lead	Reman	6 Groove	DKV14G	7/8		O-Ring
98441	5-5/8	Wire Lead	New	6 Groove	DKV14G	61/64		O-Ring
98445	4-7/8	Wire Lead	New	6 Groove	DKV14G	7/8		O-Ring
57421	5-23/64	Wire Lead	Reman	10 Groove 4 & 6	NVR140S	55/64		O-Ring
57422	5	Wire Lead	Reman	1 Groove	NVR140S	1-51/64		O-Ring
57424	5-23/64	Wire Lead	Reman	10 Groove 4 & 6	NVR140S	55/64		O-Ring
57440	5-3/4	Wire Lead	Reman	1 Groove	NVR140S	1-13/32		Pad Mount
57441	5-1/4	Wire Lead	Reman	1 Groove	NVR140S	1-51/64		Pad Mount
57443	5-1/4	Wire Lead	Reman	4 Groove	NVR140S	2-13/64		Pad Mount
57444	5-1/4	Wire Lead	Reman	4 Groove	NVR140S	1-51/64		Pad Mount
57446	4-3/4	Wire Lead	Reman	4 Groove	NVR140S	1-19/32		Pad Mount
57447	5-1/4	Wire Lead	Reman	4 Groove	NVR140S	1-19/32		Pad Mount
57449	5-5/8	Wire Lead	Reman	6 Groove	NVR140S	2-3/32		Pad Mount
58440	5-3/4	Wire Lead	New	1 Groove	NVR140S	1-13/32		Pad Mount
58444	5-1/4	Wire Lead	New	1 Groove	NVR140S	1-51/64		Pad Mount
67649	4-1/2	Wire Lead	Reman	6 Groove	SP17	1-47/64		Sealing Washer
67669	4-3/8	Wire Lead	Reman	6 Groove	SP17	2-1/2		Sealing Washer
67670	5	Wire Lead	Reman	6 Groove	SP17	2-35/64		Sealing Washer
67676	4-45/64	2 O'Clock	Reman	6 Groove	SP17	1-1/16		O-Ring / Gasket
67679	4-29/32	Wire Lead	Reman	4 Groove	SP17	1-7/32		Sealing Washer
67680	4-3/4	Wire Lead	Reman	5 Groove	SP17	1-15/64		Sealing Washer
67683	4-19/64	2 O'Clock	Reman	6 Groove	SP17	1-17/64		O-Ring / Gasket
58643	4-3/4	12	New	4 Groove	TM08HD	1-35/64		O-Ring
58660	5-1/4	12	New	2 Groove	TM13HA	1-3/32		O-Ring
58624	5-5/16	12	New	2 Groove	TM13HD	61/64		O-Ring
58625	5-1/4	12	New	2 Groove	TM13HD	61/64		O-Ring
58613	5	12	New	1 Groove	TM15	2-13/32		O-Ring
58620	5-1/4	12	New	2 Groove	TM15			O-Ring
68601	5-5/16	Wire Lead	New	2 Groove	TM15	63/64		O-Ring
68604	4-11/16	Wire Lead	New	8 Groove	TM15	55/64		O-Ring
68618	4-11/16	Wire Lead	New	8 Groove	TM15	55/64		O-Ring
68628	4-11/16	Wire Lead	New	6 Groove	TM15	1		O-Ring
68630	6-1/4	Wire Lead	New	1 Groove	TM15	1-1/4		O-Ring
57511	5-1/4	Wire Lead	Reman	2 Groove	TM15HD	61/64		Flare Fitting
58526	5-1/4	Wire Lead	New	2 Groove	TM15HD	61/64		O-Ring
58612	5-1/4	Wire Lead	New	2 Groove	TM15HD	61/64		Rear Head
58615	5-1/4	Wire Lead	New	2 Groove	TM15HD	61/64		Rear Head

# Compressors

Part No.	Pulley Dia.	Coil Clock	New / Reman	Groove	Type	Mount Dist to Groove Midpoint	Mount	Manifold
<b>Calsonic / Zexel</b>								
58616	4-3/4	Wire Lead	New	8 Groove	TM15HD	55/64		Rear Head
58618	6-1/4	Wire Lead	New	1 Groove	TM15HD	1-35/64		Rear Head
58621	5-1/4	Wire Lead	New	2 Groove	TM15HD	61/64		O-Ring
58622	6-1/4	Wire Lead	New	1 Groove	TM15HD	1-35/64		O-Ring
68623	4-11/16	Wire Lead	New	6 Groove	TM15HD	1		O-Ring
68173	4-3/4	Wire Lead	New	2 Groove	TM16	59/64		O-Ring
68175	4-11/16	Wire Lead	New	8 Groove	TM16	53/64		O-Ring
68176	4-11/16	Wire Lead	New	2 Groove	TM16	59/64		O-Ring
68600	4-5/8	Wire Lead	New	8 Groove	TM16	27/32		O-Ring
68605	4-9/16	Wire Lead	New	8 Groove	TM16	53/64		O-Ring
68606	5-5/16	Wire Lead	New	2 Groove	TM16	63/64		O-Ring
68607	5-5/16	Wire Lead	New	2 Groove	TM16	63/64		O-Ring
68608	4-59/64	Wire Lead	New	2 Groove	TM16	63/64		O-Ring
68609	4-59/64	Wire Lead	New	2 Groove	TM16	63/64		O-Ring
68612	4-11/16	Wire Lead	New	6 Groove	TM16	1		O-Ring
68613	4-11/16	Wire Lead	New	6 Groove	TM16	1		O-Ring
68614	4-11/16	Wire Lead	New	8 Groove	TM16	13/16		O-Ring
68615	4-11/16	Wire Lead	New	8 Groove	TM16	13/16		O-Ring
68620	4-11/16	Wire Lead	New	10 Groove	TM16	11/16		O-Ring
68621	4-11/16	Wire Lead	New	10 Groove	TM16	11/16		O-Ring
68631	4-11/16	Wire Lead	New	8 Groove	TM16	53/64		O-Ring
68632	6	Wire Lead	New	2 Groove	TM16	61/64		O-Ring
68633	6	Wire Lead	New	1 Groove	TM16	1-19/32		O-Ring
68634	4-11/16	Wire Lead	New	10 Groove	TM16	55/64		O-Ring
68635	4-31/64	Wire Lead	New	8 Groove	TM16	63/64		O-Ring
68636	6-1/8	Wire Lead	New	1 Groove	TM16	1-3/4		O-Ring
68637	4-11/16	Wire Lead	New	8 Groove	TM16	61/64		O-Ring
68691	5-1/4	Wire Lead	New	2 Groove	TM16	59/64		O-Ring
58619	5-3/8	Wire Lead	New	8 Groove	TM21HD	1-3/32		O-Ring
58631	5-5/8	12	New	8 Groove	TM21HD	1-5/32		O-Ring
58635	5-5/8	Wire Lead	New	2 Groove	TM21HD	1-1/8		O-Ring
58637	5-5/8	12	New	2 Groove	TM21HD	1-1/8		O-Ring
58690	5	Wire Lead	New	10 Groove	TM21HD	1-7/16		O-Ring
68616	5	Wire Lead	New	8 Groove	TM21HD	1-3/64		O-Ring
68617	5		New	8 Groove	TM21HD	1-3/64		
68619	5	Wire Lead	New	8 Groove	TM21HD	1-3/64		O-Ring
68622	5	Wire Lead	New	8 Groove	TM21HD	1-1/16		O-Ring
68625	5-13/32		New	8 Groove	TM21HD	1-7/64		
68639	5-63/64	3	New	1 Groove	TM21HD	1-11/64		O-Ring
68640	5-3/32		New	10 Groove	TM21HD			
68642	5-9/16	Wire Lead	New	10 Groove	TM21HD	7/16		
68644	5-5/16		New	6 Groove	TM21HD			
78601	5-23/64		New	6 Groove	TM21HD			
68700	6	Wire Lead	New	2 Groove	TM31	1-51/64		O-Ring
68701	6	1 Wire Lead	New	2 Groove	TM31	1-51/64		O-Ring
68702	6-1/4	Wire Lead	New	8 Groove	TM31	2-3/32		O-Ring
68703	6-1/4	Wire Lead	New	8 Groove	TM31	2-3/32		O-Ring
68704	6	Wire Lead	New	2 Groove	TM31	2-13/64		Male Insert O-Ring
68705	6		New	2 Groove	TM31			
57452	4-5/8	Wire Lead	Reman	4 Groove	V5-15F	61/64		O-Ring
67420	5-1/4	Wire Lead	Reman	4 Groove	V5-15G	1-3/32		O-Ring
67426	4-45/64	Wire Lead	Reman	4 Groove	V5-15G	29/32		O-Ring
98664	4-33/64	Wire Lead	New	6 Groove	VCS-14EC	1-5/8		O-Ring
57633			Reman		DKS13G			O-Ring
<b>CVC</b>								
157543	5	2	Reman	6 Groove	CVC	1-13/64	Tangent Mount	Sealing Washer
157546	5	2	Reman	6 Groove	CVC	1-13/64	Tangent Mount	Sealing Washer
158271	4-5/16	Wire Lead	New	5 Groove	CVC	1-43/64	Tangent Mount	Sealing Washer
158272	4-5/16		New	6 Groove	CVC	1-17/64	Tangent Mount	
158273	4-5/16	Wire Lead	New	5 Groove	CVC	1-7/32	3 Tangent One on Rear Head	Sealing Washer
158543	5	2	New	6 Groove	CVC	1-13/64	Tangent Mount	Sealing Washer



# Compressors

Part No.	Pulley Dia.	Coil Clock	New / Reman	Groove	Type	Mount Dist to Groove Midpoint	Mount	Manifold
<b>CVC</b>								
158546	5	2	New	6 Groove	CVC	1-13/64	Tangent Mount	Sealing Washer
198546	5	2	New	6 Groove	CVC	1-13/64	Tangent Mount	Sealing Washer
67217	4-5/16	2 O'Clock	Reman	5 Groove	CVC	1-13/64	Tangent Mount	Sealing Washer
67218	4-45/64	Wire Lead	Reman	6 Groove	CVC	1-23/32	Tangent Mount	Sealing Washer
67219	4-45/64	Coil Less	Reman	6 Groove	CVC	1-7/32	Tangent Mount	Sealing Washer
67229	5	3	Reman	6 Groove	CVC	5/8	Tangent Mount	Sealing Washer
67239	4-5/16	3	Reman	6 Groove	CVC	1-15/32	Tangent Mount	Sealing Washer
67241	4-1/4	1	Reman	6 Groove	CVC	1-3/64	Tangent Mount	Sealing Washer
67275	4	3	Reman	5 Groove	CVC	27/32	Tangent Mount	Sealing Washer
67280	5-5/8	5	Reman	5 Groove	CVC	1-13/64	Tangent Mount	Sealing Washer
67282	4-21/64	Wire Lead	Reman	6 Groove	CVC	1-51/64	Tangent Mount	Sealing Washer
67283	4-3/4	4	Reman	6 Groove	CVC	2	Tangent Mount	Sealing Washer
67296	4-5/16	3	Reman	6 Groove	CVC	1-1/2	Tangent Mount	Sealing Washer
68217	4-5/16	2 O'Clock	New	5 Groove	CVC	1-13/64	Tangent Mount	Sealing Washer
68218	4-45/64	Wire Lead	New	6 Groove	CVC	1-23/32	Tangent Mount	Sealing Washer
68219	4-45/64	N/R	New	6 Groove	CVC	1-7/32	Tangent Mount	Sealing Washer
68220	4-45/64	Wire Lead	New	6 Groove	CVC	1-23/32	Tangent Mount	Sealing Washer
68221	4-11/16		New	6 Groove	CVC	1	2 Ear & 1 Tangent	
68222	4-11/16		New	5 Groove	CVC	1-13/64	Tangent Mount	
68229	5	3	New	6 Groove	CVC	5/8	Tangent Mount	Sealing Washer
68239	4-1/2	3	New	6 Groove	CVC	1-15/32	Tangent Mount	Sealing Washer
68241	4-1/2	1	New	6 Groove	CVC	1-3/64	Tangent Mount	Sealing Washer
68242	4-21/64		New	6 Groove	CVC	1-13/16	3 Tangent One on Rear Head	
68275	4	3	New	5 Groove	CVC	27/32	Tangent Mount	Sealing Washer
68280	5-5/8	5	New	5 Groove	CVC	1-13/64	Tangent Mount	Sealing Washer
68282	4-21/64	Wire Lead	New	6 Groove	CVC	1-51/64	Tangent Mount	Sealing Washer
68283	4-3/4	4	New	6 Groove	CVC	2	Tangent Mount	Sealing Washer
68295	5-7/64	4	New	4 Groove	CVC	1-13/16	Tangent Mount	Sealing Washer
68296	4-5/16	3	New	6 Groove	CVC	1-1/2	Tangent Mount	Sealing Washer
97271	4-5/16	5	Reman	6 Groove	CVC	21/32	Tangent Mount	Sealing Washer
97273	4-1/4	4	Reman	6 Groove	CVC	21/32	Tangent Mount	Sealing Washer
97274	4-1/4	2 O'Clock	Reman	6 Groove	CVC	43/64	Ear Mount	Sealing Washer
97275	4-1/16	Wire Lead	Reman	6 Groove	CVC	41/64	Tangent Mount	O-Ring
97280	4-1/8	Wire Lead	Reman	5 Groove	CVC	1-13/64	Tangent Mount	Sealing Washer
97293	4-5/8	4	Reman	7 Groove	CVC	1-3/16	Tangent Mount	Sealing Washer
97294	5	3	Reman	4 Groove	CVC	1-53/64	Tangent Mount	Sealing Washer
97296	4-5/16	3	Reman	5 Groove	CVC	1-45/64	Tangent Mount	Sealing Washer
98243	4-23/32		New	7 Groove	CVC		3 Tangent One on Rear Head	
98246	4-23/32		New	7 Groove	CVC		3 Tangent One on Rear Head	
98271	4-5/16	5	New	6 Groove	CVC	21/32	Tangent Mount	Sealing Washer
98273	4-1/2	4	New	6 Groove	CVC	21/32	Tangent Mount	Sealing Washer
98274	4-1/2	2 O'Clock	New	6 Groove	CVC	43/64	Tangent Mount	Sealing Washer
98275	4-1/16	Wire Lead	New	6 Groove	CVC	41/64	Tangent Mount	O-Ring
98280	4-1/8		New	5 Groove	CVC	1-13/64	3 Tangent One on Rear Head	
98293	4-5/8	4	New	7 Groove	CVC	1-3/16	Tangent Mount	Sealing Washer
98294	5	3	New	4 Groove	CVC	1-53/64	Tangent Mount	Sealing Washer
98295	4-25/64	4	New	8 Groove	CVC	1-1/64	Tangent Mount	Sealing Washer
98296	4-5/16	3	New	5 Groove	CVC	1-45/64	Tangent Mount	Sealing Washer
98297	4-11/64	3	New	6 Groove	CVC	1-3/16	Tangent Mount	
<b>Delphi Series</b>								
68693	4-23/32	3	New	6 Groove	CSP15	1-23/32	Tangent Mount	Sealing Washer
68694	4-23/32	1 Wire Lead	New	6 Groove	CSP15		3 Tangent One on Rear Head	
68695	4-47/64	Wire Lead	New	6 Groove	CSP15	1-1/4	Tangent Mount	Sealing Washer
68243	4-13/32	Wire Lead	New	4 Groove	SP10	2-5/64	3 Ear	
67677	4-1/2	Wire Lead	Reman	7 Groove	SP15	1-21/32	Tangent Mount	Sealing Washer
68677	4-1/4	Wire Lead	New	7 Groove	SP15	1-21/32	Tangent Mount	Sealing Washer
68649	4-1/2	Wire Lead	New	6 Groove	SP17	1-47/64	Tangent Mount	Sealing Washer

# Compressors

Part No.	Pulley Dia.	Coil Clock	New / Reman	Groove	Type	Mount Dist to Groove Midpoint	Mount	Manifold
<b>Delphi Series</b>								
68669	4-3/8	Wire Lead	New	6 Groove	SP17	2-1/2	Tangent Mount	Sealing Washer
68670	5	Wire Lead	New	6 Groove	SP17	2-35/64	Tangent Mount	Sealing Washer
68676	4-23/32	2 O'Clock	New	6 Groove	SP17	1-3/32	Tangent Mount	Sealing Washer
68679	4-29/32	Wire Lead	New	4 Groove	SP17	1-7/32	Tangent Mount	Sealing Washer
68680	4-3/4	Wire Lead	New	5 Groove	SP17	1-15/64	Tangent Mount	Sealing Washer
68683	4-19/64	2 O'Clock	New	6 Groove	SP17	1-13/64	Tangent Mount	Sealing Washer
78664	4-33/64	Wire Lead	New	6 Groove	SP17	1-5/8	Tangent Mount	O-Ring
<b>Denso Electric</b>								
168301		Coil Less	New		ES14C		Tangent Mount	O-Ring
98360		Coil Less	New		ES18C		Tangent Mount	O-Ring
168302		Coil Less	New		ES27C		Tangent Mount	O-Ring
<b>Denso</b>								
77311	4	Wire Lead	Reman	4 Groove	10P08E	1-13/32	Ear Mount	Pad Mount
77312	4-5/8	Wire Lead	Reman	1 Groove	10P08E	1-51/64	Ear Mount	Pad Mount
78311	4	Wire Lead	New	4 Groove	10P08E	1-13/32	Ear Mount	Pad Mount
78312	4-5/8	Wire Lead	New	1 Groove	10P08E	1-51/64	Ear Mount	Pad Mount
67364	5-1/8	Wire Lead	Reman	1 Groove	10P13A	1-55/64	Ear Mount	Pad Mount
67392	5-3/8	Wire Lead	Reman	1 Groove	10P13A	1-51/64	Ear Mount	Pad Mount
67398	4-3/4	Wire Lead	Reman	5 Groove	10P13A	1-3/4	Ear Mount	Pad Mount
68398	4-3/4		New	5 Groove	10P13A		Ear Mount	
77302	4-3/4	Wire Lead	Reman	4 Groove	10P13A	1-21/32	Ear Mount	Pad Mount
77353	4-3/4	Wire Lead	Reman	4 Groove	10P13A	1-19/32	Ear Mount	Pad Mount
67303	5-1/2	Wire Lead	Reman	1 Groove	10P13C	1-55/64	Tangent Mount	Pad Mount
67365	5-3/4	Wire Lead	Reman	1 Groove	10P13C	1-3/4	Tangent Mount	Pad Mount
67370	4-3/4	Wire Lead	Reman	5 Groove	10P13C	1-19/32	Tangent Mount	Pad Mount
67379	4-3/4	Wire Lead	Reman	5 Groove	10P13C	1-19/32	Tangent Mount	Pad Mount
67385	4-3/4	Wire Lead	Reman	4 Groove	10P13C	1-21/32	Tangent Mount	Pad Mount
67386	5-1/4	Wire Lead	Reman	5 Groove	10P13C	2-35/64	Tangent Mount	O-Ring
77306	6	Wire Lead	Reman	1 Groove	10P13C	3-1/32	Tangent Mount	Pad Mount
77324	5-7/8	Wire Lead	Reman	5 Groove	10P13C	2-3/32	Tangent Mount	Pad Mount
77354	5-1/2	Wire Lead	Reman	1 Groove	10P13C	2-3/64	Tangent Mount	Pad Mount
57325	5-23/64	Wire Lead	Reman	1 Groove	10P13E	1-21/32	Ear Mount	Pad Mount
57394	4-3/4	Wire Lead	Reman	4 Groove	10P13F	1-5/8	Tangent Mount	Pad Mount
67397	4-3/4	Wire Lead	Reman	6 Groove	10P13F	1-35/64	Tangent Mount	Pad Mount
68397	4-3/4	Wire Lead	New	6 Groove	10P13F	1-35/64	Tangent Mount	O-Ring
77303	5-5/8	Wire Lead	Reman	1 Groove	10P13F	1-55/64	Tangent Mount	Pad Mount
57322	4-3/4	Wire Lead	Reman	6 Groove	10P15C	1-13/64	Tangent Mount	Pad Mount
57333	5-1/4	Wire Lead	Reman	6 Groove	10P15C	1-13/64	Tangent Mount	Pad Mount
57363	4-7/8	Wire Lead	Reman	4 Groove	10P15C	1-35/64	Tangent Mount	Pad Mount
57385	4-7/8	12 O'Clock	Reman	6 Groove	10P15C	1-43/64	Tangent Mount	Pad Mount
57389	5-1/4	Wire Lead	Reman	1 Groove	10P15C	1-59/64	Tangent Mount	Pad Mount
57393	4-7/8	12	Reman	5 Groove	10P15C	1-13/16	Tangent Mount	Pad Mount
58322	4-3/4	Wire Lead	New	6 Groove	10P15C	1-13/64	Tangent Mount	O-Ring
67302	5-5/8	Wire Lead	Reman	1 Groove	10P15C	1-11/16	Tangent Mount	Pad Mount
67368	5-1/4	Wire Lead	Reman	5 Groove	10P15C	3-3/32	Tangent Mount	Pad Mount
67382	5-1/4	Wire Lead	Reman	5 Groove	10P15C	3-3/32	Tangent Mount	Pad Mount
68302	4-1/2	Wire Lead	New	1 Groove	10P15C	1-55/64	Tangent Mount	Pad Mount
77308	6	Wire Lead	Reman	1 Groove	10P15C	3-3/64	Tangent Mount	Pad Mount
77309	5-23/64	Wire Lead	Reman	1 Groove	10P15C	2-3/32	Tangent Mount	Pad Mount
78345	5-19/32		New	1 Groove	10P15C	1-15/32	Direct Mount	
57343	4-3/4	Wire Lead	Reman	6 Groove	10P15E	1-9/16	Ear Mount	Pad Mount
57350	5-1/4	Wire Lead	Reman	4 Groove	10P15E	1-13/64	Ear Mount	Pad Mount
57352	5-23/64	Wire Lead	Reman	1 Groove	10P15E	2-21/32	Ear Mount	Pad Mount
58343	4-3/4	Wire Lead	New	6 Groove	10P15E	1-9/16	Ear Mount	Pad Mount
57365	5	Wire Lead	Reman	6 Groove	10P15F	1-45/64	Tangent Mount	Pad Mount
57338	5-1/4	Wire Lead	Reman	1 Groove	10P17C	2-19/64	Tangent Mount	Pad Mount
57357	5-1/4	Wire Lead	Reman	1 Groove	10P17C	2-13/64	Tangent Mount	Pad Mount
57364	5	Wire Lead	Reman	4 Groove	10P17C	2-19/64	Tangent Mount	Pad Mount
58338	4-1/4	Wire Lead	New	1 Groove	10P17C	2-19/64	Tangent Mount	Pad Mount
58357	1-1/4	Wire Lead	New	1 Groove	10P17C	2-13/64	Tangent Mount	Pad Mount
67383	5-5/8	Wire Lead	Reman	1 Groove	10P17C	2-19/64	Tangent Mount	Pad Mount

# Compressors

Part No.	Pulley Dia.	Coil Clock	New / Reman	Groove	Type	Mount Dist to Groove Midpoint	Mount	Manifold
<b>Denso</b>								
77355	4-3/4	Wire Lead	Reman	5 Groove	10PA15A	35/64	Ear Mount	Pad Mount
157303	4-3/4	Wire Lead	Reman	4 Groove	10PA15C	2-23/32	Tangent Mount	Pad Mount
157310	5	Wire Lead	Reman	1 Groove	10PA15C	1-21/32	Tangent Mount	Pad Mount
158303	4-3/4	Wire Lead	New	4 Groove	10PA15C	2-23/32	Tangent Mount	Pad Mount
158310	5	Wire Lead	New	1 Groove	10PA15C	1-21/32	Tangent Mount	Pad Mount
158881	3-7/8	Wire Lead	New	7 Groove	10PA15C	1-13/32	Tangent Mount	Pad Mount
168304	5-63/64	Wire Lead	New	1 Groove	10PA15C	2-29/32	Tangent Mount	Pad Mount
57300	5-1/2	Wire Lead	Reman	5 Groove	10PA15C	2-21/32	Tangent Mount	Pad Mount
57334	4-3/4	Wire Lead	Reman	6 Groove	10PA15C	1-13/64	Tangent Mount	Pad Mount
57369	4-3/4	Wire Lead	Reman	4 Groove	10PA15C	2-3/32	Tangent Mount	Pad Mount
57397	5-1/2	Wire Lead	Reman	4 Groove	10PA15C	1-21/32	Tangent Mount	Pad Mount
58300	5-1/2	Wire Lead	New	5 Groove	10PA15C	1-19/32	Tangent Mount	Pad Mount
58334	4-3/4	Wire Lead	New	6 Groove	10PA15C	1-13/64	Tangent Mount	Pad Mount
58369	4-3/4	Wire Lead	New	4 Groove	10PA15C	1-39/64	Tangent Mount	Pad Mount
58397	5-1/2	Wire Lead	New	4 Groove	10PA15C	1-21/32	Tangent Mount	Pad Mount
67301	5-5/8	Wire Lead	Reman	1 Groove	10PA15C	2-61/64	Tangent Mount	Pad Mount
67306	5-41/64	Wire Lead	Reman	1 Groove	10PA15C	2-55/64	Tangent Mount	Pad Mount
67318	5-57/64	Wire Lead	Reman	4 Groove	10PA15C	1-21/32	Tangent Mount	Pad Mount
67354	4-59/64	Wire Lead	Reman	8 Groove	10PA15C	41/64	Tangent Mount	Pad Mount
67355	5-13/32	Wire Lead	Reman	2 Groove	10PA15C	45/64	Tangent Mount	Pad Mount
67366	5-1/8	Wire Lead	Reman	4 Groove	10PA15C	1-61/64	Tangent Mount	Pad Mount
67369	5-1/8	Wire Lead	Reman	1 Groove	10PA15C	2-5/32	Tangent Mount	Pad Mount
68301	5-5/8	Wire Lead	New	1 Groove	10PA15C	2-61/64	Tangent Mount	Pad Mount
68306	5-41/64	Wire Lead	New	1 Groove	10PA15C	2-55/64	Tangent Mount	Gasket
68318	5-57/64	Wire Lead	New	4 Groove	10PA15C	1-21/32	Tangent Mount	Pad Mount
68354	4-43/64	Wire Lead	New	8 Groove	10PA15C	1-3/32	Tangent Mount	Pad Mount
68366	5-1/8	Wire Lead	New	4 Groove	10PA15C	1-61/64	Tangent Mount	Pad Mount
68369	5-1/8	Wire Lead	New	1 Groove	10PA15C	2-5/32	Tangent Mount	Pad Mount
77320	5-1/2	Wire Lead	Reman	6 Groove	10PA15C	2-3/64	Tangent Mount	Pad Mount
77329	5-1/4	Wire Lead	Reman	4 Groove	10PA15C	2-45/64	Tangent Mount	Pad Mount
77335	4-1/4	Wire Lead	Reman	4 Groove	10PA15C	1-21/32	Tangent Mount	Pad Mount
77360	4-3/4	Wire Lead	Reman	4 Groove	10PA15C	1-21/32	Tangent Mount	Pad Mount
78320	5-1/2	Wire Lead	New	6 Groove	10PA15C	2-3/64	Tangent Mount	Pad Mount
78329	5-1/4	Wire Lead	New	4 Groove	10PA15C	2-45/64	Tangent Mount	Pad Mount
78335	4-1/4	Wire Lead	New	4 Groove	10PA15C	1-21/32	Tangent Mount	Pad Mount
97335	4-7/8	Wire Lead	Reman	4 Groove	10PA15C	1-45/64	Tangent Mount	Pad Mount
97344	4-1/2	Wire Lead	Reman	4 Groove	10PA15C	2	Tangent Mount	Pad Mount
97370	4-5/8	Wire Lead	Reman	4 Groove	10PA15C	2-45/64	Tangent Mount	Pad Mount
98344	4-1/2	Wire Lead	New	4 Groove	10PA15C	2	Tangent Mount	Pad Mount
98370	4-5/8	Wire Lead	New	4 Groove	10PA15C	2-45/64	Tangent Mount	Pad Mount
98373	4-5/8	Wire Lead	New	4 Groove	10PA15C	2-45/64	Tangent Mount	Pad Mount
57353	5-1/4	Wire Lead	Reman	4 Groove	10PA15E	1-13/64	Ear Mount	Pad Mount
178307	4-59/64	Wire Lead	New	6 Groove	10PA15L	2-55/64	Tangent Mount	Pad Mount
67324	5-3/16	Wire Lead	Reman	4 Groove	10PA15L	2-1/8	Tangent Mount	Pad Mount
67391	4-3/4	Wire Lead	Reman	4 Groove	10PA15L	2-3/32	Tangent Mount	Pad Mount
68324	5-3/16	Wire Lead	New	4 Groove	10PA15L	2-1/8	Tangent Mount	Pad Mount
68391	4-1/2	Wire Lead	New	4 Groove	10PA15L	2-1/8	Tangent Mount	Pad Mount
77322	4-3/4	Wire Lead	Reman	5 Groove	10PA15L	3-3/32	Tangent Mount	Pad Mount
78322	4-3/4	Wire Lead	New	5 Groove	10PA15L	3-3/32	Tangent Mount	Pad Mount
158397	4-11/16	Wire Lead	New	6 Groove	10PA17C	2-7/8	Tangent Mount	Pad Mount
158398	4-5/8	Wire Lead	New	6 Groove	10PA17C	2-15/32	Tangent Mount	Pad Mount
178300	4-57/64	Wire Lead	New	6 Groove	10PA17C	1-17/32	Tangent Mount	Pad Mount
178301	4-21/32	Wire Lead	New	6 Groove	10PA17C	2-55/64	Tangent Mount	Pad Mount
178302	4-11/16	Wire Lead	New	6 Groove	10PA17C	2-5/32	Tangent Mount	Pad Mount
178303	4-5/8	Wire Lead	New	6 Groove	10PA17C	2-7/8	Tangent Mount	Pad Mount
57305	6-1/4	Wire Lead	Reman	6 Groove	10PA17C	2-13/32	Tangent Mount	Pad Mount
57335	4-1/4	Wire Lead	Reman	6 Groove	10PA17C	45/64	Tangent Mount	Pad Mount
57336	4-3/4	Wire Lead	Reman	6 Groove	10PA17C	11/16	Tangent Mount	Pad Mount
57344	5-5/8	Wire Lead	Reman	1 Groove	10PA17C	1-45/64	Tangent Mount	Pad Mount
57356	4-1/4	Wire Lead	Reman	5 Groove	10PA17C	61/64	Tangent Mount	Pad Mount
57381	5-1/8	Wire Lead	Reman	6 Groove	10PA17C	1-3/32	Tangent Mount	Pad Mount
57387	5-5/8	Wire Lead	Reman	1 Groove	10PA17C	3-29/64	Tangent Mount	Pad Mount
57390	5-1/8	Wire Lead	Reman	7 Groove	10PA17C	1-3/64	Tangent Mount	Pad Mount



# Compressors

Part No.	Pulley Dia.	Coil Clock	New / Reman	Groove	Type	Mount Dist to Groove Midpoint	Mount	Manifold
<b>Denso</b>								
57398	5-1/4	Wire Lead	Reman	5 Groove	10PA17C	3-3/32	Tangent Mount	Pad Mount
57399	5	Wire Lead	Reman	6 Groove	10PA17C	2-55/64	Tangent Mount	Pad Mount
58305	6-1/4	Wire Lead	New	6 Groove	10PA17C	2-13/32	Tangent Mount	Pad Mount
58335	4-1/4	Wire Lead	New	6 Groove	10PA17C	45/64	Tangent Mount	Pad Mount
58336	4-3/4	Wire Lead	New	6 Groove	10PA17C	11/16	Tangent Mount	Pad Mount
58344	5-5/8	Wire Lead	New	1 Groove	10PA17C	1-45/64	Tangent Mount	Pad Mount
58356	4-1/4	Wire Lead	New	5 Groove	10PA17C	61/64	Tangent Mount	Pad Mount
58381	5-1/8	Wire Lead	New	6 Groove	10PA17C	1-1/8	Tangent Mount	Pad Mount
58387	5-5/8	Wire Lead	New	1 Groove	10PA17C	3-29/64	Tangent Mount	Pad Mount
58390	5-1/8	Wire Lead	New	7 Groove	10PA17C	1-5/32	Tangent Mount	Pad Mount
58398	5-1/4	Wire Lead	New	5 Groove	10PA17C	1-19/32	Tangent Mount	Pad Mount
58399	5	Wire Lead	New	6 Groove	10PA17C	1-15/32	Tangent Mount	Pad Mount
67300	6-1/4	Wire Lead	Reman	5 Groove	10PA17C	2-5/16	Tangent Mount	Pad Mount
67315	5-1/8	Wire Lead	Reman	6 Groove	10PA17C	2-13/32	Tangent Mount	Pad Mount
67350	5-1/2	Wire Lead	Reman	8 Groove	10PA17C	1-1/8	Tangent Mount	Pad Mount
67351	5-3/4	Wire Lead	Reman	1 Groove	10PA17C	1	Tangent Mount	Pad Mount
67352	5-3/4	Wire Lead	Reman	1 Groove	10PA17C	1-45/64	Tangent Mount	Pad Mount
67353	5-49/64	Wire Lead	Reman	1 Groove	10PA17C	1	Tangent Mount	Pad Mount
67362	4-7/8	Wire Lead	Reman	6 Groove	10PA17C	1-45/64	Ear Mount	Pad Mount
67371	5-1/4	Wire Lead	Reman	1 Groove	10PA17C	2-51/64	Tangent Mount	Pad Mount
67373	4-3/4	Wire Lead	Reman	4 Groove	10PA17C	2-29/64	Tangent Mount	Pad Mount
68300	6-1/4	Wire Lead	New	5 Groove	10PA17C	49/64	Tangent Mount	Pad Mount
68315	5-1/8	Wire Lead	New	6 Groove	10PA17C	2-13/32	Tangent Mount	Pad Mount
68350	5-1/2	Wire Lead	New	8 Groove	10PA17C	1-1/8	Tangent Mount	Pad Mount
68351	5-3/4	Wire Lead	New	1 Groove	10PA17C	1-3/8	Tangent Mount	Rear Head
68352	5-47/64	Wire Lead	New	1 Groove	10PA17C	2-5/32	Tangent Mount	Pad Mount
68353	5-3/4	Wire Lead	New	1 Groove	10PA17C	1-7/16	Tangent Mount	Pad Mount
68371	5-1/4	Wire Lead	New	1 Groove	10PA17C	2-51/64	Tangent Mount	Pad Mount
68373	4-3/4	Wire Lead	New	4 Groove	10PA17C	7/8	Tangent Mount	Pad Mount
77304	5-1/4	Wire Lead	Reman	1 Groove	10PA17C	2-5/32	Tangent Mount	Pad Mount
77305	5-1/4	Wire Lead	Reman	1 Groove	10PA17C	1-13/32	Tangent Mount	Pad Mount
77307	6	Wire Lead	Reman	5 Groove	10PA17C	3-3/32	Tangent Mount	Pad Mount
77316	5-1/4	Wire Lead	Reman	4 Groove	10PA17C	2-3/32	Tangent Mount	Pad Mount
77318	4-3/4	Wire Lead	Reman	6 Groove	10PA17C	2-1/4	Tangent Mount	Pad Mount
77323	4-3/4	Wire Lead	Reman	4 Groove	10PA17C	2-3/32	Tangent Mount	Pad Mount
77331	4-23/64	Wire Lead	Reman	6 Groove	10PA17C	51/64	Tangent Mount	Pad Mount
77333	5-1/2	Wire Lead	Reman	4 Groove	10PA17C	3-5/32	Tangent Mount	Pad Mount
77334	5-1/8	Wire Lead	Reman	6 Groove	10PA17C	2-17/64	Tangent Mount	Pad Mount
77336	5	Wire Lead	Reman	4 Groove	10PA17C	2-27/64	Tangent Mount	Pad Mount
77341	5	Wire Lead	Reman	6 Groove	10PA17C	2-29/32	Tangent Mount	Pad Mount
77343	4-3/4	Wire Lead	Reman	6 Groove	10PA17C	21/32	Tangent Mount	Pad Mount
77344	4-3/4	Wire Lead	Reman	8 Groove	10PA17C	21/32	Tangent Mount	Pad Mount
77346	5-1/4	Wire Lead	Reman	1 Groove	10PA17C	1-9/64	Tangent Mount	Pad Mount
77351	5-1/8	Wire Lead	Reman	5 Groove	10PA17C	2-11/32	Tangent Mount	Pad Mount
77375	5-1/2	Wire Lead	Reman	8 Groove	10PA17C	1-3/32	Tangent Mount	Pad Mount
77381	5-1/2	Wire Lead	Reman	6 Groove	10PA17C	1-5/64	Tangent Mount	Pad Mount
77392	4-29/32	Wire Lead	Reman	7 Groove	10PA17C	2-1/2	Tangent Mount	Pad Mount
77393	5-3/32	Wire Lead	Reman	1 Groove	10PA17C	2-45/64	Tangent Mount	Pad Mount
78304	5-1/4	Wire Lead	New	1 Groove	10PA17C	2-5/32	Tangent Mount	Pad Mount
78305	5-1/4	Wire Lead	New	1 Groove	10PA17C	61/64	Tangent Mount	Pad Mount
78307	6	Wire Lead	New	5 Groove	10PA17C	3-3/32	Tangent Mount	Pad Mount
78316	5-1/4	Wire Lead	New	4 Groove	10PA17C	2-3/32	Tangent Mount	Pad Mount
78318	4-3/4	Wire Lead	New	6 Groove	10PA17C	2-1/4	Tangent Mount	Pad Mount
78323	4-3/4	Wire Lead	New	4 Groove	10PA17C	2-3/32	Tangent Mount	Pad Mount
78333	5-1/2	Wire Lead	New	4 Groove	10PA17C	3-5/32	Tangent Mount	Pad Mount
78334	5-1/8	Wire Lead	New	6 Groove	10PA17C	2-17/64	Tangent Mount	Pad Mount
78336	5	Wire Lead	New	4 Groove	10PA17C	2-27/64	Tangent Mount	Pad Mount
78341	5	Wire Lead	New	6 Groove	10PA17C	2-29/32	Tangent Mount	Pad Mount
78344	4-3/4	Wire Lead	New	8 Groove	10PA17C	21/32	Tangent Mount	Pad Mount
78346	4-25/64	Wire Lead	New	1 Groove	10PA17C	1-1/16	Tangent Mount	Pad Mount
78351	5-1/8	Wire Lead	New	5 Groove	10PA17C	2-11/32	Tangent Mount	Pad Mount
78357	5-5/8	Wire Lead	New	1 Groove	10PA17C	1-45/64	Tangent Mount	Pad Mount
78358	5-5/8	Wire Lead	New	1 Groove	10PA17C	1-45/64	Tangent Mount	Pad Mount

# Compressors

Part No.	Pulley Dia.	Coil Clock	New / Reman	Groove	Type	Mount Dist to Groove Midpoint	Mount	Manifold
<b>Denso</b>								
78359	5-23/64	Wire Lead	New	6 Groove	10PA17C	1-1/8	Tangent Mount	Pad Mount
78375	5-1/2	Wire Lead	New	8 Groove	10PA17C	1-1/8	Tangent Mount	Pad Mount
78381	5-1/2	Wire Lead	New	6 Groove	10PA17C	1-5/64	Tangent Mount	Pad Mount
78392	5-1/16	Wire Lead	New	7 Groove	10PA17C	2-1/2	Tangent Mount	Pad Mount
78393	5-3/32	Wire Lead	New	1 Groove	10PA17C	2-45/64	Tangent Mount	Pad Mount
97325	4-3/4	Wire Lead	Reman	4 Groove	10PA17C	11/16	Tangent Mount	Pad Mount
97334	4-11/16	Wire Lead	Reman	7 Groove	10PA17C	2-1/2	Tangent Mount	Pad Mount
97341	4-11/16	Wire Lead	Reman	7 Groove	10PA17C	2-15/32	Tangent Mount	Pad Mount
97342	4-3/4	Wire Lead	Reman	7 Groove	10PA17C	2-13/32	Tangent Mount	Pad Mount
97361	5-7/8	Wire Lead	Reman	6 Groove	10PA17C	2-13/32	Tangent Mount	Pad Mount
97374	4-7/8	Wire Lead	Reman	6 Groove	10PA17C	2-51/64	Tangent Mount	Pad Mount
98325	4-3/4	Wire Lead	New	4 Groove	10PA17C	11/16	Tangent Mount	O-Ring
98334	4-11/16	Wire Lead	New	7 Groove	10PA17C	2-1/2	Tangent Mount	Pad Mount
98342	4-3/4	Wire Lead	New	7 Groove	10PA17C	2-13/32	Tangent Mount	Pad Mount
98361	5-25/32	Wire Lead	New	6 Groove	10PA17C	2-13/32	Tangent Mount	Pad Mount
98374	4-7/8	Wire Lead	New	6 Groove	10PA17C	2-51/64	Tangent Mount	Pad Mount
77337	4-21/64	Wire Lead	Reman	4 Groove	10PA17E	2-19/64	Ear Mount	Pad Mount
77379	5-1/8	Wire Lead	Reman	6 Groove	10PA17E	41/64	Ear Mount	Pad Mount
77380	5-1/8	Wire Lead	Reman	6 Groove	10PA17E	2-3/64	Ear Mount	Pad Mount
78337	4-21/64	Wire Lead	New	4 Groove	10PA17E	2-3/8	Ear Mount	Pad Mount
78379	5-1/8	Wire Lead	New	6 Groove	10PA17E	41/64	Ear Mount	Pad Mount
78380	5-1/8	Wire Lead	New	6 Groove	10PA17E	2-3/64	Ear Mount	Pad Mount
77310	5-1/8	Wire Lead	Reman	6 Groove	10PA17H	3/4	3 Ear & 3 Boss	Pad Mount
78310	5-1/8	Wire Lead	New	6 Groove	10PA17H	3/4	3 Ear & 3 Boss	Pad Mount
57378	4-3/4	Wire Lead	Reman	6 Groove	10PA17J	19/32	Ear Mount	Pad Mount
58378	4-3/4	Wire Lead	New	6 Groove	10PA17J	61/64	Ear Mount	Pad Mount
57386	5-1/2	Wire Lead	Reman	6 Groove	10PA17K	1-7/16	Ear Mount	Pad Mount
57396	5-1/4	Wire Lead	Reman	1 Groove	10PA17K	2-13/32	Ear Mount	Pad Mount
58386	5-1/2	Wire Lead	New	6 Groove	10PA17K	1-7/16	Ear Mount	Pad Mount
58396	5-1/4	Wire Lead	New	1 Groove	10PA17K	2-13/32	Ear Mount	Pad Mount
67375	5	Wire Lead	Reman	6 Groove	10PA17VC	2-55/64	Tangent Mount	Pad Mount
67378	5-1/4	Wire Lead	Reman	5 Groove	10PA17VC	3-3/32	Tangent Mount	Pad Mount
68378	5-1/4	Wire Lead	New	5 Groove	10PA17VC	3-3/32	Tangent Mount	Pad Mount
57332	4-1/2	Wire Lead	Reman	6 Groove	10PA20C	53/64	Tangent Mount	Pad Mount
58332	4-1/2	Wire Lead	New	6 Groove	10PA20C	53/64	Tangent Mount	Pad Mount
67376	4-3/4	Wire Lead	Reman	4 Groove	10PA20C	1-29/32	Tangent Mount	Pad Mount
68376	4-47/64	Wire Lead	New	4 Groove	10PA20C	1-29/32	Tangent Mount	Pad Mount
77300	4-3/4	Wire Lead	Reman	8 Groove	10PA20C	19/32	Tangent Mount	Pad Mount
77326	4-1/2	Wire Lead	Reman	6 Groove	10PA20C	1-21/32	Tangent Mount	Pad Mount
77327	5-1/8	Wire Lead	Reman	6 Groove	10PA20C	1-21/32	Tangent Mount	Pad Mount
77328	5-1/2	Wire Lead	Reman	5 Groove	10PA20C	1-29/32	Tangent Mount	Pad Mount
77350	5-1/2	Wire Lead	Reman	5 Groove	10PA20C	1-29/32	Tangent Mount	Pad Mount
77394	4-3/32	Wire Lead	Reman	6 Groove	10PA20C	19/32	Tangent Mount	Pad Mount
77397	4-1/2	Wire Lead	Reman	6 Groove	10PA20C	1-19/32	Tangent Mount	Pad Mount
78326	4-1/2	Wire Lead	New	6 Groove	10PA20C	1-21/32	Tangent Mount	Pad Mount
78327	5-15/64	Wire Lead	New	6 Groove	10PA20C	1-21/32	Tangent Mount	Pad Mount
78328	5-1/2	Wire Lead	New	5 Groove	10PA20C		Tangent Mount	Pad Mount
78397	4-1/2	Wire Lead	New	6 Groove	10PA20C	1-19/32	Tangent Mount	Pad Mount
77382	5-1/16	Wire Lead	Reman	6 Groove	10PA20H	3/4	3 Ear & 3 Boss	Pad Mount
78382	5-1/16	Wire Lead	New	6 Groove	10PA20H	3/4	3 Ear & 3 Boss	Pad Mount
77385	4-1/2	Wire Lead	Reman	5 Groove	10S11C	41/64	Tangent Mount	O-Ring
78385	4-1/2	Wire Lead	New	5 Groove	10S11C	41/64	Tangent Mount	O-Ring
97331	4-11/16	Wire Lead	Reman	4 Groove	10S11C	33/64	Tangent Mount	O-Ring
98331	4-1/2	Wire Lead	New	4 Groove	10S11C	33/64	Tangent Mount	O-Ring
77384	4-3/4	Wire Lead	Reman	4 Groove	10S11E	1-11/64	Ear Mount	O-Ring
78384	4-3/4	Wire Lead	New	4 Groove	10S11E	1-11/64	Ear Mount	O-Ring
97339	4-1/2	Wire Lead	Reman	4 Groove	10S13C	7/16	Tangent Mount	O-Ring
97340	4-1/4	Wire Lead	Reman	5 Groove	10S13C	19/32	Tangent Mount	O-Ring
98339	4-1/2	Wire Lead	New	4 Groove	10S13C	7/16	Tangent Mount	O-Ring
98340	4-1/4	Wire Lead	New	5 Groove	10S13C	19/32	Tangent Mount	O-Ring
198372	6-3/16	Wire Lead	New	8 Groove	10S15C	1-15/32	3 Tangent	Sealing Washer
198373	5-1/2	Wire Lead	New	8 Groove	10S15C	1-15/32	3 Tangent	Sealing Washer
67332	5-1/8	Wire Lead	Reman	7 Groove	10S15C	1-21/32	Tangent Mount	O-Ring

# Compressors

Part No.	Pulley Dia.	Coil Clock	New / Reman	Groove	Type	Mount Dist to Groove Midpoint	Mount	Manifold
<b>Denso</b>								
67338	5	Wire Lead	Reman	4 Groove	10S15C	1-29/64	Tangent Mount	O-Ring
68332	5-1/8	Wire Lead	New	7 Groove	10S15C	1-21/32	Tangent Mount	O-Ring
68338	5	Wire Lead	New	4 Groove	10S15C	1-29/64	Tangent Mount	O-Ring
77387	5-1/8	Wire Lead	Reman	4 Groove	10S15C	1-29/64	Tangent Mount	O-Ring
77399	5	Wire Lead	Reman	4 Groove	10S15C	1-13/32	Tangent Mount	O-Ring
78387	5-1/8	Wire Lead	New	4 Groove	10S15C	1-29/64	Tangent Mount	O-Ring
78399	5	Wire Lead	New	4 Groove	10S15C	1-13/32	Tangent Mount	O-Ring
97365	5-1/16	Wire Lead	Reman	7 Groove	10S15C	1-41/64	Tangent Mount	O-Ring
97383	4-5/8	Wire Lead	Reman	7 Groove	10S15C	1-19/32	Tangent Mount	O-Ring
97393	4-3/4	Wire Lead	Reman	7 Groove	10S15C	1-21/32	Tangent Mount	O-Ring
98365	5-1/16	Wire Lead	New	7 Groove	10S15C	1-41/64	Tangent Mount	O-Ring
98383	4-5/8	Wire Lead	New	7 Groove	10S15C	1-21/32	Tangent Mount	O-Ring
98393	4-3/4	Wire Lead	New	7 Groove	10S15C	1-21/32	Tangent Mount	O-Ring
67311	5-1/2	Wire Lead	Reman	6 Groove	10S15L	2	Tangent Mount	O-Ring
68311	5-3/8	Wire Lead	New	6 Groove	10S15L	2-3/64	Tangent Mount	O-Ring
77391	5-1/2	Wire Lead	Reman	6 Groove	10S15L	2-3/64	Tangent Mount	O-Ring
78391	5-1/2	Wire Lead	New	6 Groove	10S15L	2-3/64	Tangent Mount	O-Ring
157300	4-1/4	Wire Lead	Reman	7 Groove	10S17C	19/32	Tangent Mount	O-Ring
157352	4-7/8	Wire Lead	Reman	6 Groove	10S17C	27/32	Tangent Mount	O-Ring / Gasket
157373	4-23/32	Wire Lead	Reman	6 Groove	10S17C	2-13/32	Tangent Mount	O-Ring
158300	4-1/4	Wire Lead	New	7 Groove	10S17C	19/32	Tangent Mount	O-Ring
158324	4-1/4	Wire Lead	New	7 Groove	10S17C	1-5/8	Tangent Mount	O-Ring
158342	4-3/4	Wire Lead	New	7 Groove	10S17C	39/64	Tangent Mount	O-Ring
158373	4-23/32	Wire Lead	New	6 Groove	10S17C	2-13/32	Tangent Mount	O-Ring
178313	4-47/64	Wire Lead	New	8 Groove	10S17C	47/64	Tangent Mount	O-Ring
198370	4-45/64	Wire Lead	New	6 Groove	10S17C	41/64	Tangent Mount	O-Ring / Gasket
198371	5-7/64	Wire Lead	New	1 Groove	10S17C	63/64	Tangent Mount	O-Ring / Gasket
67309	5	Wire Lead	Reman	4 Groove	10S17C	1-13/32	Tangent Mount	O-Ring
67337	5-1/2	Wire Lead	Reman	6 Groove	10S17C	2-13/32	Tangent Mount	O-Ring
67342	5-1/16	Wire Lead	Reman	6 Groove	10S17C	1-1/4	Tangent Mount	Gasket
67344	4-11/16	Wire Lead	Reman	6 Groove	10S17C	61/64	Tangent Mount	O-Ring
68337	5-1/2	Wire Lead	New	6 Groove	10S17C	2-13/32	Tangent Mount	Sealing Washer
68342	5-1/16	Wire Lead	New	6 Groove	10S17C	1-1/4	Tangent Mount	O-Ring / Gasket
68344	4-11/16	Wire Lead	New	6 Groove	10S17C	61/64	Tangent Mount	O-Ring
77372	4-3/4	Wire Lead	Reman	7 Groove	10S17C	1-13/64	Tangent Mount	O-Ring
77378	5	Wire Lead	Reman	4 Groove	10S17C	1-29/64	Tangent Mount	O-Ring / Gasket
77383	5	Wire Lead	Reman	6 Groove	10S17C	2-57/64	Tangent Mount	O-Ring
77386	5-1/8	Wire Lead	Reman	4 Groove	10S17C	1-29/64	Tangent Mount	O-Ring
77388	5-1/8	Wire Lead	Reman	7 Groove	10S17C	1-21/32	Tangent Mount	O-Ring
77389	5-1/8	Wire Lead	Reman	7 Groove	10S17C	1-19/64	Tangent Mount	O-Ring
77390	5-1/16	Wire Lead	Reman	6 Groove	10S17C	2-21/64	Tangent Mount	O-Ring
77395	4-23/32	Wire Lead	Reman	6 Groove	10S17C	2-1/2	Tangent Mount	O-Ring
78372	4-3/4	4	New	7 Groove	10S17C	1-13/64	Tangent Mount	O-Ring
78378	5	Wire Lead	New	4 Groove	10S17C	1-29/64	Tangent Mount	Pad Mount
78383	5	Wire Lead	New	6 Groove	10S17C	2-57/64	Tangent Mount	O-Ring
78386	5-1/8	Wire Lead	New	4 Groove	10S17C	1-29/64	Tangent Mount	O-Ring
78388	5-1/8	Wire Lead	New	7 Groove	10S17C	1-21/32	Tangent Mount	O-Ring
78389	5-1/8	10	New	7 Groove	10S17C	1-19/64	Tangent Mount	O-Ring
78390	3-11/16	Wire Lead	New	6 Groove	10S17C	2-21/64	Tangent Mount	O-Ring
78395	4-23/32	Wire Lead	New	6 Groove	10S17C	2-1/2	Tangent Mount	O-Ring
97304	4-3/4	Wire Lead	Reman	6 Groove	10S17C	1-1/2	Tangent Mount	O-Ring / Gasket
97306	4-1/2	Wire Lead	Reman	7 Groove	10S17C	1-43/64	Tangent Mount	O-Ring
97308	4-1/2	Wire Lead	Reman	6 Groove	10S17C	2-11/64	Tangent Mount	O-Ring
97309	5-1/8	Wire Lead	Reman	6 Groove	10S17C	2-17/64	Tangent Mount	O-Ring
97327	5-1/4	Wire Lead	Reman	6 Groove	10S17C	2-3/32	Tangent Mount	O-Ring
97330	4-5/8	Wire Lead	Reman	6 Groove	10S17C	1/2	Tangent Mount	O-Ring
97333	4-7/8	Wire Lead	Reman	6 Groove	10S17C	1-19/32	Tangent Mount	O-Ring
97336	4-11/16	Wire Lead	Reman	5 Groove	10S17C	29/32	Tangent Mount	O-Ring
97338	4-11/16	Wire Lead	Reman	7 Groove	10S17C	2-1/64	Tangent Mount	O-Ring
97346	4-3/4	Wire Lead	Reman	6 Groove	10S17C	1-19/32	Tangent Mount	O-Ring
97347	5-1/2	Wire Lead	Reman	6 Groove	10S17C	1-3/32	Tangent Mount	O-Ring
97349	4-5/16	Wire Lead	Reman	5 Groove	10S17C	59/64	Tangent Mount	O-Ring
97351	5-1/2	Wire Lead	Reman	6 Groove	10S17C	1-3/32	Tangent Mount	O-Ring



# Compressors

Part No.	Pulley Dia.	Coil Clock	New / Reman	Groove	Type	Mount Dist to Groove Midpoint	Mount	Manifold
<b>Denso</b>								
97355	5-1/16	Wire Lead	Reman	6 Groove	10S17C	1-35/64	Tangent Mount	O-Ring
97367	5-1/16	Wire Lead	Reman	6 Groove	10S17C	2-13/32	Tangent Mount	O-Ring
97382	4-11/16	Wire Lead	Reman	6 Groove	10S17C	1-1/32	Tangent Mount	O-Ring
97389	4-7/8	Wire Lead	Reman	6 Groove	10S17C	27/32	Tangent Mount	O-Ring / Gasket
97397	4-1/2	Wire Lead	Reman	6 Groove	10S17C	21/32	Tangent Mount	O-Ring
98306	4-5/8	Wire Lead	New	7 Groove	10S17C	1-43/64	Tangent Mount	O-Ring
98308	4-11/16	Wire Lead	New	6 Groove	10S17C	2-11/64	Tangent Mount	O-Ring
98309	5-1/8	Wire Lead	New	6 Groove	10S17C	2-17/64	Tangent Mount	O-Ring
98327	5-1/4	Wire Lead	New	6 Groove	10S17C	2-3/32	Tangent Mount	O-Ring
98330	4-5/16	Wire Lead	New	6 Groove	10S17C	1/2	Tangent Mount	O-Ring
98333	4-7/8	Wire Lead	New	6 Groove	10S17C	1-19/32	Tangent Mount	O-Ring
98336	4-11/16	Wire Lead	New	5 Groove	10S17C	29/32	Tangent Mount	O-Ring
98338	4-11/16	Wire Lead	New	7 Groove	10S17C	2-1/64	Tangent Mount	O-Ring
98346	4-3/4	Wire Lead	New	6 Groove	10S17C	1-19/32	Tangent Mount	O-Ring
98347	5-1/2	Wire Lead	New	6 Groove	10S17C	1-3/32	Tangent Mount	O-Ring
98349	4-5/16	Wire Lead	New	5 Groove	10S17C	59/64	Tangent Mount	O-Ring
98351	5-1/2	Wire Lead	New	6 Groove	10S17C	1-3/32	Tangent Mount	O-Ring
98355	5-1/16	Wire Lead	New	6 Groove	10S17C	1-35/64	Tangent Mount	O-Ring
98367	5-1/16	Wire Lead	New	6 Groove	10S17C	2-23/64	Tangent Mount	O-Ring
98382	4-11/16	Wire Lead	New	6 Groove	10S17C	1-1/32	Tangent Mount	O-Ring
98389	4-7/8	Wire Lead	New	6 Groove	10S17C	39/64	Tangent Mount	O-Ring / Gasket
98397	4-11/16	Wire Lead	New	6 Groove	10S17C	21/32	Tangent Mount	O-Ring
67308	5-1/2	Wire Lead	Reman	6 Groove	10S17E	19/32	Tangent Mount	O-Ring / Gasket
68308	5-1/8	Wire Lead	New	6 Groove	10S17E	19/32	Tangent Mount	O-Ring / Gasket
77361	4-3/4	Wire Lead	Reman	6 Groove	10S17E	41/64	Tangent Mount	O-Ring
77398	5-1/8	Wire Lead	Reman	7 Groove	10S17E	1-13/64	Ear Mount	O-Ring / Gasket
78361	4-3/4	Wire Lead	New	6 Groove	10S17E	41/64	Tangent Mount	O-Ring
78398	5-1/8	Wire Lead	New	7 Groove	10S17E	1-13/64	Ear Mount	O-Ring / Gasket
157351	4-1/2	Wire Lead	Reman	4 Groove	10S17F	5/8	Tangent Mount	O-Ring
158351	4-1/2	Wire Lead	New	4 Groove	10S17F	5/8	Tangent Mount	Sealing Washer
77348	4-1/2	Wire Lead	Reman	6 Groove	10S17F	19/32	Tangent Mount	Sealing Washer
77362	4-1/4	Wire Lead	Reman	4 Groove	10S17F	21/32	Tangent Mount	Sealing Washer
77377	4-1/4	Wire Lead	Reman	4 Groove	10S17F	21/32	Tangent Mount	Sealing Washer
78348	4-1/2	Wire Lead	New	6 Groove	10S17F	19/32	Tangent Mount	Sealing Washer
78362	4-1/4	Wire Lead	New	4 Groove	10S17F	21/32	Tangent Mount	Sealing Washer
78377	4-1/4	Wire Lead	New	4 Groove	10S17F	21/32	Tangent Mount	Sealing Washer
97303	4-1/2	Wire Lead	Reman	6 Groove	10S17F	19/32	Tangent Mount	Sealing Washer
98303	4-1/2	Wire Lead	New	6 Groove	10S17F	1/16	Tangent Mount	Sealing Washer
97343	5-1/8	Wire Lead	Reman	6 Groove	10S17H	1-3/16	Tangent Mount	O-Ring
157313	4-1/2	Wire Lead	Reman	6 Groove	10S20C	61/64	Tangent Mount	O-Ring
157314	4-1/2	Wire Lead	Reman	6 Groove	10S20C	1-5/8	Tangent Mount	O-Ring
157320	4-1/2	Wire Lead	Reman	6 Groove	10S20C	1-5/8	Tangent Mount	O-Ring
157325	4-5/8	Wire Lead	Reman	8 Groove	10S20C	1-41/64	Tangent Mount	O-Ring
157346	4-7/8	Wire Lead	Reman	6 Groove	10S20C	21/32	Tangent Mount	O-Ring / Gasket
158313	4-1/2	Wire Lead	New	6 Groove	10S20C	1-15/32	Tangent Mount	O-Ring
158314	4-1/2	Wire Lead	New	6 Groove	10S20C	1-5/8	Tangent Mount	O-Ring
158320	4-1/2	Wire Lead	New	6 Groove	10S20C	1-5/8	Tangent Mount	O-Ring
158325	4-5/8	Wire Lead	New	8 Groove	10S20C	1-41/64	Tangent Mount	O-Ring
158346	4-7/8	Wire Lead	New	6 Groove	10S20C	21/32	Tangent Mount	Sealing Washer
67312	4-1/2	Wire Lead	Reman	6 Groove	10S20C	1-39/64	Tangent Mount	O-Ring
77301	5-7/16	Wire Lead	Reman	6 Groove	10S20C	1	Tangent Mount	O-Ring
77342	5-1/4	Wire Lead	Reman	6 Groove	10S20C	2-29/32	Tangent Mount	Pad Mount
78301	5-7/16	Wire Lead	New	6 Groove	10S20C	1	Tangent Mount	Sealing Washer
78342	5-1/4	Wire Lead	New	6 Groove	10S20C	2-29/32	Tangent Mount	Pad Mount
97305	4-1/2	Wire Lead	Reman	5 Groove	10S20C	1-13/64	Tangent Mount	O-Ring
97307	5-5/16	Wire Lead	Reman	6 Groove	10S20C	2-7/64	Tangent Mount	O-Ring
97310	4-11/16	Wire Lead	Reman	6 Groove	10S20C	2-21/64	Tangent Mount	O-Ring
97328	4-1/2	Wire Lead	Reman	6 Groove	10S20C	1-19/32	Tangent Mount	O-Ring
97337	4-1/2	Wire Lead	Reman	6 Groove	10S20C	61/64	Tangent Mount	O-Ring
98305	4-1/2	Wire Lead	New	5 Groove	10S20C	1-13/64	Tangent Mount	O-Ring
98307	5-1/4	Wire Lead	New	6 Groove	10S20C	2-3/32	Tangent Mount	O-Ring
98310	4-11/16	Wire Lead	New	6 Groove	10S20C	2-21/64	Tangent Mount	O-Ring
98328	4-1/2	Wire Lead	New	6 Groove	10S20C	1-11/16	Tangent Mount	O-Ring

# Compressors

Part No.	Pulley Dia.	Coil Clock	New / Reman	Groove	Type	Mount Dist to Groove Midpoint	Mount	Manifold
<b>Denso</b>								
98337	4-1/2	Wire Lead	New	6 Groove	10S20C	61/64	Tangent Mount	O-Ring / Gasket
67343	4-11/16	Wire Lead	Reman	7 Groove	10S20E	1-13/64	Tangent Mount	Pad Mount
67357	4-3/4	Wire Lead	Reman	6 Groove	10S20E	39/64	Tangent Mount	O-Ring
68343	4-11/16	Wire Lead	New	7 Groove	10S20E	1-13/64	Tangent Mount	O-Ring / Gasket
68357	4-3/4	Wire Lead	New	6 Groove	10S20E	39/64	Tangent Mount	O-Ring
67316	4-5/16	Wire Lead	Reman	6 Groove	10S20F	5/8	Tangent Mount	Sealing Washer
68316	4-5/16	Wire Lead	New	6 Groove	10S20F	1/16	Tangent Mount	Sealing Washer
77363	4-1/4	Wire Lead	Reman	4 Groove	10S20F	21/32	Tangent Mount	Sealing Washer
77376	4-1/4	Wire Lead	Reman	4 Groove	10S20F	21/32	Tangent Mount	Sealing Washer
78363	4-1/4	Wire Lead	New	4 Groove	10S20F	21/32	Tangent Mount	Sealing Washer
78376	4-1/4	Wire Lead	New	4 Groove	10S20F	21/32	Tangent Mount	Sealing Washer
97369	4-1/2	Wire Lead	Reman	6 Groove	10S20F	5/8	Tangent Mount	Sealing Washer
77374	5-1/8	Wire Lead	Reman	6 Groove	10S20H	1-5/64	2 Ear & 2 Boss	O-Ring / Gasket
78374	5-1/8	Wire Lead	New	6 Groove	10S20H	1-5/64	2 Ear & 2 Boss	O-Ring / Gasket
198353	4-21/64	Wire Lead	New	6 Groove	10SE18	5/8	Tangent Mount	Sealing Washer
157364	4-5/8	Wire Lead	Reman	6 Groove	10SR15	39/64	Tangent Mount	O-Ring / Gasket
157333	5-1/4	Wire Lead	Reman	7 Groove	10SR15C	1-13/32	Tangent Mount	O-Ring
157335	5-1/4	Wire Lead	Reman	6 Groove	10SR15C	1-57/64	Tangent Mount	O-Ring
157339	4-1/2	Wire Lead	Reman	6 Groove	10SR15C	19/32	Tangent Mount	O-Ring
158333	5-1/4	Wire Lead	New	7 Groove	10SR15C	1-13/32	Tangent Mount	O-Ring
158335	5-1/4	Wire Lead	New	6 Groove	10SR15C	1-57/64	Tangent Mount	O-Ring
158364	4-5/8	Wire Lead	New	6 Groove	10SR15C	39/64	Tangent Mount	O-Ring
157319	5-1/2	Wire Lead	Reman	6 Groove	10SR15E	2-5/64	Tangent Mount	O-Ring
158319	5-1/2	Wire Lead	New	6 Groove	10SR15E	2-1/8	Tangent Mount	O-Ring
157312	1-1/4	Wire Lead	Reman	6 Groove	10SR15H	1-3/64	Tangent Mount	O-Ring
158312	4-1/4	Wire Lead	New	6 Groove	10SR15H	1-3/64	Tangent Mount	O-Ring
157334	5-3/16	Wire Lead	Reman	6 Groove	10SR17C	2-3/32	Tangent Mount	O-Ring
157340	4-5/8	Wire Lead	Reman	6 Groove	10SR17C	37/64	Tangent Mount	O-Ring / Gasket
157361	4-33/64	Wire Lead	Reman	6 Groove	10SR17C	2-1/8	Tangent Mount	O-Ring
158334	5-3/16	Wire Lead	New	6 Groove	10SR17C	2-3/32	Tangent Mount	O-Ring
158340	4-5/8	Wire Lead	New	6 Groove	10SR17C	379/500	Tangent Mount	O-Ring
158361	4-1/2	Wire Lead	New	6 Groove	10SR17C	2-1/8	Tangent Mount	O-Ring
67341	4-1/2	Wire Lead	Reman	6 Groove	10SR17C	19/32	Tangent Mount	O-Ring
68341	4-1/2	Wire Lead	New	6 Groove	10SR17C	19/32	Tangent Mount	O-Ring
97399	4-3/4	Wire Lead	Reman	6 Groove	10SR17C	1-33/64	Tangent Mount	O-Ring
98399	4-3/4	Wire Lead	New	6 Groove	10SR17C	1-1/2	Tangent Mount	O-Ring
157337	5-1/2	Wire Lead	Reman	6 Groove	10SR17E	2-3/32	Tangent Mount	O-Ring
158337	5-1/2	Wire Lead	New	6 Groove	10SR17E	2-3/32	Tangent Mount	O-Ring
157327	4-5/8	Wire Lead	Reman	8 Groove	10SR19C	1-41/64	Tangent Mount	O-Ring
158327	4-5/8	Wire Lead	New	8 Groove	10SR19C	1-41/64	Tangent Mount	O-Ring
158332	4-3/4	Wire Lead	New	8 Groove	10SR19C	1-43/64	Tangent Mount	O-Ring
198308	4-47/64	Wire Lead	New	8 Groove	10SR19C		Tangent Mount	O-Ring
157343	4-23/32	Wire Lead	Reman	6 Groove	10SRE18C	9/16	Tangent Mount	O-Ring / Gasket
157365	4-7/8	Wire Lead	Reman	6 Groove	10SRE18C	39/64	Tangent Mount	O-Ring / Gasket
157377	4-15/16	Wire Lead	Reman	6 Groove	10SRE18C	1-35/64	Tangent Mount	O-Ring / Gasket
158343	4-23/32	Wire Lead	New	6 Groove	10SRE18C	39/64	2 Ear & 1 Tangent	O-Ring / Gasket
158377	4-15/16	Wire Lead	New	6 Groove	10SRE18C	1-35/64	Tangent Mount	O-Ring / Gasket
97312	4-45/64	Wire Lead	Reman	6 Groove	10SRE18C	1-17/32	Tangent Mount	O-Ring / Gasket
97314	4-15/16	Wire Lead	Reman	6 Groove	10SRE18C	1-29/32	Tangent Mount	O-Ring / Gasket
98314	4-15/16	Wire Lead	New	6 Groove	10SRE18C	1-29/32	Tangent Mount	O-Ring / Gasket
158365	4-7/8	Wire Lead	New	6 Groove	10SRE20C	39/64	Tangent Mount	O-Ring / Gasket
97320	4-23/32	Wire Lead	Reman	6 Groove	10SRE20C	1-35/64	Tangent Mount	O-Ring / Gasket
98320	4-23/32	Wire Lead	New	6 Groove	10SRE20C	1-35/64	Tangent Mount	O-Ring / Gasket
198311	5-29/32	Wire Lead	New	4 Groove	10p13C	3-1/4	Tangent Mount	O-Ring
68303	5-5/8	Wire Lead	New	1 Groove	10p13C	1-11/16	Tangent Mount	O-Ring
97376	4-1/2	N/R	Reman	4 Groove	5SE09C	2	Tangent Mount	O-Ring
98376	4-1/2	N/R	New	4 Groove	5SE09C	2	Tangent Mount	O-Ring
157318	4-1/2	N/R	Reman	4 Groove	5SE11C	2-1/64	Tangent Mount	O-Ring
158318	4-1/2	N/R	New	4 Groove	5SE11C	2-1/64	Tangent Mount	O-Ring
157301	4-3/4	N/R	Reman	6 Groove	5SE12C	49/64	Tangent Mount	O-Ring / Gasket
158301	4-3/4	N/R	New	6 Groove	5SE12C	49/64	Tangent Mount	O-Ring / Gasket
97395	3-15/16	N/R	Reman	6 Groove	5SE12C	25/32	Tangent Mount	Gasket
98395	3-15/16	N/R	New	6 Groove	5SE12C	25/32	Tangent Mount	O-Ring / Gasket

# Compressors

Part No.	Pulley Dia.	Coil Clock	New / Reman	Groove	Type	Mount Dist to Groove Midpoint	Mount	Manifold
<b>Denso</b>								
67360	5-5/8	Wire Lead	Reman	1 Groove	6C17	2-13/32	Ear Mount	Gasket
67361	5-1/2	Wire Lead	Reman	6 Groove	6C17	1-7/16	Ear Mount	Gasket
68360	5-5/8	Wire Lead	New	1 Groove	6C17	2-13/32	Ear Mount	Gasket
68361	5-1/2	Wire Lead	New	6 Groove	6C17	1-7/16	Ear Mount	Gasket
77339	4-1/2	Wire Lead	Reman	6 Groove	6CA17C	21/32	Tangent Mount	O-Ring
57345	5-3/4	Wire Lead	Reman	1 Groove	6E171	1-29/32	Ear Mount	Pad Mount
57392	4-7/8	12	Reman	6 Groove	6E171	1-47/64	Ear Mount	Pad Mount
57395	6	12	Reman	1 Groove	6E171	1-63/64	Ear Mount	Pad Mount
58345	5-3/4	Wire Lead	New	1 Groove	6E171	1-29/32	Ear Mount	Pad Mount
67380	5-1/4	Wire Lead	Reman	5 Groove	6P127A	3-3/32	Ear Mount	O-Ring
57340	6	Wire Lead	Reman	1 Groove	6P127D	2-13/32	Ear Mount	Pad Mount
57388	5	Wire Lead	Reman	6 Groove	6P148A	1-47/64	Ear Mount	Pad Mount
67304	5-5/8	Wire Lead	Reman	1 Groove	6P148A	1-55/64	Ear Mount	Pad Mount
67384	5-5/8	Wire Lead	Reman	1 Groove	6P148A	1-55/64	Ear Mount	Pad Mount
57384	4-7/8	Wire Lead	Reman	6 Groove	6P148C	1-43/64	Tangent Mount	Pad Mount
68321	4-21/64	Wire Lead	New	5 Groove	6SAS14C	1-1/4	Tangent Mount	Sealing Washer
157350	4-7/8	Wire Lead	Reman	4 Groove	6SBU16	2-41/64	Tangent Mount	O-Ring
198302	4-45/64		New	6 Groove	6SBU16		Tangent Mount	
157328	4-1/2	Wire Lead	Reman	7 Groove	6SBU16C	1-5/8	Tangent Mount	O-Ring
157336	4-21/64	12	Reman	7 Groove	6SBU16C	2-3/32	Tangent Mount	O-Ring
157347	4-1/4	Wire Lead	Reman	7 Groove	6SBU16C	1-19/32	Tangent Mount	O-Ring
157348	4-5/16	Wire Lead	Reman	7 Groove	6SBU16C	1-19/32	Tangent Mount	O-Ring
157349	4-1/2	N/R	Reman	6 Groove	6SBU16C	1-11/32	Tangent Mount	O-Ring
158328	4-1/2	Wire Lead	New	7 Groove	6SBU16C	1-5/8	Tangent Mount	O-Ring
158336	4-21/64	12	New	7 Groove	6SBU16C	2-3/32	Tangent Mount	
158347	4-1/4	Wire Lead	New	7 Groove	6SBU16C	1-19/32	Tangent Mount	O-Ring
158348	4-5/16	Wire Lead	New	7 Groove	6SBU16C	1-19/32	Tangent Mount	O-Ring
158349	4-1/2	Wire Lead	New	6 Groove	6SBU16C	1-11/32	Tangent Mount	O-Ring
158350	4-7/8	Wire Lead	New	4 Groove	6SBU16C	2-41/64	Tangent Mount	O-Ring
97363	4-1/2	Wire Lead	Reman	7 Groove	6SBU16C	1-5/8	Tangent Mount	O-Ring
97371	4-5/8	Wire Lead	Reman	4 Groove	6SBU16C	2-19/32	Tangent Mount	O-Ring
98363	4-1/2	Wire Lead	New	7 Groove	6SBU16C	1-5/8	Tangent Mount	O-Ring
98371	4-5/8	Wire Lead	New	4 Groove	6SBU16C	2-19/32	Tangent Mount	O-Ring
158362	3-3/4	N/R	New	7 Groove	6SE16C	21/32	Tangent Mount	O-Ring
98317	4-21/64	Wire Lead	New	6 Groove	6SEU12C	1-15/64	3 Tangent One on Rear Head	O-Ring
157316	4-1/4	N/R	Reman	7 Groove	6SEU14C	1-39/64	Tangent Mount	O-Ring
158316	4-1/4	N/R	New	7 Groove	6SEU14C	1-21/32	Tangent Mount	O-Ring
158322	4-21/64	N/R	New	6 Groove	6SEU14C	1-3/16	3 Tangent	O-Ring
198378	4-15/16	N/R	New	6 Groove	6SEU14C	1-15/64	3 Tangent One on Rear Head	O-Ring
67328	4-11/16	N/R	Reman	6 Groove	6SEU14C	1-41/64	Tangent Mount	O-Ring
68328	4-11/16	N/R	New	6 Groove	6SEU14C	1-41/64	Tangent Mount	O-Ring
97350	4	N/R	Reman	6 Groove	6SEU14C	1-7/32	Tangent Mount	O-Ring
97390	4-15/16	N/R	Reman	6 Groove	6SEU14C	1-15/64	Tangent Mount	O-Ring
98350	4	N/R	New	6 Groove	6SEU14C	1-7/32	Tangent Mount	O-Ring
157317	4-5/16	N/R	Reman	6 Groove	6SEU16C	21/32	Tangent Mount	O-Ring
157341	4-1/4	N/R	Reman	7 Groove	6SEU16C	1-19/32	Tangent Mount	O-Ring
157379	4-21/64	Wire Lead	Reman	6 Groove	6SEU16C	41/64	Tangent Mount	O-Ring
157380	4-19/64	Wire Lead	Reman	4 Groove	6SEU16C	2-19/64	Tangent Mount	O-Ring
157388	4-23/32	N/R	Reman	6 Groove	6SEU16C	47/64	Tangent Mount	O-Ring
158359	4-21/64	Wire Lead	New	6 Groove	6SEU16C	41/64	Tangent Mount	O-Ring
158380	4-19/64	Wire Lead	New	4 Groove	6SEU16C	2-19/64	Tangent Mount	O-Ring
158388	4-23/32	Wire Lead	New	6 Groove	6SEU16C	47/64	Tangent Mount	O-Ring
198369	4-17/32		New	6 Groove	6SEU16C	51/64	Tangent Mount	O-Ring
198379	4-5/16		New	6 Groove	6SEU16C		3 Tangent One on Rear Head	
67317	4-11/16	N/R	Reman	6 Groove	6SEU16C	41/64	Tangent Mount	O-Ring / Gasket
68317	4-11/16	N/R	New	6 Groove	6SEU16C	41/64	Tangent Mount	O-Ring / Gasket
68339	4-15/16		New	4 Groove	6SEU16C		Tangent Mount	
97321	3-59/64	N/R	Reman	6 Groove	6SEU16C	1-7/32	Tangent Mount	O-Ring
97357	4-11/16	N/R	Reman	6 Groove	6SEU16C	49/64	Tangent Mount	O-Ring / Gasket
97386	4-1/2	N/R	Reman	7 Groove	6SEU16C	1-5/8	Tangent Mount	O-Ring



# Compressors

Part No.	Pulley Dia.	Coil Clock	New / Reman	Groove	Type	Mount Dist to Groove Midpoint	Mount	Manifold
<b>Denso</b>								
98357	4-11/16	N/R	New	6 Groove	6SEU16C	49/64	Tangent Mount	O-Ring / Gasket
98386	4-1/2	N/R	New	7 Groove	6SEU16C	1-5/8	Tangent Mount	O-Ring
68322	3-15/16		New	6 Groove	7SAS18H	1	3 Tangent	
157302	5-5/16	Wire Lead	Reman	6 Groove	7SB16C	59/64	Tangent Mount	O-Ring
158393	5-1/8	Wire Lead	New	6 Groove	7SB16C	1-11/16	Tangent Mount	O-Ring
67307	4-3/32	Wire Lead	Reman	5 Groove	7SB16C	29/32	Tangent Mount	O-Ring
67329	4-11/16	Wire Lead	Reman	6 Groove	7SB16C	1-45/64	Tangent Mount	O-Ring
68329	4-11/16	Wire Lead	New	6 Groove	7SB16C	1-45/64	Tangent Mount	O-Ring
77313	4-3/4	Wire Lead	Reman	6 Groove	7SB16C	1-35/64	Tangent Mount	O-Ring
77356	4-3/4	Wire Lead	Reman	6 Groove	7SB16C	45/64	Tangent Mount	O-Ring
77396	5-1/4	Wire Lead	Reman	5 Groove	7SB16C	29/32	Tangent Mount	O-Ring
78313	4-3/4	Wire Lead	New	6 Groove	7SB16C	1-35/64	Tangent Mount	O-Ring
78356	4-3/4	Wire Lead	New	6 Groove	7SB16C	45/64	Tangent Mount	O-Ring
78396	5-1/4	Wire Lead	New	5 Groove	7SB16C	29/32	Tangent Mount	O-Ring
97326	4-3/4	Wire Lead	Reman	4 Groove	7SB16C	1-45/64	Tangent Mount	O-Ring
98326	4-3/4	Wire Lead	New	4 Groove	7SB16C	1-45/64	Tangent Mount	O-Ring
157369	4-7/16	Wire Lead	Reman	7 Groove	7SB19C	1-21/32	Tangent Mount	O-Ring
157323	4-1/4	Wire Lead	Reman	7 Groove	7SBH17	1-21/32	Tangent Mount	O-Ring
157366	4-3/4	Wire Lead	Reman	7 Groove	7SBH17	1-19/32	Tangent Mount	O-Ring
158323	4-1/4	Wire Lead	New	7 Groove	7SBH17	1-21/32	Tangent Mount	O-Ring
198312	4-23/32	Wire Lead	New	5 Groove	7SBH17	1-13/64	Tangent Mount	Sealing Washer
198313	4-23/32		New	6 Groove	7SBH17		3 Tangent One on Rear Head	
198314	4-23/32		New	6 Groove	7SBH17		3 Tangent One on Rear Head	
198342	4-33/100		New	4 Groove	7SBH17	1-15/64	3 Tangent One on Rear Head	
198352	4-47/64	Wire Lead	New	6 Groove	7SBH17	61/64	2 Ear & 1 Tangent	Sealing Washer
198355	4-5/16		New	6 Groove	7SBH17	1-45/64	Tangent Mount	Sealing Washer
198357	4-5/16		New	6 Groove	7SBH17	1-45/64	3 Tangent One on Rear Head	
198358	4-5/16	Wire Lead	New	6 Groove	7SBH17	1-1/4	Tangent Mount	O-Ring
198375	4-45/64		New	6 Groove	7SBH17		Tangent Mount	
198380	4-23/32		New	6 Groove	7SBH17		3 Tangent One on Rear Head	
98332	4-5/16	Wire Lead	New	6 Groove	7SBH17	1-19/32	Tangent Mount	O-Ring
157309	4-1/4	Wire Lead	Reman	6 Groove	7SBU16C	61/64	Tangent Mount	O-Ring
157321	4-1/4	Wire Lead	Reman	7 Groove	7SBU16C	1-19/32	Tangent Mount	O-Ring
157356	4-1/2	Wire Lead	Reman	6 Groove	7SBU16C	15/16	Tangent Mount	O-Ring
158309	4-1/4	Wire Lead	New	6 Groove	7SBU16C	61/64	Tangent Mount	O-Ring
158321	4-1/4	Wire Lead	New	7 Groove	7SBU16C	1-21/32	Tangent Mount	O-Ring
158356	4-1/2	Wire Lead	New	6 Groove	7SBU16C	15/16	Tangent Mount	O-Ring
57302	4-1/2	Wire Lead	Reman	6 Groove	7SBU16C	1-21/32	Tangent Mount	O-Ring
58302	4-1/2	Wire Lead	New	6 Groove	7SBU16C	1-21/32	Tangent Mount	O-Ring
97364	4-11/16	Wire Lead	Reman	6 Groove	7SBU16C	1-13/64	Tangent Mount	O-Ring
97377	4-5/16	Wire Lead	Reman	4 Groove	7SBU16C	1-1/16	Tangent Mount	O-Ring
97380	4-3/4	Wire Lead	Reman	6 Groove	7SBU16C	1-1/4	Tangent Mount	O-Ring
97385	4-5/16	Wire Lead	Reman	5 Groove	7SBU16C	1-15/64	Tangent Mount	O-Ring
97398	5-1/8	Wire Lead	Reman	6 Groove	7SBU16C	1-3/16	Tangent Mount	Sealing Washer
98364	4-11/16	Wire Lead	New	6 Groove	7SBU16C	1-13/64	Tangent Mount	O-Ring
98377	4-5/16	Wire Lead	New	4 Groove	7SBU16C	1-1/16	Tangent Mount	O-Ring
98381	4-1/4	Wire Lead	New	8 Groove	7SBU16C	39/64	Tangent Mount	O-Ring
98385	4-5/16	Wire Lead	New	5 Groove	7SBU16C	1-15/64	Tangent Mount	O-Ring
98398	5-1/8	Wire Lead	New	6 Groove	7SBU16C	1-3/16	Tangent Mount	Sealing Washer
158308	4-47/64	Wire Lead	New	6 Groove	7SBU16H	1-15/64	2 Ear & 1 Tangent	Sealing Washer
77371	4-11/16	Wire Lead	Reman	6 Groove	7SBU16H	61/64	Tangent Mount	O-Ring
78371	4-11/16	Wire Lead	New	6 Groove	7SBU16H	61/64	Tangent Mount	O-Ring
97384	5-1/16	Wire Lead	Reman	6 Groove	7SBU16H	1-1/16	Tangent Mount	Sealing Washer
98384	5-1/16	Wire Lead	New	6 Groove	7SBU16H	1-1/16	Tangent Mount	Sealing Washer
198361	4-5/16	Wire Lead	New	8 Groove	7SBU17C	1-9/16	3 Tangent One on Rear Head	O-Ring
97329	5-1/4	Wire Lead	Reman	6 Groove	7SBU17C	2-19/64	Tangent Mount	O-Ring

# Compressors

Part No.	Pulley Dia.	Coil Clock	New / Reman	Groove	Type	Mount Dist to Groove Midpoint	Mount	Manifold
98375	4-21/64		New	8 Groove	7SBU17C		3 Tangent One on Rear Head	
157386	4-19/64	Wire Lead	Reman	6 Groove	7SEH17C	1-21/32	Tangent Mount	O-Ring
158366	4-3/8	N/R	New	7 Groove	7SEH17C	1-19/32	Tangent Mount	O-Ring
198307	4-47/64	Wire Lead	New	6 Groove	7SES17C	1-5/8	Tangent Mount	O-Ring
157374	4-17/32	Wire Lead	Reman	7 Groove	7SEU16C	1-13/64	Tangent Mount	O-Ring
157375	4-47/64		Reman	6 Groove	7SEU16C		Tangent Mount	
158357	4-1/2	Wire Lead	New	6 Groove	7SEU16C	15/16	Tangent Mount	O-Ring
158358	4-5/16	Wire Lead	New	8 Groove	7SEU16C	21/32	Tangent Mount	O-Ring
97348	4-5/16	Wire Lead	Reman	6 Groove	7SEU16C	1-15/64	Tangent Mount	O-Ring
97354	4-5/16	Wire Lead	Reman	6 Groove	7SEU16C	1-15/64	Tangent Mount	O-Ring
97358	4-5/16	Wire Lead	Reman	4 Groove	7SEU16C	61/64	Tangent Mount	O-Ring
97379	4-5/16	Wire Lead	Reman	7 Groove	7SEU16C	1-1/2	Tangent Mount	O-Ring
97388	4-5/16	Wire Lead	Reman	6 Groove	7SEU16C	19/32	Tangent Mount	O-Ring
97391	4-5/16	N/R	Reman	6 Groove	7SEU16C	29/32	Tangent Mount	O-Ring
97394	4-5/16	N/R	Reman	6 Groove	7SEU16C	19/32	Tangent Mount	O-Ring
98348	4-5/16	N/R	New	6 Groove	7SEU16C	1-15/64	Tangent Mount	O-Ring
98354	4-5/16	N/R	New	6 Groove	7SEU16C	1-15/64	Tangent Mount	O-Ring
198365	4-21/64		New	6 Groove	7SEU17A		Ear Mount	
157338	4-1/4	N/R	Reman	7 Groove	7SEU17C	1-31/64	Tangent Mount	O-Ring
157345	4-21/64	N/R	Reman	7 Groove	7SEU17C	1-3/64	Tangent Mount	O-Ring
157360	4-1/4	N/R	Reman	7 Groove	7SEU17C	41/64	Tangent Mount	O-Ring
157363	4-21/64	N/R	Reman	6 Groove	7SEU17C	5/8	Tangent Mount	O-Ring
157376	3-15/16	N/R	Reman	7 Groove	7SEU17C	21/32	Tangent Mount	O-Ring
157382	4-21/64	N/R	Reman	7 Groove	7SEU17C	1-3/64	Tangent Mount	O-Ring
158338	4-9/32	N/R	New	7 Groove	7SEU17C	1-31/64	Tangent Mount	O-Ring
158345	4-21/64	Coil Less	New	7 Groove	7SEU17C	1-3/64	Tangent Mount	
158360	4-1/4	N/R	New	7 Groove	7SEU17C	41/64	Tangent Mount	O-Ring
158363	4-21/64	N/R	New	6 Groove	7SEU17C	5/8	Tangent Mount	O-Ring
158376	3-15/16	N/R	New	7 Groove	7SEU17C	21/32	Tangent Mount	O-Ring
158382	4-21/64	N/R	New	7 Groove	7SEU17C	1-3/64	Tangent Mount	O-Ring
198362	4-21/64		New	8 Groove	7SEU17C		3 Tangent One on Rear Head	
198367	4-11/32	Wire Lead	New	4 Groove	7SEU17C	7/8	Tangent Mount	O-Ring
67305	4-7/8	N/R	Reman	4 Groove	7SEU17C	1-1/32	Tangent Mount	O-Ring
68305	4-7/8	N/R	New	4 Groove	7SEU17C	1-1/32	Tangent Mount	O-Ring
68319	3-15/16	3	New	8 Groove	7SEU17C	11/16	3 Tangent One on Rear Head	
97318	4-5/16	N/R	Reman	6 Groove	7SEU17C	49/64	Tangent Mount	O-Ring
97356	4	N/R	Reman	6 Groove	7SEU17C	43/64	Tangent Mount	O-Ring
97366	4-1/4	N/R	Reman	6 Groove	7SEU17C	21/32	Tangent Mount	O-Ring
97392		N/R	Reman	Pulley Not Included	7SEU17C		Tangent Mount	O-Ring
97396	4	N/R	Reman	6 Groove	7SEU17C	5/8	Tangent Mount	O-Ring
98318	4-21/64	N/R	New	6 Groove	7SEU17C	49/64	Tangent Mount	O-Ring
98356	4	N/R	New	6 Groove	7SEU17C	43/64	Tangent Mount	O-Ring
98358	4-5/16	N/R	New	4 Groove	7SEU17C	29/32	Tangent Mount	O-Ring
98379	4-23/32		New	7 Groove	7SEU17C	1-15/32	3 Tangent One on Rear Head	O-Ring
98392		N/R	New	Pulley Not Included	7SEU17C		One on Rear Head	O-Ring
98394	4-1/2	N/R	New	6 Groove	7SEU17C	41/64	Tangent Mount	O-Ring
158368	4-3/4	N/R	New	6 Groove	7SH17C	1-41/64	Tangent Mount	O-Ring
158386	4-19/64	Wire Lead	New	6 Groove	7SHS17C	1-21/32	Tangent Mount	
77338	4-1/8	Wire Lead	Reman	4 Groove	SC08C	2-3/8	Tangent Mount	O-Ring
78338	4-1/8	Wire Lead	New	4 Groove	SC08C	2-3/8	Tangent Mount	O-Ring
97378	4	Wire Lead	Reman	4 Groove	SC08C	2-19/64	Tangent Mount	O-Ring
67310	4-1/2	Wire Lead	Reman	6 Groove	SCS06C	2-51/64	Tangent Mount	O-Ring
68310	4-1/2	Wire Lead	New	6 Groove	SCS06C	2-51/64	Tangent Mount	O-Ring
77370	4-19/64	Wire Lead	Reman	4 Groove	SCS06C	2	Tangent Mount	O-Ring
78370	4-19/64	Wire Lead	New	4 Groove	SCS06C	2	Tangent Mount	O-Ring
97359	4-1/2	Wire Lead	Reman	3 Groove	SCS06C	2-1/32	Tangent Mount	O-Ring
168303	4-51/64	Wire Lead	New	1 Groove	SCSA06C	3	Tangent Mount	O-Ring
97332	4-5/16		Reman	6 Groove	SCSA06C	1-19/32	2 Ear & 1 Tangent	O-Ring

# Compressors

Part No.	Pulley Dia.	Coil Clock	New / Reman	Groove	Type	Mount Dist to Groove Midpoint	Mount	Manifold
<b>Denso</b>								
97362	3-11/16	Wire Lead	Reman	4 Groove	SCSA06C	2-1/4	Tangent Mount	O-Ring
98362	3-11/16	Wire Lead	New	4 Groove	SCSA06C	2-1/4	Tangent Mount	O-Ring
158384	3-19/32	Wire Lead	New	6 Groove	SCSA08A	2-1/16	Tangent Mount	O-Ring
97353	3-5/16	Wire Lead	Reman	4 Groove	SCSA08A	2-5/64	Tangent Mount	O-Ring
157383	3-21/32	Wire Lead	Reman	4 Groove	SCSA08C	2-3/32	Tangent Mount	O-Ring
157384	3-19/32	Wire Lead	Reman	6 Groove	SCSA08C	2-1/16	Tangent Mount	O-Ring
98353	3-5/16	Wire Lead	New	4 Groove	SCSA08C	2-5/64	Tangent Mount	O-Ring
68323	3-3/4		New	5 Groove	SCSB06C	53/64	Tangent Mount	
98359	4-1/2	Wire Lead	New	3 Groove	SCSB06C	2-1/32	Tangent Mount	O-Ring
98315	4-17/32	Wire Lead	New	7 Groove	TSB19C	1-39/64	Tangent Mount	O-Ring
1177321	4-7/16	Wire Lead	Reman	6 Groove	TSE14C	1-19/32	Tangent Mount	O-Ring
178321	4-7/16	Wire Lead	New	6 Groove	TSE14C	1-19/32	Tangent Mount	O-Ring
178322	4-47/64	Wire Lead	New	6 Groove	TSE14C	1-19/32	Tangent Mount	O-Ring
157367	4-3/8	Wire Lead	Reman	6 Groove	TSE17C	1-5/8	Tangent Mount	O-Ring
158367	4-3/8	Wire Lead	New	6 Groove	TSE17C	1-5/8	Tangent Mount	O-Ring
68325	4-47/64		New	6 Groove	TSE17C	1-21/32	Tangent Mount	
67377	5-1/2	Wire Lead	Reman	5 Groove	TV12	1-45/64	Tangent Mount	O-Ring
67381	5	Wire Lead	Reman	5 Groove	TV12	1-1/2	Tangent Mount	O-Ring
67387	5-3/4	Wire Lead	Reman	4 Groove	TV12	1-19/32	Tangent Mount	O-Ring
67388	5-1/2	Wire Lead	Reman	4 Groove	TV12	1-51/64	Tangent Mount	O-Ring
67393	5-1/2	Wire Lead	Reman	5 Groove	TV12	1-21/32	Tangent Mount	O-Ring
67394	5-1/2	Wire Lead	Reman	5 Groove	TV12	1-45/64	Tangent Mount	O-Ring
67395	5-1/2	Wire Lead	Reman	4 Groove	TV12	1-3/4	Tangent Mount	O-Ring
67396	5-1/2	Wire Lead	Reman	4 Groove	TV12	1-41/64	Tangent Mount	O-Ring
67399	4-3/4	Wire Lead	Reman	4 Groove	TV12	47/64	Tangent Mount	O-Ring
77314	4-3/4	12	Reman	5 Groove	TV12	1-45/64	Tangent Mount	O-Ring
77325	4-3/4	Wire Lead	Reman	4 Groove	TV12	23/32	Tangent Mount	O-Ring
78325	4-3/4	Wire Lead	New	4 Groove	TV12	23/32	Tangent Mount	O-Ring
67363	4-3/4	Wire Lead	Reman	5 Groove	TV14	1-45/64	Tangent Mount	O-Ring
1177325	4-1/2	Wire Lead	Reman	6 Groove	VS12M	2-5/8	Tangent Mount	O-Ring
198332	4-49/100		New	6 Groove	VS14M	2-31/100	3 Tangent One on Rear Head	
1177317	4-1/2	Wire Lead	Reman	6 Groove	VS16E	2-27/32	Tangent Mount	O-Ring
1177316	4-11/16		Reman	6 Groove	VS18E	2-51/64	Tangent Mount	
57380			Reman		10P08E		Ear Mount	Pad Mount
57324			Reman		10P13A		Ear Mount	Pad Mount
57360			Reman		10P13A		Ear Mount	Pad Mount
57361			Reman		10P13A		Ear Mount	Pad Mount
57306			Reman		10P13C		Tangent Mount	Pad Mount
57313			Reman		10P13C		Tangent Mount	Pad Mount
57349			Reman		10P13C		Tangent Mount	Pad Mount
57339			Reman		10P13E		Ear Mount	Pad Mount
57370			Reman		10P13E		Ear Mount	Pad Mount
57371			Reman		10P13F		Tangent Mount	Pad Mount
57303			Reman		10P15C		Tangent Mount	Pad Mount
57308			Reman		10P15C		Tangent Mount	Pad Mount
57309			Reman		10P15C		Tangent Mount	Pad Mount
57310			Reman		10P15C		Tangent Mount	Pad Mount
57326			Reman		10P15C		Tangent Mount	Pad Mount
57373			Reman		10P15C		Tangent Mount	Pad Mount
57307			Reman		10P15E		Ear Mount	Pad Mount
57327			Reman		10P17C		Tangent Mount	Pad Mount
57374			Reman		10P17C		Tangent Mount	Pad Mount
57372			Reman		10PA15A		Ear Mount	Pad Mount
57341			Reman		10PA15C		Tangent Mount	Pad Mount
57375			Reman		10PA15C		Tangent Mount	Pad Mount
58341			New		10PA15C		Tangent Mount	Pad Mount
77319			Reman		10PA15C		Tangent Mount	Pad Mount
57391			Reman		10PA15E		Ear Mount	Pad Mount
77321			Reman		10PA15L		Tangent Mount	Pad Mount
57304			Reman		10PA17C		Tangent Mount	Pad Mount
57328			Reman		10PA17C		Tangent Mount	Pad Mount
57354			Reman		10PA17C		Tangent Mount	Pad Mount



# Compressors

Part No.	Pulley Dia.	Coil Clock	New / Reman	Groove	Type	Mount Dist to Groove Midpoint	Mount	Manifold
<b>Denso</b>								
57362			Reman		10PA17C		Tangent Mount	Pad Mount
58328			New		10PA17C		Tangent Mount	Pad Mount
58362			New		10PA17C		Tangent Mount	Pad Mount
77330			Reman		10PA17C		Tangent Mount	Pad Mount
57377			Reman		10PA17E		Ear Mount	Pad Mount
57337			Reman		10PA17H		Ear Mount	Pad Mount
57383			Reman		10PA17K		Ear Mount	Pad Mount
57342			Reman		10PA17VC		Tangent Mount	Pad Mount
57351			Reman		10PA20C		Tangent Mount	Pad Mount
57359			Reman		10PA20C		Ear Mount	Pad Mount
57376			Reman		10PA20C		Tangent Mount	Pad Mount
57330			Reman		2C90		Case Mount	O-Ring
57331			Reman		2C90		Case Mount	O-Ring
57024			Reman		6C17		Tangent Mount	Flange Fitting
77340			Reman		6CA17C		Tangent Mount	O-Ring
57316			Reman		6E171		Ear Mount	Pad Mount
57321			Reman		6E171		Ear Mount	Pad Mount
57355			Reman		6E171		Ear Mount	Pad Mount
57317			Reman		6E171A		Tangent Mount	Pad Mount
57318			Reman		6P127A		Ear Mount	Pad Mount
57323			Reman		6P127AD		Ear Mount	Pad Mount
57312			Reman		6P127B		Boss Mount	Pad Mount
57311			Reman		6P134		Ear Mount	Pad Mount
57320			Reman		6P134		Ear Mount	Pad Mount
57028			Reman		6P148A		Ear Mount	Pad Mount
57314			Reman		6P148A		Ear Mount	Pad Mount
57315			Reman		6P148A		Ear Mount	Pad Mount
57382			Reman		6P148A		Ear Mount	Pad Mount
57027			Reman		6P148C		Tangent Mount	Pad Mount
57346			Reman		TV12		Tangent Mount	Pad Mount
57347			Reman		TV12		Tangent Mount	Pad Mount
57348			Reman		TV12		Tangent Mount	Pad Mount
57367			Reman		TV12		Tangent Mount	Pad Mount
57379			Reman		TV12		Tangent Mount	Pad Mount
57366			Reman		TV14		Tangent Mount	Pad Mount
<b>Dodge/Chrysler</b>								
58101	5-9/16	Wire Lead	New	1 Groove	C171	1-21/32	Ear Mount	Gasket
58106	5-1/4	Wire Lead	New	8 Groove	C171	1-35/64	Ear Mount	Gasket
<b>Doowan Series</b>								
178309	4-5/8	Wire Lead	New	6 Groove	DV-16	2-55/64	Tangent Mount	O-Ring
178310	4-57/64	Wire Lead	New	6 Groove	DV-16	2-55/64	Tangent Mount	O-Ring
178311	4-5/8	Wire Lead	New	6 Groove	DV-16	2-55/64	Tangent Mount	O-Ring
178324	4-57/64	N/R	New	6 Groove	DVE12	2-9/16	Tangent Mount	O-Ring
<b>FS Series</b>								
57100	5-3/4	2 Wire Lead	Reman	1 Groove	A590	2-35/64	Tangent Mount	O-Ring / Gasket
58100	5-3/4	2 Wire Lead	New	1 Groove	A590	2-35/64	Tangent Mount	O-Ring / Gasket
57101	5-5/8	Wire Lead	Reman	2 Groove	C171	1-21/32	Ear Mount	Gasket
57102	5-5/8	Wire Lead	Reman	2 Groove	C171	1-21/32	Ear Mount	O-Ring / Gasket
57103	5-3/4	Wire Lead	Reman	1 Groove	C171	2-1/4	Ear Mount	O-Ring / Gasket
57104	5-9/16	2 Wire Lead	Reman	2 Groove	C171	2	Ear Mount	O-Ring / Gasket
57105	5-3/4	Wire Lead	Reman	2 Groove	C171	2	Ear Mount	O-Ring / Gasket
57106	5-1/4	Wire Lead	Reman	8 Groove	C171	1-35/64	Ear Mount	O-Ring / Gasket
57116	5-3/4	Wire Lead	Reman	1 Groove	C171	1-21/32	Ear Mount	O-Ring / Gasket
57110	5	Wire Lead	Reman	6 Groove	E6DH	1-47/64	Tangent Mount	Pad Mount
58110	5	Wire Lead	New	6 Groove	E6DH	1-47/64	Tangent Mount	Pad Mount
157138	5	3	Reman	6 Groove	FS10	1-45/64	Tangent Mount	O-Ring
158120	5-5/8	3	New	6 Groove	FS10	2	Tangent Mount	O-Ring
178588	3-15/16	12	New	6 Groove	FS10		Tangent Mount	O-Ring
57118	5	Wire Lead	Reman	4 Groove	FS10	2-45/64	Tangent Mount	Block Mount
57120	5	6	Reman	6 Groove	FS10	1-45/64	Tangent Mount	Block Mount

# Compressors

Part No.	Pulley Dia.	Coil Clock	New / Reman	Groove	Type	Mount Dist to Groove Midpoint	Mount	Manifold
<b>FS Series</b>								
57122	5-5/8	12	Reman	6 Groove	FS10	1-45/64	Tangent Mount	Block Mount
57123	4-1/2	12	Reman	7 Groove	FS10	2-3/32	Tangent Mount	Block Mount
57124	5	12	Reman	6 Groove	FS10	1-45/64	Tangent Mount	Block Mount
57126	5-5/8	12	Reman	6 Groove	FS10	1-45/64	Tangent Mount	Block Mount
57127	5	6	Reman	6 Groove	FS10	1-45/64	Tangent Mount	Block Mount
57128	5-1/2	9	Reman	6 Groove	FS10	1-45/64	Tangent Mount	Block Mount
57129	4-1/2	12	Reman	6 Groove	FS10	2	Tangent Mount	Block Mount
57130	4-23/64	3	Reman	6 Groove	FS10	2	Tangent Mount	Block Mount
57131	5	3	Reman	5 Groove	FS10	1-45/64	Tangent Mount	Block Mount
57132	5	3	Reman	6 Groove	FS10	1-45/64	Tangent Mount	Block Mount
57133	5	12	Reman	6 Groove	FS10	2	Tangent Mount	Block Mount
57139	5-1/4	12	Reman	4 Groove	FS10	2-55/64	Tangent Mount	Block Mount
57140	4-1/2	12	Reman	6 Groove	FS10	1-45/64	Tangent Mount	Block Mount
57141	5	12	Reman	6 Groove	FS10	1-45/64	Tangent Mount	Block Mount
57144	5	12	Reman	6 Groove	FS10	1-45/64	Tangent Mount	Block Mount
57145	5	12	Reman	6 Groove	FS10	2-13/32	Tangent Mount	Block Mount
57146	5	3	Reman	6 Groove	FS10	2	Tangent Mount	Block Mount
57147	4-1/2	3	Reman	6 Groove	FS10	1-45/64	Tangent Mount	Block Mount
57148	4-1/2	3	Reman	6 Groove	FS10	1-45/64	Tangent Mount	Block Mount
57149	4-1/2	12	Reman	8 Groove	FS10	2	Tangent Mount	Block Mount
57150	5	3	Reman	8 Groove	FS10	1-45/64	Tangent Mount	Block Mount
57151	5	3	Reman	6 Groove	FS10	2	Tangent Mount	Block Mount
57152	5-1/8	12	Reman	8 Groove	FS10	2	Tangent Mount	Block Mount
57154	5-1/4	12	Reman	4 Groove	FS10	3-11/64	Tangent Mount	Block Mount
57157	4-1/2	12	Reman	6 Groove	FS10	1-45/64	Tangent Mount	Block Mount
57158	4-1/2	12	Reman	6 Groove	FS10	2	Tangent Mount	Block Mount
57159	5	3	Reman	8 Groove	FS10	1-45/64	Tangent Mount	Block Mount
57161	5	12	Reman	8 Groove	FS10	1-45/64	Tangent Mount	Block Mount
57162	5-3/4	6	Reman	6 Groove	FS10	1-45/64	Tangent Mount	Block Mount
57163	4-1/2	3	Reman	6 Groove	FS10	1-45/64	Tangent Mount	Block Mount
57164	4-3/8	12	Reman	8 Groove	FS10	1-29/32	Tangent Mount	Block Mount
57166	5	6	Reman	6 Groove	FS10	1-45/64	Tangent Mount	Block Mount
57167	5	12	Reman	6 Groove	FS10	1-45/64	Tangent Mount	Block Mount
57168	4-7/16	3	Reman	6 Groove	FS10	2	Tangent Mount	Block Mount
57169	5	9	Reman	6 Groove	FS10	1-45/64	Tangent Mount	Block Mount
57172	5	3	Reman	6 Groove	FS10	1-45/64	Tangent Mount	Block Mount
57176	5	3	Reman	6 Groove	FS10	2-1/2	Tangent Mount	Block Mount
57179	5-21/32	12	Reman	1 Groove	FS10	3-13/32	Tangent Mount	Block Mount
57181	5-13/64	Wire Lead	Reman	4 Groove	FS10	2-45/64	Tangent Mount	Block Mount
58118	5	Wire Lead	New	4 Groove	FS10	2-45/64	Tangent Mount	Block Mount
58120	5	6	New	6 Groove	FS10	1-45/64	Tangent Mount	Block Mount
58122	5-5/8	12	New	6 Groove	FS10	1-45/64	Tangent Mount	Block Mount
58123	4-1/2	12	New	7 Groove	FS10	2-3/32	Tangent Mount	Block Mount
58124	5	12	New	6 Groove	FS10	1-45/64	Tangent Mount	Block Mount
58126	5-5/8	12	New	6 Groove	FS10	1-45/64	Tangent Mount	Block Mount
58127	5	6	New	6 Groove	FS10	1-45/64	Tangent Mount	Block Mount
58128	5-1/2	9	New	6 Groove	FS10	1-45/64	Tangent Mount	Block Mount
58129	4-1/2	12	New	6 Groove	FS10	2	Tangent Mount	Block Mount
58130	4-23/64	3	New	6 Groove	FS10	2	Tangent Mount	Block Mount
58131	5	3	New	5 Groove	FS10	1-45/64	Tangent Mount	Block Mount
58132	5	3	New	6 Groove	FS10	1-45/64	Tangent Mount	Block Mount
58133	5	12	New	6 Groove	FS10	2	Tangent Mount	Block Mount
58138	5	3	New	6 Groove	FS10	1-45/64	Tangent Mount	Block Mount
58139	5-1/4	12	New	4 Groove	FS10	2-55/64	Tangent Mount	Block Mount
58140	4-1/2	12	New	6 Groove	FS10	1-45/64	Tangent Mount	Block Mount
58141	5	12	New	6 Groove	FS10	1-45/64	Tangent Mount	Block Mount
58144	5	12	New	6 Groove	FS10	1-45/64	Tangent Mount	Block Mount
58145	5	12	New	6 Groove	FS10	2-13/32	Tangent Mount	Block Mount
58146	5	3	New	6 Groove	FS10	2	Tangent Mount	Block Mount
58147	4-1/2	3	New	6 Groove	FS10	1-45/64	Tangent Mount	Block Mount
58148	4-1/2	3	New	6 Groove	FS10	1-45/64	Tangent Mount	Block Mount
58149	4-1/2	12	New	8 Groove	FS10	2	Tangent Mount	Block Mount
58150	5	3	New	8 Groove	FS10	1-45/64	Tangent Mount	Block Mount

# Compressors

Part No.	Pulley Dia.	Coil Clock	New / Reman	Groove	Type	Mount Dist to Groove Midpoint	Mount	Manifold
<b>FS Series</b>								
58151	5	3	New	6 Groove	FS10	2	Ear Mount	Block Mount
58152	5-1/8	12	New	8 Groove	FS10	2	Tangent Mount	Block Mount
58154	5-1/4	12	New	4 Groove	FS10	3-11/64	Tangent Mount	Block Mount
58157	4-1/2	12	New	6 Groove	FS10	1-45/64	Tangent Mount	Block Mount
58158	4-1/2	12	New	6 Groove	FS10	2	Tangent Mount	Block Mount
58159	4-1/2	3	New	8 Groove	FS10	1-45/64	Tangent Mount	Block Mount
58161	5	12	New	8 Groove	FS10	1-45/64	Tangent Mount	Block Mount
58162	5-3/4	6	New	6 Groove	FS10	1-45/64	Tangent Mount	Block Mount
58163	4-1/2	3	New	6 Groove	FS10	1-45/64	Tangent Mount	Block Mount
58164	4-3/8	12	New	8 Groove	FS10	1-29/32	Tangent Mount	Block Mount
58166	5	6	New	6 Groove	FS10	1-45/64	Tangent Mount	Block Mount
58167	5	12	New	6 Groove	FS10	2	Tangent Mount	Block Mount
58168	4-7/16	3	New	6 Groove	FS10	2	Tangent Mount	Block Mount
58169	5	9	New	6 Groove	FS10	1-45/64	Tangent Mount	Block Mount
58172	5	3	New	6 Groove	FS10	1-45/64	Tangent Mount	Block Mount
58176	5	3	New	6 Groove	FS10	2-1/2	Tangent Mount	O-Ring
58179	5-21/32	12	New	1 Groove	FS10	3-13/32	Tangent Mount	O-Ring
67124	5-1/2	Wire Lead	Reman	4 Groove	FS10	2-45/64	Tangent Mount	O-Ring
68143	5-1/2	Wire Lead	New	4 Groove	FS10	2-45/64	Tangent Mount	O-Ring
67185	4-7/16	Wire Lead	Reman	6 Groove	FS18	2	Tangent Mount	O-Ring
67186	4-7/16	3	Reman	6 Groove	FS18	63/64	Tangent Mount	O-Ring
67188	4-7/16	Wire Lead	Reman	6 Groove	FS18	1-11/16	Tangent Mount	O-Ring
67193	4-7/16	12	Reman	6 Groove	FS18	1-21/32	Tangent Mount	O-Ring
67195	4-1/2	2	Reman	6 Groove	FS18	5/8	Tangent Mount	O-Ring
67196	4-1/2	Wire Lead	Reman	5 Groove	FS18	1-5/32	Tangent Mount	O-Ring
67197	4-1/2	Wire Lead	Reman	8 Groove	FS18	2-1/64	Tangent Mount	O-Ring
67198	4-1/2	12	Reman	6 Groove	FS18	2-1/64	Tangent Mount	O-Ring
68185	4-7/16	Wire Lead	New	6 Groove	FS18	2	Tangent Mount	O-Ring
68186	4-7/16	3	New	6 Groove	FS18	63/64	Tangent Mount	O-Ring
68188	4-7/16	Wire Lead	New	6 Groove	FS18	1-11/16	Tangent Mount	O-Ring
68193	4-7/16	12	New	6 Groove	FS18	1-21/32	Tangent Mount	O-Ring
68197	4-1/2	Wire Lead	New	8 Groove	FS18	2-1/64	Tangent Mount	O-Ring
68198	4-1/2	12	New	6 Groove	FS18	2-1/64	Tangent Mount	O-Ring
68199	4-3/8	12	New	10 Groove	FS18	2-1/16	Tangent Mount	O-Ring / Gasket
67183	4-7/8	Wire Lead	Reman	6 Groove	FS20	1-11/16	Tangent Mount	O-Ring
67187	4-7/16	Wire Lead	Reman	6 Groove	FS20	2-1/32	Tangent Mount	Block Mount
67189	4-7/16	Wire Lead	Reman	6 Groove	FS20	1-11/16	Tangent Mount	O-Ring
67192	4-1/2	Wire Lead	Reman	6 Groove	FS20	2-5/64	Tangent Mount	O-Ring
67194	4-7/16	Wire Lead	Reman	6 Groove	FS20	1-47/64	Tangent Mount	O-Ring
68183	4-7/8	Wire Lead	New	6 Groove	FS20	1-11/16	Tangent Mount	O-Ring
68187	4-7/16	Wire Lead	New	6 Groove	FS20	2-1/32	Tangent Mount	O-Ring
68189	4-7/16	Wire Lead	New	6 Groove	FS20	1-11/16	Tangent Mount	O-Ring
68192	4-1/2	Wire Lead	New	6 Groove	FS20	2-5/64	Tangent Mount	O-Ring
68194	4-7/16	Wire Lead	New	6 Groove	FS20	1-47/64	Tangent Mount	O-Ring / Gasket
77190	4-15/16	Wire Lead	Reman	6 Groove	FS20	2-5/64	Tangent Mount	O-Ring / Gasket
78190	4-15/16	Wire Lead	New	6 Groove	FS20	2-5/64	Tangent Mount	O-Ring / Gasket
57111	5	Wire Lead	Reman	6 Groove	FS6	1-45/64	Ear Mount	Block Mount
57112	6	Wire Lead	Reman	1 Groove	FS6	2	Ear Mount	Block Mount
57114	5-3/4	Wire Lead	Reman	1 Groove	FS6	2-1/2	Ear Mount	Block Mount
58111	5	Wire Lead	New	6 Groove	FS6	1-45/64	Ear Mount	Block Mount
58112	6	Wire Lead	New	1 Groove	FS6	2	Ear Mount	Block Mount
58114	6	Wire Lead	New	1 Groove	FS6	2-1/2	Ear Mount	Block Mount
57186	4-1/2	Wire Lead	Reman	4 Groove	HS15	2-1/2	Tangent Mount	O-Ring
57188	4-7/8	Wire Lead	Reman	4 Groove	HS15	2-29/32	Tangent Mount	O-Ring
57191	4-7/8	Wire Lead	Reman	4 Groove	HS15	2-45/64	Tangent Mount	O-Ring
57199	4-3/4	Wire Lead	Reman	6 Groove	HS15	2-51/64	Tangent Mount	O-Ring
58115	5-1/16	Wire Lead	New	4 Groove	HS15	2-19/32	Tangent Mount	O-Ring
58117	5	12	New	4 Groove	HS15	2-1/2	Tangent Mount	O-Ring
58186	4-1/2	Wire Lead	New	4 Groove	HS15	2-1/2	Tangent Mount	O-Ring
58188	4-7/8	Wire Lead	New	4 Groove	HS15	2-29/32	Tangent Mount	O-Ring
58191	4-7/8	Wire Lead	New	4 Groove	HS15	2-45/64	Tangent Mount	O-Ring
58199	4-3/4	Wire Lead	New	6 Groove	HS15	2-51/64	Tangent Mount	O-Ring
67123	4-7/8	Wire Lead	Reman	4 Groove	HS15	2-45/64	Tangent Mount	O-Ring



# Compressors

Part No.	Pulley Dia.	Coil Clock	New / Reman	Groove	Type	Mount Dist to Groove Midpoint	Mount	Manifold
<b>FS Series</b>								
67126	5-1/16	Wire Lead	Reman	4 Groove	HS15	2-1/2	Tangent Mount	O-Ring
67181	4-7/8	Wire Lead	Reman	4 Groove	HS15	3	Tangent Mount	O-Ring
67191	5	Wire Lead	Reman	4 Groove	HS15	2-45/64	Tangent Mount	O-Ring
67314	4-7/8	Wire Lead	Reman	4 Groove	HS15	2-45/64	Tangent Mount	O-Ring
67340	4-5/8	Wire Lead	Reman	6 Groove	HS15	2-19/64	Tangent Mount	O-Ring
68123	4-7/8	Wire Lead	New	4 Groove	HS15	2-45/64	Tangent Mount	O-Ring
68126	5-1/16	Wire Lead	New	4 Groove	HS15	2-1/2	Tangent Mount	O-Ring
68181	4-7/8	Wire Lead	New	4 Groove	HS15	3	Tangent Mount	O-Ring
68191	5	Wire Lead	New	4 Groove	HS15	2-45/64	Tangent Mount	O-Ring
68314	4-7/8	Wire Lead	New	4 Groove	HS15	2-45/64	Tangent Mount	O-Ring
68340	4-5/8	Wire Lead	New	6 Groove	HS15	2-19/64	Tangent Mount	O-Ring
77347	4-7/8	Wire Lead	Reman	4 Groove	HS15	2-45/64	Tangent Mount	O-Ring
77366	5-1/4	Wire Lead	Reman	4 Groove	HS15	2-45/64	Tangent Mount	O-Ring
78347	4-7/8	Wire Lead	New	4 Groove	HS15	2-45/64	Tangent Mount	O-Ring
78366	5-1/4	Wire Lead	New	4 Groove	HS15	2-45/64	Tangent Mount	O-Ring
97319	4-21/32	3	Reman	6 Groove	HS15	2-31/64	Tangent Mount	O-Ring
98319	4-21/32	3	New	6 Groove	HS15	2-31/64	Tangent Mount	O-Ring
57189	4-7/8	Wire Lead	Reman	5 Groove	HS17	2-29/32	Tangent Mount	O-Ring
58189	4-7/8	Wire Lead	New	5 Groove	HS17	2-29/32	Tangent Mount	O-Ring
57115	5-1/16	Wire Lead	Reman	4 Groove	HS18	2-19/32	Tangent Mount	O-Ring
57119	4-7/16	Wire Lead	Reman	6 Groove	HS18	2-13/32	Tangent Mount	O-Ring
57183	5	Wire Lead	Reman	6 Groove	HS18	2-45/64	Tangent Mount	O-Ring
57185	4-25/32	Wire Lead	Reman	6 Groove	HS18	2-51/64	Tangent Mount	O-Ring
57187	4-7/8	Wire Lead	Reman	5 Groove	HS18	2-29/32	Tangent Mount	O-Ring
57190	4-1/2	Wire Lead	Reman	4 Groove	HS18	2-45/64	Tangent Mount	O-Ring
57197	5	Wire Lead	Reman	6 Groove	HS18	2-51/64	Tangent Mount	O-Ring
57198	5	Wire Lead	Reman	6 Groove	HS18	2-51/64	Tangent Mount	O-Ring
58119	4-7/16	Wire Lead	New	6 Groove	HS18	2-13/32	Tangent Mount	O-Ring
58183	5	Wire Lead	New	6 Groove	HS18	2-45/64	Tangent Mount	O-Ring
58185	4-25/32	Wire Lead	New	6 Groove	HS18	2-51/64	Tangent Mount	O-Ring
58187	4-7/8	Wire Lead	New	5 Groove	HS18	2-29/32	Tangent Mount	O-Ring
58190	4-1/2	Wire Lead	New	4 Groove	HS18	2-45/64	Tangent Mount	O-Ring
58197	5	Wire Lead	New	6 Groove	HS18	2-51/64	Tangent Mount	O-Ring
58198	5	Wire Lead	New	6 Groove	HS18	2-51/64	Tangent Mount	O-Ring
67144	4-5/8	Wire Lead	Reman	6 Groove	HS18	2-1/2	Tangent Mount	O-Ring
67182	4-5/16	Wire Lead	Reman	8 Groove	HS18	55/64	Tangent Mount	Sealing Washer
67184	5-1/16	Wire Lead	Reman	6 Groove	HS18	2-3/32	Tangent Mount	O-Ring / Gasket
67190	4-13/16	Wire Lead	Reman	6 Groove	HS18	2-51/64	Tangent Mount	O-Ring
68124	5-1/2	Wire Lead	New	4 Groove	HS18	2-45/64	Tangent Mount	O-Ring
68144	4-5/8	Wire Lead	New	6 Groove	HS18	2-1/2	Tangent Mount	O-Ring
68182	4-5/16	Wire Lead	New	8 Groove	HS18	55/64	Tangent Mount	Sealing Washer
68184	5-1/16	Wire Lead	New	6 Groove	HS18	2-3/32	Tangent Mount	O-Ring / Gasket
68190	4-13/16	Wire Lead	New	6 Groove	HS18	2-51/64	Tangent Mount	O-Ring
97120	4-45/64	Wire Lead	Reman	6 Groove	HS18	2-17/32	Tangent Mount	O-Ring
98120	4-45/64	Wire Lead	New	6 Groove	HS18	2-17/32	Tangent Mount	O-Ring
98121	4-21/32	Wire Lead	New	6 Groove	HS18	2-27/32	Tangent Mount	O-Ring
98122	5-17/64	Wire Lead	New	6 Groove	HS18	2-17/32	Tangent Mount	O-Ring
67120	4-5/8	Wire Lead	Reman	6 Groove	HS20	2-51/64	Tangent Mount	O-Ring
68120	4-5/8	Wire Lead	New	6 Groove	HS20	2-51/64	Tangent Mount	O-Ring
157550	4	Wire Lead	Reman	5 Groove	Scroll	1-13/64	Tangent Mount	Sealing Washer
158550	4	Wire Lead	New	5 Groove	Scroll	1-13/64	Tangent Mount	Sealing Washer
158553	4	Wire Lead	New	6 Groove	Scroll	1-5/64	Tangent Mount	Sealing Washer
197554	3-15/16	Wire Lead	Reman	6 Groove	Scroll	1-5/32	Tangent Mount	Sealing Washer
77540	3-15/16	12	Reman	6 Groove	Scroll	1-19/64	Tangent Mount	O-Ring
77542	3-7/8	3	Reman	6 Groove	Scroll	1-45/64	Tangent Mount	O-Ring
77549	3-7/8	12	Reman	6 Groove	Scroll	1-19/32	Tangent Mount	O-Ring
77570	4	12	Reman	5 Groove	Scroll	1-13/64	Tangent Mount	Sealing Washer
77579	3-15/16	3	Reman	8 Groove	Scroll	1-19/64	Tangent Mount	O-Ring
77586	3-15/16	Wire Lead	Reman	6 Groove	Scroll	1-55/64	Tangent Mount	O-Ring
77588	3-15/16	12	Reman	6 Groove	Scroll	2	Tangent Mount	O-Ring
78540	3-15/16	12	New	6 Groove	Scroll	1-19/64	Tangent Mount	O-Ring
78542	3-7/8	3	New	6 Groove	Scroll	1-45/64	Tangent Mount	O-Ring
78549	3-7/8	12	New	6 Groove	Scroll	1-19/32	Tangent Mount	O-Ring

# Compressors

Part No.	Pulley Dia.	Coil Clock	New / Reman	Groove	Type	Mount Dist to Groove Midpoint	Mount	Manifold
<b>FS Series</b>								
78570	4	12	New	5 Groove	Scroll	1-13/64	Tangent Mount	Sealing Washer
78579	3-15/16	3	New	8 Groove	Scroll	1-19/64	Tangent Mount	O-Ring
78586	3-7/8	Wire Lead	New	6 Groove	Scroll	1-51/64	Tangent Mount	O-Ring
78588	3-15/16	12	New	6 Groove	Scroll	2	Tangent Mount	O-Ring
97557	3-7/8	Wire Lead	Reman	6 Groove	Scroll	2	Tangent Mount	O-Ring
97561	3-7/8	Wire Lead	Reman	6 Groove	Scroll	2-17/64	Tangent Mount	O-Ring
97562	3-47/64	3	Reman	6 Groove	Scroll	2-15/32	Tangent Mount	O-Ring
97564	3-15/16	12	Reman	8 Groove	Scroll	2	Tangent Mount	O-Ring
97568	3-3/4	3	Reman	6 Groove	Scroll	1-5/8	Tangent Mount	O-Ring
97569	3-3/4	Wire Lead	Reman	6 Groove	Scroll	1-59/64	Tangent Mount	O-Ring
97577	4	12	Reman	6 Groove	Scroll	1-5/64	Tangent Mount	Sealing Washer
98554	4-11/16	12	New	6 Groove	Scroll	1-5/32	Tangent Mount	Sealing Washer
98557	3-7/8	Wire Lead	New	6 Groove	Scroll	2	Tangent Mount	O-Ring
98561	3-7/8	Wire Lead	New	6 Groove	Scroll	2-17/64	Tangent Mount	O-Ring
98562	3-47/64	3	New	6 Groove	Scroll	2-15/32	Tangent Mount	O-Ring
98564	3-15/16	12	New	8 Groove	Scroll	2	Tangent Mount	O-Ring
98568	3-3/4	Wire Lead	New	6 Groove	Scroll	1-5/8	Tangent Mount	O-Ring
98569	3-3/4	Wire Lead	New	6 Groove	Scroll	1-59/64	Tangent Mount	O-Ring
98577	4	12	New	6 Groove	Scroll	1-5/64	Tangent Mount	Sealing Washer
57026			Reman		A590		Tangent Mount	O-Ring / Gasket
57038			Reman		C171		Ear Mount	O-Ring / Gasket
57049			Reman		E6DH		Tangent Mount	O-Ring / Gasket
57037			Reman		FS6		Ear Mount	Pad Mount
58037			New		FS6		Ear Mount	Pad Mount
<b>GM V Series</b>								
57271	5-1/8	2	Reman	1 Groove	V5	1-51/64	Ear Mount	Block Mount
57274	4-1/4	2	Reman	6 Groove	V5	1-5/32	Ear Mount	Block Mount
57275	5-1/2	2	Reman	6 Groove	V5	1-5/32	Ear Mount	Block Mount
57276	5	2	Reman	5 Groove	V5	1-19/64	Ear Mount	Block Mount
57277	4-3/4	2	Reman	6 Groove	V5	1-5/32	Ear Mount	Block Mount
57278	5	10	Reman	6 Groove	V5	1-5/32	Ear Mount	Block Mount
57279	5	2	Reman	6 Groove	V5	1-5/32	Ear Mount	Block Mount
57281	5	2	Reman	5 Groove	V5	1-1/4	Ear Mount	Block Mount
57282	5	2	Reman	5 Groove	V5	1-1/4	Ear Mount	Block Mount
57283	4-45/64	2	Reman	6 Groove	V5	1-5/32	Ear Mount	Block Mount
57284	5	2	Reman	6 Groove	V5	1-5/32	Ear Mount	Block Mount
57774	4-1/4	2	Reman	6 Groove	V5	1-5/32	Ear Mount	Block Mount
57776	5	2	Reman	5 Groove	V5	1-1/4	Ear Mount	Block Mount
57777	4-1/2	2	Reman	6 Groove	V5	1-5/32	Ear Mount	Block Mount
57971	4-5/8	2	Reman	6 Groove	V5	1-5/32	Ear Mount	Sealing Washer
57972	4-5/8	2	Reman	6 Groove	V5	1-5/32	Ear Mount	Sealing Washer
57973	4-5/8	2	Reman	6 Groove	V5	1-5/32	Ear Mount	Sealing Washer
57974	4-1/4	2	Reman	6 Groove	V5	1-5/32	Ear Mount	Sealing Washer
57975	5-1/2	2	Reman	6 Groove	V5	1-5/32	Ear Mount	Sealing Washer
57976	5	2	Reman	5 Groove	V5	1-19/64	Ear Mount	Sealing Washer
57977	5-1/8	2	Reman	1 Groove	V5	1-55/64	Ear Mount	Sealing Washer
57978	5	12	Reman	6 Groove	V5	1-13/64	Ear Mount	Sealing Washer
57979	4-3/4	12	Reman	6 Groove	V5	1-13/64	Ear Mount	Sealing Washer
57980	4-1/4	2	Reman	6 Groove	V5	1-19/32	Tangent Mount	Sealing Washer
57981	5	2	Reman	5 Groove	V5	1-19/64	Ear Mount	Sealing Washer
57982	5-1/8	2	Reman	1 Groove	V5	1-55/64	Ear Mount	Sealing Washer
57983	4-3/4	12	Reman	6 Groove	V5	1-5/32	Ear Mount	Sealing Washer
57984	4-45/64	2	Reman	6 Groove	V5	1-13/64	Ear Mount	Sealing Washer
57985	4-1/4	2	Reman	5 Groove	V5	1-19/64	Ear Mount	Sealing Washer
57986	5	2	Reman	5 Groove	V5	1-19/64	Ear Mount	Sealing Washer
57987	4-3/4	2	Reman	6 Groove	V5	1-5/32	Ear Mount	Sealing Washer
57989	4-1/4	2	Reman	5 Groove	V5	1-19/64	Ear Mount	Sealing Washer
57990	4-3/4	2	Reman	6 Groove	V5	1-5/32	Ear Mount	Sealing Washer
57991	5	2	Reman	5 Groove	V5	2	Tangent Mount	Sealing Washer
57992	4-1/4	2	Reman	6 Groove	V5	1-19/32	Tangent Mount	Sealing Washer
57993	4-1/4	2	Reman	6 Groove	V5	1-5/32	Ear Mount	Sealing Washer
57994	5-1/8	2	Reman	6 Groove	V5	1-1/2	Ear Mount	Sealing Washer

# Compressors

Part No.	Pulley Dia.	Coil Clock	New / Reman	Groove	Type	Mount Dist to Groove Midpoint	Mount	Manifold
<b>GM V Series</b>								
57997	4-3/4	2	Reman	6 Groove	V5	1-5/32	Ear Mount	Sealing Washer
58271	5-1/8	2	New	1 Groove	V5	1-51/64	Ear Mount	O-Ring / Sealing Washer
58274	4-1/4	2	New	6 Groove	V5	1-5/32	Ear Mount	O-Ring / Sealing Washer
58275	5-1/2	2	New	6 Groove	V5	1-5/32	Ear Mount	O-Ring / Sealing Washer
58276	5	2	New	5 Groove	V5	1-19/64	Ear Mount	O-Ring / Sealing Washer
58277	4-45/64	2	New	6 Groove	V5	1-5/32	Ear Mount	Sealing Washer
58278	5	10	New	6 Groove	V5	1-5/32	Ear Mount	Sealing Washer
58279	5	2	New	6 Groove	V5	1-5/32	Ear Mount	Sealing Washer
58281	5	2	New	5 Groove	V5	1-1/4	Ear Mount	Sealing Washer
58282	5	2	New	5 Groove	V5	1-1/4	Ear Mount	Sealing Washer
58283	4-45/64	2	New	6 Groove	V5	1-5/32	Ear Mount	Sealing Washer
58776	5	2	New	5 Groove	V5	1-1/4	Ear Mount	Sealing Washer
58777	4-1/2	2	New	6 Groove	V5	1-5/32	Ear Mount	O-Ring / Sealing Washer
58971	4-5/8	2	New	6 Groove	V5	1-5/32	Ear Mount	Sealing Washer
58972	4-5/8	2	New	6 Groove	V5	1-5/32	Ear Mount	Sealing Washer
58973	4-5/8	2	New	6 Groove	V5	1-5/32	Ear Mount	Sealing Washer
58974	4-1/4	2	New	6 Groove	V5	1-5/32	Ear Mount	Sealing Washer
58975	5-1/2	2	New	6 Groove	V5	1-5/32	Ear Mount	Sealing Washer
58976	5	2	New	5 Groove	V5	1-19/64	Ear Mount	Sealing Washer
58977	5-1/8	2	New	1 Groove	V5	1-55/64	Ear Mount	Sealing Washer
58978	5	12	New	6 Groove	V5	1-13/64	Ear Mount	Sealing Washer
58979	4-45/64	12	New	6 Groove	V5	1-13/64	Ear Mount	Sealing Washer
58980	4-1/4	2	New	6 Groove	V5	1-19/32	Tangent Mount	Sealing Washer
58981	5	2	New	5 Groove	V5	1-19/64	Ear Mount	Sealing Washer
58982	5-1/8	2	New	1 Groove	V5	1-55/64	Ear Mount	Sealing Washer
58983	4-45/64	12	New	6 Groove	V5	1-5/32	Ear Mount	Sealing Washer
58984	4-45/64	2	New	6 Groove	V5	1-13/64	Ear Mount	Sealing Washer
58985	4-1/4	2	New	5 Groove	V5	1-19/64	Ear Mount	Sealing Washer
58986	5	2	New	5 Groove	V5	1-19/64	Ear Mount	Sealing Washer
58987	4-45/64	2	New	6 Groove	V5	1-5/32	Ear Mount	Sealing Washer
58991	5	2	New	5 Groove	V5	2	Tangent Mount	Sealing Washer
58992	4-1/4	2	New	6 Groove	V5	1-19/32	Tangent Mount	Sealing Washer
58993	4-1/4	2	New	6 Groove	V5	1-5/32	Ear Mount	Sealing Washer
58994	5-1/8	2	New	6 Groove	V5	1-1/2	Ear Mount	Sealing Washer
67270	4-11/16	Wire Lead	Reman	6 Groove	V5	1-1/64	Tangent Mount	Block Mount
67276	5	4	Reman	6 Groove	V5	1-5/32	Ear Mount	Sealing Washer
67290	4-7/8	2	Reman	6 Groove	V5	2	Ear Mount	Sealing Washer
67297	5	Wire Lead	Reman	5 Groove	V5	1-19/64	Tangent Mount	Sealing Washer
68223	4-61/64	2 O'Clock	New	6 Groove	V5	1-11/64	3 Ear	Sealing Washer
68224	4-3/32		New	6 Groove	V5	1-9/16	3 Tangent One on Rear Head	
68226	4-15/16		New	6 Groove	V5	2-45/64	Ear Mount	
68270	4-11/16	Wire Lead	New	6 Groove	V5	1-1/64	Tangent Mount	Block Mount
68271	5-13/64		New	1 Groove	V5	1-11/16	Direct Mount	
68276	5	4	New	6 Groove	V5	1-5/32	Ear Mount	Sealing Washer
68290	4-7/8	2	New	6 Groove	V5	2	Ear Mount	Sealing Washer
68297	5	Wire Lead	New	5 Groove	V5	1-19/64	Tangent Mount	Sealing Washer
97272	4-11/16	Wire Lead	Reman	6 Groove	V5	1-11/64	Ear Mount	Sealing Washer
97292	4-3/4	Wire Lead	Reman	6 Groove	V5	1-1/16	Tangent Mount	Sealing Washer
98272	4-11/16	Wire Lead	New	6 Groove	V5	1-11/64	Ear Mount	Sealing Washer
98292	4-3/4	Wire Lead	New	6 Groove	V5	1-1/16	Tangent Mount	Sealing Washer
67277	5	9	Reman	4 Groove	V7	1-55/64	Tangent Mount	Sealing Washer
67279	4-3/4	11	Reman	6 Groove	V7	1-45/64	1 Ear & 2 Boss	Sealing Washer
67288	4-1/4	9	Reman	4 Groove	V7	1-19/32	Tangent Mount	Sealing Washer
67291	4-7/8	9	Reman	6 Groove	V7	1-5/32	Ear Mount	Sealing Washer
68277	5	9	New	4 Groove	V7	1-55/64	Tangent Mount	Sealing Washer
68279	4-3/4	11	New	6 Groove	V7	1-45/64	1 Ear & 2 Boss	Sealing Washer
68288	4-1/4	9	New	4 Groove	V7	1-19/32	Tangent Mount	Sealing Washer



# Compressors

Part No.	Pulley Dia.	Coil Clock	New / Reman	Groove	Type	Mount Dist to Groove Midpoint	Mount	Manifold
<b>GM V Series</b>								
68291	4-7/8	9	New	6 Groove	V7	1-5/32	Ear Mount	Sealing Washer
97276	5-1/2	9	Reman	4 Groove	V7	1-17/32	Tangent Mount	Sealing Washer
98276	5-1/2	9	New	4 Groove	V7	1-17/32	Tangent Mount	Sealing Washer
57272			Reman		V5		Ear Mount	Block Mount
<b>H Series</b>								
57648	5-1/8	2	Reman	1 Groove	DA6	1-1/4	Type I, Metric Threads	Block Mount
57651	5-3/4	10	Reman	1 Groove	DA6	1-13/64	Type II, Metric Threads	Block Mount
57653	5-1/2	6	Reman	1 Groove	DA6	1-13/64	Type II Metric Thread	Block Mount
57655	5-1/8	10	Reman	1 Groove	DA6	1-13/64	Type II, Metric Threads	Block Mount
57657	5-1/2	6	Reman	1 Groove	DA6	55/64	Type II, Metric Threads	Block Mount
57659	5-1/8	6	Reman	1 Groove	DA6	1-13/64	Type II, Metric Threads	Block Mount
57661	5-1/2	10	Reman	1 Groove	DA6	29/32	Type II, Metric Threads	Block Mount
57663	4-1/4	2	Reman	6 Groove	DA6	19/32	Type I Metric Thread	Block Mount
57665	5-1/8	2	Reman	1 Groove	DA6	1-13/64	Type III, Metric Threads	Block Mount
57667	5-1/2	2	Reman	6 Groove	DA6	35/64	Type III, Metric Threads	Block Mount
57668	5-1/2	6	Reman	6 Groove	DA6	35/64	Type III Metric Thread	Block Mount
57669	5-1/2	2	Reman	1 Groove	DA6	29/32	Type IV, Metric Threads	Block Mount
57670	5-1/8	2	Reman	1 Groove	DA6	1-1/4	Type V, Metric Threads	Block Mount
57673	5-1/8	2	Reman	1 Groove	DA6	1-13/64	Type VI	Block Mount
57961	4-1/4	2	Reman	6 Groove	DA6, HR6, HE6	19/32	Type IV Metric Thread	Sealing Washer
57963	4-1/4	2	Reman	6 Groove	DA6, HR6, HE6	19/32	Type I, Metric Threads	Sealing Washer
57967	5-1/2	2	Reman	6 Groove	DA6, HR6, HE6	19/32	Type III Metric Thread	Sealing Washer
57969	4-1/4	10	Reman	6 Groove	DA6, HR6, HE6	19/32	Type VII (Rear Bracket)	Sealing Washer
57970	4-1/4	2	Reman	6 Groove	DA6, HR6, HE6	19/32	Type VII (Rear Bracket)	Sealing Washer
58963	4-1/4	2	New	6 Groove	DA6, HR6, HE6	19/32	Type I Middle w/ Threads	Sealing Washer
58967	5-1/2	2	New	6 Groove	DA6, HR6, HE6	19/32	Type III	Sealing Washer
58970	4-1/4	2	New	6 Groove	DA6, HR6, HE6	19/32	Type VII Rear Bracket	Sealing Washer
88963	4-1/4	2	New	6 Groove	DA6, HR6, HE6	19/32	Type I	Sealing Washer
88967	5-1/2	2	New	6 Groove	DA6, HR6, HE6	19/32	Type III	Sealing Washer
88970	4-1/4	2	New	6 Groove	DA6, HR6, HE6	19/32	Type VII Rear Bracket	Sealing Washer
57951	5	2	Reman	6 Groove	HD6	19/32	Type 10 - All Ears No Threads	Sealing Washer
57952	5	2	Reman	6 Groove	HD6	19/32	Type I, Metric Threads	Sealing Washer
57953	4-1/4	2	Reman	6 Groove	HD6	19/32	Type VII	Sealing Washer
57954	4-1/4	10	Reman	6 Groove	HD6	19/32	Type VII (Middle Ear Not Threaded)	Sealing Washer
57955	5	10	Reman	6 Groove	HD6	19/32	Type XIII (All Ears No Threads)	Sealing Washer
57956	5	2	Reman	6 Groove	HD6	19/32	Type XII (All Ears w/o Threads)	Sealing Washer

# Compressors

Part No.	Pulley Dia.	Coil Clock	New / Reman	Groove	Type	Mount Dist to Groove Midpoint	Mount	Manifold
<b>H Series</b>								
57957	5-1/2	2	Reman	6 Groove	HD6	19/32	Typr VI	Sealing Washer
57958	5-1/2	2	Reman	6 Groove	HD6	19/32	Type III	Sealing Washer
57959	5-1/2	2	Reman	6 Groove	HD6	19/32	Type III, Metric Threads	Sealing Washer
57962	5	2	Reman	6 Groove	HD6	19/32	Type X	Sealing Washer
58932	4-1/4	11	New	6 Groove	HD6	19/32	Ear Mount	Sealing Washer
58951	5	2	New	6 Groove	HD6	19/32	Type 10 - All Ears No Threads	Sealing Washer
58952	5	2	New	6 Groove	HD6	19/32	Type I, Metric Threads	Sealing Washer
58953	4-1/4	2	New	6 Groove	HD6	19/32	3 Ear	Sealing Washer
58954	4-1/4	10	New	6 Groove	HD6	19/32	Type VII (Middle Ear Not Threaded)	Sealing Washer
58955	5	10	New	6 Groove	HD6	19/32	Type XIII (All Ears No Threads)	Sealing Washer
58956	5	2	New	6 Groove	HD6	19/32	Type XII (All Ears no threads)	Sealing Washer
58957	5-1/2	2	New	6 Groove	HD6	19/32	Type VI (2-1/2 Ears)	Sealing Washer
58958	5-1/2	2	New	6 Groove	HD6	19/32	Type III, Metric Threads	Sealing Washer
58962	5	2	New	6 Groove	HD6	19/32	Type X	Sealing Washer
88932	4-5/16	10	New	6 Groove	HD6		Type XII All Ears no Threads	Sealing Washer
88951	5	2	New	6 Groove	HD6	19/32	Type X All Ears no Threads	Sealing Washer
88952	5	2	New	6 Groove	HD6	19/32	Ear Mount	Sealing Washer
88953	4-1/4	2	New	6 Groove	HD6	19/32	Type VII	Sealing Washer
88954	4-1/4	10	New	6 Groove	HD6	19/32	Type VII Middle w/o Threads	Sealing Washer
88955	5	10	New	6 Groove	HD6	19/32	Type XIII All Ears no Threads	Sealing Washer
88956	5	2	New	6 Groove	HD6	19/32	Type XII All Ears no Threads	Sealing Washer
88957	5-1/2	2	New	6 Groove	HD6	19/32	Type VI 2 1/2 ears	Sealing Washer
88958	5-1/2	2	New	6 Groove	HD6	19/32	Type III	Sealing Washer
88962	5	2	New	6 Groove	HD6	19/32	Type X	Sealing Washer
58247	5-1/2	2	New	1 Groove	HR6	1-1/4	Type I Metric Thread	Sealing Washer
58248	5-1/8	2	New	1 Groove	HR6	1-1/4	Type I Metric Thread	Sealing Washer
58251	5-3/4	10	New	1 Groove	HR6	1-13/64	Type II Metric Thread	Sealing Washer
58253	5-1/2	6	New	1 Groove	HR6	1-13/64	Type II Metric Thread	Sealing Washer
58255	5-1/8	10	New	1 Groove	HR6	1-13/64	Type II Metric Thread	Sealing Washer
58257	5-1/2	6	New	1 Groove	HR6	55/64	Type II Metric Thread	Sealing Washer
58259	5-1/8	6	New	1 Groove	HR6	1-13/64	Type II Metric Thread	Sealing Washer
58261	5-1/2	10	New	1 Groove	HR6	29/32	Type II Metric Thread	Sealing Washer
58263	4-1/4	2	New	6 Groove	HR6	19/32	Type I	Sealing Washer
58265	5-1/8	2	New	1 Groove	HR6	1-13/64	Type III Metric Thread	Sealing Washer
58267	5-1/2	2	New	6 Groove	HR6	35/64	Type III	Sealing Washer
58268	5-1/2	6	New	6 Groove	HR6	35/64	Type III Metric Thread	Sealing Washer
58269	5-1/2	2	New	1 Groove	HR6	29/32	Type IV Metric Thread	Sealing Washer
58270	5-1/8	2	New	1 Groove	HR6	1-1/4	Type V Metric Threads	Sealing Washer
58273	5-1/8	2	New	1 Groove	HR6	1-13/64	Type VI	Sealing Washer

# Compressors

Part No.	Pulley Dia.	Coil Clock	New / Reman	Groove	Type	Mount Dist to Groove Midpoint	Mount	Manifold
<b>H Series</b>								
58863	4-1/4	2	New	6 Groove	HR6	19/32	Type I	Sealing Washer
58867	4-1/4	2	New	6 Groove	HR6	19/32	Type III	Sealing Washer
58959	5-1/2	2	New	6 Groove	HR6	19/32	Type III	Sealing Washer
58961	4-1/4	2	New	6 Groove	HR6	19/32	Type IV Metric Thread	Sealing Washer
58964	4-1/4	2	New	6 Groove	HR6	19/32	Type VII Middle w/o Threads	Sealing Washer
58969	4-1/4	10	New	6 Groove	HR6	19/32	Type VII Rear Bracket	Sealing Washer
88263	4-1/4	2	New	6 Groove	HR6	19/32	Type I	Sealing Washer
88267	5-1/2	2	New	6 Groove	HR6	35/64	Type III	Sealing Washer
88863	4-1/4	2	New	6 Groove	HR6	19/32	Type I	Sealing Washer
88867	5-1/2	2	New	6 Groove	HR6	19/32	Type III	Sealing Washer
88964	4-1/4	2	New	6 Groove	HR6	19/32	Ear Mount	Sealing Washer
88969	4-1/4	10	New	6 Groove	HR6	19/32	Type VII Rear Bracket	Sealing Washer
98248	5-1/8	2	New	1 Groove	HR6	1-1/4	Ear Mount	Sealing Washer
57247	5-1/2	2	Reman	1 Groove	HR6, DA6	1-1/4	Type I, Metric Threads	Block Mount
57248	5-1/8	2	Reman	1 Groove	HR6, DA6	1-1/4	Type I, Metric Threads	Block Mount
57251	5-3/4	10	Reman	1 Groove	HR6, DA6	1-13/64	Type II, Metric Threads	Block Mount
57253	5-1/2	6	Reman	1 Groove	HR6, DA6	1-13/64	Type II Metric Thread	Block Mount
57255	5-1/8	10	Reman	1 Groove	HR6, DA6	1-13/64	Type II, Metric Threads	Block Mount
57257	5-1/2	6	Reman	1 Groove	HR6, DA6	55/64	Type II Metric Thread	Block Mount
57259	5-1/8	6	Reman	1 Groove	HR6, DA6	1-13/64	Type II, Metric Threads	Block Mount
57261	5-1/2	10	Reman	1 Groove	HR6, DA6	29/32	Type II Metric Thread	Block Mount
57263	4-1/4	2	Reman	6 Groove	HR6, DA6	19/32	Type I, Metric Threads	Block Mount
57265	5-1/2	2	Reman	1 Groove	HR6, DA6	1-13/64	Type III, Metric Threads	Block Mount
57267	5-1/2	2	Reman	6 Groove	HR6, DA6	35/64	Type III, Metric Threads	Block Mount
57268	5-1/2	6	Reman	6 Groove	HR6, DA6	35/64	Type III, Metric Threads	Block Mount
57269	5-1/2	2	Reman	1 Groove	HR6, DA6	29/32	Type IV Metric Thread	Block Mount
57270	5-1/8	2	Reman	1 Groove	HR6, DA6	1-1/4	Type V Metric Threads	Block Mount
57273	5-1/8	2	Reman	1 Groove	HR6, DA6	1-13/64	Type VI	Block Mount
57863	4-1/4	2	Reman	6 Groove	HR6, DA6	19/32	Type I, Metric Threads	Block Mount
57867	5-1/2	2	Reman	6 Groove	HR6, DA6	19/32	Type III, Metric Threads	Block Mount
57931	4-1/4	11	Reman	6 Groove	HT6	19/32	Tangent Mount	Sealing Washer
57947	4-1/4	11	Reman	6 Groove	HT6	19/32	Tangent Mount	Sealing Washer
57949	4-5/8	11	Reman	6 Groove	HT6	19/32	Tangent Mount	Sealing Washer
57950	5	11	Reman	6 Groove	HT6		Tangent Mount	Sealing Washer
58931	4-1/4	11	New	6 Groove	HT6	19/32	Tangent Mount	Sealing Washer
58947	4-1/4	11	New	6 Groove	HT6	19/32	Tangent Mount	Sealing Washer
58949	4-5/8	11	New	6 Groove	HT6	19/32	Tangent Mount	Sealing Washer
58950	5	11	New	6 Groove	HT6		Tangent Mount	Sealing Washer
88931	4-1/4	11	New	6 Groove	HT6	19/32	Tangent Mount	Sealing Washer
88947	4-1/4	11	New	6 Groove	HT6	19/32	Tangent Mount	Sealing Washer
88949	4-5/8	11	New	6 Groove	HT6	19/32	Tangent Mount	Sealing Washer
88950	5	11	New	6 Groove	HT6	19/32	Tangent Mount	Sealing Washer
57901	4-1/4	11	Reman	4 Groove	HU6	53/64	Tangent Mount	Sealing Washer



# Compressors

Part No.	Pulley Dia.	Coil Clock	New / Reman	Groove	Type	Mount Dist to Groove Midpoint	Mount	Manifold
<b>H Series</b>								
58901	4-1/4	11	New	4 Groove	HU6	19/32	Tangent Mount	Sealing Washer
88901	4-1/4	11	New	4 Groove	HU6	19/32	Tangent Mount	Sealing Washer

# Compressors

Part No.	Pulley Dia.	Coil Clock	New / Reman	Groove	Type	Mount Dist to Groove Midpoint	Mount	Manifold
<b>H Series</b>								
57250			Reman		HR6, DA6		Type I, Metric Threads	Block Mount
57254			Reman		HR6, DA6		Type II, Metric Threads	Block Mount
57256			Reman		HR6, DA6		Type III Metric Thread	Block Mount
<b>Halla Series Electric</b>								
178327			New	Electric	ESC33T		Tangent Mount	O-Ring
178332			New	Electric	ESC33T		Tangent Mount	
<b>Halla Series</b>								
198359	4-1/4	2 O'Clock	New	6 Groove	HCC	2-29/64	Tangent Mount	Sealing Washer
198360	4-17/64		New	4 Groove	HCC		Tangent Mount	
157371	4-1/2	Wire Lead	Reman	6 Groove	HCC-DV13	2-57/64	Tangent Mount	O-Ring
158371	4-1/2	Wire Lead	New	6 Groove	HCC-DV13	2-57/64	Tangent Mount	O-Ring
178323	4-57/64	Wire Lead	New	6 Groove	HCC-DV13	2-9/16	Tangent Mount	O-Ring
158396	4-57/64	Wire Lead	New	6 Groove	HCC-DVE16	2-21/25	Tangent Mount	O-Ring
178305	4-45/64	Wire Lead	New	6 Groove	HCC-DVE16	2-29/32	Tangent Mount	O-Ring
157381	4-29/64	Wire Lead	Reman	5 Groove	HCC-HS18N	2-63/64	Tangent Mount	O-Ring
158381	4-29/64	Wire Lead	New	5 Groove	HCC-HS18N	2-63/64	Tangent Mount	O-Ring
97122	5-17/64	Wire Lead	Reman	6 Groove	HCC-HS18N	2-17/32	Tangent Mount	O-Ring
1177318	4-21/32	Wire Lead	Reman	6 Groove	HCC-RS18	2-53/64	Tangent Mount	O-Ring
178318	4-21/32	Wire Lead	New	6 Groove	HCC-RS18	2-53/64	Tangent Mount	O-Ring
198305	4-45/64	Wire Lead	New	6 Groove	HCC-RS18	1-9/16	Tangent Mount	Sealing Washer
97301	5-1/2	12 O'Clock	Reman	6 Groove	HCC-RS18	2-7/16	Tangent Mount	O-Ring / Gasket
97311	4-45/64	1	Reman	6 Groove	HCC-RS18	1-17/32	Tangent Mount	O-Ring / Gasket
98301	5-1/2	12 O'Clock	New	6 Groove	HCC-RS18	2-7/16	Tangent Mount	O-Ring
98311	4-45/64	1	New	6 Groove	HCC-RS18	1-17/32	Tangent Mount	O-Ring / Gasket
97322	4-15/32	Wire Lead	Reman	8 Groove	HCC-RS20	1-55/64	Tangent Mount	O-Ring
97324	4-11/16	Wire Lead	Reman	6 Groove	HCC-RS20	2-19/32	Tangent Mount	O-Ring
98302	4-11/16	1	New	6 Groove	HCC-RS20	1-17/32	Tangent Mount	O-Ring / Gasket
98322	4-15/32	Wire Lead	New	8 Groove	HCC-RS20	1-55/64	Tangent Mount	O-Ring
98324	4-11/16	Wire Lead	New	6 Groove	HCC-RS20	2-19/32	3 Tangent	O-Ring
157370	4-29/32	Wire Lead	Reman	4 Groove	HCC-VS12	2-49/64	Tangent Mount	O-Ring
157389	4-57/64	Wire Lead	Reman	4 Groove	HCC-VS12	2-25/32	Tangent Mount	O-Ring
158370	4-1/2	Wire Lead	New	4 Groove	HCC-VS12	2-49/64	Tangent Mount	O-Ring
158389	4-57/64	Wire Lead	New	4 Groove	HCC-VS12	2-25/32	Tangent Mount	O-Ring
158399	4-29/32	Wire Lead	New	6 Groove	HCC-VS12	2-41/64	Tangent Mount	O-Ring
178325	4-1/2	Wire Lead	New	6 Groove	HCC-VS12	2-5/8	Tangent Mount	O-Ring
178326	4-1/2	Wire Lead	New	6 Groove	HCC-VS12	2-21/64	Tangent Mount	O-Ring
178330	4-37/64	Wire Lead	New	6 Groove	HCC-VS12	2-23/64	Tangent Mount	O-Ring
198354	4-1/2	Wire Lead	New	6 Groove	HCC-VS12		Tangent Mount	O-Ring
157306	4-7/8	Wire Lead	Reman	6 Groove	HCC-VS16	2-51/64	Tangent Mount	O-Ring
157307	4-7/8	Wire Lead	Reman	4 Groove	HCC-VS16	2-45/64	Tangent Mount	O-Ring
157372	4-1/2	Wire Lead	Reman	6 Groove	HCC-VS16	2-55/64	Tangent Mount	O-Ring
158372	4-1/2	Wire Lead	New	6 Groove	HCC-VS16	2-55/64	Tangent Mount	O-Ring
67358	5	Wire Lead	Reman	4 Groove	HCC-VS16	2-45/64	Tangent Mount	O-Ring
97323	4-17/64	12 O'Clock	Reman	5 Groove	HCC-VS16	2-17/32	Tangent Mount	O-Ring
67348	4-11/16	Wire Lead	Reman	6 Groove	HCC-VS18	2-51/64	Tangent Mount	O-Ring
178317	4-1/2	Wire Lead	New	6 Groove	VS16E	2-27/32	Tangent Mount	O-Ring
178328	4-1/2	Wire Lead	New	6 Groove	VS16E	2-27/32	Tangent Mount	O-Ring
158305	4-7/8	Wire Lead	New	6 Groove	VS16N	2-13/32	Tangent Mount	O-Ring
158306	4-7/8	Wire Lead	New	6 Groove	VS16N	2-51/64	Tangent Mount	O-Ring
158307	4-7/8	Wire Lead	New	4 Groove	VS16N	2-45/64	Tangent Mount	O-Ring
68358	5	Wire Lead	New	4 Groove	VS16N	2-45/64	Tangent Mount	O-Ring
98323	4-17/64	Wire Lead	New	5 Groove	VS16N	2-17/32	Tangent Mount	O-Ring
178315	4-11/16	Wire Lead	New	6 Groove	VS18E	1-1/2	Tangent Mount	O-Ring
178316	4-11/16	Wire Lead	New	6 Groove	VS18E	2-51/64	Tangent Mount	O-Ring
198376	4-11/16	Wire Lead	New	6 Groove	VS18E	2-53/64	Tangent Mount	O-Ring
198377	4-11/16	Wire Lead	New	6 Groove	VS18E	2-53/64	Tangent Mount	O-Ring
158304	4-7/8	Wire Lead	New	6 Groove	VS18M	2-53/64	Tangent Mount	O-Ring
178314	4-11/16	Wire Lead	New	6 Groove	VS18M	2-23/64	Tangent Mount	O-Ring

# Compressors

Part No.	Pulley Dia.	Coil Clock	New / Reman	Groove	Type	Mount Dist to Groove Midpoint	Mount	Manifold
<b>Halla Series</b>								
198300	4-11/16	Wire Lead	New	6 Groove	VS18M	2-23/64	Tangent Mount	O-Ring
198301	4-7/8	Wire Lead	New	6 Groove	VS18M	2-51/64	Tangent Mount	O-Ring
68313	4-11/16	Wire Lead	New	6 Groove	VS18M	2-51/64	Tangent Mount	O-Ring
68348	4-11/16	Wire Lead	New	6 Groove	VS18M	2-51/64	Tangent Mount	O-Ring
<b>Hitachi</b>								
57438	5-3/4	Wire Lead	Reman	1 Groove	A5000	1-29/64	Ear Mount	O-Ring
57432	5-1/4	Wire Lead	Reman	1 Groove	MJS167	2-5/32	Ear Mount	O-Ring
57425	5-1/4	Wire Lead	Reman	4 Groove	MJS170	1-1/4	Ear Mount	O-Ring
57426	5-5/8	Wire Lead	Reman	10 Groove 4 & 6	MJS170	51/64	Ear Mount	O-Ring
57429	5-1/4	Wire Lead	Reman	1 Groove	MJS170	1-51/64	Ear Mount	O-Ring
57430	5-1/2	Wire Lead	Reman	1 Groove	MJS170	1-51/64	Ear Mount	O-Ring
57431	5-1/4	Wire Lead	Reman	1 Groove	MJS170	1-51/64	Ear Mount	O-Ring
57433	5-3/4	Wire Lead	Reman	1 Groove	MJS170	1-13/32	Ear Mount	O-Ring
57439	5-1/4	Wire Lead	Reman	4 Groove	MJS170	1-19/32	Ear Mount	O-Ring
57448	5-5/8	Wire Lead	Reman	10 Groove 4 & 6	MJS170	51/64	Ear Mount	O-Ring
57453	5-23/64	Wire Lead	Reman	2 Groove	MJS170	21/32	Case Mount	O-Ring
57454	5-5/8	Wire Lead	Reman	4 Groove	MJS170	29/64	Boss Mount	O-Ring
57414			Reman		MJ167		Boss Mount	O-Ring
57415			Reman		MJ167		Boss Mount	O-Ring
57406			Reman		MJS170		Boss Mount	O-Ring
57416			Reman		MJS170		Boss Mount	O-Ring
57417			Reman		MJS170		Ear Mount	O-Ring
57412			Reman		SWP167		Boss Mount	O-Ring
<b>Keihin</b>								
57872	5-37/100	Wire Lead	Reman	1 Groove	150R	1-3/5	Ear Mount	
57871	4-31/50	Wire Lead	Reman	4 Groove	A150L	1-1/2	Ear Mount	
57876	5-1/2	Wire Lead	Reman	1 Groove	A150L	1-3/5	Ear Mount	
57873	5-1/2	Wire Lead	Reman	1 Groove	AN150L	1-5/64	Ear Mount	
57870	5	Wire Lead	Reman	1 Groove	CN150L	1-31/50	Ear Mount	O-Ring
57875	5-37/100	Wire Lead	Reman	1 Groove	CN150L	1-3/5	Ear Mount	
57878	4-37/100	Wire Lead	Reman	6 Groove	HS090	23/25	Tangent Mount	
57882	3-7/8	Wire Lead	Reman	7 Groove	HS090	1-3/10	Tangent Mount	O-Ring
57884	3-7/8	Wire Lead	Reman	6 Groove	HS090	1-17/20	Tangent Mount	O-Ring
57889	4-33/100	Wire Lead	Reman	7 Groove	HS090	1-7/20	Tangent Mount	O-Ring
58878	4-37/100	Wire Lead	New	6 Groove	HS090	23/25	Tangent Mount	O-Ring
58882	3-7/8	Wire Lead	New	7 Groove	HS090	1-3/10	Tangent Mount	O-Ring
58884	4		New	6 Groove	HS090	1-17/20	Tangent Mount	O-Ring
58889	4-33/100	Wire Lead	New	7 Groove	HS090	1-7/20	Tangent Mount	
57879	6-1/4	Wire Lead	Reman	5 Groove	HS110R	61/64	Tangent Mount	Pad Mount
57881	3-7/8	Wire Lead	Reman	7 Groove	HS110R	1-2/5	Tangent Mount	O-Ring
57886	4-3/8	Wire Lead	Reman	7 Groove	HS110R	1-3/10	Tangent Mount	O-Ring
58881	3-7/8	Wire Lead	New	7 Groove	HS110R	1-2/5	Tangent Mount	O-Ring
58886	4-3/8	Wire Lead	New	7 Groove	HS110R	1-3/10	Tangent Mount	O-Ring
57891	4-2/5	3 Wire Lead	Reman	4 Groove	HSK70KR	1-53/100	Tangent Mount	O-Ring
58891	4-2/5	3 Wire Lead	New	4 Groove	HSK70KR	1-53/100	Tangent Mount	O-Ring
57874	5-1/2	Wire Lead	Reman	1 Groove	N150R	1-1/2	Ear Mount	
57880	6-1/4	Wire Lead	Reman	6 Groove	RC17D	1	Tangent Mount	
<b>Matsushita/Panasonic</b>								
67480	5-1/8	Wire Lead	Reman	4 Groove	H12A0AH4EL	1	Tangent Mount	O-Ring
68480	5-1/8	Wire Lead	New	4 Groove	H12A0AH4EL	1	Tangent Mount	O-Ring
67478	5-5/16	Wire Lead	Reman	5 Groove	H12A0AH4JU	1-13/32	Tangent Mount	O-Ring
67479	4-55/64	Wire Lead	Reman	5 Groove	H12A0AH4JU	1-13/32	Tangent Mount	O-Ring
68478	5-1/2	Wire Lead	New	5 Groove	H12A0AH4JU	1-13/32	Tangent Mount	O-Ring
68479	5-1/4	Wire Lead	New	5 Groove	H12A0AH4JU	1-13/32	Tangent Mount	O-Ring
67473	5	Wire Lead	Reman	5 Groove	H12A0AM4NU	25/32	Tangent Mount	O-Ring
57463	3-7/8	Wire Lead	Reman	5 Groove	H12A1AH4DX	1-13/32	Tangent Mount	O-Ring
58463	3-7/8	Wire Lead	New	5 Groove	H12A1AH4DX	1-13/32	Tangent Mount	O-Ring
98472	4-17/32	Wire Lead	New	5 Groove	H12A1AH4DX	1-27/64	Tangent Mount	O-Ring



# Compressors

Part No.	Pulley Dia.	Coil Clock	New / Reman	Groove	Type	Mount Dist to Groove Midpoint	Mount	Manifold
<b>Matsushita/Panasonic</b>								
97470	4-7/8	Wire Lead	Reman	6 Groove	H12A1AK4DW	1-25/64	Tangent Mount	O-Ring
97471	3-7/8	Wire Lead	Reman	6 Groove	H12A1AK4DW	1-13/32	Tangent Mount	O-Ring
98471	3-7/8	Wire Lead	New	6 Groove	H12A1AL4CX	1-13/32	Tangent Mount	O-Ring
57496	5	Wire Lead	Reman	1 Groove	N1300AC4	1-1/4	Ear Mount	O-Ring
57470	5-1/4	Wire Lead	Reman	4 Groove	N1301AB4	1-13/64	Tangent Mount	O-Ring
57487	5-1/4	Wire Lead	Reman	5 Groove	N1301AE4	1-29/64	Ear Mount	O-Ring
57495	5-1/4	Wire Lead	Reman	5 Groove	N1301AE4	51/64	Ear Mount	O-Ring
58487	5-1/4	Wire Lead	New	5 Groove	N1301AE4	1-29/64	Tangent Mount	O-Ring
67471	5	Wire Lead	Reman	7 Groove	N13A0AH4	1-19/64	Tangent Mount	O-Ring
67475	5	Wire Lead	Reman	5 Groove	N13A0AH4	51/64	Tangent Mount	O-Ring
58495	5-1/4	Wire Lead	New	5 Groove	N13A1AA4N4F	4/5	Ear Mount	Pad Mount
57419	4-7/8	Wire Lead	Reman	4 Groove	N1500AB4	1-1/4	Ear Mount	O-Ring
57418	4-7/8	Wire Lead	Reman	5 Groove	N15A0B4	1-5/32	Ear Mount	O-Ring
57494	5-3/4	Wire Lead	Reman	5 Groove	NL1300AA4	55/64	Ear Mount	O-Ring
67470	4-3/4	Wire Lead	Reman	4 Groove	NL1300AE4	1-1/4	Tangent Mount	O-Ring
57490	5-1/4	Wire Lead	Reman	4 Groove	NL1302AD4	1	Ear Mount	O-Ring
57497	4-3/4	Wire Lead	Reman	2 Groove	S1150F3	1/2	Tangent Mount	O-Ring
57472	5-1/4	Wire Lead	Reman	4 Groove	SA1150AE4	1	Ear Mount	O-Ring
57473	4-3/4	Wire Lead	Reman	4 Groove	SA1150AE4	1	Ear Mount	O-Ring
68470	4-3/4	Wire Lead	New	4 Groove	SA11A0AA4	1-1/4	Tangent Mount	O-Ring
57471	4-5/16	Wire Lead	Reman	5 Groove	V08A0AA4AJ	17/64	Tangent Mount	O-Ring
98473	4-19/32	Wire Lead	New	6 Groove	V09A1AD4AP	1-13/32	Tangent Mount	O-Ring
57481			Reman		N1301A0		Ear Mount	Pad Mount
<b>Mitsubishi Electric</b>								
98492			New	Electric	Electric		Tangent Mount	
<b>Mitsubishi</b>								
67490	4-1/4	Wire Lead	Reman	4 Groove	AX105VSR	2-59/64	Tangent Mount	
57483	4-23/64	Wire Lead	Reman	1 Groove	FX105	3	Tangent Mount	Pad Mount
57484	4-1/4	Wire Lead	Reman	4 Groove	FX105V	2-29/32	Tangent Mount	O-Ring
57485	5	Wire Lead	Reman	4 Groove	FX105V	2-59/64	Tangent Mount	O-Ring
67486	4-1/4	Wire Lead	Reman	4 Groove	FX105VS	3-9/64	Tangent Mount	Pad Mount
67487	4	Wire Lead	Reman	6 Groove	FX105VS	3-9/32	Tangent Mount	O-Ring
77481	4-13/32	Wire Lead	Reman	5 Groove	FXA105VSL4	39/64	Ear Mount	O-Ring
57480	4-23/64	Wire Lead	Reman	1 Groove	FXA80	3-3/32	Tangent Mount	Pad Mount
77487	3-41/64	Wire Lead	Reman	1 Groove	MSC105C	2-15/16	Tangent Mount	O-Ring
77493	3-3/4	Wire Lead	Reman	6 Groove	MSC105C	1-3/32	Tangent Mount	O-Ring
77494	4-1/8	Wire Lead	Reman	6 Groove	MSC105C	1-5/32	Tangent Mount	O-Ring
77495	4-5/16	Wire Lead	Reman	6 Groove	MSC105C	1-5/32	Tangent Mount	O-Ring
77497	4-1/16	Wire Lead	Reman	6 Groove	MSC105C	1-3/32	Tangent Mount	O-Ring
78487	3-41/64	Wire Lead	New	1 Groove	MSC105C	2-15/16	Tangent Mount	O-Ring
78493	3-3/4	Wire Lead	New	6 Groove	MSC105C	1-3/32	Tangent Mount	O-Ring
78494	4-1/8	Wire Lead	New	6 Groove	MSC105C	1-5/32	Tangent Mount	O-Ring
78497	4-1/16	Wire Lead	New	6 Groove	MSC105CA	1-3/32	Tangent Mount	O-Ring
97482	3-15/16	Wire Lead	Reman	6 Groove	MSC105CG1	1-13/32	Tangent Mount	Sealing Washer
97489	3-15/16	Wire Lead	Reman	6 Groove	MSC105CG1	1-13/32	Tangent Mount	Sealing Washer
77499	4	Wire Lead	Reman	6 Groove	MSC105CG2	55/64	Tangent Mount	Sealing Washer
78499	4	Wire Lead	New	6 Groove	MSC105CG2	55/64	Tangent Mount	Sealing Washer
67461	3	Wire Lead	Reman	4 Groove	MSC105CVS	2-45/64	Tangent Mount	O-Ring
67474	3-3/4	Wire Lead	Reman	6 Groove	MSC105CVS	1-1/2	Tangent Mount	O-Ring
67485	4	Wire Lead	Reman	6 Groove	MSC105CVS	2-23/32	Tangent Mount	O-Ring
67488	4-1/4	Wire Lead	Reman	4 Groove	MSC105CVS	2-23/32	Tangent Mount	O-Ring
67489	4-1/4	Wire Lead	Reman	4 Groove	MSC105CVS	2-3/4	Tangent Mount	O-Ring
68461	3	Wire Lead	New	4 Groove	MSC105CVS	2-45/64	Tangent Mount	O-Ring
68474	3-3/4	Wire Lead	New	6 Groove	MSC105CVS	1-1/2	Tangent Mount	Sealing Washer
68489	4-1/4	Wire Lead	New	4 Groove	MSC105CVS	2-3/4	Tangent Mount	O-Ring
77400	3-11/16	Wire Lead	Reman	6 Groove	MSC105CVS	63/64	Tangent Mount	Sealing Washer
78400	3-5/16	Wire Lead	New	6 Groove	MSC105CVS		3 Ear & 1 Tangent	
67477	3-3/4	Wire Lead	Reman	6 Groove	MSC105CVSG1	1-45/64	Tangent Mount	Sealing Washer
68477	3-15/16	Wire Lead	New	6 Groove	MSC105CVSG1	1-45/64	1 Ear & 1 Tangent	Sealing Washer
68485	3-15/16	Wire Lead	New	6 Groove	MSC105CVSG1	2-43/64	Tangent Mount	O-Ring
97480	3-15/16	Wire Lead	Reman	6 Groove	MSC105CVSG2	1-1/64	Tangent Mount	Sealing Washer

# Compressors

Part No.	Pulley Dia.	Coil Clock	New / Reman	Groove	Type	Mount Dist to Groove Midpoint	Mount	Manifold
<b>Mitsubishi</b>								
97481	4-1/4	Wire Lead	Reman	6 Groove	MSC130CG1	1-33/64	Tangent Mount	Sealing Washer
67476	4	Wire Lead	Reman	6 Groove	MSC130CVSG	33/64	Tangent Mount	Sealing Washer
68476	4	Wire Lead	New	6 Groove	MSC130CVSG	33/64	Tangent Mount	Sealing Washer
77482	4	Wire Lead	Reman	6 Groove	MSC130CVSG	1-3/64	2 Ear & 2 Boss	Sealing Washer
78482	4	Wire Lead	New	6 Groove	MSC130CVSG	1-3/64	Tangent Mount	Sealing Washer
57488	3-3/4	Wire Lead	Reman	10 Groove	MSC90C	2-7/32	Tangent Mount	O-Ring
58488	3-3/4	Wire Lead	New	5 Groove	MSC90C	2-3/4	Tangent Mount	O-Ring
67491	4	Wire Lead	Reman	1 Groove	MSC90C	2-51/64	Tangent Mount	O-Ring
67492	3-5/8	Wire Lead	Reman	1 Groove	MSC90C	3	Tangent Mount	
68492	3-5/8	Wire Lead	New	1 Groove	MSC90C	3	Tangent Mount	O-Ring
77402	3-13/16	Wire Lead	Reman	4 Groove	MSC90C	2-45/64	Tangent Mount	O-Ring
77483	3-25/32	Wire Lead	Reman	5 Groove	MSC90C	1-13/64	Tangent Mount	O-Ring
77484	3-11/16	Wire Lead	Reman	6 Groove	MSC90C	1-13/64	Tangent Mount	O-Ring
77485	3-11/16	Wire Lead	Reman	6 Groove	MSC90C	1-13/64	Tangent Mount	O-Ring
77486	3-3/4	Wire Lead	Reman	4 Groove	MSC90C	1-3/32	Tangent Mount	O-Ring
77492	4-1/2	Wire Lead	Reman	6 Groove	MSC90C	1-11/64	Tangent Mount	O-Ring
77496	3-3/4	Wire Lead	Reman	5 Groove	MSC90C	2-11/16	Tangent Mount	O-Ring
78402	3-13/16	Wire Lead	New	4 Groove	MSC90C	2-45/64	Tangent Mount	O-Ring
78483	3-13/16	Wire Lead	New	5 Groove	MSC90C	1-13/64	Tangent Mount	O-Ring
78484	3-25/32	Wire Lead	New	6 Groove	MSC90C	1-13/64	Tangent Mount	O-Ring
78485	3-11/16	Wire Lead	New	6 Groove	MSC90C	1-13/64	Tangent Mount	O-Ring
78486	3-3/4	Wire Lead	New	4 Groove	MSC90C	1-3/32	Tangent Mount	O-Ring
78492	4-1/2	Wire Lead	New	6 Groove	MSC90C	1-11/64	Tangent Mount	O-Ring
78496	3-11/16	Wire Lead	New	5 Groove	MSC90C	2-11/16	Tangent Mount	O-Ring
97486	4-1/8	Wire Lead	Reman	6 Groove	MSC90CAS	25/32	Tangent Mount	Sealing Washer
97487	3-3/4	Wire Lead	Reman	6 Groove	MSC90CAS	25/32	Tangent Mount	O-Ring
98486	4-1/8	Wire Lead	New	6 Groove	MSC90CAS	25/32	Tangent Mount	O-Ring
98487	3-3/4	Wire Lead	New	6 Groove	MSC90CAS	39/50	Tangent Mount	O-Ring
168486	4-1/8		New	6 Groove	QS90		3 Tangent One on Rear Head	
97491	3-57/64	Wire Lead	Reman	6 Groove	QS90	13/16	Tangent Mount	O-Ring
98453	3-3/4	Wire Lead	New	4 Groove	QS90	1-1/8	Tangent Mount	Sealing Washer
98491	3-57/64	Wire Lead	New	6 Groove	QS90	13/16	Tangent Mount	O-Ring
57486			Reman		FX105V		Tangent Mount	O-Ring
<b>R4 Series</b>								
57219	5-3/32	12	Reman	1 Groove	R4 Heavy	2-13/32	Case Mount	O-Ring / Sealing Washer
57220	5	12	Reman	1 Groove	R4 Heavy	3-3/4	Case Mount	O-Ring / Sealing Washer
57221	5	12	Reman	1 Groove	R4 Heavy	1-13/64	Case Mount	O-Ring / Sealing Washer
57223	5	12	Reman	1 Groove	R4 Heavy	1-13/64	Case Mount	O-Ring / Sealing Washer
57225	5	12	Reman	1 Groove	R4 Heavy	1-13/64	Case Mount	O-Ring / Sealing Washer
57227	5	12	Reman	1 Groove	R4 Heavy	1-13/64	Case Mount	O-Ring / Sealing Washer
57228	5	9	Reman	1 Groove	R4 Heavy	1-13/64	Case Mount	O-Ring / Sealing Washer
57229	5	12	Reman	1 Groove	R4 Heavy	1-13/64	Case Mount	O-Ring / Sealing Washer
57231	5	12	Reman	1 Groove	R4 Heavy	1-13/64	Case Mount	O-Ring / Sealing Washer
58223	5	12	New	1 Groove	R4 Heavy	1-13/64	Case Mount	Block Mount
58228	5	9	New	1 Groove	R4 Heavy	1-13/64	Case Mount	O-Ring / Sealing Washer
58229	5	12	New	1 Groove	R4 Heavy	1-13/64	Case Mount	O-Ring / Sealing Washer
58231	5	12	New	1 Groove	R4 Heavy	1-13/64	Case Mount	O-Ring / Sealing Washer
67231	5-1/2	3	Reman	1 Groove	R4 Heavy	1-13/64	Case Mount	O-Ring

# Compressors

Part No.	Pulley Dia.	Coil Clock	New / Reman	Groove	Type	Mount Dist to Groove Midpoint	Mount	Manifold
57234	5-1/2	9	Reman	1 Groove	R4 Lightweight	1-1/2	Case Mount	O-Ring / Sealing Washer
57235	5-1/8	9	Reman	1 Groove	R4 Lightweight	1-1/2	Case Mount	O-Ring / Sealing Washer
57236	5-1/2	12	Reman	1 Groove	R4 Lightweight	1-13/64	Case Mount	O-Ring / Sealing Washer
57237	4-1/4	12	Reman	6 Groove	R4 Lightweight	55/64	Case Mount	O-Ring / Sealing Washer
57238	5	12	Reman	6 Groove	R4 Lightweight	55/64	Case Mount	O-Ring / Sealing Washer
57239	4-1/4	9	Reman	6 Groove	R4 Lightweight	55/64	Case Mount	O-Ring / Sealing Washer
57240	5-1/8	12	Reman	1 Groove	R4 Lightweight	1-1/2	Case Mount	O-Ring / Sealing Washer
57241	4-1/4	12	Reman	6 Groove	R4 Lightweight	55/64	Case Mount	O-Ring / Sealing Washer
57735	4-1/4	12	Reman	6 Groove	R4 Lightweight	55/64	Case Mount	O-Ring / Sealing Washer
57935	4-1/4	12	Reman	6 Groove	R4 Lightweight	55/64	Case Mount	Sealing Washer
57937	4-1/4	12	Reman	6 Groove	R4 Lightweight	55/64	Case Mount	Sealing Washer
57941	5	12	Reman	6 Groove	R4 Lightweight	55/64	Case Mount	Sealing Washer
57942	4-1/4	12	Reman	6 Groove	R4 Lightweight	55/64	Case Mount	Sealing Washer
57943	4-1/4	12	Reman	6 Groove	R4 Lightweight	55/64	Case Mount	Sealing Washer
57948	4-1/4	12	Reman	6 Groove	R4 Lightweight	55/64	Case Mount	Sealing Washer
58234	5-1/2	9	New	1 Groove	R4 Lightweight	1-1/2	Case Mount	O-Ring / Sealing Washer
58235	5-1/8	9	New	1 Groove	R4 Lightweight	1-1/2	Case Mount	O-Ring / Sealing Washer
58237	4-1/4	12	New	6 Groove	R4 Lightweight	55/64	Case Mount	O-Ring / Sealing Washer
58238	5	12	New	6 Groove	R4 Lightweight	55/64	Case Mount	O-Ring / Sealing Washer
58239	4-1/4	9	New	6 Groove	R4 Lightweight	55/64	Case Mount	O-Ring / Sealing Washer
58240	5-1/8	12	New	1 Groove	R4 Lightweight	1-1/2	Case Mount	O-Ring / Sealing Washer
58937	4-1/4	12	New	6 Groove	R4 Lightweight	55/64	Case Mount	Sealing Washer
58941	5	12	New	6 Groove	R4 Lightweight	55/64	Case Mount	Sealing Washer
58942	4-1/4	12	New	6 Groove	R4 Lightweight	55/64	Case Mount	Sealing Washer
58948	4-1/4	12	New	6 Groove	R4 Lightweight	55/64	Case Mount	Sealing Washer
67013	5	12	Reman	1 Groove	R4 Lightweight	1-13/64	Case Mount	Sealing Washer
67225	5	3	Reman	6 Groove	R4 Lightweight	55/64	Case Mount	O-Ring / Sealing Washer
68013	5	12	New	1 Groove	R4 Lightweight	1-13/64	Case Mount	Sealing Washer
68225	5	3	New	6 Groove	R4 Lightweight	55/64	Case Mount	Sealing Washer
68231	5-1/2	9	New	1 Groove	R4 Lightweight	1-13/64	Case Mount	Sealing Washer
57019			Reman		R4 Heavy		Case Mount	Block Mount
57054			Reman		R4 Heavy		Case Mount	O-Ring / Sealing Washer
57230			Reman		R4 Lightweight		Case Mount	O-Ring / Sealing Washer
57233			Reman		R4 Lightweight		Case Mount	
<b>Sanden</b>								
68157	4-59/64	Wire Lead	New	2 Groove	FLX7		Direct Mount	O-Ring
68158	4-11/16	Wire Lead	New	8 Groove	FLX7		Direct Mount	O-Ring
68159	4-59/64	Wire Lead	New	2 Groove	FLX7		Ear Mount	O-Ring
68160	4-59/64	Wire Lead	New	2 Groove	FLX7		Ear Mount	O-Ring
68161	4-11/16	Wire Lead	New	8 Groove	FLX7		Ear Mount	O-Ring
68162	4-11/16	Wire Lead	New	8 Groove	FLX7		Ear Mount	O-Ring
68163	6-7/32	Wire Lead	New	1 Groove	FLX7		Ear Mount	O-Ring
68164	6-7/32	Wire Lead	New	1 Groove	FLX7		Ear Mount	O-Ring
68165	4-59/64	Wire Lead	New	10 Groove	FLX7		Ear Mount	O-Ring
68166	4-11/16	Wire Lead	New	8 Groove	FLX7		Ear Mount	O-Ring



# Compressors

Part No.	Pulley Dia.	Coil Clock	New / Reman	Groove	Type	Mount Dist to Groove Midpoint	Mount	Manifold
<b>Sanden</b>								
68167	5-7/16	Wire Lead	New	1 Groove	FLX7		Ear Mount	O-Ring
68168	5-7/16	Wire Lead	New	1 Groove	FLX7		Ear Mount	O-Ring
68169	5-63/64	Wire Lead	New	2 Groove	FLX7		Ear Mount	O-Ring
68170	5-3/16	Wire Lead	New	2 Groove	FLX7		Ear Mount	O-Ring
68171	5-3/16	Wire Lead	New	2 Groove	FLX7		Ear Mount	O-Ring
98585	4-17/32	Wire Lead	New	6 Groove	PXC14		Tangent Mount	O-Ring
98244	4-23/32	Wire Lead	New	6 Groove	PXC16		3 Tangent One on Rear Head	
98245	4-23/32	Wire Lead	New	5 Groove	PXC16		3 Tangent One on Rear Head	
98586	4-23/32	Wire Lead	New	6 Groove	PXC16	13/16	3 Tangent	Sealing Washer
167646	4-5/16	N/R	Reman	6 Groove	PXE16	1-15/64	Tangent Mount	O-Ring
168646	4-5/16	N/R	New	6 Groove	PXE16	1-15/64	Tangent Mount	O-Ring
197567	4-3/8	Wire Lead	Reman	10 Groove	PXE16	63/64	Tangent Mount	O-Ring
198567	4-3/8	Wire Lead	New	10 Groove	PXE16	63/64	Tangent Mount	O-Ring
67565	4-23/32	Wire Lead	Reman	6 Groove	PXE16	1-19/64	Tangent Mount	Sealing Washer
68565	4-23/32	Wire Lead	New	6 Groove	PXE16	1-19/64	Tangent Mount	Sealing Washer
97565	4-1/4	Wire Lead	Reman	6 Groove	PXE16	1-19/64	Tangent Mount	Sealing Washer
97573	4-21/64		Reman	6 Groove	PXE16	23/32	Tangent Mount	
98565	4-21/32	Wire Lead	New	6 Groove	PXE16	1-1/64	Tangent Mount	Sealing Washer
98587	4-17/32	Wire Lead	New	6 Groove	PXV14	1-25/64	Tangent Mount	O-Ring
57578	4-3/4	Wire Lead	Reman	6 Groove	PXV16	1-13/64	Tangent Mount	O-Ring
58578	4-3/4	Wire Lead	New	6 Groove	PXV16	1-13/64	Tangent Mount	O-Ring
97552	4-11/16	Wire Lead	Reman	5 Groove	PXV16	1-15/64	Tangent Mount	Sealing Washer
97556	4-3/4	Wire Lead	Reman	5 Groove	PXV16	1-15/64	Tangent Mount	Sealing Washer
97563	4-3/4	Wire Lead	Reman	5 Groove	PXV16	1-15/64	Tangent Mount	Sealing Washer
97566	4-11/16	Wire Lead	Reman	6 Groove	PXV16	1-15/64	Tangent Mount	O-Ring
97567	4-3/8	Wire Lead	Reman	10 Groove	PXV16	1	Tangent Mount	O-Ring
97570	4-5/16	Wire Lead	Reman	6 Groove	PXV16	49/64	Tangent Mount	O-Ring
97571	4-3/4	Wire Lead	Reman	6 Groove	PXV16	1-13/64	Tangent Mount	Sealing Washer
98552	4-15/16	Wire Lead	New	5 Groove	PXV16	1-15/64	Tangent Mount	Sealing Washer
98556	4-3/4	Wire Lead	New	5 Groove	PXV16	1-15/64	Tangent Mount	Sealing Washer
98563	4-3/4	Wire Lead	New	5 Groove	PXV16	1-15/64	Tangent Mount	O-Ring
98570	4-5/16	Wire Lead	New	6 Groove	PXV16	49/64	Tangent Mount	O-Ring
98571	4-3/4	Wire Lead	New	6 Groove	PXV16	1-13/64	Tangent Mount	Sealing Washer
158584	4-29/32	Wire Lead	New	2 Groove	SD505	55/64	Ear Mount	O-Ring
158587	4-29/32	Wire Lead	New	2 Groove	SD505	53/64	Ear Mount	O-Ring
58542	4-7/8	Wire Lead	New	2 Groove	SD505	51/64	Ear Mount	O-Ring
57577	5-1/4	Wire Lead	Reman	2 Groove	SD507	1-5/32	Ear Mount	O-Ring
57622	5-1/4	Wire Lead	Reman	2 Groove	SD507	29/64	Ear Mount	O-Ring
58567	4-7/8	Wire Lead	New	2 Groove	SD507	1-1/8	Ear Mount	O-Ring
58568	4-7/8	Wire Lead	New	2 Groove	SD507	1-1/8	Ear Mount	O-Ring
77551	6	Wire Lead	Reman	1 Groove	SD507	1-5/32	Ear Mount	O-Ring
57033	5-1/4	Wire Lead	Reman	2 Groove	SD508	61/64	Ear Mount	O-Ring
57113	5-1/8	Wire Lead	Reman	2 Groove	SD508	61/64	Ear Mount	O-Ring
57508	5	Wire Lead	Reman	10 Groove	SD508	3/4	Ear Mount	O-Ring
57551	5-1/4	Wire Lead	Reman	2 Groove	SD508	61/64	Ear Mount	O-Ring
57580	4-3/4	Wire Lead	Reman	6 Groove	SD508	1-1/4	Ear Mount	O-Ring
57585	5	Wire Lead	Reman	1 Groove	SD508	1-29/64	Ear Mount	O-Ring
57594	5-1/4	Wire Lead	Reman	2 Groove	SD508	21/32	Ear Mount	O-Ring
57658	4-3/4	Wire Lead	Reman	6 Groove	SD508	61/64	Ear Mount	O-Ring
58033	5-1/4	Wire Lead	New	2 Groove	SD508	61/64	Ear Mount	O-Ring
58113	5-1/8	Wire Lead	New	2 Groove	SD508	61/64	Ear Mount	O-Ring
58541	4-7/8	Wire Lead	New	2 Groove	SD508	1-1/4	Ear Mount	O-Ring
58548	5-1/8	Wire Lead	New	2 Groove	SD508	61/64	Ear Mount	O-Ring
58551	5-1/4	Wire Lead	New	2 Groove	SD508	61/64	Ear Mount	O-Ring
58561	6	Wire Lead	New	2 Groove	SD508	61/64	Ear Mount	O-Ring
58580	4-3/4	Wire Lead	New	6 Groove	SD508	1-1/4	Ear Mount	O-Ring
58587	5-1/8	Wire Lead	New	2 Groove	SD508	61/64	Ear Mount	O-Ring
58588	5-1/8	Wire Lead	New	2 Groove	SD508	61/64	Ear Mount	O-Ring
58589	4-3/4	Wire Lead	New	7 Groove	SD508	61/64	Ear Mount	O-Ring
58638	5	Wire Lead	New	1 Groove	SD508	2-11/32	Ear Mount	O-Ring
67598	5-1/2	Wire Lead	Reman	1 Groove	SD508	1-35/64	Ear Mount	O-Ring

# Compressors

Part No.	Pulley Dia.	Coil Clock	New / Reman	Groove	Type	Mount Dist to Groove Midpoint	Mount	Manifold
<b>Sanden</b>								
57547	5-1/4	Wire Lead	Reman	2 Groove	SD508HD	61/64	Ear Mount	O-Ring
58547	5-1/4	Wire Lead	New	2 Groove	SD508HD	61/64	Ear Mount	O-Ring
58554	5-1/8	Wire Lead	New	2 Groove	SD508HD	61/64	Ear Mount	O-Ring
78550	5-1/16	Wire Lead	New	2 Groove	SD508HD	61/64	Ear Mount	O-Ring
57586	5-1/2	Wire Lead	Reman	1 Groove	SD510	1	Ear Mount	O-Ring
58557	5-1/8	Wire Lead	New	2 Groove	SD510	61/64	Ear Mount	O-Ring
58590	5-1/4	Wire Lead	New	2 Groove	SD510	61/64	Ear Mount	O-Ring
58787	5-11/64	Wire Lead	New	2 Groove	SD510	29/32	Ear Mount	O-Ring
57034	6-1/4	Wire Lead	Reman	1 Groove	SD510HD	1-1/2	Ear Mount	O-Ring
57035	5-1/4	Wire Lead	Reman	2 Groove	SD510HD	61/64	Ear Mount	O-Ring
57559	5-1/8	Wire Lead	Reman	2 Groove	SD510HD	61/64	Ear Mount	O-Ring
58034	6-1/4	Wire Lead	New	1 Groove	SD510HD	1-1/2	Ear Mount	O-Ring
58035	5-1/4	Wire Lead	New	2 Groove	SD510HD	61/64	Ear Mount	O-Ring
58507	5-1/8	Wire Lead	New	2 Groove	SD510HD	61/64	Ear Mount	O-Ring
58545	5-1/8	Wire Lead	New	2 Groove	SD510HD	61/64	Ear Mount	O-Ring
58546	5-5/8	Wire Lead	New	6 Groove	SD510HD	61/64	Ear Mount	O-Ring
58559	5-1/8	Wire Lead	New	2 Groove	SD510HD	61/64	Ear Mount	O-Ring
58640	6-1/4	Wire Lead	New	1 Groove	SD510HD	1-35/64	Ear Mount	O-Ring
58641	6-1/4	Wire Lead	New	1 Groove	SD510HD	1-35/64	Ear Mount	O-Ring
98572	4-5/8	Wire Lead	New	8 Groove	SD510HD	1-9/64	Tangent Mount	O-Ring
158585	4-29/32	Wire Lead	New	2 Groove	SD5H11	1-1/8	Ear Mount	O-Ring
58591	4-5/8	Wire Lead	New	2 Groove	SD5H14	61/64	Ear Mount	O-Ring
58592	4-5/8	Wire Lead	New	7 Groove	SD5H14	1	Ear Mount	O-Ring
58646	6-1/4	Wire Lead	New	1 Groove	SD5H14	1-35/64	Ear Mount	O-Ring
58649	6-1/8	Wire Lead	New	1 Groove	SD5H14	1-35/64	Ear Mount	O-Ring
58650	4-7/8	Wire Lead	New	10 Groove	SD5H14	3/4	Ear Mount	O-Ring
58666	5-1/8	Wire Lead	New	2 Groove	SD5H14	61/64	Ear Mount	O-Ring
78557	5-1/8	Wire Lead	New	2 Groove	SD5H14	61/64	Ear Mount	O-Ring
97581	4-11/16	Wire Lead	Reman	6 Groove	SD6V12	1-1/8	Tangent Mount	O-Ring
98549	4-921/1000	Wire Lead	New	6 Groove	SD6V12		Tangent Mount	
98581	4-11/16	Wire Lead	New	6 Groove	SD6V12	1-1/8	Tangent Mount	O-Ring
98583	4-9/32	Wire Lead	New	6 Groove	SD6V12		Ear Mount	
98589	3-59/64	Wire Lead	New	6 Groove	SD6V12	1-35/64	3 Tangent One on Rear Head	
57574	5	Wire Lead	Reman	1 Groove	SD708	1-1/4	Tangent Mount	O-Ring
57575	5	Wire Lead	Reman	1 Groove	SD708	1-35/64	Tangent Mount	O-Ring
57579	5	Wire Lead	Reman	6 Groove	SD708	1-21/32	Tangent Mount	O-Ring
57583	5	Wire Lead	Reman	1 Groove	SD708	1-29/64	Ear Mount	O-Ring
57584	5	Wire Lead	Reman	1 Groove	SD708	1-29/64	Ear Mount	O-Ring
67599	4-7/8	Wire Lead	Reman	1 Groove	SD708	1-3/4	Ear Mount	O-Ring
77581	5-1/4	Wire Lead	Reman	1 Groove	SD708	1-35/64	Tangent Mount	O-Ring
57552	4-7/8	Wire Lead	Reman	2 Groove	SD709	61/64	Ear Mount	O-Ring
57555	4-3/4	Wire Lead	Reman	6 Groove	SD709	1-13/32	Tangent Mount	O-Ring
57560	5-1/2	Wire Lead	Reman	1 Groove	SD709	2-3/64	Tangent Mount	O-Ring
57563	5-1/2	Wire Lead	Reman	1 Groove	SD709	1-35/64	Ear Mount	O-Ring
57581	4-55/64	Wire Lead	Reman	6 Groove	SD709	1-45/64	Tangent Mount	O-Ring
57590	5-1/8	Wire Lead	Reman	2 Groove	SD709	21/32	Ear Mount	O-Ring
57593	5-1/4	Wire Lead	Reman	2 Groove	SD709	21/32	Ear Mount	O-Ring
57632	4-11/16	Wire Lead	Reman	6 Groove	SD709	1-17/64	Tangent Mount	O-Ring
58552	4-7/8	Wire Lead	New	2 Groove	SD709	61/64	Ear Mount	O-Ring
58555	4-3/4	Wire Lead	New	6 Groove	SD709	1-13/32	Tangent Mount	O-Ring
58581	4-55/64	Wire Lead	New	6 Groove	SD709	1-45/64	Tangent Mount	O-Ring
58593	5-1/4	Wire Lead	New	2 Groove	SD709	21/32	Ear Mount	O-Ring
58632	4-11/16	Wire Lead	New	6 Groove	SD709	1-17/64	Tangent Mount	O-Ring
67550	4-3/4	Wire Lead	Reman	6 Groove	SD709	1-29/64	Tangent Mount	O-Ring
67551	4-3/4	Wire Lead	Reman	6 Groove	SD709	1-29/64	Tangent Mount	O-Ring
67558	5-1/4	Wire Lead	Reman	6 Groove	SD709	1-11/32	Tangent Mount	O-Ring
67559	5-1/8	Wire Lead	Reman	2 Groove	SD709	1-13/64	Ear Mount	O-Ring
67575	4-3/4	Wire Lead	Reman	5 Groove	SD709	1-19/32	Tangent Mount	O-Ring
68550	4-3/4	Wire Lead	New	6 Groove	SD709	1-29/64	Tangent Mount	O-Ring
68551	4-3/4	Wire Lead	New	6 Groove	SD709	1-29/64	Tangent Mount	O-Ring
68559	5-1/8	Wire Lead	New	2 Groove	SD709	1-13/64	Ear Mount	O-Ring
77546	5-1/16	Wire Lead	Reman	5 Groove	SD709	45/64	Tangent Mount	O-Ring

# Compressors

Part No.	Pulley Dia.	Coil Clock	New / Reman	Groove	Type	Mount Dist to Groove Midpoint	Mount	Manifold
<b>Sanden</b>								
77582	5-1/8	Wire Lead	Reman	2 Groove	SD709	61/64	Ear Mount	O-Ring
77583	4-3/4	Wire Lead	Reman	8 Groove	SD709	55/64	Ear Mount	O-Ring
77589	5-1/8	Wire Lead	Reman	1 Groove	SD709	1-35/64	Ear Mount	O-Ring
77591	5-1/4	Wire Lead	Reman	2 Groove	SD709	61/64	Ear Mount	O-Ring
77594	4-3/4	Wire Lead	Reman	8 Groove	SD709	55/64	Tangent Mount	O-Ring
78546	4-11/16	Wire Lead	New	5 Groove	SD709	45/64	Tangent Mount	O-Ring
78589	5-1/8	Wire Lead	New	1 Groove	SD709	1-35/64	Ear Mount	O-Ring
78594	4-3/4	Wire Lead	New	8 Groove	SD709	55/64	Tangent Mount	O-Ring
98575	5	Wire Lead	New	5 Groove	SD709	1-19/32	Tangent Mount	O-Ring
98590	5-1/4	Wire Lead	New	2 Groove	SD709	21/32	Ear Mount	O-Ring
168511	4-33/64	Wire Lead	New	2 Groove	SD7B10	1-3/32	Ear Mount	O-Ring
168515	4-13/32	Wire Lead	New	6 Groove	SD7B10	1	Tangent Mount	O-Ring
67572	4-3/4	Wire Lead	Reman	4 Groove	SD7B10	1-5/32	Ear Mount	O-Ring
67573	4	Wire Lead	Reman	4 Groove	SD7B10	1-5/32	Ear Mount	O-Ring
68572	4-3/4	Wire Lead	New	4 Groove	SD7B10	1-5/32	Ear Mount	O-Ring
68573	4	Wire Lead	New	4 Groove	SD7B10	1-5/32	Ear Mount	O-Ring
68362	4-7/8	Wire Lead	New	6 Groove	SD7B15	1-45/64	Ear Mount	Pad Mount
158570	4-11/16	Wire Lead	New	6 Groove	SD7H13	1-1/8	Ear Mount	O-Ring
168522	4-29/32	Wire Lead	New	1 Groove	SD7H13	1-59/64	Tangent Mount	O-Ring
158500	5-1/2	Wire Lead	New	1 Groove	SD7H15	1-1/2	Ear Mount	O-Ring
158502	5	Wire Lead	New	7 Groove	SD7H15	1-29/64	Tangent Mount	O-Ring
158505	5-1/2	Wire Lead	New	8 Groove	SD7H15	1-7/16	Tangent Mount	Sealing Washer
158533	4-11/16	2 Wire Lead	New	12 Groove	SD7H15	15/16	Tangent Mount	
158534	4-689/1000	Wire Lead	New	8 Groove	SD7H15	15/16	Tangent Mount	O-Ring
158552	4-5/8	Wire Lead	New	8 Groove	SD7H15	53/64	Ear Mount	O-Ring
158554	5-1/4	Wire Lead	New	2 Groove	SD7H15	1-5/32	Tangent Mount	O-Ring
158555	4-3/4	Wire Lead	New	8 Groove	SD7H15	55/64	Tangent Mount	O-Ring
158566	5-1/8	Wire Lead	New	6 Groove	SD7H15	1-27/32	Tangent Mount	Sealing Washer
158567	4-11/16	Wire Lead	New	7 Groove	SD7H15	45/64	Tangent Mount	Sealing Washer
158568	5-1/2	Wire Lead	New	8 Groove	SD7H15		Tangent Mount	O-Ring
158569	4-11/16	Wire Lead	New	8 Groove	SD7H15	1-1/64	Tangent Mount	O-Ring
158571	4-11/16	Wire Lead	New	8 Groove	SD7H15	1-5/32	Tangent Mount	O-Ring
158572	4-59/64	Wire Lead	New	6 Groove	SD7H15	1-5/32	Tangent Mount	O-Ring
158573	4-11/16	Wire Lead	New	8 Groove	SD7H15	1-5/32	Tangent Mount	O-Ring
158574	4-11/16	Wire Lead	New	8 Groove	SD7H15	11/16	Tangent Mount	O-Ring
158575	5-7/16	Wire Lead	New	1 Groove	SD7H15	1-53/64	Tangent Mount	O-Ring
158576	4-59/64	Wire Lead	New	6 Groove	SD7H15	1-5/32	Tangent Mount	O-Ring
158577	5-63/64	Wire Lead	New	2 Groove	SD7H15	1	Ear Mount	O-Ring
158578	4-59/64	Wire Lead	New	6 Groove	SD7H15	1-5/32	Tangent Mount	O-Ring
158579	4-59/64	Wire Lead	New	6 Groove	SD7H15	1-5/32	Tangent Mount	O-Ring
158580	4-3/4	Wire Lead	New	1 Groove	SD7H15	1-47/64	Tangent Mount	O-Ring
158581	5-15/64	Wire Lead	New	8 Groove	SD7H15	1-11/64	Tangent Mount	O-Ring
158582	5-3/16	Wire Lead	New	2 Groove	SD7H15	1	Ear Mount	O-Ring
158583	4-19/32	Wire Lead	New	8 Groove	SD7H15	55/64	Ear Mount	O-Ring
158586	4-11/16	Wire Lead	New	10 Groove	SD7H15	1-5/32	Tangent Mount	O-Ring
158588	5-63/64	Wire Lead	New	2 Groove	SD7H15	61/64	Ear Mount	O-Ring
158589	6-63/64	Wire Lead	New	8 Groove	SD7H15	27/32	Tangent Mount	O-Ring
158590	4-59/64	Wire Lead	New	2 Groove	SD7H15	1-5/32	Tangent Mount	O-Ring
158591	5-13/64	Wire Lead	New	2 Groove	SD7H15	1-1/4	Tangent Mount	Sealing Washer
158592	4-11/16	Wire Lead	New	8 Groove	SD7H15	45/64	Tangent Mount	O-Ring
158593	5-15/64	Wire Lead	New	8 Groove	SD7H15	55/64	Ear Mount	O-Ring
158594	5-13/64	Wire Lead	New	8 Groove	SD7H15	55/64	Ear Mount	O-Ring
158595	4-13/32	Wire Lead	New	4 Groove	SD7H15	1-3/4	Tangent Mount	O-Ring
158596	5-3/16	Wire Lead	New	2 Groove	SD7H15	61/64	Ear Mount	O-Ring
158597	4-61/64	Wire Lead	New	10 Groove	SD7H15	1-3/64	Tangent Mount	O-Ring
158598	4-11/16	Wire Lead	New	8 Groove	SD7H15	1-7/64	Tangent Mount	O-Ring
158599	4-11/16	Wire Lead	New	8 Groove	SD7H15	1-5/32	Tangent Mount	O-Ring
168500	4-61/64	Wire Lead	New	7 Groove	SD7H15	1-3/64	Tangent Mount	O-Ring
168501	4-11/16	Wire Lead	New	8 Groove	SD7H15	1	Ear Mount	O-Ring
168502	4-11/16	Wire Lead	New	8 Groove	SD7H15	1-5/32	Tangent Mount	O-Ring
168503	4-61/64	Wire Lead	New	10 Groove	SD7H15	1-7/16	Tangent Mount	O-Ring
168504	4-61/64	Wire Lead	New	10 Groove	SD7H15	1-15/64	Tangent Mount	O-Ring
168505	4-11/16	Wire Lead	New	8 Groove	SD7H15	1-5/16	Tangent Mount	Sealing Washer



# Compressors

Part No.	Pulley Dia.	Coil Clock	New / Reman	Groove	Type	Mount Dist to Groove Midpoint	Mount	Manifold
<b>Sanden</b>								
168506	4-61/64	Wire Lead	New	10 Groove	SD7H15	1-1/8	Tangent Mount	Sealing Washer
168507	4-59/64	Wire Lead	New	10 Groove	SD7H15	23/32	Ear Mount	O-Ring
168508	4-61/64	Wire Lead	New	12 Groove	SD7H15	1-5/16	Tangent Mount	O-Ring
168509	4-61/64	Wire Lead	New	12 Groove	SD7H15	1-1/32	Tangent Mount	Sealing Washer
168510	4-61/64	Wire Lead	New	12 Groove	SD7H15	1-3/64	Tangent Mount	O-Ring
168512	4-29/32	Wire Lead	New	6 Groove	SD7H15	1-3/32	Ear Mount	O-Ring
168513	4-61/64	Wire Lead	New	12 Groove	SD7H15	1-5/16	Tangent Mount	O-Ring
168514	4-23/64	Wire Lead	New	4 Groove	SD7H15	15/16	Tangent Mount	O-Ring
168516	4-61/64	Wire Lead	New	12 Groove	SD7H15	7/16	Tangent Mount	O-Ring
168518	4-11/16	Wire Lead	New	8 Groove	SD7H15	1-3/64	Tangent Mount	O-Ring
168519	4-59/64	Wire Lead	New	6 Groove	SD7H15	1-1/32	Tangent Mount	O-Ring
168520	4-11/16	Wire Lead	New	8 Groove	SD7H15	1-7/64	Tangent Mount	Sealing Washer
168523	4-59/64	Wire Lead	New	2 Groove	SD7H15	1-33/64	Ear Mount	O-Ring
168525	4-11/16	Wire Lead	New	8 Groove	SD7H15	1-7/16	Tangent Mount	O-Ring
168526	4-15/16	Wire Lead	New	6 Groove	SD7H15	1-1/2	Tangent Mount	O-Ring
168527	4-29/32	Wire Lead	New	6 Groove	SD7H15	1-15/32	Tangent Mount	O-Ring
168528	4-11/16	Wire Lead	New	8 Groove	SD7H15	1-25/64	Tangent Mount	O-Ring
168529	4-11/16	Wire Lead	New	8 Groove	SD7H15	1-29/64	Tangent Mount	Sealing Washer
168530	6-29/32	Wire Lead	New	8 Groove	SD7H15	1-15/64	Tangent Mount	O-Ring
168531	4-11/16	Wire Lead	New	8 Groove	SD7H15		Tangent Mount	
168532	5	Wire Lead	New	10 Groove	SD7H15	1-29/64	Tangent Mount	O-Ring / Gasket
168533	4-61/64	Wire Lead	New	12 Groove	SD7H15	1-7/16	Tangent Mount	O-Ring/ Gasket
168534	5-1/4	Wire Lead	New	8 Groove	SD7H15	1-3/64	Tangent Mount	O-Ring
168537	4-11/16	Wire Lead	New	8 Groove	SD7H15	1-1/8	Tangent Mount	O-Ring
168538	4-11/16	Wire Lead	New	8 Groove	SD7H15	1-1/8	Tangent Mount	
168539	4-23/32	Wire Lead	New	10 Groove	SD7H15	1-5/64	Tangent Mount	
168540	4-11/16	Wire Lead	New	8 Groove	SD7H15		Tangent Mount	
168541	5-1/2	Wire Lead	New	8 Groove	SD7H15	1-5/32	Tangent Mount	
168582	4-11/16	Wire Lead	New	8 Groove	SD7H15	1-7/16	Tangent Mount	O-Ring
57553	5-1/8	Wire Lead	Reman	7 Groove	SD7H15	1-3/64	Tangent Mount	Sealing Washer
57595	4-3/4	Wire Lead	Reman	6 Groove	SD7H15	1-11/64	Ear Mount	Sealing Washer
58553	5-1/8	Wire Lead	New	7 Groove	SD7H15	1-3/64	Tangent Mount	Sealing Washer
58595	4-3/4	Wire Lead	New	6 Groove	SD7H15	1-11/64	Ear Mount	O-Ring
58596	5-7/64	Wire Lead	New	6 Groove	SD7H15	1-3/32	Tangent Mount	O-Ring
58642	5-1/8	Wire Lead	New	2 Groove	SD7H15	61/64	Ear Mount	O-Ring
58700	4-7/8	Wire Lead	New	2 Groove	SD7H15	61/64	Ear Mount	O-Ring
58701	5-1/8	Wire Lead	New	2 Groove	SD7H15	61/64	Ear Mount	O-Ring
58702	4-3/4	Wire Lead	New	8 Groove	SD7H15	1-3/32	Tangent Mount	O-Ring
58703	4-3/4	Wire Lead	New	8 Groove	SD7H15	55/64	Ear Mount	O-Ring
58704	5-1/8	Wire Lead	New	2 Groove	SD7H15	61/64	Ear Mount	O-Ring
58705	5-1/8	Wire Lead	New	2 Groove	SD7H15	61/64	Ear Mount	O-Ring
58706	4-3/4	Wire Lead	New	8 Groove	SD7H15	55/64	Ear Mount	O-Ring
58707	5-1/4	Wire Lead	New	2 Groove	SD7H15	1-5/32	Tangent Mount	O-Ring
58708	4-7/8	Wire Lead	New	6 Groove	SD7H15	1-3/32	Tangent Mount	O-Ring
58709	4-7/8	Wire Lead	New	6 Groove	SD7H15	1-3/32	Tangent Mount	O-Ring
58710	4-3/4	Wire Lead	New	8 Groove	SD7H15	1-3/32	Tangent Mount	O-Ring
58711	4-3/4	Wire Lead	New	7 Groove	SD7H15	1	Ear Mount	O-Ring
58740	4-5/8	Wire Lead	New	8 Groove	SD7H15	51/64	Ear Mount	O-Ring
58768	5-1/2	Wire Lead	New	1 Groove	SD7H15	1-1/2	Ear Mount	O-Ring
58770	4-7/8	Wire Lead	New	2 Groove	SD7H15	51/64	Ear Mount	O-Ring
58778	5-1/4	Wire Lead	New	8 Groove	SD7H15	1	Tangent Mount	O-Ring
58779	5-1/2	Wire Lead	New	8 Groove	SD7H15	51/64	Ear Mount	O-Ring
58780	4-5/8	Wire Lead	New	8 Groove	SD7H15	51/64	Ear Mount	O-Ring
58781	5-11/64	Wire Lead	New	8 Groove	SD7H15	51/64	Ear Mount	O-Ring
58782	4-5/8	Wire Lead	New	8 Groove	SD7H15	51/64	Ear Mount	O-Ring
58783	5-1/4	Wire Lead	New	8 Groove	SD7H15	1	Tangent Mount	O-Ring
58784	4-11/16	Wire Lead	New	8 Groove	SD7H15	1	Tangent Mount	O-Ring
58785	4-5/8	Wire Lead	New	8 Groove	SD7H15	1	Tangent Mount	O-Ring
58786	4-11/16	Wire Lead	New	8 Groove	SD7H15	1	Tangent Mount	Sealing Washer
58788	5-3/16	Wire Lead	New	2 Groove	SD7H15	15/16	Ear Mount	Sealing Washer
58789	5-1/4	Wire Lead	New	2 Groove	SD7H15	29/32	Ear Mount	O-Ring
58790	5-7/8	Wire Lead	New	8 Groove	SD7H15	1-3/32	Tangent Mount	O-Ring
58791	6	Wire Lead	New	2 Groove	SD7H15	29/32	Ear Mount	O-Ring

# Compressors

Part No.	Pulley Dia.	Coil Clock	New / Reman	Groove	Type	Mount Dist to Groove Midpoint	Mount	Manifold
<b>Sanden</b>								
58792	5-7/8	Wire Lead	New	8 Groove	SD7H15	1-3/32	Tangent Mount	O-Ring
58793	4-11/16	Wire Lead	New	8 Groove	SD7H15	1	Tangent Mount	O-Ring
58794	5-11/64	Wire Lead	New	2 Groove	SD7H15	1	Tangent Mount	O-Ring
58796	4-5/8	Wire Lead	New	8 Groove	SD7H15	1	Tangent Mount	O-Ring
58797	4-13/16	Wire Lead	New	6 Groove	SD7H15	1	Tangent Mount	Sealing Washer
58798	6	Wire Lead	New	8 Groove	SD7H15	1	Tangent Mount	O-Ring
58799	4-7/8	Wire Lead	New	6 Groove	SD7H15	1	Tangent Mount	O-Ring
67557	5-1/4	Wire Lead	Reman	6 Groove	SD7H15	1-13/32	Tangent Mount	O-Ring
67574	5	Wire Lead	Reman	6 Groove	SD7H15	1-11/32	Ear Mount	O-Ring
67576	5-1/8	Wire Lead	Reman	6 Groove	SD7H15	2-3/32	Tangent Mount	P-Nut Fitting
67589	4-3/4	Wire Lead	Reman	8 Groove	SD7H15	29/32	Tangent Mount	O-Ring
67594	4-7/8	Wire Lead	Reman	2 Groove	SD7H15	61/64	Ear Mount	Sealing Washer
68574	4-3/4	Wire Lead	New	6 Groove	SD7H15	1-11/32	Ear Mount	O-Ring
68575	4-3/4	Wire Lead	New	8 Groove	SD7H15	1-3/32	Tangent Mount	O-Ring
68576	5-1/8	Wire Lead	New	2 Groove	SD7H15	61/64	Ear Mount	O-Ring
68577	6-5/8	Wire Lead	New	1 Groove	SD7H15	1-13/64	Tangent Mount	O-Ring
68578	4-3/4	Wire Lead	New	8 Groove	SD7H15	55/64	Ear Mount	O-Ring
68589	4-3/4	Wire Lead	New	8 Groove	SD7H15	29/32	Tangent Mount	Sealing Washer
68594	4-7/8	Wire Lead	New	2 Groove	SD7H15	61/64	Ear Mount	O-Ring
77558	5-1/16	Wire Lead	Reman	6 Groove	SD7H15	25/32	Tangent Mount	Sealing Washer
77562	5-1/8	Wire Lead	Reman	7 Groove	SD7H15	1-3/64	Tangent Mount	Sealing Washer
77578	5-1/4	Wire Lead	Reman	6 Groove	SD7H15	2-3/32	Tangent Mount	O-Ring
77580	5-13/64	Wire Lead	Reman	1 Groove	SD7H15	1-45/64	Ear Mount	O-Ring
77584	5-1/4	Wire Lead	Reman	1 Groove	SD7H15	1-21/32	Tangent Mount	Sealing Washer
78551	6	Wire Lead	New	2 Groove	SD7H15	61/64	Ear Mount	O-Ring
78553	5	Wire Lead	New	2 Groove	SD7H15	61/64	Ear Mount	O-Ring
78556	5-1/2	Wire Lead	New	1 Groove	SD7H15	1-35/64	Ear Mount	O-Ring
78558	5-1/8	Wire Lead	New	6 Groove	SD7H15	25/32	Tangent Mount	O-Ring
78559	4-7/8	Wire Lead	New	2 Groove	SD7H15	61/64	Ear Mount	O-Ring
78562	5-1/8	Wire Lead	New	7 Groove	SD7H15	1-3/64	Tangent Mount	Sealing Washer
78565	4-3/4	Wire Lead	New	8 Groove	SD7H15	55/64	Ear Mount	O-Ring
78567	5-1/4	Wire Lead	New	8 Groove	SD7H15	55/64	Ear Mount	O-Ring
78578	5-1/4	Wire Lead	New	6 Groove	SD7H15	2-3/32	Tangent Mount	O-Ring
78584	5-1/4	Wire Lead	New	1 Groove	SD7H15	1-21/32	Tangent Mount	Sealing Washer
78595	4-11/16	Wire Lead	New	6 Groove	SD7H15	1-3/32	Tangent Mount	O-Ring
78596	4-3/4	Wire Lead	New	6 Groove	SD7H15	1-27/64	Ear Mount	O-Ring
78597	4-3/4	Wire Lead	New	7 Groove	SD7H15	1	Ear Mount	O-Ring
97550	5-9/16	Wire Lead	Reman	6 Groove	SD7H15	1-3/32	Tangent Mount	O-Ring
97551	4-15/16	Wire Lead	Reman	2 Groove	SD7H15	15/16	Ear Mount	O-Ring
98550	3-7/8	Wire Lead	New	6 Groove	SD7H15	1-3/32	Tangent Mount	O-Ring
98551	5-9/16	Wire Lead	New	2 Groove	SD7H15	15/16	Ear Mount	O-Ring
98576	5-1/8	Wire Lead	New	6 Groove	SD7H15	2-3/32	Tangent Mount	Sealing Washer
98593	5-7/64	Wire Lead	New	8 Groove	SD7H15	55/64	Tangent Mount	O-Ring
98594	5-3/16	Wire Lead	New	2 Groove	SD7H15	61/64	Tangent Mount	O-Ring
98595	5-3/16	Wire Lead	New	2 Groove	SD7H15	61/64	Ear Mount	O-Ring
98596	5-7/64	Wire Lead	New	6 Groove	SD7H15	63/64	Tangent Mount	Sealing Washer
98597	5-3/16	Wire Lead	New	6 Groove	SD7H15	61/64	Tangent Mount	O-Ring
98598	5-7/64	Wire Lead	New	6 Groove	SD7H15	1-1/8	Tangent Mount	O-Ring
98599	5-7/64	Wire Lead	New	8 Groove	SD7H15	1-3/32	Tangent Mount	O-Ring
57591	5-1/8	Wire Lead	Reman	6 Groove	SD7V16	1-13/32	Ear Mount	O-Ring
57592	4-3/4	Wire Lead	Reman	7 Groove	SD7V16	1-19/64	Ear Mount	O-Ring
77554	4-3/4	Wire Lead	Reman	6 Groove	SD7V16	1-29/64	Ear Mount	O-Ring
77555	4-3/4	Wire Lead	Reman	7 Groove	SD7V16	1-19/64	Ear Mount	O-Ring
78541	3-3/4	Wire Lead	New	6 Groove	SD7V16	1-13/32	Ear Mount	O-Ring
78543	4-3/4	Wire Lead	New	7 Groove	SD7V16	1-19/64	Ear Mount	O-Ring
97558	5-3/4	Wire Lead	Reman	5 Groove	SD7V16	1-3/16	Tangent Mount	Sealing Washer
98591	4-5/8	Wire Lead	New	6 Groove	SD7V16	1-13/32	Ear Mount	O-Ring
98592	4-5/8	Wire Lead	New	7 Groove	SD7V16	1-19/64	Ear Mount	O-Ring
57562	5-5/8	Wire Lead	Reman	7 Groove	SDB709	1-3/64	Tangent Mount	O-Ring
57570	3-1/2	Wire Lead	Reman	4 Groove	TR70	2-3/64	Tangent Mount	O-Ring
57571	3-3/4	Wire Lead	Reman	1 Groove	TR70	2	Tangent Mount	O-Ring
58570	3-1/2	Wire Lead	New	4 Groove	TR70	2-3/64	Tangent Mount	O-Ring
67571	3-7/8	12	Reman	5 Groove	TR70	1-51/64	Tangent Mount	Pad Mount

# Compressors

Part No.	Pulley Dia.	Coil Clock	New / Reman	Groove	Type	Mount Dist to Groove Midpoint	Mount	Manifold
<b>Sanden</b>								
57572	3-3/4	Wire Lead	Reman	4 Groove	TRF090	2	Tangent Mount	O-Ring
58572	3-3/4	Wire Lead	New	4 Groove	TRF090	2	Tangent Mount	O-Ring
67553	4-55/64	Wire Lead	Reman	5 Groove	TRF090	55/64	Tangent Mount	O-Ring
67554	4-1/2	Wire Lead	Reman	4 Groove	TRF090	2-45/64	Tangent Mount	O-Ring
68553	4-55/64	Wire Lead	New	5 Groove	TRF090	55/64	Tangent Mount	O-Ring
57556	3-3/4	Wire Lead	Reman	7 Groove	TRF105	1-29/32	Tangent Mount	O-Ring
58556	3-3/4	Wire Lead	New	7 Groove	TRF105	1-29/32	Tangent Mount	O-Ring
77545	3-3/4	Wire Lead	Reman	7 Groove	TRF105	1-29/32	Tangent Mount	Sealing Washer
77547	4	Wire Lead	Reman	6 Groove	TRF105	1-19/32	Tangent Mount	O-Ring
77553	4-23/64	Wire Lead	Reman	2 Groove	TRF105	1-55/64	Ear Mount	O-Ring
77614	4-5/16	Wire Lead	Reman	6 Groove	TRF105	1-51/64	Tangent Mount	O-Ring
78545	3-3/4	Wire Lead	New	7 Groove	TRF105	1-29/32	Tangent Mount	Sealing Washer
78547	4	Wire Lead	New	6 Groove	TRF105	1-19/32	Tangent Mount	O-Ring
57582	4	Wire Lead	Reman	6 Groove	TRS090	2-29/64	Tangent Mount	O-Ring
58582	4	Wire Lead	New	6 Groove	TRS090	2-29/64	Tangent Mount	O-Ring
77544	4-3/4	Wire Lead	Reman	6 Groove	TRS090	2-19/64	Tangent Mount	O-Ring
77550	3-3/4	Wire Lead	Reman	4 Groove	TRS090	2-1/4	Tangent Mount	O-Ring
77560	4	Wire Lead	Reman	4 Groove	TRS090	1-61/64	Tangent Mount	O-Ring
78560	4	Wire Lead	New	4 Groove	TRS090	1-61/64	Tangent Mount	O-Ring
78599	4-1/2	Wire Lead	New	6 Groove	TRS090	2-1/2	Tangent Mount	O-Ring
78609	3-3/4	Wire Lead	New	4 Groove	TRS090	2-1/4	Tangent Mount	O-Ring
78613	3-15/16	Wire Lead	New	6 Groove	TRS090	2-1/2	Tangent Mount	O-Ring
97554	3-45/64	Wire Lead	Reman	6 Groove	TRS090	2-7/16	Tangent Mount	O-Ring
157551	3-3/4	Wire Lead	Reman	6 Groove	TRS105	39/64	Tangent Mount	O-Ring
77593	3-11/16	Wire Lead	Reman	7 Groove	TRS105	2	Tangent Mount	O-Ring
78593	3-61/64	Wire Lead	New	7 Groove	TRS105	2	Tangent Mount	O-Ring
198553	4-11/16	Wire Lead	New	5 Groove	TRSA090	2-1/64	Direct Mount	
67593	3-7/8	Wire Lead	Reman	6 Groove	TRSA090	2-19/64	Tangent Mount	O-Ring
68593	3-7/8	Wire Lead	New	6 Groove	TRSA090	2-19/64	Tangent Mount	O-Ring
77552	4-5/32	Wire Lead	Reman	4 Groove	TRSA090	2	Tangent Mount	O-Ring
77592	4	Wire Lead	Reman	5 Groove	TRSA090	2-3/64	Tangent Mount	O-Ring
77599	4-1/2	Wire Lead	Reman	6 Groove	TRSA090	2-1/2	Ear Mount	O-Ring
77613	4-1/2	Wire Lead	Reman	6 Groove	TRSA090	2-1/2	Tangent Mount	O-Ring
78552	4-5/32	Wire Lead	New	4 Groove	TRSA090	2	Tangent Mount	O-Ring
78592	4	Wire Lead	New	5 Groove	TRSA090	2-3/64	Tangent Mount	O-Ring
97553	4-11/16	Wire Lead	Reman	5 Groove	TRSA090	2-1/64	Tangent Mount	O-Ring
97582	3-51/64	Wire Lead	Reman	4 Groove	TRSA09K	1-53/64	Tangent Mount	Sealing Washer
77561	3-7/8	Wire Lead	Reman	6 Groove	TRSA12	2	Tangent Mount	Sealing Washer
78561	3-7/8	Wire Lead	New	6 Groove	TRSA12	2	Tangent Mount	Sealing Washer
77548	3-7/8	Wire Lead	Reman	4 Groove	TRSA12B	1-19/32	Tangent Mount	Sealing Washer
78548	3-7/8	Wire Lead	New	4 Groove	TRSA12B	1-19/32	Tangent Mount	Sealing Washer
97555	3-15/16	Wire Lead	Reman	7 Groove	TRSE07	1-51/64	Tangent Mount	O-Ring
97559	4-3/8	Wire Lead	Reman	5 Groove	TRSE07	1-11/16	Tangent Mount	O-Ring
97560	3-7/8	Wire Lead	Reman	7 Groove	TRSE07	1-13/32	Tangent Mount	O-Ring
97579	4-3/8	Wire Lead	Reman	5 Groove	TRSE07	1-35/64	Tangent Mount	O-Ring
98555	3-15/16	Wire Lead	New	7 Groove	TRSE07	1-7/8	Tangent Mount	O-Ring
98559	4-3/8	Wire Lead	New	5 Groove	TRSE07	1-11/16	Tangent Mount	O-Ring
98560	3-7/8	Wire Lead	New	7 Groove	TRSE07	1-13/32	Tangent Mount	O-Ring
98579	4-3/8	Wire Lead	New	5 Groove	TRSE07	1-35/64	Tangent Mount	O-Ring
97580	4-11/64	Wire Lead	Reman	7 Groove	TRSE09	1-11/32	Tangent Mount	O-Ring
97584	4-13/32	Wire Lead	Reman	6 Groove	TRSE09	1-27/32	Tangent Mount	O-Ring
98580	4-11/64	Wire Lead	New	7 Groove	TRSE09	1-11/32	Tangent Mount	O-Ring
98584	4-13/32	Wire Lead	New	6 Groove	TRSE09	1-27/32	Tangent Mount	O-Ring
57046			Reman		SD508		Ear Mount	O-Ring
57081			Reman		SD508		Ear Mount	O-Ring
57082			Reman		SD508		Ear Mount	O-Ring
57083			Reman		SD508		Ear Mount	O-Ring
58046			New	Pulley Not Included	SD508		Ear Mount	O-Ring
57630			Reman		SD709		Ear Mount	O-Ring
57558			Reman		SD7H15		Tangent Mount	Sealing Washer
57636			Reman		TRF090		Tangent Mount	O-Ring

## Seiko Seiki



# Compressors

Part No.	Pulley Dia.	Coil Clock	New / Reman	Groove	Type	Mount Dist to Groove Midpoint	Mount	Manifold
<b>Seiko Seiki</b>								
57405	5-1/4	Wire Lead	Reman	1 Groove	SS-148DW7	1-9/32	Boss Mount	O-Ring
57499	5-1/4	Wire Lead	Reman	1 Groove	SS-170PSS	1-11/32	Ear Mount	O-Ring
77491	4-1/2	Wire Lead	Reman	5 Groove	SS10L	1-19/32	Ear Mount	O-Ring
78491	4-1/2	Wire Lead	New	5 Groove	SS10L	1-19/32	Ear Mount	O-Ring
67402	4-5/16	Wire Lead	Reman	5 Groove	SS120DL1	59/64	Tangent Mount	O-Ring
57409	5	Wire Lead	Reman	6 Groove	SS121DN2	1-61/64	Tangent Mount	O-Ring
57465	4-5/8	Wire Lead	Reman	2 Groove	SS121DS5	29/32	Ear Mount	O-Ring
67645	5-1/8	Wire Lead	Reman	2 Groove	SS121DS5	61/64	Ear Mount	O-Ring
67497	4-1/2	Wire Lead	Reman	4 Groove	SS96D1	2-29/64	Ear Mount	O-Ring
68497	4-1/2	Wire Lead	New	4 Groove	SS96D1	1-21/64	Ear Mount	O-Ring
67498	4-21/64	Wire Lead	Reman	5 Groove	SS96D2	1-35/64	Ear Mount	O-Ring
68498	4-21/64	Wire Lead	New	5 Groove	SS96D2	9/16	Ear Mount	O-Ring
58407	4-1/4	Wire Lead	New	4 Groove	Seiko Seiki	1-11/16	Ear Mount	O-Ring
68401	4-25/32		New	4 Groove	Seiko Seiki		Tangent Mount	
<b>York/Tecumseh</b>								
57022	6-1/4	Wire Lead	Reman	1 Groove	209-210		Case Mount	Tube O-Fitting
58022	6-1/4	Wire Lead	New	1 Groove	209-210	2-7/8	Case Mount	Tube O-Fitting
68027	5-7/8	Wire Lead	New	6 Groove	209-210	1-47/64	Case Mount	Tube O-Fitting
68028	5-7/8	Wire Lead	New	6 Groove	209-210	1-61/64	Case Mount	Tube O-Fitting
58025	5-3/4	Wire Lead	New	6 Groove	CCI 209/210	1-23/32	Case Mount	Tube O-Fitting
68020	6	Wire Lead	New	2 Groove	CCI 209/210	1-43/64	Case Mount	Tube O-Fitting
68021	6	Wire Lead	New	2 Groove	CCI 209/210	1-43/64	Case Mount	Tube O-Fitting
68022	6-1/8	Wire Lead	New	8 Groove	CCI 209/210	1-7/16	Case Mount	Tube O-Fitting
68025	6	Wire Lead	New	2 Groove	CCI 209/210	1-43/64	Case Mount	Rotolock Fitting
68026	6-1/8	Wire Lead	New	8 Groove	CCI 209/210	1-15/32	Case Mount	Slim Line
57044			Reman		206		Case Mount	Flange Fitting
57075			Reman		206		Case Mount	Rotolock Fitting
58044			New		206		Direct Mount	Flange Fitting
57030			Reman		209-210		Case Mount	Flange Fitting
57056			Reman		209-210		Case Mount	Rotolock Fitting
57057			Reman		209-210		Case Mount	Flange Fitting
57064			Reman		209-210		Case Mount	Tube O-Fitting
57066			Reman		209-210		Case Mount	Rotolock Fitting
57068			Reman		209-210		Case Mount	Tube O-Fitting
58031			New		209-210		Case Mount	Sealing Washer
58056			New		209-210		Case Mount	Rotolock Fitting
58057			New		209-210		Case Mount	Flange Fitting
58064			New		209-210		Direct Mount	Tube O-Fitting
58066			New		209-210		Case Mount	Rotolock Fitting
58068			New		209-210		Case Mount	Tube O-Fitting
57070			Reman		HG500		Case Mount	Rotolock Fitting
57061			Reman		HG850-1000		Case Mount	Rotolock Fitting
57069			Reman		HG850-1000		Case Mount	Tube O-Fitting
57073			Reman		HG850-1000		Case Mount	Flange Fitting
58061			New		HG850-1000		Case Mount	Rotolock Fitting
57029			Reman		Mini-206		Case Mount	Flange Fitting
57063			Reman		Mini-206		Case Mount	Flange Fitting
57280			Reman		Mini-206		Case Mount	Flange Fitting
57074			Reman		Mini-209		Case Mount	Flange Fitting
58074			New		Mini-209		Case Mount	Flange Fitting
57059			Reman		RV2		Case Mount	Flange Fitting

# Compressors

## Harrison DA6 - HR6 Identification

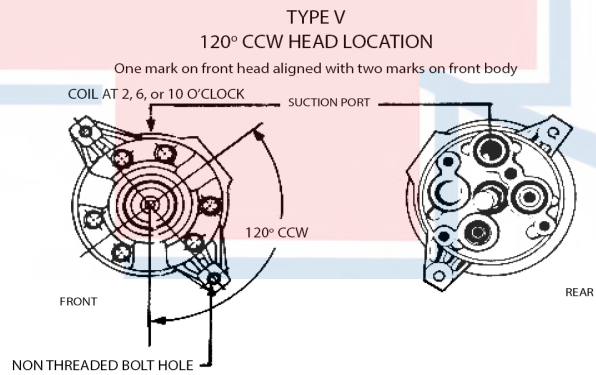
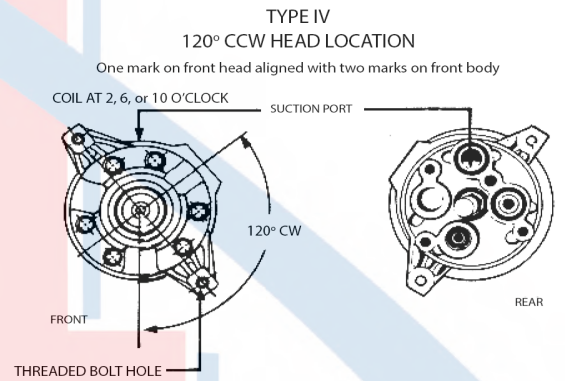
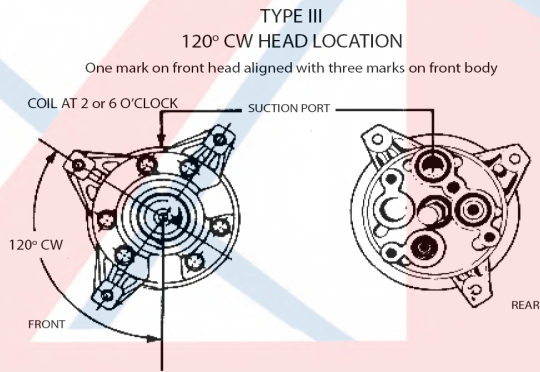
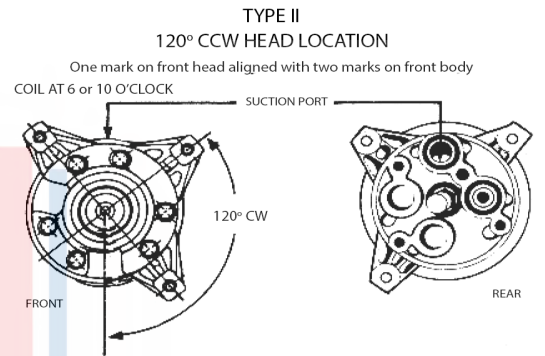
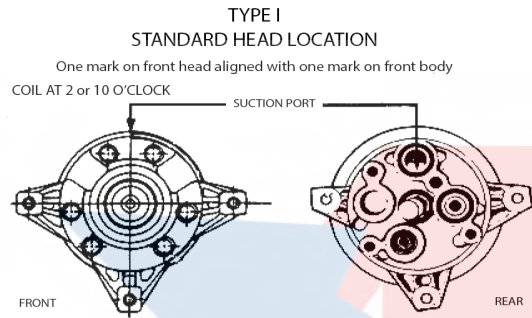

# Compressors

## Harrison DA6 - HR6 Identification

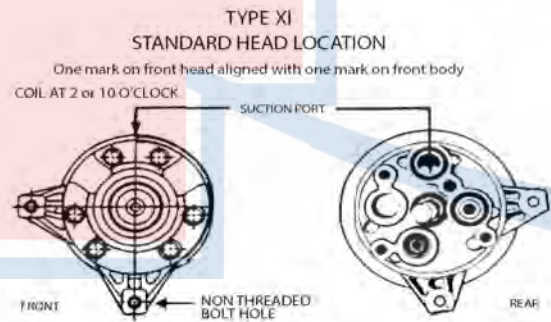
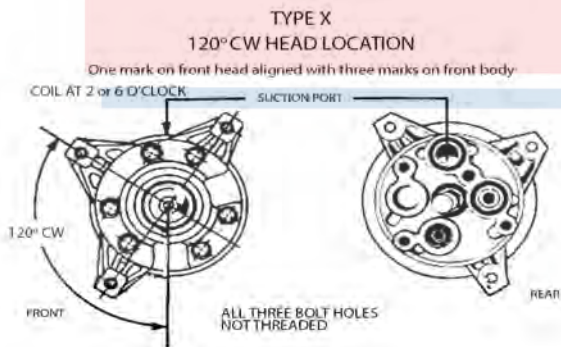
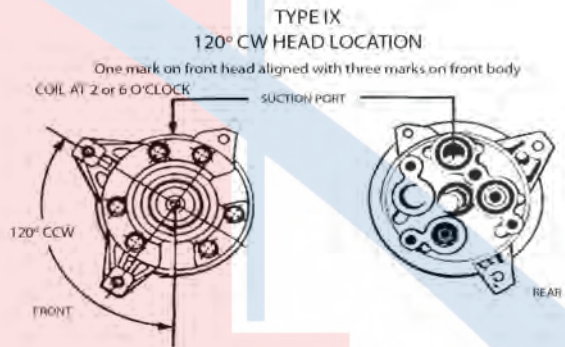
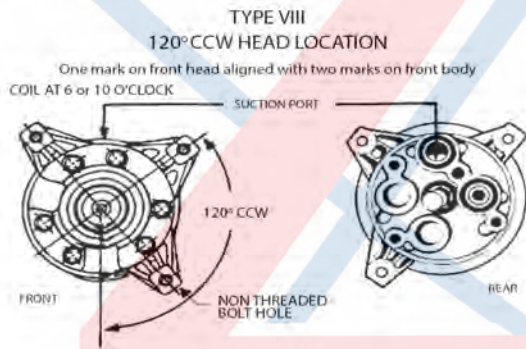
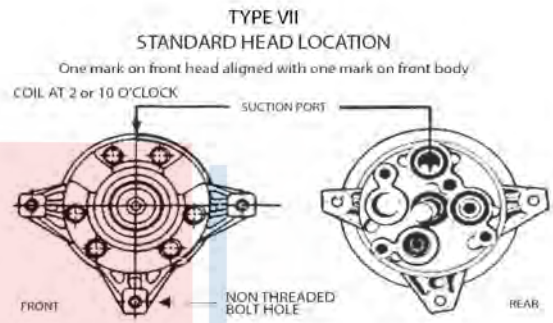
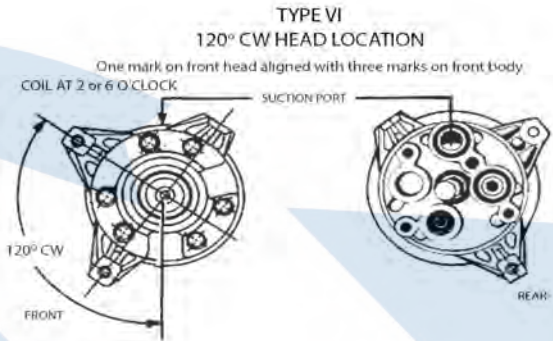



# Compressors

## Sanden FLX Specifications

Sanden Model #	Compressor Type	Mount	FLX & FITTING NEEDED		Head	FLX Fitting Description and Cylinder Head Description	Clutch OD	Belt Groove	Coil Volt
			SD7H15 FLX REPLACEMENT	SD7H15 FLX FITTING					
4506	SD5H14	Ear	68171	12204	FL	V-Standard O-ring 3/4" x 7/8"	5.19"	Double	24
4507	SD5H14	Ear	68171	12204	FL	V-Standard O-ring 3/4" x 7/8"	5.19"	Double	24
4508	SD5H14	Ear	68165	12204	FL	V-Standard O-ring 3/4" x 7/8"	4.92"	10	12
4509	SD5H14	Ear	68170	12204	FL	V-Standard O-ring 3/4" x 7/8"	5.19"	Double	12
4510	SD5H14	Ear	68170	12204	FL	V-Standard O-ring 3/4" x 7/8"	5.19"	Double	12
4511	SD5H14 HD	Ear	68163	12205	C	V-1" x 14 Tube O-ring	6.22"	Single	12
4513	SD5H14	Ear	68170	12209	M	H-1" x 14 Tube O-ring	5.19"	Double	12
4514	SD5H14	Ear	68161	12204	FL	V-Standard O-ring 3/4" x 7/8"	4.68"	7	12
4515	SD5H14 HD	Ear	68163	12204	FL	V-Standard O-ring 3/4" x 7/8"	6.22"	Single	12
4516	SD5H14 HD	Ear	68164	12204	FL	V-Standard O-ring 3/4" x 7/8"	6.22"	Single	24
4519	SD510 HD	Ear	68168	None	QM	H-Pad	5.43"	Single	24
4521	SD5H14	Ear	68171	12209	M	H-1" x 14 Tube O-ring	5.19"	Double	24
4522	SD5H14	Ear	68161	12209	M	H-1" x 14 Tube O-ring	4.68"	7	12
4523	SD5H14	Ear	68161	12209	M	H-1" x 14 Tube O-ring	4.68"	6	12
4525	SD5H14	Ear	68170	12205	C	V-1" x 14 Tube O-ring	5.19"	Double	12
4526	SD5H14	Ear	68165	12209	M	H-1" x 14 Tube O-ring	4.92"	10	12
4527	SD5H14 HD	Ear	68171	12205	C	V-1" x 14 Tube O-ring	5.19"	Double	24
4529	SD5H14 HD	Ear	68170	12205	C	V-1" x 14 Tube O-ring	5.19"	Double	12
4532	SD5H14	Ear	68169	12204	FL	V-3/4" x 7/8" Tube O-ring	5.98"	Double	24
4536	SD5H14	Ear	68170	12203	K	H-3/4" x 7/8"	5.19"	Double	12
4537	SD5H14	Ear	68171	12203	K	H-3/4" x 7/8"	5.19"	Double	24
4626	SD7H15 HD	Direct	68157	12204	JD	V-Tube O-ring 3/4" x 7/8"	5.19"	Double	12
4627	SD7H15 HD	Ear	68159	12204	JD	V-Tube O-ring 3/4" x 7/8"	4.92"	Double	12
4637	SD7H15 SHD	Ear	68166	12203	KC	H-Tube O-ring 3/4" x 7/8"	5.23"	8	12
4641	SD7H15	Direct	68158	12209	MD	H-1" x 14 Tube O-ring	4.68"	6	12
4643	SD7H15 HD	Ear	68170	12205	CB	V-1" x 14 Tube O-ring	5.19"	Double	12
4646	SD7H15	Ear	68170	12209	MJ	H-1" x 14 Tube O-ring	5.19"	Double	12
4647	SD7H15 HD	Ear	68170	12204	JDA	V-Tube O-ring 3/4" x 7/8" (Diode)	5.19"	Double	12
4652	SD7H15 HD	Ear	68160	12204	JD	V-Tube O-ring 3/4" x 7/8"	4.92"	Double	24
4661	SD7H15 SHD	Ear	68167	12203	KC	H-Tube O-ring 3/4" x 7/8"	5.43"	Single	12
4663	SD7H15	Ear	68159	12204	JD	V-Tube O-ring 3/4" x 7/8"	4.92"	Double	12
4664	SD7H15 HD	Ear	68170	12204	JD	V-Tube O-ring 3/4" x 7/8"	5.19"	Double	12
4665	SD7H15 HD	Ear	68161	12204	JD	V-Tube O-ring 3/4" x 7/8"	4.68"	7	12
4666	SD7H15	Direct	68158	12203	KC	H-3/4" x 7/8" Tube O-ring	4.68"	8	12
4706	SD7H15	Ear	68159	12205	CB	V-1" x 14 Tube O-ring	4.92"	Double	12
4707	SD7H15	Ear	68161	None	QC	H-Pad	4.68"	8	12
4708	SD7H15	Ear	68159	None	QC	H-Pad	4.92"	Double	12
4709	SD7H15	Ear	68159	12203	KG	H-3/4" x 7/8"	4.92"	Double	12
4710	SD7H15	Ear	68161	12205	CB	V-1" x 14 Tube O-ring	4.68"	8	12
4711	SD7H15	Ear	68161	12204	JD	V-3/4" x 7/8"	4.68"	8	12
4712	SD7H15	Ear	68161	12203	KG	H-3/4" x 7/8"	4.68"	8	12
4741	SD7H15 HD Spline	Ear	68160	12204	JD	V-3/4" x 7/8"	4.92"	Double	24
4742	SD7H15 HD Spline	Ear	68160	12203	KG	H-3/4" x 7/8"	4.92"	Double	24
4743	SD7H15 HD Spline	Ear	68160	12205	CB	V-1" x 14 Tube O-ring	4.92"	Double	24
4744	SD7H15 HD Spline	Ear	68160	12209	MD	H-1" x 14 Tube O-ring	4.92"	Double	24
4745	SD7H15 HD Spline	Ear	68164	12204	JD	V-3/4" x 7/8"	6.22"	Single	24
4746	SD7H15 HD Spline	Ear	68163	12204	JD	V-3/4" x 7/8"	6.22"	Single	12
4747	SD7H15 HD Spline	Ear	68163	12205	CB	V-1" x 14 Tube O-ring	6.22"	Single	12
4762	SD7H15 HD Spline	Ear	68162	12204	JD	V-3/4" x 7/8"	4.68"	8	24
4763	SD7H15 HD Spline	Ear	68162	12205	CB	V-1" x 14 Tube O-ring	4.68"	8	24
4764	SD7H15 HD Spline	Ear	68162	12209	MD	H-1" x 14 Tube O-ring	4.68"	8	24
4765	SD7H15 HD Spline	Ear	68162	12203	KG	H-3/4" x 7/8"	4.68"	8	24
4779	SD7H15 HD Spline	Ear	68159	12204	JD	V-3/4" x 7/8"	4.92"	Double	12
5407	SD508 HD	Ear	68160	12204	FG	V-Standard O-ring 3/4" x 7/8"	5.19"	Double	24
5411	SD508	Ear	68167	12209	M	H-1" x 14 Tube O-ring	4.92"	10	12
5413	SD508	Ear	68160	12204	FG	V-Standard O-ring 3/4" x 7/8"	5.19"	Double	24
5415	SD508	Ear	68167	12204	FG	V-Standard O-ring 3/4" x 7/8"	4.92"	10	12
5425	SD508	Ear	68163	12204	FG	V-Standard O-ring 3/4" x 7/8"	6.22"	Single	12
6626	SD5H14	Ear	68170	12204	FL	V-Standard O-ring 3/4" x 7/8"	5.19"	Double	12
6627	SD5H14	Ear	68171	12204	FL	V-Standard O-ring 3/4" x 7/8"	5.19"	Double	24
6629	SD5H14	Ear	68161	12204	FL	V-Standard O-ring 3/4" x 7/8"	4.68"	7	12
6630	SD5H14	Ear	68170	12203	K	H-3/4" x 7/8"	5.19"	Double	12
6631	SD5H14	Ear	68170	12209	M	H-1" x 14 Tube O-ring	5.19"	Double	12
6632	SD5H14	Ear	68171	12209	M	H-1" x 14 Tube O-ring	5.19"	Double	24
6634	SD5H14	Ear	68171	12203	K	H-3/4" x 7/8"	5.19"	Double	24
6642	SD5H14 HD	Ear	68170	12205	C	V-1" x 14 Tube O-ring	5.19"	Double	12
6655	SD5H14	Ear	68161	12209	M	H-1" x 14 Tube O-ring	4.68"	7	12
6656	SD5H14	Ear	68165	12204	FL	V-Standard O-ring 3/4" x 7/8"	4.92"	10	12

# Compressors

## Sanden FLX Specifications

Sanden Model #	Compressor Type	Mount	FLX & FITTING NEEDED		Head	FLX Fitting Description and Cylinder Head Description	Clutch OD	Belt Groove	Coil Volt
			SD7H15 FLX REPLACEMENT	SD7H15 FLX FITTING					
6664	SD5H14	Ear	68170	12204	FL	V-Standard O-ring 3/4" x 7/8"	5.19"	Double	12
6665	SD5H14	Ear	68171	12204	FL	V-Standard O-ring 3/4" x 7/8"	5.19"	Double	24
6667	SD5H14 HD	Ear	68171	12205	C	V-1" x 14 Tube O-ring	5.19"	Double	24
6670	SD5H14	Ear	68165	12209	M	H-1" x 14 Tube O-ring	4.92"	10	12
6671	SD5H14 HD	Ear	68163	12205	C	V-1" x 14 Tube O-ring	6.22"	Single	12
6672	SD5H14 HD	Ear	68164	12204	FL	V-Standard O-ring 3/4" x 7/8"	6.22"	Single	24
6673	SD5H14 HD	Ear	68163	12204	FL	V-Standard O-ring 3/4" x 7/8"	6.22"	Single	12
6675	SD5H14	Ear	68161	12209	M	H-1" x 14 Tube O-ring	4.68"	6	12
6676	SD5H14	Ear	68170	12203	K	H-3/4" x 7/8"	5.19"	Double	12
6678	SD5H14	Ear	68170	12205	C	V-1" x 14 Tube O-ring	5.19"	Double	12
6679	SD5H14	Ear	68169	12204	FL	V-3/4" x 7/8" Tube O-ring	5.98"	Double	24
7401	SD709	Ear	68159	12205	CB	V-1" x 14 Tube O-ring	4.92"	Double	12
7402	SD709	Ear	68159	12209	MD	H-1" x 14 Tube O-ring	4.92"	Double	12
7409	SD709	Ear	68159	12204	FC	V-Tube O-ring 3/4" x 7/8"	4.92"	Double	12
7427	SD709	Ear	68161	12205	CB	V-1" x 14 Tube O-ring	4.68"	6	12
7492	SD709	Ear	68161	12204	FC	V-Tube O-ring 3/4" x 7/8"	4.68"	8	12
7819	SD7H15	Ear	68159	12209	MD	H-1" x 14 Tube O-ring	4.92"	Double	12
7822	SD7H15	Ear	68161	12209	MD	H-1" x 14 Tube O-ring	4.68"	8	12
8103	SD7H15	Ear	68161	12204	JD	V-3/4" x 7/8"	4.68"	8	12
8103	SD7H15	Ear	68161	12204	JD	V-3/4" x 7/8"	4.68"	8	12
8104	SD7H15 HD	Ear	68170	12204	JD	V-Tube O-ring 3/4" x 7/8"	5.19"	Double	12
8104	SD7H15 HD	Ear	68170	12204	JD	V-Tube O-ring 3/4" x 7/8"	5.19"	Double	12
8390	SD508	Ear	68159	12207	B	V-Flare	5.19"	Double	12
8396	SD508	Ear	68169	12207	B	V-Flare	5.98"	Double	24
8399	SD508	Ear	68160	12207	B	V-Flare	5.19"	Double	24
9005	SD508	Ear	68160	12205	C	V-1" x 14 Tube O-ring	5.19"	Double	12
9026	SD508 HD	Ear	68159	12209	M	H-1" x 14 Tube O-ring	5.19"	Double	12
9040	SD508	Ear	68159	12204	FG	V-Standard O-ring 3/4" x 7/8"	5.19"	Double	12
9103	SD510 HD	Ear	68159	12207	B	V-Flare	5.19"	Double	12
9105	SD510 HD	Ear	68160	12207	B	V-Flare	5.19"	Double	24
9114	SD510 HD	Ear	68159	12205	C	V-1" x 14 Tube O-ring	5.19"	Double	12
9119	SD510 HD	Ear	68163	12205	C	V-1" x 14 Tube O-ring	6.22"	Single	12
9120	SD510 HD	Ear	68159	12204	FG	V-Tube O-ring 3/4" x 7/8"	5.19"	Double	12
9122	SD510 HD	Ear	68164	12205	C	V-1" x 14 Tube O-ring	6.22"	Single	24
9125	SD510 HD	Ear	68159	12209	M	H-1" x 14 Tube O-ring	5.19"	Double	12
9133	SD510 HD	Ear	68160	12209	M	H-1" x 14 Tube O-ring	5.19"	Double	24
9137	SD510 HD	Ear	68160	12205	C	V-1" x 14 Tube O-ring	5.19"	Double	24
9143	SD510 HD	Ear	68160	12204	FG	V-Tube O-ring 3/4" x 7/8"	5.19"	Double	24
9263	SD508	Ear	68159	12205	N	V-1" x 14 Tube O-ring	5.19"	Double	12
9264	SD508	Ear	68159	12209	M	H-1" x 14 Tube O-ring	5.19"	Double	12
9265	SD508	Ear	68160	12209	M	H-1" x 14 Tube O-ring	5.19"	Double	24
9283	SD508	Ear	68161	12207	B	V-Flare	4.68"	7	12
9285	SD508	Ear	68159	12204	FG	V-Tube O-ring 3/4" x 7/8"	5.19"	Double	12
9505	SD508 HD	Ear	68160	12205	C	V-1" x 14 Tube O-ring	5.19"	Double	24
9513	SD508	Ear	68165	12207	B	V-Flare	4.92"	10	12
9515	SD508 HD	Ear	68159	12204	FG	V-Tube O-ring 3/4" x 7/8"	5.19"	Double	12
9519	SD508 HD	Ear	68159	12205	C	V-1" x 14 Tube O-ring	5.19"	Double	12
9537	SD508	Ear	68161	12204	FG	V-Tube O-ring 3/4" x 7/8"	4.68"	7	12
9540	SD508	Ear	68161	12209	M	H-1" x 14 Tube O-ring	4.68"	6	12
9546	SD508	Ear	68161	12205	N	V-1" x 14 Tube O-ring	4.68"	6	12
9563	SD508 HD	Ear	68159	None	QH	H-Pad	5.19"	Double	12
9565	SD508	Ear	68161	12207	B	V-Flare	4.68"	6	12
9570	SD508	Ear	68161	12209	M	H-1" x 14 Tube O-ring	4.68"	7	12
9663	SD510 HD	Ear	68161	12204	FG	V-Tube O-ring 3/4" x 7/8"	4.68"	7	12
9674	SD510 HD	Ear	68160	12204	FG	V-Tube O-ring 3/4" x 7/8"	5.19"	Double	24
9675	SD510 HD	Ear	68163	12204	FG	V-Tube O-ring 3/4" x 7/8"	6.22"	Single	12
9676	SD510 HD	Ear	68164	12204	FG	V-Tube O-ring 3/4" x 7/8"	6.22"	Single	24
9689	SD510 HD	Ear	68159	None	QF	H-Pad	5.19"	Double	12

# Compressors

## SANDEN/SANKYO – YORK/DIESEL KIKI – SELTEC/ZEXEL IDENTIFICATION

Sankyo produces several models of this 5 cylinder rotary compressor. The SD508 is an 8 cu. in. displacement compressor which can be used to replace the SD506 - 6 cu. in. compressor. The SD507, 575, and 510 compressors are 7, 7.5 and 10 cu. in. respectively, and are NOT interchangeable with the SD508.

### Shaft Seal Kit

-SD505-575	24024
-SD508-510	24021
-SD709	24031

### Service Port O-Ring

#8 - O-Ring	24608
#10 - O-Ring	24610
#8 - Flare Gasket	24328
#10 - Flare Gasket	24330
Tube-O	NS

### York/Diesel Kiki Shaft Seal Kit

Bh Series	24042
Ch Series	24043

### Gasket Kit

-SD508, 510	24025
-SD709	24030

**Most Sankyo/Sanden, York/Diesel Kiki and Seltec/Zexel compressors are interchangeable. Check mounting ear distance and belt alignment.**

**NOTE:** Use comparable cubic inch displacements when interchanging units. Complete units are interchangeable but not components. Sanden SD508, SD510, Diesel Kiki and Seltec/Zexel compressors have a common 8-ear mounting configuration with a 3.25" spacing between mounts.

**NOTE:** The SD Series compressor was produced with two different styles of clutch coil mounting. 1978 and earlier models used three screws to mount the coil, 1979 and later models use a snap ring. The snap ring style supplied will replace either style.

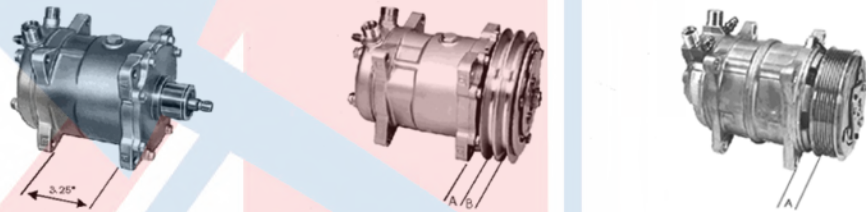

The belt spacing measurement will be made from the outside of the front mounting ear to the center of each belt groove or on a poly-groove to the center of the first poly-groove.

**NOTE:** Due to OE design changes, not all Sanden compressors are equipped with service valves. In these instances use other service valves located in system, or install new valves. Refer to "Fittings/Splicers" section of this catalog.

<p>Serial Number</p> <p>Month of Mfg. (1-12)</p> <p>Year of Mfg. (last digit)</p> <p>Manufacturing Locations 00 - 06 = Japan 70 - 79 = USA 80 - 89 = Singapore</p>	<div style="border: 1px solid black; padding: 5px; margin-bottom: 5px;"> <p><b>SANDEN</b></p> <p>SERIAL NO. 1930306571</p> <p>REFRIGERANT: R-12</p> <p><b>SANDEN INTERNATIONAL (U.S.A.) INC.</b></p> <p>MFD. UNDER U.S. PAT. 4,008,005 AND OTHER U.S. AND FOREIGN PATENTS REGISTERED AND/OR PENDING</p> <p>LICENSED BY SANDEN CORPORATION    MADE IN U.S.A.</p> </div>	<p>MODEL NO. U9119</p> <p>OIL AMT: 135cc OIL SUNISO 5GS or EO</p>
--	--	---

Identification numbers stamped on the mounting ears

Year Code (1995)

Month Code  
January thru September = Number of Month (1-9),  
October = X, November = Y and December = Z

Part Number

Lubricant Amount

Lubricant Type

Code for Internal Sanden use only



# Compressors

## Sanden Rear Head Identification

Model No	Head Type	Part No	Series	Head Configuration
1100	VQ	57591	SD7V16	Rear-Horiz-Pad
1100	VQD	57591	SD7V16	Rear-Vert-Pad
1102	VQR	57592	SD7V16	Rear-Vert-Pad
1206	VQL	77554	SD7V16	Vert-Peanut Fitting
1206	VQL	77555	SD7V16	Vert-Peanut Fitting
2523	UB	57508	SD508	Top-Horiz-Pad
4506	FG	58666	SD5H14	Top-Vert O-Ring
4508	FG	58650	SD5H14	Top-Vert O-Ring
4509	FG	58591	SD5H14	Top-Vert O-Ring
4509	FL	58591	SD5H14	Top-Vert O-Ring
4514	FG	58592	SD5H14	Top-Vert O-Ring
4514	FL	58592	SD5H14	Top-Vert O-Ring
4515	FG	58646	SD5H14	Top-Vert O-Ring
4516	FG	58649	SD5H14	Top-Vert O-Ring
4536	K	78557	SD5H14	Rear-Horiz-"O" Ring
4602	HM	68577	SD7H15	Top-Horiz-Pad -InternalThreads
4602	WH	68577	SD7H15	Top-Horiz-Pad
4603	WJ	68576	SD7H15	Top-Horiz-Pad -InternalThreads
4605	GF	57553	SD7H15	Top-Horiz-Pad Sealing Washer
4605	GF	58553	SD7H15	Top-Horiz-Pad Sealing Washer
4606	GH	67589	SD7H15	Rear-Vert-Pad Sealing Washer
4606	GH	68589	SD7H15	Rear-Vert-Pad Sealing Washer
4607	GJ	77584	SD7H15	Horiz-Pad
4609	MD	78551	SD7H15	Rear-Horiz-Tube O
4617	MD	58642	SD7H15	Rear-Horiz-Tube O
4622	PC	67573	SD7B10	No Ports on Head
4623	PC	67572	SD7B10	No Ports on Head
4625	KC	67551	SD709	Rear-Vert-"O" Ring
4626	JD	68579	SD7H15	Top-Vert-"O" Ring
4627	JD	58700	SD7H15	Top-Vert-"O" Ring
4637	KC	78567	SD7H15	Rear-Vert-"O" Ring
4645	JD	58711	SD7H15	Top-Vert-"O" Ring
4647	JDA	58701	SD7H15	Top-Vert-"O" Ring
4650	GN	67550	SD7H15	Horiz-Pad Sealing Washer
4650	GN	68550	SD7H15	Horiz-Pad Sealing Washer
4655	KC	67551	SD709	Rear-Vert-"O" Ring
4661	KC	78556	SD7H15	Rear-Vert-"O" Ring
4666	KC	58702	SD7H15	Rear-Vert-"O" Ring
4682	GH	67589	SD7H15	Rear-Vert-Pad Sealing Washer
4682	GH	68589	SD7H15	Rear-Vert-Pad Sealing Washer
4683	GF	57553	SD7H15	Top-Horiz-Pad Sealing Washer
4683	GF	58553	SD7H15	Top-Horiz-Pad Sealing Washer
4685	KC	67551	SD709	Rear-Vert-"O" Ring
4691	GN	67550	SD7H15	Horiz-Pad Sealing Washer
4691	GN	68550	SD7H15	Horiz-Pad Sealing Washer
4692	GF	57553	SD7H15	Top-Horiz-Pad Sealing Washer
4692	GF	58553	SD7H15	Top-Horiz-Pad Sealing Washer
4703	GN	67550	SD7H15	Horiz-Pad Sealing Washer
4703	GN	68550	SD7H15	Horiz-Pad Sealing Washer
4708	QC	78559	SD7H15	Rear-Vert-Pad
4709	KG	78553	SD7H15	Rear-Horiz-"O" Ring
4711	JE	78565	SD7H15	Vert-"O" Ring
4712	KG	58706	SD7H15	Rear-Horiz-"O" Ring
4721	GH	67589	SD7H15	Rear-Vert-Pad Sealing Washer
4721	GH	68589	SD7H15	Rear-Vert-Pad Sealing Washer
4722	GN	67550	SD7H15	Horiz-Pad Sealing Washer
4722	GN	68550	SD7H15	Horiz-Pad Sealing Washer
4723	GF	57553	SD7H15	Top-Horiz-Pad Sealing Washer
4723	GF	58553	SD7H15	Top-Horiz-Pad Sealing Washer
4725	GF	57553	SD7H15	Top-Horiz-Pad Sealing Washer
4725	GF	58553	SD7H15	Top-Horiz-Pad Sealing Washer
4729	GRA	78578	SD7H15	Horiz-Pad Sealing Washer
4734	MJA	58703	SD7H15	Rear-Horiz-Tube O

Model No	Head Type	Part No	Series	Head Configuration
4735	MJA	58704	SD7H15	Rear-Horiz-Tube O
4736	JD	58705	SD7H15	Top-Vert-"O" Ring
4748	GF	57553	SD7H15	Top-Horiz-Pad Sealing
4748	GF	58553	SD7H15	Top-Horiz-Pad Sealing
4750	GH	67589	SD7H15	Rear-Vert-Pad Sealing
4750	GH	68589	SD7H15	Rear-Vert-Pad Sealing
4752	JD	58707	SD7H15	Top-Vert-"O" Ring
4756	CBA	58708	SD7H15	Top-Vert-Tube-O
4760	GRA	78578	SD7H15	Horiz-Pad Sealing Washer
4761	MJA	58709	SD7H15	Rear-Horiz-Tube O
4770	GN	67550	SD7H15	Horiz-Pad Sealing Washer
4770	GN	68550	SD7H15	Horiz-Pad Sealing Washer
4771	GF	57553	SD7H15	Top-Horiz-Pad Sealing
4771	GF	58553	SD7H15	Top-Horiz-Pad Sealing
4773	GF	57553	SD7H15	Top-Horiz-Pad Sealing
4774	GF	57553	SD7H15	Top-Horiz-Pad Sealing
4774	GF	58553	SD7H15	Top-Horiz-Pad Sealing
4775	GH	67589	SD7H15	Rear-Vert-Pad Sealing
4775	GH	68589	SD7H15	Rear-Vert-Pad Sealing
4776	MJA	58710	SD7H15	Rear-Horiz-Tube O
4782	GF	57553	SD7H15	Top-Horiz-Pad Sealing
4782	GF	58553	SD7H15	Top-Horiz-Pad Sealing
4784	GN	67550	SD7H15	Horiz-Pad Sealing Washer
4784	GN	68550	SD7H15	Horiz-Pad Sealing Washer
4785	GF	57553	SD7H15	Top-Horiz-Pad Sealing
4785	GF	58553	SD7H15	Top-Horiz-Pad Sealing
4787	GRA	78578	SD7H15	Horiz-Pad Sealing Washer
4788	GF	57553	SD7H15	Top-Horiz-Pad Sealing
4788	GF	58553	SD7H15	Top-Horiz-Pad Sealing
4789	GH	67589	SD7H15	Rear-Vert-Pad Sealing
4789	GH	68589	SD7H15	Rear-Vert-Pad Sealing
4791	GRA	78578	SD7H15	Horiz-Pad Sealing Washer
4794	GF	57553	SD7H15	Top-Horiz-Pad Sealing
4794	GF	58553	SD7H15	Top-Horiz-Pad Sealing
4797	GF	57553	SD7H15	Top-Horiz-Pad Sealing
4797	GF	58553	SD7H15	Top-Horiz-Pad Sealing
4798	GN	67550	SD7H15	Horiz-Pad Sealing Washer
4798	GN	68550	SD7H15	Horiz-Pad Sealing Washer
4823	FJ	57630	SD709	Top-Vert O-Ring
4823	JD	57630	SD709	Top-Vert O-Ring
4824	GRA	78578	SD7H15	Horiz-Pad Sealing Washer
4825	GRA	78578	SD7H15	Horiz-Pad Sealing Washer
4826	GN	67550	SD7H15	Horiz-Pad Sealing Washer
4826	GN	67550	SD7H15	Horiz-Pad Sealing Washer
4826	GN	68550	SD7H15	Horiz-Pad Sealing Washer
4827	GN	67550	SD7H15	Horiz-Pad Sealing Washer
4827	GN	68550	SD7H15	Horiz-Pad Sealing Washer
4829	GH	67589	SD7H15	Rear-Vert-Pad Sealing
4829	GH	68589	SD7H15	Rear-Vert-Pad Sealing
4833	GF	57553	SD7H15	Top-Horiz-Pad Sealing
4833	GF	58553	SD7H15	Top-Horiz-Pad Sealing
4834	GF	57553	SD7H15	Top-Horiz-Pad Sealing
4834	GF	58553	SD7H15	Top-Horiz-Pad Sealing
4844	GN	67550	SD7H15	Horiz-Pad Sealing Washer
4844	GN	68550	SD7H15	Horiz-Pad Sealing Washer
4845	GF	57553	SD7H15	Top-Horiz-Pad Sealing
4845	GF	58553	SD7H15	Top-Horiz-Pad Sealing
4846	GF	57553	SD7H15	Top-Horiz-Pad Sealing
4846	GF	58553	SD7H15	Top-Horiz-Pad Sealing
4847	GRA	78578	SD7H15	Horiz-Pad Sealing Washer
5104	FN	58567	SD507	Top-Vert O-Ring
5668	QB	57586	SD510	Rear-Horiz-Pad

# Compressors

## Sanden Rear Head Identification









Model No	Head Type	Part No	Series	Head Configuration
6676	K	78557	SD5H14	Rear-Horiz-"O" Ring
7200	UK	57574	SD708	Top-Horiz-Pad
7200	UZ	57574	SD708	Top-Horiz-Pad
7208	RC	57583	SD708	Top-Horiz-Pad
7213	FJ	77581	SD708	Top-Vert O-Ring
7225	UW	57584	SD708	Rear-Vert-Pad
7227	UZ	57575	SD708	Top-Horiz-Pad
7229	UZ	57574	SD708	Top-Horiz-Pad
7240	WE	67599	SD708	Vert-Peanut Fitting
7243	VQD	57579	SD708	Rear-Vert-Pad
7402	MD	57552	SD709	Rear-Horiz-Tube O
7411	QJ	57593	SD709	Rear-Vert-Pad
7413	VQD	57555	SD709	Rear-Vert-Pad
7413	VQD	58555	SD709	Rear-Vert-Pad
7423	KC	57590	SD709	Rear-Vert-"O" Ring
7423	KC	67561	SD709	Rear-Vert-"O" Ring
7429	FK	57563	SD709	Top-Vert O-Ring
7445	CB	77591	SD709	Top-Vert-Tube-O
7463	QS	77589	SD709	Rear-Vert-Pad
7466	WB	57560	SD709	Top-Horiz-Pad
7467	QK	67559	SD709	Top-Horiz-Pad
7468	QU	67559	SD709	Top-Horiz-Pad
7469	QU	67558	SD709	Top-Horiz-Pad
7470	UK	77583	SD709	Top-Horiz-Pad
7479	QU	67558	SD709	Top-Horiz-Pad
7483	FJ	77582	SD709	Top-Vert O-Ring
7494	QS	77589	SD709	Rear-Vert-Pad
7495	QU	67559	SD709	Top-Horiz-Pad
7496	QU	67558	SD709	Top-Horiz-Pad
7501	FJ	57581	SD709	Top-Vert O-Ring
7501	FJ	58581	SD709	Top-Vert O-Ring
7503	QU	67558	SD709	Top-Horiz-Pad
7526	QS	77589	SD709	Rear-Vert-Pad
7543	QS	77589	SD709	Rear-Vert-Pad
7556	GC	77580	SD7H15	No Ports on Head
7557	GC	57562	SDB709	No Ports on Head
7701	MD	57632	SD709	Rear-Horiz-Tube O
7710	QU	67559	SD709	Top-Horiz-Pad
7711	QU	67559	SD709	Top-Horiz-Pad
7713	QU	67559	SD709	Top-Horiz-Pad
7714	QU	67559	SD709	Top-Horiz-Pad
7736	QU	67558	SD709	Top-Horiz-Pad
7803	SJ	68594	SD7H15	Top-Horiz-Pad
7803	VQD	67594	SD7H15	Rear-Vert-Pad
7803	VQD	68594	SD7H15	Rear-Vert-Pad
7804	WH	68575	SD7H15	Top-Horiz-Pad
7812	QY	77589	SD709	Rear-Vert-Pad
7814	SE	67557	SD7H15	Vert-Pad
7820	HS	57595	SD7H15	Rear-Vert-Pad
7820	QB	57595	SD7H15	Rear-Vert-Pad
7820	QP	57595	SD7H15	Rear-Vert-Pad
7820	SH	57595	SD7H15	Rear-Vert-Pad
7822	MD	68578	SD7H15	Rear-Horiz-Tube O
7846	SR	67574	SD7H15	Top-Horiz-Pad
7935	SR	67574	SD7H15	Top-Horiz-Pad
7942	SE	67557	SD7H15	Vert-Pad
8103	JE	78565	SD7H15	Vert-"O" Ring
8353	E	57622	SD507	Top-Vert-Flare
8387	B	58561	SD508	Top-Vert-Flare
8390	B	57033	SD508	Top-Vert-Flare
8390	B	58033	SD508	Top-Vert-Flare
8399	B	58541	SD508	Top-Vert-Flare
9021	C	57658	SD508	Top-Vert-Tube-O

Model No	Head Type	Part No	Series	Head Configuration
9026	M	78550	SD508HD	Rear-Horiz-Tube O
9056	E	58542	SD505	Top-Vert-Flare
9076	C	58543	SD505	Top-Vert-Tube-O
9103	B	57035	SD510	Top-Vert-Flare
9103	B	58035	SD510	Top-Vert-Flare
9105	B	58545	SD510	Top-Vert-Flare
9108	FV	58507	SD510HD	Top-Vert O-Ring
9114	C	58546	SD510HD	Top-Vert-Tube-O
9119	C	57034	SD510HD	Top-Vert-Tube-O
9119	C	58034	SD510HD	Top-Vert-Tube-O
9120	FG	58507	SD510HD	Top-Vert O-Ring
9125	M	58559	SD510	Rear-Horiz-Tube O
9149	Q	58564	SD510HD	Rear-Horiz-Pad
9165	R	57577	SD575	Top-Horiz-Pad
9167	UB	57577	SD575	Top-Horiz-Pad
9168	UB	57578	SD507	Top-Horiz-Pad
9173	E	58568	SD507	Top-Vert-Flare
9189	UB	77551	SD507	Top-Horiz-Pad
9251	UB	57508	SD508	Top-Horiz-Pad
9261	C	57658	SD508	Top-Vert-Tube-O
9263	N	57547	SD508HD	Top-Vert-Tube O
9263	N	58547	SD508HD	Top-Vert-Tube O
9264	M	58548	SD508	Rear-Horiz-Tube O
9265	M	58549	SD508	Rear-Horiz-Tube O
9279	M	57594	SD508	Rear-Horiz-Tube O
9285	FG	57551	SD508	Top-Vert O-Ring
9285	FG	58551	SD508	Top-Vert O-Ring
9288	KB	57596	SD508	Rear-Horiz-"O" Ring
9291	C	57580	SD508	Top-Vert-Tube-O
9291	C	58580	SD508	Top-Vert-Tube-O
9505	C	58587	SD508	Top-Vert-Tube-O
9511	RB	57508	SD508	Top-Horiz-Pad
9511	UB	57508	SD508	Top-Horiz-Pad
9514	FG	58638	SD508	Top-Vert O-Ring
9515	FG	57551	SD508	Top-Vert O-Ring
9515	FG	58551	SD508	Top-Vert O-Ring
9516	UD	57585	SD508	Rear-Horiz-Pad
9519	C	58554	SD508HD	Top-Vert-Tube-O
9533	KB	57113	SD508	Rear-Horiz-"O" Ring
9537	FC	58589	SD508	Top-Vert O-Ring
9537	FG	58589	SD508	Top-Vert O-Ring
9563	QH	58588	SD508	Rear-Horiz-Pad
9564	CE	57580	SD508	Top-Vert-Tube-O
9564	CE	58580	SD508	Top-Vert-Tube-O
9674	FG	58590	SD510	Top-Vert O-Ring
9675	FG	58640	SD510HD	Top-Vert O-Ring
9676	FG	58641	SD510HD	Top-Vert O-Ring
9689	QF	58557	SD510	Rear-Horiz-Pad
9689	QH	58557	SD510	Rear-Horiz-Pad
46053	GF	57558	SD7H15	Top-Horiz-Pad Sealing
83663	B	57083	SD508	Top-Vert-Flare
83903	B	57083	SD508	Top-Vert-Flare
90053	C	57046	SD508	Top-Vert-Tube-O
90053	C	58046	SD508	Top-Vert-Tube-O
90293	W	57082	SD508	Top-Horiz-Pad
92853	FG	57081	SD508	Top-Vert O-Ring
92983	U	57082	SD508	Top-Horiz-Pad
92983	W	57082	SD508	Top-Horiz-Pad
95153	FG	57081	SD508	Top-Vert O-Ring
95643	CE	57046	SD508	Top-Vert-Tube-O
95643	CE	58046	SD508	Top-Vert-Tube-O
-	B	67598	SD508	Top-Vert-Flare

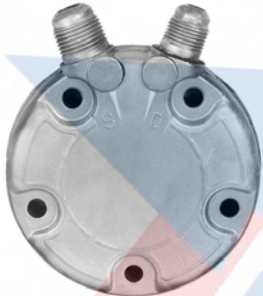
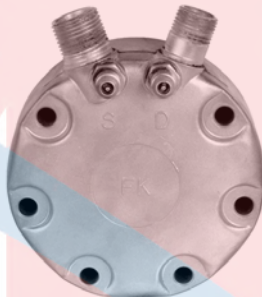

# Compressors

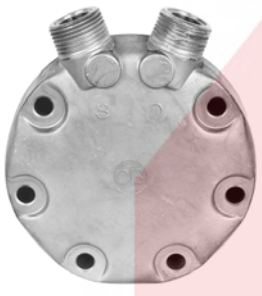
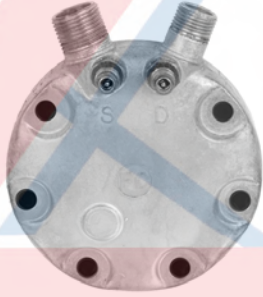
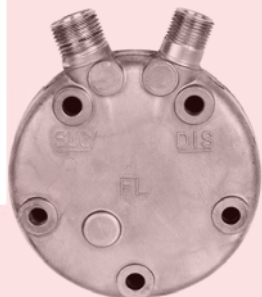
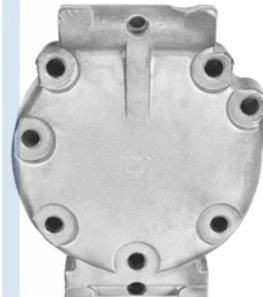

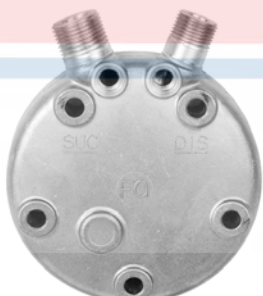
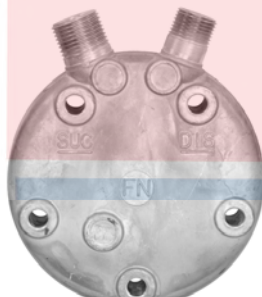
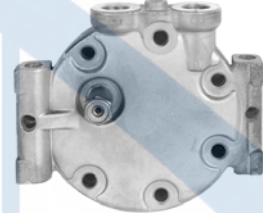
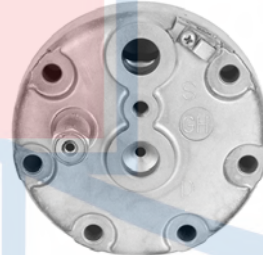







## Sanden / Sankyo Rear Head Identification

Rear Head				
				
<p><b>B</b> Top-Vertical-Flare 7/8"-14 x 3/4"-16 Fine *Charge Ports No Longer Available</p>		<p><b>CE</b> Top-Vertical-Tube-O 1" - 14 Coarse</p>		<p><b>FJ</b> Top-Vertical O-Ring 7/8"-14 x 3/4"-16 Fine *Charge Ports No Longer Available</p>
				
<p><b>C</b> Top-Vertical-Tube-O 1" - 14 Coarse</p>	<p><b>E</b> Top-Vertical-Flare 7/8"-14 x 3/4"-16 Fine</p>	<p><b>FK</b> Top-Vertical O-Ring 7/8"-14 x 3/4"-16 Fine *Charge Ports No Longer Available</p>		<p><b>FV</b> Top-Vertical O-Ring 7/8"-14 x 3/4"-16 Fine *Charge Ports No Longer Available</p>
				
<p><b>CB</b> Top-Vertical-Tube-O 1" - 14 Coarse</p>	<p><b>FC</b> Top-Vertical O-Ring 7/8"-14 x 3/4"-16 Fine *Charge Ports No Longer Available</p>	<p><b>FL</b> Top-Vertical O-Ring 7/8"-14 x 3/4"-16 Fine *Charge Ports No Longer Available</p>		<p><b>GC</b> No Ports on Head</p>
				
<p><b>CBA</b> Top-Vertical-Tube-O 1" - 14 Coarse</p>	<p><b>FG</b> Top-Vertical O-Ring 7/8"-14 x 3/4"-16 Fine *Charge Ports No Longer Available</p>	<p><b>FN</b> Top-Vertical O-Ring 7/8"-14 x 3/4"-16 Fine *Charge Ports No Longer Available</p>		<p><b>GF</b> Top-Horizontal-Pad Sealing Washer</p>
				
				<p><b>GH</b> Rear-Vertical-Pad Sealing Washer</p>

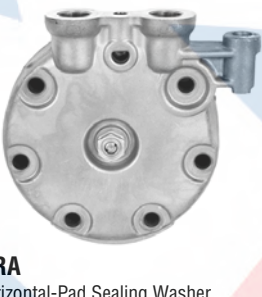
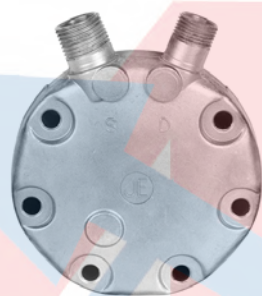
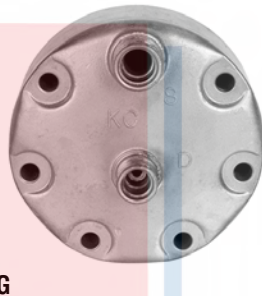

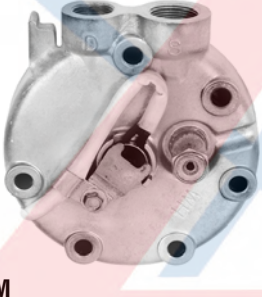
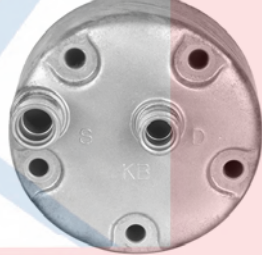
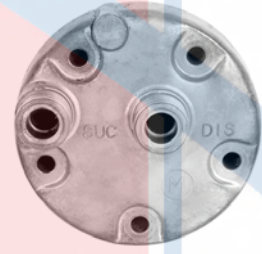
# Compressors

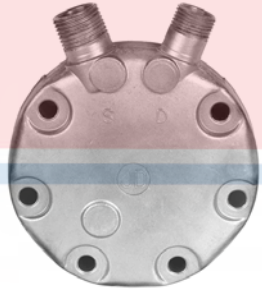
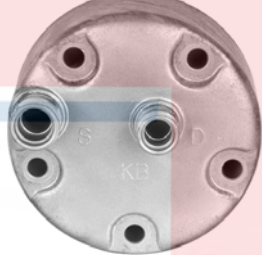
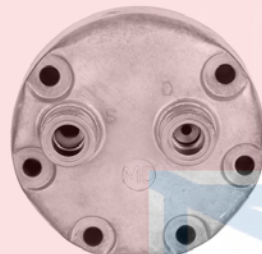









## Sanden / Sankyo Rear Head Identification

Rear Head Cont'd			
 <b>GN</b> Horizontal-Pad Sealing Washer	 <b>JDA</b> Top-Vertical-"O" Ring 7/8"-14 x 3/4"-16 Fine	 <b>KC</b> Rear-Vertical-"O" Ring 7/8"-14 x 3/4"-16 Fine	 <b>MJA</b> Rear-Horizontal-Tube O 1" - 14 Coarse
 <b>GRA</b> Horizontal-Pad Sealing Washer	 <b>JE</b> Vertical-"O" Ring 7/8"-14 x 3/4"-16 Fine	 <b>KG</b> Rear-Horizontal-"O" Ring 7/8"-14 x 3/4"-16 Fine	 <b>N</b> Top-Vertical-Tube O 1" - 14 Coarse
 <b>HM</b> Top-Horizontal-Pad - Internal Threads	 <b>K</b> Rear-Horizontal-"O" Ring 7/8"-14 x 3/4"-16 Fine	 <b>M</b> Rear-Horizontal-Tube O 1" - 14 Coarse	 <b>PC</b> No Ports on Head
 <b>JD</b> Top-Vertical-"O" Ring 7/8"-14 x 3/4"-16 Fine *Charge Ports No Longer Available	 <b>KB</b> Rear-Horizontal-"O" Ring 7/8"-14 x 3/4"-16 Fine	 <b>MD</b> Rear-Horizontal-Tube O 1" - 14 Coarse	 <b>QB</b> Rear-Horizontal-Pad *Charge Ports No Longer Available

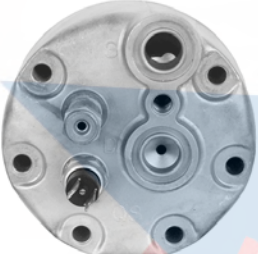
Use Compressor Model Number & Head Type Pictured Above To Determine Part Number  
Replacement Compressors No Longer Include Charge Ports

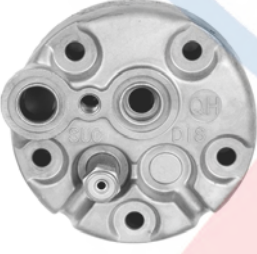
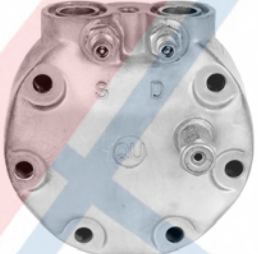
# Compressors

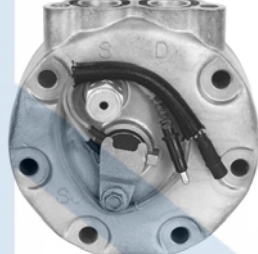
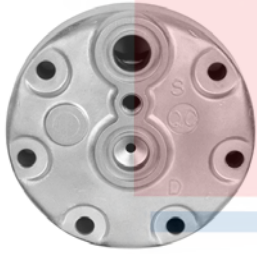

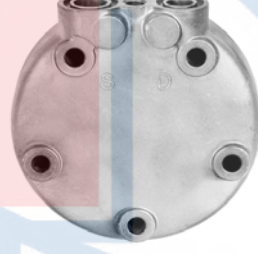



## Sanden / Sankyo Rear Head Identification

Rear Head Cont'd			
 <b>QC</b> Rear-Vertical-Pad	 <b>QK</b> Top-Horizontal-Pad *Charge Ports No Longer Available	 <b>R</b> Top-Horizontal-Pad	 <b>SJ</b> Rear-Horizontal-Pad
 <b>QF</b> Rear-Horizontal-Pad	 <b>QS</b> Rear-Vertical-Pad *Charge Ports No Longer Available	 <b>RB</b> Top-Horizontal-Pad	 <b>SR</b> Top-Horizontal-Pad
 <b>QH</b> Rear-Horizontal-Pad	 <b>QU</b> Top-Horizontal-Pad *Charge Ports No Longer Available	 <b>RC</b> Top-Horizontal-Pad	 <b>SR</b> Top-Horizontal-Pad
 <b>QJ</b> Rear-Vertical-Pad	 <b>QY</b> Rear-Vertical-Pad	 <b>SH</b> Rear-Vertical-Pad *Charge Ports No Longer Available	 <b>U</b> Top-Horizontal-Pad

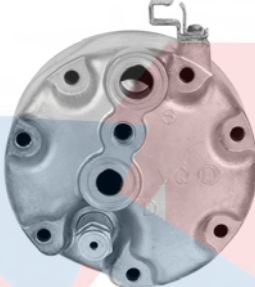
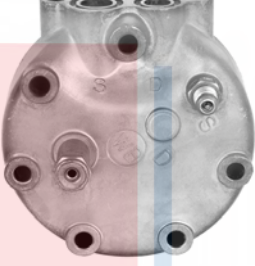
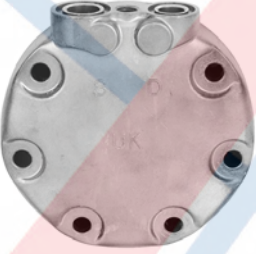
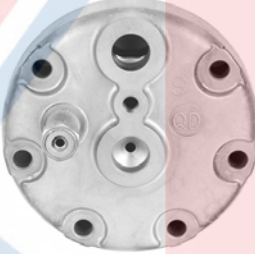
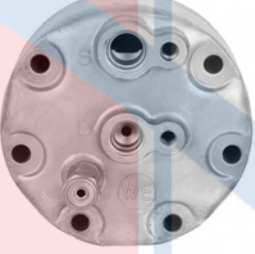
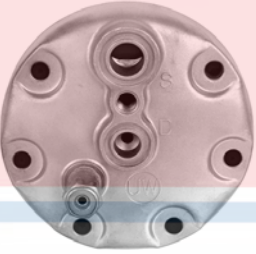

# **Compressors**

## **Sanden / Sankyo Rear Head Identification**

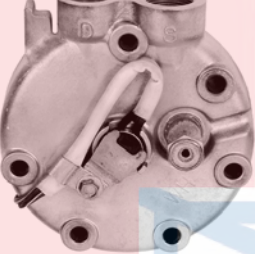
Rear Head Cont'd			
 <b>UB</b> Top-Horizontal-Pad	 <b>UZ</b> Top-Horizontal-Pad	 <b>W</b> Top-Horizontal-Pad	 <b>WJ</b> Top-Horizontal-Pad - Internal Threads
 <b>UD</b> Rear-Horizontal-Pad	 <b>VQ</b> Rear-Horizontal-Pad	 <b>WB</b> Top-Horizontal-Pad *Charge Ports No Longer Available	
 <b>UK</b> Top-Horizontal-Pad	 <b>VQD</b> Rear-Vertical-Pad	 <b>WE</b> Vertical- P-Nut Fitting	
 <b>UW</b> Rear-Vertical-Pad	 <b>VQR</b> Rear-Vertical-Pad	 <b>WH</b> Top-Horizontal-Pad	

Use Compressor Model Number & Head Type Pictured Above To Determine Part Number  
Replacement Compressors No Longer Include Charge Ports



# Compressors

**A6**



**158050 New**

A6  
8 Groove  
12 Volt  
Switch: Heat Switch  
Mount: Direct Mount  
Pulley Dia.: 4-13/16  
Coil Clock: Wire Lead  
Connector: Spade  
Carrier: 180007301, 766202799  
Kysor: 1404028



**57052 Reman**

A6  
Coil Less  
Switch: Superheat  
Mount: Direct Mount  
Buick (77-62); Cadillac (76-62); Chevy (79-62); Ford (80-72); GMC (77-62); Jaguar (84-82), (79-71); Lincoln (80); Mercury (80-75); Olds (79-62); Pontiac (81-62); Rolls Royce (84)  
General Motors Corp: 2724150, 2724153  
Allis Chalmers: 02567824, 02701175, 1131075, 1131124, 256782  
AMC: 256782  
ARA: 529938  
Case New Holland: A135362  
Caterpillar: 1P2780  
Deutz: 0034155, 1131075, 1131124, 256782  
Euclid: E801703RM  
Evans: AM80414  
Hinker: 116016017  
Hy-Capacity: 880106REM  
Kysor: 402571, 402583  
Massey Ferguson: 521257M92, 530713M91, 530748M91, 533713M92, 586126M91, 595995M91  
New Idea: 731155



**57055 Reman**

A6  
1 Groove  
12 Volt  
Switch: Superheat  
Mount: Direct Mount  
Belt Width: 1/2  
Pulley Dia.: 5  
Coil Clock: 10  
Connector: Spade  
Reman Compr w/o Clutch: **57052**  
Euclid: E801706RM  
Northern: 500252



**57060 Reman**

A6  
1 Groove  
12 Volt  
Switch: Superheat  
Mount: Direct Mount  
Belt Width: 1/2  
Pulley Dia.: 5-5/8  
Coil Clock: 2  
Connector: Spade  
Reman Compr w/o Clutch: **57052**  
Euclid: E801705RM



**57062 Reman**

A6  
Coil Less  
Mount: Direct Mount  
Ford (80-75); Lincoln (78-71); Mercury (80-75)  
ARA: 529909  
Full Vison: 5300001



**57079 Reman**

A6  
1 Groove  
12 Volt  
Switch: Superheat  
Mount: Direct Mount  
Belt Width: 7/16  
Pulley Dia.: 5-5/8  
Coil Clock: 2  
Connector: Spade  
Reman Compr w/o Clutch: **57052**  
Pontiac (76-75)



**57085 Reman**

A6  
1 Groove  
24 Volt  
Switch: Superheat  
Mount: Direct Mount  
Belt Width: 7/16  
Pulley Dia.: 5-5/8  
Coil Clock: 10  
Connector: Pin  
Reman Compr w/o Clutch: **57052**  
Northern: 500228



**57086 Reman**

A6  
1 Groove  
24 Volt  
Switch: Superheat  
Mount: Direct Mount  
Belt Width: 7/16  
Pulley Dia.: 6-7/8  
Coil Clock: 10  
Connector: Pin  
New Clutch Assy:  
Reman Clutch Assy: **48275**  
Reman Compr w/o Clutch: **57052**  
Caterpillar: 1P6416, 2P8232, 7N4296  
Dallas Truck AC: 0106018  
Euclid: E801708RM  
Kysor: 402763  
NaviStar: 13341  
Northern: 500695  
Red Dot: 75R8174



**57091 Reman**

A6  
1 Groove  
12 Volt  
Switch: Superheat  
Mount: Direct Mount  
Belt Width: 1/2  
Pulley Dia.: 5-5/8  
Coil Clock: 2  
Connector: Spade  
Reman Compr w/o Clutch: **57052**  
Cadillac (76-69); Olds (76-68)



**57092 Reman**

A6  
1 Groove  
12 Volt  
Switch: Superheat  
Mount: Direct Mount  
Belt Width: 7/16  
Pulley Dia.: 5-1/8  
Coil Clock: 2  
Connector: Spade  
New Clutch Assy:  
Reman Clutch Assy:  
Reman Compr w/o Clutch: **57052**  
Buick (77); Cadillac (76); Olds (79-65)



**57093 Reman**

A6  
1 Groove  
12 Volt  
Switch: High Pressure  
Mount: Direct Mount  
Belt Width: 7/16  
Pulley Dia.: 5-3/4  
Coil Clock: 2  
Connector: Spade  
Cadillac (79-77); Chevy (83-77); GMC (82-78); Pontiac (81-77)  
Hy-Capacity: 880114REM, 880121REM, 880159REM

# Compressors

## A6 Cont'd



### 57095 Reman

A6  
1 Groove  
12 Volt  
Switch: High Pressure  
Mount: Direct Mount  
Belt Width: 7/16  
Pulley Dia.: 5-1/8  
Coil Clock: 2  
Connector: Spade  
New Clutch Assy:  
Reman Clutch Assy:  
Buick (77); Cadillac (79-77); Olds (79-77); Pontiac (79-77)



### 58047 New

A6  
6 Groove  
12 Volt  
Mount: Direct Mount  
Pulley Dia.: 5-1/2  
Coil Clock: 10  
Connector: Spade



### 58051 New

A6  
8 Groove  
12 Volt  
Mount: Flange  
Pulley Dia.: 4-51/64  
Coil Clock: 10  
Connector: Spade



### 58053 New

A6  
1 Groove  
12 Volt  
Mount: Direct Mount  
Pulley Dia.: 6-49/64  
Coil Clock: 10  
Case New Holland: AR160638



### 58058 New

A6  
6 Groove  
12 Volt  
Mount: Direct Mount  
Pulley Dia.: 5-1/2  
Coil Clock: 2  
Connector: Spade



### 58077 New

58077 Reman  
A6  
1 Groove  
12 Volt  
Mount: Direct Mount  
Belt Width: 7/16  
Pulley Dia.: 5  
Coil Clock: 2  
Connector: Spade  
Ford (80-75); GMC (85); Lincoln (78-71); Mercury (80-75)

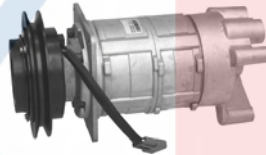

### 58078 New

58078 Reman  
A6  
1 Groove  
12 Volt  
Switch: Superheat  
Mount: Direct Mount  
Belt Width: 7/16  
Pulley Dia.: 5-3/4  
Coil Clock: 10  
Connector: Spade  
John Deere: TY6665



### 58084 New

58084 Reman  
A6  
1 Groove  
12 Volt  
Switch: Superheat  
Mount: Direct Mount  
Belt Width: 7/16  
Pulley Dia.: 6-7/8  
Coil Clock: 10  
Connector: Spade

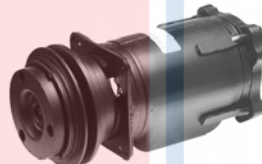

### 58087 New

58087 Reman  
A6  
1 Groove  
12 Volt  
Switch: Superheat  
Mount: Direct Mount  
Belt Width: 7/16  
Pulley Dia.: 6  
Coil Clock: 2  
Connector: Spade  
Buick (76-62); Chevy (79-62); GMC (79-78), (72-62); GMC & CHEVY (84-80); Olds (79-77), (74), (70-62); Pontiac (82), (76-62)  
General Motors Corp: 12300271



### 58088 New

58088 Reman  
A6  
2 Groove  
12 Volt  
Switch: Superheat  
Mount: Direct Mount  
Pulley Dia.: 5-1/8  
Coil Clock: 2  
Connector: Spade  
Buick (74-62); Cadillac (74-62); Chevy (70-62); GMC (70-62); Olds (64-62)



### 58089 New

58089 Reman  
A6  
1 Groove  
12 Volt  
Switch: Superheat  
Mount: Direct Mount  
Belt Width: 7/16  
Pulley Dia.: 5  
Coil Clock: 2  
Connector: Spade  
Reman Clutch Assy: **48284**  
Buick (76-62); Cadillac (72-63); Chevy (84-62); Ford (80-72); GMC (84-62); Jaguar (84-82), (79-71); Lincoln (80); Mercedes (79); Mercury (80-75); Olds (81-78), (75), (71-62)  
Pontiac (81-62); Rolls Royce (84)



### 58096 New

58096 Reman  
A6  
1 Groove  
12 Volt  
Switch: High Pressure  
Mount: Direct Mount  
Belt Width: 7/16  
Pulley Dia.: 5-1/8  
Coil Clock: 2  
Connector: Spade  
Reman Clutch Assy:  
Buick (85-77); Cadillac (79-77); Chevy (93-78); GMC (93-80), (77); Jaguar (92-80); Mercedes (81); Olds (77); Pontiac (81-78); Volvo (81-76)



### 58097 New

A6  
1 Groove  
12 Volt  
Switch: Superheat  
Mount: Direct Mount  
Pulley Dia.: 5-37/64  
Coil Clock: 2

# Compressors

## A6 Cont'd



**58098** New  
**57098** Reman

A6  
1 Groove  
12 Volt  
Switch: Superheat  
Mount: Direct Mount  
Belt Width: 7/16  
Pulley Dia.: 4-7/8  
Coil Clock: 2  
Connector: Spade  
Reman Clutch Assy: **48284**  
Audi (86-78); Buick (81-62); Cadillac (77-73), (71-68), (64-62); Chevy (86-62); Ford (80-76); GMC (86-63); Jaguar (90-88), (84-81), (79-71); Lincoln (80-71); Mercedes (85-63) Mercury (80-71); Olds (82), (80-62); Pontiac (81-62)



**58099** New

A6  
1 Groove  
12 Volt  
Switch: High Pressure  
Mount: Direct Mount  
Pulley Dia.: 5-37/64  
Coil Clock: 2  
General Motors Corp: 19192364

## Bosch Series

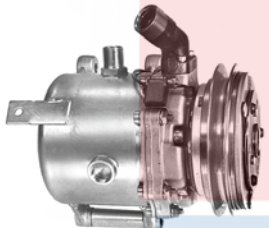

**57400** Reman

Bosch  
1 Groove  
12 Volt  
Switch: Temp Sensor  
Mount: Boss Mount  
Belt Width: 1/2  
Pulley Dia.: 5-1/4  
Coil Clock: 12  
BMW (93-78)



**57401** Reman

Bosch  
1 Groove  
12 Volt  
Mount: Boss Mount  
Belt Width: 1/2  
Pulley Dia.: 5-1/4  
Coil Clock: 12  
BMW (84-78)  
BMW: 64521374558



**57402** Reman

Bosch  
1 Groove  
12 Volt  
Switch: Temp Sensor  
Mount: Boss Mount  
Belt Width: 1/2  
Pulley Dia.: 5-1/4  
Coil Clock: 12  
BMW (85-79)

## Calsonic / Zexel

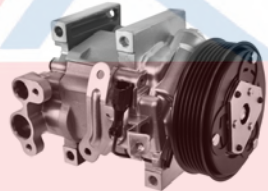

**158485** New

**157485** Reman  
DKV10R  
6 Groove  
12 Volt  
Pulley Dia.: 4-19/64  
Subaru (13-11)  
Subaru: 73111SC020



**158486** New  
**157486** Reman

DKS17D  
4 Groove  
12 Volt  
Pulley Dia.: 4-29/32  
Coil Clock: Wire Lead  
Ford (14-11)  
Ford: BR3Z19703A



**168484** New

DKV14G  
6 Groove  
12 Volt  
Pulley Dia.: 4-29/32  
Coil Clock: Wire Lead  
Isuzu (03-99)

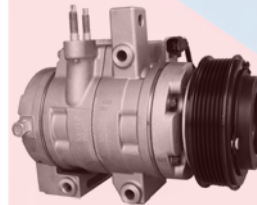

**168660** New  
**167660** Reman

DKS20  
6 Groove  
12 Volt  
Pulley Dia.: 4-33/64  
Coil Clock: Wire Lead  
Ford (14-11)  
Ford: BL3Z19703D

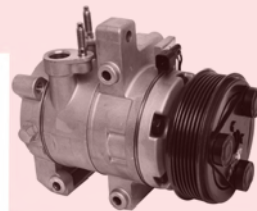

**168661** New  
**167661** Reman

DKS17D  
6 Groove  
12 Volt  
Pulley Dia.: 4-1/2  
Coil Clock: Wire Lead  
Ford (14-11)



**168662** New  
**167662** Reman

DKS20  
4 Groove  
12 Volt  
Pulley Dia.: 4-1/2  
Coil Clock: Wire Lead  
Ford (14-11)  
Ford: BL3Z19703A



**197486** Reman

DKS17S  
6 Groove  
12 Volt  
Pulley Dia.: 4-5/16  
Coil Clock: Wire Lead  
Mazda (13-09)  
Mazda: GS4H61450C

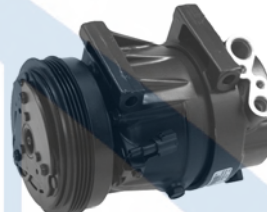

**57420** Reman

DKS15  
1 Groove  
12 Volt  
Belt Width: 1/2  
Pulley Dia.: 5  
Coil Clock: Wire Lead  
Mazda (91-90)  
Mazda: HF9061450



**57421** Reman

NVR140S  
10 Groove 4 & 6  
12 Volt  
Switch: Heat Sensor  
Pulley Dia.: 5-23/64  
Coil Clock: Wire Lead  
Nissan (89-86)  
Nissan: 92600D4026



# Compressors

## Calsonic / Zexel Cont'd



**57422 Reman**  
NVR140S  
1 Groove  
12 Volt  
Switch: Heat Sensor  
Belt Width: 1/2  
Pulley Dia.: 5  
Coil Clock: Wire Lead  
Nissan (88-87)  
Nissan: 9260061A21



**57424 Reman**  
NVR140S  
10 Groove 4 & 6  
12 Volt  
Switch: Heat Sensor  
Pulley Dia.: 5-23/64  
Coil Clock: Wire Lead  
Nissan (90-89)  
Nissan: 9260085M01



**57435 Reman**  
DKS15  
1 Groove  
12 Volt  
Belt Width: 1/2  
Pulley Dia.: 5  
Coil Clock: Wire Lead  
Mazda (91-88)  
Mazda: HF0861450

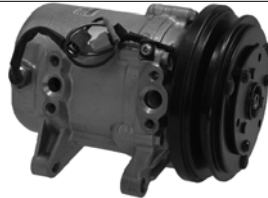

**57441 Reman**  
NVR140S  
1 Groove  
12 Volt  
Switch: Heat Sensor  
Belt Width: 1/2  
Pulley Dia.: 5-1/4  
Coil Clock: Wire Lead  
Nissan (86-85)  
Nissan: 9260036M00, 9260036M03



**57442 Reman**  
DKV14C  
4 Groove  
12 Volt  
Switch: Heat Sensor  
Pulley Dia.: 5-1/4  
Coil Clock: Wire Lead  
Nissan (92-91)  
Nissan: 9260065Y02



**57443 Reman**  
NVR140S  
4 Groove  
12 Volt  
Switch: Heat Sensor  
Pulley Dia.: 5-1/4  
Coil Clock: Wire Lead  
Nissan (92-88)  
Nissan: 9260084A16



**57446 Reman**  
NVR140S  
4 Groove  
12 Volt  
Switch: Heat Sensor  
Pulley Dia.: 4-3/4  
Coil Clock: Wire Lead  
Nissan (92-90)  
Nissan: 9260065E04



**57447 Reman**  
NVR140S  
4 Groove  
12 Volt  
Switch: Heat Sensor  
Pulley Dia.: 5-1/4  
Coil Clock: Wire Lead  
Nissan (90-89)

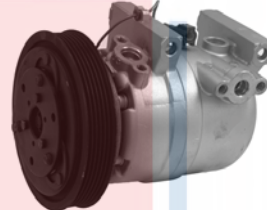

**57449 Reman**  
NVR140S  
6 Groove  
12 Volt  
Switch: Heat Sensor  
Pulley Dia.: 5-5/8  
Coil Clock: Wire Lead  
Infiniti (96-91); Nissan (92-91)  
Infiniti: 9260062J21  
Nissan: 9260069Y01

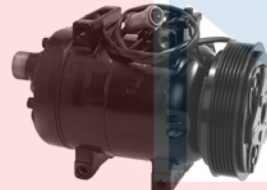

**57450 Reman**  
DCW17B  
6 Groove  
12 Volt  
Switch: Heat Sensor  
Pulley Dia.: 5  
Coil Clock: Wire Lead  
Audi (93-92)

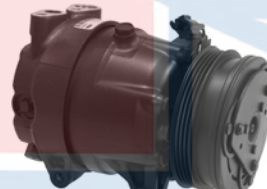

**57452 Reman**  
V5-15F  
4 Groove  
12 Volt  
Pulley Dia.: 4-5/8  
Coil Clock: Wire Lead  
Infiniti (93-90)  
Infiniti: 9260064U25



**57455 Reman**  
DKS16H  
4 Groove  
12 Volt  
Belt Width: 5/8  
Pulley Dia.: 4-5/8  
Coil Clock: Wire Lead  
Nissan (95-89)  
Nissan: 926007E002, 926007E065,  
9260085E13, 9260096E01



**57457 Reman**  
DKS13  
1 Groove  
12 Volt  
Pulley Dia.: 5-1/4  
Coil Clock: Wire Lead  
Isuzu (93-88)  
Isuzu: 8944351701



**57459 Reman**  
DKS13G  
1 Groove  
12 Volt  
Pulley Dia.: 4-3/4  
Coil Clock: Wire Lead  
Isuzu (87-85)  
Isuzu: 8941365891, 8941579791



**57509 Reman**  
DKV14D  
6 Groove  
12 Volt  
Pulley Dia.: 5  
Coil Clock: Wire Lead  
Geo (93-90); Isuzu (93-90), (85)  
General Motors Corp: 19192292,  
94343957, 97065108  
Isuzu: 8943439572, 8970651080

# Compressors

## Calsonic / Zexel Cont'd



**57517 Reman**  
DKS15CH  
2 Groove  
12 Volt  
Belt Width: 1/2  
Pulley Dia.: 5-1/4  
Coil Clock: Wire Lead  
Freightliner (94-92)



**57526 Reman**  
DCV11A  
5 Groove  
12 Volt  
Pulley Dia.: 5  
Coil Clock: Wire Lead  
Saturn (97)  
General Motors Corp: 19187782



**57528 Reman**  
DKV11A  
5 Groove  
12 Volt  
Pulley Dia.: 5  
Coil Clock: Wire Lead  
Saturn (96)  
General Motors Corp: 19192298



**57529 Reman**  
DCV11G  
5 Groove  
12 Volt  
Pulley Dia.: 5  
Coil Clock: 2  
Saturn (98)



**57533 Reman**  
DCV11A  
5 Groove  
12 Volt  
Switch: Heat Sensor  
Belt Width: 3/4  
Pulley Dia.: 5  
Coil Clock: Wire Lead  
Saturn (95-94)



**57541 Reman**  
DKV11A  
5 Groove  
12 Volt  
Pulley Dia.: 4-7/8  
Coil Clock: Wire Lead  
Saturn (02-99)  
General Motors Corp: 19192299  
Saturn: 19130488

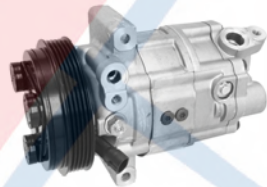

**57543 Reman**  
DCV14J  
5 Groove  
12 Volt  
Pulley Dia.: 5  
Coil Clock: 2  
Saturn (04-00)

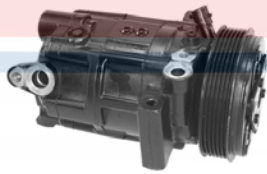

**57546 Reman**  
DCV14J  
6 Groove  
12 Volt  
Pulley Dia.: 5  
Coil Clock: 2 O'Clock



**57633 Reman**  
DKS13G  
Isuzu (93-88)

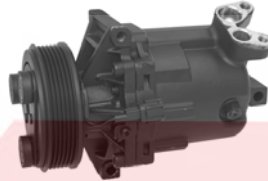

**57887 Reman**  
CR10  
6 Groove  
12 Volt  
Pulley Dia.: 4-5/16  
Coil Clock: Wire Lead  
Nissan (15-07)  
Nissan: 92600CJ60B, 92600CJ60C

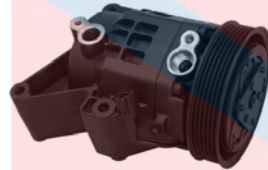

**57888 Reman**  
CR08  
6 Groove  
12 Volt  
Pulley Dia.: 4-5/8  
Coil Clock: Wire Lead  
Mazda (09-06)  
Mazda: NEY161450



**57890 Reman**  
CR10  
6 Groove  
12 Volt  
Pulley Dia.: 4-21/64  
Coil Clock: Wire Lead  
Nissan (12-09)  
Nissan: 92610CJ63A



**57892 Reman**  
CR08  
7 Groove  
12 Volt  
Pulley Dia.: 3-15/16  
Coil Clock: Wire Lead  
Nissan (15-11)



**58410 New**  
**57410 Reman**  
DKS17D  
7 Groove  
12 Volt  
Pulley Dia.: 4-1/2  
Coil Clock: Wire Lead  
Nissan (15-05)  
Nissan: 92600ZL90B  
Nippondenso: 96200ZT00B



**58411 New**  
**57411 Reman**  
DKS17D  
6 Groove  
12 Volt  
Pulley Dia.: 4-7/8  
Coil Clock: Wire Lead  
Mazda (08-03)  
Mazda: GN3G61450A

# Compressors

## Calsonic / Zexel Cont'd



**58440** New  
**57440** Reman  
 NVR140S  
 1 Groove  
 12 Volt  
 Switch: Heat Sensor  
 Belt Width: 1/2  
 Pulley Dia.: 5-3/4  
 Coil Clock: Wire Lead  
 Nissan (96-86)  
 Nissan: 9260057G11



**58442** New  
 DKV14C  
 4 Groove  
 12 Volt  
 Switch: Heat Sensor  
 Pulley Dia.: 5-1/4  
 Coil Clock: Wire Lead  
 Nissan (92-91)  
 Nissan: 9260065Y02

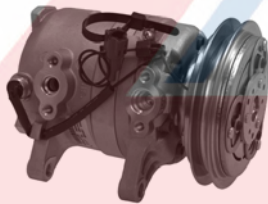

**58444** New  
**57444** Reman  
 NVR140S  
 1 Groove  
 12 Volt  
 Switch: Heat Sensor  
 Belt Width: 1/2  
 Pulley Dia.: 5-1/4  
 Coil Clock: Wire Lead  
 Nissan (97-85)  
 Nissan: 9260056G11



**58445** New  
**57445** Reman  
 DKV14C  
 4 Groove  
 12 Volt  
 Switch: Heat Sensor  
 Pulley Dia.: 4-3/4  
 Coil Clock: Wire Lead  
 Nissan (97-93)  
 Nissan: 926001E413

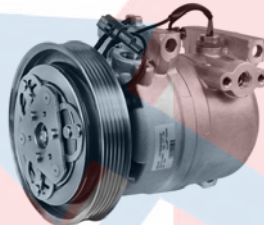

**58449** New  
 DKV14C  
 6 Groove  
 12 Volt  
 Pulley Dia.: 5-5/8  
 Infiniti (96-91); Nissan (92-91)  
 Infiniti: 9260088N07

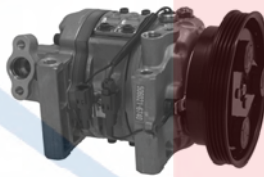

**58451** New  
**57451** Reman  
 DKV14D  
 4 Groove  
 12 Volt  
 Switch: Heat Sensor  
 Pulley Dia.: 5-1/4  
 Coil Clock: Wire Lead  
 Nissan (94-93)  
 Nissan: 9260064Y21



**58456** New  
**57456** Reman  
 DKV14D  
 6 Groove  
 12 Volt  
 Switch: Heat Sensor  
 Belt Width: 7/8  
 Pulley Dia.: 5-5/8  
 Coil Clock: Wire Lead  
 Nissan (99-93)  
 Nissan: 926005B400, 9260068Y21,  
 926009B460

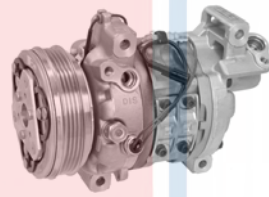

**58458** New  
**57458** Reman  
 DKV14D  
 4 Groove  
 12 Volt  
 Switch: Heat Sensor  
 Pulley Dia.: 4-1/4  
 Coil Clock: Wire Lead  
 Acura (97-96); Honda (97-94); Isuzu (97-93)  
 Isuzu: 8970858960, 8970961490

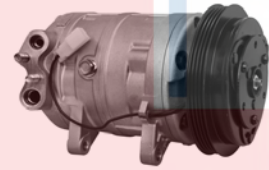

**58460** New  
**57460** Reman  
 DKS16H  
 4 Groove  
 12 Volt  
 Pulley Dia.: 5-5/8  
 Coil Clock: Wire Lead  
 Nissan (96-89)  
 Nissan: 9260030P05, 9260048P01



**58461** New  
**57461** Reman  
 DKS17D  
 6 Groove  
 12 Volt  
 Pulley Dia.: 4-7/8  
 Coil Clock: Wire Lead  
 Nissan (06-02)  
 Nissan: 926008J03B



**58462** New  
**57462** Reman  
 DKS17D  
 6 Groove  
 12 Volt  
 Pulley Dia.: 4-1/2  
 Coil Clock: Wire Lead  
 Mazda (08-03)  
 Mazda: GK2G61450M

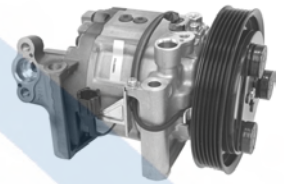

**58474** New  
**57474** Reman  
 DKV14D  
 6 Groove  
 12 Volt  
 Switch: Heat Switch  
 Pulley Dia.: 5-5/8  
 Coil Clock: Wire Lead  
 Ford (93); Nissan (99-98)  
 Nissan: 926008Z000, 926008Z060

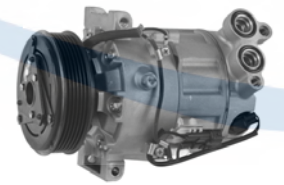

**58489** New  
 DCS17E  
 6 Groove  
 12 Volt  
 Pulley Dia.: 4-33/100  
 Volvo (11-07)



# Compressors

## Calsonic / Zexel Cont'd



**58492 New**  
DKV10R  
6 Groove  
12 Volt  
Pulley Dia.: 4-5/16  
Subaru (15-12)  
Subaru: 73111FJ000, 73111FJ040



**58512 New**  
DKS15BH  
2 Groove  
12 Volt  
Belt Width: 1/2  
Pulley Dia.: 5-1/4  
Coil Clock: 12  
Freightliner (94-92)  
Diesel Kiki: 5096400305  
Euclid: E801221, E801230  
Kenworth: 48822011  
Kysor: 1401001, 1403004, 1403104,  
1403128, 402722, 402825, 402864

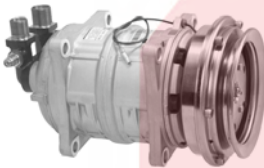

**58513 New**  
**57513 Reman**  
DKS15CH  
May Require Use of O.E. Manifold  
1 Groove  
12 Volt  
Belt Width: 1/2  
Pulley Dia.: 5  
Coil Clock: Wire Lead  
Freightliner (94-92)  
Climatech: LE1005  
Dallas Truck AC: 0105514  
Diesel Kiki: 5060110211  
Euclid: E801228  
Kysor: 1403010, 402761  
Mack: 4379RD558750  
NaviStar: 14590  
Red Dot: 75R8502  
Seltec: 48825063



**58514 New**  
DKS15  
May Require Use of O.E. Manifold  
1 Groove  
12 Volt  
Belt Width: 3/4  
Pulley Dia.: 6-1/4  
Coil Clock: Wire Lead  
Freightliner (94-92)  
Dallas Truck AC: 0105675  
Diesel Kiki: 48825065, 5060111700  
Euclid: E801226  
Kysor: 1403011, 402723  
NaviStar: 1691740C92  
Peterbilt: 48823065  
Seltec: 48825065

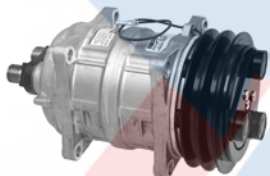

**58515 New**  
DKS15CH  
May Require Use of O.E. Manifold  
2 Groove  
12 Volt  
Belt Width: 1/2  
Pulley Dia.: 5-1/4  
Coil Clock: Wire Lead  
Diesel Kiki: 5060111910  
Euclid: E801210  
Kenworth: 402760, 48823030  
Kysor: 1403006, 1403114, 402760  
Seltec: 48825030



**58519 New**  
**57519 Reman**  
DKS15CH  
6 Groove  
12 Volt  
Pulley Dia.: 4-11/16  
Coil Clock: Wire Lead  
Volvo (97-93)  
Diesel Kiki: 5060111970  
Mack: 48823070



**58520 New**  
**57520 Reman**  
DKS15CH  
6 Groove  
12 Volt  
Pulley Dia.: 4-3/4  
Coil Clock: Wire Lead  
Volvo (01-98)  
Volvo: 8601533  
Kysor: 402735



**58521 New**  
**57521 Reman**  
DKS15BH  
May Require use of OE Manifold  
2 Groove  
12 Volt  
Belt Width: 1/2  
Pulley Dia.: 5-1/4  
Coil Clock: Wire Lead  
Freightliner (94-92); Volvo (95-85)  
Volvo: 8603374  
Carrier: 501271A  
Climatech: LF1005  
Diesel Kiki: 5060111510  
Euclid: E801220  
Kysor: 1403001  
Mack: 4379RD558760  
NaviStar: 19062, 705003  
Seltec: 48825011, 48845011

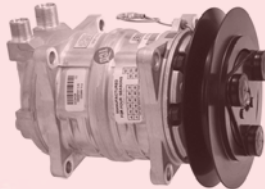

**58522 New**  
DKS15  
1 Groove  
24 Volt  
Pulley Dia.: 6-1/4  
Coil Clock: Wire Lead  
Diesel Kiki: 5060112050  
Euclid: E801227  
Kysor: 1403009, 402724  
Seltec: 48825057



**58526 New**  
TM15HD  
May Require use of OE Manifold  
2 Groove  
24 Volt  
Belt Width: 1/2  
Pulley Dia.: 5-1/4  
Coil Clock: Wire Lead  
Euclid: E801225, E801322  
Hy-Capacity: 8814620444  
Kysor: 1403002, 1403101, 1403110,  
1403126, 1403132, 402817, 402828,  
402855, 402863, 402877  
NaviStar: 705031  
Red Dot: 75R8614  
Seltec: 48825015



**58527 New**  
**57527 Reman**  
DCV14A  
5 Groove  
12 Volt  
Switch: Heat Sensor  
Pulley Dia.: 5-1/4  
Coil Clock: Wire Lead  
Saturn (93-91)  
Saturn: 21031322

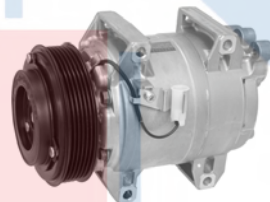

**58544 New**  
**57544 Reman**  
DKS17D  
6 Groove  
12 Volt  
Pulley Dia.: 5-1/4  
Coil Clock: Wire Lead  
Volvo (12), (09-99)  
Volvo: 1161627, 36001066, 8602998,  
8603132

# Compressors

## Calsonic / Zexel Cont'd



**58612 New**  
 TM15HD  
 2 Groove  
 12 Volt  
 Belt Width: 1/2  
 Pulley Dia.: 5-1/4  
 Coil Clock: Wire Lead  
 Euclid: E801321  
 Kysor: 1403163  
 NaviStar: 14591, 1691723C92, 705029, 705057  
 Seltec: 48845021



**58613 New**  
 TM15  
 May Require use of OE Manifold  
 1 Groove  
 12 Volt  
 Belt Width: 1/2  
 Pulley Dia.: 5  
 Coil Clock: 12  
 Freightliner (06-96)  
 Euclid: E801324  
 Kysor: 1403112, 402830  
 NaviStar: 705005  
 Red Dot: 75R8532  
 Seltec: 48845063

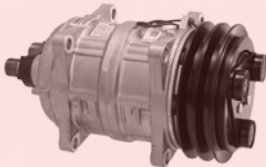

**58615 New**  
 TM15HD  
 May Require Use of O.E. Manifold  
 2 Groove  
 12 Volt  
 Belt Width: 1/2  
 Pulley Dia.: 5-1/4  
 Coil Clock: Wire Lead  
 Freightliner (06-96)  
 Kysor: 402829  
 Red Dot: 75R8542



**58616 New**  
 TM15HD  
 8 Groove  
 12 Volt  
 Pulley Dia.: 4-3/4  
 Coil Clock: Wire Lead  
 GMC & CHEVY (98-90)  
 Euclid: E801233, E801333  
 Kysor: 1403120, 402834  
 NaviStar: 705033, 705035  
 Seltec: 48845121

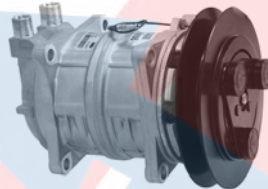

**58618 New**  
 TM15HD  
 1 Groove  
 12 Volt  
 Belt Width: 3/4  
 Pulley Dia.: 6-1/4  
 Coil Clock: Wire Lead  
 Freightliner (06-96)  
 Euclid: E801325, E801326  
 Kysor: 1403007, 1403105, 1403106, 1403107, 1403129, 402826, 402850, 402861  
 NaviStar: 705034, 705056  
 Red Dot: 75R85712, 75R8632

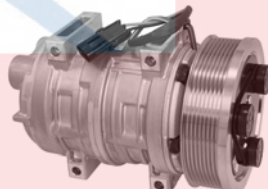

**58619 New**  
 TM21HD  
 8 Groove  
 12 Volt  
 Pulley Dia.: 5-3/8  
 Coil Clock: Wire Lead  
 Seltec: 10357244, 48847244



**58620 New**  
 TM15  
 2 Groove  
 24 Volt  
 Belt Width: 1/2  
 Pulley Dia.: 5-1/4  
 Coil Clock: 12  
 Freightliner (06-96)  
 Kysor: 402856

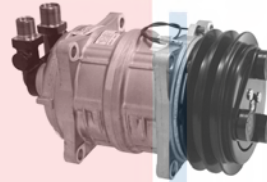

**58621 New**  
 TM15HD  
 May Require Use of O.E. Manifold  
 2 Groove  
 12 Volt  
 Belt Width: 1/2  
 Pulley Dia.: 5-1/4  
 Coil Clock: Wire Lead  
 Freightliner (06-96)  
 Climatech: LF1025  
 Diesel Kiki: 48845011  
 Euclid: E801314, E801329  
 Kysor: 1403013, 1403015, 1403100, 1403115, 1403125, 402783, 402818, 402969  
 Mack: 4379RD570230  
 NaviStar: 1696863C91, 705036  
 Red Dot: 75R8612  
 Seltec: 48825069, 48825078

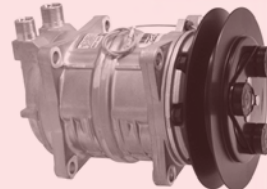

**58622 New**  
 TM15HD  
 1 Groove  
 24 Volt  
 Belt Width: 3/4  
 Pulley Dia.: 6-1/4  
 Coil Clock: Wire Lead  
 Euclid: E801323  
 Kysor: 1403103, 1403111, 1403133, 402827, 402851  
 Red Dot: 75R8634



**58624 New**  
 TM13HD  
 May Require Use of O.E. Manifold  
 2 Groove  
 12 Volt  
 Belt Width: 1/2  
 Pulley Dia.: 5-5/16  
 Coil Clock: 12  
 Kysor: 402832



**58625 New**  
 TM13HD  
 May Require Use of O.E. Manifold  
 2 Groove  
 12 Volt  
 Belt Width: 1/2  
 Pulley Dia.: 5-1/4  
 Coil Clock: 12  
 Euclid: E801319  
 Kysor: 1403116, 402833  
 Red Dot: 75R86152



**58631 New**  
 TM21HD  
 8 Groove  
 24 Volt  
 Pulley Dia.: 5-5/8  
 Coil Clock: 12

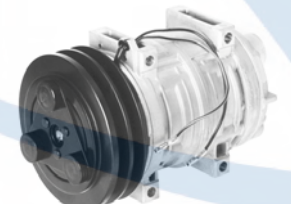

**58635 New**  
 TM21HD  
 2 Groove  
 12 Volt  
 Pulley Dia.: 5-5/8  
 Coil Clock: Wire Lead



# Compressors

## Calsonic / Zexel Cont'd



**58637 New**  
TM21HD  
2 Groove  
24 Volt  
Pulley Dia.: 5-5/8  
Coil Clock: 12  
Seltec: 48847242



**58643 New**  
TM08HD  
4 Groove  
12 Volt  
Pulley Dia.: 4-3/4  
Coil Clock: 12  
Chevy (98-95)  
Seltec: 48842080



**58647 New**  
CSE17C  
6 Groove  
12 Volt  
Pulley Dia.: 4-11/32  
Coil Clock: Wire Lead  
BMW (10-07)  
BMW: 64529185143



**58660 New**  
TM13HA  
2 Groove  
12 Volt  
Belt Width: 1/2  
Pulley Dia.: 5-1/4  
Coil Clock: 12  
Honda (84)



**58690 New**  
TM21HD  
10 Groove  
12 Volt  
Pulley Dia.: 5  
Coil Clock: Wire Lead



**58883 New**  
**57883 Reman**  
**67658 Reman**  
CR14  
4 Groove  
12 Volt  
Pulley Dia.: 5  
Coil Clock: Wire Lead  
Subaru (07-02)  
Subaru: 73111FE021, 73111FE040

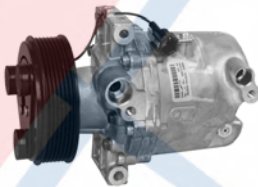

**58885 New**  
**57885 Reman**  
CR14  
7 Groove  
12 Volt  
Pulley Dia.: 4-1/2  
Coil Clock: Wire Lead  
Nissan (15-05)  
Nissan: 92600EA31A

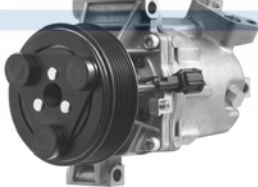

**58887 New**  
CR-10  
6 Groove  
12 Volt  
Pulley Dia.: 4-5/32  
Nissan (15-07)  
Nissan: 92600CJ60B, 92600CJ60C,  
92610CJ60C

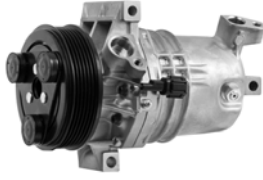

**58890 New**  
CR-10  
6 Groove  
12 Volt  
Pulley Dia.: 4-21/64  
Nissan (12-09)  
Nissan: 92600CJ63E

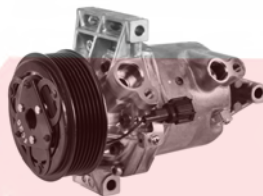

**58892 New**  
CR08  
8 Groove  
12 Volt  
Pulley Dia.: 3-15/16  
Nissan (15-11)  
Nissan: 926003HNO0C

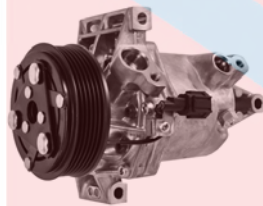

**58893 New**  
CR08  
6 Groove  
12 Volt  
Pulley Dia.: 3-15/16  
Coil Clock: Wire Lead  
Nissan (11)  
Nissan: 926001KC1A



**67420 Reman**  
V5-15G  
4 Groove  
12 Volt  
Pulley Dia.: 5-1/4  
Coil Clock: Wire Lead  
Nissan (93-91)  
Nissan: 9260053F25



**67421 Reman**  
CWV617  
4 Groove  
12 Volt  
Pulley Dia.: 5-1/4  
Coil Clock: Wire Lead  
Nissan (96-95)  
Nissan: 9260070F10



**67422 Reman**  
CWV615  
4 Groove  
12 Volt  
Pulley Dia.: 5-1/4  
Coil Clock: Wire Lead  
Nissan (94)  
Nissan: 9260053F72



**67423 Reman**  
DKS16H  
4 Groove  
12 Volt  
Belt Width: 1/2  
Pulley Dia.: 5-1/4  
Coil Clock: Wire Lead  
Nissan (95-90)

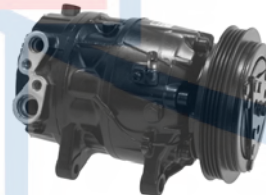

**67425 Reman**  
CWV618  
4 Groove  
12 Volt  
Pulley Dia.: 5-1/4  
Coil Clock: Wire Lead  
Infiniti (97-93)



# Compressors

## Calsonic / Zexel Cont'd



**67426 Reman**  
V5-15G  
4 Groove  
12 Volt  
Pulley Dia.: 4-45/64  
Coil Clock: Wire Lead  
Subaru (93-90)  
Subaru: 73008AA710



**67434 Reman**  
CWV618  
4 Groove  
12 Volt  
Pulley Dia.: 4-7/8  
Coil Clock: Wire Lead  
Infiniti (03)  
Infiniti: 92600AM71A  
Nissan: 92600AM71A



**67450 Reman**  
DKV14D  
4 Groove  
12 Volt  
Switch: Heat Sensor  
Pulley Dia.: 5-1/4  
Coil Clock: Wire Lead  
Nissan (93)



**67469 Reman**  
CSV614  
6 Groove  
12 Volt  
Pulley Dia.: 4-21/64  
Coil Clock: Wire Lead  
Suzuki (12-09)



**67630 Reman**  
DKS13G  
9 Groove  
12 Volt  
Pulley Dia.: 4-7/8  
Coil Clock: Wire Lead  
Mazda (87-86)

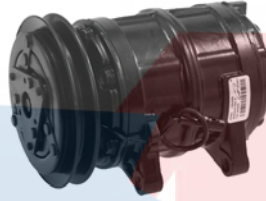

**67631 Reman**  
DKS13CH  
1 Groove  
12 Volt  
Belt Width: 1/2  
Pulley Dia.: 5-1/4  
Coil Clock: Wire Lead  
Isuzu (95-93)  
Isuzu: 8970688202



**67633 Reman**  
DKS13G  
1 Groove  
12 Volt  
Pulley Dia.: 4-3/4  
Coil Clock: Wire Lead  
Chevy (88-85); Geo (89); Isuzu (89-85)  
Isuzu: 8941644950



**67634 Reman**  
DKS17S  
2 Groove  
12 Volt  
Belt Width: 1/2  
Pulley Dia.: 4-3/4  
Coil Clock: Wire Lead  
Isuzu (89-88)



**67635 Reman**  
DKS17G  
2 Groove  
12 Volt  
Belt Width: 1/2  
Pulley Dia.: 4-3/4  
Coil Clock: Wire Lead  
Isuzu (87-85)



**67636 Reman**  
DKS17S  
1 Groove  
12 Volt  
Belt Width: 1/2  
Pulley Dia.: 5-23/64  
Coil Clock: Wire Lead  
Isuzu (97-87)  
Isuzu: 8944386060



**67637 Reman**  
DKS17G  
1 Groove  
12 Volt  
Belt Width: 1/2  
Pulley Dia.: 5-1/4  
Coil Clock: Wire Lead  
Isuzu (86-85)  
Isuzu: 8941644890

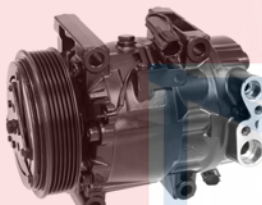

**67643 Reman**  
CWE618  
6 Groove  
12 Volt  
Pulley Dia.: 4-7/8  
Coil Clock: Wire Lead  
Infiniti (08-03)



**67650 Reman**  
DKS16H  
4 Groove  
12 Volt  
Pulley Dia.: 5-1/4  
Coil Clock: Wire Lead  
Infiniti (92-90)  
Infiniti: 92600F6605



**67651 Reman**  
CWV617  
4 Groove  
12 Volt  
Pulley Dia.: 5-1/4  
Coil Clock: Wire Lead  
Infiniti (96-93)  
Infiniti: 9260067U61



**67654 Reman**  
DCW17  
4 Groove  
12 Volt  
Pulley Dia.: 4-3/4  
Coil Clock: Wire Lead  
Subaru (92-90)  
Subaru: 73011AA040, 73011AA080



**67656 Reman**  
CWV618  
4 Groove  
12 Volt  
Pulley Dia.: 5  
Coil Clock: Wire Lead  
Infiniti (98-97)

# Compressors

## Calsonic / Zexel Cont'd



**67663 Reman**  
DCS171C  
4 Groove  
12 Volt  
Pulley Dia.: 4-3/8  
Coil Clock: Wire Lead  
Suzuki (08-07)

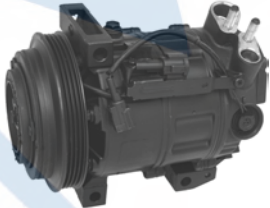

**67665 Reman**  
DCS17E  
4 Groove  
12 Volt  
Switch: Control Valve  
Pulley Dia.: 5-1/4  
Coil Clock: Wire Lead  
Infiniti (08-06)  
Infiniti: 92600EG00C

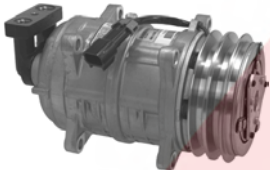

**68173 New**  
TM16  
2 Groove  
12 Volt  
Pulley Dia.: 4-3/4  
Coil Clock: Wire Lead

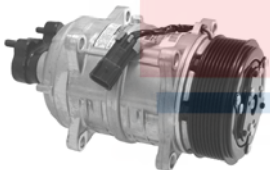

**68175 New**  
TM16  
8 Groove  
12 Volt  
Pulley Dia.: 4-11/16  
Coil Clock: Wire Lead



**68176 New**  
TM16  
2 Groove  
12 Volt  
Pulley Dia.: 4-11/16  
Coil Clock: Wire Lead

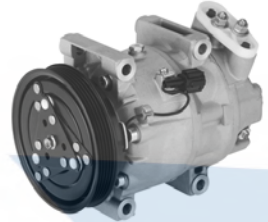

**68427 New**  
**67427 Reman**  
**57423 Reman**  
CWV618  
5 Groove  
12 Volt  
Pulley Dia.: 5-1/4  
Coil Clock: Wire Lead  
Infiniti (00-97); Nissan (01-96)  
Infiniti: 92600W010  
Nissan: 92600W010

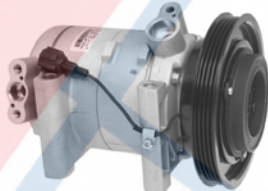

**68428 New**  
**67428 Reman**  
**67429 Reman**  
DKV14C  
4 Groove  
12 Volt  
Switch: Heat Sensor  
Pulley Dia.: 5-5/8  
Coil Clock: Wire Lead  
Nissan (04-99)  
Nissan: 926007B410



**68435 New**  
**67435 Reman**  
CWV618  
4 Groove  
12 Volt  
Pulley Dia.: 5-1/4  
Coil Clock: Wire Lead  
Infiniti (03-01); Nissan (04-02)  
Infiniti: 926004W00A  
Nissan: 926004W00A  
Nippondenso: 926004W00A

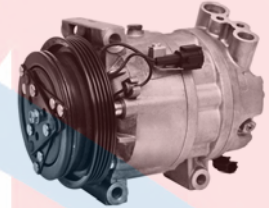

**68436 New**  
**67436 Reman**  
**67642 Reman - CWE615M**  
CWE618  
4 Groove  
12 Volt  
Pulley Dia.: 5-19/64  
Coil Clock: Wire Lead  
Infiniti (08-03)  
Infiniti: 92600AC00B, 92600AM80A



**68437 New**  
**67437 Reman**  
DKV14G  
4 Groove  
12 Volt  
Pulley Dia.: 5  
Coil Clock: Wire Lead  
Subaru (07-03)  
Subaru: 73111AE09A, 73111SA001



**68438 New**  
**67438 Reman**  
DKS17D  
6 Groove  
12 Volt  
Pulley Dia.: 5-1/4  
Coil Clock: Wire Lead  
Nissan (07-02)  
Nissan: 92600CA03B, 92600ZK32B



**68439 New**  
**67439 Reman**  
CWV615M  
4 Groove  
12 Volt  
Pulley Dia.: 5-1/4  
Coil Clock: Wire Lead  
Nissan (06-03)  
Nissan: 92600CD10B

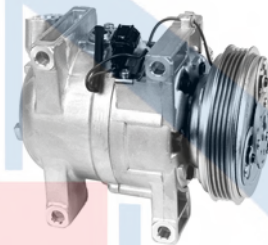

**68442 New**  
**67442 Reman**  
DKV14C  
4 Groove  
12 Volt  
Switch: Heat Sensor  
Pulley Dia.: 4-3/4  
Coil Clock: Wire Lead  
Nissan (99-98)

# Compressors

## Calsonic / Zexel Cont'd



**68443 New**  
**67443 Reman**  
 DKV14D  
 4 Groove  
 12 Volt  
 Switch: Heat Sensor  
 Pulley Dia.: 5  
 Coil Clock: Wire Lead  
 Subaru (97-95)  
 Subaru: 73111AC002, 73111AC040



**68444 New**  
**67444 Reman**  
 DKV14G  
 4 Groove  
 12 Volt  
 Pulley Dia.: 5  
 Coil Clock: Wire Lead  
 Subaru (02-01), (99-98)  
 Subaru: 73111AC130, 73111AE021

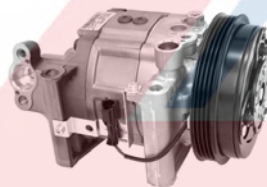

**68445 New**  
**67445 Reman**  
 DKV14G  
 4 Groove  
 12 Volt  
 Pulley Dia.: 5  
 Coil Clock: Wire Lead  
 Subaru (03-00)  
 Subaru: 73111AE05A

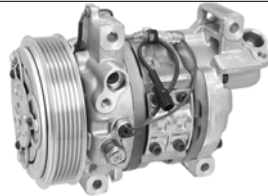

**68448 New**  
**67448 Reman**  
 DKV14D  
 6 Groove  
 12 Volt  
 Switch: Heat Sensor  
 Pulley Dia.: 5  
 Coil Clock: Wire Lead  
 Honda (98); Isuzu (98)  
 Isuzu: 8972273200

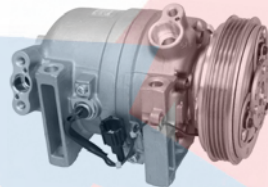

**68449 New**  
**67449 Reman**  
**67442 Reman**  
 DKV14C  
 4 Groove  
 12 Volt  
 Switch: Heat Sensor  
 Pulley Dia.: 4-3/4  
 Coil Clock: Wire Lead  
 Nissan (01-00)  
 Nissan: 926000Z010, 926000Z011, 926000Z800

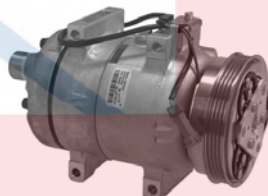

**68451 New**  
**67451 Reman**  
 DCW17D  
 4 Groove  
 12 Volt  
 Pulley Dia.: 4-3/4  
 Coil Clock: Wire Lead  
 Audi (05-97); VW (00-98)  
 Volkswagen: 8D0260805MX



**68452 New**  
**67460 Reman**  
 DKV11G  
 6 Groove  
 12 Volt  
 Switch: Heat Sensor  
 Pulley Dia.: 4-29/32  
 Coil Clock: Wire Lead  
 Nissan (06-00)  
 Nissan: 926004Z003

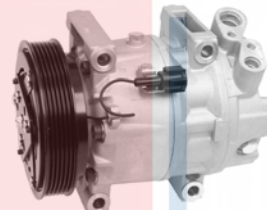

**68453 New**  
**67453 Reman**  
 CWV618  
 6 Groove  
 12 Volt  
 Pulley Dia.: 5-1/2  
 Coil Clock: Wire Lead  
 Infiniti (97-96); Nissan (96-95)  
 Infiniti: 9260040U01  
 Nissan: 9260040U01

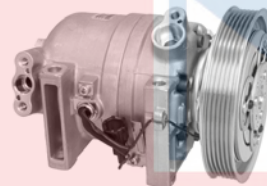

**68454 New**  
**67454 Reman - DKV14C**  
 DKV14D  
 6 Groove  
 12 Volt  
 Switch: Heat Sensor  
 Pulley Dia.: 5-5/8  
 Coil Clock: Wire Lead  
 Nissan (04-01)  
 Nissan: 926006S300



**68455 New**  
**67455 Reman**  
**67456 Reman**  
 DKV14C  
 1 Groove  
 12 Volt  
 Switch: Sensor Port  
 Belt Width: 1/2  
 Pulley Dia.: 5-1/2  
 Coil Clock: Wire Lead  
 Nissan (04-93)  
 Nissan: 926008B401  
 Nippondenso: 926008B406



**68457 New**  
**67457 Reman**  
 CR14  
 6 Groove  
 12 Volt  
 Pulley Dia.: 5  
 Coil Clock: Wire Lead  
 Nissan (15-05); Suzuki (12-09)  
 Nissan: 92600EA01A  
 Suzuki: 9520082Z20

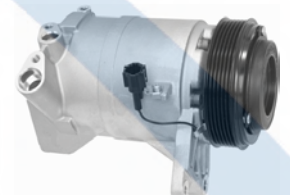

**68465 New**  
**67465 Reman**  
 DKS17D  
 6 Groove  
 12 Volt  
 Pulley Dia.: 4-11/16  
 Coil Clock: Wire Lead  
 Nissan (10-03)  
 Nissan: 926005Z01B



# Compressors

## Calsonic / Zexel Cont'd



**68466 New**  
**67466 Reman**  
 DKV14G  
 6 Groove  
 12 Volt  
 Pulley Dia.: 5  
 Coil Clock: Wire Lead  
 Nissan (06-02)  
 Nissan: 926008J001



**68467 New**  
**67467 Reman**  
 DKS15CH  
 6 Groove  
 12 Volt  
 Pulley Dia.: 4-5/8  
 Coil Clock: Wire Lead  
 Volvo (04-99)  
 Volvo: 8603127



**68484 New**  
**67452 Reman**  
 DKV14G  
 6 Groove  
 12 Volt  
 Pulley Dia.: 4-29/32  
 Coil Clock: Wire Lead  
 Honda (02-99); Isuzu (04-99)  
 Isuzu: 8972645083



**68600 New**  
 TM16  
 8 Groove  
 12 Volt  
 Pulley Dia.: 4-5/8  
 Coil Clock: Wire Lead  
 Kysor: 1403137

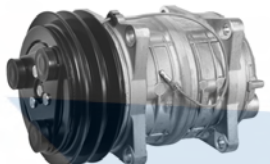

**68601 New**  
 TM15  
 2 Groove  
 24 Volt  
 Pulley Dia.: 5-5/16  
 Coil Clock: Wire Lead  
 Seltec: 10355212, 43545212, 48855212



**68604 New**  
 TM15  
 8 Groove  
 12 Volt  
 Pulley Dia.: 4-11/16  
 Coil Clock: Wire Lead  
 Seltec: 10355234, 43555234, 48845234

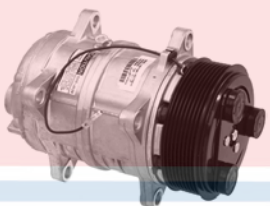

**68605 New**  
 TM16  
 8 Groove  
 12 Volt  
 Pulley Dia.: 4-9/16  
 Coil Clock: Wire Lead  
 Kysor: 1403141  
 Western Star: 3006193



**68606 New**  
 TM16  
 2 Groove  
 12 Volt  
 Pulley Dia.: 5-5/16  
 Coil Clock: Wire Lead  
 Seltec: 10356210, 43556210, 48846210

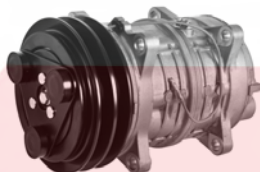

**68607 New**  
 TM16  
 2 Groove  
 24 Volt  
 Pulley Dia.: 5-5/16  
 Coil Clock: Wire Lead  
 Kysor: 1403020, 1403139  
 Seltec: 10356212, 43556212, 48846212

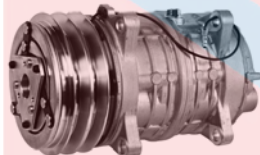

**68608 New**  
 TM16  
 2 Groove  
 12 Volt  
 Pulley Dia.: 4-59/64  
 Coil Clock: Wire Lead  
 Seltec: 10356222, 43546222, 48846222

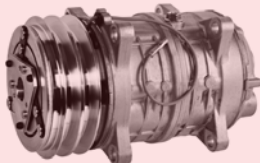

**68609 New**  
 TM16  
 2 Groove  
 24 Volt  
 Pulley Dia.: 4-59/64  
 Coil Clock: Wire Lead  
 Seltec: 10356241, 43556241, 48846241

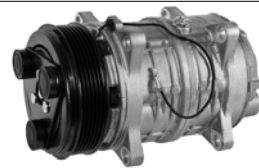

**68612 New**  
 TM16  
 6 Groove  
 12 Volt  
 Pulley Dia.: 4-11/16  
 Coil Clock: Wire Lead  
 Seltec: 10356218, 43556218, 48846218



**68613 New**  
 TM16  
 6 Groove  
 24 Volt  
 Pulley Dia.: 4-11/16  
 Coil Clock: Wire Lead  
 Seltec: 10356220, 43556220, 48846220



**68614 New**  
 TM16  
 8 Groove  
 24 Volt  
 Pulley Dia.: 4-11/16  
 Coil Clock: Wire Lead  
 Seltec: 10356125, 10356236, 43546236, 48846125, 48846236

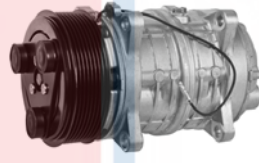

**68615 New**  
 TM16  
 8 Groove  
 12 Volt  
 Pulley Dia.: 4-11/16  
 Coil Clock: Wire Lead  
 Seltec: 10356234, 43556124, 48846124

# Compressors

## Calsonic / Zexel Cont'd



**68616 New**  
TM21HD  
8 Groove  
12 Volt  
Pulley Dia.: 5  
Coil Clock: Wire Lead  
Seltec: 10367275



**68617 New**  
TM21HD  
8 Groove  
24 Volt  
Pulley Dia.: 5  
Seltec: 10357394

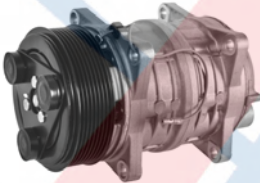

**68618 New**  
TM15  
8 Groove  
24 Volt  
Pulley Dia.: 4-11/16  
Coil Clock: Wire Lead  
Seltec: 10355236, 48845236

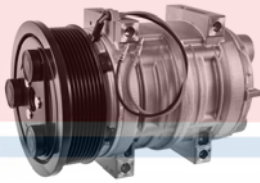

**68619 New**  
TM21HD  
8 Groove  
12 Volt  
Pulley Dia.: 5  
Coil Clock: Wire Lead  
Seltec: 10367260, 43567260, 48867260  
Western Star: 3006971



**68620 New**  
TM16  
10 Groove  
12 Volt  
Pulley Dia.: 4-11/16  
Coil Clock: Wire Lead  
Seltec: 10356558

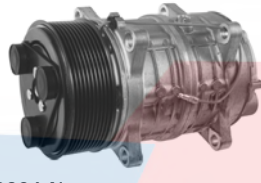

**68621 New**  
TM16  
10 Groove  
24 Volt  
Pulley Dia.: 4-11/16  
Coil Clock: Wire Lead  
Seltec: 10356551

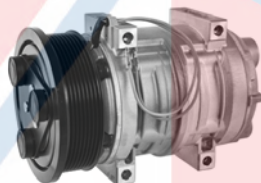

**68622 New**  
TM21HD  
8 Groove  
24 Volt  
Pulley Dia.: 5  
Coil Clock: Wire Lead  
Seltec: 10367262, 43567262

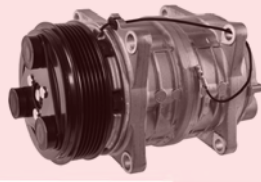

**68623 New**  
TM15HD  
6 Groove  
12 Volt  
Pulley Dia.: 4-11/16  
Coil Clock: Wire Lead  
Seltec: 10355218, 48845218



**68625 New**  
TM21HD  
8 Groove  
24 Volt  
Pulley Dia.: 5-13/32  
Red Dot: 75R86144  
Seltec: 10357246, 48847246

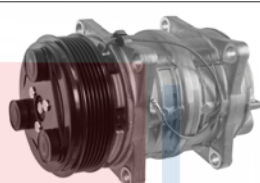

**68628 New**  
TM15  
6 Groove  
24 Volt  
Pulley Dia.: 4-11/16  
Coil Clock: Wire Lead  
Seltec: 10355479

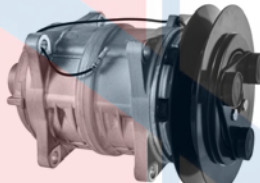

**68630 New**  
TM15  
1 Groove  
12 Volt  
Pulley Dia.: 6-1/4  
Coil Clock: Wire Lead  
Seltec: 10355226, 10356226, 43556226, 48845226, 48846226



**68631 New**  
TM16  
8 Groove  
12 Volt  
Pulley Dia.: 4-11/16  
Coil Clock: Wire Lead  
Seltec: 10356225, 48846225



**68632 New**  
TM16  
2 Groove  
24 Volt  
Pulley Dia.: 6  
Coil Clock: Wire Lead  
Seltec: 10356048

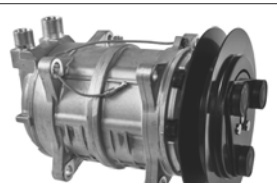

**68633 New**  
TM16  
1 Groove  
24 Volt  
Pulley Dia.: 6  
Coil Clock: Wire Lead  
Seltec: 10356057, 43556057, 48856057

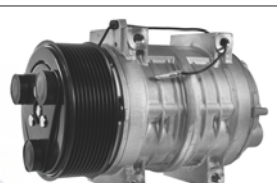

**68634 New**  
TM16  
10 Groove  
12 Volt  
Pulley Dia.: 4-11/16  
Coil Clock: Wire Lead  
Seltec: 10356400



**68635 New**  
TM16  
8 Groove  
12 Volt  
Pulley Dia.: 4-31/64  
Coil Clock: Wire Lead  
Red Dot: 75R85102, RD5128990  
Seltec: 10356282, 48856282

# Compressors

## Calsonic / Zexel Cont'd



**68636 New**  
TM16  
1 Groove  
12 Volt  
Pulley Dia.: 6-1/8  
Coil Clock: Wire Lead  
Seltec: 10356410



**68637 New**  
TM16  
8 Groove  
12 Volt  
Pulley Dia.: 4-11/16  
Coil Clock: Wire Lead  
Seltec: 10356458, 48846024



**68638 New**  
**67638 Reman**  
DCW17B  
6 Groove  
12 Volt  
Pulley Dia.: 5  
Coil Clock: Wire Lead  
Audi (02-88)  
Audi: 4A0260805AH, 8D0260805E  
Volkswagen: 4A0260805AH



**68639 New**  
TM21HD  
1 Groove  
12 Volt  
Pulley Dia.: 5-63/64  
Coil Clock: 3  
Seltec: 10347250



**68640 New**  
TM21HD  
10 Groove  
12 Volt  
Pulley Dia.: 5-3/32  
Carrier: 18102310



**68641 New**  
**67641 Reman**  
DKS17D  
7 Groove  
12 Volt  
Pulley Dia.: 4-1/2  
Coil Clock: Wire Lead  
Infiniti (10-04); Nissan (15-04)  
Infiniti: 926009FE0D  
Nissan: 926009FE0D

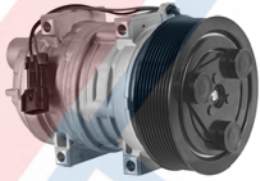

**68642 New**  
TM21HD  
10 Groove  
12 Volt  
Pulley Dia.: 5-9/16  
Coil Clock: Wire Lead

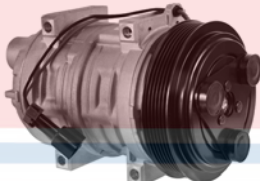

**68644 New**  
TM21HD  
6 Groove  
12 Volt  
Pulley Dia.: 5-5/16



**68646 New**  
**67646 Reman**  
DCS17E  
May Require Use of O.E. Manifold  
6 Groove  
12 Volt  
Pulley Dia.: 4-5/16  
Coil Clock: Coil Less  
Audi (10-06); VW (14), (10-06)

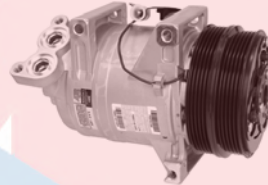

**68647 New**  
**67647 Reman**  
DKS15CH  
5 Groove  
12 Volt  
Pulley Dia.: 4-11/16  
Coil Clock: Wire Lead  
Volvo (13-04), (00-99)  
Volvo: 36001118

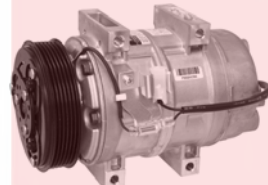

**68648 New**  
**67648 Reman**  
DKS17CH  
6 Groove  
12 Volt  
Pulley Dia.: 4-5/8  
Coil Clock: Wire Lead  
Volvo (02-99)  
Volvo: 8602621, 9166103



**68652 New**  
**67652 Reman**  
DKS15CH  
4 Groove  
12 Volt  
Pulley Dia.: 4-3/4  
Coil Clock: Wire Lead  
Subaru (95-93)  
Subaru: 73111AC010



**68653 New**  
**67653 Reman**  
CR14  
4 Groove  
12 Volt  
Switch: Heat Switch  
Pulley Dia.: 4-3/4  
Coil Clock: Wire Lead  
Subaru (01-93)  
Subaru: 73111FA001, 73111FA133

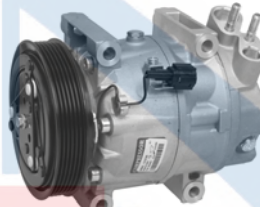

**68655 New**  
**67655 Reman**  
**67424 Reman**  
CWV618  
6 Groove  
12 Volt  
Pulley Dia.: 5-1/4  
Coil Clock: Wire Lead  
Infiniti (01-97); Nissan (01-97)  
Nissan: 926002Y01C, 92600AM71A



# Compressors

## Calsonic / Zexel Cont'd



**68657 New**  
**67657 Reman**  
 CWV618  
 6 Groove  
 12 Volt  
 Pulley Dia.: 5  
 Coil Clock: Wire Lead  
 Infiniti (04-02); Nissan (03-02)  
 Infiniti: 926005Y700



**68659 New**  
**67659 Reman**  
 CWV618  
 4 Groove  
 12 Volt  
 Pulley Dia.: 4-7/8  
 Coil Clock: Wire Lead  
 Infiniti (01-99)  
 Infiniti: 926006P311

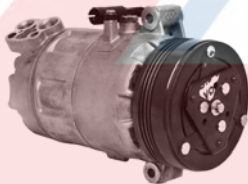

**68660 New**  
**67660 Reman**  
 CSV613  
 4 Groove  
 12 Volt  
 Pulley Dia.: 4-5/16  
 Coil Clock: Wire Lead  
 BMW (05-03)  
 BMW: 64526905643



**68661 New**  
**67661 Reman**  
 DKS17D  
 6 Groove  
 12 Volt  
 Pulley Dia.: 4-5/8  
 Coil Clock: Wire Lead  
 Chevy (09-06); Pontiac (09-06)  
 General Motors Corp: 19130251

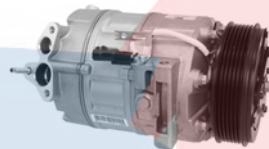

**68662 New**  
**67662 Reman**  
 DCS171C  
 6 Groove  
 12 Volt  
 Pulley Dia.: 4-1/2  
 Coil Clock: Wire Lead  
 Nissan (11-07)  
 Nissan: 926003SH1C, 926009AA0A

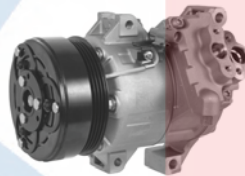

**68663 New**  
 DCS-141C  
 4 Groove  
 12 Volt  
 Pulley Dia.: 4-23/64  
 Coil Clock: Wire Lead  
 Suzuki (08-07)  
 Suzuki: 9520064JC0

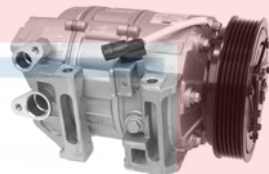

**68664 New**  
**67664 Reman**  
 DCS171C  
 6 Groove  
 12 Volt  
 Switch: Control Valve  
 Pulley Dia.: 5  
 Coil Clock: Wire Lead  
 Nissan (12-07)  
 Nissan: 92600ZE90B, 92600ZX50A



**68666 New**  
**67666 Reman**  
 DCS17E  
 6 Groove  
 12 Volt  
 Pulley Dia.: 4-29/32  
 Coil Clock: Wire Lead  
 Infiniti (10-06)  
 Infiniti: 92600EH00B

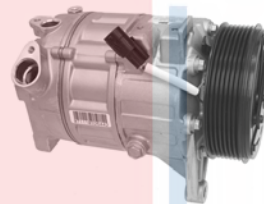

**68667 New**  
**67667 Reman**  
 DCS171C  
 7 Groove  
 12 Volt  
 Pulley Dia.: 4-1/2  
 Coil Clock: Wire Lead  
 Nissan (12-07)  
 Nissan: 92600ZN41B

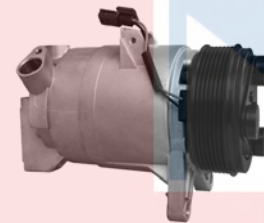

**68671 New**  
**67671 Reman**  
 DKS17D  
 7 Groove  
 12 Volt  
 Pulley Dia.: 4-1/4  
 Coil Clock: Wire Lead  
 Infiniti (15-13); Nissan (15-08)  
 Nissan: 926001JA1A, 92600JP01C,  
 92610JP01C



**68672 New**  
**67672 Reman**  
 DKS17D  
 6 Groove  
 12 Volt  
 Pulley Dia.: 4-33/64  
 Coil Clock: Wire Lead  
 Ford (12-08); Mazda (11-08); Mercury  
 (11-07)  
 Ford: 9L8Z19703A  
 Mazda: ZZD46145Z



**68673 New**  
**67673 Reman**  
 DKS17D  
 6 Groove  
 12 Volt  
 Pulley Dia.: 4-5/8  
 Coil Clock: Wire Lead  
 Dodge (11-07)  
 Chrysler: R5111412AG, RL111412AG

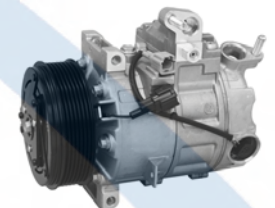

**68674 New**  
**67674 Reman**  
**67668 Reman**  
 DCS17E  
 May Require use of OE Manifold  
 7 Groove  
 12 Volt  
 Pulley Dia.: 4-1/2  
 Coil Clock: Wire Lead  
 Infiniti (10-07)  
 Infiniti: 92600JK20B, 92600JK21B

# Compressors

## Calsonic / Zexel Cont'd



**68675 New**  
**67675 Reman**  
 DCS17E  
 6 Groove  
 12 Volt  
 Pulley Dia.: 5-1/8  
 Coil Clock: Wire Lead  
 Land Rover (12-08); Volvo (13-07)  
 Land Rover: LR020193  
 Volvo: 36002746, 36011359, 36051068



**68678 New**  
**67678 Reman**  
 DKS17DS  
 6 Groove  
 12 Volt  
 Pulley Dia.: 4-3/4  
 Coil Clock: Wire Lead  
 Chevy (09-08); Pontiac (09-08); Suzuki (09-07)  
 General Motors Corp: 19130252  
 Suzuki: 9520078J01

**68681 New**  
**67681 Reman**  
 DCS171C  
 7 Groove  
 12 Volt  
 Pulley Dia.: 4-17/32  
 Coil Clock: Wire Lead  
 Nissan (09-07)  
 Nissan: 92600EV00A



**68682 New**  
**67682 Reman**  
 CSE617  
 May Require Use of O.E. Manifold  
 7 Groove  
 12 Volt  
 Pulley Dia.: 4-17/32  
 Coil Clock: Wire Lead  
 Infiniti (15-09); Nissan (15-09)  
 Infiniti: 926001CB1C  
 Nissan: 926001CB1C

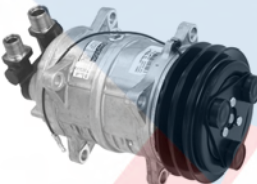

**68691 New**  
 TM16  
 May Require use of OE Manifold  
 2 Groove  
 12 Volt  
 Pulley Dia.: 5-1/4  
 Coil Clock: Wire Lead  
 Kysor: 1406003, 402050  
 Peterbilt: 46969910  
 Red Dot: 75R84412, 75R8722  
 Seltec: 43556018

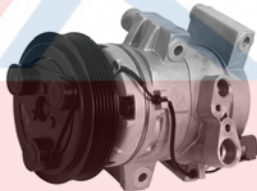

**68692 New**  
**67692 Reman**  
 DKS17DS  
 6 Groove  
 12 Volt  
 Pulley Dia.: 4-29/32  
 Coil Clock: Wire Lead  
 Mazda (13-09)  
 Mazda: GS3L61450E



**68700 New**  
 TM31  
 2 Groove  
 12 Volt  
 Pulley Dia.: 6  
 Coil Clock: Wire Lead  
 Kysor: 1403143  
 Seltec: 10368500, 48846500  
 Western Star: 3006778



**68701 New**  
 TM31  
 2 Groove  
 24 Volt  
 Pulley Dia.: 6  
 Coil Clock: 1 Wire Lead  
 Seltec: 10368510



**68702 New**  
 TM31  
 8 Groove  
 12 Volt  
 Pulley Dia.: 6-1/4  
 Coil Clock: Wire Lead  
 Kysor: 1403149  
 Western Star: 3006780



**68703 New**  
 TM31  
 8 Groove  
 24 Volt  
 Pulley Dia.: 6-1/4  
 Coil Clock: Wire Lead  
 Seltec: 10368550



**68704 New**  
 TM31  
 2 Groove  
 12 Volt  
 Belt Width: 5/8  
 Pulley Dia.: 6  
 Coil Clock: Wire Lead  
 International (05-92)



**68705 New**  
 TM31  
 2 Groove  
 24 Volt  
 Pulley Dia.: 6  
 Seltec: 10368530, 48846530

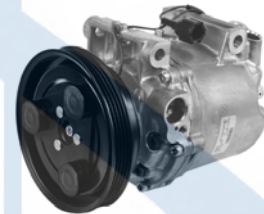

**68880 New**  
 CR14  
 4 Groove  
 12 Volt  
 Pulley Dia.: 5-5/16  
 Nissan (13-00)

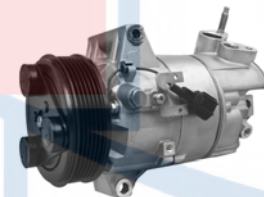

**78404 New**  
**77404 Reman**  
 CSV511  
 6 Groove  
 12 Volt  
 Pulley Dia.: 4-1/4  
 Coil Clock: Wire Lead  
 Nissan (10-07)  
 Nissan: 926001U600

# Compressors

## Calsonic / Zexel Cont'd



**78601 New**  
 TM21HD  
 6 Groove  
 12 Volt  
 Pulley Dia.: 5-23/64  
 Blue Bird (16-00)  
 Seltec: 10367256, 43567256



**98441 New**  
**97440 Reman**  
 DKV14G  
 6 Groove  
 12 Volt  
 Pulley Dia.: 5-5/8  
 Infiniti (02-99)



**98445 New**  
**97445 Reman**  
 DKV14G  
 6 Groove  
 12 Volt  
 Switch: Heat Switch  
 Pulley Dia.: 4-7/8  
 Coil Clock: Wire Lead  
 Subaru (04-01)  
 Subaru: 73111AE040



**98454 New**  
 DKS17DS  
 6 Groove  
 12 Volt  
 Pulley Dia.: 4-17/32  
 Coil Clock: N/R  
 Ford (10)  
 Ford: AR3Z19703A

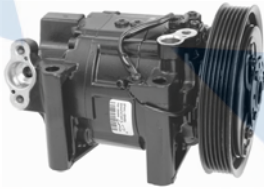

**97441 Reman**  
 DKV14G  
 6 Groove  
 12 Volt  
 Switch: Heat Switch  
 Pulley Dia.: 5-5/8  
 Coil Clock: Wire Lead  
 Infiniti (99)

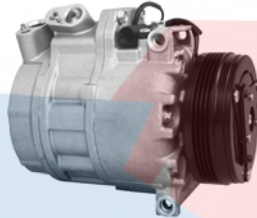

**98442 New**  
**97442 Reman**  
 CSV717  
 4 Groove  
 12 Volt  
 Pulley Dia.: 4-5/16  
 Coil Clock: Wire Lead  
 BMW (06-04)  
 BMW: 64526917864

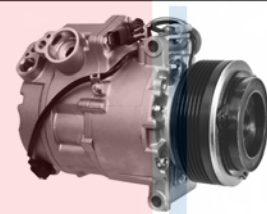

**98447 New**  
**97447 Reman**  
 CSE717  
 6 Groove  
 12 Volt  
 Pulley Dia.: 4-1/4  
 Coil Clock: Wire Lead  
 BMW (10-07)  
 BMW: 64529185142



**98483 New**  
**97483 Reman**  
 DKS17D  
 4 Groove  
 12 Volt  
 Pulley Dia.: 4-3/4  
 Coil Clock: Wire Lead  
 Suzuki (06-03)  
 Suzuki: 9520054JA0, 9520054JB0

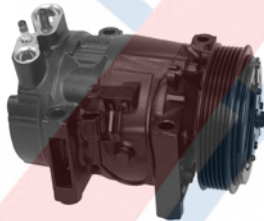

**97443 Reman**  
 CWV618  
 6 Groove  
 12 Volt  
 Pulley Dia.: 4-7/8  
 Coil Clock: Wire Lead  
 Infiniti (02)

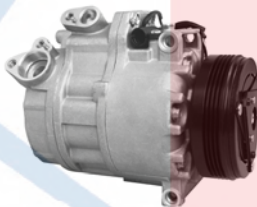

**98444 New**  
**97444 Reman**  
 CSV717  
 4 Groove  
 12 Volt  
 Pulley Dia.: 4-5/16  
 Coil Clock: Wire Lead  
 BMW (06-03)  
 BMW: 64526918000

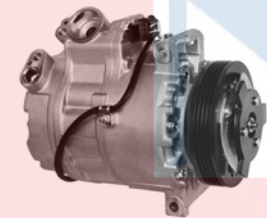

**98448 New**  
**97448 Reman**  
 CSE717  
 4 Groove  
 12 Volt  
 Pulley Dia.: 4-5/16  
 Coil Clock: Wire Lead  
 BMW (10-07)  
 BMW: 64529185144



**98484 New**  
**97484 Reman**  
 DKS17D  
 6 Groove  
 12 Volt  
 Pulley Dia.: 4-5/8  
 Coil Clock: Wire Lead  
 Jeep (11-07)  
 Chrysler: R5111401AF  
 Jeep: RL111401AF



**97446 Reman**  
 CWV618  
 6 Groove  
 12 Volt  
 Pulley Dia.: 5-1/4  
 Coil Clock: Wire Lead  
 Infiniti (02)



# Compressors

## Calsonic / Zexel Cont'd



**98485 New**  
**97485 Reman**  
 DKV10R  
 4 Groove  
 12 Volt  
 Pulley Dia.: 4-1/16  
 Coil Clock: Wire Lead  
 Subaru (15-07)  
 Subaru: 73111FG002

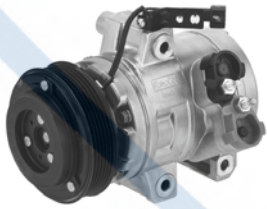

**98488 New**  
**97488 Reman**  
 DKS17DS  
 6 Groove  
 12 Volt  
 Pulley Dia.: 4-15/32  
 Coil Clock: Wire Lead  
 Ford (13-08)  
 Ford: 8S4Z19703BA

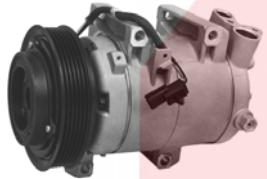

**98490 New**  
**97490 Reman**  
 DKS17D  
 6 Groove  
 12 Volt  
 Pulley Dia.: 4-57/64  
 Coil Clock: Wire Lead  
 Nissan (15-08)  
 Nissan: 92600JM01E



**98664 New**  
 VCS-14EC  
 6 Groove  
 12 Volt  
 Pulley Dia.: 4-33/64  
 Coil Clock: Wire Lead  
 Nissan (15-13)  
 Nissan: 926003TA5E



**98673 New**  
**97673 Reman**  
 DKS17DS  
 6 Groove  
 12 Volt  
 Pulley Dia.: 4-921/1000  
 Coil Clock: Wire Lead  
 Ford (12-08); Mazda (11-08); Mercury (11-08)  
 Ford: 8L8Z19703B  
 Mazda: ZZCB6145Z

### CVC

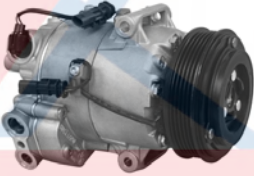

**158271 New**  
 CVC  
 5 Groove  
 12 Volt  
 Mount: Tangent Mount  
 Pulley Dia.: 4-5/16  
 Coil Clock: Wire Lead  
 Chevy (15-12)  
 General Motors Corp: 13414019



**158272 New**  
 CVC  
 6 Groove  
 12 Volt  
 Mount: Tangent Mount  
 Pulley Dia.: 4-5/16  
 Chevy (15), (13-12)  
 General Motors Corp: 13413335

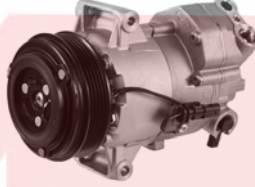

**158273 New**  
 CVC  
 5 Groove  
 12 Volt  
 Mount: 3 Tangent One on Rear Head  
 Pulley Dia.: 4-5/16  
 Coil Clock: Wire Lead  
 Buick (14-13)  
 General Motors Corp: 13414021

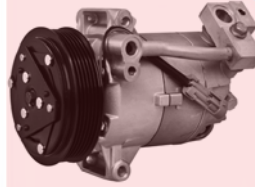

**158543 New**  
**157543 Reman**  
 CVC  
 6 Groove  
 12 Volt  
 Mount: Tangent Mount  
 Pulley Dia.: 5  
 Coil Clock: 2  
 Saturn (04-00)  
 Saturn: 22676735



**158546 New**  
**157546 Reman**  
 CVC  
 6 Groove  
 12 Volt  
 Mount: Tangent Mount  
 Pulley Dia.: 5  
 Coil Clock: 2  
 Saturn (05-00)



**198546 New**  
**157546 Reman**  
 CVC  
 6 Groove  
 12 Volt  
 Mount: Tangent Mount  
 Pulley Dia.: 5  
 Coil Clock: 2  
 Saturn (05-00)  
 Saturn: 22676737

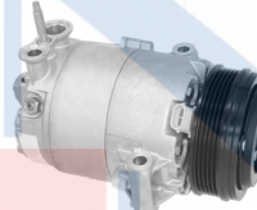

**68217 New**  
**67217 Reman**  
 CVC  
 5 Groove  
 12 Volt  
 Mount: Tangent Mount  
 Pulley Dia.: 4-5/16  
 Coil Clock: 2 O'Clock  
 Cadillac (09-04)  
 General Motors Corp: 89019334

# Compressors

## CVC Cont'd



**68218 New**  
**67218 Reman**  
 CVC  
 6 Groove  
 12 Volt  
 Mount: Tangent Mount  
 Pulley Dia.: 4-45/64  
 Coil Clock: Wire Lead  
 Chevy (11)  
 General Motors Corp: 13395695



**68221 New**  
 CVC  
 6 Groove  
 12 Volt  
 Mount: 2 Ear & 1 Tangent  
 Pulley Dia.: 4-11/16  
 Buick (14-13); Cadillac (14-13); Chevy (15-14)  
 General Motors Corp: 23314079



**68239 New**  
**67239 Reman**  
 CVC  
 6 Groove  
 12 Volt  
 Mount: Tangent Mount  
 Pulley Dia.: 4-1/2  
 Coil Clock: 3  
 Chevy (05-04)  
 General Motors Corp: 89019333



**68275 New**  
**67275 Reman**  
 CVC  
 5 Groove  
 12 Volt  
 Mount: Tangent Mount  
 Pulley Dia.: 4  
 Coil Clock: 3  
 Chevy (10-02); Pontiac (07-02); Saturn (07-03)  
 General Motors Corp: 15893103  
 Saturn: 15893103

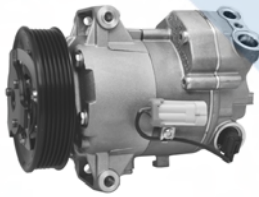

**68219 New**  
**67219 Reman**  
 CVC  
 6 Groove  
 12 Volt  
 Mount: Tangent Mount  
 Pulley Dia.: 4-45/64  
 Coil Clock: N/R  
 Chevy (11)  
 General Motors Corp: 13271264

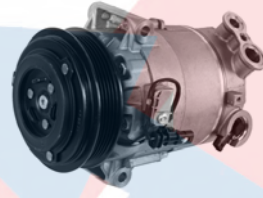

**68222 New**  
 CVC  
 5 Groove  
 12 Volt  
 Mount: Tangent Mount  
 Pulley Dia.: 4-11/16  
 Buick (14); Chevy (15-13)  
 General Motors Corp: 23314082

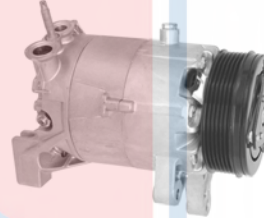

**68241 New**  
**67241 Reman**  
 CVC  
 6 Groove  
 12 Volt  
 Mount: Tangent Mount  
 Pulley Dia.: 4-1/2  
 Coil Clock: 1  
 Buick (08-05)  
 General Motors Corp: 89019340



**68280 New**  
**67280 Reman**  
 CVC  
 5 Groove  
 12 Volt  
 Mount: Tangent Mount  
 Pulley Dia.: 5-5/8  
 Coil Clock: 5  
 Chevy (06-04); Olds (04-02); Pontiac (06-02)  
 General Motors Corp: 89019330

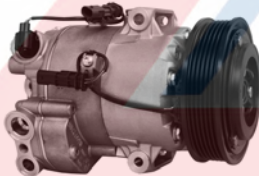

**68220 New**  
 CVC  
 6 Groove  
 12 Volt  
 Mount: Tangent Mount  
 Pulley Dia.: 4-45/64  
 Coil Clock: Wire Lead  
 Chevy (11)  
 General Motors Corp: 13346489

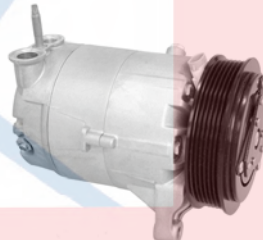

**68229 New**  
**67229 Reman**  
 CVC  
 6 Groove  
 12 Volt  
 Mount: Tangent Mount  
 Pulley Dia.: 5  
 Coil Clock: 3  
 Buick (09-08); Chevy (09-06); Pontiac (08-05)  
 General Motors Corp: 89019342

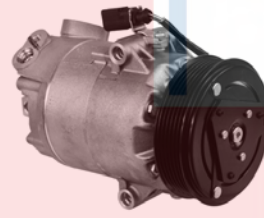

**68242 New**  
 CVC  
 6 Groove  
 12 Volt  
 Mount: 3 Tangent One on Rear Head  
 Pulley Dia.: 4-21/64  
 VW (09-03)

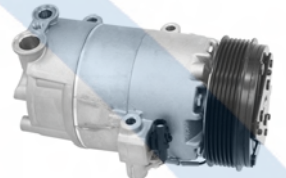

**68282 New**  
**67282 Reman**  
 CVC  
 6 Groove  
 12 Volt  
 Mount: Tangent Mount  
 Pulley Dia.: 4-21/64  
 Coil Clock: Wire Lead  
 Pontiac (08-03)  
 General Motors Corp: 88974336

# Compressors

## CVC Cont'd



**68283 New**  
**67283 Reman**  
 CVC  
 6 Groove  
 12 Volt  
 Mount: Tangent Mount  
 Pulley Dia.: 4-3/4  
 Coil Clock: 4  
 Buick (09-05); Chevy (05-04); Pontiac (08-04)  
 General Motors Corp: 89019336

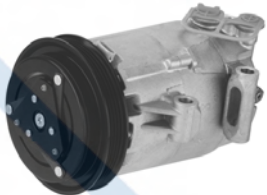

**68295 New**  
 CVC  
 4 Groove  
 12 Volt  
 Mount: Tangent Mount  
 Pulley Dia.: 5-7/64  
 Coil Clock: 4  
 Chevy (13-06)  
 General Motors Corp: 89019338

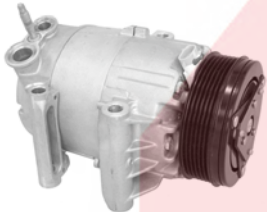

**68296 New**  
**67296 Reman**  
 CVC  
 6 Groove  
 12 Volt  
 Mount: Tangent Mount  
 Pulley Dia.: 4-5/16  
 Coil Clock: 3  
 Chevy (06-04); Pontiac (06-05)  
 General Motors Corp: 89019332



**97280 Reman**  
 CVC  
 5 Groove  
 12 Volt  
 Mount: Tangent Mount  
 Pulley Dia.: 4-1/8  
 Coil Clock: Wire Lead  
 Saturn (08)  
 Saturn: 93168628

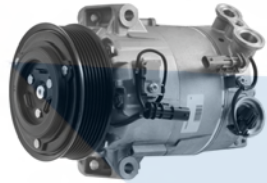

**98243 New**  
 CVC  
 7 Groove  
 12 Volt  
 Mount: 3 Tangent One on Rear Head  
 Pulley Dia.: 4-23/32  
 Buick (12)  
 General Motors Corp: 13309045

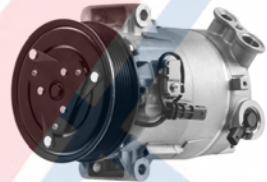

**98246 New**  
 CVC  
 7 Groove  
 12 Volt  
 Mount: 3 Tangent One on Rear Head  
 Pulley Dia.: 4-23/32  
 Buick (14-13); Chevy (14-13)  
 General Motors Corp: 22947669

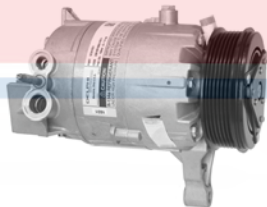

**98271 New**  
**97271 Reman**  
 CVC  
 6 Groove  
 12 Volt  
 Switch: High Pressure  
 Mount: Tangent Mount  
 Pulley Dia.: 4-5/16  
 Coil Clock: 5  
 Chevy (11-06); Pontiac (06)  
 General Motors Corp: 89019341

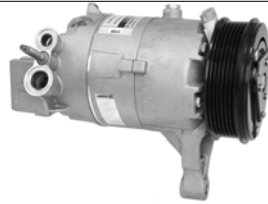

**98273 New**  
**97273 Reman**  
 CVC  
 6 Groove  
 12 Volt  
 Mount: Tangent Mount  
 Pulley Dia.: 4-1/2  
 Coil Clock: 4  
 Chevy (10-07); Pontiac (10-07); Saturn (08-07)  
 General Motors Corp: 25821208

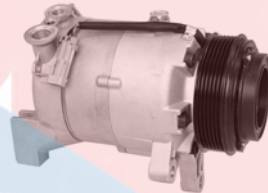

**98274 New**  
**97274 Reman**  
 CVC  
 6 Groove  
 12 Volt  
 Switch: High Pressure  
 Mount: Tangent Mount  
 Pulley Dia.: 4-1/2  
 Coil Clock: 2 O'Clock  
 Chevy (12-08); Pontiac (09-07); Saturn (09-07)  
 General Motors Corp: 20899505

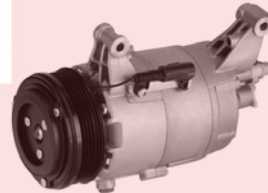

**98275 New**  
**97275 Reman**  
 CVC  
 6 Groove  
 12 Volt  
 Mount: Tangent Mount  
 Pulley Dia.: 4-1/16  
 Coil Clock: Wire Lead  
 Mini (10-01)  
 BMW: 64526918122



**98280 New**  
 CVC  
 5 Groove  
 12 Volt  
 Mount: 3 Tangent One on Rear Head  
 Pulley Dia.: 4-1/8  
 Saturn (08)  
 Saturn: 93168628





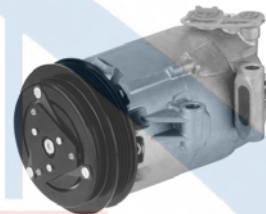





**98293 New**  
**97293 Reman**  
 CVC  
 7 Groove  
 12 Volt  
 Mount: Tangent Mount  
 Pulley Dia.: 4-5/8  
 Coil Clock: 4  
 Chevy (10-08); Saturn (09-07)  
 General Motors Corp: 20879911



**98294 New**  
**97294 Reman**  
 CVC  
 4 Groove  
 12 Volt  
 Mount: Tangent Mount  
 Pulley Dia.: 5  
 Coil Clock: 3  
 Chevy (13-05)  
 General Motors Corp: 89019337, 89019339

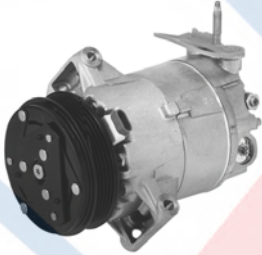
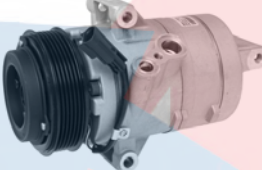
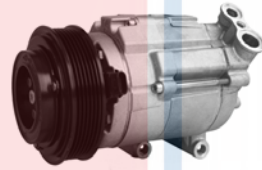

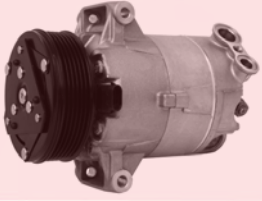
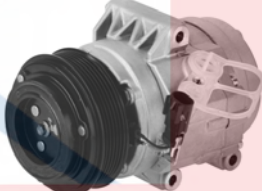
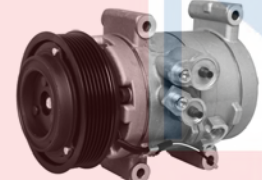
# Compressors

CVC Cont'd	Delphi Series		
 <p><b>98295 New</b> CVC 8 Groove 12 Volt Mount: Tangent Mount Pulley Dia.: 4-25/64 Coil Clock: 4 Cadillac (09-06) General Motors Corp: 89019335</p>	 <p><b>68243 New</b> SP10 4 Groove 12 Volt Mount: 3 Ear Pulley Dia.: 4-13/32 Coil Clock: Wire Lead Dodge (12-01)</p>	 <p><b>68670 New</b> <b>67670 Reman</b> SP17 6 Groove 12 Volt Mount: Tangent Mount Pulley Dia.: 5 Coil Clock: Wire Lead Ford (12-06); Lincoln (10), (06); Mercury (11-06)</p>	 <p><b>68679 New</b> <b>67679 Reman</b> SP17 4 Groove 12 Volt Mount: Tangent Mount Pulley Dia.: 4-29/32 Coil Clock: Wire Lead Chevy (14-10) General Motors Corp: 22798909</p>
 <p><b>98296 New</b> <b>97296 Reman</b> CVC 5 Groove 12 Volt Mount: Tangent Mount Pulley Dia.: 4-5/16 Coil Clock: 3 Chevy (12-07); Pontiac (10-07); Saturn (09-08) General Motors Corp: 22853678</p>	 <p><b>68649 New</b> <b>67649 Reman</b> SP17 6 Groove 12 Volt Mount: Tangent Mount Pulley Dia.: 4-1/2 Coil Clock: Wire Lead Ford (12-11); Lincoln (12-11), (09-07)</p>	 <p><b>68676 New</b> <b>67676 Reman</b> SP17 6 Groove 12 Volt Mount: Tangent Mount Pulley Dia.: 4-23/32 Coil Clock: 2 O'Clock Chevy (11-10); GMC (11-10) General Motors Corp: 22853048</p>	 <p><b>68680 New</b> <b>67680 Reman</b> SP17 5 Groove 12 Volt Mount: Tangent Mount Pulley Dia.: 4-3/4 Coil Clock: Wire Lead Chevy (11-10); GMC (11-10) General Motors Corp: 22853050</p>
 <p><b>98297 New</b> CVC 6 Groove 12 Volt Mount: Tangent Mount Pulley Dia.: 4-11/64 Coil Clock: 3 Chevy (07); Saturn (07-04) General Motors Corp: 15893104</p>	 <p><b>68669 New</b> <b>67669 Reman</b> SP17 6 Groove 12 Volt Mount: Tangent Mount Pulley Dia.: 4-3/8 Coil Clock: Wire Lead Connector: Butt Connector Ford (12-06); Lincoln (10), (06); Mercury (11-06)</p>	 <p><b>68677 New</b> <b>67677 Reman</b> SP15 May Require Use of OE Speed / Lock Sensor 7 Groove 12 Volt Mount: Tangent Mount Pulley Dia.: 4-1/4 Coil Clock: Wire Lead Toyota (14-05) Toyota: 8832004060</p>	 <p><b>68683 New</b> <b>67683 Reman</b> SP17 6 Groove 12 Volt Mount: Tangent Mount Pulley Dia.: 4-19/64 Coil Clock: 2 O'Clock Connector: 8mm Pin Connector Chevy (13-10) General Motors Corp: 22798908</p>

# Compressors

## Delphi Series Cont'd



**68693** New  
CSP15  
6 Groove  
12 Volt  
Mount: Tangent Mount  
Pulley Dia.: 4-23/32  
Coil Clock: 3  
Connector: 8mm Pin Connector  
Buick (12)



**78664** New  
SP17  
6 Groove  
12 Volt  
Mount: Tangent Mount  
Pulley Dia.: 4-33/64  
Coil Clock: Wire Lead  
Nissan (15-13)  
Nissan: 926003TA2E



**157345** Reman  
7SEU17C  
May Require use of OE Manifold  
7 Groove  
12 Volt  
Mount: Tangent Mount  
Pulley Dia.: 4-21/64  
Coil Clock: N/R  
BMW (10-08)  
BMW: 64529195721



**157374** Reman  
7SEU16C  
May Require use of OE Manifold  
7 Groove  
12 Volt  
Mount: Tangent Mount  
Pulley Dia.: 4-17/32  
Coil Clock: Wire Lead  
Audi (06-04); VW (06-04)  
Audi: 4E0260805F



**68694** New  
CSP15  
6 Groove  
12 Volt  
Mount: 3 Tangent One on Rear Head  
Pulley Dia.: 4-23/32  
Coil Clock: 1 Wire Lead  
Chevy (12)  
General Motors Corp: 95935303



**Denso**

**157302** Reman  
7SB16C  
May Require use of OE Manifold  
6 Groove  
12 Volt  
Mount: Tangent Mount  
Pulley Dia.: 5-5/16  
Coil Clock: Wire Lead  
BMW (01-98)  
BMW: 64526910461



**157364** Reman  
10SR15  
May Require use of OE Manifold  
6 Groove  
12 Volt  
Mount: Tangent Mount  
Pulley Dia.: 4-5/8  
Coil Clock: Wire Lead  
Dodge (10-09)



**157375** Reman  
7SEU16C  
May Require use of OE Manifold  
6 Groove  
12 Volt  
Mount: Tangent Mount  
Pulley Dia.: 4-47/64  
Jaguar (09-04)

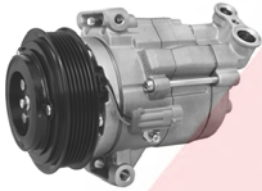

**68695** New  
CSP15  
6 Groove  
12 Volt  
Mount: Tangent Mount  
Pulley Dia.: 4-47/64  
Coil Clock: Wire Lead  
Chevy (15)  
General Motors Corp: 95935304

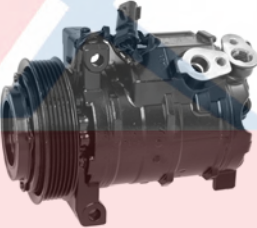

**157340** Reman  
10SR17C  
May Require use of OE Manifold  
6 Groove  
12 Volt  
Mount: Tangent Mount  
Pulley Dia.: 4-5/8  
Coil Clock: Wire Lead  
Dodge (10-09)





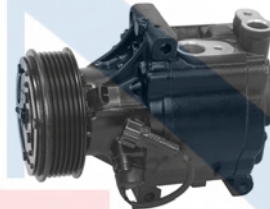



**157373** Reman  
10S17C  
May Require use of OE Manifold  
6 Groove  
12 Volt  
Mount: Tangent Mount  
Pulley Dia.: 4-23/32  
Coil Clock: Wire Lead  
Mazda (06-02)

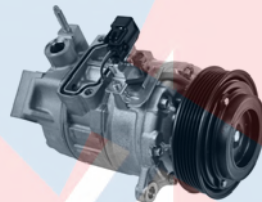
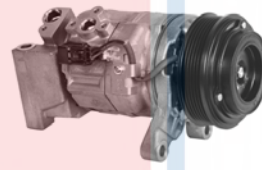
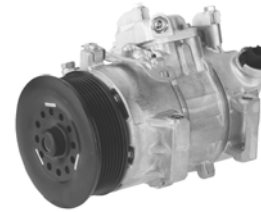
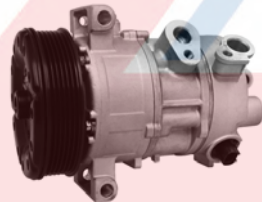
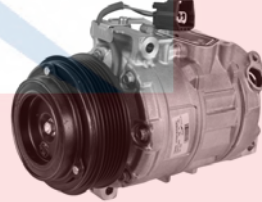
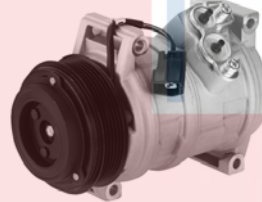

**157384** Reman  
SCSA08C  
May Require use of OE Manifold  
6 Groove  
12 Volt  
Switch: Speed Sensor  
Mount: Tangent Mount  
Pulley Dia.: 3-19/32  
Coil Clock: Wire Lead  
Subaru (09-05)  
Subaru: 73111AG012

# Compressors

Denso Cont'd			
 <p><b>157386 Reman</b> 7SEH17C May Require use of OE Manifold 6 Groove 12 Volt Switch: Control Valve Mount: Tangent Mount Pulley Dia.: 4-19/64 Coil Clock: Wire Lead Lexus (14-07)</p>	 <p><b>158303 New</b> <b>157303 Reman</b> 10PA15C May Require use of OE Manifold 4 Groove 12 Volt Mount: Tangent Mount Pulley Dia.: 4-3/4 Coil Clock: Wire Lead Hyundai (08); Kia (10) Hyundai: 977012E400</p>	 <p><b>158310 New</b> <b>157310 Reman</b> 10PA15C May Require use of OE Manifold 1 Groove 12 Volt Mount: Tangent Mount Pulley Dia.: 5 Coil Clock: Wire Lead Porsche (98-89) Porsche: 96412612101</p>	 <p><b>158314 New</b> <b>157314 Reman</b> 10S20C May require use of OE connector 6 Groove 12 Volt Mount: Tangent Mount Pulley Dia.: 4-1/2 Coil Clock: Wire Lead Ford (14-07); Lincoln (14-07) Ford: 8T4Z19703A, BT4Z19703A</p>
 <p><b>158300 New</b> <b>157300 Reman</b> 10S17C May Require use of OE Manifold 7 Groove 12 Volt Mount: Tangent Mount Belt Width: 1-3/16 Pulley Dia.: 4-1/4 Coil Clock: Wire Lead Dodge (10-08), (06-03)</p>	 <p><b>158308 New</b> 7SBU16H May Require use of OE Manifold 6 Groove 12 Volt Mount: 2 Ear &amp; 1 Tangent Pulley Dia.: 4-47/64 Coil Clock: Wire Lead Buick (11-10) General Motors Corp: 15897600</p>	 <p><b>158312 New</b> <b>157312 Reman</b> 10SR15H May Require use of OE Manifold 6 Groove 12 Volt Mount: Tangent Mount Pulley Dia.: 4-1/4 Coil Clock: Wire Lead Cadillac (14-08) General Motors Corp: 25865635</p>	 <p><b>158316 New</b> <b>157316 Reman</b> 6SEU14C May Require use of OE Manifold 7 Groove 12 Volt Switch: Control Valve Mount: Tangent Mount Pulley Dia.: 4-1/4 Coil Clock: N/R Pontiac (10-09); Scion (14-08); Toyota (13-09), (07) General Motors Corp: 19184680, 19184682 Toyota: 883100252084, 883101A731</p>
 <p><b>158301 New</b> <b>157301 Reman</b> 5SE12C May Require use of OE Manifold 6 Groove 12 Volt Switch: Control Valve Mount: Tangent Mount Pulley Dia.: 4-3/4 Coil Clock: N/R Jeep (08) Jeep: RL111555AA</p>	 <p><b>158309 New</b> <b>157309 Reman</b> 7SBU16C May Require use of OE Manifold 6 Groove 12 Volt Mount: Tangent Mount Pulley Dia.: 4-1/4 Coil Clock: Wire Lead Cadillac (11-05) General Motors Corp: 89023452</p>	 <p><b>158313 New</b> <b>157313 Reman</b> 10S20C May Require use of OE Manifold 6 Groove 12 Volt Mount: Tangent Mount Pulley Dia.: 4-1/2 Coil Clock: Wire Lead Buick (12-08); Chevy (12-09); GMC (12-07); Saturn (10-07) General Motors Corp: 20844676</p>	 <p><b>158318 New</b> <b>157318 Reman</b> 5SE11C May Require use of OE Manifold 4 Groove 12 Volt Mount: Tangent Mount Pulley Dia.: 4-1/2 Coil Clock: N/R Toyota (12-07) Toyota: 8831052481</p>



# Compressors

## Denso Cont'd



**158319** New  
**157319** Reman  
 10SR15E  
 May Require use of OE Manifold  
 6 Groove  
 12 Volt  
 Mount: Tangent Mount  
 Pulley Dia.: 5-1/2  
 Coil Clock: Wire Lead  
 Dodge (13-08); Jeep (10-08)  
 Chrysler: R5111436AB, RL111437AD



**158320** New  
**157320** Reman  
 10S20C  
 May Require use of OE Manifold  
 6 Groove  
 12 Volt  
 Mount: Tangent Mount  
 Pulley Dia.: 4-1/2  
 Coil Clock: Wire Lead  
 Mazda (14-07)  
 Mazda: TD1561450A



**158321** New  
**157321** Reman  
 7SBU16C  
 May Require use of OE Manifold  
 7 Groove  
 12 Volt  
 Mount: Tangent Mount  
 Pulley Dia.: 4-1/4  
 Coil Clock: Wire Lead  
 Toyota (12-06)  
 Toyota: 883204212084



**158322** New  
 6SEU14C  
 May Require use of OE Manifold  
 6 Groove  
 12 Volt  
 Mount: 3 Tangent  
 Pulley Dia.: 4-21/64  
 Coil Clock: N/R  
 Audi (14-03); VW (14-11), (09)  
 Audi: 1K0820808A  
 Volkswagen: 1K0820808A

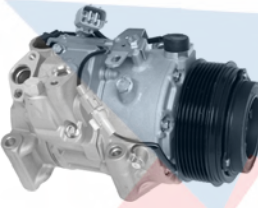

**158323** New  
**157323** Reman  
 7SBH17  
 May Require use of OE Manifold  
 7 Groove  
 12 Volt  
 Mount: Tangent Mount  
 Pulley Dia.: 4-1/4  
 Coil Clock: Wire Lead  
 Toyota (10-08)  
 Toyota: 883204815084, 883204816084

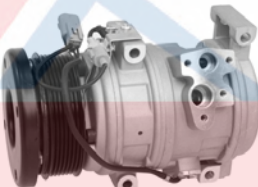

**158324** New  
 10S17C  
 May Require use of OE Manifold  
 7 Groove  
 12 Volt  
 Switch: Switch  
 Mount: Tangent Mount  
 Pulley Dia.: 4-1/4  
 Coil Clock: Wire Lead  
 Toyota (14-07)  
 Toyota: 883200C120, 883206A540



**158325** New  
**157325** Reman  
 10S20C  
 May Require use of OE Manifold  
 8 Groove  
 12 Volt  
 Mount: Tangent Mount  
 Pulley Dia.: 4-5/8  
 Coil Clock: Wire Lead  
 Toyota (14-07)  
 Toyota: 883200C130, 883200C160

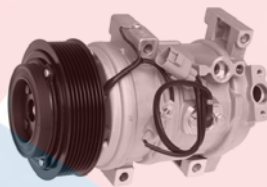

**158327** New  
**157327** Reman  
 10SR19C  
 May Require use of OE Manifold  
 8 Groove  
 12 Volt  
 Switch: Switch  
 Mount: Tangent Mount  
 Pulley Dia.: 4-5/8  
 Coil Clock: Wire Lead  
 Toyota (14-08)  
 Toyota: 883200C150



**158328** New  
**157328** Reman  
 6SBU16C  
 May Require use of OE Manifold  
 7 Groove  
 12 Volt  
 Mount: Tangent Mount  
 Pulley Dia.: 4-1/2  
 Coil Clock: Wire Lead  
 Toyota (12-07)  
 Toyota: 883203320084



**158332** New  
 10SR19C  
 May Require use of OE Manifold  
 8 Groove  
 12 Volt  
 Switch: Switch  
 Mount: Tangent Mount  
 Pulley Dia.: 4-3/4  
 Coil Clock: Wire Lead  
 Toyota (09-08)  
 Toyota: 883200C140



**158333** New  
**157333** Reman  
 10SR15C  
 May Require use of OE Manifold  
 7 Groove  
 12 Volt  
 Mount: Tangent Mount  
 Pulley Dia.: 5-1/4  
 Coil Clock: Wire Lead  
 Honda (15-08)  
 Honda: 38810R40A01

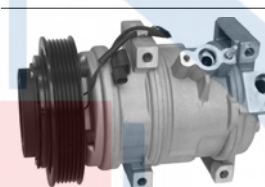

**158334** New  
**157334** Reman  
 10SR17C  
 May Require use of OE Manifold  
 6 Groove  
 12 Volt  
 Mount: Tangent Mount  
 Pulley Dia.: 5-3/16  
 Coil Clock: Wire Lead  
 Acura (13-07); Honda (15-08)  
 Acura: 38810RN0A01  
 Honda: 38810RGLA02, 38810RN0A01

# Compressors

## Denso Cont'd



**158335** New  
**157335** Reman  
 10SR15C  
 May Require use of OE Manifold  
 6 Groove  
 12 Volt  
 Mount: Tangent Mount  
 Pulley Dia.: 5-1/4  
 Coil Clock: Wire Lead  
 Acura (15-09); Honda (14), (12-08)  
 Acura: 38810R70A01  
 Honda: 38810R70A01



**158336** New  
**157336** Reman  
 6SBU16C  
 May Require use of OE Manifold  
 7 Groove  
 12 Volt  
 Switch: Control Valve  
 Mount: Tangent Mount  
 Pulley Dia.: 4-21/64  
 Coil Clock: 12  
 Lexus (09-07)  
 Lexus: 883204812084



**158337** New  
**157337** Reman  
 10SR17E  
 May Require use of OE Manifold  
 6 Groove  
 12 Volt  
 Switch: Switch  
 Mount: Tangent Mount  
 Pulley Dia.: 5-1/2  
 Coil Clock: Wire Lead  
 Chrysler (09-08); Dodge (09-08); Jeep (10-08); VW (14)  
 Chrysler: RL111438AC, RL111440AC  
 Jeep: 55111439AB



**158338** New  
**157338** Reman  
 7SEU17C  
 May Require use of OE Manifold  
 7 Groove  
 Coil Less  
 Mount: Tangent Mount  
 Pulley Dia.: 4-9/32  
 Coil Clock: N/R  
 Audi (10-07); VW (14-06)  
 Audi: 7P0820803M  
 Volkswagen: 7P0820803M

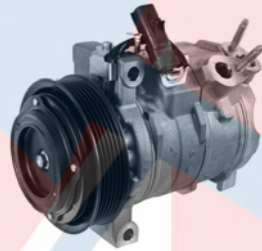

**158340** New  
 10SR17C  
 May Require use of OE Manifold  
 6 Groove  
 12 Volt  
 Mount: Tangent Mount  
 Pulley Dia.: 4-5/8  
 Coil Clock: Wire Lead  
 Dodge (10-09)  
 Chrysler: RL111425AC

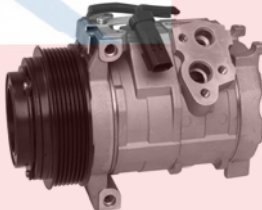

**158342** New  
 10S17C  
 May Require use of OE Manifold  
 7 Groove  
 12 Volt  
 Mount: Tangent Mount  
 Pulley Dia.: 4-3/4  
 Coil Clock: Wire Lead  
 Jeep (10-07)  
 Jeep: 55116835AF



**158343** New  
**157343** Reman  
 10SRE18C  
 May Require use of OE Manifold  
 6 Groove  
 12 Volt  
 Mount: 2 Ear & 1 Tangent  
 Pulley Dia.: 4-23/32  
 Coil Clock: Wire Lead  
 Chrysler (10-09); Dodge (10-09)  
 Chrysler: RL111541AC

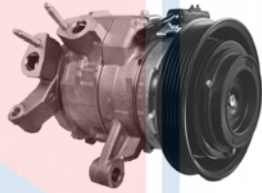

**158345** New  
 7SEU17C  
 May Require use of OE Manifold  
 7 Groove  
 12 Volt  
 Mount: Tangent Mount  
 Pulley Dia.: 4-21/64  
 Coil Clock: Coil Less  
 BMW (10-08)  
 BMW: 64529195721

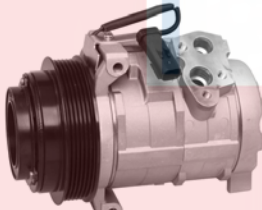

**158346** New  
**157346** Reman  
 10S20C  
 May Require use of OE Manifold  
 6 Groove  
 12 Volt  
 Mount: Tangent Mount  
 Pulley Dia.: 4-7/8  
 Coil Clock: Wire Lead  
 Chrysler (10-08); Dodge (10-08)  
 Chrysler: RL111424AB



**158347** New  
**157347** Reman  
 6SBU16C  
 May Require use of OE Manifold  
 7 Groove  
 12 Volt  
 Switch: Switch  
 Mount: Tangent Mount  
 Pulley Dia.: 4-1/4  
 Coil Clock: Wire Lead  
 Lexus (13-06)  
 Lexus: 883203A28084, 883203A31084



**158348** New  
**157348** Reman  
 6SBU16C  
 May Require use of OE Manifold  
 7 Groove  
 12 Volt  
 Switch: Speed Sensor  
 Mount: Tangent Mount  
 Pulley Dia.: 4-5/16  
 Coil Clock: Wire Lead  
 Lexus (13-06)  
 Lexus: 883203A270

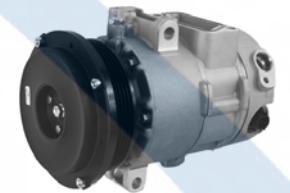

**158349** New  
**157349** Reman  
 6SBU16C  
 May Require use of OE Manifold  
 6 Groove  
 12 Volt  
 Switch: Speed Sensor  
 Mount: Tangent Mount  
 Pulley Dia.: 4-1/2  
 Coil Clock: Wire Lead  
 Lexus (06-04)  
 Lexus: 8831050152

# Compressors

## Denso Cont'd



**158350** New  
**157350** Reman  
 6SBU16C  
 May Require use of OE Manifold  
 4 Groove  
 12 Volt  
 Switch: Control Valve  
 Mount: Tangent Mount  
 Pulley Dia.: 4-7/8  
 Coil Clock: Wire Lead  
 Kia (09-07)  
 Kia: 977012F130DR

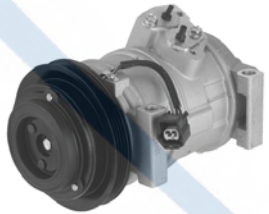

**158351** New  
**157351** Reman  
 10S17F  
 May Require use of OE Manifold  
 4 Groove  
 12 Volt  
 Mount: Tangent Mount  
 Pulley Dia.: 4-1/2  
 Coil Clock: Wire Lead  
 Cadillac (14-04)  
 General Motors Corp: 19130461



**158356** New  
**157356** Reman  
 7SBU16C  
 May Require use of OE Manifold  
 6 Groove  
 12 Volt  
 Mount: Tangent Mount  
 Pulley Dia.: 4-1/2  
 Coil Clock: Wire Lead  
 BMW (13-12), (10-06)  
 BMW: 64526918749



**158357** New  
**97391** Reman  
 7SEU16C  
 May Require use of OE Manifold  
 6 Groove  
 12 Volt  
 Mount: Tangent Mount  
 Pulley Dia.: 4-1/2  
 Coil Clock: Wire Lead  
 BMW (13-04)  
 BMW: 64509174803, 64509180550,  
 64526956716, 64529122618

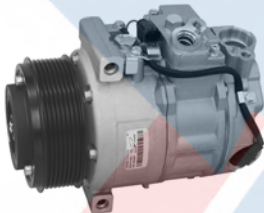

**158358** New  
 7SEU16C  
 May Require use of OE Manifold  
 8 Groove  
 12 Volt  
 Mount: Tangent Mount  
 Pulley Dia.: 4-5/16  
 Coil Clock: Wire Lead  
 Mercedes (04-02)  
 Mercedes Benz: 0002307811

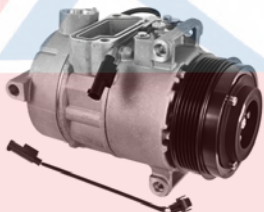

**158359** New  
 6SEU16C  
 May Require use of OE Manifold  
 6 Groove  
 12 Volt  
 Mount: Tangent Mount  
 Pulley Dia.: 4-21/64  
 Coil Clock: Wire Lead  
 Mercedes (10-08), (06)  
 Mercedes Benz: 0012305011,  
 0012308711, 0022305111



**158360** New  
**157360** Reman  
 7SEU17C  
 May Require use of OE Manifold  
 7 Groove  
 12 Volt  
 Mount: Tangent Mount  
 Pulley Dia.: 4-1/4  
 Coil Clock: N/R  
 Mercedes (09-03); Porsche (14-09),  
 (07), (04-02)  
 Mercedes Benz: 0002306211,  
 0012304511, 0012305511, 001230811,  
 0012308411  
 Porsche: 94812601103, 9A112601102



**158361** New  
**157361** Reman  
 10SR17C  
 May Require use of OE Manifold  
 6 Groove  
 12 Volt  
 Mount: Tangent Mount  
 Pulley Dia.: 4-1/2  
 Coil Clock: Wire Lead  
 Subaru (14-06)  
 Subaru: 73111XA010

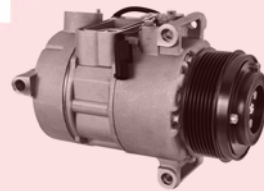

**158362** New  
 6SE16C  
 May Require use of OE Manifold  
 7 Groove  
 12 Volt  
 Mount: Tangent Mount  
 Pulley Dia.: 3-3/4  
 Coil Clock: N/R  
 Mercedes (09-07)  
 Mercedes Benz: 0012308611



**158363** New  
**157363** Reman  
 7SEU17C  
 May Require use of OE Manifold  
 6 Groove  
 12 Volt  
 Mount: Tangent Mount  
 Pulley Dia.: 4-21/64  
 Coil Clock: N/R  
 Mercedes (10-05)  
 Mercedes Benz: 0012301911,  
 0022300811

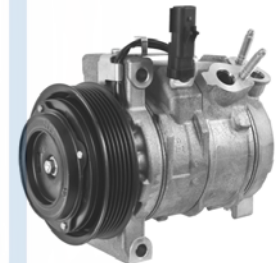



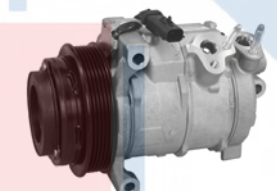





**158364** New  
 10SR15C  
 May Require use of OE Manifold  
 6 Groove  
 12 Volt  
 Mount: Tangent Mount  
 Pulley Dia.: 4-5/8  
 Coil Clock: Wire Lead  
 Dodge (10-09)  
 Chrysler: RL111090AC



**158365** New  
**157365** Reman - 10SRE18C  
 10SRE20C  
 May Require use of OE Manifold  
 6 Groove  
 12 Volt  
 Mount: Tangent Mount  
 Pulley Dia.: 4-7/8  
 Coil Clock: Wire Lead  
 Chrysler (10-09); Dodge (10-09); Jeep  
 (10-09)  
 Chrysler: RL111097AC

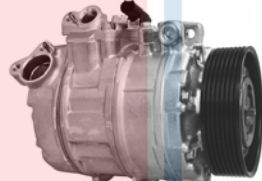

# Compressors

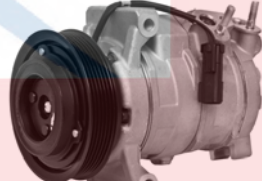
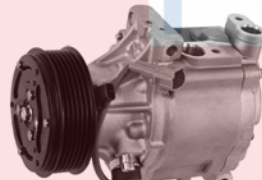
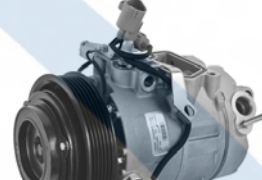
Denso Cont'd			
 <p><b>158366 New</b>  <b>157366 Reman</b>            7SEH17C            May Require use of OE Manifold            7 Groove            12 Volt            Switch: Control Valve            Mount: Tangent Mount            Pulley Dia.: 4-3/8            Coil Clock: N/R            Lexus (14-07); Toyota (14-07)            Lexus: 8832006160, 883200T01084            Toyota: 883200806084, 883200T01084</p>	 <p><b>158373 New</b>            10S17C            May Require use of OE Manifold            6 Groove            12 Volt            Mount: Tangent Mount            Pulley Dia.: 4-23/32            Coil Clock: Wire Lead            Mazda (06-02)            Mazda: LC7061K00</p>	 <p><b>158380 New</b>  <b>157380 Reman</b>            6SEU16C            May Require use of OE Manifold            4 Groove            12 Volt            Switch: Control Valve            Mount: Tangent Mount            Pulley Dia.: 4-19/64            Coil Clock: Wire Lead            Toyota (11-09)            Toyota: 8831006390</p>	 <p><b>158386 New</b>            7SHS17C            May Require use of OE Manifold            6 Groove            12 Volt            Mount: Tangent Mount            Pulley Dia.: 4-19/64            Coil Clock: Wire Lead            Lexus (14-07)            Lexus: 883105016084</p>
 <p><b>158367 New</b>  <b>157367 Reman</b>            TSE17C            May Require use of OE Manifold            6 Groove            12 Volt            Switch: Control Valve            Mount: Tangent Mount            Pulley Dia.: 4-3/8            Coil Clock: Wire Lead            Toyota (14-09)            Toyota: 883100R014</p>	 <p><b>158376 New</b>  <b>157376 Reman</b>            7SEU17C            May Require use of OE Manifold            7 Groove            12 Volt            Mount: Tangent Mount            Pulley Dia.: 3-15/16            Coil Clock: N/R            Dodge (09-07); Mercedes (15-13),            (10)            Chrysler: 68012247AA            Mercedes Benz: 0012303211</p>	 <p><b>158382 New</b>  <b>157382 Reman</b>            7SEU17C            May Require use of OE Manifold            7 Groove            12 Volt            Switch: Control Valve            Mount: Tangent Mount            Pulley Dia.: 4-21/64            Coil Clock: N/R            BMW (15-07)            BMW: 64526956719</p>	 <p><b>158388 New</b>  <b>157388 Reman</b>            6SEU16C            May Require use of OE Manifold            6 Groove            12 Volt            Mount: Tangent Mount            Pulley Dia.: 4-23/32            Coil Clock: Wire Lead            Dodge (12-09); Jeep (15-09)            Chrysler: 55111610AC            Jeep: 55111610AC</p>
 <p><b>158368 New</b>            7SH17C            May Require use of OE Manifold            6 Groove            12 Volt            Switch: ECV            Mount: Tangent Mount            Pulley Dia.: 4-3/4            Coil Clock: N/R            Toyota (14-09)            Toyota: 883100T020, 8831048240</p>	 <p><b>158377 New</b>  <b>157377 Reman</b>            10SRE18C            May Require use of OE Manifold            6 Groove            12 Volt            Mount: Tangent Mount            Pulley Dia.: 4-15/16            Coil Clock: Wire Lead            Dodge (15-09); Dodge Medium Duty            Truck (15-14)            Chrysler: 55111442AG</p>	 <p><b>158384 New</b>            SCSA08A            May Require use of OE Manifold            6 Groove            12 Volt            Mount: Tangent Mount            Pulley Dia.: 3-19/32            Coil Clock: Wire Lead            Subaru (09-05)            Subaru: 73111AG012</p>	 <p><b>158393 New</b>            7SB16C            May Require use of OE Manifold            6 Groove            12 Volt            Mount: Tangent Mount            Pulley Dia.: 5-1/8            Coil Clock: Wire Lead            Lexus (07-01)</p>

# Compressors

## Denso Cont'd



**158397 New**  
10PA17C  
May Require use of OE Manifold  
6 Groove  
12 Volt  
Mount: Tangent Mount  
Pulley Dia.: 4-11/16  
Coil Clock: Wire Lead  
Hyundai (12-10)  
Hyundai: 977012M100

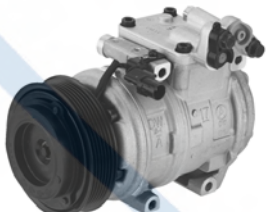

**158398 New**  
10PA17C  
May Require use of OE Manifold  
6 Groove  
12 Volt  
Mount: Tangent Mount  
Pulley Dia.: 4-5/8  
Coil Clock: Wire Lead  
Hyundai (12-10)  
Hyundai: 977012M000

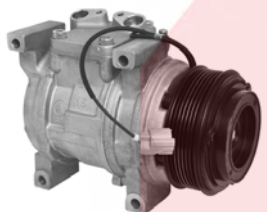

**158881 New**  
**58881 New - HS110R**  
10PA15C  
May Require use of OE Manifold  
7 Groove  
12 Volt  
Mount: Tangent Mount  
Pulley Dia.: 3-7/8  
Coil Clock: Wire Lead  
Honda (06-02)



**168303 New**  
SCSA06C  
May Require use of OE Manifold  
1 Groove  
12 Volt  
Mount: Tangent Mount  
Pulley Dia.: 4-51/64  
Coil Clock: Wire Lead  
John Deere: MIA10078



**168304 New**  
10PA15C  
May Require use of OE Manifold  
1 Groove  
24 Volt  
Mount: Tangent Mount  
Pulley Dia.: 5-63/64  
Coil Clock: Wire Lead

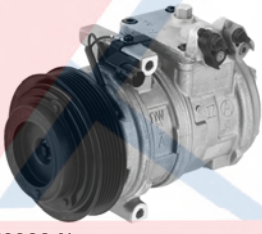

**178300 New**  
10PA17C  
May Require use of OE Manifold  
6 Groove  
12 Volt  
Mount: Tangent Mount  
Pulley Dia.: 4-57/64  
Coil Clock: Wire Lead  
Kia (11-09)  
Kia: 977012J200



**178301 New**  
10PA17C  
May Require use of OE Manifold  
6 Groove  
12 Volt  
Mount: Tangent Mount  
Pulley Dia.: 4-21/32  
Coil Clock: Wire Lead  
Kia (11-09)  
Kia: 977012J100DR

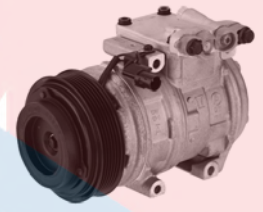

**178302 New**  
10PA17C  
May Require use of OE Manifold  
6 Groove  
12 Volt  
Mount: Tangent Mount  
Pulley Dia.: 4-11/16  
Coil Clock: Wire Lead  
Kia (10)  
Kia: 977011D350

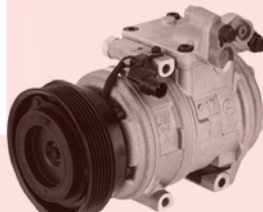

**178303 New**  
10PA17C  
May Require use of OE Manifold  
6 Groove  
12 Volt  
Mount: Tangent Mount  
Pulley Dia.: 4-5/8  
Coil Clock: Wire Lead  
Kia (10)  
Kia: 977011D100DR



**178307 New**  
10PA15L  
May Require use of OE Manifold  
6 Groove  
12 Volt  
Mount: Tangent Mount  
Pulley Dia.: 4-59/64  
Coil Clock: Wire Lead  
Kia (10)  
Kia: 977012E350DR



**178313 New**  
10S17C  
May Require use of OE Manifold  
8 Groove  
12 Volt  
Mount: Tangent Mount  
Pulley Dia.: 4-47/64  
Coil Clock: Wire Lead  
Dodge (15-10); Dodge Medium Duty  
Truck (15-11)

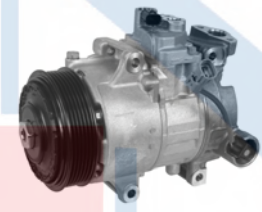

**178321 New**  
**1177321 Reman**  
TSE14C  
May Require use of OE Manifold  
6 Groove  
12 Volt  
Switch: Control Valve  
Mount: Tangent Mount  
Pulley Dia.: 4-7/16  
Coil Clock: Wire Lead  
Subaru (15-10)  
Subaru: 73111AJ000, 73111AJ00A,  
73111AJ03A

# Compressors

## Denso Cont'd



**178322 New**  
TSE14C  
May Require use of OE Manifold  
6 Groove  
12 Volt  
Switch: Control Valve  
Mount: Tangent Mount  
Pulley Dia.: 4-47/64  
Coil Clock: Wire Lead  
Toyota (13-11)  
Toyota: 8831002711



**198302 New**  
6SBU16  
May Require use of OE Manifold  
6 Groove  
12 Volt  
Mount: Tangent Mount  
Pulley Dia.: 4-45/64  
Dodge (14-13)  
Chrysler: 68102839AD

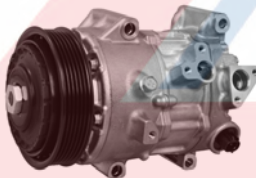

**198307 New**  
7SES17C  
May Require use of OE Manifold  
6 Groove  
12 Volt  
Mount: Tangent Mount  
Pulley Dia.: 4-47/64  
Coil Clock: Wire Lead  
Toyota (14-13)  
Toyota: 883100R040

**198308 New**  
10SR19C  
May Require use of OE Manifold  
8 Groove  
12 Volt  
Mount: Tangent Mount  
Pulley Dia.: 4-47/64  
Lexus (14-08); Toyota (14-08)  
Lexus: 883206A520



**198311 New**  
10p13C  
May Require use of OE Manifold  
4 Groove  
12 Volt  
Mount: Tangent Mount  
Pulley Dia.: 5-29/32  
Coil Clock: Wire Lead  
Toyota (95-91)  
Toyota: 883201709184, 883201710084

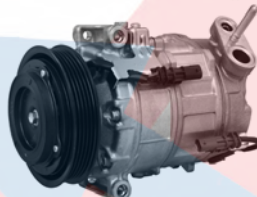

**198312 New**  
7SBH17  
May Require use of OE Manifold  
5 Groove  
12 Volt  
Mount: Tangent Mount  
Pulley Dia.: 4-23/32  
Coil Clock: Wire Lead  
Chevy (15-12); GMC (14-12)  
General Motors Corp: 23255703

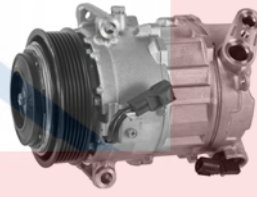

**198313 New**  
7SBH17  
May Require use of OE Manifold  
6 Groove  
12 Volt  
Mount: 3 Tangent One on Rear Head  
Pulley Dia.: 4-23/32  
Chrysler (15); Jeep (15-14)  
Chrysler: 68103198AB  
Jeep: 68103198AB



**198314 New**  
7SBH17  
May Require use of OE Manifold  
6 Groove  
12 Volt  
Mount: 3 Tangent One on Rear Head  
Pulley Dia.: 4-23/32  
Chrysler (15); Jeep (15-14)  
Jeep: 68103197AC

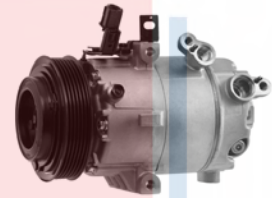

**198332 New**  
VS14M  
May Require use of OE Manifold  
6 Groove  
12 Volt  
Mount: 3 Tangent One on Rear Head  
Pulley Dia.: 4-49/100  
Kia (14)  
Kia: 97701A5100

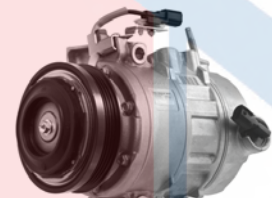

**198342 New**  
7SBH17  
May Require use of OE Manifold  
4 Groove  
12 Volt  
Mount: 3 Tangent One on Rear Head  
Pulley Dia.: 4-33/100  
Ford (14-13); Lincoln (14)  
Ford: FB5Z19703C



**198352 New**  
7SBH17  
May Require use of OE Manifold  
6 Groove  
12 Volt  
Mount: 2 Ear & 1 Tangent  
Pulley Dia.: 4-47/64  
Coil Clock: Wire Lead  
Chevy (15-12); GMC (14-12)  
General Motors Corp: 23232322



**198353 New**  
10SE18  
May Require use of OE Manifold  
6 Groove  
12 Volt  
Mount: Tangent Mount  
Pulley Dia.: 4-21/64  
Coil Clock: Wire Lead  
Chevy (14-10); GMC (14-10); GMC & CHEVY (14-10)  
General Motors Corp: 20762515, 20880831

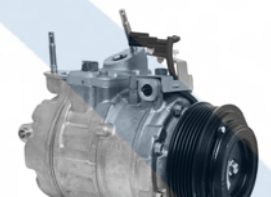

**198355 New**  
7SBH17  
May Require use of OE Manifold  
6 Groove  
12 Volt  
Mount: Tangent Mount  
Pulley Dia.: 4-5/16  
Ford (14-12); Lincoln (13-12)  
Ford: BB5Z19703C, CT4Z19703C



# Compressors

## Denso Cont'd



**198357 New**  
7SBH17  
May Require use of OE Manifold  
6 Groove  
12 Volt  
Mount: 3 Tangent One on Rear Head  
Pulley Dia.: 4-5/16  
Ford (14-13)  
Ford: DG9Z19703B



**198358 New**  
7SBH17  
May Require use of OE Manifold  
6 Groove  
12 Volt  
Mount: Tangent Mount  
Pulley Dia.: 4-5/16  
Coil Clock: Wire Lead  
Ford (14-13); Lincoln (14-13)  
Ford: DA8Z19703A

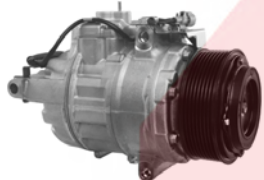

**198361 New**  
7SBU17C  
May Require use of OE Manifold  
8 Groove  
12 Volt  
Mount: 3 Tangent One on Rear Head  
Pulley Dia.: 4-5/16  
Coil Clock: Wire Lead  
BMW (15-10)  
BMW: 64529217868



**198362 New**  
7SEU17C  
May Require use of OE Manifold  
8 Groove  
12 Volt  
Mount: 3 Tangent One on Rear Head  
Pulley Dia.: 4-21/64  
BMW (15-11)  
BMW: 64529217869

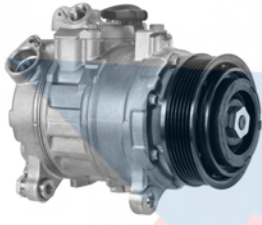

**198365 New**  
7SEU17A  
May Require use of OE Manifold  
6 Groove  
12 Volt  
Mount: Ear Mount  
Pulley Dia.: 4-21/64  
BMW (15-13)  
BMW: 64529216467

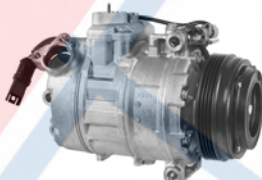

**198367 New**  
7SEU17C  
May Require use of OE Manifold  
4 Groove  
12 Volt  
Mount: Tangent Mount  
Pulley Dia.: 4-11/32  
Coil Clock: Wire Lead  
BMW (15-09)  
BMW: 64509154072



**198369 New**  
6SEU16C  
May Require use of OE Manifold  
6 Groove  
12 Volt  
Mount: Tangent Mount  
Pulley Dia.: 4-17/32  
Mercedes (15-12)



**198370 New**  
10S17C  
May Require use of OE Manifold  
6 Groove  
12 Volt  
Mount: Tangent Mount  
Pulley Dia.: 4-45/64  
Coil Clock: Wire Lead  
Mercedes (15-13), (10)  
Mercedes Benz: 0012307111

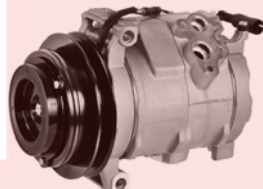

**198371 New**  
10S17C  
May Require use of OE Manifold  
1 Groove  
12 Volt  
Mount: Tangent Mount  
Pulley Dia.: 5-7/64  
Coil Clock: Wire Lead



**198372 New**  
10S15C  
May Require use of OE Manifold  
8 Groove  
12 Volt  
Mount: 3 Tangent  
Pulley Dia.: 6-3/16  
Coil Clock: Wire Lead  
Freightliner (11-10)  
Western Star: 2265771000, 3003850A

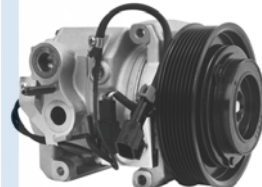

**198373 New**  
10S15C  
May Require use of OE Manifold  
8 Groove  
12 Volt  
Mount: 3 Tangent  
Pulley Dia.: 5-1/2  
Coil Clock: Wire Lead

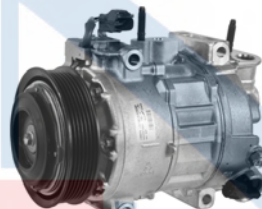

**198375 New**  
7SBH17  
May Require use of OE Manifold  
6 Groove  
12 Volt  
Mount: Tangent Mount  
Pulley Dia.: 4-45/64  
Chrysler (15-14); Dodge (15-14)  
Chrysler: 68160395AE

# Compressors

## Denso Cont'd



**198378 New**  
6SEU14C  
May Require use of OE Manifold  
6 Groove  
12 Volt  
Mount: 3 Tangent One on Rear Head  
Pulley Dia.: 4-15/16  
Coil Clock: N/R  
Audi (14-12)  
Audi: 4G0260805A

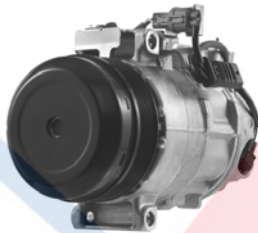

**198379 New**  
6SEU16C  
May Require use of OE Manifold  
6 Groove  
Coil Less  
Mount: 3 Tangent One on Rear Head  
Pulley Dia.: 4-5/16  
Mercedes (14)  
Mercedes Benz: 0008302700

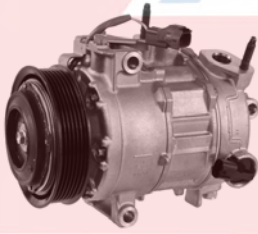

**198380 New**  
7SBH17  
May Require use of OE Manifold  
6 Groove  
12 Volt  
Mount: 3 Tangent One on Rear Head  
Pulley Dia.: 4-23/32  
Dodge (14)  
Chrysler: 68140664AC



**57024 Reman**  
6C17  
May Require use of OE Manifold  
Mount: Tangent Mount  
Chrysler (93-89); Dodge (93-88);  
Plymouth (92-89)  
Chrysler: 4462811

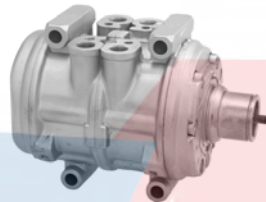

**57027 Reman**  
6P148C  
May Require use of OE Manifold  
Mount: Tangent Mount  
Ford (87-82); Mercury (86-82)

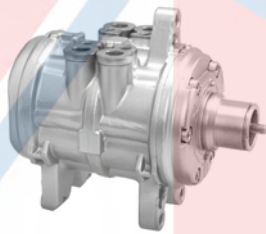

**57028 Reman**  
6P148A  
May Require use of OE Manifold  
Mount: Ear Mount  
Ford (93-81); Mercury (88-85),  
(83-81)  
Euclid: E801607RM

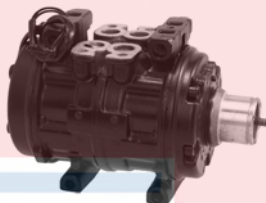

**57303 Reman**  
10P15C  
May Require use of OE Manifold  
Switch: Speed Sensor  
Mount: Tangent Mount  
Mercedes (94-82)  
Mercedes Benz: 000230241188



**57304 Reman**  
10PA17C  
May Require use of OE Manifold  
Switch: Speed Sensor  
Mount: Tangent Mount  
Mercedes (02-86)  
Mercedes Benz: 000230051188,  
000230061188

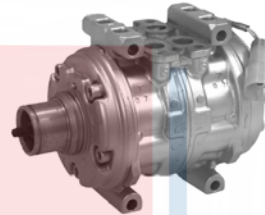

**57306 Reman**  
10P13C  
May Require use of OE Manifold  
Switch: Speed Sensor  
Mount: Tangent Mount  
Toyota (87-83)  
Toyota: 883201232084

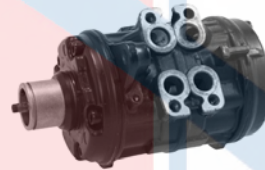

**57307 Reman**  
10P15E  
May Require use of OE Manifold  
Mount: Ear Mount  
Mercur (89-85); Toyota (85)

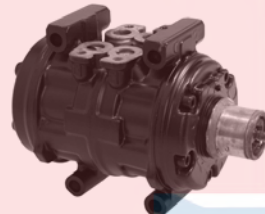

**57308 Reman**  
10P15C  
May Require use of OE Manifold  
Mount: Tangent Mount  
Ford (94-87); Lincoln (90-88); Mercury  
(94-87)



**57309 Reman**  
10P15C  
May Require use of OE Manifold  
Switch: Speed Sensor  
Mount: Tangent Mount  
Acura (89-86); Toyota (86-83)  
Acura: 38810PH3N01



**57310 Reman**  
10P15C  
May Require use of OE Manifold  
Mount: Tangent Mount  
Acura (89-86); Chevy (88-86); Dodge  
(91-85); Eagle (91), (89); Hyundai  
(91-89); Mazda (91); Mitsubishi  
(90-85); Plymouth (91-85); Porsche  
(89-84); Toyota (88-80)



**57311 Reman**  
6P134  
May Require use of OE Manifold  
Mount: Ear Mount  
Honda (81-76)  
Hinker: 4720006000

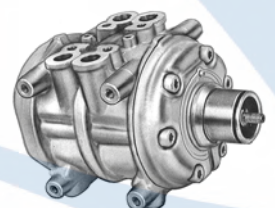

**57312 Reman**  
6P127B  
May Require use of OE Manifold  
Mount: Boss Mount  
Toyota (82-80)  
Toyota: 883201602084

# Compressors

## Denso Cont'd



**57313 Reman**  
10P13C  
May Require use of OE Manifold  
Mount: Tangent Mount  
Chevy (85); Chrysler (89-87); Dodge  
(89-85); Mitsubishi (90-84); Plymouth  
(89-85); Toyota (89-82)  
General Motors Corp: 19192142  
Euclid: E801605RM



**57314 Reman**  
6P148A  
May Require use of OE Manifold  
Mount: Ear Mount  
Toyota (81-78)  
Toyota: 883201425084

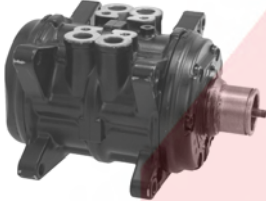

**57315 Reman**  
6P148A  
May Require use of OE Manifold  
Mount: Ear Mount  
Chrysler (89-87); Mitsubishi (89-86);  
Toyota (87-79)  
Toyota: 8832060050



**57316 Reman**  
6E171  
May Require use of OE Manifold  
Mount: Ear Mount  
Lincoln (80); Toyota (80-78)  
Toyota: 883202214084  
Dallas Truck AC: 0106010, 0147362  
Euclid: E801608RM



**57317 Reman**  
6E171A  
May Require use of OE Manifold  
Mount: Tangent Mount  
Toyota (82-80)  
Toyota: 883202220084



**57318 Reman**  
6P127A  
May Require use of OE Manifold  
Mount: Ear Mount  
Toyota (86), (83-78)

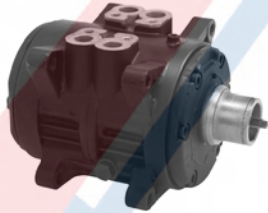

**57320 Reman**  
6P134  
May Require use of OE Manifold  
Mount: Ear Mount  
Mazda (83-81); Porsche (83-78)



**57321 Reman**  
6E171  
May Require use of OE Manifold  
Mount: Ear Mount  
Ford (91-84); Mercury (88-82)



**57323 Reman**  
6P127AD  
May Require use of OE Manifold  
Mount: Ear Mount  
Toyota (82-80)  
Toyota: 883203510084

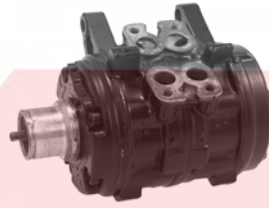

**57324 Reman**  
10P13A  
May Require use of OE Manifold  
Mount: Ear Mount  
Toyota (86-82)  
Toyota: 883201603084

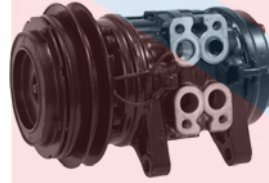

**57325 Reman**  
10P13E  
May Require use of OE Manifold  
1 Groove  
12 Volt  
Mount: Ear Mount  
Belt Width: 1/2  
Pulley Dia.: 5-23/64  
Coil Clock: Wire Lead  
Reman Compr w/o Clutch: **57339**  
Honda (85-84)



**57326 Reman**  
10P15C  
May Require use of OE Manifold  
Switch: Speed Sensor  
Mount: Tangent Mount  
Toyota (88-85)  
Toyota: 883202045084



**57327 Reman**  
10P17C  
May Require use of OE Manifold  
Mount: Tangent Mount  
Audi (94-85); Mercedes (91-86);  
Toyota (86)  
Mercedes Benz: 1161310001  
Toyota: 883202243084





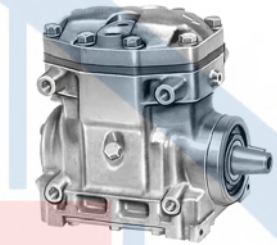





**57330 Reman**  
2C90  
May Require use of OE Manifold  
Mount: Case Mount  
Toyota (77-76), (74-70)  
Toyota: 8832012030



**57331 Reman**  
2C90  
May Require use of OE Manifold  
Mount: Case Mount  
Toyota (79-74)  
Toyota: 883201250084  
Euclid: E801606RM

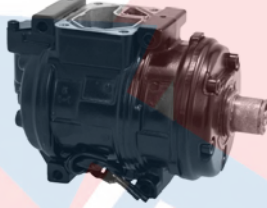
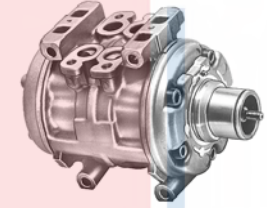

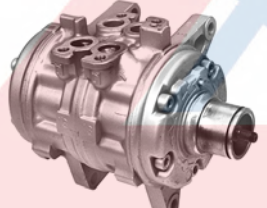
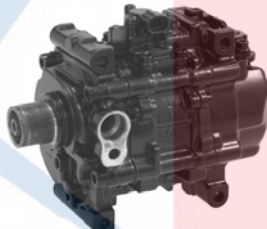
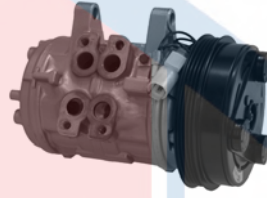
# Compressors

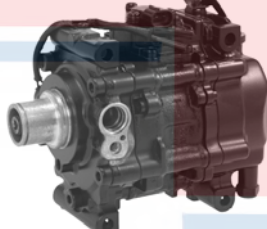
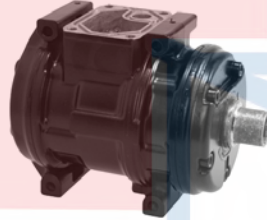
Denso Cont'd			
 <p><b>57333 Reman</b> 10P15C May Require use of OE Manifold 6 Groove 12 Volt Switch: Speed Sensor Mount: Tangent Mount Pulley Dia.: 5-1/4 Coil Clock: Wire Lead Mercedes (85-84)</p>	 <p><b>57340 Reman</b> 6P127D May Require use of OE Manifold 1 Groove 12 Volt Mount: Ear Mount Belt Width: 1/2 Pulley Dia.: 6 Coil Clock: Wire Lead Honda (83-82) Honda: 06388PC2664</p>	 <p><b>57348 Reman</b> TV12 May Require use of OE Manifold Mount: Tangent Mount Mazda (93-90); Toyota (96-94), (89-86) Mack: NA0261K00</p>	 <p><b>57352 Reman</b> 10P15E May Require use of OE Manifold 1 Groove 12 Volt Mount: Ear Mount Belt Width: 1/2 Pulley Dia.: 5-23/64 Coil Clock: Wire Lead New Clutch Assy: Reman Clutch Assy: BMW (93-83)</p>
 <p><b>57337 Reman</b> 10PA17H May Require use of OE Manifold Switch: Speed Sensor Mount: Ear Mount Lexus (00-92); Toyota (98-93) Lexus: 883202410084</p>	 <p><b>57342 Reman</b> 10PA17VC May Require use of OE Manifold Mount: Tangent Mount Lexus (91-90); Toyota (96-88) Toyota: 883203209084</p>	 <p><b>57349 Reman</b> 10P13C May Require use of OE Manifold Switch: Speed Sensor Mount: Tangent Mount Toyota (97-96), (89-87)</p>	 <p><b>57353 Reman</b> 10PA15E May Require use of OE Manifold 4 Groove 12 Volt Mount: Ear Mount Pulley Dia.: 5-1/4 Coil Clock: Wire Lead Reman Compr w/o Clutch: <b>57391</b> Honda (89-86)</p>
 <p><b>57339 Reman</b> 10P13E May Require use of OE Manifold Mount: Ear Mount Honda (85-84)</p>	 <p><b>57346 Reman</b> TV12 May Require use of OE Manifold Mount: Tangent Mount Toyota (93-88) Toyota: 883201625084</p>	 <p><b>57350 Reman</b> 10P15E May Require use of OE Manifold 4 Groove 12 Volt Mount: Ear Mount Pulley Dia.: 5-1/4 Coil Clock: Wire Lead Honda (89-86)</p>	 <p><b>57354 Reman</b> 10PA17C May Require use of OE Manifold Mount: Tangent Mount Chrysler (04-91); Dodge (04-91); Eagle (97-93); Jeep (98-93); Plymouth (00-91) Chrysler: R1017016</p>
 <p><b>57347 Reman</b> TV12 May Require use of OE Manifold Switch: Speed Sensor Mount: Tangent Mount Geo (92-89); Toyota (93-88) General Motors Corp: 19192173</p>	 <p><b>57351 Reman</b> 10PA20C May Require use of OE Manifold Mount: Tangent Mount Acura (04-91); Toyota (92-89)</p>		

# Compressors

## Denso Cont'd



**57355 Reman**  
6E171  
May Require use of OE Manifold  
Mount: Ear Mount  
Porsche (91-83)  
Porsche: 94412600702



**57359 Reman**  
10PA20C  
May Require use of OE Manifold  
Switch: Speed Sensor  
Mount: Ear Mount  
Lexus (07-90); Toyota (07-98)

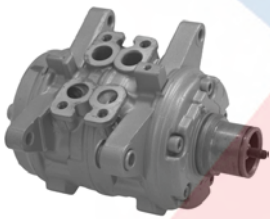

**57360 Reman**  
10P13A  
May Require use of OE Manifold  
Mount: Ear Mount  
Chrysler (91); Mazda (92-88)

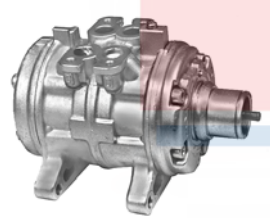

**57361 Reman**  
10P13A  
May Require use of OE Manifold  
Mount: Ear Mount  
Mazda (87-86); Mercury (87)  
Mack: 000067D20A6G, 00067D00A6F,  
00067D10A6F



**57363 Reman**  
10P15C  
May Require use of OE Manifold  
4 Groove  
12 Volt  
Mount: Tangent Mount  
Pulley Dia.: 4-7/8  
Coil Clock: Wire Lead  
New Clutch Assy:  
Reman Clutch Assy:  
Reman Compr w/o Clutch: **57373**  
Acura (90-86)



**57364 Reman**  
10P17C  
May Require use of OE Manifold  
4 Groove  
12 Volt  
Mount: Tangent Mount  
Pulley Dia.: 5  
Coil Clock: Wire Lead  
Reman Compr w/o Clutch: **57374**  
Acura (90-87)

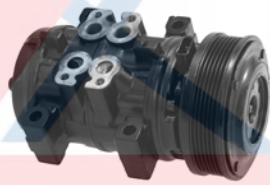

**57365 Reman**  
10P15F  
May Require use of OE Manifold  
6 Groove  
12 Volt  
Mount: Tangent Mount  
Belt Width: 7/8  
Pulley Dia.: 5  
Coil Clock: Wire Lead  
New Clutch Assy: **47853**  
Reman Clutch Assy: **48853**  
Ford (95-89)



**57366 Reman**  
TV14  
May Require use of OE Manifold  
Switch: Speed Sensor  
Mount: Tangent Mount  
Mazda (93); Toyota (91-90), (88-86)

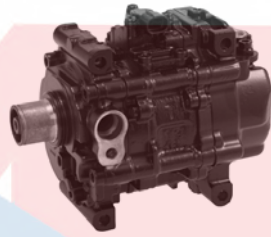

**57367 Reman**  
TV12  
May Require use of OE Manifold  
Mount: Tangent Mount  
Mazda (03-99), (97-94); Toyota  
(96-94)  
Toyota: 8832016420

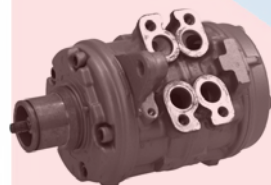

**57370 Reman**  
10P13E  
May Require use of OE Manifold  
Mount: Ear Mount  
Mazda (85-84)



**57371 Reman**  
10P13F  
May Require use of OE Manifold  
Mount: Tangent Mount  
Ford (97-91); Mazda (89-86); Mercury  
(97-91), (89-87)  
Mack: 000067D00B6G, 000067D10B6F



**57372 Reman**  
10PA15A  
May Require use of OE Manifold  
Mount: Ear Mount  
Ford (92-89)



**57373 Reman**  
10P15C  
May Require use of OE Manifold  
Mount: Tangent Mount  
Acura (90-86)  
Acura: 38810PH7013  
Honda: 38810PH7013



**57374 Reman**  
10P17C  
May Require use of OE Manifold  
Mount: Tangent Mount  
Acura (90-87)

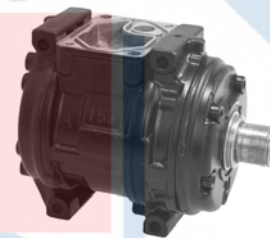

**57375 Reman**  
10PA15C  
May Require use of OE Manifold  
Mount: Tangent Mount  
Acura (05-90); Honda (97-96)



# Compressors

## Denso Cont'd



**57376 Reman**  
10PA20C  
May Require use of OE Manifold  
Switch: Speed Sensor  
Mount: Tangent Mount  
Lexus (00-92)  
Lexus: 883202409084, 883202414084



**57377 Reman**  
10PA17E  
May Require use of OE Manifold  
Mount: Ear Mount  
Toyota (95-91)  
Toyota: 8832028160

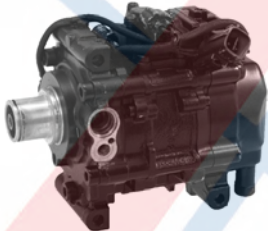

**57379 Reman**  
TV12  
May Require use of OE Manifold  
Switch: Speed Sensor  
Mount: Tangent Mount  
Toyota (98-94)  
Toyota: 883201624184, 883201641084

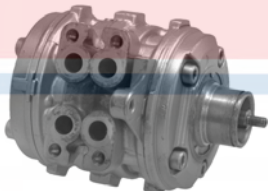

**57380 Reman**  
10P08E  
May Require use of OE Manifold  
Mount: Ear Mount  
Chevy (94-85); Geo (94-89); Suzuki (98-86)  
General Motors Corp: 19192204  
Suzuki: 9520067A50, 9520067A60, 9523083000



**57382 Reman**  
6P148A  
May Require use of OE Manifold  
Mount: Ear Mount  
VW (93-87)

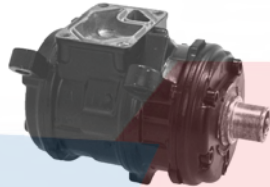

**57383 Reman**  
10PA17K  
May Require use of OE Manifold  
Mount: Ear Mount  
Chrysler (95-93); Dodge (95-93); Plymouth (95-93)  
Chrysler: 4677347

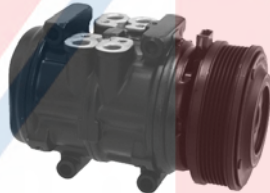

**57384 Reman**  
6P148C  
May Require use of OE Manifold  
6 Groove  
12 Volt  
Mount: Tangent Mount  
Belt Width: 7/8  
Pulley Dia.: 4-7/8  
Coil Clock: Wire Lead  
New Clutch Assy: **47853**  
Reman Clutch Assy: **48853**  
Reman Compr w/o Clutch: **57027**  
Ford (87-82); Mercury (86-82)



**57385 Reman**  
10P15C  
May Require use of OE Manifold  
6 Groove  
12 Volt  
Mount: Tangent Mount  
Belt Width: 7/8  
Pulley Dia.: 4-7/8  
Coil Clock: 12 O'Clock  
New Clutch Assy: **47853**  
Reman Clutch Assy: **48853**  
Reman Compr w/o Clutch: **57308**  
Ford (94-87); Lincoln (90-88); Mercury (94-87)

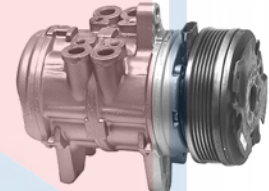

**57388 Reman**  
6P148A  
May Require use of OE Manifold  
6 Groove  
12 Volt  
Mount: Ear Mount  
Belt Width: 7/8  
Pulley Dia.: 5  
Coil Clock: Wire Lead  
New Clutch Assy: **47854**  
Reman Clutch Assy: **48854**  
Reman Compr w/o Clutch: **57028**  
Ford (93-82); Mercury (88)



**57389 Reman**  
10P15C  
May Require use of OE Manifold  
1 Groove  
12 Volt  
Mount: Tangent Mount  
Belt Width: 1/2  
Pulley Dia.: 5-1/4  
Coil Clock: Wire Lead  
New Clutch Assy:  
Reman Clutch Assy:  
Reman Compr w/o Clutch: **57310**  
Dodge (90-89); Plymouth (90-89); Toyota (85-81)  
Toyota: 883200101184



**57391 Reman**  
10PA15E  
May Require use of OE Manifold  
Mount: Ear Mount  
Honda (89-86)



**57393 Reman**  
10P15C  
May Require use of OE Manifold  
5 Groove  
12 Volt  
Mount: Tangent Mount  
Belt Width: 3/4  
Pulley Dia.: 4-7/8  
Coil Clock: 12  
New Clutch Assy: **47851**  
Reman Clutch Assy:  
Reman Compr w/o Clutch: **57308**  
Ford (89-87); Mercury (87)



**57394 Reman**  
10P13F  
May Require use of OE Manifold  
4 Groove  
12 Volt  
Mount: Tangent Mount  
Belt Width: 5/8  
Pulley Dia.: 4-3/4  
Coil Clock: Wire Lead  
New Clutch Assy:  
Reman Clutch Assy:  
Reman Compr w/o Clutch: **57371**  
Ford (97-91); Mazda (89-86); Mercury (97-91), (89-87)  
Mazda: BK0561K00, BK5061L10



# Compressors

## Denso Cont'd



**57395 Reman**  
6E171  
May Require use of OE Manifold  
1 Groove  
12 Volt  
Mount: Ear Mount  
Belt Width: 1/2  
Pulley Dia.: 6  
Coil Clock: 12  
New Clutch Assy: **47849**  
Reman Clutch Assy: **48849**  
Reman Compr w/o Clutch: **57321**  
Ford (87), (85-84)



**58305 New**  
**57305 Reman**  
10PA17C  
May Require use of OE Manifold  
6 Groove  
12 Volt  
Mount: Tangent Mount  
Belt Width: 7/8  
Pulley Dia.: 6-1/4  
Coil Clock: Wire Lead  
New Clutch Assy: **47889**  
Acura (97-95); Honda (97-94)  
Honda: 38810P1E003



**58332 New**  
**57332 Reman**  
10PA20C  
May Require use of OE Manifold  
6 Groove  
12 Volt  
Switch: Speed Sensor  
Mount: Tangent Mount  
Pulley Dia.: 4-1/2  
Coil Clock: Wire Lead  
New Clutch Assy: **47571**  
Chevy (96-88)  
General Motors Corp: 10268616



**58336 New**  
**57336 Reman**  
**77343 Reman**  
10PA17C  
May Require use of OE Manifold  
6 Groove  
12 Volt  
Switch: Speed Sensor  
Mount: Tangent Mount  
Pulley Dia.: 4-3/4  
Coil Clock: Wire Lead  
New Clutch Assy: **47536**  
Reman Compr w/o Clutch: **57304**  
Mercedes (02-86)  
Mercedes Benz: 0002300511,  
0002300611, 0002303611, 116130051



**58300 New**  
**57300 Reman**  
10PA15C  
May Require use of OE Manifold  
5 Groove  
12 Volt  
Mount: Tangent Mount  
Belt Width: 3/4  
Pulley Dia.: 5-1/2  
Coil Clock: Wire Lead  
New Clutch Assy: **47824**  
Reman Clutch Assy: **48824**  
Toyota (96-90)  
Toyota: 883202075084

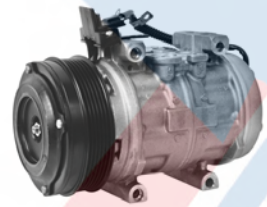

**58322 New**  
**57322 Reman**  
10P15C  
May Require use of OE Manifold  
6 Groove  
12 Volt  
Mount: Tangent Mount  
Pulley Dia.: 4-3/4  
Coil Clock: Wire Lead  
Mercedes (94-82)  
Mercedes Benz: 0002302411,  
0031319501

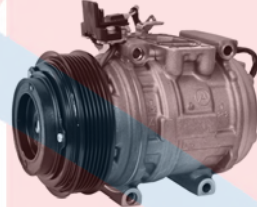

**58334 New**  
**57334 Reman**  
10PA15C  
May Require use of OE Manifold  
6 Groove  
12 Volt  
Switch: Speed Sensor  
Mount: Tangent Mount  
Pulley Dia.: 4-3/4  
Coil Clock: Wire Lead  
Mercedes (93-85)  
Mercedes Benz: 0002301111



**58338 New**  
**57338 Reman**  
10P17C  
May Require use of OE Manifold  
1 Groove  
12 Volt  
Switch: Speed Sensor  
Mount: Tangent Mount  
Pulley Dia.: 4-1/4  
Coil Clock: Wire Lead  
New Clutch Assy: **47535**  
Mercedes (91-86)  
Mercedes Benz: 0002302511,  
1161310001

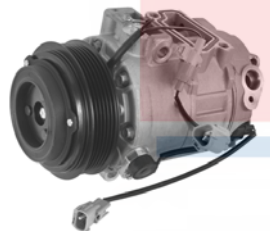

**58302 New**  
**57302 Reman**  
7SBU16C  
May Require use of OE Manifold  
6 Groove  
12 Volt  
Mount: Tangent Mount  
Pulley Dia.: 4-1/2  
Coil Clock: Wire Lead  
Lexus (03-01)  
Lexus: 8832050102, 883205010284



**58328 New**  
**57328 Reman**  
10PA17C  
May Require use of OE Connector and  
OE Manifold; DeSluggler **36142**  
Recommended to Eliminate  
Compressor Damage on Vehicles with  
Low Mount Compressor  
Mount: Tangent Mount  
Chrysler (99-95); Dodge (99-95); Eagle  
(98-95); Lexus (98-92); Mitsubishi  
(99-95); Toyota (03-86)  
Mitsubishi: MR201716  
Toyota: 883203310084



**58335 New**  
**57335 Reman**  
10PA17C  
May Require use of OE Manifold  
6 Groove  
12 Volt  
Switch: Speed Sensor  
Mount: Tangent Mount  
Pulley Dia.: 4-1/4  
Coil Clock: Wire Lead  
Mercedes (96-90)  
Mercedes Benz: 1191300015

# Compressors

## Denso Cont'd



**58341 New**  
**57341 Reman**  
 10PA15C  
 May Require use of OE Manifold  
 Mount: Tangent Mount  
 Chevy (98); Dodge (89); Geo (97-89);  
 Hyundai (95-93); Kia (01-95);  
 Mitsubishi (00-94), (91-89); Porsche  
 (98-89); Toyota (04-88)  
 Acura: 38810P9KE01  
 General Motors Corp: 19192416  
 Mitsubishi: MB609768  
 Porsche: 96412612102  
 Toyota: 883201252084

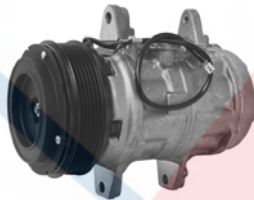

**58343 New**  
**57343 Reman**  
 10P15E  
 May Require use of OE Manifold  
 6 Groove  
 12 Volt  
 Mount: Ear Mount  
 Pulley Dia.: 4-3/4  
 Coil Clock: Wire Lead  
 Porsche (95-85)  
 Porsche: 94412600800, 94412600801



**58344 New**  
**57344 Reman**  
 10PA17C  
 May Require use of OE Manifold  
 1 Groove  
 12 Volt  
 Mount: Tangent Mount  
 Belt Width: 1/2  
 Pulley Dia.: 5-5/8  
 Coil Clock: Wire Lead  
 New Clutch Assy: **47320**  
 Reman Clutch Assy:  
 Reman Compr w/o Clutch: **57354**  
 Chrysler (04-86); Dodge (04-91); Eagle  
 (97-93); Plymouth (01-91)  
 Chrysler: 4815912AD, R1017016

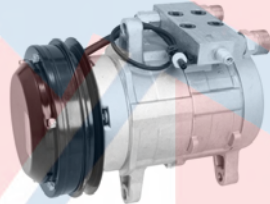

**58345 New**  
**57345 Reman**  
 6E171  
 May Require use of OE Manifold  
 1 Groove  
 12 Volt  
 Mount: Ear Mount  
 Belt Width: 1/2  
 Pulley Dia.: 5-3/4  
 Coil Clock: Wire Lead  
 John Deere: RE12513  
 Western Star: 3003749A



**58356 New**  
**57356 Reman**  
 10PA17C  
 May Require use of OE Manifold  
 5 Groove  
 12 Volt  
 Mount: Tangent Mount  
 Pulley Dia.: 4-1/4  
 Coil Clock: Wire Lead  
 New Clutch Assy: **47563**  
 BMW (99-88)  
 BMW: 64521470093, 64528390741,  
 64528390743, 64528391880



**58357 New**  
**57357 Reman**  
 10P17C  
 May Require use of OE Manifold  
 1 Groove  
 12 Volt  
 Mount: Tangent Mount  
 Pulley Dia.: 1-1/4  
 Coil Clock: Wire Lead  
 Audi (94-85)

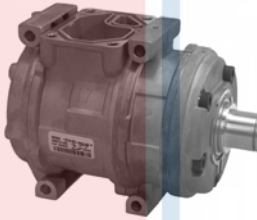

**58362 New**  
**57362 Reman**  
 10PA17C  
 May Require use of OE Manifold  
 Mount: Tangent Mount  
 Acura (98-92); Dodge (94-92); Eagle  
 (96-90); Honda (98-90); Isuzu (99-96);  
 Jeep (03); Mazda (98-89); Mitsubishi  
 (95-88); Plymouth (94-90); Toyota  
 (02-86)  
 Acura: 38810P3G003  
 Mazda: LA0861450  
 Toyota: 883201452184, 883206058084



**58369 New**  
**57369 Reman**  
 10PA15C  
 May Require use of OE Manifold  
 4 Groove  
 12 Volt  
 Mount: Tangent Mount  
 Pulley Dia.: 4-3/4  
 Coil Clock: Wire Lead  
 New Clutch Assy:  
 Toyota (89-88)  
 Toyota: 8841012270



**58378 New**  
**57378 Reman**  
 10PA17J  
 May Require use of OE Manifold  
 6 Groove  
 12 Volt  
 Mount: Ear Mount  
 Pulley Dia.: 4-3/4  
 Coil Clock: Wire Lead  
 New Clutch Assy: **47866**  
 Chrysler (00-95); Dodge (00-96);  
 Plymouth (00-96)  
 Chrysler: 4677156AB  
 Jeep: 55036151



**58381 New**  
**57381 Reman**  
 10PA17C  
 May Require use of OE Manifold  
 6 Groove  
 12 Volt  
 Mount: Tangent Mount  
 Pulley Dia.: 5-1/8  
 Coil Clock: Wire Lead  
 Jeep (98-93)  
 Chrysler: 55036151



**58386 New**  
**57386 Reman**  
 10PA17K  
 May Require use of OE Manifold  
 6 Groove  
 12 Volt  
 Mount: Ear Mount  
 Pulley Dia.: 5-1/2  
 Coil Clock: Wire Lead  
 New Clutch Assy: **47319**  
 Chrysler (95-93); Dodge (95-93);  
 Plymouth (95-93)  
 Chrysler: 4677347

# Compressors

## Denso Cont'd



**58387 New**  
**57387 Reman**  
 10PA17C  
 May Require use of OE Manifold  
 1 Groove  
 12 Volt  
 Mount: Tangent Mount  
 Belt Width: 1/2  
 Pulley Dia.: 5-5/8  
 Coil Clock: Wire Lead  
 New Clutch Assy: **47592**  
 Eagle (94-93); Mitsubishi (94-88);  
 Plymouth (94-90); Toyota (95-88)  
 Toyota: 883200101184, 883203535184



**58390 New**  
**57390 Reman**  
 10PA17C  
 May Require use of OE Manifold  
 7 Groove  
 12 Volt  
 Mount: Tangent Mount  
 Belt Width: 1  
 Pulley Dia.: 5-1/8  
 Coil Clock: Wire Lead  
 New Clutch Assy: **47565**  
 Jeep (98-93)

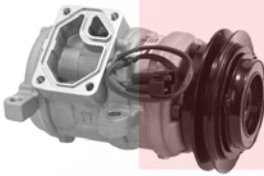

**58396 New**  
**57396 Reman**  
 10PA17K  
 May Require use of OE Manifold  
 1 Groove  
 12 Volt  
 Mount: Ear Mount  
 Belt Width: 1/2  
 Pulley Dia.: 5-1/4  
 Coil Clock: Wire Lead  
 New Clutch Assy: **47318**  
 Dodge (95-93); Plymouth (95-93)



**58397 New**  
**57397 Reman**  
 10PA15C  
 May Require use of OE Manifold  
 4 Groove  
 12 Volt  
 Mount: Tangent Mount  
 Pulley Dia.: 5-1/2  
 Coil Clock: Wire Lead  
 Reman Clutch Assy: **48598**  
 Geo (97-89); Toyota (97-88)  
 General Motors Corp: 12367708,  
 19192426  
 Toyota: 883201271084, 883201274084

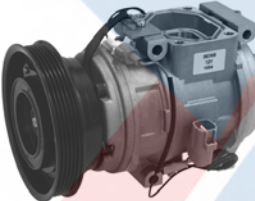

**58398 New**  
**57398 Reman**  
 10PA17C  
 May Require use of OE Manifold  
 5 Groove  
 12 Volt  
 Switch: Switch  
 Mount: Tangent Mount  
 Belt Width: 3/4  
 Pulley Dia.: 5-1/4  
 Coil Clock: Wire Lead  
 New Clutch Assy: **47824**  
 Toyota (01-86)  
 Toyota: 883203306084



**58399 New**  
**57399 Reman**  
 10PA17C  
 May Require use of OE Manifold  
 6 Groove  
 12 Volt  
 Switch: Switch  
 Mount: Tangent Mount  
 Belt Width: 7/8  
 Pulley Dia.: 5  
 Coil Clock: Wire Lead  
 New Clutch Assy: **47570**  
 Lexus (93-92); Toyota (93-92)  
 Toyota: 883203303084, 8841033040



**67304 Reman**  
 6P148A  
 May Require use of OE Manifold  
 1 Groove  
 12 Volt  
 Mount: Ear Mount  
 Pulley Dia.: 5-5/8  
 Coil Clock: Wire Lead  
 Reman Clutch Assy:  
 Reman Compr w/o Clutch: **57382**  
 VW (93-87)

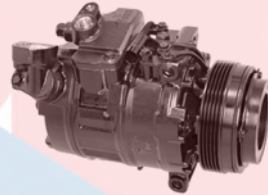

**67307 Reman**  
 7SB16C  
 May Require use of OE Manifold  
 5 Groove  
 12 Volt  
 Mount: Tangent Mount  
 Pulley Dia.: 4-3/32  
 Coil Clock: Wire Lead



**67309 Reman**  
 10S17C  
 May Require use of OE Manifold  
 4 Groove  
 12 Volt  
 Mount: Tangent Mount  
 Pulley Dia.: 5  
 Coil Clock: Wire Lead  
 Chrysler (03)  
 Chrysler: RL058033AC



**67350 Reman**  
 10PA17C  
 May Require use of OE Manifold  
 8 Groove  
 24 Volt  
 Mount: Tangent Mount  
 Pulley Dia.: 5-1/2  
 Coil Clock: Wire Lead  
 John Deere: TY6783



**67351 Reman**  
 10PA17C  
 May Require use of OE Manifold  
 1 Groove  
 12 Volt  
 Mount: Tangent Mount  
 Belt Width: 1/2  
 Pulley Dia.: 5-3/4  
 Coil Clock: Wire Lead  
 New Clutch Assy: **47338**



**67352 Reman**  
 10PA17C  
 May Require use of OE Manifold  
 1 Groove  
 12 Volt  
 Mount: Tangent Mount  
 Belt Width: 1/2  
 Pulley Dia.: 5-3/4  
 Coil Clock: Wire Lead  
 New Clutch Assy: **47339**  
 Case New Holland: A95830  
 John Deere: TY6797  
 Red Dot: 75R822, RD5110480P



# Compressors

## Denso Cont'd



**67353 Reman**  
10PA17C  
May Require use of OE Manifold  
1 Groove  
12 Volt  
Mount: Tangent Mount  
Belt Width: 1/2  
Pulley Dia.: 5-49/64  
Coil Clock: Wire Lead  
New Clutch Assy: **47335**  
John Deere: TY6784

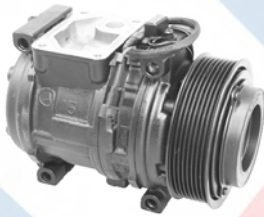

**67354 Reman**  
10PA17C  
May Require use of OE Manifold  
8 Groove  
12 Volt  
Mount: Tangent Mount  
Pulley Dia.: 4-59/64  
Coil Clock: Wire Lead  
New Clutch Assy: **47335**  
John Deere: TY6769

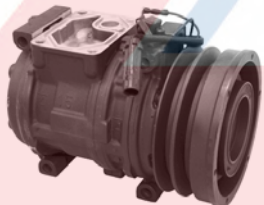

**67355 Reman**  
10PA15C  
May Require use of OE Manifold  
2 Groove  
12 Volt  
Mount: Tangent Mount  
Pulley Dia.: 5-13/32  
Coil Clock: Wire Lead  
New Clutch Assy: **47336**



**67363 Reman**  
TV14  
May Require use of OE Manifold  
5 Groove  
12 Volt  
Switch: Speed Sensor  
Mount: Tangent Mount  
Belt Width: 7/8  
Pulley Dia.: 4-3/4  
Coil Clock: Wire Lead  
Reman Clutch Assy:  
Mazda (93); Toyota (91-90), (88-86)  
Toyota: 883201270084, 8841012200

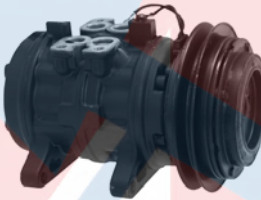

**67364 Reman**  
10P13A  
May Require use of OE Manifold  
1 Groove  
12 Volt  
Mount: Ear Mount  
Pulley Dia.: 5-1/8  
Coil Clock: Wire Lead  
Reman Clutch Assy:  
Mazda (87-86)

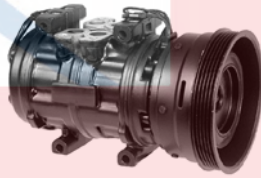

**67368 Reman**  
10P15C  
May Require use of OE Manifold  
5 Groove  
12 Volt  
Switch: Speed Sensor  
Mount: Tangent Mount  
Pulley Dia.: 5-1/4  
Coil Clock: Wire Lead  
Reman Clutch Assy:  
Toyota (86-83)  
Toyota: 8841032010



**67370 Reman**  
10P13C  
May Require use of OE Manifold  
5 Groove  
12 Volt  
Mount: Tangent Mount  
Belt Width: 3/4  
Pulley Dia.: 4-3/4  
Coil Clock: Wire Lead  
Reman Clutch Assy:  
Toyota (87-85)

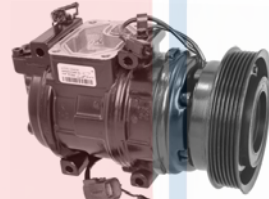

**67375 Reman**  
10PA17VC  
May Require use of OE Manifold  
6 Groove  
12 Volt  
Switch: Speed Sensor  
Mount: Tangent Mount  
Belt Width: 7/8  
Pulley Dia.: 5  
Coil Clock: Wire Lead  
New Clutch Assy: **47570**  
Lexus (91-90); Toyota (91-88)

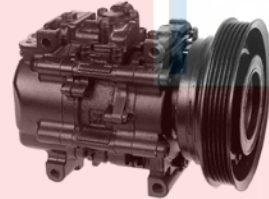

**67377 Reman**  
TV12  
May Require use of OE Manifold  
5 Groove  
12 Volt  
Switch: No Speed Sensor  
Mount: Tangent Mount  
Belt Width: 3/4  
Pulley Dia.: 5-1/2  
Coil Clock: Wire Lead  
Reman Clutch Assy: **48824**  
Toyota (96-94)



**67379 Reman**  
10P13C  
May Require use of OE Manifold  
5 Groove  
12 Volt  
Switch: Speed Sensor  
Mount: Tangent Mount  
Belt Width: 3/4  
Pulley Dia.: 4-3/4  
Coil Clock: Wire Lead  
Reman Clutch Assy:  
Toyota (87-83)  
Toyota: 883201240084, 8841012150



**67380 Reman**  
6P127A  
May Require use of OE Manifold  
5 Groove  
12 Volt  
Mount: Ear Mount  
Pulley Dia.: 5-1/4  
Coil Clock: Wire Lead  
Reman Clutch Assy:  
Toyota (86)  
Toyota: 8841002010

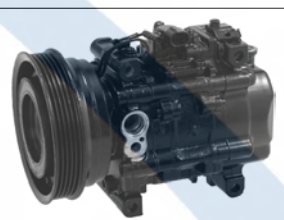

**67381 Reman**  
TV12  
May Require use of OE Manifold  
5 Groove  
12 Volt  
Switch: No Speed Sensor  
Mount: Tangent Mount  
Belt Width: 7/8  
Pulley Dia.: 5  
Coil Clock: Wire Lead  
Reman Clutch Assy:  
Toyota (89-86)  
Toyota: 8841016021

# Compressors

## Denso Cont'd



**67382 Reman**  
10P15C  
May Require use of OE Manifold  
5 Groove  
12 Volt  
Mount: Tangent Mount  
Belt Width: 3/4  
Pulley Dia.: 5-1/4  
Coil Clock: Wire Lead  
Reman Clutch Assy:  
Toyota (88-86)



**67385 Reman**  
10P13C  
May Require use of OE Manifold  
4 Groove  
12 Volt  
Mount: Tangent Mount  
Belt Width: 5/8  
Pulley Dia.: 4-3/4  
Coil Clock: Wire Lead  
Reman Clutch Assy:  
Toyota (89-85)  
Toyota: 8841017010



**67388 Reman**  
TV12  
May Require use of OE Manifold  
4 Groove  
12 Volt  
Switch: Speed Sensor  
Mount: Tangent Mount  
Belt Width: 5/8  
Pulley Dia.: 5-1/2  
Coil Clock: Wire Lead  
Reman Clutch Assy:  
Toyota (93-91)



**67394 Reman**  
TV12  
May Require use of OE Manifold  
5 Groove  
12 Volt  
Switch: Speed Sensor  
Mount: Tangent Mount  
Belt Width: 3/4  
Pulley Dia.: 5-1/2  
Coil Clock: Wire Lead  
Reman Clutch Assy: **48824**  
Toyota (90-88)



**67383 Reman**  
10P17C  
May Require use of OE Manifold  
1 Groove  
12 Volt  
Mount: Tangent Mount  
Belt Width: 1/2  
Pulley Dia.: 5-5/8  
Coil Clock: Wire Lead  
Toyota (86)

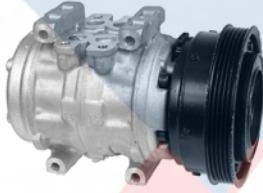

**67386 Reman**  
10P13C  
May Require use of OE Manifold  
5 Groove  
12 Volt  
Switch: Speed Sensor  
Mount: Tangent Mount  
Pulley Dia.: 5-1/4  
Coil Clock: Wire Lead  
Reman Clutch Assy:  
Toyota (89-87)  
Toyota: 883201707084, 8841017020

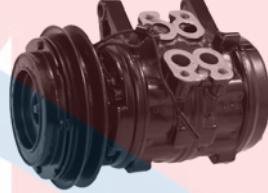

**67392 Reman**  
10P13A  
May Require use of OE Manifold  
1 Groove  
12 Volt  
Mount: Ear Mount  
Belt Width: 1/2  
Pulley Dia.: 5-3/8  
Coil Clock: Wire Lead  
Reman Clutch Assy:  
Toyota (86-84)  
Toyota: 8841012180



**67395 Reman**  
TV12  
May Require use of OE Manifold  
4 Groove  
12 Volt  
Switch: No Speed Sensor  
Mount: Tangent Mount  
Belt Width: 5/8  
Pulley Dia.: 5-1/2  
Coil Clock: Wire Lead  
Reman Clutch Assy:  
Toyota (93-91)

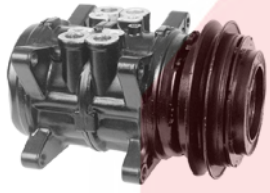

**67384 Reman**  
6P148A  
May Require use of OE Manifold  
1 Groove  
12 Volt  
Mount: Ear Mount  
Pulley Dia.: 5-5/8  
Coil Clock: Wire Lead  
Reman Clutch Assy: **48598**  
Mitsubishi (89-86); Toyota (87-79)  
Toyota: 8841014090

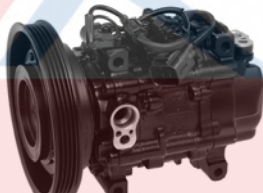

**67387 Reman**  
TV12  
May Require use of OE Manifold  
4 Groove  
12 Volt  
Switch: Speed Sensor  
Mount: Tangent Mount  
Belt Width: 5/8  
Pulley Dia.: 5-3/4  
Coil Clock: Wire Lead  
Reman Clutch Assy:  
Toyota (98-94)

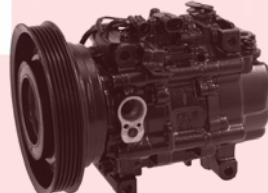



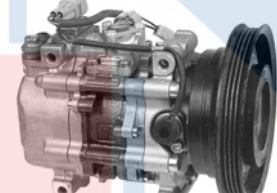

**67393 Reman**  
TV12  
May Require use of OE Manifold  
5 Groove  
12 Volt  
Switch: Speed Sensor  
Mount: Tangent Mount  
Belt Width: 3/4  
Pulley Dia.: 5-1/2  
Coil Clock: Wire Lead  
Reman Clutch Assy: **48824**  
Toyota (90-88)



**67396 Reman**  
TV12  
May Require use of OE Manifold  
4 Groove  
12 Volt  
Switch: No Speed Sensor  
Mount: Tangent Mount  
Belt Width: 5/8  
Pulley Dia.: 5-1/2  
Coil Clock: Wire Lead  
Reman Clutch Assy:  
Toyota (96-94)  
Toyota: 8841016090

# Compressors

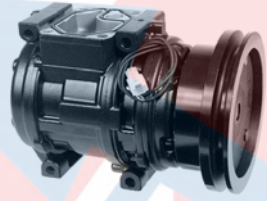
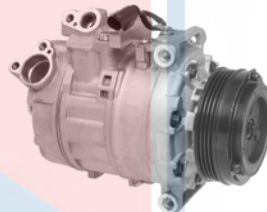
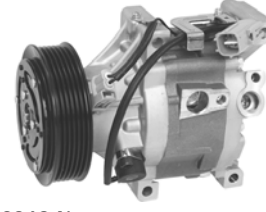
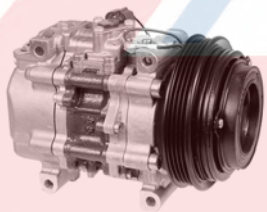
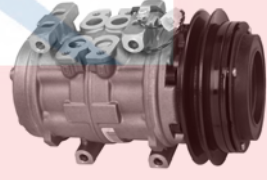
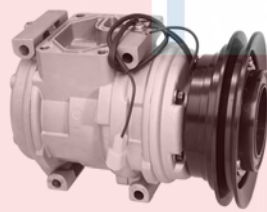
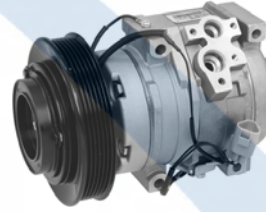
Denso Cont'd			
 <p><b>67397 Reman</b> 10P13F May Require use of OE Manifold 6 Groove 12 Volt Mount: Tangent Mount Belt Width: 7/8 Pulley Dia.: 4-3/4 Coil Clock: Wire Lead Reman Clutch Assy: Ford (91); Mazda (89-88); Mercury (91)</p>	 <p><b>68300 New</b> <b>67300 Reman</b> 10PA17C May Require use of OE Manifold 5 Groove 12 Volt Mount: Tangent Mount Pulley Dia.: 6-1/4 Coil Clock: Wire Lead New Clutch Assy: <b>47893</b> Honda (93-90)</p>	 <p><b>68303 New</b> <b>67303 Reman</b> <b>67365 Reman</b> 10p13C May Require use of OE Manifold 1 Groove 12 Volt Mount: Tangent Mount Pulley Dia.: 5-5/8 Coil Clock: Wire Lead Chrysler (89-87); Dodge (89-85); Mitsubishi (89-85); Plymouth (89-85); Toyota (88-84)</p>	 <p><b>68308 New</b> <b>67308 Reman</b> 10S17E May Require use of OE Manifold 6 Groove 12 Volt Mount: Tangent Mount Pulley Dia.: 5-1/8 Coil Clock: Wire Lead Dodge (07-04); Mitsubishi (09-06) Chrysler: RL056444AC Mitsubishi: RL056435AB</p>
 <p><b>67398 Reman</b> 10P13A May Require use of OE Manifold 5 Groove 12 Volt Mount: Ear Mount Belt Width: 3/4 Pulley Dia.: 4-3/4 Coil Clock: Wire Lead New Clutch Assy: <b>47890</b> Mazda (92-88)</p>	 <p><b>68301 New</b> <b>67301 Reman</b> 10PA15C May Require use of OE Manifold 1 Groove 12 Volt Mount: Tangent Mount Pulley Dia.: 5-5/8 Coil Clock: Wire Lead New Clutch Assy: <b>47592</b> Dodge (89); Mitsubishi (91-89); Toyota (94-88)</p>	 <p><b>68305 New</b> <b>67305 Reman</b> 7SEU17C May Require use of OE Manifold 4 Groove 12 Volt Mount: Tangent Mount Pulley Dia.: 4-7/8 Coil Clock: N/R BMW (11-01) BMW: 64509174802, 64509180548</p>	 <p><b>68310 New</b> <b>67310 Reman</b> SCS06C May Require use of OE Manifold 6 Groove 12 Volt Switch: Speed Sensor Mount: Tangent Mount Pulley Dia.: 4-1/2 Coil Clock: Wire Lead Toyota (05-00) Toyota: 883201712084</p>
 <p><b>67399 Reman</b> TV12 May Require use of OE Manifold 4 Groove 12 Volt Switch: No Speed Sensor Mount: Tangent Mount Pulley Dia.: 4-3/4 Coil Clock: Wire Lead Mazda (93-90) Mazda: NA0261450A</p>	 <p><b>68302 New</b> <b>67302 Reman</b> 10P15C May Require use of OE Manifold 1 Groove 12 Volt Mount: Tangent Mount Pulley Dia.: 4-1/2 Coil Clock: Wire Lead Mazda (91); Toyota (88-84)</p>	 <p><b>68306 New</b> <b>67306 Reman</b> 10PA15C May Require use of OE Manifold 1 Groove 12 Volt Mount: Tangent Mount Pulley Dia.: 5-41/64 Coil Clock: Wire Lead Mitsubishi (00-94) Mitsubishi: MR149363</p>	 <p><b>68311 New</b> <b>67311 Reman</b> 10S15L May Require use of OE Manifold 6 Groove 12 Volt Switch: Speed Sensor Mount: Tangent Mount Pulley Dia.: 5-3/8 Coil Clock: Wire Lead Toyota (05-00)</p>



# Compressors

## Denso Cont'd



**68315 New**  
**67315 Reman**  
 10PA17C  
 May Require use of OE Manifold  
 6 Groove  
 12 Volt  
 Mount: Tangent Mount  
 Pulley Dia.: 5-1/8  
 Coil Clock: Wire Lead  
 Honda (98-95); Isuzu (99-96)  
 Isuzu: 5862055440

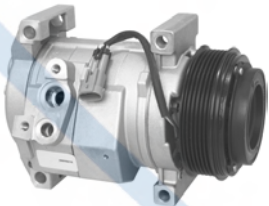

**68316 New**  
**67316 Reman**  
**97369 Reman**  
 10S20F  
 May Require use of OE Manifold  
 6 Groove  
 12 Volt  
 Switch: High Pressure  
 Mount: Tangent Mount  
 Pulley Dia.: 4-5/16  
 Coil Clock: Wire Lead  
 Cadillac (05-00); Chevy (14-12), (02);  
 GMC (14-12), (02)  
 General Motors Corp: 19130452,  
 19130456, 20784066, 25891794

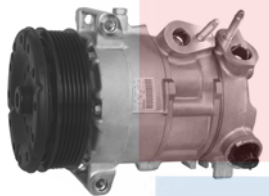

**68317 New**  
**67317 Reman**  
 6SEU16C  
 May Require use of OE Manifold  
 6 Groove  
 12 Volt  
 Mount: Tangent Mount  
 Pulley Dia.: 4-11/16  
 Coil Clock: N/R  
 Chrysler (08-07); Dodge (08)  
 Chrysler: RL111408AD



**68318 New**  
**67318 Reman**  
 10PA15C  
 May Require use of OE Manifold  
 4 Groove  
 12 Volt  
 Mount: Tangent Mount  
 Pulley Dia.: 5-57/64  
 Coil Clock: Wire Lead  
 Geo (89); Toyota (97-88)  
 Toyota: 883201A16084, 883201A42084

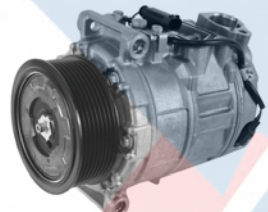

**68319 New**  
 7SEU17C  
 May Require use of OE Manifold  
 8 Groove  
 12 Volt  
 Mount: 3 Tangent One on Rear Head  
 Pulley Dia.: 3-15/16  
 Coil Clock: 3  
 Mercedes (08-07)  
 Mercedes Benz: 0012308311,  
 0022305811

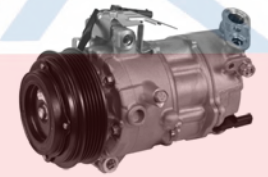

**68321 New**  
 6SAS14C  
 May Require use of OE Manifold  
 5 Groove  
 12 Volt  
 Mount: Tangent Mount  
 Pulley Dia.: 4-21/64  
 Coil Clock: Wire Lead  
 Cadillac (14-13)  
 General Motors Corp: 23192235



**68322 New**  
 7SAS18H  
 May Require use of OE Manifold  
 6 Groove  
 12 Volt  
 Mount: 3 Tangent  
 Pulley Dia.: 3-15/16  
 Buick (14-13); Chevy (15-13); GMC  
 (14-13)  
 General Motors Corp: 23229830

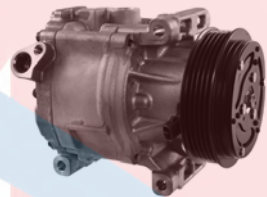

**68323 New**  
 SCSB06C  
 May Require use of OE Manifold  
 5 Groove  
 12 Volt  
 Mount: Tangent Mount  
 Pulley Dia.: 3-3/4  
 Fiat (14-12)  
 Fiat: 68225320AA

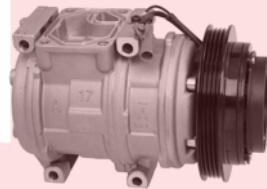

**68324 New**  
**67324 Reman**  
 10PA15L  
 May Require use of OE Manifold  
 4 Groove  
 12 Volt  
 Mount: Tangent Mount  
 Pulley Dia.: 5-3/16  
 Coil Clock: Wire Lead  
 Toyota (04-95)



**68325 New**  
 TSE17C  
 May Require use of OE Manifold  
 6 Groove  
 12 Volt  
 Mount: Tangent Mount  
 Pulley Dia.: 4-47/64  
 Scion (14-11)  
 Toyota: 8831021151



**68328 New**  
**67328 Reman**  
 6SEU14C  
 May Require use of OE Manifold  
 6 Groove  
 12 Volt  
 Switch: Control Valve  
 Mount: Tangent Mount  
 Pulley Dia.: 4-11/16  
 Coil Clock: N/R  
 Scion (14-08); Toyota (12), (10-09)  
 Toyota: 8831002510, 883101A660

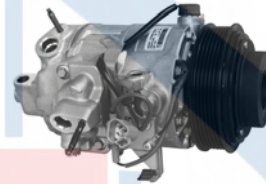

**68329 New**  
**67329 Reman**  
 7SB16C  
 May Require use of OE Manifold  
 6 Groove  
 12 Volt  
 Mount: Tangent Mount  
 Pulley Dia.: 4-11/16  
 Coil Clock: Wire Lead  
 Lexus (10-98)

# Compressors

## Denso Cont'd



**68332** New  
**67332** Reman  
 10S15C  
 May Require use of OE Manifold  
 7 Groove  
 12 Volt  
 Mount: Tangent Mount  
 Pulley Dia.: 5-1/8  
 Coil Clock: Wire Lead  
 Chevy (14); Toyota (05-01)  
 Toyota: 883204208084



**68337** New  
**67337** Reman  
 10S17C  
 May Require use of OE Manifold  
 6 Groove  
 12 Volt  
 Mount: Tangent Mount  
 Pulley Dia.: 5-1/2  
 Coil Clock: Wire Lead  
 Chevy (12-04); GMC (12-04); Isuzu (08-06)  
 General Motors Corp: 25891795  
 Isuzu: 8258917950

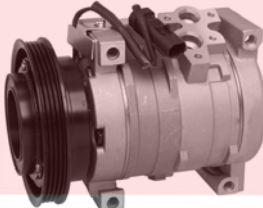

**68338** New  
**67338** Reman  
 10S15C  
 May Require use of OE Manifold  
 4 Groove  
 12 Volt  
 Mount: Tangent Mount  
 Pulley Dia.: 5  
 Coil Clock: Wire Lead  
 Chrysler (03)



**68339** New  
 6SEU16C  
 May Require use of OE Manifold  
 4 Groove  
 12 Volt  
 Mount: Tangent Mount  
 Pulley Dia.: 4-15/16  
 Pontiac (09-08)  
 General Motors Corp: 92265300

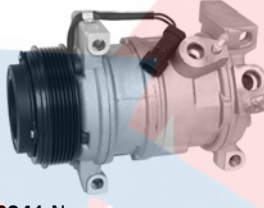

**68341** New  
**157339** Reman - 10SR15C  
**67341** Reman  
 10SR17C  
 May Require use of OE Manifold  
 6 Groove  
 12 Volt  
 Mount: Tangent Mount  
 Pulley Dia.: 4-1/2  
 Coil Clock: Wire Lead  
 Chrysler (09-08); Dodge (10-08)  
 Chrysler: 55111416AC, 55111417AE  
 Volkswagen: 7B0820803B



**68342** New  
**67342** Reman  
 10S17C  
 May Require use of OE Manifold  
 6 Groove  
 12 Volt  
 Mount: Tangent Mount  
 Pulley Dia.: 5-1/16  
 Coil Clock: Wire Lead  
 Chrysler (06-04)



**68343** New  
**67343** Reman  
 10S20E  
 May Require use of OE Manifold  
 7 Groove  
 12 Volt  
 Mount: Tangent Mount  
 Pulley Dia.: 4-11/16  
 Coil Clock: Wire Lead  
 Chrysler (08-07); Dodge (08-04)  
 Chrysler: RL056157AD

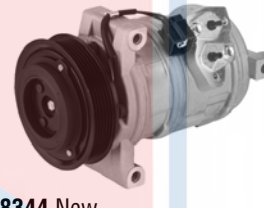

**68344** New  
**67344** Reman  
 10S17C  
 May Require use of OE Manifold  
 6 Groove  
 12 Volt  
 Mount: Tangent Mount  
 Pulley Dia.: 4-11/16  
 Coil Clock: Wire Lead  
 Cadillac (04-03)  
 General Motors Corp: 19130458

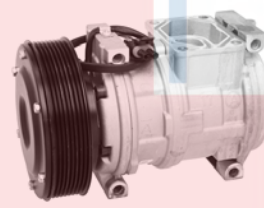

**68350** New  
 10PA17C  
 May Require use of OE Manifold  
 8 Groove  
 24 Volt  
 Mount: Tangent Mount  
 Pulley Dia.: 5-1/2  
 Coil Clock: Wire Lead  
 New Clutch Assy: **47332**  
 John Deere: AT1211063, AT168543,  
 AT211063, AT226273  
 Red Dot: 75R8934, RD110500P  
 Western Star: 3003828



**68351** New  
 10PA17C  
 May Require use of OE Manifold  
 1 Groove  
 12 Volt  
 Mount: Tangent Mount  
 Pulley Dia.: 5-3/4  
 Coil Clock: Wire Lead  
 John Deere: 4471002499, TY6765  
 Western Star: 3003802



**68352** New  
 10PA17C  
 May Require use of OE Manifold  
 1 Groove  
 12 Volt  
 Mount: Tangent Mount  
 Pulley Dia.: 5-47/64  
 Coil Clock: Wire Lead  
 John Deere: 4471008154, TY6789



**68353** New  
 10PA17C  
 May Require use of OE Manifold  
 1 Groove  
 12 Volt  
 Mount: Tangent Mount  
 Pulley Dia.: 5-3/4  
 Coil Clock: Wire Lead  
 John Deere: RE55422

# Compressors

## Denso Cont'd



**68354** New  
10PA15C  
May Require use of OE Manifold  
8 Groove  
12 Volt  
Mount: Tangent Mount  
Pulley Dia.: 4-43/64  
Coil Clock: Wire Lead  
John Deere: 4471708931, AL155836

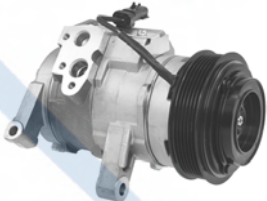

**68357** New  
**67357** Reman  
10S20E  
May Require use of OE Manifold  
6 Groove  
12 Volt  
Mount: Tangent Mount  
Pulley Dia.: 4-3/4  
Coil Clock: Wire Lead  
Chrysler (07); Dodge (07-04); Jeep (07-06)  
Chrysler: RL056287AD, RL056288AD

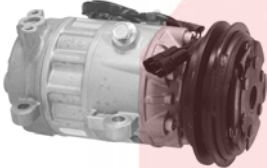

**68360** New  
**67360** Reman  
6C17  
May Require use of OE Manifold  
1 Groove  
12 Volt  
Mount: Ear Mount  
Pulley Dia.: 5-5/8  
Coil Clock: Wire Lead  
Reman Clutch Assy:  
Chrysler (91-89); Dodge (93-88);  
Plymouth (92-89)



**68361** New  
**67361** Reman  
6C17  
May Require use of OE Manifold  
6 Groove  
12 Volt  
Mount: Ear Mount  
Pulley Dia.: 5-1/2  
Coil Clock: Wire Lead  
Reman Clutch Assy:  
Chrysler (93-90); Dodge (93-90);  
Plymouth (92-90)



**68366** New  
**67366** Reman  
**97335** Reman  
10PA15C  
May Require use of OE Manifold  
4 Groove  
12 Volt  
Mount: Tangent Mount  
Belt Width: 5/8  
Pulley Dia.: 5-1/8  
Coil Clock: Wire Lead  
New Clutch Assy: **47598**  
Acura (05-90); Honda (00-99), (97-96)



**68369** New  
**67369** Reman  
10PA15C  
May Require use of OE Manifold  
1 Groove  
12 Volt  
Mount: Tangent Mount  
Pulley Dia.: 5-1/8  
Coil Clock: Wire Lead  
New Clutch Assy: **47567**  
Kia (01-95); Toyota (95-89)  
Kia: 0K01B61450B, 0K01B61450C,  
K997961035B  
Toyota: 883203554084



**68371** New  
**67371** Reman  
10PA17C  
May Require use of OE Manifold  
1 Groove  
12 Volt  
Mount: Tangent Mount  
Belt Width: 1/2  
Pulley Dia.: 5-1/4  
Coil Clock: Wire Lead  
New Clutch Assy: **47821**  
Mazda (94-89); Toyota (88-87)



**68373** New  
**67373** Reman  
10PA17C  
May Require use of OE Manifold  
4 Groove  
12 Volt  
Mount: Tangent Mount  
Belt Width: 5/8  
Pulley Dia.: 4-3/4  
Coil Clock: Wire Lead  
New Clutch Assy: **47826**  
Toyota (93-86)  
Toyota: 8832060450



**68376** New  
**67376** Reman  
10PA20C  
May Require use of OE Manifold  
4 Groove  
12 Volt  
Mount: Tangent Mount  
Pulley Dia.: 4-47/64  
Coil Clock: Wire Lead  
Toyota (92-89)



**68378** New  
**67378** Reman  
10PA17VC  
May Require use of OE Manifold  
5 Groove  
12 Volt  
Mount: Tangent Mount  
Pulley Dia.: 5-1/4  
Coil Clock: Wire Lead  
Lexus (91-90); Toyota (96-88)  
Lexus: 883203209084



**68391** New  
**67391** Reman  
10PA15L  
May Require use of OE Manifold  
4 Groove  
12 Volt  
Mount: Tangent Mount  
Pulley Dia.: 4-1/2  
Coil Clock: Wire Lead  
Toyota (04-00), (98-95)  
Toyota: 8832060H91

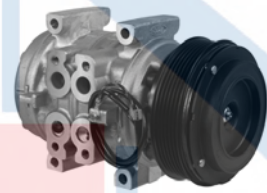

**68397** New  
10P13F  
May Require use of OE Manifold  
6 Groove  
12 Volt  
Mount: Tangent Mount  
Belt Width: 7/8  
Pulley Dia.: 4-3/4  
Coil Clock: Wire Lead  
New Clutch Assy:  
Ford (91); Mazda (89-88); Mercury (91)



# Compressors

Denso Cont'd			
 <p><b>68398</b> New 10P13A May Require use of OE Manifold 5 Groove 12 Volt Mount: Ear Mount Pulley Dia.: 4-3/4 Mazda (92-88) Mazda: GJ5161450B</p>	 <p><b>77303</b> Reman 10P13F May Require use of OE Manifold 1 Groove 12 Volt Mount: Tangent Mount Pulley Dia.: 5-5/8 Coil Clock: Wire Lead New Clutch Assy: Mazda (87-86)</p>	 <p><b>77309</b> Reman 10P15C May Require use of OE Manifold 1 Groove 12 Volt Mount: Tangent Mount Belt Width: 1/2 Pulley Dia.: 5-23/64 Coil Clock: Wire Lead Reman Clutch Assy: Mazda (89-86)</p>	 <p><b>77321</b> Reman 10PA15L May Require use of OE Manifold Switch: Speed Sensor Mount: Tangent Mount Toyota (00-98) Toyota: 883204205084</p>
 <p><b>77300</b> Reman 10PA20C May Require use of OE Manifold 8 Groove 12 Volt Switch: Speed Sensor Mount: Tangent Mount Pulley Dia.: 4-3/4 Coil Clock: Wire Lead Mercedes (93-92) Mercedes Benz: 1192300011</p>	 <p><b>77306</b> Reman 10P13C May Require use of OE Manifold 1 Groove 12 Volt Mount: Tangent Mount Pulley Dia.: 6 Coil Clock: Wire Lead Dodge (88-87); Mitsubishi (88-86), (84)</p>	 <p><b>77314</b> Reman TV12 May Require use of OE Manifold 5 Groove 12 Volt Switch: Speed Sensor Mount: Tangent Mount Belt Width: 7/8 Pulley Dia.: 4-3/4 Coil Clock: 12 New Clutch Assy: Geo (92-89); Toyota (91-88) General Motors Corp: 19193548</p>	 <p><b>77324</b> Reman 10P13C May Require use of OE Manifold 5 Groove 12 Volt Switch: Speed Sensor Mount: Tangent Mount Pulley Dia.: 5-7/8 Coil Clock: Wire Lead Reman Clutch Assy: Toyota (97-96)</p>
 <p><b>77302</b> Reman 10P13A May Require use of OE Manifold 4 Groove 12 Volt Mount: Ear Mount Belt Width: 5/8 Pulley Dia.: 4-3/4 Coil Clock: Wire Lead Reman Clutch Assy: Mazda (87-86); Mercury (87) Mazda: BK0461450</p>	 <p><b>77308</b> Reman 10P15C May Require use of OE Manifold 1 Groove 12 Volt Mount: Tangent Mount Pulley Dia.: 6 Coil Clock: Wire Lead Dodge (91-85); Hyundai (91-89); Mitsubishi (90-85); Plymouth (91-85) Mitsubishi: MB276327</p>	 <p><b>77319</b> Reman 10PA15C May Require use of OE Manifold Switch: Speed Sensor Mount: Tangent Mount Toyota (02-98) Toyota: 883200205084</p>	 <p><b>77330</b> Reman 10PA17C May Require use of OE Manifold Mount: Tangent Mount Chevy (95-90)</p>
			 <p><b>77331</b> Reman 10PA17C May Require use of OE Manifold 6 Groove 12 Volt Mount: Tangent Mount Pulley Dia.: 4-23/64 Coil Clock: Wire Lead New Clutch Assy: <b>47571</b> Chevy (95-90)</p>

# Compressors

## Denso Cont'd



**77339 Reman**  
6CA17C  
May Require use of OE Manifold  
6 Groove  
12 Volt  
Switch: Sensor Port  
Mount: Tangent Mount  
Pulley Dia.: 4-1/2  
Coil Clock: Wire Lead  
Mercedes (95-94)  
Mercedes Benz: 0002301428

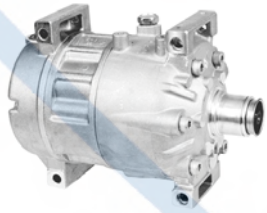

**77340 Reman**  
6CA17C  
May Require use of OE Manifold  
Switch: Sensor Port  
Mount: Tangent Mount  
Mercedes (95-94)



**77353 Reman**  
10P13A  
May Require use of OE Manifold  
4 Groove  
12 Volt  
Mount: Ear Mount  
Belt Width: 5/8  
Pulley Dia.: 4-3/4  
Coil Clock: Wire Lead  
Reman Clutch Assy:  
Ford (93-90)



**77354 Reman**  
10P13C  
May Require use of OE Manifold  
1 Groove  
12 Volt  
Mount: Tangent Mount  
Belt Width: 1/2  
Pulley Dia.: 5-1/2  
Coil Clock: Wire Lead  
Reman Clutch Assy:  
Dodge (89-85); Mitsubishi (90-85);  
Plymouth (86-85)  
Mitsubishi: MB239982, MB630218

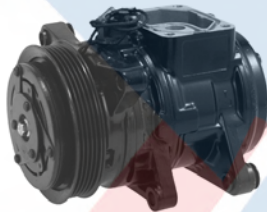

**77355 Reman**  
10PA15A  
May Require use of OE Manifold  
5 Groove  
12 Volt  
Mount: Ear Mount  
Belt Width: 3/4  
Pulley Dia.: 4-3/4  
Coil Clock: Wire Lead  
Reman Clutch Assy:  
Ford (92-89)



**77360 Reman**  
10PA15C  
May Require use of OE Manifold  
4 Groove  
12 Volt  
Mount: Tangent Mount  
Pulley Dia.: 4-3/4  
Coil Clock: Wire Lead  
Reman Clutch Assy:  
Toyota (04-94)



**77382 Reman**  
10PA20H  
May Require use of OE Manifold  
6 Groove  
12 Volt  
Switch: Speed Sensor  
Mount: 3 Ear & 3 Boss  
Pulley Dia.: 5-1/16  
Coil Clock: Wire Lead  
Lexus (97-93)

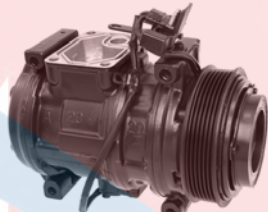

**77394 Reman**  
10PA20C  
May Require use of OE Manifold  
6 Groove  
12 Volt  
Switch: Speed Sensor  
Mount: Tangent Mount  
Pulley Dia.: 4-3/32  
Coil Clock: Wire Lead  
Mercedes (99-96), (93-92)  
Mercedes Benz: 0002301711



**78301 New**  
**77301 Reman**  
**97347 Reman - 10S17C**  
10S20C  
May Require use of OE Manifold  
6 Groove  
12 Volt  
Mount: Tangent Mount  
Pulley Dia.: 5-7/16  
Coil Clock: Wire Lead  
New Clutch Assy: **47375**  
Chrysler (03-01); Dodge (07-04),  
(02-01)  
Chrysler: 5005498AF



**78304 New**  
**77304 Reman**  
10PA17C  
May Require use of OE Manifold  
1 Groove  
12 Volt  
Mount: Tangent Mount  
Pulley Dia.: 5-1/4  
Coil Clock: Wire Lead  
Mazda (98-89)  
Mazda: LB8361450A



**78305 New**  
**77305 Reman**  
10PA17C  
May Require use of OE Manifold  
1 Groove  
12 Volt  
Mount: Tangent Mount  
Belt Width: 1/2  
Pulley Dia.: 5-1/4  
Coil Clock: Wire Lead  
New Clutch Assy: **47318**  
Chrysler (00); Dodge (00-96);  
Plymouth (00-96)  
Chrysler: 4677143

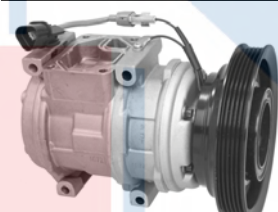

**78307 New**  
**77307 Reman**  
10PA17C  
May Require use of OE Manifold  
5 Groove  
12 Volt  
Switch: Speed Sensor  
Mount: Tangent Mount  
Pulley Dia.: 6  
Coil Clock: Wire Lead  
Acura (89-86); Chrysler (99-95);  
Dodge (99-95); Eagle (98-95);  
Mitsubishi (99-95)  
Mitsubishi: MR201706



# Compressors

## Denso Cont'd



**78310 New**  
**77310 Reman**  
 10PA17H  
 May Require use of OE Manifold  
 6 Groove  
 12 Volt  
 Mount: 3 Ear & 3 Boss  
 Pulley Dia.: 5-1/8  
 Coil Clock: Wire Lead  
 Lexus (00-92); Toyota (98-93)  
 Lexus: 883202412084



**78311 New**  
**77311 Reman**  
 10P08E  
 May Require use of OE Manifold  
 4 Groove  
 12 Volt  
 Mount: Ear Mount  
 Pulley Dia.: 4  
 Coil Clock: Wire Lead  
 Chevy (94-85); Geo (94-89); Suzuki (98-89)



**78312 New**  
**77312 Reman**  
 10P08E  
 May Require use of OE Manifold  
 1 Groove  
 12 Volt  
 Mount: Ear Mount  
 Pulley Dia.: 4-5/8  
 Coil Clock: Wire Lead  
 Chevy (94-85); Suzuki (94-86)  
 Suzuki: 9520067A50, 9520083080, 9523082116



**78313 New**  
**77313 Reman**  
 7SB16C  
 May Require use of OE Manifold  
 6 Groove  
 12 Volt  
 Mount: Tangent Mount  
 Pulley Dia.: 4-3/4  
 Coil Clock: Wire Lead  
 Audi (05-94); Porsche (12-96); Skoda (08-01); VW (05-97)  
 Audi: 4B0260805B  
 Porsche: 99612601152  
 Volkswagen: 4B0260805B

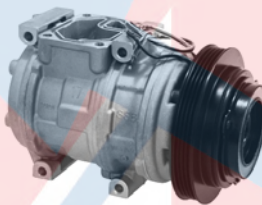

**78316 New**  
**77316 Reman**  
 10PA17C  
 May Require use of OE Manifold  
 4 Groove  
 12 Volt  
 Mount: Tangent Mount  
 Belt Width: 5/8  
 Pulley Dia.: 5-1/4  
 Coil Clock: Wire Lead  
 New Clutch Assy: **47598**  
 Reman Clutch Assy: **48598**  
 Toyota (02-96)  
 Toyota: 8841035340

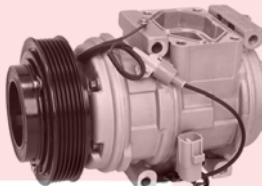

**78318 New**  
**77318 Reman**  
 10PA17C  
 May Require use of OE Manifold  
 6 Groove  
 12 Volt  
 Switch: Speed Sensor  
 Mount: Tangent Mount  
 Belt Width: 7/8  
 Pulley Dia.: 4-3/4  
 Coil Clock: Wire Lead  
 Reman Clutch Assy:  
 Toyota (03-98)  
 Toyota: 883200801084



**78320 New**  
**77320 Reman**  
 10PA15C  
 May Require use of OE Manifold  
 6 Groove  
 12 Volt  
 Switch: Speed Sensor  
 Mount: Tangent Mount  
 Pulley Dia.: 5-1/2  
 Coil Clock: Wire Lead  
 Reman Clutch Assy:  
 Toyota (02-98)  
 Toyota: 883200205084



**78322 New**  
**77322 Reman**  
 10PA15L  
 May Require use of OE Manifold  
 5 Groove  
 12 Volt  
 Switch: Switch  
 Mount: Tangent Mount  
 Pulley Dia.: 4-3/4  
 Coil Clock: Wire Lead  
 Reman Clutch Assy:  
 Toyota (00-98)

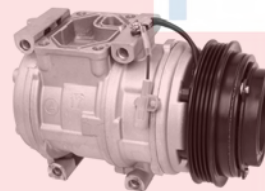

**78323 New**  
**77323 Reman**  
 10PA17C  
 May Require use of OE Manifold  
 4 Groove  
 12 Volt  
 Mount: Tangent Mount  
 Pulley Dia.: 4-3/4  
 Coil Clock: Wire Lead  
 Reman Clutch Assy:  
 Toyota (00-96)



**78325 New**  
**77325 Reman**  
 TV12  
 May Require use of OE Manifold  
 4 Groove  
 12 Volt  
 Switch: No Speed Sensor  
 Mount: Tangent Mount  
 Pulley Dia.: 4-3/4  
 Coil Clock: Wire Lead  
 Mazda (03-99), (97-94)  
 Mazda: NA7561450



**78326 New**  
**77326 Reman**  
 10PA20C  
 May Require use of OE Manifold  
 6 Groove  
 12 Volt  
 Switch: Speed Sensor  
 Mount: Tangent Mount  
 Pulley Dia.: 4-1/2  
 Coil Clock: Wire Lead  
 Reman Clutch Assy:  
 Lexus (00-90)  
 Lexus: 883205003084

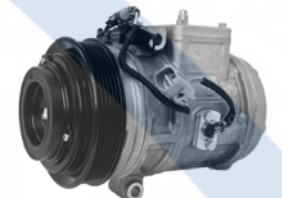

**78327 New**  
**77327 Reman**  
 10PA20C  
 May Require use of OE Manifold  
 6 Groove  
 12 Volt  
 Mount: Tangent Mount  
 Pulley Dia.: 5-15/64  
 Coil Clock: Wire Lead  
 Lexus (00-92)  
 Lexus: 883202414084



# Compressors

## Denso Cont'd



**78328 New**  
**77328 Reman**  
**77350 Reman**  
 10PA20C  
 May Require use of OE Manifold  
 5 Groove  
 12 Volt  
 Mount: Tangent Mount  
 Pulley Dia.: 5-1/2  
 Coil Clock: Wire Lead  
 Reman Clutch Assy:  
 Acura (04-91)  
 Acura: 38810PY3043



**78329 New**  
**77329 Reman**  
 10PA15C  
 May Require use of OE Manifold  
 4 Groove  
 12 Volt  
 Mount: Tangent Mount  
 Pulley Dia.: 5-1/4  
 Coil Clock: Wire Lead  
 Hyundai (95-93)  
 Hyundai: 9770123701

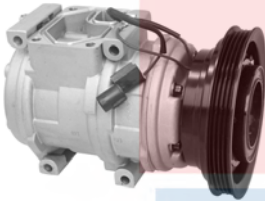

**78333 New**  
**77333 Reman**  
 10PA17C  
 May Require use of OE Manifold  
 4 Groove  
 12 Volt  
 Mount: Tangent Mount  
 Pulley Dia.: 5-1/2  
 Coil Clock: Wire Lead  
 Eagle (96-90); Mitsubishi (95-90);  
 Plymouth (94-90)  
 Mitsubishi: MB609192, MB899714



**78334 New**  
**77334 Reman**  
 10PA17C  
 May Require use of OE Manifold  
 6 Groove  
 12 Volt  
 Switch: Speed Sensor  
 Mount: Tangent Mount  
 Pulley Dia.: 5-1/8  
 Coil Clock: Wire Lead  
 Lexus (98-94); Toyota (03-94)  
 Lexus: 883203303084

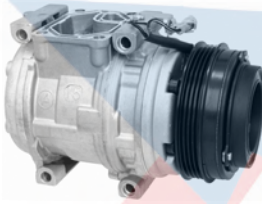

**78335 New**  
**77335 Reman**  
 10PA15C  
 May Require use of OE Manifold  
 4 Groove  
 12 Volt  
 Mount: Tangent Mount  
 Pulley Dia.: 4-1/4  
 Coil Clock: Wire Lead  
 Toyota (04-94)

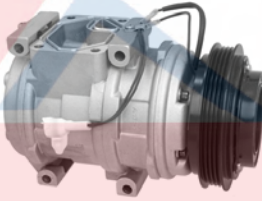

**78336 New**  
**77336 Reman**  
 10PA17C  
 May Require use of OE Manifold  
 4 Groove  
 12 Volt  
 Mount: Tangent Mount  
 Pulley Dia.: 5  
 Coil Clock: Wire Lead  
 Reman Clutch Assy:  
 Toyota (97-94)  
 Toyota: 8841028110



**78337 New**  
**77337 Reman**  
 10PA17E  
 May Require use of OE Manifold  
 4 Groove  
 12 Volt  
 Mount: Ear Mount  
 Pulley Dia.: 4-21/64  
 Coil Clock: Wire Lead  
 New Clutch Assy: **47331**  
 Toyota (95-91)  
 Toyota: 883202820084

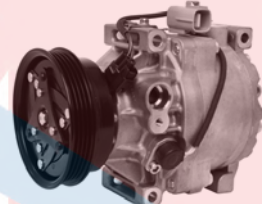

**78338 New**  
**77338 Reman**  
**97378 Reman**  
 SC08C  
 May Require use of OE Manifold  
 4 Groove  
 12 Volt  
 Mount: Tangent Mount  
 Pulley Dia.: 4-1/8  
 Coil Clock: Wire Lead  
 Toyota (98-96)  
 Toyota: 883201051184, 883201052084



**78341 New**  
**77341 Reman**  
 10PA17C  
 May Require use of OE Manifold  
 6 Groove  
 12 Volt  
 Mount: Tangent Mount  
 Pulley Dia.: 5  
 Coil Clock: Wire Lead  
 New Clutch Assy: **47570**  
 Acura (99-97); Honda (02-98)  
 Acura: 38810P8AA01



**78342 New**  
**77342 Reman**  
 10S20C  
 May Require use of OE Manifold;  
 DeSluggler **36140** Recommended to  
 Eliminate Compressor Damage on  
 Vehicles with Low Mount Compressor  
 6 Groove  
 12 Volt  
 Mount: Tangent Mount  
 Pulley Dia.: 5-1/4  
 Coil Clock: Wire Lead  
 Acura (02-01); Honda (04-99)  
 Honda: 38810P8FA01



**78344 New**  
**77344 Reman**  
 10PA17C  
 May Require use of OE Manifold  
 8 Groove  
 12 Volt  
 Switch: Speed Sensor  
 Mount: Tangent Mount  
 Pulley Dia.: 4-3/4  
 Coil Clock: Wire Lead  
 New Clutch Assy: **47570**  
 Mercedes (99-92)  
 Mercedes Benz: 0002300211

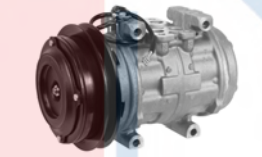

**78345 New**  
 10P15C  
 May Require use of OE Manifold  
 1 Groove  
 12 Volt  
 Mount: Direct Mount  
 Belt Width: 1/2  
 Pulley Dia.: 5-19/32  
 Porsche (89-85)  
 Porsche: 93012602101

# Compressors

## Denso Cont'd



**78346 New**  
**77346 Reman**  
 10PA17C  
 May Require use of OE Manifold  
 1 Groove  
 12 Volt  
 Mount: Tangent Mount  
 Pulley Dia.: 4-25/64  
 Coil Clock: Wire Lead  
 BMW (93-91)



**78348 New**  
**77348 Reman**  
 10S17F  
 May Require use of OE Manifold  
 6 Groove  
 12 Volt  
 Mount: Tangent Mount  
 Pulley Dia.: 4-1/2  
 Coil Clock: Wire Lead  
 Chevy (11-03); GMC (11-03)  
 General Motors Corp: 25891793

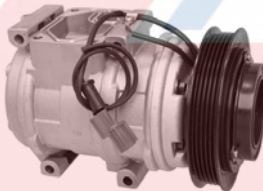

**78351 New**  
**77351 Reman**  
 10PA17C  
 May Require use of OE Manifold  
 5 Groove  
 12 Volt  
 Mount: Tangent Mount  
 Pulley Dia.: 5-1/8  
 Coil Clock: Wire Lead  
 Acura (98-97), (94-92)



**78356 New**  
**77356 Reman**  
 7SB16C  
 May Require use of OE Manifold  
 6 Groove  
 12 Volt  
 Mount: Tangent Mount  
 Pulley Dia.: 4-3/4  
 Coil Clock: Wire Lead  
 Chrysler (08-04); Dodge (06-03);  
 Mercedes (04-96)  
 Chrysler: 5117666AA, 5117668AA  
 Mercedes Benz: 0002302011,  
 0002306811, 0002307011, 000230971

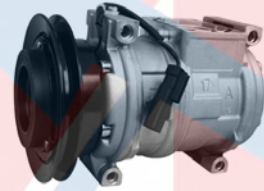

**78357 New**  
**57344 Reman**  
 10PA17C  
 May Require use of OE Manifold  
 1 Groove  
 12 Volt  
 Mount: Tangent Mount  
 Belt Width: 1/2  
 Pulley Dia.: 5-5/8  
 Coil Clock: Wire Lead  
 New Clutch Assy: **47320**  
 Plymouth (95)



**78358 New**  
**57344 Reman**  
 10PA17C  
 May Require use of OE Manifold  
 1 Groove  
 12 Volt  
 Mount: Tangent Mount  
 Belt Width: 1/2  
 Pulley Dia.: 5-5/8  
 Coil Clock: Wire Lead  
 New Clutch Assy: **47320**  
 Chrysler (01-99), (97-93)  
 Chrysler: 4758452



**78359 New**  
**57381 Reman**  
 10PA17C  
 May Require use of OE Manifold  
 6 Groove  
 12 Volt  
 Mount: Tangent Mount  
 Belt Width: 7/8  
 Pulley Dia.: 5-23/64  
 Coil Clock: Wire Lead  
 Chrysler (00); Dodge (00-96); Jeep  
 (02-00); Plymouth (00-96)  
 Jeep: RL037432AB

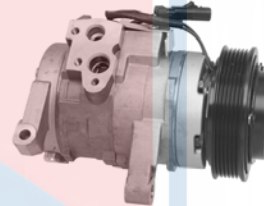

**78361 New**  
**77361 Reman**  
 10S17E  
 May Require use of OE Manifold  
 6 Groove  
 12 Volt  
 Mount: Tangent Mount  
 Pulley Dia.: 4-3/4  
 Coil Clock: Wire Lead  
 Jeep (07-05)  
 Jeep: RL116834AD

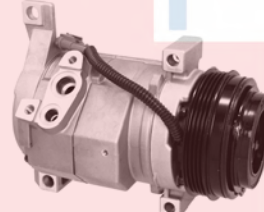

**78362 New**  
**77362 Reman**  
 10S17F  
 May Require use of OE Manifold;  
 DeSluggler **36141** Recommended to  
 Eliminate Compressor Damage on  
 Vehicles with Low Mount Compressor  
 4 Groove  
 12 Volt  
 Mount: Tangent Mount  
 Pulley Dia.: 4-1/4  
 Coil Clock: Wire Lead  
 New Clutch Assy: **47362**  
 Cadillac (02); Chevy (15-00); GMC  
 (13-00); GMC & CHEVY (13-09)  
 General Motors Corp: 19130457,  
 20880829, 89019357, 89024907,  
 89024925



**78363 New - w/ HP Switch**  
**77363 Reman**  
**77376 Reman**  
**77377 Reman - w/o HP Switch**  
 10S20F  
 May Require use of OE Manifold;  
 DeSluggler **36141** Recommended to  
 Eliminate Compressor Damage on  
 Vehicles with Low Mount Compressor  
 4 Groove  
 12 Volt  
 Mount: Tangent Mount  
 Pulley Dia.: 4-1/4  
 Coil Clock: Wire Lead  
 New Clutch Assy: **47362**  
 Cadillac (14-10), (02); Chevy (14-09),  
 (02-00); GMC (14-09), (02-00)  
 General Motors Corp: 19130450,  
 25940199, 25940200

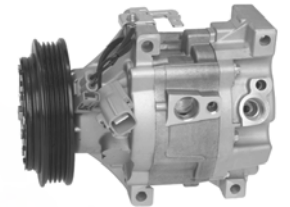

**78370 New**  
**77370 Reman**  
 SCS06C  
 May Require use of OE Manifold  
 4 Groove  
 12 Volt  
 Mount: Tangent Mount  
 Pulley Dia.: 4-19/64  
 Coil Clock: Wire Lead  
 Toyota (05-00)  
 Toyota: 883205201084, 883205204084,  
 883205212084, 883205240084



**78371 New**  
**77371 Reman**  
 7SBU16H  
 May Require use of OE Manifold  
 6 Groove  
 12 Volt  
 Switch: Speed Sensor  
 Mount: Tangent Mount  
 Pulley Dia.: 4-11/16  
 Coil Clock: Wire Lead  
 Lexus (05-98)  
 Lexus: 883202A05184, 883203A18184

# Compressors

## Denso Cont'd



**78372 New**  
**77372 Reman**  
 10S17C  
 May Require use of OE Manifold;  
 DeSluggger **36140** Recommended to  
 Eliminate Compressor Damage on  
 Vehicles with Low Mount Compressor  
 7 Groove  
 12 Volt  
 Mount: Tangent Mount  
 Pulley Dia.: 4-3/4  
 Coil Clock: 4  
 Honda (11-03)  
 Honda: 38810PZDA00

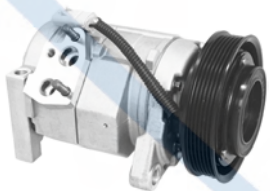

**78374 New**  
**77374 Reman**  
**97343 Reman - 10S17H**  
 10S20H  
 May Require use of OE Connector and  
 OE Manifold; DeSluggger **36142**  
 Recommended to Eliminate  
 Compressor Damage on Vehicles with  
 Low Mount Compressor  
 6 Groove  
 12 Volt  
 Mount: 2 Ear & 2 Boss  
 Pulley Dia.: 5-1/8  
 Coil Clock: Wire Lead  
 New Clutch Assy: **47374**  
 Chrysler (07-01); Dodge (07-01)



**78375 New**  
**77375 Reman**  
 10PA17C  
 May Require use of OE Manifold  
 8 Groove  
 12 Volt  
 Mount: Tangent Mount  
 Pulley Dia.: 5-1/2  
 Coil Clock: Wire Lead  
 New Clutch Assy:  
 John Deere: RE46609, RE69716,  
 TY24304, TY6764  
 Red Dot: 79R8932  
 Western Star: 3003805

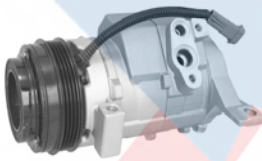

**78376 New**  
**77376 Reman**  
 10S20F  
 May Require use of OE Manifold;  
 DeSluggger **36141** Recommended to  
 Eliminate Compressor Damage on  
 Vehicles with Low Mount Compressor  
 4 Groove  
 12 Volt  
 Mount: Tangent Mount  
 Pulley Dia.: 4-1/4  
 Coil Clock: Wire Lead  
 New Clutch Assy: **47362**  
 Cadillac (09-03); Chevy (11-03); GMC  
 (11-03)  
 General Motors Corp: 25891792

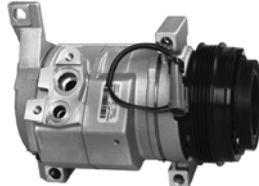

**78377 New**  
**77377 Reman**  
 10S17F  
 May Require use of OE Manifold;  
 DeSluggger **36141** Recommended to  
 Eliminate Compressor Damage on  
 Vehicles with Low Mount Compressor  
 4 Groove  
 12 Volt  
 Mount: Tangent Mount  
 Pulley Dia.: 4-1/4  
 Coil Clock: Wire Lead  
 New Clutch Assy: **47362**  
 Cadillac (09-03); Chevy (11-03); GMC  
 (11-03)  
 General Motors Corp: 22994155,  
 25891791

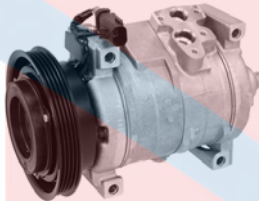

**78378 New**  
**77378 Reman**  
 10S17C  
 May Require use of OE Manifold  
 4 Groove  
 12 Volt  
 Mount: Tangent Mount  
 Pulley Dia.: 5  
 Coil Clock: Wire Lead  
 New Clutch Assy: **47378**  
 Chrysler (09-01); Dodge (02-00);  
 Plymouth (01-00)  
 Chrysler: 5058031AD

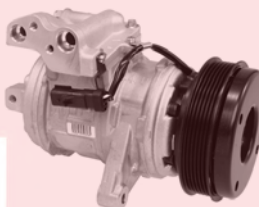

**78379 New**  
**77379 Reman**  
 10PA17E  
 May Require use of OE Manifold  
 6 Groove  
 12 Volt  
 Mount: Ear Mount  
 Pulley Dia.: 5-1/8  
 Coil Clock: Wire Lead  
 New Clutch Assy: **47564**  
 Jeep (06-99)



**78380 New**  
**77380 Reman**  
 10PA17E  
 May Require use of OE Manifold  
 6 Groove  
 12 Volt  
 Mount: Ear Mount  
 Pulley Dia.: 5-1/8  
 Coil Clock: Wire Lead  
 New Clutch Assy: **47564**  
 Jeep (04-99)  
 Jeep: RL116810AA



**78381 New**  
**77381 Reman**  
 10PA17C  
 May Require use of OE Manifold  
 6 Groove  
 12 Volt  
 Mount: Tangent Mount  
 Pulley Dia.: 5-1/2  
 Coil Clock: Wire Lead  
 New Clutch Assy:  
 Chrysler (04-98); Dodge (04-98)  
 Chrysler: 4698723AD

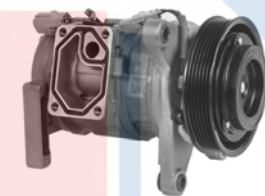

**78382 New**  
 10PA20H  
 May Require use of OE Manifold  
 6 Groove  
 12 Volt  
 Mount: 3 Ear & 3 Boss  
 Pulley Dia.: 5-1/16  
 Coil Clock: Wire Lead  
 Lexus (97-93)  
 Lexus: 8832030651



# Compressors

## Denso Cont'd



**78383 New**  
**77383 Reman**  
 10S17C  
 May Require use of OE Manifold  
 6 Groove  
 12 Volt  
 Mount: Tangent Mount  
 Pulley Dia.: 5  
 Coil Clock: Wire Lead  
 Reman Clutch Assy:  
 Acura (03-99); Honda (02-01)  
 Honda: 38810P8EA01



**78384 New**  
**77384 Reman**  
 10S11E  
 May Require use of OE Manifold;  
 DeSluggger **36140** Recommended to  
 Eliminate Compressor Damage on  
 Vehicles with Low Mount Compressor  
 4 Groove  
 12 Volt  
 Mount: Ear Mount  
 Pulley Dia.: 4-3/4  
 Coil Clock: Wire Lead  
 Chevy (00-99)

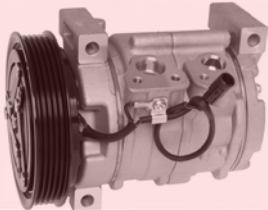

**78385 New**  
**77385 Reman**  
 10S11C  
 May Require use of OE Manifold;  
 DeSluggger **36140** Recommended to  
 Eliminate Compressor Damage on  
 Vehicles with Low Mount Compressor  
 5 Groove  
 12 Volt  
 Mount: Tangent Mount  
 Pulley Dia.: 4-1/2  
 Coil Clock: Wire Lead  
 Chevy (03-99); Suzuki (03-99)  
 General Motors Corp: 30026931  
 Suzuki: 9520067D00, 9520067D10



**78386 New**  
**77386 Reman**  
 10S17C  
 May Require use of OE Manifold  
 4 Groove  
 12 Volt  
 Switch: High Pressure  
 Mount: Tangent Mount  
 Pulley Dia.: 5-1/8  
 Coil Clock: Wire Lead  
 Chrysler (09-01)

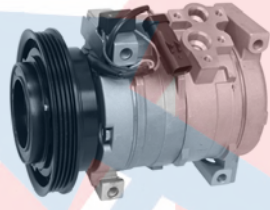

**78387 New**  
**77387 Reman**  
 10S15C  
 May Require use of OE Manifold  
 4 Groove  
 12 Volt  
 Mount: Tangent Mount  
 Pulley Dia.: 5-1/8  
 Coil Clock: Wire Lead  
 Chrysler (10-01)  
 Chrysler: R5058032AC, RL058032AC

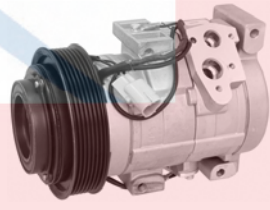

**78388 New**  
**77388 Reman**  
 10S17C  
 May Require use of OE Manifold;  
 DeSluggger **36140** Recommended to  
 Eliminate Compressor Damage on  
 Vehicles with Low Mount Compressor  
 7 Groove  
 12 Volt  
 Switch: Speed Sensor  
 Mount: Tangent Mount  
 Pulley Dia.: 5-1/8  
 Coil Clock: Wire Lead  
 Toyota (08-01)  
 Toyota: 883200608084



**78389 New**  
**77389 Reman**  
 10S17C  
 May Require use of OE Manifold;  
 DeSluggger **36140** Recommended to  
 Eliminate Compressor Damage on  
 Vehicles with Low Mount Compressor  
 7 Groove  
 12 Volt  
 Mount: Tangent Mount  
 Pulley Dia.: 5-1/8  
 Coil Clock: 10  
 Honda (07-03)

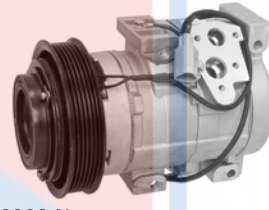

**78390 New**  
**77390 Reman**  
 10S17C  
 May Require use of OE Manifold  
 6 Groove  
 12 Volt  
 Switch: Speed Sensor  
 Mount: Tangent Mount  
 Pulley Dia.: 3-11/16  
 Coil Clock: Wire Lead  
 Lexus (06-99); Toyota (08-95)  
 Toyota: 883200709084, 883203314084

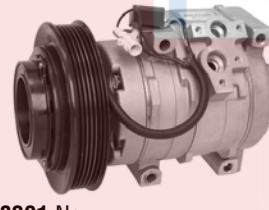

**78391 New**  
**77391 Reman**  
 10S15L  
 May Require use of OE Manifold  
 6 Groove  
 12 Volt  
 Mount: Tangent Mount  
 Pulley Dia.: 5-1/2  
 Coil Clock: Wire Lead  
 Toyota (08-03)  
 Toyota: 883200212084



**78392 New**  
**77392 Reman**  
 10PA17C  
 May Require use of OE Manifold  
 7 Groove  
 12 Volt  
 Mount: Tangent Mount  
 Pulley Dia.: 5-1/16  
 Coil Clock: Wire Lead  
 New Clutch Assy: **47565**  
 Land Rover (98-94)  
 Land Rover: BTR5750, LRNA350004A



**78393 New**  
**77393 Reman**  
 10PA17C  
 May Require use of OE Manifold  
 1 Groove  
 12 Volt  
 Mount: Tangent Mount  
 Pulley Dia.: 5-3/32  
 Coil Clock: Wire Lead  
 Reman Clutch Assy:  
 Lexus (97-96); Toyota (97-93)

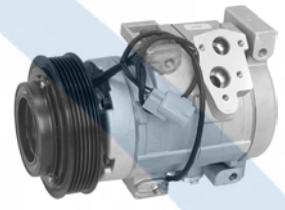

**78395 New**  
**77395 Reman**  
 10S17C  
 May Require use of OE Manifold  
 6 Groove  
 12 Volt  
 Switch: Speed Sensor  
 Mount: Tangent Mount  
 Pulley Dia.: 4-23/32  
 Coil Clock: Wire Lead  
 Toyota (06-00)  
 Toyota: 883200C01084

# Compressors

## Denso Cont'd



**78396 New**  
**77396 Reman**  
 7SB16C  
 May Require use of OE Manifold  
 5 Groove  
 12 Volt  
 Mount: Tangent Mount  
 Pulley Dia.: 5-1/4  
 Coil Clock: Wire Lead  
 BMW (06-96)  
 BMW: 64526910458, 64526910460,  
 64528385919, 64528385921



**78397 New**  
**77397 Reman**  
 10PA20C  
 May Require use of OE Manifold  
 6 Groove  
 12 Volt  
 Mount: Tangent Mount  
 Pulley Dia.: 4-1/2  
 Coil Clock: Wire Lead  
 Lexus (07-98); Toyota (07-98)  
 Toyota: 883206068184

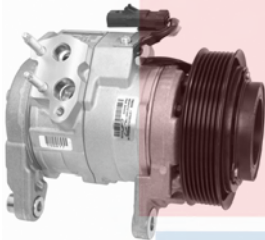

**78398 New**  
**77398 Reman**  
 10S17E  
 May Require use of OE Manifold  
 7 Groove  
 12 Volt  
 Mount: Ear Mount  
 Pulley Dia.: 5-1/8  
 Coil Clock: Wire Lead  
 Dodge (08-03)



**78399 New**  
**77399 Reman**  
 10S15C  
 May Require use of OE Manifold  
 4 Groove  
 12 Volt  
 Switch: Heat Switch  
 Mount: Tangent Mount  
 Pulley Dia.: 5  
 Coil Clock: Wire Lead  
 New Clutch Assy: **47378**  
 Dodge (05-03)

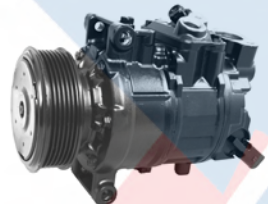

**97321 Reman**  
 6SEU16C  
 May Require use of OE Manifold  
 6 Groove  
 12 Volt  
 Mount: Tangent Mount  
 Pulley Dia.: 3-59/64  
 Coil Clock: N/R  
 Audi (15-01)



**97325 Reman**  
 10PA17C  
 May Require use of OE Manifold  
 4 Groove  
 12 Volt  
 Mount: Tangent Mount  
 Pulley Dia.: 4-3/4  
 Coil Clock: Wire Lead  
 Jaguar (97-95)



**97329 Reman**  
 7SBU17C  
 May Require use of OE Manifold  
 6 Groove  
 12 Volt  
 Switch: Control Valve  
 Mount: Tangent Mount  
 Pulley Dia.: 5-1/4  
 Coil Clock: Wire Lead  
 Acura (12-05)



**97341 Reman**  
 10PA17C  
 May Require use of OE Manifold  
 7 Groove  
 12 Volt  
 Switch: Speed Sensor  
 Mount: Tangent Mount  
 Pulley Dia.: 4-11/16  
 Coil Clock: Wire Lead  
 Jaguar (03-97)



**97390 Reman**  
 6SEU14C  
 May Require use of OE Manifold  
 6 Groove  
 12 Volt  
 Mount: Tangent Mount  
 Pulley Dia.: 4-15/16  
 Coil Clock: N/R  
 Audi (11-05)  
 Audi: 4F0260805AF



**98303 New**  
**97303 Reman**  
 10S17F  
 May Require use of OE Manifold  
 6 Groove  
 12 Volt  
 Mount: Tangent Mount  
 Pulley Dia.: 4-1/2  
 Coil Clock: Wire Lead  
 Chevy (07-04); GMC (07-03)  
 General Motors Corp: 19130455



**98305 New**  
**97305 Reman**  
 10S20C  
 May Require use of OE Manifold  
 5 Groove  
 12 Volt  
 Mount: Tangent Mount  
 Pulley Dia.: 4-1/2  
 Coil Clock: Wire Lead  
 Cadillac (09-04)  
 General Motors Corp: 19130477

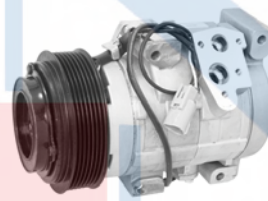

**98306 New**  
**97306 Reman**  
 10S17C  
 May Require use of OE Manifold  
 7 Groove  
 12 Volt  
 Mount: Tangent Mount  
 Pulley Dia.: 4-5/8  
 Coil Clock: Wire Lead  
 Toyota (09-03)  
 Toyota: 883203570084



# Compressors

## Denso Cont'd



**98307 New**  
**97307 Reman**  
**97327 Reman - 10S17C**  
 10S20C  
 May Require use of OE Manifold  
 6 Groove  
 12 Volt  
 Mount: Tangent Mount  
 Pulley Dia.: 5-1/4  
 Coil Clock: Wire Lead  
 Acura (06-03); Honda (08-05)  
 Acura: 38810RDAA01  
 Honda: 38810RCAA01, 38810RDJA01, 38810RGLA01



**98308 New**  
**97308 Reman**  
 10S17C  
 May Require use of OE Manifold  
 6 Groove  
 12 Volt  
 Mount: Tangent Mount  
 Pulley Dia.: 4-11/16  
 Coil Clock: Wire Lead  
 Chrysler (05); Dodge (05)  
 Chrysler: RL596490AC

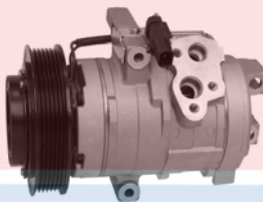

**98309 New**  
**97309 Reman**  
 10S17C  
 May Require use of OE Manifold  
 6 Groove  
 12 Volt  
 Mount: Tangent Mount  
 Pulley Dia.: 5-1/8  
 Coil Clock: Wire Lead  
 Chrysler (10-06); Dodge (10-06)  
 Chrysler: RL111034AB



**98310 New**  
**97310 Reman**  
 10S20C  
 May Require use of OE Manifold  
 6 Groove  
 12 Volt  
 Mount: Tangent Mount  
 Pulley Dia.: 4-11/16  
 Coil Clock: Wire Lead  
 Toyota (07-04)  
 Toyota: 8832008051

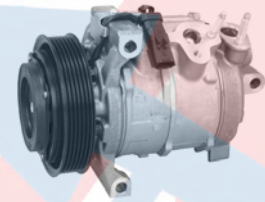

**98314 New**  
**97314 Reman**  
 10SRE18C  
 May Require use of OE Manifold  
 6 Groove  
 12 Volt  
 Mount: Tangent Mount  
 Pulley Dia.: 4-15/16  
 Coil Clock: Wire Lead  
 Chrysler (13-11); Dodge (15-11); Jeep (15-11)  
 Chrysler: 68202994AA  
 Jeep: 68202994AA

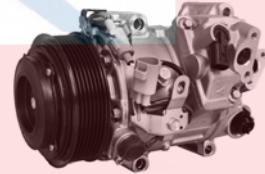

**98315 New**  
**157369 Reman**  
 TSB19C  
 May Require use of OE Manifold  
 7 Groove  
 12 Volt  
 Switch: Control Valve  
 Mount: Tangent Mount  
 Pulley Dia.: 4-17/32  
 Coil Clock: Wire Lead  
 Lexus (14-10); Toyota (14-11)  
 Lexus: 8832006190, 883203A460, 8832048280  
 Toyota: 8832006190, 8832008150, 8832048280



**98317 New**  
 6SEU12C  
 May Require use of OE Manifold  
 6 Groove  
 12 Volt  
 Mount: 3 Tangent One on Rear Head  
 Pulley Dia.: 4-21/64  
 Coil Clock: Wire Lead  
 Audi (12-09)

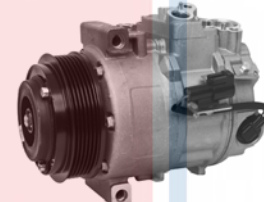

**98318 New**  
**97318 Reman**  
 7SEU17C  
 May Require use of OE Manifold  
 6 Groove  
 12 Volt  
 Mount: Tangent Mount  
 Belt Width: 7/8  
 Pulley Dia.: 4-21/64  
 Coil Clock: N/R  
 Jaguar (10-09); Land Rover (09-05)  
 Jaguar: C2Z1137  
 Land Rover: LR012593, LR015151

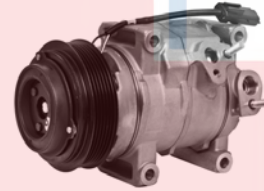

**98320 New**  
**97320 Reman**  
**97312 Reman - 10SRE18C**  
 10SRE20C  
 May Require use of OE Manifold  
 6 Groove  
 12 Volt  
 Mount: Tangent Mount  
 Pulley Dia.: 4-23/32  
 Coil Clock: Wire Lead  
 Chrysler (15-11); Dodge (15-11)  
 Chrysler: 55111103AC, 55111103AD, 55111104AD, 68084913AC, 68084914AC  
 Volkswagen: 7B0820803H



**98325 New**  
 10PA17C  
 May Require use of OE Manifold  
 4 Groove  
 12 Volt  
 Mount: Tangent Mount  
 Pulley Dia.: 4-3/4  
 Coil Clock: Wire Lead  
 Jaguar (97-95)  
 Jaguar: MNA7300AB



**98326 New**  
**97326 Reman**  
 7SB16C  
 May Require use of OE Manifold  
 4 Groove  
 12 Volt  
 Mount: Tangent Mount  
 Pulley Dia.: 4-3/4  
 Coil Clock: Wire Lead  
 Audi (04-94); Skoda (08-01); VW (09-96)  
 Volkswagen: 8D0260805RX

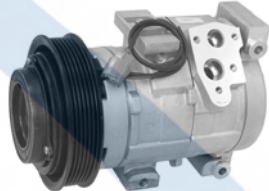

**98327 New**  
**97327 Reman**  
 10S17C  
 May Require use of OE Manifold  
 6 Groove  
 12 Volt  
 Mount: Tangent Mount  
 Pulley Dia.: 5-1/4  
 Coil Clock: Wire Lead  
 Acura (08-04); Honda (07-03)



# Compressors

## Denso Cont'd



**98328** New  
**97328** Reman  
**67312** Reman  
 10S20C  
 May Require use of OE Manifold  
 6 Groove  
 12 Volt  
 Switch: Speed Sensor  
 Mount: Tangent Mount  
 Pulley Dia.: 4-1/2  
 Coil Clock: Wire Lead  
 Lexus (09-05); Toyota (09-01)  
 Lexus: 883206A11184  
 Toyota: 883200C110

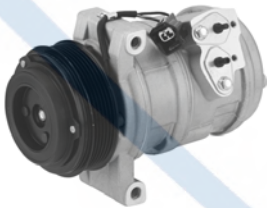

**98330** New  
**97330** Reman  
 10S17C  
 May Require use of OE Manifold  
 6 Groove  
 12 Volt  
 Mount: Tangent Mount  
 Pulley Dia.: 4-5/16  
 Coil Clock: Wire Lead  
 Cadillac (07-04)  
 General Motors Corp: 19130460

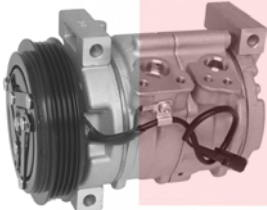

**98331** New  
**97331** Reman  
 10S11C  
 May Require use of OE Manifold  
 4 Groove  
 12 Volt  
 Mount: Tangent Mount  
 Pulley Dia.: 4-1/2  
 Coil Clock: Wire Lead  
 Chevy (04-01)  
 General Motors Corp: 30025286



**98332** New  
**97332** Reman  
 7SBH17  
 May Require use of OE Manifold  
 6 Groove  
 12 Volt  
 Mount: Tangent Mount  
 Pulley Dia.: 4-5/16  
 Coil Clock: Wire Lead  
 Ford (14-11)  
 Ford: EB5Z19703B

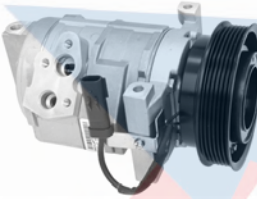

**98333** New  
**97333** Reman  
**97304** Reman  
 10S17C  
 May Require use of OE Manifold  
 6 Groove  
 12 Volt  
 Mount: Tangent Mount  
 Pulley Dia.: 4-7/8  
 Coil Clock: Wire Lead  
 Chrysler (06); Dodge (06)

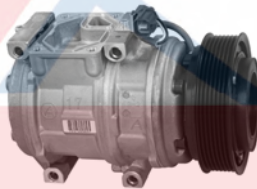

**98334** New  
**97334** Reman  
 10PA17C  
 May Require use of OE Manifold  
 7 Groove  
 12 Volt  
 Mount: Tangent Mount  
 Pulley Dia.: 4-11/16  
 Coil Clock: Wire Lead  
 Land Rover (05-99)  
 Land Rover: JPB101330



**98336** New  
**97336** Reman  
 10S17C  
 May Require use of OE Manifold  
 5 Groove  
 12 Volt  
 Mount: Tangent Mount  
 Pulley Dia.: 4-11/16  
 Coil Clock: Wire Lead  
 BMW (03-00)  
 BMW: 64526909628

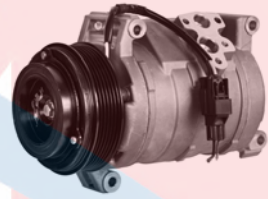

**98337** New  
**97337** Reman  
 10S20C  
 May Require use of OE Manifold  
 6 Groove  
 12 Volt  
 Mount: Tangent Mount  
 Pulley Dia.: 4-1/2  
 Coil Clock: Wire Lead  
 Cadillac (09-04)  
 General Motors Corp: 19130463



**98338** New  
**97338** Reman  
 10S17C  
 May Require use of OE Manifold  
 7 Groove  
 12 Volt  
 Switch: Speed Sensor  
 Mount: Tangent Mount  
 Pulley Dia.: 4-11/16  
 Coil Clock: Wire Lead  
 Mitsubishi (06-01)  
 Mitsubishi: MR568288



**98339** New  
**97339** Reman  
 10S13C  
 May Require use of OE Manifold  
 4 Groove  
 12 Volt  
 Mount: Tangent Mount  
 Pulley Dia.: 4-1/2  
 Coil Clock: Wire Lead  
 Suzuki (05-01)  
 Suzuki: 9520065DC1, 9520065DF1



**98340** New  
**97340** Reman  
 10S13C  
 May Require use of OE Manifold  
 5 Groove  
 12 Volt  
 Mount: Tangent Mount  
 Pulley Dia.: 4-1/4  
 Coil Clock: Wire Lead  
 Suzuki (07-02)  
 Suzuki: 9520065DE0

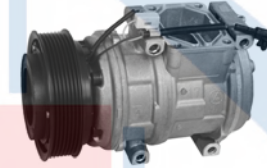

**98342** New  
**97342** Reman  
 10PA17C  
 May Require use of OE Manifold  
 7 Groove  
 12 Volt  
 Mount: Tangent Mount  
 Pulley Dia.: 4-3/4  
 Coil Clock: Wire Lead  
 Jaguar (03-98)  
 Jaguar: MCA7300AE

# Compressors

## Denso Cont'd



**98344 New**  
**97344 Reman**  
 10PA15C  
 May Require use of OE Manifold  
 4 Groove  
 12 Volt  
 Mount: Tangent Mount  
 Pulley Dia.: 4-1/2  
 Coil Clock: Wire Lead  
 Kia (02)  
 Kia: 0K03861450



**98346 New**  
**97346 Reman**  
 10S17C  
 May Require use of OE Manifold  
 6 Groove  
 12 Volt  
 Mount: Tangent Mount  
 Pulley Dia.: 4-3/4  
 Coil Clock: Wire Lead  
 Chrysler (10-05); Dodge (10-05); Jeep (10-05)  
 Chrysler: RL596492AD  
 Jeep: RL116917AD



**98347 New**  
 10S17C  
 May Require use of OE Manifold  
 6 Groove  
 12 Volt  
 Mount: Tangent Mount  
 Pulley Dia.: 5-1/2  
 Coil Clock: Wire Lead



**98348 New**  
**97348 Reman**  
 7SEU16C  
 May Require use of OE Manifold  
 6 Groove  
 12 Volt  
 Switch: Heat Sensor  
 Mount: Tangent Mount  
 Pulley Dia.: 4-5/16  
 Coil Clock: N/R  
 Audi (09-00); Skoda (10-07), (04); SRT (10-04); VW (12-01)  
 Audi: 8E0260805S  
 Volkswagen: 8E0260805AJ

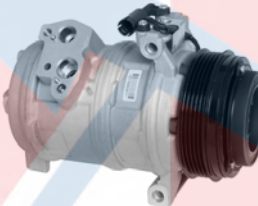

**98349 New**  
**97349 Reman**  
 10S17C  
 May Require use of OE Manifold  
 5 Groove  
 12 Volt  
 Mount: Tangent Mount  
 Pulley Dia.: 4-5/16  
 Coil Clock: Wire Lead  
 BMW (02-00); Land Rover (09-02)  
 BMW: 64526921650  
 Land Rover: JPB000110



**98350 New**  
**97350 Reman**  
 6SEU14C  
 May Require use of OE Manifold  
 6 Groove  
 12 Volt  
 Switch: Control Valve  
 Mount: Tangent Mount  
 Pulley Dia.: 4  
 Coil Clock: N/R  
 Audi (15-01)  
 Audi: 8E0260805AS, 8E0260805BJ, 8E0260805CB, 8K0260805L, 8K0260805M, 8T0260805N



**98351 New**  
**97351 Reman**  
 10S17C  
 May Require use of OE Manifold  
 6 Groove  
 12 Volt  
 Mount: Tangent Mount  
 Pulley Dia.: 5-1/2  
 Coil Clock: Wire Lead  
 Jeep (06-03)

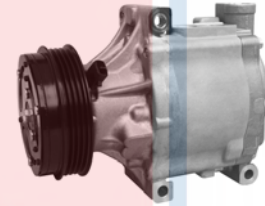

**98353 New**  
**97353 Reman**  
**157383 Reman**  
 SCSA08C  
 May Require use of OE Manifold  
 4 Groove  
 12 Volt  
 Mount: Tangent Mount  
 Pulley Dia.: 3-5/16  
 Coil Clock: Wire Lead  
 Subaru (09-05)  
 Subaru: 73111AG001, 73111AG03A



**98354 New**  
**97354 Reman**  
 7SEU16C  
 May Require use of OE Manifold  
 6 Groove  
 12 Volt  
 Mount: Tangent Mount  
 Pulley Dia.: 4-5/16  
 Coil Clock: N/R  
 Audi (04-02)  
 Audi: 4B0260805H, 8E0260805F



**98355 New**  
**97355 Reman**  
 10S17C  
 May Require use of OE Manifold  
 6 Groove  
 12 Volt  
 Mount: Tangent Mount  
 Pulley Dia.: 5-1/16  
 Coil Clock: Wire Lead  
 Chrysler (08-05)  
 Chrysler: RL005450AF



**98356 New**  
**97356 Reman**  
 7SEU17C  
 May Require use of OE Manifold  
 6 Groove  
 12 Volt  
 Mount: Tangent Mount  
 Pulley Dia.: 4  
 Coil Clock: N/R  
 Mercedes (14-98)  
 Mercedes Benz: 0002309111, 0012300811, 0012301011, 001230121, 0012301411, 0012301611, 001230181, 0012302911, 0012305811, 001230821, 0022300911, 0022301211, 002230521, 0022306011, 0022306211, 002230661, 0022306711



**98357 New**  
**97357 Reman**  
 6SEU16C  
 May Require use of OE Manifold  
 6 Groove  
 12 Volt  
 Mount: Tangent Mount  
 Pulley Dia.: 4-11/16  
 Coil Clock: N/R  
 Chrysler (14-07); Dodge (15-08)  
 Chrysler: 55111410AF, 68156572AA

# Compressors

## Denso Cont'd



**98358** New  
**97358** Reman - 7SEU16C  
 7SEU17C  
 May Require use of OE Manifold  
 4 Groove  
 12 Volt  
 Mount: Tangent Mount  
 Pulley Dia.: 4-5/16  
 Coil Clock: N/R  
 BMW (09-02)  
 BMW: 64509174805, 64509175481

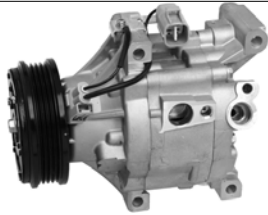

**98362** New  
**97362** Reman  
 SCSA06C  
 May Require use of OE Manifold  
 4 Groove  
 12 Volt  
 Mount: Tangent Mount  
 Pulley Dia.: 3-11/16  
 Coil Clock: Wire Lead  
 Mazda (10-04)  
 Mazda: F15161K00A



**98365** New  
**97365** Reman  
 10S15C  
 May Require use of OE Manifold  
 7 Groove  
 12 Volt  
 Mount: Tangent Mount  
 Pulley Dia.: 5-1/16  
 Coil Clock: Wire Lead  
 Scion (06-05)



**98371** New  
**97371** Reman  
 6SBU16C  
 May Require use of OE Manifold  
 4 Groove  
 12 Volt  
 Mount: Tangent Mount  
 Pulley Dia.: 4-5/8  
 Coil Clock: Wire Lead  
 Kia (11-06)  
 Kia: 977011G010DR

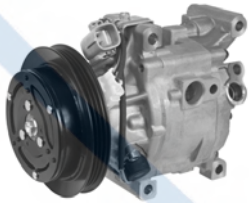

**98359** New  
**97359** Reman  
 SCSB06C  
 May Require use of OE Manifold  
 3 Groove  
 12 Volt  
 Switch: Speed Sensor  
 Mount: Tangent Mount  
 Pulley Dia.: 4-1/2  
 Coil Clock: Wire Lead  
 Toyota (03-01)  
 Toyota: 883204704084



**98363** New  
**97363** Reman  
 6SBU16C  
 May Require use of OE Manifold  
 7 Groove  
 12 Volt  
 Mount: Tangent Mount  
 Pulley Dia.: 4-1/2  
 Coil Clock: Wire Lead  
 Toyota (06-05)  
 Toyota: 883200711084

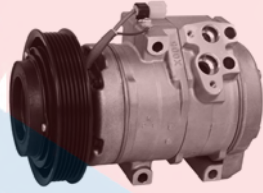

**98367** New  
**97367** Reman  
 10S17C  
 May Require use of OE Manifold  
 6 Groove  
 12 Volt  
 Mount: Tangent Mount  
 Pulley Dia.: 5-1/16  
 Coil Clock: Wire Lead  
 Mazda (01-00)



**98373** New  
**97370** Reman  
 10PA15C  
 May Require use of OE Manifold  
 4 Groove  
 12 Volt  
 Mount: Tangent Mount  
 Pulley Dia.: 4-5/8  
 Coil Clock: Wire Lead  
 Hyundai (09), (07-05); Kia (09-05)  
 Kia: 977012D700DR

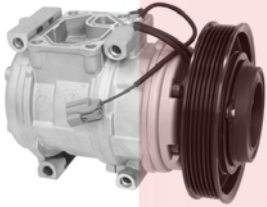

**98361** New  
**97361** Reman  
 10PA17C  
 May Require use of OE Manifold  
 6 Groove  
 12 Volt  
 Mount: Tangent Mount  
 Pulley Dia.: 5-25/32  
 Coil Clock: Wire Lead  
 Acura (99-98); Honda (02-98)  
 Honda: 38810P3G003

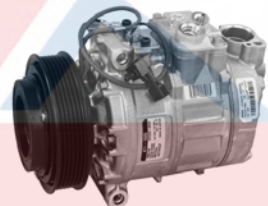

**98364** New  
**97364** Reman  
**97566** Reman - PXV16  
 7SBU16C  
 May Require use of OE Manifold  
 6 Groove  
 12 Volt  
 Mount: Tangent Mount  
 Pulley Dia.: 4-11/16  
 Coil Clock: Wire Lead  
 Saab (09-99)  
 Saab: 12758380, 5048095





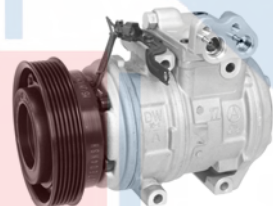





**98370** New  
**97370** Reman  
 10PA15C  
 May Require use of OE Manifold  
 4 Groove  
 12 Volt  
 Mount: Tangent Mount  
 Pulley Dia.: 4-5/8  
 Coil Clock: Wire Lead  
 Kia (06-04)  
 Kia: 977012F100



**98374** New  
**97374** Reman  
 10PA17C  
 May Require use of OE Manifold  
 6 Groove  
 12 Volt  
 Mount: Tangent Mount  
 Pulley Dia.: 4-7/8  
 Coil Clock: Wire Lead  
 Hyundai (10-04); Kia (09-05)  
 Kia: 977012E300, 977012E300DR

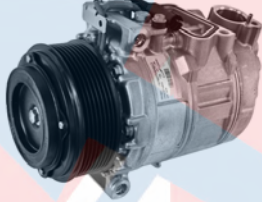
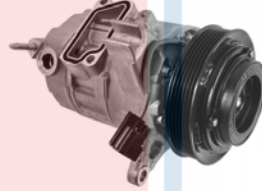

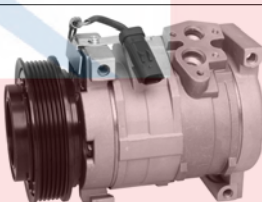
# Compressors

Denso Cont'd			
 <p><b>98375 New</b> 7SBU17C May Require use of OE Manifold 8 Groove 12 Volt Mount: 3 Tangent One on Rear Head Pulley Dia.: 4-21/64 BMW (11) BMW: 64529165808</p>	 <p><b>98379 New</b> <b>97379 Reman - 7SEU16C</b> 7SEU17C May Require use of OE Manifold 7 Groove 12 Volt Mount: 3 Tangent One on Rear Head Pulley Dia.: 4-23/32 Porsche (14-08), (06-03); VW (10-02) Porsche: 95812601200, 95812601401 Volkswagen: 3B0820803C</p>	 <p><b>98383 New</b> <b>97383 Reman</b> 10S15C May Require use of OE Manifold 7 Groove 12 Volt Mount: Tangent Mount Pulley Dia.: 4-5/8 Coil Clock: Wire Lead Toyota (06-05) Toyota: 883200C09084</p>	 <p><b>98386 New</b> <b>97386 Reman</b> <b>157341 Reman</b> 6SEU16C May Require use of OE Manifold 7 Groove 12 Volt Mount: Tangent Mount Pulley Dia.: 4-1/2 Coil Clock: N/R Toyota (12-06) Toyota: 8831006240, 883102F030, 8831042270</p>
 <p><b>98376 New</b> <b>97376 Reman</b> 5SE09C May Require use of OE Manifold 4 Groove 12 Volt Mount: Tangent Mount Pulley Dia.: 4-1/2 Coil Clock: N/R Scion (06-04) Toyota: 883105225084, 883105257084</p>	 <p><b>98381 New</b> 7SBU16C May Require use of OE Manifold 8 Groove 12 Volt Mount: Tangent Mount Pulley Dia.: 4-1/4 Coil Clock: Wire Lead Chrysler (06-04); Mercedes (12-10), (04-02) Chrysler: 5135468AA Mercedes Benz: 0002307611</p>	 <p><b>98384 New</b> <b>97384 Reman</b> 7SBU16H May Require use of OE Manifold 6 Groove 12 Volt Mount: Tangent Mount Pulley Dia.: 5-1/16 Coil Clock: Wire Lead Buick (11-06); Cadillac (11-06) General Motors Corp: 21992588</p>	 <p><b>98389 New</b> <b>97389 Reman</b> <b>157352 Reman</b> 10S17C May Require use of OE Manifold 6 Groove 12 Volt Mount: Tangent Mount Pulley Dia.: 4-7/8 Coil Clock: Wire Lead Chrysler (10-07); Dodge (10-07) Chrysler: RL111418AC</p>
 <p><b>98377 New</b> <b>97377 Reman</b> 7SBU16C May Require use of OE Manifold 4 Groove 12 Volt Mount: Tangent Mount Pulley Dia.: 4-5/16 Coil Clock: Wire Lead BMW (06-03) BMW: 64526916232</p>	 <p><b>98382 New</b> <b>97382 Reman</b> 10S17C May Require use of OE Manifold 6 Groove 12 Volt Mount: Tangent Mount Pulley Dia.: 4-11/16 Coil Clock: Wire Lead Jeep (06-05) Jeep: 55037467AD</p>	 <p><b>98385 New</b> <b>97385 Reman</b> 7SBU16C May Require use of OE Manifold 5 Groove 12 Volt Mount: Tangent Mount Pulley Dia.: 4-5/16 Coil Clock: Wire Lead Cadillac (10-05) General Motors Corp: 89023453</p>	 <p><b>98392 New</b> <b>97392 Reman</b> 7SEU17C May Require use of OE Manifold Pulley Not Included 12 Volt Mount: One on Rear Head Coil Clock: N/R Audi (14-04); VW (09-08) Audi: 4E0260805AS, 4F0260805AH, 8K0260805H Volkswagen: 4E0260805AS</p>

# Compressors

## Denso Cont'd



**98393 New**  
**97393 Reman**  
 10S15C  
 May Require use of OE Manifold  
 7 Groove  
 12 Volt  
 Mount: Tangent Mount  
 Pulley Dia.: 4-3/4  
 Coil Clock: Wire Lead  
 Scion (10-07)

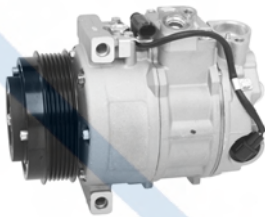

**98394 New**  
**97394 Reman - 7SEU16C**  
**97366 Reman**  
**97396 Reman**  
**157379 Reman - 6SEU16C**  
**157317 Reman - 6SEU16C**  
**97388 Reman - 7SEU16C**  
 7SEU17C  
 May Require use of OE Manifold  
 6 Groove  
 12 Volt  
 Mount: Tangent Mount  
 Pulley Dia.: 4-1/2  
 Coil Clock: N/R  
 Mercedes (15-97), (95)  
 Mercedes Benz: 0002306511,  
 0002308011, 0002308111, 000230851  
 0002308611, 0002308811, 000230901  
 0008302300, 0012300011, 001230011  
 0012300211, 0012302811, 001230411  
 0012305411, 0012305611, 001230621  
 0022300711, 0022303111, 003230481



**98395 New**  
**97395 Reman**  
 5SE12C  
 May Require use of OE Manifold  
 6 Groove  
 12 Volt  
 Mount: Tangent Mount  
 Pulley Dia.: 3-15/16  
 Coil Clock: N/R  
 Chrysler (12-08); Dodge (09-07); Jeep  
 (08-07)  
 Jeep: RL058228A1

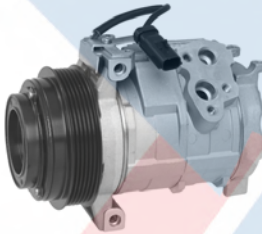

**98397 New**  
**97397 Reman**  
 10S17C  
 May Require use of OE Manifold  
 6 Groove  
 12 Volt  
 Mount: Tangent Mount  
 Pulley Dia.: 4-11/16  
 Coil Clock: Wire Lead  
 Chrysler (08-07)  
 Chrysler: RL111409AD

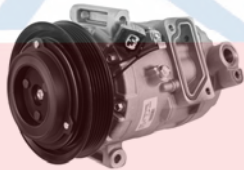

**98398 New**  
**97398 Reman**  
 7SBU16C  
 May Require use of OE Manifold  
 6 Groove  
 12 Volt  
 Mount: Tangent Mount  
 Pulley Dia.: 5-1/8  
 Coil Clock: Wire Lead  
 Buick (09-06)  
 General Motors Corp: 21992587



**98399 New**  
**97399 Reman**  
 10SR17C  
 May Require use of OE Manifold  
 6 Groove  
 12 Volt  
 Mount: Tangent Mount  
 Pulley Dia.: 4-3/4  
 Coil Clock: Wire Lead  
 Jeep (09-06)  
 Jeep: RL111414AA

## Denso Electric

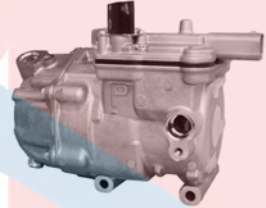

**168301 New**  
 ES14C  
 May Require use of OE Manifold  
 Mount: Tangent Mount  
 Coil Clock: Coil Less  
 Toyota (12-10)  
 Toyota: 8837047033

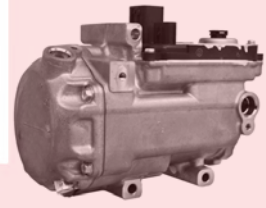

**168302 New**  
 ES27C  
 May Require use of OE Manifold  
 Mount: Tangent Mount  
 Coil Clock: Coil Less  
 Lexus (08-07); Toyota (11-07)  
 Lexus: 8837030021  
 Toyota: 8837030021



**98360 New**  
 ES18C  
 May Require use of OE Manifold;  
 Special Installation Tool Will be  
 Required  
 Mount: Tangent Mount  
 Coil Clock: Coil Less  
 Toyota (09-04)  
 Toyota: 8837047010

## Dodge/Chrysler



**58101 New**  
**57101 Reman**  
 C171  
 1 Groove  
 12 Volt  
 Mount: Ear Mount  
 Belt Width: 3/8  
 Pulley Dia.: 5-9/16  
 Coil Clock: Wire Lead  
 New Clutch Assy: **47831**  
 Reman Clutch Assy:  
 Reman Compr w/o Clutch: **57038**  
 Chrysler (89-84); Dodge (92-81);  
 Plymouth (89-84), (81)  
 Chrysler: 4728917

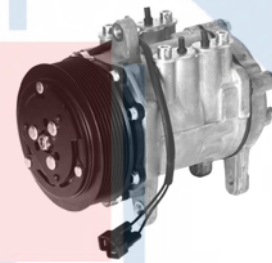

**58106 New**  
**57106 Reman**  
 C171  
 8 Groove  
 12 Volt  
 Mount: Ear Mount  
 Pulley Dia.: 5-1/4  
 Coil Clock: Wire Lead  
 Dodge (91-89)  
 Chrysler: R4428903

# Compressors

## Doowan Series



**178309 New**  
DV-16  
Use when replacing OE 6SBU16 compressor. Includes (DV16) compressor, hoses, and hardware.  
6 Groove  
12 Volt  
Mount: Tangent Mount  
Pulley Dia.: 4-5/8  
Coil Clock: Wire Lead  
Kia (09-07)  
Kia: 977011D200AS



**178310 New**  
DV-16  
Use when replacing OE 6SBU16 compressor. Includes (DV16) compressor, bracket, hoses, and hardware.  
6 Groove  
12 Volt  
Mount: Tangent Mount  
Pulley Dia.: 4-5/8  
Coil Clock: Wire Lead  
Kia (09-07)  
Kia: 977011D300AS



**178311 New**  
DV-16  
Use when replacing aftermarket DV16 compressor only.  
6 Groove  
12 Volt  
Mount: Tangent Mount  
Pulley Dia.: 4-5/8  
Coil Clock: Wire Lead  
Kia (09-07)  
Kia: 977012P310



**178324 New**  
DVE12  
6 Groove  
12 Volt  
Mount: Tangent Mount  
Pulley Dia.: 4-57/64  
Coil Clock: N/R  
Hyundai (14-12); Kia (14-12)  
Hyundai: 977011R100  
Kia: 977011R100DR

## FS Series

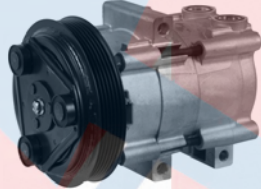

**158120 New**  
FS10  
6 Groove  
12 Volt  
Mount: Tangent Mount  
Pulley Dia.: 5-5/8  
Coil Clock: 3  
Connector: Harness Connector  
New Clutch Assy: **47869**  
Ford (08-02)

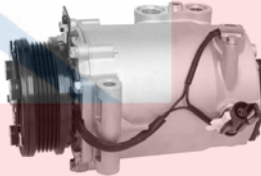

**158550 New**  
**157550 Reman**

Scroll  
5 Groove  
12 Volt  
Switch: Heat Sensor  
Mount: Tangent Mount  
Pulley Dia.: 4  
Coil Clock: Wire Lead  
Saturn (04-02)  
Saturn: 15922970



**158553 New**  
Scroll  
6 Groove  
12 Volt  
Switch: Heat Sensor  
Mount: Tangent Mount  
Pulley Dia.: 4  
Coil Clock: Wire Lead  
Saturn (03-02)

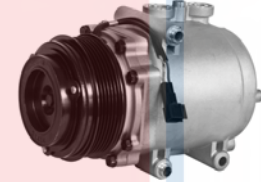

**178588 New**  
FS10  
6 Groove  
12 Volt  
Mount: Tangent Mount  
Pulley Dia.: 3-15/16  
Coil Clock: 12  
Ford (07-02); Lincoln (05-02); Mercury (05-02)

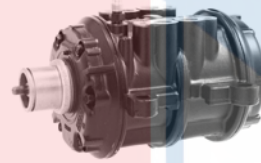

**57026 Reman**  
A590  
Coil Less  
Mount: Tangent Mount  
Chrysler (91-85); Dodge (92-85);  
Plymouth (92-85)

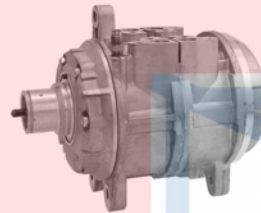

**57038 Reman**  
C171  
Coil Less  
Mount: Ear Mount  
Chrysler (89-79); Dodge (92-78);  
Plymouth (89-78)  
Allis Chalmers: 11445566



**57049 Reman**  
E6DH  
12 Volt  
Mount: Tangent Mount  
Ford (93-86); Mercury (88-86)  
Euclid: E801610RM

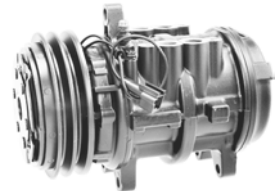

**57102 Reman**  
C171  
2 Groove  
12 Volt  
Mount: Ear Mount  
Belt Width: 3/8  
Pulley Dia.: 5-5/8  
Coil Clock: Wire Lead  
Reman Compr w/o Clutch: **57038**  
Chrysler (83-79); Dodge (83-79);  
Dodge Medium Duty Truck (81);  
Plymouth (83-79)



**57103 Reman**  
C171  
1 Groove  
12 Volt  
Mount: Ear Mount  
Belt Width: 7/16  
Pulley Dia.: 5-3/4  
Coil Clock: Wire Lead  
New Clutch Assy:  
Reman Clutch Assy:  
Reman Compr w/o Clutch: **57038**  
Chrysler (84-82); Dodge (86), (84-80);  
Plymouth (84-80)



# Compressors

## FS Series Cont'd



**57104 Reman**  
C171  
2 Groove  
12 Volt  
Mount: Ear Mount  
Belt Width: 3/8  
Pulley Dia.: 5-9/16  
Coil Clock: 2 Wire Lead  
New Clutch Assy: **47830**  
Reman Clutch Assy:  
Reman Compr w/o Clutch: **57038**  
Chrysler (85-83); Dodge (88-84);  
Plymouth (87-84)  
Euclid: E801602RM

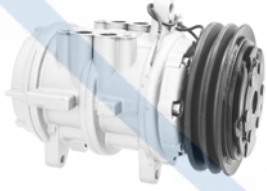

**57105 Reman**  
C171  
2 Groove  
12 Volt  
Mount: Ear Mount  
Belt Width: 3/8  
Pulley Dia.: 5-3/4  
Coil Clock: Wire Lead  
New Clutch Assy: **47818**  
Reman Clutch Assy:  
Reman Compr w/o Clutch: **57038**  
Chrysler (83-82); Dodge (83-81);  
Plymouth (83-81)

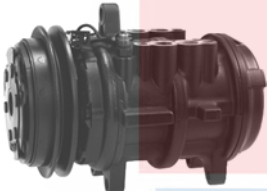

**57116 Reman**  
C171  
1 Groove  
12 Volt  
Mount: Ear Mount  
Belt Width: 7/16  
Pulley Dia.: 5-3/4  
Coil Clock: Wire Lead  
New Clutch Assy:  
Reman Clutch Assy:  
Chrysler (84); Dodge (84); Plymouth  
(84)



**57118 Reman**  
FS10  
May Require Use of O.E. Manifold  
4 Groove  
12 Volt  
Mount: Tangent Mount  
Pulley Dia.: 5  
Coil Clock: Wire Lead  
Hyundai (97-96); Kia (98)  
Kia: 1K2A361450

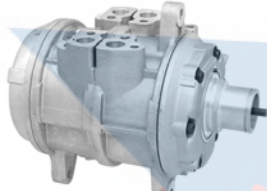

**58037 New**  
**57037 Reman**  
FS6  
Coil Less  
Mount: Ear Mount  
Ford (92-81); Lincoln (88-81); Mercury  
(88-81)  
Red Dot: 75R8906

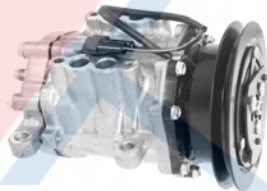

**58100 New**  
**57100 Reman**  
A590  
1 Groove  
12 Volt  
Mount: Tangent Mount  
Belt Width: 7/16  
Pulley Dia.: 5-3/4  
Coil Clock: 2 Wire Lead  
New Clutch Assy: **47840**  
Reman Clutch Assy:  
Chrysler (91-85); Dodge (92-85);  
Plymouth (92-85)



**58110 New**  
**57110 Reman**  
E6DH  
6 Groove  
12 Volt  
Mount: Tangent Mount  
Pulley Dia.: 5  
Coil Clock: Wire Lead  
Connector: Pin  
New Clutch Assy: **47854**  
Reman Clutch Assy: **48854**  
Reman Compr w/o Clutch: **57049**  
Ford (93-86); Mercury (88-86)  
Kysor: 1405001  
Red Dot: 75R8917

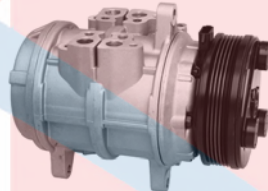

**58111 New**  
**57111 Reman**  
**57392 Reman - 6E171**  
FS6  
6 Groove  
12 Volt  
Mount: Ear Mount  
Pulley Dia.: 5  
Coil Clock: Wire Lead  
Connector: Pin  
New Clutch Assy: **47854**  
Reman Clutch Assy: **48854**  
New Compr w/o Clutch: **58037**  
Reman Compr w/o Clutch: **57037**  
Ford (91-81); Lincoln (88-81); Mercury  
(88-81)  
Kysor: 1405002  
Red Dot: 75R8907



**58112 New**  
**57112 Reman**  
FS6  
1 Groove  
12 Volt  
Mount: Ear Mount  
Belt Width: 1/2  
Pulley Dia.: 6  
Coil Clock: Wire Lead  
Connector: Pin  
New Clutch Assy: **47849**  
Reman Clutch Assy: **48849**  
New Compr w/o Clutch: **58037**  
Reman Compr w/o Clutch: **57037**  
Ford (92-82); Mercury (85-84)  
Kysor: 1405003  
Red Dot: 75R8909



**58114 New**  
**57114 Reman**  
FS6  
1 Groove  
12 Volt  
Mount: Ear Mount  
Belt Width: 1/2  
Pulley Dia.: 6  
Coil Clock: Wire Lead  
Connector: Pin  
New Clutch Assy: **47848**  
Reman Clutch Assy:  
New Compr w/o Clutch: **58037**  
Reman Compr w/o Clutch: **57037**  
Ford (92-82)  
Kysor: 1405004  
Red Dot: 75R8910

# Compressors

## FS Series Cont'd

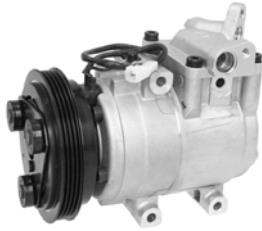

**58115 New**  
**57115 Reman**  
 HS15  
 May Require Use of O.E. Manifold  
 4 Groove  
 12 Volt  
 Mount: Tangent Mount  
 Pulley Dia.: 5-1/16  
 Coil Clock: Wire Lead  
 Kia (99)  
 Kia: 1K2A661450

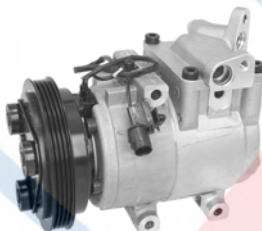

**58117 New**  
**57117 Reman**  
 HS15  
 May Require Use of O.E. Manifold  
 4 Groove  
 12 Volt  
 Mount: Tangent Mount  
 Pulley Dia.: 5  
 Coil Clock: 12  
 Kia (99)  
 Kia: 1K2A661450A



**58118 New**  
**57118 Reman**  
 FS10  
 May Require use of OE Manifold  
 4 Groove  
 12 Volt  
 Mount: Tangent Mount  
 Pulley Dia.: 5  
 Coil Clock: Wire Lead  
 Hyundai (97-96); Kia (98)  
 Hyundai: 9770129000  
 Kia: 1K2A361450



**58119 New**  
**57119 Reman**  
 HS18  
 DeSlugger **36140** Recommended to  
 Eliminate Compressor Damage on  
 Vehicles with Low Mount Compressor  
 6 Groove  
 12 Volt  
 Mount: Tangent Mount  
 Pulley Dia.: 4-7/16  
 Coil Clock: Wire Lead  
 Kia (05-02)  
 Kia: RK52Y61450U

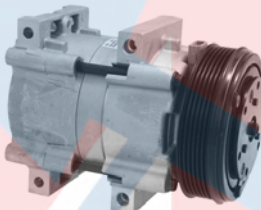

**58120 New**  
**57120 Reman**  
 FS10  
 6 Groove  
 12 Volt  
 Mount: Tangent Mount  
 Belt Width: 7/8  
 Pulley Dia.: 5  
 Coil Clock: 6  
 Connector: Pin  
 New Clutch Assy: **47867**  
 Reman Clutch Assy:  
 Ford (98-90); Lincoln (94-93)

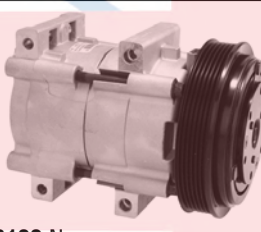

**58122 New**  
**57122 Reman**  
 FS10  
 6 Groove  
 12 Volt  
 Mount: Tangent Mount  
 Belt Width: 7/8  
 Pulley Dia.: 5-5/8  
 Coil Clock: 12  
 Connector: Pin  
 New Clutch Assy: **47869**  
 Ford (95-90)  
 Kysor: 1405006



**58123 New**  
**57123 Reman**  
 FS10  
 7 Groove  
 12 Volt  
 Mount: Tangent Mount  
 Belt Width: 1  
 Pulley Dia.: 4-1/2  
 Coil Clock: 12  
 Connector: Pin  
 New Clutch Assy: **47880**  
 Ford (93-92); Lincoln (93-91); Mercury  
 (93-92)

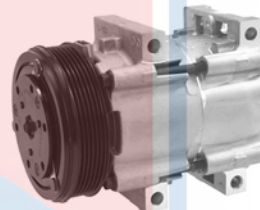

**58124 New**  
**57124 Reman**  
 FS10  
 6 Groove  
 12 Volt  
 Mount: Tangent Mount  
 Belt Width: 7/8  
 Pulley Dia.: 5  
 Coil Clock: 12  
 Connector: Pin  
 New Clutch Assy: **47867**  
 Ford (94-88); Lincoln (92-90); Mercury  
 (94-88)  
 Kysor: 1405007

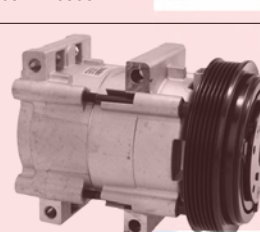

**58126 New**  
**57126 Reman**  
 FS10  
 6 Groove  
 12 Volt  
 Mount: Tangent Mount  
 Belt Width: 7/8  
 Pulley Dia.: 5-5/8  
 Coil Clock: 12  
 Connector: Pin  
 New Clutch Assy: **47869**  
 Ford (89)  
 Kysor: 1405008

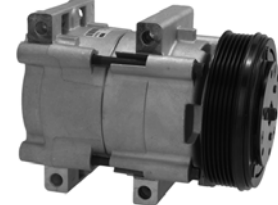

**58127 New**  
**57127 Reman**  
 FS10  
 6 Groove  
 12 Volt  
 Mount: Tangent Mount  
 Belt Width: 7/8  
 Pulley Dia.: 5  
 Coil Clock: 6  
 Connector: Pin  
 New Clutch Assy: **47867**  
 Reman Clutch Assy:  
 Ford (97-89); Mercury (97-89)

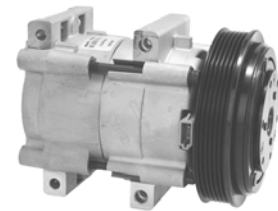

**58128 New**  
**57128 Reman**  
 FS10  
 6 Groove  
 12 Volt  
 Mount: Tangent Mount  
 Belt Width: 7/8  
 Pulley Dia.: 5-1/2  
 Coil Clock: 9  
 Connector: Pin  
 New Clutch Assy: **47869**  
 Ford (01-90); Mazda (01-94)

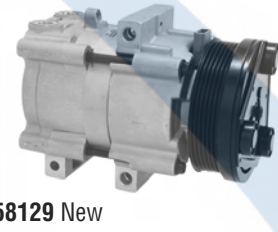

**58129 New**  
**57129 Reman**  
 FS10  
 6 Groove  
 12 Volt  
 Mount: Tangent Mount  
 Belt Width: 7/8  
 Pulley Dia.: 4-1/2  
 Coil Clock: 12  
 Connector: Pin  
 New Clutch Assy: **47881**  
 Ford (06-93); Lincoln (02-93); Mercury  
 (02-93)  
 Ford: F5VY19D798A

# Compressors

## FS Series Cont'd



**58130 New**  
**57130 Reman**  
 FS10  
 6 Groove  
 12 Volt  
 Mount: Tangent Mount  
 Belt Width: 7/8  
 Pulley Dia.: 4-23/64  
 Coil Clock: 3  
 Connector: Pin  
 New Clutch Assy: **47881**  
 Ford (02-92); Mercury (99-92)  
 Ford: F5VY19D784A

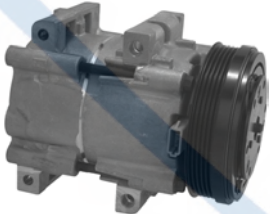

**58131 New**  
**57131 Reman**  
 FS10  
 5 Groove  
 12 Volt  
 Mount: Tangent Mount  
 Belt Width: 7/8  
 Pulley Dia.: 5  
 Coil Clock: 3  
 Connector: Pin  
 New Clutch Assy: **47871**  
 Ford (94-92); Mercury (94-92)

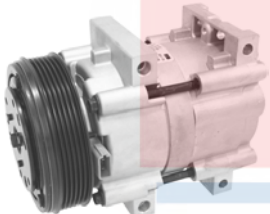

**58132 New**  
**57132 Reman**  
 FS10  
 6 Groove  
 12 Volt  
 Mount: Tangent Mount  
 Belt Width: 7/8  
 Pulley Dia.: 5  
 Coil Clock: 3  
 Connector: Pin  
 New Clutch Assy: **47867**  
 Ford (11-90); Mazda (06-91); Mercury (01-98)



**58133 New**  
**57133 Reman**  
 FS10  
 6 Groove  
 12 Volt  
 Mount: Tangent Mount  
 Belt Width: 7/8  
 Pulley Dia.: 5  
 Coil Clock: 12  
 Connector: Pin  
 New Clutch Assy: **47874**  
 Ford (98-92); Mercury (95-92)

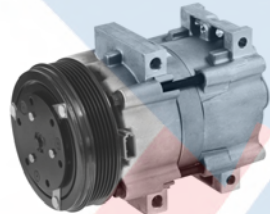

**58138 New**  
**157138 Reman**  
 FS10  
 6 Groove  
 12 Volt  
 Mount: Tangent Mount  
 Pulley Dia.: 5  
 Coil Clock: 3  
 New Clutch Assy: **47876**  
 Ford (04-03)

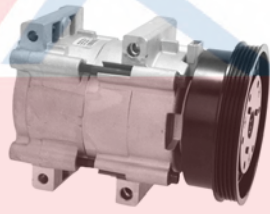

**58139 New**  
**57139 Reman**  
 FS10  
 4 Groove  
 12 Volt  
 Mount: Tangent Mount  
 Belt Width: 5/8  
 Pulley Dia.: 5-1/4  
 Coil Clock: 12  
 Connector: Pin  
 New Clutch Assy: **47877**  
 Ford (92); Mercury (02-93); Nissan (02-93)

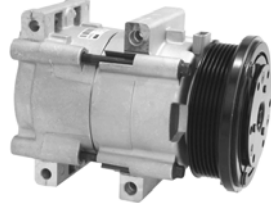

**58140 New**  
**57140 Reman**  
 FS10  
 6 Groove  
 12 Volt  
 Mount: Tangent Mount  
 Belt Width: 7/8  
 Pulley Dia.: 4-1/2  
 Coil Clock: 12  
 Connector: Pin  
 New Clutch Assy: **47881**  
 Ford (06-05), (01-90); Mercury (01-97), (93-91)

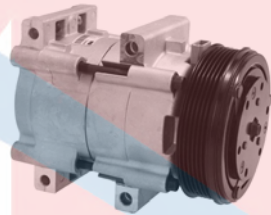

**58141 New**  
**57141 Reman**  
 FS10  
 6 Groove  
 12 Volt  
 Mount: Tangent Mount  
 Belt Width: 7/8  
 Pulley Dia.: 5  
 Coil Clock: 12  
 Connector: Pin  
 New Clutch Assy: **47876**  
 Ford (04-93); Mercury (95-93)  
 Kysor: 1405009

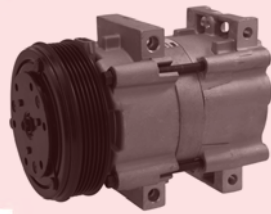

**58144 New**  
**57144 Reman**  
 FS10  
 6 Groove  
 12 Volt  
 Mount: Tangent Mount  
 Belt Width: 7/8  
 Pulley Dia.: 5  
 Coil Clock: 12  
 Connector: Pin  
 New Clutch Assy: **47876**  
 Ford (04-95); Mazda (04-01); Mercury (02-95)



**58145 New**  
**57145 Reman**  
 FS10  
 6 Groove  
 12 Volt  
 Mount: Tangent Mount  
 Belt Width: 7/8  
 Pulley Dia.: 5  
 Coil Clock: 12  
 Connector: Pin  
 New Clutch Assy: **47874**  
 Ford (07-95); Mazda (06-01); Mercury (07-05), (02-95)

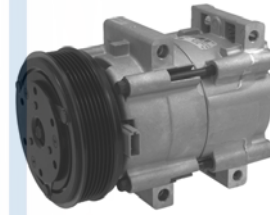

**58146 New**  
**57146 Reman**  
 FS10  
 6 Groove  
 12 Volt  
 Mount: Tangent Mount  
 Belt Width: 7/8  
 Pulley Dia.: 5  
 Coil Clock: 3  
 Connector: Pin  
 New Clutch Assy: **47874**  
 Ford (04-03), (00-96); Lincoln (02-95); Mercury (00-96)

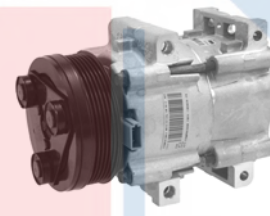

**58147 New**  
**57147 Reman**  
 FS10  
 6 Groove  
 12 Volt  
 Mount: Tangent Mount  
 Belt Width: 7/8  
 Pulley Dia.: 4-1/2  
 Coil Clock: 3  
 Connector: Pin  
 New Clutch Assy: **47881**  
 Ford (97-90)



# Compressors

## FS Series Cont'd



**58148 New**  
**57148 Reman**  
 FS10  
 6 Groove  
 12 Volt  
 Mount: Tangent Mount  
 Belt Width: 7/8  
 Pulley Dia.: 4-1/2  
 Coil Clock: 3  
 Connector: Pin  
 New Clutch Assy: **47881**  
 Ford (01-97)  
 Kysor: 1405010

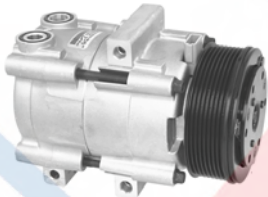

**58149 New**  
**57149 Reman**  
 FS10  
 8 Groove  
 12 Volt  
 Mount: Tangent Mount  
 Belt Width: 1-3/16  
 Pulley Dia.: 4-1/2  
 Coil Clock: 12  
 Connector: Pin  
 New Clutch Assy: **47878**  
 Ford (03-97); Lincoln (01-98)  
 Ford: F7UZ19D784AA  
 Kysor: 1405011

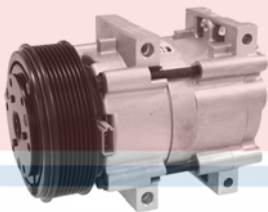

**58150 New**  
**57150 Reman**  
 FS10  
 8 Groove  
 12 Volt  
 Mount: Tangent Mount  
 Belt Width: 1-3/16  
 Pulley Dia.: 5  
 Coil Clock: 3  
 Connector: Pin  
 New Clutch Assy: **47868**  
 Ford (97-92)  
 Ford: F6TZ19D784A  
 Kysor: 1405012



**58151 New**  
**57151 Reman**  
 FS10  
 6 Groove  
 12 Volt  
 Mount: Ear Mount  
 Belt Width: 7/8  
 Pulley Dia.: 5  
 Coil Clock: 3  
 Connector: Pin  
 New Clutch Assy: **47876**  
 Ford (06-97)  
 Kysor: 1405013

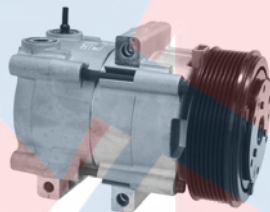

**58152 New**  
**57152 Reman**  
 FS10  
 8 Groove  
 12 Volt  
 Mount: Tangent Mount  
 Belt Width: 1-3/16  
 Pulley Dia.: 5-1/8  
 Coil Clock: 12  
 Connector: Pin  
 New Clutch Assy: **47868**  
 Ford (07-97); Lincoln (02)  
 Ford: 4C3Z19V703AB  
 Kysor: 1405014

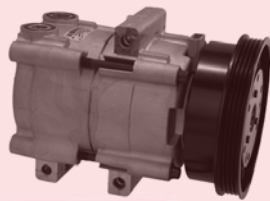

**58154 New**  
**57154 Reman**  
 FS10  
 4 Groove  
 12 Volt  
 Mount: Tangent Mount  
 Belt Width: 5/8  
 Pulley Dia.: 5-1/4  
 Coil Clock: 12  
 Connector: Harness Connector  
 New Clutch Assy: **47877**  
 Hyundai (98-90)  
 Hyundai: 9770133100, 9770134080,  
 9770134880



**58157 New**  
**57157 Reman**  
 FS10  
 6 Groove  
 12 Volt  
 Mount: Tangent Mount  
 Pulley Dia.: 4-1/2  
 Coil Clock: 12  
 Connector: Pin  
 New Clutch Assy: **47871**  
 Ford (07-99); Mercury (07-04)

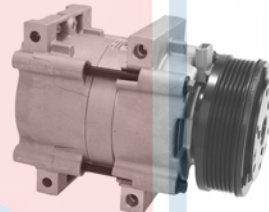

**58158 New**  
**57158 Reman**  
 FS10  
 6 Groove  
 12 Volt  
 Mount: Tangent Mount  
 Pulley Dia.: 4-1/2  
 Coil Clock: 12  
 Connector: Pin  
 Ford (00-99)

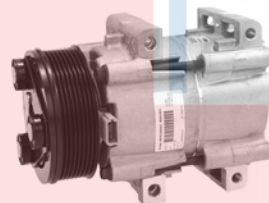

**58159 New**  
**57159 Reman**  
 FS10  
 8 Groove  
 12 Volt  
 Mount: Tangent Mount  
 Belt Width: 1-3/16  
 Pulley Dia.: 4-1/2  
 Coil Clock: 3  
 Connector: Pin  
 New Clutch Assy: **47878**  
 Ford (01-98)

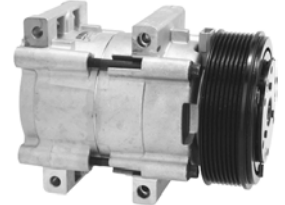

**58161 New**  
**57161 Reman**  
 FS10  
 8 Groove  
 12 Volt  
 Mount: Tangent Mount  
 Belt Width: 1-3/16  
 Pulley Dia.: 5  
 Coil Clock: 12  
 Connector: Pin  
 New Clutch Assy: **47868**  
 Ford (03-99)



**58162 New**  
**57162 Reman**  
 FS10  
 6 Groove  
 12 Volt  
 Mount: Tangent Mount  
 Belt Width: 7/8  
 Pulley Dia.: 5-3/4  
 Coil Clock: 6  
 Connector: Pin  
 New Clutch Assy: **47869**  
 Ford (02-00)

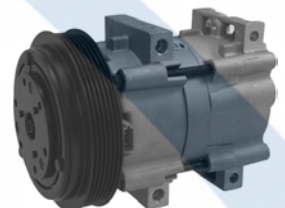

**58163 New**  
**57163 Reman**  
 FS10  
 6 Groove  
 12 Volt  
 Mount: Tangent Mount  
 Belt Width: 7/8  
 Pulley Dia.: 4-1/2  
 Coil Clock: 3  
 Connector: Pin  
 New Clutch Assy: **47869**  
 Ford (03-00)

# Compressors

## FS Series Cont'd



**58164 New**  
**57164 Reman**  
 FS10  
 8 Groove  
 12 Volt  
 Mount: Tangent Mount  
 Pulley Dia.: 4-3/8  
 Coil Clock: 12  
 New Clutch Assy: **47878**  
 Ford (03-00)

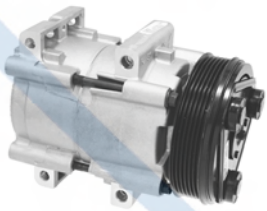

**58166 New**  
**57166 Reman**  
 FS10  
 6 Groove  
 12 Volt  
 Mount: Tangent Mount  
 Belt Width: 7/8  
 Pulley Dia.: 5  
 Coil Clock: 6  
 New Clutch Assy: **47876**  
 Ford (04-03)

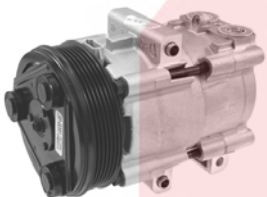

**58167 New**  
**57167 Reman**  
 FS10  
 6 Groove  
 12 Volt  
 Mount: Tangent Mount  
 Belt Width: 7/8  
 Pulley Dia.: 5  
 Coil Clock: 12  
 New Clutch Assy: **47876**  
 Ford (07-02)



**58168 New**  
**57168 Reman**  
 FS10  
 6 Groove  
 12 Volt  
 Mount: Tangent Mount  
 Belt Width: 7/8  
 Pulley Dia.: 4-7/16  
 Coil Clock: 3  
 Ford (07-01); Mercury (05-01)

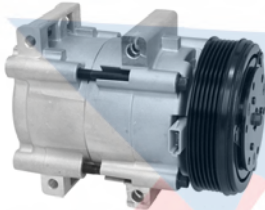

**58169 New**  
**57169 Reman**  
 FS10  
 6 Groove  
 12 Volt  
 Mount: Tangent Mount  
 Pulley Dia.: 5  
 Coil Clock: 9  
 New Clutch Assy: **47876**  
 Ford (11-01); Mazda (09-01)  
 Mazda: EFX26145Z, ZZN061450A

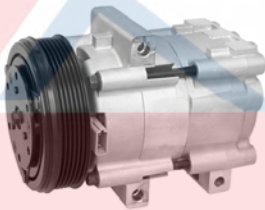

**58172 New**  
**57172 Reman**  
 FS10  
 6 Groove  
 12 Volt  
 Mount: Tangent Mount  
 Pulley Dia.: 5  
 Coil Clock: 3  
 New Clutch Assy: **47876**  
 Ford (08-02); Mazda (07-02)  
 Mazda: 1F2061450A



**58176 New**  
**57176 Reman**  
 FS10  
 6 Groove  
 12 Volt  
 Mount: Tangent Mount  
 Pulley Dia.: 5  
 Coil Clock: 3  
 Ford (07-03)

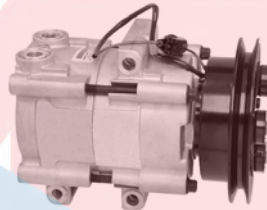

**58179 New**  
**57179 Reman**  
 FS10  
 1 Groove  
 12 Volt  
 Mount: Tangent Mount  
 Pulley Dia.: 5-21/32  
 Coil Clock: 12  
 Hyundai (94)  
 Hyundai: 9770124A20

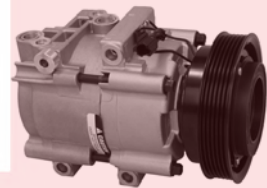

**58183 New**  
**57183 Reman**  
 HS18  
 May Require Use of O.E. Manifold  
 6 Groove  
 12 Volt  
 Mount: Tangent Mount  
 Pulley Dia.: 5  
 Coil Clock: Wire Lead  
 Hyundai (06-01)  
 Hyundai: 9770126300



**58185 New**  
**57185 Reman**  
 HS18  
 May Require Use of O.E. Manifold  
 6 Groove  
 12 Volt  
 Mount: Tangent Mount  
 Pulley Dia.: 4-25/32  
 Coil Clock: Wire Lead  
 Hyundai (06-99); Kia (06-01)  
 Hyundai: 9770138171  
 Kia: 9770138171RU



**58186 New**  
**57186 Reman**  
 HS15  
 May Require use of OE Manifold  
 4 Groove  
 12 Volt  
 Mount: Tangent Mount  
 Pulley Dia.: 4-1/2  
 Coil Clock: Wire Lead  
 Kia (04-00)

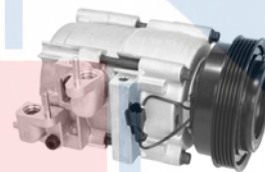

**58187 New**  
**57187 Reman**  
 HS18  
 DeSluggler **36140** Recommended to  
 Eliminate Compressor Damage on  
 Vehicles with Low Mount Compressor  
 5 Groove  
 12 Volt  
 Mount: Tangent Mount  
 Pulley Dia.: 4-7/8  
 Coil Clock: Wire Lead  
 Hyundai (04-01)  
 Hyundai: 9770126011

# Compressors

## FS Series Cont'd



**58188** New  
**57188** Reman  
 HS15  
 May Require use of OE Manifold  
 4 Groove  
 12 Volt  
 Mount: Tangent Mount  
 Pulley Dia.: 4-7/8  
 Coil Clock: Wire Lead  
 Hyundai (02-00)  
 Hyundai: 9770125000

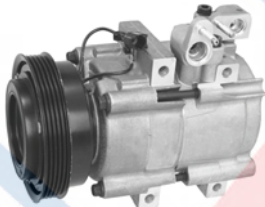

**58189** New  
**57189** Reman  
 HS17  
 May Require Use of O.E. Manifold  
 5 Groove  
 12 Volt  
 Mount: Tangent Mount  
 Pulley Dia.: 4-7/8  
 Coil Clock: Wire Lead  
 Hyundai (05-99); Kia (06-01)  
 Hyundai: 9770138071

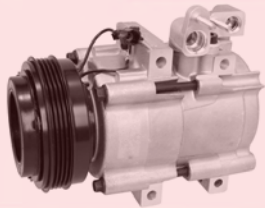

**58190** New  
**57190** Reman  
 HS18  
 May Require Use of O.E. Manifold  
 4 Groove  
 12 Volt  
 Mount: Tangent Mount  
 Pulley Dia.: 4-1/2  
 Coil Clock: Wire Lead  
 Kia (06-03)  
 Kia: 977013E200RU



**58191** New  
**57191** Reman  
 HS15  
 May Require use of OE Manifold  
 4 Groove  
 12 Volt  
 Mount: Tangent Mount  
 Pulley Dia.: 4-7/8  
 Coil Clock: Wire Lead  
 Kia (02-01)  
 Kia: RK30A61450U

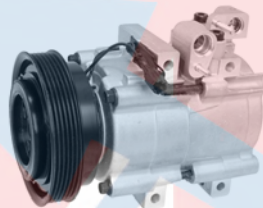

**58197** New  
**57197** Reman  
 HS18  
 DeSluggler **36140** Recommended to  
 Eliminate Compressor Damage on  
 Vehicles with Low Mount Compressor  
 6 Groove  
 12 Volt  
 Mount: Tangent Mount  
 Pulley Dia.: 5  
 Coil Clock: Wire Lead  
 Hyundai (05-01); Kia (09-04)  
 Hyundai: 9770139882  
 Kia: 9770139881RU



**58198** New  
**57198** Reman  
 HS18  
 May Require Use of O.E. Manifold  
 6 Groove  
 12 Volt  
 Mount: Tangent Mount  
 Pulley Dia.: 5  
 Coil Clock: Wire Lead  
 Hyundai (06-03)  
 Hyundai: 9770126350



**58199** New  
**57199** Reman  
 HS15  
 May Require Use of O.E. Manifold  
 6 Groove  
 12 Volt  
 Mount: Tangent Mount  
 Pulley Dia.: 4-3/4  
 Coil Clock: Wire Lead  
 Hyundai (08-03)  
 Hyundai: 977012C600

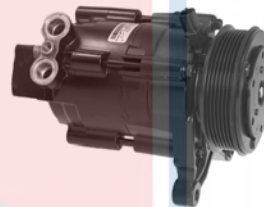

**67195** Reman  
 FS18  
 6 Groove  
 12 Volt  
 Mount: Tangent Mount  
 Pulley Dia.: 4-1/2  
 Coil Clock: 2  
 Connector: Pin  
 Saturn (09-08)  
 Saturn: 19130315



**67196** Reman  
 FS18  
 5 Groove  
 12 Volt  
 Mount: Tangent Mount  
 Pulley Dia.: 4-1/2  
 Coil Clock: Wire Lead  
 Saturn (10-08)  
 Saturn: 19130316



**68120** New  
**67120** Reman  
 HS20  
 6 Groove  
 12 Volt  
 Mount: Tangent Mount  
 Pulley Dia.: 4-5/8  
 Coil Clock: Wire Lead  
 Hyundai (09-07); Kia (09-06)  
 Kia: 977013E930RU, 977014D900RU



**68123** New  
**67123** Reman  
 HS15  
 May Require Use of O.E. Manifold  
 4 Groove  
 12 Volt  
 Mount: Tangent Mount  
 Pulley Dia.: 4-7/8  
 Coil Clock: Wire Lead  
 Kia (05-03)  
 Kia: 97701FD000RU

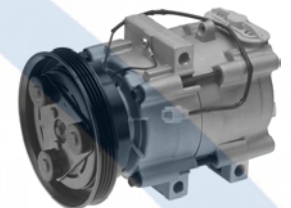

**68124** New  
**67124** Reman  
 HS18  
 May Require Use of O.E. Manifold  
 4 Groove  
 12 Volt  
 Mount: Tangent Mount  
 Pulley Dia.: 5-1/2  
 Coil Clock: Wire Lead  
 Kia (97)



# Compressors

## FS Series Cont'd



**68126 New**  
**67126 Reman**  
 HS15  
 May Require Use of O.E. Manifold  
 4 Groove  
 12 Volt  
 Mount: Tangent Mount  
 Pulley Dia.: 5-1/16  
 Coil Clock: Wire Lead  
 Kia (01-00)  
 Kia: 1K2N561450A



**68143 New**  
**67144 Reman**  
 FS10  
 May Require Use of O.E. Manifold  
 4 Groove  
 12 Volt  
 Mount: Tangent Mount  
 Pulley Dia.: 5-1/2  
 Coil Clock: Wire Lead  
 Kia (96-93)  
 Kia: 0K24C61450A

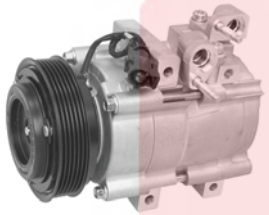

**68144 New**  
**67144 Reman**  
 HS18  
 May Require use of OE Manifold  
 6 Groove  
 12 Volt  
 Mount: Tangent Mount  
 Pulley Dia.: 4-5/8  
 Coil Clock: Wire Lead  
 Ford (07-05); Mazda (06-05); Mercury (07-05)  
 Ford: 5L8Z19703AA



**68181 New**  
**67181 Reman**  
 HS15  
 May Require use of OE Manifold  
 4 Groove  
 12 Volt  
 Mount: Tangent Mount  
 Pulley Dia.: 4-7/8  
 Coil Clock: Wire Lead  
 Hyundai (99-98)  
 Hyundai: 9770122261

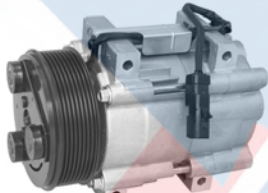

**68182 New**  
**67182 Reman**  
 HS18  
 8 Groove  
 12 Volt  
 Mount: Tangent Mount  
 Pulley Dia.: 4-5/16  
 Coil Clock: Wire Lead  
 Dodge (09-06); Dodge Medium Duty Truck (10-08)  
 Chrysler: R5111411AM, RL111411AH

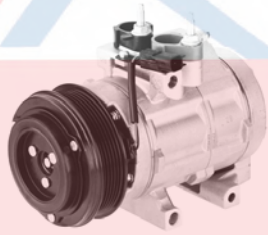

**68183 New**  
**67183 Reman**  
 FS20  
 6 Groove  
 12 Volt  
 Mount: Tangent Mount  
 Pulley Dia.: 4-7/8  
 Coil Clock: Wire Lead  
 Ford (08-07)  
 Ford: 8L3Z19703B



**68184 New**  
**67184 Reman**  
 HS18  
 6 Groove  
 12 Volt  
 Mount: Tangent Mount  
 Pulley Dia.: 5-1/16  
 Coil Clock: Wire Lead  
 Dodge (08-07); Jeep (08-06)  
 Jeep: RL111400AE, RL111406AD

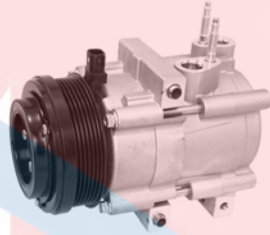

**68185 New**  
**67185 Reman**  
 FS18  
 6 Groove  
 12 Volt  
 Mount: Tangent Mount  
 Pulley Dia.: 4-7/16  
 Coil Clock: Wire Lead  
 Connector: Pin  
 Ford (11-06); Lincoln (11-06); Mercury (11-06)



**68186 New**  
**67186 Reman**  
 FS18  
 6 Groove  
 12 Volt  
 Mount: Tangent Mount  
 Pulley Dia.: 4-7/16  
 Coil Clock: 3  
 Connector: Pin  
 Saturn (10-08)  
 General Motors Corp: 19130314



**68187 New**  
**67187 Reman**  
 FS20  
 6 Groove  
 12 Volt  
 Mount: Tangent Mount  
 Pulley Dia.: 4-7/16  
 Coil Clock: Wire Lead  
 Connector: Pin  
 Ford (08-06); Mercury (10-06)  
 Ford: AL2Z19703A

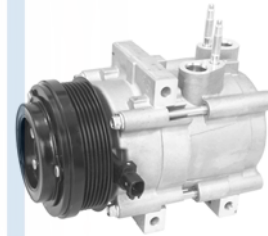

**68188 New**  
**67188 Reman**  
 FS18  
 6 Groove  
 12 Volt  
 Mount: Tangent Mount  
 Pulley Dia.: 4-7/16  
 Coil Clock: Wire Lead  
 Connector: Pin  
 Ford (10-06); Mercury (10-06)  
 Ford: 8L2Z19703D

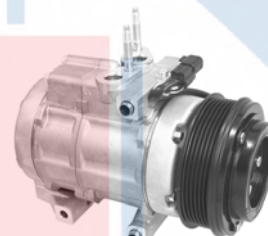

**68189 New**  
**67189 Reman**  
 FS20  
 May Require Use of O.E. Manifold  
 6 Groove  
 12 Volt  
 Mount: Tangent Mount  
 Pulley Dia.: 4-7/16  
 Coil Clock: Wire Lead  
 Connector: Pin  
 Ford (10-06); Mercury (10-06)  
 Ford: AL2Z19703B

# Compressors

## FS Series Cont'd



**68190 New**  
**67190 Reman**  
 HS18  
 May Require Use of O.E. Manifold  
 6 Groove  
 12 Volt  
 Mount: Tangent Mount  
 Pulley Dia.: 4-13/16  
 Coil Clock: Wire Lead  
 Hyundai (09-05)  
 Hyundai: 977012E100

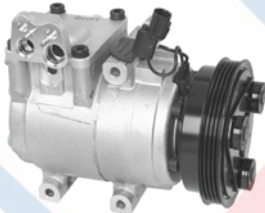

**68191 New**  
**67191 Reman**  
 HS15  
 May Require Use of O.E. Manifold  
 4 Groove  
 12 Volt  
 Mount: Tangent Mount  
 Pulley Dia.: 5  
 Coil Clock: Wire Lead  
 Hyundai (09), (07-05)  
 Hyundai: 977012E000  
 Hy-Capacity: 977012E000

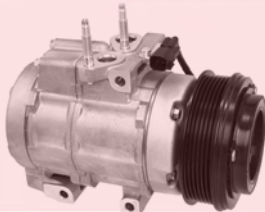

**68192 New**  
**67192 Reman**  
 FS20  
 6 Groove  
 12 Volt  
 Mount: Tangent Mount  
 Pulley Dia.: 4-1/2  
 Coil Clock: Wire Lead  
 Ford (14-06); Lincoln (14-07)  
 Ford: AL1Z19703B, BL3Z19703C



**68193 New**  
**67193 Reman**  
 FS18  
 6 Groove  
 12 Volt  
 Mount: Tangent Mount  
 Pulley Dia.: 4-7/16  
 Coil Clock: 12  
 Connector: Pin  
 Ford (10-07)

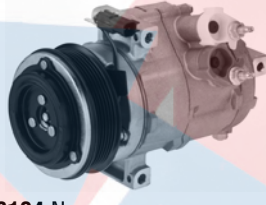

**68194 New**  
**67194 Reman**  
 FS20  
 6 Groove  
 12 Volt  
 Mount: Tangent Mount  
 Pulley Dia.: 4-7/16  
 Coil Clock: Wire Lead  
 Ford (12-08); Lincoln (12-09); Mercury (09-08)  
 Ford: 9G1Z19703B

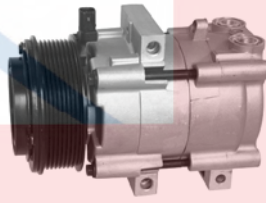

**68197 New**  
**67197 Reman**  
 FS18  
 8 Groove  
 12 Volt  
 Mount: Tangent Mount  
 Pulley Dia.: 4-1/2  
 Coil Clock: Wire Lead  
 Ford (10-08)  
 Ford: 8C2Z19703CA

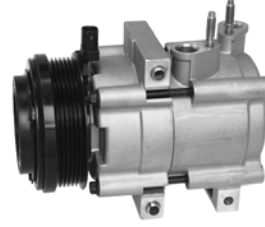

**68198 New**  
**67198 Reman**  
 FS18  
 6 Groove  
 12 Volt  
 Mount: Tangent Mount  
 Pulley Dia.: 4-1/2  
 Coil Clock: 12  
 Connector: Pin  
 Ford (14-07)

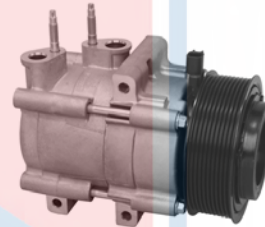

**68199 New**  
 FS18  
 10 Groove  
 12 Volt  
 Mount: Tangent Mount  
 Pulley Dia.: 4-3/8  
 Coil Clock: 12  
 Ford (09-07)

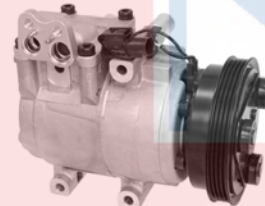

**68314 New**  
**67314 Reman**  
 HS15  
 May Require Use of O.E. Manifold  
 4 Groove  
 12 Volt  
 Mount: Tangent Mount  
 Pulley Dia.: 4-7/8  
 Coil Clock: Wire Lead  
 Hyundai (05-01)  
 Hyundai: 9770125100



**68340 New**  
**67340 Reman**  
 HS15  
 May Require Use of O.E. Manifold  
 6 Groove  
 12 Volt  
 Mount: Tangent Mount  
 Pulley Dia.: 4-5/8  
 Coil Clock: Wire Lead  
 Chrysler (06-04); Dodge (06-04)  
 Chrysler: RL596550AC



**78190 New**  
**77190 Reman**  
 FS20  
 6 Groove  
 12 Volt  
 Mount: Tangent Mount  
 Pulley Dia.: 4-15/16  
 Coil Clock: Wire Lead  
 Ford (10-08)  
 Ford: 9C3Z19703B

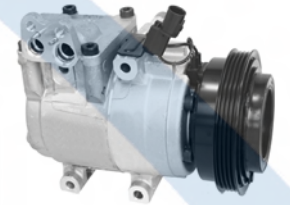

**78347 New**  
**77347 Reman**  
 HS15  
 May Require use of OE Manifold  
 4 Groove  
 12 Volt  
 Mount: Tangent Mount  
 Pulley Dia.: 4-7/8  
 Coil Clock: Wire Lead  
 Hyundai (08-01)  
 Hyundai: 977012C100

# Compressors

## FS Series Cont'd



**78366 New**  
**77366 Reman**  
 HS15  
 4 Groove  
 12 Volt  
 Mount: Tangent Mount  
 Pulley Dia.: 5-1/4  
 Coil Clock: Wire Lead  
 Hyundai (01-98)  
 Hyundai: 9770127000



**78540 New**  
**77540 Reman**  
 Scroll  
 6 Groove  
 12 Volt  
 Mount: Tangent Mount  
 Pulley Dia.: 3-15/16  
 Coil Clock: 12  
 Ford (03-02)

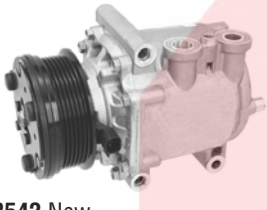

**78542 New**  
**77542 Reman**  
 Scroll  
 6 Groove  
 12 Volt  
 Mount: Tangent Mount  
 Pulley Dia.: 3-7/8  
 Coil Clock: 3  
 Ford (05-02); Mercury (05-02)  
 Ford: 1L2Z19703EA



**78549 New**  
**77549 Reman**  
 Scroll  
 6 Groove  
 12 Volt  
 Switch: Heat Sensor  
 Mount: Tangent Mount  
 Pulley Dia.: 3-7/8  
 Coil Clock: 12  
 Ford (05-02); Jaguar (08-00); Lincoln (06-00)  
 Jaguar: AJ812568



**78570 New**  
**77570 Reman**  
 Scroll  
 5 Groove  
 12 Volt  
 Switch: Heat Sensor  
 Mount: Tangent Mount  
 Pulley Dia.: 4  
 Coil Clock: 12  
 Saturn (07-02)  
 General Motors Corp: 15922970,  
 19187873

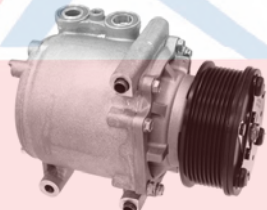

**78579 New**  
**77579 Reman**  
 Scroll  
 8 Groove  
 12 Volt  
 Mount: Tangent Mount  
 Pulley Dia.: 3-15/16  
 Coil Clock: 3  
 Ford (03-02)



**78586 New**  
**77586 Reman**  
 Scroll  
 6 Groove  
 12 Volt  
 Switch: Heat Sensor  
 Mount: Tangent Mount  
 Pulley Dia.: 3-7/8  
 Coil Clock: Wire Lead  
 Jaguar (08-00); Lincoln (05-00)  
 Ford: BU2Z19V703KA  
 Jaguar: XR858532

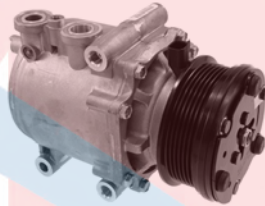

**78588 New**  
**77588 Reman**  
 Scroll  
 6 Groove  
 12 Volt  
 Mount: Tangent Mount  
 Pulley Dia.: 3-15/16  
 Coil Clock: 12  
 Ford (07-02); Lincoln (05-02); Mercury (05-02)  
 Ford: 5W1Z19V703AA

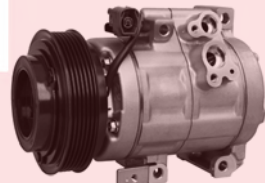

**98120 New**  
**97120 Reman**  
 HS18  
 6 Groove  
 12 Volt  
 Mount: Tangent Mount  
 Pulley Dia.: 4-45/64  
 Coil Clock: Wire Lead  
 Mazda (12-09)  
 Mazda: EG2161450G



**98121 New**  
 HS18  
 6 Groove  
 12 Volt  
 Mount: Tangent Mount  
 Pulley Dia.: 4-21/32  
 Coil Clock: Wire Lead  
 Kia (09)  
 Kia: 977013E935

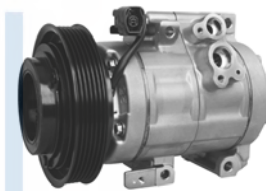

**98122 New**  
**97122 Reman**  
 HS18  
 6 Groove  
 12 Volt  
 Mount: Tangent Mount  
 Pulley Dia.: 5-17/64  
 Coil Clock: Wire Lead  
 Mazda (14-10)  
 Mazda: BBN261450D

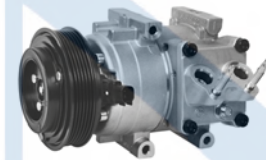

**98319 New**  
**97319 Reman**  
 HS15  
 May Require Use of O.E. Manifold  
 6 Groove  
 12 Volt  
 Mount: Tangent Mount  
 Pulley Dia.: 4-21/32  
 Coil Clock: 3  
 Ford (13-11)  
 Ford: BE8Z19703A



# Compressors

## FS Series Cont'd



**98554 New**  
**197554 Reman**

Scroll  
6 Groove  
12 Volt  
Switch: Heat Switch  
Mount: Tangent Mount  
Pulley Dia.: 4-11/16  
Coil Clock: 12  
Saturn (07-04)  
General Motors Corp: 19259841

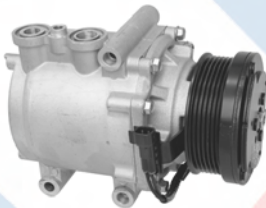

**98557 New**  
**97557 Reman**

Scroll  
6 Groove  
12 Volt  
Mount: Tangent Mount  
Pulley Dia.: 3-7/8  
Coil Clock: Wire Lead  
Ford (06-03); Lincoln (06-03)  
Ford: 2L1Z19V703CA

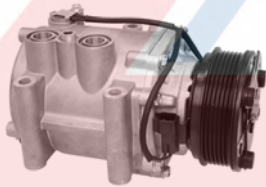

**98561 New**  
**97561 Reman**

Scroll  
6 Groove  
12 Volt  
Switch: Heat Sensor  
Mount: Tangent Mount  
Pulley Dia.: 3-7/8  
Coil Clock: Wire Lead  
Chevy (05)  
General Motors Corp: 19259840



**98562 New**  
**97562 Reman**

Scroll  
6 Groove  
12 Volt  
Switch: Heat Sensor  
Mount: Tangent Mount  
Pulley Dia.: 3-47/64  
Coil Clock: 3  
Ford (09-06); Mercury (09-06)  
Ford: 7M6Z19703A  
Mazda: ZZCC6145Z

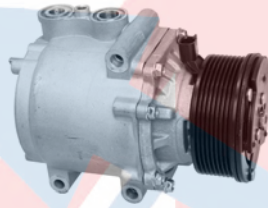

**98564 New**  
**97564 Reman**

Scroll  
8 Groove  
12 Volt  
Mount: Tangent Mount  
Pulley Dia.: 3-15/16  
Coil Clock: 12  
Ford (09-04)

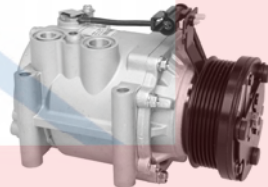

**98568 New**  
**97568 Reman**

Scroll  
6 Groove  
12 Volt  
Mount: Tangent Mount  
Pulley Dia.: 3-3/4  
Coil Clock: Wire Lead  
Ford (03)



**98569 New**  
**97569 Reman**

Scroll  
6 Groove  
12 Volt  
Switch: Heat Switch  
Mount: Tangent Mount  
Pulley Dia.: 3-3/4  
Coil Clock: Wire Lead  
Ford (07-05); Mercury (07-05)  
Ford: 5F9Z19V703DA

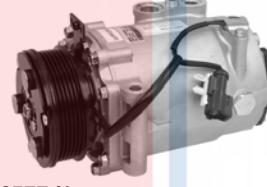

**98577 New**  
**97577 Reman**

Scroll  
6 Groove  
12 Volt  
Switch: Heat Sensor  
Mount: Tangent Mount  
Pulley Dia.: 4  
Coil Clock: 12  
Saturn (03-02)  
General Motors Corp: 15922972



## GM V Series

**57272 Reman**

V5  
Coil Less  
Switch: High Pressure  
Mount: Ear Mount  
Buick (91-85); Cadillac (87-85); Chevy (91-85); Olds (91-85); Pontiac (93-85)



**57284 Reman**

V5  
This compressor is equipped with an R12 Control Valve. If retrofitting to R134a, Control Valve **38846** is recommended for optimum system performance.  
6 Groove  
12 Volt  
Switch: High Pressure  
Mount: Ear Mount  
Pulley Dia.: 5  
Coil Clock: 2  
Connector: Spade  
New Clutch Assy:  
Reman Clutch Assy: **48660**  
Chevy (91)



**57990 Reman**

V5  
6 Groove  
12 Volt  
Mount: Ear Mount  
Belt Width: 7/8  
Pulley Dia.: 4-3/4  
Coil Clock: 2  
Connector: 8mm Pin Connector  
Reman Clutch Assy: **48660**  
Chevy (93); Pontiac (93-92)



**57991 Reman**

V5  
5 Groove  
12 Volt  
Mount: Tangent Mount  
Pulley Dia.: 5  
Coil Clock: 2  
Connector: 8mm Pin Connector  
Reman Clutch Assy: **48664**  
Buick (98-96); Chevy (02-96); Olds (01-96); Pontiac (02-96)

# Compressors

## GM V Series Cont'd



### 57997 Reman

V5  
This compressor is equipped with an R12 Control Valve. If retrofitting to R134a, Control Valve **38846** is recommended for optimum system performance.  
6 Groove  
12 Volt  
Mount: Ear Mount  
Pulley Dia.: 4-3/4  
Coil Clock: 2  
Connector: 8mm Pin Connector  
Reman Clutch Assy: **48660**  
Chevy (94-93); Pontiac (94)



### 58274 New 57274 Reman

V5  
6 Groove  
12 Volt  
Switch: High Pressure  
Mount: Ear Mount  
Pulley Dia.: 4-1/4  
Coil Clock: 2  
Connector: Spade  
Reman Clutch Assy: **48660**  
Buick (88-87); Chevy (88-87); Olds (88-87); Pontiac (88-87)



### 58277 New 57277 Reman

V5  
6 Groove  
12 Volt  
Switch: High Pressure  
Mount: Ear Mount  
Pulley Dia.: 4-45/64  
Coil Clock: 2  
Connector: Spade  
Reman Clutch Assy:  
Buick (88-87); Cadillac (87); Chevy (88-87); Olds (88-87); Pontiac (91-87)



### 58281 New 57281 Reman

V5  
5 Groove  
12 Volt  
Mount: Ear Mount  
Pulley Dia.: 5  
Coil Clock: 2  
Connector: Spade  
Reman Clutch Assy:  
Buick (91-88); Olds (91-87); Pontiac (91-88)

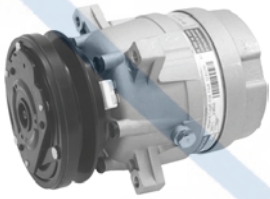

### 58271 New 57271 Reman

V5  
This compressor is equipped with an R12 Control Valve. If retrofitting to R134a, Control Valve **38846** is recommended for optimum system performance.  
1 Groove  
12 Volt  
Switch: High Pressure  
Mount: Ear Mount  
Belt Width: 1/2  
Pulley Dia.: 5-1/8  
Coil Clock: 2  
Connector: Spade  
Reman Clutch Assy:  
Buick (91-85); Cadillac (86-85); Chevy (86-85); Olds (91-85); Pontiac (93-85)

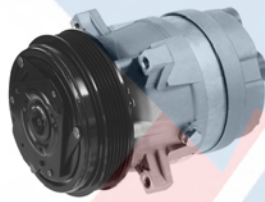

### 58275 New 57275 Reman

V5  
6 Groove  
12 Volt  
Switch: High Pressure  
Mount: Ear Mount  
Pulley Dia.: 5-1/2  
Coil Clock: 2  
Connector: Spade  
Reman Clutch Assy:  
Buick (91-87); Chevy (88); Olds (91-87); Pontiac (87)

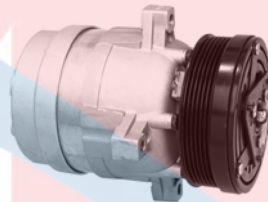

### 58278 New 57278 Reman

V5  
6 Groove  
12 Volt  
Switch: High Pressure  
Mount: Ear Mount  
Pulley Dia.: 5  
Coil Clock: 10  
Connector: Spade  
Reman Clutch Assy: **48633**  
Chevy (92-87); GMC (92-87)  
General Motors Corp: 1135128



### 58282 New 57282 Reman

V5  
5 Groove  
12 Volt  
Switch: High Pressure  
Mount: Ear Mount  
Pulley Dia.: 5  
Coil Clock: 2  
Connector: 8mm Pin Connector  
Reman Clutch Assy: **48664**  
Chevy (91-90); Olds (91-90); Pontiac (91-90)  
General Motors Corp: 12337716

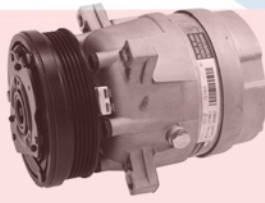

### 58276 New 57276 Reman

V5  
5 Groove  
12 Volt  
Switch: High Pressure  
Mount: Ear Mount  
Pulley Dia.: 5  
Coil Clock: 2  
Connector: Spade  
Reman Clutch Assy:  
Buick (89-87); Chevy (91-87); Olds (88-87)

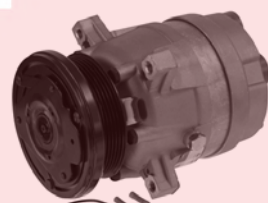

### 58279 New 57279 Reman

V5  
6 Groove  
12 Volt  
Switch: High Pressure  
Mount: Ear Mount  
Pulley Dia.: 5  
Coil Clock: 2  
Connector: 7mm Pin Connector  
Buick (88); Olds (88); Pontiac (88)



### 58283 New 57283 Reman

V5  
6 Groove  
12 Volt  
Switch: High Pressure  
Mount: Ear Mount  
Pulley Dia.: 4-45/64  
Coil Clock: 2  
Connector: Spade  
Reman Clutch Assy:  
Cadillac (88); Chevy (91-88)

# Compressors

## GM V Series Cont'd



**58776 New**  
**57776 Reman**  
 V5  
 5 Groove  
 12 Volt  
 Switch: High Pressure  
 Mount: Ear Mount  
 Pulley Dia.: 5  
 Coil Clock: 2  
 Connector: 8mm Pin Connector  
 Reman Clutch Assy: **48664**  
 Chevy (91-89)



**58777 New**  
**57777 Reman**  
 V5  
 6 Groove  
 12 Volt  
 Switch: High Pressure  
 Mount: Ear Mount  
 Pulley Dia.: 4-1/2  
 Coil Clock: 2  
 Connector: 8mm Pin Connector  
 Reman Clutch Assy: **48660**  
 Buick (91), (89); Chevy (91-89); Olds (91-89); Pontiac (91-89)

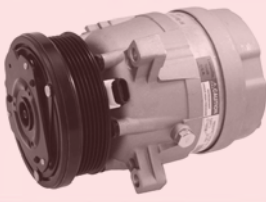

**58971 New**  
**57971 Reman**  
 V5  
 6 Groove  
 12 Volt  
 Mount: Ear Mount  
 Pulley Dia.: 4-5/8  
 Coil Clock: 2  
 Connector: 8mm Pin Connector  
 Reman Clutch Assy: **48660**  
 Chevy (02-95); Pontiac (02-95)  
 General Motors Corp: 89018889



**58972 New**  
**57972 Reman**  
 V5  
 6 Groove  
 12 Volt  
 Switch: High Pressure  
 Mount: Ear Mount  
 Pulley Dia.: 4-5/8  
 Coil Clock: 2  
 Connector: 8mm Pin Connector  
 Reman Clutch Assy: **48660**  
 Chevy (95-93); Olds (94-93); Pontiac (95-93)  
 General Motors Corp: 1135402

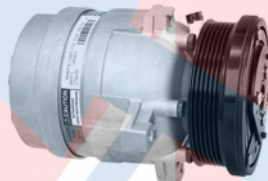

**58973 New**  
**57973 Reman**  
 V5  
 6 Groove  
 12 Volt  
 Mount: Ear Mount  
 Pulley Dia.: 4-5/8  
 Coil Clock: 2  
 Connector: 8mm Pin Connector  
 Reman Clutch Assy: **48660**  
 Chevy (94-93); Pontiac (94)

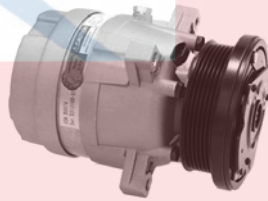

**58974 New**  
**57974 Reman**  
**57774 Reman**  
 V5  
 6 Groove  
 12 Volt  
 Switch: High Pressure  
 Mount: Ear Mount  
 Pulley Dia.: 4-1/4  
 Coil Clock: 2  
 Connector: 8mm Pin Connector  
 Reman Clutch Assy: **48654**  
 Buick (93-89); Chevy (93-89); Olds (93-89); Pontiac (93-89)  
 General Motors Corp: 89018893



**58975 New**  
**57975 Reman**  
 V5  
 6 Groove  
 12 Volt  
 Mount: Ear Mount  
 Pulley Dia.: 5-1/2  
 Coil Clock: 2  
 Connector: 8mm Pin Connector  
 Reman Clutch Assy: **48663**  
 Buick (93-92); Olds (93-92); Pontiac (93-92)

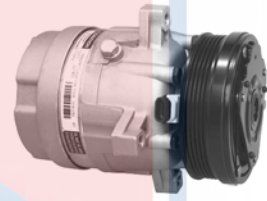

**58976 New**  
**57976 Reman**  
 V5  
 5 Groove  
 12 Volt  
 Mount: Ear Mount  
 Pulley Dia.: 5  
 Coil Clock: 2  
 Connector: 8mm Pin Connector  
 Reman Clutch Assy: **48664**  
 Buick (93-92); Chevy (93-92); Olds (93-92); Pontiac (93-92)



**58977 New**  
**57977 Reman**  
 V5  
 1 Groove  
 12 Volt  
 Mount: Ear Mount  
 Pulley Dia.: 5-1/8  
 Coil Clock: 2  
 Connector: 8mm Pin Connector  
 Pontiac (94-92)



**58978 New**  
**57978 Reman**  
 V5  
 6 Groove  
 12 Volt  
 Switch: High Pressure  
 Mount: Ear Mount  
 Pulley Dia.: 5  
 Coil Clock: 12  
 Connector: 8mm Pin Connector  
 Chevy (93-92); GMC (93-92)



**58979 New**  
**57979 Reman**  
 V5  
 6 Groove  
 12 Volt  
 Switch: High Pressure  
 Mount: Ear Mount  
 Pulley Dia.: 4-45/64  
 Coil Clock: 12  
 Connector: 8mm Pin Connector  
 Reman Clutch Assy: **48660**  
 Chevy (92); Olds (92); Pontiac (92)



**58980 New**  
**57980 Reman**  
 V5  
 6 Groove  
 12 Volt  
 Mount: Tangent Mount  
 Pulley Dia.: 4-1/4  
 Coil Clock: 2  
 Connector: 8mm Pin Connector  
 Reman Clutch Assy: **48654**  
 Buick (98-94); Chevy (96-94); Olds (98-94); Pontiac (98-94)  
 General Motors Corp: 89018886



# Compressors

## GM V Series Cont'd



**58981** New  
**57981** Reman  
V5  
5 Groove  
12 Volt  
Mount: Ear Mount  
Pulley Dia.: 5  
Coil Clock: 2  
Connector: 8mm Pin Connector  
Reman Clutch Assy: **48664**  
Buick (95-94); Chevy (02-94); Olds (95-94); Pontiac (02-94)  
General Motors Corp: 89018890



**58982** New  
**57982** Reman  
V5  
1 Groove  
12 Volt  
Mount: Ear Mount  
Pulley Dia.: 5-1/8  
Coil Clock: 2  
Connector: 8mm Pin Connector  
Pontiac (94-92)

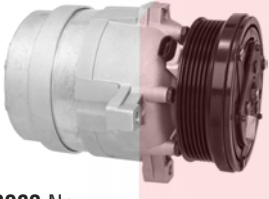

**58983** New  
**57983** Reman  
V5  
6 Groove  
12 Volt  
Mount: Ear Mount  
Pulley Dia.: 4-45/64  
Coil Clock: 12  
Connector: 8mm Pin Connector  
Reman Clutch Assy: **48660**  
Chevy (93-92); Pontiac (93-92)



**58984** New  
**57984** Reman  
V5  
6 Groove  
12 Volt  
Switch: High Pressure  
Mount: Ear Mount  
Pulley Dia.: 4-45/64  
Coil Clock: 2  
Connector: 8mm Pin Connector  
Reman Clutch Assy: **48660**  
Chevy (96-94); GMC (96-94)  
General Motors Corp: 89018860

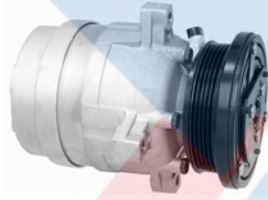

**58985** New  
**57985** Reman  
**57989** Reman  
V5  
5 Groove  
12 Volt  
Switch: Switch  
Mount: Ear Mount  
Pulley Dia.: 4-1/4  
Coil Clock: 2  
Connector: 8mm Pin Connector  
Buick (96-93); Olds (96-93)  
General Motors Corp: 1135210, 89018863



**58986** New  
**57986** Reman  
V5  
5 Groove  
12 Volt  
Mount: Ear Mount  
Pulley Dia.: 5  
Coil Clock: 2  
Connector: 8mm Pin Connector  
Reman Clutch Assy: **48664**  
Chevy (02-94)  
General Motors Corp: 1135104



**58987** New  
**57987** Reman  
V5  
6 Groove  
12 Volt  
Mount: Ear Mount  
Belt Width: 7/8  
Pulley Dia.: 4-45/64  
Coil Clock: 2  
Connector: 8mm Pin Connector  
Reman Clutch Assy:  
Buick (04-96); Chevy (03-98); Olds (99-98); Pontiac (03-97)  
General Motors Corp: 89018897

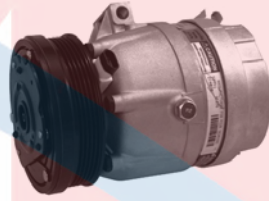

**58991** New  
V5  
5 Groove  
12 Volt  
Mount: Tangent Mount  
Pulley Dia.: 5  
Coil Clock: 2  
Connector: 8mm Pin Connector  
Reman Clutch Assy: **48664**  
Buick (98-96); Chevy (02-96); Olds (01-96); Pontiac (02-96)  
General Motors Corp: 89018887

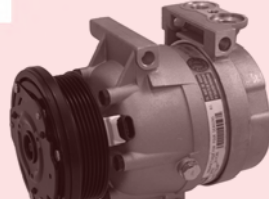

**58992** New  
**57992** Reman  
V5  
6 Groove  
12 Volt  
Mount: Tangent Mount  
Pulley Dia.: 4-1/4  
Coil Clock: 2  
Connector: 8mm Pin Connector  
Buick (05-96); Chevy (03-96); Olds (04-96); Pontiac (05-96)  
General Motors Corp: 89018888, 89018902



**58993** New  
**57993** Reman  
V5  
6 Groove  
12 Volt  
Mount: Ear Mount  
Pulley Dia.: 4-1/4  
Coil Clock: 2  
Connector: 8mm Pin Connector  
Reman Clutch Assy: **48654**  
Buick (96-94); Chevy (97-94); GMC (97); Isuzu (97-96); Olds (96-94); Pontiac (96-94)  
General Motors Corp: 89018856, 89018864



**58994** New  
**57994** Reman  
V5  
6 Groove  
12 Volt  
Mount: Ear Mount  
Pulley Dia.: 5-1/8  
Coil Clock: 2  
Connector: 8mm Pin Connector  
Reman Clutch Assy: **48663**  
Buick (05-96); Olds (99-96); Pontiac (05-96)  
General Motors Corp: 89018865

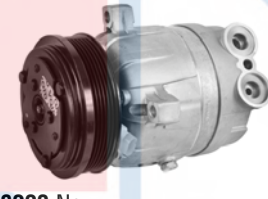

**68223** New  
V5  
6 Groove  
12 Volt  
Mount: 3 Ear  
Pulley Dia.: 4-61/64  
Coil Clock: 2 O'Clock  
Chevy (10-03)

# Compressors

## GM V Series Cont'd



**68224 New**  
V5  
6 Groove  
12 Volt  
Mount: 3 Tangent One on Rear Head  
Pulley Dia.: 4-3/32  
Chevy (03-00); VW (10-02), (99)



**68226 New**  
V5  
6 Groove  
12 Volt  
Mount: Ear Mount  
Pulley Dia.: 4-15/16  
Chevy (12-94)

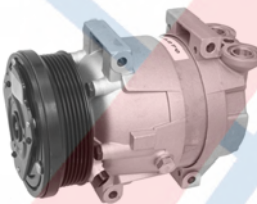

**68270 New**  
**67270 Reman**  
V5  
6 Groove  
12 Volt  
Mount: Tangent Mount  
Pulley Dia.: 4-11/16  
Coil Clock: Wire Lead  
Connector: 8mm Pin Connector  
Chevy (09-04); Pontiac (08-05)  
General Motors Corp: 96618810



**68271 New**  
V5  
1 Groove  
12 Volt  
Mount: Direct Mount  
Belt Width: 1/2  
Pulley Dia.: 5-13/64  
Daewoo (02-99)  
Daewoo: 96460070



**68276 New**  
**67276 Reman**  
V5  
6 Groove  
12 Volt  
Mount: Ear Mount  
Pulley Dia.: 5  
Coil Clock: 4  
Cadillac (01-97); Daewoo (02-98); Opel (03-94)  
General Motors Corp: 1135310, 89019240

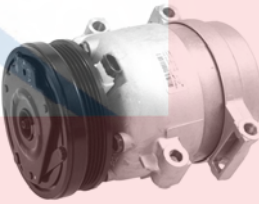

**68277 New**  
**67277 Reman**  
V7  
4 Groove  
12 Volt  
Mount: Tangent Mount  
Pulley Dia.: 5  
Coil Clock: 9  
Connector: 8mm Pin Connector  
Chevy (04-97)  
General Motors Corp: 89018958



**68279 New**  
**67279 Reman**  
V7  
6 Groove  
12 Volt  
Mount: 1 Ear & 2 Boss  
Pulley Dia.: 4-3/4  
Coil Clock: 11  
Connector: 8mm Pin Connector  
Olds (02-99)  
General Motors Corp: 89018957

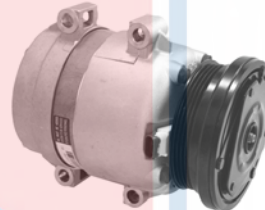

**68288 New**  
**67288 Reman**  
V7  
4 Groove  
12 Volt  
Mount: Tangent Mount  
Pulley Dia.: 4-1/4  
Coil Clock: 9  
Connector: 8mm Pin Connector  
Chevy (02-98); Pontiac (02-98)  
General Motors Corp: 89018956

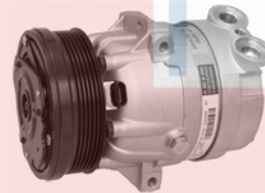

**68290 New**  
**67290 Reman**  
V5  
6 Groove  
12 Volt  
Mount: Ear Mount  
Pulley Dia.: 4-7/8  
Coil Clock: 2  
Connector: 8mm Pin Connector  
Chevy (02-98)  
General Motors Corp: 19169351



**68291 New**  
**67291 Reman**  
V7  
6 Groove  
12 Volt  
Mount: Ear Mount  
Pulley Dia.: 4-7/8  
Coil Clock: 9  
Connector: 8mm Pin Connector  
Chevy (03-98); GMC (03-98); Isuzu (00-98)  
General Motors Corp: 89018955



**68297 New**  
**67297 Reman**  
V5  
5 Groove  
12 Volt  
Mount: Tangent Mount  
Pulley Dia.: 5  
Coil Clock: Wire Lead  
Connector: 8mm Pin Connector  
Chevy (11-09); Pontiac (10-07)  
General Motors Corp: 95907421, 95966587



**98272 New**  
**97272 Reman**  
V5  
6 Groove  
12 Volt  
Mount: Ear Mount  
Pulley Dia.: 4-11/16  
Coil Clock: Wire Lead  
Opel (05-88); Suzuki (08-04)  
Suzuki: 9520085Z01, 9520085Z14

# Compressors

## GM V Series Cont'd



**98276 New**  
**97276 Reman**  
 V7  
 4 Groove  
 12 Volt  
 Mount: Tangent Mount  
 Pulley Dia.: 5-1/2  
 Coil Clock: 9  
 Connector: 8mm Pin Connector  
 Pontiac (06-04)  
 General Motors Corp: 89019077



**98292 New**  
**97292 Reman**  
 V5  
 6 Groove  
 12 Volt  
 Mount: Tangent Mount  
 Pulley Dia.: 4-3/4  
 Coil Clock: Wire Lead  
 Connector: 8mm Pin Connector  
 Suzuki (06-04)  
 Suzuki: 9520086220

## H Series



**57648 Reman**  
 DA6  
 1 Groove  
 12 Volt  
 Switch: High Pressure  
 Mount: Type I, Metric Threads  
 Belt Width: 1/2  
 Pulley Dia.: 5-1/8  
 Coil Clock: 2  
 Connector: Spade  
 Reman Clutch Assy:  
 Reman Compr w/o Clutch: **57250**  
 Ford (88-83); GMC & CHEVY (88-87);  
 Mercury (86-83)  
 Euclid: E801733RM  
 NaviStar: 14588



**57863 Reman**  
 HR6, DA6  
 6 Groove  
 12 Volt  
 Mount: Type I, Metric Threads  
 Pulley Dia.: 4-1/4  
 Coil Clock: 2  
 Connector: 8mm Pin Connector  
 Reman Clutch Assy: **48655**  
 Reman Compr w/o Clutch: **57250**  
 Cadillac (93-89)



**57963 Reman**  
**58963 New**  
 DA6, HR6, HE6  
 6 Groove  
 12 Volt  
 Mount: Type I, Metric Threads  
 Pulley Dia.: 4-1/4  
 Coil Clock: 2  
 Connector: 8mm Pin Connector  
 Reman Clutch Assy: **48655**  
 Cadillac (93-92); Chevy (94); GMC  
 (95-94)  
 General Motors Corp: 19169376



**58247 New**  
**57247 Reman**  
 HR6  
 1 Groove  
 12 Volt  
 Switch: High Pressure  
 Mount: Type I Metric Thread  
 Pulley Dia.: 5-1/2  
 Coil Clock: 2  
 Connector: Spade  
 GMC & CHEVY (92-90), (87), (84)



**58248 New**  
**57248 Reman**  
 HR6  
 1 Groove  
 12 Volt  
 Switch: High Pressure  
 Mount: Type I Metric Thread  
 Pulley Dia.: 5-1/8  
 Coil Clock: 2  
 Connector: Spade  
 Reman Clutch Assy:  
 GMC & CHEVY (88-87)



**58251 New**  
**57251 Reman**  
**57651 Reman - DA6**  
 HR6  
 1 Groove  
 12 Volt  
 Switch: High Pressure  
 Mount: Type II Metric Thread  
 Belt Width: 1/2  
 Pulley Dia.: 5-3/4  
 Coil Clock: 10  
 Connector: Spade  
 Pontiac (85-84)



**58253 New**  
**57253 Reman**  
**57653 Reman - DA6**  
 HR6  
 1 Groove  
 12 Volt  
 Switch: High Pressure  
 Mount: Type II Metric Thread  
 Belt Width: 1/2  
 Pulley Dia.: 5-1/2  
 Coil Clock: 6  
 Connector: Spade  
 Buick (85-83); Olds (85-83)



**58255 New**  
**57255 Reman**  
**57655 Reman - DA6**  
 HR6  
 1 Groove  
 12 Volt  
 Switch: High Pressure  
 Mount: Type II Metric Thread  
 Belt Width: 1/2  
 Pulley Dia.: 5-1/8  
 Coil Clock: 10  
 Connector: Spade  
 Reman Clutch Assy:  
 Chevy (88-83); GMC (86-85); Pontiac  
 (88-83)



**58257 New**  
**57257 Reman**  
**57657 Reman - DA6**  
 HR6  
 1 Groove  
 12 Volt  
 Switch: High Pressure  
 Mount: Type II Metric Thread  
 Belt Width: 7/16  
 Pulley Dia.: 5-1/2  
 Coil Clock: 6  
 Connector: Spade  
 Buick (87-85); Olds (85); Pontiac  
 (90-85)

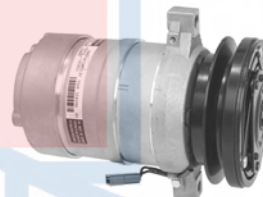

**58259 New**  
**57259 Reman**  
**57659 Reman - DA6**  
 HR6  
 1 Groove  
 12 Volt  
 Switch: High Pressure  
 Mount: Type II Metric Thread  
 Belt Width: 1/2  
 Pulley Dia.: 5-1/8  
 Coil Clock: 6  
 Connector: Spade  
 Reman Clutch Assy:  
 Buick (85); Olds (85)



# Compressors

## H Series Cont'd



**58261** New  
**57261** Reman  
**57661** Reman - DA6  
 HR6  
 1 Groove  
 12 Volt  
 Switch: High Pressure  
 Mount: Type II Metric Thread  
 Belt Width: 7/16  
 Pulley Dia.: 5-1/2  
 Coil Clock: 10  
 Connector: Spade  
 Buick (84-83); Chevy (84-83); Olds (86-83); Pontiac (89-87), (84-83)



**58263** New  
**57263** Reman  
**57663** Reman - DA6  
 HR6  
 6 Groove  
 12 Volt  
 Mount: Type I  
 Pulley Dia.: 4-1/4  
 Coil Clock: 2  
 Connector: Spade  
 Reman Clutch Assy:  
 Cadillac (88-85)  
 General Motors Corp: 89019212

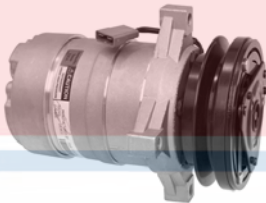

**58265** New  
**57265** Reman  
**57665** Reman - DA6  
 HR6  
 1 Groove  
 12 Volt  
 Switch: High Pressure  
 Mount: Type III Metric Thread  
 Pulley Dia.: 5-1/8  
 Coil Clock: 2  
 Connector: Spade  
 Reman Clutch Assy:  
 Buick (86-83); Cadillac (93); Chevy (91-83); GMC (91-85); Olds (86-83); Pontiac (86-83)

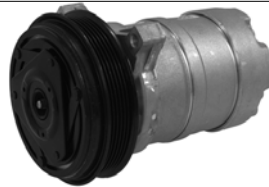

**58267** New  
**57267** Reman  
**57667** Reman - DA6  
 HR6  
 6 Groove  
 12 Volt  
 Switch: High Pressure  
 Mount: Type III  
 Pulley Dia.: 5-1/2  
 Coil Clock: 2  
 Connector: Spade  
 Reman Clutch Assy: **48661**  
 Buick (89-85); Olds (89-85); Pontiac (88-85)  
 General Motors Corp: 19188293, 89019216

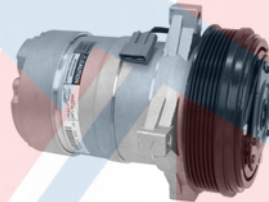

**58268** New  
**57268** Reman  
**57668** Reman - DA6  
 HR6  
 6 Groove  
 12 Volt  
 Switch: High Pressure  
 Mount: Type III Metric Thread  
 Pulley Dia.: 5-1/2  
 Coil Clock: 6  
 Connector: Spade  
 Reman Clutch Assy: **48661**  
 Buick (88-86); Olds (88-86)



**58269** New  
**57269** Reman  
**57669** Reman - DA6  
 HR6  
 2 Threaded Ears (No Middle Ear)  
 1 Groove  
 12 Volt  
 Switch: High Pressure  
 Mount: Type IV Metric Thread  
 Belt Width: 7/16  
 Pulley Dia.: 5-1/2  
 Coil Clock: 2  
 Connector: Spade  
 Cadillac (86-84); Chevy (86-85); Pontiac (85)  
 General Motors Corp: 1136463, 12332680

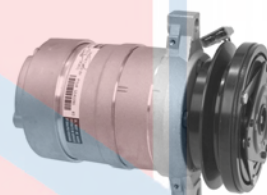

**58270** New  
**57270** Reman  
**57670** Reman - DA6  
 HR6  
 2 Ear (No Middle Ear) 1 Threaded Ear  
 1 Groove  
 12 Volt  
 Switch: High Pressure  
 Mount: Type V Metric Threads  
 Belt Width: 1/2  
 Pulley Dia.: 5-1/8  
 Coil Clock: 2  
 Connector: Spade  
 Reman Clutch Assy:  
 Buick (85); Olds (85)



**58273** New  
**57273** Reman  
**57673** Reman - DA6  
 HR6  
 2 1/2 Ears  
 1 Groove  
 12 Volt  
 Switch: High Pressure  
 Mount: Type VI  
 Pulley Dia.: 5-1/8  
 Coil Clock: 2  
 Connector: Spade  
 Reman Clutch Assy:  
 Chevy (91-85); GMC (91-85)



**58863** New  
 HR6  
 6 Groove  
 12 Volt  
 Mount: Type I  
 Pulley Dia.: 4-1/4  
 Coil Clock: 2  
 Connector: 8mm Pin Connector  
 Reman Clutch Assy: **48655**  
 Cadillac (93-89)



**58867** New  
**57867** Reman  
 HR6  
 6 Groove  
 12 Volt  
 Switch: High Pressure  
 Mount: Type III  
 Pulley Dia.: 4-1/4  
 Coil Clock: 2  
 Connector: 8mm Pin Connector  
 Reman Clutch Assy: **48655**  
 Buick (91-89); Olds (91-89); Pontiac (91-89)

# Compressors

## H Series Cont'd



**58901** New  
**57901** Reman  
 HU6  
 4 Groove  
 12 Volt  
 Switch: High Pressure  
 Mount: Tangent Mount  
 Pulley Dia.: 4-1/4  
 Coil Clock: 11  
 Connector: 8mm Pin Connector  
 Cadillac (02); Chevy (02-99); GMC (02-99)  
 General Motors Corp: 19169352



**58947** New  
**57947** Reman  
 HT6  
 6 Groove  
 12 Volt  
 Switch: High Pressure  
 Mount: Tangent Mount  
 Belt Width: 7/8  
 Pulley Dia.: 4-1/4  
 Coil Clock: 11  
 Connector: 8mm Pin Connector  
 Reman Clutch Assy: **48655**  
 Chevy (05-96); GMC (05-96); Isuzu (00-99); Olds (01-98)  
 General Motors Corp: 19188297, 89019403



**58951** New  
**57951** Reman  
 HD6  
 6 Groove  
 12 Volt  
 Mount: Type 10 - All Ears No Threads  
 Belt Width: 7/8  
 Pulley Dia.: 5  
 Coil Clock: 2  
 Connector: 8mm Pin Connector  
 Reman Clutch Assy: **48667**  
 Cadillac (93)  
 General Motors Corp: 1136545, 19188300



**58954** New  
**57954** Reman  
 HD6  
 6 Groove  
 12 Volt  
 Switch: High Pressure  
 Mount: Type VII (Middle Ear Not Threaded)  
 Pulley Dia.: 4-1/4  
 Coil Clock: 10  
 Connector: Spade  
 Reman Clutch Assy: **48658**  
 Chevy (96-95); GMC (96-95)  
 General Motors Corp: 19188303, 89019369



**58931** New  
**57931** Reman  
 HT6  
 6 Groove  
 12 Volt  
 Switch: High Pressure  
 Mount: Tangent Mount  
 Pulley Dia.: 4-1/4  
 Coil Clock: 11  
 Connector: 8mm Pin Connector  
 Chevy (02-99); GMC (02-99); GMC & CHEVY (07-03)  
 General Motors Corp: 89019356, 89019400

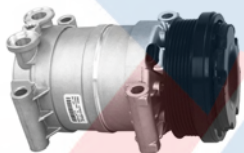

**58949** New  
**57949** Reman  
 HT6  
 6 Groove  
 12 Volt  
 Switch: High Pressure  
 Mount: Tangent Mount  
 Belt Width: 7/8  
 Pulley Dia.: 4-5/8  
 Coil Clock: 11  
 Connector: 8mm Pin Connector  
 Reman Clutch Assy: **48667**  
 Chevy (05-96); GMC (05-96)  
 General Motors Corp: 19188298

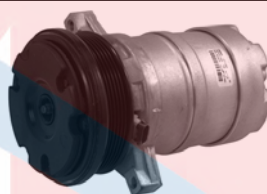

**58952** New  
**57952** Reman  
 HD6  
 6 Groove  
 12 Volt  
 Mount: Type I, Metric Threads  
 Belt Width: 7/8  
 Pulley Dia.: 5  
 Coil Clock: 2  
 Connector: 8mm Pin Connector  
 Reman Clutch Assy: **48667**  
 Cadillac (95-94)  
 General Motors Corp: 19188301, 89019359



**58955** New  
**57955** Reman  
 HD6  
 6 Groove  
 12 Volt  
 Mount: Type XIII (All Ears No Threads)  
 Pulley Dia.: 5  
 Coil Clock: 10  
 Connector: 8mm Pin Connector  
 Reman Clutch Assy: **48667**  
 Buick (96-94); Cadillac (96-94); Chevy (97-93); Pontiac (97-93)  
 General Motors Corp: 19169357, 19188306, 89019368

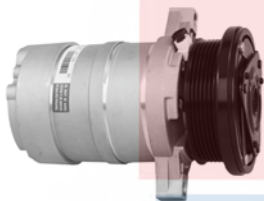

**58932** New  
 HD6  
 6 Groove  
 12 Volt  
 Mount: Ear Mount  
 Pulley Dia.: 4-1/4  
 Coil Clock: 11  
 Connector: 8mm Pin Connector



**58950** New  
**57950** Reman  
 HT6  
 6 Groove  
 12 Volt  
 Switch: High Pressure  
 Mount: Tangent Mount  
 Belt Width: 7/8  
 Pulley Dia.: 5  
 Coil Clock: 11  
 Connector: 8mm Pin Connector  
 Reman Clutch Assy: **48667**  
 Cadillac (00-99); Chevy (02-96); GMC (02-96); Isuzu (98-97); Olds (98-96)  
 General Motors Corp: 19188299, 89019367  
 Kysor: 1404012

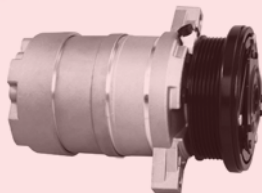

**58953** New  
**57953** Reman  
 HD6  
 Open cavity on rear head for bracket, 3 Ears, Middle Ear Not Threaded  
 6 Groove  
 12 Volt  
 Switch: High Pressure  
 Mount: 3 Ear  
 Pulley Dia.: 4-1/4  
 Coil Clock: 2  
 Connector: 8mm Pin Connector  
 Reman Clutch Assy: **48655**  
 Cadillac (93); Chevy (95); GMC (95)  
 General Motors Corp: 19188302, 89019402

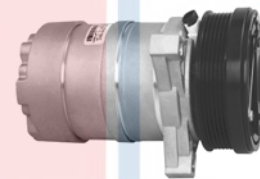

**58956** New  
**57956** Reman  
 HD6  
 6 Groove  
 12 Volt  
 Switch: High Pressure  
 Mount: Type XII (All Ears no threads)  
 Pulley Dia.: 5  
 Coil Clock: 2  
 Connector: 8mm Pin Connector  
 Reman Clutch Assy: **48667**  
 Acura (99-98); Cadillac (02-93), (85); Isuzu (01-98)  
 General Motors Corp: 19188309  
 Isuzu: 8972585280

# Compressors

## H Series Cont'd



**58957 New**  
**57957 Reman**  
 HD6  
 6 Groove  
 12 Volt  
 Switch: High Pressure  
 Mount: Type VI (2-1/2 Ears)  
 Pulley Dia.: 5-1/2  
 Coil Clock: 2  
 Connector: 8mm Pin Connector  
 Reman Clutch Assy: **48665**  
 Buick (95); Olds (95); Pontiac (95)  
 General Motors Corp: 19188321, 89019206



**58958 New**  
**57958 Reman**  
 HD6  
 6 Groove  
 12 Volt  
 Switch: High Pressure  
 Mount: Type III, Metric Threads  
 Pulley Dia.: 5-1/2  
 Coil Clock: 2  
 Connector: 8mm Pin Connector  
 Reman Clutch Assy: **48665**  
 Buick (95-94); Chevy (95-94); Olds (95-94); Pontiac (95-94)  
 General Motors Corp: 1136548, 19169371, 19188338, 89019360

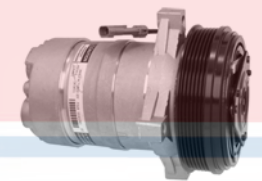

**58959 New**  
**57959 Reman - HD6**  
 HR6  
 Front Hub has Tapped Holes  
 6 Groove  
 12 Volt  
 Switch: High Pressure  
 Mount: Type III  
 Pulley Dia.: 5-1/2  
 Coil Clock: 2  
 Connector: 8mm Pin Connector  
 Buick (95)



**58961 New**  
**57961 Reman - HE6**  
 HR6  
 6 Groove  
 12 Volt  
 Switch: High Pressure  
 Mount: Type IV Metric Thread  
 Belt Width: 7/8  
 Pulley Dia.: 4-1/4  
 Coil Clock: 2  
 Connector: 8mm Pin Connector  
 Reman Clutch Assy: **48665**  
 Chevy (93-92); Olds (93-92); Pontiac (93-92)

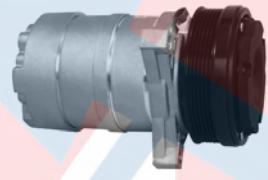

**58962 New**  
**57962 Reman**  
 HD6  
 6 Groove  
 12 Volt  
 Switch: High Pressure  
 Mount: Type X  
 Pulley Dia.: 5  
 Coil Clock: 2  
 Connector: 8mm Pin Connector  
 Olds (99-95)  
 General Motors Corp: 19188339, 89019366

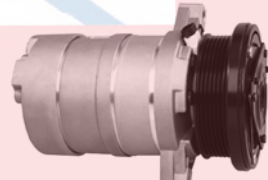

**58963 New**  
**57963 Reman**  
 DA6, HR6, HE6  
 6 Groove  
 12 Volt  
 Mount: Type I Middle w/ Threads  
 Pulley Dia.: 4-1/4  
 Coil Clock: 2  
 Connector: 8mm Pin Connector  
 Reman Clutch Assy: **48655**  
 Cadillac (93-92); Chevy (94); GMC (95-94)  
 General Motors Corp: 19188294, 19188340, 89019230, 89019362



**58964 New**  
 HR6  
 6 Groove  
 12 Volt  
 Mount: Type VII Middle w/o Threads  
 Pulley Dia.: 4-1/4  
 Coil Clock: 2  
 Connector: 8mm Pin Connector  
 Chevy (95-94); GMC (95-94)

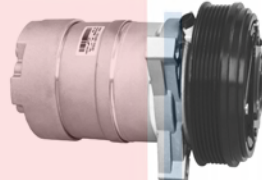

**58967 New**  
**57967 Reman**  
 DA6, HR6, HE6  
 6 Groove  
 12 Volt  
 Mount: Type III  
 Pulley Dia.: 5-1/2  
 Coil Clock: 2  
 Connector: 8mm Pin Connector  
 Buick (94-92); Chevy (93-92); Olds (94-90); Pontiac (94-92)  
 General Motors Corp: 12334819, 19188295, 19188341, 89019355

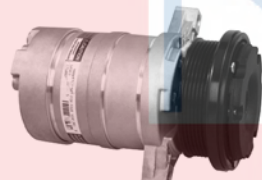

**58969 New**  
**57969 Reman - HE6**  
 HR6  
 3 Ear, Middle Ear Not threaded  
 6 Groove  
 12 Volt  
 Switch: High Pressure  
 Mount: Type VII Rear Bracket  
 Pulley Dia.: 4-1/4  
 Coil Clock: 10  
 Connector: Spade  
 Reman Clutch Assy: **48658**  
 Chevy (94-92), (90); GMC (94-92), (90)



**58970 New**  
**57970 Reman**  
 DA6, HR6, HE6  
 3 Ear, Middle Ear Not threaded  
 6 Groove  
 12 Volt  
 Switch: High Pressure  
 Mount: Type VII Rear Bracket  
 Pulley Dia.: 4-1/4  
 Coil Clock: 2  
 Connector: 8mm Pin Connector  
 Reman Clutch Assy: **48655**  
 Chevy (94-91); GMC (94-91)  
 General Motors Corp: 19188342, 89019365



**88263 New**  
 HR6  
 6 Groove  
 12 Volt  
 Mount: Type I  
 Pulley Dia.: 4-1/4  
 Coil Clock: 2  
 Connector: Spade  
 Cadillac (88-85)

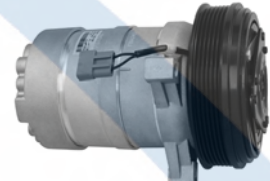

**88267 New**  
 HR6  
 6 Groove  
 12 Volt  
 Switch: High Pressure  
 Mount: Type III  
 Pulley Dia.: 5-1/2  
 Coil Clock: 2  
 Connector: Spade  
 Buick (89-85); Olds (89-85); Pontiac (88-85)



# Compressors

## H Series Cont'd



**88863 New**  
 HR6  
 6 Groove  
 12 Volt  
 Mount: Type I  
 Pulley Dia.: 4-1/4  
 Coil Clock: 2  
 Connector: 8mm Pin Connector



**88867 New**  
 HR6  
 6 Groove  
 12 Volt  
 Switch: High Pressure  
 Mount: Type III  
 Pulley Dia.: 5-1/2  
 Coil Clock: 2  
 Connector: 8mm Pin Connector  
 Buick (91-89); Olds (91-89); Pontiac (91-89)



**88901 New**  
 HU6  
 4 Groove  
 12 Volt  
 Switch: High Pressure  
 Mount: Tangent Mount  
 Pulley Dia.: 4-1/4  
 Coil Clock: 11  
 Connector: 8mm Pin Connector  
 Cadillac (02); Chevy (02-99); GMC (02-99)



**88931 New**  
 HT6  
 6 Groove  
 12 Volt  
 Switch: High Pressure  
 Mount: Tangent Mount  
 Pulley Dia.: 4-1/4  
 Coil Clock: 11  
 Connector: 8mm Pin Connector  
 Chevy (02-99); GMC (02-99); GMC & CHEVY (07-03)

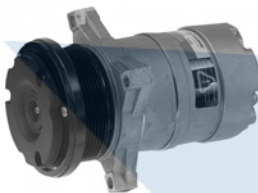

**88932 New**  
 HD6  
 6 Groove  
 12 Volt  
 Mount: Type XII All Ears no Threads  
 Pulley Dia.: 4-5/16  
 Coil Clock: 10  
 Connector: 8mm Pin Connector

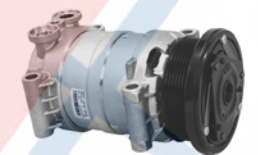

**88947 New**  
 HT6  
 6 Groove  
 12 Volt  
 Switch: High Pressure  
 Mount: Tangent Mount  
 Belt Width: 7/8  
 Pulley Dia.: 4-1/4  
 Coil Clock: 11  
 Connector: 8mm Pin Connector  
 Chevy (05-96); GMC (05-96); Isuzu (00-99); Olds (01-98)



**88949 New**  
 HT6  
 6 Groove  
 12 Volt  
 Switch: High Pressure  
 Mount: Tangent Mount  
 Belt Width: 7/8  
 Pulley Dia.: 4-5/8  
 Coil Clock: 11  
 Connector: 8mm Pin Connector  
 Chevy (05-96); GMC (05-96)  
 General Motors Corp: 89019373



**88950 New**  
 HT6  
 6 Groove  
 12 Volt  
 Switch: High Pressure  
 Mount: Tangent Mount  
 Belt Width: 7/8  
 Pulley Dia.: 5  
 Coil Clock: 11  
 Connector: 8mm Pin Connector  
 Cadillac (00-99); Chevy (02-96); GMC (02-96); Isuzu (98-97); Olds (98-96)

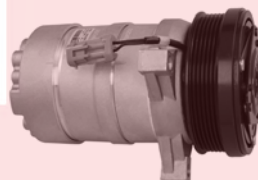

**88951 New**  
 HD6  
 6 Groove  
 12 Volt  
 Mount: Type X All Ears no Threads  
 Belt Width: 7/8  
 Pulley Dia.: 5  
 Coil Clock: 2  
 Connector: 8mm Pin Connector  
 Cadillac (93)



**88952 New**  
 HD6  
 6 Groove  
 12 Volt  
 Mount: Ear Mount  
 Belt Width: 7/8  
 Pulley Dia.: 5  
 Coil Clock: 2  
 Connector: 8mm Pin Connector  
 Cadillac (95-94)



**88953 New**  
 HD6  
 Open cavity on rear head for bracket, 3 Ears, Middle Ear Not Threaded  
 6 Groove  
 12 Volt  
 Switch: High Pressure  
 Mount: Type VII  
 Pulley Dia.: 4-1/4  
 Coil Clock: 2  
 Connector: 8mm Pin Connector  
 Cadillac (93); Chevy (95); GMC (95)



**88954 New**  
 HD6  
 6 Groove  
 12 Volt  
 Switch: High Pressure  
 Mount: Type VII Middle w/o Threads  
 Pulley Dia.: 4-1/4  
 Coil Clock: 10  
 Connector: Spade  
 Chevy (96-95); GMC (96-95)

# Compressors

## H Series Cont'd



**88955 New**  
 HD6  
 6 Groove  
 12 Volt  
 Mount: Type XIII All Ears no Threads  
 Pulley Dia.: 5  
 Coil Clock: 10  
 Connector: 8mm Pin Connector  
 Buick (96-94); Cadillac (96-94); Chevy (97-93); Pontiac (97-93)



**88956 New**  
 HD6  
 6 Groove  
 12 Volt  
 Switch: High Pressure  
 Mount: Type XII All Ears no Threads  
 Pulley Dia.: 5  
 Coil Clock: 2  
 Connector: 8mm Pin Connector  
 Reman Clutch Assy: **48667**  
 Acura (99-98); Cadillac (02-93), (85);  
 Isuzu (01-98)  
 General Motors Corp: 19193989

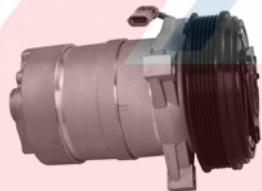

**88957 New**  
 HD6  
 6 Groove  
 12 Volt  
 Switch: High Pressure  
 Mount: Type VI 2 1/2 ears  
 Pulley Dia.: 5-1/2  
 Coil Clock: 2  
 Connector: 8mm Pin Connector  
 Buick (95); Olds (95); Pontiac (95)



**88958 New**  
 HD6  
 6 Groove  
 12 Volt  
 Switch: High Pressure  
 Mount: Type III  
 Pulley Dia.: 5-1/2  
 Coil Clock: 2  
 Connector: 8mm Pin Connector  
 Buick (95-94); Chevy (95-94); Olds (95-94); Pontiac (95-94)

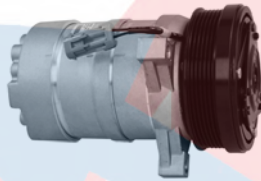

**88962 New**  
 HD6  
 6 Groove  
 12 Volt  
 Switch: High Pressure  
 Mount: Type X  
 Pulley Dia.: 5  
 Coil Clock: 2  
 Connector: 8mm Pin Connector  
 Olds (99-95)



**88963 New**  
 DA6, HR6, HE6  
 3 Ear, Middle Ear Not threaded  
 6 Groove  
 12 Volt  
 Mount: Type I  
 Pulley Dia.: 4-1/4  
 Coil Clock: 2  
 Connector: 8mm Pin Connector  
 Cadillac (93-89); Chevy (94); GMC (95-94)



**88964 New**  
 HR6  
 6 Groove  
 12 Volt  
 Mount: Ear Mount  
 Pulley Dia.: 4-1/4  
 Coil Clock: 2  
 Connector: 8mm Pin Connector  
 Chevy (95-94); GMC (95-94)

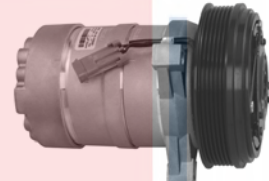

**88967 New**  
 DA6, HR6, HE6  
 6 Groove  
 12 Volt  
 Mount: Type III  
 Pulley Dia.: 5-1/2  
 Coil Clock: 2  
 Connector: 8mm Pin Connector  
 Buick (94-92); Chevy (93-92); Olds (94-90); Pontiac (94-92)

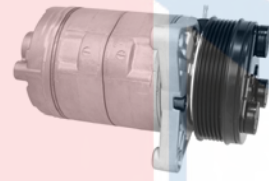

**88969 New**  
 HR6  
 6 Groove  
 12 Volt  
 Switch: High Pressure  
 Mount: Type VII Rear Bracket  
 Pulley Dia.: 4-1/4  
 Coil Clock: 10  
 Connector: Spade  
 Chevy (94-92), (90); GMC (94-92), (90)



**88970 New**  
 DA6, HR6, HE6  
 3 Ear, Middle Ear Not threaded  
 6 Groove  
 12 Volt  
 Switch: High Pressure  
 Mount: Type VII Rear Bracket  
 Pulley Dia.: 4-1/4  
 Coil Clock: 2  
 Connector: 8mm Pin Connector  
 Chevy (94-91); GMC (94-91)  
 General Motors Corp: 1136551



**98248 New**  
 HR6  
 1 Groove  
 12 Volt  
 Switch: High Pressure  
 Mount: Ear Mount  
 Pulley Dia.: 5-1/8  
 Coil Clock: 2  
 Connector: 8mm Pin Connector  
 GMC & CHEVY (93-90), (88-87), (84)

# Compressors

## H Series Cont'd



**57250** Reman  
HR6, DA6  
Coil Less  
Switch: High Pressure  
Mount: Type I, Metric Threads  
Cadillac (93-85)  
Euclid: E801732RM, E801739RM  
Kysor: 1494017



**57254** Reman  
HR6, DA6  
Coil Less  
Switch: High Pressure  
Mount: Type II, Metric Threads  
Buick (87-83); Chevy (86-83); GMC  
(86-85); Olds (86-83); Pontiac (90-83)  
Euclid: E801736RM



**57256** Reman  
HR6, DA6  
Coil Less  
Switch: High Pressure  
Mount: Type III Metric Thread  
New Clutch Assy:  
Reman Clutch Assy: **48661**  
Buick (91-83); Chevy (91-83); GMC  
(91-85); Olds (91-83); Pontiac (91-83)  
Euclid: E801737RM

## Halla Series



**158304** New  
**67348** Reman - HCC-VS18M  
VS18M  
May Require use of OE Manifold  
6 Groove  
12 Volt  
Switch: Control Valve  
Mount: Tangent Mount  
Pulley Dia.: 4-7/8  
Coil Clock: Wire Lead  
Hyundai (09-07)  
Hyundai: 977012B251  
Kia: 977013F400RU



**158305** New  
VS16N  
May Require use of OE Manifold  
6 Groove  
12 Volt  
Switch: Control Valve  
Mount: Tangent Mount  
Pulley Dia.: 4-7/8  
Coil Clock: Wire Lead  
Kia (10-09)  
Kia: 977012G270

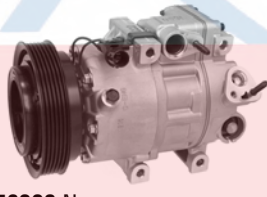

**158306** New  
**157306** Reman  
VS16N  
May Require use of OE Manifold  
6 Groove  
12 Volt  
Switch: Control Valve  
Mount: Tangent Mount  
Pulley Dia.: 4-7/8  
Coil Clock: Wire Lead  
Hyundai (10-08)  
Hyundai: 977013K425



**158307** New  
**157307** Reman  
VS16N  
May Require use of OE Manifold  
4 Groove  
12 Volt  
Switch: Control Valve  
Mount: Tangent Mount  
Pulley Dia.: 4-7/8  
Coil Clock: Wire Lead  
Hyundai (12-07)  
Hyundai: 977012H140

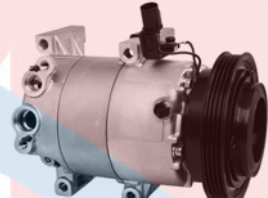

**158370** New  
**157370** Reman  
HCC-VS12  
4 Groove  
12 Volt  
Mount: Tangent Mount  
Pulley Dia.: 4-1/2  
Coil Clock: Wire Lead  
Hyundai (11-10)  
Hyundai: 977011E100

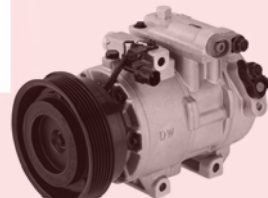

**158371** New  
**157371** Reman  
HCC-DV13  
6 Groove  
12 Volt  
Mount: Tangent Mount  
Pulley Dia.: 4-1/2  
Coil Clock: Wire Lead  
Kia (13-10)  
Kia: 977011M130DR



**158372** New  
**157372** Reman  
HCC-VS16  
6 Groove  
12 Volt  
Mount: Tangent Mount  
Pulley Dia.: 4-1/2  
Coil Clock: Wire Lead  
Hyundai (10); Kia (10-09)  
Hyundai: 977013K520  
Kia: 977013K520RU



**158381** New  
**157381** Reman  
HCC-HS18N  
5 Groove  
12 Volt  
Mount: Tangent Mount  
Pulley Dia.: 4-29/64  
Coil Clock: Wire Lead  
Mazda (13-10)  
Mazda: BBM461450C

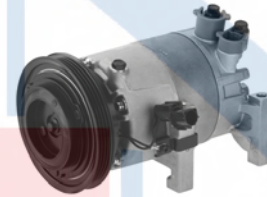

**158389** New  
**157389** Reman  
HCC-VS12  
4 Groove  
12 Volt  
Mount: Tangent Mount  
Pulley Dia.: 4-57/64  
Coil Clock: Wire Lead  
Kia (11-10)  
Kia: 977012K101RU



# Compressors

## Halla Series Cont'd



**158396 New**  
HCC-DVE16  
Use when replacing aftermarket DV16 compressor only.  
6 Groove  
12 Volt  
Mount: Tangent Mount  
Pulley Dia.: 4-57/64  
Coil Clock: Wire Lead  
Kia (09-07)  
Kia: 977012P710

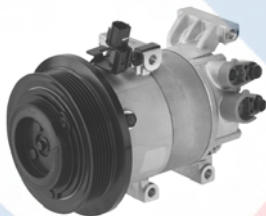

**158399 New**  
HCC-VS12  
6 Groove  
12 Volt  
Mount: Tangent Mount  
Pulley Dia.: 4-29/32  
Coil Clock: Wire Lead  
Kia (11-10)  
Kia: 977012K051

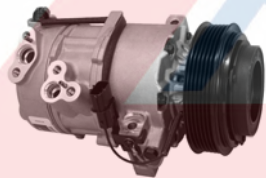

**178305 New**  
HCC-DVE16  
6 Groove  
12 Volt  
Mount: Tangent Mount  
Pulley Dia.: 4-45/64  
Coil Clock: Wire Lead  
Hyundai (15-10); Kia (14-11)  
Hyundai: 977012S500  
Kia: 977012S500DR



**178314 New**  
VS18M  
May Require use of OE Manifold  
6 Groove  
12 Volt  
Mount: Tangent Mount  
Pulley Dia.: 4-11/16  
Coil Clock: Wire Lead  
Hyundai (12-10); Kia (12-11)  
Kia: 977011U200, 977011U250RU

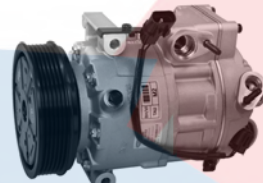

**178315 New**  
VS18E  
May Require use of OE Manifold  
6 Groove  
12 Volt  
Mount: Tangent Mount  
Pulley Dia.: 4-11/16  
Coil Clock: Wire Lead  
Hyundai (13-09)  
Hyundai: 977013M102

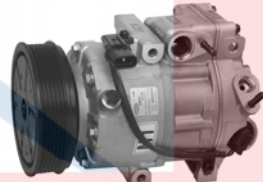

**178316 New**  
**1177316 Reman**  
VS18E  
May Require use of OE Manifold  
6 Groove  
12 Volt  
Mount: Tangent Mount  
Pulley Dia.: 4-11/16  
Coil Clock: Wire Lead  
Hyundai (12-09)  
Hyundai: 977013M001



**178317 New**  
**1177317 Reman**  
VS16E  
May Require use of OE Manifold  
6 Groove  
12 Volt  
Mount: Tangent Mount  
Pulley Dia.: 4-1/2  
Coil Clock: Wire Lead  
Hyundai (14-11); Kia (11)  
Hyundai: 977013R000  
Kia: 977013R000RU

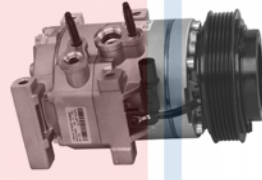

**178318 New**  
**1177318 Reman**  
HCC-RS18  
6 Groove  
12 Volt  
Mount: Tangent Mount  
Pulley Dia.: 4-21/32  
Coil Clock: Wire Lead  
Kia (14), (12-10)  
Kia: 977014D910

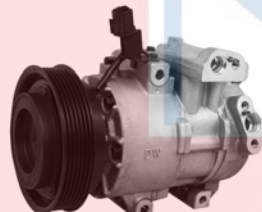

**178323 New**  
HCC-DV13  
May Require Use of O.E. Manifold  
6 Groove  
12 Volt  
Mount: Tangent Mount  
Pulley Dia.: 4-57/64  
Coil Clock: Wire Lead  
Hyundai (14-12)  
Hyundai: 977012V000



**178325 New**  
**1177325 Reman - HHC-VS12M**  
HCC-VS12  
6 Groove  
12 Volt  
Mount: Tangent Mount  
Pulley Dia.: 4-1/2  
Coil Clock: Wire Lead  
Kia (13-12)  
Kia: 977012K600



**178326 New**  
HCC-VS12  
6 Groove  
12 Volt  
Mount: Tangent Mount  
Pulley Dia.: 4-1/2  
Coil Clock: Wire Lead  
Hyundai (12-11)



**178328 New**  
VS16E  
May Require use of OE Manifold  
6 Groove  
Coil Less  
Mount: Tangent Mount  
Pulley Dia.: 4-1/2  
Coil Clock: Wire Lead  
Hyundai (14-12); Kia (14-12)  
Hyundai: 977013V110  
Kia: 977013V110RU

# Compressors

## Halla Series Cont'd



**178330 New**  
HCC-VS12  
6 Groove  
12 Volt  
Switch: Control Valve  
Mount: Tangent Mount  
Pulley Dia.: 4-37/64  
Coil Clock: Wire Lead  
Hyundai (11)  
Hyundai: 977013X600



**198300 New**  
VS18M  
May Require use of OE Manifold  
6 Groove  
12 Volt  
Mount: Tangent Mount  
Pulley Dia.: 4-11/16  
Coil Clock: Wire Lead  
Hyundai (12-10); Kia (13-11)  
Hyundai: 977011U100  
Kia: 977011U100RU

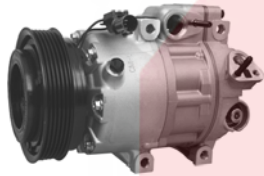

**198301 New**  
VS18M  
May Require use of OE Manifold  
6 Groove  
12 Volt  
Switch: Control Valve  
Mount: Tangent Mount  
Pulley Dia.: 4-7/8  
Coil Clock: Wire Lead  
Hyundai (12-07)  
Hyundai: 977012B300



**198305 New**  
HCC-RS18  
6 Groove  
12 Volt  
Mount: Tangent Mount  
Pulley Dia.: 4-45/64  
Coil Clock: Wire Lead  
Dodge (13); Jeep (15-12)  
Chrysler: 68105755AB  
Jeep: 55111374AD

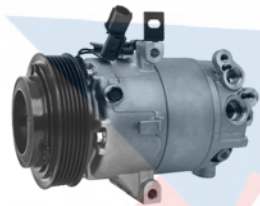

**198354 New**  
HCC-VS12  
6 Groove  
12 Volt  
Mount: Tangent Mount  
Pulley Dia.: 4-1/2  
Coil Clock: Wire Lead  
Hyundai (13); Kia (13-12)  
Hyundai: 977013X101  
Kia: 977012K700

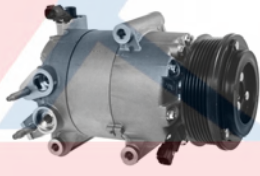

**198359 New**  
HCC  
6 Groove  
12 Volt  
Mount: Tangent Mount  
Belt Width: 7/8  
Pulley Dia.: 4-1/4  
Coil Clock: 2 O'Clock  
Ford (14-13)  
Ford: CV6Z19703M



**198360 New**  
HCC  
4 Groove  
12 Volt  
Mount: Tangent Mount  
Pulley Dia.: 4-17/64  
Ford (14-13)  
Ford: CV6Z19703K

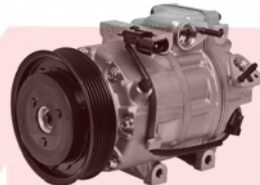

**198376 New**  
VS18E  
May Require use of OE Manifold  
6 Groove  
12 Volt  
Mount: Tangent Mount  
Pulley Dia.: 4-11/16  
Coil Clock: Wire Lead  
Hyundai (14-13); Kia (14-13)  
Hyundai: 977011U650  
Kia: 977011U600RU, 977011U650RU

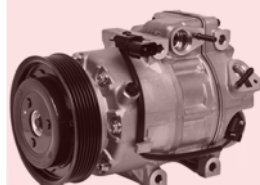

**198377 New**  
VS18E  
May Require use of OE Manifold  
6 Groove  
12 Volt  
Mount: Tangent Mount  
Pulley Dia.: 4-11/16  
Coil Clock: Wire Lead  
Hyundai (14-13); Kia (14)  
Hyundai: 977011U500  
Kia: 977011U500RU



**68313 New**  
**67348 Reman - HCC-VS18M**  
VS18M  
May Require use of OE Manifold  
6 Groove  
12 Volt  
Switch: Control Valve  
Mount: Tangent Mount  
Pulley Dia.: 4-11/16  
Coil Clock: Wire Lead  
Hyundai (09-06); Kia (08-07)  
Hyundai: 977013K220



**68348 New**  
**67348 Reman - HCC-VS18M**  
VS18M  
May Require use of OE Manifold  
6 Groove  
12 Volt  
Switch: Control Valve  
Mount: Tangent Mount  
Pulley Dia.: 4-11/16  
Coil Clock: Wire Lead  
Hyundai (11-06); Kia (08-07)  
Hyundai: 977013K125

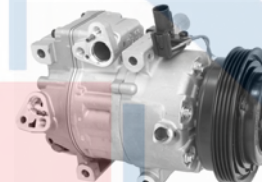

**68358 New**  
**67358 Reman**  
VS16N  
May Require use of OE Manifold  
4 Groove  
12 Volt  
Mount: Tangent Mount  
Pulley Dia.: 5  
Coil Clock: Wire Lead  
Hyundai (09-06)  
Hyundai: 977011E001

# Compressors

## Halla Series Cont'd



**98301 New**  
**97301 Reman**  
 HCC-RS18  
 6 Groove  
 12 Volt  
 Mount: Tangent Mount  
 Pulley Dia.: 5-1/2  
 Coil Clock: 12 O'Clock  
 Dodge (11-09); Jeep (12-09)  
 Chrysler: 55111506AC

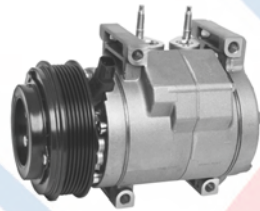

**98302 New**  
 HCC-RS20  
 6 Groove  
 12 Volt  
 Mount: Tangent Mount  
 Pulley Dia.: 4-11/16  
 Coil Clock: 1  
 Dodge (15-12)  
 Chrysler: 68021638AG

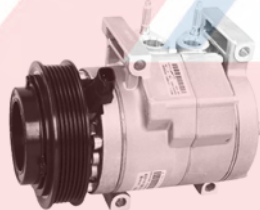

**98311 New**  
**97311 Reman**  
 HCC-RS18  
 6 Groove  
 12 Volt  
 Mount: Tangent Mount  
 Pulley Dia.: 4-45/64  
 Coil Clock: 1  
 Chrysler (13-11); Dodge (15-11); Jeep (15-11)  
 Chrysler: 68021637AG  
 Jeep: 68021637AG



**98322 New**  
**97322 Reman**  
 HCC-RS20  
 8 Groove  
 12 Volt  
 Mount: Tangent Mount  
 Pulley Dia.: 4-15/32  
 Coil Clock: Wire Lead  
 Ford (15-11)  
 Ford: BC3Z19703A

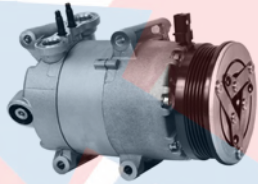

**98323 New**  
**97323 Reman**  
 VS16N  
 May Require use of OE Manifold  
 5 Groove  
 12 Volt  
 Mount: Tangent Mount  
 Pulley Dia.: 4-17/64  
 Coil Clock: Wire Lead  
 Ford (15-12)  
 Ford: CV6Z19703J

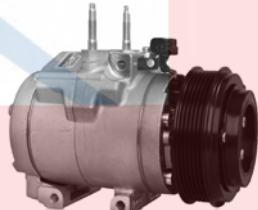

**98324 New**  
**97324 Reman**  
 HCC-RS20  
 6 Groove  
 12 Volt  
 Mount: 3 Tangent  
 Pulley Dia.: 4-11/16  
 Coil Clock: Wire Lead  
 Ford (15-11)  
 Ford: BC3Z19703B

## Halla Series Electric



**178327 New**  
 ESC33T  
 Electric  
 Mount: Tangent Mount  
 Hyundai (12-11); Kia (13-11)  
 Hyundai: 977014R000  
 Kia: 977014R000

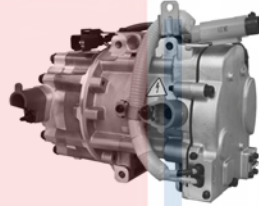

**178332 New**  
 ESC33T  
 Electric  
 Mount: Tangent Mount  
 Hyundai (15-12); Kia (14-13)  
 Hyundai: 977014U000  
 Kia: 977014U000

## Hitachi

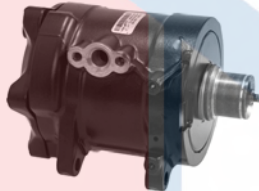

**57406 Reman**  
 MJS170  
 Coil Less  
 Mount: Boss Mount  
 Nissan (87-85)

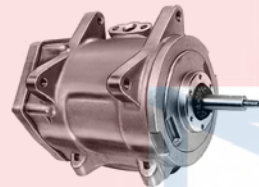

**57412 Reman**  
 SWP167  
 Coil Less  
 Mount: Boss Mount  
 Nissan (84-79)  
 Nissan: 92600N8501, 92610N8501, 92640W3285

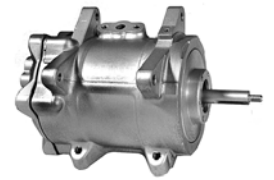

**57414 Reman**  
 MJ167  
 Coil Less  
 Mount: Boss Mount  
 Nissan (81-77)  
 Nissan: 27631P7100, 27631P8201

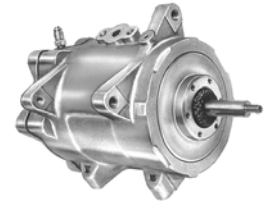

**57415 Reman**  
 MJ167  
 Coil Less  
 Mount: Boss Mount  
 Nissan (83-80)  
 Nissan: 27630M6606, 27631P9010, 27631P9110



**57416 Reman**  
 MJS170  
 Coil Less  
 Mount: Boss Mount  
 Nissan (88-85)  
 Nissan: 92610V6101



**57417 Reman**  
 MJS170  
 Coil Less  
 Mount: Ear Mount  
 Nissan (89-85)  
 Nissan: 9261004W10, 92640D1290



# Compressors

## Hitachi Cont'd



**57425 Reman**  
MJS170  
4 Groove  
12 Volt  
Mount: Ear Mount  
Pulley Dia.: 5-1/4  
Coil Clock: Wire Lead  
Nissan (88-86)  
Nissan: 9260021P01

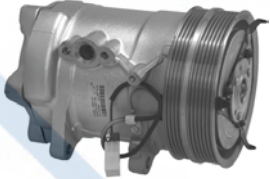

**57426 Reman**  
MJS170  
10 Groove 4 & 6  
12 Volt  
Mount: Ear Mount  
Pulley Dia.: 5-5/8  
Coil Clock: Wire Lead  
New Clutch Assy: **47992**  
Reman Clutch Assy:  
Reman Compr w/o Clutch: **57406**  
Nissan (87-85)  
Nissan: 9260016E02



**57429 Reman**  
MJS170  
1 Groove  
12 Volt  
Mount: Ear Mount  
Belt Width: 7/16  
Pulley Dia.: 5-1/4  
Coil Clock: Wire Lead  
Nissan (89-85)  
Nissan: 9260029R06

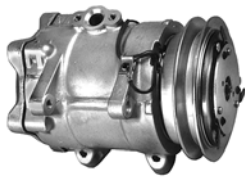

**57430 Reman**  
MJS170  
1 Groove  
12 Volt  
Mount: Ear Mount  
Belt Width: 5/8  
Pulley Dia.: 5-1/2  
Coil Clock: Wire Lead  
Reman Compr w/o Clutch: **57417**  
Nissan (86-85)  
Nissan: 92600D1607



**57431 Reman**  
MJS170  
1 Groove  
12 Volt  
Mount: Ear Mount  
Belt Width: 1/2  
Pulley Dia.: 5-1/4  
Coil Clock: Wire Lead  
Reman Compr w/o Clutch: **57416**  
Nissan (86-85)  
Nissan: 9260006F05, 9260047A00,  
92600V2501

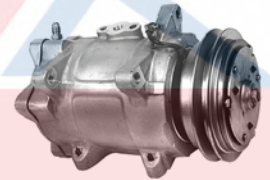

**57432 Reman**  
MJS167  
1 Groove  
12 Volt  
Mount: Ear Mount  
Belt Width: 7/16  
Pulley Dia.: 5-1/4  
Coil Clock: Wire Lead  
Reman Compr w/o Clutch: **57415**  
Nissan (83-82)  
Nissan: 27630P9011



**57433 Reman**  
MJS170  
1 Groove  
12 Volt  
Mount: Ear Mount  
Belt Width: 1/2  
Pulley Dia.: 5-3/4  
Coil Clock: Wire Lead  
Nissan (87-84)  
Nissan: 9260001P06



**57438 Reman**  
A5000  
1 Groove  
12 Volt  
Mount: Ear Mount  
Belt Width: 1/2  
Pulley Dia.: 5-3/4  
Coil Clock: Wire Lead  
Nissan (84)  
Nissan: 9260006F00

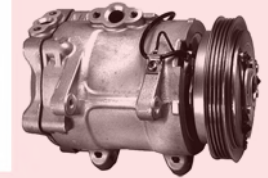

**57439 Reman**  
MJS170  
4 Groove  
12 Volt  
Mount: Ear Mount  
Pulley Dia.: 5-1/4  
Coil Clock: Wire Lead  
Nissan (88-85)  
Nissan: 9260033F12



**57448 Reman**  
MJS170  
10 Groove 4 & 6  
12 Volt  
Mount: Ear Mount  
Pulley Dia.: 5-5/8  
Coil Clock: Wire Lead  
New Clutch Assy: **47990**  
Reman Clutch Assy:  
Nissan (88-87)



**57453 Reman**  
MJS170  
2 Groove  
12 Volt  
Mount: Case Mount  
Belt Width: 7/16  
Pulley Dia.: 5-23/64  
Coil Clock: Wire Lead  
Subaru (94-85)  
Subaru: SOA332A260



**57454 Reman**  
MJS170  
4 Groove  
12 Volt  
Mount: Boss Mount  
Pulley Dia.: 5-5/8  
Coil Clock: Wire Lead  
Subaru (91-85)

# Compressors

## Keihin



**57870 Reman**  
CN150L  
Not Recommended for Use with R134a  
1 Groove  
12 Volt  
Mount: Ear Mount  
Pulley Dia.: 5  
Coil Clock: Wire Lead  
Honda (87-86)



**57871 Reman**  
A150L  
Not Recommended for Use with R134a  
4 Groove  
12 Volt  
Mount: Ear Mount  
Pulley Dia.: 4-31/50  
Coil Clock: Wire Lead  
Honda (89-86)  
Honda: 38020PJ0R60

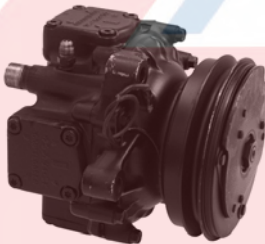

**57872 Reman**  
150R  
Not Recommended for Use with R134a  
1 Groove  
12 Volt  
Mount: Ear Mount  
Pulley Dia.: 5-37/100  
Coil Clock: Wire Lead  
Honda (83-82)  
Honda: 06388PC3660



**57873 Reman**  
AN150L  
Not Recommended for Use with R134a  
1 Groove  
12 Volt  
Mount: Ear Mount  
Pulley Dia.: 5-1/2  
Coil Clock: Wire Lead  
Honda (87-83)

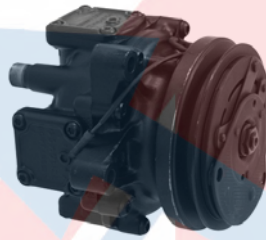

**57874 Reman**  
N150R  
Not Recommended for Use with R134a  
1 Groove  
12 Volt  
Mount: Ear Mount  
Pulley Dia.: 5-1/2  
Coil Clock: Wire Lead  
Honda (83)

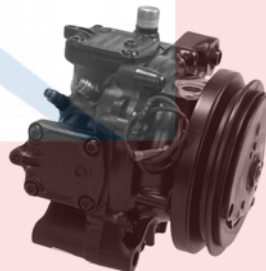

**57875 Reman**  
CN150L  
Not Recommended for Use with R134a  
1 Groove  
12 Volt  
Mount: Ear Mount  
Pulley Dia.: 5-37/100  
Coil Clock: Wire Lead  
Honda (87-84)



**57876 Reman**  
A150L  
Not Recommended for Use with R134a  
1 Groove  
12 Volt  
Mount: Ear Mount  
Pulley Dia.: 5-1/2  
Coil Clock: Wire Lead  
Honda (87-85)

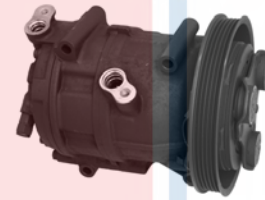

**57879 Reman**  
HS110R  
5 Groove  
12 Volt  
Mount: Tangent Mount  
Pulley Dia.: 6-1/4  
Coil Clock: Wire Lead  
Honda (93)  
Honda: 38810PT6A04

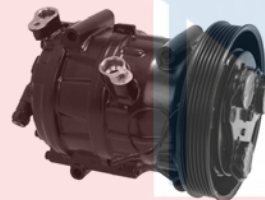

**57880 Reman**  
RC17D  
6 Groove  
12 Volt  
Mount: Tangent Mount  
Pulley Dia.: 6-1/4  
Coil Clock: Wire Lead  
Honda (94)  
Honda: 38810P0A006



**58878 New**  
HS090  
6 Groove  
12 Volt  
Switch: Heat Sensor  
Mount: Tangent Mount  
Pulley Dia.: 4-37/100  
Coil Clock: Wire Lead  
Honda (01-97)



**58881 New**  
**57881 Reman**  
**158881 New - 10PA15C**  
HS110R  
7 Groove  
12 Volt  
Mount: Tangent Mount  
Pulley Dia.: 3-7/8  
Coil Clock: Wire Lead  
Honda (06-02)  
Honda: 38810PNB006



**58882 New**  
**57882 Reman**  
HS090  
7 Groove  
12 Volt  
Switch: Heat Sensor  
Mount: Tangent Mount  
Pulley Dia.: 3-7/8  
Coil Clock: Wire Lead  
Acura (06-02); Honda (05-02)  
Acura: 38810PND006  
Honda: 38810PND006

# Compressors

## Keihin Cont'd



**58884** New  
**57884** Reman  
 HS090  
 6 Groove  
 12 Volt  
 Mount: Tangent Mount  
 Pulley Dia.: 4  
 Honda (09-00)  
 Honda: 38810PCX016



**58886** New  
**57886** Reman  
 HS110R  
 7 Groove  
 12 Volt  
 Mount: Tangent Mount  
 Pulley Dia.: 4-3/8  
 Coil Clock: Wire Lead  
 Acura (08-04)  
 Acura: 38810RBBA01



**58889** New  
**57889** Reman  
 HS090  
 7 Groove  
 12 Volt  
 Switch: Heat Switch  
 Mount: Tangent Mount  
 Pulley Dia.: 4-33/100  
 Coil Clock: Wire Lead  
 Acura (14-09)  
 Acura: 38810RL5A02



**58891** New  
**57891** Reman  
 HSK70KR  
 4 Groove  
 12 Volt  
 Switch: Heat Switch  
 Mount: Tangent Mount  
 Pulley Dia.: 4-2/5  
 Coil Clock: 3 Wire Lead  
 Honda (11-10)



**57470** Reman  
 N1301AB4  
 4 Groove  
 12 Volt  
 Mount: Tangent Mount  
 Pulley Dia.: 5-1/4  
 Coil Clock: Wire Lead  
 Mazda (95-92)  
 Mazda: EA0161450



**57473** Reman  
 SA1150AE4  
 4 Groove  
 12 Volt  
 Mount: Ear Mount  
 Pulley Dia.: 4-3/4  
 Coil Clock: Wire Lead  
 Mazda (94-90)  
 Mazda: BR7061450A

## Matsushita/Panasonic

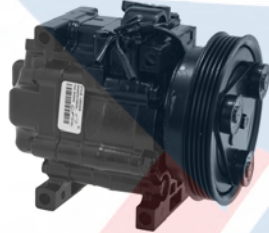

**57418** Reman  
 N15A0B4  
 5 Groove  
 12 Volt  
 Mount: Ear Mount  
 Pulley Dia.: 4-7/8  
 Coil Clock: Wire Lead  
 Mazda (95-94)  
 Mazda: HG5461450B

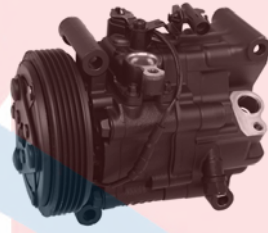

**57471** Reman  
 V08A0AA4AJ  
 5 Groove  
 12 Volt  
 Mount: Tangent Mount  
 Pulley Dia.: 4-5/16  
 Coil Clock: Wire Lead  
 Connector: Butt Connector  
 Suzuki (09-07)  
 Suzuki: 9520080JA2

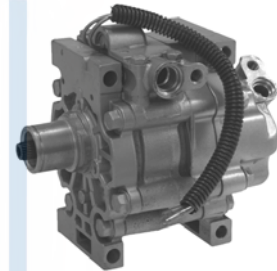

**57481** Reman  
 N1301A0  
 Coil Less  
 Mount: Ear Mount  
 Ford (97-93); Mazda (97-93)

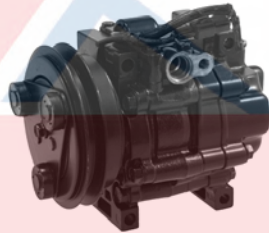

**57419** Reman  
 N1500AB4  
 4 Groove  
 12 Volt  
 Mount: Ear Mount  
 Pulley Dia.: 4-7/8  
 Coil Clock: Wire Lead  
 Mazda (93-92)  
 Mazda: HG3061450B

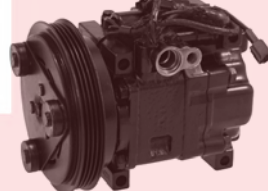

**57472** Reman  
 SA1150AE4  
 4 Groove  
 12 Volt  
 Mount: Ear Mount  
 Pulley Dia.: 5-1/4  
 Coil Clock: Wire Lead  
 Mazda (95-90)  
 Mazda: BR7461450A

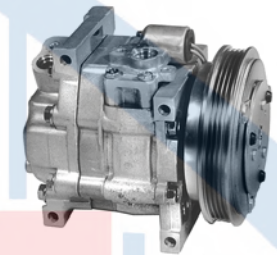

**57490** Reman  
 NL1302AD4  
 4 Groove  
 12 Volt  
 Mount: Ear Mount  
 Pulley Dia.: 5-1/4  
 Coil Clock: Wire Lead  
 Honda (93), (91-88)  
 Honda: 38810PM3R23



# Compressors

## Matsushita/Panasonic Cont'd



**57494 Reman**  
NL1300AA4  
5 Groove  
12 Volt  
Mount: Ear Mount  
Pulley Dia.: 5-3/4  
Coil Clock: Wire Lead  
Honda (90-88)  
Honda: 38810PK2R03



**57495 Reman**  
N1301AE4  
5 Groove  
12 Volt  
Mount: Ear Mount  
Belt Width: 5/8  
Pulley Dia.: 5-1/4  
Coil Clock: Wire Lead  
Ford (97-93); Mazda (97-92)  
Mack: EA0361450

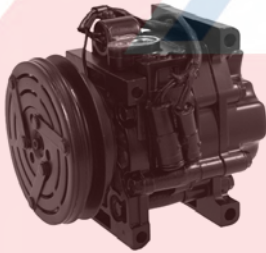

**57496 Reman**  
N1300AC4  
1 Groove  
12 Volt  
Mount: Ear Mount  
Belt Width: 7/16  
Pulley Dia.: 5  
Coil Clock: Wire Lead  
Subaru (89-88)  
Subaru: SOA438A265



**57497 Reman**  
S1150F3  
2 Groove  
12 Volt  
Mount: Tangent Mount  
Belt Width: 1/2  
Pulley Dia.: 4-3/4  
Coil Clock: Wire Lead  
Subaru (88-85)

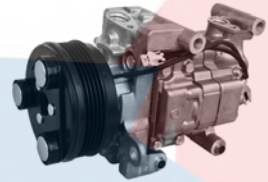

**58463 New**  
**57463 Reman**  
H12A1AH4DX  
May require use of OE connector  
5 Groove  
12 Volt  
Switch: Heat Switch  
Mount: Tangent Mount  
Pulley Dia.: 3-7/8  
Coil Clock: Wire Lead  
Mazda (10-04)  
Mazda: BP4S61K00, CC4361450E

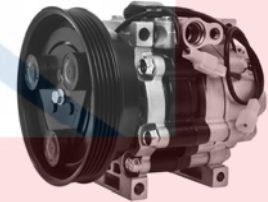

**58487 New**  
**57487 Reman**  
N1301AE4  
5 Groove  
12 Volt  
Switch: Switch  
Mount: Tangent Mount  
Pulley Dia.: 5-1/4  
Coil Clock: Wire Lead  
Ford (97-93); Mazda (97-93)  
Mazda: GA2A61450, GB6H61450D



**58495 New**  
N13A1AA4N4F  
5 Groove  
12 Volt  
Mount: Ear Mount  
Belt Width: 5/8  
Pulley Dia.: 5-1/4  
Coil Clock: Wire Lead  
Ford (97-93); Mazda (97-92)  
Mazda: EA0361450

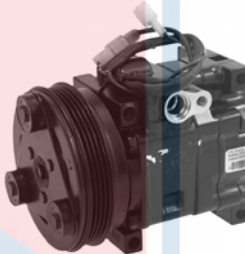

**67470 Reman**  
NL1300AE4  
4 Groove  
12 Volt  
Mount: Tangent Mount  
Pulley Dia.: 4-3/4  
Coil Clock: Wire Lead  
Ford (97-94); Mazda (95)

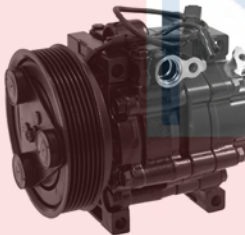

**67471 Reman**  
N13A0AH4  
7 Groove  
12 Volt  
Mount: Tangent Mount  
Pulley Dia.: 5  
Coil Clock: Wire Lead  
Mazda (02-95)



**67473 Reman**  
H12A0AM4NU  
5 Groove  
12 Volt  
Switch: Heat Switch  
Mount: Tangent Mount  
Pulley Dia.: 5  
Coil Clock: Wire Lead  
Mazda (02-99)  
Mazda: TC4461K00



**67475 Reman**  
N13A0AH4  
5 Groove  
12 Volt  
Mount: Tangent Mount  
Pulley Dia.: 5  
Coil Clock: Wire Lead  
Mazda (98-95)



**68470 New**  
SA11A0AA4  
4 Groove  
12 Volt  
Mount: Tangent Mount  
Pulley Dia.: 4-3/4  
Coil Clock: Wire Lead  
Ford (97-94); Mazda (95)

# Compressors

## Matsushita/Panasonic Cont'd

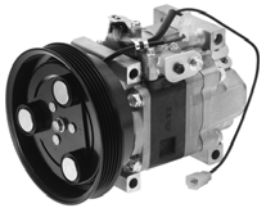

**68478 New**  
**67478 Reman**  
 H12A0AH4JU  
 5 Groove  
 12 Volt  
 Mount: Tangent Mount  
 Pulley Dia.: 5-1/2  
 Coil Clock: Wire Lead  
 Mazda (00-99)  
 Mazda: BJ1H61450

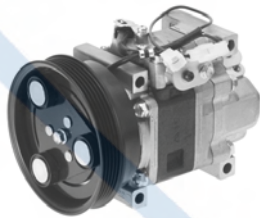

**68479 New**  
**67479 Reman**  
 H12A0AH4JU  
 5 Groove  
 12 Volt  
 Mount: Tangent Mount  
 Pulley Dia.: 5-1/4  
 Coil Clock: Wire Lead  
 Mazda (03-01)  
 Mazda: C10061K00

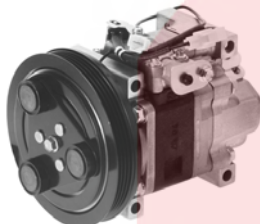

**68480 New**  
**67480 Reman**  
 H12A0AH4EL  
 4 Groove  
 12 Volt  
 Mount: Tangent Mount  
 Pulley Dia.: 5-1/8  
 Coil Clock: Wire Lead  
 Mazda (00-99)  
 Mazda: BJ0E61450



**97470 Reman**  
 H12A1AK4DW  
 6 Groove  
 12 Volt  
 Mount: Tangent Mount  
 Pulley Dia.: 4-7/8  
 Coil Clock: Wire Lead  
 Mazda (07-06)

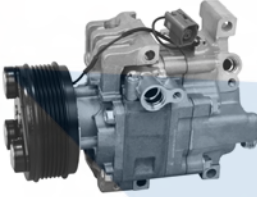

**98471 New**  
**97471 Reman - H12A1AK4DW**  
 H12A1AL4CX  
 6 Groove  
 12 Volt  
 Mount: Tangent Mount  
 Pulley Dia.: 3-7/8  
 Coil Clock: Wire Lead  
 Mazda (08-07)  
 Mazda: EGY16145Z

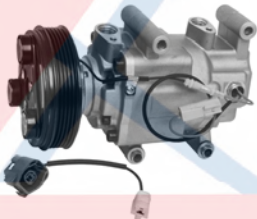

**98472 New**  
 H12A1AH4DX  
 5 Groove  
 12 Volt  
 Mount: Tangent Mount  
 Pulley Dia.: 4-17/32  
 Coil Clock: Wire Lead  
 Mazda (08-06)  
 Mazda: BR9R61K00D



**98473 New**  
 V09A1AD4AP  
 6 Groove  
 12 Volt  
 Mount: Tangent Mount  
 Pulley Dia.: 4-19/32  
 Coil Clock: Wire Lead  
 Mazda (13-11)  
 Mazda: DR6161450

## Mitsubishi

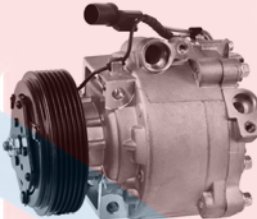

**168486 New**  
 QS90  
 6 Groove  
 12 Volt  
 Mount: 3 Tangent One on Rear Head  
 Pulley Dia.: 4-1/8  
 Mitsubishi (11-10)  
 Mitsubishi: 7813A354, 7813A622,  
 7813A624

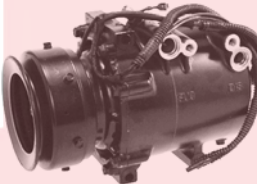

**57480 Reman**  
 FXA80  
 1 Groove  
 12 Volt  
 Mount: Tangent Mount  
 Belt Width: 7/16  
 Pulley Dia.: 4-23/64  
 Coil Clock: Wire Lead  
 Dodge (93-90); Mitsubishi (94-90)  
 Mitsubishi: MB630342



**57483 Reman**  
 FX105  
 1 Groove  
 12 Volt  
 Switch: Sensor Port  
 Mount: Tangent Mount  
 Belt Width: 7/16  
 Pulley Dia.: 4-23/64  
 Coil Clock: Wire Lead  
 Dodge (93-89); Eagle (94-89);  
 Mitsubishi (92-89); Plymouth (93-89)  
 Mitsubishi: MB946125



**57484 Reman**  
 FX105V  
 4 Groove  
 12 Volt  
 Switch: Sensor Port  
 Mount: Tangent Mount  
 Pulley Dia.: 4-1/4  
 Coil Clock: Wire Lead  
 Mitsubishi (93-91)



**57485 Reman**  
 FX105V  
 4 Groove  
 12 Volt  
 Switch: Sensor Port  
 Mount: Tangent Mount  
 Pulley Dia.: 5  
 Coil Clock: Wire Lead  
 Dodge (89); Mitsubishi (92), (90-89);  
 Plymouth (89)



**57486 Reman**  
 FX105V  
 Coil Less  
 Mount: Tangent Mount  
 Dodge (92-89); Eagle (92-89);  
 Mitsubishi (93-89); Plymouth (92-89)

# Compressors

## Mitsubishi Cont'd



**58488 New**  
**57488 Reman**  
 MSC90C  
 Requires Use of Original Manifold  
 5 Groove  
 12 Volt  
 Switch: Sensor Port  
 Mount: Tangent Mount  
 Pulley Dia.: 3-3/4  
 Coil Clock: Wire Lead  
 Dodge (94); Eagle (96-94); Mitsubishi (97-93); Plymouth (94)  
 Mitsubishi: MR360240



**67486 Reman**  
 FX105VS  
 4 Groove  
 12 Volt  
 Switch: Heat Switch  
 Mount: Tangent Mount  
 Pulley Dia.: 4-1/4  
 Coil Clock: Wire Lead  
 Dodge (93-91); Mitsubishi (93-92)

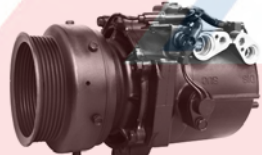

**67487 Reman**  
 FX105VS  
 6 Groove  
 12 Volt  
 Mount: Tangent Mount  
 Pulley Dia.: 4  
 Coil Clock: Wire Lead  
 Dodge (93-91); Mitsubishi (93-91)



**67488 Reman**  
 MSC105CVS  
 May Require Use of O.E. Manifold  
 4 Groove  
 12 Volt  
 Mount: Tangent Mount  
 Pulley Dia.: 4-1/4  
 Coil Clock: Wire Lead  
 Dodge (96-94); Mitsubishi (99-94)



**67490 Reman**  
 AX105VSR  
 4 Groove  
 12 Volt  
 Switch: Control Valve  
 Mount: Tangent Mount  
 Pulley Dia.: 4-1/4  
 Coil Clock: Wire Lead  
 Mitsubishi (95-94)

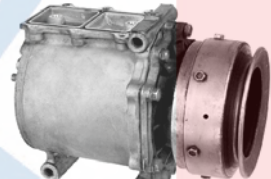

**67491 Reman**  
 MSC90C  
 1 Groove  
 12 Volt  
 Mount: Tangent Mount  
 Pulley Dia.: 4  
 Coil Clock: Wire Lead  
 Mitsubishi (96-94)  
 Mitsubishi: MR315266



**68461 New**  
**67461 Reman**  
 MSC105CVS  
 May Require Use of O.E. Manifold  
 4 Groove  
 12 Volt  
 Switch: Heat Switch  
 Mount: Tangent Mount  
 Pulley Dia.: 3  
 Coil Clock: Wire Lead  
 Chrysler (97-95); Dodge (97-95); Eagle (97-95); Mitsubishi (99-96)  
 Chrysler: MR315254  
 Mitsubishi: MR315254

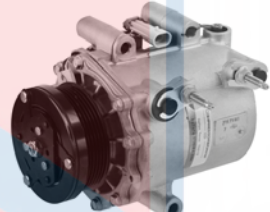

**68474 New**  
**67474 Reman**  
 MSC105CVS  
 6 Groove  
 12 Volt  
 Switch: Heat Sensor  
 Mount: Tangent Mount  
 Pulley Dia.: 3-3/4  
 Coil Clock: Wire Lead  
 Buick (07-02); Chevy (05-01); Olds (04-01); Pontiac (05-01)  
 General Motors Corp: 19258621, 88892650



**68476 New**  
**67476 Reman**  
 MSC130CVSG  
 6 Groove  
 12 Volt  
 Switch: Heat Switch  
 Mount: Tangent Mount  
 Pulley Dia.: 4  
 Coil Clock: Wire Lead  
 Chevy (05-01); Olds (04-01); Pontiac (05-01)  
 General Motors Corp: 19130448



**68477 New**  
**67477 Reman**  
 MSC105CVSG1  
 Sanden / Diesel Kiki Manifold O-Ring  
 6 Groove  
 12 Volt  
 Switch: Heat Switch  
 Mount: 1 Ear & 1 Tangent  
 Pulley Dia.: 3-15/16  
 Coil Clock: Wire Lead  
 Connector: Butt Connector  
 Olds (02-01)  
 General Motors Corp: 25740050



**68485 New**  
**67485 Reman**  
 MSC105CVSG1  
 May Require Use of O.E. Manifold  
 6 Groove  
 12 Volt  
 Switch: Heat Switch  
 Mount: Tangent Mount  
 Pulley Dia.: 3-15/16  
 Coil Clock: Wire Lead  
 Dodge (96-94); Mitsubishi (99-94)  
 Mitsubishi: AW339830, MR513342



**68489 New**  
**67489 Reman**  
 MSC105CVS  
 May Require Use of O.E. Manifold  
 4 Groove  
 12 Volt  
 Mount: Tangent Mount  
 Pulley Dia.: 4-1/4  
 Coil Clock: Wire Lead  
 Chrysler (95); Mitsubishi (98-94)



# Compressors

## Mitsubishi Cont'd



**68492 New**  
**67492 Reman**  
 MSC90C  
 May Require use of OE Manifold  
 1 Groove  
 12 Volt  
 Mount: Tangent Mount  
 Pulley Dia.: 3-5/8  
 Coil Clock: Wire Lead  
 Dodge (94); Eagle (96-94); Mitsubishi  
 (96-93); Plymouth (94)  
 Mitsubishi: MR360234



**77400 Reman**  
 MSC105CVS  
 6 Groove  
 12 Volt  
 Switch: Heat Switch  
 Mount: Tangent Mount  
 Pulley Dia.: 3-11/16  
 Coil Clock: Wire Lead  
 Buick (06-04)

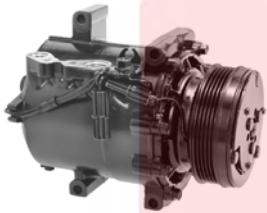

**77481 Reman**  
 FXA105VSL4  
 5 Groove  
 12 Volt  
 Switch: Switch  
 Mount: Ear Mount  
 Pulley Dia.: 4-13/32  
 Coil Clock: Wire Lead  
 Dodge (93); Eagle (93-92); Mitsubishi  
 (93); Plymouth (93)



**78400 New**  
 MSC105CVS  
 6 Groove  
 12 Volt  
 Mount: 3 Ear & 1 Tangent  
 Pulley Dia.: 3-5/16  
 Coil Clock: Wire Lead  
 Buick (06-04)  
 General Motors Corp: 19129934



**78402 New**  
**77402 Reman**  
 MSC90C  
 4 Groove  
 12 Volt  
 Switch: Heat Switch  
 Mount: Tangent Mount  
 Pulley Dia.: 3-13/16  
 Coil Clock: Wire Lead  
 Eagle (98-95); Mitsubishi (99-95)  
 Mitsubishi: MR315815, MR360245

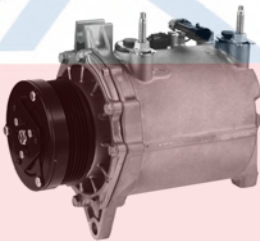

**78482 New**  
**77482 Reman**  
 MSC130CVSG  
 6 Groove  
 12 Volt  
 Switch: Heat Switch  
 Mount: Tangent Mount  
 Pulley Dia.: 4  
 Coil Clock: Wire Lead  
 Cadillac (05-98); Pontiac (05-04)  
 General Motors Corp: 19258826



**78483 New**  
**77483 Reman**  
 MSC90C  
 5 Groove  
 12 Volt  
 Switch: Heat Switch  
 Mount: Tangent Mount  
 Pulley Dia.: 3-13/16  
 Coil Clock: Wire Lead  
 Chrysler (05-01); Dodge (05-01);  
 Mitsubishi (07-98)  
 Mitsubishi: 7813A040

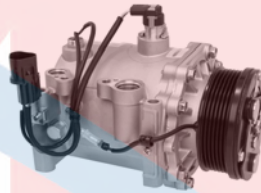

**78484 New**  
**77484 Reman**  
 MSC90C  
 6 Groove  
 12 Volt  
 Switch: Heat Switch / Speed Sensor  
 Mount: Tangent Mount  
 Pulley Dia.: 3-25/32  
 Coil Clock: Wire Lead  
 Mitsubishi (05-99)  
 Mitsubishi: MR398303



**78485 New**  
**77485 Reman**  
 MSC90C  
 6 Groove  
 12 Volt  
 Switch: Switch  
 Mount: Tangent Mount  
 Pulley Dia.: 3-11/16  
 Coil Clock: Wire Lead  
 Chrysler (05-01); Dodge (05-01);  
 Mitsubishi (05-00)  
 Mitsubishi: 7813A041, MR315460



**78486 New**  
**77486 Reman**  
 MSC90C  
 4 Groove  
 12 Volt  
 Switch: Heat Switch  
 Mount: Tangent Mount  
 Pulley Dia.: 3-3/4  
 Coil Clock: Wire Lead  
 Chrysler (00-98); Dodge (00-98)



**78487 New**  
**77487 Reman**  
 MSC105C  
 1 Groove  
 12 Volt  
 Switch: Heat Switch  
 Mount: Tangent Mount  
 Pulley Dia.: 3-41/64  
 Coil Clock: Wire Lead  
 Mitsubishi (04-97)  
 Mitsubishi: MR315442

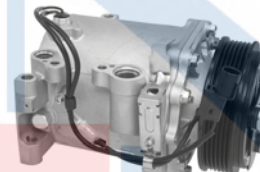

**78492 New**  
**77492 Reman**  
 MSC90C  
 6 Groove  
 12 Volt  
 Switch: Heat Sensor  
 Mount: Tangent Mount  
 Pulley Dia.: 4-1/2  
 Coil Clock: Wire Lead  
 Mitsubishi (05-03), (99)  
 Mitsubishi: MR500250

# Compressors

## Mitsubishi Cont'd



**78493 New**  
**77493 Reman**  
 MSC105C  
 6 Groove  
 12 Volt  
 Switch: Heat Sensor  
 Mount: Tangent Mount  
 Pulley Dia.: 3-3/4  
 Coil Clock: Wire Lead  
 Mitsubishi (12), (10-04)



**78494 New**  
**77494 Reman**  
 MSC105C  
 6 Groove  
 12 Volt  
 Switch: Heat Sensor  
 Mount: Tangent Mount  
 Pulley Dia.: 4-1/8  
 Coil Clock: Wire Lead  
 Mitsubishi (06), (03)  
 Mitsubishi: 7813A037, MR513148

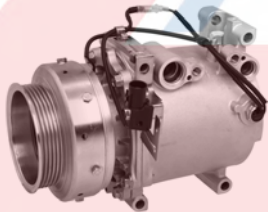

**78496 New**  
**77496 Reman**  
 MSC90C  
 5 Groove  
 12 Volt  
 Switch: Heat Switch  
 Mount: Tangent Mount  
 Pulley Dia.: 3-11/16  
 Coil Clock: Wire Lead  
 Mitsubishi (99)  
 Mitsubishi: MR460058

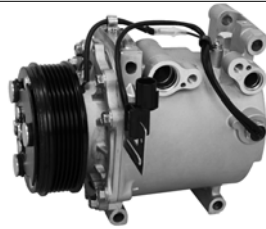

**78497 New**  
**77497 Reman**  
**77495 Reman**  
 MSC105CA  
 6 Groove  
 12 Volt  
 Switch: Heat Switch  
 Mount: Tangent Mount  
 Pulley Dia.: 4-1/16  
 Coil Clock: Wire Lead  
 Mitsubishi (11-04)  
 Mitsubishi: 7813A325, MN185237

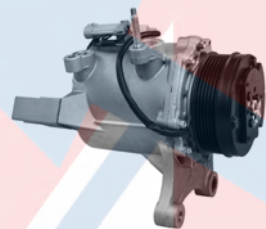

**78499 New**  
**77499 Reman**  
 MSC105CG2  
 6 Groove  
 12 Volt  
 Mount: Tangent Mount  
 Pulley Dia.: 4  
 Coil Clock: Wire Lead  
 Buick (07-06); Chevy (09-06); Pontiac (08-06); Saturn (07-06)  
 General Motors Corp: 19257978

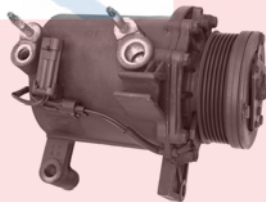

**97480 Reman**  
 MSC105CVSG2  
 6 Groove  
 12 Volt  
 Switch: Heat Switch  
 Mount: Tangent Mount  
 Pulley Dia.: 3-15/16  
 Coil Clock: Wire Lead  
 Olds (03-01)  
 General Motors Corp: 19257921



**97481 Reman**  
 MSC130CG1  
 6 Groove  
 12 Volt  
 Mount: Tangent Mount  
 Pulley Dia.: 4-1/4  
 Coil Clock: Wire Lead  
 Buick (06-05); Chevy (06-05); Pontiac (06-05); Saturn (06-05)  
 General Motors Corp: 19129938

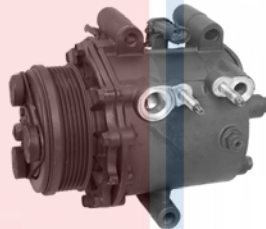

**97482 Reman**  
 MSC105CG1  
 6 Groove  
 12 Volt  
 Mount: Tangent Mount  
 Pulley Dia.: 3-15/16  
 Coil Clock: Wire Lead  
 Buick (06-05); Chevy (06-05); Pontiac (06-05); Saturn (06-05)

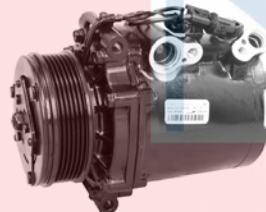

**97486 Reman**  
 MSC90CAS  
 6 Groove  
 12 Volt  
 Mount: Tangent Mount  
 Pulley Dia.: 4-1/8  
 Coil Clock: Wire Lead  
 Mitsubishi (11-07)



**97489 Reman**  
 MSC105CG1  
 6 Groove  
 12 Volt  
 Switch: Heat Switch  
 Mount: Tangent Mount  
 Pulley Dia.: 3-15/16  
 Coil Clock: Wire Lead  
 Connector: Butt Connector  
 Buick (06-05); Chevy (06-05); Pontiac (06-05); Saturn (06-05)



**97491 Reman**  
 QS90  
 6 Groove  
 12 Volt  
 Switch: Heat Switch  
 Mount: Tangent Mount  
 Pulley Dia.: 3-57/64  
 Coil Clock: Wire Lead  
 Mitsubishi (11-09)  
 Mitsubishi: 7813A824



**98453 New**  
 QS90  
 4 Groove  
 12 Volt  
 Mount: Tangent Mount  
 Pulley Dia.: 3-3/4  
 Coil Clock: Wire Lead  
 Chevy (14-13)  
 General Motors Corp: 95371557

# Compressors

## Mitsubishi Cont'd



**98486 New**  
MSC90CAS  
6 Groove  
12 Volt  
Mount: Tangent Mount  
Pulley Dia.: 4-1/8  
Coil Clock: Wire Lead  
Mitsubishi (11-07)  
Mitsubishi: 7813A322, 7813A323,  
7813A366



**98487 New**  
**97487 Reman**  
MSC90CAS  
6 Groove  
12 Volt  
Switch: Heat Switch  
Mount: Tangent Mount  
Pulley Dia.: 3-3/4  
Coil Clock: Wire Lead  
Mitsubishi (09-07)  
Mitsubishi: 7813A321

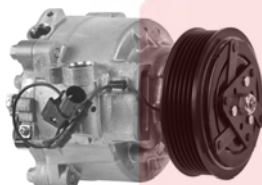

**98491 New**  
QS90  
6 Groove  
12 Volt  
Mount: Tangent Mount  
Pulley Dia.: 3-57/64  
Coil Clock: Wire Lead  
Mitsubishi (11-09)  
Mitsubishi: 7813A350, 7813A835,  
7813A857

## Mitsubishi Electric



**98492 New**  
Electric  
Electric  
Mount: Tangent Mount  
Ford (12-10); Lincoln (12-11); Mercury  
(11-10)  
Ford: BM6Z19703A

## R4 Series



**57019 Reman**  
R4 Heavy  
Coil Less  
Switch: High Pressure  
Mount: Case Mount  
Buick (90-86), (81-80); Chevy (93-86),  
(83-80); GMC (93-91), (87-86);  
Mercedes (87), (85-77), (73-68); Olds  
(90-85); Pontiac (89-86)  
Euclid: E801725RM

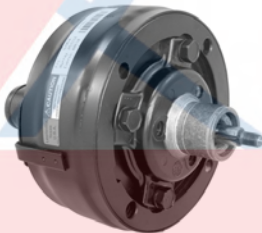

**57054 Reman**  
R4 Heavy  
Coil Less  
Mount: Case Mount  
AMC (81-80); Buick (85-77); Cadillac  
(89-77); Chevy (93-92), (90-75); GMC  
(93-80), (77); Mercedes (84); Olds  
(86-77); Pontiac (87-76); Volvo  
(87-83)  
Euclid: E801726RM



**57219 Reman**  
R4 Heavy  
1 Groove  
12 Volt  
Switch: High Pressure  
Mount: Case Mount  
Belt Width: 7/16  
Pulley Dia.: 5-3/32  
Coil Clock: 12  
Connector: Spade  
Reman Compr w/o Clutch: **57054**  
Northern: 5005000



**57220 Reman**  
R4 Heavy  
1 Groove  
12 Volt  
Mount: Case Mount  
Belt Width: 1/2  
Pulley Dia.: 5  
Coil Clock: 12  
Connector: Spade  
Reman Compr w/o Clutch: **57054**  
Volvo (87-83)



**57225 Reman**  
R4 Heavy  
1 Groove  
12 Volt  
Switch: High Pressure  
Mount: Case Mount  
Belt Width: 1/2  
Pulley Dia.: 5  
Coil Clock: 12  
Connector: Spade  
New Clutch Assy: **47298**  
Reman Clutch Assy:  
Buick (79-77); Cadillac (79-77); Chevy  
(79-76); GMC (79-77); Olds (79-76);  
Pontiac (79-77)  
Euclid: E801729RM

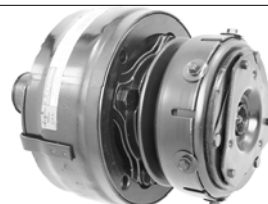

**57227 Reman**  
R4 Heavy  
1 Groove  
12 Volt  
Mount: Case Mount  
Belt Width: 1/2  
Pulley Dia.: 5  
Coil Clock: 12  
Connector: Spade  
New Clutch Assy: **47298**  
Reman Clutch Assy:  
Buick (79-75); Cadillac (79-77); Chevy  
(79-75); GMC (79-75); Olds (79-76);  
Pontiac (79-77)



**57230 Reman**  
R4 Lightweight  
Coil Less  
Switch: High Pressure  
Mount: Case Mount  
Buick (85-84); Chevy (87-83); GMC  
(87-85); Olds (87), (85-84); Pontiac  
(86-84)  
Euclid: E801713RM

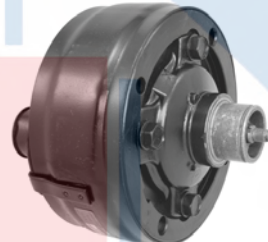

**57233 Reman**  
R4 Lightweight  
Coil Less  
Mount: Case Mount  
Chevy (91-84); Chrysler (90-89);  
Dodge (93-92); GMC (91-87); Isuzu  
(92-89); Olds (91); Plymouth (92);  
Pontiac (89-86)  
General Motors Corp: 19192125  
Euclid: E801714RM



# Compressors

## R4 Series Cont'd



**57236 Reman**  
 R4 Lightweight  
 1 Groove  
 12 Volt  
 Switch: High Pressure  
 Mount: Case Mount  
 Belt Width: 7/16  
 Pulley Dia.: 5-1/2  
 Coil Clock: 12  
 Connector: Spade  
 New Clutch Assy:  
 Reman Clutch Assy:  
 Reman Compr w/o Clutch: **57233**  
 Buick (85-84); Chevy (86-83); Olds  
 (85-84); Pontiac (86-84)

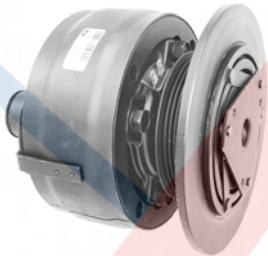

**57241 Reman**  
 R4 Lightweight  
 6 Groove  
 12 Volt  
 Switch: High Pressure  
 Mount: Case Mount  
 Pulley Dia.: 4-1/4  
 Coil Clock: 12  
 Connector: Spade  
 Reman Compr w/o Clutch: **57233**  
 Chevy (91-88); GMC (91-88)  
 Kysor: 1494003



**57943 Reman**  
 R4 Lightweight  
 6 Groove  
 12 Volt  
 Switch: High Pressure  
 Mount: Case Mount  
 Pulley Dia.: 4-1/4  
 Coil Clock: 12  
 Connector: Spade  
 Reman Clutch Assy: **48657**  
 Chevy (92); GMC (92)  
 Euclid: E801723RM  
 Kysor: 1494009

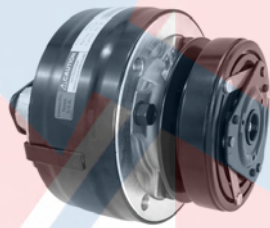

**58223 New**  
**57223 Reman**  
 R4 Heavy  
 1 Groove  
 12 Volt  
 Switch: Superheat  
 Mount: Case Mount  
 Pulley Dia.: 5  
 Coil Clock: 12  
 Connector: Spade  
 Buick (76-75); Chevy (77-75); GMC  
 (77-75); Olds (78-75); Pontiac (76-75)



**58228 New**  
**57228 Reman**  
 R4 Heavy  
 Due to new enhancements,  
 compressor may differ in appearance  
 from OE Please refer to installation kit  
 provided w/ each compressor.  
 1 Groove  
 12 Volt  
 Switch: High Pressure  
 Mount: Case Mount  
 Pulley Dia.: 5  
 Coil Clock: 9  
 Connector: Spade  
 Reman Clutch Assy:  
 Reman Compr w/o Clutch: **57019**  
 Buick (87-86), (81-80); Chevy (93-86),  
 (83-80); GMC (93-91), (87-86),  
 (83-82); GMC & CHEVY (84);  
 Mercedes (87), (85-77), (73-68); Olds  
 (88-85); Pontiac (87-86)  
 General Motors Corp: 88964871,  
 88964873

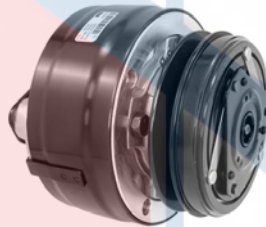

**58229 New**  
**57229 Reman**  
 R4 Heavy  
 1 Groove  
 12 Volt  
 Switch: High Pressure  
 Mount: Case Mount  
 Belt Width: 1/2  
 Pulley Dia.: 5  
 Coil Clock: 12  
 Connector: Spade  
 Reman Clutch Assy:  
 Buick (85-80); Cadillac (83-82); Chevy  
 (88-75); GMC (88-86), (84); Olds (87),  
 (85-77); Pontiac (87-77)  
 General Motors Corp: 88964872



**58231 New**  
**57221 Reman**  
**57231 Reman**  
 R4 Heavy  
 1 Groove  
 12 Volt  
 Switch: High Pressure  
 Mount: Case Mount  
 Pulley Dia.: 5  
 Coil Clock: 12  
 Connector: Spade  
 New Clutch Assy: **47298**  
 Reman Clutch Assy:  
 Reman Compr w/o Clutch: **57054**  
 AMC (81-80); Buick (90-77); Cadillac  
 (89-77); Chevy (93-74); GMC (93-74);  
 Mercedes (84); Olds (90-76); Pontiac  
 (89-76)  
 General Motors Corp: 19192411,  
 2724593, 88964865  
 Mercedes Benz: 1021300615  
 Massey Ferguson: 294184M91



**58234 New**  
**57234 Reman**  
 R4 Lightweight  
 1 Groove  
 12 Volt  
 Switch: High Pressure  
 Mount: Case Mount  
 Pulley Dia.: 5-1/2  
 Coil Clock: 9  
 Connector: Spade  
 Reman Compr w/o Clutch: **57233**  
 Buick (85); Chevy (88-85); GMC (85);  
 Olds (87), (85-84); Pontiac (89),  
 (87-85)

# Compressors

## R4 Series Cont'd



**58235** New  
**57235** Reman  
 R4 Lightweight  
 1 Groove  
 12 Volt  
 Switch: High Pressure  
 Mount: Case Mount  
 Pulley Dia.: 5-1/8  
 Coil Clock: 9  
 Connector: Spade  
 Reman Clutch Assy:  
 Reman Compr w/o Clutch: **57233**  
 Buick (85); Chevy (91-84); Chrysler  
 (90-89); Dodge (93-92); GMC (91-84);  
 Olds (85); Plymouth (92); Pontiac  
 (85-84)



**58237** New  
**57237** Reman  
 R4 Lightweight  
 6 Groove  
 Switch: High Pressure  
 Mount: Case Mount  
 Pulley Dia.: 4-1/4  
 Coil Clock: 12  
 Connector: Spade  
 Reman Clutch Assy: **48622**  
 Reman Compr w/o Clutch: **57233**  
 Chevy (91-86), (84); GMC (91-87);  
 Olds (91)



**58238** New  
**57238** Reman  
 R4 Lightweight  
 6 Groove  
 12 Volt  
 Switch: High Pressure  
 Mount: Case Mount  
 Pulley Dia.: 5  
 Coil Clock: 12  
 Connector: Spade  
 Reman Clutch Assy: **48633**  
 Reman Compr w/o Clutch: **57233**  
 Chevy (91-85); GMC (91-87); Isuzu  
 (92-89); Pontiac (89-87)  
 General Motors Corp: 19192412,  
 88964869  
 Kysor: 1404019

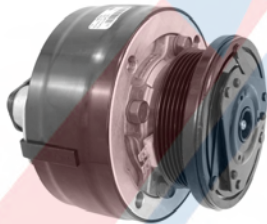

**58239** New  
**57239** Reman  
 R4 Lightweight  
 6 Groove  
 12 Volt  
 Switch: High Pressure  
 Mount: Case Mount  
 Pulley Dia.: 4-1/4  
 Coil Clock: 9  
 Connector: Spade  
 Reman Clutch Assy: **48622**  
 Reman Compr w/o Clutch: **57233**  
 Chevy (91-87); GMC (91-87)  
 Kysor: 1404002



**58240** New  
**57240** Reman  
 R4 Lightweight  
 1 Groove  
 12 Volt  
 Switch: High Pressure  
 Mount: Case Mount  
 Pulley Dia.: 5-1/8  
 Coil Clock: 12  
 Connector: Spade  
 Reman Clutch Assy:  
 Reman Compr w/o Clutch: **57233**  
 Chevy (91-84); GMC (91-84)  
 General Motors Corp: 88964868  
 Kysor: 1404020

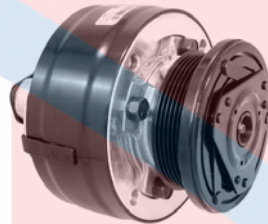

**58937** New  
**57937** Reman  
**57237** Reman  
 R4 Lightweight  
 6 Groove  
 12 Volt  
 Switch: High Pressure  
 Mount: Case Mount  
 Pulley Dia.: 4-1/4  
 Coil Clock: 12  
 Connector: Spade  
 Reman Clutch Assy: **48657**  
 Chevy (92), (83-82); GMC (92); Olds  
 (93-92)  
 General Motors Corp: 19169404,  
 2724591, 88964864  
 Kysor: 1404018



**58941** New  
**57941** Reman  
 R4 Lightweight  
 6 Groove  
 12 Volt  
 Switch: High Pressure  
 Mount: Case Mount  
 Pulley Dia.: 5  
 Coil Clock: 12  
 Connector: 8mm Pin Connector  
 Cadillac (92-90); Chevy (93-90); GMC  
 (93-92); Pontiac (92-89)  
 General Motors Corp: 88964863  
 Kysor: 1404007



**58942** New  
**57735** Reman  
**57942** Reman  
**57935** Reman  
 R4 Lightweight  
 6 Groove  
 12 Volt  
 Switch: High Pressure  
 Mount: Case Mount  
 Pulley Dia.: 4-1/4  
 Coil Clock: 12  
 Connector: 8mm Pin Connector  
 Reman Clutch Assy: **48656**  
 Buick (92); Chevy (93-92); GMC  
 (93-92); Olds (92)

# Compressors

## R4 Series Cont'd



**58948** New  
**57948** Reman  
 R4 Lightweight  
 6 Groove  
 12 Volt  
 Switch: High Pressure  
 Mount: Case Mount  
 Pulley Dia.: 4-1/4  
 Coil Clock: 12  
 Connector: 8mm Pin Connector  
 Reman Clutch Assy: **48656**  
 Buick (96-91); Cadillac (93); Chevy (95-91), (87); GMC (95-92); Olds (94), (92-91)  
 General Motors Corp: 88964862  
 Kysor: 1404005, 1404008, 1404011  
 Northern: 5001211



**68013** New  
**67013** Reman  
 R4 Lightweight  
 1 Groove  
 12 Volt  
 Switch: High Pressure  
 Mount: Case Mount  
 Pulley Dia.: 5  
 Coil Clock: 12  
 Connector: 8mm Pin Connector  
 Reman Clutch Assy: **48656**  
 Chevy (95-94); GMC (95-94)



**68225** New  
**67225** Reman  
 R4 Lightweight  
 6 Groove  
 12 Volt  
 Switch: High Pressure  
 Mount: Case Mount  
 Pulley Dia.: 5  
 Coil Clock: 3  
 Connector: Spade  
 Reman Clutch Assy: **48633**  
 Buick (87-86)

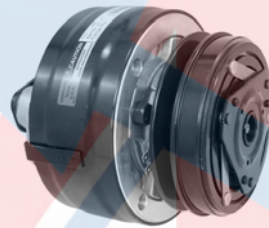

**68231** New  
**67231** Reman - R4 Heavy  
 R4 Lightweight  
 1 Groove  
 12 Volt  
 Switch: High Pressure  
 Mount: Case Mount  
 Pulley Dia.: 5-1/2  
 Coil Clock: 9  
 Connector: Spade  
 Chevy (88-87), (85); GMC (87); Pontiac (87)  
 General Motors Corp: 88964874

## Sanden

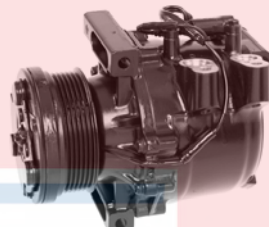

**157551** Reman  
 TRS105  
 6 Groove  
 12 Volt  
 Switch: Heat Switch  
 Mount: Tangent Mount  
 Pulley Dia.: 3-3/4  
 Coil Clock: Wire Lead  
 Mercedes (02-99)  
 Mercedes Benz: 0002304411



**158500** New  
 SD7H15  
 1 Groove  
 12 Volt  
 Mount: Ear Mount  
 Pulley Dia.: 5-1/2  
 Coil Clock: Wire Lead  
 Caterpillar: 3E1908  
 Mack: 4379RD5112200,  
 4379RD5113110  
 Sanden: 4608, 4996, 8057, 8108

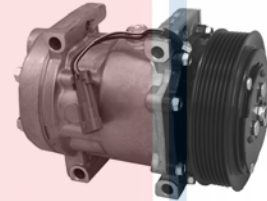

**158502** New  
 SD7H15  
 7 Groove  
 12 Volt  
 Mount: Tangent Mount  
 Pulley Dia.: 5  
 Coil Clock: Wire Lead  
 General Motors Corp: 19130042  
 Sanden: 4397, 4754

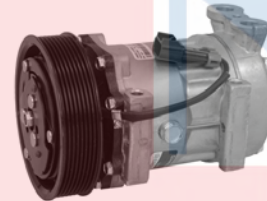

**158505** New  
 SD7H15  
 8 Groove  
 12 Volt  
 Mount: Tangent Mount  
 Pulley Dia.: 5-1/2  
 Coil Clock: Wire Lead  
 Kysor: 1402046  
 Sanden: 4097, 4108, 4802  
 Western Star: 2265917000, 3004266



**158533** New  
 SD7H15  
 12 Groove  
 12 Volt  
 Mount: Tangent Mount  
 Pulley Dia.: 4-11/16  
 Coil Clock: 2 Wire Lead  
 Kenworth (06-03); Peterbilt (03)  
 Bergstrom: 1000141363  
 Kenworth: F696003151  
 Kysor: 1401416  
 Peterbilt: F696003151  
 Red Dot: 75R89532, RD5132100P  
 Sanden: 4370



**158534** New  
 SD7H15  
 8 Groove  
 12 Volt  
 Mount: Tangent Mount  
 Pulley Dia.: 4-689/1000  
 Coil Clock: Wire Lead  
 Bergstrom: 1000141480  
 Kysor: 1401420  
 Sanden: 4084, 4808

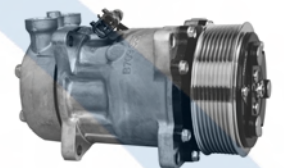

**158552** New  
 SD7H15  
 8 Groove  
 12 Volt  
 Mount: Ear Mount  
 Pulley Dia.: 4-5/8  
 Coil Clock: Wire Lead  
 Kenworth: F696001211  
 Kysor: 1406006, 1410042  
 Peterbilt: 1804178, F696001211  
 Sanden: 4705



# Compressors

## Sanden Cont'd



**158554 New**  
SD7H15  
2 Groove  
12 Volt  
Mount: Tangent Mount  
Pulley Dia.: 5-1/4  
Coil Clock: Wire Lead  
Kysor: 1410001  
Red Dot: RD510737  
Sanden: 4306, 4428



**158555 New**  
SD7H15  
8 Groove  
12 Volt  
Mount: Tangent Mount  
Pulley Dia.: 4-3/4  
Coil Clock: Wire Lead  
Kenworth: 1804219, F6960021402,  
F696002214  
Kysor: 1410084  
Peterbilt: 1804291, F6960021402  
Red Dot: 75R81562, 75R81582,  
RD51133340  
Sanden: 4739  
TRP Parts: LE16450

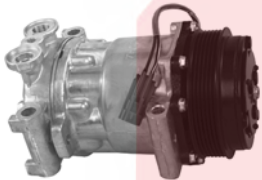

**158566 New**  
SD7H15  
6 Groove  
12 Volt  
Mount: Tangent Mount  
Pulley Dia.: 5-1/8  
Coil Clock: Wire Lead  
General Motors Corp: 19130046  
Sanden: 4061



**158567 New**  
SD7H15  
7 Groove  
12 Volt  
Mount: Tangent Mount  
Pulley Dia.: 4-11/16  
Coil Clock: Wire Lead  
GMC & CHEVY (10-08)  
General Motors Corp: 19130043  
Kenworth: F696003142  
Peterbilt: F696001142  
Sanden: 4013, 4333, 4351, 4362, 4369,  
4396, 4796

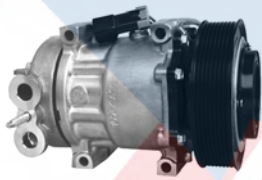

**158568 New**  
SD7H15  
8 Groove  
12 Volt  
Mount: Tangent Mount  
Pulley Dia.: 5-1/2  
Coil Clock: Wire Lead  
Connector: Packard

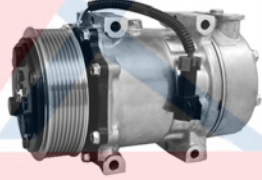

**158569 New**  
SD7H15  
8 Groove  
12 Volt  
Mount: Tangent Mount  
Pulley Dia.: 4-11/16  
Coil Clock: Wire Lead  
Connector: Packard  
Kenworth: F696001112  
Sanden: 4322



**158570 New**  
SD7H13  
6 Groove  
12 Volt  
Mount: Ear Mount  
Pulley Dia.: 4-11/16  
Coil Clock: Wire Lead  
Connector: Bullet Connector  
Sanden: 4455

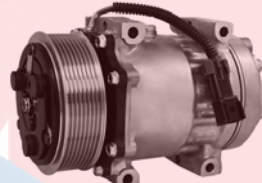

**158571 New**  
SD7H15  
8 Groove  
12 Volt  
Mount: Tangent Mount  
Pulley Dia.: 4-11/16  
Coil Clock: Wire Lead  
Connector: Packard  
Sanden: 4404

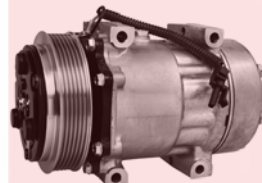

**158572 New**  
SD7H15  
6 Groove  
12 Volt  
Mount: Tangent Mount  
Pulley Dia.: 4-59/64  
Coil Clock: Wire Lead  
Connector: Packard  
Sanden: 4027



**158573 New**  
SD7H15  
8 Groove  
24 Volt  
Mount: Tangent Mount  
Pulley Dia.: 4-11/16  
Coil Clock: Wire Lead  
Connector: Packard  
Sanden: 4327



**158574 New**  
SD7H15  
8 Groove  
24 Volt  
Mount: Tangent Mount  
Pulley Dia.: 4-11/16  
Coil Clock: Wire Lead  
NaviStar: 8500795  
Sanden: 8144



**158575 New**  
SD7H15  
1 Groove  
12 Volt  
Mount: Tangent Mount  
Pulley Dia.: 5-7/16  
Coil Clock: Wire Lead  
Connector: Packard  
Sanden: 4402

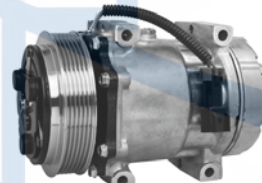

**158576 New**  
SD7H15  
6 Groove  
12 Volt  
Mount: Tangent Mount  
Pulley Dia.: 4-59/64  
Coil Clock: Wire Lead  
Connector: Packard  
Sanden: 4019

# Compressors

## Sanden Cont'd



**158577 New**  
SD7H15  
2 Groove  
12 Volt  
Mount: Ear Mount  
Pulley Dia.: 5-63/64  
Coil Clock: Wire Lead  
Connector: Packard  
Kysor: 1410073  
Sanden: 4308, 4807



**158578 New**  
SD7H15  
6 Groove  
12 Volt  
Mount: Tangent Mount  
Pulley Dia.: 4-59/64  
Coil Clock: Wire Lead  
Connector: Packard  
Sanden: 4897

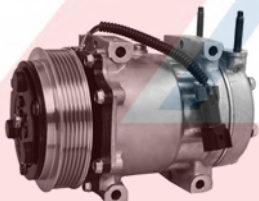

**158579 New**  
SD7H15  
6 Groove  
12 Volt  
Mount: Tangent Mount  
Pulley Dia.: 4-59/64  
Coil Clock: Wire Lead  
Connector: Packard  
Sanden: 4803



**158580 New**  
SD7H15  
1 Groove  
24 Volt  
Mount: Tangent Mount  
Pulley Dia.: 4-3/4  
Coil Clock: Wire Lead  
Connector: Bullet Connector  
Sanden: 7360

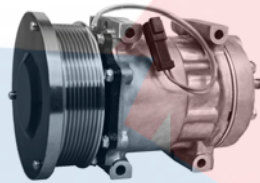

**158581 New**  
SD7H15  
8 Groove  
24 Volt  
Mount: Tangent Mount  
Pulley Dia.: 5-15/64  
Coil Clock: Wire Lead  
Connector: Deutsch  
Sanden: 4355

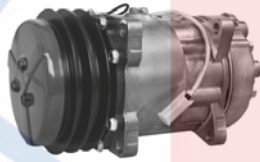

**158582 New**  
SD7H15  
2 Groove  
24 Volt  
Mount: Ear Mount  
Pulley Dia.: 5-3/16  
Coil Clock: Wire Lead  
Connector: Bullet Connector  
Sanden: 8045

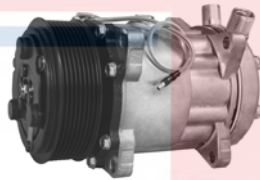

**158583 New**  
SD7H15  
8 Groove  
24 Volt  
Mount: Ear Mount  
Pulley Dia.: 4-19/32  
Coil Clock: Wire Lead  
Caterpillar: N83304912  
Sanden: 4762



**158584 New**  
SD505  
2 Groove  
12 Volt  
Mount: Ear Mount  
Pulley Dia.: 4-29/32  
Coil Clock: Wire Lead  
Caterpillar: N83304413  
Sanden: 5077

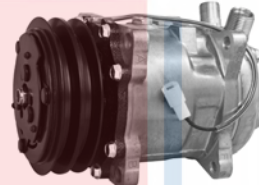

**158585 New**  
SD5H11  
2 Groove  
12 Volt  
Mount: Ear Mount  
Pulley Dia.: 4-29/32  
Coil Clock: Wire Lead  
International (11-08); New Holland  
(15-08), (06-04)  
Case New Holland: 87362509, 87546525

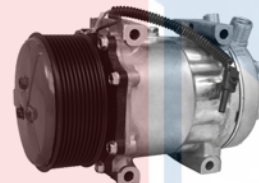

**158586 New**  
SD7H15  
10 Groove  
12 Volt  
Mount: Tangent Mount  
Pulley Dia.: 4-11/16  
Coil Clock: Wire Lead  
Connector: Packard  
Sanden: 4405



**158587 New**  
SD505  
2 Groove  
24 Volt  
Mount: Ear Mount  
Pulley Dia.: 4-29/32  
Coil Clock: Wire Lead  
Caterpillar: N83304662  
Kysor: 1403113  
Sanden: 5073



**158588 New**  
SD7H15  
2 Groove  
24 Volt  
Mount: Ear Mount  
Pulley Dia.: 5-63/64  
Coil Clock: Wire Lead  
Sanden: 4409



**158589 New**  
SD7H15  
8 Groove  
24 Volt  
Mount: Tangent Mount  
Pulley Dia.: 6-63/64  
Coil Clock: Wire Lead  
Connector: Bullet Connector  
Sanden: 4116, 4324

# Compressors

## Sanden Cont'd



**158590 New**  
SD7H15  
2 Groove  
24 Volt  
Mount: Tangent Mount  
Pulley Dia.: 4-59/64  
Coil Clock: Wire Lead  
Connector: Bullet Connector  
Sanden: 4052



**158591 New**  
SD7H15  
2 Groove  
12 Volt  
Mount: Tangent Mount  
Pulley Dia.: 5-13/64  
Coil Clock: Wire Lead  
Connector: Packard  
Sanden: 4540

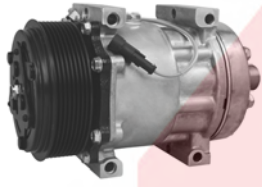

**158592 New**  
SD7H15  
8 Groove  
12 Volt  
Mount: Tangent Mount  
Pulley Dia.: 4-11/16  
Coil Clock: Wire Lead  
Sanden: 8090



**158593 New**  
SD7H15  
8 Groove  
12 Volt  
Mount: Ear Mount  
Pulley Dia.: 5-15/64  
Coil Clock: Wire Lead  
Connector: Packard  
Case New Holland: 9847944  
Sanden: 4738



**158594 New**  
SD7H15  
8 Groove  
12 Volt  
Mount: Ear Mount  
Pulley Dia.: 5-13/64  
Coil Clock: Wire Lead  
Connector: Bullet Connector  
Sanden: 8112

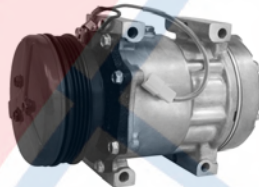

**158595 New**  
SD7H15  
4 Groove  
12 Volt  
Mount: Tangent Mount  
Pulley Dia.: 4-13/32  
Coil Clock: Wire Lead  
Connector: Spade  
Sanden: 8147

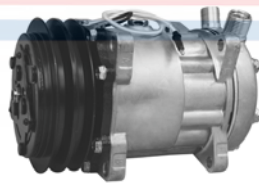

**158596 New**  
SD7H15  
2 Groove  
24 Volt  
Mount: Ear Mount  
Pulley Dia.: 5-3/16  
Coil Clock: Wire Lead  
Sanden: 8069



**158597 New**  
SD7H15  
10 Groove  
12 Volt  
Mount: Tangent Mount  
Pulley Dia.: 4-61/64  
Coil Clock: Wire Lead  
Kenworth: F696003145  
Sanden: 4114, 4411, 4412

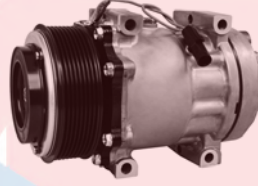

**158598 New**  
SD7H15  
8 Groove  
24 Volt  
Mount: Tangent Mount  
Pulley Dia.: 4-11/16  
Coil Clock: Wire Lead  
Kenworth: SK14086  
Sanden: 4086

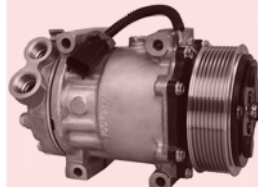

**158599 New**  
SD7H15  
8 Groove  
12 Volt  
Mount: Tangent Mount  
Pulley Dia.: 4-11/16  
Coil Clock: Wire Lead  
Sanden: 40548, 4083

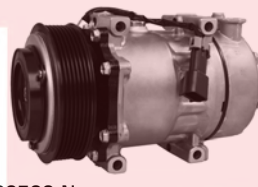

**168500 New**  
SD7H15  
7 Groove  
12 Volt  
Mount: Tangent Mount  
Pulley Dia.: 4-61/64  
Coil Clock: Wire Lead  
Connector: Pin  
Kysor: 1410080  
Peterbilt: 43796000  
Sanden: 4087, 4379



**168501 New**  
SD7H15  
8 Groove  
12 Volt  
Mount: Ear Mount  
Pulley Dia.: 4-11/16  
Coil Clock: Wire Lead  
Connector: Bullet Connector  
Case New Holland: 84032734  
NaviStar: 84032734  
Sanden: 8901



**168502 New**  
SD7H15  
8 Groove  
24 Volt  
Mount: Tangent Mount  
Pulley Dia.: 4-11/16  
Coil Clock: Wire Lead  
Sanden: 4066



**168503 New**  
SD7H15  
10 Groove  
12 Volt  
Mount: Tangent Mount  
Pulley Dia.: 4-61/64  
Coil Clock: Wire Lead  
Kenworth: F696003141  
Sanden: 4384



**168504 New**  
SD7H15  
10 Groove  
12 Volt  
Mount: Tangent Mount  
Pulley Dia.: 4-61/64  
Coil Clock: Wire Lead  
Sanden: 4407



# Compressors

## Sanden Cont'd



**168505 New**  
SD7H15  
8 Groove  
12 Volt  
Mount: Tangent Mount  
Pulley Dia.: 4-11/16  
Coil Clock: Wire Lead  
Sanden: 4020

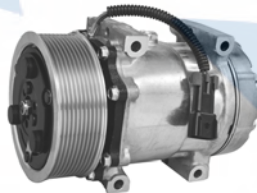

**168506 New**  
SD7H15  
10 Groove  
12 Volt  
Mount: Tangent Mount  
Pulley Dia.: 4-61/64  
Coil Clock: Wire Lead  
Sanden: 4036

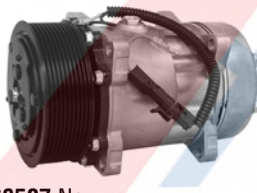

**168507 New**  
SD7H15  
10 Groove  
24 Volt  
Mount: Ear Mount  
Pulley Dia.: 4-59/64  
Coil Clock: Wire Lead  
Connector: Bullet Connector  
Sanden: 4309

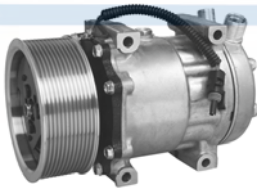

**168508 New**  
SD7H15  
12 Groove  
12 Volt  
Mount: Tangent Mount  
Pulley Dia.: 4-61/64  
Coil Clock: Wire Lead  
Sanden: 4678

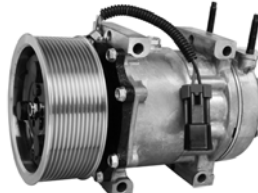

**168509 New**  
SD7H15  
12 Groove  
12 Volt  
Mount: Tangent Mount  
Pulley Dia.: 4-61/64  
Coil Clock: Wire Lead  
Sanden: 4541

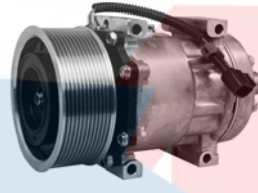

**168510 New**  
SD7H15  
12 Groove  
12 Volt  
Mount: Tangent Mount  
Pulley Dia.: 4-61/64  
Coil Clock: Wire Lead  
Freightliner (14-01); Western Star (15-00)  
Bergstrom: 1000141389  
Kysor: 1401425  
Sanden: 4088, 4091, 4381, 4408

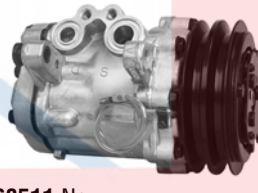

**168511 New**  
SD7B10  
2 Groove  
12 Volt  
Mount: Ear Mount  
Pulley Dia.: 4-33/64  
Coil Clock: Wire Lead  
Connector: Bullet Connector  
Sanden: 7170



**168512 New**  
SD7H15  
6 Groove  
12 Volt  
Mount: Ear Mount  
Pulley Dia.: 4-29/32  
Coil Clock: Wire Lead  
Connector: Spade  
Sanden: 4600

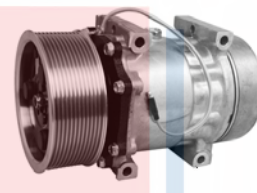

**168513 New**  
SD7H15  
12 Groove  
24 Volt  
Mount: Tangent Mount  
Pulley Dia.: 4-61/64  
Coil Clock: Wire Lead  
Connector: Bullet Connector  
Sanden: 4051

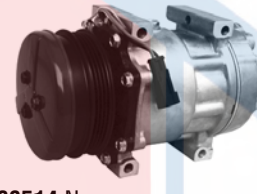

**168514 New**  
SD7H15  
4 Groove  
12 Volt  
Mount: Tangent Mount  
Pulley Dia.: 4-23/64  
Coil Clock: Wire Lead  
Sanden: 8148

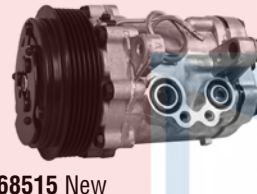

**168515 New**  
SD7B10  
6 Groove  
12 Volt  
Mount: Tangent Mount  
Pulley Dia.: 4-13/32  
Coil Clock: Wire Lead  
Connector: Bullet Connector  
Sanden: 7176



**168516 New**  
SD7H15  
12 Groove  
12 Volt  
Mount: Tangent Mount  
Pulley Dia.: 4-61/64  
Coil Clock: Wire Lead  
Sanden: 4070



**168518 New**  
SD7H15  
8 Groove  
12 Volt  
Mount: Tangent Mount  
Pulley Dia.: 4-11/16  
Coil Clock: Wire Lead  
Sanden: 4025



**168519 New**  
SD7H15  
6 Groove  
12 Volt  
Mount: Tangent Mount  
Pulley Dia.: 4-59/64  
Coil Clock: Wire Lead  
Sanden: 4071, 4119U  
Western Star: SK14071



**168520 New**  
SD7H15  
8 Groove  
12 Volt  
Mount: Tangent Mount  
Pulley Dia.: 4-11/16  
Coil Clock: Wire Lead  
Chevy HD (09-04); GMC HD (09-04)  
General Motors Corp: 19130045  
Sanden: 4342, 4850

# Compressors

## Sanden Cont'd



**168522 New**  
SD7H13  
1 Groove  
24 Volt  
Mount: Tangent Mount  
Pulley Dia.: 4-29/32  
Coil Clock: Wire Lead  
Caterpillar (02-93)  
Sanden: 7361, 8944

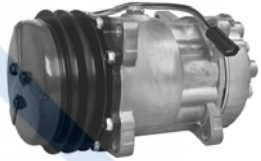

**168523 New**  
SD7H15  
2 Groove  
24 Volt  
Mount: Ear Mount  
Pulley Dia.: 4-59/64  
Coil Clock: Wire Lead  
Volvo HD (12-04)  
Sanden: 8152

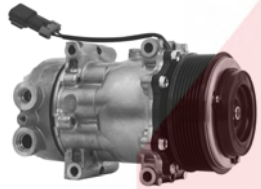

**168525 New**  
SD7H15  
8 Groove  
12 Volt  
Mount: Tangent Mount  
Pulley Dia.: 4-11/16  
Coil Clock: Wire Lead  
Kenworth: F696003111  
Kysor: 1401413  
Peterbilt: F696003111  
Sanden: 4077, 4368, 4614



**168526 New**  
SD7H15  
6 Groove  
12 Volt  
Mount: Tangent Mount  
Pulley Dia.: 4-15/16  
Coil Clock: Wire Lead  
Kenworth: F696003122  
Kysor: 1401435  
Peterbilt: F696003122  
Sanden: 4079, 4376  
Western Star: 3004320



**168527 New**  
SD7H15  
6 Groove  
12 Volt  
Mount: Tangent Mount  
Pulley Dia.: 4-29/32  
Coil Clock: Wire Lead  
Kenworth: F696003121  
Kysor: 1401414  
Peterbilt: F696003121  
Red Dot: 75R89492, 75R89492Q  
Sanden: 4080, 4377

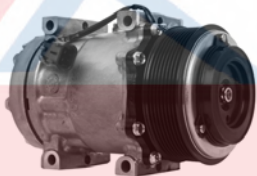

**168528 New**  
SD7H15  
8 Groove  
12 Volt  
Mount: Tangent Mount  
Pulley Dia.: 4-11/16  
Coil Clock: Wire Lead



**168529 New**  
SD7H15  
8 Groove  
12 Volt  
Mount: Tangent Mount  
Pulley Dia.: 4-11/16  
Coil Clock: Wire Lead  
Kysor: 1401394  
Sanden: 4314, 4615



**168530 New**  
SD7H15  
8 Groove  
12 Volt  
Mount: Tangent Mount  
Pulley Dia.: 6-29/32  
Coil Clock: Wire Lead  
Mack: 206RD52M, 206RD53M  
Sanden: 4326, 4326U  
Western Star: 3004736

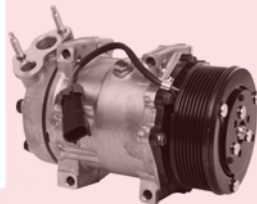

**168531 New**  
SD7H15  
8 Groove  
12 Volt  
Mount: Tangent Mount  
Pulley Dia.: 4-11/16  
Coil Clock: Wire Lead  
Sanden: 4720



**168532 New**  
SD7H15  
10 Groove  
12 Volt  
Mount: Tangent Mount  
Pulley Dia.: 5  
Coil Clock: Wire Lead  
NaviStar: 3811773C1  
Sanden: 4018



**168533 New**  
SD7H15  
12 Groove  
12 Volt  
Mount: Tangent Mount  
Pulley Dia.: 4-61/64  
Coil Clock: Wire Lead  
NaviStar: 38174741C1  
Sanden: 4675



**168534 New**  
SD7H15  
8 Groove  
12 Volt  
Mount: Tangent Mount  
Pulley Dia.: 5-1/4  
Coil Clock: Wire Lead  
John Deere: RE68372  
Sanden: 4698



**168537 New**  
SD7H15  
8 Groove  
12 Volt  
Mount: Tangent Mount  
Pulley Dia.: 4-11/16  
Coil Clock: Wire Lead  
Kenworth: F696003112  
Kysor: 1401417  
Sanden: 4081, 4398

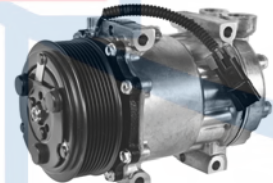

**168538 New**  
SD7H15  
8 Groove  
12 Volt  
Mount: Tangent Mount  
Pulley Dia.: 4-11/16  
Coil Clock: Wire Lead  
Sanden: 4307  
Western Star: SKI4307

# Compressors

## Sanden Cont'd



**168539** New  
SD7H15  
10 Groove  
12 Volt  
Switch: No Speed Sensor  
Mount: Tangent Mount  
Pulley Dia.: 4-23/32  
Coil Clock: Wire Lead  
Kysor: 1401422  
NaviStar: 3611894C91  
Sanden: 4347



**168540** New  
SD7H15  
8 Groove  
12 Volt  
Mount: Tangent Mount  
Pulley Dia.: 4-11/16  
Coil Clock: Wire Lead  
General Motors Corp: 19130041  
Sanden: 4334, 4400, 4465, 4547

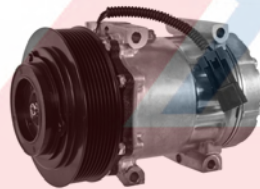

**168541** New  
SD7H15  
8 Groove  
12 Volt  
Switch: No Speed Sensor  
Mount: Tangent Mount  
Pulley Dia.: 5-1/2  
Coil Clock: Wire Lead  
Kysor: 1401396  
Sanden: 4082, 4543  
Western Star: SKI4543S



**168582** New  
SD7H15  
8 Groove  
12 Volt  
Mount: Tangent Mount  
Pulley Dia.: 4-11/16  
Coil Clock: Wire Lead  
Kysor: 1410088  
NaviStar: 3582435C1  
Sanden: 4418  
Western Star: 3004388

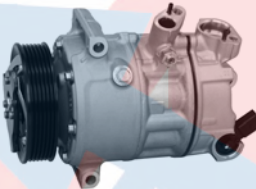

**168646** New  
**167646** Reman  
**67646** Reman - DCS17E  
PXE16  
6 Groove  
12 Volt  
Mount: Tangent Mount  
Pulley Dia.: 4-5/16  
Coil Clock: N/R  
Audi (13-10), (08); VW (14-09)  
Audi: 5K0820803  
Volkswagen: 1K0820808F, 1K0820859S,  
5C0820803C, 5C0820803G  
Sanden: 4569, 4571, 4573

**198553** New  
**97553** Reman  
TRSA090  
5 Groove  
12 Volt  
Mount: Direct Mount  
Pulley Dia.: 4-11/16  
Coil Clock: Wire Lead  
Honda (06-00)  
Sanden: 3603



**198567** New  
**197567** Reman  
**97567** Reman - PXV16  
PXE16  
10 Groove  
12 Volt  
Mount: Tangent Mount  
Pulley Dia.: 4-3/8  
Coil Clock: Wire Lead  
Audi (13-12); VW (14-05)  
Audi: 1K0820808G  
Volkswagen: 1K0820808G  
Sanden: 1616

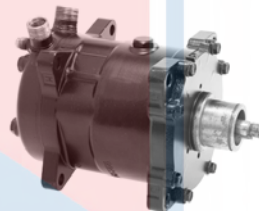

**57081** Reman  
SD508  
Does Not Include Service Fittings  
Coil Less  
Mount: Ear Mount  
Ford (87-85); Jeep (90-81); Mercury  
(89-85)

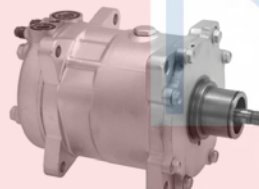

**57082** Reman  
SD508  
Coil Less  
Mount: Ear Mount  
AMC (83-82); Mazda (85-83); Renault  
(87-83)  
AMC: 8134182, 8983501450



**57083** Reman  
SD508  
Coil Less  
Mount: Ear Mount  
AMC (88-79); Chrysler (86-80); Dodge  
(85-78); Jeep (86-80); Mazda (83-72);  
Plymouth (85-78); Porsche (78);  
Subaru (81-80); VW (81-79)  
Volkswagen: 321820804  
Allis Chalmers: 2084709  
AMC: 8131196, 8132866



**57508** Reman  
SD508  
10 Groove  
12 Volt  
Mount: Ear Mount  
Pulley Dia.: 5  
Coil Clock: Wire Lead  
New Clutch Assy: **47995**  
Reman Compr w/o Clutch: **57082**  
Mazda (85-83)



**57558** Reman  
SD7H15  
Coil Less  
Mount: Tangent Mount  
Dodge (02-94)



# Compressors

## Sanden Cont'd



**57560 Reman**  
SD709  
1 Groove  
12 Volt  
Switch: High Pressure  
Mount: Tangent Mount  
Belt Width: 1/2  
Pulley Dia.: 5-1/2  
Coil Clock: Wire Lead  
Hyundai (95-90); Mitsubishi (94-90)  
Hyundai: 9770124A00

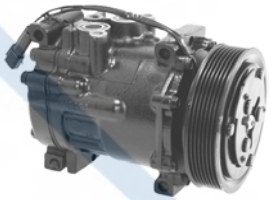

**57562 Reman**  
SDB709  
7 Groove  
12 Volt  
Mount: Tangent Mount  
Pulley Dia.: 5-5/8  
Coil Clock: Wire Lead  
Dodge (93-91)  
Chrysler: 55035703

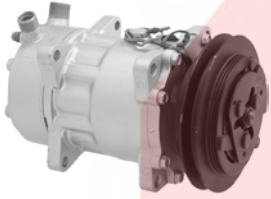

**57563 Reman**  
SD709  
1 Groove  
12 Volt  
Switch: High Pressure  
Mount: Ear Mount  
Belt Width: 1/2  
Pulley Dia.: 5-1/2  
Coil Clock: Wire Lead  
Hyundai (89-86)  
Hyundai: 9770121251

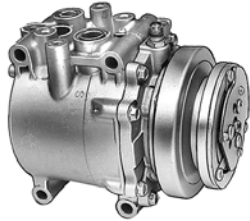

**57571 Reman**  
TR70  
1 Groove  
12 Volt  
Mount: Tangent Mount  
Belt Width: 7/16  
Pulley Dia.: 3-3/4  
Coil Clock: Wire Lead  
Honda (86-84)

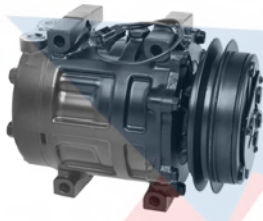

**57574 Reman**  
SD708  
1 Groove  
12 Volt  
Mount: Tangent Mount  
Belt Width: 1/2  
Pulley Dia.: 5  
Coil Clock: Wire Lead  
Mazda (90-86)



**57575 Reman**  
SD708  
1 Groove  
12 Volt  
Mount: Tangent Mount  
Belt Width: 1/2  
Pulley Dia.: 5  
Coil Clock: Wire Lead  
Mazda (93-89)  
Mazda: UE3861450



**57577 Reman**  
SD507  
2 Groove  
12 Volt  
Mount: Ear Mount  
Belt Width: 1/2  
Pulley Dia.: 5-1/4  
Coil Clock: Wire Lead  
Mazda (85-82)  
Mazda: 000067D00B3F



**57579 Reman**  
SD708  
6 Groove  
12 Volt  
Mount: Tangent Mount  
Pulley Dia.: 5  
Coil Clock: Wire Lead  
Ford (94-91); Mercury (94-91)



**57583 Reman**  
SD708  
1 Groove  
12 Volt  
Mount: Ear Mount  
Belt Width: 1/2  
Pulley Dia.: 5  
Coil Clock: Wire Lead  
Mazda (88-87)



**57584 Reman**  
SD708  
1 Groove  
12 Volt  
Mount: Ear Mount  
Belt Width: 1/2  
Pulley Dia.: 5  
Coil Clock: Wire Lead  
Mazda (90-87)



**57585 Reman**  
SD508  
1 Groove  
12 Volt  
Mount: Ear Mount  
Belt Width: 7/16  
Pulley Dia.: 5  
Coil Clock: Wire Lead  
Mazda (89-86)



**57586 Reman**  
SD510  
1 Groove  
12 Volt  
Mount: Ear Mount  
Belt Width: 1/2  
Pulley Dia.: 5-1/2  
Coil Clock: Wire Lead  
Jaguar (91-85)

# Compressors

## Sanden Cont'd



**57594 Reman**  
SD508  
2 Groove  
12 Volt  
Mount: Ear Mount  
Belt Width: 1/2  
Pulley Dia.: 5-1/4  
Coil Clock: Wire Lead  
VW (87-86)  
Volkswagen: 255272806A

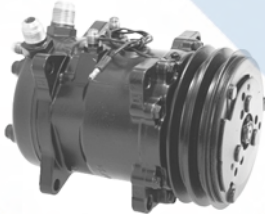

**57622 Reman**  
SD507  
2 Groove  
12 Volt  
Mount: Ear Mount  
Belt Width: 1/2  
Pulley Dia.: 5-1/4  
Coil Clock: Wire Lead  
Hyundai (89-87); Mitsubishi (89-87)  
Hyundai: 9770131010

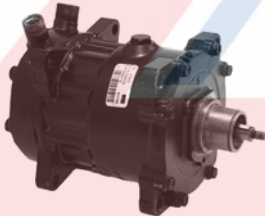

**57630 Reman**  
SD709  
Coil Less  
Mount: Ear Mount  
Ford (97-87)  
Red Dot: 75R84452



**57636 Reman**  
TRF090  
Coil Less  
Switch: Heat Sensor  
Mount: Tangent Mount  
Honda (93-92)  
Honda: 38810P06A03

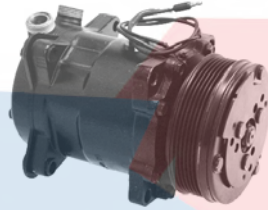

**57658 Reman**  
SD508  
6 Groove  
12 Volt  
Mount: Ear Mount  
Pulley Dia.: 4-3/4  
Coil Clock: Wire Lead  
New Clutch Assy: **47330**  
New Compr w/o Clutch: **58046**  
Reman Compr w/o Clutch: **57046**  
AMC (83-80); Jeep (90-88), (86-81)  
AMC: 3728152

## CAUTION

DO NOT use compressed air to blow out refrigerant hoses or other components on vehicles equipped with R134a systems. Tests have shown compressed air and R134a together can be explosive.



**58033 New**  
**57033 Reman**  
**57511 Reman - TM15HD**

SD508  
2 Groove  
12 Volt  
Mount: Ear Mount  
Belt Width: 1/2  
Pulley Dia.: 5-1/4  
Coil Clock: Wire Lead  
New Clutch Assy: **47586**  
Reman Compr w/o Clutch: **57083**  
Alfa Romeo (89-82); Mazda (83-71);  
Porsche (78-77); Renault (86-85);  
Subaru (82-81); VW (81-79)  
Bergstrom: 525722  
Climatech: LE1040  
Dallas Truck AC: 0105012  
Euclid: E801109  
Kysor: 1401004, 1403005, 402787  
Mack: 07007099, 4379RD551990  
NaviStar: 14193  
Northern: 500244  
Red Dot: 75R8282  
Renault: 7700724191  
Sanden: 8390  
Steiger: 13769

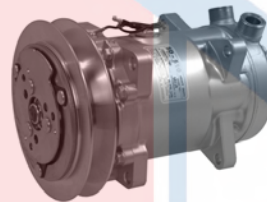

**58034 New**  
**57034 Reman**  
SD510HD  
1 Groove  
12 Volt  
Mount: Ear Mount  
Belt Width: 3/4  
Pulley Dia.: 6-1/4  
Coil Clock: Wire Lead  
Bergstrom: 525725, 525726, 575725,  
606101  
Climatech: LE1030, LE1130, LE1200  
Dallas Truck AC: 0105119, 0105511,  
0105513  
Euclid: E801124, E801161  
Kysor: 1401009, 1401024, 1401104,  
402630  
Mack: 4379RD552000  
NaviStar: 11041, 19319  
Red Dot: 75R8222, 75R8252  
Sanden: 8478, 9119, 9628, 9680



**58035 New**  
**57035 Reman**  
SD510HD  
2 Groove  
12 Volt  
Mount: Ear Mount  
Belt Width: 1/2  
Pulley Dia.: 5-1/4  
Coil Clock: Wire Lead  
Climatech: AB1925, LE1060  
Dallas Truck AC: 0105013, 0105509  
Euclid: E801133  
Evans: AM80413  
Kysor: 1401006, 402596, 402837  
Mack: 206RD47A, 4379RD561640  
Massey Ferguson: D45070015  
NaviStar: 19823  
Northern: 500318  
Red Dot: 75R8202, 75R8262  
Sanden: 8353, 9103



**58046 New**  
**57046 Reman**  
SD508  
Pulley Not Included  
Coil Less  
Mount: Ear Mount  
AMC (88-80); Jeep (90-81); Renault  
(87-83)  
AMC: 8133449  
Sanden: 90053, 95643  
Steiger: 21796

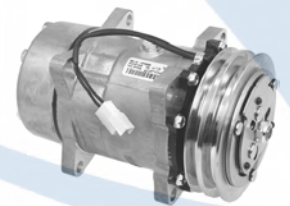

**58113 New**  
**57113 Reman**  
SD508  
2 Groove  
12 Volt  
Mount: Ear Mount  
Belt Width: 3/8  
Pulley Dia.: 5-1/8  
Coil Clock: Wire Lead  
VW (93-85)  
Volkswagen: 191820803A  
Sanden: 9288, 9533

# Compressors

## Sanden Cont'd



**58507 New**  
SD510HD  
2 Groove  
12 Volt  
Mount: Ear Mount  
Belt Width: 1/2  
Pulley Dia.: 5-1/8  
Coil Clock: Wire Lead  
Volvo (86-82)  
Volvo: 3513598  
Carrier: 501200A  
Climatech: LE1000, LE1055  
Kysor: 402810  
Mack: 206RD45, 206RD45A,  
206RD48AM, 25164625,  
4379RD5113480, 4379RD554430  
Massey Ferguson: 690711M1  
NaviStar: 544929C1, 705024  
Northern: 500450  
Sanden: 5424, 5742, 9108, 9120, 9139,  
9677, 9694

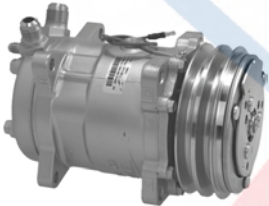

**58541 New**  
SD508  
2 Groove  
12 Volt  
Mount: Ear Mount  
Belt Width: 1/2  
Pulley Dia.: 4-7/8  
Coil Clock: Wire Lead  
Freightliner (94-92)  
Kysor: 402793  
Sanden: 8399

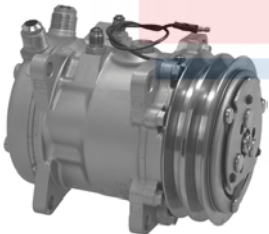

**58542 New**  
SD505  
2 Groove  
12 Volt  
Mount: Ear Mount  
Pulley Dia.: 4-7/8  
Coil Clock: Wire Lead  
Freightliner (94-92)  
Sanden: 9056



**58545 New**  
SD510HD  
2 Groove  
24 Volt  
Mount: Ear Mount  
Belt Width: 1/2  
Pulley Dia.: 5-1/8  
Coil Clock: Wire Lead  
Dallas Truck AC: 0105105  
Euclid: E801132  
Kysor: 1401007, 402597  
NaviStar: 13504  
Sanden: 9105

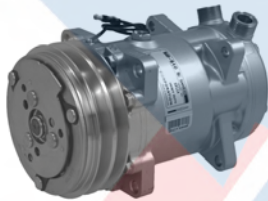

**58546 New**  
SD510HD  
6 Groove  
12 Volt  
Mount: Ear Mount  
Belt Width: 1/2  
Pulley Dia.: 5-5/8  
Coil Clock: Wire Lead  
Climatech: LE1065  
Euclid: E801126, E801173  
Kysor: 1401008  
Northern: 500496  
Sanden: 9114

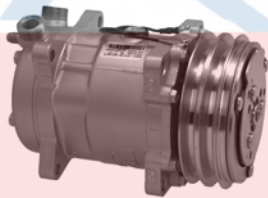

**58547 New**  
**57547 Reman**  
SD508HD  
2 Groove  
12 Volt  
Mount: Ear Mount  
Belt Width: 1/2  
Pulley Dia.: 5-1/4  
Coil Clock: Wire Lead  
Jeep (86-84); Renault (87-85)  
Dallas Truck AC: 0105525  
Euclid: E801112  
Northern: 500965, 5041443  
Sanden: 9263



**58548 New**  
SD508  
2 Groove  
12 Volt  
Mount: Ear Mount  
Belt Width: 1/2  
Pulley Dia.: 5-1/8  
Coil Clock: Wire Lead  
Case New Holland: 89508380  
Dallas Truck AC: 0105125  
Euclid: E801103, E801150  
Mack: 4379RD575480  
Red Dot: 75R8312  
Sanden: 4513, 5728, 6631, 9264

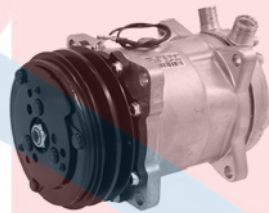

**58551 New**  
**57551 Reman**  
SD508  
2 Groove  
12 Volt  
Mount: Ear Mount  
Belt Width: 1/2  
Pulley Dia.: 5-1/4  
Coil Clock: Wire Lead  
Freightliner (94-92); Jeep (91-85);  
Mercury (89-87); Saab (88-86)  
Saab: 4319992  
Bergstrom: 304022, 525688, 525689,  
525732, 525759  
Climatech: LC1160, LE1015, LE1050,  
LE1215  
Dallas Truck AC: 0105285  
Diesel Kiki: 5060111720  
Kenworth: 48823069  
Kysor: 1401012, 1401015, 1403012,  
402766  
Mack: 4379RD555750, 5428E,  
7979402534  
NaviStar: 11065, 16653, 19294, 705002  
Northern: 500270  
Peterbilt: 48823069  
Red Dot: 75R8292, 75R8512  
Sanden: 5428, 5429, 8482, 9285



**58552 New**  
**57552 Reman**  
SD709  
12 Volt  
2 Groove  
12 Volt  
Mount: Ear Mount  
Belt Width: 1/2  
Pulley Dia.: 4-7/8  
Coil Clock: Wire Lead  
Chevy (91-86); GMC (91-86)  
Sanden: 4680, 7402, 7819



**58553 New**  
**57553 Reman**  
SD7H15  
7 Groove  
12 Volt  
Mount: Tangent Mount  
Pulley Dia.: 5-1/8  
Coil Clock: Wire Lead  
Dodge (02-94)  
Chrysler: 55055540AC, 55055802AD,  
RL055540AM  
Sanden: 4359, 4360, 4605, 4683, 4692,  
4723, 4725, 4748, 4749, 4771, 4773,  
4774, 4782, 4783, 4785, 4788, 4794,  
4797, 4832, 4833, 4834, 4842, 4845,  
4846, 4887

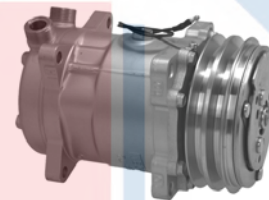

**58554 New**  
SD508HD  
2 Groove  
12 Volt  
Mount: Ear Mount  
Belt Width: 1/2  
Pulley Dia.: 5-1/8  
Coil Clock: Wire Lead  
Dallas Truck AC: 0105476  
Euclid: E801104  
Hy-Capacity: 0008819114  
Kysor: 1401016, 402538  
NaviStar: 11068  
Northern: 500676  
Sanden: 9005, 9519, 9588



# Compressors

## Sanden Cont'd



**58555 New**  
**57555 Reman**  
 SD709  
 6 Groove  
 12 Volt  
 Mount: Tangent Mount  
 Pulley Dia.: 4-3/4  
 Coil Clock: Wire Lead  
 Dodge (92-90); Eagle (92-88); Jeep (03-97)  
 Sanden: 7413, 7444



**58556 New**  
**57556 Reman**  
 TRF105  
 7 Groove  
 12 Volt  
 Switch: Heat Sensor  
 Mount: Tangent Mount  
 Pulley Dia.: 3-3/4  
 Coil Clock: Wire Lead  
 Dodge (97-92)  
 Sanden: 2214, 3201, 3210

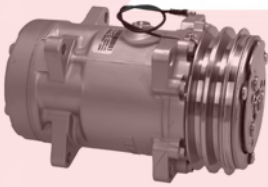

**58557 New**  
 SD510  
 2 Groove  
 12 Volt  
 Mount: Ear Mount  
 Belt Width: 1/2  
 Pulley Dia.: 5-1/8  
 Coil Clock: Wire Lead  
 Dallas Truck AC: 0105689  
 Euclid: E801129  
 Hy-Capacity: 0008817952, H8814708  
 Kysor: 1401025, 402771  
 Massey Ferguson: 1688310M1  
 Northern: 500427  
 Sanden: 9689

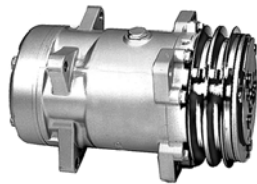

**58559 New**  
**57559 Reman**  
 SD510HD  
 2 Groove  
 12 Volt  
 Mount: Ear Mount  
 Belt Width: 1/2  
 Pulley Dia.: 5-1/8  
 Coil Clock: Wire Lead  
 Chevy (91), (89-86); GMC (91-86); Peugeot (91-80)  
 Hy-Capacity: 0008819125  
 Northern: 5004040  
 Peugeot: 6455A5, 6455A9  
 Red Dot: 75R8242  
 Sanden: 5740, 9125

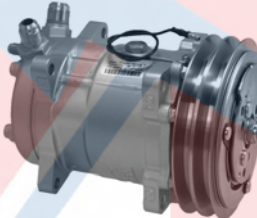

**58561 New**  
 SD508  
 2 Groove  
 12 Volt  
 Mount: Ear Mount  
 Belt Width: 1/2  
 Pulley Dia.: 6  
 Coil Clock: Wire Lead  
 Deutz: 04363723, 4363723  
 Northern: 500243  
 Sanden: 8387

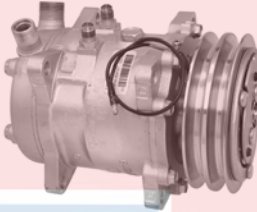

**58567 New**  
 SD507  
 2 Groove  
 12 Volt  
 Mount: Ear Mount  
 Belt Width: 1/2  
 Pulley Dia.: 4-7/8  
 Coil Clock: Wire Lead  
 Honda (84)  
 Sanden: 5104, 6321



**58568 New**  
 SD507  
 2 Groove  
 12 Volt  
 Mount: Ear Mount  
 Belt Width: 1/2  
 Pulley Dia.: 4-7/8  
 Coil Clock: Wire Lead  
 Alfa Romeo (89-82); Honda (84)  
 Alfa Romeo: 60522419  
 Sanden: 9173

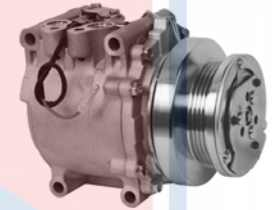

**58570 New**  
**57570 Reman**  
 TR70  
 4 Groove  
 12 Volt  
 Mount: Tangent Mount  
 Pulley Dia.: 3-1/2  
 Coil Clock: Wire Lead  
 Honda (91-87)  
 Honda: 38810PM5S01

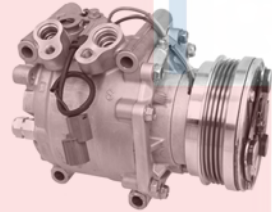

**58572 New**  
**57572 Reman**  
 TRF090  
 4 Groove  
 12 Volt  
 Switch: Temp Switch  
 Mount: Tangent Mount  
 Pulley Dia.: 3-3/4  
 Coil Clock: Wire Lead  
 Honda (93-92)  
 Sanden: 2050, 2051, 2054



**58578 New**  
**57578 Reman**  
**97380 Reman - 7SBU16C**  
 PXV16  
 6 Groove  
 12 Volt  
 Mount: Tangent Mount  
 Pulley Dia.: 4-3/4  
 Coil Clock: Wire Lead  
 Land Rover (05-02)  
 Land Rover: JPB500130  
 Sanden: 8621



**58580 New**  
**57580 Reman**  
 SD508  
 6 Groove  
 12 Volt  
 Mount: Ear Mount  
 Pulley Dia.: 4-3/4  
 Coil Clock: Wire Lead  
 New Clutch Assy:  
 AMC (88-83); Jeep (90-81); Renault (87-85)  
 Sanden: 7719, 9291, 9564

# Compressors

## Sanden Cont'd



**58581 New**  
**57581 Reman**  
 SD709  
 6 Groove  
 12 Volt  
 Mount: Tangent Mount  
 Pulley Dia.: 4-5/64  
 Coil Clock: Wire Lead  
 New Clutch Assy: **47997**  
 Ford (97-85); Mazda (94-93), (91);  
 Mercury (91-88)  
 Caterpillar: 2329270  
 Dallas Truck AC: 0105416, 0105628  
 Euclid: E801140, E801170  
 Kysor: 1401335, 1491001, 402788,  
 402840  
 Mack: 4379RD5102900  
 NaviStar: 15778  
 Red Dot: 75R8302, 75R84512  
 Sanden: 4628, 7501, 8105



**58582 New**  
**57582 Reman**  
**77544 Reman**  
 TRS090  
 6 Groove  
 12 Volt  
 Switch: High Temp  
 Mount: Tangent Mount  
 Pulley Dia.: 4  
 Coil Clock: Wire Lead  
 Chrysler (02-95); Dodge (05-95);  
 Plymouth (00-96)  
 Chrysler: 5069028AA, RL016695AA  
 Sanden: 3006, 4590, 4954, 4960, 4961,  
 4962, 4963, 4964, 4975



**58587 New**  
 SD508  
 2 Groove  
 12 Volt  
 Mount: Ear Mount  
 Belt Width: 1/2  
 Pulley Dia.: 5-1/8  
 Coil Clock: Wire Lead  
 Dallas Truck AC: 0105764  
 Euclid: E801141, E801168, E801182  
 Kysor: 1401013, 402558  
 Sanden: 4525, 9205, 9505



**58588 New**  
 SD508  
 2 Groove  
 12 Volt  
 Mount: Ear Mount  
 Belt Width: 1/2  
 Pulley Dia.: 5-1/8  
 Coil Clock: Wire Lead  
 Euclid: E801102  
 Kysor: 1401019, 402770  
 NaviStar: 705000  
 Sanden: 9563

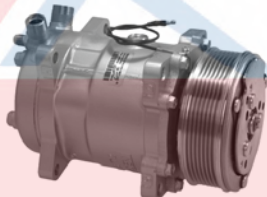

**58589 New**  
 SD508  
 7 Groove  
 12 Volt  
 Mount: Ear Mount  
 Pulley Dia.: 4-3/4  
 Coil Clock: Wire Lead  
 Freightliner (94-92)  
 Bergstrom: 525915  
 Climatech: LE1090  
 Euclid: E801101  
 Kysor: 1401017, 402792  
 Mack: 4379RD556960  
 Red Dot: 75R8272  
 Sanden: 9537



**58590 New**  
 SD510  
 2 Groove  
 12 Volt  
 Mount: Ear Mount  
 Belt Width: 1/2  
 Pulley Dia.: 5-1/4  
 Coil Clock: Wire Lead  
 Dallas Truck AC: 0105652, 0105674  
 Euclid: E801180  
 Kysor: 1401022, 402806  
 Red Dot: 75R8214  
 Sanden: 9674

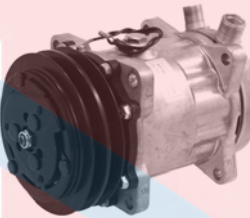

**58591 New**  
 SD5H14  
 2 Groove  
 12 Volt  
 Mount: Ear Mount  
 Belt Width: 1/2  
 Pulley Dia.: 4-5/8  
 Coil Clock: Wire Lead  
 Bergstrom: 525692  
 Climatech: LE1115, LE1245, LE1260  
 Dallas Truck AC: 0105664  
 Euclid: E801163, E801174  
 Kysor: 1401102, 1401103, 1401115,  
 1401331, 1401343, 1401383  
 Massey Ferguson: D45080062  
 NaviStar: 13503, 705007  
 Red Dot: 75R8382, 75R84612  
 Sanden: 4509, 4510, 4662, 6664, 8404  
 Western Star: 3004214



**58592 New**  
 SD5H14  
 7 Groove  
 12 Volt  
 Mount: Ear Mount  
 Pulley Dia.: 4-5/8  
 Coil Clock: Wire Lead  
 Climatech: LE1020  
 Dallas Truck AC: 0104514  
 Euclid: E801120, E801151  
 Kysor: 402845  
 NaviStar: 19258, 19297  
 Red Dot: 75R83172, 75R84572  
 Sanden: 4323, 4514, 5748, 6629, 9663

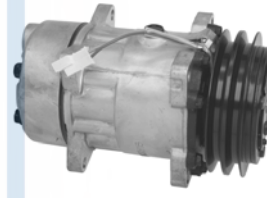

**58593 New**  
**57593 Reman**  
 SD709  
 2 Groove  
 12 Volt  
 Mount: Ear Mount  
 Belt Width: 1/2  
 Pulley Dia.: 5-1/4  
 Coil Clock: Wire Lead  
 VW (91-85)  
 Volkswagen: 253260797A  
 Sanden: 7411

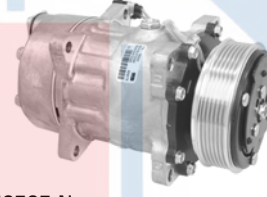

**58595 New**  
**57595 Reman**  
 SD7H15  
 6 Groove  
 12 Volt  
 Mount: Ear Mount  
 Pulley Dia.: 4-3/4  
 Coil Clock: Wire Lead  
 VW (95-93)  
 Sanden: 7820

# Compressors

## Sanden Cont'd



**58596 New**  
SD7H15  
6 Groove  
12 Volt  
Mount: Tangent Mount  
Pulley Dia.: 5-7/64  
Coil Clock: Wire Lead  
Kysor: 1402049  
Red Dot: 75R81372, RD5112570  
Sanden: 4085, 4285

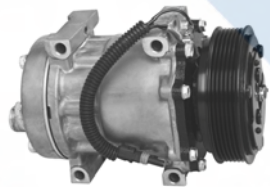

**58632 New**  
**57632 Reman**  
SD709  
6 Groove  
12 Volt  
Mount: Tangent Mount  
Pulley Dia.: 4-11/16  
Coil Clock: Wire Lead  
Jeep (95-91)  
Jeep: 56004354  
Sanden: 4649, 7701, 7712

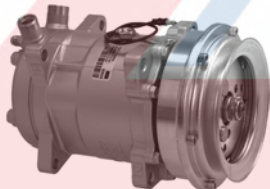

**58638 New**  
SD508  
1 Groove  
12 Volt  
Mount: Ear Mount  
Pulley Dia.: 5  
Coil Clock: Wire Lead  
Freightliner (94-92)  
Bergstrom: 304032, 525695, 525696  
Climatech: LE1005, LE1025, LE1045, LE1125  
Dallas Truck AC: 015514A  
Euclid: E801105, E801183  
Kysor: 1401014, 1401332, 402753  
Mack: 4379RD556840, 4379RD599850  
NaviStar: 19778, A95830  
Red Dot: 75R8322, 75R8342  
Sanden: 4530, 6674, 9514, 9583



**58640 New**  
SD510HD  
1 Groove  
12 Volt  
Mount: Ear Mount  
Belt Width: 3/4  
Pulley Dia.: 6-1/4  
Coil Clock: Wire Lead  
Freightliner (94-92)  
Climatech: LE1205, LE1240  
Euclid: E801111, E801130  
Kysor: 1401023  
Red Dot: 75R8232, 75R8362  
Sanden: 9675

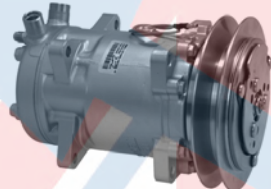

**58641 New**  
SD510HD  
1 Groove  
24 Volt  
Mount: Ear Mount  
Pulley Dia.: 6-1/4  
Coil Clock: Wire Lead  
Climatech: LE1120  
Dallas Truck AC: 0105122, 0105680  
Euclid: E801113, E801131  
Kysor: 1401020  
Mack: 4379RD556280  
NaviStar: 11042  
Red Dot: 75R8234  
Sanden: 9568, 9676



**58642 New**  
SD7H15  
2 Groove  
12 Volt  
Mount: Ear Mount  
Belt Width: 1/2  
Pulley Dia.: 5-1/8  
Coil Clock: Wire Lead  
Freightliner (06-96)  
Euclid: E801178  
Kysor: 1401367  
Red Dot: 75R84532  
Sanden: 4617



**58646 New**  
SD5H14  
1 Groove  
12 Volt  
Mount: Ear Mount  
Belt Width: 3/4  
Pulley Dia.: 6-1/4  
Coil Clock: Wire Lead  
Climatech: LE1010, LE1210  
Dallas Truck AC: 0105515  
Euclid: E801162, E801181  
Mack: 4379RD570900  
Red Dot: 75R8372  
Sanden: 4515, 4528, 5747, 6673, 6681

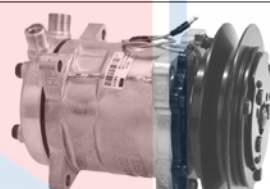

**58649 New**  
SD5H14  
1 Groove  
24 Volt  
Mount: Ear Mount  
Belt Width: 3/4  
Pulley Dia.: 6-1/8  
Coil Clock: Wire Lead  
Climatech: LE1270  
Dallas Truck AC: 0105516, 0145024  
Euclid: E801165, E801185  
Kysor: 1401140  
Mack: 4379RD570910  
Red Dot: 75R8374  
Sanden: 4516, 4533, 6672, 9696

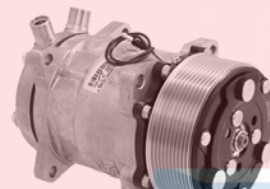

**58650 New**  
SD5H14  
10 Groove  
12 Volt  
Mount: Ear Mount  
Pulley Dia.: 4-7/8  
Coil Clock: Wire Lead  
Climatech: LE1080  
Dallas Truck AC: 0105508, 0109415  
Euclid: E801160  
Kysor: 1401101, 402844  
Red Dot: 75R83152  
Sanden: 4508, 5749, 6656



**58666 New**  
SD5H14  
2 Groove  
24 Volt  
Mount: Ear Mount  
Belt Width: 1/2  
Pulley Dia.: 5-1/8  
Coil Clock: Wire Lead  
Climatech: LE1235, LE1265  
Dallas Truck AC: 0105506  
Euclid: E801110, E801164  
Kysor: 1401100, 1401113, 1401336, 1410062, 402842, 402843  
Mack: 4379RD571240  
Red Dot: 75R8294, 75R8384, 75R8424  
Sanden: 4271, 4506, 4507, 4652, 5407



**58700 New**  
SD7H15  
2 Groove  
12 Volt  
Mount: Ear Mount  
Belt Width: 1/2  
Pulley Dia.: 4-7/8  
Coil Clock: Wire Lead  
Bergstrom: 525723  
Carrier: 180009300  
Caterpillar: 2329275  
Climatech: LE1145, LE1150  
Dallas Truck AC: 0105120, 0105627  
Euclid: E801177  
Kysor: 1401010, 1401108, 1401116, 1410014, 1410029, 402838  
Mack: 4379RD5102950, 4379RD5113470, 4379RD571200  
Massey Ferguson: 1690711M1  
NaviStar: 16315, 1691745C91, 19296, 2003413C91, 2602742C91, 544929C1  
Peterbilt: LE1145  
Red Dot: 75R8212, 75R8422  
Sanden: 4627, 4663, 9515



# Compressors

## Sanden Cont'd



### 58701 New

SD7H15  
2 Groove  
12 Volt  
Mount: Ear Mount  
Belt Width: 1/2  
Pulley Dia.: 5-1/8  
Coil Clock: Wire Lead  
Bergstrom: 525691, 525694  
Climatech: LE1135, LE1640  
Euclid: E801176  
Kysor: 1401112, 1410016, 1410070, 402051  
Mack: 206RD413M, 25157790, 4379RD570880P, 85130015  
NaviStar: 19730  
Peterbilt: 1803787, 1804088  
Sanden: 4639, 4644, 4647, 4664, 4674, 8017  
TRP Parts: LE1620  
Western Star: 3004426



### 58702 New

SD7H15  
8 Groove  
12 Volt  
Mount: Tangent Mount  
Pulley Dia.: 4-3/4  
Coil Clock: Wire Lead  
Ford: 4C4Z19703A  
Bergstrom: 525997  
Carrier: 501298  
Caterpillar: 2329267  
Climatech: LE1085  
Kysor: 1401117, 1401371, 1410041, 402876  
Mack: 4379RD5102850, 4379RD5113260  
NaviStar: 3579878C1, 705016  
Peterbilt: LE1085  
Red Dot: 75R84472  
Sanden: 4666, 4667, 4823



### 58703 New

SD7H15  
8 Groove  
12 Volt  
Mount: Ear Mount  
Pulley Dia.: 4-3/4  
Coil Clock: Wire Lead  
Freightliner (06-96), (94-92)  
Kysor: 1401120, 1410006  
Mack: 4379RD5112470  
NaviStar: 705013  
Red Dot: 75R84162  
Sanden: 4431, 4477, 4734

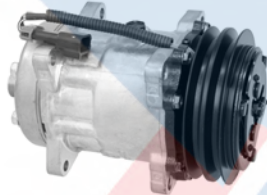

### 58704 New

SD7H15  
2 Groove  
12 Volt  
Mount: Ear Mount  
Belt Width: 1/2  
Pulley Dia.: 5-1/8  
Coil Clock: Wire Lead  
Freightliner (06-96)  
Caterpillar: 2329244  
Climatech: LE1305  
Kysor: 1410005  
Mack: 4379RD5102630  
Red Dot: 75R84172  
Sanden: 4471, 4735

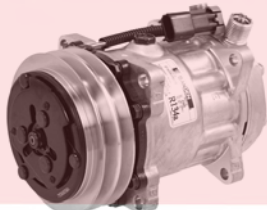

### 58705 New

SD7H15  
2 Groove  
12 Volt  
Mount: Ear Mount  
Belt Width: 1/2  
Pulley Dia.: 5-1/8  
Coil Clock: Wire Lead  
Caterpillar: 2329245  
Kysor: 1401122, 1410008  
Mack: 4379RD5102640  
NaviStar: 705011  
Red Dot: 75R84182  
Sanden: 4488, 4736



### 58706 New

SD7H15  
8 Groove  
12 Volt  
Mount: Ear Mount  
Pulley Dia.: 4-3/4  
Coil Clock: Wire Lead  
Kysor: 1401374  
Sanden: 4781

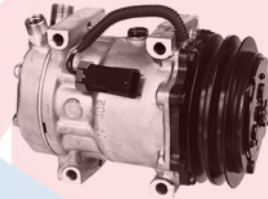

### 58707 New

SD7H15  
2 Groove  
12 Volt  
Mount: Tangent Mount  
Belt Width: 1/2  
Pulley Dia.: 5-1/4  
Coil Clock: Wire Lead  
Freightliner (06-96)  
Caterpillar: 2329246  
Kenworth: F691002  
Kysor: 1401121, 1401125, 1410018  
Mack: 4379RD5102650  
NaviStar: 481813C1, 705012, 705015, ZGG14513  
Red Dot: 75R84192, RD5102650P, RD5113300P  
Sanden: 4491, 4695, 4699, 4752, 4894  
TRP Parts: LE16650



### 58708 New

SD7H15  
6 Groove  
12 Volt  
Mount: Tangent Mount  
Pulley Dia.: 4-7/8  
Coil Clock: Wire Lead  
Freightliner (06-96), (94-92)  
Caterpillar: 2329247  
Kysor: 1401119, 1401126  
Mack: 4379RD5102660  
NaviStar: 705014  
Red Dot: 75R84212  
Sanden: 4475, 4756



### 58709 New

SD7H15  
6 Groove  
12 Volt  
Mount: Tangent Mount  
Pulley Dia.: 4-7/8  
Coil Clock: Wire Lead  
Kysor: 1401127  
Mack: 4379RD5112540  
NaviStar: 3541235C91, 705017  
Sanden: 4492, 4761



### 58710 New

SD7H15  
8 Groove  
12 Volt  
Mount: Tangent Mount  
Pulley Dia.: 4-3/4  
Coil Clock: Wire Lead  
Freightliner (06-96)  
Kysor: 1401130  
NaviStar: 705022  
Red Dot: 75R84232  
Sanden: 4885

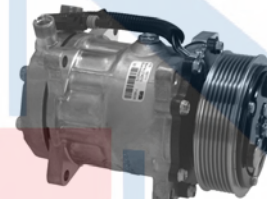

### 58711 New

SD7H15  
7 Groove  
12 Volt  
Mount: Ear Mount  
Pulley Dia.: 4-3/4  
Coil Clock: Wire Lead  
Euclid: E801175  
Kysor: 1401110, 1401330, 402853  
Mack: 4379RD5113130  
NaviStar: 2006413C91, ZGG705130  
Peterbilt: 2003413C91  
Sanden: 4645, 4665, 4687  
Western Star: 2003413691

# Compressors

## Sanden Cont'd



**58740 New**  
SD7H15  
8 Groove  
12 Volt  
Mount: Ear Mount  
Pulley Dia.: 4-5/8  
Coil Clock: Wire Lead  
Freightliner (06-96), (94-92)  
Kysor: 1401340  
Mack: 4379RD5113400  
Sanden: 4820



**58768 New**  
SD7H15  
1 Groove  
24 Volt  
Mount: Ear Mount  
Pulley Dia.: 5-1/2  
Coil Clock: Wire Lead  
Carrier: 1065122  
Caterpillar: 1065122, 3E1906  
Kysor: 1401139, 1410061  
Mack: 4379RD5112400,  
4379RD5112480  
Sanden: 4468, 4479, 4604, 4640, 8107,  
8109, 9684



**58770 New**  
SD7H15  
2 Groove  
12 Volt  
Mount: Ear Mount  
Pulley Dia.: 4-7/8  
Coil Clock: Wire Lead  
Kysor: 1401342, 1410004  
Peterbilt: F696001233  
Sanden: 4433, 4484, 4713, 4740, 4896



**58778 New**  
SD7H15  
8 Groove  
24 Volt  
Mount: Tangent Mount  
Pulley Dia.: 5-1/4  
Coil Clock: Wire Lead  
Carrier: 1630872  
Caterpillar: 1630872  
Mack: 4379RD5112350  
Sanden: 4301, 4769  
Western Star: 3005102

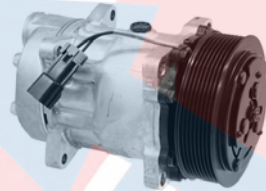

**58779 New**  
SD7H15  
8 Groove  
12 Volt  
Mount: Ear Mount  
Pulley Dia.: 5-1/2  
Coil Clock: Wire Lead  
Kysor: 1401400  
Sanden: 4490, 4716

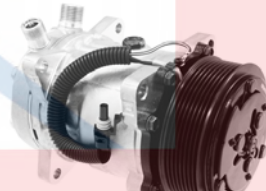

**58780 New**  
SD7H15  
8 Groove  
12 Volt  
Mount: Ear Mount  
Pulley Dia.: 4-5/8  
Coil Clock: Wire Lead  
Kysor: 1401373, 1401385



**58781 New**  
SD7H15  
8 Groove  
24 Volt  
Mount: Ear Mount  
Pulley Dia.: 5-11/64  
Coil Clock: Wire Lead  
Carrier: 1419676, 2180234  
Caterpillar: 1419676, 2180234  
Mack: 4379RD5102600  
Sanden: 4487, 4726  
Western Star: 3005101

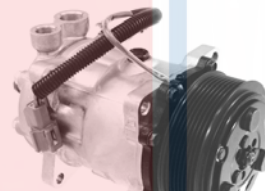

**58782 New**  
SD7H15  
8 Groove  
12 Volt  
Switch: Heat Sensor  
Mount: Ear Mount  
Pulley Dia.: 4-5/8  
Coil Clock: Wire Lead  
Kysor: 1401355, 1401364  
Sanden: 4305, 4427, 4496, 4718

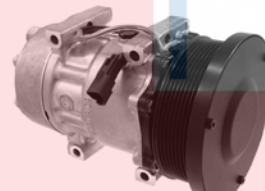

**58783 New**  
SD7H15  
8 Groove  
12 Volt  
Mount: Tangent Mount  
Pulley Dia.: 5-1/4  
Coil Clock: Wire Lead  
Carrier: 1789570  
Caterpillar: 1789570  
Kysor: 1401378  
Mack: 4379RD5112600  
Sanden: 4498, 4813



**58784 New**  
SD7H15  
8 Groove  
12 Volt  
Mount: Tangent Mount  
Pulley Dia.: 4-11/16  
Coil Clock: Wire Lead  
Kysor: 1401338, 1401346, 1410007  
Red Dot: 75R84252  
Sanden: 4417, 4485, 4818



**58785 New**  
SD7H15  
8 Groove  
12 Volt  
Mount: Tangent Mount  
Pulley Dia.: 4-5/8  
Coil Clock: Wire Lead  
Caterpillar: 2329280  
Kysor: 1401133, 1410027  
Mack: 4379RD5107380  
Sanden: 4321, 4822

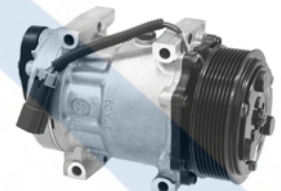

**58786 New**  
SD7H15  
8 Groove  
12 Volt  
Mount: Tangent Mount  
Pulley Dia.: 4-11/16  
Coil Clock: Wire Lead  
Kysor: 1401428, 1410079  
Sanden: 4075, 4352  
Western Star: 3004248

# Compressors

## Sanden Cont'd



**58787 New**  
SD510  
2 Groove  
12 Volt  
Mount: Ear Mount  
Belt Width: 7/16  
Pulley Dia.: 5-11/64  
Coil Clock: Wire Lead  
Freightliner (94-92)



**58788 New**  
SD7H15  
2 Groove  
12 Volt  
Mount: Ear Mount  
Pulley Dia.: 5-3/16  
Coil Clock: Wire Lead  
Freightliner (06-96)  
Caterpillar: 2329252  
Kysor: 1401341, 1401359, 1402040  
Mack: 4379RD5102690,  
4379RD5112430  
Red Dot: 75R84262  
Sanden: 4429, 4472, 4821

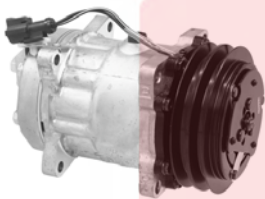

**58789 New**  
SD7H15  
2 Groove  
12 Volt  
Mount: Ear Mount  
Belt Width: 7/16  
Pulley Dia.: 5-1/4  
Coil Clock: Wire Lead  
Kysor: 1401352, 1401365  
Sanden: 4497, 4704



**58790 New**  
SD7H15  
8 Groove  
24 Volt  
Mount: Tangent Mount  
Pulley Dia.: 5-7/8  
Coil Clock: Wire Lead  
NaviStar: 352524A2, 86983968  
Sanden: 4300, 4795



**58791 New**  
SD7H15  
2 Groove  
24 Volt  
Mount: Ear Mount  
Belt Width: 1/2  
Pulley Dia.: 6  
Coil Clock: Wire Lead  
NaviStar: 1999760C2, 86983967  
Sanden: 4489, 4611

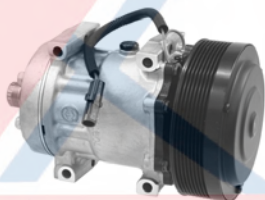

**58792 New**  
SD7H15  
8 Groove  
12 Volt  
Mount: Tangent Mount  
Pulley Dia.: 5-7/8  
Coil Clock: Wire Lead  
NaviStar: 317008A3, 86993463  
Sanden: 4499, 4768  
Western Star: 3004549



**58793 New**  
SD7H15  
8 Groove  
12 Volt  
Mount: Tangent Mount  
Pulley Dia.: 4-11/16  
Coil Clock: Wire Lead  
Kysor: 1401129, 1401353  
Mack: 4379RD5112520  
NaviStar: ZGG705135  
Sanden: 4303, 4422, 4486, 4730, 4767  
Sterling: A2248973000, SKI4422

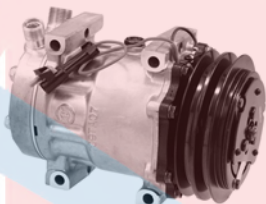

**58794 New**  
SD7H15  
2 Groove  
12 Volt  
Mount: Tangent Mount  
Belt Width: 1/2  
Pulley Dia.: 5-11/64  
Coil Clock: Wire Lead  
Climatech: LE1140  
Euclid: E801172  
Kenworth: F696001153  
Kysor: 1401107, 1401345, 1401376,  
1401381, 1410013  
NaviStar: 19316  
Red Dot: 75R8432  
Sanden: 4626, 4780  
TRP Parts: LE11400  
Western Star: 3004425

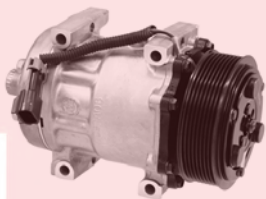

**58796 New**  
SD7H15  
8 Groove  
12 Volt  
Mount: Tangent Mount  
Pulley Dia.: 4-5/8  
Coil Clock: Wire Lead  
Carrier: 180009304  
Caterpillar: 2329249  
Kysor: 1410023  
Mack: 4379RD5102670,  
4379RD5112490  
NaviStar: 2602732C91  
Sanden: 4421, 4482, 4776



**58797 New**  
SD7H15  
6 Groove  
12 Volt  
Mount: Tangent Mount  
Pulley Dia.: 4-13/16  
Coil Clock: Wire Lead  
Freightliner (06-96), (94-92)  
Climatech: LE1695  
Kysor: 1401339, 1401360, 1410026  
Mack: 4379RD5112440,  
4379RD5113390  
NaviStar: 2602733C91  
Red Dot: 75R81602  
Sanden: 4430, 4473, 4819  
Western Star: 3004247



**58798 New**  
SD7H15  
8 Groove  
24 Volt  
Mount: Tangent Mount  
Pulley Dia.: 6  
Coil Clock: Wire Lead  
Carrier: 1835106  
Caterpillar: 1835106  
Mack: 4379RD5112360  
Sanden: 4302, 4840  
Western Star: 3005103

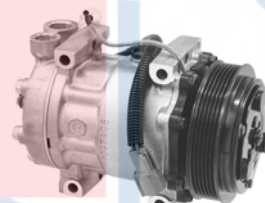

**58799 New**  
SD7H15  
6 Groove  
12 Volt  
Mount: Tangent Mount  
Pulley Dia.: 4-7/8  
Coil Clock: Wire Lead  
Kysor: 1401354, 1401377  
Sanden: 4304, 4423, 4810  
Sterling: SKI4423, SKI8410



# Compressors

## Sanden Cont'd



**67554 Reman**  
TRF090  
4 Groove  
12 Volt  
Switch: Heat Sensor  
Mount: Tangent Mount  
Pulley Dia.: 4-1/2  
Coil Clock: Wire Lead  
Honda (96-92); Hyundai (93-92)



**67571 Reman**  
TR70  
5 Groove  
12 Volt  
Switch: Heat Sensor / Speed Sensor  
Mount: Tangent Mount  
Pulley Dia.: 3-7/8  
Coil Clock: 12  
Honda (91-90)



**68157 New**  
FLX7  
2 Groove  
12 Volt  
Mount: Direct Mount  
Pulley Dia.: 4-59/64  
Coil Clock: Wire Lead  
Carrier: 180009314  
Kysor: 1401200, 1410030  
Mack: 4379RD5110060  
Red Dot: 75R89462  
Sanden: 4419



**68160 New**  
FLX7  
2 Groove  
24 Volt  
Mount: Ear Mount  
Pulley Dia.: 4-59/64  
Coil Clock: Wire Lead  
Carrier: 2409707  
Kysor: 1401204, 1401205  
Mack: 4379RD5108880  
Sanden: 4862, 4863



**67557 Reman**  
SD7H15  
6 Groove  
12 Volt  
Mount: Tangent Mount  
Pulley Dia.: 5-1/4  
Coil Clock: Wire Lead  
Saab (98-94)  
Saab: 30557465, 4635108

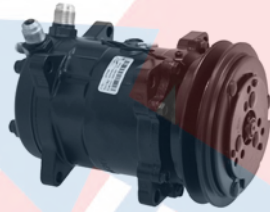

**67598 Reman**  
SD508  
1 Groove  
12 Volt  
Mount: Ear Mount  
Belt Width: 1/2  
Pulley Dia.: 5-1/2  
Coil Clock: Wire Lead  
AMC (88-79); Chrysler (86-80); Dodge (85-78); Jeep (86-82); Plymouth (85-78)

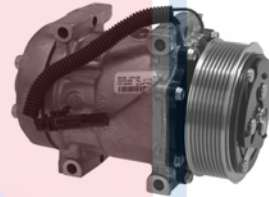

**68158 New**  
FLX7  
8 Groove  
12 Volt  
Mount: Direct Mount  
Pulley Dia.: 4-11/16  
Coil Clock: Wire Lead  
General Motors Corp: 19192968  
Caterpillar: 2409704  
Kysor: 1401201, 1410031  
Mack: 4379RD5108850  
Red Dot: 75R89302  
Sanden: 4420, 4800



**68161 New**  
FLX7  
8 Groove  
12 Volt  
Mount: Ear Mount  
Pulley Dia.: 4-11/16  
Coil Clock: Wire Lead  
Bergstrom: 526374  
Caterpillar: 2409709  
Kysor: 1401206, 1401207  
Mack: 4379RD5108900  
Sanden: 4451, 4707, 4805, 4864, 4865

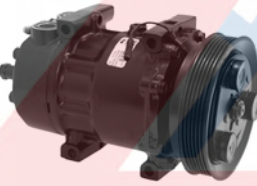

**67558 Reman**  
SD709  
6 Groove  
12 Volt  
Mount: Tangent Mount  
Pulley Dia.: 5-1/4  
Coil Clock: Wire Lead  
Saab (98), (93-91)  
Saab: 30542750

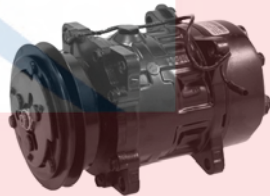

**67599 Reman**  
SD708  
1 Groove  
12 Volt  
Mount: Ear Mount  
Belt Width: 1/2  
Pulley Dia.: 4-7/8  
Coil Clock: Wire Lead  
Mazda (93-90)  
Mazda: UE5461450

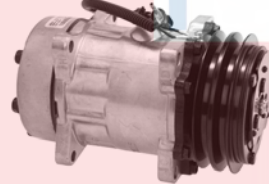

**68159 New**  
FLX7  
2 Groove  
12 Volt  
Mount: Ear Mount  
Pulley Dia.: 4-59/64  
Coil Clock: Wire Lead  
Caterpillar: 2409705  
Kysor: 1401003, 1401202, 1401203  
Mack: 4379RD5108860, 4379RD566250  
Sanden: 4616, 4860, 4861



**68162 New**  
FLX7  
8 Groove  
24 Volt  
Mount: Ear Mount  
Pulley Dia.: 4-11/16  
Coil Clock: Wire Lead  
Caterpillar: 2409711  
Kysor: 1401208, 1401209  
Mack: 4379RD5108920  
Sanden: 4866, 4867

# Compressors

## Sanden Cont'd



**68163 New**  
 FLX7  
 1 Groove  
 12 Volt  
 Mount: Ear Mount  
 Pulley Dia.: 6-7/32  
 Coil Clock: Wire Lead  
 Caterpillar: 2409712  
 Kysor: 1401210, 1401211, 1410050  
 Mack: 4379RD5108930  
 Sanden: 4868, 4869, 5425



**68164 New**  
 FLX7  
 1 Groove  
 24 Volt  
 Mount: Ear Mount  
 Pulley Dia.: 6-7/32  
 Coil Clock: Wire Lead  
 Caterpillar: 2409714  
 Kysor: 1401011, 1401212, 1401213, 1401222  
 Mack: 4379RD5108950  
 Sanden: 4870, 4871

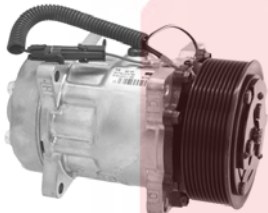

**68165 New**  
 FLX7  
 10 Groove  
 12 Volt  
 Mount: Ear Mount  
 Pulley Dia.: 4-59/64  
 Coil Clock: Wire Lead  
 Bergstrom: 526383  
 Caterpillar: 2329717  
 Kysor: 1401214  
 Mack: 4379RD5108970  
 Sanden: 4872, 4873



**68166 New**  
 FLX7  
 8 Groove  
 12 Volt  
 Mount: Ear Mount  
 Pulley Dia.: 4-11/16  
 Coil Clock: Wire Lead  
 Kysor: 1401216  
 Sanden: 4874



**68167 New**  
 FLX7  
 1 Groove  
 12 Volt  
 Mount: Ear Mount  
 Pulley Dia.: 5-7/16  
 Coil Clock: Wire Lead  
 Kysor: 1401215, 1401217, 1401218  
 Sanden: 4875, 4876, 5411

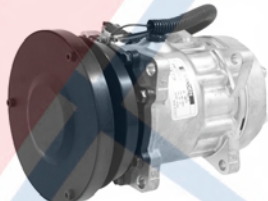

**68168 New**  
 FLX7  
 1 Groove  
 24 Volt  
 Mount: Ear Mount  
 Pulley Dia.: 5-7/16  
 Coil Clock: Wire Lead  
 Bergstrom: 526388  
 Caterpillar: 2473512  
 Kysor: 1401219, 1401220  
 Mack: 4379RD5110090  
 Sanden: 4877



**68169 New**  
 FLX7  
 2 Groove  
 24 Volt  
 Mount: Ear Mount  
 Pulley Dia.: 5-63/64  
 Coil Clock: Wire Lead  
 General Motors Corp: 19192979  
 Caterpillar: 2473511  
 Kysor: 1401223, 1401224  
 Mack: 4379RD5110100  
 Sanden: 4881, 4882



**68170 New**  
 FLX7  
 2 Groove  
 12 Volt  
 Mount: Ear Mount  
 Pulley Dia.: 5-3/16  
 Coil Clock: Wire Lead  
 Caterpillar: 2409719  
 Kysor: 1401225, 1401348  
 Mack: 4379RD5108990  
 Red Dot: 75R89422  
 Sanden: 4434

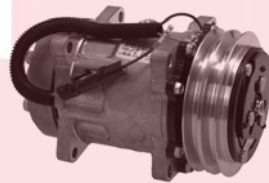

**68171 New**  
 FLX7  
 2 Groove  
 24 Volt  
 Mount: Ear Mount  
 Pulley Dia.: 5-3/16  
 Coil Clock: Wire Lead  
 Caterpillar: 2409720  
 Kysor: 1401226, 1410033  
 Mack: 4379RD5109000  
 Red Dot: 75R89424  
 Sanden: 4435



**68362 New**  
**67362 Reman - 10PA17C**  
 SD7B15  
 Unit is a Sanden Aftermarket Drop-in Replacement  
 6 Groove  
 12 Volt  
 Mount: Ear Mount  
 Pulley Dia.: 4-7/8  
 Coil Clock: Wire Lead  
 Reman Clutch Assy:  
 Ford (91-89); Lincoln (92-89); Mercury (91-89)



**68550 New**  
**67550 Reman**  
 SD709  
 6 Groove  
 12 Volt  
 Mount: Tangent Mount  
 Pulley Dia.: 4-3/4  
 Coil Clock: Wire Lead  
 New Clutch Assy: **47351**  
 Dodge (02-96); Jeep (01-97)  
 Chrysler: 55037205AH  
 Jeep: RL056108AE  
 Sanden: 4650, 4691, 4703, 4722, 4770, 4784, 4798, 4826, 4827, 4844

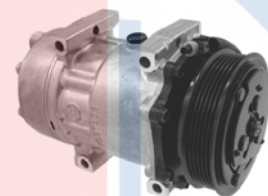

**68551 New**  
**67551 Reman**  
 SD709  
 6 Groove  
 12 Volt  
 Mount: Tangent Mount  
 Pulley Dia.: 4-3/4  
 Coil Clock: Wire Lead  
 Jeep (96-94)  
 Sanden: 4625, 4655, 4685

# Compressors

## Sanden Cont'd



**68553 New**  
**67553 Reman**  
 TRF090  
 5 Groove  
 12 Volt  
 Mount: Tangent Mount  
 Pulley Dia.: 4-55/64  
 Coil Clock: Wire Lead  
 New Clutch Assy: **47554**  
 Honda (96-92)  
 Sanden: 2055, 3052



**68559 New**  
**67559 Reman**  
 SD709  
 2 Groove  
 12 Volt  
 Mount: Ear Mount  
 Belt Width: 1/2  
 Pulley Dia.: 5-1/8  
 Coil Clock: Wire Lead  
 Saab (90-89)  
 Saab: 4319810  
 Sanden: 7467, 7468, 7495, 7710, 7711,  
 7713, 7714



**68565 New**  
**67565 Reman**  
 PXE16  
 6 Groove  
 12 Volt  
 Mount: Tangent Mount  
 Pulley Dia.: 4-23/32  
 Coil Clock: Wire Lead  
 Buick (11-10); Saab (11)  
 General Motors Corp: 13262836  
 Sanden: 1603



**68572 New**  
**67572 Reman**  
 SD7B10  
 4 Groove  
 12 Volt  
 Mount: Ear Mount  
 Pulley Dia.: 4-3/4  
 Coil Clock: Wire Lead  
 Chevy (98-95); Suzuki (98-95)  
 Suzuki: 9520050G11  
 Sanden: 4623

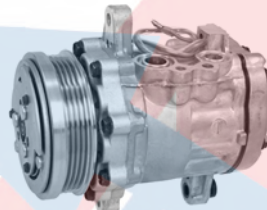

**68573 New**  
**67573 Reman**  
 SD7B10  
 4 Groove  
 12 Volt  
 Mount: Ear Mount  
 Pulley Dia.: 4  
 Coil Clock: Wire Lead  
 Chevy (01-98); Geo (97-95); Suzuki  
 (01-95)  
 Suzuki: 9520050G01  
 Sanden: 4622

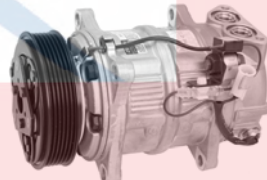

**68574 New**  
**67574 Reman**  
 SD7H15  
 6 Groove  
 12 Volt  
 Switch: Heat Sensor  
 Mount: Ear Mount  
 Pulley Dia.: 4-3/4  
 Coil Clock: Wire Lead  
 Volvo (98-95)  
 Sanden: 7846, 7935



**68575 New**  
 SD7H15  
 8 Groove  
 12 Volt  
 Switch: Heat Sensor  
 Mount: Tangent Mount  
 Pulley Dia.: 4-3/4  
 Coil Clock: Wire Lead  
 Carrier: 502214A  
 Kysor: 1401361  
 Mack: 4379RD5112450  
 Sanden: 4474, 4848, 7804  
 Western Star: 3004686

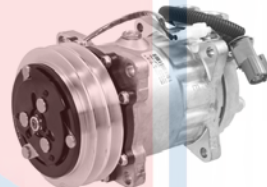

**68576 New**  
 SD7H15  
 2 Groove  
 12 Volt  
 Switch: Heat Sensor  
 Mount: Ear Mount  
 Belt Width: 1/2  
 Pulley Dia.: 5-1/8  
 Coil Clock: Wire Lead  
 Ford: F4HZ19703F  
 Kysor: 1401106, 1401366, 1410057  
 Sanden: 4469, 4603  
 Western Star: 3004707

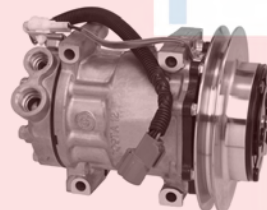

**68577 New**  
 SD7H15  
 1 Groove  
 12 Volt  
 Switch: Heat Sensor  
 Mount: Tangent Mount  
 Belt Width: 1/2  
 Pulley Dia.: 6-5/8  
 Coil Clock: Wire Lead  
 Sanden: 4602



**68578 New**  
 SD7H15  
 8 Groove  
 12 Volt  
 Mount: Ear Mount  
 Pulley Dia.: 4-3/4  
 Coil Clock: Wire Lead  
 Freightliner (06-96), (94-92)  
 Kenworth: F696001215  
 Kysor: 1401118, 1401384, 1402038,  
 402056  
 NaviStar: 705009  
 Red Dot: 75R84582  
 Sanden: 4672, 7822  
 TRP Parts: LE16700



**68589 New**  
**67589 Reman**  
 SD7H15  
 8 Groove  
 12 Volt  
 Mount: Tangent Mount  
 Pulley Dia.: 4-3/4  
 Coil Clock: Wire Lead  
 Dodge (05-94)  
 Chrysler: 55055339AE, RL055339AH  
 Sanden: 4330, 4606, 4682, 4721, 4750,  
 4775, 4789, 4829



**68593 New**  
**67593 Reman**  
 TRSA090  
 6 Groove  
 12 Volt  
 Switch: Heat Sensor  
 Mount: Tangent Mount  
 Pulley Dia.: 3-7/8  
 Coil Clock: Wire Lead  
 Chrysler (03-01); Dodge (03-01)  
 Chrysler: RL069029AA  
 Sanden: 4976



# Compressors

## Sanden Cont'd



**68594 New**  
**67594 Reman**  
 SD7H15  
 2 Groove  
 12 Volt  
 Mount: Ear Mount  
 Belt Width: 1/2  
 Pulley Dia.: 4-7/8  
 Coil Clock: Wire Lead  
 Chevy (95-93); GMC (95-93); GMC & CHEVY (98-94)  
 Ford: XC3Z19703AB  
 Bergstrom: 695016  
 Climatech: LE1275  
 Kysor: 1401350  
 NaviStar: 705020  
 Red Dot: 75R83132  
 Sanden: 7803



**77551 Reman**  
 SD507  
 1 Groove  
 12 Volt  
 Mount: Ear Mount  
 Belt Width: 1/2  
 Pulley Dia.: 6  
 Coil Clock: Wire Lead  
 Honda (85)

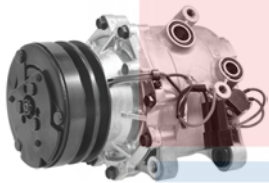

**77553 Reman**  
 TRF105  
 2 Groove  
 12 Volt  
 Switch: Heat Sensor  
 Mount: Ear Mount  
 Pulley Dia.: 4-23/64  
 Coil Clock: Wire Lead  
 Dodge (93-91)



**77580 Reman**  
 SD7H15  
 1 Groove  
 12 Volt  
 Mount: Ear Mount  
 Belt Width: 1/2  
 Pulley Dia.: 5-13/64  
 Coil Clock: Wire Lead  
 Dodge (93-92)

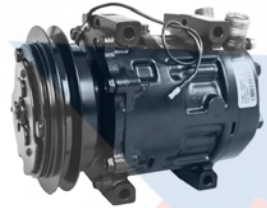

**77581 Reman**  
 SD708  
 1 Groove  
 12 Volt  
 Mount: Tangent Mount  
 Belt Width: 1/2  
 Pulley Dia.: 5-1/4  
 Coil Clock: Wire Lead  
 Ford (93-88)

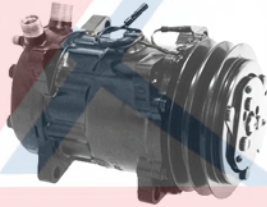

**77582 Reman**  
 SD709  
 2 Groove  
 12 Volt  
 Mount: Ear Mount  
 Belt Width: 1/2  
 Pulley Dia.: 5-1/8  
 Coil Clock: Wire Lead  
 Ford (93-89)



**77583 Reman**  
 SD709  
 8 Groove  
 12 Volt  
 Mount: Ear Mount  
 Pulley Dia.: 4-3/4  
 Coil Clock: Wire Lead  
 Ford (92-90)

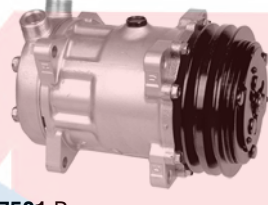

**77591 Reman**  
 SD709  
 2 Groove  
 12 Volt  
 Mount: Ear Mount  
 Belt Width: 3/8  
 Pulley Dia.: 5-1/4  
 Coil Clock: Wire Lead  
 Jeep (91-87)  
 Chrysler: 56003127  
 Jeep: 56003127



**77614 Reman**  
 TRF105  
 6 Groove  
 12 Volt  
 Mount: Tangent Mount  
 Pulley Dia.: 4-5/16  
 Coil Clock: Wire Lead  
 Dodge (93-91)



**78541 New**  
**77554 Reman**  
 SD7V16  
 6 Groove  
 12 Volt  
 Mount: Ear Mount  
 Pulley Dia.: 3-3/4  
 Coil Clock: Wire Lead  
 Audi (06-96); Ford (06-95); Skoda (10-98); SRT (10-96); VW (15-95)  
 Volkswagen: 1J0820803N, 1J0820803NX  
 Sanden: 1206, 1215, 1233



**78543 New**  
**77555 Reman**  
 SD7V16  
 7 Groove  
 12 Volt  
 Mount: Ear Mount  
 Pulley Dia.: 4-3/4  
 Coil Clock: Wire Lead  
 Audi (01-00); Skoda (10-96); SRT (10-95); VW (10-95)  
 Volkswagen: 1J0820803E, 1J0820805  
 Sanden: 1208, 1216

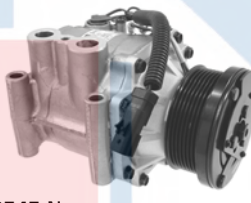

**78545 New**  
**77545 Reman**  
 TRF105  
 7 Groove  
 12 Volt  
 Switch: Heat Sensor  
 Mount: Tangent Mount  
 Pulley Dia.: 3-3/4  
 Coil Clock: Wire Lead  
 Dodge (03-98)  
 Chrysler: RL036741AF  
 Sanden: 4952, 4970, 4979

# Compressors

## Sanden Cont'd



**78546 New**  
**77546 Reman**  
 SD709  
 5 Groove  
 12 Volt  
 Mount: Tangent Mount  
 Pulley Dia.: 4-11/16  
 Coil Clock: Wire Lead  
 Mazda (02-98)  
 Mazda: GD7E61450  
 Sanden: 4688

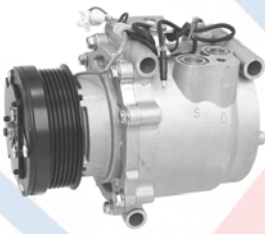

**78547 New**  
**77547 Reman**  
 TRF105  
 6 Groove  
 12 Volt  
 Switch: Heat Sensor  
 Mount: Tangent Mount  
 Pulley Dia.: 4  
 Coil Clock: Wire Lead  
 Saab (03-99)  
 Saab: 4635892  
 Sanden: 3211



**78548 New**  
**77548 Reman**  
 TRSA12B  
 4 Groove  
 12 Volt  
 Switch: Heat Sensor  
 Mount: Tangent Mount  
 Pulley Dia.: 3-7/8  
 Coil Clock: Wire Lead  
 Buick (07-04); Chevy (09-03); GMC (09-03); Isuzu (06-03); Saab (09-05)  
 General Motors Corp: 25825338, 25825340  
 Isuzu: 8103993660  
 Saab: 25825340  
 Sanden: 3451



**78550 New**  
 SD508HD  
 2 Groove  
 12 Volt  
 Mount: Ear Mount  
 Belt Width: 1/2  
 Pulley Dia.: 5-1/16  
 Coil Clock: Wire Lead  
 Case New Holland: 3405689R2  
 Climatech: LE1225  
 Kysor: 1401005  
 Red Dot: 75R82242  
 Sanden: 9026

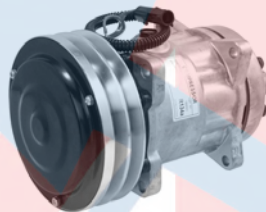

**78551 New**  
 SD7H15  
 2 Groove  
 12 Volt  
 Mount: Ear Mount  
 Belt Width: 1/2  
 Pulley Dia.: 6  
 Coil Clock: Wire Lead  
 Case New Holland: 1977959C1, 1999755C2, 97204C1  
 Northern: 5007000  
 Red Dot: 75R84112  
 Sanden: 4478, 4609  
 Western Star: 3004547



**78552 New**  
**77552 Reman**  
 TRSA090  
 4 Groove  
 12 Volt  
 Switch: Heat Sensor  
 Mount: Tangent Mount  
 Pulley Dia.: 4-5/32  
 Coil Clock: Wire Lead  
 Connector: Butt Connector  
 Honda (05-03)  
 Honda: 38810PZA004



**78553 New**  
 SD7H15  
 2 Groove  
 12 Volt  
 Mount: Ear Mount  
 Belt Width: 1/2  
 Pulley Dia.: 5  
 Coil Clock: Wire Lead  
 Chrysler: 55035507AB  
 Case New Holland: 84018078, 89831429  
 Euclid: E801190  
 Northern: 5004060  
 Sanden: 4269, 4272, 4709



**78556 New**  
 SD7H15  
 1 Groove  
 12 Volt  
 Mount: Ear Mount  
 Belt Width: 1/2  
 Pulley Dia.: 5-1/2  
 Coil Clock: Wire Lead  
 Sanden: 4661

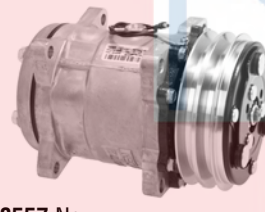

**78557 New**  
 SD5H14  
 2 Groove  
 12 Volt  
 Mount: Ear Mount  
 Belt Width: 1/2  
 Pulley Dia.: 5-1/8  
 Coil Clock: Wire Lead  
 Euclid: E801186  
 Kysor: 1401333  
 Northern: 5004050  
 Red Dot: 75R8332  
 Sanden: 4536, 6630, 6676



**78558 New**  
**77558 Reman**  
 SD7H15  
 6 Groove  
 12 Volt  
 Switch: Pressure Relief Valve  
 Mount: Tangent Mount  
 Pulley Dia.: 5-1/8  
 Coil Clock: Wire Lead  
 Dodge (03-02)  
 Sanden: 4853, 4854, 4898



**78559 New**  
 SD7H15  
 2 Groove  
 12 Volt  
 Mount: Ear Mount  
 Belt Width: 1/2  
 Pulley Dia.: 4-7/8  
 Coil Clock: Wire Lead  
 Euclid: E801189  
 Hy-Capacity: 0008814708  
 Massey Ferguson: 3763384M91  
 NaviStar: 705021  
 Northern: 5004000  
 Sanden: 4708, 9669



**78560 New**  
**77560 Reman**  
 TRS090  
 4 Groove  
 12 Volt  
 Switch: Heat Sensor  
 Mount: Tangent Mount  
 Pulley Dia.: 4  
 Coil Clock: Wire Lead  
 Honda (01-94)  
 Sanden: 3057, 3059, 3060, 3061, 4955, 4956, 4959, 4993

# Compressors

## Sanden Cont'd



**78561 New**  
**77561 Reman**  
 TRSA12  
 6 Groove  
 12 Volt  
 Switch: Heat Sensor  
 Mount: Tangent Mount  
 Pulley Dia.: 3-7/8  
 Coil Clock: Wire Lead  
 Buick (07-04); Chevy (09-02); GMC (09-02); Isuzu (08-03); Olds (04-02); Saab (09-05)  
 General Motors Corp: 25825339  
 Isuzu: 8258253390  
 Saab: 25825339, 25825341  
 Massey Ferguson: 3712528M2  
 Sanden: 3450, 3452



**78562 New**  
**77562 Reman**  
 SD7H15  
 7 Groove  
 12 Volt  
 Switch: Pressure Relief Valve  
 Mount: Tangent Mount  
 Pulley Dia.: 5-1/8  
 Coil Clock: Wire Lead  
 Dodge (03-02)  
 Chrysler: RL056095AB, RL057334AA  
 Sanden: 4331, 4356, 4363, 4365, 4835, 4843



**78565 New**  
 SD7H15  
 8 Groove  
 12 Volt  
 Mount: Ear Mount  
 Pulley Dia.: 4-3/4  
 Coil Clock: Wire Lead  
 Carrier: 180009302  
 Case New Holland: 82002069, 82008688  
 Caterpillar: 2329279  
 Euclid: E801192  
 Kysor: 1401114  
 Mack: 4379RD592510  
 NaviStar: 705006  
 Red Dot: 75R8462  
 Sanden: 4660, 4711, 8103  
 Western Star: 3004429

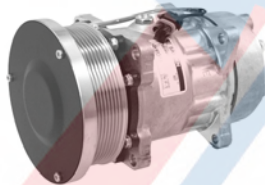

**78567 New**  
 SD7H15  
 8 Groove  
 12 Volt  
 Mount: Ear Mount  
 Pulley Dia.: 5-1/4  
 Coil Clock: Wire Lead  
 Dallas Truck AC: 0145017  
 Kysor: 1401109, 1401334, 1401344, 1401382, 1410083  
 Red Dot: 75R84362, 75R84482  
 Sanden: 4637, 4659, 4700, 4895

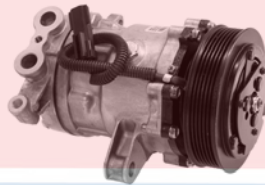

**78578 New**  
**77578 Reman**  
 SD7H15  
 6 Groove  
 12 Volt  
 Mount: Tangent Mount  
 Pulley Dia.: 5-1/4  
 Coil Clock: Wire Lead  
 Dodge (01-00)  
 Chrysler: RL056107AE  
 Sanden: 4729, 4760, 4787, 4791, 4824, 4825, 4847



**78584 New**  
**77584 Reman**  
 SD7H15  
 1 Groove  
 12 Volt  
 Mount: Tangent Mount  
 Belt Width: 1/2  
 Pulley Dia.: 5-1/4  
 Coil Clock: Wire Lead  
 Dodge (95-94)  
 Sanden: 4607

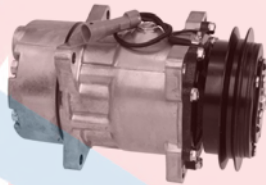

**78589 New**  
**77589 Reman**  
 SD709  
 1 Groove  
 12 Volt  
 Switch: Sensor Port  
 Mount: Ear Mount  
 Belt Width: 1/2  
 Pulley Dia.: 5-1/8  
 Coil Clock: Wire Lead  
 Jaguar (96-90)  
 Jaguar: MHE7300AA, MNA7300BB  
 Sanden: 7463, 7494, 7526, 7543, 7812



**78592 New**  
**77592 Reman**  
 TRSA090  
 5 Groove  
 12 Volt  
 Switch: Heat Sensor  
 Mount: Tangent Mount  
 Pulley Dia.: 4  
 Coil Clock: Wire Lead  
 Honda (97-95)



**78593 New**  
**77593 Reman**  
 TRS105  
 7 Groove  
 12 Volt  
 Switch: Heat Sensor  
 Mount: Tangent Mount  
 Pulley Dia.: 3-61/64  
 Coil Clock: Wire Lead  
 Land Rover (98-95)  
 Land Rover: ERR4534

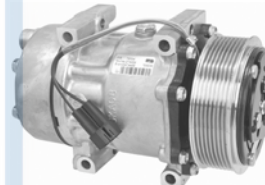

**78594 New**  
**77594 Reman**  
 SD709  
 8 Groove  
 12 Volt  
 Mount: Tangent Mount  
 Pulley Dia.: 4-3/4  
 Coil Clock: Wire Lead  
 Dodge (93-90)  
 Sanden: 7702

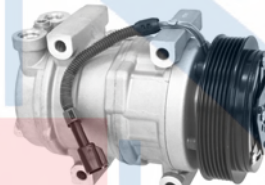

**78595 New**  
 SD7H15  
 6 Groove  
 12 Volt  
 Mount: Tangent Mount  
 Pulley Dia.: 4-11/16  
 Coil Clock: Wire Lead  
 Caterpillar: 2329255  
 Climatech: F696001122, F696003122, LF0122  
 Kenworth: F696001122, F696002121  
 Kysor: 1401415, 1410002  
 Mack: 4379RD5102730  
 Peterbilt: 1805000, F696001122  
 Sanden: 4039, 4424, 4731  
 TRP Parts: LE16500  
 Western Star: 3004318



# Compressors

## Sanden Cont'd



**78596 New**  
SD7H15  
6 Groove  
12 Volt  
Mount: Ear Mount  
Pulley Dia.: 4-3/4  
Coil Clock: Wire Lead  
Sanden: 4653, 7427



**78597 New**  
SD7H15  
7 Groove  
12 Volt  
Mount: Ear Mount  
Pulley Dia.: 4-3/4  
Coil Clock: Wire Lead  
GMC & CHEVY (98-94)  
General Motors Corp: 19130044  
Kysor: 1401347, 1410036  
Sanden: 4618

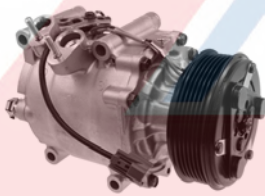

**78599 New**  
**77599 Reman**  
TRS090  
6 Groove  
12 Volt  
Switch: Heat Sensor  
Mount: Tangent Mount  
Pulley Dia.: 4-1/2  
Coil Clock: Wire Lead  
Honda (02-01)



**78609 New**  
**77550 Reman**  
TRS090  
4 Groove  
12 Volt  
Switch: Heat Sensor  
Mount: Tangent Mount  
Pulley Dia.: 3-3/4  
Coil Clock: Wire Lead  
Mazda (98-95)  
Mazda: BC1M61450A  
Sanden: 3005, 4987

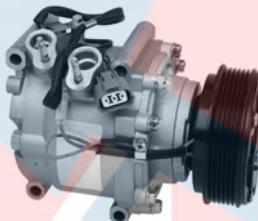

**78613 New**  
**77613 Reman - TRSA090**  
**57878 Reman - HS090**  
**77599 Reman - TRSA090**  
TRS090  
6 Groove  
12 Volt  
Mount: Tangent Mount  
Pulley Dia.: 3-15/16  
Coil Clock: Wire Lead  
Honda (05-02)  
Honda: 38810P5M016, 38810PLMA12  
Sanden: 3654, 36584, 3661, 3665, 3666,  
3857, 4913, 4968, 4973, 49734, 4980,  
4985



**97554 Reman**  
TRS090  
6 Groove  
12 Volt  
Switch: Heat Sensor  
Mount: Tangent Mount  
Pulley Dia.: 3-45/64  
Coil Clock: Wire Lead  
Ford (99-96)



**97573 Reman**  
PXE16  
6 Groove  
12 Volt  
Mount: Tangent Mount  
Pulley Dia.: 4-21/64  
Land Rover (13-10)

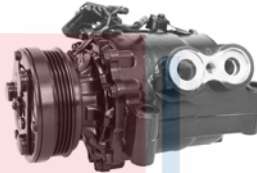

**97582 Reman**  
TRSA09K  
4 Groove  
12 Volt  
Switch: Heat Switch  
Mount: Tangent Mount  
Pulley Dia.: 3-51/64  
Coil Clock: Wire Lead  
Buick (04); Chevy (06-03); GMC  
(04-03)

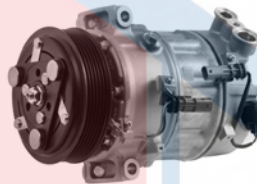

**98244 New**  
PXC16  
6 Groove  
12 Volt  
Mount: 3 Tangent One on Rear Head  
Pulley Dia.: 4-23/32  
Coil Clock: Wire Lead  
Buick (12)  
General Motors Corp: 22780219

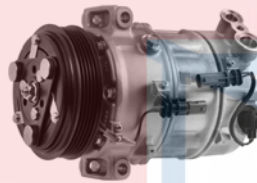

**98245 New**  
PXC16  
5 Groove  
12 Volt  
Mount: 3 Tangent One on Rear Head  
Pulley Dia.: 4-23/32  
Coil Clock: Wire Lead  
Buick (12)  
General Motors Corp: 22780218



**98549 New**  
SD6V12  
6 Groove  
12 Volt  
Mount: Tangent Mount  
Pulley Dia.: 4-921/1000  
Coil Clock: Wire Lead  
Nissan (05-03)



**98550 New**  
**97550 Reman**  
SD7H15  
6 Groove  
12 Volt  
Mount: Tangent Mount  
Pulley Dia.: 3-7/8  
Coil Clock: Wire Lead  
Jeep (05-02)  
Sanden: 4851

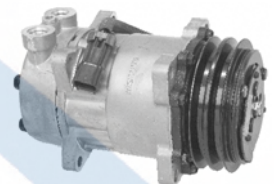

**98551 New**  
**97551 Reman**  
SD7H15  
2 Groove  
12 Volt  
Mount: Ear Mount  
Pulley Dia.: 5-9/16  
Coil Clock: Wire Lead  
Kenworth: F691000, F696001231,  
F696002231  
Kysor: 1410019  
Peterbilt: 1804145, F691000,  
F696001231, F696002231  
Sanden: 194696, 4041, 4383, 4426,  
4696  
Western Star: 3004305

# Compressors

## Sanden Cont'd



**98552 New**  
**97552 Reman**  
**97558 Reman - SD7V16**  
 PXV16  
 5 Groove  
 12 Volt  
 Mount: Tangent Mount  
 Pulley Dia.: 4-15/16  
 Coil Clock: Wire Lead  
 Opel (05-00); Saab (11-03)  
 Saab: 12758381  
 Sanden: 4575, 8607, 8617, 8631



**98559 New**  
**97559 Reman**  
 TRSE07  
 5 Groove  
 12 Volt  
 Switch: Heat Switch  
 Mount: Tangent Mount  
 Pulley Dia.: 4-3/8  
 Coil Clock: Wire Lead  
 Honda (08-07)  
 Honda: 38810RMEA02



**98565 New**  
**97565 Reman**  
 PXE16  
 6 Groove  
 12 Volt  
 Mount: Tangent Mount  
 Pulley Dia.: 4-21/32  
 Coil Clock: Wire Lead  
 Buick (11-10); Cadillac (11-10)  
 General Motors Corp: 20934127

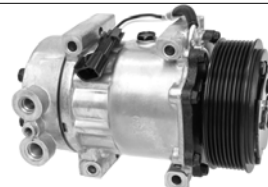

**98572 New**  
 SD510HD  
 8 Groove  
 12 Volt  
 Mount: Tangent Mount  
 Pulley Dia.: 4-5/8  
 Coil Clock: Wire Lead  
 Climatch: LF0111  
 Kenworth: F691003, F696001111  
 Kysor: 1410022  
 Peterbilt: F691003, F696001111,  
 F696002111  
 Sanden: 4042, 4432, 4759

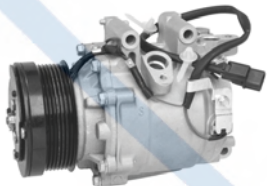

**98555 New**  
**97555 Reman**  
 TRSE07  
 7 Groove  
 12 Volt  
 Switch: Heat Switch  
 Mount: Tangent Mount  
 Pulley Dia.: 3-15/16  
 Coil Clock: Wire Lead  
 Honda (11-06)  
 Honda: 38810RNAA02  
 Sanden: 4901, 4905

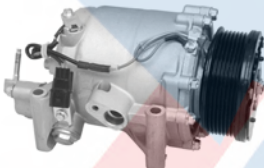

**98560 New**  
**97560 Reman**  
 TRSE07  
 7 Groove  
 12 Volt  
 Switch: Heat Switch  
 Mount: Tangent Mount  
 Pulley Dia.: 3-7/8  
 Coil Clock: Wire Lead  
 Honda (11-06)  
 Honda: 38810RRBA02  
 Sanden: 3401

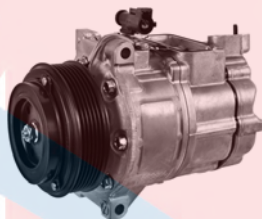

**98570 New**  
**97570 Reman**  
 PXV16  
 6 Groove  
 12 Volt  
 Mount: Tangent Mount  
 Pulley Dia.: 4-5/16  
 Coil Clock: Wire Lead  
 Land Rover (09-06)  
 Land Rover: JPB500211  
 Sanden: 8648



**98575 New**  
**67575 Reman**  
 SD709  
 5 Groove  
 12 Volt  
 Mount: Tangent Mount  
 Pulley Dia.: 5  
 Coil Clock: Wire Lead  
 Mazda (02-98)  
 Sanden: 4689

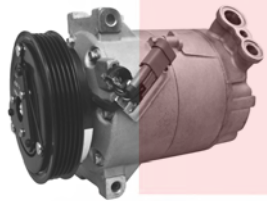

**98556 New**  
**97556 Reman**  
 PXV16  
 5 Groove  
 12 Volt  
 Mount: Tangent Mount  
 Pulley Dia.: 4-3/4  
 Coil Clock: Wire Lead  
 Connector: Butt Connector  
 Chevy (11-06); Pontiac (10-08); Saturn  
 (07-05)  
 General Motors Corp: 19130592,  
 20772560, 22709080  
 Saturn: 22709080  
 Sanden: 8705



**98563 New**  
**97563 Reman**  
 PXV16  
 5 Groove  
 12 Volt  
 Mount: Tangent Mount  
 Pulley Dia.: 4-3/4  
 Coil Clock: Wire Lead  
 Connector: 7mm Pin Connector  
 Pontiac (09-06); Saturn (10-07)  
 General Motors Corp: 19130591

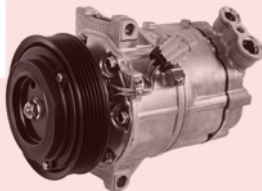

**98571 New**  
**97571 Reman**  
 PXV16  
 6 Groove  
 12 Volt  
 Mount: Tangent Mount  
 Pulley Dia.: 4-3/4  
 Coil Clock: Wire Lead  
 Saab (09-06)  
 Saab: 12792669  
 Sanden: 4122

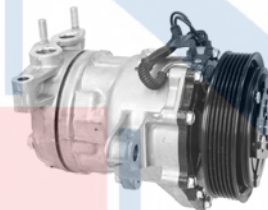

**98576 New**  
**67576 Reman**  
 SD7H15  
 6 Groove  
 12 Volt  
 Mount: Tangent Mount  
 Pulley Dia.: 5-1/8  
 Coil Clock: Wire Lead  
 Jeep (05-02)  
 Jeep: 55037466AE  
 Sanden: 4335, 4852

# Compressors

## Sanden Cont'd



**98579 New**  
**97579 Reman**  
 TRSE07  
 5 Groove  
 12 Volt  
 Switch: Heat Switch  
 Mount: Tangent Mount  
 Pulley Dia.: 4-3/8  
 Coil Clock: Wire Lead  
 Honda (13-09)  
 Honda: 38810RP3305, 38810RP3A04



**98580 New**  
**97580 Reman**  
 TRSE09  
 7 Groove  
 12 Volt  
 Switch: Heat Sensor  
 Mount: Tangent Mount  
 Pulley Dia.: 4-11/64  
 Coil Clock: Wire Lead  
 Acura (15-07); Honda (15-07)  
 Acura: 38810RWCA03  
 Honda: 388105LAA01, 38810RWCA03,  
 38810RX0A01, 38810RZYA01  
 Sanden: 37744

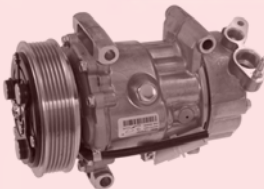

**98581 New**  
**97581 Reman**  
 SD6V12  
 6 Groove  
 12 Volt  
 Mount: Tangent Mount  
 Pulley Dia.: 4-11/16  
 Coil Clock: Wire Lead  
 Citroen (09-08), (03-02); Mini (15-07)  
 BMW: 64522758433, 64529223392



**98583 New**  
 SD6V12  
 6 Groove  
 12 Volt  
 Mount: Ear Mount  
 Pulley Dia.: 4-9/32  
 Coil Clock: Wire Lead  
 Mini (15), (13), (09-07)

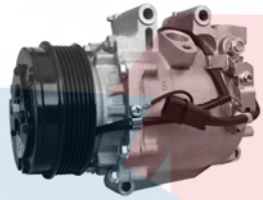

**98584 New**  
**97584 Reman**  
 TRSE09  
 6 Groove  
 12 Volt  
 Switch: Heat Switch  
 Mount: Tangent Mount  
 Pulley Dia.: 4-13/32  
 Coil Clock: Wire Lead  
 Acura (15-14); Honda (15-12)  
 Honda: 38810R1AA01  
 Sanden: 3770A

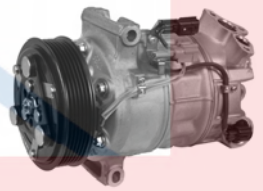

**98585 New**  
 PXC14  
 6 Groove  
 12 Volt  
 Mount: Tangent Mount  
 Pulley Dia.: 4-17/32  
 Coil Clock: Wire Lead  
 Nissan (15-13)  
 Nissan: 926003SH1C



**98586 New**  
 PXC16  
 6 Groove  
 12 Volt  
 Mount: 3 Tangent  
 Pulley Dia.: 4-23/32  
 Coil Clock: Wire Lead  
 Buick (12); Cadillac (14-12)  
 General Motors Corp: 22951491  
 Sanden: 1689

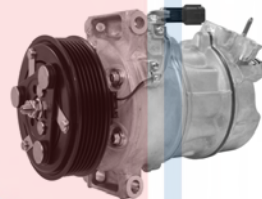

**98587 New**  
**67662 Reman - DCS171C**  
 PXV14  
 6 Groove  
 12 Volt  
 Mount: Tangent Mount  
 Pulley Dia.: 4-17/32  
 Coil Clock: Wire Lead  
 Nissan (12), (10-09)

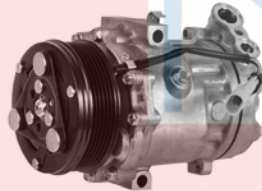

**98589 New**  
 SD6V12  
 6 Groove  
 12 Volt  
 Mount: 3 Tangent One on Rear Head  
 Pulley Dia.: 3-59/64  
 Coil Clock: Wire Lead  
 Chevy (09-02)



**98590 New**  
**57590 Reman**  
 SD709  
 2 Groove  
 12 Volt  
 Mount: Ear Mount  
 Pulley Dia.: 5-1/4  
 Coil Clock: Wire Lead  
 VW (92-90)  
 Volkswagen: 357820803R  
 Sanden: 7423



**98591 New**  
**57591 Reman**  
 SD7V16  
 6 Groove  
 12 Volt  
 Mount: Ear Mount  
 Belt Width: 3/4  
 Pulley Dia.: 4-5/8  
 Coil Clock: Wire Lead  
 Ford (00-97); VW (03-90)  
 Volkswagen: 1H0820803DX  
 Sanden: 1100

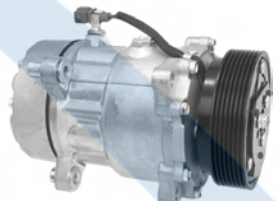

**98592 New**  
**57592 Reman**  
 SD7V16  
 7 Groove  
 12 Volt  
 Mount: Ear Mount  
 Belt Width: 15/16  
 Pulley Dia.: 4-5/8  
 Coil Clock: Wire Lead  
 Ford (00-95); SRT (10-91); VW  
 (00-91)  
 Sanden: 1102



# Compressors

## Sanden Cont'd



**98593 New**  
SD7H15  
8 Groove  
12 Volt  
Mount: Tangent Mount  
Pulley Dia.: 5-7/64  
Coil Clock: Wire Lead  
Peugeot (10), (08), (05)  
Kysor: 1401362, 1410010  
Sanden: 4493, 4733, 4892  
Western Star: 3004727



**98594 New**  
SD7H15  
2 Groove  
12 Volt  
Mount: Tangent Mount  
Pulley Dia.: 5-3/16  
Coil Clock: Wire Lead  
Kysor: 1410024  
Red Dot: 75R84382, RD5102780P,  
RD5102810P  
Sanden: 4715, 4778, 4890

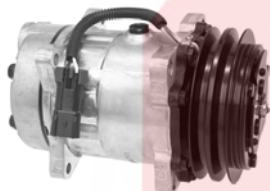

**98595 New**  
SD7H15  
2 Groove  
12 Volt  
Mount: Ear Mount  
Pulley Dia.: 5-3/16  
Coil Clock: Wire Lead  
Kysor: 1410021  
Sanden: 4717, 4777, 4893



**98596 New**  
SD7H15  
6 Groove  
12 Volt  
Mount: Tangent Mount  
Pulley Dia.: 5-7/64  
Coil Clock: Wire Lead  
Kenworth: F696000, F696001121,  
F696002122  
Kysor: 1410003  
Peterbilt: F696001121  
Red Dot: 75R81632  
Sanden: 4040, 4425, 4792  
Western Star: 3004301

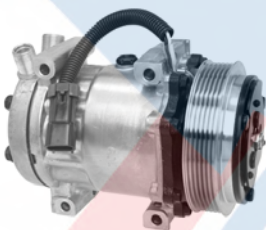

**98597 New**  
SD7H15  
6 Groove  
12 Volt  
Mount: Tangent Mount  
Pulley Dia.: 5-3/16  
Coil Clock: Wire Lead  
Caterpillar: M6X0062  
Kysor: 1401397, 1410028  
Mack: 206RD51M, 206RD51MREVB,  
85119605  
Red Dot: RD5113520P  
Sanden: 4883  
TRP Parts: LE4883  
Western Star: 3004427

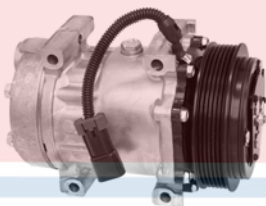

**98598 New**  
SD7H15  
6 Groove  
12 Volt  
Mount: Tangent Mount  
Pulley Dia.: 5-7/64  
Coil Clock: Wire Lead  
Kysor: 1401349, 1406004, 1410025  
NaviStar: 2602121C91, 3547916C1,  
3547918C1, 3615169C2, 3628699C1  
Sanden: 4382, 4546, 4815  
Western Star: 3004377



**98599 New**  
SD7H15  
8 Groove  
12 Volt  
Mount: Tangent Mount  
Pulley Dia.: 5-7/64  
Coil Clock: Wire Lead  
Kysor: 1401426, 1406005, 1410046  
NaviStar: 3547917C1, 3628700C1  
Sanden: 4544, 4816  
Western Star: 3004378

## Seiko Seiki

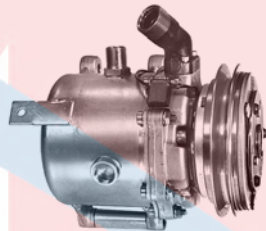

**57405 Reman**  
SS-148DW7  
May Require OE Suction Pipe  
1 Groove  
12 Volt  
Switch: Temp Sensor  
Mount: Boss Mount  
Belt Width: 1/2  
Pulley Dia.: 5-1/4  
Coil Clock: Wire Lead  
BMW (93-85)

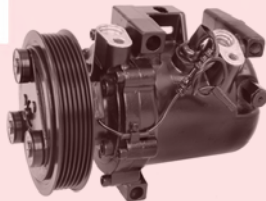

**57409 Reman**  
SS121DN2  
6 Groove  
12 Volt  
Mount: Tangent Mount  
Pulley Dia.: 5  
Coil Clock: Wire Lead  
Saab (98-94)  
Saab: 4759148



**57465 Reman**  
SS121DS5  
2 Groove  
12 Volt  
Switch: Heat Sensor  
Mount: Ear Mount  
Pulley Dia.: 4-5/8  
Coil Clock: Wire Lead  
Volvo (95-94)  
Volvo: 36000819



**57499 Reman**  
SS-170PSS  
1 Groove  
12 Volt  
Switch: Heat Sensor  
Mount: Ear Mount  
Belt Width: 1/2  
Pulley Dia.: 5-1/4  
Coil Clock: Wire Lead  
Saab (94-86)  
Saab: 4073995

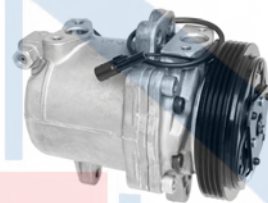

**58407 New**  
Seiko Seiki  
4 Groove  
12 Volt  
Switch: Heat Switch  
Mount: Ear Mount  
Pulley Dia.: 4-1/4  
Coil Clock: Wire Lead  
Suzuki (04-95)  
Suzuki: 9520067D30, 990009908865B

# Compressors

## Seiko Seiki Cont'd



**67402 Reman**  
SS120DL1  
5 Groove  
12 Volt  
Switch: Heat Switch  
Mount: Tangent Mount  
Pulley Dia.: 4-5/16  
Coil Clock: Wire Lead  
BMW (02-01)



**67645 Reman**  
SS121DS5  
2 Groove  
12 Volt  
Switch: Heat Switch  
Mount: Ear Mount  
Pulley Dia.: 5-1/8  
Coil Clock: Wire Lead  
Volvo (95-94)  
Volvo: 36000820



**68401 New**  
Seiko Seiki  
4 Groove  
12 Volt  
Mount: Tangent Mount  
Pulley Dia.: 4-25/32  
Smart (15-09)  
Mercedes Benz: 1322300011



**68497 New**  
**67497 Reman**  
SS96D1  
4 Groove  
12 Volt  
Switch: Heat Sensor  
Mount: Ear Mount  
Pulley Dia.: 4-1/2  
Coil Clock: Wire Lead  
BMW (99-92)  
BMW: 64528390228

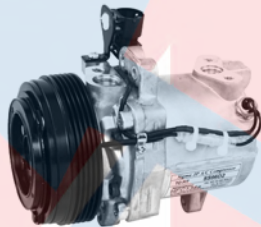

**68498 New**  
**67498 Reman**  
SS96D2  
5 Groove  
12 Volt  
Switch: Heat Sensor  
Mount: Ear Mount  
Pulley Dia.: 4-21/64  
Coil Clock: Wire Lead  
BMW (00-96)  
BMW: 64528391474

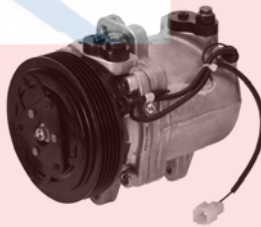

**78491 New**  
**77491 Reman**  
SS10L  
5 Groove  
12 Volt  
Switch: Heat Sensor  
Mount: Ear Mount  
Pulley Dia.: 4-1/2  
Coil Clock: Wire Lead  
Suzuki (03-96)  
Suzuki: 990009908870C,  
99000990887CH

## York/Tecumseh



**57029 Reman**  
Mini-206  
Coil Less  
Mount: Case Mount  
Ford (85-81); Mercury (85-81); VW (85)  
Nissan: 27631H8806W0

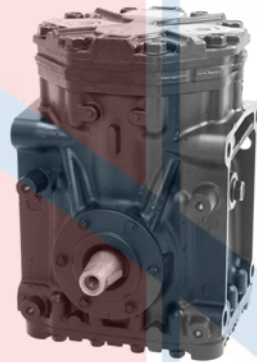

**57030 Reman**  
209-210  
Coil Less  
Mount: Case Mount  
Hy-Capacity: 880149REM

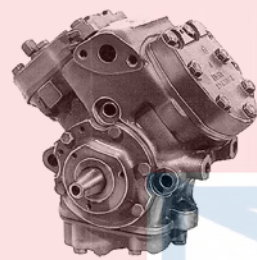

**57059 Reman**  
RV2  
Coil Less  
Mount: Case Mount  
Chrysler (79-61); Dodge (80-60);  
Dodge Medium Duty Truck (80-78);  
Plymouth (80-60)



**57063 Reman**  
Mini-206  
Coil Less  
Mount: Case Mount  
AMC (79-77); Audi (85); Dodge (80-71); Ford (80-78); Honda (79-76);  
Plymouth (80-76); Subaru (81-75)  
Nissan: 27630W8700  
AMC: 8129027



**57069 Reman**  
HG850-1000  
Coil Less  
Mount: Case Mount  
Mercury (70)  
Case New Holland: 83912949  
Euclid: E801481RM  
Evans: AM80419, AM80444  
Kysor: 1402009  
NaviStar: 13505, 990334C91  
Northern: 500293  
Red Dot: 75R7140

# Compressors

## York/Tecumseh Cont'd



**57070 Reman**  
HG500  
Coil Less  
Mount: Case Mount  
Mazda (73-72)  
Audi: ZVW231100  
Volkswagen: ZVW231100



**57075 Reman**  
206  
Coil Less  
Mount: Case Mount  
AMC (79-77); Jaguar (79-72); Mazda (75-72)  
AMC: 3693222



**58022 New**  
**57022 Reman**  
209-210  
1 Groove  
12 Volt  
Mount: Case Mount  
Belt Width: 1/2  
Pulley Dia.: 6-1/4  
Coil Clock: Wire Lead  
New Clutch Assy: **47809**  
Reman Clutch Assy: **48809**  
Ford (82-70); Ford Medium Duty (77-76); Mercury (82-70)



**58031 New**  
209-210  
12 Volt  
Mount: Case Mount  
Caterpillar: 2329199  
Kysor: 1402010  
Mack: 4379RD5100290



**57073 Reman**  
HG850-1000  
Coil Less  
Mount: Case Mount  
Ford (67-58); Lincoln (62-58); Mercury (62-58)  
Case New Holland: 1144556  
Deutz: 1144556  
Hy-Capacity: 880140REM  
Massey Ferguson: 1042505M91  
Northern: 500291

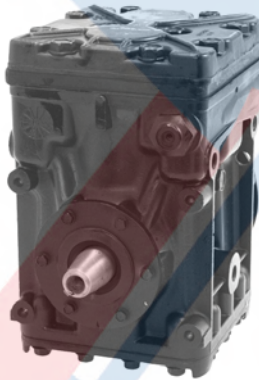

**57280 Reman**  
Mini-206  
Coil Less  
Mount: Case Mount  
Ford (87-85); Mercury (87-86)

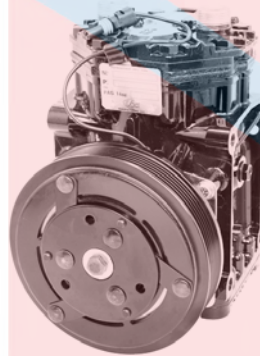

**58025 New**  
CCI 209/210  
6 Groove  
12 Volt  
Mount: Case Mount  
Pulley Dia.: 5-3/4  
Coil Clock: Wire Lead  
Navistar: ET210L25078C



**58044 New**  
**57044 Reman**  
206  
Coil Less  
Mount: Direct Mount  
Dodge (79-75); Ford (81-71); Mercury (73-71); Plymouth (79-76)



# Compressors

## York/Tecumseh Cont'd



**58056 New**  
**57056 Reman**  
 209-210  
 Coil Less  
 Mount: Case Mount  
 AMC (68-63); Audi (87-80); Ford (70-58); Int'l (78-73); Lincoln (68-63); Mercedes (79-59); Mercury (75-63); VW (88-85)  
 AMC: 3171622, 8126592  
 Bergstrom: 525741  
 Carrier: 1924004C1, 417888C92  
 Case New Holland: A141060, A42954, A64810, A66245  
 Caterpillar: 2329197  
 Climatech: LC1000, LC1005, LC1080, LC1100, LC1105, LC1110, LC2000  
 Dallas Truck AC: 0105043  
 Euclid: E801501, E801502, E801503, E801509, E801511  
 Evans: HV31176  
 Hy-Capacity: 0000880253  
 John Deere: AH17726  
 Kysor: 1402001, 1411001, 402886  
 Mack: 203RD433P2, 206RD39302, 206RD41, 207RD22P2, 4379RD58637, 79321001, 79321045  
 Massey Ferguson: 250951M91, 269925M91  
 NaviStar: 117886C92, 118250C91, 12213, 1676831C91, 1685127C91, 417888C91, A64810, A66245  
 Northern: 500222  
 Peterbilt: ER210L25149  
 Red Dot: 75R7200, 75R7220, 75R7280  
 TRP Parts: LC20000



**58057 New**  
**57057 Reman**  
 209-210  
 Coil Less  
 Mount: Case Mount  
 AMC (82-65), (62-59); Chrysler (79-75); Dodge (83-70); Ford (88-70); Ford Medium Duty (77-75); Jeep (86-74); Mercury (88-71); Plymouth (83-74); Porsche (77-74); Volvo (84-75)  
 Allis Chalmers: 2085013  
 NaviStar: 12212  
 Northern: 500210  
 Year-A-Round: 14009099



**58061 New**  
**57061 Reman**  
 HG850-1000  
 Coil Less  
 Mount: Case Mount  
 AMC (68-65); Ford (69), (66-64); Lincoln (69-68)  
 Bergstrom: 525747  
 Case New Holland: A42953  
 Climatech: LD1000  
 Dallas Truck AC: 0105039, 0105040  
 Euclid: E801483, E801484  
 Kenworth: 992076  
 Mack: 4379RD536920, 4379RD536930, 7979402031, 7979402542  
 NaviStar: 11818, 417888C91  
 Northern: 500294  
 Peterbilt: 992396  
 Red Dot: 75R7100, 75R7130  
 Versatile: 17905



**58064 New**  
**57064 Reman**  
 209-210  
 12 Volt  
 Mount: Direct Mount  
 New Clutch Assy: **47809**  
 Reman Clutch Assy: **48809**  
 Ford (83-69); Ford Medium Duty (77-75); Int'l (80-79); Lincoln (71-70); Mercury (83-70)  
 Bergstrom: 525742  
 Case New Holland: 80417398  
 Caterpillar: 2329198  
 Climatech: KA1095, LC1010, LC1015, LC1020, LC1130, LC1140, LC2100  
 Dallas Truck AC: 0105042, 0105050  
 Euclid: E801506, E801510, E801512  
 Kysor: 1402002, 1411002, 402887  
 Mack: 206RD34, 4379RD586380, 79325150  
 Massey Ferguson: 1026088M91  
 NaviStar: 117887C93, 14891, 1676832C91, 2000820C91, 2502459C91, 2509452C91, 2509453C91, 2509456C91, 417887C93, 468323C91, 468323C92, 48821909, 554712C91  
 Northern: 500236  
 Red Dot: 75R7230, 75R7240, 75R7290, 75R7295  
 TRP Parts: LC21000



**58066 New**  
**57066 Reman**  
 209-210  
 Coil Less  
 Mount: Case Mount  
 AMC (81-69); Audi (79-70); Int'l (79); Jaguar (79-72); Jeep (75-63); VW (80-74)  
 Case New Holland: 118250C91  
 Hy-Capacity: 0000880255  
 Massey Ferguson: D45054800  
 Northern: 500266, 500282



**58068 New**  
**57068 Reman**  
 209-210  
 Coil Less  
 Mount: Case Mount  
 AMC (79-75); Audi (77-70); Jeep (90-76)  
 AMC: 3228826

# Compressors

## York/Tecumseh Cont'd



**58074 New**  
**57074 Reman**  
 Mini-209  
 Coil Less  
 Mount: Case Mount  
 Audi (87-80); VW (85)



**68021 New**  
 CCI 209/210  
 2 Groove  
 12 Volt  
 Mount: Case Mount  
 Pulley Dia.: 6  
 Coil Clock: Wire Lead  
 Kysor: 1402006, 1411015



**68025 New**  
 CCI 209/210  
 2 Groove  
 12 Volt  
 Mount: Case Mount  
 Pulley Dia.: 6  
 Coil Clock: Wire Lead  
 Kysor: 1411014



**68027 New**  
 209-210  
 6 Groove  
 12 Volt  
 Mount: Case Mount  
 Pulley Dia.: 5-7/8  
 Coil Clock: Wire Lead



**68020 New**  
 CCI 209/210  
 2 Groove  
 12 Volt  
 Mount: Case Mount  
 Pulley Dia.: 6  
 Coil Clock: Wire Lead  
 Kysor: 1402004, 1411013

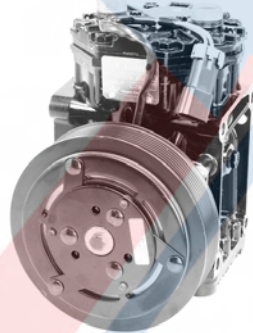

**68022 New**  
 CCI 209/210  
 8 Groove  
 12 Volt  
 Mount: Case Mount  
 Pulley Dia.: 6-1/8  
 Coil Clock: Wire Lead  
 Kysor: 1402005, 1402007

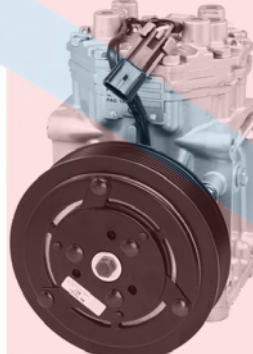







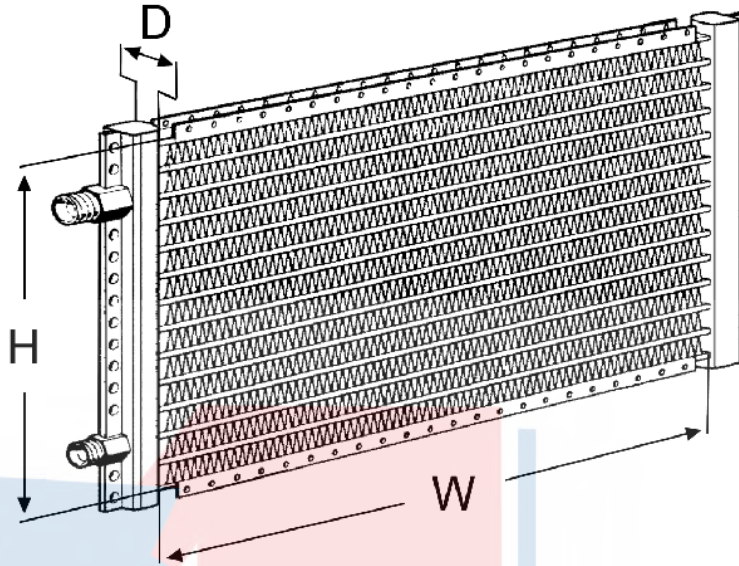

**68026 New**  
 CCI 209/210  
 8 Groove  
 12 Volt  
 Mount: Case Mount  
 Pulley Dia.: 6-1/8  
 Coil Clock: Wire Lead  
 New Compr w/o Clutch: **58031**  
 Kysor: 1402011  
 Western Star: 3007144

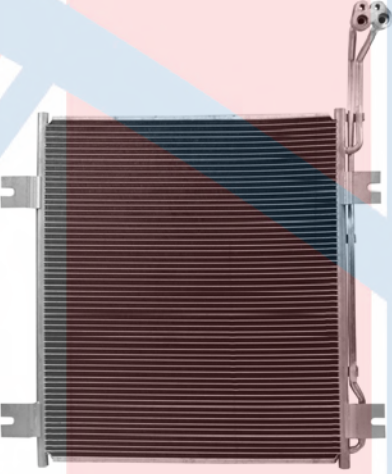

**68028 New**  
 209-210  
 6 Groove  
 12 Volt  
 Mount: Case Mount  
 Pulley Dia.: 5-7/8  
 Coil Clock: Wire Lead  
 New Clutch Assy: **47815**

# Condensers

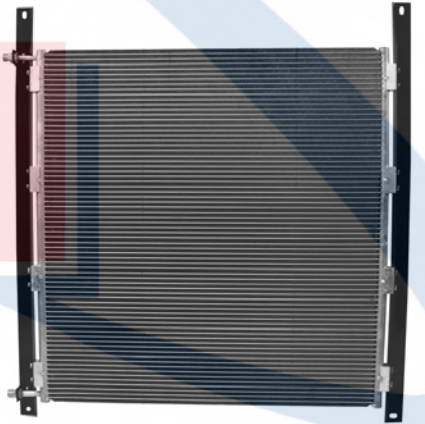

Condensers		
 <p><b>152000</b> Parallel Flow</p>	 <p><b>152003</b> Parallel Flow NaviStar: 1E5114, 2508698C92 TRP Parts: PA12850</p>	 <p><b>152005</b> Parallel Flow Kenworth: 4866845008</p>
 <p><b>152001</b> Parallel Flow Kysor: 1512015 Red Dot: 77R6977, 77R6978, RD464320</p>	 <p><b>152004</b> Parallel Flow Kenworth: K122125</p>	 <p><b>152006</b> Parallel Flow Kysor: 1517002 Peterbilt: 1803809, 1804015, 1804454, 651414, F316097 Red Dot: RD456580</p>
 <p><b>152002</b> Parallel Flow</p>		



# Condensers

## Condensers Cont'd



**152007**  
Parallel Flow  
Peterbilt: 1E4582



**152008**  
Parallel Flow  
Peterbilt: 1E5611, F316043



**152009**  
Parallel Flow  
Kysor: 8022509

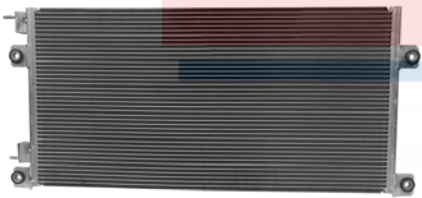

**152010**  
Parallel Flow  
Kysor: 1518010



**152011**  
Parallel Flow  
NaviStar: 3504377C1

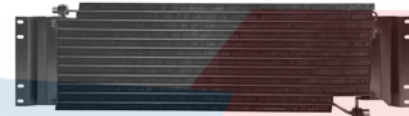

**152012**  
Serpentine  
Peterbilt: 1803093

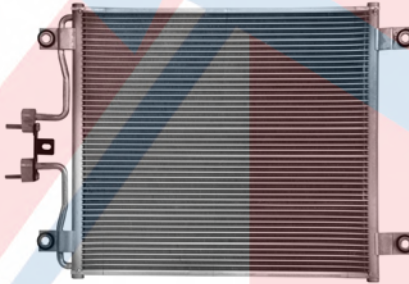

**152013**  
Parallel Flow  
International (07-01)  
Kysor: 1513027  
NaviStar: 1E5001, 2507482C92



**152014**  
Parallel Flow  
Freightliner (00-96)

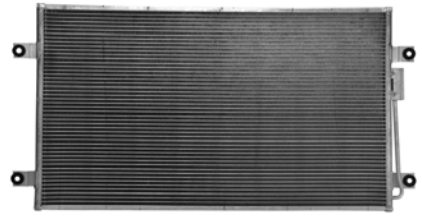

**152015**  
Parallel Flow  
Ford HD (10-08); Freightliner (14-08); Sterling (10-08)  
Kysor: 1512013, 1512025

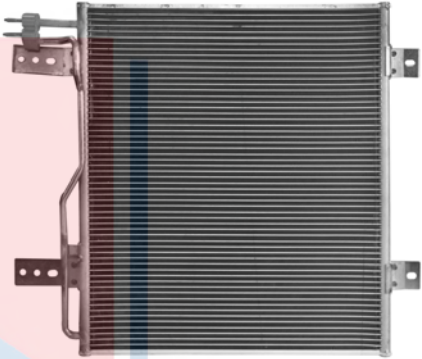

**152016**  
Parallel Flow  
International (04-01)  
NaviStar: 2505650C92



**152017**  
Serpentine  
Kenworth: K122103, K12293



**152018**  
Parallel Flow  
Mack: 210RD510M

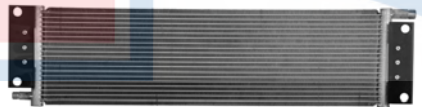

**152019**  
Parallel Flow  
Peterbilt: 1803543

# Condensers

## Condensers Cont'd

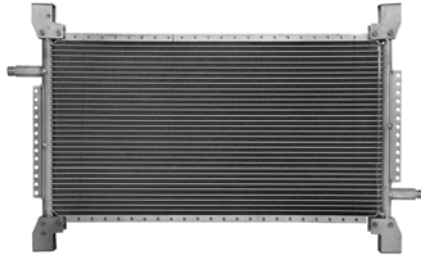

**152022**  
Parallel Flow  
Kysor: 1518009



**152023**  
Tube & Fin  
Ford HD (97-96); Sterling (03-98)  
Sterling: F6HZ19712A



**152024**  
Parallel Flow  
Sterling: VAB1210364, VAL1210364

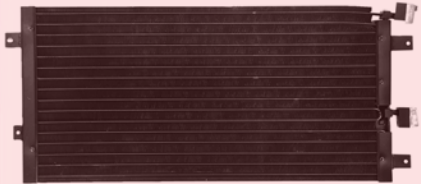

**40000**  
Parallel Flow  
Chrysler (04-98); Dodge (04-98)  
Chrysler: 4758305AE



**40001**  
Parallel Flow  
Nissan (01-98)  
Nissan: 921107Z800

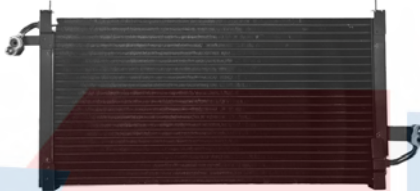

**40002**  
Parallel Flow  
Subaru (00-98)



**40003**  
6mm  
Toyota (03-98)  
Toyota: 8846008010

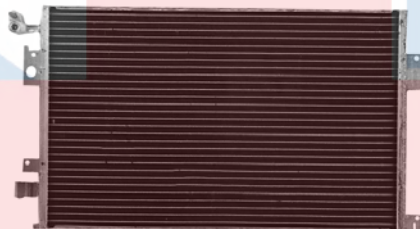

**40004**  
Parallel Flow  
Chevy (02-98); Pontiac (02-98)  
General Motors Corp: 52472662



**40005**  
Parallel Flow  
Honda (01-98); Isuzu (01-98)



**40006**  
Parallel Flow  
Mazda (02-98)  
Mazda: GD7A61480A



**40007**  
Parallel Flow  
Buick (07-04); Chevy (09-06); Pontiac (09-06);  
Saturn (07-06)  
General Motors Corp: 10357778

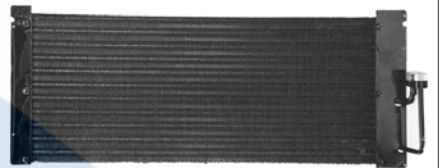

**40008**  
Parallel Flow  
Chevy (02-98)  
General Motors Corp: 52475984

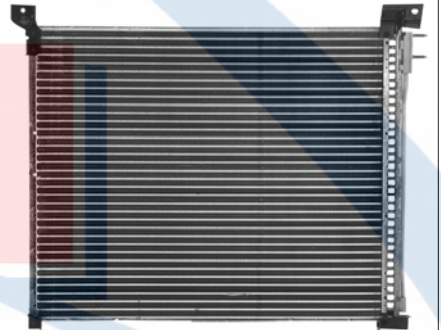

**40009**  
Parallel Flow  
Ford (10-04)  
Ford: 6C2Z19712AB

# Condensers

## Condensers Cont'd

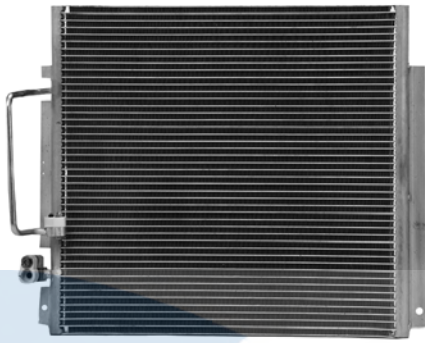

**40010**  
Parallel Flow  
Chevy (12-04); GMC (12-04); Isuzu (08-07)  
General Motors Corp: 15199317

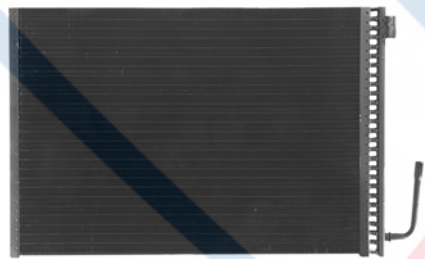

**40011**  
6mm  
Dodge (02-98)

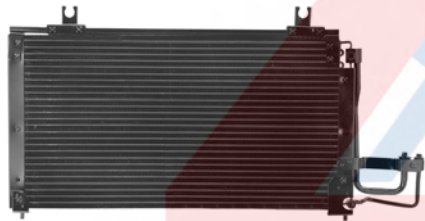

**40012**  
Parallel Flow  
Kia (04-02)  
Kia: 1K2N161480B



**40013**  
Parallel Flow  
Ford (05-02); Jaguar (02-00); Lincoln (06-00)  
Ford: 1W6Z19712AA

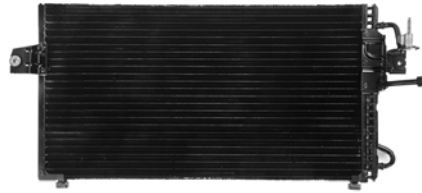

**40014**  
6mm  
Mercury (02-99); Nissan (02-99)



**40015**  
Parallel Flow  
Ford (07-99); Mercury (07-04)  
Ford: 6F2Z19712A



**40016**  
Parallel Flow  
Lexus (99-98); Toyota (07-98)  
Lexus: 8846060272



**40017**  
Parallel Flow  
Lexus (07-98); Toyota (07-98)  
Lexus: 8846060261



**40018**  
Parallel Flow  
Cadillac (06-02); Chevy (13-08), (06-99); GMC  
(13-11), (06-99)  
General Motors Corp: 20913752

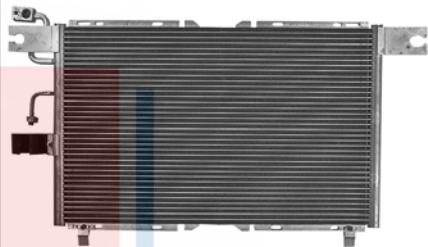

**40019**  
Parallel Flow  
Isuzu (01)  
Isuzu: 8972310870



**40020**  
Parallel Flow  
Jaguar (05-98)

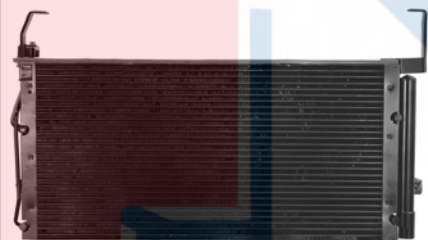

**40021**  
Parallel Flow  
Hyundai (06-01)  
Hyundai: 9760626001



# Condensers

## Condensers Cont'd



**40022**  
Parallel Flow  
Daewoo (01-00)  
Daewoo: 96450097

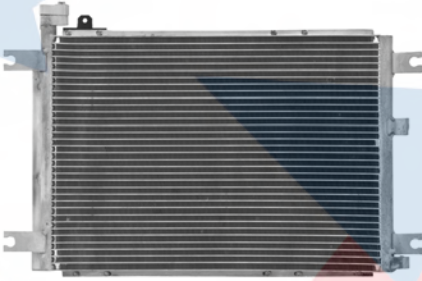

**40023**  
Parallel Flow  
Suzuki (03-99)  
Suzuki: 9531065D30



**40024**  
Parallel Flow  
Nissan (09-04)



**40025**  
Parallel Flow  
Infiniti (02-00)  
Infiniti: 921107J100



**40026**  
Parallel Flow  
Infiniti (01-00); Nissan (01-00)  
Infiniti: 921103Y100



**40027**  
Parallel Flow  
Infiniti (99)  
Infiniti: 921103J615



**40028**  
Parallel Flow  
VW (05-01)



**40029**  
Parallel Flow  
Isuzu (04-02)  
Isuzu: 8973040112



**40030**  
Parallel Flow  
Toyota (07-01)  
Toyota: 884600C030



**40031**  
Parallel Flow  
Lexus (10-02)  
Lexus: 8846024091

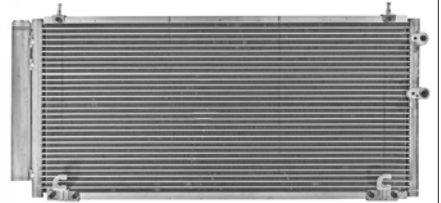

**40032**  
Parallel Flow  
Toyota (05-00)  
Toyota: 8846017130



**40033**  
Parallel Flow  
Honda (06-00)  
Honda: 80110S3YA01

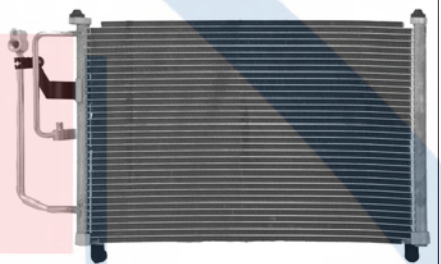

**40034**  
Parallel Flow  
Daewoo (02-99)  
Daewoo: 96274635

# Condensers

## Condensers Cont'd

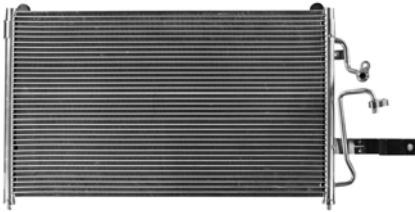

**40035**  
Parallel Flow  
Daewoo (02-99)  
Daewoo: 96484258



**40036**  
Parallel Flow  
Buick (07-02); Chevy (06-01); Olds (04-01); Pontiac (06-01); Saturn (06-05)  
General Motors Corp: 10339103



**40037**  
Parallel Flow  
Saturn (05-00)  
Saturn: 19256744



**40038**  
Parallel Flow  
Lexus (06-02); Toyota (08-02)  
Lexus: 8846006070



**40039**  
Parallel Flow  
Toyota (07-01)  
Toyota: 8846048020



**40040**  
Parallel Flow  
Buick (07-04); Chevy (09-02); GMC (09-02); Isuzu (08-03); Olds (04-02); Saab (09-05)  
General Motors Corp: 89019255

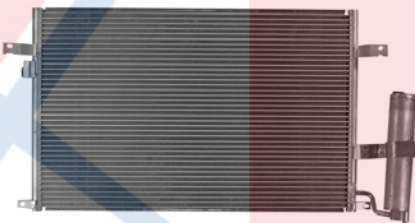

**40041**  
Parallel Flow  
Suzuki (08-04)  
Suzuki: 9531085Z02

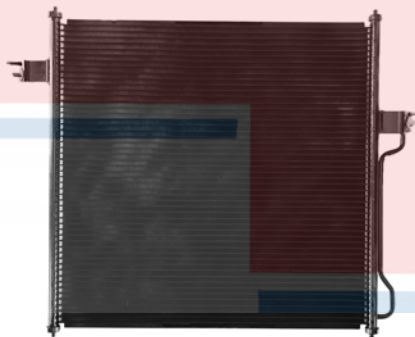

**40042**  
Parallel Flow  
Ford (05-02); Mercury (05-02)



**40043**  
Parallel Flow  
Nissan (08-02)  
Nissan: 921008J050

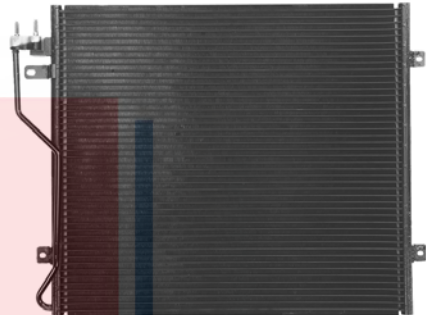

**40044**  
Parallel Flow  
Jeep (05-02)  
Chrysler: 5183560AC



**40045**  
Parallel Flow  
Acura (06-02)  
Acura: 80110S6MA01



**40046**  
Parallel Flow  
Infiniti (04-02); Nissan (03-02)  
Infiniti: 921002Y960

# Condensers

## Condensers Cont'd

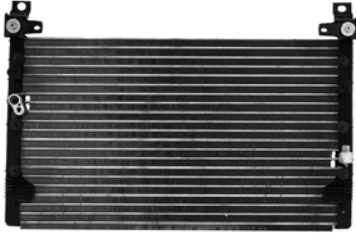

**40047**  
Parallel Flow  
Toyota (04-01)  
Toyota: 8846104030

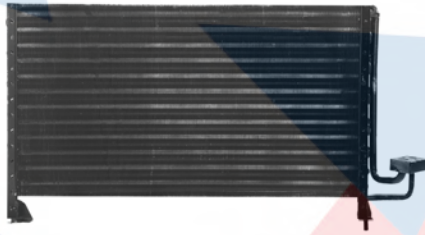

**40048**  
Parallel Flow  
Kia (05-02)  
Kia: 1K52Y61E01C



**40049**  
Parallel Flow  
Kia (03-01)  
Kia: 0K30A61480E

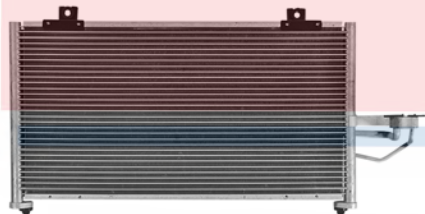

**40050**  
Serpentine  
Kia (01-00)  
Kia: 1K2B161480C

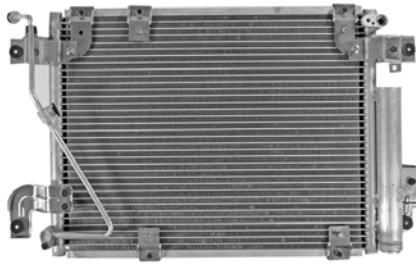

**40051**  
Parallel Flow  
Suzuki (04-99)

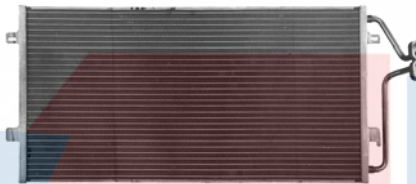

**40052**  
Parallel Flow  
Cadillac (05-00)  
General Motors Corp: 89019239

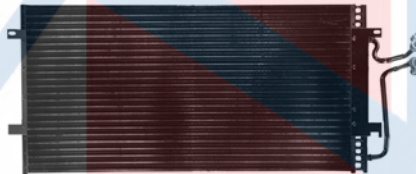

**40053**  
Parallel Flow  
Olds (03-01)  
General Motors Corp: 52477251



**40054**  
Parallel Flow  
Saab (01-99)

**40055**  
Parallel Flow  
Land Rover (04-99)  
Land Rover: JRB100790



**40056**  
Parallel Flow  
Volvo (04-00)  
Volvo: 30897260

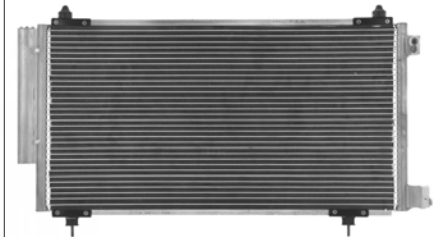

**40057**  
Parallel Flow  
Toyota (02-00)  
Toyota: 8846020560



**40058**  
Parallel Flow  
Lexus (05-01)  
Lexus: 8846053010

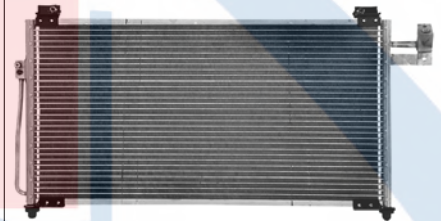

**40059**  
Parallel Flow  
Mazda (03-01)  
Mazda: B25F61480B



# Condensers

## Condensers Cont'd

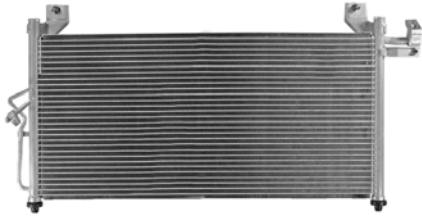

**40060**  
Parallel Flow  
Mazda (03-01)  
Mazda: B25H61480B

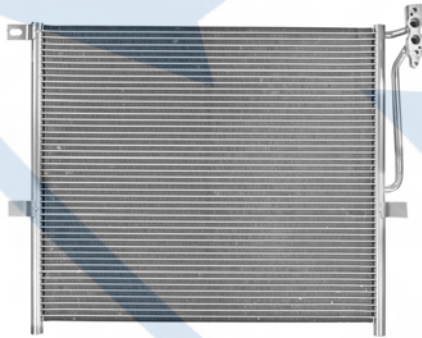

**40061**  
Parallel Flow  
BMW (10-04)  
BMW: 17113400400

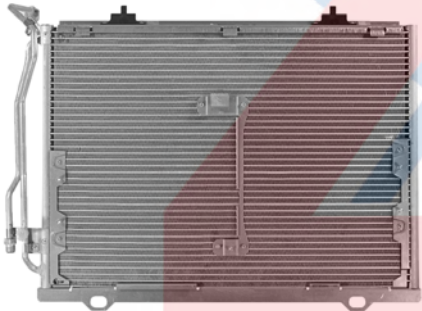

**40062**  
Parallel Flow  
Mercedes (00-99)  
Mercedes Benz: 2028300770



**40063**  
Parallel Flow  
Mazda (01-00)  
Mazda: LC7061480C



**40064**  
Parallel Flow  
Jeep (06-04), (02-00)  
Chrysler: 55037618AH



**40065**  
Serpentine  
Mazda (98-97)  
Mazda: LC2961480

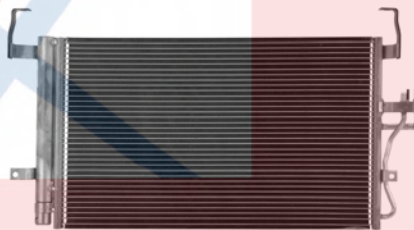

**40066**  
Parallel Flow  
Hyundai (08-01)  
Hyundai: 976062D000

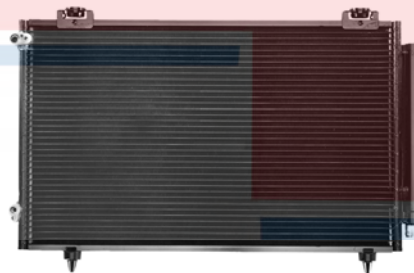

**40067**  
Parallel Flow  
Toyota (04-03)  
Toyota: 8845002170, 8845012231

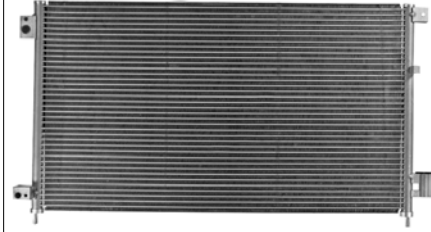

**40068**  
Parallel Flow  
Honda (07-03)  
Honda: 80110SDAA02

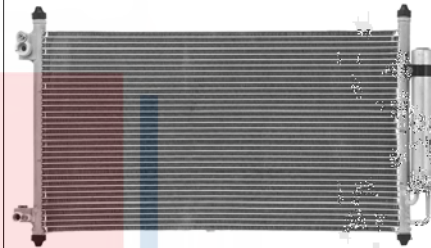

**40069**  
Parallel Flow  
Acura (08-04)  
Acura: 80110SEPA01



**40070**  
6mm  
Ford (08-04); Lincoln (08-06)



**40071**  
Parallel Flow  
Toyota (09-04)  
Toyota: 8845047020

# Condensers

## Condensers Cont'd

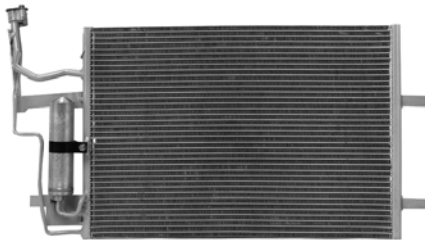

**40072**  
Parallel Flow  
Mazda (10-04)  
Mazda: BP4K61480D



**40073**  
Parallel Flow  
Chevy (05-02); Olds (04-02); Pontiac (05-02)  
General Motors Corp: 22719427



**40074**  
Parallel Flow  
Kia (04-03)  
Kia: 976063E601



**40075**  
Parallel Flow  
Nissan (06-01)  
Nissan: 921104Z010

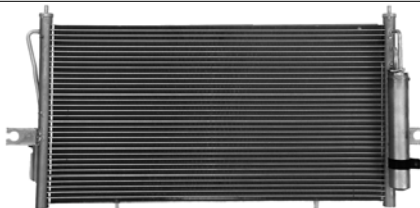

**40076**  
Parallel Flow  
Nissan (04-03)  
Nissan: 921001Z600

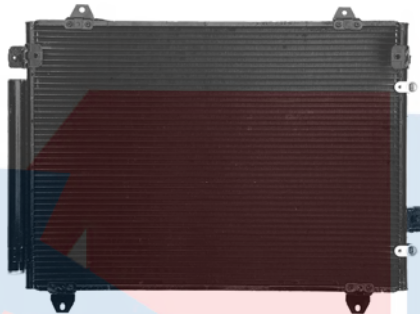

**40077**  
Parallel Flow  
Cadillac (07-03)  
General Motors Corp: 19129982



**40078**  
Parallel Flow  
Mitsubishi (03-02)

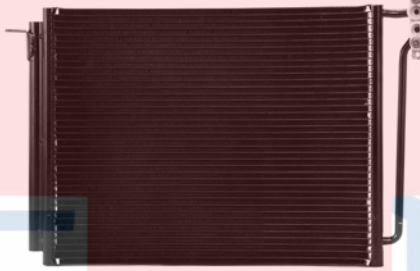

**40079**  
Parallel Flow  
BMW (06-00)  
BMW: 64536914216



**40080**  
Parallel Flow  
Infiniti (04-02)  
Infiniti: 92100AR270

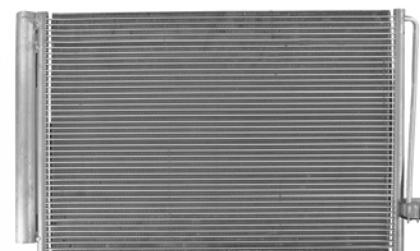

**40081**  
Parallel Flow  
BMW (10-02)  
BMW: 64509122825

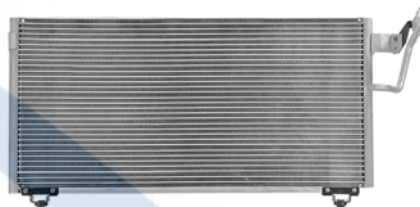

**40082**  
Parallel Flow  
Mitsubishi (04-00)



**40083**  
6mm  
Saturn (04-02)  
Saturn: 15807005



**40084**  
Parallel Flow  
Subaru (03-02)  
Subaru: 73210FE001

# Condensers

## Condensers Cont'd



**40085**  
Parallel Flow  
Infiniti (03-01); Nissan (04-01)



**40086**  
Parallel Flow  
Mazda (05-01)



**40087**  
Parallel Flow  
Lexus (06-01)  
Lexus: 8846050181

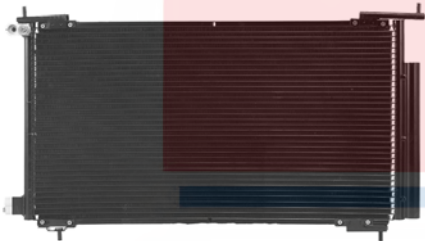

**40088**  
Parallel Flow  
Honda (06-02)  
Honda: 80110S9A013

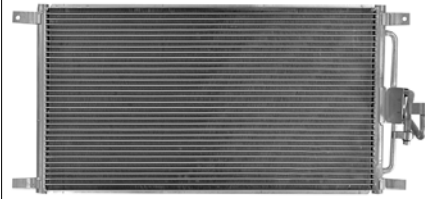

**40089**  
Parallel Flow  
Jaguar (99-97)

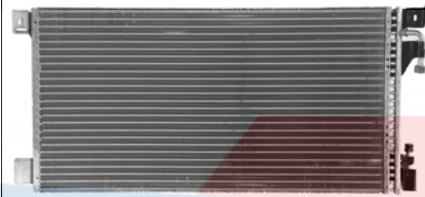

**40090**  
6mm  
Lincoln (02-98)



**40091**  
Parallel Flow  
Hyundai (05-00)  
Hyundai: 9760625500

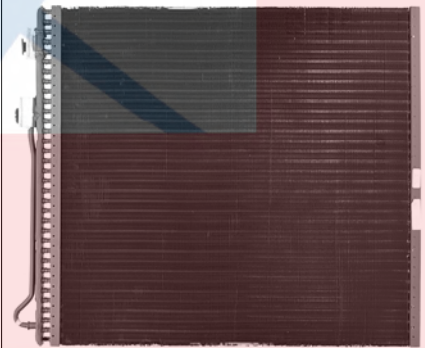

**40092**  
6mm  
Dodge (06-03)

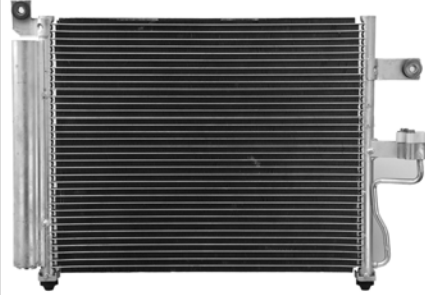

**40093**  
Parallel Flow  
Hyundai (02-00)  
Hyundai: 9760625600

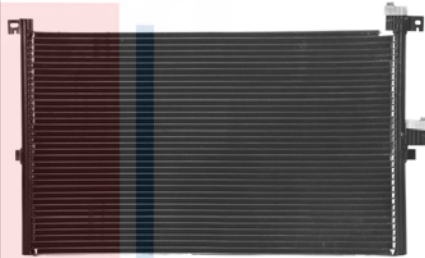

**40094**  
Parallel Flow  
Jaguar (08-02)

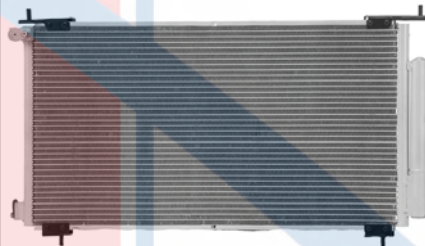

**40095**  
Parallel Flow  
Honda (11-03)  
Honda: 80110SCVA01



**40096**  
Parallel Flow  
Honda (07-03)  
Honda: 80110SDNA01



# Condensers

## Condensers Cont'd



**40097**  
Parallel Flow  
Honda (05-02)  
Honda: 80110S5TE01

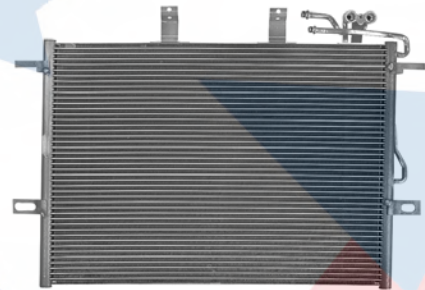

**40098**  
Parallel Flow  
Mercedes (11-03)  
Mercedes Benz: 2115000154



**40099**  
Parallel Flow  
Audi (04-03)  
Audi: 8E0260403B



**40100**  
Parallel Flow  
Acura (02-01); Honda (08-03)  
Acura: 80100S3V305

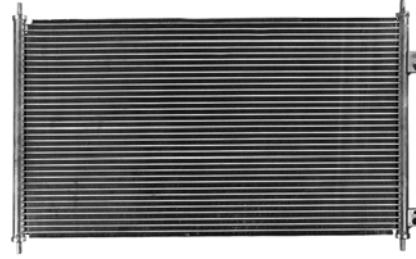

**40101**  
Parallel Flow  
Honda (05-03)  
Honda: 80110S5B003



**40102**  
6mm  
Buick (85-77); Chevy (90-81), (79-77); Olds (85-77); Pontiac (86-83), (81-79)

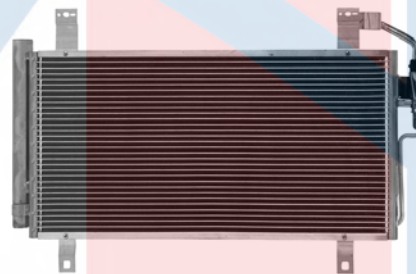

**40103**  
Parallel Flow  
Mazda (08-03)  
Mazda: GJYG6148Z

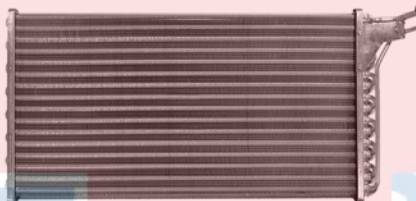

**40104**  
Tube & Fin  
Cadillac (88-77)

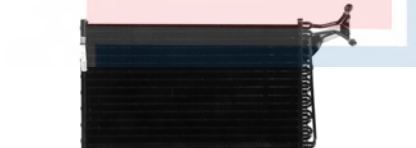

**40105**  
Tube & Fin  
Cadillac (85-79)



**40106**  
6mm  
Buick (89-86); Cadillac (89-86); Olds (89-86)



**40107**  
6mm  
Chevy (91-86); Pontiac (91-86)



**40108**  
6mm  
Buick (80-78); Chevy (88-75); GMC (87-78); Olds (80-78); Pontiac (80-78)



**40109**  
Tube & Fin  
Buick (85-79); Olds (85-79)

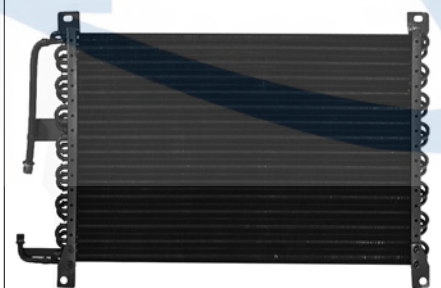

**40110**  
Tube & Fin  
Buick (85-80); Chevy (83-80); Olds (84-80); Pontiac (84-80)

# Condensers

## Condensers Cont'd

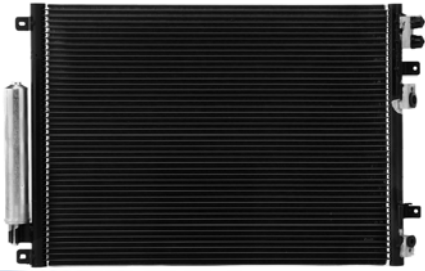

**40111**  
Parallel Flow  
Chrysler (14-05); Dodge (14-05)  
Chrysler: 5137693AD

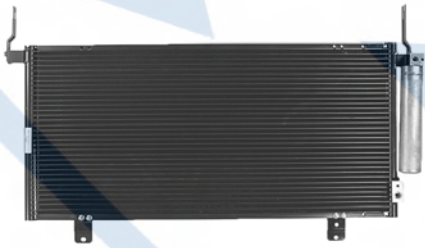

**40112**  
Parallel Flow  
Mitsubishi (12-04)  
Mitsubishi: 7812A173

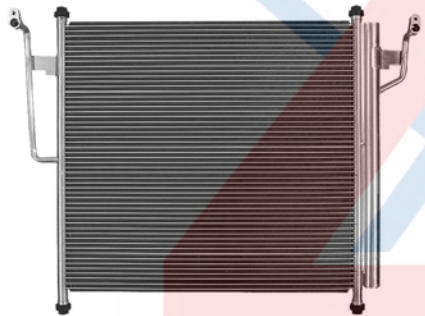

**40113**  
Parallel Flow  
Infiniti (10-04); Nissan (14-04)  
Infiniti: 921009GF0A  
Nissan: 921009GF0A



**40114**  
Parallel Flow  
Chevy (08-04); Pontiac (08-05); Suzuki (09-04)  
General Motors Corp: 96834083

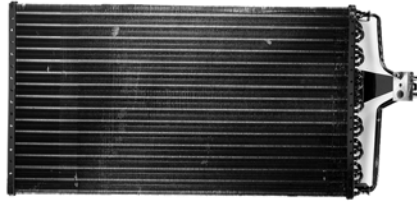

**40115**  
Tube & Fin  
Buick (88); Olds (88); Pontiac (88)



**40116**  
6mm  
Buick (93-89); Chevy (93-90); Olds (93-89); Pontiac (93-89)  
General Motors Corp: 52452050



**40117**  
Parallel Flow  
Chevy (05)  
General Motors Corp: 15232871



**40118**  
Parallel Flow  
Honda (10-05)  
Honda: 80110SHJA01



**40119**  
Parallel Flow  
Jeep (10-05)  
Chrysler: 55116928AA

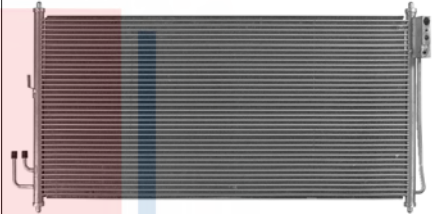

**40120**  
Parallel Flow  
Nissan (07-03)  
Nissan: 92110CN000



**40121**  
6mm  
Buick (05); Chevy (05-04); Pontiac (05-04)  
General Motors Corp: 19130292

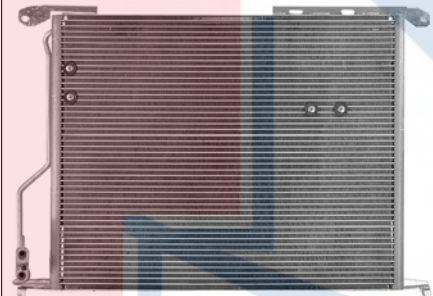

**40122**  
Parallel Flow  
Mercedes (09-00)  
Mercedes Benz: 2205000054

# Condensers

## Condensers Cont'd

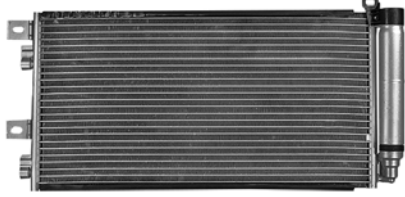

**40123**  
Parallel Flow  
Mini (07-02)

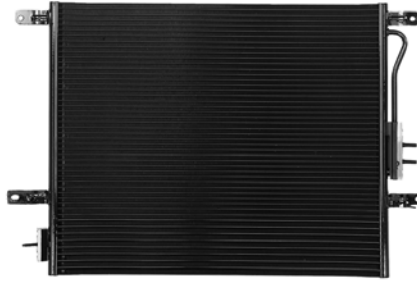

**40127**  
Parallel Flow  
Jeep (04)  
Chrysler: 55116931AA



**40131**  
Parallel Flow  
Toyota (05-03)  
Toyota: 8845052141

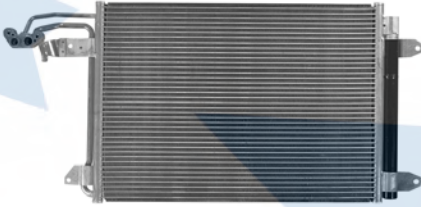

**40124**  
Parallel Flow  
Audi (15-06); VW (14-06)  
Audi: 1K0820411Q

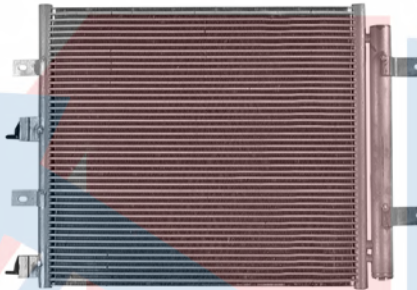

**40128**  
Parallel Flow  
Jaguar (15-03)  
Jaguar: XR856373



**40132**  
Parallel Flow  
Mercedes (14-01)  
Mercedes Benz: 2035000554, 2035001254

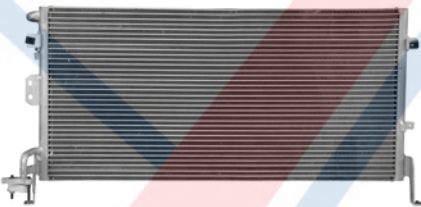

**40125**  
Parallel Flow  
Hyundai (04-02); Kia (04)  
Hyundai: 9760638003

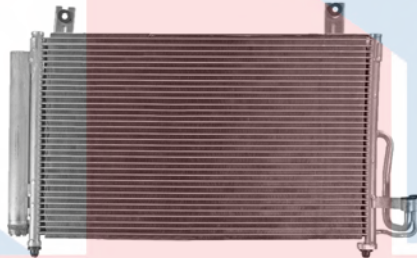

**40129**  
Parallel Flow  
Kia (05-04)  
Kia: 97606FD000



**40133**  
Parallel Flow  
Audi (11-04)  
Audi: 4E0260403Q

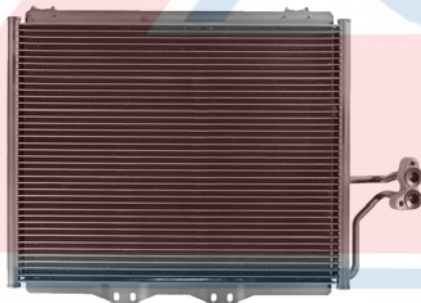

**40126**  
Parallel Flow  
Jeep (03)  
Chrysler: 55037618AD

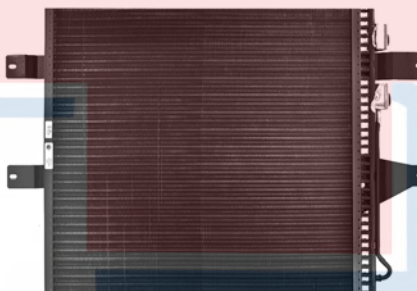

**40130**  
6mm  
Dodge (04-03)  
Chrysler: 68240781AA

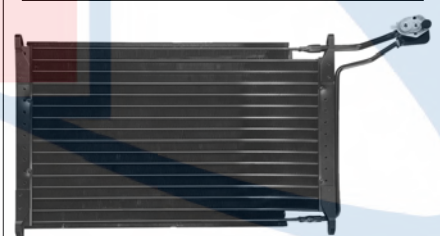

**40134**  
Tube & Fin  
Cadillac (88-87); Chevy (88-85); Olds (87-85)



# Condensers

## Condensers Cont'd

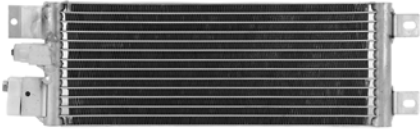

**40135**  
Parallel Flow  
Chrysler (00); Dodge (00); Plymouth (00)  
Chrysler: 4809195AB

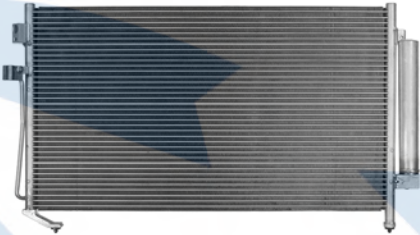

**40136**  
Parallel Flow  
Subaru (08-03)

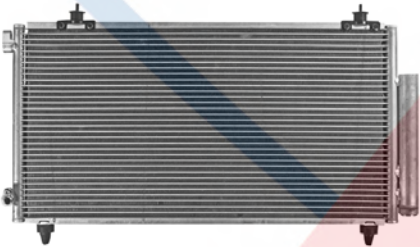

**40138**  
Parallel Flow  
Toyota (05-03)  
Toyota: 8846020600

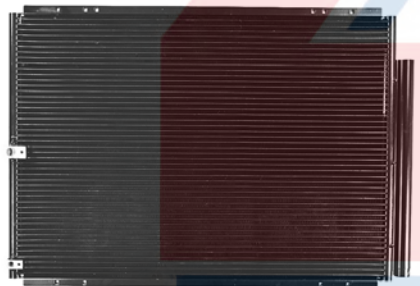

**40139**  
Parallel Flow  
Lexus (06-04)  
Lexus: 884600E011

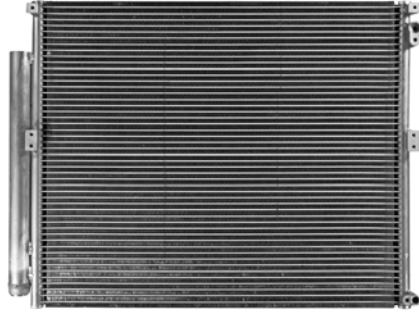

**40140**  
Parallel Flow  
Lexus (09-03); Toyota (09-03)

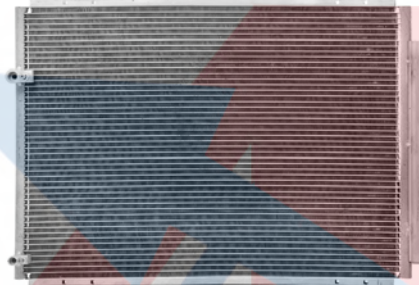

**40141**  
Parallel Flow  
Toyota (10-04)  
Toyota: 8846108010



**40142**  
Parallel Flow  
Chrysler (08-03)  
Chrysler: 5096191AC

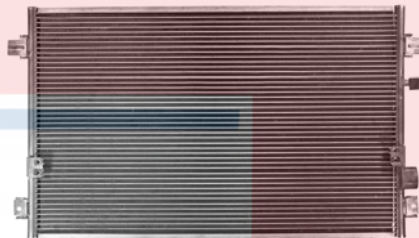

**40143**  
Parallel Flow  
Chrysler (06-04)  
Chrysler: 5102434AC



**40144**  
Parallel Flow  
Chrysler (09-07); Dodge (09-04)  
Chrysler: 55056165AA

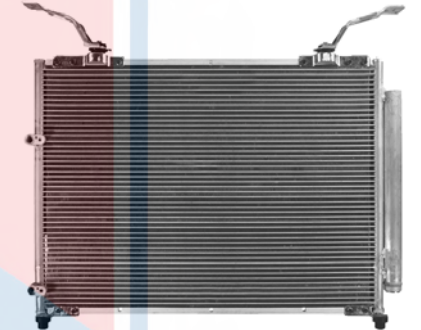

**40145**  
Parallel Flow  
Acura (06-03)  
Acura: 80100S3V306

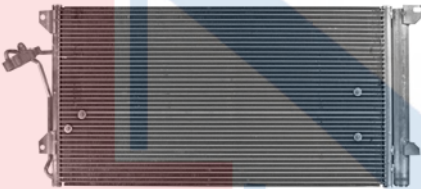

**40146**  
Parallel Flow  
Audi (14-07); Porsche (10-08), (06-03); VW (10-04)  
Audi: 4L0260401A  
Volkswagen: 4L0260401A

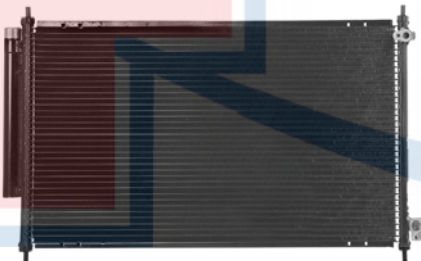

**40147**  
Parallel Flow  
Acura (08-04)  
Acura: 80110SEA013

# Condensers

## Condensers Cont'd

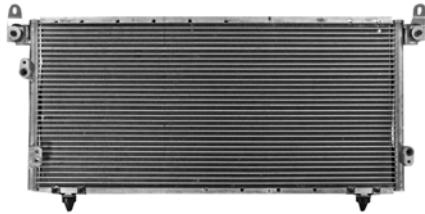

**40148**  
Parallel Flow  
Toyota (05-00)  
Toyota: 884600C050

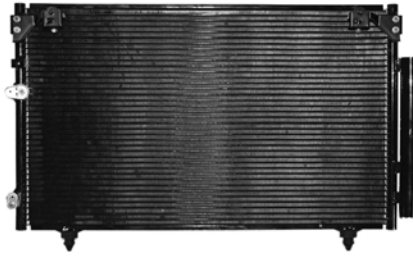

**40153**  
Parallel Flow  
Scion (10-05)  
Toyota: 8846021050

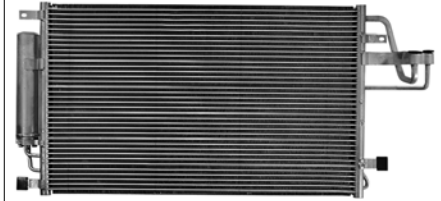

**40157**  
Parallel Flow  
Hyundai (09-05); Kia (10-05)  
Hyundai: 976062E000



**40150**  
6mm  
Ford (07-04); Mazda (06-05); Mercury (07-05)  
Ford: 7L8Z19712AC

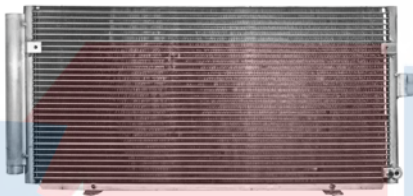

**40154**  
Parallel Flow  
Subaru (09-05)

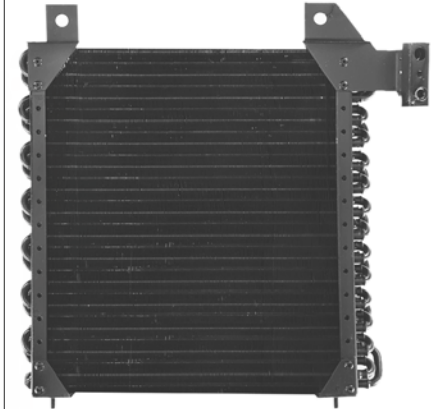

**40158**  
Serpentine  
Chrysler (88-84); Dodge (89-84); Plymouth (89-84)



**40151**  
Parallel Flow  
Toyota (08-05)  
Toyota: 8845002261

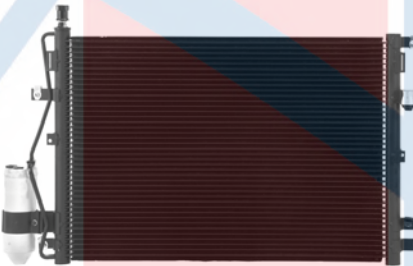

**40155**  
Parallel Flow  
Volvo (05-03)  
Volvo: 30665563



**40159**  
6mm  
Dodge (93-87)

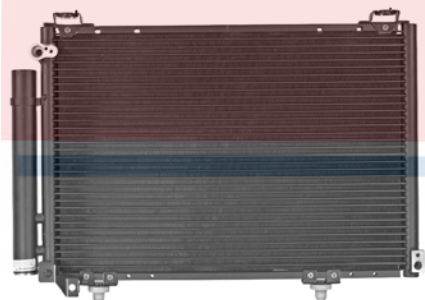

**40152**  
Parallel Flow  
Scion (04)

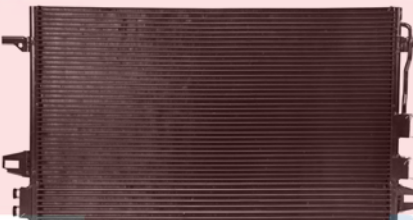

**40156**  
Parallel Flow  
Chrysler (07-05); Dodge (07-05)  
Chrysler: 68059739AB

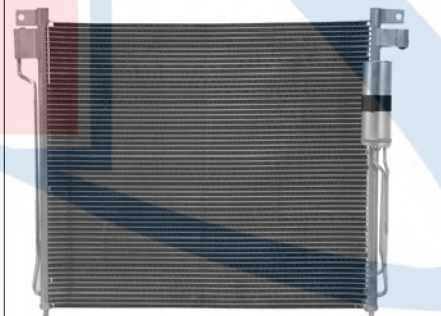

**40160**  
Parallel Flow  
Nissan (15-05); Suzuki (11-09)  
Nissan: 92100EA500



# Condensers

## Condensers Cont'd

**40161**

6mm  
Chrysler (89-80); Dodge (89-80); Plymouth (89-82),  
(80-79)

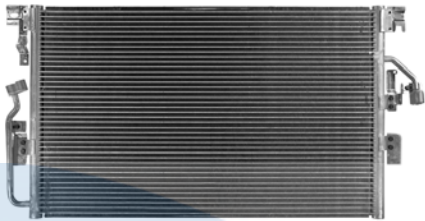

**40162**

Parallel Flow  
Saturn (07-04)  
Saturn: 15897864



**40163**

6mm  
Chrysler (90-83); Dodge (90-78); Plymouth (90-80)



**40164**

Parallel Flow  
Kia (09-04)  
Kia: 976063F100

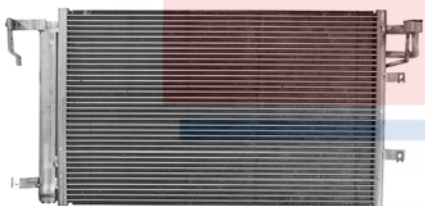

**40165**

Parallel Flow  
Kia (09-04)  
Kia: 976062F000

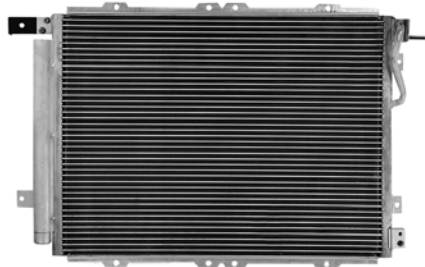
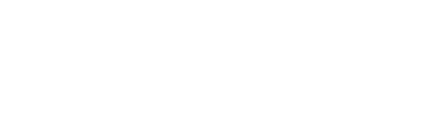

**40166**

Parallel Flow  
Kia (06-03)  
Kia: 976063E601



**40167**

Parallel Flow  
Cadillac (11-04)  
General Motors Corp: 88957420

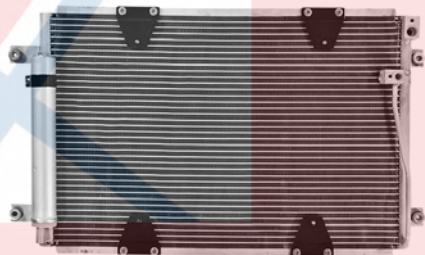

**40168**

Parallel Flow  
Suzuki (03)  
Suzuki: 9531054J00

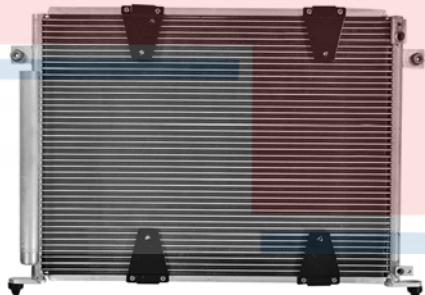

**40169**

Parallel Flow  
Suzuki (06-04)  
Suzuki: 9531054J11



**40170**

Parallel Flow  
Mercedes (05-98)  
Mercedes Benz: 1638300170

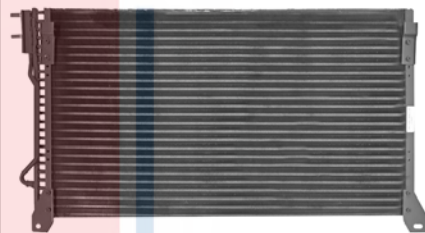

**40171**

6mm  
Ford (05)  
Ford: 5F9Z19712AA

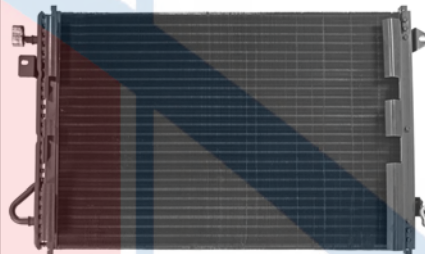

**40172**

6mm  
Ford (09-05)  
Ford: 6R3Z19712AC



**40173**

6mm  
Saturn (07-04)  
Saturn: 15807010



# Condensers

## Condensers Cont'd

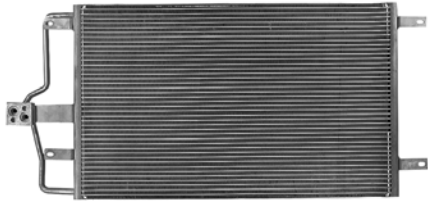

**40174**

Parallel Flow  
Ford (11-05); Mazda (10-08); Mercury (11-06)  
Ford: 6M6Z19712A



**40175**

Parallel Flow  
Suzuki (00-99)  
Suzuki: 9531065D00



**40176**

Parallel Flow  
Hyundai (05); Kia (05)  
Hyundai: 9760638004

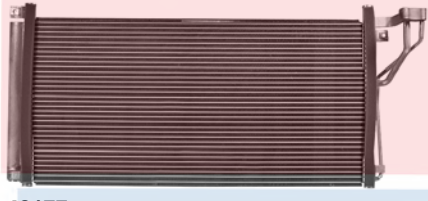

**40177**

Parallel Flow  
Hyundai (11-06); Kia (10-06)  
Hyundai: 976063L180



**40178**

Parallel Flow  
Audi (05-00)

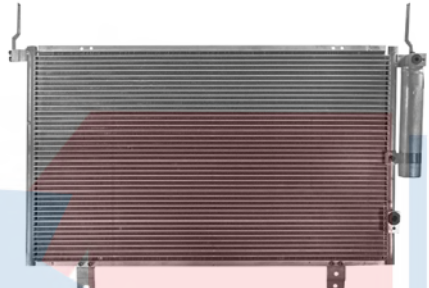

**40179**

Parallel Flow  
Mitsubishi (11-10), (08-04)  
Mitsubishi: 7812A172

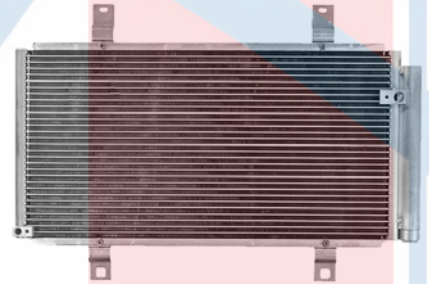

**40180**

Parallel Flow  
Mazda (11-04)  
Mazda: F15161480

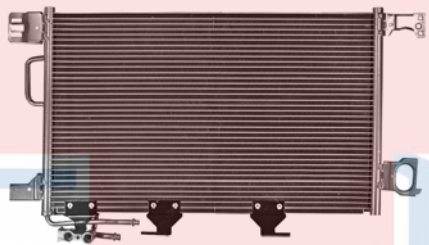

**40181**

Parallel Flow  
Mercedes (09-04)  
Mercedes Benz: 2035000854

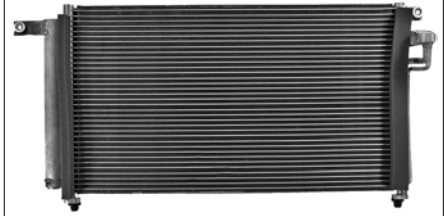

**40182**

Parallel Flow  
Hyundai (14); Kia (12-06)  
Hyundai: 976061R000, 976062M000, 976062S500,  
976062V000  
Kia: 976061G000, 976061R000, 976062V000

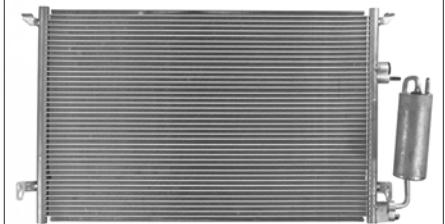

**40183**

Parallel Flow  
Saab (11-03)  
Saab: 12793296

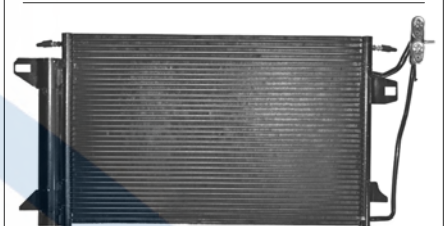

**40184**

Parallel Flow  
Ford (12-06); Lincoln (12-06); Mercury (09-06)  
Ford: 9N7Z19712A

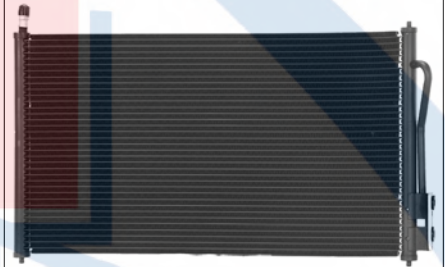

**40185**

Parallel Flow  
Ford (07-05)  
Ford: 6S4Z19712A

# Condensers

## Condensers Cont'd



**40186**  
Parallel Flow  
Saab (06-05); Subaru (07-03)

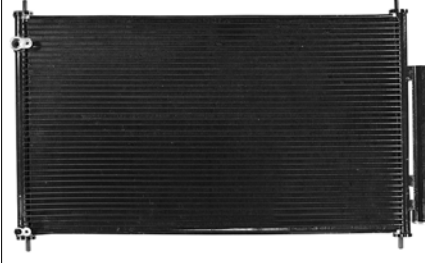

**40190**  
Parallel Flow  
Acura (12-05)  
Acura: 80110SJA003



**40194**  
Parallel Flow  
Infiniti (08-03)  
Infiniti: 92100CG010

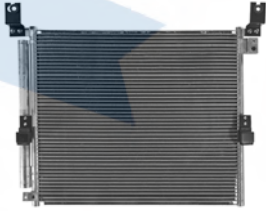

**40187**  
Aluminum  
Toyota (12-05)  
Toyota: 8846004210



**40191**  
Parallel Flow  
Mitsubishi (07-04)  
Mitsubishi: MN151100

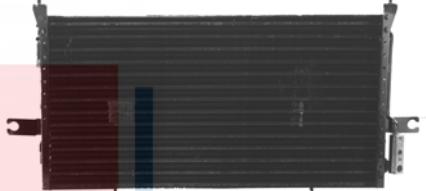

**40195**  
Parallel Flow  
Nissan (03)

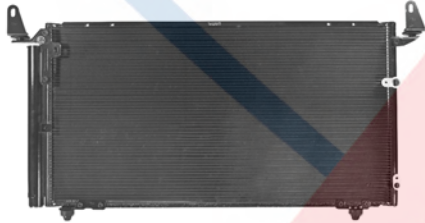

**40188**  
Parallel Flow  
Toyota (05-03)  
Toyota: 884600C090

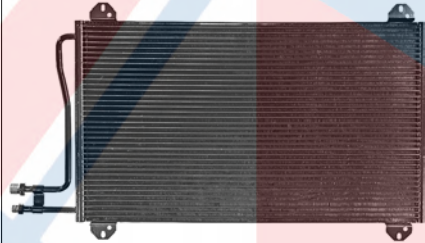

**40192**  
Parallel Flow  
Dodge (06-03); Freightliner (06-03)  
Chrysler: 5104114AA

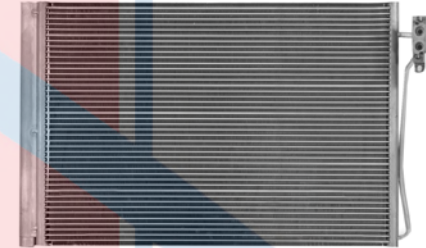

**40196**  
Parallel Flow  
Land Rover (12-03)  
Land Rover: JRW000020

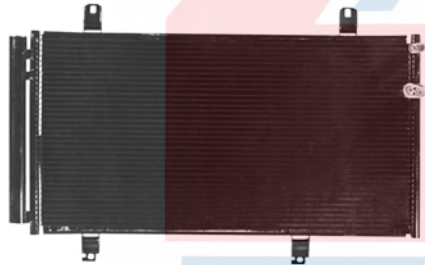

**40189**  
Parallel Flow  
Lexus (12-07); Toyota (14-05)  
Lexus: 8846006210



**40193**  
Parallel Flow  
Dodge (06-03); Freightliner (06-03)  
Chrysler: 5132357AA

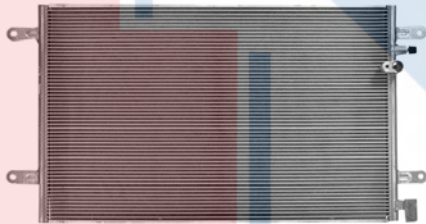

**40197**  
Parallel Flow  
Audi (11-06)

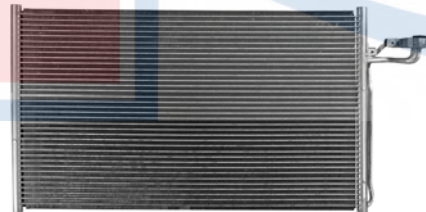

**40198**  
Parallel Flow  
Volvo (13-04)

# Condensers

## Condensers Cont'd



**40199**  
Parallel Flow  
Jaguar (09-04)  
Jaguar: C2C26832

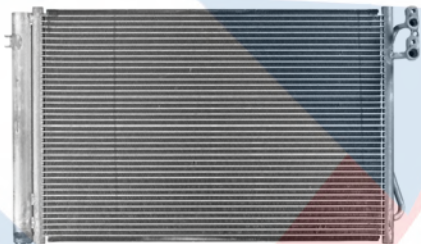

**40200**  
Parallel Flow  
BMW (14-06)  
BMW: 64539229022

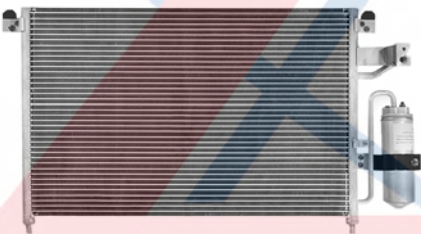

**40201**  
Parallel Flow  
Chevy (06-04); Suzuki (06-04)

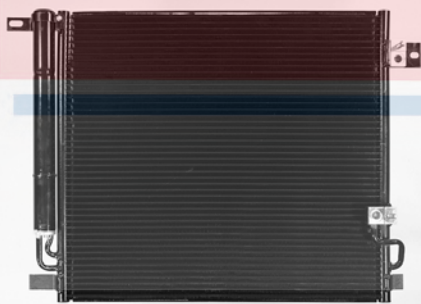

**40202**  
Parallel Flow  
Chevy (12-09); GMC (12-09)  
General Motors Corp: 25964057

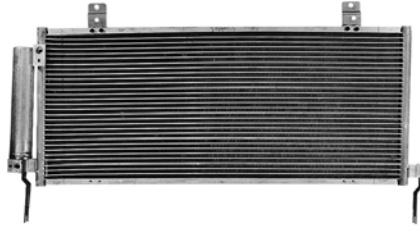

**40203**  
Parallel Flow  
Mitsubishi (12-06)  
Mitsubishi: 7812A174

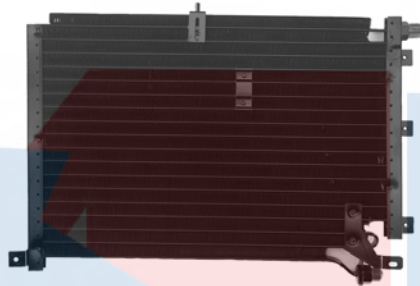

**40204**  
Serpentine  
Saab (93-79)

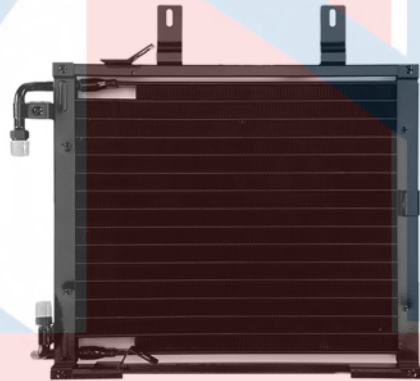

**40206**  
Parallel Flow  
BMW (92-84)



**40208**  
Parallel Flow  
Chevy (09-06); Pontiac (09-06)  
General Motors Corp: 19256971

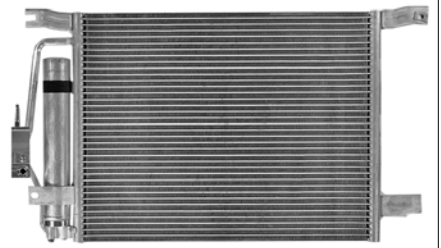

**40209**  
Parallel Flow  
Pontiac (09-06); Saturn (10-07)  
General Motors Corp: 19130430



**40211**  
Parallel Flow  
Mercedes (13-06)  
Mercedes Benz: 2515000054



**40212**  
Parallel Flow  
Subaru (12-06)  
Subaru: 73210XA00A

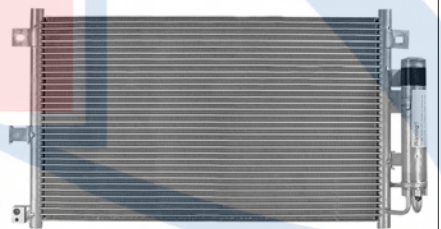

**40213**  
Parallel Flow  
Mazda (14-06)  
Mazda: NE5161480C



# Condensers

## Condensers Cont'd



**40214**  
Parallel Flow  
Lexus (11-06)  
Lexus: 8846030871



**40215**  
Parallel Flow  
Infiniti (10-06)  
Infiniti: 92100EG000



**40216**  
Parallel Flow  
VW (14-06)  
Volkswagen: 3C0820411D

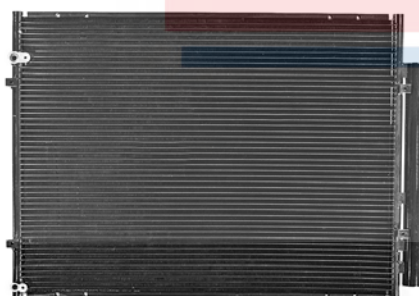

**40217**  
Parallel Flow  
Lexus (08-06); Toyota (07-06)  
Lexus: 8846048061

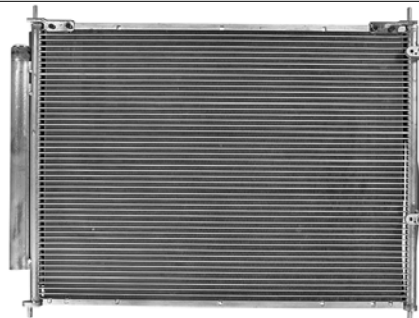

**40218**  
Parallel Flow  
Honda (14-06)  
Honda: 80110SJCA01

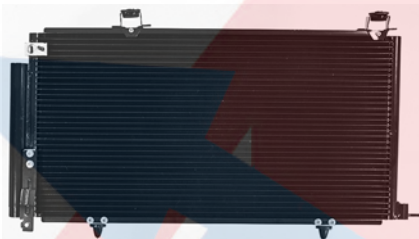

**40219**  
Parallel Flow  
Scion (05)  
Toyota: 8845052230

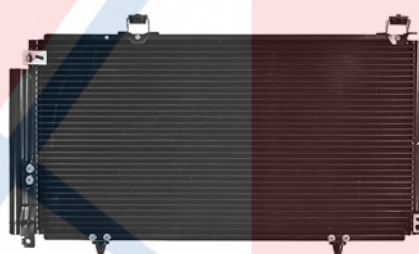

**40220**  
Parallel Flow  
Scion (06-05)  
Toyota: 8845052231

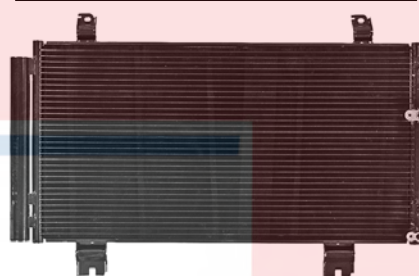

**40222**  
Parallel Flow  
Lexus (14-06)  
Lexus: 8846053030

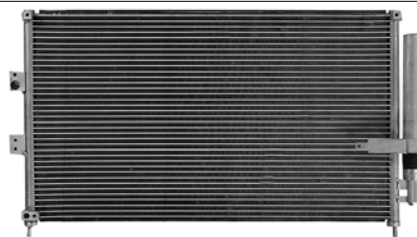

**40223**  
Parallel Flow  
Acura (10-06); Honda (11-06)  
Honda: 80110SNAA42

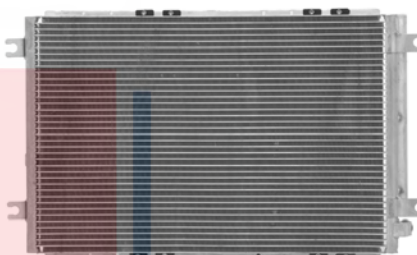

**40224**  
Parallel Flow  
Suzuki (05-02)  
Suzuki: 9531065D20



**40225**  
Parallel Flow  
Audi (05-00)  
Audi: 4B0260403S



**40226**  
Parallel Flow  
Pontiac (06-05)  
General Motors Corp: 92148168

# Condensers

## Condensers Cont'd

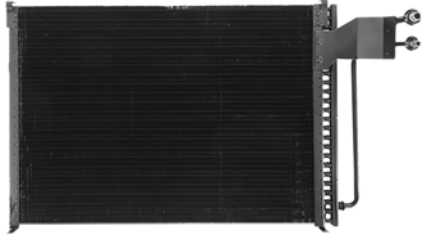

**40227**

6mm  
Ford (93-81); Lincoln (92-84); Mercury (88-82)



**40228**

6mm  
Ford (91-82); Mercury (91-82)



**40229**

Parallel Flow  
Ford (11-06); Lincoln (11-06); Mercury (11-06)  
Ford: BW7Z19712A

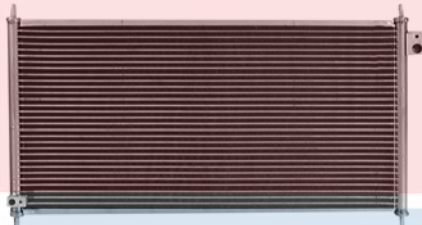

**40230**

Parallel Flow  
Honda (09-04)  
Honda: 80110S2A900

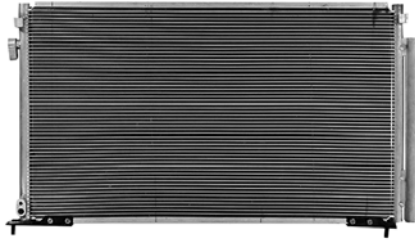

**40231**

Parallel Flow  
Honda (11-06)  
Honda: 80102SVAA02

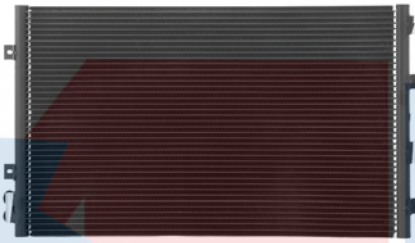

**40232**

Parallel Flow  
Chrysler (06-05)  
Chrysler: 5143537AB

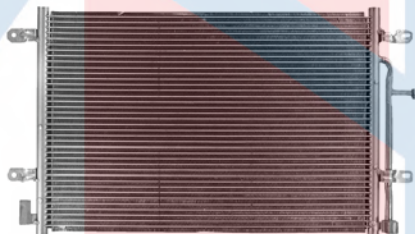

**40233**

Parallel Flow  
Audi (09-06)



**40234**

6mm  
Ford (07-05); Mercury (07-05)  
Ford: 6F9Z19712AB

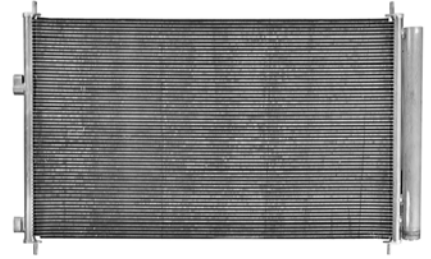

**40235**

Parallel Flow  
Toyota (12-06)  
Toyota: 884600R011

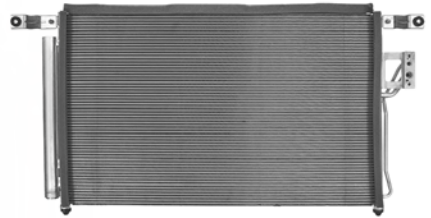

**40236**

Parallel Flow  
Hyundai (09-07)  
Hyundai: 976062B000



**40237**

Parallel Flow  
Hyundai (10-07); Kia (14), (12-06)  
Hyundai: 976064D900

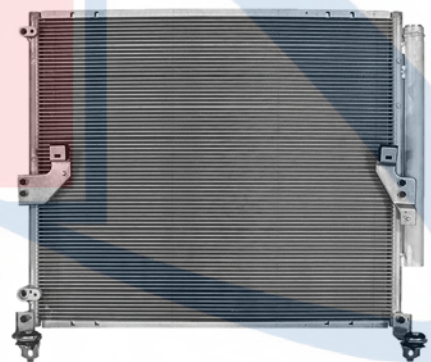

**40238**

Parallel Flow  
Toyota (14-07)  
Toyota: 8846035380



# Condensers

## Condensers Cont'd

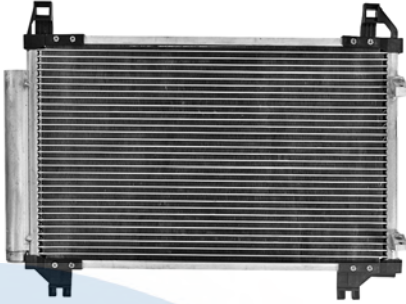

**40239**  
Parallel Flow  
Scion (14-08); Toyota (14-06)  
Toyota: 8846052110

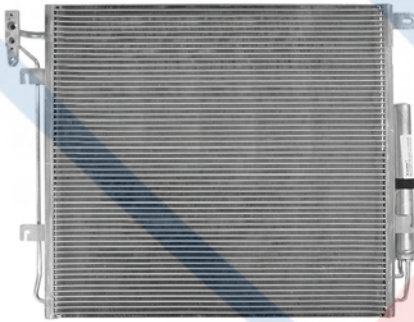

**40240**  
Parallel Flow  
Land Rover (12-05)  
Land Rover: JRB500140

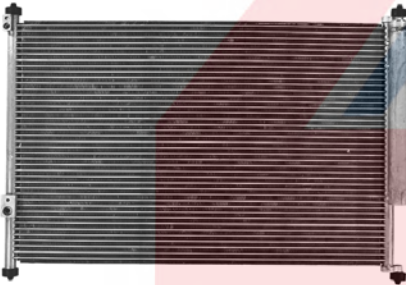

**40241**  
Parallel Flow  
Suzuki (13-06)  
Suzuki: 9531064JA0

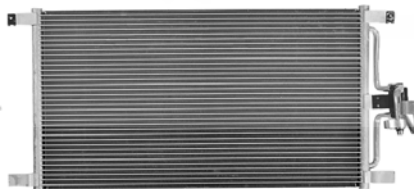

**40242**  
Parallel Flow  
Jaguar (06-00)  
Jaguar: MJD7390AE

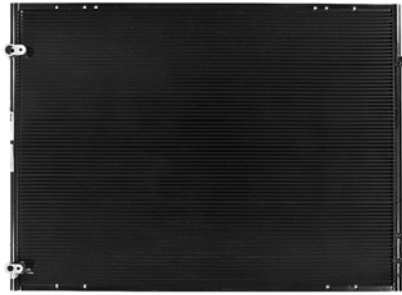

**40243**  
Parallel Flow  
Lexus (09-07)  
Lexus: 884600E020



**40244**  
Parallel Flow  
Chrysler (14-07); Dodge (14-07); Jeep (13-07)

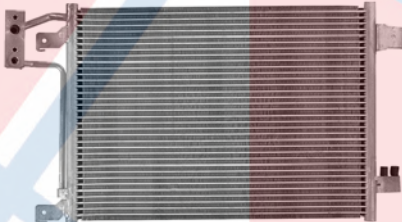

**40245**  
Parallel Flow  
Jeep (11-07)  
Chrysler: 55056726AA

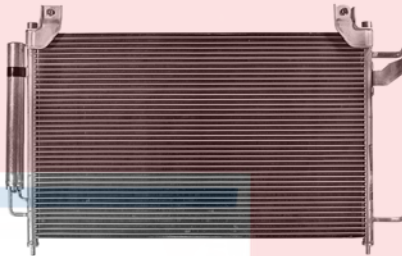

**40246**  
Parallel Flow  
Mazda (11-07)  
Mazda: EH4461480A

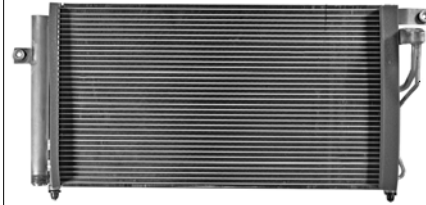

**40247**  
Parallel Flow  
Hyundai (13-06)  
Hyundai: 976061E000

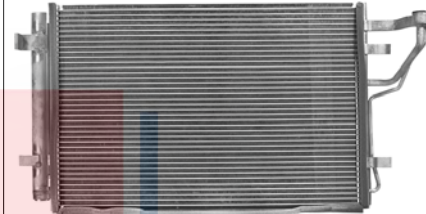

**40248**  
Parallel Flow  
Hyundai (12-07)  
Hyundai: 976062H010



**40249**  
Parallel Flow  
Acura (12-07)  
Acura: 80110STKA01

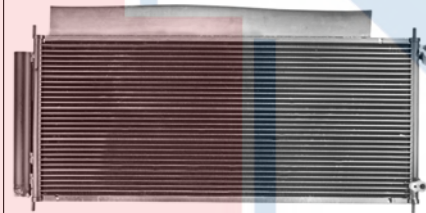

**40250**  
Parallel Flow  
Honda (08-07)  
Honda: 80110SAA013



# Condensers

## Condensers Cont'd

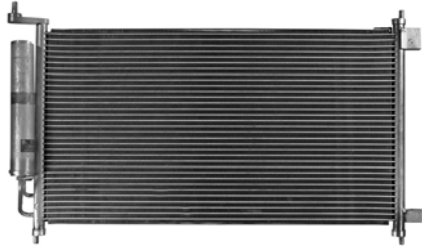

**40251**  
Parallel Flow  
Nissan (14-07)  
Nissan: 92100ZW40D

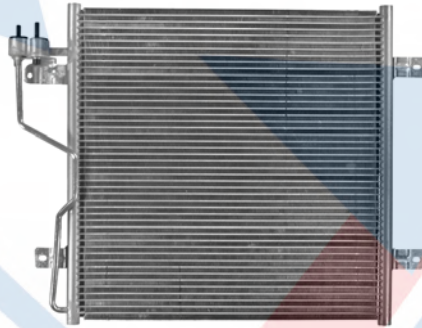

**40252**  
Parallel Flow  
Jeep (07-06)  
Chrysler: 5183560AC

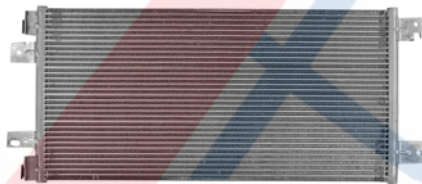

**40253**  
Parallel Flow  
Dodge (12), (08-07); Jeep (12-07)  
Chrysler: 5191252AA



**40254**  
Parallel Flow  
Toyota (14-06)  
Toyota: 884600C100

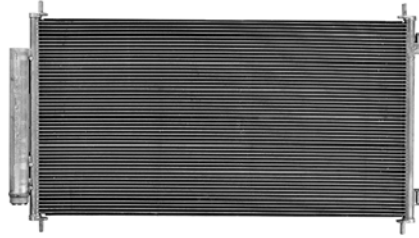

**40255**  
Parallel Flow  
Honda (11-07)  
Honda: 80110SWAA01



**40256**  
Parallel Flow  
Acura (13-07)  
Acura: 80110STXA01

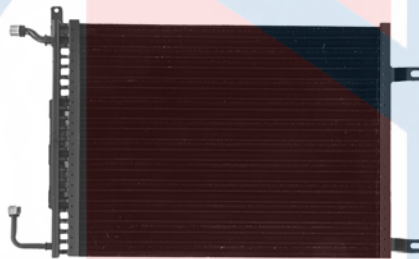

**40257**  
6mm  
Ford (79-73)

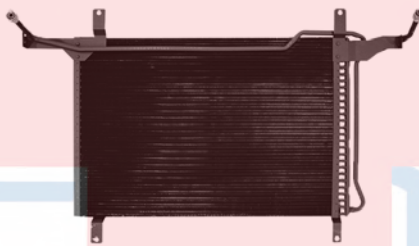

**40258**  
6mm  
Ford (93-80)

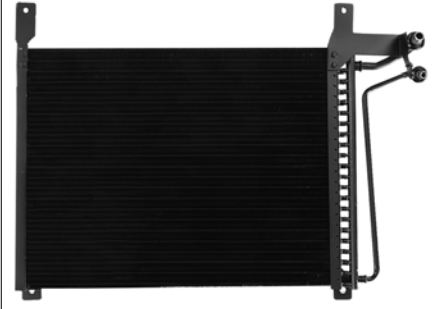

**40259**  
6mm  
Ford (89-83)

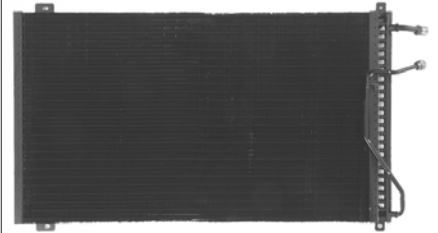

**40260**  
6mm  
Chevy (80-75); GMC (80-75)

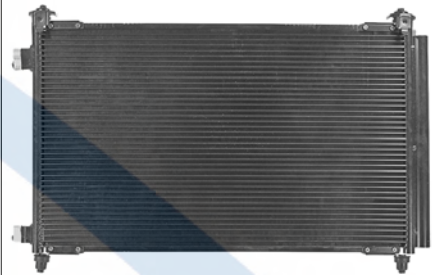

**40261**  
Parallel Flow  
Mazda (12-07)  
Mazda: TD1161480A

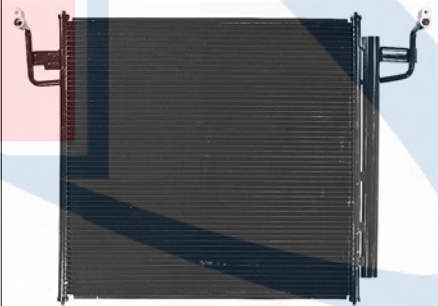

**40262**  
Parallel Flow  
Infiniti (09-05); Nissan (09-05)  
Infiniti: 921009GFOA  
Nissan: 921009GFOA

# Condensers

## Condensers Cont'd



**40263**  
6mm  
Chevy (81); GMC (81)



**40264**  
Parallel Flow  
Ford (14-07); Lincoln (14-07)  
Ford: AL1Z19712B



**40265**  
Parallel Flow  
Nissan (12-07)  
Nissan: 92100ZE80A

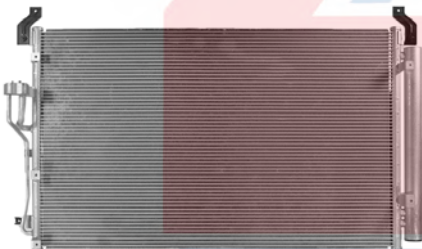

**40266**  
Parallel Flow  
Hyundai (12-07)  
Hyundai: 976063J100

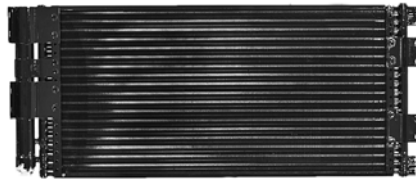

**40267**  
Parallel Flow  
Land Rover (05-02)  
Land Rover: JRB101070

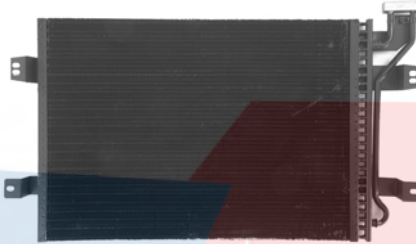

**40268**  
6mm  
Dodge (93-80); Dodge Medium Duty Truck (81-80);  
Plymouth (81)



**40269**  
6mm  
Dodge (97-89), (87-82); Plymouth (83-81)

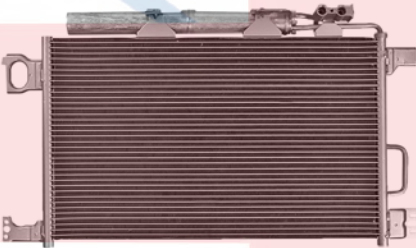

**40270**  
Parallel Flow  
Mercedes (09-06)  
Mercedes Benz: 2035002154

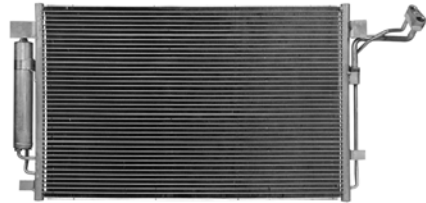

**40271**  
Parallel Flow  
Nissan (14-07)  
Nissan: 92100ZN50B



**40272**  
6mm  
Chevy (93-82); GMC (93-82)

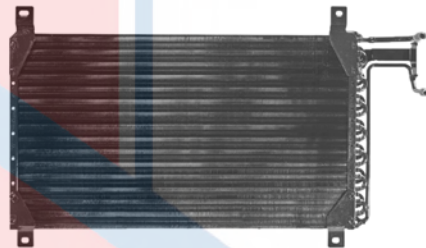

**40273**  
Tube & Fin  
Chevy (84-82); GMC (84-82)



**40274**  
6mm  
Chevy (91-82); GMC (91-82)

# Condensers

## Condensers Cont'd



**40275**  
Parallel Flow  
Lexus (14-07)  
Lexus: 8846050201



**40276**  
6mm  
Chevy (89-85); GMC (89-85)



**40277**  
Parallel Flow  
Buick (15-08); Chevy (15-09); GMC (15-07); Saturn (10-07)  
General Motors Corp: 22918340



**40278**  
Parallel Flow  
Ford (12-07); Lincoln (12-07)  
Ford: 7T4Z19708B

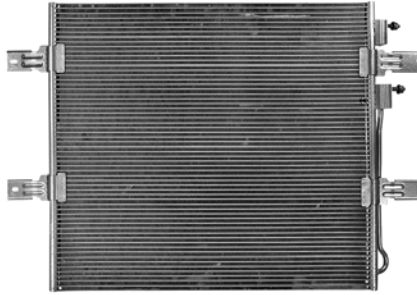

**40279**  
Parallel Flow  
Dodge (09-05); Dodge Medium Duty Truck (08)  
Chrysler: 55057095AA

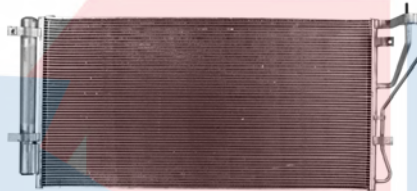

**40280**  
Parallel Flow  
Kia (12-07)  
Kia: 976061D110

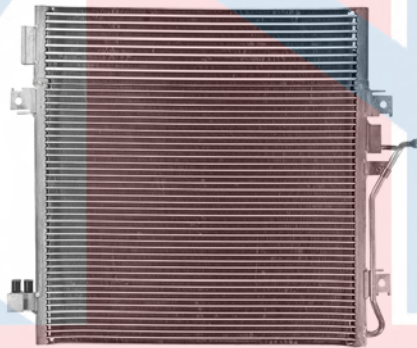

**40281**  
Parallel Flow  
Dodge (11-07); Jeep (12-08)

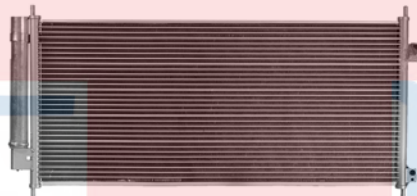

**40282**  
Parallel Flow  
Dodge (11-05); Mitsubishi (09-06)  
Chrysler: 55056352AC

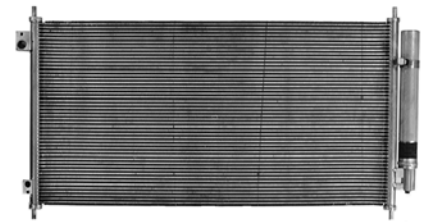

**40283**  
Parallel Flow  
Honda (14-08)  
Honda: 80110TA0A01

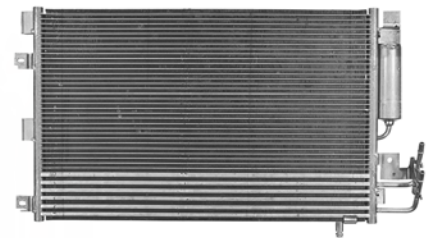

**40284**  
Parallel Flow  
Ford (11-08)  
Ford: AS4Z19712A

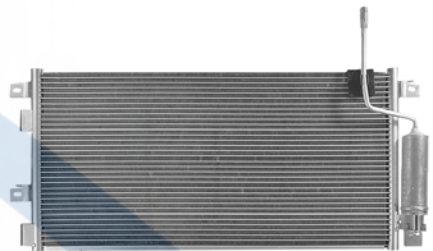

**40285**  
Parallel Flow  
Ford (10-08)  
Ford: AS4Z19712B

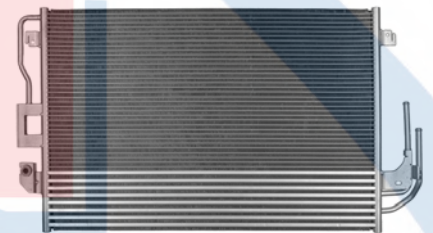

**40286**  
Parallel Flow  
Ford (12-08); Mazda (11-08); Mercury (11-08)  
Ford: 8L8Z19712G



# Condensers

## Condensers Cont'd



**40287**  
Parallel Flow  
Ford (12-08); Lincoln (13-09); Mercury (09-08)  
Ford: BG1Z19712A

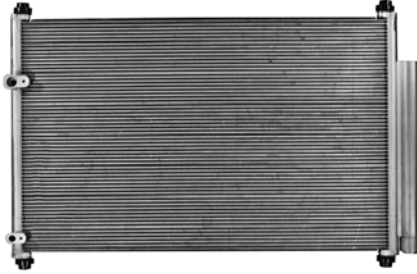

**40291**  
Parallel Flow  
Pontiac (10-09); Scion (14-08); Toyota (14-09)  
Toyota: 8845002330

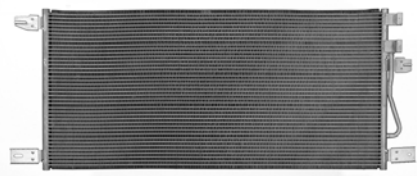

**40295**  
Parallel Flow  
Ford (10-08)  
Ford: 7C3Z19712A

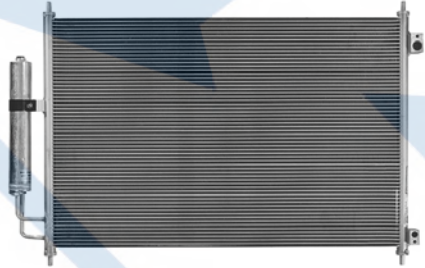

**40288**  
Parallel Flow  
Nissan (13-08)  
Nissan: 92100JG000

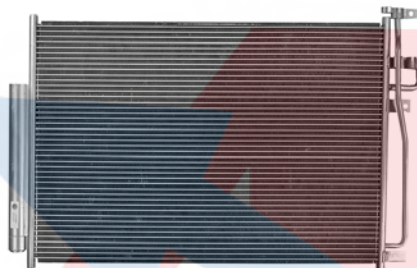

**40292**  
Parallel Flow  
Chevy (14-12); Saturn (10-08)  
General Motors Corp: 20759645, 95326122



**40296**  
Parallel Flow  
Ford (10-08)  
Ford: 7C3Z19712B

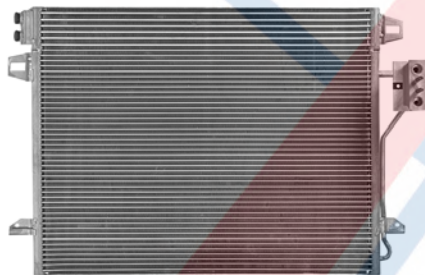

**40289**  
Parallel Flow  
Chrysler (14-08); Dodge (14-08); VW (12-09)  
Chrysler: 4677782AC

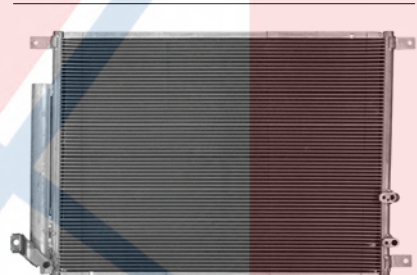

**40293**  
Parallel Flow  
Cadillac (13-08)  
General Motors Corp: 20929423



**40297**  
Parallel Flow  
VW (12-06)  
Volkswagen: 1C0820413F



**40290**  
Parallel Flow  
Toyota (13-08)  
Toyota: 884600E050

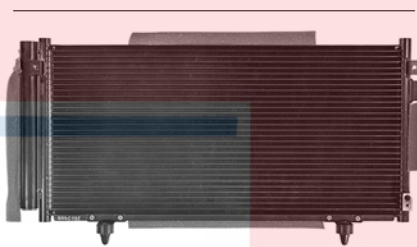

**40294**  
Parallel Flow  
Subaru (14-08)  
Subaru: 73210SC012

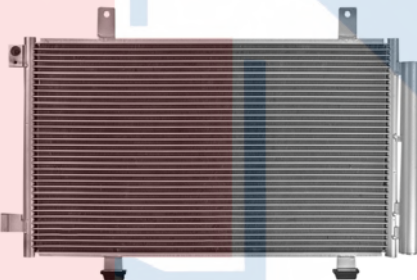

**40298**  
Parallel Flow  
Suzuki (13-07)  
Suzuki: 9531080J01

# Condensers

## Condensers Cont'd

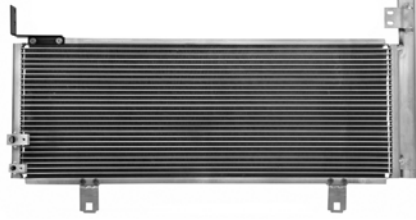

**40299**  
Parallel Flow  
Toyota (14-07)  
Toyota: 8846033120, 8846033130

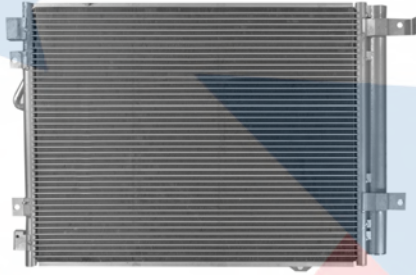

**40300**  
Parallel Flow  
Kia (10-07)  
Kia: 976063E930

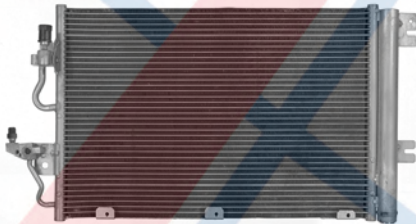

**40301**  
Parallel Flow  
Saturn (09-08)  
Saturn: 93178958

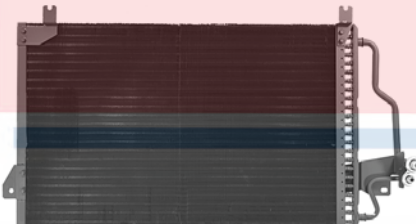

**40302**  
6mm  
Dodge (92-90); Eagle (92-88)  
Chrysler: 36002788

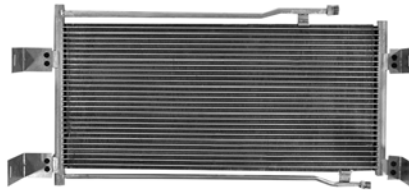

**40303**  
Parallel Flow  
Jeep (91-84)  
Chrysler: J8127461

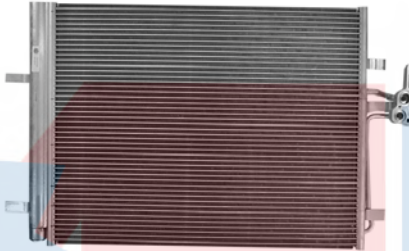

**40304**  
Parallel Flow  
Land Rover (14-08); Volvo (15-08)  
Land Rover: LR023921

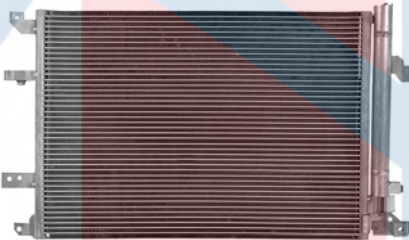

**40305**  
Parallel Flow  
Volvo (09-05)

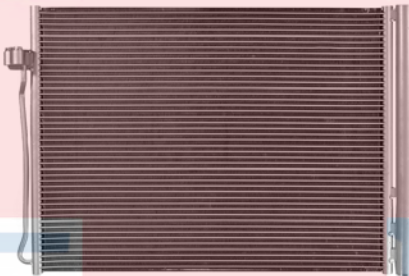

**40306**  
Parallel Flow  
BMW (14-08)  
BMW: 64509239944, 64509239992, 64509391489  
Ford: BC3Z19712A, CV6Z19712J



**40307**  
Aluminum  
BMW (15-07)  
BMW: 64539229021

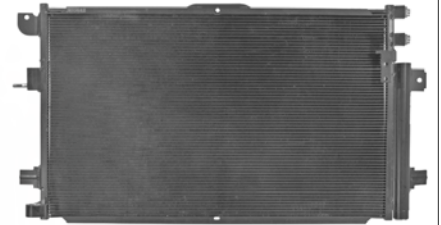

**40308**  
Parallel Flow  
Chrysler (08-07)  
Chrysler: 68002779AA

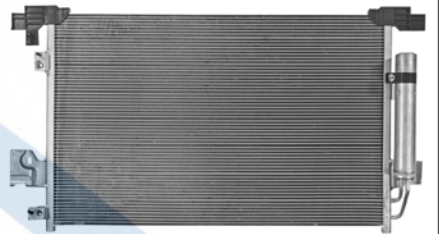

**40309**  
Parallel Flow  
Mitsubishi (14-07)  
Mitsubishi: 7812A274

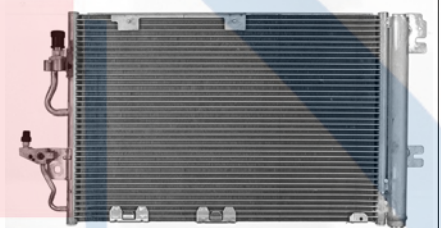

**40310**  
Parallel Flow  
Saturn (09-08)  
Saturn: 93178959

# Condensers

## Condensers Cont'd



**40311**  
Parallel Flow  
Ford (14-08)  
Ford: 9C2Z19712A

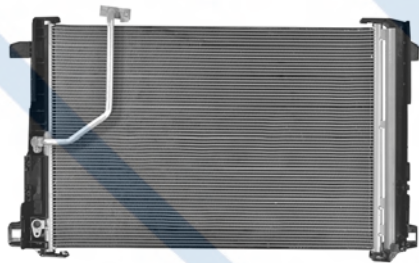

**40312**  
Parallel Flow  
Mercedes (14-08)  
Mercedes Benz: 2045000654



**40313**  
Parallel Flow  
Hyundai (12-09)  
Hyundai: 976063N160

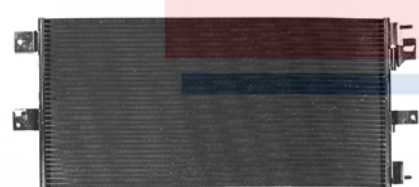

**40314**  
Parallel Flow  
Jeep (14-07)  
Chrysler: 68004296AA



**40315**  
Parallel Flow  
Acura (14-09)  
Acura: 80110TK4A01

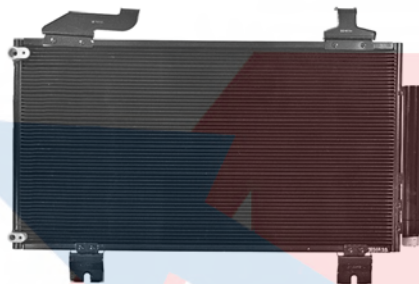

**40316**  
Parallel Flow  
Acura (14-09)  
Acura: 80100TL2A01



**40317**  
Parallel Flow  
Jeep (11-07)  
Chrysler: 55056635AA



**40318**  
Parallel Flow  
Honda (14-09)  
Honda: 80110SZA01

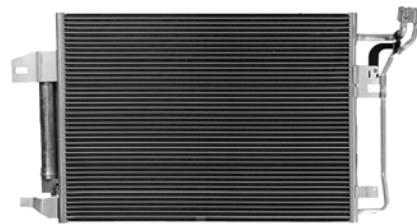

**40319**  
Parallel Flow  
Mazda (13-09)

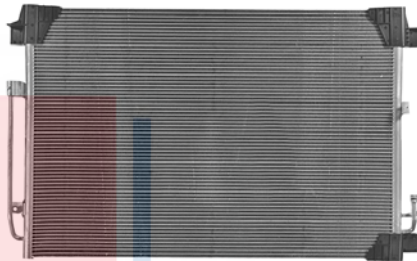

**40320**  
Parallel Flow  
Nissan (14-09)  
Nissan: 921101AA0A

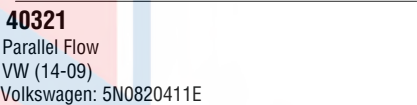

**40321**  
Parallel Flow  
VW (14-09)  
Volkswagen: 5N0820411E

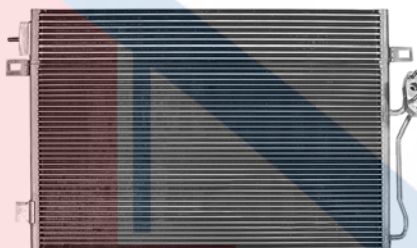

**40322**  
Parallel Flow  
Dodge (13-09)

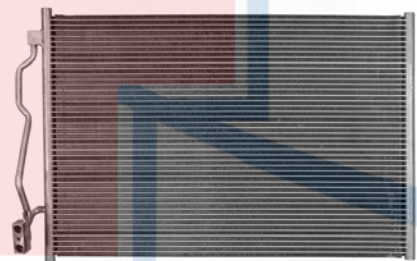

**40323**  
Parallel Flow  
Mercedes (08-07)  
Mercedes Benz: 2215000554



# Condensers

## Condensers Cont'd



**40324**  
Parallel Flow  
Honda (13-09)  
Honda: 80110TK6A01

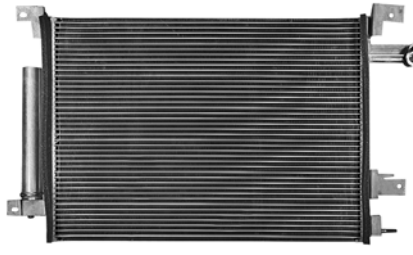

**40328**  
Parallel Flow  
Ford (14-10)  
Ford: AR3Z19712A

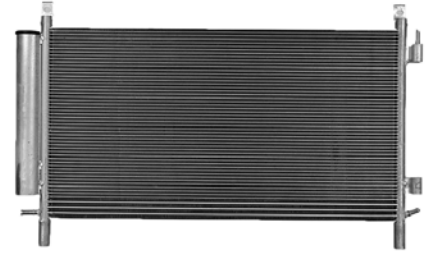

**40332**  
Parallel Flow  
Chevy (11-10)  
General Motors Corp: 20966055

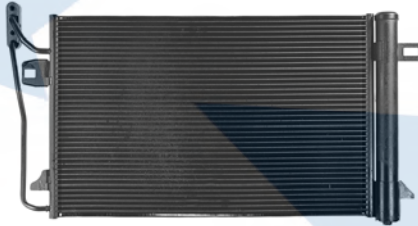

**40325**  
Parallel Flow  
Ford (12-10); Lincoln (12-11); Mercury (11-10)  
Ford: 9E5Z19712A

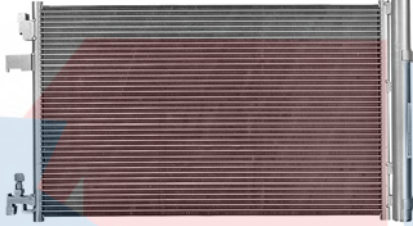

**40329**  
Parallel Flow  
Buick (15-10); Cadillac (14-13); Chevy (15-10)  
General Motors Corp: 23305638



**40333**  
Parallel Flow  
Volvo (13-05)

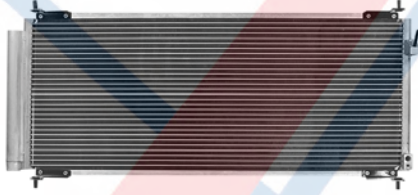

**40326**  
Parallel Flow  
Honda (14-10)  
Honda: 80110TM8A01

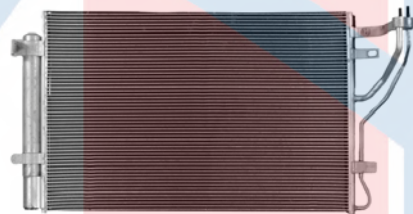

**40330**  
Parallel Flow  
Kia (12-10)  
Kia: 976061M101

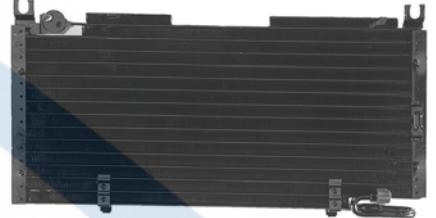

**40334**  
Serpentine  
Nissan (90-87)  
Nissan: 9211061A60

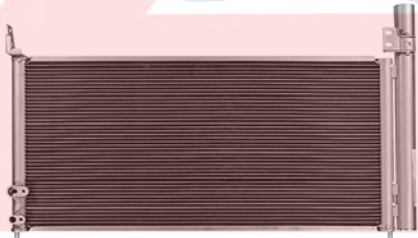

**40327**  
Parallel Flow  
Lexus (13-11); Toyota (14-10)  
Lexus: 8846047150



**40331**  
Parallel Flow  
Chevy (14-08); GMC (14-10); Pontiac (09-08);  
Suzuki (09-07)  
General Motors Corp: 19256972, 20839794

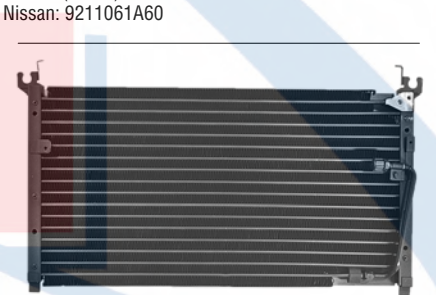

**40335**  
Serpentine  
Nissan (89-84)

# Condensers

## Condensers Cont'd



**40336**  
Serpentine  
Mazda (93-86)

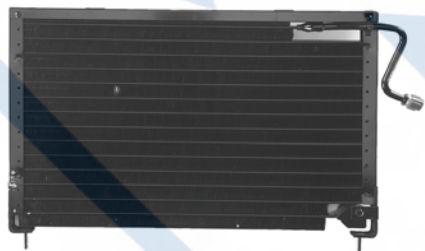

**40337**  
Serpentine  
Mazda (92-88)

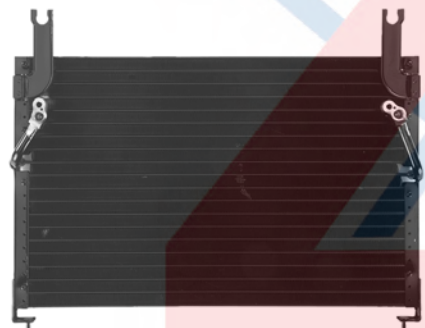

**40338**  
Serpentine  
Mazda (93-89)

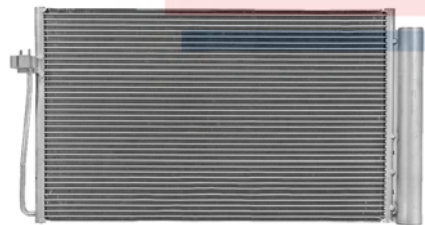

**40339**  
Parallel Flow  
BMW (10-08)  
BMW: 64509122827

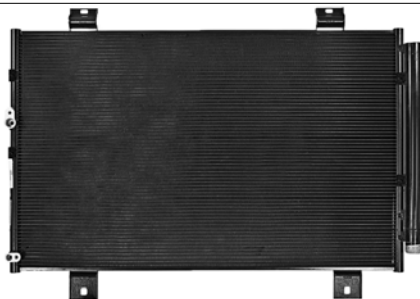

**40340**  
Parallel Flow  
Toyota (13-08)  
Toyota: 8846048110



**40341**  
Parallel Flow  
Hyundai (14-10); Kia (14-11)  
Hyundai: 976062S500

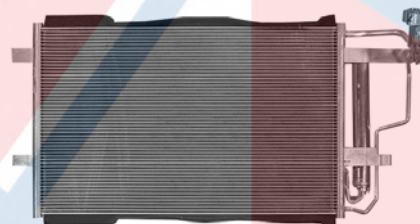

**40342**  
Parallel Flow  
Mazda (13-10)  
Mazda: BBP261480C



**40343**  
Parallel Flow  
Audi (14-08)  
Volkswagen: 8K0260403AF

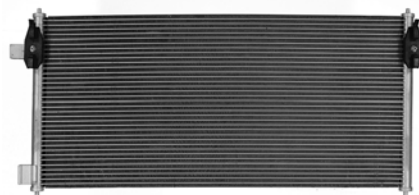

**40344**  
Parallel Flow  
Ford (13-10)  
Ford: 9T1Z19712A

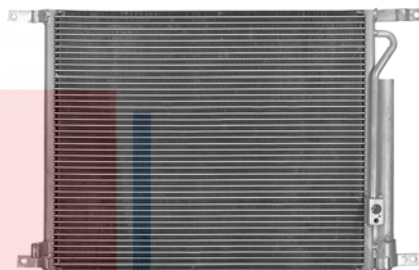

**40345**  
Parallel Flow  
Chevy (11-09); Pontiac (09)  
General Motors Corp: 95227758



**40346**  
Parallel Flow  
Dodge (14-13), (11-09)  
Chrysler: 52014588AB, 55056824AB



**40347**  
Parallel Flow  
Hyundai (12-10); Kia (15-11)  
Hyundai: 976061U100  
Kia: 976061U100

# Condensers

## Condensers Cont'd

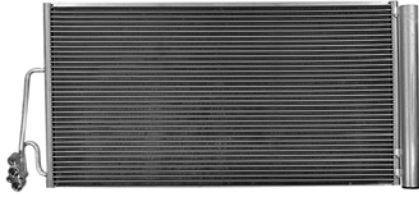

**40348**  
Parallel Flow  
Mini (15-07)  
BMW: 64539228607

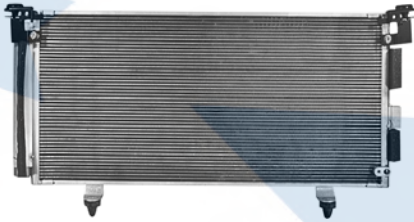

**40349**  
Parallel Flow  
Subaru (14-10)  
Subaru: 73210AJ00A



**40350**  
Parallel Flow  
Dodge (12-10)  
Chrysler: 55057091AB



**40351**  
Parallel Flow  
Chevy (14-03); GMC (14-03); GMC & CHEVY  
(14-11)  
General Motors Corp: 23469929

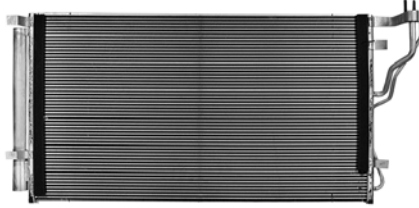

**40352**  
Parallel Flow  
Hyundai (14-11); Kia (13-11)  
Hyundai: 976063R00



**40353**  
Parallel Flow  
Honda (14-11)  
Honda: 80110TK8A01

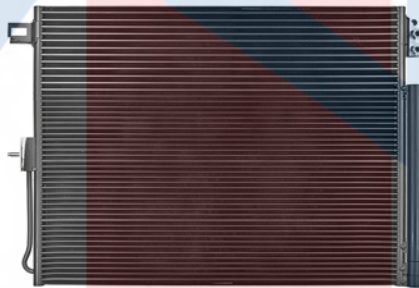

**40354**  
Parallel Flow  
Dodge (14-11); Jeep (14-11)  
Chrysler: 55038003AG  
Jeep: 55038003AG



**40355**  
Serpentine  
Toyota (88-84)  
Toyota: 8846089109

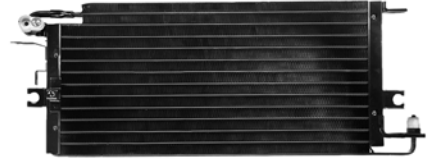

**40356**  
Serpentine  
Toyota (94-89)  
Toyota: 8846035020

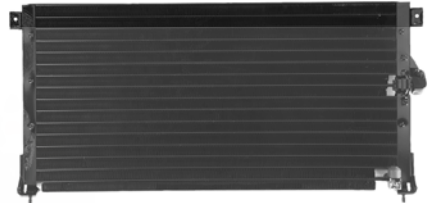

**40357**  
Serpentine  
Honda (89-86)  
Honda: 80100SE0A1A

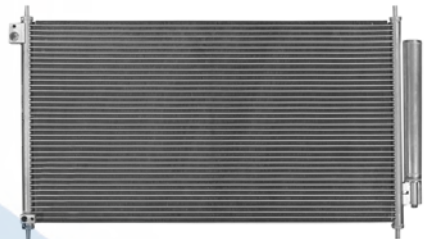

**40358**  
Parallel Flow  
Acura (14-13); Honda (14-12)  
Honda: 80110TR0A02



**40359**  
Serpentine  
Isuzu (92-88)  
Isuzu: 8941254411

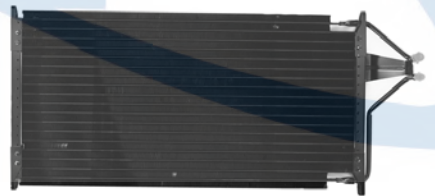

**40360**  
6mm  
Buick (88-85); Cadillac (88-85); Olds (88-85);  
Pontiac (88-87)



# Condensers

## Condensers Cont'd



**40361**  
6mm  
Buick (88-85); Olds (88-85); Pontiac (88-87)



**40362**  
6mm  
Buick (91-89); Olds (91-89); Pontiac (91-89)



**40363**  
6mm  
Buick (91-89); Cadillac (93-89); Olds (91-89); Pontiac (91-89)



**40364**  
6mm  
Buick (93-90); Cadillac (93-90); Olds (92-90)

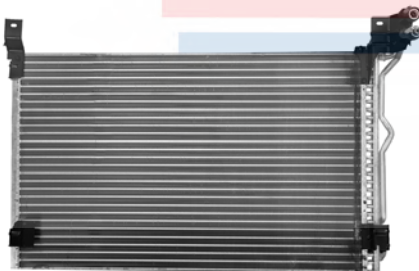

**40365**  
6mm  
Ford (05-03); Lincoln (05-03); Mercury (05-03)



**40366**  
Parallel Flow  
Mazda (06-02)  
Mazda: LD4761480B



**40367**  
6mm  
Buick (87-78); Chevy (87-78); Olds (88-78); Pontiac (87-78)



**40368**  
6mm  
Chevy (89); Pontiac (89)

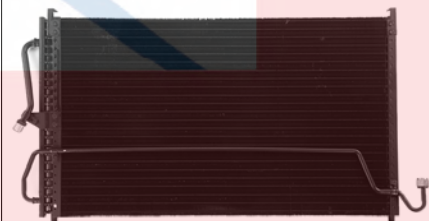

**40369**  
6mm  
Buick (93-82); Chevy (90-82); Olds (93-82); Pontiac (91-82)

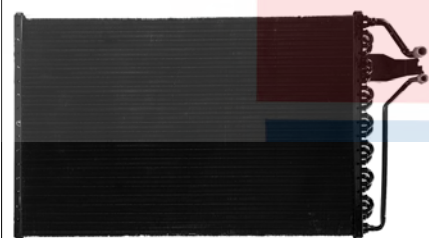

**40370**  
6mm  
Chevy (89), (87-84)



**40371**  
Serpentine  
Chevy (92-89); Geo (93-89); Pontiac (91-90); Suzuki (01-89)

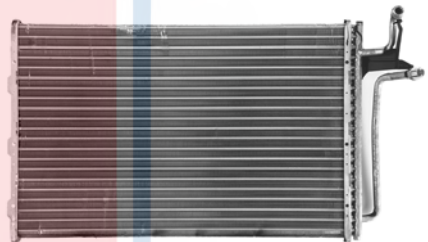

**40372**  
6mm  
Buick (91-89); Olds (91-89); Pontiac (91-89)

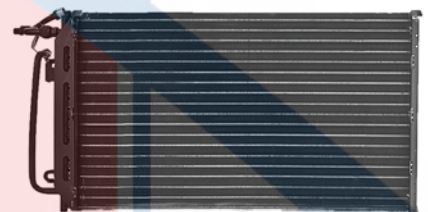

**40373**  
6mm  
Chevy (90-89)



**40374**  
6mm  
Buick (89); Chevy (94-89); Pontiac (94-89)

# Condensers

## Condensers Cont'd

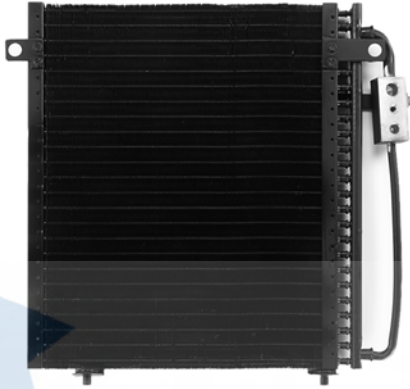

**40375**  
6mm  
Chrysler (92-90); Dodge (92-90); Plymouth (92-90)



**40376**  
6mm  
Dodge (90-89); Plymouth (90-89)  
Chrysler: 5012647AA

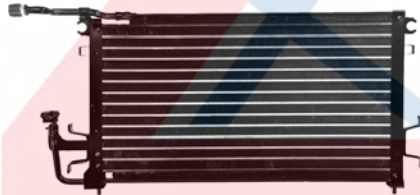

**40377**  
Serpentine  
Dodge (92-90); Eagle (92-89); Mitsubishi (92-89);  
Plymouth (92-89)



**40378**  
Tube & Fin  
Mercedes (93-87)



**40379**  
Tube & Fin  
Mercedes (89-82)

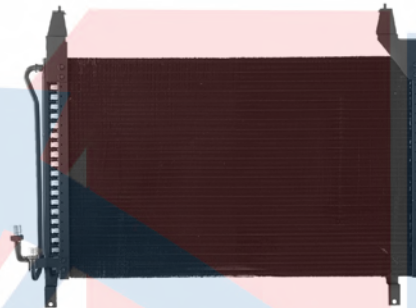

**40380**  
6mm  
Mercedes (85-72)

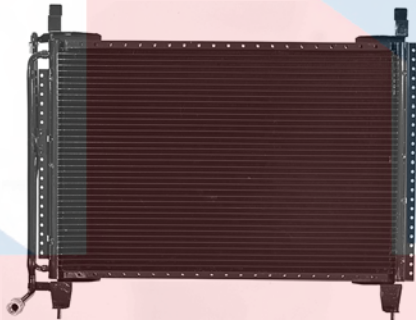

**40381**  
Tube & Fin  
Mercedes (91-81)  
Mercedes Benz: 1268302470

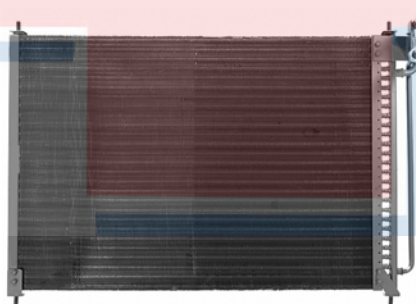

**40382**  
6mm  
Jaguar (92-88)

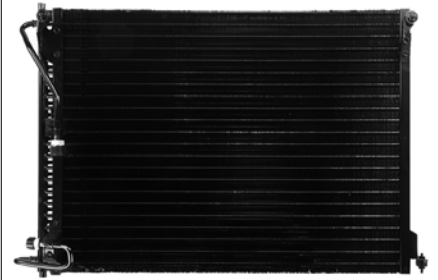

**40383**  
Tube & Fin  
Volvo (89-85)



**40384**  
6mm  
Volvo (91-85)  
Volvo: 1362149



**40385**  
6mm  
Volvo (91-88)  
Volvo: 1388737

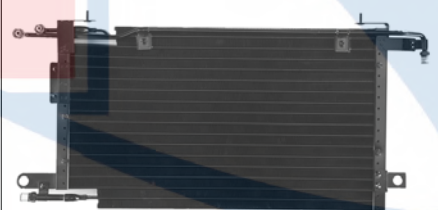

**40386**  
Tube & Fin  
VW (92-85)  
Volkswagen: 175820413B

# Condensers

## Condensers Cont'd

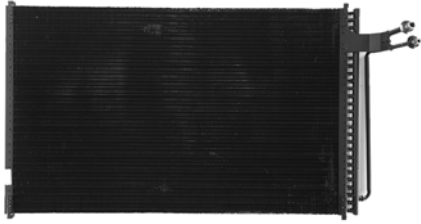

**40387**  
6mm  
Ford (91-86); Lincoln (90-86); Mercury (91-86)

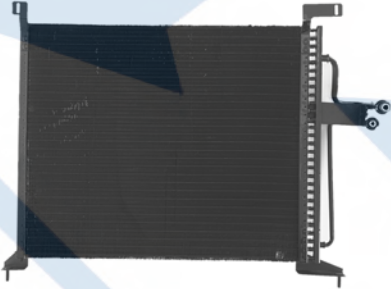

**40388**  
6mm  
Ford (89-86)

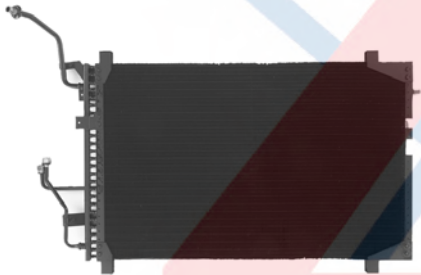

**40389**  
6mm  
Ford (87-75)

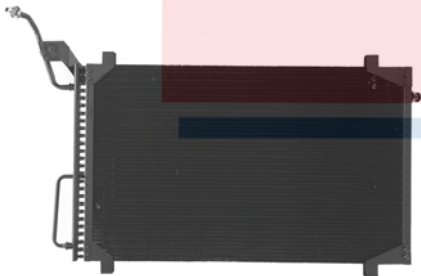

**40390**  
6mm  
Ford (91-88)

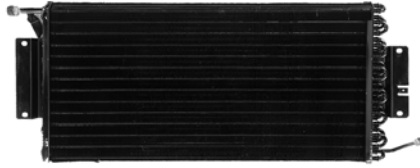

**40391**  
Tube & Fin  
Chevy (91-83); GMC (91-83)

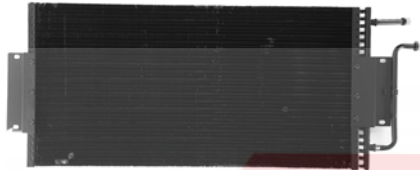

**40392**  
6mm  
Chevy (91-83); GMC (91-83)



**40393**  
6mm  
Chevy (90-88); GMC (90-88)  
General Motors Corp: 3059855

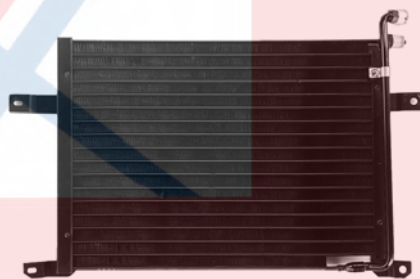

**40394**  
6mm  
Jeep (95-87)

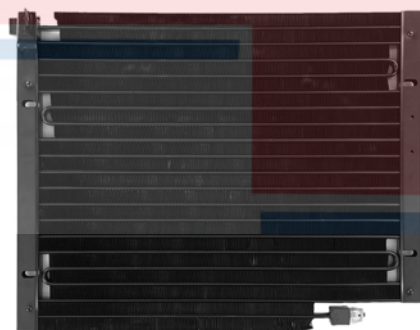

**40395**  
Parallel Flow  
Jeep (96-84)  
Chrysler: 53001437

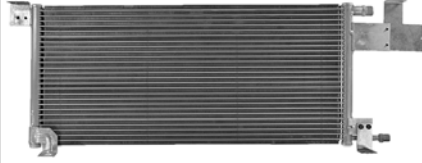

**40396**  
Parallel Flow  
Jeep (92-87)



**40397**  
Parallel Flow  
Jeep (96-87)  
Chrysler: 55036595AG

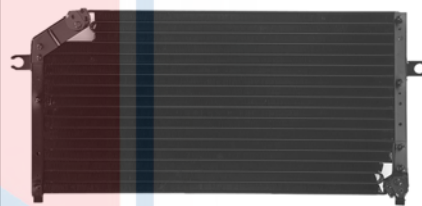

**40398**  
Serpentine  
Nissan (92-90)  
Nissan: 9211065E60



**40399**  
Serpentine  
Nissan (92-86)  
Nissan: 9210001G60



**40400**  
Serpentine  
Nissan (92-89)



# Condensers

## Condensers Cont'd

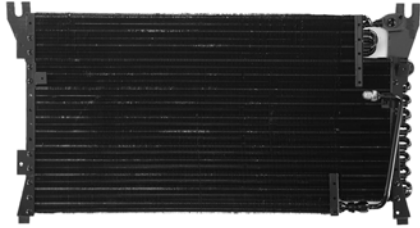

**40401**  
Tube & Fin  
Nissan (89-84)  
Nissan: 9211020P10

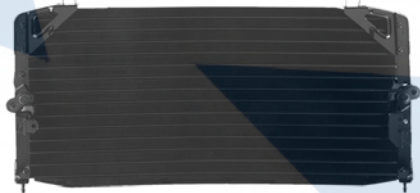

**40402**  
Serpentine  
Lexus (91-90); Toyota (91-85)  
Lexus: 8846032070



**40403**  
Serpentine  
Geo (92-89); Toyota (92-88)  
General Motors Corp: 94846220



**40404**  
Serpentine  
Toyota (92-89)  
Toyota: 8846022450



**40405**  
Serpentine  
Toyota (89-84)  
Toyota: 8846089110

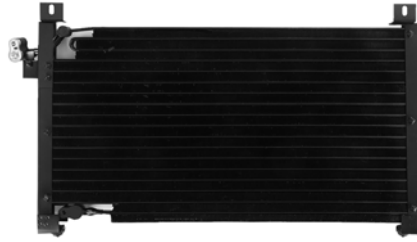

**40406**  
Parallel Flow  
Acura (93-90)

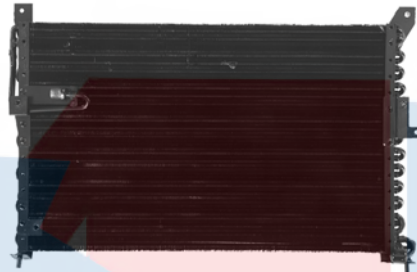

**40407**  
Serpentine  
Acura (90-86)  
Acura: 38600SD2A1A

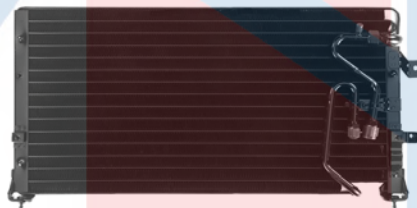

**40408**  
Serpentine  
Honda (91-88)  
Honda: 80100SF1A1A



**40409**  
Serpentine  
Honda (91-88)

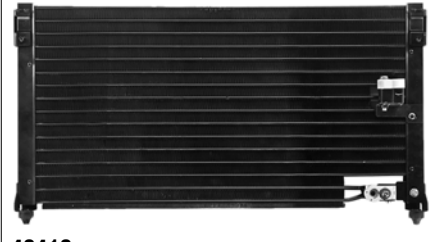

**40410**  
Serpentine  
Honda (93-90)

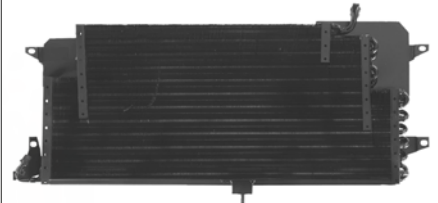

**40411**  
Serpentine  
VW (94-90)



**40412**  
6mm  
Ford (94-90); Mazda (94-91)

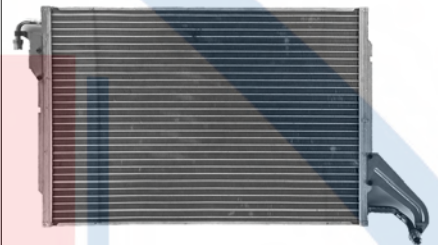

**40413**  
Tube & Fin  
Chevy (93-90); GMC (93-90)  
General Motors Corp: 52452018

# Condensers

## Condensers Cont'd



**40414**  
Tube & Fin  
Toyota (93-90)

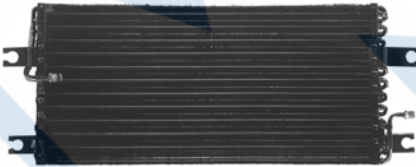

**40415**  
Serpentine  
Acura (89-86)



**40416**  
Serpentine  
Mazda (97-90)  
Mazda: NA7561480

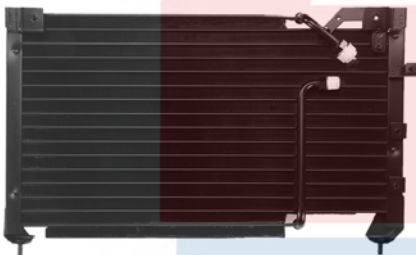

**40417**  
Parallel Flow  
Mazda (95-90)  
Mazda: BB7C61480

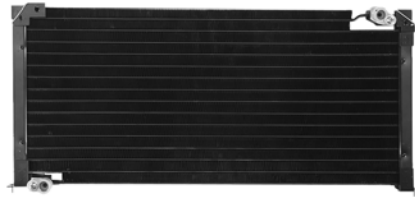

**40418**  
Serpentine  
Subaru (92-90)



**40419**  
Serpentine  
Toyota (93-90)  
Toyota: 8846020310



**40420**  
6mm  
Chevy (91-90); Pontiac (91-90)

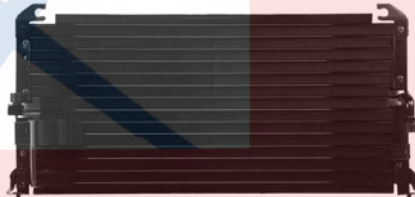

**40421**  
Serpentine  
Eagle (94-90); Mitsubishi (93-90); Plymouth (94-90)

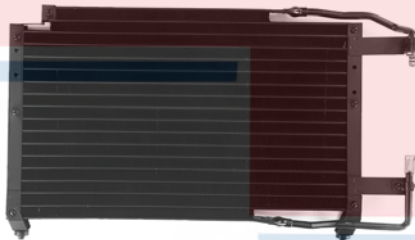

**40422**  
Serpentine  
Ford (93-90)

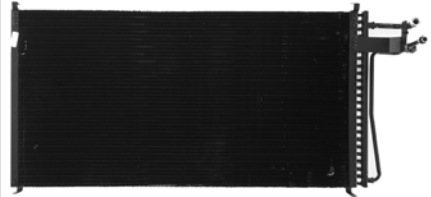

**40423**  
6mm  
Buick (93-91); Cadillac (93); Chevy (93-91); Olds (92-91)

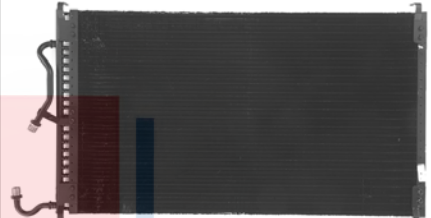

**40424**  
6mm  
Chevy (93-90); Olds (93-90); Pontiac (93-90)



**40425**  
6mm  
Buick (93-91); Olds (93-91); Pontiac (93-92)



**40426**  
6mm  
Chevy (93-90); GMC (93-90)  
General Motors Corp: 52411109



**40427**  
6mm  
Ford (91); Mercury (91)

# Condensers

## Condensers Cont'd

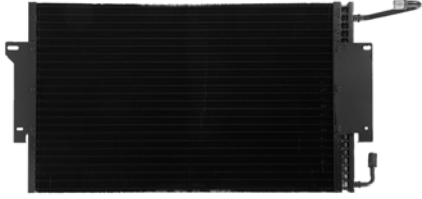

**40428**  
6mm  
Buick (93-92); Chevy (93-92); Olds (93-92); Pontiac (93-92)



**40429**  
6mm  
Chevy (93-91); Pontiac (93-91)

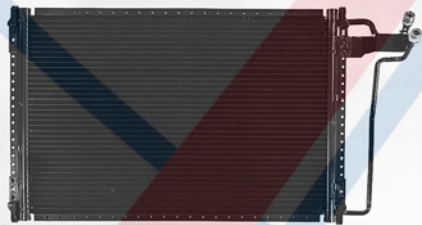

**40430**  
6mm  
Chevy (93-90)



**40431**  
6mm  
Chrysler (95-90); Dodge (95-90); Plymouth (95-91)



**40432**  
Parallel Flow  
Dodge (96-91); Mitsubishi (99-91)



**40433**  
Serpentine  
Acura (92-91)



**40434**  
6mm  
Ford (95-86); Lincoln (94-88); Mercury (95-86)



**40435**  
6mm  
Ford (93-89); Mercury (93-89)

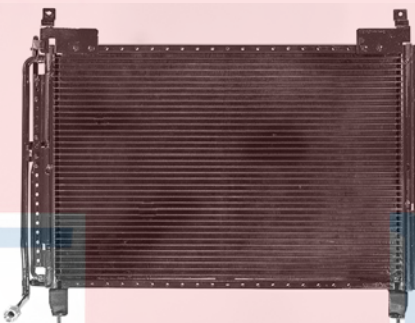

**40436**  
Serpentine  
Mercedes (91-86)  
Mercedes Benz: 1268302870



**40437**  
Tube & Fin  
Subaru (91-90)  
Subaru: 73020AA040

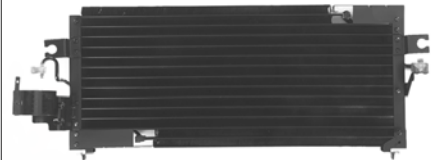

**40438**  
Serpentine  
Nissan (94-91)  
Nissan: 921108B000



**40439**  
Tube & Fin  
BMW (92)

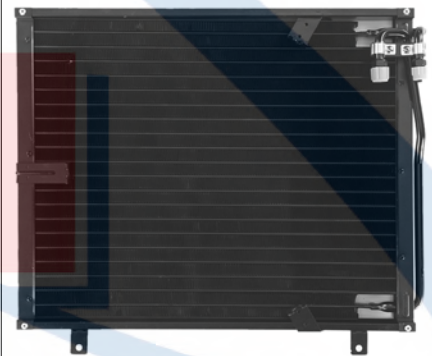

**40440**  
Serpentine  
BMW (95-85)  
BMW: 64536965952



# Condensers

## Condensers Cont'd



**40441**  
6mm  
Ford (95-90)



**40442**  
6mm  
Dodge (93-89), (80)



**40443**  
6mm  
Ford (94-92); Mercury (94-92)

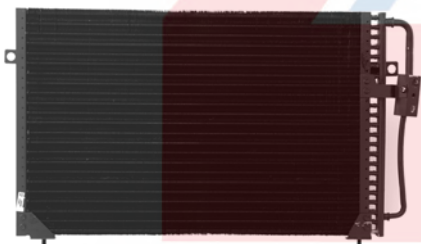

**40444**  
6mm  
Chrysler (91-90); Dodge (90)



**40445**  
6mm  
Ford (94-92); Mercury (94-92)

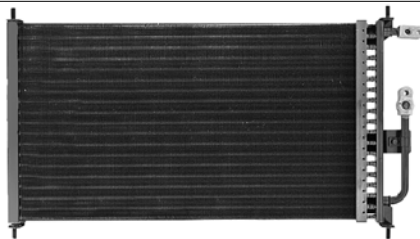

**40446**  
6mm  
Honda (96-95)



**40447**  
Tube & Fin  
Lexus (92-90)  
Lexus: 8846050020



**40448**  
Parallel Flow  
Lexus (93-92); Toyota (93-92)  
Lexus: 8846033010

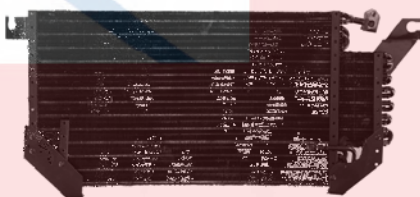

**40449**  
Serpentine  
Nissan (94-91)  
Nissan: 9211053F10

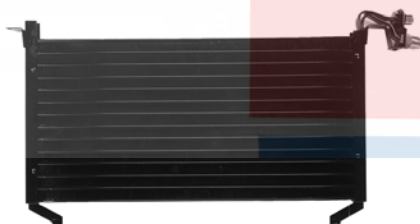

**40450**  
Serpentine  
Saab (93-79)

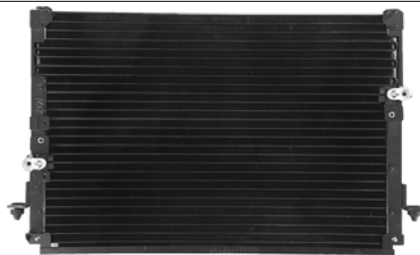

**40451**  
Serpentine  
Toyota (93-91)  
Toyota: 8846095D08

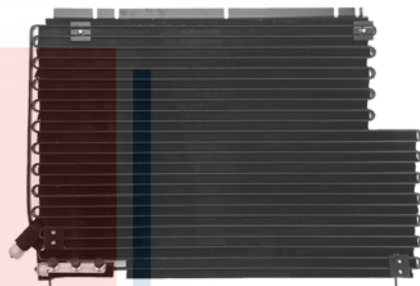

**40452**  
Serpentine  
Volvo (93-92)

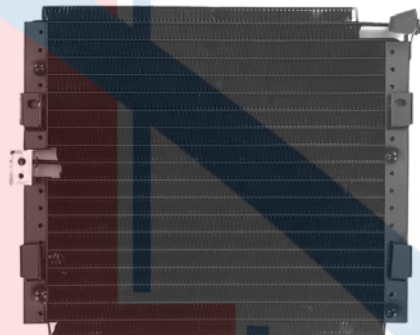

**40453**  
Parallel Flow  
Honda (93-92)  
Honda: 80110SR1A22



**40454**  
6mm  
Chevy (94-88); GMC (93-88); Olds (94-91)  
General Motors Corp: 52450235

# Condensers

## Condensers Cont'd

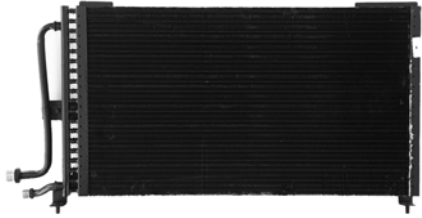

**40455**  
6mm  
Mazda (96-92)  
Mazda: EA0161480A

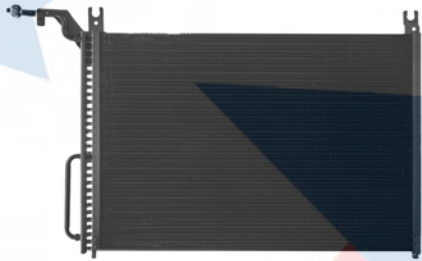

**40456**  
6mm  
Ford (96-92)



**40457**  
6mm  
Jeep (98-93)  
Chrysler: 55115864AC



**40458**  
Parallel Flow  
Chrysler (97-93); Dodge (97-93); Eagle (97-93)  
Chrysler: 4758586

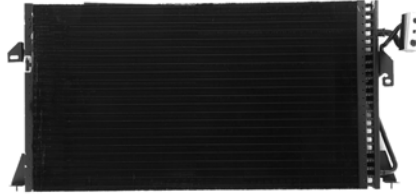

**40459**  
6mm  
Chrysler (95-93); Dodge (95-93); Plymouth (95-93)  
Chrysler: 5012969AA

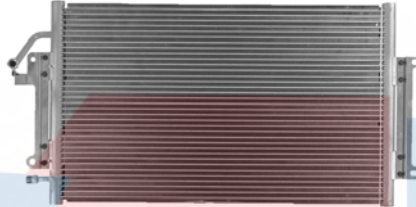

**40460**  
Parallel Flow  
Saturn (93-91)  
Saturn: 52461156



**40461**  
6mm  
Dodge (93-89), (80)

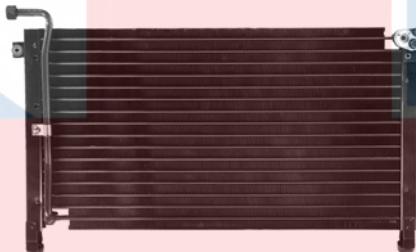

**40462**  
Serpentine  
Nissan (97-93)  
Nissan: 921108B000



**40463**  
Parallel Flow  
Chevy (97-93); Pontiac (97-93)



**40464**  
Parallel Flow  
Chevy (99-92); GMC (99-92)

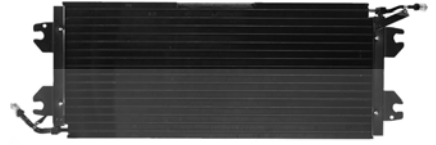

**40465**  
Tube & Fin  
Chevy (96), (91-88); GMC (96), (93-88)  
General Motors Corp: 52457929



**40466**  
Serpentine  
Infiniti (96-91)  
Infiniti: 9211062J07

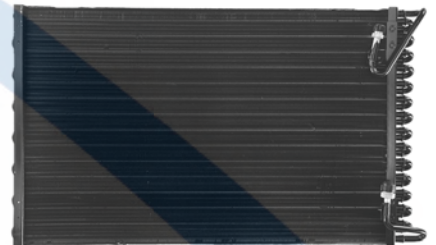

**40467**  
Tube & Fin  
Volvo (93-90)

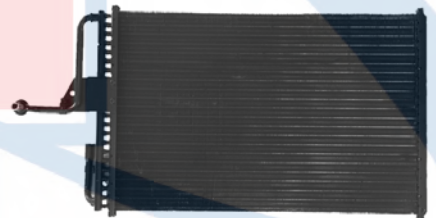

**40468**  
6mm  
Ford (03-92); Mercury (99-92)

# Condensers

## Condensers Cont'd

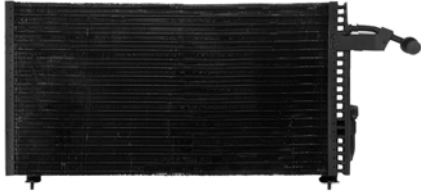

**40469**  
6mm  
Ford (97-93)

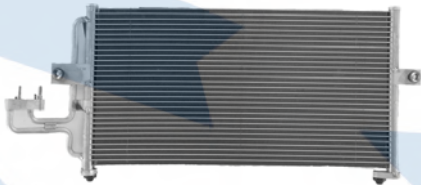

**40470**  
Serpentine  
Hyundai (93-92)  
Hyundai: 9760628000



**40471**  
6mm  
Ford (97-94); Lincoln (98-93); Mercury (97-94)

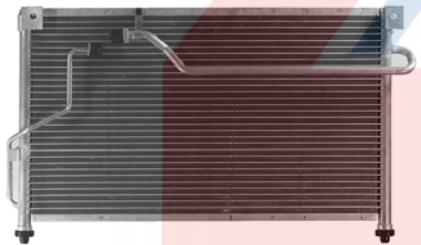

**40472**  
Parallel Flow  
Mazda (97-93)  
Mazda: GB6H61480

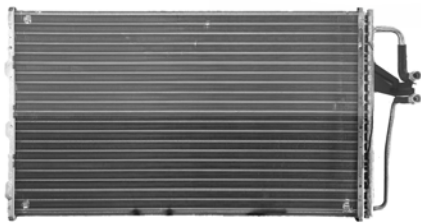

**40473**  
6mm  
Chevy (92-91); Pontiac (92)  
General Motors Corp: 52460637

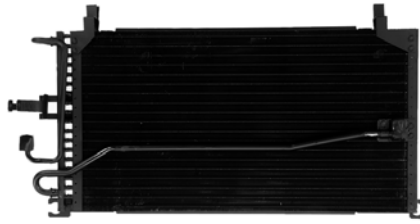

**40474**  
6mm  
Honda (96-94); Isuzu (97-93)  
Isuzu: 8970760802



**40475**  
Parallel Flow  
Nissan (97-93)  
Nissan: 921102B000

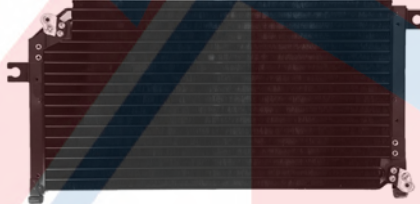

**40476**  
Serpentine  
Nissan (94-93)  
Nissan: 921107E000

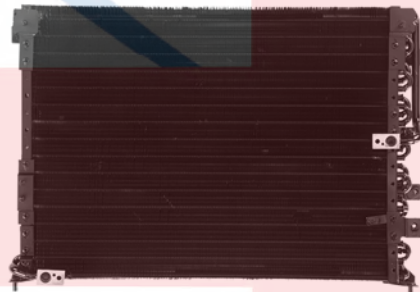

**40477**  
Parallel Flow  
Acura (95-93)

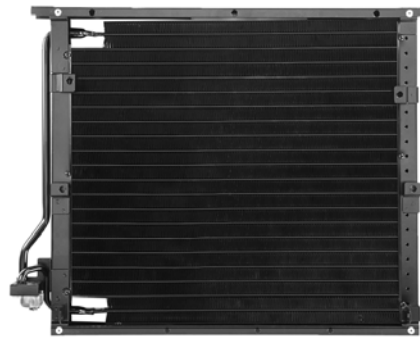

**40478**  
Parallel Flow  
BMW (99-91)

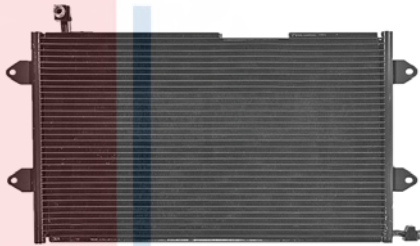

**40479**  
Parallel Flow  
VW (02-93)



**40480**  
Tube & Fin  
Cadillac (92)

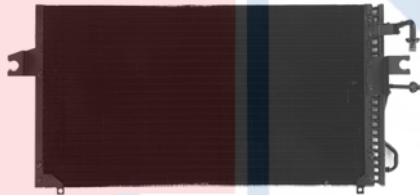

**40481**  
6mm  
Mercury (98-93); Nissan (98-93)



# Condensers

## Condensers Cont'd

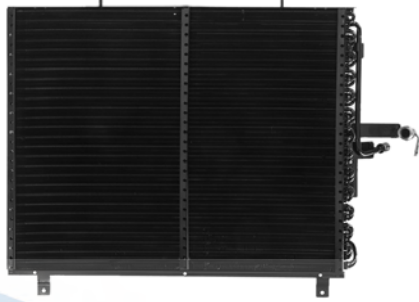

**40482**  
Tube & Fin  
Mercedes (95-90)  
Mercedes Benz: 1248301670

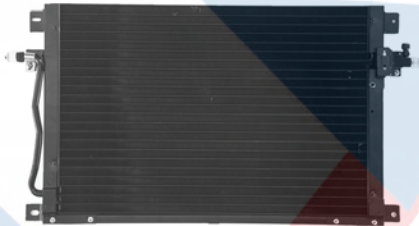

**40483**  
Tube & Fin  
Volvo (93)



**40484**  
Parallel Flow  
Dodge (93); Eagle (96-94); Mitsubishi (93)

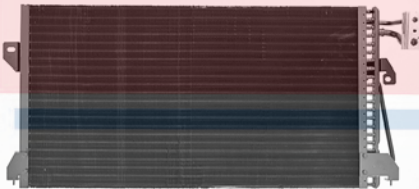

**40485**  
6mm  
Chrysler (95-93); Dodge (95-93); Plymouth (95-93)



**40486**  
Parallel Flow  
Ford (97-96)

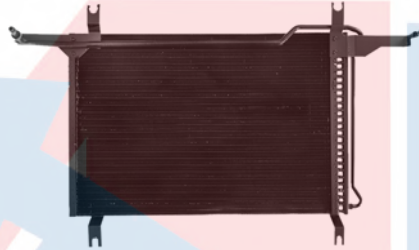

**40487**  
6mm  
Ford (98-94)



**40488**  
Parallel Flow  
Dodge (94-93); Eagle (96-93); Mitsubishi (96-93)

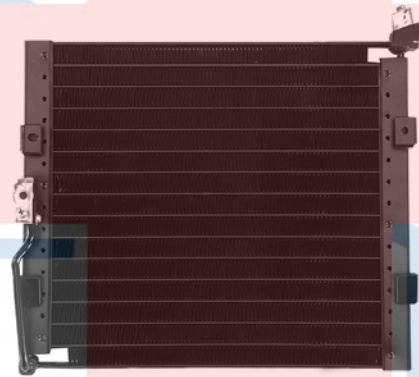

**40489**  
Parallel Flow  
Honda (97-94)  
Honda: 04801SR1305



**40490**  
Parallel Flow  
Cadillac (00-99); Chevy (02-94); GMC (02-94)  
General Motors Corp: 52402209



**40491**  
Parallel Flow  
Buick (96-94); Cadillac (96-94); Chevy (96-94)



**40492**  
6mm  
Buick (99-94); Olds (99-94); Pontiac (99-94)



**40493**  
6mm  
Buick (96-94); Chevy (01-94); Olds (97-94); Pontiac (96-94)

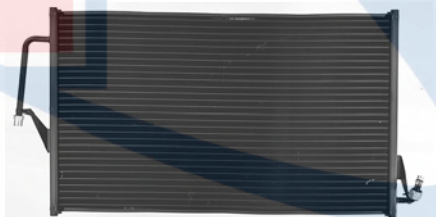

**40494**  
Parallel Flow  
Buick (96-94); Olds (96-94)  
General Motors Corp: 52464191

# Condensers

## Condensers Cont'd



**40495**  
6mm  
Buick (95-94); Olds (95-94); Pontiac (95-94)

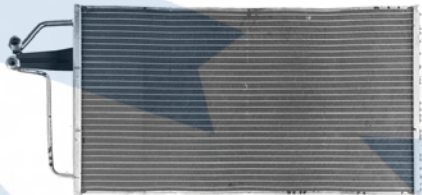

**40496**  
6mm  
Cadillac (95-94)  
General Motors Corp: 52461751

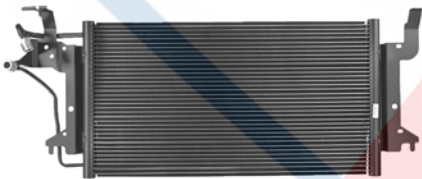

**40497**  
Parallel Flow  
Cadillac (95-94)

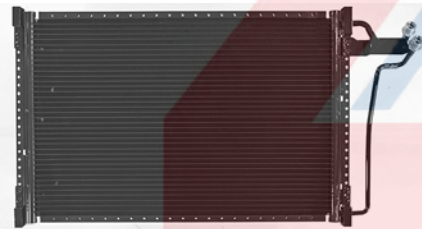

**40498**  
Parallel Flow  
Chevy (96-94)



**40499**  
6mm  
Chevy (96-94); Olds (96-94); Pontiac (96-94)  
General Motors Corp: 52461229



**40500**  
Parallel Flow  
Chevy (94); GMC (94)

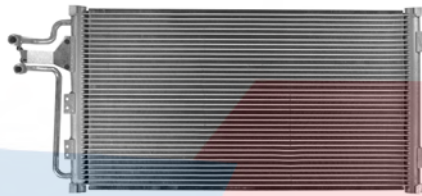

**40501**  
Parallel Flow  
Chevy (05-94); GMC (05-94); Olds (01-96)

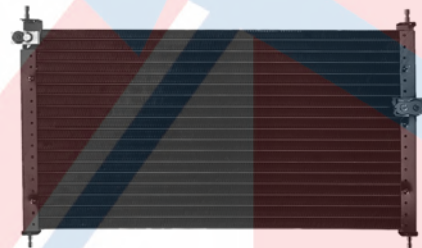

**40502**  
Parallel Flow  
Acura (01-94); Honda (01-97)



**40503**  
6mm  
Buick (98-96); Chevy (96-94); Olds (98-96); Pontiac (98-96)



**40504**  
Parallel Flow  
Subaru (97-95)  
Subaru: 73210AC021



**40505**  
Parallel Flow  
Lexus (96-94); Toyota (96-94)



**40506**  
Parallel Flow  
Toyota (98-93)  
Toyota: 8846034020



**40507**  
Tube & Fin  
Toyota (93)  
Toyota: 8846016290



**40508**  
Serpentine  
Mazda (95-94)  
Mazda: LB7061480

# Condensers

## Condensers Cont'd

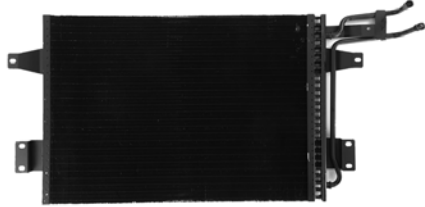

**40509**  
6mm  
Dodge (96-94)  
Chrysler: 55055346



**40510**  
Serpentine  
Geo (93); Toyota (93)  
General Motors Corp: 94854245



**40511**  
6mm  
Dodge (97-94)  
Chrysler: 55036277

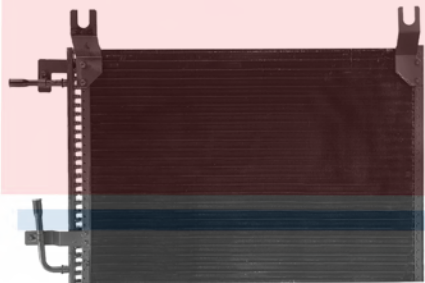

**40512**  
6mm  
Dodge (97-94)  
Chrysler: 55036275AC

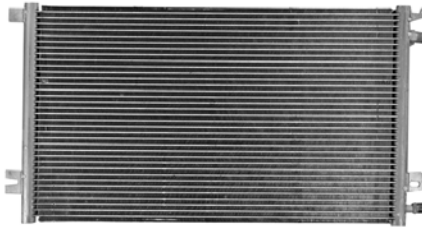

**40513**  
Parallel Flow  
Saturn (02-94)  
Saturn: 52473615



**40514**  
Serpentine  
Toyota (94)  
Toyota: 8846016311



**40515**  
Serpentine  
Toyota (97-94)  
Toyota: 8846028220

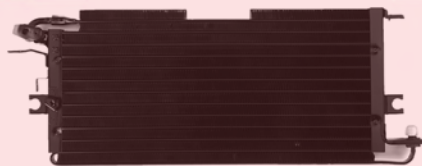

**40516**  
Parallel Flow  
Toyota (95-94)  
Toyota: 8846035130

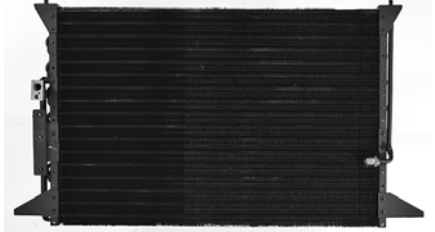

**40517**  
Serpentine  
Lexus (00-94)  
Lexus: 8846024070

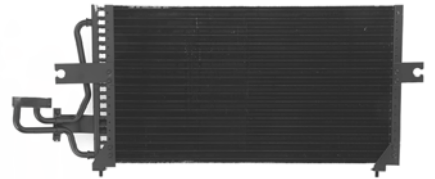

**40518**  
6mm  
Hyundai (95-94)  
Hyundai: 9760628042

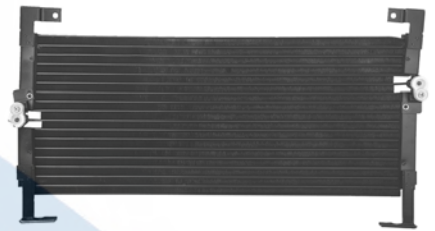

**40519**  
Parallel Flow  
Dodge (99-95); Plymouth (99-95)  
Chrysler: 4740109



**40520**  
Parallel Flow  
Mazda (98-95)  
Mazda: BC1M61480

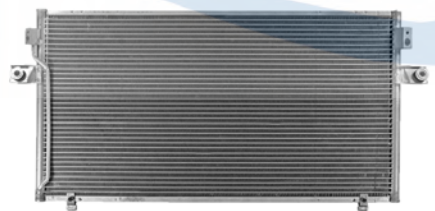

**40521**  
Parallel Flow  
Nissan (96-95)



# Condensers

## Condensers Cont'd

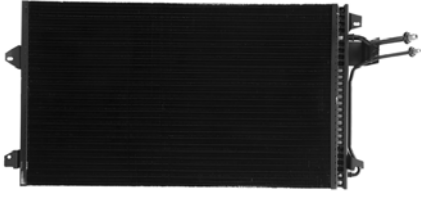

**40522**  
6mm  
Ford (96-95)



**40523**  
Tube & Fin  
Buick (94); Olds (94)  
General Motors Corp: 52464190

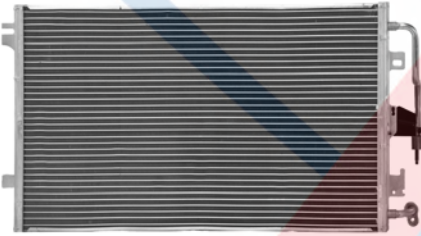

**40524**  
Parallel Flow  
Chevy (05-95); Pontiac (05-95)



**40525**  
Parallel Flow  
Honda (97-94); Isuzu (97-94)  
Honda: 8970948730



**40526**  
6mm  
Chrysler (00-95); Dodge (00-95); Plymouth (00-96)  
Chrysler: 5011395AE



**40527**  
Serpentine  
Geo (97-94); Toyota (97-93)  
General Motors Corp: 94855107

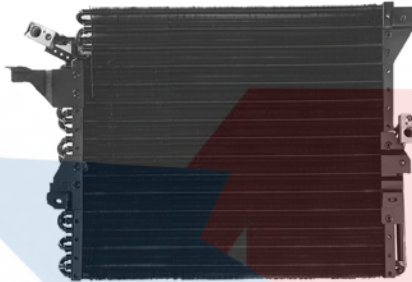

**40528**  
Serpentine  
Toyota (95-94)  
Toyota: 8846035080



**40529**  
Serpentine  
Subaru (96-93)  
Subaru: 73210FA140



**40530**  
Parallel Flow  
Chevy (05-95); GMC (05-95)  
General Motors Corp: 89019058



**40531**  
Parallel Flow  
Chevy (05-95); GMC (05-98)  
General Motors Corp: 52456513



**40532**  
Parallel Flow  
Chevy (98-94); Pontiac (97-94); Suzuki (98-94)  
General Motors Corp: 30011736

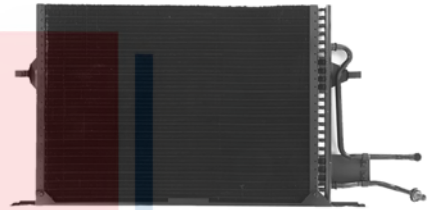

**40533**  
6mm  
Ford (96-95); Mercury (97-95)



**40534**  
6mm  
Lincoln (97-95)

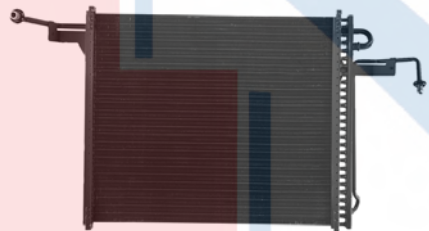

**40535**  
6mm  
Ford (97-95); Mazda (97-95)

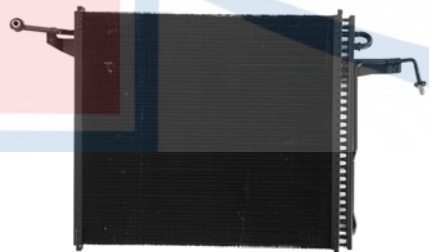

**40536**  
6mm  
Ford (97-95)

# Condensers

## Condensers Cont'd



**40537**  
6mm  
Ford (97-95); Lincoln (97-95); Mercury (97-95)

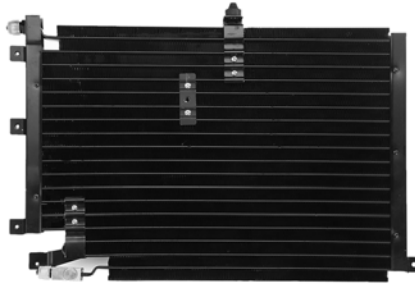

**40541**  
Parallel Flow  
Saab (98-91)



**40545**  
Serpentine  
Volvo (98-97), (95-93)

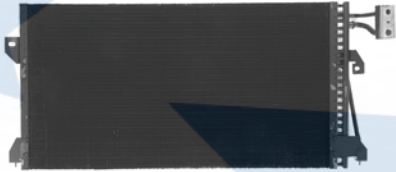

**40538**  
6mm  
Chrysler (95-93); Dodge (95-93)



**40542**  
Parallel Flow  
Toyota (99-94)  
Toyota: 8845020210



**40546**  
Parallel Flow  
Nissan (97-95)

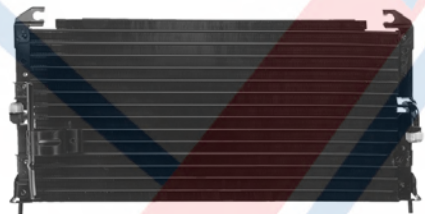

**40539**  
Parallel Flow  
Eagle (98-95); Mitsubishi (99-95)

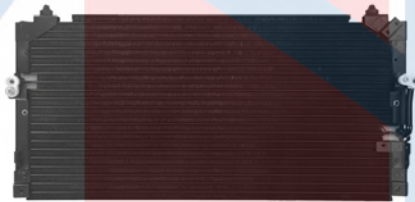

**40543**  
Parallel Flow  
Lexus (97-96); Toyota (97-93)  
Lexus: 8846060060

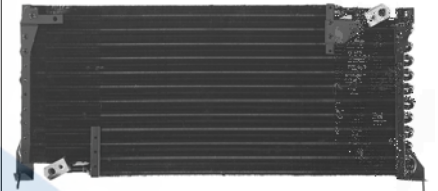

**40547**  
Tube & Fin  
Subaru (93-92)  
Subaru: 73020AA080

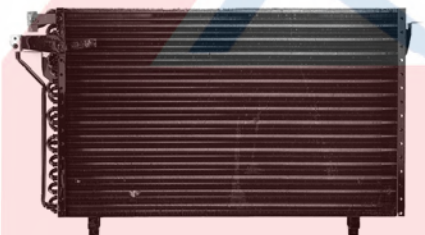

**40540**  
Tube & Fin  
Infiniti (97-93)  
Infiniti: 9211010Y00

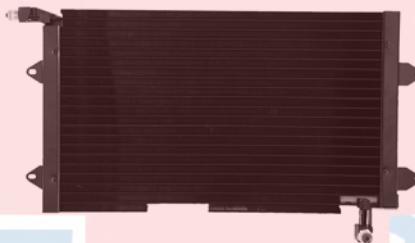

**40544**  
Parallel Flow  
VW (01-93)



**40548**  
6mm  
Mitsubishi (98-94)  
Mitsubishi: MB813733



**40549**  
Parallel Flow  
Hyundai (98-95)  
Hyundai: 9760634003

# Condensers

## Condensers Cont'd



**40550**  
Serpentine  
VW (97-95)

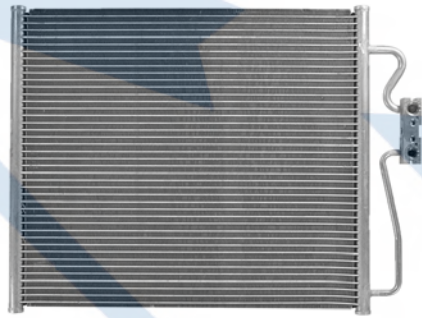

**40551**  
Parallel Flow  
BMW (97-95)  
BMW: 64538373924

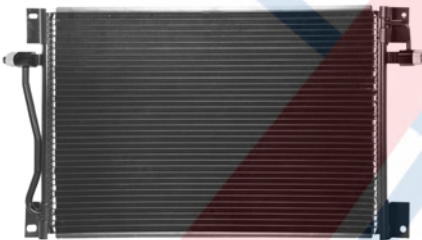

**40552**  
Parallel Flow  
Volvo (04-94)  
Volvo: 31390445

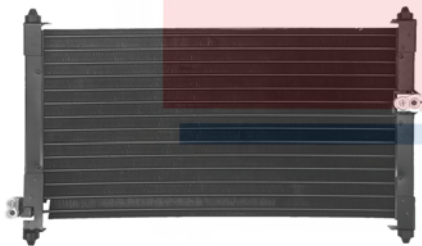

**40553**  
Parallel Flow  
Acura (99-97); Honda (97-94)  
Acura: 80110SV1A21



**40554**  
Parallel Flow  
Chevy (01-98); Geo (97-95)  
General Motors Corp: 91174026



**40555**  
Serpentine  
Eagle (98-95); Mitsubishi (99-95)



**40556**  
Parallel Flow  
Toyota (97-95)  
Toyota: 8846104020



**40557**  
Tube & Fin  
Mercedes (89-82)  
Mercedes Benz: 1248301770

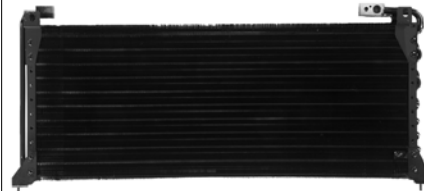

**40558**  
Serpentine  
Subaru (94)  
Subaru: 73020AA120

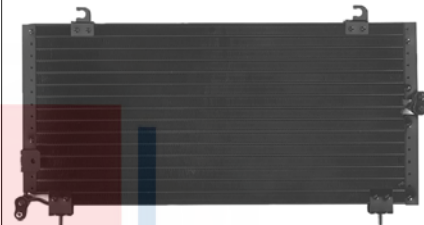

**40559**  
Parallel Flow  
Toyota (97-95)  
Toyota: 8846016340



**40560**  
Parallel Flow  
Nissan (96-95)  
Nissan: 9211070F00

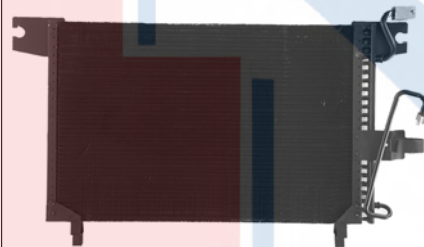

**40561**  
6mm  
Acura (97-96); Isuzu (97-93)  
Acura: 8971167610



**40562**  
Serpentine  
Eagle (94); Mitsubishi (94-92); Plymouth (93)



# Condensers

## Condensers Cont'd

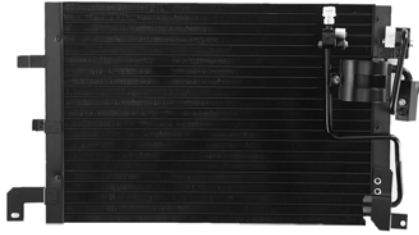

**40563**  
Parallel Flow  
Saab (98-94)

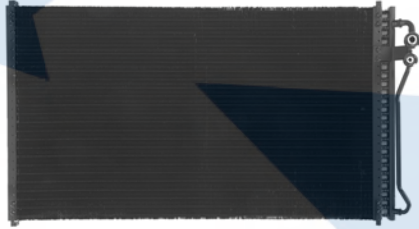

**40564**  
6mm  
Ford (98-96)



**40565**  
6mm  
Ford (04-97)

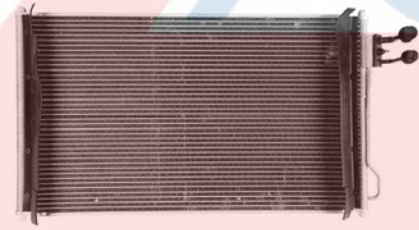

**40566**  
Parallel Flow  
Ford (96); Mercury (96)

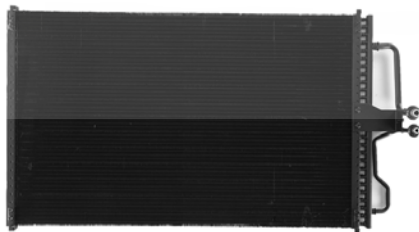

**40567**  
6mm  
Lincoln (94-91)



**40568**  
Parallel Flow  
Hyundai (99-95)  
Hyundai: 9760622010

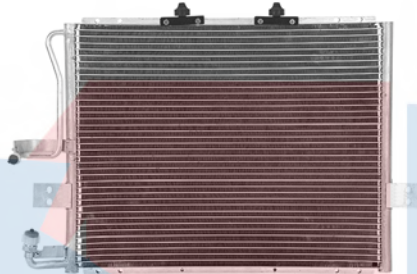

**40569**  
Parallel Flow  
Kia (96-95)  
Kia: 0K01161480M

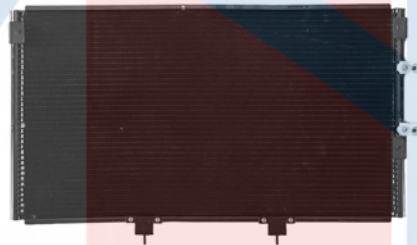

**40570**  
Parallel Flow  
Lexus (00-95)  
Lexus: 8846050120



**40571**  
Parallel Flow  
Audi (98-93)

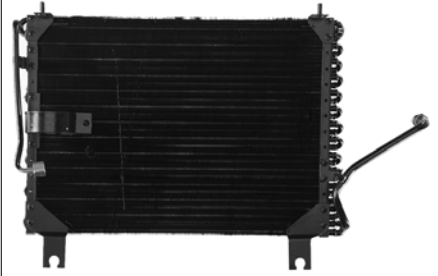

**40572**  
Parallel Flow  
Kia (97-94)  
Kia: 0K24161480D



**40573**  
Parallel Flow  
Mercedes (04-94)  
Mercedes Benz: 2028300570

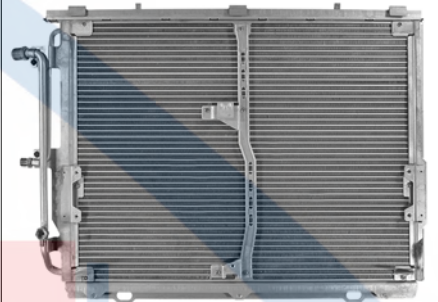

**40574**  
Parallel Flow  
Mercedes (99-92)  
Mercedes Benz: 1408300570

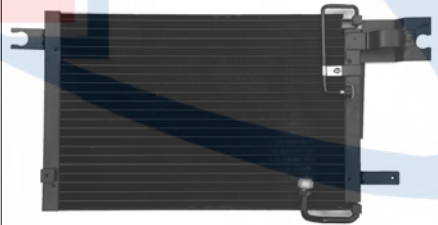

**40575**  
Parallel Flow  
Mazda (02-95)  
Mazda: T00161480B

# Condensers

## Condensers Cont'd

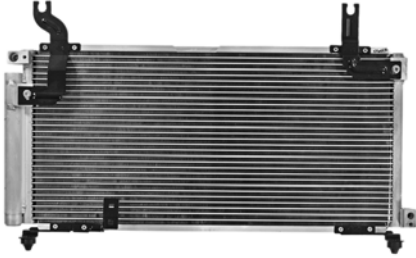

**40576**  
Parallel Flow  
Suzuki (07-02)  
Suzuki: 9531054G12



**40577**  
Parallel Flow  
Subaru (02-00)  
Subaru: 73210FC050

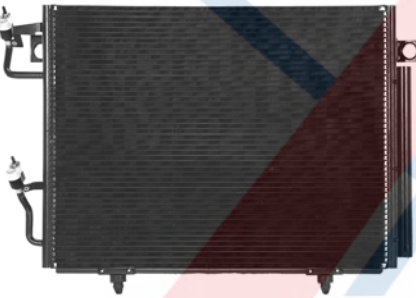

**40578**  
Parallel Flow  
Mitsubishi (06-00)  
Mitsubishi: MN123332

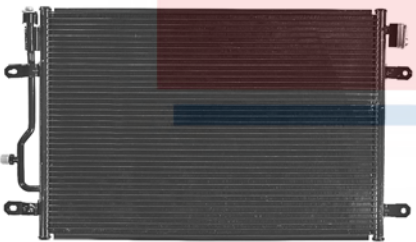

**40579**  
Parallel Flow  
Audi (05-02)  
Audi: 8E0260403B



**40580**  
Parallel Flow  
Honda (07-05)  
Honda: 80110SDBA62

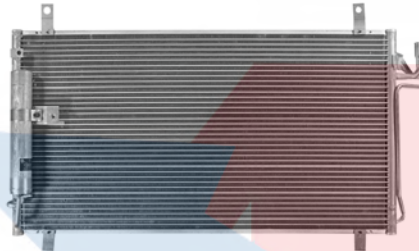

**40581**  
Parallel Flow  
Infiniti (07-03)  
Infiniti: 92100AL570

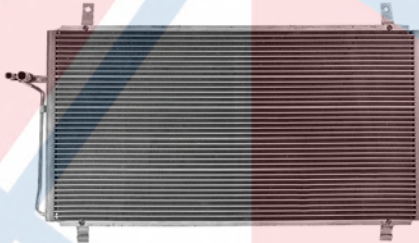

**40582**  
Parallel Flow  
Nissan (09-03)  
Nissan: 92100CD00A



**40583**  
Parallel Flow  
Chrysler (00-96); Dodge (00-96); Plymouth (00-96)



**40584**  
Parallel Flow  
Chrysler (00-96); Dodge (00-96); Plymouth (00-96)  
Chrysler: 5016793AC

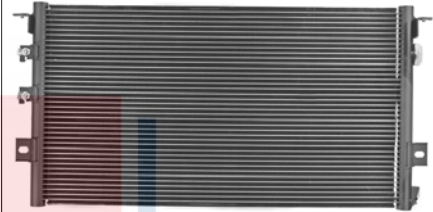

**40585**  
Parallel Flow  
Chrysler (00-96); Dodge (00-96); Plymouth (00-96)  
Chrysler: 4682590

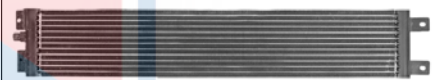

**40586**  
Parallel Flow  
Chrysler (00-96); Dodge (00-96); Plymouth (00-96)  
Chrysler: 4682591AC

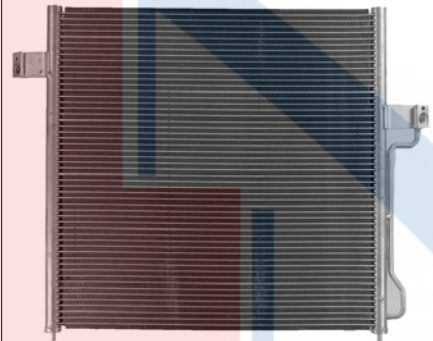

**40587**  
Parallel Flow  
Ford (11-06); Lincoln (05-03); Mercury (10-06)

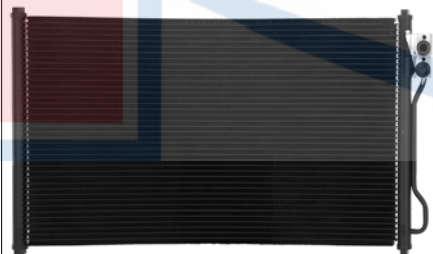

**40588**  
Parallel Flow  
Ford (04-03)

# Condensers

## Condensers Cont'd



**40589**  
Serpentine  
Mazda (97-96)  
Mazda: LB9061480

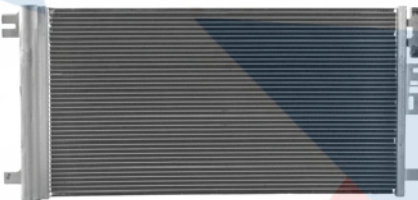

**40590**  
Aluminum  
Chevy (10-05); Pontiac (10-05); Saturn (07-03)  
General Motors Corp: 20841583



**40591**  
Parallel Flow  
Buick (07-04); Chevy (09-03); GMC (09-03); Isuzu (06-03); Saab (09-05)  
General Motors Corp: 89019256

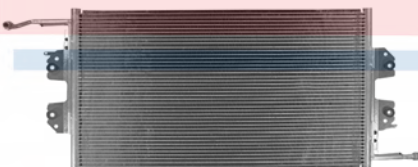

**40592**  
Parallel Flow  
Chevy (02-96); GMC (02-96)  
General Motors Corp: 52497546



**40593**  
Parallel Flow  
Pontiac (08-03)  
General Motors Corp: 88972207

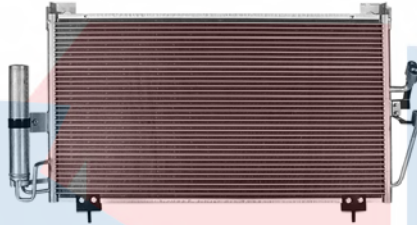

**40594**  
Parallel Flow  
Mitsubishi (06-03)  
Mitsubishi: MR958462

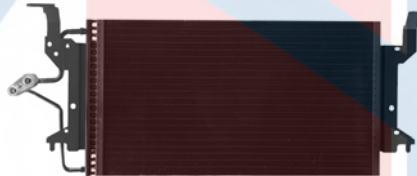

**40595**  
6mm  
Cadillac (02-96)

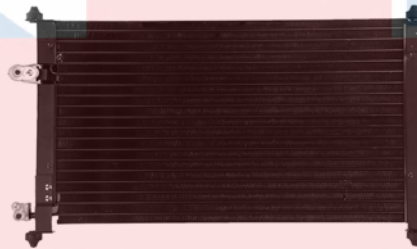

**40596**  
Parallel Flow  
Acura (99-97); Honda (97-95)  
Acura: 80110SS8A21

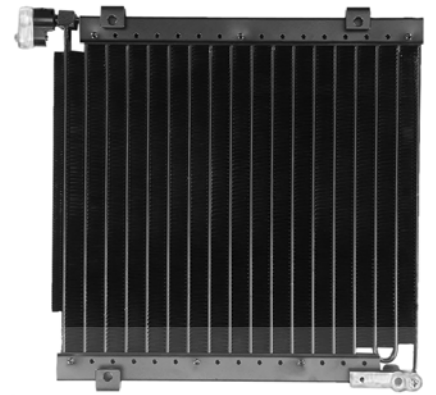

**40597**  
Parallel Flow  
Honda (00-96)  
Honda: 80110S01A11



**40598**  
Parallel Flow  
Toyota (00-96)



**40599**  
Parallel Flow  
Honda (98-95); Isuzu (99-96)  
Honda: 80110SX0003

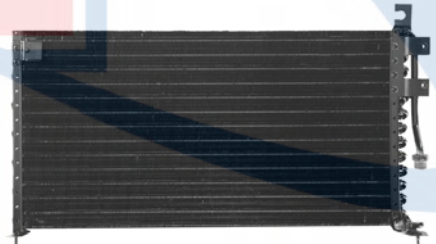

**40600**  
Serpentine  
Eagle (96-94); Mitsubishi (95-94); Plymouth (94-93)



# Condensers

## Condensers Cont'd

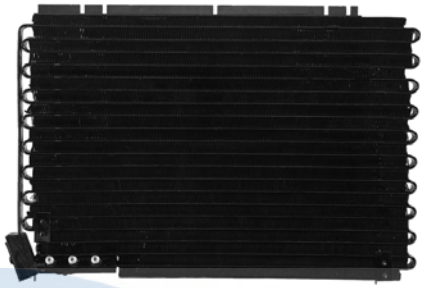

**40601**  
Serpentine  
Volvo (95-94)



**40602**  
Parallel Flow  
Honda (02); Isuzu (04-02)  
Honda: 8973050051

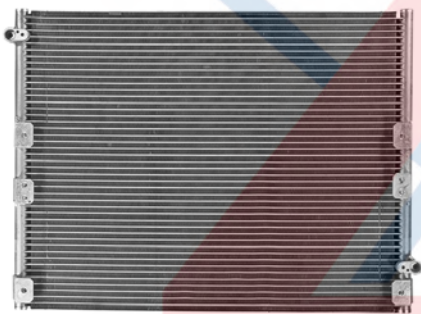

**40603**  
Parallel Flow  
Toyota (02-96)  
Toyota: 8846135050



**40604**  
Parallel Flow  
Audi (02-00), (97-96)

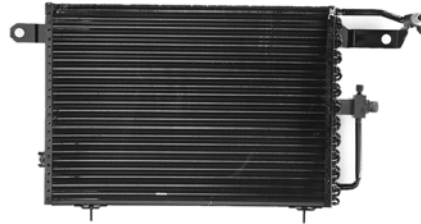

**40605**  
Parallel Flow  
Audi (97-92)  
Audi: 4A0260403AC

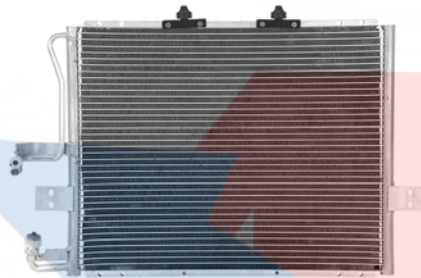

**40606**  
Parallel Flow  
Kia (02-96)  
Kia: 0K01161480M



**40607**  
6mm  
Honda (94-92)  
Honda: 04801SS0000



**40608**  
Parallel Flow  
Infiniti (98-96); Nissan (98-97)  
Infiniti: 921101L020

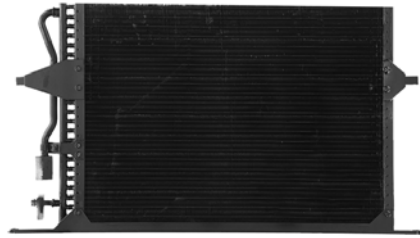

**40609**  
Parallel Flow  
Ford (00-97); Mercury (02-98)

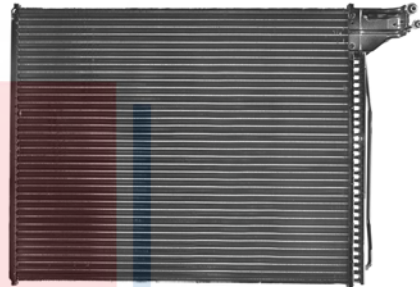

**40610**  
Parallel Flow  
Ford (07-97)



**40611**  
Parallel Flow  
Ford (01-96); Mercury (01-97)

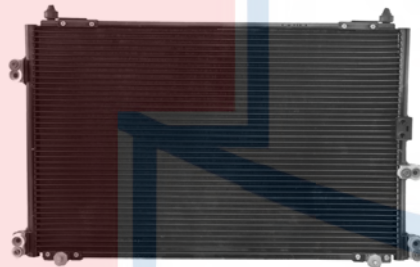

**40612**  
Parallel Flow  
Acura (04-96)  
Acura: 80101SZ3A01

# Condensers

## Condensers Cont'd



**40613**  
Parallel Flow  
Acura (98-95)

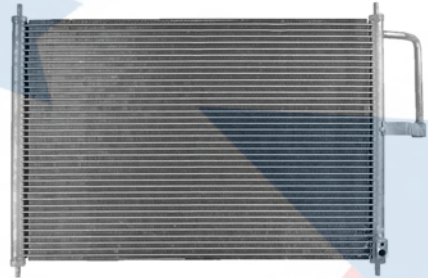

**40614**  
Parallel Flow  
Acura (98-96)



**40615**  
6mm  
Ford (07-97); Mercury (05-97)  
Ford: 1F1Z19712AC

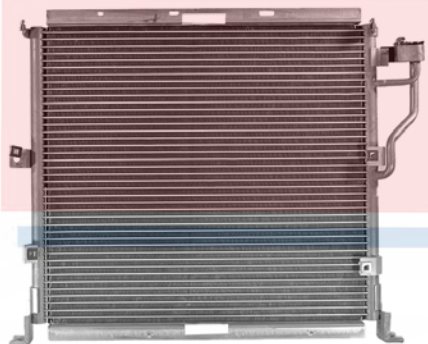

**40616**  
Tube & Fin  
BMW (02-96)  
BMW: 64539113678

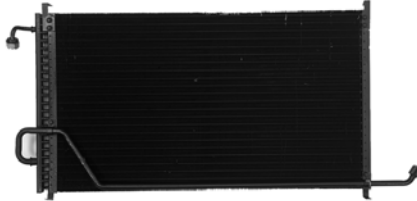

**40617**  
6mm  
Buick (96-95); Olds (96-95)  
General Motors Corp: 52472297

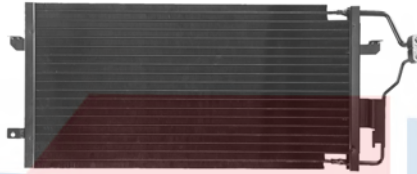

**40618**  
6mm  
Buick (05-97)  
General Motors Corp: 52484260

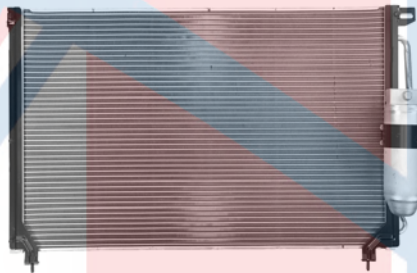

**40619**  
Parallel Flow  
Cadillac (01-97)

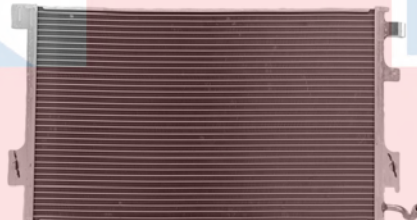

**40620**  
Parallel Flow  
Chevy (04-97)  
General Motors Corp: 52470569



**40621**  
Parallel Flow  
Chevy (01-97); Olds (01-98); Pontiac (01-99)  
General Motors Corp: 52472268



**40622**  
6mm  
Chevy (00-97); Olds (00-97); Pontiac (00-97)

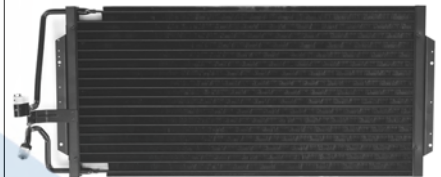

**40623**  
Parallel Flow  
Chevy (00-97); Olds (00-97); Pontiac (00-97)  
General Motors Corp: 52477673

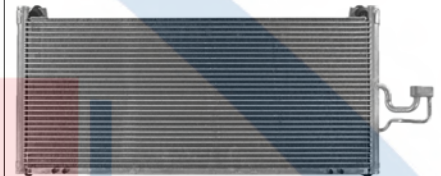

**40624**  
Parallel Flow  
Chrysler (00-95); Dodge (99-95)

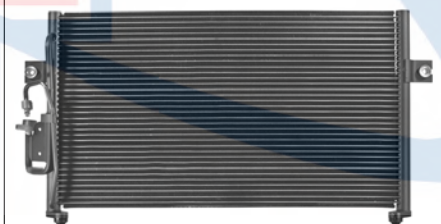

**40625**  
Parallel Flow  
Hyundai (00-96)  
Hyundai: 9760629100

# Condensers

## Condensers Cont'd



**40626**  
Parallel Flow  
Chrysler (98-95); Dodge (99), (97-95)



**40630**  
6mm  
Buick (05-97); Chevy (03-00); Olds (02-98); Pontiac (03-97)



**40635**  
Tube & Fin  
Nissan (98-97)  
Nissan: 9211081F10

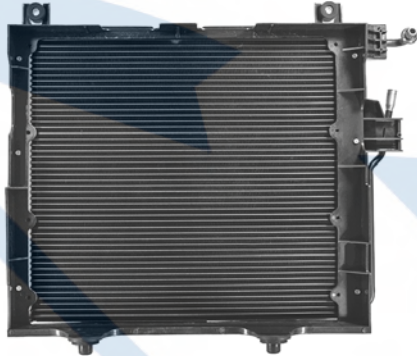

**40627**  
Parallel Flow  
Dodge (99-97)



**40631**  
6mm  
Ford (98-97)



**40636**  
Parallel Flow  
Mercedes (02-95)



**40628**  
Parallel Flow  
Honda (03-97)  
Honda: 80110S30003

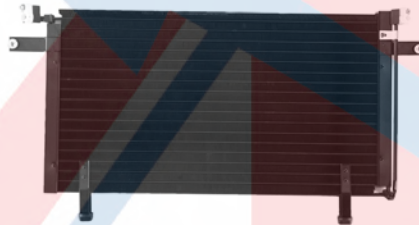

**40632**  
Parallel Flow  
Infiniti (97); Nissan (98-96)  
Infiniti: 921100W710

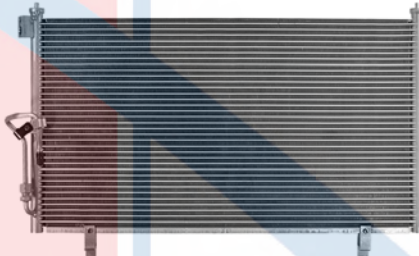

**40637**  
Parallel Flow  
Infiniti (01-97)  
Infiniti: 921106P110

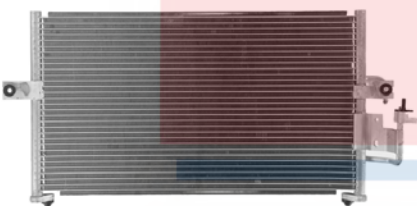

**40629**  
Parallel Flow  
Hyundai (01-97)  
Hyundai: 9760627060

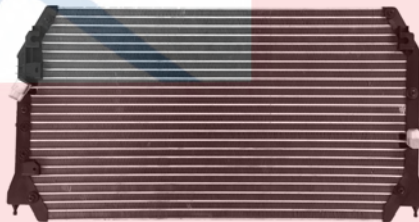

**40633**  
Parallel Flow  
Lexus (01-97); Toyota (98-97)  
Lexus: 8846006060

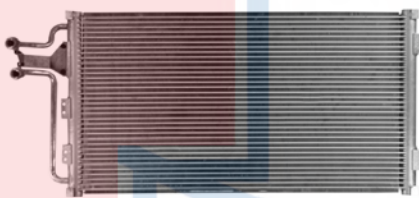

**40638**  
Parallel Flow  
Isuzu (00-96)  
Isuzu: 8524746470

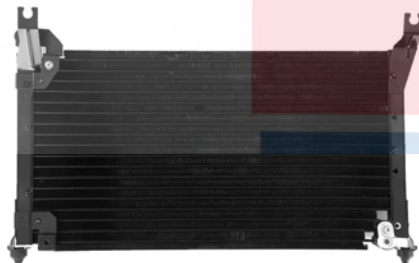

**40634**  
Parallel Flow  
Suzuki (02-95)  
Suzuki: 9531060G00



# Condensers

## Condensers Cont'd



**40639**  
Parallel Flow  
Ford (11-97); Mazda (09-01); Mercury (01-98)

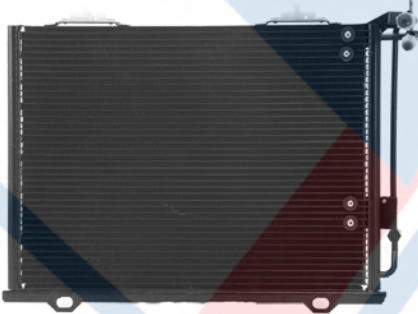

**40640**  
Parallel Flow  
Chrysler (08-04); Mercedes (04-95)

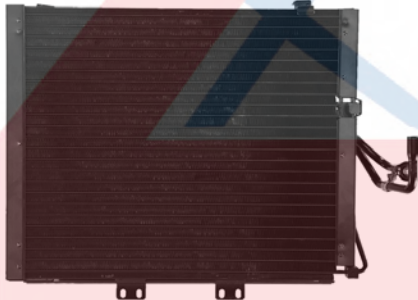

**40641**  
Parallel Flow  
Jeep (99-97)  
Chrysler: 55036366AC



**40642**  
Serpentine  
Mitsubishi (99-97)  
Mitsubishi: MR922875



**40643**  
Parallel Flow  
Mitsubishi (02-97)  
Mitsubishi: MR218428



**40644**  
Serpentine  
Mitsubishi (00-94)  
Mitsubishi: MB918439



**40645**  
Parallel Flow  
Mitsubishi (04-97)  
Mitsubishi: MR360415



**40646**  
Serpentine  
Toyota (93)  
Toyota: 8846016310



**40647**  
6mm  
Buick (99-95); Olds (99-95)  
General Motors Corp: 52484206

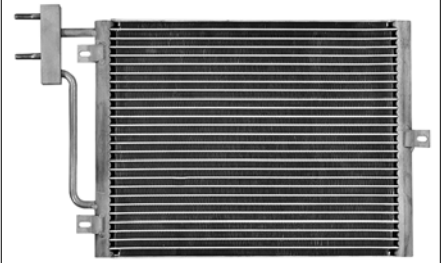

**40648**  
Parallel Flow  
Porsche (04-97)



**40649**  
Serpentine  
Land Rover (02-95)  
Land Rover: AWR1624



**40650**  
Parallel Flow  
Subaru (01-97)  
Subaru: 73210FA140

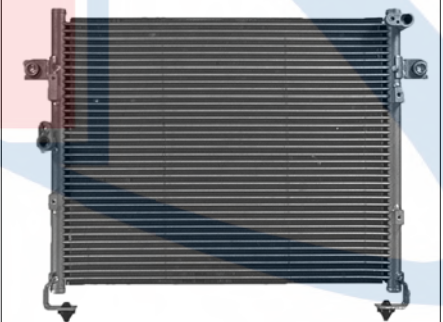

**40651**  
Parallel Flow  
Suzuki (98-94)  
Suzuki: 9531058B50

# Condensers

## Condensers Cont'd



**40652**  
Serpentine  
Toyota (96-94)  
Toyota: 8846033030

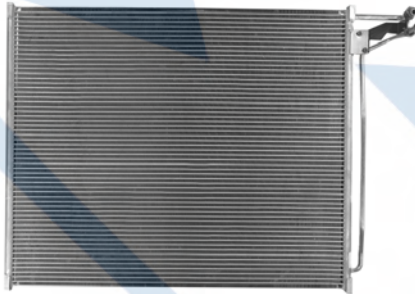

**40653**  
Parallel Flow  
Toyota (98-96)



**40654**  
6mm  
Ford (06-97); Lincoln (06-98)

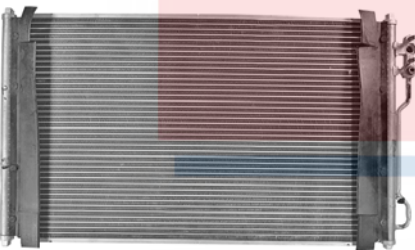

**40655**  
6mm  
Ford (97); Mercury (97)

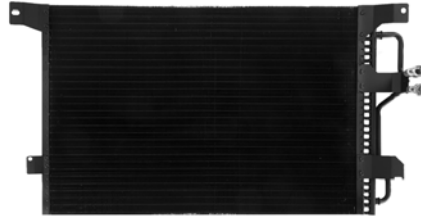

**40656**  
6mm  
Ford (02-98); Lincoln (02-98); Mercury (02-98)

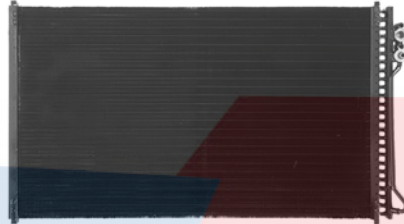

**40657**  
6mm  
Ford (04-99)  
Ford: 1R3Z19712CA

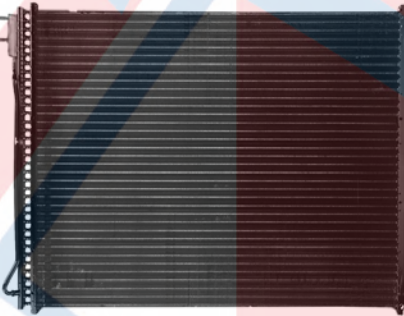

**40658**  
Parallel Flow  
Ford (07-99)



**40659**  
Parallel Flow  
Nissan (00-97)  
Nissan: 921100Z803



**40660**  
Parallel Flow  
Jeep (01-97)

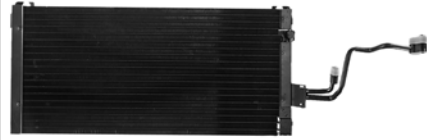

**40661**  
Serpentine  
Dodge (00), (98)

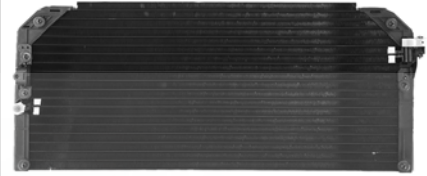

**40662**  
Parallel Flow  
Toyota (02-98)  
Toyota: 8846002050

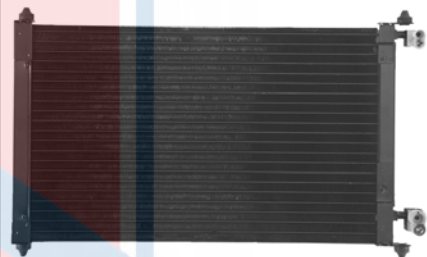

**40663**  
Parallel Flow  
Acura (03-99); Honda (02-98)



**40664**  
Parallel Flow  
Toyota (00-98)  
Toyota: 8846004090



**40665**  
Parallel Flow  
Honda (02-98)  
Honda: 80100S84A00

# Condensers

## Condensers Cont'd

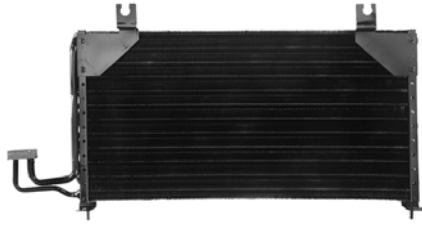

**40666**  
Parallel Flow  
Kia (01-98)  
Kia: 1K2A161480A

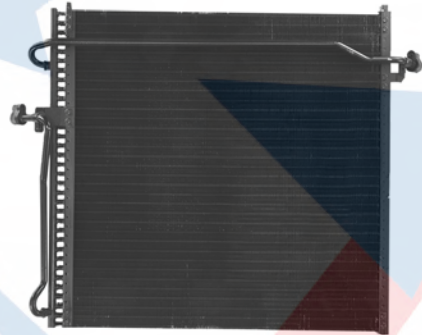

**40667**  
6mm  
Ford (11-98); Mazda (09-98)  
Ford: 6L5Z19712AC

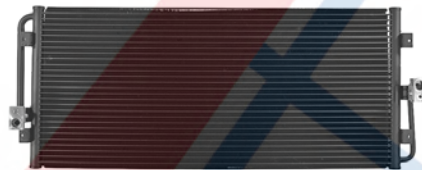

**40668**  
Parallel Flow  
Dodge (99-95); Plymouth (99-95)  
Chrysler: 4798950



**40669**  
Parallel Flow  
Dodge (99-97)  
Chrysler: 55055593AF

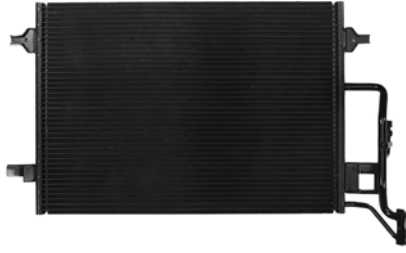

**40670**  
Parallel Flow  
Audi (02-98); VW (02-98)  
Audi: 8D0260403C



**40671**  
Parallel Flow  
Mazda (01-99)  
Mazda: BJ0E61480A

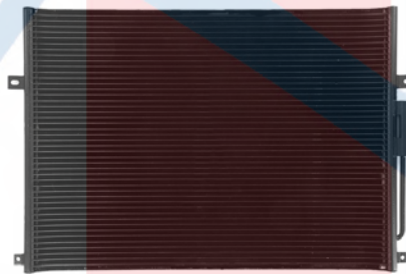

**40672**  
Parallel Flow  
Jeep (03-99)

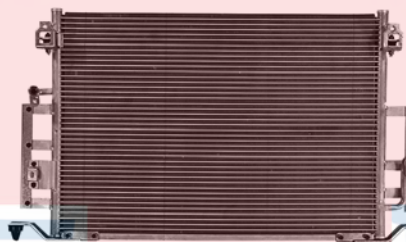

**40673**  
Parallel Flow  
Toyota (99-95)  
Toyota: 8846007010

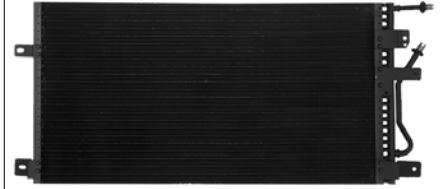

**40674**  
6mm  
Ford (96)

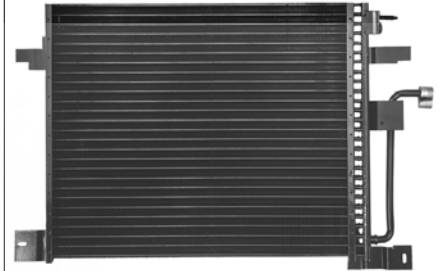

**40675**  
6mm  
Dodge (04-00)

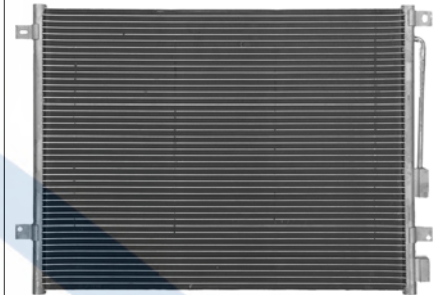

**40676**  
Parallel Flow  
Dodge (03-00)



**40677**  
Serpentine  
Lexus (01-97); Toyota (03-97)

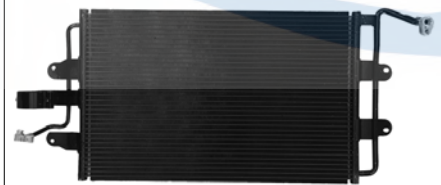

**40678**  
Parallel Flow  
VW (06-98)  
Volkswagen: 1C0820413G



# Condensers

## Condensers Cont'd

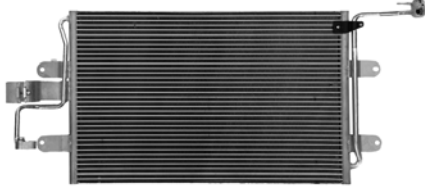

**40679**  
Parallel Flow  
Audi (06-00); VW (05-99)



**40680**  
6mm  
Dodge (03-98)  
Chrysler: 55055471AB



**40681**  
Parallel Flow  
Audi (03-97)  
Audi: 4D0260401A

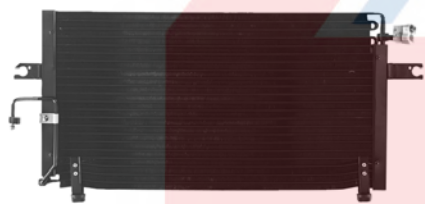

**40682**  
Parallel Flow  
Infiniti (99); Nissan (99-98)  
Infiniti: 921104L015

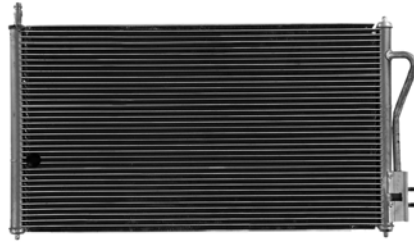

**40683**  
Parallel Flow  
Ford (05-00)  
Ford: YS4Z19712AB



**40684**  
Parallel Flow  
Nissan (99-98)  
Nissan: 921108B800

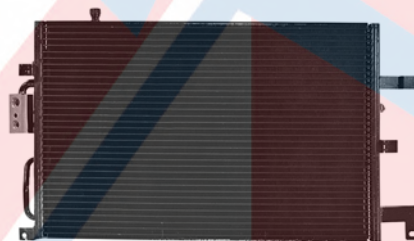

**40685**  
Parallel Flow  
Saab (02-99)



**40686**  
Parallel Flow  
Cadillac (04-98)

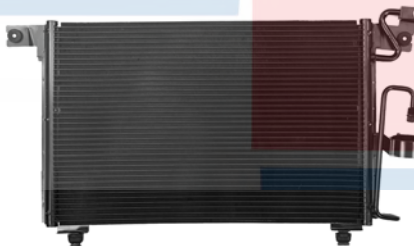

**40687**  
Parallel Flow  
Acura (99-98); Isuzu (00-98)  
Acura: 8524814600

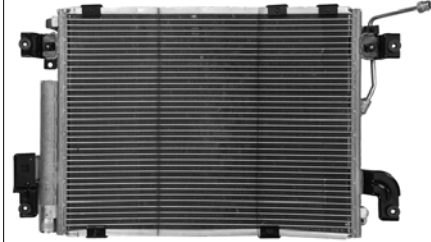

**40688**  
Parallel Flow  
Chevy (04-99)  
General Motors Corp: 91176896

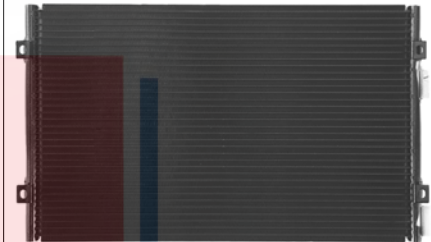

**40689**  
Parallel Flow  
Chrysler (10-01)  
Chrysler: 5093598AC



**40690**  
Parallel Flow  
Hyundai (02-99); Kia (03-01)  
Hyundai: 9760638002



**40691**  
6mm  
Buick (05-00); Pontiac (05-00)  
General Motors Corp: 52482155

# Condensers

## Condensers Cont'd



**40692**  
Parallel Flow  
Cadillac (14-02); Chevy (14-99); GMC (14-99)  
General Motors Corp: 20913751

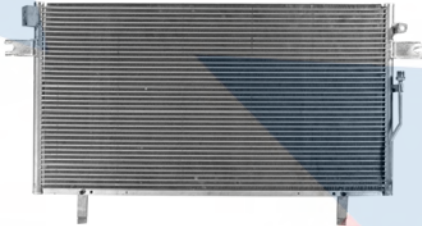

**40693**  
Parallel Flow  
Infiniti (00-98); Nissan (00-98)  
Infiniti: 921102W110



**40694**  
Parallel Flow  
Chrysler (04-01); Dodge (04-01)



**40695**  
Parallel Flow  
Ford (01-97)



**40696**  
Parallel Flow  
Toyota (05-00)  
Toyota: 884600C020



**40697**  
Parallel Flow  
Mitsubishi (03-99)  
Mitsubishi: MR993588

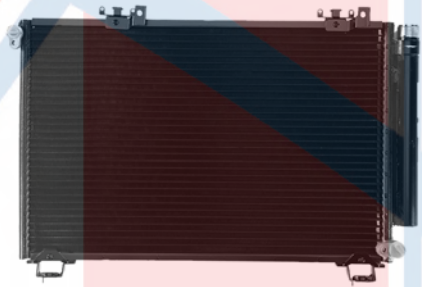

**40698**  
Parallel Flow  
Toyota (02-00)  
Toyota: 8846052040



**40699**  
Parallel Flow  
Chrysler (05-01); Dodge (05-01); Mitsubishi (05-00)  
Chrysler: 7812A066



**40700**  
Parallel Flow  
Toyota (04-00)  
Toyota: 8846007032

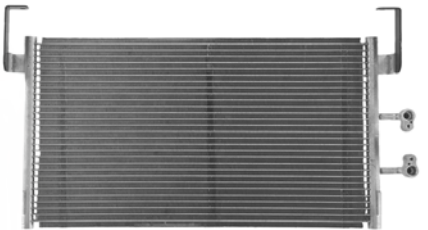

**40701**  
Parallel Flow  
Chrysler (02-00); Dodge (05-00); Plymouth (01-00)  
Chrysler: 5014582AE



**40702**  
Parallel Flow  
Volvo (05-99)  
Volvo: 30676602



**40703**  
Parallel Flow  
Audi (05-98)  
Audi: 4B0260403S

# Condensers

## Condensers Cont'd



**40704**  
Parallel Flow  
BMW (01-98)  
BMW: 64538378439

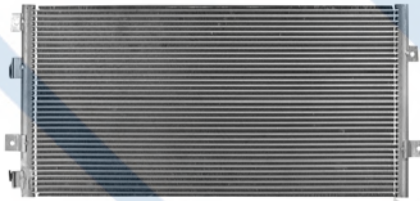

**40705**  
Parallel Flow  
Chrysler (04-99)

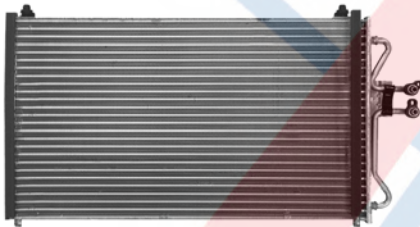

**40706**  
6mm  
Ford (03-01); Mazda (04-01)



**40707**  
Parallel Flow  
Subaru (99-97)  
Subaru: 73210AC050



**40708**  
Parallel Flow  
Honda (05-01)  
Honda: 80110S5A003



**40709**  
Parallel Flow  
Nissan (02-00)  
Nissan: 921107Z800



**40710**  
Parallel Flow  
Nissan (01-00)  
Nissan: 921100Z803



**40711**  
Parallel Flow  
Nissan (01-00)

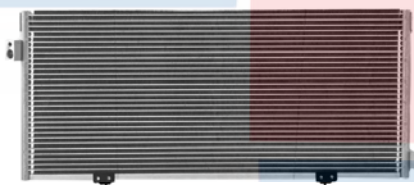

**40712**  
Parallel Flow  
Subaru (07-00)



**40713**  
Parallel Flow  
Lexus (05-98)

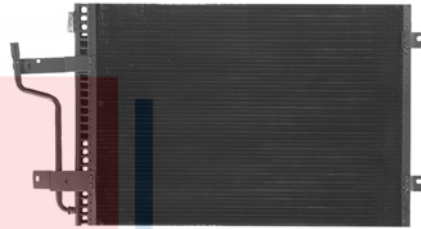

**40714**  
6mm  
Dodge (02-98)

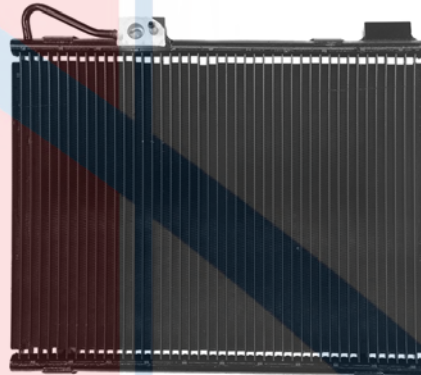

**40715**  
Parallel Flow  
Dodge (08-02)  
Chrysler: 5072993AB

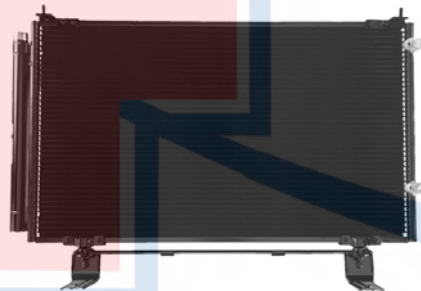

**40716**  
Parallel Flow  
Honda (04-99)  
Honda: 80100S0X305



# Condensers

## Condensers Cont'd



**40717**  
Parallel Flow  
Toyota (05-01)

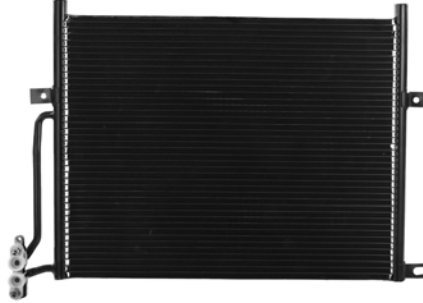

**40721**  
Parallel Flow  
BMW (08-99)



**40727**  
Parallel Flow

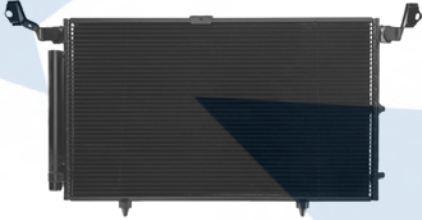

**40718**  
Parallel Flow  
Lexus (03-99)



**40722**  
Parallel Flow  
Chrysler (04-01); Dodge (04-01)

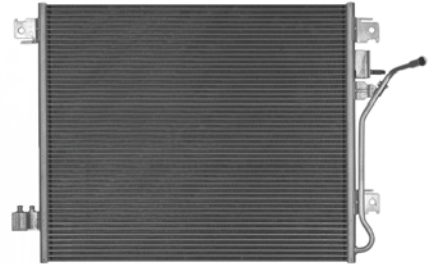

**40728**  
Parallel Flow

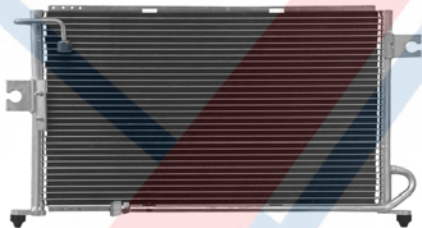

**40719**  
Parallel Flow  
Mazda (00-99)



**40723**  
Parallel Flow



**40724**  
Parallel Flow



**40729**  
Parallel Flow



**40720**  
Parallel Flow  
BMW (05-97)



**40725**  
Parallel Flow



**40730**  
Parallel Flow

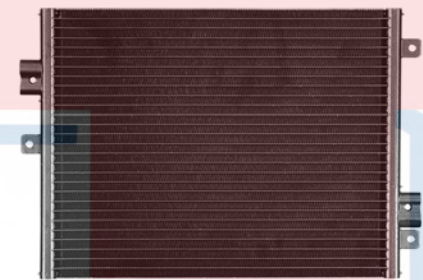

**40726**  
Parallel Flow



**40731**  
Parallel Flow

# Condensers

## Condensers Cont'd

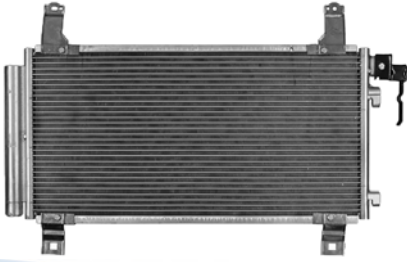

**40732**  
Parallel Flow

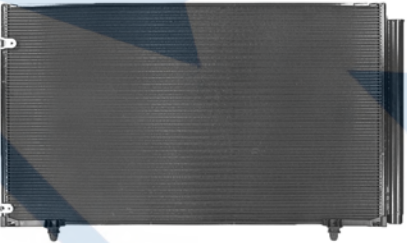

**40733**  
Parallel Flow

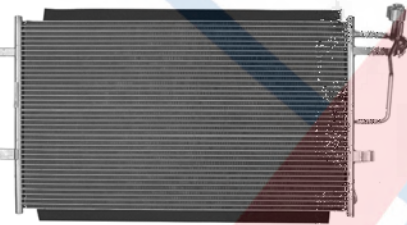

**40734**  
Parallel Flow



**40735**  
Parallel Flow

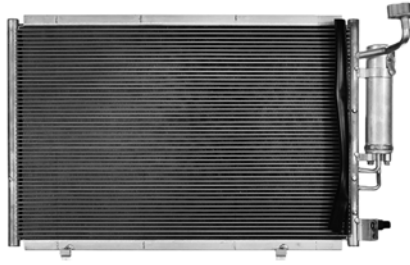

**40736**  
Parallel Flow

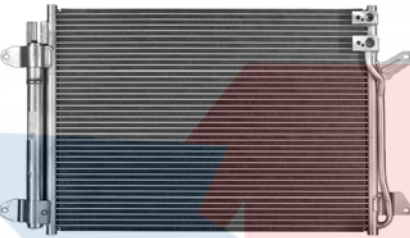

**40737**  
Parallel Flow



**40738**  
Parallel Flow



**40739**  
Parallel Flow

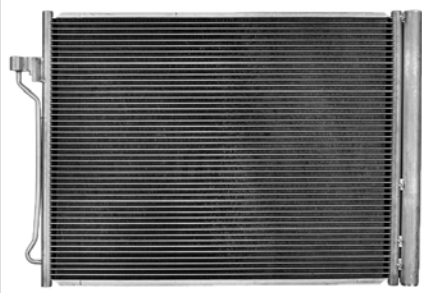

**40740**  
Parallel Flow



**40741**  
Parallel Flow

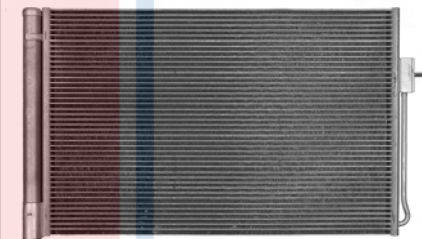

**40742**  
Parallel Flow



**40743**  
Parallel Flow

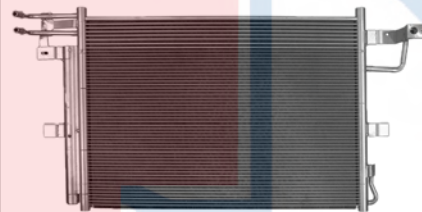

**40744**  
Parallel Flow

# Condensers

## Condensers Cont'd

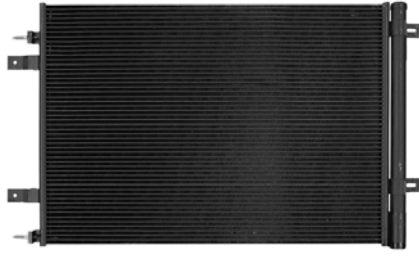

**40745**  
Parallel Flow



**40746**  
Parallel Flow



**40747**  
Parallel Flow



**40748**  
Parallel Flow



**40749**  
Parallel Flow



**40750**  
Parallel Flow

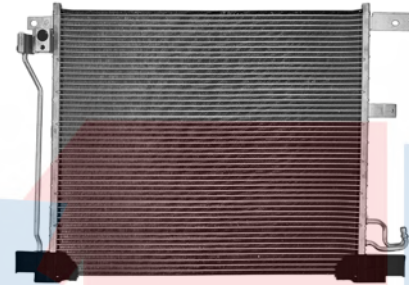

**40751**  
Parallel Flow



**40752**  
Parallel Flow



**40753**  
Parallel Flow

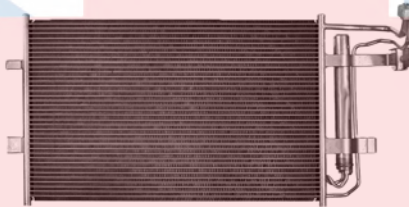

**40754**  
Parallel Flow



**40755**  
Parallel Flow

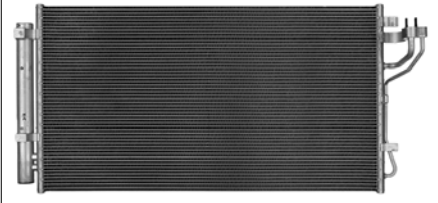

**40756**  
Parallel Flow

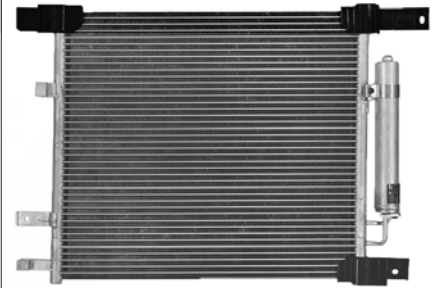

**40757**  
Parallel Flow

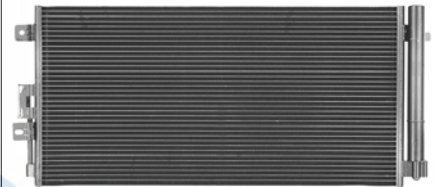

**40758**  
Parallel Flow



**40759**  
Parallel Flow

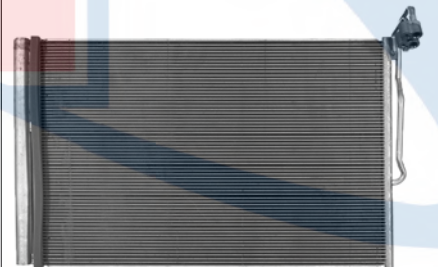

**40760**  
Parallel Flow

**40761**  
Parallel Flow

**40762**  
Parallel Flow



# Condensers

## Condensers Cont'd

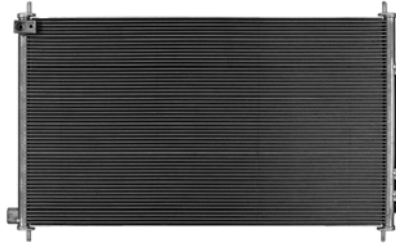

**40763**  
Parallel Flow

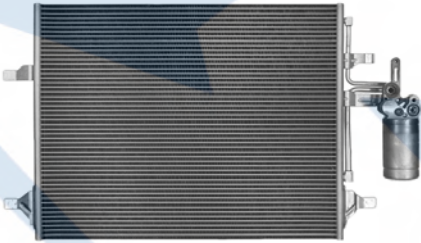

**40764**  
Parallel Flow



**40765**  
Parallel Flow

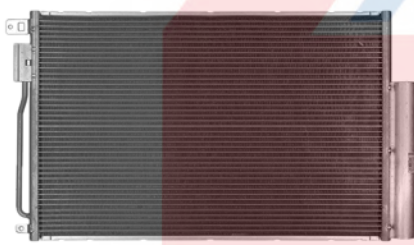

**40766**  
Parallel Flow

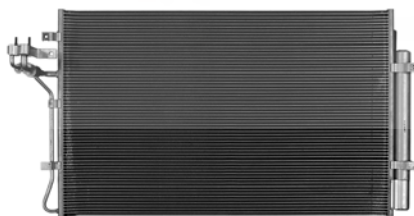

**40767**  
Parallel Flow

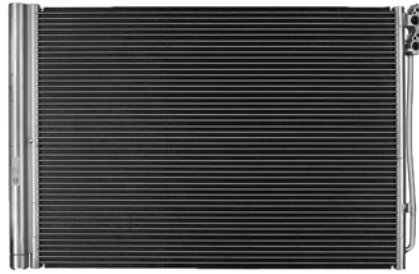

**40768**  
Parallel Flow

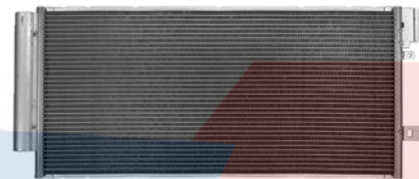

**40769**  
Parallel Flow



**40770**  
Parallel Flow

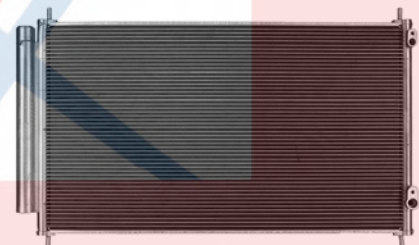

**40771**  
Parallel Flow

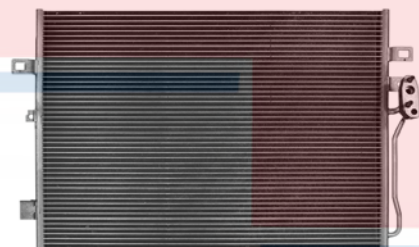

**40772**  
Parallel Flow

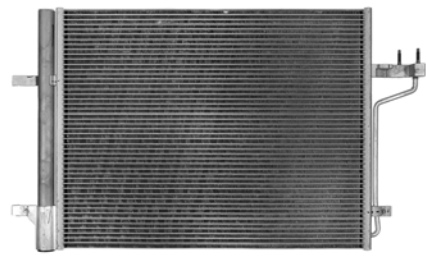

**40773**  
Parallel Flow

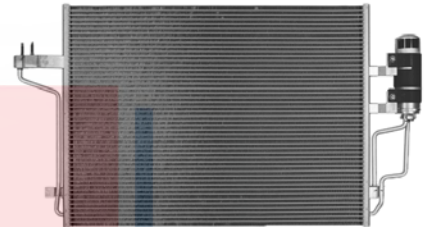

**40774**  
Parallel Flow

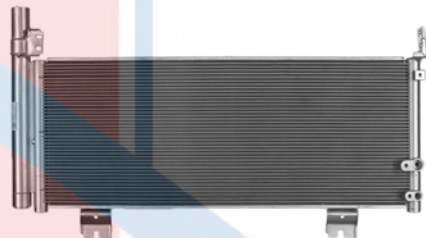

**40775**  
Parallel Flow



**40776**  
Parallel Flow



**40777**  
Parallel Flow

# Condensers

## Condensers Cont'd

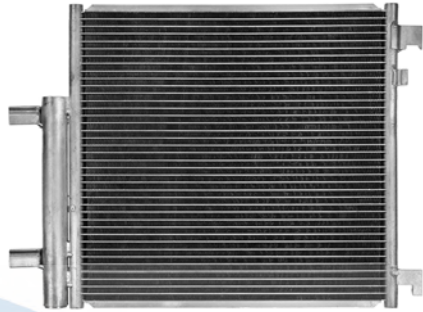

**40778**  
Parallel Flow

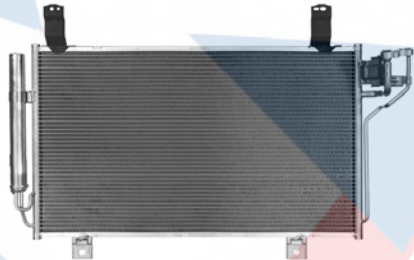

**40779**  
Parallel Flow



**40780**  
Parallel Flow

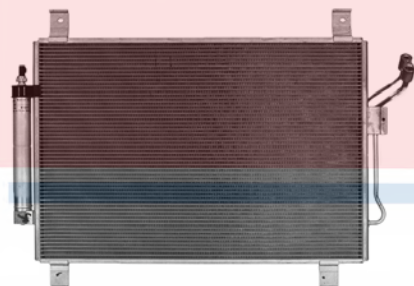

**40781**  
Parallel Flow

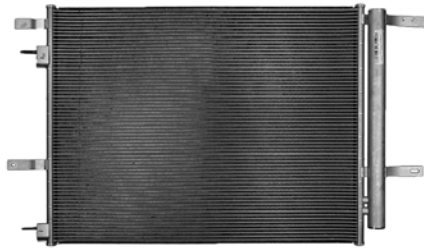

**40782**  
Parallel Flow

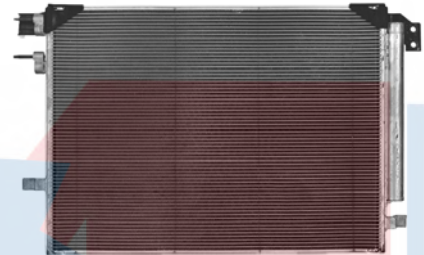

**40783**  
Parallel Flow

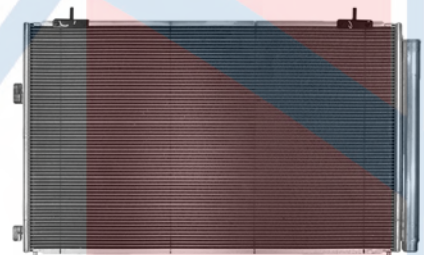

**40784**  
Parallel Flow



**40785**  
Parallel Flow



**40786**  
Parallel Flow

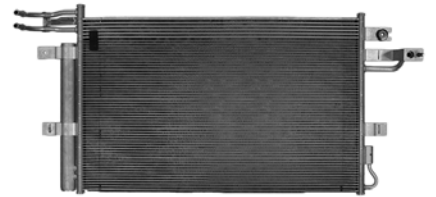

**40787**  
Parallel Flow



**40788**  
Parallel Flow

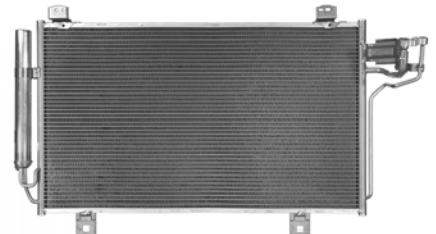

**40789**  
Parallel Flow



**40790**  
Parallel Flow

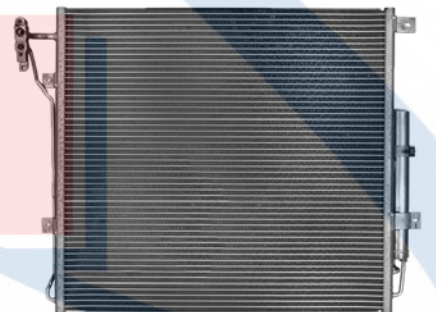

**40791**  
Parallel Flow



# Condensers

## Condensers Cont'd



**40792**  
Parallel Flow



**40793**  
Parallel Flow



**40794**  
Parallel Flow



**40795**  
Parallel Flow

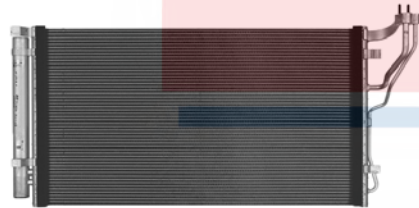

**40796**  
Parallel Flow

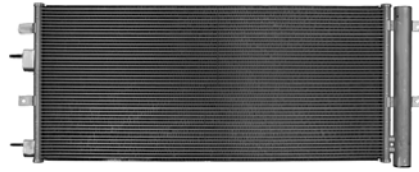

**40797**  
Parallel Flow

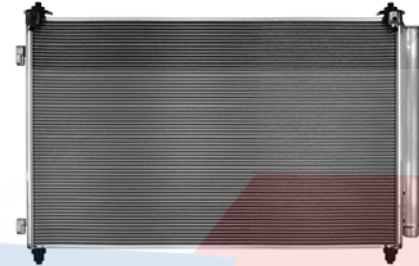

**40798**  
Parallel Flow



**40799**  
Parallel Flow

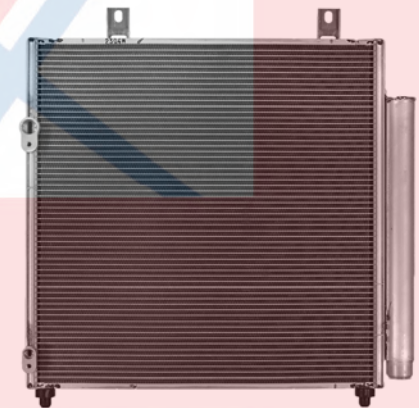

**40800**  
Parallel Flow

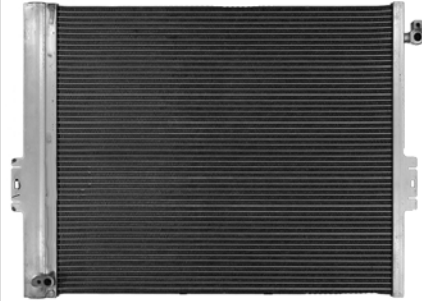

**40801**  
Parallel Flow

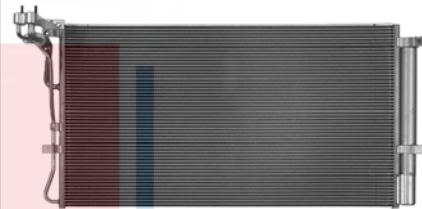

**40802**  
Parallel Flow

**40803**  
Parallel Flow

**40804**  
Parallel Flow

**40805**  
Parallel Flow

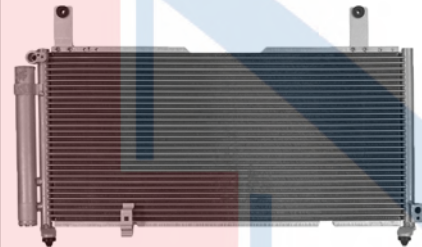

**40806**  
Parallel Flow

**40807**  
Parallel Flow

**40808**  
Parallel Flow



# Condensers

## Condensers Cont'd

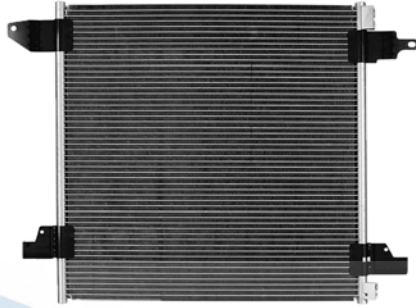

**40809**  
Parallel Flow



**83906**  
Filter Driers  
Buick (09-06); Chevy (11-06); Pontiac (08-06)  
General Motors Corp: 89019322



**83907**  
Filter Driers  
Buick (11-06); Cadillac (11-06)  
General Motors Corp: 25769583

## Condenser Drier Assembly

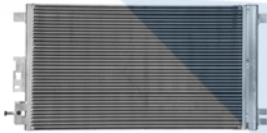

**83902**  
Filter Driers  
Chevy (12-04); Pontiac (10-05); Saturn (09-07)  
General Motors Corp: 20820057, 20820058

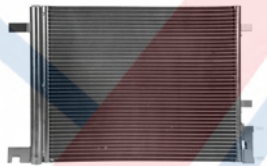

**83903**  
Filter Driers  
Chevy (11-06)  
General Motors Corp: 15834081, 20889194



**83904**  
Filter Driers  
Cadillac (09-04); Chevy (13-03)  
General Motors Corp: 10442892

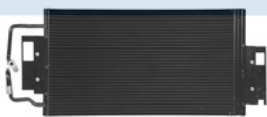

**83905**  
Filter Driers  
Buick (09-08); Chevy (14-06); Pontiac (08-05)  
General Motors Corp: 23287351

# Electric Fans And Accessories

## Reversible Fans



**35215**  
9" Fan Kit  
Reversible Fan  
Width: 9.500  
Height: 10.310  
Depth: 2.875  
Free Airflow (CFM): 590  
AMP Draw: 6.900



**36895**  
10" Fan Kit  
Reversible Fan  
Width: 11.375  
Height: 10.875  
Depth: 2.625  
Free Airflow (CFM): 650  
AMP Draw: 5.400



**36896**  
12" Fan Kit  
Reversible Fan  
Width: 12.500  
Height: 11.875  
Depth: 2.750  
Free Airflow (CFM): 800  
AMP Draw: 8.800



**36897**  
14" Fan Kit  
Reversible Fan  
Width: 14.750  
Height: 13.875  
Depth: 3.625  
Free Airflow (CFM): 1250  
AMP Draw: 11.500

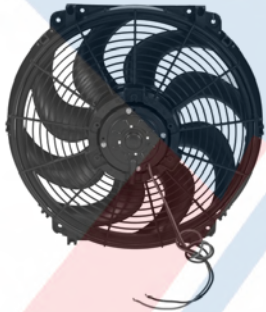

**36898**  
16" Fan Kit  
Reversible Fan  
Width: 16.750  
Height: 15.750  
Depth: 4.250  
Free Airflow (CFM): 1400  
AMP Draw: 16.500

## Dual Fans

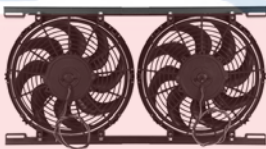

**36899**  
12" Dual Fan Kit  
Dual Fan  
Width: 25.500  
Height: 13.1875  
Depth: 2.625  
Free Airflow (CFM): 1600  
AMP Draw: 16.600

## Fan Accessories



**36800**  
Fan Accessory  
Mount Bracket  
Width: 0.000  
Height: 0.000  
Depth: 0.000

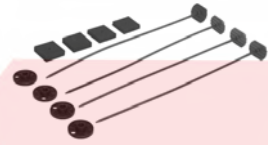

**53014**  
Fan Accessory  
Pull Tie  
Width: 0.000  
Height: 0.000  
Depth: 0.000

# Evaporator Cores

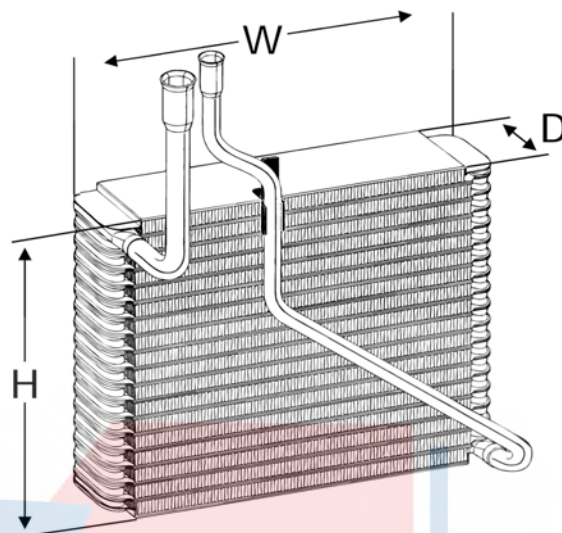

## Evaporator Cores

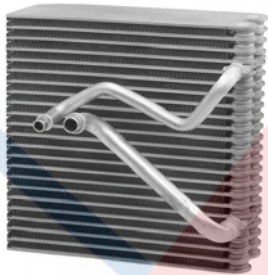

### 44001

Depth	Height	Width
2-3/8	9-1/4	9-1/4

Plate & Fin Evaporator Core

Inlet: Flange

Outlet: Flange

O-Rings: (1) **24608**, (1) **24610**

Audi (14-06); VW (14-06)

Volkswagen: 1K1820103E

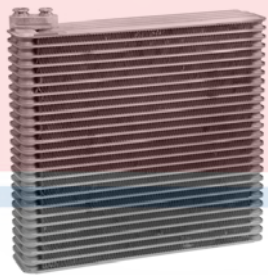

### 44002

Depth	Height	Width
2-1/4	11-9/16	2-1/4

Plate & Fin Evaporator Core

Inlet: Block Fitting

Outlet: Block Fitting

O-Rings: (1) **24661**, (1) **24681**

Toyota (07-06)

Toyota: 8850148030

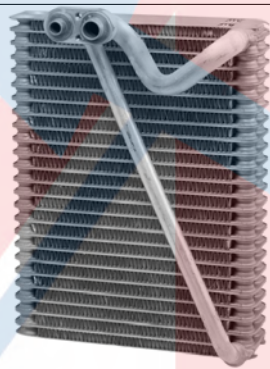

### 44003

Depth	Height	Width
1-7/8	10-5/8	4-1/8

Plate & Fin Evaporator Core

Inlet: Block Fitting

Outlet: Block Fitting

O-Rings: (1) **24608**, (1) **24610**

Subaru (07-02)

Subaru: 73523FE020

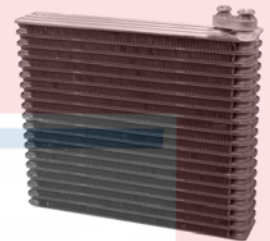

### 44014

Depth	Height	Width
2-5/8	10-1/8	2-5/16

Plate & Fin Evaporator Core

Inlet: Block Fitting

Outlet: Block Fitting

O-Rings: (1) **24661**, (1) **24681**

Suzuki (07-02)

Suzuki: 9541054G10

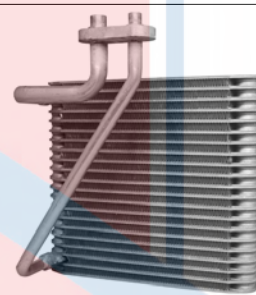

### 44015

Depth	Height	Width
1-7/8	10-7/16	5-1/8

Plate & Fin Evaporator Core

Inlet: Block Fitting

Outlet: Block Fitting

O-Rings: (1) **24608**, (1) **24610**

Chevy (07-04); Suzuki (08-04)

Suzuki: 9541085Z00, 9541085Z10

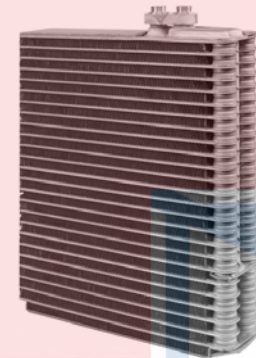

### 44017

Plate & Fin Evaporator Core

Suzuki (06-03)

Suzuki: 9541054J10, 9541154J10



### 44030

Depth	Height	Width
2-3/8	13-15/16	2-3/8

Plate & Fin Evaporator Core

Inlet: Block Fitting

Outlet: Block Fitting

O-Rings: (1) **24608**, (1) **24610**

BMW (06-00)

BMW: 64118385560



# Evaporator Cores

## Evaporator Cores Cont'd



**44031**  
 Depth 2-15/16    Height 15-1/8    Width 2-15/16  
 Tube & Fin Evaporator Core  
 Inlet: Block Fitting  
 Outlet: Block Fitting  
 O-Rings: (1) **24608**, (1) **24610**  
 BMW (00-97)

BMW: 64118363782

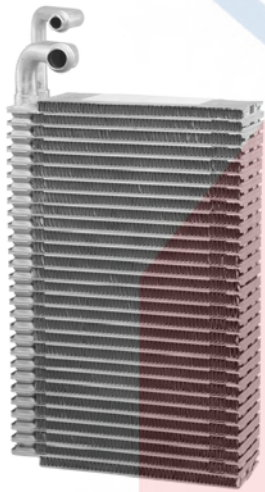

**44032**  
 Depth 2-5/8    Height 15-1/8    Width 5-3/8  
 Plate & Fin Evaporator Core  
 Inlet: Block Fitting  
 Outlet: Block Fitting  
 O-Rings: (1) **24608**, (1) **24612**  
 BMW (15-04)

BMW: 64119238655, 64119383678



**44033**  
 Depth 1-15/16    Height 15-3/4    Width 5-11/16  
 Plate & Fin Evaporator Core  
 Inlet: Block Fitting  
 Outlet: Block Fitting  
 O-Rings: (1) **24608**, (1) **24610**  
 BMW (15-07)

BMW: 64119281416

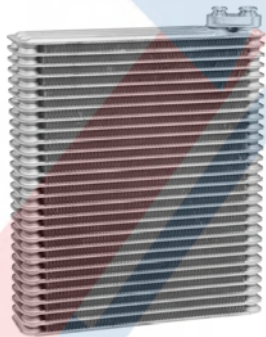

**44034**  
 Depth 2-1/4    Height 12-1/4    Width 2-1/4  
 Plate & Fin Evaporator Core  
 Inlet: Block Fitting  
 Outlet: Block Fitting  
 O-Rings: (1) **24661**, (1) **24662**  
 BMW (06-00)

BMW: 64118385690



**44035**  
 Depth 2-3/8    Height 11-1/2    Width 5-1/8  
 Plate & Fin Evaporator Core  
 Inlet: Block Fitting  
 Outlet: Block Fitting  
 O-Rings: (1) **24608**, (1) **24610**  
 Mini (09-02)

BMW: 64111499134

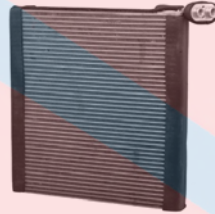

**44036**  
 Depth 1-1/2    Height 12-7/8    Width 2-7/8  
 Plate & Fin Evaporator Core  
 Inlet: Block Fitting  
 Outlet: Block Fitting  
 O-Rings: (1) **24661**, (1) **24681**  
 Ford (12-07); Lincoln (12-07); Mazda (14-07)

Ford: 9T4Z19B555G, CT4Z19B555J, CT4Z19B555K  
 Mazda: L20661J10A

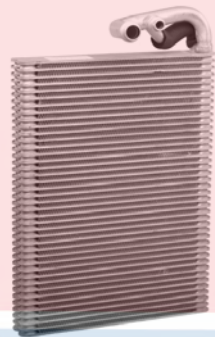

**44037**  
 Depth 1-1/2    Height 14    Width 4-1/2  
 Plate & Fin Evaporator Core  
 Inlet: Block Fitting  
 Outlet: Block Fitting  
 O-Rings: (1) **24608**, (1) **24612**  
 Mercedes (14-08)

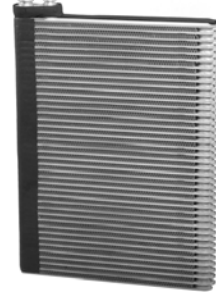

**44038**  
 Depth 1-1/2    Height 13-1/8    Width 1-5/8  
 Plate & Fin Evaporator Core  
 Inlet: Block Fitting  
 Outlet: Block Fitting  
 O-Rings: (1) **24661**, (1) **24681**  
 Cadillac (14-05); Chevy (13-11); Pontiac (09-08)



**44039**  
 Depth 1-1/2    Height 9-1/2    Width 1-3/4  
 Plate & Fin Evaporator Core  
 Inlet: Block Fitting  
 Outlet: Block Fitting  
 O-Rings: (1) **24661**, (1) **24681**  
 Honda (13-09)

Honda: 80211TF0G01

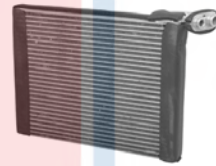

**44040**  
 Depth 1-1/2    Height 8-3/4    Width 2-3/4  
 Plate & Fin Evaporator Core  
 Inlet: Block Fitting  
 Outlet: Block Fitting  
 O-Rings: (1) **24661**, (1) **24681**  
 Scion (14-08); Toyota (14-07)

Toyota: 8850152103

# Evaporator Cores

## Evaporator Cores Cont'd



**44041**  
 Depth Height Width  
 1-1/2 15-1/4 4-1/4  
 Plate & Fin Evaporator Core  
 Inlet: Block Fitting  
 Outlet: Block Fitting  
 O-Rings: (1) **24661**, (1) **24681**  
 Honda (14-08)

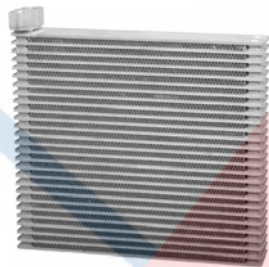

**44042**  
 Depth Height Width  
 1-1/2 8-3/4 1-7/8  
 Plate & Fin Evaporator Core  
 Inlet: Block Fitting  
 Outlet: Block Fitting  
 O-Rings: (1) **24608**, (1) **24610**  
 Nissan (10-07); Suzuki (13-07)

Nissan: 27281EL00A, 27281EL01A  
 Suzuki: 9541180JA2

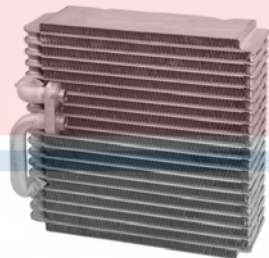

**44044**  
 Depth Height Width  
 2-15/16 8-7/8 4-7/8  
 Plate & Fin Evaporator Core  
 Inlet: Block Fitting  
 Outlet: Block Fitting  
 O-Rings: (2) **24610**  
 Kia (02)

Kia: 1K55261R02

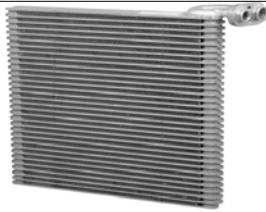

**44045**  
 Depth Height Width  
 1-1/2 9-3/4 2-3/4  
 Plate & Fin Evaporator Core  
 Inlet: Block Fitting  
 Outlet: Block Fitting  
 O-Rings: (1) **24661**, (1) **24681**  
 Pontiac (10-09); Scion (12-08); Toyota (14-06)

General Motors Corp: 19205446  
 Toyota: 8850102222, 8850126211

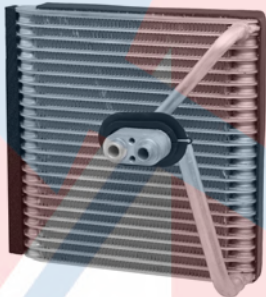

**44046**  
 Depth Height Width  
 1-7/8 9-7/8 6-5/8  
 Plate & Fin Evaporator Core  
 Inlet: Block Fitting  
 Outlet: Block Fitting  
 Hyundai (11-06)

Hyundai: 971401E002

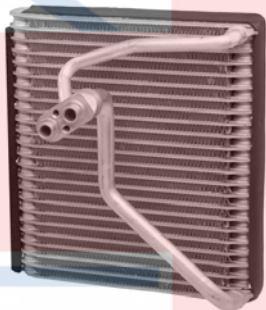

**44047**  
 Depth Height Width  
 1-7/8 10-5/16 7-7/8  
 Plate & Fin Evaporator Core  
 Inlet: Block Fitting  
 Outlet: Block Fitting  
 O-Rings: (2) **24109**  
 Kia (09-04)

Kia: 971392F000



**44048**  
 Depth Height Width  
 1-15/16 14-1/8 6  
 Plate & Fin Evaporator Core  
 Inlet: Flange  
 Outlet: Flange  
 O-Rings: (1) **24608**, (1) **24610**  
 Mazda (13-09)

Mazda: GS3L61J10

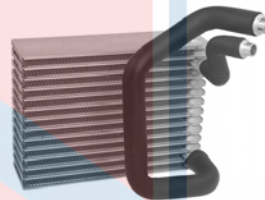

**44049**  
 Depth Height Width  
 2-3/8 7-15/16 7-1/8  
 Plate & Fin Evaporator Core  
 Inlet: Flange  
 Outlet: Flange  
 O-Rings: (1) **24608**, (1) **24610**  
 Mercedes (15-06)

Mercedes Benz: 1648300258

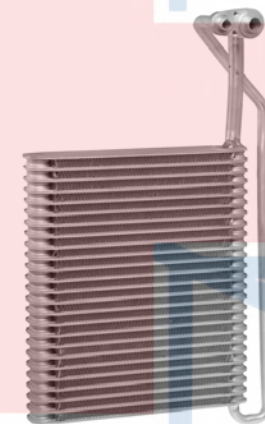

**44050**  
 Depth Height Width  
 1-7/8 17-5/8 4-1/4  
 Plate & Fin Evaporator Core  
 Inlet: Block Fitting  
 Outlet: Block Fitting  
 O-Rings: (1) **24402**, (1) **24403**  
 Toyota (14-05)

Toyota: 8851104010

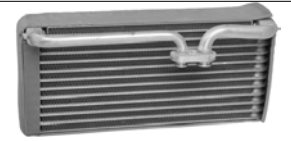

**44051**  
 Depth Height Width  
 2-1/4 5-1/8 4  
 Plate & Fin Evaporator Core  
 Inlet: Block Fitting  
 O-Rings: (1) **24661**, (1) **24681**  
 Lexus (09-03)

Lexus: 8850144080



**44052**  
 Depth Height Width  
 1-1/2 11-5/8 1-1/2  
 Plate & Fin Evaporator Core  
 Inlet: Block Fitting  
 Outlet: Block Fitting  
 O-Rings: (1) **24661**, (1) **24681**  
 Acura (14-09)

Acura: 80211TCOP41

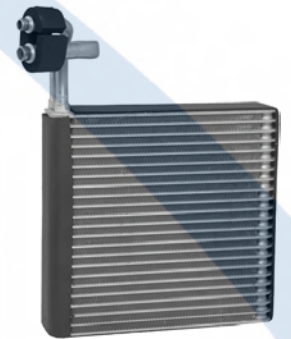

**44053**  
 Depth Height Width  
 2-5/16 13-1/4 4-15/16  
 Plate & Fin Evaporator Core  
 Inlet: Flange  
 Outlet: Flange  
 O-Rings: (1) **24608**, (1) **24610**, (1) **38635**  
 Mazda (08-03)

Mazda: GK3J61J10



# Evaporator Cores

## Evaporator Cores Cont'd



**44054**  
 Depth 2-9/16 Height 14-3/4 Width 5-1/8  
 Plate & Fin Evaporator Core  
 O-Rings: ( ) , (1) **24608**, (3) **24672**  
 Mazda (03-01)

Mazda: BJOM61J10

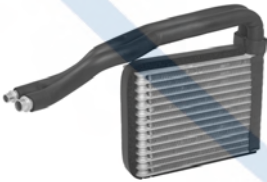

**44055**  
 Depth 1-7/8 Height 8 Width 2-3/4  
 Plate & Fin Evaporator Core  
 Inlet: Flange  
 Outlet: Flange  
 O-Rings: (1) **24608**, (1) **24610**  
 Dodge (11-09)

Chrysler: 68038191AB

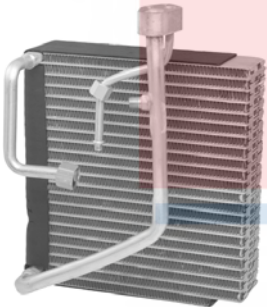

**44057**  
 Depth 2-9/16 Height 12 Width 5-7/16  
 Plate & Fin Evaporator Core  
 Inlet: Block Fitting  
 Outlet: Block Fitting  
 O-Rings: ( ) , (1) **24607**, (1) **24610**  
 Mitsubishi (04-97)

Mitsubishi: MR315966, MR500191, MR513490



**44058**  
 Depth 2-1/4 Height 10 Width 2-1/4  
 Plate & Fin Evaporator Core  
 Inlet: Block Fitting  
 Outlet: Block Fitting  
 O-Rings: (2) **24610**  
 Mazda (12-06)

Mazda: EG2161J10, GJYA61J1ZB

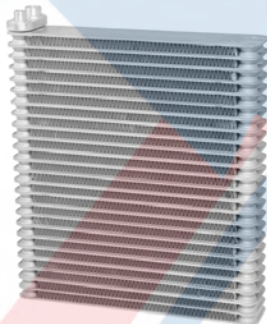

**44059**  
 Depth 1-15/16 Height 10-7/8 Width 2  
 Plate & Fin Evaporator Core  
 Inlet: Block Fitting  
 Outlet: Block Fitting  
 O-Rings: (1) **24661**, (1) **24681**  
 Nissan (10-08)

Nissan: 27281JM00A



**44060**  
 Depth 1-15/16 Height 10-3/4 Width 2-1/16  
 Plate & Fin Evaporator Core  
 Inlet: Block Fitting  
 Outlet: Block Fitting  
 O-Rings: (1) **24150**, (1) **24661**  
 Nissan (12-07)

Nissan: 27280ZE80A, 27281EN000

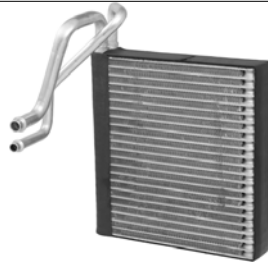

**44061**  
 Depth 1-7/8 Height 11-7/8 Width 7  
 Plate & Fin Evaporator Core  
 Inlet: Flange  
 Outlet: Flange  
 O-Rings: (1) **24608**, (1) **24610**  
 Ford (11-08)

Ford: 9S4Z19B555A, AS4Z19B555C

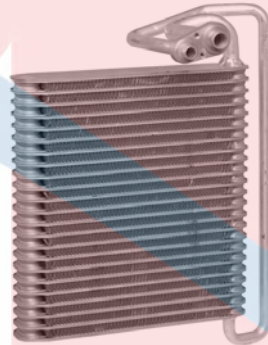

**44062**  
 Depth 1-7/8 Height 13-3/4 Width 6  
 Plate & Fin Evaporator Core  
 Inlet: Block Fitting  
 Outlet: Block Fitting  
 O-Rings: (1) **24402**, (1) **24403**  
 Ford (12-10); Lincoln (12-10); Mercury (11-10)

Ford: AH6Z19860A

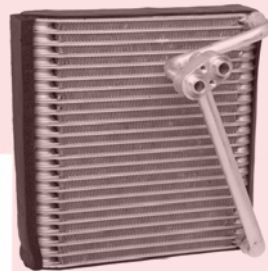

**44063**  
 Depth 1-7/8 Height 9-7/8 Width 6-5/8  
 Plate & Fin Evaporator Core  
 Inlet: Block Fitting  
 Outlet: Block Fitting  
 O-Rings: (2) **24109**  
 Hyundai (12-08)

Hyundai: 971392H000, 971401H000

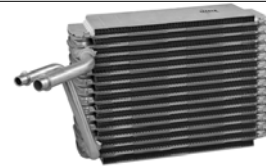

**44064**  
 Depth 3-5/8 Height Width  
 Plate & Fin Evaporator Core  
 Inlet: Flange  
 Outlet: Flange  
 O-Rings: (1) **24608**, (1) **24610**  
 Ford (14-05); Lincoln (14-05)

Ford: 5L1Z19860CA

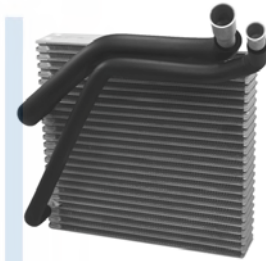

**44065**  
 Depth 2-5/16 Height 12-3/4 Width 7-5/8  
 Plate & Fin Evaporator Core  
 O-Rings: (3) **24668**, (3) **24672**  
 Ford (10-08)

Ford: 7C3Z19860B

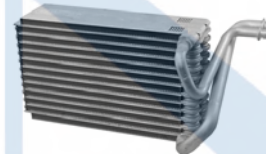

**44066**  
 Plate & Fin Evaporator Core  
 Chrysler (07-06); Dodge (07-06)

Chrysler: 5183207AC, 5183207AD



# Evaporator Cores

## Evaporator Cores Cont'd



**44067**

Depth	Height	Width
3	8-3/4	5-1/4

Plate & Fin Evaporator Core

Inlet: Block Fitting

Outlet: Block Fitting

O-Rings: (2) **24610**

Kia (05-02)

Kia: 1K55261R02C

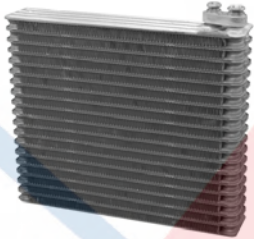

**44068**

Depth	Height	Width
2-5/16	10-1/8	2-5/16

Plate & Fin Evaporator Core

Inlet: Block Fitting

Outlet: Block Fitting

O-Rings: (1) **24661**, (1) **24681**

Mitsubishi (06-01)

Mitsubishi: MR398361

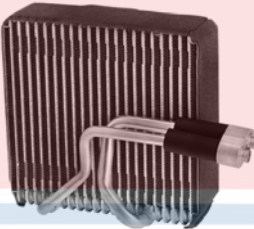

**44069**

Plate & Fin Evaporator Core

O-Rings: (2) **24641**

Kia (05-02)

Kia: 1K52Y61C02B

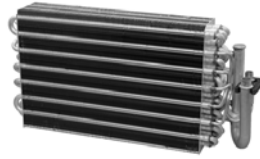

**44070**

Depth	Height	Width
2-5/8	14-5/8	2-5/8

Tube & Fin Evaporator Core

Inlet: Block Fitting

Outlet: Block Fitting

O-Rings: (1) **24608**, (1) **24610**

BMW (99-92)

BMW: 64118391356

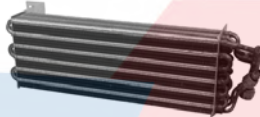

**44071**

Depth	Height	Width
2-5/8	21	5-1/8

Tube & Fin Evaporator Core

O-Rings: (1) **24608**, (1) **24610**

Ford (91-75)

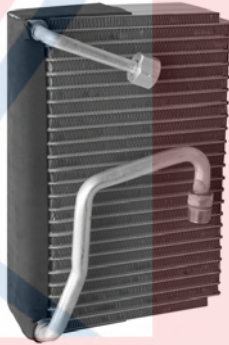

**44074**

Plate & Fin Evaporator Core

O-Rings: (1) **24608**, (3) **24670**

Kia (97-94)

Kia: 0K20B61J10

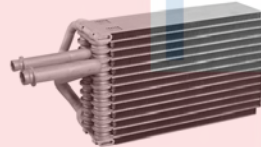

**44081**

Plate & Fin Evaporator Core

O-Rings: (1) **24622**, (1) **24628**

Chrysler (12-08); Dodge (12-08)

Chrysler: 68057709AA



**44073**

Plate & Fin Evaporator Core

O-Rings: (1) **24608**, (1) **24610**

Nissan (92-90)

Nissan: 2728065E01

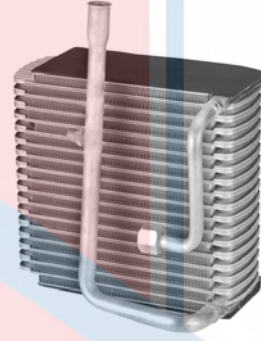

**44082**

Depth	Height	Width
3-3/8	13	5-3/8

Serpentine Evaporator Core

O-Rings: (1) **24608**, (1) **24610**

Dodge (89-87); Mitsubishi (89-87)

Mitsubishi: MB380795

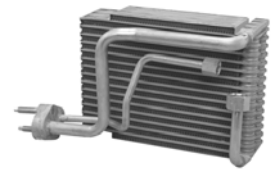

**44083**

Depth	Height	Width
2-3/8	6-5/8	5

Plate & Fin Evaporator Core

Inlet: Block Fitting

Outlet: Block Fitting

O-Rings: (1) **24606**, (1) **24608**, (1)

**24402**, (1) **24404**

Chevy (09-05); GMC (09-05); Isuzu (08-05)



**44084**

Depth	Height	Width
1-15/16		

Plate & Fin Evaporator Core

Inlet: Flange

Outlet: Flange

O-Rings: (1) **24608**, (1) **24610**

Dodge (11-07); Jeep (11-08)

Chrysler: 68003994AC

# Evaporator Cores

## Evaporator Cores Cont'd



**44085**  
 Depth Height Width  
 2-3/8  
 Plate & Fin Evaporator Core  
 Inlet: Block Fitting  
 Outlet: Block Fitting  
 O-Rings: (2)  
 Hyundai (08-05)

Hyundai: 971392D002

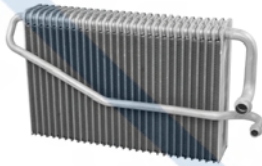

**44086**  
 Depth Height Width  
 2-3/8  
 Plate & Fin Evaporator Core  
 Inlet: Flange  
 Outlet: Flange  
 O-Rings: (1) **24608**, (1) **24612**  
 Mercedes (12-00)

Mercedes Benz: 2038300158,  
 2098300158, 2098300358

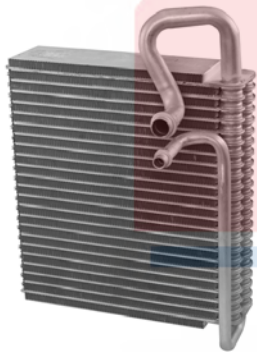

**44087**  
 Depth Height Width  
 2-3/8  
 Plate & Fin Evaporator Core  
 Inlet: Flange  
 Outlet: Flange  
 O-Rings: (1) **24608**, (1) **24612**  
 Dodge (09-07)



**44088**  
 Depth Height Width  
 2  
 Plate & Fin Evaporator Core  
 Inlet: Block Fitting  
 Outlet: Block Fitting  
 O-Rings: (1) **24661**, (1) **24681**  
 Honda (08-07)

Honda: 80213SAAG01

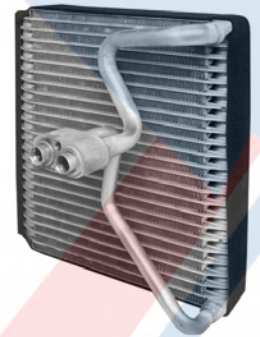

**44089**  
 Depth Height Width  
 1-7/8 10-1/8 6-1/2  
 Plate & Fin Evaporator Core  
 Inlet: Block Fitting  
 Outlet: Block Fitting  
 O-Rings: (2) **24109**  
 Kia (11-06)

Kia: 971391G000



**44090**  
 Depth Height Width  
 2-3/8 16 5-1/2  
 Plate & Fin Evaporator Core  
 Inlet: Flange  
 Outlet: Flange  
 O-Rings: (1) **24649**, (1) **24622**  
 Chrysler (09-07); Dodge (09-07)

Chrysler: 68019145AA

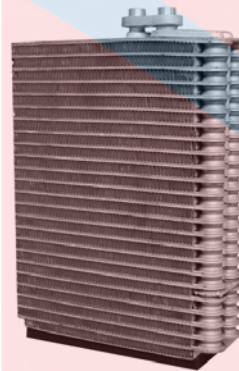

**44091**  
 Depth Height Width  
 2-3/8 11 2-3/8  
 Plate & Fin Evaporator Core  
 Inlet: Block Fitting  
 Outlet: Block Fitting  
 O-Rings: (2) **24109**  
 Subaru (07-03)

Subaru: 73523SA010

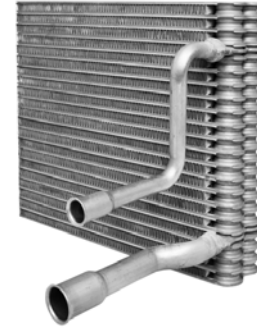

**44092**  
 Depth Height Width  
 2-5/16 9 8-5/16  
 Plate & Fin Evaporator Core  
 O-Rings: (3) **24668**, (3) **24672**  
 Ford (08-06); Mercury (08-06)

Ford: 8L2Z19850D

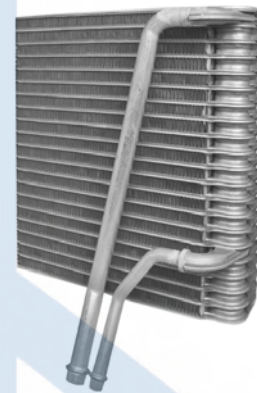

**44093**  
 Depth Height Width  
 2-7/8 12-7/8 5-1/2  
 Plate & Fin Evaporator Core  
 Inlet: Flange  
 Outlet: Flange  
 O-Rings: (1) **24608**, (1) **24612**  
 Audi (12-07); Porsche (06-03); VW (10-04)

Porsche: 95557230002  
 Volkswagen: 7L0819087AA

# Evaporator Cores

## Evaporator Cores Cont'd

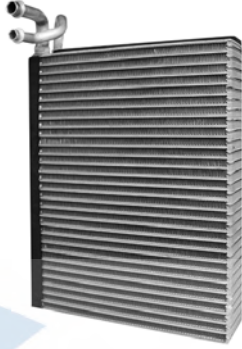

### 44094

Depth	Height	Width
2-3/8	15	4-7/8

Plate & Fin Evaporator Core  
 Inlet: Flange  
 Outlet: Flange  
 O-Rings: (1) **24608**, (1) **24610**  
 Mercedes (12-06)

Mercedes Benz: 1648300158

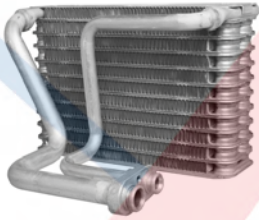

### 44095

Depth	Height	Width
2-5/16	5-1/2	6-3/4

Plate & Fin Evaporator Core  
 Inlet: Block Fitting  
 Outlet: Block Fitting  
 O-Rings: (1) **24661**, (1) **24681**  
 Chrysler (08-07); Dodge (09-07)

Chrysler: 68020263AA

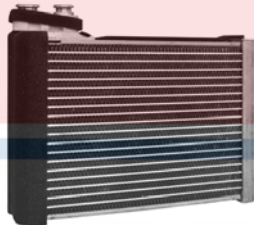

### 44096

Depth	Height	Width
1-1/2	6-3/8	1-5/8

Plate & Fin Evaporator Core  
 Inlet: Block Fitting  
 Outlet: Block Fitting  
 O-Rings: (1) **24661**, (1) **24681**  
 Acura (13-08); Honda (12-09)

Honda: 80225STXA03, 80225SZAA01



### 44097

Depth	Height	Width
1-1/2	14-3/16	3-15/16

Plate & Fin Evaporator Core  
 Inlet: Block Fitting  
 Outlet: Block Fitting  
 O-Rings: (1) **24661**, (1) **24681**  
 Acura (12-07)

Acura: 80211STKA41

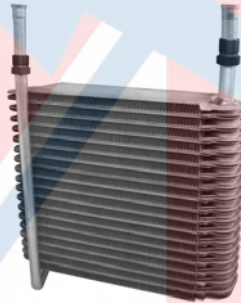

### 44098

Depth	Height	Width
2-7/8	13-3/8	3-3/4

Plate & Fin Evaporator Core  
 O-Rings: (1) **24608**, (1) **24610**

Peterbilt: P93CAB150101S

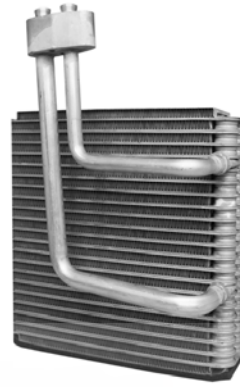

### 44099

Depth	Height	Width
2-3/8	12-3/4	4-3/4

Plate & Fin Evaporator Core  
 Inlet: Block Fitting  
 Outlet: Block Fitting  
 O-Rings: (1) , (1)  
 Kia (04-01)

Kia: 1K2N161J10

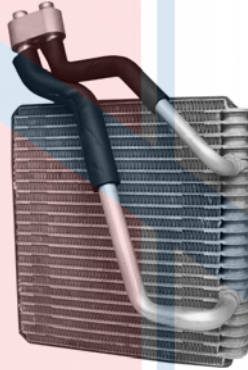

### 44100

Depth	Height	Width
2-15/16	13-1/4	5-3/4

Plate & Fin Evaporator Core  
 Inlet: Block Fitting  
 Outlet: Block Fitting  
 O-Rings: (1) **24109**, (1) **24109**  
 Kia (09-07)

Kia: 976073E260



### 44101

Depth	Height	Width
1-3/4	12-1/2	4-11/16

Plate & Fin Evaporator Core  
 Inlet: Flange  
 Outlet: Flange  
 O-Rings: (1) **24402**, (1) **24403**  
 Chevy (14-10); GMC (14-10)

General Motors Corp: 20945510

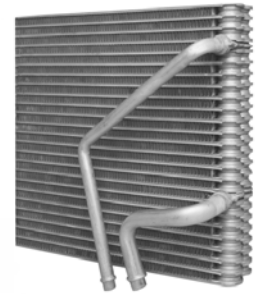

### 44102

Depth	Height	Width
4-1/2		

Plate & Fin Evaporator Core  
 Inlet: Male Insert O-Ring  
 Outlet: Male Insert O-Ring  
 O-Rings: (1) **24608**, (1) **24670**  
 Ford (12-08); Mazda (11-08); Mercury (11-08)

Ford: AL8Z19B555A, AL8Z19B555B  
 Mazda: ZZCA61130A, ZZCC61130A



# Evaporator Cores

## Evaporator Cores Cont'd



**44103**  
 Depth 1-7/8    Height 11-5/8    Width 4-3/4  
 Plate & Fin Evaporator Core  
 Inlet: Flange  
 Outlet: Flange  
 O-Rings: (1) **24402**, (1) **24403**  
 Ford (12-10)

Ford: DR3Z19850A, DR3Z19850B

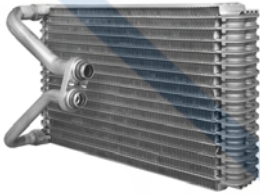

**44104**  
 Plate & Fin Evaporator Core  
 Hyundai (12-07)

Hyundai: 979273J000



**44105**  
 Plate & Fin Evaporator Core  
 Kia (10-06)

Kia: 971402G010



**44106**  
 Plate & Fin Evaporator Core  
 Kia (13-10)

Kia: 971402K000

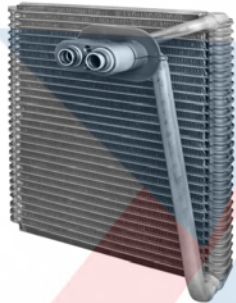

**44108**  
 Plate & Fin Evaporator Core  
 Hyundai (12-07)

Hyundai: 971403J000

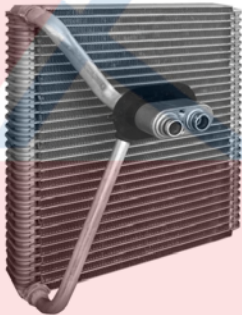

**44109**  
 Plate & Fin Evaporator Core  
 Hyundai (15-09)

Hyundai: 971403M000

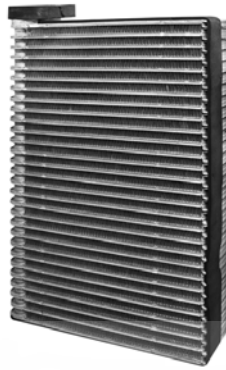

**44110**  
 Depth 2-3/8    Height 13    Width 2-3/8  
 Plate & Fin Evaporator Core  
 O-Rings: (1) **24661**, (1) **24602**  
 International (07-01)

Kysor: 1613008  
 NaviStar: 3542576C2

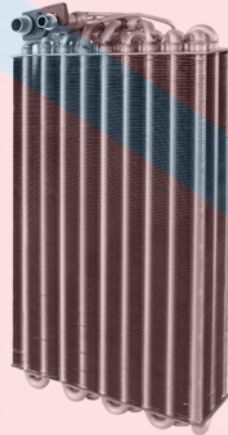

**44111**  
 Tube & Fin Evaporator Core  
 Mercedes (03-94)

Mercedes Benz: 2028300758



**44112**  
 Depth 2-5/16    Height    Width  
 Plate & Fin Evaporator Core  
 Inlet: Block Fitting  
 Outlet: Block Fitting  
 O-Rings: (1) **24661**, (1) **24681**  
 Mazda (05-01)

Mazda: NC7261J10



**44113**  
 Depth 2-7/8    Height    Width

Plate & Fin Evaporator Core  
 Inlet: Block Fitting  
 Outlet: Block Fitting  
 O-Rings: (1) **24661**, (1) **24681**  
 Subaru (01-98)

Subaru: 73523FC014

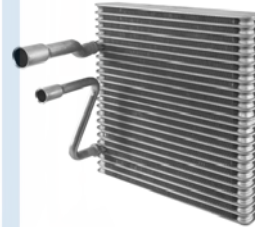

**44114**  
 Depth 2-5/16    Height    Width

Plate & Fin Evaporator Core  
 Inlet: Female Springlock  
 Outlet: Female Springlock  
 O-Rings: (3) **24668**, (3) **24672**  
 Ford (10-08); Mercury (10-09)

Ford: 9L2Z19850A, 9L2Z19850B

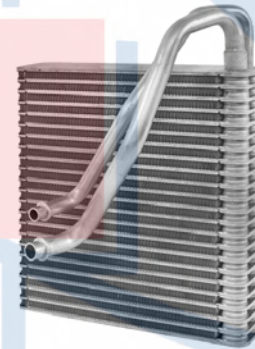

**44115**  
 Depth 1-7/8    Height    Width

Plate & Fin Evaporator Core  
 Inlet: Flange  
 Outlet: Flange  
 O-Rings: (1) **24608**, (1) **24610**  
 Mini (15-08)

BMW: 64119262788

# Evaporator Cores

## Evaporator Cores Cont'd

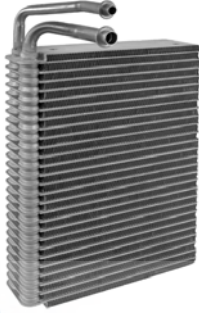

### 44116

Depth 2-9/16  
Height  
Width

Plate & Fin Evaporator Core  
O-Rings: (1) **24608**, (1) **24610**  
Chrysler (13-11); Dodge (13-11)

Chrysler: 68110611AA

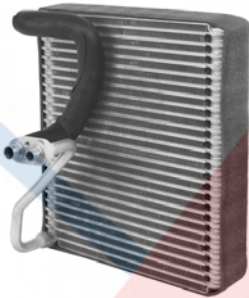

### 44128

Plate & Fin Evaporator Core  
Ford (10-08); Lincoln (10); Mercury (09-08)

Ford: AE9Z19850C, AG1Z19850B

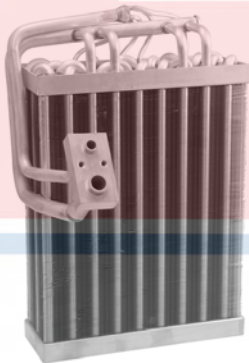

### 54102

Depth 3-1/8  
Height 14-5/8  
Width 8-1/2

Tube & Fin Evaporator Core  
Inlet: Block Fitting  
Outlet: Block Fitting  
O-Rings: (1) **24149**  
Chrysler (81-77); Dodge (79-76);  
Plymouth (79-76)

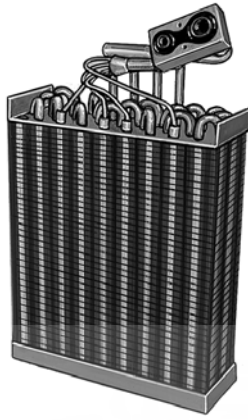

### 54104

Tube & Fin Evaporator Core  
Inlet: Block Fitting  
Outlet: Block Fitting  
Chrysler (89-80); Dodge (89-80);  
Plymouth (89-82), (80)

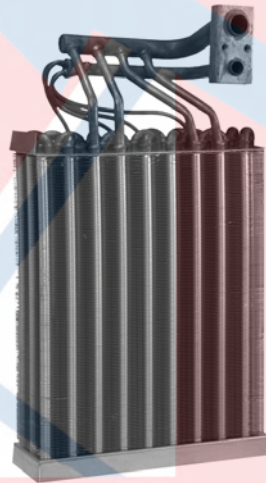

### 54105

Tube & Fin Evaporator Core  
Inlet: Block Fitting  
Outlet: Block Fitting  
O-Rings: (1) **24149**  
Dodge (94-79)

Euclid: E811000  
Kysor: 1617002



### 54107

Tube & Fin Evaporator Core  
Inlet: Block Fitting  
Outlet: Block Fitting  
O-Rings: (1) **24149**  
Dodge (90-78); Plymouth (90-78)

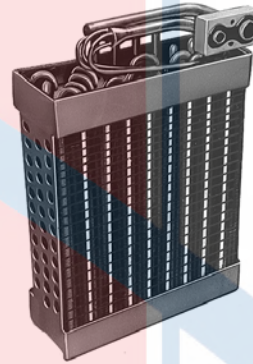

### 54108

Tube & Fin Evaporator Core  
Inlet: Block Fitting  
Outlet: Block Fitting  
O-Rings: (1) **24149**  
Dodge (93-81); Dodge Medium Duty  
Truck (81); Plymouth (81)

Euclid: E819300

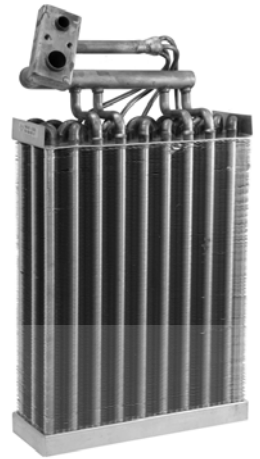

### 54110

Tube & Fin Evaporator Core  
Inlet: Block Fitting  
Outlet: Block Fitting  
O-Rings: (1) **24149**  
Chrysler (91-90), (88-84); Dodge  
(90-84); Plymouth (90-84)

Chrysler: 4882978AC  
Euclid: E819301

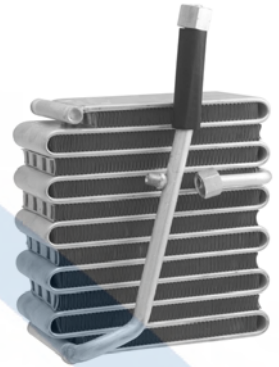

### 54112

Serpentine Evaporator Core  
O-Rings: (1) **24608**, (1) **24610**  
Nissan (97-92)

Nissan: 2728059G05

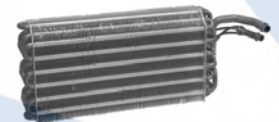

### 54128

Tube & Fin Evaporator Core  
Inlet: Block Fitting  
O-Rings: (1) **24608**, (1) **24610**, (1)  
Mercedes (02-90)

Mercedes Benz: 0008305558,  
1298300258, 1298300358



# Evaporator Cores

## Evaporator Cores Cont'd

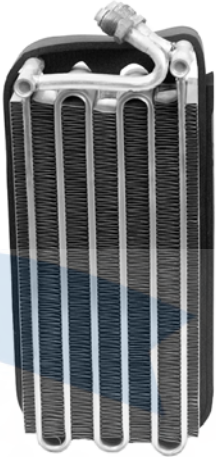

**54130**  
Serpentine Evaporator Core  
O-Rings: (1) **24608**, (1) **24610**  
BMW (91-84)  
BMW: 64518391780



**54132**  
Tube & Fin Evaporator Core  
Inlet: Block Fitting  
O-Rings: (1) **24608**, (1) **24610**, (1)  
Mercedes (95-86)  
Mercedes Benz: 0008305458,  
1248300758

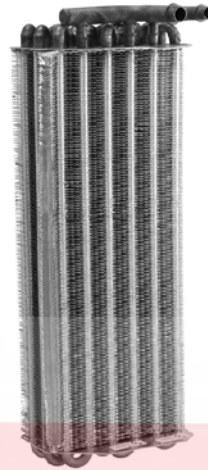

**54135**  
Tube & Fin Evaporator Core  
Inlet: Block Fitting  
O-Rings: (1) **24608**, (1) **24610**  
Mercedes (93-84)  
Mercedes Benz: 0008305158



**54143**  
Serpentine Evaporator Core  
O-Rings: (1) **24608**, (1) **24610**  
Honda (87-82)  
Honda: 38655SA5661



**54131**  
Depth    Height    Width  
3        19        4-1/2  
Tube & Fin Evaporator Core  
Inlet: Flare Fitting  
Mercedes (89-73)  
Mercedes Benz: 0008304858

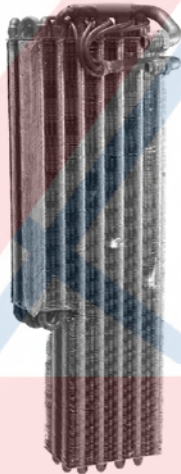

**54133**  
Tube & Fin Evaporator Core  
O-Rings: (1) **24608**, (1) **24610**  
Mercedes (91-81)  
Mercedes Benz: 0008305058

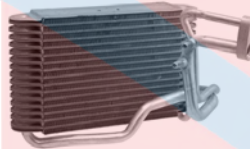

**54136**  
Plate & Fin Evaporator Core  
O-Rings: (1) **24608**, (1) **24612**, (1)  
**38623**  
Audi (93-88)



**54150**  
Serpentine Evaporator Core  
O-Rings: (1) **24608**, (1) **24610**  
Chevy (88-85); Mazda (81); Toyota  
(88-83)  
Toyota: 8850112302, 8850116051



**54138**  
Depth    Height    Width  
3-5/8                          
Plate & Fin Evaporator Core  
O-Rings: (1) **24608**, (1) **24610**  
Volvo (92-87)

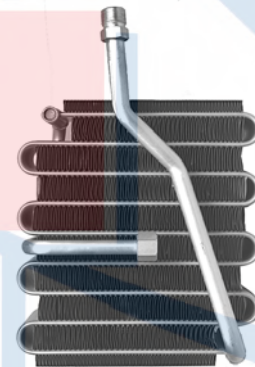

**54151**  
Depth    Height    Width  
3-15/16    4                
Serpentine Evaporator Core  
O-Rings: (1) **24608**, (1) **24610**  
Toyota (85-81)  
Toyota: 8850114090, 8850114192



# Evaporator Cores

## Evaporator Cores Cont'd



### 54153

Depth	Height	Width
3-7/8	12-1/2	6-5/8

Serpentine Evaporator Core  
O-Rings: (1) **24608**, (1) **24610**  
Toyota (83-80)

Toyota: 8850122170

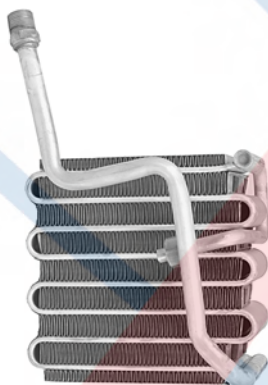

### 54154

Depth	Height	Width
3-7/8	4	

Serpentine Evaporator Core  
O-Rings: (1) **24608**, (1) **24610**  
Toyota (83-80)

Toyota: 8850192301



### 54155

Depth	Height	Width
3-3/8	12-1/2	6

Serpentine Evaporator Core  
O-Rings: (1) **24608**, (1) **24610**  
Toyota (89-84)

Toyota: 8850189109



### 54156

Serpentine Evaporator Core  
O-Rings: (1) **24608**, (1) **24610**  
Toyota (90-80)

Toyota: 8850190A07

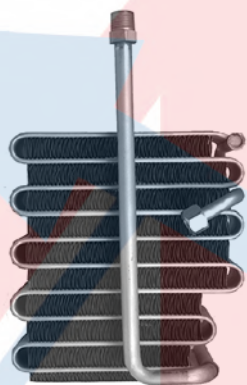

### 54157

Serpentine Evaporator Core  
O-Rings: (1) **24608**, (1) **24610**  
Toyota (86-83)

Toyota: 8850132021



### 54158

Depth	Height	Width
3-1/8	12	5-7/8

Serpentine Evaporator Core  
O-Rings: (1) **24608**, (1) **24610**  
Toyota (89-85)

Toyota: 8850117021



### 54165

Plate & Fin Evaporator Core  
O-Rings: (3) **24668**, (3) **24672**  
Ford (04-97); Lincoln (02-98)

Ford: XL7Z19860AA

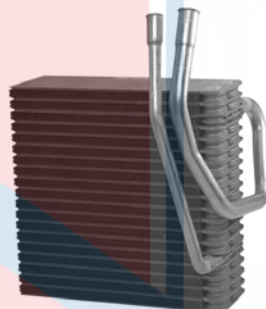

### 54166

Depth	Height	Width
3-1/2	12-1/2	8-3/8

Plate & Fin Evaporator Core  
O-Rings: (3) **24668**, (3) **24670**  
Dodge (02-95); Jeep (98-95)

Chrysler: 5012534AC

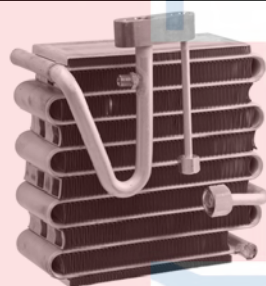

### 54167

Depth	Height	Width
3-3/8	3-1/8	

Serpentine Evaporator Core  
Outlet: Block Fitting  
O-Rings: (1) **24082**, (1) **24121**, (1) **24604**, (1) **24661**, (1) **24675**  
Acura (97-94); Honda (97-94)

Honda: 80210SR1A12

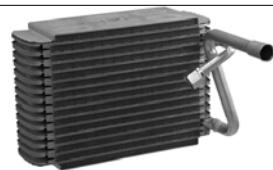

### 54168

Plate & Fin Evaporator Core  
O-Rings: (3) **24668**, (3) **24670**  
Ford (96-95)



### 54169

Serpentine Evaporator Core  
O-Rings: (1) **24608**, (1) **24610**  
Mazda (97-90)

Mazda: NA7561520D



### 54171

Depth	Height	Width
3-1/2	12-3/4	3-1/2

Plate & Fin Evaporator Core  
O-Rings: (3) **24668**, (3) **24670**  
Ford (04-96)

# Evaporator Cores

## Evaporator Cores Cont'd



**54173**  
Serpentine Evaporator Core  
O-Rings: (1) **24604**, (1) **24608**, (1) **24610**, (1) **24661**, (1) **24681**  
Nissan (86-82)

Nissan: 2728014A05



**54174**  
Depth      Height      Width  
4            8-5/8      7-1/4  
Serpentine Evaporator Core  
O-Rings: (1) **24604**, (1) **24608**, (1) **24610**  
Nissan (90-85)

Nissan: 2728061A61

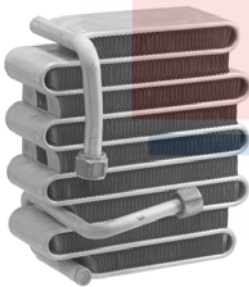

**54175**  
Serpentine Evaporator Core  
Nissan (85-84)

Nissan: 2728015E01



**54177**  
Depth      Height      Width  
3-9/16      14            5-3/4  
Plate & Fin Evaporator Core  
O-Rings: (1) **24610**, (2) **24668**, (1) **38635**  
Ford (05-98); Mazda (01-98); Mercury (00-98)

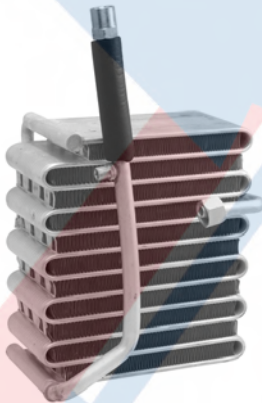

**54179**  
Serpentine Evaporator Core  
O-Rings: (1) **24604**, (1) **24608**, (1) **24610**  
Nissan (92-86)

Nissan: 2728001G60

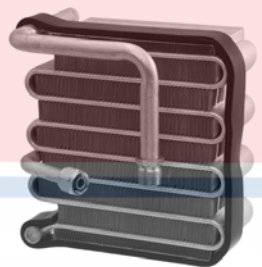

**54182**  
Serpentine Evaporator Core  
O-Rings: (1) **24608**, (1) **24610**  
Suzuki (95-86)

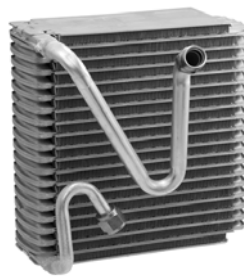

**54183**  
Plate & Fin Evaporator Core  
O-Rings: (1) **24608**, (1) **24610**  
Chevy (91-89); Geo (94-89); Suzuki (93-89)

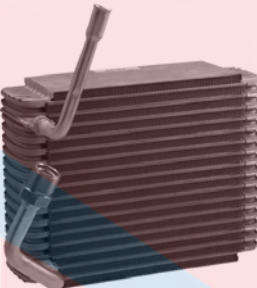

**54184**  
Depth      Height      Width  
3-9/16      11-1/2      7-1/2  
Plate & Fin Evaporator Core  
O-Rings: (1) **24610**, (2) **24668**, (1) **38635**  
Ford (07-99)

Ford: 4C3Z19860AB

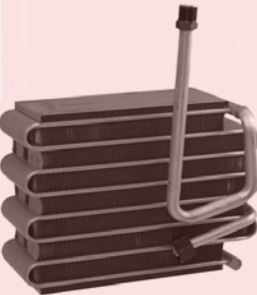

**54185**  
Serpentine Evaporator Core  
O-Rings: (1) **24608**, (1) **24610**  
Mazda (98-94)

Mazda: LB4061J10



**54186**  
Depth      Height      Width  
3-1/8      13-3/16      3-1/8  
Plate & Fin Evaporator Core  
Inlet: Block Fitting  
Outlet: Block Fitting  
Chrysler (93-92); Dodge (00-98), (93-92)

Chrysler: 4677011, 4885438AA, 4885582AC

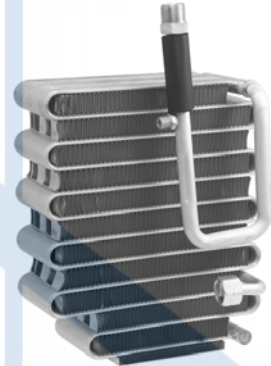

**54187**  
Depth      Height      Width  
3-3/8      14-1/2      7-1/4  
Serpentine Evaporator Core  
O-Rings: (1) **24661**, (1) **24681**  
Acura (99-97); Honda (97-94)

Honda: 80211SV1305



# Evaporator Cores

## Evaporator Cores Cont'd



### 54188

Depth 3-1/8    Height 14-3/4    Width 3-1/8  
 Plate & Fin Evaporator Core  
 O-Rings: (3) **24668**, (3) **24670**  
 Jeep (01-97)

Chrysler: 4864999AE

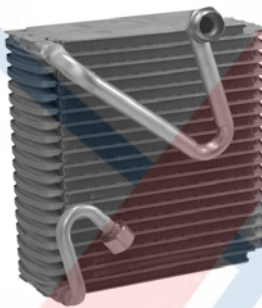

### 54189

Plate & Fin Evaporator Core  
 O-Rings: (1) **24661**, (1) **24681**  
 Chevy (01-98); Geo (97-95); Pontiac (99-95); Suzuki (01-95)

General Motors Corp: 91171580



### 54190

Tube & Fin Evaporator Core  
 O-Rings: (1) **24608**, (1) **24610**  
 Hyundai (89-86)

Hyundai: 9762221001



### 54191

Plate & Fin Evaporator Core  
 Inlet: Block Fitting  
 Outlet: Block Fitting  
 O-Rings: (2) **24610**  
 Geo (93); Mitsubishi (93-92); Toyota (93-89)

General Motors Corp: 94854234  
 Toyota: 8850112370

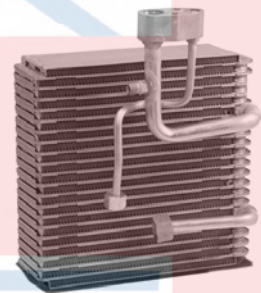

### 54193

Plate & Fin Evaporator Core  
 Outlet: Block Fitting  
 O-Rings: (1) **24604**, (1) **24608**, (1) **24610**  
 Kia (97-95)

Kia: 0K01A61J1X



### 54194

Depth 3-1/2    Height 10    Width 5-1/2  
 Plate & Fin Evaporator Core  
 Inlet: Block Fitting  
 Outlet: Block Fitting  
 O-Rings: (2) **24682**  
 Lexus (01-94); Toyota (99-94)

Lexus: 8850133080  
 Toyota: 8850133080

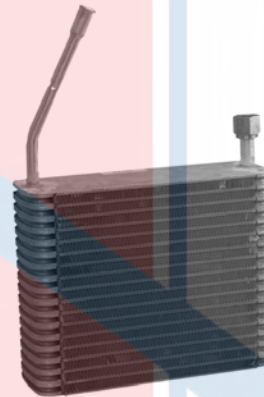

### 54195

Depth 3-9/16    Height 15-1/4    Width 3-9/16  
 Plate & Fin Evaporator Core  
 O-Rings: (1) **24610**, (2) **24668**, (1) **38639**  
 Ford (02-98); Lincoln (02-98); Mercury (02-98)

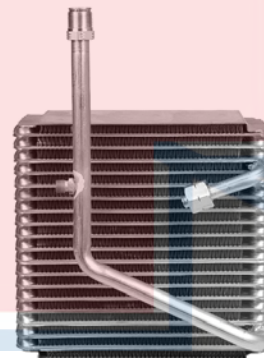

### 54196

Plate & Fin Evaporator Core  
 O-Rings: (3) **24668**, (3) **24670**  
 Mazda (97-93)

Mazda: GA2A61520C



### 54198

Serpentine Evaporator Core  
 O-Rings: (1) **24608**, (1) **24610**  
 Mazda (93-89)

Mazda: LA0561P10



### 54199

Serpentine Evaporator Core  
 O-Rings: (1) **24608**, (1) **24610**  
 Mazda (98-94)

Mazda: LB4061P10

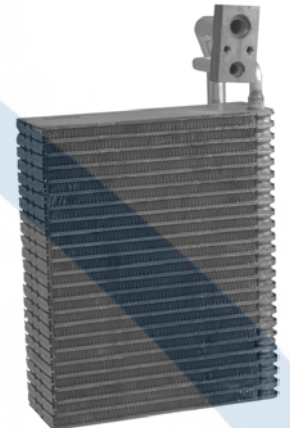

### 54262

Depth 3-1/2    Height 14-11/16    Width 7-1/4  
 Plate & Fin Evaporator Core  
 Inlet: Block Fitting  
 Outlet: Block Fitting  
 O-Rings: (1) **24149**  
 Dodge (03-95)

Chrysler: 4882355AD, 4882817AB



# Evaporator Cores

## Evaporator Cores Cont'd



**54263**  
Plate & Fin Evaporator Core  
Inlet: Block Fitting  
Outlet: Block Fitting  
O-Rings: (2) **24610**  
Eagle (96-94); Geo (97-94); Mitsubishi (00-94); Plymouth (94); Toyota (96-94)

General Motors Corp: 94856112  
Mitsubishi: MR117220, MR149524

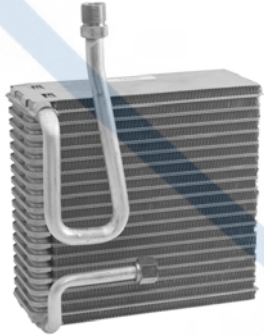

**54265**  
Plate & Fin Evaporator Core  
O-Rings: (1) **24604**, (1) **24608**, (1) **24610**  
Geo (92-89); Toyota (92-88)

General Motors Corp: 94845942  
Toyota: 8850112350

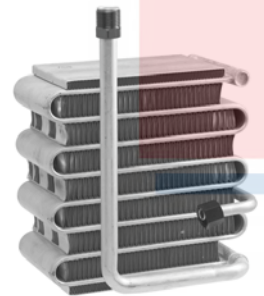

**54266**  
Serpentine Evaporator Core  
O-Rings: (1) **24608**, (1) **24610**  
Ford (93-88); Honda (85-83)

Depth	Height	Width
3-15/16	4	



**54267**  
Plate & Fin Evaporator Core  
O-Rings: (1) **24608**, (1) **24612**  
Infiniti (96), (92-91)

Infiniti: 2728063J01, 2728078J00, 2728078J03

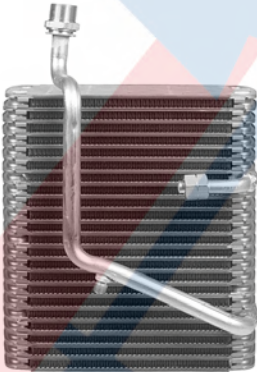

**54268**

Depth	Height	Width
3-3/8	13-3/4	4-7/8

Plate & Fin Evaporator Core  
O-Rings: (1) **24608**, (1) **24612**  
Infiniti (95-93)

Infiniti: 2728010Y02

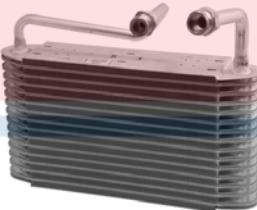

**54269**  
Plate & Fin Evaporator Core  
O-Rings: (1) **24682**, (1) **24678**  
Chevy (02-95); Pontiac (05-95)

General Motors Corp: 52463721, 89018226



**54271**  
Plate & Fin Evaporator Core  
Inlet: Block Fitting  
Outlet: Block Fitting  
O-Rings: (1) **24403**, (1) **24404**  
Chevy (05-97); Olds (04-98); Pontiac (05-99)

General Motors Corp: 52474457

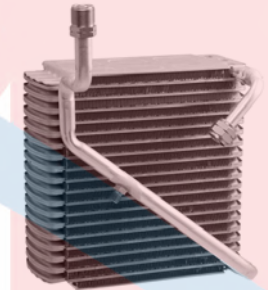

**54272**  
Plate & Fin Evaporator Core  
O-Rings: (1) **24608**, (1) **24610**  
Ford (97-94)

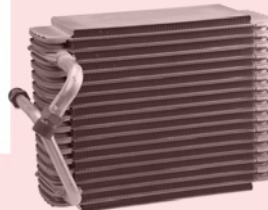

**54273**  
Plate & Fin Evaporator Core  
O-Rings: (1) **24608**, (1) **24610**, (1) **38635**  
Ford (14-97)

Ford: 6C2Z19860C

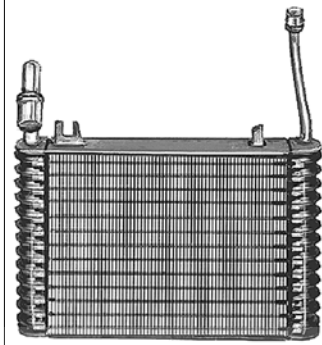

**54275**  
Plate & Fin Evaporator Core  
O-Rings: (1) **24608**, (1) **24612**  
Chevy (91-77); GMC (91-77)

General Motors Corp: 3036687  
Euclid: E811012, E811013  
Kysor: 1610004



**54277**  
Plate & Fin Evaporator Core  
O-Rings: (1) **24608**, (1) **24612**, (1) **38623**  
Buick (87-78); Chevy (88-78); GMC (87-78); Olds (88-78); Pontiac (87-78)

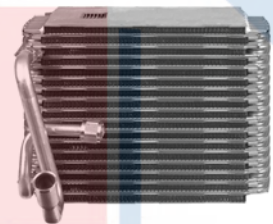

**54278**

Depth	Height	Width
3-9/16	8	8-1/2

Plate & Fin Evaporator Core  
O-Rings: (1) **24608**, (1) **24670**  
Ford (14-94)

Ford: 6C2Z19860B

# Evaporator Cores

## Evaporator Cores Cont'd



**54281**

Plate & Fin Evaporator Core  
Buick (85-79), (77); Cadillac (85-79);  
Chevy (77); Olds (85-79), (77); Pontiac  
(77-76)

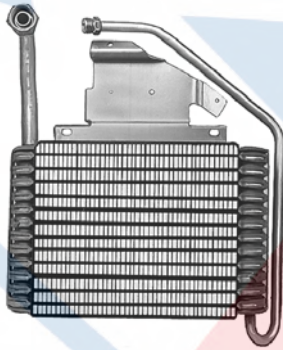

**54283**

Plate & Fin Evaporator Core  
O-Rings: (1) **24608**, (1) **24612**, (1)  
**38621**  
Ford (85-80); Lincoln (85-82), (80);  
Mercury (85-80)

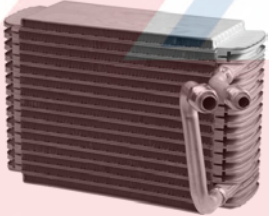

**54286**

Depth	Height	Width
3-9/16	6-7/8	8-7/8

Plate & Fin Evaporator Core  
O-Rings: (1) **24608**, (1) **24610**  
Ford (05-97); Lincoln (02-98)

Ford: 4L1Z19860CA

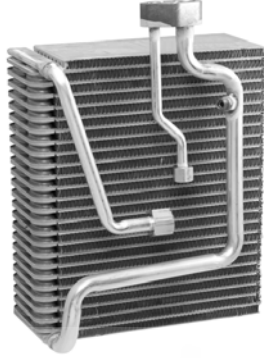

**54288**

Plate & Fin Evaporator Core  
Outlet: Block Fitting  
O-Rings: (2) **24607**, (1) **24608**, (1)  
**24610**  
Chrysler (00-95); Dodge (00-95); Eagle  
(98-95); Mitsubishi (99-95)

Chrysler: MR206121AC  
Mitsubishi: MR206121

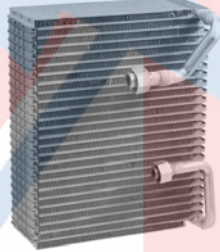

**54289**

Plate & Fin Evaporator Core  
O-Rings: (1) **24628**, (1) **24681**  
Chrysler (99-95); Dodge (99-95); Eagle  
(98-95); Mitsubishi (99-95)

Mitsubishi: MR201713

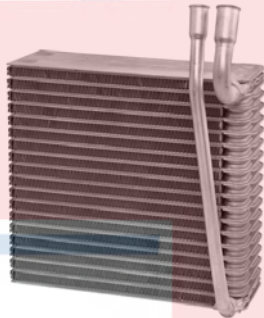

**54290**

Depth	Height	Width
3-1/2	11-3/4	5-1/2

Plate & Fin Evaporator Core  
O-Rings: (3) **24668**, (3) **24670**  
Jeep (98-96)

Chrysler: 4882168  
Jeep: 4882168

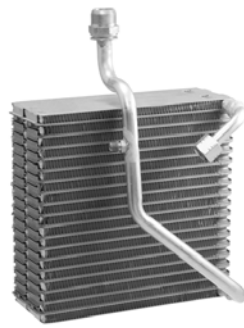

**54291**

Depth	Height	Width
3-3/8	12-7/8	

Plate & Fin Evaporator Core  
O-Rings: (1) **24604**, (1) **24608**, (1)  
**24612**, (2) **24610**  
Infiniti (96-90)

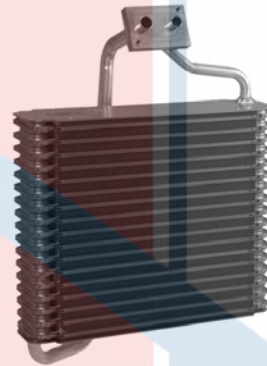

**54292**

Plate & Fin Evaporator Core  
Inlet: Block Fitting  
Outlet: Block Fitting  
O-Rings: (1) **24642**, (1) **24661**  
Saturn (02-91)

General Motors Corp: 19187706



**54293**

Plate & Fin Evaporator Core  
O-Rings: (3) **24668**, (3) **24670**  
Dodge (00-94)

Chrysler: 4885441AA

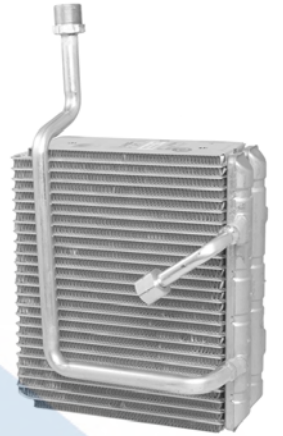

**54294**

Depth	Height	Width
2-7/8	15-7/8	5-1/8

Plate & Fin Evaporator Core  
Inlet: Block Fitting  
O-Rings: (1) **24608**, (1) **24682**  
Nissan (01-00)

Nissan: 272800Z800

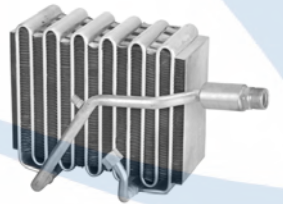

**54295**

Plate & Fin Evaporator Core  
Inlet: Block Fitting  
O-Rings: (1) **24604**, (1) **24608**, (1)  
**24612**, (2) **24610**  
Nissan (97-93)

Nissan: 272802B000



# Evaporator Cores

## Evaporator Cores Cont'd

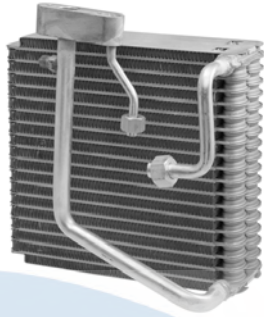

**54296**  
Plate & Fin Evaporator Core  
Inlet: Block Fitting  
Outlet: Block Fitting  
O-Rings: (1) **24604**, (1) **24629**  
Acura (01-98); Honda (06-97)  
Honda: 80215ST3G01, 80215ST3G11

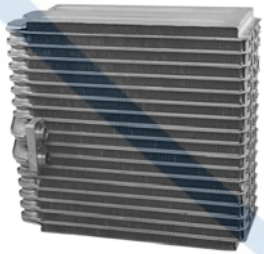

**54299**  
Plate & Fin Evaporator Core  
Inlet: Block Fitting  
Outlet: Block Fitting  
O-Rings: (2) **24682**  
Toyota (02-94)  
Toyota: 8850102021

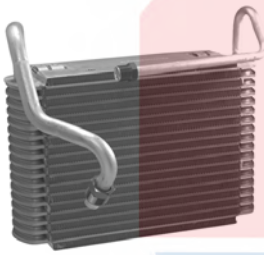

**54401**  
Plate & Fin Evaporator Core  
O-Rings: (1) **24608**, (1) **24612**, (1) **38623**  
Chevy (84-80); GMC (84-80)

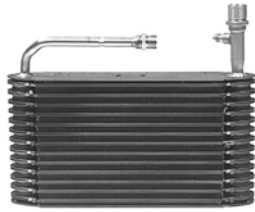

**54402**  
Plate & Fin Evaporator Core  
O-Rings: (1) **24608**, (1) **24612**, (1) **38623**  
Chevy (95-90)



**54404**  

Depth	Height	Width
3-9/16	12-7/8	3-9/16

 Plate & Fin Evaporator Core  
O-Rings: (1) **24608**, (1) **24610**  
Chevy (93-90); Olds (93-90); Pontiac (93-90)



**54407**  
Tube & Fin Evaporator Core  
O-Rings: (1) **24608**, (1) **24610**  
Chevy (96-93); GMC (96-93)  
Kysor: 1610008



**54408**  
Plate & Fin Evaporator Core  
O-Rings: (1) **24608**, (1) **24610**  
Chevy (96-93); GMC (96-93)  
General Motors Corp: 52459628  
Kysor: 1610007

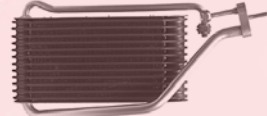

**54409**  
Plate & Fin Evaporator Core  
Outlet: Block Fitting  
O-Rings: (1) **24608**  
Chevy (94); GMC (94)  
General Motors Corp: 52465502

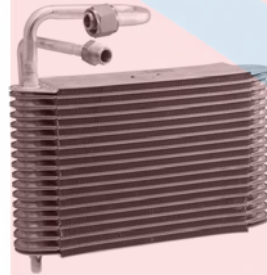

**54411**  
Plate & Fin Evaporator Core  
O-Rings: (1) **24682**, (1) **23680**  
Buick (91-89); Cadillac (91); Olds (91-89); Pontiac (91-89)  
General Motors Corp: 52450552

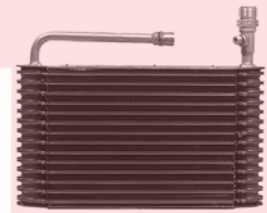

**54413**  
Plate & Fin Evaporator Core  
O-Rings: (1) **24608**, (1) **24612**  
Chevy (96-94)



**54414**  

Depth	Height	Width
2-7/8	13-1/4	3-3/8

 Plate & Fin Evaporator Core  
O-Rings: (1) **24608**, (1) **24612**

General Motors Corp: 52464049  
Kysor: 1610013  
NaviStar: 708030



**54415**  

Depth	Height	Width
3-9/16	10-7/8	5

 Plate & Fin Evaporator Core  
O-Rings: (1) **24608**, (1) **24612**, (1) **38623**  
Chevy (05-94); GMC (05-94)

General Motors Corp: 52464883, 88878540

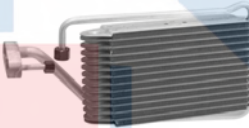

**54417**  

Depth	Height	Width
2-7/8	8-3/4	4

 Plate & Fin Evaporator Core  
Outlet: Block Fitting  
O-Rings: (2) **24606**, (1) **24403**, (1) **24404**  
Chevy (05-95); GMC (05-95)

General Motors Corp: 52465673



# Evaporator Cores

## Evaporator Cores Cont'd



**54425**  
Plate & Fin Evaporator Core  
O-Rings: (2) **24612**  
Chevy (75-73); GMC (75-73)

Euclid: E811018, E811019



**54427**  
Depth Height Width  
3-5/8 13 5-7/8  
Plate & Fin Evaporator Core  
O-Rings: (1) **24608**, (1) **24612**  
Buick (88-87); Olds (88-87)

General Motors Corp: 3093588

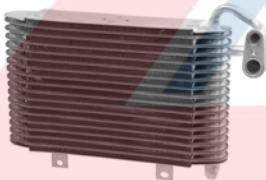

**54429**  
Plate & Fin Evaporator Core  
Inlet: Block Fitting  
Outlet: Block Fitting  
O-Rings: (1) **24628**, (1) **24642**  
Buick (96-88); Chevy (01-90); Olds  
(97-88); Pontiac (96-88)

General Motors Corp: 3093285

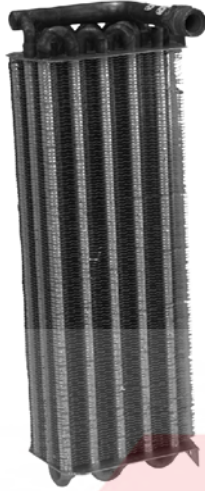

**54430**  
Depth Height Width  
3 15-7/8 6-1/2  
Tube & Fin Evaporator Core  
O-Rings: (1) **24606**, (2) **24610**  
Chevy (91-88), (80-72); GMC (91-88),  
(84-72)

Kysor: 1610010

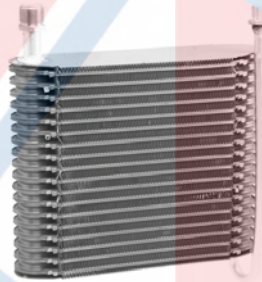

**54431**  
Depth Height Width  
2-7/8 13-1/8 3-1/4  
Plate & Fin Evaporator Core  
O-Rings: (1) **24608**, (1) **24612**, (1)  
**38623**  
Chevy (90-88); GMC (90-88)

Euclid: E811025, E811026  
Kysor: 1610003



**54432**  
Depth Height Width  
3-9/16 12 5-3/4  
Plate & Fin Evaporator Core  
Buick (90-77); Cadillac (89-77); Chevy  
(90-77); Olds (85-77); Pontiac (89-77)

General Motors Corp: 3058130

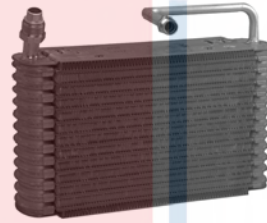

**54433**  
Plate & Fin Evaporator Core  
O-Rings: (1) **24608**, (1) **24612**, (1)  
**38623**  
Buick (79-77); Cadillac (79-77); Chevy  
(79-77); Olds (79-77); Pontiac (79-77)

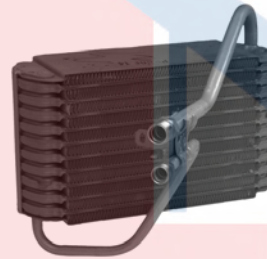

**54439**  
Plate & Fin Evaporator Core  
O-Rings: (1) **24608**, (1) **24610**  
Ford (88-82); Mercury (87-82)

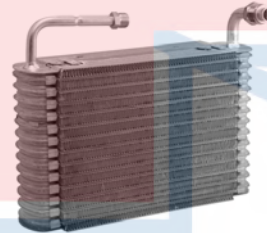

**54451**  
Plate & Fin Evaporator Core  
O-Rings: (1) **24608**, (1) **24612**, (1)  
**38623**  
Chevy (93-90); GMC (93-90)

General Motors Corp: 52456440



**54454**  
Plate & Fin Evaporator Core  
O-Rings: (2) **24612**, (1) **24608**, (1)  
**24610**  
Cadillac (90-89)

General Motors Corp: 52450550



**54455**  
Plate & Fin Evaporator Core  
O-Rings: (2) **24608**, (2) **24612**  
Cadillac (88)

General Motors Corp: 3095723

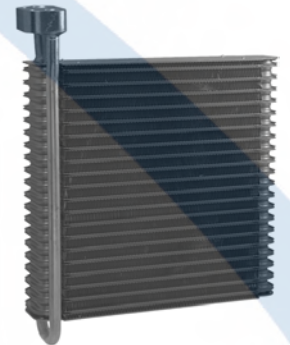

**54467**  
Depth Height Width  
2-7/8 13-3/4 3-3/4  
Plate & Fin Evaporator Core  
Inlet: Block Fitting  
Outlet: Block Fitting  
O-Rings: (1) **24659**, (1) **24682**  
Buick (96-91); Cadillac (96-93); Chevy  
(96-91); Olds (92-85)

# Evaporator Cores

## Evaporator Cores Cont'd

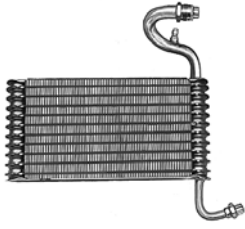

**54472**  
Plate & Fin Evaporator Core  
O-Rings: (1) **24608**, (1) **24612**  
Buick (92-87); Chevy (90-87); Olds (92-87); Pontiac (91-87)

General Motors Corp: 52453528

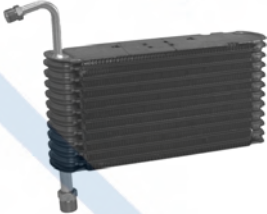

**54473**  
Plate & Fin Evaporator Core  
Buick (93-90); Chevy (90); Olds (93-90); Pontiac (91-90)

General Motors Corp: 52453514



**54474**  
Plate & Fin Evaporator Core  
O-Rings: (1) **24608**, (2) **24612**, (1) **38623**  
Buick (93-91); Cadillac (93-91); Olds (93-91); Pontiac (93-92)

General Motors Corp: 52457704



**54475**  
Plate & Fin Evaporator Core  
O-Rings: (1) **24608**, (1) **24610**  
Chevy (93-92); GMC (93-92)

General Motors Corp: 52457491  
Euclid: E811022, E811023  
Kysor: 1610006

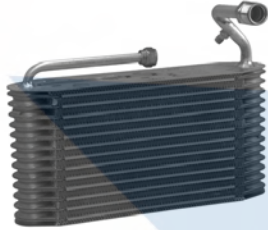

**54476**  
Plate & Fin Evaporator Core  
O-Rings: (1) **24608**, (1) **24612**  
Buick (93-92); Chevy (93-92); Olds (93-92); Pontiac (93-92)

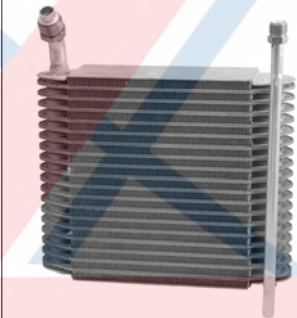

**54478**

Depth	Height	Width
2-7/8	13-1/4	3-1/4

Plate & Fin Evaporator Core  
O-Rings: (1) **24608**, (1) **24612**  
Chevy (93-91); GMC (93-91)

Kysor: 1610002



**54497**

Depth	Height	Width
3-1/2	14-1/2	5-5/8

Plate & Fin Evaporator Core  
O-Rings: (1) **24608**, (1) **24612**, (1) **38623**  
Chevy (77-76); GMC (77-76)

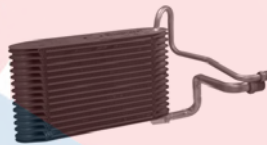

**54502**  
Plate & Fin Evaporator Core  
O-Rings: (1) **24608**, (1) **24610**  
Volvo (93-91)



**54507**  
Plate & Fin Evaporator Core  
Inlet: Block Fitting  
Outlet: Block Fitting  
O-Rings: (1) **24628**, (1) **24642**  
Buick (91-85); Cadillac (88-85); Chevy (94-85); Olds (91-85); Pontiac (94-85)

General Motors Corp: 19190520, 52457218



**54509**  
Plate & Fin Evaporator Core  
O-Rings: (1) **24608**, (1) **24612**, (1) **38623**  
Buick (88-86); Olds (88-86)

General Motors Corp: 3058764, 3095760



**54510**  
Plate & Fin Evaporator Core  
O-Rings: (1) **24608**, (1) **24612**, (1) **38623**  
Chevy (89-85)



**54511**  
Plate & Fin Evaporator Core  
O-Rings: (1) **24608**, (1) **24612**, (1) **38623**  
Chevy (89-85); GMC (89-85)

# Evaporator Cores

## Evaporator Cores Cont'd



### 54515

Depth	Height	Width
2-7/8	11-7/16	3-3/8

Plate & Fin Evaporator Core  
 Inlet: Block Fitting  
 Outlet: Block Fitting  
 O-Rings: (1) **24608**, (1) **24612**, (1) **38623**  
 Buick (89-85); Cadillac (90-85); Olds (89-86)

General Motors Corp: 3092972

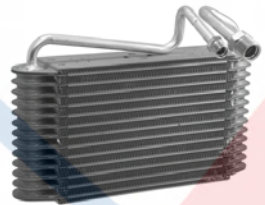

### 54516

Plate & Fin Evaporator Core  
 O-Rings: (1) **24608**, (1) **24612**, (1) **24628**  
 Buick (84-82); Cadillac (84-82); Chevy (84-82); Olds (84-82); Pontiac (93-88), (84-82)

General Motors Corp: 3053166, 3053940, 3090511



### 54518

Plate & Fin Evaporator Core  
 O-Rings: (1) **24608**, (1) **24612**, (1) **38623**  
 Buick (86-80); Chevy (86-80); Olds (86-80); Pontiac (86-80)



### 54520

Plate & Fin Evaporator Core  
 O-Rings: (1) **24608**, (1) **24612**, (1) **38642**  
 Chevy (93-82); GMC (94-82); Olds (94-91)

Euclid: E811015  
 Kysor: 1610012

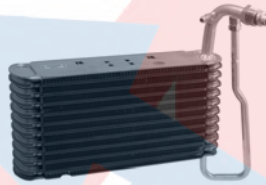

### 54521

Depth	Height	Width
3-1/2	13	5-1/2

Plate & Fin Evaporator Core  
 O-Rings: (1) **24608**, (1) **24612**, (1) **38623**  
 Buick (86-82); Chevy (85-82); Olds (86-82); Pontiac (85-82)

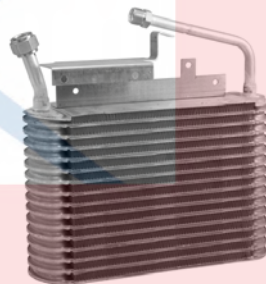

### 54525

Plate & Fin Evaporator Core  
 O-Rings: (1) **24608**, (1) **24610**, (1) **38623**  
 Ford (86-82)

Euclid: E819302  
 Kysor: 1611008



### 54526

Depth	Height	Width
4	13-1/4	4-5/8

Plate & Fin Evaporator Core  
 O-Rings: (1) **24608**, (1) **24612**, (1) **38623**  
 Ford (81-80)

Euclid: E811009, E811011  
 Kysor: 1611009

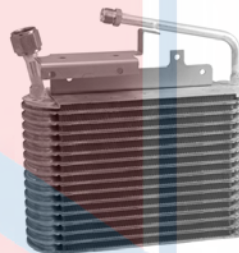

### 54527

Plate & Fin Evaporator Core  
 O-Rings: (1) **24608**, (1) **24612**, (1) **38623**  
 Ford (81)

Kysor: 1611010

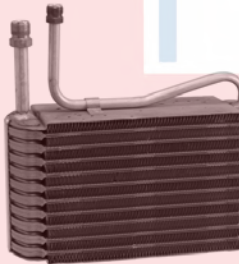

### 54528

Plate & Fin Evaporator Core  
 O-Rings: (1) **24608**, (1) **24610**, (1) **38623**  
 Ford (86-82); Lincoln (87-81); Mercury (89), (86-82)

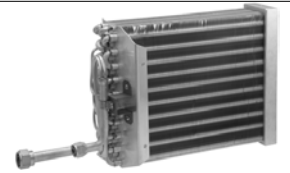

### 54529

Depth	Height	Width
2-1/2	19-3/4	5-1/2

Serpentine Evaporator Core  
 O-Rings: (1) **24608**, (1) **24610**  
 Ford (87-75)

Kysor: 1611005



### 54531

Plate & Fin Evaporator Core  
 Ford (93-87); Lincoln (87); Mercury (88-87)



### 54532

Plate & Fin Evaporator Core  
 O-Rings: (1) **24608**, (1) **24612**  
 Ford (89-86); Mercury (89-86)



# Evaporator Cores

## Evaporator Cores Cont'd



**54533**  
Plate & Fin Evaporator Core  
O-Rings: (1) **24612**, (3) **24668**, (1) **38621**  
Ford (91-86); Lincoln (90-86); Mercury (91-86)

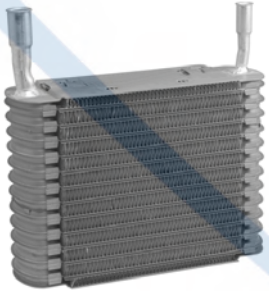

**54534**  
Plate & Fin Evaporator Core  
O-Rings: (2) **24608**, (2) **24612**  
Ford (95-86); Lincoln (94-88); Mercury (95-86)

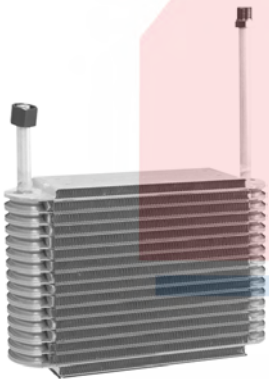

**54535**

Depth	Height	Width
4	15-7/16	4

Plate & Fin Evaporator Core  
O-Rings: (1) **24608**, (1) **24610**, (1) **38623**  
Ford (94-83); Mazda (94-91)



**54537**  
Plate & Fin Evaporator Core  
O-Rings: (1) **24608**, (1) **24612**, (1) **38623**  
Chevy (88-82); Pontiac (88-82)

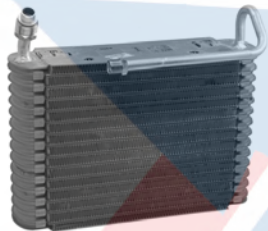

**54538**  
Plate & Fin Evaporator Core  
O-Rings: (1) **24608**, (1) **24612**, (1) **38623**  
Chevy (92-85); GMC (92-85)

Euclid: E811014  
Kysor: 1610009

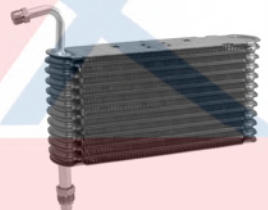

**54539**  
Plate & Fin Evaporator Core  
O-Rings: (1) **24608**, (1) **24612**  
Buick (89-87); Chevy (89-87); Olds (89-87); Pontiac (89-87)  
General Motors Corp: 3093584, 3095931



**54540**  
Plate & Fin Evaporator Core  
O-Rings: (2) **24608**, (2) **24612**, (1) **38639**  
Ford (97-86)

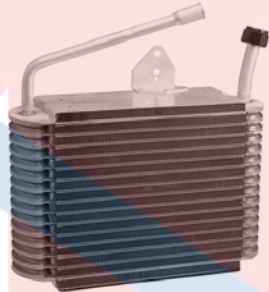

**54541**

Depth	Height	Width
4	11-7/16	4-1/4

Plate & Fin Evaporator Core  
O-Rings: (2) **24608**, (1) **24610**, (1) **38621**  
Ford (93-87)

Kysor: 1611007



**54542**  
Plate & Fin Evaporator Core  
O-Rings: (1) **24608**, (1) **24610**  
Ford (90-88)



**54543**  
Plate & Fin Evaporator Core  
O-Rings: (2) **24608**, (2) **24612**  
Ford (97-86)



**54544**  
Plate & Fin Evaporator Core  
O-Rings: (1) **24608**, (1) **24610**  
Ford (93-89); Mercury (93-89)

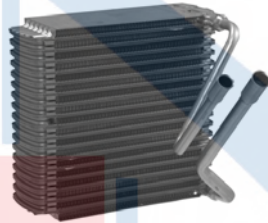

**54545**  
Plate & Fin Evaporator Core  
O-Rings: (1) **24608**, (1) **24610**  
Ford (94-88); Mercury (94-88)

# Evaporator Cores

## Evaporator Cores Cont'd

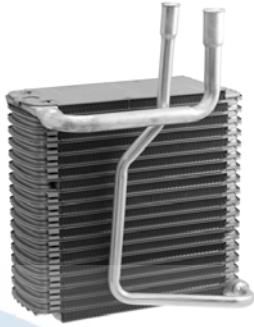

**54546**  
Plate & Fin Evaporator Core  
O-Rings: (1) **24608**, (1) **24610**  
Ford (92-89)

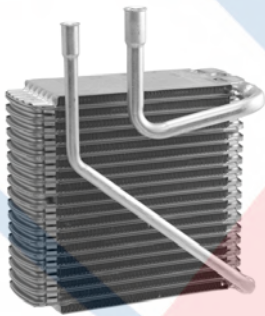

**54548**  
Plate & Fin Evaporator Core  
O-Rings: (1) **24608**, (1) **24610**  
Ford (03-91); Mercury (99-91)

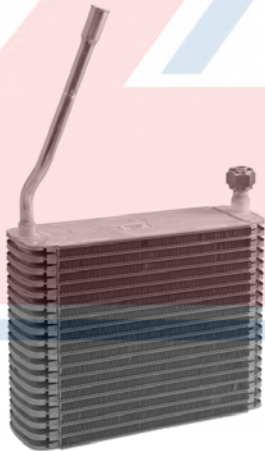

**54549**  
Plate & Fin Evaporator Core  
O-Rings: (2) **24608**, (1) **24610**, (1) **38621**  
Ford (97-92); Lincoln (97-91); Mercury (97-92)



**54550**  
Plate & Fin Evaporator Core  
O-Rings: (2) **24608**, (2) **24612**, (1) **38639**  
Ford (91-88)

Kysor: 1611004

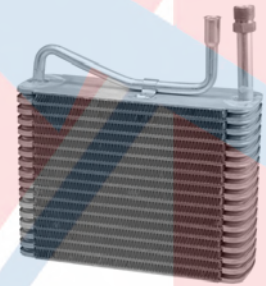

**54551**

Depth	Height	Width
3-9/16	11-5/8	3-9/16

Plate & Fin Evaporator Core  
O-Rings: (1) **24610**, (2) **24608**  
Lincoln (92-88); Mercury (88-87)

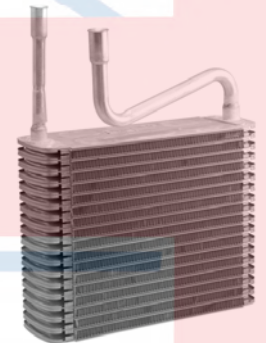

**54552**  
Plate & Fin Evaporator Core  
O-Rings: (1) **24608**, (1) **24610**

Euclid: E811079, E812000  
Red Dot: 76R7505



**54553**  
Plate & Fin Evaporator Core  
O-Rings: (1) **24608**, (1) **24670**  
Ford (93-92)

Euclid: E811027  
Kysor: 1611002

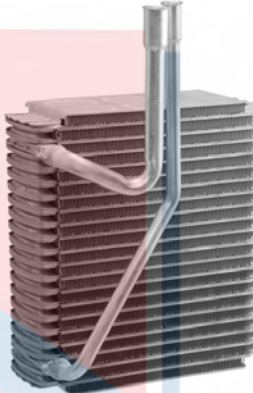

**54554**  
Plate & Fin Evaporator Core  
O-Rings: (1) **24608**, (1) **24610**  
Mercury (98-93); Nissan (98-93)

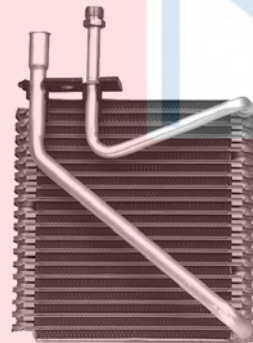

**54555**  
Plate & Fin Evaporator Core  
O-Rings: (1) **24608**, (1) **24670**  
Ford (97-93)



**54556**  
Plate & Fin Evaporator Core  
O-Rings: (1) **24608**, (1) **24670**  
Ford (96-94)

Kysor: 1611001



**54557**  
Plate & Fin Evaporator Core  
O-Rings: (1) **24608**, (1) **24610**  
Ford (95-94)



**54558**  
Plate & Fin Evaporator Core  
O-Rings: (1) **24610**, (1) **24666**, (1) **38635**  
Ford (97-94)

Kysor: 1611006

# Evaporator Cores

## Evaporator Cores Cont'd

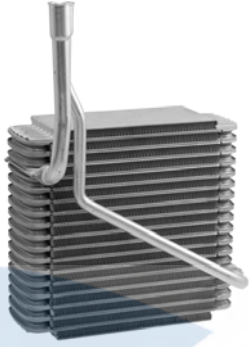

**54560**  
Plate & Fin Evaporator Core  
O-Rings: (1) **24608**, (1) **24610**  
Ford (97-94); Lincoln (98-93); Mercury (97-94)



**54567**  
Plate & Fin Evaporator Core  
Inlet: Block Fitting  
Outlet: Block Fitting  
O-Rings: (1) **24608**, (1) **24612**  
Buick (05-97); Chevy (04-97); Olds (02-97); Pontiac (03-97)

General Motors Corp: 52494507



**54568**  
Depth Height Width  
3-1/8 16-3/8 4  
Plate & Fin Evaporator Core  
Inlet: Block Fitting  
Outlet: Block Fitting  
O-Rings: (1) **24149**  
Chrysler (95-92); Dodge (95-91);  
Plymouth (95-91)

Chrysler: 4724458AE, 4797131,  
4797131AD

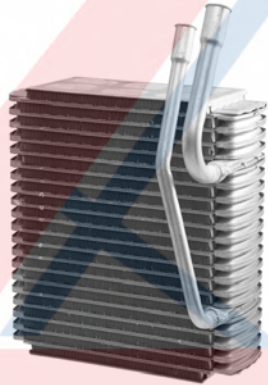

**54569**  
Depth Height Width  
3-9/16 13-1/8 6-1/4  
Plate & Fin Evaporator Core  
O-Rings: (3) **24668**, (3) **24670**  
Dodge (94); Jeep (94-93)

Chrysler: 4723518



**54570**  
Depth Height Width  
3-1/2 11-1/4 11-1/8  
Plate & Fin Evaporator Core  
Inlet: Block Fitting  
O-Rings: (1) **24608**, (1) **24612**  
Chrysler (00-96); Dodge (00-96);  
Plymouth (00-96)

Chrysler: 4882355

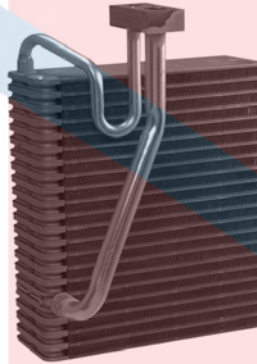

**54571**  
Plate & Fin Evaporator Core  
Inlet: Block Fitting  
Outlet: Block Fitting  
O-Rings: (1) **24149**  
Chrysler (02-93); Dodge (02-93); Eagle (97-93)

Chrysler: 4797129, 4882864AE

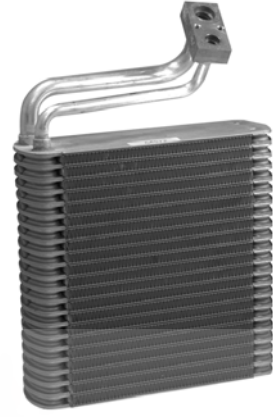

**54572**  
Depth Height Width  
3-1/8 14-1/2 3-3/4  
Plate & Fin Evaporator Core  
Inlet: Block Fitting  
Outlet: Block Fitting  
O-Rings: (1) **24149**  
Chrysler (04-01); Dodge (04-95);  
Plymouth (01-95)

Chrysler: 4864959, 4864959AC,  
4864959AE

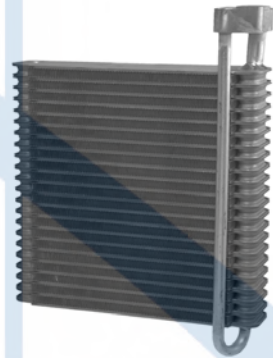

**54573**  
Depth Height Width  
2-7/8 14-1/4 3-5/8  
Plate & Fin Evaporator Core  
Inlet: Block Fitting  
Outlet: Block Fitting  
O-Rings: (1) **24402**, (1) **24404**  
Chevy (02-99); GMC (02-99)

General Motors Corp: 89018270



# Evaporator Cores

## Evaporator Cores Cont'd



### 54574

Depth	Height	Width
3-9/16	13	5

Plate & Fin Evaporator Core  
O-Rings: (2) **24610**  
Mazda (92-88)

Mazda: GJ5161J10B

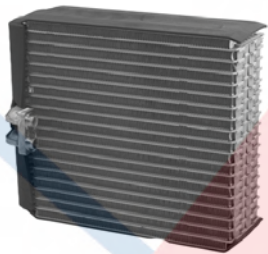

### 54575

Depth	Height	Width
3-1/2	9-3/4	5-1/2

Plate & Fin Evaporator Core  
Inlet: Block Fitting  
Outlet: Block Fitting  
O-Rings: (2) **24610**  
Lexus (93-92); Toyota (93-92)

Toyota: 8850133010

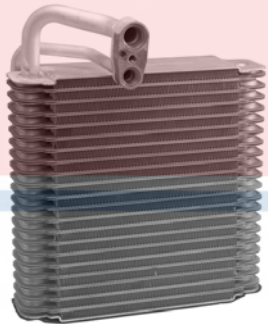

### 54576

Plate & Fin Evaporator Core  
Inlet: Block Fitting  
Outlet: Block Fitting  
O-Rings: (1) **24608**, (1) **24612**  
Buick (05-97)

General Motors Corp: 52494341



### 54577

Plate & Fin Evaporator Core  
Inlet: Block Fitting  
O-Rings: (2) **24608**, (2) **24612**  
Chevy (95-93); GMC (95-93)

General Motors Corp: 12543631

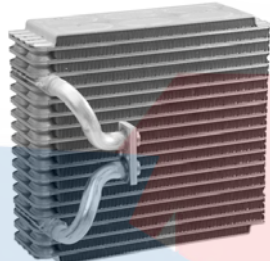

### 54578

Depth	Height	Width
2-7/8	8-5/16	5

Plate & Fin Evaporator Core  
Inlet: Block Fitting  
O-Rings: (2) **24610**  
Hyundai (01-96)

Hyundai: 9760429001  
Kia: 1K2A161J10A

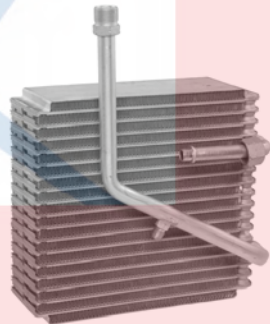

### 54579

Depth	Height	Width
2-7/8	12	4-3/4

Plate & Fin Evaporator Core  
Inlet: Block Fitting  
O-Rings: (1) **24608**, (1) **24610**  
Acura (97-96); Honda (97-94); Isuzu (97-92)

Isuzu: 8970464880



### 54580

Depth	Height	Width
3-7/16	9-1/2	7-1/8

Plate & Fin Evaporator Core  
O-Rings: (1) **24608**, (1) **24610**  
Mercury (98-93); Nissan (98-93)

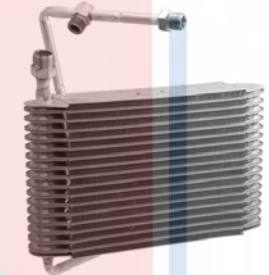

### 54581

Plate & Fin Evaporator Core  
O-Rings: (2) **24608**, (2) **24612**  
Cadillac (93-92)

General Motors Corp: 52457705

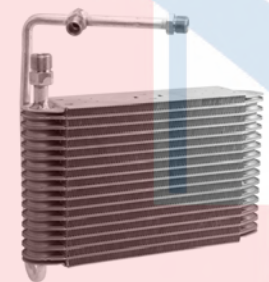

### 54582

Depth	Height	Width
2-7/8	14-1/2	5-1/2

Plate & Fin Evaporator Core  
O-Rings: (1) **24606**, (1) **24610**, (1) **24612**  
Buick (93-91); Cadillac (93-91); Olds (92-91)

General Motors Corp: 52456012



### 54583

Plate & Fin Evaporator Core  
O-Rings: (1) **24608**, (1) **24612**  
Chevy (93-92); Olds (93-92); Pontiac (93-92)

General Motors Corp: 52457393

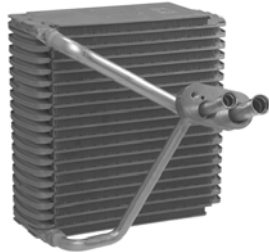

### 54584

Plate & Fin Evaporator Core  
O-Rings: (2) **24608**, (2) **24612**  
Hyundai (98-94)

Hyundai: 9702734001



### 54585

Plate & Fin Evaporator Core  
O-Rings: (1) **24608**, (2) **24612**, (1) **38623**  
Cadillac (92-90)

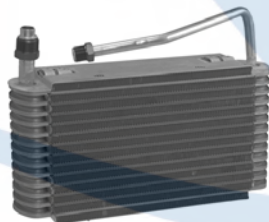

### 54586

Plate & Fin Evaporator Core  
O-Rings: (1) **24608**, (1) **24610**, (1) **38623**  
Chevy (92-88); Pontiac (92-88)

General Motors Corp: 52453621

# Evaporator Cores

## Evaporator Cores Cont'd



**54587**  
Plate & Fin Evaporator Core  
O-Rings: (2) **24608**, (2) **24612**  
Buick (90); Cadillac (90); Olds (90)

General Motors Corp: 52454628

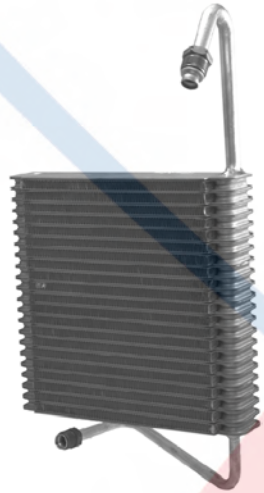

**54588**  
Depth Height Width  
2-7/8 19-3/4 5-3/8  
Plate & Fin Evaporator Core  
O-Rings: (1) **24608**, (2) **24612**, (1) **38623**  
Chevy (98-96); GMC (98-96)

General Motors Corp: 19194254



**54589**  
Plate & Fin Evaporator Core  
Inlet: Block Fitting  
O-Rings: (1) **24608**, (1) **24610**  
Chevy (97-93); Pontiac (97-93)



**54590**  
Depth Height Width  
2-7/8 13-5/8 7-5/8  
Plate & Fin Evaporator Core  
O-Rings: (2) **24608**, (2) **24612**  
Buick (99-94); Olds (99-94); Pontiac (99-94)

General Motors Corp: 52463867

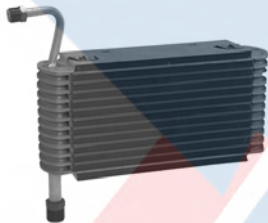

**54591**  
Depth Height Width  
3-9/16 12 3-9/16  
Plate & Fin Evaporator Core  
O-Rings: (2) **24608**, (2) **24612**  
Buick (96-94); Olds (96-94)

General Motors Corp: 52464079



**54592**  
Plate & Fin Evaporator Core  
O-Rings: (2) **24608**, (2) **24612**  
Buick (98-94); Chevy (96-94); Olds (98-94); Pontiac (98-94)



**54593**  
Plate & Fin Evaporator Core  
O-Rings: (1) **24608**, (2) **24612**, (1) **38623**  
Cadillac (02-94)

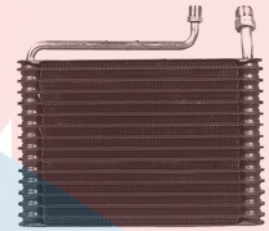

**54594**  
Plate & Fin Evaporator Core  
O-Rings: (2) **24608**, (2) **24612**  
Chevy (96-94); Olds (96-94); Pontiac (96-94)

General Motors Corp: 52463451

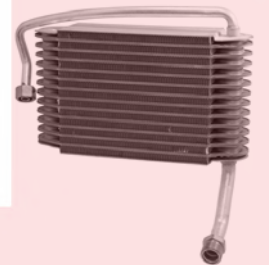

**54595**  
Depth Height Width  
2-7/8 11-1/2 6  
Plate & Fin Evaporator Core  
O-Rings: (2) **24608**, (2) **24612**  
Chevy (96-94); Olds (96-94); Pontiac (96-94)

General Motors Corp: 52463444



**54596**  
Plate & Fin Evaporator Core  
O-Rings: (1) **24606**, (2) **24608**, (1) **24610**  
Chevy (93-90); GMC (93-90)

General Motors Corp: 52457459



**54597**  
Depth Height Width  
2-7/8 4  
Plate & Fin Evaporator Core  
O-Rings: (1) **24608**, (1) **24612**, (1) **38623**  
Chevy (05-94); GMC (05-94); Isuzu (00-96); Olds (01-96)

General Motors Corp: 52463741  
Isuzu: 8524637410, 8524788640  
Kysor: 1610011

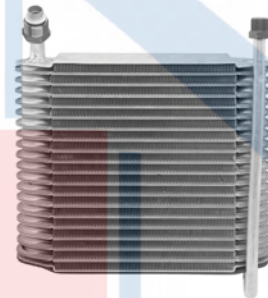

**54598**  
Depth Height Width  
2-7/8 12-7/8 3-3/8  
Plate & Fin Evaporator Core  
O-Rings: (1) **24608**, (1) **24612**  
Cadillac (00-99); Chevy (02-94); GMC (02-94)

General Motors Corp: 52464036  
Kysor: 1610001  
NaviStar: 708031



# Evaporator Cores

## Evaporator Cores Cont'd



### 54599

Depth	Height	Width
2-7/8	10-1/2	2-7/8

Plate & Fin Evaporator Core  
O-Rings: (1) **24608**, (1) **24612**  
Chevy (99-94); GMC (99-94)

Kysor: 1610005

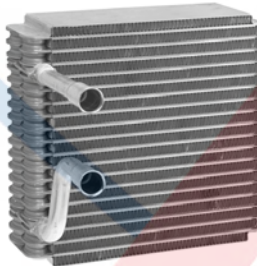

### 54601

Depth	Height	Width
2-7/8	8-7/8	7-3/4

Plate & Fin Evaporator Core  
O-Rings: (4) **24670**  
Ford (12-10), (07-00)

Ford: 2T1Z19B555C, 6S4Z19850BB

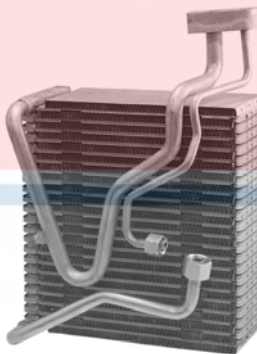

### 54602

Plate & Fin Evaporator Core  
Outlet: Block Fitting  
O-Rings: (1) **24604**, (1) **24608**, (1) **24610**  
Mazda (02-95)

Mazda: TA0161J10B



### 54603

Tube & Fin Evaporator Core  
O-Rings: (2) **24608**, (2) **24612**  
Volvo (90-74)

General Motors Corp: 19191217

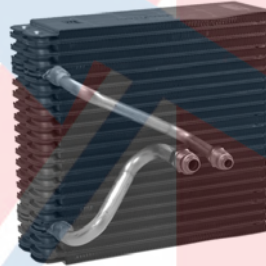

### 54604

Plate & Fin Evaporator Core  
Inlet: Block Fitting  
O-Rings: (1) **24608**, (1) **24610**  
Ford (05-02); Jaguar (08-00); Lincoln (06-00)

Ford: 6W4Z19860A  
Jaguar: XR855744

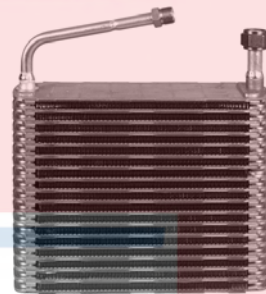

### 54605

Depth	Height	Width
3-5/8		

Plate & Fin Evaporator Core  
O-Rings: (1) **24608**, (1) **24610**

Ford: F5TZ19860A

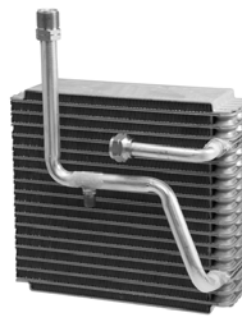

### 54607

Depth	Height	Width
3-1/2		

Plate & Fin Evaporator Core  
Inlet: Female O-Ring  
Outlet: Male Insert O-Ring  
O-Rings: (1) **24608**, (1) **24610**  
Isuzu (93-88)

Isuzu: 8943247952, 8943870490

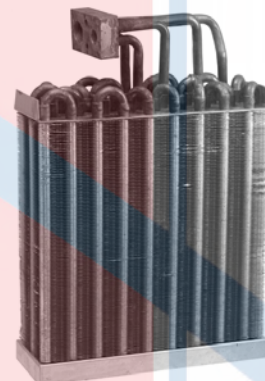

### 54608

Tube & Fin Evaporator Core  
Inlet: Block Fitting  
Outlet: Block Fitting  
O-Rings: (1) **24149**  
Chrysler (95-90); Dodge (95-88);  
Plymouth (95-89)

Chrysler: 4882966AC

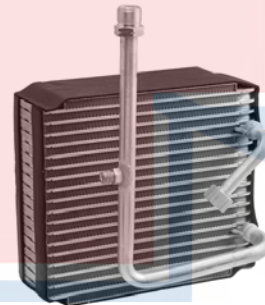

### 54609

Depth	Height	Width
2-15/16	7-3/8	5-3/8

Plate & Fin Evaporator Core  
O-Rings: (1) **24608**, (1) **24610**  
Mazda (98-95)

Mazda: BC1M61J10

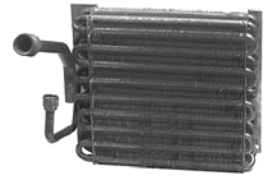

### 54610

Tube & Fin Evaporator Core  
O-Rings: (1) **24608**, (1) **24612**  
Dodge (97-89)

Chrysler: 4361401



### 54613

Tube & Fin Evaporator Core  
Inlet: Flare Fitting  
O-Rings: (1) **24608**, (1) **24610**  
Jeep (86-74)

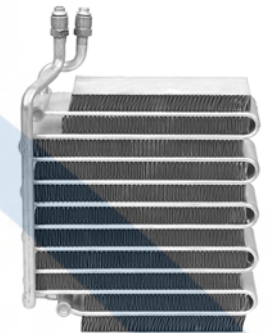

### 54614

Serpentine Evaporator Core  
O-Rings: (2) **24608**  
Jeep (91-85)



# Evaporator Cores

## Evaporator Cores Cont'd

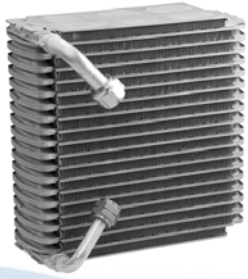

**54615**  
 Depth 3-1/2    Height 8-1/2    Width 5-1/4

Plate & Fin Evaporator Core  
 O-Rings: (1) **24608**, (1) **24610**  
 Subaru (94-90)

Subaru: 73061AA010



**54616**  
 Plate & Fin Evaporator Core  
 Inlet: Block Fitting  
 O-Rings: (2) **24610**  
 Toyota (99-91)

Toyota: 8850110110

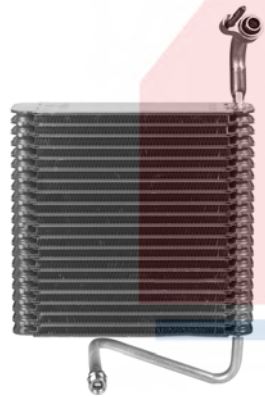

**54617**  
 Depth 2-7/8    Height 17-5/8    Width 5-3/8

Plate & Fin Evaporator Core  
 Outlet: Block Fitting  
 O-Rings: (1) **24608**, (1) **24404**  
 Chevy (02-98); GMC (02-98)

General Motors Corp: 52484205



**54618**  
 Depth 2-7/8    Height 14-1/2    Width 3-9/16

Plate & Fin Evaporator Core

Inlet: Block Fitting  
 Outlet: Block Fitting  
 O-Rings: (1) **24402**, (1) **24404**  
 Chevy (02-98); Pontiac (02-98)

General Motors Corp: 52477813

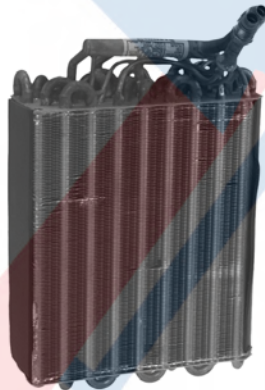

**54619**  
 Tube & Fin Evaporator Core  
 O-Rings: (2) **24608**  
 VW (92-85)

Volkswagen: 176271103A

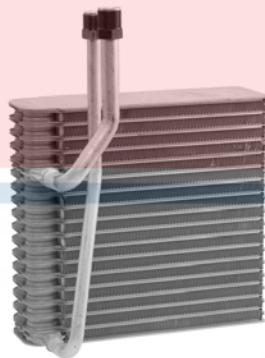

**54620**  
 Depth 2-7/8    Height 12-3/4    Width 5-1/2

Plate & Fin Evaporator Core  
 O-Rings: (1) **24608**, (1) **24610**  
 Chevy (02-98)

General Motors Corp: 52481709

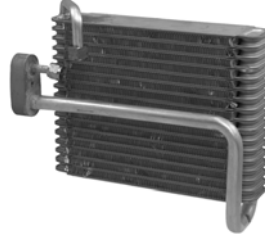

**54621**  
 Plate & Fin Evaporator Core  
 Outlet: Block Fitting  
 O-Rings: (1) **24608**, (1) **24646**, (1) **24403**, (1) **24404**  
 Chevy (14-97); GMC (14-97); GMC & CHEVY (11-09)

General Motors Corp: 52481840, 89019348

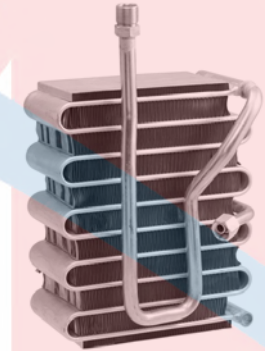

**54622**  
 Serpentine Evaporator Core  
 O-Rings: (1) **24608**, (1) **24610**  
 Acura (90-86)

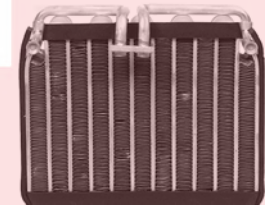

**54623**  
 Serpentine Evaporator Core  
 Inlet: Block Fitting  
 Outlet: Block Fitting  
 O-Rings: (2) **24610**  
 Toyota (92-89)

Toyota: 8850122190

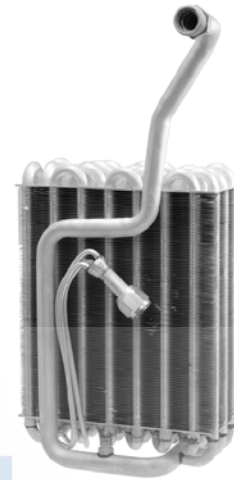

**54626**  
 Depth 3    Height 15    Width 6-1/2

Tube & Fin Evaporator Core  
 O-Rings: (1) **24608**, (1) **24610**  
 BMW (89-82)

BMW: 64511372363

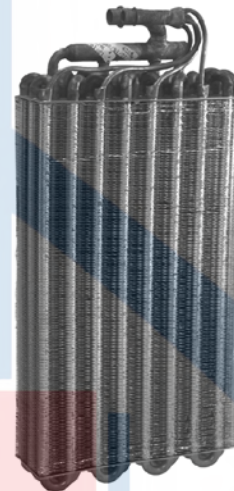

**54628**  
 Tube & Fin Evaporator Core  
 O-Rings: (1) **24608**, (1) **24610**  
 BMW (97-87)

BMW: 64111468404, 64118391277

# Evaporator Cores

## Evaporator Cores Cont'd



**54629**

Depth	Height	Width
3		

Tube & Fin Evaporator Core  
Inlet: Flare Fitting  
O-Rings: (1) **24608**, (1) **24610**  
BMW (83-77)

BMW: 84017403006

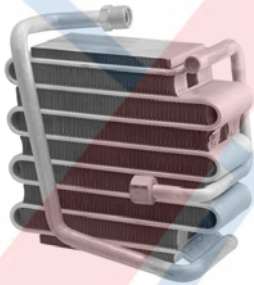

**54633**

Serpentine Evaporator Core  
O-Rings: (1) **24608**, (1) **24610**  
Toyota (89-84)

Toyota: 8850128011

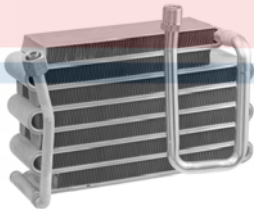

**54635**

Serpentine Evaporator Core  
O-Rings: (1) **24608**, (1) **24610**  
Toyota (89-86), (84)

Toyota: 8850187010



**54636**

Tube & Fin Evaporator Core  
O-Rings: (1) **24131**, (1) **24610**, (1) **24604**

Saab (91-86)

Saab: 9624925

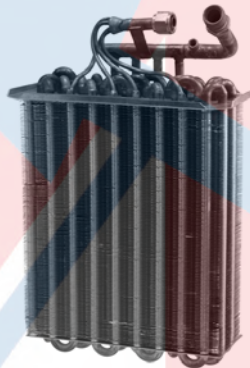

**54637**

Depth	Height	Width
3-1/8	14-3/8	4-7/8

Tube & Fin Evaporator Core  
O-Rings: (1) **24604**, (1) **24608**, (1) **24610**

Saab (94-81)

General Motors Corp: 19191241

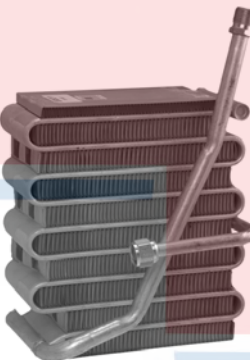

**54640**

Depth	Height	Width
3-7/8	4	

Serpentine Evaporator Core  
O-Rings: (1) **24608**, (1) **24610**  
Acura (89-86)

Acura: 38655SD2A11

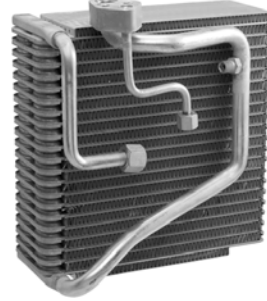

**54643**

Depth	Height	Width
3-3/8	11-3/8	5-1/8

Plate & Fin Evaporator Core

Outlet: Block Fitting

O-Rings: (1) **24608**, (1) **24610**, (1) **24616**

Mitsubishi (98-94)

Mitsubishi: MR147013



**54647**

Serpentine Evaporator Core  
O-Rings: (1) **24608**, (2) **24670**  
Toyota (95-89)

Toyota: 8850114230, 8850189111

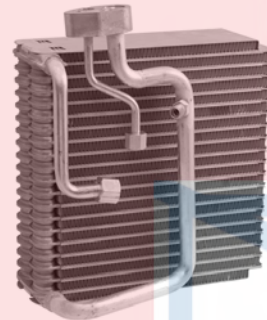

**54655**

Depth	Height	Width
2-7/8	11	4-3/4

Plate & Fin Evaporator Core

O-Rings: (1) **24604**, (1) **24608**, (1) **24610**

Dodge (94); Eagle (96-94); Mitsubishi (98-94); Plymouth (94)

Mitsubishi: MR360015

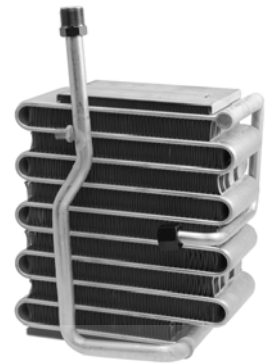

**54658**

Depth	Height	Width
3-15/16	13-1/2	6-1/2

Serpentine Evaporator Core

O-Rings: (1) **24608**, (1) **24610**  
Honda (91-88)

Honda: 80210SH3A11



**54660**

Serpentine Evaporator Core  
O-Rings: (1) **24608**, (2) **24670**  
Lexus (91-90); Toyota (91-86)

Lexus: 8850132050

Toyota: 8850120211, 8850132050

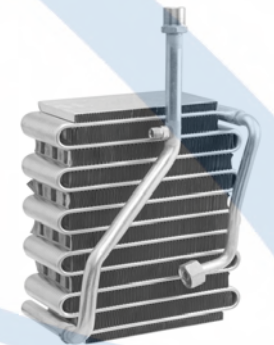

**54661**

Depth	Height	Width
3-1/8	12-3/8	4-7/8

Serpentine Evaporator Core

O-Rings: (1) **24608**, (1) **24610**  
Nissan (89-86)

Nissan: 27280D4501



# Evaporator Cores

## Evaporator Cores Cont'd



**54662**  
Serpentine Evaporator Core  
O-Rings: (3) **24668**, (3) **24670**  
Hyundai (93-90)

Hyundai: 9760124001

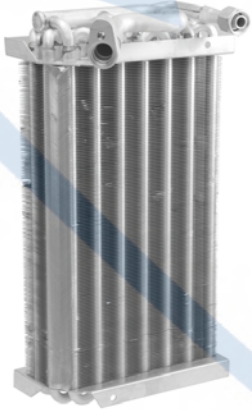

**54664**  
Depth Height Width  
2-1/2 13-7/8 7-1/2  
Tube & Fin Evaporator Core  
Outlet: Block Fitting  
O-Rings: (1) **24608**, (1) **24610**  
Porsche (95-85)

Porsche: 94457321101

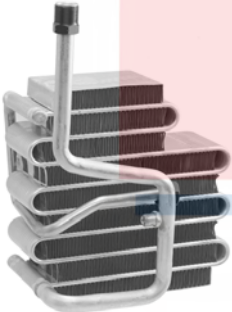

**54666**  
Serpentine Evaporator Core  
O-Rings: (1) **24608**, (1) **24610**  
Nissan (85-83)



**54668**  
Depth Height Width  
3-1/8 14-7/8 3-1/2  
Tube & Fin Evaporator Core  
O-Rings: (1) **24608**, (1) **24610**  
VW (93-75)

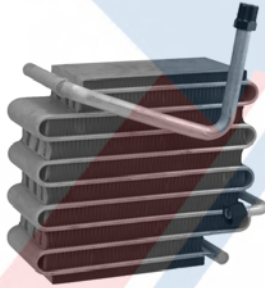

**54669**  
Serpentine Evaporator Core  
O-Rings: (1) **24608**, (1) **24610**  
Dodge (89-87); Mitsubishi (91-83)

Mitsubishi: MB298878

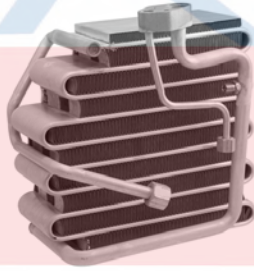

**54670**  
Serpentine Evaporator Core  
Outlet: Block Fitting  
O-Rings: (1) **24608**, (1) **24612**, (1) **24616**  
Mitsubishi (93-92)

Mitsubishi: MB630802



**54671**  
Serpentine Evaporator Core  
O-Rings: (1) **24604**, (1) **24608**, (1) **24610**, (1) **24604**, (1) **24608**, (1) **24610**  
Honda (91-88)

Honda: 80210SF1A62

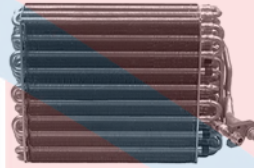

**54672**  
Tube & Fin Evaporator Core  
Inlet: Block Fitting  
O-Rings: (1) **24608**, (1) **24610**  
VW (02-90)

Volkswagen: 1H1820103C, 357820103D



**54677**  
Serpentine Evaporator Core  
O-Rings: (1) **24608**, (1) **24610**  
Honda (89-86)

Honda: 80210SE0A11



**54680**  
Serpentine Evaporator Core  
Inlet: Block Fitting  
Outlet: Block Fitting  
O-Rings: (2) **24610**  
Lexus (00-94); Toyota (98-93)

Lexus: 8850124091  
Toyota: 8850124091

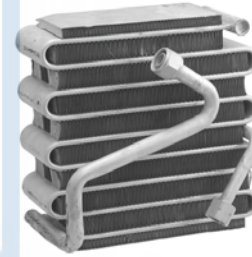

**54681**  
Serpentine Evaporator Core  
O-Rings: (1) **24608**, (1) **24610**  
Nissan (89-86)

Nissan: 2728038E01

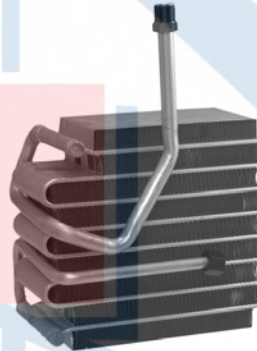

**54682**  
Depth Height Width  
4 13-1/4 6-5/8  
Serpentine Evaporator Core  
O-Rings: (1) **24608**, (1) **24610**  
Toyota (88-84)

Toyota: 8850122161, 8850122162



# Evaporator Cores

## Evaporator Cores Cont'd



**54684**  
Tube & Fin Evaporator Core  
Inlet: Block Fitting  
O-Rings: (1) **24608**, (1) **24610**  
Jaguar (93-90)

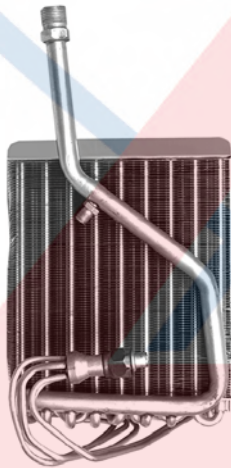

**54686**  
Tube & Fin Evaporator Core  
O-Rings: (1) **24604**, (1) **24608**, (1) **24610**  
Isuzu (91-84)  
Isuzu: 8941369511



**54687**  
Serpentine Evaporator Core  
Outlet: Block Fitting  
O-Rings: (1) **24608**, (1) **24610**  
Dodge (88-85); Eagle (88); Mitsubishi (89-85); Plymouth (88-85)

Mitsubishi: MB276584, MB276591

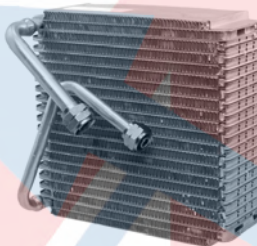

**54688**  
Serpentine Evaporator Core  
O-Rings: (1) **24608**, (1) **24610**  
Nissan (92-90)

Nissan: 2728086E01

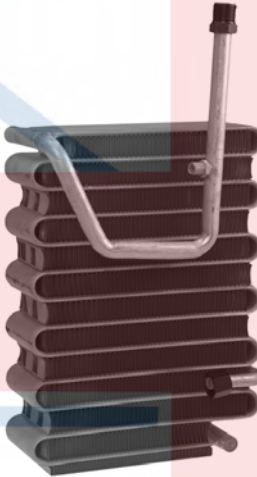

**54689**  
Serpentine Evaporator Core  
O-Rings: (1) **24604**, (1) **24608**, (1) **24610**  
Honda (93-90)

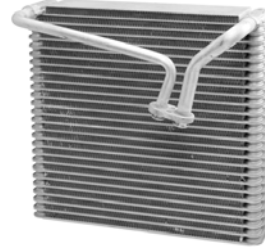

**54690**  
Serpentine Evaporator Core  
Inlet: Block Fitting  
O-Rings: (1) **24661**, (1) **24681**  
Acura (06-01); Honda (08-99)

Honda: 80210SOXA01

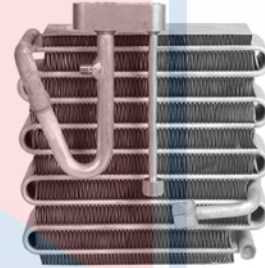

**54691**  
Serpentine Evaporator Core  
Outlet: Block Fitting  
O-Rings: (1) **24604**, (1) **24604**, (1) **24608**, (1) **24610**  
Honda (93-92)

Honda: 80210SR1A11

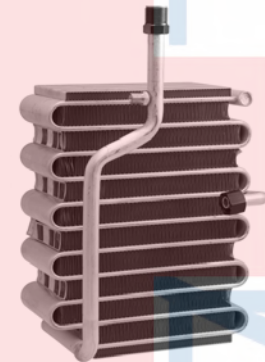

**54692**  
Serpentine Evaporator Core  
O-Rings: (1) **24604**, (1) **24608**, (1) **24610**  
Acura (93-90)



**54696**  
Serpentine Evaporator Core  
Outlet: Block Fitting  
O-Rings: (1) **24604**, (1) **24608**, (1) **24610**  
Dodge (92-89); Eagle (92-89); Mitsubishi (93-89); Plymouth (92-89)

Mitsubishi: MB630051



**54697**  
Tube & Fin Evaporator Core  
O-Rings: (1) **24608**, (1) **24610**  
Dodge (86-85); Mitsubishi (86-83)

Mitsubishi: MB276066



**54698**  
Serpentine Evaporator Core  
O-Rings: (1) **24608**, (1) **24610**  
Eagle (94-90); Mitsubishi (94-90); Plymouth (94-90)

Mitsubishi: MB657065

# Evaporator Cores

## Evaporator Cores Cont'd



**54700**  
Serpentine Evaporator Core  
Nissan (94-91)

Nissan: 2728065Y01



**54704**  
Serpentine Evaporator Core  
O-Rings: (1) **24604**, (1) **24608**, (1) **24610**  
Mazda (95-90)

Mazda: BR7061J10A



**54709**  
Serpentine Evaporator Core  
O-Rings: (1) **24604**, (1) **24608**, (1) **24610**  
Honda (96-92)

Depth	Height	Width
3-1/8	16	6-1/8



**54712**  
Plate & Fin Evaporator Core  
O-Rings: (1) **24608**, (1) **24610**  
Chevy (93-89); Suzuki (93-89)

General Motors Corp: 96061884  
Suzuki: 9580060A50



**54701**  
Serpentine Evaporator Core  
Outlet: Block Fitting  
O-Rings: (1) **24608**, (1) **24610**  
Mitsubishi (93-89)

Depth	Height	Width
4	9-3/4	6-1/2

Mitsubishi: MB276831

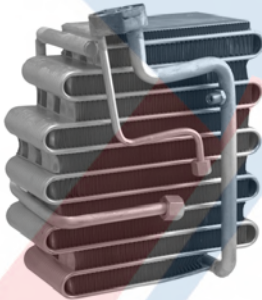

**54708**  
Serpentine Evaporator Core  
Outlet: Block Fitting  
O-Rings: (1) **24608**, (2) **24612**, (2) **24616**  
Dodge (96-94); Mitsubishi (99-93)

Chrysler: MR168023

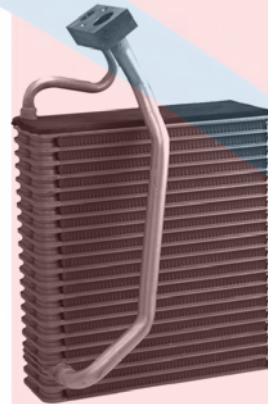

**54710**  
Plate & Fin Evaporator Core  
Inlet: Block Fitting  
Outlet: Block Fitting  
O-Rings: (1) **24149**  
Chrysler (00-95); Dodge (00-95);  
Plymouth (00-96)

Depth	Height	Width
3	13-5/8	5

Chrysler: 5013064AA, 5013064AD

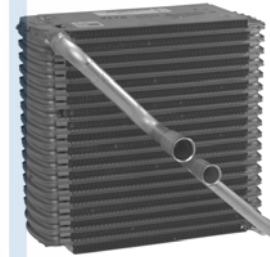

**54717**  
Plate & Fin Evaporator Core  
O-Rings: (3) **24668**, (3) **24670**  
Hyundai (93-89)

Hyundai: 9761133000

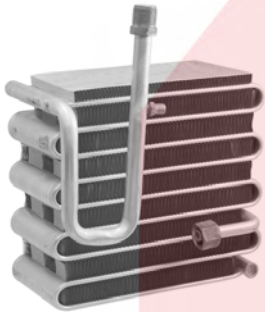

**54702**  
Serpentine Evaporator Core  
O-Rings: (1) **24608**, (1) **24610**  
Mazda (89-86)

Depth	Height	Width
3-7/8	11-7/16	6-1/4

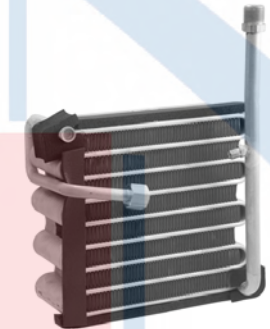

**54719**  
Serpentine Evaporator Core  
O-Rings: (1) **24604**, (1) **24608**, (1) **24610**  
Mitsubishi (96-94)

Mitsubishi: MR168049



# Evaporator Cores

## Evaporator Cores Cont'd



**54720**  
Serpentine Evaporator Core  
Outlet: Block Fitting  
O-Rings: (1) **24604**, (1) **24608**, (1) **24610**  
Honda (93-91)  
Honda: 80210SM1Z01

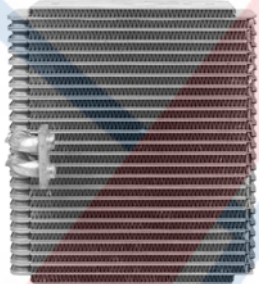

**54721**  
Plate & Fin Evaporator Core  
Inlet: Block Fitting  
Outlet: Block Fitting  
O-Rings: (2) **24682**  
Acura (95-91)  
Acura: 80210SP0A01



**54722**  
Plate & Fin Evaporator Core  
Inlet: Block Fitting  
O-Rings: (1) **24608**, (1) **24610**  
Geo (93-92); Isuzu (92-90)  
General Motors Corp: 97045847  
Isuzu: 8943805520

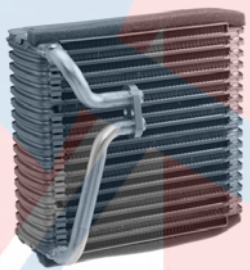

**54723**  
Plate & Fin Evaporator Core  
Inlet: Block Fitting  
O-Rings: (2) **24608**  
Hyundai (99-98)  
Hyundai: 9760922001



**54724**  
Plate & Fin Evaporator Core  
O-Rings: (1) **24608**, (1) **24610**  
Infiniti (95-93); Nissan (94-91)

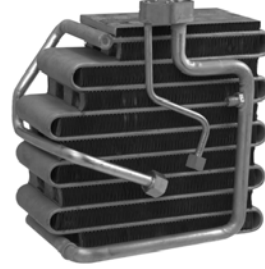

**54726**  
Depth      Height      Width  
3-15/16    10-1/2    6-1/4  
Serpentine Evaporator Core  
Outlet: Block Fitting  
O-Rings: (1) **24604**, (1) **24608**, (1) **24610**  
Mitsubishi (96-94)  
Mitsubishi: MR147651



**54727**  
Plate & Fin Evaporator Core  
Inlet: Block Fitting  
Outlet: Block Fitting  
O-Rings: (2) **24610**  
Toyota (02-00)  
Toyota: 885010C010

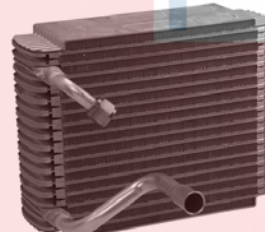

**54728**  
Plate & Fin Evaporator Core  
O-Rings: (1) **24608**, (1) **24670**  
Mercury (02-99); Nissan (02-99)



**54729**  
Plate & Fin Evaporator Core  
O-Rings: (3) **24668**, (3) **24670**  
Mercury (02-99); Nissan (02-99)  
Nissan: 272816B000

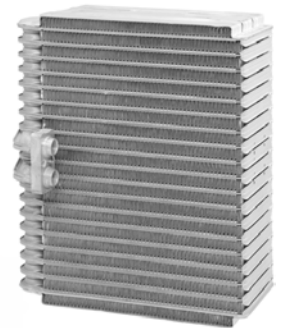

**54730**  
Depth      Height      Width  
3-9/16    10-1/2    5  
Plate & Fin Evaporator Core  
Inlet: Block Fitting  
Outlet: Block Fitting  
O-Rings: (2) **24610**  
Toyota (04-95)  
Toyota: 8850104030



**54731**  
Serpentine Evaporator Core  
Inlet: Block Fitting  
O-Rings: (2) **24610**  
Toyota (00-96)  
Toyota: 8850142040



# Evaporator Cores

## Evaporator Cores Cont'd



**54732**  
Plate & Fin Evaporator Core  
O-Rings: (2) **23680**, (1) **24608**  
Chevy (98-94); Suzuki (98-94)

General Motors Corp: 96068948

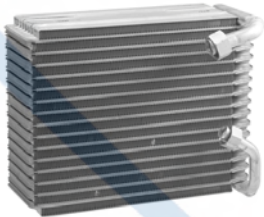

**54733**

Depth	Height	Width
3-1/2	8-1/8	4

Serpentine Evaporator Core  
O-Rings: (1) **24661**, (1) **24681**  
Toyota (03-01)

Toyota: 8850108050

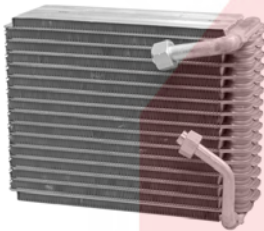

**54734**

Depth	Height	Width
3-9/16	4	

Serpentine Evaporator Core  
O-Rings: (1) **24661**, (1) **24681**  
Toyota (00-98)

Toyota: 8850108020



**54736**  
Plate & Fin Evaporator Core  
Inlet: Block Fitting  
Outlet: Block Fitting  
O-Rings: (2) **24604**, (1) **24608**, (1) **24610**  
Dodge (93); Eagle (93); Mitsubishi (93);  
Plymouth (93)

Mitsubishi: MB939448

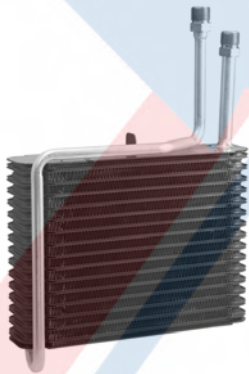

**54737**  
Plate & Fin Evaporator Core  
O-Rings: (2) **24610**  
Chevy (97-95); Pontiac (97-95)

General Motors Corp: 52474506

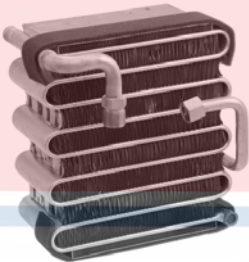

**54740**  
Universal Serpentine Evaporator Core  
O-Rings: (1) **24608**, (1) **24610**



**54741**  
Universal Serpentine Evaporator Core  
O-Rings: (1) **24608**, (1) **24610**



**54742**  
Universal Serpentine Evaporator Core  
O-Rings: (1) **24608**, (1) **24610**

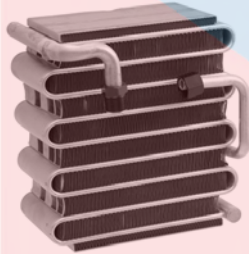

**54743**

Depth	Height	Width
4		

Universal Serpentine Evaporator Core  
O-Rings: (1) **24608**, (1) **24610**



**54750**  
Serpentine Evaporator Core  
Outlet: Block Fitting  
O-Rings: (2) **24610**  
Dodge (93-91); Mitsubishi (93-91)

Mitsubishi: MB630454

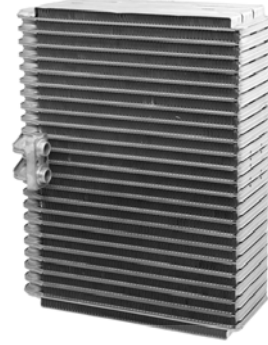

**54751**  
Serpentine Evaporator Core  
Inlet: Block Fitting  
O-Rings: (2) **24610**  
Toyota (93-91)

Toyota: 8850195D03

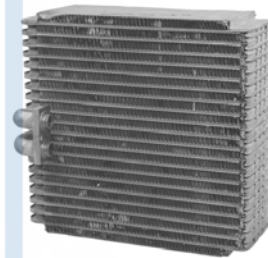

**54754**  
Serpentine Evaporator Core  
Inlet: Block Fitting  
O-Rings: (2) **24610**  
Dodge (92); Eagle (93-92); Mazda (90);  
Mitsubishi (93-92); Plymouth (93-92)

Mitsubishi: MB899697



**54755**  
Serpentine Evaporator Core  
O-Rings: (1) **24608**, (1) **24610**  
Mazda (93-89)

Mazda: LA0161520, LA0161J10

# Evaporator Cores

## Evaporator Cores Cont'd



### 54758

Depth	Height	Width
4-1/8	8-7/8	5-1/2

Serpentine Evaporator Core

Inlet: Block Fitting

Outlet: Block Fitting

O-Rings: (2) **24610**

Toyota (94-90)

Toyota: 8850120271

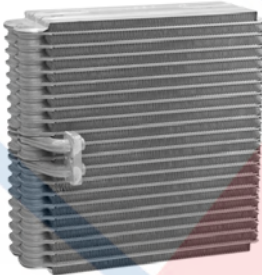

### 54759

Depth	Height	Width
3-1/2	10-15/16	5

Serpentine Evaporator Core

Inlet: Block Fitting

O-Rings: (2) **24610**

Lexus (92-90)

Lexus: 8850150170

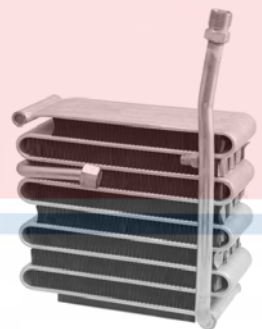

### 54760

Serpentine Evaporator Core

O-Rings: (1) **24608**, (1) **24610**

Dodge (93-90); Mitsubishi (93-90)

Mitsubishi: MB657220

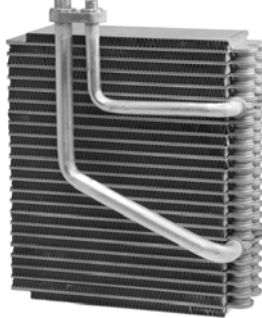

### 54771

Depth	Height	Width
2-7/8	11-1/2	4-5/8

Plate & Fin Evaporator Core

Inlet: Block Fitting

Outlet: Block Fitting

O-Rings: (1) **24642**, (1) **24677**

Infiniti (03-97); Nissan (04-96)

Infiniti: 272807J200

Nissan: 272800W001, 272800W002, 272800W020

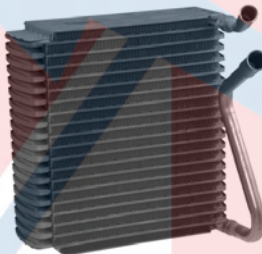

### 54772

Plate & Fin Evaporator Core

O-Rings: (3) **24668**, (3) **24670**

Volvo (04-93)

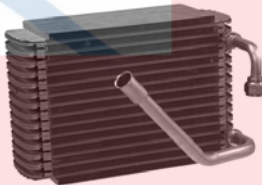

### 54774

Depth	Height	Width
3-9/16	3-5/8	

Plate & Fin Evaporator Core

O-Rings: (1) **24608**, (1) **24670**

Ford (07-99); Mercury (07-04)

Ford: 6F2Z19860SA



### 54776

Depth	Height	Width
3-9/16	3-5/8	

Plate & Fin Evaporator Core

O-Rings: (3) **24668**, (3) **24672**

Ford (02-01); Mercury (02-01)

Ford: 4L2Z19860BA

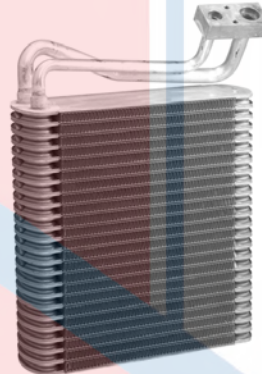

### 54778

Depth	Height	Width
3-1/8	14-3/8	3-1/8

Plate & Fin Evaporator Core

Inlet: Block Fitting

Outlet: Block Fitting

O-Rings: (1) **24149**

Dodge (03-01)

Chrysler: 5019700AD

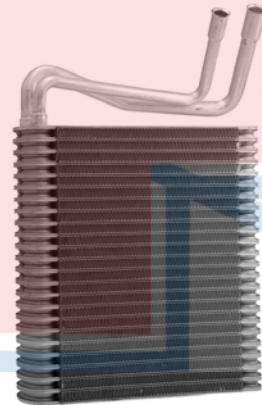

### 54780

Depth	Height	Width
3-1/8	3-1/4	

Plate & Fin Evaporator Core

O-Rings: (3) **24668**, (3) **24670**

Dodge (04-01)

Chrysler: 5019696AF

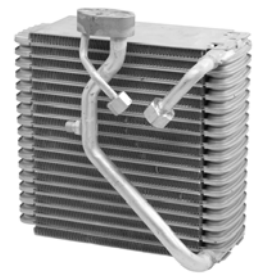

### 54781

Depth	Height	Width
3-1/2	9-3/4	5-1/2

Serpentine Evaporator Core

Inlet: Block Fitting

Outlet: Block Fitting

O-Rings: (1) **24608**, (1) **24610**

Hyundai (97-95)



### 54782

Depth	Height	Width
3-3/8	13-1/2	5-1/2

Plate & Fin Evaporator Core

O-Rings: (1) **24608**, (2) **24610**

Nissan (10), (04-98)

Nissan: 272803S500, 272807Z800

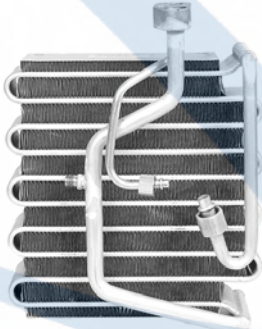

### 54783

Serpentine Evaporator Core

Outlet: Block Fitting

O-Rings: (1) **24604**, (1) **24606**, (1) **24608**

Mazda (93-92)

Mazda: HG3061J10B

Mack: HG3061J10A



# Evaporator Cores

## Evaporator Cores Cont'd

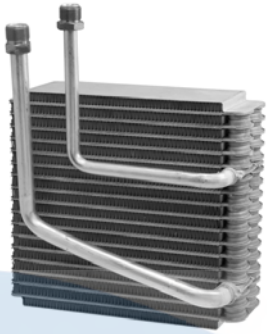

**54784**  
 Depth 3    Height 3-1/8    Width  
 Plate & Fin Evaporator Core  
 O-Rings: (1) **24608**, (1) **24610**  
 Mazda (02-98)  
 Mazda: GD7A61J10A

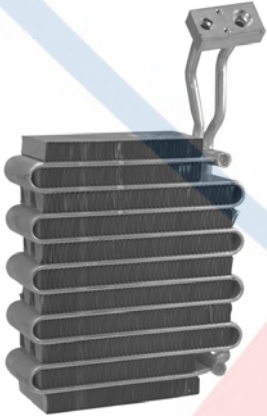

**54785**  
 Serpentine Evaporator Core  
 Inlet: Block Fitting  
 Outlet: Block Fitting  
 O-Rings: (1) **24149**  
 Chrysler (92-90); Dodge (93-91)  
 Chrysler: 4882976AC  
 Euclid: E811001, E811006



**54786**  
 Serpentine Evaporator Core  
 O-Rings: (1) **24608**, (1) **24610**  
 Toyota (91)

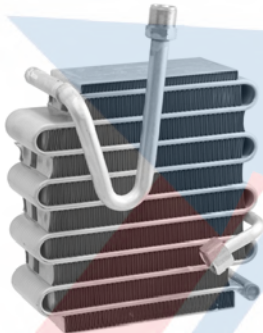

**54788**  
 Serpentine Evaporator Core  
 O-Rings: (1) **24608**, (1) **24610**  
 Toyota (98-93)  
 Toyota: 8850134010

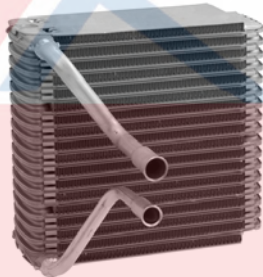

**54790**  
 Plate & Fin Evaporator Core  
 O-Rings: (3) **24668**, (3) **24670**  
 Ford (00-95); Mercury (00-95)



**54791**  
 Depth 3-1/2    Height 3-5/8    Width  
 Plate & Fin Evaporator Core  
 O-Rings: (3) **24668**, (3) **24670**  
 Ford (97-95); Mazda (97-95); Mercury (97)

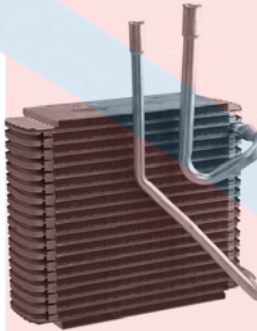

**54792**  
 Plate & Fin Evaporator Core  
 O-Rings: (3) **24668**, (3) **24670**  
 Ford (03-95)  
 Ford: F58Z19850BA

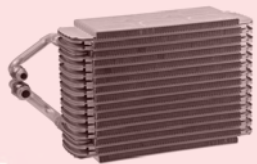

**54793**  
 Plate & Fin Evaporator Core  
 O-Rings: (1) **24608**, (1) **24610**  
 Ford (98-97)



**54794**  
 Serpentine Evaporator Core  
 O-Rings: (1) **24608**, (1) **24610**  
 Nissan (99-95)  
 Nissan: 272801M200

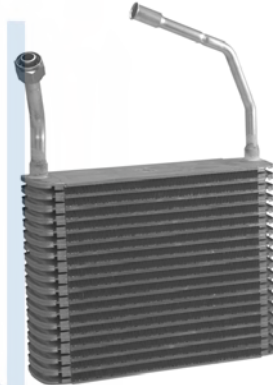

**54795**  
 Plate & Fin Evaporator Core  
 O-Rings: (1) **24610**, (2) **24668**, (1) **38635**  
 Ford (09-01); Mazda (09-02)  
 Ford: 1L5Z19850FC  
 Mazda: 1F2161J41B



**54796**  
 Plate & Fin Evaporator Core  
 O-Rings: (1) **24608**, (2) **24670**  
 Ford (93-92)  
 Kysor: 1611003



# Evaporator Cores

## Evaporator Cores Cont'd



### 54798

Depth	Height	Width
3-9/16	3-5/8	

Plate & Fin Evaporator Core  
O-Rings: (3) **24668**, (3) **24672**  
Ford (07-96); Lincoln (02-95); Mercury (05-96)

Ford: 1F1Z19850CA, 1F1Z19850DA

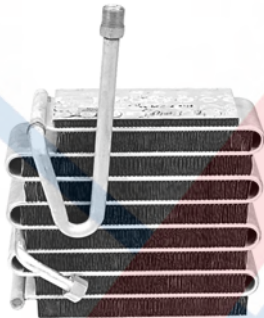

### 54799

Serpentine Evaporator Core  
O-Rings: (1) **24608**, (1) **24610**  
Toyota (90-87)

Toyota: 8850116070



### 54800

Depth	Height	Width
3-1/2	3-1/4	

Serpentine Evaporator Core  
Mazda (90-86)

Mazda: 000067B31A0P

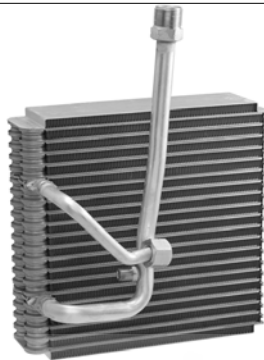

### 54801

Plate & Fin Evaporator Core  
O-Rings: (1) **24676**, (1) **24677**  
Mazda (00-99)

Mazda: BJ0E61J10A

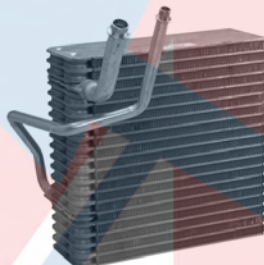

### 54802

Depth	Height	Width
3-1/2	3-3/4	

Plate & Fin Evaporator Core  
O-Rings: (1) **24668**, (1) **24679**  
Jeep (04-02)

Chrysler: 5101786AB

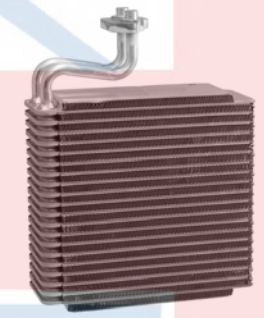

### 54803

Plate & Fin Evaporator Core  
Inlet: Block Fitting  
Outlet: Block Fitting  
O-Rings: (2) **24608**  
Geo (91-90)

General Motors Corp: 94380552



### 54804

Plate & Fin Evaporator Core  
O-Rings: (3) **24668**, (3) **24672**  
Ford (05-03); Lincoln (05-03); Mercury (05-03)

Ford: 4L2Z19850FB

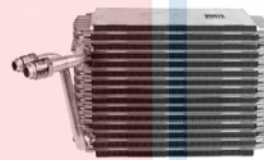

### 54805

Plate & Fin Evaporator Core  
O-Rings: (1) **24608**, (1) **24610**  
Ford (04-03); Lincoln (04-03)

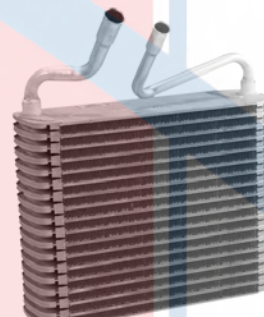

### 54806

Plate & Fin Evaporator Core  
O-Rings: (3) **24668**, (3) **24670**  
Ford (08-03); Lincoln (08-03)

Ford: 7L3Z19860B

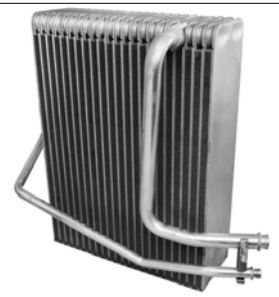

### 54807

Depth	Height	Width
3-1/2	3-5/8	

Plate & Fin Evaporator Core  
O-Rings: (1) **24622**, (1) **24649**  
Chrysler (08-01); Dodge (07-01)  
For Use with Vertical Mounted TXV

Chrysler: 5019217AG



### 54808

Depth	Height	Width
3	2-7/8	

Plate & Fin Evaporator Core  
O-Rings: (2) **24608**, (2) **24612**  
Chrysler (00-96); Dodge (00-96);  
Plymouth (00-96)

Chrysler: 4798681AC

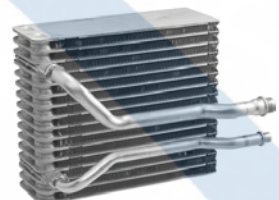

### 54809

Plate & Fin Evaporator Core  
Inlet: Block Fitting  
O-Rings: (1) **24622**, (1) **24649**  
Chrysler (03-01); Dodge (05-01)

Chrysler: 68064307AB

# Evaporator Cores

## Evaporator Cores Cont'd

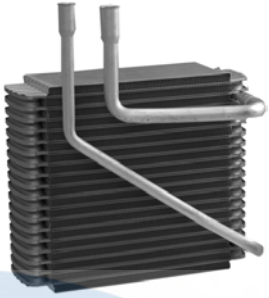

**54810**  
Plate & Fin Evaporator Core  
O-Rings: (3) **24668**, (3) **24670**  
Ford (07-01); Mazda (06-01); Mercury (07-05)

Ford: 4L8Z19860AA, 6L8Z18456AB, 6L8Z19850AA  
Mazda: EFY061J10A

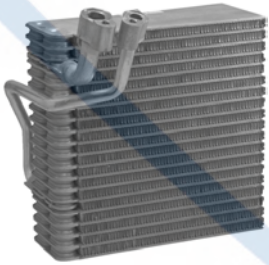

**54811**  
Depth Height Width  
3-1/2 10-3/4 9-3/4  
Plate & Fin Evaporator Core  
Inlet: Block Fitting  
Outlet: Block Fitting  
O-Rings: (1) **24402**, (1) **24404**  
Jeep (01-99)

Chrysler: 5012697AD

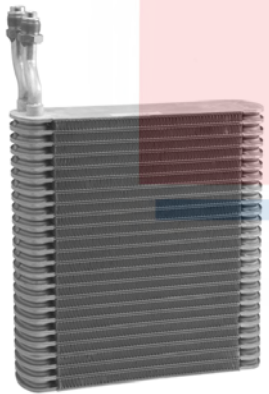

**54812**  
Plate & Fin Evaporator Core  
O-Rings: (1) **24608**, (1) **24610**  
Jeep (96-91)

Chrysler: 4773117

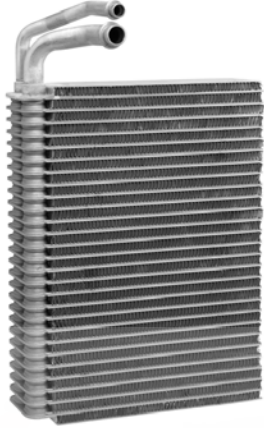

**54817**  
Depth Height Width  
2-9/16 15-1/8 5-3/4

Plate & Fin Evaporator Core  
O-Rings: (1) **24622**, (1) **24649**  
Chrysler (10-05); Dodge (10-05)

Chrysler: 5061585AA

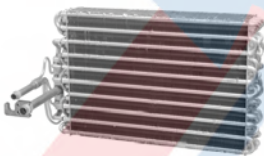

**54818**  
Depth Height Width  
2-5/8 16-1/4 7-1/8

Tube & Fin Evaporator Core  
O-Rings: (1) **24649**, (1) **24681**  
Chrysler (08-04); Mercedes (04-00)

Chrysler: 5101290AA  
Mercedes Benz: 1708300258



**54822**  
Depth Height Width  
1-1/2 12-7/16 1-1/2

Plate & Fin Evaporator Core  
Inlet: Block Fitting  
Outlet: Block Fitting  
O-Rings: (1) **24661**, (1) **24681**  
Jaguar (15-09); Lexus (14-06); Toyota (14-10)

Jaguar: C2Z6527  
Lexus: 885013A161, 8850160421  
Toyota: 8850160421



**54826**  
Depth Height Width  
3-1/2 11 5-1/2

Plate & Fin Evaporator Core  
Inlet: Block Fitting  
Outlet: Block Fitting  
O-Rings: (2) **24610**  
Lexus (95-93)

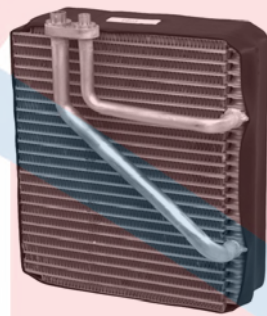

**54827**  
Depth Height Width  
2-7/8 11-1/4 4-1/2

Plate & Fin Evaporator Core  
Inlet: Block Fitting  
Outlet: Block Fitting  
O-Rings: (1) **24608**, (1) **24610**  
Infiniti (02-00)

Infiniti: 272807J201

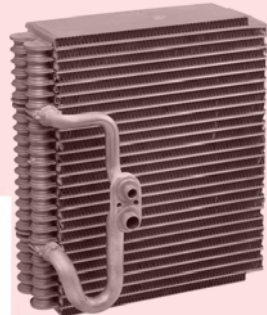

**54828**  
Depth Height Width  
2-7/8 10-51/64 5-3/4

Plate & Fin Evaporator Core  
Inlet: Block Fitting  
Outlet: Block Fitting  
O-Rings: (1) **24608**, (1) **24610**  
Infiniti (06-02)

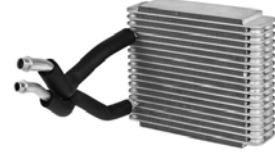

**54829**  
Depth Height Width  
2-1/4 7-3/8 12-7/8

Plate & Fin Evaporator Core  
Inlet: Block Fitting  
Outlet: Block Fitting  
O-Rings: (1) **24608**, (1) **24610**  
Infiniti (10-04); Nissan (15-04)

Nissan: 27411ZF00A, 27411ZQ00A

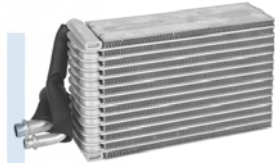

**54830**  
Depth Height Width  
2-9/16 5-1/2 4

Plate & Fin Evaporator Core  
Inlet: Block Fitting  
Outlet: Block Fitting  
O-Rings: (1) **24109**, (1) **24649**  
Jeep (10-06)

Chrysler: 68057726AA

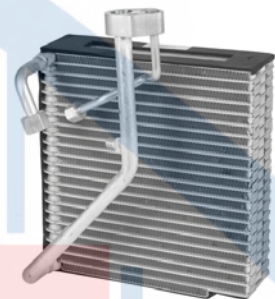

**54831**  
Depth Height Width  
2-9/16 11-1/4 5

Plate & Fin Evaporator Core  
Inlet: Block Fitting  
Outlet: Block Fitting  
O-Rings: (1) **24607**, (1) **24608**, (1) **24642**, (1) **24676**  
Mitsubishi (03-00)



# Evaporator Cores

## Evaporator Cores Cont'd



### 54833

Depth	Height	Width
2-5/16	10-1/8	2-5/16

Plate & Fin Evaporator Core

Inlet: Block Fitting

O-Rings: (1) **24661**, (1) **24681**

Mitsubishi (12-04)

Mitsubishi: 7801A639

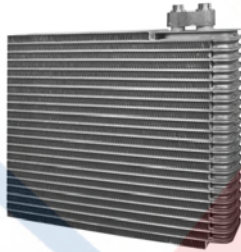

### 54834

Depth	Height	Width
2-5/16		

Plate & Fin Evaporator Core

Inlet: Block Fitting

Outlet: Block Fitting

O-Rings: (1) **24608**, (1) **24610**

Mitsubishi (03-99)

Mitsubishi: MR460371



### 54835

Depth	Height	Width
1-7/8	12	5

Plate & Fin Evaporator Core

Inlet: Block Fitting

O-Rings: (1) **24402**, (1) **24403**

Ford (07-06); Lincoln (09-06); Mercury (07-06)

Ford: 6H6Z19860BA



### 54837

Depth	Height	Width
2-3/8	15-1/4	2-7/16

Plate & Fin Evaporator Core

O-Rings: (3) **24668**, (3) **24670**

Jeep (06-02)

Chrysler: 5073178AA

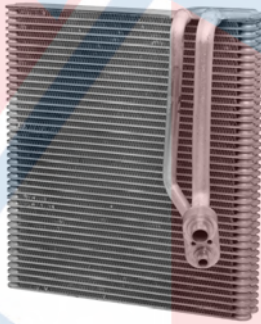

### 54838

Plate & Fin Evaporator Core

O-Rings: (1) **24622**, (1) **24661**

Jeep (11-07)

Chrysler: 68004194AC



### 54840

Depth	Height	Width
2-1/4	10-3/4	2-1/4

Plate & Fin Evaporator Core

Inlet: Block Fitting

Outlet: Block Fitting

O-Rings: (1) **24150**, (1) **24661**

Infiniti (08-07); Nissan (15-03)

Infiniti: 27280AM60B, 27280AM60C

Nissan: 272808J000, 272808J500,

27280AM60B, 27280AM60C,

27281CB62A

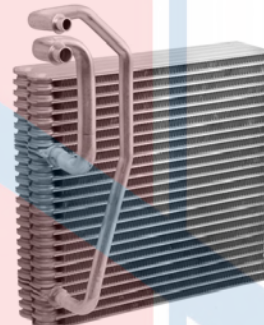

### 54841

Depth	Height	Width
2-1/4	13-1/4	7

Plate & Fin Evaporator Core

O-Rings: (1) **24150**, (1) **24661**

Nissan (09-04)

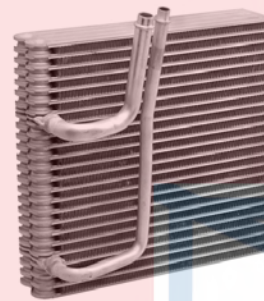

### 54843

Depth	Height	Width
2-1/4	11-1/8	5

Plate & Fin Evaporator Core

O-Rings: (1) **24608**, (1) **24610**

Nissan (09-05)

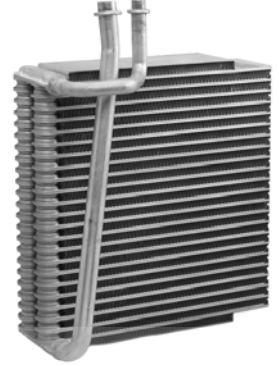

### 54845

Depth	Height	Width
2-3/8	12-1/4	4-3/8

Plate & Fin Evaporator Core

O-Rings: (1) **24402**, (1) **24403**

Pontiac (09-06); Saturn (10-07)

General Motors Corp: 24301327,

89024990

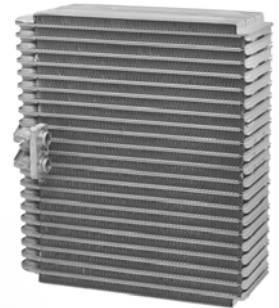

### 54846

Depth	Height	Width
3-1/2	11-1/2	5

Plate & Fin Evaporator Core

Inlet: Block Fitting

Outlet: Block Fitting

O-Rings: (2) **24610**

Pontiac (06-04)

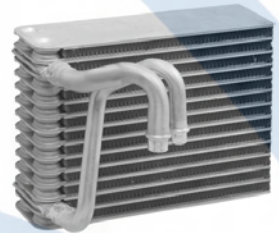

### 54849

Depth	Height	Width
2-3/8	5-5/8	6

Plate & Fin Evaporator Core

O-Rings: (1) **24608**, (1) **24610**

Volvo (11-03)

Volvo: 30767300



# Evaporator Cores

## Evaporator Cores Cont'd



**54850**  
 Depth 2-3/8 Height 10-11/16 Width 7-1/2  
 Plate & Fin Evaporator Core  
 Inlet: Block Fitting  
 Outlet: Block Fitting  
 O-Rings: (2) **24109**  
 Hyundai (12-06)

Hyundai: 971403K000, 971403K001



**54851**  
 Depth 2-7/8 Height 10-1/2 Width 6-1/2  
 Plate & Fin Evaporator Core  
 O-Rings: (1) **24608**, (1) **24610**  
 Saturn (05-00)

Saturn: 22713734



**54852**  
 Depth 1-1/2 Height 11-1/2 Width 4-1/2

Plate & Fin Evaporator Core  
 Inlet: Block Fitting  
 O-Rings: (1) **24661**, (1) **24681**  
 Lexus (14-07); Toyota (14-05)

Lexus: 8850106113, 8850148301, 8850148311  
 Toyota: 8850106111, 8850106113, 8850106230, 8850133210, 885014830, 8850148311

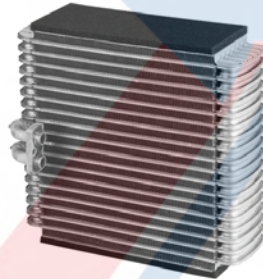

**54853**  
 Plate & Fin Evaporator Core  
 O-Rings: (2) **24610**  
 Toyota (99-94)

Toyota: 8850120381



**54854**  
 Depth 2-15/16 Height Width

Plate & Fin Evaporator Core  
 Inlet: Captive O-Ring  
 Outlet: Captive O-Ring  
 O-Rings: (2) **24109**  
 Hyundai (10-05); Kia (10-05)

Hyundai: 971392E210  
 Kia: 971391F200

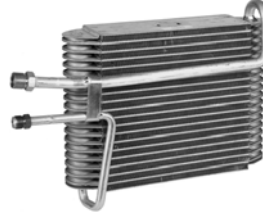

**54855**  
 Plate & Fin Evaporator Core  
 O-Rings: (1) **24668**, (1) **24672**  
 Volvo (98-92)

Volvo: 3506736

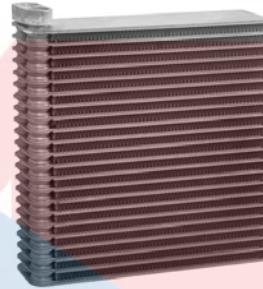

**54856**  
 Plate & Fin Evaporator Core  
 Inlet: Block Fitting  
 Outlet: Block Fitting  
 O-Rings: (1) **24668**, (1) **24670**  
 Volvo (13-04)

Volvo: 30767329

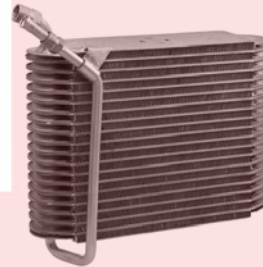

**54858**  
 Depth 2-7/8 Height 12-1/2 Width 3-1/2  
 Plate & Fin Evaporator Core  
 O-Rings: (1) **24668**, (1) **24670**  
 Volvo (95-92)



**54859**  
 Depth 3-1/2 Height 10 Width 5

Plate & Fin Evaporator Core  
 Inlet: Block Fitting  
 Outlet: Block Fitting  
 O-Rings: (2) **24682**  
 Toyota (02-96)

Toyota: 8850135050



**54860**  
 Plate & Fin Evaporator Core  
 Inlet: Block Fitting  
 Outlet: Block Fitting  
 O-Rings: (1) **24149**  
 Chrysler (02-01); Dodge (02-01)

Chrysler: 5018751AA, 5018751AC

# Evaporator Cores

## Evaporator Cores Cont'd



### 54861

Plate & Fin Evaporator Core  
O-Rings: (1) **24622**, (1) **24628**  
Chrysler (06-03); Dodge (06-03)

Chrysler: 68234946AA



### 54862

Depth	Height	Width
3-1/8	13	3-1/8

Plate & Fin Evaporator Core  
Inlet: Block Fitting  
Outlet: Block Fitting  
O-Rings: (1) **24068**, (1) **24069**  
Jeep (05-02)

Chrysler: 5066549AD



### 54863

Plate & Fin Evaporator Core  
Inlet: Block Fitting  
Outlet: Block Fitting  
O-Rings: (1) **24402**, (1) **24404**  
Buick (07-04); Chevy (09-03); GMC (09-03); Isuzu (08-03); Olds (04-03); Saab (09-05)

General Motors Corp: 89019026

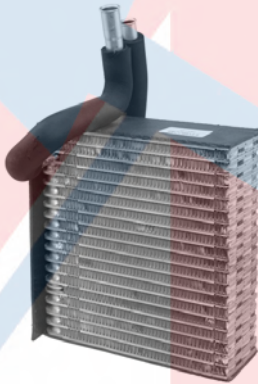

### 54864

Depth	Height	Width
2-15/16	14	8

Plate & Fin Evaporator Core  
O-Rings: (3) **24668**, (3) **24670**  
Dodge (06-02)

Chrysler: 5073970AB

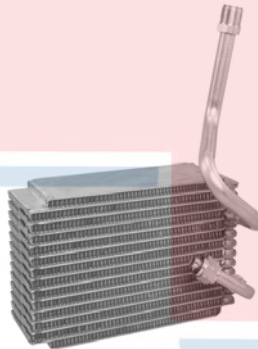

### 54865

Depth	Height	Width
2-7/8	3-1/4	

Plate & Fin Evaporator Core  
O-Rings: (1) **24608**, (1) **24610**  
Cadillac (00-99); Chevy (00-97); GMC (00-97)

General Motors Corp: 12472427



### 54867

Depth	Height	Width
2-3/8	6-5/8	4-5/8

Serpentine Evaporator Core  
O-Rings: (1) **24608**, (1) **24642**  
Buick (04); Chevy (04-02); GMC (04-02); Isuzu (04-03); Olds (02)

General Motors Corp: 89023466

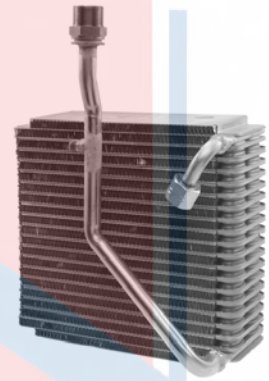

### 54869

Plate & Fin Evaporator Core  
O-Rings: (1) **24082**, (1) **24608**  
Nissan (94-93)

Nissan: 272807E102

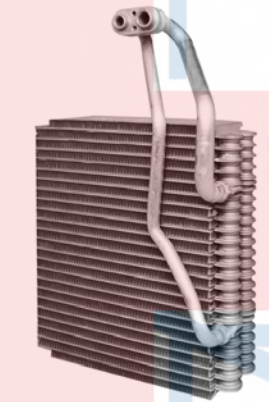

### 54870

Plate & Fin Evaporator Core  
Inlet: Block Fitting  
Outlet: Block Fitting  
O-Rings: (1) **24661**, (1) **24681**  
Acura (05-02); Honda (05-02)

Honda: 80211S6DG12

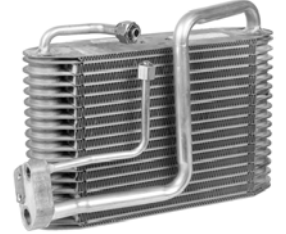

### 54871

Depth	Height	Width
2-7/8	10-1/8	4-5/8

Plate & Fin Evaporator Core  
Inlet: Block Fitting  
Outlet: Block Fitting  
O-Rings: (1) **24402**, (1) **24404**, (1) **24606**, (1) **24608**  
Cadillac (06-03); Chevy (06-00); GMC (06-00)

General Motors Corp: 89019057



### 54873

Plate & Fin Evaporator Core  
Inlet: Block Fitting  
Outlet: Block Fitting  
O-Rings: (1) **24402**, (1) **24404**  
Cadillac (14-02); Chevy (14-03); GMC (14-03)

General Motors Corp: 89019027



# Evaporator Cores

## Evaporator Cores Cont'd

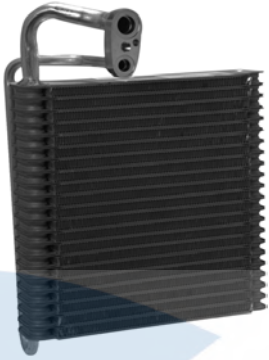

**54874**  
 Plate & Fin Evaporator Core  
 Inlet: Block Fitting  
 Outlet: Block Fitting  
 O-Rings: (1) **24402**, (1) **24404**  
 Buick (05-00); Cadillac (05-00); Olds (03-01); Pontiac (05-00)  
 General Motors Corp: 52494344



**54875**  
 Plate & Fin Evaporator Core  
 Inlet: Block Fitting  
 Outlet: Block Fitting  
 O-Rings: (1) **24402**, (1) **24404**, (1) **24606**, (1) **24608**  
 Cadillac (06-02); Chevy (06-00); GMC (06-00)  
 General Motors Corp: 12477713

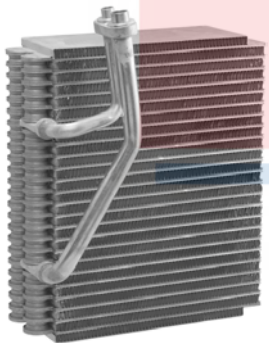

**54876**  
 Plate & Fin Evaporator Core  
 O-Rings: (1) **24608**, (1) **24610**  
 Infiniti (04-00); Nissan (03-00)  
 Nissan: 272802Y960

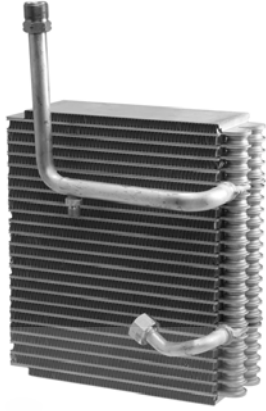

**54877**  
 Plate & Fin Evaporator Core  
 O-Rings: (1) **24608**, (1) **24610**  
 Infiniti (96); Nissan (96-95)  
 Nissan: 2728040U01, 2728040U03

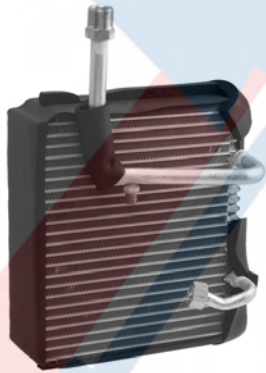

**54878**  
 Plate & Fin Evaporator Core  
 O-Rings: (1) **24604**, (1) **24608**, (1) **24682**  
 Infiniti (99-96); Nissan (99-95)  
 Nissan: 272800L700, 2728040U08, 2728040U11



**54879**  
 Plate & Fin Evaporator Core  
 Inlet: Block Fitting  
 O-Rings: (1) **24608**, (1) **24610**  
 Audi (06-00); VW (08-98)  
 Volkswagen: 1J1820007, 1J1820007B

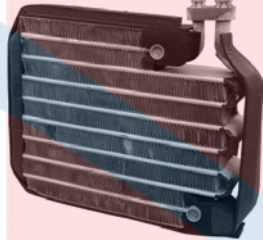

**54882**  
 Serpentine Evaporator Core  
 Inlet: Block Fitting  
 Outlet: Block Fitting  
 O-Rings: (1) **24661**, (1) **24681**  
 Chrysler (05-01); Dodge (05-01); Mitsubishi (05-00)  
 Chrysler: MR500465  
 Mitsubishi: MR500465

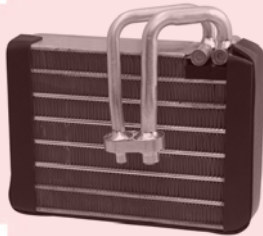

**54883**  
 Serpentine Evaporator Core  
 Inlet: Block Fitting  
 Outlet: Block Fitting  
 O-Rings: (1) **24402**, (1) **24404**  
 Chevy (05-01); Olds (04-01); Pontiac (05-01)  
 General Motors Corp: 10323437

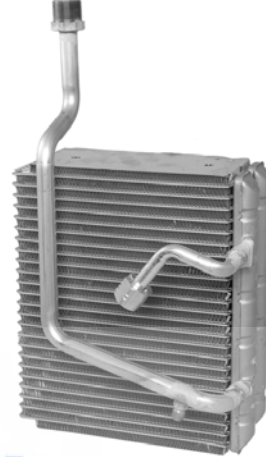

**54884**  
 Plate & Fin Evaporator Core  
 O-Rings: (1) **24608**, (1) **24682**  
 Nissan (99-98)

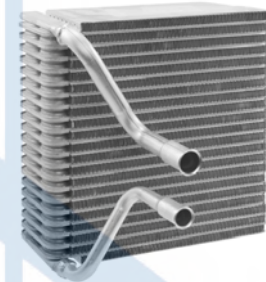

**54888**  
 Plate & Fin Evaporator Core  
 O-Rings: (2) **24668**, (2) **24670**  
 Jaguar (08-02); Mercury (02-01)  
 Jaguar: C2S15776

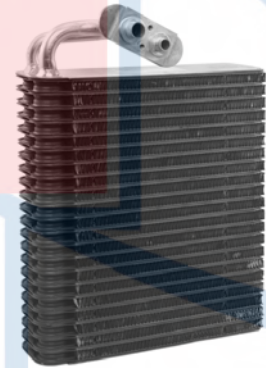

**54890**  
 Plate & Fin Evaporator Core  
 Inlet: Block Fitting  
 Outlet: Block Fitting  
 O-Rings: (1) **24402**, (1) **24403**  
 Buick (09-04); Chevy (14-04); Pontiac (08-04)  
 General Motors Corp: 89019127



# Evaporator Cores

## Evaporator Cores Cont'd



### 54891

Plate & Fin Evaporator Core  
O-Rings: (1) **24608**, (3) **24670**  
Ford (10-02); Lincoln (05-03); Mercury (10-03)

Ford: 6L2Z19860EB

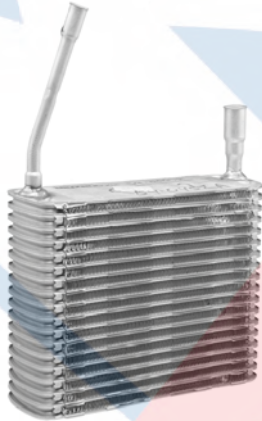

### 54893

Depth	Height	Width
3-9/16	3-1/2	

Plate & Fin Evaporator Core  
O-Rings: (3) **24668**, (3) **24670**, (1) **38639**  
Ford (11-03); Mercury (11-03)

Ford: 3W7Z19860AA



### 54895

Depth	Height	Width
2-1/4	11	2-1/4

Plate & Fin Evaporator Core  
Inlet: Block Fitting  
O-Rings: (1) **24661**, (1) **24681**  
Toyota (05-00)

Toyota: 8850120500



### 54896

Depth	Height	Width
2-3/8	15	3-1/2

Plate & Fin Evaporator Core  
Inlet: Block Fitting  
Outlet: Block Fitting  
O-Rings: (1) **24149**  
Chrysler (05-04); Dodge (05-04)

Chrysler: 5139813AA

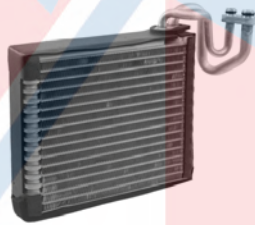

### 54898

Depth	Height	Width
2-5/16	9-3/4	3-3/4

Plate & Fin Evaporator Core  
Inlet: Block Fitting  
Outlet: Block Fitting  
O-Rings: (1) **24661**, (1) **24681**  
Honda (11-01)

Honda: 80215S5DG01

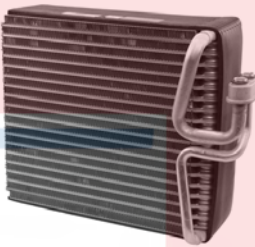

### 54899

Plate & Fin Evaporator Core  
Inlet: Block Fitting  
Outlet: Block Fitting  
O-Rings: (2) **24681**  
Toyota (03-97)

Toyota: 8850106030



### 54900

Plate & Fin Evaporator Core  
O-Rings: (1) **24661**, (1) **24681**  
Acura (03-99); Honda (02-98)

Honda: 80215S84A01



### 54903

Plate & Fin Evaporator Core  
Inlet: Block Fitting  
Outlet: Block Fitting  
O-Rings: (1) **24661**, (1) **24681**  
Scion (06-04); Toyota (05-00)

Toyota: 8850152041, 8850152080

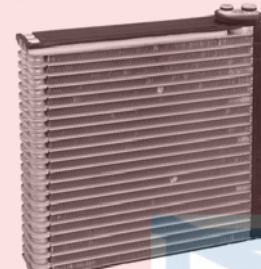

### 54904

Depth	Height	Width
2-5/16	11-7/8	2-1/4

Plate & Fin Evaporator Core  
Inlet: Block Fitting  
O-Rings: (1) **24661**, (1) **24681**  
Lexus (06-02); Toyota (08-00)

Lexus: 8850133090  
Toyota: 8850107020

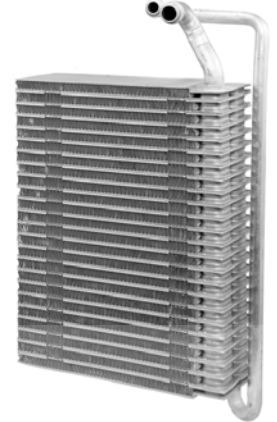

### 54907

Plate & Fin Evaporator Core  
Inlet: Block Fitting  
O-Rings: (1) **24608**, (1) **24610**  
BMW (10-99)

BMW: 64118372772, 64119135744



### 54908

Depth	Height	Width
2-7/8	10	3

Plate & Fin Evaporator Core  
Inlet: Block Fitting  
Outlet: Block Fitting  
O-Rings: (1) **24608**, (1) **24610**  
Nissan (06-00)

Nissan: 272804Z410

# Evaporator Cores

## Evaporator Cores Cont'd



**54909**  
 Depth 2-3/8 Height 14-1/4 Width 7-1/4  
 Plate & Fin Evaporator Core  
 Inlet: Block Fitting  
 Outlet: Block Fitting  
 O-Rings: (1) **24608**, (1) **24612**  
 Audi (02-97); VW (05-98)

Volkswagen: 8D1820103G

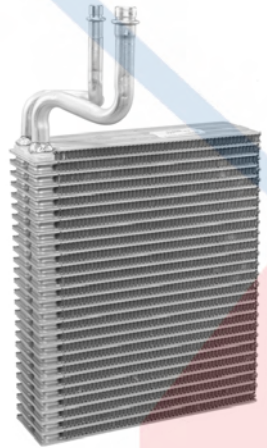

**54910**  
 Depth 2-9/16 Height 16-3/8 Width 5-1/4  
 Plate & Fin Evaporator Core  
 Inlet: Flange  
 O-Rings: (1) **24626**, (1) **24642**  
 Dodge (06-04)

Chrysler: 5061341AC



**54911**  
 Plate & Fin Evaporator Core  
 O-Rings: (3) **24668**, (3) **24670**  
 Dodge (11-05); Mitsubishi (09-06)

Chrysler: 5161083AA

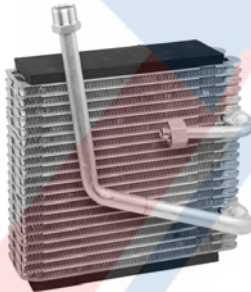

**54912**  
 Depth 2-3/8 Height Width  
 Plate & Fin Evaporator Core  
 O-Rings: (1) **24608**, (1) **24681**  
 Acura (99); Honda (02-99); Isuzu (04-97)

Isuzu: 8971652911, 8972029450, 8972591471, 8972891450, 897357692

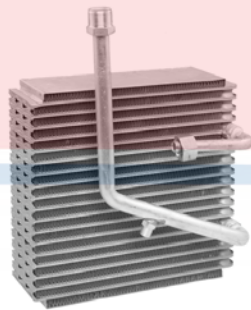

**54913**  
 Depth 2-7/8 Height 12-7/16 Width 4-7/8  
 Plate & Fin Evaporator Core  
 O-Rings: (1) **24608**, (1) **24681**  
 Honda (98); Isuzu (98)

Honda: 8971678190  
 Isuzu: 8971673180



**54914**  
 Depth 2-1/4 Height 2-5/16 Width  
 Plate & Fin Evaporator Core  
 O-Rings: (1) **24608**, (1) **24612**  
 Cadillac (06-03); Chevy (07-03); GMC (07-03)

General Motors Corp: 19258418

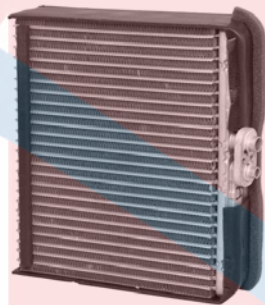

**54915**  
 Plate & Fin Evaporator Core  
 Inlet: Block Fitting  
 Outlet: Block Fitting  
 O-Rings: (1) **24608**, (1) **24610**  
 Mitsubishi (07-02)

Mitsubishi: MR958417



**54916**  
 Depth 2-7/8 Height 16 Width 5-5/8

Plate & Fin Evaporator Core  
 Inlet: Block Fitting  
 O-Rings: (1) **24402**, (1) **24404**  
 Chevy (14-03); GMC (14-03); GMC & CHEVY (14-09)

General Motors Corp: 89019018



**54917**  
 Depth 3-1/2 Height Width

Plate & Fin Evaporator Core  
 O-Rings: (1) **24622**, (1) **24628**  
 Chrysler (04-02); Dodge (04-02)

Chrysler: 5093737AD

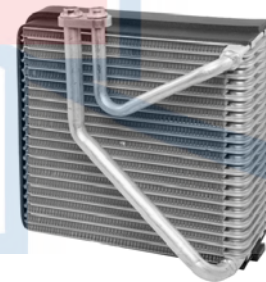

**54918**  
 Depth 3-3/8 Height Width

Plate & Fin Evaporator Core  
 Inlet: Block Fitting  
 O-Rings: (2) **24610**  
 Chevy (06-04); Pontiac (06-05)

General Motors Corp: 96539646



# Evaporator Cores

## Evaporator Cores Cont'd



**54919**

Depth	Height	Width
3		

Plate & Fin Evaporator Core  
O-Rings: (2) **24109**  
Hyundai (02-00)

Hyundai: 9760925000

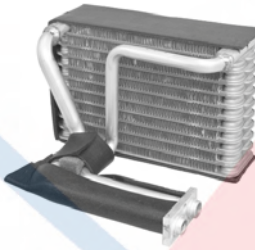

**54920**

Depth	Height	Width
2-1/4	5-9/16	7

Plate & Fin Evaporator Core  
Inlet: Block Fitting  
Outlet: Block Fitting  
O-Rings: (2) **24681**  
Dodge (06-01)

Chrysler: 5019642AA

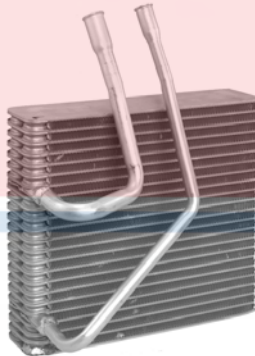

**54922**

Depth	Height	Width
2-1/4		

Plate & Fin Evaporator Core  
O-Rings: (3) **24668**, (3) **24670**  
Ford (07-04); Mercury (07-04)

Ford: 3F2Z19860AA



**54924**

Depth	Height	Width
2-15/16	8-7/8	4-15/16

Plate & Fin Evaporator Core  
Inlet: Block Fitting  
Outlet: Block Fitting  
O-Rings: (2) **24610**  
Kia (02-98)

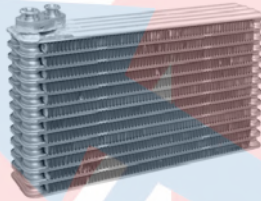

**54925**

Plate & Fin Evaporator Core  
Inlet: Block Fitting  
Outlet: Block Fitting  
O-Rings: (1) **24661**, (1) **24681**  
Honda (04-99)

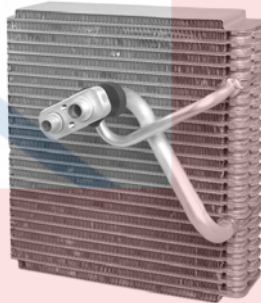

**54926**

Depth	Height	Width
2-3/8		

Plate & Fin Evaporator Core  
Inlet: Block Fitting  
Outlet: Block Fitting  
O-Rings: (1) **24641**, (1) **24649**  
Hyundai (07), (04-01)

Hyundai: 971392D000

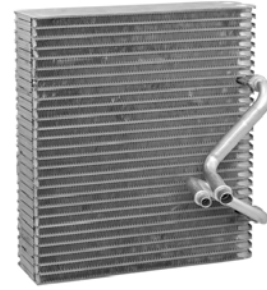

**54927**

Plate & Fin Evaporator Core  
O-Rings: (1) **24608**, (1) **24610**  
Ford (07-05); Mercury (07-05)

Ford: 5F9Z19860CA

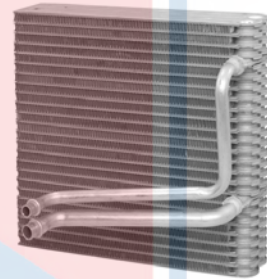

**54928**

Plate & Fin Evaporator Core  
O-Rings: (1) **24608**, (1) **24670**  
Ford (09-05)

Ford: 5R3Z19850A

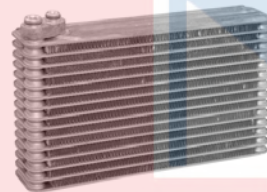

**54930**

Plate & Fin Evaporator Core  
O-Rings: (1) **24642**, (1) **24661**  
Toyota (06-01)

Toyota: 885010C030



**54931**

Plate & Fin Evaporator Core  
O-Rings: (1) **24642**, (1) **24661**  
Lexus (06-01)

Lexus: 8850150211

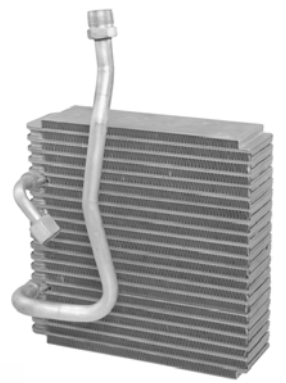

**54932**

Depth	Height	Width
2-3/8	13-3/8	4-1/2

Plate & Fin Evaporator Core  
O-Rings: (1) **24608**, (1) **24642**  
Subaru (99-98)

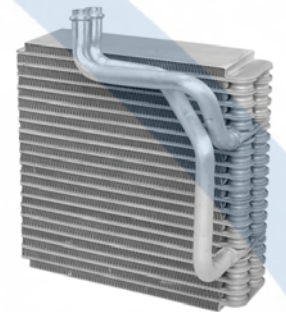

**54933**

Plate & Fin Evaporator Core  
O-Rings: (2) **24610**  
Subaru (06-00)

Subaru: 73523AE010



# Evaporator Cores

## Evaporator Cores Cont'd

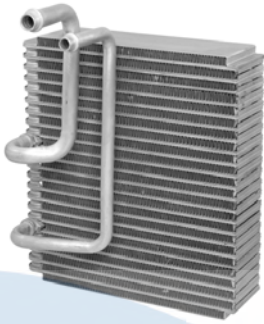

**54934**  
 Depth Height Width  
 2-3/8 11-1/8 6-3/8  
 Plate & Fin Evaporator Core  
 Inlet: Flange  
 O-Rings: (1) **24608**, (1) **24610**  
 Chevy (05); Saturn (05-02)

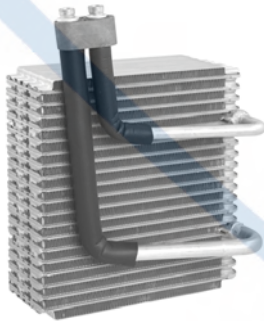

**54935**  
 Plate & Fin Evaporator Core  
 O-Rings: (2) **24659**  
 Hyundai (06-99); Kia (06-01)  
  
 Hyundai: 9761038000  
 Kia: 976073E400

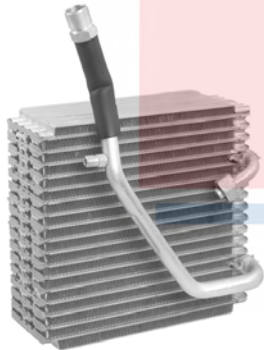

**54937**  
 Depth Height Width  
 2-7/8 13-1/2 5  
 Plate & Fin Evaporator Core  
 O-Rings: (1) **24606**, (2) **24608**, (1) **24610**  
 Subaru (96-93)  
  
 Subaru: 73520FA100



**54938**  
 Plate & Fin Evaporator Core  
 O-Rings: (1) **24661**, (1) **24681**  
 Toyota (07-03)

Toyota: 885010C040

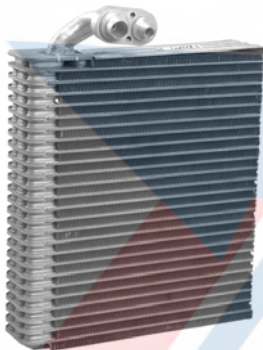

**54939**  
 Plate & Fin Evaporator Core  
 Inlet: Block Fitting  
 Outlet: Block Fitting  
 O-Rings: (1) **24402**, (1) **24404**  
 Buick (07-02); Chevy (08-01); Olds  
 (04-01); Pontiac (06-01); Saturn  
 (07-05)

General Motors Corp: 10318580,  
 10364925

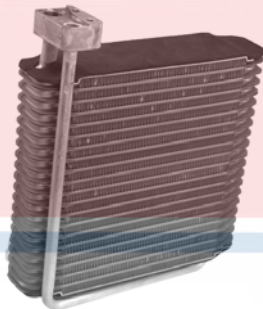

**54940**  
 Depth Height Width  
 2-7/8 13-1/8 3-7/8  
 Plate & Fin Evaporator Core  
 Inlet: Block Fitting  
 Outlet: Block Fitting  
 O-Rings: (1) **24402**, (1) **24404**  
 Chevy (02); GMC (02); Olds (02)  
  
 General Motors Corp: 52495720



**54941**  
 Plate & Fin Evaporator Core  
 O-Rings: (1) **24661**, (1) **24681**  
 Lexus (07-98); Toyota (07-98)

Toyota: 8850160190

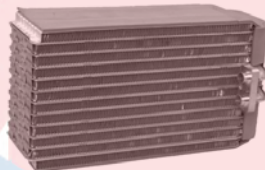

**54942**  
 Depth Height Width  
 3-1/2 6-1/16 5-1/4  
 Plate & Fin Evaporator Core  
 Outlet: Block Fitting  
 O-Rings: (2) **24109**  
 Toyota (03-98)

Toyota: 8850108040

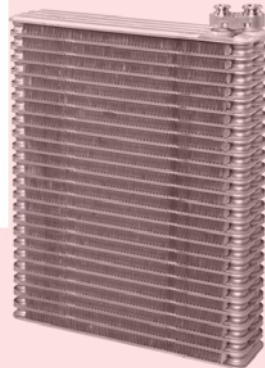

**54943**  
 Plate & Fin Evaporator Core  
 Inlet: Block Fitting  
 Outlet: Block Fitting  
 O-Rings: (1) **24661**, (1) **24681**  
 Lexus (10-98)

Lexus: 885013A050



**54944**  
 Depth Height Width  
 2-5/16 9-1/8 2-5/16  
 Plate & Fin Evaporator Core  
 Inlet: Block Fitting  
 Outlet: Block Fitting  
 O-Rings: (1) **24661**, (1) **24681**  
 Chevy (04-99); Suzuki (04-99)

General Motors Corp: 91175919  
 Suzuki: 9541065D11



**54945**  
 Depth Height Width  
 1-1/2 12-1/8 1-1/2  
 Plate & Fin Evaporator Core  
 Inlet: Block Fitting  
 Outlet: Block Fitting  
 O-Rings: (1) **24661**, (1) **24681**  
 Lexus (09-03); Toyota (14-03)

Lexus: 8850135160  
 Toyota: 8850135151, 8850135160

# Evaporator Cores

## Evaporator Cores Cont'd



### 54946

Depth	Height	Width
3-3/8	10-7/16	5-3/8

Plate & Fin Evaporator Core  
O-Rings: (1) **24610**, (1) **24661**  
Lexus (97-93)

Lexus: 8850130751

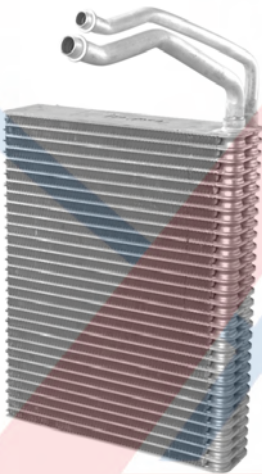

### 54948

Plate & Fin Evaporator Core  
O-Rings: (1) **24642**, (1) **24661**  
Jeep (10-05)

Chrysler: 5143096AC

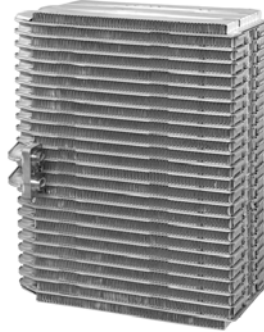

### 54949

Plate & Fin Evaporator Core  
O-Rings: (2) **24681**  
Acura (05-96)

Acura: 80211SZ3A01

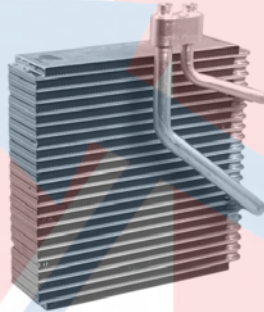

### 54950

Plate & Fin Evaporator Core  
Inlet: Block Fitting  
Outlet: Block Fitting  
O-Rings: (1) **24681**  
Hyundai (05-02)

Hyundai: 976091C001

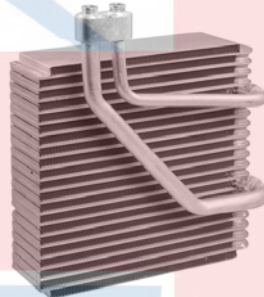

### 54951

Plate & Fin Evaporator Core  
Inlet: Block Fitting  
Outlet: Block Fitting  
O-Rings: (2) **24641**  
Kia (05-01)

Kia: 0K30A61J10, 0K30A61J10A,  
0K30B61J10



### 54954

Depth	Height	Width
1-1/2	14	3-7/16

Plate & Fin Evaporator Core  
Inlet: Block Fitting  
Outlet: Block Fitting  
O-Rings: (1) **24661**, (1) **24681**  
Honda (11-06)

Honda: 80211SNA01

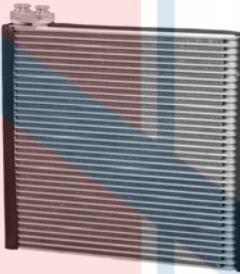

### 54955

Plate & Fin Evaporator Core  
Inlet: Block Fitting  
O-Rings: (1) **24661**, (1) **24681**  
Honda (11-06)

Honda: 80211SVAA01, 80211SWAA03

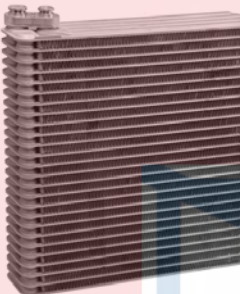

### 54956

Depth	Height	Width
2-1/4	11-9/16	2-1/4

Plate & Fin Evaporator Core  
Inlet: Block Fitting  
Outlet: Block Fitting  
O-Rings: (1) **24661**, (1) **24681**  
Acura (08-04)

Acura: 80211SEAG41



### 54957

Depth	Height	Width
2-5/16	6-1/2	2-5/16

Plate & Fin Evaporator Core  
Inlet: Block Fitting  
Outlet: Block Fitting  
O-Rings: (1) **24661**, (1) **24681**  
Acura (07-01); Honda (08-03)

Acura: 80225S3VA51



### 54958

Plate & Fin Evaporator Core  
Inlet: Block Fitting  
Outlet: Block Fitting  
O-Rings: (1) **24661**, (1) **24681**  
Cadillac (09-04)

General Motors Corp: 19129798

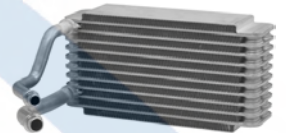

### 54959

Depth	Height	Width
2-5/16	2-1/4	

Plate & Fin Evaporator Core  
Inlet: Flange  
O-Rings: (1) **24608**, (1) **24610**  
Ford (07-05); Mercury (07-06)

Ford: 6M6Z10B810AA



# Evaporator Cores

## Evaporator Cores Cont'd



**54961**

Depth	Height	Width
3-9/16	6-1/16	5

Plate & Fin Evaporator Core

Inlet: Block Fitting

Outlet: Block Fitting

O-Rings: (2) **24610**

Lexus (07-98); Toyota (07-98)

Toyota: 8850160150

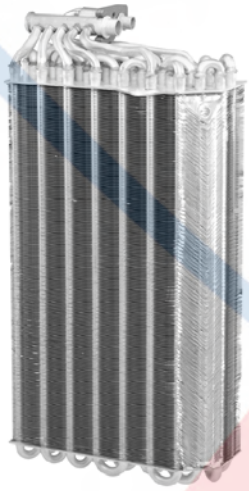

**54962**

Depth	Height	Width
2-5/8	15-1/2	2-7/8

Tube & Fin Evaporator Core

Inlet: Flange

O-Rings: (1) **24608**, (1) **24610**

Cadillac (01-97)



**54963**

Depth	Height	Width
2-5/16	5-1/2	2-5/16

Plate & Fin Evaporator Core

Inlet: Block Fitting

Outlet: Block Fitting

O-Rings: (1) **24402**, (1) **24403**

Buick (14-08); Cadillac (14-07); Chevy (14-07); GMC (14-07); Saturn (10-07)

General Motors Corp: 20827668

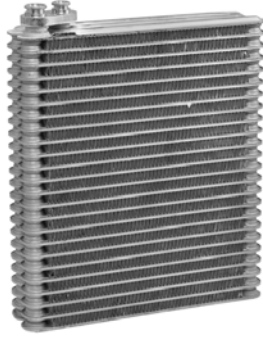

**54964**

Depth	Height	Width
2	10-3/4	2

Plate & Fin Evaporator Core

Inlet: Block Fitting

Outlet: Block Fitting

O-Rings: (1) **24661**, (1) **24681**

Dodge (09-07); Dodge Medium Duty Truck (10-08)

Chrysler: 68004242AA

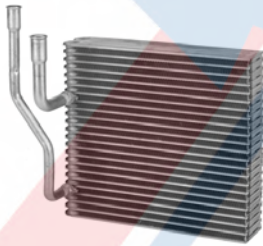

**54965**

Depth	Height	Width
2-5/16	11-3/4	5-1/2

Plate & Fin Evaporator Core

O-Rings: ( ) , (3) **24668**, (3) **24670**

Lincoln (05-03)

Ford: 6W1Z19850CA



**54966**

Depth	Height	Width
2-9/16	21-5/8	4-1/4

Plate & Fin Evaporator Core

Inlet: Block Fitting

Outlet: Block Fitting

Chrysler (10-06)

Chrysler: 5179484AA

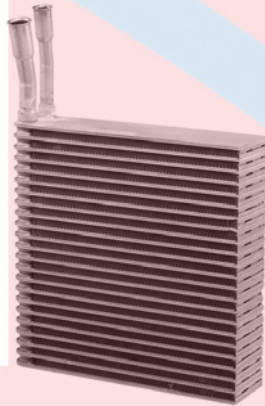

**54967**

Depth	Height	Width
2-3/8	13-1/4	2-3/4

Plate & Fin Evaporator Core

O-Rings: (3) **24668**, (3) **24670**

Jeep (07-06)

Chrysler: 5189335AA

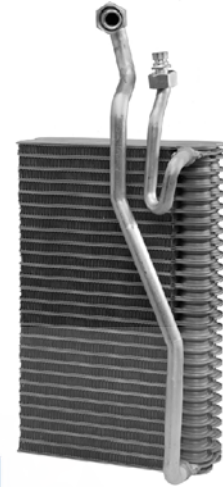

**54968**

Depth	Height	Width
2-7/8	18-1/4	4-7/8

Plate & Fin Evaporator Core

Inlet: Block Fitting

O-Rings: (1) **24661**, (1) **24681**

Acura (98-95)

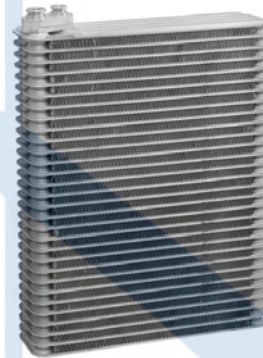

**54969**

Depth	Height	Width
2-5/16	13-1/8	2-5/16

Plate & Fin Evaporator Core

Inlet: Block Fitting

Outlet: Block Fitting

O-Rings: (1) **24661**, (1) **24681**

Cadillac (09-03)

General Motors Corp: 89024954



# Evaporator Cores

## Evaporator Cores Cont'd



### 54970

Depth	Height	Width
3-3/8	18-1/4	11-1/2

Serpentine Evaporator Core  
 Inlet: Block Fitting  
 Outlet: Block Fitting  
 O-Rings: (1) **24606**, (1) **24607**,  
 (1) **24608**, (1) **24672**  
 Acura (94-92)

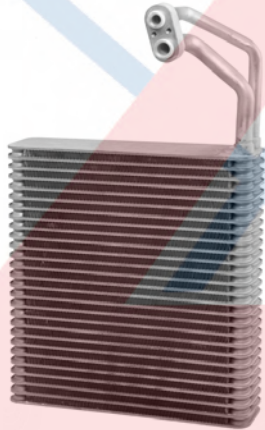

### 54971

Plate & Fin Evaporator Core  
 Inlet: Block Fitting  
 Outlet: Block Fitting  
 O-Rings: (1) **24661**, (1) **24681**  
 Honda (07-03)

Honda: 80211SDAA01



### 54973

Depth	Height	Width
1-1/2	12-3/8	5

Plate & Fin Evaporator Core  
 Inlet: Flange  
 O-Rings: (1) **24402**, (1) **24403**  
 Chevy (09-06); Pontiac (09-06); Saturn  
 (09-08); Suzuki (09-07)

General Motors Corp: 19257977  
 Suzuki: 9541078J01

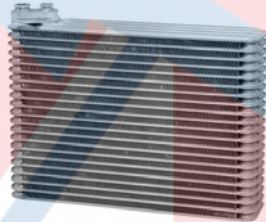

### 54975

Depth	Height	Width
2-5/16	9-5/8	2-5/16

Plate & Fin Evaporator Core  
 Inlet: Block Fitting  
 O-Rings: (1) **24661**, (1) **24681**  
 Mazda (06-00)

Mazda: LC7061J10A

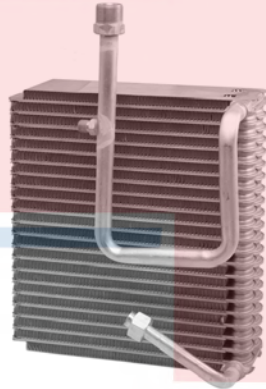

### 54976

Depth	Height	Width
2-15/16	13-5/8	5-1/4

Plate & Fin Evaporator Core  
 O-Rings: (1) **24642**, (1) **24661**  
 Honda (01-97)

Honda: 80215S30A01



### 54978

Depth	Height	Width
3-1/2	10-1/2	5

Plate & Fin Evaporator Core  
 Inlet: Block Fitting  
 O-Rings: (2) **24610**  
 Honda (98-95); Isuzu (99-96)

Honda: 80211SX0A01  
 Isuzu: 5862040690

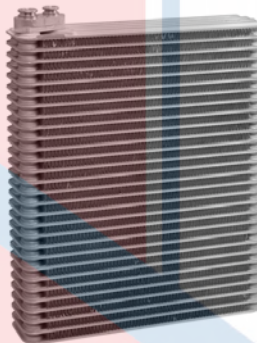

### 54979

Depth	Height	Width
2-5/16	12-3/16	2-5/16

Plate & Fin Evaporator Core  
 Inlet: Block Fitting  
 Outlet: Block Fitting  
 O-Rings: (1) **24661**, (1) **24681**  
 Lexus (05-99)

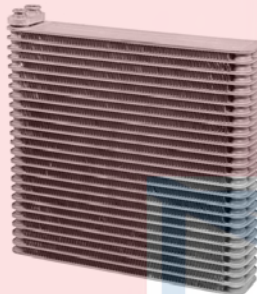

### 54981

Depth	Height	Width
2-5/16	10-3/4	2-5/16

Plate & Fin Evaporator Core  
 Inlet: Block Fitting  
 O-Rings: (1) **24661**, (1) **24681**  
 Acura (09-04); Honda (07-03)

Honda: 80211SDNA11



### 54983

Depth	Height	Width
1-1/2	7-1/2	1-1/2

Plate & Fin Evaporator Core  
 Inlet: Block Fitting  
 Outlet: Block Fitting  
 O-Rings: (1) **24661**, (1) **24681**  
 Honda (10-08), (06-05)

Honda: 80225SHJA02, 80225SHJA03



### 54985

Depth	Height	Width
2-7/8	14-5/8	4-7/16

Plate & Fin Evaporator Core  
 Inlet: Block Fitting  
 Outlet: Block Fitting  
 O-Rings: (1) **24608**, (1) **24610**  
 Pontiac (08-03)

General Motors Corp: 88970280

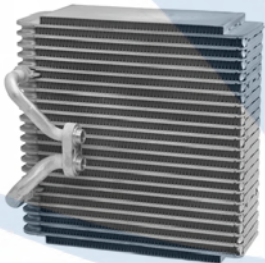

### 54987

Plate & Fin Evaporator Core  
 Inlet: Block Fitting  
 Outlet: Block Fitting  
 O-Rings: (2) **24610**  
 Kia (02)

Kia: 1K52Y61C02

# Evaporator Cores

## Evaporator Cores Cont'd

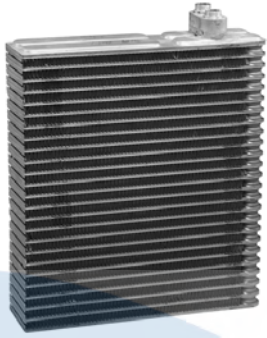

**54988**  
 Depth 2-3/8 Height 11-1/4 Width 2-3/8  
 Plate & Fin Evaporator Core  
 Inlet: Block Fitting  
 Outlet: Block Fitting  
 O-Rings: (2) **24681**  
 Honda (09-00)

Honda: 80215S2A315, 80215S2AA02

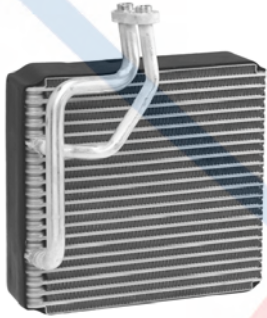

**54989**  
 Depth 2-3/8 Height 11-1/4 Width 5-1/8  
 Plate & Fin Evaporator Core  
 Inlet: Block Fitting  
 Outlet: Block Fitting  
 O-Rings: (2) **24610**  
 Subaru (02-01)



**54991**  
 Depth 2-15/16 Height 13-7/16 Width 5  
 Plate & Fin Evaporator Core  
 Inlet: Block Fitting  
 O-Rings: (1) **24608**, (1) **24646**, (1) **24670**  
 Subaru (97-95)

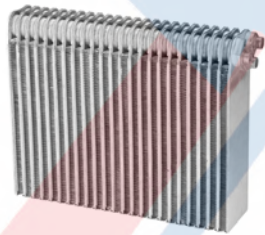

**54992**  
 Plate & Fin Evaporator Core  
 O-Rings: (3) **24610**  
 Lexus (00-95)

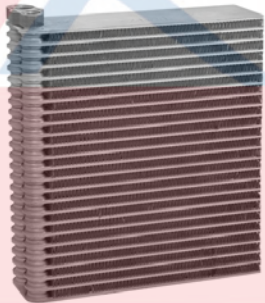

**54993**  
 Depth 2-3/8 Height 10-5/8 Width 2-3/8  
 Plate & Fin Evaporator Core  
 Inlet: Block Fitting  
 Outlet: Block Fitting  
 O-Rings: (1) **24668**, (1) **24672**  
 Volvo (15-08)  
 Volvo: 31436487



**54994**  
 Depth 2-5/16 Height 11 Width 2-5/16  
 Plate & Fin Evaporator Core  
 Inlet: Block Fitting  
 Outlet: Block Fitting  
 O-Rings: (1) **24661**, (1) **24681**  
 Toyota (04-03)

Toyota: 8850102080

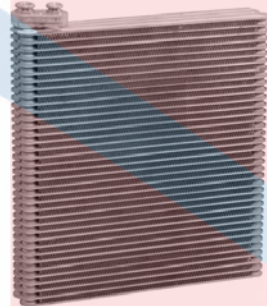

**54995**  
 Depth 1-1/2 Height 11 Width 1-1/2  
 Plate & Fin Evaporator Core  
 Inlet: Block Fitting  
 Outlet: Block Fitting  
 O-Rings: (1) **24661**, (1) **24681**  
 Scion (10-05); Toyota (09-04)

Toyota: 8850102180, 8850121032, 8850147041

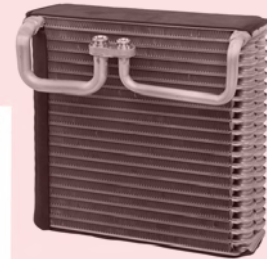

**54996**  
 Depth 3-9/16 Height 10-1/4 Width 5-1/16  
 Plate & Fin Evaporator Core  
 Inlet: Block Fitting  
 Outlet: Block Fitting  
 O-Rings: (1) **24661**, (1) **24681**  
 Toyota (07-01)

Toyota: 885010C020



**54997**  
 Depth 1-7/8 Height 11-1/2 Width 5-1/4  
 Plate & Fin Evaporator Core  
 Inlet: Block Fitting  
 Outlet: Block Fitting  
 O-Rings: (1) **24661**, (1) **24681**  
 Ford (09-06); Mercury (09-06)

Ford: 6E5Z19860AA

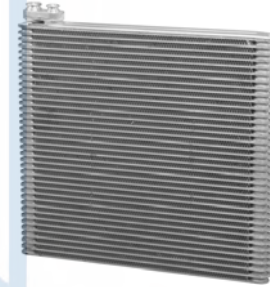

**54998**  
 Depth 1-1/2 Height 11-5/8 Width 1-1/2  
 Plate & Fin Evaporator Core  
 Inlet: Block Fitting  
 Outlet: Block Fitting  
 O-Rings: (1) **24661**, (1) **24681**  
 Lexus (09-04)

Lexus: 8850148252

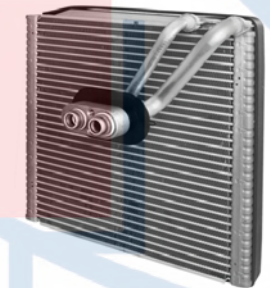

**64000**  
 Depth 1-1/2 Height Width  
 Parallel Flow Evaporator Core  
 Inlet: Captive O-Ring  
 Outlet: Captive O-Ring  
 O-Rings: (2) **24109**  
 Hyundai (13-11)

Hyundai: 971393X000



# Evaporator Cores

## Evaporator Cores Cont'd



### 64001

Depth Height Width  
1-1/2

Parallel Flow Evaporator Core  
Inlet: Captured O-Ring  
Outlet: Captured O-Ring  
O-Rings: (2) **24109**  
Hyundai (14-11); Kia (14-11)

Hyundai: 971402T000, 971403S000  
Kia: 971402T000

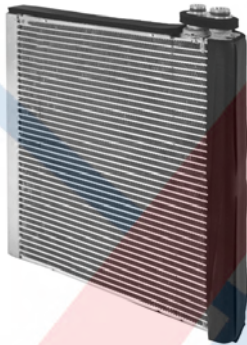

### 64003

Depth Height Width  
1-1/2

Parallel Flow Evaporator Core  
Lexus (09-03); Toyota (14-03)

Toyota: 8850135160

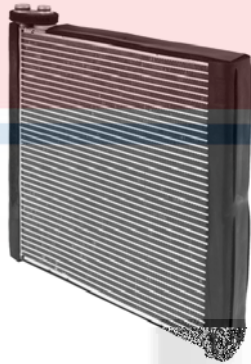

### 64004

Parallel Flow Evaporator Core  
Buick (11-06); Cadillac (11-06)

General Motors Corp: 25770666



### 64005

Parallel Flow Evaporator Core  
Chrysler (14-07); Dodge (14-07); Jeep  
(09-07)

Chrysler: 5191346AA

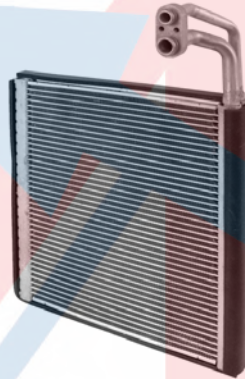

### 64006

Depth Height Width  
1-1/2

Parallel Flow Evaporator Core  
Honda (15-08)

Honda: 80211TA0A01

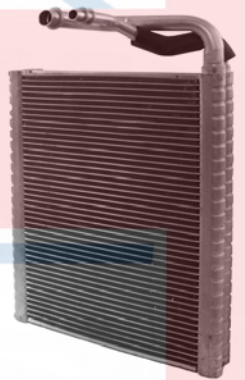

### 64007

Depth Height Width  
1-1/2

Parallel Flow Evaporator Core  
Mercedes (15-08)

Mercedes Benz: 2048300058



### 64008

Depth Height Width  
1-1/2

Parallel Flow Evaporator Core  
Ford (12-07); Lincoln (12-07); Mazda  
(14-07)

Ford: 9T4Z19B555G



### 64009

Depth Height Width  
1-1/2

Parallel Flow Evaporator Core  
Lexus (14-07); Toyota (14-05)

Toyota: 8850148301



### 64010

Depth Height Width  
1-1/2

Parallel Flow Evaporator Core  
Scion (14-08); Toyota (14-07)

Toyota: 8850152103



### 64011

Depth Height Width  
1-1/2

Parallel Flow Evaporator Core  
Pontiac (10-09); Scion (12-08); Toyota  
(14-06)

Toyota: 8850102222

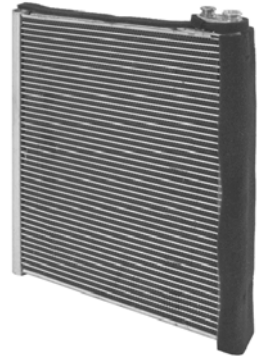

### 64012

Parallel Flow Evaporator Core  
Subaru (14-06)

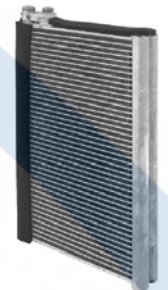

### 64013

Parallel Flow Evaporator Core  
Subaru (08-04)

Subaru: 73523AG01A



# Evaporator Cores

## Evaporator Cores Cont'd



**64014**  
Parallel Flow Evaporator Core  
Chevy (14-08); GMC (14-11)

General Motors Corp: 20871103



**64015**  
Parallel Flow Evaporator Core  
Land Rover (09-05)

Land Rover: JQB500010

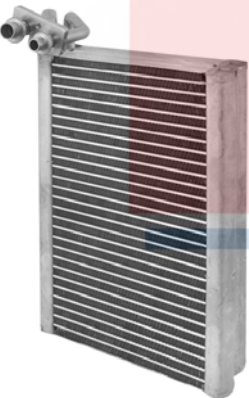

**64016**  
Parallel Flow Evaporator Core  
Chrysler (15-13), (10-08); Dodge  
(15-13), (10-08); VW (14-09)

Chrysler: 68029726AC  
Volkswagen: 7B0820103A, 7B0820103B



**64017**  
Parallel Flow Evaporator Core  
Ford (14-09); Lincoln (14-09)

Ford: AL3Z19850P

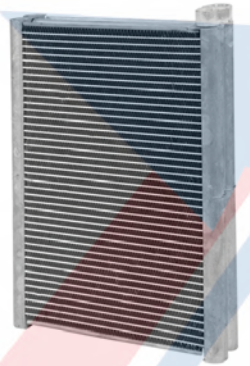

**64018**  
Parallel Flow Evaporator Core  
Subaru (14-08)

Subaru: 73523FG051

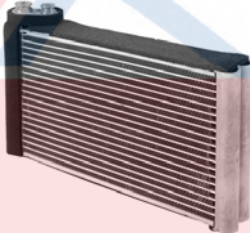

**64019**  
Parallel Flow Evaporator Core  
Land Rover (15-05)

Land Rover: LR066866

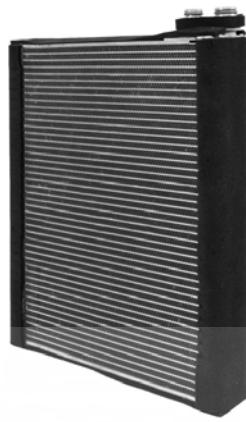

**64022**  
Parallel Flow Evaporator Core  
Cadillac (14-05); Chevy (13-11); Pontiac  
(09-08)

General Motors Corp: 25865640,  
89022546, 92192029, 92265275

## Evaporator Core Repair Kits



**16149**  
**16152 w/ 38623 Tube**  
Evaporator Core Repair Kit w/o Orifice  
Tube  
Buick (94-76); Cadillac (94-76); Chevy  
(94-76); Ford (94-80); GMC (94-76);  
Lincoln (94-80); Mercury (94-80); Olds  
(94-76); Pontiac (94-76)

General Motors Corp: 19187961



**16150**  
**16153 Includes 38621 Tube**  
Liquid Line



**16152**  
**16149 w/o Orifice Tube**  
Evaporator Core Repair Kit w/ White  
Orifice Tube  
Buick (94-76); Cadillac (94-76); Chevy  
(94-76); Ford (94-80); GMC (94-76);  
Lincoln (94-80); Mercury (94-80); Olds  
(94-76); Pontiac (94-76)

Dallas Truck AC: 0415013  
Euclid: E805052



**16153**  
**16150 w/o Orifice Tube**  
Liquid Line

Euclid: E805053



**16155**  
Evaporator Core Repair Kit w/o Orifice  
Tube  
Ford (94-80); Lincoln (94-80); Mercury  
(94-80)

## Expansion Valves - Orifice Tubes

Part No	Fitting Type	Liquid Inlet	Liquid Outlet	Suction Inlet	Suction Outlet	Superheat	Ton
<b>Expansion Valve</b>							
38002	Flange	#6 Dual O-Ring	#8 Flange	#12 Flange	#12 Dual O-Ring	6.500	1.500
38602	O-Ring	#6 FIO	#8 FIO	#10 FIO	#10 FIO	6.300	2.000
38618	O-Ring	#6 FIO	#8 FIO	#10 FIO	#10 FIO	5.000	2.000
38620	O-Ring	#6 FOR	#8 FOR	#8 FOR	#10 FOR	6.300	2.000
38630	Flange	#6 FIO	#8 FIO	#10 FIO	#12 FIO	5.400	2.000
38669	O-Ring	#6 FIO	#8 FIO	#8 FIO	#10 FIO	7.900	2.000
38670	Flange	#6 FIO	#8 FIO	#10 FIO	#12 FIO	5.000	1.500
38677	O-Ring	#6 FIO	#8 FIO	#8 FIO	#10 FIO	8.000	2.000
38679	O-Ring	#6 FIO	#8 FIO	#8 FIO	#10 FIO	5.000	2.000
38685	Flange	#6 FIO	#8 FIO	#10 FIO	#10 FIO	5.000	2.000
38686	Flange	#6 FIO	#8 FIO	#10 FIO	#12 FIO	3.000	2.000
38750	Flange	#6 FIO	#8 FIO	#10 FIO	#12 FIO	11.000	2.000
38772	Flange	#6 FIO	#8 FIO	#10 FIO	#12 FIO	8.000	1.700
38801	Flange	#6 Dual O-Ring	#8 Flange	#12 Flange	#12 Dual O-Ring	9.300	1.500
38804	O-Ring	#8 FOR	#8 FIO	#10 FIO	#10 FOR	7.000	1.500
38807	Flange	#8 FIO	#8 FIO	#12 FIO	#12 FIO	6.500	2.000
38808	Flange	#8 FIO	#8 FIO	#12 FIO	#12 FIO	6.500	2.000
38811	Flange	#6 Dual O-Ring	#8 Flange	#12 Flange	#12 Dual O-Ring	7.000	1.000
38812	O-Ring	#6 FOR	#8 FOR	#10 FOR	#10 FOR	5.000	1.500
38813	Flange	#6 FIO	#8 FIO	#10 FIO	#12 FIO	9.000	1.500
38814	Flange	#6 FIO	#8 FIO	#10 FIO	#12 FIO	7.000	2.000
38822	Flange	#6 FIO	#8 FIO	#10 FIO	#10 FIO	14.400	2.000
38823	O-Ring	#6 Dual O-Ring	#8 Flange	#12 Flange	#12 Dual O-Ring	3.500	1.500
38848	Flange	#6 Dual O-Ring	#8 Flange	#12 Flange	#12 Dual O-Ring	7.500	1.500
38849	Flange	#6 Dual O-Ring	#8 Flange	#12 Flange	#12 Dual O-Ring	10.000	1.500
38850	Flange	#6 Springlock	#6 Flange	#10 Flange	#10 Springlock	16.000	1.500
38866	Flange	#6 FIO	#8 FIO	#10 FIO	#12 FIO	6.300	2.000
38876	O-Ring	#6 FIO	#8 FIO	#10 FIO	#12 FIO	7.000	2.000
38878	O-Ring	#6 FOR	#8 FOR	#8 FOR	#10 FOR	5.000	1.500
38879	O-Ring	#6 FOR	#8 FOR	#8 FOR	#10 FOR	8.000	1.500
38880	O-Ring	#6 FOR	#8 FOR	#10 FOR	#10 FOR	5.000	1.500
38881	O-Ring	#6 FOR	#8 FOR	#8 FOR	#10 FOR	8.000	1.500
38882	Flange	#6 FIO	#8 FIO	#10 FIO	#10 FIO	3.000	2.500
38883	Flange	#6 FIO	#10 FOR	#10 FIO	#10 FIO	8.000	1.500
38884	Flange	#6 FIO	#12 FIO	#12 FIO	#12 FIO	8.000	1.500
38886	Flange	#6 FIO	#8 FIO	#8 FIO	#10 FIO	8.000	2.000
38888	O-Ring	#6 Captured O-Ring	#10 Captured O-Ring	#12 Captured O-Ring	#12 Captured O-Ring	7.500	1.000
38892	O-Ring	#6 FIO	#8 FIO	#10 FIO	#12 FIO	1.500	2.000
38898	Flange	#6 Flange	#8 Flange	#10 Flange	#12 Flange	4.000	1.500
38901	O-Ring	#6 FOR	#8 FOR	#8 FOR	#10 FOR	8.000	1.500
39003	O-Ring	#8 FOR	#8 FIO	#10 FIO	#10 FOR	-1.000	1.500
39004	O-Ring	#8 FOR	#8 Grooved O-Ring	#10 Grooved O-Ring	#10 FOR	-1.000	2.000
39005	O-Ring	#6 Captured O-Ring	#10 Captured O-Ring	#12 Captured O-Ring	#12 Captured O-Ring	2.400	1.500
39006	O-Ring	#6 Captured O-Ring	#10 Captured O-Ring	#12 Captured O-Ring	#12 Captured O-Ring	-1.500	1.500
39007	O-Ring	#6 Captured O-Ring	#10 Captured O-Ring	#12 Captured O-Ring	#12 Captured O-Ring	7.500	1.500

## ***Expansion Valves - Orifice Tubes***

<b>Part No</b>	<b>Fitting Type</b>	<b>Liquid Inlet</b>	<b>Liquid Outlet</b>	<b>Suction Inlet</b>	<b>Suction Outlet</b>	<b>Superheat</b>	<b>Ton</b>
39009	O-Ring	#8 Long Pilot	#8 Long Pilot	#10 Long Pilot	#12 Long Pilot	1.000	1.500
39014	O-Ring	#10 Captured O-Ring	#8 Female Insert O-Ring	#12 Female Insert O-Ring	#12 Captured O-Ring	4.000	1.500
39015	O-Ring	#8 FIO	#8 FIO	#12 FIO	#12 FIO	4.000	1.500
39016	O-Ring	#10 Captured O-Ring	#8 Female Insert O-Ring	#12 Female Insert O-Ring	#12 Captured O-Ring	3.000	1.500
39017	O-Ring	#6 FIO	#8 FIO	#10 FIO	#10 FIO	3.500	1.200
39018	O-Ring	#6 Long Pilot	#8 FIO	#10 FIO	#12 Long Pilot	4.000	1.500
39020	O-Ring	#6 Captured O-Ring	#10 Captured O-Ring	#12 Captured O-Ring	#12 Captured O-Ring	7.500	1.000
39021	O-Ring	#6 Captured O-Ring	#10 Captured O-Ring	#12 Captured O-Ring	#12 Captured O-Ring	-2.000	1.000
39022	O-Ring	#6 Captured O-Ring	#10 Captured O-Ring	#12 Captured O-Ring	#12 Captured O-Ring	-1.500	1.300
39023	O-Ring	#6 Captured O-Ring	#8 Female Insert O-Ring	#12 Female Insert O-Ring	#12 Captured O-Ring	1.000	1.500
39024	O-Ring	#6 Captured O-Ring	#8 Female Insert O-Ring	#12 Female Insert O-Ring	#12 Captured O-Ring	-0.050	1.200
39026	O-Ring	#6 Captured O-Ring	#8 Female Insert O-Ring	#12 Female Insert O-Ring	#12 Captured O-Ring	0.400	1.500
39028	O-Ring	#6 Captured O-Ring	#10 Captured O-Ring	#12 Captured O-Ring	#12 Captured O-Ring	8.000	1.000
39029	O-Ring	#6 Captured O-Ring	#10 Captured O-Ring	#12 Captured O-Ring	#12 Captured O-Ring	5.000	1.000
39030	O-Ring	#6 Captured O-Ring	#10 Captured O-Ring	#12 Captured O-Ring	#12 Captured O-Ring	5.000	1.000
39033	O-Ring	#6 FIO	#10 FIO	#10 FIO	#10 FIO	2.200	1.300
39035	O-Ring	#8 Captured O-Ring	#8 Female Insert O-Ring	#10 Female Insert O-Ring	#12 Captured O-Ring	-1.500	2.000
39036	O-Ring	#6 FIO	#8 FIO	#10 FIO	#10 FIO	6.000	1.300
39037	O-Ring	#6 FIO	#8 FIO	#10 FIO	#10 FIO	2.000	1.500
39040	O-Ring	#6 FIO	#8 FIO	#8 FIO	#10 FIO	4.000	1.500
39043	O-Ring	#6 Captured O-Ring	#10 Captured O-Ring	#12 Captured O-Ring	#12 Captured O-Ring	-2.000	1.500
39044	O-Ring	#8 FIO	#8 Flange	#12 Flange	#12 FIO	6.000	1.500
39045	O-Ring	#6 FIO	#8 FIO	#10 FIO	#10 FIO	-2.500	1.500
39046	O-Ring	#8 FIO	#8 Flange	#12 Flange	#12 FIO	2.500	1.500
39047	O-Ring	#8 FIO	#8 FIO	#12 FIO	#12 FIO	3.500	1.500
39048	O-Ring	#6 Captured O-Ring	#10 Captured O-Ring	#12 Captured O-Ring	#12 Captured O-Ring	-1.000	1.500
39049	O-Ring	#6 Captured O-Ring	#10 Captured O-Ring	#12 Captured O-Ring	#12 Captured O-Ring	-1.000	1.500
39051	O-Ring	#6 FIO	#10 FIO	#10 FIO	#10 FIO	4.000	1.500
39052	O-Ring	#6 FIO	#10 FIO	#10 FIO	#10 FIO	7.500	1.000
39056	O-Ring	#8 FIO	#8 FIO	#10 FIO	#10 FIO	-2.000	1.500
39058	O-Ring	#8 FIO	#8 FIO	#10 FIO	#10 FIO	-1.000	1.500
39061	O-Ring	#8 Flange	#8 FIO	#12 FIO	#12 Flange	8.000	1.500
39062	Flange	#6 Dual O-Ring	#8 Flange	#12 Flange	#12 Dual O-Ring	4.700	1.500
39063	O-Ring	#6 FIO	#8 FIO	#10 FIO	#10 FIO	7.500	1.000
39064	O-Ring	#8 Captured O-Ring	#8 FIO	#12 FIO	#10 Captured O-Ring	3.000	1.500
39065	O-Ring	#6 FIO	#8 FIO	#10 FIO	#10 FIO	8.000	1.000
39066	O-Ring	#6 Captured O-Ring	#10 Captured O-Ring	#12 Captured O-Ring	#12 Captured O-Ring	6.500	1.000
39070	O-Ring	#6 Captured O-Ring	#10 Captured O-Ring	#12 Captured O-Ring	#12 Captured O-Ring	5.000	1.500
39073	Flange	#6 FOR	#8 FOR	#10 FOR	#10 FOR	6.300	2.000



## Expansion Valves - Orifice Tubes

Part No	Fitting Type	Liquid Inlet	Liquid Outlet	Suction Inlet	Suction Outlet	Superheat	Ton
<b>Expansion Valve</b>							
39074	O-Ring	#6 Captured O-Ring	#10 Captured O-Ring	#12 Captured O-Ring	#12 Captured O-Ring	8.000	1.000
39076	O-Ring	#6 Captured O-Ring	#8 Female Insert O-Ring	#12 Female Insert O-Ring	#12 Captured O-Ring	-0.500	1.500
39077	O-Ring	#6 Captured O-Ring	#10 Captured O-Ring	#12 Captured O-Ring	#12 Captured O-Ring	8.000	1.000
39079	O-Ring	#6 FIO	#8 FIO	#12 FIO	#12 FIO	9.000	1.000
39080	O-Ring	#6 FIO	#8 FIO	#12 FIO	#12 FIO	5.000	1.500
39081	O-Ring	#6 Captured O-Ring	#10 Captured O-Ring	#12 Captured O-Ring	#12 Captured O-Ring	9.000	1.000
39082	O-Ring	#6 FIO	#8 FIO	#10 FIO	#12 FIO	-1.000	1.500
39083	O-Ring	#6 FIO	#8 FIO	#10 FIO	#12 FIO	2.500	1.500
39084	O-Ring	#6 FIO	#8 FIO	#10 FIO	#12 FIO	2.000	1.000
39086	O-Ring	#6 FIO	#10 FIO	#10 FIO	#10 FIO	4.000	1.500
39087	O-Ring	#6 FIO	#10 FIO	#10 FIO	#10 FIO	5.000	1.000
39088	O-Ring	#6 FIO	#10 FIO	#10 FIO	#10 FIO	7.500	1.000
39089	O-Ring	#6 FIO	#10 FIO	#10 FIO	#10 FIO	6.500	1.000
39092	O-Ring	#6 FOR	#8 FOR	#10 FOR	#10 FOR	-0.500	1.500
39093	O-Ring	#6 FOR	#6 Flange	#10 Flange	#10 Springlock	4.000	1.500
39094	O-Ring	#6 Captured O-Ring	#10 Female Insert O-Ring	#10 Female Insert O-Ring	#12 Captured O-Ring	1.500	2.000
39095	O-Ring	#6 Sealing Washer	#8 Sealing Washer	#12 Sealing Washer	#12 Sealing Washer	6.500	1.500
39096	O-Ring	#6 FIO	#10 FIO	#10 FIO	#10 FIO	3.000	1.500
39097	O-Ring	#6 Captured O-Ring	#10 Captured O-Ring	#12 Captured O-Ring	#12 Captured O-Ring	3.000	1.500
39099	O-Ring	#6 Sealing Washer	#8 Sealing Washer	#12 Sealing Washer	#12 Sealing Washer	-1.000	1.500
39100	O-Ring	#8 Grooved O-Ring	#8 Grooved O-Ring	#10 Grooved O-Ring	#10 Grooved O-Ring	3.500	1.500
39101	O-Ring	#6 Captured O-Ring	#8 Flange	#12 Flange	#12 Captured O-Ring	4.500	1.500
39110	O-Ring	#6 FIO	#8 FIO	#10 FIO	#12 FIO	4.000	1.500
39113	O-Ring	#6 FIO	#8 FIO	#10 FIO	#10 FIO	-1.000	2.000
39115	O-Ring	#6 Captured O-Ring	#8 Female Insert O-Ring	#10 Female Insert O-Ring	#12 Captured O-Ring	8.500	1.000
39116	O-Ring	#6 Captured O-Ring	#8 Female Insert O-Ring	#12 Female Insert O-Ring	#12 Captured O-Ring	4.000	1.500
39117	O-Ring	#6 Captured O-Ring	#8 Female Insert O-Ring	#10 Female Insert O-Ring	#12 Captured O-Ring	5.500	1.000
39118	O-Ring	#6 FIO	#10 FIO	#10 FIO	#10 FIO	1.000	1.500
39119	O-Ring	#6 FIO	#10 FIO	#10 FIO	#10 FIO	4.000	1.300
39120	O-Ring	#6 FIO	#10 FIO	#10 FIO	#10 FIO	3.000	1.500
39123	O-Ring	#6 FIO	#10 FIO	#10 FIO	#10 FIO	-0.500	1.500
39125	O-Ring	#6 FIO	#10 FIO	#10 FIO	#10 FIO	3.500	1.000
39126	O-Ring	#6 FIO	#8 FIO	#10 FIO	#12 FIO	1.500	1.500
39127	O-Ring	#6 Captured O-Ring	#10 Captured O-Ring	#12 Captured O-Ring	#12 Captured O-Ring	5.000	1.500
39128	O-Ring	#6 Captured O-Ring	#10 Captured O-Ring	#12 Captured O-Ring	#12 Captured O-Ring	-1.000	1.500
39134	O-Ring	#6 Captured O-Ring	#10 Captured O-Ring	#12 Captured O-Ring	#12 Captured O-Ring	-1.000	1.500
39135	O-Ring	#6 FIO	#10 FIO	#10 FIO	#10 FIO	5.000	1.500
39137	O-Ring	#6 Sealing Washer	#8 FIO	#10 FIO	#10 Sealing Washer	-1.000	2.000
39138	O-Ring	#8 FIO	#8 FIO	#10 FIO	#10 FIO	3.500	1.000
39140	O-Ring	#6 Captured O-Ring	#10 Female Insert O-Ring	#10 Female Insert O-Ring	#12 Captured O-Ring	7.500	1.500

## **Expansion Valves - Orifice Tubes**

<b>Part No</b>	<b>Fitting Type</b>	<b>Liquid Inlet</b>	<b>Liquid Outlet</b>	<b>Suction Inlet</b>	<b>Suction Outlet</b>	<b>Superheat</b>	<b>Ton</b>
<b>Expansion Valve</b>							
39141	O-Ring	#6 Captured O-Ring	#10 Captured O-Ring	#12 Captured O-Ring	#12 Captured O-Ring	4.000	1.000
39142	O-Ring	#6 Captured O-Ring	#10 Captured O-Ring	#12 Captured O-Ring	#12 Captured O-Ring	8.500	1.000
39143	O-Ring	#6 Captured O-Ring	#10 Captured O-Ring	#12 Captured O-Ring	#12 Captured O-Ring	4.000	1.500
39146	O-Ring	#8 Threaded	#8 Grooved O-Ring	#10 Grooved O-Ring	#10 Threaded	-1.000	2.000
39147	O-Ring	#6 FIO	#8 FIO	#10 FIO	#10 FIO	0.500	1.500
39151	O-Ring	#6 Sealing Washer	#8 Sealing Washer	#12 Sealing Washer	#12 Sealing Washer	8.500	1.000
39152	O-Ring	#6 Sealing Washer	#8 Sealing Washer	#12 Sealing Washer	#12 Sealing Washer	3.000	1.500
39153	O-Ring	#6 FIO	#8 FIO	#10 FIO	#10 FIO	1.500	1.500
39154	O-Ring	#8 Sealing Washer	#8 Sealing Washer	#10 Sealing Washer	#12 Sealing Washer	3.000	1.500
39158	O-Ring	#6 FIO	#8 FIO	#10 FIO	#12 FIO	-2.500	2.000
39159	O-Ring	O-Ring				1.500	
39160	O-Ring	#6 FIO	#8 FIO	#10 FIO	#12 FIO	3.000	2.000
39161	O-Ring	#6 FIO	#8 FIO	#10 FIO	#12 FIO	-2.500	2.000
39162	O-Ring	#6 FIO	#8 FIO	#12 FIO	#12 FIO	5.000	1.500
39163	O-Ring	#6 Sealing Washer	#8 Sealing Washer	#10 Sealing Washer	#10 Sealing Washer	5.500	1.000
39164	O-Ring	#6 FIO	#8 FIO	#10 FIO	#12 FIO	2.000	1.500
39165	O-Ring	#6 FIO	#8 FIO	#10 FIO	#12 FIO	2.500	1.500
39167	O-Ring	#6 FIO	#10 FIO	#10 FIO	#10 FIO	6.500	1.000
39168	O-Ring	#6 FIO	#8 FIO	#10 FIO	#12 FIO	3.000	1.000
39170	O-Ring	#6 Captured O-Ring	#8 FIO	#10 Captured O-Ring	#10 Captured O-Ring	7.500	1.000
39171	O-Ring	#6 Captured O-Ring	#8 FIO	#10 FIO	#10 FIO	5.000	1.000
39172	O-Ring	#6 Captured O-Ring	#8 Female Insert O-Ring	#12 Female Insert O-Ring	#12 Captured O-Ring	3.500	1.500
39175	O-Ring	#6 Captured O-Ring	#10 Captured O-Ring	#12 Captured O-Ring	#12 Captured O-Ring	0.500	1.500
39177	O-Ring	#6 Sealing Washer	#8 Sealing Washer	#10 Sealing Washer	#10 Sealing Washer	2.000	1.000
39179	O-Ring	#6 Captured O-Ring	#10 Captured O-Ring	#12 Captured O-Ring	#12 Captured O-Ring	8.500	1.000
39180	O-Ring	#8 Captured O-Ring	#8 FIO	#12 FIO	#10 Captured O-Ring	3.000	1.500
39181	O-Ring	#6 FIO	#8 FIO	#10 FIO	#12 FIO	4.000	1.500
39182	O-Ring	#6 FIO	#8 FIO	#10 FIO	#10 FIO	3.000	1.000
39183	O-Ring	#6 FIO	#10 FIO	#10 FIO	#10 FIO	7.500	1.000
39184	O-Ring	#6 FIO	#10 FIO	#10 FIO	#10 FIO	4.500	1.000
39185	O-Ring	#6 FIO	#10 FIO	#10 FIO	#10 FIO	1.500	1.000
39186	O-Ring	#6 Captured O-Ring	#10 Captured O-Ring	#12 Captured O-Ring	#12 Captured O-Ring	-0.250	1.500
39189	O-Ring	#8 FIO	#8 FIO	#10 FIO	#10 FIO	3.000	1.000
39190	O-Ring	#6 FIO	#10 FIO	#10 FIO	#10 FIO	7.500	1.000
39193	O-Ring	#6 FIO	#8 FIO	#10 FIO	#10 FIO		1.500
39195	O-Ring	#8 Sealing Washer	#8 Sealing Washer	#10 Sealing Washer	#12 Sealing Washer	4.000	1.000
39196	O-Ring	#6 Captured O-Ring	#10 Captured O-Ring	#12 Captured O-Ring	#12 Captured O-Ring	-0.500	1.000
39206	Flange	#6 FIO	#8 FIO	#10 FIO	#10 FIO	4.500	1.000
39208	O-Ring	#6 Captive O-ring	#8 FIO	#10 FIO	#12 Captive O-Ring	2.000	2.000

## Expansion Valves - Orifice Tubes

Part No	Fitting Type	Liquid Inlet	Liquid Outlet	Suction Inlet	Suction Outlet	Superheat	Ton
39209	Flange	#8 Sealing Washer	#8 Sealing Washer	#12 Sealing Washer	#12 Sealing Washer	5.000	1.000
39210	O-Ring	#6 FIO	#8 FIO	#10 FIO	#12 FIO	5.500	2.000
39211	O-Ring	#6 FIO	#8 FIO	#12 FIO	#12 FIO	-2.000	2.000
39212	O-Ring	#6 Captured O-Ring	#10 Captured O-Ring	#12 Captured O-Ring	#12 Captured O-Ring	-0.500	1.300
39213	O-Ring	#6 Captured O-Ring	#10 Captured O-Ring	#12 Captured O-Ring	#12 Captured O-Ring	-2.500	1.000
39214	O-Ring	#6 Captured O-Ring	#10 Captured O-Ring	#12 Captured O-Ring	#12 Captured O-Ring	-2.000	1.000
39215	O-Ring	#6 FIO	#10 FIO	#10 FIO	#10 FIO	5.500	1.000
39218	O-Ring	#6 Captured O-Ring	#10 Captured O-Ring	#12 Captured O-Ring	#12 Captured O-Ring	-1.500	1.500
39219	O-Ring	#6 Captured O-Ring	#10 Captured O-Ring	#12 Captured O-Ring	#12 Captured O-Ring	-0.500	1.000
39220	O-Ring	#8 Captured O-Ring	#8 Female Insert O-Ring	#10 Female Insert O-Ring	#12 Captured O-Ring	-1.000	1.500
39222	O-Ring	#8 Captured O-Ring	#8 Female Insert O-Ring	#12 Female Insert O-Ring	#12 Captured O-Ring	-2.500	2.000
39223	O-Ring	#8 Captured O-Ring	#10 Captured O-Ring	#12 Captured O-Ring	#12 Captured O-Ring	1.000	1.000
39224	O-Ring	#6 FIO	#8 FIO	#10 FIO	#12 FIO	-2.500	2.000
39225	O-Ring	#6 FIO	#10 FIO	#10 FIO	#10 FIO	5.500	1.000
39226	O-Ring	#6 FIO	#10 FIO	#10 FIO	#10 FIO	-0.500	1.000
39227	O-Ring	#6 FIO	#10 FIO	#10 FIO	#10 FIO	4.500	1.000
39228	O-Ring	#6 FIO	#10 FIO	#10 FIO	#10 FIO	4.000	1.500
39229	O-Ring	#6 Captured O-Ring	#10 Captured O-Ring	#12 Captured O-Ring	#12 Captured O-Ring	5.000	1.000
39230	O-Ring	#6 FIO	#10 FIO	#10 FIO	#10 FIO	5.500	1.500
39238	O-Ring	#6 FIO	#8 FIO	#10 FIO	#10 FIO	5.500	1.500
39241	O-Ring	#6 Sealing Washer	#8 FIO	#10 FIO	#12 Sealing Washer	-1.500	1.500
39242	O-Ring	#8 Sealing Washer	#8 Sealing Washer	#12 Sealing Washer	#12 Sealing Washer	-0.500	1.500
39243	O-Ring	#6 FIO	#8 FIO	#10 FIO	#12 FIO	-1.500	1.000
39254	O-Ring	#6 Captured O-Ring	#8 Female Insert O-Ring	#12 Female Insert O-Ring	#12 Captured O-Ring	5.000	1.000
39259	O-Ring	#6 FIO	#8 FIO	#10 FIO	#12 FIO	3.000	1.500
39260	O-Ring	#8 Captive O-Ring	#8 FIO	#10 FIO	#12 Captive O-Ring	-3.200	1.000
39264	O-Ring	#6 FIO	#10 FIO	#10 FIO	#10 FIO	-0.500	1.000
39265	O-Ring	#6 FIO	#8 FIO	#10 FIO	#10 FIO	-1.000	1.000
39266	O-Ring	#6 FIO	#8 FIO	#12 FIO	#12 FIO	1.500	1.000
39267	O-Ring	#6 FIO	#8 FIO	#10 FIO	#10 FIO	4.500	1.000
39268	Flange	#6 Sealing Washer	#8 Sealing Washer	#10 Sealing Washer	#12 Sealing Washer	5.500	
39271	O-Ring	#6 Captured O-Ring	#10 Captured O-Ring	#12 Captured O-Ring	#12 Captured O-Ring	-2.000	
39274	O-Ring	#6 Captured O-Ring	#10 Captured O-Ring	#12 Captured O-Ring	#12 Captured O-Ring	-0.500	1.000
39275	O-Ring	#8 Captured O-Ring	#8 Female Insert O-Ring	#10 Female Insert O-Ring	#12 Captured O-Ring	-2.000	2.000
39276	O-Ring	#8 Captured O-Ring	#8 Female Insert O-Ring	#10 Female Insert O-Ring	#12 Captured O-Ring	-1.000	
39277	O-Ring	#6 FIO	#6 FIO	#10 FIO	#12 FIO	-2.500	1.500
39278	O-Ring	#6 Captured O-Ring	#10 Captured O-Ring	#12 Captured O-Ring	#12 Captured O-Ring	-1.000	
39279	Flange	#6 Captured O-Ring	#10 Captured O-Ring	#12 Captured O-Ring	#12 Captured O-Ring	-2.000	



## ***Expansion Valves - Orifice Tubes***

<b>Part No</b>	<b>Fitting Type</b>	<b>Liquid Inlet</b>	<b>Liquid Outlet</b>	<b>Suction Inlet</b>	<b>Suction Outlet</b>	<b>Superheat</b>	<b>Ton</b>
39280	O-Ring	#6 Captured O-Ring	#10 Captured O-Ring	#12 Captured O-Ring	#12 Captured O-Ring	-3.500	
39281	O-Ring	#6 Captured O-Ring	#10 Captured O-Ring	#12 Captured O-Ring	#12 Captured O-Ring	-3.000	
39282	Flange	#6 Captured O-Ring	#10 Captured O-Ring	#12 Captured O-Ring	#10 Captured O-Ring		
39283	Flange	#6 Captured O-Ring	#10 Captured O-Ring	#12 Captured O-Ring	#12 Captured O-Ring	4.500	
39284	O-Ring	#6 Captured O-Ring	#10 Captured O-Ring	#12 Captured O-Ring	#12 Captured O-Ring	5.500	
39285	O-Ring	#6 FIO	#8 FIO	#12 FIO	#12 FIO	8.000	1.500
39286	O-Ring	#6 FIO	#8 FIO	#10 FIO	#12 FIO	4.500	1.500
39287	Flange	#6 Captured O-Ring	#10 Captured O-Ring	#12 Captured O-Ring	#12 Captured O-Ring		
39288	O-Ring	#8 Female Insert O-Ring	#8 Female Insert O-Ring	#12 Female Insert O-Ring	#12 Captured O-Ring	1.000	
39289	O-Ring	#8 Captured O-Ring	#8 Female Insert O-Ring	#12 Female Insert O-Ring	#12 Captured O-Ring	-2.500	
39290	O-Ring	#6 FIO	#8 FIO	#10 FIO	#10 FIO	3.000	1.000
39291	O-Ring	#6 FIO	#8 FIO	#10 FIO	#12 FIO	-2.000	
39292	O-Ring	#6 Captured O-Ring	#8 Female Insert O-Ring	#12 Female Insert O-Ring	#12 Captured O-Ring	-2.000	1.500
39293	O-Ring	#6 Caputred O-Ring	#8 FIO	#10 FIO	#12 Caputred O-Ring	-2.500	1.000
39294	O-Ring	#6 FIO	#8 FIO	#10 FIO	#12 FIO	4.000	1.000
39295	O-Ring	#8 Caputred O-Ring	#10 Caputred O-Ring	#12 Caputred O-Ring	#12 Caputred O-Ring	-2.000	
39296	O-Ring	#6 FIO	#8 FIO	#10 FIO	#12 FIO	-1.500	2.000
39297	O-Ring	#6 FIO	#10 FIO	#10 FIO	#10 FIO	-2.500	1.500
39298	O-Ring	#6 Captured O-Ring	#10 Captured O-Ring	#12 Captured O-Ring	#12 Captured O-Ring	-3.500	
39299	O-Ring	#6 FIO	#8 FIO	#10 FIO	#12 FIO	-1.500	1.500
39300	O-Ring	#8 Captured O-Ring	#8 Female Insert O-Ring	#12 Female Insert O-Ring	#12 Captured O-Ring	-2.000	
39301	O-Ring	#6 FIO	#10 FIO	#10 FIO	#12 FIO	5.500	1.000
39302	O-Ring	#6 Captured O-Ring	#10 Captured O-Ring	#12 Captured O-Ring	#12 Captured O-Ring	3.500	
39303	O-Ring	#6 Captured O-Ring	#10 Captured O-Ring	#12 Captured O-Ring	#12 Captured O-Ring	8.000	1.000
39304	O-Ring	#6 FIO	#10 FIO	#10 FIO	#10 FIO	-3.300	1.500
39305	O-Ring	#6 FIO	#10 FIO	#10 FIO	#10 FIO	-3.000	1.000
39306	Flange	#8 Sealing Washer	#8 Sealing Washer	#10 Sealing Washer	#12 Sealing Washer	2.800	1.000
39307	Flange	#6 Sealing Washer	#8 Sealing Washer	#10 Sealing Washer	#12 Sealing Washer	-1.000	2.000
39308	O-Ring	#8 Sealing Washer	#8 FIO	#10 FIO	#10 Sealing Washer	8.000	1.000
39309	O-Ring	#6 FIO	#8 FIO	#10 FIO	#10 FIO	-3.500	1.500
39310	O-Ring	#6 FIO	#10 FIO	#10 FIO	#10 FIO	-3.500	1.000
39311	O-Ring	#6 FIO	#10 FIO	#12 FIO	#12 FIO	-3.500	1.000
39312	O-Ring	#6 Sealing Washer	#8 Sealing Washer	#10 Sealing Washer	#12 Sealing Washer	-3.000	2.000
39313	O-Ring	#6 Sealing Washer	#6 Sealing Washer	#10 Sealing Washer	#12 Sealing Washer	5.000	1.700
39314	O-Ring	#6 Sealing Washer	#8 Sealing Washer	#10 Sealing Washer	#12 Sealing Washer	5.500	1.200
39315	O-Ring	#8 Sealing Washer	#8 Sealing Washer	#10 Sealing Washer	#12 Sealing Washer	-0.050	1.500
39316	O-Ring	#6 FIO	#8 FIO	#10 FIO	#12 FIO	-1.500	2.000

## Expansion Valves - Orifice Tubes

Part No	Fitting Type	Liquid Inlet	Liquid Outlet	Suction Inlet	Suction Outlet	Superheat	Ton
39317	O-Ring	#6 Sealing Washer	#10 Sealing Washer	#10 Sealing Washer	#12 Sealing Washer	-3.000	1.500
39318	O-Ring	#6 FIO	#10 FIO	#10 FIO	#10 FIO	3.500	1.500
39319	O-Ring	#6 FIO	#10 FIO	#10 FIO	#10 FIO	-3.000	1.200
39320	O-Ring	#6 Captive O-ring	#8 FIO	#10 FIO	#12 Captive O-Ring	1.000	0.800
39321	Flange	#6 Sealing Washer	#8 Sealing Washer	#10 Sealing Washer	#12 Sealing Washer	-1.000	1.000
39322	Flange	#6 Sealing Washer	#8 Sealing Washer	#10 Sealing Washer	#12 Sealing Washer	5.400	0.800
39323	O-Ring	#6 Captured O-Ring	#10 Captured O-Ring	#12 Captured O-Ring	#12 Captured O-Ring	7.000	1.300
39324	O-Ring	#6 Captured O-Ring	#10 Captured O-Ring	#12 Captured O-Ring	#12 Captured O-Ring	-3.000	1.000
39325	O-Ring	#6 Captured O-Ring	#10 Captured O-Ring	#12 Captured O-Ring	#12 Captured O-Ring	-5.500	1.000
39326	O-Ring	#6 FIO	#8 FIO	#12 FIO	#12 FIO	-3.500	1.000
39327	O-Ring	#8 Sealing Washer	#8 FIO	#10 FIO	#10 Sealing Washer	7.000	1.200
39328	O-Ring	#6 Captured O-Ring	#10 Captured O-Ring	#12 Captured O-Ring	#12 Captured O-Ring	-6.000	1.000
39329	O-Ring	#6 Captured O-Ring	#8 Female Insert O-Ring	#10 Female Insert O-Ring	#12 Captured O-Ring	-3.500	2.000
39330	O-Ring	#6 FIO	#8 FIO	#10 FIO	#12 FIO	12.000	1.000
39331	O-Ring	#6 Captured O-Ring	#10 Captured O-Ring	#12 Captured O-Ring	#12 Captured O-Ring	-13.500	1.200
39332	O-Ring	#6 Captured O-Ring	#10 Captured O-Ring	#12 Captured O-Ring	#12 Captured O-Ring	13.000	1.200
39333	O-Ring	#6 Captured O-Ring	#10 Captured O-Ring	#12 Captured O-Ring	#12 Captured O-Ring	19.500	0.800
39334	Flange	#6 Sealing Washer	#8 Sealing Washer	#10 Sealing Washer	#12 Sealing Washer	8.000	1.000
39342	O-Ring	#6 Captured O-Ring	#10 Captured O-Ring	#12 Captured O-Ring	#12 Captured O-Ring	-2.500	1.500
39343	O-Ring	#6 Captured O-Ring	#10 Captured O-Ring	#12 Captured O-Ring	#12 Captured O-Ring	-0.500	1.500
39345	O-Ring	#6 Captured O-Ring	#10 Captured O-Ring	#12 Captured O-Ring	#12 Captured O-Ring	-5.000	1.500
39346	O-Ring	#6 Captured O-Ring	#8 Female Insert O-Ring	#12 Female Insert O-Ring	#12 Captured O-Ring	1.500	1.500
39347	O-Ring	#6 FIO	#10 FIO	#10 FIO	#10 FIO	8.500	1.000
39348	O-Ring	#6 Captured O-Ring	#10 Captured O-Ring	#12 Captured O-Ring	#12 Captured O-Ring	-0.500	1.500
39349	Flange	#6 Sealing Washer	#8 Sealing Washer	#10 Sealing Washer	#12 Sealing Washer	3.500	1.000
39351	Flange	#6 Sealing Washer	#8 Sealing Washer	#10 Sealing Washer	#12 Sealing Washer	-0.500	1.500
39352	O-Ring	#6 FIO	#10 FIO	#10 FIO	#10 FIO	-0.500	1.500
39353	O-Ring	#6 Captured O-Ring	#8 FIO	#10 FIO	#12 Captured O-Ring	9.000	1.000
39354	O-Ring	#6 Captured O-Ring	#8 FIO	#10 FIO	#12 Captured O-Ring	7.500	1.000
39355	O-Ring	#6 Sealing Washer	#8 FIO	#10 FIO	#12 Sealing Washer	11.000	0.800
39356	Flange	#8 Sealing Washer	#8 Sealing Washer	#10 Sealing Washer	#12 Sealing Washer	7.500	1.000
39357	O-Ring	#6 Captured O-Ring	#10 Captured O-Ring	#12 Captured O-Ring	#12 Captured O-Ring	-1.500	1.500
39359	O-Ring	#6 Captured O-Ring	#8 FIO	#10 FIO	#12 Captured O-Ring	5.000	1.000

## Expansion Valves - Orifice Tubes

Part No	Fitting Type	Liquid Inlet	Liquid Outlet	Suction Inlet	Suction Outlet	Superheat	Ton
<b>Expansion Valve</b>							
39360	O-Ring	#6 Caputred O-Ring	#10 Caputred O-Ring	#12 Caputred O-Ring	#12 Caputred O-Ring	6.500	1.000
39361	O-Ring	#6 Caputred O-Ring	#10 Captured O-Ring	#12 Captured O-Ring	#12 Captured O-Ring	10.000	1.000
39362	O-Ring	#6 Caputred O-Ring	#10 Captured O-Ring	#12 Captured O-Ring	#12 Captured O-Ring	-5.000	1.500
39363	O-Ring	#6 Caputred O-Ring	#10 Captured O-Ring	#12 Captured O-Ring	#12 Captured O-Ring	-2.500	1.500
39364	Flange	#8 Sealing Washer	#8 Sealing Washer	#10 Sealing Washer	#12 Sealing Washer	11.000	0.800
39365	O-Ring	#8 FIO	#8 FIO	#10 FIO	#12 FIO	4.700	1.000
39366	O-Ring	#6 FIO	#10 FIO	#10 FIO	#10 FIO	-2.500	1.000
39367	O-Ring	#6 FIO	#10 FIO	#10 FIO	#10 FIO	-1.500	1.000
39368	Flange	#6 Sealing Washer	#8 Sealing Washer	#10 Sealing Washer	#12 Sealing Washer	-0.500	1.000
39369	O-Ring	#6 Captured O-Ring	#10 Captured O-Ring	#12 Captured O-Ring	#12 Captured O-Ring	11.000	0.800
39370	O-Ring	#6 FIO	#8 FIO	#10 FIO	#12 FIO	-2.500	1.000
39371	O-Ring	#6 FIO	#10 FIO	#10 FIO	#10 FIO	-2.500	1.500
39372	O-Ring	#6 Captured O-Ring	#8 Female Insert O-Ring	#12 Female Insert O-Ring	#12 Captured O-Ring	-0.500	1.500
39373	O-Ring	#6 FIO	#8 FIO	#10 FIO	#10 FIO	11.000	1.000
39374	O-Ring	#6 FIO	#8 FIO	#10 FIO	#10 FIO	18.000	1.000
39375	O-Ring	#5 FIO	#10 FIO	#10 FIO	#10 FIO	0.500	
39377	O-Ring	#6 Caputred O-Ring	#10 FIO	#10 FIO	#12 Captured O-Ring	3.500	1.500
39378	O-Ring	#6 Caputred O-Ring	#10 FIO	#10 FIO	#12 Captured O-Ring	5.300	1.500
39379	O-Ring	#6 FIO	#10 FIO	#10 FIO	#10 FIO	4.000	1.500
39380	O-Ring	#6 FIO	#10 FIO	#10 FIO	#10 FIO	4.500	1.000
39381	O-Ring	#6 Caputred O-Ring	#10 Captured O-Ring	#10 Captured O-Ring	#10 Captured O-Ring	8.500	1.000
39382	O-Ring	#5 FOR	#10 FOR	#10 FOR	#10 FOR	-2.600	2.000
39383	O-Ring	#5 FOR	#10 FOR	#10 FOR	#10 FOR	4.600	1.500
39384	O-Ring	#6 Captured O-Ring	#10 Captured O-Ring	#12 Captured O-Ring	#12 Captured O-Ring	-3.900	2.500
39385	O-Ring	#6 Sealing Washer	#10 FOR	#10 FOR	#12 Sealing Washer	-1.000	2.000
39386	O-Ring	#5 FOR	#10 FOR	#10 FOR	#10 FOR	-1.500	2.000
39387	O-Ring	#5 FOR	#10 FOR	#10 FOR	#10 FOR	3.100	1.500
39388	O-Ring	#5 FOR	#10 FOR	#10 FOR	#10 FOR	1.100	2.000
39389	O-Ring	#5 FOR	#10 FOR	#10 FOR	#10 FOR	4.700	1.500
39390	O-Ring	#5 FOR	#10 FOR	#10 FOR	#10 FOR	-2.600	2.000
39391	UNK	#6 Sealing Washer	#8 Sealing Washer	#10 Sealing Washer	#12 Sealing Washer	4.500	
39392	O-Ring	#6 FIO	#8 FIO	#8 FIO	#10 FIO	8.500	1.500
39393	O-Ring	#6 FIO	#8 FIO	#8 FIO	#10 FIO	8.500	1.500
39394	O-Ring	#6 FIO	#8 FIO	#8 FIO	#10 FIO	8.500	2.000
39395	O-Ring	#6	#8	#10	#10	5.000	2.000
39396	O-Ring	#6 FIO	#8 FIO	#10 FOR	#10 FIO	8.000	2.000
39397	O-Ring	#6	#8	#8	#10	5.500	1.500
39399	O-Ring	#8 Captured O-Ring	#10 Captured O-Ring	#12 Captured O-Ring	#12 Captured O-Ring	-1.500	2.000
39400	O-Ring	#6	#8	#8	#10	8.500	2.000
39419	Flange	#6 Sealing Washer	#8 Sealing Washer	#10 Sealing Washer	#10 Sealing Washer		1.500
39420	Flange	#6 Female Insert O-Ring	#8 Female Insert O-Ring	#8 Female Insert O-Ring	#10 FIO		1.500



## ***Expansion Valves - Orifice Tubes***

<b>Part No</b>	<b>Fitting Type</b>	<b>Liquid Inlet</b>	<b>Liquid Outlet</b>	<b>Suction Inlet</b>	<b>Suction Outlet</b>	<b>Superheat</b>	<b>Ton</b>
39421	Flange	#8 Sealing Washer	#8 Sealing Washer	#10 Sealing Washer	#12 Sealing Washer		2.000
39422	O-Ring	#6 Female Insert O-Ring	#8 Female Insert O-Ring	#8 Female Insert O-Ring	#10 FIO		2.000
39423	Flange	#6 Sealing Washer	#8 Sealing Washer	#10 Sealing Washer	#10 Sealing Washer		1.500

## ***Expansion Valves - Orifice Tubes***

<b>Part No</b>	<b>Capillary Tube Length</b>	<b>Equalizer Tube Length</b>	<b>Equalizer Fitting</b>	<b>Inlet Fitting</b>	<b>Outlet Fitting</b>	<b>Superheat</b>	<b>Ton</b>
<b>Expansion Valve</b>							
38604	8	10.500	Female Flare Fitting 7/16" - 20	#6 Flare Fitting	#8 Flare Fitting	9.900	2.000
38606	10-1/2	13.000	Female Flare Fitting 7/16" - 20	#6 Flare Fitting	#8 Flare Fitting	7.000	1.500
38608	14-1/2			#6 Flare Fitting	#8 Flare Fitting	8.000	1.500
38613	40-1/2	41.500	Female Flare Fitting 7/16" - 20	#6 Flare Fitting	#8 Flare Fitting	5.000	2.000
38722	32			#6 Flare Fitting	#8 Flare Fitting	8.000	1.500
38723	23	17.000	Female Flare Fitting 7/16" - 20	#6 Flare Fitting	#8 Flare Fitting	8.000	2.000
38725	18	18.500	Female Flare Fitting 7/16" - 20	#6 Flare Fitting	#8 Flare Fitting	8.000	1.500
38727	13			#6 Flare Fitting	#8 Flare Fitting	5.000	2.000
38870	30			#6 Flare Fitting	#8 Flare Fitting	8.000	1.500
38873	13-1/2	17.000	Male Flare Fitting 7/16" - 24	#6 Flare Fitting	#8 Flare Fitting	8.000	1.500
38874	13-1/2	18.000	Female Flare Fitting 7/16" - 20	#6 Flare Fitting	#8 Flare Fitting	10.500	2.000
39344	8-1/2			#6 Captured O-Ring	#8 Captured O-Ring	6.000	1.500
38607	15	12.000	Female O-Ring 7/16" - 20	#6 Male O-Ring	#8 Male O-Ring	8.000	2.000
38609	8-1/2	11.000	Female O-Ring 7/16" - 20	#6 Male O-Ring	#8 Male O-Ring	8.000	2.000
38610	20	16.000	Female O-Ring 7/16" - 20	#6 Male O-Ring	#8 Male O-Ring	8.000	1.500
38611	21-1/2	17.000	Female O-Ring 7/16" - 20	#6 Male O-Ring	#8 Male O-Ring	5.000	1.500
38616	14			#6 Male O-Ring	#8 Male O-Ring	9.000	1.500
38622	33	31.000	Male O-Ring 7/16" - 24	#6 Male O-Ring	#8 Male O-Ring	10.500	2.000
38629	15	34.000	Female O-Ring M12x1.250	#6 Flare Fitting	#8 Flare Fitting	8.000	2.000
38631	15	34.000	Female O-Ring 7/16" - 20	#6 Male O-Ring	#8 Male O-Ring	8.000	1.500
38633	13			#6 Male O-Ring	#8 Male O-Ring	8.000	1.500
38637	13	13.500	Female O-Ring M12x1.250	#6 Male O-Ring	#8 Male O-Ring	8.000	1.500
38652	37	34.500	Male O-Ring 7/16" - 24	#6 Male O-Ring	#8 Male O-Ring	10.500	1.500
38654	16-1/2			#6 Male O-Ring	#8 Male O-Ring	4.500	2.000
38655	6	4.000	Female O-Ring M12x1.500	#6 Male O-Ring	#8 Male O-Ring	5.000	1.500
38663	12	9.500	Female O-Ring M12x1.250	#6 Male O-Ring	#8 Male O-Ring	8.000	1.500
38683	20-1/2			#6 Male O-Ring	#8 Male O-Ring	8.000	1.500

## Expansion Valves - Orifice Tubes

Part No	Capillary Tube Length	Equalizer Tube Length	Equalizer Fitting	Inlet Fitting	Outlet Fitting	Superheat	Ton
38720	11-1/2			#6 Male O-Ring	#8 Male O-Ring	10.500	1.500
38728	31	18.000	Male O-Ring 7/16" - 24	#6 Male O-Ring	#8 Male O-Ring	12.000	1.500
38729	10-1/4	8.000	Male O-Ring 7/16" - 24	#6 Male O-Ring	#8 Male O-Ring	6.000	1.000
38730	14			#6 Male O-Ring	#8 Male O-Ring	8.000	2.000
38733	24-1/2			#6 Male O-Ring	#8 Male O-Ring	5.000	2.000
38762	10-1/2	9.750	Female O-Ring M12x1.250	#6 Male O-Ring	#8 Male O-Ring	1.000	1.500
38770	9	9.750	Female O-Ring 7/16" - 20	#6 Male O-Ring	#8 Male O-Ring	8.000	2.000
38805	6	4.000	Female O-Ring 7/16" - 20	#6 Male O-Ring	#8 Male O-Ring	4.000	1.500
38806	15-1/2			#6 Male O-Ring	#8 Male O-Ring	12.000	1.500
38844	16	11.000	Female O-Ring 7/16" - 20	#6 Male O-Ring	#8 Male O-Ring	8.000	1.500
38863	10-3/4			#6 Male O-Ring	#8 Male O-Ring	5.000	1.500
38864	9-1/2	8.500	Male O-Ring 7/16" - 24	#6 Male O-Ring	#8 Male O-Ring	7.500	1.000
38869	11			#6 Male O-Ring	#8 Male O-Ring	5.300	2.000
38872	14-1/2	18.000	Female O-Ring 7/16" - 20	#6 Male O-Ring	#8 Male O-Ring	8.000	2.000
38877	9-3/4	10.750	Female O-Ring 7/16" - 20	#6 Male O-Ring	#8 Male O-Ring	5.000	2.000
38889	5-3/4	4.000	Female O-Ring 7/16" - 20	#6 Male O-Ring	#8 Male O-Ring	2.000	1.500
38891	15-1/2			#6 Male O-Ring	#8 Male O-Ring	12.000	1.500
38906	5-3/4	4.000	Female O-Ring M12x1.500	#6 Male O-Ring	#8 Male O-Ring	8.000	1.500
38907	8-1/2			#6 Male O-Ring	#8 Male O-Ring	4.500	1.500
38908	12-1/2			#6 Male O-Ring	#8 Male O-Ring	4.500	1.500
39000	13-1/4	11.250	Female O-Ring M12x1.250	#6 Captured O-Ring	#8 Captured O-Ring	4.500	1.500
39008	5			#6 Male O-Ring	#8 Male O-Ring	0.500	1.500
39010	7-1/4			#6 Male O-Ring	#8 Male O-Ring	8.000	0.500
39011	10-1/2			#6 Male O-Ring	#8 Male O-Ring	3.500	1.500
39012	11-1/2			#6 Captured O-Ring	#8 Captured O-Ring	2.700	1.500
39013	13-1/4			#6 Male O-Ring	#8 Male O-Ring	7.000	1.500
39019	15-1/2			#6 Captured O-Ring	#8 Captured O-Ring	2.500	1.300
39025	9			#6 Male O-Ring	#8 Male O-Ring	1.000	1.500



## ***Expansion Valves - Orifice Tubes***

<b>Part No</b>	<b>Capillary Tube Length</b>	<b>Equalizer Tube Length</b>	<b>Equalizer Fitting</b>	<b>Inlet Fitting</b>	<b>Outlet Fitting</b>	<b>Superheat</b>	<b>Ton</b>
39027	11-1/4	9.250	Female O-Ring M12x1.250	#6 Male O-Ring	#8 Male O-Ring	3.500	1.500
39031	8-3/4			#6 Male O-Ring	#8 Male O-Ring	2.000	1.300
39032	10-1/2			#6 Captured O-Ring	#8 Captured O-Ring	2.700	1.500
39034	7-1/4	8.500	Female O-Ring 7/16" - 20	#6 Male O-Ring	#8 Male O-Ring	4.000	1.500
39038	9-1/4			#6 Male O-Ring	#8 Male O-Ring	-3.000	1.500
39039	8-3/8	21.000	O-Ring	#6 Male O-Ring	#8 Male O-Ring	5.000	1.500
39041	9-1/8	53.000	O-Ring	#6 Male O-Ring	#8 Male O-Ring	5.000	1.500
39042	10	21.000	O-Ring	#6 Male O-Ring	#8 Male O-Ring	4.000	1.500
39053	11	9.250	Female O-Ring M12x1.250	#6 Male O-Ring	#8 Male O-Ring	1.500	1.500
39054	11-1/4	9.500	Female O-Ring M12x1.250	#6 Male O-Ring	#8 Male O-Ring	3.000	1.500
39055	9-3/4	13.000	Female O-Ring M12x1.250	#6 Male O-Ring	#8 Male O-Ring	5.000	1.200
39059	7-1/2	8.250	Female O-Ring 7/16" - 20	#6 Male O-Ring	#8 Male O-Ring	6.000	1.000
39060	11	9.250	Female O-Ring 7/16" - 20	#6 Male O-Ring	#8 Male O-Ring	3.500	1.500
39068	7-1/2	8.500	Female O-Ring 7/16" - 20	#6 Male O-Ring	#8 Male O-Ring	4.000	1.500
39069	7-1/2	8.500	Female O-Ring 7/16" - 20	#6 Male O-Ring	#8 Male O-Ring	-0.050	1.500
39075	9-1/4	9.250	Female O-Ring 7/16" - 20	#6 Male O-Ring	#8 Male O-Ring	-0.500	1.500
39078	13	12.000	Female O-Ring M12x1.250	#6 Male O-Ring	#8 Male O-Ring	4.000	1.500
39085	8-1/4			#6 Male O-Ring	#8 Male O-Ring	-1.000	1.500
39090	11	11.000	Female O-Ring M12x1.250	#6 Male O-Ring	#10 Male O-Ring	4.500	1.500
39091	11-5/8			#6 Male O-Ring	#10 Male O-Ring	6.500	1.000
39098	10-3/4	10.500	Female O-Ring M12x1.250	#6 Male O-Ring	#10 Male O-Ring	5.500	1.500
39109	8-3/4			#6 Captured O-Ring	#8 Captured O-Ring	3.500	1.000
39114	9-1/4	9.250	Female O-Ring 7/16" - 20	#6 Male O-Ring	#8 Male O-Ring	-2.000	1.500
39121	8			#6 Male O-Ring	#10 Male O-Ring	8.500	1.000
39122	11-1/4	9.250	Female O-Ring M12x1.250	#6 Male O-Ring	#8 Male O-Ring	3.000	1.500
39124	11-1/8			#6 Male O-Ring	#8 Male O-Ring	3.500	1.000
39129	9			#6 Male O-Ring	#8 Male O-Ring	7.000	1.000
39130	16-1/4	5.1875	Female O-Ring 7/16" - 20	#6 Male O-Ring	#8 Male O-Ring	4.000	1.500

## **Expansion Valves - Orifice Tubes**

<b>Part No</b>	<b>Capillary Tube Length</b>	<b>Equalizer Tube Length</b>	<b>Equalizer Fitting</b>	<b>Inlet Fitting</b>	<b>Outlet Fitting</b>	<b>Superheat</b>	<b>Ton</b>
39131	16-1/4	5.1875	Female O-Ring M12x1.250	#6 Captured O-Ring	#8 Captured O-Ring	4.500	1.500
39132	11	34.500	O-Ring M12x1.250	#6 Captured O-Ring	#8 Captured O-Ring	3.000	1.500
39133	5-3/4			#6 Male O-Ring	#8 Male O-Ring	3.000	1.500
39136	4-3/4			#6 Male O-Ring	#8 Male O-Ring	3.000	1.500
39139	7-5/8			#6 Male O-Ring	#8 Male O-Ring	5.500	1.500
39144	11-1/4			#6 Male O-Ring	#8 Male O-Ring	3.500	1.500
39145	10-1/8			#6 Male O-Ring	#8 Male O-Ring	2.000	1.000
39148	5-1/4			#6 Male O-Ring	#8 Male O-Ring	4.000	1.500
39149	10-1/2			#6 Captured O-Ring	#8 Captured O-Ring	6.000	1.000
39150	11			#6 Male O-Ring	#8 Male O-Ring	4.000	1.500
39166	10	9.250	Female O-Ring M12x1.250	#6 Male O-Ring	#8 Male O-Ring	-2.500	1.500
39169	11	9.250	Female O-Ring M12x1.250	#6 Male O-Ring	#8 Male O-Ring	1.500	1.500
39173	10-1/2			#6 Male O-Ring	#8 Male O-Ring	3.500	1.500
39174	10-1/2			#6 Male O-Ring	#10 Male O-Ring	5.500	1.500
39176	11	9.000	Female O-Ring 7/16" - 20	#6 Male O-Ring	#8 Male O-Ring	5.000	1.500
39178	10-1/2			#6 Male O-Ring	#8 Male O-Ring	1.000	1.000
39191	16-1/2			#6 Male O-Ring	#8 Male O-Ring	4.500	2.000
39192	6-1/2			#6 Male O-Ring	#8 Male O-Ring	2.500	1.500
39197	10-1/2	10.000	Female O-Ring M12x1.250	#6 Male O-Ring	#10 Male O-Ring	4.000	1.000
39207	8			#6 Male O-Ring	#8 Male O-Ring	3.500	1.000
39216	11-1/2	9.750	Female O-Ring M12x1.250	#6 Male O-Ring	#8 Male O-Ring		1.500
39217	10-1/2			#6 Male O-Ring	#8 Male O-Ring	0.500	1.500
39231	16-1/2	24.750	O-Ring	#6 Male O-Ring	#8 Male O-Ring	0.500	1.500
39232	19-3/4	24.750	O-Ring	#6 Male O-Ring	#8 Male O-Ring	3.000	1.500
39233	11-3/4	13.000	Female O-Ring M12x1.250	#6 Male O-Ring	#8 Male O-Ring	1.000	1.500
39234	11-1/2	13.000	Female O-Ring 7/16" - 20	#6 Male O-Ring	#8 Male O-Ring	-0.500	1.500
39235	11			#6 Male O-Ring	#8 Male O-Ring	5.500	1.000
39236	10-1/2			#6 Male O-Ring	#8 Male O-Ring	5.000	1.000

## ***Expansion Valves - Orifice Tubes***

<b>Part No</b>	<b>Capillary Tube Length</b>	<b>Equalizer Tube Length</b>	<b>Equalizer Fitting</b>	<b>Inlet Fitting</b>	<b>Outlet Fitting</b>	<b>Superheat</b>	<b>Ton</b>
39237	11-1/2	9.250	Female O-Ring M12x1.250	#6 Male O-Ring	#8 Male O-Ring	0.500	1.500
39240	12-1/2	13.500	O-Ring	#6 Male O-Ring	#8 Male O-Ring	2.500	1.500
39246	13	9.250	Female O-Ring 7/16" - 20	#6 Male O-Ring	#8 Male O-Ring	4.500	1.500
39248	13			#6 Male O-Ring	#8 Male O-Ring	5.000	1.000
39250	7-1/2	33.750	O-Ring	#6 Male O-Ring	#8 Male O-Ring	3.500	1.500
39255	10-3/4	12.750	Female O-Ring M12x1.250	#6 Male O-Ring	#8 Male O-Ring	5.000	1.500
39273	11-3/4	14.000	O-Ring M12x1.250			-0.500	1.500



# Expansion Valves and Orifice Tubes

## Expansion Valve

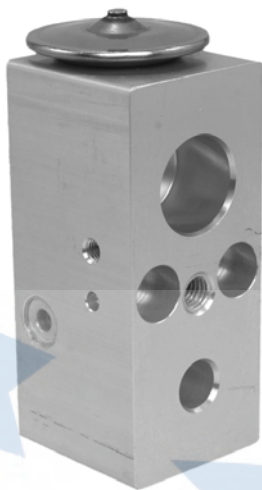

**38002**  
Block Type Flange Expansion Valve  
Ton: 1.500  
Superheat: 6.500  
Liquid Inlet: No. 6  
Suction Inlet: No. 12  
Liquid Outlet: No. 8  
Suction Outlet: No. 12  
Color: Aluminum  
O-Rings: (1) , (1) **24138**, (1) **24149**, (1) **24167**, (2) **24632**, (2) **24633**  
Chrysler (95-93); Dodge (95-93);  
Plymouth (95-93)  
Chrysler: 4677334

## CAUTION

DO NOT use compressed air to blow out refrigerant hoses or other components on vehicles equipped with R134a systems. Tests have shown compressed air and R134a together can be explosive.

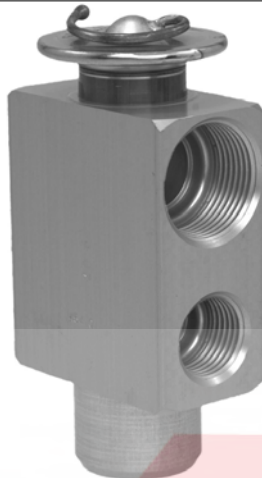

**38602**  
Block Type O-Ring Expansion Valve  
Ton: 2.000  
Superheat: 6.300  
Liquid Inlet: No. 6  
Suction Inlet: No. 10  
Liquid Outlet: No. 8  
Suction Outlet: No. 10  
Color: Aluminum  
O-Rings: (1) **24606**, (1) **24608**, (2) **24610**  
BMW (91-89); Jaguar (93-82);  
Mercedes (93-77); VW (91-86)  
Jaguar: CAC2423, CAC8169  
Mercedes Benz: 1268300284,  
1268300384  
Climatech: EA1085  
Euclid: E805028

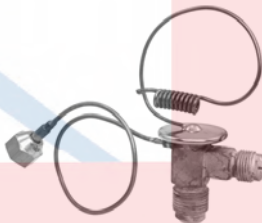

**38604**  
TXV Type Flare Expansion Valve  
Ton: 2.000  
Superheat: 9.900  
Cap Tube Length: 8  
Equal Tube Length: 10.500  
Equalizer Fitting: Female  
Inlet Fitting: No. 6  
Outlet Fitting: No. 8  
BMW (88-75); Dodge (64-63);  
Mercedes (85-73)  
BMW: 64511354379  
Mercedes Benz: 1158350072



**38606**  
TXV Type Flare Expansion Valve  
Ton: 1.500  
Superheat: 7.000  
Cap Tube Length: 10-1/2  
Equal Tube Length: 13.000  
Equalizer Fitting: Female  
Inlet Fitting: No. 6  
Outlet Fitting: No. 8  
Ford (78), (72-65)  
Brockway: 5576  
Case New Holland: F61389, F63727,  
FA42625  
Deutz: 0034236  
Euclid: E805013  
Hy-Capacity: 0000888193  
Massey Ferguson: 1626141M91,  
250902M1  
NaviStar: 244562R91  
Northern: 904204  
Red Dot: RD41261P

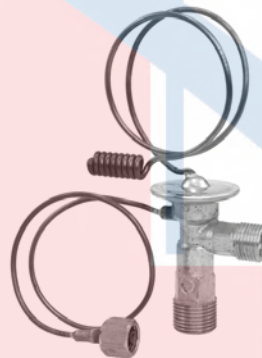

**38607**  
TXV O-Ring Expansion Valve  
Ton: 2.000  
Superheat: 8.000  
Cap Tube Length: 15  
Equal Tube Length: 12.000  
Equalizer Fitting: Female  
Inlet Fitting: No. 6  
Outlet Fitting: No. 8  
O-Rings: (1) **24604**, (1) **24606**, (1) **24608**  
Dodge (64-62); Plymouth (64-62);  
Volvo (90-75)  
Volvo: 1394712  
Kysor: 1875003, 1899037



**38608**  
TXV Type Flare Expansion Valve  
Ton: 1.500  
Superheat: 8.000  
Cap Tube Length: 14-1/2  
Inlet Fitting: No. 6  
Outlet Fitting: No. 8  
AMC (88-58); Chrysler (79-74); Dodge (86-64); Ford (99-62); Honda (81-73);  
Int'l (80-73); Jeep (93), (91-63);  
Lincoln (65-64), (60); Mazda (82-70);  
Mercury (91-60); Nissan (81-72)  
Olds (60-58); Peugeot (82), (79-77);  
Plymouth (84-74); Porsche (76-71);  
Toyota (80-68)  
General Motors Corp: 19189758  
Nissan: 27624H7300  
Toyota: 8851510010, 8851512032,  
8851520010, 8851520031, 885152204  
AMC: 3162784, 3166968, 3171974,  
3176453, 3212116, 3216282,  
7711025861, 8121823, 8121824,  
SE2087090  
ARA: 1296300, 1296301, 1296339,  
1298000  
Bergstrom: 540131, 540133  
Carrier: 168903C91, 20179C1  
Case New Holland: 83915986  
Climatech: EA1055, EA1390  
Euclid: E805003  
Kysor: 1813002  
Mack: 4379RD560990  
Massey Ferguson: 1024984M92,  
237409M1, 3038920M9, 529876M91  
NaviStar: 168903C11, 539064R1,  
709005  
Northern: 904202, 904215, 904244,  
904298  
Red Dot: 71R8210  
TRP Parts: EA10550



**38609**  
TXV O-Ring Expansion Valve  
Ton: 2.000  
Superheat: 8.000  
Cap Tube Length: 8-1/2  
Equal Tube Length: 11.000  
Equalizer Fitting: Female  
Inlet Fitting: No. 6  
Outlet Fitting: No. 8  
O-Rings: (1) **24604**, (1) **24606**, (1) **24608**  
Porsche (92-77); VW (93-84)  
Volkswagen: 171820679

# Expansion Valves and Orifice Tubes

## Expansion Valve Cont'd



**38610**  
TXV O-Ring Expansion Valve  
Ton: 1.500  
Superheat: 8.000  
Cap Tube Length: 20  
Equal Tube Length: 16.000  
Equalizer Fitting: Female  
Inlet Fitting: No. 6  
Outlet Fitting: No. 8  
O-Rings: (1) **24604**, (1) **24606**, (1) **24608**

Audi (87-75); BMW (84-77); Chevy (88-85); Geo (89); Isuzu (91-81); Mazda (93-90), (86); Porsche (85-83); Volvo (93-91); VW (93-87), (81-79)  
Audi: 321820679  
Isuzu: 8973020560  
Volkswagen: 321820679  
Allis Chalmers: 02617645, 259379, 261764  
Brockway: 56380, 57627P  
Euclid: E805016, E805023  
Hesston: 9955073  
Kenworth: 402717  
NaviStar: 118305C1, 12244  
Northern: 904296



**38611**  
TXV O-Ring Expansion Valve  
Ton: 1.500  
Superheat: 5.000  
Cap Tube Length: 21-1/2  
Equal Tube Length: 17.000  
Equalizer Fitting: Female  
Inlet Fitting: No. 6  
Outlet Fitting: No. 8  
O-Rings: (1) **24604**, (1) **24606**, (1) **24608**  
Hyundai (95-92); Mazda (90-81); Mitsubishi (93)



**38613**  
TXV Type Flare Expansion Valve  
Ton: 2.000  
Superheat: 5.000  
Cap Tube Length: 40-1/2  
Equal Tube Length: 41.500  
Equalizer Fitting: Female  
Inlet Fitting: No. 6  
Outlet Fitting: No. 8  
O-Rings: (1) **24606**, (1) **24608**

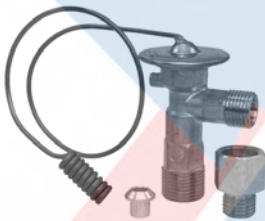

**38616**  
TXV O-Ring Expansion Valve  
Ton: 1.500  
Superheat: 9.000  
Cap Tube Length: 14  
Inlet Fitting: No. 6  
Outlet Fitting: No. 8  
O-Rings: (1) **24606**, (1) **24608**, (1) **24607**  
Acura (97-96), (90-86); Chevy (93-91), (88-85); Dodge (90-85); Eagle (94-89); Ford (93-88); Geo (92-89); Honda (85-82); Hyundai (89-86); Isuzu (95-93); Lexus (91-90); Mazda (95-81)  
Mercury (96-91), (89-87); Mitsubishi (94-83); Plymouth (94-85); Toyota (95-78)  
General Motors Corp: 19189763  
Honda: 38650SA5003  
Hyundai: 9762321000  
Mitsubishi: MB276282, MB276578, MB298891  
Toyota: 8851512051, 885151603183, 8851516040, 8851520040, 885152013, 8851587002, 8851587003

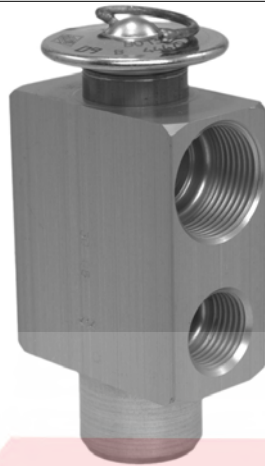

**38618**  
Block Type O-Ring Expansion Valve  
Ton: 2.000  
Superheat: 5.000  
Liquid Inlet: No. 6  
Suction Inlet: No. 10  
Liquid Outlet: No. 8  
Suction Outlet: No. 10  
Color: Aluminum  
O-Rings: (1) **24606**, (1) **24608**, (2) **24610**  
BMW (91-84)  
BMW: 64518391209  
Euclid: E805054  
Massey Ferguson: CL622838C0

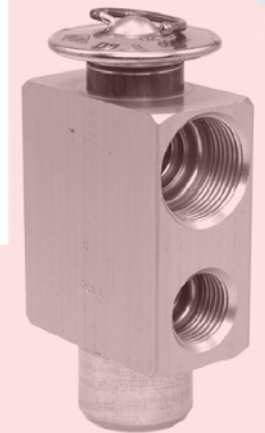

**38620**  
Block Type O-Ring Expansion Valve  
Ton: 2.000  
Superheat: 6.300  
Liquid Inlet: No. 6  
Suction Inlet: No. 8  
Liquid Outlet: No. 8  
Suction Outlet: No. 10  
Color: Aluminum  
O-Rings: (1) **24606**, (2) **24608**, (1) **24610**  
VW (92-85)  
General Motors Corp: 19189765  
Volkswagen: 191820679  
Massey Ferguson: 3311533M91  
Northern: 9041850



**38622**  
TXV O-Ring Expansion Valve  
Ton: 2.000  
Superheat: 10.500  
Cap Tube Length: 33  
Equal Tube Length: 31.000  
Equalizer Fitting: Male  
Inlet Fitting: No. 6  
Outlet Fitting: No. 8  
O-Rings: (1) **24604**, (1) **24606**, (1) **24608**  
Buick (75-62); Cadillac (73-63); Chevy (74-60); Chrysler (73-65); Dodge (73-65); GMC (70), (68-67); Olds (74-61); Plymouth (68-65); Pontiac (73-60)  
General Motors Corp: 19189767  
ARA: 1296372, 1296601  
Bergstrom: 540176  
Brockway: 5638  
Case New Holland: 83906905, 83960933  
Climatex: EA1225  
Dallas Truck AC: 0415005  
Deutz: 259379  
Euclid: E805022, E805024  
Evans: AM89800  
Kysor: 1813001, 404111  
NaviStar: 21590R1, 2684700C1, 434683C1, 451996C1, 454608C1, 454685C1, 454695C1, 455788C1  
Northern: 904217  
Red Dot: 71R8130, 71R8180



**38629**  
TXV O-Ring Expansion Valve  
Ton: 2.000  
Superheat: 8.000  
Cap Tube Length: 15  
Equal Tube Length: 34.000  
Equalizer Fitting: Female  
Inlet Fitting: No. 6  
Outlet Fitting: No. 8  
O-Rings: (1) **24607**, (1) **24604**, (1) **24608**  
Toyota (89-81)  
Toyota: 8851522200

# Expansion Valves and Orifice Tubes

## Expansion Valve Cont'd



### 38630

Block Type Flange Expansion Valve  
 Ton: 2.000  
 Superheat: 5.400  
 Liquid Inlet: No. 6  
 Suction Inlet: No. 10  
 Liquid Outlet: No. 8  
 Suction Outlet: No. 12  
 Color: Aluminum  
 O-Rings: (1) **24608**, (1) **24606**, (1) **24610**, (1) **24612**  
 BMW (01-87)  
 BMW: 64118362851



### 38631

TXV O-Ring Expansion Valve  
 Ton: 1.500  
 Superheat: 8.000  
 Cap Tube Length: 15  
 Equal Tube Length: 34.000  
 Equalizer Fitting: Female  
 Inlet Fitting: No. 6  
 Outlet Fitting: No. 8  
 O-Rings: (1) **24604**, (1) **24606**, (1) **24608**  
 Acura (94-92); Dodge (94-90); Eagle (96-91); Honda (95-90); Mitsubishi (93-89); Plymouth (95-89); Toyota (85), (81)  
 Chrysler: MB276764  
 Honda: 80220SR1A11  
 Mitsubishi: MB276764  
 Toyota: 8851514080



### 38633

TXV O-Ring Expansion Valve  
 Ton: 1.500  
 Superheat: 8.000  
 Cap Tube Length: 13  
 Inlet Fitting: No. 6  
 Outlet Fitting: No. 8  
 O-Rings: (1) **24608**, (1) **24606**  
 Nissan (85-82); Subaru (91-83)  
 Nissan: 92200D0100  
 Hy-Capacity: 0000888104

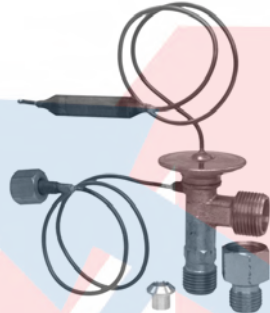

### 38637

TXV O-Ring Expansion Valve  
 Ton: 1.500  
 Superheat: 8.000  
 Cap Tube Length: 13  
 Equal Tube Length: 13.500  
 Equalizer Fitting: Female  
 Inlet Fitting: No. 6  
 Outlet Fitting: No. 8  
 O-Rings: (1) **24604**, (1) **24606**, (1) **24608**  
 Honda (98-94); Infiniti (99-93); Isuzu (98-92); Nissan (99-79); Subaru (97-90)  
 Infiniti: 9220031U00  
 Isuzu: 1835691580  
 Nissan: 9220001E00, 9220001R00, 9220004A02, 9220031U00, 92200W1000



### 38652

TXV O-Ring Expansion Valve  
 Ton: 1.500  
 Superheat: 10.500  
 Cap Tube Length: 37  
 Equal Tube Length: 34.500  
 Equalizer Fitting: Male  
 Inlet Fitting: No. 6  
 Outlet Fitting: No. 8  
 O-Rings: (2) **24626**, (1) **24149**, (1) **24604**  
 Buick (72-63); Cadillac (75-63); Chevy (72-69); GMC (73-68); Olds (66-62); Pontiac (66-62)  
 Kysor: 1899026

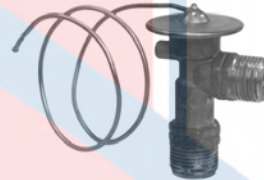

### 38654

TXV O-Ring Expansion Valve  
 Ton: 2.000  
 Superheat: 4.500  
 Cap Tube Length: 16-1/2  
 Inlet Fitting: No. 6  
 Outlet Fitting: No. 8  
 O-Rings: (1) **24606**, (1) **24608**  
 Chevy (96-92); GMC (96-92)  
 Kysor: 1810005, 1899012  
 NaviStar: 16406, 16917106C1, 19272



### 38655

TXV O-Ring Expansion Valve  
 Ton: 1.500  
 Superheat: 5.000  
 Cap Tube Length: 6  
 Equal Tube Length: 4.000  
 Equalizer Fitting: Female  
 Inlet Fitting: No. 6  
 Outlet Fitting: No. 8  
 O-Rings: (1) **24604**, (1) **24606**, (1) **24608**  
 Buick (95-94); Chevy (96-94); Olds (95-94); Pontiac (95-94)



### 38663

TXV O-Ring Expansion Valve  
 Ton: 1.500  
 Superheat: 8.000  
 Cap Tube Length: 12  
 Equal Tube Length: 9.500  
 Equalizer Fitting: Female  
 Inlet Fitting: No. 6  
 Outlet Fitting: No. 8  
 O-Rings: (1) **24604**, (1) **24606**, (1) **24608**  
 Mazda (97-90)  
 Mazda: BC1M61J14



# Expansion Valves and Orifice Tubes

## Expansion Valve Cont'd



**38669**  
Block Type O-Ring Expansion Valve  
Ton: 2.000  
Superheat: 7.900  
Liquid Inlet: No. 6  
Suction Inlet: No. 8  
Liquid Outlet: No. 8  
Suction Outlet: No. 10  
Color: Aluminum  
O-Rings: (1) **24606**, (2) **24608**, (1) **24610**  
Case New Holland: 81874718, 82000932

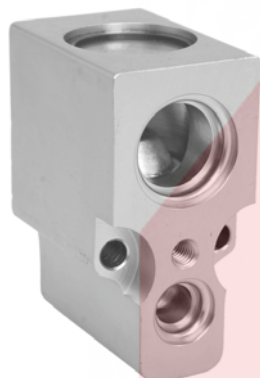

**38670**  
Block Type Flange Expansion Valve  
Ton: 1.500  
Superheat: 5.000  
Liquid Inlet: No. 6  
Suction Inlet: No. 10  
Liquid Outlet: No. 8  
Suction Outlet: No. 12  
Color: Gold  
O-Rings: (2) **24612**, (1) **24606**, (2) **24608**, (1) **24610**  
Audi (06-00); Nissan (10-02); Renault (10-02); VW (15-92)  
Volkswagen: 6N0820679C

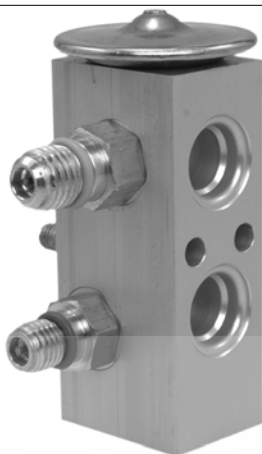

**38677**  
Block Type O-Ring Expansion Valve  
Ton: 2.000  
Superheat: 8.000  
Liquid Inlet: No. 6  
Suction Inlet: No. 8  
Liquid Outlet: No. 8  
Suction Outlet: No. 10  
Color: Aluminum  
O-Rings: (1) **24606**, (2) **24608**, (1) **24610**  
Bergstrom: 540057  
Climatech: 540057BSM  
Kenworth: 540057BSM, 549708BSM  
Kysor: 1899030  
Peterbilt: 540057BSM, 549708BSM  
Red Dot: 71R8430, RD58936OP  
TRP Parts: EA14650

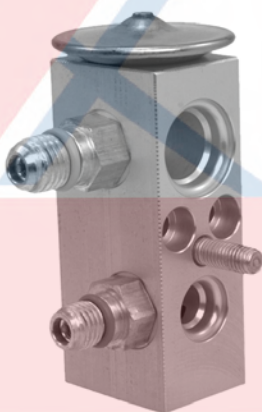

**38679**  
Block Type O-Ring Expansion Valve  
Ton: 2.000  
Superheat: 5.000  
Liquid Inlet: No. 6  
Suction Inlet: No. 8  
Liquid Outlet: No. 8  
Suction Outlet: No. 10  
Color: Aluminum  
O-Rings: (1) **24606**, (2) **24608**, (1) **24610**  
Kenworth: 540254BSM  
Kysor: 1813007  
NaviStar: 1699955C1, 1699955C2, 2501794C92  
TRP Parts: EA13100



**38683**  
TXV O-Ring Expansion Valve  
Ton: 1.500  
Superheat: 8.000  
Cap Tube Length: 20-1/2  
Inlet Fitting: No. 6  
Outlet Fitting: No. 8  
O-Rings: (1) **24606**, (1) **24608**  
Acura (89-86); AMC (81-74); Buick (63-61); Chevy (93-60); Dodge (93), (73-69); Ford (10-73); GMC (93-62); Honda (89-86), (84-79); Jeep (95-91); Mazda (82-81); Olds (63-61)  
Plymouth (73-69); Pontiac (61-60)  
Ford: F4UZ19849A  
General Motors Corp: 19189786  
Honda: SC826050  
AMC: 3222003, 3693087  
ARA: 1296341  
Euclid: E805008  
Kysor: 1899001  
Massey Ferguson: 3478520M91  
Northern: 9041830, 904240  
TRP Parts: EA13900

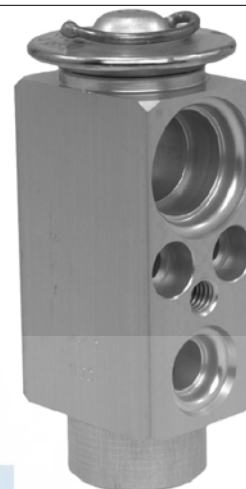

**38686**  
Block Type Flange Expansion Valve  
Ton: 2.000  
Superheat: 3.000  
Liquid Inlet: No. 6  
Suction Inlet: No. 10  
Liquid Outlet: No. 8  
Suction Outlet: No. 12  
Color: Aluminum  
O-Rings: (2) **24612**, (1) **24606**, (1) **24608**, (2) **24610**  
BMW (06-97)  
BMW: 64116981454  
Kysor: 1813013, 1818006  
NaviStar: 3660853C2



**38685**  
Block Type Flange Expansion Valve  
Ton: 2.000  
Superheat: 5.000  
Liquid Inlet: No. 6  
Suction Inlet: No. 10  
Liquid Outlet: No. 8  
Suction Outlet: No. 10  
Color: Aluminum  
O-Rings: (1) **24606**, (1) **24608**, (2) **24610**  
Porsche (98-86)  
Porsche: 92857312305



**38720**  
TXV O-Ring Expansion Valve  
Ton: 1.500  
Superheat: 10.500  
Cap Tube Length: 11-1/2  
Inlet Fitting: No. 6  
Outlet Fitting: No. 8  
O-Rings: (1) **24606**, (1) **24608**  
AMC (75-71); Audi (77-75); Buick (61-59); Cadillac (62-61); Chevy (60-58); Ford (76), (72-71); Honda (84-82); Mercury (72-71); VW (86-80), (77-75)  
AMC: 3205085, 3216522, 3216523, 3616523  
Bergstrom: 540129, 540132  
Climatech: EA1375  
Euclid: E805004, E805005, E805006, E805007  
Kysor: 1818001  
Massey Ferguson: 1034564M91  
NaviStar: 1691706C1  
Northern: 904221, 904266, 904268  
Red Dot: RD560990P

# Expansion Valves and Orifice Tubes

## Expansion Valve Cont'd



### 38722

TXV Type Flare Expansion Valve  
 Ton: 1.500  
 Superheat: 8.000  
 Cap Tube Length: 32  
 Inlet Fitting: No. 6  
 Outlet Fitting: No. 8  
 Audi (74-69); Jeep (90-87)  
 Allis Chalmers: 1162473, 11624731  
 AMC: 3201603, 3201982, 3204477, 3205087, 3216823, 8126988, SE2087049  
 ARA: 129770, 1298408  
 Case New Holland: 130226, 251038, 274571  
 Euclid: E805002  
 Evans: AM89812  
 Full Vison: 5858  
 Hesston: 8414290  
 Kysor: 404105  
 Massey Ferguson: 529877M1  
 NaviStar: 11523, 430303C1  
 Northern: 904203, 904247  
 Red Dot: 71R8200  
 Versatile: 18384

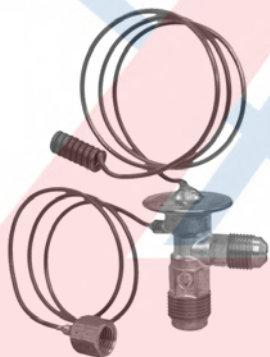

### 38723

TXV Type Flare Expansion Valve  
 Ton: 2.000  
 Superheat: 8.000  
 Cap Tube Length: 23  
 Equal Tube Length: 17.000  
 Equalizer Fitting: Female  
 Inlet Fitting: No. 6  
 Outlet Fitting: No. 8  
 Chrysler (64-61)  
 Nissan: 27625S5000, 27635W8700  
 Bergstrom: 540175  
 Climatech: EA1005  
 Hy-Capacity: 0000888142  
 NaviStar: 173899C1, 66398C1  
 Northern: 904253



### 38725

TXV Type Flare Expansion Valve  
 Ton: 1.500  
 Superheat: 8.000  
 Cap Tube Length: 18  
 Equal Tube Length: 18.500  
 Equalizer Fitting: Female  
 Inlet Fitting: No. 6  
 Outlet Fitting: No. 8  
 Audi (74-73); Ford (89-83); Int'l (80-73); Jeep (93), (91-74), (68); Mazda (81-79); Mercedes (78-65); Mercury (89-82); Nissan (85-79); Porsche (83-78); Subaru (89-85); VW (88-82)  
 Nissan: 27635H9116, 27635S0100, 9220003W00  
 Toyota: 8851522060  
 AMC: 5464379, 5484379, 8121594, 8124475  
 ARA: 1295201, 1295301, 1296315, 1296600  
 Case New Holland: 31510, 66398C1  
 Caterpillar: 1P6526  
 Deutz: 0034238  
 Euclid: E805012  
 Evans: AM89801, AM89805, HV26117, HV27738, HV30728  
 Frigiking: 5721002  
 Full Vison: 172924, 2975002  
 Hesston: 7022304  
 Hinker: 116001022  
 Hupp: 27010501, 62386G1  
 Hy-Capacity: 0000888141  
 John Deere: AH80191  
 Kenworth: 404021, RD4126  
 Kysor: 1899008, 404021  
 Mack: 2790HV26117, 2790HV30728, 404021, 41156121002, 4379RD4126, 7979404021  
 Massey Ferguson: 1072136M91, 1626141M1, 276675W1, 303178706  
 NaviStar: 11838, 1691711C1, 2684701C1, 426147C1, 647669C91, C62386G1  
 Northern: 904252  
 Peterbilt: 404021, HV32668  
 Red Dot: 71R8050, RD4126  
 Versatile: 31510



### 38727

TXV Type Flare Expansion Valve  
 Ton: 2.000  
 Superheat: 5.000  
 Cap Tube Length: 13  
 Inlet Fitting: No. 6  
 Outlet Fitting: No. 8  
 Dallas Truck AC: 0415001  
 Euclid: E805000, E805001  
 Full Vison: 58580  
 Hesston: 841429  
 Hy-Capacity: 0000888190  
 John Deere: AR45882, AR49961  
 Kysor: 404000  
 Mack: 4379RD4157, 7979404000  
 New Idea: 731737  
 Northern: 904211  
 Steiger: 17844, 251038  
 Stople: 38495

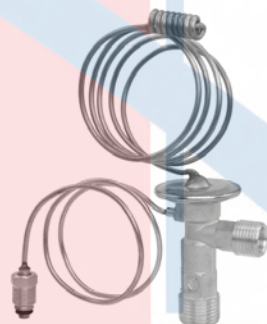

### 38728

TXV O-Ring Expansion Valve  
 Ton: 1.500  
 Superheat: 12.000  
 Cap Tube Length: 31  
 Equal Tube Length: 18.000  
 Equalizer Fitting: Male  
 Inlet Fitting: No. 6  
 Outlet Fitting: No. 8  
 O-Rings: (1) 24604, (1) 24606, (1) 24608  
 Euclid: E805015  
 Northern: 904219, 904289  
 Red Dot: 71R8150



### 38729

TXV O-Ring Expansion Valve  
 Ton: 1.000  
 Superheat: 6.000  
 Cap Tube Length: 10-1/4  
 Equal Tube Length: 8.000  
 Equalizer Fitting: Male  
 Inlet Fitting: No. 6  
 Outlet Fitting: No. 8  
 O-Rings: (1) 24604, (1) 24606, (1) 24608  
 Int'l (09-90), (87), (80-73)  
 Bergstrom: 540022, 540027, 540172  
 Climatech: EA1015, EA1300, EA1410  
 Kysor: 1813003, 1813009, 1899036  
 NaviStar: 12029, 19057  
 Northern: 904222  
 Red Dot: 71R8080, RD558620P, RD558620P



### 38730

TXV O-Ring Expansion Valve  
 Ton: 2.000  
 Superheat: 8.000  
 Cap Tube Length: 14  
 Inlet Fitting: No. 6  
 Outlet Fitting: No. 8  
 O-Rings: (1) 24606, (1) 24608  
 Honda (87-82), (79-76)  
 Honda: 38650SA7003

# Expansion Valves and Orifice Tubes

## Expansion Valve Cont'd



### 38733

TXV O-Ring Expansion Valve  
 Ton: 2.000  
 Superheat: 5.000  
 Cap Tube Length: 24-1/2  
 Inlet Fitting: No. 6  
 Outlet Fitting: No. 8  
 O-Rings: (1) **24606**, (1) **24608**  
 Hy-Capacity: 0000888105  
 Massey Ferguson: 3038920M91  
 NaviStar: 709001  
 Northern: 904216



### 38762

TXV O-Ring Expansion Valve  
 Ton: 1.500  
 Superheat: 1.000  
 Cap Tube Length: 10-1/2  
 Equal Tube Length: 9.750  
 Equalizer Fitting: Female  
 Inlet Fitting: No. 6  
 Outlet Fitting: No. 8  
 O-Rings: (1) **24604**, (1) **24606**, (1) **24608**  
 Isuzu (93-88); Mazda (92-88)  
 Mazda: GJ5161J14



### 38772

Block Type Flange Expansion Valve  
 Ton: 1.700  
 Superheat: 8.000  
 Liquid Inlet: No. 6  
 Suction Inlet: No. 10  
 Liquid Outlet: No. 8  
 Suction Outlet: No. 12  
 Color: Aluminum  
 O-Rings: (1) **24606**, (1) **24608**, (1) **24610**, (1) **24612**  
 Saab (92-91)



### 38804

Block Type O-Ring Expansion Valve  
 Ton: 1.500  
 Superheat: 7.000  
 Liquid Inlet: No. 8  
 Suction Inlet: No. 10  
 Liquid Outlet: No. 8  
 Suction Outlet: No. 10  
 Color: Aluminum  
 O-Rings: (2) **24608**, (2) **24610**  
 Chevy (97-93); Pontiac (97-93)  
 General Motors Corp: 52477944



### 38750

Block Type Flange Expansion Valve  
 Ton: 2.000  
 Superheat: 11.000  
 Liquid Inlet: No. 6  
 Suction Inlet: No. 10  
 Liquid Outlet: No. 8  
 Suction Outlet: No. 12  
 Color: Aluminum  
 O-Rings: (1) **24606**, (1) **24606**, (1) **24608**, (1) **24610**, (1) **24612**  
 Mercedes (93-84); Olds (73-71)  
 Mercedes Benz: 1408300484



### 38770

TXV O-Ring Expansion Valve  
 Ton: 2.000  
 Superheat: 8.000  
 Cap Tube Length: 9  
 Equal Tube Length: 9.750  
 Equalizer Fitting: Female  
 Inlet Fitting: No. 6  
 Outlet Fitting: No. 8  
 O-Rings: (1) **24604**, (1) **24606**, (1) **24608**  
 Saab (93-79)



### 38801

Block Type Flange Expansion Valve  
 Ton: 1.500  
 Superheat: 9.300  
 Liquid Inlet: No. 6  
 Suction Inlet: No. 12  
 Liquid Outlet: No. 8  
 Suction Outlet: No. 12  
 Color: Gold  
 O-Rings: (1) **24511**, (1) **24138**, (1) **24149**, (1) **24167**, (2) **24632**, (2) **24633**  
 Chrysler (93-90); Dodge (93-88);  
 Plymouth (92-89)  
 Chrysler: 4796464  
 Northern: 9041860



### 38805

TXV O-Ring Expansion Valve  
 Ton: 1.500  
 Superheat: 4.000  
 Cap Tube Length: 6  
 Equal Tube Length: 4.000  
 Equalizer Fitting: Female  
 Inlet Fitting: No. 6  
 Outlet Fitting: No. 8  
 O-Rings: (1) **24604**, (1) **24606**, (1) **24608**  
 Buick (93-92); Chevy (93-92); Olds (93-92); Pontiac (93-92)  
 General Motors Corp: 52460955



# Expansion Valves and Orifice Tubes

## Expansion Valve Cont'd



### 38806

TXV O-Ring Expansion Valve  
 Ton: 1.500  
 Superheat: 12.000  
 Cap Tube Length: 15-1/2  
 Inlet Fitting: No. 6  
 Outlet Fitting: No. 8  
 O-Rings: (1) **24606**, (1) **24608**  
 Chevy (93-91); GMC (93-91); Olds (93-92); Pontiac (93-92)  
 General Motors Corp: 52460953, 52465709



### 38808

Block Type Flange Expansion Valve  
 Ton: 2.000  
 Superheat: 6.500  
 Liquid Inlet: No. 8  
 Suction Inlet: No. 12  
 Liquid Outlet: No. 8  
 Suction Outlet: No. 12  
 Color: Aluminum  
 O-Rings: (2) **24608**, (2) **24612**  
 Chrysler (00-96); Dodge (00-96); Plymouth (00-96)  
 Chrysler: 4798682



### 38812

Block Type O-Ring Expansion Valve  
 Ton: 1.500  
 Superheat: 5.000  
 Liquid Inlet: No. 6  
 Suction Inlet: No. 10  
 Liquid Outlet: No. 8  
 Suction Outlet: No. 10  
 Color: Aluminum  
 O-Rings: (1) **24606**, (1) **24608**, (2) **24610**  
 Ford (02-97); Lincoln (02-98); Mercury (98-93); Nissan (98-94)



### 38814

Block Type Flange Expansion Valve  
 Ton: 2.000  
 Superheat: 7.000  
 Liquid Inlet: No. 6  
 Suction Inlet: No. 10  
 Liquid Outlet: No. 8  
 Suction Outlet: No. 12  
 O-Rings: (1) **24606**, (1) **24608**, (1) **24610**, (1) **24612**  
 Chevy (00); Mercedes (03-94)  
 Mercedes Benz: 2028300184  
 Red Dot: 71R8455

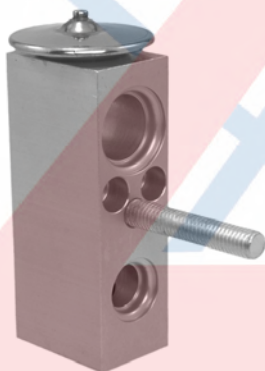

### 38807

Block Type Flange Expansion Valve  
 Ton: 2.000  
 Superheat: 6.500  
 Liquid Inlet: No. 8  
 Suction Inlet: No. 12  
 Liquid Outlet: No. 8  
 Suction Outlet: No. 12  
 Color: Aluminum  
 O-Rings: (2) **24608**, (2) **24612**  
 Chrysler (00-96); Dodge (00-96); Plymouth (00-96)

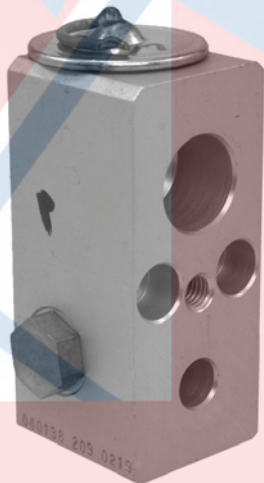

### 38811

Block Type Flange Expansion Valve  
 Ton: 1.000  
 Superheat: 7.000  
 Liquid Inlet: No. 6  
 Suction Inlet: No. 12  
 Liquid Outlet: No. 8  
 Suction Outlet: No. 12  
 Color: Aluminum  
 O-Rings: (1) **24511**, (1) **24138**, (1) **24149**, (1) **24167**, (2) **24632**, (2) **24633**  
 Chrysler (95-90); Dodge (95-90), (88); Plymouth (95-90)  
 Chrysler: 4644186

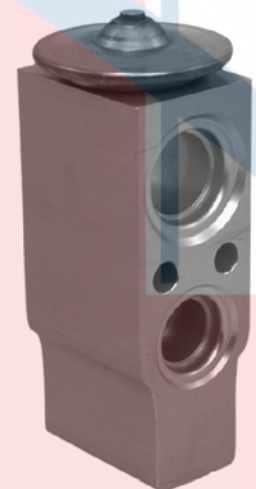

### 38813

Block Type Flange Expansion Valve  
 Ton: 1.500  
 Superheat: 9.000  
 Liquid Inlet: No. 6  
 Suction Inlet: No. 10  
 Liquid Outlet: No. 8  
 Suction Outlet: No. 12  
 O-Rings: (1) **24606**, (1) **24608**, (2) **24612**, (1) **24610**  
 Saab (98-93)  
 Saab: 30541969

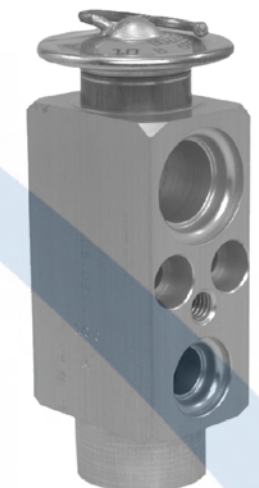

### 38822

Block Type Flange Expansion Valve  
 Ton: 2.000  
 Superheat: 14.400  
 Liquid Inlet: No. 6  
 Suction Inlet: No. 10  
 Liquid Outlet: No. 8  
 Suction Outlet: No. 10  
 O-Rings: (1) **24606**, (1) **24608**, (2) **24610**  
 Jaguar (99-94)  
 Jaguar: MMC6442AA  
 John Deere: AL77579, RE62137

# Expansion Valves and Orifice Tubes

## Expansion Valve Cont'd



**38823**  
Block Type O-Ring Expansion Valve  
Ton: 1.500  
Superheat: 3.500  
Liquid Inlet: No. 6  
Suction Inlet: No. 12  
Liquid Outlet: No. 8  
Suction Outlet: No. 12  
O-Rings: (1) **24149**, (2) **24626**, (2) **24642**  
Chrysler (02); Dodge (03-94), (89);  
Plymouth (01-99)  
Chrysler: 55036079AF

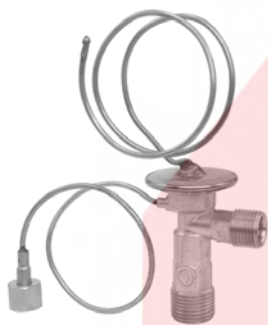

**38844**  
TXV O-Ring Expansion Valve  
Ton: 1.500  
Superheat: 8.000  
Cap Tube Length: 16  
Equal Tube Length: 11.000  
Equalizer Fitting: Female  
Inlet Fitting: No. 6  
Outlet Fitting: No. 8  
O-Rings: (1) **24604**, (1) **24606**, (1) **24608**  
Chrysler (75), (73-65); Dodge (85-65);  
Dodge Medium Duty Truck (80-78);  
Plymouth (83-62); Shelby (67-65)  
ARA: 1298205  
Dallas Truck AC: 0415002  
Euclid: E805042, E805043  
Evans: AM89806, HV28697  
NaviStar: 709004  
Northern: 904227  
Red Dot: 71R8100, RD538241P

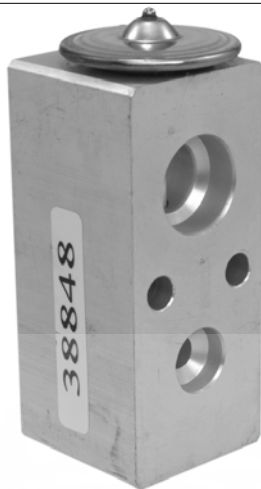

**38848**  
Block Type Flange Expansion Valve  
Ton: 1.500  
Superheat: 7.500  
Liquid Inlet: No. 6  
Suction Inlet: No. 12  
Liquid Outlet: No. 8  
Suction Outlet: No. 12  
O-Rings: ( ) , (1) **24138**, (1) , (1) **24167**, (2) **24632**, (2) **24633**  
Dodge (93-89), (85-79); Dodge  
Medium Duty Truck (81); Plymouth  
(81-79)  
Chrysler: 4796893

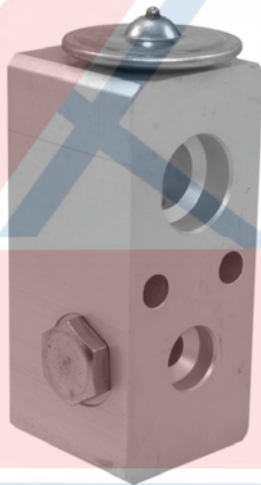

**38849**  
Block Type Flange Expansion Valve  
Ton: 1.500  
Superheat: 10.000  
Liquid Inlet: No. 6  
Suction Inlet: No. 12  
Liquid Outlet: No. 8  
Suction Outlet: No. 12  
O-Rings: ( ) , (1) **24138**, (1) , (1) **24167**, (2) **24632**, (2) **24633**  
Chrysler (95-74); Dodge (99-74);  
Dodge Medium Duty Truck (80-79);  
Plymouth (99-74)  
Chrysler: 4176999  
Euclid: E805040, E805041



**38850**  
Block Type Flange Expansion Valve  
Ton: 1.500  
Superheat: 16.000  
Liquid Inlet: No. 6  
Suction Inlet: No. 10  
Liquid Outlet: No. 6  
Suction Outlet: No. 10  
O-Rings: (1) **24149**, (3) **24666**, (3) **24670**  
Chrysler (00-93); Dodge (00-93); Eagle  
(97-93); Plymouth (00-96)  
Chrysler: 4596192

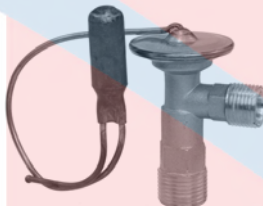

**38863**  
TXV O-Ring Expansion Valve  
Ton: 1.500  
Superheat: 5.000  
Cap Tube Length: 10-3/4  
Inlet Fitting: No. 6  
Outlet Fitting: No. 8  
O-Rings: (1) **24606**, (1) **24608**  
Ford (79-76); Lincoln (80-76); Mercury  
(79-74)  
Hy-Capacity: 0000888110, 0000888146



**38864**  
TXV O-Ring Expansion Valve  
Ton: 1.000  
Superheat: 7.500  
Cap Tube Length: 9-1/2  
Equal Tube Length: 8.500  
Equalizer Fitting: Male  
Inlet Fitting: No. 6  
Outlet Fitting: No. 8  
O-Rings: (1) **24604**, (1) **24606**, (1) **24608**  
Ford (89-86), (79-71); Int'l (02-90);  
Lincoln (76-71); Mercury (89-88),  
(80-72)  
Dallas Truck AC: 0415003  
Euclid: E805021  
Kysor: 404104



**38866**  
Block Type Flange Expansion Valve  
Ton: 2.000  
Superheat: 6.300  
Liquid Inlet: No. 6  
Suction Inlet: No. 10  
Liquid Outlet: No. 8  
Suction Outlet: No. 12  
O-Rings: (1) **24606**, (1) **24608**, (1) **24610**, (1) **24612**  
BMW (92-87); Merkur (89-85)

# Expansion Valves and Orifice Tubes

## Expansion Valve Cont'd



**38869**  
TXV O-Ring Expansion Valve  
Ton: 2.000  
Superheat: 5.300  
Cap Tube Length: 11  
Inlet Fitting: No. 6  
Outlet Fitting: No. 8  
O-Rings: (1) **24606**, (1) **24608**  
Mazda (91-86)  
Mazda: 000067B40B6A  
Case New Holland: F63726



**38870**  
TXV Type Flare Expansion Valve  
Ton: 1.500  
Superheat: 8.000  
Cap Tube Length: 30  
Inlet Fitting: No. 6  
Outlet Fitting: No. 8  
Caterpillar: 2G0397  
Climatech: EA1050



**38872**  
TXV O-Ring Expansion Valve  
Ton: 2.000  
Superheat: 8.000  
Cap Tube Length: 14-1/2  
Equal Tube Length: 18.000  
Equalizer Fitting: Female  
Inlet Fitting: No. 6  
Outlet Fitting: No. 8  
O-Rings: (1) **24604**, (1) **24606**, (1) **24608**  
Acura (93-90); Honda (91-86); Int'l (80-73); Jaguar (93-72); Mazda (87-83); Mercury (78-76), (74); Nissan (85-79)  
Acura: 80220SK7A11  
Honda: 80220SF1A11, 80220SH3A11  
Nissan: 27625H9160  
Allis Chalmers: 02684702, 259978, 268470, 2684700  
ARA: 1296355  
Bergstrom: 540058, 5638  
Case New Holland: 1280333C1, 1280333C2, 80430417, 80449624, 84004106, 89153793  
Climatech: EA1020  
Deutz: 0034586  
Euclid: E805017, E805018, E805019, E805020  
Evans: AM89803  
Hy-Capacity: 0000888215  
John Deere: 5638, 56380, 57627P  
Kenworth: 5638  
Kysor: 1814001, 1899025, 404073, 404110  
Mack: 2790HV27738, 4379RD538240, 7979404073  
Massey Ferguson: 3321511M91  
NaviStar: 118305C2, 11845, 739612C1  
Northern: 9041840, 904243, 904304  
Peterbilt: 404073  
Versatile: 70267



**38873**  
TXV Type Flare Expansion Valve  
Ton: 1.500  
Superheat: 8.000  
Cap Tube Length: 13-1/2  
Equal Tube Length: 17.000  
Equalizer Fitting: Male  
Inlet Fitting: No. 6  
Outlet Fitting: No. 8  
O-Rings: (1) **24604**  
Euclid: E805014  
Hupp: 62386G2  
Hy-Capacity: 0000888216  
NaviStar: C62386G2

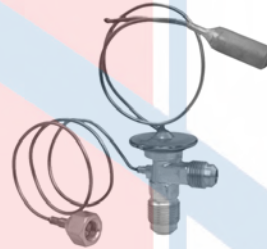

**38874**  
TXV Type Flare Expansion Valve  
Ton: 2.000  
Superheat: 10.500  
Cap Tube Length: 13-1/2  
Equal Tube Length: 18.000  
Equalizer Fitting: Female  
Inlet Fitting: No. 6  
Outlet Fitting: No. 8  
O-Rings: (1) **24606**, (1) **24608**  
Case New Holland: F64389  
Frigiking: 5711579, 9111579, 9113983  
Northern: 9041880, 904236, 904275, 904299



**38876**  
Block Type O-Ring Expansion Valve  
Ton: 2.000  
Superheat: 7.000  
Liquid Inlet: No. 6  
Suction Inlet: No. 10  
Liquid Outlet: No. 8  
Suction Outlet: No. 12  
O-Rings: (1) **24606**, (1) **24608**, (1) **24610**, (1) **24612**  
Cadillac (01-97)  
General Motors Corp: 9117610  
Brockway: 5638P  
Caterpillar: 2G401  
Evans: HV32582  
Frigiking: 3601131, 5701131  
Kenworth: 404073, 56380, 57627P, RD538240  
Mack: 404073



# Expansion Valves and Orifice Tubes

## Expansion Valve Cont'd



### 38877

TXV O-Ring Expansion Valve

Ton: 2.000

Superheat: 5.000

Cap Tube Length: 9-3/4

Equal Tube Length: 10.750

Equalizer Fitting: Female

Inlet Fitting: No. 6

Outlet Fitting: No. 8

O-Rings: (1) **24604**, (1) **24606**, (1)

**24608**

Deutz: 259978

Euclid: E805075

Evans: AM89802, AM89807, HV32338,

HV32668

Hy-Capacity: 0000888176

John Deere: AL37525, AR58482,

RE13886

Massey Ferguson: 3038918M1,

3038918M91, 3380223M1

NaviStar: 539064R91

Northern: 904213, 904288

# Expansion Valves and Orifice Tubes

## Expansion Valve Cont'd



### 38878

Block Type O-Ring Expansion Valve  
Ton: 1.500

Superheat: 5.000  
Liquid Inlet: No. 6  
Suction Inlet: No. 8  
Liquid Outlet: No. 8  
Suction Outlet: No. 10  
Color: Aluminum  
O-Rings: (1) **24606**, (2) **24608**, (1) **24610**

Porsche (85-78)  
BMW: 64111363581  
Mercedes Benz: 1238301184  
Allis Chalmers: 1195532, 13072020, 404098, 40498, 713072023  
AMC: 8134620  
AutoCar: 404098  
Bergstrom: 540035, 540343, 57055  
Brockway: 57055, 57055P, 58294P  
Caterpillar: 3V0258, 3V258  
Climatech: EA1060, EA1095, EA1210, EA1255  
Dallas Truck AC: 0415004  
Deutz: 04322165  
Euclid: E805025, E805032, E805036  
Evans: AM89804, HV30927  
Frigiking: 3600087, 5700087  
Hy-Capacity: 0000888135  
John Deere: 58294P, 842830000  
Kenworth: 404098, 404255, 540031BSM, 58294P, RD4157  
Kysor: 1817001, 1875001, 1899004, 1899027, 1899035, 404087, 404098, 404255  
Mack: 404098, 404255, 430057104, 4379RD568680, 4379RD568681, 7979404098, RD4157  
Massey Ferguson: 284238M1, D45092100  
NaviStar: 12467, 13586, 1669337C1, 1676665C91, 19058, 431606R1  
Northern: 9041800, 9041820, 904245, 904297  
Peterbilt: 1804275, 404098, P93CAB2500, RD4157, RD56868  
Red Dot: 71R8300, 71R8301, RD4157, RD56868OP  
TRP Parts: EA10650, EA10660, EA10750, EA12550, EA14200  
Western Star: 600125001, RD56868



### 38879

Block Type O-Ring Expansion Valve  
Ton: 1.500

Superheat: 8.000  
Liquid Inlet: No. 6  
Suction Inlet: No. 8  
Liquid Outlet: No. 8  
Suction Outlet: No. 10  
Color: Aluminum  
O-Rings: (1) **24606**, (2) **24608**, (1) **24610**

Bergstrom: 589500  
Climatech: EA1090  
Dallas Truck AC: 0415009  
Euclid: E805027  
John Deere: 71R8400  
Kenworth: 404146, 71R8400  
Kysor: 1899010, 404146, 404264  
Mack: 4379RD571550  
NaviStar: 14700  
Northern: 904248  
Red Dot: 71R8400, RD571550P



### 38880

Block Type O-Ring Expansion Valve  
Ton: 1.500

Superheat: 5.000  
Liquid Inlet: No. 6  
Suction Inlet: No. 10  
Liquid Outlet: No. 8  
Suction Outlet: No. 10  
Color: Aluminum  
O-Rings: (1) **24606**, (1) **24608**, (2) **24610**

Freightliner (04); Jeep (96-91)  
Chrysler: 55037271  
Case New Holland: 1990756C2, 98370C3  
Climatech: EA1315, EA1365  
Dallas Truck AC: 04150041  
Euclid: E805026, E805029, E805030, E805037  
Hy-Capacity: 0000888228, H888263  
Kysor: 1812001, 1818003, 404225, 404238, 404256  
Mack: 4379RD575670, 71R8320, RD55382, RD57015  
NaviStar: 11135, 13615, 19226, 2684680C91  
Northern: 9041870, 904254, 904617  
Red Dot: 71R8320, 71R8370, RD553820, RD575670P  
TRP Parts: 14300, EA10800  
Western Star: RD57015



### 38881

Block Type O-Ring Expansion Valve  
Ton: 1.500

Superheat: 8.000  
Liquid Inlet: No. 6  
Suction Inlet: No. 8  
Liquid Outlet: No. 8  
Suction Outlet: No. 10  
Color: Aluminum  
O-Rings: (1) **24606**, (2) **24608**, (1) **24610**  
BMW (87-78); Mercedes (83-75)

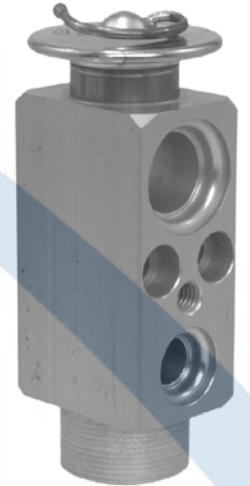

### 38882

Block Type Flange Expansion Valve  
Ton: 2.500

Superheat: 3.000  
Liquid Inlet: No. 6  
Suction Inlet: No. 10  
Liquid Outlet: No. 8  
Suction Outlet: No. 10  
O-Rings: (2) **24606**, (1) **24608**, (1) **24610**  
Jaguar (94-93)

# Expansion Valves and Orifice Tubes

## Expansion Valve Cont'd



**38883**  
 Block Type Flange Expansion Valve  
 Ton: 1.500  
 Superheat: 8.000  
 Liquid Inlet: No. 6  
 Suction Inlet: No. 10  
 Liquid Outlet: No. 10  
 Suction Outlet: No. 10  
 O-Rings: (2) **24607**, (2) **24610**  
 Geo (93); Lexus (93-92); Mitsubishi (93-89); Toyota (93-89)  
 General Motors Corp: 19189833  
 Toyota: 885153301083



**38884**  
 Block Type Flange Expansion Valve  
 Ton: 1.500  
 Superheat: 8.000  
 Liquid Inlet: No. 6  
 Suction Inlet: No. 12  
 Liquid Outlet: No. 12  
 Suction Outlet: No. 12  
 O-Rings: (1) **24626**, (3) **24642**  
 Geo (97-94); Hyundai (98-97); Isuzu (99-96); Lexus (01-94); Mitsubishi (00-94); Suzuki (02-95); Toyota (04-94); VW (10-98)  
 General Motors Corp: 19189834  
 Suzuki: 9543171B10  
 Toyota: 8851522240

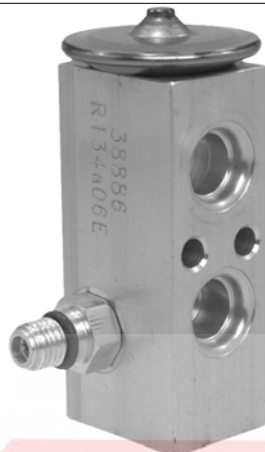

**38886**  
 Block Type Flange Expansion Valve  
 Ton: 2.000  
 Superheat: 8.000  
 Liquid Inlet: No. 6  
 Suction Inlet: No. 8  
 Liquid Outlet: No. 8  
 Suction Outlet: No. 10  
 O-Rings: (1) **24606**, (2) **24608**, (1) **24610**  
 Int'l (09-90), (87)  
 Bergstrom: 540044  
 Caterpillar: 2328564  
 Climatch: 540056BSM, EA1305  
 Euclid: E805055  
 Kysor: 1813004  
 Mack: 4379RD5104470  
 NaviStar: 1696846C1, 1696846C2, 19276, 19837  
 TRP Parts: EA13200

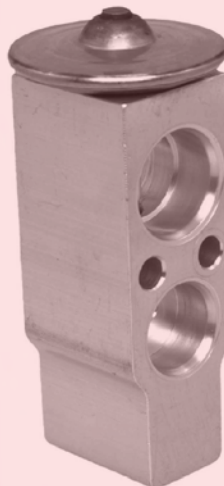

**38888**  
 Block Type O-Ring Expansion Valve  
 Ton: 1.000  
 Superheat: 7.500  
 Liquid Inlet: No. 6  
 Suction Inlet: No. 12  
 Liquid Outlet: No. 10  
 Suction Outlet: No. 12  
 O-Rings: (1) **24661**, (1) **24666**, (2) **24681**  
 Lexus (03-98); Toyota (06-98)  
 Toyota: 8851507040



**38889**  
 TXV O-Ring Expansion Valve  
 Ton: 1.500  
 Superheat: 2.000  
 Cap Tube Length: 5-3/4  
 Equal Tube Length: 4.000  
 Equalizer Fitting: Female  
 Inlet Fitting: No. 6  
 Outlet Fitting: No. 8  
 O-Rings: (1) **24604**, (1) **24606**, (1) **24608**  
 Buick (93-92); Chevy (93-92); Olds (93-92); Pontiac (93-92)



**38891**  
 TXV O-Ring Expansion Valve  
 Ton: 1.500  
 Superheat: 12.000  
 Cap Tube Length: 15-1/2  
 Inlet Fitting: No. 6  
 Outlet Fitting: No. 8  
 O-Rings: (1) **24606**, (1) **24608**  
 Chevy (96-94); Olds (96-94); Pontiac (96-94)  
 Kysor: 1817002  
 Red Dot: 71R8090, RD5107340P



# Expansion Valves and Orifice Tubes

## Expansion Valve Cont'd



### 38892

Block Type O-Ring Expansion Valve  
Ton: 2.000  
Superheat: 1.500  
Liquid Inlet: No. 6  
Suction Inlet: No. 10  
Liquid Outlet: No. 8  
Suction Outlet: No. 12  
O-Rings: (1) **24606**, (1) **24608**, (1) **24610**, (1) **24612**  
John Deere: RE283957, RE57575  
Kysor: 1813011, 1818002  
Red Dot: 71R8423, RD581000P  
TRP Parts: EA14150



### 38898

Block Type Flange Expansion Valve  
Ton: 1.500  
Superheat: 4.000  
Liquid Inlet: No. 6  
Suction Inlet: No. 10  
Liquid Outlet: No. 8  
Suction Outlet: No. 12  
O-Rings: (1) **24610**, (1) **24629**, (1) **24642**, (1) **24661**  
Saturn (02-91)  
General Motors Corp: 19189838, 21030587  
Saturn: 21030587



### 38901

Block Type O-Ring Expansion Valve  
Ton: 1.500  
Superheat: 8.000  
Liquid Inlet: No. 6  
Suction Inlet: No. 8  
Liquid Outlet: No. 8  
Suction Outlet: No. 10  
Color: Aluminum  
O-Rings: (1) **24606**, (2) **24608**, (1) **24610**

Chrysler (85-84), (80); Dodge (89-88), (85-80); Ford (79-68); Freightliner (96-74); Int'l (80-73); International (94-84); Jeep (90-84), (80-63); Mercury (77-68); Plymouth (85-80)  
Renault (87-77); Sterling (93-70)  
AMC: 7701025083, 7701026533, 8956000212, 8983501907, SE2087249, SE2087282  
ARA: 1298207  
Bergstrom: 540031, 582940  
Climatech: EA1065  
Hy-Capacity: H888214  
Kysor: 1875002  
NaviStar: 1676649C1  
Northern: 904225  
Renault: 7701025083, 7701026533



### 38906

TXV O-Ring Expansion Valve  
Ton: 1.500  
Superheat: 8.000  
Cap Tube Length: 5-3/4  
Equal Tube Length: 4.000  
Equalizer Fitting: Female  
Inlet Fitting: No. 6  
Outlet Fitting: No. 8  
O-Rings: (1) **24604**, (1) **24606**, (1) **24608**  
Buick (98-96); Chevy (96); Olds (98-96); Pontiac (98-96)



### 38907

TXV O-Ring Expansion Valve  
Ton: 1.500  
Superheat: 4.500  
Cap Tube Length: 8-1/2  
Inlet Fitting: No. 6  
Outlet Fitting: No. 8  
O-Rings: (2) **24626**, (1) **24149**  
Chevy (99-94); GMC (02-94)  
Kysor: 1810004

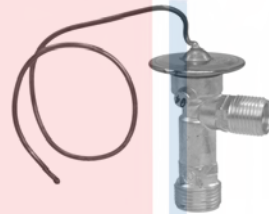

### 38908

TXV O-Ring Expansion Valve  
Ton: 1.500  
Superheat: 4.500  
Cap Tube Length: 12-1/2  
Inlet Fitting: No. 6  
Outlet Fitting: No. 8  
O-Rings: (2) **24626**, (1) **24149**  
Chevy (05-94); GMC (05-94)  
General Motors Corp: 52468324

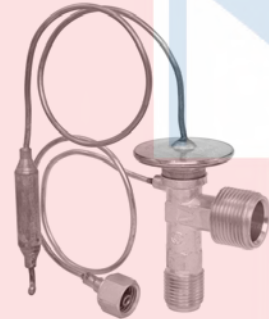

### 39000

TXV O-Ring Expansion Valve  
Ton: 1.500  
Superheat: 4.500  
Cap Tube Length: 13-1/4  
Equal Tube Length: 11.250  
Equalizer Fitting: Female  
Inlet Fitting: No. 6  
Outlet Fitting: No. 8  
O-Rings: (1) **24629**, (1) **24659**  
Acura (01-94); Honda (06-94)  
Honda: 80220S84A02, 80220ST7A12, 80220SV1A12



### 39003

Block Type O-Ring Expansion Valve  
Ton: 1.500  
Superheat: -1.000  
Liquid Inlet: No. 8  
Suction Inlet: No. 10  
Liquid Outlet: No. 8  
Suction Outlet: No. 10  
Color: Aluminum  
O-Rings: (2) **24615**, (1) **24608**, (1) **24610**  
Ford (04-03); Lincoln (04-03)  
Ford: 2L1Z19849AB



### 39004

Block Type O-Ring Expansion Valve  
Ton: 2.000  
Superheat: -1.000  
Liquid Inlet: No. 8  
Suction Inlet: No. 10  
Liquid Outlet: No. 8  
Suction Outlet: No. 10  
O-Rings: (1) **24608**, (1) **24610**, (2) **24615**  
Ford (04); Lincoln (04)  
Ford: 4L1Z19849AB

# Expansion Valves and Orifice Tubes

## Expansion Valve Cont'd



**39005**  
Block Type O-Ring Expansion Valve  
Ton: 1.500  
Superheat: 2.400  
Liquid Inlet: No. 6  
Suction Inlet: No. 12  
Liquid Outlet: No. 10  
Suction Outlet: No. 12  
O-Rings: (2) **24082**, (1) **24666**, (1) **24670**  
Acura (06-01); Honda (08-99)  
General Motors Corp: 25740393  
Honda: 80220STXA01

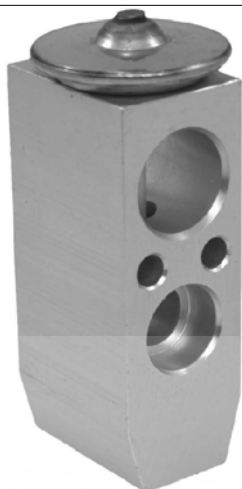

**39007**  
Block Type O-Ring Expansion Valve  
Ton: 1.500  
Superheat: 7.500  
Liquid Inlet: No. 6  
Suction Inlet: No. 12  
Liquid Outlet: No. 10  
Suction Outlet: No. 12  
O-Rings: (1) **24606**, (1) **24670**, (2) **24672**  
Acura (09-02); Honda (07-02)  
Acura: 80220S6A013  
Honda: 80220S6A013



**39009**  
Block Type O-Ring Expansion Valve  
Ton: 1.500  
Superheat: 1.000  
Liquid Inlet: No. 8  
Suction Inlet: No. 10  
Liquid Outlet: No. 8  
Suction Outlet: No. 12  
O-Rings: (2) **24402**, (1) **24403**, (1) **24404**  
Buick (09-05); Cadillac (14-13), (11-07); Chevy (14-04); GMC (13-08); Pontiac (10-04); Saturn (09-03)  
General Motors Corp: 52495729



**39011**  
TXV O-Ring Expansion Valve  
Ton: 1.500  
Superheat: 3.500  
Cap Tube Length: 10-1/2  
Inlet Fitting: No. 6  
Outlet Fitting: No. 8  
O-Rings: (2) **24626**, (1) **24149**  
Buick (07-04); Chevy (09-02); GMC (09-02); Isuzu (08-03); Nissan (01-98); Olds (04); Saab (09-05)  
General Motors Corp: 88892986  
Isuzu: 8888929860



**39012**  
TXV O-Ring Expansion Valve  
Ton: 1.500  
Superheat: 2.700  
Cap Tube Length: 11-1/2  
Inlet Fitting: No. 6  
Outlet Fitting: No. 8  
O-Rings: (1) **24611**, (1) **24661**  
Acura (13-07); Honda (15-09), (04-99)  
Acura: 80221STXA01  
Honda: 80221S0XA51, 80221STXA01

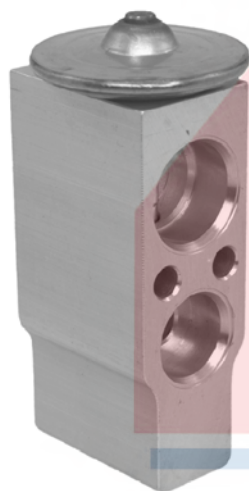

**39006**  
Block Type O-Ring Expansion Valve  
Ton: 1.500  
Superheat: -1.500  
Liquid Inlet: No. 6  
Suction Inlet: No. 12  
Liquid Outlet: No. 10  
Suction Outlet: No. 12  
O-Rings: (1) **24611**, (1) **24661**, (2) **24681**  
Honda (11-01)  
Honda: 80220SDET01



**39008**  
TXV O-Ring Expansion Valve  
Ton: 1.500  
Superheat: 0.500  
Cap Tube Length: 5  
Inlet Fitting: No. 6  
Outlet Fitting: No. 8  
O-Rings: (1) **24606**, (1) **24608**  
Ford (07-99); Mercury (07-04), (02)  
Ford: YF2Z19849AA



**39010**  
TXV O-Ring Expansion Valve  
Ton: 0.500  
Superheat: 8.000  
Cap Tube Length: 7-1/4  
Inlet Fitting: No. 6  
Outlet Fitting: No. 8  
O-Rings: (1) **24606**, (1) **24608**  
Cadillac (06-02); Chevy (06-01); GMC (06-01)  
General Motors Corp: 89022575

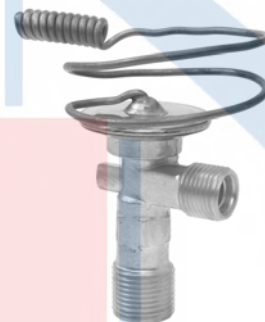

**39013**  
TXV O-Ring Expansion Valve  
Ton: 1.500  
Superheat: 7.000  
Cap Tube Length: 13-1/4  
Inlet Fitting: No. 6  
Outlet Fitting: No. 8  
O-Rings: (1) **24606**, (1) **24608**  
Dodge (97-94)  
Chrysler: 55036181

# Expansion Valves and Orifice Tubes

## Expansion Valve Cont'd

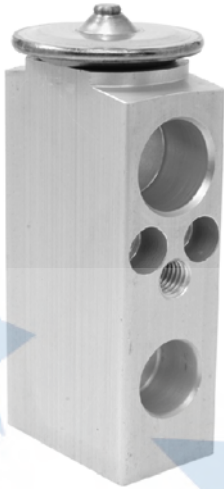

**39014**  
Block Type O-Ring Expansion Valve  
Ton: 1.500  
Superheat: 4.000  
Liquid Inlet: No. 10  
Suction Inlet: No. 12  
Liquid Outlet: No. 8  
Suction Outlet: No. 12  
O-Rings: (1) **24608**, (1) **24612**, (1) **24661**, (1) **24681**  
Jeep (04-02)  
Chrysler: 4885974AD

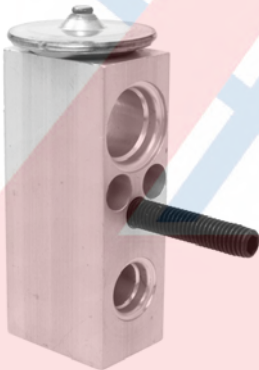

**39015**  
Block Type O-Ring Expansion Valve  
Ton: 1.500  
Superheat: 4.000  
Liquid Inlet: No. 8  
Suction Inlet: No. 12  
Liquid Outlet: No. 8  
Suction Outlet: No. 12  
O-Rings: (2) **24622**, (2) **24649**  
Chrysler (05-01); Dodge (05-01)  
Chrysler: 5019186AB



**39016**  
Block Type O-Ring Expansion Valve  
Ton: 1.500  
Superheat: 3.000  
Liquid Inlet: No. 10  
Suction Inlet: No. 12  
Liquid Outlet: No. 8  
Suction Outlet: No. 12  
O-Rings: (1) **24608**, (1) **24612**, (1) **24661**, (1) **24681**  
Chrysler (08-06), (03-01); Dodge (07-02)  
Chrysler: 5136101AB



**39017**  
Block Type O-Ring Expansion Valve  
Ton: 1.200  
Superheat: 3.500  
Liquid Inlet: No. 6  
Suction Inlet: No. 10  
Liquid Outlet: No. 8  
Suction Outlet: No. 10  
O-Rings: (2) **24622**, (1) **24626**, (1) **24649**  
Chrysler (10-05); Dodge (10-05)  
Chrysler: 5139687AA

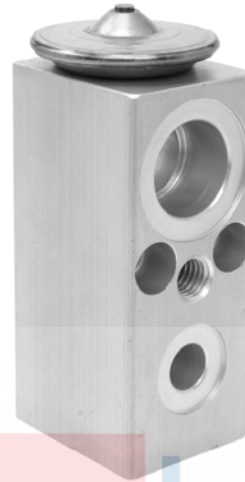

**39018**  
Block Type O-Ring Expansion Valve  
Ton: 1.500  
Superheat: 4.000  
Liquid Inlet: No. 6  
Suction Inlet: No. 10  
Liquid Outlet: No. 8  
Suction Outlet: No. 12  
O-Rings: (1) **24401**, (1) **24404**, (1) **24668**, (1) **24670**  
Jeep (10-05)  
Jeep: 5143544AC

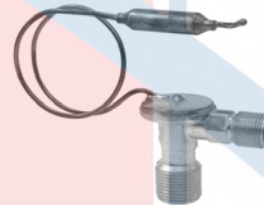

**39019**  
TXV O-Ring Expansion Valve  
Ton: 1.300  
Superheat: 2.500  
Cap Tube Length: 15-1/2  
Inlet Fitting: No. 6  
Outlet Fitting: No. 8  
O-Rings: (1) **24626**  
Acura (06-01); Honda (08-03)  
Honda: 80220S3VA51



**39020**  
Block Type O-Ring Expansion Valve  
Ton: 1.000  
Superheat: 7.500  
Liquid Inlet: No. 6  
Suction Inlet: No. 12  
Liquid Outlet: No. 10  
Suction Outlet: No. 12  
O-Rings: (1) **24606**, (1) **24608**, (2) **24610**  
Honda (05-04); Suzuki (04-03)  
Honda: 80220S5A003



**39021**  
Block Type O-Ring Expansion Valve  
Ton: 1.000  
Superheat: -2.000  
Liquid Inlet: No. 6  
Suction Inlet: No. 12  
Liquid Outlet: No. 10  
Suction Outlet: No. 12  
O-Rings: (1) **24606**, (1) **24608**, (2) **24610**  
Honda (07-03)  
Honda: 80221SDAA01



# Expansion Valves and Orifice Tubes

## Expansion Valve Cont'd



**39022**  
Block Type O-Ring Expansion Valve  
Ton: 1.300  
Superheat: -1.500  
Liquid Inlet: No. 6  
Suction Inlet: No. 12  
Liquid Outlet: No. 10  
Suction Outlet: No. 12  
O-Rings: (1) **24606**, (1) **24608**, (2) **24610**  
Honda (07-05)  
Honda: 80221SHJA01, 80221SHJA02



**39024**  
Block Type O-Ring Expansion Valve  
Ton: 1.200  
Superheat: -0.050  
Liquid Inlet: No. 6  
Suction Inlet: No. 12  
Liquid Outlet: No. 8  
Suction Outlet: No. 12  
O-Rings: (1) **24606**, (1) **24608**, (2) **24610**  
Nissan (02-00)  
Nissan: 922004M405



**39026**  
Block Type O-Ring Expansion Valve  
Ton: 1.500  
Superheat: 0.400  
Liquid Inlet: No. 6  
Suction Inlet: No. 12  
Liquid Outlet: No. 8  
Suction Outlet: No. 12  
O-Rings: (1) **24611**, (1) **24649**, (1) **24681**, (1) **24682**  
Infiniti (06-00); Nissan (08-00)  
Nissan: 922004Y80A



**39028**  
Block Type O-Ring Expansion Valve  
Ton: 1.000  
Superheat: 8.000  
Liquid Inlet: No. 6  
Suction Inlet: No. 12  
Liquid Outlet: No. 10  
Suction Outlet: No. 12  
O-Rings: (1) **24606**, (1) **24608**, (2) **24610**  
Lexus (06-04); Toyota (08-03)  
Toyota: 8851507040

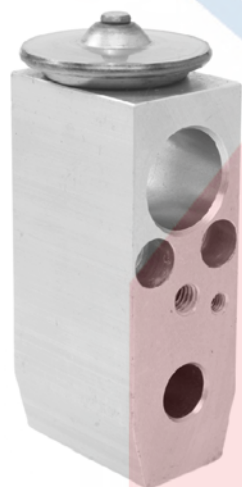

**39023**  
Block Type O-Ring Expansion Valve  
Ton: 1.500  
Superheat: 1.000  
Liquid Inlet: No. 6  
Suction Inlet: No. 12  
Liquid Outlet: No. 8  
Suction Outlet: No. 12  
O-Rings: (1) **24606**, (1) **24608**, (2) **24610**  
Nissan (08), (06-02)



**39025**  
TXV O-Ring Expansion Valve  
Ton: 1.500  
Superheat: 1.000  
Cap Tube Length: 9  
Inlet Fitting: No. 6  
Outlet Fitting: No. 8  
O-Rings: (1) **24606**, (1) **24608**  
Nissan (04-01)  
Nissan: 922007B400, 922007Z400



**39027**  
TXV O-Ring Expansion Valve  
Ton: 1.500  
Superheat: 3.500  
Cap Tube Length: 11-1/4  
Equal Tube Length: 9.250  
Equalizer Fitting: Female  
Inlet Fitting: No. 6  
Outlet Fitting: No. 8  
O-Rings: (1) **24604**, (1) **24606**, (1) **24608**  
Infiniti (96-95); Nissan (13), (01-93)  
Nissan: 9220059G00



**39029**  
Block Type O-Ring Expansion Valve  
Ton: 1.000  
Superheat: 5.000  
Liquid Inlet: No. 6  
Suction Inlet: No. 12  
Liquid Outlet: No. 10  
Suction Outlet: No. 12  
O-Rings: (1) **24606**, (1) **24608**, (2) **24610**  
Toyota (05-04)  
Toyota: 8851507040

# Expansion Valves and Orifice Tubes

## Expansion Valve Cont'd

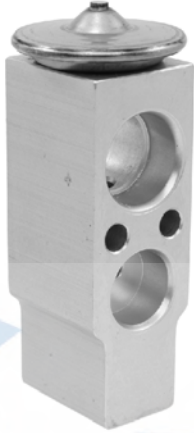

### 39030

Block Type O-Ring Expansion Valve  
 Ton: 1.000  
 Superheat: 5.000  
 Liquid Inlet: No. 6  
 Suction Inlet: No. 12  
 Liquid Outlet: No. 10  
 Suction Outlet: No. 12  
 O-Rings: (1) **24606**, (1) **24608**, (2) **24610**  
 Toyota (08-05)  
 Toyota: 8851502110



### 39031

TXV O-Ring Expansion Valve  
 Ton: 1.300  
 Superheat: 2.000  
 Cap Tube Length: 8-3/4  
 Inlet Fitting: No. 6  
 Outlet Fitting: No. 8  
 O-Rings: (1) **24608**, (1) **24606**  
 Honda (10-09), (06-05); Toyota (08-01)  
 Honda: 80221SHJA51  
 Toyota: 8851508080



### 39032

TXV O-Ring Expansion Valve  
 Ton: 1.500  
 Superheat: 2.700  
 Cap Tube Length: 10-1/2  
 Inlet Fitting: No. 6  
 Outlet Fitting: No. 8  
 O-Rings: (2) **24626**, (1) **24149**  
 Chrysler (99-95); Dodge (99-95); Eagle (98-94); Mitsubishi (99-94); Plymouth (94)

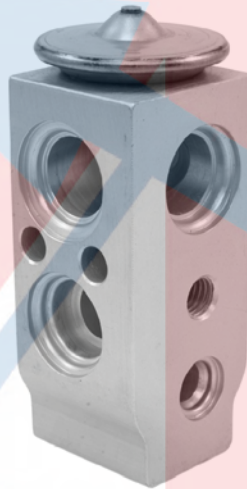

### 39033

Block Type O-Ring Expansion Valve  
 Ton: 1.300  
 Superheat: 2.200  
 Liquid Inlet: No. 6  
 Suction Inlet: No. 10  
 Liquid Outlet: No. 10  
 Suction Outlet: No. 10  
 O-Rings: (1) **24606**, (3) **24610**  
 Hyundai (06-05)  
 Hyundai: 976262D100



### 39034

TXV O-Ring Expansion Valve  
 Ton: 1.500  
 Superheat: 4.000  
 Cap Tube Length: 7-1/4  
 Equal Tube Length: 8.500  
 Equalizer Fitting: Female  
 Inlet Fitting: No. 6  
 Outlet Fitting: No. 8  
 O-Rings: (1) **24604**, (1) **24606**, (1) **24608**  
 Chrysler (00-98); Dodge (00-98); Eagle (98)  
 Chrysler: MR360172

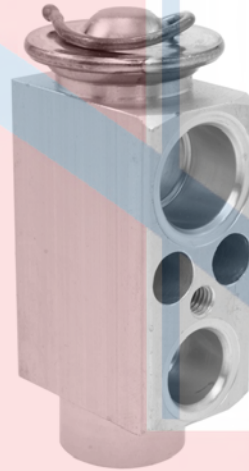

### 39035

Block Type O-Ring Expansion Valve  
 Ton: 2.000  
 Superheat: -1.500  
 Liquid Inlet: No. 8  
 Suction Inlet: No. 10  
 Liquid Outlet: No. 8  
 Suction Outlet: No. 12  
 O-Rings: (1) **24608**, (1) **24612**, (1) **24628**  
 BMW (05-99); Mini (10-07)  
 BMW: 64503452759



### 39036

Block Type O-Ring Expansion Valve  
 Ton: 1.300  
 Superheat: 6.000  
 Liquid Inlet: No. 6  
 Suction Inlet: No. 10  
 Liquid Outlet: No. 8  
 Suction Outlet: No. 10  
 O-Rings: (1) **24606**, (1) **24608**, (2) **24610**  
 Ford (06-05); Lincoln (06-05)  
 Ford: 5L1Z19849BA



### 39037

Block Type O-Ring Expansion Valve  
 Ton: 1.500  
 Superheat: 2.000  
 Liquid Inlet: No. 6  
 Suction Inlet: No. 10  
 Liquid Outlet: No. 8  
 Suction Outlet: No. 10  
 O-Rings: (1) **24606**, (1) **24608**, (2) **24610**  
 Ford (07-05); Mercury (07-06)  
 Ford: 6M6Z19849AA  
 Kysor: 1813014

# Expansion Valves and Orifice Tubes

## Expansion Valve Cont'd



**39038**  
TXV O-Ring Expansion Valve  
Ton: 1.500  
Superheat: -3.000  
Cap Tube Length: 9-1/4  
Inlet Fitting: No. 6  
Outlet Fitting: No. 8  
O-Rings: (2) **24626**, (1) **24149**  
Nissan (01-00)



**39039**  
TXV O-Ring Expansion Valve  
Ton: 1.500  
Superheat: 5.000  
Cap Tube Length: 8-3/8  
Equal Tube Length: 21.000  
Inlet Fitting: No. 6  
Outlet Fitting: No. 8  
O-Rings: (2) **24626**, (1) **24149**, (1) **24604**  
Lexus (94-93)  
Lexus: 8851550031



**39040**  
Block Type O-Ring Expansion Valve  
Ton: 1.500  
Superheat: 4.000  
Liquid Inlet: No. 6  
Suction Inlet: No. 8  
Liquid Outlet: No. 8  
Suction Outlet: No. 10  
O-Rings: (1) **24606**, (2) **24608**, (1) **24610**  
Geo (91-90); Isuzu (92-91); Mazda (91-88)  
Isuzu: 8943805570  
Mazda: H72061J14



**39041**  
TXV O-Ring Expansion Valve  
Ton: 1.500  
Superheat: 5.000  
Cap Tube Length: 9-1/8  
Equal Tube Length: 53.000  
Inlet Fitting: No. 6  
Outlet Fitting: No. 8  
O-Rings: (2) **24626**, (1) **24149**, (1) **24604**  
Lexus (00-95)  
Lexus: 8851550150



**39042**  
TXV O-Ring Expansion Valve  
Ton: 1.500  
Superheat: 4.000  
Cap Tube Length: 10  
Equal Tube Length: 21.000  
Inlet Fitting: No. 6  
Outlet Fitting: No. 8  
O-Rings: (1) **24604**, (1) **24606**, (1) **24608**  
Lexus (92-90)  
Lexus: 8851550060  
Toyota: 8851522210

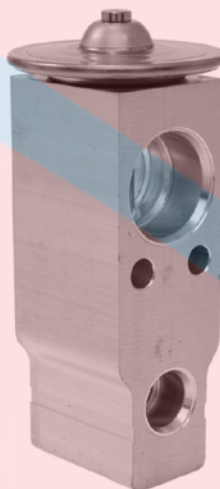

**39043**  
Block Type O-Ring Expansion Valve  
Ton: 1.500  
Superheat: -2.000  
Liquid Inlet: No. 6  
Suction Inlet: No. 12  
Liquid Outlet: No. 10  
Suction Outlet: No. 12  
O-Rings: (1) **24611**, (1) **24661**, (2) **24681**  
Lexus (05-98)  
Lexus: 8851522260



**39044**  
Block Type O-Ring Expansion Valve  
Ton: 1.500  
Superheat: 6.000  
Liquid Inlet: No. 8  
Suction Inlet: No. 12  
Liquid Outlet: No. 8  
Suction Outlet: No. 12  
O-Rings: (1) **24149**, (1) **24608**, (1) **24612**  
Dodge (00-98)  
Chrysler: 55055773AI



**39045**  
Block Type O-Ring Expansion Valve  
Ton: 1.500  
Superheat: -2.500  
Liquid Inlet: No. 6  
Suction Inlet: No. 10  
Liquid Outlet: No. 8  
Suction Outlet: No. 10  
O-Rings: (1) **24606**, (1) **24608**, (2) **24610**  
Dodge (00-98)  
Chrysler: 55055876AB



# Expansion Valves and Orifice Tubes

## Expansion Valve Cont'd



### 39046

Block Type O-Ring Expansion Valve  
 Ton: 1.500  
 Superheat: 2.500  
 Liquid Inlet: No. 8  
 Suction Inlet: No. 12  
 Liquid Outlet: No. 8  
 Suction Outlet: No. 12  
 O-Rings: (1) **24149**, (1) **24608**, (1) **24612**  
 Dodge (03-01)  
 Chrysler: 55056025AE

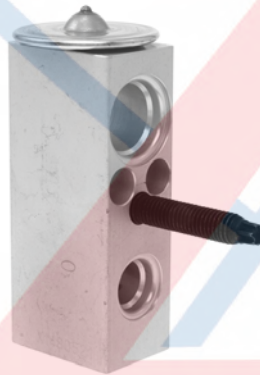

### 39047

Block Type O-Ring Expansion Valve  
 Ton: 1.500  
 Superheat: 3.500  
 Liquid Inlet: No. 8  
 Suction Inlet: No. 12  
 Liquid Outlet: No. 8  
 Suction Outlet: No. 12  
 O-Rings: (1) **24622**, (1) **24628**  
 Dodge (06-04)  
 Chrysler: 5061342AD



### 39048

Block Type O-Ring Expansion Valve  
 Ton: 1.500  
 Superheat: -1.000  
 Liquid Inlet: No. 6  
 Suction Inlet: No. 12  
 Liquid Outlet: No. 10  
 Suction Outlet: No. 12  
 O-Rings: (1) **24611**, (1) **24661**, (2) **24681**  
 Subaru (09-05); Toyota (03-00)  
 Subaru: 73531AG010  
 Toyota: 8851552040

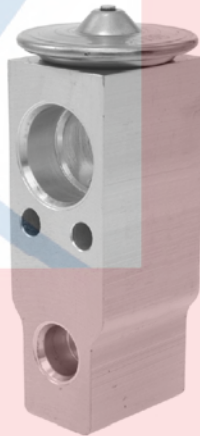

### 39049

Block Type O-Ring Expansion Valve  
 Ton: 1.500  
 Superheat: -1.000  
 Liquid Inlet: No. 6  
 Suction Inlet: No. 12  
 Liquid Outlet: No. 10  
 Suction Outlet: No. 12  
 O-Rings: (1) **24611**, (1) **24661**, (2) **24681**  
 Toyota (08-01)  
 Toyota: 885150C070



### 39051

Block Type O-Ring Expansion Valve  
 Ton: 1.500  
 Superheat: 4.000  
 Liquid Inlet: No. 6  
 Suction Inlet: No. 10  
 Liquid Outlet: No. 10  
 Suction Outlet: No. 10  
 O-Rings: (1) **24606**, (3) **24610**  
 Dodge (02-01)  
 Chrysler: 5019630AB

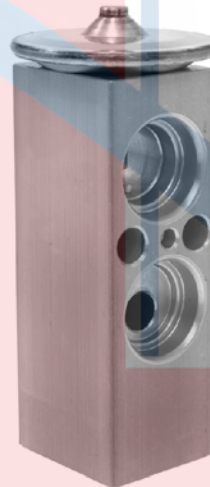

### 39052

Block Type O-Ring Expansion Valve  
 Ton: 1.000  
 Superheat: 7.500  
 Liquid Inlet: No. 6  
 Suction Inlet: No. 10  
 Liquid Outlet: No. 10  
 Suction Outlet: No. 10  
 O-Rings: (1) **24611**, (3) **24681**  
 Dodge (06-03)  
 Chrysler: 5139280AB



### 39053

TXV O-Ring Expansion Valve  
 Ton: 1.500  
 Superheat: 1.500  
 Cap Tube Length: 11  
 Equal Tube Length: 9.250  
 Equalizer Fitting: Female  
 Inlet Fitting: No. 6  
 Outlet Fitting: No. 8  
 O-Rings: (1) **24604**, (1) **24606**, (1) **24608**  
 Mazda (98-94)  
 Mazda: BC1M61J14



### 39054

TXV O-Ring Expansion Valve  
 Ton: 1.500  
 Superheat: 3.000  
 Cap Tube Length: 11-1/4  
 Equal Tube Length: 9.500  
 Equalizer Fitting: Female  
 Inlet Fitting: No. 6  
 Outlet Fitting: No. 8  
 O-Rings: (1) **24604**, (1) **24606**, (1) **24608**  
 Mazda (00-99), (97-94)  
 Mazda: NA7561J14

# Expansion Valves and Orifice Tubes

## Expansion Valve Cont'd



**39055**  
TXV O-Ring Expansion Valve  
Ton: 1.200  
Superheat: 5.000  
Cap Tube Length: 9-3/4  
Equal Tube Length: 13.000  
Equalizer Fitting: Female  
Inlet Fitting: No. 6  
Outlet Fitting: No. 8  
O-Rings: (1) **24604**, (1) **24606**, (1) **24608**  
Mazda (03-00)  
Mazda: GE7T61J14A

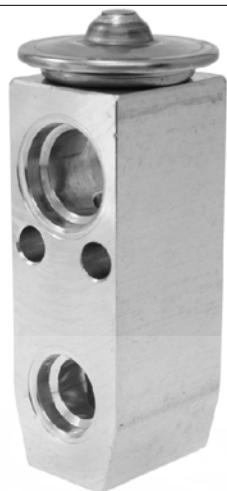

**39058**  
Block Type O-Ring Expansion Valve  
Ton: 1.500  
Superheat: -1.000  
Liquid Inlet: No. 8  
Suction Inlet: No. 10  
Liquid Outlet: No. 8  
Suction Outlet: No. 10  
O-Rings: (1) **24608**, (1) **24610**  
Infiniti (01-00); Nissan (01-00)  
Nissan: 922002W100



**39060**  
TXV O-Ring Expansion Valve  
Ton: 1.500  
Superheat: 3.500  
Cap Tube Length: 11  
Equal Tube Length: 9.250  
Equalizer Fitting: Female  
Inlet Fitting: No. 6  
Outlet Fitting: No. 8  
O-Rings: (1) **24604**, (1) **24606**, (1) **24608**  
Mitsubishi (04-97)  
Mitsubishi: AW349191

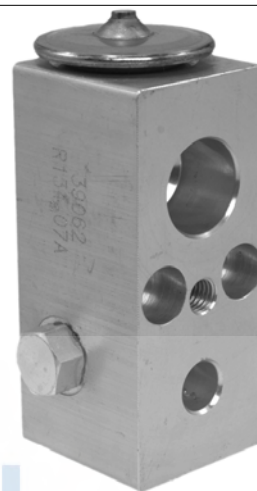

**39062**  
Block Type Flange Expansion Valve  
Ton: 1.500  
Superheat: 4.700  
Liquid Inlet: No. 6  
Suction Inlet: No. 12  
Liquid Outlet: No. 8  
Suction Outlet: No. 12  
O-Rings: (2) **23682**, (1) **24149**, (2) **24626**  
Dodge (01-00); Plymouth (01-00)  
Chrysler: 5278510AE



**39056**  
Block Type O-Ring Expansion Valve  
Ton: 1.500  
Superheat: -2.000  
Liquid Inlet: No. 8  
Suction Inlet: No. 10  
Liquid Outlet: No. 8  
Suction Outlet: No. 10  
O-Rings: (1) **24608**, (1) **24610**  
Infiniti (01-97); Nissan (99-96)  
Nissan: 922004P001, 922004P002

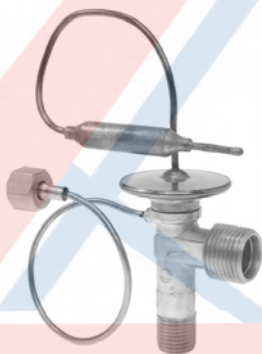

**39059**  
TXV O-Ring Expansion Valve  
Ton: 1.000  
Superheat: 6.000  
Cap Tube Length: 7-1/2  
Equal Tube Length: 8.250  
Equalizer Fitting: Female  
Inlet Fitting: No. 6  
Outlet Fitting: No. 8  
O-Rings: (1) **24604**, (1) **24606**, (1) **24608**  
Mitsubishi (04-93)  
Mitsubishi: MR168050, MR168189

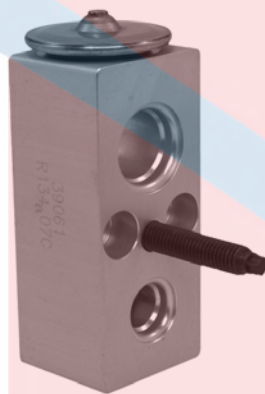

**39061**  
Block Type O-Ring Expansion Valve  
Ton: 1.500  
Superheat: 8.000  
Liquid Inlet: No. 8  
Suction Inlet: No. 12  
Liquid Outlet: No. 8  
Suction Outlet: No. 12  
O-Rings: (1) **24149**, (1) **24622**, (1) **24649**  
Chrysler (02-98); Dodge (02-98)  
Chrysler: 4734728



**39063**  
Block Type O-Ring Expansion Valve  
Ton: 1.000  
Superheat: 7.500  
Liquid Inlet: No. 6  
Suction Inlet: No. 10  
Liquid Outlet: No. 8  
Suction Outlet: No. 10  
O-Rings: (1) **24606**, (1) **24608**, (2) **24610**  
Mitsubishi (06-02)  
Mitsubishi: MR568829

# Expansion Valves and Orifice Tubes

## Expansion Valve Cont'd

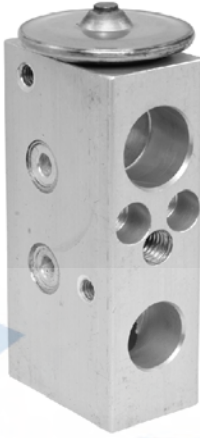

**39064**  
Block Type O-Ring Expansion Valve  
Ton: 1.500  
Superheat: 3.000  
Liquid Inlet: No. 8  
Suction Inlet: No. 12  
Liquid Outlet: No. 8  
Suction Outlet: No. 10  
O-Rings: (1) **24608**, (1) **24612**, (1) **24661**, (1) **24681**  
Chrysler (05-02); Dodge (05-01)

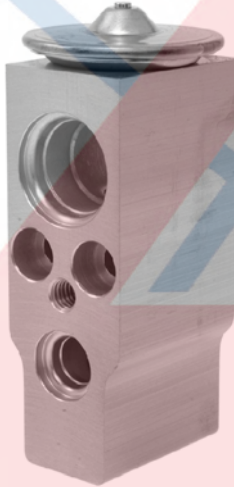

**39065**  
Block Type O-Ring Expansion Valve  
Ton: 1.000  
Superheat: 8.000  
Liquid Inlet: No. 6  
Suction Inlet: No. 10  
Liquid Outlet: No. 8  
Suction Outlet: No. 10  
O-Rings: (1) **24606**, (1) **24608**, (2) **24610**  
Mitsubishi (03-99), (96)  
Mitsubishi: MR460369

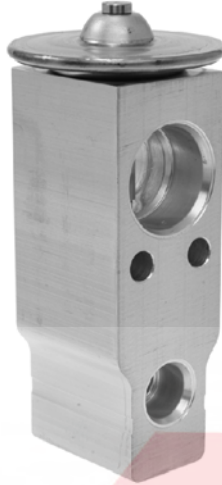

**39066**  
Block Type O-Ring Expansion Valve  
Ton: 1.000  
Superheat: 6.500  
Liquid Inlet: No. 6  
Suction Inlet: No. 12  
Liquid Outlet: No. 10  
Suction Outlet: No. 12  
O-Rings: (1) **24611**, (1) **24661**, (2) **24681**  
Mitsubishi (06-03)  
Mitsubishi: MR500662

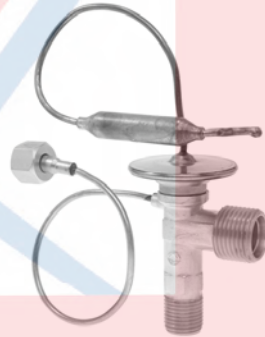

**39068**  
TXV O-Ring Expansion Valve  
Ton: 1.500  
Superheat: 4.000  
Cap Tube Length: 7-1/2  
Equal Tube Length: 8.500  
Equalizer Fitting: Female  
Inlet Fitting: No. 6  
Outlet Fitting: No. 8  
O-Rings: (1) **24604**, (1) **24606**, (1) **24608**  
Mitsubishi (98-97)  
Mitsubishi: MR315809



**39069**  
TXV O-Ring Expansion Valve  
Ton: 1.500  
Superheat: -0.050  
Cap Tube Length: 7-1/2  
Equal Tube Length: 8.500  
Equalizer Fitting: Female  
Inlet Fitting: No. 6  
Outlet Fitting: No. 8  
O-Rings: (1) **24604**, (1) **24606**, (1) **24608**  
Mitsubishi (98-97), (95-94)  
Mitsubishi: MR240612

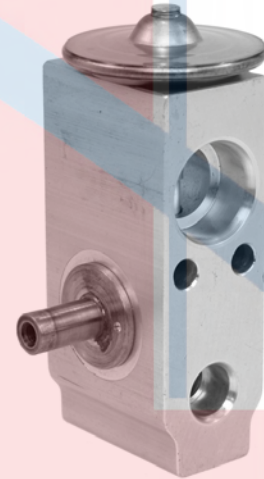

**39070**  
Block Type O-Ring Expansion Valve  
Ton: 1.500  
Superheat: 5.000  
Liquid Inlet: No. 6  
Suction Inlet: No. 12  
Liquid Outlet: No. 10  
Suction Outlet: No. 12  
O-Rings: (1) **24611**, (1) **24661**, (2) **24681**  
Mitsubishi (06-03)  
Mitsubishi: 7840A006



**39073**  
Block Type Flange Expansion Valve  
Ton: 2.000  
Superheat: 6.300  
Liquid Inlet: No. 6  
Suction Inlet: No. 10  
Liquid Outlet: No. 8  
Suction Outlet: No. 10  
Color: Aluminum  
O-Rings: (1) **24606**, (1) **24608**, (2) **24610**  
Bergstrom: 1000039682, 540021, 540128, 540174, 540275  
Carrier: 1990756C1, 1990756C2, 20210019, 98370C3  
Climatech: EA1075  
John Deere: AH122867, AH137702, AH203871  
Kysor: 1812003, 1812009, 1899005, 1899006, 1899028  
Mack: 4379RD553820, 4379RD570150, 4379RD570151, 7787540021  
NaviStar: 1676665C1  
Red Dot: 71R8321, RD570150P, RD570150P  
TRP Parts: EA13150



# Expansion Valves and Orifice Tubes

## Expansion Valve Cont'd



**39074**  
Block Type O-Ring Expansion Valve  
Ton: 1.000  
Superheat: 8.000  
Liquid Inlet: No. 6  
Suction Inlet: No. 12  
Liquid Outlet: No. 10  
Suction Outlet: No. 12  
O-Rings: (2) **24083**, (1) **24611**, (1) **24681**  
Mazda (05-01); Toyota (05-00)  
Mazda: N05361J14A  
Toyota: 8851547020



**39076**  
Block Type O-Ring Expansion Valve  
Ton: 1.500  
Superheat: -0.500  
Liquid Inlet: No. 6  
Suction Inlet: No. 12  
Liquid Outlet: No. 8  
Suction Outlet: No. 12  
O-Rings: (1) **24083**, (1) **24608**, (1) **24611**, (1) **24612**  
Infiniti (08-03); Nissan (09-03)  
Nissan: 92200AL500



**39078**  
TXV O-Ring Expansion Valve  
Ton: 1.500  
Superheat: 4.000  
Cap Tube Length: 13  
Equal Tube Length: 12.000  
Equalizer Fitting: Female  
Inlet Fitting: No. 6  
Outlet Fitting: No. 8  
O-Rings: (1) **24604**, (1) **24606**, (1) **24608**  
Mazda (02-95)  
Mazda: TA0161J14



**39080**  
Block Type O-Ring Expansion Valve  
Ton: 1.500  
Superheat: 5.000  
Liquid Inlet: No. 6  
Suction Inlet: No. 12  
Liquid Outlet: No. 8  
Suction Outlet: No. 12  
O-Rings: (2) **24612**, (1) **24606**, (1) **24608**  
Chrysler (04-03); Dodge (04-02)  
Chrysler: 5093736AA

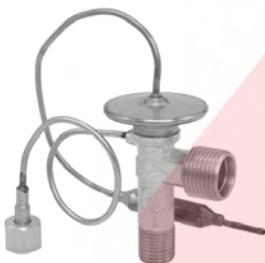

**39075**  
TXV O-Ring Expansion Valve  
Ton: 1.500  
Superheat: -0.500  
Cap Tube Length: 9-1/4  
Equal Tube Length: 9.250  
Equalizer Fitting: Female  
Inlet Fitting: No. 6  
Outlet Fitting: No. 8  
O-Rings: (1) **24604**, (1) **24606**, (1) **24608**  
Chrysler (97-96); Dodge (97-94); Eagle (97-95); Mitsubishi (99-94)  
Mitsubishi: MR168024

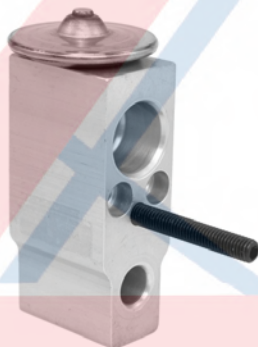

**39077**  
Block Type O-Ring Expansion Valve  
Ton: 1.000  
Superheat: 8.000  
Liquid Inlet: No. 6  
Suction Inlet: No. 12  
Liquid Outlet: No. 10  
Suction Outlet: No. 12  
O-Rings: (1) **24611**, (1) **24661**, (2) **24681**  
Chrysler (05-01); Dodge (05-01); Mitsubishi (05-00)  
Mitsubishi: MR500467

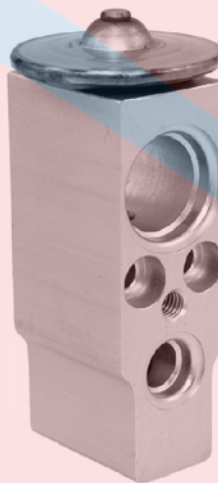

**39079**  
Block Type O-Ring Expansion Valve  
Ton: 1.000  
Superheat: 9.000  
Liquid Inlet: No. 6  
Suction Inlet: No. 12  
Liquid Outlet: No. 8  
Suction Outlet: No. 12  
O-Rings: (2) **24612**, (1) **24606**, (1) **24608**, (2) **24610**  
Chrysler (06-02); Dodge (06-02)  
Chrysler: 5093476AB



**39081**  
Block Type O-Ring Expansion Valve  
Ton: 1.000  
Superheat: 9.000  
Liquid Inlet: No. 6  
Suction Inlet: No. 12  
Liquid Outlet: No. 10  
Suction Outlet: No. 12  
O-Rings: (1) **24611**, (1) **24661**, (2) **24681**  
Chevy (04-99)  
General Motors Corp: 91176918

# Expansion Valves and Orifice Tubes

## Expansion Valve Cont'd



### 39082

Block Type O-Ring Expansion Valve  
 Ton: 1.500  
 Superheat: -1.000  
 Liquid Inlet: No. 6  
 Suction Inlet: No. 10  
 Liquid Outlet: No. 8  
 Suction Outlet: No. 12  
 O-Rings: (1) **24087**, (1) **24626**, (1) **24608**, (1) **24610**  
 Saturn (05-00)  
 General Motors Corp: 19187638  
 Saturn: 24426739



### 39083

Block Type O-Ring Expansion Valve  
 Ton: 1.500  
 Superheat: 2.500  
 Liquid Inlet: No. 6  
 Suction Inlet: No. 10  
 Liquid Outlet: No. 8  
 Suction Outlet: No. 12  
 O-Rings: (1) **24606**, (1) **24608**, (2) **24612**, (1) **24610**  
 Volvo (04-01)



### 39084

Block Type O-Ring Expansion Valve  
 Ton: 1.000  
 Superheat: 2.000  
 Liquid Inlet: No. 6  
 Suction Inlet: No. 10  
 Liquid Outlet: No. 8  
 Suction Outlet: No. 12  
 O-Rings: (1) **24606**, (1) **24608**, (2) **24612**, (1) **24610**  
 Volvo (01-99)  
 Volvo: 31101176

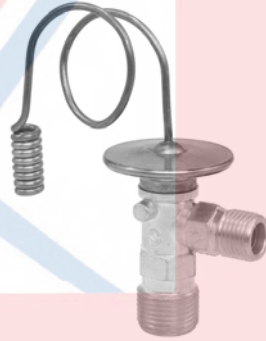

### 39085

TXV O-Ring Expansion Valve  
 Ton: 1.500  
 Superheat: -1.000  
 Cap Tube Length: 8-1/4  
 Inlet Fitting: No. 6  
 Outlet Fitting: No. 8  
 O-Rings: (1) **24606**, (1) **24608**  
 Volvo (04-00)  
 Volvo: 30890090



### 39086

Block Type O-Ring Expansion Valve  
 Ton: 1.500  
 Superheat: 4.000  
 Liquid Inlet: No. 6  
 Suction Inlet: No. 10  
 Liquid Outlet: No. 10  
 Suction Outlet: No. 10  
 O-Rings: (1) **24606**, (3) **24610**  
 Hyundai (05-00)  
 Hyundai: 976041C100

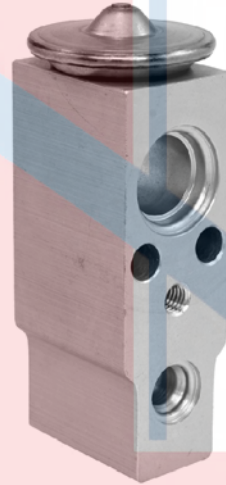

### 39087

Block Type O-Ring Expansion Valve  
 Ton: 1.000  
 Superheat: 5.000  
 Liquid Inlet: No. 6  
 Suction Inlet: No. 10  
 Liquid Outlet: No. 10  
 Suction Outlet: No. 10  
 O-Rings: (1) **24606**, (3) **24610**  
 Hyundai (09-01)  
 Hyundai: 9760426001



### 39088

Block Type O-Ring Expansion Valve  
 Ton: 1.000  
 Superheat: 7.500  
 Liquid Inlet: No. 6  
 Suction Inlet: No. 10  
 Liquid Outlet: No. 10  
 Suction Outlet: No. 10  
 O-Rings: (1) **24606**, (3) **24610**  
 Hyundai (05-99); Kia (06-01)  
 Hyundai: 9762638000

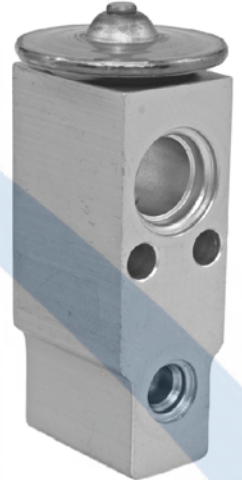

### 39089

Block Type O-Ring Expansion Valve  
 Ton: 1.000  
 Superheat: 6.500  
 Liquid Inlet: No. 6  
 Suction Inlet: No. 10  
 Liquid Outlet: No. 10  
 Suction Outlet: No. 10  
 O-Rings: (1) **24606**, (3) **24610**  
 Hyundai (05-03)  
 Hyundai: 9760417001

# Expansion Valves and Orifice Tubes

## Expansion Valve Cont'd



**39090**  
TXV O-Ring Expansion Valve  
Ton: 1.500  
Superheat: 4.500  
Cap Tube Length: 11  
Equal Tube Length: 11.000  
Equalizer Fitting: Female  
Inlet Fitting: No. 6  
Outlet Fitting: No. 10  
O-Rings: (2) **24626**, (1) **24149**, (1) **24604**  
Honda (01-97)  
Honda: 80220S30003



**39091**  
TXV O-Ring Expansion Valve  
Ton: 1.000  
Superheat: 6.500  
Cap Tube Length: 11-5/8  
Inlet Fitting: No. 6  
Outlet Fitting: No. 10  
O-Rings: (1) **24606**, (1) **24610**  
Chevy (98-94); Geo (98-94); Toyota (98-93)  
Toyota: 8851534010

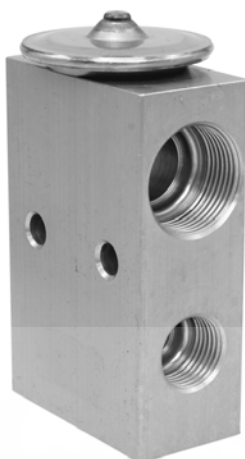

**39092**  
Block Type O-Ring Expansion Valve  
Ton: 1.500  
Superheat: -0.500  
Liquid Inlet: No. 6  
Suction Inlet: No. 10  
Liquid Outlet: No. 8  
Suction Outlet: No. 10  
Color: Gold  
O-Rings: (1) **24606**, (1) **24608**, (2) **24610**  
Ford (04-03); Lincoln (04-03)  
Ford: 2L1Z19849BA

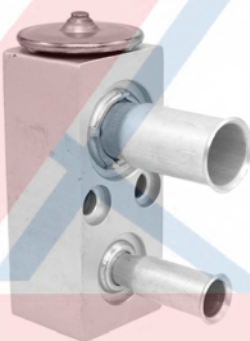

**39093**  
Block Type O-Ring Expansion Valve  
Ton: 1.500  
Superheat: 4.000  
Liquid Inlet: No. 6  
Suction Inlet: No. 10  
Liquid Outlet: No. 6  
Suction Outlet: No. 10  
O-Rings: (1) **24149**, (3) **24666**, (3) **24670**  
Chrysler (02-01); Dodge (02-01)  
Chrysler: 4596318AA



**39094**  
Block Type O-Ring Expansion Valve  
Ton: 2.000  
Superheat: 1.500  
Liquid Inlet: No. 6  
Suction Inlet: No. 10  
Liquid Outlet: No. 10  
Suction Outlet: No. 12  
O-Rings: (1) **24083**, (2) **24610**, (1) **24611**  
Subaru (06-00)  
Subaru: 73531TC010

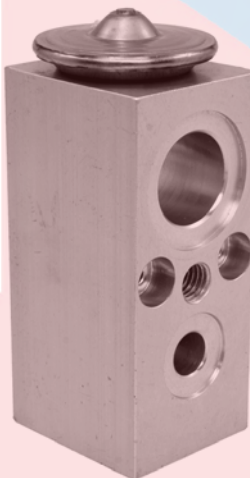

**39095**  
Block Type O-Ring Expansion Valve  
Ton: 1.500  
Superheat: 6.500  
Liquid Inlet: No. 6  
Suction Inlet: No. 12  
Liquid Outlet: No. 8  
Suction Outlet: No. 12  
O-Rings: (1) **24401**, (1) **24402**, (2) **24404**  
Buick (07-06); Chevy (05-01); Olds (04-01); Pontiac (05-01)  
General Motors Corp: 10318613



**39096**  
Block Type O-Ring Expansion Valve  
Ton: 1.500  
Superheat: 3.000  
Liquid Inlet: No. 6  
Suction Inlet: No. 10  
Liquid Outlet: No. 10  
Suction Outlet: No. 10  
O-Rings: (1) **24606**, (3) **24610**  
Kia (01-98)  
Kia: 1K2A161J11



**39097**  
Block Type O-Ring Expansion Valve  
Ton: 1.500  
Superheat: 3.000  
Liquid Inlet: No. 6  
Suction Inlet: No. 12  
Liquid Outlet: No. 10  
Suction Outlet: No. 12  
O-Rings: (1) **24611**, (1) **24661**, (2) **24681**  
Toyota (05-01)  
Toyota: 8851542080



# Expansion Valves and Orifice Tubes

## Expansion Valve Cont'd



### 39098

TXV O-Ring Expansion Valve  
 Ton: 1.500  
 Superheat: 5.500  
 Cap Tube Length: 10-3/4  
 Equal Tube Length: 10.500  
 Equalizer Fitting: Female  
 Inlet Fitting: No. 6  
 Outlet Fitting: No. 10  
 O-Rings: (1) **24604**, (1) **24606**, (1) **24610**  
 Acura (03-99)  
 Acura: 80220S0KA01

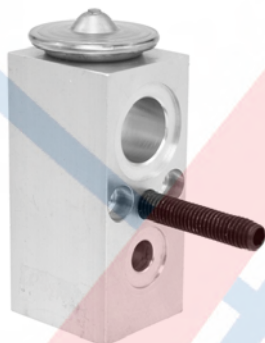

### 39099

Block Type O-Ring Expansion Valve  
 Ton: 1.500  
 Superheat: -1.000  
 Liquid Inlet: No. 6  
 Suction Inlet: No. 12  
 Liquid Outlet: No. 8  
 Suction Outlet: No. 12  
 O-Rings: (1) **24401**, (1) **24402**, (2) **24404**  
 Buick (05-02); Chevy (05-01); Olds (04-01); Pontiac (05-01)  
 General Motors Corp: 15221028



### 39100

Block Type O-Ring Expansion Valve  
 Ton: 1.500  
 Superheat: 3.500  
 Liquid Inlet: No. 8  
 Suction Inlet: No. 10  
 Liquid Outlet: No. 8  
 Suction Outlet: No. 10  
 Color: Aluminum  
 O-Rings: (1) **24608**, (1) **24610**, (2) **24615**  
 Ford (05-02); Jaguar (08-00); Lincoln (06-00)  
 Ford: XW4Z19849AA  
 Jaguar: XR855582



### 39101

Block Type O-Ring Expansion Valve  
 Ton: 1.500  
 Superheat: 4.500  
 Liquid Inlet: No. 6  
 Suction Inlet: No. 12  
 Liquid Outlet: No. 8  
 Suction Outlet: No. 12  
 Color: Aluminum  
 O-Rings: (2) **23678**, (2) **23682**, (1) **24149**  
 Dodge (05-03)  
 Chrysler: 5290240AB, 5290240AC



### 39109

TXV O-Ring Expansion Valve  
 Ton: 1.000  
 Superheat: 3.500  
 Cap Tube Length: 8-3/4  
 Inlet Fitting: No. 6  
 Outlet Fitting: No. 8  
 O-Rings: (1) **24611**, (1) **24661**  
 Cadillac (09-04)  
 General Motors Corp: 19129799

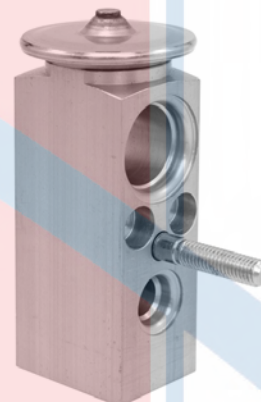

### 39110

Block Type O-Ring Expansion Valve  
 Ton: 1.500  
 Superheat: 4.000  
 Liquid Inlet: No. 6  
 Suction Inlet: No. 10  
 Liquid Outlet: No. 8  
 Suction Outlet: No. 12  
 O-Rings: (1) **24606**, (1) **24608**, (2) **24612**, (1) **24610**  
 Chevy (00-97); Olds (00-97); Pontiac (00-97)  
 General Motors Corp: 10436282



### 39113

Block Type O-Ring Expansion Valve  
 Ton: 2.000  
 Superheat: -1.000  
 Liquid Inlet: No. 6  
 Suction Inlet: No. 10  
 Liquid Outlet: No. 8  
 Suction Outlet: No. 10  
 O-Rings: (1) **24606**, (1) **24608**, (1) **24610**, (1) **24612**  
 Dodge (03-98)



### 39114

TXV O-Ring Expansion Valve  
 Ton: 1.500  
 Superheat: -2.000  
 Cap Tube Length: 9-1/4  
 Equal Tube Length: 9.250  
 Equalizer Fitting: Female  
 Inlet Fitting: No. 6  
 Outlet Fitting: No. 8  
 O-Rings: (1) **24604**, (1) **24606**, (1) **24608**  
 Chrysler (95); Dodge (95)

# Expansion Valves and Orifice Tubes

## Expansion Valve Cont'd



**39115**  
Block Type O-Ring Expansion Valve  
Ton: 1.000  
Superheat: 8.500  
Liquid Inlet: No. 6  
Suction Inlet: No. 10  
Liquid Outlet: No. 8  
Suction Outlet: No. 12  
O-Rings: (1) **24608**, (1) **24610**, (1) **24611**, (1) **24681**  
Infiniti (10-04); Nissan (15-04)  
Infiniti: 922005Z000  
Nissan: 922005Z000



**39117**  
Block Type O-Ring Expansion Valve  
Ton: 1.000  
Superheat: 5.500  
Liquid Inlet: No. 6  
Suction Inlet: No. 10  
Liquid Outlet: No. 8  
Suction Outlet: No. 12  
O-Rings: (1) **24608**, (1) **24610**, (1) **24611**, (1) **24642**  
Infiniti (10-04); Nissan (15-04)  
Infiniti: 92200ZC00A  
Nissan: 92200ZC00A

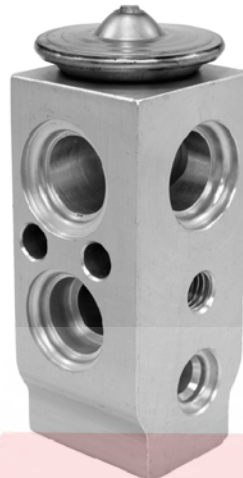

**39119**  
Block Type O-Ring Expansion Valve  
Ton: 1.300  
Superheat: 4.000  
Liquid Inlet: No. 6  
Suction Inlet: No. 10  
Liquid Outlet: No. 10  
Suction Outlet: No. 10  
O-Rings: (1) **24606**, (3) **24610**  
Kia (06-04)  
Kia: 976262F000



**39121**  
TXV O-Ring Expansion Valve  
Ton: 1.000  
Superheat: 8.500  
Cap Tube Length: 8  
Inlet Fitting: No. 6  
Outlet Fitting: No. 10  
O-Rings: (1) **24604**, (1) **24611**, (1) **24661**  
Toyota (03-98)  
Toyota: 8851508050



**39122**  
TXV O-Ring Expansion Valve  
Ton: 1.500  
Superheat: 3.000  
Cap Tube Length: 11-1/4  
Equal Tube Length: 9.250  
Equalizer Fitting: Female  
Inlet Fitting: No. 6  
Outlet Fitting: No. 8  
O-Rings: (2) **24626**, (1) **24149**, (1) **24604**  
Kia (97-94)  
Kia: 0K20B61J12

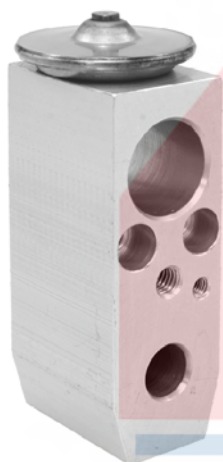

**39116**  
Block Type O-Ring Expansion Valve  
Ton: 1.500  
Superheat: 4.000  
Liquid Inlet: No. 6  
Suction Inlet: No. 12  
Liquid Outlet: No. 8  
Suction Outlet: No. 12  
O-Rings: (1) **24606**, (1) **24661**, (1) **24672**, (1) **24681**  
Nissan (13-03)  
Nissan: 922009H205



**39118**  
Block Type O-Ring Expansion Valve  
Ton: 1.500  
Superheat: 1.000  
Liquid Inlet: No. 6  
Suction Inlet: No. 10  
Liquid Outlet: No. 10  
Suction Outlet: No. 10  
O-Rings: (1) **24606**, (3) **24610**  
Kia (03-00)



**39120**  
Block Type O-Ring Expansion Valve  
Ton: 1.500  
Superheat: 3.000  
Liquid Inlet: No. 6  
Suction Inlet: No. 10  
Liquid Outlet: No. 10  
Suction Outlet: No. 10  
O-Rings: (1) **24606**, (3) **24610**  
Kia (02-98)  
Kia: 0K08A61E13

# Expansion Valves and Orifice Tubes

## Expansion Valve Cont'd

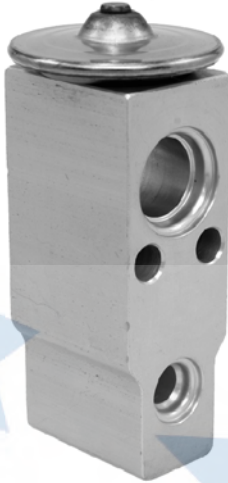

### 39123

Block Type O-Ring Expansion Valve  
 Ton: 1.500  
 Superheat: -0.500  
 Liquid Inlet: No. 6  
 Suction Inlet: No. 10  
 Liquid Outlet: No. 10  
 Suction Outlet: No. 10  
 O-Rings: (1) **24606**, (3) **24610**  
 Kia (05-01)  
 Kia: 0K30A61570A, 97626FD200

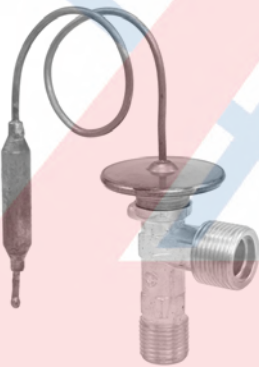

### 39124

TXV O-Ring Expansion Valve  
 Ton: 1.000  
 Superheat: 3.500  
 Cap Tube Length: 11-1/8  
 Inlet Fitting: No. 6  
 Outlet Fitting: No. 8  
 O-Rings: (2) **24626**, (1) **24149**  
 Acura (99-98); Honda (02-99); Isuzu (01-99); Subaru (99-95)  
 Honda: 8972029470  
 Subaru: 73531AC060, 73531AC100



### 39125

Block Type O-Ring Expansion Valve  
 Ton: 1.000  
 Superheat: 3.500  
 Liquid Inlet: No. 6  
 Suction Inlet: No. 10  
 Liquid Outlet: No. 10  
 Suction Outlet: No. 10  
 O-Rings: (1) **24606**, (3) **24610**  
 Hyundai (99-98)  
 Hyundai: 9762629002

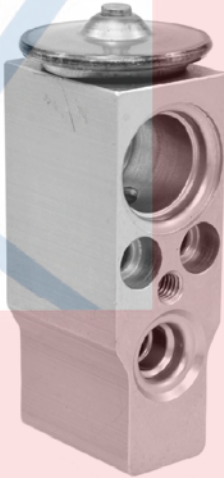

### 39126

Block Type O-Ring Expansion Valve  
 Ton: 1.500  
 Superheat: 1.500  
 Liquid Inlet: No. 6  
 Suction Inlet: No. 10  
 Liquid Outlet: No. 8  
 Suction Outlet: No. 12  
 O-Rings: (1) **24606**, (1) **24608**, (2) **24612**, (1) **24610**  
 Saab (03-94)  
 Saab: 4758686, 5045166



### 39127

Block Type O-Ring Expansion Valve  
 Ton: 1.500  
 Superheat: 5.000  
 Liquid Inlet: No. 6  
 Suction Inlet: No. 12  
 Liquid Outlet: No. 10  
 Suction Outlet: No. 12  
 O-Rings: (1) **24611**, (1) **24661**, (2) **24681**  
 Lexus (03); Scion (10-05)  
 Toyota: 8851560150

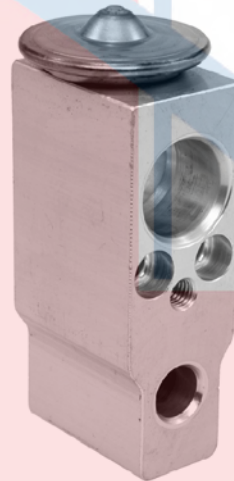

### 39128

Block Type O-Ring Expansion Valve  
 Ton: 1.500  
 Superheat: -1.000  
 Liquid Inlet: No. 6  
 Suction Inlet: No. 12  
 Liquid Outlet: No. 10  
 Suction Outlet: No. 12  
 O-Rings: (1) **24611**, (1) **24661**, (2) **24681**  
 Scion (06-04)  
 Toyota: 8851552020, 8851552040



### 39129

TXV O-Ring Expansion Valve  
 Ton: 1.000  
 Superheat: 7.000  
 Cap Tube Length: 9  
 Inlet Fitting: No. 6  
 Outlet Fitting: No. 8  
 O-Rings: (1) **24604**, (1) **24611**, (1) **24661**  
 Toyota (00-98)  
 Toyota: 8851508030



### 39130

TXV O-Ring Expansion Valve  
 Ton: 1.500  
 Superheat: 4.000  
 Cap Tube Length: 16-1/4  
 Equal Tube Length: 5.1875  
 Equalizer Fitting: Female  
 Inlet Fitting: No. 6  
 Outlet Fitting: No. 8  
 O-Rings: (1) **24604**, (1) **24606**, (1) **24608**  
 Acura (92-91)



# Expansion Valves and Orifice Tubes

## Expansion Valve Cont'd



**39131**  
TXV O-Ring Expansion Valve  
Ton: 1.500  
Superheat: 4.500  
Cap Tube Length: 16-1/4  
Equal Tube Length: 5.1875  
Equalizer Fitting: Female  
Inlet Fitting: No. 6  
Outlet Fitting: No. 8  
O-Rings: (1) **24604**, (1) **24611**, (1) **24661**  
Acura (95-93)



**39132**  
TXV O-Ring Expansion Valve  
Ton: 1.500  
Superheat: 3.000  
Cap Tube Length: 11  
Equal Tube Length: 34.500  
Inlet Fitting: No. 6  
Outlet Fitting: No. 8  
O-Rings: (1) **24604**, (1) **24611**, (1) **24661**  
Acura (04-96)  
Acura: 80220SZ3A01



**39133**  
TXV O-Ring Expansion Valve  
Ton: 1.500  
Superheat: 3.000  
Cap Tube Length: 5-3/4  
Inlet Fitting: No. 6  
Outlet Fitting: No. 8  
O-Rings: (1) **24606**, (1) **24608**  
Chevy (14-97); GMC (14-99); GMC & CHEVY (12-09)  
General Motors Corp: 52484737



**39134**  
Block Type O-Ring Expansion Valve  
Ton: 1.500  
Superheat: -1.000  
Liquid Inlet: No. 6  
Suction Inlet: No. 12  
Liquid Outlet: No. 10  
Suction Outlet: No. 12  
O-Rings: (1) **24611**, (1) **24661**, (2) **24681**  
Lexus (06-01)  
Lexus: 8851550160



**39135**  
Block Type O-Ring Expansion Valve  
Ton: 1.500  
Superheat: 5.000  
Liquid Inlet: No. 6  
Suction Inlet: No. 10  
Liquid Outlet: No. 10  
Suction Outlet: No. 10  
O-Rings: (1) **24606**, (3) **24610**  
Hyundai (01-96)  
Hyundai: 9762629002



**39136**  
TXV O-Ring Expansion Valve  
Ton: 1.500  
Superheat: 3.000  
Cap Tube Length: 4-3/4  
Inlet Fitting: No. 6  
Outlet Fitting: No. 8  
O-Rings: (1) **24606**, (1) **24608**  
Cadillac (06-03); Chevy (07-00); GMC (07-00)  
General Motors Corp: 52401710



**39137**  
Block Type O-Ring Expansion Valve  
Ton: 2.000  
Superheat: -1.000  
Liquid Inlet: No. 6  
Suction Inlet: No. 10  
Liquid Outlet: No. 8  
Suction Outlet: No. 10  
O-Rings: (1) **24402**, (1) **24403**, (1) **24608**, (1) **24610**  
Chevy (05); Saturn (05-02)  
General Motors Corp: 89023423  
Saturn: 22681894



**39138**  
Block Type O-Ring Expansion Valve  
Ton: 1.000  
Superheat: 3.500  
Liquid Inlet: No. 8  
Suction Inlet: No. 10  
Liquid Outlet: No. 8  
Suction Outlet: No. 10  
O-Rings: (2) **24608**, (2) **24610**  
Infiniti (02-99)  
Infiniti: 922005J000

# Expansion Valves and Orifice Tubes

## Expansion Valve Cont'd



### 39139

TXV O-Ring Expansion Valve  
 Ton: 1.500  
 Superheat: 5.500  
 Cap Tube Length: 7-5/8  
 Inlet Fitting: No. 6  
 Outlet Fitting: No. 8  
 O-Rings: (1) **24606**, (1) **24608**  
 Mercury (02-99); Nissan (02-99)  
 Nissan: 922002Z300

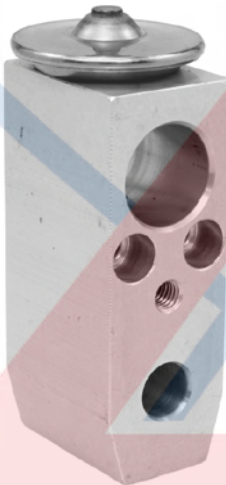

### 39140

Block Type O-Ring Expansion Valve  
 Ton: 1.500  
 Superheat: 7.500  
 Liquid Inlet: No. 6  
 Suction Inlet: No. 10  
 Liquid Outlet: No. 10  
 Suction Outlet: No. 12  
 O-Rings: (2) **24610**, (1) **24611**, (1) **24681**  
 Suzuki (06-03)  
 Suzuki: 9543154J00



### 39141

Block Type O-Ring Expansion Valve  
 Ton: 1.000  
 Superheat: 4.000  
 Liquid Inlet: No. 6  
 Suction Inlet: No. 12  
 Liquid Outlet: No. 10  
 Suction Outlet: No. 12  
 O-Rings: (1) **24611**, (1) **24661**, (2) **24681**  
 Toyota (05-04)  
 Toyota: 8851552050



### 39142

Block Type O-Ring Expansion Valve  
 Ton: 1.000  
 Superheat: 8.500  
 Liquid Inlet: No. 6  
 Suction Inlet: No. 12  
 Liquid Outlet: No. 10  
 Suction Outlet: No. 12  
 O-Rings: (1) **24611**, (1) **24661**, (2) **24681**  
 Toyota (04-03)  
 Toyota: 8851507040



### 39143

Block Type O-Ring Expansion Valve  
 Ton: 1.500  
 Superheat: 4.000  
 Liquid Inlet: No. 6  
 Suction Inlet: No. 12  
 Liquid Outlet: No. 10  
 Suction Outlet: No. 12  
 O-Rings: (1) **24611**, (1) **24661**, (2) **24681**  
 Lexus (09-05); Toyota (14-03)  
 Toyota: 8851560190

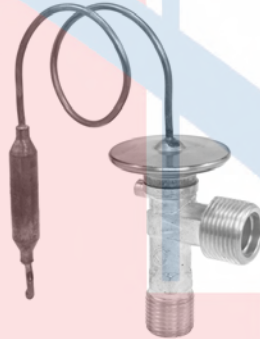

### 39144

TXV O-Ring Expansion Valve  
 Ton: 1.500  
 Superheat: 3.500  
 Cap Tube Length: 11-1/4  
 Inlet Fitting: No. 6  
 Outlet Fitting: No. 8  
 O-Rings: (2) **24626**, (1) **24149**  
 Isuzu (04-97)  
 General Motors Corp: 19189964  
 Isuzu: 8972296280



### 39145

TXV O-Ring Expansion Valve  
 Ton: 1.000  
 Superheat: 2.000  
 Cap Tube Length: 10-1/8  
 Inlet Fitting: No. 6  
 Outlet Fitting: No. 8  
 O-Rings: (1) **24608**, (1) **24646**  
 Toyota (03-98)  
 Toyota: 8851508060



### 39146

Block Type O-Ring Expansion Valve  
 Ton: 2.000  
 Superheat: -1.000  
 Liquid Inlet: No. 8  
 Suction Inlet: No. 10  
 Liquid Outlet: No. 8  
 Suction Outlet: No. 10  
 Color: Aluminum  
 O-Rings: (1) **24608**, (1) **24610**, (2) **24615**  
 Lincoln (05-03)  
 Ford: 3L2Z19849BA

# Expansion Valves and Orifice Tubes

## Expansion Valve Cont'd



**39147**  
Block Type O-Ring Expansion Valve  
Ton: 1.500  
Superheat: 0.500  
Liquid Inlet: No. 6  
Suction Inlet: No. 10  
Liquid Outlet: No. 8  
Suction Outlet: No. 10  
O-Rings: (1) **24606**, (1) **24608**, (2) **24610**  
Ford (11-05); Lincoln (13), (11-09); Mercury (09-05)  
Ford: 8G1Z19849A



**39148**  
TXV O-Ring Expansion Valve  
Ton: 1.500  
Superheat: 4.000  
Cap Tube Length: 5-1/4  
Inlet Fitting: No. 6  
Outlet Fitting: No. 8  
O-Rings: (1) **24606**, (1) **24608**  
Ford (10-03); Lincoln (05-03); Mercury (10-03)  
Ford: 2L2Z19849CA



**39149**  
TXV O-Ring Expansion Valve  
Ton: 1.000  
Superheat: 6.000  
Cap Tube Length: 10-1/2  
Inlet Fitting: No. 6  
Outlet Fitting: No. 8  
O-Rings: (1) **24611**, (1) **24661**  
Chevy (01-98); Geo (97-95); Suzuki (04), (01-95)  
General Motors Corp: 91171919  
Suzuki: 9543150G00



**39150**  
TXV O-Ring Expansion Valve  
Ton: 1.500  
Superheat: 4.000  
Cap Tube Length: 11  
Inlet Fitting: No. 6  
Outlet Fitting: No. 8  
O-Rings: (1) **24606**, (1) **24608**  
Geo (94-89); Suzuki (93-89)  
General Motors Corp: 96061713



**39151**  
Block Type O-Ring Expansion Valve  
Ton: 1.000  
Superheat: 8.500  
Liquid Inlet: No. 6  
Suction Inlet: No. 12  
Liquid Outlet: No. 8  
Suction Outlet: No. 12  
O-Rings: (1) **24401**, (1) **24402**, (1) **24404**  
Buick (07-05); Chevy (08-05); Pontiac (06-05); Saturn (07-05)  
General Motors Corp: 15871957

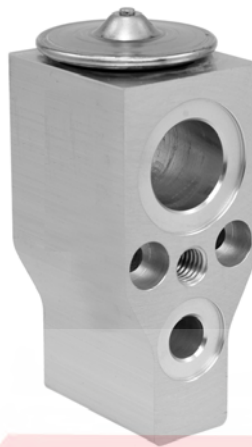

**39152**  
Block Type O-Ring Expansion Valve  
Ton: 1.500  
Superheat: 3.000  
Liquid Inlet: No. 6  
Suction Inlet: No. 12  
Liquid Outlet: No. 8  
Suction Outlet: No. 12  
O-Rings: (1) **24401**, (1) **24402**, (1) **24404**  
Buick (07-05); Chevy (08-05); Pontiac (06); Saturn (07-05)  
General Motors Corp: 15871954

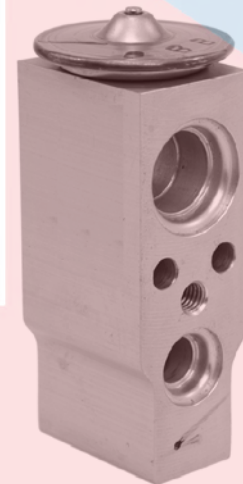

**39153**  
Block Type O-Ring Expansion Valve  
Ton: 1.500  
Superheat: 1.500  
Liquid Inlet: No. 6  
Suction Inlet: No. 10  
Liquid Outlet: No. 8  
Suction Outlet: No. 10  
O-Rings: (1) **24606**, (1) **24608**, (2) **24610**  
Pontiac (08-03)  
General Motors Corp: 88970274



**39154**  
Block Type O-Ring Expansion Valve  
Ton: 1.500  
Superheat: 3.000  
Liquid Inlet: No. 8  
Suction Inlet: No. 10  
Liquid Outlet: No. 8  
Suction Outlet: No. 12  
O-Rings: (2) **24402**, (1) **24403**, (1) **24404**  
Chevy (12-03); GMC (12-04); Isuzu (08-06)  
General Motors Corp: 15218251, 19257722  
Isuzu: 8192577220



**39158**  
Block Type O-Ring Expansion Valve  
Ton: 2.000  
Superheat: -2.500  
Liquid Inlet: No. 6  
Suction Inlet: No. 10  
Liquid Outlet: No. 8  
Suction Outlet: No. 12  
O-Rings: (1) **24606**, (1) **24608**, (1) **24610**, (1) **24612**  
Land Rover (12-04)  
BMW: 64116981454  
Land Rover: JQD000050



# Expansion Valves and Orifice Tubes

## Expansion Valve Cont'd



### 39159

Block Type O-Ring Expansion Valve  
 Superheat: 1.500  
 O-Rings: (1) **24608**, (1) **24610**  
 Land Rover (04-97)  
 Land Rover: STC3140



### 39160

Block Type O-Ring Expansion Valve  
 Ton: 2.000  
 Superheat: 3.000  
 Liquid Inlet: No. 6  
 Suction Inlet: No. 10  
 Liquid Outlet: No. 8  
 Suction Outlet: No. 12  
 O-Rings: (1) **24606**, (1) **24608**, (2)  
**24612**, (1) **24610**  
 Land Rover (03-95)  
 Land Rover: JQD100340



### 39161

Block Type O-Ring Expansion Valve  
 Ton: 2.000  
 Superheat: -2.500  
 Liquid Inlet: No. 6  
 Suction Inlet: No. 10  
 Liquid Outlet: No. 8  
 Suction Outlet: No. 12  
 O-Rings: (1) **24606**, (1) **24608**, (1)  
**24610**, (1) **24612**  
 Land Rover (05-02)  
 Land Rover: JQD100440



### 39162

Block Type O-Ring Expansion Valve  
 Ton: 1.500  
 Superheat: 5.000  
 Liquid Inlet: No. 6  
 Suction Inlet: No. 12  
 Liquid Outlet: No. 8  
 Suction Outlet: No. 12  
 O-Rings: (2) **24612**, (1) **24606**, (1)  
**24608**  
 Lexus (06-01)  
 Lexus: 8851550170



### 39163

Block Type O-Ring Expansion Valve  
 Ton: 1.000  
 Superheat: 5.500  
 Liquid Inlet: No. 6  
 Suction Inlet: No. 10  
 Liquid Outlet: No. 8  
 Suction Outlet: No. 10  
 O-Rings: (1) **24401**, (1) **24402**, (2)  
**24403**  
 Freightliner (04-02)  
 Kysor: 1812002  
 TRP Parts: EA14550, EA14900



### 39164

Block Type O-Ring Expansion Valve  
 Ton: 1.500  
 Superheat: 2.000  
 Liquid Inlet: No. 6  
 Suction Inlet: No. 10  
 Liquid Outlet: No. 8  
 Suction Outlet: No. 12  
 O-Rings: (1) **24606**, (1) **24608**, (2)  
**24612**, (1) **24610**  
 Volvo HD (02-96)  
 Red Dot: 71R8440, RD5103330P

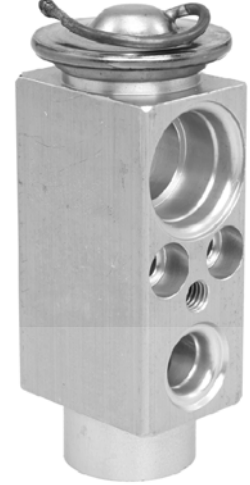

### 39165

Block Type O-Ring Expansion Valve  
 Ton: 1.500  
 Superheat: 2.500  
 Liquid Inlet: No. 6  
 Suction Inlet: No. 10  
 Liquid Outlet: No. 8  
 Suction Outlet: No. 12  
 O-Rings: (1) **24606**, (1) **24608**, (1)  
**24610**, (1) **24612**  
 Dodge (05-02); Volvo (03-00)  
 Volvo: 30767081, 31101177  
 Mack: 3543T4935001



### 39166

TXV O-Ring Expansion Valve  
 Ton: 1.500  
 Superheat: -2.500  
 Cap Tube Length: 10  
 Equal Tube Length: 9.250  
 Equalizer Fitting: Female  
 Inlet Fitting: No. 6  
 Outlet Fitting: No. 8  
 O-Rings: (1) **24604**, (1) **24606**, (1)  
**24608**  
 Ford (97-94)

# Expansion Valves and Orifice Tubes

## Expansion Valve Cont'd



**39167**  
Block Type O-Ring Expansion Valve  
Ton: 1.000  
Superheat: 6.500  
Liquid Inlet: No. 6  
Suction Inlet: No. 10  
Liquid Outlet: No. 10  
Suction Outlet: No. 10  
O-Rings: (1) **24606**, (3) **24610**  
Mazda (10-04)  
Mazda: BP4K61J14A



**39168**  
Block Type O-Ring Expansion Valve  
Ton: 1.000  
Superheat: 3.000  
Liquid Inlet: No. 6  
Suction Inlet: No. 10  
Liquid Outlet: No. 8  
Suction Outlet: No. 12  
O-Rings: (1) **24606**, (1) **24608**, (2) **24612**, (1) **24610**  
Mazda (08-03)  
Mazda: GK3J61J14



**39169**  
TXV O-Ring Expansion Valve  
Ton: 1.500  
Superheat: 1.500  
Cap Tube Length: 11  
Equal Tube Length: 9.250  
Equalizer Fitting: Female  
Inlet Fitting: No. 6  
Outlet Fitting: No. 8  
O-Rings: (1) **24604**, (1) **24606**, (1) **24608**  
Mazda (00-99)  
Mazda: NC1061J14

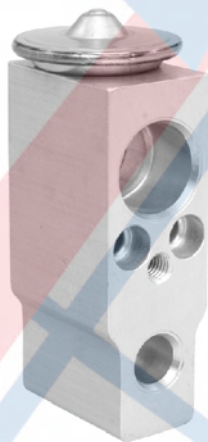

**39170**  
Block Type O-Ring Expansion Valve  
Ton: 1.000  
Superheat: 7.500  
Liquid Inlet: No. 6  
Suction Inlet: No. 10  
Liquid Outlet: No. 8  
Suction Outlet: No. 10  
O-Rings: (1) **24611**, (1) **24661**, (2) **24681**  
Mazda (06-00)  
Mazda: LC7061J14



**39171**  
Block Type O-Ring Expansion Valve  
Ton: 1.000  
Superheat: 5.000  
Liquid Inlet: No. 6  
Suction Inlet: No. 10  
Liquid Outlet: No. 8  
Suction Outlet: No. 10  
O-Rings: (1) **24611**, (1) **24661**, (2) **24681**  
Subaru (07-03)  
Subaru: 73531SA000



**39172**  
Block Type O-Ring Expansion Valve  
Ton: 1.500  
Superheat: 3.500  
Liquid Inlet: No. 6  
Suction Inlet: No. 12  
Liquid Outlet: No. 8  
Suction Outlet: No. 12  
O-Rings: (1) **24606**, (1) **24608**, (1) **24610**, (1) **24612**  
Subaru (01-98)  
Subaru: 73531FC012



**39173**  
TXV O-Ring Expansion Valve  
Ton: 1.500  
Superheat: 3.500  
Cap Tube Length: 10-1/2  
Inlet Fitting: No. 6  
Outlet Fitting: No. 8  
O-Rings: (1) **24606**, (1) **24608**  
Suzuki (95-85)  
Suzuki: 9543160B10



**39174**  
TXV O-Ring Expansion Valve  
Ton: 1.500  
Superheat: 5.500  
Cap Tube Length: 10-1/2  
Inlet Fitting: No. 6  
Outlet Fitting: No. 10  
O-Rings: (1) **24606**, (1) **24610**  
Dodge (02-92); Honda (98-95); Suzuki (98-94)  
Chrysler: 4709102  
Honda: 80220SX0961  
Suzuki: 9543167A50

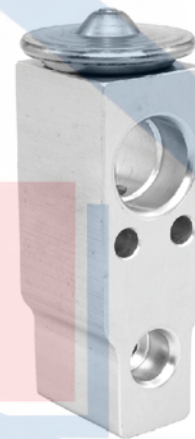

**39175**  
Block Type O-Ring Expansion Valve  
Ton: 1.500  
Superheat: 0.500  
Liquid Inlet: No. 6  
Suction Inlet: No. 12  
Liquid Outlet: No. 10  
Suction Outlet: No. 12  
O-Rings: (1) **24611**, (1) **24661**, (2) **24681**  
Lexus (06-04); Toyota (09-04)  
Toyota: 885150E070

# Expansion Valves and Orifice Tubes

## Expansion Valve Cont'd



### 39176

TXV O-Ring Expansion Valve  
 Ton: 1.500  
 Superheat: 5.000  
 Cap Tube Length: 11  
 Equal Tube Length: 9.000  
 Equalizer Fitting: Female  
 Inlet Fitting: No. 6  
 Outlet Fitting: No. 8  
 O-Rings: (1) **24604**, (1) **24606**, (1) **24608**  
 Mitsubishi (99-97)  
 Mitsubishi: MR283295



### 39177

Block Type O-Ring Expansion Valve  
 Ton: 1.000  
 Superheat: 2.000  
 Liquid Inlet: No. 6  
 Suction Inlet: No. 10  
 Liquid Outlet: No. 8  
 Suction Outlet: No. 10  
 O-Rings: (1) **24401**, (1) **24402**, (1) **24404**  
 Freightliner (07-02)  
 Kysor: 1812007  
 Red Dot: 71R8457



### 39178

TXV O-Ring Expansion Valve  
 Ton: 1.000  
 Superheat: 1.000  
 Cap Tube Length: 10-1/2  
 Inlet Fitting: No. 6  
 Outlet Fitting: No. 8  
 O-Rings: (1) **24606**, (1) **24608**  
 Acura (05-93)



### 39179

Block Type O-Ring Expansion Valve  
 Ton: 1.000  
 Superheat: 8.500  
 Liquid Inlet: No. 6  
 Suction Inlet: No. 12  
 Liquid Outlet: No. 10  
 Suction Outlet: No. 12  
 O-Rings: (1) **24611**, (1) **24661**, (2) **24681**  
 Mitsubishi (08-04)  
 Mitsubishi: 7801A195

### 39180

Block Type O-Ring Expansion Valve  
 Ton: 1.500  
 Superheat: 3.000  
 Liquid Inlet: No. 8  
 Suction Inlet: No. 12  
 Liquid Outlet: No. 8  
 Suction Outlet: No. 10  
 O-Rings: (1) **24608**, (1) **24612**, (1) **24661**, (1) **24681**  
 Chrysler (01); Dodge (01)



### 39181

Block Type O-Ring Expansion Valve  
 Ton: 1.500  
 Superheat: 4.000  
 Liquid Inlet: No. 6  
 Suction Inlet: No. 10  
 Liquid Outlet: No. 8  
 Suction Outlet: No. 12  
 O-Rings: (1) **24109**, (1) **24642**, (1) **24649**, (1) **24675**  
 Chrysler (07-06); Dodge (07-06); Jeep (10-06)  
 Chrysler: 5189088AA, 5189088AB

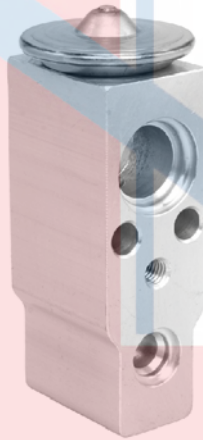

### 39182

Block Type O-Ring Expansion Valve  
 Ton: 1.000  
 Superheat: 3.000  
 Liquid Inlet: No. 6  
 Suction Inlet: No. 10  
 Liquid Outlet: No. 8  
 Suction Outlet: No. 10  
 O-Rings: (1) **24606**, (3) **24610**  
 Kia (05-02)  
 Kia: 1K53C61J12C



### 39183

Block Type O-Ring Expansion Valve  
 Ton: 1.000  
 Superheat: 7.500  
 Liquid Inlet: No. 6  
 Suction Inlet: No. 10  
 Liquid Outlet: No. 10  
 Suction Outlet: No. 10  
 O-Rings: (1) **24606**, (3) **24610**  
 Kia (05-02)  
 Kia: 1K56E61R16B



### 39184

Block Type O-Ring Expansion Valve  
 Ton: 1.000  
 Superheat: 4.500  
 Liquid Inlet: No. 6  
 Suction Inlet: No. 10  
 Liquid Outlet: No. 10  
 Suction Outlet: No. 10  
 O-Rings: (1) **24606**, (3) **24610**  
 Hyundai (09-07); Kia (14), (12-06)  
 Kia: 979164D001



# Expansion Valves and Orifice Tubes

## Expansion Valve Cont'd



**39185**  
Block Type O-Ring Expansion Valve  
Ton: 1.000  
Superheat: 1.500  
Liquid Inlet: No. 6  
Suction Inlet: No. 10  
Liquid Outlet: No. 10  
Suction Outlet: No. 10  
O-Rings: (1) **24606**, (3) **24610**  
Kia (06-04)  
Kia: 972173F000



**39189**  
Block Type O-Ring Expansion Valve  
Ton: 1.000  
Superheat: 3.000  
Liquid Inlet: No. 8  
Suction Inlet: No. 10  
Liquid Outlet: No. 8  
Suction Outlet: No. 10  
O-Rings: (2) **24608**, (2) **24610**  
Subaru (07-02)  
Subaru: 73531FE000



**39191**  
TXV O-Ring Expansion Valve  
Ton: 2.000  
Superheat: 4.500  
Cap Tube Length: 16-1/2  
Inlet Fitting: No. 6  
Outlet Fitting: No. 8  
O-Rings: (1) **24606**, (1) **24608**  
Chevy (96-93); GMC (96-93)  
General Motors Corp: 52472991



**39195**  
Block Type O-Ring Expansion Valve  
Ton: 1.000  
Superheat: 4.000  
Liquid Inlet: No. 8  
Suction Inlet: No. 10  
Liquid Outlet: No. 8  
Suction Outlet: No. 12  
O-Rings: (2) **24402**, (1) **24403**, (1) **24404**  
Toyota (14-05)  
Toyota: 8851504060



**39192**  
TXV O-Ring Expansion Valve  
Ton: 1.500  
Superheat: 2.500  
Cap Tube Length: 6-1/2  
Inlet Fitting: No. 6  
Outlet Fitting: No. 8  
O-Rings: (1) **24606**, (1) **24608**  
Chevy (99-96); GMC (99-96)



**39186**  
Block Type O-Ring Expansion Valve  
Ton: 1.500  
Superheat: -0.250  
Liquid Inlet: No. 6  
Suction Inlet: No. 12  
Liquid Outlet: No. 10  
Suction Outlet: No. 12  
O-Rings: (1) **24611**, (1) **24661**, (2) **24681**  
Cadillac (14-05); Lexus (14-07);  
Toyota (13-05)  
General Motors Corp: 19129999  
Lexus: 8851507030, 8851533020  
Toyota: 8851507030, 8851533020

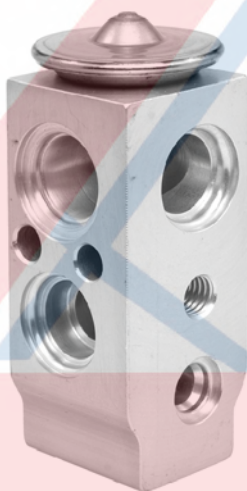

**39190**  
Block Type O-Ring Expansion Valve  
Ton: 1.000  
Superheat: 7.500  
Liquid Inlet: No. 6  
Suction Inlet: No. 10  
Liquid Outlet: No. 10  
Suction Outlet: No. 10  
O-Rings: (1) **24606**, (3) **24610**  
Hyundai (09-05); Kia (10-05)  
Hyundai: 976262E100

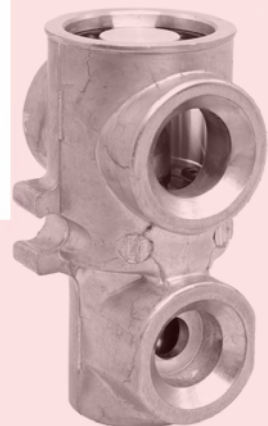

**39193**  
Block Type O-Ring Expansion Valve  
Ton: 1.500  
Liquid Inlet: No. 6  
Suction Inlet: No. 10  
Liquid Outlet: No. 8  
Suction Outlet: No. 10  
O-Rings: (1) **24606**, (1) **24608**, (1) **24641**, (1) **24642**  
Geo (93-92); Isuzu (93-92)  
General Motors Corp: 97047198  
Isuzu: 8970471980



**39196**  
Block Type O-Ring Expansion Valve  
Ton: 1.000  
Superheat: -0.500  
Liquid Inlet: No. 6  
Suction Inlet: No. 12  
Liquid Outlet: No. 10  
Suction Outlet: No. 12  
O-Rings: (1) **24611**, (1) **24661**, (2) **24681**  
Mazda (11-04)  
Mazda: F15461J14, FE0461J14

# Expansion Valves and Orifice Tubes

## Expansion Valve Cont'd



### 39197

TXV O-Ring Expansion Valve  
Ton: 1.000  
Superheat: 4.000  
Cap Tube Length: 10-1/2  
Equal Tube Length: 10.000  
Equalizer Fitting: Female  
Inlet Fitting: No. 6  
Outlet Fitting: No. 10  
O-Rings: (1) **24606**, (1) **24610**  
Acura (98-95)  
Acura: 80220SW5003, 80220SW5023

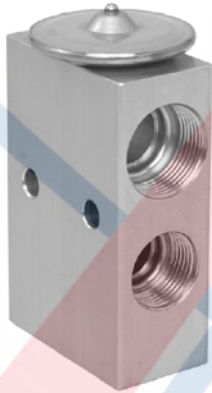

### 39206

Block Type Flange Expansion Valve  
Ton: 1.000  
Superheat: 4.500  
Liquid Inlet: No. 6  
Suction Inlet: No. 10  
Liquid Outlet: No. 8  
Suction Outlet: No. 10  
Color: Gold  
O-Rings: (1) **24606**, (1) **24608**, (2) **24610**, (1) **24629**  
Ford (05-00)  
Ford: YC3Z19849AA



### 39207

TXV O-Ring Expansion Valve  
Ton: 1.000  
Superheat: 3.500  
Cap Tube Length: 8  
Inlet Fitting: No. 6  
Outlet Fitting: No. 8  
O-Rings: (1) **24608**, (1) **24646**  
Cadillac (00-99); Chevy (00-97); GMC (00-97)  
General Motors Corp: 12472428

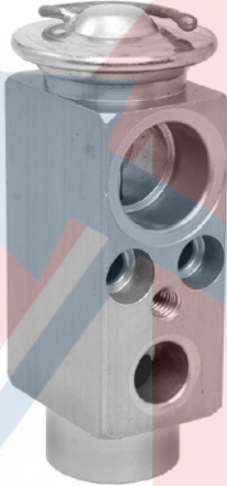

### 39208

Block Type O-Ring Expansion Valve  
Ton: 2.000  
Superheat: 2.000  
Liquid Inlet: No. 6  
Suction Inlet: No. 10  
Liquid Outlet: No. 8  
Suction Outlet: No. 12  
O-Rings: (1) **24608**, (1) **24610**, (1) **24626**, (1) **24681**  
Chrysler (08-04); Mercedes (04-00)  
Chrysler: 5098803AA



### 39209

Block Type Flange Expansion Valve  
Ton: 1.000  
Superheat: 5.000  
Liquid Inlet: No. 8  
Suction Inlet: No. 12  
Liquid Outlet: No. 8  
Suction Outlet: No. 12  
O-Rings: (2) **24402**, (1) **24403**, (1) **24404**  
Chevy (09-06); Pontiac (09-06); Saturn (09-08); Suzuki (09-07)  
General Motors Corp: 19129828

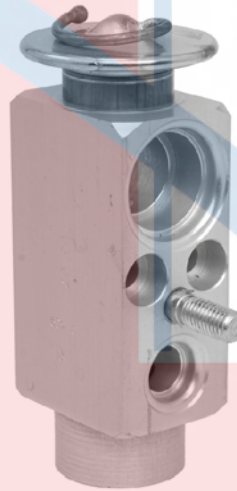

### 39210

Block Type O-Ring Expansion Valve  
Ton: 2.000  
Superheat: 5.500  
Liquid Inlet: No. 6  
Suction Inlet: No. 10  
Liquid Outlet: No. 8  
Suction Outlet: No. 12  
O-Rings: (1) **24606**, (1) **24608**, (1) **24610**, (1) **24612**  
Mercedes (02-91)

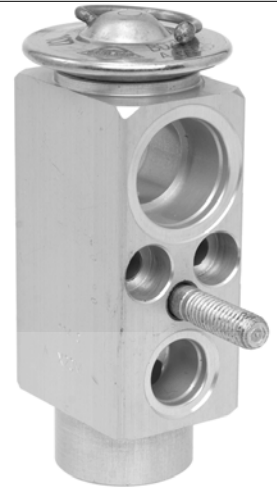

### 39211

Block Type O-Ring Expansion Valve  
Ton: 2.000  
Superheat: -2.000  
Liquid Inlet: No. 6  
Suction Inlet: No. 12  
Liquid Outlet: No. 8  
Suction Outlet: No. 12  
O-Rings: (1) **24608**, (1) **24612**, (1) **24642**, (1) **24662**  
Dodge (09-07); Mercedes (15-01)  
Chrysler: 68012686AA  
Mercedes Benz: 2128300284, 2308300184



### 39212

Block Type O-Ring Expansion Valve  
Ton: 1.300  
Superheat: -0.500  
Liquid Inlet: No. 6  
Suction Inlet: No. 12  
Liquid Outlet: No. 10  
Suction Outlet: No. 12  
O-Rings: (1) **24606**, (1) **24670**, (1) **24678**, (1) **24682**  
Mercedes (05-98)  
Mercedes Benz: 1638300084

# Expansion Valves and Orifice Tubes

## Expansion Valve Cont'd



**39213**  
Block Type O-Ring Expansion Valve  
Ton: 1.000  
Superheat: -2.500  
Liquid Inlet: No. 6  
Suction Inlet: No. 12  
Liquid Outlet: No. 10  
Suction Outlet: No. 12  
O-Rings: (1) **24611**, (1) **24661**, (2) **24681**  
Honda (12-06)  
Honda: 80221SNAA01

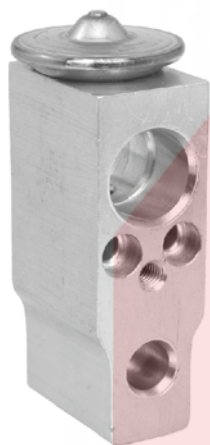

**39214**  
Block Type O-Ring Expansion Valve  
Ton: 1.000  
Superheat: -2.000  
Liquid Inlet: No. 6  
Suction Inlet: No. 12  
Liquid Outlet: No. 10  
Suction Outlet: No. 12  
O-Rings: (1) **24611**, (1) **24661**, (2) **24681**  
Honda (12-06)  
Honda: 80221SVAA01



**39215**  
Block Type O-Ring Expansion Valve  
Ton: 1.000  
Superheat: 5.500  
Liquid Inlet: No. 6  
Suction Inlet: No. 10  
Liquid Outlet: No. 10  
Suction Outlet: No. 10  
O-Rings: (1) **24611**, (3) **24681**  
Honda (98-95)  
Honda: 80220SV4003

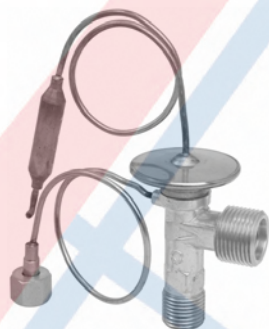

**39216**  
TXV O-Ring Expansion Valve  
Ton: 1.500  
Cap Tube Length: 11-1/2  
Equal Tube Length: 9.750  
Equalizer Fitting: Female  
Inlet Fitting: No. 6  
Outlet Fitting: No. 8  
O-Rings: (1) **24604**, (1) **24606**, (1) **24608**  
Hyundai (97-94)  
Hyundai: 9762228010



**39217**  
TXV O-Ring Expansion Valve  
Ton: 1.500  
Superheat: 0.500  
Cap Tube Length: 10-1/2  
Inlet Fitting: No. 6  
Outlet Fitting: No. 8  
O-Rings: (1) **24606**, (1) **24608**  
Acura (92-91)  
Acura: 80220SF4A01

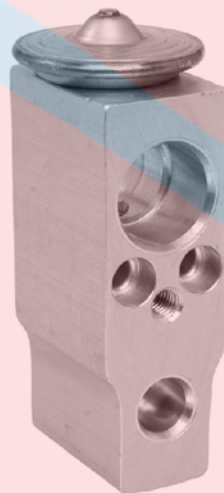

**39218**  
Block Type O-Ring Expansion Valve  
Ton: 1.500  
Superheat: -1.500  
Liquid Inlet: No. 6  
Suction Inlet: No. 12  
Liquid Outlet: No. 10  
Suction Outlet: No. 12  
O-Rings: (1) **24611**, (1) **24661**, (2) **24681**  
Acura (12-05)  
Acura: 80221SJAA01



**39219**  
Block Type O-Ring Expansion Valve  
Ton: 1.000  
Superheat: -0.500  
Liquid Inlet: No. 6  
Suction Inlet: No. 12  
Liquid Outlet: No. 10  
Suction Outlet: No. 12  
O-Rings: (1) **24611**, (1) **24661**, (2) **24681**  
Acura (08-04)  
Acura: 80221SEAG43

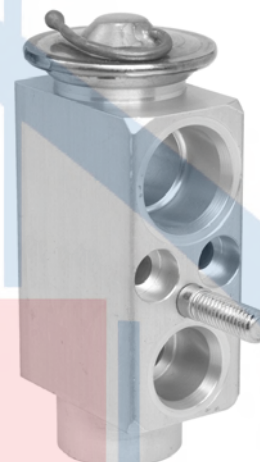

**39220**  
Block Type O-Ring Expansion Valve  
Ton: 1.500  
Superheat: -1.000  
Liquid Inlet: No. 8  
Suction Inlet: No. 10  
Liquid Outlet: No. 8  
Suction Outlet: No. 12  
O-Rings: (2) **24608**, (1) **24610**, (1) **24682**  
BMW (06-01)  
BMW: 64503452759



# Expansion Valves and Orifice Tubes

## Expansion Valve Cont'd



### 39222

Block Type O-Ring Expansion Valve  
 Ton: 2.000  
 Superheat: -2.500  
 Liquid Inlet: No. 8  
 Suction Inlet: No. 12  
 Liquid Outlet: No. 8  
 Suction Outlet: No. 12  
 O-Rings: (2) **24608**, (1) **24610**, (1) **24612**  
 BMW (10-04)  
 BMW: 64119178316



### 39224

Block Type O-Ring Expansion Valve  
 Ton: 2.000  
 Superheat: -2.500  
 Liquid Inlet: No. 6  
 Suction Inlet: No. 10  
 Liquid Outlet: No. 8  
 Suction Outlet: No. 12  
 O-Rings: (1) **24606**, (1) **24608**, (1) **24610**, (1) **24612**  
 BMW (02-01)  
 BMW: 64118384379

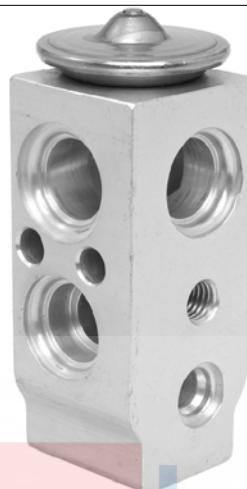

### 39226

Block Type O-Ring Expansion Valve  
 Ton: 1.000  
 Superheat: -0.500  
 Liquid Inlet: No. 6  
 Suction Inlet: No. 10  
 Liquid Outlet: No. 10  
 Suction Outlet: No. 10  
 O-Rings: (1) **24606**, (1) **24608**, (2) **24610**  
 Kia (09-06)  
 Kia: 976041G000



### 39228

Block Type O-Ring Expansion Valve  
 Ton: 1.500  
 Superheat: 4.000  
 Liquid Inlet: No. 6  
 Suction Inlet: No. 10  
 Liquid Outlet: No. 10  
 Suction Outlet: No. 10  
 O-Rings: (1) **24611**, (3) **24681**  
 Lexus (07-03); Toyota (07-03)  
 Lexus: 8851560160  
 Toyota: 8851560160

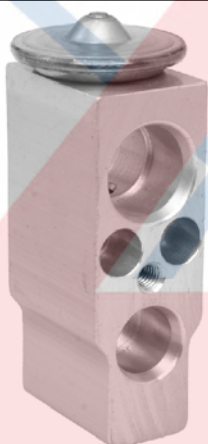

### 39223

Block Type O-Ring Expansion Valve  
 Ton: 1.000  
 Superheat: 1.000  
 Liquid Inlet: No. 8  
 Suction Inlet: No. 12  
 Liquid Outlet: No. 10  
 Suction Outlet: No. 12  
 O-Rings: (2) **23682**, (1) **24608**, (1) **24652**  
 BMW (03)  
 BMW: 64116929991

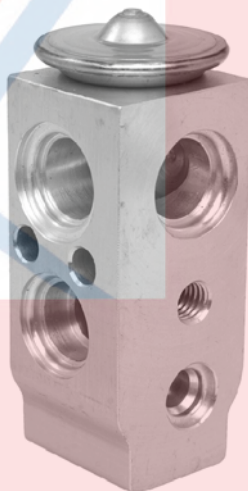

### 39225

Block Type O-Ring Expansion Valve  
 Ton: 1.000  
 Superheat: 5.500  
 Suction Inlet: No. 10  
 Liquid Inlet: No. 6  
 Suction Inlet: No. 10  
 Liquid Outlet: No. 10  
 Suction Outlet: No. 10  
 O-Rings: (1) **24606**, (3) **24610**  
 Hyundai (09-06)  
 Hyundai: 976262C000



### 39227

Block Type O-Ring Expansion Valve  
 Ton: 1.000  
 Superheat: 4.500  
 Liquid Inlet: No. 6  
 Suction Inlet: No. 10  
 Liquid Outlet: No. 10  
 Suction Outlet: No. 10  
 O-Rings: (3) **24109**  
 Kia (06-03)  
 Kia: 976263E200



### 39229

Block Type O-Ring Expansion Valve  
 Ton: 1.000  
 Superheat: 5.000  
 Liquid Inlet: No. 6  
 Suction Inlet: No. 12  
 Liquid Outlet: No. 10  
 Suction Outlet: No. 12  
 O-Rings: (1) **24606**, (1) **24661**, (2) **24681**  
 Lexus (07-03)  
 Lexus: 8851560120  
 Toyota: 8851560120

# Expansion Valves and Orifice Tubes

## Expansion Valve Cont'd



**39230**  
Block Type O-Ring Expansion Valve  
Ton: 1.500  
Superheat: 5.500  
Liquid Inlet: No. 6  
Suction Inlet: No. 10  
Liquid Outlet: No. 10  
Suction Outlet: No. 10  
O-Rings: (1) **24611**, (3) **24681**  
Lexus (02-98); Toyota (02-98)  
Lexus: 8851560060



**39231**  
TXV O-Ring Expansion Valve  
Ton: 1.500  
Superheat: 0.500  
Cap Tube Length: 16-1/2  
Equal Tube Length: 24.750  
Inlet Fitting: No. 6  
Outlet Fitting: No. 8  
O-Rings: (1) **24626**  
Lexus (00-94)  
Lexus: 8851524031



**39232**  
TXV O-Ring Expansion Valve  
Ton: 1.500  
Superheat: 3.000  
Cap Tube Length: 19-3/4  
Equal Tube Length: 24.750  
Inlet Fitting: No. 6  
Outlet Fitting: No. 8  
O-Rings: (1) **24604**, (1) **24606**, (1) **24608**  
Lexus (93-92)  
Lexus: 8851530333



**39233**  
TXV O-Ring Expansion Valve  
Ton: 1.500  
Superheat: 1.000  
Cap Tube Length: 11-3/4  
Equal Tube Length: 13.000  
Equalizer Fitting: Female  
Inlet Fitting: No. 6  
Outlet Fitting: No. 8  
O-Rings: (1) **24604**, (1) **24606**, (1) **24608**  
Mazda (95-94)  
Mazda: HG5461J14



**39234**  
TXV O-Ring Expansion Valve  
Ton: 1.500  
Superheat: -0.500  
Cap Tube Length: 11-1/2  
Equal Tube Length: 13.000  
Equalizer Fitting: Female  
Inlet Fitting: No. 6  
Outlet Fitting: No. 8  
O-Rings: (1) **24604**, (1) **24606**, (1) **24608**  
Mazda (93-92)

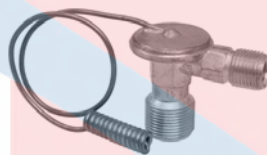

**39235**  
TXV O-Ring Expansion Valve  
Ton: 1.000  
Superheat: 5.500  
Cap Tube Length: 11  
Inlet Fitting: No. 6  
Outlet Fitting: No. 8  
O-Rings: (1) **24611**, (1) **24661**  
Mazda (98-96)  
Mazda: LB5061J14



**39236**  
TXV O-Ring Expansion Valve  
Ton: 1.000  
Superheat: 5.000  
Cap Tube Length: 10-1/2  
Inlet Fitting: No. 6  
Outlet Fitting: No. 8  
O-Rings: (1) **24611**, (1) **24681**  
Mazda (98-96)  
Mazda: LB4061P14



**39237**  
TXV O-Ring Expansion Valve  
Ton: 1.500  
Superheat: 0.500  
Cap Tube Length: 11-1/2  
Equal Tube Length: 9.250  
Equalizer Fitting: Female  
Inlet Fitting: No. 6  
Outlet Fitting: No. 8  
O-Rings: (1) **24606**, (1) **24608**  
Infiniti (92-91); Nissan (93-91)  
Nissan: 9220062J00



**39238**  
Block Type O-Ring Expansion Valve  
Ton: 1.500  
Superheat: 5.500  
Liquid Inlet: No. 6  
Suction Inlet: No. 10  
Liquid Outlet: No. 8  
Suction Outlet: No. 10  
Color: Aluminum  
O-Rings: (1) **24606**, (1) **24608**, (2) **24610**  
Nissan (93)  
Nissan: 922000B700

# Expansion Valves and Orifice Tubes

## Expansion Valve Cont'd



### 39240

TXV O-Ring Expansion Valve  
 Ton: 1.500  
 Superheat: 2.500  
 Cap Tube Length: 12-1/2  
 Equal Tube Length: 13.500  
 Inlet Fitting: No. 6  
 Outlet Fitting: No. 8  
 O-Rings: (1) **24604**, (1) **24606**, (1) **24608**  
 Nissan (92-90)

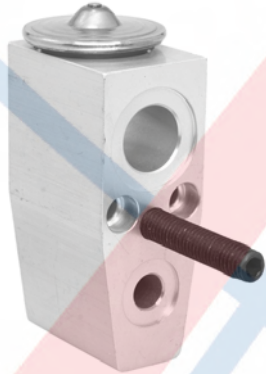

### 39241

Block Type O-Ring Expansion Valve  
 Ton: 1.500  
 Superheat: -1.500  
 Liquid Inlet: No. 6  
 Suction Inlet: No. 10  
 Liquid Outlet: No. 8  
 Suction Outlet: No. 12  
 O-Rings: (1) **24401**, (1) **24404**, (1) **24661**, (1) **24681**  
 Buick (11-06); Cadillac (11-09)  
 General Motors Corp: 15266666



### 39242

Block Type O-Ring Expansion Valve  
 Ton: 1.500  
 Superheat: -0.500  
 Liquid Inlet: No. 8  
 Suction Inlet: No. 12  
 Liquid Outlet: No. 8  
 Suction Outlet: No. 12  
 O-Rings: (1) **24402**, (1) **24402**, (1) **24403**, (1) **24404**  
 Cadillac (09-04); Chevy (13-05)  
 General Motors Corp: 89018980



### 39243

Block Type O-Ring Expansion Valve  
 Ton: 1.000  
 Superheat: -1.500  
 Liquid Inlet: No. 6  
 Suction Inlet: No. 10  
 Liquid Outlet: No. 8  
 Suction Outlet: No. 12  
 O-Rings: (1) **24606**, (1) **24608**, (1) **24610**, (1) **24612**  
 Dodge (06-03); Freightliner (06-02)  
 Chrysler: 5143304AA



### 39246

TXV O-Ring Expansion Valve  
 Ton: 1.500  
 Superheat: 4.500  
 Cap Tube Length: 13  
 Equal Tube Length: 9.250  
 Equalizer Fitting: Female  
 Inlet Fitting: No. 6  
 Outlet Fitting: No. 8  
 O-Rings: (2) **24626**, (1) **24149**, (1) **24604**  
 Honda (96-94)  
 Honda: 80220SS0H01

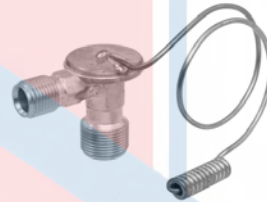

### 39248

TXV O-Ring Expansion Valve  
 Ton: 1.000  
 Superheat: 5.000  
 Cap Tube Length: 13  
 Inlet Fitting: No. 6  
 Outlet Fitting: No. 8  
 O-Rings: (1) **24611**, (1) **24661**  
 Land Rover (96-94)  
 Land Rover: STC3143



### 39250

TXV O-Ring Expansion Valve  
 Ton: 1.500  
 Superheat: 3.500  
 Cap Tube Length: 7-1/2  
 Equal Tube Length: 33.750  
 Inlet Fitting: No. 6  
 Outlet Fitting: No. 8  
 O-Rings: (1) **24604**, (1) **24611**, (1) **24661**  
 Lexus (97-93)  
 Lexus: 8851530461



### 39254

Block Type O-Ring Expansion Valve  
 Ton: 1.000  
 Superheat: 5.000  
 Liquid Inlet: No. 6  
 Suction Inlet: No. 12  
 Liquid Outlet: No. 8  
 Suction Outlet: No. 12  
 O-Rings: (1) **24606**, (1) **24608**, (1) **24610**, (1) **24612**  
 Subaru (97)  
 Subaru: 73531FA112



### 39255

TXV O-Ring Expansion Valve  
 Ton: 1.500  
 Superheat: 5.000  
 Cap Tube Length: 10-3/4  
 Equal Tube Length: 12.750  
 Equalizer Fitting: Female  
 Inlet Fitting: No. 6  
 Outlet Fitting: No. 8  
 O-Rings: (1) **24604**, (1) **24606**, (1) **24608**  
 Subaru (96-93)  
 Subaru: 73067FA030



# Expansion Valves and Orifice Tubes

## Expansion Valve Cont'd



**39259**  
Block Type O-Ring Expansion Valve  
Ton: 1.500  
Superheat: 3.000  
Liquid Inlet: No. 6  
Suction Inlet: No. 10  
Liquid Outlet: No. 8  
Suction Outlet: No. 12  
O-Rings: (1) **24611**, (1) **24661**, (1) **24681**  
VW (03-93)  
Volkswagen: 701820679D



**39264**  
Block Type O-Ring Expansion Valve  
Ton: 1.000  
Superheat: -0.500  
Liquid Inlet: No. 6  
Suction Inlet: No. 10  
Liquid Outlet: No. 10  
Suction Outlet: No. 10  
O-Rings: (1) **24606**, (3) **24610**  
Hyundai (07-06)  
Hyundai: 976263K000



**39266**  
Block Type O-Ring Expansion Valve  
Ton: 1.000  
Superheat: 1.500  
Liquid Inlet: No. 6  
Suction Inlet: No. 12  
Liquid Outlet: No. 8  
Suction Outlet: No. 12  
O-Rings: (1) **24606**, (1) **24608**, (2) **24612**  
Volvo (09-05)  
Volvo: 30780559



**39268**  
Block Type Flange Expansion Valve  
Superheat: 5.500  
Liquid Inlet: No. 6  
Suction Inlet: No. 10  
Liquid Outlet: No. 8  
Suction Outlet: No. 12  
O-Rings: (1) **24401**, (1) **24402**, (1) **24403**, (1) **24404**  
Kysor: 1812006

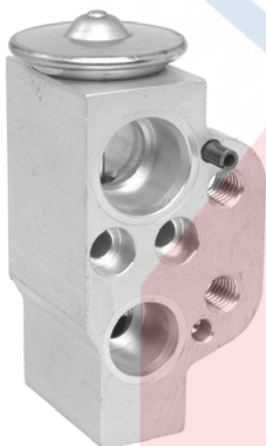

**39260**  
Block Type O-Ring Expansion Valve  
Ton: 1.000  
Superheat: -3.200  
Liquid Inlet: No. 8  
Suction Inlet: No. 10  
Liquid Outlet: No. 8  
Suction Outlet: No. 12  
O-Rings: (1) **24608**, (1) **24610**, (1) **24642**, (1) **24649**  
Audi (14-06); VW (14-06)  
Audi: 1K0820679  
Volkswagen: 1K0820679

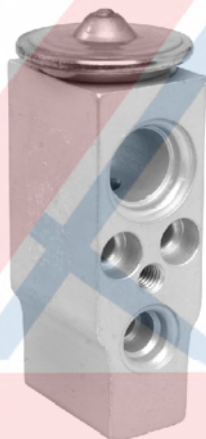

**39265**  
Block Type O-Ring Expansion Valve  
Ton: 1.000  
Superheat: -1.000  
Liquid Inlet: No. 6  
Suction Inlet: No. 10  
Liquid Outlet: No. 8  
Suction Outlet: No. 10  
O-Rings: (1) **24606**, (1) **24608**, (2) **24610**  
Volvo (10-08), (06-05)  
Volvo: 30665087



**39267**  
Block Type O-Ring Expansion Valve  
Ton: 1.000  
Superheat: 4.500  
Liquid Inlet: No. 6  
Suction Inlet: No. 10  
Liquid Outlet: No. 8  
Suction Outlet: No. 10  
O-Rings: (1) **24606**, (1) **24608**, (1) **24610**  
Volvo (09-03)  
Volvo: 8648253

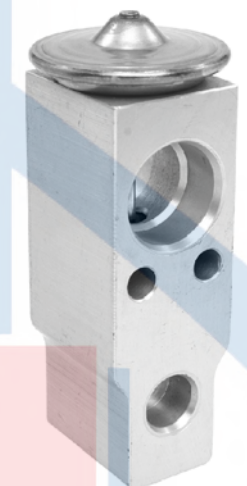

**39271**  
Block Type O-Ring Expansion Valve  
Superheat: -2.000  
Liquid Inlet: No. 6  
Suction Inlet: No. 12  
Liquid Outlet: No. 10  
Suction Outlet: No. 12  
O-Rings: (1) **24109**, (1) **24626**, (2) **24642**  
Acura (13-07); Cadillac (09-07); Honda (15-06)  
Acura: 80221STXA41  
General Motors Corp: 19130353  
Honda: 80221STXA41

# Expansion Valves and Orifice Tubes

## Expansion Valve Cont'd



### 39273

TXV O-Ring Expansion Valve  
 Ton: 1.500  
 Superheat: -0.500  
 Cap Tube Length: 11-3/4  
 Equal Tube Length: 14.000  
 O-Rings: (1) **24605**, (1) **24608**, (1) **24646**  
 Infiniti (96-90)  
 Infiniti: 9220067U03

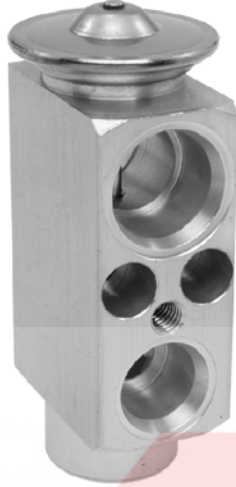

### 39275

Block Type O-Ring Expansion Valve  
 Ton: 2.000  
 Superheat: -2.000  
 Liquid Inlet: No. 8  
 Suction Inlet: No. 10  
 Liquid Outlet: No. 8  
 Suction Outlet: No. 12  
 O-Rings: (1) **24608**, (1) **24610**, (1) **24642**, (1) **24661**  
 BMW (15-07)  
 BMW: 64119187630



### 39277

Block Type O-Ring Expansion Valve  
 Ton: 1.500  
 Superheat: -2.500  
 Liquid Inlet: No. 6  
 Suction Inlet: No. 10  
 Liquid Outlet: No. 6  
 Suction Outlet: No. 12  
 O-Rings: (1) **24608**, (2) **24610**, (1) **24612**  
 Chevy (10-04); Suzuki (08-04)  
 Suzuki: 9543185Z00



### 39279

Block Type Flange Expansion Valve  
 Superheat: -2.000  
 Liquid Inlet: No. 6  
 Suction Inlet: No. 12  
 Liquid Outlet: No. 10  
 Suction Outlet: No. 12  
 O-Rings: (1) **24611**, (1) **24661**, (2) **24681**  
 Lexus (10-05)



### 39274

Block Type O-Ring Expansion Valve  
 Ton: 1.000  
 Superheat: -0.500  
 Liquid Inlet: No. 6  
 Suction Inlet: No. 12  
 Liquid Outlet: No. 10  
 Suction Outlet: No. 12  
 O-Rings: (1) **24109**, (1) **24626**, (2) **24642**  
 Lexus (14-10); Scion (15-08); Subaru (15-10); Toyota (15-06)  
 Lexus: 8851526070, 8851533050  
 Subaru: 73531AJ01A  
 Toyota: 8851502200, 8851502420, 8851502530, 8851526070

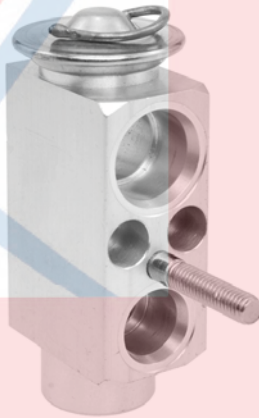

### 39276

Block Type O-Ring Expansion Valve  
 Superheat: -1.000  
 Liquid Inlet: No. 8  
 Suction Inlet: No. 10  
 Liquid Outlet: No. 8  
 Suction Outlet: No. 12  
 O-Rings: (1) **24608**, (1) **24610**, (1) **24642**, (1) **24661**  
 BMW (10-04); Mini (15-11)  
 BMW: 64503452759



### 39278

Block Type O-Ring Expansion Valve  
 Superheat: -1.000  
 Liquid Inlet: No. 6  
 Suction Inlet: No. 12  
 Liquid Outlet: No. 10  
 Suction Outlet: No. 12  
 O-Rings: (1) **24109**, (1) **24626**, (2) **24642**  
 Suzuki (13-06)  
 Suzuki: 9543164J80



### 39280

Block Type O-Ring Expansion Valve  
 Superheat: -3.500  
 Liquid Inlet: No. 6  
 Suction Inlet: No. 12  
 Liquid Outlet: No. 10  
 Suction Outlet: No. 12  
 O-Rings: (1) **24611**, (1) **24661**, (1) **24681**  
 Lexus (14-07)  
 Lexus: 8851550210

# Expansion Valves and Orifice Tubes

## Expansion Valve Cont'd



**39281**  
Block Type O-Ring Expansion Valve  
Superheat: -3.000  
Liquid Inlet: No. 6  
Suction Inlet: No. 12  
Liquid Outlet: No. 10  
Suction Outlet: No. 12  
O-Rings: (1) **24611**, (1) **24661**, (1) **24681**  
Lexus (14-07)  
Lexus: 8851550220



**39283**  
Block Type Flange Expansion Valve  
Superheat: 4.500  
Liquid Inlet: No. 6  
Suction Inlet: No. 12  
Liquid Outlet: No. 10  
Suction Outlet: No. 12  
O-Rings: (1) **24611**, (1) **24661**, (2) **24681**  
Lexus (11-06); Toyota (07-06)  
Lexus: 8851528180  
Toyota: 885150E080, 8851528180



**39285**  
Block Type O-Ring Expansion Valve  
Ton: 1.500  
Superheat: 8.000  
Liquid Inlet: No. 6  
Suction Inlet: No. 12  
Liquid Outlet: No. 8  
Suction Outlet: No. 12  
O-Rings: (2) **24622**, (1) **24649**, (1) **24662**  
Chrysler (09-07); Dodge (09-07)  
Chrysler: 68019148AA



**39287**  
Block Type Flange Expansion Valve  
Liquid Inlet: No. 6  
Suction Inlet: No. 12  
Liquid Outlet: No. 10  
Suction Outlet: No. 12  
O-Rings: (1) **24608**, (2) **24610**, (1) **24611**  
Honda (08-07)  
Honda: 80221SAA013



**39282**  
Block Type Flange Expansion Valve  
Liquid Inlet: No. 6  
Suction Inlet: No. 12  
Liquid Outlet: No. 10  
Suction Outlet: No. 10  
O-Rings: (1) **24611**, (2) **24661**, (1) **24681**  
Lexus (14-07)  
Lexus: 8851530740



**39284**  
Block Type O-Ring Expansion Valve  
Superheat: 5.500  
Liquid Inlet: No. 6  
Suction Inlet: No. 12  
Liquid Outlet: No. 10  
Suction Outlet: No. 12  
O-Rings: (1) **24121**  
Chrysler (08-07); Dodge (08-07)  
Chrysler: 68020270AA, 68027237AA



**39286**  
Block Type O-Ring Expansion Valve  
Ton: 1.500  
Superheat: 4.500  
Liquid Inlet: No. 6  
Suction Inlet: No. 10  
Liquid Outlet: No. 8  
Suction Outlet: No. 12  
O-Rings: (1) **24606**, (1) **24608**, (1) **24610**, (1) **24612**  
Dodge (11-07); Jeep (11-08)  
Chrysler: 68003989AA  
Jeep: 68003989AA

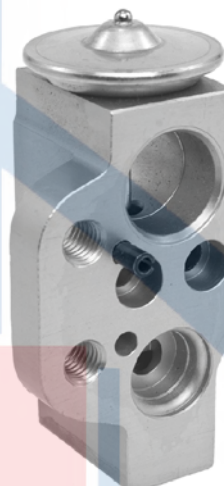

**39288**  
Block Type O-Ring Expansion Valve  
Superheat: 1.000  
Liquid Inlet: No. 8  
Suction Inlet: No. 12  
Liquid Outlet: No. 8  
Suction Outlet: No. 12  
O-Rings: (2) **24668**, (2) **24672**  
Audi (09-07); VW (14-04)  
Volkswagen: 7L0820712B



# Expansion Valves and Orifice Tubes

## Expansion Valve Cont'd



### 39289

Block Type O-Ring Expansion Valve  
 Superheat: -2.500  
 Liquid Inlet: No. 8  
 Suction Inlet: No. 12  
 Liquid Outlet: No. 8  
 Suction Outlet: No. 12  
 O-Rings: (1) **24668**, (1) **24672**  
 Audi (14-07); VW (10-04)  
 Audi: 7L0820679D



### 39291

Block Type O-Ring Expansion Valve  
 Superheat: -2.000  
 Liquid Inlet: No. 6  
 Suction Inlet: No. 10  
 Liquid Outlet: No. 8  
 Suction Outlet: No. 12  
 O-Rings: (1) **24666**, (1) **24668**, (1) **24670**, (1) **24672**  
 BMW (09-02)  
 BMW: 64119178315



### 39293

Block Type O-Ring Expansion Valve  
 Ton: 1.000  
 Superheat: -2.500  
 Liquid Inlet: No. 6  
 Suction Inlet: No. 10  
 Liquid Outlet: No. 8  
 Suction Outlet: No. 12  
 O-Rings: (1) **24661**, (1) **24668**, (1) **24670**, (1) **24672**  
 Nissan (10-07)  
 Nissan: 92200EE91A



### 39295

Block Type O-Ring Expansion Valve  
 Superheat: -2.000  
 Liquid Inlet: No. 8  
 Suction Inlet: No. 12  
 Liquid Outlet: No. 10  
 Suction Outlet: No. 12  
 O-Rings: (1) **23680**, (1) **24670**, (2) **24672**  
 BMW (08-03)

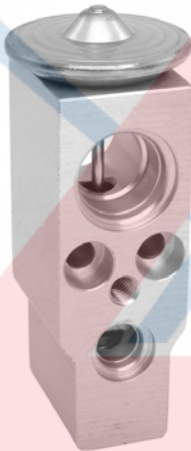

### 39290

Block Type O-Ring Expansion Valve  
 Ton: 1.000  
 Superheat: 3.000  
 Liquid Inlet: No. 6  
 Suction Inlet: No. 10  
 Liquid Outlet: No. 8  
 Suction Outlet: No. 10  
 O-Rings: (1) **24608**, (2) **24610**, (1) **24616**  
 Mitsubishi (15-07)  
 Mitsubishi: 7810A068, 7810A126



### 39292

Block Type O-Ring Expansion Valve  
 Ton: 1.500  
 Superheat: -2.000  
 Liquid Inlet: No. 6  
 Suction Inlet: No. 12  
 Liquid Outlet: No. 8  
 Suction Outlet: No. 12  
 O-Rings: (1) **24611**, (1) **24661**, (1) **24681**, (1) **24682**  
 Infiniti (11-06); Nissan (15-07)  
 Infiniti: 922006N205  
 Nissan: 922006N205

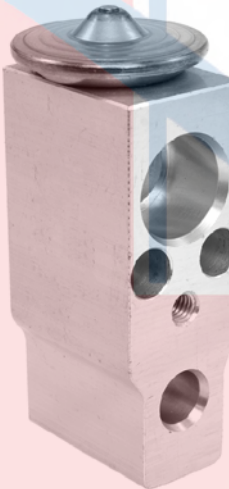

### 39294

Block Type O-Ring Expansion Valve  
 Ton: 1.000  
 Superheat: 4.000  
 Liquid Inlet: No. 6  
 Suction Inlet: No. 10  
 Liquid Outlet: No. 8  
 Suction Outlet: No. 12  
 O-Rings: (1) **24661**, (1) **24668**, (1) **24670**, (1) **24672**  
 Nissan (15-07)  
 Nissan: 922001U60A

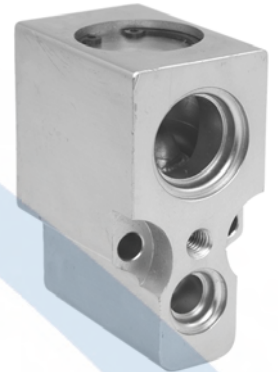

### 39296

Block Type O-Ring Expansion Valve  
 Ton: 2.000  
 Superheat: -1.500  
 Liquid Inlet: No. 6  
 Suction Inlet: No. 10  
 Liquid Outlet: No. 8  
 Suction Outlet: No. 12  
 O-Rings: (1) **24606**, (1) **24608**, (1) **24610**, (1) **24612**  
 Saab (09-99)  
 Saab: 5048590

# Expansion Valves and Orifice Tubes

## Expansion Valve Cont'd



**39297**  
Block Type O-Ring Expansion Valve  
Ton: 1.500  
Superheat: -2.500  
Liquid Inlet: No. 6  
Suction Inlet: No. 10  
Liquid Outlet: No. 10  
Suction Outlet: No. 10  
O-Rings: (1) **24606**, (1) **24610**, (2) **24670**  
Chevy (11-04); Pontiac (10-07)  
General Motors Corp: 95946961



**39299**  
Block Type O-Ring Expansion Valve  
Ton: 1.500  
Superheat: -1.500  
Liquid Inlet: No. 6  
Suction Inlet: No. 10  
Liquid Outlet: No. 8  
Suction Outlet: No. 12  
O-Rings: (1) **24246**, (1) **24668**, (1) **24670**, (2) **24672**  
Pontiac (06-04)  
General Motors Corp: 92117402



**39301**  
Block Type O-Ring Expansion Valve  
Ton: 1.000  
Superheat: 5.500  
Liquid Inlet: No. 6  
Suction Inlet: No. 10  
Liquid Outlet: No. 10  
Suction Outlet: No. 12  
O-Rings: (1) **24607**, (3) **24610**  
Mazda (12-06)  
Mazda: GJ6A61J14B



**39303**  
Block Type O-Ring Expansion Valve  
Ton: 1.000  
Superheat: 8.000  
Liquid Inlet: No. 6  
Suction Inlet: No. 12  
Liquid Outlet: No. 10  
Suction Outlet: No. 12  
O-Rings: (1) **24606**, (1) **24670**, (2) **24672**  
Mazda (14-07)  
Mazda: TD1461J14A

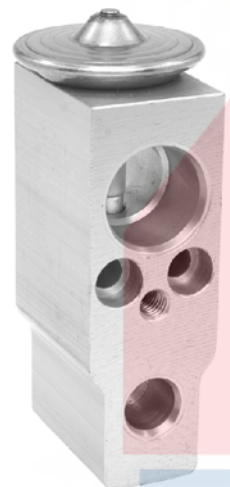

**39298**  
Block Type O-Ring Expansion Valve  
Superheat: -3.500  
Liquid Inlet: No. 6  
Suction Inlet: No. 12  
Liquid Outlet: No. 10  
Suction Outlet: No. 12  
O-Rings: (1) **24109**, (2) **24642**, (1) **24675**  
Acura (12-07)  
Acura: 80221STKA41

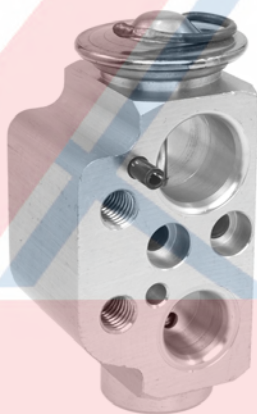

**39300**  
Block Type O-Ring Expansion Valve  
Superheat: -2.000  
Liquid Inlet: No. 8  
Suction Inlet: No. 12  
Liquid Outlet: No. 8  
Suction Outlet: No. 12  
O-Rings: (1) **24608**, (1) **24661**, (1) **24672**, (1) **24681**  
Porsche (10-03)  
Porsche: 95557231904

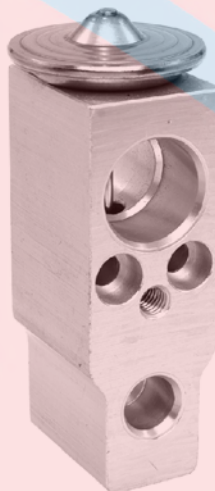

**39302**  
Block Type O-Ring Expansion Valve  
Superheat: 3.500  
Liquid Inlet: No. 6  
Suction Inlet: No. 12  
Liquid Outlet: No. 10  
Suction Outlet: No. 12  
O-Rings: (1) **24606**, (1) **24670**, (2) **24672**  
Mazda (14-07)  
Mazda: L20661J14

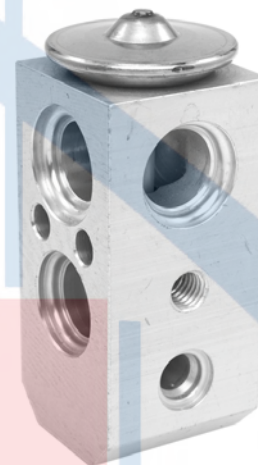

**39304**  
Block Type O-Ring Expansion Valve  
Ton: 1.500  
Superheat: -3.300  
Liquid Inlet: No. 6  
Suction Inlet: No. 10  
Liquid Outlet: No. 10  
Suction Outlet: No. 10  
O-Rings: (1) **24606**, (3) **24670**  
Hyundai (11-06)  
Hyundai: 976041E300  
Hy-Capacity: 976041E000

# Expansion Valves and Orifice Tubes

## Expansion Valve Cont'd



### 39305

Block Type O-Ring Expansion Valve  
 Ton: 1.000  
 Superheat: -3.000  
 Liquid Inlet: No. 6  
 Suction Inlet: No. 10  
 Liquid Outlet: No. 10  
 Suction Outlet: No. 10  
 O-Rings: (1) **24606**, (3) **24670**  
 Hyundai (09-07)  
 Hyundai: 976262H000



### 39307

Block Type Flange Expansion Valve  
 Ton: 2.000  
 Superheat: -1.000  
 Liquid Inlet: No. 6  
 Suction Inlet: No. 10  
 Liquid Outlet: No. 8  
 Suction Outlet: No. 12  
 O-Rings: (1) **24401**, (1) **24402**, (1) **24403**, (1) **24404**  
 Buick (12-08); Chevy (12-09); GMC (12-07); Saturn (10-07)  
 General Motors Corp: 22804122  
 Saturn: 25786451



### 39309

Block Type O-Ring Expansion Valve  
 Ton: 1.500  
 Superheat: -3.500  
 Liquid Inlet: No. 6  
 Suction Inlet: No. 10  
 Liquid Outlet: No. 8  
 Suction Outlet: No. 10  
 O-Rings: (1) **24606**, (3) **24670**  
 Kia (08-06)  
 Kia: 976262G000



### 39311

Block Type O-Ring Expansion Valve  
 Ton: 1.000  
 Superheat: -3.500  
 Liquid Inlet: No. 6  
 Suction Inlet: No. 12  
 Liquid Outlet: No. 10  
 Suction Outlet: No. 12  
 O-Rings: (2) **24610**, (1) **24606**, (2) **24612**  
 Subaru (14-07)  
 Subaru: 73531XA02A

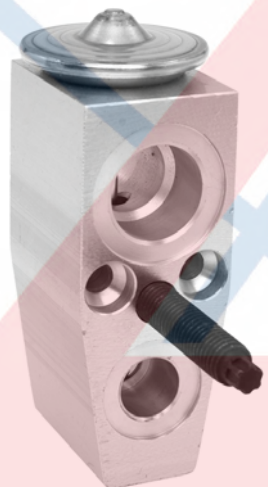

### 39306

Block Type Flange Expansion Valve  
 Ton: 1.000  
 Superheat: 2.800  
 Liquid Inlet: No. 8  
 Suction Inlet: No. 10  
 Liquid Outlet: No. 8  
 Suction Outlet: No. 12  
 O-Rings: (2) **24402**, (1) **24403**, (1) **24404**  
 Ford (09-06); Lincoln (09-06); Mercury (09-06)  
 Ford: 6E5Z19849AA

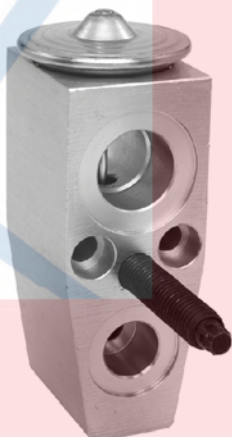

### 39308

Block Type O-Ring Expansion Valve  
 Ton: 1.000  
 Superheat: 8.000  
 Liquid Inlet: No. 8  
 Suction Inlet: No. 10  
 Liquid Outlet: No. 8  
 Suction Outlet: No. 10  
 O-Rings: (1) **24608**, (1) **24402**, (1) **24610**, (1) **24403**  
 Chevy (05); Saturn (07-05)  
 General Motors Corp: 89024964

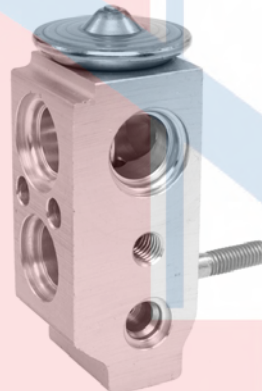

### 39310

Block Type O-Ring Expansion Valve  
 Ton: 1.000  
 Superheat: -3.500  
 Liquid Inlet: No. 6  
 Suction Inlet: No. 10  
 Liquid Outlet: No. 10  
 Suction Outlet: No. 10  
 O-Rings: (1) **24606**, (3) **24670**  
 Kia (10-07)  
 Kia: 976262F700



### 39312

Block Type O-Ring Expansion Valve  
 Ton: 2.000  
 Superheat: -3.000  
 Liquid Inlet: No. 6  
 Suction Inlet: No. 10  
 Liquid Outlet: No. 8  
 Suction Outlet: No. 12  
 O-Rings: (1) **24401**, (1) **24402**, (1) **24403**, (1) **24404**  
 Saab (11-04)  
 Saab: 93171816



# Expansion Valves and Orifice Tubes

## Expansion Valve Cont'd



**39313**  
Block Type O-Ring Expansion Valve  
Ton: 1.700  
Superheat: 5.000  
Liquid Inlet: No. 6  
Suction Inlet: No. 10  
Liquid Outlet: No. 6  
Suction Outlet: No. 12  
O-Rings: (1) **24402**, (1) **24402**, (1) **24403**, (1) **24404**  
General Motors Corp: 15871702

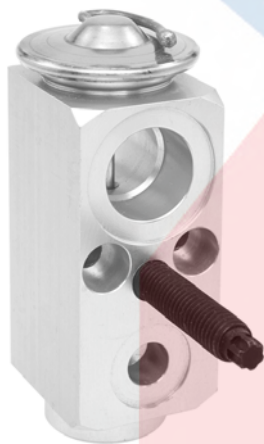

**39314**  
Block Type O-Ring Expansion Valve  
Ton: 1.200  
Superheat: 5.500  
Liquid Inlet: No. 6  
Suction Inlet: No. 10  
Liquid Outlet: No. 8  
Suction Outlet: No. 12  
O-Rings: (1) **24401**, (1) **24402**, (1) **24403**, (1) **24404**  
Cadillac (14-12), (10-07); Chevy (14-07); GMC (14-07)  
General Motors Corp: 25994366



**39315**  
Block Type O-Ring Expansion Valve  
Ton: 1.500  
Superheat: -0.050  
Liquid Inlet: No. 8  
Suction Inlet: No. 10  
Liquid Outlet: No. 8  
Suction Outlet: No. 12  
O-Rings: (1) **24402**, (1) **24402**, (1) **24403**, (1) **24404**  
Pontiac (09-06); Saturn (10-07)  
General Motors Corp: 89025005



**39316**  
Block Type O-Ring Expansion Valve  
Ton: 2.000  
Superheat: -1.500  
Liquid Inlet: No. 6  
Suction Inlet: No. 10  
Liquid Outlet: No. 8  
Suction Outlet: No. 12  
O-Rings: (1) **24629**, (1) **24654**, (1) **24668**, (1) **24670**  
Mini (08-02)  
BMW: 64516924984



**39317**  
Block Type O-Ring Expansion Valve  
Ton: 1.500  
Superheat: -3.000  
Liquid Inlet: No. 6  
Suction Inlet: No. 10  
Liquid Outlet: No. 10  
Suction Outlet: No. 12  
O-Rings: (1) **24662**, (2) **24672**, (1) **24679**  
Hyundai (11-06)  
Hyundai: 976263L000



**39318**  
Block Type O-Ring Expansion Valve  
Ton: 1.500  
Superheat: 3.500  
Liquid Inlet: No. 6  
Suction Inlet: No. 10  
Liquid Outlet: No. 10  
Suction Outlet: No. 10  
O-Rings: (3) **24610**, (1) **24616**  
Hyundai (04-01)  
Hyundai: 976262D000

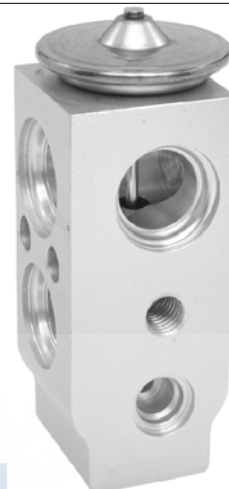

**39319**  
Block Type O-Ring Expansion Valve  
Ton: 1.200  
Superheat: -3.000  
Liquid Inlet: No. 6  
Suction Inlet: No. 10  
Liquid Outlet: No. 10  
Suction Outlet: No. 10  
O-Rings: (3) **24610**, (1) **24616**  
Hyundai (11-07)  
Hyundai: 976042B100  
Kia: 976042B100



**39320**  
Block Type O-Ring Expansion Valve  
Ton: 0.800  
Superheat: 1.000  
Liquid Inlet: No. 6  
Suction Inlet: No. 10  
Liquid Outlet: No. 8  
Suction Outlet: No. 12  
O-Rings: (1) **24608**, (1) **24610**, (1) **24626**, (1) **24642**  
Suzuki (13-07)  
Suzuki: 9543180J01

# Expansion Valves and Orifice Tubes

## Expansion Valve Cont'd



### 39321

Block Type Flange Expansion Valve  
 Ton: 1.000  
 Superheat: -1.000  
 Liquid Inlet: No. 6  
 Suction Inlet: No. 10  
 Liquid Outlet: No. 8  
 Suction Outlet: No. 12  
 O-Rings: (1) **24401**, (1) **24402**, (1) **24403**, (1) **24404**  
 Chrysler (15-08); Dodge (15-08); VW (14-09)  
 Chrysler: 68029727AA  
 Volkswagen: 7B0820679

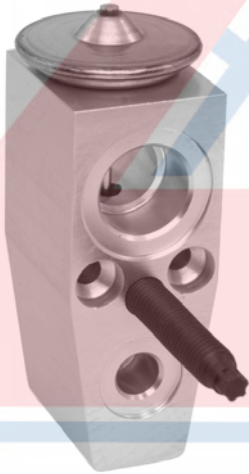

### 39322

Block Type Flange Expansion Valve  
 Ton: 0.800  
 Superheat: 5.400  
 Liquid Inlet: No. 6  
 Suction Inlet: No. 10  
 Liquid Outlet: No. 8  
 Suction Outlet: No. 12  
 O-Rings: (1) **24401**, (1) **24402**, (1) **24403**, (1) **24404**  
 Ford (12-10); Lincoln (12-10); Mercury (11-10)  
 Ford: AE5Z19849A



### 39323

Block Type O-Ring Expansion Valve  
 Ton: 1.300  
 Superheat: 7.000  
 Liquid Inlet: No. 6  
 Suction Inlet: No. 12  
 Liquid Outlet: No. 10  
 Suction Outlet: No. 12  
 O-Rings: (1) **24611**, (1) **24661**, (2) **24681**  
 Toyota (14-06)  
 Toyota: 885150C110



### 39324

Block Type O-Ring Expansion Valve  
 Ton: 1.000  
 Superheat: -3.000  
 Liquid Inlet: No. 6  
 Suction Inlet: No. 12  
 Liquid Outlet: No. 10  
 Suction Outlet: No. 12  
 O-Rings: (1) **24611**, (1) **24661**, (2) **24681**  
 Ford (14-07); Lincoln (14-07)  
 Ford: 7T4Z19849A



### 39325

Block Type O-Ring Expansion Valve  
 Ton: 1.000  
 Superheat: -5.500  
 Liquid Inlet: No. 6  
 Suction Inlet: No. 12  
 Liquid Outlet: No. 10  
 Suction Outlet: No. 12  
 O-Rings: (1) **24611**, (1) **24661**, (2) **24681**  
 Honda (10-08)

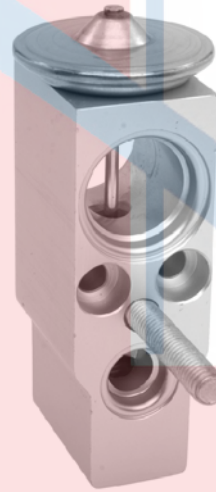

### 39326

Block Type O-Ring Expansion Valve  
 Ton: 1.000  
 Superheat: -3.500  
 Liquid Inlet: No. 6  
 Suction Inlet: No. 12  
 Liquid Outlet: No. 8  
 Suction Outlet: No. 12  
 O-Rings: (1) **24606**, (1) **24608**, (2) **24612**  
 Dodge (11-09); Jeep (11-07)  
 Chrysler: 68004206AB



### 39327

Block Type O-Ring Expansion Valve  
 Ton: 1.200  
 Superheat: 7.000  
 Liquid Inlet: No. 8  
 Suction Inlet: No. 10  
 Liquid Outlet: No. 8  
 Suction Outlet: No. 10  
 O-Rings: (1) **24402**, (1) **24403**, (1) **24608**, (1) **24610**  
 Ford (12-08); Mazda (11-08); Mercury (11-08)  
 Ford: AL8Z19849A



### 39328

Block Type O-Ring Expansion Valve  
 Ton: 1.000  
 Superheat: -6.000  
 Liquid Inlet: No. 6  
 Suction Inlet: No. 12  
 Liquid Outlet: No. 10  
 Suction Outlet: No. 12  
 O-Rings: (1) **24611**, (1) **24661**, (2) **24681**  
 Acura (14-09)  
 Acura: 80221TC0Z41

# Expansion Valves and Orifice Tubes

## Expansion Valve Cont'd



**39329**  
Block Type O-Ring Expansion Valve  
Ton: 2.000  
Superheat: -3.500  
Liquid Inlet: No. 6  
Suction Inlet: No. 10  
Liquid Outlet: No. 8  
Suction Outlet: No. 12  
O-Rings: (1) **24606**, (1) **24608**, (1) **24610**, (1) **24681**  
Mercedes (11-03)  
Mercedes Benz: 1698300684,  
1718300184, 2208300384



**39331**  
Block Type O-Ring Expansion Valve  
Ton: 1.200  
Superheat: -13.500  
Liquid Inlet: No. 6  
Suction Inlet: No. 12  
Liquid Outlet: No. 10  
Suction Outlet: No. 12  
O-Rings: (1) **24611**, (1) **24661**, (2) **24681**  
Honda (11-07)  
Honda: 80221SWAA02



**39333**  
Block Type O-Ring Expansion Valve  
Ton: 0.800  
Superheat: 19.500  
Liquid Inlet: No. 6  
Suction Inlet: No. 12  
Liquid Outlet: No. 10  
Suction Outlet: No. 12  
O-Rings: (1) **24611**, (1) **24661**, (2) **24681**  
Toyota (15-08)  
Toyota: 8851508120



**39342**  
Block Type O-Ring Expansion Valve  
Ton: 1.500  
Superheat: -2.500  
Liquid Inlet: No. 6  
Suction Inlet: No. 12  
Liquid Outlet: No. 10  
Suction Outlet: No. 12  
O-Rings: (1) **24611**, (1) **24661**, (2) **24681**  
Honda (15-08)  
Honda: 80221TA0A01

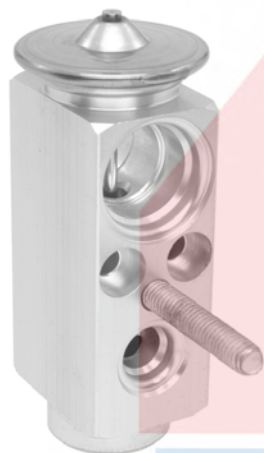

**39330**  
Block Type O-Ring Expansion Valve  
Ton: 1.000  
Superheat: 12.000  
Liquid Inlet: No. 6  
Suction Inlet: No. 10  
Liquid Outlet: No. 8  
Suction Outlet: No. 12  
O-Rings: (1) **24606**, (1) **24608**, (1) **24610**, (1) **24612**  
Chrysler (12-08); Dodge (12-08); VW (11-09)  
Chrysler: 68057718AA  
Volkswagen: 7B0819679B



**39332**  
Block Type O-Ring Expansion Valve  
Ton: 1.200  
Superheat: 13.000  
Liquid Inlet: No. 6  
Suction Inlet: No. 12  
Liquid Outlet: No. 10  
Suction Outlet: No. 12  
O-Rings: (1) **24611**, (1) **24661**, (2) **24681**  
Mitsubishi (12-09)

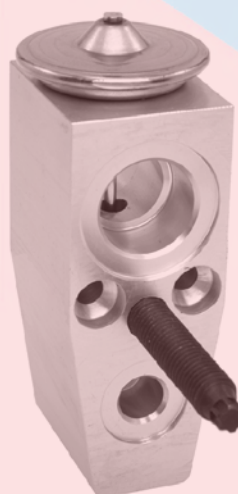

**39334**  
Block Type Flange Expansion Valve  
Ton: 1.000  
Superheat: 8.000  
Liquid Inlet: No. 6  
Suction Inlet: No. 10  
Liquid Outlet: No. 8  
Suction Outlet: No. 12  
O-Rings: (1) **24401**, (1) **24402**, (1) **24403**, (1) **24404**  
Ford (14-10)  
Ford: DR3Z19849A



**39343**  
Block Type O-Ring Expansion Valve  
Ton: 1.500  
Superheat: -0.500  
Liquid Inlet: No. 6  
Suction Inlet: No. 12  
Liquid Outlet: No. 10  
Suction Outlet: No. 12  
O-Rings: (1) **24611**, (1) **24661**, (2) **24681**  
Toyota (14-09)  
Toyota: 885150C120



# Expansion Valves and Orifice Tubes

## Expansion Valve Cont'd



### 39344

TXV Type Flare Expansion Valve  
 Ton: 1.500  
 Superheat: 6.000  
 Cap Tube Length: 8-1/2  
 Inlet Fitting: No. 6  
 Outlet Fitting: No. 8  
 O-Rings: (1) **24611**, (1) **24661**  
 Toyota (10-07)  
 Toyota: 8851508110



### 39346

Block Type O-Ring Expansion Valve  
 Ton: 1.500  
 Superheat: 1.500  
 Liquid Inlet: No. 6  
 Suction Inlet: No. 12  
 Liquid Outlet: No. 8  
 Suction Outlet: No. 12  
 O-Rings: (1) **24608**, (1) **24610**, (1) **24611**, (1) **24681**  
 Ford (14-13); Nissan (11-09)  
 Nissan: 922004M405



### 39348

Block Type O-Ring Expansion Valve  
 Ton: 1.500  
 Superheat: -0.500  
 Liquid Inlet: No. 6  
 Suction Inlet: No. 12  
 Liquid Outlet: No. 10  
 Suction Outlet: No. 12  
 O-Rings: (1) **24611**, (1) **24661**, (2) **24681**  
 Acura (15-13); Honda (15-09)  
 Honda: 80213TF0G01, 80221TR0A02, 80221TR3A01



### 39351

Block Type Flange Expansion Valve  
 Ton: 1.500  
 Superheat: -0.500  
 Liquid Inlet: No. 6  
 Suction Inlet: No. 10  
 Liquid Outlet: No. 8  
 Suction Outlet: No. 12  
 O-Rings: (1) **24401**, (1) **24402**, (1) **24403**, (1) **24404**  
 Chevy (14-10); GMC (14-10)  
 General Motors Corp: 20879991

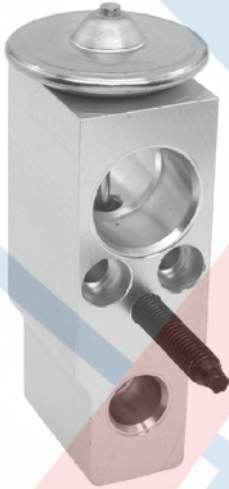

### 39345

Block Type O-Ring Expansion Valve  
 Ton: 1.500  
 Superheat: -5.000  
 Liquid Inlet: No. 6  
 Suction Inlet: No. 12  
 Liquid Outlet: No. 10  
 Suction Outlet: No. 12  
 O-Rings: (1) **24611**, (1) **24661**, (2) **24681**  
 Dodge (12-09); Dodge Medium Duty Truck (11)  
 Chrysler: 68048896AB



### 39347

Block Type O-Ring Expansion Valve  
 Ton: 1.000  
 Superheat: 8.500  
 Liquid Inlet: No. 6  
 Suction Inlet: No. 10  
 Liquid Outlet: No. 10  
 Suction Outlet: No. 10  
 O-Rings: (3) **24610**, (1) **24616**  
 Mazda (13-10); Nissan (15-11)  
 Mazda: BBP261J14

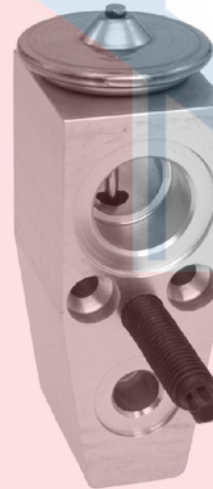

### 39349

Block Type Flange Expansion Valve  
 Ton: 1.000  
 Superheat: 3.500  
 Liquid Inlet: No. 6  
 Suction Inlet: No. 10  
 Liquid Outlet: No. 8  
 Suction Outlet: No. 12  
 O-Rings: (1) **24401**, (1) **24402**, (1) **24403**, (1) **24404**  
 Chevy (14-10)  
 General Motors Corp: 92229746



### 39352

Block Type O-Ring Expansion Valve  
 Ton: 1.500  
 Superheat: -0.500  
 Liquid Inlet: No. 6  
 Suction Inlet: No. 10  
 Liquid Outlet: No. 10  
 Suction Outlet: No. 10  
 O-Rings: (1) **24616**, (3) **24670**  
 Kia (09-07)  
 Kia: 976263E930

# Expansion Valves and Orifice Tubes

## Expansion Valve Cont'd



**39353**  
Block Type O-Ring Expansion Valve  
Ton: 1.000  
Superheat: 9.000  
Liquid Inlet: No. 6  
Suction Inlet: No. 10  
Liquid Outlet: No. 8  
Suction Outlet: No. 12  
O-Rings: (1) **24608**, (1) **24610**, (1) **24611**, (1) **24681**  
Subaru (09-08)  
Subaru: 73531FG000



**39355**  
Block Type O-Ring Expansion Valve  
Ton: 0.800  
Superheat: 11.000  
Liquid Inlet: No. 6  
Suction Inlet: No. 10  
Liquid Outlet: No. 8  
Suction Outlet: No. 12  
O-Rings: (1) **24401**, (1) **24403**, (1) **24403**, (1) **24608**, (1) **24610**  
Ford (11-08)  
Ford: 8S4Z19849A



**39357**  
Block Type O-Ring Expansion Valve  
Ton: 1.500  
Superheat: -1.500  
Liquid Inlet: No. 6  
Suction Inlet: No. 12  
Liquid Outlet: No. 10  
Suction Outlet: No. 12  
O-Rings: (1) **24611**, (1) **24661**, (1) **24681**  
Honda (15-10)  
Honda: 80222TM8A01



**39360**  
Block Type O-Ring Expansion Valve  
Ton: 1.000  
Superheat: 6.500  
Liquid Inlet: No. 6  
Suction Inlet: No. 12  
Liquid Outlet: No. 10  
Suction Outlet: No. 12  
O-Rings: (1) **24611**, (1) **24661**, (2) **24681**  
Lexus (14-10); Toyota (14-10)  
Lexus: 8851560230  
Toyota: 8851560230

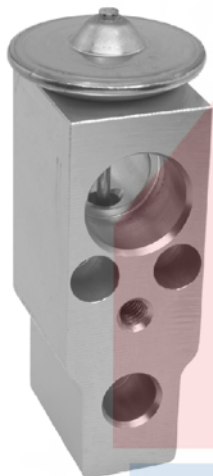

**39354**  
Block Type O-Ring Expansion Valve  
Ton: 1.000  
Superheat: 7.500  
Liquid Inlet: No. 6  
Suction Inlet: No. 10  
Liquid Outlet: No. 8  
Suction Outlet: No. 12  
O-Rings: (1) **24608**, (1) **24610**, (1) **24611**, (1) **24681**  
Subaru (15-09)  
Subaru: 73531YC001

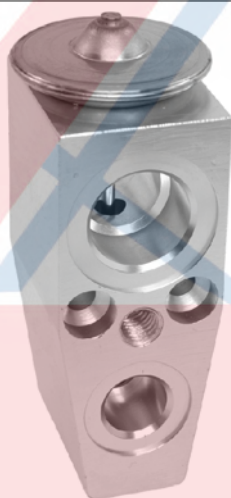

**39356**  
Block Type Flange Expansion Valve  
Ton: 1.000  
Superheat: 7.500  
Liquid Inlet: No. 8  
Suction Inlet: No. 10  
Liquid Outlet: No. 8  
Suction Outlet: No. 12  
O-Rings: (2) **24402**, (1) **24403**, (1) **24404**  
Ford (14-09); Lincoln (14-09)  
Ford: 9L1Z19849A, 9L3Z19849A



**39359**  
Block Type O-Ring Expansion Valve  
Ton: 1.000  
Superheat: 5.000  
Liquid Inlet: No. 6  
Suction Inlet: No. 10  
Liquid Outlet: No. 8  
Suction Outlet: No. 12  
O-Rings: (1) **24608**, (1) **24610**, (1) **24611**, (1) **24681**  
Nissan (10-09)  
Nissan: 922001FA0A



**39361**  
Block Type O-Ring Expansion Valve  
Ton: 1.000  
Superheat: 10.000  
Liquid Inlet: No. 6  
Suction Inlet: No. 12  
Liquid Outlet: No. 10  
Suction Outlet: No. 12  
O-Rings: (1) **24611**, (1) **24661**, (2) **24681**  
Toyota (14-09)  
Toyota: 885150C100

# Expansion Valves and Orifice Tubes

## Expansion Valve Cont'd



**39362**  
Block Type O-Ring Expansion Valve  
Ton: 1.500  
Superheat: -5.000  
Liquid Inlet: No. 6  
Suction Inlet: No. 12  
Liquid Outlet: No. 10  
Suction Outlet: No. 12  
O-Rings: (1) **24611**, (1) **24661**, (2) **24681**  
Pontiac (10-09); Toyota (14-10)  
General Motors Corp: 19205241  
Toyota: 8851547040

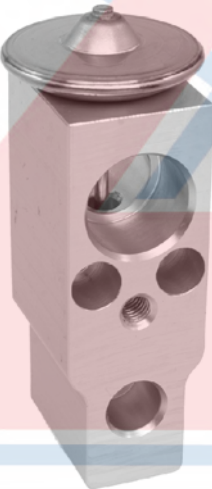

**39363**  
Block Type O-Ring Expansion Valve  
Ton: 1.500  
Superheat: -2.500  
Liquid Inlet: No. 6  
Suction Inlet: No. 12  
Liquid Outlet: No. 10  
Suction Outlet: No. 12  
O-Rings: (1) **24611**, (1) **24661**, (2) **24681**  
Toyota (10-07)

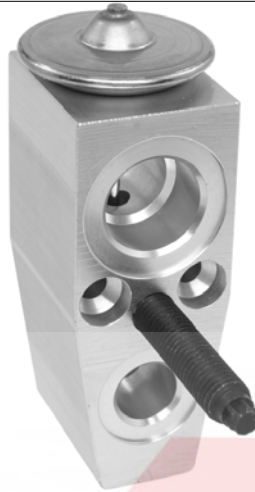

**39364**  
Block Type Flange Expansion Valve  
Ton: 0.800  
Superheat: 11.000  
Liquid Inlet: No. 8  
Suction Inlet: No. 10  
Liquid Outlet: No. 8  
Suction Outlet: No. 12  
O-Rings: (2) **24402**, (1) **24403**, (1) **24404**  
Ford (12-07); Lincoln (12-07)  
Ford: 7L1Z19849A



**39365**  
Block Type O-Ring Expansion Valve  
Ton: 1.000  
Superheat: 4.700  
Liquid Inlet: No. 8  
Suction Inlet: No. 10  
Liquid Outlet: No. 8  
Suction Outlet: No. 12  
O-Rings: (2) **24608**, (1) **24610**, (1) **24612**  
Ford (08-07); Lincoln (08-07)  
Ford: 7L1Z19849C



**39366**  
Block Type O-Ring Expansion Valve  
Ton: 1.000  
Superheat: -2.500  
Liquid Inlet: No. 6  
Suction Inlet: No. 10  
Liquid Outlet: No. 10  
Suction Outlet: No. 10  
O-Rings: (3) **24610**, (1) **24646**  
Hyundai (12); Kia (13-10)  
Kia: 976262K000

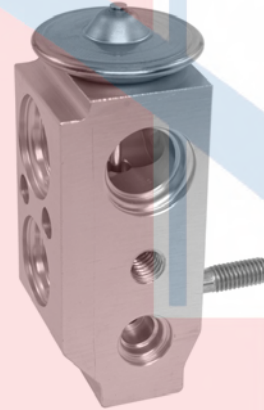

**39367**  
Block Type O-Ring Expansion Valve  
Ton: 1.000  
Superheat: -1.500  
Liquid Inlet: No. 6  
Suction Inlet: No. 10  
Liquid Outlet: No. 10  
Suction Outlet: No. 10  
O-Rings: (3) **24610**, (1) **24646**  
Kia (12-10)  
Kia: 976041J000



**39368**  
Block Type Flange Expansion Valve  
Ton: 1.000  
Superheat: -0.500  
Liquid Inlet: No. 6  
Suction Inlet: No. 10  
Liquid Outlet: No. 8  
Suction Outlet: No. 12  
O-Rings: (1) **24401**, (1) **24402**, (1) **24403**, (1) **24404**  
Buick (14-10); Cadillac (14-10); Chevy (14-11); Saab (11-10)  
General Motors Corp: 13313727, 20782085



**39369**  
Block Type O-Ring Expansion Valve  
Ton: 0.800  
Superheat: 11.000  
Liquid Inlet: No. 6  
Suction Inlet: No. 12  
Liquid Outlet: No. 10  
Suction Outlet: No. 12  
O-Rings: (1) **24611**, (1) **24661**, (2) **24681**  
Suzuki (07-99)  
Suzuki: 9543165D10



# Expansion Valves and Orifice Tubes

## Expansion Valve Cont'd



**39370**  
Block Type O-Ring Expansion Valve  
Ton: 1.000  
Superheat: -2.500  
Liquid Inlet: No. 6  
Suction Inlet: No. 10  
Liquid Outlet: No. 8  
Suction Outlet: No. 12  
O-Rings: (1) **24606**, (1) **24608**, (1) **24610**, (1) **24612**  
Mercedes (14-06)  
Mercedes Benz: 1648300084



**39372**  
Block Type O-Ring Expansion Valve  
Ton: 1.500  
Superheat: -0.500  
Liquid Inlet: No. 6  
Suction Inlet: No. 12  
Liquid Outlet: No. 8  
Suction Outlet: No. 12  
O-Rings: (1) **24608**, (1) **24612**, (1) **24675**, (1) **24681**  
Dodge (09-07); Freightliner (09-07);  
Mercedes (15-10)  
Chrysler: 68012634AA  
Mercedes Benz: 0038309784



**39374**  
Block Type O-Ring Expansion Valve  
Ton: 1.000  
Superheat: 18.000  
Liquid Inlet: No. 6  
Suction Inlet: No. 10  
Liquid Outlet: No. 8  
Suction Outlet: No. 10  
O-Rings: (1) **24606**, (1) **24608**, (2) **24610**  
Ford (06-05); Lincoln (06-05)  
Ford: 6L1Z19849B



**39377**  
Block Type O-Ring Expansion Valve  
Ton: 1.500  
Superheat: 3.500  
Liquid Inlet: No. 6  
Suction Inlet: No. 10  
Liquid Outlet: No. 10  
Suction Outlet: No. 12  
O-Rings: (2) **24610**, (1) **24611**, (1) **24681**  
Suzuki (02-01)  
Suzuki: 9543166D00

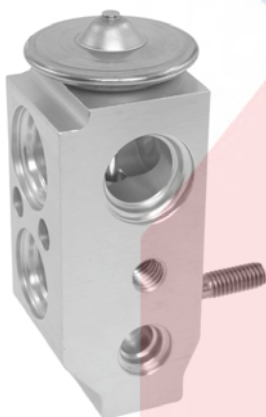

**39371**  
Block Type O-Ring Expansion Valve  
Ton: 1.500  
Superheat: -2.500  
Liquid Inlet: No. 6  
Suction Inlet: No. 10  
Liquid Outlet: No. 10  
Suction Outlet: No. 10  
O-Rings: (3) **24610**, (1) **24646**  
Kia (10-09), (06)  
Kia: 976262G100



**39373**  
Block Type O-Ring Expansion Valve  
Ton: 1.000  
Superheat: 11.000  
Liquid Inlet: No. 6  
Suction Inlet: No. 10  
Liquid Outlet: No. 8  
Suction Outlet: No. 10  
O-Rings: (1) **24606**, (1) **24608**, (2) **24610**  
Ford (14-07); Lincoln (14-07)  
Ford: 7L1Z19849B



**39375**  
Block Type O-Ring Expansion Valve  
Superheat: 0.500  
Liquid Inlet: No. 5  
Suction Inlet: No. 10  
Liquid Outlet: No. 10  
Suction Outlet: No. 10  
O-Rings: (1) **24607**, (3) **24610**  
Hyundai (12-07)  
Hyundai: 979163J000

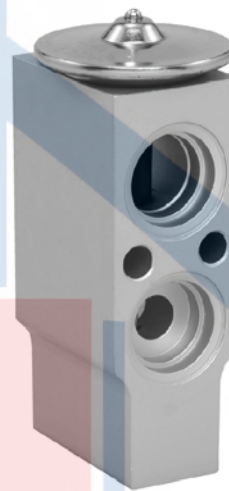

**39378**  
Block Type O-Ring Expansion Valve  
Ton: 1.500  
Superheat: 5.300  
Liquid Inlet: No. 6  
Suction Inlet: No. 10  
Liquid Outlet: No. 10  
Suction Outlet: No. 12  
O-Rings: (2) **24610**, (1) **24611**, (1) **24681**  
Suzuki (06-03)  
Suzuki: 9543154J20

# Expansion Valves and Orifice Tubes

## Expansion Valve Cont'd



### 39379

Block Type O-Ring Expansion Valve  
 Ton: 1.500  
 Superheat: 4.000  
 Liquid Inlet: No. 6  
 Suction Inlet: No. 10  
 Liquid Outlet: No. 10  
 Suction Outlet: No. 10  
 O-Rings: (3) **24610**, (1) **24616**  
 Hyundai (12-09); Kia (14)  
 Hyundai: 976262L100  
 Kia: 976262L100

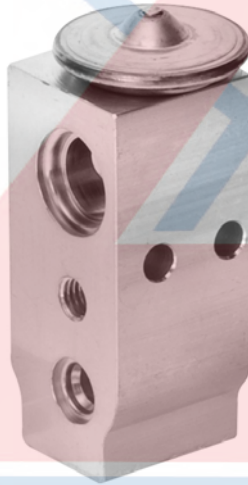

### 39380

Block Type O-Ring Expansion Valve  
 Ton: 1.000  
 Superheat: 4.500  
 Liquid Inlet: No. 6  
 Suction Inlet: No. 10  
 Liquid Outlet: No. 10  
 Suction Outlet: No. 10  
 O-Rings: (1) **24606**, (3) **24610**  
 Hyundai (08-07); Kia (14), (12-06)  
 Kia: 976264D900



### 39381

Block Type O-Ring Expansion Valve  
 Ton: 1.000  
 Superheat: 8.500  
 Liquid Inlet: No. 6  
 Suction Inlet: No. 10  
 Liquid Outlet: No. 10  
 Suction Outlet: No. 10  
 O-Rings: (1) **24611**, (3) **24681**  
 Honda (09-00)  
 Honda: 80220S2A003, 80220S2A013

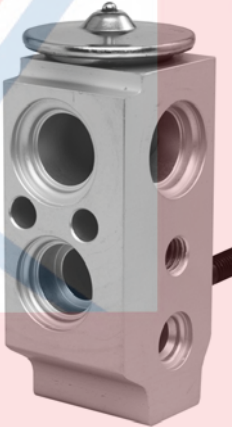

### 39382

Block Type O-Ring Expansion Valve  
 Ton: 2.000  
 Superheat: -2.600  
 Liquid Inlet: No. 5  
 Suction Inlet: No. 10  
 Liquid Outlet: No. 10  
 Suction Outlet: No. 10  
 O-Rings: (1) **24607**, (3) **24109**  
 Hyundai (15-10); Kia (14-11)  
 Hyundai: 976262S000  
 Kia: 976262S000

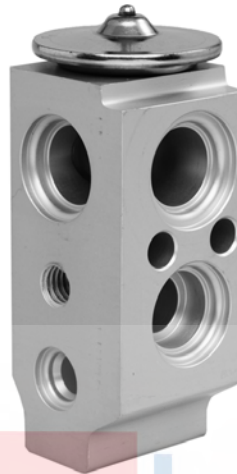

### 39383

Block Type O-Ring Expansion Valve  
 Ton: 1.500  
 Superheat: 4.600  
 Liquid Inlet: No. 5  
 Suction Inlet: No. 10  
 Liquid Outlet: No. 10  
 Suction Outlet: No. 10  
 O-Rings: (1) **24607**, (3) **24109**  
 Hyundai (12-11)  
 Hyundai: 976262M010



### 39384

Block Type O-Ring Expansion Valve  
 Ton: 2.500  
 Superheat: -3.900  
 Liquid Inlet: No. 6  
 Suction Inlet: No. 12  
 Liquid Outlet: No. 10  
 Suction Outlet: No. 12  
 O-Rings: (1) **24611**, (1) **24661**, (1) **24681**  
 Scion (14-11); Toyota (14-11)  
 Toyota: 8851502480



### 39385

Block Type O-Ring Expansion Valve  
 Ton: 2.000  
 Superheat: -1.000  
 Liquid Inlet: No. 6  
 Suction Inlet: No. 10  
 Liquid Outlet: No. 10  
 Suction Outlet: No. 12  
 O-Rings: (1) **24401**, (1) **24608**, (1) **24610**, (1) **24404**  
 Ford (12-11); Lincoln (13-11)  
 Ford: BB5Z19849A



### 39386

Block Type O-Ring Expansion Valve  
 Ton: 2.000  
 Superheat: -1.500  
 Liquid Inlet: No. 5  
 Suction Inlet: No. 10  
 Liquid Outlet: No. 10  
 Suction Outlet: No. 10  
 O-Rings: (1) **24607**, (3) **24109**  
 Hyundai (12); Kia (13-10)  
 Hyundai: 976041G001  
 Kia: 976041G001, 976041G300

# Expansion Valves and Orifice Tubes

## Expansion Valve Cont'd



**39387**  
Block Type O-Ring Expansion Valve  
Ton: 1.500  
Superheat: 3.100  
Liquid Inlet: No. 5  
Suction Inlet: No. 10  
Liquid Outlet: No. 10  
Suction Outlet: No. 10  
O-Rings: (1) **24607**, (3) **24109**  
Kia (11-08)  
Kia: 976262J100



**39389**  
Block Type O-Ring Expansion Valve  
Ton: 1.500  
Superheat: 4.700  
Liquid Inlet: No. 5  
Suction Inlet: No. 10  
Liquid Outlet: No. 10  
Suction Outlet: No. 10  
O-Rings: (1) **24607**, (3) **24109**  
Hyundai (10)  
Hyundai: 976262M000



**39391**  
Expansion Valve  
Superheat: 4.500  
Liquid Inlet: No. 6  
Suction Inlet: No. 10  
Liquid Outlet: No. 8  
Suction Outlet: No. 12  
O-Rings: (1) **24401**, (1) **24402**, (1) **24403**, (1) **24404**  
Chrysler (13-11); Dodge (13-11)  
Chrysler: 68110614AA



**39393**  
Block Type O-Ring Expansion Valve  
Ton: 1.500  
Superheat: 8.500  
Liquid Inlet: No. 6  
Suction Inlet: No. 8  
Liquid Outlet: No. 8  
Suction Outlet: No. 10  
O-Rings: (1) **24606**, (2) **24608**, (1) **24610**  
Bergstrom: 540056BSM  
Kenworth: 540056, 540056BSM  
Kysor: 1899031  
Peterbilt: 540056BSM  
Red Dot: 71R8420, RD571790P



**39388**  
Block Type O-Ring Expansion Valve  
Ton: 2.000  
Superheat: 1.100  
Liquid Inlet: No. 5  
Suction Inlet: No. 10  
Liquid Outlet: No. 10  
Suction Outlet: No. 10  
O-Rings: (1) **24607**, (3) **24109**  
Kia (11-08)  
Kia: 976262J200



**39390**  
Block Type O-Ring Expansion Valve  
Ton: 2.000  
Superheat: -2.600  
Liquid Inlet: No. 5  
Suction Inlet: No. 10  
Liquid Outlet: No. 10  
Suction Outlet: No. 10  
O-Rings: (1) **24607**, (3) **24109**  
Kia (09-07)  
Kia: 972173B500



**39392**  
Block Type O-Ring Expansion Valve  
Ton: 1.500  
Superheat: 8.500  
Liquid Inlet: No. 6  
Suction Inlet: No. 8  
Liquid Outlet: No. 8  
Suction Outlet: No. 10  
O-Rings: (1) **24606**, (2) **24608**, (1) **24610**  
Bergstrom: 549707BSM  
Kenworth: F906000  
Kysor: 1813010, 1817003  
Peterbilt: F906000

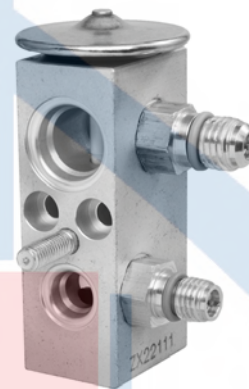

**39394**  
Block Type O-Ring Expansion Valve  
Ton: 2.000  
Superheat: 8.500  
Liquid Inlet: No. 6  
Suction Inlet: No. 8  
Liquid Outlet: No. 8  
Suction Outlet: No. 10  
O-Rings: (2) **24606**, (2) **24608**, (1) **24610**, (1) **24676**  
Bergstrom: 549708BSM  
Caterpillar: 2328568  
Climatech: EA1310  
Kenworth: F906001  
Kysor: 1817004  
Mack: 4379RD589360



# Expansion Valves and Orifice Tubes

## Expansion Valve Cont'd

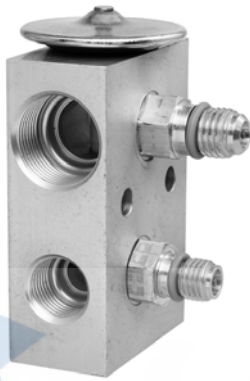

**39395**  
Block Type O-Ring Expansion Valve  
Ton: 2.000  
Superheat: 5.000  
Liquid Inlet: No. 6  
Suction Inlet: No. 10  
Liquid Outlet: No. 8  
Suction Outlet: No. 10  
Color: Aluminum  
O-Rings: (2) **24606**, (1) **24608**, (2) **24610**, (1) **24676**  
Red Dot: 71R8450, RD599350  
Western Star: RD599350



**39397**  
Block Type O-Ring Expansion Valve  
Ton: 1.500  
Superheat: 5.500  
Liquid Inlet: No. 6  
Suction Inlet: No. 8  
Liquid Outlet: No. 8  
Suction Outlet: No. 10  
Color: Aluminum  
O-Rings: (1) **24606**, (2) **24608**, (1) **24610**  
Bergstrom: 540446  
Kenworth: 540446  
Kysor: 1814002  
TRP Parts: EA15000



**39400**  
Block Type O-Ring Expansion Valve  
Ton: 2.000  
Superheat: 8.500  
Liquid Inlet: No. 6  
Suction Inlet: No. 8  
Liquid Outlet: No. 8  
Suction Outlet: No. 10  
O-Rings: (1) **24606**, (2) **24608**, (1) **24610**  
Bergstrom: 521C028  
Caterpillar: 1065121



**39420**  
Block Type Flange Expansion Valve  
Ton: 1.500  
Liquid Inlet: No. 6  
Suction Inlet: No. 8  
Liquid Outlet: No. 8  
Suction Outlet: No. 10  
Color: Aluminum  
International (01-95)  
Kysor: 1813005  
NaviStar: 1696846C3  
Red Dot: 71R8405, RD5104470P

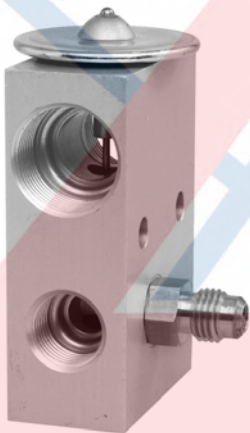

**39396**  
Block Type O-Ring Expansion Valve  
Ton: 2.000  
Superheat: 8.000  
Liquid Inlet: No. 6  
Suction Inlet: No. 10  
Liquid Outlet: No. 8  
Suction Outlet: No. 10  
Color: Aluminum  
O-Rings: (1) **24606**, (1) **24608**, (2) **24610**, (1) **24650**  
Red Dot: RD5119210P

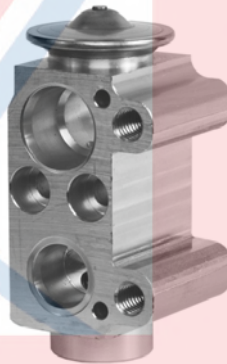

**39399**  
Block Type O-Ring Expansion Valve  
Ton: 2.000  
Superheat: -1.500  
Liquid Inlet: No. 8  
Suction Inlet: No. 12  
Liquid Outlet: No. 10  
Suction Outlet: No. 12  
O-Rings: (2) **24150**, (1) **24661**, (1) **24131**  
BMW (15-06)  
BMW: 64119226078



**39419**  
Block Type Flange Expansion Valve  
Ton: 1.500  
Liquid Inlet: No. 6  
Suction Inlet: No. 10  
Liquid Outlet: No. 8  
Suction Outlet: No. 10  
Color: Gold  
Freightliner (07-00)  
Kysor: 1812011  
Red Dot: 71R8453, RD5125200P



**39421**  
Block Type Flange Expansion Valve  
Ton: 2.000  
Liquid Inlet: No. 8  
Suction Inlet: No. 10  
Liquid Outlet: No. 8  
Suction Outlet: No. 12  
Color: Aluminum  
Freightliner (13-08); Kenworth (13-08)  
Kysor: 1812008

# Expansion Valves and Orifice Tubes

## Expansion Valve Cont'd



### 39422

Block Type O-Ring Expansion Valve  
 Ton: 2.000  
 Liquid Inlet: No. 6  
 Suction Inlet: No. 8  
 Liquid Outlet: No. 8  
 Suction Outlet: No. 10  
 Color: Aluminum  
 Kenworth (13-08)  
 Kenworth: 540446BSM  
 Red Dot: 71R8479



### 39423

Block Type Flange Expansion Valve  
 Ton: 1.500  
 Liquid Inlet: No. 6  
 Suction Inlet: No. 10  
 Liquid Outlet: No. 8  
 Suction Outlet: No. 10  
 Color: Brass  
 Freightliner (02-00)  
 Red Dot: 5109020P, 71R8425

## Expansion Device Parts

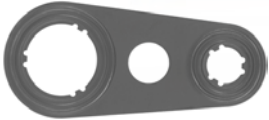

### 24138

Block Type Expansion Valve Gasket  
 Color: Black  
 Packaged in Quantities of: 10  
 Gasket for Hose End of Chrysler  
 Expansion Block  
 Chrysler: 3846834, 3846836  
 General Motors Corp: 19188262  
 Euclid: E809706



### 24149

Block Type Expansion Valve Gasket  
 Color: Black  
 Packaged in Quantities of: 10  
 Foam Metal Gasket for Chrysler  
 Expansion Valve 75-94  
 Chrysler: 3846836, 4677045  
 Euclid: E809709, E809715



### 38910

Expansion Solenoid Valve  
 ARA: 1296357  
 Bergstrom: 650254, 650890, 865060  
 Brockway: 65089P, 7065  
 Caterpillar: 2328580  
 Climatech: CD1000, CD1025, LA1225, UE1000  
 Dallas Truck AC: 0313024  
 Euclid: E805044  
 Evans: AM80822, HV30412  
 Kysor: 1812004, 1899019, 1899020, 404084, 404318  
 Mack: 4379RD4188, 4379RD41880, 7979404084  
 NaviStar: 730001, 730002  
 Red Dot: 71R9002, RD41880P

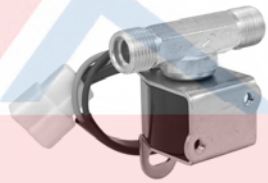

### 38911

Expansion Solenoid Valve

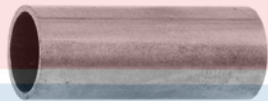

### 38913

Orifice Tube Adapter

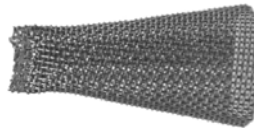

### 38990

Expansion Valve Screen  
 ARA: 1296353  
 Bergstrom: 580111  
 Climatech: EA1285  
 Dallas Truck AC: 0415012  
 Euclid: E805046  
 Evans: AM89818  
 Hy-Capacity: 0000088481  
 Kysor: 2799104, 407224  
 NaviStar: 706040  
 Northern: 904286

## Evaporator Core Repair Kits



### 16152

16149 w/o Orifice Tube  
 Evaporator Core Repair Kit w/ White Orifice Tube  
 Buick (94-76); Cadillac (94-76); Chevy (94-76); Ford (94-80); GMC (94-76); Lincoln (94-80); Mercury (94-80); Olds (94-76); Pontiac (94-76)  
 Dallas Truck AC: 0415013  
 Euclid: E805052

## Expansion Service Valve

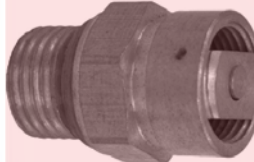

### 38832

Expansion Service Valve  
 O-Rings: (1) 24668  
 Ford: F4TZ19D644B

## Orifice Tubes



### 38621 Single Pkg

621 10 pc. Bulk Pkg

8621 25 pc. Bulk Pkg

Blue Orifice Tube 1 pkg

Color: Blue

Packaged in Quantities of: 1

Ford (10-07), (04-80); Lincoln (91-80);

Mazda (09-94); Mercury (10-08),

(02-93), (91-80); Merkur (85); Nissan

(02-94)

Optional AAOT Part No. 38902, For

climates above 105° use (Severe Duty)

AAOT 38904; Bulk Package of 10

621; Bulk Package of 25 8621.

Ford: F5XZ19D990AB

Mazda: ZZM161179B

ARA: 1298416

Climatech: EC1020

Dallas Truck AC: 0415015

Euclid: E805049

Evans: AM89816

Kysor: 1811001, 404154

NaviStar: 11246, 19315

Red Dot: 71R8503, RD598070P



### 38623 Single Pack

623 10 pc. Bulk Pkg

8623 25 pc. Bulk Pkg

White Orifice Tube 1 pkg

Color: White

Packaged in Quantities of: 1

Audi (93-84); Buick (07-04), (99-77);

Cadillac (05-77); Chevy (14), (12-76);

GMC (14), (12-76); GMC & CHEVY

(14-03); Isuzu (00-96); Jaguar

(84-81); Olds (04-77); Pontiac (05),

(03-76)

Optional AAOT Part No. 38902, For

climates above 105° use (Severe Duty)

AAOT 38904; Bulk Package of 10

623; Bulk Package of 25 8623.

Audi: 302272679

General Motors Corp: 19189768,

3033879

Volkswagen: 302272679

Volvo: 1324829

ARA: 1298293

Bergstrom: 525712

Climatech: EC1005, EC1010

Dallas Truck AC: 0415014

Euclid: E805047

Evans: AM89814

Kysor: 1810003, 404153

Mack: 4379RD549190

NaviStar: 13867, 1676822C91, 19409

Northern: 440475

Red Dot: 71R8500, RD549190P

# Expansion Valves and Orifice Tubes

## Orifice Tubes Cont'd



**38628**  
Colorless Orifice Tube  
Color: Colorless  
Packaged in Quantities of: 1  
Chevy (76-73); GMC (75-73)  
See Evaporator Core Repair Kits When  
Orifice Tube Breaks Off Inside  
Evaporator Core  
General Motors Corp: 3031086



**38635** Single Pkg  
**635** 10 pc. Bulk Pkg  
**8635** 25 pc. Bulk Pkg  
Red Orifice Tube 1 pkg  
Color: Red  
Packaged in Quantities of: 1  
Ford (11-86); Lincoln (08-06), (02-98);  
Mazda (09-91); Mercury (10-97)  
Optional AAOT Part No. **38902**. For  
climates above 105° use (Severe Duty)  
AAOT **38904**; Bulk Package of 10  
**635**; Bulk Package of 25 **8635**.  
Ford: F5UZ19D990AB  
Mazda: ZZM061179B  
Bergstrom: 540018  
Caterpillar: 7X2049, 7X2149  
Climatech: EC250001S  
Euclid: E805050  
Kysor: 1899003  
Mack: 4379RD590820  
NaviStar: 16244, 2684711C91  
Peterbilt: 308007, 308007BSM,  
BSM308007, EC1015, P93CAB250001  
Red Dot: 71R8505, 758505,  
RD590820P, RD595640P



**38638** Single Pkg  
**638** 10 pc. Bulk Pkg  
**8638** 25 pc. Bulk Pkg  
Black(OE Red) Orifice Tube 1 pkg  
Color: Black  
Packaged in Quantities of: 1  
Buick (97-94), (91-86); Cadillac  
(06-02), (96-89); Chevy (09-88); GMC  
(09-90); Olds (91-88); Pontiac (05-88);  
Saab (09-05)  
Optional AAOT Part No. **38903**. For  
climates above 105° use (Severe Duty)  
AAOT **38905**; Bulk Package of 10  
**638**; Bulk Package of 25 **8638**.  
General Motors Corp: 3096068  
Bergstrom: 540268  
Caterpillar: 2328573  
Climatech: EC1030  
Euclid: E805048  
Kysor: 1810002, 1811002  
Mack: 4379RD5100120  
NaviStar: 19413  
Red Dot: 71R8501, RD5100120P



**38639** Single Pkg  
**639** 10 pc. Bulk Pkg  
**8639** 25 pc. Bulk Pkg  
Orange Orifice Tube 1 pkg  
Color: Orange  
Packaged in Quantities of: 1  
Audi (14), (12-04); Dodge (05-00);  
Ford (14-88); Hyundai (98-89); Jaguar  
(08-02); Lincoln (11-91); Mazda  
(06-01); Mercury (11-88); Nissan  
(02-94); VW (06-04)  
Optional AAOT Part No. **38902**. For  
climates above 105° use (Severe Duty)  
AAOT **38904**; Bulk Package of 10  
**639**; Bulk Package of 25 **8639**.  
Audi: 8E0820177  
Ford: F5DZ19D990AB  
Jaguar: C2S10844  
Climatech: EC1015, EC1025  
Euclid: E805051  
Kysor: 1899002  
Peterbilt: 5X010061  
Red Dot: 71R8504, RD5100110P  
TRP Parts: EC10250



**38643**  
Green Orifice Tube  
Color: Green  
Packaged in Quantities of: 1  
Ford (97-94); Mazda (02-98)



**38644**  
Dark Grey Porous Orifice Tube  
Color: Gray  
Cadillac (14-06); Chevy (14-01); GMC  
(14-01)  
General Motors Corp: 19259601



**38645**  
Dark Grey Porous Orifice Tube  
Color: Gray / White  
Buick (05-99); Chevy (03-00); Olds  
(02-99); Pontiac (03-99)  
General Motors Corp: 10411717



**38646**  
Orange/White Orifice Tube  
Color: Orange / White  
Packaged in Quantities of: 1  
Chevy (02-98); Jeep (06-00)  
General Motors Corp: 19189780,  
52486385



**38887**  
Yellow/White Orifice Tube  
Color: Yellow / White  
Packaged in Quantities of: 1  
Cadillac (00-99), (97-94); Chevy  
(09-96); GMC (09-02), (00-96); Isuzu  
(08-03); Saab (09-05)  
General Motors Corp: 52477004  
Kysor: 1810001

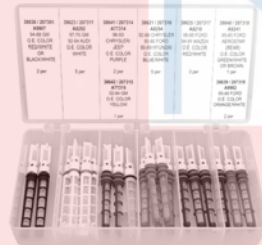

**38899** Assortment  
**38621** 5 pcs. Blue  
**38623** 5 pcs. White  
**38635** 3 pcs. Red  
**38638** 2 pcs. Black, OE Red  
**38639** 2 pcs. Orange  
**38640** 1 pc. Brown  
**38641** 2 pcs. Purple  
**38642** 1 pc. Yellow  
Orifice Tube Assortment  
Kysor: 1899022



**38902**  
Standard Temp Automatic Adjusting  
Orifice Tube  
General Motors Corp: 19189841  
Kysor: 1899015



**38903**  
Standard Temp Automatic Adjusting  
Orifice Tube  
General Motors Corp: 19189842  
Kysor: 1899014



**38904**  
Severe Temp Automatic Adjusting  
Orifice Tube  
General Motors Corp: 19189843



**38905**  
Severe Temp Automatic Adjusting  
Orifice Tube



**39071**  
Black/White Orifice Tube  
Color: Black / White  
Packaged in Quantities of: 1  
Ford (14-02)  
Ford: XC4Z19D990AA



**39072**  
Yellow/White Orifice Tube  
Color: Yellow / White  
Packaged in Quantities of: 1  
Buick (05-97)  
General Motors Corp: 25671803



**39194**  
Electronic Orifice Tube  
Olds (03-01)  
General Motors Corp: 25687578



# Expansion Valves and Orifice Tubes

## POA, EPR, STV Valves



**38847**  
STV Valve  
Evans: AM89808  
Kysor: 404127  
Red Dot: 71R8750

## Refrigerant Filter

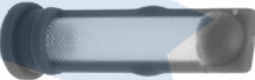

**39335**  
Refrigerant Filter  
Buick (11-08); Chevy (12-09); GMC  
(12-07); Saturn (10-07)  
General Motors Corp: 25914263



**39336**  
Refrigerant Filter  
Cadillac (14-07); Chevy (14-02); GMC  
(14-02); Isuzu (06-03)  
General Motors Corp: 89022560



**39337**  
Refrigerant Filter  
Olds (03-01)  
General Motors Corp: 25687579



**39338**  
Refrigerant Filter  
Buick (09-06); Chevy (11-06); Pontiac  
(08-05)  
General Motors Corp: 10356437



**39339**  
Refrigerant Filter  
Buick (11-06); Cadillac (11-06)  
General Motors Corp: 21999762



**39340**  
Refrigerant Filter  
Cadillac (14-04); Chevy (12-04); GMC  
(13-09); Toyota (13-05)  
General Motors Corp: 52494593  
Toyota: 8837704010



**39341**  
Refrigerant Filter  
Ford (09-02); Lincoln (05-03); Mazda  
(09-08); Mercury (09-02)  
Ford: 1L2Z19E771AA



**39999**  
Filter Screen Kit

# Fan Clutch Dimension Chart

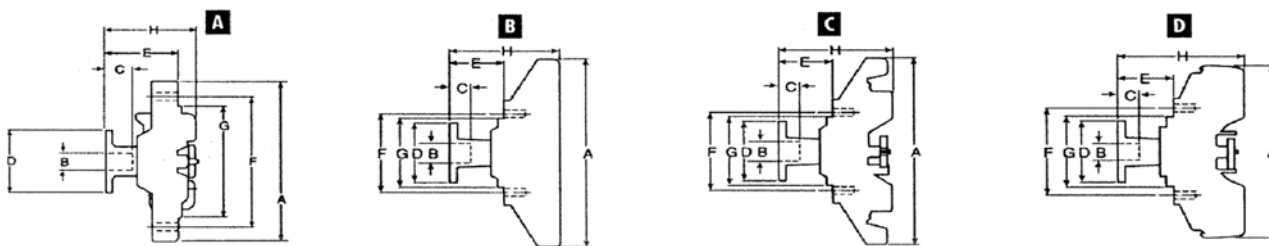

Part No.	Rotatio	Dia.	Overall Dia. (A)	Pilot Dia. (B)	Pilot Depth (C)	Flange Cir. (D)	Flange Mnt. Hght (E)	Fan Bolt Cir. (F)	Fan Mnt. Dia. (G)	Overall Height (H)	Bolt/Nut Type
<b>Fan Clutches</b>											
36700	REV	D	6.450	5/16-18 Hole	0.703125	1.44 ~` HEX	1.75	3.250	2.62	3-49/64	5/16-18 Hole (4)
36701	REV	D	6.450	M6 x 1.0 Hole	0.703125	1.44 ~` HEX	1.25	3.250	2.52	3-17/64	M6 x 1.0 Hole (4)
36702	REV	D	6.450	M6 x 1.0 Hole	0.703125	1.44 ~` HEX	2.42	3.250	2.62	4-7/16	M6 x 1.0 Hole (4)
36703	REV	D	6.450	5/16-18 Hole	0.625	2.46	1.63	3.250	2.62	3-21/32	5/16-18 Hole (4)
36704	STD	D	6.450	5/16-18 Hole	0.625	2.58	1.63	3.250	2.62	3-21/32	5/16-18 Hole (4)
36705	STD	D	6.450	5/16-18 Hole	0.703125	1.44 ~` HEX	1.25	3.250	2.62	3-5/8	5/16-18 Hole (4)
36706	STD	A	6.300	M6 x 1.0 Hole	0.52	1.25 HEX	1.440	5.790	5.31	1-61/64	M6 x 1.0 Hole (3)
36707	REV	C	7.200	5/16-18 Hole	0.703125	1.44 ~` HEX	1.250	3.250	2.62	2-61/64	5/16-18 Hole (4)
36708	REV	A	6.300	M6 x 1.0 Hole		0.59	0.953125	5.790	5.31	1-1/2	M6 x 1.0 Hole (3)
36709	STD	A	6.340	M6 x 1.0 Hole	0.26	2.31	2.070	5.984375	5.203125	2.8 to 3.57	M6 x 1.0 Hole (4)
36710	STD	A	5.430	M6 x 1.0 Hole	0.570	1.25 HEX	1.37	4.880	4.37	2-1/64	M6 x 1.0 Hole (4)
36711	REV	D	7.400	M8 x 1.25 Hole	0.65625	3.22	1.760	6.000	5.00	4-5/64	M8 x 1.25 Hole (6)
36712	REV	D	7.400	M8 x 1.25 Hole	0.65625	3.22	1.760	6.000	5.00	4-5/64	M8 x 1.25 Hole (6)
36713	STD	B	7.200	5/16-18 Hole	1.03125	2.59	1.750	3.250	2.62	3-19/64	5/16-18 Hole (4)
36714	STD	A	6.650	M6 x 1.0 Hole	0.953125	3.625	2.859375	5.830	5.109375	3-17/32	M6 x 1.0 Hole (4)
36715	REV	C	7.200	5/16-18 Hole	0.703125	1.44 ~` HEX	1.250	3.250	2.62	2-61/64	5/16-18 Hole (4)
36719	REV	D	6.450	5/16-18 Hole	0.703125	1.44 ~` HEX	2.42	3.250	2.62	4-7/16	5/16-18 Hole (4)
36720	REV	D	6.450	M6 x 1.0 Hole	0.703125	1.44 ~` HEX	1.25	3.250	2.52	3-17/64	M6 x 1.0 Hole (4)
36723	STD	D	7.400	5/16-18 Hole	0.65625	1.88 ~` Hex	1.203125	6.000	5.00	3-33/64	5/16-18 Hole (6)
36724	REV	D	6.450	5/16-18 Hole	0.703125	1.44 ~` HEX	1.500	3.250	2.62	3-33/64	5/16-18 Hole (4)
36725	REV	B	7.200	M10 x 1.5 Hole	1.03125	2.43	1.750	3.250	2.52	3-21/64	M10 x 1.5 Hole (4)
36726	REV	B	7.200	M10 x 1.5 Hole	1.03125	2.47	2.000	3.250	2.52	3-37/64	M10 x 1.5 Hole (4)
36729	REV	B	5.990	M10 x 1.5 Hole	0.703125	1.44 ~` HEX	1.750	3.250	2.52	3-5/16	M10 x 1.5 Hole (4)
36730	STD	D	6.450	M6 x 1.0 Hole	0.703125	1.44 ~` HEX	2.765625	3.250	2.62	4-25/32	M6 x 1.0 Hole (4)
36731	STD	A	6.650	M6 x 1.0 Hole	0.750	2.56	2.53	6.030	5.390	3-3/32	M6 x 1.0 Hole (4)
36732	STD	B	5.990	M6 x 1.0 Hole	1.03125	2.43	1.750	3.250	2.62	3-5/16	M6 x 1.0 Hole (4)
36733	STD	B	5.90625	5/16-18 Hole	0.560	2.32	1.09	3.250	2.62	2-59/64	5/16-18 Hole (4)
36734	STD	A	6.650	M6 x 1.0 Hole	0.8125	3.07	2.7	5.350	4.09	3-25/64	M6 x 1.0 Hole (4)
36740	STD	A	4.450	M6 x 1.0 Hole	0.240	2.06	2.015625	3.860	3.234375	2-7/8	M6 x 1.0 Hole (4)
36741	STD	A	4.450	M6 x 1.0 Hole	0.240	2.06	1.859375	3.860	3.234375	2-45/64	M6 x 1.0 Hole (4)
36743	STD	A	6.840	M6 x 1.0 Hole	0.46	2.84	1.84	4.180	3.625	3-37/64	M6 x 1.0 Hole (4)
36745	STD	A	6.836	M6x1.000	0.598	2.759	1.560	4.171875	3.623	3-19/64	M6x1.000 (4)
36746	STD	A	6.460	M6 x 1.0 Hole	0.46	2.84	2.380	5.470	4.84	4-1/2	M6 x 1.0 Hole (4)
36747	STD	C	7.200	5/16-18 Hole	0.625	2.56	1.796875	3.250	2.62	3-33/64	5/16-18 Hole (4)
36748	STD	A	6.650	M6 x 1.0 Hole	0.550	2.44	2.09375	6.030	5.390	2-43/64	M6 x 1.0 Hole (4)
36749	STD	D	7.400	5/16-18 Hole	0.671875	1.88 ~` Hex	1.203125	6.000	5.00	3-17/32	5/16-18 Hole (6)
36750	REV	D	7.400	5/16-18 Hole	0.671875	1.88 ~` Hex	1.21875	6.000	5.00	3-35/64	5/16-18 Hole (6)
36751	REV	D	7.400	5/16-18 Hole	0.78125	1.86 HEX	2.420	3.250	2.62	4-15/16	5/16-18 Hole (4)
36752	REV	D	7.400	5/16-18 Hole	0.78125	1.86 HEX	2.420	3.250	2.62	4-15/16	5/16-18 Hole (4)
36753	REV	D	7.400	5/16-18 Hole	0.640625	1.86 HEX	1.203125	3.250	2.62	3-45/64	5/16-18 Hole (4)

## Fan Clutch Dimension Chart

Part No.	Rotatio	Dia.	Overall Dia. (A)	Pilot Dia. (B)	Pilot Depth (C)	Flange Cir. (D)	Flange Mnt. Hght (E)	Fan Bolt Cir. (F)	Fan Mnt. Dia. (G)	Overall Height (H)	Bolt/Nut Type
36754	REV	D	7.400	M8 x 1.25 Hole	0.65625	2.82	1.750	3.810	3.250	4-17/64	M8 x 1.25 Hole (4)
36755	REV	D	7.400	M8 x 1.25 Hole	0.78125	1.86 HEX	1.750	3.810	3.250	4-17/64	M8 x 1.25 Hole (4)
36756	STD	A	5.850	M8 x 1.25 Hole	0.703125	1.44 ~` HEX	0.84375	3.9375	3.37	2-9/16	M8 x 1.25 Hole (4)
36757	REV	A	6.650	M6 x 1.0 Hole	0.8125	3.07	2.7	5.350	4.09	3-25/64	M6 x 1.0 Hole (4)
36765	STD	B	5.990	M8 x 1.25 Hole	1.03125	2.59	1.750	3.250	2.62	3-5/64	M8 x 1.25 Hole (4)
36766	REV	B	5.990	M10 x 1.5 Hole	1.03125	2.43	1.750	3.250	2.52	3-15/32	M10 x 1.5 Hole (4)
36767	REV	B	5.990	M10 x 1.5 Hole	0.703125	1.44 ~` HEX	1.750	3.250	2.52	3-15/32	M10 x 1.5 Hole (4)
36768	REV	A	6.650	M6 x 1.0 Hole	0.8125	3.07	2.7	5.350	4.09	3-25/64	M6 x 1.0 Hole (4)
36769	STD	A	6.200	M6 x 1.0 Hole	0.500	3	2.36	5.65625	5.070	2-15/16	M6 x 1.0 Hole (4)
36770	STD	A	6.200	M6 x 1.0 Hole	0.440	3	3.15	5.65625	5.070	3-23/32	M6 x 1.0 Hole (4)
36771	STD	A	6.200	M6 x 1.0 Hole	0.500	3	2.171875	5.65625	5.070	2-47/64	M6 x 1.0 Hole (4)
36772	STD	A	6.650	M6 x 1.0 Hole	0.230	2.75	2.280	5.270	5.390	2-61/64	M6 x 1.0 Hole (Re-use 4 from O.E.)
36773	STD	A	6.650	M6 x 1.0 Hole	0.500	3	2.350	5.98	5.35	3-1/32	M6 x 1.0 Hole (4)
36774	REV	A	6.650	M6 x 1.0 Hole	0.880	3.625	2.590	5.350	4.09	3-9/32	M6 x 1.0 Hole (4)
36775	REV	A	6.650	M6 x 1.0 Hole	0.880	3.625	2.590	5.350	4.09	3-9/32	M6 x 1.0 Hole (4)
36776	REV	A	6.650	M6 x 1.0 Hole	0.880	3.625	2.590	5.35	4.09	3-9/32	M6 x 1.0 Hole (4)
36777	STD	A	6.650	M6 x 1.0 Hole	0.880	2.6	2.250	6.03	5.390	2-15/16	M6 x 1.0 Hole (4)
36778	REV	A	6.650	M6 x 1.0 Hole	0.703125	1.44 ~` HEX	2.19	6.030	5.390	2-49/64	M6 x 1.0 Hole (4)
36780	STD	B	7.200	5/16-18 Hole	0.625	2.59	1.625	3.250	2.62	3-3/16	5/16-18 Hole (4)
36781	REV	C	7.200	5/16-18 Hole	0.703125	1.44 ~` HEX	1.250	3.250	2.62	2-61/64	5/16-18 Hole (4)
36782	REV	D	6.450	M6 x 1.0 Hole	0.703125	1.44 ~` HEX	1.25	3.250	2.43	3-17/64	M6 x 1.0 Hole (4)
36783	STD	D	6.450	5/16-18 Hole	0.625	2.58	1.63	3.250	2.62	3-21/32	5/16-18 Hole (4)
36784	REV	C	7.230	M8 x 1.25 Hole	0.609375	1.44 ~` HEX	0.59375	3.810	3.250	2-11/16	M8 x 1.25 Hole (4)
36785	STD	D	7.400	5/16-18 Hole	0.703125	1.44 ~` HEX	1.203125	3.250	2.620	3-23/32	5/16-18 Hole (4)
36786	REV	D	7.400	M8 x 1.25 Hole	0.78125	1.86 HEX	1.750	3.810	3.250	4-17/64	M8 x 1.25 Hole (4)
36787	STD & REV	B	7.200	5/16-18 Hole	1.03125	2.59	1.750	3.250	2.62	3-21/64	5/16-18 Hole (4)
36900	REV	A	5.65625	M6 x 1.0 Hole	0.703125	2.7	2.15625	5.030	4.359375	2-11/16	M6 x 1.0 Hole (4)
36901	STD	B	5.990	5/16-18 Hole	1.03125	2.6	1.53	3.250	2.62	3-7/64	5/16-18 Hole (4)
36902	STD	B	5.990	M6 x 1.0 Hole	0.703125	1.44 ~` HEX	2.320	3.250	2.62	3-29/32	M6 x 1.0 Hole (4)
36903	STD	A	6.650	M6 x 1.0 Hole	0.550	3.00	2.14	6.030	5.390	2-45/64	M6 x 1.0 Hole (4)
36904	STD	A	6.650	M6 x 1.0 Hole	0.450	3.00	1.94	6.030	5.390	2-1/2	M6 x 1.0 Hole (4)
36906	STD	A	5.590	M6 x 1.0 Hole	0.550	2.68	1.59375	5.109375	4.4	2-47/64	M6 x 1.0 Hole (4)
36907	STD	A	5.850	M6 x 1.0 Hole	0.500	2.28	1.8125	4.796875	4.09375	2-21/64	M6 x 1.0 Hole (4)
36908	STD	A	6.200	M6 x 1.0 Hole	0.500	3.00	2.36	5.65625	5.070	2-15/16	M6 x 1.0 Hole (4)
36911	STD & REV	B	7.200	5/16-18 Hole	0.750	2.33	1.750	3.000	2.370	3-5/16	5/16-18 Hole (4)
36913	REV	B	5.990	5/16-18 Hole	0.703125	1.44 ~` HEX	1.250	3.250	2.62	2-25/32	5/16-18 Hole (4)
36916	STD & REV	B	7.200	5/16-18 Hole	1.03125	2.6	2.03125	3.250	2.62	3-19/32	5/16-18 Hole (4)
36917	STD	A	5.850	M6 x 1.0 Hole	0.880	2.28	2.15625	4.796875	4.09375	2-11/16	M6 x 1.0 Hole (4)
36918	STD	A	5.850	M6 x 1.0 Hole	0.500	2.56	1.790	4.796875	4.09375	2-5/16	M6 x 1.0 Hole (4)
36919	STD	A	5.850	M6 x 1.0 Hole	0.59375	3.00	2.09375	4.796875	4.09375	2-5/8	M6 x 1.0 Hole (4)
36921	STD	A	5.850	M6 x 1.0 Hole	0.750	3.07	1.960	4.796875	4.09375	2-31/64	M6 x 1.0 Hole (4)
36922	STD	A	6.650	M6 x 1.0 Hole	0.90625	3.07	2.440	5.350	4.09	3-1/64	M6 x 1.0 Hole (4)
36923	STD	A	5.850	M6 x 1.0 Hole	0.59375	3.00	1.760	5.030	3.540	2-19/64	M6 x 1.0 Hole (4)
36924	STD	A	5.850	M6 x 1.0 Hole	0.500	3.00	1.9375	5.270	4.71875	2-15/32	M6 x 1.0 Hole (4)
36925	STD	A	6.650	M6 x 1.0 Hole	0.90625	3.07	2.440	5.350	4.09	3-1/64	M6 x 1.0 Hole (4)
36927	STD	A	5.480	M6 x 1.0 Hole	0.625	2.56	1.890625	4.880	4.359375	2-27/64	M6 x 1.0 Hole (4)
36930	REV	A	6.650	M6 x 1.0 Hole	0.90625	3.7	2.55	5.350	4.09	3-1/8	M6 x 1.0 Hole (4)
36931	STD	A	5.850	M6 x 1.0 Hole	0.160	2.75	2.460	4.796875	4.09375	2-63/64	M6 x 1.0 Hole (4)



## Fan Clutch Dimension Chart

Part No.	Rotatio	Dia.	Overall Dia. (A)	Pilot Dia. (B)	Pilot Depth (C)	Flange Cir. (D)	Flange Mnt. Hght (E)	Fan Bolt Cir. (F)	Fan Mnt. Dia. (G)	Overall Height (H)	Bolt/Nut Type
36932	REV	A	6.650	M6 x 1.0 Hole	0.703125	2.7	2.29 to 1.55	6.030	5.390	2-55/64	M6 x 1.0 Hole (4)
36933	REV	D	6.450	5/16-18 Hole	0.703125	1.44 ~ HEX	1.25	3.250	2.62	3-17/64	5/16-18 Hole (4)
36935	STD	A	6.650	M6 x 1.0 Hole	0.828125	3.07	2.859375	5.350	4.09	3-27/64	M6 x 1.0 Hole (4)
36936	STD	D	6.450	5/16-18 Hole	0.703125	1.44 ~ HEX	1.25	3.250	2.62	3-17/64	5/16-18 Hole (4)
36940	REV	B	7.200	5/16-18 Hole	0.625	1.63 ~ HEX	1.250	3.000	2.370	2-53/64	5/16-18 Hole (4)
36942	REV	C	7.200	5/16-18 Hole	1.03125	2.6	1.53	3.250	2.62	3-15/64	5/16-18 Hole (4)
36944	STD	B	7.200	5/16-18 Hole	0.560	2.32	1.09375	3.250	2.62	2-43/64	5/16-18 Hole (4)
36945	REV	C	7.200	M10 x 1.5 Hole	0.703125	1.44 ~ HEX	1.750	3.250	2.52	3-15/32	M10 x 1.5 Hole (4)
36946	REV	C	7.200	5/16-18 Hole	0.703125	1.44 ~ HEX	1.750	3.250	2.62	3-15/32	5/16-18 Hole (4)
36947	REV	D	6.450	M10 x 1.5 Hole	0.703125	1.44 ~ HEX	1.25	3.250	2.52	3-17/64	M10 x 1.5 Hole (4)
36949	STD & REV	B	7.200	5/16" - 18	1.03125	2.600	1.530	3.250	2.621	3-9/100	5/16" - 18 (4)
36950	REV	B	5.990	5/16-18 Hole	1.03125	2.6	1.530	3.250	2.62	3-3/32	5/16-18 Hole (4)
36951	REV	D	6.450	5/16-18 Hole	0.625	2.58	1.796875	3.250	2.62	3-53/64	5/16-18 Hole (4)
36952	STD	B	7.200	5/16-18 Hole	1.03125	2.6	1.53	3.250	2.62	3-7/64	5/16-18 Hole (4)
36954	STD	B	7.200	5/16-18 Hole	0.750	2.33	1.750	3.000	2.370	3-19/64	5/16-18 Hole (4)
36955	REV	D	6.450	M10 x 1.5 Hole	0.625	2.46	1.63	3.250	2.52	3-21/32	M10 x 1.5 Hole (4)
36956	STD	C	7.200	5/16-18 Hole	0.625	2.59	1.625	3.250	2.62	3-11/32	5/16-18 Hole (4)
36957	REV	B	7.200	5/16-18 Hole	1.03125	2.59	1.750	3.250	2.62	3-21/64	5/16-18 Hole (4)
36958	STD	B	7.200	5/16-18 Hole	1.03125	2.6	2.03125	3.250	2.62	3-19/32	5/16-18 Hole (4)
36959	REV	C	7.200	5/16-18 Hole	0.703125	1.44 ~ HEX	1.250	3.250	2.62	2-61/64	5/16-18 Hole (4)
36960	STD	D	6.450	3/8-16 Hole	0.65625	3.22	1.500	3.810	3.25	3-61/64	3/8-16 Hole (4)
36961	STD	D	6.450	3/8-16 Hole	0.65625	3.22	2.125	3.810	3.25	4-37/64	3/8-16 Hole (4)
36962	STD	D	7.400	5/16-18 Hole	0.65625	3.18	1.500	6.000	5.00	3-53/64	5/16-18 Hole (6)
36963	STD	D	7.400	5/16-18 Hole	0.65625	1.88 ~ Hex	1.203125	6.000	5.00	3-33/64	5/16-18 Hole (6)
36964	STD	B	7.200	5/16-18 Hole	0.750	2.33	1.400	3.000	2.370	2-63/64	5/16-18 Hole (4)
36966	STD	A	5.850	M6 x 1.0 Hole	0.750	2.56	2.400	4.880	4.359375	2-59/64	M6 x 1.0 Hole (4)
36968	STD	B	5.990	M6 x 1.0 Hole	0.703125	1.44 ~ HEX	1.750	3.250	2.62	3-11/32	M6 x 1.0 Hole (4)
36969	STD	B	7.200	5/16-18 Hole	0.703125	1.44 ~ HEX	1.250	3.000	2.370	2-53/64	5/16-18 Hole (4)
36970	STD	B	7.200	5/16-18 Hole	0.625	2.56	1.796875	3.250	2.62	3-5/16	5/16-18 Hole (4)
36972	STD	B	5.990	M6 x 1.0 Hole	0.703125	1.44 ~ HEX	2.760	3.250	2.62	4-11/32	M6 x 1.0 Hole (4)
36973	REV	D	6.450	M10 x 1.5 Hole	0.703125	1.44 ~ HEX	1.75	3.250	2.52	3-49/64	M10 x 1.5 Hole (4)
36974	REV	B	7.200	5/16-18 Hole	0.703125	1.44 ~ HEX	1.250	3.000	2.370	2-53/64	5/16-18 Hole (4)
36976	REV	B	7.200	M10 x 1.5 Hole	1.03125	2.43	1.625	3.250	2.52	3-13/64	M10 x 1.5 Hole (4)
36977	REV	B	7.200	M10 x 1.5 Hole	1.03125	2.43	2.250	3.250	2.52	3-51/64	M10 x 1.5 Hole (4)
36979	STD	B	5.990	M6 x 1.0 Hole	1.03125	2.43	2.320	3.250	2.62	3-7/8	M6 x 1.0 Hole (4)
36980	REV	B	5.990	5/16-18 Hole	1.03125	2.6	1.53	3.250	2.62	3-7/64	5/16-18 Hole (4)
36983	STD	A	5.850	M6 x 1.0 Hole				6.025	4.72	4-63/64	M6 x 1.0 Hole (4)
36984	STD	A	5.850	M6 x 1.0 Hole	0.290	2.6	2.210	5.270	4.71875	2-47/64	M6 x 1.0 Hole (4)
36986	STD	A	5.850	M6 x 1.0 Hole	0.703125	2.7	2.15625	4.796875	4.09375	2-11/16	M6 x 1.0 Hole (4)
36987	REV	D	6.450	M10 x 1.5 Hole	0.625	2.46	1.63	3.250	2.52	3-21/32	M10 x 1.5 Hole (4)
36990	REV	C	7.200	5/16-18 Hole	1.03125	2.59	1.750	3.250	2.62	3-15/32	5/16-18 Hole (4)
36991	STD	A	6.650	M6 x 1.0 Hole	0.953125	4.18	2.34375	5.350	4.09	2-29/32	M6 x 1.0 Hole (4)
36992	REV	C	7.200	M10 x 1.5 Hole	1.03125	2.43	1.63	3.250	2.52	3-11/32	M10 x 1.5 Hole (4)
36993	REV	B	7.200	M6 x 1.0 Hole	0.703125	1.44 ~ HEX	1.250	3.250	2.52	2-53/64	M6 x 1.0 Hole (4)
36994	REV	B	5.990	M8 x 1.25 Hole	0.703125	1.44 ~ HEX	2.420	3.250	2.62	3-61/64	M8 x 1.25 Hole (4)
36996	STD	D	6.450	5/16-18 Hole	0.625	2.58	1.63	3.250	2.62	3-21/32	5/16-18 Hole (4)
36997	STD	A	6.650	M6 x 1.0 Hole	0.200	2.734375	2.29	5.350	4.09	2-55/64	M6 x 1.0 Hole (4)
36998	STD	A	6.650	M6 x 1.0 Hole	0.550	2.68	2.34375	6.030	5.390	2-29/32	M6 x 1.0 Hole (4)
36999	STD	C	7.200	5/16-18 Hole	1.03125	2.43	2.250	3.250	2.62	3-61/64	5/16-18 Hole (4)
46000	STD	A	5.850	M6 x 1.0 Hole	0.460	3.00	1.828125	5.270	4.71875	2-11/32	M6 x 1.0 Hole (4)
46001	STD	A	6.300	M6 x 1.0 Hole	0.51	1.25 HEX	1.46	5.790	5.31	2-5/64	M6 x 1.0 Hole (3)

## Fan Clutch Dimension Chart

Part No.	Rotatio	Dia.	Overall Dia. (A)	Pilot Dia. (B)	Pilot Depth (C)	Flange Cir. (D)	Flange Mnt. Hght (E)	Fan Bolt Cir. (F)	Fan Mnt. Dia. (G)	Overall Height (H)	Bolt/Nut Type
<b>Fan Clutches</b>											
46002	STD	A	6.300	M6 x 1.0 Hole	0.58	1.26 HEX	1.46	5.790	5.31	2-5/32	M6 x 1.0 Hole (3)
46003	STD	A	6.320	M6 x 1.0 Hole	0.59375	1.26 HEX	1.03125	3.828125	3.250	2-25/32	M6 x 1.0 Hole (4)
46004	STD	A	5.500	M6 x 1.0 Hole	0.33	1.953125	1.550	4.880	4.380	2-1/4	M6 x 1.0 Hole (4)
46005	STD	A	5.490	M6 x 1.0 Hole	0.51	1.26 HEX	1.280	4.880	4.380	1-61/64	M6 x 1.0 Hole (3)
46006	REV	B	5.990	5/16-18 Hole	0.703125	1.44 ~` HEX	2.000	3.250	2.62	3-45/64	5/16-18 Hole (4)
46007	REV	B	5.990	5/16-18 Hole	0.703125	1.44 ~` HEX	1.750	3.250	2.62	3-5/16	5/16-18 Hole (4)
46008	REV	A	6.300	M6 x 1.0 Hole		0.59	0.953125	5.790	5.31	1-5/8	M6 x 1.0 Hole (4)
46009	STD	A	6.300	M6 x 1.0 Hole	0.520	1.44 ~` HEX	1.410	5.790	5.31	2-1/32	M6 x 1.0 Hole (3)
46010	STD	A	6.510	M6 x 1.0 Hole		0.59	1.26	5.984375	5.2	2.76 to 2.05	M6 x 1.0 Hole (3)
46011	REV	A	6.300	M6 x 1.0 Hole	0.520	1.44 ~` HEX	1.410	5.790	5.31	2-3/64	M6 x 1.0 Hole (3)
46012	REV	A	6.300	M6 x 1.0 Hole	0.520	1.44 ~` HEX	1.410	5.790	5.3125	2-1/16	M6 x 1.0 Hole (3)
46013	REV	C	7.200	5/16-18 Hole	0.703125	1.44 ~` HEX	2.703125	3.250	2.62	4-27/64	5/16-18 Hole (4)
46014	REV	C	7.200	5/16-18 Hole	0.703125	1.44 ~` HEX	2.703125	3.250	2.62	4-27/64	5/16-18 Hole (4)
46015	REV	C	7.200	5/16-18 Hole	0.703125	1.44 ~` HEX	2.000	3.250	2.62	3-23/32	5/16-18 Hole (4)
46016	REV	C	7.200	5/16-18 Hole	0.703125	1.44 ~` HEX	2.703125	3.250	2.62	4-27/64	5/16-18 Hole (4)
46017	REV	D	6.450	M10 x 1.5 Hole	0.703125	1.44 ~` HEX	2.59375	3.250	2.52	4-5/8	M10 x 1.5 Hole (4)
46018	REV	D	6.450	M10 x 1.5 Hole	0.703125	1.44 ~` HEX	1.75	3.250	2.52	3-49/64	M10 x 1.5 Hole (4)
46019	REV	C	6.450	5/16-18 Hole	0.703125	1.44 ~` HEX	2.203125	3.250	2.62	4-7/32	5/16-18 Hole (4)
46020	REV	D	6.450	5/16-18 Hole	0.703125	1.44 ~` HEX	2.203125	3.250	2.62	4-7/32	5/16-18 Hole (4)
46021	REV	D	6.450	5/16-18 Hole	0.703125	1.44 ~` HEX	2.59375	3.250	2.62	4-5/8	5/16-18 Hole (4)
46022	REV	D	6.450	M6 x 1.0 Hole	0.703125	1.44 ~` HEX	1.25	3.250	2.52	3-17/64	M6 x 1.0 Hole (4)
46023	REV	D	6.450	M10 x 1.5 Hole	0.703125	1.44 ~` HEX	1.75	3.250	2.52	3-49/64	M10 x 1.5 Hole (4)
46024	REV	D	7.480	M8 x 1.25 Hole	0.765625	1.44 ~` HEX	1.540	3.810	3.250	5-33/64	M8 x 1.25 Hole (4)
46025	REV	A	6.300	M6 x 1.0 Hole		0.59	0.953125	5.790	5.31	1-1/2	M6 x 1.0 Hole (3)
46026	STD	A	6.200	M6 x 1.0 Hole	0.500	3.00	2.171875	5.65625	5.070	2-47/64	M6 x 1.0 Hole (4)
46027	STD	A	6.650	M6 x 1.0 Hole	0.8125	3.07	2.7	5.350	4.09	3-25/64	M6 x 1.0 Hole (4)
46028	REV	A	6.650	M6 x 1.0 Hole	0.703125	1.44 ~` HEX	2.190	6.030	5.390	2-7/8	M6 x 1.0 Hole (4)
46029	STD	A	6.650	M6 x 1.0 Hole	0.90625	3.07	2.984375	5.350	4.09	3-21/32	M6 x 1.0 Hole (4)
46030	REV	D	7.350	5/16-18 Hole	0.78125	1.86 ~` HEX	1.880	6.000	5.000	5-23/64	5/16-18 Hole (6)
46031	REV	D	7.350	5/16-18 Hole	0.78125	1.86 ~` HEX	1.880	6.000	5.000	5-23/64	5/16-18 Hole (6)
46032	REV	D	7.400	5/16-18 Hole	0.828125	1.44 ~` HEX	1.69	3.250	2.62	4-13/64	5/16-18 Hole (4)
46033	REV	D	7.400	5/16-18 Hole	0.703125	1.44 ~` HEX	1.203125	3.250	2.620	3-23/32	5/16-18 Hole (4)
46034	STD	D	7.400	5/16-18 Hole	0.578125	1.88 ~` Hex	2.070	6.000	5.00	4-25/64	5/16-18 Hole (6)
46035	STD	D	7.400	5/16-18 Hole	0.578125	1.88 ~` Hex	1.703125	6.000	5.00	4-1/64	5/16-18 Hole (6)
46036	STD	D	7.400	5/16-18 Hole	0.671875	1.88 ~` Hex	2.070	6.000	5.00	4-25/64	5/16-18 Hole (6)
46037	REV	D	7.400	M8 x 1.25 Hole	0.765625	1.86 HEX	1.320	3.810	3.25	3-53/64	M8 x 1.25 Hole (4)
46038	STD	D	7.400	5/16-18 Hole	0.671875	1.88 ~` Hex	1.203125	6.000	5.00	3-17/32	5/16-18 Hole (6)
46039	STD	D	7.400	5/16-18 Hole	0.65625	3.22	1.500	6.000	5.00	3-53/64	5/16-18 Hole (6)
46040	STD	D	7.400	5/16-18 Hole	0.578125	1.88 ~` Hex	1.703125	6.000	5.00	4-1/64	5/16-18 Hole (6)
46041	REV	D	6.450	5/16-18 Hole	0.703125	1.44 ~` HEX	2.42	3.250	2.62	4-7/16	5/16-18 Hole (4)
46043	STD	C	7.200	5/16-18 Hole	0.578125	1.25 HEX	1.02	3.250	2.62	2-47/64	5/16-18 Hole (4)
46044	STD	D	6.450	3/8-16 Hole	0.671875	1.88 ~` Hex	1.203125	3.810	3.25	3-21/32	3/8-16 Hole (4)
46045	REV	D	6.450	5/16-18 Hole	0.703125	1.44 ~` HEX	1.25	3.250	2.62	3-17/64	5/16-18 Hole (4)
46046	STD	D	6.450	M10 x 1.5 Hole	0.90625	1.44 ~` HEX	2.070	3.250	2.52	4-3/32	M10 x 1.5 Hole (4)
46047	REV	C	7.200	M8 x 1.25 Hole	0.703125	1.44 ~` HEX	1.500	3.250	2.62	3-13/64	M8 x 1.25 Hole (4)
46048	REV	D	7.400	5/16-18 Hole	0.703125	1.44 ~` HEX	1.203125	3.250	2.620	3-23/32	5/16-18 Hole (4)
46049	REV	D	7.400	M8 x 1.25 Hole	0.765625	1.44 ~` HEX	1.540	3.810	3.25	4-17/64	M8 x 1.25 Hole (4)
46050	REV	D	7.400	M8 x 1.25 Hole	0.88	1.86 HEX	2.078125	3.810	3.25	4-19/32	M8 x 1.25 Hole (4)
46051	REV	D	6.450	5/16-18 Hole	0.703125	1.44 ~` HEX	1.500	3.250	2.62	3-1/4	5/16-18 Hole (4)
46052	REV	D	6.450	5/16-18 Hole	0.703125	1.44 ~` HEX	2.42	3.250	2.62	4-7/16	5/16-18 Hole (4)
46053	REV	D	6.450	M6 x 1.0 Hole	0.703125	1.44 ~` HEX	2.42	3.250	2.62	4-7/16	M6 x 1.0 Hole (4)

## Fan Clutch Dimension Chart

Part No.	Rotatio	Dia.	Overall Dia. (A)	Pilot Dia. (B)	Pilot Depth (C)	Flange Cir. (D)	Flange Mnt. Hght (E)	Fan Bolt Cir. (F)	Fan Mnt. Dia. (G)	Overall Height (H)	Bolt/Nut Type
<b>Fan Clutches</b>											
46054	REV	D	6.450	M8 x 1.25 Hole	0.56	1.44 ~` HEX	1.09375	3.250	2.62	3-1/8	M8 x 1.25 Hole (4)
46055	REV	D	7.730	M6 x 1.0 Hole	0.703125	1.44 ~` HEX	2.620	7.01	6.450	3-37/64	M6 x 1.0 Hole (4)
46056	REV	D	7.730	M6 x 1.0 Hole	0.8125	1.86 ~` HEX	2.84375	7.010	6.450	3-25/32	M6 x 1.0 Hole (4)
46057	REV	A	6.300	M6 x 1.0 Hole		0.59	0.90625	5.790	5.3125	1-29/64	M6 x 1.0 Hole (3)
46058	REV	A	6.300	M6 x 1.0 Hole	0.52	1.44 ~` HEX	1.410	5.790	5.31	2-1/16	M6 x 1.0 Hole (3)
46059	REV	D	7.350	5/16-18 Hole	0.550	1.44 ~` HEX	1.015625	6.000	5.000	4-11/32	5/16-18 Hole (6)
46060	REV	A	6.610	M6 x 1.0 STUD	0.921875	3.62	3.09375	5.350	4.09	3-49/64	M6 x 1.0 STUD (4)
46061	STD	A	6.650	M6 x 1.0 Hole	0.8125	3.07	2.7	5.350	4.09	3-25/64	M6 x 1.0 Hole (4)
46062	STD	D	7.730	M6 x 1.0 Hole	0.703125	1.86 ~` HEX	1.21875	6.000	5.000	4-13/16	M6 x 1.0 Hole (6)
46063	REV	D	7.730	M6 x 1.0 Hole	0.703125	1.44 ~` HEX	2.620	7.010	6.450	3-9/16	M6 x 1.0 Hole (4)
46064	STD	A	6.650	M6 x 1.0 Hole	0.220	2.68	2.00 to 1.25	6.030	5.390	2-9/16	M6 x 1.0 Hole (4)
46065	STD	A	6.650	M6 x 1.0 Hole	0.220	2.68	2.000	6.030	5.390	2-9/16	M6 x 1.0 Hole (4)
46066	REV	D	7.400	M6 x 1.0 Hole	0.78125	1.86 ~` HEX	2.420	3.250	2.620	4-15/16	M6 x 1.0 Hole (4)
46067	REV	D	7.400	M8 x 1.25 Hole	0.78125	1.86 ~` HEX	1.203125	3.810	3.250	3-23/32	M8 x 1.25 Hole (4)
46068	STD	A	7.080	M6 x 1.0 Hole	0.440	3.19	2.230	6.580	6.020	3-17/32	M6 x 1.0 Hole (4)
46069	REV	D	7.350	5/16-18 Hole	0.550	1.44 ~` HEX	1.015625	6.000	5.000	4-11/32	5/16-18 Hole (6)
46070	REV	A	7.010	M6 x 1.0 Hole	0.450	3.07	2.660	6.480	5.71	3-9/16	M6 x 1.0 Hole (4)
46071	REV	B	6.000	M8 x 1.25 Hole	0.56	1.44 HEX	1.12	3.250	2.62	2-27/32	M8 x 1.25 Hole (4)
46073	STD	D	6.450	3/8-16 Hole	0.520	3.22	2.380	3.810	3.25	4-1/2	3/8-16 Hole (4)
46074	STD	D	6.450	3/8-16 Hole	0.78	1.48 HEX	1.828125	3.810	3.25	3-7/8	3/8-16 Hole (4)
46075	STD	D	6.450	3/8-16 Hole	0.5	1.88 ~` Hex	1.1	3.810	3.25	3-13/64	3/8-16 Hole (4)
46076	STD	D	6.450	3/8-16 Hole	0.520	2.37	1.36	3.810	3.25	2-31/64	3/8-16 Hole (4)
46077	STD	D	7.340	5/16-18 Hole	0.170	4.18	1.400	6.000	5.00	3-19/32	5/16-18 Hole (6)
46078	STD	D	6.450	3/8-16 Hole	0.52		2.00	3.810	3.25	4-7/64	3/8-16 Hole (4)
46082	REV	A	6.300	M6 x 1.0 Hole	0.578125	1.25 HEX	1.450	5.790	5.31	2-11/64	M6 x 1.0 Hole (3)
46085	STD	A	7.600	M6 x 1.0 Hole	0.67	2.765625	2.890625	6.990	6.29	3-23/32	M6 x 1.0 Hole (4)
46086	REV	B	6.000	5/16-18 Hole	0.703125	1.44 ~` HEX	1.515625	3.250	2.62	3-15/64	5/16-18 Hole (4)
46087	REV	C	7.200	5/16-18 Hole	0.703125	1.44 ~` HEX	1.76	3.250	2.62	3-15/32	5/16-18 Hole (4)
46088	STD	D	7.400	5/16-18 Hole	0.703125	1.44 ~` HEX	1.75	3.250	2.62	3-49/64	5/16-18 Hole (4)
46089	REV	C	5.990	5/16" - 18	0.703125	1.440	1.750	3.250	2.621	3-15/32	5/16" - 18 (4)
46090	REV	D	6.450	M10x1.500	0.703125	1.44 ~` HEX	2.415	3.250	2.516	4-7/16	M10x1.500 (4)
46091	REV	D	7.422	M6x1.000	0.643	3.296875	0.535	6.840	6.050	3-25/32	M6x1.000 (4)
46092	REV	D	7.23	M8x1.250	0.71875	1.53 ~` HEX	0.59375	3.802	3.243	7-7/32	M8x1.250 (4)
46093	STD	A	6.2	M6 x 1.0 Hole		3.00	1.96	5.65	5.07	2-14/25	M6 x 1.0 Hole
46094	REV	D	9.39	M6 x 1.0 STUD	0.9	1.86 ~` HEX	2.901	8.9	7.873	4-43/100	M6 x 1.0 STUD
46095	REV	D	7.47	M6 x 1.0 Hole	0.877	1.86 ~` HEX	2.374	3.839	3.25	5-81/100	M6 x 1.0 Hole
46096	REV	D	7.35	5/16" - 18		1.88 ~` Hex	1.21	6.000	5.00	3-9/20	5/16" - 18
46101	STD	A	6.3	M6 x 1.0 Hole		1.25 HEX	1.45	5.79	5.31	2-29/100	M6 x 1.0 Hole



# Fan Clutches

## Fan Clutches



**36700**  
REV  
Severe Duty  
Dodge (03-92); Jeep (98-94)  
Chrysler: 52027848, 52027885,  
52028743



**36701**  
REV  
Severe Duty  
Ford (03-90); Mazda (97-91)



**36702**  
REV  
Severe Duty  
Ford (06-92); Lincoln (03-93); Mercury  
(06-92)  
Ford: F6AZ8A616AA

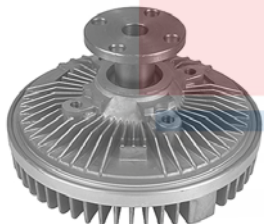

**36703**  
REV  
Severe Duty  
Jeep (98-93)  
Chrysler: 52027823, 52027824  
Jeep: 52027824



**36704**  
STD  
Severe Duty  
Buick (96-94), (85-77); Cadillac  
(96-94), (76-64); Chevy (96-70);  
Dodge (93-90); Ford (87-70); GMC  
(95-70); Olds (87-68); Pontiac (87-64)  
General Motors Corp: 15665117,  
19149243, 88961767

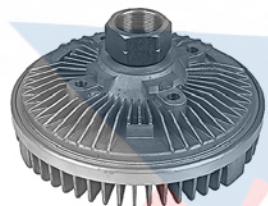

**36705**  
STD  
Severe Duty  
Chrysler (09); Dodge (09), (93-89)  
Chrysler: 55056946AA

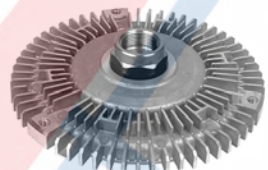

**36706**  
STD  
Standard Duty  
BMW (06-91), (87)  
BMW: 11527505302



**36707**  
REV  
Heavy Duty  
Jeep (93)

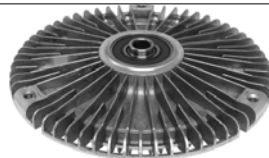

**36708**  
REV  
Standard Duty  
Mercedes (97-84)  
Mercedes Benz: 1032000422,  
1042000122, 6032000022, 603200022

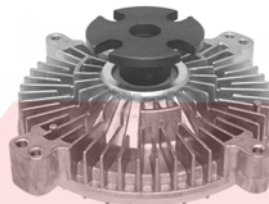

**36709**  
STD  
Standard Duty  
Mercedes (91-81)  
Mercedes Benz: 1162001122

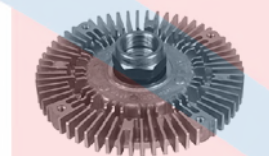

**36710**  
STD  
Standard Duty  
BMW (02-75)  
BMW: 11521466000, 11521468471,  
11521723918



**36711**  
REV  
Severe Duty  
Chevy (98-94); GMC (98-94)

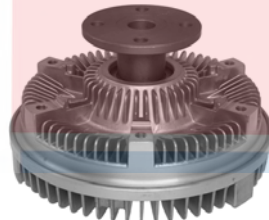

**36712**  
REV  
Severe Duty  
Chevy (93-92); GMC (93-92)  
General Motors Corp: 15969543



**36713**  
STD  
Standard Duty  
Cadillac (87), (67-65); Chevy (86-66);  
Chrysler (89-66); Dodge (92-60);  
Dodge Medium Duty Truck (81-78);  
GMC (86-67); Jeep (87-81); Plymouth  
(84-72)  
Chrysler: 4095704  
General Motors Corp: 19189594,  
22050678



**36714**  
STD  
Standard Duty  
Lexus (00-92); Toyota (98-93)  
Lexus: 1621046042  
Toyota: 1621046030, 1621046042



**36715**  
REV  
Heavy Duty  
Dodge (04-93)  
Chrysler: 52028944AB, 68064765AA

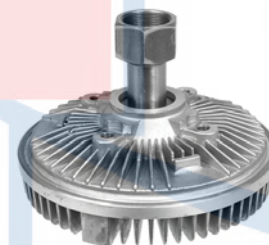

**36719**  
REV  
Severe Duty  
Ford (05-97); Lincoln (04-98); Mercury  
(04-03)  
Ford: 5C2Z8A616CA, 5C2Z8A616DA,  
5L3Z8A616DB, AU2Z8A616J,  
F65Z8A616CA, F81Z8A616LA

# Fan Clutches

## Fan Clutches Cont'd



**36720**  
REV  
Severe Duty  
Ford (11-05), (02-98); Mazda (09-98);  
Mercury (01-98)  
Ford: 6L5Z8A616BA  
Mazda: 1F8215150, ZZL415150



**36723**  
STD  
Severe Duty  
Ford (94-92)

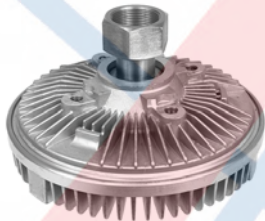

**36724**  
REV  
Severe Duty  
Ford (08-97)  
Ford: 5L3Z8A616AB, 5L3Z8A616BB



**36725**  
REV  
Standard Duty  
Chevy (96-88); GMC (96-88); Isuzu  
(96); Olds (94)  
General Motors Corp: 22082085,  
22135391



**36726**  
REV  
Standard Duty  
Chevy (93-88); GMC (93-88); Olds  
(93-91)  
Isuzu: 8150735800

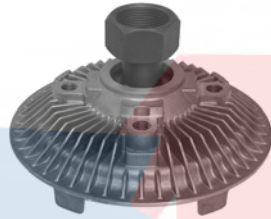

**36729**  
REV  
Standard Duty  
Cadillac (00-99); Chevy (03-96); GMC  
(05-96); Isuzu (00-97); Olds (01-96)  
General Motors Corp: 15073580,  
19161341



**36730**  
STD  
Severe Duty  
Ford (08-95); Mazda (07-94)  
Ford: 6L5Z8A616AA  
Mazda: 1F8115150, ZZMA15150



**36731**  
STD  
Standard Duty  
Ford (01-98); Mazda (01-98)  
Ford: F87Z8A616BA  
Mazda: ZZP015150



**36732**  
STD  
Standard Duty  
Honda (96-94); Isuzu (97-93)  
Honda: 8970806880  
Isuzu: 8970806880

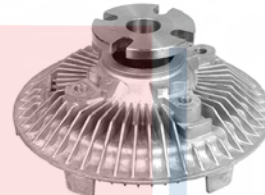

**36733**  
STD  
Standard Duty  
Jaguar (96-80)  
Jaguar: EAC4751, NBC2215AA

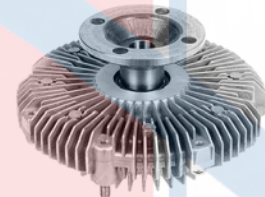

**36734**  
STD  
Standard Duty  
Acura (97-96); Honda (97-94); Isuzu  
(97-94); Toyota (04-95)  
Isuzu: 8971029030  
Toyota: 0892104950, 1621062030

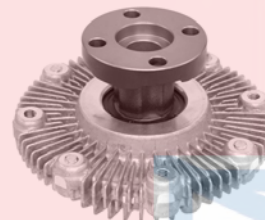

**36740**  
STD  
Standard Duty  
Chevy (02-89); Suzuki (98-92)  
When present stock is exhausted use  
**36777**  
General Motors Corp: 19189611,  
91173035  
Suzuki: 1712057B01, 1712077E07

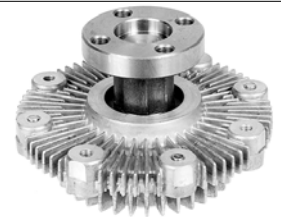

**36741**  
STD  
Standard Duty  
Suzuki (02-99), (95-85)



**36743**  
STD  
Standard Duty  
Mazda (91-88)  
Mazda: JF0415150A



**36745**  
STD  
Heavy Duty  
Mazda (89-87)  
Mazda: FE2H15150B



**36746**  
STD  
Standard Duty  
Mazda (98-92)  
Mazda: JE4815150C



# Fan Clutches

## Fan Clutches Cont'd



**36747**  
STD  
Heavy Duty  
Chevy (80-74)



**36748**  
STD  
Standard Duty  
Mitsubishi (99-97)  
Mitsubishi: MD317679



**36749**  
STD  
Severe Duty  
GMC (96-92); GMC & CHEVY (00-90)

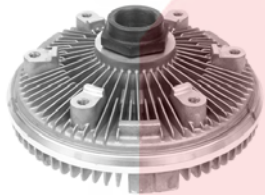

**36750**  
REV  
Severe Duty  
Ford (97-93)  
Ford: F5T28A616KB



**36751**  
REV  
Severe Duty  
Ford (14-97); Ford Medium Duty  
(07-99)  
Ford: 5C3Z8A616MA



**36752**  
REV  
Severe Duty  
Ford (03-99); Ford Medium Duty  
(03-99)  
Ford: AU2Z8A616L

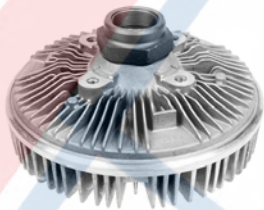

**36753**  
REV  
Severe Duty  
Ford (03-98)  
Ford: AU2Z8A616TA



**36754**  
REV  
Severe Duty  
Chevy (99-97); GMC (99-97)  
General Motors Corp: 15022302  
AMC: 06008664, 06009791, 6008664,  
6009791



**36755**  
REV  
Severe Duty  
Chevy (02-99); GMC (02-99)  
General Motors Corp: 15029405



**36756**  
STD  
Standard Duty  
Mercur (89-88)

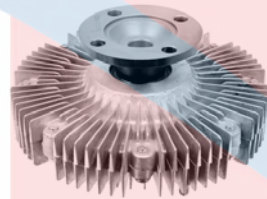

**36757**  
REV  
Standard Duty  
Acura (99-98); Isuzu (02-98)  
Isuzu: 8971303621

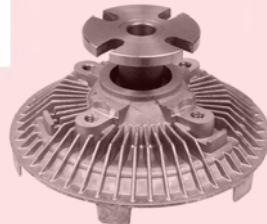

**36765**  
STD  
Standard Duty  
Chevy (85); GMC (85)  
General Motors Corp: 88961756



**36766**  
REV  
Standard Duty  
Chevy (96-94); GMC (96-94); Isuzu  
(96)  
General Motors Corp: 88961757  
Isuzu: 8889617570

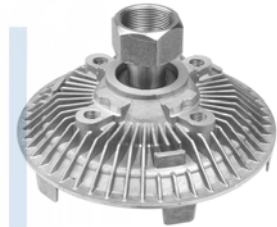

**36767**  
REV  
Standard Duty  
Chevy (03-97); GMC (03-97); Isuzu  
(00-97)  
General Motors Corp: 15723124,  
88961758



**36768**  
REV  
Standard Duty  
Honda (02-98); Isuzu (02-98)  
Isuzu: 8971722002

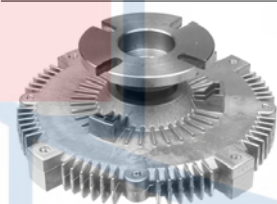

**36769**  
STD  
Standard Duty  
Infiniti (00-93); Nissan (04-95)  
Nissan: 210820W00A, 2108240P00,  
2108240P10, 210825S700, 2108288G



# Fan Clutches

## Fan Clutches Cont'd



**36770**  
STD  
Standard Duty  
Infiniti (97-93)  
Infiniti: 210820P505



**36771**  
STD  
Standard Duty  
Infiniti (92-90)

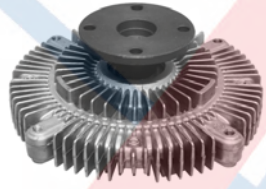

**36772**  
STD  
Standard Duty  
Mitsubishi (04-97)  
Mitsubishi: MD303502, MD334660,  
MD335271, MN119786



**36773**  
STD  
Standard Duty  
Infiniti (08-97); Nissan (04-01)  
Infiniti: 210826P00A  
Nissan: 210826P00A



**36774**  
REV  
Standard Duty  
Lexus (00-97); Toyota (02-00)  
Lexus: 1621050061  
Toyota: 1621050051, 1621050080

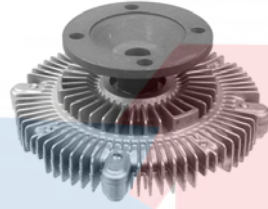

**36775**  
REV  
Standard Duty  
Lexus (05-98); Toyota (05-98)

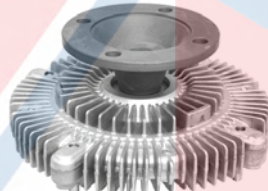

**36776**  
REV  
Standard Duty  
Lexus (05-03); Toyota (05-01)  
Toyota: 1621050090

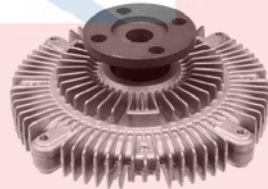

**36777**  
STD  
Standard Duty  
Chevy (04-99); Suzuki (05-96)  
General Motors Corp: 91174490,  
91177535  
Suzuki: 1712052D03



**36778**  
REV  
Standard Duty  
Ford (04-01); Mazda (09-01)  
Ford: 6L5Z8A616CA  
Mazda: 1F8015150

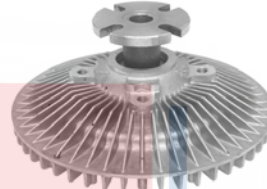

**36780**  
STD  
Standard Duty  
Chevy (74-69)

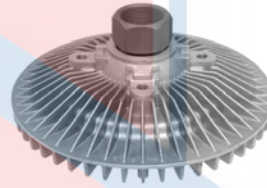

**36781**  
REV  
Heavy Duty  
Dodge (03-00); Jeep (08-99)  
Chrysler: 55038106AA

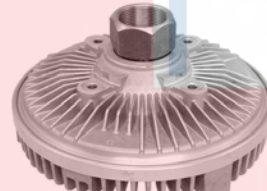

**36782**  
REV  
Severe Duty  
Ford (05-01); Lincoln (05-03); Mercury  
(05-01)  
Ford: 4L2Z8A616AA, AU2Z8A616F

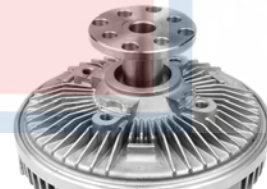

**36783**  
STD  
Severe Duty  
Chevy (95-90); GMC (95-90)



**36784**  
REV  
Heavy Duty  
Ford (01-96); Mercury (01-97)



**36785**  
STD  
Heavy Duty  
Dodge (02-00)  
Chrysler: 52028894AA



**36786**  
REV  
Severe Duty  
Chevy (09-01); GMC (09-01)  
General Motors Corp: 15130067



**36787**  
STD & REV  
Standard Duty  
Cadillac (90-87); Chevy (86-67);  
Chrysler (89-66); Dodge (92-63); GMC  
(86-67); Jeep (87-81)

# Fan Clutches

## Fan Clutches Cont'd

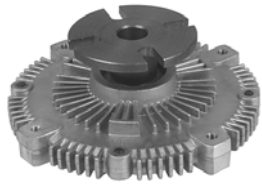

**36900**  
REV  
Standard Duty  
Chevy (93-87); GMC (93-87)  
General Motors Corp: 15549993,  
15642505, 19149906



**36901**  
STD  
Standard Duty  
AMC (88); Chevy (85-82); GMC  
(85-82); Jeep (90-80)  
Chrysler: J3241857  
General Motors Corp: 19189648,  
88961755  
Jeep: J3241857  
AMC: J3239377, J3241856, J3241857

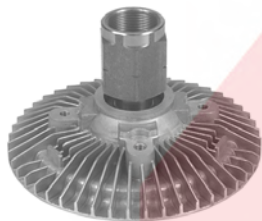

**36902**  
STD  
Standard Duty  
Ford (87-85)

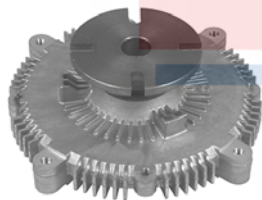

**36903**  
STD  
Standard Duty  
Mazda (94-89)  
Mazda: G60115150A, G60715150A



**36904**  
STD  
Standard Duty  
Mazda (91-89)  
Mazda: JE1515150, JE2315150,  
JE5615150

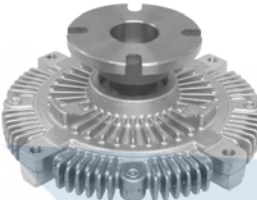

**36906**  
STD  
Standard Duty  
Mazda (93-82)  
Mazda: 808623907, FE6623907

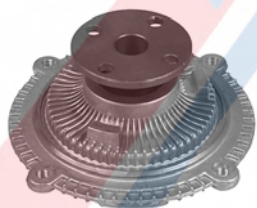

**36907**  
STD  
Standard Duty  
Chrysler (89-87); Dodge (05-01),  
(89-78); Mazda (88-87); Mitsubishi  
(89-83); Plymouth (86-78)  
Mazda: AM15159X3  
Mitsubishi: MD023697, MD104576



**36908**  
STD  
Standard Duty  
Nissan (96-90)



**36911**  
STD & REV  
Standard Duty  
Buick (68); Cadillac (64); Checker  
(69-65); Chevy (70-55); Ford (91-60);  
Lincoln (90-68); Mercury (91-61)

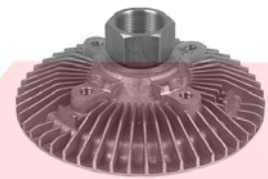

**36913**  
REV  
Standard Duty  
Ford (93-91); Mercury (93-91)



**36916**  
STD & REV  
Standard Duty  
Buick (87-73), (71-64); Cadillac  
(90-89), (87-81); Checker (82-80);  
Chevy (88-68); Chrysler (71-59);  
Dodge (76-59); GMC (88-66); Jeep  
(83-81); Olds (87-75); Plymouth  
(89-58)  
Pontiac (87-68)

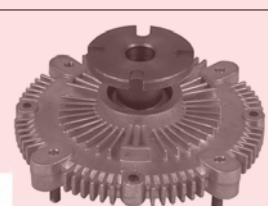

**36917**  
STD  
Standard Duty  
Dodge (93-79); Mitsubishi (96-83);  
Plymouth (82-80); Toyota (89-84)  
Mitsubishi: MD023698, MD041079,  
MD108270  
Toyota: 1621031010, 1621073010,  
1621073041



**36918**  
STD  
Standard Duty  
Volvo (93-69)  
Volvo: 1274938, 1306259, 1328622,  
1357433



**36919**  
STD  
Standard Duty  
Chevy (82-72); Isuzu (87-81)  
Isuzu: 8941153580, 8942444090,  
8944649160

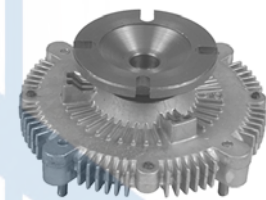

**36921**  
STD  
Standard Duty  
Toyota (95-75)  
Toyota: 1621035020, 1621038030,  
1621038050, 1621038060, 162105404  
1621054070

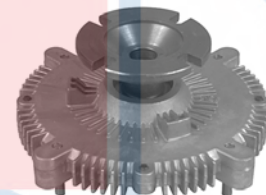

**36922**  
STD  
Standard Duty  
Buick (91); Chevy (90); Toyota (92-78)  
Toyota: 1621042030, 1621042040,  
1621042050, 1621042060, 162104207  
1621045100



# Fan Clutches

## Fan Clutches Cont'd



### 36923

STD  
Standard Duty  
Toyota (87-71)  
Toyota: 1621016010, 1621018010,  
1621028020



### 36924

STD  
Standard Duty  
Infiniti (92-90); Nissan (98-71)  
Infiniti: 2108216V00  
Nissan: 2108201P04, 2108210G21,  
2108212G10, 2108240F00, 21082E872  
21082Y4161

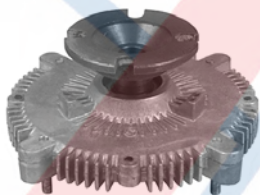

### 36925

STD  
Standard Duty  
Isuzu (94-92); Toyota (95-75)  
Toyota: 1621061070, 1621061072,  
1621061121, 1621061160, 162106502  
1621065030

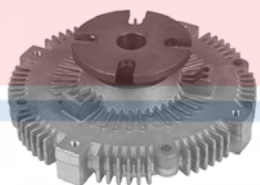

### 36927

STD  
Standard Duty  
Chevy (87-76); GMC (86-83); Pontiac  
(87-76)  
General Motors Corp: 14001193,  
14076343

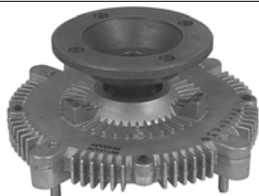

### 36930

REV  
Standard Duty  
Lexus (00-90)  
Lexus: 1621050021

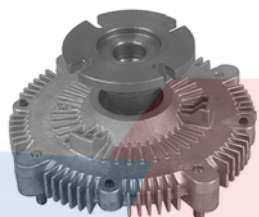

### 36931

STD  
Heavy Duty  
Isuzu (89-85)  
Isuzu: 8944741810

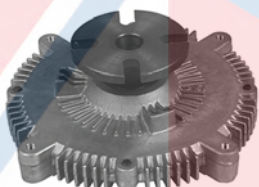

### 36932

REV  
Standard Duty  
Isuzu (94-89)  
Isuzu: 8970617020



### 36933

REV  
Severe Duty  
Dodge (03-92)  
Chrysler: 52027710AB, 52027862,  
52027882AB, 52028940AB,  
52029275AD, 52029276AD,  
52079671AB, 68064766AA



### 36935

STD  
Standard Duty  
Lexus (97-96); Toyota (97-93)  
Toyota: 1621066020



### 36936

STD  
Severe Duty  
Dodge (99-90)  
Chrysler: 52028615AB, 52028760

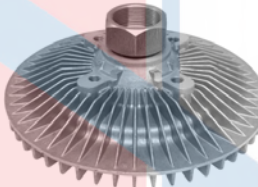

### 36940

REV  
Standard Duty  
Ford (96-92)

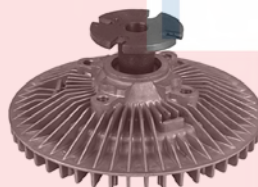

### 36942

REV  
Heavy Duty  
Jeep (00-91)  
Chrysler: 4637575AB, 68064285AA

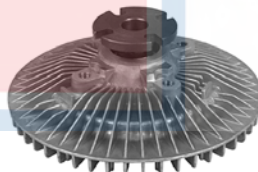

### 36944

STD  
Standard Duty  
Jaguar (92-87)

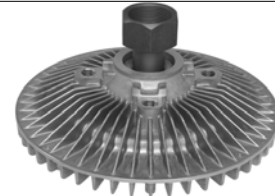

### 36945

REV  
Heavy Duty  
Cadillac (06-04); Chevy (13-96); GMC  
(13-96); GMC & CHEVY (13-09)  
General Motors Corp: 15911779,  
19150977, 20913877, 22150377



### 36946

REV  
Heavy Duty  
Dodge (03-92); Jeep (06-00)



### 36947

REV  
Severe Duty  
Chevy (12-04), (99-96); GMC (12-04),  
(99-96); GMC & CHEVY (08-97); Isuzu  
(08-06); Isuzu Medium Duty (15-97)  
General Motors Corp: 25948772  
Isuzu: 8259487720, 8981836130

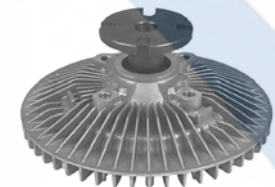

### 36949

STD & REV  
Standard Duty  
AMC (87-65); Buick (90-66); Cadillac  
(85-82), (79-76), (69-68); Checker  
(82-65); Chevy (90-61), (58-57);  
Chrysler (64-61); GMC (88-61); Int'l  
(80-57); Jeep (91-72); Olds (90-60)  
Pontiac (89-67)  
General Motors Corp: 19189675



# Fan Clutches

## Fan Clutches Cont'd



**36950**  
REV  
Standard Duty  
AMC (88), (84-83); Jeep (95-81)  
Chrysler: J3241858  
AMC: 3241858, 5262520, 8953001693



**36951**  
REV  
Severe Duty  
Dodge (91-90); Ford (97-88), (86-84);  
Mercury (86-84)  
Ford: F4TZ8A616A

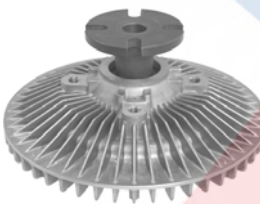

**36952**  
STD  
Standard Duty  
AMC (87-65); Buick (90-66); Cadillac  
(85-82), (79-76), (69-68); Checker  
(82-65); Chevy (90-61), (58-57);  
Chrysler (64-61); Dodge (79-74); GMC  
(88-61); Int'l (80-57); Jaguar (73-71)  
Jeep (91-72); Olds (90-60); Pontiac  
(89-67)  
General Motors Corp: 19189678,  
22050677, 88961759  
AMC: 3173394, 3231995, 3236603,  
3237559, 3237560, 3237591, 3238907  
3239377, 3239378, 3241856, 3241857  
5354432, 5362722, 994277, 998761



**36954**  
STD  
Standard Duty  
Buick (80-75), (68); Cadillac (64);  
Checker (69-65); Chevy (80-78),  
(70-55); Ford (91-60); Lincoln (90-68);  
Mercury (91-61); Pontiac (80-76)  
General Motors Corp: 19189679



**36955**  
REV  
Severe Duty  
Buick (93-91); Cadillac (93-90); Chevy  
(00-87); GMC (00-87); Olds (94-91)  
General Motors Corp: 12383420

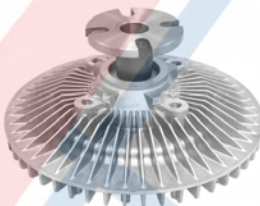

**36956**  
STD  
Heavy Duty  
Buick (96-94), (90-59); Cadillac  
(96-94), (85-82), (78-65); Chevy  
(96-64); Chrysler (89-60); Dodge  
(93-60); Dodge Medium Duty Truck  
(78); Ford (87-68); GMC (95-67); Jeep  
(73-72)  
Olds (90-65); Plymouth (89-80),  
(78-60); Pontiac (87-59)  
General Motors Corp: 14044660



**36957**  
REV  
Standard Duty  
AMC (87-81); Ford (95-80); Jeep  
(87-81); Lincoln (92-85), (82);  
Mercury (94-80)  
Ford: AU2Z8A616M



**36958**  
STD  
Standard Duty  
Buick (87-73), (71-64); Cadillac  
(90-81); Checker (82-80); Chevy  
(88-68); Chrysler (71-59); Dodge (89),  
(76-59); GMC (88-66); Jeep (83-81);  
Olds (87-75); Plymouth (89-58);  
Pontiac (87-68)  
General Motors Corp: 14045258,  
19189681, 88961761  
AMC: 5344432, 5362170



**36959**  
REV  
Heavy Duty  
Dodge (96-92); Jeep (93)



**36960**  
STD  
Severe Duty  
GMC & CHEVY (91-80)  
General Motors Corp: 15625786



**36961**  
STD  
Severe Duty  
Ford Medium Duty (87-80), (78-67)



**36962**  
STD  
Severe Duty  
Chevy (82); GMC (82)



**36963**  
STD  
Severe Duty  
Ford (92-83)



**36964**  
STD  
Standard Duty  
Chevy (79-72), (69-55); Ford (83-62);  
GMC (87-86); Mercury (83-64)  
General Motors Corp: 19189687,  
88961763

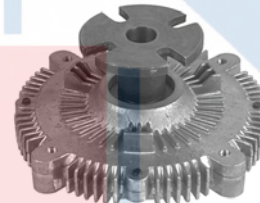

**36966**  
STD  
Standard Duty  
Chevy (85); Ford (01-83); GMC (85);  
Mazda (01-94)  
General Motors Corp: 19189688  
Mazda: ZP315150

# Fan Clutches

## Fan Clutches Cont'd



**36968**  
STD  
Standard Duty  
Ford (92-83)



**36969**  
STD  
Standard Duty  
Ford (86-80)

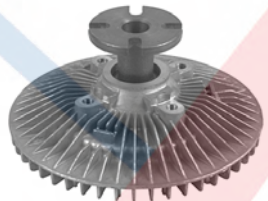

**36970**  
STD  
Standard Duty  
Chevy (82-80)  
General Motors Corp: 14047080

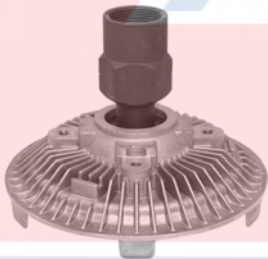

**36972**  
STD  
Standard Duty  
Ford (97-86); Mazda (07-94)  
Mazda: ZZM415150, ZZM715150,  
ZZMD15150



**36973**  
REV  
Severe Duty  
Chevy (14-96); GMC (14-96); GMC &  
CHEVY (14-09), (96); Isuzu (00-97);  
Isuzu Medium Duty (96); Olds (01-96)  
General Motors Corp: 15022300,  
15049054, 15089746, 15154901,  
25744727, 25744728  
Isuzu: 8151549010, 8971166560

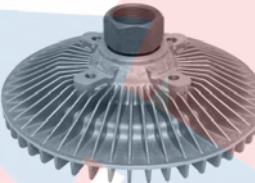

**36974**  
REV  
Standard Duty  
Ford (96-87)  
Ford: F3TZ8A616C

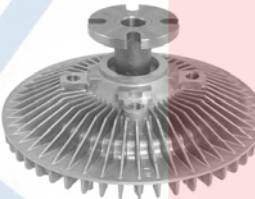

**36976**  
REV  
Standard Duty  
Chevy (95-87); GMC (95-87)  
General Motors Corp: 15981250,  
19189693



**36977**  
REV  
Standard Duty  
Chevy (93-87); GMC (93-87)



**36979**  
STD  
Standard Duty  
Ford (87-86)

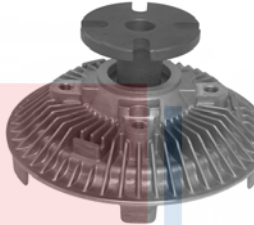

**36980**  
REV  
Standard Duty  
Jeep (06-87)  
Chrysler: 68064284AA, 68064764AA,  
68065080AA  
AMC: 52028327

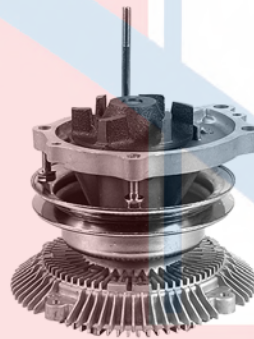

**36983**  
STD  
Standard Duty  
Nissan (89-74)  
Nissan: 21010G3928, 21010N5885,  
BA01080W89

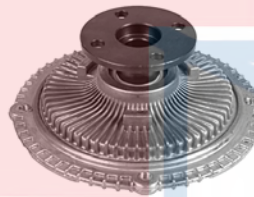

**36984**  
STD  
Standard Duty  
Nissan (88-84)  
Nissan: 2108217C15, 2108217C16,  
21082W4405



**36986**  
STD  
Standard Duty  
Isuzu (95-86)  
Isuzu: 8943105180, 8943112520,  
8944120300, 8944120330



**36987**  
REV  
Severe Duty  
Chevy (98-85); GMC (98-85)  
General Motors Corp: 19150658  
Isuzu: 8155631270  
AMC: 06003082, 6003082



**36990**  
REV  
Heavy Duty  
Dodge (91); Ford (97-83); Mercury  
(86-82)



**36991**  
STD  
Standard Duty  
Toyota (97-91)  
Toyota: 1621076010



# Fan Clutches

## Fan Clutches Cont'd



**36992**  
REV  
Heavy Duty  
Buick (93-92); Cadillac (93-90); Chevy (95-87); GMC (95-87); Olds (94-91)  
General Motors Corp: 19150657, 22088612  
AMC: 06004284, 6004284



**36993**  
REV  
Standard Duty  
Ford (97-90); Mazda (97-91)  
Ford: AU2Z8A616N  
Mazda: ZZM115150

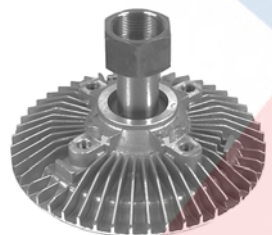

**36994**  
REV  
Standard Duty  
Lincoln (92-91); Mercury (92)

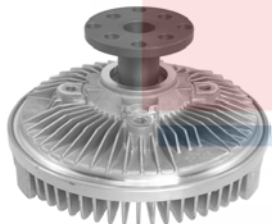

**36996**  
STD  
Severe Duty  
Chevy (93-82), (74-70); Ford (97-73), (70); GMC (93-82)  
Ford: AU2Z8A616P  
General Motors Corp: 15677108, 19189703, 88961768



**36997**  
STD  
Standard Duty  
Volvo (90-87)  
Volvo: 1274963

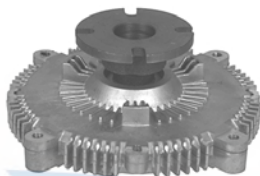

**36998**  
STD  
Standard Duty  
Dodge (91-89), (85-83); Mitsubishi (02-89), (85-83)  
Mitsubishi: MD050472, MD106546, MD142419

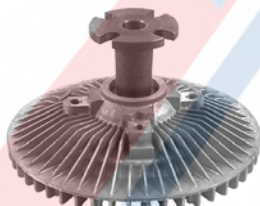

**36999**  
STD  
Heavy Duty  
Cadillac (84-77)  
General Motors Corp: 19161464, 22050668



**46000**  
STD  
Standard Duty  
Nissan (14-90), (83-81), (75), (70)  
Nissan: 2108286G0A

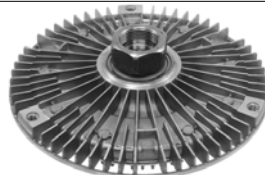

**46001**  
STD  
Standard Duty  
BMW (03-88)  
BMW: 11527500339, 11527502804

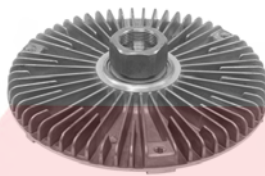

**46002**  
STD  
Standard Duty  
BMW (06-01), (93-87)  
BMW: 11527831619

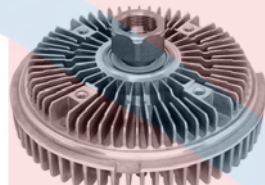

**46003**  
STD  
Standard Duty  
BMW (08-00); Land Rover (05-03)  
BMW: 17417505109  
Land Rover: PGB000040



**46004**  
STD  
Standard Duty  
Audi (01-97); VW (05-98)  
Audi: 058121350  
Volkswagen: 058121350

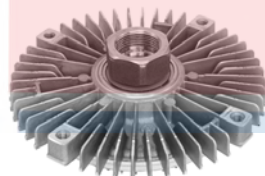

**46005**  
STD  
Standard Duty  
Audi (04-96); VW (05-98)  
Audi: 078121350A  
Volkswagen: 078121350A



**46006**  
REV  
Standard Duty  
Chrysler (09-07); Dodge (08-04)  
Chrysler: 52028992AC, 52028994AC

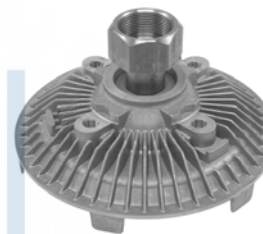

**46007**  
REV  
Standard Duty  
Dodge (04)  
Chrysler: 55056508AA

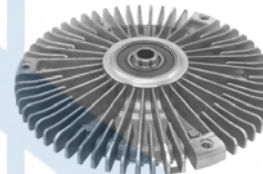

**46008**  
REV  
Standard Duty  
Mercedes (99-90), (87-75), (67-54)  
Mercedes Benz: 1032000622

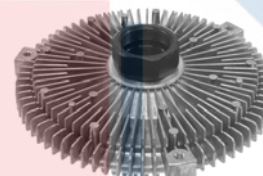

**46009**  
STD  
Standard Duty  
Mercedes (00-94)  
Mercedes Benz: 1112000422



# Fan Clutches

## Fan Clutches Cont'd



**46010**  
STD  
Standard Duty  
Mercedes (00-90), (81)  
Mercedes Benz: 1192000022



**46011**  
REV  
Standard Duty  
Mercedes (03-98)  
Mercedes Benz: 112200122

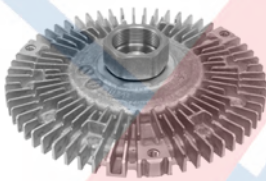

**46012**  
REV  
Standard Duty  
Mercedes (05-98)  
Mercedes Benz: 1122000222



**46013**  
REV  
Heavy Duty  
Dodge (08-02)  
Chrysler: 52029876AC



**46014**  
REV  
Heavy Duty  
Dodge (08-02)  
Chrysler: 55057111AA, 68064767AA

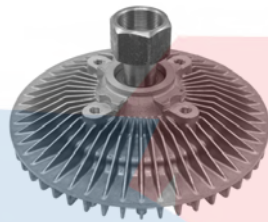

**46015**  
REV  
Heavy Duty  
Chrysler (09-07); Dodge (09-04)  
Chrysler: 52028995AA

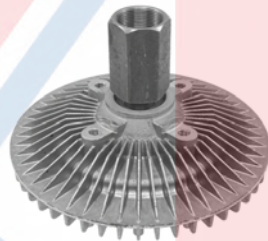

**46016**  
REV  
Heavy Duty  
Dodge (08-02)



**46017**  
REV  
Heavy Duty  
Chevy (12-04); GMC (12-04); Isuzu (08-06)  
General Motors Corp: 15106620  
Isuzu: 8151066200



**46018**  
REV  
Severe Duty  
Chevy (07-01); GMC (07-01)  
General Motors Corp: 15091842, 15712914

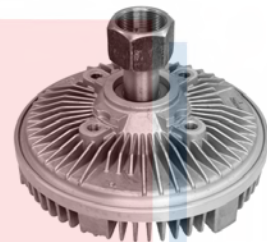

**46019**  
REV  
Severe Duty  
Dodge (08-03)  
Chrysler: 52028877AC, 55056963AB

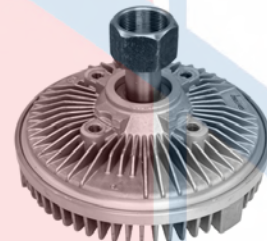

**46020**  
REV  
Severe Duty  
Dodge (04-03)  
Chrysler: 52029860AC

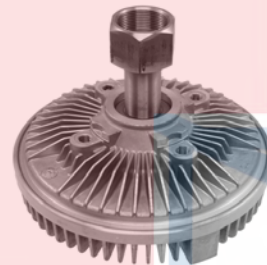

**46021**  
REV  
Severe Duty  
Dodge (08-03)



**46022**  
REV  
Severe Duty  
Ford (04-03)



**46023**  
REV  
Severe Duty  
Cadillac (06-02), (00-99); Chevy (13-99); GMC (13-99)



**46024**  
REV  
Severe Duty  
Buick (05-04); Chevy (05-02); GMC (05-02); Isuzu (05-03); Olds (04-02)  
General Motors Corp: 25790869  
Isuzu: 8257908690

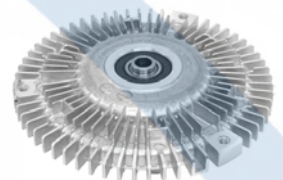

**46025**  
REV  
Standard Duty  
Dodge (06-03); Freightliner (06-02)  
Chrysler: 68004915AA  
Mercedes Benz: 0002005822

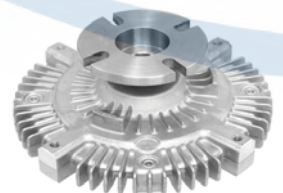

**46026**  
STD  
Standard Duty  
Infiniti (05-03)  
Infiniti: 21082AG20A

# Fan Clutches

## Fan Clutches Cont'd



**46027**  
STD  
Standard Duty  
Toyota (05)  
Toyota: 1621075100

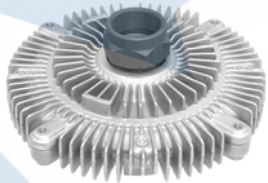

**46028**  
REV  
Standard Duty  
Ford (11-05)



**46029**  
STD  
Standard Duty  
Toyota (15-03)  
Toyota: 162100P010



**46030**  
REV  
Severe Duty  
Ford (10-03); Ford Medium Duty  
(07-03)  
Ford: 4C3Z8A616AA, 4C3Z8A616SA



**46031**  
REV  
Severe Duty  
Ford (07-03); Ford Medium Duty  
(07-03)



**46032**  
REV  
Severe Duty  
Dodge (03)  
Chrysler: 52029300AE



**46033**  
REV  
Severe Duty  
Dodge (00-97)  
Chrysler: 52029291AE, 52029767AA

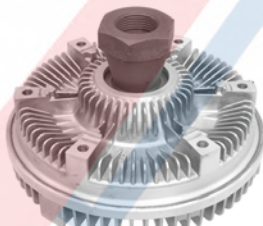

**46034**  
STD  
Severe Duty  
GMC & CHEVY (00-99)  
General Motors Corp: 15157106,  
15157107

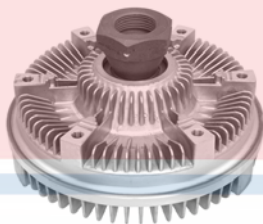

**46035**  
STD  
Severe Duty  
GMC & CHEVY (02-01)  
General Motors Corp: 15030120,  
15764819, 15768378



**46036**  
STD  
Severe Duty  
GMC & CHEVY (98-97)

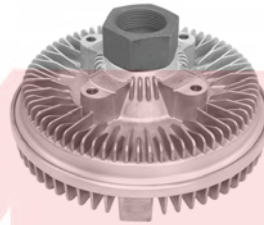

**46037**  
REV  
Severe Duty  
Chevy (10-06), (02-99); GMC (10-06),  
(02-99)  
General Motors Corp: 15102145,  
15152298

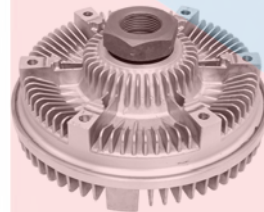

**46038**  
STD  
Severe Duty  
GMC & CHEVY (02-97)  
General Motors Corp: 15815059



**46039**  
STD  
Severe Duty  
Chevy (89-85); GMC (90-85); GMC &  
CHEVY (91-85)  
General Motors Corp: 15640670



**46040**  
STD  
Severe Duty  
GMC & CHEVY (02-01), (98-97)

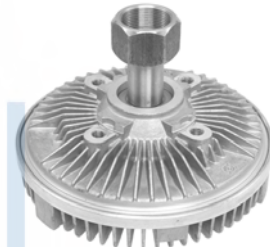

**46041**  
REV  
Severe Duty  
Lincoln (02)



**46043**  
STD  
Heavy Duty  
Land Rover (95-87)  
Land Rover: ETC1260

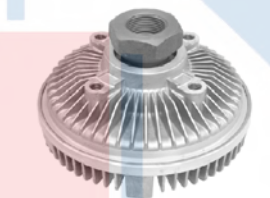

**46044**  
STD  
Severe Duty  
GMC & CHEVY (00-90)  
General Motors Corp: 15651264



# Fan Clutches

## Fan Clutches Cont'd



**46045**  
REV  
Severe Duty  
Dodge (11-05); Mitsubishi (09-06)  
Chrysler: 52029290AC, 55056585AA



**46046**  
STD  
Severe Duty  
Cadillac (09-04)  
General Motors Corp: 10382029

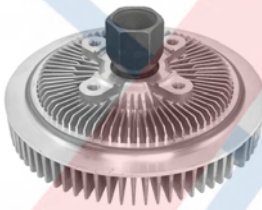

**46047**  
REV  
Heavy Duty  
Jeep (10-07)  
Chrysler: 68085950AA

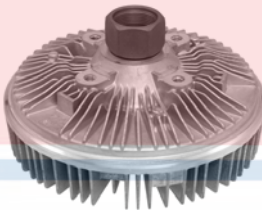

**46048**  
REV  
Heavy Duty  
Dodge (11-05)



**46049**  
REV  
Severe Duty  
Chevy (09-06); GMC (09-06); Isuzu (08); Saab (09-08)  
General Motors Corp: 25816289  
Isuzu: 8258162890

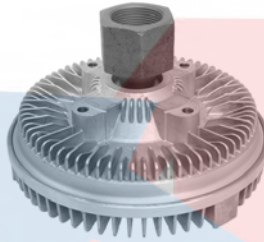

**46050**  
REV  
Severe Duty  
GMC & CHEVY (07-03)  
General Motors Corp: 15816068

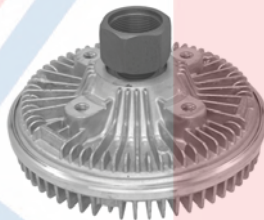

**46051**  
REV  
Severe Duty  
Jeep (09-05)  
Chrysler: 55037733AD



**46052**  
REV  
Severe Duty  
Ford (08-03); Lincoln (08-04)  
Ford: 5C3Z8A616B, 5L3Z8A616CB



**46053**  
REV  
Severe Duty  
Ford (15-07)  
Ford: 7C2Z8A616A, 7C2Z8A616B, 7C3Z8A616A, 7C3Z8A616C

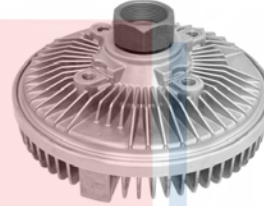

**46054**  
REV  
Severe Duty  
Land Rover (04-95)  
Land Rover: ERR4996

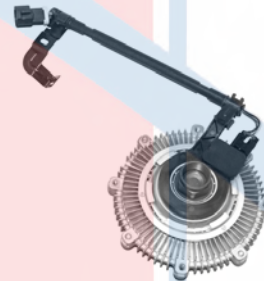

**46055**  
REV  
Severe Duty  
Ford (10-06); Mercury (10-06)  
Ford: 7L2Z8A616A

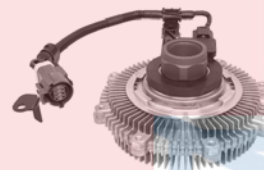

**46056**  
REV  
Severe Duty  
Ford (08-07); Lincoln (08-07)  
Ford: 7L1Z8A616A

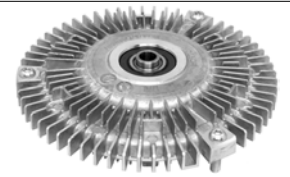

**46057**  
REV  
Standard Duty  
Mercedes (93-87)  
Mercedes Benz: 1032000522



**46058**  
REV  
Standard Duty  
Mercedes (03-98)  
Mercedes Benz: 1132000022



**46059**  
REV  
Severe Duty  
Dodge (04-03)  
Chrysler: 52028879AF



**46060**  
REV  
Standard Duty  
Lexus (09-05); Toyota (09-04)  
Toyota: 1621050102

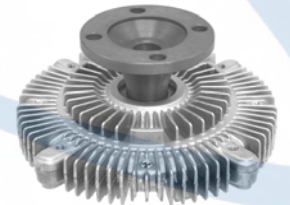

**46061**  
STD  
Standard Duty  
Toyota (15-94)  
Toyota: 1621075060, 1621075111



# Fan Clutches

## Fan Clutches Cont'd



**46062**  
STD  
Severe Duty  
Ford (10-08); Ford Medium Duty (09-08)  
Ford: 7C3Z8A616F



**46063**  
REV  
Severe Duty  
Ford (10-09); Lincoln (09)  
Ford: 9L3Z8A616B

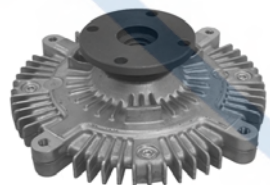

**46064**  
STD  
Standard Duty  
Kia (01-95)  
Kia: 0K01115140, 0K02815140

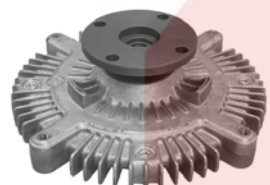

**46065**  
STD  
Standard Duty  
Kia (02-01)  
Kia: 0K04815140A



**46066**  
REV  
Severe Duty  
Ford (15-05); Ford Medium Duty (09-05)  
Ford: 7C3Z8A616B, 7C3Z8A616D



**46067**  
REV  
Severe Duty  
GMC & CHEVY (09-03)  
General Motors Corp: 94670096

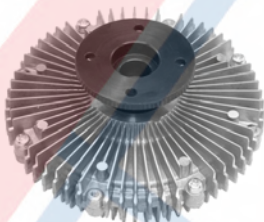

**46068**  
STD  
Heavy Duty  
Infiniti (10-04); Nissan (15-04); Suzuki (12-09)  
Nissan: 210827S00A  
Suzuki: 1712082Z21

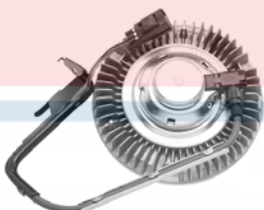

**46069**  
REV  
Severe Duty  
Dodge (09-05); Dodge Medium Duty Truck (10-08)  
Chrysler: 55056990AC

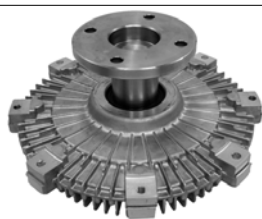

**46070**  
REV  
Heavy Duty  
Nissan (15-05); Suzuki (12-09)  
Nissan: 21082EA200  
Suzuki: 1712082Z10

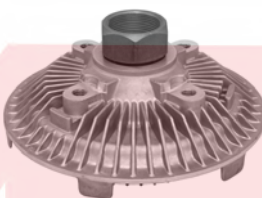

**46071**  
REV  
Standard Duty  
Land Rover (99-94)  
Land Rover: ERR3443

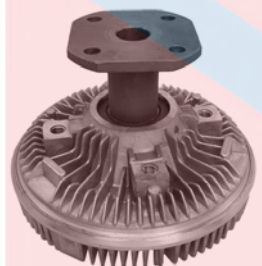

**46073**  
STD  
Severe Duty  
Ford Medium Duty (99-85)  
Ford: FOHZ8A616G



**46074**  
STD  
Severe Duty  
Ford Medium Duty (99-80)  
Ford: E3HZ8A616J



**46075**  
STD  
Severe Duty  
Ford Medium Duty (91-90)  
Ford: F1HZ8A616E



**46076**  
STD  
Severe Duty  
Ford Medium Duty (91-87)



**46077**  
STD  
Severe Duty  
Ford HD (87); Ford Medium Duty (89-83)



**46078**  
STD  
Severe Duty  
Ford Medium Duty (87-80)  
Ford: E3HZ8A616H

# Fan Clutches

## Fan Clutches Cont'd



**46082**  
REV  
Standard Duty  
Audi (04-97)  
Audi: 077121350D



**46088**  
STD  
Severe Duty  
Dodge (15-09)  
Chrysler: 55056840AC, 55057087AA,  
55057152AA, 55057153AA



**46092**  
REV  
Severe Duty  
Chevy (12-09); GMC (12-09)  
General Motors Corp: 25844696



**46101**  
STD  
Standard Duty  
Audi (05-01)  
Audi: 4Z7121350  
Volkswagen: 4Z7121350

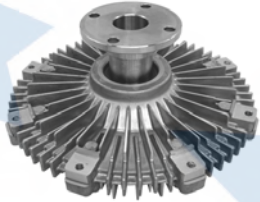

**46085**  
STD  
Heavy Duty  
Mitsubishi (06-01)  
Mitsubishi: MD356867, MN176301

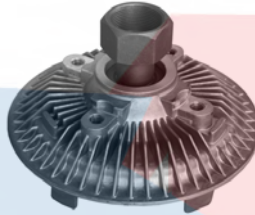

**46089**  
REV  
Heavy Duty  
Jeep (11)

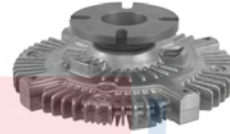

**46093**  
STD  
Standard Duty  
Nissan (13-00)

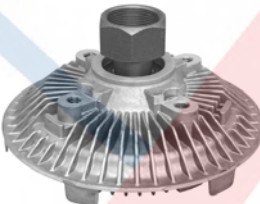

**46086**  
REV  
Heavy Duty  
Dodge (11-09); Jeep (12-08)  
Chrysler: 68088545AA

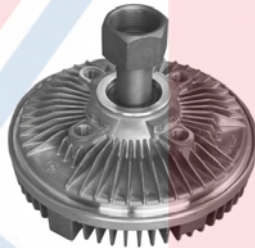

**46090**  
REV  
Severe Duty  
Chevy (15-11); GMC (15-11)  
General Motors Corp: 20989849

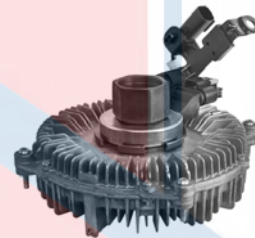

**46094**  
REV  
Severe Duty  
Ford (14-11)  
Ford: BC3Z8A616D



**46087**  
REV  
Heavy Duty  
Dodge (13-09)  
Chrysler: 55056860AC



**46091**  
REV  
Severe Duty  
Lexus (15-13), (11-08); Toyota (15-07)  
Lexus: 1621038071  
Toyota: 1621038071

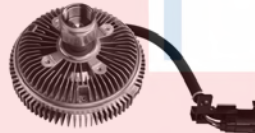

**46095**  
REV  
Severe Duty  
Ford (15-11)  
Ford: BC3Z8A616C

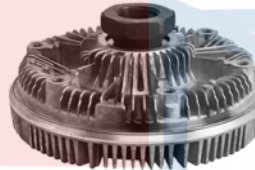

**46096**  
REV  
Severe Duty  
Ford Medium Duty (03-01), (97-93)  
Ford: 1C4Z8A616BA

## Fan Blades



**36882**  
CCW  
Fan Clutch Fan Blade  
Blades: 10  
Material: Plastic  
Ford (97-90)



**36890**  
CW  
Fan Clutch Fan Blade  
Blades: 7  
Material: Plastic  
Toyota (04-95)



**36891**  
CW  
Fan Clutch Fan Blade  
Blades: 7  
Material: Plastic  
Toyota (12-11)

# Fan Clutches

## Fan Blades Cont'd



**36892**

CW  
Fan Clutch Fan Blade  
Blades: 7  
Material: Plastic  
Toyota (95-93)



**36893**

CCW  
Fan Clutch Fan Blade  
Blades: 11  
Material: Plastic  
Chevy (06-96); GMC (06-96); Olds  
(01-96)  
General Motors Corp: 15976889



**76029**

CCW  
Fan Clutch Fan Blade  
Blades: 10  
Material: Plastic  
Buick (07-04); Chevy (09-02); GMC  
(09-02); GMC & CHEVY (07-03); Olds  
(04-02)  
OE style fan requires re-use of OE bolts  
General Motors Corp: 15229250



# Filter Drier, Accumulator and Desiccant

**Accumulator**



**33022**  
Accumulator  
Outlet Fitting: 3/4"  
Buick (99-98); Olds (99-98); Pontiac (99-98)  
General Motors Corp: 2724977

---



**33033**  
Accumulator  
Outlet Fitting: 3/4"  
Dodge (92-90); Eagle (92-88)

---



**33034**  
Accumulator  
Outlet Fitting: 5/8"  
Ford (04-96)  
Ford: 3R3Z19C836AB



**33044**  
Accumulator  
Outlet Fitting: 5/8"  
Ford (93-92); Mercury (92)

---



**33048**  
Accumulator  
Inlet Fitting: 5/8"  
Outlet Fitting: 5/8"  
Dallas Truck AC: 0675660  
Euclid: E804521  
Kysor: 1999014  
NaviStar: 19314  
Red Dot: 74R5660

---



**33049**  
Accumulator  
Outlet Fitting: 3/4"  
Ford HD (10-95); Sterling (10-00)  
Kysor: 1911013  
Red Dot: 74R5095, RD5115460



**33050**  
Accumulator  
Outside Dia.: 3.500  
Length: 12.000  
Inlet Fitting Type: Female Springlock  
Inlet Fitting: 5/8"  
Outlet Fitting Type: Barb Fitting  
Outlet Fitting: 3/4"  
O-Rings: (1) **24220**, (3) **24670**, (2) **24606**  
Ford (90-88); Mercury (87)

---



**33051**  
Accumulator  
Outlet Fitting: 3/4"  
Ford (93-92)  
Kysor: 1911006

---



**33052**  
Accumulator  
Outlet Fitting: 5/8"  
Ford (93-91); Mercury (93-91)



**33053**  
Accumulator  
Outlet Fitting: 5/8"  
Ford (93-91); Mazda (93-91)

---



**33054**  
Accumulator  
Outside Dia.: 3.500  
Length: 10.500  
Inlet Fitting Type: Male Springlock  
Inlet Fitting: 5/8"  
Outlet Fitting Type: Male Springlock  
Outlet Fitting: 5/8"  
O-Rings: (1) **24220**, (3) **24670**, (2) **24612**  
Ford (93-92)  
Euclid: E804522  
Kysor: 1911002  
Red Dot: 74R5065

# Filter Drier, Accumulator and Desiccant

## Accumulator Cont'd

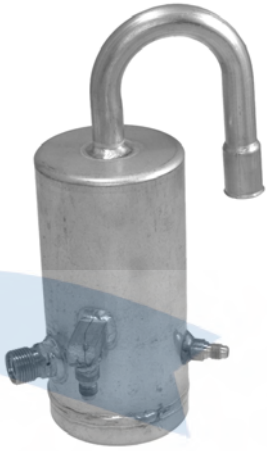

**33055**  
Accumulator  
Outlet Fitting: 5/8"  
Ford (93-92); Lincoln (92-91); Mercury (93-92)



**33056**  
Accumulator  
Outlet Fitting: 5/8"  
Lincoln (93)



**33057**  
Accumulator  
Outlet Fitting: 5/8"  
Ford (95-94)



**33058**  
Accumulator  
Outlet Fitting: 3/4"  
Ford (97-95); Mazda (97-95); Mercury (97)  
Ford: F5TZ19C836A



**33059**  
Accumulator  
Outlet Fitting: 5/8"  
Ford (97-94); Mercury (97-94)



**33060**  
Accumulator  
Outlet Fitting: 3/4"  
Ford (95-94); Mercury (95-94)



**33061**  
Accumulator  
Outlet Fitting: 3/4"  
Ford (97-94)



**33062**  
Accumulator  
Outlet Fitting: 3/4"



**33064**  
Accumulator  
Outlet Fitting: 5/8"  
Ford (97-94)



**33065**  
Accumulator  
Outlet Fitting: 5/8"  
Ford (93)



**33066**  
Accumulator  
Outlet Fitting: 5/8"  
Ford (94); Mazda (94)

# Filter Drier, Accumulator and Desiccant

## Accumulator Cont'd



**33067**  
Accumulator  
Outlet Fitting: 5/8"  
Ford (94); Mazda (94)



**33068**  
Accumulator  
Outlet Fitting: 5/8"  
Dallas Truck AC: 0675670  
Kysor: 1999004  
Red Dot: 74R5670



**33069**  
Accumulator  
Outlet Fitting: 5/8"  
Ford (96-94); Mercury (96-94)



**33070**  
Accumulator  
Outlet Fitting: 5/8"  
Ford (92-89)



**33071**  
Accumulator  
Outlet Fitting: 3/4"  
Ford (97-96); Lincoln (98-93); Mercury (97-96)



**33072**  
Accumulator  
Outlet Fitting: 5/8"  
Ford (97-94)



**33073**  
Accumulator  
Outlet Fitting: 5/8"  
Ford (93-91); Mercury (93-91)



**33089**  
Accumulator  
Outlet Fitting: 3/4"  
Lincoln (02-95)



**33090**  
Accumulator  
Outlet Fitting: 5/8"  
Ford (94); Mercury (94)



**33091**  
Accumulator  
Outlet Fitting: 3/4"  
Ford (97-94)  
Kysor: 1911005  
NaviStar: 19453



**33092**  
Accumulator  
Outlet Fitting: 5/8"  
Ford (00-95); Mercury (02-95)  
Ford: F5RZ19C836DA



# Filter Drier, Accumulator and Desiccant

## Accumulator Cont'd



**33093**  
Accumulator  
Outlet Fitting: 3/4"  
Ford (97-94); Lincoln (97-94); Mercury (97-94)  
General Motors Corp: 19188499



**33099**  
Accumulator  
Outlet Fitting: 3/4"  
Ford (96-94)  
Kysor: 1911001  
Red Dot: 74R5067



**33104**  
Accumulator  
Buick (97-94); Olds (98-94); Pontiac (97-94)  
General Motors Corp: 2724900



**33106**  
Accumulator  
Chevy (95-94); Olds (95-94); Pontiac (95-94)  
General Motors Corp: 88968514, 88968515



**33094**  
Accumulator  
Outlet Fitting: 5/8"  
Ford (02-94); Mercury (99-94)

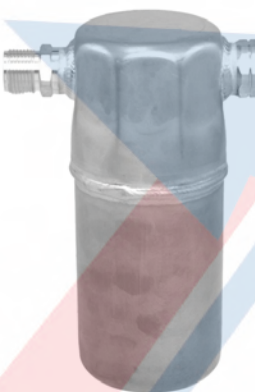

**33102**  
Accumulator  
Chevy (96-94)  
General Motors Corp: 19188505



**33105**  
Accumulator  
Chevy (95-94); Olds (94); Pontiac (95-94)  
General Motors Corp: 88968518

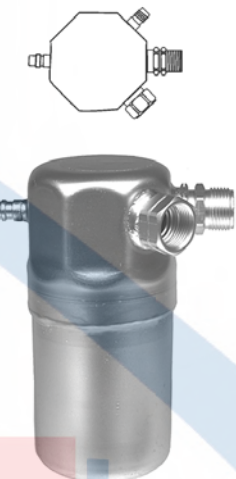

**33107**  
Accumulator  
Buick (96-94); Cadillac (96-85); Chevy (96-94)





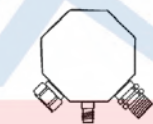

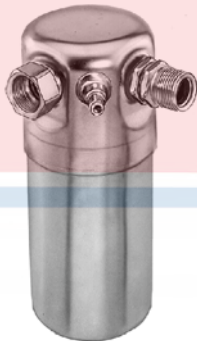

**33098**  
Accumulator  
Outlet Fitting: 5/8"  
Dodge (97-94)  
Chrysler: 55036734AB

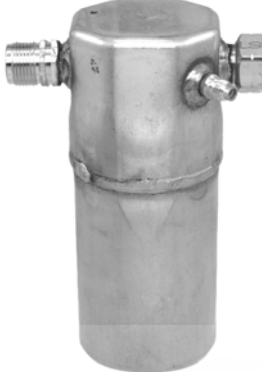

**33103**  
Accumulator  
Buick (95-94)  
General Motors Corp: 2724828

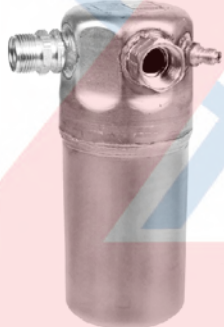

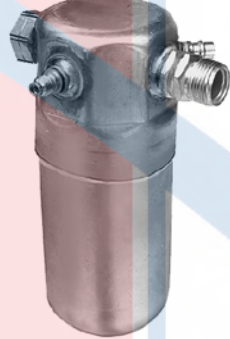
# Filter Drier, Accumulator and Desiccant

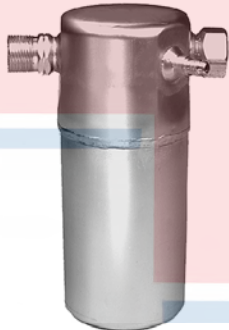
Accumulator Cont'd			
 <p><b>33109</b> Accumulator Outlet Fitting: 5/8" Volvo (04-93) Volvo: 9187629</p>	 <p><b>33111</b> Accumulator Volvo (94-93) Volvo: 6847510</p>	 <p><b>33118</b> Accumulator Chevy (98-82); GMC (98-93) General Motors Corp: 2724886 Kysor: 1910009</p>	 <p><b>33122</b> Accumulator Outlet Fitting: 3/4" Chevy (93-92); GMC (93-92) Swivel Top/Universal Accumulator also available Part No. <b>33705</b> - Tube kit not required.</p>
 <p><b>33110</b> Accumulator Volvo (98-93) Volvo: 6847508, 6847510</p>	 <p><b>33112</b> Accumulator Volvo (93) Volvo: 9131972</p>	 <p><b>33119</b> Accumulator Chevy (96-93); GMC (96-93) Kysor: 1910010</p>	 <p><b>33124</b> Accumulator Outlet Fitting: 3/4" Buick (93-91); Cadillac (93-91); Olds (92-91)</p>
 <p><b>33115</b> Accumulator Outlet Fitting: 3/4" Cadillac (85); Chevy (93-88)</p>			

# Filter Drier, Accumulator and Desiccant

## Accumulator Cont'd



**33125**  
Accumulator  
Outlet Fitting: 3/4"  
Chevy (92); Olds (92); Pontiac (92)  
General Motors Corp: 2724688

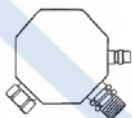

**33126**  
Accumulator  
Chevy (94); Pontiac (94)  
General Motors Corp: 2724906



**33129**  
Accumulator  
Outlet Fitting: 3/4"  
Buick (93-92); Cadillac (93-91); Olds (93-92); Pontiac (93-92)

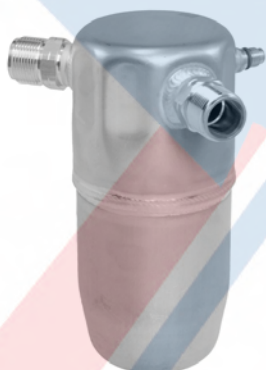

**33130**  
Accumulator  
Outlet Fitting: 3/4"  
Buick (91); Olds (91); Pontiac (93-92)

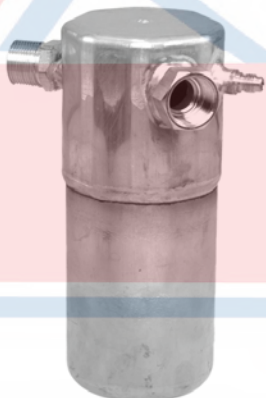

**33131**  
Accumulator  
Outlet Fitting: 3/4"  
Chevy (93), (90); GMC (90); Olds (93); Pontiac (93)  
General Motors Corp: 2724706

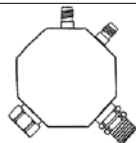

**33132**  
Accumulator  
Outlet Fitting: 3/4"  
Cadillac (93); Chevy (93-92); Olds (92)  
Swivel Top/Universal Accumulator also available Part No. **33705** - Tube kit not required.



**33133**  
Accumulator  
Outlet Fitting: 3/4"  
Chevy (90-89); GMC (90-89)  
Swivel Top/Universal Accumulator also available Part No. **33705** - Tube kit not required.  
Euclid: E804512  
Kysor: 1910004, 1910005  
NaviStar: 19408

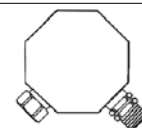

**33134**  
Accumulator  
Buick (97-94); Chevy (97-94); Olds (97-94); Pontiac (96-94)  
General Motors Corp: 2724929

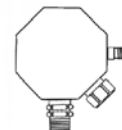

**33135**  
Accumulator  
Chevy HD (96-94); GMC HD (96-94)  
Kysor: 1910023  
NaviStar: 712001



# Filter Drier, Accumulator and Desiccant

## Accumulator Cont'd



**33136**  
Accumulator  
Chevy (97-94); GMC (97-94); Isuzu (97-96)  
Kysor: 1910013



**33137**  
Accumulator  
Chevy (94); GMC (94)



**33138**  
Accumulator  
Chevy (94); GMC (94)



**33139**  
Accumulator  
Buick (99-95); Olds (99-95)  
General Motors Corp: 2724878



**33140**  
Accumulator  
Chevy (05-94); GMC (05-94); Isuzu (00-97); Olds (01-96)  
General Motors Corp: 89038598  
Euclid: E804514  
Kysor: 1910012

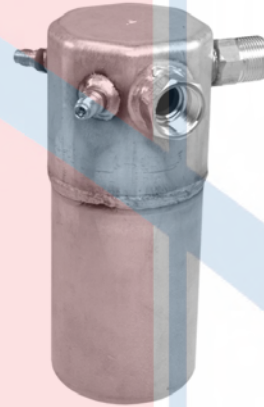

**33141**  
Accumulator  
Outlet Fitting: 3/4"  
Volvo (92-91)

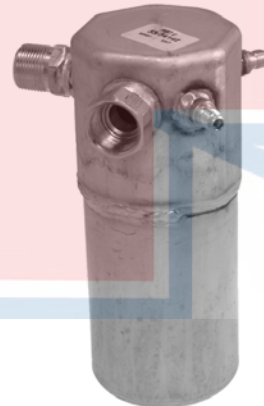

**33142**  
Accumulator  
Outlet Fitting: 3/4"  
Volvo (90-88)



**33143**  
Accumulator  
Outlet Fitting: 3/4"  
Buick (93-91); Cadillac (93); Chevy (91)  
Swivel Top/Universal Accumulator also available Part No. **33705** - Tube kit not required.  
General Motors Corp: 2724897



**33145**  
Accumulator  
Outlet Fitting: 3/4"  
Audi (93-92); Buick (92-91); Olds (92-91)  
Swivel Top/Universal Accumulator also available Part No. **33705** - Tube kit not required.

# Filter Drier, Accumulator and Desiccant

## Accumulator Cont'd



**33147**  
Accumulator  
Outlet Fitting: 3/4"  
Cadillac (90-89)

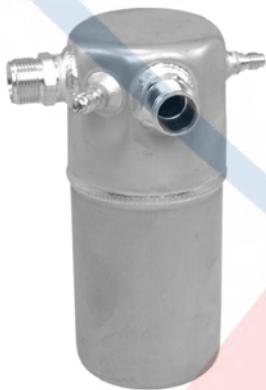

**33148**  
Accumulator  
Outlet Fitting: 3/4"  
Cadillac (92-91)

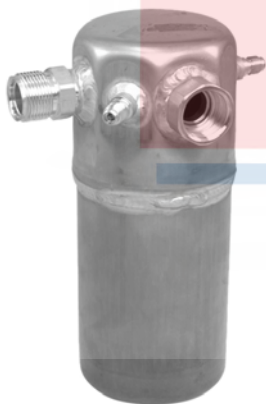

**33149**  
Accumulator  
Inlet Fitting: 3/4"  
Outlet Fitting: 3/4"  
Cadillac (90-87)

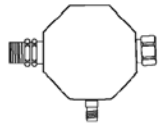

**33150**  
Accumulator  
Outside Dia.: 3.500  
Length: 9.000  
Inlet Fitting Type: Female O-Ring  
Inlet Fitting: 3/4"  
Outlet Fitting Type: Male Insert O-Ring  
Outlet Fitting: 3/4"  
O-Rings: (2) **24650**, (2) **24612**  
Audi (93-91), (89-88); Chevy (93-91);  
GMC (93-91)  
Audi: 8A0820191B  
General Motors Corp: 19188514  
Volkswagen: 8A0820191B  
Euclid: E804504  
Kysor: 1910003

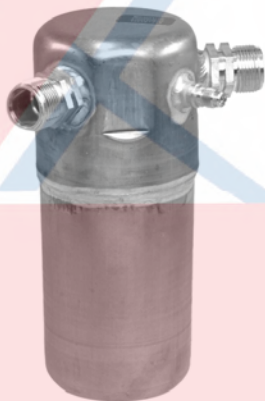

**33151**  
Accumulator  
Outside Dia.: 3.500  
Length: 9.000  
Inlet Fitting Type: Dual O-Ring  
Inlet Fitting: 3/4"  
Outlet Fitting Type: Dual O-Ring  
Outlet Fitting: 3/4"  
O-Rings: (1) **24222**, (3) **24672**, (2) **24650**  
Buick (90); Cadillac (92-90); Olds (90)

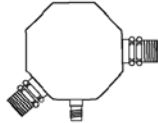

**33152**  
Accumulator  
Outside Dia.: 3.500  
Length: 9.000  
Inlet Fitting Type: Dual O-Ring  
Inlet Fitting: 3/4"  
Outlet Fitting Type: Dual O-Ring  
Outlet Fitting: 3/4"  
O-Rings: (1) **24222**, (3) **24672**, (2) **24650**  
General Motors Corp: 2724875

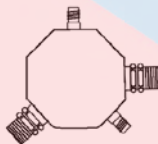

**33153**  
Accumulator  
Outside Dia.: 3.500  
Length: 9.000  
Inlet Fitting Type: Dual O-Ring  
Inlet Fitting: 3/4"  
Outlet Fitting Type: Dual O-Ring  
Outlet Fitting: 3/4"  
O-Rings: (1) **24222**, (3) **24672**, (2) **24650**  
Buick (91-89); Olds (91-89); Pontiac (91-89)



**33155**  
Accumulator  
Outside Dia.: 3.500  
Length: 12.000  
Inlet Fitting Type: Male Springlock  
Inlet Fitting: 5/8"  
Outlet Fitting Type: Female Springlock  
Outlet Fitting: 5/8"  
O-Rings: (1) **24220**, (3) **24670**, (2) **24650**  
Ford (94-88); Mercury (94-88)

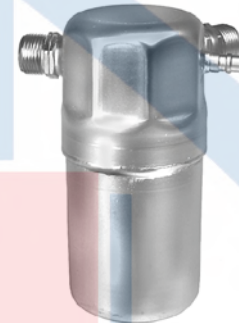
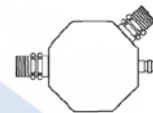

**33156**  
Accumulator  
Outside Dia.: 3.500  
Length: 8.000  
Inlet Fitting Type: Dual O-Ring  
Outlet Fitting Type: Dual O-Ring  
O-Rings: (4) **24082**  
Cadillac (02-93)  
General Motors Corp: 2724914

# Filter Drier, Accumulator and Desiccant

## Accumulator Cont'd



### 33160

Accumulator  
 Outside Dia.: 3.500  
 Length: 9.000  
 Inlet Fitting Type: Female Springlock  
 Inlet Fitting: 5/8"  
 Outlet Fitting Type: Male Springlock  
 Outlet Fitting: 5/8"  
 O-Rings: (1) **24220**, (3) **24670**, (2) **24650**  
 Ford (93-89); Mercury (90-89)



### 33162

Accumulator  
 Outside Dia.: 3.500  
 Length: 12.000  
 Inlet Fitting Type: Barb Fitting  
 Inlet Fitting: 5/8"  
 Outlet Fitting Type: Male Springlock  
 Outlet Fitting: 3/4"  
 O-Rings: (1) **24222**, (3) **24672**, (2) **24650**  
 Ford (93-86); Lincoln (93-88); Mercury (93-86)



### 33164

Accumulator  
 Outside Dia.: 3.500  
 Length: 12.000  
 Inlet Fitting Type: Male Springlock  
 Inlet Fitting: 3/4"  
 Outlet Fitting Type: Male Springlock  
 Outlet Fitting: 5/8"  
 O-Rings: (1) **24222**, (3) **24672**, (1) **24220**, (3) **24670**, (2) **24650**  
 Ford (91-88)  
 Euclid: E804520  
 Kysor: 1911003  
 Northern: 804804

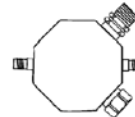

### 33166

Accumulator  
 Outside Dia.: 3.500  
 Length: 9.000  
 Inlet Fitting Type: Female O-Ring  
 Inlet Fitting: 3/4"  
 Outlet Fitting Type: Male Insert O-Ring  
 Outlet Fitting: 3/4"  
 O-Rings: (2) **24650**, (2) **24612**  
 Buick (90-89); Chevy (90-87); GMC (89-87); Olds (90-89); Pontiac (90-89)  
 Swivel Top/Universal Accumulator also available Part No. **33705** - Tube kit not required.

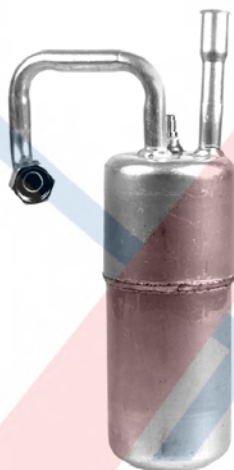

### 33161

Accumulator  
 Outside Dia.: 3.500  
 Length: 12.000  
 Inlet Fitting Type: Male Insert O-Ring  
 Inlet Fitting: 5/8"  
 Outlet Fitting Type: Female Springlock  
 Outlet Fitting: 5/8"  
 O-Rings: (1) **24610**, (1) **24220**, (3) **24670**, (2) **24650**  
 Ford (87-86); Mercury (87-86)



### 33163

Accumulator  
 Outside Dia.: 3.500  
 Length: 12.000  
 Inlet Fitting Type: Female O-Ring  
 Inlet Fitting: 5/8"  
 Outlet Fitting Type: Barb Fitting  
 Outlet Fitting: 3/4"  
 O-Rings: (2) **24610**, (2) **24650**  
 Ford (88-84); Mercury (87-84)



### 33165

Accumulator  
 Outside Dia.: 3.500  
 Length: 9.000  
 Inlet Fitting Type: Male Insert O-Ring  
 Inlet Fitting: 5/8"  
 Outlet Fitting Type: Barb Fitting  
 Outlet Fitting: 3/4"  
 O-Rings: (2) **24610**, (2) **24650**  
 Ford (89-86); Mercury (87-86)



### 33167

Accumulator  
 Outside Dia.: 3.500  
 Length: 7.000  
 Inlet Fitting Type: Male Insert O-Ring  
 Inlet Fitting: 5/8"  
 Outlet Fitting Type: Male Insert O-Ring  
 Outlet Fitting: 5/8"  
 O-Rings: (2) **24610**, (2) **24650**  
 Ford (83)



# Filter Drier, Accumulator and Desiccant

## Accumulator Cont'd



**33168**  
Accumulator  
Outside Dia.: 3.500  
Length: 10.000  
Inlet Fitting Type: Male Insert O-Ring  
Inlet Fitting: 3/4"  
Outlet Fitting Type: Male Springlock  
Outlet Fitting: 5/8"  
O-Rings: (1) **24222**, (3) **24672**, (2) **24650**  
Ford (91-86); Lincoln (90-86); Mercury (91-85)



**33169**  
Accumulator  
Outside Dia.: 3.500  
Length: 8.000  
Inlet Fitting Type: Female O-Ring  
Inlet Fitting: 3/4"  
Outlet Fitting Type: Male Insert O-Ring  
Outlet Fitting: 3/4"  
O-Rings: (2) **24650**, (2) **24612**  
Audi (91-90); Chevy (88); GMC (88); Pontiac (90-87)  
Swivel Top/Universal Accumulator also available Part No. **33705** - Tube kit not required.  
General Motors Corp: 19188524  
Euclid: E804506  
Kysor: 1910006



**33170**  
Accumulator  
Outside Dia.: 3.500  
Length: 12.000  
Inlet Fitting Type: Female O-Ring  
Inlet Fitting: 3/4"  
Outlet Fitting Type: Male Insert O-Ring  
Outlet Fitting: 3/4"  
O-Rings: (2) **24650**, (2) **24612**  
Chevy (84-80); GMC (84-80); Pontiac (75)  
General Motors Corp: 2724246



**33171**  
Accumulator  
Outside Dia.: 3.500  
Length: 8.000  
Inlet Fitting Type: Female O-Ring  
Inlet Fitting: 3/4"  
Outlet Fitting Type: Male Insert O-Ring  
Outlet Fitting: 3/4"  
O-Rings: (2) **24612**  
Buick (93-87); Chevy (93-90); Olds (93-88); Pontiac (93-87)  
Swivel Top/Universal Accumulator also available Part No. **33705** - Tube kit not required.



**33172**  
Accumulator  
Outside Dia.: 3.500  
Length: 9.000  
Inlet Fitting Type: Female O-Ring  
Inlet Fitting: 3/4"  
Outlet Fitting Type: Male Insert O-Ring  
Outlet Fitting: 3/4"  
O-Rings: (2) **24650**, (2) **24612**  
Buick (88-87); Olds (88-87)



**33173**  
Accumulator  
Outside Dia.: 3.500  
Length: 9.000  
Inlet Fitting Type: Female O-Ring  
Inlet Fitting: 3/4"  
Outlet Fitting Type: Male Insert O-Ring  
Outlet Fitting: 3/4"  
O-Rings: (2) **24650**, (2) **24612**  
Buick (89); Chevy (91-87); Olds (88-87)  
Swivel Top/Universal Accumulator also available Part No. **33705** - Tube kit not required.



**33174**  
Accumulator  
Outside Dia.: 3.500  
Length: 9.000  
Inlet Fitting Type: Male Springlock  
Inlet Fitting: 3/4"  
Outlet Fitting Type: Female Springlock  
Outlet Fitting: 5/8"  
O-Rings: (1) **24222**, (3) **24672**, (1) **24220**, (3) **24670**, (2) **24650**  
Ford (93-86)



**33175**  
Accumulator  
Outside Dia.: 3.500  
Length: 9.000  
Inlet Fitting Type: Male Springlock  
Inlet Fitting: 3/4"  
Outlet Fitting Type: Female Springlock  
Outlet Fitting: 3/4"  
O-Rings: (1) **24222**, (3) **24672**, (2) **24650**  
Ford (93-86)

# Filter Drier, Accumulator and Desiccant

## Accumulator Cont'd



**33177**  
Accumulator  
Outside Dia.: 3.500  
Length: 9.000  
Inlet Fitting Type: Female O-Ring  
Inlet Fitting: 3/4"  
Outlet Fitting Type: Male Insert O-Ring  
Outlet Fitting: 3/4"  
O-Rings: (2) **24650**, (2) **24612**  
Buick (88-86); Chevy (87-84); Olds (88-86); Pontiac (88-87)  
Swivel Top/Universal Accumulator also available Part No. **33705** - Tube kit not required.

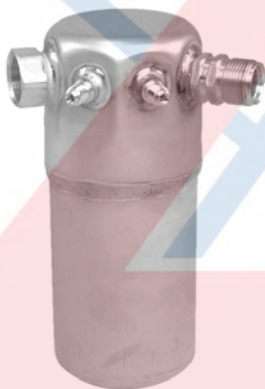

**33178**  
Accumulator  
Outside Dia.: 3.500  
Length: 9.000  
Inlet Fitting Type: Female O-Ring  
Inlet Fitting: 3/4"  
Outlet Fitting Type: Male Insert O-Ring  
Outlet Fitting: 3/4"  
O-Rings: (2) **24650**, (2) **24612**  
Audi (93-90); Buick (90-82); Cadillac (89-82); Chevy (90-82); Olds (90-82); Pontiac (91-82)  
Swivel Top/Universal Accumulator also available Part No. **33705** - Tube kit not required.  
General Motors Corp: 19188527



**33179**  
Accumulator  
Outside Dia.: 3.500  
Length: 9.000  
Inlet Fitting Type: Female O-Ring  
Inlet Fitting: 3/4"  
Outlet Fitting Type: Male Insert O-Ring  
Outlet Fitting: 3/4"  
O-Rings: (2) **24650**, (2) **24612**  
Euclid: E804511  
Kysor: 1910020

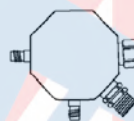

**33180**  
Accumulator  
Outside Dia.: 3.500  
Length: 9.000  
Inlet Fitting Type: Female O-Ring  
Inlet Fitting: 3/4"  
Outlet Fitting Type: Male Insert O-Ring  
Outlet Fitting: 3/4"  
O-Rings: (2) **24650**, (2) **24612**  
Kysor: 1910024  
NaviStar: 15376



**33181**  
Accumulator  
Outside Dia.: 3.500  
Length: 9.000  
Inlet Fitting Type: Female O-Ring  
Inlet Fitting: 3/4"  
Outlet Fitting Type: Male Insert O-Ring  
Outlet Fitting: 3/4"  
O-Rings: (2) **24650**, (2) **24612**  
Pontiac (88-85)  
Swivel Top/Universal Accumulator also available Part No. **33705** - Tube kit not required.

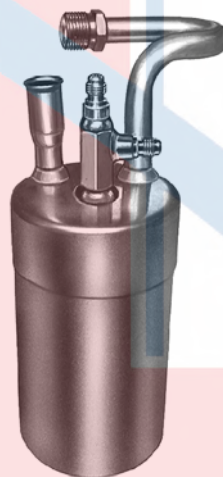

**33182**  
Accumulator  
Outside Dia.: 3.500  
Length: 10.000  
Inlet Fitting Type: Female Springlock  
Inlet Fitting: 5/8"  
Outlet Fitting Type: Male Insert O-Ring  
Outlet Fitting: 5/8"  
O-Rings: (1) **24220**, (3) **24670**, (2) **24610**, (2) **24650**  
Ford (93-83); Mazda (91)

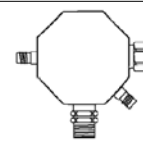

**33183**  
Accumulator  
Outside Dia.: 3.500  
Length: 9.000  
Inlet Fitting Type: Female O-Ring  
Inlet Fitting: 3/4"  
Outlet Fitting Type: Male Insert O-Ring  
Outlet Fitting: 3/4"  
O-Rings: (2) **24650**, (2) **24612**  
Buick (87-84); Chevy (91-85); GMC (91-85)  
Swivel Top/Universal Accumulator also available Part No. **33705** - Tube kit not required.  
Dallas Truck AC: 0675020  
Euclid: E804509, E804515  
Kysor: 1910007

# Filter Drier, Accumulator and Desiccant

## Accumulator Cont'd

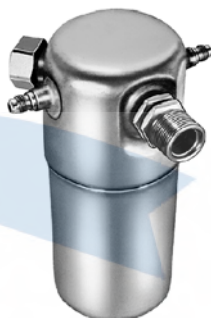
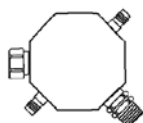

**33184**  
Accumulator  
Outside Dia.: 3.500  
Length: 9.000  
Inlet Fitting Type: Female O-Ring  
Inlet Fitting: 3/4"  
Outlet Fitting Type: Male Insert O-Ring  
Outlet Fitting: 3/4"  
O-Rings: (2) **24650**, (2) **24612**  
Chevy (93-82); GMC (93-83)  
Swivel Top/Universal Accumulator also available Part No. **33705** - Tube kit not required.  
Euclid: E804507  
Kysor: 1910015

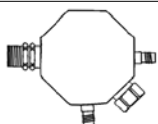

**33185**  
Accumulator  
Outside Dia.: 3.500  
Length: 9.000  
Inlet Fitting Type: Female O-Ring  
Inlet Fitting: 3/4"  
Outlet Fitting Type: Male Insert O-Ring  
Outlet Fitting: 3/4"  
O-Rings: (2) **24650**, (2) **24612**  
Buick (87-85); Chevy (92-91), (88-85); GMC (87-85); Olds (92), (88-85); Pontiac (93-85)  
Swivel Top/Universal Accumulator also available Part No. **33705** - Tube kit not required.



**33186**  
Accumulator  
Outside Dia.: 3.500  
Length: 9.000  
Inlet Fitting Type: Female O-Ring  
Inlet Fitting: 3/4"  
Outlet Fitting Type: Male Insert O-Ring  
Outlet Fitting: 3/4"  
O-Rings: (2) **24650**, (2) **24612**  
Buick (91-85); Cadillac (88-85); Chevy (94-84); Olds (91-85); Pontiac (94-85)

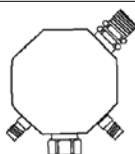

**33187**  
Accumulator  
Outside Dia.: 3.500  
Length: 9.000  
Inlet Fitting Type: Female O-Ring  
Inlet Fitting: 3/4"  
Outlet Fitting Type: Male Insert O-Ring  
Outlet Fitting: 3/4"  
O-Rings: (2) **24650**, (2) **24612**  
Buick (90-84); Chevy (90-84); Olds (85-84); Pontiac (89-84)  
General Motors Corp: 2724807



**33188**  
Accumulator  
Outside Dia.: 3.500  
Length: 10.000  
Inlet Fitting Type: Male Insert O-Ring  
Inlet Fitting: 3/4"  
Outlet Fitting Type: Male Insert O-Ring  
Outlet Fitting: 5/8"  
O-Rings: (2) **24610**, (2) **24650**, (2) **24612**  
Ford (82)  
Euclid: E804518  
NaviStar: 15403



**33189**  
Accumulator  
Outside Dia.: 3.500  
Length: 9.500  
Inlet Fitting Type: Male Insert O-Ring  
Inlet Fitting: 5/8"  
Outlet Fitting Type: Male Insert O-Ring  
Outlet Fitting: 3/4"  
O-Rings: (2) **24650**, (1) **24606**, (1) **24610**, (1) **24612**  
Ford (93-83)  
Dallas Truck AC: 0675002  
Euclid: E804519  
NaviStar: 15648  
Red Dot: 74R5063

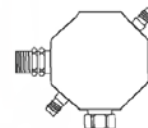

**33190**  
Accumulator  
Outside Dia.: 3.500  
Length: 9.000  
Inlet Fitting Type: Female O-Ring  
Inlet Fitting: 3/4"  
Outlet Fitting Type: Male Insert O-Ring  
Outlet Fitting: 3/4"  
O-Rings: (2) **24650**, (2) **24612**  
Buick (84); Chevy (84); GMC (84); Olds (84); Pontiac (84)



# Filter Drier, Accumulator and Desiccant

## Accumulator Cont'd



**33191**  
Accumulator  
Outside Dia.: 3.500  
Length: 9.000  
Inlet Fitting Type: Female O-Ring  
Inlet Fitting: 3/4"  
Outlet Fitting Type: Male Insert O-Ring  
Outlet Fitting: 3/4"  
O-Rings: (2) **24650**, (2) **24612**  
Buick (87); Olds (87); Pontiac (87)

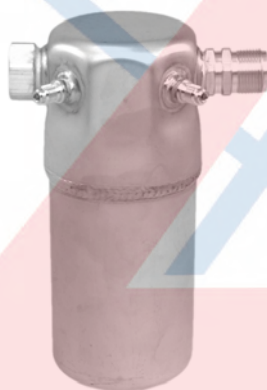

**33192**  
Accumulator  
Outside Dia.: 3.500  
Length: 9.000  
Inlet Fitting Type: Female O-Ring  
Inlet Fitting: 3/4"  
Outlet Fitting Type: Male Insert O-Ring  
Outlet Fitting: 3/4"  
O-Rings: (2) **24650**, (2) **24612**  
Audi (88-84); Chevy (92-85); GMC (92-85); Pontiac (84)  
Swivel Top/Universal Accumulator also available Part No. **33705** - Tube kit not required.  
General Motors Corp: 19188533  
Euclid: E804508, E804510  
Kysor: 1910011, 1911011



**33193**  
Accumulator  
Outside Dia.: 3.500  
Length: 9.000  
Inlet Fitting Type: Male Insert O-Ring  
Inlet Fitting: 5/8"  
Outlet Fitting Type: Female Springlock  
Outlet Fitting: 5/8"  
O-Rings: (1) **24220**, (3) **24670**, (1) **24610**, (1) **24650**  
Ford (85-84); Mercury (85-84)



**33196**  
Accumulator  
Outside Dia.: 3.500  
Length: 10.500  
Inlet Fitting Type: Female O-Ring  
Inlet Fitting: 5/8"  
Outlet Fitting Type: Barb Fitting  
Outlet Fitting: 3/4"  
O-Rings: (1) **24650**, (1) **24610**  
Ford (93-82); Lincoln (85-82); Mercury (88-82)  
w/ Beadlock Fitting use **33062**

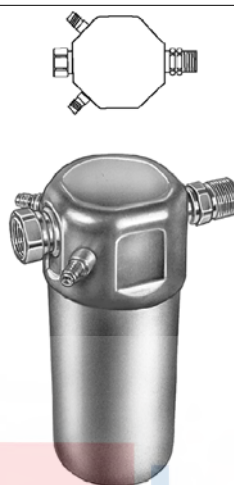

**33197**  
Accumulator  
Outside Dia.: 3.500  
Length: 9.000  
Inlet Fitting Type: Female O-Ring  
Inlet Fitting: 3/4"  
Outlet Fitting Type: Male Insert O-Ring  
Outlet Fitting: 3/4"  
O-Rings: (2) **24650**  
Audi (91-88); Buick (85-82); Cadillac (88-80); Chevy (83-82); Olds (85-82); Pontiac (84-82); Volvo (92-83)  
Swivel Top/Universal Accumulator also available Part No. **33705** - Tube kit not required.  
General Motors Corp: 19188537



**33198**  
Accumulator  
Outside Dia.: 3.500  
Length: 9.000  
Inlet Fitting Type: Female O-Ring  
Inlet Fitting: 3/4"  
Outlet Fitting Type: Male Insert O-Ring  
Outlet Fitting: 3/4"  
O-Rings: (2) **24650**, (2) **24612**  
Buick (85); Cadillac (85-84); Chevy (94-82); GMC (94-82); Olds (94-91); Pontiac (92-82)  
Swivel Top/Universal Accumulator also available Part No. **33705** - Tube kit not required.  
General Motors Corp: 19188538, 2724700  
Euclid: E804503



**33200**  
Accumulator  
Outside Dia.: 3.500  
Length: 10.000  
Inlet Fitting Type: Male Insert O-Ring  
Inlet Fitting: 3/4"  
Outlet Fitting Type: Male Insert O-Ring  
Outlet Fitting: 3/4"  
O-Rings: (2) **24650**, (2) **24612**  
Ford (81-80)  
Euclid: E804517  
Evans: AM82223  
Kysor: 1911012

# Filter Drier, Accumulator and Desiccant

## Accumulator Cont'd



**33201**  
Accumulator  
Outside Dia.: 3.500  
Length: 10.500  
Inlet Fitting Type: Male Insert O-Ring  
Inlet Fitting: 3/4"  
Outlet Fitting Type: Male Insert O-Ring  
Outlet Fitting: 3/4"  
O-Rings: (2) **24650**, (2) **24612**  
Lincoln (85-80); Mercury (85-80)



**33206**  
Accumulator  
Outside Dia.: 3.500  
Length: 9.000  
Inlet Fitting Type: Female O-Ring  
Inlet Fitting: 3/4"  
Outlet Fitting Type: Male Insert O-Ring  
Outlet Fitting: 3/4"  
O-Rings: (2) **24650**, (2) **24612**  
Buick (93-90); Olds (93-92)  
Swivel Top/Universal Accumulator also available Part No. **33705** - Tube kit not required.  
General Motors Corp: 2724686



**33208**  
Accumulator  
Outside Dia.: 3.500  
Length: 9.000  
Inlet Fitting Type: Female O-Ring  
Inlet Fitting: 3/4"  
Outlet Fitting Type: Male Insert O-Ring  
Outlet Fitting: 3/4"  
O-Rings: (2) **24650**, (2) **24612**  
Chevy (93); Olds (93); Pontiac (93)  
General Motors Corp: 2724707



**33214**  
Accumulator  
Outside Dia.: 3.500  
Length: 8.000  
Inlet Fitting Type: P-Nut Fitting  
Outlet Fitting Type: Male Insert O-Ring  
O-Rings: (2) **24612**  
Buick (05-97); Chevy (03-97); Olds (00-97); Pontiac (03-97)  
General Motors Corp: 1132766, 1132767

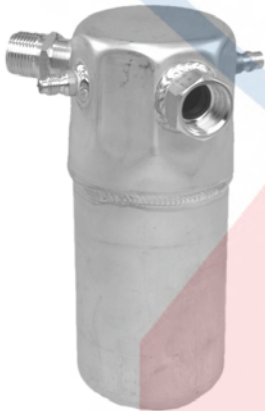

**33203**  
Accumulator  
Outside Dia.: 3.500  
Length: 9.000  
Inlet Fitting Type: Female O-Ring  
Outlet Fitting Type: Male Insert O-Ring  
O-Rings: (1) **24676**, (2) **24612**  
Chevy (95); GMC (95)



**33207**  
Accumulator  
Outside Dia.: 3.500  
Length: 9.000  
Inlet Fitting Type: Female O-Ring  
Inlet Fitting: 3/4"  
Outlet Fitting Type: Male Insert O-Ring  
Outlet Fitting: 3/4"  
O-Rings: (2) **24612**  
Chevy (93); Olds (93); Pontiac (93)



**33209**  
Accumulator  
Outside Dia.: 3.500  
Length: 8.000  
Inlet Fitting Type: Female O-Ring  
Outlet Fitting Type: Male Insert O-Ring  
O-Rings: (1) **24676**, (2) **24612**  
Chevy (95-94); GMC (95-94); GMC & CHEVY (99)  
General Motors Corp: 1132816, 2724818, 52479110  
Bergstrom: 525711  
Climatech: JC1100  
Euclid: E804513  
Kysor: 1910002, 1910008  
NaviStar: 12001



**33217**  
Accumulator  
Outside Dia.: 3.500  
Length: 9.000  
Inlet Fitting Type: Female O-Ring  
Outlet Fitting Type: Male Insert O-Ring  
O-Rings: (1) **24676**, (2) **24612**  
Chevy (96); Olds (96); Pontiac (96)  
General Motors Corp: 88968520, 88968521

# Filter Drier, Accumulator and Desiccant

## Accumulator Cont'd



### 33218

Accumulator  
 Outside Dia.: 3.500  
 Length: 8.000  
 Inlet Fitting Type: Female O-Ring  
 Outlet Fitting Type: Male Insert O-Ring  
 O-Rings: (1) **24676**, (2) **24612**  
 Chevy (05-96); GMC (05-96)  
 General Motors Corp: 89018433

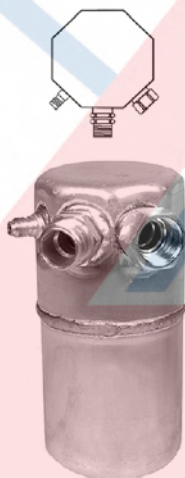

### 33219

Accumulator  
 Outside Dia.: 3.500  
 Length: 8.000  
 Inlet Fitting Type: Dual O-Ring  
 Outlet Fitting Type: Female O-Ring  
 O-Rings: (1) **24676**, (2) **24672**, (1) **24612**  
 Cadillac (00-99); Chevy (02-96); GMC (02-96)  
 General Motors Corp: 2724924, 2724962  
 Kysor: 1910001



### 33221

Accumulator  
 Outside Dia.: 3.500  
 Length: 9.000  
 Inlet Fitting Type: Female O-Ring  
 Inlet Fitting: 3/4"  
 Outlet Fitting Type: Female O-Ring  
 Outlet Fitting: 3/4"  
 O-Rings: (2) **24612**  
 Climatech: JC1080  
 Euclid: E804575  
 John Deere: F124088  
 Kysor: 1917003, 402882  
 Mack: 4379RD5109270  
 NaviStar: 19786  
 Peterbilt: 1803837

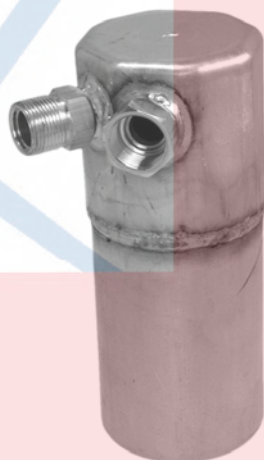

### 33316

Accumulator  
 Outside Dia.: 3.500  
 Length: 9.000  
 Inlet Fitting Type: Female O-Ring  
 Inlet Fitting: 3/4"  
 Outlet Fitting Type: Male Insert O-Ring  
 Outlet Fitting: 3/4"  
 O-Rings: (2) **24612**  
 Audi (93-92)  
 Audi: 4A0820191D  
 Volkswagen: 4A0820191D



### 33327

Accumulator  
 Outside Dia.: 3.500  
 Length: 9.000  
 Inlet Fitting Type: Female O-Ring  
 Inlet Fitting: 3/4"  
 Outlet Fitting Type: Male Insert O-Ring  
 Outlet Fitting: 3/4"  
 O-Rings: (2) **24612**  
 Audi (94-93)  
 Audi: 4A0820191AB  
 Volkswagen: 4A0820191AB

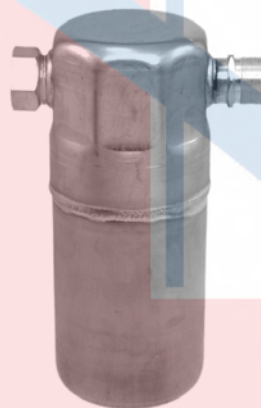

### 33328

Accumulator  
 Outside Dia.: 3.500  
 Length: 9.000  
 Inlet Fitting Type: Female O-Ring  
 Inlet Fitting: 3/4"  
 Outlet Fitting Type: Male Insert O-Ring  
 Outlet Fitting: 1-1/8"  
 O-Rings: (2) **24612**  
 Audi (01-93); VW (99-98)  
 Volkswagen: 8A0820193AB



### 33331

Accumulator  
 Outside Dia.: 3.500  
 Length: 9.000  
 Inlet Fitting Type: Female O-Ring  
 Inlet Fitting: 3/4"  
 Outlet Fitting Type: Male Insert O-Ring  
 Outlet Fitting: 1-1/8"  
 O-Rings: (2) **24622**  
 Audi (97-93)  
 Audi: 4A0820191AA  
 Volkswagen: 4A0820191AA



### 33352

Accumulator  
 Outside Dia.: 3.500  
 Length: 8.000  
 Inlet Fitting Type: P-Nut Fitting  
 Outlet Fitting Type: P-Nut Fitting  
 O-Rings: (2) **24612**  
 Kysor: 1917004  
 Peterbilt: 1804171, F316063, F376000C  
 Red Dot: 74R5060



# Filter Drier, Accumulator and Desiccant

## Accumulator Cont'd



**33511**  
Accumulator  
Outside Dia.: 3.500  
Length: 8.500  
Inlet Fitting Type: Male Springlock  
Inlet Fitting: 5/8"  
Outlet Fitting Type: Female Springlock  
Outlet Fitting: 5/8"  
O-Rings: (1) **24676**, (1) **24220**, (3) **24670**  
Dodge (99-97)  
Chrysler: 5183841AA, 55036545AB



**33512**  
Accumulator  
Outside Dia.: 3.500  
Length: 9.500  
Inlet Fitting Type: Male Springlock  
Inlet Fitting: 5/8"  
Outlet Fitting Type: Female O-Ring  
O-Rings: (1) **24676**, (1) **24220**, (3) **24670**  
Dodge (96-95)  
Chrysler: 55036715AB



**33513**  
Accumulator  
Outside Dia.: 3.500  
Length: 8.000  
Inlet Fitting Type: Male Springlock  
Inlet Fitting: 5/8"  
Outlet Fitting Type: Female O-Ring  
O-Rings: (1) **24676**, (1) **24220**, (3) **24670**  
Dodge (02-98)  
Chrysler: 68054876AA



**33568**  
Accumulator  
Outside Dia.: 3.500  
Length: 10.000  
Inlet Fitting Type: Male Springlock  
Inlet Fitting: 5/8"  
Outlet Fitting Type: Pad Mount  
O-Rings: (1) **24220**, (3) **24670**, (1) **24676**, (1) **24610**  
Jeep (01-97)  
Chrysler: 55036630  
Jeep: 55036630



**33570**  
Accumulator  
Outside Dia.: 3.500  
Length: 15.000  
Inlet Fitting Type: Male Springlock  
Inlet Fitting: 5/8"  
Outlet Fitting Type: Male Springlock  
Outlet Fitting: 5/8"  
O-Rings: (1) **24676**, (1) **24220**, (3) **24670**  
Jeep (98-97)  
Chrysler: 55036293  
Jeep: 55036293



**33626**  
Accumulator  
Outside Dia.: 3.500  
Length: 9.000  
Inlet Fitting Type: Male Springlock  
Inlet Fitting: 3/4"  
Outlet Fitting Type: Barb Fitting  
Outlet Fitting: 5/8"  
O-Rings: (1) **24676**, (1) **24222**, (3) **24672**  
Ford (95-94); Mercury (95-94)



**33635**  
Accumulator  
Outside Dia.: 3.500  
Length: 9.000  
Inlet Fitting Type: Male Springlock  
Inlet Fitting: 5/8"  
Outlet Fitting Type: Male Springlock  
Outlet Fitting: 5/8"  
O-Rings: (1) **24220**, (3) **24670**, (2) **24650**  
Hyundai (92), (89-86)  
Hyundai: 9780128000



**33636**  
Accumulator  
Outside Dia.: 3.500  
Length: 8.000  
Inlet Fitting Type: Male Insert O-Ring  
Inlet Fitting: 5/8"  
Outlet Fitting Type: Male Springlock  
Outlet Fitting: 5/8"  
O-Rings: (1) **24220**, (3) **24670**, (1) **24608**, (1) **24610**, (2) **24650**  
Hyundai (93-90)  
Hyundai: 9782033330



**33637**  
Accumulator  
Outside Dia.: 3.500  
Length: 8.000  
Inlet Fitting Type: Male Insert O-Ring  
Inlet Fitting: 5/8"  
Outlet Fitting Type: Male Insert O-Ring  
Outlet Fitting: 5/8"  
O-Rings: (2) **24610**, (2) **24650**  
Hyundai (91-89)  
Hyundai: 9782033002

# Filter Drier, Accumulator and Desiccant

## Accumulator Cont'd



### 33650

Accumulator  
 Outside Dia.: 3.500  
 Length: 9.000  
 Inlet Fitting Type: Male Springlock  
 Inlet Fitting: 5/8"  
 Outlet Fitting Type: Male Springlock  
 Outlet Fitting: 5/8"  
 O-Rings: (1) **24220**, (3) **24670**, (2) **24650**  
 Hyundai (93-90); Mitsubishi (94-90)  
 Hyundai: 9782024000  
 Mitsubishi: 9782024001

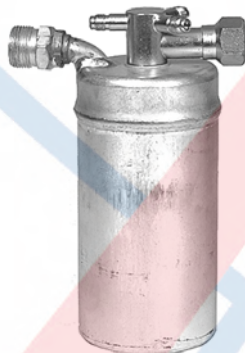

### 33705

Accumulator  
 Outside Dia.: 3.500  
 Length: 8.500  
 Inlet Fitting Type: Female O-Ring  
 Inlet Fitting: 3/4"  
 Outlet Fitting Type: Male Insert O-Ring  
 Outlet Fitting: 3/4"  
 O-Rings: (2) **24612**  
 Dallas Truck AC: 0650385



### 33735

Accumulator  
 Outside Dia.: 3.500  
 Length: 10.000  
 Inlet Fitting Type: Female O-Ring  
 Outlet Fitting Type: Female O-Ring  
 O-Rings: (2) **24612**  
 Caterpillar: 08932000, 1976218

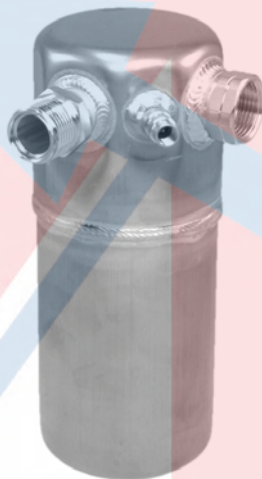

### 33750

Accumulator  
 Outside Dia.: 3.500  
 Length: 8.000  
 Inlet Fitting Type: Female O-Ring  
 Outlet Fitting Type: Male Insert O-Ring  
 Outlet Fitting: 3/4"  
 O-Rings: (2) **24612**  
 Chevy (96-95); Pontiac (96-95)



### 33752

Accumulator  
 Outside Dia.: 3.500  
 Length: 8.000  
 Inlet Fitting Type: P-Nut Fitting  
 Outlet Fitting Type: Male Insert O-Ring  
 O-Rings: (2) **24612**  
 Chevy (04-97)  
 General Motors Corp: 1132765



### 33754

Accumulator  
 Outside Dia.: 3.500  
 Length: 8.000  
 Inlet Fitting Type: P-Nut Fitting  
 Outlet Fitting Type: Dual O-Ring  
 Outlet Fitting: 1"  
 O-Rings: (1) **24682**, (2) **24612**  
 Chevy (01-97); Olds (01-98); Pontiac (01-99)  
 General Motors Corp: 1132770



### 33756

Accumulator  
 Outside Dia.: 3.500  
 Length: 8.000  
 Inlet Fitting Type: Female O-Ring  
 Outlet Fitting Type: Male Insert O-Ring  
 O-Rings: (1) **24676**, (2) **24612**  
 Chevy (03-98); GMC (03-98); Isuzu (00-99)  
 General Motors Corp: 89038599  
 Kysor: 1910026



### 33796

Accumulator  
 Outside Dia.: 3.625  
 Length: 7.000  
 Inlet Fitting Type: Female O-Ring  
 Inlet Fitting: 5/8"  
 Outlet Fitting Type: Beadlock  
 O-Rings: (1) **24610**, (1) **24650**  
 Ford (93-91), (89-85)

# Filter Drier, Accumulator and Desiccant

## Accumulator Cont'd



**33900**  
Accumulator  
Outside Dia.: 3.500  
Length: 6.500  
Inlet Fitting Type: Male Springlock  
Inlet Fitting: 5/8"  
Outlet Fitting Type: Barb Fitting  
Outlet Fitting: 5/8"  
O-Rings: (1) **24676**, (1) **24220**, (3) **24670**  
Ford (93-91); Mercury (93-91)



**33902**  
Accumulator  
Outside Dia.: 3.500  
Length: 8.000  
Inlet Fitting Type: Barb Fitting  
Inlet Fitting: 5/8"  
Outlet Fitting Type: Barb Fitting  
Outlet Fitting: 3/4"  
O-Rings: (1) **24676**  
Jeep (98-93)



**83010**  
Accumulator  
Outside Dia.: 3.500  
Length: 8.000  
Inlet Fitting Type: Female Springlock  
Inlet Fitting: 5/8"  
Outlet Fitting Type: Female O-Ring  
O-Rings: (1) **24676**, (1) **24220**, (3) **24670**  
Ford (03-98)



**83012**  
Accumulator  
Outside Dia.: 3.500  
Length: 9.000  
Inlet Fitting Type: Male Springlock  
Inlet Fitting: 3/4"  
Outlet Fitting Type: Male Springlock  
Outlet Fitting: 3/4"  
O-Rings: (1) **24676**, (1) **24220**, (3) **24670**, (1) **24222**, (3) **24672**  
Ford (98-95)



**33901**  
Accumulator  
Outside Dia.: 3.500  
Length: 8.000  
Inlet Fitting Type: Barb Fitting  
Inlet Fitting: 5/8"  
Outlet Fitting Type: Barb Fitting  
Outlet Fitting: 5/8"  
O-Rings: (1) **24676**  
Jeep (98-93)

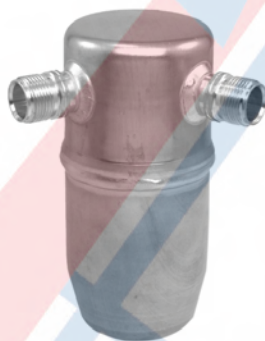

**83000**  
Accumulator  
Outside Dia.: 3.500  
Length: 8.000  
Inlet Fitting Type: Dual O-Ring  
Outlet Fitting Type: Dual O-Ring  
O-Rings: (1) **24222**, (3) **24672**  
Chevy (05-95); Pontiac (05-95)  
General Motors Corp: 1132850



**83011**  
Accumulator  
Outside Dia.: 3.500  
Length: 9.000  
Inlet Fitting Type: Male Springlock  
Inlet Fitting: 3/4"  
Outlet Fitting Type: Male Springlock  
Outlet Fitting: 3/4"  
O-Rings: (1) **24676**, (1) **24222**, (3) **24672**  
Ford (98-95)  
NaviStar: 12002



**83014**  
Accumulator  
Outside Dia.: 3.500  
Length: 9.500  
Inlet Fitting Type: Male Insert O-Ring  
Inlet Fitting: 5/8"  
Outlet Fitting Type: Female Springlock  
Outlet Fitting: 3/4"  
O-Rings: (1) **24222**, (3) **24672**, (1) **24610**, (1) **24650**, (1) **24676**  
Ford (11-98); Mazda (09-98); Mercury (01-98)  
Ford: XL2Z19C836AC  
Mazda: ZZS061500



# Filter Drier, Accumulator and Desiccant

## Accumulator Cont'd



**83017**  
Accumulator  
Outside Dia.: 3.500  
Length: 8.250  
Inlet Fitting Type: P-Nut Fitting  
Outlet Fitting Type: P-Nut Fitting  
O-Rings: (1) **24676**, (2) **24404**  
Chevy (06-05); GMC (06-05)  
General Motors Corp: 19130067



**83023**  
Accumulator  
Outside Dia.: 3.500  
Length: 9.000  
Inlet Fitting Type: Pad Mount  
Outlet Fitting Type: Pad Mount  
O-Rings: (2) **24642**  
Ford (03-99)  
Ford: XF2Z19C836AB



**83025**  
Accumulator  
Outside Dia.: 3.500  
Length: 7.500  
Inlet Fitting Type: Female Springlock  
Inlet Fitting: 5/8"  
Outlet Fitting Type: Male Springlock  
Outlet Fitting: 3/4"  
O-Rings: (1) **24222**, (3) **24672**, (1) **24220**, (3) **24670**, (1) **24676**  
Ford (00-95); Mercury (02-95)



**83026**  
Accumulator  
Outside Dia.: 3.500  
Length: 9.000  
Inlet Fitting Type: Female Springlock  
Inlet Fitting: 3/4"  
Outlet Fitting Type: Male Insert O-Ring  
Outlet Fitting: 5/8"  
O-Rings: (1) **24222**, (3) **24672**, (1) **24676**, (1) **24610**  
Ford (02-98); Lincoln (02-98); Mercury (02-98)  
Ford: F8AZ19C836AA



**83030**  
Accumulator  
Outside Dia.: 3.500  
Length: 7.000  
Inlet Fitting Type: Male Insert O-Ring  
Outlet Fitting Type: Female O-Ring  
O-Rings: (1) **24676**, (2) **24610**  
Mazda (02-98)  
Mazda: GD7A615A0

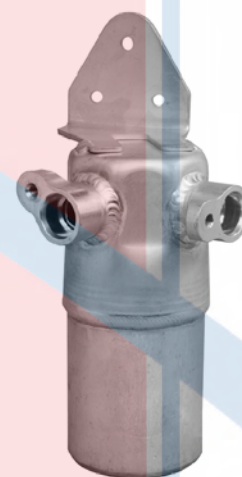

**83034**  
Accumulator  
Outside Dia.: 3.000  
Length: 7.000  
Inlet Fitting Type: P-Nut Fitting  
Outlet Fitting Type: P-Nut Fitting  
Audi (10-04)  
Audi: 4E0820189G



**83035**  
Accumulator  
Outside Dia.: 3.000  
Length: 7.000  
Inlet Fitting Type: P-Nut Fitting  
Outlet Fitting Type: P-Nut Fitting  
Audi (09), (07-05)  
Audi: 4E0820189M



**83038**  
Accumulator  
Hyundai (98-94)  
Hyundai: 9782034001

# Filter Drier, Accumulator and Desiccant

## Accumulator Cont'd



**83040**  
Accumulator  
Outside Dia.: 3.500  
Length: 8.000  
Inlet Fitting Type: P-Nut Fitting  
Outlet Fitting Type: Female Springlock  
O-Rings: (1) **24222**, (3) **24672**, (1) **24642**, (1) **24404**  
Ford (07-00)  
Ford: 6S4Z19C836A

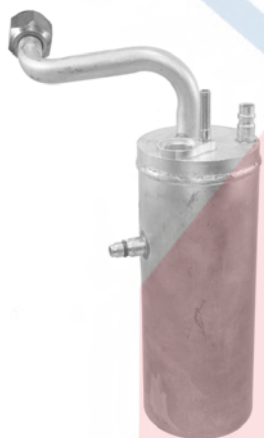

**83043**  
Accumulator  
Outside Dia.: 3.500  
Length: 9.000  
Inlet Fitting Type: P-Nut Fitting  
Outlet Fitting Type: Male Insert O-Ring  
O-Rings: (1) **24676**, (2) **24612**  
Ford (07-99)  
Ford: 6C3Z19C836B



**83044**  
Accumulator  
Outside Dia.: 3.000  
Length: 8.000  
Inlet Fitting Type: Female Springlock  
Inlet Fitting: 3/4"  
Outlet Fitting Type: Female Springlock  
Outlet Fitting: 3/4"  
O-Rings: (2) **24676**, (1) **24222**, (3) **24672**  
Ford (11-06); Lincoln (11-06); Mercury (11-06)  
Ford: 8W7Z19C836A

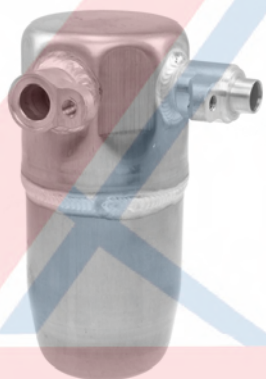

**83047**  
Accumulator  
Outside Dia.: 3.500  
Length: 8.000  
Inlet Fitting Type: P-Nut Fitting  
Outlet Fitting Type: P-Nut Fitting  
O-Rings: (2) **24404**  
Cadillac (04-98)  
General Motors Corp: 1132772



**83052**  
Accumulator  
Outside Dia.: 3.000  
Length: 8.000  
Inlet Fitting Type: Pad Mount  
Outlet Fitting Type: Pad Mount  
O-Rings: (2) **24612**  
VW (05-01)  
Audi: 3B0820193

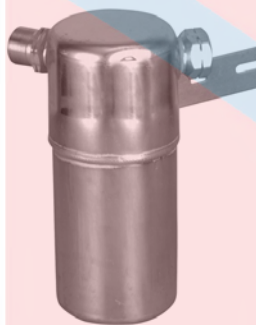

**83054**  
Accumulator  
Outside Dia.: 3.500  
Length: 8.000  
Inlet Fitting Type: Female O-Ring  
Outlet Fitting Type: Male Insert O-Ring  
O-Rings: (2) **24612**  
Audi (04-97)  
Audi: 4B0820193A, 4D0820193A



**83055**  
Accumulator  
O-Rings: (3) **24672**, (1) **24641**  
Ford (03-00)  
Ford: 6S4Z19C836A



**83058**  
Accumulator  
Outside Dia.: 3.500  
Length: 9.000  
Inlet Fitting Type: P-Nut Fitting  
Outlet Fitting Type: P-Nut Fitting  
O-Rings: (1) **24676**, (2) **24404**  
Cadillac (13-09); Chevy (13-08); GMC (13-08)  
General Motors Corp: 22949450

# Filter Drier, Accumulator and Desiccant

## Accumulator Cont'd



**83060**  
Accumulator  
Outside Dia.: 3.500  
Length: 8.000  
Inlet Fitting Type: Male Springlock  
Inlet Fitting: 5/8"  
Outlet Fitting Type: Male Springlock  
Outlet Fitting: 5/8"  
O-Rings: (2) **24676**, (1) **24220**, (3) **24670**  
Hyundai (93-92)  
Hyundai: 9782033370



**83071**  
Accumulator  
Outside Dia.: 3.500  
Length: 8.000  
Inlet Fitting Type: Male Insert O-Ring  
Inlet Fitting: 7/8"  
Outlet Fitting Type: P-Nut Fitting  
O-Rings: (1) **24608**, (1) **24610**  
Hyundai (94)  
Hyundai: 9782024800



**83094**  
Accumulator  
Hyundai (94)



**83095**  
Accumulator  
Outside Dia.: 3.500  
Length: 9.750  
Inlet Fitting Type: Pad Mount  
Outlet Fitting Type: Pad Mount  
O-Rings: (4) **23682**, (2) **24608**  
Ford (05-02); Mercury (05-02)  
Ford: 1L2Z19C836BA



**83096**  
Accumulator  
Outside Dia.: 3.500  
Length: 9.750  
Inlet Fitting Type: Pad Mount  
Outlet Fitting Type: Pad Mount  
O-Rings: (2) **24682**  
Ford (05-02); Mercury (05-02)  
Ford: 1L2Z19C836AA



**83097**  
Accumulator  
Outside Dia.: 3.500  
Length: 8.000  
Inlet Fitting Type: Female Springlock  
Inlet Fitting: 5/8"  
Outlet Fitting Type: Female Springlock  
Outlet Fitting: 3/4"  
O-Rings: (1) **24222**, (3) **24672**, (1) **24220**, (3) **24670**  
Ford (09-05)

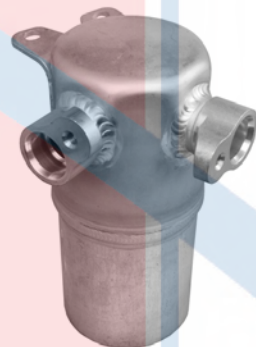

**83098**  
Accumulator  
Outside Dia.: 3.000  
Length: 7.000  
Inlet Fitting Type: P-Nut Fitting  
Outlet Fitting Type: P-Nut Fitting  
Audi (09-08)  
Audi: 4E0820189Q



**83099**  
Accumulator  
Outside Dia.: 3.000  
Length: 8.000  
Inlet Fitting Type: P-Nut Fitting  
Outlet Fitting Type: Female Springlock  
Outlet Fitting: 3/4"  
Ford (13-10)  
Ford: 9T1Z19C836A



**83106**  
Accumulator  
Outside Dia.: 3.563  
Length: 8.500  
Inlet Fitting Type: Pad Mount  
Outlet Fitting Type: Pad Mount  
O-Rings: (1) **24676**, (1) **24333**  
Dodge (02); Jeep (07-99)  
Jeep: 55037803AC



# Filter Drier, Accumulator and Desiccant

## Accumulator Cont'd



**83107**  
Accumulator  
Outside Dia.: 3.500  
Length: 7.500  
Inlet Fitting Type: Male Springlock  
Inlet Fitting: 5/8"  
Outlet Fitting Type: Male Springlock  
Outlet Fitting: 5/8"  
O-Rings: (1) **24220**, (3) **24670**  
Dodge (09-03)  
Chrysler: 55057016AA



**83112**  
Accumulator  
Outside Dia.: 3.500  
Length: 8.250  
Inlet Fitting Type: P-Nut Fitting  
Outlet Fitting Type: P-Nut Fitting  
O-Rings: (2) **24684**  
Chrysler (08-07); Dodge (08-07); Jeep (08-07)  
Chrysler: 5189376AA



**83116**  
Accumulator  
Outside Dia.: 3.500  
Length: 8.000  
Inlet Fitting Type: P-Nut Fitting  
Outlet Fitting Type: P-Nut Fitting  
Chrysler (14-09); Dodge (14-09)  
Chrysler: 5058824AA, 5058824AC



**83121**  
Accumulator  
Outside Dia.: 3.500  
Length: 8.000  
Inlet Fitting Type: Pad Mount  
Outlet Fitting Type: Pad Mount  
O-Rings: (1) **24676**, (2) **24346**  
Dodge (01-00)  
Chrysler: 5080882AA



**83109**  
Accumulator  
Outside Dia.: 3.500  
Length: 8.000  
Inlet Fitting Type: Pad Mount  
Outlet Fitting Type: Pad Mount  
O-Rings: (2) **24681**, (1) **24676**  
Chrysler (09-01)  
Chrysler: 5017441AA, 5096289AA, 5142568AA, 5179157AA, 68029242AA

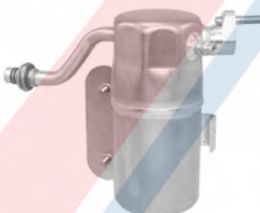

**83115**  
Accumulator  
Outside Dia.: 3.500  
Length: 8.000  
Inlet Fitting Type: Male Springlock  
Outlet Fitting Type: P-Nut Fitting  
O-Rings: (1) **24676**, (3) **24670**, (1) **24612**  
Dodge (11-05); Mitsubishi (09-06)  
Chrysler: 55056596AD



**83119**  
Accumulator  
Outside Dia.: 3.500  
Length: 8.500  
Inlet Fitting Type: P-Nut Fitting  
Outlet Fitting Type: P-Nut Fitting  
Chrysler (14-08); Dodge (14-08)  
Chrysler: 5058235AG

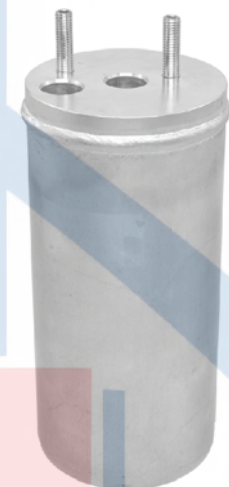

**83127**  
Accumulator  
Outside Dia.: 3.500  
Length: 8.000  
Inlet Fitting Type: Pad Mount  
Outlet Fitting Type: Pad Mount  
O-Rings: (2) **24346**  
Dodge (04-02)  
Chrysler: 5093432AA

# Filter Drier, Accumulator and Desiccant

## Accumulator Cont'd

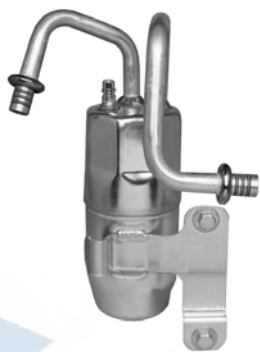

### 83129

Accumulator  
Outside Dia.: 3.500  
Length: 8.000  
Inlet Fitting Type: Male Springlock  
Inlet Fitting: 5/8"  
Outlet Fitting Type: Male Springlock  
Outlet Fitting: 5/8"  
Dodge (08-07); Dodge Medium Duty  
Truck (10-08)  
Chrysler: 55056758AC

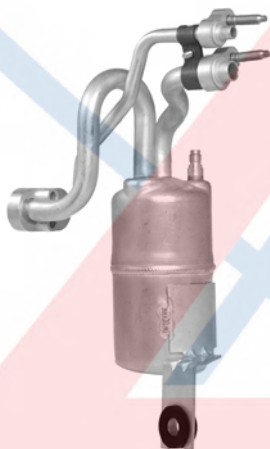

### 83136

Accumulator  
Outside Dia.: 3.500  
Length: 6.500  
Inlet Fitting Type: Block Fitting  
Outlet Fitting Type: P-Nut Fitting  
O-Rings: (1) **24676**, (1) **24402**, (1)  
**24404**  
Chrysler (10-04)  
Chrysler: 5058271AD, 68029229AA



### 83138

Accumulator  
Outside Dia.: 3.500  
Length: 8.000  
Inlet Fitting Type: Female O-Ring  
Inlet Fitting: 1"  
Outlet Fitting Type: Male Insert O-Ring  
Outlet Fitting: 1"  
Chevy (98-97)  
General Motors Corp: 2724963



### 83148

Accumulator  
Outside Dia.: 3.500  
Length: 8.000  
Inlet Fitting Type: Female Springlock  
Inlet Fitting: 3/4"  
Outlet Fitting Type: Female Springlock  
Outlet Fitting: 3/4"  
O-Rings: (1) **24676**, (1) **24222**, (3)  
**24672**  
Ford (05-03); Lincoln (05-03); Mercury  
(05-03)



### 83155

Accumulator  
Outside Dia.: 3.500  
Length: 9.250  
Inlet Fitting Type: P-Nut Fitting  
Outlet Fitting Type: P-Nut Fitting  
Cadillac (14-10); Chevy (14-11); GMC  
(14-11)  
General Motors Corp: 22949455



### 83159

Accumulator  
Outside Dia.: 3.500  
Length: 8.000  
Inlet Fitting Type: P-Nut Fitting  
Outlet Fitting Type: P-Nut Fitting  
Switch/Service Port: 0.250  
O-Rings: (2) **24650**  
Dodge (09-08); Jeep (09-08)  
Chrysler: 5058261AG



### 83202

Accumulator  
Outside Dia.: 3.500  
Length: 8.500  
Inlet Fitting Type: P-Nut Fitting  
Outlet Fitting Type: Male Insert O-Ring  
O-Rings: (1) **24676**, (2) **24612**, (1)  
**24404**  
Chevy (02-98); GMC (02-98)  
General Motors Corp: 15005371



### 83203

Accumulator  
Outside Dia.: 3.500  
Length: 9.000  
Inlet Fitting Type: Female O-Ring  
Inlet Fitting: 3/4"  
Outlet Fitting Type: Male Insert O-Ring  
Outlet Fitting: 3/4"  
O-Rings: (2) **24650**, (2) **24612**  
Chevy (93-90); GMC (93-92); Olds  
(92-90)

# Filter Drier, Accumulator and Desiccant

## Accumulator Cont'd



**83207**  
Accumulator  
Outside Dia.: 3.500  
Length: 8.000  
Inlet Fitting Type: P-Nut Fitting  
Outlet Fitting Type: P-Nut Fitting  
O-Rings: (1) **24676**, (2) **24404**  
Chevy (07-99); GMC (07-99)  
General Motors Corp: 15932423



**83210**  
Accumulator  
Inlet Fitting Type: P-Nut Fitting  
Outlet Fitting Type: P-Nut Fitting  
O-Rings: (1) **24676**, (2) **24404**  
Cadillac (02); Chevy (02-01); GMC (02-01)



**83212**  
Accumulator  
Outside Dia.: 3.500  
Length: 8.000  
Inlet Fitting Type: Dual O-Ring  
Outlet Fitting Type: Male Insert O-Ring  
Outlet Fitting: 3/4"  
O-Rings: (1) **24404**  
Chevy (05-02); Olds (04-02); Pontiac (05-02)  
General Motors Corp: 1132851



**83219**  
Accumulator  
Outside Dia.: 3.250  
Length: 8.000  
Inlet Fitting Type: Male Insert O-Ring  
Inlet Fitting: 1"  
Outlet Fitting Type: P-Nut Fitting  
O-Rings: (2) **24612**  
Olds (02-99)  
General Motors Corp: 1132768



**83208**  
Accumulator  
Outside Dia.: 3.500  
Length: 8.000  
Inlet Fitting Type: P-Nut Fitting  
Outlet Fitting Type: P-Nut Fitting  
O-Rings: (1) **24676**, (2) **24404**  
Cadillac (06-02); Chevy (06-99); GMC (06-99)  
General Motors Corp: 19130063, 25821905, 2724986



**83211**  
Accumulator  
Outside Dia.: 3.500  
Length: 8.000  
Inlet Fitting Type: P-Nut Fitting  
Outlet Fitting Type: P-Nut Fitting  
O-Rings: (1) **24676**, (2) **24404**  
Chevy (04-02); GMC (04-02)  
General Motors Corp: 19130065



**83214**  
Accumulator  
Outside Dia.: 2.500  
Length: 10.500  
Inlet Fitting Type: Pad Mount  
Outlet Fitting Type: Pad Mount  
O-Rings: (1) **24661**, (1) **24606**  
Cadillac (01-97)  
General Motors Corp: 52482791



**83221**  
Accumulator  
Outside Dia.: 3.500  
Length: 9.000  
Inlet Fitting Type: P-Nut Fitting  
Outlet Fitting Type: P-Nut Fitting  
O-Rings: (1) **24676**, (2) **24404**  
Cadillac (06-03); Chevy (06-03); GMC (06-03)  
General Motors Corp: 19130064



# Filter Drier, Accumulator and Desiccant

## Accumulator Cont'd



**83223**  
Accumulator  
Outside Dia.: 3.250  
Length: 8.000  
Inlet Fitting Type: Dual O-Ring  
Inlet Fitting: 1"  
Outlet Fitting Type: P-Nut Fitting  
O-Rings: (2) **24672**, (1) **24404**  
Buick (05-00)  
General Motors Corp: 1132773



**83227**  
Accumulator  
Outside Dia.: 3.500  
Length: 8.000  
Inlet Fitting Type: P-Nut Fitting  
Outlet Fitting Type: P-Nut Fitting  
O-Rings: (2) **24404**  
Chevy (00); Olds (00); Pontiac (00)  
General Motors Corp: 1132759



**83232**  
Accumulator  
Outside Dia.: 3.500  
Length: 8.000  
Inlet Fitting Type: P-Nut Fitting  
Outlet Fitting Type: P-Nut Fitting  
Cadillac (13), (11); Chevy (14-10);  
GMC (14-10)  
General Motors Corp: 22949456



**83238**  
Accumulator  
Outside Dia.: 3.500  
Length: 8.750  
Inlet Fitting Type: P-Nut Fitting  
Outlet Fitting Type: P-Nut Fitting  
O-Rings: (1) **24676**, (2) **24404**  
Chevy (14-03); GMC (14-03); GMC &  
CHEVY (14-09)  
General Motors Corp: 25890358

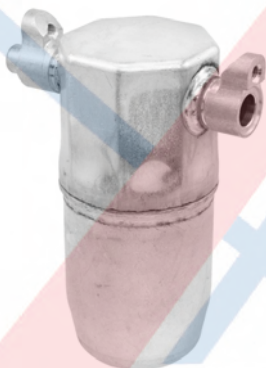

**83225**  
Accumulator  
Outside Dia.: 3.500  
Length: 8.000  
Inlet Fitting Type: P-Nut Fitting  
Outlet Fitting Type: P-Nut Fitting  
O-Rings: (1) **24676**, (2) **24404**  
Buick (05-00); Cadillac (05-00); Olds  
(03-01); Pontiac (05-00)  
General Motors Corp: 1132771



**83229**  
Accumulator  
Outside Dia.: 3.500  
Length: 8.000  
Inlet Fitting Type: P-Nut Fitting  
Outlet Fitting Type: P-Nut Fitting  
O-Rings: (1) **24676**, (2) **24404**  
Chevy (05-04); GMC (05-04)  
General Motors Corp: 89018601

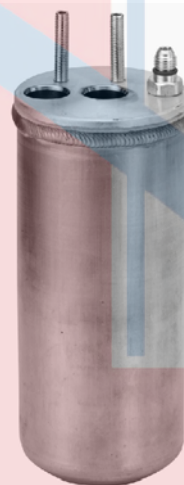

**83234**  
Accumulator  
Outside Dia.: 3.625  
Length: 5.250  
O-Rings: (2) **24083**  
Dodge (05-03)  
Chrysler: 5140325AA



**83239**  
Accumulator  
Outside Dia.: 3.250  
Length: 8.000  
Inlet Fitting Type: P-Nut Fitting  
Outlet Fitting Type: P-Nut Fitting  
O-Rings: (1) **24676**, (2) **24404**  
Cadillac (10-06); Chevy (10-06); GMC  
(10-06)  
General Motors Corp: 20828234

# Filter Drier, Accumulator and Desiccant

## Accumulator Cont'd



**83257**  
Accumulator  
Outside Dia.: 3.500  
Length: 8.000  
Inlet Fitting Type: P-Nut Fitting  
Outlet Fitting Type: P-Nut Fitting  
O-Rings: (1) **24632**, (1) **24610**  
Volvo (12-05)  
Volvo: 31332650



**83279**  
Accumulator  
Outside Dia.: 3.500  
Length: 8.000  
Inlet Fitting Type: Female O-Ring  
Inlet Fitting: 1-1/8"  
Outlet Fitting Type: Male Insert O-Ring  
Outlet Fitting: 1-1/8"  
Audi (04-00)  
Audi: 4B3820193



**83290**  
Accumulator  
Outside Dia.: 3.500  
Length: 9.000  
Inlet Fitting Type: P-Nut Fitting  
Outlet Fitting Type: P-Nut Fitting  
O-Rings: (1) **24676**, (3) **24404**  
Cadillac (02); Chevy (02-00); GMC (02-00)  
General Motors Corp: 89018647



**83359**  
Accumulator  
Chevy (10-07); GMC (10-07)  
General Motors Corp: 20828223,  
20828224

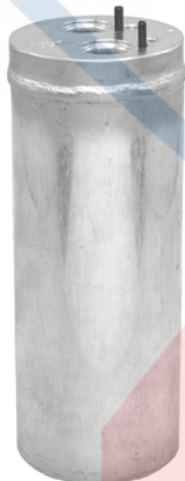

**83259**  
Accumulator  
Outside Dia.: 3.000  
Length: 8.500  
Inlet Fitting Type: Pad Mount  
Outlet Fitting Type: Pad Mount  
O-Rings: (2) **24633**  
Audi (07-02)  
Audi: 8E0820193R

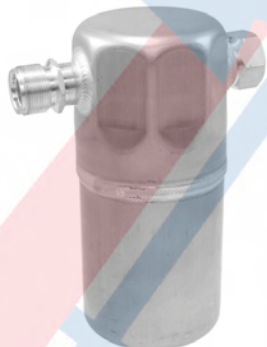

**83280**  
Accumulator  
Outside Dia.: 3.500  
Length: 8.000  
Inlet Fitting Type: Female O-Ring  
Inlet Fitting: 1-1/8"  
Outlet Fitting Type: Male Insert O-Ring  
Outlet Fitting: 1-1/8"  
O-Rings: (2) **24612**  
Audi (08-07), (05-98); VW (00)  
Audi: 4B0820193, 8D0820193A  
Volkswagen: 4B0820193



**83291**  
Accumulator  
Outside Dia.: 3.500  
Length: 9.500  
Inlet Fitting Type: P-Nut Fitting  
Outlet Fitting Type: P-Nut Fitting  
O-Rings: (1) **24676**, (3) **24404**  
Chevy (07-03); GMC (07-03)



**83363**  
Accumulator  
Outside Dia.: 3.250  
Length: 9.500  
Inlet Fitting Type: Pad Mount  
Outlet Fitting Type: Pad Mount  
O-Rings: (1) **24676**, (2) **24404**  
Ford (10-06); Mercury (10-06)  
Ford: 6L2Z19C836B, 7L2Z19C836B

# Filter Drier, Accumulator and Desiccant

## Accumulator Cont'd



### 83366

Accumulator  
Outside Dia.: 3.250  
Length: 8.000  
Inlet Fitting Type: P-Nut Fitting  
Outlet Fitting Type: P-Nut Fitting  
O-Rings: (1) **24676**, (2) **24404**  
Chevy (07-06); GMC (07-06)

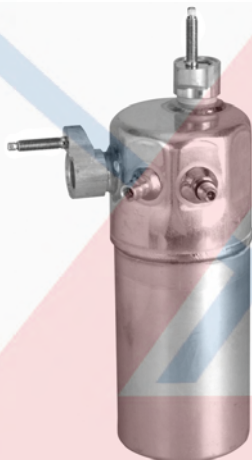

### 83368

Accumulator  
O-Rings: (2) **24404**  
GMC & CHEVY (10-03)  
General Motors Corp: 94669705



### 83668

Accumulator  
Outside Dia.: 3.500  
Length: 8.000  
Inlet Fitting Type: Pad Mount  
Outlet Fitting Type: Pad Mount  
Dodge (10-08), (06-03)  
Chrysler: 5264990AD



### 83720

Accumulator  
Outside Dia.: 3.500  
Length: 9.000  
Inlet Fitting Type: Pad Mount  
Outlet Fitting Type: Pad Mount  
O-Rings: (2) **24602**  
Bergstrom: 526333  
Kysor: 1913007  
Mack: 4379RD5126230  
NaviStar: 3542577C2, BOA8032300139  
Red Dot: RD5126230



### 83731

Accumulator  
Outside Dia.: 2.750  
Length: 8.000  
Inlet Fitting Type: Pad Mount  
Outlet Fitting Type: Pad Mount  
O-Rings: (2) **24612**  
Audi (14), (12-04)  
Audi: 4F0820191B, 8E0820193P  
Volkswagen: 8E0820193Q

## Accumulator Tube

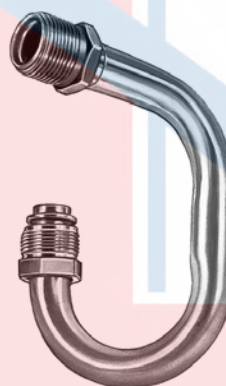

### 34203

Accumulator Tube  
Inlet Fitting: 3/4"  
Outlet Fitting: 3/4"  
O-Rings: (2) **24612**  
Chevy (84-81); GMC (84-81)  
Euclid: E804605



### 34206

Accumulator Tube  
Inlet Fitting: 3/4"  
Outlet Fitting: 3/4"  
O-Rings: (2) **24612**  
Buick (89), (79), (77); Cadillac (85-79);  
Chevy (81-77); GMC (77); Olds (79);  
Pontiac (81-76)



### 34207

Accumulator Tube  
Inlet Fitting: 3/4"  
Outlet Fitting: 3/4"  
O-Rings: (2) **24612**  
Buick (85-77); Cadillac (83-77); Chevy  
(87-73); GMC (79-78); Olds (85),  
(83-77); Pontiac (87-76)  
General Motors Corp: 2724242  
Climatech: JC1070  
Euclid: E804600  
Evans: AM82220  
Kysor: 1910018, 405688  
Mack: 4379RD549620  
NaviStar: 13849  
Red Dot: 74R5600



# Filter Drier, Accumulator and Desiccant

## Accumulator Tube Cont'd

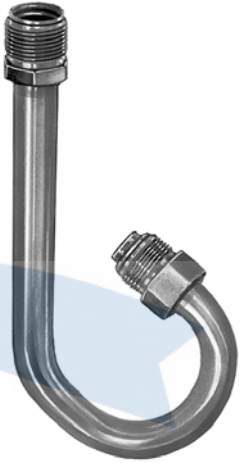

**34208**  
Accumulator Tube  
Inlet Fitting: 3/4"  
Outlet Fitting: 3/4"  
O-Rings: (2) **24612**  
Buick (83-77); Cadillac (81-77); Chevy (83-77); Olds (84-77); Pontiac (81-76)



**34209**  
Accumulator Tube  
Inlet Fitting: 3/4"  
Outlet Fitting: 3/4"  
O-Rings: (2) **24612**  
Chevy (80-73); GMC (80-73)  
Climatech: UD1110  
Euclid: E804602  
Kysor: 405689  
NaviStar: 13851  
Red Dot: 74R5650

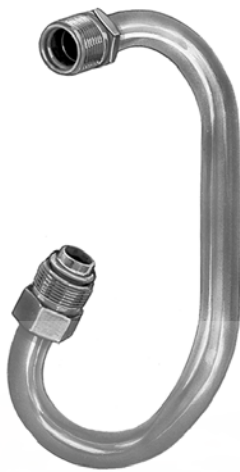

**34210**  
Accumulator Tube  
Inlet Fitting: 3/4"  
Outlet Fitting: 3/4"  
O-Rings: (2) **24612**  
Buick (83-78); Chevy (84-77); GMC (84-78); Olds (84-78); Pontiac (84-78)  
Euclid: E804603

## Hose Assembly

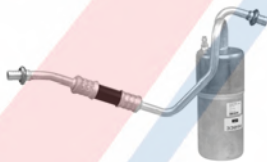

**33096**  
Accumulator w/ Hose  
Outside Dia.: 3.500  
Length: 9.000  
Inlet Fitting Type: Male Springlock  
Outlet Fitting Type: Male Springlock  
Outlet Fitting: 5/8"  
O-Rings: (1) **24220**, (3) **24650**  
Mercury (93); Nissan (93)



**33097**  
Accumulator w/ Hose  
Outside Dia.: 3.500  
Length: 9.000  
Inlet Fitting Type: Male Springlock  
Outlet Fitting Type: Male Springlock  
Outlet Fitting: 5/8"  
O-Rings: (1) **24676**, (1) **24220**, (3) **24670**  
Mercury (98-94); Nissan (98-94)  
Nissan: 921401B001



**33157**  
Accumulator w/ Hose  
Outside Dia.: 3.500  
Length: 8.000  
Inlet Fitting Type: P-Nut Fitting  
Outlet Fitting Type: P-Nut Fitting  
O-Rings: (2) **24404**  
Chevy (02-98); Pontiac (02-98)  
General Motors Corp: 1132796



**33751**  
Accumulator w/ Hose  
Outside Dia.: 3.500  
Length: 8.000  
Inlet Fitting Type: Male Insert O-Ring  
Outlet Fitting Type: Male Insert O-Ring  
Outlet Fitting: 3/4"  
O-Rings: (1) **24109**, (2) **24612**  
Chevy (97); Ford (79); Pontiac (97)  
General Motors Corp: 2724937



**33757**  
Accumulator w/ Hose  
Outside Dia.: 3.500  
Length: 8.000  
Inlet Fitting Type: Male Insert O-Ring  
Outlet Fitting Type: Male Insert O-Ring  
O-Rings: (2) **24612**  
Chevy (99-98)  
General Motors Corp: 2724974



**55307**  
Accumulator w/ Hose  
Outside Dia.: 3.000  
Length: 8.000  
Inlet Fitting Type: Female Springlock  
Outlet Fitting Type: Male Springlock  
Outlet Fitting: 5/8"  
O-Rings: (1) **24220**, (3) **24670**, (2) **24606**, (1) **24650**  
Ford (07-02); Mercury (05-02)  
Ford: 4F1Z19C836AB, 5F1Z19C836AB



**55308**  
Accumulator w/ Hose  
Outside Dia.: 3.500  
Length: 8.000  
Inlet Fitting Type: Male Springlock  
Outlet Fitting Type: Female Springlock  
Outlet Fitting: 5/8"  
Ford (01-96); Mercury (01-96)  
Ford: F7DZ19C836EA, XF1Z19C836AA



**55550**  
Accumulator w/ Hose  
Outside Dia.: 3.500  
Length: 8.000  
Inlet Fitting Type: Male Springlock  
Outlet Fitting Type: Male Insert O-Ring  
Outlet Fitting: 3/4"  
O-Rings: (1) **24222**, (3) **24672**, (1) **24606**, (2) **24612**, (3) **24672**  
Eagle (92-88)  
AMC: 36003706



**55556**  
Accumulator w/ Hose  
Outside Dia.: 3.500  
Length: 8.000  
Inlet Fitting Type: Male Springlock  
Outlet Fitting Type: Male Springlock  
Outlet Fitting: 5/8"  
Dodge (96-94)

# Filter Drier, Accumulator and Desiccant

## Hose Assembly Cont'd



**55557**  
Accumulator w/ Hose  
Outside Dia.: 3.500  
Length: 8.000  
Inlet Fitting Type: Male Springlock  
Outlet Fitting Type: P-Nut Fitting  
Outlet Fitting: 5/8"  
Jeep (93)  
Chrysler: 4720847  
Jeep: 4720847

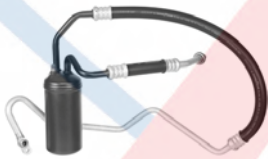

**55558**  
Accumulator w/ Hose  
Outside Dia.: 3.500  
Length: 8.000  
Inlet Fitting Type: Male Springlock  
Outlet Fitting Type: P-Nut Fitting  
Jeep (98-93)  
Chrysler: 4740767  
Jeep: 4740767



**55559**  
Accumulator w/ Hose  
Outside Dia.: 3.500  
Length: 8.000  
Inlet Fitting Type: Male Springlock  
Outlet Fitting Type: P-Nut Fitting  
Outlet Fitting: 5/8"  
Jeep (98-93)  
Chrysler: 55036152  
Jeep: 55036152



**55603**  
Accumulator w/ Hose  
Outside Dia.: 3.500  
Length: 8.000  
Inlet Fitting Type: Male Springlock  
Outlet Fitting Type: Female Springlock  
Outlet Fitting: 3/4"  
Ford (90-88); Lincoln (90-88); Mercury (90-88)



**55604**  
Accumulator w/ Hose  
Outside Dia.: 3.500  
Length: 8.000  
Inlet Fitting Type: Male Springlock  
Outlet Fitting Type: Female Springlock  
Outlet Fitting: 3/4"  
Ford (90-86); Mercury (90-86)



**55605**  
Accumulator w/ Hose  
Outside Dia.: 3.500  
Length: 8.000  
Inlet Fitting Type: Male Springlock  
Outlet Fitting Type: Female Springlock  
Outlet Fitting: 5/8"  
Ford (93-89); Mercury (93-89)  
Ford: FOSZ19C836AA



**55606**  
Accumulator w/ Hose  
Outside Dia.: 3.500  
Length: 8.000  
Inlet Fitting Type: Male Springlock  
Outlet Fitting Type: Female Springlock  
Outlet Fitting: 3/4"  
Ford (93-91); Lincoln (94-91); Mercury (93-91)



**55608**  
Accumulator w/ Hose  
Outside Dia.: 3.500  
Length: 8.000  
Inlet Fitting Type: Female O-Ring  
Outlet Fitting Type: Male Insert O-Ring  
Outlet Fitting: 5/8"  
Ford (86-83); Mercury (86-83)



**55609**  
Accumulator w/ Hose  
Outside Dia.: 3.500  
Length: 8.000  
Inlet Fitting Type: Female O-Ring  
Outlet Fitting Type: Male Insert O-Ring  
Ford (85-82); Lincoln (85-83); Mazda (89); Mercury (85-82)

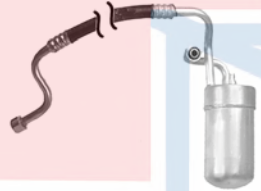

**55612**  
Accumulator w/ Hose  
Outside Dia.: 3.500  
Length: 8.000  
Inlet Fitting Type: Female O-Ring  
Outlet Fitting Type: Male Insert O-Ring  
Outlet Fitting: 5/8"  
Ford (88-86); Lincoln (89-86); Mercury (88-86)



**55614**  
Accumulator w/ Hose  
Outside Dia.: 3.500  
Length: 8.000  
Inlet Fitting Type: Male Springlock  
Outlet Fitting Type: Male Springlock  
Outlet Fitting: 5/8"  
Ford (93-91); Mercury (94-91)



**55619**  
Accumulator w/ Hose  
Outside Dia.: 3.500  
Length: 8.000  
Inlet Fitting Type: Male Springlock  
Outlet Fitting Type: Male Insert O-Ring  
Outlet Fitting: 5/8"  
O-Rings: (1) 24220, (3) 24670, (2) 24610, (2) 24650  
Ford (90-88); Mercury (87)

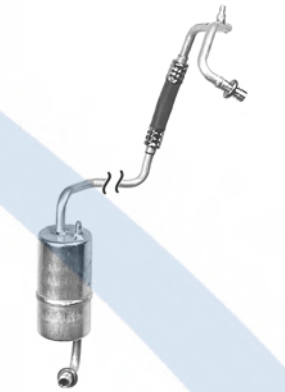

**55620**  
Accumulator w/ Hose  
Outside Dia.: 3.500  
Length: 8.000  
Inlet Fitting Type: Male Springlock  
Outlet Fitting Type: Male Springlock  
Outlet Fitting: 3/4"  
Ford (93-89)

# Filter Drier, Accumulator and Desiccant

## Hose Assembly Cont'd



**55621**  
Accumulator w/ Hose  
Outside Dia.: 3.500  
Length: 8.000  
Inlet Fitting Type: Male Springlock  
Outlet Fitting Type: Male Springlock  
Outlet Fitting: 3/4"  
O-Rings: (1) **24220**, (3) **24670**, (2) **24650**  
Ford (90-89)



**55623**  
Accumulator w/ Hose  
Outside Dia.: 3.500  
Length: 8.000  
Inlet Fitting Type: Male Springlock  
Outlet Fitting Type: Female Springlock  
Outlet Fitting: 3/4"  
Ford (93-92); Mercury (93-92)



**55626**  
Accumulator w/ Hose  
Outside Dia.: 3.500  
Length: 8.000  
Inlet Fitting Type: Male Springlock  
Outlet Fitting Type: Female Springlock  
Outlet Fitting: 3/4"  
Ford (95-94); Lincoln (94); Mercury (95-94)



**55628**  
Accumulator w/ Hose  
Outside Dia.: 3.500  
Length: 8.000  
Inlet Fitting Type: Female O-Ring  
Outlet Fitting Type: Male Springlock  
Outlet Fitting: 5/8"  
Ford (88); Mercury (88)



**55630**  
Accumulator w/ Hose  
Outside Dia.: 3.500  
Length: 8.000  
Inlet Fitting Type: Female O-Ring  
Outlet Fitting Type: Male Springlock  
Outlet Fitting: 5/8"  
Ford (88-87)



**55631**  
Accumulator w/ Hose  
Outside Dia.: 3.500  
Length: 8.000  
Inlet Fitting Type: Female O-Ring  
Outlet Fitting Type: Male Insert O-Ring  
Outlet Fitting: 5/8"  
Ford (85-83); Mercury (85-83)

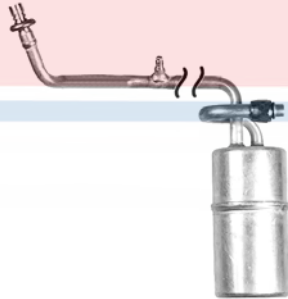

**55632**  
Accumulator w/ Hose  
Outside Dia.: 3.500  
Length: 8.000  
Inlet Fitting Type: Female O-Ring  
Outlet Fitting Type: Male Springlock  
Outlet Fitting: 5/8"  
Ford (88-87)



**55634**  
Accumulator w/ Hose  
Outside Dia.: 3.500  
Length: 8.000  
Inlet Fitting Type: Male Springlock  
Outlet Fitting Type: Male Insert O-Ring  
Outlet Fitting: 5/8"  
O-Rings: (1) **24220**, (3) **24670**, (2) **24610**, (2) **24650**  
Ford (87-83); Mercury (87-82)



**55636**  
Accumulator w/ Hose  
Outside Dia.: 3.500  
Length: 8.000  
Inlet Fitting Type: Female O-Ring  
Outlet Fitting Type: Male Insert O-Ring  
Outlet Fitting: 5/8"  
Ford (93-86); Mercury (86)



**55637**  
Accumulator w/ Hose  
Outside Dia.: 3.500  
Length: 8.000  
Inlet Fitting Type: Female O-Ring  
Outlet Fitting Type: Male Springlock  
Outlet Fitting: 5/8"  
O-Rings: (1) **24220**, (3) **24670**, (2) **24650**  
Ford (89-86); Mercury (87-86)



**55640**  
Accumulator w/ Hose  
Outside Dia.: 3.500  
Length: 8.000  
Inlet Fitting Type: Male Springlock  
Outlet Fitting Type: Female Springlock  
Outlet Fitting: 3/4"  
Ford (97-94); Mercury (96-94)



**55641**  
Accumulator w/ Hose  
Outside Dia.: 3.500  
Length: 7.000  
Inlet Fitting Type: Male Springlock  
Outlet Fitting Type: Female Springlock  
Outlet Fitting: 3/4"  
Ford (95-94)



**55642**  
Accumulator w/ Hose  
Outside Dia.: 3.500  
Length: 8.000  
Inlet Fitting Type: Male Springlock  
Outlet Fitting Type: Male Springlock  
Outlet Fitting: 3/4"  
O-Rings: (1) **24222**, (3) **24672**, (2) **24650**  
Ford (95-94)



**55664**  
Accumulator w/ Hose  
Outside Dia.: 3.500  
Length: 8.000  
Ford (93-89)



# Filter Drier, Accumulator and Desiccant

## Hose Assembly Cont'd



**55682**  
Accumulator w/ Hose  
Outside Dia.: 3.500  
Length: 8.000  
Lincoln (92-89)



**55724**  
Accumulator w/ Hose  
Outside Dia.: 3.500  
Length: 8.000  
Inlet Fitting Type: Male Springlock  
Outlet Fitting Type: Male Springlock  
Outlet Fitting: 3/4"  
O-Rings: (1) **24222**, (3) **24672**, (2) **24650**  
Ford (93)



**56790**  
Accumulator w/ Hose  
Jeep (01-99)  
Chrysler: 68054875AA



**56840**  
Accumulator w/ Hose  
Outside Dia.: 3.500  
Length: 8.500  
Inlet Fitting Type: Male Springlock  
Outlet Fitting Type: P-Nut Fitting  
Ford (04-99)  
Ford: YL3Z19C836AA



**56841**  
Accumulator w/ Hose  
Outside Dia.: 3.500  
Length: 8.000  
Inlet Fitting Type: P-Nut Fitting  
Outlet Fitting Type: P-Nut Fitting  
Jeep (01-99)  
Chrysler: 55115910AC



**83013**  
Accumulator w/ Hose  
Outside Dia.: 3.500  
Length: 9.500  
Inlet Fitting Type: Male Springlock  
Outlet Fitting Type: Male Insert O-Ring  
Outlet Fitting: 5/8"  
O-Rings: (2) **24676**, (1) **24222**, (3) **24672**  
Ford (98-97)  
Ford: F75Z19C836AA  
Red Dot: 74R5077



**83015**  
Accumulator w/ Hose  
Outside Dia.: 3.500  
Length: 9.500  
Inlet Fitting Type: Male Springlock  
Outlet Fitting Type: Male Insert O-Ring  
Outlet Fitting: 3/4"  
O-Rings: (1) **24222**, (3) **24672**, (1) **24676**, (1) **24610**  
Ford (08-97)  
Ford: 2C2Z19C836BB



**83021**  
Accumulator w/ Hose  
Outside Dia.: 3.500  
Length: 8.500  
Inlet Fitting Type: Male Springlock  
Outlet Fitting Type: P-Nut Fitting  
O-Rings: (1) **24222**, (3) **24672**, (1) **24676**, (1) **24087**  
Ford (04-97); Lincoln (02-98)  
Ford: XL3Z19C836BA



**83027**  
Accumulator w/ Hose  
Outside Dia.: 3.500  
Length: 8.500  
Inlet Fitting Type: Male Springlock  
Outlet Fitting Type: Male Springlock  
Outlet Fitting: 5/8"  
O-Rings: (1) **24676**, (1) **24220**, (3) **24670**  
Mercury (98-93); Nissan (98-93)



**83028**  
Accumulator w/ Hose  
Outside Dia.: 3.500  
Length: 8.500  
Outlet Fitting Type: Female Springlock  
Outlet Fitting: 1"  
O-Rings: (1) **24676**, (1) **24606**, (1) **24610**, (1) **24612**  
Ford (06-97)  
Ford: 5C2Z19C836AB



**83042**  
Accumulator w/ Hose  
Outside Dia.: 3.500  
Length: 9.000  
Inlet Fitting Type: Female Springlock  
Outlet Fitting Type: Male Springlock  
Outlet Fitting: 5/8"  
O-Rings: (1) **24676**, (1) **24220**, (3) **24670**  
Ford (05-01); Mazda (06-01); Mercury (05)  
Ford: YL8Z19C836AA, YL8Z19C836AB  
Mazda: EC01615AOC



**83045**  
Accumulator w/ Hose  
Outside Dia.: 3.500  
Length: 8.000  
Inlet Fitting Type: P-Nut Fitting  
Outlet Fitting Type: P-Nut Fitting  
O-Rings: (1) **24676**, (2) **24404**  
Chevy (02); GMC (02); Olds (02)  
General Motors Corp: 89018645

# Filter Drier, Accumulator and Desiccant

## Hose Assembly Cont'd



**83046**  
Accumulator w/ Hose  
Outside Dia.: 3.500  
Length: 9.000  
Inlet Fitting Type: P-Nut Fitting  
Outlet Fitting Type: P-Nut Fitting  
O-Rings: (1) **24676**, (2) **24404**  
Chevy (02); GMC (02)



**83073**  
Accumulator w/ Hose  
O-Rings: (1) **24676**, (1) **24220**, (3) **24670**  
Ford (07-05); Mercury (07-06)  
Ford: 6M6Z19C836AB



**83074**  
Accumulator w/ Hose  
Outside Dia.: 3.500  
Length: 10.500  
Inlet Fitting Type: Female O-Ring  
Outlet Fitting Type: Female O-Ring  
Outlet Fitting: 3/4"  
O-Rings: (1) **24676**, (1) **24612**, (1) **24610**  
Ford (07-04)  
Ford: 4C2Z19C836AB



**83089**  
Accumulator w/ Hose  
Outside Dia.: 3.000  
Length: 9.000  
Inlet Fitting Type: Male Springlock  
Outlet Fitting Type: P-Nut Fitting  
Outlet Fitting: 5/8"  
O-Rings: (1) **24222**, (3) **24672**  
Ford (10-08)  
Ford: 8C3Z19C836C



**83092**  
Accumulator w/ Hose  
Outside Dia.: 3.500  
Length: 9.000  
Inlet Fitting Type: Male Springlock  
Outlet Fitting Type: Pad Mount  
O-Rings: (1) **24650**, (1) **24222**, (3) **24672**  
Ford (10-08)  
Ford: 8C3Z19C836D



**83144**  
Accumulator w/ Hose  
Outside Dia.: 3.500  
Length: 8.500  
Inlet Fitting Type: Male Springlock  
Outlet Fitting Type: Male Springlock  
Outlet Fitting: 3/4"  
O-Rings: (1) **24222**, (3) **24672**, (1) **24220**, (3) **24670**  
Ford (07-05); Mazda (09-08), (06-05);  
Mercury (07-06)  
Ford: 6L8Z19C836AB  
Mazda: ZC261460



**83177**  
Accumulator w/ Hose  
Outside Dia.: 3.000  
Length: 10.000  
Outlet Fitting Type: P-Nut Fitting  
O-Rings: (1) **24681**, (1) **24668**, (1) **24652**  
Ford (14-07)  
Ford: 7C2Z19C836A



**83186**  
Accumulator w/ Hose  
Ford (10-08)  
Ford: 7C2Z19C836B



**83222**  
Accumulator w/ Hose  
Outside Dia.: 3.500  
Length: 8.000  
Inlet Fitting Type: P-Nut Fitting  
Outlet Fitting Type: P-Nut Fitting  
O-Rings: (1) **24676**, (2) **24404**  
Buick (07-04); Chevy (09-03); GMC (09-03); Isuzu (08-03); Olds (04-03);  
Saab (09-05)  
General Motors Corp: 15883409,  
15883410



**83228**  
Accumulator w/ Hose  
Outside Dia.: 3.250  
Length: 8.000  
Inlet Fitting Type: Female O-Ring  
Outlet Fitting Type: Male Insert O-Ring  
O-Rings: (2) **24150**  
Chevy (02-00)  
General Motors Corp: 1132743



**83350**  
Accumulator w/ Hose  
Outside Dia.: 3.500  
Length: 8.000  
Inlet Fitting Type: Male Springlock  
Outlet Fitting Type: Male Insert O-Ring  
Outlet Fitting: 1"  
O-Rings: (1) **24676**, (3) **24670**, (1) **24612**  
Mercury (02-99); Nissan (02-99)  
Nissan: 921407B011

# Filter Drier, Accumulator and Desiccant

## Hose Assembly Cont'd



**83364**  
Accumulator w/ Hose  
Outside Dia.: 3.500  
Length: 9.000  
Inlet Fitting Type: Male Springlock  
Outlet Fitting Type: Male Springlock  
O-Rings: (1) **24608**, (3) **24670**, (1) **24404**, (1) **24676**  
Ford (08-04); Lincoln (08-06)  
Ford: 6L3Z19C836AB



**83372**  
Accumulator w/ Hose  
Outside Dia.: 3.500  
Length: 7.875  
Inlet Fitting Type: Male Springlock  
Outlet Fitting Type: P-Nut Fitting  
O-Rings: (3) **24672**, (1) **24613**  
Jaguar (05-02)  
Jaguar: C2S6013

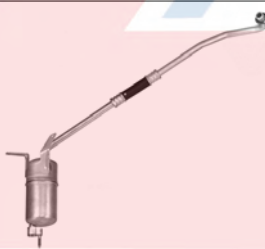

**83373**  
Accumulator w/ Hose  
Outside Dia.: 3.500  
Length: 7.875  
Inlet Fitting Type: Male Springlock  
Outlet Fitting Type: P-Nut Fitting  
Outlet Fitting: 3/4"  
O-Rings: (3) **24672**, (1) **24613**  
Jaguar (08-06)  
Jaguar: C2S41872

## Accumulator w/ Tubes

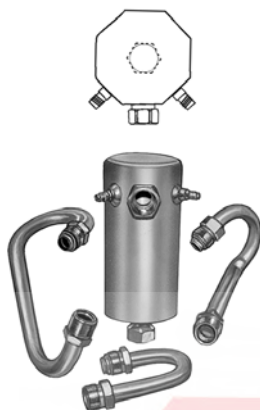

**33176**  
Accumulator w/ Tube Kit  
Outside Dia.: 3.500  
Length: 9.000  
Inlet Fitting Type: Female O-Ring  
Inlet Fitting: 3/4"  
Outlet Fitting Type: Female O-Ring  
Outlet Fitting: 3/4"  
O-Rings: (1) , (1) **34207**, (2) **24612**, (1) **34210**, (2) **24650**  
Buick (85), (83-77); Cadillac (83-77); Chevy (85-73); GMC (83-78); Olds (85-77); Pontiac (87-76)

## Condenser Drier Assembly



**83902**  
Condenser Drier Assembly  
O-Rings: (1) **24402**, (1) **24401**  
Chevy (12-04); Pontiac (10-05); Saturn (09-07)  
General Motors Corp: 20820057, 20820058



**83903**  
Condenser Drier Assembly  
O-Rings: (1) **24402**, (1) **24401**  
Chevy (11-06)  
General Motors Corp: 15834081, 20889194



**83904**  
Condenser Drier Assembly  
O-Rings: (2) **24404**  
Cadillac (09-04); Chevy (13-03)  
General Motors Corp: 10442892



**83905**  
Condenser Drier Assembly  
O-Rings: (1) **24402**  
Buick (09-08); Chevy (14-06); Pontiac (08-05)  
General Motors Corp: 23287351



**83906**  
Condenser Drier Assembly  
O-Rings: (1) **24402**  
Buick (09-06); Chevy (11-06); Pontiac (08-06)  
General Motors Corp: 89019322

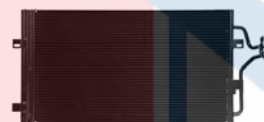

**83907**  
Condenser Drier Assembly  
O-Rings: (2) **24402**  
Buick (11-06); Cadillac (11-06)  
General Motors Corp: 25769583

## Desiccant Bag Kit



**34218**  
VIR Desiccant Bag Kit  
Chevy (76-73)  
General Motors Corp: 19188833  
ARA: 1273068  
Kysor: 1912013



**83004**  
Filter Drier Desiccant Bag Kit  
Outside Dia.: 1.000  
Length: 8.000  
Hyundai (15-00); Kia (14), (11-03)  
Hyundai: 9780217000  
Kia: 9780217000

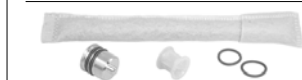

**83006**  
Filter Drier Desiccant Bag Kit  
Outside Dia.: 2.000  
Length: 11.000  
O-Rings: (2) **24623**  
Acura (02-01); Honda (07-99)  
BMW: 64536905171  
Honda: 80101S7A305



**83009**  
Filter Drier Desiccant Bag Kit  
Outside Dia.: 3.500  
Length: 8.000  
BMW (10-08)  
BMW: 64536907403



**83019**  
Filter Drier Desiccant Bag Kit  
Outside Dia.: 2.000  
Length: 9.000  
O-Rings: (2) **24623**  
Cadillac (07-03); Chevy (04-99); Honda (04-03); Lexus (10-98); Toyota (08-98)  
General Motors Corp: 19193683  
Honda: 80101SEA305  
Lexus: 8847447010  
Toyota: 8847447010



# Filter Drier, Accumulator and Desiccant

## Desiccant Bag Kit Cont'd

### 83029

Filter Drier Desiccant Bag Kit  
Outside Dia.: 1.000  
Length: 9.000  
O-Rings: (2) **24651**, (1) **24138**, (1) **24152**

Acura (15-05); Audi (14-10); Cadillac (14-04); Chevy (14-12); Chrysler (02-01); Dodge (14-09), (02-01); Dodge Medium Duty Truck (13-11); Ford (14-07); Honda (15-05); Jaguar (15-04)  
Jeep (11); Kia (09); Lexus (14-03); Lincoln (14-07); Mazda (12-04), (01-00); Pontiac (10-09); Scion (14-04); Subaru (14-05); Toyota (14-03)

Acura: 80101S9A013, 80101SFE003  
Audi: 8K0298403A

Ford: 7T4Z19C836A, BT4Z19708B  
General Motors Corp: 88975769, 89023442

Honda: 80101S9A013, 80101SFE003, 80101SVAA01, 80101T3VA01, 80102SVAA03, 80102SVAA13, 80110SCVA91, 80111SJCA01

Jaguar: XR828836

Kia: 976062F001, 976062J200  
Lexus: 884600E030, 8847408010, 8847417010

Mazda: LE4761480B

Subaru: 73210AG01A, 73210XA01A

Toyota: 8846006210, 8846006230, 8847408010, 8847417010

### 83057

Filter Drier Desiccant Bag Kit  
BMW (10-02)  
BMW: 64536907402

### 83059

Filter Drier Desiccant Bag Kit  
Buick (12-08); Chevy (12-09); GMC (12-07); Saturn (10-07)  
General Motors Corp: 15951315

### 83061

Filter Drier Desiccant Bag Kit  
Chevy (11); Pontiac (09-08)  
General Motors Corp: 92191928

### 83063

Filter Drier Desiccant Bag Kit  
Audi (14-11); Mercedes (15-08)  
Audi: 4H0298403  
Mercedes Benz: 2048350147

### 83064

Filter Drier Desiccant Bag Kit  
BMW (15-13), (11-07); Land Rover (12-09), (06); Mini (14), (10-07)  
BMW: 64506935921, 64539127927  
Land Rover: LR010843

### 83066

Filter Drier Desiccant Bag Kit  
Lexus (14-08)  
Lexus: 8847450020

### 83069

Filter Drier Desiccant Bag Kit  
Porsche (10-08), (06-03)

### 83077

Filter Drier Desiccant Bag Kit  
BMW (14-06)  
BMW: 64536936557

### 83086

Filter Drier Desiccant Bag Kit  
BMW (11-00)  
BMW: 64536942025

### 83124

Filter Drier Desiccant Bag Kit  
Length: 8.750  
Acura (06-03); Honda (08-02); Mitsubishi (06-00)  
Acura: 80101SEA305  
Honda: 80101SEA305  
Mitsubishi: 7812A125

### 83146

Filter Drier Desiccant Bag Kit  
Outside Dia.: 1.000  
Length: 8.500  
Hyundai (14-08); Kia (14-11)  
Hyundai: 976063Q000, 976064R000  
Kia: 976063Q000, 976064D970, 976064R001

### 83147

Filter Drier Desiccant Bag Kit  
Outside Dia.: 1.000  
Length: 8.000  
BMW (15-10); Mini (15-11)  
BMW: 64509202689, 64509237857, 64536805452

### 83149

Filter Drier Desiccant Bag Kit  
Outside Dia.: 1.000  
Length: 17.000  
Land Rover (09-03)  
Land Rover: JRE500030

### 83150

Filter Drier Desiccant Bag Kit  
Length: 6.000  
Suzuki (07-03)  
Suzuki: 9533978F01

### 83151

Filter Drier Desiccant Bag Kit  
Length: 9.625  
Suzuki (04-01)  
Suzuki: 9533958J10

### 83154

Filter Drier Desiccant Bag Kit  
Saturn (08)  
General Motors Corp: 13148307

### 83165

Filter Drier Desiccant Bag Kit  
Outside Dia.: 1.000  
Length: 10.000  
Kia (05-03)

### 83167

Filter Drier Desiccant Bag Kit  
Hyundai (15-10); Kia (14-04)  
Hyundai: 978532F000, 978532F100  
Kia: 978532F000, 978532F100

### 83169

Filter Drier Desiccant Bag Kit  
Outside Dia.: 1.000  
Length: 9.000  
O-Rings: (1) **24619**  
Kia (07-04)

### 83185

Filter Drier Desiccant Bag Kit  
Outside Dia.: 1.000  
Length: 8.500  
O-Rings: (2) **24623**  
Jaguar (09-04)  
Jaguar: C2C15230

### 83187

Filter Drier Desiccant Bag Kit  
Ford (14-11); Lincoln (14-13)  
Ford: BB5Z19C836A, EB5Z19C836A

### 83188

Filter Drier Desiccant Bag Kit  
Outside Dia.: 1.000  
Length: 9.750  
Ford (14-13); Lincoln (14-13)  
Ford: DG9Z19C836A

# Filter Drier, Accumulator and Desiccant

## Desiccant Bag Kit Cont'd



**83195**  
Filter Drier Desiccant Bag Kit  
Mazda (08-03)  
Mazda: GK2G61480K



**83196**  
Filter Drier Desiccant Bag Kit  
VW (14-12)  
Volkswagen: 3C0898191A



**83198**  
Filter Drier Desiccant Bag Kit  
Ford (14-13); Lincoln (14-13)  
Ford: DG9Z19712A, DG9Z19712C,  
DG9Z19C836B



**83199**  
Filter Drier Desiccant Bag Kit  
Buick (14-13); Cadillac (14); Chevy  
(14-11); GMC (14-13)  
General Motors Corp: 20842140,  
22740368, 22931656, 22945112,  
23479280



**83200**  
Filter Drier Desiccant Bag Kit  
Chevy (14-12)



**83205**  
Filter Drier Desiccant Bag Kit  
Ford (14); Volvo (14-07)  
Ford: CV6Z19C836B  
Volvo: 30776238



**83248**  
Filter Drier Desiccant Bag Kit  
Outside Dia.: 1.000  
Length: 8.500  
Suzuki (13-99)  
Suzuki: 9533958J10



**83253**  
Filter Drier Desiccant Bag Kit  
Length: 14.675  
Audi (14-07); VW (10-04)  
Audi: 7L0898191A  
Volkswagen: 7L0898191A



**83261**  
Filter Drier Desiccant Bag Kit  
Outside Dia.: 1.250  
Length: 10.750  
O-Rings: (1) **24651**  
Lexus (14-06); Toyota (14-06)  
Lexus: 8847447020  
Toyota: 8846047150, 8847447020



**83281**  
Filter Drier Desiccant Bag Kit  
Length: 13.875  
VW (11-06)  
Volkswagen: 3C0898191



**83302**  
Filter Drier Desiccant Bag Kit  
Length: 14.500  
O-Rings: (2) **24635**  
Mercedes (09-01)  
Mercedes Benz: 2038350147



**83348**  
Filter Drier Desiccant Bag Kit  
Outside Dia.: 1.250  
Length: 20.000  
Ford (14-11)  
Ford: BC3Z19712B, BL3Z19C836B



**83349**  
Filter Drier Desiccant Bag Kit  
Length: 15.000  
O-Rings: (2) **24635**  
Ford (14-08); Lincoln (14-08)  
Ford: BL3Z19712B, BL3Z19C836B



**83361**  
Filter Drier Desiccant Bag Kit  
Outside Dia.: 1.000  
Ford (12-06); Lincoln (12-06); Mercury  
(09-06)  
Ford: 6E5Z19C836A



**83362**  
Filter Drier Desiccant Bag Kit  
Outside Dia.: 1.500  
Ford (12-11); Lincoln (12); Mercury  
(11-10)  
Ford: AE5Z19C836A

## Filter Drier



**33114**  
Aluminum Filter Drier w/o Pad Mount  
Chevy (97-96), (94-93); Pontiac  
(97-96), (94-93)  
General Motors Corp: 2724698

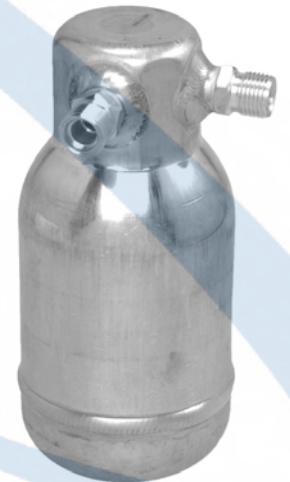

**33116**  
Aluminum Filter Drier w/o Pad Mount  
Outlet Fitting: 3/8"  
Buick (93-92); Chevy (93-92); Olds  
(93-92); Pontiac (93-92)  
General Motors Corp: 88959208

# Filter Drier, Accumulator and Desiccant

## Filter Drier Cont'd



**33158**  
Aluminum Filter Drier w/o Pad Mount  
Outside Dia.: 3.000  
Length: 6.500  
Inlet Fitting Type: Male Insert O-Ring  
Outlet Fitting Type: Male Insert O-Ring  
O-Rings: (2) **24608**  
Buick (98-94); Chevy (96-94); Olds (98-94); Pontiac (98-94)  
General Motors Corp: 88959210



**33211**  
Steel Filter Drier  
Outside Dia.: 3.000  
Length: 8.500  
Inlet Fitting Type: Female O-Ring  
Inlet Fitting: 3/8"  
Outlet Fitting Type: Female O-Ring  
Outlet Fitting: 3/8"  
O-Rings: (2) **24612**  
Buick (74-68); Cadillac (72-68); Chevy (81-68); GMC (84-71); Olds (74-68); Pontiac (75-68)  
General Motors Corp: 3046236  
ARA: 1273107, 12731078  
Case New Holland: 1990758C1  
Climatech: JA1745, JA1835  
Dallas Truck AC: 0612010  
Euclid: E804106  
Evans: AM82248  
Kysor: 1910019, 1999035, 402567  
NaviStar: 12243  
Northern: 804370, 804917  
Red Dot: 74R3000



**33213**  
Steel Filter Drier  
Outside Dia.: 2.500  
Length: 12.000  
Inlet Fitting Type: Female O-Ring  
Inlet Fitting: 3/8"  
Outlet Fitting Type: Female O-Ring  
Outlet Fitting: 3/8"  
O-Rings: (2) **24612**  
Buick (72-68); Cadillac (74-68); Olds (73); Pontiac (73-68)



**33216**  
Steel Filter Drier  
Outside Dia.: 2.500  
O-Rings: (2) **24606**  
Jeep (86-84)  
AMC: 8956000687



**33215**  
Steel Filter Drier  
Outside Dia.: 3.000  
Length: 8.000  
Inlet Fitting Type: Female O-Ring  
Inlet Fitting: 3/8"  
Outlet Fitting Type: Female O-Ring  
Outlet Fitting: 3/8"  
O-Rings: (2) **24612**  
Buick (67-62); Cadillac (67-60); Chevy (72-62); GMC (72-65); Olds (68-62); Pontiac (67)  
General Motors Corp: 3046235  
ARA: 1273023  
Euclid: E804127  
Evans: AM82215  
NaviStar: 12242  
Northern: 804214  
Red Dot: 74R2856

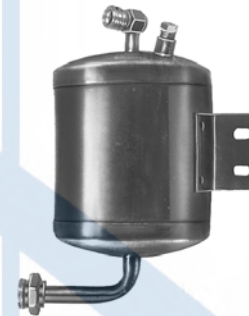

**33228**  
Steel Filter Drier  
Outside Dia.: 4.000  
Length: 7.500  
Inlet Fitting Type: Male Insert O-Ring  
Inlet Fitting: 3/8"  
Outlet Fitting Type: Quick Disconnect  
O-Rings: (2) **24612**  
Hy-Capacity: 0008890145  
Northern: 804788



# Filter Drier, Accumulator and Desiccant

## Filter Drier Cont'd



### 33234

Steel Filter Drier  
 Outside Dia.: 2.500  
 Length: 8.000  
 Inlet Fitting Type: Flare Fitting  
 Inlet Fitting: 3/8"  
 Outlet Fitting Type: Flare Fitting  
 Outlet Fitting: 3/8"  
 O-Rings: (2) **24612**  
 Mazda (82-81)  
 AutoCar: 564252  
 Bergstrom: 57042  
 Brockway: 57042  
 Euclid: E804003  
 Red Dot: 74R1056



### 33236

Steel Filter Drier  
 Outside Dia.: 2.500  
 Length: 9.000  
 Inlet Fitting Type: Male Insert O-Ring  
 Outlet Fitting Type: Female O-Ring  
 O-Rings: (2) **24629**  
 Mazda (95-90)



### 33238

Steel Filter Drier  
 Outside Dia.: 2.750  
 Length: 7.500  
 Inlet Fitting Type: Male Insert O-Ring  
 Outlet Fitting Type: Male Insert O-Ring  
 O-Rings: (2) **24607**  
 Toyota (93-87)  
 Toyota: 8847195401

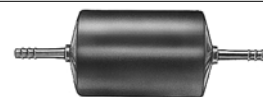

### 33244

Barb In-Line Filter w/ Desiccant for Liquid Line  
 Outside Dia.: 2.500  
 Length: 3.000  
 Inlet Fitting Type: Barb Fitting  
 Inlet Fitting: 5/16"  
 Outlet Fitting Type: Barb Fitting  
 Outlet Fitting: 5/16"



### 33245

Compression In-Line Filter w/ Desiccant for Liquid Line  
 Outside Dia.: 2.500  
 Length: 3.000  
 Inlet Fitting Type: Compression Fitting  
 Inlet Fitting: 3/8"  
 Outlet Fitting Type: Compression Fitting  
 Outlet Fitting: 3/8"  
 O-Rings: (2) **24676**, (2) **24606**



### 33235

Steel Filter Drier  
 Outside Dia.: 3.500  
 Length: 7.000  
 Inlet Fitting Type: Male Insert O-Ring  
 Inlet Fitting: 3/8"  
 Outlet Fitting Type: Male Insert O-Ring  
 O-Rings: (2) **24606**  
 Jeep (90-87)  
 Jeep: 4773765  
 AMC: 8956001665  
 Dallas Truck AC: 0612034

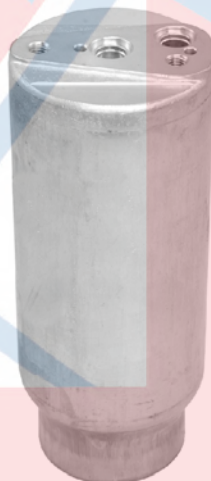

### 33237

Aluminum Filter Drier w/ Pad Mount  
 Outside Dia.: 2.250  
 Length: 6.000  
 Inlet Fitting Type: Pad Mount  
 Outlet Fitting Type: Pad Mount  
 O-Rings: (2) **24607**  
 Acura (92-91); Chevy (93-89); Eagle (94-90); Geo (94-89); Lexus (91-90); Mazda (93); Mercury (93-91); Suzuki (94-86); Toyota (92-87)  
 Acura: 80350SP0N60  
 General Motors Corp: 19188548, 96059451  
 Mitsubishi: MR227446  
 Toyota: 8847112040, 8847112060



### 33241

Flare In-Line Filter w/o Desiccant for Liquid Line  
 Outside Dia.: 2.500  
 Length: 6.750  
 Inlet Fitting Type: Flare Fitting  
 Inlet Fitting: 1/2"  
 Outlet Fitting Type: Flare Fitting  
 Outlet Fitting: 1/2"



### 33246

Beadlock In-Line Filter w/ Desiccant for Liquid Line  
 Outside Dia.: 2.500  
 Length: 3.000  
 Euclid: E8047086, E8047096



### 33243

Flare In-Line Filter w/o Desiccant for Liquid Line  
 Outside Dia.: 2.500  
 Length: 6.750  
 Inlet Fitting Type: Flare Fitting  
 Inlet Fitting: 3/8"  
 Outlet Fitting Type: Flare Fitting  
 Outlet Fitting: 3/8"  
 NaviStar: 19425

# Filter Drier, Accumulator and Desiccant

## Filter Drier Cont'd



**33247**  
Steel Filter Drier  
Outside Dia.: 4.000  
Length: 8.000  
Inlet Fitting Type: Female O-Ring  
Inlet Fitting: 11/16"  
Outlet Fitting Type: Female O-Ring  
Outlet Fitting: 11/16"  
O-Rings: (2) **24612**  
Case New Holland: 83936848  
Hy-Capacity: 0008890146  
Northern: 804789



**33248**  
Beadlock In-Line Filter w/ Desiccant for Liquid Line  
Outside Dia.: 2.500  
Length: 6.000  
Inlet Fitting Type: Beadlock  
Outlet Fitting Type: Beadlock  
Euclid: E8047098



**33250**  
Beadlock In-Line Filter w/ Desiccant for Liquid Line  
Outside Dia.: 2.500  
Length: 6.000  
Inlet Fitting Type: Beadlock  
Outlet Fitting Type: Beadlock  
Euclid: E80470910



**33252**  
Beadlock In-Line Filter w/ Desiccant for Liquid Line  
Outside Dia.: 2.500  
Length: 6.000  
Inlet Fitting Type: Beadlock  
Outlet Fitting Type: Beadlock  
General Motors Corp: 19188559  
Euclid: E80470912



**33253**  
Steel Filter Drier  
Outside Dia.: 3.000  
Outlet Fitting: 3/8"  
O-Rings: (2) **24612**  
Bergstrom: 540071  
Climatech: JA1195, JA1270, JA1755, JA1790  
Euclid: E804025  
Hy-Capacity: 0008890134, 0008890205  
Kysor: 1918001  
NaviStar: 11249  
Northern: 804735  
Red Dot: 74R3066



**33254**  
Steel Filter Drier  
Outside Dia.: 4.000  
Length: 7.000  
Inlet Fitting Type: Male Insert O-Ring  
Inlet Fitting: 3/8"  
Outlet Fitting Type: Male Insert O-Ring  
Outlet Fitting: 3/8"  
O-Rings: (2) **24612**  
Case New Holland: 1990758C2  
Euclid: E804091  
Hy-Capacity: 0008890163  
NaviStar: 143469C2, 14396902  
Northern: 804999



**33255**  
Steel Filter Drier  
Outside Dia.: 2.500  
Length: 8.000  
Inlet Fitting Type: Male Insert O-Ring  
Inlet Fitting: 3/8"  
Outlet Fitting Type: Male Insert O-Ring  
Outlet Fitting: 3/8"  
O-Rings: (3) **24606**  
Saab (86-79)  
Hy-Capacity: 0008890193



**33257**  
Steel Filter Drier  
Outside Dia.: 2.500  
Length: 6.500  
Inlet Fitting Type: Pad Mount  
Outlet Fitting Type: Pad Mount  
O-Rings: (2) **24152**  
Chrysler (90-83); Dodge (88-83);  
Plymouth (89-78)  
Chrysler: 4798589, 4798590AC



**33258**  
Steel Filter Drier  
Outside Dia.: 2.500  
Length: 8.500  
Inlet Fitting Type: Flare Fitting  
Inlet Fitting: 3/8"  
Outlet Fitting Type: Flare Fitting  
Outlet Fitting: 3/8"  
O-Rings: (1) **24650**, (1) **24606**  
Chrysler (82); Dodge (83-81); Mazda (77), (71-70); Plymouth (83-81)  
ARA: 1273136  
Case New Holland: L77169  
Caterpillar: 605818T4  
Dallas Truck AC: 0612012  
Evans: AM82240  
Frigiking: 9113997, 9116997  
Kysor: 1918006  
NaviStar: 13407, 13425  
Northern: 8041970, 804997

# Filter Drier, Accumulator and Desiccant

## Filter Drier Cont'd



### 33259

Steel Filter Drier  
 Outside Dia.: 2.750  
 Length: 10.000  
 Inlet Fitting Type: Male Insert O-Ring  
 Inlet Fitting: 3/8"  
 Outlet Fitting Type: Male Insert O-Ring  
 Outlet Fitting: 3/8"  
 O-Rings: (2) **24612**  
 Chrysler (75-71); Dodge (78), (75-71);  
 Dodge Medium Duty Truck (78);  
 Plymouth (78), (76-71)



### 33260

Steel Filter Drier  
 Outside Dia.: 2.500  
 Length: 6.500  
 Inlet Fitting Type: Male Insert O-Ring  
 Inlet Fitting: 3/8"  
 Outlet Fitting Type: Male Insert O-Ring  
 Outlet Fitting: 3/8"  
 O-Rings: (2) **24606**  
 Dodge (89-88), (86-84); Plymouth  
 (86-84)  
 Euclid: E804153



### 33262

Steel Filter Drier  
 Outside Dia.: 2.500  
 Length: 8.000  
 Inlet Fitting Type: Male Insert O-Ring  
 Inlet Fitting: 3/8"  
 Outlet Fitting Type: Male Insert O-Ring  
 Outlet Fitting: 3/8"  
 O-Rings: (2) **24606**  
 Jeep (90-79)  
 AMC: 8130314, 8130315  
 Northern: 8042010



### 33264

Steel Filter Drier  
 Outside Dia.: 2.500  
 Length: 8.000  
 Inlet Fitting Type: Male Insert O-Ring  
 Inlet Fitting: 3/8"  
 Outlet Fitting Type: Male Insert O-Ring  
 Outlet Fitting: 3/8"  
 O-Rings: (3) **24606**  
 Volvo (90-85), (82-80)  
 Volvo: 1370235



### 33266

Steel Filter Drier  
 Outside Dia.: 3.000  
 Length: 10.000  
 Inlet Fitting Type: Male Insert O-Ring  
 Inlet Fitting: 3/8"  
 Outlet Fitting Type: Male Insert O-Ring  
 Outlet Fitting: 3/8"  
 O-Rings: (2) **24612**  
 Euclid: E804027, E804067, E804068,  
 E804114  
 Kysor: 1911014, 402795  
 NaviStar: 11322, 11332  
 Northern: 804785  
 Red Dot: 74R3316



### 33270

Steel Filter Drier  
 Outside Dia.: 2.500  
 Length: 6.500  
 Inlet Fitting Type: Male Insert O-Ring  
 Inlet Fitting: 3/8"  
 Outlet Fitting Type: Male Insert O-Ring  
 Outlet Fitting: 1/2"  
 O-Rings: (1) **24606**, (2) **24608**  
 Climatch: JA1030  
 Dallas Truck AC: 0612033  
 Euclid: E804004  
 Evans: AM82255  
 Kysor: 1910016, 1999002, 402619  
 NaviStar: 15371  
 Northern: 8041850, 804698  
 Red Dot: 74R0450



### 33273

Steel Filter Drier  
 Outside Dia.: 2.000  
 Length: 11.000  
 Inlet Fitting Type: Male Insert O-Ring  
 Inlet Fitting: 3/8"  
 Outlet Fitting Type: Flare Fitting  
 Outlet Fitting: 3/8"  
 O-Rings: (2) **24612**  
 Mercury (66-65)



### 33274

Steel Filter Drier  
 Outside Dia.: 2.000  
 Length: 12.000  
 Inlet Fitting Type: Male Insert O-Ring  
 Inlet Fitting: 3/8"  
 Outlet Fitting Type: Female O-Ring  
 Outlet Fitting: 3/8"  
 O-Rings: (2) **24612**  
 Ford (71), (68-67); Mercury (71),  
 (68-67)



# Filter Drier, Accumulator and Desiccant

## Filter Drier Cont'd



**33276**  
Steel Filter Drier  
Outside Dia.: 2.500  
Length: 7.500  
Inlet Fitting Type: Male Insert O-Ring  
Inlet Fitting: 3/8"  
Outlet Fitting Type: Male Insert O-Ring  
Outlet Fitting: 3/8"  
O-Rings: (3) **24606**  
BMW (83-80); Chevy (88-85); Dodge (86); Geo (89); Hyundai (93); Isuzu (91-83); Mazda (82-81); Porsche (82-77); Renault (83-80); VW (85)  
Acura: 80351SD2H11  
Isuzu: 8941540861  
AMC: 7700674083  
Bergstrom: 540075, 540087  
Climatech: JA1045  
Kysor: 402754  
Mack: 4379RD549500, 7979402492, 7979402537, 7979402562  
NaviStar: 1691709C91, A61688  
Renault: 7700674083



**33277**  
Steel Filter Drier  
Outside Dia.: 2.500  
Length: 11.000  
Inlet Fitting Type: Male Insert O-Ring  
Inlet Fitting: 3/8"  
Outlet Fitting Type: Male Insert O-Ring  
Outlet Fitting: 3/8"  
O-Rings: (2) **24612**  
Honda (87-86)  
Honda: 38640SF0003



**33278**  
Steel Filter Drier  
Outside Dia.: 2.750  
Length: 7.500  
Inlet Fitting Type: Male Insert O-Ring  
Inlet Fitting: 3/8"  
Outlet Fitting Type: Male Insert O-Ring  
Outlet Fitting: 3/8"  
O-Rings: (2) **24612**  
Honda (91-88)  
Honda: 80351SH3H11



**33279**  
Steel Filter Drier  
Outside Dia.: 2.750  
Length: 7.500  
Inlet Fitting Type: Male Insert O-Ring  
Inlet Fitting: 3/8"  
Outlet Fitting Type: Male Insert O-Ring  
Outlet Fitting: 3/8"  
O-Rings: (2) **24606**  
Acura (93-90)  
Acura: 80351SK7H11  
Northern: 804867



**33280**  
Steel Filter Drier  
Outside Dia.: 2.500  
Length: 8.000  
Inlet Fitting Type: Barb Fitting  
Inlet Fitting: 3/8"  
Outlet Fitting Type: Barb Fitting  
Outlet Fitting: 3/8"  
O-Rings: (2) **24612**  
AMC (78); Chrysler (83-71); Dodge (83-71); Ford (93-69); Honda (79-73); Jeep (73-71); Mercury (94-73); Plymouth (85-74)  
Audi: ZVW433433  
Dallas Truck AC: 0612019  
Euclid: E804000, E804063  
Evans: HV82201  
Kysor: 1911017  
NaviStar: 12571  
Northern: 804222  
Red Dot: 74R0756



**33283**  
Steel Filter Drier  
Outside Dia.: 1.750  
Length: 20.000  
Inlet Fitting Type: Flare Fitting  
Inlet Fitting: 3/8"  
Outlet Fitting Type: Flare Fitting  
Outlet Fitting: 3/8"  
Ford (79-69); Mercury (75-67)  
Kysor: 1999024, 402777  
NaviStar: 12579  
Northern: 804253  
Red Dot: 73R0156, 74R0156



**33284**  
Steel Filter Drier  
Outside Dia.: 2.500  
Length: 8.000  
Inlet Fitting Type: Beadlock  
Inlet Fitting: 3/8"  
Outlet Fitting Type: Beadlock  
Outlet Fitting: 3/8"



**33288**  
Steel Filter Drier  
Outside Dia.: 3.000  
Length: 7.000  
Inlet Fitting Type: Male Insert O-Ring  
Outlet Fitting Type: Male Insert O-Ring  
O-Rings: (2) **24616**, (1) **24606**  
Nissan (86-80)  
Nissan: 9213006W61, J213006W10



**33289**  
Steel Filter Drier  
Outside Dia.: 2.000  
Length: 11.500  
Inlet Fitting Type: Flare Fitting  
Inlet Fitting: 3/8"  
Outlet Fitting Type: Flare Fitting  
Outlet Fitting: 3/8"  
O-Rings: (2) **24606**  
Ford (72-68)  
Northern: 804293

# Filter Drier, Accumulator and Desiccant

## Filter Drier Cont'd



### 33297

Steel Filter Drier  
 Outside Dia.: 3.000  
 Length: 9.000  
 Inlet Fitting Type: Male Insert O-Ring  
 Inlet Fitting: 3/8"  
 Outlet Fitting Type: Male Insert O-Ring  
 Outlet Fitting: 3/8"  
 O-Rings: (3) **24606**  
 Dallas Truck AC: 0612008  
 Euclid: E804096  
 Kysor: 1915003, 402564, 402750  
 Northern: 804737  
 Red Dot: 74R2256



### 33300

Steel Filter Drier  
 Outside Dia.: 2.250  
 Length: 10.000  
 Inlet Fitting Type: Male Insert O-Ring  
 Inlet Fitting: 3/8"  
 Outlet Fitting Type: Male Insert O-Ring  
 Outlet Fitting: 3/8"  
 O-Rings: (2) **24606**  
 Euclid: E804113  
 Kysor: 1911016, 1999021, 402765



### 33301

Steel Filter Drier  
 Outside Dia.: 2.500  
 Length: 8.000  
 Inlet Fitting Type: Male Insert O-Ring  
 Inlet Fitting: 3/8"  
 Outlet Fitting Type: Male Insert O-Ring  
 Outlet Fitting: 3/8"  
 O-Rings: (2) **24606**  
 Euclid: E804124



### 33302

Steel Filter Drier  
 Outside Dia.: 3.000  
 Length: 9.500  
 Inlet Fitting Type: Flare Fitting  
 Inlet Fitting: 3/8"  
 Outlet Fitting Type: Flare Fitting  
 Outlet Fitting: 3/8"  
 Int'l (78-73)  
 ARA: 1272100, 1273131  
 Euclid: E804159  
 Evans: AM82200  
 Kysor: 402495, 402569  
 NaviStar: 402495C91



### 33303

Steel Filter Drier  
 Outside Dia.: 2.500  
 Length: 6.000  
 Inlet Fitting Type: Flare Fitting  
 Inlet Fitting: 3/8"  
 Outlet Fitting Type: Flare Fitting  
 Outlet Fitting: 3/8"  
 O-Rings: (2) **24612**  
 ARA: 1273042  
 Climatech: JA1020  
 Euclid: E804001, E804007, E804062  
 Evans: AM82203  
 Frigiking: 9108734, 9131122  
 Hesston: 841551  
 Kysor: 1999033, 402561, 402651  
 NaviStar: 11425, 301319C1  
 Northern: 804269  
 Red Dot: 74R0306  
 Stople: 3105V003



### 33304

Steel Filter Drier  
 Outside Dia.: 2.500  
 Length: 8.000  
 Inlet Fitting Type: Flare Fitting  
 Inlet Fitting: 3/8"  
 Outlet Fitting Type: Barb Fitting  
 Outlet Fitting: 3/8"  
 O-Rings: (2) **24606**  
 AMC (87-65); Jeep (91-74)  
 AMC: 132643, 8121825, 8132643  
 NaviStar: 118418C1  
 Northern: 804223, 804790



### 33306

Steel Filter Drier  
 Outside Dia.: 4.000  
 Length: 5.750  
 Inlet Fitting Type: Flare Fitting  
 Inlet Fitting: 3/8"  
 Outlet Fitting Type: Flare Fitting  
 Outlet Fitting: 3/8"  
 Case New Holland: 111218C1  
 Dallas Truck AC: 0612045  
 Full Vison: 172825  
 Hesston: 8022147  
 Hupp: 63148G1  
 Hy-Capacity: 0008890119  
 NaviStar: 111218C1, 539049R91,  
 572832R91  
 Northern: 804463, 804474  
 Red Dot: 74R4016

# Filter Drier, Accumulator and Desiccant

## Filter Drier Cont'd



**33307**  
Steel Filter Drier  
Outside Dia.: 3.000  
Length: 9.000  
Inlet Fitting Type: Male Insert O-Ring  
Inlet Fitting: 3/8"  
Outlet Fitting Type: Male Insert O-Ring  
Outlet Fitting: 3/8"  
O-Rings: (2) **24612**  
Porsche (77-74)  
Bergstrom: 540095, 540261  
Case New Holland: 80417372,  
80441099, 84004558  
Climatech: JA1305, JC1085  
Dallas Truck AC: 0612032  
Euclid: E804021  
Hy-Capacity: 0008890175  
Kenworth: K251459  
Kysor: 1999009, 402529  
Massey Ferguson: 3383321M2,  
D45091000  
NaviStar: 13406  
Northern: 8041830, 804538, 804864



**33309**  
Steel Filter Drier  
Outside Dia.: 3.000  
Length: 8.500  
Inlet Fitting Type: Flare Fitting  
Inlet Fitting: 3/8"  
Outlet Fitting Type: Flare Fitting  
Outlet Fitting: 3/8"  
O-Rings: (2) **24612**  
Hy-Capacity: 0008890148  
Massey Ferguson: 3347710W1,  
72161835  
Northern: 804791

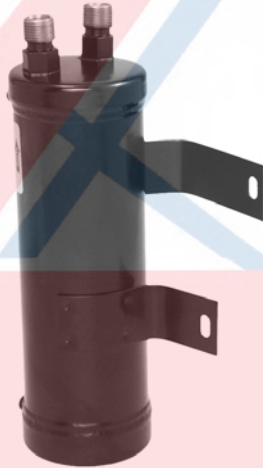

**33312**  
Steel Filter Drier  
Outside Dia.: 2.500  
Length: 9.000  
O-Rings: (2) **24612**  
Ford (87-75)  
Dallas Truck AC: 0217006  
Euclid: E804140  
Kysor: 1911004  
Northern: 804465



**33313**  
Steel Filter Drier  
Outside Dia.: 3.000  
Length: 6.000  
Inlet Fitting Type: Flare Fitting  
Inlet Fitting: 3/8"  
Outlet Fitting Type: Flare Fitting  
Outlet Fitting: 3/8"  
Carrier: 916384C1  
Case New Holland: 130217  
Climatech: JA1155  
Dallas Truck AC: 0612002, 0612006  
Deutz: 256818  
Hupp: 62418G1  
Hy-Capacity: 0008890102  
John Deere: AR45867  
Kenworth: 402007, 402494  
Kysor: 1999030, 402494  
Mack: 4379RD549540  
Massey Ferguson: 1034581M91,  
237411M91, 250929M91, 34581M91,  
772075M91  
NaviStar: 11816, 13352, 301319C91,  
924804C1  
Northern: 8041860, 804260  
Red Dot: 74R2406  
Stopler: 3105V002  
Year-A-Round: 14007374



**33314**  
Steel Filter Drier  
Outside Dia.: 4.000  
Length: 7.000  
Inlet Fitting Type: Flare Fitting  
Inlet Fitting: 3/8"  
Outlet Fitting Type: Flare Fitting  
Outlet Fitting: 3/8"  
O-Rings: (2) **24606**  
Allis Chalmers: 1143539, 1143549,  
1162967, 11629672, 1193543,  
11935434, 711935437  
ARA: 1273062  
Deutz: 1162967  
Euclid: E804129  
Evans: AM82218  
Hesston: 7722994  
Kenworth: 402000  
Kysor: 402000  
NaviStar: 11815  
Peterbilt: 402000  
Versatile: 30080



# Filter Drier, Accumulator and Desiccant

## Filter Drier Cont'd



### 33315

Steel Filter Drier  
 Outside Dia.: 4.000  
 Length: 8.000  
 Inlet Fitting Type: Flare Fitting  
 Inlet Fitting: 3/8"  
 Outlet Fitting Type: Flare Fitting  
 Outlet Fitting: 3/8"  
 O-Rings: (2) **24606**  
 Caterpillar: 6P1309  
 Climatech: JA1925  
 Dallas Truck AC: 0612063  
 Euclid: E804121  
 Mack: 4379RD559540  
 NaviStar: 13350, 739553C91  
 Northern: 804460  
 Red Dot: 74R3506

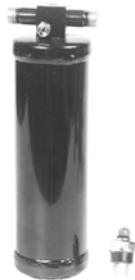

### 33317

Steel Filter Drier  
 Outside Dia.: 2.750  
 Length: 10.250  
 Inlet Fitting Type: Male Insert O-Ring  
 Inlet Fitting: 3/8"  
 Outlet Fitting Type: Male Insert O-Ring  
 Outlet Fitting: 3/8"  
 O-Rings: (1) **35758**, (3) **24606**, (2) **16746**

Chrysler (70-64); Dodge (71-65);  
 Jaguar (86-84); Jeep (71); Plymouth  
 (70-65)  
 AMC: 8121608, SE2087023  
 ARA: 1273011, 1273134, 1273135,  
 1273181  
 AutoCar: 615100001, 615100003,  
 615103803  
 Bergstrom: 540059, 540064, 540142,  
 570420  
 Brockway: 57042P  
 Case New Holland: A76085, A76312  
 Climatech: JA1085, JA1120, JA1125,  
 JA1170, JA2000  
 Dallas Truck AC: 0612015  
 Euclid: E804084, E804100  
 Evans: AM82209, AM82210, AM82211,  
 AM82212, AM82226  
 Hy-Capacity: 0008890103  
 John Deere: 08807900, K251306,  
 K251363, K251459, K251486  
 Kenworth: 57042, K251263, K251306,  
 K251363, K251486, RD41601,  
 RD416012, RD546320, RD546324  
 Kysor: 1999007, 1999034, 402564,  
 402565, 402566  
 Mack: 7979402565  
 NaviStar: 11006, 11055, 11066,  
 124552C1, 13437, 134522C1,  
 1676653C1  
 New Idea: 731157  
 Northern: 804349  
 Peterbilt: RD41601  
 Red Dot: 08807900, 74R1656, 74R1756,  
 74R2106, RD41601, RD422548,  
 RD535931, RD536931, RD546320



### 33318

Steel Filter Drier  
 Outside Dia.: 2.500  
 Length: 8.500  
 Inlet Fitting Type: Flare Fitting  
 Inlet Fitting: 3/8"  
 Outlet Fitting Type: Flare Fitting  
 Outlet Fitting: 3/8"  
 O-Rings: (2) **24606**  
 Dodge (82-80); Ford (73-71); Honda  
 (81-75); Int'l (78-73); Jaguar (86-76);  
 Jeep (86-82); Mazda (82-70); Mercury  
 (74-70); Plymouth (82-80); Porsche  
 (83-78); Toyota (80-70)  
 Toyota: 8847020030, 8847020050,  
 8847020070, 8847130270  
 AMC: 8134556  
 Climatech: JA1825  
 Dallas Truck AC: 0612003  
 Euclid: E804064  
 Mack: 402479, 7979202479,  
 7979402352  
 Massey Ferguson: 167843M1  
 NaviStar: 13450, 175254C1



### 33319

Steel Filter Drier  
 Outside Dia.: 3.000  
 Length: 6.000  
 Inlet Fitting Type: Male Insert O-Ring  
 Inlet Fitting: 3/8"  
 Outlet Fitting Type: Male Insert O-Ring  
 Outlet Fitting: 3/8"  
 O-Rings: (3) **24606**  
 Bergstrom: 540237  
 Caterpillar: 2182277, 9D6888  
 Climatech: JA2025  
 Deutz: 0034228, 0034583  
 Euclid: E804019  
 John Deere: 842976600  
 Kenworth: 5698  
 Kysor: 1975001, 199003, 1999037,  
 402496, 402752  
 Mack: 2790HV31147, 4379RD538420,  
 4379RD570612  
 Northern: 804380  
 Peterbilt: 402496

# Filter Drier, Accumulator and Desiccant

## Filter Drier Cont'd



**33320**  
Steel Filter Drier  
Outside Dia.: 4.000  
Length: 4.500  
Inlet Fitting Type: Male Insert O-Ring  
Inlet Fitting: 3/8"  
Outlet Fitting Type: Male Insert O-Ring  
Outlet Fitting: 3/8"  
O-Rings: (3) **24606**  
ARA: 1273093  
Euclid: E804060, E804131  
Evans: AM82217  
Kysor: 1975002, 1999031, 402498,  
402527, 402592, 402708  
NaviStar: 16448  
Northern: 804371  
Peterbilt: 402498



**33321**  
Steel Filter Drier  
Outside Dia.: 2.500  
Length: 8.000  
Inlet Fitting Type: Male Insert O-Ring  
Inlet Fitting: 3/8"  
Outlet Fitting Type: Male Insert O-Ring  
Outlet Fitting: 3/8"  
O-Rings: (1) **35758**, (3) **24606**, (2) **16746**  
Audi (77-75); Chevy (88-87), (85);  
Chrysler (76), (63-59); Land Rover  
(97), (95-94); Mazda (85-83); Porsche  
(92-78); VW (84-80)  
Acura: 80351SD2H11  
General Motors Corp: 19188603  
Porsche: 94457394300  
Volkswagen: ZVW433433  
ARA: 1273002, 1273130  
Case New Holland: A61688, L109036  
Caterpillar: 1018789  
Dallas Truck AC: 06120111  
Euclid: E804006, E804095  
Evans: AM82201, AM82206, HV32420  
Frigiking: 3601099, 6300328, 6300452,  
6301099, 6331372, 9131372  
Kysor: 1911009, 1999008, 1999036,  
402492, 402537, 402562, 402700  
Massey Ferguson: 1018462M91,  
3039149M91, D45070017  
NaviStar: 11825, 12007, 1691709C91  
Northern: 804297, 804424  
Red Dot: 74R0606, 74R0906  
Versatile: 18395



**33322**  
Steel Filter Drier  
Outside Dia.: 3.000  
Length: 11.000  
Inlet Fitting Type: Flare Fitting  
Inlet Fitting: 3/8"  
Outlet Fitting Type: Flare Fitting  
Outlet Fitting: 3/8"  
O-Rings: (2) **24606**  
Euclid: E804128  
Evans: HV82200  
NaviStar: 11931, 42619C1, 933608C1  
Northern: 804391  
Red Dot: 74R3156



**33329**  
Steel Filter Drier  
Outside Dia.: 2.000  
Length: 11.000  
Inlet Fitting Type: Male Insert O-Ring  
Inlet Fitting: 3/8"  
Outlet Fitting Type: Male Insert O-Ring  
Outlet Fitting: 3/8"  
O-Rings: (2) **24606**  
Ford (75-74); Mercury (75-74)



**33323**  
Steel Filter Drier  
Outside Dia.: 3.000  
Length: 10.000  
Inlet Fitting Type: Female O-Ring  
Outlet Fitting Type: Female O-Ring  
Outlet Fitting: 3/8"  
O-Rings: (2) **24606**  
Dodge (90-86); Eagle (90-89);  
Plymouth (90-88)  
ARA: 1273025, 1273137  
Bergstrom: 540107  
Climatech: JA1325  
Evans: AM82216  
Kysor: 1913001, 402505, 402620  
NaviStar: 12032, 343614C1, 426169C1,  
454614C1, 454631C1, 498189C91  
Red Dot: 74R3450



**33333**  
Steel Filter Drier  
Outside Dia.: 2.500  
Length: 8.000  
Inlet Fitting Type: Flare Fitting  
Inlet Fitting: 3/8"  
Outlet Fitting Type: Flare Fitting  
Outlet Fitting: 3/8"  
O-Rings: (1) **35758**, (1) **24606**  
Audi (74-73)  
Nissan: 27640M6600, 9999001043  
AutoCar: 615100003  
Dallas Truck AC: 0612014  
Hy-Capacity: 0008890162  
Northern: 804640, 804998

# Filter Drier, Accumulator and Desiccant

## Filter Drier Cont'd



### 33334

Steel Filter Drier  
 Outside Dia.: 2.500  
 Length: 8.000  
 Inlet Fitting Type: Male Insert O-Ring  
 Inlet Fitting: 3/8"  
 Outlet Fitting Type: Male Insert O-Ring  
 Outlet Fitting: 3/8"  
 O-Rings: (3) **24606**  
 Hy-Capacity: 0008890116  
 Kysor: 402621, 402680  
 NaviStar: 712007  
 Northern: 8041870



### 33335

Steel Filter Drier  
 Outside Dia.: 4.000  
 Length: 6.625  
 Inlet Fitting Type: Flare Fitting  
 Inlet Fitting: 3/8"  
 Outlet Fitting Type: Flare Fitting  
 Outlet Fitting: 3/8"  
 O-Rings: (2) **24606**  
 Northern: 804870  
 Peterbilt: 35001



### 33338

Steel Filter Drier  
 Outside Dia.: 3.000  
 Length: 7.000  
 Inlet Fitting Type: Female O-Ring  
 Inlet Fitting: 3/8"  
 Outlet Fitting Type: Male Insert O-Ring  
 Outlet Fitting: 3/8"  
 O-Rings: (2) **24606**  
 Chrysler (80); VW (94-90)  
 Volkswagen: 357820191C



### 33339

Steel Filter Drier  
 Outside Dia.: 2.000  
 Length: 6.500  
 Inlet Fitting Type: Pad Mount  
 Outlet Fitting Type: Pad Mount  
 O-Rings: (2) **24152**  
 Chrysler (82); Dodge (82-81);  
 Plymouth (82-81)



### 33340

Steel Filter Drier  
 Outside Dia.: 2.500  
 Length: 6.000  
 Inlet Fitting Type: Male Insert O-Ring  
 Inlet Fitting: 3/8"  
 Outlet Fitting Type: Female O-Ring  
 Outlet Fitting: 3/8"  
 O-Rings: (3) **24606**  
 Chevy (88-86); Chrysler (79-76);  
 Dodge (80-76); Dodge Medium Duty  
 Truck (80-79); Plymouth (80-76)  
 General Motors Corp: 19188616  
 Allis Chalmers: 722487436  
 Mack: 4379RD4183



### 33341

Steel Filter Drier  
 Outside Dia.: 2.500  
 Length: 5.500  
 Inlet Fitting Type: Pad Mount  
 Outlet Fitting Type: Pad Mount  
 O-Rings: (2) **24152**  
 Chrysler (89-80); Dodge (89-79);  
 Plymouth (89-79)  
 Chrysler: 4773665AB, 4773667  
 Allis Chalmers: 71193543



### 33343

Steel Filter Drier  
 Outside Dia.: 2.500  
 Length: 10.000  
 Inlet Fitting Type: Male Insert O-Ring  
 Inlet Fitting: 3/8"  
 Outlet Fitting Type: Female O-Ring  
 Outlet Fitting: 3/8"  
 O-Rings: (2) **24606**  
 Ford (81-78); Mercury (84-78)  
 Euclid: E804122



### 33344

Steel Filter Drier  
 Outside Dia.: 2.500  
 Length: 10.000  
 Inlet Fitting Type: Male Insert O-Ring  
 Inlet Fitting: 3/8"  
 Outlet Fitting Type: Female O-Ring  
 Outlet Fitting: 3/8"  
 O-Rings: (2) **24606**  
 Ford (80-76); Lincoln (80-77); Mercury  
 (80-76)



# Filter Drier, Accumulator and Desiccant

## Filter Drier Cont'd



**33345**  
Steel Filter Drier  
Outside Dia.: 4.250  
Length: 8.000  
Inlet Fitting Type: Male Insert O-Ring  
Inlet Fitting: 3/8"  
Outlet Fitting Type: Male Insert O-Ring  
Outlet Fitting: 3/8"  
O-Rings: (3) **24606**  
Case New Holland: 89832539  
Caterpillar: 5V5698, 8P991, 8P9991  
Dallas Truck AC: 0612061, 0612066  
Evans: AM82259  
Kysor: 1915002, 402779  
Northern: 8042020, 804520  
Red Dot: 74R3516



**33351**  
Steel Filter Drier  
Outside Dia.: 2.500  
Length: 14.000  
Inlet Fitting Type: Female O-Ring  
Inlet Fitting: 3/8"  
Outlet Fitting Type: Male Insert O-Ring  
Outlet Fitting: 5/16"  
O-Rings: (1) **24608**, (1) **24606**, (1) **24606**, (2) **24608**  
AMC (88-77)  
AMC: 3229446



**33354**  
Steel Filter Drier  
Outside Dia.: 3.000  
Length: 9.000  
Inlet Fitting Type: Male Insert O-Ring  
Inlet Fitting: 3/8"  
Outlet Fitting Type: Female O-Ring  
Outlet Fitting: 3/8"  
O-Rings: (2) **24606**  
Bergstrom: 540242, 540299  
Caterpillar: 2328908  
Climatech: JA2080  
Dallas Truck AC: 0612076  
Kysor: 1918004  
Mack: 4379RD5107420  
NaviStar: 12004  
Red Dot: 74R1406, 74R3064



**33356**  
Steel Filter Drier  
Outside Dia.: 2.750  
Length: 10.000  
Inlet Fitting Type: Male Insert O-Ring  
Inlet Fitting: 3/8"  
Outlet Fitting Type: Male Insert O-Ring  
Outlet Fitting: 3/8"  
O-Rings: (1) **24650**, (2) **24606**  
Bergstrom: 540234, 540239  
Climatech: JA1095, JA1895  
Dallas Truck AC: 0612020, 0612028  
Euclid: E804070, E804111  
Kysor: 1915005, 402799  
Mack: 221RD327, 221RD328, 4379RD555720, 4379RD559790  
NaviStar: 1676664C1, 1691601C91, 19067  
Red Dot: 74R1866, 74R2676  
TRP Parts: JA18950



**33349**  
Steel Filter Drier  
Outside Dia.: 4.000  
Length: 7.000  
Inlet Fitting Type: Flare Fitting  
Inlet Fitting: 3/8"  
Outlet Fitting Type: Flare Fitting  
Outlet Fitting: 3/8"  
Carrier: 539049R1  
Case New Holland: 30080  
Climatech: JA1940, JA2155  
Hy-Capacity: 0008890104  
Kysor: 1913006  
Mack: 4379RD560770  
NaviStar: 539049R91  
Northern: 804356



**33353**  
Steel Filter Drier  
Outside Dia.: 2.250  
Length: 5.000  
Inlet Fitting Type: Pad Mount  
Outlet Fitting Type: Pad Mount  
O-Rings: (2) **24152**  
Chrysler (81-79); Dodge (88-78);  
Plymouth (90-79)  
Chrysler: 4798591AB



**33355**  
Steel Filter Drier  
Outside Dia.: 2.500  
Inlet Fitting Type: Flare Fitting  
Inlet Fitting: 3/8"  
Outlet Fitting Type: Flare Fitting  
Outlet Fitting: 3/8"  
Jeep (79-75)  
AMC: 8127462

# Filter Drier, Accumulator and Desiccant

## Filter Drier Cont'd



### 33357

Steel Filter Drier  
 Outside Dia.: 3.000  
 Length: 10.000  
 Inlet Fitting Type: Quick Disconnect  
 Outlet Fitting Type: Quick Disconnect  
 Bergstrom: 540238  
 Climatech: JA2035  
 Kenworth: 0883410, K251593,  
 PH08834100  
 Kysor: 1914004  
 NaviStar: 12003, 712003



### 33358

Steel Filter Drier  
 Outside Dia.: 3.000  
 Length: 8.500  
 Inlet Fitting Type: Male Insert O-Ring  
 Inlet Fitting: 3/8"  
 Outlet Fitting Type: Female O-Ring  
 Outlet Fitting: 3/8"  
 O-Rings: (3) **24606**  
 Bergstrom: 540071  
 Climatech: JA1790  
 Dallas Truck AC: 0612055  
 Euclid: E804030, E804033  
 NaviStar: 11037



### 33359

Steel Filter Drier  
 Outside Dia.: 2.500  
 Length: 6.000  
 Inlet Fitting Type: Quick Disconnect  
 Outlet Fitting Type: Quick Disconnect  
 Outlet Fitting: 3/8"  
 Peterbilt: 1804019



### 33360

Steel Filter Drier  
 Outside Dia.: 3.000  
 Length: 6.500  
 Inlet Fitting Type: Male Insert O-Ring  
 Inlet Fitting: 3/8"  
 Outlet Fitting Type: Female O-Ring  
 Outlet Fitting: 1/2"  
 O-Rings: (1) **24610**, (1) **24650**, (1)  
**24606**, (2) **24608**  
 Porsche (92-78)  
 Porsche: 92857394103



### 33361

Steel Filter Drier  
 Outside Dia.: 2.500  
 Length: 8.500  
 Inlet Fitting Type: Flare Fitting  
 Inlet Fitting: 3/8"  
 Outlet Fitting Type: Flare Fitting  
 Outlet Fitting: 3/8"  
 Jeep (86-74)  
 AMC: 8124759, 8128141, 8128175



### 33363

Steel Filter Drier  
 Outside Dia.: 2.500  
 Length: 6.000  
 Inlet Fitting Type: Male Insert O-Ring  
 Inlet Fitting: 3/8"  
 Outlet Fitting Type: Female O-Ring  
 Outlet Fitting: 3/8"  
 O-Rings: (1) **24610**, (1) **24650**, (2)  
**24606**  
 Audi (87-75); Eagle (89-88); Land  
 Rover (97), (95-94); Peugeot (86-80);  
 VW (93-78)  
 Audi: 813820191  
 Volkswagen: 171820191, 171820191B,  
 813820191  
 Northern: 8041930



### 33364

Steel Filter Drier  
 Outside Dia.: 3.000  
 Length: 7.000  
 Inlet Fitting Type: Male Insert O-Ring  
 Inlet Fitting: 3/8"  
 Outlet Fitting Type: Male Insert O-Ring  
 Outlet Fitting: 3/8"  
 O-Rings: (2) **24606**  
 VW (92-85)

# Filter Drier, Accumulator and Desiccant

## Filter Drier Cont'd



**33365**  
Steel Filter Drier  
Outside Dia.: 2.750  
Length: 8.500  
Inlet Fitting Type: Male Insert O-Ring  
Inlet Fitting: 3/8"  
Outlet Fitting Type: Male Insert O-Ring  
Outlet Fitting: 3/8"  
O-Rings: (2) **24606**  
Allis Chalmers: 721618353  
AutoCar: 402566, 515105005  
Bergstrom: 540060  
Climatech: JA1130  
Dallas Truck AC: 0612021  
Euclid: E804066, E804156  
Evans: AM82213, AM82214  
John Deere: 74R1906, 842600200  
Kenworth: 74R1906, K251486,  
RD535691, RD535931, RD546321,  
RDA5035691, RDA5D35691  
Kysor: 1999010, 1999012, 402566,  
402679  
Mack: 221RD323P2, 4379RD535931  
Massey Ferguson: 3447710W1  
NaviStar: 12316  
Peterbilt: 1801800  
Red Dot: 74R1906, RD535691



**33366**  
Steel Filter Drier  
Outside Dia.: 2.000  
Length: 8.750  
Inlet Fitting Type: Male Insert O-Ring  
Inlet Fitting: 3/8"  
Outlet Fitting Type: Female O-Ring  
Outlet Fitting: 3/8"  
O-Rings: (2) **24606**  
Ford (78), (73-72)



**33367**  
Steel Filter Drier  
O-Rings: (2) **24606**  
Ford (79-73)  
ARA: 1273101  
Euclid: E804147  
Northern: 804387



**33369**  
Steel Filter Drier  
Outside Dia.: 3.000  
Length: 7.000  
Inlet Fitting Type: Female O-Ring  
Inlet Fitting: 1/2"  
Outlet Fitting Type: Male Insert O-Ring  
Outlet Fitting: 3/8"  
O-Rings: (1) **24650**, (1) **24606**, (2)  
**24608**, (1) **24610**, (1) **24650**  
VW (88-82)



**33371**  
Steel Filter Drier  
Outside Dia.: 2.000  
Length: 12.000  
Inlet Fitting Type: Male Insert O-Ring  
Inlet Fitting: 3/8"  
Outlet Fitting Type: Female O-Ring  
Outlet Fitting: 3/8"  
O-Rings: (2) **24606**  
Ford (77-75), (73-72); Mercury  
(77-76), (73-71)



**33372**  
Steel Filter Drier  
Outside Dia.: 2.000  
Length: 12.000  
Inlet Fitting Type: Male Insert O-Ring  
Inlet Fitting: 3/8"  
Outlet Fitting Type: Female O-Ring  
Outlet Fitting: 3/8"  
O-Rings: (2) **24606**  
Ford (73-71); Mercury (72-68)



**33373**  
Steel Filter Drier  
Outside Dia.: 3.000  
Length: 7.000  
Inlet Fitting Type: Male Insert O-Ring  
Inlet Fitting: 3/8"  
Outlet Fitting Type: Female O-Ring  
Outlet Fitting: 3/8"  
O-Rings: (2) **24606**  
VW (93-87)



**33374**  
Steel Filter Drier  
Outside Dia.: 2.750  
Length: 7.000  
Inlet Fitting Type: Male Insert O-Ring  
Inlet Fitting: 3/8"  
Outlet Fitting Type: Male Insert O-Ring  
Outlet Fitting: 3/8"  
O-Rings: (3) **24606**  
VW (91-86)



**33376**  
Aluminum Filter Drier w/o Pad Mount  
Outside Dia.: 3.000  
Length: 7.500  
Inlet Fitting Type: Female O-Ring  
Inlet Fitting: 3/8"  
Outlet Fitting Type: Female O-Ring  
Outlet Fitting: 3/8"  
O-Rings: (3) **24606**  
Mercedes (00-92)  
Mercedes Benz: 1408300183



# Filter Drier, Accumulator and Desiccant

## Filter Drier Cont'd



**33377**  
Steel Filter Drier  
Outside Dia.: 2.500  
Length: 11.000  
Inlet Fitting Type: Male Insert O-Ring  
Inlet Fitting: 3/8"  
Outlet Fitting Type: Male Insert O-Ring  
Outlet Fitting: 3/8"  
O-Rings: (2) **24606**  
Ford (79-72); Lincoln (77-72); Mercury (79-72)



**33378**  
Aluminum Filter Drier w/o Pad Mount  
Outside Dia.: 3.000  
Length: 6.750  
Inlet Fitting Type: Female O-Ring  
Inlet Fitting: 3/8"  
Outlet Fitting Type: Female O-Ring  
Outlet Fitting: 1/2"  
O-Rings: (1) **24650**, (1) **24606**, (2) **24608**  
VW (02-93)



**33380**  
Steel Filter Drier  
Outside Dia.: 2.500  
Length: 10.000  
Inlet Fitting Type: Male Insert O-Ring  
Inlet Fitting: 3/8"  
Outlet Fitting Type: Male Insert O-Ring  
Outlet Fitting: 3/8"  
O-Rings: (2) **24606**  
Ford (76); Lincoln (79-74); Mercury (78-73)



**33383**  
Steel Filter Drier  
Outside Dia.: 4.000  
Length: 7.500  
Inlet Fitting Type: Pad Mount  
Outlet Fitting Type: Pad Mount  
O-Rings: (1) **24676**, (1) **24610**, (1) **24650**  
BMW (97-91)  
BMW: 64538390483



**33384**  
Steel Filter Drier  
Outside Dia.: 3.000  
Inlet Fitting Type: Male Insert O-Ring  
Inlet Fitting: 3/8"  
Outlet Fitting Type: Male Insert O-Ring  
Outlet Fitting: 3/8"  
O-Rings: (2) **24650**, (2) **24606**  
Mercedes (91-86), (66-60)  
Mercedes Benz: 1268300383



**33389**  
Steel Filter Drier  
Outside Dia.: 3.000  
Length: 7.000  
Inlet Fitting Type: Male Insert O-Ring  
Inlet Fitting: 3/8"  
Outlet Fitting Type: Male Insert O-Ring  
Outlet Fitting: 3/8"  
O-Rings: (3) **24606**  
Mercedes (97-90)  
Mercedes Benz: 1298300183



**33390**  
Steel Filter Drier  
Outside Dia.: 4.000  
Length: 7.000  
O-Rings: (2) **24606**  
Mercedes (02-96)  
Mercedes Benz: 1298300283  
Hinker: 116002011, 116020042



**33391**  
Steel Filter Drier  
Outside Dia.: 2.500  
Length: 10.000  
Inlet Fitting Type: Male Insert O-Ring  
Inlet Fitting: 3/8"  
Outlet Fitting Type: Male Insert O-Ring  
Outlet Fitting: 3/8"  
O-Rings: (2) **24606**  
Ford (79-72); Mercury (78)

# Filter Drier, Accumulator and Desiccant

## Filter Drier Cont'd



**33394**  
Steel Filter Drier  
Outside Dia.: 3.000  
Length: 7.000  
Inlet Fitting Type: Flare Fitting  
Inlet Fitting: 3/8"  
Outlet Fitting Type: Flare Fitting  
Outlet Fitting: 1/2"  
O-Rings: (2) **24606**  
Mercedes (80-73)  
Mercedes Benz: 1078300083  
Hy-Capacity: 0008890208  
Northern: 8041980



**33395**  
Steel Filter Drier  
Outside Dia.: 4.000  
Length: 7.500  
Inlet Fitting Type: Flare Fitting  
Inlet Fitting: 3/8"  
Outlet Fitting Type: Flare Fitting  
Outlet Fitting: 3/8"  
O-Rings: (1) **24606**, (2) **24606**  
Euclid: E804177  
Hupp: 62786G1  
Hy-Capacity: 0008890130  
John Deere: AH80693, AH84394,  
AH84591, AR63170, AR84591  
Northern: 804478, 804487



**33396**  
Steel Filter Drier  
Outside Dia.: 3.000  
Length: 6.500  
Inlet Fitting Type: Male Insert O-Ring  
Inlet Fitting: 3/8"  
Outlet Fitting Type: Male Insert O-Ring  
Outlet Fitting: 3/8"  
O-Rings: (3) **24606**  
Mercedes (87), (85-77), (68-65)  
Mercedes Benz: 1238300683



**33397**  
Steel Filter Drier  
Outside Dia.: 3.000  
Length: 6.500  
Inlet Fitting Type: Flare Fitting  
Inlet Fitting: 3/8"  
Outlet Fitting Type: Flare Fitting  
Outlet Fitting: 3/8"  
O-Rings: (2) **24606**  
Mercedes (80-70)  
Mercedes Benz: 1168300483



**33398**  
Steel Filter Drier  
Outside Dia.: 3.000  
Length: 6.500  
Inlet Fitting Type: Flare Fitting  
Inlet Fitting: 3/8"  
Outlet Fitting Type: Flare Fitting  
Outlet Fitting: 1/2"  
O-Rings: (2) **24606**  
Mercedes (85-72)  
Mercedes Benz: 1078301183,  
1078301283, 1078301483



**33399**  
Steel Filter Drier  
Outside Dia.: 3.000  
Length: 7.000  
Inlet Fitting Type: Male Insert O-Ring  
Inlet Fitting: 3/8"  
Outlet Fitting Type: Male Insert O-Ring  
Outlet Fitting: 3/8"  
O-Rings: (3) **24606**  
Mercedes (85-78)



**33400**  
Steel Filter Drier  
Outside Dia.: 3.000  
Length: 7.000  
Inlet Fitting Type: Male Insert O-Ring  
Inlet Fitting: 3/8"  
Outlet Fitting Type: Male Insert O-Ring  
Outlet Fitting: 3/8"  
O-Rings: (2) **24606**  
Mercedes (93-84)  
Mercedes Benz: 2018300083



**33401**  
Steel Filter Drier  
Outside Dia.: 3.000  
Length: 7.000  
Inlet Fitting Type: Flare Fitting  
Inlet Fitting: 1/2"  
Outlet Fitting Type: Flare Fitting  
Outlet Fitting: 1/2"  
O-Rings: (2) **24606**  
Mercedes (76-59)  
Mercedes Benz: 1158350471

# Filter Drier, Accumulator and Desiccant

## Filter Drier Cont'd



**33402**  
Steel Filter Drier  
Outside Dia.: 2.500  
Length: 9.500  
Inlet Fitting Type: Male Insert O-Ring  
Inlet Fitting: 3/8"  
Outlet Fitting Type: Male Insert O-Ring  
Outlet Fitting: 3/8"  
O-Rings: (2) **24606**  
Honda (87-83)  
Honda: 80351SB2H61



**33404**  
Steel Filter Drier  
Outside Dia.: 2.500  
Length: 9.500  
Inlet Fitting Type: Male Insert O-Ring  
Inlet Fitting: 3/8"  
Outlet Fitting Type: Male Insert O-Ring  
Outlet Fitting: 3/8"  
O-Rings: (2) **24606**  
Honda (85-84)  
Honda: 80351SA5H91



**33412**  
Steel Filter Drier  
Outside Dia.: 2.625  
Length: 9.000  
Inlet Fitting Type: Male Insert O-Ring  
Outlet Fitting Type: Male Insert O-Ring  
O-Rings: (2) **24607**  
Acura (05-86); Ford (89-88); Honda  
(93-90); Sterling (88-87); Toyota  
(89-85), (83-80)  
Acura: 80350SD4N00  
Honda: 80351SM1H11  
Toyota: 8847116010



**33414**  
Steel Filter Drier  
Outside Dia.: 2.625  
Length: 8.000  
Inlet Fitting Type: Male Insert O-Ring  
Inlet Fitting: 3/8"  
Outlet Fitting Type: Male Insert O-Ring  
Outlet Fitting: 3/8"  
O-Rings: (2) **24606**  
Volvo (84-75); Yugo (91-87)



**33403**  
Steel Filter Drier  
Outside Dia.: 2.500  
Length: 8.000  
Inlet Fitting Type: Male Insert O-Ring  
Outlet Fitting Type: Male Insert O-Ring  
O-Rings: (3) **24606**  
Chevy (88-85); Dodge (91-86); Eagle  
(91); Honda (85-82); Mazda (92-79);  
Mercury (89-87); Mitsubishi (91-83);  
Plymouth (90-86); Toyota (90-80)  
General Motors Corp: 19188665,  
94841727  
Honda: 38640SA5003  
Mazda: 857261510, LA0161500  
Toyota: 8847014010



**33406**  
Steel Filter Drier  
Outside Dia.: 2.500  
Length: 8.000  
Inlet Fitting Type: Female O-Ring  
Inlet Fitting: 3/8"  
Outlet Fitting Type: Male Insert O-Ring  
Outlet Fitting: 3/8"  
O-Rings: (3) **24606**  
Honda (83-80)  
Honda: 80351SA0H61



**33413**  
Steel Filter Drier  
Outside Dia.: 2.625  
Length: 8.000  
Inlet Fitting Type: Male Insert O-Ring  
Inlet Fitting: 3/8"  
Outlet Fitting Type: Male Insert O-Ring  
Outlet Fitting: 3/8"  
Toyota (80-79)  
Toyota: 8847012031



**33415**  
Steel Filter Drier  
Outside Dia.: 2.500  
Length: 8.000  
Inlet Fitting Type: Male Insert O-Ring  
Outlet Fitting Type: Male Insert O-Ring  
O-Rings: (1) **24606**, (2) **24608**, (2)  
**24606**  
Nissan (97-82)  
Nissan: 9213001G02, 9213006F00,  
9213017C01, 9213085M10,  
92130N8222



# Filter Drier, Accumulator and Desiccant

## Filter Drier Cont'd



**33416**  
Steel Filter Drier  
Outside Dia.: 3.000  
Length: 6.500  
Inlet Fitting Type: Flare Fitting  
Inlet Fitting: 3/8"  
Outlet Fitting Type: Flare Fitting  
Outlet Fitting: 3/8"  
O-Rings: (2) **24606**  
Nissan (81-79)  
Nissan: B7640P7101



**33418**  
Steel Filter Drier  
O-Rings: (1) **24606**, (2) **24608**, (1) **24606**, (2) **24608**, (1) **24610**, (2) **24606**  
Nissan (89-85)  
Nissan: 9213001E10, 9213016E10



**33420**  
Steel Filter Drier  
Outside Dia.: 2.500  
Length: 8.000  
Inlet Fitting Type: Male Insert O-Ring  
Outlet Fitting Type: Male Insert O-Ring  
O-Rings: (2) **24606**, (2) **24608**  
Nissan (85-82)  
Nissan: 9213136A00



**33422**  
Steel Filter Drier  
Outside Dia.: 2.750  
Length: 7.000  
Inlet Fitting Type: Male Insert O-Ring  
Outlet Fitting Type: Male Insert O-Ring  
O-Rings: (3) **24606**  
Nissan (83-81)  
Nissan: B7640P9100



**33417**  
Steel Filter Drier  
Outside Dia.: 2.500  
Length: 8.500  
Inlet Fitting Type: Male Insert O-Ring  
Outlet Fitting Type: Male Insert O-Ring  
O-Rings: (3) **24606**  
Isuzu (90-88); Nissan (89-84)  
Isuzu: 8943248230  
Nissan: J213001P01



**33419**  
Steel Filter Drier  
Outside Dia.: 3.000  
Length: 6.500  
Inlet Fitting Type: Male Insert O-Ring  
Outlet Fitting Type: Male Insert O-Ring  
O-Rings: (3) **24606**  
Nissan (86-85)  
Nissan: 92130D3400



**33421**  
Steel Filter Drier  
Outside Dia.: 2.750  
Length: 6.500  
Inlet Fitting Type: Male Insert O-Ring  
Outlet Fitting Type: Male Insert O-Ring  
O-Rings: (3) **24606**  
Nissan (84-82)  
Nissan: 27640M6681, 92130D0101



**33423**  
Steel Filter Drier  
Outside Dia.: 3.000  
Length: 7.000  
Inlet Fitting Type: Male Insert O-Ring  
Inlet Fitting: 3/8"  
Outlet Fitting Type: Male Insert O-Ring  
Outlet Fitting: 3/8"  
O-Rings: (2) **24606**  
Mercedes (95-86)  
Mercedes Benz: 1248300283

# Filter Drier, Accumulator and Desiccant

## Filter Drier Cont'd



### 33426

Steel Filter Drier  
 Outside Dia.: 2.750  
 Length: 7.000  
 Inlet Fitting Type: Male Insert O-Ring  
 Inlet Fitting: 3/8"  
 Outlet Fitting Type: Male Insert O-Ring  
 Outlet Fitting: 3/8"  
 O-Rings: (2) **24606**  
 Honda (91-86)  
 Honda: 80351SE0H11, 80351SF1H01,  
 80351SS0H91



### 33427

Steel Filter Drier  
 Outside Dia.: 2.500  
 Length: 8.000  
 Inlet Fitting Type: Male Insert O-Ring  
 Inlet Fitting: 3/8"  
 Outlet Fitting Type: Male Insert O-Ring  
 Outlet Fitting: 3/8"  
 O-Rings: (3) **24606**  
 Mazda (86-83)



### 33428

Steel Filter Drier  
 Outside Dia.: 2.500  
 Length: 8.000  
 Inlet Fitting Type: Male Insert O-Ring  
 Inlet Fitting: 3/8"  
 Outlet Fitting Type: Male Insert O-Ring  
 Outlet Fitting: 3/8"  
 O-Rings: (3) **24606**  
 Acura (89-86); Dodge (85); Hyundai  
 (92); Mazda (85-83); Plymouth (85)  
 Northern: 804367



### 33429

Steel Filter Drier  
 Outside Dia.: 3.750  
 Length: 7.000  
 Inlet Fitting Type: Pad Mount  
 Outlet Fitting Type: Pad Mount  
 O-Rings: (1) **24650**, (3) **24606**  
 BMW (95-87)  
 BMW: 64538390469



### 33430

Steel Filter Drier  
 Outside Dia.: 2.500  
 Length: 8.000  
 Inlet Fitting Type: Male Insert O-Ring  
 Outlet Fitting Type: Male Insert O-Ring  
 O-Rings: (1) **24606**, (2) **24608**, (2)  
**24606**, (2) **24608**  
 BMW (86-78)  
 BMW: 64531466049, 64538363554



### 33433

Steel Filter Drier  
 Outside Dia.: 3.000  
 Length: 6.500  
 Inlet Fitting Type: Male Insert O-Ring  
 Outlet Fitting Type: Male Insert O-Ring  
 O-Rings: (3) **24606**  
 BMW (88-82)  
 BMW: 64531466048, 64538363555



### 33436

Steel Filter Drier  
 Outside Dia.: 3.000  
 Length: 7.000  
 Inlet Fitting Type: Flare Fitting  
 Inlet Fitting: 1/2"  
 Outlet Fitting Type: Flare Fitting  
 Outlet Fitting: 1/2"  
 O-Rings: (2) **24606**  
 BMW (82-75)  
 BMW: 64531362127



### 33438

Steel Filter Drier  
 Outside Dia.: 3.000  
 Length: 5.500  
 Inlet Fitting Type: Male Insert O-Ring  
 Inlet Fitting: 3/8"  
 Outlet Fitting Type: Male Insert O-Ring  
 Outlet Fitting: 3/8"  
 O-Rings: (3) **24606**  
 BMW (93-84)  
 BMW: 64531466051

# Filter Drier, Accumulator and Desiccant

## Filter Drier Cont'd



**33439**  
Steel Filter Drier  
Outside Dia.: 2.750  
Length: 8.000  
Inlet Fitting Type: Male Insert O-Ring  
Outlet Fitting Type: Male Insert O-Ring  
O-Rings: (2) **24616**  
Nissan (84-81)  
Subaru: J2130W2400



**33440**  
Steel Filter Drier  
Outside Dia.: 2.500  
Length: 8.000  
Inlet Fitting Type: Male Insert O-Ring  
Inlet Fitting: 3/8"  
Outlet Fitting Type: Male Insert O-Ring  
Outlet Fitting: 3/8"  
O-Rings: (1) **35752**, (3) **24606**  
Subaru (84-83)



**33441**  
Steel Filter Drier  
Outside Dia.: 2.750  
Length: 7.000  
Inlet Fitting Type: Male Insert O-Ring  
Inlet Fitting: 3/8"  
Outlet Fitting Type: Male Insert O-Ring  
Outlet Fitting: 3/8"  
O-Rings: (3) **24606**  
Subaru (88-83)  
Subaru: SOA329A315



**33442**  
Steel Filter Drier  
Outside Dia.: 2.500  
Length: 9.500  
Inlet Fitting Type: Male Insert O-Ring  
Inlet Fitting: 3/8"  
Outlet Fitting Type: Male Insert O-Ring  
Outlet Fitting: 3/8"  
O-Rings: (2) **24606**  
Honda (87-83)  
Honda: 80351SB0H11



**33443**  
Steel Filter Drier  
Outside Dia.: 2.750  
Length: 7.000  
Inlet Fitting Type: Male Insert O-Ring  
Outlet Fitting Type: Male Insert O-Ring  
O-Rings: (2) **24616**  
Subaru (94-85)



**33444**  
Steel Filter Drier  
Outside Dia.: 3.000  
Length: 6.000  
Inlet Fitting Type: Male Insert O-Ring  
Inlet Fitting: 3/8"  
Outlet Fitting Type: Male Insert O-Ring  
Outlet Fitting: 3/8"  
O-Rings: (3) **24606**  
BMW (93-84); Mercury (77)  
BMW: 64538391025



**33445**  
Steel Filter Drier  
Outside Dia.: 2.750  
Length: 7.000  
Inlet Fitting Type: Male Insert O-Ring  
Outlet Fitting Type: Male Insert O-Ring  
O-Rings: (2) **24606**, (2) **24616**  
Subaru (84)



**33446**  
Barb In-Line Filter w/o Desiccant for Liquid Line  
Outside Dia.: 2.500  
Length: 3.000  
Inlet Fitting Type: Beadlock  
Outlet Fitting Type: Beadlock



**33448**  
Barb In-Line Filter w/o Desiccant for Liquid Line



**33450**  
Barb In-Line Filter w/o Desiccant for Liquid Line  
Outside Dia.: 2.500  
Length: 3.000  
Inlet Fitting Type: Beadlock  
Outlet Fitting Type: Beadlock



**33452**  
Barb In-Line Filter w/o Desiccant for Liquid Line  
Outside Dia.: 2.500  
Length: 3.000  
Inlet Fitting Type: Beadlock  
Outlet Fitting Type: Beadlock



# Filter Drier, Accumulator and Desiccant

## Filter Drier Cont'd



### 33453

Steel Filter Drier  
 Outside Dia.: 2.750  
 Length: 8.000  
 Inlet Fitting Type: Male Insert O-Ring  
 Outlet Fitting Type: Male Insert O-Ring  
 O-Rings: (2) **24629**  
 Subaru (90-85)



### 33454

Steel Filter Drier  
 Outside Dia.: 2.750  
 Length: 7.500  
 Inlet Fitting Type: Male Insert O-Ring  
 Outlet Fitting Type: Male Insert O-Ring  
 O-Rings: (2) **24607**, (2) **24606**  
 Mazda (93-90); Nissan (89-86)  
 Mazda: NA0161500A  
 Nissan: 9213029R10



### 33455

Steel Filter Drier  
 Outside Dia.: 2.500  
 Length: 9.000  
 Inlet Fitting Type: Male Insert O-Ring  
 Inlet Fitting: 3/8"  
 Outlet Fitting Type: Male Insert O-Ring  
 Outlet Fitting: 3/8"  
 O-Rings: (2) **24606**  
 Swivel Top/Universal Accumulator also available Part No. **33705** - Tube kit not required.



### 33460

O-Ring In-Line Filter w/o Desiccant for Liquid Line  
 O-Rings: (2) **24606**  
 General Motors Corp: 15982368  
 Bergstrom: 525709  
 Climatech: JA2150  
 Euclid: E804011  
 Kysor: 1910022  
 NaviStar: 12000, 712000



### 33462

Steel Filter Drier  
 Outside Dia.: 3.000  
 Length: 7.500  
 Inlet Fitting Type: Male Insert O-Ring  
 Inlet Fitting: 3/8"  
 Outlet Fitting Type: Male Insert O-Ring  
 Outlet Fitting: 3/8"  
 O-Rings: (2) **24650**, (2) **24606**  
 Allis Chalmers: 71355100  
 Bergstrom: 540152  
 Caterpillar: 2328936  
 Climatech: JA2140  
 Deutz: 71355100  
 Euclid: E804039  
 Hy-Capacity: 0008890206  
 Kysor: 1917001  
 Mack: 4379RD5107770  
 NaviStar: 19147  
 Peterbilt: 1803619  
 Red Dot: 74R2616



### 33463

Steel Filter Drier  
 Outside Dia.: 3.000  
 Length: 9.000  
 Inlet Fitting Type: Male Insert O-Ring  
 Inlet Fitting: 3/8"  
 Outlet Fitting Type: Male Insert O-Ring  
 Outlet Fitting: 3/8"  
 O-Rings: (2) **24606**  
 Bergstrom: 540098, 540101  
 Climatech: JA1260, JA2110  
 Euclid: E804040  
 Kysor: 1915004, 1918003  
 Mack: 221RD312  
 NaviStar: 1691703C91, 19143



### 33464

Steel Filter Drier  
 Outside Dia.: 2.500  
 Length: 8.000  
 Inlet Fitting Type: Quick Disconnect  
 Outlet Fitting Type: Quick Disconnect  
 Caterpillar: 3E3535  
 Dallas Truck AC: 0612075  
 Mack: 4379RD586050  
 Red Dot: 74R0470

# Filter Drier, Accumulator and Desiccant

## Filter Drier Cont'd



**33466**  
Steel Filter Drier  
Outside Dia.: 3.000  
Length: 10.000  
Inlet Fitting Type: Male Insert O-Ring  
Inlet Fitting: 3/8"  
Outlet Fitting Type: Male Insert O-Ring  
Outlet Fitting: 3/8"  
O-Rings: (1) **24650**, (2) **24606**  
Bergstrom: 540102, 540137  
Climatech: JA1905, JA1975  
Dallas Truck AC: 0612058  
Euclid: E804036, E804135, E804150  
John Deere: AT262561  
Kysor: 1915006, 1918002  
Mack: 221RD331, 221RD334, 4379RD567681  
Massey Ferguson: 3712495M1  
NaviStar: 19142, 19144  
Northern: 8041950, 8042000  
Red Dot: 74R3136, 74R3306



**33468**  
Steel Filter Drier  
Outside Dia.: 3.000  
Length: 10.500  
Inlet Fitting Type: Male Insert O-Ring  
Inlet Fitting: 3/8"  
Outlet Fitting Type: Male Insert O-Ring  
Outlet Fitting: 3/8"  
O-Rings: (2) **24606**  
Euclid: E804023  
Kysor: 1914001, 402717  
Northern: 804736



**33470**  
Steel Filter Drier  
Outside Dia.: 3.000  
Length: 10.000  
Inlet Fitting Type: Male Insert O-Ring  
Inlet Fitting: 3/8"  
Outlet Fitting Type: Female O-Ring  
Outlet Fitting: 3/8"  
O-Rings: (2) **24606**  
Bergstrom: 540077, 540092, 541177  
Caterpillar: 2473546  
Climatech: JA1885  
Euclid: E804034, E804104  
Kysor: 1912001, 1912005, 1912014, 1999017, 402797  
NaviStar: 19134, 19135  
Red Dot: 74R3336



**33472**  
Steel Filter Drier  
Outside Dia.: 3.000  
Length: 9.000  
Inlet Fitting Type: Quick Disconnect  
Outlet Fitting Type: Quick Disconnect  
Bergstrom: 540093  
Euclid: E804119, E804120  
Kysor: 1912007, 402772, 402804, 402880, 402881  
NaviStar: 19136



**33469**  
Steel Filter Drier  
Outside Dia.: 3.000  
Length: 10.000  
Inlet Fitting Type: Male Insert O-Ring  
Inlet Fitting: 3/8"  
Outlet Fitting Type: Female O-Ring  
Outlet Fitting: 3/8"  
O-Rings: (2) **24606**  
Dallas Truck AC: 0612059  
Euclid: E804042, E804044  
NaviStar: 11092, 19148  
Peterbilt: 1803638



**33471**  
Steel Filter Drier  
Outside Dia.: 3.000  
Length: 9.000  
Inlet Fitting Type: Male Insert O-Ring  
Inlet Fitting: 3/8"  
Outlet Fitting Type: Male Insert O-Ring  
Outlet Fitting: 3/8"  
O-Rings: (2) **24650**  
Bergstrom: 540094, 540109  
Case New Holland: 402529  
Climatech: JA1300  
NaviStar: 16449, 16484, 16658  
Northern: 804719  
Red Dot: 74R2706  
Versatile: 48510, 9705765



**33473**  
Steel Filter Drier  
Outside Dia.: 3.000  
Length: 9.000  
Inlet Fitting Type: Quick Disconnect  
Outlet Fitting Type: Quick Disconnect  
Bergstrom: 540076  
Caterpillar: 2328955, 2473550  
Climatech: JA1795, JA1995  
Euclid: E804047  
Kysor: 1912004, 402820, 404296, 406888  
Mack: 4379RD597910  
NaviStar: 19137

# Filter Drier, Accumulator and Desiccant

## Filter Drier Cont'd



### 33474

Steel Filter Drier  
 Outside Dia.: 3.000  
 Length: 9.000  
 Inlet Fitting Type: Male Insert O-Ring  
 Inlet Fitting: 3/8"  
 Outlet Fitting Type: Male Insert O-Ring  
 Outlet Fitting: 3/8"  
 O-Rings: (2) **24606**  
 Bergstrom: 540103, 540139  
 Caterpillar: 2328945  
 Climatech: JA1980  
 Dallas Truck AC: 0612073  
 Euclid: E804048  
 Kysor: 1915001, 402870  
 Mack: 221RD335, 25169273,  
 4379RD5115340, 4379RD582410  
 NaviStar: 19145  
 Red Dot: 74R2306, 74R3076  
 TRP Parts: JA19800



### 33475

Steel Filter Drier  
 Outside Dia.: 3.000  
 Length: 8.500  
 Inlet Fitting Type: Male Insert O-Ring  
 Inlet Fitting: 3/8"  
 Outlet Fitting Type: Male Insert O-Ring  
 Outlet Fitting: 3/8"  
 O-Rings: (2) **24606**  
 Bergstrom: 540245  
 Climatech: JA1280  
 Euclid: E804049, E804130, E804163  
 Mack: 221RD44M  
 NaviStar: 12005, 19150  
 Northern: 804734  
 Red Dot: 74R3106



### 33478

Steel Filter Drier  
 Outside Dia.: 3.000  
 Length: 9.000  
 Inlet Fitting Type: Female O-Ring  
 Inlet Fitting: 3/8"  
 Outlet Fitting Type: Female O-Ring  
 Outlet Fitting: 3/8"  
 O-Rings: (2) **24606**  
 Bergstrom: 540096  
 Caterpillar: 2328964  
 Climatech: GD1135, K251571  
 Dallas Truck AC: 0612071  
 Euclid: E804053  
 Kenworth: F371003, K251571, K251751  
 Kysor: 1914003, 1914005, 402871  
 Mack: 4379RD582540  
 NaviStar: 19141

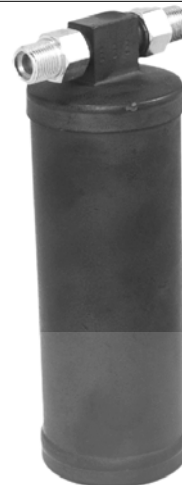

### 33480

Steel Filter Drier  
 Outside Dia.: 2.500  
 Length: 8.000  
 Inlet Fitting Type: Flare Fitting  
 Inlet Fitting: 3/8"  
 Outlet Fitting Type: Flare Fitting  
 Outlet Fitting: 3/8"  
 General Motors Corp: 19188722



### 33476

Steel Filter Drier  
 Outside Dia.: 3.000  
 Length: 7.000  
 Inlet Fitting Type: Male Insert O-Ring  
 Inlet Fitting: 3/8"  
 Outlet Fitting Type: Female O-Ring  
 Outlet Fitting: 3/8"  
 O-Rings: (2) **24606**  
 Bergstrom: 540113  
 Climatech: JA2145  
 Dallas Truck AC: 0612079  
 Euclid: E804050  
 NaviStar: 19149  
 Peterbilt: 1803783  
 Red Dot: 74R3326



### 33479

Steel Filter Drier  
 Outside Dia.: 3.000  
 Length: 9.000  
 Inlet Fitting Type: Female O-Ring  
 Inlet Fitting: 3/8"  
 Outlet Fitting Type: Female O-Ring  
 Outlet Fitting: 3/8"  
 Bergstrom: 540072  
 Caterpillar: 2473547, 2473551  
 Euclid: E804054  
 John Deere: AT306881  
 Kysor: 1912008, 402872  
 Mack: 4379RD5109440  
 NaviStar: 19138



### 33481

Steel Filter Drier  
 Outside Dia.: 2.500  
 Length: 8.000  
 Inlet Fitting Type: Male Insert O-Ring  
 Inlet Fitting: 3/8"  
 Outlet Fitting Type: Male Insert O-Ring  
 Outlet Fitting: 3/8"  
 O-Rings: (2) **24606**  
 Mazda (93-89)  
 Mazda: UC8661500A



# Filter Drier, Accumulator and Desiccant

## Filter Drier Cont'd



**33482**  
Steel Filter Drier  
Outside Dia.: 3.000  
Length: 6.000  
Inlet Fitting Type: Male Insert O-Ring  
Inlet Fitting: 3/8"  
Outlet Fitting Type: Male Insert O-Ring  
Outlet Fitting: 3/8"  
O-Rings: (2) **24606**  
Euclid: E804059, E804117  
Hy-Capacity: 0008890115  
NaviStar: 12008  
Northern: 804360, 804738  
Red Dot: 74R2526, 74R2546



**33484**  
Steel Filter Drier  
Outside Dia.: 2.500  
Length: 8.000  
Inlet Fitting Type: Male Insert O-Ring  
Inlet Fitting: 3/8"  
Outlet Fitting Type: Male Insert O-Ring  
Outlet Fitting: 3/8"  
O-Rings: (3) **24606**  
Ford (93-88); Mercury (93-88)



**33486**  
Steel Filter Drier  
Outside Dia.: 2.500  
Length: 8.000  
Inlet Fitting Type: Male Insert O-Ring  
Inlet Fitting: 3/8"  
Outlet Fitting Type: Male Insert O-Ring  
Outlet Fitting: 3/8"  
O-Rings: (3) **24606**  
Mazda (91-86)



**33488**  
Steel Filter Drier  
Outside Dia.: 2.500  
Length: 8.000  
Inlet Fitting Type: Male Insert O-Ring  
Outlet Fitting Type: Male Insert O-Ring  
O-Rings: (2) **24607**, (2) **24628**  
Mazda (92-87)  
Mazda: GJ5461500A



**33483**  
Steel Filter Drier  
Outside Dia.: 2.500  
Length: 8.000  
Inlet Fitting Type: Barb Fitting  
Inlet Fitting: 3/8"  
Outlet Fitting Type: Barb Fitting  
Outlet Fitting: 3/8"  
O-Rings: (2) **24606**  
Ford (93-87)  
Northern: 804388



**33485**  
Steel Filter Drier  
Outside Dia.: 2.500  
Length: 8.000  
Inlet Fitting Type: Male Insert O-Ring  
Inlet Fitting: 3/8"  
Outlet Fitting Type: Male Insert O-Ring  
Outlet Fitting: 3/8"  
O-Rings: (3) **24606**  
Mazda (93-86)



**33487**  
Steel Filter Drier  
Outside Dia.: 2.500  
Length: 8.000  
Inlet Fitting Type: Male Insert O-Ring  
Inlet Fitting: 3/8"  
Outlet Fitting Type: Male Insert O-Ring  
Outlet Fitting: 3/8"  
O-Rings: (2) **24606**  
Mazda (87-86)

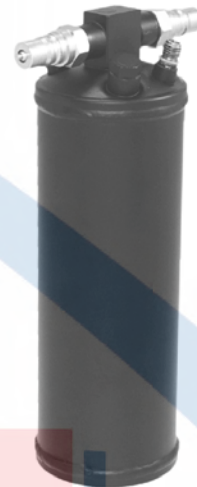

**33489**  
Steel Filter Drier  
Outside Dia.: 3.000  
Length: 9.000  
Outlet Fitting: 3/8"  
O-Rings: (2) **24606**  
Bergstrom: 540073  
Climatech: JA2020  
Euclid: E804055  
Kysor: 1913005  
NaviStar: 19139  
Red Dot: 74R3310

# Filter Drier, Accumulator and Desiccant

## Filter Drier Cont'd



### 33490

Steel Filter Drier  
 Outside Dia.: 2.750  
 Length: 10.000  
 Inlet Fitting Type: Male Insert O-Ring  
 Inlet Fitting: 3/8"  
 Outlet Fitting Type: Male Insert O-Ring  
 Outlet Fitting: 3/8"  
 O-Rings: (2) **24606**  
 Bergstrom: 540062, 540233  
 Climatech: JA1090, JA1845  
 Dallas Truck AC: 0612025, 0612068  
 Euclid: E804098, E804154  
 Kysor: 1999011, 1999901, 402879  
 Mack: 4379RD555710, 4379RD570621  
 NaviStar: 16450  
 Northern: 804869  
 Red Dot: 74R1806, 74R1826  
 Western Star: 049041020



### 33492

Steel Filter Drier  
 O-Rings: (2) **24606**  
 Jaguar (96-85), (83-78)  
 Jaguar: CAC1881



### 33493

Steel Filter Drier  
 Outside Dia.: 2.500  
 Length: 7.500  
 Inlet Fitting Type: Male Insert O-Ring  
 Inlet Fitting: 3/8"  
 Outlet Fitting Type: Male Insert O-Ring  
 Outlet Fitting: 3/8"  
 O-Rings: (2) **24606**  
 Dallas Truck AC: 0612062  
 Kysor: 1999205  
 Northern: 8041900  
 Red Dot: 74R0460, RD570640,  
 RD580090



### 33494

Steel Filter Drier  
 Outside Dia.: 1.750  
 Length: 20.500  
 Inlet Fitting Type: Male Insert O-Ring  
 Inlet Fitting: 3/8"  
 Outlet Fitting Type: Male Insert O-Ring  
 Outlet Fitting: 3/8"  
 O-Rings: (2) **24606**  
 Jaguar (97-94)  
 Jaguar: MMD7410AA



### 33495

Steel Filter Drier  
 Outside Dia.: 2.500  
 Length: 7.000  
 Inlet Fitting Type: Flare Fitting  
 Inlet Fitting: 3/8"  
 Outlet Fitting Type: Flare Fitting  
 Outlet Fitting: 3/8"  
 O-Rings: (2) **24606**  
 Massey Ferguson: 1039481M91,  
 1618743M1  
 NaviStar: 11821  
 Northern: 8041920, 804212, 804289  
 Red Dot: RD549510



### 33497

Steel Filter Drier  
 Outside Dia.: 2.750  
 Length: 5.500  
 Inlet Fitting Type: Male Insert O-Ring  
 Inlet Fitting: 3/8"  
 Outlet Fitting Type: Female O-Ring  
 Outlet Fitting: 3/8"  
 O-Rings: (2) **24606**  
 Jaguar (93-88)  
 Jaguar: CBC2319



### 33498

Steel Filter Drier  
 Outside Dia.: 3.000  
 Length: 9.000  
 Inlet Fitting Type: Female O-Ring  
 Inlet Fitting: 3/8"  
 Outlet Fitting Type: Female O-Ring  
 Outlet Fitting: 11/16"  
 O-Rings: (2) **24606**  
 Bergstrom: 540061, 540127  
 Climatech: JA1865, JA1960  
 Euclid: E804136  
 Kysor: 1913004, 402874  
 Mack: 4379RD575630  
 NaviStar: 1693117C1, 19844,  
 2000821C1, 2000821C2, 540127C1,  
 BSM319370  
 Red Dot: 74R3476



### 33499

Filter Drier w/ Hose  
 Outside Dia.: 3.000  
 Length: 6.000  
 Inlet Fitting Type: Male Insert O-Ring  
 Inlet Fitting: 3/8"  
 Outlet Fitting Type: Female O-Ring  
 Outlet Fitting: 3/8"  
 O-Rings: (2) **24606**  
 Saturn (93-91)  
 General Motors Corp: 19188739,  
 21030794  
 Saturn: 21030794

# Filter Drier, Accumulator and Desiccant

## Filter Drier Cont'd



**33519**  
Steel Filter Drier  
Outside Dia.: 3.000  
Length: 11.500  
Inlet Fitting Type: Female O-Ring  
Inlet Fitting: 3/8"  
Outlet Fitting Type: Female O-Ring  
Outlet Fitting: 11/16"  
O-Rings: (2) **24606**  
Bergstrom: 540151  
Climatech: JA2120  
Dallas Truck AC: 0612070  
Euclid: E804094  
Kysor: 1913003, 402767  
NaviStar: 11129



**33520**  
Steel Filter Drier  
Outside Dia.: 4.000  
Length: 8.000  
Inlet Fitting Type: Female O-Ring  
Inlet Fitting: 3/8"  
Outlet Fitting Type: Male Insert O-Ring  
Outlet Fitting: 3/8"  
O-Rings: (2) **24606**  
Allis Chalmers: 02684645, 268464,  
702758475  
ARA: 1273141  
Caterpillar: 2328902  
Climatech: JA1935  
Dallas Truck AC: 0612038, 0612040  
Deutz: 268464  
Euclid: E804105, E804175, E804176  
Hy-Capacity: 0000000285, 0008890118,  
0008890120  
John Deere: AL49169, AL77581,  
AR59780, AR74486, RE49169,  
RE49169A  
Kysor: 1999015, 402591  
Mack: 4379RD560760, 4379RD588620  
NaviStar: 13430  
Northern: 8041990, 804464  
Red Dot: 74R0400, 74R4116



**33521**  
Steel Filter Drier  
Outside Dia.: 3.000  
Length: 14.500  
Inlet Fitting Type: Female Springlock  
Inlet Fitting: 3/8"  
Outlet Fitting Type: Female Springlock  
Outlet Fitting: 3/8"  
O-Rings: (1) **24218**, (3) **24668**  
Case New Holland: 08850100,  
08915400, 82000471, F0NN19825AC  
Northern: 8041940



**33527**  
Steel Filter Drier  
Outside Dia.: 3.000  
Length: 6.500  
Inlet Fitting Type: Male Insert O-Ring  
Inlet Fitting: 3/8"  
Outlet Fitting Type: Female O-Ring  
Outlet Fitting: 3/8"  
O-Rings: (2) **24606**  
Kysor: 1999016  
Northern: 8041960  
Red Dot: 74R2566



**33524**  
Steel Filter Drier  
Outside Dia.: 3.000  
Length: 6.500  
Inlet Fitting Type: Male Insert O-Ring  
Inlet Fitting: 3/8"  
Outlet Fitting Type: Female O-Ring  
Outlet Fitting: 3/8"  
O-Rings: (2) **24606**  
Caterpillar: 2328977  
Euclid: E804178, E804179  
John Deere: AT125596, AT151981  
Kysor: 402798  
Mack: 4379RD590550  
Northern: 8041890  
Red Dot: 74R4206



**33528**  
Steel Filter Drier  
Outside Dia.: 4.000  
Length: 8.000  
Inlet Fitting Type: Male Insert O-Ring  
Inlet Fitting: 3/8"  
Outlet Fitting Type: Male Insert O-Ring  
Outlet Fitting: 3/8"  
O-Rings: (3) **24606**  
Caterpillar: 8T8642  
Climatech: JA1750  
Dallas Truck AC: 0612065  
Mack: 4379RD575640  
Northern: 804863  
Red Dot: 74R3536



# Filter Drier, Accumulator and Desiccant

## Filter Drier Cont'd



### 33530

Steel Filter Drier  
 Outside Dia.: 3.000  
 Length: 10.000  
 Inlet Fitting Type: Male Insert O-Ring  
 Inlet Fitting: 3/8"  
 Outlet Fitting Type: Male Insert O-Ring  
 Outlet Fitting: 3/8"  
 O-Rings: (3) **24606**  
 Euclid: E804035  
 Kysor: 1999003, 402720  
 NaviStar: 19140  
 Northern: 804868



### 33531

Steel Filter Drier  
 Outside Dia.: 3.000  
 Length: 6.500  
 Inlet Fitting Type: Male Insert O-Ring  
 Inlet Fitting: 3/8"  
 Outlet Fitting Type: Male Insert O-Ring  
 Outlet Fitting: 3/8"  
 O-Rings: (2) **24606**  
 Bergstrom: 540097, 540106  
 Climatech: JA1165, JA2005  
 Dallas Truck AC: 0612004  
 Euclid: E804097, E804152  
 John Deere: 842829500  
 Kysor: 402680  
 Mack: 221RD32, 4379RD538430  
 Massey Ferguson: 3323018M91  
 NaviStar: 11828, 13353  
 Northern: 8041910  
 Peterbilt: 1802346  
 Red Dot: 74R2556, 74R2576, RD538430



### 33533

Steel Filter Drier  
 Outside Dia.: 3.000  
 Length: 9.000  
 Inlet Fitting Type: Male Insert O-Ring  
 Inlet Fitting: 3/8"  
 Outlet Fitting Type: Female O-Ring  
 Outlet Fitting: 3/8"  
 O-Rings: (2) **24606**  
 Bergstrom: 540088, 540091  
 Caterpillar: 2328951  
 Climatech: JA1205, JA1210, JA1225, JA1740, JA1755, JA1920  
 Euclid: E804108, E804161  
 Kysor: 1912003, 1913002, 1917002, 1999019  
 Mack: 4379RD5107350  
 NaviStar: 13403, 14119, 426169C1  
 Red Dot: 74R2656, 74R2666, 74R3146, 74R3346



### 33535

Steel Filter Drier  
 Outside Dia.: 4.000  
 Length: 7.000  
 Inlet Fitting Type: Male Insert O-Ring  
 Inlet Fitting: 3/8"  
 Outlet Fitting Type: Male Insert O-Ring  
 Outlet Fitting: 3/8"  
 O-Rings: (2) **24606**  
 Case New Holland: 83930929, E4NN19825A  
 Northern: 804865



### 33536

Steel Filter Drier  
 Outside Dia.: 4.000  
 Length: 6.000  
 Inlet Fitting Type: Male Insert O-Ring  
 Inlet Fitting: 3/8"  
 Outlet Fitting Type: Female O-Ring  
 Outlet Fitting: 3/8"  
 O-Rings: (2) **24606**  
 Case New Holland: 118304C1  
 Hy-Capacity: 0008890131  
 NaviStar: 118304C1  
 Northern: 804533, 804534



### 33532

Steel Filter Drier  
 Outside Dia.: 3.000  
 Length: 10.000  
 Inlet Fitting Type: Female O-Ring  
 Inlet Fitting: 3/8"  
 Outlet Fitting Type: Female O-Ring  
 Outlet Fitting: 11/16"  
 O-Rings: (3) **24606**  
 Dallas Truck AC: 0612016  
 Euclid: E804020  
 NaviStar: 1615694C1, 1682171C1, 454613C1  
 Northern: 804423



### 33534

Steel Filter Drier  
 Outside Dia.: 3.000  
 Length: 10.000  
 Inlet Fitting Type: Male Insert O-Ring  
 Inlet Fitting: 3/8"  
 Outlet Fitting Type: Male Insert O-Ring  
 Outlet Fitting: 3/8"  
 O-Rings: (2) **24606**  
 Euclid: E804126, E804148  
 NaviStar: 11333  
 Northern: 804718, 804862

# Filter Drier, Accumulator and Desiccant

## Filter Drier Cont'd



**33537**  
Steel Filter Drier  
Outside Dia.: 3.000  
Length: 10.000  
Inlet Fitting Type: Male Insert O-Ring  
Inlet Fitting: 3/8"  
Outlet Fitting Type: Male Insert O-Ring  
Outlet Fitting: 3/8"  
O-Rings: (2) **24606**  
Bergstrom: 540078  
Climatech: JA1135, JA1140  
Euclid: E804026  
Kenworth: K251521  
Kysor: 1919003  
Mack: 4379RD565040  
NaviStar: 16451  
Red Dot: 74R3322



**33538**  
Steel Filter Drier  
Outside Dia.: 3.000  
Length: 8.500  
Inlet Fitting Type: Male Insert O-Ring  
Inlet Fitting: 3/8"  
Outlet Fitting Type: Male Insert O-Ring  
Outlet Fitting: 3/8"  
O-Rings: (2) **24606**  
Bergstrom: 540116, 540121, 540122, 540126, 540426  
Caterpillar: 2328938, 2328946  
Climatech: JA1275, JA1870, JA1890, JA2050, JA2055  
Dallas Truck AC: 0612030  
Euclid: E804118, E804142, E804149  
Kysor: 1919001, 402754, 402814  
Mack: 20447319, 4379RD5115330P, 4379RD595150, 4379RD597890  
NaviStar: 12006, 16311, 19357, 712006  
Red Dot: 74R2606, 74R3056  
Western Star: 049045678, 615023402



**33539**  
Steel Filter Drier  
Outside Dia.: 3.000  
Length: 10.000  
Inlet Fitting Type: Male Insert O-Ring  
Inlet Fitting: 3/8"  
Outlet Fitting Type: Male Insert O-Ring  
Outlet Fitting: 3/8"  
O-Rings: (2) **24606**  
Climatech: JA1315  
Dallas Truck AC: 0612060  
Euclid: E804103, E804107  
Kysor: 1999013, 1999038, 402794  
Mack: 4379RD564220  
NaviStar: 16446  
Northern: 804786



**33541**  
Steel Filter Drier  
Outside Dia.: 3.000  
Length: 8.500  
Inlet Fitting Type: Male Insert O-Ring  
Inlet Fitting: 3/8"  
Outlet Fitting Type: Male Insert O-Ring  
Outlet Fitting: 3/8"  
O-Rings: (2) **24606**  
Bergstrom: 540063, 540111  
Climatech: JA1235, JA1240  
Dallas Truck AC: 0612007  
Euclid: E804092  
Kysor: 1999006, 402568  
Mack: 2RD39303, 4379RD549550  
NaviStar: 11831  
Northern: 804351, 804440



**33540**  
Steel Filter Drier  
Outside Dia.: 3.000  
Length: 10.000  
Inlet Fitting Type: Male Insert O-Ring  
Inlet Fitting: 3/8"  
Outlet Fitting Type: Male Insert O-Ring  
Outlet Fitting: 3/8"  
O-Rings: (2) **24606**  
Euclid: E804115  
Kysor: 1911008  
NaviStar: 13444



**33542**  
Steel Filter Drier  
Outside Dia.: 2.750  
Length: 9.000  
Inlet Fitting Type: Male Insert O-Ring  
Inlet Fitting: 3/8"  
Outlet Fitting Type: Male Insert O-Ring  
Outlet Fitting: 3/8"  
O-Rings: (3) **24606**  
Climatech: JA1070, JA1075  
Euclid: E804155  
John Deere: 842600200  
Kysor: 1999010  
Mack: 221RD323P2, 4379RD535931, 7979402566  
NaviStar: 16444, 1676651C1  
Peterbilt: 402568  
Red Dot: 74R1606, 74R1706, RD35691

## ***Filter Drier, Accumulator and Desiccant***

### **Filter Drier Cont'd**



#### **33549**

Steel Filter Drier  
 Outside Dia.: 2.500  
 Length: 6.000  
 Inlet Fitting Type: Pad Mount  
 Outlet Fitting Type: Pad Mount  
 O-Rings: (2) **24152**  
 Chrysler (95-93), (91); Dodge (95-93);  
 Plymouth (95-93)  
 Chrysler: 4677138AC



#### **33551**

Steel Filter Drier  
 Outside Dia.: 2.500  
 Length: 6.000  
 Inlet Fitting Type: Pad Mount  
 Inlet Fitting: 7/8"  
 Outlet Fitting Type: Pad Mount  
 O-Rings: (2) **24152**  
 Chrysler (91-89); Dodge (90-89);  
 Plymouth (90-89)  
 Chrysler: 4773662AB



#### **33553**

Steel Filter Drier  
 Outside Dia.: 3.000  
 Length: 6.500  
 Inlet Fitting Type: Flange  
 Inlet Fitting: 1"  
 Outlet Fitting Type: Flange  
 Outlet Fitting: 1"  
 O-Rings: (2) **24152**  
 Chrysler (90-89); Dodge (93-89),  
 (87-86); Plymouth (90-89)  
 Chrysler: 4773662AB, 4798590AC



#### **33555**

Steel Filter Drier  
 Outside Dia.: 2.500  
 Length: 5.500  
 Inlet Fitting Type: Pad Mount  
 Outlet Fitting Type: Pad Mount  
 O-Rings: (2) **24152**  
 Dodge (93-81); Dodge Medium Duty  
 Truck (81); Plymouth (81)  
 Chrysler: 4798592, 4883284AC



#### **33550**

Steel Filter Drier  
 Outside Dia.: 2.500  
 Length: 6.000  
 Inlet Fitting Type: Pad Mount  
 Outlet Fitting Type: Pad Mount  
 O-Rings: (2) **24152**  
 Chrysler (94-91); Dodge (93-91);  
 Plymouth (93-91)  
 Chrysler: 4773669AC



#### **33552**

Steel Filter Drier  
 Outside Dia.: 2.500  
 Length: 6.500  
 Inlet Fitting Type: Pad Mount  
 Outlet Fitting Type: Pad Mount  
 O-Rings: (2) **24152**  
 Dodge (90-89)



#### **33554**

Steel Filter Drier  
 Outside Dia.: 2.500  
 Length: 5.500  
 Inlet Fitting Type: Pad Mount  
 Outlet Fitting Type: Pad Mount  
 O-Rings: (2) **24152**  
 Dodge (97-89)  
 Chrysler: 55036003AB



#### **33557**

Steel Filter Drier  
 Outside Dia.: 2.500  
 Length: 5.000  
 Inlet Fitting Type: Male Insert O-Ring  
 Inlet Fitting: 3/8"  
 Outlet Fitting Type: Male Insert O-Ring  
 Outlet Fitting: 3/8"  
 O-Rings: (2) **24606**  
 Chrysler (93); Dodge (93)  
 Chrysler: 4773656



# Filter Drier, Accumulator and Desiccant

## Filter Drier Cont'd



**33560**  
Steel Filter Drier  
Outside Dia.: 3.000  
Length: 5.500  
Inlet Fitting Type: Male Insert O-Ring  
Inlet Fitting: 3/8"  
Outlet Fitting Type: Quick Disconnect  
O-Rings: (2) **24606**  
Jeep (93-91)  
Chrysler: 4773767  
AMC: 55035772



**33562**  
Steel Filter Drier  
Outside Dia.: 3.000  
Length: 4.500  
Inlet Fitting Type: Male Insert O-Ring  
Inlet Fitting: 3/8"  
Outlet Fitting Type: Male Insert O-Ring  
Outlet Fitting: 3/8"  
O-Rings: (3) **24606**  
Jeep (96-94)  
Chrysler: 4797002  
Jeep: 4797002



**33564**  
Steel Filter Drier  
Outside Dia.: 2.500  
Length: 7.000  
Inlet Fitting Type: Male Insert O-Ring  
Inlet Fitting: 3/8"  
Outlet Fitting Type: Male Insert O-Ring  
Outlet Fitting: 3/8"  
O-Rings: (3) **24606**, (2) **24606**  
Jeep (95-94)  
Chrysler: 4773764, 4797003  
Jeep: 4773764, 4797003  
Northern: 804532, 804690



**33566**  
Steel Filter Drier  
Outside Dia.: 2.250  
Length: 4.000  
Inlet Fitting Type: Male Insert O-Ring  
Inlet Fitting: 3/8"  
Outlet Fitting Type: Female O-Ring  
Outlet Fitting: 1/2"  
O-Rings: (1) **24216**, (3) **24666**, (1) **24216**, (3) **24666**, (2) **24606**  
Dodge (97-94)  
Chrysler: 55036078AB



**33561**  
Steel Filter Drier  
Outside Dia.: 2.500  
Length: 8.000  
Inlet Fitting Type: Male Insert O-Ring  
Inlet Fitting: 3/8"  
Outlet Fitting Type: Quick Disconnect  
O-Rings: (3) **24606**  
Jeep (93-87)  
Chrysler: 4773764  
Jeep: 4773764  
AMC: 56001485



**33563**  
Steel Filter Drier  
Outside Dia.: 2.750  
Length: 8.500  
Inlet Fitting Type: Male Insert O-Ring  
Inlet Fitting: 3/8"  
Outlet Fitting Type: Female O-Ring  
Outlet Fitting: 3/8"  
O-Rings: (2) **24606**  
Jeep (96-87)  
Chrysler: 4797001  
Jeep: 4797001



**33565**  
Steel Filter Drier  
Outside Dia.: 2.250  
Length: 5.000  
Inlet Fitting Type: Female O-Ring  
Inlet Fitting: 3/8"  
Outlet Fitting Type: Female Springlock  
Outlet Fitting: 3/8"  
O-Rings: (1) **24216**, (3) **24666**, (2) **24606**  
Chrysler (97-93); Dodge (97-93); Eagle (97-93)  
Chrysler: 4797148AB



**33567**  
Steel Filter Drier  
Outside Dia.: 2.500  
Length: 6.000  
Inlet Fitting Type: Male Insert O-Ring  
Inlet Fitting: 3/8"  
Outlet Fitting Type: Female O-Ring  
Outlet Fitting: 3/8"  
O-Rings: (3) **24606**  
Dodge (96-95); Plymouth (96-95)  
Chrysler: 5264580AB

## Filter Drier, Accumulator and Desiccant

### Filter Drier Cont'd



**33569**  
Aluminum Filter Drier w/ Pad Mount  
Outside Dia.: 2.375  
Length: 7.000  
Inlet Fitting Type: Pad Mount  
Outlet Fitting Type: Pad Mount  
O-Rings: (2) **24606**  
Honda (93-92)  
Honda: 80351SR1H11



**33574**  
Aluminum Filter Drier w/o Pad Mount  
Outside Dia.: 2.375  
Length: 6.000  
Inlet Fitting Type: Dual O-Ring  
Outlet Fitting Type: Dual O-Ring  
O-Rings: (2) **24606**  
Acura (99-97); Honda (01-94)  
Honda: 80351SV1A11



**33575**  
Steel Filter Drier  
Outside Dia.: 2.500  
Length: 8.000  
Inlet Fitting Type: Male Insert O-Ring  
Inlet Fitting: 3/8"  
Outlet Fitting Type: Male Insert O-Ring  
O-Rings: (2) **24606**  
Dodge (93-90); Eagle (92-89);  
Mitsubishi (93-89); Plymouth (92-91)  
Mitsubishi: MB813459, MB849083  
Kysor: 402621



**33576**  
Steel Filter Drier  
Outside Dia.: 2.500  
Length: 8.000  
Inlet Fitting Type: Male Insert O-Ring  
Outlet Fitting Type: Male Insert O-Ring  
O-Rings: (3) **24606**, (2) **24607**  
Chrysler (89-87); Dodge (88-85);  
Mitsubishi (88-85); Plymouth (91-85)  
Mitsubishi: MB199664, MB298666



**33577**  
Steel Filter Drier  
Outside Dia.: 2.500  
Length: 6.000  
Inlet Fitting Type: Male Insert O-Ring  
Outlet Fitting Type: Male Insert O-Ring  
O-Rings: (2) **24606**  
Honda (96-93)  
Honda: 80351SS0H91



**33578**  
Aluminum Filter Drier w/o Pad Mount  
Outside Dia.: 2.500  
Length: 7.000  
Inlet Fitting Type: Male Insert O-Ring  
Outlet Fitting Type: Male Insert O-Ring  
Outlet Fitting: 3/8"  
O-Rings: (2) **24607**  
Isuzu (92-91)  
Isuzu: 8943835760



**33579**  
Steel Filter Drier  
Outside Dia.: 2.500  
Length: 6.500  
Inlet Fitting Type: Male Insert O-Ring  
Outlet Fitting Type: Male Insert O-Ring  
Outlet Fitting: 3/8"  
O-Rings: (2) **24607**  
Honda (92)



**33580**  
Steel Filter Drier  
Outside Dia.: 2.500  
Length: 5.000  
Inlet Fitting Type: Male Insert O-Ring  
Outlet Fitting Type: Male Insert O-Ring  
O-Rings: (2) **24607**  
Mazda (97-93)

# Filter Drier, Accumulator and Desiccant

## Filter Drier Cont'd



**33581**  
Steel Filter Drier  
Outside Dia.: 2.500  
Length: 5.000  
Inlet Fitting Type: Male Insert O-Ring  
Outlet Fitting Type: Male Insert O-Ring  
O-Rings: (2) **24607**  
Mazda (95-92)  
Mazda: EA7061500



**33582**  
Steel Filter Drier  
Outside Dia.: 2.500  
Length: 5.000  
Inlet Fitting Type: Male Insert O-Ring  
Outlet Fitting Type: Male Insert O-Ring  
Outlet Fitting: 3/8"  
O-Rings: (1) **24606**, (2) **24608**  
Nissan (95-93)  
Nissan: 9213270P00



**33583**  
Aluminum Filter Drier w/ Pad Mount  
Outside Dia.: 2.500  
Length: 7.500  
Inlet Fitting Type: Pad Mount  
Outlet Fitting Type: Pad Mount  
O-Rings: (2) **24606**  
Lexus (93-90); Mitsubishi (94-90);  
Plymouth (94-90); Toyota (94-89)  
Toyota: 8847116050

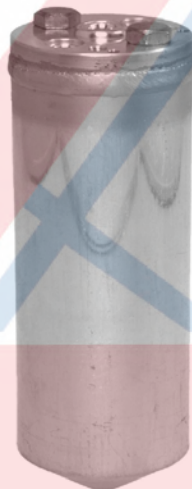

**33584**  
Aluminum Filter Drier w/ Pad Mount  
Outside Dia.: 2.500  
Length: 7.000  
Inlet Fitting Type: Pad Mount  
Outlet Fitting Type: Pad Mount  
Outlet Fitting: 3/8"  
O-Rings: (2) **24607**  
Mazda (95-94)  
Mazda: H40561500



**33585**  
Aluminum Filter Drier w/o Pad Mount  
Outside Dia.: 2.375  
Length: 8.000  
Inlet Fitting Type: Flare Fitting  
Outlet Fitting Type: Flare Fitting  
Mazda (97-94)  
Mazda: NA7561500  
Mack: NA7561500



**33586**  
Aluminum Filter Drier w/ Pad Mount  
Outside Dia.: 2.500  
Length: 6.000  
Inlet Fitting Type: Pad Mount  
Outlet Fitting Type: Pad Mount  
Outlet Fitting: 3/8"  
O-Rings: (2) **24607**  
Ford (97-90)



**33588**  
Aluminum Filter Drier w/ Pad Mount  
Outside Dia.: 2.500  
Length: 6.500  
Inlet Fitting Type: Pad Mount  
Outlet Fitting Type: Pad Mount  
O-Rings: (2) **24607**  
Acura (01-94); Honda (97-94); Saturn  
(02-00)  
Honda: 80351ST7A11



**33589**  
Aluminum Filter Drier w/ Pad Mount  
Outside Dia.: 2.500  
Length: 7.000  
Inlet Fitting Type: Pad Mount  
Outlet Fitting Type: Pad Mount  
Outlet Fitting: 3/8"  
O-Rings: (2) **24607**  
Acura (04-93); Chrysler (99-95);  
Dodge (02-92); Eagle (98-95); Geo  
(97-94); Land Rover (04-94); Lexus  
(01-92); Mazda (95-94); Mitsubishi  
(00-93); Suzuki (98-94); Toyota  
(06-93); VW (10-98)  
General Motors Corp: 19188794  
Lexus: 8847050010  
Mazda: LC2961500A



# Filter Drier, Accumulator and Desiccant

## Filter Drier Cont'd

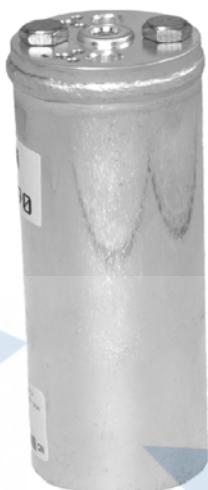

### 33590

Aluminum Filter Drier w/ Pad Mount  
 Outside Dia.: 2.500  
 Length: 6.625  
 Inlet Fitting Type: Pad Mount  
 Outlet Fitting Type: Pad Mount  
 Outlet Fitting: 3/8"  
 O-Rings: (2) **24607**  
 Acura (97-96); Geo (93-92); Honda (97-94); Infiniti (93-90); Isuzu (97-90); Mazda (91-88); Nissan (97-90); Subaru (01-90)  
 General Motors Corp: 19188795  
 Infiniti: 9213162J05  
 Isuzu: 8970956580  
 Nissan: 9213153F01, 9213162J05, 9213196E05  
 Subaru: 73030AA061

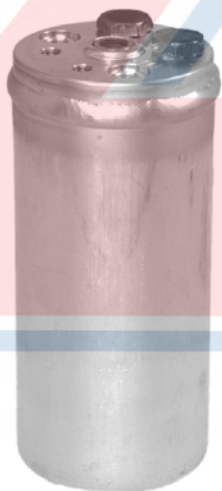

### 33591

Aluminum Filter Drier w/ Pad Mount  
 Outside Dia.: 2.750  
 Length: 6.500  
 Inlet Fitting Type: Pad Mount  
 Outlet Fitting Type: Pad Mount  
 O-Rings: (2) **24606**  
 Mazda (93-92)  
 Mazda: HG3061500C  
 Mack: HG3061500C



### 33592

Aluminum Filter Drier w/ Pad Mount  
 Outside Dia.: 2.500  
 Length: 6.500  
 Inlet Fitting Type: Pad Mount  
 Outlet Fitting Type: Pad Mount  
 O-Rings: (2) **24606**  
 Chevy (01-94); Geo (97-95); Mazda (95-94); Porsche (14-93); Suzuki (02-94)  
 General Motors Corp: 19188797, 30012864  
 Porsche: 94457314301  
 Suzuki: 9533071B00, 9533071B10



### 33593

Aluminum Filter Drier w/ Pad Mount  
 Outside Dia.: 2.500  
 Length: 6.000  
 Inlet Fitting Type: Pad Mount  
 Outlet Fitting Type: Pad Mount  
 O-Rings: (2) **24607**, (2) **24606**  
 Infiniti (93-90); Nissan (90-89)  
 Nissan: 9213130R00, 9213140F16, 9213185E16



### 33594

Aluminum Filter Drier w/ Pad Mount  
 Outside Dia.: 2.500  
 Length: 7.000  
 Inlet Fitting Type: Pad Mount  
 Outlet Fitting Type: Pad Mount  
 O-Rings: (2) **24650**  
 Chrysler (98-95); Dodge (05-02), (98-91); Eagle (98-93); Mitsubishi (04-91); Plymouth (94-93)  
 Mitsubishi: MB657712, MB813589, MB869217, MB869218, MB899260, MR175421, MR270457, MR270458, MR315071, MR398069

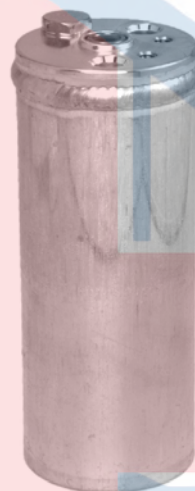

### 33595

Aluminum Filter Drier w/ Pad Mount  
 Outside Dia.: 2.500  
 Length: 6.000  
 Inlet Fitting Type: Pad Mount  
 Outlet Fitting Type: Pad Mount  
 Outlet Fitting: 3/8"  
 O-Rings: (3) **24606**  
 Acura (06-02); Honda (06-96); Suzuki (00-99)  
 Honda: 80351S01A01, 80351S04003, 80351S3YA01  
 Suzuki: 9533072B10



### 33596

Aluminum Filter Drier w/ Pad Mount  
 Outside Dia.: 2.500  
 Length: 8.000  
 Inlet Fitting Type: Pad Mount  
 Outlet Fitting Type: Pad Mount  
 O-Rings: (2) **24606**  
 Honda (98-95); Isuzu (99-96)  
 Honda: 80351SX0961  
 Isuzu: 5862040960



### 33597

Aluminum Filter Drier w/ Pad Mount  
 Outside Dia.: 2.500  
 Length: 6.250  
 Inlet Fitting Type: Pad Mount  
 Outlet Fitting Type: Pad Mount  
 Outlet Fitting: 3/8"  
 O-Rings: (3) **24606**  
 Infiniti (97-93); Mercury (94); Nissan (13), (02-95)

# Filter Drier, Accumulator and Desiccant

## Filter Drier Cont'd



**33598**  
Aluminum Filter Drier w/ Pad Mount  
Outside Dia.: 2.500  
Length: 7.500  
Inlet Fitting Type: Pad Mount  
Outlet Fitting Type: Pad Mount  
O-Rings: (3) **24606**  
Infiniti (94-93); Nissan (98-93)  
Infiniti: 9213178J02  
Nissan: 921311M210, 9213186Y01

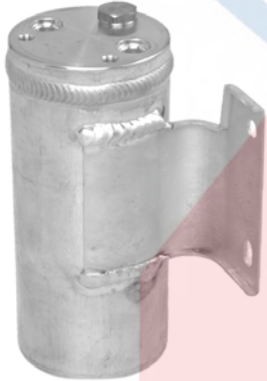

**33599**  
Aluminum Filter Drier w/ Pad Mount  
Outside Dia.: 2.500  
Length: 6.000  
Inlet Fitting Type: Pad Mount  
Outlet Fitting Type: Pad Mount  
Outlet Fitting: 3/8"  
O-Rings: (3) **24606**  
Mazda (98-95)  
Mazda: BC1M61500A  
Mack: BC1M61500A, BC1M61500B



**33601**  
Aluminum Filter Drier w/ Pad Mount  
Outside Dia.: 2.500  
Length: 7.000  
Inlet Fitting Type: Pad Mount  
Outlet Fitting Type: Pad Mount  
O-Rings: (1) **24641**, (1) **24606**  
Chrysler (00-96); Dodge (00-96);  
Plymouth (00-96)  
Chrysler: 4682623AB



**33602**  
Steel Filter Drier  
Outside Dia.: 2.375  
Length: 8.000  
Inlet Fitting Type: Flare Fitting  
Outlet Fitting Type: Flare Fitting  
Mazda (98-96)  
Mazda: LB9061500  
Mack: LB9061500



**33603**  
Aluminum Filter Drier w/ Pad Mount  
Outside Dia.: 2.203125  
Length: 6.500  
Inlet Fitting Type: Pad Mount  
Outlet Fitting Type: Pad Mount  
O-Rings: (2) **24606**  
Chevy (12-02)  
Opel: 9165715



**33630**  
Steel Filter Drier  
Outside Dia.: 2.500  
Length: 7.500  
Inlet Fitting Type: Male Insert O-Ring  
Inlet Fitting: 3/8"  
Outlet Fitting Type: Male Insert O-Ring  
Outlet Fitting: 3/8"  
O-Rings: (3) **24606**  
Hyundai (93), (89-86); Mitsubishi  
(89-87)



**33659**  
Steel Filter Drier  
Outside Dia.: 3.000  
Length: 5.500  
Inlet Fitting Type: Male Insert O-Ring  
Inlet Fitting: 3/8"  
Outlet Fitting Type: Male Insert O-Ring  
Outlet Fitting: 3/8"  
O-Rings: (2) **24606**  
Saab (98-92)  
General Motors Corp: 19188813  
Saab: 4074340, 4383584



**33660**  
Steel Filter Drier  
Outside Dia.: 2.500  
Length: 8.500  
Inlet Fitting Type: Male Insert O-Ring  
Inlet Fitting: 3/8"  
Outlet Fitting Type: Female O-Ring  
Outlet Fitting: 3/8"  
O-Rings: (3) **24606**  
Saab (94-90)  
General Motors Corp: 19188814  
Saab: 4383527

# Filter Drier, Accumulator and Desiccant

## Filter Drier Cont'd



**33661**  
Steel Filter Drier  
Outside Dia.: 3.000  
Length: 10.000  
Inlet Fitting Type: Male Insert O-Ring  
Inlet Fitting: 3/8"  
Outlet Fitting Type: Female O-Ring  
Outlet Fitting: 3/8"  
O-Rings: (3) **24606**  
Saab (91-90)  
Saab: 4071007



**33662**  
Steel Filter Drier  
Outside Dia.: 2.875  
Length: 7.000  
Inlet Fitting Type: Male Insert O-Ring  
Inlet Fitting: 3/8"  
Outlet Fitting Type: Female O-Ring  
Outlet Fitting: 3/8"  
O-Rings: (2) **24606**  
Mercedes (89-86)



**33665**  
Steel Filter Drier  
Outside Dia.: 3.750  
Length: 8.000  
Inlet Fitting Type: Pad Mount  
Outlet Fitting Type: Pad Mount  
O-Rings: (2) **24606**  
BMW (89-87)  
BMW: 64531466052



**33668**  
Aluminum Filter Drier w/ Pad Mount  
Outside Dia.: 4.750  
Length: 4.000  
Inlet Fitting Type: Pad Mount  
Outlet Fitting Type: Pad Mount  
O-Rings: (2) **24606**  
BMW (00-92)  
BMW: 64538372977



**33669**  
Steel Filter Drier  
Outside Dia.: 2.875  
Length: 7.000  
Inlet Fitting Type: Male Insert O-Ring  
Inlet Fitting: 3/8"  
Outlet Fitting Type: Male Insert O-Ring  
Outlet Fitting: 3/8"  
O-Rings: (2) **24606**  
Mercedes (95), (93-92)  
Mercedes Benz: 1248300383



**33700**  
Aluminum Filter Drier w/o Pad Mount  
Outside Dia.: 3.000  
Length: 6.750  
Inlet Fitting Type: Female O-Ring  
Inlet Fitting: 3/8"  
Outlet Fitting Type: Female O-Ring  
Outlet Fitting: 3/8"  
O-Rings: (2) **24606**  
Mercedes (03-94)  
Mercedes Benz: 2028300083,  
2028300283



**33701**  
Aluminum Filter Drier w/o Pad Mount  
Outside Dia.: 3.000  
Length: 7.500  
Inlet Fitting Type: Female O-Ring  
Inlet Fitting: 3/8"  
Outlet Fitting Type: Female O-Ring  
Outlet Fitting: 1/2"  
O-Rings: (1) **24606**, (2) **24608**  
VW (99), (97), (95-93)  
Volkswagen: 7D1820191A



**33703**  
Steel Filter Drier  
Outside Dia.: 2.625  
Length: 8.000  
Inlet Fitting Type: Male Insert O-Ring  
Inlet Fitting: 3/8"  
Outlet Fitting Type: Female O-Ring  
Outlet Fitting: 3/8"  
O-Rings: (3) **24606**  
Saab (89-87)  
Saab: 4383550



**33704**  
Steel Filter Drier  
Outside Dia.: 3.000  
Length: 7.000  
Inlet Fitting Type: Male Insert O-Ring  
Inlet Fitting: 3/8"  
Outlet Fitting Type: Male Insert O-Ring  
Outlet Fitting: 3/8"  
O-Rings: (2) **24606**  
Mercedes (02-95)  
Mercedes Benz: 2108300483



# Filter Drier, Accumulator and Desiccant

## Filter Drier Cont'd



**33708**  
Steel Filter Drier  
Outside Dia.: 4.000  
Length: 5.500  
Inlet Fitting Type: Female O-Ring  
Inlet Fitting: 3/8"  
Outlet Fitting Type: Male Insert O-Ring  
Outlet Fitting: 3/8"  
O-Rings: (2) **24606**  
John Deere: AL162467



**33709**  
Aluminum Filter Drier w/ Pad Mount  
Outside Dia.: 2.500  
Length: 10.000  
Inlet Fitting Type: Pad Mount  
Outlet Fitting Type: Pad Mount  
O-Rings: (2) **24675**  
Caterpillar: 1761902



**33710**  
Steel Filter Drier  
Outside Dia.: 3.000  
Length: 8.000  
Inlet Fitting Type: Male Insert O-Ring  
Inlet Fitting: 3/8"  
Outlet Fitting Type: Female O-Ring  
Outlet Fitting: 3/8"  
O-Rings: (2) **24606**  
Case New Holland: 82007131, 82012480



**33712**  
Aluminum Filter Drier w/o Pad Mount  
Outside Dia.: 3.000  
Length: 6.500  
Outlet Fitting Type: P-Nut Fitting  
O-Rings: (1) **24241**, (1) **24606**  
International (10-07)  
NaviStar: 3666273C1



**33713**  
Steel Filter Drier  
Outside Dia.: 3.000  
Length: 9.000  
Inlet Fitting Type: Male Insert O-Ring  
Inlet Fitting: 3/8"  
Outlet Fitting Type: Male Insert O-Ring  
Outlet Fitting: 3/8"  
O-Rings: (2) **24606**  
John Deere: 5821662227, AT275160  
Red Dot: 74R1986, RD5140780



**33714**  
Steel Filter Drier  
Outside Dia.: 4.000  
Length: 7.750  
Inlet Fitting Type: Male Insert O-Ring  
Inlet Fitting: 3/8"  
Outlet Fitting Type: Female O-Ring  
Outlet Fitting: 3/8"  
O-Rings: (2) **24606**  
Case New Holland: 86984155  
NaviStar: 1990758C2



**33715**  
Steel Filter Drier  
Outside Dia.: 4.000  
Length: 6.750  
Inlet Fitting Type: Male Insert O-Ring  
Outlet Fitting Type: Male Insert O-Ring  
O-Rings: (2) **24606**  
Red Dot: 74R4006



**33716**  
Filter Drier w/ Hose  
Outside Dia.: 2.375  
Length: 6.000  
Inlet Fitting Type: Male Insert O-Ring  
Outlet Fitting Type: Female O-Ring  
O-Rings: (1) **24646**, (1) **24606**  
Saturn (02-94)  
General Motors Corp: 19188824  
Saturn: 21031426

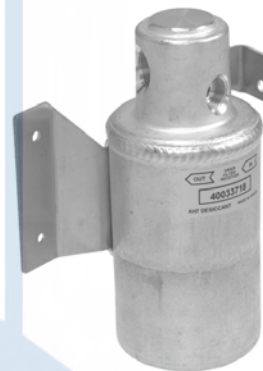

**33718**  
Aluminum Filter Drier w/o Pad Mount  
Outside Dia.: 3.000  
Length: 7.000  
Inlet Fitting Type: Female O-Ring  
Inlet Fitting: 3/8"  
Outlet Fitting Type: Female O-Ring  
Outlet Fitting: 1/2"  
O-Rings: (1) **24606**, (2) **24608**  
VW (97-95)  
Volkswagen: 3A0820191



**33719**  
Steel Filter Drier  
Outside Dia.: 3.000  
Length: 12.000  
Inlet Fitting Type: Female O-Ring  
Inlet Fitting: 3/8"  
Outlet Fitting Type: Male Insert O-Ring  
Outlet Fitting: 3/8"  
O-Rings: (2) **24606**  
John Deere: 08854900, AL163559

# Filter Drier, Accumulator and Desiccant

## Filter Drier Cont'd



**33720**  
Steel Filter Drier  
Outside Dia.: 3.000  
Length: 10.500  
Inlet Fitting Type: O-Ring  
Outlet Fitting Type: O-Ring  
O-Rings: (2) **24632**



**33722**  
Aluminum Filter Drier w/o Pad Mount  
Outside Dia.: 2.500  
Length: 6.000  
Inlet Fitting Type: Female O-Ring  
Inlet Fitting: 3/8"  
Outlet Fitting Type: Male Insert O-Ring  
Outlet Fitting: 3/8"  
O-Rings: (2) **24606**  
Chrysler (00-95); Dodge (00-95);  
Plymouth (00-96)  
Chrysler: 4596172



**33724**  
Steel Filter Drier  
Outside Dia.: 3.000  
Length: 11.500  
Inlet Fitting Type: Male Insert O-Ring  
Outlet Fitting Type: Male Insert O-Ring  
O-Rings: (2) **24608**  
Carrier: ADK304, DR004, WLD304,  
WSG304MOI



**33727**  
Steel Filter Drier  
Outside Dia.: 3.500  
Length: 8.000  
Inlet Fitting Type: Male Insert O-Ring  
Outlet Fitting Type: Female O-Ring  
O-Rings: (2) **24610**  
John Deere: AT190809



**33721**  
Aluminum Filter Drier w/ Pad Mount  
Outside Dia.: 5.000  
Length: 7.500  
Inlet Fitting Type: Pad Mount  
Outlet Fitting Type: Pad Mount  
O-Rings: (2) **24109**  
BMW (97-95)  
BMW: 64538372978



**33725**  
Steel Filter Drier  
Outside Dia.: 2.500  
Length: 6.500  
O-Rings: (2) **24606**  
Chevy HD (99-96); GMC HD (99-96)



**33728**  
Steel Filter Drier  
Outside Dia.: 3.000  
Length: 10.000  
Inlet Fitting Type: Male Insert O-Ring  
Inlet Fitting: 3/8"  
Outlet Fitting Type: Male Insert O-Ring  
Outlet Fitting: 3/8"  
O-Rings: (2) **24606**  
Western Star: 08858600, PH08858600



**33723**  
Steel Filter Drier  
Outside Dia.: 3.000  
Length: 7.250  
Inlet Fitting Type: Male Insert O-Ring  
Inlet Fitting: 3/8"  
Outlet Fitting Type: Male Insert O-Ring  
Outlet Fitting: 3/8"  
O-Rings: (2) **24606**  
Kysor: 1999032



**33726**  
Steel Filter Drier  
Outside Dia.: 4.000  
Length: 6.750  
Inlet Fitting Type: Pad Mount  
Outlet Fitting Type: Pad Mount  
O-Rings: (2) **24236**  
Freightliner (11-08)

# Filter Drier, Accumulator and Desiccant

## Filter Drier Cont'd



**33730**  
Steel Filter Drier  
Outside Dia.: 3.500  
Length: 10.000  
Inlet Fitting Type: Flare Fitting  
Inlet Fitting: 3/4"  
Outlet Fitting Type: Flare Fitting  
Outlet Fitting: 3/4"  
Carrier: 101303



**33731**  
Steel Filter Drier  
Outside Dia.: 2.500  
Length: 11.000  
Inlet Fitting Type: Male Insert O-Ring  
Outlet Fitting Type: Male Insert O-Ring  
O-Rings: (1) **24606**, (1) **24608**  
Caterpillar: 2573227



**33732**  
Aluminum Filter Drier w/o Pad Mount  
Outside Dia.: 3.000  
Length: 6.000  
Outlet Fitting Type: P-Nut Fitting  
O-Rings: (1) **24242**, (1) **24606**  
International (10-07)  
Kysor: 1913008  
NaviStar: 3670134C1, P6546001  
Red Dot: 74R5405, RD5140450



**33733**  
Steel Filter Drier  
Outside Dia.: 1.500  
Length: 11.750  
Inlet Fitting Type: Pad Mount  
Outlet Fitting Type: Pad Mount  
O-Rings: (2) **24606**  
Dodge (09-07)  
Chrysler: 68013634AA  
Mercedes Benz: 9068350047



**33734**  
Steel Filter Drier  
Length: 8.000  
Inlet Fitting Type: Male Insert O-Ring  
Inlet Fitting: 3/8"  
Outlet Fitting Type: Male Insert O-Ring  
Outlet Fitting: 3/8"  
O-Rings: (2) **24606**  
Red Dot: RD549500P



**33736**  
Steel Filter Drier  
Outside Dia.: 2.500  
Length: 7.500  
Inlet Fitting Type: Flare Fitting  
Outlet Fitting Type: Flare Fitting  
Carrier: 101321, 212006, WAH164FO, WLD164FO



**33737**  
Steel Filter Drier  
Outside Dia.: 3.000  
Length: 6.250  
Inlet Fitting Type: Male Insert O-Ring  
Inlet Fitting: 3/8"  
Outlet Fitting Type: Male Insert O-Ring  
Outlet Fitting: 3/8"  
O-Rings: (2) **24606**  
Red Dot: 74R2590, RD594190



**33738**  
Steel Filter Drier  
Outside Dia.: 3.000  
Length: 8.000  
Inlet Fitting Type: Flare Fitting  
Inlet Fitting: 5/8"  
Outlet Fitting Type: Flare Fitting  
Outlet Fitting: 5/8"  
Carrier: WAH305, WLD305, WSC305



**33739**  
Steel Filter Drier  
Outside Dia.: 2.500  
Length: 8.250  
Inlet Fitting Type: Male Insert O-Ring  
Outlet Fitting Type: Male Insert O-Ring  
O-Rings: (2) **24606**



**33740**  
Aluminum Filter Drier w/ Pad Mount  
Outside Dia.: 2.375  
Length: 7.500  
Inlet Fitting Type: Pad Mount  
Outlet Fitting Type: Pad Mount  
O-Rings: (2) **24650**  
Caterpillar: 1133497, 9E549



**33742**  
Steel Filter Drier  
Outside Dia.: 2.500  
Length: 8.500  
Inlet Fitting Type: Flare O-Ring  
Outlet Fitting Type: Flare O-Ring  
Carrier: WSG164FO  
Red Dot: RD5146880



**33743**  
Steel Filter Drier  
Outside Dia.: 3.000  
Length: 7.000  
Inlet Fitting Type: Female O-Ring  
Inlet Fitting: 3/4"  
Outlet Fitting Type: Male Insert O-Ring  
Outlet Fitting: 3/4"  
Switch/Service Port: 0.250  
O-Rings: (2) **24608**  
Carrier: 650019300



# Filter Drier, Accumulator and Desiccant

## Filter Drier Cont'd



**33744**  
Steel Filter Drier  
Outside Dia.: 3.000  
Length: 8.500  
Inlet Fitting Type: Male Insert O-Ring  
Outlet Fitting Type: Male Insert O-Ring  
O-Rings: (2) **24606**

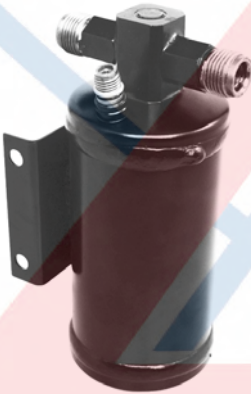

**33985**  
Steel Filter Drier  
GMC (99-97)



**33986**  
Steel Filter Drier  
Outside Dia.: 2.500  
Length: 6.500  
Inlet Fitting Type: Male Insert O-Ring  
Inlet Fitting: 3/8"  
Outlet Fitting Type: Quick Disconnect  
Outlet Fitting: 1/4"  
Chevy (93); GMC (95-85)



**33987**  
Steel Filter Drier  
Outside Dia.: 3.000  
Length: 5.250  
Inlet Fitting Type: Male Insert O-Ring  
Inlet Fitting: 3/8"  
Outlet Fitting Type: Male Insert O-Ring  
Outlet Fitting: 3/8"  
Red Dot: RD572720



**33988**  
Steel Filter Drier  
Outside Dia.: 4.000  
Length: 6.250  
Inlet Fitting Type: Pad Mount  
Outlet Fitting Type: Pad Mount  
Kysor: 1912015



**33989**  
Steel Filter Drier  
Outside Dia.: 3.500  
Length: 8.000  
Inlet Fitting Type: Pad Mount  
Outlet Fitting Type: Pad Mount  
Kysor: 1917007  
Peterbilt: F376009, F376011



**33990**  
Steel Filter Drier  
Outside Dia.: 3.000  
Length: 8.500  
Inlet Fitting Type: Pad Mount  
Outlet Fitting Type: Pad Mount  
Bergstrom: 1000028709  
Kysor: 1917006  
Peterbilt: F376003, F376008, F376010



**33991**  
Steel Filter Drier  
Outside Dia.: 3.000  
Length: 8.500  
Inlet Fitting Type: Pad Mount  
Outlet Fitting Type: Pad Mount  
Kenworth: F376002  
Kysor: 1917005  
Peterbilt: F376002, F376013

# Filter Drier, Accumulator and Desiccant

## Filter Drier Cont'd



**33992**  
Steel Filter Drier  
Outside Dia.: 2.500  
Length: 8.250  
Inlet Fitting Type: Male Insert O-Ring  
Inlet Fitting: 1/2"  
Outlet Fitting Type: Male Insert O-Ring  
Outlet Fitting: 1/2"



**33994**  
Steel Filter Drier  
Outside Dia.: 4.000  
Length: 6.250  
Inlet Fitting Type: Pad Mount  
Outlet Fitting Type: Pad Mount



**33997**  
Steel Filter Drier  
Outside Dia.: 3.000  
Length: 10.250  
Inlet Fitting Type: Pad Mount  
Outlet Fitting Type: Pad Mount  
Kysor: 1912011  
Red Dot: 74R3120, RD5105891P



**33999**  
Steel Filter Drier  
Outside Dia.: 2.500  
Length: 8.250  
Inlet Fitting Type: Male Insert O-Ring  
Inlet Fitting: 3/8"  
Outlet Fitting Type: Male Insert O-Ring  
Outlet Fitting: 3/8"  
Caterpillar: 08827300  
Kysor: 1999040  
Mack: 4379RD575590



**34246**  
Beadlock In-Line Filter w/ Desiccant for Liquid Line  
Outside Dia.: 2.750  
Length: 6.750  
Kysor: 402526  
Northern: 804311, 804845



**33993**  
Steel Filter Drier  
Outside Dia.: 3.000  
Length: 8.500  
Inlet Fitting Type: Male Insert O-Ring  
Inlet Fitting: 3/8"  
Outlet Fitting Type: Male Insert O-Ring  
Outlet Fitting: 3/8"  
Peterbilt: 2314233

**33995**  
Steel Filter Drier  
Outside Dia.: 4.000  
Length: 6.250  
Inlet Fitting Type: Pad Mount  
Outlet Fitting Type: Pad Mount



**33996**  
Steel Filter Drier  
Outside Dia.: 3.000  
Length: 10.000  
Inlet Fitting Type: Flare Fitting  
Inlet Fitting: 1/2"  
Outlet Fitting Type: Flare Fitting  
Outlet Fitting: 1/2"



**33998**  
Steel Filter Drier  
Outside Dia.: 4.000  
Length: 6.750  
Inlet Fitting Type: Pad Mount  
Outlet Fitting Type: Pad Mount  
Red Dot: 74R4210, RD5132160P

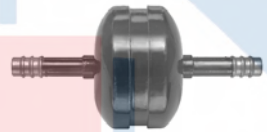

**34248**  
Beadlock In-Line Filter w/ Desiccant for Liquid Line  
Outside Dia.: 2.500  
Length: 3.000  
Inlet Fitting Type: Barb Fitting  
Outlet Fitting Type: Barb Fitting  
Euclid: E8047088  
Northern: 804312

# Filter Drier, Accumulator and Desiccant

## Filter Drier Cont'd



### 34250

Beadlock In-Line Filter w/ Desiccant for Liquid Line  
 Outside Dia.: 2.500  
 Length: 3.000  
 Inlet Fitting Type: Barb Fitting  
 Outlet Fitting Type: Barb Fitting  
 Euclid: E80470810  
 Northern: 804313



### 34252

In-Line Barb Filter w/o Desiccant for Liquid Line  
 Euclid: E80470812  
 Northern: 804314



### 34450

Barb In-Line Filter w/o Orifice for Liquid Line  
 Outside Dia.: 2.500  
 Length: 3.000  
 Inlet Fitting Type: Barb Fitting  
 Outlet Fitting Type: Barb Fitting  
 General Motors Corp: 19188838



### 34452

Barb In-Line Filter w/o Orifice for Liquid Line  
 Outside Dia.: 2.500  
 Length: 3.000  
 Inlet Fitting Type: Barb Fitting  
 Outlet Fitting Type: Barb Fitting



### 34456

Compression In-Line Filter w/ Desiccant for Liquid Line



### 34458

Compression In-Line Filter w/ Desiccant for Liquid Line



### 34506

Compression In-Line Filter w/o Desiccant for Liquid Line  
 Euclid: E804700  
 Northern: 804753

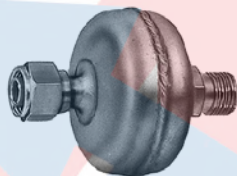

### 34508

O-Ring In-Line Filter w/o Desiccant for Liquid Line  
 Outside Dia.: 2.500  
 Inlet Fitting Type: Female O-Ring  
 Outlet Fitting Type: Male Insert O-Ring  
 O-Rings: (1) 24606, (2) 24608, (1) 24610  
 Euclid: E804701

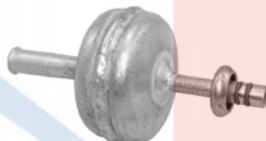

### 34510

Springlock In-Line Filter w/o Desiccant for Liquid Line  
 Outside Dia.: 2.440  
 Length: 5.380  
 Inlet Fitting Type: Male Springlock  
 Outlet Fitting Type: Female Springlock  
 O-Rings: (1) 24606, (2) 24608  
 General Motors Corp: 19188844  
 Euclid: E804706  
 Northern: 8041216



### 34511

O-Ring In-Line Filter w/o Desiccant for Liquid Line  
 Outside Dia.: 2.440  
 Length: 5.000  
 Inlet Fitting Type: Male Springlock  
 Outlet Fitting Type: Female Springlock  
 O-Rings: (2) 24606  
 Euclid: E804705  
 Northern: 8041217



### 34512

Compression In-Line Filter w/o Desiccant for Liquid Line  
 Outside Dia.: 2.440  
 Length: 5.680  
 Inlet Fitting Type: Compression Fitting  
 Outlet Fitting Type: Compression Fitting  
 Euclid: E804704

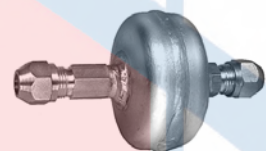

### 34516

Compression In-Line Filter w/ Fixed Orifice for Liquid Line  
 General Motors Corp: 52450924  
 Euclid: E804702  
 Northern: 804754

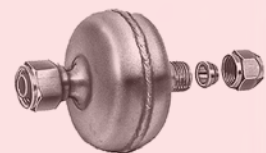

### 34518

Compression/O-Ring In-Line Filter w/o Desiccant for Liquid Line  
 Outside Dia.: 2.440  
 Length: 4.000  
 Inlet Fitting Type: Compression Fitting  
 Outlet Fitting Type: Female O-Ring  
 O-Rings: (2) 24608  
 Euclid: E804703  
 Northern: 804846



### 38600

VIR Assembly Unit  
 O-Rings: (1) 24608, (1) 24610, (1) 11012, (2) 24612, (1) 35751, (1) 12012



### 56792

Filter Drier w/ Hose  
 Chrysler (02-01); Dodge (02-01)  
 Chrysler: 4596270AC



### 83001

Aluminum Filter Drier w/ Pad Mount  
 Outside Dia.: 2.375  
 Length: 6.000  
 Inlet Fitting Type: Pad Mount  
 Outlet Fitting Type: Pad Mount  
 O-Rings: (3) 24606  
 Hyundai (99-95)  
 Hyundai: 9780122001



# Filter Drier, Accumulator and Desiccant

## Filter Drier Cont'd



**83002**  
Aluminum Filter Drier w/ Pad Mount  
Outside Dia.: 2.375  
Length: 6.000  
Inlet Fitting Type: Pad Mount  
Outlet Fitting Type: Pad Mount  
O-Rings: (2) **24607**  
Hyundai (01-94)  
Hyundai: 9780129000



**83005**  
Filter Drier w/ Hose  
Outside Dia.: 3.500  
Length: 8.000  
Inlet Fitting Type: P-Nut Fitting  
Outlet Fitting Type: P-Nut Fitting  
O-Rings: (2) **24069**  
Ford (12-08); Lincoln (14-09); Mercury (09-08)  
Ford: BG1Z19959B



**83016**  
Filter Drier w/ Hose  
Outside Dia.: 3.000  
Length: 4.500  
Outlet Fitting Type: P-Nut Fitting  
O-Rings: (1) **24675**, (1) **24649**  
Ford (05); Mercury (05)  
Ford: 7F9Z19C836BA



**83020**  
Aluminum Filter Drier w/ Pad Mount  
Outside Dia.: 2.500  
Length: 6.000  
Inlet Fitting Type: Pad Mount  
Outlet Fitting Type: Pad Mount  
O-Rings: (2) **24607**  
Toyota (91-87)



**83003**  
Aluminum Filter Drier w/ Pad Mount  
Outside Dia.: 2.375  
Length: 6.000  
Inlet Fitting Type: Pad Mount  
Outlet Fitting Type: Pad Mount  
O-Rings: (2) **24607**  
Acura (03-99); Honda (09-98)  
Acura: 80351S3MA01, 80351S84A01  
Honda: 80351S04A01, 80351S2A901, 80351S84A01



**83008**  
Aluminum Filter Drier w/ Pad Mount  
Outside Dia.: 1.375  
Length: 10.500  
Inlet Fitting Type: Pad Mount  
Outlet Fitting Type: Pad Mount  
O-Rings: (2) **24666**  
Acura (12-07); Honda (14-03)  
Acura: 80351SDCA01  
Honda: 80351SDCA01



**83018**  
Aluminum Filter Drier w/ Pad Mount  
Outside Dia.: 2.375  
Length: 9.750  
Inlet Fitting Type: Pad Mount  
Outlet Fitting Type: Pad Mount  
O-Rings: (2) **24662**  
Toyota (07-91)  
Toyota: 8847128070



**83031**  
Aluminum Filter Drier w/ Pad Mount  
Outside Dia.: 1.750  
Length: 6.750  
Outlet Fitting Type: Pad Mount  
O-Rings: (2) **24606**  
Mazda (14-04)  
Mazda: D65161501A, DF7161480C

# Filter Drier, Accumulator and Desiccant

## Filter Drier Cont'd



**83032**  
 Aluminum Filter Drier w/ Pad Mount  
 Outside Dia.: 1.563  
 Length: 9.000  
 Inlet Fitting Type: Pad Mount  
 Outlet Fitting Type: Pad Mount  
 O-Rings: (2) **24629**  
 Acura (08-04); Honda (08-03); Nissan (06-00)  
 Acura: 80351SDNA01  
 Honda: 80351SDCA01, 80351SDNA01  
 Nissan: 921334Z010

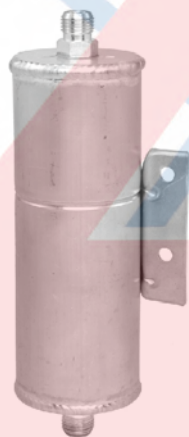

**83033**  
 Aluminum Filter Drier w/o Pad Mount  
 Outside Dia.: 2.250  
 Length: 6.625  
 Inlet Fitting: 3/8"  
 Outlet Fitting Type: Male Insert O-Ring  
 Outlet Fitting: 3/8"  
 O-Rings: (2) **24606**  
 Mazda (00-99)  
 Mazda: NC1061500A



**83036**  
 Aluminum Filter Drier w/ Pad Mount  
 Outside Dia.: 2.375  
 Length: 7.000  
 Inlet Fitting Type: Pad Mount  
 Outlet Fitting Type: Pad Mount  
 O-Rings: (2) **24662**  
 Honda (98)



**83037**  
 Aluminum Filter Drier w/ Pad Mount  
 Outside Dia.: 2.375  
 Length: 5.625  
 Outlet Fitting Type: Pad Mount  
 O-Rings: (1) **24611**, (1) **24610**, (1) **24606**  
 Hyundai (05-02); Kia (06-02)  
 Hyundai: 9780138003



**83039**  
 Aluminum Filter Drier w/ Pad Mount  
 Outside Dia.: 2.375  
 Length: 5.625  
 Inlet Fitting Type: Pad Mount  
 Outlet Fitting Type: Pad Mount  
 O-Rings: (1) **24676**, (2) **24606**  
 Mazda (00-99)  
 Mazda: BJ0M61500, BJ3D61500A

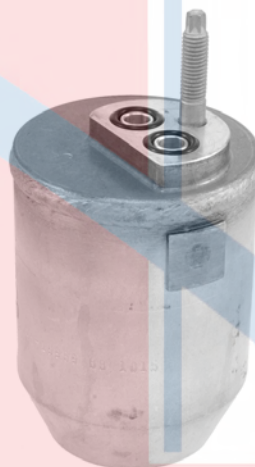

**83041**  
 Aluminum Filter Drier w/ Pad Mount  
 Outside Dia.: 3.000  
 Length: 4.500  
 Inlet Fitting Type: Flange  
 Outlet Fitting Type: Flange  
 O-Rings: (2) **24661**  
 Ford (05-02); Jaguar (03-00); Lincoln (06-00)  
 Ford: 6W4Z19959A  
 Jaguar: XR854220



**83048**  
 Filter Drier w/ Hose  
 Outside Dia.: 2.750  
 Length: 8.000  
 Outlet Fitting Type: P-Nut Fitting  
 O-Rings: (1) **24650**, (1) **24628**  
 Lincoln (05-03)  
 Ford: 1L2Z19959AA



**83049**  
 Aluminum Filter Drier w/ Pad Mount  
 Outside Dia.: 1.375  
 Length: 11.500  
 Inlet Fitting Type: Pad Mount  
 Outlet Fitting Type: Pad Mount  
 O-Rings: (2) **24167**  
 Pontiac (09-08); Saturn (10-08)  
 General Motors Corp: 19130435

# Filter Drier, Accumulator and Desiccant

## Filter Drier Cont'd



**83050**  
Aluminum Filter Drier w/ Pad Mount  
Outside Dia.: 2.500  
Length: 7.000  
Inlet Fitting Type: Pad Mount  
Outlet Fitting Type: Pad Mount  
Outlet Fitting: 3/8"  
O-Rings: (3) **24606**  
Acura (99-98); Honda (02-99); Isuzu (04-98)  
Acura: 8524814530  
Honda: 8971678410  
Isuzu: 8972050760, 8972238750, 8972238760, 8973227310



**83053**  
Aluminum Filter Drier w/ Pad Mount  
Outside Dia.: 2.250  
Length: 6.250  
Outlet Fitting Type: Pad Mount  
O-Rings: (2) **24677**  
VW (15-98)  
Volkswagen: 1C0820191, 1C0820191C  
Versatile: 1C0820191



**83062**  
Steel Filter Drier  
Outside Dia.: 2.500  
Length: 4.000  
Inlet Fitting Type: Male Insert O-Ring  
Inlet Fitting: 13/16"  
Outlet Fitting Type: Male Insert O-Ring  
O-Rings: (1) **24676**, (1) **24616**, (1) **24131**  
Hyundai (02-99); Kia (01)  
Hyundai: 9780138000



**83067**  
Aluminum Filter Drier w/ Pad Mount  
Outside Dia.: 2.375  
Chrysler (02-01); Plymouth (01-99), (97)  
Chrysler: 4815319

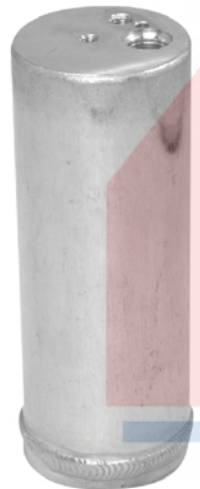

**83051**  
Aluminum Filter Drier w/ Pad Mount  
Outside Dia.: 2.500  
Length: 6.000  
Inlet Fitting Type: Pad Mount  
Outlet Fitting Type: Pad Mount  
O-Rings: (2) **24677**  
Audi (06-00); VW (06-99)  
Volkswagen: 1J0820191A



**83056**  
Steel Filter Drier  
Land Rover (01-95)  
Land Rover: AWR1374



**83065**  
Filter Drier w/ Hose  
Outside Dia.: 3.000  
Length: 4.500  
Inlet Fitting Type: P-Nut Fitting  
Outlet Fitting Type: P-Nut Fitting  
O-Rings: (1) **24682**, (1) **24649**  
Ford (07-05); Mercury (07-05)  
Ford: 7F9Z19C836AA



**83068**  
Aluminum Filter Drier w/ Pad Mount  
Land Rover (05-02); Mini (09-02)  
BMW: 64506917489  
Land Rover: JRB500080



# Filter Drier, Accumulator and Desiccant

## Filter Drier Cont'd



**83070**  
Aluminum Filter Drier w/ Pad Mount  
Outside Dia.: 2.500  
Length: 6.500  
Inlet Fitting Type: Pad Mount  
Outlet Fitting Type: Pad Mount  
O-Rings: (2) **24661**  
BMW (10-98)  
BMW: 64538377330



**83078**  
Steel Filter Drier  
Outside Dia.: 2.500  
Length: 5.250  
Inlet Fitting: 3/8"  
Outlet Fitting Type: Male Insert O-Ring  
Outlet Fitting: 3/8"  
O-Rings: (2) **24606**  
BMW (89-88)

**83072**  
Aluminum Filter Drier w/ Pad Mount  
Outside Dia.: 5.000  
Length: 7.125  
Inlet Fitting Type: Pad Mount  
Outlet Fitting Type: Pad Mount  
O-Rings: (2) **24661**  
BMW (98)  
BMW: 64538375760



**83079**  
Aluminum Filter Drier w/ Pad Mount  
Outside Dia.: 3.875  
Length: 3.625  
Inlet Fitting Type: Pad Mount  
Outlet Fitting Type: Pad Mount  
O-Rings: (2) **24606**  
BMW (02-01), (99-96)  
BMW: 64538375754



**83076**  
Filter Drier w/ Hose  
Outside Dia.: 3.000  
Length: 5.500  
Inlet Fitting Type: P-Nut Fitting  
Outlet Fitting Type: P-Nut Fitting  
O-Rings: (2) **24649**  
Ford (07-03); Lincoln (07-03)  
Ford: 6L1Z19959AA



**83080**  
Aluminum Filter Drier w/ Pad Mount  
Outside Dia.: 1.500  
Length: 9.000  
Inlet Fitting Type: Pad Mount  
Outlet Fitting Type: Pad Mount  
O-Rings: (2) **24607**  
Mitsubishi (07-02)  
Mitsubishi: MR500065

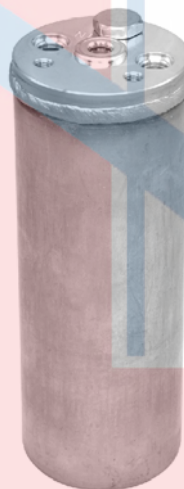

**83081**  
Aluminum Filter Drier w/ Pad Mount  
Outside Dia.: 2.375  
Length: 7.250  
Outlet Fitting Type: Pad Mount  
O-Rings: (1) **24668**, (2) **24606**  
Mitsubishi (04-98)  
Mitsubishi: MR922120



**83082**  
Aluminum Filter Drier w/ Pad Mount  
Outside Dia.: 5.000  
Length: 7.500  
Outlet Fitting Type: Pad Mount  
O-Rings: (2) **24109**  
BMW (97)  
BMW: 64538372985



**83083**  
Aluminum Filter Drier w/ Pad Mount  
Outside Dia.: 2.625  
Length: 6.500  
Outlet Fitting Type: Pad Mount  
O-Rings: (2) **24606**  
Jaguar (03-98)  
Jaguar: MNC7412AB

# Filter Drier, Accumulator and Desiccant

## Filter Drier Cont'd



**83084**  
Aluminum Filter Drier w/ Pad Mount  
Outside Dia.: 2.625  
Length: 6.500  
Outlet Fitting Type: Pad Mount  
O-Rings: (1) **24670**, (2) **24606**, (1) **24650**  
Jaguar (06-97)  
Jaguar: MJA7410AE



**83087**  
Steel Filter Drier  
O-Rings: (2) **24606**  
Porsche (89-84)  
Porsche: 91157393903



**83091**  
Aluminum Filter Drier w/o Pad Mount  
Outside Dia.: 3.000  
Length: 5.250  
Inlet Fitting Type: Male Insert O-Ring  
Inlet Fitting: 3/8"  
Outlet Fitting Type: Female O-Ring  
Outlet Fitting: 3/8"  
O-Rings: (2) **24606**  
VW (95), (93)



**83100**  
Aluminum Filter Drier w/ Pad Mount  
Outside Dia.: 2.500  
Length: 6.500  
Inlet Fitting Type: Pad Mount  
Outlet Fitting Type: Pad Mount  
O-Rings: (2) **24121**  
Dodge (03-98); Saturn (05-00)  
Chrysler: 5010445AA  
General Motors Corp: 19193709



**83085**  
Steel Filter Drier  
Outside Dia.: 2.500  
Jeep (90-87)



**83090**  
Steel Filter Drier  
O-Rings: (2) **24607**  
Sterling (91-89)  
Sterling: 8218217032



**83093**  
Filter Drier  
Chrysler (08-04); Mercedes (04-01)  
Chrysler: 5098258AA  
Mercedes Benz: 1708300383



**83101**  
Filter Drier w/ Hose  
Outside Dia.: 3.000  
Length: 4.000  
Outlet Fitting Type: P-Nut Fitting  
O-Rings: (2) **24402**  
Saturn (07-02)  
General Motors Corp: 19187876

# Filter Drier, Accumulator and Desiccant

## Filter Drier Cont'd



### 83102

Aluminum Filter Drier w/ Pad Mount  
 Outside Dia.: 2.500  
 Length: 5.500  
 Inlet Fitting Type: Pad Mount  
 Outlet Fitting Type: Pad Mount  
 O-Rings: (2) **24606**  
 Dodge (99-97); Plymouth (99-97)  
 Chrysler: 4883282



### 83104

Aluminum Filter Drier w/ Pad Mount  
 Outside Dia.: 2.500  
 Length: 6.000  
 Inlet Fitting Type: Pad Mount  
 Outlet Fitting Type: Pad Mount  
 O-Rings: (2) **24121**  
 Chrysler (04-98); Dodge (04-98)  
 Chrysler: 5003980AA, 5101762AA



### 83108

Aluminum Filter Drier w/ Pad Mount  
 Outside Dia.: 2.500  
 Length: 7.000  
 Inlet Fitting Type: Pad Mount  
 Outlet Fitting Type: Pad Mount  
 O-Rings: (1) **24677**, (1) **24676**  
 Chrysler (07-01); Dodge (07-01)  
 Chrysler: 5066503AB, 5066635AC,  
 5139230AA



### 83114

Aluminum Filter Drier w/ Pad Mount  
 Outside Dia.: 2.500  
 Length: 8.250  
 Outlet Fitting Type: Pad Mount  
 O-Rings: (1) **24662**, (2) **24649**  
 Dodge (06-03); Mercedes (12-11),  
 (09-00)  
 Chrysler: 5103570AA  
 Mercedes Benz: 2208300083



### 83103

Aluminum Filter Drier w/ Pad Mount  
 Outside Dia.: 2.750  
 Length: 6.000  
 Inlet Fitting Type: Pad Mount  
 Outlet Fitting Type: Pad Mount  
 O-Rings: (2) **24121**  
 Dodge (05-03), (01-00); Plymouth  
 (01-00)  
 Chrysler: 5015343AA

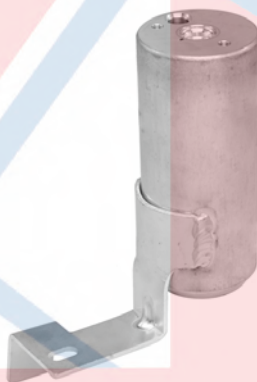

### 83105

Aluminum Filter Drier w/ Pad Mount  
 Outside Dia.: 2.375  
 O-Rings: (1) **24668**, (1) **24608**  
 Chrysler (11-08); Dodge (11-08); VW  
 (11-09)  
 Chrysler: 68031863AA  
 Volkswagen: 7B0820191



### 83110

Filter Drier w/ Hose  
 Outside Dia.: 2.500  
 Length: 8.000  
 Inlet Fitting Type: Pad Mount  
 Outlet Fitting Type: Pad Mount  
 O-Rings: (2) **24661**  
 Jeep (04-02)  
 Chrysler: 55116560AF



### 83118

Aluminum Filter Drier w/ Pad Mount  
 Outside Dia.: 2.750  
 Length: 9.000  
 Outlet Fitting Type: Pad Mount  
 O-Rings: (2) **24649**, (2) **23678**  
 Chrysler (11-05); Dodge (10-05)  
 Chrysler: 5137694AA



# Filter Drier, Accumulator and Desiccant

## Filter Drier Cont'd



**83120**  
Aluminum Filter Drier w/ Pad Mount  
Outside Dia.: 2.375  
Length: 7.500  
Inlet Fitting Type: Pad Mount  
Outlet Fitting Type: Pad Mount  
O-Rings: (2) **24676**, (1) **24167**  
Chrysler (00-99); Dodge (00-99);  
Mitsubishi (03-02)

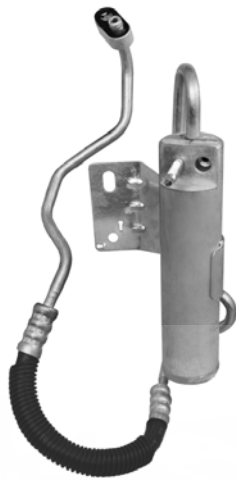

**83123**  
Aluminum Filter Drier w/ Pad Mount  
Outside Dia.: 1.750  
Length: 8.000  
Inlet Fitting Type: P-Nut Fitting  
Outlet Fitting Type: Pad Mount  
Dodge (09)  
Chrysler: 68040262AA



**83126**  
Aluminum Filter Drier w/ Pad Mount  
Outside Dia.: 1.563  
Length: 9.000  
Inlet Fitting Type: Pad Mount  
Outlet Fitting Type: Pad Mount  
O-Rings: (2) **24167**  
Mitsubishi (06-03)  
Mitsubishi: MR500038



**83131**  
Aluminum Filter Drier w/ Pad Mount  
Outside Dia.: 2.500  
Length: 7.000  
Inlet Fitting: 1/4"  
Outlet Fitting Type: Pad Mount  
Outlet Fitting: 7/16"  
O-Rings: (2) **24121**, (2) **24606**  
Infiniti (02-98); Nissan (02-97)  
Infiniti: 921310W070, 921312Y900,  
921314S110  
Nissan: 921304Z000, 921310W070,  
921310Z800, 921312Y900, 921317B40



**83122**  
Aluminum Filter Drier w/ Pad Mount  
Outside Dia.: 2.375  
Length: 8.625  
Inlet Fitting Type: Pad Mount  
Outlet Fitting Type: Pad Mount  
O-Rings: (2) **24121**  
Chrysler (08-04)  
Chrysler: 5103433AA



**83125**  
Aluminum Filter Drier w/ Pad Mount  
Outside Dia.: 1.750  
Length: 8.625  
Inlet Fitting Type: Pad Mount  
Outlet Fitting Type: Pad Mount  
O-Rings: (2) **24609**  
Mitsubishi (11-04)  
Mitsubishi: MR958868



**83128**  
Filter Drier w/ Hose  
Outside Dia.: 2.750  
Length: 4.500  
Outlet Fitting Type: Male Insert O-Ring  
O-Rings: (2) **24611**  
Chrysler (06-02); Dodge (06-02)  
Chrysler: 4596536AG



**83132**  
Aluminum Filter Drier w/ Pad Mount  
Outside Dia.: 1.625  
Length: 9.000  
Inlet Fitting Type: Pad Mount  
Outlet Fitting Type: Pad Mount  
O-Rings: (2) **24662**  
Infiniti (08-02); Mazda (10-06);  
Mitsubishi (14-07); Nissan (15-01);  
Subaru (07-02); VW (06)  
Infiniti: 921312Y920, 92131AR070  
Mazda: NE5161501  
Mitsubishi: 7815B327  
Nissan: 921312Y920  
Subaru: 73412FE000

# Filter Drier, Accumulator and Desiccant

## Filter Drier Cont'd

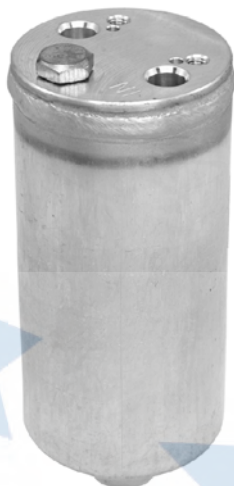

**83133**  
Aluminum Filter Drier w/ Pad Mount  
Outside Dia.: 2.375  
Length: 5.750  
Inlet Fitting Type: Pad Mount  
Outlet Fitting Type: Pad Mount  
Outlet Fitting: 3/8"  
O-Rings: (1) **24676**, (2) **24606**  
Chevy (12-94); Infiniti (01-97); Nissan (99-96); Subaru (06-00)  
Nissan: 921310W060  
Subaru: 73410AE07A



**83134**  
Aluminum Filter Drier w/ Pad Mount  
Outside Dia.: 1.625  
Length: 9.125  
Inlet Fitting: 1/4"  
Outlet Fitting Type: Pad Mount  
O-Rings: (2) **24121**  
Infiniti (14-06); Nissan (15-04)  
Infiniti: 921311DJ0A, 92131AU420, 92131JK20A  
Nissan: 921001HA3A, 921003TA1A, 921311DA1A, 921311DJ0A, 92131AU420, 92131JK20A, 92131ZW40B



**83137**  
Aluminum Filter Drier w/ Pad Mount  
Outside Dia.: 1.500  
Length: 7.000  
Inlet Fitting Type: Pad Mount  
Outlet Fitting Type: Pad Mount  
Ford (14-11)  
Ford: BE8Z19712A, BE8Z19959A

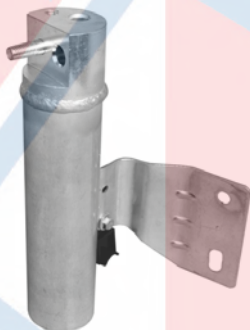

**83139**  
Aluminum Filter Drier w/ Pad Mount  
Outside Dia.: 1.750  
Length: 8.000  
Inlet Fitting Type: Pad Mount  
Outlet Fitting Type: Pad Mount  
Dodge (12), (10); Jeep (14), (10)  
Chrysler: 5058900AD



**83140**  
Aluminum Filter Drier w/ Pad Mount  
Outside Dia.: 2.375  
Length: 7.375  
Inlet Fitting Type: P-Nut Fitting  
Outlet Fitting Type: P-Nut Fitting  
O-Rings: (3) **24606**  
Volvo (04-00)  
Volvo: 30621525



**83141**  
Aluminum Filter Drier w/ Pad Mount  
Outside Dia.: 2.375  
Length: 7.000  
Outlet Fitting Type: Pad Mount  
O-Rings: (2) **24606**  
Volvo (06-99)  
Volvo: 30645016



**83143**  
Filter Drier w/ Hose  
Outside Dia.: 3.000  
Length: 4.000  
Inlet Fitting Type: Pad Mount  
Outlet Fitting Type: P-Nut Fitting  
O-Rings: (1) **24676**, (1) **24675**, (1) **24649**  
Ford (12-08); Mazda (11-08); Mercury (11-08)  
Ford: 8L8Z19C836C, BL8Z19C836B  
Mazda: ZZC061500A, ZZD061500B, ZZD261480, ZZDA61500



**83145**  
Aluminum Filter Drier w/ Pad Mount  
Outside Dia.: 3.500  
O-Rings: (1) **24676**, (2) **24642**  
Ford (07-04); Mercury (07-04)  
Ford: 6F2Z19C836AA

# Filter Drier, Accumulator and Desiccant

## Filter Drier Cont'd



**83152**  
Aluminum Filter Drier w/ Pad Mount  
Outside Dia.: 2.375  
Length: 7.000  
Inlet Fitting Type: Pad Mount  
Outlet Fitting Type: Pad Mount  
Suzuki (06-04)  
Suzuki: 9533086200



**83153**  
Aluminum Filter Drier w/ Pad Mount  
Outside Dia.: 1.250  
Length: 11.500  
Inlet Fitting Type: Pad Mount  
Outlet Fitting Type: Pad Mount  
BMW (15-12)  
BMW: 64506804722



**83156**  
Aluminum Filter Drier w/o Pad Mount  
Outside Dia.: 1.250  
Length: 15.620  
Inlet Fitting Type: Pad Mount  
Outlet Fitting Type: Pad Mount  
O-Rings: (2) **24650**  
Cadillac (14-10)  
General Motors Corp: 22973655,  
22973656



**83157**  
Filter Drier w/ Hose  
Outside Dia.: 3.000  
Length: 4.000  
Inlet Fitting Type: P-Nut Fitting  
Outlet Fitting Type: P-Nut Fitting  
O-Rings: (2) **24402**  
Saturn (07-04)

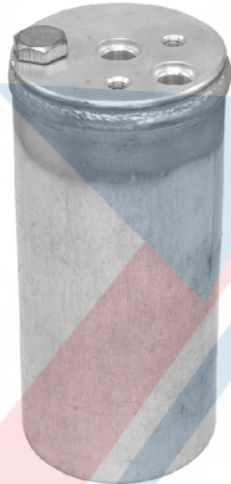

**83160**  
Aluminum Filter Drier w/o Pad Mount  
Outside Dia.: 2.375  
Length: 5.250  
Inlet Fitting Type: Pad Mount  
Outlet Fitting Type: Pad Mount  
Outlet Fitting: 3/8"  
O-Rings: (3) **24676**  
Kia (02-01)  
Kia: 0K08A61500



**83161**  
Aluminum Filter Drier w/ Pad Mount  
Outside Dia.: 2.500  
Length: 5.750  
Inlet Fitting Type: Pad Mount  
Outlet Fitting Type: Pad Mount  
O-Rings: (2) **24606**  
Kia (04-02)



**83162**  
Aluminum Filter Drier w/ Pad Mount  
Outside Dia.: 2.375  
Length: 6.000  
Inlet Fitting Type: Pad Mount  
Outlet Fitting Type: Pad Mount  
O-Rings: (2) **24629**, (1) **24606**  
Kia (02-98)  
Kia: 1K2A161500



**83163**  
Aluminum Filter Drier w/ Pad Mount  
Outside Dia.: 2.000  
Length: 10.250  
Inlet Fitting Type: Pad Mount  
Outlet Fitting Type: Pad Mount  
Outlet Fitting: 3/8"  
O-Rings: (2) **24676**  
Kia (05-02)  
Kia: 1K52Y61E02



**83166**  
Steel Filter Drier  
Outside Dia.: 2.500  
Length: 6.750  
Outlet Fitting Type: Male Insert O-Ring  
O-Rings: (2) **24609**, (1) **24605**  
Kia (00-93)  
Kia: 0K04E61500A



# Filter Drier, Accumulator and Desiccant

## Filter Drier Cont'd



### 83168

Filter Drier w/ Hose  
 Outside Dia.: 1.750  
 Length: 7.750  
 Inlet Fitting Type: Pad Mount  
 Outlet Fitting Type: P-Nut Fitting  
 Dodge (15-09)  
 Chrysler: 68058965AB



### 83171

Aluminum Filter Drier w/o Pad Mount  
 Outside Dia.: 2.375  
 Length: 6.750  
 Inlet Fitting: 3/8"  
 Outlet Fitting Type: Male Insert O-Ring  
 Outlet Fitting: 1/2"  
 O-Rings: (1) **24616**, (1) **24606**  
 Mazda (95-89)  
 Mazda: LB5061500



### 83173

Aluminum Filter Drier w/ Pad Mount  
 Outside Dia.: 1.500  
 Length: 9.000  
 Inlet Fitting Type: Pad Mount  
 Outlet Fitting Type: Pad Mount  
 O-Rings: (1) **24676**, (2) **24628**  
 Nissan (12-07)



### 83175

Aluminum Filter Drier w/o Pad Mount  
 Outside Dia.: 2.375  
 Length: 6.500  
 Inlet Fitting Type: Male Insert O-Ring  
 Outlet Fitting Type: Male Insert O-Ring  
 O-Rings: (2) **24629**  
 Acura (98-95)  
 Acura: 80351SW5A01



### 83170

Aluminum Filter Drier w/ Pad Mount  
 Outside Dia.: 2.750  
 Length: 4.750  
 Inlet Fitting Type: Pad Mount  
 Outlet Fitting Type: Pad Mount  
 O-Rings: (1) **24649**  
 Volvo (14-10)  
 Volvo: 31274799



### 83172

Aluminum Filter Drier w/ Pad Mount  
 Outside Dia.: 1.375  
 Length: 11.000  
 Outlet Fitting Type: Pad Mount  
 O-Rings: (2) **24676**  
 Mazda (15-07)  
 Mazda: BBM461480D, GJ6A61501A



### 83174

Aluminum Filter Drier w/ Pad Mount  
 Inlet Fitting Type: Pad Mount  
 Outlet Fitting Type: Pad Mount  
 VW (14-12)



### 83176

Aluminum Filter Drier w/o Pad Mount  
 Outside Dia.: 2.625  
 Length: 8.000  
 Inlet Fitting Type: Male Insert O-Ring  
 Outlet Fitting Type: Male Insert O-Ring  
 O-Rings: (2) **24607**  
 Acura (94-92)  
 Acura: 80351SL5N01

# Filter Drier, Accumulator and Desiccant

## Filter Drier Cont'd



**83181**  
Aluminum Filter Drier w/ Pad Mount  
Outside Dia.: 2.375  
Length: 6.000  
Outlet Fitting Type: Pad Mount  
Chrysler (15-12); Dodge (15-12); VW (14-12)  
Chrysler: 68142910AA  
Volkswagen: 7B0820191A



**83182**  
Aluminum Filter Drier w/ Pad Mount  
Outside Dia.: 2.000  
Length: 8.750  
Outlet Fitting Type: P-Nut Fitting  
O-Rings: (2) **24681**  
Chevy (10-04); Suzuki (08-04)  
Suzuki: 9533085Z00



**83183**  
Aluminum Filter Drier w/ Pad Mount  
Outside Dia.: 3.000  
Length: 6.875  
O-Rings: (3) **24606**  
Mercedes (15-02)  
Mercedes Benz: 4635000249



**83184**  
Steel Filter Drier  
Outside Dia.: 2.750  
O-Rings: (2) **24167**, (2) **24606**  
Saab (02-94)  
Saab: 7496847



**83189**  
Aluminum Filter Drier w/ Pad Mount  
Outside Dia.: 1.1811  
Length: 11.000  
Inlet Fitting Type: Pad Mount  
Outlet Fitting Type: Pad Mount  
O-Rings: (1) **24650**  
Audi (14-08)  
Audi: 8K0298403B, 8T0298403



**83190**  
Aluminum Filter Drier w/ Pad Mount  
Outside Dia.: 1.250  
Length: 13.000  
Inlet Fitting Type: Pad Mount  
Outlet Fitting Type: Pad Mount  
VW (14-13)  
Volkswagen: 3C0898191B

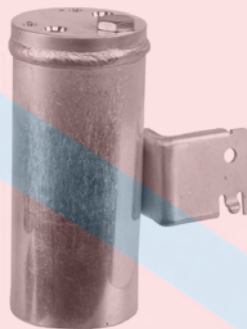

**83191**  
Aluminum Filter Drier w/ Pad Mount  
Outside Dia.: 2.375  
Length: 6.000  
Inlet Fitting Type: Pad Mount  
Outlet Fitting Type: Pad Mount  
Mazda (03-02)  
Mazda: BJOE61500A, BJOE61501A



**83192**  
Aluminum Filter Drier w/ Pad Mount  
Outside Dia.: 1.375  
Length: 10.000  
Inlet Fitting Type: Pad Mount  
Outlet Fitting Type: Pad Mount  
O-Rings: (2) **24121**  
Acura (15-13); Dodge (15); Honda (15-12)  
Acura: 80351T5A003, 80351TV9A01  
Honda: 80351T5A003, 80351TV9A01



**83193**  
Aluminum Filter Drier w/ Pad Mount  
Dodge (14-13)



**83194**  
Aluminum Filter Drier w/ Pad Mount  
Inlet Fitting Type: Pad Mount  
Outlet Fitting Type: Pad Mount  
Mercedes (11-07)  
Mercedes Benz: 2118350247



**83204**  
Aluminum Filter Drier w/ Pad Mount  
Outside Dia.: 1.375  
O-Rings: (4) **24606**, (1) **24167**  
Volvo (13-07)  
Volvo: 31369544

# Filter Drier, Accumulator and Desiccant

## Filter Drier Cont'd



**83209**  
Aluminum Filter Drier w/ Pad Mount  
Outside Dia.: 2.500  
O-Rings: (2) **24661**  
Chevy (12-04); GMC (12-04); Isuzu (08-06)  
General Motors Corp: 89019119



**83216**  
Aluminum Filter Drier w/ Pad Mount  
Outside Dia.: 1.375  
Length: 13.625  
Inlet Fitting Type: Pad Mount  
Outlet Fitting Type: Pad Mount  
Chevy (14-10); GMC (14-10)  
General Motors Corp: 25952884



**83220**  
Filter Drier w/ Hose  
Outside Dia.: 2.500  
Length: 6.000  
Inlet Fitting Type: Dual O-Ring  
Outlet Fitting Type: Dual O-Ring  
O-Rings: (4) **24668**  
Chevy (05-04); Pontiac (04)  
General Motors Corp: 10333862



**83226**  
Aluminum Filter Drier w/ Pad Mount  
O-Rings: (2) **24401**  
Buick (07-02); Chevy (06-01); Olds (04-01); Pontiac (07-01); Saturn (07-05)  
General Motors Corp: 10316617

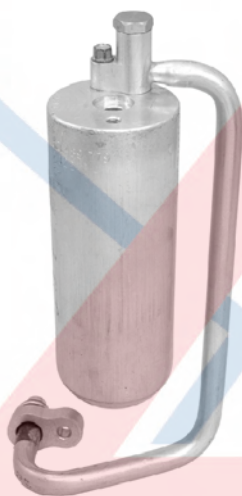

**83215**  
Aluminum Filter Drier w/ Pad Mount  
Outside Dia.: 2.375  
Length: 6.250  
Outlet Fitting Type: Pad Mount  
O-Rings: (2) **24629**, (1) **24402**, (1) **24401**  
Pontiac (08-03)



**83217**  
Aluminum Filter Drier w/ Pad Mount  
Outside Dia.: 1.375  
Length: 14.500  
Outlet Fitting Type: Pad Mount  
O-Rings: (2) **24676**  
Chevy (09-06); GMC (09); Pontiac (09-06); Suzuki (09-07)  
General Motors Corp: 25901981  
Suzuki: 9533078J11



**83224**  
Filter Drier w/ Hose  
Outside Dia.: 2.500  
Length: 6.000  
Inlet Fitting Type: Dual O-Ring  
Outlet Fitting Type: Dual O-Ring  
O-Rings: (4) **24668**  
Buick (05); Pontiac (05)  
General Motors Corp: 10344418



**83230**  
Aluminum Filter Drier w/ Pad Mount  
Outside Dia.: 2.500  
Length: 6.000  
Inlet Fitting Type: Pad Mount  
Outlet Fitting Type: Pad Mount  
O-Rings: (2) **24109**  
Dodge (03-98)  
Chrysler: 5003270AD



# Filter Drier, Accumulator and Desiccant

## Filter Drier Cont'd



**83231**  
Aluminum Filter Drier w/ Pad Mount  
Outside Dia.: 2.375  
Length: 6.500  
Inlet Fitting Type: Pad Mount  
Outlet Fitting Type: Pad Mount  
O-Rings: (2) **24650**  
Chrysler (09-07); Dodge (09-04)  
Chrysler: 5135919AA



**83237**  
Aluminum Filter Drier w/ Pad Mount  
Outside Dia.: 1.750  
Length: 10.000  
Inlet Fitting Type: Pad Mount  
Outlet Fitting Type: Pad Mount  
O-Rings: (2) **24609**  
Buick (07-04); Chevy (08-06); Pontiac (06); Saturn (07-06)  
General Motors Corp: 10327446



**83241**  
Aluminum Filter Drier w/ Pad Mount  
Outside Dia.: 2.375  
Length: 7.000  
Inlet Fitting Type: Pad Mount  
Outlet Fitting Type: Pad Mount  
O-Rings: (1) **24676**, (2) **24662**  
Subaru (00-97)  
Subaru: 73410AC061



**83243**  
Aluminum Filter Drier w/ Pad Mount  
Outside Dia.: 1.750  
Length: 8.250  
Outlet Fitting Type: Pad Mount  
O-Rings: (2) **24662**  
Hyundai (09-05); Kia (10-05)  
Hyundai: 978012E000  
Kia: 978012E000



**83236**  
Aluminum Filter Drier w/ Pad Mount  
Outside Dia.: 1.500  
Length: 11.000  
Inlet Fitting Type: Pad Mount  
Outlet Fitting Type: Pad Mount  
Suzuki (03)  
Suzuki: 9533054J00



**83240**  
Aluminum Filter Drier w/ Pad Mount  
Outside Dia.: 1.563  
Length: 10.875  
Inlet Fitting Type: Pad Mount  
Outlet Fitting Type: Pad Mount  
O-Rings: (2) **24662**  
Subaru (08-03)



**83242**  
Aluminum Filter Drier w/ Pad Mount  
Outside Dia.: 2.375  
Length: 5.500  
Inlet Fitting Type: Pad Mount  
Outlet Fitting Type: Pad Mount  
O-Rings: (1) **24676**, (2) **24606**  
Subaru (02-01)  
Subaru: 73410FC010, 73411SA000



**83246**  
Steel Filter Drier  
Outside Dia.: 2.375  
O-Rings: (2) **24646**  
Mazda (02-95)  
Mazda: T00161501

# Filter Drier, Accumulator and Desiccant

## Filter Drier Cont'd

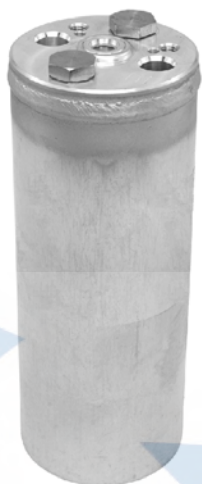

### 83250

Aluminum Filter Drier w/ Pad Mount  
 Outside Dia.: 2.375  
 Length: 7.000  
 Inlet Fitting Type: Pad Mount  
 Outlet Fitting Type: Pad Mount  
 O-Rings: (2) **24676**, (2) **24662**  
 Isuzu (04-99)  
 Isuzu: 8972172090



### 83255

Aluminum Filter Drier w/ Pad Mount  
 Outside Dia.: 2.375  
 Length: 6.500  
 Inlet Fitting Type: Pad Mount  
 Outlet Fitting Type: Pad Mount  
 Nissan (15-04)  
 Nissan: 921005Z000, 92100ZP50A



### 83262

Aluminum Filter Drier w/ Pad Mount  
 Outside Dia.: 1.563  
 O-Rings: (2) **24662**  
 Land Rover (15-05)  
 Land Rover: JRJ500020, LR021824



### 83270

Aluminum Filter Drier w/ Pad Mount  
 Outside Dia.: 1.750  
 Length: 7.875  
 Inlet Fitting Type: Pad Mount  
 Outlet Fitting Type: P-Nut Fitting  
 O-Rings: (2) **24606**  
 Jeep (10-05)  
 Jeep: 55038085AA



### 83252

Aluminum Filter Drier w/ Pad Mount  
 Outside Dia.: 1.625  
 Length: 13.000  
 Outlet Fitting Type: Pad Mount  
 O-Rings: (1) **24167**, (1) **23678**  
 Audi (14-06); VW (14-06)  
 Audi: 1K0298403A  
 Volkswagen: 1K0298403A, 1K0820411Q,  
 5C0820411G

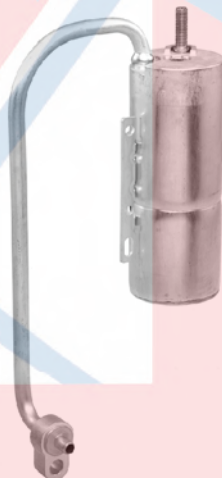

### 83256

Aluminum Filter Drier w/o Pad Mount  
 Outside Dia.: 2.250  
 Length: 6.125  
 Outlet Fitting Type: Pad Mount  
 O-Rings: (2) **24401**  
 Saab (11-03)  
 Saab: 24418370, 24418371



### 83265

Aluminum Filter Drier w/ Pad Mount  
 O-Rings: (2) **23680**  
 Ford (09-08); Mazda (10); Mercury  
 (09-08)  
 Ford: 9M6Z19959A  
 Mazda: ZZEAE61500

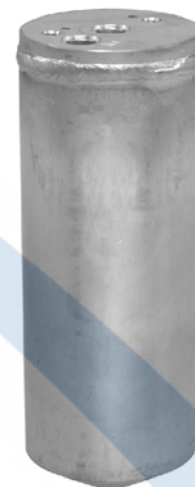

### 83300

Aluminum Filter Drier w/ Pad Mount  
 Outside Dia.: 2.375  
 O-Rings: (2) **24606**  
 Mercedes (05-98)  
 Mercedes Benz: 1638300083



### 83254

Aluminum Filter Drier w/ Pad Mount  
 Porsche (14-11); VW (15-11)  
 Porsche: 95857319102  
 Volkswagen: 7P0898191

# Filter Drier, Accumulator and Desiccant

## Filter Drier Cont'd



**83303**  
Aluminum Filter Drier w/ Pad Mount  
O-Rings: (2) **24649**, (1) **24606**  
Mercedes (14-07)  
Mercedes Benz: 2218300283



**83346**  
Aluminum Filter Drier w/ Pad Mount  
O-Rings: (2) **24606**  
Chevy (09-04)  
General Motors Corp: 96539635

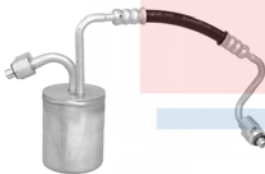

**83354**  
Filter Drier w/ Hose  
Outside Dia.: 3.000  
Length: 4.000  
Inlet Fitting Type: P-Nut Fitting  
Outlet Fitting Type: P-Nut Fitting  
O-Rings: (2) **24402**  
Chevy (05)  
General Motors Corp: 19129995



**83358**  
Aluminum Filter Drier w/ Pad Mount  
Outside Dia.: 1.750  
Length: 16.000  
Outlet Fitting Type: Pad Mount  
O-Rings: (2) **24676**  
Mercedes (11-03)  
Mercedes Benz: 2118350047



**83360**  
Aluminum Filter Drier w/ Pad Mount  
Outside Dia.: 2.000  
Length: 6.000  
Outlet Fitting Type: Pad Mount  
O-Rings: (4) **24670**, (2) **24606**  
Ford (11-08)  
Ford: 8S4Z19C836AA



**83365**  
Filter Drier w/ Hose  
Outside Dia.: 2.750  
Length: 5.500  
Inlet Fitting Type: P-Nut Fitting  
Outlet Fitting Type: P-Nut Fitting  
O-Rings: (3) **24649**  
Ford (07-03); Lincoln (07-03)  
Ford: 6L1Z19959BA



**83367**  
Aluminum Filter Drier w/ Pad Mount  
O-Rings: (2) **24676**  
Mercedes (12-06)  
Mercedes Benz: 1645000354,  
2518350047



**83371**  
Aluminum Filter Drier w/ Pad Mount  
Outside Dia.: 1.375  
O-Rings: (4) **24606**, (1) **24167**  
Volvo (09-06)  
Volvo: 30780200



**83374**  
Aluminum Filter Drier w/ Pad Mount  
O-Rings: (4) **24606**  
Dodge (12-07); Ford (14-10); Jeep  
(15-08); Mazda (13-09)  
Chrysler: 68003970AA, 68078975AB,  
68078976AA  
Ford: AR3Z19C836A  
Jeep: 68078975AB, 68078976AA  
Mazda: GEG161480, GS3L61500



# Filter Drier, Accumulator and Desiccant

## Filter Drier Cont'd



**83376**  
Aluminum Filter Drier w/ Pad Mount  
O-Rings: (4) **24606**  
Chrysler (15-05); Dodge (15-05); Jeep (15-07)  
Chrysler: 5170744AA, 68050127AB, 68050132AA, 68085784AA  
Jeep: 68003495AA, 68003945AA



**83701**  
Steel Filter Drier  
Outside Dia.: 3.000  
Length: 11.000  
Inlet Fitting Type: Flange  
Outlet Fitting Type: Flange  
O-Rings: (3) **24606**  
Kenworth: F371000, F376000, F376001  
Kysor: 1914006, 1914008, 1999046  
Peterbilt: F371002, F376000, F376001  
Red Dot: 74R2001, RD5104340P  
TRP Parts: JA22250



**83703**  
Steel Filter Drier  
Outside Dia.: 3.000  
Length: 10.000  
Inlet Fitting Type: Quick Disconnect  
Outlet Fitting Type: Quick Disconnect  
O-Rings: (2) **24676**  
Kysor: 1912009



**83705**  
Steel Filter Drier  
Outside Dia.: 3.000  
Length: 7.250  
Inlet Fitting Type: Male Insert O-Ring  
Inlet Fitting: 3/8"  
Outlet Fitting Type: Male Insert O-Ring  
Outlet Fitting: 3/8"  
O-Rings: (2) **24606**, (1) **24650**  
Bergstrom: 526024, 540121, 540126, 540426  
Caterpillar: 2328942, 2644492  
Climatech: JA1870, JA1890, JA2055  
John Deere: TCU18899  
Kysor: 3199035  
Mack: 4379RD575170, 4379RD575681, 4379RD591190



**83700**  
Steel Filter Drier  
Outside Dia.: 3.000  
Length: 8.250  
Inlet Fitting Type: Male Insert O-Ring  
Inlet Fitting: 3/8"  
Outlet Fitting Type: Male Insert O-Ring  
Outlet Fitting: 3/8"  
O-Rings: (2) **24606**  
Kysor: 1999203



**83702**  
Steel Filter Drier  
Outside Dia.: 3.000  
Length: 9.000  
Inlet Fitting Type: Male Insert O-Ring  
Inlet Fitting: 3/8"  
Outlet Fitting Type: Male Insert O-Ring  
Outlet Fitting: 3/8"  
O-Rings: (2) **24606**



**83704**  
Steel Filter Drier  
Outside Dia.: 3.000  
Length: 10.500  
Inlet Fitting Type: Pad Mount  
Outlet Fitting Type: Pad Mount  
O-Rings: (2) **24650**



**83706**  
Steel Filter Drier  
Outside Dia.: 3.000  
Length: 10.000  
Inlet Fitting Type: Quick Disconnect  
Outlet Fitting Type: Quick Disconnect  
O-Rings: (2) **24650**  
Kysor: 1912006

# Filter Drier, Accumulator and Desiccant

## Filter Drier Cont'd



**83707**  
Steel Filter Drier  
Outside Dia.: 3.000  
Length: 7.000  
Inlet Fitting Type: Male Insert O-Ring  
Outlet Fitting Type: Male Insert O-Ring  
Outlet Fitting: 3/8"  
O-Rings: (2) **24650**, (2) **24606**  
Kysor: 1912002



**83709**  
Steel Filter Drier  
Outside Dia.: 3.000  
Length: 9.000  
Inlet Fitting Type: Pad Mount  
Outlet Fitting Type: Pad Mount  
Kysor: 1912010  
Red Dot: 74R3126



**83711**  
Steel Filter Drier  
Outside Dia.: 3.000  
Length: 8.750  
Inlet Fitting Type: Female O-Ring  
Inlet Fitting: 3/4"  
Outlet Fitting Type: Female O-Ring  
Outlet Fitting: 9/16"  
O-Rings: (2) **24606**



**83713**  
Steel Filter Drier  
Outside Dia.: 3.500  
Length: 8.500  
Inlet Fitting: 3/4"  
Outlet Fitting: 3/4"  
O-Rings: (2) **24612**  
Caterpillar: 1866189



**83708**  
Steel Filter Drier  
Outside Dia.: 3.000  
Length: 9.000  
Inlet Fitting Type: Male Insert O-Ring  
Inlet Fitting: 3/8"  
Outlet Fitting Type: Female O-Ring  
Outlet Fitting: 3/8"  
O-Rings: (2) **24606**



**83710**  
Steel Filter Drier  
Outside Dia.: 3.000  
Length: 9.250  
Inlet Fitting Type: Male Insert O-Ring  
Inlet Fitting: 3/8"  
Outlet Fitting Type: Male Insert O-Ring  
Outlet Fitting: 3/8"  
O-Rings: (1) **24676**, (2) **24606**



**83712**  
Steel Filter Drier  
Outside Dia.: 3.000  
Length: 8.500  
Inlet Fitting Type: Male Insert O-Ring  
Inlet Fitting: 3/8"  
Outlet Fitting Type: Male Insert O-Ring  
Outlet Fitting: 3/8"  
O-Rings: (3) **24606**



**83714**  
Steel Filter Drier  
Outside Dia.: 2.750  
Length: 8.500  
Inlet Fitting: 3/8"  
Outlet Fitting Type: Male Insert O-Ring  
Outlet Fitting: 3/8"  
O-Rings: (3) **24606**

# Filter Drier, Accumulator and Desiccant

## Filter Drier Cont'd



**83715**  
Steel Filter Drier  
Outside Dia.: 3.500  
Length: 7.000  
Inlet Fitting Type: Male Insert O-Ring  
Inlet Fitting: 3/8"  
Outlet Fitting Type: Male Insert O-Ring  
O-Rings: (3) **24606**  
Mack: 4379RD5111920



**83717**  
Steel Filter Drier  
Outside Dia.: 3.000  
Length: 9.000  
Inlet Fitting Type: Male Insert O-Ring  
Inlet Fitting: 3/8"  
Outlet Fitting Type: Male Insert O-Ring  
Outlet Fitting: 3/8"  
O-Rings: (2) **24606**



**83721**  
Steel Filter Drier  
Outside Dia.: 2.625  
Length: 5.000  
Inlet Fitting Type: Quick Disconnect  
O-Rings: (1) **24629**, (1) **24606**  
Chevy (99-96); GMC (99-96)  
Kysor: 1999218



**83732**  
Aluminum Filter Drier w/ Pad Mount  
Saab (09-99)  
Saab: 4759072



**83716**  
Steel Filter Drier  
Outside Dia.: 3.000  
O-Rings: (3) **24606**



**83718**  
Steel Filter Drier  
Outside Dia.: 3.000  
Length: 10.000  
Inlet Fitting: 3/8"  
Outlet Fitting Type: Male Insert O-Ring  
Outlet Fitting: 3/8"  
O-Rings: (2) **24606**  
John Deere: 74R1826



**83730**  
Steel Filter Drier  
Outside Dia.: 3.000  
O-Rings: (2) **24606**  
Mercedes (00-98)  
Mercedes Benz: 1708300083

## Filter Drier Fuse Plug



**35870**  
Filter Drier Fuse Plug  
Northern: 4611000

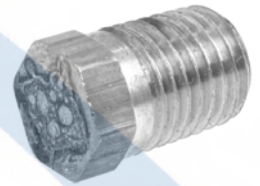

**35876**  
Filter Drier Fuse Plug

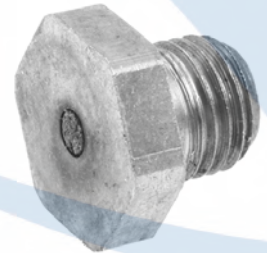

**35877**  
Filter Drier Fuse Plug  
Northern: 4611028



# Filter Drier, Accumulator and Desiccant

## Universal Tank Accumulator



### 33204

Accumulator Tank  
Outside Dia.: 3.500  
Length: 9.000  
Inlet Fitting Type: Female O-Ring  
Inlet Fitting: 3/4"  
Outlet Fitting Type: Female O-Ring  
Outlet Fitting: 3/4"  
Buick (81-79); Chevy (84-73); GMC (84-73); Olds (81-78); Pontiac (81-78)  
Dallas Truck AC: 0675001  
Euclid: E804501  
Evans: AM82219  
Kysor: 1910017  
Northern: 804556



### 33205

Accumulator Tank  
Outside Dia.: 3.500  
Length: 7.500  
Inlet Fitting Type: Female O-Ring  
Inlet Fitting: 3/4"  
Outlet Fitting Type: Female O-Ring  
Outlet Fitting: 3/4"  
Buick (89), (85-77); Cadillac (85-77); Chevy (87-73); GMC (83-77); Olds (85-77); Pontiac (87-76)  
Bergstrom: 525761  
Climatech: JC1005, JC1080  
Dallas Truck AC: 0675000  
Euclid: E804500  
Kysor: 1910021, 402751  
Mack: 4379RD549610  
Northern: 804523  
Red Dot: 74R5050

# Fittings - Aeroquip EZ Clip Chart

STRAIGHT SPLICER



STRAIGHT MALE O-RING



WELD ON OUTER



STRAIGHT FEMALE O-RING



STRAIGHT MALE INSERT O-RING



45° FEMALE O-RING



90° MALE O-RING



90° MALE INSERT O-RING

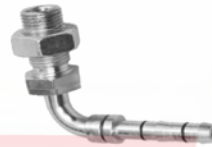

90° FEMALE O-RING



Connection Clip



Attachment Cage



Part No.	Hose Connection	Hose Size	Fitting Size	Thread Size	Service Port	Part No.	Hose Connection	Hose Size	Fitting Size	Thread Size	Service Port
<b>EZ Clip - 45° Female O-Ring</b>						19096	Steel Male Insert O-Ring	6	6	5/8" - 18	
19216	Steel Barb Fitting	6	6	5/8" - 18		19106	Steel Male Insert O-Ring	6	6	5/8" - 18	
19228	Steel Barb Fitting	8	8	3/4" - 16		19110	Steel Male Insert O-Ring	10	10	7/8" - 18	
19230	Steel Barb Fitting	10	10	7/8" - 14		19148	Steel Barb Fitting	8	8	3/4" - 16	R-134a
<b>EZ Clip - 90° Female O-Ring</b>						19150	Steel Barb Fitting	10	10	7/8" - 14	R-134a
19248	Steel Barb Fitting	8	8	3/4" - 16	R-134a	19166	Steel Barb Fitting	6	6	5/8" - 18	
19250	Steel Barb Fitting	10	10	7/8" - 14	R-134a	19178	Steel Barb Fitting	8	8	3/4" - 16	
19260	Steel Barb Fitting	12	10	7/8" - 14	R-134a	19180	Steel Barb Fitting	10	10	7/8" - 14	
19276	Steel Barb Fitting	6	6	5/8" - 18		19192	Steel Barb Fitting	12	12	1-1/16" - 14	
19288	Steel Barb Fitting	8	8	3/4" - 16		19200	Steel Barb Fitting	12	10	7/8" - 14	
19290	Steel Barb Fitting	10	10	7/8" - 14		<b>EZ Clip - Straight Male Insert O-Ring</b>					
19302	Steel Barb Fitting	12	12	1-1/16" - 14		16736	Steel Male Insert O-Ring		6	5/8" - 18	
19318	Steel Barb Fitting	10	8	3/4" - 16		16768	Steel Male Insert O-Ring		8	3/4" - 16	
19320	Steel Barb Fitting	12	10	7/8" - 14		16770	Steel Male Insert O-Ring		10	7/8" - 14	
19332	Steel Barb Fitting	10	12	1-1/16" - 14		<b>EZ Clip - Straight Splicer</b>					
19528	Steel	10	8	3/4" - 16		19016	Steel	6 x 6			
<b>EZ Clip - 90° Male Insert O-Ring</b>						19028	Steel	8 x 8			
19376	Steel Barb Fitting	6	6	5/8" - 18		19030	Steel	10 x 1			
19388	Steel Barb Fitting	8	8	3/4" - 16		19042	Steel	12 x 1			
19390	Steel Barb Fitting	10	10	7/8" - 14		19058	Steel	8 x 8			R-134a
<b>EZ Clip - 90° Male O-Ring</b>						19060	Steel	10 x 1			R-134a
19126	Steel Barb Fitting	6	6	5/8" - 18		19072	Steel	12 x 1			R-134a
19130	Steel Barb Fitting	10	10	7/8" - 18		19080	Steel	10 x 1			R-134a
<b>EZ Clip - Clips/Cages</b>						<b>EZ Clip - Weld on Outer</b>					
19406	Steel	6				19346	Steel	6	6		
19418	Steel	8				19358	Steel	8	8		
19420	Steel	10				19360	Steel	10	10		
19432	Steel	12									
19446	Steel	6									
19458	Steel	8									
19460	Steel	10									
19472	Steel	12									
19486	Steel	6									
19498	Steel	8									
19500	Steel	10									
19512	Steel	12									
<b>EZ Clip - Straight Female O-Ring</b>											

# Fittings - Burgaflex Chart

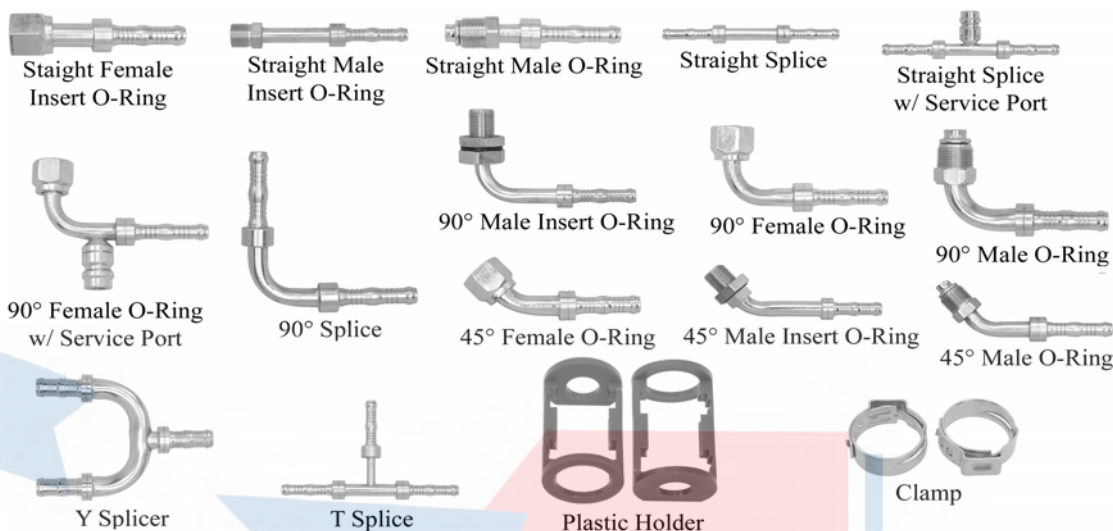

Part No.	Hose Connection	Hose Size	Fitting Size	Thread Size	Service Port
----------	-----------------	-----------	--------------	-------------	--------------

<b>Burgaflex 45° Female O-Ring</b>					
15143	Steel	8		3/4" - 16	
15144	Steel	10			
15145	Steel	No. 12		7/8" - 14	

<b>Burgaflex 45° Male O-Ring</b>					
15136	Steel Hose barb	6	6	5/8" - 18	
15137	Steel Hose barb	8	6	3/4" - 18	
15138	Steel Hose barb	10	10	7/8" - 18	
15139	Steel Hose barb	12	10	7/8" - 18	

<b>Burgaflex 45° MIO Bulkhead</b>					
15161	Steel Bulkhead	8	8	3/4" - 16	
15162	Steel Bulkhead	10	10	7/8" - 14	
15163	Steel Bulkhead	12	12	1-1/16" - 14	
15169	Steel Bulkhead	6	6	5/8" - 18	

<b>Burgaflex 90° Female O-Ring</b>					
15146	Steel	6	6	5/8" - 18	
15147	Steel	8	8	3/4" - 16	
15148	Steel	6	8	3/4" - 16	
15149	Steel	10	8	3/4" - 16	
15150	Steel	10	10	7/8" - 14	
15151	Steel	12	10	7/8" - 14	
15152	Steel	12	12	1-1/16" - 14	
15153	Steel	6	6	5/8" - 18	
15154	Steel	8	8	3/4" - 16	
15155	Steel	10	10	7/8" - 14	
15156	Steel	12	12	1-1/16" - 14	

<b>Burgaflex 90° Male O-Ring</b>					
15134	Steel Hose barb	8	6	3/4" - 18	
15135	Steel Hose barb	10	10	7/8" - 18	

<b>Burgaflex 90° MIO Bulkhead</b>					
15157	Steel Bulkhead	6	6	5/8" - 18	
15158	Steel Bulkhead	8	8	3/4" - 16	
15159	Steel Bulkhead	10	10	7/8" - 14	
15160	Steel Bulkhead	12	12	1-1/16" - 14	

<b>Burgaflex 90° Splicer</b>					
15100	Steel	6			
15101	Steel	8			
15102	Steel	10			

## Burgaflex Hose Clamp

Part No.	Hose Connection	Hose Size	Fitting Size	Thread Size	Service Port
----------	-----------------	-----------	--------------	-------------	--------------

15118	Steel	6			
15119	Steel	8			
15120	Steel	10			
15121	Steel	12			

<b>Burgaflex Hose Clamp Holder</b>					
15122	Plastic	6			
15123	Plastic	8			
15124	Plastic	10			
15125	Plastic	12			

<b>Burgaflex Straight Female Insert O-Ring</b>					
15140	Steel Hose Barb	8			
15141	Steel Hose Barb	10		7/8" - 14	
15142	Steel Hose Barb	No. 12		7/8" - 14	

<b>Burgaflex Straight Male O-Ring</b>					
15130	Steel Hose barb	6	6	5/8" - 18	
15131	Steel Hose barb	8	6	3/4" - 18	
15132	Steel Hose barb	10	10	7/8" - 18	
15133	Steel Hose barb	12	12	1-1/16" - 16	

<b>Burgaflex Straight MIO</b>					
15126	Steel	6		5/8" - 18	
15127	Steel	8			
15128	Steel	10			
15129	Steel	No. 12			

<b>Burgaflex Straight Splice</b>					
15107	3 Barb (w/ High Side Service Port)	6			
15109	3 Barb (w/ Low Side Service Port)	8			
15110	3 Barb (w/ Low Side Service Port)	10			
15111	3 Barb (w/ Low Side Service Port)	10			
15114	3 Barb (w/o Service Port)	6			
15115	3 Barb (w/o Service Port)	8			
15116	3 Barb (w/o Service Port)	10			
15117	3 Barb (w/o Service Port)	12 x 1			



## ***Fittings - Burgaflex Chart***

Part No.	Hose Connection	Hose Size	Fitting Size	Thread Size	Service Port	Part No.	Hose Connection	Hose Size	Fitting Size	Thread Size	Service Port
<b>Burgaflex Straight Splice</b>											
15166	3 Barb (w/ Low Side Service Port)	12 x 1									
<b>Burgaflex T-Type Splice</b>											
15103	3 Barb	6									
15104	3 Barb	8									
15105	3 Barb	10									
15106	3 Barb	12 x 1 x 12									
15165	3 Barb	10 x 1 x 8									
15168	3 Barb	10 x 1 x 12									
15170	3 Barb	10 x 8 x 8									
<b>Burgaflex Y-Type Splice</b>											
15164	Steel	12 x 1 x 12									
15167	Steel	10 x 1 x 10									
15171	Steel	8 x 8 x 8									
15172	Steel	6 x 6 x 6									

# Fittings - Compression Weld On Chart

## 90° COMPRESSION



## WELD ON INNER



## STRAIGHT COMPRESSION



## WELD ON OUTER



## STRAIGHT METRIC COMPRESSION



Part No.	Hose Connection	Hose Size	Fitting Size	Thread Size	Service Port	Part No.	Hose Connection	Hose Size	Fitting Size	Thread Size	Service Port
<b>90° Compression</b>						<b>Weld On Inner</b>					
17876	Beadlock	6	6			12341	Steel Barb Fitting	6	6		
17877	Beadlock	8	8			12342	Steel Barb Fitting	8	8		
17878	Beadlock	8	8			12343	Steel Barb Fitting	10	10		
17879	Beadlock	10	10			12344	Steel Barb Fitting	12	12		
17880	Beadlock	10	10			12371	Aluminum Barb Fitting	6	6		
17881	Beadlock	12	12			12372	Aluminum Barb Fitting	8	8		
17882	Beadlock	12	12			12373	Aluminum Barb Fitting	10	10		
17886	Beadlock	6	6			12374	Aluminum Barb Fitting	12	12		
17888	Beadlock	8	8			14241	Steel Beadlock	6	6		
<b>Compression - Straight Metric</b>						<b>Weld On Outer</b>					
17866	Beadlock	6	6			12381	Steel Barb Fitting	6	12		
17868	Beadlock	8	8			12382	Steel Barb Fitting	8	8		
17870	Beadlock	10	10			12383	Steel Barb Fitting	10	10		
17762						12384	Steel Barb Fitting	12	12		
17764						12391	Aluminum Barb Fitting	6	6		
17766			10			12392	Aluminum Barb Fitting	8	8		
<b>Compression - Straight Union</b>						<b>Weld On Outer</b>					
16761						12393	Aluminum Barb Fitting	10	10		
16766						12394	Aluminum Barb Fitting	12	12		
17750	Barb Fitting	6	6			14231	Steel Beadlock	6	6		
17752	Barb Fitting	8	8			14232	Steel Beadlock	8	8		
17753	Barb Fitting	8	8			14233	Steel Beadlock	10	10		
17754	Barb Fitting	10	10			14234	Steel Beadlock	12	12		
17756	Barb Fitting	12	12			14235	Steel Beadlock	12	10		
17758	Barb Fitting	10	10								
17760	Barb Fitting	12	12								
17849	Beadlock	8	8								
17850	Beadlock	6	6								
17851	Beadlock	6	1/2"								
17852	Beadlock	8	8								
17853	Beadlock	8	10								
17854	Beadlock	10	10								
17856	Steel Beadlock	12	12								
17858	Beadlock	10	10								
17860	Beadlock	12	10								
6750	Barb Fitting	6	6								
6752	Barb Fitting	8	8								
7852	Beadlock	8	1/2"								
7854	Beadlock	10	10								

## ***Fittings - Compression Weld On Chart***

Part No.	Hose Connection	Hose Size	Fitting Size	Thread Size	Service Port	Part No.	Hose Connection	Hose Size	Fitting Size	Thread Size	Service Port
14261	Aluminum Beadlock	6	6								
14262	Aluminum Beadlock	8	8								
14263	Aluminum Beadlock	10	10								
14264	Aluminum Beadlock	12	12								

### **Weld On Reduced Beadlock**

18116	Steel Beadlock	6			
18128	Steel Beadlock	8			
18130	Steel Beadlock	10			
18236	Aluminum Beadlock	8			
18237	Aluminum Beadlock	10			



# Fittings - Dual O-Ring / Insert O-Ring

STRAIGHT FEMALE DUAL O-RING



45° FEMALE DUAL O-RING



90° FEMALE DUAL O-RING



STRAIGHT MALE INSERT O-RING

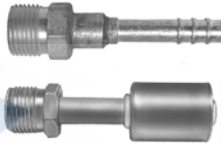

45° MALE INSERT O-RING

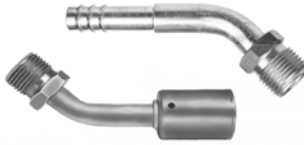

90° MALE INSERT O-RING



Part No.	Hose Connection	Hose Size	Fitting Size	Thread Size	Service Port
----------	-----------------	-----------	--------------	-------------	--------------

## 45° Female Metric Dual O-Ring

14484	Aluminum	12	12	M27x2.000	
-------	----------	----	----	-----------	--

## 45° MIO

13816	Aluminum Barb Fitting	6	6	5/8" - 18	
13818	Aluminum Barb Fitting	8	8	3/4" - 16	
13820	Aluminum Barb Fitting	10	10	7/8" - 14	
15816	Aluminum Beadlock	6	6	5/8" - 18	
15818	Aluminum Beadlock	8	8	3/4" - 16	
15820	Aluminum Beadlock	10	10	7/8" - 14	

## 90° Female Dual O-Ring

14992		8	8		
14993		10	10		

## 90° Female Metric Dual O-Ring

14982	Aluminum	8	8	M24x2.000	
14983	Aluminum	10	10	M24x2.000	

## 90° MIO

13752	Aluminum Barb Fitting	12	12	7/8" - 14	
13826	Aluminum Barb Fitting	6	6	5/8" - 18	
13828	Aluminum Barb Fitting	8	8	3/4" - 16	
13830	Aluminum Barb Fitting	10	10	7/8" - 14	
15826	Aluminum Beadlock	6	6	5/8"-18	
15828	Aluminum Beadlock	8	8	3/4" - 16	
15830	Aluminum Beadlock	10	10	7/8" - 14	

## Straight Dual FOR

14082	Aluminum	8	8	M24x2.000	
14084	Aluminum	12	12	M27x2.000	
14092	Aluminum	8	8	3/4" - 16	
14093	Aluminum	10	10	7/8" - 14	
14094	Aluminum	12	12	1-1/16" - 14	

## Straight MIO

Part No.	Hose Connection	Hose Size	Fitting Size	Thread Size	Service Port
----------	-----------------	-----------	--------------	-------------	--------------

13708	Aluminum Barb Fitting	8	8	5/8" - 18	
13710	Aluminum Barb Fitting	10	10	3/4" - 16	
13712	Aluminum Barb Fitting	12	12	7/8" - 14	
13806	Aluminum Barb Fitting	6	6	5/8" - 18	
13807	Aluminum Barb Fitting	6	6	3/4" - 18	
13808	Aluminum Barb Fitting	8	8	3/4" - 16	
13810	Aluminum Barb Fitting	10	10	7/8" - 14	
13812	Aluminum Barb Fitting	12	12	1-1/16" - 14	
15806	Aluminum Beadlock	6	6	5/8" - 18	
15808	Aluminum Beadlock	8	8	3/4" - 16	
15810	Aluminum Beadlock	10	10	7/8" - 14	
15812	Aluminum Beadlock	12	12	1-1/16" - 14	
16606	Steel Hose barb	6	6	5/8" - 18	
16608	Steel Beadlock	8	6	3/4" - 16	
16610	Steel Beadlock	10	10	7/8" - 14	

## Fittings - 45° Female Dual O-Ring

14492	Aluminum	8	8		
14493	Aluminum	10	10	7/8" - 14	
14494	Aluminum	12	12	1-1/16" - 14	

# Fittings - Flare

STRAIGHT MALE FLARE



STRAIGHT FEMALE FLARE



45° MALE FLARE



45° FEMALE FLARE



90° MALE FLARE

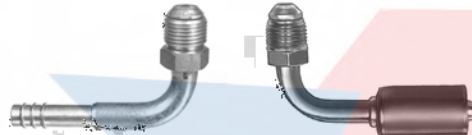

90° FEMALE FLARE



Part No.	Hose Connection	Hose Size	Fitting Size	Thread Size	Service Port
<b>45° Female Flare</b>					
10506	Aluminum Beadlock	6	6	5/8" - 16	
10508	Aluminum Beadlock	8	8	3/4" - 16	
10510		10	10	7/8" - 14	
10512	Aluminum Beadlock	12	12	1-1/16" - 14	
11506	Barb Fitting	6	6	5/8" - 18	
11508	Barb Fitting	8	8	3/4" - 16	
11510	Barb Fitting	10	10	7/8" - 14	
13956	Barb Fitting	8	8	5/8" - 18	
13960	Barb Fitting	10	10	3/4" - 16	
18508	Steel Beadlock	8	10		
18510	Steel Beadlock	10	10		
<b>45° Male Flare</b>					
10206	Aluminum Beadlock	6	6	5/8" - 18	
10208	Aluminum Beadlock	8	8	3/4" - 16	
10210	Aluminum Beadlock	10	10	7/8" - 14	
10212	Aluminum Beadlock	12	12	1-1/16" - 14	
11208	Barb Fitting	8	8	3/4" - 16	
<b>90° Female Flare</b>					
10606	Aluminum Beadlock	6	6	5/8" - 18	
10608	Aluminum Beadlock	8	8	3/4" - 16	
10610	Aluminum Beadlock	10	10	7/8" - 14	
10612	Aluminum Beadlock	12	12	1-1/16" - 14	
11606	Barb Fitting	6	6	5/8" - 18	
11608	Barb Fitting	8	8	3/4" - 16	
11610	Barb Fitting	10	10	7/8" - 14	
13916	Barb Fitting	6	6	3/4" - 16	
13920	Barb Fitting	10	10	3/4" - 16	
13928	Barb Fitting	8	8	5/8" - 18	
13938	Barb Fitting	8	8	7/8" - 14	

Part No.	Hose Connection	Hose Size	Fitting Size	Thread Size	Service Port
13940	Barb Fitting	12	12	7/8" - 14	
15916	Aluminum Beadlock	6	6	3/4" - 16	
15920	Aluminum Beadlock	10	10	3/4" - 16	
15928	Aluminum Beadlock	8	8	5/8" - 18	
15940	Aluminum Beadlock	12	12	7/8" - 14	
15946	Steel	6	6	5/8" - 18	
15947	Steel	8	8	3/4" - 16	
1606	Barb Fitting	6	6	5/8" - 18	
1608	Barb Fitting	8	6	3/4" - 16	
18606	Steel Beadlock	6	6	5/8" - 18	
18608	Steel Beadlock	8	8	3/4" - 16	
18610	Steel Beadlock	10	10	3/4" - 16	
18612	Steel	12	12	1-1/16" - 14	
<b>90° Male Flare</b>					
10306	Aluminum Beadlock	6	6	5/8" - 18	
10308	Aluminum Beadlock	8	8		
10310	Aluminum Beadlock	10	10	7/8" - 14	
10312	Aluminum Beadlock	12	12	1-1/16" - 14	
11306	Barb Fitting	6	6	5/8" - 16	
11308	Barb Fitting	8	8	3/4" - 16	
11310	Barb Fitting	10	10	7/8" - 14	
<b>Straight Female Flare</b>					
10406	Aluminum Beadlock	6	6	5/8" - 18	
10408	Aluminum Beadlock	8	8	3/4" - 16	
10410	Aluminum Beadlock	10	10		
10412	Aluminum Beadlock	12	12	1-1/16" - 14	
11406	Barb Fitting	6	6	5/8" - 18	
11408	Barb Fitting	8	8	3/4" - 16	
11410	Barb Fitting	10	10	7/8" - 14	
11412	Barb Fitting	12	12	1-1/16" - 14	

## ***Fittings - Flare***

Part No.	Hose Connection	Hose Size	Fitting Size	Thread Size	Service Port	Part No.	Hose Connection	Hose Size	Fitting Size	Thread Size	Service Port
<b>Straight Female Flare</b>											
13906	Barb Fitting	6	6	3/4" - 16							
13908	Barb Fitting	8	8	5/8" - 18							
13910	Barb Fitting	10	10	3/4" - 16							
13912	Barb Fitting	12	12	7/8" - 14							
13918	Barb Fitting	8	8	7/8" - 14							
1406	Barb Fitting	6	6	5/8" - 18							
1408	Barb Fitting	8	8	3/4" - 16							
15906	Aluminum Beadlock	6	6	3/4" - 16							
15910	Aluminum Beadlock	10	10	3/4" - 16							
15912	Aluminum Beadlock	12	12	7/8" - 14							
18406	Steel Beadlock	6	6	5/8" - 18							
18408	Steel Beadlock	8	8	3/4" - 16							
18410	Steel Beadlock	10	10	7/8" - 14							
3406	Aluminum Beadlock	6	6	5/8" - 18							
<b>Straight Male Flare</b>											
10106	Aluminum Beadlock	6	6	5/8" - 18							
10108	Aluminum Beadlock	8	8	3/4" - 16							
10110	Aluminum Bulkhead	10	10	7/8" - 14							
10112	Aluminum Beadlock	12	12	1-1/16" - 14							
11106	Barb Fitting	6	6	5/8" - 16							
11108	Barb Fitting	8	8	3/4" - 16							
11110	Barb Fitting	10	10	7/8" - 14							



# Fittings - O-Ring

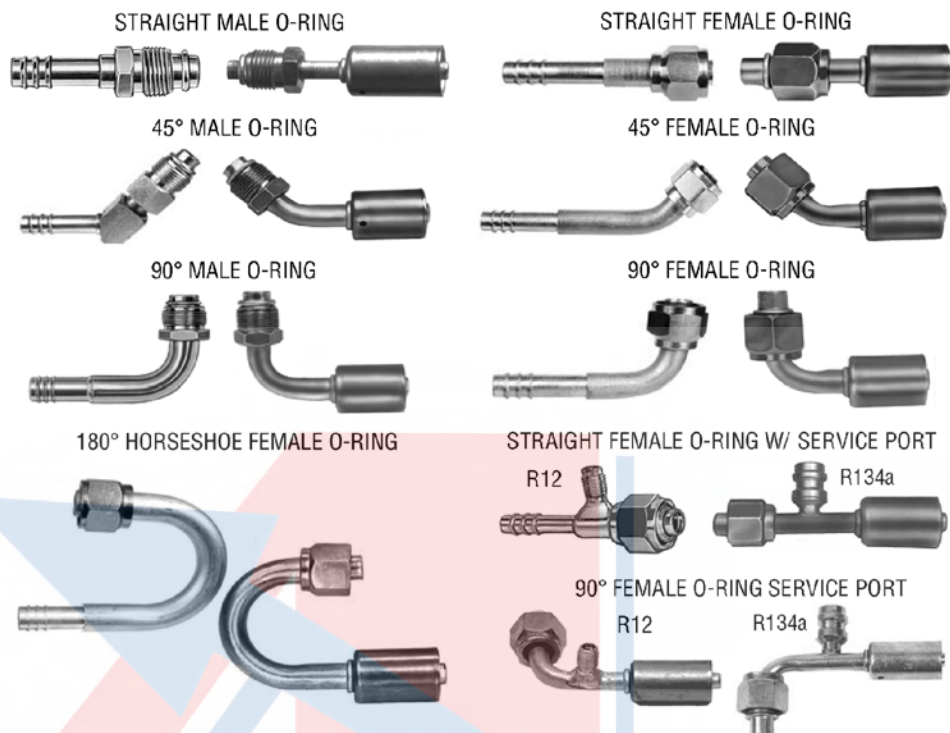

Part No.	Hose Connection	Hose Size	Fitting Size	Thread Size	Service Port
<b>180° Horseshoe Female O-Ring</b>					
17216		6			
17218		8			
17222		12			
18954		8			
18957		6			
<b>45° Female Metric O-Ring</b>					
14520	Aluminum	10	10	M22x1.500	
14526	Aluminum	6	6	M20x1.500	
14528	Aluminum	8	8	M20x1.500	
14540	Aluminum	10	10	M24x2.000	
14546	Aluminum	6	6	M14x1.500	
14566	Aluminum	6	6	M16x1.500	
14572	Aluminum	12	12	M27x2.000	
14586	Aluminum	6	6	M18x1.500	
<b>45° Female O-Ring</b>					
12106	Barb Fitting	6	6	5/8" - 18	
12108	Barb Fitting	8	8	3/4" - 16	
12110	Barb Fitting	10	10	7/8" - 14	
12112	Barb Fitting	12	12	1-1/16" - 14	
13510	Barb Fitting	10	10	3/4" - 16	
13512	Barb Fitting	12	12	7/8" - 14	
14106	Aluminum Beadlock	6	6	5/8" - 18	
14108	Aluminum Beadlock	8	8	3/4" - 16	
14110	Aluminum Beadlock	10	10	7/8" - 14	
14112	Aluminum Beadlock	12	12	1-1/16" - 14	
14216	Steel Beadlock	6	6	5/8" - 18	
14218	Steel Beadlock	8	8	3/4" - 16	
14220	Steel Beadlock	10	10	7/8" - 14	

Part No.	Hose Connection	Hose Size	Fitting Size	Thread Size	Service Port
15508	Aluminum Beadlock	8	8	5/8" - 18	
15510	Aluminum Beadlock	10	10	3/4" - 16	
15512	Aluminum Beadlock	12	12	7/8" - 14	
15943	Steel	10	10	7/8" - 14	R-134a
15944	Steel	6	6	5/8" - 18	R-134a
15949	Steel	8	8	5/8" - 18	R-134a
<b>45° Male O-Ring</b>					
10806	Aluminum Beadlock	6	6	5/8" - 16	
10808	Aluminum Beadlock	8	8		
10810	Aluminum Beadlock	10	10	7/8" - 18	
10812	Aluminum Beadlock	12	12	3/4" - 16	
11806	Barb Fitting	6	6	5/8" - 18	
11808	Barb Fitting	8	8	3/4" - 18	
11810	Barb Fitting	10	10		
12806	Aluminum Beadlock	6	6	5/8" - 18	
12830	Steel Beadlock	10	10	7/8" - 18	
15206	Aluminum Beadlock	6		3/4" - 18	
15208	Aluminum Beadlock	8	8	5/8" - 16	
18808	Steel Beadlock	8	8	3/4" - 18	
18812	Steel Beadlock	12	12	1-1/16" - 16	
<b>90° Female Metric O-Ring</b>					
14606		6	6	M14x1.500	
14608		8	8	M20x1.500	
14620	Aluminum	10	10	M22x1.500	

# Fittings - O-Ring

Part No.	Hose Connection	Hose Size	Fitting Size	Thread Size	Service Port
<b>90° Female Metric O-Ring</b>					
14626	Aluminum	6	6	M20x1.500	
14628	Aluminum	8	8	M20x1.500	
14640	Aluminum	10	10	M24x2.000	
14646	Aluminum	6	6	M14x1.500	
14666	Aluminum	6	6	M16x1.500	
14672	Aluminum	12	12	M27x2.000	
14686	Aluminum	6	6	M18x1.500	
14906		6	6	M16x1.500	

## 90° Female O-Ring

12206	Barb Fitting	6	6	5/8" - 18	
12208	Barb Fitting	8	8	3/4" - 16	
12210	Barb Fitting	10	10	7/8" - 14	
12212	Barb Fitting	12	12	1-1/16" - 14	
13606	Barb Fitting	6	6	3/4" - 16	
13608	Barb Fitting	8	8	5/8" - 18	
13610	Barb Fitting	10	10	3/4" - 16	
13612	Barb Fitting	12	12	7/8" - 14	
13620	Barb Fitting	10	10	1-1/16" - 14	
14206	Aluminum Beadlock	6	6	5/8" - 18	
14208	Aluminum Beadlock	8	8	3/4" - 16	
14210	Aluminum Beadlock	10	10	7/8" - 14	
14212	Aluminum Beadlock	12	12	1-1/16" - 14	
14226	Steel Beadlock	6	6	5/8" - 18	
14228	Steel Beadlock	8	8	3/4" - 16	
14320	Steel Beadlock	10	10	7/8" - 14	
14916	Aluminum Beadlock	6	6	5/8" - 18	R-12
14917	Aluminum Beadlock	6	8	3/4" - 16	R-12
14918	Aluminum Beadlock	8	8	3/4" - 16	R-12
14920	Aluminum Beadlock	10	10	7/8" - 14	R-12
14936	Aluminum Beadlock	6	6	5/8" - 18	R-134a
14937	Steel Beadlock	6	6	3/4" - 16	R-134a
14938	Aluminum Beadlock	8	8	3/4" - 16	R-134a
14940	Aluminum Beadlock	10	10	7/8" - 14	R-134a
14942	Aluminum Beadlock	12	12	7/8" - 14	R-134a
14958	Steel Beadlock	8	8	3/4" - 16	R-134a
14960	Steel Beadlock	10	10	7/8" - 14	R-134a
15606	Aluminum Beadlock	6	6	3/4" - 16	
15608	Aluminum Beadlock	8	8	5/8" - 18	
15610	Aluminum Beadlock	10	10	3/4" - 16	
15612	Aluminum Beadlock	12	12	7/8" - 14	
15620	Aluminum Beadlock	10	10	1-1/16" - 14	
15942	Steel	12	12	1-1/16" - 14	
16612	Steel Beadlock	12	12	7/8" - 14	
2206	Barb Fitting	6	6	5/8" - 18	
2208	Barb Fitting	8	8	3/4" - 16	
4206	Aluminum Beadlock	6	6	5/8" - 18	
4208	Aluminum Beadlock	8	8	3/4" - 16	

Part No.	Hose Connection	Hose Size	Fitting Size	Thread Size	Service Port
<b>90° Male O-Ring</b>					
10906	Aluminum Beadlock	6	6	5/8" - 18	
10908	Aluminum Beadlock	8	8	3/4" - 18	
10910	Aluminum Beadlock	10	10	7/8" - 18	
10912	Aluminum Beadlock	12	12	1-1/16" - 16	
11906	Barb Fitting	6	6	5/8" - 18	
11908	Barb Fitting	8	8	3/4" - 18	
11910	Barb Fitting	10	10	7/8" - 18	
11912	Barb Fitting	12	12	1-1/16" - 16	
12906	Steel Beadlock	6	6		
12950	Steel Beadlock	10	10	7/8" - 18	
13308	Barb Fitting	8	8	5/8" - 18	
13346	Barb Fitting	6	6	1-1/16" - 16	
15306	Aluminum Beadlock	6	6	3/4" - 18	
15308	Aluminum Beadlock	8	8	5/8" - 18	
15312	Aluminum Beadlock	12	12	7/8" - 18	
15346	Aluminum Beadlock	6	6	11/16" - 16	
18908	Steel Beadlock	8	8	3/4" - 18	
18912	Steel Beadlock	12	12	1-1/16" - 16	

## Straight Female O-Ring

12006	Barb Fitting	6	6	5/8" - 18	
12008	Barb Fitting	8	8	3/4" - 16	
12010	Barb Fitting	10	10	7/8" - 14	
12012	Barb Fitting	12	12	1-1/16" - 14	
13406	Barb Fitting	6	6	3/4" - 16	
13408	Barb Fitting	8	8	5/8" - 18	
13410	Barb Fitting	10	10	3/4" - 16	
13420	Barb Fitting	10	10	1-1/16" - 14	
13422	Barb Fitting	12	12	7/8" - 14	
14006	Aluminum Beadlock	6	6	5/8" - 18	
14008	Aluminum Beadlock	8	8	3/4" - 16	
14010	Aluminum Beadlock	10	10	7/8" - 14	
14012	Aluminum Beadlock	12	12	1-1/16" - 14	
14020	Steel Beadlock	10	10	7/8" - 14	
14116	Steel Beadlock	6	6	5/8" - 18	
14118	Steel Beadlock	8	8	3/4" - 16	
14412	Steel Beadlock	12	12	1-1/16" - 14	
14420	Aluminum Beadlock	10	10	M22x1.500	
14930	Aluminum Beadlock	10	10	7/8" - 14	R-134a
14932	Aluminum Beadlock	12	12	7/8" - 14	R-134a
15406	Aluminum Beadlock	6	6	3/4" - 18	
15408	Aluminum Beadlock	8	8	5/8" - 18	
15410	Aluminum Beadlock	10	10	3/4" - 16	
15420	Aluminum Beadlock	10	10	1-1/16" - 14	
15422	Aluminum Beadlock	12	12	7/8" - 14	
2006	Barb Fitting	6	6	5/8" - 18	

## Fittings - O-Ring

Part No.	Hose Connection	Hose Size	Fitting Size	Thread Size	Service Port	Part No.	Hose Connection	Hose Size	Fitting Size	Thread Size	Service Port
<b>Straight Female O-Ring</b>											
2008	Barb Fitting	8	8	3/4" - 16							
4006	Aluminum Beadlock	6	6	5/8" - 18							
4008	Aluminum Beadlock	8	8	3/4" - 16							
<b>Straight Male O-Ring</b>											
10706	Aluminum Beadlock	6	6	5/8" - 18							
10708	Aluminum Beadlock	8	8	3/4" - 18							
10710	Aluminum Beadlock	10	10	7/8" - 18							
10712	Aluminum Beadlock	12	12	1-1/16" - 16							
11706	Barb Fitting	6	6	5/8" - 16							
11708	Barb Fitting	8	8	3/4" - 18							
11710	Barb Fitting	10	10	7/8" - 18							
11712	Barb Fitting	12	12	1-1/16" - 16							
12706	Steel Beadlock	6	6	5/8" - 18							
12930	Steel Beadlock	10	10	7/8" - 18							
13008	Barb Fitting	8	8	5/8" - 18							
13012	Barb Fitting	12	12	7/8" - 18							
13046	Barb Fitting	6	6	11/16" - 16							
14926	Aluminum Beadlock	6	6	5/8" - 18	R-134a						
14928	Aluminum Beadlock	8	8	3/4" - 16	R-134a						
15006	Aluminum Beadlock	6	6	3/4" - 18							
15008	Aluminum Beadlock	8	8	5/8" - 18							
15012	Aluminum Beadlock	12	12	7/8" - 18							
15046	Aluminum Beadlock	6	6	1-1/16" - 16							
16422	Steel Beadlock	12	12	7/8" - 14							
16506	Barb Fitting	6 x 6	6								
17506	Steel Beadlock	6 x 6	6								
18708	Steel Beadlock	8	8								
<b>Straight Metric FOR</b>											
14406	Aluminum	6	6	M14x1.500							
14408	Aluminum	8	8	M20x1.500							
14426	Aluminum	6	6	M20x1.500							
14428	Aluminum	8	8	M20x1.500							
14440	Aluminum	10	10	M24x2.000							
14446	Aluminum	6	6	M14x1.500							
14466	Aluminum	6	6	M16x1.500							
14472	Aluminum	12	12	M27x2.000							
14486	Aluminum Beadlock	6	6	M18x1.500							
14706	Aluminum	6	6	M16x1.500							



## ***Fittings - Reduced Beadlock Chart***

STRAIGHT MALE O-RING



45° MALE O-RING



90° MALE O-RING



180° HORSESHOE FEMALE O-RING

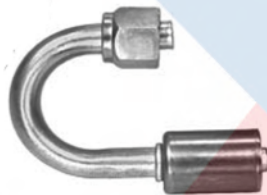

STRAIGHT FEMALE O-RING



45° FEMALE O-RING



90° FEMALE O-RING



STRAIGHT FEMALE O-RING W/ SERVICE PORT

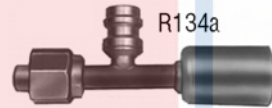

R134a

90° FEMALE O-RING SERVICE PORT



R134a

Part No.	Hose Connection	Hose Size	Fitting Size	Thread Size	Service Port
----------	-----------------	-----------	--------------	-------------	--------------

**90° Female Reduced Beadlock**

18068	Steel Beadlock	8	8	3/4" - 16	R-134a High Side
18070	Steel Beadlock	10	10	7/8" - 14	R-134a Low Side
18086	Steel Beadlock	6	6	5/8" - 18	
18098	Steel Beadlock	8	8	3/4" - 16	
18100	Steel Beadlock	10	10	7/8" - 14	

**Straight Female Reduced Beadlock**

18046	Steel Beadlock	6	6	5/8" - 18	
18058	Steel Beadlock	8	8	3/4" - 16	

Part No.	Hose Connection	Hose Size	Fitting Size	Thread Size	Service Port
----------	-----------------	-----------	--------------	-------------	--------------

**90° Female Reduced Beadlock**

18068	Steel Beadlock	8	8	3/4" - 16	R-134a High Side
18070	Steel Beadlock	10	10	7/8" - 14	R-134a Low Side
18086	Steel Beadlock	6	6	5/8" - 18	
18098	Steel Beadlock	8	8	3/4" - 16	
18100	Steel Beadlock	10	10	7/8" - 14	

**Straight Female Reduced Beadlock**

18046	Steel Beadlock	6	6	5/8" - 18	
18058	Steel Beadlock	8	8	3/4" - 16	

# Fittings - Splicer

STRAIGHT SPLICER



STRAIGHT SPLICER w/ R12 SERVICE PORT

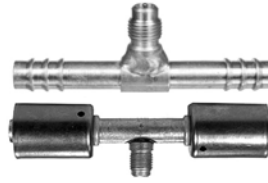

90° SPLICER

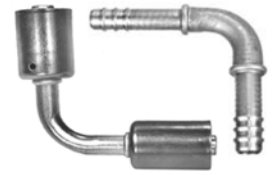

180° HORSESHOE SPLICER

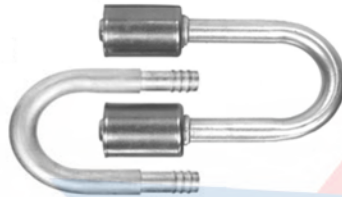

STRAIGHT SPLICER w/ R134a SERVICE PORT



T-TYPE SPLICER

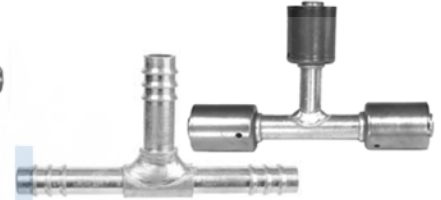

Part No.	Hose Connection	Hose Size	Fitting Size	Thread Size	Service Port
----------	-----------------	-----------	--------------	-------------	--------------

**180° Horseshoe Splicer**

16212	Barb Fitting	12 x 1			
17206	Aluminum Beadlock	6 x 6			
17208	Aluminum Beadlock	8			
17210	Aluminum Beadlock	10			
17212	Aluminum Beadlock	12 x 1			

**90° Splicer**

12328	Barb Fitting	8			
12330	Barb Fitting	10			
12332	Barb Fitting	12 x 1			
14326	Aluminum Beadlock	6 x 6			
14328	Aluminum Beadlock	8			
14330	Aluminum Beadlock	10			
14332	Aluminum Beadlock	12 x 1			
18326	Steel Beadlock	6 x 6			
18330	Steel Beadlock	10			
18332	Steel Beadlock	12 x 1			

**Splicer - Straight**

12306	Aluminum	6			
12308	Aluminum	8			
12310	Aluminum	10			
12312	Aluminum Hose barb	12 x 1			
12406	Aluminum	6 x 8			
12408	Aluminum	8 x 10			
12410	Aluminum	10 x 1			
12456	Aluminum	6			R-12
12460	Aluminum	10			R-12
12462	Aluminum	12 x 1			R-12
14176	Aluminum	6 x 6			R-12
14178	Aluminum	8			R-12
14188	Aluminum	8			R-12
14306	Aluminum	6 x 6			
14308	Aluminum	8			
14310	Aluminum	10			

Part No.	Hose Connection	Hose Size	Fitting Size	Thread Size	Service Port
----------	-----------------	-----------	--------------	-------------	--------------

14312	Aluminum	12 x 1			
14456	Aluminum	6 x 6			R-12
14458	Aluminum	8			R-12
14460	Aluminum	10			R-12
14462	Aluminum	12 x 1			R-12
14946	Aluminum	6 x 6			R-134a
14948	Aluminum	8			R-134a
14950	Aluminum	10			R-134a
14952	Aluminum	12 x 1			R-134a
14966	Steel	6			R-134a
14968	Steel	8			R-134a
14970	Steel	10			R-134a
15941	Steel	10			R-134a Low Side
15945	Steel	10 x 1			
16178	Aluminum	8			R-12
17406	Aluminum	6 x 8			
17408	Aluminum	8 x 10			
17410	Aluminum	10 x 1			
18306	Steel	6 x 6			
18308	Steel	8 x 8 x 8			
18310	Steel	10			
18312	Steel	12 x 1			
18946	Steel	6 x 6			R-134a
18948	Steel	8 x 8			R-134a
18950	Steel	10			R-134a Low Side
18952	Steel	12 x 1			R-134a
18960	Steel Beadlock	10			R-134a High Side
2306	Aluminum	6 x 6			
2308	Aluminum	8			
2310	Aluminum	10			
2312	Aluminum	12 x 1			
4306	Aluminum	6 x 6			
4312	Aluminum	12 x 1			

**Splicer - T-Type**

16306	Aluminum	6 x 6 x 6			
16308	Aluminum	8 x 8 x 8			
16310	Aluminum	10 x 1 x 10			

## ***Fittings - Splicer***

Part No.	Hose Connection	Hose Size	Fitting Size	Thread Size	Service Port	Part No.	Hose Connection	Hose Size	Fitting Size	Thread Size	Service Port
<b>Splicer - T-Type</b>											
16312	Aluminum	12 x 1 x 12									
16322	Aluminum	12 x 1 x 10									
16666	Steel Male Insert O-Ring	6									
17306	Aluminum	6 x 6 x 6									
17308	Aluminum	8 x 8 x 8									
17310	Aluminum	10 x 1 x 10									
17312	Aluminum	12 x 1 x 12									
17322	Aluminum	12 x 1 x 10									
17666	Aluminum Male Insert O-Ring	6									
17667	Aluminum Male Insert O-Ring	6									
17668	Aluminum Male Insert O-Ring	10									
<b>Straight Splicer Reduced Beadlock</b>											
18018	Steel Beadlock	8 x 8									



# Fittings - Springlock Chart

STRAIGHT MALE SPRINGLOCK



STRAIGHT FEMALE SPRINGLOCK



45° MALE SPRINGLOCK



45° FEMALE SPRINGLOCK



90° MALE SPRINGLOCK



90° FEMALE SPRINGLOCK



## SPRINGLOCK COUPLING REINFORCEMENT

Kit contains: (2) O-Rings and Instructions.

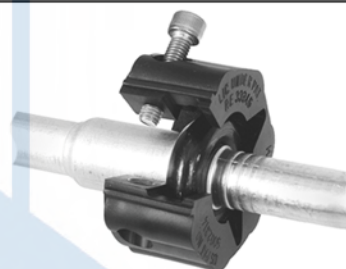

## Special Clamplock Fittings



**16901**  
Clamp  
Fits all sizes #6 to #12

### Clamplock Fittings Assembly Instructions

1. To assemble a Female Clamplock with a Male Springlock
  - A. Lubricate O-Rings with Refrigerant Oil
  - B. Slip mating parts together and engage flared end of Female into the Garter Spring on the Male end.
2. To assemble a Male Clamplock with a Ferrule Springlock, or to assemble a Male and Female Clamplock:
  - A. Lubricate O-Rings with Refrigerant Oil
    1. Slip mating parts together
    2. Cut Clamp at the proper tab corresponding to the Fitting Size refer to Figure 2. "Flex" clamp completely.
  - B. Wrap the clamp around the Flared Fitting Joint taking care to place the joint into the groove in the clamp. Using a screwdriver to engage the buckle over the tab (refer to Figure 3).

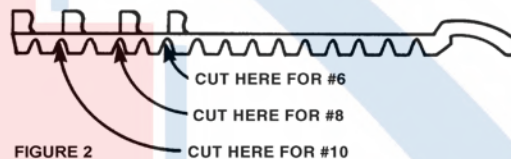

FIGURE 2

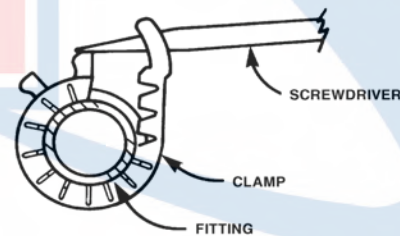

FIGURE 3

NOTE: Clamplock type fittings are interchangeable with Ford Springlock® fittings.

# Fittings - Springlock Chart

Part No.	Hose Connection	Hose Size	Fitting Size	Thread Size	Service Port
<b>45° Female Springlock</b>					
16926	Barb Fitting	6	6		
17926	Aluminum / Steel	6	6		
17928	Aluminum Beadlock	8	8		
17930	Aluminum Beadlock	10	10		
17932	Aluminum Beadlock	12	12		
17992	Aluminum Beadlock	12	12		

Part No.	Hose Connection	Hose Size	Fitting Size	Thread Size	Service Port
<b>45° Male Springlock</b>					
17976	Aluminum Beadlock	6	6		
17978	Aluminum Beadlock	8	8		
17980	Aluminum Beadlock	10	10		
17982	Aluminum Beadlock	12	12		
17986	Aluminum Beadlock	6	8		

Part No.	Hose Connection	Hose Size	Fitting Size	Thread Size	Service Port
<b>90° Female Springlock</b>					
16938	Barb Fitting	8	8		
17836	Aluminum Beadlock	6	6		
17842	Aluminum Beadlock	12	12		
17936	Aluminum Beadlock	6	6		
17938	Aluminum Beadlock	8	8		
17940	Aluminum Beadlock	10	10		
17942	Aluminum Beadlock	12	12		

Part No.	Hose Connection	Hose Size	Fitting Size	Thread Size	Service Port
<b>90° Male Springlock</b>					
17906	Aluminum Beadlock	6	6		
17908	Aluminum Beadlock	8	8		
17910	Aluminum Beadlock	10	10		
17912	Aluminum Beadlock	12	12		
17966	Aluminum Beadlock	6	6		
17972	Aluminum Beadlock	12	12		

Part No.	Hose Connection	Hose Size	Fitting Size	Thread Size	Service Port
<b>Springlock - Clamplock</b>					
16901	Plastic				

Part No.	Hose Connection	Hose Size	Fitting Size	Thread Size	Service Port
<b>Springlock - Coupling</b>					
16866					
16868					
16870					
16872					

Part No.	Hose Connection	Hose Size	Fitting Size	Thread Size	Service Port
<b>Springlock - Inline</b>					
17244	Aluminum				R-134a

Part No.	Hose Connection	Hose Size	Fitting Size	Thread Size	Service Port
<b>Straight Female Springlock</b>					
16916	Barb Fitting	6	6		
16918	Barb Fitting	8	8		
17816	Aluminum Beadlock	6	6		

Part No.	Hose Connection	Hose Size	Fitting Size	Thread Size	Service Port
17916	Aluminum Beadlock	6	6		
17918	Aluminum Beadlock	8	8		
17920	Aluminum Beadlock	10	10		
17922	Aluminum Beadlock	12	12		

Part No.	Hose Connection	Hose Size	Fitting Size	Thread Size	Service Port
<b>Straight Male Springlock</b>					
17946	Aluminum Beadlock	6	6		
17952	Aluminum Beadlock	12	12		
17956	Steel Beadlock	6	6		
17958	Aluminum Beadlock	8	8		
17960	Aluminum Beadlock	10	10		
17962	Aluminum Beadlock	12	12		

## REFRIGERATION FITTING CHART

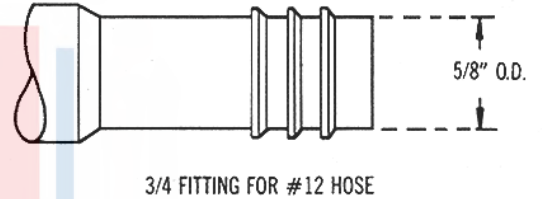
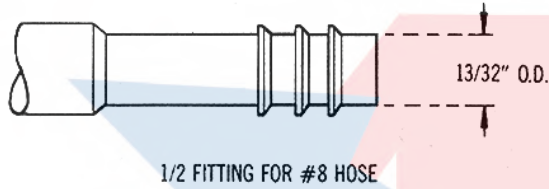
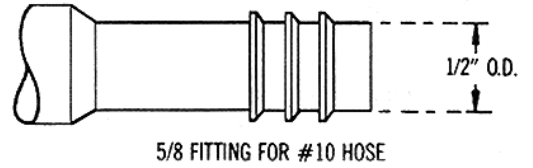
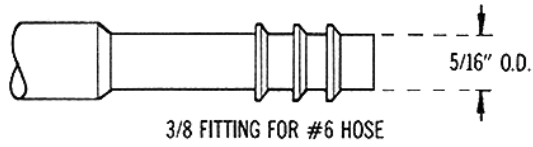

### BARB FITTINGS

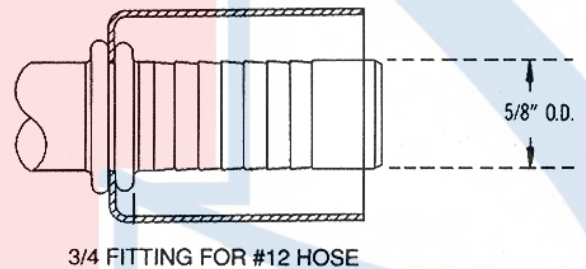
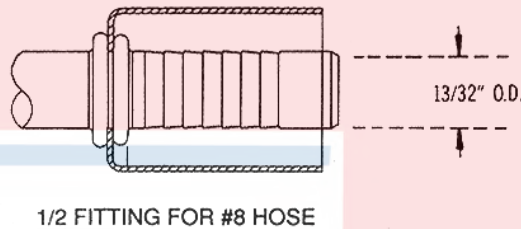
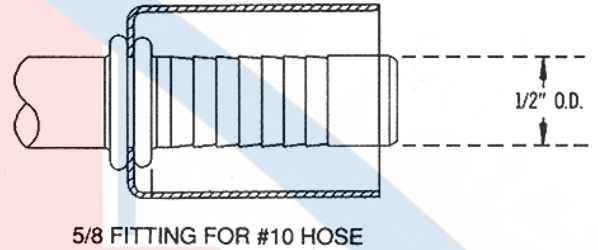
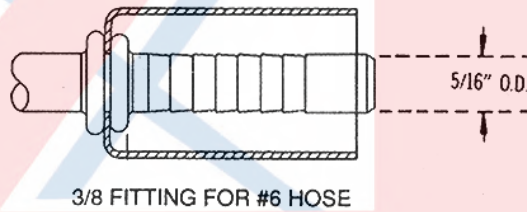

### BEADLOCK FITTINGS

**IMPORTANT:** We recommend that R134a systems use only BEADLOCK fittings with BARRIER hose. Beadlock fittings have permanently attached ferrules and require a special crimping tool. R12 systems can use either Barb or Beadlock fittings. When Barbed fittings are joined to Barrier Hose, a crimped connection should be made with a Ferrule and Barbed crimping tool.

*\*Packed with necessary O-Rings*



## REFRIGERATION FITTING CHART

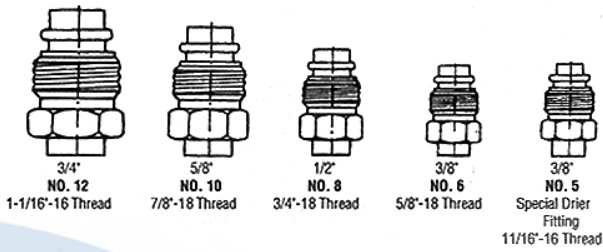

### MALE O-RING

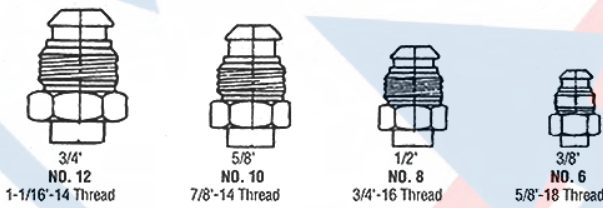

### MALE FLARE

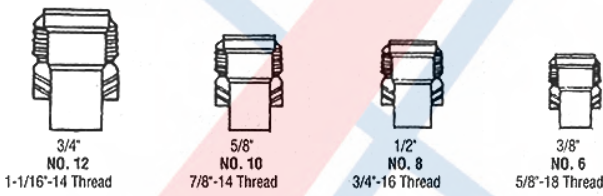

### MALE INSERT O-RING

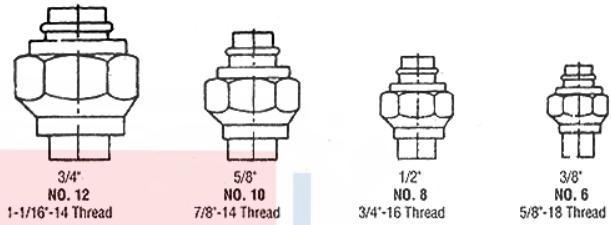

### FEMALE O-RING

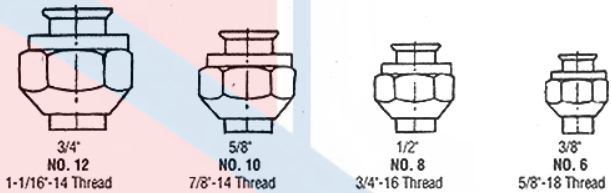

### FEMALE FLARE



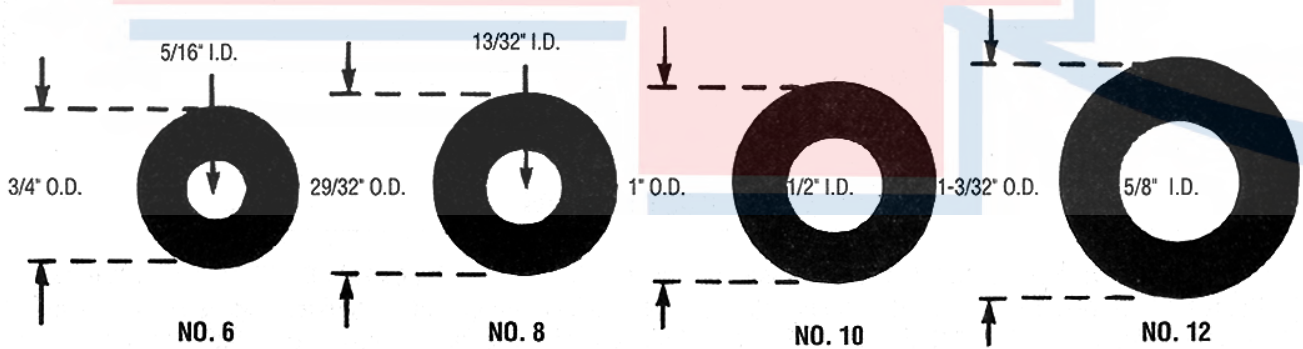

## REFRIGERATION HOSE SIZE CHART





# Temperature Control Division

## Tech Tip

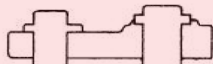
### GM – Compressor Sealing Washers

Section 1 - HOSE BLOCKS INSERTS				
Column A	Compressor Suction Port Size	Column B		Column C
Hose Block Side View		Suction Seal Washer 5/8"	3/4"	Discharge Seal Washer 5/8"
 1. Flat Face Hose Block with 4mm Pilots	5/8"	C	---	E/ S
	3/4"	B	---	E/ S
 2. Flat Face Hose Block with No Pilots	5/8"	C/S	---	E/ L
	3/4"	B/S	---	---
 3. Raised Face Hose Block with 7mm Pilots	5/8"	D	---	F
	3/4"	B	A	E or F
 4. Step Hose Block with 7mm Pilots	5/8"	D	---	D
	3/4"	---	A	D
 5. Step Hose Block with Tube Pilot	5/8"	G	---	G
	3/4"	---	---	---

Section 2 - PILOT INSERTS	
 Small	Part No.: 24359 Large Diameter: 16.0 mm (.63 in) Overall Length: 7.1 mm (.28 in) Small Diameter: 12.9 mm (.51 in)
 Large	Part No.: 24360 Large Diameter: 16.0 mm (.63 in) Overall Length: 11.4mm (.45 in) Small Diameter: 12.9 mm (.51 in)

#### NOTE:

- 1) Compare the side view of the hose manifold to the diagrams in Section 1 Column A.
- 2) Select the diagram that matches the hose manifold.
- 3) Determine the size of the pilot holes (SUCTION and DISCHARGE) on the manifold hose assembly. The Size of the pilot holes will be either 5/8" or 3/4".
- 4) The letter indicating the correct sealing washer is listed with the correct pilot insert letter size.
- 5) The sealing washer diagram is Section 3.
- 6) Using the diameter of the pilot, determine the correct SUCTION sealing washer and pilot insert (Column B).
- 7) Using the diameter of the pilot holes, determine the correct DISCHARGE sealing washer and pilot insert (Column C).
- 8) Remove the proper insert and washer from the kit.
- 9) DO NOT lubricate washers; install dry.
- 10) Install the sealing washer and pilot insert (if needed) onto the manifold block fitting.
- 11) Inserts must be fully seated, and sealing washers must be bottomed out against the block surface.
- 12) Install manifold block to compressor. A small space between manifold and compressor is normal. Torque Bolt to 25 ft/lbs.







#### IMPORTANT:

**All sealing surfaces must be lint and dirt free.**

Refer to chart on next page for washer kit information

# Temperature Control Division

## Tech Tip

Section 3 - Sealing Washers	
	<p><b>Part No.: 24354</b></p> <p><b>Edge Color:</b> Metal  <b>Thickness:</b> 1.2mm (.05 in)  <b>Outside Diameter:</b> 27.9mm (1.10 in)  <b>Inside Diameter:</b> 15.5mm (.61 in)</p>
	<p><b>Part No.: 24358</b></p> <p><b>Edge Color:</b> Yellow  <b>Thickness:</b> 3.0mm (.12 in)  <b>Outside Diameter:</b> 33.2mm (1.31 in)  <b>Inside Diameter:</b> 15.5mm (.61 in)</p>
	<p><b>Part No.: 24353</b></p> <p><b>Edge Color:</b> Black  <b>Thickness:</b> 3.0mm (.12 in)  <b>Outside Diameter:</b> 27.9mm (1.10 in)  <b>Inside Diameter:</b> 15.5mm (.61 in)</p>
	<p><b>Part No.: 24355</b></p> <p><b>Edge Color:</b> Metal  <b>Thickness:</b> 1.3mm (.05 in)  <b>Outside Diameter:</b> 31.5mm (1.24 in)  <b>Inside Diameter:</b> 17.5mm (.69 in)</p>
	<p><b>Part No.: 24357</b></p> <p><b>Edge Color:</b> Green  <b>Thickness:</b> 5.5mm (.22 in)  <b>Outside Diameter:</b> 29.9mm (1.18 in)  <b>Inside Diameter:</b> 15.5mm (.61 in)</p>
	<p><b>Part No.: 24356</b></p> <p><b>Edge Color:</b> Red  <b>Thickness:</b> 3.8mm (.15 in)  <b>Outside Diameter:</b> 29.9mm (1.18 in)  <b>Inside Diameter:</b> 15.5mm (.61 in)</p>
	<p><b>Part No.: 24403</b></p> <p><b>Edge Color:</b> Metal  <b>Thickness:</b> 1.2mm (.05 in)  <b>Outside Diameter:</b> 23.6mm (.93 in)  <b>Inside Diameter:</b> 15.5mm (.61 in)</p>



# GM "O" Ring - To - Sealing Washer Adapter Kit

**PART NO. 21000**

This sealing washer adapter kit enables the use of o-ring, or sealing washer hose block fittings. Follow the chart below to determine which combination of **Pilots** and/or **Gaskets** to use.

Kit Includes:		
Qty.	Description	Part Number
2	Red Gasket	24356
1	Green Gasket	24357
1	Short Pilot	24359
1	Long Pilot	24360
1	Instruction Sheet	NS

If the Compressor Mounting Flange looks like this... 	Compressor Mounting Flange					
And the Hose Assembly Block, from the side, looks like this... 	Discharge Side Gasket	Suction Side Gasket	Discharge Side Gasket	Suction Side Gasket	Discharge Side Gasket	Suction Side Gasket
 O-Ring Block (Flat Face)	 Green+Long Pilot	 Red+Short Pilot	 Red+Long Pilot	 Red	 Green+Long Pilot	 Red+Short Pilot
 O-Ring Block With Inserts	 Green+Long Pilot	 Red+Short Pilot	 Red+Long Pilot	 Red	 Green+Long Pilot	 Red+Short Pilot
 5/8" x 5/8" Raised	 Green	 Red	 Red	 Red	 Green	 Red
 5/8" x 5/8" Stepped	 Red	 Red	 Green	 Red	 Red	 Red

## IMPORTANT

**Do not lubricate gaskets prior to installation.**  
**Make sure all surfaces are clean and free of debris.**  
**Pilots must be pressed into hose block, not compressor mounting flange.**  
**A small space between manifold and compressor is normal.**  
**Torque manifold hold-down bolts to 25 ft/lbs.**

# HOSES/HOSE SIZE

## REFRIGERATION HOSE SIZE CHART

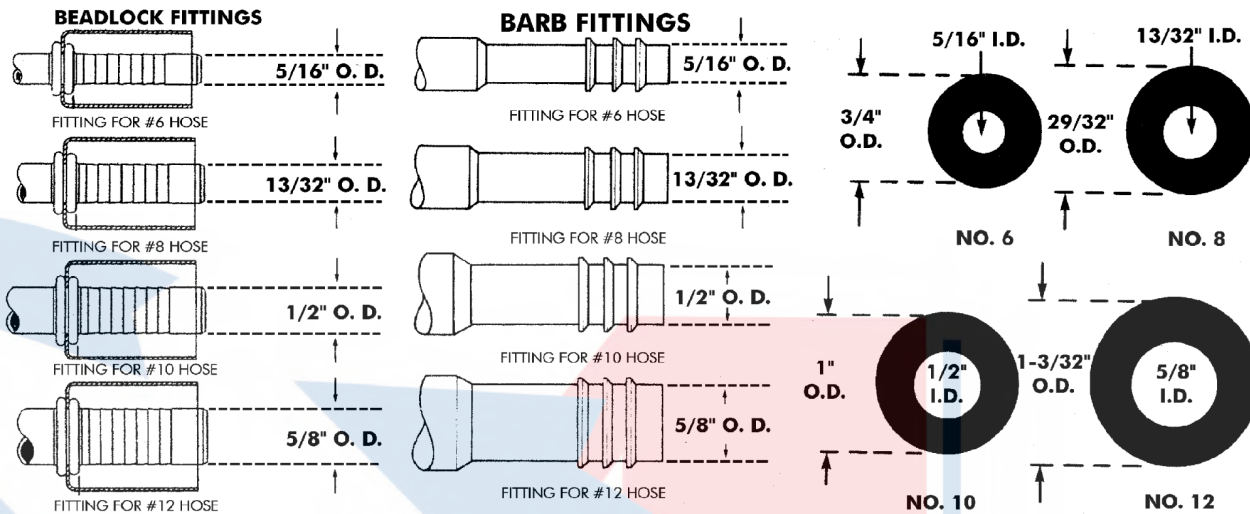

**IMPORTANT:** We recommend that R134a systems use only **BEADLOCK** fittings with **BARRIER** hose. Beadlock fittings have permanently attached ferrules and require a special crimping tool (see 59825). R12 systems can use either barb or beadlock fittings. When barbed fittings are joined to barrier hose, a crimped connection should be made with a ferrule and barbed crimping tool. Screw type clamps are only suitable for joining barbed fittings to braided (non-barrier) rubber hose.

### REFRIGERANT HOSE CLAMPS\*

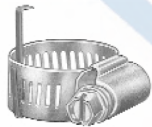

Std. Pkg.	Size	I.D.	Type
10 ea.	10-12	1/2"-5/8"	Rubber
11068	6-8	13/32"	Rubber

\*Do not use with barrier hose.

### HOSE PROTECTOR

Covers and protects hose from heat and abrasion.

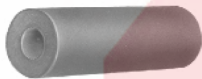

Hose Size	Length	Hose I.D.	Part No.
6 & 8	12"	5/16" & 13/32"	55023
10 & 12	12"	1/2" & 5/8"	55024

### REFRIGERANT HOSE



### BARRIER (Do not use screw type hose clamps on barrier hose.)

Part No.	Description	Hose Size	Hose I.D.	Std. Length
55216	Barrier	6	5/16"	825 ft.
55218	Barrier	8	13/32"	725 ft.
55220	Barrier	10	1/2"	700 ft.
55222	Barrier	12	5/8"	525 ft.
55006	Barrier	6	5/16"	30 ft.
55008	Barrier	8	13/32"	30 ft.
55010	Barrier	10	1/2"	30 ft.
55012	Barrier	12	5/8"	30 ft.
55416	Barrier	6	5/16"	50 ft.
55418	Barrier	8	13/32"	50 ft.
55420	Barrier	10	1/2"	50 ft.
55422	Barrier	12	5/8"	50 ft.
55106	Barrier	6	5/16"	100 ft.
55108	Barrier	8	13/32"	100 ft.
55110	Barrier	10	1/2"	100 ft.
55112	Barrier	12	5/8"	100 ft.

### HOSE MOUNTING STRAPS



**59018** 1/pkg  
For securing hoses to firewalls and fenderwells.



**59017** 20/pkg  
Nylon ties used to bundle hoses and electrical wires.

### FERRULES

Std. 25/pkg. **16016** Hose Size 6  
**16018** Hose Size 8  
**16020** Hose Size 10  
**16022** Hose Size 12

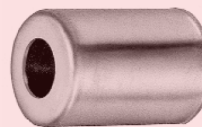

Std. 10/pkg. **16816** Hose Size 6  
**16818** Hose Size 8  
**16820** Hose Size 10  
**16822** Hose Size 12

Ferrules for Hose Make-Up. Use w/ 59700 Crimping Tool.  
Note: Not for Hydraulic Use

### DUCT HOSE

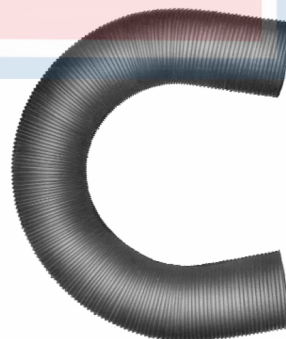

6 ft. length

Diameter	Part No.
1-1/4"	55041
1-1/2"	55042
1-3/4"	55043
2"	55044
2-1/4"	55045
2-1/2"	55046
2-3/4"	55047
3"	55048
3-1/4"	55049
3-1/2"	55050
4"	55052
4-1/2"	55054
5"	55056
6"	55059

# Fittings

## AC Hose Repair System



**450000** Contains Following

- 450006** #6 Ferrules
- 450008** #8 Ferrules
- 450010** #10 Ferrules
- 450012** #12 Ferrules
- 450013** #1 Retainer
- 450014** #2 Retainer
- 450018** #6 Retainer
- 450019** #7 Retainer
- 450020** #8 Retainer
- 450021** #9 Retainer
- 450015** #3 Retainer
- 450016** #4 Retainer
- 450017** #5 Retainer

AC Fittings  
Repair Kit

### Adapter

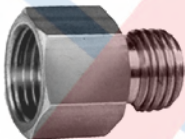

**16660**  
Adapter  
Thread Conversion  
Used to convert #6 Male Flare to  
14mm Male Insert O-Ring.  
Connector A Size: 6

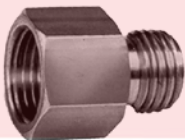

**16661**  
Adapter  
Thread Conversion  
Used to convert #6 Male Flare to  
16mm Male Insert O-Ring.  
Connector A Size: 6

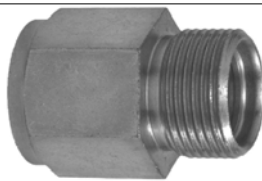

**16662**  
Adapter  
Thread Conversion  
Used to convert #8 Male Flare to  
20mm Male Insert O-Ring.  
Connector A Size: 8



**16746**  
Adapter  
O-ring to Flare  
Used to convert #6 Male Insert O-Ring  
to #6 Male Flare.  
Connector A Size: 6  
Connector B Size: 6  
Climatech: AE1045  
Dallas Truck AC: 0906240  
Euclid: E8080076  
Evans: AM84400  
Hy-Capacity: 0008813216  
Kysor: 405452  
Mack: 4379RD207500  
NaviStar: 12237, ZGG12237  
Northern: 4601035  
Red Dot: 70R3006



**16748**  
Adapter  
O-ring to Flare  
Used to convert #8 Male Insert O-Ring  
to #8 Male Flare.  
Connector A Size: 8  
Connector B Size: 8  
Climatech: AE1040  
Dallas Truck AC: 0906242  
Euclid: E8080078  
Hy-Capacity: 0008813217  
Kysor: 405493  
Mack: 4379RD208610  
NaviStar: 12240  
Northern: 4601036  
Red Dot: 70R3008



**16749**  
Adapter  
O-ring to Flare  
Used to convert #10 Male Insert  
O-Ring to #10 Male Flare.  
Connector A Size: 10  
Connector B Size: 10  
Climatech: AB2145  
Dallas Truck AC: 0906243  
Euclid: E80800710  
Hy-Capacity: 0008813218  
Kysor: 405494  
Mack: 4379RD214950  
Northern: 4601037  
Red Dot: 70R3001

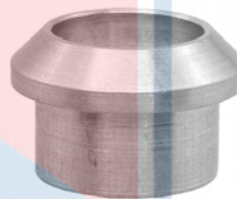

**16753**  
Adapter  
Male to Male  
Connector A Size: 12

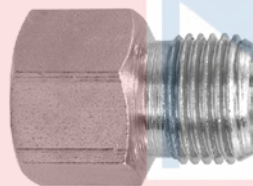

**18556**  
Adapter  
O-ring to Flare  
Used to convert #8 Male Flare to #8  
Male Insert O-Ring.  
Connector A Size: 8  
Connector B Size: 3/8"

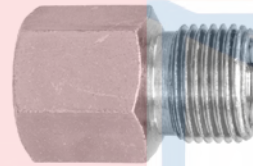

**18557**  
Adapter  
O-ring to Flare  
Used to convert #8 Male Flare to #8  
Male Insert O-Ring.  
Connector A Size: 8

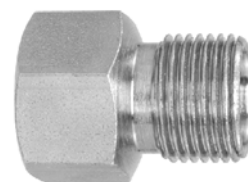

**18558**  
Adapter  
O-ring to Flare  
Used to convert #10 Male Flare to #10  
Male Insert O-Ring.  
Connector A Size: 10

## Clamp



**11012**  
Clamp  
Hose Clamp  
Dallas Truck AC: 0904001  
Euclid: E808912  
Evans: AM86006, HV27294  
Hy-Capacity: 0000088136  
Kysor: 2799060, 290244  
NaviStar: 1676805C91  
Northern: 322221  
Red Dot: 70R5506



**11068**  
Clamp  
Hose Clamp  
Climatech: ME1085  
Dallas Truck AC: 0904000  
Euclid: E808911  
Evans: AM86005, HV27293  
Hy-Capacity: 0000088135  
Kysor: 2799058, 2799076, 290243  
Mack: 4379RD5403510  
Northern: 322220  
Red Dot: 70R5501, 70R5550



# Fittings

## Compressor



**12018**  
Compressor  
Suction (R12)  
Connector A Size: 8  
Dallas Truck AC: 0956221BL  
Red Dot: 75R5858



**12019**  
Adapter  
Compressor Suction and Discharge  
Connector A Size: 12  
Connector B Size: 8  
Dallas Truck AC: 0901908BL



**12028**  
Compressor  
Discharge (R12)  
Connector A Size: 8  
Dallas Truck AC: 0913021  
Euclid: E8081338  
Kysor: 405627  
NaviStar: 11225

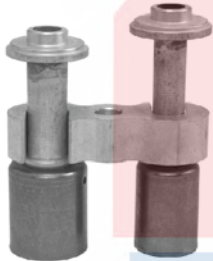

**12031**  
Adapter  
Compressor Suction and Discharge  
Connector A Size: 12  
Connector B Size: 8  
Dallas Truck AC: 0901920BL



**12034**  
Adapter  
Compressor Suction and Discharge  
Connector A Size: 12  
Connector B Size: 8  
Dallas Truck AC: 0901900BL



**12052**  
Compressor  
Suction (R12)  
Connector A Size: 12  
Red Dot: 75R5832

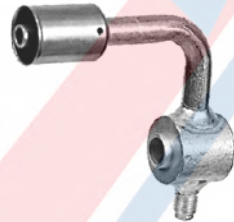

**12055**  
Compressor  
Discharge (R12)  
Connector A Size: 8  
Dallas Truck AC: 0956251BL  
Red Dot: 75R5838

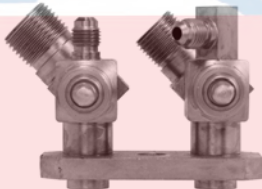

**12185**  
Adapter  
Compressor Suction and Discharge  
Connector A Size: 10  
Connector B Size: 8

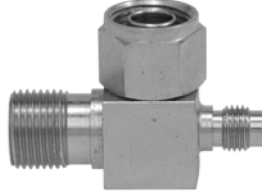

**12194**  
Compressor  
Discharge (R12) 90°  
Connector A Size: 8  
Connector B Size: 8  
Bergstrom: 540223  
Climatech: AB3300  
Euclid: E80802310  
Kysor: 1408047  
NaviStar: 706024

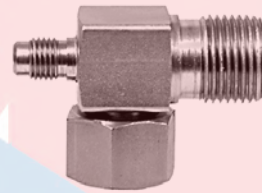

**12195**  
Compressor  
Suction (R12) 90 Degree  
Connector A Size: 10  
Connector B Size: 10  
Bergstrom: 540224  
Climatech: AB3305  
Kysor: 1408048  
NaviStar: 706025

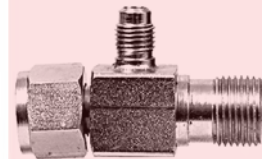

**12196**  
Compressor  
Discharge (R12) Straight  
Connector A Size: 8  
Connector B Size: 8  
Northern: 4515092

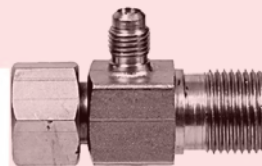

**12197**  
Compressor  
Suction (R12) Straight  
Connector A Size: 10  
Connector B Size: 10  
Northern: 4515093



**12198**  
Adapter  
Compressor Suction and Discharge  
Connector A Size: 10  
Connector B Size: 8  
Euclid: E808493



**12199**  
Adapter  
Compressor Suction and Discharge  
Connector A Size: 10  
Connector B Size: 8  
Red Dot: 75R8507, 75R8515

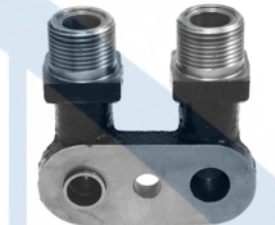

**12201**  
Adapter  
Compressor Suction and Discharge  
Euclid: E808495  
Red Dot: 75R8520



**12203**  
Adapter  
Compressor Suction and Discharge  
Connector A Size: 12  
Connector B Size: 10  
Kysor: 1401325  
Red Dot: 75R8505

# Fittings

## Compressor Cont'd



**12204**  
Adapter  
Compressor Suction and Discharge  
Connector A Size: 12  
Connector B Size: 10  
Kysor: 1401326



**12205**  
Adapter  
Compressor Suction and Discharge  
Kysor: 1401327



**12207**  
Adapter  
Compressor Suction and Discharge  
Connector A Size: 12  
Connector B Size: 10  
Kysor: 1401328



**12209**  
Adapter  
Compressor Suction and Discharge  
Kysor: 1401329



**12508**  
Compressor  
Discharge (R12)  
Connector A Size: 8  
Evans: AM80422



**12510**  
Compressor  
Suction (R12)  
Connector A Size: 10  
Evans: AM80423



**12521**  
Compressor  
Suction (R12)  
Connector A Size: 10  
Dallas Truck AC: 0956231BL

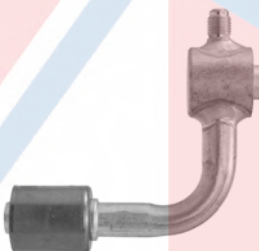

**12523**  
Compressor  
Suction (R12)  
Connector A Size: 12  
Dallas Truck AC: 0956241BL  
Red Dot: 75R5852



**12600**  
Adapter  
Compressor Fitting  
Connector A Size: 10  
Connector B Size: 10

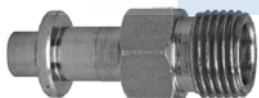

**12606**  
Adapter  
Compressor Fitting  
Connector A Size: 6  
Connector B Size: 6



**12618**  
Adapter  
Compressor Suction and Discharge  
Connector A Size: 12  
Connector B Size: 8

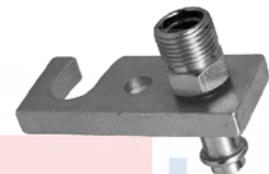

**12628**  
Adapter  
Compressor Fitting  
Connector A Size: 8  
Connector B Size: 8

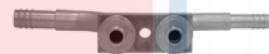

**12632**  
Adapter  
Compressor Suction and Discharge  
Connector A Size: 10  
Connector B Size: 12



**12701**  
Compressor  
90° Port Adapter  
Connector A Size: 8  
Connector B Size: 8  
Euclid: E8084458  
Kysor: 1408051  
Northern: 4515077

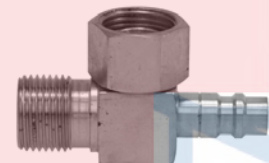

**12702**  
Compressor  
90° Port Adapter  
Connector A Size: 10  
Connector B Size: 10  
Euclid: E80844510  
Kysor: 1408052  
Northern: 4515088



**12708**  
Compressor  
90° Male O-Ring  
Connector B Size: No. 8  
Bergstrom: 540183  
Climatech: AB3100  
Dallas Truck AC: 0102020  
Euclid: E8080148  
Evans: AM80433  
Kysor: 1408007  
NaviStar: 12455



**12710**  
Compressor  
90° Male O-Ring  
Connector B Size: No. 10  
Bergstrom: 540184  
Climatech: AB3105  
Dallas Truck AC: 0102021  
Euclid: E80801410  
Evans: AM80434  
Kysor: 1408008  
NaviStar: 12456  
Northern: 451231

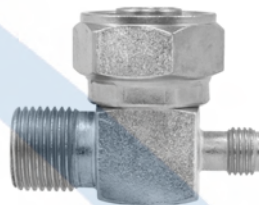

**12718**  
Compressor  
Service Valve (R12)  
Connector B Size: No. 8  
AMC: 3228593, 3233593  
Bergstrom: 540193  
Climatech: AB1210, AB3125  
Dallas Truck AC: 0102024  
Euclid: E8080178  
Hy-Capacity: 0008813266  
John Deere: 843111700  
Kysor: 1408013, 404102  
Mack: 4379RD553960  
NaviStar: 12465  
Northern: 451262  
Red Dot: 75R5718

# Fittings

## Compressor Cont'd

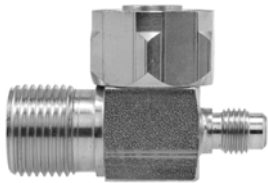

**12720**  
Compressor  
Service Valve (R12)  
Connector B Size: No. 10  
AMC: 3228592  
Bergstrom: 540194  
Climatech: AB3130  
Dallas Truck AC: 0102025  
Euclid: E80801710  
John Deere: 843111800  
Kysor: 1408014, 404103  
Mack: 4379RD553970  
NaviStar: 12466  
Northern: 451263  
Red Dot: 75R5711

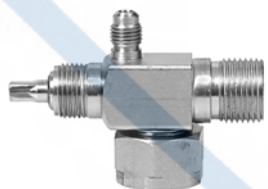

**12721**  
Compressor  
Service Valve (R12)  
Connector B Size: No. 10  
Bergstrom: 540198  
Climatech: AB3150, LA1240  
Dallas Truck AC: 0106026  
Euclid: E80802410  
Kysor: 1408016, 1408054  
Mack: 4379RD551960  
NaviStar: 11839, 12460, 706010  
Northern: 451446  
Red Dot: 75R5651

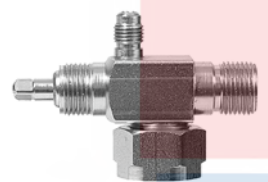

**12722**  
Compressor / Tube-O  
Service Valve (R12)  
Bergstrom: 540197  
Climatech: AB3145, LA1235  
Dallas Truck AC: 0106025  
Euclid: E8080248  
John Deere: 842741500  
Kysor: 1408015, 1408053  
Mack: 4379RD551970  
NaviStar: 706009  
Northern: 451445  
Red Dot: 75R5658

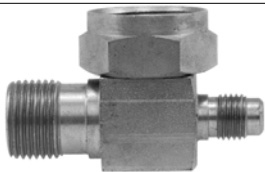

**12728**  
Compressor / Rotolock  
Service Valve (R12)  
Allis Chalmers: 13035514  
Bergstrom: 540259  
Climatech: LA1045  
Dallas Truck AC: 0102031  
Euclid: E8080198  
Evans: AM80435, HV31116  
Kysor: 1408010  
Mack: 4379RD573180  
NaviStar: 12458  
Northern: 451250

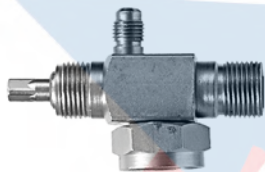

**12729**  
Compressor / Rotolock  
Service Valve (R12)  
Climatech: LA1265  
Dallas Truck AC: 0106023  
Euclid: E8080288  
Kysor: 1408003, 1408006  
NaviStar: 11840, 12217, 12285,  
1691712C1  
Northern: 451274, 451276  
Red Dot: 75R5608, 75R5618

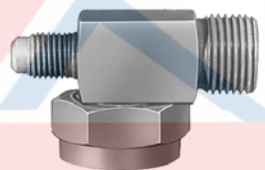

**12730**  
Compressor / Rotolock  
Service Valve (R12)  
Connector A Size: 10  
Allis Chalmers: 13033006  
Bergstrom: 540260  
Climatech: LA1040  
Dallas Truck AC: 0102032  
Euclid: E80801910  
Evans: AM80445, HV31115  
Hy-Capacity: 0008813265  
Kysor: 1408009  
Mack: 4379RD573200  
NaviStar: 12457  
Northern: 451261

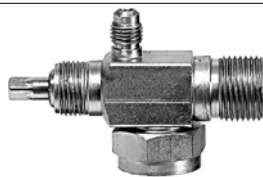

**12731**  
Compressor / Rotolock  
Service Valve (R12)  
Climatech: LA1270  
Dallas Truck AC: 0106024  
Euclid: E80802810  
Kysor: 1408004, 1408005  
Mack: 4379RD536941  
NaviStar: 12218, 12286  
Northern: 451272, 451275  
Red Dot: 75R5611

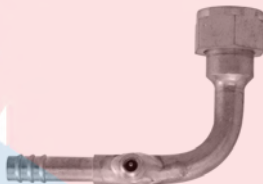

**12738**  
Compressor  
Service Valve (R12)  
Connector A Size: 8



**12759**  
Compressor  
Suction and Discharge  
Connector A Size: 8

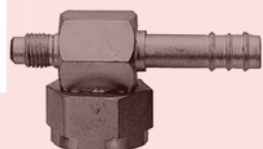

**12768**  
Compressor  
Service Valve (R12)  
Connector A Size: 8  
Euclid: E8080158  
Northern: 451232



**12769**  
Compressor  
Service Valve (R12)  
Connector A Size: 8  
Bergstrom: 540181  
Climatech: AB3090  
Dallas Truck AC: 0921321BL  
Euclid: E8080168  
Kysor: 1408011  
NaviStar: 706004

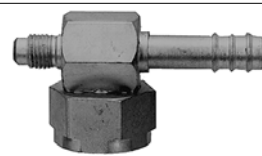

**12770**  
Compressor  
Service Valve (R12)  
Connector A Size: 10  
Euclid: E80801510  
Northern: 451233



**12771**  
Compressor  
Service Valve (R12)  
Connector A Size: 10  
Bergstrom: 540182  
Climatech: AB3095  
Dallas Truck AC: 0921331BL  
Euclid: E80801610  
Kysor: 1408012  
NaviStar: 706005



**12778**  
Compressor  
Service Valve (R12)  
AMC: 3172734  
Bergstrom: 540185  
Case New Holland: A42936  
Climatech: LA1095, LA1230  
Dallas Truck AC: 0105099  
Evans: AM80600  
John Deere: AE28664  
Kysor: 1408002, 404006, 404024,  
404025  
Mack: 4379RD551950  
Northern: 451267, 451417  
Red Dot: 75R5628

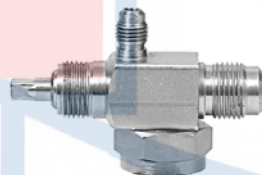

**12779**  
Compressor  
Service Valve (R12)  
Euclid: E8080278  
NaviStar: 463686C1



# Fittings

## Compressor Cont'd



**12780**  
Compressor  
Service Valve (R12)  
Connector A Size: 10  
AMC: 3216285  
Bergstrom: 540186  
Case New Holland: A42937  
Climatech: LA1250  
Dallas Truck AC: 0106020  
Evans: AM80601  
John Deere: AE28665  
Kysor: 1408001, 404011, 404015, 404023  
NaviStar: 302812C91  
Northern: 451268, 451418  
Red Dot: 75R5621



**12781**  
Compressor  
Service Valve (R12)  
Euclid: E80802710  
NaviStar: 463687C1



**12788**  
Compressor  
Service Valve (R12)  
Allis Chalmers: 1164256  
AMC: 3229426  
Euclid: E8080188



**12790**  
Compressor  
Service Valve (R12)  
Allis Chalmers: 16642550  
AMC: 3229431



**12803**  
Adapter  
Compressor Fitting  
Dallas Truck AC: 0101955  
Euclid: E808011  
Evans: AM80411  
Hy-Capacity: 0008813268  
Kysor: 1409008, 405578  
NaviStar: 12108  
Northern: 451254  
Red Dot: 75R5700

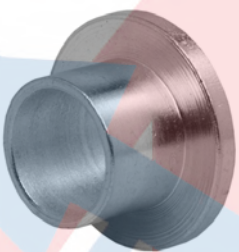

**12804**  
Adapter  
Compressor Fitting  
Connector A Size: 9/16"

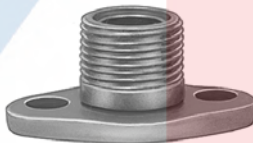

**12805**  
Adapter  
Compressor Fitting

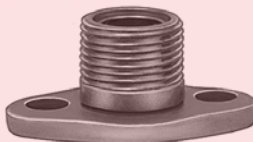

**12807**  
Adapter  
Compressor Fitting  
Bergstrom: 540229  
Climatech: AB2090  
Euclid: E808013  
NaviStar: 12107  
Northern: 451282



**12808**  
Compressor  
Service Valve (R12)  
Northern: 451226



**12810**  
Compressor  
Service Valve (R12)  
Euclid: E80801810  
Northern: 451227

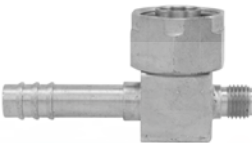

**12818**  
Compressor  
Service Valve (R12)  
Euclid: E8080228, E8080238  
NaviStar: 12459  
Northern: 451258  
Red Dot: 75R5428

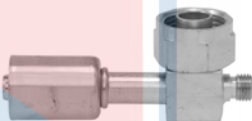

**12819**  
Compressor  
Service Valve (R12)  
Connector A Size: 8  
Bergstrom: 540189  
Climatech: AB3110  
Dallas Truck AC: 0921421BL  
Kysor: 1408017  
NaviStar: 706006  
Northern: 4613304

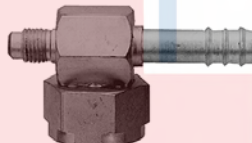

**12820**  
Compressor  
Service Valve (R12)  
Connector A Size: 10  
Northern: 451259

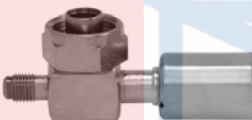

**12821**  
Compressor  
Service Valve (R12)  
Connector A Size: 10  
Bergstrom: 540191  
Climatech: AB3115  
Dallas Truck AC: 0921431BL, 0921433BL  
Euclid: E80802210  
Kysor: 1408018  
NaviStar: 706007  
Northern: 4613305

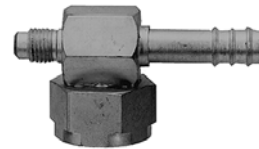

**12822**  
Compressor  
Service Valve (R12)  
Connector A Size: 12  
Euclid: E80802212  
Northern: 451410



**12823**  
Compressor  
Service Valve (R12)  
Connector A Size: 12  
Bergstrom: 540192  
Climatech: AB3120  
Dallas Truck AC: 0921441BL  
Euclid: E80802312  
Kysor: 1408019  
NaviStar: 706008  
Northern: 4613306

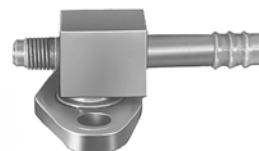

**12908**  
Compressor  
Service Valve (R12)  
Connector A Size: 8  
Euclid: E8080208  
Northern: 451211, 451228

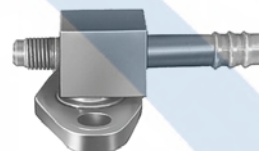

**12910**  
Compressor  
Service Valve (R12)  
Connector A Size: 10  
Euclid: E80802010  
Northern: 451212, 451229

# Fittings

## Compressor Cont'd

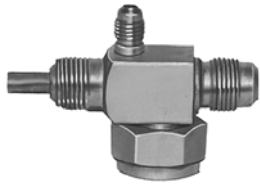

**12918**  
Compressor Service Valve (R12)  
AMC: 5459856  
Bergstrom: 540195  
Climatech: AB3135  
Euclid: E8080218  
Evans: AM80429, AM80430  
Kysor: 404218  
NaviStar: 11145  
Northern: 451443

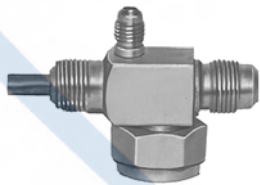

**12920**  
Compressor Service Valve (R12)  
Bergstrom: 540196  
Climatech: AB3140  
Euclid: E80802110  
Evans: AM80431, AM80432  
Kysor: 404217  
NaviStar: 11189  
Northern: 451444

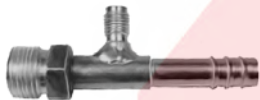

**12941**  
Compressor Discharge (R12)  
Connector A Size: 8



**14718**  
Tube-O Compressor Service Valve (R134a)  
Connector A Size: 8  
Bergstrom: 540214  
Climatech: AB3220, D20544282  
Dallas Truck AC: 0120243  
Euclid: E8080398, E8080408  
Hy-Capacity: 8813266A  
John Deere: 843109100  
Kysor: 1408034  
Mack: 4379RD576130  
NaviStar: 18422, 706030, ZGG18422  
Northern: 451507  
Red Dot: 75R5648

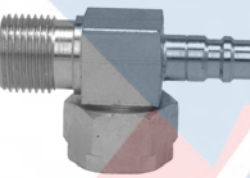

**14720**  
Tube-O Compressor Service Valve (R134a)  
Connector A Size: 10  
Bergstrom: 540215  
Climatech: AB3225, D20544295  
Dallas Truck AC: 0120253  
Euclid: E80803910, E80804010  
Hy-Capacity: 8813267A  
John Deere: 843109200  
Kysor: 1408035  
Mack: 4379RD576140  
NaviStar: 18423, 706031, ZGG18423  
Red Dot: 75R5641

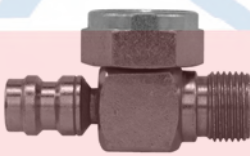

**14728**  
Rotolock Compressor Service Valve (R134a)  
Connector A Size: 8  
Bergstrom: 540208  
Climatech: AB3195  
Dallas Truck AC: 0120313  
Euclid: E8080368  
Kysor: 1408024  
Mack: 4379RD579660  
NaviStar: 18420  
Red Dot: 75R5688

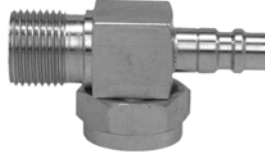

**14730**  
Rotolock Compressor Service Valve (R134a)  
Connector A Size: 8  
Bergstrom: 540209  
Climatech: AB3200  
Dallas Truck AC: 0120323  
Euclid: E80803610  
Kysor: 1408025  
Mack: 4379RD579670  
NaviStar: 18421  
Northern: 451508  
Red Dot: 75R5681

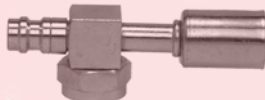

**14768**  
Rotolock Compressor Service Valve (R134a)  
Connector A Size: 10  
Bergstrom: 540204  
Caterpillar: 2329149  
Climatech: AB1750, AB3175  
Dallas Truck AC: 0921323BL  
Euclid: E8080348  
Kysor: 1408026  
Mack: 4379RD599520  
NaviStar: 706015  
Northern: 4513127, 4613300  
Red Dot: 75R5728



**14770**  
Rotolock Compressor Service Valve (R134a)  
Connector A Size: 8  
Bergstrom: 540205  
Climatech: AB1680, AB3180  
Dallas Truck AC: 0921333BL  
Euclid: E80803410  
Kysor: 1408027  
Mack: 4379RD599530  
NaviStar: 706016  
Northern: 4513128, 4613301  
Red Dot: 75R5721



**14818**  
Tube-O Compressor Service Valve (R134a)  
Connector A Size: 8  
Bergstrom: 540211  
Climatech: AB2515, AB3205  
Dallas Truck AC: 0921423BL  
Euclid: E8080388  
Kysor: 1408036  
Mack: 4379RD574300  
NaviStar: 706017  
Northern: 4513129  
Red Dot: 75R5678



**14820**  
Tube-O Compressor Service Valve (R134a)  
Connector A Size: 10  
Bergstrom: 540212  
Climatech: AB3210  
Euclid: E80803810  
Kysor: 1408037  
Mack: 4379RD574560  
NaviStar: 706018  
Northern: 4513130  
Red Dot: 75R5671









**14822**  
Tube-O Compressor Service Valve (R134a)  
Connector A Size: 8  
Bergstrom: 540213  
Climatech: AB3215  
Dallas Truck AC: 0921443BL  
Euclid: E80803812  
Kysor: 1408038  
Mack: 4379RD574800  
NaviStar: 706019  
Northern: 4513131  
Red Dot: 75R5672

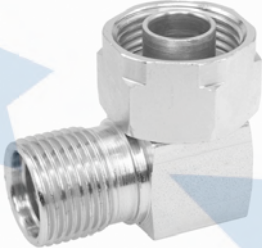
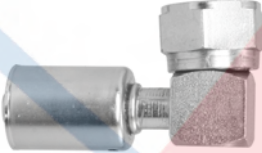
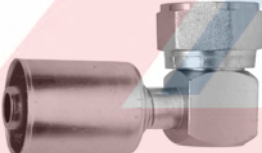
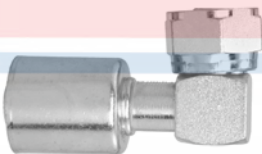

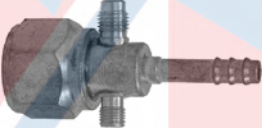
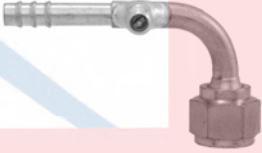
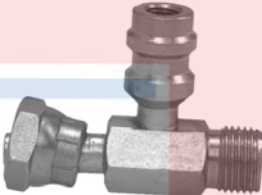
**15108**  
Compressor Discharge (R12)  
Connector A Size: 8  
Dallas Truck AC: 0956021BL  
Red Dot: 75R5848

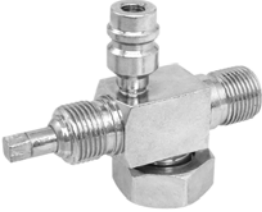
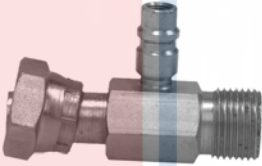
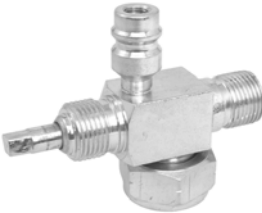
# Fittings

Compressor Cont'd				
 <p><b>15112</b> Compressor Suction (R12) Connector A Size: 12 Dallas Truck AC: 0956041BL Red Dot: 75R5842</p>	 <p><b>15209</b> Adapter Compressor Fitting Red Dot: 75R5761</p>	 <p><b>15210</b> Adapter Compressor Fitting Connector A Size: 8</p>	 <p><b>15211</b> Adapter Compressor Fitting Connector A Size: 10</p>	 <p><b>15212</b> Adapter Compressor Fitting Connector A Size: 12</p>
 <p><b>15213</b> Adapter Compressor Fitting Connector A Size: 8 Red Dot: 75R5768</p>	 <p><b>16108</b> Compressor Liquid Line (R12) Connector A Size: 8 Connector C Size: 6 Euclid: E8081336</p>	 <p><b>16156</b> Compressor Straight Female O-Ring Connector A Size: 6</p>	 <p><b>16158</b> Compressor 90° Female O-Ring Connector A Size: 6</p>	 <p><b>17231</b> Compressor Inline Dallas Truck AC: 0906301BL Euclid: E8084446 Northern: 4613205 Red Dot: 75R5806</p>
			 <p><b>17232</b> Compressor Inline Bergstrom: 540225, 540227 Climatech: AB3400, D20544055 Dallas Truck AC: 0906302BL Euclid: E8084448 Kysor: 1408049 Mack: 4379RD575390 NaviStar: 706026 Northern: 4613206 Red Dot: 75R5808</p>	 <p><b>18911</b> Compressor Service Valve (R134a) Connector A Size: 8 Kysor: 1408022 Red Dot: RD598130P</p>
			 <p><b>17233</b> Compressor Inline Bergstrom: 540226, 540228 Climatech: AB3405, D20544204 Dallas Truck AC: 0906303BL Euclid: E80844410 Kysor: 1408050 Mack: 4379RD573100 NaviStar: 706027 Northern: 4613207 Red Dot: 75R5801</p>	 <p><b>18914</b> Compressor Service Valve (R134a) Connector A Size: 8 Kysor: 1408030 Red Dot: 75R5738, RD599100P</p>
				 <p><b>18953</b> Adapter Compressor Fitting Connector A Size: 10</p>
				 <p><b>18958</b> Tube-O Compressor 90° Female O-Ring (w/ High Side Service Port) Connector A Size: 8 Connector B Size: 8</p>



# Fittings

## Compressor Cont'd



**18970**  
 Tube-O Compressor  
 90° Female O-Ring (w/ High Side  
 Service Port)  
 Connector A Size: 10  
 Connector B Size: 10

## Compressor Bolt Kit

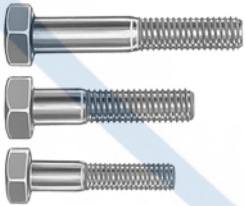

**12695**  
 Bolt Kit  
 A/C Compressor Bolt Kit  
 Northern: 5301075

## Evaporator Core Repair Kits

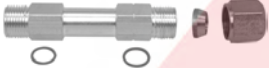

**16149**  
**16152 w/ 38623 Tube**  
 Repair Kit  
 Evaporator Core Repair Kit w/o Orifice  
 Tube  
 Buick (94-76); Cadillac (94-76); Chevy  
 (94-76); Ford (94-80); GMC (94-76);  
 Lincoln (94-80); Mercury (94-80); Olds  
 (94-76); Pontiac (94-76)  
 General Motors Corp: 19187961



**16150**  
**16153 Includes 38621 Tube**  
 Repair Kit  
 Liquid Line



**16152**  
**16149 w/o Orifice Tube**  
 Repair Kit  
 Evaporator Core Repair Kit w/ White  
 Orifice Tube  
 Buick (94-76); Cadillac (94-76); Chevy  
 (94-76); Ford (94-80); GMC (94-76);  
 Lincoln (94-80); Mercury (94-80); Olds  
 (94-76); Pontiac (94-76)  
 Dallas Truck AC: 0415013  
 Euclid: E805052



**16153**  
**16150 w/o Orifice Tube**  
 Repair Kit  
 Liquid Line  
 Euclid: E805053



**16155**  
 Repair Kit  
 Evaporator Core Repair Kit w/o Orifice  
 Tube  
 Ford (94-80); Lincoln (94-80); Mercury  
 (94-80)

## Ferrule



**16016**  
 Ferrule  
 Hose Repair (Ferrule)



**16018**  
 Ferrule  
 Hose Repair (Ferrule)



**16020**  
 Ferrule  
 Hose Repair (Ferrule)



**16022**  
 Ferrule  
 Hose Repair (Ferrule)



**16650**  
 Ferrule  
 Hose Repair (Ferrule)  
 Euclid: E8084376

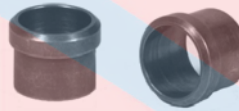

**16651**  
 Ferrule  
 Hose Repair (Ferrule)  
 Northern: 450449



**16652**  
 Ferrule  
 Hose Repair (Ferrule)  
 Euclid: E8084378

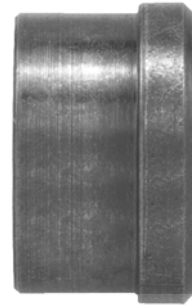

**16653**  
 Ferrule  
 Hose Repair (Ferrule)  
 Northern: 450450



**16654**  
 Ferrule  
 Hose Repair (Ferrule)  
 Euclid: E80843710

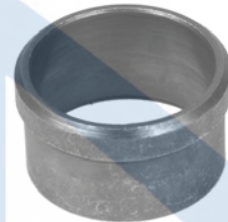

**16655**  
 Ferrule  
 Hose Repair (Ferrule)  
 Northern: 450451



**16656**  
 Ferrule  
 Hose Repair (Ferrule)  
 Euclid: E80843712

# Fittings

## Ferrule Cont'd



**16657**

Ferrule  
Hose Repair (Ferrule)  
Northern: 450452

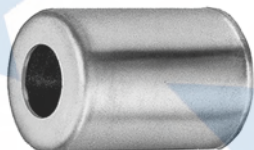

**16816** Hose Size(6) 10/pkg  
**16818** Hose Size(8) 10/pkg  
**16820** Hose Size(10) 10/Pkg  
**16822** Hose Size(12) 10/Pkg

Ferrule  
Hose Repair (Ferrule)  
Dallas Truck AC: 0903006  
Euclid: E8089006  
Kysor: 2600001, 405662  
NaviStar: 14860  
Northern: 4601042  
Red Dot: 70R5806