

TECHNICAL DATA

Fluke 114 Electrical Multimeter



Compact true-rms meter for electrical troubleshooting

The Fluke 114 is the troubleshooting tool for “go/no-go” testing. It includes a feature to prevent false readings caused by ghost voltage.

Features

- AutoVolt: automatic ac/dc voltage selection
- Large white LED backlight to work in poorly lit areas
- Resistance and continuity
- Min/Max/Average to record signal fluctuations
- CAT III 600 V safety rated

SAFETY RATING CAT III 600 V

BUILT TO LAST Three-year warranty

IDEAL FOR ELECTRICIANS AND CONTRACTORS

- Simple one-handed operation
- Automatic ac/dc voltage selection
- Holster with probe holders for easy test lead storage
- Large white LED backlit displaywarranty

Specifications

Accuracy is specified for 1 year after calibration, at operating temperatures of 18 °C to 28 °C, with relative humidity at 0 % to 90 %. The accuracy specifications take the form of: \pm ([% of reading] + [counts])

General specifications			
Maximum voltage (between any terminal and earth ground)	600 V		
Safety	IEC 61010-1: Pollution Degree 2 IEC 61010-2-033: CAT III 600 V		
Display	Digital: 6,000 counts, updates 4/sec		
Bar graph	33 segments, updates 32/sec		
Operating temperature	-10 °C to + 50 °C		
Storage temperature	-40 °C to + 60 °C		
Battery	9 volt Alkaline, IEC 6LR61		
Battery life	400 hours typical, without backlight		
Accuracy specifications			
Measurement	Range	Resolution	Accuracy \pm ([% of reading] + [counts])
DC millivolts	600.0 mV	0.1 mV	0.5 % + 2
DC volts	6.000 V 60.00 V 600.0 V	0.001 V 0.01 V 0.1 V	0.5 % + 2
Auto volts	600.0 V	0.1 V	2.0 % + 3 (dc, 45 Hz to 500 Hz) 4.0 % + 3 (500 Hz to 1 kHz)
AC millivolts ¹ true-rms	600.0 V	0.1 V	1.0 % + 3 (dc, 45 Hz to 500 Hz) 2.0 % + 3 (500 Hz to 1 kHz)
AC volts ¹ true-rms	6.000 V 60.00 V 600.0 V	0.001 V 0.01 V 0.1 V	1.0 % + 3 (45 Hz to 500 Hz) 2.0 % + 3 (500 Hz to 1 kHz)
Continuity	600 Ω	1 Ω	Beeper on < 20 Ω off > 250 Ω ; detects opens or shorts of 500 μ s or longer.
Ohms	600.0 Ω 6.000 k Ω 60.00 k Ω 600.0 k Ω 6.000 M Ω 40.00 M Ω	0.1 Ω 0.001 k Ω 0.01 k Ω 0.1 k Ω 0.001 M Ω 0.01 M Ω	0.9 % + 2 0.9 % + 1 0.9 % + 1 0.9 % + 1 0.9 % + 1 1.5 % + 2

¹ All ac voltage ranges except Auto-V/LoZ are specified from 1 % to 100 % of range. Auto-V/LoZ is specified from 0.0 V. Because inputs below 1 % of range are not specified, it is normal for this and other true-rms meters to display non-zero readings when the test leads are disconnected from a circuit or are shorted together. For volts, crest factor of \leq 3 at 4000 counts, decreasing linearly to 1.5 at full scale. AC volts is ac-coupled. Auto-V LoZ, and ac mV are dc-coupled.

Ordering information

Fluke-114 Electrical Multimeter

Included

TL75 Test Leads

Holster

User's manual

9 V battery (installed)

Fluke. Keeping your world
up and running.®

110/113/114/115/116/117

True-rms Multimeter

Calibration Information

Maintenance

Maintenance of the Meter consists of battery and fuse replacement, as well as case cleaning.

Fuse Test (115, 117)

To test the fuse:

1. Set the rotary switch to Ω .
2. Plug a test lead into the $\frac{V}{\Omega}$ jack and touch the probe to the 10A jack, as shown in Figure 1.

If the display shows a resistance value in the range of that shown in Figure 1, the fuse is good.

If the display reads ∞ , replace the fuse and test again.

If the display shows any other value, have the Meter serviced. See *How to Contact Fluke* earlier in this document.

Figure 1. Test the Fuse

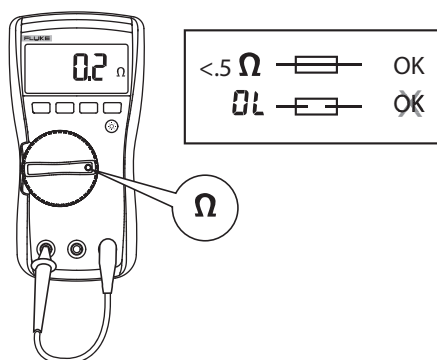

Battery and Fuse Replacement

⚠⚠ Warning

To prevent shock, injury, or damage to the Meter:

- Remove test leads from the Meter before opening the case or battery door.
- Use ONLY a fuse with the amperage, interrupt voltage, and speed ratings specified.

Static Awareness



Semiconductors and integrated circuits can be damaged by electrostatic discharge during handling. This notice explains how to minimize damage to these components.

1. Understand the problem.
2. Learn the guidelines for proper handling.
3. Use the proper procedures, packaging, and bench techniques.

Follow these practices to minimize damage to static sensitive parts.

⚠⚠ Warning

To prevent electric shock or personal injury.
De-energize the product and all active circuits
before opening a product enclosure, touching or
handling any PCBs or components.



- Minimize handling.
- Handle static-sensitive parts by non-conductive edges.
- Do not slide static-sensitive components over any surface.
- When removing plug-in assemblies, handle only by non-conductive edges.
- Never touch open-edge connectors except at a static-free work station.

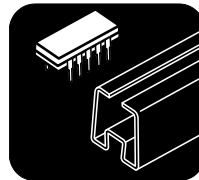

- Keep parts in the original containers until ready for use.
- Use static shielding containers for handling and transport.
- Avoid plastic, vinyl, and Styrofoam® in the work area.



- Handle static-sensitive parts only at a static-free work station.
- Put shorting strips on the edge of the connector to help protect installed static-sensitive parts.
- Use anti-static type solder extraction tools only.
- Use grounded-tip soldering irons only.

See Figure 2 for disassembly.

Figure 2. Disassembly

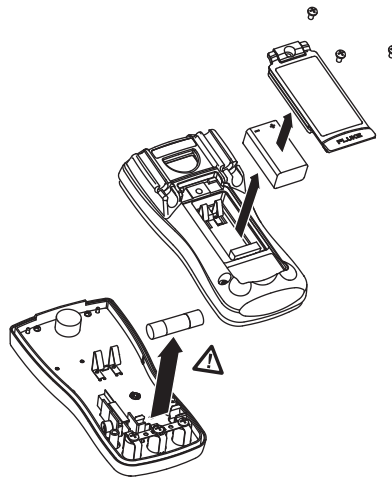

To remove the battery door for battery replacement:

1. Remove the test leads from the Meter.
2. Remove the battery door screw.
3. Use the finger recess to lift the door slightly.
4. Lift the door straight up to separate it from the case.
5. The battery fits inside the battery door, which is then inserted into the case, bottom edge first, until it is fully seated. Do not attempt to install the battery directly into the case.
6. Install and tighten battery door screw.

To open the case for fuse replacement:

1. Remove the test leads from the Meter.
2. Remove the Meter from its holster.
3. Remove two screws from the case bottom.
4. Separate the case bottom from the case top.
5. Remove the fuse from its holder and replace it with an 11 A, 1000 V, FAST fuse having a minimum interrupt rating of 17 000 A. Use only Fluke PN 803293.
6. To re-assemble the Meter, first attach the case bottom to the case top, then install the two screws. Finally, insert the Meter into its holster.

Cleaning

Wipe the case with a damp cloth and mild detergent. Dirt or moisture in the terminals can affect readings.

Features

Table 1 is a list of the features for each Meter.

Table 1. Features

Switch Position	Measurement Function	110	113	114	115	116	117
OFF	The Meter is turned off.	●	●	●	●	●	●
AUTO-V LoZ	Automatically selects ac or dc volts based on the sensed input with a low impedance input.			●		●	●
\tilde{V} Hz	AC voltage from 0.06 V to 600 V.	●		●	●	●	●
	Frequency from 5 Hz to 100 kHz.				●	●	●
$\overline{\overline{V}}$	DC voltage from 0.001 V to 600 V.	●		●	●	●	●
\tilde{mV} $\overline{\overline{mV}}$	AC voltage from 6.0 to 600 mV, dc-coupled. DC voltage from 0.1 to 600 mV.	●		●	●	●	●
Ω	Ohms from 0.1 Ω to 40 M Ω .	●		●	●	●	●
	Ohms from 0.1 Ω to 60 k Ω .		●				
 	Continuity beeper turns on at <20 Ω and turns off at >250 Ω .	●	●	●	●	●	●
V CHEK	LoZ low impedance measurement function to simultaneously test for voltage or continuity.		●				
$\rightarrow $	Diode Test. Displays OL above 2.0 V.		●		●	●	●
$\leftarrow $	Farads from 1 nF to 9999 μ F.		●		●	●	●
\tilde{A} Hz	AC current from 0.1 A to 10 A (>10 to 20 A, 30 seconds on, 10 minutes off). >10.00 A display flashes. >20 A, OL is displayed. DC-coupled. Frequency from 45 Hz to 5 kHz.				●		●
$\overline{\overline{A}}$	DC current from 0.001 A to 10 A (>10 A to 20 A, 30 seconds on, 10 minutes off). >10.00 A display flashes. >20 A, OL is displayed.				●		●
$\overline{\overline{\mu A}}$ $\tilde{\mu A}$	DC current from 0.1 to 600 μ A. AC current from 6.0 to 600 μ A. DC-coupled.					●	
I	Temperature from -40 $^{\circ}$ C to 400 $^{\circ}$ C (-40 $^{\circ}$ F to 752 $^{\circ}$ F) with K-type thermocouple					●	
Volt Alert	Non-contact sensing of ac voltage.						●

Note: All ac functions and Auto-V LoZ are true-rms. AC voltage is ac-coupled. Auto-V LoZ, AC mV and AC amps are dc-coupled.

Performance Tests

Warning

To prevent electric shock, do not perform the performance test procedures unless the Meter is fully assembled.

The following performance tests verify the complete operation of the Meter and check the accuracy of each Meter function against its specifications. The recommended calibration interval is 12 months. If the Meter fails any part of the test, calibration adjustment and/or repair is indicated.

In the performance tests, the Meter is referred to as the device under test (DUT).

See Table 1 for a list of the features for each Meter.

Required Equipment

Table 2 is a list of the equipment required to conduct a performance test on the Meter.

Table 2. Equipment Requirements

Equipment	Measurement Function	Range ^[1]
5522 Multi-product Calibrator (or equivalent)	DC Volts	10 mV to 600 V
	DC Current	600 μ A to 10 A
	AC Volts	6 mV to 600 V
	AC Current	600 μ A to 10 A
	Resistance	0 to 30 M Ω
	Capacitance	9 to 900 μ F
	Temperature	0 $^{\circ}$ C to 400 $^{\circ}$ C
	Frequency	2 V, 50 kHz
Fluke 80 AK K-type Thermocouple Adapter Accessory	Temperature	NA
K-type Thermocouple, mini-plug on both ends	Temperature	NA
Double Banana plug	VoltAlert	NA
[1] For accuracy specifications, see the Users Manual for the product.		

Display Test

110/114/115/116/117

Push **HOLD** and turn the rotary switch to the \tilde{V}^{Hz} position. Compare the display with the example in Figure 3. Check all segments for clarity and contrast.

113

Push **HOLD** and turn the rotary switch to the \checkmark *CHEK* position. Compare the display with the example in Figure 3. Check all segments for clarity and contrast.

Figure 3. Display Segments

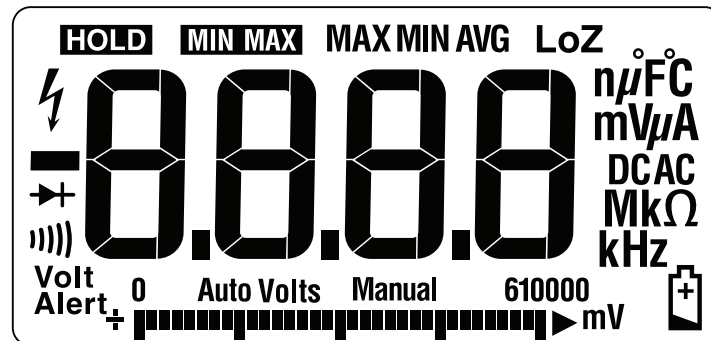

Backlight Test

To test the backlight, press \odot and verify that the backlight turns on.

Keypad Test

110/114/115/116/117

To test the keypad:

1. Turn the rotary switch to \tilde{V} .
2. Push each button separately.
Each button push should cause the Meter to beep and activate a display annunciator.
3. To reset the Meter, turn the rotary switch to **Off** and then back to the **On** position.

113

To test the keypad:

1. Turn the Meter to Ω \rightarrow \leftarrow
2. Push each button separately.
Each button push should cause the Meter to beep and activate a display annunciator.
3. To reset, turn off the Meter, and then back to any function position.

Preparing for the Performance Tests

⚠⚠ Warning

To prevent possible electric shock or personal injury:

- Do not perform the following procedures unless qualified to do so. Some procedures involve the use of high voltages.
- Before handling the test connections and in between tests, make sure the calibrator is in standby mode (STBY).

To prepare for the performance test:

1. Make sure that you have the required equipment (see Table 2).
2. Warm up the calibrator as required by its specifications.
3. Allow the temperature of the DUT to stabilize at room temperature: 23 °C ±5 °C (73 °F ±9 °F)
4. Check the fuses and battery and replace them if necessary. See *Fuse Test (115, 117)* and *Battery and Fuse Replacement*.

To verify the accuracy of the DMM functions, do the following:

1. Connect the Calibrator to the **VΩ** and **COM** input terminals on the Meter.
2. Turn the rotary switch to the function listed in each step of Table 3 (110, 114, 115, 116, 117) or Table 4 (113).
3. Apply the input level for each step listed in Table 3 (110, 114, 115, 116, 117) or Table 4 (113).
4. Compare the reading on the Meter display with the Display Reading in Table 3 (110, 114, 115, 116, 117) or Table 4 (113).

If the display reading falls outside of the range shown, the Meter requires calibration adjustment or repair.

Testing Temperature (116 only)

Connect the K-type thermocouple to the temperature input of the Meter and temperature calibrator. To ensure an accurate measurement, the Meter and the thermocouple connector must be at the same temperature. After connecting the thermocouple to the Meter, allow the junctions to stabilize before recording the displayed reading. This can take several minutes, depending on temperature gradients.

Table 3. DMM Performance Tests: 110/114/115/116/117

Step	Function	Range	Applied	Display Reading ^[1]				
				110	114	115	116	117
1.	Ω Ohms	600.0	0.0 Ω	0.0 to 0.2				
2.		600.0	500 Ω	495.3 to 504.7				
3.		6.000 k	5 kΩ	4.954 to 5.046				
4.		60.00 k	50 kΩ	49.54 to 50.46				
5.		600.0 k	500 kΩ	495.4 to 504.6				
6.		6.000 M	5 MΩ	4.954 to 5.046				
7.		40.00 M	10 MΩ	9.48 to 10.52				
8.		40.00 M	30 MΩ	28.48 to 31.52				

Table 3. DMM Performance Tests: 110/114/115/116/117 (cont.)

Step	Function	Range	Applied	Display Reading ^[1]				
				110	114	115	116	117
9.	Continuity	600 Ω	20 Ω	Beeper On				
10.		600 Ω	250 Ω	Beeper Off				
11.	AC Volts	6.000 V	5 V, 45 Hz	4.947 to 5.053				
12.		6.000 V	5 V, 1 Hz	4.897 to 5.103				
13.		60.00 V	50 V, 45 Hz	49.47 to 50.53				
14.		60.00 V	50 V, 1 Hz	48.97 to 51.03				
15.		600.0 V	600 V, 45 Hz	593.7 to 606.3				
16.		600.0 V	600 V, 1 Hz	587.7 to 612.3				
17.	AC Volts + Hz	6.000 V	2 V, 50 kHz ^[1]	NA		49.93 to 50.07		
18.	DC Volts	6.000 V	0 V	-0.002 to 0.002				
19.		6.000 V	5 V	4.973 to 5.027				
20.		60.00 V	50 V	49.73 to 50.27				
21.		600.0 V	600 V	596.8 to 603.2				
22.		600.0 V	-600 V	-596.8 to -603.2				
23.	AC Millivolts	600.0 mV	6 mV, 45 Hz	5.6 to 6.4				
24.		600.0 mV	600 mV, 1 kHz	587.7 to 612.3				
25.	DC Millivolts	600.0 mV	10 mV	5.6 to 6.4				
26.		600.0 mV	600 mV	587.7 to 612.3				
27.	Diode	2.000 V	1.9 V	NA		1.881 to 1.919		
28.	Capacitance	1000 nF	Open	NA		0 to 2		
29.		9999 μF	900 μF	NA		881 to 919		
30.	LoZ Capacitance	10.00 μF	9 μF	NA		7.18 to 10.82		

Table 3. DMM Performance Tests: 110/114/115/116/117 (cont.)

Step	Function	Range	Applied	Display Reading ^[1]				
				110	114	115	116	117
Set calibrator to standby, reconfigure leads, and program for amps output								
31.	\bar{A} DC Amps	10.00 A	10 A	NA		9.87 to 10.13	NA	9.87 to 10.13
32.	\tilde{A} AC Amps	6.000 A	5.0 A, 45 Hz	NA		4.922 to 5.078	NA	4.922 to 5.078
33.	$\bar{\mu A}$ DC μ Amps	600.0 μ A	600 μ ADC	NA			593.8 to 606.2	NA
34.	$\bar{\mu A}$ DC μ Amps	600.0 μ A	600 μ AAC, 45 HZ	NA			590.7 to 609.3	NA
35.	Temperature	---	Open input	NA			OPEN	NA
36.		---	0.0 °C	NA			-1.0 to 1.0	NA
37.		---	400 °C	NA			395.0 to 405.0	NA
38.	AUTO-V LoZ	---	0.5 V, 45 Hz	NA	0.2 to 0.8, AC Annunciator On	NA	0.2 to 0.8, AC Annunciator On	0.2 to 0.8, AC Annunciator On
39.		---	0.5 v, 0 Hz	NA	0.2 to 0.8, AC Annunciator On	NA	0.2 to 0.8, AC Annunciator On	0.2 to 0.8, AC Annunciator On
40.		---	500 V ^[2] , 500 Hz	NA	489.7 to 510.3	NA	489.7 to 510.3	489.7 to 510.3
41.	VoltAlert	H	---	NA				[3]
42.	VoltAlert	L	---	NA				[4]

[1] If using a Fluke 9100 calibrator, the Calibrator Frequency mode must be used to obtain accurate frequency.

[2] To keep from tripping the calibrator to standby, ramp up the voltage in 50 V increments with a 5 second delay between increments.

[3] See steps 1-5 in *Testing the VoltAlert Function (117 only)*.

[4] See steps 6-9 in *Testing the VoltAlert Function (117 only)*.

Table 4. DMM Performance Tests: 113

Step	Function	Range	Applied	Display Reading
1.	Ω Ohms	600.0	0.0 Ω	0.0 to 0.2 (2-Wire comp)
2.		600.0	500 Ω	495.3 to 504.7
3.		6.000 k	5 kΩ	4.954 to 5.046
4.		60.00 k	50 kΩ	49.54 to 50.46
5.	Ⓢ CHEK Continuity	NA	20 Ω	Beeper On
6.		NA	250 Ω	Beeper Off
7.	Ⓢ CHEK → Diode Test	NA	1.9 V	1.859 to 1.941
8.	Ⓢ CHEK Volts ^[1]	6.000 V	0.1 V	0.095 to 0.105
9.		6.000 V	5 V	4.897 to 5.103
10.		6.000 V	-5 V	-5.103 to -4.897
11.		6.000 V	5 V, 45 Hz	4.897 to 5.103
12.		6.000 V	5 V, 1 kHz	4.797 to 5.203
13.		60.00 V	50 V	48.97 to 51.03
14.		60.00 V	-50 V	-51.03 to -48.97
15.		60.00 V	50 V, 500 Hz	48.97 to 51.03
16.		60.00 V	50 V, 1 kHz	47.97 to 52.03
17.		600.0 V ^[2]	600 V	587.7 to 612.3
18.		600.0 V ^[2]	-600 V	-612.3 to -587.7
19.		600.0 V ^[2]	600 V, 45 Hz	587.7 to 612.3
20.		600.0 V ^[2]	600 V, 1 kHz	575.7 to 624.3
21.	Ⓢ Capacitance	1000 nF	Open	0 to 2
22.		9999 μF	900 μF	881 to 919

[1] Manually select the range by pressing **RANGE** .

[2] To keep from tripping the calibrator to standby, ramp up the voltage in 50 V increments with a five-second delay between increments.

Testing the VoltAlert Function (117 only)

Use this procedure to verify that VoltAlert functions properly.

Note

- Make sure the instrument is REMOVED from the holster before you do the test.
- Keep the Meter away from electrical noise sources during the tests, for example, florescent lights, dimming lights, and motors. These types of noise source can trigger VoltAlert and invalidate the test.
- It may be necessary in steps 4 and 8 below to slightly adjust the Meter position for maximum signal strength to get the Meter beeper to sound continuously.

Refer to Figure 4 for these steps:

1. Select the VoltAlert function and verify that **Hi** is on the display. Verify that the beeper is silent and the red LED is off.
2. Connect a double banana plug to the output voltage terminals of the calibrator (Fluke 5500A or equivalent).
3. Set the calibrator output to 10 V at 60 Hz.
4. Hold the Meter so that the top is vertically and horizontally centered and contacting the banana plug Hi terminal. Verify that the Meter beeper is on continuously and the red LED at the top of the display lights.
5. Place the calibrator in standby mode and verify that the beeper is now silent and the red LED is off.
6. Press **RANGE** (display should indicate **Lo** range).
7. Set the calibrator output to 30 V at 60 Hz.

Figure 4. VoltAlert Test

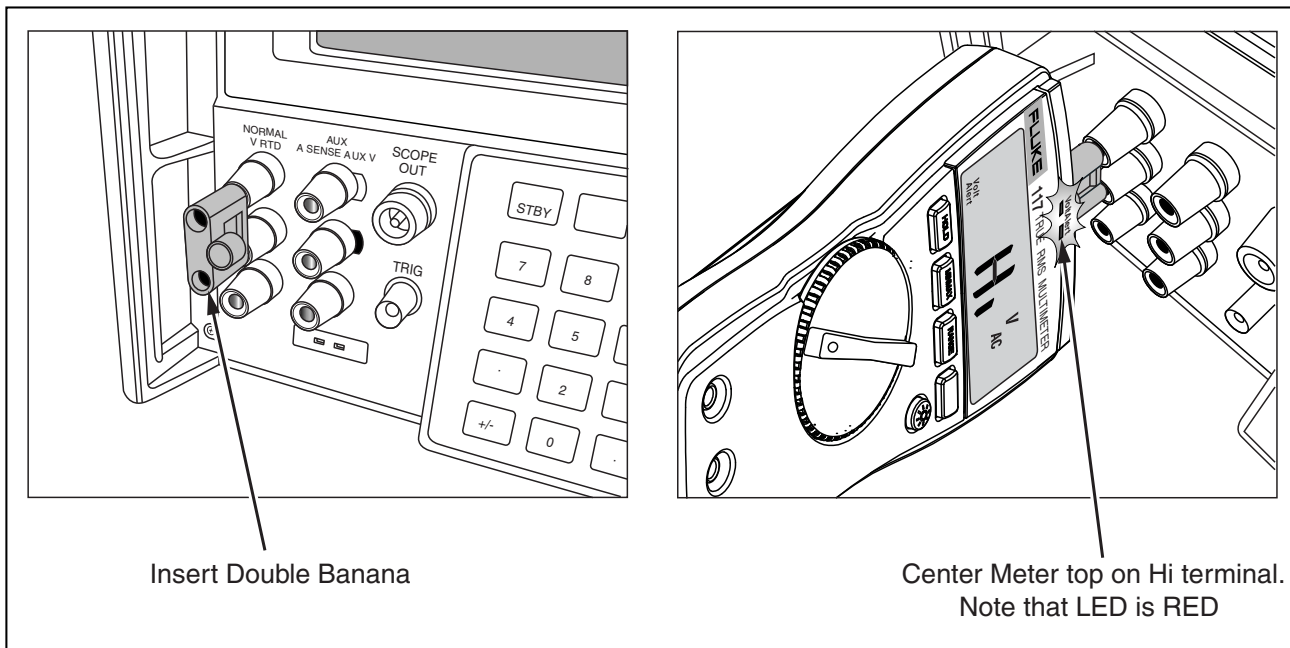

8. Hold the Meter so that the top is vertically and horizontally centered to the banana plug Hi terminal. Verify that the Meter beeper is sounding continuously and the red LED at the top of the display lights.
9. Return the calibrator to standby mode and verify the Meter beeper is silent and the red LED is off.

For Fluke 117 with S/N 38920290 through 42913406, use this alternate calibration procedure to verify that VoltAlert functions properly. See Figure 5.

1. Select the VoltAlert function:
 - a. Verify that **H** is on the display.
 - b. Verify that the beeper is silent and the red LED is off.
2. Connect wire (Pomona 4911A-12-2 or equivalent) to the High output voltage terminals of the calibrator (Fluke 5500A or equivalent).
3. Set the calibrator output to 10 V at 60 Hz.
4. Hold the Meter so that the wire contacts and runs across the top center of the unit. The wire should run perpendicular to the face of the unit (front to back of Meter, not side to side). Verify that the Meter beeper is on continuously and the red LED, at the top of the display, lights up.
5. Place the calibrator in standby mode and verify that the beeper is silent and the red LED is off.
6. Press **RANGE**.
Display should indicate **L0** range.
7. Set the calibrator output to 30 V at 60 Hz.
8. Hold the Meter so that the wire contacts and runs across the top center of the unit. The wire should run perpendicular to the face of the unit (front to back of Meter, not side to side). Verify that the Meter beeper is on continuously and the red LED, at the top of the display, lights up.
9. Return the calibrator to standby mode and verify the Meter's beeper is silent and the red LED is off.

Figure 5. Volt Alert Test (Alternate)

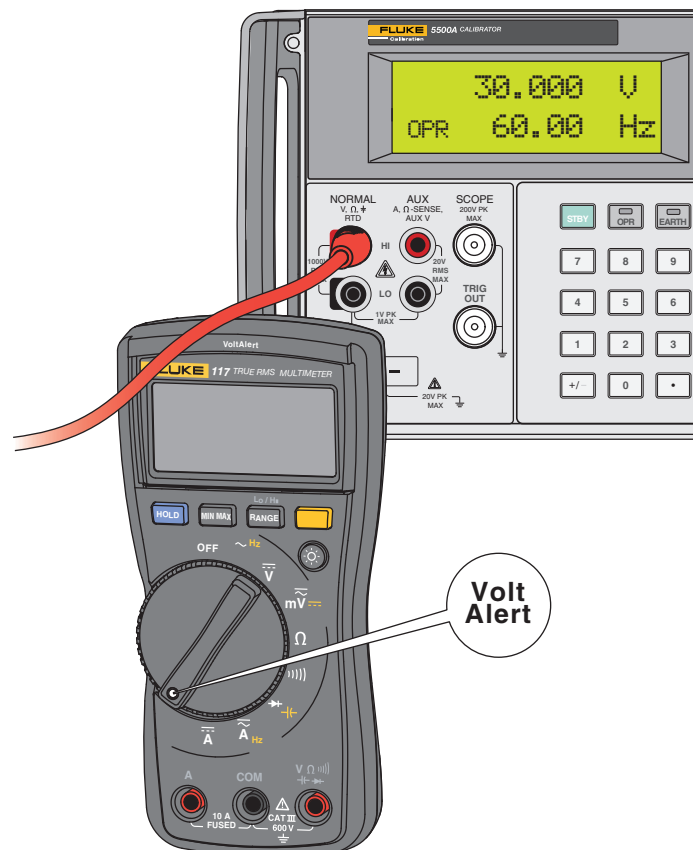

Calibration Adjustment

The Meter features closed-case calibration adjustment using known reference sources. The Meter measures the applied reference source, calculates correction factors, and stores the correction factors in nonvolatile memory. The following sections present the features and Meter pushbutton functions available during the Calibration Adjustment Procedure. Should the Meter fail any of the performance tests, perform the Calibration Adjustment Procedure.

110/114/115/116/117

Use these steps to view the Meter calibration counter:

1. While pressing **HOLD**, turn the rotary switch from **OFF** to Ω function. The Meter should display ζRL .
2. Press once to view the calibration counter. For example, $n00 l$.
3. Turn the rotary switch to **OFF**.

113

1. While pressing **RANGE**, turn the rotary switch from **OFF** to Ω function. The Meter should display ζRL .
2. Press once to view the calibration counter. For example, $n00 l$.
3. Turn the rotary switch to **OFF**.

Calibration Adjustment Password

To start the Calibration Adjustment Procedure, the correct 4-digit password must be entered. The default password is $l234$. The password can be changed or reset to the default as described in following paragraphs.

Changing the Password

Use these steps to change the Meter password:

1. **110/114/115/116/117:**

While pressing **HOLD**, turn the rotary switch from **OFF** to Ω function.

113:

While pressing **RANGE**, turn the rotary switch from **OFF** to Ω function.

The Meter should display ζRL .

2. Press once to see the calibration counter.
3. Press again to start the password entry.

The Meter displays $????$.

The Meter buttons indicated below represent the numbers 1 through 5 when you enter or change the password:

HOLD = 1 **MIN MAX** = 2 **RANGE** = 3 = 4 \oplus = 5

4. Press 4 buttons to enter the current password. To change the password for the first time, enter **HOLD** (1), **MIN MAX** (2), **RANGE** (3), and (4).
5. Press **RANGE** to change the password.
The Meter displays $----$ if the entered password is correct. If the password is not correct, the Meter emits a double beep, displays $????$, and the password must be entered again. Repeat step 4.
6. Press the 4 buttons of the new password.
7. Press to store the new password.

Restoring the Default Password

If the calibration password is forgotten, the default password (1234) can be manually restored:

⚠⚠ Warning

To prevent electric shock or personal injury, remove the test leads and any input signal before removing the Meter's back case.

1. Remove the Meter back case. Leave the PCA in the top case.
2. Apply 9.0 V across the battery contacts (XBT1) + and (XBT2) – on the back of the PCA. See Figure 6.
3. Turn the rotary switch from **OFF** to any **ON** position.
4. Short across the S7 CAL keypad on the back of the PCA. See Figure 6. The Meter should beep. The default password is now restored.
5. Remove the 9.0 V supply and replace the Meter back case.

Figure 6. Calibration Password Reset

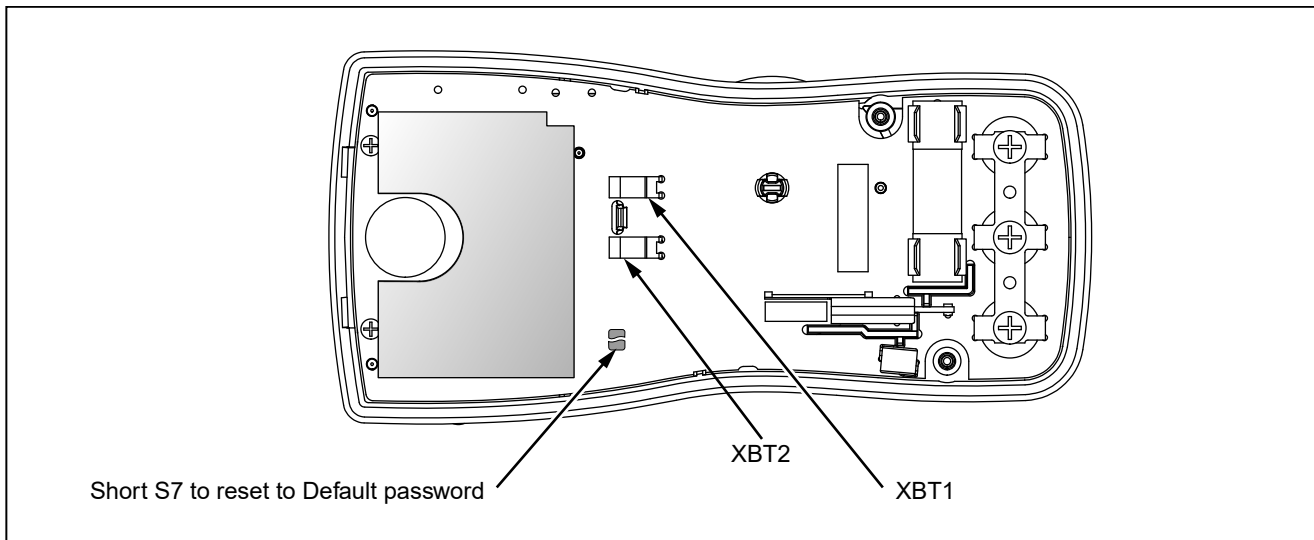

Meter Buttons Used in the Calibration Steps

For the Calibration Adjustment Procedure, the Meter buttons behave as follows:

- Press and hold **HOLD** to show the measured value. The measured value is not calibrated so it may not match the input value. This is normal.
- Press and hold **MIN MAX** to display the required input value.
- Press to store the calibration value and advance to the next step. This button is also used to exit calibration mode after the calibration adjustment sequence is complete.
- Press  to toggle the backlight on and off.

This can be useful to determine why a calibration step is not accepted and to determine the input value without referring to Table 5.

Calibration Adjustment Procedure

Note

If you turn off the Meter before completion of the adjustment procedure, the calibration constants do not change.

To adjust the Meter calibration:

1. 110/114/115/116/117:

While pressing **HOLD**, turn the rotary switch from **OFF** to Ω function.

113:

While pressing RANGE, turn the rotary switch from **OFF** to Ω function.

The Meter should display $\frac{f}{RL}$.

2. Press once to see the calibration counter.

3. Press again to start the password entry.

The Meter displays $\overline{P}P\overline{P}P$.

4. Press the 4-button password.

5. Press to go to the first calibration step. The Meter displays [] if the password is correct. If the password is not correct, the Meter emits a double beep, displays $\overline{P}P\overline{P}P$ and the password must be entered again. Repeat step 4.

6. Apply the input value listed for each calibration adjustment step. For each step, select the rotary switch position and apply the input to the terminals as indicated in Table 5 and Table 6.

Note

Some adjustment steps require additional wait time after the calibrator settles, as noted in Table 5 and Table 6.

7. After each input value is applied, press to accept the value and proceed to the next step ($\overline{E}00P$).

Note

After you press , wait until the step number advances before you change the calibrator source or turn the rotary switch. Some adjustment steps can take up to several seconds to execute before the next step.

If the rotary switch is not in the correct position for a given step, the meter will flash the unit annunciators until the rotary switch is put in a valid position. The keys that show the reading and required input values are not allowed until the rotary switch is correct.

If the rotary switch is not in the correct position or the measured value is not within the anticipated range of the input value, the Meter will emit a double beep and will not continue to the next step when you press .

After the final step, the display shows End to indicate that the calibration adjustment is complete.

8. Press to return to meter mode.

Note

Set the calibrator to Standby before you change the function switch position and after you complete adjustment of each function.

If the calibration adjustment procedure is not properly completed, the Meter will not operate correctly.

Table 5. Calibration Adjustment Steps (110/114/115/116/117)

Rotary Switch Position	Display Reading				Input Terminals	Calibrator Source Value
	110/114	115 ^[1]	116 ^[1]	117 ^[1, 2]		
Ω Ohms	NA	[00]	[00]	[00] ^[2]	no leads	no leads
$m\tilde{V}$	[00]	[002	[002	[002	V Ω /+ and COM	0 V, 0 Hz
	[002	[003	[003	[003	V Ω /+ and COM	300 mV, 0 Hz
	[003	[004	[004	[004	V Ω /+ and COM	100 mV, 0 Hz
	[004	[005	[005	[005	V Ω /+ and COM	-300 mV, 0 Hz
	[005	[006	[006	[006	V Ω /+ and COM	60 mV, 0 Hz
	[006	[007	[007	[007	V Ω /+ and COM	600 mV, 0 Hz
	[007	[008	[008	[008	V Ω /+ and COM	600 MV, 60 Hz
Ω Ohms	[008	[009	[009	[009	V Ω /+ and COM	600 Ω , 2-wire comp
	[009	[0 10	[0 10	[0 10	V Ω /+ and COM	6 k Ω
	[0 10	[0 11	[0 11	[0 11	V Ω /+ and COM	60 k Ω
	[0 11	[0 12	[0 12	[0 12	V Ω /+ and COM	600 k Ω
	[0 12	[0 13	[0 13	[0 13	V Ω /+ and COM	6 M Ω ^[3]
	[0 13	[0 14	[0 14	[0 14	V Ω /+ and COM	short ^[3]
	[0 14	[0 15	[0 15	[0 15	V Ω /+ and COM	40 M Ω ^[3]
\tilde{V}	[0 15	[0 16	[0 16	[0 16	V Ω /+ and COM	6 V, 60 Hz
	[0 16	[0 17	[0 17	[0 17	V Ω /+ and COM	60 V, 60 Hz
	[0 17	[0 18	[0 18	[0 18	V Ω /+ and COM	600 V, 60 Hz
	[0 18	[0 19	[0 19	[0 19	V Ω /+ and COM	6 V, 0 Hz
	[0 19	[020	[020	[020	V Ω /+ and COM	60 V, 0 Hz
	[020	[02]	[02]	[02]	V Ω /+ and COM	600 V, 0Hz

Table 5. Calibration Adjustment Steps (110/114/115/116/117) (cont.)





Rotary Switch Position	Display Reading				Input Terminals	Calibrator Source Value
	110/114	115 ^[1]	116 ^[1]	117 ^[1, 2]		
Set calibrator to standby, reconfigure leads, and program for amps output.						
	NA	[022	NA	[022	A and COM	6 A, 60 Hz ^[3]
	NA	[023	NA	[023	A and COM	6 A, 0 Hz
 DC μ Amps	NA	NA	[022	NA	+ and COM	600 μ A, 60 Hz
	NA	NA	[023	NA	+ and COM	600 μ A, 0 Hz
<p>[1] Models listed in this column also refer to the "C" version of the model. For example, model 115 steps are valid for the 115C.</p> <p>[2] Do not calibrate the 117 or 117C with a line-frequency power source nearby (for example, fluorescent light or power strip). These devices can produce errors in the VoltAlert calibration.</p> <p>[3] Wait an additional 5 seconds after calibrator has settled before pressing <input type="checkbox"/>.</p>						

Table 6. Calibration Adjustment Steps (113)

Rotary Switch Position	Calibration Steps	Input Terminals	Calibrator Source Value
 CHEK mV ac/dc	[- 01	+ and COM	0 V, 0 Hz
	[- 02	+ and COM	300 mV, 0 Hz
	[- 03	+ and COM	100 mV, 0 Hz
	[- 04	+ and COM	-300 mV, 0 Hz
	[- 05	+ and COM	60 mV, 0 Hz
	[- 06	+ and COM	600 mV, 0 Hz
	[- 07	+ and COM	600 mV, 60 Hz
Ω Ohms	[- 08	+ and COM	600 Ω , 2-wire comp
	[- 09	+ and COM	6 k Ω
	[- 10	+ and COM	60 k Ω
	[- 11	+ and COM	600 k Ω
 CHEK V ac	[- 12	+ and COM	6 V, 60 Hz
	[- 13	+ and COM	60 V, 60 Hz
	[- 14	+ and COM	600 V, 60 Hz ^[1]
<p>[1] To keep from tripping the calibrator to standby, ramp up the voltage in 50 V increments with a 5 second delay between increments.</p>			

Replacement Parts

See Table 7 and Figure 7 for information about replaceable parts.

Table 7. Replacement Parts

Item	Description	Part Number	QTY
①	LCD,FLUKE-11X,3.2V,TN,4-DIGIT,1/4-DUTY,1/3-BIAS,LEPTON	2509955	1
②	CONNECTOR,ELASTOMERIC,.010 IN CTR,.218 IN HIGH,.090 IN THK,2.284 IN LONG,BULK	2534229	1
③	FLUKE-117-2006,BRACKET MASK, 117	2525608	1
	FLUKE-117-2006-06,BRACKET MASK, 117 China	2631059	1
	FLUKE-117-2006-08,BRACKET MASK, 113	3088082	1
	FLUKE-117-2006-01,BRACKET MASK, 114	2527431	1
	FLUKE-117-2006-02,BRACKET MASK, 115	2527446	1
	FLUKE-117-2006-04,BRACKET MASK, 115 China	2631032	1
	FLUKE-117-2006-03,BRACKET MASK, 116	2527454	1
	FLUKE-117-2006-05,BRACKET MASK, 116 China	2631044	1
④	FLUKE-117-8005,DIFFUSER, BACKLIGHT	2535203	1
⑤	FLUKE-117-2001,CASE TOP, 117	2525553	1
	FLUKE-117-2001-07,CASE TOP, 110	5166573	1
	FLUKE-117-2001-04,CASE TOP, 113	3092058	1
	FLUKE-117-2001-01,CASE TOP, 114	2527405	1
	FLUKE-117-2001-02,CASE TOP, 115	2527410	1
	FLUKE-117-2001-03,CASE TOP, 116	2527422	1
⑥	FLUKE-117-2008,KNOB	2525624	1
⑦	FLUKE-117-7602,RSOB HOUSING ASSEMBLY	2787083	1
⑧	FLUKE-117-8001,KEYPAD	2526276	1
⑨	FLUKE-117-2009,SPRING DETENT	2525636	1
⑩	FLUKE-117-8009,SHIELD, TOP	2571277	1
⑪	FLUKE-117-8010,IC SHIELD	2571292	1
⑫	O-RING,NITRILE,SHORE A 70,15.6MM OD,12.0MM ID,1.8MM W	2535215	1

Table 7. Replacement Parts (cont.)

Item	Description	Part Number	QTY
⑬	FLUKE-117-2002,CASE BOTTOM	2525566	1
	FLUKE-117-2002,CASE BOTTOM, 11X China	2631098	1
⑭ ⑳	FLUKE-117-2003,BATTERY DOOR,TILT STAND	2720600	1
	FLUKE-117-2003,BATTERY DOOR, TILT STAND, 11X China	2720617	1
⑮	SCREW,2-28,.250,PAN,PHILLIPS,STEEL,ZINCCHROMATE, PLASTITE 48 THREAD FORMING	2516493	4
⑯	SCREW,M3,4MM,PAN,PHILLIPS,STEEL,ZINC-CHROMATE	2032811	2 (114, 110, 116) 3 (115,117)
⑰	SCREW,5-14,.750,PAN,PHILLIPS,STEEL,BLACK CHROMATE, THD FORMING	832246	2
⑱	SCREW,M3X0.5,6MM,PAN,PHILLIPS,STEEL,ZINC-BLACK CHROMATE	2032792	1
⑲	BATTERY,PRIMARY,MNO2-ZN,9V,505MAH,6LR61, ALKALINE, 17X26X48MM,BULK	614487	1
㉑	FLUKE 12-8004,SHOCK ABSORBER	878983	1
㉒	FLUKE-117-2010,HOLSTER	2525649	1
	FLUKE-117-2010,HOLSTER, 11X China	2631080	1
㉓	FUSE,11A,1000V,FAST.406INX1.5IN,BULK	803293	1 (115, 117)
not shown	110/113/114/115/117 Users Manual		
not shown	116 Users Manual		

Figure 7. Exploded View of Meter

