

FLUKE®

80 Series V

Digital Multimeter

Calibration Manual

Introduction

⚠️⚠️ Warning

To avoid shock or injury:

- **Read “Precautions and Safety Information” before performing the verification tests or calibration adjustment procedures documented in this manual.**
- **Do not perform the verification tests or calibration adjustment procedures described in this manual unless you are qualified to do so.**
- **The information provided in this manual is for the use of qualified personnel only.**

⚠️ Caution

- **The 80 Series V Digital Multimeters contains parts that can be damaged by static discharge.**
- **Follow the standard practices for handling static sensitive devices.**

The *80 Series V Calibration Manual* provides the following information:

- Safety information
- Specifications
- Basic maintenance (cleaning, replacing the battery and fuses)
- Performance test procedures
- Calibration adjustment procedures
- Replaceable parts

For complete operating instructions, refer to the *80 Series V* or *88 Series V Users Manual*.

⚠ ⚠ Warning

To avoid possible electric shock or personal injury, inspect the test leads for damaged insulation or exposed metal. Check the test leads for continuity. Replace damaged test leads before using the Meter.

Precautions and Safety Information

In this manual, a **Warning** identifies conditions and actions that pose hazard(s) to the user; a **Caution** identifies conditions and actions that may damage the Meter or the test instruments.

⚠ ⚠ Warning

To avoid possible electric shock or personal injury, follow these guidelines:

- Use this Meter only as specified in this manual or the protection provided by the Meter might be impaired.
- Do not use the Meter if it is damaged. Before using the Meter, inspect the case. Look for cracks or missing plastic. Pay particular attention to the insulation surrounding the connectors.
- Make sure the battery door is closed and latched before operating the Meter.
- Replace the battery as soon as the battery indicator (⊕) appears.
- Remove test leads from the Meter before opening the battery door.
- Inspect the test leads for damaged insulation or exposed metal. Check the test leads for continuity. Replace damaged test leads before using the Meter.
- Do not apply more than the rated voltage, as marked on the Meter, between the terminals or between any terminal and earth ground.
- Never operate the Meter with the cover removed or the case open.
- Use caution when working with voltages above 30 V ac rms, 42 V ac peak, or 60 V dc. These voltages pose a shock hazard.
- Use only the replacement fuses specified in this manual.
- Use the proper terminals, function, and range for measurements.
- Avoid working alone.
- When measuring current, turn off circuit power before connecting the Meter in the circuit. Remember to place the Meter in series with the circuit.

- **When making electrical connections, connect the common test lead before connecting the live test lead; when disconnecting, disconnect the live test lead before disconnecting the common test lead.**
- **Do not use the Meter if it operates abnormally. Protection may be impaired. When in doubt, have the Meter serviced.**
- **Do not operate the Meter around explosive gas, vapor, or dust.**
- **Use only a single 9 V battery, properly installed in the Meter case, to power the Meter.**
- **When servicing the Meter, use only specified replacement parts.**
- **When using probes, keep fingers behind the finger guards on the probes.**
- **Do not use the Low Pass Filter option to verify the presence of hazardous voltages. Voltages greater than what is indicated may be present. Make a voltage measurement without the filter to detect the possible presence of hazardous voltage, then select the filter function.**

⚠ Caution















To avoid possible damage to the Meter or to the equipment under test, follow these guidelines:

- **Disconnect circuit power and discharge all high-voltage capacitors before testing resistance, continuity, diodes, or capacitance.**
- **Before measuring current, check the Meter's fuses. See " Testing the Fuses".**

Electrical Symbols

Electrical symbols used on the Meter and in this manual are explained in Table 1.

Table 1. Electrical Symbols

	AC (Alternating Current)		Earth ground
	DC (Direct Current)		Fuse
	Hazardous voltage.		Conforms to European Union directives
	Risk of Danger. Important information. See Manual.		Conforms to relevant Canadian Standards Association directives
	Battery		Double insulated
	Continuity test or continuity beeper tone.		Capacitance
	Underwriters Laboratories		Diode
CAT III	IEC overvoltage category III CAT III equipment is designed to protect against transients in equipment in fixed-equipment installations, such as distribution panels, feeders and short branch circuits, and lighting systems in large buildings.	CAT IV	IEC overvoltage category IV CAT IV equipment is designed to protect against transients from the primary supply level, such as an electricity meter or an overhead or underground utility service.
	Inspected and licensed by TÜV Product Services.		

Specifications

General Specifications

Maximum Voltage between any Terminal and Earth Ground: 1000 V rms

 **Fuse Protection for mA or μ A inputs:** 44/100 A, 1000 V FAST Fuse

 **Fuse Protection for A input:** 11 A, 1000 V FAST Fuse

Display: Digital: 6000 counts updates 4/sec; (Model 87 and 88 also has 19,999 counts in high-resolution mode).

Analog Bargraph: 33 segments, updates 40/sec. Frequency: 19,999 counts, updates 3/sec at > 10 Hz

Temperature: Operating: -20 °C to +55 °C; Storage: -40 °C to +60 °C

Altitude: Operating: 2000 m; Storage: 10,000 m

Temperature Coefficient: 0.05 x (specified accuracy)/ °C (< 18 °C or > 28 °C)

Electromagnetic Compatibility: In an RF field of 3 V/m total accuracy = specified accuracy + 20 counts

Except: 600 μ A dc range total accuracy=specified accuracy + 60 counts.

Temperature not specified.

Relative Humidity: 0 % to 90 % (0 °C to 35 °C); 0 % to 70 % (35 °C to 55 °C)

Battery Type: 9 V zinc, NEDA 1604 or 6F22 or 006P

Battery Life: 400 hrs typical with alkaline battery (with backlight off)

Vibration: Per MIL-PRF-28800 for a Class 2 instrument

Shock: 1 Meter drop per IEC 61010-1:2001

Size (HxWxL): 1.25 in x 3.41 in x 7.35 in (3.1 cm x 8.6 cm x 18.6 cm)

Size with Holster and Flex-Stand: 2.06 in x 3.86 in x 7.93 in (5.2 cm x 9.8 cm x 20.1 cm)

Weight: 12.5 oz (355 g)

Weight with Holster and Flex-Stand: 22.0 oz (624 g)

Safety: Complies with ANSI/ISA S82.01-2004, CSA 22.2 No. 1010.1:2004 to 1000 V Overvoltage Category III, IEC

664 to 600 V Overvoltage Category IV. UL listed to UL61010-1. Licensed by TÜV to EN61010-1.

Detailed Specifications

For all detailed specifications:

Accuracy is given as $\pm([\% \text{ of reading}] + [\text{number of least significant digits}])$ at 18° C to 28° C, with relative humidity up to 90 %, for a period of one year after calibration.

For Model 87 in the 4 ½-digit mode, multiply the number of least significant digits (counts) by 10. AC conversions are ac-coupled and valid from 3 % to 100 % of range. Model 87 is true rms responding. AC crest factor can be up to 3 at full scale, 6 at half scale. For non-sinusoidal wave forms add $-(2 \% \text{ Rdg} + 2 \% \text{ full scale})$ typical, for a crest factor up to 3.

Table 2. Model 87 AC Voltage Function Specifications

Function	Range	Resolution	Accuracy						
			45 - 65 Hz	30 - 200 Hz	200 - 440 Hz	440 Hz - 1 kHz	1 - 5 kHz	5 - 20 kHz ¹	
\tilde{V} 2,4	600.0 mV	0.1 mV	$\pm (0.7 \% + 4)$	$\pm (1.0 \% + 4)$	$\pm (1.0 \% + 4)$	unspecified	$\pm (2.0 \% + 4)$	$\pm (2.0 \% + 20)$	
	6.000 V	0.001 V							
	60.00 V	0.01 V	$\pm (0.7 \% + 2)$					$\pm (2.0 \% + 4)^3$	unspecified
	600.0 V	0.1 V							
1000 V	1 V		unspecified	unspecified					
	Low pass filter		$\pm (0.7 \% + 2)$	$\pm (1.0 \% + 4)$	+1 % + 4 -6 % - 4 ⁵	unspecified	unspecified	unspecified	

1. Below 10 % of range, add 12 counts.
2. The Meter is a true rms responding meter. When the input leads are shorted together in the ac functions, the Meter may display a residual reading between 1 and 30 counts. A 30 count residual reading will cause only a 2-digit change for readings over 3 % of range. Using REL to offset this reading may produce a much larger constant error in later measurements.
3. Frequency range: 1 kHz to 2.5 kHz.
4. A residual reading of up to 13 digits with leads shorted, will not affect stated accuracy above 3 % of range.
5. Specification increases from -1% at 200 Hz to -6% at 440 Hz when filter is in use.

Table 3. Models 83 and 88 AC Voltage Function Specifications

Function	Range	Resolution	Accuracy		
			50 Hz - 60 Hz	30 Hz - 1 kHz	1 kHz - 5 kHz
\tilde{V} 1	600.0 mV	0.1 mV	$\pm (0.5 \% + 4)$	$\pm (1.0 \% + 4)$	$\pm (2.0 \% + 4)$
	6.000 V	0.001 V			
	60.00 V	0.01 V			
	600.0 V	0.1 V			
	1000 V	1 V			
					$\pm (2.0 \% + 4)^2$
					unspecified

1. Below a reading of 200 counts, add 10 counts.
2. Frequency range: 1 kHz to 2.5 kHz.

For models 83 and 88, ac conversions are ac-coupled and are average- responding, rms-indicating.

Table 4. DC Voltage, Resistance, and Conductance Function Specifications

Function	Range	Resolution	Accuracy		
			Model 83	Model 87	Model 88
\bar{V}	6.000 V	0.001 V	$\pm (0.1 \% + 1)$	$\pm (0.05 \% + 1)$	$\pm (0.1 \% + 1)$
	60.00 V	0.01 V	$\pm (0.1 \% + 1)$	$\pm (0.05 \% + 1)$	$\pm (0.1 \% + 1)$
	600.0 V	0.1 V	$\pm (0.1 \% + 1)$	$\pm (0.05 \% + 1)$	$\pm (0.1 \% + 1)$
	1000 V	1 V	$\pm (0.1 \% + 1)$	$\pm (0.05 \% + 1)$	$\pm (0.1 \% + 1)$
\bar{mV}	600.0 mV	0.1 mV	$\pm (0.3 \% + 1)$	$\pm (0.1 \% + 1)$	$\pm (0.3 \% + 1)$
Ω	600.0 Ω	0.1 Ω	$\pm (0.4 \% + 2)^1$	$\pm (0.2 \% + 2)^1$	$\pm (0.4 \% + 2)^1$
	6.000 k Ω	0.001 k Ω	$\pm (0.4 \% + 1)$	$\pm (0.2 \% + 1)$	$\pm (0.4 \% + 1)$
	60.00 k Ω	0.01 k Ω	$\pm (0.4 \% + 1)$	$\pm (0.2 \% + 1)$	$\pm (0.4 \% + 1)$
	600.0 k Ω	0.1 k Ω	$\pm (0.7 \% + 1)$	$\pm (0.6 \% + 1)$	$\pm (0.7 \% + 1)$
	6.000 M Ω	0.001 M Ω	$\pm (0.7 \% + 1)$	$\pm (0.6 \% + 1)$	$\pm (0.7 \% + 1)$
nS	50.00 M Ω	0.01 M Ω	$\pm (1.0 \% + 3)^2$	$\pm (1.0 \% + 3)^2$	$\pm (1.0 \% + 3)^2$
	60.00 nS	0.01 nS	$\pm (1.0 \% + 10)^1$	$\pm (1.0 \% + 10)^1$	$\pm (1.0 \% + 10)^1$

1. When using the REL Δ function to compensate for offsets.
2. Add 0.5 % of reading when measuring above 30 M Ω in the 50 M Ω range, and 20 counts below 33 nS in the 60 nS range.

Table 5. Temperature Specifications (87 and 88 Only)

Temperature	Resolution	Accuracy ^{1,2}
-200 °C to +1090 °C	0.1 °C	1 % + 10
-328 °F to +1994 °F	0.1 °F	1 % + 18



1. Does not include error of the thermocouple probe.
2. Accuracy specification assumes ambient temperature stable to ± 1 °C. For ambient temperature changes of ± 5 °C, rated accuracy applies after 1 hour.

Table 6. Current Function Specifications

Function	Range	Resolution	Accuracy			Burden Voltage (typical)
			Model 83 ¹	Model 87 ^{2, 3}	Model 88 ¹	
$\text{mA} \sim$ (45 Hz to 2 kHz)	60.00 mA	0.01 mA	$\pm (1.2 \% + 2)^5$	$\pm (1.0 \% + 2)$	$\pm (1.2 \% + 2)^5$	1.8 mV/mA
	400.0 mA ⁶	0.1 mA	$\pm (1.2 \% + 2)^5$	$\pm (1.0 \% + 2)$	$\pm (1.2 \% + 2)^5$	1.8 mV/mA
	6.000 A	0.001 A	$\pm (1.2 \% + 2)^5$	$\pm (1.0 \% + 2)$	$\pm (1.2 \% + 2)^5$	0.03 V/A
	10.00 A ⁴	0.01 A	$\pm (1.2 \% + 2)^5$	$\pm (1.0 \% + 2)$	$\pm (1.2 \% + 2)^5$	0.03 V/A
$\text{mA} \overline{\sim}$	60.00 mA	0.01 mA	$\pm (0.4 \% + 4)$	$\pm (0.2 \% + 4)$	$\pm (0.4 \% + 4)$	1.8 mV/mA
	400.0 mA ⁶	0.1 mA	$\pm (0.4 \% + 2)$	$\pm (0.2 \% + 2)$	$\pm (0.4 \% + 2)$	1.8 mV/mA
	6.000 A	0.001 A	$\pm (0.4 \% + 4)$	$\pm (0.2 \% + 4)$	$\pm (0.4 \% + 4)$	0.03 V/A
	10.00 A ⁴	0.01 A	$\pm (0.4 \% + 2)$	$\pm (0.2 \% + 2)$	$\pm (0.4 \% + 2)$	0.03 V/A
$\mu\text{A} \sim$ (45 Hz to 2 kHz)	600.0 μA	0.1 μA	$\pm (1.2 \% + 2)^5$	$\pm (1.0 \% + 2)$	$\pm (1.2 \% + 2)^5$	100 $\mu\text{V}/\mu\text{A}$
	6000 μA	1 μA	$\pm (1.2 \% + 2)^5$	$\pm (1.0 \% + 2)$	$\pm (1.2 \% + 2)^5$	100 $\mu\text{V}/\mu\text{A}$
$\mu\text{A} \overline{\sim}$	600.0 μA	0.1 μA	$\pm (0.4 \% + 4)$	$\pm (0.2 \% + 4)$	$\pm (0.4 \% + 4)$	100 $\mu\text{V}/\mu\text{A}$
	6000 μA	1 μA	$\pm (0.4 \% + 2)$	$\pm (0.2 \% + 2)$	$\pm (0.4 \% + 2)$	100 $\mu\text{V}/\mu\text{A}$

1. AC conversion for Model 83 and 88 is ac coupled and calibrated to the rms value of a sine wave input.
2. AC conversions for Model 87 are ac coupled, true rms responding, and valid from 3 % to 100 % of range, except 400 mA range (5 % to 100 % of range) and 10 A range (15 % to 100 % of range).
3. Model 87 is a true rms responding meter. When the input leads are shorted together in the ac functions, the Meter may display a residual reading between 1 and 30 counts. A 30 count residual reading will cause only a 2 digit change for readings over 3 % of range. Using REL to offset this reading may produce a much larger constant error in later measurements
4. Δ 10 A continuous up to 35 °C; < 20 minutes on, 5 minutes off at 35 °C to 55 °C. 20 A for 30 seconds maximum; > 10 A unspecified.
5. Below a reading of 200 counts, add 10 counts.
6. 400 mA continuous; 600 mA for 18 hrs maximum.

Table 7. Capacitance and Diode Function Specifications



Function	Range	Resolution	Accuracy
	10.00 nF	0.01 nF	$\pm (1\% + 2)^1$
	100.0 nF	0.1 nF	$\pm (1\% + 2)^1$
	1.000 μ F	0.001 μ F	$\pm (1\% + 2)$
	10.00 μ F	0.01 μ F	$\pm (1\% + 2)$
	100.0 μ F	0.1 μ F	$\pm (1\% + 2)$
	9999 μ F	1 μ F	$\pm (1\% + 2)$
	3.000 V	0.001 V	$\pm (2\% + 1)$

1. With a film capacitor or better, using Relative mode to zero residual.

Table 8. Frequency Counter Specifications (Models 87 and 83)

Function	Range	Resolution	Accuracy
Frequency (0.5 Hz to 200 kHz, pulse width > 2 μ s)	199.99	0.01 Hz	$\pm (0.005\% + 1)$
	1999.9	0.1 Hz	$\pm (0.005\% + 1)$
	19.999 kHz	0.001 kHz	$\pm (0.005\% + 1)$
	199.99 kHz	0.01 kHz	$\pm (0.005\% + 1)$
	> 200 kHz	0.1 kHz	unspecified

Table 9. Frequency Counter Specifications (Model 88)

Function	Range	Resolution	Accuracy	Pulse Width Range (ms) ¹	Resolution (ms)
Frequency ² (0.5 Hz to 200 kHz, pulse width > 2 μ s)	199.99	0.01 Hz	$\pm (0.01\% + 1)$	1999.9	0.1
	1999.9	0.1 Hz	$\pm (0.01\% + 1)$	5.00	0.01
	19.999 kHz	0.001 kHz	$\pm (0.01\% + 1)$	0.500	0.001
	199.99 kHz	0.01 kHz	$\pm (0.01\% + 1)$	0.0500	0.0001
	> 200 kHz	0.1 kHz	unspecified		
RPM 	30 to 9,000	1 RPM	± 2 RPM		
RPM 	60 to 12,000	1 RPM	± 2 RPM		
% Duty Cycle ³	0.0 to 99.9% (0.5 Hz to 200 kHz, Pulse Width >2 μ s)				
Pulse Width ³	0.002 to 1999.9 ms (4 Hz to 200 kHz, Pulse Width >2 μ s)				

1. Pulse Width range is determined by the frequency of the signal.
2. Frequency measurements can be made on voltage or current inputs. The current inputs are always dc coupled.
3. For rise times >1 μ s. Duty Cycle Accuracy: $\pm(0.2\%$ per kHz + 0.1%). Pulse Width Accuracy: $\pm(0.002$ ms + 3).

Table 10. Frequency Counter Sensitivity and Trigger Levels

Input Range ¹	Minimum Sensitivity (RMS Sine wave)		Approximate Trigger Level (DC Voltage Function)
	5 Hz - 20 kHz	0.5 Hz - 200 kHz	
600 mV dc	70 mV (to 400 Hz)	70 mV (to 400 Hz)	40 mV
600 mV ac	150 mV	150 mV	—
6 V	0.3 V	0.7 V	1.7 V
60 V	3 V	7 V (\leq 140 kHz)	4 V
600 V	30 V	70 V (\leq 14.0 kHz)	40 V
1000 V	100 V	200 V (\leq 1.4 kHz)	100 V
Duty Cycle Range	Accuracy		
0.0 to 99.9 %	Within $\pm (0.2\%$ per kHz + 0.1 %) for rise times < 1 μ s.		

1. Maximum input for specified accuracy = 10X Range or 1000 V.

Table 11. Electrical Characteristics of the Terminals

Function	Overload Protection ¹	Input Impedance (nominal)	Common Mode Rejection Ratio (1 kΩ unbalance)	Normal Mode Rejection						
\bar{V}	1000 V rms	10 MΩ < 100 pF	> 120 dB at dc, 50 Hz or 60 Hz	> 60 dB at 50 Hz or 60 Hz						
\bar{mV}	1000 V rms	10 MΩ < 100 pF	> 120 dB at dc, 50 Hz or 60 Hz	> 60 dB at 50 Hz or 60 Hz						
\tilde{V}	1000 V rms	10 MΩ < 100 pF (ac-coupled)	> 60 dB, dc to 60 Hz	Full Scale Voltage			Typical Short Circuit Current			
				Open Circuit Test Voltage	To 6.0 MΩ	50 MΩ or 60 nS	600 Ω	6 k	60 k	600 k
Ω	1000 V rms	< 7.9 V dc	< 4.1 V dc	< 4.5 V dc	1 mA	100 μA	10 μA	1 μA	1 μA	0.5 μA
\rightarrow	1000 V rms	< 3.9 V dc	3.000 V dc		0.6 mA typical					
10 ⁶ V Hz max										

Table 12. MIN MAX Recording Specifications

Model	Nominal Response	Accuracy
83	100 ms to 80 %	Specified accuracy ± 12 counts for changes > 200 ms in duration (± 40 counts in ac with beeper on)
87, 88	100 ms to 80 % (dc functions) 120 ms to 80 % (ac functions) 250 μs (peak) ¹	Specified accuracy ± 12 counts for changes > 200 ms in duration Specified accuracy ± 40 counts for changes > 350 ms and inputs > 25 % of range Specified accuracy ± 100 counts for changes > 250 μs in duration (add ± 100 counts for readings over 6000 counts) (add ± 100 counts for readings in Low Pass mode)
1. For repetitive peaks: 1 ms for single events.		

Basic Maintenance

Warning

To avoid possible electric shock or personal injury:

- Remove the test leads and any input signals before opening the case or replacing the battery or fuses.
- Repairs or servicing covered in this manual should be performed only by qualified personnel.

Cleaning the Meter

Warning

To avoid possible electric shock, personal injury, or damage to the meter, never allow water inside the case.

Caution

To avoid damaging the Meter, never apply abrasives, solvents, aromatic hydrocarbons, chlorinated solvents, or methanol-based fluids to the Meter.

Periodically wipe the Meter case with Fluke “MeterCleaner™” or a damp cloth and mild detergent.

Dirt or moisture in the **A** or **mA** μ **A** input terminals can affect readings and can falsely activate the Input Alert feature without the test leads being inserted. Such contamination may be dislodged by turning the Meter over and, with all test leads removed, gently tapping on the case.

Thoroughly clean the terminals as follows:

1. Turn the Meter off and remove all test leads.
2. Soak a clean swab with isopropyl alcohol and work the swab around in each input terminal to remove contaminants.

Opening the Meter Case

Caution

To avoid unintended circuit shorting, always place the uncovered Meter assembly on a protective surface. When the case of the Meter is open, circuit connections are exposed.

To open the Meter case, refer to Figure 1 and do the following:

1. Disconnect test leads from any live source, turn the rotary knob to **OFF**, and remove the test leads from the front terminals.
2. Remove the battery door by using a flat-blade screwdriver to turn the battery door screws 1/4-turn counterclockwise.
3. The case bottom is secured to the case top by three screws and two internal snaps (at the LCD end). Using a Phillips-head screwdriver, remove the three screws.

⚠ Caution

To avoid damaging the Meter, the gasket that is sealed to the bottom case, and is between the two case halves, must remain with the case bottom. The case top lifts away from the gasket easily. Do not damage the gasket or attempt to separate the case bottom from the gasket.

4. Hold the Meter display side up.
5. Pushing up from the inside of the battery compartment, disengage the case top from the gasket.
6. Gently unsnap the case top at the display end, see Figure 1.

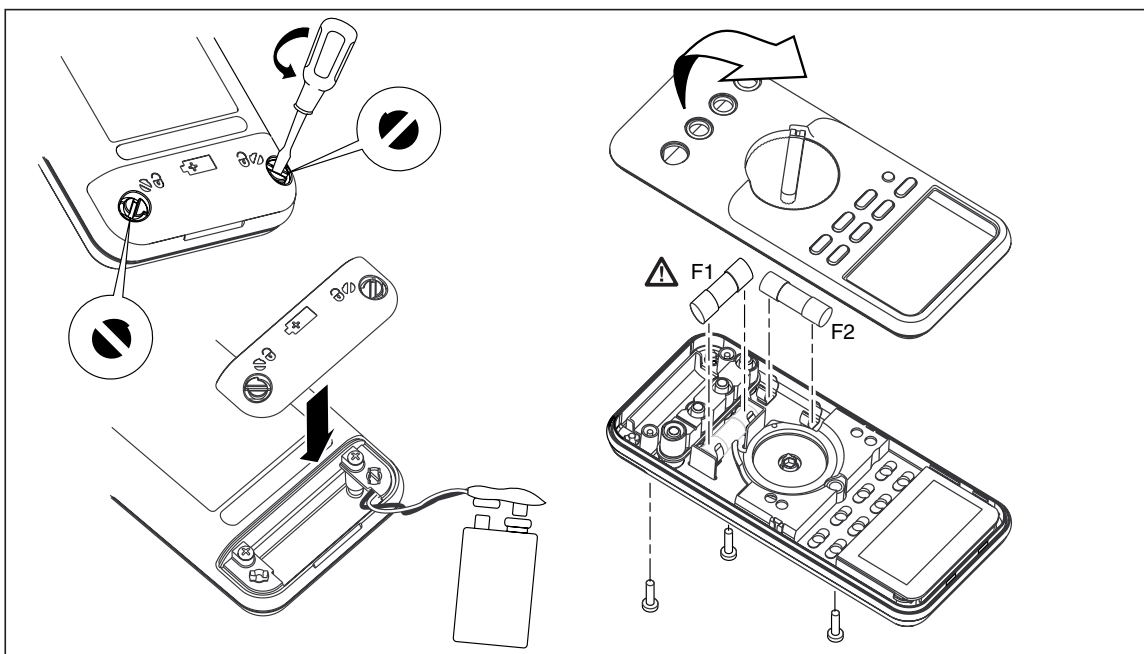

Figure 1. Opening the Meter, Battery and Fuse Replacement

ama12.eps

Accessing the PCA and Replacing the LCD

Once the case has been opened, the A1 Main PCA can easily be removed. The shields disconnect from the PCA as follows:

1. Remove the five Phillips-head screw securing the top and bottom shields to the PCA.
2. Remove the top shield assembly that also houses the LCD and lightpipe for the LCD backlight.
3. To access the LCD, unsnap the LCD mask using a small flat-blade screwdriver. The LCD may now be removed. Refer to Figure 2.

Note

Two elastomeric connectors make electrical contact between the LCD and the PCA. These connectors usually stick to the LCD when it is removed. If the connectors are to be reused, do not handle them, as the electrical contact points might become contaminated. Use tweezers to remove these connectors.

4. To reinstall the connectors, replace the LCD and LCD mask and lay the top shield face down. Install the elastomeric connector strips into the slots on the top shield.

5. Place the PCA onto the top shield so that the screw holes align.
6. Place the bottom shield onto the PCA and secure the assembly with five Phillips-head screws. Ensure that the shields are tightly attached. Properly fitted shields are required for the Meter to perform to specifications.

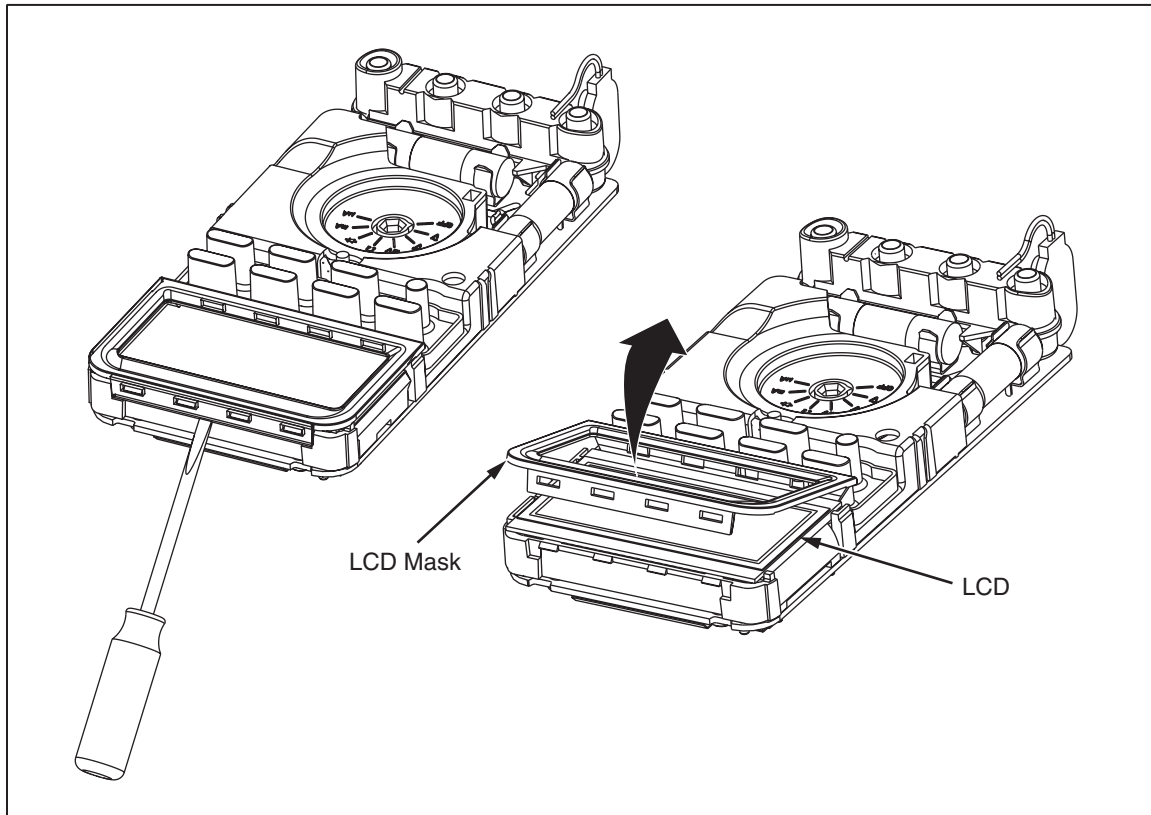

Figure 2. Removing LCD Mask to Access LCD

ama08f.eps

Reassembling the Meter Case

To reassemble the Meter case:

1. Verify that the rotary knob and circuit board switch are in the **OFF** position, and that the gasket remains secured to the bottom case.
2. Place the PCA into the bottom case.
3. Place the case top on the case bottom.
4. To avoid damaging the battery wire, ensure the wire exits the middle of the battery compartment.
5. Properly seat the case gasket and snap the case halves together above the LCD end. See Figure 1.
6. Reinstall the three case screws and the battery door.
7. Secure the battery door by turning the screw 1/4-turn clockwise.
8. Go to “Performance Tests” later in this document, and perform the procedures described.

Replacing the Battery

Replace the battery with a 9-V battery (NEDA A1604, 6F22, or 006P).

Warning

To avoid false readings, which could lead to possible electric shock or personal injury, replace the battery as soon as the battery indicator (🔋) appears. If the display shows “bAtt” the Meter will not function until the battery is replaced.

Replace the battery as follows, refer to Figure 1:

1. Turn the rotary knob to **OFF** and remove the test leads from the terminals.
2. Remove the battery door by using a standard-blade screwdriver to turn the battery door screws one-quarter turn counterclockwise.
3. Remove the old battery and replace it with a new one.
4. Align the battery leads so that they not pinched between the battery door and the case bottom.
5. Secure the door by turning the screws one-quarter turn clockwise.

Testing Fuses and Current Circuitry

If a test lead is plugged into the **mA/μA** or **A** terminal and the rotary knob is turned to a non-current function, the Meter chirps and flashes “LEAd” if the fuse associated with that current terminal is good. If the Meter does not chirp or flash “LEAd”, the fuse is bad and must be replaced. Refer to Table 17 for the appropriate replacement fuse.

After replacing the fuse, use the following procedure to verify the integrity of the new fuse and the current circuitry. Refer to Figure 3.

1. Turn the rotary knob to Ω .
2. To test F2, insert a test lead into the $V\Omega$ input terminal and touch the probe to the **A** input terminal.

Note

The input receptacles contain split contacts. Be sure to touch the probe to the half of the receptacle nearest the LCD.

3. The display should indicate between 00.0 Ω and 00.5 Ω . If the display reads OL, replace the fuse and test again. If the display reads another value, further servicing is required.
4. To test F1, move the probe from the **A** input terminal to the **mA/μA** input terminal.
5. The display should read between 0.995 k Ω and 1.005 k Ω . If the display reads OL, replace the fuse and test again. If the display reads another value, further servicing is required.

Warning

To avoid electrical shock or personal injury:

- Remove the test leads and any input signals before replacing the battery or fuses.
- Install **ONLY** specified replacement fuses with the amperage, voltage, and speed ratings shown in Table 17.

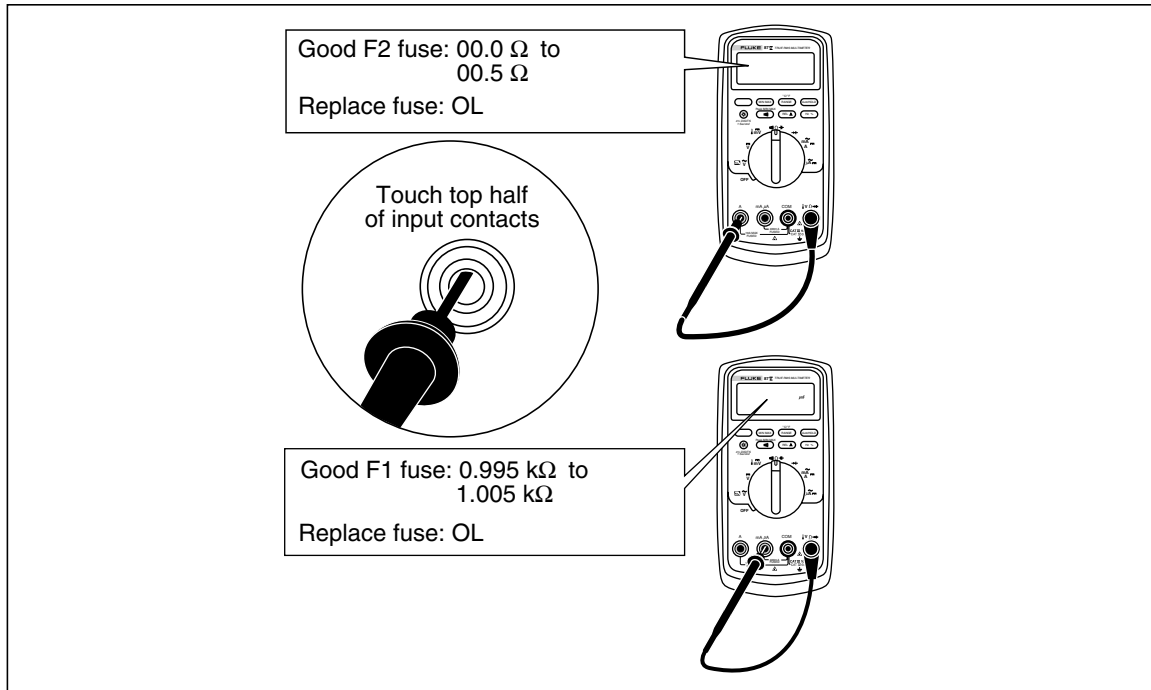

aom5f.eps

Figure 3. Testing the Current Input Fuses

Replacing the Fuses

To replace the fuse(s), perform the following procedure.

1. To open the Meter, refer to “Opening the Meter Case”. See Figure 1.
2. Grasp the fuse in the center with needle nose pliers. Pull straight up on the fuse to remove it from the fuse clips.
3. Install ONLY specified replacement fuses with the amperage, voltage, and speed ratings shown in Table 17.
4. To close the Meter, refer to “Reassembling the Meter Case”.

Required Equipment

Required equipment for the performance tests is listed in Table 13. If the recommended models are not available, equipment with equivalent specifications may be used.

⚠ ⚠ Warning

- **To avoid shock or injury, do not perform the verification tests or calibration adjustment procedures described in this manual unless you are qualified to do so.**
- **Repairs or servicing should be performed only by qualified personnel.**

Table 13. Required Equipment

Equipment	Required Characteristics	Recommended Model
Calibrator	AC Voltage Range: 0 - 1000 V ac Accuracy: $\pm 0.12\%$ Frequency Range: 60 - 20000 Hz Accuracy: $\pm 3\%$ DC Voltage Range: 0 - 1000 V dc Accuracy: $\pm 0.012\%$ Current Range: 350 μ A - 2 A Accuracy: AC (60 Hz to 1 kHz): $\pm 0.25\%$ DC: $\pm 0.05\%$ Frequency Source: 19.999 kHz - 199.99 kHz Accuracy: $\pm 0.0025\%$ Amplitude: 150 mV to 6V rms Accuracy: $\pm 5\%$ Range: 1 Ω - 100 M Ω Accuracy: 0.065 %	Fluke 5520A Multi-Product Calibrator or equivalent
Function Generator	Frequency = 900 kHz Amplitude = 8.3V Burst mode = 1 Burst rate = 100Hz Burst Phase = -90 degrees	HP33120
Fluke 80 AK TC Adapter Accessory	K-type	Fluke 80 AK
K-type Thermocouple	K-type, mini-plug on both ends	

Performance Tests

The following performance tests verify the complete operability of the Meter and check the accuracy of each Meter function against the Meter's specifications. Performance tests should be performed annually to ensure that the Meter is within accuracy specifications.

Accuracy specifications are valid for a period of one year after calibration adjustment, when measured at an operating temperature of 18 °C to 28 °C and at a maximum of 90 % relative humidity.

To perform the following tests, it is not necessary to open the case. No adjustments are necessary. Make the required connections, apply the designated inputs, and determine if the reading on the Meter display falls within the acceptable range indicated.

Note

If the Meter fails any of these tests, it needs calibration adjustment or repair.

Basic Operability Tests

Refer to the following sections to test the basic operability of the Meter.

Testing the Fuses

Refer to “Testing the Fuses”.

Testing the Display

Turn the Meter on while holding down (AutoHOLD) to view all segments of the display. Compare the display with the appropriate examples in Figure 4 and Table 14.

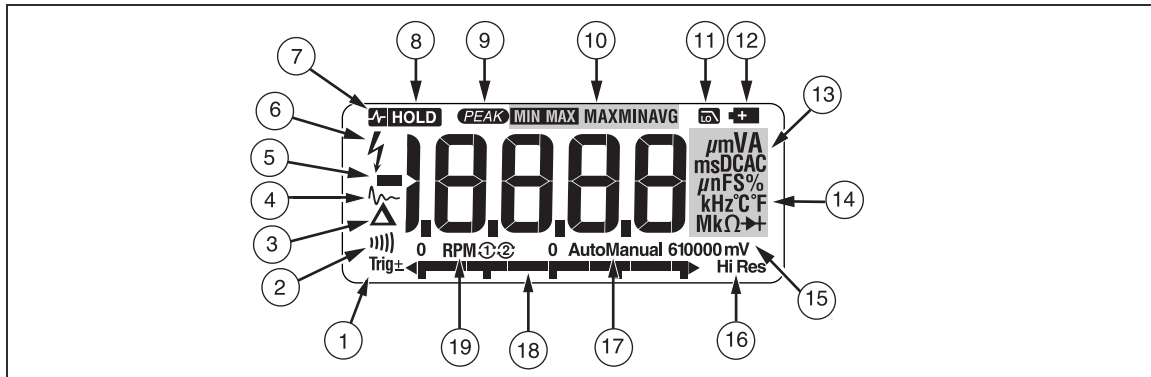







Figure 4. Display Features

ay104.eps

Table 14. Display Features



Number	Feature	Indication
①	±	Polarity indicator for the analog bar graph.
	Trig±	Positive or negative slope indicator for Hz/duty cycle triggering.
②		The continuity beeper is on.
③	△	Relative (REL) mode is active.
④	~	Smoothing is active.
⑤	-	Indicates negative readings. In relative mode, this sign indicates that the present input is less than the stored reference.
⑥	⚡	Indicates the presence of a high voltage input. Appears if the input voltage is 30 V or greater (ac or dc). Also appears in low pass filter mode. Also appears in cal, Hz, and duty cycle modes.
⑦	⏸ HOLD	AutoHOLD is active.
⑧	HOLD	Display Hold is active.
⑨	PEAK	Indicates the Meter is in Peak Min Max mode and the response time is 250 μs
⑩	MIN MAX MAX MIN AVG	Indicators for minimum-maximum recording mode.
⑪	ⓧ	Low pass filter mode.

Table 13. Display Features (cont.)

Number	Feature	Indication
⑫		The battery is low. $\Delta\Delta$ Warning: To avoid false readings, which could lead to possible electric shock or personal injury, replace the battery as soon as the battery indicator appears.
⑬	A, μA, mA V, mV μF, nF nS % Ω, MΩ, kΩ Hz, kHz AC DC	Amperes (amps), Microamp, Milliamp Volts, Millivolts Microfarad, Nanofarad Nanosiemens Percent. Used for duty cycle measurements. Ohm, Megohm, Kilohm Hertz, Kilohertz Alternating current, direct current
⑭	$^{\circ}$C, $^{\circ}$F	Degrees Celsius, Degrees Fahrenheit
⑮	610000 mV	Displays selected range
⑯	HiRes	The Meter is in high resolution (Hi Res) mode. HiRes=19,999
⑰	Auto	The Meter is in autorange mode and automatically selects the range with the best resolution.
	Manual	The Meter is in manual range mode.
⑱		The number of segments is relative to the full-scale value of the selected range. In normal operation 0 (zero) is on the left. The polarity indicator at the left of the graph indicates the polarity of the input. The graph does not operate with the capacitance, frequency counter functions, temperature, or peak min max. For more information, see "Bar Graph". The bar graph also has a zoom function, as described under "Zoom Mode".
⑲	RPM  	 conventional (4 cycle) Counts every other revolution.  waste spark of 2 cycle. Counts every revolution.
--	OL	Overload condition is detected.
Error Messages		
bAtt	Replace the battery immediately.	
diSC	In the capacitance function, too much electrical charge is present on the capacitor being tested.	
EEP Err	Invalid EEPROM data. Have Meter serviced.	
CAL Err	Invalid calibration data. Calibrate Meter.	
LEAD	Δ Test lead alert. Displayed when the test leads are in the A or mA/μA terminal and the selected rotary switch position does not correspond to the terminal being used.	

Testing the Pushbuttons

To test the pushbuttons

1. Turn the Meter rotary knob to  \tilde{V} .
2. Press each button and note that the meter responds with a beep for each button press.
3. Press and hold  a second time to exit MIN MAX mode.

Testing Meter Accuracy

Perform the accuracy test steps in Table 15.

Table 15. Accuracy Tests

Step	Test Function	Range	5500A Output	Display Reading	
				83 and 88	87
1	\tilde{V} AC Volts	600 mV	330 mV, 60 Hz	327.9 to 332.1	327.3 to 332.7
2		600 mV	600 mV, 13 kHz	N/A	586.0 to 614.0
3		6 V	3.3 V, 60 Hz	3.281 to 3.319	3.275 to 3.325
4		6 V	3.3 V, 20 kHz	N/A	3.214 to 3.386
5		60 V	33 V, 60 Hz	32.81 to 33.19	32.75 to 33.25
6		60 V	33 V, 20 kHz	N/A	32.14 to 33.86
7		600 V	330 V, 60 Hz	328.1 to 331.9	327.5 to 332.5
8		600 V	330 V, 2.5 kHz	N/A	323.0 to 337.0
9		1000 V	500 V, 60 Hz	495 to 505	494 to 506
10		1000 V	1000 V, 1 kHz	986 to 1014	986 to 1014
11	\tilde{V} Hz AC Volts Frequency	600 mV	150 mV, 99.95 kHz	99.93 to 99.97	99.93 to 99.97
12		600 mV	150 mV, 199.50 kHz	199.48 to 199.52	199.48 to 199.52
13	Sensitivity	6 V	0.7 V, 99.95 kHz	99.93 to 99.97	99.93 to 99.97
14		60 V	7 V, 99.95 kHz	99.93 to 99.97	99.93 to 99.97
15	$\overline{\overline{V}}$ Hz Trigger level	6 V	3.4 V, 1 kHz Sq. Wave	999.8 to 1000.2	999.8 to 1000.2
16	$\overline{\overline{V}}$ Hz Duty Cycle	6 V	5 V, 1 kHz, DC offset 2.5 V Sq. Wave	49.7% to 50.3 %	49.7 % to 50.3 %
17	$\overline{\overline{V}}$ DC Volts	6V	3.3 V dc	3.296 to 3.304	3.297 to 3.303
18		60 V	33 V dc	32.96 to 33.04	32.97 to 33.03
19		600 V	330 V dc	329.6 to 330.4	329.7 to 330.3
20		1000 V	1000 V dc	998 to 1002	998 to 1002
21	$\overline{\overline{mV}}$ DC Volts	600 mV	33 mV dc	32.8 to 33.2	32.9 to 33.1
22		600 mV	330 mV dc	328.9 to 331.1	329.6 to 330.4

Table 14. Accuracy Tests (cont.)

Step	Test Function	Range	5500A Output	Display Reading	
				83 and 88	87
23	Ω Ohms	600 Ω	330 Ω (Use 2 wire Comp) ¹	328.5 to 331.5	329.1 to 330.9
24		6 k Ω	3.3 k Ω (Use 2 wire Comp) ¹	3.286 to 3.314	3.292 to 3.308
25		60 k Ω	33 k Ω	32.86 to 33.14	32.92 to 33.08
26		600 k Ω	330 k Ω	327.6 to 332.4	327.9 to 332.1
27		6 M Ω	3.3 M Ω	3.276 to 3.324	3.279 to 3.321
28		50 M Ω	30 M Ω	29.67 to 30.33	29.67 to 30.33
29		nS Conductance	60 nS	Open input	- 0.30 to 0.30
30	60 nS		100 M Ω	9.60 to 10.40	9.60 to 10.40
31	\rightarrow Diode	6 V	3.0 V dc	2.939 to 3.061	2.939 to 3.061
32	\tilde{A} AC Amps	6 A	3.0 A, 60 Hz	2.962 to 3.038	2.968 to 3.032
33	$\overline{\overline{A}}$ DC Amps	6 A	3.0 A	2.984 to 3.016	2.990 to 3.010
33B	$\overline{\overline{A}}$ DC Amps	10A ⁶	10A	9.94 to 10.06	9.96 to 10.04
34	mA $\tilde{}$ AC Milliamps	60 mA	33 mA, 60 Hz	32.58 to 33.42	32.65 to 33.35
35		400 mA	330 mA, 60 Hz	325.8 to 334.2	326.5 to 333.5
36	mA $\overline{\overline{}}$ DC Milliamp	60 mA	33 mA	32.83 to 33.17	32.89 to 33.11
37		400 mA	330 mA	328.5 to 331.5	329.1 to 330.9
38	$\mu\tilde{A}$ AC Microamps	600 μ A	330 μ A, 60 Hz	325.8 to 334.2	326.5 to 333.5
39		6000 μ A	3300 μ A, 60 Hz	3258 to 3342	3265 to 3335
40	$\mu\overline{\overline{A}}$ DC Microamps	600 μ A	330 μ A	328.3 to 331.7	328.9 to 331.1
41		6000 μ A	3300 μ A	3285 to 3315	3291 to 3309
42	F Capacitance	10 nf	Open input ²	0.21 to 0.31	0.21 to 0.31
43		100 nf	5 nf ⁵	04.7 to 05.3	04.7 to 05.3
44		100 μ f	9.5 μ f	09.2 to 09.8	09.2 to 09.8
45	\tilde{V} Low Pass Filter	1000 V	400 V, 400 Hz	N/A	376 to 408
46		1000 V	400 V, 800 Hz ⁴	N/A	226 to 340 ⁴

Table 14. Accuracy Tests (cont.)

Step	Test Function	Range	5500A Output	Display Reading	
				83 and 88	87
47	\bar{V} (87 and 88 only) Peak Min/Max	6 V dc	8 Vpp, 2 kHz Sq. Wave, DC offset 2 V	Max = 5.896 to 6.104	
48				Min = -1.898 to -2.102	
49	$m\bar{V}$ (87 and 88 only) Temperature ³		0 °C	-1.0 to 1.0	-1.0 to 1.0
50			100 °C	98.0 to 102.0	98.0 to 102.0
51	Backlight		Press backlight button	Backlight comes on	
52			Press backlight button	Backlight Intensifies	
53			Press backlight button	Backlight off	
<ol style="list-style-type: none"> 1. Or short test leads and use REL to offset test lead resistance. 2. Remove test leads from unit. 3. To ensure accurate measurement, the Meter and thermocouple adapter must be at the same temperature. After connecting the thermocouple adapter to the Meter allow for reading to stabilize before recording display reading. 4. The Meter accuracy is not specified at this input signal frequency with Low-pass filter selected. The display reading shown, check that the Low-pass filter is active and follows an expected roll-off curve. 5. Use REL to compensate for internal Meter and lead capacitance. Test leads must be disconnected from the calibrator before using REL. 6. Δ 10 A continuous up to 35 °C; < 20 minutes on, 5 minutes off at 35 °C to 55 °C. 20 A for 30 seconds maximum; > 10 A unspecified. 					

Testing the Inductive Pickup (88 Only)

To test the inductive pickup, a function generator output will simulate automobile spark plug signals on a loop of wire containing a 10 Ω resistor. The pickup will be clamped to the wire and output voltage from the pickup will be monitored by an oscilloscope.

Perform the following procedure to test the inductive pickup:

1. Solder a 10-inch piece of 14 AWG wire to one end of a 10 Ω 1 % resistor.
2. Connect the other end of the 10 Ω resistor to the terminal LOW output of the function generator. Place the other end of the 14-AWG wire to the HIGH output of the function generator. See Figure 5.
3. Connect a 10X scope probe from channel 2 (dc-coupled) of the oscilloscope across the 10 Ω resistor.
4. Clamp the inductive pickup to the wire loop on the HIGH side of the resistor as shown in Figure 5.

Make sure that the jaws of the inductive pickup are closed completely, and that the side of the inductive pickup that says "SPARK PLUG SIDE" points toward the HIGH output of the function generator.

5. Connect a 10X scope probe from channel 1 (dc-coupled) of the oscilloscope across the output of the inductive pickup.

6. Set up the function generator as follows:

Frequency	900 kHz
Amplitude	8.3 V
Burst Mode	yes
Burst Count	1
Burst Rate	100 Hz
Burst Phase	-90 Degrees
7. Set the oscilloscope for 0.5 V/DIV @ 0.5 μ s/DIV.
8. Trigger the waveform on channel 2.
9. Adjust the amplitude of the function generator to produce a 3 VP-P triangle wave. See Figure 6.
10. Set the oscilloscope for 1.0 V/DIV @ 5.0 ms/DIV.
11. Trigger the waveform on Channel 1.
12. Check that the peak voltage is greater than 5.7 V and decays to less than 1.0 V between pulses. See Figure 6. Record the peak value for later use.
13. Adjust the function generator output so the peak voltage is 6 V.
14. Set the scope for 1.0 ms/DIV and trigger waveform.
15. Check the amplitude after 3.0 ms from the waveform peak, the voltage amplitude is 2.4 V \pm 0.5/-0.8 (1.6 V to 2.9 V). (See Figure 3-5(C).)
16. Re-adjust the function generator output to obtain the value recorded in step 12.
17. Set the scope for 5.0 ms/DIV.
18. Turn the inductive pickup so that "SPARK PLUG SIDE" points along the wire connected to the LOW output of the function generator. Check that the waveform is less than 2 V.

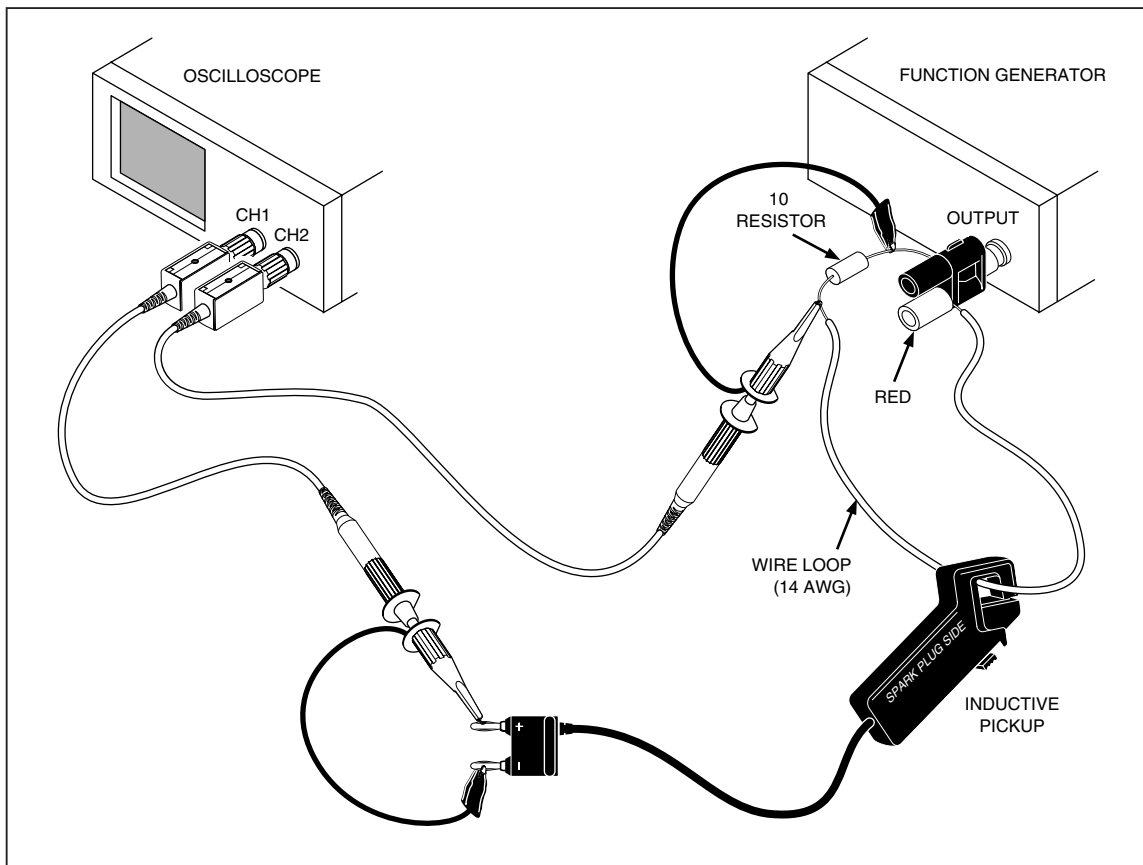

aad08f.eps

Figure 5. Setup for Inductive Pickup Test

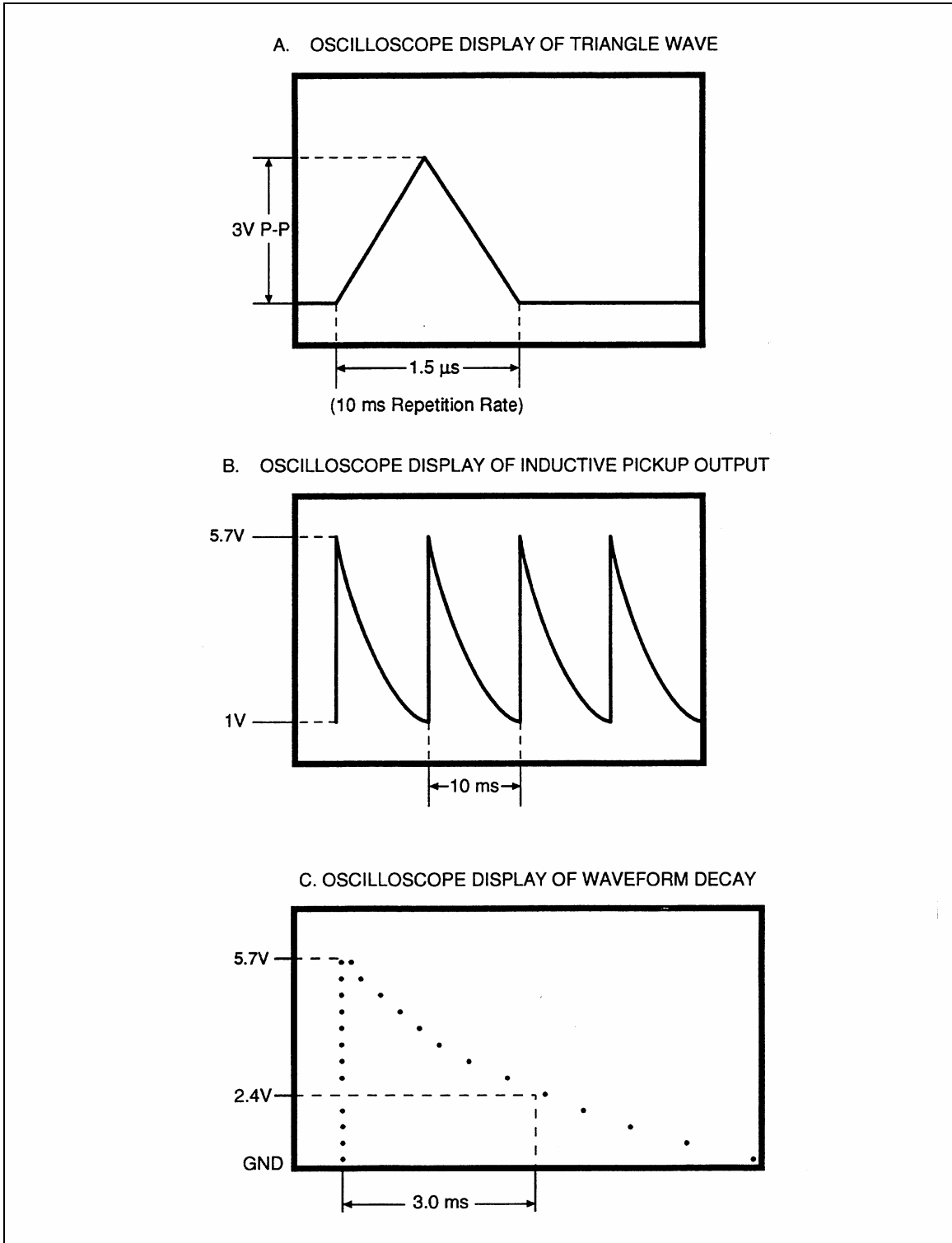

Figure 6. Waveform for Inductive Pickup Test

aad09f.wmf

Calibration Adjustment



The Meter features closed-case calibration adjustment using known reference sources. The Meter measures the applied reference source, calculates correction factors and stores the correction factors in nonvolatile memory.

The following sections present the features and Meter pushbutton functions that can be used during the Calibration Adjustment Procedure. Perform the Calibration Adjustment Procedure should the Meter fail any performance test listed in Table 15.

Calibration Adjustment Counter

The Meter contains a calibration adjustment counter. The counter is incremented each time a Calibration Adjustment Procedure is completed. The value in the counter can be recorded and used to show that no adjustments have been made during a calibration cycle.

Use the following steps to view the Meter's calibration counter.



1. While holding down , turn the rotary knob from **OFF** to **VAC**. The Meter should display “**⚡ CAL**”.
2. Press  once to see the calibration counter. For example "n001".
3. Turn the rotary knob to **OFF**.









Calibration Adjustment Password

To start the Calibration Adjustment Procedure, the correct 4-button password must be entered. The password can be changed or reset to the default as described in following paragraphs. The default password is “1234”.



Changing the Password

Use the following steps to change the Meter's password:

1. While holding down , turn the rotary knob from **OFF** to **VAC**. The Meter displays “**⚡ CAL**”.
2. Press  once to see the calibration counter.
3. Press  again to start the password entry. The Meter displays "????".
4. The Meter buttons represent the digit indicated below when entering or changing the password:

 = 1  = 2  = 3  = 4
 = 5  = 6  = 7  = 8

Press the 4 buttons to enter the old password. If changing the password for the first time, enter  (1)  (2)  (3)  (4).

5. Press  to change the password. The Meter displays "----" if the old password is correct. If the password is not correct, the Meter emits a double beep, displays "?????" and the password must be entered again. Repeat step 4.
6. Press the 4 buttons of the new password.
7. Press  to store the new password.

Restoring the Default Password

If the calibration password is forgotten, the default password (1234) can be restored using the following steps.

1. While holding down **MIN MAX**, turn the rotary knob from **OFF** to **VAC**. The Meter displays “⚡ CAL”.
2. Remove the Meter's top case. Leave the PCA in the bottom case. (See “Opening the Meter Case”.)

⚠ ⚠ Warning

To avoid electrical shock or personal injury, remove the test leads and any input signal before removing the Meter's top case.

3. Through an access hole provided in the top shield, short across the keypads on the PCA. See Figure 7. The Meter should beep. The default password is now restored.
4. Replace the Meter's top case and turn the rotary knob to **OFF**. (See “Reassembling the Meter Case”).

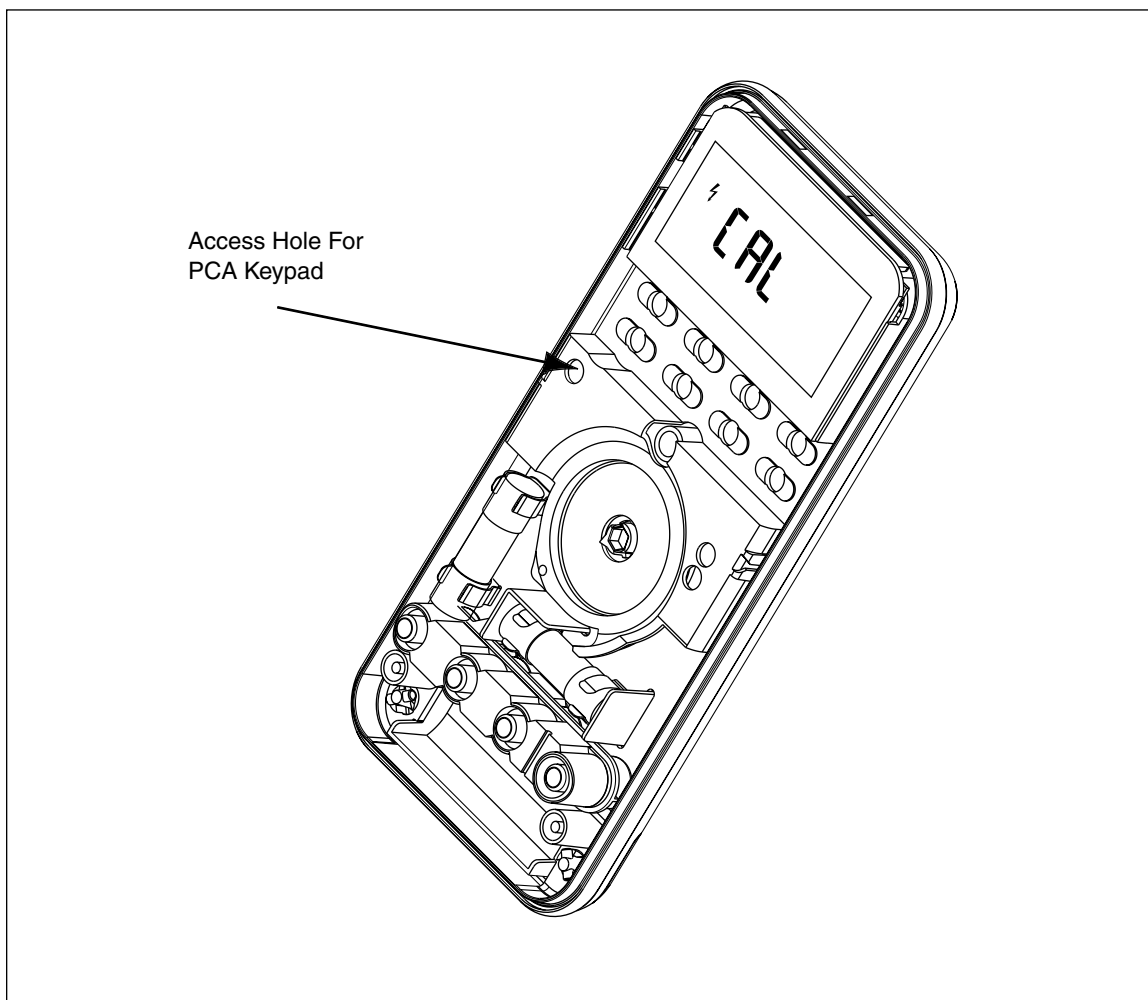





Figure 7. Restoring the Default Password

ama01f.eps





Meter Buttons Used in the Calibration Steps

The Meter buttons behave as follows when performing the Calibration Adjustment Procedure. This may be of help determining why a calibration step is not accepted and for determining the input value without referring to Table 16.

-  Press and hold to show the measured value. The measurement value is not calibrated so it may not match the input value. This is normal.
-  Press and hold to display the required input amplitude.
-  Press and hold to display the frequency of the required input.
-  Press to store the calibration value and advance to the next step. This button is also used to exit calibration mode after the calibration adjustment sequence is complete.

Calibration Adjustment Procedure

Use the following steps to adjust the Meter's calibration. If the Meter is turned off before completion of the adjustment procedure, the calibration constants are not changed.

1. While holding down , turn the rotary knob from **OFF** to **VAC**. The Meter displays “**⚡ CAL**”.
2. Press  once to see the calibration counter.
3. Press  again to start the password entry. The Meter displays "????".
4. Press 4 buttons to enter the password.
5. Press  to go to the first calibration step. The Meter displays "C-01" if the password is correct. If the password is not correct, the Meter emits a double beep, displays "????" and the password must be entered again. Repeat step 4.
6. Using Table 16, apply the input value listed for each calibration adjustment step. For each step, position the rotary switch and apply the input to the terminals as indicated in the table.
7. After each input value is applied, press  to accept the value and proceed to the next step (C-02 and so forth).

Notes

After pressing , wait until the step number advances before changing the calibrator source or turning the Meter rotary knob.

If the Meter rotary knob is not in the correct position, or if the measured value is not within the anticipated range of the input value, the Meter emits a double beep and will not continue to the next step.

Some adjustment steps take longer to execute than others (10 to 15 seconds). For these steps, the Meter will beep when the step is complete. Not all steps have this feature.

8. After the final step, the display shows "End" to indicate that the calibration adjustment is complete. Press  to go to meter mode.

Notes

Set the calibrator to Standby prior to changing the function switch position and or after completing adjustment of each function.

If the calibration adjustment procedure is not completed correctly, the Meter will not operate correctly.

Table 16. Calibration Adjustment Steps

Function (Switch Position)	Input Terminal	Adjustment Step	Input Value	
			Fluke 83-V and 88-V	Fluke 87-V
\tilde{V} (AC Volts)	$V \Omega \rightarrow \vdash$	C-01	600.0 mV, 60 Hz	600.0 mV, 60 Hz
		C-02	600.0 mV, 5 kHz	600.0 mV, 20 kHz
		C-03	6.000 V, 60 Hz	6.000 V, 60 Hz
		C-04	6.000 V, 5 kHz	6.000 V, 20 kHz
		C-05	60.00 V, 60 Hz	60.00 V, 60 Hz
		C-06	60.00 V, 5 kHz	60.00 V, 20 kHz
		C-07	600.0 V, 60 Hz	600.0 V, 60 Hz
		C-08	600.0 V, 5 kHz	600.0 V, 10 kHz
\bar{V} (DC Volts)		C-09	6.000 V	6.000 V
		C-10	60.00 V	60.00 V
		C-11	600.0 V	600.0 V
$m\bar{V}$ (DC Millivolts)	C-12	600.0 mV	600.0 mV	
	C-13	60.00 mV	60.00 mV	
Ω (Ohms)	C-14	600.0	600.0	
	C-15	6.000 k	6.000 k	
	C-16	60.00 k	60.00 k	
	C-17	600.0 k	600.0 k	
	C-18	6.000 M	6.000 M	
	C-19	0.000	0.000	
	C-20	50.0 M	50.0 M	
$\rightarrow \vdash$ (Diode Test)	C-21	3.000 V	3.000 V	
A (Amps)	A	C-22	6.000 A, 60 Hz	6.000 A, 60 Hz
		C-23	6.000 A dc	6.000 A dc
mA (Milliamps)	mA / μA	C-24	60.00 mA, 60 Hz	60.00 mA, 60 Hz
		C-25	400.0 mA, 60 Hz	400.0 mA, 60 Hz
		C-26	60.00 mA dc	60.00 mA dc
		C-27	400.0 mA dc	400.0 mA dc
μA (Microamps)		C-28	600.0 μ A ac, 60 Hz	600.0 μ A ac, 60 Hz
		C-29	6000 μ A, 60 Hz	6000 μ A, 60 Hz
		C-30	600.0 μ A dc	600.0 μ A dc
		C-31	6000 μ A dc	6000 μ A dc

Service and Parts

Replacement parts are shown in Table 17 and Figure 8. To order parts and accessories, refer to “Contacting Fluke”.

Table 17. 80 Series V Final Assembly

Ref Des	Description	Part Number	Qty
AC72	Alligator Clip, Black	1670652	1
AC72	Alligator Clip, Red	1670641	1
BT1	Battery, 9 V	2139179	1
BT2	Cable Assy, 9 V Battery Snap	2064217	1
CR6	Lightpipe	2074057	1
F1△	Fuse, 0.440 A, 1000 V, FAST	943121	1
F2△	Fuse, 11 A, 1000 V, FAST	803293	1
H2-4	Screw, Case	832246	3
H5-9	Screw, Bottom Shield	448456	5
J1-2	Elastomeric Connector	817460	2
J3	Top Shield Contact	674853	1
MP10, MP11	Foot, Non-Skid	824466	2
MP2	Shield, Top	2073906	1
MP4	Shield, Bottom	2074025	1
MP5	Case Top (PAD XFER) With Window (83-5)	2074002	
MP5	Case Top (PAD XFER) with Window (87-5)	2073992	1
MP5	Case Top (PAD XFER) with Window (88-5)	2115202	1
MP6	Case Bottom	2073871	1
MP8	Knob, Switch (PAD XFER)	2100482	1
MP9	Detent, Knob	822643	1
MP13	Shock Absorber	828541	1
MP14	O-Ring, Input Receptacle	831933	1
MP15	Holster w/ Tilt Stand	2074033	1
MP22	Battery Door	2073938	1
MP27- MP30	Contact RSOB	1567683	4
MP31	Mask, LCD (PAD XFER) (83-5)	2073961	1
MP31	Mask, LCD (PAD XFER) (87-5)	2073950	1
MP31	Mask, LCD (PAD XFER) (88-5)	2112410	1
MP41	Housing, RSOB	2073945	1
MP390- 391	Access Door Fastener	948609	2
NA	Tiltstand	2074040	1
S2	Keypad	2105884	1
TL75	Test Lead Set	855742	1
TM1	<i>80 Series V Getting Started Manual (Multi-language)</i>	2101973	1
TM2	<i>80 Series V Quick Reference Card</i>	2101986	1
TM 2	<i>88 V Quick Reference Card</i>	2279006	1
TM3	CD ROM (Contains <i>80 Series V Users Manual</i>)	2101999	1
TM3	CD ROM (Contains <i>88 V Users Manual</i>)	2278999	1
TM4 (not shown)	<i>80 Series V Calibration Manual (this manual)</i>	2102915	1
U5	LCD, 4.5 DIGIT, TN, Transflective, Bar Graph, OSPR80	2065213	1
MP81	80BK Thermocouple Assembly, K-Type, Beaded, Molded Dual Banana Plug, Coiled	1273113	1

△ To ensure safety, use exact replacement only.

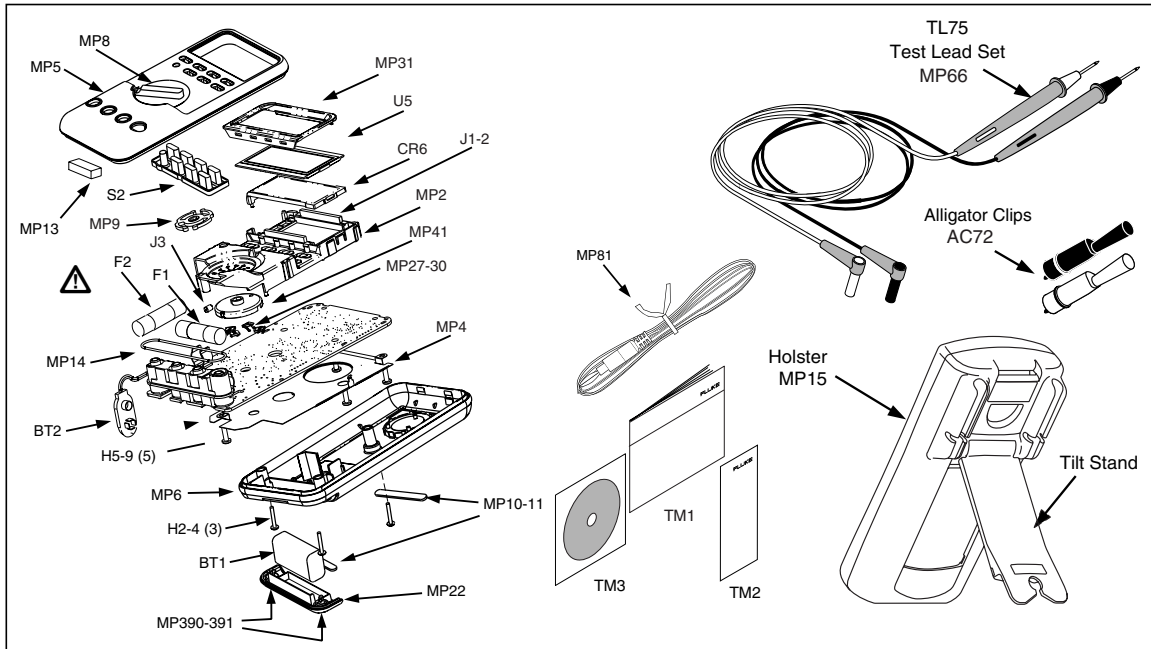

Figure 8. 80 Series V Final Assembly

aom015c.eps

FLUKE®

80 Series V

Multimeters

Users Manual

Introduction

Warning

Read "Safety Information" before you use the Meter.

Except where noted, the descriptions and instructions in this manual apply to Series V Models 83 and 87 multimeters (hereafter referred to as "the Meter"). Model 87 appears in all illustrations.

Safety Information

The Meter complies with:

- EN61010-1:2001
- ANSI/ISA S82.01-2004
- CAN/CSA C22.2 No. 1010.1:2004
- UL610101-1
- Measurement Category III, 1000V, Pollution Degree 2
- Measurement Category IV, 600V, Pollution Degree 2

In this manual, a **Warning** identifies conditions and actions that pose hazards to the user. A **Caution** identifies conditions and actions that may damage the Meter or the equipment under test.

Electrical symbols used on the Meter and in this manual are explained in Table 1.

⚠ ⚠ Warning

To avoid possible electric shock or personal injury, follow these guidelines:

- **Use this Meter only as specified in this manual or the protection provided by the Meter might be impaired.**
- **Do not use the Meter if it is damaged. Before you use the Meter, inspect the case. Look for cracks or missing plastic. Pay particular attention to the insulation surrounding the connectors.**
- **Make sure the battery door is closed and latched before operating the Meter.**
- **Replace the battery as soon as the battery indicator (🔋) appears.**
- **Remove test leads from the Meter before opening the battery door.**















- **Inspect the test leads for damaged insulation or exposed metal. Check the test leads for continuity. Replace damaged test leads before you use the Meter.**
- **Do not apply more than the rated voltage, as marked on the Meter, between the terminals or between any terminal and earth ground.**
- **Never operate the Meter with the cover removed or the case open.**
- **Use caution when working with voltages above 30 V ac rms, 42 V ac peak, or 60 V dc. These voltages pose a shock hazard.**
- **Use only the replacement fuses specified by the manual.**
- **Use the proper terminals, function, and range for measurements.**
- **Avoid working alone.**
- **When measuring current, turn off circuit power before connecting the Meter in the circuit. Remember to place the Meter in series with the circuit.**
- **When making electrical connections, connect the common test lead before connecting the live test lead; when disconnecting, disconnect the live test lead before disconnecting the common test lead.**
- **Do not use the Meter if it operates abnormally. Protection may be impaired. When in doubt, have the Meter serviced.**
- **Do not operate the Meter around explosive gas, vapor, or dust.**
- **Use only a single 9 V battery, properly installed in the Meter case, to power the Meter.**
- **When servicing the Meter, use only specified replacement parts.**
- **When using probes, keep fingers behind the finger guards on the probes.**
- **Do not use the Low Pass Filter option to verify the presence of hazardous voltages. Voltages greater than what is indicated may be present. First, make a voltage measurement without the filter to detect the possible presence of hazardous voltage. Then select the filter function.**

⚠ Caution

To avoid possible damage to the Meter or to the equipment under test, follow these guidelines:

- **Disconnect circuit power and discharge all high-voltage capacitors before testing resistance, continuity, diodes, or capacitance.**
- **Use the proper terminals, function, and range for all measurements.**
- **Before measuring current, check the Meter's fuses. (See "Fuse Test".)**

Table 1. Electrical Symbols

	AC (Alternating Current)		Earth ground
	DC (Direct Current)		Fuse
	Hazardous voltage		Conforms to European Union directives.
	Risk of Danger. Important information. See Manual.		Conforms to relevant Canadian Standards Association directives.
	Battery. Low battery when displayed.		Double insulated
	Continuity test or continuity beeper tone.		Capacitance
CAT III	IEC Overvoltage Category III CAT III equipment is designed to protect against transients in equipment in fixed-equipment installations, such as distribution panels, feeders and short branch circuits, and lighting systems in large buildings.	CAT IV	IEC Overvoltage Category IV CAT IV equipment is designed to protect against transients from the primary supply level, such as an electricity meter or an overhead or underground utility service.
	Underwriters Laboratories		Diode
	Inspected and licensed by TÜV Product Services.		

The Meter's Features

Tables 2 through 5 briefly describe the Meter's features.

Table 2. Inputs



Terminal	Description
A	Input for 0 A to 10.00 A current (20 A overload for 30 seconds maximum), current frequency, and duty cycle measurements.
mA μA	Input for 0 μ A to 400 mA current measurements (600 mA for 18 hrs.) and current frequency and duty cycle.
COM	Return terminal for all measurements.
 V Ω 	Input for voltage, continuity, resistance, diode, capacitance, frequency, temperature (87), and duty cycle measurements.

Table 3. Rotary Switch Positions









Switch Position	Function
Any Position	When the Meter is turned on, the Meter model number briefly appears on the display.
	AC voltage measurement Press <input type="button" value="□"/> for low pass filter () (87 only).
	DC voltage measurement
	600 mV dc voltage range Press <input type="button" value="□"/> for temperature () (87 only).
	Press <input type="button" value="□"/> for continuity test. Ω Resistance measurement Press <input type="button" value="□"/> for capacitance measurement.
	Diode test
	AC current measurements from 0 mA to 10.00 A Press <input type="button" value="□"/> for dc current measurements, from 0 mA to 10.00 A.
	AC current measurements from 0 μ A to 6000 μ A Press <input type="button" value="□"/> for dc current measurements from 0 μ A to 6000 μ A.

Table 4. Pushbuttons











Button	Switch Position	Function
 (Yellow)	     Power-up	<p>Selects capacitance</p> <p>Selects temperature (87 only)</p> <p>Selects ac low pass filter function (87 only)</p> <p>Switches between dc and ac current</p> <p>Switches between dc and ac current</p> <p>Disables automatic power-off feature (Meter normally powers off in 30 minutes). The Meter reads “P o F F” until  is released.</p>
	Any switch position Power-up	<p>Starts recording of minimum and maximum values. Steps the display through MAX, MIN, AVG (average), and present readings. Cancels MIN MAX (hold for 1 second)</p> <p>Enables the Meter’s calibration mode and prompts for a password. The Meter reads “f R L” and enters calibration mode. See <i>80 Series V Service Information</i>.</p>
	Any switch position  Power-up	<p>Switches between the ranges available for the selected function. To return to autoranging, hold the button down for 1 second.</p> <p>Switches between °C and °F.</p> <p>Enables the Meter’s smoothing feature. The Meter reads “S ---” until  is released.</p>

Table 4. Pushbuttons (cont.)













Button	Switch Positon	Function
	Any switch position Frequency counter MIN MAX recording Power-up	AutoHOLD (formerly TouchHold) captures the present reading on the display. When a new, stable reading is detected, the Meter beeps and displays the new reading. Stops and starts recording without erasing recorded values. Stops and starts the frequency counter. Turns on all LCD segments.
	Any switch position	Turns the backlight on, makes it brighter, and turns it off. For Model 87, hold  down for one second to enter the HiRes digit mode. The “HiRes” icon appears on the display. To return to the 3-1/2 digit mode, hold  down for one second. HiRes=19,999
	Continuity  MIN MAX recording Hz, Duty Cycle Power-up	Turns the continuity beeper on and off Switches between Peak (250 μs) and Normal (100 ms) response times. Toggles the meter to trigger on positive or negative slope. Disables the beeper for all functions. The Meter reads “bEEP” until  is released.

Table 4. Pushbuttons (cont.)

Button	Switch Position	Function
 (Relative mode)	Any switch position Power-up	Stores the present reading as a reference for subsequent readings. The display is zeroed, and the stored reading is subtracted from all subsequent readings. Enables zoom mode for the bar graph. The Meter reads “Zr E L” until  is released.
	Any switch position except diode test Power-up	Press  for frequency measurements. Starts the frequency counter. Press again to enter duty cycle mode. Enables the Meter’s high impedance mode when the mV dc function is used. The Meter reads “H, Z” until  is released.

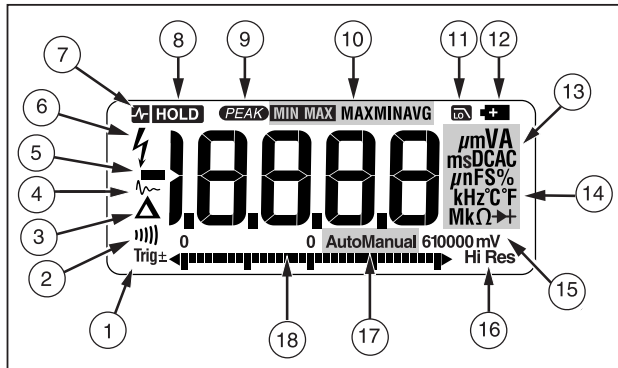

aom1_af.eps

Figure 1. Display Features (Model 87)

Table 5. Display Features

Number	Feature	Indication
①	±	Polarity indicator for the analog bar graph.
	Trig ±	Positive or negative slope indicator for Hz/duty cycle triggering.
②		The continuity beeper is on.
③	△	Relative (REL) mode is active.
④	~	Smoothing is active.

Number	Feature	Indication
⑤	-	Indicates negative readings. In relative mode, this sign indicates that the present input is less than the stored reference.
⑥	⚡	Indicates the presence of a high voltage input. Appears if the input voltage is 30 V or greater (ac or dc). Also appears in low pass filter mode. Also appears in cal, Hz, and duty cycle modes.
⑦	⏻ HOLD	AutoHOLD is active.
⑧	HOLD	Display Hold is active.
⑨	PEAK	Indicates the Meter is in Peak Min Max mode and the response time is 250 μs (87 only).
⑩	MIN MAX MAX MIN AVG	Indicators for minimum-maximum recording mode.
⑪	Lo	Low pass filter mode (87 only). See “Low Pass Filter (87).”
⑫	+	The battery is low. ⚠️⚠️ Warning: To avoid false readings, which could lead to possible electric shock or personal injury, replace the battery as soon as the battery indicator appears.

Table 5. Display Features (cont.)

Number	Feature	Indication
⑬	A, μA, mA	Amperes (amps), Microamp, Milliamp
	V, mV	Volts, Millivolts
	μF, nF	Microfarad, Nanofarad
	nS	Nanosiemens
	%	Percent. Used for duty cycle measurements.
	Ω, MΩ, kΩ	Ohm, Megohm, Kilohm
	Hz, kHz	Hertz, Kilohertz
	AC DC	Alternating current, direct current
⑭	$^{\circ}$C, $^{\circ}$F	Degrees Celsius, Degrees Fahrenheit
⑮	610000 mV	Displays selected range
⑯	HiRes	The Meter is in high resolution (Hi Res) mode. HiRes=19,999
⑰	Auto	The Meter is in autorange mode and automatically selects the range with the best resolution.
	Manual	The Meter is in manual range mode.

Number	Feature	Indication
⑱		The number of segments is relative to the full-scale value of the selected range. In normal operation 0 (zero) is on the left. The polarity indicator at the left of the graph indicates the polarity of the input. The graph does not operate with the capacitance, frequency counter functions, temperature, or peak min max. For more information, see "Bar Graph". The bar graph also has a zoom function, as described under "Zoom Mode".
--	OL	Overload condition is detected.
Display Messages		
bAtt		Replace the battery immediately.
d rC		In the capacitance function, too much electrical charge is present on the capacitor being tested.
EEP r Err		Invalid EEPROM data. Have Meter serviced.
CAL Err		Invalid calibration data. Calibrate Meter.
L EAd		⚠ Test lead alert. Displayed when the test leads are in the A or mA/μA terminal and the selected rotary switch position does not correspond to the terminal being used.
FB-Err		Invalid model. Have Meter serviced.
OPEn		Open thermocouple is detected.

Power-Up Options

Holding a button down while turning the Meter on activates a power-up option. Table 4 includes the power-up options.

Automatic Power-Off

The Meter automatically turns off if you do not turn the rotary switch or press a button for 30 minutes. If MIN MAX Recording is enabled, the Meter will not power off. To disable automatic power-off, refer to Table 4.

Input Alert™ Feature

If a test lead is plugged into the **mA/μA** or **A** terminal, but the rotary switch is not set to the correct current position, the beeper warns you by making a chirping sound and the display flashes “**L E A d**”. This warning is intended to stop you from attempting to measure voltage, continuity, resistance, capacitance, or diode values when the leads are plugged into a current terminal.

⚠ Caution

Placing the probes across (in parallel with) a powered circuit when a lead is plugged into a current terminal can damage the circuit you are testing and blow the Meter's fuse. This can happen because the resistance through the Meter's current terminals is very low, so the Meter acts like a short circuit.

Making Measurements

The following sections describe how to take measurements with the Meter.

Measuring AC and DC Voltage

Model 87 features true rms readings, which are accurate for distorted sine waves and other waveforms (with no dc offset) such as square waves, triangle waves, and staircase waves.

The Meter's voltage ranges are 600.0 mV, 6.000 V, 60.00 V, 600.0 V, and 1000 V. To select the 600.0 mV dc range, turn the rotary switch to mV.

To measure ac or dc voltage, refer to Figure 2.

When measuring voltage, the Meter acts approximately like a 10 M Ω (10,000,000 Ω) impedance in parallel with the circuit. This loading effect can cause measurement errors in high-impedance circuits. In most cases, the error is negligible (0.1% or less) if the circuit impedance is 10 k Ω (10,000 Ω) or less.

For better accuracy when measuring the dc offset of an ac voltage, measure the ac voltage first. Note the ac voltage range, then manually select a dc voltage range equal to or higher than the ac range. This procedure improves the accuracy of the dc measurement by ensuring that the input protection circuits are not activated.

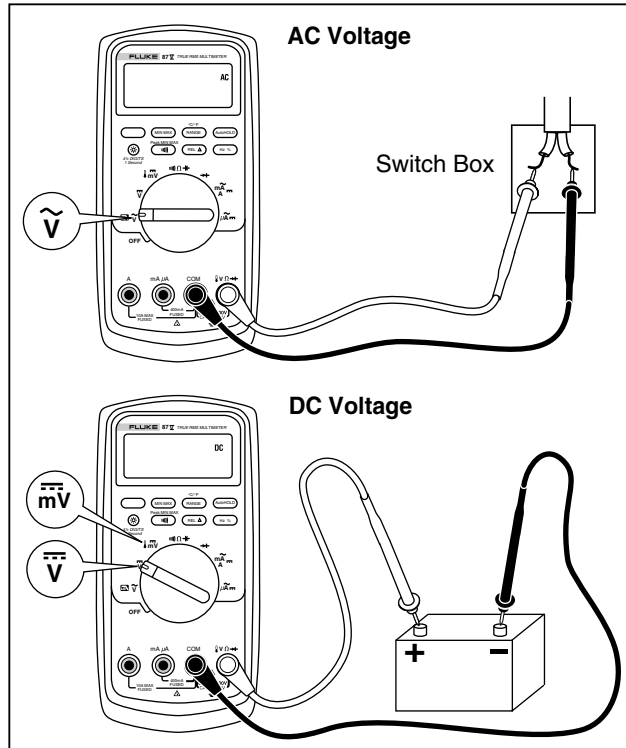

aom2f.eps

Figure 2. Measuring AC and DC Voltage



Zero Input Behavior of True RMS Meters (87)

True Rms Meters accurately measure distorted waveforms, but when the input leads are shorted together in the AC functions, the meter displays a residual reading between 1 and 30 counts. When the test leads are open, the display readings may fluctuate due to interference. These offset readings are normal. They do not affect the Meter's AC measurement accuracy over the specified measurement ranges.

Unspecified input levels are:

- AC voltage: below 3 % of 600 mV AC, or 18 mV AC
- AC current: below 3 % of 60 mA AC, or 1.8 mA AC
- AC current: below 3 % of 600 μ A AC, or 18 μ A AC

Low Pass Filter (87)

The 87 is equipped with an ac low pass filter. When measuring ac voltage or ac frequency, press  to activate the low pass filter mode (). The Meter continues measuring in the chosen ac mode, but now the signal diverts through a filter that blocks unwanted voltages above 1 kHz, refer to Figure 3. The lower frequency voltages pass with reduced accuracy to the measurement below 1 kHz. The low pass filter can improve measurement performance on composite sine waves that are typically generated by inverters and variable frequency motor drives.

Warning

To avoid possible electric shock or personal injury, do not use the Low Pass Filter option to verify the presence of hazardous voltages. Voltages greater than what is indicated may be present. First, make a voltage measurement without the filter to detect the possible presence of hazardous voltage. Then, select the filter function.

Note

In Low Pass Mode, the Meter goes to manual mode. Select ranges by pressing the RANGE button. Autoranging is not available in Low Pass Mode.

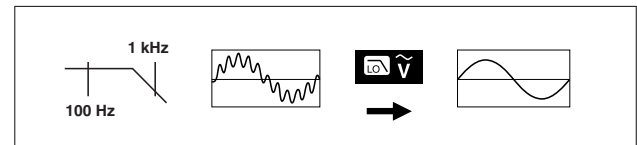

aom11f.eps

Figure 3. Low Pass Filter

Measuring Temperature (87)

The Meter measures the temperature of a type-K thermocouple (included). Choose between degrees Celsius ($^{\circ}\text{C}$) or degrees Fahrenheit ($^{\circ}\text{F}$) by pushing .

Caution



To avoid possible damage to the Meter or other equipment, remember that while the Meter is rated for $-200.0\text{ }^{\circ}\text{C}$ to $+1090.0\text{ }^{\circ}\text{C}$ and $-328.0\text{ }^{\circ}\text{F}$ to $1994.0\text{ }^{\circ}\text{F}$, the included K-Type Thermocouple is rated to $260\text{ }^{\circ}\text{C}$. For temperatures out of that range, use a higher rated thermocouple.

Display ranges are $-200.0\text{ }^{\circ}\text{C}$ to $+1090.0\text{ }^{\circ}\text{C}$ and $-328.0\text{ }^{\circ}\text{F}$ to $1994.0\text{ }^{\circ}\text{F}$. Readings outside of these ranges show **OL** on the Meter display. When there is no thermocouple connected, the display also reads **OPEn** for meters above serial number 90710501 and **OL** for meters below serial number 90710501.

Note

To locate the serial number, remove the Meter from the holster. The serial number is on the back of the Meter.

To measure temperature, do the following:

1. Connect a type-K thermocouple to the Meter's **COM** and $\downarrow\text{V } \Omega \rightarrow$ terminals.
2. Turn the rotary switch to .
3. Press  to enter temperature mode.
4. Push  to choose Celsius or Fahrenheit.

Testing for Continuity

Caution

To avoid possible damage to the Meter or to the equipment under test, disconnect circuit power and discharge all high-voltage capacitors before testing for continuity.

The continuity test features a beeper that sounds as long as a circuit is complete. The beeper allows you to perform quick continuity tests without having to watch the display.

To test for continuity, set up the Meter as shown in Figure 4.

Press  to turn the continuity beeper on or off.

The continuity function detects intermittent opens and shorts lasting as little as 1ms. A brief short causes the Meter to emit a short beep.

For in-circuit tests, turn circuit power off.

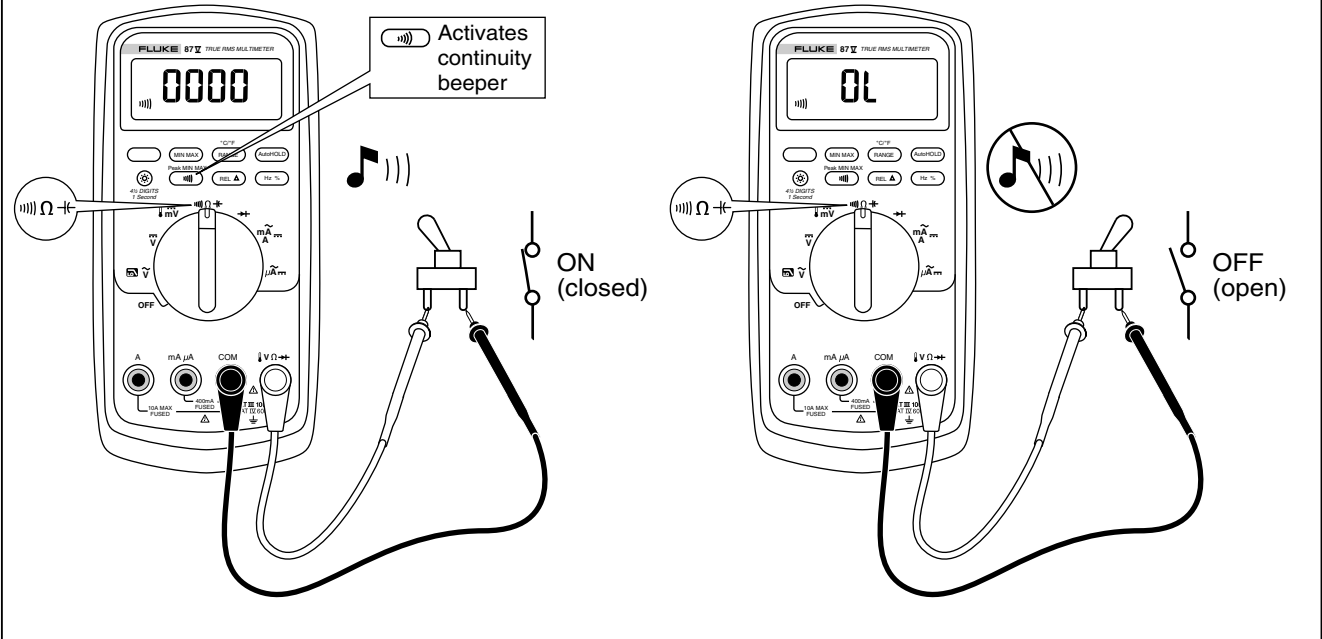

Figure 4. Testing for Continuity

Measuring Resistance

⚠ Caution

To avoid possible damage to the Meter or to the equipment under test, disconnect circuit power and discharge all high-voltage capacitors before measuring resistance.

The Meter measures resistance by sending a small current through the circuit. Because this current flows through all possible paths between the probes, the resistance reading represents the total resistance of all paths between the probes.

The Meter's resistance ranges are 600.0 Ω , 6.000 k Ω , 60.00 k Ω , 600.0 k Ω , 6.000 M Ω , and 50.00M Ω .

To measure resistance, set up the Meter as shown in Figure 5.

The following are some tips for measuring resistance:

- The measured value of a resistor in a circuit is often different from the resistor's rated value.
- The test leads can add 0.1 Ω to 0.2 Ω of error to resistance measurements. To test the leads, touch the probe tips together and read the resistance of the leads. If necessary, you can use the relative (REL) mode to automatically subtract this value.
- The resistance function can produce enough voltage to forward-bias silicon diode or transistor junctions, causing them to conduct. If this is suspected, press  to apply a lower current in the next higher range. If the value is higher, use the higher value. Refer to Table 18.

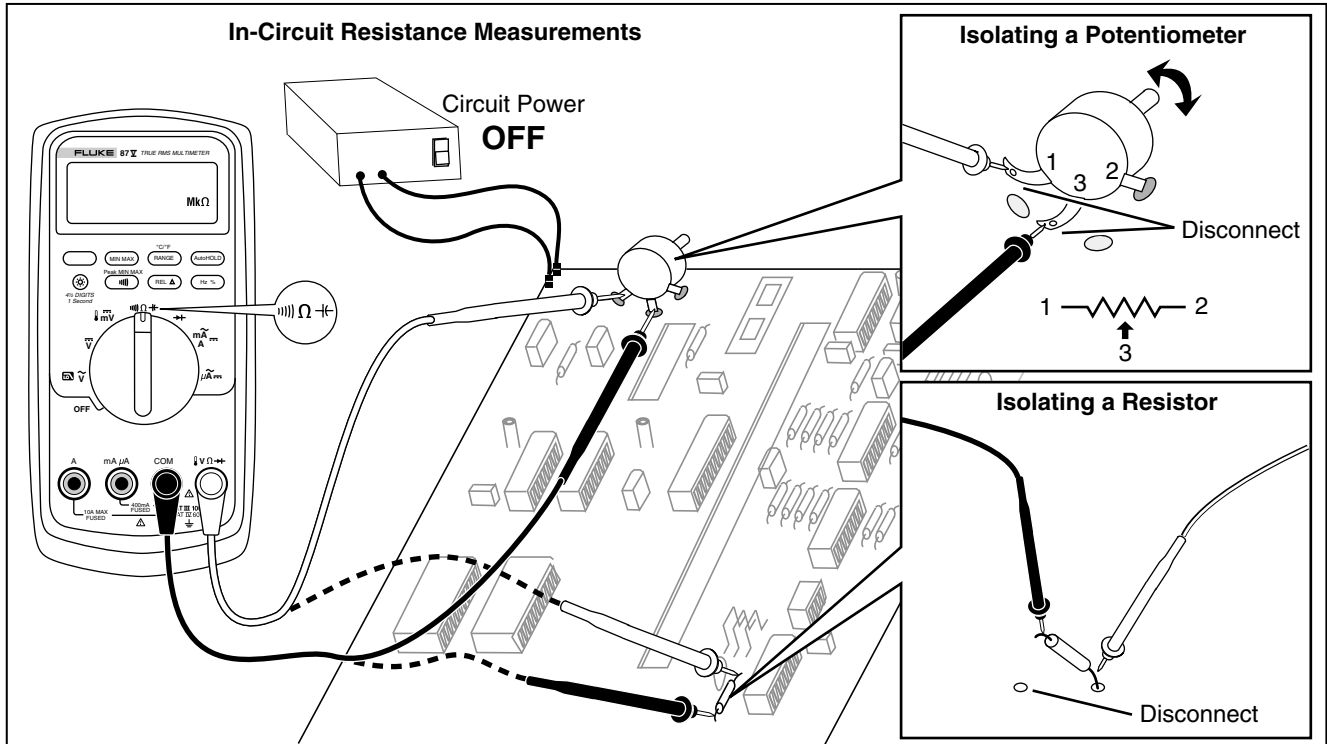



Figure 5. Measuring Resistance

Using Conductance for High Resistance or Leakage Tests

Conductance, the inverse of resistance, is the ability of a circuit to pass current. High values of conductance correspond to low values of resistance.

The Meter's 60 nS range measures conductance in nanosiemens (1 nS = 0.00000001 Siemens). Because such small amounts of conductance correspond to extremely high resistance, the nS range lets you determine the resistance of components up to 100,000 M Ω , 1/1 nS = 1,000 M Ω .

To measure conductance, set up the Meter as shown for measuring resistance (Figure 5); then press  until the nS indicator appears on the display.

The following are some tips for measuring conductance:

- High-resistance readings are susceptible to electrical noise. To smooth out most noisy readings, enter the MIN MAX recording mode; then step to the average (AVG) reading.
- There is normally a residual conductance reading with the test leads open. To ensure accurate readings, use the relative (REL) mode to subtract the residual value.

Measuring Capacitance

⚠ Caution

To avoid possible damage to the Meter or to the equipment under test, disconnect circuit power and discharge all high-voltage capacitors before measuring capacitance. Use the dc voltage function to confirm that the capacitor is discharged.

The Meter's capacitance ranges are 10.00 nF, 100.0 nF, 1.000 μ F, 10.00 μ F, 100.0 μ F, and 9999 μ F.

To measure capacitance, set up the Meter as shown in Figure 6.

To improve the accuracy of measurements less than 1000 nF, use the relative (REL) mode to subtract the residual capacitance of the Meter and leads.

Note

If too much electrical charge is present on the capacitor being tested, the display shows "diSC".

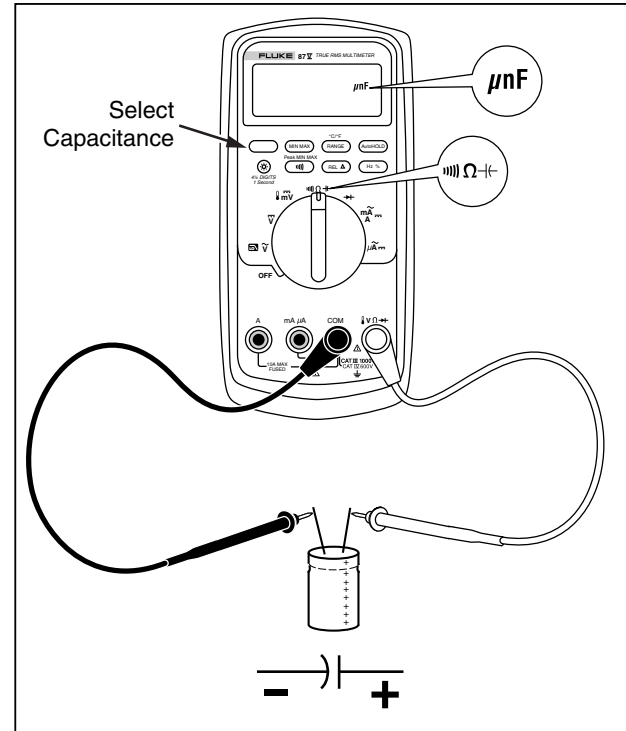

Figure 6. Measuring Capacitance

Testing Diodes

⚠ Caution

To avoid possible damage to the Meter or to the equipment under test, disconnect circuit power and discharge all high-voltage capacitors before testing diodes.

Use the diode test to check diodes, transistors, silicon controlled rectifiers (SCRs), and other semiconductor devices. This function tests a semiconductor junction by sending a current through the junction, then measuring the junction's voltage drop. A good silicon junction drops between 0.5 V and 0.8 V.

To test a diode out of a circuit, set up the Meter as shown in Figure 7. For forward-bias readings on any semiconductor component, place the red test lead on the component's positive terminal and place the black lead on the component's negative terminal.

In a circuit, a good diode should still produce a forward-bias reading of 0.5 V to 0.8 V; however, the reverse-bias reading can vary depending on the resistance of other pathways between the probe tips.

A short beep sounds if the diode is good (< 0.85 V). A continuous beep sounds if the reading is ≤ 0.100 V. This reading would indicate a short circuit. The display shows "OL" if the diode is open.

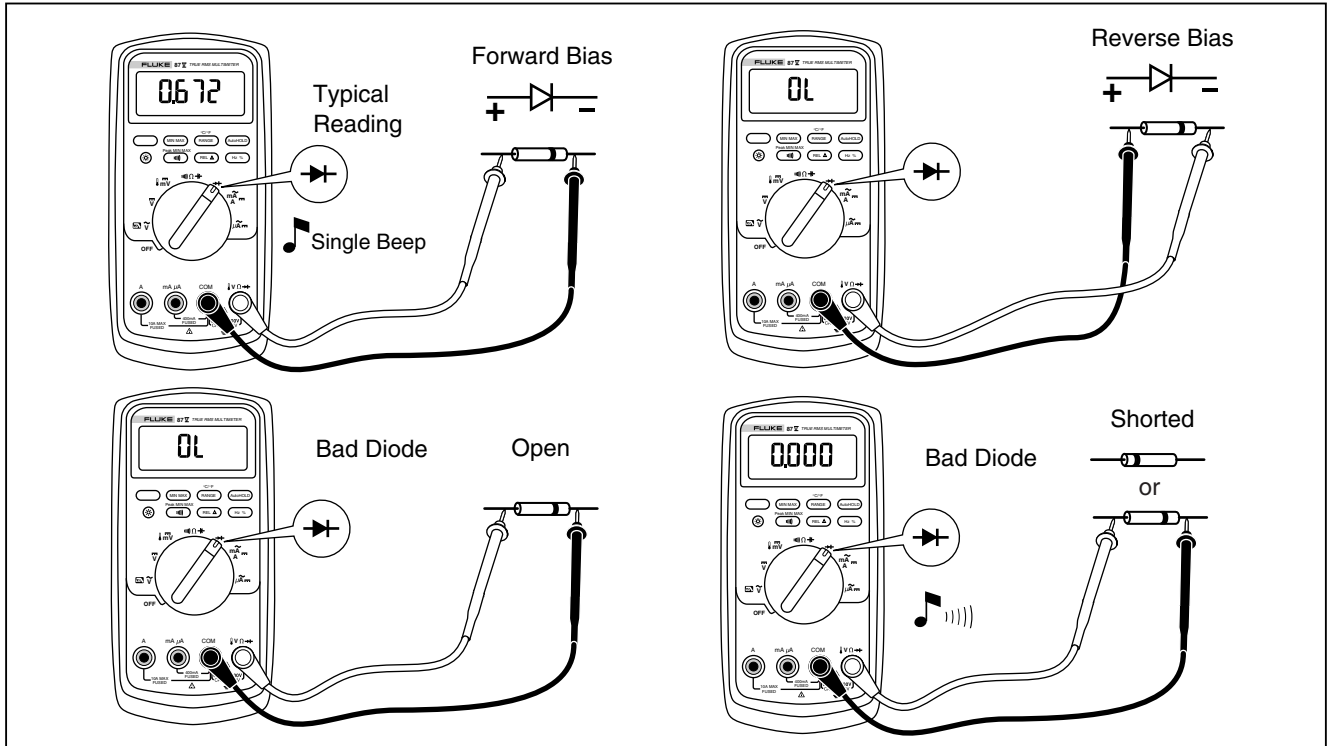

Figure 7. Testing a Diode

Measuring AC or DC Current

Warning

To avoid possible electric shock or personal injury, never attempt an in-circuit current measurement where the open-circuit potential to earth is greater than 1000 V. You may damage the Meter or be injured if the fuse blows during such a measurement.

Caution

To avoid possible damage to the Meter or to the equipment under test:

- Check the Meter's fuses before measuring current.
- Use the proper terminals, function, and range for all measurements.
- Never place the probes across (in parallel with) any circuit or component when the leads are plugged into the current terminals.

To measure current, you must break the circuit under test, then place the Meter in series with the circuit.

The Meter's current ranges are 600.0 μ A, 6000 μ A, 60.00 mA, 400.0 mA, 6000 mA, and 10 A. AC current is displayed as an rms value.

To measure current, refer to Figure 8 and proceed as follows:

1. Turn off power to the circuit. Discharge all high-voltage capacitors.
2. Insert the black lead into the **COM** terminal. For currents between 6 mA and 400 mA, insert the red lead into the **mA/ μ A** terminal. For currents above 400 mA, insert the red lead into the **A** terminal.

Note

*To avoid blowing the Meter's 400 mA fuse, use the **mA/ μ A** terminal only if you are sure the current is less than 400 mA continuously or less than 600 mA for 18 hours or less.*

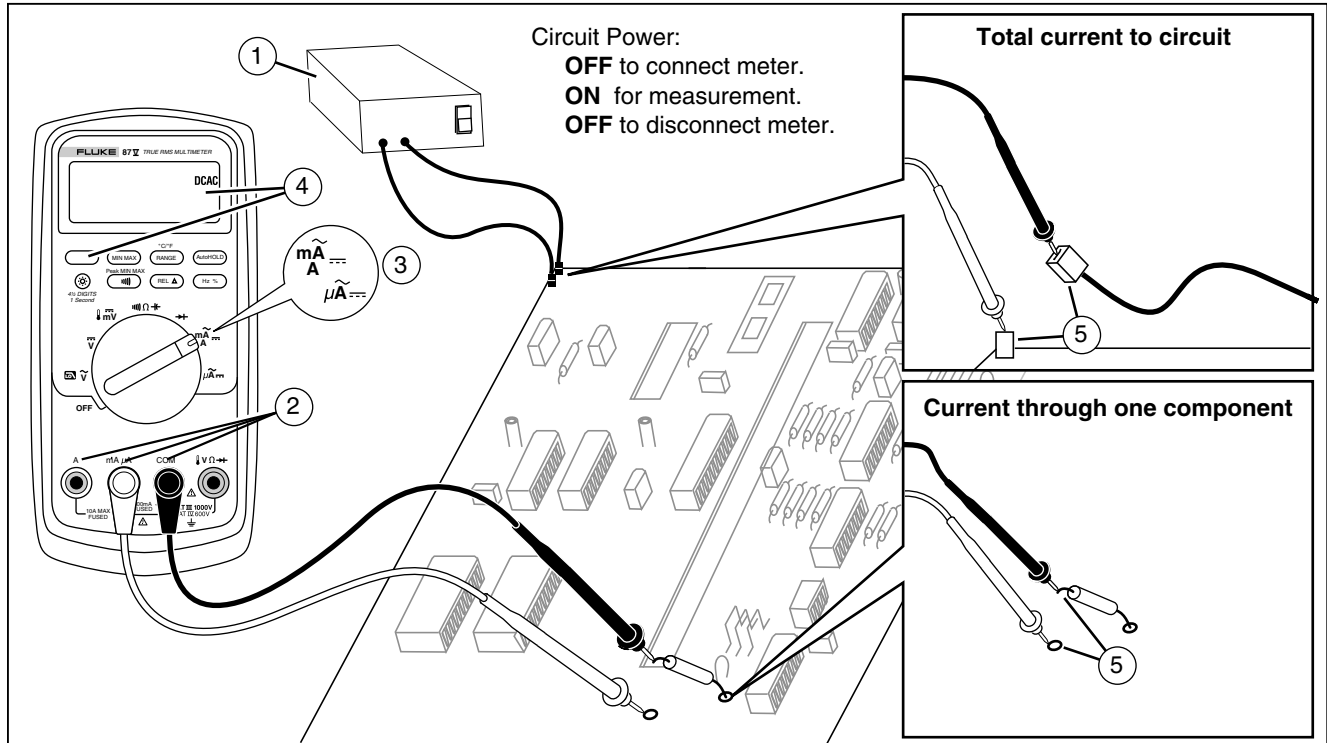



Figure 8. Measuring Current

3. If you are using the **A** terminal, set the rotary switch to mA/A. If you are using the **mA/μA** terminal, set the rotary switch to μA for currents below 6000 μA (6 mA), or mA/A for currents above 6000 μA.
4. To measure dc current, press .
5. Break the circuit path to be tested. Touch the black probe to the more negative side of the break; touch the red probe to the more positive side of the break. Reversing the leads will produce a negative reading, but will not damage the Meter.
6. Turn on power to the circuit; then read the display. Be sure to note the unit given at the right side of the display (μA, mA, or A).
7. Turn off power to the circuit and discharge all high-voltage capacitors. Remove the Meter and restore the circuit to normal operation.



The following are some tips for measuring current:

- If the current reading is 0 and you are sure the Meter is set up correctly, test the Meter's fuses as described under "Testing the Fuses".
- A current Meter drops a small voltage across itself, which might affect circuit operation. You can calculate this burden voltage using the values listed in the specifications in Table 14.

Measuring Frequency

The Meter measures the frequency of a voltage or current signal by counting the number of times the signal crosses a threshold level each second.

Table 6 summarizes the trigger levels and applications for measuring frequency using the various ranges of the Meter's voltage and current functions.

To measure frequency, connect the Meter to the signal source; then press . Pressing  switches the trigger slope between + and -, as indicated by the symbol at the left side of the display (refer to Figure 9 under "Measuring Duty Cycle"). Pressing  stops and starts the counter.

The Meter autoranges to one of five frequency ranges: 199.99 Hz, 1999.9 Hz, 19.999 kHz, 199.99 kHz, and greater than 200 kHz. For frequencies below 10 Hz, the display is updated at the frequency of the input. Below 0.5 Hz, the display may be unstable.

The following are some tips for measuring frequency:

- If a reading shows as 0 Hz or is unstable, the input signal may be below or near the trigger level. You can usually correct these problems by selecting a lower range, which increases the sensitivity of the Meter. In the \bar{V} function, the lower ranges also have lower trigger levels.
- If a reading seems to be a multiple of what you expect, the input signal may be distorted. Distortion can cause multiple triggerings of the frequency counter. Selecting a higher voltage range might solve this problem by decreasing the sensitivity of the Meter. You can also try selecting a dc range, which raises the trigger level. In general, the lowest frequency displayed is the correct one.

Table 6. Functions and Trigger Levels for Frequency Measurements

Function	Range	Approximate Trigger Level	Typical Application
\tilde{V}	6 V, 60 V, 600 V, 1000 V	$\pm 5\%$ of scale	Most signals.
\tilde{V}	600 mV	± 30 mV	High-frequency 5 V logic signals. (The dc-coupling of the \tilde{V} function can attenuate high-frequency logic signals, reducing their amplitude enough to interfere with triggering.)
$m\tilde{V}$	600 mV	40 mV	Refer to the measurement tips given before this table.
\bar{V}	6 V	1.7 V	5 V logic signals (TTL).
\bar{V}	60 V	4 V	Automotive switching signals.
\bar{V}	600 V	40 V	Refer to the measurement tips given before this table.
\bar{V}	1000 V	100 V	
Ω \rightarrow \rightarrow \rightarrow	Frequency counter characteristics are not available or specified for these functions.		
$A\sim$	All ranges	$\pm 5\%$ of scale	AC current signals.
$\mu A\rightarrow$	600 μ A, 6000 μ A	30 μ A , 300 μ A	Refer to the measurement tips given before this table.
$mA\rightarrow$	60 mA, 400 mA	3.0 mA , 30 mA	
$A\rightarrow$	6 A, 10 A	0.30 A, 3.0 A	

Measuring Duty Cycle

Duty cycle (or duty factor) is the percentage of time a signal is above or below a trigger level during one cycle (Figure 9). The duty cycle mode is optimized for measuring the on or off time of logic and switching signals. Systems such as electronic fuel injection systems and switching power supplies are controlled by pulses of varying width, which can be checked by measuring duty cycle.

To measure duty cycle, set up the Meter to measure frequency; then press Hz a second time. As with the

frequency function, you can change the slope for the Meter's counter by pressing .

For 5 V logic signals, use the 6 V dc range. For 12 V switching signals in automobiles, use the 60 V dc range. For sine waves, use the lowest range that does not result in multiple triggering. (Normally, a distortion-free signal can be up to ten times the amplitude of the selected voltage range.)

If a duty cycle reading is unstable, press MIN MAX; then scroll to the AVG (average) display.

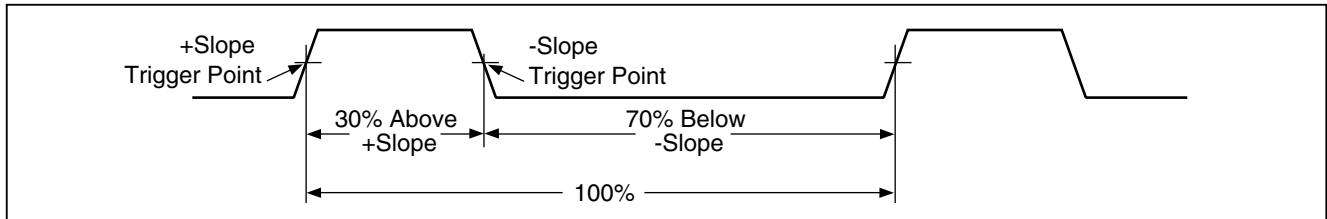



Figure 9. Components of Duty Cycle Measurements

Determining Pulse Width

For a periodic waveform (its pattern repeats at equal time intervals), you can determine the amount of time that the signal is high or low as follows:

1. Measure the signal's frequency.
2. Press  a second time to measure the signal's duty cycle. Press  to select a measurement of the signal's positive or negative pulse, refer to Figure 9.
3. Use the following formula to determine the pulse width:

$$\text{Pulse Width (in seconds)} = \frac{\% \text{ Duty Cycle} \div 100}{\text{Frequency}}$$

Bar Graph

The analog bar graph functions like the needle on an analog meter, but without the overshoot. The bar graph updates 40 times per second. Because the graph responds 10 times faster than the digital display, it is useful for making peak and null adjustments and observing rapidly changing inputs. The graph is not shown for capacitance, frequency counter functions, temperature, or peak min max.



The number of lit segments indicates the measured value and is relative to the full-scale value of the selected range.

In the 60 V range, for example, the major divisions on the scale represent 0, 15, 30, 45, and 60 V. An input of -30 V lights the negative sign and the segments up to the middle of the scale.

The bar graph also has a zoom function, as described under "Zoom Mode".

Zoom Mode (Power Up Option Only)

To use the Rel Zoom Bar Graph:



1. Hold down  while turning the Meter on. The display reads “REL”.
2. Select the relative mode by pressing  again.
3. The center of the bar graph now represents zero and the sensitivity of the bar graph increases by a factor of 10. Measured values more negative than the stored reference activate segments to the left of center; values more positive activate segments to the right of center.

Uses for the Zoom Mode

The relative mode, combined with the increased sensitivity of the bar graph's zoom mode, helps you make fast and accurate zero and peak adjustments.

For zero adjustments, set the Meter to the desired function, short the test leads together, press ; then connect the leads to the circuit under test. Adjust the circuit's variable component until the display reads zero. Only the center segment on the zoom bar graph is lit.

For peak adjustments, set the Meter to the desired function, connect the leads to the circuit under test; then press . The display reads zero. As you adjust for a positive or negative peak, the bar graph length increases

to the right or left of zero. If an overrange symbol lights (), press  twice to set a new reference; then continue with the adjustment.

HiRes Mode (Model 87)

On a Model 87 Meter, pressing  for one second causes the Meter to enter the high-resolution (HiRes), 4-1/2 digit mode. Readings are displayed at 10 times the normal resolution with a maximum display of 19,999 counts. The HiRes mode works in all modes except capacitance, frequency counter functions, temperature, and the 250 μ s (peak) MIN MAX modes.

To return to the 3-1/2 digit mode, press  again for one second.

MIN MAX Recording Mode

The MIN MAX mode records minimum and maximum input values. When the inputs go below the recorded minimum value or above the recorded maximum value, the Meter beeps and records the new value. This mode can be used to capture intermittent readings, record maximum readings while you are away or record readings while you are operating the equipment under test and cannot watch the Meter. MIN MAX mode can also calculate an average of all readings taken since the MIN MAX mode was activated. To use MIN MAX mode, refer to the functions in Table 7.

Response time is the length of time an input must stay at a new value to be recorded. A shorter response time captures shorter events, but with decreased accuracy. Changing the response time erases all recorded readings. Model 83 has 100 millisecond response time; Model 87 has 100 millisecond, and 250 μ s (peak) response times. The 250 μ s response time is indicated by "**PEAK**" on the display.

The 100 millisecond response time is best for recording power supply surges, inrush currents, and finding intermittent failures.

The true average value (AVG) displayed in the 100 ms mode is the mathematical integral of all readings taken since the start of recording (overloads are discarded).

The average reading is useful for smoothing out unstable inputs, calculating power consumption, or estimating the percentage of time a circuit is active.

Min Max records the signal extremes lasting longer than 100 ms.

Peak records the signal extremes lasting longer than 250 μ s.

Smooth Feature (Power Up Option Only)

When the input signal changes rapidly, "smoothing" provides a steadier reading on the display.

To use the smooth feature:







1. Hold down **RANGE** while turning the Meter on. The display will read "5---" until **RANGE** is released.
2. The smooth icon () will appear on the left side of the display to let you know that smoothing is active.

Table 7. MIN MAX Functions

Button	MIN MAX Function
	Enter MIN MAX recording mode. The Meter is locked in the range displayed before you entered MIN MAX mode. (Select the desired measurement function and range before entering MIN MAX.) The Meter beeps each time a new minimum or maximum value is recorded.
 (while in MIN MAX mode)	Step through maximum (MAX), minimum (MIN), average (AVG) and present values.
 PEAK MIN MAX	Model 87 only: Select 100 ms or 250 μ s response time. (The 250 μ s response time is indicated by PEAK on the display.) Stored values are erased. The present and AVG (average) values are not available when 250 μ s is selected.
	Stop recording without erasing stored values. Press again to resume recording.
 (hold for 1 second)	Exit MIN MAX mode. Stored values are erased. The Meter stays in the selected range.



AutoHOLD Mode

Warning

To avoid possible electric shock or personal injury, do not use AutoHOLD mode to determine that circuits are without power. The AutoHOLD mode will not capture unstable or noisy readings.

The AutoHOLD mode captures the present reading on the display. When a new, stable reading is detected, the Meter beeps and displays the new reading. To enter or exit AutoHOLD mode, press .

Relative Mode

Selecting relative mode () causes the Meter to zero the display and store the present reading as the reference for subsequent measurements. The Meter is locked into the range selected when you pressed . Press  again to exit this mode.

In relative mode, the reading shown is always the difference between the present reading and the stored reference value. For example, if the stored reference value is 15.00 V and the present reading is 14.10 V, the display shows -0.90 V.

Maintenance

Warning

To avoid possible electric shock or personal injury, repairs or servicing not covered in this manual should be performed only by qualified personnel as described in the 80 Series V Service Information.

General Maintenance

Periodically wipe the case with a damp cloth and mild detergent. Do not use abrasives or solvents.

Dirt or moisture in the terminals can affect readings and can falsely activate the Input Alert feature. Clean the terminals as follows:

1. Turn the Meter off and remove all test leads.
2. Shake out any dirt that may be in the terminals.
3. Soak a new swab with a cleaning and oiling agent (such as WD-40). Work the swab around in each terminal. The oiling agent insulates the terminals from moisture-related activation of the Input Alert feature.

Fuse Test

If a test lead is plugged into the mA/ μ A or A terminal and the rotary switch is turned to a non-current function, the Meter chirps and flashes “L E R d” if the fuse associated with that current terminal is good. If the Meter does not chirp or flash “L E R d”, the fuse is bad and must be replaced. Refer to Table 8 for the appropriate replacement fuse.

To test the quality of the fuse before measuring current, test the appropriate fuse as shown in Figure 10. If the tests give readings other than those shown, have the Meter serviced.

Warning

To avoid electrical shock or personal injury, remove the test leads and any input signals before replacing the battery or fuses. To prevent damage or injury, install ONLY specified replacement fuses with the amperage, voltage, and speed ratings shown in Table 8.

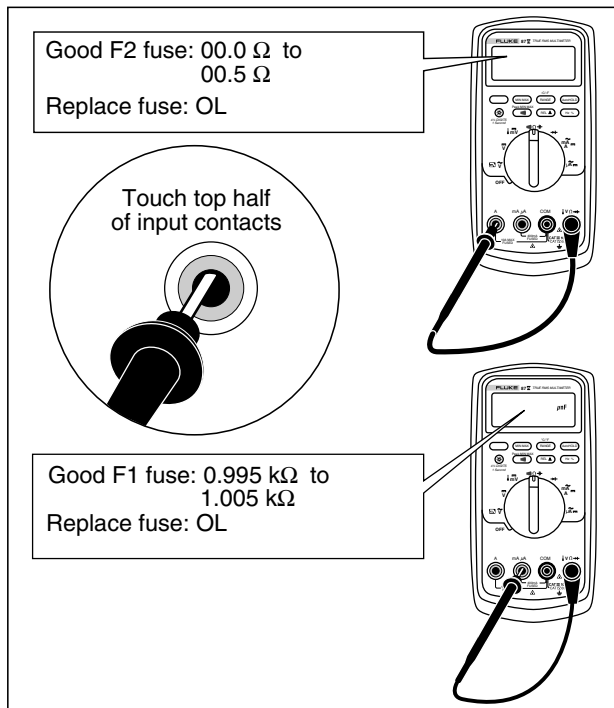

Figure 10. Testing the Current Fuses

Replacing the Battery

Replace the battery with a 9 V battery (NEDA A1604, 6F22, or 006P).

⚠ ⚠ Warning

To avoid false readings, which could lead to possible electric shock or personal injury, replace the battery as soon as the battery indicator (🔋) appears. If the display shows **bAt** the Meter will not function until the battery is replaced.

Replace the battery as follows, refer to Figure 11:

1. Turn the rotary switch to OFF and remove the test leads from the terminals.
2. Remove the battery door by using a standard-blade screwdriver to turn the battery door screws one-quarter turn counterclockwise.
3. Replace the battery and the battery door. Secure the door by turning the screws one-quarter turn clockwise.

Replacing the Fuses

Referring to Figure 11, examine or replace the Meter's fuses as follows:

1. Turn the rotary switch to OFF and remove the test leads from the terminals.
2. Remove the battery door by using a standard-blade screwdriver to turn the battery door screws one-quarter turn counterclockwise.
3. Remove the three Phillips-head screws from the case bottom and turn the case over.
4. Gently push up the input terminal-end of the top case from inside of the battery compartment to separate the two halves of the case.
5. Remove the fuse by gently prying one end loose, then sliding the fuse out of its bracket.
6. Install ONLY specified replacement fuses with the amperage, voltage, and speed ratings shown in Table 8.
7. Verify that the rotary switch and the circuit board switch are in the OFF position.
8. Replace the case top, ensuring that the gasket is properly seated and case snaps together above the LCD (item ①).
9. Reinstall the three screws and the battery door. Secure the door by turning the screws one-quarter turn clockwise.

Service and Parts

If the Meter fails, check the battery and fuses. Review this manual to verify proper use of the Meter.

Replacement parts and accessories are shown in Tables 8 and 9 and Figure 12.

To order parts and accessories, refer to "Contacting Fluke".

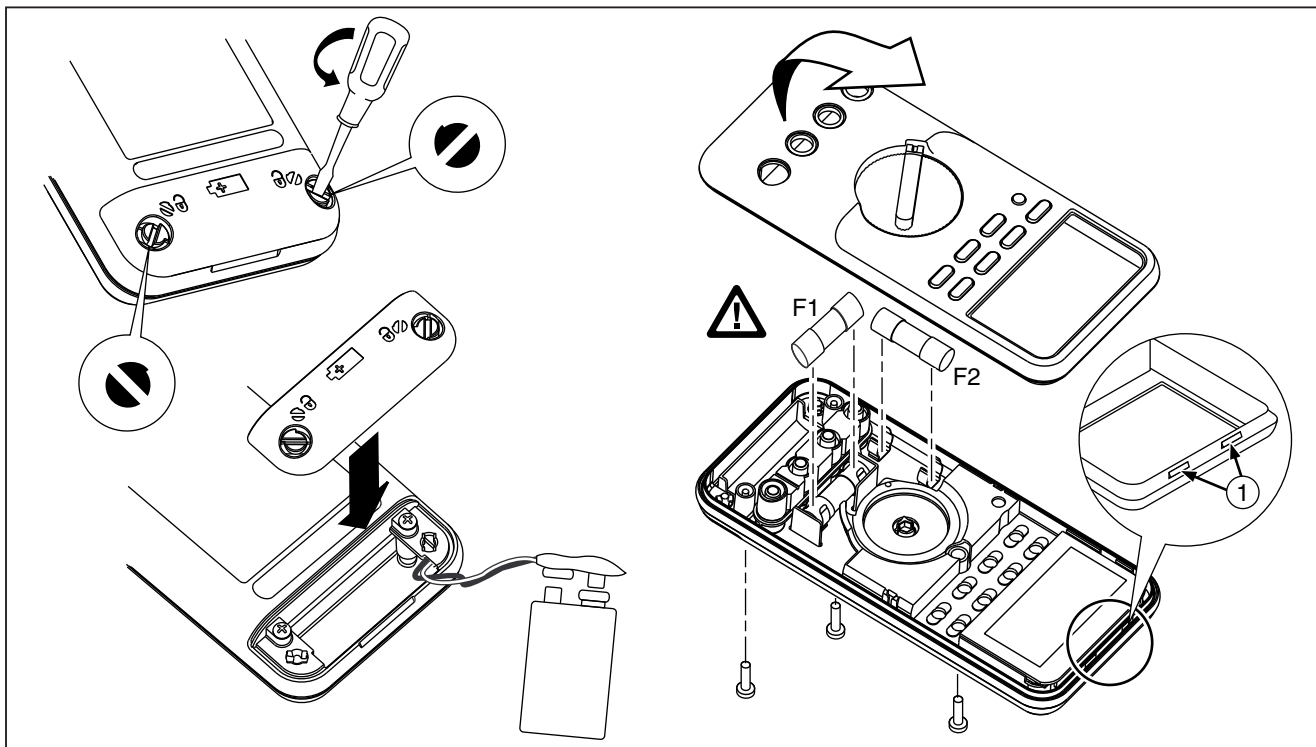



Figure 11. Battery and Fuse Replacement

Table 8. Replacement Parts

Item	Description	Qty.	Fluke Part or Model Number
BT1	Battery, 9 V	1	2139179
BT2	Cable Assy, 9 V Battery Snap	1	2064217
F1 	Fuse, 0.440 A, 1000 V, FAST	1	943121
F2 	Fuse, 11 A, 1000 V, FAST	1	803293
H2-4	Screw, Case	3	832246
H5-9	Screw, Bottom Shield	5	448456
J1-2	Elastomeric Connector	2	817460
MP2	Shield, Top	1	2073906
MP4	Shield, Bottom	1	2074025
MP5	Case Top (PAD XFER) With Window	1	2073992
MP6	Case Bottom	1	2073871
MP8	Knob, Switch (PAD XFER)	1	2100482
MP9	Detent, Knob	1	822643
MP10-11	Foot, Non-Skid	2	824466
MP13	Shock Absorber	1	828541
MP14	O-Ring, Input Receptacle	1	831933
MP15	Holster	1	2074033
MP22	Battery Door	1	2073938
MP27-MP30	Contact RSOB	4	1567683
MP31	Mask, LCD (PAD XFER)	1	2073950
MP41	Housing, RSOB	1	2073945

 To ensure safety, use exact replacement only.

Table 8. Replacement Parts (cont.)

Item	Description	Qty.	Fluke Part or Model Number
AC72	Alligator Clip, Black	1	1670652
AC72	Alligator Clip, Red	1	1670641
TL75	Test Lead Set	1	855742
MP81	Thermocouple Assembly, K-Type, Beaded, Molded Dual Banana Plug, Coiled	1	1273113
MP390-391	Access Door Fastener	2	948609
NA	Tiltstand	1	2074040
U5	LCD, 4.5 DIGIT, TN, Transflective, Bar Graph, OSPR80	1	2065213
CR6	Lightpipe	1	2074057
S2	Keypad	1	2105884
TM1	80 Series V Multi-Language Getting Started Manual	1	2101973
TM2	80 Series V Quick Reference Card	1	2101986
TM3	CD ROM, 80 Series V User Manual	1	2101999

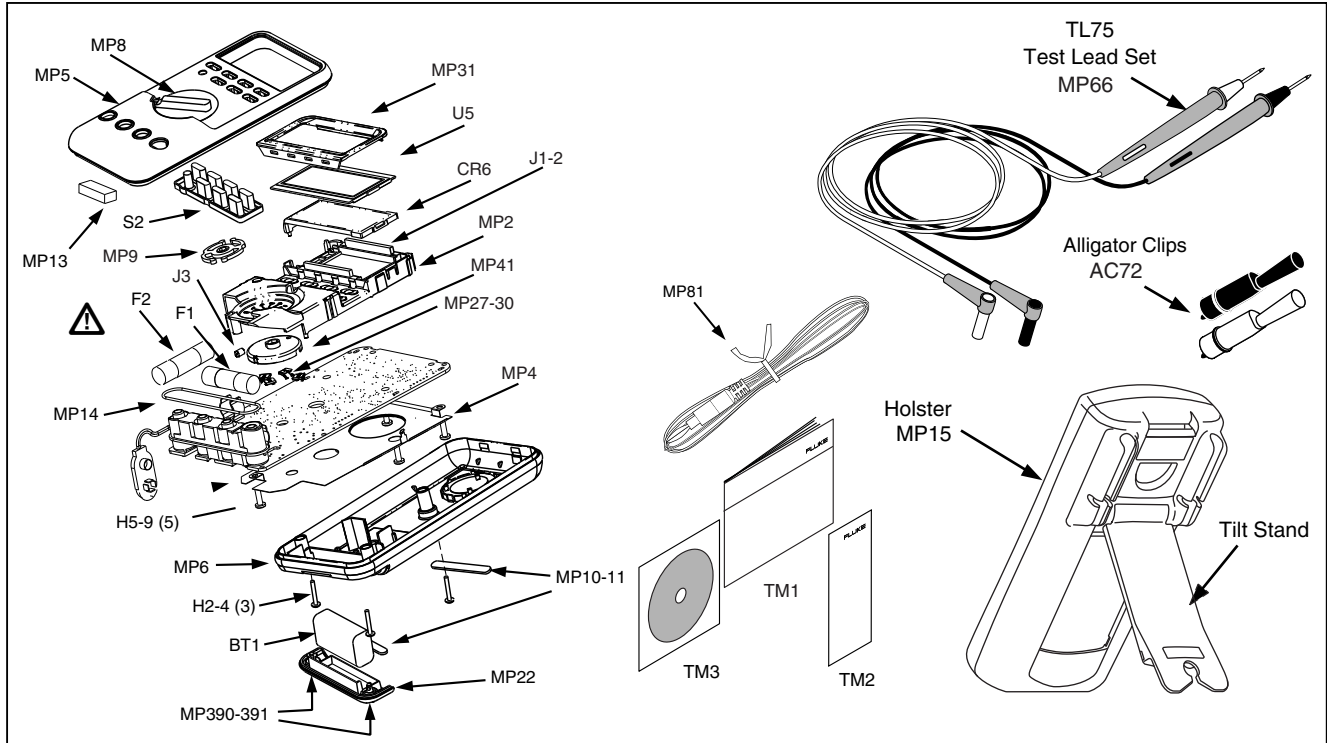

Figure 12. Replaceable Parts

Table 9. Accessories

Item	Description
AC72	Alligator Clips for use with TL75 test lead set
AC220	Safety Grip, Wide-Jaw Alligator Clips
TPAK	ToolPak Magnetic Hanger
H87	Holster, Yellow
C25	Carrying Case, Soft
TL76	4 mm Diameter Test Leads
TL220	Industrial Test Lead Set
TL224	Test Lead Set, Heat-Resistant Silicone
TP1	Test Probes, Flat Blade, Slim Reach
TP4	Test Probes, 4 mm diameter, Slim Reach
Fluke accessories are available from an authorized Fluke distributor.	

Specifications

Maximum Voltage between any Terminal and Earth Ground: 1000 V rms

⚠ Fuse Protection for mA or μ A inputs: 44/100 A, 1000 V FAST Fuse

⚠ Fuse Protection for A input: 11 A, 1000 V FAST Fuse

Display: Digital: 6000 counts updates 4/sec; (Model 87 also has 19,999 counts in high-resolution mode).

Analog Bargraph: 33 segments, updates 40/sec. Frequency: 19,999 counts, updates 3/sec at >10 Hz

Temperature: Operating: -20 °C to +55 °C; Storage: -40 °C to +60 °C

Altitude: Operating: 2000 m; Storage: 10,000 m

Temperature Coefficient: 0.05 x (specified accuracy)/ °C (<18 °C or >28 °C)

Electromagnetic Compatibility: In an RF field of 3 V/m total accuracy = specified accuracy + 20 counts

Except: 600 μ A dc range total accuracy=specified accuracy +60 counts.

Temperature not specified.

Relative Humidity: 0 % to 90 % (0 °C to 35 °C); 0 % to 70 % (35 °C to 55 °C)

Battery Type: 9 V zinc, NEDA 1604 or 6F22 or 006P

Battery Life: 400 hrs typical with alkaline (with backlight off)

Vibration: Per MIL-PRF-28800 for a Class 2 instrument

Shock: 1 Meter drop per IEC 61010-1:2001

Size (HxWxL): 1.25 in x 3.41 in x 7.35 in (3.1 cm x 8.6 cm x 18.6 cm)

Size with Holster and Flex-Stand: 2.06 in x 3.86 in x 7.93 in (5.2 cm x 9.8 cm x 20.1 cm)

Weight: 12.5 oz (355 g)

Weight with Holster and Flex-Stand: 22.0 oz (624 g)

Safety: Complies with ANSI/ISA S82.01-2004, CSA 22.2 No. 1010.1:2004 to 1000 V Overvoltage Category III, IEC 664 to 600 V Overvoltage Category IV. UL listed to UL61010-1. Licensed by TÜV to EN61010-1.

IP Rating: 30

Detailed Specifications

For all detailed specifications:

Accuracy is given as \pm ([% of reading] + [number of least significant digits]) at 18° C to 28° C, with relative humidity up to 90 %, for a period of one year after calibration.

For Model 87 in the 4 ½-digit mode, multiply the number of least significant digits (counts) by 10. AC conversions are ac-coupled and valid from 3 % to 100 % of range. Model 87 is true rms responding. AC crest factor can be up to 3 at full scale, 6 at half scale. For non-sinusoidal wave forms add $-(2 \% \text{ Rdg} + 2 \% \text{ full scale})$ typical, for a crest factor up to 3.

Table 10. Model 87 AC Voltage Function Specifications

Function	Range	Resolution	Accuracy					
\tilde{V} [2,4]	600.0 mV	0.1 mV	45 – 65 Hz	30 – 200 Hz	200 – 440 Hz	440 Hz - 1 kHz	1 - 5 kHz	5 - 20 kHz ^[1]
	6.000 V	0.001 V	$\pm (0.7 \% + 4)$	$\pm (1.0 \% + 4)$			$\pm (2.0 \% + 4)$	$\pm (2.0 \% + 20)$
	60.00 V	0.01 V	$\pm (0.7 \% + 2)$					
	600.0 V	0.1 V					$\pm (2.0 \% + 4)$ ^[3]	unspecified
	1000 V	1 V					unspecified	unspecified
	Low pass filter		Same as 45-65 Hz	$\pm (1.0 \% + 4)$	+1 % + 4 -6 % - 4 ^[5]	unspecified	unspecified	unspecified

[1] Below 10 % of range, add 12 counts.

[2] The Meter is a true rms responding meter. When the input leads are shorted together in the ac functions, the Meter may display a residual reading between 1 and 30 counts. A 30 count residual reading will cause only a 2-digit change for readings over 3 % of range. Using REL to offset this reading may produce a much larger constant error in later measurements.

[3] Frequency range: 1 kHz to 2.5 kHz.

[4] A residual reading of up to 13 digits with leads shorted, will not affect stated accuracy above 3 % of range.

[5] Specification increases from -1% at 200 Hz to -6% at 440 Hz when filter is in use.

Table 11. Model 83 AC Voltage Function Specifications

Function	Range	Resolution	Accuracy		
			50 Hz - 60 Hz	30 Hz - 1 kHz	1 kHz - 5 kHz
\tilde{V}^1	600.0 mV	0.1 mV	$\pm (0.5 \% + 4)$	$\pm (1.0 \% + 4)$	$\pm (2.0 \% + 4)$
	6.000 V	0.001 V	$\pm (0.5 \% + 2)$	$\pm (1.0 \% + 4)$	$\pm (2.0 \% + 4)$
	60.00 V	0.01 V	$\pm (0.5 \% + 2)$	$\pm (1.0 \% + 4)$	$\pm (2.0 \% + 4)$
	600.0 V	0.1 V	$\pm (0.5 \% + 2)$	$\pm (1.0 \% + 4)$	$\pm (2.0 \% + 4)^2$
	1000 V	1 V	$\pm (0.5 \% + 2)$	$\pm (1.0 \% + 4)$	unspecified
1. Below a reading of 200 counts, add 10 counts. 2. Frequency range: 1 kHz to 2.5 kHz.					

Table 12. DC Voltage, Resistance, and Conductance Function Specifications

Function	Range	Resolution	Accuracy	
			Model 83	Model 87
\bar{V}	6.000 V	0.001 V	$\pm (0.1 \% + 1)$	$\pm (0.05 \% + 1)$
	60.00 V	0.01 V	$\pm (0.1 \% + 1)$	$\pm (0.05 \% + 1)$
	600.0 V	0.1 V	$\pm (0.1 \% + 1)$	$\pm (0.05 \% + 1)$
	1000 V	1 V	$\pm (0.1 \% + 1)$	$\pm (0.05 \% + 1)$
\bar{mV}	600.0 mV	0.1 mV	$\pm (0.3 \% + 1)$	$\pm (0.1 \% + 1)$
Ω nS	600.0 Ω	0.1 Ω	$\pm (0.4 \% + 2)^1$	$\pm (0.2 \% + 2)^1$
	6.000 k Ω	0.001 k Ω	$\pm (0.4 \% + 1)$	$\pm (0.2 \% + 1)$
	60.00 k Ω	0.01 k Ω	$\pm (0.4 \% + 1)$	$\pm (0.2 \% + 1)$
	600.0 k Ω	0.1 k Ω	$\pm (0.7 \% + 1)$	$\pm (0.6 \% + 1)$
	6.000 M Ω	0.001 M Ω	$\pm (0.7 \% + 1)$	$\pm (0.6 \% + 1)$
	50.00 M Ω	0.01 M Ω	$\pm (1.0 \% + 3)^2$	$\pm (1.0 \% + 3)^2$
	60.00 nS	0.01 nS	$\pm (1.0 \% + 10)^1$	$\pm (1.0 \% + 10)^1$

1. When using the REL Δ function to compensate for offsets.
2. Add 0.5 % of reading when measuring above 30 M Ω in the 50 M Ω range, and 20 counts below 33 nS in the 60 nS range.

Table 13. Temperature Specifications (87 Only)



Temperature	Resolution	Accuracy^{1,2}
-200 °C to +1090 °C	0.1 °C	1 % + 10
-328 °F to +1994 °F	0.1 °F	1 % + 18
<p>1. Does not include error of the thermocouple probe. 2. Accuracy specification assumes ambient temperature stable to ± 1 °C. For ambient temperature changes of ± 5 °C, rated accuracy applies after 1 hour.</p>		

Table 14. Current Function Specifications

Function	Range	Resolution	Accuracy		Burden Voltage (typical)
			Model 83 ¹	Model 87 ^{2, 3}	
mA A~ (45 Hz to 2 kHz)	60.00 mA	0.01 mA	$\pm (1.2 \% + 2)^5$	$\pm (1.0 \% + 2)$	1.8 mV/mA
	400.0 mA ⁶	0.1 mA	$\pm (1.2 \% + 2)^5$	$\pm (1.0 \% + 2)$	1.8 mV/mA
	6.000 A	0.001 A	$\pm (1.2 \% + 2)^5$	$\pm (1.0 \% + 2)$	0.03 V/A
	10.00 A ⁴	0.01 A	$\pm (1.2 \% + 2)^5$	$\pm (1.0 \% + 2)$	0.03 V/A
mA A$\overline{\sim}$	60.00 mA	0.01 mA	$\pm (0.4 \% + 4)$	$\pm (0.2 \% + 4)$	1.8 mV/mA
	400.0 mA ⁶	0.1 mA	$\pm (0.4 \% + 2)$	$\pm (0.2 \% + 2)$	1.8 mV/mA
	6.000 A	0.001 A	$\pm (0.4 \% + 4)$	$\pm (0.2 \% + 4)$	0.03 V/A
	10.00 A ⁴	0.01 A	$\pm (0.4 \% + 2)$	$\pm (0.2 \% + 2)$	0.03 V/A
μA ~ (45 Hz to 2 kHz)	600.0 μ A	0.1 μ A	$\pm (1.2 \% + 2)^5$	$\pm (1.0 \% + 2)$	100 μ V/ μ A
	6000 μ A	1 μ A	$\pm (1.2 \% + 2)^5$	$\pm (1.0 \% + 2)$	100 μ V/ μ A
μA$\overline{\sim}$	600.0 μ A	0.1 μ A	$\pm (0.4 \% + 4)$	$\pm (0.2 \% + 4)$	100 μ V/ μ A
	6000 μ A	1 μ A	$\pm (0.4 \% + 2)$	$\pm (0.2 \% + 2)$	100 μ V/ μ A

1. AC conversion for Model 83 is ac coupled and calibrated to the rms value of a sine wave input.
2. AC conversions for Model 87 are ac coupled, true rms responding, and valid from 3 % to 100 % of range, except 400 mA range (5 % to 100 % of range) and 10 A range (15 % to 100 % of range).
3. Model 87 is a true rms responding meter. When the input leads are shorted together in the ac functions, the Meter may display a residual reading between 1 and 30 counts. A 30 count residual reading will cause only a 2 digit change for readings over 3 % of range. Using REL to offset this reading may produce a much larger constant error in later measurements
4. Δ 10 A continuous up to 35 °C; < 20 minutes on, 5 minutes off at 35 °C to 55 °C. 20 A for 30 seconds maximum; > 10 A unspecified.
5. Below a reading of 200 counts, add 10 counts.
6. 400 mA continuous; 600 mA for 18 hrs maximum.

Table 15. Capacitance and Diode Function Specifications

Function	Range	Resolution	Accuracy
	10.00 nF	0.01 nF	$\pm (1 \% + 2)^1$
	100.0 nF	0.1 nF	$\pm (1 \% + 2)^1$
	1.000 μ F	0.001 μ F	$\pm (1 \% + 2)$
	10.00 μ F	0.01 μ F	$\pm (1 \% + 2)$
	100.0 μ F	0.1 μ F	$\pm (1 \% + 2)$
	9999 μ F	1 μ F	$\pm (1 \% + 2)$
	3.000 V	0.001 V	$\pm (2 \% + 1)$

1. With a film capacitor or better, using Relative mode to zero residual.

Table 16. Frequency Counter Specifications

Function	Range	Resolution	Accuracy
Frequency (0.5 Hz to 200 kHz, pulse width > 2 μ s)	199.99	0.01 Hz	$\pm (0.005 \% + 1)$
	1999.9	0.1 Hz	$\pm (0.005 \% + 1)$
	19.999 kHz	0.001 kHz	$\pm (0.005 \% + 1)$
	199.99 kHz	0.01 kHz	$\pm (0.005 \% + 1)$
	> 200 kHz	0.1 kHz	unspecified

Table 17. Frequency Counter Sensitivity and Trigger Levels

Input Range ¹	Minimum Sensitivity (RMS Sine wave)		Approximate Trigger Level (DC Voltage Function)
	5 Hz - 20 kHz	0.5 Hz - 200 kHz	
600 mV dc	70 mV (to 400 Hz)	70 mV (to 400 Hz)	40 mV
600 mV ac	150 mV	150 mV	—
6 V	0.3 V	0.7 V	1.7 V
60 V	3 V	7 V (≤ 140 kHz)	4 V
600 V	30 V	70 V (≤ 14.0 kHz)	40 V
1000 V	100 V	200 V (≤ 1.4 kHz)	100 V
Duty Cycle Range	Accuracy		
0.0 to 99.9 %	Within \pm (0.2% per kHz + 0.1 %) for rise times < 1 μ s.		
1. Maximum input for specified accuracy = 10X Range or 1000 V.			

Table 18. Electrical Characteristics of the Terminals

Function	Overload Protection ¹	Input Impedance (nominal)	Common Mode Rejection Ratio (1 k Ω unbalance)		Normal Mode Rejection						
\bar{V}	1000 V rms	10 M Ω < 100 pF	> 120 dB at dc, 50 Hz or 60 Hz		> 60 dB at 50 Hz or 60 Hz						
\bar{mV}	1000 V rms	10 M Ω < 100 pF	> 120 dB at dc, 50 Hz or 60 Hz		> 60 dB at 50 Hz or 60 Hz						
\tilde{V}	1000 V rms	10 M Ω < 100 pF (ac-coupled)	> 60 dB, dc to 60 Hz								
			Open Circuit Test Voltage	Full Scale Voltage		Typical Short Circuit Current					
				To 6.0 M Ω	50 M Ω or 60 nS	600 Ω	6 k	60 k	600 k	6 M	50 M
Ω	1000 V rms	< 7.9 V dc	< 4.1 V dc	< 4.5 V dc	1 mA	100 μ A	10 μ A	1 μ A	1 μ A	0.5 μ A	
\rightarrow	1000 V rms	< 7.9 V dc	3.000 V dc		1.0 mA typical						
1. 10 ⁶ V Hz max											

Table 19. MIN MAX Recording Specifications

Model	Nominal Response	Accuracy
83	100 ms to 80 %	Specified accuracy ± 12 counts for changes > 200 ms in duration (± 40 counts in ac with beeper on)
87	100 ms to 80 % (dc functions)	Specified accuracy ± 12 counts for changes > 200 ms in duration
	120 ms to 80 % (ac functions)	Specified accuracy ± 40 counts for changes > 350 ms and inputs > 25 % of range
	250 μ s (peak) (Model 87 only) ¹	Specified accuracy ± 100 counts for changes > 250 μ s in duration (add ± 100 counts for readings over 6000 counts) (add ± 100 counts for readings in Low Pass mode)
1. For repetitive peaks: 1 ms for single events.		

FLUKE®
80 Series V
Multimeters

Getting Started Manual

Introduction

⚠ ⚠ Warning

Read "Safety Information" before you use the Meter.

Except where noted, the descriptions and instructions in this manual apply to Series V Models 83 and 87 multimeters (hereafter referred to as "the Meter").
Model 87 appears in all illustrations.

In this manual, a **Warning** identifies conditions and actions that pose hazards to the user. A **Caution** identifies conditions and actions that may damage the Meter or the equipment under test.

Electrical symbols used on the Meter and in this manual are explained in Table 1.

⚠ ⚠ Warning

To avoid possible electric shock or personal injury, follow these guidelines:

- **Use this Meter only as specified in this manual or the protection provided by the Meter might be impaired.**
- **Do not use the Meter if it is damaged. Before you use the Meter, inspect the case. Look for cracks or missing plastic. Pay particular attention to the insulation surrounding the connectors.**
- **Make sure the battery door is closed and latched before operating the Meter.**
- **Replace the battery as soon as the battery indicator (+) appears.**
- **Remove test leads from the Meter before opening the battery door.**
- **Inspect the test leads for damaged insulation or exposed metal. Check the test leads for continuity. Replace damaged test leads before you use the Meter.**
- **Do not apply more than the rated voltage, as marked on the Meter, between the terminals or between any terminal and earth ground.**

80 Series V

Getting Started Manual















- Never operate the Meter with the cover removed or the case open.
- Use caution when working with voltages above 30 V ac rms, 42 V ac peak, or 60 V dc. These voltages pose a shock hazard.
- Use only the replacement fuses specified by the manual.
- Use the proper terminals, function, and range for measurements.
- Avoid working alone.
- When measuring current, turn off circuit power before connecting the Meter in the circuit. Remember to place the Meter in series with the circuit.
- When making electrical connections, connect the common test lead before connecting the live test lead; when disconnecting, disconnect the live test lead before disconnecting the common test lead.
- Do not use the Meter if it operates abnormally. Protection may be impaired. When in doubt, have the Meter serviced.
- Do not operate the Meter around explosive gas, vapor, or dust.
- Use only a single 9 V battery, properly installed in the Meter case, to power the Meter.
- When servicing the Meter, use only specified replacement parts.
- When using probes, keep fingers behind the finger guards on the probes.
- Do not use the Low Pass Filter option to verify the presence of hazardous voltages. Voltages greater than what is indicated may be present. First, make a voltage measurement without the filter to detect the possible presence of hazardous voltage. Then select the filter function.

Caution

To avoid possible damage to the Meter or to the equipment under test, follow these guidelines:

- Disconnect circuit power and discharge all high-voltage capacitors before testing resistance, continuity, diodes, or capacitance.
- Use the proper terminals, function, and range for all measurements.
- Before measuring current, check the Meter's fuses. (See "Fuse Test" in the Users Manual on the *80 Series V User Manual CD*.)

Table 1. Electrical Symbols

	AC (Alternating Current)		Earth ground
	DC (Direct Current)		Fuse
	Hazardous voltage		Conforms to European Union directives.
	Risk of Danger. Important information. See Manual.		Conforms to relevant Canadian Standards Association directives.
	Battery. Low battery when displayed.		Double insulated
	Continuity test or continuity beeper tone.		Capacitance
CAT III	IEC Overvoltage Category III CAT III equipment is designed to protect against transients in equipment in fixed-equipment installations, such as distribution panels, feeders and short branch circuits, and lighting systems in large buildings.	CAT IV	IEC Overvoltage Category IV CAT IV equipment is designed to protect against transients from the primary supply level, such as an electricity meter or an overhead or underground utility service.
	Underwriters Laboratories		Diode
	Inspected and licensed by TÜV Product Services.		

The Meter's Features

Tables 2 through 5 briefly describe the Meter's features.

Table 2. Inputs

Terminal	Description
A	Input for 0 A to 10.00 A current (20 A overload for 30 seconds maximum), current frequency, and duty cycle measurements.
mA μ A	Input for 0 μ A to 400 mA current measurements (600 mA for 18 hrs.) and current frequency and duty cycle.
COM	Return terminal for all measurements
 V Ω \rightarrow \vdash	Input for voltage, continuity, resistance, diode, capacitance, frequency, temperature (87), and duty cycle measurements.

Table 3. Rotary Switch Positions









Switch Position	Function
Any Position	When the Meter is turned on, the Meter model number briefly appears on the display.
	AC voltage measurement Press <input type="button" value="LO"/> for low pass filter () (87 only).
	DC voltage measurement
	600 mV dc voltage range Press <input type="button" value="600"/> for temperature () (87 only).
	Press <input type="button" value=" "/> for continuity test. Ω Resistance measurement Press <input type="button" value="C"/> for Capacitance measurement.
	Diode test
	AC current measurements from 0 mA to 10.00 A Press <input type="button" value="A"/> for dc current measurements, from 0 mA to 10.00 A.
	AC current measurements from 0 μ A to 6000 μ A Press <input type="button" value="uA"/> for dc current measurements from 0 μ A to 6000 μ A.

Table 4. Pushbuttons











Button	Switch Position	Function
 (Yellow)	     Power-up	<p>Selects capacitance</p> <p>Selects temperature (87 only)</p> <p>Selects ac low pass filter function (87 only)</p> <p>Switches between dc and ac current</p> <p>Switches between dc and ac current</p> <p>Disables automatic power-off feature (Meter normally powers off in 30 minutes). The Meter reads “P o F F” until  is released.</p>
	Any switch position Power-up	<p>Starts recording of minimum and maximum values. Steps the display through MAX, MIN, AVG (average), and present readings. Cancels MIN MAX (hold for 1 second).</p> <p>Enables the Meter's calibration mode and prompts for a password. The Meter reads “CAL” and enters calibration mode. See the <i>80 Series V Service Information</i>.</p>
	Any switch position  Power-up	<p>Switches between the ranges available for the selected function. To return to autoranging, hold the button down for 1 second.</p> <p>Switches between °C and °F.</p> <p>Enables the Meter's smoothing feature. The Meter reads “S ---” until  is released.</p>

Table 4. Pushbuttons (cont.)







Button	Switch Position	Function
	Any switch position MIN MAX recording Frequency counter Power-up	AutoHOLD (formerly TouchHold) captures the present reading on the display. When a new, stable reading is detected, the Meter beeps and displays the new reading. Stops and starts recording without erasing recorded values. Stops and starts the frequency counter. Turns on all LCD segments.
	Any switch position	Turns the backlight on, makes it brighter, and turns it off. For Model 87, hold  down for one second to enter the HiRes digit mode. The “HiRes” icon appears on the display. To return to the 3-1/2 digit mode, hold  down for one second. HiRes =19,999
	Continuity  MIN MAX recording Hz, Duty Cycle Power-up	Turns the continuity beeper on and off Switches between Peak (250 μs) and Normal (100 ms) response times. Toggles the meter to trigger on positive or negative slope. Disables the beeper for all functions. The Meter reads “bEEP” until  is released.

Table 4. Pushbuttons (cont)

Button	Switch Position	Function
<p data-bbox="113 252 193 281">REL Δ</p> <p data-bbox="105 301 240 330">(Relative mode)</p>	<p data-bbox="264 252 432 281">Any switch position</p> <p data-bbox="264 317 352 347">Power-up</p>	<p data-bbox="483 252 1428 303">Stores the present reading as a reference for subsequent readings. The display is zeroed, and the stored reading is subtracted from all subsequent readings.</p> <p data-bbox="483 317 1428 369">Enables zoom mode for the bar graph. Refer to Zoom Mode in the Users Manual located on the 80 Series V User Manuals CD. The Meter reads "REL" until REL Δ is released.</p>
<p data-bbox="113 399 193 429">Hz %</p>	<p data-bbox="264 399 432 450">Any switch position except diode test</p> <p data-bbox="264 497 352 527">Power-up</p>	<p data-bbox="483 399 874 429">Press Hz % for frequency measurements.</p> <p data-bbox="483 443 730 472">Starts the frequency counter.</p> <p data-bbox="483 487 802 516">Press again to enter duty cycle mode.</p> <p data-bbox="483 530 1129 582">Enables the Meter's high impedance mode when the mV dc function is used. The Meter reads "Hi Z" until Hz % is released.</p>

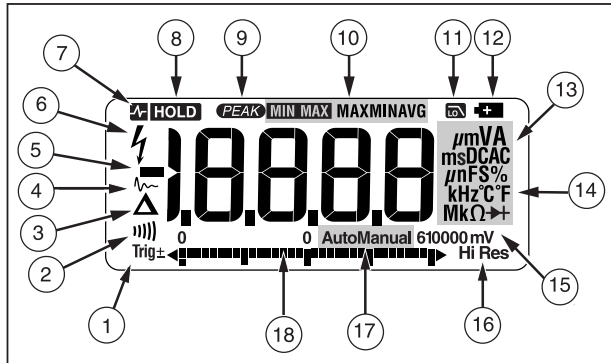

aom1_af.eps

Figure 1. Display Features (Model 87)

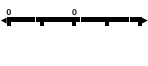

Table 5. Display Features

Number	Feature	Indication
①	±	Polarity indicator for the analog bar graph.
	Trig±	Positive or negative slope indicator for Hz/duty cycle triggering.
②)))	The continuity beeper is on.
③	△	Relative (REL) mode is active.
④	~	Smoothing is active.

Number	Feature	Indication
⑤	-	Indicates negative readings. In relative mode, this sign indicates that the present input is less than the stored reference.
⑥	⚡	Indicates the presence of a high voltage input. Appears if the input voltage is 30 V or greater (ac or dc). Also appears in low pass filter mode. Also appears in cal, Hz, and duty cycle modes.
⑦	⏸ HOLD	AutoHOLD is active.
⑧	HOLD	Display Hold is active.
⑨	PEAK	Indicates the Meter is in Peak Min Max mode and the response time is 250 μs (87 only).
⑩	MIN MAX MAX MIN AVG	Indicators for minimum-maximum recording mode.
⑪	LPF	Low pass filter mode (87 only). See “Low Pass Filter (87).”
⑫	⚡+	The battery is low. ⚠ ⚠ Warning: To avoid false readings, which could lead to possible electric shock or personal injury, replace the battery as soon as the battery indicator appears.

Table 5. Display Features (cont.)

Number	Feature	Indication
⑬	A, μA, mA	Amperes (amps), Microamp, Milliamp
	V, mV	Volts, Millivolts
	μF, nF	Microfarad, Nanofarad
	nS	Nanosiemens
	%	Percent. Used for duty cycle measurements.
	Ω, MΩ, kΩ	Ohm, Megohm, Kilohm
	Hz, kHz	Hertz, Kilohertz
	AC DC	Alternating current, direct current
⑭	$^{\circ}$C, $^{\circ}$F	Degrees Celsius, Degrees Fahrenheit
⑮	610000 mV	Displays selected range
⑯	HiRes	The Meter is in high resolution (Hi Res) mode. HiRes=19,999
⑰	Auto	The Meter is in autorange mode and automatically selects the range with the best resolution.
	Manual	The Meter is in manual range mode.

Number	Feature	Indication
⑱		The number of segments is relative to the full-scale value of the selected range. In normal operation 0 (zero) is on the left. The polarity indicator at the left of the graph indicates the polarity of the input. The graph does not operate with the capacitance, frequency counter functions, temperature, or peak min max. For more information, See "Bar Graph" in the Users Manual located on the <i>80 Series V User Manual CD</i> . The bar graph also has a zoom function, as described under "Zoom Mode".
--	OL	Overload condition is detected.
Display Messages		
bAtt		Replace the battery immediately.
d SC		In the capacitance function, too much electrical charge is present on the capacitor being tested.
EEP_r Err		Invalid EEPROM data. Have Meter serviced.
CAL Err		Invalid calibration data. Calibrate Meter.
LEAd		 Test lead alert. Displayed when the test leads are in the A or mA/μA terminal and the selected rotary switch position does not correspond to the terminal being used.
FB-Err		Invalid model. Have Meter serviced.
OPEn		Open thermocouple is detected.

Power-Up Options

Holding a button down while turning the Meter on activates a power-up option. Table 4 includes the power-up options.

Automatic Power-Off

The Meter automatically turns off if you do not turn the rotary switch or press a button for 30 minutes. If MIN MAX Recording is enabled, the Meter will not power off. To disable automatic power-off, refer to Table 4.



Input Alert™ Feature

If a test lead is plugged into the mA/μA or A terminal, but the rotary switch is not set to the correct current position, the beeper warns you by making a chirping sound and the display flashes “L E R d”. This warning is intended to stop you from attempting to measure voltage, continuity, resistance, capacitance, or diode values when the leads are plugged into a current terminal.

⚠ Caution

Placing the probes across (in parallel with) a powered circuit when a lead is plugged into a current terminal can damage the circuit you are testing and blow the Meter's fuse. This can happen because the resistance through the Meter's current terminals is very low, so the Meter acts like a short circuit.

Low Pass Filter (87)

The 87 is equipped with an ac low pass filter. When measuring ac voltage or ac frequency, press  to activate the low pass filter mode . The Meter continues measuring in the chosen ac mode, but now the signal diverts through a filter that blocks unwanted voltages above 1 kHz, refer to Figure 2. The lower frequency voltages pass with reduced accuracy to the measurement below 1 kHz. The low pass filter can improve measurement performance on composite sine waves that are typically generated by inverters and variable frequency motor drives.

⚠ ⚠ Warning

To avoid possible electric shock or personal injury, do not use the Low Pass Filter option to verify the presence of hazardous voltages. Voltages greater than what is indicated may be present. First, make a voltage measurement without the filter to detect the possible presence of hazardous voltage. Then select the filter function.

Note

In Low Pass Mode, the Meter goes to manual mode. Select ranges by pressing the RANGE button. Autoranging is not available in Low Pass Mode.

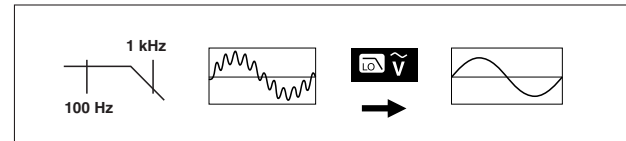

Figure 2. Low Pass Filter

Bar Graph





The analog bar graph functions like the needle on an analog meter, but without the overshoot. The bar graph updates 40 times per second. Because the graph responds 10 times faster than the digital display, it is useful for making peak and null adjustments and observing rapidly changing inputs. The graph is not shown for capacitance, frequency counter functions, temperature, or peak min max.

The number of lit segments indicates the measured value and is relative to the full-scale value of the selected range.

In the 60 V range, for example, the major divisions on the scale represent 0, 15, 30, 45, and 60 V. An input of -30 V lights the negative sign and the segments up to the middle of the scale.

The bar graph also has a zoom function, as described under “Zoom Mode” in the Users Manual located on the 80 Series V User Manuals CD.

Table 6. MIN MAX Functions

Button	MIN MAX Function
	Enter MIN MAX recording mode. The Meter is locked in the range displayed before you entered MIN MAX mode. (Select the desired measurement function and range before entering MIN MAX.) The Meter beeps each time a new minimum or maximum value is recorded.
 (while in MIN MAX mode)	Step through maximum (MAX), minimum (MIN), and average (AVG) and present values.
 PEAK MIN MAX	Model 87 only: Select 100 ms or 250 μ s response time. (The 250 μ s response time is indicated by PEAK on the display.) Stored values are erased. The present and AVG (average) values are not available when 250 μ s is selected.
	Stop recording without erasing stored values. Press again to resume recording.
 (hold for 1 second)	Exit MIN MAX mode. Stored values are erased. The Meter stays in the selected range.



AutoHOLD Mode

Warning

To avoid electrical shock or personal injury, do not use AutoHOLD mode to determine that circuits are without power. The AutoHOLD mode will not capture unstable or noisy readings.

The AutoHOLD mode captures the present reading on the display. When a new, stable reading is detected, the Meter beeps and displays the new reading. To enter or exit AutoHOLD mode, press .

Relative Mode

Selecting relative mode () causes the Meter to zero the display and store the present reading as the reference for subsequent measurements. The Meter is locked into the range selected when you pressed . Press  again to exit this mode.

In relative mode, the reading shown is always the difference between the present reading and the stored reference value. For example, if the stored reference value is 15.00 V and the present reading is 14.10 V, the display shows -0.90 V.

Maintenance

Warning

To avoid electrical shock or personal injury, repairs or servicing not covered in this manual should be performed only by qualified personnel as described in the *80 Series V Service Information*.

General Maintenance

Periodically wipe the case with a damp cloth and mild detergent. Do not use abrasives or solvents.

Fuse Test

If a test lead is plugged into the mA/μA or A terminal and the rotary switch is turned to a non-current function, the Meter chirps and flashes "L E R d" if the fuse associated with that current terminal is good. If the Meter does not chirp or flash "L E R d", the fuse is bad and must be replaced.

Warning

To avoid electrical shock or personal injury, remove the test leads and any input signals before replacing the battery or fuses. To prevent damage or injury, install ONLY specified replacement fuses with the amperage, voltage, and speed ratings shown in Replacement Parts in the Users Manual located on the *80 Series V User Manual CD*.

Specifications

Maximum Voltage between any Terminal and Earth Ground: 1000 V rms

⚠ **Fuse Protection for mA or μ A inputs:** 44/100 A, 1000 V FAST Fuse

⚠ **Fuse Protection for A input:** 11 A, 1000 V FAST Fuse

Display: Digital: 6000 counts updates 4/sec; (Model 87 also has 19,999 counts in high-resolution mode).

Analog Bargraph: 33 segments, updates 40/sec. Frequency: 19,999 counts, updates 3/sec at > 10 Hz

Temperature: Operating: -20 °C to +55 °C; Storage: -40 °C to +60 °C

Altitude: Operating: 2000 m; Storage: 10,000 m

Temperature Coefficient: 0.05 x (specified accuracy)/ °C (< 18 °C or > 28 °C)

Electromagnetic Compatibility: In an RF field of 3 V/m total accuracy = specified accuracy + 20 counts

Except: 600 μ A dc range total accuracy=specified accuracy + 60 counts.

Temperature not specified.

Relative Humidity: 0 % to 90 % (0 °C to 35 °C); 0 % to 70 % (35 °C to 55 °C)

Battery Type: 9 V zinc, NEDA 1604 or 6F22 or 006P

Battery Life: 400 hrs typical with alkaline (with backlight off)

Vibration: Per MIL-PRF-28800 for a Class 2 instrument

Shock: 1 Meter drop per IEC 61010-1:2001

Size (HxWxL): 1.25 in x 3.41 in x 7.35 in (3.1 cm x 8.6 cm x 18.6 cm)

Size with Holster and Flex-Stand: 2.06 in x 3.86 in x 7.93 in (5.2 cm x 9.8 cm x 20.1 cm)

Weight: 12.5 oz (355 g)

Weight with Holster and Flex-Stand: 22.0 oz (624 g)

Safety: Complies with ANSI/ISA S82.01-2004, CSA 22.2 No. 1010.1:2004 to 1000 V Overvoltage Category III, IEC 664 to 600 V Overvoltage Category IV. UL listed to UL61010-1. Licensed by TÜV to EN61010-1.

IP Rating: 30

Detailed Specifications

For all detailed specifications:

Accuracy is given as \pm (% of reading) + [number of least significant digits] at 18° C to 28° C, with relative humidity up to 90 %, for a period of one year after calibration.

For Model 87 in the 4 ½-digit mode, multiply the number of least significant digits (counts) by 10. AC conversions are ac-coupled and valid from 3 % to 100 % of range. Model 87 is true rms responding. AC crest factor can be up to 3 at full scale, 6 at half scale. For non-sinusoidal wave forms add -(2 % Rdg + 2 % full scale) typical, for a crest factor up to 3.

Table 7. Model 87 AC Voltage Function Specifications

Function	Range	Resolution	Accuracy					
			45 – 65 Hz	30 – 200 Hz	200 – 440 Hz	440 Hz - 1 kHz	1 - 5 kHz	5 - 20 kHz ^[1]
\tilde{V} ^[2,4]	600.0 mV	0.1 mV	\pm (0.7 % + 4)	\pm (1.0 % + 4)			\pm (2.0 % + 4)	\pm (2.0 % + 20)
	6.000 V	0.001 V	\pm (0.7 % + 2)					
	60.00 V	0.01 V						
	600.0 V	0.1 V						
	1000 V	1 V		\pm (2.0 % + 4) ^[3]	unspecified			
Low pass filter		Same as 45 - 65 Hz	\pm (1.0 % + 4)	+1 % + 4 -6 % - 4 ^[5]	unspecified	unspecified	unspecified	

- [1] Below 10 % of range, add 12 counts.
- [2] The Meter is a true rms responding meter. When the input leads are shorted together in the ac functions, the Meter may display a residual reading between 1 and 30 counts. A 30 count residual reading will cause only a 2-digit change for readings over 3 % of range. Using REL to offset this reading may produce a much larger constant error in later measurements.
- [3] Frequency range: 1 kHz to 2.5 kHz.
- [4] A residual reading of up to 13 digits with leads shorted, will not affect stated accuracy above 3 % of range.
- [5] Specification increases from -1% at 200 Hz to -6% at 440 Hz when filter is in use.

80 Series V*Getting Started Manual***Table 8. Model 83 AC Voltage Function Specifications**

Function	Range	Resolution	Accuracy		
			50 Hz - 60 Hz	30 Hz - 1 kHz	1 kHz - 5 kHz
\tilde{V}^1	600.0 mV	0.1 mV	$\pm (0.5 \% + 4)$	$\pm (1.0 \% + 4)$	$\pm (2.0 \% + 4)$
	6.000 V	0.001 V	$\pm (0.5 \% + 2)$	$\pm (1.0 \% + 4)$	$\pm (2.0 \% + 4)$
	60.00 V	0.01 V	$\pm (0.5 \% + 2)$	$\pm (1.0 \% + 4)$	$\pm (2.0 \% + 4)$
	600.0 V	0.1 V	$\pm (0.5 \% + 2)$	$\pm (1.0 \% + 4)$	$\pm (2.0 \% + 4)^2$
	1000 V	1 V	$\pm (0.5 \% + 2)$	$\pm (1.0 \% + 4)$	unspecified
1. Below a reading of 200 counts, add 10 counts.					
2. Frequency range: 1 kHz to 2.5 kHz.					

Table 9. DC Voltage, Resistance, and Conductance Function Specifications

Function	Range	Resolution	Accuracy	
			Model 83	Model 87
\bar{V}	6.000 V	0.001 V	$\pm (0.1 \% + 1)$	$\pm (0.05 \% + 1)$
	60.00 V	0.01 V	$\pm (0.1 \% + 1)$	$\pm (0.05 \% + 1)$
	600.0 V	0.1 V	$\pm (0.1 \% + 1)$	$\pm (0.05 \% + 1)$
	1000 V	1 V	$\pm (0.1 \% + 1)$	$\pm (0.05 \% + 1)$
\bar{mV}	600.0 mV	0.1 mV	$\pm (0.3 \% + 1)$	$\pm (0.1 \% + 1)$
Ω	600.0 Ω	0.1 Ω	$\pm (0.4 \% + 2)^1$	$\pm (0.2 \% + 2)^1$
	6.000 k Ω	0.001 k Ω	$\pm (0.4 \% + 1)$	$\pm (0.2 \% + 1)$
	60.00 k Ω	0.01 k Ω	$\pm (0.4 \% + 1)$	$\pm (0.2 \% + 1)$
	600.0 k Ω	0.1 k Ω	$\pm (0.7 \% + 1)$	$\pm (0.6 \% + 1)$
	6.000 M Ω	0.001 M Ω	$\pm (0.7 \% + 1)$	$\pm (0.6 \% + 1)$
nS	50.00 M Ω	0.01 M Ω	$\pm (1.0 \% + 3)^2$	$\pm (1.0 \% + 3)^2$
	60.00 nS	0.01 nS	$\pm (1.0 \% + 10)^1$	$\pm (1.0 \% + 10)^1$

1. When using the REL Δ function to compensate for offsets.
2. Add 0.5 % of reading when measuring above 30 M Ω in the 50 M Ω range, and 20 counts below 33 nS in the 60 nS range.

Table 10. Temperature Specifications (87 Only)

Temperature	Resolution	Accuracy ^{1,2}
-200 °C to +1090 °C	0.1 °C	1 % + 10
-328 °F to +1994 °F	0.1 °F	1 % + 18



1. Does not include error of the thermocouple probe.
2. Accuracy specification assumes ambient temperature stable to ± 1 °C. For ambient temperature changes of ± 5 °C, rated accuracy applies after 1 hour.

Table 11. Current Function Specifications

Function	Range	Resolution	Accuracy		Burden Voltage (typical)
			Model 83 ¹	Model 87 ^{2, 3}	
mA A ~ (45 Hz to 2 kHz)	60.00 mA	0.01 mA	$\pm (1.2 \% + 2)^5$	$\pm (1.0 \% + 2)$	1.8 mV/mA
	400.0 mA ⁶	0.1 mA	$\pm (1.2 \% + 2)^5$	$\pm (1.0 \% + 2)$	1.8 mV/mA
	6.000 A	0.001 A	$\pm (1.2 \% + 2)^5$	$\pm (1.0 \% + 2)$	0.03 V/A
	10.00 A ⁴	0.01 A	$\pm (1.2 \% + 2)^5$	$\pm (1.0 \% + 2)$	0.03 V/A
mA A ==	60.00 mA	0.01 mA	$\pm (0.4 \% + 4)$	$\pm (0.2 \% + 4)$	1.8 mV/mA
	400.0 mA ⁶	0.1 mA	$\pm (0.4 \% + 2)$	$\pm (0.2 \% + 2)$	1.8 mV/mA
	6.000 A	0.001 A	$\pm (0.4 \% + 4)$	$\pm (0.2 \% + 4)$	0.03 V/A
	10.00 A ⁴	0.01 A	$\pm (0.4 \% + 2)$	$\pm (0.2 \% + 2)$	0.03 V/A
μA ~ (45 Hz to 2 kHz)	600.0 μA	0.1 μA	$\pm (1.2 \% + 2)^5$	$\pm (1.0 \% + 2)$	100 μV/μA
	6000 μA	1 μA	$\pm (1.2 \% + 2)^5$	$\pm (1.0 \% + 2)$	100 μV/μA
μA ==	600.0 μA	0.1 μA	$\pm (0.4 \% + 4)$	$\pm (0.2 \% + 4)$	100 μV/μA
	6000 μA	1 μA	$\pm (0.4 \% + 2)$	$\pm (0.2 \% + 2)$	100 μV/μA

1. AC conversion for Model 83 is ac coupled and calibrated to the rms value of a sine wave input.
2. AC conversions for Model 87 are ac coupled, true rms responding, and valid from 3 % to 100 % of range, except 400 mA range (5 % to 100 % of range) and 10 A range (15 % to 100 % of range).
3. Model 87 is a true rms responding meter. When the input leads are shorted together in the ac functions, the Meter may display a residual reading between 1 and 30 counts. A 30 count residual reading will cause only a 2 digit change for readings over 3 % of range. Using REL to offset this reading may produce a much larger constant error in later measurements
4. **⚠** 10 A continuous up to 35 °C; < 20 minutes on, 5 minutes off at 35 °C to 55 °C. 20 A for 30 seconds maximum; > 10 A unspecified.
5. Below a reading of 200 counts, add 10 counts.
6. 400 mA continuous; 600 mA for 18 hrs maximum.

Table 12. Capacitance and Diode Function Specifications

Function	Range	Resolution	Accuracy
	10.00 nF	0.01 nF	$\pm (1 \% + 2)^1$
	100.0 nF	0.1 nF	$\pm (1 \% + 2)^1$
	1.000 μ F	0.001 μ F	$\pm (1 \% + 2)$
	10.00 μ F	0.01 μ F	$\pm (1 \% + 2)$
	100.0 μ F	0.1 μ F	$\pm (1 \% + 2)$
	9999 μ F	1 μ F	$\pm (1 \% + 2)$
	3.000 V	0.001 V	$\pm (2 \% + 1)$

1. With a film capacitor or better, using Relative mode to zero residual.

Table 13. Frequency Counter Specifications

Function	Range	Resolution	Accuracy
Frequency (0.5 Hz to 200 kHz, pulse width > 2 μ s)	199.99	0.01 Hz	$\pm (0.005 \% + 1)$
	1999.9	0.1 Hz	$\pm (0.005 \% + 1)$
	19.999 kHz	0.001 kHz	$\pm (0.005 \% + 1)$
	199.99 kHz	0.01 kHz	$\pm (0.005 \% + 1)$
	> 200 kHz	0.1 kHz	unspecified

Table 14. Frequency Counter Sensitivity and Trigger Levels

Input Range ¹	Minimum Sensitivity (RMS Sine wave)		Approximate Trigger Level (DC Voltage Function)
	5 Hz - 20 kHz	0.5 Hz - 200 kHz	
600 mV dc	70 mV (to 400 Hz)	70 mV (to 400 Hz)	40 mV
600 mV ac	150 mV	150 mV	—
6 V	0.3 V	0.7 V	1.7 V
60 V	3 V	7 V (≤ 140 kHz)	4 V
600 V	30 V	70 V (≤ 14.0 kHz)	40 V
1000 V	100 V	200 V (≤ 1.4 kHz)	100 V
Duty Cycle Range	Accuracy		
0.0 to 99.9 %	Within \pm (0.2% per kHz + 0.1 %) for rise times < 1 μ s.		
1. Maximum input for specified accuracy = 10X Range or 1000 V.			

Table 15. Electrical Characteristics of the Terminals

Function	Overload Protection ¹	Input Impedance (nominal)	Common Mode Rejection Ratio (1 k Ω unbalance)		Normal Mode Rejection					
\bar{V}	1000 V rms	10 M Ω < 100 pF	> 120 dB at dc, 50 Hz or 60 Hz		> 60 dB at 50 Hz or 60 Hz					
\bar{mV}	1000 V rms	10 M Ω < 100 pF	> 120 dB at dc, 50 Hz or 60 Hz		> 60 dB at 50 Hz or 60 Hz					
\tilde{V}	1000 V rms	10 M Ω < 100 pF (ac-coupled)	> 60 dB, dc to 60 Hz							
			Open Circuit Test Voltage		Full Scale Voltage		Typical Short Circuit Current			
			To 6.0 M Ω	50 M Ω or 60 nS	600 Ω	6 k	60 k	600 k	6 M	50 M
Ω	1000 V rms	< 7.9 V dc	< 4.1 V dc	< 4.5 V dc	1 mA	100 μ A	10 μ A	1 μ A	1 μ A	0.5 μ A
\rightarrow	1000 V rms	< 7.9 V dc	3.000 V dc		1.0 mA typical					
1. 10 ⁶ V Hz max										

Table 16. MIN MAX Recording Specifications

Model	Nominal Response	Accuracy
83	100 ms to 80 %	Specified accuracy \pm 12 counts for changes > 200 ms in duration (\pm 40 counts in ac with beeper on)
87	100 ms to 80 % (dc functions)	Specified accuracy \pm 12 counts for changes > 200 ms in duration
	120 ms to 80 % (ac functions)	Specified accuracy \pm 40 counts for changes > 350 ms and inputs > 25 % of range
	250 μ s (peak) (Model 87 only) ¹	Specified accuracy \pm 100 counts for changes > 250 μ s in duration (add \pm 100 counts for readings over 6000 counts) (add \pm 100 counts for readings in Low Pass mode)
1. For repetitive peaks: 1 ms for single events.		