

⚠ WARNING This Quick Reference Guide is not substitute for reading the operator's manual. **To reduce the risk of injury or death, user must read and understand the operator's manual before using this product.** All pages references to the operator's manual.

1 **Unpack Generator:** Remove generator, accessories, inserts and literature from carton.

2 **Removal of shipping support**

Before you can run your new generator, follow these simple instructions:

The following items must be removed before running your new generator. In order to protect your generator these items have been added to ensure safe delivery of your new generator.

⚠ CAUTION

Failure to remove these items can result in damage to your generator, possible Personal injury and void your warranty.

Refer to the following instructions and pictures to remove the attached engine support brackets (red) under the engine.

1. Before filling the engine oil, tip the generator back onto its recoil frame end as indicated in this picture. Place the generator on the flattened cardboard box or other protective surface.

2. Remove the indicated bolts and nuts from the red engine support brackets. You may use the appropriate wrenches provided.

3. You may discard this brackets, as it is no longer required for normal operation of your generator.

Your generator is now ready for use. Refer to your owner's manual for proper oil fill and startup instructions.

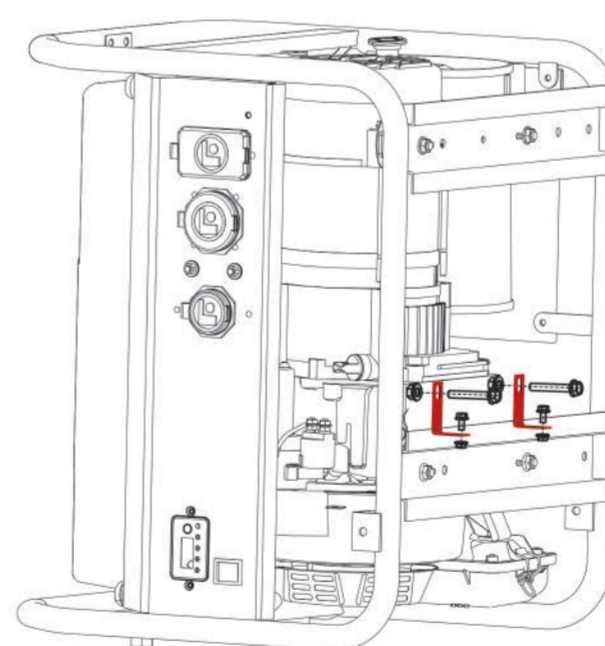

SUPPLIED WRENCHES

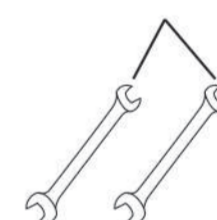

RED ENGINE SUPPORT BRACKET

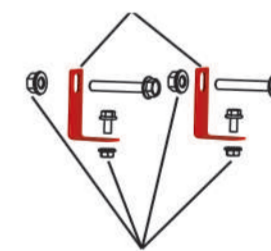

REMOVE THESE NUTS & BOLTS AS INDICATED.

Included Items

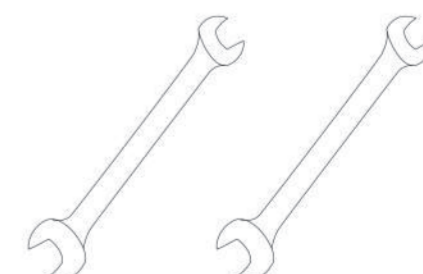
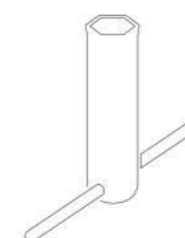
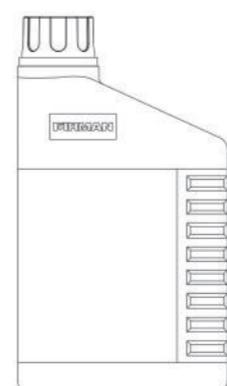
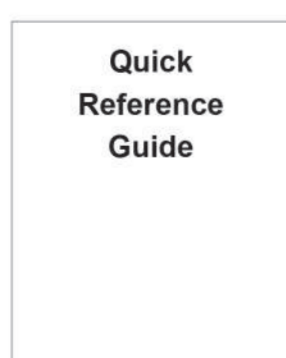
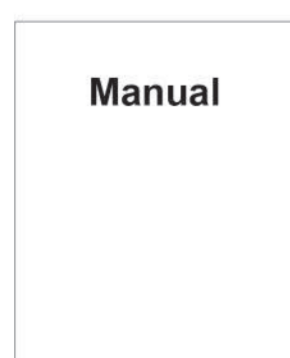

4 Add Lubricant and Fuel

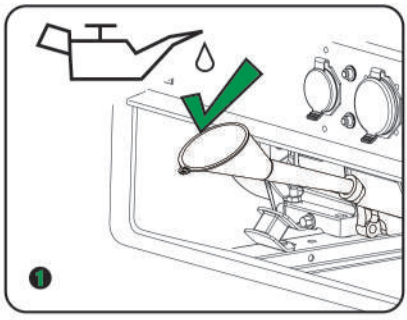

Use a funnel to pour provided engine oil into engine. Fill to the upper mark of the oil dipstick H.

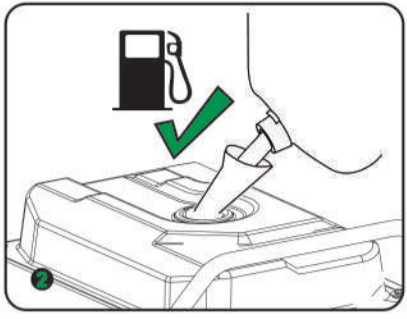

Use clean/fresh regular UNLEADED gasoline with a minimum 87 octane.

5 Start Generator

Move generator outside to a flat, level surface, away from doors, windows and vents.

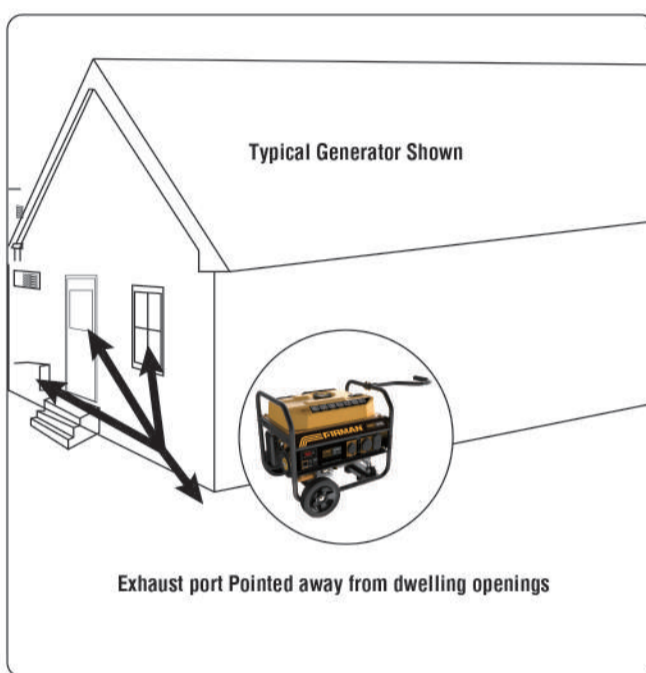

WARNING Do not overload generator or electrical cords. Consult operation manual.

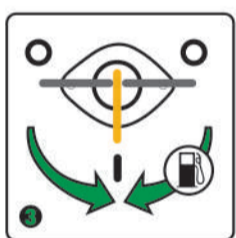

Turn fuel valve under tank to ON (I) position



Turn engine switch located on control panel to RUN (I) position



Move choke lever located on engine to START position

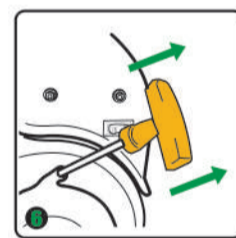

Pull cord starter to start engine

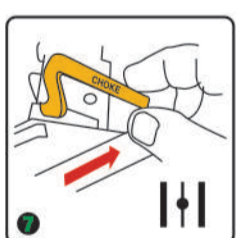

Move choke lever to RUN Position

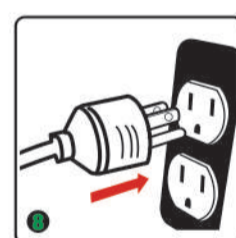

Plug in items to be powered, using only grounded extension cords

6 Shutdown and Storage

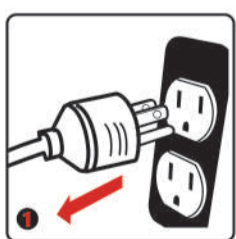

Remove any load from the generator



Run the generator at no load for 2 minutes and then turn engine switch to OFF (O) position

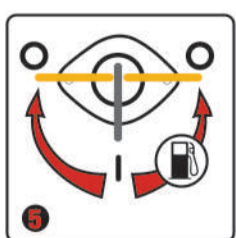

Turn fuel valve to OFF (O) position

If generator is to be stored for longer than 30 days, refer to The operator's manual for further instruction.