

FIRMAN[®]

OWNER'S MANUAL DUAL FUEL GENERATOR



MODEL NUMBER
H08051
Rev Level:00

IMPORTANT: Read all safety precautions and instructions carefully before operating equipment.



Ensure engine is stopped and level before performing any maintenance or service.

Record product information to reference when ordering parts or obtaining warranty coverage.



**DO NOT RETURN TO
STORE!**



Table of Contents

Introduction	1	Maintenance And Storage	27
Safety Precautions	2	Maintenance Schedule	27
Unpacking the Generator	6	Engine Maintenance	28
Parts Included	7	Change Engine Oil	28
Assembly	8	Air Filter Maintenance	28
Install the Wheel Kit	8	Spark Plug Maintenance	29
Install the Support Leg	8	Cleaning Fuel Strainer	29
Battery Cable Connection	9	Inspect Muffler and Spark Arrester	29
Controls and Features	10	Generator Maintenance	30
Generator	10	Battery Replacement	30
Control Panel	11	Service and Storage	31
Specifications	13	Trouble Shooting	33
Add Engine Oil	14	Parts Diagram and Parts List	34
Low Oil Shutdown	14	Generator Parts Diagram	34
Add Fuel	15	Engine Parts Diagram	35
Operation at High Altitude	17	Parts List	36
Grounding	18	Service Information	38
Connecting to a Building's Electrical System	18		
Operation	19		
Generator Location	19		
Surge Protection	19		
Starting the Generator (Recoil Start-Gasoline) ..	20		
Starting the Generator (Recoil Start-LPG) ..	20		
Starting the Generator (Electric Start-Gasoline) ..	22		
Starting the Generator (Electric Start-LPG) ..	23		
Connecting Electrical Loads	24		
Stopping the Engine	24		
Indicator light - Battery Power Saving Mode ..	25		
Low Oil Shutdown	25		
Do Not Overload Generator	25		

INTRODUCTION

Thank you for purchasing a FIRMAN generator.

This manual contains safety information to make you aware of the hazards and risks associated with generator products and how to avoid them. This generator is designed and intended only for supplying electrical power for operating compatible electrical lighting, appliances, tools and motor loads, and is not intended for any other purpose. It is important that you read and understand these instructions thoroughly before attempting to start or operate this equipment.

Save these original instructions for future reference.

This manual covers operation and maintenance of the FIRMAN generators. All information in this publication is based on the latest production information available at the time of approval for printing. The manufacturer reserves the right to change, alter or other wise improve the generator and this documentation at any time without prior change.

Important Safety Information

The manufacturer cannot possibly anticipate every possible circumstance that might involve a hazard. The warnings in this manual and the tags and decals affixed to the unit are therefore not all-inclusive. If you use a procedure, work method or operating technique that the manufacturer does not specifically recommend you must satisfy yourself that it is safe for you and others. You must also make sure that the procedure work method or operating technique that you choose does not render the generator unsafe.

SAFETY INFORMATION



DANGER

DANGER indicates a potentially hazardous situation which, if not avoided, WILL result in death or serious injury.



WARNING

WARNING indicates a potentially hazardous situation which, if not avoided, could result in death or serious injury.



CAUTION

CAUTION indicates a potentially hazardous situation which, if not avoided, may result in minor or moderate personal injury, or property damage.



Toxic Fumes



Risk of Electric Shock



Fire Hazard



Explosion Hazard



Hot Surface.
Do Not Touch the Surface.



Rotating Parts Entanglement
Hazard





Kickback



Operator's Manual

SAFETY PRECAUTIONS

⚠ DANGER	
Using a generator indoors CAN KILL YOU IN MINUTES . Generator exhaust contains carbon monoxide. This is a poison you cannot see or smell.	
 NEVER use inside a home or garage, EVEN IF doors and windows are open.	 Only use OUTSIDE and far away from windows, doors, and vents.
Avoid other generator hazards. READ MANUAL BEFORE USE.	

⚠ WARNING

POISONOUS GAS HAZARD.



Engine exhaust contains carbon monoxide, a poisonous gas that could kill you in minutes. You **CANNOT** smell it, see it, or taste it. Even if you do not smell exhaust fumes, you could still be exposed to carbon monoxide gas.

- Operate this product **ONLY** outside far away from windows, doors and vents to reduce the risk of carbon monoxide gas from accumulating and potentially being drawn towards occupied spaces.
- Install battery-operated carbon monoxide alarms or plug-in carbon monoxide alarms with battery back-up according to the manufacturer's instructions. Smoke alarms cannot detect carbon monoxide gas.
- **DO NOT** run this product inside homes, garages, basements, crawlspaces, sheds, or other partially-enclosed spaces even if using fans or opening doors and windows for ventilation. Carbon monoxide can quickly build up in these spaces and can linger for hours, even after this product has shut off.
- **ALWAYS** place this product downwind and point the engine exhaust away from occupied spaces. If you start to feel sick, dizzy, or weak while using this product, shut it off and get to fresh air **RIGHT AWAY**. See a doctor. You may have carbon monoxide poisoning.

⚠ WARNING

The engine exhaust from this product contains chemicals known to the State of California to cause cancer, birth defects, or other reproductive harm.

For Residents of California:
California proposition 65 requires that we display the warning below:

⚠ WARNING

This product contains chemicals known to the State of California to cause cancer or birth defects and other reproductive harm.

- If you start to feel sick, dizzy or weak while using the portable generator, you may have carbon monoxide poisoning. Get out side to fresh air immediately and call 911 for emergency medical attention. Very high levels of CO can rapidly cause victims to lose consciousness before they can rescue themselves. **DO NOT** attempt to shut off the generator before moving to fresh air. Entering an enclosed space where a generator is or has been running may put you at greater risk of CO poisoning.

CORRECT USAGE

Example location to reduce risk of carbon monoxide poisoning

- ONLY use outside and downwind, far away from windows, doors and vents.
- Direct exhaust **AWAY** from occupied spaces.

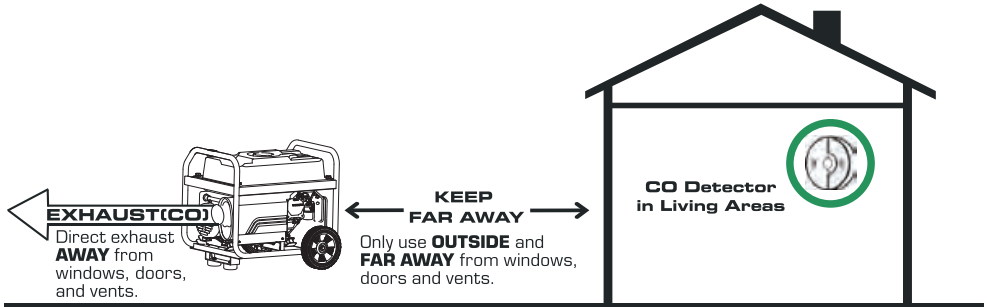

INCORRECT USAGE

Do not operate in any of the following locations:

- Near any door, window or vent
- Garage
- Basement
- Crawl Space
- Living Area
- Attic
- Entry Way
- Porch
- Mudroom

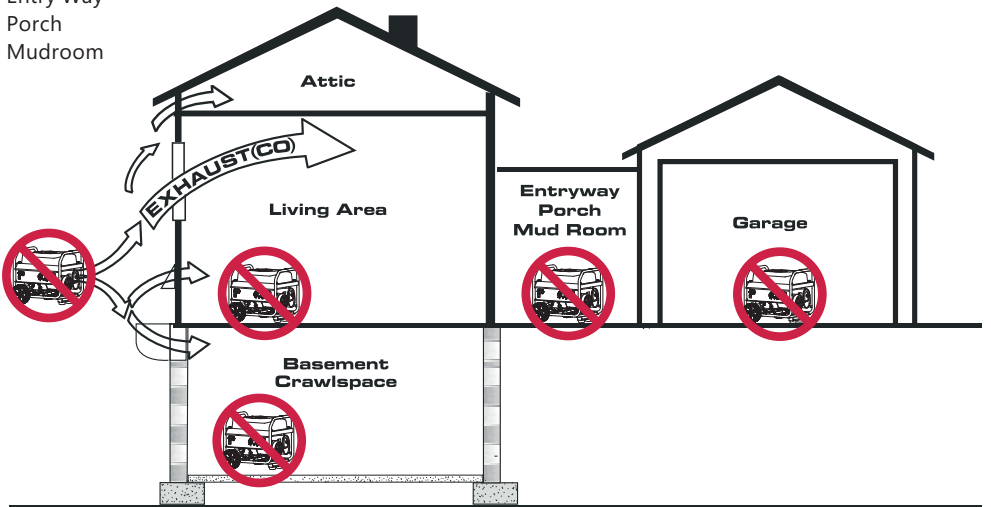

WARNING



Starter cord kickback (rapid retraction) will pull hand and arm toward engine faster than you can let go which could cause broken bones, fractures, bruises, or sprains resulting in serious injury.

- When starting engine, pull cord slowly until resistance is felt and then pull rapidly to avoid kickback.
- **NEVER** start or stop engine with electrical devices plugged in and turned on.

WARNING



Gasoline, gasoline vapors and liquid petroleum gas(LPG) are extremely flammable and explosive which could cause burns, fire, or explosion resulting in death or serious injury and/or property damage.

WHEN ADDING OR DRAINING GASOLINE

- Turn generator engine OFF and let it cool at least 2 minutes before removing fuel cap. Loosen cap slowly to relieve pressure in tank.
- Fill or drain fuel tank outdoors.
- **DO NOT** overfill tank. Allow space for fuel expansion.
- If fuel spills, wait until it evaporates before starting engine.
- Keep fuel away from sparks, open flames, pilot lights, heat, and other ignition sources.
- Check fuel lines, tank, cap, and fittings frequently for cracks or leaks. Replace if necessary.
- **DO NOT** light a cigarette or smoke.

WHEN STARTING EQUIPMENT

- Ensure spark plug, muffler, fuel cap, and air cleaner are in place.
- **DO NOT** crank engine with spark plug removed.

WHEN OPERATING EQUIPMENT

- **DO NOT** operate this product inside any building, carport, porch, mobile equipment, marine applications, or enclosure.
- **DO NOT** tip engine or equipment at angle which causes fuel or oil to spill.
- **DO NOT** stop engine by moving choke control to "Start" position.

WHEN TRANSPORTING, MOVING OR REPAIRING EQUIPMENT

- Transport/move/repair with fuel tank EMPTY or with fuel valve shut OFF.
- **DO NOT** tip engine or equipment at angle which causes fuel or oil to spill.
- Make certain that a LPG cylinder is not attached to generator and is securely stowed away.
- Disconnect spark plug wire.

WHEN STORING FUEL OR EQUIPMENT WITH FUEL IN TANK

- Store away from furnaces, stoves, water heaters, clothes dryers, or other appliances that have pilot light or other ignition source because they could ignite fuel vapors.
- Do not store gasoline or LPG cylinder near furnaces, water heaters, or any other appliances that produce heat or have automatic ignitions.

WARNING

- This generator does not meet U. S. Coast Guard Regulation 33CFR-183 and should not be used on marine applications.
- Failure to use the appropriate U. S. Coast Guard approved generator could result in death or serious injury and/or property damage.

WARNING



Generator voltage could cause electrical shock or burn resulting in death or serious injury.

- Use approved transfer equipment, suitable for the intended use, to prevent backfeed by isolating generator from electric utility workers.

- When using generator for backup power, notify utility company.
- Use a ground fault circuit interrupter (GFCI) in any damp or highly conductive area, such as metal decking or steel work.
- **DO NOT** touch bare wires or receptacles.
- **DO NOT** use generator with electrical cords which are worn, frayed, bare or otherwise damaged.
- **DO NOT** operate generator in the rain or wet weather.
- **DO NOT** handle generator or electrical cords while standing in water, while barefoot, or while hands or feet are wet.
- **DO NOT** allow unqualified persons or children to operate or service generator.

WARNING



Exhaust heat/gases could ignite combustibles, structures or damage fuel tank causing a fire, resulting in death or serious injury and/or property damage.

Contact with muffler area could cause burns resulting in serious injury.

- **DO NOT** touch hot parts and **AVOID** hot exhaust gases.
- Allow equipment to cool before touching.
- It is a violation of California Public Resource Code, Section 4442, to use or operate the engine on any forest-covered, brush-covered, or grass-covered land unless the exhaust system is equipped with a spark arrester, as defined in Section 4442, maintained in effective working order. Other states or federal jurisdictions may have similar laws. Contact the original equipment manufacturer, retailer, or dealer to obtain a spark arrester designed for the exhaust system installed on this engine.
- Replacement parts must be the same and installed in the same position as the original parts.

WARNING



Unintentional sparking could cause fire or electric shock resulting in death or serious injury.

WHEN ADJUSTING OR MAKING REPAIRS TO YOUR GENERATOR

- Disconnect the spark plug wire from the spark plug and place the wire where it cannot contact spark plug.

WHEN TESTING FOR ENGINE SPARK

- Use approved spark plug tester.
- **DO NOT** check for spark with spark plug removed.

WARNING



Starter and other rotating parts could entangle hands, hair, clothing, or accessories resulting in serious injury.

- **NEVER** operate generator without protective housing or covers.
- **DO NOT** wear loose clothing, jewelry or anything that could be caught in the starter or other rotating parts.
- Tie up long hair and remove jewelry.

CAUTION

Excessively high operating speeds could result in minor injury. Excessively low operating speeds impose a heavy load.

- **DO NOT** tamper with governor spring, links or other parts to increase engine speed. Generator supplies correct rated frequency and voltage when running at governed speed.
- **DO NOT** modify generator in any way.

NOTE:

Exceeding generators wattage/amperage capacity could damage generator and/or electrical devices connected to it.

- **DO NOT** exceed the generator's wattage amperage capacity.
- Start generator and let engine stabilize before connecting electrical loads.
- Connect electrical loads in OFF position, then turn ON for operation.
- Turn electrical loads OFF and disconnect from generator before stopping generator.

NOTE:

Improper treatment of generator could damage it and shorten its life.

- Use generator only for intended uses.
- If you have questions about intended use, ask dealer or contact local service center.
- Operate generator only on level surfaces.
- DO NOT expose generator to excessive moisture, dust, dirt, or corrosive vapors.
- DO NOT insert any objects through cooling slots.
- If connected devices overheat, turn them off and disconnect them from generator.
- Shut off generator if:
 - Electrical output is lost.
 - Equipment sparks, smokes, or emits flames.
 - Unit vibrates excessively.

WARNING

Medical and Life Support Uses.

- In case of emergency, call 911 immediately.
- NEVER use this product to power life support devices or life support appliances.
- NEVER use this product to power medical devices or medical appliances.
- Inform your electricity provider immediately if you or anyone in your household depends on electrical equipment to live.
- Inform your electrical provider immediately if a loss of power would cause you or anyone in your household to experience a medical emergency.

Fuel Safety

Gasoline:

DANGER

GASOLINE AND GASOLINE VAPORS ARE HIGHLY FLAMMABLE AND EXPLOSIVE.

Fire or explosion can cause severe burns or death. Unintentional startup can result in entanglement, traumatic amputation or laceration.

- Gasoline can cause a fire or explosion if ignited.
- Gasoline is a liquid fuel but it's vapors can ignite.

- Gasoline is a skin irritant and needs to be cleaned up immediately if spilled on skin or clothes.
- Gasoline has a distinctive odor, this will help detect potential leaks quickly.
- In any gasoline fire, flames should not be extinguished unless by doing so the fuel supply valve can be turned OFF. This is because if a fire is extinguished and a supply of fuel is not turned OFF, then an explosion hazard could be created.
- Gasoline expands or contracts with ambient temperatures. Never fill the gasoline tank to full capacity, as gasoline needs room to expand if temperatures rise.

Liquid Petroleum Gas (LPG/Propane):

This generator is dual fuel and capable of running with both gasoline and Liquid Petroleum Gas (LPG/Propane).

DANGER

- Liquid Petroleum Gas (LPG) is highly flammable and explosive. Fire or explosion can cause severe burns or death.
- Do not use or store LPG cylinder in a building, garage or enclosed area.
- Do not check for leaks with a lighted match or flame.
- The LPG cylinder valve should be fully closed when the generator is not in use or is running with gasoline.
- If you smell gas: close off the gas supply. Make sure there is no leak before using the generator.

WARNING

- Device used for handling LPG must be installed and used in strict conformance with NFPA 58 (Liquefied Petroleum Gas Code) and NFPA 54 (National Fuel Gas) and all other codes, regulations and manufacturer recommendations.
- Never use a gas container, LPG connector hose, LPG cylinder or any other fuel item that is damaged or appears damaged.
- The LPG cylinder valve should be fully closed when the generator is not in use or is running with gasoline.
- The regulator/hose assembly and cylinder valve must be inspected before each use for leaks or sign of damages.

- If you smell gas: close off the gas supply. Spray a soapy water solution to check all connections for leaks before attempting to use generator. Contact a qualified technician to inspect and repair the LPG system if a leak found before using the generator.

⚠ CAUTION

- LPG under pressure is highly flammable and can cause a fire or explosion if ignited.
- LPG is heavier than air and can accumulate in confined spaces and low places in the event of a leak.
- LPG has a distinctive odor to help detect potential leaks.
- Do not allow children to tamper or play with the LPG cylinder.
- In the event of an LPG fire, flames should not be extinguished unless by doing so the fuel supply valve can be turned off. If the fire is extinguished and a supply of fuel is not turned off, an explosion hazard greater than the fire hazard could be created.
- Keep a fire extinguisher near the generator all the time.
- Always keep the LPG cylinder in an upright position.
- Do not subject LPG cylinder to excessive heat.
- Contact with liquid contents of the cylinder will cause freeze burns to the skin.
- An LPG cylinder not connected for use shall not be stored in the vicinity of the generator.
- When transporting and storing, turn off the cylinder valve and fuel selector switch, and disconnect the cylinder.

UNPACKING THE GENERATOR

- Open carton and Remove packaging materials.
- Remove generator, accessories boxes, and literature from carton.

Parts Included

Your gasoline powered generator ships with the following parts:

1. Axle pin	2
2. 10.0" in. Wheel	2
3. Flat Washer	2
4. Cotter pin	2
5. Engine Oil(Bottle)	1
6. Oil Funnel	1
7. Wrench for Spark plug	1
8. Double Open wrench (10mm & 12mm)	2
9. Support Leg with Vibration Mounts	1
10. Flange Bolt (M8x16 for Support Leg)	2
11. Flange Lock Nut (M8)	4
12. Flange Bolt M6X25	2
13. Rubber Support	2
14. Flange Lock Nut (M6)	4
15. Handle	1
16. LPG Hose With Regulator 5 ft. (1.5 m)	1
17. Manual	1
18. Quick Reference Guide	1

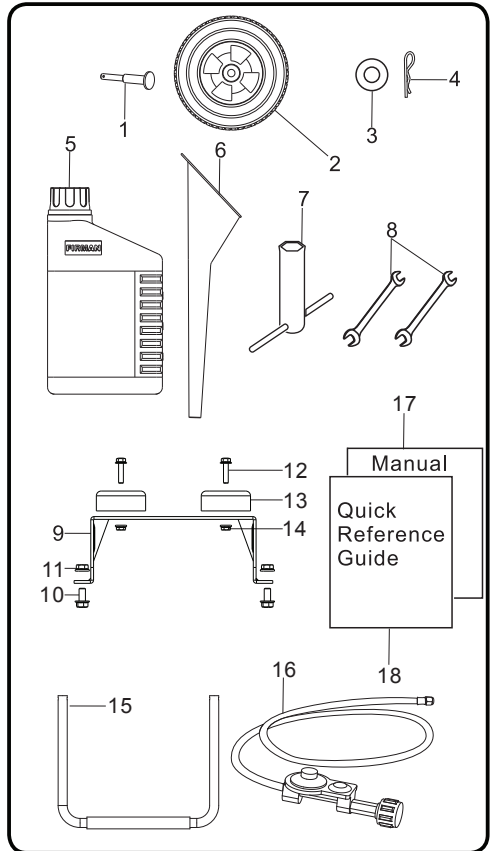

ASSEMBLY

The generator requires some assembly prior to usage.

Install the Wheel Kit

CAUTION

The wheel kit is not intended for over-the-road use.

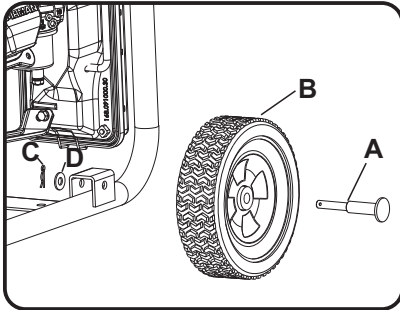

1. Before adding wheels, tip the generator on its side.
2. Slide the axle pin **A** through the wheel **B**.
3. Slide the axle pin **A** through the mount point on the frame and flat washer **D**.
4. Secure the wheel and axle pin with the cotter pin **C**.
5. Repeat steps 2-4 to attach another wheel.

Install the Support Leg

1. Attach the rubber support (**H**) to the support leg (**G**) with flange bolt (**I**) (M6X25) and flange lock nut(**J**) (M6).
2. Attach the support leg (**G**) to the generator frame with flange bolt (**E**) (M8X16) and flange lock nut(**F**) (M8).
3. Tip the generator slowly so that it rests on the wheels and support leg.
4. Tighten bolt **E** and nut **F** with provide wrenches.

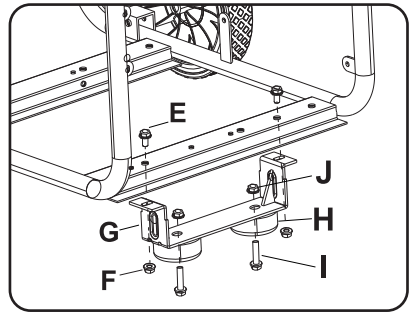

Battery Cable Connection

You will need to use 8mm box wrenches to connect the battery cables to battery.

NOTE:

The generator comes equipped with the positive red cable(red cable) already attached.

1. Verify the positive (+) battery cable (red boot) is securely tightened to the positive (+) battery post. Make sure boot is over battery post.
2. Remove bolt M5X12 and M5 nut from black cable ring.

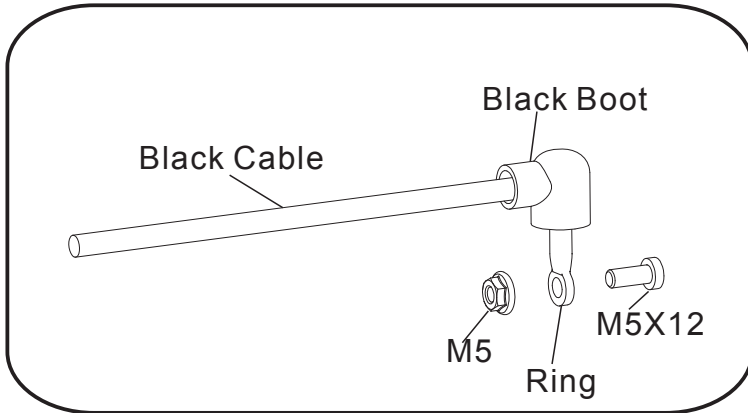

3. Remove vinyl cap from the negative(-) battery post. Locate negative (-) black cable and route to the negative(-) battery post. Tight the cable with bolt M5X12 and M5 nut. Cover the post with black boot.

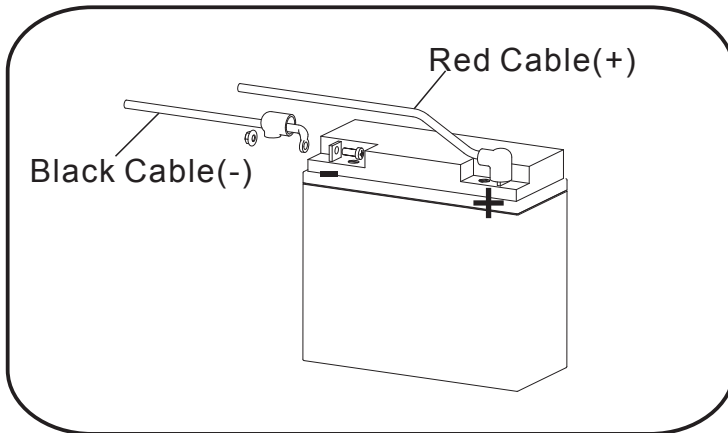

CONTROLS AND FEATURES

Generator

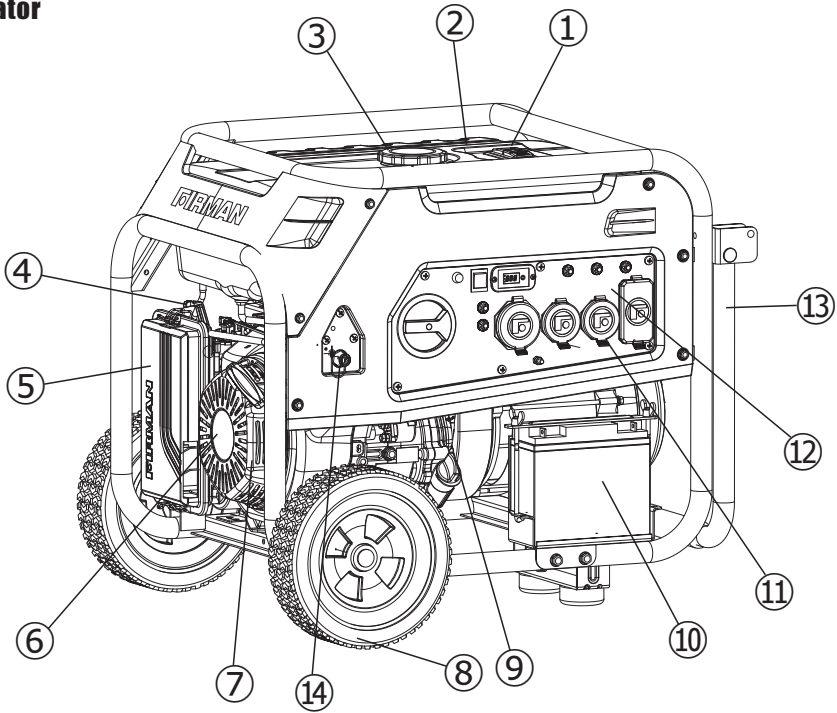

1- Fuel Gauge

2- 8.0 Gallon Capacity Fuel Tank

3- Fuel Cap

4- Choke Lever(behind air filter box)

5- Air Filter

6- 439cc FIRMAN OHV Engine

7- Recoil Starter

8- 10.0" Flat Free Wheel

9- Oil Filler Cap

10- Battery

11- Outlet Cover

12- Control Panel

13- Handle

14- LPG Hose Connector(Inlet)

*We are always working to improve our products. Therefore, the enclosed product may differ slightly from the image on this page.

Control Panel

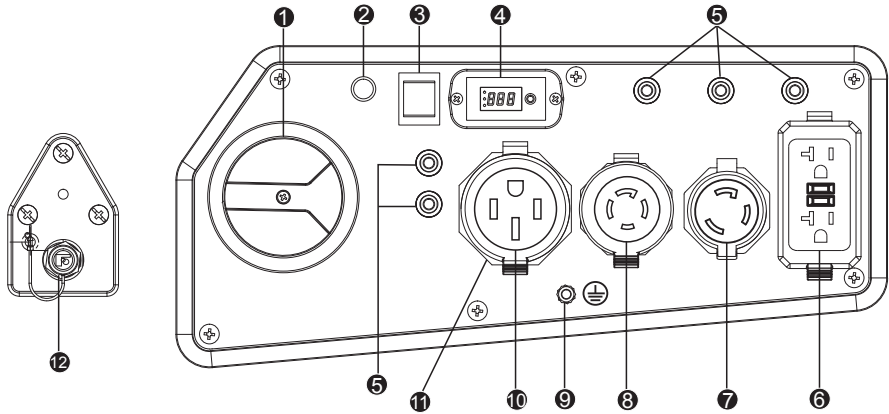

NOTE: Total power drawn from all receptacles must not exceed the name plate rating.

- 1 Fuel Selector Switch** – Use to select and turn on gasoline or LPG fuel source. Fuel (gasoline) valve is closed when the switch is on “OFF” or “LPG” positions. Engine switch is on when the switch is on “GAS” or “LPG” positions.
- 2 Indicator Light**
When the fuel selector switch is turned to the “GAS” or “LPG” position, the indicator light will become **RED** up to **4 minutes**(before goes off). Starting the engine successfully during these **4 minutes** will turn the indicator light **GREEN**. **MUST HAVE SOLID RED INDICATOR LIGHT TO BE ABLE TO START THE GENERATOR. THE GENERATOR CANNOT BE STARTED DURING BATTERY POWER SAVING MODE UNLESS THE FUEL SELECTOR SWITCH IS TURNED TO THE “OFF” POSITION AND THEN TURNED BACK TO THE “GAS” OR “LPG” POSITION. See Indicator light-Battery power Saving Mode section for more information.**
- 3 Engine Start Switch** – Used to start engine from the starter motor(Electric start model only). To start engine, press and hold the switch in the “**START**”(II) position, the engine will crank and attempt to start. When the engine starts, release the switch to the “**RUN**”(I) position.
- 4 3-1 Data-Minder(Multi-Meter)** – Push the SELECT button to show the Voltage, Hertz and running hours.
- 5 Circuit Breakers** – The receptacles are protected by an AC circuit protector. If the generator is overloaded or an external short circuit occurs the circuit protector will trip. If this occurs, disconnect all electrical loads and try to determine the cause of the problem before attempting to use the generator again. If overloading causes the circuit protector to trip, reduce the load. **Note: Continuous tripping of the circuit protector may cause damage to generator or equipment.** The circuit protector may be reset by pushing the button of the protector.
- 6 120V, 20A Duplex GFCI (Ground Fault Circuit Interrupter)** – (NEMA 5-20R)
This receptacle is rated so that a total of 20 amps may be drawn regardless of whether both halves or just one receptacle is used.
Ground Fault Circuit Interrupter conforms to UL 943, and NEC requirements. This device protects you against hazardous electrical shock that may be caused if your body becomes a path through which electricity travels to reach ground. This could happen when you touch an appliance or cord that is “live” through faulty mechanism, damp or worn insulation, etc.
- 7 120V, 30A Twist-Lock** – (NEMA L5-30R)
Maximum full load 30 Amp current may be drawn from this 120 Volt receptacle.
- 8 120/240V, 30A Twist-Lock** – (NEMA L14-30R)
Maximum 30 Amp current maybe drawn from this 120/240 Volt receptacle.

9 **Ground Terminal** – Consult an electrician for local grounding regulations.

10 **120/240V, 50A** – (NEMA 14-50R)
Supplies electrical power for the operation of 120/240 Volt AC, 50Amp, single phase. Maximum full load current may be drawn from this receptacle. If other receptacles are used at the same time, total power used must be kept within nameplate.

11 **Outlet Cover** - Protect the receptacles from dust and debris.

12 **LPG Hose Connector(Inlet)** – Used to connect LPG hose to generator.

120VAC, 20AMP GFCI RECEPTACLE

This unit is equipped with a ground fault circuit interrupter (GFCI). This device meets applicable federal, state and local codes .

A GFCI receptacle is different from conventional receptacles. In the event of a ground fault, a GFCI will trip and quickly stop the flow of electricity to prevent serious injury.

Definition: Instead of following its normal safe path, electricity passes through a persons body to reach the ground. For example, a defective appliance can cause a ground fault.

A GFCI receptacle does NOT protect against circuit overloads, short circuits, or shocks. For example, electric shock can still occur if a person touches charged electrical wires while standing on a non-conducting surface, such as a wood floor.

Testing the GFCI: Test the GFCI outlet every month as follows:

1. Plug a test lamp into the receptacle.
2. Start the generator, the test lamp should be on.
3. Press the "Test" button located on the front of the receptacle to trip the device.
4. This should stop the flow of electricity making the lamp shut off. The GFCI's indicator light comes off.
5. To restore the flow of electricity, press the "RESET" button on the front of the receptacle. If the GFCI does not perform in this manner, do not use the receptacle. Contact a local service dealer or costumer service.
6. This outlet is protected against overload by a 20A push-to-reset circuit breaker. Use the outlet to power 120V AC, single-phase, 60 Hz, electrical loads requiring up to a combined 2400 watts (2.4 kW) or 20 amps of current.

SELF-TEST OPERATION

A Self-Test GFCI receptacle has all the features of a conventional GFCI receptacle. In addition, this receptacle tests itself periodically to confirm the GFCI electronics are functional. The Indicator Light will be solid green when the GFCI is powered from Line side and working correctly.

Self-Test Indications: If the Indicator Light is solid orange or flashing red a problem may exist. Press the TEST button to trip the GFCI. If unable to Reset, replace the GFCI.

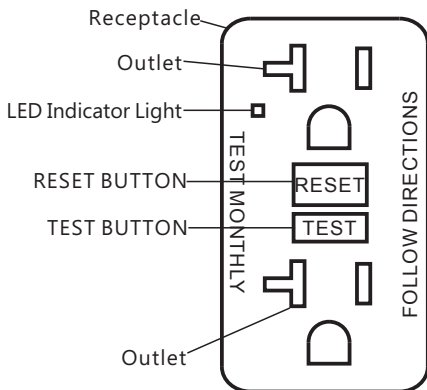

SPECIFICATIONS

Model	H08051
Starting Watts	10000(GASOLINE)/9050(LPG)
Running Watts	8000(GASOLINE)/7250(LPG)
Rated AC Voltage	120/240V
Rated Frequency	60Hz
Phase	Single
Voltage Regulator	AVR
Power Factor	1
Total Harmonic Distortion(THD)	Standard
Alternator Type	Brushed
Engine	FIRMAN
Engine Type	Single Cylinder, 4-Stroke OHV Air Cooled
Displacement	439cc
Low Oil Shutdown	Yes
Ignition System	Breakless Ignition Type, Flywheel Magneto
Starting System	Recoil/Electric Start
Fuel	Unleaded Automotive Gasoline/LPG
Capacity Fuel Tank	8.0 Gallon
Lubricating Oil Capacity	37.2 oz(1.1L)
Carburetor Type	Float
Air Cleaner	Polyurethane Type
P.T.O. Shaft Rotation	Counter Clockwise (Facing P.T.O.)
Oil Type	See "Add Engine Oil" Section
Grounding System	Neutral Bonded to Frame

AN IMPORTANT MESSAGE ABOUT TEMPERATURE:

Your Firman Power Equipment product is designed and rated for continuous operation at ambient temperatures up to 40°C (104°F). When your product is needed, your product may be operated at temperatures ranging from -15°C (5°F) to 50°C (122°F) for short periods. If the product is exposed to temperatures outside this range during storage, it should be brought back within this range before operation. In any event, the product must always be operated outdoors, in a well-ventilated area and away from doors, windows and other vents.

- When operated above 77°F(25°C) there may be a decrease in power.
- Maximum wattage and current are subject to and limited by such factors as fuel BTU content ambient temperature, altitude, engine condition and etc. Maximum power decreases about 3.5% for each 1,000 feet above sea level; and will also decrease about 1% for each 10°F(6°C) above 60°F(16°C) ambient temperature.

ADD ENGINE OIL

⚠ CAUTION

DO NOT attempt to crank or start the engine before it has been properly filled with the recommended type and amount of oil. Damage to the generator as a result of failure to follow these instructions will void your warranty.

NOTE:

The recommended oil type is 10W-30 automotive oil. However outdoor temperatures determine the space proper oil viscosity for the engine. Use the chart to select the best for the outdoor temperature range expected.

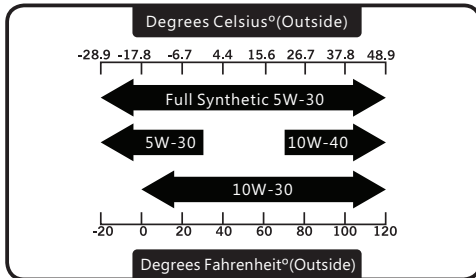

1. Place generator on a flat, level surface.
2. Clean area around oil fill and remove yellow oil fill cap/dipstick.
3. Wipe dipstick clean.

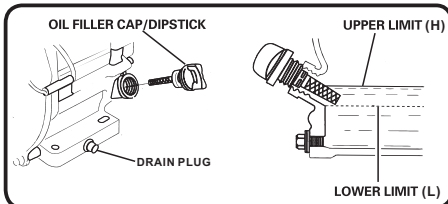
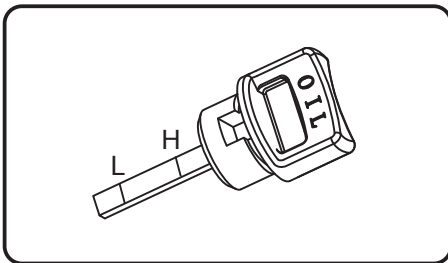

4. Using oil funnel, slowly pour contents of provided oil bottle into oil fill opening to the "H" mark on dipstick. Be careful do not overfill. Overfilling with oil could cause the engine to not start or hard starting.

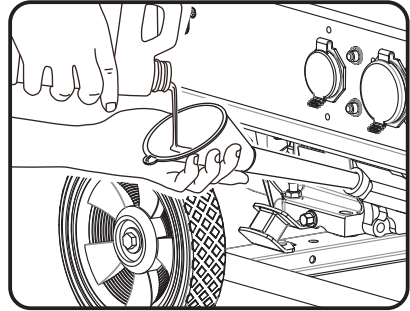

5. Replace oil fill cap/dipstick and fully tighten.
6. Oil level should be checked prior to each use or at least every 8 hours of operation. Keep oil level maintained.

⚠ CAUTION

The engine is equipped with a low oil shut-off and will stop when the oil level in the crankcase falls below the threshold level.

NOTE:

We consider the first 5 hours of run time to be the break-in period for the unit. During the break in period stay at or below 50% of the running watt rating and vary the load occasionally to allow stator windings to heat and cool. Adjusting the load will also cause engine speed to vary and help seat piston rings.

Low Oil Shutdown

The unit is equipped with a low oil shutdown. If the oil level becomes lower than required, the sensor will activate a warning device or stop the engine.

If generator shuts off and the oil level is within specifications, check to see if generator is sitting at an angle that forces oil to shift. Place on an even surface to correct this. If engine fails to start, the oil level may not be sufficient to deactivate low oil level switch. Make sure the sump is completely full of oil.

ADD FUEL

1. Gasoline

Fuel must meet these requirements:

- Clean, fresh, unleaded gasoline.
- Use regular UNLEADED gasoline with the generator engine with a minimum 87 octane / 87 AKI (91 RON).

For high altitude use, see "Operation at High Altitude".

- Do not use gasoline with more than 10% alcohol such as E85 or ethanol.

NOTE: Avoid generator damage.

Failure to follow Operator's Manual for fuel recommendations voids warranty.

- DO NOT use unapproved gasoline such as E85.
- DO NOT mix oil in gasoline.
- DO NOT modify engine to run on alternate fuels.

WARNING



Fuel and its vapors are extremely flammable and explosive which could cause burns, fire or explosion resulting in death, serious injury and/or property damage.

- Fill fuel tank outdoors.



DO NOT overfill tank. Allow space for fuel expansion. If the tank is overfilled, fuel can overflow onto a hot engine and cause fire or explosion. Wipe up any spilled fuel immediately.

- If fuel spills, wait until it evaporates before starting engine.
- Keep fuel away from sparks, open flames, pilot lights, heat, and other ignition sources.
- Check fuel lines, tank, cap and fittings frequently for cracks or leaks. Replace if necessary.



DO NOT light a cigarette or smoke when filling the fuel tank.

1. Clean area around fuel fill cap, remove cap.
2. Slowly add unleaded fuel to fuel tank. Be careful not to fill above the red fuel level indicator. This allows adequate space for fuel expansion.
3. Install fuel cap and let any spilled fuel evaporate before starting engine or wipe up any spilled gasoline.

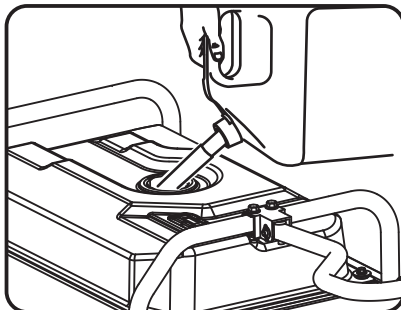

CAUTION

- Slowly add unleaded gasoline to fuel tank.
- Do not overfill tank.
- Do not fill above the red line indicator. This will allow expansion in hot weather and prevent overflow.



IMPORTANT: It is important to prevent gum deposits from forming in fuel system parts such as the carburetor, fuel hose or tank during storage. Alcohol-blended fuels (called gasohol, ethanol or methanol) can attract moisture, which leads to separation and formation of acids during storage. Acidic gas can damage the fuel system of an engine while in storage. To avoid engine problems, the fuel system should be emptied before storage of 30 days or longer. See the " Long Term Storage" section. Never use engine or carburetor cleaner products in the fuel tank as permanent damage may occur.

2-Connecting Liquid Petroleum Gas (LPG/Propane) Cylinder

DANGER

- Liquid Petroleum Gas (LPG) is highly flammable and explosive. Fire or explosion can cause severe burns or death.
- Do not place the LPG cylinder in the path of muffler outlet.
- Do not use or store LPG cylinder in a building, garage or enclosed area.

- Do not check for leaks with a lighted match or flame.
- The LPG cylinder valve should be fully closed when the generator is not in use or is running with gasoline.
- If you smell gas: close off the gas supply. Make sure there is no leak before using the generator.

⚠ WARNING

- Device used for handling LPG must be installed and used in strict conformance with NFPA 58 (Liquefied Petroleum Gas Code) and NFPA 54 (National Fuel Gas) and all other codes, regulations and manufacturer recommendations.
- Never use a gas container, LPG connector hose, LPG cylinder or any other fuel item that is damaged or appears damaged.
- The LPG cylinder valve should be fully closed when the generator is not in use or is running with gasoline.
- The regulator/hose assembly and cylinder valve must be inspected before each use for leaks or sign of damages.
- If you smell gas: close off the gas supply. Spray a soapy water solution to check all connections for leaks before attempting to use generator. Contact a qualified technician to inspect and repair the LPG system if a leak found before using the generator.
- Use only 20 or 30 lb capacity cylinders with Type 1, right hand Acme threads with this generator. Verify the re-qualification date on the tank has not expired. Do not use rusted or damaged cylinders.
- All new cylinders must be purged of air and moisture prior to filling. Used cylinders that have not been plugged or kept closed must also be purged. The purging process should be done by your propane gas supplier.
- Do not connect or disconnect the LPG cylinder in enclosed area.
- Do not install or replace the LPG cylinder near open flames, pilot lights, or sparking electrical equipment such as power tools, welders and grinders.

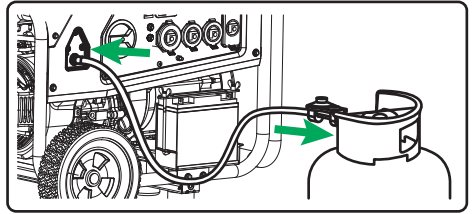

- Attach the LPG regulator/hose assembly (included) to the LPG hose connector (inlet) on the control panel of the generator. Tighten the nut with 19 mm or adjustable wrench.
- Remove the safety plug or cap from the cylinder valve.
- Attach the other end of the LPG regulator/hose assembly to the cylinder valve. Tighten the nut by hand clockwise to a positive stop. Do not use a wrench to tighten. Use of wrench may damage quick closing coupling nut and result in a hazardous condition.
- Do not use tape or any type sealant to seal the LPG hose connections.
- You must use the supplied regulator/hose assembly for safe operation.
- Always position the cylinder so the connection between the valve and the regulator won't cause bends or kinks in the hose.
- Spray a soapy water solution (one part liquid detergent and one part water) to check all connections for leaks before attempting to use generator. Slowly open the cylinder valve. A leak exists if bubbles appear or grow larger in size or number. This must be corrected before using the generator. Contact your local Authorized Service Facility for assistance. Do not attempt to make repairs yourself.
- Do not check for leaks with a lighted match or flame.
- Do not light or smoke cigarettes.
- Check the fuel system periodically for leaks or signs of damages.

⚠ CAUTION

- LPG under pressure is highly flammable and can cause a fire or explosion if ignited.
- LPG is heavier than air and can accumulate in confined spaces and low places in the event of a leak.

- LPG has a distinctive odor to help detect potential leaks.
- Do not allow children to tamper or play with the LPG cylinder.
- In the event of an LPG fire, flames should not be extinguished unless by doing so the fuel supply valve can be turned off. If the fire is extinguished and a supply of fuel is not turned off, an explosion hazard greater than the fire hazard could be created.
- Keep a fire extinguisher near the generator all the time.
- Always keep the LPG cylinder in an upright position.
- Do not subject LPG cylinder to excessive heat.
- Contact with liquid contents of the cylinder will cause freeze burns to the skin.
- An LPG cylinder not connected for use shall not be stored in the vicinity of the generator.
- When transporting and storing, turn off the cylinder valve and fuel selector switch, and disconnect the cylinder.

3-Permanent Connection to a large Propane supply tank:

In the instance that you would need to connect your generator to a large propane Supply tank, larger than 20 or 30 lb DOT cylinder, it is recommended to contact your Gas Equipment Company. Various equipment for use with LPG, is required for proper conformance to all NFPA regulations. Your Gas Equipment Company can help you select and install the proper regulator, fittings and connections to meet all the Codes and manufacturer regulations. Each installation may be different and will required proper equipment. Contact your Gas Equipment Company to assure that you are meeting all NFPA 58 (Liquefied Petroleum Gas Code) and NFPA 54 (National Fuel Gas) Codes.

Operation at High Altitude

At altitudes over 5,000 feet(1524 meters), a minimum 85 octane / 85 AKI (89 RON) gasoline is acceptable.

The density of air at high altitude is lower than at sea level. Engine power is reduced as the air mass and air-fuel ratio decrease. Engine power and generator output will be reduced approximately 3.5% for every 1000 feet of elevation above sea level. This is a natural trend and cannot be changed by adjusting the engine. At high altitudes increased exhaust emissions can also result due to the increased enrichment of the air fuel ratio.

Other high altitude issues can include hard starting, increased fuel consumption and spark plug fouling. To alleviate high altitude issues other than the natural power loss, **FIRMAN** can provide a high altitude carburetor main jet. The alternative main jet and installation instructions can be obtained by contacting Customer Support. Installation instructions are also available in the Technical Bulletin area of the FIRMAN internet site. The part number and recommended minimum altitude for the application of the high altitude carburetor main jet is listed in the table below.

	439cc	Altitude
Altitude main jet 1	380717004	3000-6000Feet
Altitude main jet 2	380717005	6000-8000Feet

WARNING

Operation using the alternative main jet at elevations lower than the recommended minimum altitude can damage the engine. For operation at lower elevations, the standard main jet must be used. Operating the engine with the wrong engine configuration at a given altitude may increase its emissions and decrease fuel efficiency and performance.

Grounding

The National Electric Code requires your generator must be properly connected to an appropriate ground to help prevent electric shock.

WARNING



Failure to properly ground the generator can result in electric shock.

A ground terminal connected to the frame of the generator has been provided on the control panel. For remote grounding, connect of a length of heavy gauge (12 AWG minimum) copper wire between the generator ground terminal and a copper rod driven into the ground. We strongly recommend that you consult with a qualified electrician to ensure compliance with local electrical codes.

THERE IS A PERMANENT CONDUCTOR BETWEEN THE GENERATOR (STATOR WINDING) AND THE FRAME.

Connecting to a Building's Electrical System

Connections for standby power to a building's electrical system must be made by a qualified electrician. The connection must isolate the generator power from utility power or other alternative power sources and must comply with all applicable laws and electrical codes.

WARNING



Generator voltage could cause electrical shock or burn resulting in death or serious injury.

- Use approved transfer equipment to prevent backfeed by isolating generator from electric utility workers.
- When using generator for backup power, notify utility company.
- Use a ground fault circuit interrupter (GFCI) in any damp or highly conductive area, such as metal decking or steel work.
- DO NOT touch bare wires or receptacles.
- DO NOT use generator with electrical cords which are worn, frayed, bare or otherwise damaged.
- DO NOT operate generator in the rain or wet weather.
- DO NOT handle generator or electrical cords while standing in water, while barefoot, or while hands or feet are wet.
- DO NOT allow unqualified persons or children to operate or service generator.

5. OPERATION

Generator Location

WARNING

Make sure you review each warning in order to prevent fire hazard.

- Keep area clear of inflammables or other hazardous materials.
- Select a site that is dry, well ventilated and protected from the weather.
- Keep exhaust pipe clear of foreign objects.
- Keep generator away from open flame.
- Keep generator on a stable and level surface.

CAUTION

Tilting can cause fuel spillage.

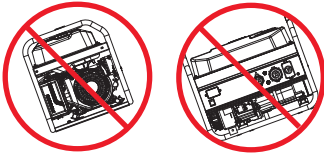

- Do not block generator air vents with paper or other material.

DANGER

Using a generator indoors **CAN KILL YOU IN MINUTES.**

Generator exhaust contains carbon monoxide. This is a poison you cannot see or smell.



NEVER use inside a home or garage, **EVEN IF** doors and windows are open.



Only use OUTSIDE and far away from windows, doors, and vents.

Avoid other generator hazards.
READ MANUAL BEFORE USE.

WARNING

POISONOUS GAS HAZARD.



Engine exhaust contains carbon monoxide, a poisonous gas that could kill you in minutes. You **CANNOT** smell it, see it, or taste it. Even if you do not smell exhaust fumes, you could still be exposed to carbon monoxide gas.

- Operate this product **ONLY** outside far away from windows, doors and vents to reduce the risk of carbon monoxide gas from accumulating and potentially being drawn towards occupied spaces.
- Install battery-operated carbon monoxide alarms or plug-in carbon monoxide alarms with battery back-up according to the manufacturer's instructions. Smoke alarms cannot detect carbon monoxide gas.
- **DO NOT** run this product inside homes, garages, basements, crawlspaces, sheds, or other partially-enclosed spaces even if using fans or opening doors and windows for ventilation. Carbon monoxide can quickly build up in these spaces and can linger for hours, even after this product has shut off.
- **ALWAYS** place this product downwind and point the engine exhaust away from occupied spaces. If you start to feel sick, dizzy, or weak while using this product, shut it off and get to fresh air **RIGHT AWAY**. See a doctor. You may have carbon monoxide poisoning.

Surge Protection

CAUTION

Voltage fluctuation may impair the proper functioning of sensitive electronic equipment.

Electronic devices, including computers and many programmable appliances use components that are designed to operate within a narrow voltage range and may be affected by momentary voltage fluctuations. While there is no way to prevent voltage fluctuations, you can take steps to protect sensitive electronic equipment.

Install UL1449, CSA-listed, plug-in surge suppressors on the outlets feeding your sensitive equipment. Surge suppressors come in single- or multi-outlet styles. They're designed to protect against virtually all short-duration voltage fluctuations.

Starting the Generator (Recoil Start-Gasoline)

1. Before starting the generator, check for loose or missing parts and for any damage which may have occurred during shipment.
2. Check oil level and fuel(Gasoline).

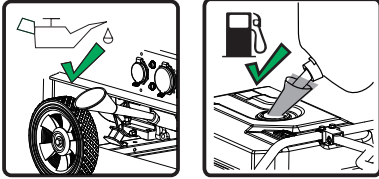

3. Make sure the LPG cylinder knob is fully closed.



4. Turn the fuel selector switch to "GAS" position.

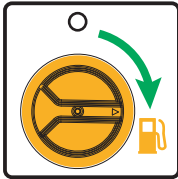

NOTE: When the fuel selector switch is turned to the "GAS" position, the indicator light will become **RED** up to **4 minutes**(before goes off). Starting the engine successfully during these **4 minutes** will turn the indicator light **GREEN**.

5. Disconnect all electrical loads from the generator. Never start or stop the generator with electrical devices plugged in or turned on.

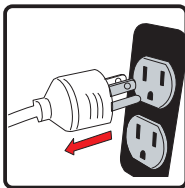

6. Move choke lever located on engine to "START" position.

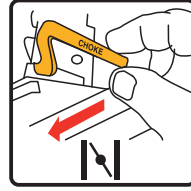

7. Pull the starter cord slowly until resistance is felt and then pull rapidly.

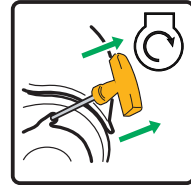

REMINDER: MUST HAVE **SOLID RED INDICATOR LIGHT** TO BE ABLE TO START THE GENERATOR. THE GENERATOR CANNOT BE STARTED DURING **BATTERY POWER SAVING MODE** UNLESS THE FUEL SELECTOR SWITCH IS TURNED TO THE "OFF" POSITION AND THEN TURNED BACK TO THE "GAS" POSITION. See **Indicator light-Battery power Saving Mode** section for more information.

8. Do not over-choke. As soon as engine starts and warms up, move the choke lever to the "RUN" position.

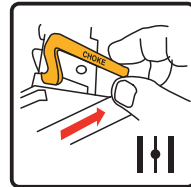

9. Allow generator to run at no load for few minutes upon each initial start-up to permit engine and generator to stabilize.

Starting the Generator (Recoil Start-LPG)

1. Before starting the generator, check for loose or missing parts and for any damage which may have occurred during shipment.
2. Check oil level .

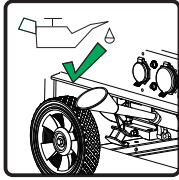

3. Connect the regulator to both LPG cylinder and generator.

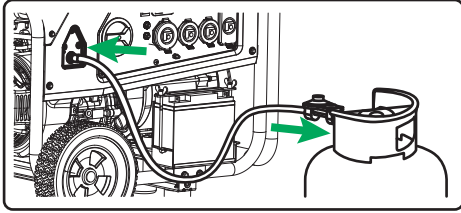

NOTE: Do not place the LPG cylinder in the path of muffler outlet.

4. Fully open the LPG cylinder knob.



5. Turn the fuel selector switch to "LPG" position.

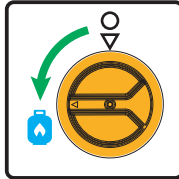

NOTE: When the fuel selector switch is turned to the "LPG" position, the indicator light will become **RED** up to **4 minutes** (before goes off). Starting the engine successfully during these **4 minutes** will turn the indicator light **GREEN**.

6. Disconnect all electrical loads from the generator. Never start or stop the generator with electrical devices plugged in or turned on.

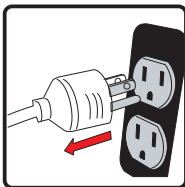

7. Move choke lever located on engine to "START" position.

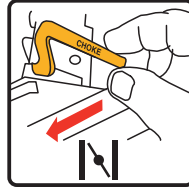

8. **PULL-TO-PRIME:**

Pull the starter cord 1-2 times. Pull slowly until resistance is felt and then pull rapidly.

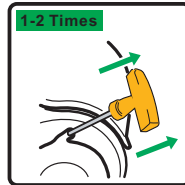

9. Move the choke lever to the "RUN" position.

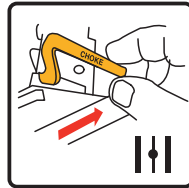

10. **PULL-TO-RUN:**

Pull the starter cord slowly until resistance is felt and pull rapidly to run the unit.

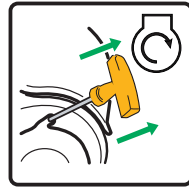

If the engine fails to start in 1-2 pulls with choke in the "RUN" position, then move choke lever to "START" position and repeat the "PULL-TO-PRIME" step.

11. Allow generator to run at no load for few minutes upon each initial start-up to permit engine and generator to stabilize.

REMINDER: MUST HAVE **SOLID RED INDICATOR LIGHT** TO BE ABLE TO START THE GENERATOR. THE GENERATOR CANNOT BE STARTED DURING **BATTERY POWER SAVING MODE** UNLESS

THE FUEL SELECTOR SWITCH IS TURNED TO THE "OFF" POSITION AND THEN TURNED BACK TO THE "LPG" POSITION.

See **Indicator light-Battery power Saving**

Mode section for more information.

WARNING



Starter cord kickback (rapid retraction) will pull hand and arm toward engine faster than you can let go which could cause broken bones, fractures, bruises, or sprains resulting in serious injury.

When starting engine, pull cord slowly until resistance is felt and then pull rapidly to avoid kickback.

NOTE:

Keep choke lever in "START" position for only 1 pull of the recoil starter. After first pull, move choke lever to the "RUN" position for up to the next 3 pulls of the recoil starter. Too much choke leads to sparkplug fouling/engine flooding due to the lack of incoming air. This will cause the engine not to start.

NOTE:

If engine starts after 3 pulls but fails to run, or if unit shuts down during operation, make sure unit is on a level surface and check for proper oil level in crankcase. This unit may be equipped with a low oil protection device. If so, oil must be at proper level for engine to start.

Starting the Generator (Electric Start-Gasoline)

1. Before starting the generator, check for loose or missing parts and for any damage which may have occurred during shipment.
2. Check oil level and fuel (Gasoline).

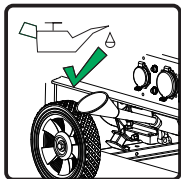

3. Make sure the LPG cylinder knob is fully closed.



4. Turn the fuel selector switch to "GAS" position.

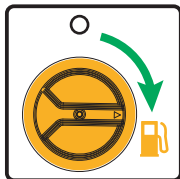

NOTE: When the fuel selector switch is turned to the "GAS" position, the indicator light will become **RED** up to **4 minutes** (before goes off). Starting the engine successfully during these **4 minutes** will turn the indicator light **GREEN**.

5. Disconnect all electrical loads from the generator. Never start or stop the generator with electrical devices plugged in or turned on.

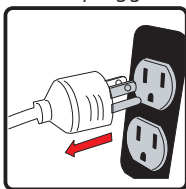

6. Move choke lever located on engine to "START" position.



7. Flip the engine switch to the "START" (II) position for few seconds and then release.



REMINDER: MUST HAVE SOLID RED INDICATOR LIGHT TO BE ABLE TO START THE GENERATOR. THE GENERATOR CANNOT BE STARTED DURING BATTERY POWER SAVING MODE UNLESS THE FUEL SELECTOR SWITCH IS TURNED TO THE "OFF" POSITION AND THEN TURNED BACK TO THE "GAS" POSITION. See Indicator light-Battery power Saving Mode section for more information.

8. Move the choke lever to the "RUN" position.



9. Allow generator to run at no load for few minutes upon each initial start-up to permit engine and generator to stabilize.

Starting the Generator (Electric Start-LPG)

1. Before starting the generator, check for loose or missing parts and for any damage which may have occurred during shipment.
2. Check oil level.

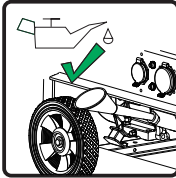

3. Connect the regulator to both LPG cylinder and generator.

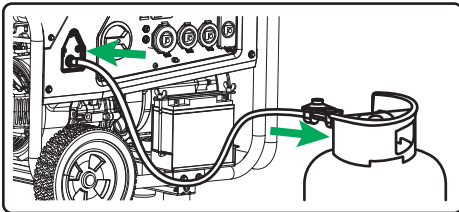

NOTE: Do not place LPG cylinder in the path of muffler outlet.

4. Fully open the LPG cylinder knob.

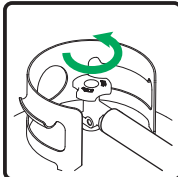

5. Turn the fuel selector switch to "LPG" position.

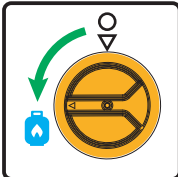

NOTE: When the fuel selector switch is turned to the "LPG" position, the indicator light will become **RED** up to **4 minutes**(before goes off). Starting the engine successfully during these **4 minutes** will turn the indicator light **GREEN**.

6. Disconnect all electrical loads from the generator. Never start or stop the generator with electrical devices plugged in or turned on.

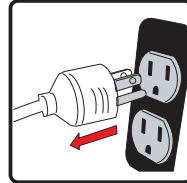

7. Move choke lever located on engine to "START" position.



8. Flip the engine switch to the "START"(II) position for few seconds and then release.



REMINDER: MUST HAVE **SOLID RED INDICATOR LIGHT** TO BE ABLE TO START THE GENERATOR. THE GENERATOR CANNOT BE STARTED DURING **BATTERY POWER SAVING MODE** UNLESS THE FUEL SELECTOR SWITCH IS TURNED TO THE "OFF" POSITION AND THEN TURNED BACK TO THE "LPG" POSITION.

See **Indicator light-Battery power Saving Mode** section for more information.

9. Move the choke lever to the "RUN" position.

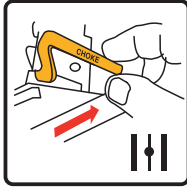

10. Allow generator to run at no load for few minutes upon each initial start-up to permit engine and generator to stabilize.

Connecting Electrical Loads

This unit has been pretested and adjusted to handle its full capacity. Before starting the generator, disconnect all load. Apply load only after generator is running. Voltage is regulated via the engine speed adjusted at the factory for correct output. Readjusting will void warranty.

CAUTION

When applying a load, do not exceed the maximum wattage rating of the generator when using one or more receptacles. Also, do not exceed the amperage rating of any one receptacle.

Do not apply heavy electrical load during break-in period (the first five hours of operations).

1. Let engine stabilize and warm up for a few minutes after starting.
2. Ensure circuit breaker on control panel is in on position.
3. Plug in and turn on the desired 120 Volt AC, single phase, 60Hz electrical loads. It is better to attach the item with largest load first.

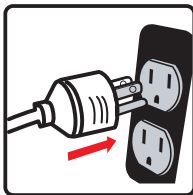

NOTE:

Connecting a generator to your electric utility company's power lines or to another power source may be against the law. In addition this action, if done incorrectly, could damage your generator and appliances and could cause serious injury or even death to you or a utility worker who may be

working on nearby power lines. If you plan to run a portable electric generator during an outage, please notify your electric utility company immediately and remember to plug your appliances directly into the generator. Do not plug the generator into any electric outlet in your home. Doing so could create a connection to the utility company power lines. You are responsible for ensuring that your generator's electricity does not feed back into the electric utility power lines. If the generator will be connected to a building electrical system, consult your local utility company or a qualified electrician. Connections must isolate generator power from utility power and must comply with all applicable laws and codes.

Stopping the Engine

1. Turn off and remove entire electrical loads. Never start or stop the generator with electrical devices plugged in or turned on.

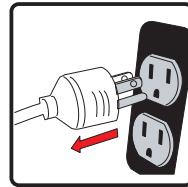

Let the generator run at no-load for two minutes to stabilize internal temperatures of the engine and generator.

2. Turn the fuel selector switch to **OFF (O)** position.

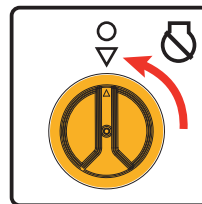

GAS

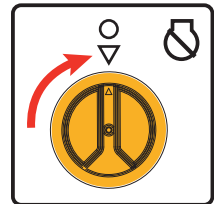

LPG

3. Fully close the LPG cylinder knob.



If a cover is used, do not install until unit has cooled.

NOTE: Disconnect the LPG cylinder from the generator during transportation.



Fuel and its vapors are extremely flammable and explosive which could cause burns, fire or explosion resulting in death, serious injury and/or property damage.

DO NOT stop engine by moving choke control to **"START"** position.

Important: Always ensure that the fuel selector switch is in the **"OFF"** position when the engine is not in use.

NOTE:

If the engine will not be used for a period of two weeks or longer, please see the Storage section for proper engine and fuel storage.

Indicator light - Battery Power Saving Mode

This generator is equipped with an electronic module which consumes battery power. When the fuel selector switch is turned to the **"GAS"** or **"LPG"** position, the indicator light will become **RED** up to **4 minutes**(before goes off).

Starting the engine successfully during these **4 minutes** will turn the indicator light **GREEN**.

Starting the engine unsuccessfully or not attempting to start the engine at all during these **4 minutes** will switch generator to **Battery Power Saving Mode** in order to conserve and increase the life of battery.

MUST HAVE SOLID RED INDICATOR LIGHT TO BE ABLE TO START THE GENERATOR. THE GENERATOR CANNOT BE STARTED DURING BATTERY POWER SAVING MODE UNLESS THE FUEL SELECTOR SWITCH IS TURNED TO THE "OFF" POSITION AND THEN TURNED BACK TO THE "GAS" OR "LPG" POSITION.

Unwanted Shutdown:

The indicator light will start **FLASHING** for **4 minutes** in the event of any unwanted shutdown such as low oil, running out of fuel(gasoline or LPG), or any other unwanted shutdown. This is a reminder that the generator is switching to **Battery Power Saving Mode**. The generator should be checked

for any unwanted shutdown.

The generator cannot be started during or after the **4 minutes** of **FLASHING** mode unless the fuel selector switch is turned to the **"OFF"** position and then turned back to the **"GAS"** or **"LPG"** position.

NOTE:

This generator is equipped with an automatic battery charging circuit and the battery will receive a proper charge when the engine is running to keep the battery charged.

Low Oil Shutdown

If the engine oil drops below a preset level, an oil switch will stop the engine. Check oil level with dipstick.

If oil level is between LOW and HIGH mark on dipstick:

1. DO NOT try to restart the engine.
2. Contact an Authorized FIRMAN Service Dealer.
3. DO NOT operate engine until oil level is corrected.

If oil level is below LOW mark on dipstick:

1. Add oil to bring level to HIGH mark.
2. Restart engine and if the engine stops again a low oil condition may still exist. DO NOT try to restart the engine.
3. Contact an Authorized FIRMAN Service Dealer.
4. DO NOT operate engine until oil level is corrected.

Do Not Overload Generator

Overloading a generator in excess of its rated wattage capacity can result in damage to the generator and to connected electrical devices.

To prolong the life of your generator and attached devices, follow these steps to add electrical load:

1. Start the generator with no electrical load attached.
2. Allow the engine to run for several minutes to stabilize.
3. Plug in and turn on the first item. It is best to attach the item with the largest load first.
4. Allow the engine to stabilize.
5. Plug in and turn on the next item.
6. Allow the engine to stabilize.
7. Repeat steps 5-6 for each additional item.

NOTE:

Observing frost on LPG cylinders and regulators is common during operation and normally is not an indication of a problem. As LPG vaporizes and travels from the tank to the generator engine it expands. The amount of frost that forms can be affected by the size of the cylinder, the amount of fuel being used, the humidity of the air and other operating conditions. In unusual situations this frost may eventually restrict the flow of LPG gas to the generator resulting in deteriorating performance. For example, if the tank temperature is reduced to a very low level then the rate at which the LPG vaporizes is also reduced and may not provide sufficient fuel flow to the engine. This is not an indication of a problem with the generator but only a problem with the flow of gas from the LPG cylinder. If generator performance seems to be deteriorating at the same time that ice formation is observed on tank valve, hose or regulator then some actions may be taken to eliminate this symptom. In these rare situations it can be helpful to reduce or eliminate the cold fuel system effects by doing one of the following:

- Exchanging fuel tanks to allow the first tank to warm up, repeating as necessary
- Placing the LPG cylinder at the end of the generator near the handle, where engine fan air flows out from the generator. This air is slightly heated by flowing over the engine.

DANGER

DO NOT PLACE THE LPG CYLINDER IN THE PATH OF MUFFLER OUTLET.

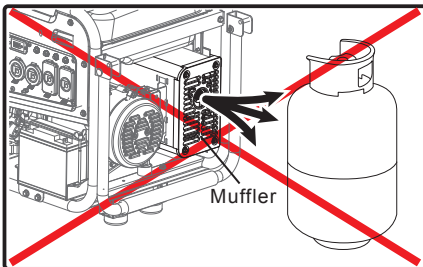

- The LPG cylinder can be temporarily warmed by pouring warm water over the top of the cylinder.

MAINTENANCE AND STORAGE

MAINTENANCE SCHEDULE

ITEM	NOTES	Daily(Before operation)	Initial 25 hours	Every 50 hours	Every 100 hours (or annual)
Spark Plug	Check condition. Adjust gap and clean. Replace if necessary.				✓
Engine Oil	Check oil level.	✓			
	Replace.		✓		✓
Air Filter	Clean, replace if necessary.			✓	
Fuel Filter	Clean fuel filter and fuel tank strainer. Replace if necessary.				✓
Fuel Line	Check fuel hose for cracks or other damage. Replace if necessary.	✓			
LPG Regulator/Hose Assy.	Check for damage and leaks. Replace if necessary.	✓			
Exhaust System	Check for leakage. Retighten or replace gasket if necessary.	✓			
	Check spark arrester screen. Clean/Replace if necessary.				✓
Carburetor	Check choke operation.	✓			
Starting System	Check recoil starter operation.	✓			
Fittings/Fasteners	Check. Replace if necessary.				✓

General Recommendations

Regular maintenance will improve the performance and extend the life of the generator. See any authorized dealer for service.

The generator's warranty does not cover items that have been subjected to operator abuse or negligence. To receive full value from the warranty, the operator must maintain the generator as instructed in this manual.

Some adjustments will need to be made periodically to properly maintain your generator. All service and adjustments should be made at least once each season. Follow the requirements in the Maintenance Schedule chart above.

Notice Once a year you should clean or replace the spark plug and replace the air filter. New spark plugs and clean air filter assure proper fuel-air mixture and help your engine run better and last longer.

ENGINE MAINTENANCE

To prevent accidental starting, remove and ground spark plug wire before performing any service.

Change Engine Oil

Change engine oil every 100 hours.
(for a new engine, change oil after 25 hours.)

If you are using your generator under extremely dirty or dusty conditions, or in extremely hot weather, change the oil more often.

CAUTION

Avoid prolonged or repeated skin contact with used motor oil.

- Used motor oil has been shown to cause skin cancer in certain laboratory animals.
 - Thoroughly wash exposed areas with soap and water.
- (a) Drain oil by removing the drain plug and the oil filler cap while the engine is warm.

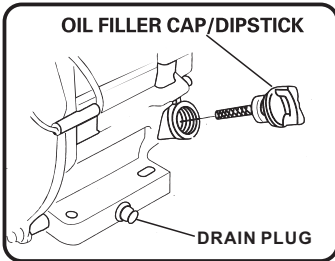

NOTE:

Please use a container to dump the used oil for protecting the environment.

(b) Reinstall the drain plug and fill the engine with oil until it reaches the HIGH(H) level on the oil filler cap.

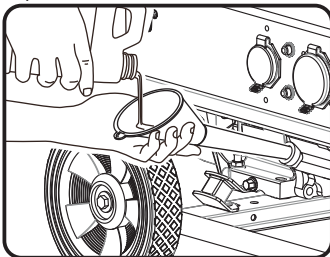

- Use fresh and high quality lubricating oil to the specified quantity.
If contaminated or deteriorated oil is used or the quantity of the engine oil is not sufficient, the engine damage will result and its life will be greatly shortened.

Air Filter Maintenance

Maintaining an air filter in proper condition is very important. Dirt induced through improperly installed, improperly serviced, or inadequate elements damages and wears out engines. Always keep the element clean.

(a) Take out the air cleaner, clean it well in kerosene and dry it.

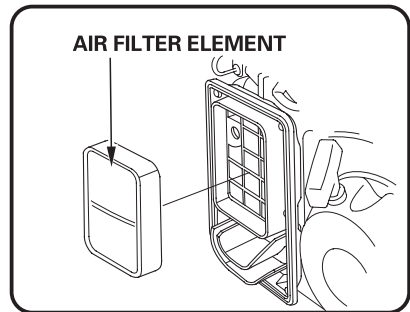
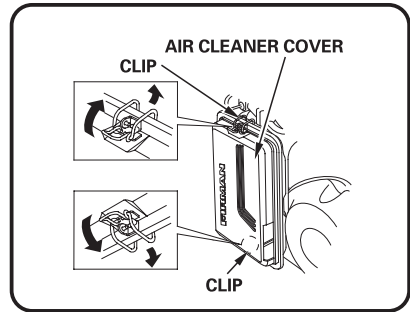

(b) After wetting the element by clean engine oil squeeze it tight by hand.

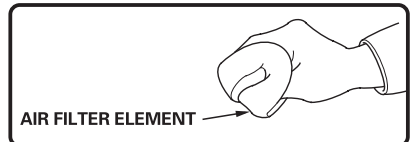

(c) Lastly, put the element in the case and install it securely.

Spark Plug Maintenance

Changing the spark plug will help your engine to start easier and run better.

- (a) Remove the spark plug cap.
- (b) Remove spark plug using provided wrench.

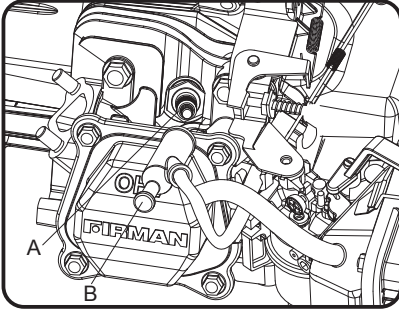

- A- Spark plug
B- Spark plug cap

- (c) Inspect spark plug for damage and clean with a wire brush before reinstalling
- (d) Adjust the electrode gap to 0.7 to 0.8 mm (0.028" to 0.031").
- (e) Seat spark plug in position and thread by hand to prevent cross threading.
- (f) Tighten plug with provided wrench and put the cap back on spark plug.

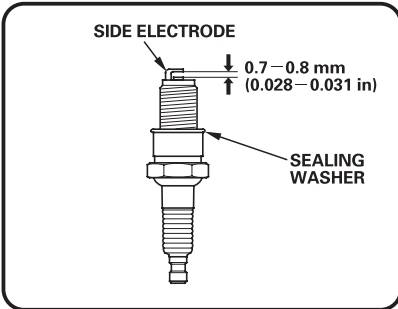

SPARK PLUG: TORCH F6RTC
NGK BPR6ES
CHAMPION RN9YC or equivalent.

Inspect Muffler and Spark Arrester

Inspect the muffler for cracks, corrosion, or other damage. Remove the spark arrester, if equipped, and inspect for damage or carbon blockage. If replacement parts are required, make sure to use only original equipment replacement parts.

⚠ WARNING



Exhaust heat/gases could ignite combustibles, structures or damage fuel tank causing a fire, resulting in death or serious injury and/or property. Contact with muffler area could cause burns resulting in serious injury.

- **DO NOT** touch hot parts and **AVOID** hot exhaust gases.
- Allow equipment to cool before touching.
- Keep at least 5 feet (1.5 m) of clearance on all sides of generator including overhead.
- Replacement parts must be the same and installed in the same position as the original parts.

Clean or replace spark arrester as follows:

Depending on the type fuel used, the type and amount of lubricant used, and/or your operating conditions, the exhaust part and muffler may become blocked with carbon deposits. If you notice power loss, you may need to remove these deposits to restore performance.

1. Allow the engine to cool completely before servicing the spark arrester.
2. Remove the screws securing the spark arrester in place and the remove it from muffler.

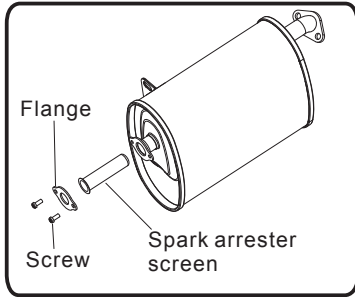

3. Carefully remove the carbon deposits from the spark arrester screen with a wire brush.

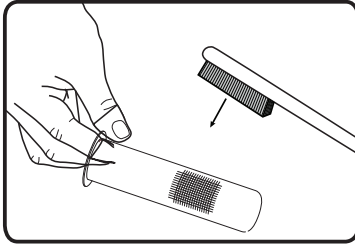

4. Replace the spark arrester if it is damaged.
5. Position the spark arrester in the muffler and attach with the screws.

⚠ CAUTION

Failure to clean the spark arrester will result in degraded engine performance.

GENERATOR MAINTENANCE

Make certain that the generator is kept clean and stored properly. Only operate the unit on a flat, level surface in a clean, dry operating environment. **DO NOT** expose the unit to extreme conditions, excessive dust, dirt, moisture or corrosive vapours.

⚠ CAUTION

DO NOT use a garden hose to clean the generator. Water can enter the generator through the cooling slots and damage the generator windings.

Use a damp cloth to clean exterior surfaces of the generator.

Use a soft bristle brush to remove dirt and oil. Use an air compressor (25 PSI) to clear dirt and debris from the generator.

Inspect all air vents and cooling slots to ensure that they are clean and unobstructed.

Battery Replacement

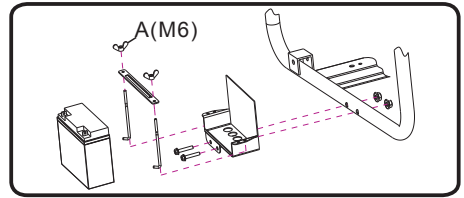

1. Remove the spark plug wire from spark plug.
2. Remove the nut and bolt from the negative(-) and positive(+) posts.
3. Loosen and remove the screw A on the battery holding bracket.
4. Remove the battery and recycle and dispose of properly.
5. Install the new battery with following specification:
12V sealed lead acid 15AH
LXWXH:180X75X165mm(7.09X2.95X6.5inch)
6. Connect the red positive(+) battery cable to the battery first.
7. Connect the black positive(-) battery cable to the battery second.
8. Cover the post with boots.
9. Install the spark plug wire onto spark plug.

⚠ WARNING



To avoid electric shock:

ALWAYS connect the positive (+) battery cable (red boot) first when connecting battery cables.

ALWAYS disconnect the negative (-) battery cable (black boot) first when disconnecting battery cables.

NEVER connect the negative (-) battery cable (black boot) to the positive (+) post on the battery.

NEVER connect the positive (+) battery cable (red boot) to the negative (-) post on the battery.

NEVER touch both battery posts simultaneously. **NEVER** place a metal tool across both battery posts.

ALWAYS use insulated or nonconducting tools when installing the battery.

SERVICE AND STORAGE

Infrequent Service

If the unit is used infrequently, difficult starting may result. To eliminate hard starting, follow these instructions:

1. Run the generator at least 30 minutes every month.
2. Run the generator, then close the fuel shut-off valve and allow the unit to run until the engine stops.
3. Move the fuel selector to the "OFF" position.

Long Term Storage

It is important to prevent gum deposits from forming in essential fuel system parts such as the carburetor, fuel hoses or tank during storage. Also, experience indicates that alcohol-blended fuels (called gasohol, ethanol or methanol) can attract moisture, which leads to separation and formation of acids during storage. Acidic gas can damage the fuel system of an engine while in storage.

When the generator set is not being operated, or is being stored for more than one month, follow these instructions to avoid engine problems:

- 1-**ADD** a properly formulated commercially **FUEL STABILIZER** to the tank if it is not already added.
- 2-Operate the engine for 5-10 minutes to circulate treated fuel into fuel lines and carburetor before shutdown.
- 3- After engine cools down, remove all gasoline from the fuel tank. Use a commercially available, non-conductive vacuum siphon.

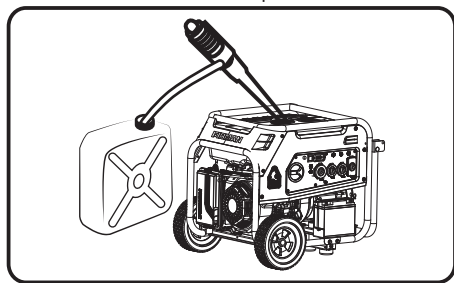

⚠ DANGER

Drain fuel into approved container outdoors, away from open flame. Be sure engine is cool. Do not smoke.

4-FUEL STARVATION: Turn fuel selector switch to "GAS" position. Start and run the generator until it stops from lack of gasoline. This will dry out all remaining gasoline in tank, fuel lines and carburetor. 5-Turn fuel selector switch to "OFF" position. Fully close the LPG cylinder knob if it is open and disconnect LPG cylinder from the generator. 6-Allow the unit to cool entirely before cleaning and storage.

7-Change oil with recommended grade oil. 8-Remove spark plug and pour about one teaspoon of engine oil through the spark plug hole, then pull the recoil starter several times to distribute the oil for lubricating the cylinder. Reattach the spark plug. Pull recoil slowly until resistance is felt. This will close the valves so moisture cannot enter engine cylinder. Gently release recoil starter. 9-Cover the unit and store in a clean, dry place out of direct sunlight. **NEVER USE WATER TO CLEAN GENERATOR.**

Note:

- We recommend always using a fuel stabilizer. A **FUEL STABILIZER** will minimize the formulation of fuel gum deposits during storage, the fuel stabilizer can be added to the gasoline in the fuel tank, or into the gasoline in a storage container.
- If it is not practical to empty the fuel tank and the unit is to be stored for some time, use a commercially available **FUEL STABILIZER** added to the gasoline to increase the life of the gasoline. Run the unit for 5-10 minutes to circulate treated gasoline into the fuel lines and carburetor before shutdown. **DO NOT STORE GENERATOR WITHOUT FUEL STABILIZER IN FUEL SYSTEM INCLUDING TANK, FUEL LINES AND CARBURETOR.**
- Any damages or hazards caused by using improper fuel, improperly stored fuel, and/or improperly formulated stabilizers, are not covered by manufacturer's warranty.
- Do not store gasoline from one season to another season.

Battery Charging & Maintenance

The battery powers up the starter motor and the control module in this generator. This product is equipped with an automatic battery charging circuit. The battery will receive charging voltage when the engine is running. The battery will maintain a proper charge if the unit is used on a regular basis (about once every two weeks). If it is used less frequently, the battery should be connected to a trickle charger (not included) or battery maintainer (not included) to keep the battery properly charged. If the battery is not able to start the engine, it can be started manually only on "GAS" position by pulling the engine recoil cord. If the battery voltage is extremely low, the charging circuit may not be able to re-charge the battery. In this case, the battery must be connected to a standard automotive style battery charger for re-charging before it can be used.

WARNING

Generator exhaust contains odorless and colorless carbon monoxide gas.

To avoid accidental or unintended ignition of your generator during periods of storage, the following precautions should be followed: When storing the generator for short or extended periods of time make sure that the fuel selector switch is in the "OFF" position and the battery leads have been disconnected from the battery.

TROUBLE SHOOTING

Problem	Cause	Correction
Engine is running, but no AC output is available.	<ol style="list-style-type: none"> 1. Circuit breaker is open. 2. Fault in generator. 3. Poor connection or defective cord set. 4. Connected device is bad. 	<ol style="list-style-type: none"> 1. Reset circuit breaker. 2. Contact authorized service facility. 3. Check and repair. 4. Connect another device that is in good condition.
Engine runs good at no-load but "bogs down" when loads are connected.	<ol style="list-style-type: none"> 1. Short circuit in a connected load. 2. Engine speed is too slow. 3. Generator is overloaded. 4. Shorted generator circuit. 5. Clogged or dirty fuel filter. 	<ol style="list-style-type: none"> 1. Disconnect shorted electrical load. 2. Contact authorized service facility. 3. See Don't Overload Generator 4. Contact authorized service facility. 5. Clean or replace fuel filter.
Engine will not start; starts and runs rough or shuts down when running.	<ol style="list-style-type: none"> 1. Fuel selector switch set to OFF (O) position. 2. The indicator light is OFF or flashing red. 3. Low oil level. 4. Dirty air cleaner. 5. Out of gasoline. 6. Stale gasoline. 7. Spark plug wire not connected to spark plug. 8. Bad spark plug. 9. Water in gasoline. 10. Flooded. 11. Excessively rich fuel mixture. 12. Intake valve stuck open or closed. 13. Engine has lost compression. 14. Clogged or dirty fuel filter. 15. Starting battery may have in sufficient charge. 16. Out of LPG. 17. LPG cylinder knob is not open. 18. Out of battery Power. 	<ol style="list-style-type: none"> 1. Set fuel selector switch to "GAS" or "LPG" position. 2. Must have solid red indicator light to be able to start the engine. 3. Fill crankcase to proper level or place generator on level surface. 4. Clean or replace air cleaner. 5. Fill fuel tank with gasoline. 6. Drain fuel tank and carburetor; fill with fresh gasoline. 7. Connect wire to spark plug. 8. Replace spark plug. 9. Drain gas tank and carburetor; fill with fresh gasoline. 10. Wait 5 minutes and re-crank engine. 11. Contact authorized service facility. 12. Contact authorized service facility. 13. Contact authorized service facility. 14. Clean or replace fuel filter. 15. Check battery output and charge battery as necessary. 16. Replace LPG tank. 17. Fully open LPG cylinder knob. 18. Start Engine in "GAS" position. Charge or replace battery.
Engine lacks power.	<ol style="list-style-type: none"> 1. Load is too high. 2. Dirty air filter. 3. Clogged or dirty fuel filter. 4. Clogged spark arrester. 	<ol style="list-style-type: none"> 1. Don't Overload Generator 2. Replace air filter. 3. Clean or replace fuel filter. 4. Clean or replace spark arrester.
Engine "hunts" or falters.	<ol style="list-style-type: none"> 1. Carburetor is running too rich or too lean. 2. Clogged or dirty fuel filter. 	<ol style="list-style-type: none"> 1. Contact authorized service facility. 2. Clean or replace fuel filter.
Engine shuts down when running.	<ol style="list-style-type: none"> 1. Out of gasoline or LPG. 2. Dirty air cleaner. 3. Low oil level. 	<ol style="list-style-type: none"> 1. Fill fuel tank with gasoline or replace LPG tank. 2. Clean or replace air cleaner. 3. Fill crankcase to proper level or place generator on level surface.

439cc DUAL FUEL ENGINE PARTS DIAGRAM

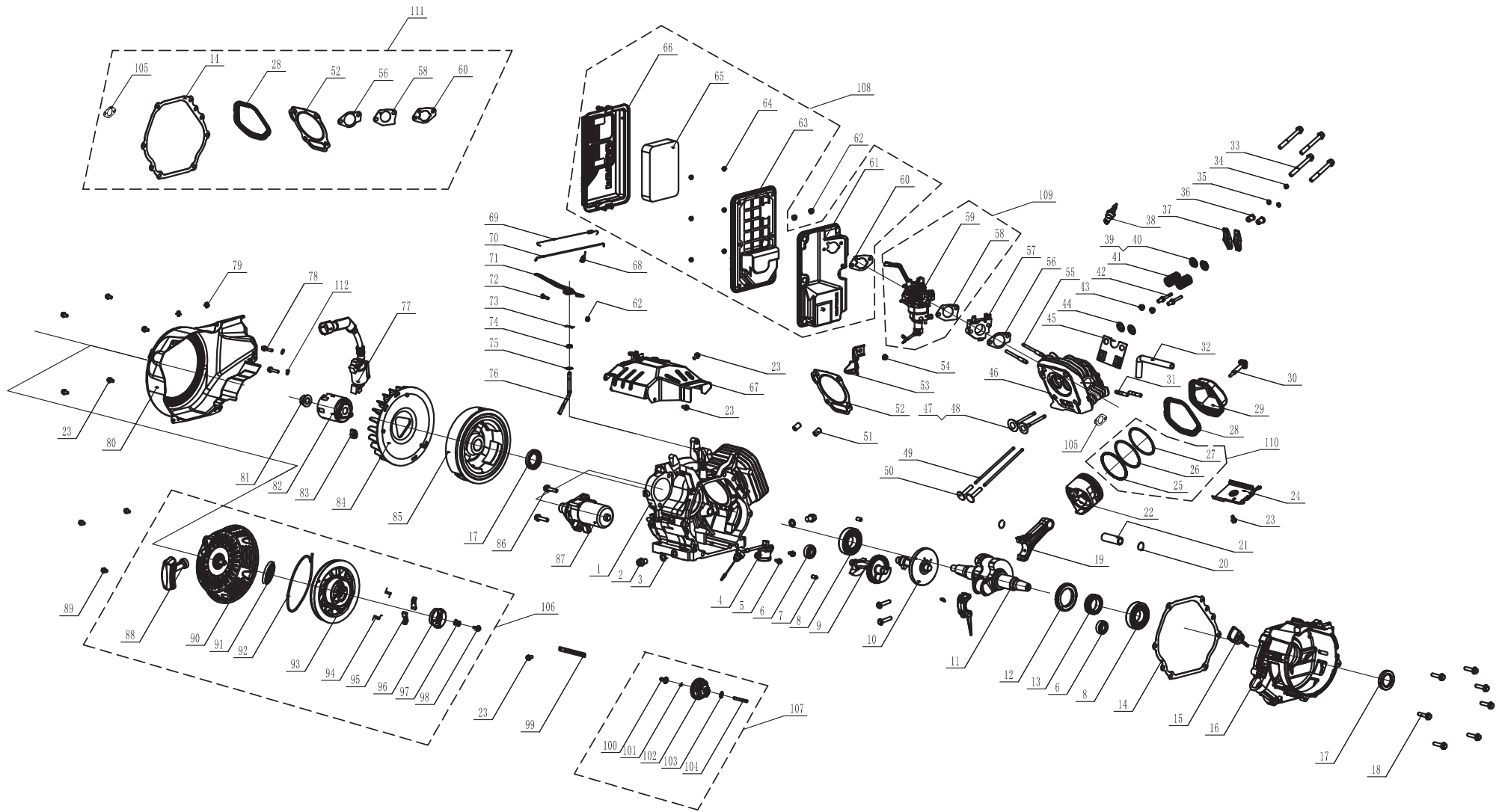

NO8051 PARTS LIST

NO	Part Number	Description	Qty.	NO	Part Number	Description	Qty.
1	357713572	FIRMAN 439cc Dual Fuel Engine	1	73	357713552	Rubber Pad	1
2	357713501	Rubber Cap B	1	74	357713553	Battery	1
3	336713528	Flange Bolt M6×8	5	75	357713554	Battery Holder	1
4	357713573	Generator Wind Shield	1	76	336713593	Flange, Bolt M8×45	2
5	380713535	Rotor Assy	1	77	357713569	Screw&washer Assy M5×10	2
6	380713536	Stator Assy	1	78	336713578	Nut M5	3
7	380713537	Stator Cover	1	79	357713555	Bolt, Bend Hook	2
8	357713506	Generator End Cover	1	80	357713556	Battery Red Cable +	1
9	357713507	Carbon Brush Assembly	1	81	336713842	Black Boot	1
10	336713525	Carbon Brush Holder	1	82	357713557	Battery Black Cable -	1
11	336713524	Bolt &washer Assemblies	1	83	357713531	Nut M10	2
12	380713504	AVR	1	84	357713532	Isolator 2	1
13	336713519	Flange Bolt M5×16	2	85	357713533	Isolator 1	1
14	336713523	Terminal Block	1	86	357713585	Motor Mount	2
15	336713520	Bolt M5×16	2	87	336713559	Flange, Bolt M8×16	4
16	336713522	Ground Wire	1	88	357713538	Support Leg	1
17	357713509	Generator End Cover Cap	1	89	336713557	Rubber, Support	2
18	336713507	Flange Bolt M5×12	3	90	336713561	Flange Bolt M6×25	4
19	380713506	Flange Bolt M6×200	4	91	336713514	Ground Wire	1
20	336713512	Lock Washer Ø6	8	92	336713516	External Star Washer Ø6	1
21	336713513	Washer Ø6	4	93	336713601	Receptacle L14-30R	1
22	336713577	Nut M5	2	94	336713817	Control Module	1
23	380713507	Side Cover Bolt M5×229	2	95	380713516	Circuit Breaker Amp 33A	2
24	357713511	Lock Washer Ø5	2	96	336713819	Tapping Screw St2.9×19	2
25	380713508	Flange Bolt M10×285	1	97	336713820	Tapping Screw St2.9×32	1
26	357713513	Lock Washer Ø10	1	98	336713821	Micro Switch 1	1
27	357713514	Washer Ø10	5	99	336713822	Micro Switch 2	2
28	336713531	Flange Bolt M8×20	4	100	336713824	Fuel Valve	1
29	357713515	Holder, Muff	1	101	336713823	Main Regulator Assy.	1
30	336713515	Flange Bolt M6×12	19	102	336713826	LPG Inlet Cover	1
31	357713516	Muffler Fixed Plate A	1	103	336713816	Screw M4×12	1
32	336713538	Screw&washer Assy M5×14	2	104	336713815	Fuel Selector Switch	1
33	357713517	Holder, Spark Arrester	1	105	336713827	Electric Start Switch	1
34	336713536	Arrester, Spark	1	106	336713828	Indicator Light	1
35	357713518	Muffler Fixed Plate B	1	107	357713586	Multi Meter	1
36	336713534	Nut M8	2	108	336713574	Outlet Cover TT-30R	1
37	336713509	Lock Washer Ø8	2	109	336713573	Outlet Cover L5-30R	2
38	336713533	Flat Washer Ø8	2	110	357713541	Outlet Cover 5-20R GFCI	1
39	357713520	Gskt., Ext.	1	111	380713512	Bolt M6×22	1
40	380713538	Muff., Assy.	1	112	380713515	Nut M6	2
41	357713523	Muffler Fixed Plate C	1	113	336713830	Tapping Screw St4.8×20	2
42	336713517	Nut M6	4	114	336713569	Screw&washer Assy M4×8	10
43	357713577	Air Filter Bracket	1	115	330713582	Screw&washer Assy M4×14	6
44	357713524	Rubber Cap A	1	116	380713539	Control Panel	1
45	336713542	Grommet, Fuel Tank	4	117	380713518	Receptacle 14-50R	1
46	336713543	Washer Tank Buffer	4	118	336713568	Nut M4	8
47	336713544	Flange Bolt M6×20	4	119	357713588	5-20R Duplex GFCI	1
48	357713578	Fuel Gauge Assy.	1	120	336713586	Circuit Breaker Amp 30A	2
49	336713546	Screw M5×10	2	121	336713585	Circuit Breaker Amp 20A	1
50	336713547	Fuel Gauge Display	1	122	336713565	Screw M5×14	4
51	357713579	Fuel Tank Assy.	1	123	336713818	Charger	1
52	336713806	Fuel Filter, Wire Mesh	1	124	336713583	Receptacle L5-30R	1
53	336713549	Fuel Cap	1	125	357713590	Control Box	1
54	336713807	Tank Fitting With Filter	1	126	357713545	Grommet	1
55	336713540	Clamp Ø8×6	7	127	357713546	Sleeve	1
56	357713580	Hose, Fuel 1	1	128	357713548	Grommet	1
57	357713581	Hose, Fuel 2	1	129	357713591	LPG Hose	1
58	336713636	Carbon Canister Shield	1	130	336713835	Metal Clamp (ø8-ø14)×b8	2
59	336713639	Carbon Canister Bracket	1	131	357713598	Waterproof Cover	2
60	336713637	Carbon Canister	1	132	336713643	VF Protection Module	1
61	336713638	Carbon Canister Holder	1	133	330713502	Screw M5×20	1
62	380713532	Vapor Hose 1	1	134	336713841	Red Boot	1
63	380713533	Vapor Hose 2	1	135	336713611	Boot, Starter	1
64	357713535	Axle Pin	2	136	380413506	Control Panel Assy.	1
65	357713592	Wheel	2	137	357413509	Wheel Kit	1
66	357713536	Cotter Pin	2	138	380413507	Rotor And Stator Set	1
67	357713582	Plastic Front Cover	1	139	357413503	Spark Arrestor Kit	1
68	357713583	Frame	1	140	357413506	Support Leg Assembly	1
69	336713558	Nut M8	8	141	336713590	Cotter Pin, Handle	2
70	357713584	Flange Bolt M8×35	2	142	336713844	Washer Ø8	2
71	357713550	Wing Nut M6	2	143	357713596	Axle Pin, Handle	2
72	357713551	Battery Pressing Bracket	1	144	357713597	Handle	1
				145	336713834	Regulator/Hose Assy.	1

