

FILL-RITE®

The Most Trusted Name in Pumps and Meters

FR300V SERIES FUEL TRANSFER PUMPS

Installation and operation manual

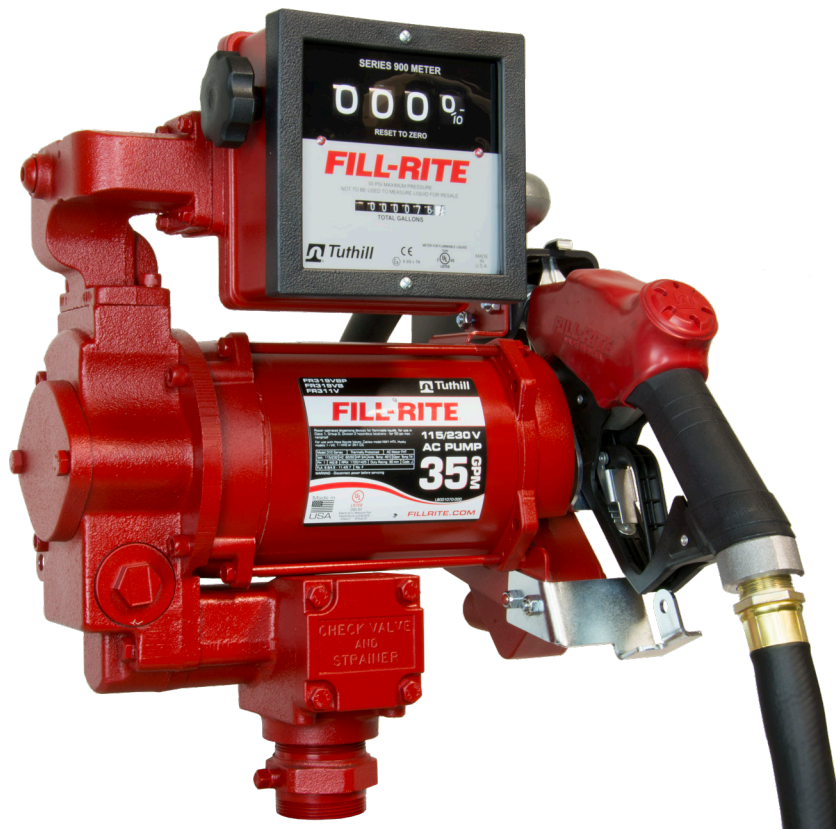

Table of Contents

Thank You!2

Warranty Policy2

About This Manual3

Safety Information3

Installation 3-4

Anti-Siphon Device5

Bung Adapter and Suction Pipe Installation5

Nozzle Boot Installation5

Electrical Wiring6

Wiring Procedure6

Operating Instructions6

Pad Locking6

Safety Testing Approvals.....7

Fluid Compatibility.....7

Technical Information / Specifications7

Troubleshooting 8-9

Accessories9

Replacement Parts Information10-11

300VE Model Information12

MODEL#	
SERIAL#	
PURCHASE DATE:	



About This Manual

From initial concept and design through its final production, your Fill-Rite pump is built to give you years of trouble-free use. To insure it provides that service, it is **critical that you read this entire manual prior to attempting to install or operate your new pump**. Become familiar with the terms and diagrams, and pay close attention to the highlighted areas with the following labels:



WARNING! Emphasizes an area in which personal injury or even death **may** result from failure to follow instructions properly. Mechanical damage may also occur.



IMPORTANT! These boxes contain information that illustrates a point that may save time, or be key to proper operation, or clarifies a step.



CAUTION! Failure to observe a “Caution” may cause damage to the equipment.

Safety Information



WARNING! Electrical wiring should be performed **ONLY** by a licensed electrician in compliance with local, state, and national electrical code NEC/ANSI/NFPA 70, NFPA30, and NFPA 30A, as appropriate to the intended use of the pump. Threaded rigid conduit, sealed fittings, and conductor seal should be used. The pump must be properly grounded. Improper installation or use of this pump can result in serious bodily injury, or death!

1. NEVER smoke near the pump, or use the pump near open flames when pumping a flammable liquid! Fire can result!
2. A “Fill-Rite” Filter should be used on the pump outlet to insure no foreign material is transferred to the fuel tank.
3. Threaded pipe joints and connections should be sealed with the appropriate sealant or sealant tape to minimize the possibility of leaks.
4. Storage tanks should be securely anchored to prevent shifting or tipping when full or empty.
5. To minimize static electricity build up, use only static wire conductive hose when pumping flammable fluids, and keep the fill nozzle in contact with the container being filled during the filling process.
6. The pump motor is equipped with thermal overload protection; if overheated, the motor will shut off to prevent damage to the windings. If this happens, **TURN THE PUMP OFF!** When the motor cools, it will restart without warning if the power is on.



WARNING! This product should not be used to transfer fluids into any type of aircraft.



WARNING! This product is not suited for use with fluids intended for human consumption or fluids containing water.

Installation

The Fill-Rite FR300V series pump is designed to offer several different mounting configurations. It can be mounted on a skid tank using the tank adapter supplied with the pump (see attached diagrams) or mounted on a concrete island using an optional pedestal adapter (available through your Fill-Rite distributor). Regardless of mounting style, all tanks must be properly vented.

The FR300V series pump has a built-in check valve with pressure relief to reduce unsafe excess pressure from thermal expansion of the fluid. It also features an integral bypass valve to help minimize wear when the pump is operating with the nozzle closed.



CAUTION! Do not use additional check valves or foot valves unless they have a proper pressure relief valve built into them. Note that additional check valves will reduce flow rate.



CAUTION! Threaded pipe joints and connections should be sealed with the appropriate sealant or sealant tape to minimize the possibility of leaks.

Typical Skid Tank Installation

Materials

- 1-1/4" pipe cut to a length that will terminate at least 3" from the bottom of the tank when installed into the tank adapter with the tank adapter installed into the tank flange (see SKID TANK INSTALLATION diagram).
- Threaded pipe joint sealant appropriate for application.

Installation Procedure

1. Thread the 1-1/4" pipe into the tank adapter. Seal threads liquid tight with appropriate thread sealant.
2. Screw the tank adapter into the tank flange; seal threads liquid tight with appropriate thread sealant.
3. Mount the pump on the adapter; seal threads liquid tight with appropriate thread sealant.
4. Fill-Rite recommends installation of an Anti-Siphon Device.

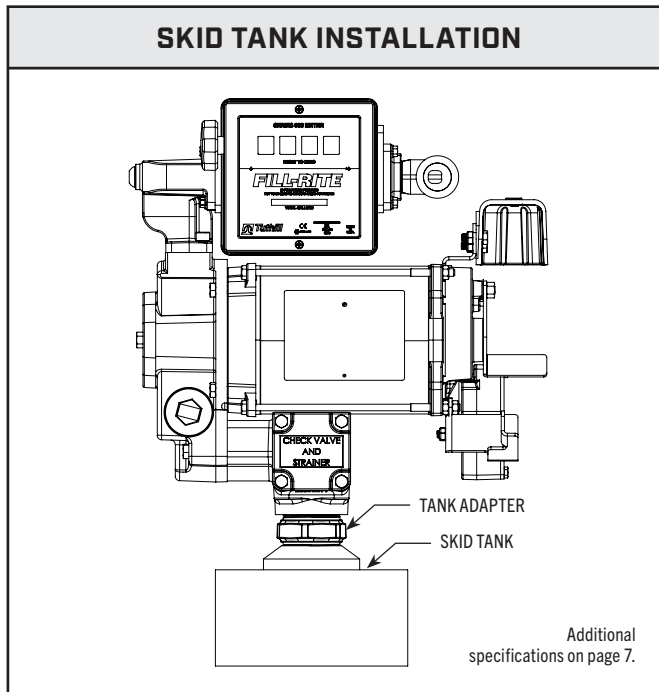

Typical "Pedestal / Island" Installation

Materials:

- 1-1/4" threaded suction pipe, cut to extend 32-1/2" above the island.
- FRPA125 Pedestal Kit (includes Pedestal Pipe, Base, & Coupler).
- Threaded pipe joint sealant appropriate for application.

Installation Procedure

1. Remove the coupler from the pedestal pipe by loosening the set screws.
2. Slip the pedestal pipe/pump base assembly over the 1-1/4" suction pipe.
3. Loosen the screws in the pedestal base to allow the pedestal pipe to slide down exposing the end of the suction pipe.
4. Screw the coupler onto the suction pipe; seal threads liquid tight with appropriate thread sealant.
5. Slide the pedestal pipe into the coupler and tighten the set screws.
6. Tighten the screws in the pedestal base.
7. Mount the pump on the coupler seal threads liquid tight with appropriate thread sealant.

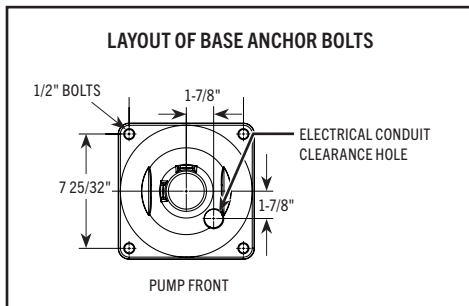
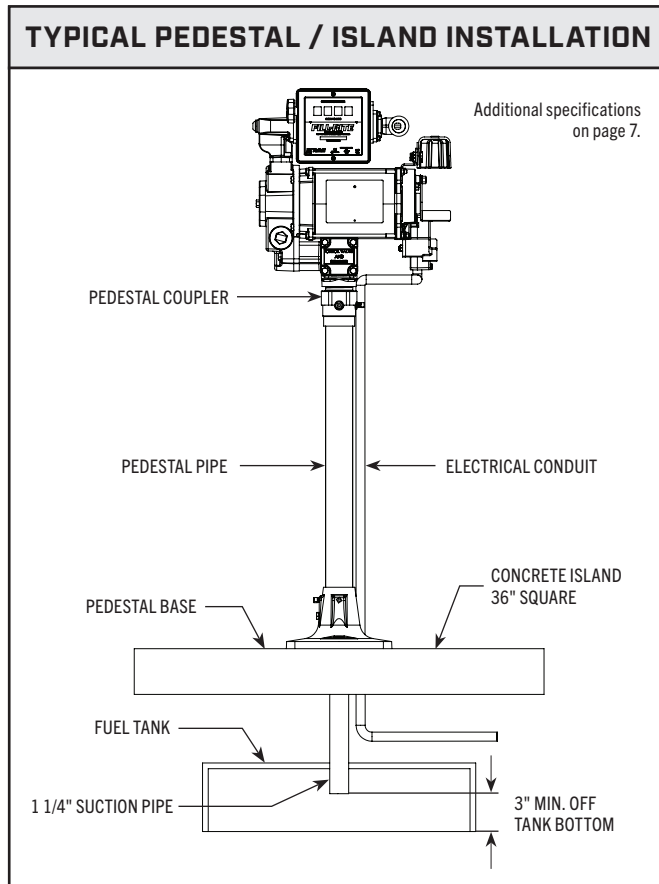



CAUTION! Threaded pipe joints and connections should be sealed with the appropriate sealant or sealant tape to minimize the possibility of leaks.

Anti-Siphon Device

Your FR300V series pump comes from the factory ready to install an anti-siphon tube back to the tank. An anti-siphon device (a.k.a. vacuum breaker) is important because it will break a liquid siphon if there is an open nozzle or a leaking hose below the fluid level in the tank when the pump is turned off. Fill-Rite recommends anti-siphon kit # KIT700AS be installed from the pump outlet back to the vapor space in the tank.

This illustration shows where to install the tube so that it terminates in the vapor space at the top of the tank. The tube must terminate in the vapor space; if it terminates below the fluid level in the tank, it will not prevent siphoning. It is very important there are no liquid traps in the tubing; it must have a continuous slope from the pump down to the tank, and can be connected into any opening in the top of the tank if the tank adapter is not used. Use reducer bushings as required for proper fit and seal.

The 1/4 NPT opening in the side of the tank adapter terminates in the vapor space of the tank. Make liquid-tight connections using the appropriate sealant from the adapter to the anti-siphon outlet using a minimum of 1/4 metal tubing that is compatible with whatever liquid is being pumped. If the anti-siphon tank adapter is being used and the 1/4 NPT opening is not used for the tubing, leave the factory installed plug in place.

Fill-Rite offers Anti-Siphon kit # KIT700AS (available through your Fill-Rite distributor). This kit contains the necessary fittings and tubing to complete the installation as pictured in this section. **NOTE:** This kit **ONLY** works for tank top installations.

If not using the KIT700AS, you will need the KIT700AVB. This will allow you to connect a line either back to the tank, or to the bung adapter.

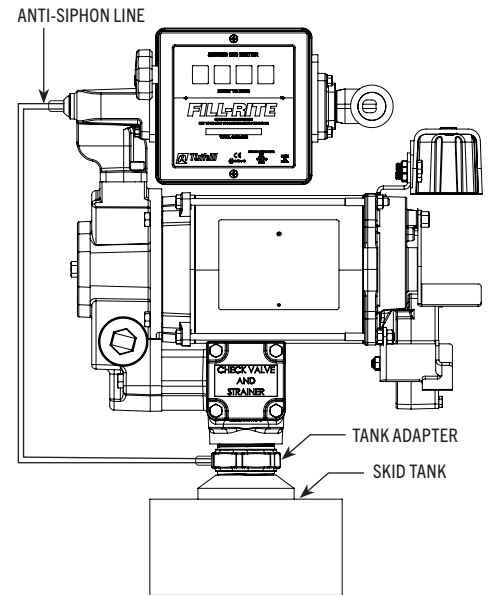

Bung Adapter / Suction Pipe Assembly and Installation

FR300V series pumps feature a 2" Bung Adapter with integral connection for an anti-siphon device. When installing the suction pipe into the bung adapter, the suction pipe must be inserted into the bung adapter correctly for proper operation. The suction pipe threads into the tank adapter, and must be cut to a length that positions it at least 3" from the bottom of the tank.

1. Measure and cut suction pipe to fit as described above.
2. Examine the bung adapter to determine top and bottom for proper insertion of the suction pipe. The bung adapter is labeled to help: the end marked "PUMP SIDE" is the top of the bung adapter. Note that the internal threads for the suction pipe are at the TOP of the opening.
3. Wrap the threads of the suction pipe with the appropriate sealant for the fluid being pumped. Insert the suction pipe (with the threaded side up) into the bottom of the bung adapter until the threads engage.
4. Tighten the suction tube into the bung adapter to create an air / fluid tight seal.
5. Apply an anti-seize thread compound to the external threads on the bottom of the bung adapter. Install the assembled bung adapter and suction pipe into the bung opening on the tank. Tighten to a fluid / air tight seal.
6. Install pump onto bung adapter using appropriate fluid sealant, and tighten to a fluid / air tight seal.

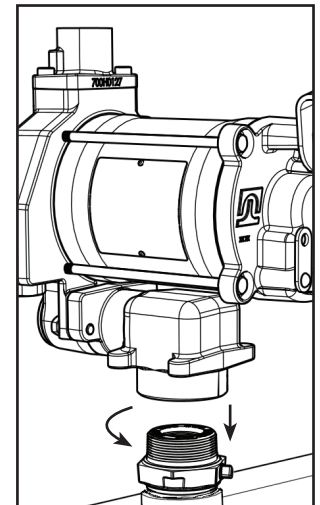
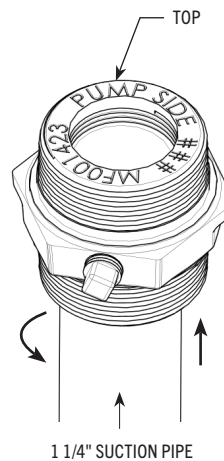

Nozzle Boot Installation

The nozzle boot is installed using the lower two screw holes on the side of the boot. Use supplied attaching hardware to install the nozzle boot.

When the nozzle is mounted correctly it will be in a horizontal position.

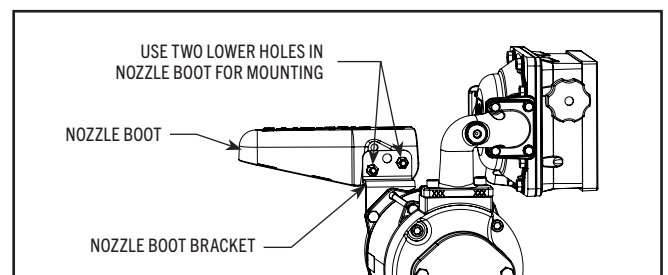

Electric Wiring



WARNING! Electrical wiring should be performed **ONLY** by a licensed electrician in compliance with local, state, and national electrical code NEC/ANSI/NFPA 70, NFPA30, and NFPA 30A, as appropriate to the intended use of the pump. Threaded rigid conduit, sealed fittings, and conductor seal should be used. The pump must be properly grounded. Improper installation or use of this pump can result in serious bodily injury, or death!



CAUTION! All pumps should be operated at the Rated Nameplate Voltage. Power should be supplied to the pump from a dedicated 30 amp circuit breaker. No other equipment should be powered by this circuit. Wiring must be of sufficient size to carry the correct current for the pump. Voltage drop will vary with distance to pump and size of wire; refer to the National Electrical Code (NEC), or local codes, for Voltage Drop Compensation to be sure you are using the correct size wire for your application.

Wiring Procedure



WARNING! The "AUX." wire IS A LIVE WIRE when the switch is on! The "AUX" lead wire is insulated and enclosed when shipped. **DO NOT** connect this wire without first verifying the "ON" line voltage of the wire for compatibility with the equipment to be installed. Maximum amperage on this wire is 1 amp. The "AUX" wire must be insulated and enclosed in the junction box if not used.

115 VOLT WIRE DIAGRAM AUX LEAD RATED 1.0 AMP

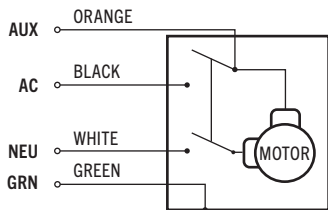

230 VOLT WIRE DIAGRAM AUX LEAD RATED 1.0 AMP

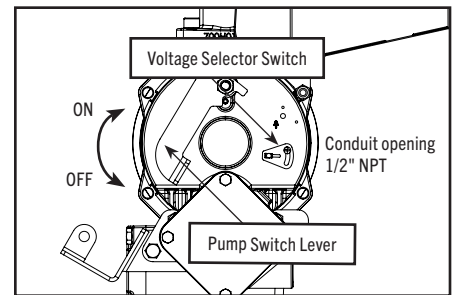
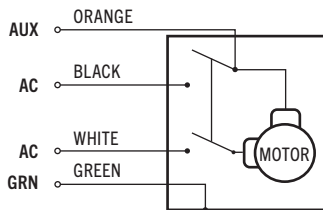

1. Remove the junction box cover and straighten the wires to make sure the stripped wire ends are accessible outside the junction box.
2. Connect the pump wires to the power supply lines according to the diagram. Be certain to properly insulate the connections with the appropriate wire nuts or other connectors. Note that the ground wire **MUST** be connected.
3. Fold the wires back into the junction box and replace the cover, making sure the cover gasket is in place.

Use the Voltage Selector Switch on the end of the pump to select the input voltage for the pump. **NOTE:** The pump comes from the factory pre-set to 115V AC position.



IMPORTANT! Be certain the gasket for the cover is in place, and the screws draw the cover down tight over the junction box. There must be no gap between the junction box and it's cover.

		MAX CABLE LENGTH IN FEET (METERS)											
		Solid Wire						Stranded Wire					
AWG		14	12	10	8	6	4	14	12	10	8	6	4
1/2 HP	115V AC [60Hz motor]	62	99	158	250	--	--	61	96	154	245	389	620
	230V AC [50Hz motor]	214	340	542	859	--	--	209	331	529	844	--	--
	230V AC [60Hz motor]	221	351	560	887	--	--	216	342	546	871	--	--
3/4 HP	115V AC [60Hz motor]	44	71	113	178	--	--	43	69	110	175	278	443
	230V AC [50Hz motor]	146	232	369	585	--	--	142	226	360	574	--	--
	230V AC [60Hz motor]	149	237	377	598	--	--	145	231	368	587	--	--

Operating Instructions

1. Reset Meter to "0" (if applicable).
2. Remove dispensing nozzle from nozzle boot.
3. Move the switch lever to the "ON" position to power the pump.
4. Insert the dispensing nozzle into the container to be filled.
5. Operate the nozzle to dispense fluid; release nozzle when the desired amount of fluid has been dispensed.
6. Move switch lever to the "OFF" position to stop the pump.
7. Remove the dispensing nozzle from the container and store it in the nozzle boot.

Padlocking

Your Fill-Rite pump nozzle can be padlocked for added security. With the pump turned off, and the nozzle in the stored position, a padlock can be inserted through the nozzle rest and nozzle handle opening. This configuration prevents the nozzle from being removed from the nozzle cover.

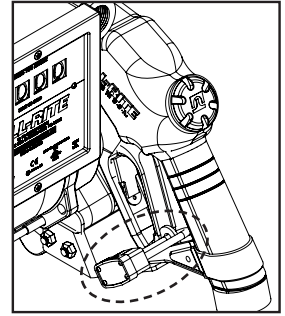

CAUTION! Always keep the nozzle in contact with the container being filled during the filling process to minimize the possibility of static electricity build up.

Safety Testing Approvals

The Fill-Rite FR300V pumps have been safety tested for compliance to the standards set forth by UL Laboratories.



Fluid Compatibility

Diesel fuel, gasoline, kerosene, mineral spirits, Stoddard solvents, heptane, bio-diesel (B20 max.), and bio-diesel (B21 – B100) using KIT300BD.



IMPORTANT! If in doubt about compatibility of a specific fluid, contact supplier of fluid to check for any adverse reactions to the following wetted materials: cast iron; steel; zinc plated steel; 300 series stainless steel; carbon; polyester; fluorocarbon; Teflon; brass; iron; copper; buna; 400 series stainless steel; aluminum.

Technical Information / Specifications

Design Features:

- Inlet: Bung: 2" male NPT; Suction pipe: 1-1/4" female NPT or for "E" series models Bung: 2" male BSPT; Suction pipe: 1-1/2" BSPP.
- Outlet: 1" NPT, or 1" BSPT (BSPT on "E" series models).
- Cast iron pump housing: iron (composite) rotor, and carbon (composite) vanes.
- Security: Pump equipped for padlocking (see page 7 for details).
- Thermal overload protection.
- Heavy duty switch.
- 30 minute duty cycle.
- Explosion proof motor UL listed with sealed bearings that require no maintenance.
- Integral check valve with pressure relief on inlet side prevents pressure build up and improves vertical lift.
- Easy access strainer.
- Automatic bypass valve.
- 2" threaded base for tank openings.
- Constant Amp Draw (Service Factor of 1.0):
 - 115V AC 60Hz – 9.8 amps / 50Hz - 11.4 amps.
 - 230V AC 60Hz – 4.9 amps / 50Hz - 5.7 amps.

Overall Dimensions:

- Model FR310V: 17.12" wide X 15" high x 14.9" deep.
- Model FR311V: 17.12" wide X 19.25" high x 14.9" deep.
- Model FR319V: 17.12" wide x 19.4" high x 14.9" deep.

Shipping Weight:

FR310V: 80 lbs. / FR311V: 91 lbs. / FR319V: 92 lbs.

Accessories:

See page 9 for a complete list of available accessories.

Performance:

- 26 psi (1.79 bar) maximum pressure at pump outlet.
- Up to 35 gallons (132 liters) per minute.
- Maximum viscosity of fluid pumped: #2 diesel fuel.
- Maximum Pump Operating Temperature: 150 degrees F (66 degrees C).
- Minimum Pump Operating Temperature: minus 13 degrees F (minus 25 degrees C) (note that for operation at lower temperatures, we recommend the "Arctic Nozzle" and "Arctic Hose" accessories section on page 9).

Suction Lift:

The lift in feet is equal to the vertical distance from the surface of the fluid in the tank to the inlet of the pump, LESS friction losses through the vertical and horizontal runs of pipe, all elbows, and other fittings. System should be set up to require a minimum amount of suction lift.

- For gasoline use models FR300VN and FR303V (1/2 hp models), suction lift cannot exceed 10' (3 m).
- For #2 diesel fuel use all other models (3/4 hp), suction lift is 18' (5.5 m).

Troubleshooting

The following Troubleshooting guide is provided to offer basic diagnostic assistance in the event you encounter abnormal service from your Tuthill product.



WARNING! DO NOT open or attempt to repair the motor on your FR300V series pump. Opening the motor case can compromise the integrity of the Explosion Proof construction and will void any existing warranty and certification (UL listing). Please refer to the warranty policy located on page 2.



WARNING! Be certain all power to the pump is turned off prior to performing any service or maintenance.

Symptom	Cause	Solution
Pump won't prime	1. Suction line problem	Check for leaks in suction line.
	2. Bypass valve open	Remove and inspect valve, must move freely & be free of debris.
	3. Vanes sticking	Check vanes and slots for nicks, burrs and wear. *
	4. Excessive rotor or vane wear	Inspect rotor & vanes for excessive wear or damage, replace if necessary. *
	5. Outlet blocked	Check pump outlet, hose, nozzle & filter for blockage.
	6. Vapor Lock	Reduce vertical and horizontal distance from pump to liquid; Remove the automatic nozzle.
Low capacity	1. Excessive dirt	Remove and clean screen.
	2. Suction line problem	Check suction line for leaks or restrictions; it may be too small, too long or not airtight.
	3. Bypass valve sticking	Remove and inspect valve; must move freely and be free of debris.
	4. Vanes sticking	Check vanes and slots of wear. *
	5. Excessive rotor or vane wear	Inspect rotor & vanes for excessive wear or damage; replace if necessary. *
	6. Hose or nozzle damage	Replace hose or nozzle.
	7. Plugged filter	Replace filter.
	8. Low fluid level	Fill tank.
Pump runs slowly	1. Incorrect voltage	Check incoming line voltage while pump is running.
	2. Vanes sticking	Inspect vanes and slots for nicks, burrs and wear. *
	3. Wiring problem	Check for loose connections.
	4. Motor problem	Refer to warranty policy.
Motor stalls	1. Bypass valve sticking	Remove and inspect valve, must move freely & be free of debris.
	2. Low voltage	Check incoming line voltage while pump is running.
	3. Excessive rotor or vane wear	Check rotor & vanes for excessive wear or damage. *
	4. Debris in pump cavity	Clean debris from pump cavity.
Motor overheats (Thermal overload tripped)	1. Pumping high viscosity fluids	These fluids can only be pumped for short periods of time (less than 30 minutes duty cycle).
	2. Clogged screen	Remove and clean screen.
	3. Restricted suction pipe	Remove and clean pipe.
	4. Motor failure	Refer to warranty policy.
	5. Pump rotor lock-up	Clean and check pump rotor and vanes. *

Troubleshooting (continued)

Symptom	Cause	Solution
Motor inoperative	1. No Power	Check incoming power.
	2. Switch failure	Refer to warranty policy.
	3. Motor failure	Refer to warranty policy.
	4. Thermal protector failure	Refer to warranty policy.
	5. Incorrect/loose wiring	Check wiring.
Fluid leakage	1. Bad o-ring gasket	Check all o-ring gaskets.
	2. Dirty shaft seal	Clean seal and seal cavity.
	3. Bad shaft seal	Replace seal.
	4. Incompatible fluid	Refer wetted parts list to fluid manufacturer (see page 7).
	5. Loose fasteners	Tighten fasteners.
Pump hums but will not operate	1. Dirt in pump cavity	Clean out pump cavity.
	2. Motor failure	Refer to warranty policy.
	3. Broken rotor insert	Remove all debris & replace insert.

Bold text indicates repairs that are not serviceable by the owner; please refer to our warranty policy on page 2 for further instructions.

* Repairs marked with an asterisk (*) will require Repair Kit #300KTF7794. This kit includes a replacement rotor and new vanes, as well as a number of other important seals and components to complete the repair.

Accessories

A wide variety of accessories are available to help you maximize the performance of your Fill-Rite pump. Listed below are the applicable available accessories for your specific product. Please contact your authorized Fill-Rite distributor to purchase the accessories you need.

Part Number	Description
F4010PM0	1" Filter (Particulate 10 micron)
F4030PM0	1" Filter (Particulate 30 micron)
700ACCF7017	1" Filter Head
FRPA125	Island Pedestal Mount Kit
KIT700AS	Anti-Siphon Kit
FRH10012	1" Hose (12')
FRH10014	1" Hose (14')
FRH10020	1" Hose (20')

Part Number	Description
FRHA10020	1" Arctic Duty Hose (20')
FRHMN100S	1" Nozzle, Manual Leaded Spout
N100DAU13G	1" Auto Shut Off Nozzle (Ultra High Flow Diesel)
N100DAU12G	1" Auto Shut Off Nozzle (High Flow Diesel)
FRNA100DAU00	1" Auto Shut Off Nozzle (Arctic Duty - Diesel)
S100H1315	1" Multi-Plane Swivel
B100F475	1" Breakaway
WH10012	1" Whip Hose

Replacement Parts Information

For repairs or routine maintenance, Fill-Rite offers the parts you need. The following parts diagram and list covers all applicable parts for your Fill-Rite product.



WARNING! DO NOT open or attempt to repair the motor on your FR300V series pump. Opening the motor case can compromise the integrity of the Explosion Proof construction and will void any existing warranty and certification (UL listing).

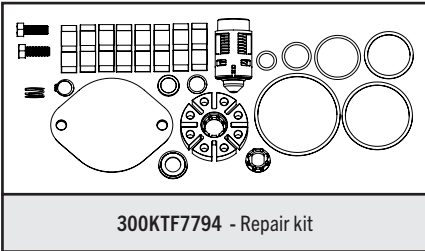

300KTF7794 - Repair kit

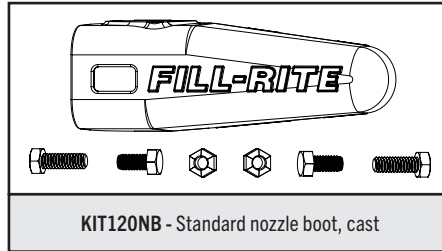

KIT120NB - Standard nozzle boot, cast

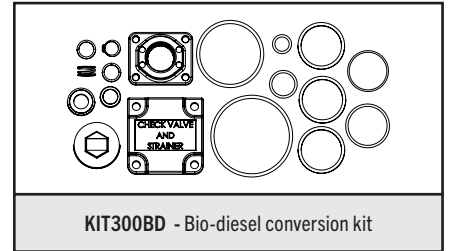

KIT300BD - Bio-diesel conversion kit

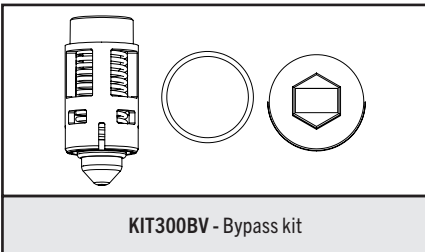

KIT300BV - Bypass kit

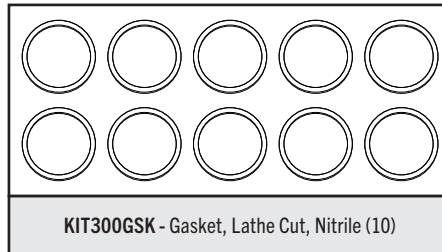

KIT300GSK - Gasket, Lathe Cut, Nitrile (10)

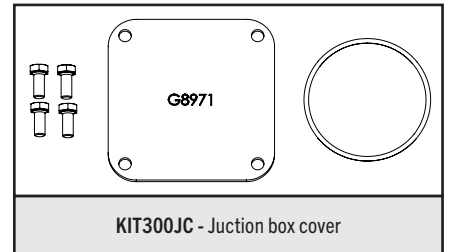

KIT300JC - Junction box cover

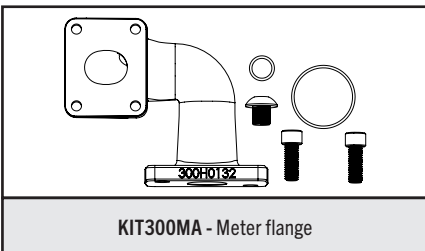

KIT300MA - Meter flange

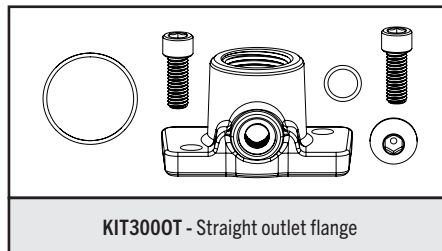

KIT3000T - Straight outlet flange

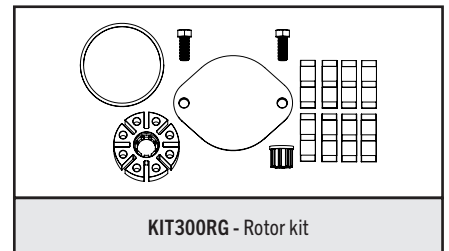

KIT300RG - Rotor kit

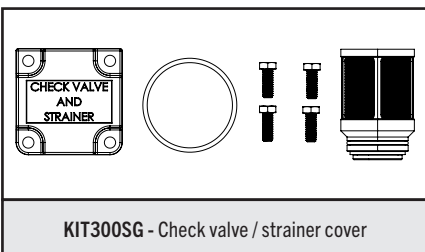

KIT300SG - Check valve / strainer cover

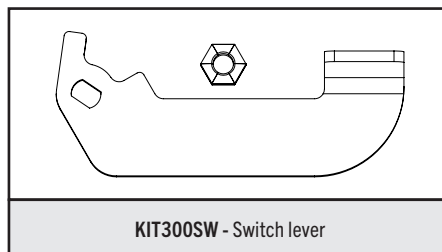

KIT300SW - Switch lever

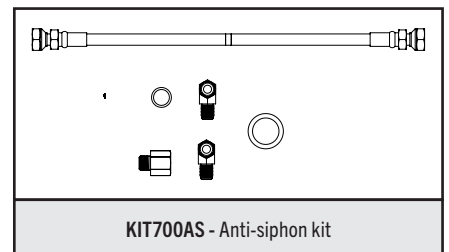

KIT700AS - Anti-siphon kit

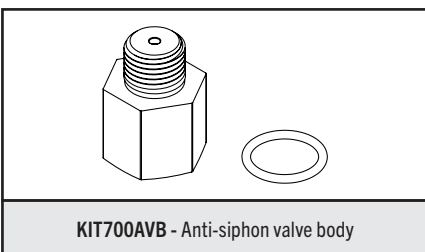

KIT700AVB - Anti-siphon valve body

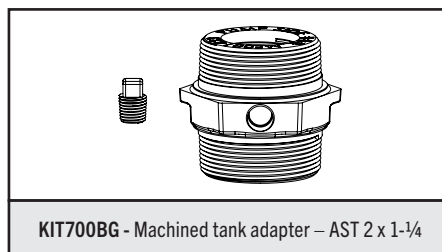

KIT700BG - Machined tank adapter – AST 2 x 1-1/4

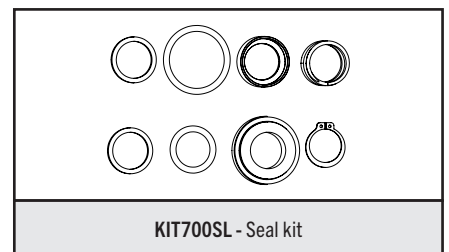

KIT700SL - Seal kit

FR300V / FR310V / FR311V / FR319V Parts List

Kit KIT300RG and Seal Kit KIT700SL Detail

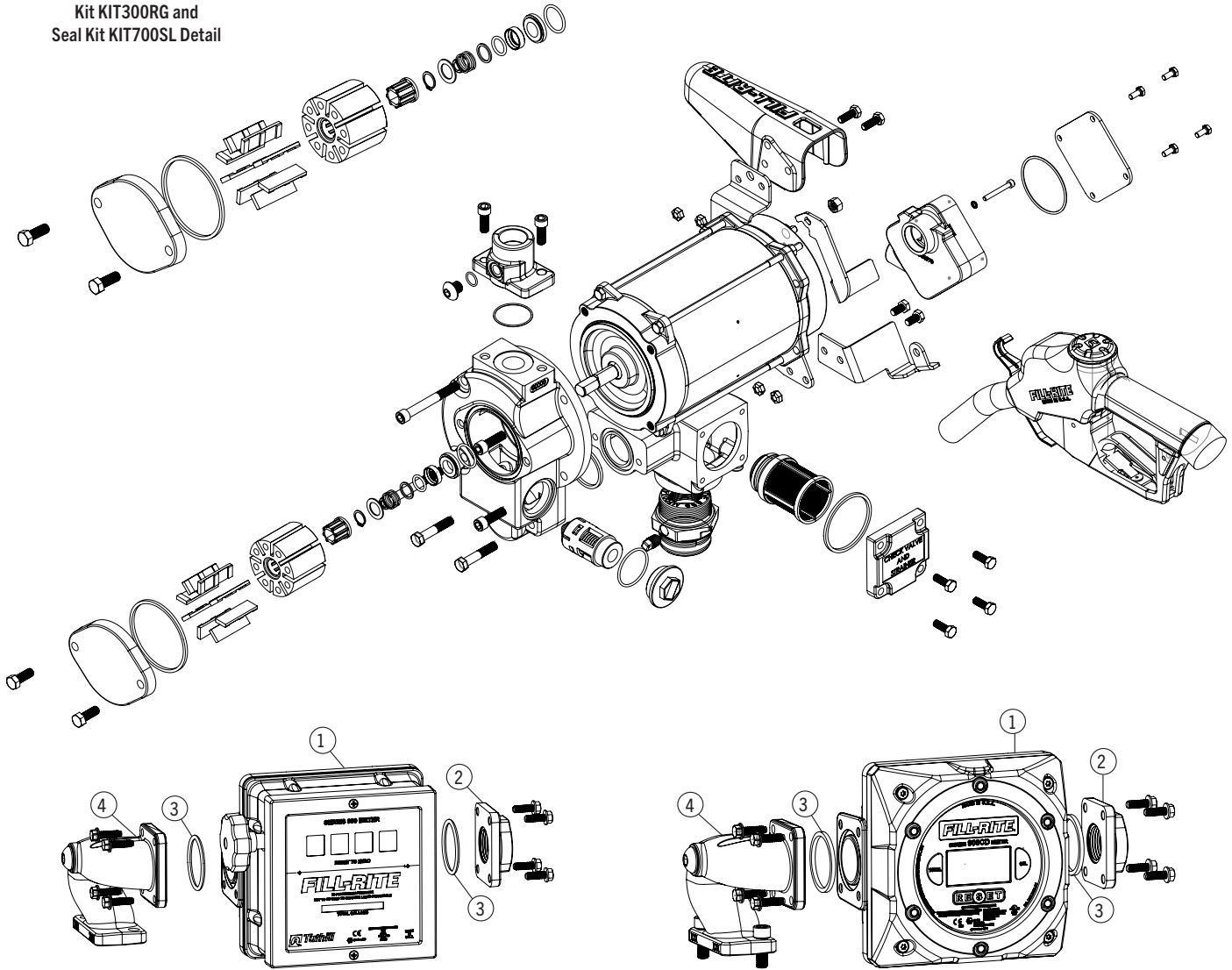

FR311V Parts List

The FR311V configuration adds a 901C Series mechanical meter, inlet meter flange, outlet meter flange, the associated attaching hardware, and gaskets. This package is available in gallon or liter register.

No.	Gallon Kit Number	Description	Liter Kit Number	Qty.
1	901C	901C Meter (only) (Gallons)	--	1
2	901C Meter (Gallon) Kit # 901CMK300V	Meter Flange	901CL Meter (Liter) Kit # 901CLMK300V	1
3		Meter Gasket		2
4		1" Meter Fitting		1
1	--	901CL Meter (only) (Liters)	901CL	1

FR319V Parts List

The FR319V configuration adds a 900CD or 900CDP series digital meter, inlet meter flange, outlet meter flange, the associated attaching hardware, and gaskets. This package is available in pulsing or non-pulsing configuration.

No.	FR319VB Kit #	Description	FR319VBP Kit #	Qty.
--	900CD Digital Meter (no pulser) FR319VB	900CDP Meter	900CDP	1
2		Meter Flange	900CDP Meter w/integral pulser FR319VBP	1
3		Meter Gasket		2
4		1" Meter Fitting		1
1	900CD	900CD Meter (only)	--	
N/S	--	Intrinsic Safety Barrier*	KIT900DPBA	1

*For use with 900CDP pulsing meter only



IMPORTANT! DO NOT open or attempt to repair the motor on your FR300V series pump. Opening the motor case can compromise the integrity of the Explosion Proof construction and will void any existing warranty and certification (UL listing). Please refer to the warranty policy located on page 2.

ATTENTION!

The following information is for suffix “E” pumps and meters. Refer to the information label applied to your pump to see if it is applicable.

Motor Plate Information

ENTRY THREADS ARE M20-1.5 6H
 VOLT: 115/230 Hz: 60/50 HP: ¾ AMB TEMP: 40°C PH: 1 RPM: 1725/1425
 DUTY RATING: 30 MIN. FLA: 9.8/4.9/11.4/5.7 INS: B

Serial Number and Year of Manufacture.

Tuthill
 8825 Aviation Drive
 Fort Wayne, IN 46809 USA



II 2 G
 Ex db h IIA T4 Gb
 FM09ATEX0075X
 Ex db IIA T4 Gb
 IECEx FMG19.0014X

WARNING – DO NOT OPEN WHEN AN EXPLOSIVE ATMOSPHERE IS PRESENT.

Materials of Construction

Materials of construction of the external surface of the unit are: painted steel; painted cast iron; painted aluminum; zinc plated steel.

Materials of construction of the wetted parts are: cast iron; steel; zinc plated steel; 300 series stainless steel; carbon; polyester; fluorocarbon; Teflon; brass; iron; copper; buna; 400 series stainless steel; aluminum.

Repair and Maintenance

Contact the place of purchase for warranty repair and maintenance

Installation

Pump must be installed in compliance with EN 60079-14 or IEC 60079-14, as applicable.

Certificates for Compliance of Safety have been obtained for the following agencies for products sold outside the US and Canada. Please refer to the tag on your particular product for its particular compliance data.

Specific Conditions of Use

1. Consult the manufacturer if dimensional information on the flameproof joints is necessary.

Specific Conditions of Use (continued)

2. ISO Class 8.8, M6 hex-head screws (Yield Stress 640 MPa) shall be used to replace the terminal cover fasteners.
3. ISO Class 8.8, M8 hex-head screws (Yield Stress 640 MPa) shall be used to replace the stator housing fasteners.
4. An electrically conductive hose and nozzle must be used with flammable liquids. To minimize static electricity buildup, always keep the nozzle in contact with the container being filled during the fueling process.

The following standards were used to show compliance in the European Union:

EN IEC 60079-0:2018, Ed 7 “Explosive atmospheres – Part 0: Equipment – General requirements”

EN 60079-1:2014, Ed 7 “Explosive atmospheres – Part 1: Equipment protection by flameproof enclosures “d””

EN ISO 80079-36:2016, Ed 1 “Explosive atmospheres – Part 36: Non-electrical equipment for explosive atmospheres – Basic method and requirements”

EN ISO 80079-37:2016, Ed 1 “Explosive atmospheres – Part 37: Non-electrical equipment for explosive atmospheres – Non electrical type of protection constructional safety “c”, control of ignition source “b”, liquid immersion “k””

Directive 2014/34/EU – Equipment and protective systems intended for use in potentially explosive atmospheres.

Directive 2011/65/EU – Restrictions of the use of certain hazardous substances in electrical and electronic equipment.

The following standards were used to show compliance for IECEx certification:

IEC 60079-0:2017, Ed 7

IEC 60079-1:2014, Ed 7

Segurança



Find out more about fuel transfer & lubrication we have.