

FILL-RITE®

The Most Trusted Name in Pumps and Meters



FR311VN

Technical Specifications

SERVICE KIT INFORMATION

Motor	
Power - AC 115,230, 115/230 VAC	115/230
HZ 50,60,50/60	60/50
Power - DC 12, 24, 12/24	N/A
HP (Horsepower) Rating	3/4 HP
Power Cord Length (feet)	N/A
Power Cord Gauge (AWG)	N/A
DC Power Cord Connectors	N/A
Amps (FLA)	9.8/4.9 11.4/5.7
RPM	1725/1425
Duty Cycle	30 min.
Thermal Protection Switch	Yes
Circuit Protection Fuse	None
Certification	UL, cUL

Pump	
Type - Rotary, Diaphragm, Gear, Vane	Rotary Vane
GPM in Supplied Configuration	28.7
GPM Open Flow - no Hose or Nozzle	34.3
By-Pass Pressure Rating (PSI) - Max	26 PSI
Dry Vac (in Hg)	14
Head - Max (Ft.)	60.06
Anti-Siphon Valve	Anti-Siphon Ready
Inlet - Size / Thread	1.25"
Outlet - Size / Thread	NPT
Mount	Bung (NPT)
Material - Pump Housing	Cast Iron
Material - Wetted Material	Buna
Rotor Material	80% Iron / % Copper
Rotor Vane Material	Carbon
Compatible Fluids	Diesel, Gasoline, Bio-Diesel up to B20, E15, Kerosene
Strainer Mesh Size	40 x 40 x .008"
Warranty	2 Years

Kit	Description	Parts
KIT300BD	Bio-Diesel Kit	Special shaft seal assembly, gasket, inlet gasket, bypass O-ring
KIT300BV	Bypass Kit	Poppet, spring, O-ring, cap
KIT300JC	Junction Box	Junction box cover, O-ring, hardware
KIT120NB	Nozzle Boot Kit	Nozzle boot, attaching hardware
KIT300NR	Nozzle Retainer Kit	Nozzle retainer and attaching hardware
KIT700BG	Inlet Kit	Inlet adapter, AST 2 x 1 1/4
KIT300SW	Switch Lever	Switch lever and nut
KIT120NB	Nozzle Boot Kit	Nozzle boot, attaching hardware
KIT300RG	Rotary Group	Rotor, 8 vanes, rotor key, gasket, rotor cover, 4 screws
KIT300SL	Shaft Seal	8 piece assembly
KIT300OT	Outlet Kit	Outlet flange, O-ring seal, attaching hardware
KIT700AS	Anti-Siphon Kit	Anti-siphon valve, Teflon tape, elbow adapter, stainless steel braided hose, attaching hardware

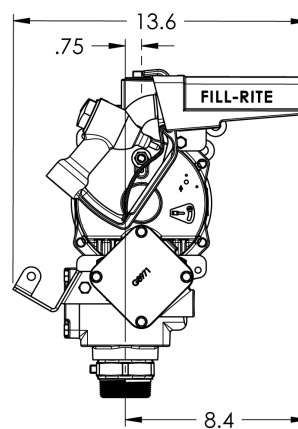
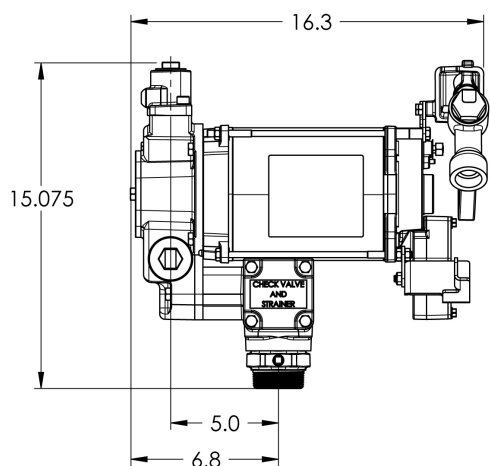
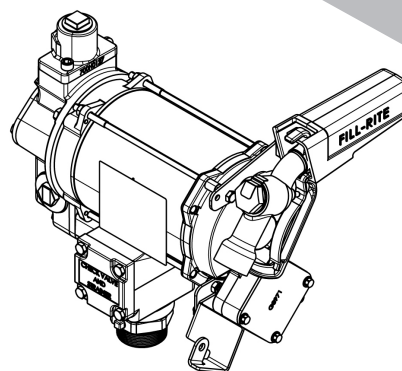
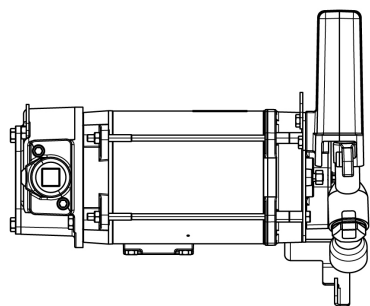

Accessories

Suction Pipe Material	N/A
Suction Pipe Length	N/A
Nozzle - Size	1" Manual
Nozzle - Manual / Automatic	Manual
Hose Diameter	1"
Hose Length	12'
Hose Material of Construction	Black Nitrile Rubber
Hose Static Wire (Yes/No)	Yes
Certifications	UL, cUL

Measurements

Overall Height	19.4"
Overall Width	17"
Overall Depth	17"
Intake Center Line to Discharge Center Line	2"
Intake Center Line to Back of Nozzle Boot	8.5"
Shipping Weight	94 lbs.
Qty per Pallet	8
Box Dimensions:	
Length	21"
Width	20"
Height	17"

