

DEWALT®



Instruction Manual

DCS367

20V Max* Cordless Compact Reciprocating Saw

Definitions: Safety Alert Symbols and Words

This instruction manual uses the following safety alert symbols and words to alert you to hazardous situations and your risk of personal injury or property damage.







-  **DANGER:** Indicates an imminently hazardous situation which, if not avoided, **will** result in **death or serious injury**.
-  **WARNING:** Indicates a potentially hazardous situation which, if not avoided, **could** result in **death or serious injury**.
-  **CAUTION:** Indicates a potentially hazardous situation which, if not avoided, **may** result in **minor or moderate injury**.
-  (Used without word) Indicates a safety related message.
- NOTICE:** Indicates a practice **not related to personal injury** which, if not avoided, **may** result in **property damage**.

Fig. A

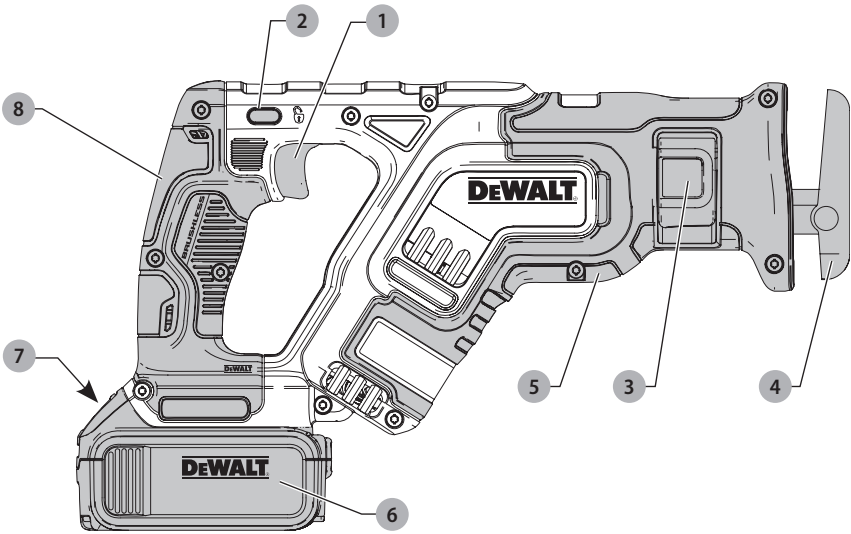

- 1 Trigger switch
- 2 Lock-off button
- 3 Blade clamp release lever
- 4 Shoe
- 5 Hand grip
- 6 Battery pack
- 7 Battery release button
- 8 Main handle

 **WARNING! Read all safety warnings and all instructions.** Failure to follow the warnings and instructions may result in electric shock, fire and/or serious injury.

 **WARNING:** To reduce the risk of injury, read the instruction manual.

GENERAL POWER TOOL SAFETY WARNINGS



WARNING! Read all safety warnings and all instructions. Failure to follow the warnings and instructions may result in electric shock, fire and/or serious injury.

SAVE ALL WARNINGS AND INSTRUCTIONS FOR FUTURE REFERENCE

The term "power tool" in the warnings refers to your mains-operated (corded) power tool or battery-operated (cordless) power tool.

1) Work Area Safety

- a) **Keep work area clean and well lit.** Cluttered or dark areas invite accidents.
- b) **Do not operate power tools in explosive atmospheres, such as in the presence of flammable liquids, gases or dust.** Power tools create sparks which may ignite the dust or fumes.
- c) **Keep children and bystanders away while operating a power tool.** Distractions can cause you to lose control.

2) Electrical Safety

- a) **Power tool plugs must match the outlet. Never modify the plug in any way. Do not use any adapter plugs with earthed (grounded) power tools.** Unmodified plugs and matching outlets will reduce risk of electric shock.
- b) **Avoid body contact with earthed or grounded surfaces such as pipes, radiators, ranges and refrigerators.** There is an increased risk of electric shock if your body is earthed or grounded.
- c) **Do not expose power tools to rain or wet conditions.** Water entering a power tool will increase the risk of electric shock.
- d) **Do not abuse the cord. Never use the cord for carrying, pulling or unplugging the power tool. Keep cord away from heat, oil, sharp edges or moving parts.** Damaged or entangled cords increase the risk of electric shock.
- e) **When operating a power tool outdoors, use an extension cord suitable for outdoor use.** Use of a cord suitable for outdoor use reduces the risk of electric shock.
- f) **If operating a power tool in a damp location is unavoidable, use a ground fault circuit interrupter (GFCI) protected supply.** Use of a GFCI reduces the risk of electric shock.

3) Personal Safety

- a) **Stay alert, watch what you are doing and use common sense when operating a power tool. Do not use a power tool while you are tired or under the influence of drugs, alcohol or medication.** A moment of inattention while operating power tools may result in serious personal injury.

- b) **Use personal protective equipment. Always wear eye protection.** Protective equipment such as dust mask, non-skid safety shoes, hard hat, or hearing protection used for appropriate conditions will reduce personal injuries.
- c) **Prevent unintentional starting. Ensure the switch is in the off position before connecting to power source and/or battery pack, picking up or carrying the tool.** Carrying power tools with your finger on the switch or energizing power tools that have the switch on invites accidents.
- d) **Remove any adjusting key or wrench before turning the power tool on.** A wrench or a key left attached to a rotating part of the power tool may result in personal injury.
- e) **Do not overreach. Keep proper footing and balance at all times.** This enables better control of the power tool in unexpected situations.
- f) **Dress properly. Do not wear loose clothing or jewelry. Keep your hair, clothing and gloves away from moving parts.** Loose clothes, jewelry or long hair can be caught in moving parts.
- g) **If devices are provided for the connection of dust extraction and collection facilities, ensure these are connected and properly used.** Use of dust collection can reduce dust-related hazards.

4) Power Tool Use and Care

- a) **Do not force the power tool. Use the correct power tool for your application.** The correct power tool will do the job better and safer at the rate for which it was designed.
- b) **Do not use the power tool if the switch does not turn it on and off.** Any power tool that cannot be controlled with the switch is dangerous and must be repaired.
- c) **Disconnect the plug from the power source and/or the battery pack from the power tool before making any adjustments, changing accessories, or storing power tools.** Such preventive safety measures reduce the risk of starting the power tool accidentally.
- d) **Store idle power tools out of the reach of children and do not allow persons unfamiliar with the power tool or these instructions to operate the power tool.** Power tools are dangerous in the hands of untrained users.
- e) **Maintain power tools. Check for misalignment or binding of moving parts, breakage of parts and any other condition that may affect the power tool's operation. If damaged, have the power tool repaired before use.** Many accidents are caused by poorly maintained power tools.
- f) **Keep cutting tools sharp and clean.** Properly maintained cutting tools with sharp cutting edges are less likely to bind and are easier to control.
- g) **Use the power tool, accessories and tool bits, etc. in accordance with these instructions, taking**

into account the working conditions and the work to be performed. Use of the power tool for operations different from those intended could result in a hazardous situation.

5) Battery Tool Use and Care

- a) **Recharge only with the charger specified by the manufacturer.** A charger that is suitable for one type of battery pack may create a risk of fire when used with another battery pack.
- b) **Use power tools only with specifically designated battery packs.** Use of any other battery packs may create a risk of injury and fire.
- c) **When battery pack is not in use, keep it away from other metal objects, like paper clips, coins, keys, nails, screws, or other small metal objects, that can make a connection from one terminal to another.** Shorting the battery terminals together may cause burns or a fire.
- d) Under abusive conditions, liquid may be ejected from the battery; **avoid contact. If contact accidentally occurs, flush with water. If liquid contacts eyes, additionally seek medical help.** Liquid ejected from the battery may cause irritation or burns.

6) Service

- a) **Have your power tool serviced by a qualified repair person using only identical replacement parts.** This will ensure that the safety of the power tool is maintained.

Additional Specific Safety Rules for Reciprocating Saws

- **Hold power tool by insulated gripping surfaces, when performing an operation where the cutting accessory may contact hidden wiring.** Cutting accessory contacting a "live" wire may make exposed metal parts of the power tool "live" and could give the operator an electric shock.
- **Use clamps or another practical way to secure and support the workpiece to a stable platform.** Holding the work by hand or against your body leaves it unstable and may lead to loss of control.
- **Hold saw firmly with both hands for all cutting operations.** During cutting operations, the blade may suddenly bind in the work and may cause the saw to kickback towards the operator.
- **Keep hands away from moving parts.** Never place your hands near the cutting area.
- **Use extra caution when cutting overhead and pay particular attention to overhead wires which may be hidden from view.** Anticipate the path of falling branches and debris ahead of time.
- **Do not operate this tool for long periods of time.** Vibration caused by the operating action of this tool may cause permanent injury to fingers, hands, and arms. Use gloves to provide extra cushion, take frequent rest periods, and limit daily time of use.

Additional Safety Information



WARNING: ALWAYS use safety glasses. Everyday eyeglasses are NOT safety glasses. Also use face or dust mask if cutting operation is dusty. ALWAYS WEAR CERTIFIED SAFETY EQUIPMENT:

- ANSI Z87.1 eye protection (CAN/CSA Z94.3),
- ANSI S12.6 (S3.19) hearing protection,
- NIOSH/OSHA/MSHA respiratory protection.



WARNING: Some dust created by power sanding, sawing, grinding, drilling, and other construction activities contains chemicals known to the State of California to cause cancer, birth defects or other reproductive harm. Some examples of these chemicals are:

- lead from lead-based paints,
- crystalline silica from bricks and cement and other masonry products, and
- arsenic and chromium from chemically-treated lumber.

Your risk from these exposures varies, depending on how often you do this type of work. To reduce your exposure to these chemicals: work in a well ventilated area, and work with approved safety equipment, such as those dust masks that are specially designed to filter out microscopic particles.

- **Avoid prolonged contact with dust from power sanding, sawing, grinding, drilling, and other construction activities. Wear protective clothing and wash exposed areas with soap and water.** Allowing dust to get into your mouth, eyes, or lay on the skin may promote absorption of harmful chemicals.



WARNING: Use of this tool can generate and/or disperse dust, which may cause serious and permanent respiratory or other injury. Always use NIOSH/OSHA approved respiratory protection appropriate for the dust exposure. Direct particles away from face and body.



WARNING: Always wear proper personal hearing protection that conforms to ANSI S12.6 (S3.19) during use. Under some conditions and duration of use, noise from this product may contribute to hearing loss.



CAUTION: When not in use, place tool on its side on a stable surface where it will not cause a tripping or falling hazard. Some tools with large battery packs will stand upright on the battery pack but may be easily knocked over.

- **Air vents often cover moving parts and should be avoided.** Loose clothes, jewelry or long hair can be caught in moving parts.

The label on your tool may include the following symbols. The symbols and their definitions are as follows:

V	volts	Ⓢ	Class I Construction (grounded)
Hz	hertz/min	per minute
min	minutes	beats per minute
==	or DC.....	direct current	

IPM.....	impacts per minute	n ₀	no load speed
RPM.....	revolutions per minute	n.....	rated speed
sfpm.....	surface feet per minute	⊕.....	earthing terminal
SPM.....	strokes per minute	⚠.....	safety alert symbol
A.....	amperes	☠.....	visible radiation
W.....	watts	☞.....	wear respiratory protection
~ or AC.....	alternating current	☞.....	wear eye protection
⎓ or AC/DC.....	alternating or direct current	👂.....	wear hearing protection
□.....	Class II Construction (double insulated)	📖.....	read all documentation

BATTERIES AND CHARGERS

The battery pack is not fully charged out of the carton. Before using the battery pack and charger, read the safety instructions below and then follow charging procedures outlined. When ordering replacement battery packs, be sure to include the catalog number and voltage. Your tool uses a DeWALT charger. Be sure to read all safety instructions before using your charger. Consult the chart at the end of this manual for compatibility of chargers and battery packs.

READ ALL INSTRUCTIONS

Important Safety Instructions for All Battery Packs

WARNING: Read all safety warnings and all instructions for the battery pack, charger and power tool. Failure to follow the warnings and instructions may result in electric shock, fire and/or serious injury.

- **Do not charge or use the battery pack in explosive atmospheres, such as in the presence of flammable liquids, gases or dust.** Inserting or removing the battery pack from the charger may ignite the dust or fumes.
 - **NEVER force the battery pack into the charger. DO NOT modify the battery pack in any way to fit into a non-compatible charger as battery pack may rupture causing serious personal injury.** Consult the chart at the end of this manual for compatibility of batteries and chargers.
 - Charge the battery packs only in designated DeWALT chargers.
 - **DO NOT splash or immerse in water or other liquids.**
 - **Do not store or use the tool and battery pack in locations where the temperature may reach or exceed 104 °F (40 °C) (such as outside sheds or metal buildings in summer).** For best life store battery packs in a cool, dry location.
- NOTE:** Do not store the battery packs in a tool with the trigger switch locked on. Never tape the trigger switch in the ON position.

- **Do not incinerate the battery pack even if it is severely damaged or is completely worn out.** The battery pack can explode in a fire. Toxic fumes and materials are created when lithium ion battery packs are burned.
- **If battery contents come into contact with the skin, immediately wash area with mild soap and water.** If battery liquid gets into the eye, rinse water over the open eye for 15 minutes or until irritation ceases. If medical attention is needed, the battery electrolyte is composed of a mixture of liquid organic carbonates and lithium salts.
- **Contents of opened battery cells may cause respiratory irritation.** Provide fresh air. If symptoms persist, seek medical attention.

WARNING: Burn hazard. Battery liquid may be flammable if exposed to spark or flame.

WARNING: Fire hazard. Never attempt to open the battery pack for any reason. If the battery pack case is cracked or damaged, do not insert into the charger. Do not crush, drop or damage the battery pack. Do not use a battery pack or charger that has received a sharp blow, been dropped, run over or damaged in any way (e.g., pierced with a nail, hit with a hammer, stepped on). Damaged battery packs should be returned to the service center for recycling.

Transportation

WARNING: Fire hazard. Do not store or carry the battery pack so that metal objects can contact exposed battery terminals. For example, do not place the battery pack in aprons, pockets, tool boxes, product kit boxes, drawers, etc., with loose nails, screws, keys, etc. **Transporting batteries can possibly cause fires if the battery terminals inadvertently come in contact with conductive materials such as keys, coins, hand tools and the like.** The US Department of Transportation Hazardous Material Regulations (HMR) actually prohibit transporting batteries in commerce or on airplanes in carry-on baggage UNLESS they are properly protected from short circuits. So when transporting individual battery packs, make sure that the battery terminals are protected and well insulated from materials that could contact them and cause a short circuit.

Shipping the DeWALT FLEXVOLT™ Battery

The DeWALT FLEXVOLT™ battery has two modes: **Use** and **Shipping**.

Use Mode: When the FLEXVOLT™ battery stands alone or is in a DeWALT 20V Max* product, it will operate as a 20V Max* battery. When the FLEXVOLT™ battery is in a 60V Max* or a 120V Max* (two 60V Max* batteries) product, it will operate as a 60V Max* battery.

Shipping Mode: When the cap is attached to the FLEXVOLT™ battery, the battery is in Shipping Mode. Strings of cells are

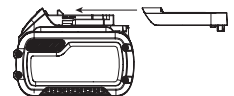

electrically disconnected within the pack resulting in three batteries with a lower Watt hour (Wh) rating as compared to one battery with a higher Watt hour rating. This increased quantity of three batteries with the lower Watt hour rating can exempt the pack from certain shipping regulations that are imposed upon the higher Watt hour batteries.

The battery label indicates two Watt hour ratings (see example). Depending on how the battery is shipped, the appropriate Watt hour rating must be used to determine the applicable shipping requirements. If utilizing the shipping cap, the pack will be considered 3 batteries at the Watt hour rating indicated for "Shipping". If shipping without the cap or in a tool, the pack will be considered one battery at the Watt hour rating indicated next to "Use".

For example, Shipping Wh rating might indicate 3 x 40 Wh, meaning 3 batteries of 40 Watt hours each. The Use Wh rating might indicate 120 Wh (1 battery implied).

Example of Use and Shipping Label Marking

USE: 120 Wh Shipping: 3 x 40 Wh

Fuel Gauge Battery Packs (Fig. B)

Some DeWALT battery packs include a fuel gauge which consists of three green LED lights that indicate the level of charge remaining in the battery pack.

The fuel gauge is an indication of approximate levels of charge remaining in the battery pack according to the following indicators:

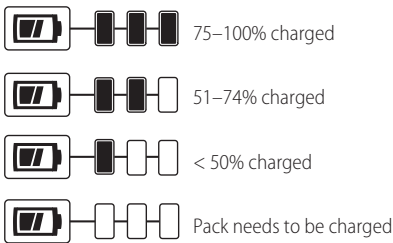

To actuate the fuel gauge, press and hold the fuel gauge button. A combination of the three green LED lights will illuminate designating the level of charge left. When the level of charge in the battery is below the usable limit, the fuel gauge will not illuminate and the battery will need to be recharged.

Fig. B

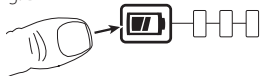

NOTE: The fuel gauge is only an indication of the charge left on the battery pack. It does not indicate tool functionality and is subject to variation based on product components, temperature and end-user application.

The RBRC® Seal

The RBRC® (Rechargeable Battery Recycling Corporation) Seal on the nickel cadmium, nickel metal hydride or lithium-ion batteries (or battery packs) indicates that the costs to recycle these batteries (or battery packs) at the end of their useful life have already been paid by DeWALT. In some areas, it is illegal to place spent nickel cadmium, nickel metal hydride or lithium-ion batteries in the trash or municipal solid waste stream and the Call 2 Recycle® program provides an environmentally conscious alternative.



Call 2 Recycle, Inc., in cooperation with DeWALT and other battery users, has established the program in the United States and Canada to facilitate the collection of spent nickel cadmium, nickel metal hydride or lithium-ion batteries. Help protect our environment and conserve natural resources by returning the spent nickel cadmium, nickel metal hydride or lithium-ion batteries to an authorized DeWALT service center or to your local retailer for recycling. You may also contact your local recycling center for information on where to drop off the spent battery. RBRC® is a registered trademark of Call 2 Recycle, Inc.

Important Safety Instructions for All Battery Chargers



WARNING: Read all safety warnings and all instructions for the battery pack, charger and power tool. Failure to follow the warnings and instructions may result in electric shock, fire and/or serious injury.

- **DO NOT attempt to charge the battery pack with any chargers other than the ones in this manual.** The charger and battery pack are specifically designed to work together.
- **These chargers are not intended for any uses other than charging DeWALT rechargeable batteries.** Any other uses may result in risk of fire, electric shock or electrocution.
- **Do not expose the charger to rain or snow.**
- **Pull by the plug rather than the cord when disconnecting the charger.** This will reduce the risk of damage to the electric plug and cord.
- **Make sure that the cord is located so that it will not be stepped on, tripped over or otherwise subjected to damage or stress.**
- **Do not use an extension cord unless it is absolutely necessary.** Use of improper extension cord could result in risk of fire, electric shock or electrocution.
- **When operating a charger outdoors, always provide a dry location and use an extension cord suitable for outdoor use.** Use of a cord suitable for outdoor use reduces the risk of electric shock.
- **An extension cord must have adequate wire size (AWG or American Wire Gauge) for safety.** The smaller the gauge number of the wire, the greater the capacity of the cable, that is, 16 gauge has more capacity than 18

gauge. An undersized cord will cause a drop in line voltage resulting in loss of power and overheating. When using more than one extension to make up the total length, be sure each individual extension contains at least the minimum wire size. The following table shows the correct size to use depending on cord length and nameplate ampere rating. If in doubt, use the next heavier gauge. The lower the gauge number, the heavier the cord.

Minimum Gauge for Cord Sets

Volts	Total Length of Cord in Feet (meters)					
	25 (7.6)	50 (15.2)	100 (30.5)	150 (45.7)	200 (61.0)	
120 V	25 (7.6)	50 (15.2)	100 (30.5)	150 (45.7)	200 (61.0)	
240 V	50 (15.2)	100 (30.5)	200 (61.0)	300 (91.4)		
Ampere Rating		American Wire Gauge				
More Than	Not More Than					
0	6	18	16	16	14	
6	10	18	16	14	12	
10	12	16	16	14	12	
12	16	14	12	Not Recommended		

- **Do not place any object on top of the charger or place the charger on a soft surface that might block the ventilation slots and result in excessive internal heat.** Place the charger in a position away from any heat source. The charger is ventilated through slots in the top and the bottom of the housing.
- **Do not operate the charger with a damaged cord or plug.**
- **Do not operate the charger if it has received a sharp blow, been dropped or otherwise damaged in any way.** Take it to an authorized service center.
- **Do not disassemble the charger; take it to an authorized service center when service or repair is required.** Incorrect reassembly may result in a risk of electric shock, electrocution or fire.
- **Disconnect the charger from the outlet before attempting any cleaning. This will reduce the risk of electric shock.** Removing the battery pack will not reduce this risk.
- **NEVER** attempt to connect 2 chargers together.
- **The charger is designed to operate on standard 120V household electrical power. Do not attempt to use it on any other voltage.** This does not apply to the vehicular charger.

WARNING: Shock hazard. Do not allow any liquid to get inside the charger. Electric shock may result.

WARNING: Burn hazard. Do not submerge the battery pack in any liquid or allow any liquid to enter the battery pack. Never attempt to open the battery pack for any reason. If the plastic housing of the battery pack breaks or cracks, return to a service center for recycling.

CAUTION: Burn hazard. To reduce the risk of injury, charge only DeWALT rechargeable battery packs. Other types of batteries may overheat and burst resulting in personal injury and property damage.

NOTICE: Under certain conditions, with the charger plugged into the power supply, the charger can be shorted by foreign material. Foreign materials of a conductive nature, such as, but not limited to, grinding dust, metal chips, steel wool, aluminum foil or any buildup of metallic particles should be kept away from the charger cavities. Always unplug the charger from the power supply when there is no battery pack in the cavity. Unplug the charger before attempting to clean.

Charging a Battery (Fig. C)

1. Plug the charger into an appropriate outlet before inserting battery pack.

Fig. C

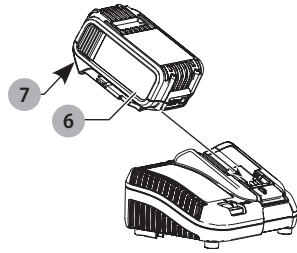

2. Insert the battery pack 6 into the charger, making sure the battery pack is fully seated in the charger. The red (charging) light will blink continuously indicating that the charging process has started.
3. The completion of charge will be indicated by the red light remaining ON continuously. The battery pack is fully charged and may be used at this time or left in the charger. To remove the battery pack from the charger, push the battery release button 7 on the battery pack.

NOTE: To ensure maximum performance and life of lithium-ion battery packs, charge the battery pack fully before first use.

Charger Operation

Refer to the indicators below for the charge status of the battery pack.

DCB101	
	Charging — — — — —
	Fully Charged —————
	Hot/Cold Pack Delay — • — • — • — •
	Problem Pack or Charger • • • • • • • •
DCB107, DCB112, DCB113, DCB115, DCB118, DCB132	
	Charging — — — — —
	Fully Charged —————
	Hot/Cold Pack Delay* — — — — — —————

***DCB107, DCB112, DCB113, DCB115, DCB118, DCB132:** The red light will continue to blink, but a yellow indicator light will be illuminated during this operation. Once the

battery pack has reached an appropriate temperature, the yellow light will turn off and the charger will resume the charging procedure.

The compatible charger(s) will not charge a faulty battery pack. The charger will indicate faulty battery pack by refusing to light or by displaying a problem pack or charger blink pattern.

NOTE: This could also mean a problem with a charger.

If the charger indicates a problem, take the charger and battery pack to be tested at an authorized service center.

Hot/Cold Pack Delay

When the charger detects a battery pack that is too hot or too cold, it automatically starts a Hot/Cold Pack Delay, suspending charging until the battery pack has reached an appropriate temperature. The charger then automatically switches to the pack charging mode. This feature ensures maximum battery pack life.

A cold battery pack will charge at a slower rate than a warm battery pack. The battery pack will charge at that slower rate throughout the entire charging cycle and will not return to maximum charge rate even if the battery pack warms.

The DCB118 charger is equipped with an internal fan designed to cool the battery pack. The fan will turn on automatically when the battery pack needs to be cooled.

Never operate the charger if the fan does not operate properly or if ventilation slots are blocked. Do not permit foreign objects to enter the interior of the charger.

Electronic Protection System

Li-Ion tools are designed with an Electronic Protection System that will protect the battery pack against overloading, overheating or deep discharge.

The tool will automatically turn off if the Electronic Protection System engages. If this occurs, place the lithium-ion battery pack on the charger until it is fully charged.

Wall Mounting

DCB107, DCB112, DCB113, DCB115, DCB118, DCB132

These chargers are designed to be wall mountable or to sit upright on a table or work surface. If wall mounting, locate the charger within reach of an electrical outlet, and away from a corner or other obstructions which may impede air flow. Use the back of the charger as a template for the location of the mounting screws on the wall. Mount the charger securely using drywall screws (purchased separately) at least 1" (25.4 mm) long, with a screw head diameter of 0.28–0.35" (7–9 mm), screwed into wood to an optimal depth leaving approximately 7/32" (5.5 mm) of the screw exposed. Align the slots on the back of the charger with the exposed screws and fully engage them in the slots.

Charger Cleaning Instructions



WARNING: Shock hazard. Disconnect the charger from the AC outlet before cleaning. Dirt and grease may be removed from the exterior of the charger using a cloth or soft non-metallic brush. Do not use water or any cleaning solutions.

Important Charging Notes

1. Longest life and best performance can be obtained if the battery pack is charged when the air temperature is between 65 °F and 75 °F (18 °C – 24 °C). DO NOT charge the battery pack in an air temperature below +40 °F (+4.5 °C), or above +104 °F (+40 °C). This is important and will prevent serious damage to the battery pack.
2. The charger and battery pack may become warm to the touch while charging. This is a normal condition, and does not indicate a problem. To facilitate the cooling of the battery pack after use, avoid placing the charger or battery pack in a warm environment such as in a metal shed or an uninsulated trailer.
3. If the battery pack does not charge properly:
 - a. Check operation of receptacle by plugging in a lamp or other appliance;
 - b. Check to see if receptacle is connected to a light switch which turns power off when you turn out the lights;
 - c. Move the charger and battery pack to a location where the surrounding air temperature is approximately 65 °F – 75 °F (18 °C – 24 °C);
 - d. If charging problems persist, take the tool, battery pack and charger to your local service center.
4. The battery pack should be recharged when it fails to produce sufficient power on jobs which were easily done previously. DO NOT CONTINUE to use under these conditions. Follow the charging procedure. You may also charge a partially used pack whenever you desire with no adverse effect on the battery pack.
5. Foreign materials of a conductive nature such as, but not limited to, grinding dust, metal chips, steel wool, aluminum foil, or any buildup of metallic particles should be kept away from charger cavities. Always unplug the charger from the power supply when there is no battery pack in the cavity. Unplug the charger before attempting to clean.
6. Do not freeze or immerse the charger in water or any other liquid.

Storage Recommendations

1. The best storage place is one that is cool and dry, away from direct sunlight and excess heat or cold.
2. For long storage, it is recommended to store a fully charged battery pack in a cool dry place out of the charger for optimal results.

NOTE: Battery packs should not be stored completely depleted of charge. The battery pack will need to be recharged before use.

SAVE THESE INSTRUCTIONS FOR FUTURE USE

COMPONENTS (FIG. A)



WARNING: Never modify the power tool or any part of it. Damage or personal injury could result.

Refer to Figure A at the beginning of this manual for a complete list of components.

INTENDED USE

This reciprocating saw is designed for professional sawing applications.

DO NOT use under wet conditions or in presence of flammable liquids or gases.

This reciprocating saw is a professional power tool. **DO NOT** let children come into contact with the tool. Supervision is required when inexperienced operators use this tool.

Variable Speed Trigger Switch (Fig. A, D)

Lock-Off Button and Trigger Switch

Your saw is equipped with a lock-off button 2.

To lock the trigger switch, press the lock-off button as shown in Figure D. Always lock the trigger switch 1 when carrying or storing the tool to eliminate unintentional starting. The lock-off button is colored **red** to indicate when the switch is in its **unlocked** position.

To unlock the trigger switch, press the lock-off button as shown in Figure D. Pull the trigger switch to turn the motor ON. Releasing the trigger switch turns the motor OFF.

Fig. D

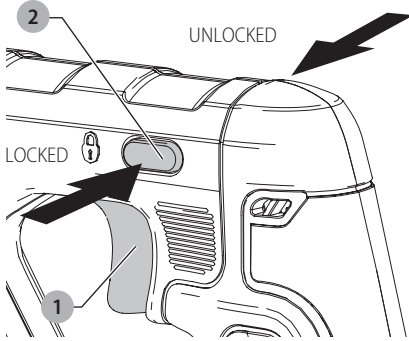

WARNING: This tool has no provision to lock the switch in the ON position, and should never be locked ON by any other means.

The variable speed trigger switch will give you added versatility. The further the trigger is depressed the higher the speed of the saw.

CAUTION: Use of very slow speed is recommended only for beginning a cut. Prolonged use at very slow speed may damage your saw.

Worklight

CAUTION: Do not stare into worklight. Serious eye injury could result.

There is a worklight located on the end of the tool near the shoe. The worklight is activated when the trigger switch is depressed, and will remain on for a short time after the trigger switch is released. If the trigger switch remains depressed, the worklight will remain on.

NOTE: The worklight is for lighting the immediate work surface and is not intended to be used as a flashlight.

OPERATION

WARNING: To reduce the risk of serious personal injury, turn unit off and remove the battery pack before making any adjustments or removing/installing attachments or accessories. An accidental start-up can cause injury.

Installing and Removing the Battery Pack (Fig. E)

NOTE: For best results, make sure your battery pack is fully charged.

To install the battery pack 6 into the tool handle, align the battery pack with the rails inside the tool's handle and slide it into the handle until the battery pack is firmly seated in the tool and ensure that it does not disengage.

To remove the battery pack from the tool, press the release button 7 and firmly pull the battery pack out of the tool handle. Insert it into the charger as described in the charger section of this manual.

Fig. E

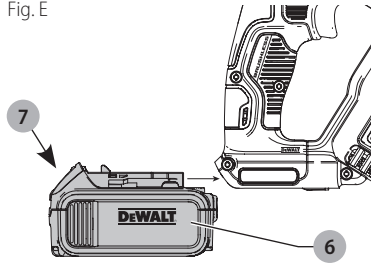

Proper Hand Position (Fig. K)

WARNING: To reduce the risk of serious personal injury, ALWAYS use proper hand position as shown.

WARNING: To reduce the risk of serious personal injury, ALWAYS hold securely in anticipation of a sudden reaction.

Proper hand position requires one hand on the main handle 8 and the other hand on the hand grip 5.

Blade Installation and Removal (Fig. F–H)

WARNING: To reduce the risk of serious personal injury, turn unit off and remove the battery pack before making any adjustments or removing/installing attachments or accessories. An accidental start-up can cause injury.

Different blade lengths are available. Use the appropriate blade for the application. The blade should be longer than 3–1/2" (89 mm) and should extend past the shoe and the thickness of the workpiece during the cut. Do not use jigsaw blades with this tool.

WARNING: Cut hazard. Blade breakage may occur if the blade does not extend past the shoe and the workpiece during the cut (Fig. F). Increased risk of personal injury, as well as damage to the shoe and workpiece may result.

FIG. F

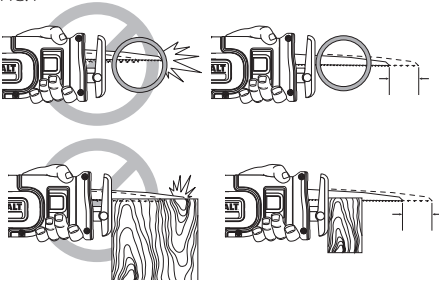

To Install Blade into Saw

1. Pull blade clamp release lever **3** up (Fig. G).

FIG. G

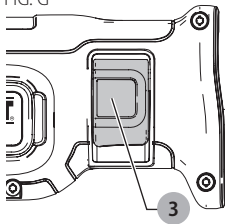

2. Insert blade shank from the front.
3. Push blade clamp release lever down.

NOTE: The blade can be installed in four positions as shown in Figure H.

FIG. H

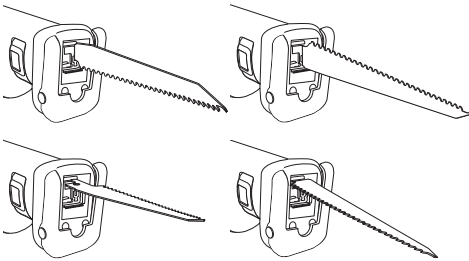

To Remove Blade from Saw

CAUTION: Burn hazard. Do not touch the the blade immediately after use. Contact with the blade may result in personal injury.

1. Open up blade clamp release lever.
2. Remove blade.

Cutting with Blade in Horizontal Position (Fig. I, J)

Your DCS367 is equipped with a horizontal blade clamp (Fig. I). Installing a blade in the horizontal orientation allows cutting close to floors, walls or ceilings where limited clearance is available. Ensure that the shoe is pressed against the framing to avoid kickback (Fig. J).

Fig. I

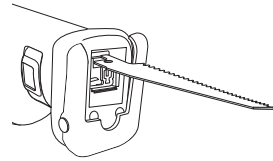
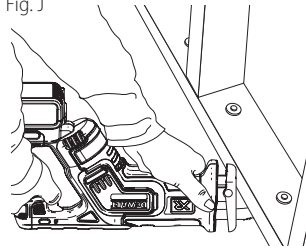

Fig. J



Cutting (Fig. K–N)



WARNING: Always use eye protection. All users and bystanders must wear eye protection that conforms to ANSI Z87.1.



WARNING: Exercise extra caution when cutting towards operator. Always hold saw firmly with both hands while cutting.

Before cutting any type of material, be sure it is firmly anchored or clamped to prevent slipping. Place blade lightly against work to be cut, switch on saw motor and allow it to obtain maximum speed before applying pressure. Whenever possible, the saw shoe must be held firmly against the material being cut (Fig. K). This will prevent the saw from jumping or vibrating and minimize blade breakage. Any cuts which put pressure on the blade such as angle or scroll cuts increase potential for vibration, kickback, and blade breakage.



WARNING: Use extra caution when cutting overhead and pay particular attention to overhead wires which may be hidden from view. Anticipate the path of falling branches and debris ahead of time.



WARNING: Inspect work site for hidden gas pipes, water pipes, or electrical wires before making blind or plunge cuts. Failure to do so may result in explosion, property damage, electric shock, and/or serious personal injury.

FIG. K

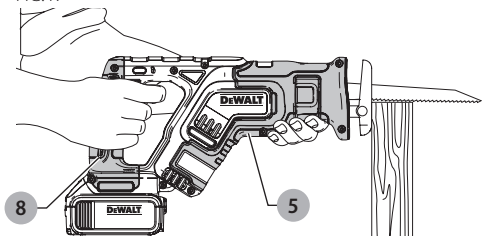

Flush-To Cutting (Fig. L)

The compact design of the saw motor housing and spindle housing permits extremely close cutting to floors, corners and other difficult areas.

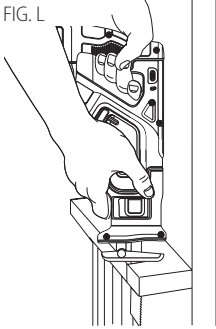

Pocket/Plunge Cutting – Wood Only (Fig. M)

The initial step in pocket cutting is to measure the surface area to be cut and mark clearly with a pencil, chalk or scribe. Use the appropriate blade for the application. The blade should be longer than 3–1/2" (89 mm) and should extend past the shoe and the thickness of the workpiece during the cut. Insert blade in blade clamp.

Next, tip the saw backward until the back edge of the shoe is resting on the work surface and the blade clears the work surface (position 1, Fig. M). Now switch motor on, and allow saw to come up to speed. Grip saw firmly with both hands and begin a slow, deliberate upward swing with the handle of the saw, keeping the bottom of the shoe firmly in contact with the workpiece (position 2, Fig. M). Blade will begin to feed into material. Always be sure blade is completely through material before continuing with pocket cut.

NOTE: In areas where blade visibility is limited, use the edge of the saw shoe as a guide. Lines for any given cut should be extended beyond edge of cut to be made.

FIG. M

1. STARTING POSITION FOR POCKET CUTTING
2. ROCK TOOL UP TO NORMAL CUTTING POSITION AFTER BLADE HAS CUT THROUGH MATERIAL.

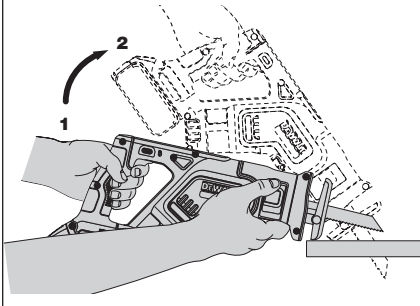

Metal Cutting (Fig. N)

Your saw has different metal cutting capacities depending upon type of blade used and the metal to be cut. Use a finer blade for ferrous metals and a coarse blade for non-ferrous materials. In thin gauge sheet metals it is best to clamp wood to both sides of sheet. This will insure a clean cut without excess vibration or tearing of metal. Always remember not to force cutting blade as this reduces blade life and causes costly blade breakage.

NOTE: It is generally recommended that when cutting metals you should spread a thin film of oil or other lubricant along the line ahead of the saw cut for easier operation and longer blade life.

FIG. N

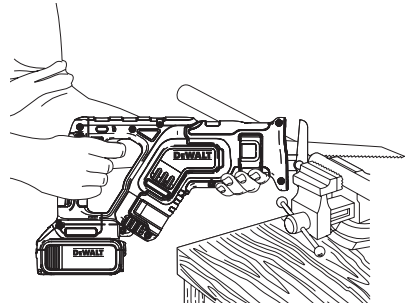

MAINTENANCE

WARNING: To reduce the risk of serious personal injury, turn unit off and remove the battery pack before making any adjustments or removing/installing attachments or accessories. An accidental start-up can cause injury.

Cleaning

WARNING: Blow dirt and dust out of all air vents with clean, dry air at least once a week. To minimize the risk of eye injury, always wear ANSI Z87.1 approved eye protection when performing this.

WARNING: Never use solvents or other harsh chemicals for cleaning the non-metallic parts of the tool. These chemicals may weaken the plastic materials used in these parts. Use a cloth dampened only with water and mild soap. Never let any liquid get inside the tool; never immerse any part of the tool into a liquid.

Accessories

WARNING: Since accessories, other than those offered by DeWALT, have not been tested with this product, use of such accessories with this tool could be hazardous. To reduce the risk of injury, only DeWALT recommended accessories should be used with this product.

Recommended accessories for use with your tool are available at extra cost from your local dealer or authorized service center. If you need assistance in

locating any accessory, please contact DeWALT Industrial Tool Co., 701 East Joppa Road, Towson, MD 21286, call 1-800-4-DeWALT (1-800-433-9258) or visit our website: www.dewalt.com.

Repairs

The charger and battery pack are not serviceable.



WARNING: To assure product SAFETY and RELIABILITY, repairs, maintenance and adjustment (including brush inspection and replacement) should be performed by a DeWALT factory service center or a DeWALT authorized service center. Always use identical replacement parts.

Register Online

Thank you for your purchase. Register your product now for:

- **WARRANTY SERVICE:** Registering your product will help you obtain more efficient warranty service in case there is a problem with your product.
- **CONFIRMATION OF OWNERSHIP:** In case of an insurance loss, such as fire, flood or theft, your registration of ownership will serve as your proof of purchase.
- **FOR YOUR SAFETY:** Registering your product will allow us to contact you in the unlikely event a safety notification is required under the Federal Consumer Safety Act.