

INSTRUCTION MANUAL

DEWALT®

DCGG571

20V Max* Grease Gun

Definitions: Safety Guidelines

The definitions below describe the level of severity for each signal word. Please read the manual and pay attention to these symbols.

⚠ DANGER: Indicates an imminently hazardous situation which, if not avoided, **will** result in **death or serious injury**.

⚠ WARNING: Indicates a potentially hazardous situation which, if not avoided, **could** result in **death or serious injury**.

⚠ CAUTION: Indicates a potentially hazardous situation which, if not avoided, **may** result in **minor or moderate injury**.

NOTICE: Indicates a practice **not related to personal injury** which, if not avoided, **may** result in **property damage**.



WARNING: To reduce the risk of injury, read the instruction manual.

General Power Tool Safety Warnings



WARNING! Read all safety warnings and all instructions. Failure to follow the warnings and instructions may result in electric shock, fire and/or serious injury.

SAVE ALL WARNINGS AND INSTRUCTIONS FOR FUTURE REFERENCE

The term “power tool” in the warnings refers to your mains-operated (corded) power tool or battery-operated (cordless) power tool.

1) WORK AREA SAFETY

- Keep work area clean and well lit.** Cluttered or dark areas invite accidents.
- Do not operate power tools in explosive atmospheres, such as in the presence of flammable liquids, gases or dust.** Power tools create sparks which may ignite the dust or fumes.
- Keep children and bystanders away while operating a power tool.** Distractions can cause you to lose control.

2) ELECTRICAL SAFETY

- Power tool plugs must match the outlet. Never modify the plug in any way. Do not use any adapter plugs with earthed (grounded) power tools.** Unmodified plugs and matching outlets will reduce risk of electric shock.
- Avoid body contact with earthed or grounded surfaces such as pipes, radiators, ranges and refrigerators.** There is an increased risk of electric shock if your body is earthed or grounded.
- Do not expose power tools to rain or wet conditions.** Water entering a power tool will increase the risk of electric shock.
- Do not abuse the cord. Never use the cord for carrying, pulling or unplugging the power tool. Keep cord away from heat, oil, sharp edges or moving parts.** Damaged or entangled cords increase the risk of electric shock.
- When operating a power tool outdoors, use an extension cord suitable for outdoor use.** Use of a cord suitable for outdoor use reduces the risk of electric shock.

- f) **If operating a power tool in a damp location is unavoidable, use a ground fault circuit interrupter (GFCI) protected supply.** Use of a GFCI reduces the risk of electric shock.

3) PERSONAL SAFETY

- a) **Stay alert, watch what you are doing and use common sense when operating a power tool. Do not use a power tool while you are tired or under the influence of drugs, alcohol or medication.** A moment of inattention while operating power tools may result in serious personal injury.
- b) **Use personal protective equipment. Always wear eye protection.** Protective equipment such as dust mask, non-skid safety shoes, hard hat, or hearing protection used for appropriate conditions will reduce personal injuries.
- c) **Prevent unintentional starting. Ensure the switch is in the off position before connecting to power source and/or battery pack, picking up or carrying the tool.** Carrying power tools with your finger on the switch or energizing power tools that have the switch on invites accidents.
- d) **Remove any adjusting key or wrench before turning the power tool on.** A wrench or a key left attached to a rotating part of the power tool may result in personal injury.
- e) **Do not overreach. Keep proper footing and balance at all times.** This enables better control of the power tool in unexpected situations.
- f) **Dress properly. Do not wear loose clothing or jewelry. Keep your hair, clothing and gloves away from moving parts.** Loose clothes, jewelry or long hair can be caught in moving parts.
- g) **If devices are provided for the connection of dust extraction and collection facilities, ensure these are connected and properly used.** Use of dust collection can reduce dust-related hazards.

4) POWER TOOL USE AND CARE

- a) **Do not force the power tool. Use the correct power tool for your application.** The correct power tool will do the job better and safer at the rate for which it was designed.
- b) **Do not use the power tool if the switch does not turn it on and off.** Any power tool that cannot be controlled with the switch is dangerous and must be repaired.
- c) **Disconnect the plug from the power source and/or the battery pack from the power tool before making any adjustments, changing accessories, or storing power tools.** Such preventive safety measures reduce the risk of starting the power tool accidentally.
- d) **Store idle power tools out of the reach of children and do not allow persons unfamiliar with the power tool or these instructions to operate the power tool.** Power tools are dangerous in the hands of untrained users.
- e) **Maintain power tools. Check for misalignment or binding of moving parts, breakage of parts and any other condition that may affect the power tool's operation. If damaged, have the power tool repaired before use.** Many accidents are caused by poorly maintained power tools.
- f) **Keep cutting tools sharp and clean.** Properly maintained cutting tools with sharp cutting edges are less likely to bind and are easier to control.
- g) **Use the power tool, accessories and tool bits, etc. in accordance with these instructions, taking into account the working conditions and the work to be performed.** Use of the power tool for operations different from those intended could result in a hazardous situation.

5) BATTERY TOOL USE AND CARE

- a) **Recharge only with the charger specified by the manufacturer.** A charger that is suitable for one type of

battery pack may create a risk of fire when used with another battery pack.

- b) **Use power tools only with specifically designated battery packs.** Use of any other battery packs may create a risk of injury and fire.
- c) **When battery pack is not in use, keep it away from other metal objects, like paper clips, coins, keys, nails, screws, or other small metal objects, that can make a connection from one terminal to another.** Shorting the battery terminals together may cause burns or a fire.
- d) **Under abusive conditions, liquid may be ejected from the battery; avoid contact. If contact accidentally occurs, flush with water. If liquid contacts eyes, additionally seek medical help.** Liquid ejected from the battery may cause irritation or burns.

6) SERVICE

- a) **Have your power tool serviced by a qualified repair person using only identical replacement parts.** This will ensure that the safety of the power tool is maintained.

Additional Safety Rules for Grease Guns

- **Parts of the tool or the hose assembly can break or rupture due to high pressure. Risk of serious injury may occur.** Before using, always inspect the tool and hose assembly for damage or wear. Never use if any part of the tool is damaged or worn.
- **Use only DEWALT-approved flexible hoses.** Hold the hose only by the flexible hose safety spring guard to avoid personal serious injury.
- **If the hose kinks or is damaged, a rupture may occur which could cause serious injury.** Replace the hose at the first sign of wear, kink or damage.

- **Only use the grease recommended in this manual.** Refer to the Technical Information chart under **Using the Grease Gun.**
- **To reduce the risk of serious personal injury, do not use the grease gun around or on moving parts, mechanisms or running equipment.**
- **Air vents often cover moving parts and should be avoided.** Loose clothes, jewelry or long hair can be caught in moving parts.

▲ WARNING: Risk of injection or severe injury. Rupture of components can inject grease into skin or eyes, causing serious injury or infection. Do not treat as a simple cut. Seek immediate medical attention.

▲ WARNING: Output can be at high pressure. Do not direct discharge at yourself or others.

▲ WARNING: The grease gun may generate high pressure—up to 10,000 psi (690 bar). Always wear gloves during operation. Keep hands clear of the exposed rubber portion of the hose.

▲ WARNING: Risk of fire. Grease may be flammable. Do not expose to fire or high temperatures. Read and follow all warnings and instructions from the lubricant manufacturer.

▲ WARNING: ALWAYS use safety glasses. Everyday eyeglasses are NOT safety glasses. Also use face or dust mask if cutting operation is dusty. ALWAYS WEAR CERTIFIED SAFETY EQUIPMENT:

- ANSI Z87.1 eye protection (CAN/CSA Z94.3),
- ANSI S12.6 (S3.19) hearing protection,
- NIOSH/OSHA/MSHA respiratory protection.

▲ WARNING: Some dust created by power sanding, sawing, grinding, drilling, and other construction activities contains chemicals known to the State of California to cause cancer, birth defects or other reproductive harm. Some examples of these chemicals are:

- lead from lead-based paints,

- crystalline silica from bricks and cement and other masonry products, and
- arsenic and chromium from chemically-treated lumber.

Your risk from these exposures varies, depending on how often you do this type of work. To reduce your exposure to these chemicals: work in a well ventilated area, and work with approved safety equipment, such as those dust masks that are specially designed to filter out microscopic particles.

- **Avoid prolonged contact with dust from power sanding, sawing, grinding, drilling, and other construction activities. Wear protective clothing and wash exposed areas with soap and water.** Allowing dust to get into your mouth, eyes, or lay on the skin may promote absorption of harmful chemicals.







⚠ WARNING: Use of this tool can generate and/or disperse dust, which may cause serious and permanent respiratory or other injury. Always use NIOSH/OSHA approved respiratory protection appropriate for the dust exposure. Direct particles away from face and body.

⚠ WARNING: Always wear proper personal hearing protection that conforms to ANSI S12.6 (S3.19) during use. Under some conditions and duration of use, noise from this product may contribute to hearing loss.

⚠ CAUTION: When not in use, place tool on its side on a stable surface where it will not cause a tripping or falling hazard. Some tools with large battery packs will stand upright on the battery pack but may be easily knocked over.

- The label on your tool may include the following symbols. The symbols and their definitions are as follows:

V..... volts	A.....amperes
Hz..... hertz	W.....watts
min minutes	~ or AC.....alternating current
== or DC... direct current	

	Class I Construction (grounded)	 or AC/DC...alternating or direct current
	Class II Construction (double insulated)	n_ono load speed
.../min per minute	nrated speed
BPM beats per minute	earthing terminal
IPM impacts per minute	 safety alert symbol
RPM revolutions per minute	 visible radiation
sfp surface feet per minute	
SPMstrokes per minute	

Important Safety Instructions for All Battery Packs

When ordering replacement battery packs, be sure to include the catalog number and voltage. Consult the chart at the end of this manual for compatibility of chargers and battery packs.

The battery pack is not fully charged out of the carton. Before using the battery pack and charger, read the safety instructions below and then follow charging procedures outlined.

READ ALL INSTRUCTIONS

- **Do not charge or use the battery pack in explosive atmospheres, such as in the presence of flammable liquids, gases or dust.** Inserting or removing the battery pack from the charger may ignite the dust or fumes.
- **NEVER force the battery pack into the charger. DO NOT modify the battery pack in any way to fit into a non-**

compatible charger as battery pack may rupture causing serious personal injury. Consult the chart at the end of this manual for compatibility of batteries and chargers.

- Charge the battery packs only in designated DEWALT chargers.
- **DO NOT** splash or immerse in water or other liquids.
- **Do not store or use the tool and battery pack in locations where the temperature may reach or exceed 104 °F (40 °C) (such as outside sheds or metal buildings in summer).** For best life store battery packs in a cool, dry location.

NOTE: Do not store the battery packs in a tool with the trigger switch locked on. Never tape the trigger switch in the ON position.

⚠WARNING: Fire hazard. Never attempt to open the battery pack for any reason. If the battery pack case is cracked or damaged, do not insert into the charger. Do not crush, drop or damage the battery pack. Do not use a battery pack or charger that has received a sharp blow, been dropped, run over or damaged in any way (e.g., pierced with a nail, hit with a hammer, stepped on). Damaged battery packs should be returned to the service center for recycling.

⚠WARNING: Fire hazard. Do not store or carry the battery pack so that metal objects can contact exposed battery terminals. For example, do not place the battery pack in aprons, pockets, tool boxes, product kit boxes, drawers, etc., with loose nails, screws, keys, etc. **Transporting batteries can possibly cause fires if the battery terminals inadvertently come in contact with conductive materials such as keys, coins, hand tools and the like.** The US Department of Transportation Hazardous Material Regulations (HMR) actually prohibit transporting batteries in commerce or on airplanes (e.g., packed in suitcases and carry-on luggage) UNLESS they are properly protected from short circuits. So when transporting individual battery packs, make sure that the battery terminals are protected and well insulated from materials that could contact them and cause a short circuit.

SPECIFIC SAFETY INSTRUCTIONS FOR LITHIUM ION (Li-Ion)

- **Do not incinerate the battery pack even if it is severely damaged or is completely worn out.** The battery pack can explode in a fire. Toxic fumes and materials are created when lithium ion battery packs are burned.
- **If battery contents come into contact with the skin, immediately wash area with mild soap and water.** If battery liquid gets into the eye, rinse water over the open eye for 15 minutes or until irritation ceases. If medical attention is needed, the battery electrolyte is composed of a mixture of liquid organic carbonates and lithium salts.
- **Contents of opened battery cells may cause respiratory irritation.** Provide fresh air. If symptoms persist, seek medical attention.

⚠WARNING: Burn hazard. Battery liquid may be flammable if exposed to spark or flame.

The RBRC® Seal

The RBRC® (Rechargeable Battery Recycling Corporation) Seal on the nickel cadmium, nickel metal hydride or lithium-ion batteries (or battery packs) indicates that the costs to recycle these batteries (or battery packs) at the end of their useful life have already been paid by DEWALT. In some areas, it is illegal to place spent nickel cadmium, nickel metal hydride or lithium-ion batteries in the trash or municipal solid waste stream and the Call 2 Recycle® program provides an environmentally conscious alternative. Call 2 Recycle, Inc., in cooperation with DEWALT and other battery users, has established the program in the United States and Canada to facilitate the collection of spent nickel cadmium, nickel metal hydride or lithium-ion batteries. Help protect our environment and conserve natural resources by returning the spent nickel cadmium, nickel metal hydride or lithium-ion batteries to an authorized DEWALT



service center or to your local retailer for recycling. You may also contact your local recycling center for information on where to drop off the spent battery. RBRC® is a registered trademark of Call 2 Recycle, Inc.

Important Safety Instructions for All Battery Chargers

SAVE THESE INSTRUCTIONS: This manual contains important safety and operating instructions for battery chargers.

- Before using the charger, read all instructions and cautionary markings on the charger, battery pack and product using the battery pack.

⚠WARNING: Shock hazard. Do not allow any liquid to get inside the charger. Electric shock may result.

⚠CAUTION: Burn hazard. To reduce the risk of injury, charge only DEWALT rechargeable battery packs. Other types of batteries may overheat and burst resulting in personal injury and property damage.

NOTICE: Under certain conditions, with the charger plugged into the power supply, the charger can be shorted by foreign material. Foreign materials of a conductive nature, such as, but not limited to, grinding dust, metal chips, steel wool, aluminum foil or any buildup of metallic particles should be kept away from the charger cavities. Always unplug the charger from the power supply when there is no battery pack in the cavity. Unplug the charger before attempting to clean.

- **DO NOT attempt to charge the battery pack with any chargers other than the ones in this manual.** The charger and battery pack are specifically designed to work together.

- **These chargers are not intended for any uses other than charging DEWALT rechargeable batteries.** Any other uses may result in risk of fire, electric shock or electrocution.
- **Do not expose the charger to rain or snow.**
- **Pull by the plug rather than the cord when disconnecting the charger.** This will reduce the risk of damage to the electric plug and cord.
- **Make sure that the cord is located so that it will not be stepped on, tripped over or otherwise subjected to damage or stress.**
- **Do not use an extension cord unless it is absolutely necessary.** Use of improper extension cord could result in risk of fire, electric shock or electrocution.
- **When operating a charger outdoors, always provide a dry location and use an extension cord suitable for outdoor use.** Use of a cord suitable for outdoor use reduces the risk of electric shock.
- **An extension cord must have adequate wire size (AWG or American Wire Gauge) for safety.** The smaller the gauge number of the wire, the greater the capacity of the cable, that is, 16 gauge has more capacity than 18 gauge. An undersized cord will cause a drop in line voltage resulting in loss of power and overheating. When using more than one extension to make up the total length, be sure each individual extension contains at least the minimum wire size. The following table shows the correct size to use depending on cord length and nameplate ampere rating. If in doubt, use the next heavier gauge. The lower the gauge number, the heavier the cord.

Minimum Gauge for Cord Sets							
Ampere Rating		Volts	Total Length of Cord in Feet (meters)				
		120 V	25 (7.6)	50 (15.2)	100 (30.5)	150 (45.7)	
			240 V	50 (15.2)	100 (30.5)	200 (61.0)	300 (91.4)
More Than	Not More Than	AWG					
0	6	18	16	16	14		
6	10	18	16	14	12		
10	12	16	16	14	12		
12	16	14	12	Not Recommended			

- **Do not place any object on top of the charger or place the charger on a soft surface that might block the ventilation slots and result in excessive internal heat.** Place the charger in a position away from any heat source. The charger is ventilated through slots in the top and the bottom of the housing.
- **Do not operate the charger with a damaged cord or plug.**
- **Do not operate the charger if it has received a sharp blow, been dropped or otherwise damaged in any way.** Take it to an authorized service center.
- **Do not disassemble the charger; take it to an authorized service center when service or repair is required.** Incorrect reassembly may result in a risk of electric shock, electrocution or fire.
- **Disconnect the charger from the outlet before attempting any cleaning. This will reduce the risk of electric shock.** Removing the battery pack will not reduce this risk.
- **NEVER** attempt to connect 2 chargers together.

- **The charger is designed to operate on standard 120V household electrical power. Do not attempt to use it on any other voltage.** This does not apply to the vehicular charger.

Chargers

Your tool uses a DEWALT charger. Be sure to read all safety instructions before using your charger. Consult the chart at the end of this manual for compatibility of chargers and battery packs.

Charging Procedure (Fig. 1)

1. Plug the charger into an appropriate outlet before inserting the battery pack.
2. Insert the battery pack (P) into the charger, as shown in Figure 1, making sure the pack is fully seated in charger. The red (charging) light will blink continuously, indicating that the charging process has started.
3. The completion of charge will be indicated by the red light remaining ON continuously. The pack is fully charged and may be used at this time or left in the charger.

FIG. 1



Indicator Light Operation

DCB101, DCB102, DCB103

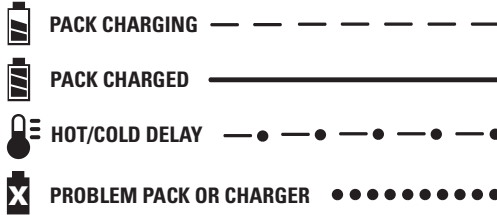

DCB107, DCB112, DCB113, DCB115

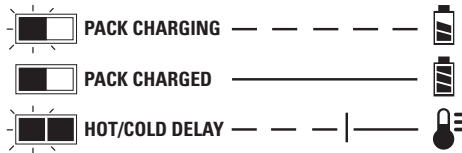

Charge Indicators

This charger is designed to detect certain problems that can arise. Problems are indicated by the red light flashing at a fast rate. If this occurs, re-insert the battery pack into the charger. If the problem persists, try a different battery pack to determine if the charger is working properly. If the new pack charges correctly, then the original pack is defective and should be returned to a service center or other collection site for recycling. If the new battery pack elicits the same trouble indication as the original, have the charger and the battery pack tested at an authorized service center.

HOT/COLD DELAY

DCB101, DCB102, DCB103

These chargers have a hot/cold delay feature. When the charger detects a battery that is too hot or too cold, it automatically starts a delay, suspending charging. The red light flashes long, then short while in the hot/cold delay mode.

Once the battery has reached an optimum temperature, the charger will automatically resume the charging procedure. This feature ensures maximum battery life.

DCB107, DCB112, DCB113, DCB115

These chargers have a hot/cold delay feature. When the charger detects a battery that is too hot or too cold, it automatically starts a delay, suspending charging. The red light will continue to blink, but a yellow indicator light will be illuminated during this suspension.

Once the battery has reached an optimum temperature, the yellow light will turn off and the charger will automatically resume the charging procedure. This feature ensures maximum battery life.

LEAVING THE BATTERY PACK IN THE CHARGER

The charger and battery pack can be left connected with the charge indicator showing Pack Charged.

WEAK BATTERY PACKS: Weak batteries will continue to function but should not be expected to perform as much work.

FAULTY BATTERY PACKS

DCB101, DCB102, DCB103

These chargers will not charge a faulty battery pack. The charger will indicate faulty battery pack by refusing to light or by displaying problem pack or charger.

NOTE: This could also mean a problem with a charger.

DCB107, DCB112, DCB113, DCB115

These chargers will not charge a faulty battery pack. The charger will indicate faulty battery pack by refusing to light.

NOTE: This could also mean a problem with a charger.

Wall Mounting**DCB107, DCB112, DCB113, DCB115**

These chargers are designed to be wall mountable or to sit upright on a table or work surface.

If wall mounting, locate the charger within reach of an electrical outlet. Mount the charger securely using drywall screws at least 1" (25.4 mm) long, screwed into wood to an optimal depth leaving approximately 7/32" (5.5 mm) of the screw exposed.

Important Charging Notes

1. Longest life and best performance can be obtained if the battery pack is charged when the air temperature is between 65 °F and 75 °F (18°–24 °C). DO NOT charge the battery pack in an air temperature below +40 °F (+4.5 °C), or above +104 °F (+40 °C). This is important and will prevent serious damage to the battery pack.
2. The charger and battery pack may become warm to the touch while charging. This is a normal condition, and does not indicate a problem. To facilitate the cooling of the battery pack after use, avoid placing the charger or battery pack in a warm environment such as in a metal shed or an uninsulated trailer.
3. A cold battery pack will charge at about half the rate of a warm battery pack. The battery pack will charge at that slower rate throughout the entire charging cycle and will not return to maximum charge rate even if the battery pack warms.
4. If the battery pack does not charge properly:

- a. Check operation of receptacle by plugging in a lamp or other appliance;
 - b. Check to see if receptacle is connected to a light switch which turns power off when you turn out the lights;
 - c. Move the charger and battery pack to a location where the surrounding air temperature is approximately 65 °F–75 °F (18°–24 °C);
 - d. If charging problems persist, take the tool, battery pack and charger to your local service center.
5. The battery pack should be recharged when it fails to produce sufficient power on jobs which were easily done previously. DO NOT CONTINUE to use under these conditions. Follow the charging procedure. You may also charge a partially used pack whenever you desire with no adverse effect on the battery pack.
 6. Foreign materials of a conductive nature such as, but not limited to, grinding dust, metal chips, steel wool, aluminum foil, or any buildup of metallic particles should be kept away from charger cavities. Always unplug the charger from the power supply when there is no battery pack in the cavity. Unplug the charger before attempting to clean.
 7. Do not freeze or immerse the charger in water or any other liquid.

▲WARNING: Shock hazard. Don't allow any liquid to get inside the charger. Electric shock may result.

▲WARNING: Burn hazard. Do not submerge the battery pack in any liquid or allow any liquid to enter the battery pack. Never attempt to open the battery pack for any reason. If the plastic housing of the battery pack breaks or cracks, return to a service center for recycling.

Storage Recommendations

1. The best storage place is one that is cool and dry, away from direct sunlight and excess heat or cold.

FIG. 2

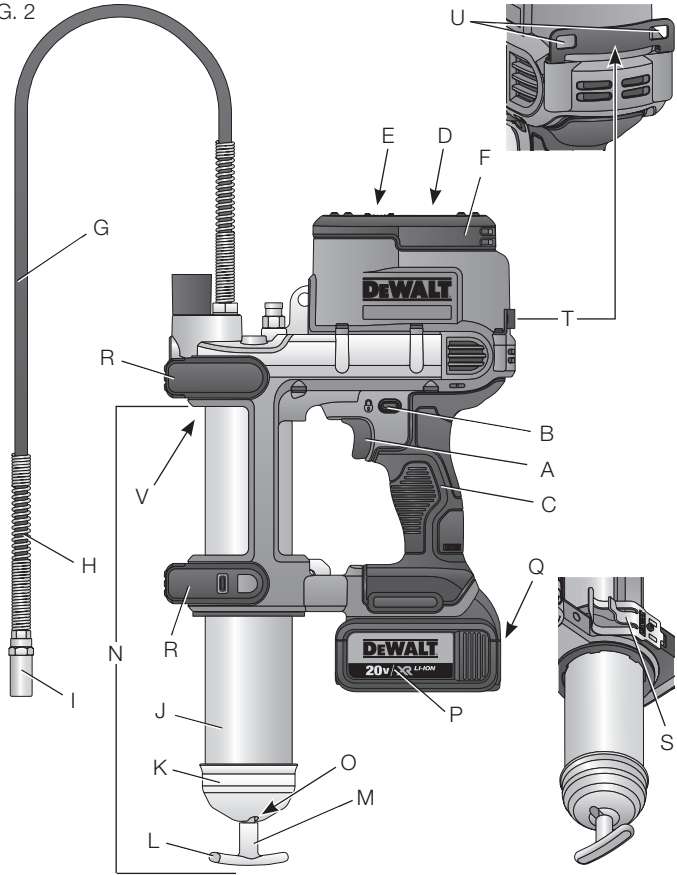

2. For long storage, it is recommended to store a fully charged battery pack in a cool dry place out of the charger for optimal results.

NOTE: Battery packs should not be stored completely depleted of charge. The battery pack will need to be recharged before use.

SAVE THESE INSTRUCTIONS FOR FUTURE USE

COMPONENTS (Fig. 2, 5)

⚠ WARNING: Never modify the power tool or any part of it. Damage or personal injury could result.

FIGURE 2

- A. Variable speed trigger switch
- B. Lock-off button
- C. Handle
- D. LED worklight
- E. LED worklight button
- F. Top cap
- G. Flexible hose
- H. Flexible hose safety spring guard
- I. Flexible hose coupler
- J. Grease tube
- K. Grease tube cap
- L. Grease tube handle
- M. Grease tube rod
- N. Grease tube assembly
- O. Retaining slot
- P. Battery
- Q. Battery release button
- R. Rubber feet
- S. Hose clip
- T. Shoulder strap mount
- U. Shoulder strap clip holes
- V. Filter

FIGURE 5

- W. Pressure relief valve
- X. Purge valve
- Y. Check valve
- Z. 1/8" NPT fill port
- AA. 1/8" NPT fill port plug

INTENDED USE

This grease gun is designed for professionally dispensing lubricant. **DO NOT** use under wet conditions or in presence of volatile flammable liquids or gases.

This grease gun is a professional power tool. **DO NOT** let children come into contact with the tool. Supervision is required when inexperienced operators use this tool.

LED Worklight (Fig. 2, 3)

⚠CAUTION: Do not stare into worklight. Serious eye injury could result.

There is a LED worklight (D) located on the top cap (F). The worklight is activated when the trigger switch is depressed and when the LED worklight button (E) is in the ON position. When the LED worklight button is in the OFF position, the LED worklight will not turn on when the trigger is depressed. The worklight will automatically turn off 20 seconds after the trigger switch is released. If the trigger switch remains depressed, the worklight will remain on.

NOTE: The worklight is for lighting the immediate work surface and is not intended to be used as a flashlight.

FIG. 3

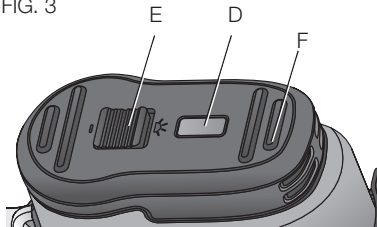

Variable Speed Trigger Switch (Fig. 2, 4)

LOCK-OFF BUTTON AND TRIGGER SWITCH

Your grease gun is equipped with a lock-off button (B).

To lock the trigger switch, press the lock-off button as shown in Figure 4. Always lock the trigger switch (A) when carrying or storing the tool to eliminate unintentional starting. The lock-off button is colored red to indicate when the switch is in its unlocked position.

To unlock the trigger switch, press the lock-off button as shown in Figure 4. Squeeze the trigger switch to turn the motor ON. Releasing the trigger switch turns the motor OFF.

NOTE: The variable speed trigger switch will give you added versatility. The further the trigger is depressed the higher the output of grease.

⚠WARNING: This tool has no provision to lock the switch in the ON position, and should never be locked ON by any other means.

Pressure Relief Valve (Fig. 5)

The pressure relief valve (W) is set at the factory to relieve pressure above 10,000 psi (690 bar). Grease coming out of the pressure relief valve indicates a clog in the fitting, line or bearing. Any of these conditions must be corrected before proceeding.

FIG. 4

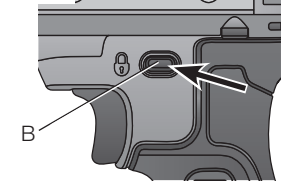
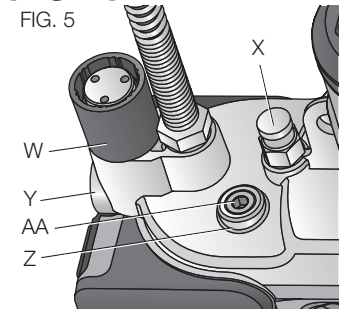

FIG. 5



⚠ WARNING: The grease gun may generate high pressure. Do not remove or tamper with the pressure relief valve. Serious injury may occur.

Shoulder Strap (Fig. 2)

Your grease gun comes with a shoulder strap. Hook the shoulder strap clips into the shoulder strap clip holes (U) found on the shoulder strap mount (T).

ASSEMBLY AND ADJUSTMENTS

⚠ WARNING: To reduce the risk of serious personal injury, turn tool off, push the lock-off button to the OFF position, and remove the battery pack before making any adjustments or removing/installing attachments or accessories. An accidental start-up can cause injury.

Installing a Grease Cartridge (Fig. 2, 5, 6)

1. Pull the grease tube handle (L) out as far as it will go, then secure the grease tube rod (M) into the retaining slot (O) by moving the rod to the side. Ensure the rod is placed securely in the slot to prevent it from disengaging.
2. Unscrew the grease tube assembly (N) from the grease gun.
3. Remove the plastic cap from the grease cartridge, then insert the cartridge, open end first, into the grease tube (J).
4. Remove the seal from the other end of the grease cartridge.

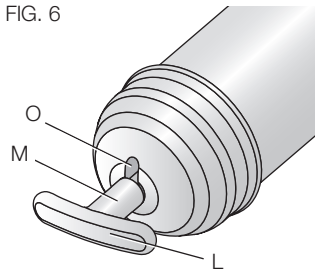

5. Thread the grease tube assembly (N) back into the grease gun and screw it in securely.
6. Release the grease tube rod (M) from the retaining slot (O) and slowly press it back into the tube.
7. Use the purge valve (X, Fig. 5) to bleed off any air that may be trapped in the cartridge. Refer to **Purging Air Pockets**.

IMPORTANT: The grease gun will lose its prime if there are air pockets in the lubricant.

Removing Empty Grease Cartridge (Fig. 2)

1. Pull the grease tube handle (L) out as far as it will go, then secure the grease tube rod (M) into the retaining slot (O) by moving the rod to the side. Ensure the rod is placed securely in the slot to prevent it from disengaging.
2. Unscrew the grease tube assembly (N) from the grease gun and remove.
3. Gently release the grease tube handle (L) to expel the empty cartridge from the grease tube.

Filling the Grease Gun from a Bulk Container (Fig. 2, 5–9)

PREPARING THE GREASE GUN FOR SUCTION AND FILLER PUMP FILLING (FIG. 1, 7)

NOTE: Be sure the grease gun is empty of grease before beginning this process.

1. Unscrew the grease tube (J) from the grease gun assembly (N).
2. Unscrew the grease tube cap (K) from the grease tube (J) and pull out the grease rod (M).

- Using your thumb and forefinger, flip the rubber seal (GG) from the rear to the front. Refer to Figure 7.

NOTE: The seal resembles a cup, which should open toward the top cap (F, Fig. 2) when prepared for suction and filler pump filling.

- Reinsert the grease tube rod (M) back into the grease tube (J).

SUCTION FILLING FROM A BULK CONTAINER (FIG. 2, 5, 6, 8)

- Put the open end of the grease tube assembly into the bulk lubricant.
- Slowly pull back the grease tube handle (L) to suction the lubricant into the grease gun.

NOTE: Be sure to keep the open end of the grease tube assembly far enough into the lubricant to prevent air pockets in the grease tube.

- When the grease tube rod (M) is fully extended, secure it into the retaining slot (O)
- Remove the grease gun tube assembly from the bulk lubricant and wipe off excess grease.
- Screw the grease gun tube assembly (N) back into the grease gun.
- Release the grease tube rod (M) from the retaining slot (O) and slowly press it back into the tube.

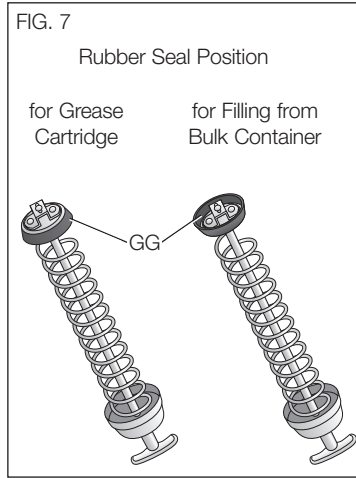
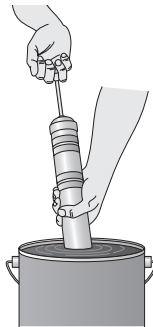

FIG. 8



- Use the purge valve (X, Fig. 5) to bleed off any air that may be trapped in the cartridge. Refer to **Purging Air Pockets**.

FILLER PUMP FILLING FROM A BULK CONTAINER (FIG. 5, 6, 9)

This tool comes with a 1/8" NPT fill port (Z, Fig. 5) for attaching a low pressure fill coupler onto the unit.

▲WARNING: *Never thread a high-pressure coupler onto the grease gun's 1/8" NPT fill port. Serious injury may occur due to excessive pressure. Use low-pressure couplers only.*

▲CAUTION: *The fill pump loader must connect correctly with the grease gun's 1/8" NPT port. The filler pump may not operate if the components are not compatible.*

Installing the low pressure coupler (not supplied with the tool)

- Thread the grease tube assembly (N) back into the grease gun and screw it in securely.
- Pull the grease tube handle (L) out as far as it will go, then secure the grease tube rod (M) into the retaining slot (O) by moving the rod to the side. Ensure the rod is placed securely in the slot to prevent it from disengaging.
- Remove the 1/8" NPT fill port plug (AA) from the fill port.
- Thread the appropriate low pressure coupler onto the 1/8" NPT fill port (Z).

FIG. 9

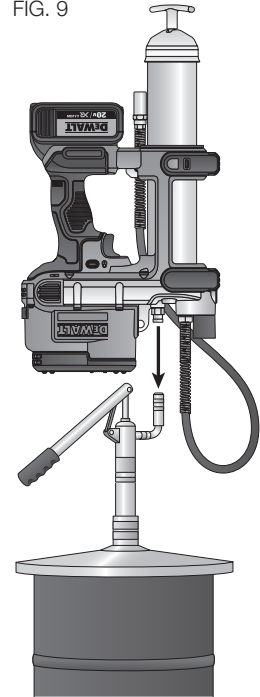

5. Release the grease tube rod (M) from the retaining slot (O) and slowly press it back into the tube.
6. Use the purge valve (X) to bleed off any air that may be trapped in the cartridge. Refer to **Purging Air Pockets**.

FILLING THE TOOL FROM THE LOW PRESSURE FILLER PUMP (FIG. 2, 5, CON9)

1. Pull back on the grease tube handle slowly and rotate the rod until it is secure in place.
NOTE: Do not lock the rod into the retaining slot (O).
2. Connect the low pressure fitting on the grease gun to the appropriate low pressure fitting on the filler pump. These fittings DO NOT lock together. This prevents the grease gun cartridge from being over filled.
3. Fill until the rod is pushed out of the grease tube approximately 8" (20 cm). Do not overfill. If the rod fails to move during the filling process, stop. This indicates that the rod is not connected to the plunger and step one must be repeated before proceeding.
4. Rotate rod to release and carefully push rod back into the grease tube.
5. Use the purge valve (X) to bleed off any air that may be trapped in the cartridge. Refer to **Purging Air Pockets**.

Purging Air Pockets (Fig. 2, 5)

IMPORTANT: Air pockets in the grease can cause the grease gun to lose prime. Eliminate air pockets after each refill or if the grease gun fails to pump grease:

1. Unscrew the purge valve (X) without removing it, until all air has escaped.
2. Tighten the purge valve (X).
3. Uncap the flexible hose (G) then depress the variable speed trigger switch (A) for 10–20 seconds.
4. If grease fails to flow through the hose, repeat from step 1.

NOTE: This tool has been tested at the factory, which may result in a small amount of grease left in the grease tube and hose assembly. It is recommended to purge the tool with the brand of grease to be used before first use.

OPERATION

⚠WARNING: To reduce the risk of serious personal injury, turn tool off and remove the battery pack before making any adjustments or removing/installing attachments or accessories. An accidental start-up can cause injury.

Installing and Removing the Battery Pack (Fig. 10)

NOTE: For best results, make sure your battery pack is fully charged. To install the battery pack (P) into the tool handle, align the battery pack with the rails inside the tool's handle and slide it into the handle until the battery pack is firmly seated in the tool and ensure that it does not disengage. To remove the battery pack from the tool, press the release button (Q) and firmly pull the battery pack out of the tool handle. Insert it into the charger as described in the charger section of this manual.

FIG. 10

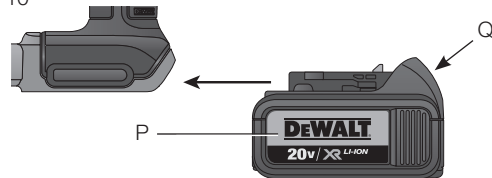

FUEL GAUGE BATTERY PACKS (FIG. 11)

Some DEWALT battery packs include a fuel gauge which consists of three green LED lights that indicate the level of charge remaining in the battery pack.

The fuel gauge is an indication of approximate levels of charge remaining in the battery pack according to the following indicators:

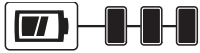

75–100% charged

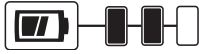

51–74% charged

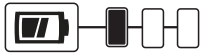

< 50% charged



Pack needs to be charged

To actuate the fuel gauge, press and hold the fuel gauge button (FF). A combination of the three green LED lights will illuminate designating the level of charge left. When the level of charge in the battery is below the usable limit, the fuel gauge will not illuminate and the battery will need to be recharged.

NOTE: The fuel gauge is only an indication of the charge left on the battery pack. It does not indicate tool functionality and is subject to variation based on product components, temperature and end-user application.

FIG. 11

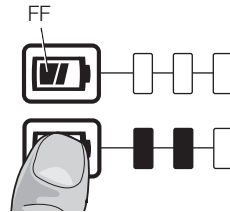

Using the Grease Gun (Fig. 2)

⚠ WARNING: To reduce the risk of serious personal injury, always maintain a grip on the handle (C) when operating the grease gun or positioning the hose onto fittings.

To operate the grease gun, hold the grease gun by the handle (C), or place it on a stable surface upright on its rubber feet (R) maintaining a grip on the handle. Holding the hose by the flexible hose grease coupler (H) or other appropriate grease coupler, connect the flexible hose grease coupler (I) or other appropriate grease coupler, onto the grease fitting to be filled. Carefully depress the variable speed trigger switch to begin the filling process. Once the correct amount of grease has been dispensed, release the trigger and remove the coupler from the grease fitting. If the coupler does not release, there may still be residual pressure in the line. Moving the coupler from side to side can relieve the residual pressure so it can be removed from the coupling. If the coupler leaks excessively or does not hold on to the grease fitting, it should be replaced.

TECHNICAL INFORMATION

Grease type	Up to NLGI #2
Voltage	20 V
Pressure	10,000 psi (690 bar)
Volume/Flow rate	5 fl. oz./min (147.87 ml/min)
Grease capacity	16 oz Bulk (453 g) 14.5 oz Cartridge (411 g)
Tool weight without battery	8 lbs (3.63 kg)
Hose length	42" (107 cm)

MAINTENANCE

⚠ WARNING: To reduce the risk of serious personal injury, turn tool off and remove the battery pack before making any adjustments or removing/installing attachments or accessories. An accidental start-up can cause injury.

Cleaning

⚠ WARNING: Blow dirt and dust out of all air vents with clean, dry air at least once a week. To minimize the risk of eye injury, always wear ANSI Z87.1 approved eye protection when performing this.

⚠ WARNING: Never use solvents or other harsh chemicals for cleaning the non-metallic parts of the tool. These chemicals may weaken the plastic materials used in these parts. Use a cloth dampened only with water and mild soap. Never let any liquid get inside the tool; never immerse any part of the tool into a liquid.

BATTERY CLEANING INSTRUCTIONS

Dirt and grease may be removed from the exterior of the battery using a cloth or soft non-metallic brush. Do not use water or any cleaning solutions.

⚠ WARNING: Never use solvents or other harsh chemicals for cleaning the battery. These chemicals may weaken the plastic parts.

CHARGER CLEANING INSTRUCTIONS

⚠ WARNING: Shock hazard. Disconnect the charger from the AC outlet before cleaning. Dirt and grease may be removed from the exterior of the charger using a cloth or soft non-metallic brush. Do not use water or any cleaning solutions.

⚠ WARNING: Never use solvents or other harsh chemicals for cleaning the charger. These chemicals may weaken the plastic parts.

CLEANING CONTAMINANTS FROM THE GREASE GUN

Cleaning Contamination from the Check Valve (Fig. 12)

Should the grease gun fail to dispense grease, the check valve (Y) should be cleaned.

FIG. 12

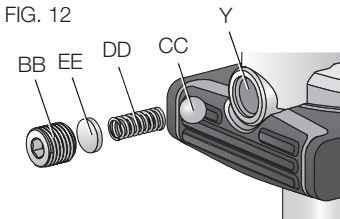

1. Remove the check valve plug (BB), then the disc (EE), spring (DD) and check valve ball (CC).
2. Clean the ball (CC) and the check valve area in the main casting.
3. Reinstall the ball (CC), the spring (DD), and then the disc (EE).
4. After all grease is cleaned from the area, reinstall the check valve plug (BB).

Cleaning Contamination from the Filter (Fig. 2, 13)

Should the grease gun fail to dispense grease, clean the filter (V).

FIG. 13

NOTE: If there is still grease in the tube, open the purge valve prior to pulling the tube handle.

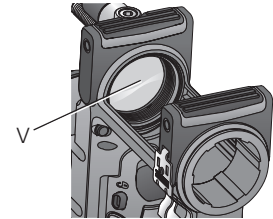

1. Pull the grease tube handle (L) out as far as it will go, then secure the grease tube rod (M) into the retaining slot (O) by moving the rod to the side. Ensure the rod is placed securely in the slot to prevent it from disengaging.
2. Unscrew the grease tube assembly (N) from the grease gun and remove.
3. Using a small flat-blade screwdriver or pick, carefully pop out the filter.

4. Wipe off the filter using a soft cloth. If the filter still has debris in it after wiping, a soft brush or swab may be used.
5. Once clean, reinsert the filter into the round groove, ensuring it is fully seated, and reattach the grease tube assembly to the grease gun.

Accessories

⚠ WARNING: *Since accessories, other than those offered by DEWALT, have not been tested with this product, use of such accessories with this tool could be hazardous. To reduce the risk of injury, only DEWALT recommended accessories should be used with this product.*

⚠ WARNING: *Extreme pressure may cause nozzle extension or flexible hose to burst. Use only DEWALT approved hoses and follow flexible hose instructions and warnings.*

Recommended accessories for use with your tool are available at extra cost from your local dealer or authorized service center.

ACCESSORIES

DCGG5701	1/8" NPT Grease Gun Coupler
DCGG5701-3	1/8" NPT Grease Gun Coupler 3-pak
DCGG5702	Right Angle Grease Gun Coupler
DCGG5703-42	1/8" NPT Grease Gun Hose Assembly (42") (107 mm)
DCGG5703-24	1/8" NPT Grease Gun Hose Assembly (24") (61 mm)
DCGG5704	Clear Grease Gun Cartridge Tube

Repairs

The charger and battery pack are not serviceable.

To assure product SAFETY and RELIABILITY, repairs, maintenance and adjustment (including brush inspection and replacement) should be performed by a DEWALT factory service center, a DEWALT authorized service center or other qualified service personnel. Always use identical replacement parts.

Register Online

Thank you for your purchase. Register your product now for:

- **WARRANTY SERVICE:** Registering your product will help you obtain more efficient warranty service in case there is a problem with your product.
- **CONFIRMATION OF OWNERSHIP:** In case of an insurance loss, such as fire, flood or theft, your registration of ownership will serve as your proof of purchase.
- **FOR YOUR SAFETY:** Registering your product will allow us to contact you in the unlikely event a safety notification is required under the Federal Consumer Safety Act.

TROUBLESHOOTING

Problem	Possible Cause	Possible Solution
Unable to pull back rod	Vacuum build up	Unscrew the purge valve to release vacuum.
Unable to push rod forward	Pressure build up	Unscrew the purge valve to release pressure.
	Rod is still connected to plunger	Rotate grease tube handle 90 degrees to disengage it.
No grease when trigger is pulled	Grease tube is empty	Add grease.
	Air pockets in the grease tube	Refer to <i>Purging Air Pockets.</i>
	Check valve is clogged	Refer to <i>Cleaning Contamination from the Check Valve.</i>
	Filter is clogged	Refer to <i>Cleaning Contamination from the Filter.</i>
Grease appears in relief valve	Zerk fitting is blocked	Disconnect coupler from fitting, clean zerk fitting and grease path.
Motor does not run when trigger is pulled	Battery	Make sure the battery is fully charged.
Grease leaks out of the back of the grease tube	Rubber seal is flipped the wrong direction	Refer to <i>Preparing the Grease Gun for Suction and Filler Pump Filling.</i>

DeWALT Battery and Charger Systems

Chargers/Charge Time (Minutes)

Battery Cat #	Output Voltage	120 Volts																			12 Volts									
		DC011	DC022	DC9000	DC9310	DC9320	DCB095	DCB100	DCB101	DCB102	DCB103	DCB107	DCB112	DCB113	DCB114	DCB115	DW911	DW9106	DW9107	DW9108	DW9116	DW9117	DW9118	DW9216	DW9226	DCB119	DW0249	DW9109	DC9319	
DCB404	40	X	X	X	X	X	X	X	X	X	X	X	X	X	90	X	X	X	X	X	X	X	X	X	X	X	X	X		
DCB406	40	X	X	X	X	X	X	X	X	X	X	X	X	X	130	X	X	X	X	X	X	X	X	X	X	X	X	X		
DC9360	36	X	X	45	X	X	X	X	X	X	X	X	X	X	X	X	X	X	X	X	X	X	X	X	X	X	X	X		
DCB361	36	X	X	45	X	X	X	X	X	X	X	X	X	X	X	X	X	X	X	X	X	X	X	X	X	X	X	X		
DC9280	28	X	X	60	X	X	X	X	X	X	X	X	X	X	X	X	X	X	X	X	X	X	X	X	X	X	X	X		
DW0242	24	X	X	X	X	X	X	X	X	X	X	X	X	X	X	X	X	X	X	X	X	X	X	X	X	X	60	X	X	
DCB200	20	X	X	X	X	X	X	X	60	60	60	140	90	67	X	60	X	X	X	X	X	X	X	X	X	X	90	X	X	X
DCB201	20	X	X	X	X	X	X	X	30	30	30	70	45	35	X	30	X	X	X	X	X	X	X	X	X	45	X	X	X	
DCB203/BT*	20	X	X	X	X	X	X	X	35	35	35	90	60	45	X	35	X	X	X	X	X	X	X	X	60	X	X	X	X	
DCB204/BT*	20	X	X	X	X	X	X	70	70	70	185	120	90	X	70	X	X	X	X	X	X	X	X	X	120	X	X	X	X	
DCB205	20	X	X	X	X	X	X	X	90	90	90	240	150	112	X	90	X	X	X	X	X	X	X	X	150	X	X	X	X	
DCB207	20	X	X	X	X	X	X	X	30	30	30	60	40	30	X	30	X	X	X	X	X	X	X	X	X	X	X	X	X	
DC9096	18	60	60	X	60	60	X	X	X	60	X	X	X	X	X	60	X	X	60	60	20	X	60	130	X	X	60	60	60	
DC9099	18	45	45	X	45	45	X	X	X	45	X	X	X	X	X	45	X	X	45	45	15	X	45	95	X	X	45	45	45	
DC9180	18	X	X	X	60	60	X	X	X	60	X	X	X	X	X	X	X	X	X	X	X	X	X	X	X	X	X	X	60	
DC9181	18	X	X	X	30	30	X	X	X	30	X	X	X	X	X	X	X	X	X	X	X	X	X	X	X	X	X	X	30	
DC9182	18	X	X	X	40	40	X	X	X	40	X	X	X	X	X	X	X	X	X	X	X	X	X	X	X	X	X	X	40	
DW9096	18	60	60	X	60	60	X	X	X	60	X	X	X	X	X	60	X	X	60	60	20	X	60	130	X	X	60	60	60	
DW9098	18	30	30	X	30	30	X	X	X	30	X	X	X	X	X	30	X	X	30	30	12	X	30	60	X	X	30	30	30	
DW9099	18	45	45	X	45	45	X	X	X	45	X	X	X	X	X	45	X	X	45	45	15	X	45	95	X	X	45	45	45	
DC9091	14.4	60	60	X	60	60	X	X	X	60	X	X	X	X	X	60	90	60	60	60	20	115	60	115	X	X	60	60	60	
DC9094	14.4	45	45	X	45	45	X	X	X	45	X	X	X	X	X	45	60	45	45	45	15	90	45	90	X	X	45	45	45	
DW9091	14.4	45	45	X	45	45	X	X	X	45	X	X	X	X	X	45	60	45	45	45	15	90	45	90	X	X	45	45	45	
DW9094	14.4	30	30	X	30	30	X	X	X	30	X	X	X	X	X	30	45	30	30	30	12	60	30	60	X	X	30	30	30	
DCB120	12	X	X	X	X	X	X	40	30	30	30	60	45	35	X	30	X	X	X	X	X	X	X	X	45	X	X	X	X	
DCB127	12	X	X	X	X	X	X	35	35	35	90	60	50	X	35	X	X	X	X	X	X	X	X	X	60	X	X	X	X	
DC9071	12	60	60	X	60	60	X	X	X	60	X	X	X	X	X	60	90	60	60	60	20	115	60	115	X	X	60	60	60	
DW9050	12	X	X	X	X	X	X	X	X	X	X	X	X	X	X	40	X	X	X	X	X	X	X	X	X	X	X	X	X	
DW9071	12	45	45	X	45	45	X	X	X	45	X	X	X	X	X	45	60	45	45	45	15	90	45	90	X	X	45	45	45	
DW9072	12	30	30	X	30	30	X	X	X	30	X	X	X	X	X	30	45	30	30	30	12	60	30	60	X	X	30	30	30	
DW9048	9.6	X	X	X	X	X	X	X	X	X	X	X	X	X	X	40	X	X	X	X	X	X	X	X	X	X	X	X	X	
DW9061	9.6	45	45	X	45	45	X	X	X	45	X	X	X	X	X	45	60	45	45	45	15	90	45	90	X	X	45	45	45	
DW9062	9.6	30	30	X	30	30	X	X	X	30	X	X	X	X	X	30	45	30	30	30	12	60	30	60	X	X	30	30	30	
DCB080	8	X	X	X	X	60	X	X	X	X	X	X	X	X	X	X	X	X	X	X	X	X	X	X	X	X	X	X	X	
DW9057	7.2	30	30	X	30	30	X	X	X	X	30	X	X	X	X	30	45	30	30	30	12	60	30	60	X	X	30	30	30	

BT - Bluetooth

NOTE: The Bluetooth* word mark and logos are registered trademarks owned by the Bluetooth*, SIG, Inc. and any use of such marks by DeWALT is under license. Other trademarks and trade names are those of their respective owners.

"X" Indicates that the battery pack is not compatible with that specific charger. All charge times are approximate. Actual charge time may vary. Read the instruction manual for more specific information.

* Maximum initial battery voltage (measured without a workload) is 20 volts. Nominal voltage is 18.