



DAYCO[®]

MOVE FORWARD. ALWAYS.[™]



CATALOG

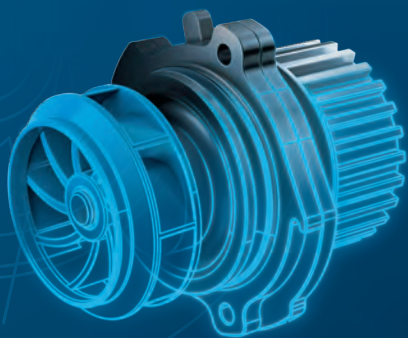

ABOUT DAYCO

Dayco is a global leader in the research, design, manufacturing, and distribution of essential engine products, drive systems, and services for automobiles, trucks, construction, agriculture, and industrial. We operate on long-held values, keeping promises, delivering on time all the time, and an intense commitment to service no matter what the obstacles. For more than a century, Dayco has overcome challenges, emerging stronger and smarter at every turn.

Dayco improves how the world moves by creating products, systems, and relationships that endure.

Move Forward. Always.™

Dayco is a leader in the original equipment market — partnering with global automotive and industrial manufacturers to engineer, design, and manufacture high-quality products for light duty, heavy duty, industrial, agricultural, off-road, and recreational vehicles.

TABLE OF CONTENTS

serpentine belts.....	3
belt tensioners & pulleys	8
harmonic balancers.....	16
water pumps.....	22
timing components	24
v-belts & industrial belts	28
snowmobile / atv belts	36
dayco racing	41
hose.....	43
coolant hose	44
hose clamps	53
service hose.....	55
garage exhaust hose.....	64
merchandise	67
stands, cabinets, & kits	68
belt & hose installation tools.....	72
hydraulic hose.....	77
adapters and couplings.....	84
crimping equipment	87
stands, cabinets and kits	90
notes.....	92

The following are Registered Trademarks of Dayco Products, LLC

DAYCO®
POLY COG®
POLY RIB®
GOLD LABEL®
NO SLACK®
TOP COG®
GPL®
VX-Wedge®
V-Wedge®
Quick-Fit®
Insulone®
Factfinder®
aWEARness®
HP®
HPX®
ela®
Autoflex®

The following are Registered Trademarks of Parker-Hannifin Corporation

Thoro-Flo®

The following are Registered Trademarks of Subaru

Subaru®
Impreza®
Forester®
Outback®

Ignoring maintenance has its price.

A worn belt drive system can jeopardize a vehicle's performance and heighten the risk of engine failure. Avoid costly breakdowns - belt inspection should begin at 60,000 miles and all worn belts and belt-related components should be replaced by 90,000 miles to ensure safe and reliable service.

DAYCO is committed to the awareness of these best practices as recommended by the Car Care Council* and providing a tool to gauge wear and tear on an individual vehicle basis.



*The Car Care Council is the source of information for the "Be Car Care Aware" consumer education campaign promoting the benefits of regular vehicle care, maintenance and repair to consumers.

SERPENTINE BELTS

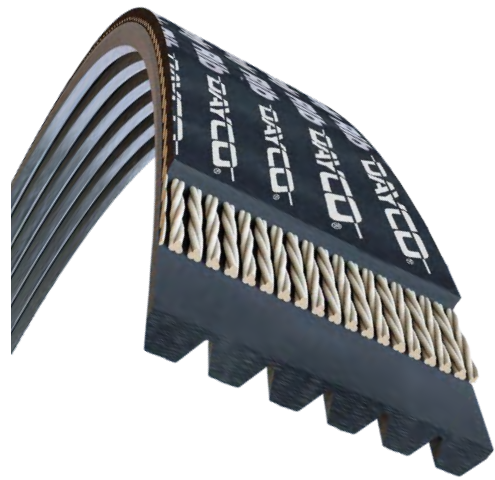

POLY RIB® Serpentine Belt

Dayco approaches the market differently from most of its competition, believing that one serpentine belt construction will not perform best with all applications.

Built for cars and light-duty trucks, Dayco's extensive line of Poly Rib® serpentine belts are engineered for high mileage, demanding drives found in today's vehicles. As the manufacturer of the first original equipment multi-ribbed serpentine belt, Dayco's commitment to automotive product excellence and innovation is unwavering.

Constructed with aramid reinforced EPDM compounds, the Dayco Poly Rib® serpentine belt delivers more than just original equipment (OE) required quality, it delivers the solution to troublesome drive problems.

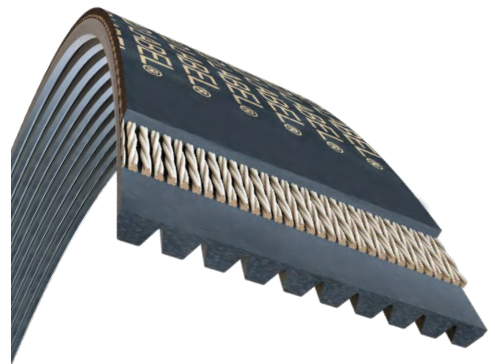

GOLD LABEL® POLY RIB® Serpentine Belt

The Dayco Gold Label® serpentine belt is a diesel grade belt that features higher performance construction over conventional light duty belts in order to meet the high torque and power pulses exerted by today's demanding diesel engines. The specially treated cords within the belt resist stretching and ensure the length stability that is essential for drive systems on high output diesel and gas engines.

The belt's heavy duty construction provides additional integrity without sacrificing flexibility or belt-to-pulley compatibility. The Dayco Gold Label® serpentine belt is also engineered with high-grade EPDM compounds and is built to resist the heat and harsh under hood environments experienced in over-the-road and off-road conditions.

SERPENTINE BELTS

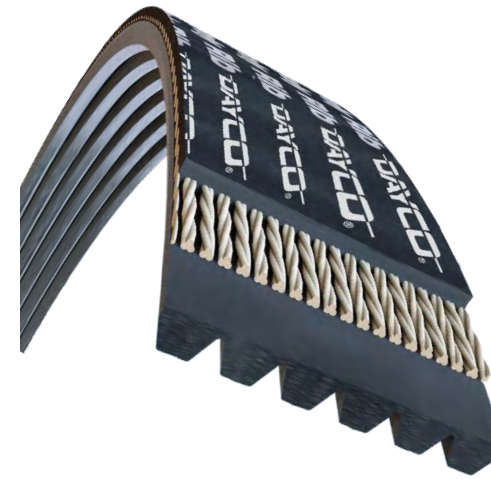

POLY RIB® Aramid Serpentine Belt

As the demand for higher output engines and tighter engine packaging increases, Original Equipment Manufacturers (OEM) have elected to use serpentine belts with aramid tensile cord on specific applications that may have noise, vibration or harshness issues, or in-drive systems in which tensioner take-up is minimal.

The Dayco Poly Rib® Aramid serpentine belt has been engineered to maintain a quiet, vibration-free belt drive system. Unlike polyester-corded belts, the Dayco Poly Rib® Aramid serpentine belt will resist the expected elongations, especially during high accessory loading. This unique feature of length stability and minimal stretch can aid in those difficult drives where span vibrations and tensioner movements are excessive, resulting in reduced belt noise. The Dayco Poly Rib® Aramid serpentine belt is built with Dayco's specially designed EPDM rubber compounds that resist cracking and perform better under extreme temperature ranges.

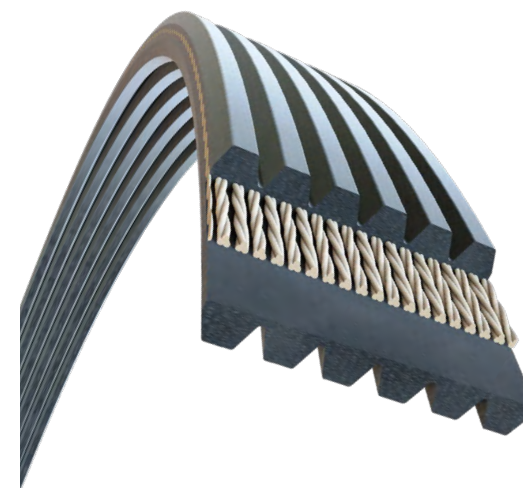

Double Sided POLY RIB® Serpentine Belt

Designed for multiple accessory drives that require the transmission of power from both sides of the belt. The double sided belt, which Dayco introduced to the automotive aftermarket, features a construction that uses a highly fiber-loaded compound on both sides of the belt to maximize load carrying requirements while minimizing pulley misalignment noise.

SERPENTINE BELTS

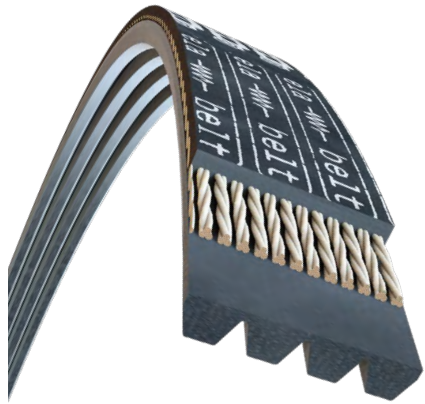

ela[®] Serpentine Belt

Dayco ela[®] belts, also known as “stretch” belts, are specifically designed for two to four point drives that do not require automatic or manual tensioning. Although these belts may look like standard poly rib belts, they are very different. These specially designed belts have self-tensioning capabilities required by specific OE drives designed for a “stretch” belt. Vehicles that are manufactured with “stretch” belts must replace those belts with “stretch” belts. These belts are not interchangeable with standard constructed belts of the same size.

Dayco ela[®] Belts utilize a proprietary EPDM construction that is designed to elongate over the fixed pulley system, and then maintain the required belt tension over the life of the belt. The backbone behind the Dayco ela[®] belt is its specially developed polyamide tensile member, which allows for high elongation required for installation, yet provides the proper tension maintenance properties to transmit the accessory loads demanded for the drive. This belt construction incorporates a wear resistant EPDM rib material, along with a highly elastic EPDM cushion rubber that surrounds the polyamide tensile cord, thus providing the required adhesion and flexibility to maintain lasting performance.

“Stretch” belts have unique installation instructions depending on the OE application. Installation may require a specialized tool for the application or a simple zip tie. Do not attempt to install by prying the belt on the pulleys. Dayco provides detailed instructions on the reverse side of the sleeve.

Dismounting and reusing stretch belts is not recommended. A new belt should be installed anytime one is removed.

Serpentine Belt Kit



Dayco serpentine belt kits have been designed for the most popular applications, ensuring that the mechanic has all the parts needed to perform a complete job. When a belt is replaced, all related components should be checked for wear at the same time. If the belt is worn, there is a good chance that the related components are worn as well. The serpentine belt kit provides all the components needed for that application. These application-specific kits can include the Dayco Poly Rib[®] serpentine belt, a Dayco automatic belt tensioner, and a Dayco idler/tensioner pulley. One part number...one complete solution.

Demanding Drive Kit



Dayco demanding drive kits provide all the required components to ensure a quiet, problem-free belt drive system. These kits have been designed to address the most demanding drives in the market. Dayco demanding drive kits include the Poly Rib[®] Quiet Design serpentine belt, using advanced, state-of-the-art manufacturing processes to ensure it is one of the quietest belts for today's vehicles.

These application-specific kits can include the Dayco Poly Rib[®] Quiet Design serpentine belt, a Dayco No Slack[®] automatic belt tensioner, a Dayco No Slack[®] idler/tensioner pulley and a Dayco overrunning alternator pulley, when applicable.

BELT TENSIONERS AND PULLEYS

DAYCO[®]

NO SLACK[®]

Serpentine belt drives consist of a single belt that powers most, if not all, of the engine's accessories. Designed to maintain constant tension on serpentine belt drives, the Dayco Automatic Belt Tensioner features the original flat spring design engineered to provide less operating range variations in tension. This innovative design

reduces the risk of premature accessory bearing failure due to high tension when a new belt is installed and lessens the risk of belt noise and slippage, or poor accessory performance caused by low tension after the belt begins to stretch and wear. A PTFE strip wound within the spring resists abrasion and the flat spring is coated to resist rust.

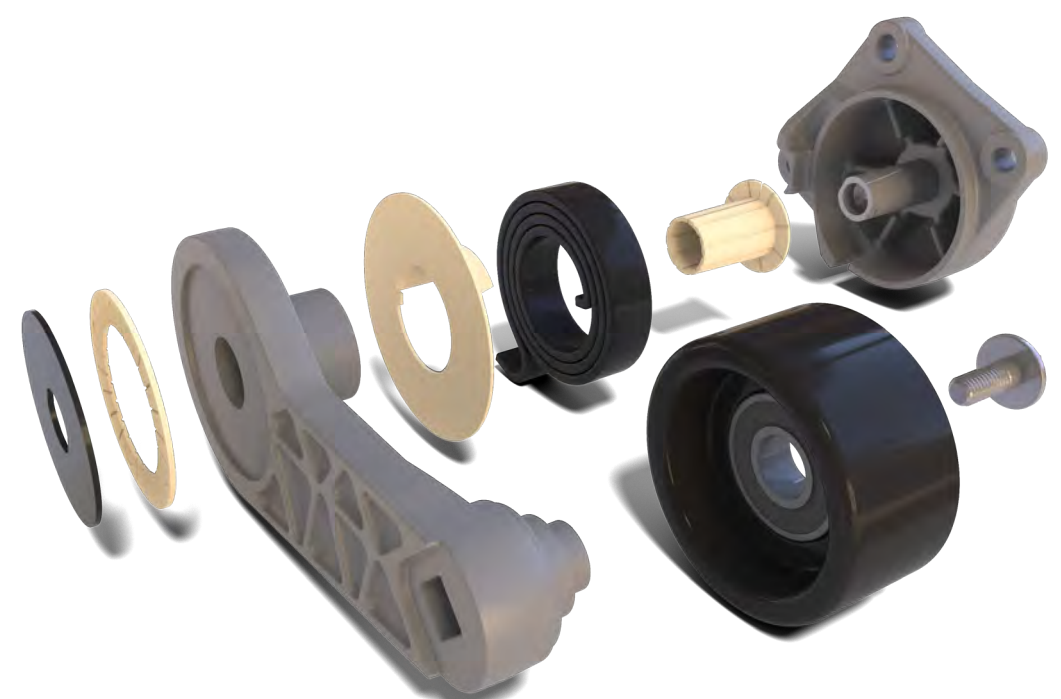

Automatic Belt Tensioner

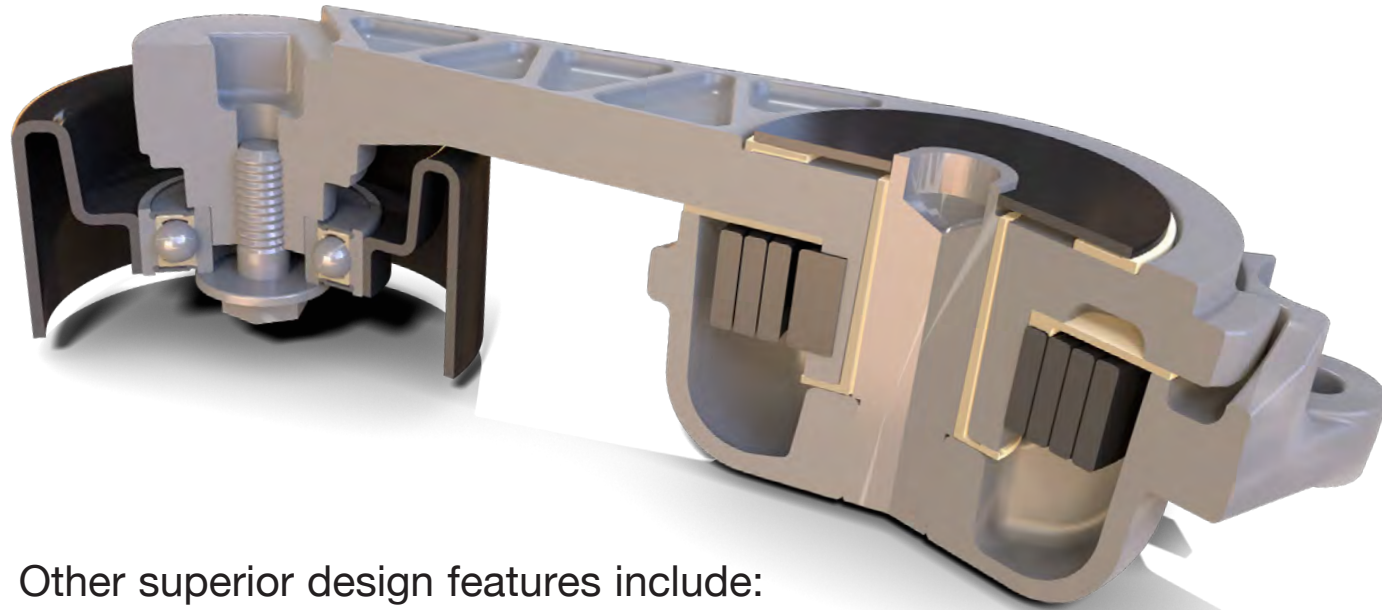

Other superior design features include:

- Steel locator pin (where the application demands)
- Heavy duty cast aluminum spring case that resists cracking and fatigue
- Heavy duty cast aluminum arm which offers additional strength and less distortion
- Steel pivot tube (where the application demands) which provides additional strength for critical torque requirements
- Thermoplastic rubber spring slot plug (where applicable) that helps keep out harmful contaminants
- Lubricated nylon pivot tube bushing and spring bushing for quieter performance
- Rubber "O" ring which seals against dust and grime (where applicable)
- Zinc-coated mounting bolt that resists rust (where applicable)

Dayco also manufactures a variety of round spring and hydraulic-controlled tensioners depending on the original equipment design and application requirements.

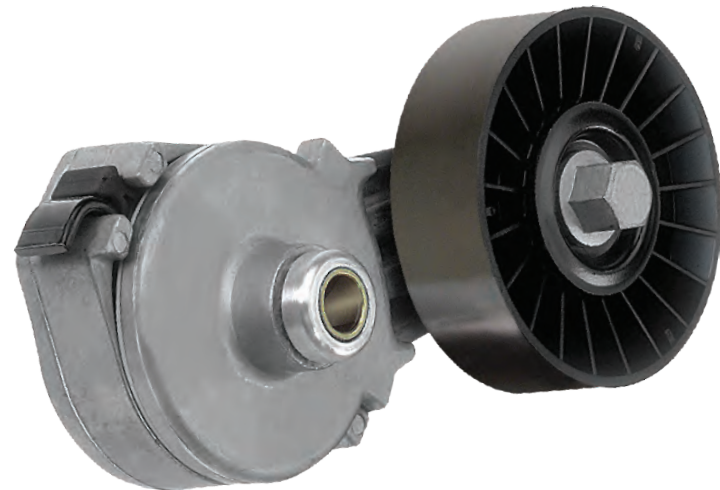

GOLD LABEL®

As the major supplier to heavy duty original equipment manufacturers, Dayco Gold Label® heavy duty tensioners are guaranteed to be engineered and manufactured to the strictest design specifications. Designed for heavy duty diesel engine accessory drive applications, the heavy duty cast aluminum body and pulley arms translate into extra strength and durability.

The Dayco Gold Label® heavy duty tensioner features multiple

patented components that are engineered to handle the higher torque and power pulses exerted by today's diesel engines. Rugged pulleys with dual permanently lubricated bearings deliver long lasting, dependable service. In addition, many of the Dayco Gold Label® heavy duty tensioners feature highly damped designs using a wave spring and a metal ring with a bonded polymeric surface to act as a radial shock absorber for the tensioner arm while reducing contamination.

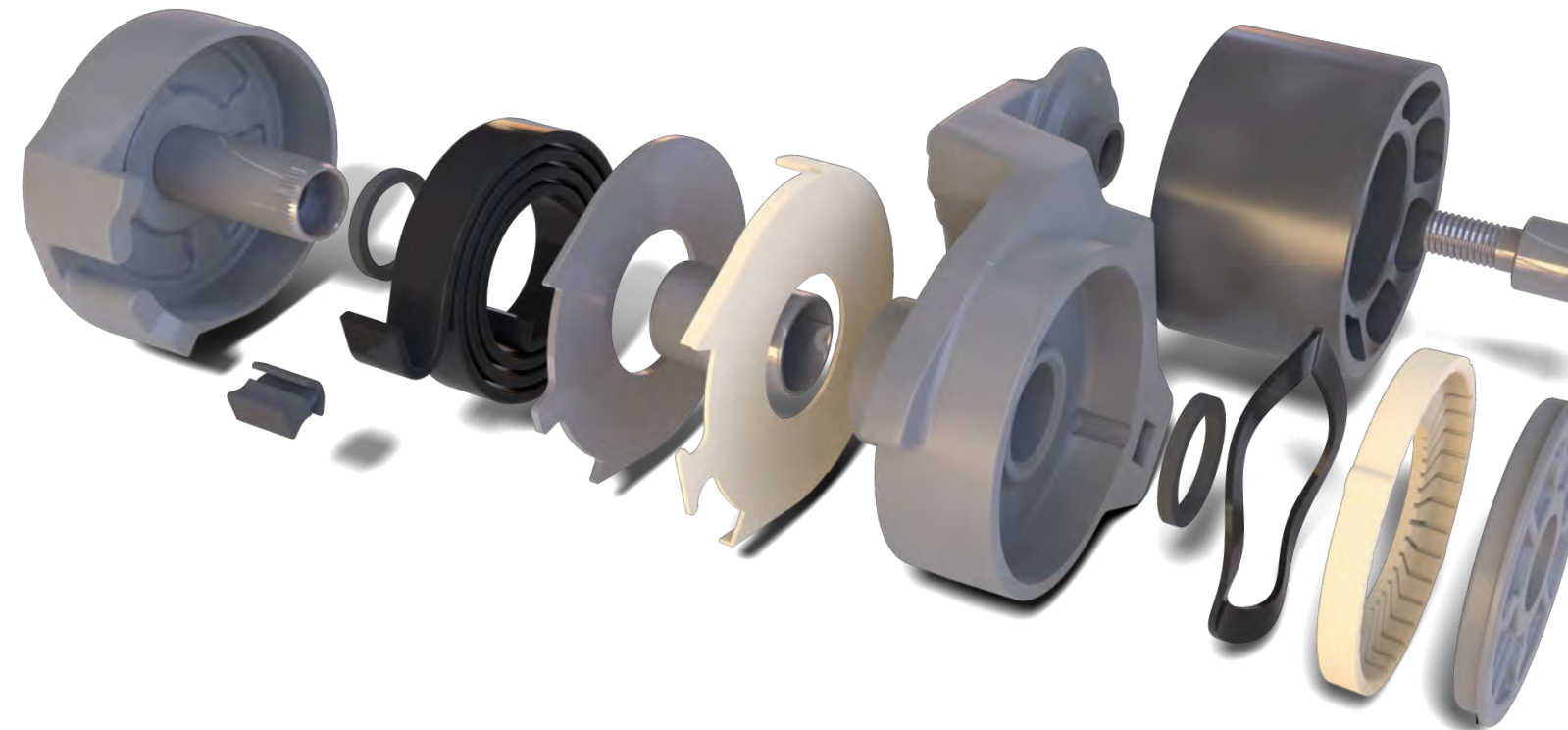

Heavy Duty Automatic Belt Tensioner

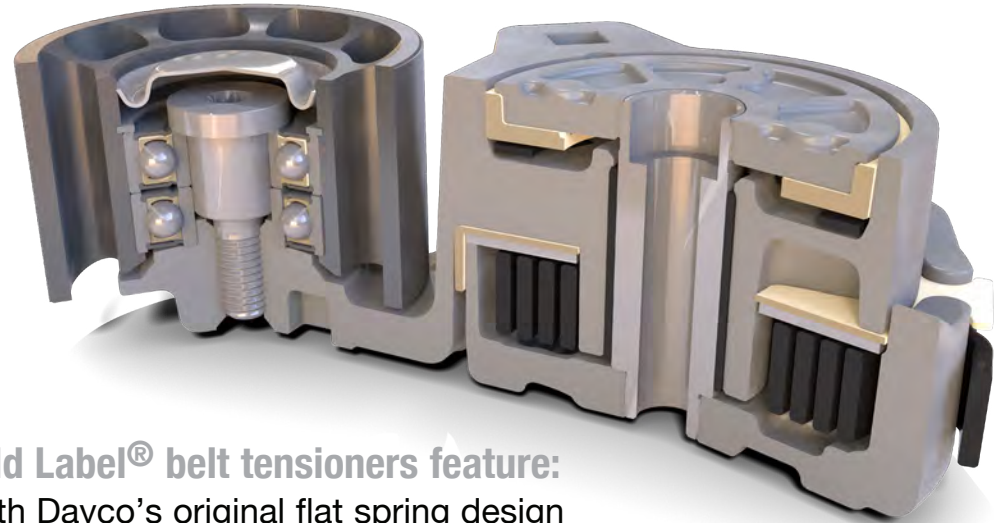

Dayco Gold Label® belt tensioners feature:

- Built with Dayco's original flat spring design
- Designed for heavy duty diesel engine accessory drive applications
- Heavy duty cast aluminum body and pulley arms translate into extra strength and durability
- Features multiple patented components that are engineered to handle the higher torque and power pulses exerted by diesel engines
- Rugged pulleys with dual permanently lubricated bearings deliver long lasting, dependable service
- Many of Dayco Gold Label® heavy duty tensioners feature highly damped designs using a wave spring and a metal ring with a bonded polymeric surface to act as a radial shock absorber for the tensioner arm while reducing contamination
- Made in USA



NO SLACK® Idler / Tensioner Pulley

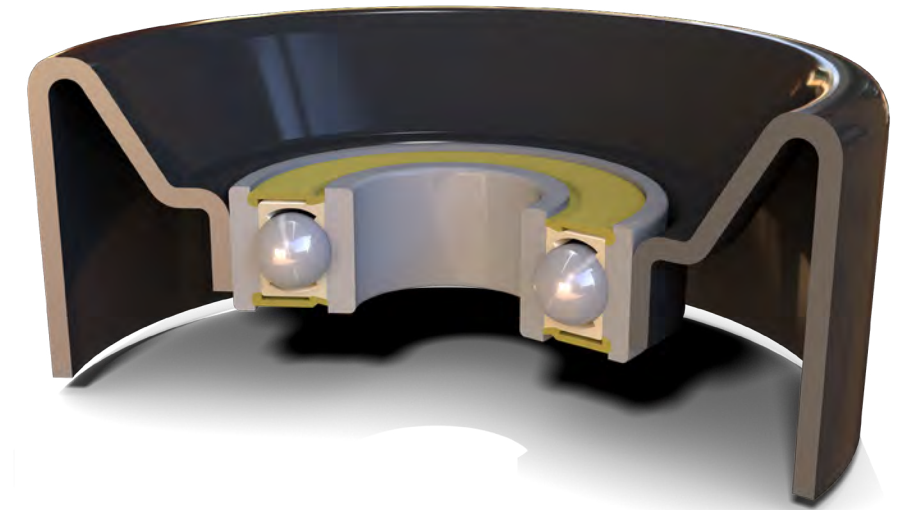

Dayco's reputation for top performance idler and tensioner pulleys is a result of advanced automotive technologies employed in materials research, design engineering, and manufacturing of our pulleys. In addition to our spun steel pulleys, Dayco also provides specially formulated glass-filled polymers to ensure a high strength, wear-resistant plastic pulley designed to replace serpentine and V-belt idler and tensioner pulleys.

The use of state-of-the-art 3-D computer aided design and finite element analysis guarantees the optimal design and maximum structural integrity for both plastic and steel pulleys. The manufacture of pulleys with smoother surfaces and tighter dimensional tolerances translates into less vibration and therefore longer belt life. Lifetime lubricated ball bearings and double high temperature seals assure peak bearing performance, the most critical element of a pulley's service life.

BELT TENSIONERS & PULLEYS



GOLD LABEL[®] Heavy Duty Idler / Tensioner Pulley

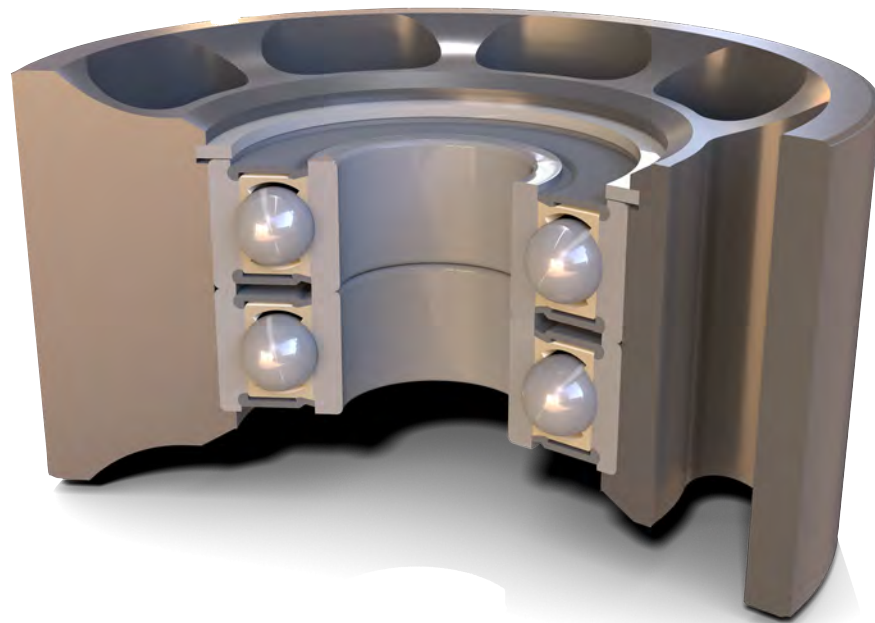

The performance demands of OEM of over-the-road trucking and off-road equipment requires a built-for-punishment heavy duty constructed pulley.

Designed to replace idler and tensioner pulleys for serpentine drives in heavy duty diesel engine applications, Dayco Gold Label[®] heavy duty pulleys are manufactured from steel, powdered metal, or engineered polymer materials to resist wear under harsh environments. Each heavy duty pulley from Dayco features dual permanently lubricated sealed bearings and retainers to provide long life despite the shock loads experienced in diesel engine applications.

BELT TENSIONERS & PULLEYS



Alternator Pulleys



With the increasing amount of accessories requiring extra electrical power, alternator pulleys are becoming increasingly popular on many late model vehicles due to the increased alternator loads and engine torsional fluctuations.

Dayco alternator pulleys allow the alternator to 'freewheel' when the belt speed drops and are engineered with a one-way clutch allowing the rotational inertia of the alternator to overrun during any belt deceleration event. Dayco alternator pulleys, which are designed for long service life, decrease drive belt vibration and reduce belt slippage during rapid acceleration or deceleration, resulting in reduced stress on the drive belt and other accessories, as well as increased drive belt life.

Note: Alternator pulleys are application specific replacement parts and require proper tools to remove and install the parts.

HARMONIC BALANCERS

HARMONIC BALANCERS



Dayco, a leader in the research, design, manufacturing and distribution of a broad range of Front Engine Accessory Drive (FEAD) components, acquired Precision Parts, manufacturer of PowerBond® harmonic balancers, in September, 2013. Harmonic balancers fit perfectly within Dayco's line of existing products, which includes accessory drive belts, tensioners, pulleys and a full line of timing products.

Established in 1976, PowerBond® is recognized as the premier brand of harmonic balancers in both the Australian and North American Aftermarkets. PowerBond® excels in the research, development, testing and manufacturing of harmonic balancers. Increasing demand for new balancers in the global automotive aftermarket has allowed PowerBond® to invest in tooling to produce an extensive range of balancers. While the bulk of PowerBond®'s product range is targeted at the standard replacement market, PowerBond® is also an industry leader in the high performance balancer segment. To cater to this market, the PowerBond® performance balancer range was launched, utilizing advanced bonded dampening technology with instant market success both in Australia and in the United States.

PowerBond® is now the fastest growing balancer brand in the U.S. performance market.

The DAYCO logo, featuring the word "DAYCO" in a bold, white, sans-serif font with a registered trademark symbol (®) to the right. The logo is set against a dark background with a horizontal line through the middle of the letters.

HARMONIC BALANCERS



PowerBond™ by DAYCO® Premium OE Replacement Harmonic Balancers

PowerBond® premium OE replacement harmonic balancers offer the professional engine rebuilder or shade tree mechanic the highest quality product in the automotive aftermarket. PowerBond® balancers use a spheroidal graphite iron casting which is considered near-steel strength material. PowerBond® balancers use both inserted and pressure-bonded rubber that produces rubber strength that is stronger than OE balancers. PowerBond® standard replacement harmonic balancers are available for the most popular passenger cars, light commercial, and four-wheel drive applications.



PowerBond™ by DAYCO® Street Performance Harmonic Balancers

The PowerBond® street series product line brings bonded balancer technology within the budget of every performance street engine builder. PowerBond® street balancers are also perfect for limited spec race classes, such as late model stock that require an OEM style balancer.

The bonded dampening rubber in every PowerBond® street series balancer eliminates spinning and component separation giving reliable performance in engines used up to 6,500 RPM. PowerBond® street series balancers use high strength spheroidal graphite iron rings and hubs that are pressure-bonded. PowerBond® uses our race series high pressure, low cure that features a natural rubber developed in our laboratory. All PowerBond® street series balancers feature an etched black primer with a double clear coat and fully etched laser timing marks.

HARMONIC BALANCERS

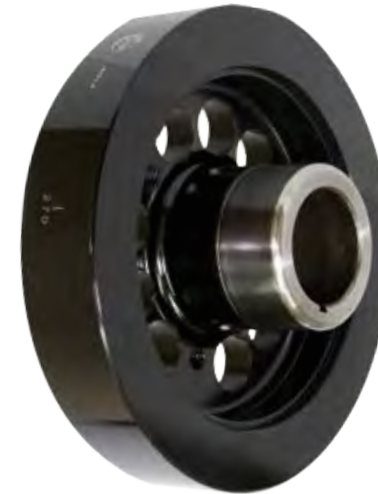

PowerBond™ by DAYCO® Race Performance Harmonic Balancers

The PowerBond® race series brings the advantages of bonded balancers to high revving and high horsepower street/race applications where an SFI-approved balancer is required. PowerBond® race series balancers have been tested beyond 21,000 RPM without failure.

Every PowerBond® race series balancer features a precision CNC machined forged steel hub bonded to an equally strong steel inertia ring. Advanced design means that race series balancers are very light for an all-steel product. In most cases, they are only marginally heavier than the original cast iron balancer and generally much lighter than other all-steel balancers on the market. The steel inertia ring on the race series model is protected against forward and backward movement. PowerBond® uses our race series high pressure, low cure that features a natural rubber developed in our laboratory.

Every model has easy-to-read computer etched timing marks. All PowerBond® race series balancers meet SFI specification 18.1.



PowerBond™ by DAYCO® Supercharger Harmonic Balancers

Designed for high performance supercharged engines featuring:

- SFI 18.1 approved design
- Twin key ways for secure crank mounting with six pulley bolt hole pattern
- High pressure bonded dampening runner for maximum torque resistance

HARMONIC BALANCERS



PowerBond™ by DAYCO® Race Series Overdrive Harmonic Balancers

Overdriving balancers are a high performance alternative. Changing the balancer diameter can alter the performance of the accessories and engine rev speeds. Using the same material and extreme pressure-bonded process as PowerBond® SFI race series harmonic balancers, PowerBond® can also increase your vehicle's horsepower output with our overdrive harmonic balancers. PowerBond® overdrive harmonic balancers increase the diameter of the pulley, which increases the speed of the supercharger leading to increased boost. These help reduce the need to lower the diameter of the blower pulley resulting in less belt wrap.



PowerBond™ by DAYCO® Race Series Underdrive Harmonic Balancers

Underdriving balancers are a high performance alternative. Changing the balancer diameter can alter the performance of the accessories and engine rev speeds.

Using the same material and extreme pressure-bonded process as PowerBond® SFI race series harmonic balancers, PowerBond® can also increase your vehicle's horsepower output with our underdrive harmonic balancers. PowerBond® race series underdrive harmonic balancers help reduce the parasitic power loss caused by the front drive accessories. Underdriving also helps prevent over-revving alternators.

HARMONIC BALANCERS



PowerBond™ by DAYCO® Diesel Performance Harmonic Balancers

Designed as a high performance alternative for diesel powered passenger trucks featuring:

- Strong billet steel construction
- Ultra reliable PowerBond race series pressure-bonded technology
- SFI approved for race use
- Available for most popular passenger truck diesel engines

WATER PUMPS

WATER PUMPS

Water Pump



Dayco water pumps feature upgraded materials for the bearing, impeller, and gasket and deliver exceptionally reliable performance to ensure the highest standards are met for every part supplied. From raw materials through the finished product, every aspect is validated for quality assurance. Dayco water pumps are designed to meet and exceed OEM specifications.



Heavy Duty Water Pump

Dayco heavy duty water pumps are OE engineered with cast iron blades and have been 100% end-of-line leak tested. Designed with the latest technology, the heavy duty water pumps feature upgraded materials for the bearing, impeller, and gasket. This expansion to Dayco's current product line offers a high-caliber component that carries the same quality as existing Dayco products.

DAYCO

TIMING COMPONENTS

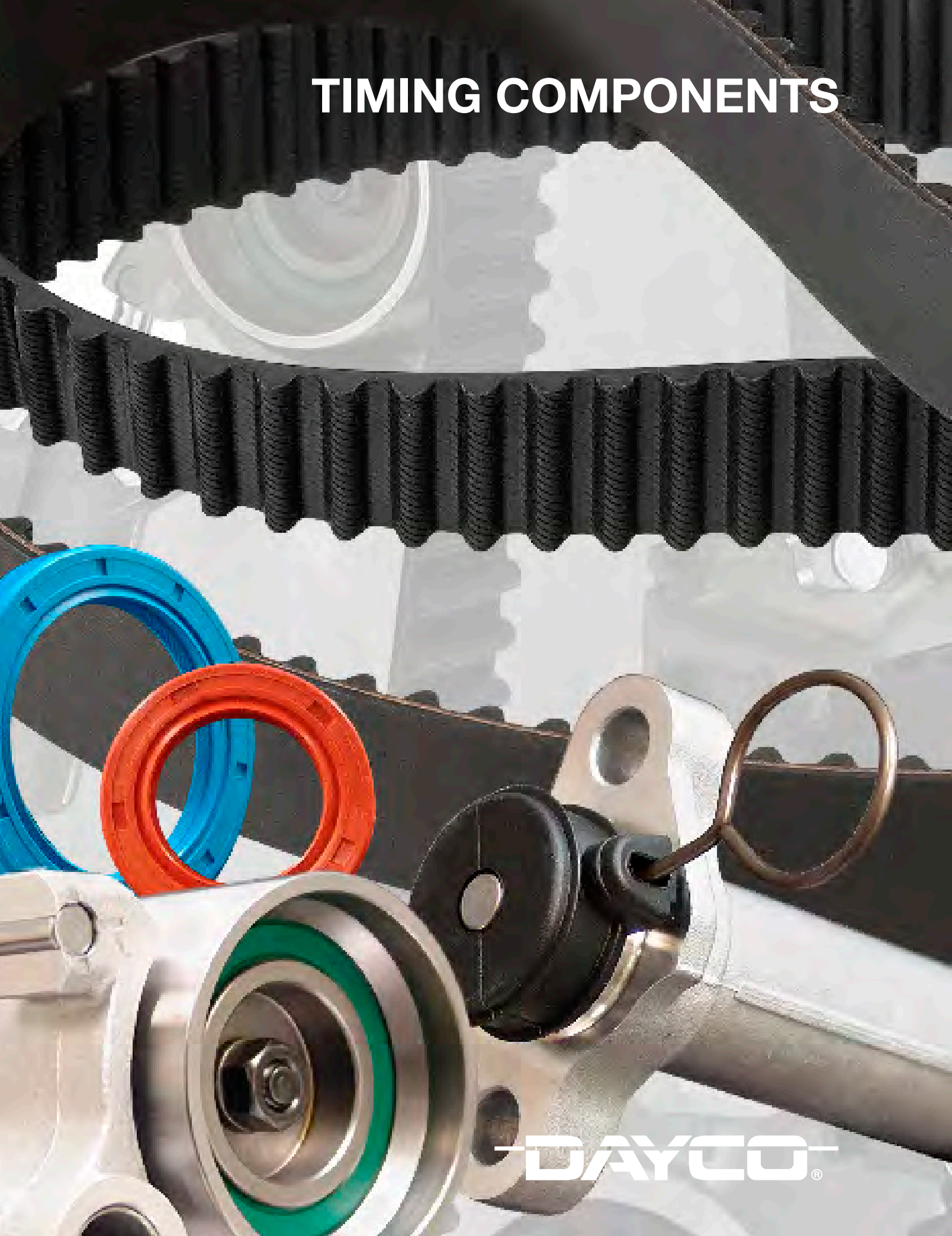

TIMING COMPONENTS



DAYCO® Timing Belt

95014
95 Dayco Timing Belt
014 Industry Standard Number

Manufactured with tough, wear-resistant fabric, high tensile strength cord and molded tooth surface, the Dayco timing belt provides consistent slip-proof power transfer and high resistance to oil and engine heat.

Dayco is recognized by the automotive industry as a world leader in the manufacture of timing belts. The Dayco timing belt, designed for OHC and DOHC type engines, features a molded cog design which runs quieter and is more economical. Our premium, high modulus glass fiber cord delivers precise length stability to keep the engine running smoothly over the life of the belt.

The belt's compounding and tooth configurations are designed for specific applications ranging from normal service to high performance, high temperature engines, where HSN compound is used. The part number includes three final digits that conform to industry standard numbering.

Dayco timing belts meet all OEM performance requirements.



Hydraulic Timing Belt Tensioner

The Dayco hydraulic timing belt tensioner is designed to absorb changes in the loss of timing belt tension.

A loss in timing belt tension may be caused by variations in engine temperatures, speed or general wear and aging of the belt. The Dayco hydraulic timing belt tensioner maintains constant tension on the timing belt during crankshaft revolution which reduces noise, prevents belt flapping and ensures proper transmission efficiency throughout the entire service life of the belt.

Dayco is one of the first aftermarket companies to offer hydraulic timing belt tensioners for the aftermarket.

TIMING COMPONENTS



Timing Belt Kits

Designed for the replacement of worn or damaged OEM timing belts, Dayco timing belt kits include belts, tensioners and idler pulleys. Dayco offers one of the most complete lines of timing belt kits in the market and all kit components and belts are manufactured to the critical original equipment quality, fit, form, and function requirements demanded by both domestic and foreign name plate vehicles.

Dayco also offers timing belt kits with seals. These kits may include timing belts, tensioners, balance shaft belt, pulleys, cam and crankshaft seals and lubricant.

Trilingual installation instructions and an extended warranty are also included with all Dayco timing belt kits.



Timing Component Kits

Designed for replacement of worn or damaged original equipment manufacturer timing belt tensioners and idler pulleys, Dayco timing component kits include prepackaged tensioners, idler pulleys and instructions, each matched to a specific make, model and year of vehicle to assure replacement part accuracy and time-saving convenience.

Dayco timing component kit tensioners and idler pulleys are manufactured to meet the critical OE quality, fit, form and function requirements demanded by both domestic and imported vehicle manufacturers to ensure long-lasting peak performance.

Dayco timing component kits eliminate the need to pay high automotive dealership tensioner and idler pulley prices, the travel time to and from the automotive dealership, and the frustration experienced from lack of the automotive dealership replacement tensioner and idler pulley inventories.

TIMING COMPONENTS



Timing Belt Waterpump Kits

Designed for the replacement of worn or damaged timing belts, tensioners, belt idlers, hydraulic actuators and water pumps, the Dayco timing belt water pump kit is a convenient solution when replacing all of the major components in a timing belt replacement job.

All kit components are manufactured at the highest quality facilities the automotive market has to offer and are prepackaged for safe delivery. These kits include trilingual installation instructions and also come with an extended warranty to ensure that the professional and do-it-yourselfer are confident they are using the very best products for their timing belt replacement.

Dayco offers the most complete line of timing belt water pump kits in the market, which include:

- Most competitive pricing in the industry
- Most complete application coverage
- Trilingual installation instructions
- Full detailed images in all E-catalogs
- OE style water pump
- Extended warranty

These application-specific kits can include timing belt, balance shaft belt, tensioners, pulleys, hydraulic actuators, cam and crank shaft seals, and water pump with gasket, as well as springs and hardware when applicable.



Timing Seal Kits

These Dayco stand-alone seal kits provide users with the required oil seals to complete a complex timing system job. These application-specific kits cover every application in which Dayco offers a timing belt. Kits may include cam seals, crankshaft seals, and lubricant.

V BELTS & INDUSTRIAL BELTS

DAYCO[®]

V-BELTS & INDUSTRIAL BELTS

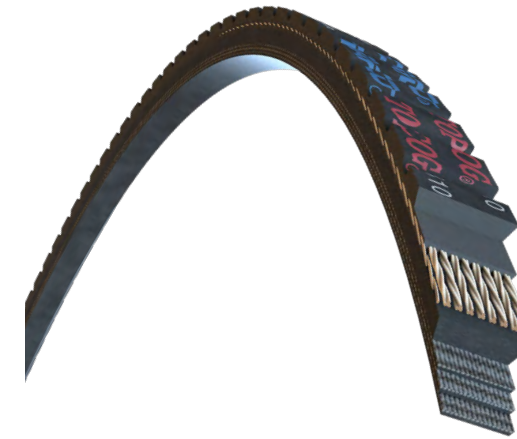

TOP COG[®] V-Belt

15445
15 15/32" Nominal Top Width
445 44.5" Effective Length

Designed for efficient power transmission to the vehicle accessory, Dayco has combined raw edge construction with Dayco's patented Top Cog[®] design to ensure the top performance on vehicles and drives that still utilize V-belts. The Dayco Top Cog[®] V-belt delivers more flexibility and increases airflow around the belt so it runs cooler and lasts longer than most competitive belts. Three layers of neoprene impregnated fabric resist heat, oil and grease while a specially formulated treatment of the polyester cord provides the strength, stability, and reliability that are required from one of the most innovative, top performing V-belts for nearly 30 years.

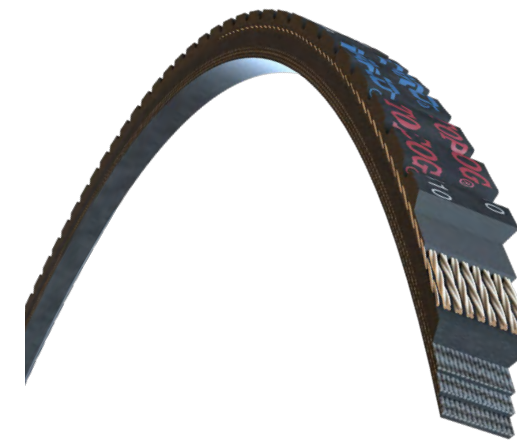

GOLD LABEL[®] TOP COG[®] Belt

with Laminated Construction

The Dayco Gold Label[®] Top Cog[®] belt is the workhorse of the heavy duty industry and is designed to deliver extended life in the most demanding diesel applications. The cogs in the top of the belt deliver increased flexibility around small pulleys while the increased surface area results in a cooler running belt. Polyester cords within the belt provide maximum power transfer and tension holding capability for the life of the belt. The laminated construction in the Dayco Gold Label[®] Top Cog[®] belt helps absorb greater shock loads associated with diesel engines.

Dayco Gold Label[®] Top Cog[®] Belts are available in matched sets of two or three on specific part numbers.

V-BELTS & INDUSTRIAL BELTS

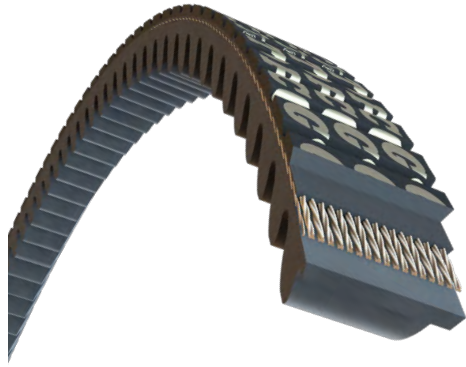

GOLD LABEL[®] TOP COG[®] Belt

with Bottom Cog Construction

Designed for heavy duty applications that require smaller diameter pulleys, Dayco combined the performance characteristics of the Dayco Gold Label[®] Top Cog[®] belt with the increased flexibility obtained through bottom cog technology to engineer the most flexible heavy duty V-belt available, the Dayco Gold Label[®] Top Cog[®] belt with bottom cog construction.

The raw edge construction maintains constant grip to eliminate slip and deliver maximum power on smaller diameter pulleys. The combination of top and bottom cogs offers extreme flexibility around smaller diameter pulleys for longer life. Polyester cord provides maximum tension holding capability for the life of the belt.

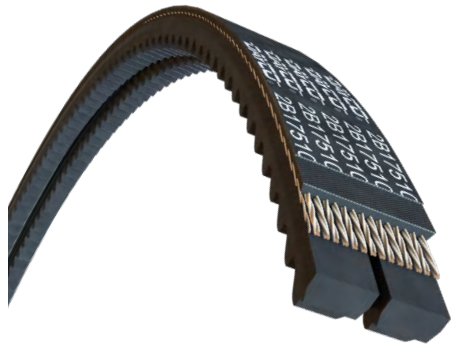

Heavy Duty Banded Belts

2B17510
2 Number of Bands
B Banded Belt
17 17/32" Top Width of Each Band Rib
510 51.0" Effective Length

Dayco heavy duty banded belts are designed for applications in which specific OE pulley design requires the use of two V-belts joined together with a common backing. Dayco banded V-belts offer the increased strength needed on heavy duty applications requiring a banded product. Extremely flexible, this belt bends easily over pulleys while providing reliability against turnover.

Please note: Not all pulleys are designed for banded belts.

V-BELTS & INDUSTRIAL BELTS

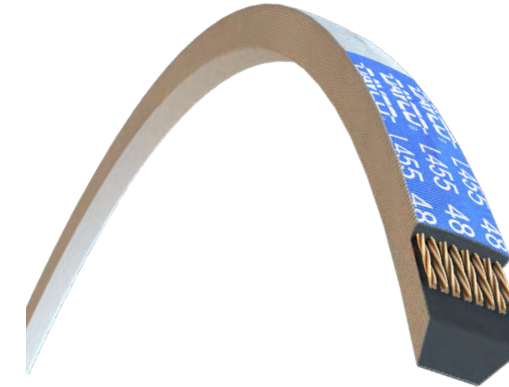

GPL[®] Premium Utility V-Belt

L350		L455		L555	
L	Dayco GPL [®] Premium Utility Belt	L	Dayco GPL [®] Premium Utility Belt	L	Dayco GPL [®] Premium Utility Belt
3	3/8" Top Width	4	4/8" or 1/2" Top Width	5	5/8" Top Width
50	50.0" Outside Circumference	55	55.0" Outside Circumference	55	55.0" Outside Circumference

Designed for light and heavy duty use on lawn and garden, home, farm, shop or industrial applications. Dayco GPL[®] Premium Utility V-Belts operate efficiently when subjected to temperature extremes, high humidity, moisture, grit, oil and grease. Aramid reinforced cords protect against shock loading and stabilize belt length. The specifically engineered low-friction cover, which closely resembles OEM type belts (salt and pepper pattern) allows for easy product identification and delivers optimum controlled clutching and maximum power transfer.

The Dayco GPL Premium Utility Belt is recommended for light and heavy duty lawn and garden equipment, especially in cases where superior load carrying capacity, extra heavy clutching and reverse bend characteristics are required.



FHP Utility

3L350		4L410		5L550	
3	3/8" Top Width	4	4/8" or 1/2" Top Width	5	5/8" Top Width
L	Light Duty (FHP)	L	Light Duty (FHP)	L	Light Duty (FHP)
350	35.0" Outside Circumference	410	41.0" Outside Circumference	550	55.0" Outside Circumference

Designed for use on lawn and garden, home, farm or shop applications, the Dayco FHP Utility V-Belt features a rubber impregnated, wrapped fabric cover, high modulus polyester cord and specially formulated belt core which offers superior performance. Designed for use with fractional horsepower motors utilizing small diameter pulleys, the Dayco FHP Utility Belt delivers extreme flexibility and smooth, quiet operation over a multitude of fractional horsepower drive applications.

The Dayco FHP Utility V-Belt's raw edge sidewall construction and lower cord placement makes it an ideal belt for all non-clutching, light duty, lower horsepower applications.

V-BELTS & INDUSTRIAL BELTS

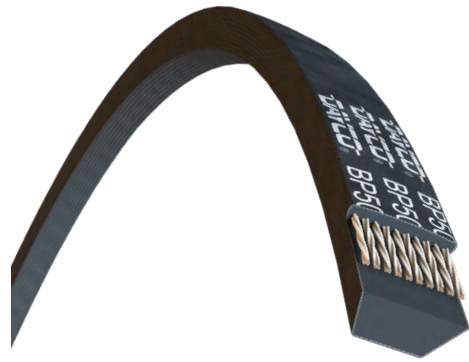

Industrial V-Belt

AP35	BP55	CP60
A 1/2" Top Width	B 21/32" Top Width	C 7/8" Top Width
P Dayco Gold Label® Industrial V-Belt	P Dayco Gold Label® Industrial V-Belt	P Dayco Gold Label® Industrial V-Belt
35 37.0" Outside Circumference	55 58.0" Outside Circumference	60 63.0" Outside Circumference

Designed for use in applications with higher horsepower and shock loads, the Dayco Industrial V-Belt is constructed with a double fabric cover and handles the most demanding industrial applications ranging from 1 to 1,000 horsepower and up to 8,000 RPM. The double fabric cover offers extreme flexibility which enables the belt to run on smaller pulleys. The construction of the cover fabric also provides excellent resistance to oil, heat and aggressive weather conditions.

The Dayco Industrial V-Belt is the ideal choice for reliable performance on an extremely wide range of applications.

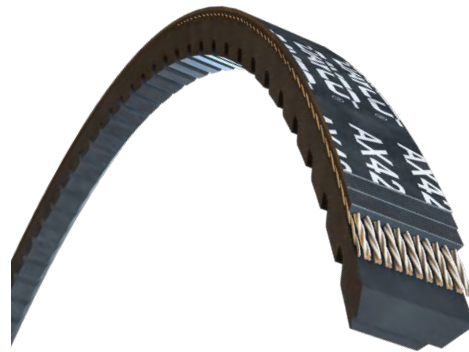

Premium Industrial V-Belt

AX35	BX55	CX96
A 1/2" Top Width	B 21/32" Top Width	C 7/8" Top Width
X Dayco Premium Industrial V-Belt	X Dayco Premium Industrial V-Belt	X Dayco Premium Industrial V-Belt
35 37.0" Outside Circumference	55 58.0" Outside Circumference	96 100.0" Outside Circumference

The Dayco Premium Industrial V-Belt's unique construction, which combines the superior flexing of precision molded cogs with the tenacious gripping power of raw edge sidewalls, provides significantly longer belt life without jeopardizing increased horsepower capacity and/or higher speeds on industrial-type drives.

Designed for applications that require increased horsepower capacity and/or higher speeds, the Dayco Premium Industrial V-Belt is also more energy efficient due to the belt's flexibility. This belt offers the highest horsepower rating for longer service while its raw edge design resists slippage even at low drive tensions.

V-BELTS & INDUSTRIAL BELTS



VX-Wedge® Belt

3VX390	5VX530
3 3/8" Top Width	5 5/8" Top Width
VX Dayco Gold Label® VX-Wedge Belt	VX Dayco Gold Label® VX-Wedge Belt
390 39.0" Outside Circumference	530 53.0" Outside Circumference

The Dayco VX-Wedge® belt features a unique construction consisting of extremely flexible precision molded cogs, raw edge sidewalls for tenacious gripping power and high-grade engineered polymer compounding for resistance to both oil and heat.

Designed for applications that require increased horsepower capacity and/or higher speeds, the Dayco VX-Wedge® belt provides significantly longer belt life without jeopardizing increased horsepower capacity and/or higher speed drives.



V-Wedge® Belt

3V375	5V750	8V1060
3 3/8" Top Width	5 5/8" Top Width	8 1" Top Width
V Dayco Gold Label® V-Wedge Belt	V Dayco Gold Label® V-Wedge Belt	V Dayco Gold Label® V-Wedge Belt
375 37.5" Outside Circumference	750 75.0" Outside Circumference	1060 106.0" Outside Circumference

Designed for smaller, more compact drives, the Dayco V-Wedge® belt offers excellent flexibility and static disposition while resistant to both oil and heat. This industrial belt's narrower, deeper wedge configuration allows for more efficient load carrying and high horsepower capabilities for smaller, more compact drives.

V-BELTS & INDUSTRIAL BELTS



Double Angle V-Belt

Designed for serpentine and reversing drives, the Dayco Double Angle V-Belt transmits power from either side of the belt. Polyester cords and a durable cotton/polyester cover delivers maximum strength and length stability while ensuring resistance to heat, ozone, grease, oil and dirt.

Specially formulated core compounding provides for long life and high horsepower capabilities. The Dayco Double Angle V-Belt flexes equally well in either direction and provides wedging action on both sides for maximum power and performance.

V-BELTS & INDUSTRIAL BELTS

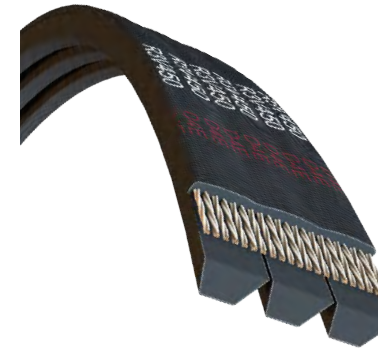

V-Wedge[®] Banded Belt

Designed for high horsepower applications, the Dayco V-Wedge[®] banded belt features a fabric rubber top band for multiple belt stability. The belt's wrapped cover is engineered with a narrower, deeper wedge configuration and polyester cord which eliminates belt whip and turnover allowing the drive to tolerate peak shock loads more effectively.



Industrial Banded Belt

The Dayco Industrial Banded Belt features the same wrapped molded construction and the same oil and heat resistant characteristics as the Dayco Gold Label[®] Industrial V-Belt with the addition of a fabric rubber top band for multiple belt stability.

Designed for high horsepower and shock load applications, these industrial banded belts are primarily employed on applications where multiple belts have the tendency to vibrate, turn over, or come off pulleys when subjected to fluctuating load tensions and high horsepower.

SNOWMOBILE & ATV BELTS

SNOWMOBILE BELTS

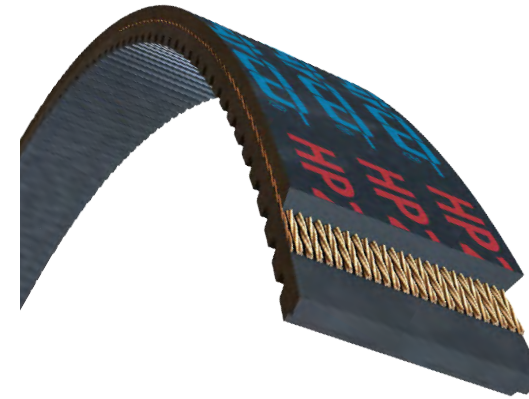

HP[®] Snowmobile Belt

Designed for use on low to mid-range horsepower snowmobiles, the Dayco HP[®] snowmobile belt is manufactured from fiber reinforced polychloroprene rubber compound and aramid cord to ensure superior strength, long-lasting dimensional integrity and longer belt life.

The Dayco HP[®] snowmobile belt ensures the dependable, smooth performance that you and your family prefer for leisurely, carefree days of trail riding.

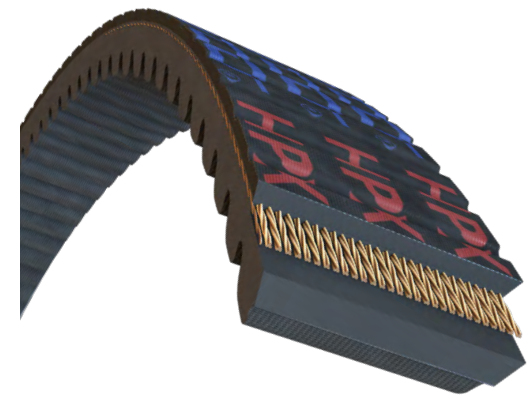

HPX[®] Snowmobile Belt

Featuring Dayco Top Cog[®] design for increased flexibility, extended belt life, and long-lasting reliable service, the Dayco HPX[®] snowmobile belt is constructed with aramid cords and CVT rubber compounding to deliver the increased strength and durability that's required to stand up to today's high power snowmobile engine RPM's and operating temperatures.

Enjoy the exhilaration that comes from knowing that when you need to clutch-down, the Dayco HPX[®] snowmobile belt will deliver a full range of power to attack any terrain without a loss of horsepower.



SNOWMOBILE BELTS

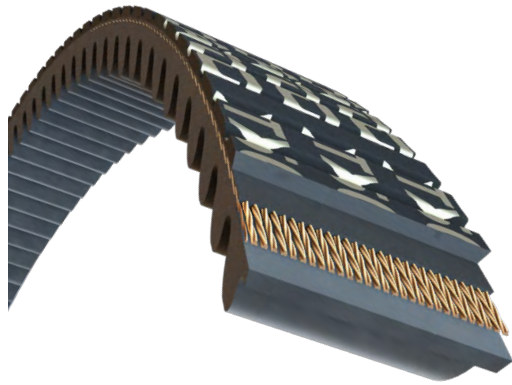

XTX™ Snowmobile Belt

Bred from a rich history of experienced belt builders, the Dayco XTX™ snowmobile belt is specifically engineered to maximize the performance of the most extreme, high horsepower snowmobiles. Beating the competition on the race course is just one of many aspects that sets the XTX™ belt apart from its competition. Specially formulated, high temperature polymer along with the highest level of engineered reinforcement proves to perform better in belt operating temperature and efficiency than leading competitors. Its innovative breakthrough design of deeper cogs on top and rounded cogs on the bottom yield the advantages of ultimate flexibility and longer belt life while being a better alternative to the OE belt.

The Dayco XTX™ snowmobile belt offers:

- Faster and more consistent throttle response at high speeds
- Quicker throttle response at mid-speed acceleration
- Greater secondary acceleration at high RPMs
- Greater secondary acceleration as primary acceleration increases
- Reduction in slippage during the highest levels of torque
- More power to track
- Better performance during deceleration (more responsive engine braking)
- Tested and proven reliability at well over 12,000 RPMs
- A cooler running temperature than the leading competitors

This race-tested Dayco XTX™ belt gives extreme riders the best out-of-the-hole acceleration, throttle response and durability, for the ride of a lifetime — every time!

ATV BELTS

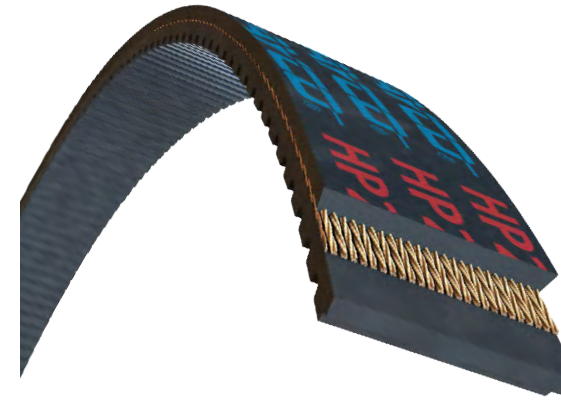

HP® ATV Belt

Designed for use on low to midrange all-terrain vehicles, golf carts and farm and ranch utility vehicles, the Dayco HP® outdoor activity belt has fast become the ATV rider's belt of choice. Manufactured from a specially formulated fiber reinforced polychloroprene and aramid cord, the Dayco HP® outdoor activity belt delivers superior strength, enhanced dimensional integrity and stability for long lasting belt life in these applications.

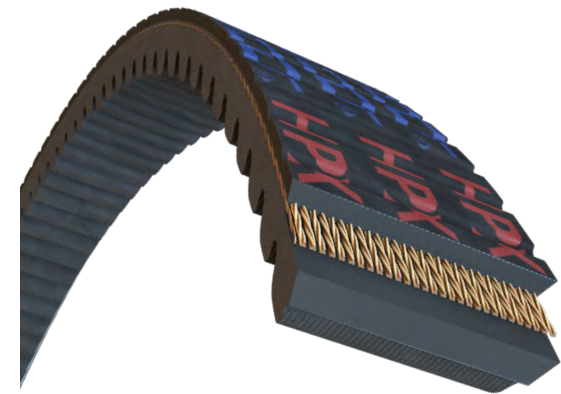

HPX® ATV Belt

From mud holes to rocky trails to hill climbs to desert treks, Dayco HPX® ATV and UTV belts deliver unparalleled response. Constructed with extra strong aramid cord reinforcement and fiber loaded polychloroprene compounding, this belt delivers the muscle and durability demanded by today's high performance engines and the high performance enthusiasts who drive them.

Tested under severe field conditions, the Dayco HPX® ATV belt has been proven to run cooler and to provide longer belt life than competitive belts.

ATV BELTS

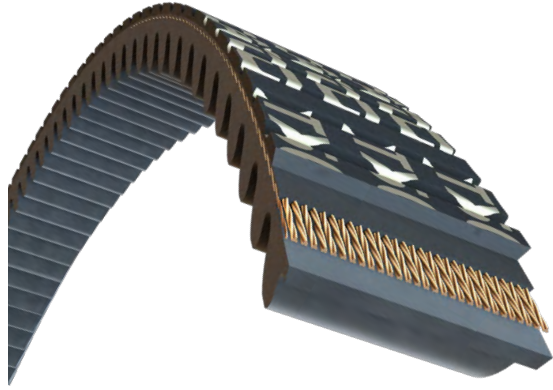

XTX™ ATV Belt

Built for the most extreme machines, Dayco XTX™ ATV and UTV belts are engineered for machines powered by 800cc and above engines. Engineered with specially formulated, high temperature polychloroprene with the highest level of aramid fiber reinforcement available delivers track churning performance for the most aggressive riders. This innovative breakthrough design features deeper cogs on top and rounded cogs on the bottom for ultimate flexibility and longer belt life while being a better alternative to the OE belt.

The Dayco XTX™ ATV belt offers:

- Faster and more consistent throttle response at high speeds
- Quicker throttle response at mid speed acceleration
- Greater secondary acceleration at high RPMs
- Reduction in slippage during the highest levels of torque
- Increased horsepower capacity
- Better performance during deceleration (more responsive engine braking)
- Tested and proven reliability over 12,000 RPMs
- A cooler running temperature than the leading competitors

This race-tested Dayco XTX™ belt gives extreme riders the best out-of-the-hole acceleration, throttle response and durability, for the ride of a lifetime — every time!



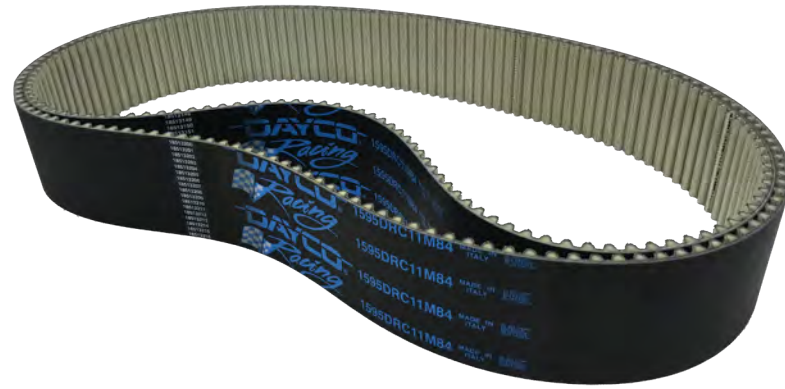

SUPER CHARGER Belt

The Dayco Racing supercharger belt, specifically designed for Top Fuel dragsters and Funny Cars, is engineered with a hybrid carbon cord encapsulated in custom rubber compounds and patented low friction PTFE tooth fabric. This standard 11mm pitch, 84mm wide and 145 teeth belt was developed using real-world track data, specifically for supercharged nitromethane engines and built to withstand some of the highest dynamic loads in racing.



COOLANT HOSE



Molded Radiator and Bypass Hose

Designed to replace OEM hose, Dayco Molded Radiator and Bypass Hose with knitted reinforcement and all EPDM construction provides the high strength and resistance to oil, mud, salt, road debris, ozone, coolants, and temperature variations of -40°F (-40°C) to +257°F (+125°C) that are required for OEM hose replacements. The inner base tube is reinforced with knitted rayon for maximum strength and burst resistance for the life of the hose. In addition to meeting SAE J20R4, Class D-1 requirements, this hose is now designed to meet Type EC electrochemical requirements as specified in SAE J1684.

Branched Radiator Hose



The Dayco Branched Radiator Hose is an ideal aftermarket replacement for OEM branched hose. The hose's all EPDM construction resists the effects of oil, mud, salt and ozone, while its knitted rayon reinforced inner tube offers resistance to temperature ranges of -40°F (-40°C) to +257°F (+125°C). Leak proof junctions ensure long service life and unrestricted flow. This hose meets SAE J20R4, Class D-1, Type EC electrochemical requirements as specified in SAE J1684.

Small I.D. Molded Heater Hose



The Dayco Small I.D. Molded Heater Hose is designed to replace OEM coolant hose in applications where molded hose in small diameters (1" I.D. or smaller) is required. The molded configuration eliminates the need for multiple connections of hoses and clamps when added to Dayco's line of molded heater hose and assemblies. The knitted reinforcement and EPDM construction provides high strength and resistance to detrimental environmental elements, coolants, and temperature variations of -40°F (-40°C) to +257°F (+125°C). In addition to meeting SAE J20R3, Class D-1 requirements, this hose is designed to meet Type EC electrochemical requirements as specified in SAE J1684. For many of the OE parts that has a quick connect end, Dayco Small I.D. Molded Heater Hoses are also made with a quick connect assembled onto the hose for fast, convenient installation.

COOLANT HOSE



90° Molded Coolant Hose

Designed for vehicles that require special heater hoses with molded 90° elbows to fit the engine compartment configuration, the Dayco 90° Molded Coolant Hose's knitted reinforcement and EPDM construction provides high strength and resistance to detrimental environmental elements, coolants, and temperature variations of -40°F (-40°C) to +257°F (+125°C). In addition to meeting SAE J20R3, Class D-1 requirements, this hose is designed to meet Type EC electrochemical requirements as specified in SAE J1684. This hose can be used to replace heater hose and other coolant hoses where a 90° elbow is required. The Dayco 90° Molded Coolant Hose hose can also be used with Dayco's Heater Hose Connectors to make a variety of routing configurations.

Part No.	I.D. x Length	Part No.	I.D. x Length	Part No.	I.D. x Length
80393	1/2" x 4" x 90° x 6"	80402	5/8" x 4" x 90° x 18"	80411	3/4" x 4" x 90° x 6"
80394	1/2" x 4" x 90° x 12"	80403	5/8" x 8" x 90° x 18"	80412	3/4" x 4" x 90° x 12"
80395	1/2" x 4" x 90° x 18"	80404	5/8" x 4" x 90° x 24"	80413	3/4" x 4" x 90° x 18"
80396	1/2" x 8" x 90° x 18"	80405	5/8" x 4" x 90° x 36"	80414	3/4" x 4" x 90° x 24"
80397	1/2" x 8" x 90° x 24"	80406	5/8" x 4" x 90° x 48"	80415	3/4" x 8" x 90° x 24"
80398	1/2" x 4" x 90° x 36"	80407	5/8" x 4" x 90° x 60"	80416	3/4" x 4" x 90° x 36"
80400	5/8" x 4" x 90° x 6"	80408	5/8" x 4" x 90° x 69"	80417	3/4" x 4" x 90° x 48"
80401	5/8" x 4" x 90° x 12"	80409	5/8" x 4" x 90° x 62"	80418	3/4" x 4" x 90° x 60"

COOLANT HOSE

Flex Radiator Hose



Precision molded in standard lengths, the Dayco Flex Radiator Hose is designed to replace straight or molded radiator hoses when routing allows. The knitted reinforcement and EPDM construction meets SAE J20R4, Class D-2 requirements, preventing splitting, ballooning, and elongation, and resisting ozone and other detrimental environmental elements, coolants, and temperature variations of -40°F (-40°C) to +257°F (+125°C). The corrugations provide excellent hose flexibility without flattening or collapse. The Dayco Flex Radiator Hose has a helical steel coil spring for increased flexibility.

Note: NOT suitable for fuel or oil transfer.

Part No.	Size
81011	1 1/4" x 7 3/8"
81021	1 1/4" x 9 5/8"
81031	1 1/4" x 11"
81041	1 1/4" x 14 3/4"
81051	1 1/4" x 17 1/4"
81061	1 1/4" x 20"
81071	1 1/4" x 23"
81081	1 1/4" - 1 1/2" x 15 1/2"
81091	1 1/4" - 1 1/2" x 19 1/2"
81101	1 1/2" x 5 3/4"
81111	1 1/2" x 7 5/8"
81121	1 1/2" x 9"
81131	1 1/2" x 10 3/4"
81141	1 1/2" x 12 1/4"
81151	1 1/2" x 13 7/8"
81161	1 1/2" x 15 3/4"
81171	1 1/2" x 17 1/4"
81181	1 1/2" x 19 7/8"
81191	1 1/2" x 22"
81201	1 1/2" x 25"
81211	1 1/2" x 27 1/2"
81221	1 1/2" x 30"
81231	1 1/2" - 1 3/4" x 13 1/4"

Part No	Size
81241	1 1/2" - 1 3/4" x 15"
81251	1 1/2" - 1 3/4" x 16 1/2"
81261	1 1/2" - 1 3/4" x 19 1/2"
81271	1 1/2" - 1 3/4" x 22"
81281	1 3/4" x 6 1/8"
81291	1 3/4" x 8 5/8"
81301	1 3/4" x 10"
81311	1 3/4" x 11 1/4"
81321	1 3/4" x 13 1/4"
81331	1 3/4" x 16 1/2"
81341	1 3/4" x 18 3/4"
81351	1 3/4" x 23 1/2"
81361	1 3/4" - 2" x 12 1/4"
81371	1 3/4" - 2" x 14 1/8"
81381	1 3/4" - 2" x 16 1/2"
81391	1 3/4" - 2" x 19"
81401	2" x 9 1/2"
81411	2" x 12 1/4"
81421	2" x 14 1/8"
81431	2" x 16 13/16"
81441	2" x 18"
* 81490	1 1/2" x 16 7/8"
* 81491	1 1/2" x 22 7/8"
* 81492	1 1/2" x 20 1/2"

* 90° Bend on one end

Plastic Heater Hose Connectors



Designed for use in making various replacement heater hose configurations, Dayco's Heater Hose Connectors accommodate 1/4", 3/8", 1/2", 5/8" and 3/4" hose I.D.s and feature a unique barbed end profile to ensure a leak-proof seal. These glass filled nylon connectors are compatible with all traditional coolants and fuels. Dayco Hose Connectors are available in straight, "Y", elbow, tee and reducing configurations. A circumferential flange provides a hose stop that assures the hose is inserted to the proper depth. Anti-rotation ribs are molded into the connectors to prevent hose rotation or twisting.

Part No.	Size	Style	Part No.	Size	Style
80650	1/4"	Straight	80671	3/8"	Elbow
80651	3/8"	Straight	80672	1/2"	Elbow
80652	1/2"	Straight	80673	5/8"	Elbow
80653	5/8"	Straight	80674	3/4"	Elbow
80654	3/4"	Straight	80680	1/4"	Tee
80660	1/2" > 3/8"	Reducer	80681	3/8"	Tee
80661	5/8" > 1/2"	Reducer	80682	1/2"	Tee
80662	3/4" > 5/8"	Reducer	80683	5/8"	Tee
80670	1/4"	Elbow	80684	3/4"	Tee

Brass Heater Hose Connectors



Designed for use in making various replacement heater hose configurations, Dayco's Heater Hose Connectors accommodate 1/4", 3/8", 1/2", and 5/8" hose I.D.s and feature a unique barbed end profile to ensure a leak-proof seal. These glass filled nylon connectors are compatible with all traditional coolants and fuels. Dayco Hose Connectors are available in straight configurations. A circumferential flange provides a hose stop that assures the hose is inserted to the proper depth. Anti-rotation ribs are molded into the connectors to prevent hose rotation or twisting.

Part No.	Size	Style
80422	1/4"	Straight
80423	3/8"	Straight
80424	1/2"	Straight
80425	5/8"	Straight
80431	5/8"	Straight
80432	5/8"	Straight
80433	5/8"	Straight

COOLANT HOSE

GOLD LABEL® Heavy Duty Flex Radiator Hose



Designed to replace molded curved radiator hose when routing allows, the Dayco Gold Label® Heavy Duty Flex Radiator Hose is hand-built with neoprene, heavy duty fabric and wire reinforcement for high burst strength and collapse resistance. The hose ribbing provides excellent flexibility and kink resistance and the heavy duty construction stands up to the effects of ozone and other detrimental environmental elements, coolants, coolant additives, and temperature variations of -40°F (-40°C) to +212°F (+100°C). The hose's construction meets or exceeds SAE J20R5, Class D-2, Class C requirements for heavy duty applications.

Note: NOT suitable for fuel or oil transfer.

Part No.	Size
82008GL	1 3/4" x 19"
82010GL	1 3/4" x 23 1/2"
82011GL	1 3/4" x 13 1/2"
82021GL	1 3/4" x 16 1/2"
82031GL	1 3/4" - 2" x 16 1/2"
82041GL	1 3/4" - 2" x 19"
82051GL	1 3/4" - 2" x 23 1/2"
82061GL	2" x 9 1/2"
82071GL	2" x 12 1/4"
82081GL	2" x 14 1/2"
82091GL	2" x 17"
82101GL	2" x 20"
82111GL	2" x 24"
82121GL	2" x 33"
82131GL	2" - 2 1/4" x 8 1/2"
82141GL	2" - 2 1/4" x 15"
82151GL	2" - 2 1/4" x 17 1/2"
82161GL	2 1/4" x 9"
82171GL	2 1/4" x 11"
82181GL	2 1/4" x 14"
82191GL	2 1/4" x 17"
82201GL	2 1/4" x 19"
82211GL	2 1/4" x 24"
82221GL	2 1/4" x 27"
82231GL	2 1/4" - 2 1/2" x 18"
82241GL	2 1/4" - 2 1/2" x 21"
82251GL	2 1/4" - 2 1/2" x 25"
82261GL	2 1/2" x 11"
82271GL	2 1/2" x 14"
82281GL	2 1/2" x 16"
82291GL	2 1/2" x 24"
82301GL	2 1/2" x 28"
82311GL	2 3/4" x 14"
82321GL	2 3/4" x 18"

COOLANT HOSE

Straight Radiator Hose



Designed for a wide range of light and heavy duty truck applications where the routing is relatively straight, the Dayco Straight Radiator Hose features knitted reinforcement and EPDM construction. It meets SAE J20R4, Class D-2 requirements and provides high strength and resistance to ozone and other detrimental environmental elements, coolants, and temperature variations from -40°F (-40°C) to +257°F (+125°C).

Note: NOT suitable for fuel or oil transfer.

Part No.	I.D.	Length	Part No.	I.D.	Length
76075	3/4"	3'	76188	1 7/8"	3'
76088	7/8"	3'	76200	2"	3'
76100	1"	3'	76213	2 1/8"	3'
76113	1 1/8"	3'	76225	2 1/4"	3'
76125	1 1/4"	3'	76238	2 3/8"	3'
76138	1 3/8"	3'	76250	2 1/2"	3'
76150	1 1/2"	3'	76263	2 5/8"	3'
76163	1 5/8"	3'	76275	2 3/4"	3'
76175	1 3/4"	3'	76300	3"	3'

GOLD LABEL® Heavy Duty Straight Radiator Hose



The Dayco Gold Label® Heavy Duty Straight Radiator Hose is made with the highest quality woven mesh fabric reinforcement, neoprene cover, and nitrile tube compounds to withstand the most corrosive elements in diesel engines: oil, coolants, coolant additives, and heat, with a temperature rating of -40°F (-40°C) to +212°F (+100°C). Designed for a wide range of light and heavy duty truck applications where the routing is relatively straight, this hose meets SAE requirements J20R1, Class B Tube, Class C Cover, standard wall construction.

Note: NOT suitable for fuel or oil transfer.

Part No.	I.D.	Length	Part No.	I.D.	Length
77075GL	3/4"	3'	77200GL	2"	3'
77088GL	7/8"	3'	77213GL	2 1/8"	3'
77100GL	1"	3'	77225GL	2 1/4"	3'
77113GL	1 1/8"	3'	77238GL	2 3/8"	3'
77125GL	1 1/4"	3'	77250GL	2 1/2"	3'
77138GL	1 3/8"	3'	77263GL	2 5/8"	3'
77150GL	1 1/2"	3'	77275GL	2 3/4"	3'
77156GL	1 9/16"	3'	77300GL	3"	3'
77163GL	1 5/8"	3'	77325GL	3 1/4"	3'
77175GL	1 3/4"	3'	77350GL	3 1/2"	3'
77188GL	1 7/8"	3'	77400GL	4"	3'

COOLANT HOSE

GOLD LABEL® Heavy Duty Quick-Fit® Radiator Hose

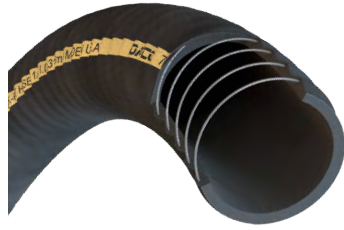

Designed to be used in applications with multiple and/or small radius bends that would cause regular straight hose to kink or collapse, the Dayco Gold Label® Heavy Duty Quick-Fit® Radiator Hose features single ply of fabric reinforcement applied over a fully embedded helical steel wire for increased strength and superior collapse resistance. The hose cover is made with the highest quality neoprene, developed to withstand the harshest environments found in heavy duty over-the-road and off-road applications. This hose meets the requirements for SAE J20R2, Class B Tube, Class C Cover, standard wall construction. The Dayco Gold Label Heavy Duty Quick-Fit Radiator Hose will withstand temperatures from -40°F (-40°C) to +212°F (+100°C).

Note: NOT suitable for fuel or oil transfer.

Part No.	I.D.	Length	Part No.	I.D.	Length
75100GL	1"	4'	75263GL	2 5/8"	4'
75113GL	1 1/8"	4'	75275GL	2 3/4"	4'
75125GL	1 1/4"	4'	75288GL	2 7/8"	4'
75138GL	1 3/8"	4'	75300GL	3"	4'
75150GL	1 1/2"	4'	75313GL	3 1/8"	4'
75163GL	1 5/8"	4'	75325GL	3 1/4"	4'
75175GL	1 3/4"	4'	75338GL	3 3/8"	4'
75188GL	1 7/8"	4'	75350GL	3 1/2"	4'
75200GL	2"	4'	75400GL	4"	4'
75213GL	2 1/8"	4'	75450GL	4 1/2"	4'
75225GL	2 1/4"	4'	75500GL	5"	4'
75238GL	2 3/8"	4'	75550GL	5 1/2"	4'
75250GL	2 1/2"	4'	75600GL	6"	4'

GOLD LABEL® Heavy Duty Silicone Radiator Hose



Designed for long life in heavy duty applications, this tough reinforced silicone rubber hose resists aging from heat, chemicals, oils, and other elements that attack hoses in heavy duty applications. When installed properly with special silicone clamps, the Dayco Gold Label® Heavy Duty Silicone Radiator Hose will give up to six times longer service life than ordinary coolant hose. The Dayco Gold Label Heavy Duty Silicone Radiator Hose meets the requirements of SAE J20R1, Class A, standard wall construction, and has a temperature rating of -65°F (-53.9°C) to +350°F (+176°C).

Note: NOT suitable for fuel or oil transfer.

Part No.	I.D.	Length	Part No.	I.D.	Length
78100GL	1"	3'	78225GL	2 1/4"	3'
78113GL	1 1/8"	3'	78238GL	2 3/8"	3'
78125GL	1 1/4"	3'	78250GL	2 1/2"	3'
78138GL	1 3/8"	3'	78275GL	2 3/4"	3'
78150GL	1 1/2"	3'	78300GL	3"	3'
78163GL	1 5/8"	3'	78325GL	3 1/4"	3'
78175GL	1 3/4"	3'	78350GL	3 1/2"	3'
78200GL	2"	3'	78375GL	3 3/4"	3'
			78400GL	4"	3'

COOLANT HOSE

Special Reducers

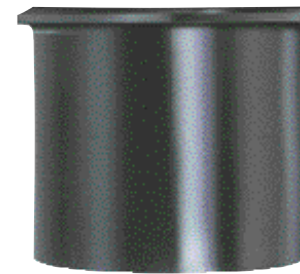

Designed to reduce the I.D. of existing straight, molded and flex hose to meet application needs, these molded rubber Dayco Special Reducers easily slip into the end of straight radiator hose to reduce the I.D. and provide a tight, leak proof connection.

Note: NOT suitable for fuel or oil transfer.

Part No.	Reduction Range
76925	Reduces 1 1/2" to 1 1/4"
76950	Reduces 1 3/4" to 1 1/2"
76963	Reduces 1 3/4" to 1 5/8"
76975	Reduces 2" to 1 3/4"

Heater Hose Packaged 6-Foot



Designed to hang on standard pegboard hooks for retail display and self-service sales, each of the three most popular Dayco heater hose sizes (1/2", 5/8", 3/4") are packaged in six foot lengths in a poly bag that measures 12" wide x 17" high. Shipped 10 bags per standard case.

Note: NOT suitable for fuel or oil transfer.

Part No.	I.D.	Length
80291	1/2"	6'
80292	5/8"	6'
80293	3/4"	6'

Standard Heater Hose



Designed to carry the heated coolant from the engine block to the heater core under the dashboard and return it to the engine, the Dayco Standard Heater Hose is made for general service on light trucks and passenger cars. Constructed using all EPDM compounds and spiral reinforcement for high burst strength and excellent heat resistance of -40°F (-40°C) to +257°F (+125°C), this hose is similar to SAE 20R3, Class D-2, and is specifically designed to be compatible with all common coolants and coolant additives.

Note: NOT suitable for fuel or oil transfer.

Part No.	I.D.	Length
80257	1/4"	50' Carton
80258	5/16"	50' Carton
80259	3/8"	50' Carton
80270	1/2"	50' Carton
80271	5/8"	50' Carton
80272	5/8"	250' Reel
80273	3/4"	50' Carton
80274	3/4"	250' Reel

COOLANT HOSE

Insulone® Heater Hose

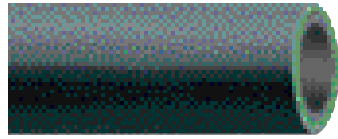

Designed for use in cold climate applications where efficient heat transfer is important for comfortable and cost-effective operation of the vehicle, this premium Dayco Insulone® heater hose delivers heated coolant to the heater core with minimal heat loss. The EPDM rubber compounds and spiral reinforcement gives this hose excellent burst strength, heat resistance and compatibility with all common coolants and coolant additives. A special compound used in the insulating layer provides an added measure of protection against heat loss. Built with a black cover, this hose is similar to SAE 20R3, Class D-2 with a temperature range of -40°F (-40°C) to +257°F (+125°C).

Note: not suitable for fuel or oil transfer.

Part No.	I.D.	Length	Part No.	I.D.	Length
80312	1/2"	50' Carton	80317	3/4"	250' Reel
80314	5/8"	50' Carton	80318	7/8"	50' Carton
80315	5/8"	250' Reel	80319	1"	50' Carton
80316	3/4"	50' Carton			

GOLD LABEL® Heavy Duty Heater Hose



Designed to provide reliable heavy duty and off-road equipment service, the Dayco Gold Label® Heavy Duty Heater Hose is our quality rubber heater hose, made with the highest quality EPDM compounds and heavy duty spiral reinforcement to withstand high coolant and underhood temperatures of -40°F (-40°C) to +257°F (+125°C), and provide excellent resistance to coolant and coolant additives. This hose exceeds SAE 20R3, Class D-1, Type EC, standard wall construction requirements.

Part No.	I.D.	Length	Part No.	I.D.	Length
80229GL	1/2"	50' Carton	80235GL	3/8"	250' Reel
80230GL	3/8"	50' Carton	80236GL	5/8"	250' Reel
80231GL	5/8"	50' Carton	80237GL	3/4"	250' Reel
80232GL	3/4"	50' Carton	80238GL	7/8"	250' Reel
80233GL	7/8"	50' Carton	80239GL	1"	250' Reel
80234GL	1"	50' Carton	80240GL	1/2"	250' Reel

GOLD LABEL® Silicone Heater Hose



The Dayco Gold Label® Silicone Heater Hose, designed for long life in heavy duty applications, is made with special silicone compounds and reinforced with one ply of braided polyester yarn. This SAE 20R3, Class A hose is highly resistant to the deteriorating effects of oil, ozone, coolants, and coolant additives. In addition to being extremely flexible, this silicone hose has the highest temperature rating, namely -65°F (-53.9°C) to +350°F (+176°C), and longest service life of any Dayco heater hose product. When installed properly with special "silicone" clamps, this hose will give up to six times longer service life than ordinary coolant hose.

Note: not suitable for fuel or oil transfer.

Part No.	I.D.	Length	Part No.	I.D.	Length
80241GL	5/8"	25' Carton	80251GL	5/8"	50' Carton
80242GL	3/4"	25' Carton	80252GL	3/4"	50' Carton
80243GL	1/2"	25' Carton	80253GL	1/2"	25' Carton
80244GL	1"	25' Carton	80254GL	1"	50' Carton
80245GL	3/8"	25' Carton	80255GL	3/8"	50' Carton

HOSE CLAMPS

Hose Clamps For Automotive And Fleet Applications

Designed for automotive and fleet applications where clamping of hoses is required, all Dayco hose clamps feature a heavy duty worm gear with stainless steel band and housing. The four piece design and arched band slots provide added strength and smooth operation.

Product offerings include "Standard" clamps with a zinc plated, slotted, hex head screw; "Stainless Steel" clamps, featuring a 410 grade, slotted hex head screw; "High Torque" clamps with an extra wide band, all stainless steel super heavy-duty construction, a 410 grade, slotted hex head screw; and "Silicone" clamps (for use on silicone hoses) with an extended inner liner that covers the band slots to prevent hose damage, and a yellow zinc plated, slotted hex head screw.



Series 91004 through 91188

- Standard clamps featuring zinc dichromate plated slotted hex head screws



Series 92004 through 92104

- All stainless steel clamps featuring 410 grade slotted hex head screws



Series 92208 through 92248

- For Use on Silicone Hose
- Silicone clamps with extended inner liner covering band slots to prevent hose damage featuring zinc dichromate plated slotted hex head screws



Series 92302 through 92305

- Hi-Torque
- Extra wide band, all stainless steel super heavy duty clamps featuring 410 grade slotted hex head screws

HOSE CLAMPS

Hose Clamps For Automotive And Fleet Applications

Fits Hose I.D.		Popular Applications	Clamp	Clamp	Standard	Stainless	Silicone
From	To		Diam. Min.	Diam. Max.	Part No.	Part No.	Part No.
3/8"	1/2"	Dayco Miniature Clamp Air Hose, Air Line Hose, Fuel Lines	7/32"	5/8"	91004	92004	-
3/8"	5/8"		7/16"	25/32"	91006	92006	-
3/8"	5/8"		1/2"	29/32"	91008	92008	-
3/8"	5/8"	Heater Hose	11/16"	15/16"	-	-	92208
3/8"	5/8"	Heater Hose	9/16"	1-1/16"	91010	92010	-
3/8"	5/8"	Heater Hose	13/16"	1-1/16"	-	-	92210
5/8"	3/4"	Heater Hose	11/16"	1-1/4"	91012	92012	-
5/8"	3/4"	Heater Hose	15/16"	1-1/4"	-	-	92212
3/4"	1"	Vacuum Hose	13/16"	1-1/2"	91016	92016	92216
1"	1-1/4"	Vacuum and Booster Brake Hose	13/16"	1-3/4"	91020	92020	92220
1-1/4"	1-1/2"		1-1/16"	2"	91024	92024	92224
1-1/4"	1-3/4"	Car Radiator Hose	1-5/16"	2-1/4"	91028	92028	92228
1-1/2"	2"	Larger Size Radiator	1-9/16"	2-1/2"	91032	92032	92232
1-3/4"	2-1/4"	Hose Truck Radiator and Gas Tank Hose	1-13/16"	2-3/4"	91036	92036	92236
2"	2-1/2"		2-1/16"	3"	91040	92040	92240
2-1/4"	2-3/4"	Truck and Tractor	2-5/16"	3-1/4"	91044	92044	92244
2-1/2"	3"		2-9/16"	3-1/2"	91048	92048	92248
3"	3-1/4"	Air Vent Hose	2-13/16"	3-3/4"	91052	92052	-
3-1/4"	3-1/2"		3-1/16"	4"	91056	92056	-
3-1/4"	3-1/2"	Air Vent Hose	3-5/16"	4-1/4"	91060	92060	-
3-1/2"	4"		3-9/16"	4-1/2"	91064	92064	-
			4-1/8"	5"	91072	92072	-
			4-5/8"	5-1/2"	91080	92080	-
			5-1/8"	6"	91088	92088	-
Order all these sizes by O.D. hose size			5"	6-1/2"	91096	92096	-
			6-1/8"	7"	91104	92104	-
			5-5/8"	8-1/2"	91128	-	-
			7-1/8"	10"	91152	-	-
(All clamps packaged 10 per box)			9-3/8"	12-1/4"	91188	-	-
			1 1/4"	2 5/8"	-	92302	-
			2 1/8"	4 1/8"	-	92303	-
			4"	6 1/8"	-	92304	-
			6 1/8"	9"	-	92305	-

SERVICE HOSE

Barrier Refrigerant Hose Style DBH



Designed for use with R12 and R134A refrigerant systems only, the Dayco Style BH/DBH Barrier Refrigerant Hose features nitrile/nylon barrier/neoprene tube construction, textile reinforcement, and black EPDM cover that is resistant to abrasion, ozone, and heat. It meets SAE J2064 (exceeds J51) type C requirements. The temperature range is from -22° F (-30°C) to +203° F (+95°C). This hose is recommended for use with Dayco coupling styles BL and SB.

Part No.	I.D.	O.D.	Length
80442	5/16"	3/4"	25' Carton
80443	5/16"	3/4"	50' Carton
80444	5/16"	3/4"	250' Reel
80447	13/32"	29/32"	25' Carton
80448	13/32"	29/32"	50' Carton
80449	13/32"	29/32"	250' Reel
80452	1/2"	1"	25' Carton
80453	1/2"	1"	50' Carton
80454	1/2"	1"	250' Reel
80457	5/8"	1 1/8"	25' Carton
80458	5/8"	1 1/8"	50' Carton
80459	5/8"	1 1/8"	250' Reel

Transmission Oil Cooler/Power Steering Return Line Hose

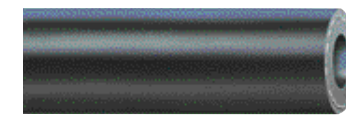

Dayco Transmission Oil Cooler/Power Steering Return Line Hose has a synthetic rubber tube and cover to resist oil, ozone, heat and aging and is designed to connect the transmission to an external cooler or as a return line between the power steering mechanism and the hydraulic pump. The hose is reinforced with braided cord for increased strength, supporting a working pressure of 250 psi. It is designed to handle transmission oil temperatures up to +257°F (+125°C).

Note: NOT suitable for power steering pressure lines.

Part No.	Braid	I.D.	Length	Working Pressure (psi)
80383	1	5/16"	25' Carton	250
80384	1	5/16"	50' Carton	250
80387	1	11/32"	25' Carton	250
80388	1	11/32"	50' Carton	250
80391	1	3/8"	25' Carton	250
80392	1	3/8"	50' Carton	250

SERVICE HOSE

Fuel Line Hose



Designed for use on all types of carbureted gasoline engines, the Dayco Fuel Line Hose offers excellent resistance to oil, gasoline, grease, and weather. The hose is constructed with a neoprene cover and nitrile tube for use with leaded, unleaded gasoline and diesel fuel. Reinforced with a single ply of braided cord, the Dayco Fuel Line Hose meets SAE J30R7 requirements and meets the fuel permeation requirements of SAE J1527 Type 2, Class B specifications. This hose specification does not meet any EPA or California Resources Board emissions requirements and should be used only on vehicles exempt from such emission regulations.

Note: Not suitable for gasoline/oil mixed fuels, alcohol blended fuels, or bio-diesel fuel. NOT suitable for fuel injection systems. For use on vehicles not subject to CARB or EPA requirements.

Part No.	I.D.	Length	Max. Working Pressure (psi)	Part No.	I.D.	Length	Max. Working Pressure (psi)
80051	1/8"	25' Spool	50	80063	3/8"	25' Spool	50
80052	1/8"	50' Carton	50	80064	3/8"	50' Carton	50
80053	1/8"	250' Reel	50	80065	3/8"	250' Reel	50
80054	3/16"	25' Spool	50	80066	7/16"	25' Spool	35
80055	3/16"	50' Carton	50	80067	7/16"	50' Carton	35
80056	3/16"	250' Reel	50	80068	7/16"	250' Reel	35
80057	1/4"	25' Spool	50	80073	1/4"	2' Clamshell	50
80058	1/4"	50' Carton	50	80074	5/16"	2' Clamshell	50
80059	1/4"	250' Reel	50	80075	3/8"	2' Clamshell	50
80060	5/16"	25' Spool	50	93036	1/2"	25' Spool	35
80061	5/16"	50' Carton	50	93037	5/8"	25' Spool	35
80062	5/16"	250' Reel	50	93038	3/4"	25' Spool	35

DAYPERM® Hose



This low permeation, multi-layered rubber hose is recommended as a fuel liquid or vapor carrying component for low to medium pressure (50 psi or less, not fuel injection). The Dayco Dayperm® Hose is ideally suited for automotive, lawn and garden, off-road and small industrial trucks and truck fleet applications. Compatible with leaded, unleaded, diesel, and gasohol fuels, the Dayco Dayperm® Hose has received approval for use in California market under Component Executive Order C-U-06-030 and meets SAE30R11 applications. It meets SAE 30R7 pressure requirements and should be used in place of conventional 30R7 for gasohol and oil/gas mixes.

Note: NOT suitable for bio-diesel fuel.

Part No.	I.D.	Length	Part No.	I.D.	Length
80142	1/4"	2' Clamshell	80148	5/16"	50' Box
80143	1/4"	25' Spool	80149	5/16"	250' Reel
80144	1/4"	50' Box	80150	3/8"	2' Clamshell
80145	1/4"	250' Reel	80151	3/8"	25' Spool
80146	5/16"	2' Clamshell	80152	3/8"	50' Box
80147	5/16"	25' Spool	80153	3/8"	250' Reel

SERVICE HOSE

DAYPERM® II Hose



The Dayco Dayperm® II Hose is a multi-layered rubber hose with low permeation recommended for carburetion applications on small engines and older carbureted vehicles using liquid fuels. This hose meets all SAE J30R14T2 requirements and is CARB and EPA compliant. The Dayco Dayperm® II Hose is compatible with leaded, unleaded, and gasohol fuels, as well as diesel and biodiesel fuel and ethanol blended gasoline.

Part No.	I.D.	Length	Part No.	I.D.	Length
80520	1/4"	2' Clamshell	80526	3/8"	2' Clamshell
80521	1/4"	25' Spool	80527	3/8"	25' Spool
80522	1/4"	250' Reel	80528	3/8"	250' Reel
80523	5/16"	2' Clamshell			
80524	5/16"	25' Spool			
80525	5/16"	250' Reel			

Fuel Injection Hose



Designed to safely and efficiently handle the higher pressure, temperatures, and chemical problems inherent in today's hotter running, fuel injected engines, the Dayco Fuel Injection Hose is constructed with a tough fluoro-elastomer, low permeation, gasohol and diesel fuel inner tube that provides exceptional resistance to alcohol blended fuels that weaken normal fuel injection hose.

A special braided reinforcement delivers a recommended working pressure of 100 psi, with a burst strength of 900 psi. The abrasion-resistant outer cover resists temperature extremes of -30°F (-34.5°C) to +300°F (+148.9°C) as well as oil, grease, ozone, and coolants. Dayco Fuel Injection Hose meets SAE J30R9 and meets CARB requirements (EO#C-U-05-002). For easy and attractive merchandising, this hose is available in 18" clamshell packs. Note: Suitable for diesel and biodiesel fuel.

Part No.	I.D.	Length	Part No.	I.D.	Length
80078	1/4"	18" Clamshell	80088	1/4"	25' Spool
80079	5/16"	18" Clamshell	80089	5/16"	25' Spool
80080	3/8"	18" Clamshell	80090	3/8"	25' Spool
80083	1/4"	10' Carton	80091	1/4"	250' Reel
80084	5/16"	10' Carton	80092	5/16"	250' Reel
80085	3/8"	10' Carton	80093	3/8"	250' Reel

In-Tank Fuel Line Hose



The Dayco In-Tank Fuel Line Hose is capable of handling gasoline, alcohol blended gasoline or diesel fuel used in mobile and stationary applications. Designed for use in fuel injection systems where the hose may be submerged in the fuel tank, this hose has a maximum working pressure of 0.69 MPa (100 psi) and is suitable for use in normal operating temperatures of -29°F (-33.9°C) to 212°F (100°C) and intermittent use at 257°F (125°C). This Dayco In-Tank Fuel Line Hose also meets SAE J30R10 requirements.

Part No.	I.D.	Length	Part No.	I.D.	Length
80159	1/4"	12"	80162	1/4"	10'
80160	5/16"	12"	80163	5/16"	10'
80161	3/8"	12"	80164	3/8"	10'

SERVICE HOSE

Plastic Fuel Line And Vacuum Tubing Connectors



These Dayco glass-filled nylon, straight, "Y", elbow, tee and reducing connectors produce a leak-proof splice between vacuum line tubing, fuel line hose, coolant hose, or other small I.D. hoses and are ideally suited for all jobs requiring 3/32", 1/8", 5/32" and 3/16" I.D. connections. A molded circumferential flange provides a hose stop that assures that the hose is inserted to the proper depth. The connectors are packaged and sold in poly bags, one per package.

PartNo.	Size	Style	PartNo.	Size	Style
80600	3/32"	Y	80622	5/32"	Elbow
80601	1/8"	Y	80623	3/16"	Elbow
80603	3/16"	Y	80630	3/32"	Tee
80610	3/32"	Straight	80631	1/8"	Tee
80611	1/8"	Straight	80632	5/32"	Tee
80612	5/32"	Straight	80633	3/16"	Tee
80613	3/16"	Straight	80640	1/8" > 3/32"	Reducer
80620	3/32"	Elbow	80642	5/32" > 1/8"	Reducer
80621	1/8"	Elbow	80643	1/4" > 3/16"	Reducer

Anti-Smog/PCV Hose

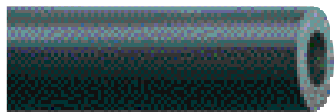

Designed for applications in cars and trucks where petroleum vapors and blow-by gases are recirculated through the intake manifold for total combustion and reduced emissions, and on gasoline engines for fuel line applications, the Dayco Anti-Smog/PCV Hose features a tube and cover compound that resists oil and helps reduce emissions to acceptable EPA levels. The single ply of cord reinforcement provides increased strength and flexibility. The Dayco Anti-Smog/PCV Hose meets SAE J30R7 requirements and is available in either 50' cartons or 20" clamshell packs for ease of merchandising.

Note: NOT suitable for fuel injection applications.

Part No.	I.D.	Max. Working Pressure (psi)	Length
80069	11/32"	50	50' Carton
80070	15/32"	35	50' Carton
80071	19/32"	35	50' Carton
80369	11/32"	50	20" Clamshell
80370	15/32"	35	20" Clamshell
80371	19/32"	35	20" Clamshell

SERVICE HOSE

Windshield Washer/Vacuum Tubing

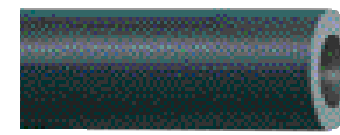

Designed to replace worn windshield washer tubing, as well as general automotive vacuum applications such as retractable headlights, sensors, etc., the Dayco Windshield Washer/Vacuum Tubing has a temperature rating of -40°F (-40°C) to +212°F (+100°C). It features a flexible, long-life EPDM rubber construction that resists normal use exposure to oil, grease, and heat deterioration, and remains flexible at low temperatures. The tubing meets the material specification for SAE J1037. The hose is available in either 50' spools, or 6' clamshell packs for easy merchandising.

Part No.	I.D.	O.D.	Length
80204	1/4"	29/64"	50' Spool
80205	7/64"	7/32"	50' Spool
80206	5/32"	11/32"	50' Spool
80207	7/32"	23/64"	50' Spool
80208	9/32"	3/8"	50' Spool
80209	7/64"	7/32"	6' Clamshell
80210	5/32"	11/32"	6' Clamshell
80211	7/32"	23/64"	6' Clamshell
80216	5/32"	11/32"	250' Reel
80217	7/32"	23/64"	250' Reel

Emission Control Carburetor Pre-Heater Duct Hose



Designed to connect the air cleaner to the exhaust manifold to prevent carburetor icing in cold weather, the Dayco Emission Control Carburetor Pre-Heater Duct Hose features a heavy duty, flexible, aluminum core and corrugated construction that can easily be cut with a sharp knife to facilitate the proper fit between air cleaner and exhaust manifold. The close inside diameter tolerance provides a tight fit to reduce carburetor icing.

Part No.	I.D.	Length
80098	1 1/2"	36"
80101	1 3/4"	36"
80104	2"	36"

Autoflex® Defroster Duct Hose



The Dayco Autoflex® Defroster Duct Hose, designed for all under-dash air connections, hot or cold, including defroster vents and fresh air intakes, is made with tough, lightweight, and flexible reinforced vinyl. The hose can be installed in minutes and can be clamped or taped to existing fittings. Available in 15 I.D. sizes, it services a wide range of applications. Individually boxed 6' lengths are compressed to 28" per box for easy stocking.

Part No.	I.D.	Length	Part No.	I.D.	Length
80165	1 1/4"	6'	80173	3 1/2"	6'
80166	1 1/2"	6'	80174	3 3/4"	6'
80167	1 3/4"	6'	80175	4"	6'
80168	2"	6'	80176	4 1/2"	6'
80169	2 1/4"	6'	80177	5"	6'
80170	2 1/2"	6'			
80171	2 3/4"	6'			
80172	3"	6'			

SERVICE HOSE

Driveway Signal Hose



Designed for driveway use in service station and garages, the Dayco Driveway Signal Hose is tough enough to withstand the weight of any vehicle, yet sensitive enough to detect the slightest pressure, signaling a customer's presence.

Part No.	I.D.	Length
80186	3/8"	50' Carton
80187	3/8"	100' Carton
80188	3/8"	125' Carton
80189	3/8"	200' Carton

Fuel Filler Hose



Dayco Fuel Filler Hose handles leaded and unleaded gasoline, diesel fuel, gasohol, and oxygenated fuels. The rugged, double reinforced construction helps prevent hose collapse. Designed to connect the filler neck to the fuel tank on cars, light trucks and boats as well as auxiliary fuel tanks on RVs, the hose meets SAE J30R7 and SAE J1527, Style R2 requirements. Dayco Fuel Filler Hose is supplied in three foot lengths in six different I.D.s to maximize application coverage.

Part No.	I.D.	Length	Part No.	I.D.	Length
80303	1 1/2"	3'	80306	2"	3'
80304	1 3/4"	3'	80307	2 1/4"	3'
80305	1 7/8"	3'	80308	2 1/2"	3'

Service Station Shop Air and Air Impact Tool Hose



The Dayco Service Station Shop Air and Air Impact Tool Hose features a heavy, abrasion resistant cover combined with a specially reinforced, seamless, nonporous smooth tube that provides increased pull and burst strength, durability, and maximum service life. Designed for high quality general purpose air hose, the Dayco Air Hose fills many applications around a service station or manufacturing shop such as inflating tires, blow nozzles, and machine air connection.

Part No.	Hose I.D.	Length	Max Working Pressure (psi)	Couplings
80001	1/4"	250' Reel	200	None
80002	1/4"	25' Coupled	200	1/4" - Male/Male
80003	1/4"	50' Coupled	200	1/4" - Male/Male
80004	3/8"	25' Coupled	200	3/8" - Male/Male
80005	3/8"	50' Coupled	200	3/8" - Male/Male
80006	3/8"	25' Coupled	200	1/4" - Male/Male
80007	3/8"	50' Coupled	200	1/4" - Male/Male
80010	1/2"	25' Coupled	200	1/2" - Male/Male
80011	1/2"	50' Coupled	200	1/2" - Male/Male

SERVICE HOSE

Multi-Purpose Hose

The Dayco Multi-Purpose Hose replaces the Dayco GST® II Hose



Constructed of EPDM tube and cover and designed to handle air and water service as well as many agricultural chemicals up to 200 psi, the Dayco Multi-Purpose Hose resists heat, sunlight, ozone and weathering while the hose's two-ply of reinforcement provides strength and resistance to kinking. This hose exceeds RMA Class C medium oil resistance requirement. In addition, the Dayco Multi-Purpose Hose has been designed to withstand temperature variations of -40°F (-40°C) to +212°F (+100°C).

Note: NOT suitable for the transfer of petroleum products, steam, paint spray, gasoline, anhydrous ammonia, or LP gas service.

Part No.	Reel Qty.	I.D.	Braid	O.D.	Max Recommended Working Pressure
80130	900' + 50'-0'	1/4"	2	1/2"	200
80131	700' + 50'-0'	3/8"	2	5/8"	200
80132	550' + 50'-0'	1/2"	2	13/16"	200
80133	450' + 50'-0'	5/8"	2	31/32"	200
80134	400' + 50'-0'	3/4"	2	1 7/64"	200
80135	250' + 50'-0'	1"	2	1 13/32"	200

Premium Multi-Purpose Hose

The Dayco Premium Multi-Purpose Hose replaces the Dayco Thoro-Flo® Multi-Purpose Hose



Designed to transmit air, water, oil and chemicals in service up to 300 psi, the Dayco Premium Multi-Purpose Hose, consisting of a nitrile tube, neoprene cover and two-ply of textile reinforcement, can be depended upon to provide long lasting service in a variety of applications requiring the transmission of air, water, oil or chemicals. The Dayco Premium Multi-Purpose Hose features a tube compounded to deliver maximum oil resistance. In addition, the Dayco Premium Multi-Purpose Hose has been designed to withstand temperature variations of -20°F (-29°C) to +212°F (+100°C). This hose is electrically nonconductive with a minimum resistance of one megohm per inch at 1000 volts DC.

Note: NOT suitable for steam, paint spray, gasoline, anhydrous ammonia, or LP gas service. Do NOT use for hot, dry air applications.

50 Ft. Part No	250 Ft. Part No	I.D.	Reinforcing Layers	O.D.	Max Recommended Working Pressure
80015	80016	1/4"	2	5/8"	300
80019	80020	5/16"	2	11/16"	300
80023	80024	3/8"	2	3/4"	300
80027	80028	1/2"	2	29/32"	300
80031	80032	5/8"	4	1 1/16"	300
80035	80036	3/4"	4	1 1/4"	300

SERVICE HOSE

Air Brake Hose



The Dayco Air Brake Hose features a high quality, smooth rubber cover that is weather, abrasion, and ozone resistant. Designed for use on truck and bus compressed air brake systems, the hose is reinforced by four textile spirals for a rated minimum burst pressure of 900 psi (225 psi maximum working pressure) and possesses a seamless synthetic inner tube with a temperature rating of -40°F (-40°C) to +212°F (+100°C). This hose meets SAE J1402 and DOT FMVSS 106, Type A requirements for 3/8" and 1/2" SP dimension hose.

Note: Air Brake Hose assemblies must be identified by the assembler per DOT FMVSS 571.106 if used in motor vehicle air brake applications.

Part No.	I.D.	Length	
80372	3/8"	50'	Carton
80373	3/8"	250'	Reel
80374	3/8"	500'	Reel
80376	1/2"	50'	Carton
80377	1/2"	250'	Reel

GOLD LABEL® Heavy Duty Hump Hose, Elbows and Reducer Sleeves



Designed as a fitting to aid in conveying air from an exterior air filter to the engine, the Dayco Gold Label® Heavy Duty Hump Hose, Elbows, and Reducer Sleeves are molded neoprene rubber with smooth radii and inside surfaces to maximize air flow and keep the air column streamlined and out of the turbulent flow range. This line of fittings has a temperature range of -40°F (-40°C) to +250°F (+121°C). The Dayco Hump Hose fittings allow up to 20 degrees of misalignment and cushion the system from harmful vibrations.

SERVICE HOSE

Air Intake Hump Hose

- 78601GL 3"
- 78604GL 3.5"
- 78607GL 4"
- 78610GL 4.5"
- 78613GL 5"
- 78616GL 5.5"
- 78619GL 6"
- 78625GL 7"
- 78631GL 8"
- 78643GL 10"

Reducing Hump Hose

- 78651GL 3.5" to 3"
- 78655GL 4" to 3"
- 78659GL 5" to 4"
- 78663GL 5.5" to 4"
- 78667GL 5.5" to 5"
- 78671GL 6" to 5"
- 78675GL 6" to 5.5"
- 78679GL 7" to 5.5"
- 78683GL 7" to 6"
- 78687GL 8" to 5.5"
- 78691GL 8" to 6"
- 78695GL 8" to 7"
- 78699GL 10" to 8"

Insert Reducers

- 78952GL 4.5" to 4"
- 78956GL 5" to 4"
- 78960GL 5" to 4.5"
- 78964GL 5.5" to 4"
- 78968GL 5.5" to 5"
- 78972GL 6" to 5"
- 78976GL 6" to 5.5"
- 78980GL 7" to 6"
- 78994GL 8" to 7"

Short Radius 90° Elbows

- 78890GL 5"
- 78892GL 6"

Air Intake 45° Elbows

- 78711GL 3"
- 78715GL 3.5"
- 78719GL 4"
- 78723GL 4.5"
- 78717GL 5"
- 78731GL 5.5"
- 78715GL 6"
- 78719GL 7"
- 78743GL 8"
- 78717GL 10"

Reducing 45° Elbows

- 78775GL 6" to 5.5"
- 78783GL 7" to 6"

90° Elbows

- 78802GL 3"
- 78805GL 3.5"
- 78808GL 4"
- 78811GL 4.5"
- 78814GL 5"
- 78817GL 5.5"
- 78820GL 6"
- 78826GL 7"
- 78832GL 8"
- 78841GL 10"

Reducing 90° Elbows

- 78873GL 6" to 5"
- 78875GL 6" to 5.5"
- 78879GL 7" to 5"
- 78892GL 7" to 5.5"

Special Elbows

- 78902GL 22° Elbow, 4"
- 78906GL 22° Elbow, 5.5"
- 78910GL 22° Elbow, 6"
- 78925GL 54° Elbow, 5.5"
- 78927GL 54° Elbow, 6"
- 78930GL 68° Elbow, 4.5"
- 78934GL 68° Elbow, 5.5"
- 78939GL 68° Elbow, 6"

GARAGE EXHAUST HOSE

Garage Exhaust Hose And Accessories

Exhaust Systems: In service stations, garages or car dealerships which have overhead or under floor exhaust systems, the entire system (blower, primary and intermediate ductwork, etc.) should be checked periodically to ensure that the system conforms to OSHA specifications. Of particular concern in under floor systems, is the prevention of clogging of the ductwork (with rags, water, or other foreign material). The system will be expected to maintain an environmental reading in the shop of LESS than 55 parts per million of carbon monoxide or other noxious emittants.

Suggestions to Prolong Hose Life

Heat Resistance: With catalytic converter equipped cars which produce heat (up to 600°F) at the tailpipe, attention should be paid to the following:

1. Always use the proper tailpipe adapter. It is not advisable to put hose directly over the tailpipe. This will significantly decrease the service life of the hose. Select adapters which will have an opening at least one and a half times the O.D. of the tailpipe to allow for the influx of cooler, room temperature air. 64030 = 3" I.D. 64035 = 3 1/2" 64048 = oval-shaped for oval pipes and twin VW pipes 2" x 5" opening.
2. Select the proper size of hose. OSHA recommendations call for a minimum of 3" I.D. hose. The larger the hose, the greater the flow capability of the system. This is important because when the fumes attain the high heat characteristic of today's vehicles, these fumes have to be evacuated through a line which offers the least friction loss or static pressure (resistance). 2 1/2" I.D. hose can be used where the exhaust system is exceptionally efficient and the blower is sized to overcome the increased resistance.

APPLICATION SIZE DATA	
I.D.	TYPE
2"	Motorcycles
2 1/2"	Small Passenger Cars
3"	Regular Passenger Cars
3 1/2"	Light Trucks
4"	Gasoline Trucks
5"	Diesel Trucks

Flare-Vent Hose



Designed to connect the vehicle's exhaust pipe to a central exhaust system or a garage door vent, the Dayco Flare-Vent Hose features an accordion-type design for added flexibility, and a flared end for connecting one length to another. No separate connectors are required.

Part No.	I.D.	Length	Part No.	I.D.	Length
63520	2"	11'	63535	3 1/2"	11'
63525	2 1/2"	11'	63540	4"	11'
63530	3"	11'			

Super-Vent® Hose



Designed for overhead exhaust systems where a tight bend radius is required, the Dayco Super-Vent® Hose features an accordion-type design which enables it to make turns with a small bend radius. It is available in either 4" or 5" I.D.

Part No.	I.D.	Extended Length
63640	4"	20'
63650	5"	12'

GARAGE EXHAUST HOSE

Tailpipe Adapters

Designed to interface between an auto or truck tailpipe or diesel truck stack and the garage exhaust hose itself and constructed to withstand the high tailpipe temperatures of modern vehicles, a variety of shapes and sizes of Dayco Tailpipe Adaptors are available to enable an exact match for virtually every application need. The adapters feature a universal design that will mate with the appropriate connectors.

Universal Straight Adapter



Part Number 64025
• Use with tailpipes 1 1/2" O.D. to 2" O.D.

Part Number 64030
• Use with tailpipes 2" O.D. to 2 1/2" O.D.

Part Number 64035
• Use with tailpipes 2 1/2" O.D. to 3" O.D.

Universal Bell-Shaped Adapter



Part Number 64125
• Use with 2 1/2" and 3 1/2" hose.
• Screws over 2 1/2" or into 3 1/2" hose

Part Number 64130
• Use with 2" and 3" hose. Screws over 2" or into 3" hose

Universal Oval Adapter



Part Number 64048
• Use with 3" or 4" flare vent hose.
• For use on twin tailpipes and oval tailpipes. Screws over 3" or into 4" hose. 2 1/2" x 6" oval

Universal Straight Truck Adapter

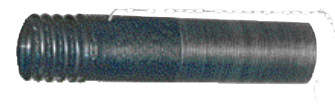

Part Number 64140
• Use with tailpipe adapter for trucks (4" I.D. opening)
• Threads over 3 1/2" or into 4" hose

Universal Truck Stack Adapter



Part Number 64060
• Use with tailpipe adapter for trucks (5.5" I.D. opening)

Part Number 64066
• Use with tailpipe adapter for trucks (6" I.D. opening)

GARAGE EXHAUST HOSE

Y-Connectors



Designed for the merging of two hoses into one typically used with dual exhaust vehicles.

Part Number 64220

- Use with 2" hose

Part Number 64225

- Use with 2 1/2" hose

Part Number 64230

- Use with 3" hose

Part Number 64240*

- Use with 4" hose

*Aluminum Connector

Door Port Fittings



Designed for service station and garage doors.

Part Number 64425

- Use with 2 1/2" hose

Part Number 64430*

- Use with 3" hose

Part Number 64440*

- Use with 4" hose

*Aluminum Connector

Splice Connectors



Designed for joining multiple lengths of exhaust hose.

Part Number 64520

- Use with 2" hose

Part Number 64525

- Use with 2 1/2" hose

Part Number 64530

- Use with 3" hose

Part Number 64540

- Use with 4" hose

merchandise



DAYCO®

STANDS, CABINETS, & KITS

Wallboard Merchandiser



The most popular inventory and display system for Dayco V-Belts, Flex Hose, Curved Hose and Straight Radiator Hose. Includes 10 boards and 80 wallboard hooks.

Part Number 93902 (Wallboard Merchandiser without product)
Part Number 93897 (6" Wallboard Hooks)

Finger Rack Merchandiser



The Dayco Finger Rack Merchandiser is essential when space is at a premium. Each rack is 4-feet long and will accommodate 55 belts. There are four nail holes for easy mounting on the wall. When hanging the belt on the rack (sideways), pull the belt down through the sleeve. The sleeve will remain on the hook, which will enable the user to re-order belts for stock.

Part Number 93900

Hose Clamp Merchandiser

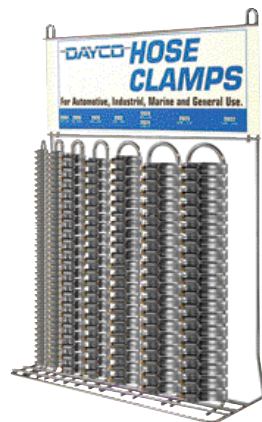

This Dayco Display Merchandiser provides an easy method to organize and sell the most popular hose clamps for both jobbers and dealers. This display can be purchased separately or can be shipped with 200 clamps, featuring eight of the most popular sizes.

Part Number 99051
Part Number 99056 (Hose Clamp Display Merchandiser without product)

Part No.	Qty.	Part No.	Qty.
91004	40	91020	10
91006	40	91024	10
91010	30	91028	20
91012	30	91032	20

STANDS, CABINETS, & KITS

Heater Hose Merchandiser Stand And 6-Spool Cabinet With Product



The Dayco Heater Hose Merchandiser Stand features heavy duty steel racks (22 3/4" wide x 51 1/2" high x 19 1/2" deep) which hold six spools of Dayco hose and tubing and three cartons of Dayco heater hose. Included is a 12" measurement guide for tubing and a 36" guide for measuring heater hose.

Part Number 99103

Part No.	I.D.	Length	Part No.	I.D.	Length
80057	1/4"	25'	80207	7/32"	50'
80060	5/16"	25'	80312	1/2"	50'
80063	3/8"	25'	80314	5/8"	50'
80205	7/64"	50'	80316	3/4"	50'
80206	5/32"	50'			

Heater Hose Merchandiser Stand And 9-Spool Cabinet with Product



The Dayco Heater Hose Merchandiser Stand with heavy duty steel racks (22 3/4" wide x 53" high x 21" deep) is designed to hold nine spools of Dayco hose and tubing and three cartons of Dayco heater hose. Included is a 12" measurement guide for tubing and a 36" guide for measuring heater hose.

Part Number 99104

Part No.	I.D.	Length	Part No.	I.D.	Length
80057	1/4"	25'	80205	7/64"	50'
80060	5/16"	25'	80206	5/32"	50'
80063	3/8"	25'	80207	7/32"	50'
80088	1/4"	25'	80312	1/2"	50'
80089	5/16"	25'	80314	5/8"	50'
80090	3/8"	25'	80316	3/4"	50'

Heater Hose Merchandiser Stand With Product



Only 22 3/4" wide x 39 1/2" high x 19 1/2" deep, this rugged steel Dayco Heater Hose Merchandiser Stand holds three cartons of Dayco Heater Hose. Included is a 36" guide for measuring heater hose.

Part Number 99100
Part Number 99080 (Merchandiser Stand without product)

Part No.	I.D.	Length
80312	1/2"	50'
80314	5/8"	50'
80316	3/4"	50'

STANDS, CABINETS, & KITS

6-Spool Windshield Washer Vacuum Tubing And Fuel Line Hose Merchandiser Cabinet with Product



Designed to hold six Dayco spools of hose, the Dayco Windshield Washer Vacuum Tubing and Fuel Line Hose Merchandiser Cabinet measures 22 3/4" wide x 12" high x 19 1/2" deep for convenient mounting on the Dayco Heater Hose Merchandiser Rack or counter. Includes a 12" guide for easy measuring.

Part Number 99101
 Part Number 99081 (Merchandiser Cabinet without product)
 Merchandiser shipped with nine spools each of the following hose.

Part No.	I.D.	Length	Part No.	I.D.	Length
80057	1/4"	25'	80205	7/64"	50'
80060	5/16"	25'	80206	5/32"	50'
80063	3/8"	25'	80207	7/32"	50'

9-Spool Windshield Washer Vacuum Tubing And Fuel Line Hose Merchandiser Cabinet with Product



Fabricated from heavy duty steel (22 3/4" wide x 14" high x 21" deep), this Dayco Merchandiser Cabinet holds nine spools of Dayco hose. Includes a 12" measurement guide for easy use. For maximum utility this unit can be mounted on the Dayco Heater Hose Rack or on counter.

Part Number 99102
 Part Number 99083 (Merchandiser Cabinet without product)
 Merchandiser shipped with nine spools each of the following hose.

Part No.	I.D.	Length	Part No.	I.D.	Length
80057	1/4"	25'	80090	3/8"	25'
80060	5/16"	25'	80205	7/64"	50'
80063	3/8"	25'	80206	5/32"	50'
80088	1/4"	25'	80207	7/32"	50'
80089	5/16"	25'			

STANDS, CABINETS, & KITS

Fuel Line And Vacuum Tubing Connector Kit



This sturdy, plastic kit provides a convenient storage display unit for fuel line and vacuum tubing connectors. The cover is labeled to identify the connectors stocked in each compartment.

Part Number 99105

Each kit contains two each of the following part numbers:

Part No.	Size	Style	Part No.	Size	Style
80600	3/32"	Y	80622	5/32"	Elbow
80601	1/8"	Y	80623	3/16"	Elbow
80603	3/16"	Y	80630	3/32"	Tee
80610	3/32"	Straight	80631	1/8"	Tee
80611	1/8"	Straight	80632	5/32"	Tee
80612	5/32"	Straight	80633	3/16"	Tee
80613	3/16"	Straight	80640	1/8" - 3/32"	Reducer
80620	3/32"	Elbow	80642	5/32" - 1/8"	Reducer
80621	1/8"	Elbow	80643	1/4" - 3/16"	Reducer

Heater Hose Connector Kit



This sturdy, plastic unit provides a functional method of displaying or storing an assortment of heater hose connectors. The unit opens from both sides to provide multiple storage compartments. Each cover is labeled to identify the connectors stored in each compartment.

Part Number 99106

Each kit contains two each of the following part numbers:

Part No.	Size	Style	Part No.	Size	Style
80650	1/4"	Straight	80671	3/8"	Elbow
80651	3/8"	Straight	80672	1/2"	Elbow
80652	1/2"	Straight	80673	5/8"	Elbow
80653	5/8"	Straight	80674	3/4"	Elbow
80654	3/4"	Straight	80680	1/4"	Tee
80660	1/2" > 3/8"	Reducer	80681	3/8"	Tee
80661	5/8" > 1/2"	Reducer	80682	1/2"	Tee
80662	3/4" > 5/8"	Reducer	80683	5/8"	Tee
80670	1/4"	Elbow	80684	3/4"	Tee

BELT & HOSE INSTALLATION TOOLS

Belt Diagnostic Kit



The number one complaint with belts today is noise and the number one cause for belt noise is misalignment. Designed to diagnose misalignment, tension and wear within a belt drive system, the Dayco Belt Diagnostic Kit has all the tools needed to properly identify misalignment, belt tension and worn multi-rib belts.

Kit includes: belt tension gauge, two piece laser alignment tool, belt wear gauges, tension chart, replacement battery and battery installation wrench.

Part Number 93874

Belt Tension Gauges



Improperly tensioned belts cause slippage, squealing, heat build-up and premature failure. Dayco engineers recommend careful belt tensioning. After a new belt has been installed, run the engine for three to five minutes to seat the belt.

Kriket Pocket Gauge for V-Belts - Part Number 93865

Kriket II Pocket Gauge for Ribbed Belts - Part Number 93866

Dayco Recommended Tensioning Levels						
	Belt Top Width / Size SAE / Dayco Series			New Belt Installation Tension	RETENSION Amount (After 3-5 minute Run-in)	*Used Belt Tension (Measured after belt is allowed to cool)
	IN	DAYCO	METRIC	Lbs.	Lbs.	Lbs.
V-BELTS	1/4 / 0.250	09	6A	90	70	45
	5/16 / 0.315	11	8A	110	90	50
	3/8 / 0.380	13	10A	140	112	65
	7/16 / 0.440	15	11A	150	120	70
	1/2 / 0.500	17	13A	160	128	75
	11/16 / 0.600	22	15A	175	140	80
	3/4 / 0.660	24	17A	190	152	90
	7/8 / 0.790	28	20A	200	160	90
POLYRIB	3K	3PK	3 Ribs	105	90	45
	4K	4PK	4 Ribs	140	120	60
	5K	5PK	5 Ribs	175	150	75
	6K	6PK	6 Ribs	210	180	90
	7K	7PK	7 Ribs	245	210	105
	8K	8PK	8 Ribs	280	240	120

*The used belt tension is the amount of tension that would typically be maintained under normal drive conditions by the given belt size. If the tension drops below the used belt tension, then the belt should be re-tensioned according to the RETENSION amount. If the belt is shown to be worn, either caused by excessive slipping or just normal long term operation, then the belt should be REPLACED rather than retensioned.

aWEARness® Gauge



By simply placing the notched area lengthwise over the ribbed section of the belt, this pocket size device quickly and easily identifies the potential of serpentine belt failure. If there are more than four cracks per inch in the belt, trade practice recommends the belt be replaced.

Inspects belt wear in these unique ways:

- Rib Profile
- Rib Depth
- Rib Cracking

Part Number 047337

BELT & HOSE INSTALLATION TOOLS

Factfinder® Gauge II



A quick check shows the top width and length/part number of the corresponding Dayco FHP Utility V-Belt or GPL® Premium Utility Belt, Industrial A and B Belts, plus 3VX and 5VX Dayco Gold Label® VX-Wedge® Belts. Measures belts up to 100”.

Part Number 93859

Factfinder® Gauge III



front view



back view

Measures all multi-ribbed belts (competitive or OEM) up 115” in effective length and indicates the corresponding Dayco replacement belt size. The Dayco Factfinder® Gauge III measures V-Belts up to 28/32” top width and 100” effective length.

Part Number 93860

Factfinder® Gauge III Extension



Extends measurement of V-Belts up to 130” and multi-ribbed belt measurements up to 145”. Easily attaches to the Dayco Factfinder® Gauge III for accurate measurement of larger sized V-Belts and multi-ribbed belts and quick identification of corresponding Dayco replacement sizes.

Part Number 93863

BELT & HOSE INSTALLATION TOOLS

Factfinder® Gauge III Brackets



These “holding” brackets allow the Dayco Factfinder® Gauge III to be mounted on a wall, counter or convenient location of your choice permitting both hands to be free for the accurate measuring and easy size verification of conventional V-Belts or multi-rib belts.

Part Number 93861

ela® Belt Installation Tool



The Dayco ela® Belt installation tool is required when specified on certain ela® “stretch” belt applications. Some ela® belts require only a simple zip tie to install, so please verify the Dayco ela® belt installation tool is required for your application. Do not attempt to install by prying the belt on the pulleys.

- ela belt and belt tool sold separately
- Can be used on multiple Dayco ela “Stretch” belts
- Includes reusable mounting bolt
- Includes installation instructions

Part Number 93875

Subaru® ela® Belt Installation Tool



Dayco now offers the required tool for proper installation of Dayco ela® belts on 2008-2010 Subaru® Impreza®, Forester® and Outback® models with 2.5L engines. Attempting to install the belt without this tool will result in damage to the belt.

Part Number 93878

BELT & HOSE INSTALLATION TOOLS

OAP and OAD Tool Kit



Overrunning alternator pulleys (OAP) and overrunning alternator decoupler pulleys (OAD) should only be removed from the alternator using the proper tools.

The Dayco OAP and OAD Tool Kit contains all of the tools needed to remove and fit a new OAP or OAD. Made from the highest quality materials, our tool kit can be used with hand ratchets or impact guns. This 13-piece kit features interchangeable components to work on almost all vehicles and comes in a handy molded carrying case.

Kit Includes:

- Removal and Installation Instructions
- OAP/OAD Connectors in 33T Spline and 17mm Hex
- Alternator Shaft Connectors in T40, T50, M8, M10, 8 Hex and 10 Hex

Note: OAPs and OADs are application-specific replacement parts, and if a vehicle requires an OAP or an OAD, the same category of pulley must be installed. Proper tools must be used to remove and install OAPs and OADs.

Part Number 93877

Timing Belt Cam Tool

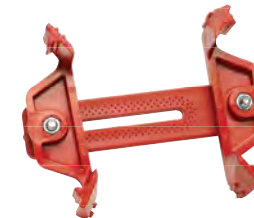

The Dayco Timing Belt Cam Tool is designed for locking timing belt gears during service. To retain engine timing position during timing belt removal and installation, twin camshafts must be locked on their timing marks. The Dayco Timing Belt Cam Tool's adjustable arms fit into the gear's teeth and expand to securely hold in place gear sizes from 4” to 6” (101mm to 152mm) with gear separation up to 3” (76mm).

Part Number 93873

Telescopic Retrieval Pole



This sturdy aluminum telescoping pole extends from 52” to 94 1/4” providing that “extra reach” for retrieving belts or hoses from wall boards or finger racks. When extended to the desired length, the poles' unique twist and lock feature prevents the pole from unexpectedly retracting.

Note: NOT recommended for uses other than belt and hose retrieval.

Part Number 93868

Part Number 93870 (replacement hook)

BELT & HOSE INSTALLATION TOOLS

Hose And Tubing Cutter



The Dayco Hose and Tubing Cutter handles non-reinforced and textile reinforced rubber hose and tubing through 2" I.D. A replaceable hardened stainless steel blade allows for a clear cut with no burrs or residue. Featuring a safe to use tough glass filled nylon handle with attached ring, this cutter also allows for ease of carrying or for attaching to the Dayco Hose Display Merchandiser.

Part Number 93847
Part Number 93848 (replacement blades)

Tensioner Retainer Pin Set



The Dayco Tensioner Retainer Pin Set is designed for the installation and maintenance of timing belt tensioners. To safely retain the hydraulic pin of a timing belt tensioner in a compressed state during servicing, Dayco recommends the use of this handy Tensioner Retainer Pin Set. Consisting of six different sized spring hardened steel pins, the set accommodates a wide variety of timing belt tensioners, including certain serpentine belt applications.

Part Number 93872

Belt Installation Tool



This time saving tool from Dayco gives the technician the control and extended reach necessary when installing serpentine belts. The tool has also been designed to help install V-Belts and timing belts that are located in hard-to-access areas. The three-pin design provides convenient belt push/pull capability while the handle gives the technician the twisting control required to install belts in confined or restricted areas.

Part Number 93871

Belt Drive Display



Designed with the technician in mind, the Dayco Belt Drive Display is an educational piece that provides:

- The complete Serpentine and Timing Belt Drive Systems
- Timing Belt replacement complexity
- Wear rate relationship of components

U.S. Part Number 99112
Canada Part Number 99113

HYDRAULIC HOSE



HYDRAULIC HOSE

Style DR6 Hydraulic Hose

Meets SAE 100R6

Designed for use as a low pressure hydraulic line, flexible fuel line, power steering return line, and lubrication line



Dayco's Style DR6 Hydraulic Hose features a nitrile tube and neoprene MSHA-approved cover, with a single textile braid reinforcement. The temperature range is from -40° F to +212° F. This hose is recommended for use with coupling Style DC.

Note: NOT suitable for use in fuel injection applications or bio diesel fuels.

Style DFL Fuel and Oil Hose

Designed for low pressure transmission of oil, gasoline, air or water



Dayco's Style DFL Fuel and Oil Hose features a nitrile tube and black synthetic rubber cover that is resistant to both oil and weather, with one or two textile braid(s) reinforcement. The temperature range is from -40° F to +212° F. This hose is recommended for use with coupling Styles BI and DC.

Note: NOT suitable for use in fuel injection applications or bio diesel fuels.

Style D6FL Fuel and Oil Hose

Designed for low pressure transmission of oil, gasoline, air or water



Dayco's style D6FL fuel and oil hose features a nitrile tube and black synthetic rubber cover that is resistant to both oil and weather, with one, or two textile braid(s) reinforcement. The temperature range is from -40 deg F to + 212 deg F.

Note: not suitable for use in fuel injection applications, or bio diesel fuels.

HYDRAULIC HOSE

Style DR16s Hydraulic Hose

Meets SAE 100R16S

DR16s is designed as a higher pressure version of the conventional SAE100R16. DR16s is used for hydraulic lines on off-the-road construction equipment, machine tools, and mining equipment.



Dayco style DR16s hydraulic hose features an oil resistant synthetic rubber tube and synthetic rubber cover that is resistant to oil, weather and abrasion. DR16s has a reinforcement of two high-tensile steel wire braids. DR16s hose has a 50% smaller bend radius for tighter installations and easier routing. The temperature range is from -40°F to + 250°F. This hose is recommended for use with coupling styles PG and XG.

Style DR15x Hydraulic Hose

Meets SAE 100R15

Designed for extreme high pressure hydraulic service.



Dayco's style DR15x hydraulic hose features an oil resistant synthetic rubber tube and a synthetic rubber cover that is resistant to both oil and weather and is MSHA listed.

The reinforcement is four spiral layers of high-tensile steel wire. The operating temperature range is from -40°F to +250°F. DR15x hose is impulse tested to one million cycles, twice the required number of one-half million cycles the recommended coupling for DR15x is the TG series.

Style DB7 Push-On Hose

Designed for low-pressure transmission of oil, air, water, coolants, etc.



Dayco's Style DB7 Specialty Push-On Hose features a nitrile tube and black synthetic rubber cover that is resistant to both oil and weather, and MSHA-approved, with a single textile braid reinforcement. The temperature range is from -40° F to +212° F (160° F on compressed air applications). This hose is recommended for use with coupling Series PO, BI, and DC. Not intended for alcohol blended fuels.

Note: NOT suitable for impulse applications.

HYDRAULIC HOSE

Style DTC Push-On Hose

Designed for low pressure transmission of oil, air, water, coolants, etc. where operating pressures do not exceed 300 PSI



Dayco's Style DTC Push-On Hose features a nitrile tube and impregnated textile braid cover that is oil and mildew resistant, with a single textile braid reinforcement. The temperature range is from -40° F to +200° F (160° F on compressed air applications). This hose is recommended for use with coupling Styles PO and BI.

Note: NOT recommended for use on impulse applications.

Style DR1 Hydraulic Hose

Meets SAE 100R1AT

Designed for use as medium pressure hydraulic lines on mobile equipment, machine tools and farm machinery



Dayco's Style DR1 Hydraulic Hose features an oil resistant, seamless synthetic rubber tube and cover that is weather resistant with a single high-tensile-steel wire braid reinforcement for increased strength. Style DR1 Hose meets SAE 100R1 AT requirements. The temperature range is from -40° F to +212° F. This hose is recommended for use with coupling Series PG and DC.

Style DR7 Hydraulic Hose

Meets SAE 100R7

Designed for use in medium pressure hydraulic systems which require a thermoplastic tube



Dayco's Style DR7 Hose features a thermoplastic tube and black polyurethane, pin-pricked cover that is abrasion resistant, with a single polyester fiber braid reinforcement. The temperature range is from -40° F to +200° F. This hose is recommended for use with coupling Style DC and TC.

Style DR7E Hydraulic Hose

Meets SAE 100R7 Non-Conductive

Designed for use in medium pressure hydraulic systems which require a non-conductive hose and a thermoplastic tube



Dayco's Style DR7E Hydraulic Hose features a thermoplastic tube and orange polyurethane, non-pin-pricked cover that resists abrasion, with a single polyester fiber braid reinforcement. The temperature range is from -40° F to +200° F. This hose is

HYDRAULIC HOSE

Style DR17 Hydraulic Hose

Exceeds SAE 100R17

Designed for timber processing and handling, agricultural and construction industries requiring an extra tough rubber cover for abrasion resistant applications



Dayco's Style DR17 Hydraulic Hose features a synthetic rubber tube and abrasion resistant cover. Hose IDs of 1/4", 3/8" and 1/2" have one braid of high tensile strength steel reinforcement. Hose IDs of 5/8", 3/4" and 1" consist of two high tensile strength steel reinforcement braids. It is recommended for use with coupling Series DC (sizes 4 thru 12) and PG (Sizes 12 thru 16).

Style DR2 Hydraulic Hose

Meets SAE 100R2AT

Designed for high pressure hydraulic lines on off-the-road construction equipment, machine tools, farm and marine equipment



Dayco's Style DR2 Hydraulic Hose features an oil resistant synthetic rubber tube, a black synthetic rubber cover that is resistant to both oil and weather and, a reinforcement of two high-tensile steel wire braids. The temperature range is from -40° F to +212° F. This hose is recommended for use with coupling Styles PG and DC.

Style DR16 Hydraulic Hose

Meets SAE 100R16

Designed as a replacement for SAE 100R2 high pressure hydraulic lines on off-the-road construction equipment, machine tools and mining equipment



Dayco's Style DR16 Hydraulic Hose features an oil resistant synthetic rubber tube and synthetic rubber cover that is resistant to both oil and weather and a reinforcement of two high-tensile steel wire braids. Compared to SAE 100R2 hose, Dayco's DR16 hose has a 50% smaller bend radius for tighter installations and easier routing. The temperature range is from -40° F to +250° F. This hose is recommended for use with coupling Styles PG and DC.

Style DR12X / DR12 Hydraulic Hose

Meets SAE 100R12

Designed for high pressure hydraulic service

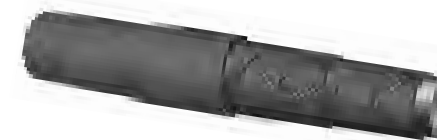

Dayco's Style DR12X / DR12 Hydraulic Hose features an oil resistant synthetic rubber tube and a synthetic rubber cover that is resistant to both oil and weather and MSHA approved, with a reinforcement of four spiral layers of high-tensile steel wire. The temperature range is from -40° F to +250° F. Compared to braided hose, this hose provides longer life under the higher temperatures and pressures of modern hydraulically operated equipment, and meets all SAE 100R12 requirements. This hose is recommended for use with coupling Style PG.

HYDRAULIC HOSE

Style DR4 Hydraulic Hose

Meets SAE 100R4

Designed for use as suction or return line on hydraulic systems



Dayco's Style DR4 Hydraulic Hose features a nitrile tube and synthetic rubber cover that is both oil and weather resistant, with a single textile braid and helix wire reinforcement for exceptional flexibility. Its vacuum rating is 25 inches Hg, and the temperature range is from -40° F to +250° F. This hose is recommended for use with coupling Styles DC (12, 16 & 20 size only) and PG.

Style DGL Hydraulic Hose

Meets SAE J1402 Type A1, DOT FMVSS-106

Designed for use on high temperature truck and bus applications such as diesel fuel, gasoline, hot oil, air brakes and hydraulic lines



Dayco's Style DGL Hydraulic Hose features a seamless chlorinated polyethylene tube and a black textile braid cover that is oil and mildew resistant, with a reinforcement of an inner textile braid and a high-tensile steel wire braid. DGL Hose meets SAE specification J1402, Type A1 and is approved for DOT FMVSS-106 air brake applications (GL couplings only). The temperature range is from -40° F to +300° F. This hose is recommended for use with coupling Styles GL and DC.

Style DR5 Hydraulic Hose

Meets SAE 100R5, SAE J1402 Type A11 and DOT FMVSS-106

Designed for use as a high temperature, medium pressure hydraulic hose on material handling equipment, off-the-road equipment, machine tools and other air, water or oil service



Dayco's Style DR5 Hydraulic Hose features an oil resistant synthetic rubber tube, an impregnated textile braid cover that is resistant to oil and mildew, with a single textile inner braid and single high-tensile steel wire braid reinforcement. DR5 hose meets SAE specifications J1402, Type A11 and DOT FMVSS-106 air brake application (DN couplings only). The temperature range for sizes 4-16 from -40° F to 300° F Continuous service. Size 20 from -40° F to +212° F (300° F intermittent). This hose is recommended for use with coupling Styles DN and DC.

Style DPW DayBlast™ Pressure Washer Hose

Designed for use with pressure washer applications

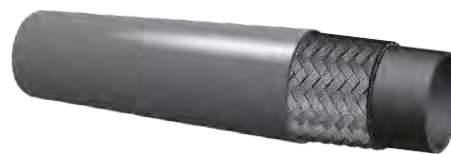

Dayco's DayBlast™ pressure washer hose is a 1 wire SN construction designed specifically for the demands of today's pressure washer applications. This hose features a grey non-marking synthetic rubber cover, a nitrile synthetic rubber blend tube, a temperature capability of up to 300° F and working pressures up to 3,625 psi. This hose is recommended for use with DC couplings.

Note: NOT suitable for steam applications.

HYDRAULIC HOSE

Barrier Refrigerant Hose Style DBH

Exceeds SAE J51, Meets SAE J2064, type C

Designed for use with R12 and R134A refrigerant systems only



Dayco's Style DBH Barrier Refrigerant Hose features nitrile/nylon barrier/neoprene tube construction, and black EPDM cover that is resistant to abrasion, ozone, and heat, with textile reinforcement. The temperature range is from -22° F to +257° F. This hose is recommended for use with coupling style BL and SB.

Style DR14 Hose

Meets SAE 100R14A

Designed for use with corrosive and/or high temperature fluids, but NOT recommended for fuel applications

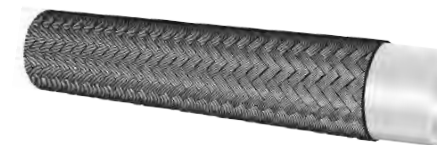

Dayco's Style DR14 Specialty Hose features a white extruded PTFE smooth-bore tube. The cover consists of one braid of high-tensile stainless steel wire. The temperature range is from -65°F to +450°F. For steam, the maximum operating pressure is 200 PSI at +388°F. This hose is recommended for use with coupling Style 91N.

Note: May be used from the air compressor to the air reservoir on truck air brake applications.

HOW TO READ HOSE PART NUMBERS

Dayco hose part numbers are composed of letter(s) and numbers which identify the hose style, and a two-digit number which designates the size. The last two digits in a Dayco part number always designates hose I.D. The numerical size code follows the industry standard "dash number" system which gives the hose I.D. in sixteenths of an inch.

Part Number Definition	Dash Number		Dash Number for Styles DBH, DGL, DR5, DR14			
	Inches	Millimeters	Inches	millimeters		
	-02	1/8	3.2	--	--	
	-03	3/16	4.8	-04	3/16	4.8
	-04	1/4	6.4	-05	1/4	6.4
	-05	5/16	7.9	-06	5/16	7.9
	-06	3/8	9.5	--	--	--
	--	--	--	-08	13/32	10.3
	-08	1/2	12.7	-10	1/2	12.7
	-10	5/8	15.9	-12	5/8	15.9
	-12	3/4	19.0	--	--	--
	--	--	--	-16	7/8	22.2
	-16	1	25.4	--	--	--
	--	--	--	-20	1 1/8	28.6
	-20	1 1/4	31.8	--	--	--
	--	--	--	-24	1 3/8	34.9
	-24	1 1/2	38.1	--	--	--
	--	--	--	-32	1 13/16	46.0
-32	2	50.8	--	--	--	
-40	2 1/2	63.5	--	--	--	
-48	3	76.2	--	--	--	

Examples:
 DR2-08 = STYLE DR2 WITH 1/2" I.D.
 DR12X-16 = STYLE DR12X WITH 1" I.D.

ADAPTERS & COUPLINGS

ADAPTERS & COUPLINGS

Adapters

Designed for use with all styles of Permanent Crimp Couplings

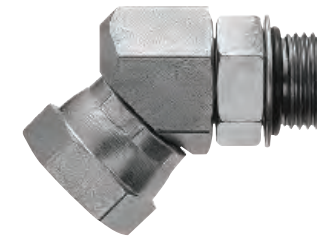

Constructed of steel and/or brass, Dayco's Adapters allow you to conveniently adapt your couplings to meet applications beyond your normal coupling stock. Adapters allow for lower inventory investments with permanent couplings.

Specialty Couplings

Available in coupling styles P0 and BI

Designed for use with styles DB7, DDFL and DTC hose



This Specialty Coupling category covers one piece couplings and barbed inserts. Made of steel and/or brass, these couplings are suited for applications such as low pressure transmission of oil, gas, air, water, etc. In some cases, they are also used on medium pressure applications for transmission of corrosive or high temperature fluids.

Reusable Couplings

Available in coupling styles DN and GL

Designed for use with styles DGL and DR5 hose



Constructed of steel, Dayco's Reusable Couplings are commonly used for medium pressure applications found on truck and bus applications, material handling equipment, off-the-road equipment and machine tools.

ADAPTERS & COUPLINGS

Beadlock Couplings

Designed for use with style DBH hose



Constructed of Aluminum and/or Steel, Dayco's Beadlock AC Couplings are commonly used for low to high pressure refrigerant applications for automotive and heavy duty vehicles.

Permanent Crimp Couplings

Available in coupling styles 91N, BI, DC and PG

Designed for use with the following hose styles: DR6, DFL, DB7, DTC, DR1, DR7, DR7E, DR17, DR2, DR16, DR12, DR12X, DR4, DGL, DR5, DPW and DR14



Dayco's Permanent Crimp Couplings are one piece steel or brass material. Typically, permanent crimp couplings are used in a wide variety of applications, ranging from low-pressure refrigerant applications to high-pressure hydraulic lines on off-the-road construction equipment, machine tools and farm equipment.

HOW TO READ COUPLING PART NUMBER DESCRIPTIONS

Dayco coupling part number descriptions have two basic components. The first is the coupling style and hose size, which is indicated by a two-letter series and followed by a two-digit SAE "dash" size. This is followed by the termination size and style.

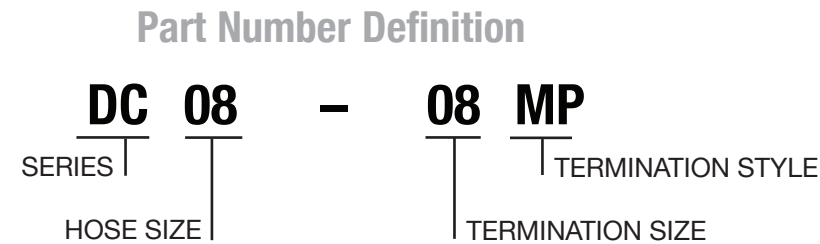

CRIMPING EQUIPMENT



CRIMPING EQUIPMENT

3710 Bubble Style Hose Crimper

Part Number 200074

Designed for hand operated hose end-crimping of Beadlock couplings



This complete kit for air impact wrench operation, features the portable, light weight 3710 Dayco Bubble Style Crimper and 6 standard color coded dies in a convenient carrying case. Designed for use with the Dayco Beadlock Fitting. The Dayco 3710 Crimper delivers 100 PSIG max force for a secure OE Style triple bubble crimp on both 2 braid and reduced OD barrier hose. For BH/DBH hose only.

D100S Crimper

Part Number 200140

Designed to deliver 35 tons of crimping force



Strong yet lightweight top and bottom plates, an integrated handle-and base design, plus a new micrometer gauging mechanism make this Dayco portable crimper ideal for hose assembly. Dayco's D100S Crimper has four strain rods for reinforcement and added precision and durability. Color-coded die sets make correct die selection easy. This Dayco crimper can be easily customized with your choice of optional pumps, dies, and a die storage box. The D100S delivers 35 tons of force through eleven sets of optional dies to let you crimp 1 and 2 wire hose up to 1" I.D. and 4 spiral wire hose through 1" I.D.

D105DC Crimper

Part Number 200142 (with dies)

Designed to deliver 35 tons of crimping force



The D105DC Crimper incorporates all of the D100S features plus it has a 1 HP pump attached to avoid using hand or foot pumps. The D105DC has four strain rods for reinforcement and added precision and durability. Color coded die sets make correct die selection easy. This Dayco Crimper can be easily customized with your choice of optional die sets and die storage box. The D105DC delivers 35 tons of force through eleven sets of optional dies to let you crimp 1 and 2 wire hose and up to 1" I.D. and 4 spiral wire hose through 1" I.D.

CRIMPING EQUIPMENT

D165DC Crimper

Part number 200230 (Includes Dies and Die Cabinet)

Designed to deliver 60 tons of crimping force



The D165 Crimper will deliver the power to quickly and easily crimp the tough fittings that most small crimpers are unable to handle. The fully adjustable micrometer style crimp adjustment accommodates a wide range of hose and fittings without the need for special shims or spacers. The easily removable coupling stop and cylinder retraction stop permit repetitive crimps to be made quickly and easily. This workhorse crimper will handle up to 1-1/4" 4-spiral hose with standard die sets.

D206DC Crimper

Part Number 200150 (without dies)

Part Number 200151 (with dies and cabinet)

Designed for crimping of many hydraulic applications



The D206DC Crimper is designed for crimping a wide range of hose and coupling styles and is the most versatile machine we offer. A real workhorse with 80 tons of crimping force, the Dayco D206DC Crimper comes with 7 sets of crimp dies that allow the capability of crimping 1 and 2 wire braid and 4 spiral wire hose through and including the 1 1/4" ID sizes. Optional dies can provide increased coverage to include 1 1/2" and 2" ID 4 and 6 spiral wire hose. Color coding the dies saves time and helps prevent mistakes. The addition of a standard crimp coupling stop makes it easier to set crimp lengths for normal crimping. This sturdy machine has 4 strain rods to increase crimping precision, a micrometer gauge with limit switch for greater crimping accuracy, a simplified controller design, featuring a built in circuit breaker and emergency stop switch. Standard features include a coupling stop, pusher retraction stop, seven standard color coded die sets and built in hydraulic pump.

CC4-50 Crimper

Part Number 200119

Designed to deliver 340 tons of crimping force



The CC4-50 Crimper incorporates all the features of the D206DC Crimper, plus it offers the increased capacity to crimp up to 2" on 2 braid, 4 and 6 spiral wire hose using the optional die sets. The CC4-50 delivers 340 tons of force through ten (10) optional die sets. This is the ideal crimper for repeated crimps of large quantities. The digital crimp control center eliminates the need for crimp specs and can store your settings for easy call up on future crimps. This machine can handle it all!

STANDS, CABINETS, & KITS

Hydraulic Roller Platform

Part Number 202021

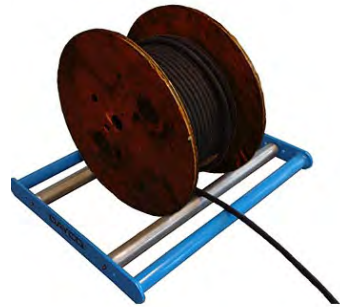

Dayco hose roller platform is an ideal way to dispense reel quantities of hydraulic hose. The roller platform accommodates reel diameters of 12 through 30 inches and a maximum reel width of 21 inches. Designed for floor-level use only, the roller platform greatly reduces the need for lifting heavy hose reels. Made in the USA of steel, powder coated and fully assembled.

Hydraulic Crimper Stand

Part number 200185

Designed to hold the D206 crimper



This stand will give you the safety of a secure stand with versatility of casters to allow you to safely and easily move your crimper set up anywhere at your location. Dayco's D206 crimper can be easily mounted on top of this stand using four attachment bolts. With the available bottom shelf, this stand is ideal for utilizing Dayco's Die Storage Cabinets to create an easy access hydraulic set up that is convenient and practical.

Dayco Metric & BSPP Thread ID Kit

Part Number 202024



Dayco metric and BSPP thread identification kit is intended to allow the customer to easily identify metric and BSPP couplings and adapters. The kit contains plated steel male and female adapters, thread chart and a metric/BSPP end-style data booklet. Mating threads are the most certain way to identify a thread size and large color illustrations and thread charts make identification of the coupling end-style a much easier job.

STANDS, CABINETS, & KITS

Hydraulic O-Ring Kit

Part Number 201964

Designed for storing & quick access to commonly used O-rings



Dayco's convenient Hydraulic O-Ring Kit comes pre-packaged with 180 Nitrile O-Rings representing 18 of the most popular sizes for the following applications:

- O-ring Flange Ends (Code 61 and Code 62)
- Straight Thread Boss Couplings and Adapters
- O-Ring Face Seal Male Ends
- For Komatsu - 10PK Flange Ends.

Options: Extra compartments for up to 6 additional O-Ring sizes. Individual O-Ring packages sold as packages of 10.

Straight Thread Boss O-Ring		Flange O-Ring		Face Seal O-Ring	
Part No.	Flange Part Dash Size	Part No.	Flange Part Dash Size	Part No.	Thread Size
124338	4	124304	10	124311	9/16-18
124339	5	124305	8	124312	11/16-16
124340	6	124306	12	124313	13/16-16
124341	8	124307	16	124314	1-14
124342	10	124308	20	124315	1 3/16-12
124343	12	124309	24	124316	1 7/16-12
124344	14	124310	32	124317	1 11/16-12
124345	16			124318	2-12
124346	20				

6-Drawer Hydraulics Cabinet

Part Number 201890



Measuring only 41 1/8" wide x 12 1/2" deep x 30 5/8" high, this Dayco 6-Drawer Hydraulics Cabinet maximizes your work space efficiency. The cabinet's drawers are mounted on roller bearing slides for smooth, reliable operation and fully extend to provide total and easy access. Included are 40 3 1/2" wide bins and 10 7" wide bins designed with removable dividers to permit inventory adjustment. Options include stationary leg sets, caster legs, additional bins and plastic inserts.

Part No. 201891
3 1/2" Wide Plastic Bins (Box of 10)

Part No. 201892
7" Wide Plastic Bins (Box of 5)

Part No. 201893
Plastic Inserts for Plastic Bins (Package of 50 Small Inserts)

Part No. 201893A
Plastic Inserts for Plastic Bins (Package of 50 Large Inserts)

Part No. 201897
Heavy Duty Stationary/Caster Leg Set (Holds up to 750 lbs.)