



**Chicago
Pneumatic**

Manual

CP879C & CP887C

Pneumatic Drill



WARNING

To reduce risk of injury, everyone using, installing, repairing, maintaining, changing accessories on, or working near this tool must read and understand these instructions, as well as separately provided safety instructions part number 6159948740, before performing any such task.

Air Diagram:

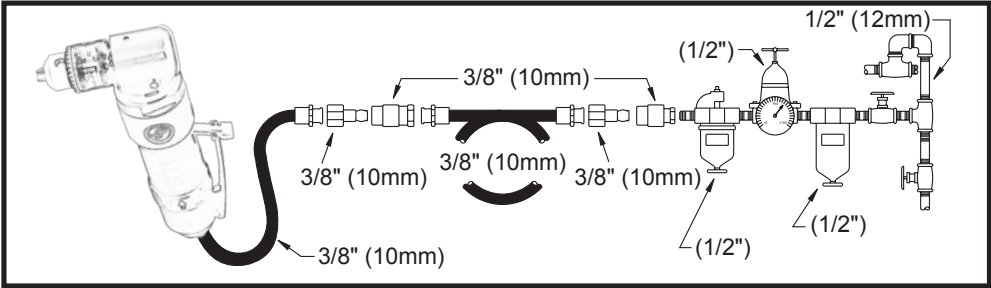
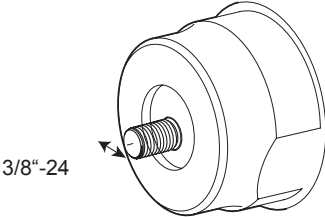

Fig. 01



Fig. 02





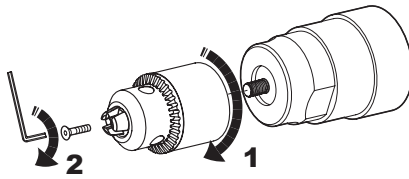



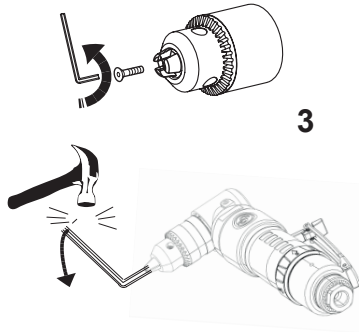





ASSEMBLY













DISSASSEMBLY



Model	Stall Torque	Free Speed	Power	Chuck Capacity	Dimension LxWxH LxH	Weight	Air Consumption	Air Inlet	Inner Hose Dia.	Sound Pressure LpA	Sound Power LwA	Vibrations		
													ahd	K
	1	2	3	4	5	6	7	8	9	10	11	12		
[ft.lb] [Nm]	[rpm]	[hp] [kW]	[inch] [mm]	[inch] [mm]	[lb] [Kg]	[SCFM] [l/s]	[inch]	[inch] [mm]	[dB(A)]	[dB(A)]	[m/s ²]	[m/s ²]		
CP879C	3,2 4,4	2000	0,3 0,26	3/8 10	8,6 x 1,7 x 3,5 218 x 43 x 89	2,6 1,2	21,2 10	1/4" NPT	3/8" 10	80,6	91,6	<2,5	/	
CP887C	3,8 5,1	2100	0,4 0,3	3/8 10	9,2 x 1,9 235 x 49	2,4 1,1	21,2 10	1/4" NPT	3/8" 10	82,7	83,7	<2,5	/	

1. Technical Data

Model	stall torque	Free speed	Power	chuck capacity	Dimension LxWxH	Weight	Air Consumption Average	Air Inlet	Inner Hose Dia.	Sound pressure	Sound power	Vibrations	
												a _{hd}	K
	1	2	3	4	5	6	7	8	9		10	11	12
	[ft.lbs] [Nm]	[rpm]	[hp] [kW]	[inch] [mm]	[inch] [mm]	[lb] [kg]	[SCFM] [l/s]	[inch]	[inch] [mm]	[dB(A)]		[m/s ²]	[m/s ²]

max. pressure 6.3bar(90psi)

a_v : Vibration level, k Uncertainty : L_{pa} Sound pressure dB(A), K_{pa} = K_{wa} = 3 dB Uncertainty.

Declaration of noise and vibration statement (ISO 15744 and ISO 28927-5)

All values are current as of the date of this publication.

These declared values were obtained by laboratory type testing in accordance with the stated standards and are suitable for comparison with the declared values of other tools tested in accordance with the same standards. These declared values are not adequate for use in risk assessments and values measured in individual work places may be higher. The actual exposure values and risk of harm experienced by an individual user are unique and depend upon the way the user works, the workpiece and the workstation design, as well upon the exposure time and the physical condition of the user. We, CHICAGO PNEUMATIC TOOLS, cannot be held liable for the consequences of using the declared values, instead of values reflecting the actual exposure, in an individual risk assessment in a work place situation over which we have no control. This tool may cause hand-arm vibration syndrome if its use is not adequately managed. We recommend a programme of health surveillance to detect early symptoms which may relate to noise or vibration exposure, so that management procedures can be modified to help prevent future impairment.

2. Machine type(s)

- This product is designed for drilling or reaming holes. No other use permitted. For professional use only.
- Please read the instructions carefully before starting the machine.

3. Operation

- Connect device as shown in Fig. 01.
- Fix the accessories properly to the tool.
- To operate tool in reverse rotation, push the lever (B) in reverse direction as sign showing.
- To start the machine, pull the trigger (A). Machine speed is increase by increasing pressure on the trigger. Release the trigger to stop.
- The use of a side handle is recommended for a torque higher than 4 Nm

4. Lubrication

Motor

- Use an air line lubricator with SAE #10 oil, adjusted to two drops per minute. If an air line lubricator cannot be used, add air motor oil to the inlet once a day.
- 4 oz (0.12l) P/N: CA149661
- 20.8 oz (0.59l) P/N: CA000046
- 1gal (3.8l) P/N: P089507

Clutch

- Use Mobilux EP-2 Moly or equivalent grease.

5. Maintenance instruction

- Follow local country environmental regulations for safe handling and disposal of all components.
- Maintenance and repair work must be carried out by qualified personnel using only original spare parts. Contact the manufacturer or your nearest authorised dealer for advice on technical service or if you require spare parts.
- Always ensure that the machine is disconnected from energy source to avoid accidental operation.
- Disassemble and inspect the tool every three 3 months if the tool is used every day. Replace damaged or worn parts.
- To keep downtime to a minimum, the following service kits are recommended :

Tune-up kit : see part list

6. Disposal

- The disposal of this equipment must follow the legislation of the respective country.
- All damaged, badly worn or improperly functioning devices MUST BE TAKEN OUT OF OPERATION.
- Repair only by technical maintenance staff.

7. EU Declaration of conformity

We : **CHICAGO PNEUMATIC Tool Co.**

Machine type(s): **Drill**

Declare that the product(s): **CP879C & CP887C**

Serial Number: **00001-99999**

Origin of the product : **Taiwan**

is in conformity with the requirements of the council Directives on the approximation of the laws of the Member States relating : to "Machinery" **2006/42/EC (17/05/2006)**

applicable harmonised standard(s) : **EN ISO 11148-3:2012**

Name and position of issuer : **Pascal Roussy(R&D Manager)**



Technical file available from EU headquarter. Pascal Roussy R&D manager CP Technocenter 38, rue Bobby Sands - BP10273 44800 Saint Herblain - France