



**Chicago
Pneumatic**

Operator's Manual

CP9426 & CP9427

Ratchet Wrench



WARNING

To reduce risk of injury, everyone using, installing, repairing, maintaining, changing accessories on, or working near this tool must read and understand these instructions, as well as separately provided safety instructions part number 6159948710, before performing any such task.

Air Diagram

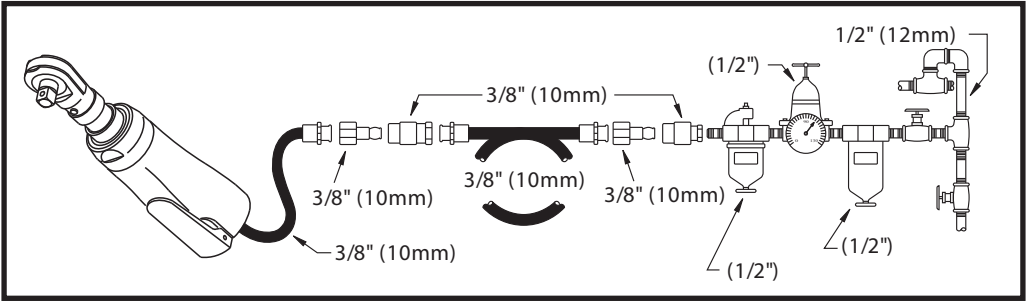

Fig. 01

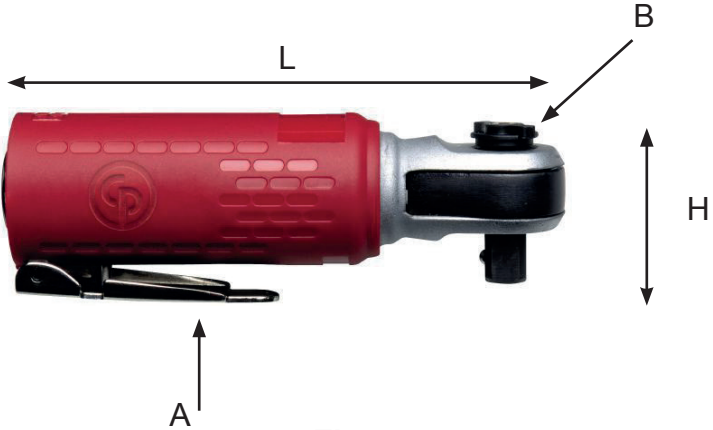
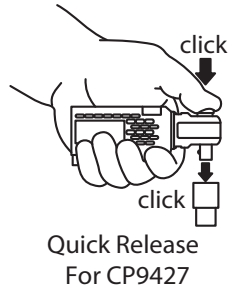













Fig. 02

Model	Drive	Torque		Free speed	Dimension L	Air Consumption Average	Weight	Inner Hose Dia.	Air Inlet	Sound pressure L_{PA}	Sound power L_{WA}	Vibrations	
		Working	Max									a_{hd}	K
	1	2	3	4	5	6	7	8	9	10			
[Inch]	[ft-lb] [Nm]	[RPM]	[inch] [mm]	[NI/s] [SCFM]	[kg] [lb]	[inch] [mm]	[inch]	[dB(A)]	[dB(A)]	[m/s ²] [m/s ²]			
CP9426	1/4	5 7	27 35	270	5.1 128	1.4 3	0.5 1.1	3/8 10	1/4"	82	93	5	1.5
CP9427	3/8	5 7	27 35	270	5.1 128	1.4 3	0.5 1.1	3/8 10	1/4"	82	93	5	1.5

CP9426 & CP9427 Ratchet Wrench

1. Technical Data

Model	Drive	Torque		Free speed	Dimension L	Air Consumption Average	Weight	Inner Hose Dia.	Air Inlet	Sound pressure L_{pA}	Sound power L_{wA}	Vibrations	
		Working	Max									a_{hd}	K
	1	2	3	4	5	6	7	8	9	10			
													
	[min-1]	[inch] [Nm]	[RPM]	[inch] [mm]	[NI/s] [SCFM]	[kg] [lb]	[inch] [mm]	[inch]	[dB(A)]	[dB(A)]	[m/s ²]	[m/s ²]	

max. pressure 6.3bar(90psi)

a_h : Vibration level, k Uncertainty ; L_{pA} Sound pressure dB(A), $K_{pA} = K_{wA} = 3$ dB Uncertainty.

Additional Vibration Information

This tool may cause hand-arm vibration syndrome if its use is not adequately managed.

This additional vibration information may be of assistance to employers in meeting their obligations (for example under EU Directive 2002/44/EC) to assess the risks to their workers arising from hand arm vibration associated with the use of this tool.

Ratchet wrenches are suitable for assembly and disassembly operations in confined spaces.

- The declared vibration value can be used to estimate vibration during rundown. Continuous ratcheting against a run-down bolt may produce a vibration emission in the range 3.5 m/s² to 7.5 m/s² (vibration total values)
- Only use this tool for work which other types of wrenches, which present lower vibration risks, are unable to perform satisfactorily.
- The vibration emission varies greatly with task and operator technique. Emissions outside the quoted range may occur for some applications.
- Operators should optimize their technique and select a suitable wrench in order to minimize the ratcheting time at the end of each run-down or when backing-off assembled fasteners.
- For the intended application of this tool, we estimate that normal operation should involve a ratcheting time against a run-down fastener of less than 0.5s per fastener on a hard joint and up to 3s on a soft joint.
- We point out that application of the tool to a sole specialist task may produce a different average emission and in such cases we strongly recommend a specific evaluation of the vibration emission.

2. Machine type(s)

- This product is designed for installing and removing threaded fasteners in wood, metal and plastic. No other use permitted. For professional use only.
- Please read the instructions carefully before starting the machine.

3. Operation

- Fix the accessories properly to the tool.
- Connect device as shown in Fig. 01 to a clean and dry air supply.
- To start the machine, pull the trigger (A). Machine speed is increase by increasing pressure on the trigger. Release the trigger to stop.
- To switch rotation, turn the switch (B) as shown in Fig. 02.

4. Lubrication

- Use an air line lubricator with SAE #10 oil, adjusted to two drops per minute. If an air line lubricator cannot be used, add air motor oil to the inlet once a day.

5. Maintenance instruction

- Follow local country environmental regulations for safe handling and disposal of all components.**
- Maintenance and repair work must be carried out by qualified personnel using only original spare parts. Contact the manufacturer or your nearest authorised dealer for advice on technical service or if you require spare parts.
- Always ensure that the machine is disconnected from energy source to avoid accidental operation.
- Disassemble and inspect the tool every three 3 months if the tool is used every day. Replace damaged or worn parts.
- High wear parts are underlined in the parts list.

6. Disposal

- The disposal of this equipment must follow the legislation of the respective country.
- All damaged, badly worn or improperly functioning devices MUST BE TAKEN OUT OF OPERATION.
- Repair only by technical maintenance staff.**