



**Chicago  
Pneumatic**

# *Operator's Manual*

**CP8848 Series**

**20V 1/2" Impact Wrench**



## **WARNING**



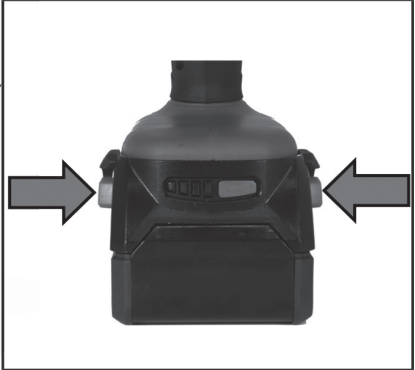

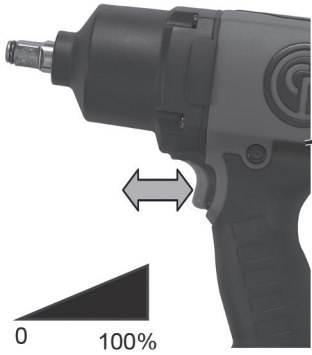





*To reduce risk of injury, everyone using, installing, repairing, maintaining, changing accessories on, or working near this tool must read and understand these instructions, as well as separately provided safety instructions part number 6159948800, before performing any such task.*

















Model	Drive	Torque	Free speed	Weight	Blows per minute	Dimension LxWxH	Battery Voltage	Sound pressure	Sound power	Vibrations	
											
	1	2	3	4	5	6	7	8		9	10
	[inch]	[ft.lbs] [Nm]	min-1	[lb] [kg]	min-1	[inch] [mm]	[volt]	[dB(A)]	[dB(A)]	[m/s <sup>2</sup> ]	[m/s <sup>2</sup> ]
CP8848	1/2"	775 1050	0-1900	6.9 3.1	0-2500	243x251x81.6 9.6x9.8x3.2	20	89	100	12.2	2.3
CP8848-2	1/2"	775 1050	0-1900	7.38 3.35	0-2500	291x251x81.6 11.5x9.8x3.2	20	89	100	12.2	2.3

## 1. Technical Data

Model	Drive	Torque	Free speed	Weight	Blows per minute	Dimension LxWxH	Battery Voltage	Sound pressure $L_{pa}$	Sound power $L_{wa}$	Vibrations	
										$a_{hd}$	K
	1	2	3	4	5	6	7	8	9	10	
	[inch]	[ft.lbs] [Nm]	min-1	[lb] [kg]	min-1	[mm] [inch]	[volt]	[dB(A)]	[dB(A)]	[m/s <sup>2</sup> ]	[m/s <sup>2</sup> ]

ah :Vibration level, k Uncertainty,  $L_{pa}$  Sound pressure dB(A),  $K_{pa} = K_{wa} = 3$  dB Uncertainty

### Declaration of noise and vibration statement (EN60745)

All values are current as of the date of this publication.

These declared values were obtained by laboratory type testing in accordance with the stated standards and are suitable for comparison with the declared values of other tools tested in accordance with the same standards. These declared values are not adequate for use in risk assessments and values measured in individual work places may be higher. The actual exposure values and risk of harm experienced by an individual user are unique and depend upon the way the user works, the workpiece and the workstation design, as well upon the exposure time and the physical condition of the user. We, CHICAGO PNEUMATIC TOOLS, cannot be held liable for the consequences of using the declared values, instead of values reflecting the actual exposure, in an individual risk assessment in a work place situation over which we have no control. This tool may cause hand-arm vibration syndrome if its use is not adequately managed.

## 2. Machine type(s)

- This product is designed for installing and removing threaded fasteners in wood, metal and plastic. No other use permitted. For professional use only.
- Please read the instructions carefully before starting the machine.

## 3. Mounting instruction

- See figures.

## 4. Battery

- New battery packs reach full loading capacity after 4 - 5 charging and discharging. Battery packs which have not been used for some time should be recharged before use.
- Temperatures in excess of 50°C (122°F) reduce the performance of the battery pack. Avoid extended exposure to heat or sunshine (risk of overheating).
- The contacts of chargers and battery packs must be kept clean.
- For an optimum life-time, the battery packs have to be fully charged, after use.

## 5. Maintenance instruction

### Follow local country environmental regulations for safe handling and disposal of all components.

- Maintenance and repair work must be carried out by qualified personnel using only original spare parts. Contact the manufacturer or your nearest authorised dealer for advice on technical service or if you require spare parts.
- Disassemble and inspect the tool every three 3 months if the tool is used every day. Replace damaged or worn parts.
- Always ensure that the machine is disconnected from energy source to avoid accidental operation.
- High wear parts are underlined in the parts list.
- To keep downtime to a minimum, the following service kits are recommended :  
**Tune-up kit:** see part list

## 6. Disposal

- The disposal of this equipment must follow the legislation of the respective country.
- All damaged, badly worn or improperly functioning devices **MUST BE TAKEN OUT OF OPERATION.**
- Repair only by technical maintenance staff.**

## 7. SYMBOL



Please read the instructions carefully before starting the machine.



Do not dispose of electric tools together with household waste material! In observance of European Directive on waste electrical and electronic equipment and its implementation in accordance with national law, electric tools that have reached the end of their life must be collected separately and returned to an environmentally compatible recycling facility.



European  
Conformity  
Mark



Remove the battery pack before starting any work on the machine.



Korean Conformity Mark



EurAsian  
Conformity  
Mark.

## 8. EC Declaration of conformity

We : : CHICAGO PNEUMATIC Tool Co. LLC 1800 Overview Drive Rock Hill, SC 29730 - USA

Machine type(s) : **impact wrench**

Declare that the product(s) : **CP8848**

Serial Number: **From 00001 to 99999**

Origin of the product : **Hungary**

is in conformity with the requirements of the council Directives on the approximation of the laws of the Member States relating : to "Machinery" : (2006/42/EC), RoHS (2011/65/EU), EMC (2014/30/EU), applicable harmonised standard(s) :

EN 60745-1:2009 + A11:2010 EN 60745-2-1:2010 EN 60745-2-2:2010

EN 55014-1:2006 + A1:2009 + A2:2011 EN 55014-2:1997 + A1:2001 + A2:2008

Name and position of issuer: **Pascal Roussy (R&D Manager)**