

**CAMICO USA**



*Residential Electric Water Heater*  
**Troubleshooting Manual**





# Residential Water Heater Construction

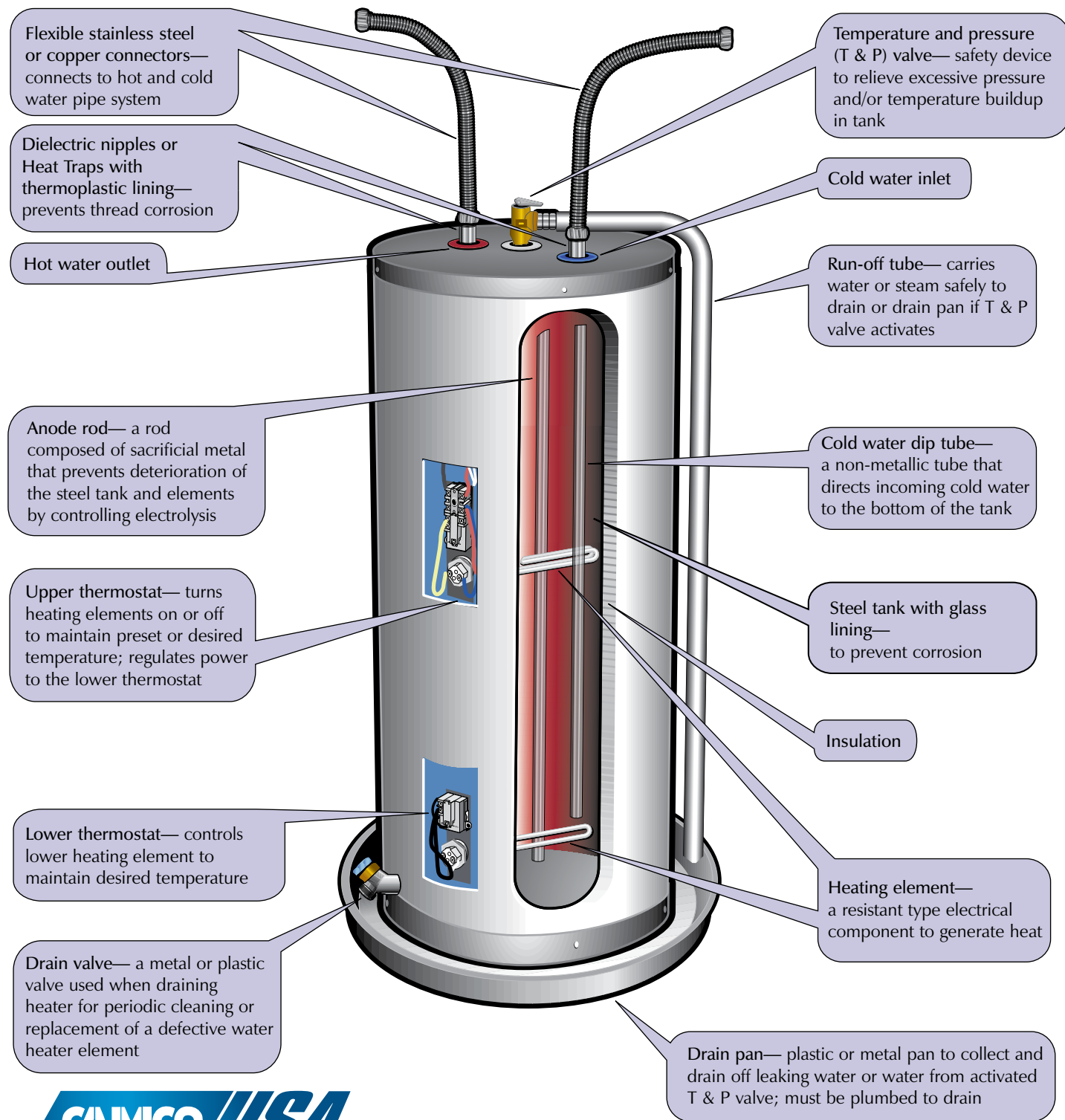

## Table of Contents

- Residential Water Heater Construction* ..... 2
- Choosing the Correct Heating Element*..... 4
- Element Flange Styles* ..... 5
- Thermostats* ..... 7
- Double Element Thermostats* ..... 8
- Double Element Thermostat Wiring* ..... 9
- Single Element Thermostat Wiring*..... 10
- Testing Elements and Thermostats for Failure*..... 11
- Dip Tubes, Run-off Tubes and Anode Rods*..... 12
- Drain Pans, Dielectric Nipples & Heat Traps, T & P Valves*..... 13
- Frequently Asked Questions about Water Heater Parts* ..... 14
- Troubleshooting Guide*..... 16
- Speciality Items*..... 18

# Choosing the Correct Heating Element

When choosing the correct replacement element, three factors must be considered:

- 1. Element Flange Style** (Screw-In, Flat, etc...) **2. Voltage/wattage** **3. Watt-density**

## 1. Element Flange Style

Water heater elements are offered in several styles. Since the development of the modern water heater, manufacturers have used various methods of installing elements in their water heaters. There are still many of these older units in operation today that have the older style elements. The most common are the Universal Flange, Flat Flange and the Round Head style. The Universal and the Flat Flange elements are bolted to the tank with four 3/8" bolts. The Round Head element is secured to the tank with a separate 4-bolt flange.

**Note: The Universal Adapter Kit (Camco #07223) will adapt a screw-in style element to a bolt-in style element that can replace the above elements.**

Today, all manufacturers of residential water heaters use only Screw-in style elements. This style provides for easy installation and serviceability because it screws into a spud welded directly on the tank of the water heater. The thread is a 1" (diameter) x 11-1/2 NPSM thread and is standard for all residential water heaters that use screw-in elements.



**EXCEPTION: For a period of time, State Industries manufactured a Duron brand heater that used a 1-3/8" thread. These elements are not interchangeable with the standard 1" threaded element.**

## 2. Voltages and Wattages

The majority of residential style water heaters use 240v power. The 120v elements are primarily used for smaller water heaters, point-of-use heaters and in locations where a 240v circuit is not available. The wattage rating, which determines the heat output, of the 240v elements can be anywhere from 1000 watts to 6000 watts. The wattage rating of 120v elements is 1000 watts to 2500 watts. Each model water heater is designed for a specific voltage/wattage rated element. **The replacement element must be the same voltage and wattage as the element being replaced. Never exceed the nameplate rating on the water heater.**

## 3. Watt-Density

Another significant difference that should be noted when choosing a replacement element is the watt-density construction. Whether the element is 120v or 240v, screw-in or bolt-in, there are three watt-density ratings available. The watt-density of an element is basically the amount of heat concentrated on any point on the surface of the element.

The lower the watt-density, the greater the amount of element surface. The heat per square inch of the surface is reduced, but the total surface is increased so that the total heat of the element is the same for a particular wattage. Generally, a lower watt-density in an element would mean a longer expected life. The lower watt-density elements normally last longer in water with high lime content. It helps lower lime deposit build-up. The **fold-back feature** of most low watt-density and Lime Life elements is to keep the length short enough to fit all tanks.

### STANDARD: Regular High Watt-Density Element

Most common; same as original equipment provided with most water heaters. It is the least expensive. Can be used in all replacement situations if the same wattage and voltage are used.

### BETTER: Low Watt Density Element

Most are fold-back elements. Better suited for areas with problem water (hard water, lime, etc). The lower watt-density provides no loss of efficiency, yet reduces lime deposit build-up. Can be used to replace any high watt-density element if same wattage and voltage are used. Normally it is more expensive than high watt-density.

### PREMIUM: Lime Life Element

Carries a limited 5 year warranty. Ultra low watt-density and special metal surface (premium grade nickel and stainless steel) reduce chances of lime build-up. Also resists dry-firing. Ideal for problem water areas and locations with intermittent water supply. Higher initial cost, but may last the life of the water heater.

# Element Flange Styles

## Screw-In Flange

Fits most GE, Rheem, Rudd, Richmond, Montgomery Ward, Sears/ Kenmore, State, Norge, Westinghouse, Reliance, Noland, A.O. Smith, Bradford White, CS Wood, Maytag, Whirlpool and Duro-Matic water heaters, some Mor-Flo, American and Craftmaster prior to 1991 and all water heaters manufactured after 1994.



## Universal Flange

Fits older Bradford-White, U.S. Water Heater, most D&R, Day and Night, Briggs, Jackson, Tennessee Tank and early models of State and A.O. Smith.



## Flat Flange

Fits most older Mor-Flo, American, Craftmaster, some older State, Reliance, Rheem, Rudd, Richmond, Montgomery Ward, Norge, Intertherm and Westinghouse models. Fits some Briggs, Bradford-White, U.S. Water Heater, Republic, Day and Night, Jackson, Tennessee Tank and Duro-Matic.



## Round Head Style

Fits July 1975 or older models of State, Reliance, Sears, J.C. Penney, Crane and some A.O. Smith. Camco no longer stocks this style. To replace this style, use a Screw-In Flange element with a Universal Adapter Kit (#07223).

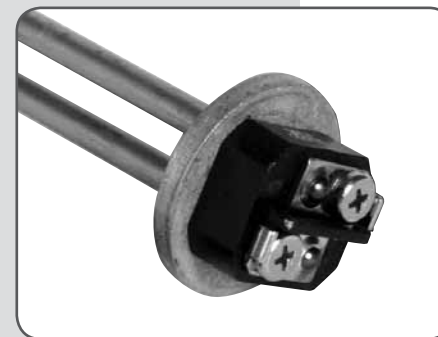



## Element Removal

A long socket wrench is needed to remove and install the **Screw-in** style elements. The **Camco element wrench (#09943, 09951, 09883)** is designed specifically for the standard and the Duron screw-in elements.



## Element Conversion Kit

Use a standard screw-in element to replace a flat, universal or round flange element using the Element Conversion Kit.

This adapter kit is intended for use with a screw-in type element to replace water heater elements that look like figures 1, 2 or 3.

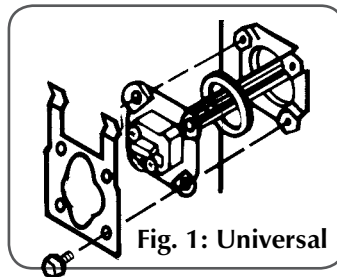

Fig 1: Universal

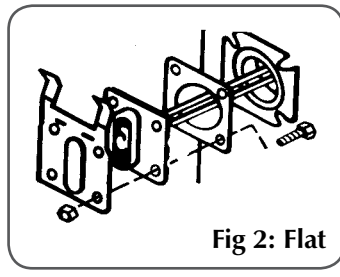

Fig 2: Flat

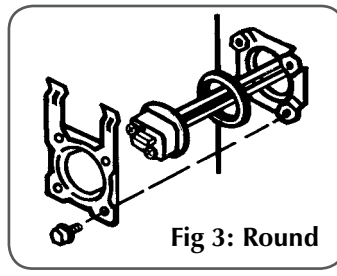
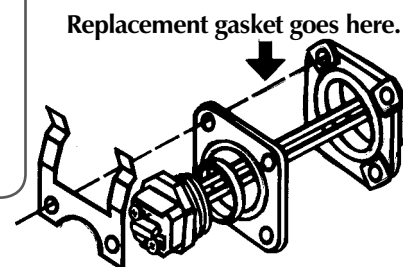

Fig 3: Round



Replacement gasket goes here.

## Directions:

1. Remove screws and discard old element and thermostat bracket.
2. Install screw-in element and gasket supplied with element into square adapter flange. Tighten firmly.
3. Install gasket (supplied with this kit) in element seat, being careful to ensure a good seat. See diagrams above to determine which gasket to use.
4. Install element with new thermostat bracket using old screws or new ones provided. Be careful that screws are not too long and bottom out against the tank.

## Dry-Fired Elements

**Dry-fired means the element operated without being immersed in water.**

High watt-density and low watt-density elements are manufactured with a resistance coil wire imbedded in a magnesium oxide material covered by copper tubing. Water heater elements are designed to operate only in water. Dry-firing (applying power to an element with inadequate or no water in the tank) raises the internal and tubing temperatures on the copper element to cause melt-down of the sheath and failure of the internal heating resistance wire. The expected life of a dry-fired copper element is 30-45 seconds. In a dry tank the element temperature may reach 1900 to 2000° F.

**Lime Life elements are manufactured of premium grade nickel and stainless steel and will resist dry-firing.**

## Evidence of Dry-Firing

1. The element shaft is annealed so soft you can bend it with your fingers.
2. Shows evidence of melting.
3. Plastic terminal block melted, even slightly, indicates that you have positive proof that element was dry-fired.

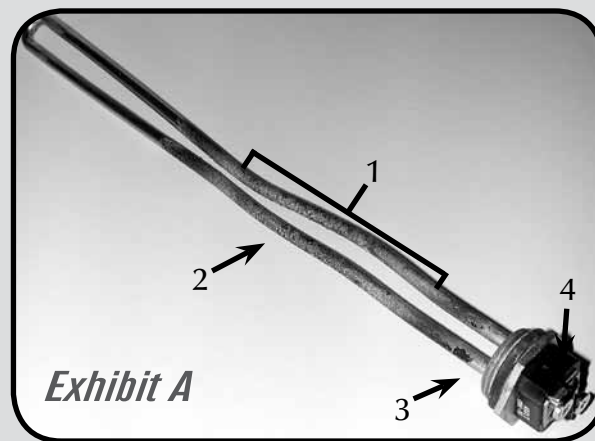

Exhibit A

An immersion element that has been dry-fired has been misused and therefore is not covered by any manufacturer's warranty.

**NOTE: A melted sheath can also be caused by an electrical storm, which is obviously not a defect in material or workmanship and is therefore not covered by warranty.**

We bring this to your attention with the hope that it will be of some value to you, as it might avoid the cost and effort of returning the elements.

## Thermostat Settings

All residential thermostats are factory preset at 120°. This is a safe, energy-efficient setting. If a higher or lower setting is desired or required, the thermostat dial may be turned to the new setting. A flat head screwdriver may be needed to turn the dial.

**Use caution when setting to higher setting. Scalding can occur.**

Therm-O-Disc thermostats have the temperature settings marked on the dial. Apcom thermostats do not have the temperatures on the dial.

Apcom settings:

White Dot	=	110° F
Hot	=	120° F
A	=	130° F
B	=	140° F
C	=	150° F
Very Hot	=	160° F

The settings on both the Apcom and the Therm-O-Disc thermostats are accurate to +/- 5° F.

## Apcom Style



## Therm-O-Disc Style

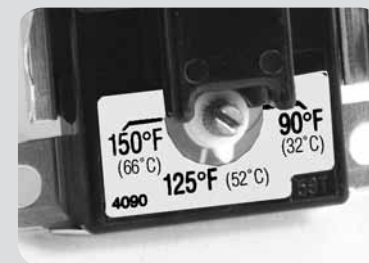

## Thermostats

### Double Element Water Heaters

The majority of residential water heaters are designed with two elements controlled by two different thermostats. **(See drawings on pages 8-9.)** The upper thermostat is the "brain" of the water heater. It controls the heat generated by the upper and lower element. Most, if not all, residential water heaters are designed to have the upper and lower thermostats work separately. The lower element provides the main heat supply.

**The upper and the lower thermostats never operate simultaneously.**

The upper thermostat has a safety device attached to it called a **High Limit Control (HLC)**. It has a heat sensor that will shut down the power to the heater if the temperature of the tank exceeds safety limits. The button may be reset to restore power to the heater.

Do not reset the HLC until the problem causing the unit to trip is corrected.

### Operation Cycle of Double Element Water Heaters

1. The upper thermostat senses cold water and has energized the upper element. Although contacts on both thermostats are normally closed in response to the cold water, the double throw upper thermostat completes the circuit only to the upper heating element. Because of the double throw action, power to the lower thermostat is cut off.
2. As the upper element operates, it heats the water above it (approximately one quarter of the tank's capacity).
3. The water in the upper quarter of the tank is heated until it reaches the temperature set on the upper thermostat. The upper thermostat then breaks the circuit to the upper heating element and completes the circuit to the lower thermostat.
4. The lower element then operates and heats the remainder of the water in the tank.
5. The lower thermostat breaks the circuit to the lower element when the water in the lower portion of the tank has been heated to its set temperature. The entire tank is now filled with hot water.
6. As hot water is drawn from the top of the tank, cool water comes in at the bottom through the dip tube. The lower thermostat reacts to the entering cold water by closing its contacts, energizing the lower heating element and heating the water as it enters the tank.
7. Thermostats are factory preset at 120°F.



# Double Element Thermostats

## Apcom Style

Fits: State/Reliance, Sears, A.O. Smith, American, Whirlpool and Bradford White Heater

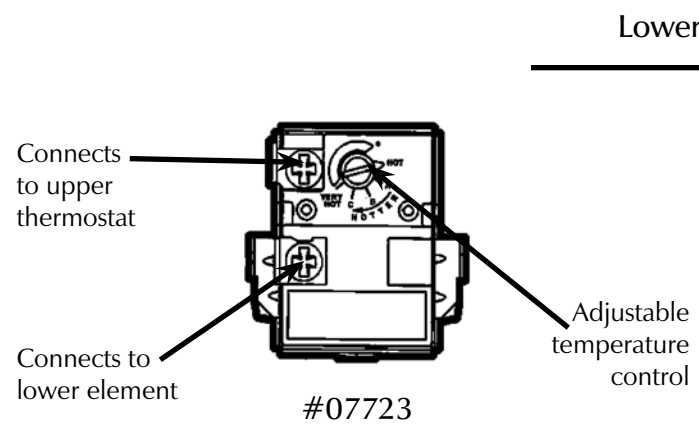
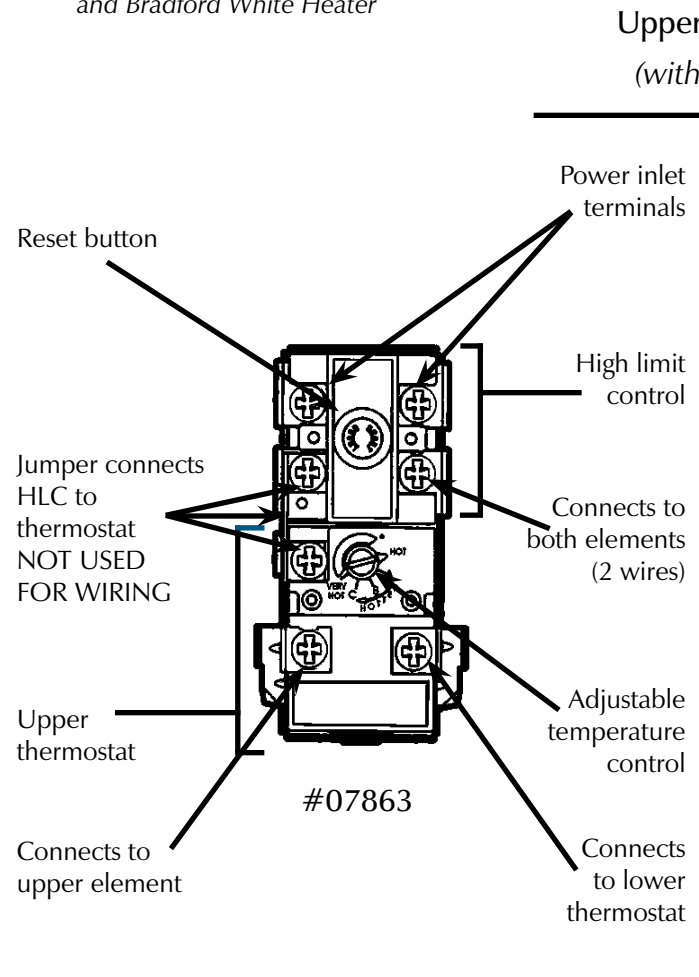

## Therm-O-Disc Style

Fits: Rheem/Rudd/Richmond, GE, and GSW

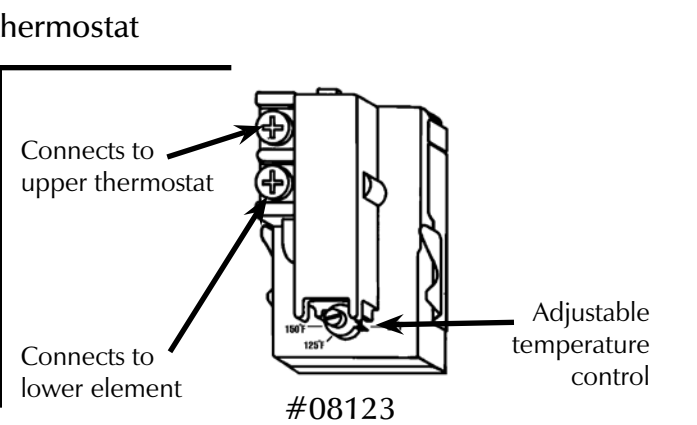
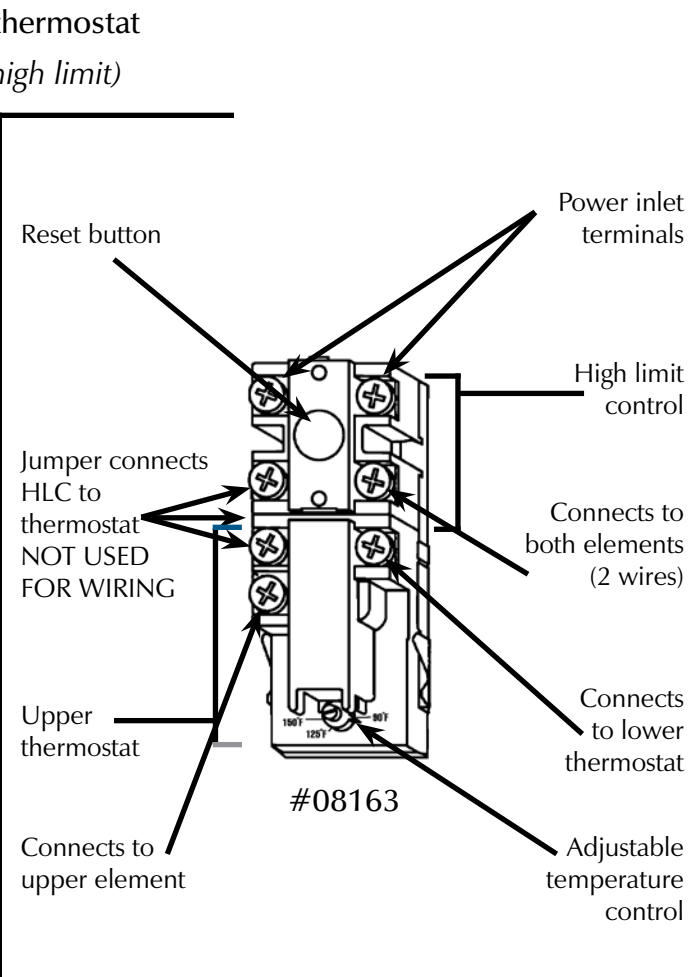

# Double Element Thermostat Wiring

Note: Wire color may vary on some water heaters, but connections remain the same.

## Apcom Style

Wiring diagram of thermostats to standard water heater elements

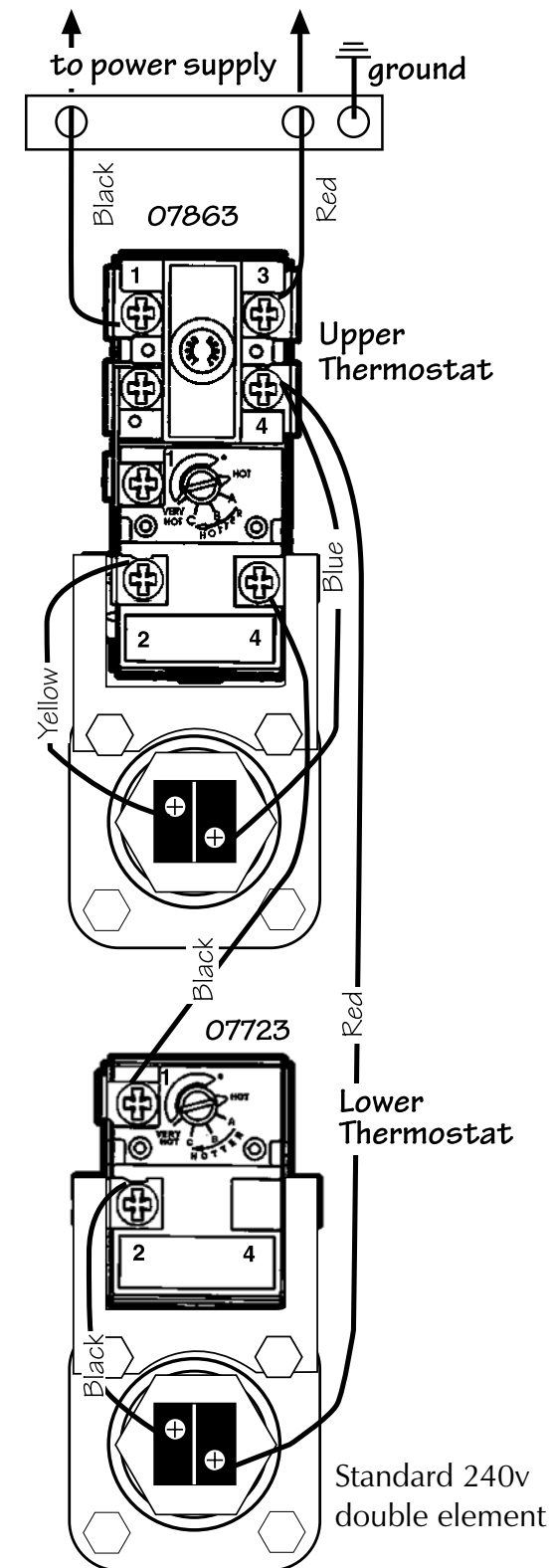

## Therm-O-Disc Style

Wiring diagram of thermostats to standard water heater elements

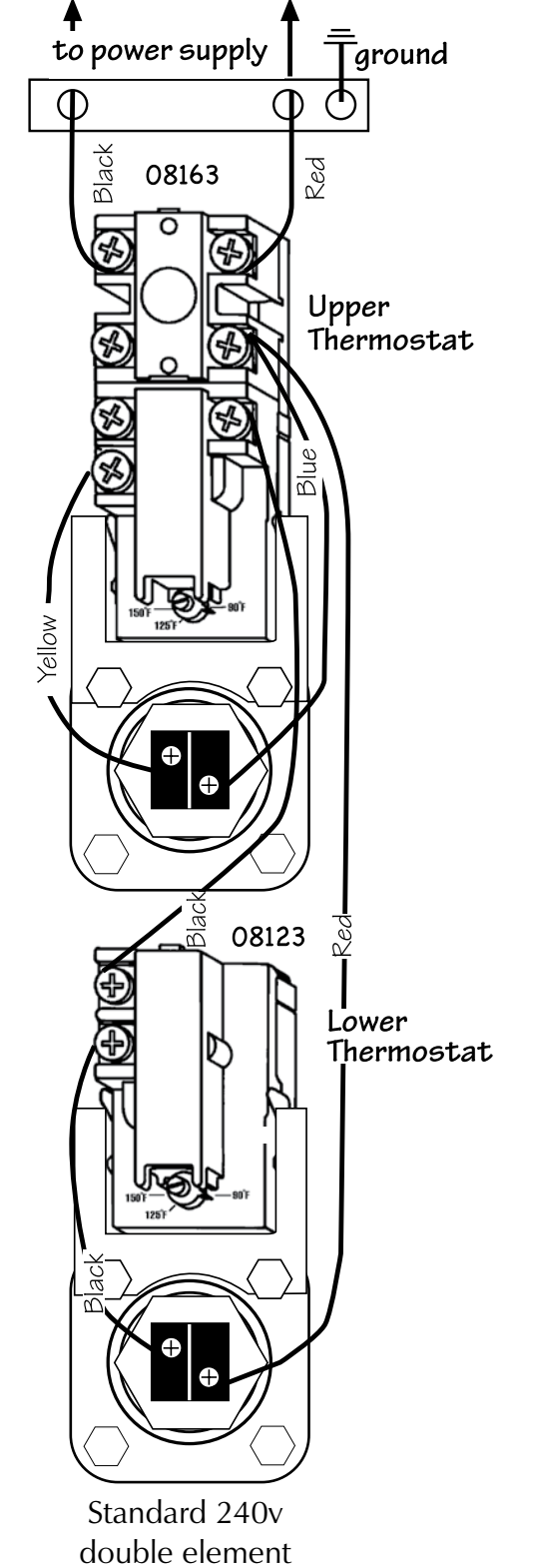



# Single Element Thermostat Wiring

(with high limit)

Most of the smaller water heaters and point-of-use heaters are designed with only one element and thus only one thermostat. Most of the single element water heaters are wired for 120v. Never connect or adapt a 120v water heater to a 240v system.

Because there is no "upper" thermostat on this type heater, the high limit control is attached to the only or lower thermostat. (See diagrams for proper wiring.)

**NOTE:** Because the HLC is attached to the single element thermostat, it looks similar to an upper thermostat for a two-element heater. Care should be taken in choosing the correct replacement thermostat. An upper thermostat will not work on a single element heater.

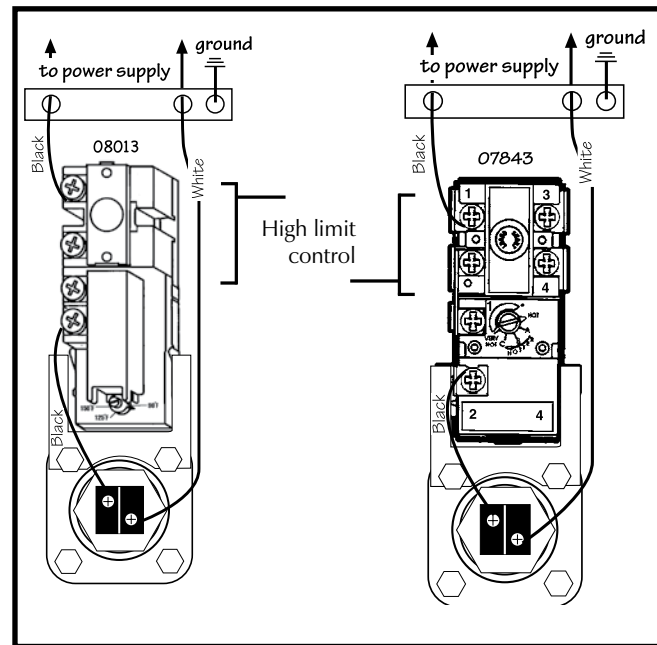

# Testing Elements and Thermostats for Failure

Camco's Water Heater Tester (#10023) is designed specifically for use on electric water heaters. The elements and thermostats are tested while installed on the heater. The tester's specially engineered light emitting diode will identify filament connections that other testers routinely miss.

**Never use this tester on live electrical circuits. Electricity must be turned off at the power source.**

The tester comes with 2 AAA batteries installed. To test the batteries, touch the alligator clip to the test probe. The diode should glow.

## Element Testing

**Be sure the power is off.** Disconnect the two wires from the element. Attach or touch the clip to one of the element terminals and the tester probe to the other element contact. The tester diode light should glow. Touch the probe to the metal on the element flange. The diode should **NOT** glow. Now attach the clip to the other terminal and touch the probe to the element flange. The diode should **NOT** glow.

If any or all of these three tests fail, replace the element.

## Lower Thermostat Testing

**Be sure the power is off.** Disconnect wires from the lower element terminals. Touch the clip and the probe to terminals on the lower thermostat. If the water in the tank is colder than the thermostat setting – thermostat calling for heat – the diode will glow. If not, replace the thermostat. If the water is hot, turn the setting higher and perform the test.

**Be sure to return the setting back to the proper setting.**

## Upper Thermostat Testing

**Be sure the power is off.** Disconnect wires from the upper element terminals. Touch the clip and the probe to terminals 1 and 2 on the thermostat. (See diagram.) If the water in the tank is cold – thermostat calling for heat – the diode should glow. If not, replace the thermostat. If the tank is hot, turn the thermostat setting to a higher setting and perform the test.

Be sure to return the thermostat to the proper setting if the thermostat is not replaced.

## Single Element Thermostat

The test is the same as the one for the lower thermostat (above). Use terminals 1 and 2 on the thermostat.

## Therm-O-Disc Style for Single element heater

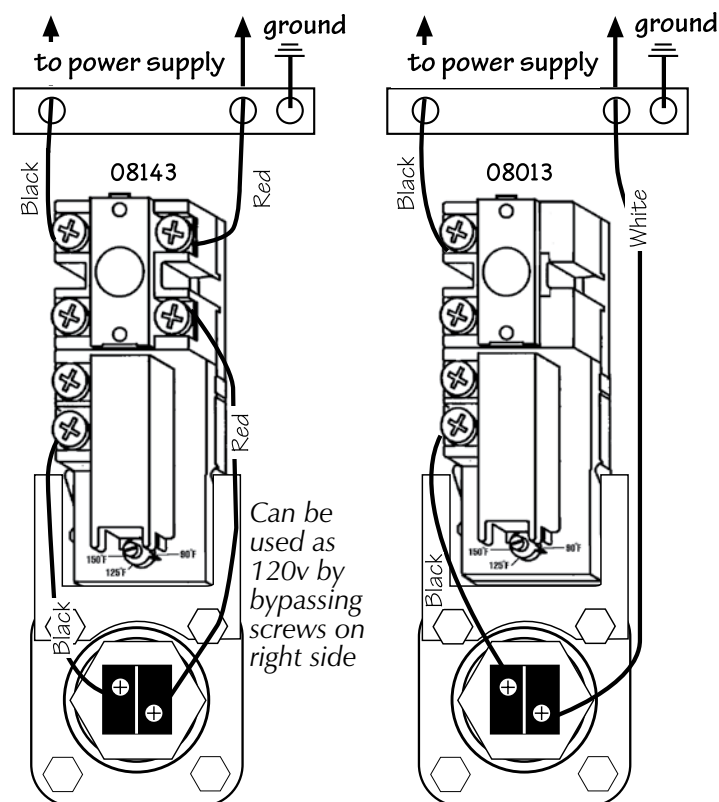

Standard 240v single element

Standard 120v single element

## Apcom Style

for Single element heater

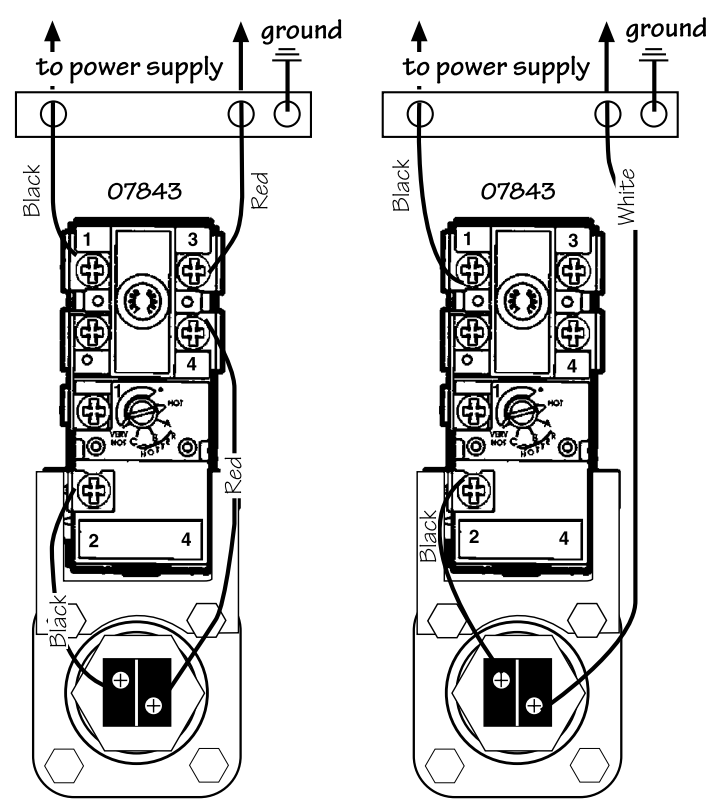

Standard 240v single element

Standard 120v single element

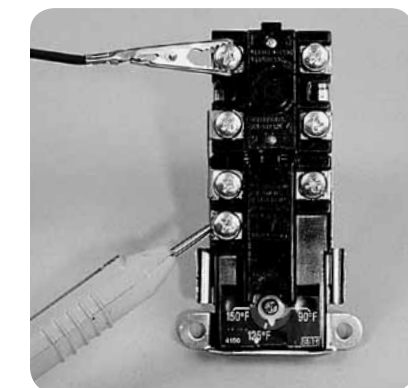
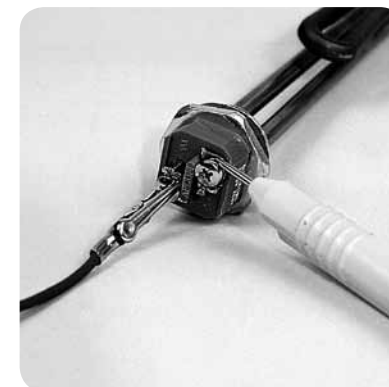

## Dip Tubes, Run-off Tubes and Anode Rods

### Temperature and Pressure Relief Valve

The T&P valve is the most important safety device on the water heater. **No water heater should be installed without a T&P valve.**

In the event of thermostat failure (thermostat fails to shut off properly and continues to heat water beyond safe limits), the T&P valve will open and relieve the pressure in the tank to prevent catastrophic explosion. The T&P valve is set to open at 150 psi and/or 210°F. If this valve leaks or opens within the safe operating temperatures set on the thermostats, it should be replaced.



### Anode Rod: Corrosion Protection

#### What is it?

It is a simple and inexpensive system designed to prevent or deter corrosion of any metal exposed to the water inside the water heater.

#### What metal is exposed?

All heaters today are coated on the inside with a dense, impermeable, corrosion-resistant coating, but there is still exposed metal, some intended and some not: elements, T&P valve threads, welded joints in the tank, pin holes in the coating, unprotected fittings in the waterway, etc.

#### How does it work?

First, let's explain the process of corrosion. When a pure metal is immersed in an electrolyte (conductive) – in this instance water – it tends to dissolve in the solution; in other words, corrode. In the process, the atoms of the metal become positively charged and accumulate on the metal. Since most common, commercially used metals are not pure (usually an alloy) a single piece of metal will exhibit areas within the metal with different potentials (electric charge). The electric current will flow to the other areas of the metal with less potential, or it will flow to another metal of a lesser charge in the water, taking minute particles of metal with it, causing corrosion.

The anode rod is made of a metal with a higher current potential than other metals in the water heater. This is to ensure that the galvanic current flows from the rod to other exposed metals, preventing their corrosion. In other words, the anode rod corrodes and not the tank or the element. The anode rod is "self-sacrificing."



#### What metals are used?

Aluminum, magnesium and zinc or an alloy of any of the three. Aluminum is the most common because it is inexpensive and works in most areas of the country.

#### Why is magnesium used in some areas?

Not all water has the same conductivity (e.g., pure water is much less conductive than seawater.) Different areas of the country have different degrees of hardness or may have several natural chemicals that could affect conductivity. Magnesium is the best conductor of the three, but it is expensive. If magnesium were used in water with good conductivity, the rod would not last very long. It would dissolve at an undesirable rate, causing the heater to eventually be unprotected.

#### What about odor?

The odor is hydrogen sulfide gas. The source is sulfate-reducing bacteria present in many water systems. A water temperature of 140°–170°F makes for a rich growth medium. This type of anaerobic bacteria feeds off the hydrogen gas produced by the magnesium anode rod. Periodic flushing of the tank with bleach solution will reduce the problem.

## Drain Pans, Dielectric Nipples & Heat Traps, T & P Valves

### Dielectric Nipples

When two dissimilar metals are used for water heater inlet and outlet hook-ups (i.e., copper piping to steel tank of the heater), the connection must be protected from galvanic corrosion of the threads, which will cause leaking. Dielectric nipples are provided with a thermoplastic lining for this purpose. Use only dielectric fittings or dielectric heat traps and connectors when installing a water heater.



### Dielectric Heat Traps

A heat trap is an energy savings device for connecting a water heater to the inlet and outlet water pipes. It is an alternative to the dielectric nipple.

A water heater is typically responsible for about 20% of a homeowner's utility bill. A water heater can waste up to 15% of the heat it produces through stand-by losses. Heat loss occurs through the tank walls, pipes, and into the surrounding air of the utility room, garage or basement.

Heat traps prevent this heat loss through the inlet and outlet pipes. Hot water is less dense than cold water, it will rise in the outlet pipe and the cold water

will sink down from the inlet pipe. This results in a continuous and wasteful cooling circulation. Camco's flapper style heat trap design (see diagram) prevents this process while allowing proper flow when the heater is in use.

Flapper Style

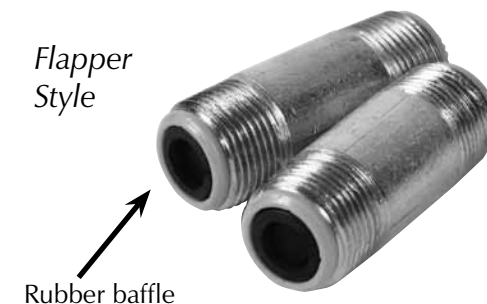

Rubber baffle

### Water Heater Drain Pans

Water heaters should be set into drain pans when the heater is installed in a living space or over a living space, where water leaks or T&P valve activation would damage property. Pans should be plumbed to a proper drain or to a safe disposal area.

Pans are provided in various diameters to accommodate all size water heaters. Pans should be 4" wider in diameter than the diameter of the water heater.

**Metal pans can be used for both gas and electric water heaters.**

**Plastic pans should only be used for electric water heaters.**



### Water Heater Dip Tube

This is a non-metallic tube inside the tank under the cold-water inlet connection. It directs the cold water to the bottom of the tank, so as not to cool the hot water in the top of the tank. The detachment or deterioration of this tube can be the cause of insufficient hot water production.

To inspect the dip tube, turn off power to the water heater, turn off the main water supply, and drain the tank. Disconnect the cold water inlet pipe from the nipple on the top of the tank. Remove the nipple and the dip tube can be removed. On some heaters the dip tube is attached to the nipple.

### Run-Off Tubes

This is a metal or plastic tube that is attached to the outlet of the T&P valve, to safely pipe away the steam and scalding hot water in the event the valve activates. It can be directed to the water heater pan if the pan is plumbed to a drain or other disposal area. Orient the run-off tube so that any discharge will exit only within 6" above the structure floor or any distance below the structure floor. **Do not connect directly to a discharge drain unless air gap is provided.**

There are three configurations of run-off tubes: side mount, top mount and center top mount. Which configuration to use depends on the location of the T&P valve on the water heater.



# Frequently Asked Questions

## Water Heater Elements

**Q:** *I don't have hot water. How do I determine what is wrong?*

**A:** Check the breaker or fuse box for a blown fuse or tripped breaker. If this is not the problem, shut off the power to the water heater. (IMPORTANT!) The problem may be caused by a defective or shorted element(s) or thermostat(s) or both. If you are experienced with plumbing and electrical tools, you can do the repairs yourself. If you are at all hesitant, call a plumber or electrician. Camco Mfg. provides a water heater tester (#10023) that lets you test the elements and thermostats while they remain installed on the heater. Instructions are included.

**Q:** *What causes water heater elements to fail, some sooner than others?*

**A:** Several reasons: power surges, lightning, dry-firing (see below) and lime build-up. Most water heaters come with standard high watt-density (HWD) elements. These are the least expensive type, and are more susceptible to these problems. On a "Standard-Better-Premium" scale the HWD elements are Standard.

**Q:** *Why are some water heater elements folded back?*

**A:** These are low watt-density (LWD) elements. The heat (watts) per square inch of surface has been lowered by 50% from that of a regular element. In order for total heat to be the same, the total surface has been increased. It is folded back so the length will fit the tank. Not all LWD elements are fold-backs. In areas with "hard" water, a LWD element resists lime build-up on its surface, thus extending its life. These elements are BETTER.

**Q:** *What are Lime Life elements?*

**A:** These elements are Premium. They are made of nickel/stainless steel and are ultra low watt-density. These features prevent lime build-up and extend the life of the element. A Lime Life element resists dry-firing. These elements carry a limited 5 year warranty. Because of the low watt-density, these elements are folded back to reduce the length. Some are rippled to further reduce the length to fit the diameter of the tank.

**Q:** *What is meant by the term "dry-firing?"*

**A:** High watt density and low watt-density are designed to function in water. If not surrounded by water, the intense heat they generate (dry fire) will cause them to burn out. The water tank must be full of water whenever the power is on. Dry-fire failure is not covered by any warranty. It is a human error. Dry-fired elements are easily detected. The element is soft and easily bent. In most cases, a hole is burned through the surface.

**Q:** *Can I replace the element in my water heater with elements with higher wattage?*

**A:** It is not recommended. The water heater is designed for that element size. Higher wattage might require heavier gauge wire and a larger capacity circuit breaker.

**Q:** *Why do some elements of the same style, wattage and voltage come in different lengths?*

**A:** Different manufacturers have different designs. The shorter element has a wider diameter tubing; the longer element has a narrower diameter, but heat output is measured by total surface. Both have the same amount of surface and both will fit all standard water heaters. Quality is the same.

**Q:** *Can I use a water heater element in an application other than a water heater?*

**A:** It is not recommended. These elements are designed specifically for residential water heaters. We have no experience or knowledge of other uses. You may do so at your own risk. Non-water heater use of our elements and thermostats voids all warranties.

**Q:** *I just installed a water heater element and now my heater makes a humming sound.*

**A:** This is called a "harmonic." If the element is installed so that the loop is horizontal, the vibration from the electric current will cause the element to hum. This noise can be prevented by installing so that the loop is vertical. The flanged elements have arrows on the flange indicating the vertical position of the loop. To eliminate the humming on screw-in elements, tighten the element another half turn. In some instances, less than a half turn will stop the harmonic.

**Q:** *Why aren't the two elements operating simultaneously?*

**A:** In most residential water heaters only one element is on at any given time. The lower element does 90% or more of the heating. During periods of heavy use, the upper element clicks on (the lower switches off) and heats the upper part of the tank to 120°. It then shuts off, turns on the lower, and it heats the water to the setting of the lower thermostat.

# ...about Water Heater Parts

## Water Heater Thermostats

**Q:** *Are water heater thermostats adjustable?*

**A:** Most water heater thermostats provided by Camco are adjustable. They are factory set at 120°. On a two-element water heater, it is not recommended that the upper thermostat be adjusted. If higher water temperature is desired, adjust the lower to a higher setting. Both may be lowered if a cooler temperature is desired.

**Q:** *On thermostats without a degree dial, what are the temperatures of the dial settings?*

**A:** The temperature range is:

the Dot = 110° F  
Hot = 120° F  
A = 130° F  
B = 140° F  
C = 150° F  
Very Hot = 160° F

**Q:** *At what temperature should I set the thermostats?*

**A:** Water heater thermostats are factory pre-set at 120°. However, most are adjustable. It is recommended that the upper thermostat remain set at 120°. If a higher temperature is desired, adjust only the lower thermostat. Caution: High temperature can cause injury.

**Q:** *I noticed that there are two styles of water heater thermostats. Are they interchangeable?*

**A:** Yes, like models of the two thermostat manufacturers are interchangeable. Use caution in selecting the correct model for their position on the heater (upper, lower, single element T-stat).

**Q:** *How do I know which thermostat to buy?*

**A:** A two-element water heater has two thermostats: an upper and a lower. Each must be replaced with a thermostat with the same function: upper for upper, lower for lower. They cannot be interchanged, as they perform specific functions. A single-element water heater has only one thermostat and that is called a "single element thermostat." The upper and lower thermostats for a two-element heater cannot be used on a single-element water heater and vice versa.

## Other Miscellaneous Questions

**Q:** *The Temperature and Pressure relief valve has a threaded outlet. What attaches to it?*

**A:** The T&P valve outlet must have a run-off tube attached to it. Most building codes require a tube that terminates 6" from the floor. If the T&P valve activates, water should flow into a drain or into a water heater pan that is plumbed to a drain. This run-off tube may be metal or plastic. Check local plumbing codes for correct material for your area.

**Q:** *What are dielectric fittings and connectors?*

**A:** When fittings of unlike metals are joined together (copper with brass, brass with steel, etc.) the faint electrical current that is present in any water pipe system will cause erosion of the threads in one or both of the fittings and cause leaking. The plastic liner or sleeve in the dielectric fittings and connectors prevents this from happening. Note: Stainless steel fittings and connectors are naturally dielectric and do not need the plastic lining.

**Q:** *What is an anode rod?*

**A:** It is a magnesium or aluminum rod inserted in the heater, from the top, in an opening of its own or as part of the outlet nipple. The metal is self-sacrificing (corrodes); this protects the tank and elements from corroding. Replacement anode rods are available and easy to install.

**Q:** *Are water heater drain pans necessary?*

**A:** It depends on the plumbing codes in your area and the location of your water heater. If your heater is in a garage or a non-finished basement where leaking water would flow harmlessly into a drain, a pan is not necessary. However, if the heater is in or above a living space where leaking could cause extensive water damage, it is cheap insurance to protect your home from such an event.

**Q:** *What type of pan should be used?*

**A:** For gas water heaters, only metal pans can be used. Codes in some areas require metal pans for all water heaters installed in a living space. If codes allow, plastic pans can be used with electric water heaters.

**Q:** *I opened the drain valve and very little water flowed.*

**A:** You probably have sediment and scale build-up on the bottom of the tank that is blocking the valve. In areas where the water is very "hard" or well water is used, lime build-up can occur. The high heat of the heater elements will cause scale and sediment to coat the elements and settle on the tank bottom. Light build-up of sediment may be removed by attaching a water hose to the drain valve. Drain the tank every 6-12 months, more often if necessary. Important: Turn off power first or it could cause element burn out.

**Q:** *What is the purpose of a water heater stand?*

**A:** A stand is used primarily with gas water heaters when installed in garages and basements where combustible fumes may exist. Gas heaters have an open flame, and tests have shown that placing a gas water heater at least 16" above the floor will offer some protection against combustion of volatile fumes.



## Troubleshooting Guide

<b><i>Condition</i></b>	<b><i>Cause</i></b>	<b><i>Remedy</i></b>
No hot water	No power	Check fuses/circuit breaker; replace/reset
	Loose wiring connection	Locate, clean carefully, reconnect properly
	Lightning	Inspect/replace fuse, heater elements and thermostat
	High voltage	Check utility for correction
	Short	Locate short circuit and correct
	Element burn-out	Check element and replace as needed
	Inoperative thermostat	Replace
	Open high limit (HLC)	Reset
Insufficient hot water	Lower element burn-out	Replace element
	Undersized heater	Replace with larger heater
	Elements too small	Replace with higher watt element (check with utility) Do not exceed nameplate wattage on heater
	Leaking faucets/nipples	Locate and correct
	Wasted hot water	Advise consumer
	Sediment or lime in tank	Check to see if water treatment is necessary
	Check to see if dip tube is installed and nipple tight	If not, install and tighten
	Lime formation on elements	Clean elements, replace if necessary
	Loose wiring connection	Locate, clean carefully, reconnect properly
	Thermostat set too low	Turn knob to desired temperature <b>CAUTION:</b> Hotter water increases the risk of scalding injury. Before changing temperature setting, see instruction manual
	Inoperative thermostat	Replace
	Inoperative high limit (ECO)	Replace
Slow hot water recovery	Elements too small	Replace with higher watt element (check with utility) Do not exceed nameplate wattage on heater
	Lime formation on elements	Clean elements, replace if necessary
	Loose wiring connection	Locate, clean carefully, reconnect properly
	Excessive mineral deposits	Flush tank thoroughly, install water filter
	Check to see if dip tube is installed and nipple tight	If not, install and tighten
Overheated water steaming	Short in element or thermostat	Locate short circuit and correct
	Thermostat set too high	Turn knob to desired temperature
	Defective thermostat	Replace
Drip from T & P relief valve	Defective T&P relief valve	Replace
	Sediment or lime in tank	Check to see if water treatment is necessary
	Excessive water pressure	Install proper pressure-reducing valve with built-in by-pass
	Surge from washer solenoid valve	Install blind pipe air cushion valve
	Defective thermostat	Replace

## Troubleshooting Guide

<b><i>Condition</i></b>	<b><i>Cause</i></b>	<b><i>Remedy</i></b>	
Excessive T & P relief valve operation	Defective T&P relief valve	Replace	
	Excessive water pressure	Install proper pressure-reducing valve with built-in by-pass	
	Restriction in cold water line	Remove restriction; no check valve should be installed in cold water line unless you have expansion tank	
	Surge from washer solenoid valve	Install blind pipe air cushion	
	Defective thermostat	Replace	
Element failure	Loose wiring connection	Locate, clean carefully, reconnect properly	
	Lightning	Inspect/replace fuse, heater elements and thermostat	
	Power surge	Inspect/replace fuse, heater elements and thermostat	
	Low voltage	Check utility for correction	
	High voltage	Check utility for correction	
Continuous operation	Short	Locate short circuit and correct	
	Undersized heater	Replace with larger heater	
	Elements too small	Replace with higher watt element (check with utility) Do not exceed nameplate wattage on heater	
	Thermostat not flush with tank	Position properly; be sure insulation covers thermostat	
	Defective thermostat	Replace	
Wet Insulation	Leak in faucets on hot water line	Repair leak	
	Leaking fitting	Check all fittings and correct leaks	
	Leaks around heat trap (side plumbing)	Remove; apply pipe "dope" and reinstall	
Thermostat failure	Leaks around heating elements	Tighten, clean and smooth face to tank flange and gasket	
	Loose wiring connection	Locate, clean carefully, reconnect properly	
	Lightning	Inspect/replace fuse, heater elements and thermostat	
	Power surge	Inspect/replace fuse, heater elements and thermostat	
	Low voltage	Check utility for correction	
Gas odor and/or taste in water	High voltage	Check utility for correction	
	Short	Locate short circuit and correct	
	Gas from anode rod	Replace with aluminum anode rod and chlorinate system	
	Fluctuating temperature	Thermostat not flush with tank	Position properly; be sure insulation covers thermostat
		Thermostat or element(s) installed wrong	Reinstall properly, making sure to cover with insulation
Loose wiring connection		Locate, clean carefully, reconnect properly	
Wrong piping connections		Reconnect pipes to proper fittings	
Long runs of exposed piping		Insulate piping	
Hot water piping in outside walls		Insulate piping	
Defective thermostat		Replace	
Dip tube missing or floating		Install dip tube or tighten nipple	

## Speciality Items

### Professional Element Socket For Electric Water Heaters

Chrome Plated Element Socket fits standard 1/2" socket drive to make easy work of replacing screw-in water heater elements.

09951



### Plumber's Packs Therm-O-Disc and Apcom Water Heater Repair Kits

All the parts needed to repair or renew an electric water heater system

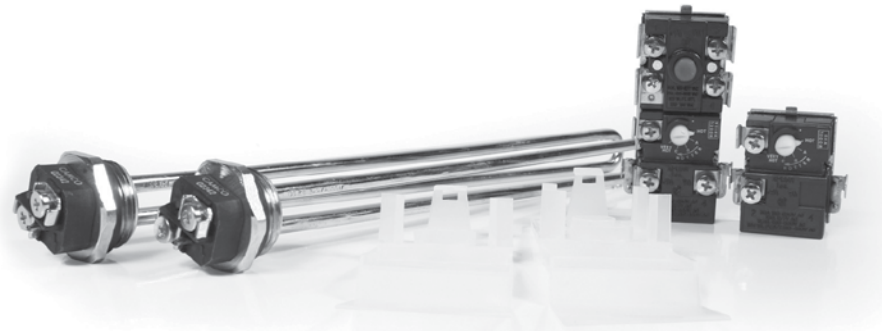

#### HWD Plumber's Packs

07013 Plumber's Pack  
w/Therm-O-Disc Style T-stats

Contains:  
(2) High Watt Density Elements #02342 4500w 240v  
(1) TOD lower thermostat #08122  
(1) TOD upper thermostat #08162

07023 Plumber's Pack w/Apcom Style Thermostats

Contains:  
(2) High Watt Density Elements #02342 4500w 240v  
(1) Apcom style lower thermostat w/protector #07722  
(1) Apcom style upper thermostat w/protector #07862

#### LWD Plumber's Packs

07033 Plumber's Pack  
w/Therm-O-Disc Style T-stats

Contains:  
(2) Low Watt Density Elements #02582 4500w 240v  
(1) TOD style lower thermostat #08122  
(1) TOD style upper thermostat #08162

07043 Plumber's Pack w/Apcom Style Thermostats

Contains:  
(2) Low Watt Density Elements #02582 4500w 240v  
(1) Apcom style lower thermostat w/protector #07722  
(1) Apcom style upper thermostat w/protector #07862

### Water Heater Tester

Test elements and thermostats while they are in the heater. May also be used to test continuity in fluorescent lights, fuses and all appliances. Sensitive enough to measure even the fine filament wire in a light bulb. LED light indicates continuity. Batteries included.

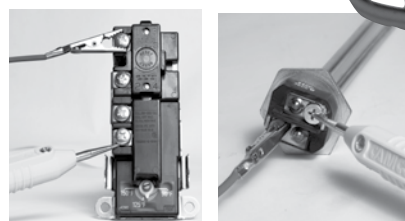

### Water Heater Element Quick Change

Save time and water with Camco's Water Heater Element Quick Change.

Turn off water at the water heater to create a vacuum. Securely attach Water Heater Element Quick Change and place bucket handle in grooves of tool to catch excess water while replacing your water heater elements.



**NO NEED  
to drain  
your tank**



# HEAVY DUTY CONTRACTOR HOSE

AVAILABLE IN LENGTHS OF 25', 50' & 100'

- Reinforced
- Abrasion resistant
- For hot water use
- 10-year limited replacement warranty
- Spring reinforced to reduce kinking
- Easier to clean
- Drinking water safe

